

ETSI TS 151 010-1 V7.8.0 (2008-01)

Technical Specification

**Digital cellular telecommunications system (Phase 2+);
Mobile Station (MS) conformance specification;
Part 1: Conformance specification
(3GPP TS 51.010-1 version 7.8.0 Release 7)**



Reference

RTS/TSGG-0351010-1v780

Keywords

GSM

ETSI

650 Route des Lucioles
F-06921 Sophia Antipolis Cedex - FRANCE

Tel.: +33 4 92 94 42 00 Fax: +33 4 93 65 47 16

Siret N° 348 623 562 00017 - NAF 742 C
Association à but non lucratif enregistrée à la
Sous-Préfecture de Grasse (06) N° 7803/88

Important notice

Individual copies of the present document can be downloaded from:

<http://www.etsi.org>

The present document may be made available in more than one electronic version or in print. In any case of existing or perceived difference in contents between such versions, the reference version is the Portable Document Format (PDF). In case of dispute, the reference shall be the printing on ETSI printers of the PDF version kept on a specific network drive within ETSI Secretariat.

Users of the present document should be aware that the document may be subject to revision or change of status. Information on the current status of this and other ETSI documents is available at

<http://portal.etsi.org/tb/status/status.asp>

If you find errors in the present document, please send your comment to one of the following services:

http://portal.etsi.org/chaicor/ETSI_support.asp

Copyright Notification

No part may be reproduced except as authorized by written permission.
The copyright and the foregoing restriction extend to reproduction in all media.

© European Telecommunications Standards Institute 2008.
All rights reserved.

DECT™, PLUGTESTS™, UMTS™, TIPHON™, the TIPHON logo and the ETSI logo are Trade Marks of ETSI registered for the benefit of its Members.

3GPP™ is a Trade Mark of ETSI registered for the benefit of its Members and of the 3GPP Organizational Partners.

Intellectual Property Rights

IPRs essential or potentially essential to the present document may have been declared to ETSI. The information pertaining to these essential IPRs, if any, is publicly available for **ETSI members and non-members**, and can be found in ETSI SR 000 314: *"Intellectual Property Rights (IPRs); Essential, or potentially Essential, IPRs notified to ETSI in respect of ETSI standards"*, which is available from the ETSI Secretariat. Latest updates are available on the ETSI Web server (<http://webapp.etsi.org/IPR/home.asp>).

Pursuant to the ETSI IPR Policy, no investigation, including IPR searches, has been carried out by ETSI. No guarantee can be given as to the existence of other IPRs not referenced in ETSI SR 000 314 (or the updates on the ETSI Web server) which are, or may be, or may become, essential to the present document.

Foreword

This Technical Report (TR) has been produced by ETSI 3rd Generation Partnership Project (3GPP).

The present document may refer to technical specifications or reports using their 3GPP identities, UMTS identities or GSM identities. These should be interpreted as being references to the corresponding ETSI deliverables.

The cross reference between GSM, UMTS, 3GPP and ETSI identities can be found under <http://webapp.etsi.org/key/queryform.asp>.

Contents

Intellectual Property Rights	2
Foreword.....	2
Foreword.....	62
1 Scope	63
2 References	63
3 Definitions, conventions and applicability	72
3.1 Mobile station definition and configurations.....	72
3.2 Applicability.....	72
3.2.1 Applicability of this specification.....	72
3.2.1.1 MS equipped with a connector.....	72
3.2.1.2 GPRS.....	72
3.2.2 Applicability of the individual tests	73
3.2.3 Applicability to terminal equipment	73
3.3 Definitions.....	73
3.4 Conventions for mathematical notations	73
3.4.1 Mathematical signs	73
3.4.2 Powers to the base 10.....	73
3.5 Conventions on electrical terms	74
3.5.1 Radio Frequency (RF) input signal level	74
3.5.2 Reference sensitivity level.....	74
3.5.3 Power level of fading signal	74
3.6 Terms on test conditions.....	75
3.6.1 Radio test conditions.....	75
4 Test Equipment	76
4.1 Terms used to describe test equipment in the present document.....	76
4.2 Functional requirements of test equipment	76
5 Testing methodology in general (layers 1, 2, and 3)	76
5.1 Testing of optional functions and procedures.....	76
5.2 Test interfaces and facilities	77
5.3 Different protocol layers	77
5.4 Information to be provided by the apparatus supplier	77
5.5 Definitions of transmit and receive times.....	77
6 Reference test methods.....	78
6.1 General	78
6.2 Choice of frequencies in the frequency hopping mode	78
6.3 "Ideal" radio conditions	79
6.4 Standard test signals	79
6.5 Power (control) levels	79
7 Implicit testing.....	80
8 Measurement uncertainty	80
9 Format of tests.....	80
10 Generic call set up procedures.....	82
10.1 Generic call set-up procedure for mobile terminating speech calls	82
10.1.1 Initial conditions	82
10.1.2 Definition of system information messages.....	82
10.1.3 Procedure	85
10.1.4 Specific message contents	86
10.2 Generic call set-up procedure for mobile originating speech calls.....	87
10.2.1 Initial conditions	87
10.2.2 Definition of system information messages.....	87

10.2.3	Procedure	87
10.2.4	Specific message contents	88
10.3	Generic call set-up procedure for mobile terminating data calls	89
10.3.1	Initial conditions	89
10.3.2	Definition of system information messages	90
10.3.3	Procedure	90
10.3.4	Specific message contents	90
10.4	Generic call set-up procedure for mobile originating data calls	92
10.4.1	Initial conditions	92
10.4.2	Definition of system information messages	92
10.4.3	Procedure	92
10.4.4	Specific message contents	93
10.5	Generic call set-up procedure for mobile terminating multislot configuration, minimum number of timeslots allocated	95
10.5.1	Initial conditions	95
10.5.2	Definition of system information messages	95
10.5.3	Procedure	95
10.5.4	Specific message contents	96
10.6	Generic call set-up procedure for mobile originating multislot configuration, minimum number of timeslots allocated	98
10.6.1	Initial conditions	98
10.6.2	Definition of system information messages	98
10.6.3	Procedure	99
10.6.4	Specific message contents	99
10.7	Generic procedure for GPRS downlink data transfer	101
10.7.1	Initial conditions	101
10.7.2	Definition of system information messages	101
10.7.3	Procedure	101
10.7.4	Specific message contents	102
10.8	Generic procedure for GPRS uplink data transfer	102
10.8.1	Initial conditions	102
10.8.2	Definition of system information messages	102
10.8.3	Procedure	102
10.8.4	Specific message contents	103
10.9	GPS Scenario and Assistance data for Assisted GPS signalling tests	104
10.9.1	General	104
10.9.2	GPS Scenario	105
10.9.3	Assistance Data Reference Time	105
10.9.4	Assistance Data Reference Location	105
10.9.5	Assistance Data Navigation Model	106
10.9.6	Assistance Data Ionospheric Model	107
10.9.7	Assistance Data Almanac	107
10.9.8	Assistance Data Acquisition Assistance	108
10.10	GPS Scenarios and Assistance Data for Assisted GPS Minimum Performance tests	108
10.10.1	General	108
10.10.1.1	Satellite constellations and assistance data for performance testing	109
10.10.1.2	GPS Scenarios for performance testing	109
10.10.1.2.1	GPS Scenario #1	109
10.10.1.2.2	GPS Scenario #2	109
10.10.1.2.3	GPS Scenario #3	110
10.10.1.2.4	MS Location for TTFF test cases	110
10.10.1.2.4.1	MS Location Offset	110
10.10.1.2.4.2	MS Altitude	111
10.10.1.2.5	Satellites to be simulated in each test case	111
10.10.2	Information elements required for normal MS based testing	111
10.10.3	Information elements required for MS based Sensitivity Fine Time Assistance test case	112
10.10.4	Information elements available for normal MS assisted testing	112
10.10.5	Information elements available for MS assisted Sensitivity Fine Time Assistance test case	113
10.10.6	Contents of Information elements for Minimum performance testing	114
10.10.6.1	General	114
10.10.6.2	IE Random Offset Values	114
10.10.6.2.1	GPS TOW	114

10.10.6.2.1	GPS bit number (BN or Bit #).....	114
10.10.6.3	Assistance Data Reference Time.....	114
10.10.6.4	Assistance Data Reference Location.....	116
10.10.6.5	Assistance Data Navigation Model.....	116
10.10.6.6	Assistance Data Ionospheric Model.....	117
10.10.6.7	Assistance Data Almanac.....	117
10.10.6.8	Assistance Data Acquisition Assistance.....	118
11	General tests	121
11.1	Verification of support and non-support of services (multiple numbering scheme or ISDN).....	121
11.1.1	Mobile Terminated (MT) calls.....	121
11.1.1.1	Definition	121
11.1.1.2	Conformance requirement.....	121
11.1.1.3	Test purpose	121
11.1.1.4	Method of test	121
11.1.1.4.1	Initial conditions	121
11.1.1.4.2	Procedure.....	121
11.1.1.5	Test requirement	122
11.1.2	Mobile Originated (MO) calls	122
11.1.2.1	Definition	122
11.1.2.2	Conformance requirement.....	122
11.1.2.3	Test purpose	122
11.1.2.4	Method of test	122
11.1.2.4.1	Initial conditions	122
11.1.2.4.2	Procedure.....	123
11.1.2.5	Test requirement	123
11.2	Verification of support of the single numbering scheme.....	123
11.2.1	Definition.....	123
11.2.2	Conformance requirement	123
11.2.3	Test purpose.....	123
11.2.4	Method of test	123
11.2.4.1	Initial conditions	123
11.2.4.2	Procedure	124
11.2.5	Test requirement	124
11.3	Verification of non-support of services (Advice of Charge Charging (AoCC)).....	124
11.3.1	Definition.....	124
11.3.2	Conformance requirement	124
11.3.3	Test purpose.....	124
11.3.4	Method of test	125
11.3.4.1	Initial conditions	125
11.3.4.2	Procedure	125
11.3.5	Test requirement	125
11.4	Verification of non-support of services (call hold).....	125
11.4.1	Definition.....	125
11.4.2	Conformance requirement	125
11.4.3	Test purpose.....	125
11.4.4	Method of test	126
11.4.4.1	Initial conditions	126
11.4.4.2	Procedure	126
11.4.5	Test requirement	126
11.5	Verification of non-support of services (multiparty).....	126
11.5.1	Definition.....	126
11.5.2	Conformance requirement	126
11.5.3	Test purpose.....	126
11.5.4	Method of test	126
11.5.4.1	Initial conditions	126
11.5.4.2	Procedure	126
11.5.5	Test requirement	126
11.6	Verification of non-support of feature (Fixed Dialling Number (FDN))	127
11.6.1	Definition.....	127
11.6.2	Conformance requirement	127
11.6.3	Test purpose.....	127

11.6.4	Method of test	127
11.6.4.1	Initial conditions	127
11.6.4.2	Procedure	127
11.6.5	Test requirement	127
11.7	IMEI Security	128
11.7.1	Conformance requirements	128
11.7.2	Test purpose	128
11.7.3	Method of test	128
11.7.4	Declaration	128
11.8	Coding of the Bearer Capability information element	128
11.8.1	Network to MS Direction	129
11.8.1.1	BS 21 to 26 - Asynchronous Service	129
11.8.1.1.1	BS 21	129
11.8.1.1.2	BS 22	132
11.8.1.1.3	BS 24	133
11.8.1.1.4	BS 25	133
11.8.1.1.5	BS 26	133
11.8.1.1.6	BS 23	133
11.8.1.2	BS 31 to 34 - Synchronous Service	134
11.8.1.2.1	BS 32	134
11.8.1.2.2	BS 31	138
11.8.1.2.3	BS 33	138
11.8.1.2.4	BS 34	139
11.8.1.3	BS 61 - Alternate Speech / Data	139
11.8.1.3.1	Speech/Asynchronous Data, Transparent	139
11.8.1.3.2	Speech/Asynchronous Data, Non Transparent	141
11.8.1.3.3	Speech/Synchronous Data	142
11.8.1.4	BS 81 - Speech followed by Data	143
11.8.1.4.1	Speech followed by Asynchronous Data	143
11.8.1.4.2	Speech followed by Synchronous Data	143
11.8.1.5	TS 61 - Alternate Speech / Facsimile group 3	143
11.8.1.5.1	TS 61 - Alternate Speech / Facsimile group 3, Transparent	144
11.8.1.5.2	TS 61 - Alternate Speech / Facsimile group 3, Non-Transparent	145
11.8.1.6	TS 62 - Automatic Facsimile group 3	146
11.8.2	MS to SS direction	146
11.8.2.1	BS 21 to 26 - Asynchronous Service	146
11.8.2.1.1	BS 21	147
11.8.2.1.2	BS 22	150
11.8.2.1.3	BS 24	151
11.8.2.1.4	BS 25	151
11.8.2.1.5	BS 26	151
11.8.2.1.6	BS 23	151
11.8.2.2	BS 31 to 34 - Synchronous Service	152
11.8.2.2.1	BS 32	152
11.8.2.2.2	BS 31	156
11.8.2.2.3	BS 33	156
11.8.2.2.4	BS 34	157
11.8.2.3	BS 41 to 46 - PAD Access Asynchronous	157
11.8.2.3.1	²⁾ BS 41	157
11.8.2.3.2	BS 42	158
11.8.2.3.3	BS 44	159
11.8.2.3.4	BS 45	159
11.8.2.3.5	BS 46	159
11.8.2.3.6	BS 43	159
11.8.2.4	BS 51 to 53 - Packet Service Synchronous	160
11.8.2.4.1	²⁾ BS 51	160
11.8.2.4.2	BS 52	160
11.8.2.4.3	BS 53	160
11.8.2.5	BS 61 - Alternate Speech / Data	160
11.8.2.5.1	Speech/Asynchronous Data, Transparent	161
11.8.2.5.2	Speech/Asynchronous Data, Non Transparent	163
11.8.2.5.3	Speech/Synchronous Data	164

11.8.2.6	BS 81 - Speech followed by Data	166
11.8.2.6.1	Speech followed by Asynchronous Data	166
11.8.2.6.2	Speech followed by Synchronous Data	166
11.8.2.7	TS 61 - Alternate Speech / Facsimile group 3	166
11.8.2.7.1	TS 61 - Alternate Speech / Facsimile group 3, Transparent	167
11.8.2.7.2	TS 61 - Alternate Speech / Facsimile group 3, Non Transparent	168
11.8.2.8	TS 62 - Automatic Facsimile group 3	168
11.8.2.9	TS 11 and TS 12 - Speech	169
11.8.2.9.1	Support of only full/half rate speech version 1	169
11.8.2.9.2	Support of speech full rate version 2 (Enhanced Full Rate)	169
11.8.2.9.3	Support of full rate speech version 2 (EFR) and full and/or half rate speech version 3 (AMR)...	170
12	Transceiver	173
12.1	Conducted spurious emissions	173
12.1.1	MS allocated a channel	173
12.1.2	MS in idle mode	176
12.2	Radiated spurious emissions	178
12.2.1	MS allocated a channel	178
12.2.2	MS in idle mode	180
12.3	Conducted spurious emissions for MS supporting the R-GSM frequency band	182
12.3.1	MS allocated a channel	182
12.3.2	MS in idle mode	184
12.4	Radiated spurious emissions for MS supporting the R-GSM frequency band	185
12.4.1	MS allocated a channel	186
12.4.2	MS in idle mode	187
13	Transmitter	189
13.1	Frequency error and phase error	189
13.1.1	Definition	189
13.1.2	Conformance requirement	189
13.1.3	Test purpose	190
13.1.4	Method of test	190
13.1.5	Test requirements	192
13.2	Frequency error under multipath and interference conditions	192
13.2.1	Definition	192
13.2.2	Conformance requirement	192
13.2.3	Test purpose	193
13.2.4	Method of test	193
13.2.5	Test requirements	194
13.3	Transmitter output power and burst timing	194
13.3.1	Definition	194
13.3.2	Conformance requirement	195
13.3.3	Test purpose	196
13.3.4	Methods of test	196
13.3.5	Test requirements	199
13.4	Output RF spectrum	202
13.4.1	Definition	202
13.4.2	Conformance requirement	202
13.4.3	Test purpose	203
13.4.4	Method of test	204
13.4.5	Test requirements	206
13.5	Void	210
13.6	Frequency error and phase error in HSCSD multislot configurations	210
13.6.1	Definition	210
13.6.2	Conformance requirement	210
13.6.3	Test purpose	211
13.6.4	Method of test	211
13.6.5	Test requirements	213
13.7	Transmitter output power and burst timing in HSCSD configurations	213
13.7.1	Definition	213
13.7.2	Conformance requirement	213
13.7.3	Test purpose	215

13.7.4	Methods of test	216
13.7.5	Test requirements.....	218
13.8	Output RF spectrum in HSCSD multislot configuration	225
13.8.1	Definition.....	225
13.8.2	Conformance requirement	225
13.8.3	Test purpose.....	226
13.8.4	Method of test	226
13.8.5	Test requirements.....	228
13.9	Output RF spectrum for MS supporting the R-GSM band	231
13.9.1	Definition.....	231
13.9.2	Conformance requirement	232
13.9.3	Test purpose.....	232
13.9.4	Method of test	232
13.9.5	Test requirements.....	234
13.10	(void).....	236
13.11	(void).....	236
13.12	(void).....	236
13.13	(void).....	236
13.14	(void).....	236
13.15	(void).....	236
13.16	GPRS transmitter tests.....	236
13.16.1	Frequency error and phase error in GPRS multislot configuration.....	236
13.16.2	Transmitter output power in GPRS multislot configuration	240
13.16.3	Output RF spectrum in GPRS multislot configuration	252
13.17	EGPRS transmitter tests	259
13.17.1	Frequency error and Modulation accuracy in EGPRS Configuration.....	259
13.17.2	Frequency error under multipath and interference conditions	263
13.17.3	EGPRS Transmitter output power	266
13.17.4	Output RF spectrum in EGPRS configuration	274
13.17.5	Void	281
14	Receiver.....	282
14.1	Bad frame indication	288
14.1.1	Bad frame indication - TCH/FS.....	288
14.1.2	Bad frame indication - TCH/HS	290
14.1.3	Void	292
14.1.4	Void	292
14.1.5	Bad frame indication - TCH/AFS (Speech frame).....	292
14.1.6	Bad frame indication - TCH/AHS	294
14.1.6.1	Bad frame indication - TCH/AHS - Random RF input	294
14.1.7	Void	295
14.2	Reference sensitivity	295
14.2.1	Reference sensitivity - TCH/FS	295
14.2.2	Reference sensitivity - TCH/HS (Speech frames)	297
14.2.3	Reference sensitivity - FACCH/F	299
14.2.4	Reference sensitivity - FACCH/H	300
14.2.5	Reference sensitivity - full rate data channels.....	301
14.2.6	Reference sensitivity - half rate data channels.....	302
14.2.7	Reference sensitivity - TCH/EFS.....	303
14.2.8	Reference sensitivity - full rate data channels in multislot configuration.....	305
14.2.9	Reference sensitivity - TCH/FS for MS supporting the R-GSM band.....	306
14.2.10	Reference sensitivity - TCH/AFS	308
14.2.18	Reference sensitivity - TCH/AHS	311
14.2.19	Reference sensitivity - TCH/AFS-INB	319
14.2.20	Reference sensitivity - TCH/AHS-INB	321
14.2.21	Reference sensitivity - O-TCH/AHS.....	322
14.2.22	Reference sensitivity - O-TCH/WFS	325
14.2.23	Reference sensitivity - O-TCH/WHS.....	327
14.2.24	Reference sensitivity - TCH/WFS	330
14.2.25	Reference sensitivity - Repeated FACCH/F	335
14.2.26	Reference sensitivity - Repeated SACCH.....	337
14.2.27	Reference sensitivity - TCH/FS - DARP Phase II.....	339

14.3	Usable receiver input level range	342
14.4	Co-channel rejection.....	343
14.4.1	Co-channel rejection - TCH/FS	343
14.4.2	Co-channel rejection - TCH/HS.....	345
14.4.3	Void	347
14.4.4	Co-channel rejection - FACCH/F	347
14.4.5	Co-channel rejection - FACCH/H	348
14.4.6	Co-channel rejection - TCH/EFS	349
14.4.7	Receiver performance in the case of frequency hopping and co-channel interference on one carrier	350
14.4.8	Co-channel rejection - TCH/AFS	351
14.4.9 to 14.4.15	(void).....	356
14.4.16	Co-channel rejection - TCH/AHS.....	356
14.4.17	Co-channel rejection - TCH/AFS-INB	362
14.4.18	Co-channel rejection - TCH/AHS-INB.....	364
14.4.19	Co-channel rejection - O-TCH/AHS	366
14.4.20	Co-channel rejection – O-TCH/AHS-INB.....	369
14.4.21	Co-channel rejection – O-FACCH/H.....	371
14.4.24	Co-channel interference - O-TCH/WFS	373
14.4.25	Co-channel interference – O-TCH/WHS	376
14.4.26	Co-channel rejection - O-TCH/WFS-INB	379
14.4.27	Void	382
14.4.28	Co-channel rejection - TCH/WFS	382
14.4.29	Co-channel interference - TCH/WFS-INB	386
14.4.30	Co-channel interference - O-FACCH/F.....	388
14.4.31	Co-channel rejection – Repeated FACCH/F.....	390
14.4.32	Co-channel rejection – Repeated SACCH	392
14.5	Adjacent channel rejection	396
14.5.1	Adjacent channel rejection - speech channels.....	396
14.5.1.1	TCH/FS	396
14.5.1.2	TCH/AFS	398
14.5.1.3	TCH/AHS	403
14.5.1.4	O-TCH/AHS	408
14.5.1.5	O-TCH/WFS	411
14.5.1.6	Adjacent channel interference O-TCH/WHS	415
14.5.1.7	TCH/WFS Adjacent Channel Interference.....	418
14.5.2	Adjacent channel rejection - control channels	422
14.6	Intermodulation rejection	424
14.6.1	Intermodulation rejection - speech channels.....	424
14.6.2	Intermodulation rejection - control channels	425
14.7	Blocking and spurious response	427
14.7.1	Blocking and spurious response - speech channels.....	427
14.7.2	Blocking and spurious response - control channels	433
14.7.3	Blocking and spurious response - speech channels for MS supporting the R-GSM band	438
14.7.4	Blocking and spurious response - control channels for MS supporting the R-GSM band.....	441
14.8	AM suppression.....	444
14.8.1	AM suppression - speech channels	444
14.8.2	AM suppression - control channels.....	445
14.9	Paging performance at high input levels	447
14.10	Performance of the Codec Mode Request Generation for Adaptive Multi-Rate Codecs	448
14.10.1	Performance of the Codec Mode Request Generation – TCH/AFS.....	448
14.10.2	Performance of the Codec Mode Request Generation – TCH/AHS	454
14.10.3	Performance of the Codec Mode Request Generation – TCH/AFS - improved RX.....	460
14.10.4	Performance of the Codec Mode Request Generation – TCH/AHS – improved RX	468
14.10.5	Performance of the Codec Mode Request Generation – O-TCH/AHS.....	476
14.10.6	Performance of the Codec Mode Request Generation – O-TCH/WFS.....	482
14.10.7	Performance of the Codec Mode Request Generation – O-TCH/WHS	487
14.10.8	Performance of the Codec Mode Request Generation – TCH/WFS.....	493
14.10.9	Performance of the Codec Mode Request Generation – TCH/WFS - improved RX.....	499
14.11	DARP Phase 1 Speech bearer tests.....	507
14.11.1	TCH/FS.....	507
14.11.2	TCH/AFS.....	509
14.11.3	TCH/AHS	519

14.12	DARP Phase 1 Signalling bearer tests.....	526
14.12.1	FACCH/F.....	526
14.12.1.1	FACCH – DTS-1	526
14.12.1.2	FACCH – DTS-2-3	529
14.13	(void).....	532
14.14	(void).....	532
14.15	(void).....	532
14.16	GPRS receiver tests	532
14.16.1	Minimum Input level for Reference Performance	535
14.16.2	Co-channel rejection	539
14.16.3	Acknowledged mode / Downlink TBF / I_LEVEL measurement report.....	541
14.16.3.1	Conformance requirements	541
14.16.3.2	References	542
14.16.3.3	Test purpose	542
14.16.3.4	Method of test	542
14.16.3.5	Initial Conditions.....	542
14.16.3.6	Void.....	542
14.16.3.7	Test Procedure.....	542
14.16.4	DARP Phase 1 GPRS tests	544
14.16.4.1	Synchronous single co-channel interferer (DTS-1).....	544
14.16.4.2	Synchronous multiple interferers (DTS-2 / DTS-3).....	546
14.16.5	DARP Phase II GPRS tests.....	548
14.16.5.1	Synchronous single co-channel interferer (DTS-1).....	548
14.16.5.2	Multiple interferers (DTS-2 / DTS-5)	550
14.18	EGPRS receiver tests.....	553
14.18.1	Minimum Input level for Reference Performance	555
14.18.2	Co-channel rejection	561
14.18.3	Adjacent channel rejection.....	564
14.18.4	Intermodulation rejection.....	569
14.18.5	Blocking and spurious response.....	572
14.18.6	EGPRS Usable receiver input level range	581
14.18.7	Incremental Redundancy Performance	583
14.18.8	DARP Phase 1 EGPRS tests	585
14.18.8.1	Synchronous single co-channel interferer (DTS-1).....	585
14.18.8.2	Synchronous single co-channel interferer (DTS-2 / DTS-3).....	587
14.18.9	DARP Phase II EGPRS tests	590
14.18.9.1	Synchronous single co-channel interferer (DTS-1).....	590
14.18.9.2	Synchronous single co-channel interferer (DTS-1b).....	592
14.18.9.3	Multiple interferers (DTS-2 / DTS-5)	594
14.19	DARP Phase II Speech bearer tests	597
14.19.1	TCH/FS.....	597
14.19.2	TCH/AFS.....	600
14.19.3	TCH/AHS	606
15	Timing advance and absolute delay	612
15.1	GSM Timing advance and absolute delay.....	612
15.2	Void.....	613
15.3	Void.....	613
15.4	Void.....	613
15.5	Void.....	613
15.6	GPRS Timing advance and absolute delay.....	613
15.7	ECSD Timing advance and absolute delay	617
15.8	EGPRS timing advance and absolute delay	618
15.9	Timing Advance whilst in DTM	622
16	Reception time tracking speed	624
17	Access times during handover.....	626
17.1	Intra cell channel change.....	626
17.2	Inter cell handover.....	629
18	Temporary reception gaps	632
18.1	Temporary reception gaps, single slot.....	632

18.2	Temporary reception gaps in HSCSD multislot configurations	633
19	Channel release after unrecoverable errors	634
19.1	Channel release after unrecoverable errors - 1	634
19.2	Channel release after unrecoverable errors - 2	635
19.3	Channel release after unrecoverable errors - 3	636
20	Cell selection and reselection	637
20.1	Cell selection	640
20.2	Cell selection with varying signal strength values	641
20.3	Basic cell reselection	643
20.4	Cell reselection using TEMPORARY_OFFSET, CELL_RESELECT_OFFSET, POWER_OFFSET and PENALTY_TIME parameters	645
20.5	Cell reselection using parameters transmitted in the System Information type 2bis, type 2ter, type 7 and type 8 messages	647
20.6	Cell reselection timings	649
20.7	Priority of cells	650
20.8	Cell reselection when C1 (serving cell) < 0 for 5 s	651
20.9	Running average of the surrounding cell BCCH carrier signal levels	653
20.10	Running average of the serving cell BCCH carrier signal level	654
20.11	Updating the list of six strongest neighbour carriers and decoding the BCCH information of a new carrier on the list	655
20.12	Decoding the BCCH information of the neighbour carriers on the list of six strongest neighbour carriers	656
20.13	Decoding the BSIC of the neighbour carriers on the list of six strongest neighbour carriers	657
20.14	Emergency calls	657
20.15	Cell reselection due to MS rejection "LA not allowed"	659
20.16	Downlink signalling failure	660
20.17	Cell selection if no suitable cell found in 10 s	662
20.18	Cell reselection due to MS rejection "Roaming not allowed in this LA"	662
20.19	Cell selection on release of SDCCH and TCH	664
20.20	Multiband cell selection and reselection	665
20.20.1	Multiband cell selection and reselection / Cell Selection	665
20.20.2	Multiband cell selection and reselection / Cell reselection	667
20.21	R-GSM cell selection and reselection	669
20.21.1	R-GSM cell selection	670
20.21.2	R-GSM cell selection with varying signal strength values	672
20.21.3	R-GSM basic cell reselection	674
20.21.4	R-GSM cell reselection using TEMPORARY_OFFSET, CELL_RESELECT_OFFSET, POWER_OFFSET and PENALTY_TIME parameters	676
20.21.5	R-GSM cell reselection using parameters transmitted in the System Information type 2bis, type 2ter, type 7 and type 8 messages	677
20.21.6	R-GSM cell reselection timings	679
20.21.7	R-GSM priority of cells	680
20.21.8	R-GSM cell reselection when C1 (serving cell) < 0 for 5 s	682
20.21.9	R-GSM running average of the surrounding cell BCCH carrier signal levels	683
20.21.10	R-GSM running average of the serving cell BCCH carrier signal level	684
20.21.11	Updating the list of six strongest neighbour carriers and decoding the BCCH information of a new carrier on the list	685
20.21.12	R-GSM decoding the BCCH information of the neighbour carriers on the list of six strongest neighbour carriers	686
20.21.13	R-GSM decoding the BSIC of the neighbour carriers on the list of six strongest neighbour carriers	687
20.21.14	R-GSM emergency calls	688
20.21.15	R-GSM cell reselection due to MS rejection "LA not allowed"	689
20.21.16	R-GSM downlink signalling failure	690
20.21.17	R-GSM cell selection if no suitable cell found in 10 s	692
20.21.18	R-GSM cell reselection due to MS rejection "Roaming not allowed in this LA"	692
20.21.19	R-GSM cell selection on release of SDCCH and TCH	694
20.22	GPRS Cell Selection and Reselection	695
20.22.1	Cell selection	696
20.22.2	Cell reselection in Packet Idle mode	698
20.22.3	Priority of cells	700
20.22.4	Cell re-selection with cells in different routing area	701

20.22.5	Network controlled Cell re-selection in Idle Mode.....	703
20.22.6	Cell reselection timings	704
20.22.7	Downlink signalling failure	705
20.22.8	Cell selection when the best cell does not support GPRS.....	707
20.22.9	Cell reselection when the best cell does not support GPRS.....	709
20.22.10	Cell Selection-Search for Suitable Cell/ cell priority.....	711
20.22.11	Cell Selection/No normal priority cell.....	712
20.22.12	Cell Selection on "LA Not Allowed"	713
20.22.13	Cell Reselection based on C32 quality	714
20.22.14	Void	716
20.22.15	Cell Reselection/ ready state / no reselection.....	716
20.22.16	Cell Reselection/ ready state/ Reselection and Cell update procedure	717
20.22.17	C2 reselection in another RA - no cell reselection.....	719
20.22.18	C2 reselection in another Routing Area - Routing Area Update.....	720
20.22.19	Borders between routing areas - reselection of a GPRS cell in a homogenous network	721
20.22.20	Void	723
20.22.21	Void	723
20.22.22	Cell Reselection with cells in different Routing area - Cell Reselection on CCCH - PBCCCH not present.....	723
20.22.23	Void	725
20.22.24	Void	725
20.22.25	Void	725
20.22.26	Void	725
20.22.27	Void	725
20.22.28	Void	725
20.22.29	Packet Measurement order procedure / Downlink transfer / Normal case/ 3G cell reselection dedicated parameters.....	725
20.22.30	Cell Reselection/usage of BA(GPRS).....	731
20.22.30.1	Cell Reselection/usage of BA(GPRS)/ Most suitable cell not in BA(GPRS)	731
20.22.30.2	Cell Reselection / usage of BA(GPRS) / Change of BA(GPRS)	732
20.22.30.3	Cell Reselection/usage of BA(GPRS)/ Measurement on first 32 entries.	733
20.22.31	Network controlled cell reselection / Transfer mode.....	734
20.22.31.1	Network controlled cell reselection / Downlink transfer / Normal case/ Location and Routing Area Update/ NMO I.....	734
20.22.31.2	Network controlled cell reselection / Downlink transfer / Normal case/ Location and Routing Area Update/ NMO II	736
20.23	COMPACT Cell Selection and Reselection	738
20.23.1	Cell selection	739
20.23.2	Cell reselection in Packet Idle mode.....	741
20.23.3	Priority of cells	742
20.23.4	Cell re-selection with cells in different routing area	744
20.23.5	Network controlled Cell re-selection in Transfer Mode	745
20.23.6	Cell reselection timings	746
20.23.7	Downlink signalling failure	747
20.23.8	COMPACT Cell re-selection when target cell is BCCH supporting EGPRS and different routing area.....	748
20.23.9	Cell re-selection when target cell is COMPACT CPBCCCH in different routing area	750
20.24	SoLSA Cell Selection and Reselection	751
20.24.1	SoLSA Cell Selection suitable cell.....	757
20.24.2	SoLSA Cell (Re)Selection Emergency Call	763
20.24.3	SoLSA Cell Reselection / idle mode support enabled	764
20.24.3.1	General conformance requirement	764
20.24.3.2	SoLSA Cell Reselection / idle mode support enabled / LSA Priority	766
20.24.3.3	SoLSA Cell Reselection / idle mode support enabled / LSA Priority / different location area.....	768
20.24.3.4	SoLSA Cell Reselection / idle mode support enabled / Priority Threshold	771
20.24.3.5	SoLSA Cell Reselection / idle mode support enabled / LSA Priority / LSA_OFFSET	774
20.24.3.6	SoLSA Cell Reselection / idle mode support enabled / LSA Priority / cell combinations.....	775
20.24.3.7	SoLSA Cell Reselection / roaming	778
20.24.4	SoLSA Cell Reselection / idle mode support / any value	780
20.24.5	SoLSA Cell Reselection / LSA indication for idle mode.....	781
20.24.5.1	General Definition.....	782
20.24.5.2	General conformance requirement	782

20.24.5.3	SoLSA Cell Reselection / LSA indication for idle mode / idle mode support enabled.....	782
20.24.5.4	SoLSA Cell Reselection / LSA indication for idle mode / idle mode support disabled.....	784
20.25	Intersystem Cell Reselection.....	786
20.25.1	Definition of system information messages.....	786
20.25.2	Intersystem Cell Reselection/Idle Mode/FDD_Qmin.....	787
20.25.3	Intersystem Cell Reselection/Idle Mode/FDD_Qoffset.....	789
20.25.4	Intersystem Cell Reselection/Idle Mode/Qsearch_I.....	791
21	Received signal measurements.....	794
21.1	Signal strength.....	794
21.2	Signal strength selectivity.....	798
21.3	Signal quality under static conditions.....	800
21.3.1	Signal quality under static conditions - TCH/FS no DTX.....	800
21.3.2	Signal quality under static conditions - TCH/HS.....	802
21.3.3	Signal quality under static conditions - TCH/AFS – DTX off.....	804
21.3.4	Signal quality under static conditions - TCH/AHS - DTX Off.....	806
21.3.5	Signal quality under static conditions - TCH/AFS – DTX on.....	808
21.3.6	Signal quality under static conditions - TCH/AHS – DTX On.....	811
21.4	Signal quality under TUhigh propagation conditions.....	813
21.4.1	Signal quality under TUhigh propagation conditions - TCH/FS.....	813
21.4.2	Signal quality under TUhigh propagation conditions - TCH/AFS.....	815
21.4.3	Signal quality under TUhigh propagation conditions - TCH/AHS.....	817
21.4.4	Signal quality under TU High propagation conditions - O-TCH/WFS.....	819
21.8	GMSK_MEAN_BEP Measurement for PDTCH.....	822
21.9	8PSK_MEAN_BEP Measurement for PDTCH.....	825
22	Transmit power control timing and confirmation.....	829
22.1	Transmit power control timing and confirmation, single slot.....	829
22.2	Void.....	830
22.3	GPRS Uplink Power Control - Use of α and Γ_{CH} parameters.....	830
22.4	GPRS Uplink Power Control - Independence of TS Power Control.....	834
22.5	Void.....	836
22.6	Normal transmit power control timing and confirmation in ECSD.....	836
22.7	ECSD Fast Power Control (FPC) timing and interworking with normal power control.....	837
22.8	EGPRS Uplink Power Control - Use of α and Γ_{CH} parameters.....	840
22.9	EGPRS Uplink Power Control - Independence of TS Power Control.....	844
22.10	Void.....	846
22.11	Power control in exclusive allocation mode.....	846
22.12	Downlink power control, PR mode A, GPRS TBF.....	847
22.13	Enhanced Power Control (EPC) timing and measurement reporting in single slot operation.....	850
22.14	Enhanced Power Control (EPC) timing and measurement reporting in multislot operation.....	853
23	Single frequency reference.....	857
24	Tests of the layer 1 signalling functions.....	857
25	Tests of the layer 2 signalling functions.....	857
25.1	Introduction, objective and scope.....	857
25.1.1	General.....	857
25.1.2	Test configurations.....	858
25.1.3	Pre-conditions.....	858
25.1.4	Layer 2 test frames.....	858
25.1.5	Establishment of the dedicated physical resource.....	859
25.1.6	Release of the dedicated physical resource.....	859
25.2	Test sequences.....	859
25.2.1	Initialization.....	861
25.2.1.1	Initialization when contention resolution required.....	861
25.2.1.1.1	Normal initialization.....	861
25.2.1.1.2	Initialization failure.....	862
25.2.1.1.3	Initialization denial.....	864
25.2.1.1.4	Total initialization failure.....	865
25.2.1.2	Initialization, contention resolution not required.....	866
25.2.1.2.1	Normal initialization without contention resolution.....	866

25.2.1.2.2	Initialization failure	867
25.2.1.2.3	Initialization denial	868
25.2.1.2.4	Total initialization failure	869
25.2.2	Normal information transfer	870
25.2.2.1	Sequence counting and I frame acknowledgements.....	870
25.2.2.2	Receipt of an I frame in the timer recovery state	873
25.2.2.3	Segmentation and concatenation	875
25.2.3	Normal layer 2 disconnection	878
25.2.4	Test of link failure	879
25.2.4.1	I frame loss (MS to SS).....	879
25.2.4.2	RR response frame loss (SS to MS)	880
25.2.4.3	RR response frame loss (MS to SS)	880
25.2.5	Test of frame transmission with incorrect C/R values	881
25.2.5.1	I frame with C bit set to zero.....	881
25.2.5.2	SABM frame with C bit set to zero.....	882
25.2.6	Test of errors in the control field	883
25.2.6.1	N(S) sequence error.....	883
25.2.6.2	N(R) sequence error	885
25.2.6.3	Improper F bit	885
25.2.7	Test on receipt of invalid frames	886
26	Testing of layer 3 functions.....	891
26.1	Default conditions and structured sequence of tests.....	891
26.1.1	Default test conditions during layer 3 tests.....	891
26.1.2	Structured sequence of the tests.....	896
26.1.3	General rules for message parameters	896
26.1.4	General rules for layer 3 testing.....	896
26.1.5	Format of layer 3 test descriptions.....	897
26.2	Initial tests	898
26.2.1	Channel request	898
26.2.1.1	Channel request / initial time	898
26.2.1.2	Channel request / repetition time	899
26.2.1.3	Channel request / random reference.....	901
26.2.2	IMSI detach and IMSI attach.....	902
26.2.3	Sequenced MM / CM message transfer	906
26.2.4	Establishment cause	907
26.3	Test of MS functions in idle mode	914
26.3.1	Initial conditions	914
26.3.2	MS indication of available PLMNs	920
26.3.3	MS will send only if BSS is "on air"	920
26.3.4	Manual mode of PLMN selection.....	921
26.4	Lower layer failures in layer 3 testing	922
26.4.1	Introduction.....	922
26.4.2	Layer 1 reception failures	923
26.4.3	Data link layer failures.....	923
26.4.4	Lower layer failures, used for the tests in clause 25	923
26.5	Handling of unknown, unforeseen, and erroneous protocol data, and of parallel transactions	923
26.5.1	Handling of unknown, unforeseen, and erroneous protocol data, and of parallel transactions / unknown protocol discriminator	923
26.5.2	Handling of unknown, unforeseen, and erroneous protocol data, and of parallel transactions / TI and skip indicator	924
26.5.2.1	TI and skip indicator / RR.....	924
26.5.2.1.1	TI and skip indicator / RR / Idle Mode.....	924
26.5.2.1.2	TI and skip indicator / RR / RR-Connection established.....	925
26.5.2.2	TI and skip indicator / MM	927
26.5.2.3	TI and skip indicator / CC	928
26.5.3	Handling of unknown, unforeseen, and erroneous protocol data, and of parallel transactions / undefined or unexpected message type.....	930
26.5.3.1	Undefined or unexpected message type / undefined message type / CC.....	930
26.5.3.2	Undefined or unexpected message type / undefined message type / MM.....	931
26.5.3.3	Undefined or unexpected message type / undefined message type / RR.....	932
26.5.3.4	Undefined or unexpected message type / unexpected message type / CC	934

26.5.4	Handling of unknown, unforeseen, and erroneous protocol data, and of parallel transactions / unforeseen information elements in the non-imperative message part	935
26.5.4.1	Unforeseen information elements in the non-imperative message part / duplicated information elements	935
26.5.5	Handling of unknown, unforeseen, and erroneous protocol data, and of parallel transactions / non-semantic mandatory IE errors	936
26.5.5.1	Non-semantic mandatory IE errors / RR	936
26.5.5.1.1	Non-semantic mandatory IE errors / RR / missing mandatory IE error.....	936
26.5.5.1.2	Non-semantic mandatory IE errors / RR / comprehension required.....	939
26.5.5.2	Non-semantic mandatory IE errors / MM	940
26.5.5.2.1	Non-semantic mandatory IE errors / MM / syntactically incorrect mandatory IE.....	940
26.5.5.2.2	Non-semantic mandatory IE errors / MM / syntactically incorrect mandatory IE.....	941
26.5.5.2.3	Non-semantic mandatory IE errors / MM / comprehension required	942
26.5.5.3	Non-semantic mandatory IE errors / CC	944
26.5.5.3.1	Non-semantic mandatory IE errors / CC / missing mandatory IE	944
26.5.5.3.2	Non-semantic mandatory IE errors / CC / comprehension required.....	946
26.5.6	Handling of unknown, unforeseen, and erroneous protocol data, and of parallel transactions / unknown IE, comprehension not required	947
26.5.6.1	Unknown information elements in the non-imperative message part / MM	947
26.5.6.1.1	Unknown IE, comprehension not required / MM / IE unknown in the protocol	947
26.5.6.1.2	Unknown IE, comprehension not required / MM / IE unknown in the message	948
26.5.6.2	Unknown information elements in the non-imperative message part / CC	950
26.5.6.2.1	Unknown information elements in the non-imperative message part / CC / Call establishment... ..	950
26.5.6.2.2	Unknown information elements in the non-imperative message part / CC / disconnect	951
26.5.6.2.3	Unknown information elements in the non-imperative message part / CC / release	952
26.5.6.2.4	Unknown information elements in the non-imperative message part / CC / release complete.....	953
26.5.6.3	Unknown IE in the non-imperative message part, comprehension not required / RR	954
26.5.7	Handling of unknown, unforeseen, and erroneous protocol data, and of parallel transactions / spare bits	956
26.5.7.1	Spare bits / RR	956
26.5.7.1.1	Spare bits / RR / paging channel.....	956
26.5.7.1.2	Spare bits / RR / BCCH.....	958
26.5.7.1.3	Spare bits / RR / AGCH	959
26.5.7.1.4	Spare bits / RR / Connected Mode	961
26.5.7.2	Spare bits / MM.....	963
26.5.7.3	Spare bits / CC	965
26.5.8	Default contents of messages.....	967
26.6	Test of the elementary procedures for radio resource management	969
26.6.1	Immediate assignment	969
26.6.1.1	Immediate assignment / SDCCH or TCH assignment	969
26.6.1.2	Immediate assignment / extended assignment	970
26.6.1.3	Immediate assignment / assignment rejection	972
26.6.1.4	Immediate assignment / ignore assignment.....	974
26.6.1.5	Immediate assignment after immediate assignment reject	975
26.6.2	Test of paging	977
26.6.2.1	Normal paging.....	977
26.6.2.1.1	Paging / normal / type 1.....	977
26.6.2.1.2	Paging / normal / type 2.....	980
26.6.2.1.3	Paging / normal / type 3.....	982
26.6.2.2	Paging / extended.....	983
26.6.2.3	Paging / reorganization	986
26.6.2.3.1	Paging / reorganization / procedure 1	986
26.6.2.3.2	Paging / reorganization / procedure 2.....	989
26.6.2.4	Paging / same as before.....	990
26.6.2.5	Paging / multislot CCCH	991
26.6.3	Test of measurement report	992
26.6.3.1	Measurement / no neighbours	992
26.6.3.2	Measurement / all neighbours present.....	995
26.6.3.3	Measurement / barred cells and non-permitted NCCs.....	999
26.6.3.4	Measurement / DTX.....	1002
26.6.3.5	Measurement / Frequency Formats	1005
26.6.3.6	Measurement / multiband environment.....	1009

26.6.3.7	Measurement / new cell reporting	1012
26.6.3.8	Enhanced Measurement /all neighbours present	1016
26.6.3.8.1	Conformance requirements.....	1016
26.6.3.8.2	Test purpose	1017
26.6.3.8.3	Method of test.....	1017
26.6.3.9	Enhanced Measurement Report / Measurement Parameters.....	1021
26.6.3.10	Enhanced Measurement Report / EMR Reporting after Handover	1024
26.6.4	Test of the channel assignment procedure	1027
26.6.4.1	Dedicated assignment / successful case	1027
26.6.4.2	Dedicated assignment / failure	1035
26.6.4.2.1	Dedicated assignment / failure / failure during active state	1035
26.6.4.2.2	Dedicated assignment / failure / general case	1036
26.6.5	Test of handover	1037
26.6.5.1	Handover / successful / active call / non-synchronized.....	1038
26.6.5.2	Handover / successful / call under establishment / non-synchronized	1047
26.6.5.3	Handover / successful / active call / finely synchronized.....	1062
26.6.5.4	Handover / successful / call under establishment / finely synchronized	1066
26.6.5.5	Pre-synchronized handovers	1076
26.6.5.5.1	Handover / successful / active call / pre-synchronized / Timing Advance IE not included.....	1076
26.6.5.5.2	Handover / successful / call being established / pre-synchronized / timing advance IE is included / reporting of observed time difference requested.....	1077
26.6.5.6	Handover / successful / active call / pseudo synchronized.....	1079
26.6.5.7	Handover / successful / active call / non-synchronized / reporting of observed time difference requested	1081
26.6.5.8	Handover / layer 3 failure	1083
26.6.5.9	Handover / layer 1 failure	1084
26.6.6	Test of frequency redefinition.....	1086
26.6.6.1	Frequency redefinition	1086
26.6.7	Test of the channel mode modify procedure.....	1089
26.6.7.1	Test of the channel mode modify procedure / full rate.....	1089
26.6.7.2	Test of the channel mode modify procedure / half rate	1091
26.6.8	Test of ciphering mode setting.....	1094
26.6.8.1	Ciphering mode / start ciphering	1094
26.6.8.2	Ciphering mode / no ciphering.....	1095
26.6.8.3	Ciphering mode / old cipher key	1097
26.6.8.4	Ciphering mode / change of mode, algorithm and key.....	1098
26.6.8.5	Ciphering mode / IMEISV request.....	1104
26.6.8.6	Ciphering mode / Non support of algorithm A5/2	1106
26.6.9	Test of additional assignment	1107
26.6.10	Test of partial release	1107
26.6.11	Test of classmark	1107
26.6.11.1	Classmark change	1107
26.6.11.2	Classmark interrogation	1109
26.6.11.3	Classmark interrogation / UTRAN Classmark Change.....	1111
26.6.11.4	Early UTRAN Classmark Sending	1112
26.6.12	Test of channel release.....	1114
26.6.12.1	Channel release / SDCCH.....	1114
26.6.12.2	Channel release / SDCCH - no L2 ACK.....	1116
26.6.12.3	Channel release / TCH-F.....	1117
26.6.12.4	Channel release / TCH-F - no L2 ACK.....	1118
26.6.13	Test of starting time	1119
26.6.13.1	Dedicated assignment with starting time / successful case / time not elapsed	1121
26.6.13.2	Dedicated assignment with starting time / successful case / time elapsed	1123
26.6.13.3	Dedicated assignment with starting time and frequency redefinition / failure case / time not elapsed.....	1125
26.6.13.4	Dedicated assignment with starting time and frequency redefinition / failure case / time elapsed	1128
26.6.13.5	Handover with starting time / successful case / time not elapsed.....	1130
26.6.13.6	Handover with starting time / successful case / time elapsed.....	1132
26.6.13.7	Handover with starting time and frequency redefinition / failure case / time not elapsed	1134
26.6.13.8	Handover with starting time and frequency redefinition / failure case / time elapsed	1136
26.6.13.9	Immediate assignment with starting time / successful case / time not elapsed	1139
26.6.13.10	Immediate assignment with starting time / successful case / time elapsed	1140

26.6.14	Default contents of GSM 900 layer 3 messages for RR tests	1142
26.6.15	Default contents of DCS 1 800 layer 3 messages for RR tests	1151
26.6.16	Default contents of GSM 450 layer 3 messages for RR tests	1161
26.6.17	Default contents of GSM 480 layer 3 messages for RR tests	1170
26.6.18	Default contents of PCS 1 900 layer 3 messages for RR tests	1179
26.6.19	Default contents of GSM 750 layer 3 messages for RR tests	1189
26.6.20	Default contents of GSM 850 layer 3 messages for RR tests	1198
26.6.21	Default contents of GSM 710 layer 3 messages for RR tests	1207
26.6.22	Default contents of T-GSM 810 layer 3 messages for RR tests.....	1216
26.6.23	Test of Repeated SACCH	1225
26.6.23.1	Repeated SACCH / Downlink Repeated SACCH.....	1225
26.6.23.2	Repeated SACCH / Uplink Repeated SACCH	1227
26.6.23.3	Repeated SACCH / Uplink Repeated SACCH with SAPI 3 frames	1228
26.7	Elementary procedures of mobility management	1230
26.7.0	Default contents of messages.....	1230
26.7.1	TMSI reallocation.....	1233
26.7.2	Authentication.....	1235
26.7.2.1	Authentication accepted	1236
26.7.2.2	Authentication rejected	1237
26.7.3	Identification.....	1240
26.7.3.1	General Identification.....	1240
26.7.3.2	Handling of IMSI shorter than the maximum length	1242
26.7.4	Location updating	1245
26.7.4.1	Location updating / accepted.....	1245
26.7.4.2	Location updating / rejected.....	1250
26.7.4.2.1	Location updating / rejected / IMSI invalid.....	1250
26.7.4.2.2	Location updating / rejected / PLMN not allowed	1253
26.7.4.2.3	Location updating / rejected / location area not allowed	1257
26.7.4.2.4	Location updating / rejected / roaming not allowed in this location area	1260
26.7.4.3	Location updating / abnormal cases	1267
26.7.4.3.1	Location updating / abnormal cases / random access fails	1267
26.7.4.3.2	Location updating / abnormal cases / attempt counter less or equal to 4, LAI different	1269
26.7.4.3.3	Location updating / abnormal cases / attempt counter equal to 4.....	1275
26.7.4.3.4	Location updating / abnormal cases / attempt counter less or equal to 4, stored LAI equal to broadcast LAI	1281
26.7.4.4	Location updating / release / expiry of T3240	1288
26.7.4.5	Location updating / periodic	1289
26.7.4.5.1	Location updating / periodic spread	1289
26.7.4.5.2	Location updating / periodic normal / test 1	1291
26.7.4.5.3	Location updating / periodic normal / test 2	1293
26.7.4.5.4	Location updating / periodic HPLMN search.....	1295
26.7.4.6	Location updating / interworking of attach and periodic	1304
26.7.5	MM connection.....	1306
26.7.5.1	Introduction.....	1306
26.7.5.2	MM connection / establishment with cipher and repeated FACCH.....	1306
26.7.5.3	MM connection / establishment without cipher	1308
26.7.5.4	MM connection / establishment rejected.....	1309
26.7.5.5	MM connection / establishment rejected cause 4.....	1310
26.7.5.6	MM connection / expiry T3230	1312
26.7.5.7	MM connection / abortion by the network.....	1313
26.7.5.7.1	MM connection / abortion by the network / cause #6	1313
26.7.5.7.2	MM connection / abortion by the network / cause not equal to #6.....	1316
26.7.5.8	MM connection / follow-on request pending	1317
26.7.5.8.1	MM connection / follow-on request pending / test 1	1317
26.7.5.8.2	MM connection / follow-on request pending / test 2.....	1318
26.7.5.8.3	MM connection / follow-on request pending / test 3.....	1319
26.7.6	Network Identity and Timezone (NITZ).....	1321
26.7.6.1	NITZ and CS location update procedures	1321
26.7.6.1.1	NITZ / CS location update / Timezone, Time and DST Handling	1321
26.8	Tests related to circuit switched call control	1326
26.8.1	Circuit switched Call Control (CC) state machine verification	1326
26.8.1.1	General on CC state machine verification.....	1326

26.8.1.2	Establishment of an outgoing call	1327
26.8.1.2.1	Outgoing call / U0 null state	1329
26.8.1.2.2	Outgoing call / U0.1 MM connection pending	1331
26.8.1.2.3	Outgoing call / U1 call initiated	1334
26.8.1.2.4	Outgoing call / U3 MS originating call proceeding	1343
26.8.1.2.5	Outgoing call / U4 call delivered	1359
26.8.1.2.6	U10 call active	1368
26.8.1.2.7	U11 disconnect request	1376
26.8.1.2.8	U12 disconnect indication	1382
26.8.1.2.9	Outgoing call / U19 release request	1387
26.8.1.3	Establishment of an incoming call / Initial conditions	1393
26.8.1.3.1	Incoming call / U0 null state	1395
26.8.1.3.2	Incoming call / U6 call present	1396
26.8.1.3.3	Incoming call / U9 mobile terminating call confirmed	1398
26.8.1.3.4	Incoming call / U7 call received	1405
26.8.1.3.5	Incoming call / U8 connect request	1415
26.8.1.4	In call functions	1426
26.8.1.4.1	In-call functions / DTMF information transfer	1426
26.8.1.4.2	In-call functions / user notification	1427
26.8.1.4.3	In-call functions / channel changes	1428
26.8.1.4.4	In-call functions / MS terminated in-call modification	1432
26.8.1.4.5	In-call functions / MS originated in-call modification	1434
26.8.2	Call Re-establishment	1448
26.8.2.1	Call Re-establishment/call present, re-establishment allowed	1448
26.8.2.2	Call Re-establishment/call present, re-establishment not allowed	1450
26.8.2.3	Call Re-establishment/call under establishment, transmission stopped	1451
26.8.3	User to user signalling	1453
26.8.4	Default contents of message	1455
26.9	Structured procedures	1461
26.9.1	Structured procedures / general	1461
26.9.2	Structured procedures / MS originated call / early assignment	1462
26.9.3	Structured procedures / MS originated call / late assignment	1464
26.9.4	Structured procedures / MS terminated call / early assignment	1466
26.9.5	Structured procedures / MS terminated call / late assignment	1469
26.9.6	Structured procedures / emergency call	1471
26.9.6.1	Structured procedures / emergency call / idle updated	1472
26.9.6.1.1	Structured procedures / emergency call / idle updated / preferred channel rate	1472
26.9.6.1.2	Structured procedures / emergency call / idle updated, non-preferred channel rate	1474
26.9.6.2	Structured procedures / emergency call / idle, no IMSI	1474
26.9.6.2.1	Structured procedures / emergency call / idle, no IMSI / accept case	1474
26.9.6.2.2	Structured procedures / emergency call / idle, no IMSI / reject case	1476
26.9.7	Directed Retry / Mobile Originated Call	1478
26.9.8	Directed Retry / Mobile Terminated Call	1484
26.9.9	Default contents of messages	1490
26.10	E-GSM or R-GSM signalling	1496
26.10.1	E-GSM or R-GSM signalling / general considerations	1496
26.10.2	E-GSM or R-GSM signalling / RR	1497
26.10.2.1	E-GSM or R-GSM signalling / RR / Measurement	1497
26.10.2.2	E-GSM or R-GSM signalling / RR / Immediate assignment	1504
26.10.2.3	E-GSM or R-GSM signalling / RR / channel assignment procedure	1506
26.10.2.4	E-GSM or R-GSM signalling / RR / Handover	1510
26.10.2.4.1	E-GSM or R-GSM signalling / RR / Handover / Successful handover	1510
26.10.2.4.2	E-GSM or R-GSM signalling / RR / Handover / layer 1 failure	1515
26.10.2.5	E-GSM or R-GSM signalling / RR / Frequency Redefinition	1517
26.10.3	E-GSM or R-GSM signalling / Structured procedure	1520
26.10.3.1	E-GSM or R-GSM signalling / Structured procedure / Mobile originated call	1520
26.10.3.2	E-GSM or R-GSM signalling / Structured procedures / emergency call	1522
26.10.3.3	Default contents of messages	1525
26.10.4	E-GSM or R-GSM signalling / Default message contents	1526
26.11	Multiband signalling	1530
26.11.1	General considerations	1530
26.11.2	Multiband signalling / RR	1530

26.11.2.1	Multiband signalling / RR / Immediate assignment procedure	1530
26.11.2.2	Multiband signalling / RR / Handover	1539
26.11.2.2.1	Multiband signalling / RR / Handover / successful / active call / non-synchronized	1539
26.11.2.2.2	Multiband signalling / RR / Handover / layer 1 failure	1560
26.11.2.2.3	Multiband signalling / RR / Handover / Multiband BCCH / successful / active call / non synchronized.....	1566
26.11.2.2.4	Multiband signalling / RR / Handover/ Multiband BCCH / Intracell Handover - Interband Assignment	1583
26.11.2.3	Multiband signalling / RR / Measurement reporting.....	1604
26.11.3	Multiband signalling / MM.....	1620
26.11.3.1	Multiband signalling / MM / Location updating.....	1620
26.11.3.1.1	Location updating / accepted.....	1620
26.11.3.1.2	Location updating / periodic.....	1623
26.11.4	Multiband signalling / CC.....	1626
26.11.5	Multiband signalling / Structured procedures	1626
26.11.5.1	Multiband signalling / Structured procedures / MS originated call / early assignment.....	1626
26.11.5.2	Structured procedures / MS terminated call / late assignment	1636
26.11.6	Multiband signalling / Default messages contents.....	1646
26.12	Enhanced Full Rate signalling.....	1675
26.12.1	EFR signalling/ test of the channel mode modify procedure.....	1675
26.12.2	EFR signalling/ tests of handover.....	1678
26.12.2.1	EFR signalling / Handover / active call / successful case	1679
26.12.3	EFR Signalling / Structured procedures / MS originated call / late assignment	1689
26.12.4	Structured procedures / MS terminated call / early assignment.....	1692
26.12.5	Structured procedures / emergency call.....	1695
26.12.6	EFR Signalling / Directed Retry / Mobile Originated Call.....	1698
26.12.7	EFR Signalling / Directed Retry / Mobile Terminated Call.....	1701
26.12.8	Default contents of layer 3 messages for Enhanced Full rate speech tests	1707
26.13	Multislot signalling.....	1710
26.13.1	Multislot signalling / RR.....	1710
26.13.1.1	Multislot signalling / RR / Measurement	1710
26.13.1.1.1	Multislot signalling / RR / Measurement / symmetric.....	1710
26.13.1.1.2	Multislot signalling / RR / Measurement / asymmetric	1713
26.13.1.1.3	Multislot signaling / RR / Measurement / asymmetric / change of the reported subchannel.....	1717
26.13.1.2	Multislot signalling / RR / Dedicated assignment.....	1723
26.13.1.2.1	Multislot signalling / RR / Dedicated assignment / successful case	1723
26.13.1.2.2	Multislot signalling / RR / Dedicated assignment / failure / general case	1757
26.13.1.3	Test of handover.....	1792
26.13.1.3.1	Multislot signalling / RR / Handover / successful / active call / non-synchronized	1793
26.13.1.3.2	Multislot signalling / RR / Handover / successful / call under establishment / non synchronized / resource upgrading	1801
26.13.1.3.3	Multislot signalling / RR / Handover / successful / active call / finely synchronized / resource downgrading	1811
26.13.1.3.4	Multislot signalling / RR / Handover / successful / call under establishment / finely synchronized / relocation of channels.....	1818
26.13.1.3.5	Multislot signalling / RR / Handover / successful / call under establishment / pre-synchronized / resource upgrading	1833
26.13.1.4	Multislot signalling / RR / Test of the channel mode modify procedure	1841
26.13.1.5	Multislot signalling / RR / Early classmark sending	1843
26.13.1.6	Default contents of layer 3 messages for RR tests	1845
26.13.1.6.1	Default contents of GSM 900 layer 3 messages for RR tests	1845
26.13.1.6.2	Default contents of DCS 1 800 layer 3 messages for RR tests	1855
26.13.1.6.3	Default contents of GSM 450 layer 3 messages for RR tests	1867
26.13.1.6.4	Default contents of GSM 480 layer 3 messages for RR tests	1877
26.13.1.6.5	Default contents of GSM 700 layer 3 messages for RR tests	1888
26.13.1.6.6	Default contents of GSM 850 layer 3 messages for RR tests	1899
26.13.2	Multislot signalling / CC.....	1910
26.13.2.1	Multislot signalling / CC / In-call functions.....	1910
26.13.2.1.1	Multislot signalling / CC / In-call functions / User initiated service level upgrade / successful ..	1910
26.13.2.1.2	Multislot signalling / CC / In-call functions / User initiated service level downgrade / successful.....	1911

26.13.2.1.3	Multislot signalling / CC / In-call functions / User initiated service level upgrade / Time-out of timer T323	1913
26.13.2.1.4	Multislot signalling / CC / In-call functions / User initiated service level upgrade / modify reject	1914
26.13.2.1.5	Multislot signalling / CC / In call functions / contents of some of the messages	1915
26.13.3	Multislot signalling / Structured procedures	1917
26.13.3.1	Multislot signalling / Structured procedures / MS originated call / early assignment / HSCSD / non-transparent	1917
26.13.3.2	Multislot signalling / Structured procedures / MS originated call / late assignment / HSCSD / non-transparent	1920
26.13.3.3	Multislot signalling / Structured procedures / MS originated call / early assignment / HSCSD / Transparent	1923
26.13.3.4	Multislot signalling / Structured procedures / MS Terminated call / early assignment / HSCSD / non-transparent	1925
26.13.3.5	Multislot signalling / Structured procedures / MS Terminated call / early assignment / HSCSD / Transparent	1929
26.13.3.6	Default test conditions during layer 3 tests	1932
26.13.3.7	Default contents of messages	1936
26.14	VGCS and VBS Tests	1942
26.14.1	VGCS-VBS / Notification	1943
26.14.1.1	VGCS-VBS / Notification / notification indication	1943
26.14.1.2	VGCS-VBS / Notification / NCH position	1947
26.14.1.3	VGCS-VBS / Notification / Reduced NCH monitoring	1948
26.14.1.4	VGCS-VBS / Notification / Limited Service state	1953
26.14.2	VGCS-VBS / Paging	1955
26.14.2.1	VGCS-VBS / Paging / Paging indication	1955
26.14.2.2	VGCS-VBS / Paging / Notification	1958
26.14.3	VGCS-VBS / RR Procedures	1962
26.14.3.1	VGCS-VBS / RR Procedures / frequency redefinition	1962
26.14.3.2	VGCS-VBS / RR Procedures / assignment	1967
26.14.3.3	VGCS-VBS / RR Procedures / handover / successful in group transmit mode	1971
26.14.3.4	VGCS-VBS / RR Procedures / handover / successful at group call establishment	1977
26.14.3.5	VGCS-VBS / RR Procedures / handover / failure	1982
26.14.3.6	VGCS-VBS / RR / Measurement Report	1983
26.14.3.6.1	Measurement / all neighbours present	1983
26.14.4	VGCS-VBS / Uplink Access and Uplink Reply Procedures	1987
26.14.4.1	VGCS-VBS / Uplink Access / uplink investigation	1987
26.14.4.2	Uplink Access / uplink access procedure	1989
26.14.4.3	VGCS-VBS / Uplink Reply in VGCS receive mode	1991
26.14.5	VGCS-VBS / Leaving Group Receive or Group Transmit Mode	1993
26.14.5.1	VGCS-VBS / Leaving group receive mode	1993
26.14.5.2	VGCS-VBS / Leaving group transmit mode	1995
26.14.6	VGCS-VBS / GCC-BCC Procedures	1997
26.14.6.1	VGCS-VBS / GCC-BCC Procedures / MO call establishment	1997
26.14.6.2	VGCS-VBS / GCC-BCC Procedures / Transaction Identifier	2000
26.14.6.3	VGCS-VBS / GCC-BCC Procedures / Call Termination / originator / group transmit mode	2001
26.14.6.4	VGCS-VBS / GCC-BCC Procedures / Call Termination / originator in group receive mode	2003
26.14.6.5	VGCS-VBS / GCC-BCC Procedures / Call Termination / not originator	2005
26.14.6.6	VGCS-VBS / GCC-BCC Procedures / GCC states	2006
26.14.6.7	VGCS-VBS / GCC-BCC Procedures / BCC states	2009
26.14.7	VGCS-VBS / Error Handling	2010
26.14.7.1	VGCS-VBS / Error Handling / short message length, unknown message type and TI	2010
26.14.7.2	VGCS-VBS / Error Handling / incorrect information elements	2014
26.14.7.3	VGCS-VBS / Messages not addressing VGCS receive mode	2018
26.14.8	VGCS-VBS / Structured Procedures	2019
26.14.8.1	VGCS-VBS / Structured Procedures / Very early and early assignment	2019
26.14.9	VGCS-VBS / Cell change	2022
26.14.9.1	VGCS-VBS / Cell Change / Same LA	2022
26.14.9.2	VGCS-VBS / Cell Change / Different LA	2025
26.14.9.3	VGCS-VBS / Cell Change / Different PLMN	2028
26.14.10	VGCS-VBS / Default Message Contents	2031
26.14.11	VGCS-VBS / User-to-Dispatcher Information	2035

26.14.11.1	VGCS-VBS / User-to-Dispatcher Information / BCC MO call	2035
26.14.11.2	VGCS-VBS / User-to-Dispatcher information / GCC MO call	2037
26.14.11.3	VGCS-VBS / User-to-Dispatcher information / Compressed user information in VBS fast call set-up.....	2039
26.14.11.4	VGCS-VBS / User-to-Dispatcher information / Compressed User-to-Dispatcher information in VGCS fast call set-up.....	2041
26.15	SoLSA signalling	2043
26.15.1	General considerations.....	2043
26.15.1.1	Default message content	2043
26.15.1.2	General initial conditions for SIM card.....	2044
26.15.2	SoLSA signalling / RR	2044
26.15.2.1	SoLSA signalling / RR / classmark interrogation	2044
26.15.3	SoLSA signalling / MM.....	2046
26.15.3.1	SoLSA signalling / MM / location updating	2046
26.15.3.1.1	Location updating / accepted.....	2047
26.15.3.2	SoLSA signalling / MM / MM information	2051
26.15.4	SoLSA signalling / CC	2053
26.15.4.1	SoLSA signalling / CC / call re-establishment / call present	2053
26.15.5	SoLSA signalling / structured procedures	2056
26.15.5.1	SoLSA signalling / structured procedures / MS originated call / early assignment	2056
26.15.5.2	SoLSA signalling / structured procedures / MS originated call / late assignment.....	2059
26.15.5.3	SoLSA signalling / structured procedures / MS terminated call / early assignment	2062
26.15.5.4	SoLSA signalling / structured procedures / MS terminated call / late assignment.....	2065
26.15.5.5	SoLSA signalling / structured procedures / emergency call / idle updated.....	2068
26.15.5.6	SoLSA signalling / structured procedures / emergency call / idle, no IMSI	2071
26.16	Adaptive Multi Rate Signalling.....	2075
26.16.0	Default contents of layer 3 messages for AMR signalling tests	2075
26.16.1	Void	2075
26.16.2	Inband Signalling, Uplink Codec Adaptation	2075
26.16.3	Structured procedures / MS terminated call / early assignment / no initial codec mode	2078
26.16.3a	Structured procedures / MS terminated call / early assignment / specified initial codec mode	2081
26.16.4	Structured procedures / MS originated call / late assignment / specified initial codec mode	2084
26.16.4a	Structured procedures / MS originated call / late assignment / no initial codec mode.....	2087
26.16.5	AMR signalling / Handover / active call / successful case	2090
26.16.6	Structured procedures / emergency call	2106
26.16.7	AMR Signalling / Directed Retry / Mobile Originated Call	2108
26.16.8	AMR Signalling / Directed Retry / Mobile Terminated Call.....	2112
26.16.9	AMR RATSCCH Protocol	2118
26.16.9.1	AMR Configuration Change (normal)	2118
26.16.9.2	AMR Configuration Change (abnormal)	2121
26.16.9.3	Codec Mode Phase Change (normal).....	2123
26.16.9.4	Codec Mode Phase Change (abnormal).....	2125
26.16.9.5	Threshold Change (normal)	2126
26.16.9.6	Threshold Change (abnormal).....	2128
26.16.9.7	Unknown RATSCCH REQ Message.....	2130
26.16.9.8	Ignore subsequent REQ prior to expiry of REQ_Activation counter.....	2132
26.16.9.9	Initiation of Transaction with ACK_ERR or ACK_UNKNOWN	2135
26.16.9.10	Inversion of the Phase of the CMR/CMI.....	2136
26.16.9.11	Change of Active Codec Set	2139
26.16.9.12	Void.....	2143
26.16.10	AMR signalling/ test of the channel mode modify procedure	2143
26.16.11	Handover / layer 1 failure	2146
26.17	Adaptive Multi Rate Signalling – 8PSK.....	2150
26.17.1	Void	2150
26.17.2	Inband Signalling, Uplink Codec Adaptation	2150
26.17.3	8-PSK AMR HR / Structured procedures / MS terminated call / early assignment / no initial codec mode	2152
26.17.3a	8-PSK AMR HR / Structured procedures / MS terminated call / early assignment / specified initial codec mode	2155
26.17.4	8-PSK AMR HR / Structured procedures / MS originated call / late assignment / specified initial codec mode	2158

26.17.4a	8-PSK AMR HR / Structured procedures / MS originated call / late assignment / no initial codec mode	2161
26.17.6	8-PSK AMR HR / Structured procedures / emergency call	2163
26.17.9	8-PSK AMR HR / RATSCCH Protocol	2165
26.17.9.1	AMR Configuration Change (normal)	2165
26.17.9.2	AMR Configuration Change (abnormal)	2168
26.17.9.3	Codec Mode Phase Change (normal)	2170
26.17.9.4	Codec Mode Phase Change (abnormal)	2172
26.17.9.5	Threshold Change (normal)	2174
26.17.9.6	Threshold Change (abnormal).....	2176
26.17.9.7	Unknown RATSCCH REQ Message.....	2178
26.17.9.8	Ignore subsequent REQ prior to expiry of REQ_Activation counter.....	2180
26.17.9.9	Initiation of Transaction with ACK_ERR or ACK_UNKNOWN	2183
26.17.9.10	Inversion of the Phase of the CMR/CMI.....	2184
26.17.9.11	Change of Active Codec Set	2187
26.17.10	8-PSK AMR HR signalling/ test of the channel mode modify procedure	2191
26.17.10.1	Void.....	2191
26.17.10.2	8-PSK AMR HR signalling/ test of the channel mode modify procedure/ half rate	2191
26.18	Dynamic ARFCN mapping tests	2193
26.18.1	Control of dynamic ARFCN mapping with SI14 and SI15	2193
26.19	AMR WB - signalling	2197
26.19.1	Reserved for future use	2197
26.19.2	Reserved for future use	2197
26.19.3	Reserved for future use	2197
26.19.3a	WB AMR / Structured procedures / MS terminated call / early assignment / specified initial codec mode	2197
26.19.4	Reserved for future use	2202
26.19.5	WB AMR / Adaptive Multi Rate Signalling / AMR signalling / Handover / active call / successful case	2202
26.19.6	Reserved for future use	2222
26.19.7	Reserved for future use	2222
26.19.8	Reserved for future use	2222
26.19.9	WB AMR RATSCCH Protocol	2222
26.19.9.1	WB AMR Configuration Change (normal).....	2222
26.19.9.2	WB AMR Configuration Change (abnormal)	2225
26.19.9.3	Codec Mode Phase Change (normal)	2227
26.19.9.4	Reserved for future use	2230
26.19.9.5	Threshold Change (normal)	2230
26.19.9.6	Reserved for future use	2232
26.19.9.7	Reserved for future use	2232
26.19.9.8	Reserved for future use	2232
26.19.9.9	Reserved for future use	2232
26.19.9.10	Inversion of the Phase of the CMR/CMI.....	2232
26.19.9.11	Change of Active Codec Set	2235
26.19.10	AMR signalling/ test of the channel mode modify procedure	2240
26.19.10.1	WB AMR signalling test of the channel mode modify procedure / full rate	2240
26.20	Enhanced Power Control.....	2242
26.20.1	Enhanced Power Control / MS Supports EPC	2242
27	Testing of the SIM/ME interface.....	2246
27.1	MS identification by short IMSI.....	2250
27.1.1	MS identification by short IMSI - Normal case.....	2250
27.1.2	MS identification by short IMSI, Phase 1 DCS SIM.....	2251
27.2	MS identification by short TMSI	2252
27.3	MS identification by long TMSI	2253
27.4	MS identification by long IMSI, TMSI updating and cipher key sequence number assignment	2254
27.5	Forbidden PLMNs, location updating and undefined cipher key	2256
27.6	MS updating forbidden PLMNs	2259
27.7	MS deleting forbidden PLMNs	2260
27.8	MS updating the PLMN selector list	2262
27.9	MS recognizing the priority order of the PLMN selector list.....	2263
27.10	MS access control management	2265

27.11	Exchange protocol tests.....	2271
27.11.1	Character transmission.....	2271
27.11.1.1	Bit/character duration during the transmission from the ME to the SIM	2271
27.11.1.2	Bit/character duration during the transmission from the SIM simulator to the ME	2271
27.11.1.3	Inter-character delay.....	2272
27.11.1.4	Error handling during the transmission from the ME to the SIM	2273
27.11.1.5	Error handling during transmission from the SIM to the ME	2274
27.11.2	Answer to reset (RST)	2274
27.11.2.1	Void.....	2274
27.11.2.2	Acceptance of SIMs with active low RST	2274
27.11.2.3	Characters of the answer to reset.....	2275
27.11.2.4	PPS procedure	2276
27.11.2.5	Reset repetition	2277
27.11.2.6	Speed Enhancement	2277
27.11.3	Command processing, procedure bytes	2279
27.12	Evaluation of directory characteristics	2280
27.12.1	Operating speed in authentication procedure.....	2280
27.12.2	Clock stop	2280
27.13	Mechanical tests	2282
27.13.1	Contact pressure.....	2282
27.13.2	Shape of contacts for IC card SIM card reader	2282
27.14	Secret code usage	2283
27.14.1	Entry of PIN.....	2283
27.14.2	Change of PIN	2284
27.14.3	Disabling the PIN	2284
27.14.4	PUK entry	2285
27.14.5	Entry of PIN2.....	2286
27.14.6	Change of PIN2	2287
27.14.7	PUK2 entry	2288
27.15	Abbreviated Dialling Numbers (ADN)	2288
27.16	MMI reaction to SIM status encoding.....	2290
27.17	Electrical tests	2290
27.17.1	Test of the power transition phases.....	2291
27.17.1.1	Phase preceding ME power on.....	2291
27.17.1.2	Phase during SIM power on.....	2291
27.17.1.3	Phase during ME power off with clock stop forbidden.....	2293
27.17.1.4	Phase during ME power off with clock stop allowed.....	2294
27.17.1.5	SIM Type Recognition and Voltage Switching.....	2296
27.17.1.5.1	Reaction of 3V only MEs on SIM type recognition failure	2296
27.17.1.5.2	Reaction of 3V only MEs on type recognition of 5V only SIMs	2297
27.17.1.5.3	Reaction of 3V technology MEs on type recognition of 5V only SIMs	2298
27.17.1.5.4	Reaction of 3V technology MEs on type recognition of 3V technology SIMs	2299
27.17.1.5.5	Reaction of 1,8V only MEs on SIM type recognition failure	2300
27.17.1.5.6	Reaction of 1,8V only MEs on type recognition of 3V SIMs.....	2301
27.17.1.5.7	Reaction of 1,8V technology MEs on type recognition of 3V technology SIMs	2302
27.17.1.5.8	Reaction of 1,8V technology MEs on type recognition of 1,8V technology SIMs	2303
27.17.2	Electrical tests on each ME contact	2304
27.17.2.1	Electrical tests on contact C1	2304
27.17.2.1.1	Test 1	2305
27.17.2.1.2	Test 2	2305
27.17.2.2	Electrical tests on contact C2	2308
27.17.2.3	Electrical tests on contact C3	2310
27.17.2.4	[Not used].....	2311
27.17.2.5	Electrical tests on contact C7	2311
27.18	Fixed Number Dialling (FND)	2314
27.18.1	ME and SIM with FND activated	2314
27.18.1.1	EF _{ADN} invalidated and not readable or updatable.....	2314
27.18.1.2	EF _{ADN} invalidated but readable and updatable	2315
27.18.2	ME and SIM with FND deactivated	2316
27.18.3	Enabling, disabling and updating of FND	2317
27.19	Phase identification	2318
27.20	SIM presence detection	2319

27.21	Advice of Charge (AoC)	2320
27.21.1	AoC not supported by SIM	2320
27.21.2	Maximum frequency of ACM updating.....	2321
27.21.3	Call terminated when ACM greater than ACMmax	2323
27.21.4	Response codes of increase command.....	2326
28	Test of autocalling restrictions	2328
28.1	General	2328
28.2	Constraining the access to a single number (3GPP TS 02.07 category 3).....	2328
28.3	Constraining the access to a single number (3GPP TS 02.07 categories 1 and 2).....	2330
28.4	Behaviour of the MS when its list of blacklisted numbers is full.....	2332
29	Testing of bearer services.....	2334
29.1	General	2334
29.2	Testing of transparent data services.....	2335
29.2.1	Verification of synchronization	2335
29.2.2	Filtering of channel control information for transparent BCs.....	2338
29.2.3	Correct Terminal Compatibility Decision.....	2339
29.2.3.1	Negotiation of Radio Channel Requirement (RCR).....	2339
29.2.3.2	Negotiation of Connection Element (CE)	2340
29.2.3.3	Negotiation of Number of Stop Bits, Number of Data bits, and Parity.....	2340
29.2.3.4	Negotiation of Modem Type	2341
29.2.3.5	Negotiation of Intermediate Rate	2342
29.2.3.6	Negotiation of User Information Layer 2 Protocol	2343
29.2.3.7	Negotiation between TS 61 and TS 62: Mobile Originated call	2343
29.2.3.8	Negotiation between TS 61 and TS 62: Mobile Terminated call	2344
29.2.4	Data Rate Adaptation for Synchronous Transparent Bearer Capabilities	2345
29.2.5	Network Independent Clocking	2346
29.2.6	Asynchronous Transparent Bearer Capabilities.....	2346
29.2.6.1	Data Rate Adaptation	2346
29.2.6.2	Passage of the Break Signal	2347
29.2.6.3	Overspeed/Underspeed Handling (Local Terminal)	2348
29.2.6.4	Overspeed/Underspeed Handling (Remote Terminal)	2349
29.2.7	Interchange circuit mapping for transparent bearer capabilities	2350
29.3	Testing of non transparent data services (RLP tests).....	2351
29.3.1	Initialization.....	2351
29.3.1.1	Normal initialization done by the MS	2351
29.3.1.2	Initialization failure	2352
29.3.1.2.1	Loss of UA frame	2352
29.3.1.2.2	Total loss of UA frame	2354
29.3.2	Data transfer.....	2355
29.3.2.1	Default conditions	2355
29.3.2.2	MS sends I+S frames	2355
29.3.2.2.1	N(S) sequence number	2355
29.3.2.2.2	Transmission window.....	2356
29.3.2.2.3	Busy condition.....	2358
29.3.2.3	SS sends I+S frames.....	2360
29.3.2.3.1	N(R) sequence number	2360
29.3.2.3.2	Busy condition.....	2361
29.3.2.4	SS rejects I+S frames	2363
29.3.2.4.1	REJ frame	2363
29.3.2.4.2	SREJ frame	2365
29.3.2.4.3	I+S reject frame	2368
29.3.2.5	MS rejects I+S frames.....	2371
29.3.2.5.1	Rejection with REJ or SREJ supervisory frames.....	2371
29.3.2.5.2	Retransmission of REJ or SREJ frames.....	2377
29.3.2.5.3	I+S reject frame	2381
29.3.2.6	Checkpoint recovery	2384
29.3.2.6.1	SS in checkpoint recovery mode	2384
29.3.2.6.2	End of the window.....	2388
29.3.2.6.3	End of a sequence	2391
29.3.2.6.4	Time-out of one frame	2393

29.3.2.6.5	No response to checkpointing.....	2394
29.3.2.6.6	Incorrect response to checkpointing	2397
29.3.2.6.7	Total loss of response to checkpointing.....	2401
29.3.2.6.8	Retransmission of a sequence.....	2404
29.3.2.6.9	N2 retransmission of a sequence	2408
29.3.3	Negotiation of the RLP parameters.....	2412
29.3.3.1	Negotiation initiated by the SS.....	2412
29.3.3.2	Negotiation initiated by the MS	2417
29.3.3.3	Collision of XID frames.....	2422
29.3.3.4	Loss of XID frames.....	2427
29.3.3.5	Total loss of XID frames.....	2428
29.4	Facsimile tests for the transparent network support	2430
29.4.1	General.....	2430
29.4.2	Mobile originated call.....	2432
29.4.2.1	Call establishment procedure	2432
29.4.2.1.1	Alternate speech / facsimile.....	2432
29.4.2.1.2	Automatic facsimile.....	2433
29.4.2.2	Pre-message procedure.....	2434
29.4.2.3	Message procedure.....	2435
29.4.2.4	Post-message procedure	2437
29.4.2.5	Call release procedure.....	2438
29.4.2.6	CTC processing - 4th PPR for the same block	2438
29.4.2.7	Transition from Facsimile to Speech - Procedure interrupt generated by receiving station.....	2440
29.4.2.8	Transition from Facsimile to Speech - Procedure interrupt generated by transmitting station	2442
29.4.2.9	Quality check	2443
29.4.3	Mobile terminated call.....	2444
29.4.3.1	Call Establishment Procedure	2444
29.4.3.1.1	Alternate Speech/Facsimile	2444
29.4.3.1.2	Automatic facsimile.....	2446
29.4.3.2	Pre-message procedure.....	2447
29.4.3.3	Message procedure.....	2449
29.4.3.4	Post-message procedure	2450
29.4.3.5	Call release procedure.....	2451
29.4.3.6	Speed conversion factor	2451
29.4.3.7	Quality Check	2454
29.4.4	Notes.....	2454
30	Speech teleservices.....	2455
30.1	Sending sensitivity/frequency response.....	2455
30.2	Sending loudness rating.....	2457
30.3	Receiving sensitivity/frequency response	2458
30.4	Receiving loudness rating	2459
30.5	Side tones	2460
30.5.1	Side Tone Masking Rating (STMR).....	2460
30.5.2	Listener Side Tone Rating (LSTR).....	2461
30.6	Telephone Acoustic coupling Loss (TAL).....	2462
30.6.1	Echo Loss (EL).....	2462
30.6.2	Stability margin	2463
30.7	Distortion.....	2463
30.7.1	Sending	2463
30.7.2	Receiving	2464
30.8	Sidetone distortion.....	2465
30.9	Out-of-band signals	2466
30.9.1	Sending	2466
30.9.2	Receiving	2467
30.10	Idle channel noise.....	2468
30.10.1	Sending	2468
30.10.2	Receiving.....	2468
30.11	Ambient Noise Rejection	2469
30.12	Sending sensitivity/frequency response.....	2471
30.13	Sending loudness rating.....	2472
30.14	Receiving sensitivity/frequency response	2473

30.15	Receiving loudness rating	2474
30.16	Side Tone Masking Rating (STMR)	2475
30.17	Telephone Acoustic coupling Loss (TAL)	2475
30.17.1	Echo Loss (EL)	2475
30.17.2	Stability margin	2476
30.18	Sending Distortion.....	2476
30.19	Ambient Noise Rejection	2477
31	Test of supplementary services	2479
31.1	Number identification supplementary services	2479
31.1.1	CLIP.....	2479
31.1.1.1	Normal operation	2479
31.1.1.2	Interrogation.....	2480
31.1.1.2.1	Interrogation accepted	2480
31.1.1.2.2	Interrogation rejected.....	2481
31.1.2	CLIR	2483
31.1.2.1	Normal operation - requesting presentation of CLI	2483
31.1.2.2	Normal operation - requesting restriction of CLI presentation	2484
31.1.2.3	Interrogation.....	2485
31.1.2.3.1	Interrogation accepted	2485
31.1.2.3.2	Interrogation rejected.....	2486
31.1.3	COLP	2488
31.1.3.1	Normal operation	2488
31.1.3.2	Interrogation.....	2489
31.1.3.2.1	Interrogation accepted	2489
31.1.3.2.2	Interrogation rejected	2490
31.1.4	COLR.....	2492
31.1.4.1	Interrogation.....	2492
31.1.4.1.1	Interrogation accepted	2492
31.1.4.1.2	Interrogation rejected.....	2493
31.1.4.2	Void.....	2495
31.1.5	CNAP.....	2495
31.1.5.1.1	Normal Operation – Name indication contained in Setup message.....	2495
31.1.5.1.2	Normal Operation – Name indication contained in Facility message.....	2496
31.1.5.2.1	Interrogation accepted	2497
31.1.5.2.2	Interrogation rejected.....	2498
31.2	Call offering supplementary services	2500
31.2.1	Call forwarding supplementary services.....	2500
31.2.1.1	Registration	2500
31.2.1.1.1	Registration accepted.....	2500
31.2.1.1.2	Registration rejected.....	2503
31.2.1.2	Erasure by the subscriber	2506
31.2.1.2.1	Erasure accepted.....	2506
31.2.1.2.2	Erasure rejected	2509
31.2.1.3	Activation.....	2511
31.2.1.4	Deactivation	2514
31.2.1.5	Invocation.....	2516
31.2.1.6	Interrogation.....	2516
31.2.1.6.1	Interrogation accepted	2516
31.2.1.6.2	Interrogation rejected.....	2519
31.2.1.7	Normal operation	2521
31.2.1.7.1	Served mobile subscriber side	2521
31.2.1.7.2	Forwarded-to mobile subscriber side.....	2525
31.2.2	Call transfer and mobile access hunting supplementary services	2527
31.3	Call completion supplementary services	2527
31.3.1	Call Waiting.....	2527
31.3.1.1	Waiting call indication and confirmation	2527
31.3.1.2	Normal operation with successful outcome	2528
31.3.1.2.1	Waiting call accepted; existing call released	2528
31.3.1.2.2	Waiting call accepted; existing call on hold	2529
31.3.1.2.3	Existing call released by user A; waiting call accepted	2530
31.3.1.3	Normal operation with unsuccessful outcome	2531

31.3.1.3.1	Waiting call released by subscriber B	2531
31.3.1.3.2	Waiting call released by calling user C	2532
31.3.1.4	Activation.....	2533
31.3.1.5	Deactivation	2536
31.3.1.6	Interrogation.....	2539
31.3.1.6.1	Interrogation accepted	2539
31.3.1.6.2	Interrogation rejected.....	2541
31.3.2	Call Hold.....	2543
31.3.2.1	Hold invocation	2543
31.3.2.2	Retrieve procedure.....	2544
31.3.2.3	Alternate from one call to the other.....	2545
31.4	Multi-party supplementary services	2547
31.4.1	Beginning the MultiParty service	2547
31.4.1.1	Beginning the MultiParty service, successful case.....	2547
31.4.1.2	Beginning the MultiParty service, unsuccessful case.....	2548
31.4.1.3	Beginning the MultiParty service, expiry of timer T(BuildMPTY).....	2550
31.4.2	Managing an active MultiParty call.....	2552
31.4.2.1	Served mobile subscriber	2552
31.4.2.1.1	Put the MultiParty call on hold.....	2552
31.4.2.1.2	Create a private communication with one of the remote parties.....	2556
31.4.2.1.3	Terminate the entire MultiParty call.....	2561
31.4.2.1.4	Explicitly disconnect a remote party	2562
31.4.2.2	Remote parties.....	2563
31.4.2.2.1	Release from the MultiParty call	2563
31.4.3	Managing a held MultiParty call.....	2564
31.4.3.1	Retrieve the held MultiParty call	2564
31.4.3.1.1	Retrieve the held MultiParty call, successful case.....	2564
31.4.3.1.2	Retrieve the held MultiParty call, unsuccessful case.....	2565
31.4.3.1.3	Retrieve the held MultiParty call, expiry of timer T(RetrieveMPTY).....	2567
31.4.3.2	Initiate a new call	2569
31.4.3.3	Process a call waiting request.....	2570
31.4.3.4	Terminate the held MultiParty call.....	2571
31.4.4	Managing a single call and a MultiParty call.....	2572
31.4.4.1	Served mobile subscriber	2572
31.4.4.1.1	Disconnect the single call	2572
31.4.4.1.2	Disconnect the MultiParty call	2575
31.4.4.2	Disconnect all calls	2578
31.4.4.3	Add the single call to the MPTY.....	2579
31.4.4.3.1	Add the single call to the MPTY, successful case.....	2579
31.4.4.3.2	Add the single call to the MPTY, maximum number of participants exceeded	2581
31.4.4.4	Alternate between the MPTY call and the single call	2582
31.4.5	Adding extra remote parties.....	2584
31.5	Community of interest supplementary services.....	2586
31.6	Charging supplementary services.....	2586
31.6.1	Advice of Charge Charging	2586
31.6.1.1	AoCC time related charging / MS originated call	2586
31.6.1.2	AoCC time related charging / MS terminated call	2589
31.6.1.3	AoCC volume related charging / MS originated call	2591
31.6.1.4	AoCC volume related charging / MS terminated call	2591
31.6.1.5	Change in charging information during a call.....	2591
31.6.1.6	Different formats of charging information	2594
31.6.1.7	AoCC on a Call Hold call	2597
31.6.1.8	AoCC on a Multi-party call.....	2600
31.6.2	Charge Storage.....	2603
31.6.2.1	Removal of SIM during an active call.....	2603
31.6.2.2	Interruption of power supply during an active call	2606
31.6.2.3	MS going out of coverage during an active AoCC call.....	2607
31.6.2.4	ACMmax operation / Mobile Originating.....	2610
31.6.2.5	ACMmax operation / Mobile Terminating	2613
31.6.3	Advice of Charge Information	2616
31.6.3.1	AoCI time related charging / MS originated call	2616
31.6.3.2	AoCI time related charging / MS terminated call	2618

31.6.3.3	AoCI volume related charging / MS originated call	2620
31.6.3.4	AoCI volume related charging / MS terminated call.....	2620
31.6.3.5	Change in charging information during a call.....	2620
31.6.3.6	Different formats of charging information	2623
31.6.3.7	AoCI on a Call Hold call.....	2626
31.6.3.8	AoCI on a Multi-party call.....	2629
31.6.4	Default contents of messages.....	2632
31.7	Additional information transfer supplementary services.....	2633
31.8	Call restriction supplementary services.....	2634
31.8.1	Registration of a password.....	2634
31.8.1.1	Registration accepted	2634
31.8.1.2	Registration rejected.....	2636
31.8.1.2.1	Rejection after invoke of the RegisterPassword operation	2636
31.8.1.2.2	Rejection after password check with negative result.....	2638
31.8.1.2.3	Rejection after new password mismatch	2641
31.8.2	Erasure	2643
31.8.3	Activation	2643
31.8.3.1	Activation accepted.....	2643
31.8.3.2	Activation rejected.....	2646
31.8.3.2.1	Rejection after invoke of ActivateSS operation	2646
31.8.3.2.2	Rejection after use of password procedure	2648
31.8.4	Deactivation.....	2651
31.8.4.1	Deactivation accepted	2651
31.8.4.2	Deactivation rejected.....	2654
31.8.4.2.1	Rejection after invoke of DeactivateSS operation	2654
31.8.4.2.2	Rejection after use of password procedure	2656
31.8.5	Invocation	2658
31.8.6	Interrogation	2658
31.8.6.1	Interrogation accepted.....	2658
31.8.6.2	Interrogation rejected	2660
31.8.7	Normal operation	2663
31.9	Handling of undefined (future) GSM supplementary services.....	2665
31.9.1	Mobile station initiated Unstructured supplementary service data operation	2665
31.9.1.1	ProcessUnstructuredSS-request/accepted	2665
31.9.1.2	ProcessUnstructuredSS-request/cross phase compatibility and error handling.....	2670
31.9.2	Network initiated unstructured supplementary service operations	2675
31.9.2.1	UnstructuredSS-Notify/accepted.....	2675
31.9.2.2	UnstructuredSS-Notify/rejected on user busy	2677
31.9.2.3	UnstructuredSS-Request/accepted	2679
31.10	MMI input for USSD	2684
31.11	Specific message contents and ASN.1 codings	2685
31.12	eMLPP Service.....	2731
31.12.1	eMLPP Service / priority level of MO call.....	2731
31.12.2	eMLPP Service / automatic answering point-to-point MT call	2735
31.12.3	eMLPP Service / automatic answering MT VGCS or VBS call.....	2739
31.12.4	eMLPP Service / registration.....	2741
31.12.5	eMLPP Service / interrogation.....	2743
31.13	Explicit Call Transfer (ECT)	2745
31.13.1	Explicit Call Transfer invocation.....	2745
31.13.1.1	Explicit Call Transfer invocation, successful case, both calls active, clearing using DISCONNECT	2745
31.13.1.2	Explicit Call Transfer invocation, successful case, both calls active, clearing using RELEASE	2746
31.13.1.3	Explicit Call Transfer invocation, successful case, both calls active, clearing using RELEASE COMPLETE.....	2747
31.13.1.4	Explicit Call Transfer invocation, successful case, second call alerting	2749
31.13.1.5	Explicit Call Transfer invocation, unsuccessful case	2750
31.13.1.6	Explicit Call Transfer invocation, expiry of T(ECT)	2752
31.14	User-to-User Signalling (UUS)	2753
31.14.1	UUS / Implicit UUS1.....	2754
31.14.1.1	UUS / Implicit UUS1 / CC MO call	2754
31.14.1.2	UUS / Implicit UUS1 / CC MT call.....	2757
31.14.1.3	UUS / Implicit UUS1 / Interactions with Call Waiting and call HOLD supplementary services	2761

31.15	Follow Me (FM).....	2766
31.15.1	Follow Me (FM) / Registration.....	2766
31.15.2	Follow Me (FM) / Interrogation	2772
31.15.3	Follow Me (FM) / Erasure	2775
32	Testing of speech transcoding functions	2781
32.1	Full Rate Downlink speech transcoding	2781
32.2	Full Rate Downlink receiver DTX functions.....	2782
32.3	Full Rate Uplink speech transcoding.....	2785
32.4	Full Rate Uplink transmitter DTX functions	2786
32.5	Full Rate Speech channel transmission delay.....	2787
32.5.1	Definition.....	2787
32.5.2	Conformance requirement	2787
32.5.3	Test purpose.....	2787
32.5.4	Downlink processing delay.....	2787
32.5.5	Downlink coding delay	2788
32.5.6	Uplink processing delay.....	2788
32.5.7	Uplink coding delay	2789
32.6	Half Rate Downlink speech transcoding	2789
32.7	Half Rate Downlink receiver DTX functions	2790
32.8	Half Rate Uplink speech transcoding	2791
32.9	Half Rate Uplink transmitter DTX functions	2792
32.10	Half Rate Speech channel transmission delay	2794
32.10.1	Definition.....	2794
32.10.2	Conformance requirement	2794
32.10.3	Test purpose.....	2794
32.10.4	Downlink processing delay.....	2794
32.10.5	Downlink coding delay	2795
32.10.6	Uplink processing delay.....	2795
32.10.7	Uplink coding delay.....	2796
32.11	Intra cell channel change from a TCH/HS to a TCH/FS	2796
32.12	Intra cell channel change from a TCH/FS to a TCH/HS	2798
33	Mobile station features	2800
33.1	Entry and display of called number.....	2800
33.2	Indication of call progress signals	2801
33.2.1	Definition.....	2801
33.2.2	Conformance requirement	2802
33.2.3	Test purpose.....	2802
33.2.4	Ringing tone.....	2802
33.2.5	Busy tone	2802
33.2.6	Congestion tone	2803
33.2.7	Authentication failure tone	2803
33.2.8	Number unobtainable tone.....	2803
33.2.9	Call dropped tone.....	2804
33.3	Network selection / indication.....	2804
33.4	Invalid and blocked PIN indicators	2809
33.5	Service indicator.....	2809
33.6	Subscription identity management	2810
33.7	Barring of outgoing calls.....	2810
33.8	Prevention of unauthorized calls	2811
34	Short message service (SMS).....	2811
34.1	General	2812
34.2	Short message service point to point	2812
34.2.1	SMS mobile terminated	2812
34.2.2	SMS mobile originated	2817
34.2.3	Test of memory full condition and memory available notification:.....	2822
34.2.4	Test of the status report capabilities and of SMS-COMMAND:	2826
34.2.5	Test of message class 0 to 3.....	2829
34.2.5.1	Short message class 0.....	2829
34.2.5.2	Test of class 1 short messages.....	2831
34.2.5.3	Test of class 2 short messages.....	2833

34.2.5.4	Test of class 3 short messages.....	2836
34.2.6	Test of short message type 0 (Ph2, R96...R99 and REL-4)	2836
34.2.6a	Test of short message type 0 (\geq REL 5).....	2837
34.2.7	Test of the replace mechanism for SM type 1-7	2840
34.2.8	Test of the reply path scheme	2843
34.2.9	Multiple SMS mobile originated	2846
34.2.9.1	MS in idle mode	2846
34.2.9.2	MS in active mode	2850
34.3	Short message service cell broadcast.....	2852
34.4	Short message service point to point over GPRS	2854
34.4.1	SMS mobile terminated	2854
34.4.2	SMS mobile originated	2858
34.4.3	Test of the status report capabilities and of SMS-COMMAND over GPRS:	2862
34.4.4	Test of capabilities of simultaneously receiving a short message whilst sending a mobile originated short message.....	2864
34.4.5	Void	2865
34.4.6	Concatenated MO SMS over GPRS	2865
34.4.7	Concatenated MT SMS over GPRS.....	2867
34.4.8	Short Messaging Service – Handling of unknown, unforeseen, and erroneous protocol data	2869
34.4.8.1	CP Error Handling	2869
34.4.8.2	RP Error Handling	2871
34.5	Default message contents	2874
35	Low battery voltage detection	2876
36	Individual equipment type requirements and interworking - special conformance testing functions	2877
37 to 39	Void	2877
40	GPRS default conditions, message contents and macros	2878
40.1	Default test conditions	2878
40.1.1	Default settings for cell A.....	2878
40.1.2	Default settings for cell B	2883
40.1.3	Default settings for cell C	2884
40.1.4	Default settings for cell D.....	2885
40.1.5	Default settings for cell E	2886
40.1.6	Default settings for cell F.....	2887
40.2	Default message contents	2888
40.2.1	System Information messages.....	2888
40.2.1.1	Cell A	2888
40.2.1.2	Cell B	2892
40.2.1.3	Cell C	2894
40.2.1.4	Cell D.....	2895
40.2.1.5	Cell E	2897
40.2.1.6	Cell F.....	2899
40.2.2	Packet System Information messages	2901
40.2.2.1	Cell A	2901
40.2.2.2	Cell B	2915
40.2.2.3	Cell C	2919
40.2.2.4	Cell D	2923
40.2.2.5	Cell E	2927
40.2.2.6	Cell F.....	2931
40.2.3	Default contents of Layer 2 messages.....	2936
40.2.4	Default contents of Layer 3 messages.....	2939
40.2.4.1	ACTIVATE PDP CONTEXT ACCEPT message:	2940
40.2.4.2	ACTIVATE PDP CONTEXT REJECT message:	2940
40.2.4.3	ATTACH ACCEPT message:.....	2940
40.2.4.4	ATTACH REJECT message:.....	2940
40.2.4.5	AUTHENTICATION AND CIPHERING REJECT message:	2940
40.2.4.6	AUTHENTICATION AND CIPHERING REQUEST message:	2941
40.2.4.7	CHANNEL RELEASE message:.....	2941
40.2.4.8	DEACTIVATE PDP CONTEXT ACCEPT message:	2941
40.2.4.9	DETACH ACCEPT message (for mobile terminated detach):	2941

40.2.4.10	DETACH REQUEST message (mobile terminated detach):	2941
40.2.4.11	GMM INFORMATION message:	2941
40.2.4.12	GMM STATUS message:	2941
40.2.4.13	IDENTITY REQUEST message:.....	2942
40.2.4.14	IMMEDIATE ASSIGNMENT messages	2942
40.2.4.14.1	IMMEDIATE ASSIGNMENT message (Packet Downlink Construction):	2942
40.2.4.14.2	IMMEDIATE ASSIGNMENT message (Packet Uplink construction):	2943
40.2.4.14.3	IMMEDIATE ASSIGNMENT message (Single block allocation construction):	2944
40.2.4.15	IMMEDIATE ASSIGNMENT EXTENDED message:.....	2944
40.2.4.16	IMMEDIATE ASSIGNMENT REJECT message:.....	2945
40.2.4.17	MODIFY PDP CONTEXT REQUEST message:.....	2945
40.2.4.18	PAGING REQUEST TYPE 1 message:	2945
40.2.4.19	PAGING REQUEST TYPE 2 message:	2946
40.2.4.20	PAGING REQUEST TYPE 3 message:	2946
40.2.4.21	PDCH ASSIGNMENT COMMAND message (downlink):	2947
40.2.4.22	REQUEST PDP CONTEXT ACTIVATION message (mobile originated detach):.....	2947
40.2.4.23	ROUTING AREA UPDATE ACCEPT message:	2948
40.2.4.24	ROUTING AREA UPDATE REJECT message:.....	2948
40.2.4.25	RR-CELL CHANGE ORDER message:	2948
40.2.4.26	SM STATUS message:	2948
40.2.4.27	DETACH ACCEPT message (for mobile originated detach):	2948
40.2.4.28	DTM Assignment Command	2949
40.2.4.29	DTM Reject.....	2950
40.2.4.30	Packet Notification.....	2950
40.2.4.31	Packet Assignment.....	2951
40.2.4.32	Assignment Command	2952
40.2.4.33	Handover Command	2952
40.2.4.34	Physical Information	2952
40.2.4.35	Connect Acknowledge	2953
40.2.4.36	Location Updating Accept	2953
40.2.4.37	System Information Type 6.....	2953
40.2.4.38	DTM Information.....	2954
40.3	Default GPRS Conditions and Message Contents for the Higher Layer Test Cases	2955
40.3.1	Default Test Conditions for the Higher Layer Test Cases	2955
40.3.2	Default Message for the Higher Layer Test Cases.....	2955
40.3.2.1	Default Contents of System Information Messages for the Higher Layer Test Cases	2955
40.3.3	Contents Of Packet System Information Messages for the Higher Layer Test Cases	2956
40.3.4	Contents of Layer 2 Messages for the Higher Layer Test Cases	2957
40.3.5	Contents of Layer 3 Messages for the Higher Layer Test Cases	2958
40.3.6	Timer tolerance for higher layer test cases	2958
40.4	Macros.....	2958
40.4.1	Overview	2958
40.4.1.1	Definition	2958
40.4.1.2	Syntax	2958
40.4.1.2.1	Message contents.....	2958
40.4.1.2.2	Message sequence	2959
40.4.2	Default message contents.....	2959
40.4.3	Macro message sequences	2960
40.4.3.1	Acknowledged downlink data.....	2960
40.4.3.2	Classmark and measurement.....	2960
40.4.3.3	Downlink data	2960
40.4.3.4	Downlink data transfer	2961
40.4.3.5	Measurement reporting	2961
40.4.3.6	Uplink data transfer.....	2962
40.4.3.7	Uplink dynamic allocation one phase access	2962
40.4.3.8	Uplink dynamic allocation one phase access with contention resolution.....	2963
40.4.3.9	Uplink dynamic allocation two phase access	2964
40.4.3.10	Completion of uplink RLC data block transfer	2964
40.4.3.11	Void.....	2966
40.4.3.12	Void.....	2966
40.4.3.13	Void.....	2966
40.4.3.14	Downlink TBF establishment.....	2966

40.4.3.15	PDP Context Activation	2966
40.4.3.16	PDP Context Deactivation	2966
40.4.3.17	Inter-SGSN Routing Area Update.....	2967
40.4.3.18	PDP Context Modification.....	2967
40.4.3.19	Location Update Procedure.....	2967
40.4.3.20	MT Call in GPRS cell	2968
40.4.3.21	Uplink data.....	2970
40.4.3.22	Bring MS in the active state (U10).....	2971
40.4.3.23	Completion of uplink RLC data block transfer in extended dynamic mode	2972
40.5	Test PDP contexts	2972
41	GPRS Paging, TBF establishment/release and DCCH related procedures	2978
41.1	RR / Paging	2978
41.1.1	RR / Paging / on PCCCH for GPRS service successful.....	2978
41.1.1.1	RR / Paging / on PCCCH for GPRS service / normal paging with P-TMSI successful.....	2978
41.1.1.2	RR / Paging / on PCCCH for GPRS service / normal paging with IMSI successful	2980
41.1.1.3	RR / Paging / on PCCCH for GPRS service / extended paging with P-TMSI successful.....	2982
41.1.1.4	RR / Paging / on PCCCH for GPRS service / paging reorganisation successful	2985
41.1.2	RR / Paging / on PCCCH for circuit-switched services / paging successful.....	2988
41.1.3	RR / Paging / on PCCCH / paging ignored.....	2991
41.1.4	RR / Paging / on PACCH for circuit-switched services.....	2993
41.1.4.1	RR / Paging / on PACCH for circuit-switched services/ paging successful.....	2993
41.1.4.2	RR / Paging / on PACCH for circuit-switched services/ paging ignored.....	2995
41.1.5	RR / Paging / on CCCH for GPRS service	2996
41.1.5.1	RR / Paging / on CCCH for GPRS service / normal paging	2996
41.1.5.1.1	RR / Paging / on CCCH for GPRS service / normal paging with P-TMSI successful	2996
41.1.5.1.2	RR / Paging / on CCCH for GPRS service / normal paging with IMSI successful	2999
41.1.5.1.3	RR / Paging / on CCCH for GPRS service / normal paging with P-TMSI ignored.....	3001
41.1.5.2	RR / Paging / on CCCH for GPRS service / extended paging	3003
41.1.5.2.1	RR / Paging / on CCCH for GPRS service / extended paging with P-TMSI successful	3003
41.1.5.3	RR / Paging / on CCCH for GPRS service / paging reorganisation	3005
41.1.5.4	RR / Paging / on CCCH for GPRS service / default message contents.....	3008
41.1.6	RR / Paging / Before T3172 expiry	3009
41.2	RR procedures on CCCH related to temporary block flow establishment	3011
41.2.1	Permission to access the network	3011
41.2.1.1	Permission to access the network / priority classes	3011
41.2.2	Initiation of the packet access procedure	3012
41.2.2.1	Initiation of the packet access procedure / establishment causes	3012
41.2.2.2	Random references for single block packet access	3014
41.2.2.3	Random references for one phase packet access.....	3015
41.2.2.4	Initiation of the packet access procedure / timer T3146.....	3016
41.2.2.5	Initiation of the packet access procedure / Request Reference.....	3018
41.2.3	Packet immediate assignment / One phase packet access.....	3019
41.2.3.1	Two-message assignment / Successful case.....	3019
41.2.3.2	Two-message assignment / Failure cases	3021
41.2.3.3	Packet uplink assignment / Polling bit set.....	3023
41.2.3.4	One phase packet access / Contention resolution / Successful case	3024
41.2.3.5	One phase packet access / Contention resolution / TLLI mismatch.....	3025
41.2.3.6	One phase packet access / Contention resolution / Counter N3104	3026
41.2.3.7	One phase packet access / Contention resolution / Timer T3166.....	3027
41.2.3.8	One phase packet access / Contention resolution / 4 access repetition attempts	3029
41.2.3.9	One phase packet access / TBF starting time	3031
41.2.3.10	One phase packet access / Timing Advance Index present	3033
41.2.3.11	One phase packet access / Timing Advance Index not present	3035
41.2.4	Packet immediate assignment / Single block packet access	3036
41.2.4.1	Single block packet access / Packet Resource Request.....	3036
41.2.4.2	Single block packet access / Packet Measurement Report.....	3037
41.2.5	Packet immediate assignment / Packet access rejection	3038
41.2.5.1	Packet access rejection / wait indication	3038
41.2.5.2	Packet access rejection / assignment before T3142 expires.....	3039
41.2.6	Packet downlink assignment procedure using CCCH	3041
41.2.6.1	Initiation of packet downlink assignment procedure / MS listens to correct CCCH block.....	3041

41.2.6.2	Initiation of packet downlink assignment procedure / timer T3190.....	3042
41.2.6.3	Initiation of packet downlink assignment procedure / TBF starting time	3043
41.2.6.4	Initiation of packet downlink assignment procedure / incorrect TFI	3044
41.2.7	Single block packet downlink assignment.....	3045
41.2.7.1	Single block packet downlink assignment / TBF Starting Time	3045
41.2.7.2	Single block packet downlink assignment / MS returns to packet idle mode	3047
41.2.8	Macros and default message contents	3048
41.2.8.1	Macros.....	3048
41.2.8.1.1	GPRS attach procedure.....	3048
41.2.8.1.2	Uplink data transfer	3049
41.2.8.1.3	Downlink data transfer	3050
41.2.8.2	Default message contents.....	3051
41.3	MAC/RLC Release.....	3057
41.3.1	TBF Release / Uplink / Normal / MS initiated	3057
41.3.1.1	TBF Release / Uplink / Normal / MS initiated / Acknowledged mode.....	3057
41.3.1.2	TBF Release / Uplink / Normal / MS initiated / Unacknowledged mode	3061
41.3.1.2.3	Method of test.....	3061
41.3.1.3	TBF Release / Uplink / Normal / MS initiated / Channel coding change during countdown	3064
41.3.1.4	TBF release / Uplink / Normal / MS initiated / Whilst in DTM	3066
41.3.2	TBF Release / Uplink / Normal / Network initiated	3067
41.3.2.1	TBF Release / Uplink / Normal / Network initiated / Acknowledged mode.....	3067
41.3.2.2	TBF Release / Uplink / Normal / Network initiated / Unacknowledged mode	3069
41.3.2.3	TBF release / Uplink / Normal / Network initiated / Whilst in DTM	3071
41.3.3	TBF Release / Uplink / Network initiated / Abnormal release	3074
41.3.4	TBF Release / Downlink / Normal / Network initiated	3075
41.3.4.1	TBF Release / Downlink / Normal / Network initiated / Acknowledged mode.....	3075
41.3.4.2	TBF Release / Downlink / Normal / Network initiated / Unacknowledged mode	3078
41.3.4.3	TBF release / Downlink / Normal / Network initiated / Whilst in DTM	3080
41.3.5	PDCH Release	3082
41.3.5.1	Void.....	3082
41.3.5.2	PDCH Release / With TIMESLOTS_AVAILABLE	3082
41.3.6	TBF Release / Extended Uplink	3086
41.3.6.1	TBF Release / Extended Uplink / Recalculation of CV before CV = 0	3086
41.3.6.1.1	Conformance requirements.....	3086
41.3.6.2	TBF Release / Extended Uplink / Recalculation of CV after CV = 0	3087
41.3.6.2.1	Conformance requirements.....	3087
41.3.6.3	TBF Release / Extended Uplink / CS change order while CV=0.....	3089
41.3.6.3.1	Conformance requirements.....	3089
41.3.6.4	TBF Release / Extended Uplink / TBF reconfigure by PACKET TIMESLOT RECONFIGURE ...	3091
41.3.6.4.1	Conformance requirements.....	3091
41.3.6.5	TBF Release / Extended Uplink / TBF reconfigure by PACKET UPLINK ASSIGNMENT.....	3095
41.3.6.5.1	Conformance requirements.....	3095
41.3.6.6	Extended Uplink TBF / Cell Change while in Extended Uplink/ No Packet Neighbouring Cell Data	3097
41.3.6.6.1	Conformance requirements	3097
41.3.6.7	Extended Uplink TBF / Cell Change failure while in Extended Uplink/ No Packet Neighbouring Cell Data	3100
41.3.6.7.1	Conformance requirements	3100
41.3.6.8	Extended Uplink TBF / Cell Change while in Extended Uplink/ With Packet Neighbouring Cell Data	3103
41.3.6.8.1	Conformance requirements	3103
41.3.6.9	TBF Release / Extended Uplink / Change of RLC mode / Normal release.....	3107
41.3.6.9.1	Conformance requirements.....	3107
41.3.6.10	TBF Release / Extended Uplink / Change of RLC mode / Abnormal release.....	3110
41.3.6.10.1	Conformance requirements.....	3110
41.3.7	Default message contents.....	3113
41.4	Void.....	3113
41.5	Dual transfer mode	3113
41.5.1	PS establishment whilst in dedicated mode	3113
41.5.1.1	Uplink TBF establishment	3113
41.5.1.1.1	Uplink TBF establishment with no reallocation of CS resources.....	3113

41.5.1.1.1.1	Uplink TBF establishment with no reallocation of CS resources / Successful case / Uplink resources assigned.....	3113
41.5.1.1.1.2	Uplink TBF establishment with no reallocation of CS resources / Successful case / Downlink resources assigned.....	3115
41.5.1.1.1.3	Uplink TBF establishment with no reallocation of CS resources / Abnormal cases / DTM reject	3117
41.5.1.1.1.4	Uplink TBF establishment with no reallocation of CS resources / Abnormal cases / Inter System to UTRAN Handover Command.....	3118
41.5.1.1.1.5	Uplink TBF establishment with no reallocation of CS resources / Abnormal cases / Assignment Command.....	3123
41.5.1.1.1.6	Uplink TBF establishment with no reallocation of CS resources / Abnormal cases / Handover Command	3125
41.5.1.1.1.7	Uplink TBF establishment with no reallocation of CS resources / Abnormal cases / Channel Release.....	3127
41.5.1.1.2	Uplink TBF establishment with reallocation of CS resources.....	3128
41.5.1.1.2.1	Uplink TBF establishment with reallocation of CS resources / Successful case	3128
41.5.1.1.2.2	Uplink TBF establishment with reallocation of CS resources / Abnormal case / Assignment Failure	3129
41.5.1.1.2.3	Uplink TBF establishment with reallocation of CS resources / Abnormal case / Multislot class violation	3131
41.5.1.1.2.3.1	Void.....	3131
41.5.1.1.2.3.2	Void.....	3131
41.5.1.1.2.3.3	Void.....	3131
41.5.1.1.2.3.4	Uplink TBF establishment with reallocation of CS resources / Abnormal case / Multislot class violation / Singleslot allocation.....	3131
41.5.1.1.2.3.5	Uplink TBF establishment with reallocation of CS resources / Abnormal case / Multislot class violation / Incorrect Allocation	3133
41.5.1.1.3	Uplink TBF establishment required whilst DTM is not supported in cell.....	3134
41.5.1.2	Downlink TBF establishment.....	3135
41.5.1.2.1	Whilst in Ready State	3135
41.5.1.2.1.1	Downlink TBF establishment in Ready State / Successful case	3135
41.5.1.2.1.2	Downlink TBF establishment in Ready State / Abnormal cases / No cell allocation available	3137
41.5.1.2.2	Whilst in Standby State / Packet Notification	3138
41.5.2	CS establishment whilst in packet transfer mode	3139
41.5.2.1	MT CS establishment whilst in packet transfer mode with a downlink TBF established	3139
41.5.2.2	MT CS establishment whilst in packet transfer mode with a uplink TBF established	3142
41.5.2.3	MO CS establishment whilst in packet transfer mode with uplink and downlink TBFs established	3144
41.5.2.4	MO CS establishment whilst in packet transfer mode and DTM is not supported in current cell	3145
41.5.3	PS establishment whilst in dual transfer mode	3147
41.5.3.1	Uplink TBF establishment with a downlink TBF established.....	3147
41.5.3.1.1	Uplink TBF establishment with a downlink TBF established and no PS downlink reallocation	3147
41.5.3.1.2	Uplink TBF establishment with a downlink TBF established and PS downlink reallocation	3149
41.5.3.2	Downlink TBF establishment with a uplink established.....	3151
41.5.3.2.1	Downlink TBF establishment with a uplink TBF established and no PS uplink reallocation	3151
41.5.3.2.2	Downlink TBF establishment with a uplink TBF established and PS uplink reallocation	3152
41.5.4	Enhanced DTM CS Establishment	3154
41.5.4.1	MT Call Establishment - No Reallocation of PS Resources	3154
41.5.4.2	MT Call Establishment - Reallocation of PS Resources - Allocation of New Downlink TBF	3155
41.5.4.3	MT Call Establishment - Allocation of CS Resources Only - Downlink TBF.....	3157
41.5.4.4	MO Call Establishment - No Reallocation of PS Resources.....	3159
41.5.4.5	MO Call Establishment - Reallocation of PS Resources.....	3161
41.5.4.6	MO Call Establishment - Allocation of CS Resources Only - Downlink TBF.....	3163
41.5.4.7	MO Call Establishment - IMMEDIATE ASSIGNMENT REJECT.....	3165
41.5.4.8	MO Call Establishment - Dedicated Channel Establishment Failure.....	3168
41.5.5	Enhanced DTM CS Release.....	3170
41.5.5.1	SI Acquisition - No Reallocation of PS Resources	3170
41.5.5.2	Reallocation of PS Resources for Uplink and Downlink TBFs	3174
41.5.5.3	Change of LA in NW Mode II	3177
41.5.5.4	Change of LA in NW Mode I.....	3181
42	Test of Medium Access Control (MAC) protocol.....	3184

42.1	Test of Medium Access Control (MAC) Procedures on PCCCH in idle mode.....	3184
42.1.1	Packet Channel Request.....	3184
42.1.1.1	Packet Channel Request / Message format	3184
42.1.1.2	Packet Channel Request / Response to Packet Paging	3185
42.1.1.3	void	3187
42.1.1.4	Packet Channel Request / Access persistence control on PRACH.....	3187
42.1.1.4.1	Packet Channel Request / Access persistence control on PRACH / M+1 attempts.....	3187
42.1.1.4.2	Packet Channel Request / Access persistence control on PRACH / Persistence level	3189
42.1.1.4.3	Packet Channel Request / Access persistence control on PRACH / Successive Attempts	3191
42.1.2	Packet Uplink/Downlink Assignment.....	3193
42.1.2.1	Packet uplink assignment procedure	3193
42.1.2.1.1	Packet Uplink Assignment / Packet access queuing notification procedure.....	3193
42.1.2.1.1.1	Packet Uplink Assignment / Packet queuing notification / Stop sending Packet Channel Requests.....	3193
42.1.2.1.1.2	Packet Uplink Assignment / Packet queuing notification / Ignoring Packet Queuing Notification.....	3194
42.1.2.1.1.3	Packet Uplink Assignment / Packet queuing notification / Assigned PDCHs.....	3195
42.1.2.1.1.4	Packet Uplink Assignment / Packet queuing notification / Expiry of timer T3162.....	3196
42.1.2.1.2	Packet Uplink Assignment / Response to packet polling request.....	3197
42.1.2.1.3	Packet Uplink Assignment / Packet access reject procedure.....	3199
42.1.2.1.3.1	Packet Uplink Assignment / Packet access reject / Action during Wait_Indication.....	3199
42.1.2.1.3.2	Packet Uplink Assignment / Packet access reject / No respond	3200
42.1.2.1.3.3	Void	3201
42.1.2.1.4	Packet Uplink Assignment / Packet Uplink Assignment handling.....	3201
42.1.2.1.5	Packet Uplink Assignment / One or two phase access	3202
42.1.2.1.6	Packet Uplink Assignment / Decoding of frequency parameters	3204
42.1.2.1.7	Packet Uplink Assignment / Most recently received Packet Uplink Assignment	3206
42.1.2.1.8	Packet Uplink Assignment / One phase access	3207
42.1.2.1.8.1	Packet Uplink Assignment / One phase access / Contention Resolution.....	3207
42.1.2.1.8.1.1	Packet Uplink Assignment / One phase access / Contention resolution / Inclusion of TLLI in RLC data blocks	3207
42.1.2.1.8.1.2	Packet Uplink Assignment / One phase access / Contention resolution / Counter N3104	3210
42.1.2.1.8.1.3	Packet Uplink Assignment / One phase access / Contention resolution / Timer T3166.....	3211
42.1.2.1.8.1.4	Packet Uplink Assignment / One phase access / Contention resolution / TLLI mismatch.....	3214
42.1.2.1.8.1.5	Packet Uplink Assignment / One phase access / Contention resolution / 3 or 4 access repetition attempts	3215
42.1.2.1.8.1.6	Packet Uplink Assignment / One phase access / Contention resolution / Retransmission / Inclusion of TLLI in RLC data blocks after completion	3216
42.1.2.1.8.2	Packet Uplink Assignment / One phase access / Timing Advance.....	3219
42.1.2.1.8.2.1	Packet Uplink Assignment / One phase access / Timing Advance / TA Index present.....	3219
42.1.2.1.8.2.2	Packet Uplink Assignment / One phase access / Timing Advance / TA Index not present.....	3220
42.1.2.1.9	Packet Uplink Assignment / Two phase access.....	3221
42.1.2.1.9.1	Packet Uplink Assignment / Two phase access / Packet Resource Request / RLC Octet Count	3221
42.1.2.1.9.2	Packet Uplink Assignment / Two phase access / Contention resolution	3223
42.1.2.1.9.2.1	Packet Uplink Assignment / Two phase access / Contention resolution / Expiry of timer T3168	3223
42.1.2.1.9.2.2	Packet Uplink Assignment / Two phase access / Contention resolution / TLLI mismatch	3224
42.1.2.1.9.3	Packet Uplink Assignment / Two phase access / Packet Resource Request / No respond to Packet Downlink Assignment	3225
42.1.2.1.10	Packet Uplink Assignment / Abnormal cases.....	3226
42.1.2.1.10.1	Packet Uplink Assignment / Abnormal cases / Incorrect PDCH assignment	3226
42.1.2.1.10.2	Packet Uplink Assignment / Abnormal cases / Expiry of timer T3164.....	3228
42.1.2.1.11	Non DRX Mode on PCCCH	3229
42.1.2.1.12	Variable PBCCH and PSI Scheduling	3231
42.1.2.1.13	Several PCCCHs supported by the cell	3232
42.1.2.1.14	Several Non-hopping PCCCHs supported by the cell, PBCCH on timeslot 0	3234
42.1.2.1.15	Several Non-hopping PCCCHs supported by the cell, PBCCH on timeslot 3	3236
42.1.2.1.16	Several Non-hopping PCCCHs supported by the cell, PBCCH on timeslot 7	3238
42.1.2.1.17	Several Non-hopping PCCCHs supported by the cell, PBCCH on timeslot 4	3240
42.1.2.1.18	Several Hopping PCCCHs and non-Hopping PCCCHs supported by the cell	3242
42.1.2.1.19	Packet Uplink/downlink Assignment using Variable Bitmap format / PBCCH Cell	3244
42.1.2.2	Packet Downlink Assignment	3248

42.1.2.2.1	Packet Downlink Assignment / Response to poll bit.....	3248
42.1.2.2.2	Packet Downlink Assignment / PCCCH monitoring.....	3249
42.1.2.2.3	Packet Downlink Assignment / Frequency hopping.....	3251
42.1.2.2.4	Packet Downlink Assignment / Response to Packet Polling	3253
42.1.2.2.5	Packet Downlink Assignment / Abnormal cases	3255
42.1.2.2.5.1	Packet Downlink Assignment / Abnormal cases / Incorrect PDCH assignment	3255
42.1.2.2.5.2	Packet Downlink Assignment / Abnormal cases / Expiry of timer T3190.....	3256
42.1.2.2.6	Packet Downlink Assignment Timing Advance / TA value field not provided	3257
42.1.3	Macro and default message contents	3258
42.1.3.1	Macro	3258
42.1.3.1.1	GPRS attach procedure.....	3258
42.1.3.1.2	Uplink data transfer, dynamic allocation.....	3260
42.1.3.1.3	GPRS detach procedure.....	3260
42.1.3.2	Default Messages	3260
42.2	Fixed Allocation in Packet Transfer Mode.....	3265
42.2.1	Generic procedures to bring the MS into uplink transfer mode	3265
42.2.1.1	One phase access.....	3265
42.2.1.2	Two phase access	3266
42.2.2	Fixed Allocation / Uplink Transfer.....	3268
42.2.2.1	Fixed Allocation / Uplink Transfer /Normal operation	3268
42.2.2.1.1	Fixed Allocation / Uplink Transfer / Normal operation / Blocks	3268
42.2.2.1.2	Fixed Allocation / Uplink Transfer / Normal operation / Block Periods	3270
42.2.2.2	Fixed Allocation / Uplink Transfer / Operation with TS_OVERRIDE for single-slot TX	3272
42.2.2.3	Fixed Allocation / Uplink Transfer / Operation with TS_OVERRIDE for multi-slot TX	3273
42.2.2.4	Fixed Allocation / Uplink Transfer / T3184 Expiry.....	3275
42.2.2.5	Fixed Allocation / Uplink Transfer / T3188.....	3277
42.2.2.5.1	Fixed Allocation / Uplink Transfer / T3188/Expiry	3277
42.2.2.5.2	Fixed Allocation / Uplink Transfer / T3188/Stop with Packet Uplink Assignment	3278
42.2.2.5.3	Fixed Allocation / Uplink Transfer / T3188/Stop with Packet Uplink Ack/Nack with REPEAT_ALLOCATION	3280
42.2.2.6	Fixed Allocation / Uplink Transfer / MS requests new resources/ T3168	3281
42.2.2.6.1	Fixed Allocation / Uplink Transfer / MS requests new resources/ T3168/Expiry.....	3281
42.2.2.6.2	Fixed Allocation / Uplink Transfer / MS requests new resources/ T3168/Stop with Packet Uplink Assignment.....	3283
42.2.2.6.3	Fixed Allocation / Uplink Transfer / MS requests new resources/ T3168/Stop with Packet Uplink Ack/Nack with REPEAT_ALLOCATION	3285
42.2.2.6.4	Fixed Allocation / Uplink Transfer / MS requests new resources/ T3168/Stop with Packet Access Reject	3286
42.2.2.6.5	Fixed Allocation / Uplink Transfer / MS requests new resources/ T3168/Continue with Packet Uplink Ack/Nack without REPEAT_ALLOCATION and without ALLOCATION_BITMAP	3288
42.2.2.7	Fixed Allocation / Uplink Transfer / MS requests new resources/ Successful.....	3289
42.2.2.7.1	Fixed Allocation / Uplink Transfer / MS requests new resources/ Successful/ Packet Uplink Assignment with ALLOCATION_BITMAP	3289
42.2.2.7.2	Fixed Allocation / Uplink Transfer / MS requests new resources/ Successful/Multiple Packet Uplink Assignments	3291
42.2.2.7.3	Fixed Allocation / Uplink Transfer / MS requests new resources/ Successful/ Packet Uplink Ack/Nack with ALLOCATION_BITMAP	3292
42.2.2.7.4	Fixed Allocation / Uplink Transfer / MS requests new resources/ Successful/Multiple Packet Uplink Ack/Nack with ALLOCATION_BITMAP	3294
42.2.2.7.5	Fixed Allocation / Uplink Transfer / MS requests new resources/ Successful/Multiple Packet Uplink Ack/Nack with REPEAT_ALLOCATION	3296
42.2.2.8	Fixed Allocation / Uplink Transfer / MS requests new resources/ Failure	3297
42.2.2.8.1	Fixed Allocation / Uplink Transfer / MS requests new resources/ Failure/ Packet Access Reject.....	3297
42.2.2.8.2	Fixed Allocation / Uplink Transfer / MS requests new resources/ Failure/ Packet Access Reject with WAIT_INDICATION during allocation in progress	3299
42.2.2.9	Fixed Allocation / Uplink Transfer / Network initiates new resources	3300
42.2.2.10	Fixed Allocation / Uplink Transfer / PACCH operation.....	3302
42.2.2.10.1	Fixed Allocation / Uplink Transfer / PACCH operation/ Normal Operation	3302
42.2.2.10.2	Fixed Allocation / Uplink Transfer / PACCH operation/ PACCH message addressed to another MS	3303

42.2.2.10.3	Fixed Allocation/ Uplink Transfer / Abnormal cases / PACCH timeslot removed	3304
42.2.2.11	Fixed Allocation/ Uplink Transfer / Abnormal cases.....	3306
42.2.2.11.1	Fixed Allocation/ Uplink Transfer / Abnormal cases / Assignment without fixed allocation	3306
42.2.2.11.2	Fixed Allocation/ Uplink Transfer / Abnormal cases / Frequency not supported	3308
42.2.2.11.3	Fixed Allocation/ Uplink Transfer / Abnormal cases / Invalid MA_NUMBER	3309
42.2.3	Fixed Allocation / Uplink Transfer with Downlink TBF Establishment	3311
42.2.3.1	Fixed Allocation / Uplink Transfer with Downlink TBF Establishment/T3190	3311
42.2.3.1.1	Fixed Allocation / Uplink Transfer with Downlink TBF Establishment/ T3190/Half-Duplex ...	3311
42.2.3.1.2	Fixed Allocation / Uplink Transfer with Downlink TBF Establishment/ T3190/Non Half-Duplex	3313
42.2.3.2	Fixed Allocation / Uplink Transfer with Downlink TBF Establishment/ Ending uplink TBF.....	3315
42.2.3.2.1	Fixed Allocation / Uplink Transfer with Downlink TBF Establishment/ Ending uplink TBF/ Half-Duplex	3315
42.2.3.2.2	Fixed Allocation / Uplink Transfer with Downlink TBF Establishment/ Ending uplink TBF/ Non Half-Duplex	3317
42.2.3.3	Fixed Allocation/ Uplink Transfer with Downlink TBF Establishment/ Abnormal cases	3319
42.2.3.3.1	Fixed Allocation/ Uplink Transfer with Downlink TBF Establishment/ Abnormal cases / Violation of multi-slot capabilities	3319
42.2.3.3.2	Fixed Allocation/ Uplink Transfer with Downlink TBF Establishment/ Abnormal cases / No defined PDCH	3320
42.2.4	Fixed Allocation / Downlink Transfer with Uplink TBF Establishment	3322
42.2.4.1	Void.....	3322
42.2.4.2	Fixed Allocation/ Downlink Transfer with Uplink TBF Establishment/ Packet Uplink Assignment.....	3322
42.2.4.2.1	Fixed Allocation/ Downlink Transfer with Uplink TBF Establishment/Packet Uplink Assignment/ Non half-duplex.....	3322
42.2.4.2.2	Fixed Allocation/ Downlink Transfer with Uplink TBF Establishment/Packet Uplink Assignment/ Half-duplex.....	3325
42.2.4.3	Fixed Allocation/ Downlink Transfer with Uplink TBF Establishment/Packet Timeslot Reconfigure.....	3327
42.2.4.3.1	Fixed Allocation/ Downlink Transfer with Uplink TBF Establishment/Packet Timeslot Reconfigure/Starting time with AFN encoding	3327
42.2.4.3.2	Fixed Allocation/ Downlink Transfer with Uplink TBF Establishment/Packet Timeslot Reconfigure/Starting time with relative encoding	3330
42.2.5	Default message contents.....	3332
42.3	Dynamic Allocation in Packet Transfer Mode	3337
42.3.1	Dynamic Allocation / Uplink Transfer	3337
42.3.1.1	Dynamic Allocation / Uplink Transfer / Normal	3337
42.3.1.1.1	Dynamic Allocation / Uplink Transfer / Normal / Successful.....	3337
42.3.1.1.2	Void	3340
42.3.1.1.3	Dynamic Allocation / Uplink Transfer / Normal / Starting frame number encoding	3340
42.3.1.1.4	Dynamic Allocation / Uplink Transfer / Normal / Starting time	3341
42.3.1.1.5	Void	3345
42.3.1.1.6	Dynamic Allocation / Uplink Transfer / Normal / T3180 expiry	3345
42.3.1.1.7	Dynamic Allocation / Uplink Transfer / Normal / PACCH operation.....	3347
42.3.1.1.8	Dynamic Allocation / Uplink Transfer / Normal / Two uplink timeslots	3348
42.3.1.1.9	Dynamic Allocation / Uplink Transfer / Normal / Frequency parameters.....	3350
42.3.1.1.10	Dynamic Allocation / Uplink Transfer / Normal / USF assigned with MCS-1 to MCS-4	3364
42.3.1.2	Dynamic Allocation / Uplink Transfer / Abnormal	3365
42.3.1.2.1	Void	3365
42.3.1.2.2	Dynamic Allocation / Uplink Transfer / Abnormal / with cell reselection in acknowledged mode	3365
42.3.1.2.3	Dynamic Allocation / Uplink Transfer / Abnormal / with cell reselection in unacknowledged mode	3368
42.3.2	Dynamic Allocation / Uplink Transfer with Downlink TBF establishment (concurrent).....	3370
42.3.2.1	Dynamic Allocation / Uplink Transfer with Downlink TBF establishment / Normal	3370
42.3.2.1.1	Dynamic Allocation / Uplink Transfer with Downlink TBF establishment / Normal / Successful	3370
42.3.2.1.2	Dynamic Allocation / Uplink Transfer with Downlink TBF establishment / Normal / Multislot capabilities	3374
42.3.2.2	Dynamic Allocation / Uplink Transfer with Downlink TBF establishment / Abnormal	3383

42.3.2.2.1	Dynamic Allocation / Uplink Transfer with Downlink TBF establishment / Abnormal / with random access.....	3383
42.3.2.2.2	Dynamic Allocation / Uplink Transfer with Downlink TBF establishment / Abnormal / Continuation of normal operation.....	3387
42.3.3	Dynamic Allocation / Resource reallocation	3388
42.3.3.1	Dynamic Allocation / Resource reallocation / Successful.....	3388
42.3.3.1.1	Dynamic Allocation / Resource reallocation / Successful / Higher throughput class or higher radio priority.....	3389
42.3.3.1.2	Dynamic Allocation / Resource reallocation / Successful / Lower throughput class	3392
42.3.3.1.3	Dynamic Allocation / Resource reallocation / Successful / Different RLC mode and higher radio priority.....	3395
42.3.3.2	Dynamic Allocation / Resource reallocation / Abnormal	3398
42.3.3.2.1	Dynamic Allocation / Resource reallocation / Abnormal / T3168 expiry	3398
42.3.3.2.2	Dynamic Allocation / Resource reallocation / Abnormal / Invalid assignment.....	3400
42.3.3.3	Dynamic Allocation / Resource reallocation / Reject	3404
42.3.3.4	Dynamic Allocation / Resource reallocation / Successful / Lower Coding Scheme Command	3407
42.3.4	Default message contents.....	3410
42.4	Measurement reports and Cell change order procedures.....	3415
42.4.1	Measurement reports.....	3416
42.4.1.1	Network Control measurement reporting / Uplink / Normal case.....	3416
42.4.1.2	Network Control measurement reporting / Idle mode / New cell reselection	3419
42.4.1.3	Network Control measurement reporting / Downlink transfer / Normal case.....	3422
42.4.1.4	Network Control measurement reporting / Uplink transfer / Continuation in Idle mode.	3425
42.4.1.5	Network Control measurement reporting / Idle mode / DSC failure/ reselection.	3428
42.4.2	Cell change order procedures.....	3430
42.4.2.1	Cell change order procedure / Uplink transfer	3430
42.4.2.1.1	Cell change order procedure / Uplink transfer / Normal case.....	3430
42.4.2.1.2	Void.....	3432
42.4.2.1.3	Cell change order procedure / Uplink transfer / Failure cases / REJECT from the new cell.....	3432
42.4.2.1.4	Cell change order procedure / Uplink transfer / Failure cases / Contention resolution failure ...	3435
42.4.2.1.5	Void.....	3440
42.4.2.1.6	Cell change order procedure / Uplink transfer / Failure cases / Frequency not implemented	3440
42.4.2.2	Cell change order procedure / Downlink transfer	3441
42.4.2.2.1	Cell change order procedure / Downlink transfer / Normal case.....	3441
42.4.2.2.2	Cell change order procedure / Downlink transfer / Failure cases / REJECT from the new cell ..	3444
42.4.2.2.3	Cell change order procedure / Downlink transfer / Failure cases / Frequency not implemented ..	3446
42.4.2.3	Cell change order procedure / Simultaneous uplink and downlink transfer.....	3448
42.4.2.3.1	Cell change order procedure / Simultaneous uplink and downlink transfer / Normal case	3448
42.4.2.3.2	Void.....	3452
42.4.2.3.3	Packet Measurement order procedure / Downlink transfer / Normal case/ Dedicated parameters	3452
42.4.2.3.4	Packet Measurement order procedure / Downlink transfer / Normal case/ Routing Area Update/ NMO II	3454
42.4.2.3.5	Packet Measurement order procedure / Downlink transfer / Normal case/ Routing Area Update/ NMO I.....	3458
42.4.2.3.6	MT CS establishment whilst in NC2 with a downlink TBF established	3461
42.4.2.3.7	MT CS establishment whilst in NC2 with a uplink TBF established	3463
42.4.3	Macros and Default Message contents.....	3466
42.4.3.1	Macros.....	3466
42.4.3.1.1	Void.....	3466
42.4.3.1.2	Void.....	3466
42.4.3.2	Default Messages	3466
42.4.3.2.1	PACKET CELL CHANGE ORDER message	3466
42.4.3.2.2	PACKET CELL CHANGE FAILURE message.....	3466
42.4.3.2.3	PACKET MEASUREMENT ORDER message	3467
42.4.4	Cell Change Order Procedures without PBCCH	3467
42.4.4.1	Network Controlled Cell Reselection – Packet Measurement Order Procedure	3467
42.4.4.2	Network Controlled Cell Reselection/validity of reselection parameters/MS enters standby state...	3468
42.4.4.3	Network Control measurement reporting / Idle mode / Returning to Broadcast parameters	3470
42.4.4.4	Void.....	3472
42.4.4.5	Network Control measurement reporting / Idle mode / Reselection due to RA failure	3472
42.4.5	Network Assisted Cell Change	3473

42.4.5.1	Network Assisted Cell Change / Expiry of T3206.....	3473
42.4.5.2	Network Assisted Cell Change / No Packet Neighbouring Cell Data and Packet Cell Change Continue.....	3475
42.4.5.3	Network Assisted Cell Change / Packet Neighbour Cell Data and Packet Cell Change Continue ...	3477
42.4.5.4	Network Assisted Cell Change / Packet Neighbour Cell Data and Packet Cell Change Order	3483
42.4.5.5	Network Assisted Cell Change / Expiry of T3208 and T3210.....	3489
42.4.5.6	Network Assisted Cell Change / Entering packet idle mode.....	3492
42.4.5.7	Network Assisted Cell Change / CCN not supported towards target cell	3494
42.4.5.8	Network Assisted Cell Change / NC mode change.....	3497
42.4.5.9	Network Assisted Cell Change / NC mode change / Packet Neighbour Cell Data	3499
42.4.6	Packet Enhanced Measurement Report (PEMR)	3506
42.4.6.1	Network Control PEMR – Activation with SI Messages	3506
42.4.6.2	Network Control PEMR – Activation with PSI messages	3509
42.4.6.3	Network Control PEMR – Packet Measurement Order	3511
42.4.6.4	Network Control PEMR – Uplink Data Transfer.....	3514
42.4.6.5	Network Control PEMR – Downlink Data Transfer.....	3517
42.4.6.6	Network Control PEMR / Packet Cell Change Order	3520
42.4.6.7	Network Control PEMR / Packet Enhanced Measurement Report / Measurement reporting with PBCCH / Invalid BSIC	3522
42.4.7	Inter-RAT (GPRS to UTRAN) Cell Change Order	3525
42.4.7.1	Inter-RAT Cell Change Order (Known Cell) – Uplink Data Transfer	3525
42.4.7.2	Inter-RAT Cell Change Order (Unknown Cell) – Uplink Data Transfer	3528
42.4.7.3	Inter-RAT Cell Change Order (Known Cell) – Downlink Data Transfer	3529
42.4.7.4	Inter-RAT Cell Change Order (Known Cell) – Simultaneous uplink and downlink transfer	3532
42.4.7.5	Inter-RAT (GPRS to UTRAN) Cell Change Order (Known cell) / Failure.....	3535
42.4.7.5.1	Inter-RAT (GPRS to UTRAN) Cell Change Order (Known cell) / Failure / Uplink transfer / T3174 expiry.....	3535
42.4.7.5.2	Inter-RAT (GPRS to UTRAN) Cell Change Order (Known cell) / Failure / Downlink transfer / REJECT from target UTRAN cell with Inter-RAT info set to GSM.	3537
42.4.8	NC2 Procedures	3540
42.4.8.1	NC2 and DRX	3540
42.4.8.1.1	NC2 and DRX / NC_NON_DRX_PERIOD / Respect of NC2 non-DRX mode period	3540
42.4.8.1.2	NC2 and DRX / NC_NON_DRX_PERIOD / NC2 non-DRX mode period ordered in Packet Cell Change Order.....	3543
42.4.8.1.3	NC2 and DRX / NC_NON_DRX_PERIOD / NC2 non-DRX mode period broadcast in PSI5 ..	3546
42.4.8.1.4	NC2 and DRX / NC_NON_DRX_PERIOD / NC2 non-DRX mode period broadcast in SI2Quater.....	3550
42.4.8.1.5	NC2 and DRX / NC_NON_DRX_PERIOD / NC2 non-DRX mode period / PBCCH present / Default Value	3555
42.4.8.1.6	NC2 and DRX / NC_NON_DRX_PERIOD / NC2 non-DRX mode period / PBCCH absent / Default Value	3559
42.4.8.2	User Data vs Measurement Report Sending / Conflict situation.....	3563
42.4.8.2.1	User Data Vs Measurement Report Sending / Conflict situation / DL TBF Establishment and Packet Access for Measurement Report Sending	3563
42.4.8.2.2	User Data vs Measurement Report Sending / Conflict situation / Expiry of T3192 and T3158..	3565
42.4.8.2.3	User Data vs Measurement Report Sending / Conflict situation / Expiry of T3182 and T3158..	3568
42.4.8.2.4	User Data vs Measurement Report Sending / Conflict situation / Random Access procedure for PMR sending and User Data transmission.....	3571
42.4.8.3	Network Control measurement reporting and Dedicated connection.....	3573
42.4.8.3.1	Network Control measurement reporting / Dedicated connection / Timer Ready expiry	3573
42.4.8.3.2	Network Control measurement reporting / Dedicated connection / Different NC parameters / No T3158 expiry.....	3575
42.4.8.3.3	Network Control measurement reporting / Dedicated connection / Handover / No T3158 expiry.....	3578
42.4.8.3.4	Network Control measurement reporting / Dedicated connection / Different NC parameters / T3158 expiry	3581
42.4.8.3.5	Network Control measurement reporting / Dedicated connection / Handover / T3158 expiry ...	3584
42.4.8.3.6	Network Control measurement reporting / Dedicated connection / Assignment Reject/	3587
42.4.8.4	Network Control measurement reporting / NC_FREQUENCY_LIST	3588
42.4.8.4.1	Network Control measurement reporting / NC_FREQUENCY_LIST / NC_FREQUENCY_LIST in Packet measurement order.....	3588

42.4.8.4.2	Network Control measurement reporting / NC_FREQUENCY_LIST / NC_FREQUENCY_LIST in Packet Cell Change Order.....	3594
42.4.8.4.3	Network Control measurement reporting / NC_FREQUENCY_LIST / PMO with empty NC_FREQUENCY_LIST/ Return to BA(GPRS).....	3598
42.4.8.4.4	Network Control measurement reporting / NC_FREQUENCY_LIST / Changes in BA(GPRS)/ Return to BA(GPRS).....	3601
42.4.8.4.5	Network Control measurement reporting / NC_FREQUENCY_LIST / Dedicated connection/ Return to BA(GPRS).....	3605
42.4.8.4.6	Network Control measurement reporting / NC_FREQUENCY_LIST / PMO sent in multiple instances.....	3608
42.4.8.4.7	Network Control measurement reporting / NC_FREQUENCY_LIST / same cell present twice in the list.....	3612
42.4.8.5	NC2 and DTM	3614
42.4.8.5.1	Ignoring Packet Measurement Order and Packet Cell Change Order whilst in DTM.....	3614
42.5	Downlink Transfer	3616
42.5.1	Downlink Transfer / Normal Operation.....	3616
42.5.1.1	Downlink Transfer/ Normal Operation / Relative Encoding TBF starting time	3616
42.5.1.2	Downlink Transfer/ Normal Operation / Without TBF starting time.....	3618
42.5.2	Downlink Transfer / Polling	3619
42.5.2.1	Downlink Transfer/ Polling/ Normal operation/RLC data block	3619
42.5.2.2	Downlink Transfer/ Polling/ Packet Polling Request/ Access Burst format	3621
42.5.2.3	Downlink Transfer/ Polling/ Packet Polling Request/ Control block format	3622
42.5.3	Downlink Transfer / T3190 Expiry / Initial allocation	3624
42.5.3.1	Downlink Transfer/ T3190 Expiry / Initial allocation / Restart with valid RLC data block	3624
42.5.4	Downlink Transfer / T3190 Expiry / Resource reallocation.....	3625
42.5.4.1	Downlink Transfer/ T3190 Expiry / Resource reallocation / Without TBF starting time	3625
42.5.4.2	Downlink Transfer/ T3190 Expiry / Resource reallocation / With TBF starting time	3627
42.5.4.3	Downlink Transfer/ T3190 Expiry / Resource reallocation / Restart with valid RLC data block.....	3629
42.5.5	Downlink Transfer / Reestablishment.....	3631
42.5.5.1	Downlink Transfer/ Reestablishment/ T3192 Expiry.....	3631
42.5.5.2	Downlink Transfer/ Reestablishment/ Packet Downlink Assignment	3634
42.5.5.3	Downlink Transfer/ Reestablishment/ Invalid Frequency Parameters IE	3636
42.6	MAC Modes whilst in DTM	3638
42.6.1	Exclusive allocation in single-slot configuration.....	3638
42.6.2	Void	3640
42.6.3	Void	3640
42.7	Packet assignment/ TA Value	3640
42.7.1	Packet Assignment / TA Value/TA present in second Packet downlink assignment	3640
42.7.2	Packet Assignment / TA Value/TA not present in Packet uplink assignment sent On the PACCH.....	3641
42.7.3	Packet Assignment / TA Value/ PACKET POWER CONTROL/TIMING ADVANCE during contention resolution.....	3642
42.7.4	Packet Assignment / TA Value/TAI present/ multislot capabilities	3644
42.7.5	Packet Assignment / TA Value/ Update of TA using PACKET POWER CONTROL/TIMING ADVANCE.....	3645
42.7.6	Packet Uplink Assignment / One phase access / Timing Advance / TA Index present	3647
42.7.7	Packet Uplink Assignment / One phase access / Timing Advance / TA value field not provided.....	3648
42.8	Dynamic allocation/ Downlink Transfer with Uplink TBF Establishment/ T3168.....	3649
42.8.1	Dynamic Allocation/ Downlink Transfer with Uplink TBF Establishment/ T3168/ Expiry	3649
42.8.2	Dynamic Allocation/ Downlink Transfer with Uplink TBF Establishment/ T3168/ Stop with Packet Uplink Assignment	3651
42.8.3	Dynamic Allocation/ Downlink Transfer with Uplink TBF Establishment/ T3168/Packet Access Reject/ With WAIT_INDICATION	3653
42.8.4	Dynamic Allocation/ Downlink Transfer with Uplink TBF Establishment/ T3168/Packet Access Reject/No WAIT_INDICATION	3655
42.8.5	Dynamic Allocation/ Downlink Transfer with Uplink TBF Establishment/T3168/Packet Access Reject/With Polling.....	3656
42.9	Extended Dynamic Allocation in Packet Transfer Mode	3658
42.9.1	Default message contents.....	3658
42.9.2	Extended Dynamic Allocation / Uplink Transfer	3663
42.9.2.1	Extended Dynamic Allocation / Uplink Transfer / Normal	3663
42.9.2.1.1	Extended Dynamic Allocation / Uplink Transfer / Normal / Successful.....	3663

42.9.2.1.2	Extended Dynamic Allocation / Uplink Transfer / Normal / USF_GRANULARITY = 4 blocks	3666
42.9.2.1.3	Extended Dynamic Allocation / Uplink Transfer / Normal / Allocation via polling mechanism	3668
42.9.2.1.4	Extended Dynamic Allocation / Uplink Transfer / Normal / PACCH operation in downlink	3672
42.9.2.1.5	Extended Dynamic Allocation / Uplink Transfer / Normal / Polling for PDAN.....	3677
42.9.2.2	Extended Dynamic Allocation / Uplink Transfer / Configuration Change	3679
42.9.2.2.1	Extended Dynamic Allocation / Uplink Transfer / configuration change / Changes in the Allocation from Dynamic to Extended Dynamic.	3679
42.9.2.2.2	Extended Dynamic Allocation / Uplink Transfer / configuration change / Changes in the Allocation from Extended Dynamic to Dynamic.	3682
42.9.2.2.3	Extended Dynamic Allocation / Uplink Transfer / configuration change / Reduction in number of uplink slots using PACKET UPLINK ASSIGNMENT	3685
42.9.2.2.4	Extended Dynamic Allocation / Uplink Transfer / configuration change / Reduction in number of uplink slots using PACKET PDCH RELEASE.	3688
42.9.2.2.5	Extended Dynamic Allocation / Uplink Transfer / configuration change / Increase in number of uplink slots.	3691
42.9.3	Extended Dynamic Allocation / Shifted USF	3694
42.9.3.1	Extended Dynamic Allocation / Shifted USF / Normal	3694
42.9.3.1.1	Extended Dynamic Allocation / Shifted USF / Normal / PACCH management	3694
42.9.3.1.2	Extended Dynamic Allocation / Shifted USF / Normal / USF assignment on 2 nd PDCH	3696
42.9.3.1.3	Extended Dynamic Allocation / Shifted USF / Normal / Release of 2 nd PDCH.....	3697
43	RLC Test Cases	3700
43.1	Acknowledged Mode	3700
43.1.1	Acknowledged mode / Uplink TBF.....	3700
43.1.1.1	Acknowledged mode / Uplink TBF / Send state variable V(S)	3700
43.1.1.2	Acknowledged mode / Uplink TBF / Transmit window size	3701
43.1.1.3	Acknowledged mode / Uplink TBF / Acknowledge state variable V(A).....	3703
43.1.1.4	Acknowledged mode / Uplink TBF / Negatively acknowledged RLC data blocks	3706
43.1.1.5	Acknowledged mode / Uplink TBF / Invalid Negative Acknowledgment	3708
43.1.1.6	Acknowledged mode / Uplink TBF / Decoding of Received Block Bitmap.....	3709
43.1.2	Acknowledged mode / Downlink TBF	3711
43.1.2.1	Acknowledged mode / Downlink TBF / Receive state variable V(R)	3711
43.1.2.2	Acknowledged mode / Downlink TBF / Receive window state variable V(Q)	3712
43.1.2.3	Acknowledged mode / Downlink TBF / Re-assembly of RLC data blocks	3713
43.1.2.4	Acknowledged mode / Downlink TBF / Re-assembly / Length Indicator	3715
43.2	Control Blocks.....	3716
43.2.1	Control Blocks Re-assembly.....	3716
43.3	Default Message Contents and Macros	3718
43.3.1	Message Contents	3718
43.3.2	Macros	3719
43.3.2.1	Macro for uplink dynamic allocation two phase access (PBCCH not present).....	3719
43.3.2.2	Macro for downlink TBF establishment (PBCCH not present)	3719
44	Test case requirements for GPRS mobility management.....	3720
44.1	Default conditions and default messages.....	3720
44.2	Elementary procedures of GPRS mobility management	3720
44.2.1	GPRS attach procedure	3720
44.2.1.1	Normal GPRS attach.....	3720
44.2.1.1.1	GPRS attach / accepted	3720
44.2.1.1.2	GPRS attach / rejected / IMSI invalid / illegal MS.....	3723
44.2.1.1.3	GPRS attach / rejected / IMSI invalid / GPRS services not allowed	3725
44.2.1.1.4	GPRS attach / rejected / PLMN not allowed	3727
44.2.1.1.5	GPRS attach / rejected / roaming not allowed in this location area.....	3730
44.2.1.1.6	GPRS attach / abnormal cases / access barred due to access class control.....	3738
44.2.1.1.7	GPRS attach / abnormal cases / change of cell into new routing area.....	3741
44.2.1.1.8	GPRS attach / abnormal cases / power off	3743
44.2.1.1.9	GPRS attach / abnormal cases / GPRS detach procedure collision	3745
44.2.1.1.10	GPRS attach / rejected / GPRS services not allowed in this PLMN.....	3746
44.2.1.2	Combined GPRS attach.....	3749
44.2.1.2.1	Combined GPRS attach / GPRS and non-GPRS attach accepted.....	3749
44.2.1.2.2	Combined GPRS attach / GPRS only attach accepted.....	3752

44.2.1.2.3	Combined GPRS attach / GPRS attach while IMSI attach	3757
44.2.1.2.4	Combined GPRS attach / rejected / IMSI invalid / illegal ME	3759
44.2.1.2.5	Combined GPRS attach / rejected / GPRS services and non-GPRS services not allowed	3762
44.2.1.2.6	Combined GPRS attach / rejected / GPRS services not allowed	3765
44.2.1.2.7	Combined GPRS attach / rejected / location area not allowed	3768
44.2.1.2.8	Combined GPRS attach / abnormal cases / attempt counter check / miscellaneous reject causes	3771
44.2.1.2.9	Combined GPRS attach / abnormal cases / GPRS detach procedure collision	3775
44.2.2	GPRS detach procedure	3777
44.2.2.1	MS initiated GPRS detach procedure	3778
44.2.2.1.1	GPRS detach / power off / accepted	3778
44.2.2.1.2	GPRS detach / accepted	3779
44.2.2.1.3	GPRS detach / abnormal cases / attempt counter check / procedure timeout	3781
44.2.2.1.4	GPRS detach / abnormal cases / GMM common procedure collision	3784
44.2.2.1.5	GPRS detach / power off / accepted	3785
44.2.2.1.6	GPRS detach / accepted / GPRS/IMSI detach	3786
44.2.2.1.7	GPRS detach / accepted / IMSI detach	3788
44.2.2.1.8	GPRS detach / abnormal cases / change of cell into new routing area	3791
44.2.2.1.9	GPRS detach / abnormal cases / GPRS detach procedure collision	3792
44.2.2.2	Network initiated GPRS detach procedure	3794
44.2.2.2.1	GPRS detach / re-attach not required / accepted	3794
44.2.2.2.2	GPRS detach / rejected / IMSI invalid / GPRS services not allowed	3796
44.2.2.2.3	GPRS detach / IMSI detach / accepted	3798
44.2.2.2.4	GPRS detach / re-attach requested / accepted	3799
44.2.2.2.5	GPRS detach / rejected / location area not allowed	3802
44.2.2.2.6	GPRS detach / rejected / GPRS services not allowed in this PLMN	3805
44.2.3	Routing area updating procedure	3808
44.2.3.1	Normal routing area updating	3808
44.2.3.1.1	Routing area updating / accepted	3808
44.2.3.1.1a	Routing area updating / accepted / old P-TMSI	3811
44.2.3.1.2	Routing area updating / rejected / IMSI invalid / illegal ME	3813
44.2.3.1.3	Routing area updating / rejected / MS identity cannot be derived by the network	3815
44.2.3.1.4	Routing area updating / rejected / location area not allowed	3818
44.2.3.1.5	Routing area updating / abnormal cases / attempt counter check / miscellaneous reject causes	3820
44.2.3.1.6	Routing area updating / abnormal cases / change of cell into new routing area	3824
44.2.3.1.7	Routing area updating / abnormal cases / change of cell during routing area updating procedure	3826
44.2.3.1.8	Routing area updating / abnormal cases / P-TMSI reallocation procedure collision	3828
44.2.3.2	Combined routing area updating	3829
44.2.3.2.1	Combined routing area updating / combined RA/LA accepted	3829
44.2.3.2.2	Combined routing area updating / MS in CS operation at change of RA	3832
44.2.3.2.3	Combined routing area updating / RA only accepted	3835
44.2.3.2.4	Combined routing area updating / rejected / PLMN not allowed	3842
44.2.3.2.5	Combined routing area updating / rejected / roaming not allowed in this location area	3845
44.2.3.2.6	Combined routing area updating / abnormal cases / access barred due to access class control	3852
44.2.3.2.7	Combined routing area updating / abnormal cases / attempt counter check / procedure timeout	3856
44.2.3.2.8	Combined routing area updating / abnormal cases / change of cell into new routing area	3860
44.2.3.2.9	Combined routing area updating / abnormal cases / change of cell during routing area updating procedure	3862
44.2.3.2.10	Combined routing area updating / abnormal cases / GPRS detach procedure collision	3864
44.2.3.3	Periodic routing area updating	3867
44.2.3.3.1	Periodic routing area updating / accepted	3867
44.2.3.3.2	Periodic routing area updating / accepted / T3312 default value	3868
44.2.3.3.3	Periodic routing area updating / no cell available / network mode I	3870
44.2.3.3.4	Periodic routing area updating / no cell available	3872
44.2.4	P-TMSI reallocation	3874
44.2.5	GPRS authentication and ciphering	3876
44.2.5.1	Test of authentication	3876
44.2.5.1.1	Authentication accepted	3877
44.2.5.1.2	Authentication rejected	3878
44.2.5.2	Test of ciphering mode setting	3881

44.2.5.2.1	Ciphering mode / start ciphering	3881
44.2.5.2.2	Ciphering mode / stop ciphering.....	3883
44.2.5.2.3	Ciphering mode / IMEISV request	3886
44.2.6	Identification procedure	3889
44.2.6.1	General Identification.....	3889
44.2.7	GMM READY timer handling	3890
44.2.8	DTM mobility management.....	3898
44.2.8.1	Change of cell between two LAs in idle mode.....	3898
44.2.8.1.1	Change of cell between two LAs in idle mode / RAU completes first.....	3898
44.2.8.1.2	Change of cell between two LAs in idle mode / LAU completes first / SS releases channel.....	3899
44.2.8.1.3	Change of cell between two LAs in idle mode / LAU completes first / SS maintains channel...	3900
44.2.8.2	Void.....	3902
44.2.9	Network Identity and Timezone (NITZ).....	3902
44.2.9.1	NITZ and GPRS procedures	3902
44.2.9.1.1	NITZ / GPRS / Timezone, Time and DST Handling.....	3902
44.2.9.1.2	NITZ / GPRS / NITZ Parameters / Storage / Deletion	3905
44.2.9.1.3	NITZ / GPRS / MM and GMM Signaling.....	3907
44.2.10	MS Radio Access Capability Interrogation	3912
44.2.11	Cell Notification	3913
45	Session Management Procedures	3917
45.1	Definition	3917
45.2	PDP context activation	3918
45.2.1	Initiated by the mobile station.....	3918
45.2.1.1	Attach initiated by context activation/QoS Offered by Network is the QoS Requested	3918
45.2.1.2	QoS Offered by Network is a lower QoS.....	3920
45.2.1.2.1	QoS Accepted by MS	3920
45.2.1.2.2	QoS Rejected by MS	3921
45.2.2	PDP context activation requested by the network, successful and unsuccessful	3923
45.2.3	Void	3926
45.2.4	Abnormal cases.....	3926
45.2.4.1	T3380 Expiry	3926
45.2.4.2	Collision of MS initiated and network requested PDP context activation	3928
45.2.4.3	Network initiated PDP context activation request for an already activated PDP context (on the MS side)	3930
45.2.5	Secondary PDP context activation procedures	3931
45.2.5.1	Successful Secondary PDP Context Activation Procedure Initiated by the MS	3931
45.2.5.1.1	QoS Offered by Network is the QoS Requested.....	3931
45.2.5.1.2	QoS Offered by Network is a lower QoS	3933
45.2.5.1.2.1	QoS accepted by MS.....	3933
45.2.5.1.2.2	QoS rejected by MS.....	3934
45.2.5.2	Unsuccessful Secondary PDP Context Activation Procedure Initiated by the MS	3936
45.2.5.3	Abnormal cases	3937
45.2.5.3.1	T3380 Expiry.....	3937
45.3	PDP context modification procedure.....	3938
45.3.1	Network initiated PDP context modification	3938
45.3.2	MS initiated PDP context modification	3941
45.3.2.1	MS initiated PDP Context Modification accepted by network	3941
45.3.2.2	MS initiated PDP Context Modification not accepted by the network	3942
45.3.3	Abnormal cases.....	3944
45.3.3.1	T3381 Expiry	3944
45.3.3.2	Collision of MS and network initiated PDP context modification procedures.....	3945
45.4	PDP context deactivation procedure.....	3947
45.4.1	PDP context deactivation initiated by the MS	3947
45.4.2	PDP context deactivation initiated by the network.....	3949
45.4.3	Abnormal cases.....	3951
45.4.3.1	T3390 Expiry	3951
45.4.3.2	Collision of MS and network initiated PDP context deactivation requests.....	3954
45.4.4	PDP context deactivation initiated by the network / Tear down indicator.....	3956
45.5	Unknown or Unforeseen Transaction Identifier/Non-semantical Mandatory Information Element Errors	3957
45.5.1	Error cases	3957

46	LLC and SNDCP Tests	3964
46.1	LLC Tests	3964
46.1.1	Default Conditions	3964
46.1.2	Test cases	3964
46.1.2.1	Unacknowledged data transfer	3964
46.1.2.1.1	Data transmission in protected mode	3964
46.1.2.1.2	Data transmission in unprotected mode	3965
46.1.2.1.3	Reception of I frame in ADM	3966
46.1.2.2	Acknowledged data transfer	3967
46.1.2.2.1	Link establishment	3967
46.1.2.2.1.1	Link establishment from MS to SS	3967
46.1.2.2.1.2	Link establishment from SS to MS	3968
46.1.2.2.1.3	Loss of UA frame	3969
46.1.2.2.1.4	Total loss of UA frame	3970
46.1.2.2.1.5	DM response	3971
46.1.2.2.2	MS sends I+S frames	3972
46.1.2.2.2.1	Checking N(S)	3972
46.1.2.2.2.2	Busy condition at the peer, with RR sent for resumption of transmission	3973
46.1.2.2.2.3	Busy condition at the peer, with ACK sent for resumption of transmission	3975
46.1.2.2.2.4	SACK frame	3977
46.1.2.2.3	Reception of I + S frames at the MS	3978
46.1.2.2.3.1	Checking N(R)	3978
46.1.2.2.3.2	MS handling busy condition during bi-directional data transfer	3979
46.1.2.2.3.3	SACK frame	3981
46.1.2.2.3.4	ACK frame	3982
46.1.2.2.4	Link Reestablishment	3983
46.1.2.2.4.1	Reestablishment due to reception of SABM	3983
46.1.2.2.4.2	Reestablishment due to N200 failures	3985
46.1.2.2.4.3	Reestablishment due to reception of DM	3986
46.1.2.3	Collision of commands and responses	3987
46.1.2.3.1	Collision of SABM	3987
46.1.2.3.2	Collision of SABM and DISC	3988
46.1.2.3.3	Collision of SABM and XID commands	3989
46.1.2.4	Unsolicited response frames	3990
46.1.2.4.1	Unsolicited DM	3990
46.1.2.5	FRMR frames	3991
46.1.2.5.1	Sending FRMR due to undefined command control field	3991
46.1.2.5.2	Sending FRMR due to reception of an S frame with incorrect length	3992
46.1.2.5.3	Sending FRMR due to reception of an I frame information field exceeding the maximum length	3993
46.1.2.5.4	Frame reject condition during establishment of ABM	3995
46.1.2.6	Multiple Connections	3996
46.1.2.6.1	Simultaneous acknowledged and unacknowledged data transfer on the same SAPI	3996
46.1.2.6.2	Simultaneous acknowledged and unacknowledged data transfer on different SAPIs	3997
46.1.2.7	XID Negotiation	3998
46.1.2.7.1	Negotiation initiated by the SS during ABM, for T200 and N200	3998
46.1.2.7.2	Negotiation initiated by the SS during ADM, for N201-I	3999
46.1.2.7.3	Negotiation initiated by the SS (using SABM, for IOV-I)	4000
46.1.2.7.4	Negotiation initiated by the SS (during ADM, for N201-U)	4002
46.1.2.7.5	Negotiation initiated by the SS (during ADM, for IOV-UI)	4003
46.1.2.7.6	Negotiation initiated by the SS (during ABM, for Reset)	4004
46.1.2.7.7	XID command with unrecognised type field	4006
46.1.2.7.8	XID Response with out of range values	4007
46.2	SNDCP Tests	4008
46.2.1	Default Conditions	4008
46.2.2	Test cases	4009
46.2.2.1	Data transfer	4009
46.2.2.1.1	Mobile originated normal data transfer with LLC in acknowledged mode	4009
46.2.2.1.2	Mobile originated normal data transfer with LLC in unacknowledged mode	4010
46.2.2.1.3	Usage of acknowledged mode for data transmission before and after PDP Context modification, on different SAPIs	4012
46.2.2.1.4	Reset indication during unacknowledged mode	4014

46.2.2.1.5	Reset indication during acknowledged mode	4015
46.2.2.2	Segmentation.....	4017
46.2.2.2.1	LLC link re-establishment on reception of SN-DATA PDU with F=0 in ack mode in the Receive First Segment state.....	4017
46.2.2.2.2	LLC link re-establishment on receiving second segment with F=1 and with different PCOMP and DCOMP values in the acknowledged mode data transfer.....	4018
46.2.2.2.3	Single segment N-PDU from MS	4019
46.2.2.3	Link Release.....	4019
46.2.2.3.1	LLC link release on receiving DM from the SS during link establishment.....	4019
46.2.2.4	XID negotiation.....	4020
46.2.2.4.1	Response from MS on receiving XID request from the SS	4020
46.2.2.4.2	Response from MS on receiving an XID request from the SS with an unassigned entity number.....	4023
46.2.2.4.3	Response from MS on receiving an XID response from the SS with unrecognised type field....	4024
46.2.2.5	LLC link release on receiving "Invalid XID response" from the network during link establishment procedure.....	4025
47	Dual Transfer Mode	4026
47.1	Reallocation of CS resources.....	4026
47.1.1	Reallocation of CS resources / Assignment Command	4026
47.1.2	Reallocation of CS resources / Handover Command.....	4028
47.1.3	Intra frequency reallocation of CS resources / DTM Assignment Command	4030
47.1.4	Inter frequency reallocation of CS resources / DTM Assignment Command.....	4032
47.2	Release of CS resources	4034
47.2.1	Mobile originating CS release	4034
47.3	Handover	4035
47.3.1	Handover to same routeing area	4035
47.3.1.1	Handover to same routeing area whilst in dedicated mode & MM Ready / Completed on the main DCCH.....	4035
47.3.1.2	Handover to same routeing area whilst in DTM with downlink TBF Established.....	4037
47.3.1.3	Handover to same routeing area whilst in DTM with both DL & UL TBFs.....	4039
47.3.1.3.1	Handover to same routeing area whilst in DTM with both DL & UL TBFs / Successful case ...	4039
47.3.1.3.2	Handover to same routeing area whilst in DTM with both DL & UL TBFs / Abnormal case / Handover Failure	4042
47.3.2	Handover to different routeing area whilst in DM.....	4045
47.3.2.1	Handover to different routeing area whilst in DM / Performed on main DCCH / RAU complete before CS release	4045
47.3.2.2	Handover to different routeing area whilst in DM / Performed on main DCCH / CS release before RAU complete	4046
47.3.3	Handover to different routeing area whilst in DTM	4048
47.3.3.1	Handover to different routeing area whilst in DTM / Performed on TBFs.....	4048
47.3.3.1.1	Handover to different routeing area whilst in DTM / Performed on TBFs / RAU complete before CS release.....	4048
47.3.3.1.2	Handover to different routeing area whilst in DTM / Performed on TBFs / CS release before RAU complete	4051
47.3.4	Handover to UTRAN while in DTM.....	4054
47.3.4.1	Handover to UTRAN while in DTM / Downlink TBF	4054
47.3.4.2	Handover to UTRAN while in DTM / Uplink TBF.....	4060
47.4	Session Management.....	4066
47.4.1	PDP Context Activation / Performed on main DCCH and TBFs	4066
48 to 49	Void	4070
50	EGPRS Default Conditions, Message Contents and Macros	4071
50.1	EGPRS Default Test Conditions	4071
50.2	EGPRS Default Message Contents.....	4071
50.2.1	EGPRS System Information Messages.....	4071
50.2.2	EGPRS Packet System Information messages.....	4072
50.2.2.1	Cell A	4072
50.2.3	EGPRS default contents of Layer 2 messages	4073
50.2.3.1	PACKET UPLINK ASSIGNMENT message.....	4074
50.2.3.2	PACKET DOWNLINK ASSIGNMENT message	4076
50.2.4	EGPRS Default contents of Layer 3 messages	4076

50.2.4.1	IMMEDIATE ASSIGNMENT messages	4077
50.2.4.1.1	IMMEDIATE ASSIGNMENT message (Packet Downlink Construction).....	4077
50.2.4.1.2	IMMEDIATE ASSIGNMENT message (Packet Uplink construction):	4078
50.2.4.1.3	IMMEDIATE ASSIGNMENT message (Multiblock allocation construction):.....	4079
50.2.4.2	IMMEDIATE ASSIGNMENT REJECT message.....	4079
50.2.4.3	PDCH ASSIGNMENT COMMAND message (downlink)	4080
50.2.4.4	DTM Assignment Command	4080
50.3	Default EGPRS Conditions, Message Contents and Macros for the Higher Layer Test Cases.....	4081
50.4	EGPRS Macros	4081
50.4.1	Overview	4081
50.4.2	EGPRS Default Message Contents.....	4081
50.4.3	EGPRS Macro Message Sequences.....	4081
50.4.3.1	Acknowledged downlink data.....	4081
50.4.3.2	Downlink data transfer.....	4081
50.4.3.3	Uplink data transfer.....	4082
50.4.3.4	Uplink dynamic allocation one phase access	4083
50.4.3.5	Uplink dynamic allocation one phase access with contention resolution.....	4084
50.4.3.6	Uplink dynamic allocation two phase access	4085
50.4.3.7	Void.....	4086
50.4.3.8	Void.....	4086
50.4.3.9	Void.....	4086
50.4.3.10	Downlink TBF establishment.....	4086
50.4.3.10A	Uplink data.....	4086
50.4.3.11	GPRS Attach using EGPRS messages on CCCH	4086
50.4.3.12	GPRS Attach using EGPRS messages on PCCCH	4087
50.4.3.13	PDP Context Activation On CCCH	4089
50.4.3.14	PDP Context Activation On PCCCH	4091
50.5	Test PDP contexts	4094
51	EGPRS Paging, TBF establishment/release and DCCH related procedures.....	4096
51.1	RR / Paging	4096
51.1.1	RR / Paging / on PCCCH for EGPRS service successful	4096
51.1.1.1	RR / Paging / on PCCCH for EGPRS service / normal paging with P-TMSI successful	4096
51.1.1.2	RR / Paging / on PCCCH for EGPRS service / normal paging with IMSI successful.....	4098
51.1.1.3	RR / Paging / on PCCCH for EGPRS service / extended paging with P-TMSI successful	4101
51.1.1.4	RR / Paging / on PCCCH for EGPRS service / paging reorganisation successful.....	4104
51.1.2	RR / Paging / on PCCCH for circuit-switched services / paging successful.....	4107
51.1.3	RR / Paging / on PCCCH / paging ignored.....	4110
51.1.4	RR / Paging / on PACCH for circuit-switched services.....	4113
51.1.4.1	RR / Paging / on PACCH for circuit-switched services/ paging successful.....	4113
51.1.4.2	RR / Paging / on PACCH for circuit-switched services/ paging ignored.....	4114
51.1.5	RR / Paging / on CCCH for EGPRS service.....	4116
51.1.5.1	RR / Paging / on CCCH for EGPRS service / normal paging	4116
51.1.5.1.1	RR / Paging / on CCCH for EGPRS service / normal paging with P-TMSI successful	4116
51.1.5.1.2	RR / Paging / on CCCH for EGPRS service / normal paging with IMSI successful.....	4120
51.1.5.1.3	RR / Paging / on CCCH for EGPRS service / normal paging with P-TMSI ignored	4122
51.1.5.2	RR / Paging / on CCCH for EGPRS service / extended paging.....	4125
51.1.5.2.1	RR / Paging / on CCCH for EGPRS service / extended paging with P-TMSI successful	4125
51.1.5.3	RR / Paging / on CCCH for EGPRS service / paging reorganisation	4127
51.1.5.4	RR / Paging / on CCCH for EGPRS service / default message contents	4131
51.1.6	RR / Paging / Before T3172 expiry	4131
51.2	RR procedures on CCCH related to temporary block flow establishment	4133
51.2.1	Permission to access the network	4134
51.2.1.1	Permission to access the network / priority classes	4134
51.2.2	Initiation of the packet access procedure	4135
51.2.2.1	Initiation of the packet access procedure / establishment causes	4135
51.2.2.2	Random references for two phase packet access.....	4136
51.2.2.3	Random references for one phase packet access and for Access Type 'signalling'	4138
51.2.2.4	Initiation of the packet access procedure / timer T3146.....	4140
51.2.2.5	Initiation of the packet access procedure / Request Reference.....	4141
51.2.2.6	Two phase packet access / establishment cause	4143
51.2.3	Packet immediate assignment / One phase packet access	4144

51.2.3.1	Two-message assignment / Successful case.....	4144
51.2.3.2	Two-message assignment / Failure cases	4145
51.2.3.3	Packet uplink assignment / Polling bit set.....	4148
51.2.3.4	One phase packet access / Contention resolution / Successful case	4149
51.2.3.5	One phase packet access / Contention resolution / TLLI mismatch.....	4150
51.2.3.6	One phase packet access / Contention resolution / Counter N3104	4152
51.2.3.7	One phase packet access / Contention resolution / Timer T3166.....	4153
51.2.3.8	One phase packet access / Contention resolution / 4 access repetition attempts	4156
51.2.3.9	One phase packet access / TBF starting time	4157
51.2.3.10	One phase packet access / Timing Advance Index present	4160
51.2.3.11	One phase packet access / Timing Advance Index not present	4161
51.2.4	Packet immediate assignment / Multiblock packet access	4162
51.2.4.1	Multiblock packet access / Packet Resource Request	4162
51.2.4.2	Void.....	4163
51.2.5	Packet immediate assignment / Packet access rejection	4163
51.2.5.1	Packet access rejection / wait indication	4163
51.2.5.2	Packet access rejection / assignment before T3142 expires	4165
51.2.5.3	Packet access rejection / Interpretation of Extended RA i / Correct value of Extended RA i	4167
51.2.5.4	Packet access rejection / Interpretation of Extended RA i / Extended RA i not included	4169
51.2.6	Packet downlink assignment procedure using CCCH	4171
51.2.6.1	Initiation of packet downlink assignment procedure / MS listens to correct CCCH block.....	4171
51.2.6.2	Initiation of packet downlink assignment procedure / timer T3190.....	4172
51.2.6.3	Initiation of packet downlink assignment procedure / TBF starting time	4174
51.2.6.4	Initiation of packet downlink assignment procedure / incorrect TFI	4176
51.3	MAC/RLC Release.....	4177
51.3.1	TBF Release / Uplink / Normal / MS initiated	4177
51.3.1.1	TBF Release / Uplink / Normal / MS initiated / Acknowledged mode	4177
51.3.1.2	TBF Release / Uplink / Normal / MS initiated / Unacknowledged mode	4181
51.3.1.3	TBF Release / Uplink / Normal / MS initiated / Channel coding change during countdown	4184
51.3.2	TBF Release / Uplink / Normal / Network initiated	4187
51.3.2.1	TBF Release / Uplink / Normal / Network initiated / Acknowledged mode.....	4187
51.3.2.2	TBF Release / Uplink / Normal / Network initiated / Unacknowledged mode	4188
51.3.3	TBF Release / Uplink / Network initiated / Abnormal release	4190
51.3.4	TBF Release / Downlink / Normal / Network initiated	4191
51.3.4.1	TBF Release / Downlink / Normal / Network initiated / Acknowledged mode.....	4191
51.3.4.2	TBF Release / Downlink / Normal / Network initiated / Unacknowledged mode	4194
51.3.5	PDCH Release	4197
51.3.5.1	Void.....	4197
51.3.5.2	PDCH Release / With TIMESLOTS_AVAILABLE	4197
51.3.6	TBF Release / Extended Uplink	4201
51.3.6.1	TBF Release / Extended Uplink / Recalculation of CV before CV = 0	4201
51.3.6.1.1	Conformance requirements.....	4201
51.3.6.2	TBF Release / Extended Uplink / Recalculation of CV after CV = 0	4202
51.3.6.3	TBF Release / Extended Uplink / MCS change order while CV=0	4204
51.3.6.4	TBF Release / Extended Uplink / TBF reconfigure by PACKET TIMESLOT RECONFIGURE ...	4207
51.3.6.5	TBF Release / Extended Uplink / TBF reconfigure by PACKET UPLINK ASSIGNMENT.....	4210
51.3.6.6	Extended Uplink TBF / Cell Change while in Extended Uplink/ No Packet Neighbouring Cell Data	4212
51.3.6.7	Extended Uplink TBF / Cell Change failure while in Extended Uplink/ No Packet Neighbouring Cell Data	4215
51.3.6.8	Extended Uplink TBF / Cell Change while in Extended Uplink/ With Packet Neighbouring Cell Data	4218
51.3.6.9	TBF Release / Extended Uplink / Change of RLC mode / Normal release.....	4222
51.3.6.10	TBF Release / Extended Uplink / Change of RLC mode / Abnormal release.....	4225
51.3.7	Default message contents.....	4228
51.4	Void.....	4228
51.5	EGPRS Dual transfer mode.....	4228
51.5.1	PS establishment whilst in dedicated mode	4228
51.5.1.1	Uplink TBF establishment	4228
51.5.1.1.1	Uplink TBF establishment with no reallocation of CS resources.....	4228
51.5.1.1.1.1	Uplink TBF establishment with no reallocation of CS resources / Successful case / Uplink resources assigned.....	4228

51.5.1.1.1.2	Uplink TBF establishment with no reallocation of CS resources / Successful case / Downlink resources assigned.....	4230
51.5.1.1.2	Uplink TBF establishment with reallocation of CS resources.....	4233
51.5.1.1.2.1	Uplink TBF establishment with reallocation of CS resources / Successful case	4233
51.5.1.2	Downlink TBF establishment.....	4234
51.5.1.2.1	Whilst in Ready State	4234
51.5.1.2.1.1	Downlink TBF establishment in Ready State / Successful case	4234
51.5.3	PS establishment whilst in dual transfer mode	4236
51.5.3.1	Uplink TBF establishment with a downlink TBF established.....	4236
51.5.3.1.1	Uplink TBF establishment with a downlink TBF established and no PS downlink reallocation	4236
51.5.3.2	Downlink TBF establishment with a uplink established.....	4238
51.5.3.2.1	Downlink TBF establishment with a uplink TBF established and no PS uplink reallocation	4238
51.6	Dynamic ARFCN mapping tests.....	4240
51.6.1	Control of dynamic ARFCN mapping with PSI8	4240
52	EGPRS Test of Medium Access Control (MAC) protocol	4245
52.1	Test of Medium Access Control (MAC) Procedures onPCCCH in idle mode.....	4245
52.1.1	Packet Channel Request.....	4245
52.1.1.1	Void.....	4245
52.1.1.2	Packet Channel Request / Support of EGPRS PACKET CHANNEL REQUEST	4245
52.1.1.2.1	Conformance requirements.....	4245
52.1.1.2.2	Test purpose	4245
52.1.1.2.3	Method of test.....	4245
52.1.1.3	Packet Channel Request / Response to Packet Paging/Non-RR Connection Paging	4246
52.1.1.3.1	Conformance requirements.....	4246
52.1.1.3.2	Test purpose	4247
52.1.1.3.3	Method of test.....	4247
52.1.1.4	Packet Channel Request / Response to Packet Paging/RR Connection Paging	4248
52.1.1.4.1	Conformance requirements.....	4248
52.1.1.4.2	Test purpose	4249
52.1.1.4.3	Method of test.....	4249
52.1.1.5	Void.....	4250
52.1.1.6	Packet Channel Request / Access persistence control on PRACH.....	4250
52.1.1.6.1	Packet Channel Request / Access persistence control on PRACH / M+1 attempts.....	4250
52.1.1.6.2	Packet Channel Request / Access persistence control on PRACH / Persistence level	4252
52.1.1.6.3	Packet Channel Request / Access persistence control on PRACH / Successive Attempts	4254
52.1.1.7	Packet Channel Request / EGPRS Packet Channel Request.....	4257
52.1.1.7.1	Conformance requirements.....	4257
52.1.1.7.2	Test purpose	4257
52.1.1.7.3	Method of test.....	4257
52.1.2	Packet Uplink/Downlink Assignment.....	4258
52.1.2.1	Packet uplink assignment procedure	4258
52.1.2.1.1	Packet Uplink Assignment / Packet access queuing notification procedure.....	4258
52.1.2.1.1.1	Packet Uplink Assignment / Packet queuing notification / Stop sending Packet Channel Requests	4258
52.1.2.1.1.2	Packet Uplink Assignment / Packet queuing notification / Ignoring Packet Queuing Notification	4259
52.1.2.1.1.3	Packet Uplink Assignment / Packet queuing notification / Assigned PDCHs	4261
52.1.2.1.1.4	Packet Uplink Assignment / Packet queuing notification / Expiry of timer T3162	4262
52.1.2.1.2	Packet Uplink Assignment / Response to packet polling request.....	4263
52.1.2.1.3	Packet Uplink Assignment / Packet access reject procedure.....	4265
52.1.2.1.3.1	Packet Uplink Assignment / Packet access reject / Action during Wait_Indication.....	4265
52.1.2.1.3.2	Packet Uplink Assignment / Packet access reject / No respond.....	4266
52.1.2.1.4	Packet Uplink Assignment / Packet Uplink Assignment handling.....	4268
52.1.2.1.5	Packet Uplink Assignment / One or two phase access	4269
52.1.2.1.6	Packet Uplink Assignment / Decoding of frequency parameters	4271
52.1.2.1.7	Packet Uplink Assignment / Most recently received Packet Uplink Assignment	4273
52.1.2.1.8	Packet Uplink Assignment / One phase access	4274
52.1.2.1.8.1	Packet Uplink Assignment / One phase access / Contention Resolution.....	4274
52.1.2.1.8.1.1	Packet Uplink Assignment / One phase access / Contention resolution / Inclusion of TLLI in RLC data blocks	4274

52.1.2.1.8.1.2	Packet Uplink Assignment / One phase access / Contention resolution / Counter N3104.....	4277
52.1.2.1.8.1.3	Packet Uplink Assignment / One phase access / Contention resolution / Timer T3166 ..	4278
52.1.2.1.8.1.4	Packet Uplink Assignment / One phase access / Contention resolution / TLLI mismatch	4281
52.1.2.1.8.1.5	Packet Uplink Assignment / One phase access / Contention resolution / 3 or 4 access repetition attempts	4282
52.1.2.1.8.1.6	Packet Uplink Assignment / One phase access / Contention resolution / Retransmission / Inclusion of TLLI in RLC data blocks after completion.....	4283
52.1.2.1.8.1.7	Packet Uplink Assignment / One phase access / Contention resolution / MCS-7 to MCS-9 / Inclusion of TLLI in both RLC data blocks	4286
52.1.2.1.8.1.8	Packet Uplink Assignment / One phase access / Contention resolution / TLLI in Packet Resource Request message retransmission	4288
52.1.2.1.8.2	Packet Uplink Assignment / One phase access / Timing Advance	4292
52.1.2.1.8.2.1	Packet Uplink Assignment / One phase access / Timing Advance / TA Index present ...	4292
52.1.2.1.8.2.2	Packet Uplink Assignment / One phase access / Timing Advance / TA Index not present	4293
52.1.2.1.8.2.3	Void.....	4294
52.1.2.1.9	Packet Uplink Assignment / Two phase access	4294
52.1.2.1.9.1	Packet Uplink Assignment / Two phase access / Packet Resource Request / RLC Octet Count.....	4294
52.1.2.1.9.2	Packet Uplink Assignment / Two phase access / Contention resolution.....	4296
52.1.2.1.9.2.1	Packet Uplink Assignment / Two phase access / Contention resolution / Expiry of timer T3168.....	4296
52.1.2.1.9.2.2	Packet Uplink Assignment / Two phase access / Contention resolution / TLLI in Packet Resource Request message	4297
52.1.2.1.9.2.3	Packet Uplink Assignment / Two phase access / Contention resolution / TLLI mismatch	4299
52.1.2.1.9.3	Packet Uplink Assignment / Two phase access / Radio Access Capabilities	4300
52.1.2.1.9.4	Packet Uplink Assignment / Two phase access / Radio Access Capabilities/ Frequency band not supported.....	4303
52.1.2.1.9.5	Packet Uplink Assignment / Two phase access / Packet Resource Request / No respond to Packet Downlink Assignment.....	4304
52.1.2.1.10	Packet Uplink Assignment / Abnormal cases.....	4306
52.1.2.1.10.1	Packet Uplink Assignment / Abnormal cases / Incorrect PDCH assignment	4306
52.1.2.1.10.2	Packet Uplink Assignment / Abnormal cases / Expiry of timer T3164	4307
52.1.2.2	Packet Downlink Assignment	4308
52.1.2.2.1	Packet Downlink Assignment / Response to poll bit.....	4308
52.1.2.2.2	Packet Downlink Assignment / PCCCH monitoring.....	4310
52.1.2.2.3	Void.....	4311
52.1.2.2.4	Packet Downlink Assignment / Response to Packet Polling	4311
52.1.2.2.5	Packet Downlink Assignment / Abnormal cases	4313
52.1.2.2.5.1	Packet Downlink Assignment / Abnormal cases / Incorrect PDCH assignment	4313
52.1.2.2.5.2	Packet Downlink Assignment / Abnormal cases / Expiry of timer T3190	4314
52.1.2.2.6	Packet Downlink Assignment Timing Advance / TA value field not provided	4315
52.1.3	Macro and default message contents	4316
52.1.3.1	Macro	4316
52.1.3.1.1	GPRS attach procedure.....	4316
52.1.3.1.2	Uplink data transfer, dynamic allocation.....	4318
52.1.3.1.3	GPRS detach procedure.....	4318
52.1.3.2	Default Messages	4318
52.1.3.2.1	EGPRS PACKET CHANNEL REQUEST message:.....	4318
52.1.3.2.2	PACKET CONTROL ACKNOWLEDGEMENT message:	4319
52.1.3.2.3	EGPRS PACKET DOWNLINK ACK/NACK message:	4319
52.1.3.2.4	PACKET DOWNLINK ASSIGNMET message:	4320
52.1.3.2.5	PACKET PAGING REQUEST message:	4321
52.1.3.2.6	PACKET RESOURCE REQUEST message (two phase access):.....	4321
52.1.3.2.7	PACKET UPLINK ACK/NACK message:.....	4322
52.1.3.2.8	PACKET UPLINK ASSIGNMENT message (dynamic allocation).....	4323
52.1.3.2.9	Void.....	4324
52.1.3.2.10	PACKET UPLINK ASSIGNMENT message (multi block allocation):	4324
52.2	Void.....	4325

52.3	EGPRS Testcases for Dynamic Allocation in Packet Transfer Mode.....	4325
52.3.1	Dynamic Allocation / Uplink Transfer	4325
52.3.1.1	Dynamic Allocation / Uplink Transfer / Normal	4325
52.3.1.1.1	Dynamic Allocation / Uplink Transfer / Normal / Successful.....	4325
52.3.1.1.2	Void.....	4328
52.3.1.1.3	Dynamic Allocation / Uplink Transfer / Normal / Starting frame number encoding	4328
52.3.1.1.4	Dynamic Allocation / Uplink Transfer / Normal / Starting time	4329
52.3.1.1.5	void.....	4333
52.3.1.1.6	Dynamic Allocation / Uplink Transfer / Normal / T3180 expiry	4333
52.3.1.1.7	Dynamic Allocation / Uplink Transfer / Normal / PACCH operation.....	4336
52.3.1.1.8	Dynamic Allocation / Uplink Transfer / Normal / Two uplink timeslots	4337
52.3.1.1.9	Void.....	4339
52.3.1.2	Dynamic Allocation / Uplink Transfer / Abnormal	4339
52.3.1.2.1	Void.....	4339
52.3.1.2.2	Dynamic Allocation / Uplink Transfer / Abnormal / with cell reselection in acknowledged mode.....	4339
52.3.1.2.3	Dynamic Allocation / Uplink Transfer / Abnormal / with cell reselection in unacknowledged mode.....	4342
52.3.2	Dynamic Allocation / Uplink Transfer with Downlink TBF establishment (concurrent).....	4345
52.3.2.1	Dynamic Allocation / Uplink Transfer with Downlink TBF establishment / Normal	4345
52.3.2.1.1	Dynamic Allocation / Uplink Transfer with Downlink TBF establishment / Normal / Successful.....	4345
52.3.2.1.2	Dynamic Allocation / Uplink Transfer with Downlink TBF establishment / Normal / Multislot capabilities	4349
52.3.2.2	Dynamic Allocation / Uplink Transfer with Downlink TBF establishment / Abnormal	4358
52.3.2.2.1	Dynamic Allocation / Uplink Transfer with Downlink TBF establishment / Abnormal / with random access.....	4358
52.3.2.2.2	Dynamic Allocation / Uplink Transfer with Downlink TBF establishment / Abnormal / Continuation of normal operation.....	4363
52.3.3	Dynamic Allocation / Resource reallocation	4364
52.3.3.1	Dynamic Allocation / Resource reallocation / Successful.....	4364
52.3.3.1.1	Dynamic Allocation / Resource reallocation / Successful / Higher throughput class or higher radio priority.....	4364
52.3.3.1.2	Dynamic Allocation / Resource reallocation / Successful / Lower throughput class	4367
52.3.3.1.3	Dynamic Allocation / Resource reallocation / Successful / Different RLC mode and higher radio priority.....	4370
52.3.3.2	Dynamic Allocation / Resource reallocation / Abnormal	4372
52.3.3.2.1	Dynamic Allocation / Resource reallocation / Abnormal / T3168 expiry	4372
52.3.3.2.2	Dynamic Allocation / Resource reallocation / Abnormal / Invalid assignment.....	4375
52.3.3.3	Dynamic Allocation / Resource reallocation / Reject	4379
52.3.4	Default message contents.....	4381
52.4	Void.....	4388
52.5	EGPRS Downlink Transfer	4388
52.5.1	Void	4388
52.5.2	Void	4388
52.5.3	Void	4388
52.5.4	Void	4388
52.5.5	Downlink Transfer / Reestablishment.....	4388
52.5.5.1	Downlink Transfer/ Reestablishment/ T3192 Expiry.....	4388
52.5.5.2	Downlink Transfer/ Reestablishment/ Packet Downlink Assignment	4391
52.5.5.3	Downlink Transfer/ Reestablishment/ Invalid Frequency Parameters IE	4393
52.6	EGPRS Packet Access for signalling	4396
52.6.1	EGPRS Packet Access for signalling / EGPRS Packet Channel Request not supported / CCCH case ..	4396
52.6.2	EGPRS Packet Access for signalling / EGPRS Packet Channel Request supported / CCCH case	4399
52.6.3	EGPRS Packet Access for signalling / EGPRS Packet Channel Request not supported / PCCCH case ..	4401
52.6.4	EGPRS Packet Access for signalling / EGPRS Packet Channel Request supported / PCCCH case	4403
52.7	Void.....	4405
52.8	One phase access/ CONTENTION_RESOLUTION_TLLI.....	4405
52.8.1	One phase access/ PBCCH present/ CONTENTION_RESOLUTION_TLLI / Contention Resolution.....	4405
52.8.1.1	One phase access/PBCCH present/ CONTENTION_RESOLUTION_TLLI / Contention resolution / Inclusion of TLLI in RLC data blocks	4406
52.8.1.2	One phase access/ PBCCH present / CONTENTION_RESOLUTION_TLLI	4408

52.8.1.3	One phase access/ PBCCH present / CONTENTION_RESOLUTION_TLLI / Contention resolution / Timer T3166	4410
52.8.1.4	One phase access/ PBCCH present / CONTENTION_RESOLUTION_TLLI/ Contention resolution / TLLI mismatch.....	4412
52.8.1.5	One phase access/ PBCCH present / CONTENTION_RESOLUTION_TLLI / Contention resolution / 4 access repetition attempts.....	4414
52.8.1.6	One phase access/ PBCCH not present/ CONTENTION_RESOLUTION_TLLI / Contention resolution / Inclusion of TLLI in RLC data blocks	4415
52.8.1.7	One phase access/ PBCCH not present / CONTENTION_RESOLUTION_TLLI / Contention resolution / Counter N3104.....	4418
52.8.1.8	One phase access/ PBCCH not present / CONTENTION_RESOLUTION_TLLI / Contention resolution / Timer T3166	4419
52.8.1.9	One phase access/ PBCCH not present / CONTENTION_RESOLUTION_TLLI / Contention resolution / TLLI mismatch.....	4422
52.8.1.10	One phase access/ PBCCH not present / CONTENTION_RESOLUTION_TLLI / Contention resolution / 4 access repetition attempts.....	4424
52.8.1.11	One phase access/PBCCH present/CONTENTION_RESOLUTION_TLLI/ Contention resolution / Successful Resource Reallocation.....	4425
52.8.1.12	One phase access/PBCCH absent/CONTENTION_RESOLUTION_TLLI/ Contention resolution / Successful Resource Reallocation.....	4428
52.9	Extended Dynamic Allocation in Packet Transfer Mode	4430
52.9.1	Default message contents.....	4430
52.9.2	Extended Dynamic Allocation / Uplink Transfer	4435
52.9.2.1	Extended Dynamic Allocation / Uplink Transfer / Normal	4435
52.9.2.1.1	Extended Dynamic Allocation / Uplink Transfer / Normal / Successful.....	4435
52.9.2.1.2	Extended Dynamic Allocation / Uplink Transfer / Normal / USF_GRANULARITY = 4 blocks	4438
52.9.2.1.4	Extended Dynamic Allocation / Uplink Transfer / Normal / PACCH operation in downlink	4441
52.9.2.1.5	Extended Dynamic Allocation / Uplink Transfer / Normal / Polling for EPDAN	4446
53	Test of EGPRS Radio Link Control (RLC) Protocol	4449
53.1	Acknowledged Mode	4449
53.1.1	Acknowledged Mode/ Uplink TBF	4449
53.1.1.1	Acknowledged Mode/ Uplink TBF/ Send State Variable V(S)	4449
53.1.1.2	Acknowledged Mode/ Uplink TBF/ Acknowledge State Variable V(A).....	4450
53.1.1.3	Acknowledged Mode/ Uplink TBF/ Window Size/ Default Value.....	4453
53.1.1.4	Acknowledged Mode/ Uplink TBF/ Window Size/ Assigned Value.....	4455
53.1.1.5	Acknowledged mode/ Uplink TBF/ Invalid Negative Acknowledgement.....	4458
53.1.1.6	Acknowledged Mode/ Uplink TBF/ Countdown Value.....	4459
53.1.1.7	Acknowledged Mode/ Uplink TBF/ Interpretation of Receive Block Bitmap.....	4461
53.1.1.8	Acknowledged Mode/ Uplink TBF/ Pre-emptive Transmission/ Default Mode.....	4463
53.1.1.9	Acknowledged Mode/ Uplink TBF/ Pre-emptive Transmission Bit Set to '1'.....	4465
53.1.1.10	Acknowledged Mode/ Uplink TBF/ Pre-emptive Transmission Bit Set to '0'/ PENDING_ACK Blocks	4468
53.1.1.11	Acknowledged Mode/ Uplink TBF/ Pre-emptive Transmission Bit Set to '0'/ Negative Acknowledgement.....	4469
53.1.1.12	Acknowledged Mode/ Uplink TBF/ Retransmission/ Split RLC Data Block.....	4472
53.1.1.13	Acknowledged Mode/ Uplink TBF/ Calculation of BSN2	4473
53.1.1.14	Acknowledged Mode/ Uplink TBF/ Verification of Coding Schemes	4475
53.1.1.15	Acknowledged Mode/ Uplink TBF/ Recalculation of CV on MCS change.....	4478
53.1.1.16	Acknowledged Mode/ Uplink TBF/ Retransmission/ Padding in the Data Field.....	4481
53.1.1.17	Acknowledged Mode/ Uplink TBF/ Retransmission/ Puncturing Scheme Cycle.....	4483
53.1.1.18	EGPRS Acknowledged mode / Uplink TBF / Link Adaptation Procedure for retransmission.....	4486
53.1.1.19	EGPRS Acknowledged mode / Uplink TBF / Link Adaptation Procedure for initial transmission..	4492
53.1.1.20	Acknowledged Mode/ Uplink TBF/ Retransmission/ MCS Selection without Re-segmentation	4494
53.1.1.21	Acknowledged Mode/ Uplink TBF/ Initial Puncturing Scheme After MCS Switching	4500
53.1.1.22	Acknowledged Mode/ Uplink TBF/ Recalculation of CV on TBC change	4502
53.1.1.23	Acknowledged Mode/ Uplink TBF/ Interpretation of Compressed Bitmap.....	4504
53.1.1.24	Acknowledged Mode/ Uplink TBF/ Interpretation of PBSN.....	4506
53.1.1.25	Acknowledged Mode/ Uplink TBF/ TBF Reallocation/Window Size.....	4510
53.1.2	Acknowledged Mode/ Downlink TBF.....	4514
53.1.2.1	Acknowledged Mode/ Downlink TBF/ Receive State Variable V(R)	4514

53.1.2.2	Acknowledged Mode/ Downlink TBF/ Receive Window State Variable V(Q)	4515
53.1.2.3	Acknowledged Mode/ Downlink TBF/ Window Size/ Default Value	4517
53.1.2.4	Acknowledged Mode/ Downlink TBF/ Window Size/ Assigned Value	4521
53.1.2.5	Acknowledged Mode/ Downlink TBF/ BOW	4523
53.1.2.6	Acknowledged Mode/ Downlink TBF/ EOW	4524
53.1.2.7	Acknowledged Mode/ Downlink TBF/ Measurement Report	4526
53.1.2.8	Acknowledged Mode/ Downlink TBF/ Generation of Bitmap	4527
53.1.2.9	Acknowledged Mode/ Downlink TBF/ Interpretation of BSN2	4528
53.1.2.10	Acknowledged Mode/ Downlink TBF/ Split RLC Data Block	4530
53.1.2.11	Acknowledged Mode/ Downlink TBF/ First Partial Bitmap and Next Partial Bitmap	4531
53.1.2.12	Acknowledged Mode/ Downlink TBF/ Decoding of Coding Schemes	4532
53.1.2.13	Void	4534
53.1.2.14	Acknowledged Mode/ Downlink TBF/ Received Bitmap/ Compressed	4534
53.1.2.15	Acknowledged Mode/ Downlink TBF/ Received Bitmap/ Uncompressed	4535
53.1.2.16	Acknowledged Mode/ Downlink TBF/ Received Block Bitmap/ Compressed Bitmap Starting Colour Code	4537
53.1.2.17	Acknowledged Mode/ Downlink TBF/ Received Block Bitmap/ Terminating Code and Make-up Code	4538
53.1.2.18	Acknowledged Mode/ Downlink TBF/ Retransmission/ Padding	4539
53.1.2.19	Acknowledged Mode/ Downlink TBF/ TBF Reallocation/Window Size	4541
53.2	Unacknowledged Mode	4543
53.2.1	Unacknowledged Mode/ Uplink TBF	4543
53.2.1.1	Unacknowledged Mode/ Uplink TBF/ Stall Indicator	4543
53.2.1.2	Unacknowledged Mode/ Uplink TBF/ RBB and SSN	4545
53.2.2	Unacknowledged Mode/ Downlink TBF	4546
53.2.2.1	Unacknowledged Mode/ Downlink TBF/ V(R) and V(Q)	4546
53.3	Default Message Contents and Macros	4547
53.3.1	Message Contents	4547
53.3.2	Macros	4548
53.3.2.1	Macro for uplink dynamic allocation two phase access (PBCCH not present)	4548
53.3.2.2	Macro for downlink TBF establishment (PBCCH not present)	4548
53.3.2.3	Macro for downlink TBF establishment using ACCESS TYPE = "signalling" (PBCCH not present)	4548
54 to 56	Void	4550
57	EGPRS Dual Transfer Mode	4550
57.1	Reallocation of CS resources	4550
57.1.1	Void	4550
57.1.2	Void	4550
57.1.3	Intra frequency reallocation of CS resources / DTM Assignment Command	4550
57.1.4	Inter frequency reallocation of CS resources / DTM Assignment Command	4552
57.2	Release of CS resources	4554
57.2.1	Network originating CS release	4554
58 to 59	Void	4556
60	Inter-system hard handover from GSM to UTRAN	4557
60.1	Inter system handover to UTRAN/From GSM/Speech/Success	4559
60.2a	Inter system handover to UTRAN/From GSM/Data/Same data rate/Success	4563
60.2b	Inter system handover to UTRAN/From GSM/Data/Same data rate/Extended Rates/Success	4565
60.3a	Inter system handover to UTRAN/From GSM/Data/Data rate upgrading/Success	4568
60.3b	Inter system handover to UTRAN/From GSM/Data/Data rate upgrading/Extended Rates/Success	4570
60.4	Inter system handover to UTRAN/From GSM/SDCCH/CC Establishment/Success	4572
60.5	Inter system handover to UTRAN/From GSM/Speech/Blind HO/Success	4576
60.6	Inter system handover to UTRAN/From GSM/Speech/Failure	4577
60.7	Inter system handover to UTRAN/From GSM/Failure/Cause: Frequency not implemented	4579
60.8	Inter system handover to UTRAN/From GSM/Failure/Cause: UTRAN configuration unknown	4581
60.9	Inter system handover to UTRAN/From GSM/Failure/Cause: Protocol Error	4584
60.10	Inter system handover to UTRAN/From GSM/Integrity Protection Activation	4585
61-69	Void	4589
70	Location Services	4590

70.1	Default conditions during LCS tests.....	4590
70.1.1	Default conditions during EOTD tests.....	4590
70.1.2	Default conditions during A-GPS signalling tests	4590
70.2	EOTD Network Induced Location Request.....	4590
70.2.1	LCS Network Induced Emergency Call on an SDCCH / idle, no IMSI for Mobiles supporting MS-Assisted EOTD	4590
70.2.2	Positioning / RR / Classmark Interrogation tests for MS-Assisted EOTD	4594
70.2.3	Network Induced Location Request Emergency Call on an SDCCH for MS-Assisted EOTD Mobiles	4595
70.2.4	Emergency Call NI-LR while Voice is Through Connected for Mobiles supporting MS-Assisted EOTD.....	4599
70.3	Mobile Originating Location Request	4602
70.3.1	MO_LR Basic Self Location Request.....	4602
70.3.1.1	MO_LR Basic Self Location Request In Idle Mode (Normal Case).....	4602
70.3.1.2	MO_LR Basic Self Location Request In Dedicated Mode (Normal case).....	4605
70.3.2	MO_LR Transfer to 3 rd Party.....	4607
70.3.3	MO_LR Autonomous Location	4610
70.3.4	MO_LR Positioning Measurement.....	4612
70.3.4.1	MO_LR Positioning Measurement / Protocol Error	4612
70.3.4.2	MO_LR Positioning Measurement /Location Error.....	4615
70.3.4.3	MO_LR Positioning Measurement / Multiple RRLP REQUEST with same Reference Number.....	4618
70.3.4.4	MO_LR Positioning Measurement / Multiple RRLP REQUEST with different Reference Number	4621
70.3.4.5	MO_LR Positioning Measurement / RR Management Commands	4624
70.4	Mobile Terminated Location Request for Mobiles supporting MS-Assisted EOTD	4627
70.4.1	MT-LR Location Notification for MS-Assisted EOTD.....	4627
70.4.2	MT-LR Privacy Options for Mobiles supporting MS-Assisted EOTD	4629
70.4.2.1	MT-LR Privacy Options/ Verification – Location Allowed If No Response for mobiles supporting MS-Assisted EOTD	4630
70.4.2.2	MT-LR Privacy Options/ Verification – Location Not Allowed If No Response for Mobiles supporting MS-Assisted EOTD	4633
70.5	Void.....	4637
70.6	E-OTD Timing Measurement Accuracy	4637
70.6.1	E-OTD Accuracy, Sensitivity Performance Tests using GMSK Signals.....	4637
70.6.2	E-OTD Accuracy, Interference Performance Tests	4639
70.6.3	E-OTD Accuracy, Multipath Performance Test using GMSK Modulated Signals.	4641
70.6.4	E-OTD Accuracy, Interference Performance Tests, 8PSK BCCH	4644
70.6.5	E-OTD Accuracy, Multipath Performance Test, 8PSK BCCH	4646
70.6.6	E-OTD Accuracy, Sensitivity Performance Tests for 8PSK Modulated signals	4649
70.7	Assisted GPS Network Induced Tests	4651
70.7.1	Void.....	4651
70.7.2	Positioning/ RR/ Classmark Interrogation tests.....	4651
70.7.2.1	Positioning/ RR/ Classmark Interrogation test for mobile supporting MS-Based GPS	4651
70.7.2.2	Positioning/ RR/ Classmark Interrogation test for mobile supporting MS-Assisted GPS.....	4652
70.7.3	Void	4653
70.7.4	Network Induced Location Request Emergency Call on TCH Radio Channel	4653
70.7.4.1	Network Induced Location Request Emergency Call on TCH Radio Channel for Mobiles Supporting MS-Based GPS.....	4653
70.7.4.2	Network Induced Location Request Emergency Call on TCH Radio Channel for mobiles supporting MS-Assisted GPS.....	4659
70.7.4.3	Network Induced Location Request Emergency Call on TCH Radio Channel, no IMSI for Mobiles Supporting MS-Based GPS.....	4663
70.7.4.4	Network Induced Location Request Emergency Call on TCH Radio Channel, no IMSI for mobiles supporting MS-Assisted GPS	4669
70.8	Assisted GPS Mobile Originated Tests	4673
70.8.1	Basic Self Location	4673
70.8.2	Basic Self Location in Dedicated Mode	4678
70.8.3	Transfer to 3 rd Party	4683
70.8.4	MO-LR Positioning Measurement.....	4688
70.8.4.1	MO-LR Positioning Measurement / Protocol Error	4688
70.8.4.2	MO-LR Positioning Measurement / Location Error	4693
70.8.4.2.1	Location Error: Requested Method not Supported	4693
70.8.4.2.2	Location Error: GPS Assistance Data Missing.....	4698

70.8.4.3	MO-LR Positioning Measurement / Multiple RRLP Requests with Same Reference Number	4702
70.8.4.4	MO-LR Positioning Measurement / Multiple RRLP Requests with Different Reference Number ..	4708
70.8.4.5	MO-LR Positioning Measurement / RR Management Commands	4715
70.8.5	MO_LR Basic Self Location Request for MS-Based AGPS	4722
70.8.5.1	MO_LR Basic Self Location Request in Idle Mode (Normal Case)	4722
70.8.5.2	MO_LR Basic Self Location Request in Dedicated Mode (Normal case)	4726
70.8.5.2.1	Conformance Requirement:	4726
70.8.5.2.2	Test Purpose	4726
70.8.5.2.3	Method of Test	4727
70.8.5.3	MO_LR Basic Self Location Request in Idle Mode (Alternative Case)	4729
70.8.5.4	MO_LR Basic Self Location Request in Dedicated Mode (Alternative Case)	4734
70.8.6	MO-LR Transfer to 3 rd Party for MS-Based A-GPS	4739
70.9	Assisted GPS Mobile Terminated Tests	4745
70.9.1	MT-LR Location Notification	4745
70.9.1.1	MT-LR Location Notification for Mobiles Supporting MS-Based GPS	4745
70.9.1.2	MT-LR Location Notification for Mobiles Supporting MS-Assisted GPS	4747
70.9.2	MT-LR Privacy Options/Verification – Location Allowed If No Response	4749
70.9.2.1	MT-LR Privacy Options/Verification– Location Allowed If No Response for mobiles supporting MS-Based GPS	4749
70.9.2.2	MT-LR Privacy Options/Verification– Location Allowed If No Response for Mobiles Supporting MS-Assisted GPS	4753
70.9.3	MT-LR Privacy Options/Verification – Location Not Allowed If No Response	4757
70.9.3.1	MT-LR Privacy Options/Verification– Location Not Allowed If No Response for Mobiles Supporting MS-Based GPS	4757
70.9.3.2	MT-LR Privacy Options/Verification– Location Not Allowed If No Response for mobiles supporting MS-Assisted GPS	4761
70.9.4	MT-LR / RRLP Error Handling for MS-Based A-GPS	4765
70.9.4.1	RRLP Protocol Error	4765
70.9.4.2	RRLP Location Error – Requested Method Not Supported	4769
70.9.4.3	RRLP Location Error – GPS Assistance Data Missing	4774
70.9.4.4	Multiple RRLP Requests with same Reference Number	4778
70.9.4.5	Multiple RRLP Requests with different Reference Number	4783
70.9.4.6	RR Management Commands	4789
70.10	Conventional GPS Network Induced Tests	4797
70.10.1	Void	4797
70.10.2	Network Induced Location Request Emergency Call on TCH Radio Channel	4797
70.10.2.1	Network Induced Location Request Emergency Call on TCH Radio Channel for Mobiles Supporting Conventional GPS	4797
70.11	A-GPS Minimum Performance tests	4800
70.11.1	Abbreviations	4800
70.11.2	GPS test conditions	4800
70.11.2.1	GPS signals	4800
70.11.2.2	GPS frequency	4800
70.11.2.3	GPS static propagation conditions	4800
70.11.2.4	GPS multi-path conditions	4800
70.11.3	GSM test conditions	4801
70.11.3.1	GSM frequency band and frequency range	4801
70.11.3.2	GSM frequency	4801
70.11.4	A-GPS test conditions	4801
70.11.4.1	General	4801
70.11.4.2	Measurement parameters	4801
70.11.4.2.1	MS based A-GPS measurement parameters	4801
70.11.4.2.2	MS assisted A-GPS measurement parameters	4801
70.11.4.2.3	2D position error	4801
70.11.4.2.4	Response time	4801
70.11.4.3	Converting MS-assisted measurement reports into position estimates	4802
70.11.4.3.1	MS measurement reports	4802
70.11.4.3.2	WLS position solution	4802
70.11.5	Sensitivity	4804
70.11.5.1	Sensitivity Coarse Time Assistance	4804
70.11.5.2	Sensitivity Fine Time Assistance	4806
70.11.6	Nominal Accuracy	4808

70.11.7	Dynamic Range	4810
70.11.8	Multi-Path scenario.....	4813
80	Generic Access default conditions, message contents and macros	4817
80.1	Default test conditions.....	4817
80.1.1	Unlicensed Radio Access.....	4817
80.1.1.1	IEEE 802.11	4817
80.1.1.2	Bluetooth.....	4817
80.1.2	Protocol Settings.....	4817
80.1.2.1	Dynamic Host Configuration Protocol - DHCP.....	4817
80.1.2.2	Domain Name System – DNS.....	4817
80.1.2.2.1	Public DNS Server	4817
80.1.2.2.2	DNS associated with GANC	4818
80.1.2.3	Secure Gateway (SEGW).....	4818
80.1.2.4	Generic Access Network Controller (GANC).....	4818
80.1.2.5	Secure Internet Protocol - IPsec	4818
80.2	Default message contents	4818
80.3	Macros.....	4818
80.3.1	Overview	4818
80.3.1.1	Definition	4818
80.3.1.2	Syntax	4819
80.3.1.2.1	Message contents.....	4819
80.3.1.2.2	Message sequence	4819
80.3.2	Default message contents.....	4820
80.3.3	Macro message sequences	4820
80.3.3.1	Location Update Procedure.....	4820
80.4	Test PDP contexts	4820
81	GAN Discovery and Registration Procedures.....	4820
81.1	Discovery Procedure	4820
81.1.1	Discovery Procedure, Accepted.....	4820
81.1.1.1	Discovery Procedure, MS holds the IP address of the provisioning SEGW and FQDN of provisioning GANC, provisioning GANC and default GANC belong to the same SEGW.....	4820
81.1.1.2	Discovery procedure, the MS holds the FQDN of the provisioning SEGW and IP address of the provisioning GANC, provisioning GANC and default GANC belong to different SEGWs.....	4822
81.1.1.3	Discovery procedure, the MS is not provisioned with information about the provisioning GANC or its SEGW	4824
81.1.2	Discovery Procedure, Rejected.....	4826
81.1.2.1	Discovery Procedure, Discovery Reject, Network Congestion.....	4826
81.1.2.2	Discovery Procedure, Discovery Reject, IMSI not allowed.....	4827
81.1.2.3	Void.....	4829
81.1.3	Discovery Procedure, Abnormal Cases	4829
81.1.3.1	Discovery Procedure, TU3901/TU3903 Expires	4829
81.1.3.2	Void.....	4832
81.1.3.3	Void.....	4832
81.1.3.4	Void.....	4832
81.1.3.5	Void.....	4832
81.1.3.6	Void.....	4832
81.1.3.7	SEGW certificate checking, the MS holds the “invalid” FQDN of the provisioning SEGW	4832
81.2	Registration Procedure	4833
81.2.1	Registration Procedure, Accepted.....	4833
81.2.1.1	Registration Procedure, MS in GSM Coverage, Serving GANC for CGI Known.....	4833
81.2.1.2	Registration Procedure, MS in GSM Coverage, Serving GANC for CGI Not Known; MS not in GSM Coverage, Serving GANC for AP Known.....	4835
81.2.1.3	Void.....	4836
81.2.1.4	Registration Procedure, MS Holds The IP Address to The serving SEGW And The FQDN to The Serving GANC.....	4836
81.2.1.5	Registration Procedure, MS Holds The FQDN to The serving SEGW And The IP Address to The Serving GANC.....	4838
81.2.2	Registration Procedure, Redirected	4839
81.2.2.1	Registration Procedure, Redirected, Not Possible to Reuse Secure Connection.....	4839

81.2.2.2	Registration Procedure, Redirected, Current And Received GANC Belongs to The Same SEGW, IP Address Matches.....	4841
81.2.2.3	Registration Procedure, Redirected, Current And Received GANC Belongs to The Same SEGW, FQDN Matches	4842
81.2.3	Registration Procedure, Rejected.....	4844
81.2.3.1	Registration Procedure, Registration rejected, Network congestion	4844
81.2.3.2	Registration Procedure, Registration rejected, AP not allowed	4845
81.2.3.3	Registration Procedure, Registration rejected, Location not allowed	4847
81.2.3.4	Registration Procedure, Registration rejected, IMSI not allowed	4849
81.2.3.5	Void.....	4851
81.2.3.6	Registration Procedure, Registration rejected, invalid GANC.....	4851
81.2.3.7	Registration Procedure, Registration rejected, Geo location not known.....	4853
81.2.4	Registration Procedure, Abnormal Cases	4855
81.2.4.1	Registration Procedure, TU3904/TU3905 expiry, Serving GANC.....	4855
81.2.4.2	Registration Procedure, Registration Rejected, Network Congestion, Persistent Fault	4856
81.2.4.3	Void.....	4858
81.2.4.4	Void.....	4858
81.2.4.5	Void.....	4858
81.2.4.6	Void.....	4858
81.2.4.7	Void.....	4858
81.2.5	Registration Procedure, Register Update	4858
81.2.5.1	Registration Procedure, Register Update, Rejected	4858
81.2.5.2	Registration Procedure, Register Update, Redirection.....	4860
81.2.6	Registration Procedure, Deregister	4861
81.2.6.1	Registration Procedure, Deregister, Network Congestion, MS in State GA-CSR DEDICATED.....	4861
81.2.6.2	Registration Procedure, Deregister, AP Not Allowed, MS in State GA-RC REGISTERED.....	4862
81.2.6.3	Registration Procedure, Deregister, Location Not Allowed, MS in State GA-CSR IDLE	4863
81.2.6.4	Registration Procedure, Deregister, IMSI Not Allowed.....	4865
81.2.6.5	Registration Procedure, Deregister, Unspecified	4866
81.2.6.6	Registration Procedure, Deregister, Unspecified, Persistent Fault, Default GANC.....	4868
81.2.6.7	Registration Procedure, Deregister, Invalid GANC, Serving GANC	4870
81.2.6.8	Registration Procedure, Deregister, Geo Location Not Known	4871
81.2.6.9	Registration Procedure, Deregister, MS Initiated.....	4873
81.3	Lower Layer Faults	4874
81.3.1	TCP Reset	4874
81.3.1.1	TCP Reset, Successful Re-establishment, MS in State GA-CSR DEDICATED	4874
81.3.1.2	TCP Reset, Unsuccessful Re-establishment, MS in State GA-CSR IDLE	4875
81.3.2	Lower Layer Faults, MS is Registered.....	4876
81.3.2.1	IPSec Tunnel Failure, MS in State GA-CSR IDLE	4876
81.3.2.2	TCP Failure, MS in State GA-CSR DEDICATED	4877
82	GAN CS Domain Procedures.....	4878
82.1	GA-CSR connection establishment.....	4878
82.1.1	GA-CSR connection establishment / successful case	4878
82.1.1.1	GA-CSR connection establishment, Upper Layer Message Transmission and GA-CRS connection release by GANC.....	4878
82.1.2	GA-CSR connection establishment / negative cases	4880
82.1.2.1	GA-CSR REQUEST rejected.....	4880
82.1.2.2	MS receives GA-CSR REQUEST ACCEPT message after TU3908 expiry	4881
82.2	Upper layer message transmission	4883
82.2.1	Upper layer message transmission / successful cases	4883
82.2.1.1	Void.....	4883
82.2.2	Upper layer message transmission / negative cases	4883
82.2.2.1	MS receives GA-CSR DOWNLINK DIRECT TRANSFER message when not in GA-CSR-DEDICATED state.....	4883
82.3	Paging for CS domain	4884
82.3.1	Paging for CS domain / successful case.....	4884
82.3.1.1	Paging for CS domain	4884
82.3.2	Paging for CS domain / negative cases	4886
82.3.2.1	Void.....	4886
82.3.2.2	MS receives GA-CSR PAGING REQUEST when TU3908 is active	4886
82.3.2.3	MS receives GA-CSR PAGING REQUEST when in GA-CSR DEDICATED state	4887

82.3.2.4	MS receives GA-CSR PAGING REQUEST when in GA-RC REGISTERED state	4888
82.4	Traffic Channel assignment.....	4889
82.4.1	Traffic Channel assignment / successful cases	4889
82.4.1.1	Traffic Channel assignment	4889
82.4.1.1	Traffic Channel assignment and Release	4889
82.4.2	Traffic Channel assignment / negative cases	4891
82.4.2.1	MS fails to establish the traffic channel	4891
82.5	Release of GA-CSR.....	4892
82.5.1	Release of GA-CSR.....	4892
82.5.1.1	Void.....	4892
82.5.1.2	Void.....	4892
82.6	Classmark Indication.....	4892
82.6.1	Classmark Indication Procedure	4892
82.6.1.1	Classmark Indication, Initiation of Classmark Interrogation by MS.....	4892
82.7	Handover to GAN	4893
82.7.1	Handover to GAN / successful cases	4893
82.7.1.1	Handover from GERAN to GAN.....	4893
82.7.1.2	Handover from GERAN to GAN signalling case	4895
82.7.1.3	Handover from UTRAN to GAN.....	4896
82.7.2	Handover to GAN / negative cases.....	4899
82.7.2.1	Void.....	4899
82.7.2.2	TU3920 expires during handover procedure.....	4899
82.8	Handover from GAN.....	4901
82.8.1	Handover from GAN / successful cases	4901
82.8.1.1	Handover from GAN to GERAN.....	4901
82.8.1.2	Handover from GAN to UTRAN.....	4903
82.8.2	Handover from GAN / negative cases	4905
82.8.2.1	Connection establishment fails on GERAN cell	4905
82.8.2.2	Handover command with non-supported configuration.....	4906
82.9	Ciphering Configuration Procedure.....	4907
82.9.1	Ciphering Configuration Procedure, Normal cases	4907
82.9.1.1	Ciphering Configuration Procedure	4907
82.9.1.2	Void.....	4909
82.9.2	Ciphering Configuration Procedure, Abnormal cases.....	4909
82.9.2.1	Ciphering Configuration Procedure, Invalid Ciphering Mode Command	4909
82.10	Channel mode modify procedure	4910
82.10.1	Channel mode modify procedure / successful cases	4910
82.10.1.1	Channel mode modify / successful case.....	4910
82.10.2	Channel mode modify procedure / negative cases	4911
82.10.2.1	Channel mode modify indicates non-supported mode	4911
83	GAN PS Domain Procedures	4913
83.1	GA-PSR Transport Channel Activation & Deactivation Procedures	4913
83.1.1	GA-PSR Transport Channel Activation & Deactivation Procedures, Normal Cases	4913
83.1.1.1	MS Initiated GA-PSR TC Activation.....	4913
83.1.2	GA-PSR Transport Channel Activation & Deactivation Procedures, Abnormal Cases.	4914
83.1.2.1	GA-PSR TC Activation Collision	4914
83.1.2.2	GANC Rejects GA-PSR TC Activation.....	4915
83.1.3	Network Initiated GA-PSR Transport Channel Activation, Normal Case.....	4917
83.1.3.1	Processing of the GA-PSR TC Activation Request by the MS.....	4917
83.1.4	Network Initiated GA-PSR Transport Channel Activation, Abnormal Cases	4918
83.1.4.1	Void.....	4918
83.1.4.2	MS Rejects GA-PSR TC Activation when the GPRS Service is suspended.....	4918
83.1.4.3	MS Receives GA-PSR TC Activation Request while GA-PSR TC active	4920
83.1.5	MS Initiated Deactivation of GA-PSR Transport Channel, Normal Case	4921
83.1.5.1	GA-PSR TC Deactivation Initiation by the MS	4921
83.1.6	MS Initiated Deactivation of GA-PSR Transport Channel, Abnormal Cases.....	4922
83.1.6.1	Uplink User Data Transfer is initiated while GA-PSR TC Deactivation is in Progress.....	4922
83.1.6.2	Downlink User Data Transfer is received while the GA-PSR TC Deactivation is in Progress.....	4923
83.1.6.3	Unexpected GA-PSR-DEACTIVATE-UTC-ACK response	4924
83.1.6.4	Unexpected GA-PSR-ACTIVATE-UTC-REQ.....	4926
83.1.7	GANC Initiated Deactivation of GA-PSR Transport Channel, Normal Case.....	4927

83.1.7.1.	GA-PSR TC Deactivation Initiation by the GANC	4927
83.1.8	Void	4928
83.2	GA-PSR GPRS User Data Transport	4928
83.2.1	GA-PSR GPRS User Data Transport , Normal Cases	4928
83.2.1.1	MS Initiates Uplink GPRS User Data Transfer.....	4928
83.2.2	GA-PSR GPRS User Data Transport , Abnormal Cases	4930
83.2.2.1	Void.....	4930
83.2.2.2	Void.....	4930
83.3	Packet paging for packet service	4930
83.3.1	PS Paging Request Processed by the MS, Normal Case.....	4930
83.3.1.1	PS Paging Request Processed by the MS	4930
83.4	GPRS Suspend Procedure	4931
83.4.1	GPRS Suspension Initiation by the MS, normal Case	4931
83.4.1.1	GPRS Suspension Initiation by the MS	4931
83.5	Downlink Flow Control.....	4932
83.5.1	Initiation of the Downlink Flow Control and Processing of the TU4003 Timer Expiry by the MS, Normal Case	4932
83.5.1.1	Initiation of the Downlink Flow Control and Processing of the TU4003 Timer Expiry by the MS	4932
83.6	Uplink Flow Control	4933
83.6.1	Processing of the Uplink Flow Control Request by the MS, Normal Case	4933
83.6.1.1	Processing of the Uplink Flow Control Request by the MS.....	4933
83.6.2	Processing of the Uplink Flow Control Request by the MS, Abnormal Cases.....	4935
83.6.2.1	GA-PSR TC in not Active.....	4935
90	Text Telephony (TTY) Services.....	4935
90.1	Transmission of CTM Bearer Code	4936
90.1.1	Mobile Originated TTY Call	4936
90.1.2	Mobile Terminated TTY Call	4937
Annex 1 (normative): Reference test methods		4938
A1.1	General Conditions (GC).....	4938
A1.1.1	Outdoor test site and general arrangements for measurements involving the use of radiated fields (GC4)	4938
A1.1.2	Anechoic shielded chamber (GC5).....	4938
A1.1.3	Temporary antenna connector (GC7).....	4939
A1.1.4	Temporary antenna connector characteristics	4939
A1.1.5	Calibration of the temporary antenna connector	4940
A1.1.5.1	Antenna radiation pattern.....	4940
A1.1.5.2	Test range calibration.....	4942
A1.1.5.3	Temporary antenna connector coupling factor	4942
A1.1.6	Connection of devices with multiple antennae.....	4943
A1.1.6.1	DARP phase 2 MS	4943
A1.2	Normal and extreme Test Conditions (TC).....	4943
A1.2.1	Power sources and ambient temperatures (TC2).....	4943
A1.2.2	Normal test conditions (TC2.1).....	4944
A1.2.3	Extreme test conditions (TC2.2).....	4944
A1.2.4	Vibration requirements (TC4).....	4945
Annex 2: Not used		4946
Annex 3: Protocol implementation information.....		4947
A3.1	Protocol Implementation Conformance Statement (PICS)	4947
A3.1.1	LAPDm protocol (3GPP TS 04.05 and 04.06).....	4947
A3.1.1.1	Simplified protocol - 3GPP TS 04.06 clause 6	4947
A3.1.1.2	Management of SAPI = 3 - 3GPP TS 04.11 subclause 2.3	4947
A3.1.2	Mobility management.....	4947
A3.1.2.1	IMSI detach initiation by the MS - 3GPP TS 04.08 / 3GPP TS 24.008 subclause 4.3.4.1	4947
A3.1.2.2	IMSI detach completion by the MS - 3GPP TS 04.08 / 3GPP TS 24.008 subclause 4.3.4.3.....	4947
A3.1.2.3	MM specific procedures - 3GPP TS 04.08 / 3GPP TS 24.008 subclauses 4.4 and 4.5.1.1	4947
A3.1.2.4	Receiving an MM STATUS message - 3GPP TS 04.08 / 3GPP TS 24.008 subclause 4.6	4947
A3.1.3	Call control.....	4948
A3.1.3.1	Status enquiry procedures - 3GPP TS 04.08 / 3GPP TS 24.008 subclause 5.5.3.1.....	4948

A3.1.3.2	Receiving a STATUS message by a CC entity - 3GPP TS 04.08 / 3GPP TS 24.008 subclause 5.5.3.2	4948
A3.1.3.3	Called side compatibility checking - 3GPP TS 04.08 / 3GPP TS 24.008 clause B.3	4948
A3.1.3.4	Disconnect on incoming call	4948
A3.1.4	Layer 1	4948
A3.1.4.1	Optional storage of BCCH carrier information - 3GPP TS 05.08 subclause 6.3	4948
A3.1.5	Autocalling - (ref.: 3GPP TS 02.07, annex 1)	4948
A3.1.6	Transient states	4948
A3.2	Protocol Implementation Extra Information for Testing (PIXIT)	4949
A3.2.0	Introduction	4949
A3.2.1	Basic characteristics	4949
A3.2.1.1	Type of antenna	4949
A3.2.1.2	Power supply	4950
A3.2.1.3	Power class of the MS	4950
A3.2.1.4	Channel modes supported	4950
A3.2.1.5	Teleservices supported	4950
A3.2.1.6	Supplementary services supported	4950
A3.2.1.7	Bearer services supported	4950
A3.2.1.8	SIM removal	4951
A3.2.1.9	Classmark	4951
A3.2.1.10	Type of SIM/ME interface (ref. 3GPP TS 11.11 and 3GPP TS 11.12)	4952
A3.2.1.11	Multislot class	4952
A3.2.2	Man machine interface	4952
A3.2.2.1	Mobile station features	4952
A3.2.2.2	Short message service	4953
A3.2.2.3	Supplementary services	4953
A3.2.2.3.1	Call forwarding	4953
A3.2.2.3.2	Call restriction	4953
A3.2.2.3.3	Handling of (undefined) GSM supplementary services	4954
A3.2.3	Electrical Man Machine Interface (EMMI)	4954
A3.2.3.1	Methods supported for activation/deactivation of EMMI	4954
A3.2.3.2	Transmission rate supported by the ME on the EMMI	4954
A3.2.3.3	Layer 3 messages supported on the EMMI	4954
A3.2.3.4	Keystroke sequence messages	4954
A3.2.3.5	Internal malfunction detected messages	4954
A3.2.4	Digital Audio Interface (DAI)	4954
A3.2.5	Characteristics related to bearer services or teleservices	4955
A3.2.5.1	Access interface	4955
A3.2.5.2	Configuration of the MT	4955
A3.2.5.3	Capability information	4955
A3.2.5.4	Subaddress or DDI number	4955
A3.2.5.5	User to user signalling	4955
A3.2.5.6	Data call set-up and data call clearing	4955
A3.2.5.7	Characteristics of non-transparent data services	4956
A3.2.5.8	Possible ways of setting-up a call from either an external interface or internally	4956
A3.2.5.9	Application layer causing automatic call termination	4956
A3.2.5.10	Call re-establishment for MS not supporting speech	4956
A3.2.6	International mobile station equipment identity	4956
A3.2.7	Receiver intermediate frequencies	4956
A3.2.8	Artificial ear	4956
Annex 4:	Test SIM Parameters	4960
A4.1	Introduction	4960
A4.1.1	Definitions	4960
A4.1.2	Definition of the test algorithm for authentication	4960
A4.2	Default Parameters for the test SIM	4960
A4.3	Default settings for the Elementary Files (EFs)	4960
A4.3.1	EF _{ICCID} (ICC Identification)	4961
A4.3.2	EF _{LP} (Language preference)	4961
A4.3.3	EF _{IMSI} (IMSI)	4961
A4.3.4	EF _{Kc} (Ciphering key Kc)	4961

A4.3.5	EF _{PLMNsel} (PLMN selector)	4961
A4.3.6	EF _{HPLMN} (HPLMN search period)	4962
A4.3.7	EF _{ACMmax} (ACM maximum value)	4962
A4.3.8	EF _{SST} (SIM service table)	4962
A4.3.9	EF _{ACM} (Accumulated call meter)	4963
A4.3.10	EF _{PUCT} (Price per unit and currency table)	4963
A4.3.11	EF _{CBMI} (Cell broadcast Message Identifier Selection)	4963
A4.3.12	EF _{BCCH} (Broadcast control channels)	4963
A4.3.13	EF _{ACC} (Access control class)	4963
A4.3.14	EF _{FPLMN} (Forbidden PLMNs)	4963
A4.3.15	EF _{LOCi} (Location information)	4963
A4.3.16	EF _{AD} (Administrative data)	4964
A4.3.17	EF _{Phase} (Phase identification)	4964
A4.3.18	EF _{ADN} (Abbreviated dialling numbers)	4964
A4.3.19	EF _{FDN} (Fixed dialling numbers)	4964
A4.3.20	EF _{SMS} (Short messages)	4964
A4.3.21	EF _{CCP} (Capability configuration parameters)	4965
A4.3.22	EF _{MSISDN} (MSISDN)	4965
A4.3.23	EF _{SMSp} (Short message service parameters)	4965
A4.3.24	EF _{SMSs} (SMS status)	4965
A4.3.25	EF _{EXT1} (Extension 1)	4965
A4.3.26	EF _{EXT2} (Extension 2)	4965
A4.3.27	EF _{VGCS} (Voice Group Call Service)	4965
A4.3.28	EF _{VGCSs} (Voice Group Call Service Status)	4966
A4.3.29	EF _{VBS} (Voice Broadcast Service)	4966
A4.3.30	EF _{VBSs} (Voice Broadcast Service Status)	4967
A4.3.31	EF _{eMLPP} (enhanced Multi Level Pre-emption and Priority)	4967
A4.3.32	EF _{AAeM} (Automatic Answer for eMLPP Service)	4968
A4.3.33	EF _{KcGPRS} (GPRS Ciphering key KcGPRS)	4968
A4.3.34	EF _{LOCIGPRS} (GPRS location information)	4968
Annex 5:	Test equipment	4969
A5.1	Introduction	4969
A5.1.1	General	4969
A5.1.2	Test equipment terms	4969
A5.1.3	Confidence level	4969
A5.2	Standard test signals	4970
A5.3	SS functional requirements	4970
A5.3.1	Level setting range	4970
A5.3.2	Level Measurement / operation range	4970
A5.3.3	MS power supply interface	4970
A5.3.4	MS antenna interface	4971
A5.3.4.1	Uplink receiver error	4971
A5.3.4.2	Power and Power versus time measurements	4971
A5.3.4.3	Wideband selective power measurement	4974
A5.3.4.4	Inband selective power measurements	4974
A5.3.4.5	Modulation accuracy and frequency error measurements	4975
A5.3.4.6	RF delay measurements relative to nominal times	4975
A5.3.4.7	The wanted signal or traffic channel of serving cell	4975
A5.3.4.8	The first interfering signal or traffic channel of the first adjacent cell	4977
A5.3.4.9	The second interfering signal	4977
A5.3.4.10	BCCH carriers of serving and adjacent cells	4978
A5.3.4.11	The wide frequency range signal	4979
A5.3.4.12	The multipath fading function	4980
A5.3.5	MS audio interface and DAI	4980
A5.3.5.1	General uncertainties	4980
A5.3.5.2	Analogue single test tone	4980
A5.3.5.3	Delay measurement between Um and DAI	4980
A5.4	SIM simulator functional requirements	4980
A5.4.1	General	4980

A5.4.2	Contacts C1, C2, C6, C7	4981
A5.4.2.1	Default measurement / setting uncertainties	4981
A5.4.2.2	Contact C1	4981
A5.4.2.3	Contact C7	4982
A5.4.3	Contact C3.....	4983
A5.4.4	Definition of timing.....	4983
A5.5	A-GPS Minimum Performance Test System requirements.....	4983
A5.5.1	Test System Uncertainty for A-GPS Minimum Performance tests.....	4983
A5.5.2	Test Parameter Relaxations (This clause is informative).....	4984
A5.5.3	Interpretation of measurement results.....	4985
A5.5.4	Derivation of Test Requirements (This clause is informative).....	4985
Annex 6 (informative): E-OTD Accuracy Measurement Test Environment		4987
A6.1	Recommended Timing Accuracy Test Environment (Unassisted)	4987
A6.2	Recommended Timing Accuracy Test Environment (Assisted).....	4988
Annex 7 (informative): General rules for statistical testing.....		4992
A7.1	Statistical testing of receiver performance	4992
A7.1.1	Basics.....	4992
A7.1.1.1	Definition of (error) events	4992
A7.1.1.2	Test Method	4992
A7.1.1.3	Test Criteria.....	4992
A7.1.1.4	Calculation assumptions.....	4993
A7.1.2	Definition of good pass fail decision	4994
A7.1.3	Implementation.....	4995
A7.1.3.1	Proceeding.....	4995
A7.1.3.2	Limit lines	4995
A7.1.4	Good balance between test time and statistical significance.....	4997
A7.1.5	Minimum and maximum expected duration of tests.....	4998
A7.2	Statistical testing of 2 D position error and TTFF for A-GPS Minimum Performance test cases.....	4998
A7.2.1	Test Method.....	4998
A7.2.2	Error Ratio (ER)	4999
A7.2.3	Test Design	4999
A7.2.3.1	Confidence level	4999
A7.2.3.2	Introduction: Supplier Risk versus Customer Risk	4999
A7.2.3.3	Supplier Risk versus Customer Risk	4999
A7.2.3.4	Introduction: Standard test versus early decision concept.....	5000
A7.2.3.5	Standard test versus early decision concept	5000
A7.2.3.6	Selectivity.....	5001
A7.2.3.7	Design of the test.....	5001
A7.2.4	Pass fail decision.....	5003
A7.2.4.1	Numerical definition of the pass fail limits	5003
A7.2.4.2	Pass fail decision rules	5003
A7.2.4.3	Background information to the pass fail limits	5004
Annex 8 (normative): GPS data files		5005
A8.1	GPS data files for signalling tests.....	5005
A8.2	GPS data files for Minimum Performance tests	5005
Annex 9 (normative): GAN certificate		5006
A9.1	Files relating to GAN certificate for testing	5006
A9.1.1	Overview and usage of certificate files.....	5006
A9.1.2	Privacy of private keys and usage of certificate.....	5006
Annex 10 (informative): Repeated SACCH Layer 1 Test Method:		5007
A10.1	Details on Repeated SACCH Testing.....	5007
Annex B (informative): Change history		5010
History		5105

Foreword

This Technical Specification has been produced by the 3rd Generation Partnership Project (3GPP).

The contents of the present document are subject to continuing work within the TSG and may change following formal TSG approval. Should the TSG modify the contents of the present document, it will be re-released by the TSG with an identifying change of release date and an increase in version number as follows:

Version x.y.z

where:

- x the first digit:
 - 1 presented to TSG for information;
 - 2 presented to TSG for approval;
 - 3 or greater indicates TSG approved document under change control.
- y the second digit is incremented for all changes of substance, i.e. technical enhancements, corrections, updates, etc.
- z the third digit is incremented when editorial only changes have been incorporated in the document.

The present document is part 1 of a multi-part deliverable covering the Digital cellular telecommunications system (GSM Phase2 and Phase 2+ Releases 1996, 1997, 1998, 1999, 3GPP Release 4, 3GPP Release 5, 3GPP Release 6 and 3GPP Release 7); Mobile Station (MS) conformance specification, as identified below:

Part 1: Conformance specification

Reference: 3GPP TS 51.010-1.

Part 2: Protocol Implementation Conformance Statement (PICS) proforma specification.
Reference: 3GPP TS 51.010-2.

Part 3: Layer 3 (L3) Abstract Test Suite (ATS).
Reference: 3GPP TS 51.010-3.

Part 4: SIM Application Toolkit conformance specification.
Reference: 3GPP TS 11.10-4.

Part 5: Inter-RAT (GERAN to UTRAN) Abstract Test Suite (ATS)
Reference: 3GPP TS 51.010-5.

1 Scope

The present document describes the technical characteristics and methods of test for Mobile Stations (MS), for the Pan European digital cellular communications system and Personal Communication Systems (PCS) operating in the 400 MHz, 700 MHz, 810 MHz, 850 MHz, 900 MHz, 1 800 MHz and 1 900 MHz band (GSM 450, GSM 480, GSM 710, GSM 750, T-GSM 810, GSM 850, GSM 900, DCS 1 800 and PCS 1 900), standardized by ETSI Special Mobile Group (SMG).

The present document is valid for MS implemented according to GSM Phase2 or Phase2+ R96, or R97, or R98, or R99 or 3GPP Release 4 or 3GPP Release 5 or 3GPP Release 6 or 3GPP Release 7.

A subset of the tests is referenced in the GSM Common Technical Regulations (CTRs) and is used for regulatory conformance testing according to the EEC procedures for Telecommunications Terminal Equipment (TTE) type approval (EC Directive 91/263/EEC; also known as the "Terminal Directive" or "Second Phase Directive"). The remaining tests can be used to verify conformance with the GSM core technical specifications for those requirements that are not considered "essential" in the sense of the EC Directive 91/263/EEC (Article 4).

The present document covers the minimum characteristics considered necessary in order to provide sufficient performance for mobile equipment and to prevent interference to other services or to other users, and to the PLMNs.

It does not necessarily include all the characteristics which may be required by a user or subscriber, nor does it necessarily represent the optimum performance achievable.

It applies to the public land mobile radio service in the GSM systems named above, using constant envelope modulation and operating on radio frequencies in the frequency bands listed above respectively with a channel separation of 200 kHz and carrying 8 full rate channels or 16 half rate channels per carrier according to the TDMA principle.

The present document is part of the GSM-series of technical specifications. The present document neither replaces any of the other GSM technical specifications or GSM related ETSs or ENs, nor is it created to provide full understanding of (or parts of) GSM systems. The present document lists the requirements, and provides the methods of test for testing a MS for conformance to the GSM standard.

For a full description of the system, reference should be made to all the GSM technical specifications or GSM related ETSs or ENs. Clause 2 provides a complete list of the GSM technical specifications, GSM related ETSs, ENs, and ETRs, on which this conformance test specifications is based.

The present document applies to the unit which includes the hardware to establish a connection across the radio interface.

If there is a difference between this conformance document, and any other GSM technical specification or GSM related ETS or EN, or 3GPP TS, then the other GSM technical specification or GSM related ETS or EN or 3GPP TS shall prevail.

2 References

The following documents contain provisions which, through reference in this text, constitute provisions of the present document.

- References are either specific (identified by date of publication and/or edition number or version number) or non-specific.
- For a specific reference, subsequent revisions do not apply.
- For a non-specific reference, the latest version applies. In the case of a reference to a 3GPP document (including a GSM document), a non-specific reference implicitly refers to the latest version of that document *in the relevant Release*.
 - For a GSM Phase 2+ Release 7 MS, references to GSM documents are to version 7.x.y, when available.
 - For a GSM Phase 2+ Release 6 MS, references to GSM documents are to version 6.x.y, when available.

- For a GSM Phase 2+ Release 5 MS, references to GSM documents are to version 5.x.y, when available.
- For a GSM Phase 2+ Release 4 MS, references to GSM documents are to version 4.x.y, when available.
- For a GSM Phase 2+ Release 1999 MS, references to GSM documents are to version 8.x.y (for 01.-series to 12.-series) or (3.x.y for 21.-series to 35.-series), when available.
- For a GSM Phase 2+ Release 1998 MS, references to GSM documents are to version 7.x.y, when available.
- For a GSM Phase 2+ Release 1997 MS, references to GSM documents are to version 6.x.y, when available.
- For a GSM Phase 2+ Release 1996 MS, references to GSM documents are to version 5.x.y, when available.
- For a GSM Phase 2 MS, references to GSM documents are to version 4.x.y.

NOTE: References to 3GPP Technical Specifications and Technical Reports throughout the present document shall be interpreted according to the Release shown in the formal reference in this clause, based upon the Release of the implementation under test.

EXAMPLE 1: References for a Ph2 MS shall be interpreted as:

[1] 3GPP TS 01.04 Ph2

[2] 3GPP TS 02.02 Ph2

etc.

EXAMPLE 2: References for a Rel-4 MS shall be interpreted as:

[1] 3GPP TS 21.905 Rel-4

[2] 3GPP TS 22.002 Rel-4

etc.

- [1] 3GPP TS 01.04 (Ph2 to R99): "Abbreviations and acronyms".
3GPP TR 21.905 (R99 onwards): "Vocabulary for 3GPP Specifications".
- [2] 3GPP TS 02.02 (Ph2 to R98): "Bearer Services (BS) supported by a GSM Public Land Mobile Network (PLMN)".
3GPP TS 22.002 (R99 onwards): "Circuit Bearer Services (BS) supported by a Public Land Mobile Network (PLMN)".
- [3] 3GPP TS 02.03 (Ph2 to R98): "Teleservices supported by a GSM Public Land Mobile Network (PLMN)".
3GPP TS 22.003 (R99 onwards): "Circuit Teleservices supported by a Public Land Mobile Network (PLMN)".
- [4] 3GPP TS 02.04 (Ph2 to R98): "General on supplementary services".
3GPP TS 22.004 (R99 onwards): "General on supplementary services".
- [5] 3GPP TS 02.06 (Ph2 to R98): "Types of Mobile Stations (MS)".
- [6] 3GPP TS 02.07 (Ph2 to R98): "Mobile Station (MS) features".
- [7] 3GPP TS 02.09 (Ph2 to R99): "Security aspects".
3GPP TS 42.009 (Rel-4 onwards): "Security aspects".
- [8] 3GPP TS 02.11 (Ph2 to R98): "Service accessibility".
3GPP TS 22.011 (R99 onwards): "Service accessibility".
- [9] 3GPP TS 02.17 (Ph2 to R99): "Subscriber Identity Modules (SIM); Functional characteristics".
3GPP TS 42.017 (Rel-4 onwards): "Subscriber Identity Modules (SIM); Functional characteristics".
- [10] 3GPP TS 02.24 (Ph2 to R98): "Description of Charge Advice Information (CAI)".
3GPP TS 22.024 (R99 onwards): "Description of Charge Advice Information (CAI)".

- [11] 3GPP TS 02.30 (Ph2 to R98): "Man-Machine Interface (MMI) of the Mobile Station (MS)".
3GPP TS 22.030 (R99 onwards): "Man-Machine Interface (MMI) of the User Equipment (UE)".
- [12] 3GPP TS 02.81 (Ph2 to R98): "Line identification supplementary services; Stage 1".
3GPP TS 22.081 (R99 onwards): "Line identification supplementary services; Stage 1".
- [13] 3GPP TS 02.83 (Ph2 to R98): "Call Waiting (CW) and Call Holding (HOLD); Supplementary Services; Stage 1".
3GPP TS 22.083 (R99 onwards): "Call Waiting (CW) and Call Holding (HOLD); Supplementary Services; Stage 1".
- [14] 3GPP TS 02.84 (Ph2 to R98): "MultiParty (MPTY) supplementary services; Stage 1".
3GPP TS 22.084 (R99 onwards): "MultiParty (MPTY) Supplementary Services; Stage 1".
- [15] 3GPP TS 02.86 (Ph2 to R98): "Advice of Charge (AoC) Supplementary Services; Stage 1".
3GPP TS 22.086 (R99 onwards): "Advice of Charge (AoC) Supplementary Services; Stage 1".
- [16] 3GPP TS 02.88 (Ph2 to R98): "Call Barring (CB) Supplementary Services; Stage 1".
3GPP TS 22.088 (R99 onwards): "Call Barring (CB) Supplementary Services; Stage 1".
- [17] 3GPP TS 02.90 (Ph2 to R98): "Unstructured Supplementary Service Data (USSD); Stage 1".
3GPP TS 22.090 (R99 onwards): "Unstructured Supplementary Service Data (USSD); Stage 1".
- [18] 3GPP TS 03.03 (Ph2 to R98): "Numbering, addressing and identification".
3GPP TS 23.003 (R99 onwards): "Numbering, Addressing and Identification".
- [19] 3GPP TS 03.11 (Ph2 to R98): "Technical realization of supplementary services".
3GPP TS 23.011 (R99 onwards): "Technical realization of Supplementary Services".
- [20] 3GPP TS 03.20 (Ph2 to R99): "Security related network functions".
3GPP TS 43.020 (Rel-4 onwards): "Security related network functions".
- [21] 3GPP TS 03.22 (Ph2 to R99): "Functions related to Mobile Station (MS) in idle mode and group receive mode".
3GPP TS 43.022 (Rel-4 onwards): "Functions related to Mobile Station (MS) in idle mode and group receive mode".
- [22] 3GPP TS 03.38 (Ph2 to R98): "Alphabets and language-specific information".
3GPP TS 23.038 (R99 onwards): "Alphabets and language-specific information".
- [23] 3GPP TS 03.40 (Ph2 to R98): "Technical realization of the Short Message Service (SMS); Point-to-Point (PP)".
3GPP TS 23.040 (R99 onwards): "Technical realization of the Short Message Service (SMS)".
- [24] 3GPP TS 03.41 (Ph2 to R98): "Technical realization of Cell Broadcast Service (CBS)".
3GPP TS 23.041 (R99 onwards): "Technical realization of Cell Broadcast Service (CBS)".
- [25] 3GPP TS 03.45 (Ph2 to R99): "Technical realization of facsimile group 3 transparent".
3GPP TS 43.045 (Rel-4 onwards): "Technical realization of facsimile group 3 service - transparent".
- [26] 3GPP TS 03.50 (Ph2 to R99): "Transmission planning aspects of the speech service in the GSM Public Land Mobile Network (PLMN) system".
3GPP TS 43.050 (Rel-4 onwards): "Transmission planning aspects of the speech service in the GSM Public Land Mobile Network (PLMN) system".
- [27] 3GPP TS 03.86 (Ph2 to R98): "Advice of Charge (AoC) supplementary services; Stage 2".
3GPP TS 23.086 (R99 onwards): "Advice of Charge (AoC) supplementary services; Stage 2".
- [28] 3GPP TS 04.04 (Ph2 to R99): "Layer 1; General requirements".
3GPP TS 44.004 (Rel-4 onwards): "Layer 1; General requirements".
- [29] 3GPP TS 04.05 (Ph2 to R99): "Data Link (DL) layer; General aspects".
3GPP TS 44.005 (Rel-4 onwards): "Data Link (DL) layer; General aspects".

- [30] 3GPP TS 04.06 (Ph2 to R99): "Mobile Station - Base Station System (MS-BSS) interface; Data Link (DL) layer specification".
3GPP TS 44.006 (Rel-4 onwards): "Mobile Station - Base Station System (MS-BSS) interface; Data Link (DL) layer specification".
- [31] 3GPP TS 04.07 (Ph2 to R98): "Mobile radio interface signalling layer 3; General aspects".
3GPP TS 24.007 (R99 onwards): "Mobile radio interface signalling layer 3; General aspects".
- [32] 3GPP TS 04.08 (Ph2 to R99): "Mobile radio interface layer 3 specification" (see note 1).3GPP TS 24.008 (R99 onwards): "Mobile radio interface layer 3 specification; Core network protocols; Stage 3" (see note 1).
3GPP TS 44.008 (Rel-4): "Mobile radio interface layer 3 specification" (see note 1).
- [33] 3GPP TS 04.10 (Ph2 to R98): "Mobile radio interface layer 3; Supplementary services specification; General aspects".
3GPP TS 24.010 (R99 onwards): "Mobile radio Interface Layer 3; Supplementary services specification; General aspects".
- [34] 3GPP TS 04.11 (Ph2 to R98): "Point-to-Point (PP) Short Message Service (SMS) support on mobile radio interface".
3GPP TS 24.011 (R99 onwards): "Point-to-Point (PP) Short Message Service (SMS) Support on mobile radio interface".
- [35] 3GPP TS 04.12 (Ph2 to R99): "Short Message Service Cell Broadcast (SMSCB) support on the mobile radio interface".
3GPP TS 44.012 (Rel-4 onwards): "Short Message Service Cell Broadcast (SMSCB) Support on the mobile radio interface".
- [36] 3GPP TS 04.13 (Ph2 to R99): "Performance requirements on the mobile radio interface".3GPP TS 44.013 (Rel-4 onwards): "Performance requirements on the mobile radio interface".
- [37] 3GPP TS 04.21 (Ph2 to R99): "Rate adaption on the Mobile Station - Base Station System (MS - BSS) Interface".
3GPP TS 44.021 (Rel-4 onwards): "Rate adaption on the Mobile Station - Base Station System (MS - BSS) Interface".
- [38] 3GPP TS 04.22 (Ph2 to R98): "Radio Link Protocol (RLP) for data and telematic services on the Mobile Station - Base Station System (MS-BSS) interface and the Base Station System - Mobile-services Switching Centre (BSS-MSC) interface".3GPP TS 24.022 (R99 onwards): " Radio Link Protocol (RLP) for circuit switched bearer and teleservices".
- [39] 3GPP TS 04.80 (Ph2 to R98): "Mobile radio interface layer 3 supplementary services specification; Formats and coding".
3GPP TS 24.080 (R99 onwards): "Mobile radio layer 3 supplementary services specification; Formats and coding".
- [40] 3GPP TS 04.81 (Ph2 to R98): "Line identification supplementary services; Stage 3".
3GPP TS 24.081 (R99 onwards): "Line identification supplementary services; Stage 3".
- [41] 3GPP TS 04.82 (Ph2 to R98): "Call Forwarding (CF) supplementary services; Stage 3".
3GPP TS 24.082 (R99 onwards): "Call Forwarding (CF) supplementary services; Stage 3".
- [42] 3GPP TS 04.83 (Ph2 to R98): "Call Waiting (CW) and Call Hold (HOLD) supplementary services; Stage 3".
3GPP TS 24.083 (R99 onwards): "Call Waiting (CW) and Call Hold (HOLD) supplementary services; Stage 3".
- [43] 3GPP TS 04.84 (Ph2 to R98): "MultiParty (MPTY) supplementary services; Stage 3".
3GPP TS 24.084 (R99 onwards): "Multiparty (MPTY) supplementary services; Stage 3".
- [44] 3GPP TS 04.86 (Ph2 to R98): "Advice of Charge (AoC) supplementary services; Stage 3".
3GPP TS 24.086 (R99 onwards): "Advice of Charge (AoC) supplementary services; Stage 3".
- [45] 3GPP TS 04.88 (Ph2 to R98): "Call Barring (CB) supplementary services; Stage 3".
3GPP TS 24.088 (R99 onwards): "Call Barring (CB) supplementary services; Stage 3".

- [46] 3GPP TS 04.90 (Ph2 to R98): "Unstructured Supplementary Service Data (USSD); Stage 3".
3GPP TS 24.090 (R99 onwards): "Unstructured Supplementary Service Data (USSD); Stage 3".
- [47] 3GPP TS 05.02 (Ph2 to R99): "Multiplexing and multiple access on the radio path".
3GPP TS 45.002 (Rel-4 onwards): "Multiplexing and multiple access on the radio path".
- [48] 3GPP TS 05.03 (Ph2 to R99): "Channel coding".
3GPP TS 45.003 (Rel-4 onwards): "Channel coding".
- [49] 3GPP TS 05.04 (Ph2 to R99): "Modulation".
3GPP TS 45.004 (Rel-4 onwards): "Modulation".
- [50] 3GPP TS 05.05 (Ph2 to R99): "Radio transmission and reception".
3GPP TS 45.005 (Rel-4 onwards): "Radio transmission and reception".
- [51] 3GPP TS 05.08 (Ph2 to R99): "Radio subsystem link control".
3GPP TS 45.008 (Rel-4 onwards): "Radio subsystem link control".
- [52] 3GPP TS 05.09 (Ph2 to R99): "Link Adaptation".
3GPP TS 45.009 (Rel-4 onwards): "Link Adaptation".
- [53] 3GPP TS 05.10 (Ph2 to R99): "Radio subsystem synchronization".
3GPP TS 45.010 (Rel-4 onwards): "Radio subsystem synchronization".
- [54] 3GPP TS 06.01 (Ph2 to R99): "Full rate speech; Processing functions".
3GPP TS 46.001 (Rel-4 onwards): "Full rate speech; Processing functions".
- [55] 3GPP TS 06.02 (Ph2 to R99): "Half rate speech; Half rate speech processing functions".
3GPP TS 46.002 (Rel-4 onwards): "Half rate speech processing functions".
- [56] 3GPP TS 06.07 (Ph2 to R99): "Half rate speech; Test sequences for the GSM half rate speech codec".
3GPP TS 46.007 (Rel-4 onwards): "Half rate speech; Test sequences for the GSM half rate speech codec".
- [57] 3GPP TS 06.10 (Ph2 to R99): "Full rate speech; Transcoding".
3GPP TS 46.010 (Rel-4 onwards): "Full rate speech transcoding".
- [58] 3GPP TS 06.11 (Ph2 to R99): "Full rate speech; Substitution and muting of lost frames for full rate speech channels".
3GPP TS 46.011 (Rel-4 onwards): "Substitution and muting of lost frames for full rate speech channels".
- [59] 3GPP TS 06.12 (Ph2 to R99): "Comfort noise aspect for full rate speech traffic channels".
3GPP TS 46.012 (Rel-4 onwards): "Comfort noise aspect for full rate speech traffic channels".
- [60] 3GPP TS 06.20 (Ph2 to R99): "Half rate speech; Half rate speech transcoding".
3GPP TS 46.020 (Rel-4 onwards): "Half rate speech transcoding".
- [61] 3GPP TS 06.21 (Ph2 to R99): "Half rate speech; Substitution and muting of lost frames for half rate speech traffic channels".
3GPP TS 46.021 (Rel-4 onwards): "Half rate speech; Substitution and muting of lost frames for half rate speech traffic channels".
- [62] 3GPP TS 06.22 (Ph2 to R99): "Half rate speech; Comfort noise aspects for the half rate speech traffic channels".
3GPP TS 46.022 (Rel-4 onwards): "Half rate speech; Comfort noise aspects for the half rate speech traffic channels".
- [63] 3GPP TS 06.31 (Ph2 to R99): "Full rate speech; Discontinuous Transmission (DTX) for full rate speech traffic channels".
3GPP TS 46.031 (Rel-4 onwards): "Full rate speech; Discontinuous Transmission (DTX) for full rate speech traffic channels".

- [64] 3GPP TS 06.32 (Ph2 to R99): "Full rate speech; Voice Activity Detector (VAD) for full rate speech traffic channels".
3GPP TS 46.032 (Rel-4 onwards): "Full rate speech; Voice Activity Detector (VAD) for full rate speech traffic channels".
- [65] 3GPP TS 06.41 (Ph2 to R99): "Half rate speech; Discontinuous Transmission (DTX) for half rate speech traffic channels".
3GPP TS 46.041 (Rel-4 onwards): "Half rate speech; Discontinuous Transmission (DTX) for half rate speech traffic channels".
- [66] 3GPP TS 06.42 (Ph2 to R99): "Half rate speech; Voice Activity Detector (VAD) for half rate speech traffic channels".
3GPP TS 46.042 (Rel-4 onwards): "Half rate speech; Voice Activity Detector (VAD) for half rate speech traffic channels".
- [67] 3GPP TS 07.01 (Ph2 to R98): "General on Terminal Adaptation Functions (TAF) for Mobile Stations (MS)".
3GPP TS 27.001 (R99 onwards): "General on Terminal Adaptation Functions (TAF) for Mobile stations (MS)".
- [68] 3GPP TS 07.02 (Ph2 to R98): "Terminal Adaptation Functions (TAF) for services using asynchronous bearer capabilities".
3GPP TS 27.002 (R99 onwards): "Terminal Adaptation Functions (TAF) for services using asynchronous bearer capabilities".
- [69] 3GPP TS 07.03 (Ph2 to R98): "Terminal Adaptation Functions (TAF) for services using synchronous bearer capabilities".
3GPP TS 27.003 (R99 onwards): "Terminal Adaptation Functions (TAF) for services using synchronous bearer capabilities".
- [70] 3GPP TS 09.02 (Ph2 to R98): "Mobile Application Part (MAP) specification".
3GPP TS 29.002 (R99 onwards): "Mobile Application Part (MAP) specification".
- [71] 3GPP TS 09.06 (Ph2 to R98): "Interworking between a Public Land Mobile Network (PLMN) and a Packet Switched Public Data Network/Integrated Services digital Network (PSPDN/ISDN) for support of packet switched data transmission services".
3GPP TS 29.006 (R99 onwards): "Interworking between a Public Land Mobile Network (PLMN) and a Packet Switched Public Data Network/Integrated Services Digital Network (PSPDN/ISDN) for the support of packet switched data transmission services".
- [72] 3GPP TS 09.07 (Ph2 to R98): "General requirements on interworking between the Public Land Mobile Network (PLMN) and the Integrated Services Digital Network (ISDN) or Public Switched Telephone Network (PSTN)".
3GPP TS 29.007 (R99 onwards): "General requirements on interworking between the Public Land Mobile Network (PLMN) and the Integrated Services Digital Network (ISDN) or Public Switched Telephone Network (PSTN)".
- [73] 3GPP TS 11.11 (Ph2 to R99): "Specification of the Subscriber Identity Module - Mobile Equipment (SIM-ME) interface".
3GPP TS 51.011 (Rel-4 onwards): "Specification of the Subscriber Identity Module - Mobile Equipment (SIM-ME) interface".
- [74] 3GPP TS 11.12 (Ph2): "Specification of the 3 Volt Subscriber Identity Module - Mobile Equipment (SIM-ME) interface".
- [75] ITU-T Recommendation E.164: "The international public telecommunication numbering plan".
- [76] ITU-T Recommendation G.122: "Influence of national systems on stability and talker echo in international connections".
- [77] ITU-T Recommendation G.223: "Assumptions for the calculation of noise on hypothetical reference circuits for telephony".

- [78] ITU-T Recommendation G.714: "Separate performance characteristics for the encoding and decoding sides of PCM channels applicable to 4-wire voice-frequency interfaces".
- [79] ITU-T Recommendation G.721: "32 kbit/s Adaptive Differential Pulse Code Modulation (ADPCM)".
- [80] ITU-T Recommendation O.131: "Quantizing distortion measuring equipment using a pseudo-random noise test signal".
- [81] ITU-T Recommendation O.132: "Quantizing distortion measuring equipment using a sinusoidal test signal".
- [82] ITU-T Recommendation O.153: "Basic parameters for the measurement of error performance at bit rates below the primary rate".
- [83] ITU-T Recommendation P.340: "Transmission characteristics of hands-free telephones".
- [84] ITU-T Recommendation P.35: "Handset telephones".
- [85] ITU-T Recommendation P.50: "Artificial voices".
- [86] ITU-T Recommendation P.51: "Artificial mouth".
- [87] ITU-T Recommendation P.64: "Determination of sensitivity/frequency characteristics of local telephone systems".
- [88] ITU-T Recommendation P.76: "Determination of loudness ratings; fundamental principles".
- [89] ITU-T Recommendation P.79: "Calculation of loudness ratings for telephone sets".
- [90] ITU-T Recommendation T.4: "Standardization of Group 3 facsimile terminals for document transmission".
- [91] ITU-T Recommendation T.21: "Standardized tests charts for document facsimile transmission".
- [92] ITU-T Recommendation T.30: "Procedures for document facsimile transmission in the general switched telephone network".
- [93] ITU-T Recommendation V.1: "Equivalence between binary notation symbols and the significant conditions of a two-condition code".
- [94] ITU-T Recommendation V.14: "Transmission of start-stop characters over synchronous bearer channels".
- [95] ITU-T Recommendation V.24: "List of definitions for interchange circuits between data terminal equipment (DTE) and data circuit-terminating equipment (DCE)".
- [96] ITU-T Recommendation V.25bis: "Synchronous and asynchronous automatic dialling procedures on switched networks".
- [97] ITU-T Recommendation V.110: "Support by an ISDN of data terminal equipments with V-Series type interfaces".
- [98] ITU-T Recommendation X.21: "Interface between data terminal equipment and data circuit-terminating equipment for synchronous operation on public data networks".
- [99] ITU-T Recommendation X.208: "Specification of Abstract Syntax Notation One (ASN.1)".
- [100] ITU-T Recommendation X.290: "OSI conformance testing methodology and framework for protocol Recommendations for ITU-T applications - General concepts".
- [101] ISO 3: "Preferred Numbers - Series of preferred Numbers".
- [102] ISO 2110: "Information technology - Data Communication - 25-Pole DTE/DCE interface connector and contact number assignments".

- [103] ISO/IEC 7816-3: "Information technology - Identification cards - Integrated circuit(s) cards with contacts - Part 3: Electronic signals and transmission protocols".
- [104] IEC publication 6068-2-1: "Environmental Testing - Part 2: Tests - Tests A: Cold".
- [105] IEC publication 6068-2-2: "Environmental Testing - Part 2: Tests - Tests B: Dry heat".
- [106] IEC publication 6068-2-36: "Environmental Testing - Part 2: Tests - Test Fdb: Random vibration wide band - Reproducibility Medium".
- [107] ETSI ETR 028: "Radio Equipment and Systems (RES); Uncertainties in the measurement of mobile radio equipment characteristics".
- [108] ITU-T Recommendation P.57 (2005): "Artificial ears".
- [109] 3GPP TS 02.43 (R98 to R99): "Support of Localised Service Area (SoLSA); Service description; Stage 1".
- [110] 3GPP TS 03.73 (R98): "Support of Localised Service Area (SoLSA); Stage 2".
3GPP TS 23.073 (R99 onwards): "Support of Localised Service Area (SoLSA); Stage 2".
- [111] 3GPP TS 04.18 (R99): "Mobile radio interface layer 3 specification; Radio Resource Control Protocol" (see note 1).

3GPP TS 44.018 (Rel-4 onwards): "Mobile radio interface layer 3 specification; Radio Resource Control Protocol" (see note 1).
- [112] Void.
- [114] 3GPP TS 02.67 (R96 to R98): "enhanced Multi-Level Precedence and Pre-emption Service (eMLPP); Stage 1".
3GPP TS 22.067 (R99 onwards): "enhanced Multi-Level Precedence and Pre-emption service (eMLPP); Stage 1".
- [115] 3GPP TS 02.68 (R96 to R99): "Voice Group Call Service (VGCS); Stage 1".

3GPP TS 42.068 (Rel-4 onwards): "Voice Group Call Service (VGCS); Stage 1".
- [116] 3GPP TS 02.69 (R96 to R99): "Voice Broadcast Service (VBS); Stage 1".
3GPP TS 42.069 (Rel-4 onwards): "Voice Broadcast Service (VBS); Stage 1".
- [117] 3GPP TS 02.87 (R98): "User-to-User Signalling (UUS); Service description; Stage 1".
3GPP TS 22.087 (R99 onwards): "User-to-User Signalling (UUS); Service description; Stage 1".
- [118] 3GPP TS 22.094 (R99 onwards): "Follow Me Service description; Stage 1".
- [119] 3GPP TS 03.67 (R96 to R98): "enhanced Multi-Level Precedence and Pre-emption service (eMLPP); Stage 2".
3GPP TS 23.067 (R99 onwards): "enhanced Multi-Level Precedence and Pre-emption service (eMLPP); Stage 2".
- [120] 3GPP TS 03.68 (R96 to R99): "Voice Group Call Service (VGCS); Stage 2".
3GPP TS 43.068 (Rel-4 onwards): "Voice Group Call Service (VGCS); Stage 2".
- [121] 3GPP TS 03.69 (R96 to R99): "Voice Broadcast Service (VBS); Stage 2".
3GPP TS 43.069 (Rel-4 onwards): "Voice Broadcast Service (VBS); Stage 2".
- [122] 3GPP TS 23.094 (R99 onwards): "Follow-Me (FM); Stage 2".
- [123] 3GPP TS 04.67 (R96 to R98): "enhanced Multi-Level Precedence and Pre-emption service (eMLPP); Stage 3".
3GPP TS 24.067 (R99 onwards): "enhanced Multi-Level Precedence and Pre-emption service (eMLPP); Stage 3".
- [124] 3GPP TS 04.68 (R96 to R98): "Group Call Control (GCC) protocol".
3GPP TS 44.068 (Rel-4 onwards): "Group Call Control (GCC) protocol".

- [125] 3GPP TS 04.69 (R96 to R99): "Broadcast Call Control (BCC) protocol".
3GPP TS 44.069 (Rel-4 onwards): "Broadcast Call Control (BCC) protocol".
- [126] 3GPP TS 04.87 (R98): "User-to-User Signalling (UUS) Supplementary Service; Stage 3".
3GPP TS 24.087 (R99 onwards): "User-to-User Signalling (UUS) Supplementary Service; Stage 3".
- [127] Void
- [128] 3GPP TS 25.331 (R99 onwards): "Radio Resource Control (RRC) protocol specification".
- [129] Void
- [130] 3GPP TS 26.131 (R99 onwards): "Terminal Acoustic Characteristics for Telephony: Requirements".
- [131] 3GPP TS 26.132 (R99 onwards): "Narrow band (3,1 kHz) speech and video telephony terminal acoustic test specification".
- [132] 3GPP TS 04.60 (R97 to R99): "General Packet Radio Service (GPRS); Mobile Station (MS) - Base Station System (BSS) interface; Radio Link Control/Medium Access Control (RLC/MAC) protocol".
3GPP TS 44.060 (Rel-4 onwards): "General Packet Radio Service (GPRS); Mobile Station (MS) - Base Station System (BSS) interface; Radio Link Control/Medium Access Control (RLC/MAC) protocol".
- [133] 3GPP TS 04.64 (R97 to R99): "General Packet Radio Service (GPRS); Mobile Station - Serving GPRS Support Node (MS-SGSN) Logical Link Control (LLC) layer specification".
3GPP TS 44.064 (Rel-4 onwards): "Mobile Station - Serving GPRS Support Node (MS-SGSN) Logical Link Control (LLC) layer specification".
- [134] 3GPP TS 04.65 (R97 to R99): "General Packet Radio Service (GPRS); Mobile Station (MS) - Serving GPRS Support Node (SGSN); Subnetwork Dependent Convergence Protocol (SNDTCP)".
3GPP TS 44.065 (Rel-4 onwards): "Mobile Station (MS) - Serving GPRS Support Node (SGSN); Subnetwork Dependent Convergence Protocol (SNDTCP)".[135]3GPP TS 03.87 (R98): User-to-User Signalling (UUS); Stage 2".
3GPP TS 23.087 (R99 onwards): "User-to-User Signalling (UUS) Supplementary Service; Stage 2".
- [136] Council Directive 91/263/EEC of 29 April 1991 on the approximation of the laws of the Member States concerning telecommunications terminal equipment, including the mutual recognition of their conformity".
- [137] 3GPP TS 11.18 (R98): "Specification of the 1.8 Volr Subscriber Identity Module - Mobile Equipment (SIM-ME) interface".
3GPP TS 31.101 (R99 onwards): "UICC-terminal interface; Physical and logical characteristics".
- [138] ISO 6429: "Information technology - Control funtions for coded character sets".
- [139] ICD-GPS 200, Navstar GPS Space Segment/Navigation User Interfaces, Rev. C.
- [140] P. Axelrad, R.G. Brown, "GPS Navigation Algorithms", in Chapter 9 of "Global Positioning System: Theory and Applications", Volume 1, B.W. Parkinson, J.J. Spilker (Ed.), Am. Inst. of Aeronautics and Astronautics Inc., 1996.
- [141] S.K. Gupta, "Test and Evaluation Procedures for the GPS User Equipment", ION-GPS Red Book, Volume 1, p. 119.
- [142] STANAG 4294 Issue 1, NATO Standard Agreement.
- NOTE 1: From Rel-4 onwards, references to 3GPP TS 04.08 are replaced by references to 3GPP TS 44.018 (for RR) and 3GPP TS 24.008 (for CN).

3 Definitions, conventions and applicability

For the purposes of the present document, the abbreviations and acronyms given in 3GPP TS 01.04 apply.

3.1 Mobile station definition and configurations

In the present document, a MS can be:

- a vehicle mounted station;
- a portable station;
- a handheld station;
- a vehicle mounted/portable station;
- a vehicle mounted/handheld station.

A MS is the complete equipment configuration which may take part in a communication. However, this may not be the MS as it is offered to a test house for conformance testing.

In general, the MS, as it will be presented to a test house for conformance testing, is the station without all the additional Terminal Equipment (TE). Such a piece of hardware is also called a Mobile Termination (MT), but in the present document, the expression MS is used for any form of MS hardware as it is offered to the test house.

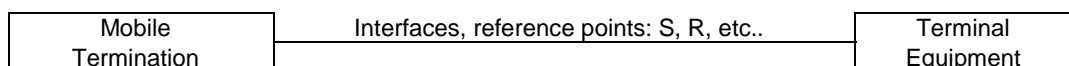

Figure 3-1

During the tests, the interfaces of the MT shall be connected to a System Simulator (SS), which will also emulate the TE. For some tests, it may be necessary to establish a pre-configured setup of the MS.

EXAMPLE: For reception of automatic fax group 3 to a fax machine on the R-interface, the MS needs configuration information about the presence of such a machine on that interface.

As an alternative, the TE may be physically integrated.

For a more detailed description of MS-configurations, see 3GPP TS 02.06.

3.2 Applicability

3.2.1 Applicability of this specification

3.2.1.1 MS equipped with a connector

If a MS is equipped with a connector, to connect terminal equipment on an S or R reference point as defined in 3GPP TS 04.02, then testing of the MS may include testing of appropriate functioning to and from this connector.

The present document does not apply to TE which is to be connected to that connector, even if it is delivered with the MS.

3.2.1.2 GPRS

Several important tests are missing in the present document for the following types of GPRS MS:

- Type 2 MS [3GPP TS 05.02].
- MS with 3 or more TX-slots (included in the test cases are multislot classes 1, 2, 3, 4, 5, 6, 8, 9, 10, 19 and 24) [3GPP TS 05.02].
- GPRS only MS.
- Mobiles that can operate in class A [3GPP TS 03.60], excluding Dual Transfer Mode.

- Mobiles that can operate in class B in Network mode III [3GPP TS 03.60].
- Optional GPRS features.

3.2.2 Applicability of the individual tests

This information has been moved to 3GPP TS 51.010-2, annex B.

3.2.3 Applicability to terminal equipment

If a MS is delivered for conformance testing, and it contains physically integrated TE, then the present document applies to the complete MS including that TE.

The present document also applies to separate TE that is delivered for conformance testing with the MS. The MS is then tested as an MT0. In that case, the specific TE with which the MS is tested is documented in the test report.

3.3 Definitions

For the purposes of the present document, the following terms and definitions apply:

idle updated: MS is defined to be "idle updated" if the following three conditions are fulfilled:

- its update status is U1 UPDATED (see 3GPP TS 04.08 / 3GPP TS 24.008);
- it is in the MM state MM-IDLE (see 3GPP TS 04.08 / 3GPP TS 24.008);
- it is in the RR idle mode (see 3GPP TS 04.08 / 3GPP TS 44.018).

idle not updated: MS is defined to be "idle not updated" if the following three conditions are fulfilled:

- its update status is U2 NOT UPDATED (see 3GPP TS 04.08 / 3GPP TS 24.008);
- it is in the MM state MM-IDLE (see 3GPP TS 04.08 / 3GPP TS 24.008);
- it is in the RR idle mode (see 3GPP TS 04.08 / 3GPP TS 44.018).

arbitrary: if for a test, a test purpose, a test group, or a test suite, which uses a certain parameter the value of that parameter has to be chosen arbitrarily in a certain set of values, this means that:

- for each value in the set the MS is required to fulfil the requirements of the test, test purpose, test group, or test suite, but that
- the test, test purpose, test group, or test suite is only performed for one value in the set, the selection of which is made by the test operator.

3.4 Conventions for mathematical notations

For the purpose of the present document mathematical terms used throughout the present document are given in this subclause.

3.4.1 Mathematical signs

The "plus or minus" sign is expressed by " \pm ".

The sign "multiplied by" is expressed by "*".

The sign "divided by" is expressed by "/", or the common division bar.

The sign "greater than or equal to" is expressed by " \geq ".

The sign "less than or equal to" is expressed by " \leq ".

3.4.2 Powers to the base 10

Powers to the base 10 are expressed by "10Ex", where x is the exponent, e.g. 10E-5, 10E6.

3.5 Conventions on electrical terms

3.5.1 Radio Frequency (RF) input signal level

In general, the RF input signal level to the MS is expressed in terms of the received field strength E in dB μ V/m (assuming a 0 dBi gain antenna). This is related to the power level P in dBm by the following formula (see 3GPP TS 05.05):

GSM 450: $E \text{ (dB}\mu\text{V/m)} = P \text{ (dBm)} + 130.5$ (calculated for a frequency of 460 MHz).

GSM 480: $E \text{ (dB}\mu\text{V/m)} = P \text{ (dBm)} + 130.5$ (calculated for a frequency of 460 MHz).

GSM 710: $E \text{ (dB}\mu\text{V/m)} = P \text{ (dBm)} + 134.9$ (calculated for a frequency of 770 MHz).

GSM 750: $E \text{ (dB}\mu\text{V/m)} = P \text{ (dBm)} + 134.9$ (calculated for a frequency of 770 MHz).

T-GSM 810: $E \text{ (dB}\mu\text{V/m)} = P \text{ (dBm)} + 135.6$ (calculated for a frequency of 831 MHz).

GSM 850: $E \text{ (dB}\mu\text{V/m)} = P \text{ (dBm)} + 135.9$ (calculated for a frequency of 859 MHz).

GSM 900: $E \text{ (dB}\mu\text{V/m)} = P \text{ (dBm)} + 136,5$ (calculated for a frequency of 925 MHz).

DCS 1 800: $E \text{ (dB}\mu\text{V/m)} = P \text{ (dBm)} + 142,3$ (calculated for a frequency of 1 795 MHz).

PCS 1 900: $E \text{ (dB}\mu\text{V/m)} = P \text{ (dBm)} + 142,9$ (calculated for a frequency of 1 920 MHz).

According to annex 1 subclause A.1.1.5.3, in all tests in which a handheld MS normally only equipped with integral antenna is the unit under test, the equivalent input signal level into a temporary test connector is determined from:

$$E_{in} = E_{req} + F;$$

where:

E_{in} = input signal level to a temporary antenna connector (dB μ Vemf);

E_{req} = signal level required by the test (dB μ Vemf);

F = coupling factor (dB) at the respective ARFCN.

Since F has to be determined by each test house individually, E_{in} cannot be given as a figure in test procedures.

If the case of integral antenna is applicable, the input signal level is then expressed in the test procedures as:

$$E_{req} \text{ dB}\mu\text{Vemf} ();$$

where the empty parenthesis is to be read as E_{in} .

Alternatively, the input signal level to the MS at the antenna connector can be expressed in dB μ Vemf(). This is related to the power level P in dBm by the following formula, assuming a 50 Ω antenna connector:

$$\text{Input signal level (dB}\mu\text{Vemf())} = P(\text{dBm}) + 113.$$

3.5.2 Reference sensitivity level

In the present document the term:

Reference Sensitivity level ()

is used to indicate that the SS establishes reference sensitivity level taking account of any losses associated with the RF connection to the MS.

3.5.3 Power level of fading signal

The power level of a fading signal is defined as the total signal level averaged over time.

3.6 Terms on test conditions

Unless otherwise stated, all Test Cases in this document apply to all the frequency bands mentioned in this section.

The MNC values used in this document have either 2 digits or 3 digits according to Frequency Band – see Table 3.1

Table 3.1: MNC values

Band	MNC value
GSM 450, GSM 480, GSM 900, DCS 1 800	2 digits
Otherwise	3 digits

3.6.1 Radio test conditions

The radio propagation conditions refer to multipath propagation models of 3GPP TS 05.05.

They are expressed by typical profiles:

- static;
- rural area (RA);
- hilly terrain (HT);
- urban area (TU); or for
- equalization test (EQ).

The non-static profiles are also related to typical speeds of movement of the MS expressed in km/h, e.g. TU1,5, TU3, TU50, HT100, EQ50.

In the present document the following conventions are used.

Table 3.2

Term	for GSM 400 represents	for GSM 700 represents	For GSM 850 and GSM 900 represents	for DCS 1800 and PCS 1 900 represents
RA	RA500	RA300	RA250	RA130
HT	HT200	HT120	HT100	HT100
TUhigh	TU100	TU60	TU50	TU50
TUlow	TU6	TU3.6	TU3	TU1,5
EQ	EQ100	EQ60	EQ50	EQ50

For tests using ARFCN ranges the following table 3.3 and shall be used.

Table 3.3

Band	Term		
	Low ARFCN range	Mid ARFCN range	High ARFCN range
GSM 450	259 to 261	275 to 277	291 to 293
GSM 480	306 to 308	322 to 324	338 to 340
GSM 710	438 to 452	472 to 474	507 to 511
GSM 750	438 to 452	472 to 474	507 to 511
T-GSM 810	438 to 452	472 to 474	507 to 511
GSM 850	128 to 132	188 to 192	247 to 251
P-GSM 900	1 to 5	60 to 65	120 to 124
E-GSM 900	975 to 980	60 to 65	120 to 124
R-GSM 900	955 to 960 (R-GSM) and 975 to 980 (E-GSM)	60 to 65	120 to 124
DCS 1800	513 to 523	690 to 710	874 to 884
PCS 1900	513 to 523	650 to 670	799 to 809

NOTE 1: For definitions of GSM 450, GSM 480, GSM 710, GSM 750, T-GSM 810, GSM 850, P-GSM 900, DCS 1 800, PCS 1 900, E-GSM 900 and R-GSM 900 refer to 3GPP TS 05.05.

NOTE 2: In the present document the term "GSM 900" is used to cover the primary GSM band, the extended GSM band and the railway-GSM band.

NOTE3: For R-GSM two low ARFCN ranges are defined. Unless specified otherwise for a specific test the ARFCN range defined for E-GSM900 MS is used for the testing of MS supporting the R-GSM 900 frequency range.

NOTE4: GSM 710 and T-GSM 810 use dynamic ARFCN mapping. The numbering scheme chosen here is the same as that for GSM 750 for ease of specifying default message contents.

4 Test Equipment

4.1 Terms used to describe test equipment in the present document

In order to perform MS conformity testing, the use of test equipment is necessary to provide the MS with stimulus signals and to analyse and record the resulting responses.

Throughout the present document the term "System Simulator" is used to describe the suite of test equipment required to interact with the following MS interfaces:

- antenna;
- acoustic;
- data port;
- power supply;
- DAI.

The term "SIM simulator" is used to describe the test equipment required to interact with the SIM/ME interface.

A "test SIM" has the physical characteristics of a standard SIM card, (see 3GPP TS 11.11) with specific parameters defined in annex 4.

4.2 Functional requirements of test equipment

The present document does not include a functional description of the test equipment required to perform the tests. These requirements should be deduced from the test descriptions and the information in annex 5.

Annex 5 describes the requirements for the test equipment which cannot be derived from, and which are assumed in, the conformance test descriptions described in the present document. Specifically, stimulus setting and measurement uncertainty requirements are defined in annex 5.

5 Testing methodology in general (layers 1, 2, and 3)

5.1 Testing of optional functions and procedures

Any function or procedure which is optional, as indicated in the present document, may be subject to a conformance test if it is implemented in the MS.

A declaration by the apparatus supplier (PICS/PIXIT) is used to determine whether an optional function/procedure has been implemented.

5.2 Test interfaces and facilities

The air interface (Um reference point) provides the main test interface for the purpose of performing conformance tests.

The SS layer 2 and layer 3 shall react with the MS on the air interface in accordance with the BSS requirements in the 3GPP TS 04.xx and 05.xx series recommendations, except where the description defines otherwise.

The provision of the following special conformance test facilities is mandatory where applicable:

- support of special conformance test functions, which are enabled by the insertion of a dedicated SIM for testing (test-SIM);
- provision of a Digital Audio Interface (only for MS which support speech services, or alternate speech/data services);
- for equipment which does not have a permanent external 50 Ω connector, a temporary 50 Ω antenna connector shall be provided in accordance with the requirements of annex 1 GC7;
- for MS supporting diversity, or for any other reason having more than one RF connector (or temporary connector in the case of integral antenna MS) the manufacturer shall supply coupling and / or terminating devices so that the tests can be performed via a single transmit / receive RF connection.

Furthermore, an optional Electrical Man Machine Interface (EMMI), is specified.

These special conformance test facilities, with the exception of the temporary antenna connector, are described in subclause 36.1.

Actions at the user side of the equipment under test (i.e. at the man-machine Interface, at the S- or R- interface, at the SIM-interface, execution of higher layer processes in the case of data services) are used to invoke actions at layers 1, 2 and 3 of the Dm-channel protocol within the equipment under test.

5.3 Different protocol layers

The conformance tests for each layer of the Dm-channel protocol are specified separately and the test configuration(s) to be used in testing each layer is specified in the subclause of the present document relating to the conformance tests for that layer.

5.4 Information to be provided by the apparatus supplier

The apparatus supplier shall provide two kinds of information:

- information with respect to the protocol: Protocol Implementation Conformance Statement (PICS);
- information with respect to the man machine interface: Protocol Implementation Extra Information required for Testing (PIXIT).

The complete list of the information to be provided by the apparatus supplier is a matter between the apparatus supplier and the test house but an example of the information to be supplied is given in informative annex 3 of the present document.

5.5 Definitions of transmit and receive times

The time a burst is received or transmitted is defined to be in the middle of the burst, i.e. transition from Bit Number BN74 to BN75 for all bursts except random access bursts, the middle of which is the transition from BN48 to BN49.

The reception/transmission time of speech or data blocks or a signalling frame (layer 2 and layer 3) is defined to be the reception/transmission time of the last burst containing part of the block or frame.

The start of a layer 2 or 3 frame is defined to be the time of the first burst containing part of the layer 2 or 3 frame. (The time of a burst is defined to be in the middle of the burst.)

The end of a layer 2 or 3 frame is defined to be the time of the last burst containing part of the layer 2 or 3 frame.

6 Reference test methods

6.1 General

Annex 1 gives reference test conditions to be used throughout the present document, unless otherwise specified. It consists of a part on general conditions, and a part on normal and extreme test conditions.

Unless otherwise specified, tests are run using the normal test conditions.

If a test is to be run using the extreme test conditions then this is identified in the test description.

For all tests, the MS is connected to the SS. This connection, unless otherwise specified, is to the permanent antenna connector for a MS which is equipped with one, or via the temporary antenna connector defined in annex 1, GC7, for a MS with an integral antenna, and not normally having a means of connecting an external antenna.

6.2 Choice of frequencies in the frequency hopping mode

For the tests using frequency hopping, 38 frequencies are used over:

- GSM 850: a 21 MHz band;
- P-GSM 900: a 21 MHz band;
- E-GSM 900: a [21] MHz band;
- R-GSM 900: a 23 MHz band;
- DCS 1 800: a 75 MHz band;
- PCS 1 900: a 60 MHz band.

For the tests using frequency hopping, 14 frequencies are used over:

- GSM 450: a 6.4 MHz band;
- GSM 480: a 6.4 MHz band.

For the tests using frequency hopping, 24 frequencies are used over:

- GSM 710: a 12.4 MHz band.
- GSM 750: a 12.4 MHz band.
- T-GSM 810: a 12.4 MHz band.

Table 6.1: Hopping frequencies

	ARFCN
GSM 450	260, 262, 265, 267, 269, 272, 274, 278, 280, 282, 285, 287, 290, 292
GSM 480	307, 309, 312, 314, 316, 319, 321, 325, 327, 329, 332, 334, 337, 339
GSM 710, GSM 750, T-GSM 810	444, 447, 450, 451, 455, 457, 459, 463, 464, 467, 471, 475, 479, 482, 483, 486, 489, 490, 494, 496, 498, 502, 503, 505
GSM 850	137, 141, 144, 145, 149, 151, 153, 157, 158, 161, 165, 169, 172, 173, 177, 179, 181, 185, 186, 189, 193, 197, 200, 201, 205, 207, 209, 213, 214, 217, 221, 225, 228, 229, 233, 235, 237, 241
P-GSM900	10, 14, 17, 18, 22, 24, 26, 30, 31, 34, 38, 42, 45, 46, 50, 52, 54, 58, 59, 62, 66, 70, 73, 74, 78, 80, 82, 86, 87, 90, 94, 98, 101, 102, 106, 108, 110, 114
E-GSM900	984, 988, 991, 992, 996, 998, 1 000, 1 004, 1 005, 1 008, 1 012, 1 016, 1 019, 1 020, 1 022, 2, 6, 10, 14, 17, 18, 22, 24, 26, 30, 31, 34, 38, 42, 45, 46, 50, 52, 54, 58, 59, 62, 64
R-GSM 900	955, 963, 966, 967, 971, 974, 984, 988, 991, 992, 996, 998, 1 000, 1 004, 1 005, 1 008, 1 012, 1016, 1019, 1020, 1022, 2, 6, 10, 14, 17, 18, 22, 24, 26, 30, 31, 34, 36, 38, 42, 43, 45
DCS 1 800	522, 539, 543, 556, 564, 573, 585, 590, 606, 607, 624, 627, 641, 648, 658, 669, 675, 690, 692, 709, 711, 726, 732, 743, 753, 760, 774, 777, 794, 795, 811, 816, 828, 837, 845, 858, 862, 879
PCS 1 900	522, 539, 543, 547, 556, 564, 573, 585, 590, 596, 606, 607, 615, 624, 627, 633, 641, 648, 658, 669, 675, 684, 690, 692, 703, 709, 711, 726, 732, 743, 753, 760, 774, 777, 789, 794, 795, 803

NOTE: The range of frequencies available during tests under simulated fading conditions is restricted by the fading simulator bandwidth.

For the tests using frequency hopping on packet data channels a reduced number of frequencies shall be used for certain bands.

Table 6.2: Packet Data Channel Hopping frequencies

	ARFCN
E-GSM900	2, 14, 22, 30, 38, 46, 54, 62, 988, 996, 998, 1004, 1012, 1016, 1020, 1022
DCS 1 800	522, 564, 585, 606, 625, 648, 669, 690, 709, 726, 743, 760, 777, 795, 816, 837, 858, 879
PCS 1 900	522, 547, 573, 596, 606, 624, 641, 669, 675, 692, 711, 743, 753, 777, 789, 794, 795, 803

6.3 "Ideal" radio conditions

In the present document the following conditions are referenced by the term "ideal" radio conditions:

- No multipath conditions.

MS power control level:

DCS 1 800, PCS 1 900:		3
All other bands		7
RF level to MS:	63 dB μ Vemf ()	(not tests in subclauses 14.4, 14.5 or 18.1.4)
RF level to MS:	20 dB above reference sensitivity level ()	(subclauses 14.4 and 14.5)
RF level to MS:	28 dB μ Vemf ()	(tests in subclause 18.1.4)

6.4 Standard test signals

The standard test signals C0, C1, I0, I1 and I2 as used in the present document, are defined in annex 5.

6.5 Power (control) levels

In the present document, except where explicitly stated otherwise, if the MS is commanded to its minimum power (control) level, the SS is allowed to signal power control level 15 for DCS 1 800 and PCS 1 900 and 19 for all other bands. Furthermore, except where explicitly stated otherwise, if the MS is commanded to its maximum power (control) level, and if MS_TXPWR_MAX_CCH is set to the maximum output power of the MS, the SS is allowed to signal the power control level corresponding to the maximum output power for the power class of the MS. For a GSM 450, GSM 480 or GSM 900 power class 2 MS, the SS is allowed to signal power control level 2.

7 Implicit testing

For some GSM features conformance is not verified explicitly in the present document. This does not imply that correct functioning of these features is not essential, but that these are implicitly tested to a sufficient degree in other tests. Examples for implicitly tested features are frequency hopping and encryption.

It should be noted that for these features some aspects have to be and are explicitly tested, e.g. the ability to switch to frequency hopping or non-hopping, and the ability to change the encryption mode setting.

8 Measurement uncertainty

The measured value relating to the corresponding limit shall be used to determine whether or not a terminal equipment meets the requirement. (ETR 028 annex B).

This process is often referred to as "shared risk".

9 Format of tests

For lower layer tests the following basic format for tests is used:

..* Title

..*.1 Definition

This subclause provides, if necessary, a definition of the feature/function being tested and the applicability of the test to different MS (e.g. speech only, data only etc.). The applicability information in this clause is informative. The normative applicability information is in 51.010-2.

..*.2 Conformance requirement

This subclause details the core specification requirements being tested and includes any necessary core specification references.

..*.3 Test purpose

This subclause details the purpose of the test.

..*.4 Method of test

..*.4.1 Initial conditions

If present this subclause defines the initial conditions to be established before running the test.

..*.4.2 Procedure

This subclause details the test procedure.

..*.5 Test requirements

This subclause details the conditions to be met for successful completion of the test.

However for the higher layer tests, in general, a slightly modified format, as described below, is used:

..* Title

Definition

This subclause provides, if necessary, a definition of the feature/function being tested and optionally the applicability of the test to different MS (e.g. speech only, data only etc.). The applicability information in this clause is informative. The normative applicability information is in 51.010-2.

..*.1 Conformance requirement

This subclause details the core specification requirements being tested. Normally this is a direct quote from the core specification. In some cases due to the core specification structure it is hard to find a direct quote, then the conformance requirement can be a summary of the core specification requirements.

References

This subclause gives the core specification number and subclause of the conformance requirement.

..*.2 Test purpose

The test purpose describes the purpose of the test i.e. what shall be tested. The test purpose must be justified by the conformance requirement. The complete conformance requirement needs not to be tested i.e. the test purpose can be a subset of the conformance requirement but not vice versa.

..*.3 Method of test

Initial conditions

For every test initial conditions for both the System Simulator and the Mobile Station are given. Normally the System Simulator simulates a network with one or several cells and all necessary channels to set up a network. The network set-up that is used in different sections of this specification varies but is normally defined in a default section that applies for a certain test. In each test is only specified the deviations from the default network set-up.

If a test contains several test procedures or if a test sequence is repeated with an execution counter then the initial conditions shall be re-established before each execution.

Related PICS/PIXIT statement

For every test the related PICS/PIXIT statements that are necessary for performing the test are given.

Foreseen final state of the MS

This subclause is optional. If included the text is informative i.e. non-normative and does not contain a description of verifications to be performed.

Test Procedure

This subclause describes the test procedure. The text is non-normative.

Maximum duration of the test

This is a rough estimate of the time to run the test sequence. If the last step of the test sequence is not passed within this time the test has failed. The time shall be long enough to guarantee that all correctly implemented MS will pass the test but not unnecessarily long since this would increase testing time if the test fails.

Expected sequence

This subclause defines the exact test steps and the verifications to be performed in the test. The subclause is normative and gives requirements for the MS behaviour.

The expected sequence specifies the actions in numbered steps in a tabular form. In the column "direction", "SS -> MS" denotes a message sent from the SS to the MS, i.e. downlink. "MS -> SS" denotes a message sent from the MS to the SS i.e. uplink. "SS" denotes an action at the SS and "MS" denotes an action at the MS (e.g. interaction with the user or higher layers). The column "message" defines the messages to be sent from the SS or expected by the SS. The "comments" column contains further normative information e.g. message parameters or timing requirements.

In some cases, different alternative behaviours are possible in a test. Then test steps in alternative sequences are numbered as:

"A n", "A n + 1", ..., "A n + k";

"B n", "B n + 1", ..., "B n + l";

"C n", "C n + 1", ..., "C n + m";

etc. (n, m, l, k integers > 0).

In some cases the complete set of test steps is to be repeated with minor variations. In this case an execution counter is used and the following text is included "The test sequence is repeated for k = 1 ... n."

Unless specified in the test sequence there are no timing requirements on the uplink messages except maximum duration of the test. The System Simulator shall send the next downlink message "immediately" after the previous message unless something else is specified in the test sequence. "Immediately" means as fast as the performance of the System Simulator allows, i.e. without any delays.

The Message Type of all uplink messages shall be checked. If the value of a parameter of an uplink message is specified in a test, the SS shall check the value. If the value is not specified, the SS shall not check the parameter unless stated otherwise. If an optional field or Information Element is not indicated for the uplink - unless specified otherwise - , it may be included or not.

Specific message contents

This subclause specifies the content of all downlink messages unless they are specified in a referenced default section. Then only the deviations from the default messages are specified. All optional fields or optional Information Elements of a downlink message that shall be included have to be specified otherwise they shall not be included.

Content of uplink messages that shall be checked can also be specified in this subclause.

10 Generic call set up procedures

10.1 Generic call set-up procedure for mobile terminating speech calls

In the test procedures described in the present document, unless otherwise stated in the test description, the Mobile Terminating Speech call set-up procedure shall be as described in this subclause.

NOTE: In test cases where a fading profile is required, a different and appropriate ARFCN may be selected, for instance if the fading simulator bandwidth does not allow use of the default ARFCN.

10.1.1 Initial conditions

System Simulator:

1 cell, default parameters.

Mobile Station:

- the MS shall be operated under normal test conditions (see annex 1 TC.2.1);
- the special Test-SIM (see annex 4) shall be inserted;
- the MS is "idle, updated", with a TMSI assigned and listening to the BCCH/CCCH of the active cell.

10.1.2 Definition of system information messages

The following parameters shall be coded into the system information messages. Parameters shall be coded according to 3GPP TS 04.08 / 3GPP TS 44.018.

The RACH Control Parameters IE shall be the same in SYSTEM INFORMATION TYPE 1, TYPE 2, TYPE 3 and TYPE 4 messages.

The Location Area Identification IE, Cell Selection Parameters IE, and P1 bit shall be the same in SYSTEM INFORMATION TYPE 3 and TYPE 4 messages.

SYSTEM INFORMATION TYPE 1

Information Element	Value/remark
Cell channel description	Includes the hopping sequence ARFCNs, if hopping is used
RACH control parameters	
MAX RETRANS	Any Value
TX-INTEGER	Any Value
CELL BAR ACCESS	Not barred
CALL RE-ESTABLISHMENT	Not Allowed
EMERGENCY CALL	Allowed
ACCESS CONTROL CLASS (0...9, 11...15)	None Barred
S11 rest octets	Spare Octets

SYSTEM INFORMATION TYPE 2

Information Element	Value/remark
BCCH Frequency list	Indicates seven surrounding cells on any ARFCN of the supported band, excluding ARFCNs in or immediately adjacent to those specified in subclause 6.2
NCC permitted	
NCC PERMITTED	e.g. all NCCs permitted
RACH control parameters	
MAX RETRANS	Any Value
TX-INTEGER	Any Value
CELL BAR ACCESS	Not barred
CALL RE-ESTABLISHMENT	Not Allowed
EMERGENCY CALL	Allowed
ACCESS CONTROL CLASS (0...9, 11...15)	None Barred

SYSTEM INFORMATION TYPE 3

Information Element	Value/remark
Cell identity	
CI VALUE	0001 hex (not relevant)
Location Area Identification	
MCC	001 decimal (not relevant)
MNC	01 or 011 (see Table 3.1) decimal (not relevant)
LAC	0001 hex (not relevant)
Control Channel Description	
ATT (IMSI att/det)	MS shall not apply (not relevant)
BS-AG-BLKS-RES	0 blocks reserved (not relevant)
CCCH-CONF	Combined CCCH/SDCCH (not relevant)
BS-PA-MFRMS	5 multiframes (not relevant)
T3212	Infinite
Cell options	
PWRC	power control not set
DTX	MS must not use DTX
RADIO LINK TIME-OUT	8
Cell selection parameters	
CELL RESELECT HYSTERESIS	0 dB
MS-TXPWR-MAX-CCH	Max. output power of MS
RXLEV-ACCESS-MIN	-90 dBm
ACS	There are no additional cell parameters included in SI7 and SI8
NECI	New establishment cause not supported
RACH control parameters	
MAX RETRANS	Any Value
TX-INTEG	Any Value
CELL BAR ACCESS	Not barred
CALL RE-ESTABLISHMENT	Not Allowed
EMERGENCY CALL	Allowed
ACCESS CONTROL CLASS	None Barred
(0...9, 11...15)	
SI3 rest octets	
P1	C2 parameters not present

SYSTEM INFORMATION TYPE 4

Information Element	Value/remark
Location Area Identification	
MCC	001 decimal (not relevant)
MNC	01 or 011 (see Table 3.1) decimal (not relevant)
LAC	0001 hex (not relevant)
Cell selection parameters	
CELL RESELECT HYSTERESIS	0 dB
MS-TXPWR-MAX-CCH	Max. output power of MS
RXLEV-ACCESS-MIN	-90 dBm
RACH control parameters	
MAX RETRANS	Any Value
TX-INTEG	Any Value
CELL BAR ACCESS	Not barred
CALL RE-ESTABLISHMENT	Not Allowed
EMERGENCY CALL	Allowed
ACCESS CONTROL CLASS	None Barred
(0...9, 11...15)	
CBCH Channel Description	Omitted
CBCH Mobile Allocation	Omitted
SI4 rest octets	
P1	C2 parameters not present

SYSTEM INFORMATION TYPE 5

Information Element	Value/remark
Neighbour cell description	As BCCH Frequency list in SI 2

SYSTEM INFORMATION TYPE 6

Information Element	Value/remark
Cell identity CI VALUE	0001 hex (not relevant)
Location Area Identification MCC	001 decimal (not relevant)
MNC	01 or 011 (see Table 3.1) decimal (not relevant)
LAC	0001 hex (not relevant)
Cell options PWRC	power control not set
DTX	MS must not use DTX
RADIO LINK TIME-OUT	8
NCC permitted NCC PERMITTED	e.g. all NCCs permitted

10.1.3 Procedure

An MS terminating call on a TCH/FS shall be established under ideal radio conditions and with Timing advance set to 0, as follows:

Step	Direction	Message	Comments
1	SS -> MS	PAGING REQUEST TYPE 1	Sent on the correct paging subchannel
2	MS -> SS	CHANNEL REQUEST	Establishment cause indicates "answer to paging"
3	SS -> MS	IMMEDIATE ASSIGNMENT	
4	MS -> SS	PAGING RESPONSE	Message is contained in SABM
5	SS -> MS	AUTHENTICATION REQUEST	
6	MS -> SS	AUTHENTICATION RESPONSE	SRES specifies correct value
7	SS -> MS	CIPHERING MODE COMMAND	SS starts deciphering after sending the message
8	MS -> SS	CIPHERING MODE COMPLETE	Shall be sent enciphered. All following messages shall be sent enciphered
9	SS		SS starts ciphering
10	SS -> MS	SETUP	Message contains the signal IE
11	MS -> SS	CALL CONFIRMED	
A12	MS -> SS	CONNECT	
B12	MS -> SS	ALERTING	An alerting indication as defined in a PICS/PIXIT statement given by the MS
B13	MS		The MS is made to accept the call in a way described in a PICS/PIXIT statement
B14	MS		
B15	MS -> SS	CONNECT	
16	SS -> MS	ASSIGNMENT COMMAND	
17	MS -> SS	ASSIGNMENT COMPLETE	
18	MS		The TCH is through connected in both directions
19	SS -> MS	CONNECT ACKNOWLEDGE	

10.1.4 Specific message contents

PAGING REQUEST TYPE 1 (3GPP TS 04.08 / 3GPP TS 44.018, subclause 9.1.22) to the MS

Information Element	Value/remark
Protocol Discriminator	RR
Skip Indicator	0000
Message Type	
Page Mode	Normal Paging
Channel Needed	spare, any channel
Mobile Identity 1	
Odd/even no of digits	As applicable for TMSI
Type of Identity	TMSI
Identity digits	As applicable
Mobile Identity 2	Omitted
P1 rest octets	Spare octets

IMMEDIATE ASSIGNMENT (3GPP TS 04.08 / 3GPP TS 44.018, subclause 9.1.18) to the MS

Information Element	Value/remark
Protocol Discriminator	RR
Skip Indicator	0000
Message Type	
Page Mode	Normal
Channel Description	
Channel Type	SDCCH/SACCH 1(4)
Time slot number	zero
Training seq. code	same as BCCH
Hopping	No
ARFCN	ARFCN of the BCCH
Random Reference	
Random access info	As in CHAN REQ
N51, N32, N26	As applicable
Timing Advance	0
Mobile allocation	length 0 due to hopping
IA rest octets	Spare octets

AUTHENTICATION REQUEST (3GPP TS 04.08 / 3GPP TS 24.008, subclause 9.2.2) to the MS

Information Element	Value/remark
Protocol Discriminator	MM
Skip Indicator	0000
Message Type	
Ciphering key seq. number	Arbitrary
Authent. parameter RAND	Arbitrary

CIPHERING MODE COMMAND (3GPP TS 04.08 / 3GPP TS 44.018, subclause 9.1.9) to the MS

Information Element	Value/remark
Protocol Discriminator	RR
Skip Indicator	0000
Message Type	
Ciphering mode setting	Start ciphering
Algorithm Identifier	Supported by the MS
Cipher Response	IMEISV shall not be included

SETUP (3GPP TS 04.08 / 3GPP TS 24.008, subclause 9.3.23) to the MS

Information Element	Value/remark
Protocol Discriminator	CC
Transaction Identifier	SS orig.
Message Type	
Signal	any non-reserved value
Bearer capability 1	Appropriate for the basic service selected for the test or omitted

ASSIGNMENT COMMAND (3GPP TS 04.08 / 3GPP TS 44.018, subclause 9.1.2) to the MS

Information Element	Value/remark
Protocol Discriminator	RR
Skip Indicator	0000
Message Type	
Channel Description	
Channel type	Bm + ACCHs
Time slot number	Arbitrary
Training seq. code	Default
Hopping	No
ARFCN	Default
Power level	Power control level 7
Channel mode	Speech full rate

CONNECT ACKNOWLEDGE (3GPP TS 04.08 / 3GPP TS 24.008, subclause 9.3.6) to the MS

Information Element	Value/remark
Protocol Discriminator	CC
Transaction Identifier	SS orig.
Message Type	

10.2 Generic call set-up procedure for mobile originating speech calls

In the test procedures described in the present document, unless otherwise stated in the test description, the Mobile Originating Speech (MOC) call set-up procedure shall be as described in this subclause.

NOTE: In test cases where a fading profile is required, a different and appropriate ARFCN may be selected, for instance if the fading simulator bandwidth does not allow use of the default ARFCN.

10.2.1 Initial conditions

System Simulator:

1 cell, default parameters.

Mobile Station:

- the MS shall be operated under normal test conditions (see annex 1 TC.2.1);
- the special Test-SIM (see annex 4) shall be inserted;
- the MS is "idle, updated", with a TMSI assigned and listening to the BCCH/CCCH of the active cell.

10.2.2 Definition of system information messages

See subclause 10.1.2.

10.2.3 Procedure

An MS originating call on a TCH/FS shall be established under ideal radio conditions and with Timing advance set to 0, as follows:

Step	Direction	Message	Comments
1	MS		"called number" entered
2	MS -> SS	CHANNEL REQUEST	Establishment cause indicates "originating call, NECI <> 1"
3	SS -> MS	IMMEDIATE ASSIGNMENT	
4	MS -> SS	CM SERVICE REQUEST	Message is contained in SABM
5	SS -> MS	AUTHENTICATION REQUEST	
6	MS -> SS	AUTHENTICATION RESPONSE	SRES specifies correct value
7	SS -> MS	CIPHERING MODE COMMAND	SS starts deciphering after sending the message
8	MS -> SS	CIPHERING MODE COMPLETE	Shall be sent enciphered. All following messages shall be sent enciphered
9	SS		SS starts ciphering
10	MS -> SS	SETUP	
11	SS -> MS	CALL PROCEEDING	
12	SS -> MS	ALERTING	
13	MS		An alerting indication as defined in an PICS/PIXIT statement is given by the MS
14	SS -> MS	ASSIGNMENT COMMAND	
15	MS -> SS	ASSIGNMENT COMPLETE	
16	SS -> MS	CONNECT	
17	MS -> SS	CONNECT ACKNOWLEDGE	
18	MS		The TCH is through connected in both directions

10.2.4 Specific message contents

IMMEDIATE ASSIGNMENT (3GPP TS 04.08 / 3GPP TS 44.018, subclause 9.1.18) to the MS

Information Element	Value/remark
Protocol Discriminator	RR
Skip Indicator	0000
Message Type	
Page Mode	Normal
Channel Description	
Channel Type	SDCCH/SACCH 1(4)
Time slot number	zero
Training seq. code	same as BCCH
Hopping	No
ARFCN	ARFCN of the BCCH
Random Reference	
Random access info	As in CHAN REQ
N51, N32, N26	As applicable
Timing Advance	0
Mobile allocation	length 0 due to hopping
IA rest octets	Spare octets

AUTHENTICATION REQUEST (3GPP TS 04.08 / 3GPP TS 24.008, subclause 9.2.2) to the MS

Information Element	Value/remark
Protocol Discriminator	MM
Skip Indicator	0000
Message Type	
Ciphering key seq. number	Arbitrary
Authent. parameter RAND	Arbitrary

CIPHERING MODE COMMAND (3GPP TS 04.08 / 3GPP TS 44.018, subclause 9.1.9) to the MS

Information Element	Value/remark
Protocol Discriminator	RR
Skip Indicator	0000
Message Type	
Ciphering mode setting	Start ciphering
Algorithm Identifier	Supported by the MS
Cipher Response	IMEISV shall not be included

CALL PROCEEDING (3GPP TS 04.08 / 3GPP TS 24.008, subclause 9.3.3) to the MS

Information Element	Value/remark
Protocol Discriminator	CC
Transaction Identifier	As derived from SETUP
Message Type	
Repeat Indicator	Omitted
Bearer Capability 1	Omitted
Bearer Capability 2	Omitted
Facility	Omitted
Progress Indicator	Omitted

ALERTING (3GPP TS 04.08 / 3GPP TS 24.008, subclause 9.3.1) to the MS

Information Element	Value/remark
Protocol Discriminator	CC
Transaction Identifier	As derived from SETUP
Message Type	
Facility	Omitted
Progress Indicator	Omitted
User-user	Omitted

ASSIGNMENT COMMAND (3GPP TS 04.08 / 3GPP TS 44.018, subclause 9.1.2) to the MS

Information Element	Value/remark
Protocol Discriminator	RR
Skip Indicator	0000
Message Type	
Channel Description	
Channel type	Bm + ACCHs
Time slot number	Arbitrary
Training seq. code	Default
Hopping	No
ARFCN	Default
Power level	Power control level 7
Channel mode	Speech full rate

CONNECT (3GPP TS 04.08 / 3GPP TS 24.008, subclause 9.3.5) to the MS

Information Element	Value/remark
Protocol Discriminator	CC
Transaction Identifier	As derived from SETUP
Message Type	
Facility	Omitted
Progress Indicator	Omitted
Connected number	Omitted
Connected Subaddress	Omitted
User-user	Omitted

10.3 Generic call set-up procedure for mobile terminating data calls

In the test procedures described in the present document, unless otherwise stated in the test description, the Mobile Terminating Data call set-up procedure shall be as described in this subclause.

NOTE: In test cases where a fading profile is required, a different and appropriate ARFCN may be selected, for instance if the fading simulator bandwidth does not allow use of the default ARFCN.

10.3.1 Initial conditions

System Simulator:

1 cell, default parameters.

Mobile Station:

- the MS shall be operated under normal test conditions (see annex 1 TC.2.1).
- the special Test-SIM (see annex 4) shall be inserted;
- the MS is "idle, updated", with a TMSI assigned and listening to the BCCH/CCCH of the active cell.

10.3.2 Definition of system information messages

See subclause 10.1.2.

10.3.3 Procedure

An MS terminating call on a TCH shall be established under ideal radio conditions and with Timing advance set to 0, as follows:

Step	Direction	Message	Comments
1	SS -> MS	PAGING REQUEST TYPE 1	Sent on the correct paging subchannel
2	MS -> SS	CHANNEL REQUEST	Establishment cause indicates "answer to paging"
3	SS -> MS	IMMEDIATE ASSIGNMENT	
4	MS -> SS	PAGING RESPONSE	Message is contained in SABM
5	SS -> MS	AUTHENTICATION REQUEST	
6	MS -> SS	AUTHENTICATION RESPONSE	SRES specifies correct value
7	SS -> MS	CIPHERING MODE COMMAND	SS starts deciphering after sending the message
8	MS -> SS	CIPHERING MODE COMPLETE	Shall be sent enciphered. All following messages shall be sent enciphered
9	SS		SS starts ciphering
10	SS -> MS	SETUP	A call is set up according to the required characteristics of the test procedure. Bearer Capability and Signal IEs included
11	MS -> SS	CALL CONFIRMED	Bearer Capability shall or shall not be included according to the rules given in 3GPP TS 04.08 / 3GPP TS 24.008 and 3GPP TS 07.01
A12	MS -> SS	CONNECT	
B12	MS -> SS	ALERTING	
B13	MS		An alerting indication as defined in a PICS/PIXIT statement given by the MS
B14	MS		The MS is made to accept the call in a way described in a PICS/PIXIT statement
B15	MS -> SS	CONNECT	
16	SS -> MS	ASSIGNMENT COMMAND	
17	MS -> SS	ASSIGNMENT COMPLETE	
18	MS		The TCH is through connected in both directions
19	SS -> MS	CONNECT ACKNOWLEDGE	

10.3.4 Specific message contents

PAGING REQUEST TYPE 1 (3GPP TS 04.08 / 3GPP TS 44.018, subclause 9.1.22) to the MS

Information Element	Value/remark
Protocol Discriminator	RR
Skip Indicator	0000
Message Type	
Page Mode	Normal Paging
Channel Needed	spare, any channel
Mobile Identity 1	
Odd/even no of digits	As applicable for TMSI
Type of Identity	TMSI
Identity digits	As applicable
Mobile Identity 2	Omitted
P1 rest octets	Spare octets

IMMEDIATE ASSIGNMENT (3GPP TS 04.08 / 3GPP TS 44.018, subclause 9.1.18) to the MS

Information Element	Value/remark
Protocol Discriminator	RR
Skip Indicator	0000
Message Type	
Page Mode	Normal
Channel Description	
Channel Type	SDCCH/SACCH 1(4)
Time slot number	zero
Training seq. code	same as BCCH
Hopping	No
ARFCN	ARFCN of the BCCH
Random Reference	
Random access info	As in CHAN REQ
N51, N32, N26	As applicable
Timing Advance	0
Mobile allocation	length 0 due to hopping
IA rest octets	Spare octets

AUTHENTICATION REQUEST (3GPP TS 04.08 / 3GPP TS 24.008, subclause 9.2.2) to the MS

Information Element	Value/remark
Protocol Discriminator	MM
Skip Indicator	0000
Message Type	
Ciphering key seq. number	Arbitrary
Authent. parameter RAND	Arbitrarily selected

CIPHERING MODE COMMAND (3GPP TS 04.08 / 3GPP TS 44.018, subclause 9.1.9) to the MS

Information Element	Value/remark
Protocol Discriminator	RR
Skip Indicator	0000
Message Type	
Ciphering mode setting	Start ciphering
Algorithm Identifier	Supported by the MS
Cipher Response	IMEISV shall not be included

SETUP (3GPP TS 04.08 / 3GPP TS 24.008, subclause 9.3.23) to the MS

Information Element	Value/remark
Protocol Discriminator	CC
Transaction Identifier	SS orig.
Message Type	
Bearer Capability	
Radio Channel Requirement	
Connection Element	T or NT and declared as supported by the MS (Not "Both ...")
NIRR	No meaning
Other parameters	Declared as supported by the MS
Signal	any non-reserved value

ASSIGNMENT COMMAND (3GPP TS 04.08 / 3GPP TS 44.018, subclause 9.1.2) to the MS

Information Element	Value/remark
Protocol Discriminator	RR
Skip Indicator	0000
Message Type	
Channel Description	
Channel type	Bm + ACCHs
Time slot number	Arbitrary
Training seq. code	Default
Hopping	No
ARFCN	Default
Power level	Power control level 7
Channel mode	Proper data rate, according to BC-IE included in the Set-Up and to the following table

Table 10-1: Correspondence between User rate (UR) and Channel Mode (CM) for transparent (T) and non transparent (NT) connections

UR	9,6kbit/s	4,8kbit/s	2,4kbit/s	1,2kbit/s	1,2/0,075kbit/s	0,3kbit/s
CM T FR	12 FR	6 FR	3,6 FR	3,6 FR	3,6 FR	3,6 FR
CM T HR	n.a	6 HR	3,6 HR	3,6 HR	3,6 HR	3,6 HR
CM NT FR	12 FR	12 FR	12 FR	12 FR	12 FR	12 FR
CM NT HR	n.a	6 HR	6 HR	6 HR	6 HR	6 HR

CONNECT ACKNOWLEDGE (3GPP TS 04.08 / 3GPP TS 24.008, subclause 9.3.6) to the MS

Information Element	Value/remark
Protocol Discriminator	CC
Transaction Identifier	SS orig.
Message Type	

10.4 Generic call set-up procedure for mobile originating data calls

In the test procedures described in the present document, unless otherwise stated in the test description, the Mobile Originating Data call set-up procedure shall be as described in this subclause.

NOTE: In test cases where a fading profile is required, a different and appropriate ARFCN may be selected, for instance if the fading simulator bandwidth does not allow use of the default ARFCN.

10.4.1 Initial conditions

System Simulator:

1 cell, default parameters.

Mobile Station:

- the MS shall be operated under normal test conditions (see annex 1 TC.2.1);
- the special Test-SIM (see annex 4) shall be inserted;
- the MS is "idle, updated", with a TMSI assigned and listening to the BCCH/CCCH of the active cell.

10.4.2 Definition of system information messages

See subclause 10.1.2.

10.4.3 Procedure

An MS originating call on a TCH shall be established under ideal radio conditions and with Timing advance set to 0, as follows:

Step	Direction	Message	Comments
1	MS		"called number" entered
2	MS -> SS	CHANNEL REQUEST	Establishment cause indicates "originating call, NECI <> 1"
3	SS -> MS	IMMEDIATE ASSIGNMENT	
4	MS -> SS	CM SERVICE REQUEST	Message is contained in SABM
5	SS -> MS	AUTHENTICATION REQUEST	
6	MS -> SS	AUTHENTICATION RESPONSE	SRES specifies correct value
7	SS -> MS	CIPHERING MODE COMMAND	SS starts deciphering after sending the message
8	MS -> SS	CIPHERING MODE COMPLETE	Shall be sent enciphered. All following messages shall be sent enciphered
9	SS		SS starts ciphering
10	MS -> SS	SETUP	
11	SS -> MS	CALL PROCEEDING	
12	SS -> MS	ALERTING	
13	MS		An alerting indication as defined in an PICS/PIXIT statement is given by the MS
14	SS -> MS	ASSIGNMENT COMMAND	
15	MS -> SS	ASSIGNMENT COMPLETE	
16	SS -> MS	CONNECT	
17	MS -> SS	CONNECT ACKNOWLEDGE	
18	MS		The TCH is through connected in both directions

10.4.4 Specific message contents

IMMEDIATE ASSIGNMENT (3GPP TS 04.08 / 3GPP TS 44.018, subclause 9.1.18) to the MS

Information Element	Value/remark
Protocol Discriminator	RR
Skip Indicator	0000
Message Type	
Page Mode	Normal
Channel Description	
Channel Type	SDCCH/SACCH 1(4)
Time slot number	zero
Training seq. code	same as BCCH
Hopping	No
ARFCN	ARFCN of the BCCH
Random Reference	
Random access info	As in CHAN REQ
N51, N32, N26	As applicable
Timing Advance	0
Mobile allocation	length 0 due to hopping
IA rest octets	Spare octets

AUTHENTICATION REQUEST (3GPP TS 04.08 / 3GPP TS 24.008, subclause 9.2.2) to the MS

Information Element	Value/remark
Protocol Discriminator	MM
Skip Indicator	0000
Message Type	
Ciphering key seq. number	Arbitrary
Authent. parameter RAND	Arbitrarily selected

CIPHERING MODE COMMAND (3GPP TS 04.08 / 3GPP TS 44.018, subclause 9.1.9) to the MS

Information Element	Value/remark
Protocol Discriminator	RR
Skip Indicator	0000
Message Type	
Ciphering mode setting	Start ciphering
Algorithm Identifier	Supported by the MS
Cipher Response	IMEISV shall not be included

CALL PROCEEDING (3GPP TS 04.08 / 3GPP TS 24.008, subclause 9.3.3) to the MS

Information Element	Value/remark
Protocol Discriminator	CC
Transaction Identifier	As derived from SETUP
Message Type	
Repeat Indicator	Present if and only if Bearer Capability 1 and Bearer Capability 2 are present in this message
Bearer Capability 1	Present if negotiation of BC 1 or BC 2 necessary (e.g. reception of "Both" for CE parameter in SETUP), else omitted
Radio Channel Requirement	spare
Connection element	T (in case of "Both T (NT) preferred" received)
NIRR	No meaning
Other parameters	Same as sent by the MS in the SETUP, where applicable
Bearer Capability 2	Present if dual BC-IE received and negotiation of either BC 1 or BC 2 necessary, else omitted
Radio Channel Requirement	spare
Connection element	T in case of "Both, T (NT) preferred" in the SETUP message else same as in the SETUP message
NIRR	No meaning
Other parameters	Same as sent by the MS in the SETUP, where applicable
NOTE:	If both BC 1 and BC 2 are present, then one and only one of them shall indicate speech.
Facility	Omitted
Progress Indicator	Omitted

ALERTING (3GPP TS 04.08 / 3GPP TS 24.008, subclause 9.3.1) to the MS

Information Element	Value/remark
Protocol Discriminator	CC
Transaction Identifier	As derived from SETUP
Message Type	
Facility	Omitted
Progress Indicator	Omitted
User-user	Omitted

ASSIGNMENT COMMAND (3GPP TS 04.08 / 3GPP TS 44.018, subclause 9.1.2) to the MS

Information Element	Value/remark
Protocol Discriminator	RR
Transaction Identifier	Not used
Message Type	
Channel Description	
Channel type	Bm + ACCHs
Time slot number	Arbitrary
Training seq. code	Default
Hopping	No
FB no	Band no 0
ARFCN	Default
Power level	Power control level 7
Channel mode	If no negotiation took place: <ul style="list-style-type: none"> - Speech FR (resp. HR) if first BC IE in the SETUP indicated speech FR (resp. HR); - Set according to the table below if first BC - IE in the SETUP indicates data or fax If negotiation took place; - Speech FR (resp. HR) if first BC-IE in the CALL PROCEEDING indicated speech FR (resp. HR); - Set according to the table below if first BC - IE in the CALL PROCEEDING indicates data or fax

Table 10-2: Correspondence between User rate (UR) and Channel Mode (CM) for transparent (T) and non transparent (NT) connections

UR	9,6kbit/s	4,8kbit/s	2,4kbit/s	1,2kbit/s	1,2/0,075kbit/s	0,3kbit/s
CM T FR	12FR	6 FR	3,6 FR	3,6 FR	3,6 FR	3,6 FR
CM T HR	n.a	6 HR	3,6 HR	3,6 HR	3,6 HR	3,6 HR
CM NT FR	12 FR	12 FR	12 FR	12 FR	12 FR	12 FR
CM NT HR	n.a	6 HR	6 HR	6 HR	6 HR	6 HR

CONNECT (3GPP TS 04.08 / 3GPP TS 24.008, subclause 9.3.5) to the MS

Information Element	Value/remark
Protocol Discriminator	CC
Transaction Identifier	As derived from SETUP
Message Type	
Facility	Omitted
Progress Indicator	Omitted
Connected number	Omitted
Connected Subaddress	Omitted
User-user	Omitted

10.5 Generic call set-up procedure for mobile terminating multislot configuration, minimum number of timeslots allocated

In the test procedures described in the present document, unless otherwise stated in the test description, the Mobile Terminating multislot connection set-up procedure shall be as described in this subclause.

NOTE: In test cases where a fading profile is required, a different and appropriate ARFCN may be selected, for instance if the fading simulator bandwidth does not allow use of the default ARFCN.

10.5.1 Initial conditions

System Simulator:

1 cell, default parameters.

Mobile Station:

- the MS shall be operated under normal test conditions (see annex 1 TC.2.1);
- the special Test-SIM (see annex 4) shall be inserted;
- the MS is "idle, updated", with a TMSI assigned and listening to the BCCH/CCCH of the active cell.

10.5.2 Definition of system information messages

See subclause 10.1.2.

10.5.3 Procedure

An MS terminating multislot connection shall be established under ideal radio conditions and with Timing advance set to 0, as follows:

Step	Direction	Message	Comments
1	SS -> MS	PAGING REQUEST TYPE 1	Sent on the correct paging subchannel
2	MS -> SS	CHANNEL REQUEST	Establishment cause indicates "answer to paging"
3	SS -> MS	IMMEDIATE ASSIGNMENT	
4	MS -> SS	PAGING RESPONSE	Message is contained in SABM
5	MS -> SS	CLASSMARK CHANGE	Multislot class
6	SS -> MS	AUTHENTICATION REQUEST	
7	MS -> SS	AUTHENTICATION RESPONSE	SRES specifies correct value
8	SS -> MS	CIPHERING MODE COMMAND	SS starts deciphering after sending the message
9	MS -> SS	CIPHERING MODE COMPLETE	Shall be sent enciphered. All following messages shall be sent enciphered
10	SS		SS starts ciphering
11	SS -> MS	SETUP	A multislot connection is set up according to the required characteristics of the test procedure. Bearer Capability and Signal IEs included
12	MS -> SS	CALL CONFIRMED	Bearer Capability shall or shall not be included according to the rules given in 3GPP TS 04.08 / 3GPP TS 24.008 and 3GPP TS 07.01
A12	MS -> SS	CONNECT	
B13	MS -> SS	ALERTING	
B14	MS		An alerting indication as defined in a PICS/PIXIT statement given by the MS
B15	MS		The MS is made to accept the call in a way described in a PICS/PIXIT statement
B16	MS -> SS	CONNECT	
17	SS -> MS	ASSIGNMENT COMMAND	In multislot allocation only one timeslot is allocated.
18	MS -> SS	ASSIGNMENT COMPLETE	Sent on the TCH/Sm channel
19	MS		The TCH(s) is through connected in both directions
20	SS -> MS	CONNECT ACKNOWLEDGE	

10.5.4 Specific message contents

PAGING REQUEST TYPE 1 (3GPP TS 04.08 / 3GPP TS 44.018, subclause 9.1.22) to the MS

Information Element	Value/remark
Protocol Discriminator	RR
Skip Indicator	0000
Message Type	
Page Mode	Normal Paging
Channel Needed	spare, any channel
Mobile Identity 1	
Odd/even no of digits	As applicable for TMSI
Type of Identity	TMSI
Identity digits	As applicable
Mobile Identity 2	Omitted
P1 rest octets	Spare octets

IMMEDIATE ASSIGNMENT (3GPP TS 04.08 / 3GPP TS 44.018, subclause 9.1.18) to the MS

Information Element	Value/remark
Protocol Discriminator	RR
Skip Indicator	0000
Message Type	
Page Mode	Normal
Channel Description	
Channel Type	SDCCH/SACCH 1(4)
Time slot number	zero
Training seq. code	same as BCCH
Hopping	No
ARFCN	ARFCN of the BCCH
Random Reference	
Random access info	As in CHAN REQ
N51, N32, N26	As applicable
Timing Advance	0
Mobile allocation	length 0 due to hopping
IA rest octets	Spare octets

AUTHENTICATION REQUEST (3GPP TS 04.08 / 3GPP TS 24.008, subclause 9.2.2) to the MS

Information Element	Value/remark
Protocol Discriminator	MM
Skip Indicator	0000
Message Type	
Ciphering key seq. number	Arbitrary
Authent. parameter RAND	Arbitrarily selected

CIPHERING MODE COMMAND (3GPP TS 04.08 / 3GPP TS 44.018, subclause 9.1.9) to the MS

Information Element	Value/remark
Protocol Discriminator	RR
Skip Indicator	0000
Message Type	
Ciphering mode setting	Start ciphering
Algorithm Identifier	Supported by the MS
Cipher Response	IMEISV shall not be included

SETUP (3GPP TS 04.08 / 3GPP TS 24.008, subclause 9.3.23) to the MS

Information Element	Value/remark
Protocol Discriminator	CC
Transaction Identifier	SS orig.
Message Type	
Bearer Capability	
Radio Channel Requirement	
Connection Element	T or NT and declared as supported by the MS (Not "Both ...")
NIRR	No meaning
Other parameters	Declared as supported by the MS
Signal	any non-reserved value

ASSIGNMENT COMMAND (3GPP TS 04.08 / 3GPP TS 44.018, subclause 9.1.2) to the MS

Information Element	Value/remark
Protocol Discriminator	RR
Skip Indicator	0000
Message Type	
Channel Description 2	
Channel type	TCH/F + FACCH/F and SACCH/M
Time slot number	Arbitrary
Training seq. code	Default
Hopping	No
ARFCN	Default
Power level	Power control level 7
Multislot allocation	
- Downlink assignment	Only one timeslot is assigned in downlink direction.
- Uplink assignment	Only one timeslot is assigned in uplink direction.

CONNECT ACKNOWLEDGE (3GPP TS 04.08 / 3GPP TS 24.008, subclause 9.3.6) to the MS

Information Element	Value/remark
Protocol Discriminator	CC
Transaction Identifier	SS orig.
Message Type	

10.6 Generic call set-up procedure for mobile originating multislot configuration, minimum number of timeslots allocated

In the test procedures described in the present document, unless otherwise stated in the test description, the Mobile Originating multislot connection set-up procedure shall be as described in this subclause.

NOTE: In test cases where a fading profile is required, a different and appropriate ARFCN may be selected, for instance if the fading simulator bandwidth does not allow use of the default ARFCN.

10.6.1 Initial conditions

System Simulator:

1 cell, default parameters.

Mobile Station:

- the MS shall be operated under normal test conditions (see annex 1 TC.2.1);
- the special Test-SIM (see annex 4) shall be inserted;
- the MS is "idle, updated", with a TMSI assigned and listening to the BCCH/CCCH of the active cell.

10.6.2 Definition of system information messages

See subclause 10.1.2.

10.6.3 Procedure

An MS originating multislot connection shall be established under ideal radio conditions and with Timing advance set to 0, as follows:

Step	Direction	Message	Comments
1	MS		"called number" entered
2	MS -> SS	CHANNEL REQUEST	Establishment cause indicates "originating call, NECI <> 1"
3	SS -> MS	IMMEDIATE ASSIGNMENT	
4	MS -> SS	CM SERVICE REQUEST	Message is contained in SABM
5	MS -> SS	CLASSMARK CHANGE	Multislot class
6	SS -> MS	AUTHENTICATION REQUEST	
7	MS -> SS	AUTHENTICATION RESPONSE	SRES specifies correct value
8	SS -> MS	CIPHERING MODE COMMAND	SS starts deciphering after sending the message
9	MS -> SS	CIPHERING MODE COMPLETE	Shall be sent enciphered. All following messages shall be sent enciphered
10	SS		SS starts ciphering
11	MS -> SS	SETUP	A multislot connection is set up according to the required characteristics of the test procedure.
12	SS -> MS	CALL PROCEEDING	
13	SS -> MS	ALERTING	
14	MS		An alerting indication as defined in an PICS/PIXIT statement is given by the MS
15	SS -> MS	ASSIGNMENT COMMAND	In multislot allocation only one timeslot is allocated.
16	MS -> SS	ASSIGNMENT COMPLETE	Sent on TCH/Sm channel.
17	SS -> MS	CONNECT	
18	MS -> SS	CONNECT ACKNOWLEDGE	
19	MS		The TCH(s) is through connected in both directions

10.6.4 Specific message contents

IMMEDIATE ASSIGNMENT (3GPP TS 04.08 / 3GPP TS 44.018, subclause 9.1.18) to the MS

Information Element	Value/remark
Protocol Discriminator	RR
Skip Indicator	0000
Message Type	
Page Mode	Normal
Channel Description	
Channel Type	SDCCH / SACCH 1(4)
Time slot number	zero
Training seq. code	same as BCCH
Hopping	No
ARFCN	ARFCN of the BCCH
Random Reference	
Random access info	As in CHAN REQ
N51, N32, N26	As applicable
Timing Advance	0
Mobile allocation	length 0 due to hopping
IA rest octets	Spare octets

AUTHENTICATION REQUEST (3GPP TS 04.08 / 3GPP TS 24.008, subclause 9.2.2) to the MS

Information Element	Value/remark
Protocol Discriminator	MM
Skip Indicator	0000
Message Type	
Ciphering key seq. number	Arbitrary
Authent. parameter RAND	Arbitrarily selected

CIPHERING MODE COMMAND (3GPP TS 04.08 / 3GPP TS 24.008, subclause 9.1.9) to the MS

Information Element	Value/remark
Protocol Discriminator	RR
Skip Indicator	0000
Message Type	
Ciphering mode setting	Start ciphering
Algorithm Identifier	Supported by the MS
Cipher Response	IMEISV shall not be included

CALL PROCEEDING (3GPP TS 04.08 / 3GPP TS 24.008, subclause 9.3.3) to the MS

Information Element	Value/remark
Protocol Discriminator	CC
Transaction Identifier	As derived from SETUP
Message Type	
Repeat Indicator	Present if and only if Bearer Capability 1 and Bearer Capability 2 are present in this message
Bearer Capability 1	Present if negotiation of BC 1 necessary (e.g. reception of "Both" for CE parameter in SETUP), else omitted
Radio Channel Requirement	spare
Connection element	T (in case of "Both T (NT) preferred" received)
NIRR	No meaning
Other parameters	Same as sent by the MS in the SETUP, where applicable
Facility	Omitted
Progress Indicator	Omitted

ALERTING (3GPP TS 04.08 / 3GPP TS 24.008, subclause 9.3.1) to the MS

Information Element	Value/remark
Protocol Discriminator	CC
Transaction Identifier	As derived from SETUP
Message Type	
Facility	Omitted
Progress Indicator	Omitted
User-user	Omitted

ASSIGNMENT COMMAND (3GPP TS 04.08 / 3GPP TS 44.018, subclause 9.1.2) to the MS

Information Element	Value/remark
Protocol Discriminator	RR
Transaction Identifier	Not used
Message Type	
Channel Description 2	
Channel type	TCH/F + FACCH/F + SACCH/M
Time slot number	Arbitrary
Training seq. code	Default
Hopping	No
FB no	Band no 0
ARFCN	Default
Power level	Power control level 7
Multislot allocation	
- Downlink assignment	Only one timeslot is assigned in downlink direction.
- Uplink assignment	Only one timeslot is assigned in uplink direction.

CONNECT (3GPP TS 04.08 / 3GPP TS 24.008, subclause 9.3.5) to the MS

Information Element	Value/remark
Protocol Discriminator	CC
Transaction Identifier	As derived from SETUP
Message Type	
Facility	Omitted
Progress Indicator	Omitted
Connected number	Omitted
Connected Subaddress	Omitted
User-user	Omitted

10.7 Generic procedure for GPRS downlink data transfer

In the test procedures described in the present document, unless otherwise stated in the test description, the Mobile Terminating Data transfer procedure shall be as described in this subclause.

NOTE: In test cases where a fading profile is required, a different and appropriate ARFCN may be selected, for instance if the fading simulator bandwidth does not allow use of the default ARFCN.

10.7.1 Initial conditions

System Simulator:

- 1 cell, default parameters as specified in clause 40;
- ideal radio conditions and Timing advance set to 0.

Mobile Station:

- the MS shall be operated under normal test conditions (see annex 1 TC.2.1);
- the special Test-SIM (see annex 4) shall be inserted;
- the MS is GPRS attached with a P-TMSI allocated and the test PDP context2 activated.

10.7.2 Definition of system information messages

See clause 40.

10.7.3 Procedure

Step	Direction	Message	Comments
1			Start an application in the MS that continually reads all received data
2	SS -> MS	PACKET PAGING REQUEST	Contains P-TMSI of the MS. Sent on PPCH.
3	MS -> SS	PACKET CHANNEL REQUEST	ACCESS TYPE = " Page Response ". Received on PRACH.
4	SS -> MS	PACKET UPLINK ASSIGNMENT	Random Reference = pertaining to the message received in step 3. Sent on PAGCH. Single block assignment.
5	MS -> SS	UPLINK RLC DATA BLOCK	LLC PDU implicitly indicating paging response, containing TLLI in the RLC/MAC header. .
6	SS -> MS	PACKET UPLINK ACK/NACK	Acknowledge the received RLC data block. Sent on PACCH. Poll bit in the MAC header is set to indicate a valid RRBP.
7	MS -> SS	PACKET CONTROL ACKNOWLEDGEMENT	As RLC/MAC control block. Received on PACCH.
8	SS -> MS	PACKET DOWNLINK ASSIGNMENT	Poll bit in the MAC header is set to indicate a valid RRBP. Sent on PCCCH. TIMESLOT_ALLOCATION arbitrarily chosen but shall not exceed the multislot capabilities of the MS. Other parameters as specified in each test case.
9	MS -> SS	PACKET CONTROL ACKNOWLEDGEMENT	Received on PACCH.

NOTE: The MS is always granted a USF whenever the MS is expected to send.

10.7.4 Specific message contents

See clause 40.

10.8 Generic procedure for GPRS uplink data transfer

In the test procedures described in the present document, unless otherwise stated in the test description, the Mobile Originated Data transfer procedure shall be as described in this subclause.

NOTE: In test cases where a fading profile is required, a different and appropriate ARFCN may be selected, for instance if the fading simulator bandwidth does not allow use of the default ARFCN.

10.8.1 Initial conditions

System Simulator:

- 1 cell, default parameters as specified in clause 40;
- ideal radio conditions and Timing advance set to 0.

Mobile Station:

- the MS shall be operated under normal test conditions (see annex 1 TC.2.1);
- the special Test-SIM (see annex 4) shall be inserted;
- the MS is GPRS attached with a P-TMSI allocated and the test PDP context3 activated.

10.8.2 Definition of system information messages

See clause 40.

10.8.3 Procedure

Step	Direction	Message	Comments
1			Start an application in the MS that continually sends data
2	MS -> SS	PACKET CHANNEL REQUEST	Received on PRACH.
3	SS -> MS	PACKET UPLINK ASSIGNMENT	Single block assignment, to order the MS to follow the two phase access procedure. Sent on PAGCH.
4	MS -> SS	PACKET RESOURCE REQUEST	Two phase access procedure. Received on the single block assigned in step 3.
5	SS -> MS	PACKET UPLINK ASSIGNMENT	Sent on PACCH of the same PDCH assigned in step 2. TIMESLOT_ALLOCATION arbitrarily chosen but shall not exceed the multislot capabilities of the MS. Open ended assignment.
6	SS -> MS	PACKET DOWNLINK DUMMY CONTROL BLOCK	Sent on PACCH containing USF assigned to the MS.

NOTE: The MS is always granted a USF whenever the MS is expected to send.

10.8.4 Specific message contents

PACKET UPLINK ACK/NACK message:

MESSAGE_TYPE	001001
PAGE_MODE	Normal Paging
UPLINK_TFI	00, same as the TFI value of the TBF which the message applies
CHANNEL_CODING_COMMAND	0, message escape Same coding scheme as in the assigned TBF which the message applies to
Ack/Nack Description	
- FINAL_ACK_INDICATION	0 (not a final ACK)
- STARTING_SEQUENCE_NUMBER	V(R)
- RECEIVED_BLOCK_BITMAP	Acknowledge the all data blocks transmitted by the MS
{0 1<CONTENTION_RESOLUTION_TLLI>}	0 (no contention resolution TLLI)
{0 1<Packet Timing Advance>}	0 (no packet timing advance)
{0 1<Power Control Parameters>}	0 (no power control parameters)
{0 1<Extension bits>}	0 (no extension bits present)
{0 1<Fixed Allocation parameters>}	0 (no fixed allocation parameters present)
spare padding	Spare Padding

PACKET UPLINK ASSIGNMENT message (two-phase dynamic allocation assigning a TBF):

MESSAGE_TYPE	001010
PAGE_MODE	Normal Paging
{0 1<PERSISTENCE_LEVEL>}	0 (no persistence level present)
- Address information	10 (TLLI)
- TLLI	The value received from the MS
CHANNEL_CODING_COMMAND	0, message escape
TLLI_BLOCK_CHANNEL_CODING	Arbitrarily chosen from the valid values (default CS-1)
Packet Timing Advance	'0'B, cs-1
- {0 1<TIMING_ADVANCE_VALUE>}	1 (timing advance value)
- TIMING_ADVANCE_VALUE	0 bit periods
- {0 1<TIMING_ADVANCE_INDEX>	0 (no timing advance index)
<TIMING_ADVANCE_TIMESLOT_NUMBER >}	
{0 1<Frequency Parameters>}	1 (Frequency Parameters present)
- Frequency Parameters	
- TSC	Arbitrarily chosen (default 5)
-	01 (indirect encoding)
- MAIO	Value arbitrarily chosen
- MA_NUMBER	Value arbitrarily chosen from PSI2s defined (default 0001)
- {0 1<CHANGE_MARK_1>	00
{0 1<CHANGE_MARK_2>}}	
Dynamic allocation	01
- Extended Dynamic Allocation	0 (Dynamic allocation)
- {0 1<P0><PR_MODE>}	0
- USF GRANULARITY	0, one block
- {0 1<UPLINK_TFI_ASSIGNMENT>}	1 (uplink TFI assignment)
- UPLINK_TFI_ASSIGNMENT	Arbitrarily chosen (default 00101)
- {0 1<RLC_DATA_BLOCKS_GRANTED>}	0 (no RLC_DATA_BLOCKS_GRANTED, open-ended TBF)
- {0 1<TBF_STARTING_TIME>}	0 (no starting time)
-	1 (Timeslot Allocation with Power Control Parameters)
	one slot arbitrarily chosen and the following USF_TNx and GAMMA_TNx shall be corresponding to the chosen value, default timeslot 2 assigned)
- ALPHA	0.5
- {0 1<USF_TN0><GAMMA_TN0>}	0 (timeslot 0 not assigned)
- {0 1<USF_TN1><GAMMA_TN1>}	0 (timeslot 1 not assigned)
- {0 1<USF_TN2><GAMMA_TN2>}	1 (timeslot 2 assigned)
- USF_TN2	Arbitrarily chosen (default 101)
- GAMMA_TN2	For DCS 1800, +6 dBmPCS 1 900, +6 dBm
	For other bands +9 dBm
- {0 1<USF_TN3><GAMMA_TN3>}	0 (timeslot 3 not assigned)
- {0 1<USF_TN4><GAMMA_TN4>}	0 (timeslot 4 not assigned)
- {0 1<USF_TN5><GAMMA_TN5>}	0 (timeslot 5 not assigned)
- {0 1<USF_TN6><GAMMA_TN6>}	0 (timeslot 6 not assigned)
- {0 1<USF_TN7><GAMMA_TN7>}	0 (timeslot 7 not assigned)
spare padding	Spare Padding

See also clause 40.

10.9 GPS Scenario and Assistance data for Assisted GPS signalling tests

10.9.1 General

This section defines the GPS scenario and the associated assistance data that shall be used for all Assisted GPS signalling tests defined in clause 70.7 to 70.9.

Where assistance data is required on a per-satellite basis, or where the values of the data also varies with time it is specified in comma-separated-variable files in the GPS data zip file specified in annex 8.1. These files specify the values to be used for each satellite, indexed by satellite PRN, and, where applicable, the values to be used indexed by both time and satellite PRN.

Assistance data that is marked as “time varying” and the GPS TOW field are only specified and used in 0.96 second increments. Interpolation between these values shall not be used.

The accuracy of the GPS TOW and assistance data that is marked as “time varying” in the provided assistance data shall be within +/- 2 s relative to the GPS time in the system simulator.

Assistance data Information Elements and fields that are not specified shall not be used.

10.9.2 GPS Scenario

The following GPS scenario shall be used. The assistance data specified in the following sections is consistent with this GPS scenario:

- Yuma Almanac data: see file Tokyo Yuma.txt in the GPS data zip file specified in annex 8.1
- MS location and Reference location: static at latitude: 35 degrees 40 minutes north, longitude: 139 degrees 45 minutes east, (Tokyo) height: = 50m
- Start time: 12th September 2003 21:30:00
- Visible satellites simulated: PRNs: 4, 6, 9, 10, 13, 22
- Ionospheric model: see values in section 10.9.6

10.9.3 Assistance Data Reference Time

Reference Time

Reference Time (Fields occurring once per message)

Parameter	Units	Value/remark
GPS Week	weeks	211
GPS TOW	sec	509400 s. Start time. Add integer number of 0.96 seconds as required. (Note)

Note: GPS TOW

This is the value of GPS TOW when the GPS scenario is started in the GPS simulator. The value of GPS TOW to be used in the Reference Time IE shall be calculated at the time the IE is required by adding the elapsed time since the time the scenario was started in the GPS simulator to this value, rounded up to the next 0.96 second interval. This “current GPS TOW” is then also used to determine the value of any other parameters marked as “Time varying” in clause 10.9

10.9.4 Assistance Data Reference Location

Reference Location**Reference Location**

Parameter	Units	Value/remark
Type of Shape	Bit field	Ellipsoid point with altitude and uncertainty Ellipsoid
Degrees of latitude	degrees	+3.566666666666667 10E1
Degrees of longitude	degrees	+1.397500000000000 10E2
Altitude	m	+50
Uncertainty semi-major	m	3000
Uncertainty semi-minor	m	3000
Orientation of major axis	degrees	0
Uncertainty altitude	m	500
Confidence	%	68

10.9.5 Assistance Data Navigation Model**Navigation Model****Navigation Model (Fields occurring once per message)**

Parameter	Units	Value/remark
Num_Sats_Total	---	6

Navigation Model (Fields occurring once per satellite)

Parameter	Units	Value/remark
SatID	---	PRNs: 4, 6, 9, 10, 13, 22.
Satellite Status	Boolean	See file: Navigation model.csv
C/A or P on L2	Boolean	See file: Navigation model.csv
URA Index	Boolean	See file: Navigation model.csv
SV Health	Boolean	See file: Navigation model.csv
IODC	---	See file: Navigation model.csv
L2 P Data Flag	Boolean	See file: Navigation model.csv
SF 1 Reserved	---	See file: Navigation model.csv
T_{GD}	sec	See file: Navigation model.csv
t_{oc}	sec	See file: Navigation model.csv
af_2	sec/sec ²	See file: Navigation model.csv
af_1	sec/sec	See file: Navigation model.csv
af_0	sec	See file: Navigation model.csv
C_{rs}	meters	See file: Navigation model.csv
Δn	semi-circles/sec	See file: Navigation model.csv
M_0	semi-circles	See file: Navigation model.csv
C_{uc}	radians	See file: Navigation model.csv
e	---	See file: Navigation model.csv
C_{us}	radians	See file: Navigation model.csv
$(A)^{1/2}$	meters ^{1/2}	See file: Navigation model.csv
t_{oe}	sec	See file: Navigation model.csv
Fit Interval Flag	Boolean	See file: Navigation model.csv
AODO	sec	See file: Navigation model.csv
C_{ic}	radians	See file: Navigation model.csv
OMEGA ₀	semi-circles	See file: Navigation model.csv
C_{is}	radians	See file: Navigation model.csv
i_0	semi-circles	See file: Navigation model.csv
C_{rc}	meters	See file: Navigation model.csv
ω	semi-circles	See file: Navigation model.csv
OMEGA _{dot}	semi-circles/sec	See file: Navigation model.csv
Idot	semi-circles/sec	See file: Navigation model.csv

10.9.6 Assistance Data Ionospheric Model

Ionospheric Model

Parameter	Units	Value/remark
α_0	seconds	4.6566129 10E-9
α_1	sec/semi-circle	1.4901161 10E-8
α_2	sec/(semi-circle) ²	-5.96046 10E-8
α_3	sec/(semi-circle) ³	-5.96046 10E-8
β_0	seconds	79872
β_1	sec/semi-circle	65536
β_2	sec/(semi-circle) ²	-65536
β_3	sec/(semi-circle) ³	-393216

10.9.7 Assistance Data Almanac

Almanac

Almanac (Fields occurring once per message)

Parameter	Units	Value/remark
Num_Sats_Total	---	24
WN _a	weeks	212

Almanac (Fields occurring once per satellite)

Parameter	Units	Value/remark
SatID	---	PRNs: 1 to 24
e	dimensionless	See file: Almanac.csv
t_{oa}	sec	See file: Almanac.csv
δ_i	semi-circles	See file: Almanac.csv
OMEGADOT	semi-circles/sec	See file: Almanac.csv
SV Health	Boolean	See file: Almanac.csv
$A^{1/2}$	meters ^{1/2}	See file: Almanac.csv
Ω_0	semi-circles	See file: Almanac.csv
ω	semi-circles	See file: Almanac.csv
M_0	semi-circles	See file: Almanac.csv
af_0	seconds	See file: Almanac.csv
af_1	sec/sec	See file: Almanac.csv

10.9.8 Assistance Data Acquisition Assistance**Acquisition Assistance****GPS Acquisition Assist - Parameters appearing once per message**

Parameter	Units	Value/remark
Number of Satellites	---	6
GPS TOW	sec	509400 s. Start time. Add integer number of 0.96 seconds as required. (Note)

Note: GPS TOW

This is the value of GPS TOW when the GPS scenario is started in the GPS simulator. The value of GPS TOW to be used in the Acquisition Assistance IE shall be calculated at the time the IE is required by adding the elapsed time since the time the scenario was started in the GPS simulator to this value, rounded up to the next 0.96 second interval.

GPS Acquisition Assist - Parameters appearing [number of satellites] times per message

Parameter	Units	Value/remark
SVID/PRNID	---	PRNs: 4, 6, 9, 10, 13, 22.
Doppler (0 th order term)	Hz	Time varying. See file: Acquisition assist .csv (Note)
Doppler (1 st order term)	Hz/sec	Time varying. See file: Acquisition assist .csv (Note)
Doppler Uncertainty	Hz	Time varying. See file: Acquisition assist .csv (Note)
Code Phase	chips	Time varying. See file: Acquisition assist .csv (Note)
Integer Code Phase	---	Time varying. See file: Acquisition assist .csv (Note)
GPS Bit number	---	Time varying. See file: Acquisition assist .csv (Note)
Code Phase Search Window	chips	Time varying. See file: Acquisition assist .csv (Note)
Azimuth	deg	Time varying. See file: Acquisition assist .csv (Note)
Elevation	deg	Time varying. See file: Acquisition assist .csv (Note)

Note: Acquisition Assist parameters

This field is “Time varying” and its value depends on the “current GPS TOW” as described in clause 10.9.3. The value of this field to be used shall be determined by taking the “current GPS TOW” value and selecting the field value in the Acquisition assist.csv file corresponding to the value of “current GPS TOW”.

**10.10 GPS Scenarios and Assistance Data for Assisted GPS
Minimum Performance tests****10.10.1 General**

This clause defines the GPS scenarios and assistance data IEs which shall be available for use as specified in all A-GPS Minimum Performance test cases defined in clause 70.11.

The information elements are given with reference to 3GPP TS 44.031, where the details are defined.

Clauses 10.10.2 and 10.10.3 list the assistance data IEs required for performance testing of MS-based mode, and clauses 10.10.4 and 10.10.5 list the assistance data available for performance testing of MS-assisted mode. Clause 10.10.6 lists the values of the assistance data IE fields for all performance testing.

The A-GPS minimum performance requirements are defined by assuming that all relevant and valid assistance data is received by the MS in order to perform GPS measurements and/or position calculation. This clause does not include nor consider delays occurring in the various signalling interfaces of the network.

10.10.1.1 Satellite constellations and assistance data for performance testing

The satellite constellations for performance testing shall consist of 24 satellites. Almanac assistance data shall be available for all these 24 satellites. At least 9 of the satellites shall be visible to the MS (that is above 5 degrees elevation with respect to the MS). Other assistance data shall be available for 9 of these visible satellites. In each test, signals are generated for only a sub-set of these satellites for which other assistance data is available. The number of satellites in this sub-set is specified in the test. The satellites in this sub-set shall all be above 15 degrees elevation with respect to the MS. The HDOP for the test shall be calculated using this sub-set of satellites. The selection of satellites for this sub-set shall be random and consistent with achieving the required HDOP for the test.

10.10.1.2 GPS Scenarios for performance testing

This section defines the GPS scenarios that shall be used for all Assisted GPS performance tests defined in clause 70.11.

The GPS scenarios achieve the required HDOP for the Test Cases as defined in the Requirements specification TS 45.005. They also satisfy the requirement that for each test instance the reference location shall change sufficiently such that the MS shall have to use the new assistance data.

The satellites to be simulated in each test case are specified in clause 10.10.1.2.5.

The viable running time during which the scenario maintains the required HDOP or HDOPs is given. Once this time has been reached the scenario shall be restarted from its nominal start time.

10.10.1.2.1 GPS Scenario #1

The following GPS scenario #1 shall be used during the TTFB tests defined in clause 70.11. The assistance data specified in the following sections for GPS scenario #1 is consistent with this GPS scenario.

Yuma Almanac data: see file GPS 1 Yuma.txt in the GPS data perf zip file specified in A8.2.

MS location: the MS location is calculated as a random offset from the reference location using the method described in section 10.10.1.2.4. The reference location is: latitude: 33 degrees 45 minutes 0.019 seconds north, longitude: 84 degrees 23 minutes 0.011 seconds west, (Atlanta USA), height: = 300m.

Nominal start time: 22nd January 2005 (Saturday) 00:08:00.

Viable running time to maintain specified HDOP values: 19 minutes.

Visible satellites available for simulation and for which Assistance Data (other than Almanac) shall be generated: PRNs: 2, 6, 10, 17, 18, 21, 26, 29, 30.

Ionospheric model: see values in section 10.10.6.6.

Tropospheric model: STANAG with SRI equal to 324.8, as defined in [STANAG 4294].

10.10.1.2.2 GPS Scenario #2

The following GPS scenario #2 shall be used during the TTFB tests defined in clause 70.11. The assistance data specified in the following sections for GPS scenario #2 is consistent with this GPS scenario.

Yuma Almanac data: see file GPS 2 Yuma.txt in the GPS data perf zip file specified in A8.2.

MS location: the MS location is calculated as a random offset from the reference location using the method described in section 10.10.1.2.4. The reference location is: latitude: 37 degrees 48 minutes 59.988 seconds south, longitude: 144 degrees 58 minutes 0.013 seconds east, (Melbourne Australia), height: = 100m.

Nominal start time: 22nd January 2004 (Thursday) 00:08:00.

Viable running time to maintain specified HDOP values: 19 minutes.

Visible satellites available for simulation and for which Assistance Data (other than Almanac) shall be generated:
PRNs: 3, 11, 14, 15, 18, 22, 23, 25, 31.

Ionospheric model: see values in section 10.10.6.6.

Tropospheric model: STANAG with SRI equal to 324.8, as defined in [STANAG 4294].

10.10.1.2.3 GPS Scenario #3

The following GPS scenario #3 shall be used during the Moving Scenario and Periodic Location test case defined in clause 70.11. The assistance data specified in the following sections for GPS scenario #3 is consistent with this GPS scenario.

Yuma Almanac data: see file GPS 3 Yuma.txt in the GPS data perf zip file specified in A8.2.

MS location: the MS location is given as a trajectory as shown in Figure 70.11.9.1 of clause 70.11. The reference location is at the centre of the trajectory and is at: latitude: 37 degrees 48 minutes 59.988 seconds south, longitude: 144 degrees 58 minutes 0.013 seconds east, (Melbourne Australia), height: = 100m.

Start time: 22nd January 2004 (Thursday) 00:08:00.

Start location: at the point between I_{11} and I_{12} in Figure 70.11.9.1 of clause 70.11, going in a clock-wise direction.

Visible satellites available for simulation and for which Assistance Data (other than Almanac) shall be generated:
PRNs: 3, 11, 14, 15, 18, 22, 23, 25, 31.

Viable running time to maintain specified HDOP values: 19 minutes.

Ionospheric model: see values in section 10.10.6.6.

Tropospheric model: STANAG with SRI equal to 324.8, as defined in [STANAG 4294].

10.10.1.2.4 MS Location for TTFF test cases

This section defines the method for generating the random MS locations that are required to be used for the TTFF tests defined in clause 70.11.

For every Test Instance in each TTFF test case, the MS location shall be randomly selected to be within 3 km of the Reference Location. The Altitude of the MS shall be randomly selected between 0 m to 500 m above WGS-84 reference ellipsoid. These values shall have uniform random distributions.

The MS location is calculated as an offset from the Reference Location.

10.10.1.2.4.1 MS Location Offset

The MS location offset shall be calculated by selecting the next pair of random numbers, representing a pair of latitude and longitude offsets in degrees, from a standard uniform random number generator, with the following properties:

The ranges of the latitude and longitude offsets values shall be such that when translated onto the surface of the earth they shall lie within a 3km radius circle, centred on the Reference location specified for the GPS scenario under consideration. For the purposes of this calculation make the following assumptions:

- Over the 3km radius circle at the Reference location the earth is flat and the meridians and parallels form a rectangular grid
- The earth is spherical with a radius of 6371141m (equal to the WGS 84 value at 35 degrees latitude)

The resolution used for the latitude and longitude offsets values shall be $90/2E23$ for the latitude offset values and $360/2E24$ for the longitude offset values, representing the coding resolution in degrees specified in 3GPP TS 23.032.

10.10.1.2.4.2 MS Altitude

The MS altitude value shall be calculated by selecting the next random number from a standard uniform random number generator, in the range 0 to 500, representing meters. The resolution used for the random number shall be 1, representing 1 meter.

10.10.1.2.5 Satellites to be simulated in each test case

The satellites to be simulated in each test case have been selected in order to achieve the required HDOP for that test case.

Satellites to be simulated

Test case	PRNs GPS #1	PRNs GPS #2	PRNs GPS #3
Sensitivity Coarse Time Assistance	2, 6, 10, 17, 18, 21, 26, 29	3, 11, 14, 15, 22, 23, 25, 31	-
Sensitivity Fine Time Assistance	2, 6, 10, 17, 18, 21, 26, 29	3, 11, 14, 15, 22, 23, 25, 31	-
Nominal Accuracy	2, 6, 10, 17, 18, 21, 26, 29	3, 11, 14, 15, 22, 23, 25, 31	-
Dynamic Range	2, 6, 10, 17, 26, 29	3, 14, 15, 22, 25, 31	-
Multi-Path scenario	2, 6, 17, 21, 26	3, 14, 15, 22, 25	-
Moving Scenario and Periodic location	-	-	3, 14, 15, 22, 25

10.10.2 Information elements required for normal MS based testing

The following A-GPS assistance data IEs and fields shall be present for each test. Fields not specified shall not be present. The values of the fields are specified in clause 10.10.6.

- a) **Reference Time IE.** This information element is defined in subclause A.4.2.4 of 3GPP TS 44.031.

Fields of the IE
GPS Week
GPS TOW
GPS TOW Assist
SatID
TLM Message
Anti-Spoof
Alert
TLM Reserved

- b) **Reference Location IE.** This information element is defined in subclause A.4.2.4 of 3GPP TS 44.031.

Fields of the IE
Ellipsoid point with Altitude and uncertainty ellipsoid

- c) **Navigation Model IE.** This information element is defined in subclause A.4.2.4 of 3GPP TS 44.031.

Fields of the IE
All satellite information

- d) **Ionospheric Model IE.** This information element is defined in subclause A.4.2.4 of 3GPP TS 44.031.

Fields of the IE
All

10.10.3 Information elements required for MS based Sensitivity Fine Time Assistance test case

The A-GPS assistance data IEs and fields that shall be present for the Sensitivity Fine Time Assistance test case shall be those specified in clause 10.10.2 with the following exception. Fields not specified shall not be present. The values of the fields are specified in clause 10.10.6.

Reference Time IE. This information element is defined in subclause A.4.2.4 of 3GPP TS 44.031.

Fields of the IE
GPS Week
GPS TOW
BCCH Carrier
BSIC
FNm
TN
BN
GPS TOW Assist
SatID
TLM Message
Anti-Spoof
Alert
TLM Reserved

10.10.4 Information elements available for normal MS assisted testing

The following A-GPS assistance data IEs and fields shall be available for use in each test. Fields not specified shall not be present. The values of the fields are specified in clause 10.10.6.

a) **Reference Time IE.** This information element is defined in subclause A.4.2.4 of 3GPP TS 44.031.

Fields of the IE
GPS Week
GPS TOW
GPS TOW Assist
SatID
TLM Message
Anti-Spoof
Alert
TLM Reserved

b) **Reference Location IE.** This information element is defined in subclause A.4.2.4 of 3GPP TS 44.031.

Fields of the IE
Ellipsoid point with Altitude and uncertainty ellipsoid

c) **Almanac IE.** This information element is defined in subclause A.4.2.4 of 3GPP TS 44.031.

Fields of the IE
Almanac Reference Week
All Satellite information

d) **Navigation Model IE.** This information element is defined in subclause A.4.2.4 of 3GPP TS 44.031.

Fields of the IE
All satellite information

e) **Acquisition Assistance IE.** This information element is defined in subclause A.4.2.4 of 3GPP TS 44.031.

Fields of the IE
GPS TOW
Satellite information
SVID/PRNID
Doppler (0 th order term)
Doppler (1 st order term)
Doppler Uncertainty
Code Phase
Integer Code Phase
GPS Bit number
Code Phase Search Window
Azimuth
Elevation

10.10.5 Information elements available for MS assisted Sensitivity Fine Time Assistance test case

The A-GPS assistance data IEs and fields that shall be available for use for the Sensitivity Fine Time Assistance test case shall be those specified in clause 10.10.4 with the following exceptions. Fields not specified shall not be present. The values of the fields are specified in clause 10.10.6.

a) **Reference Time IE.** This information element is defined in subclause A.4.2.4 of 3GPP TS 44.031.

Fields of the IE
GPS Week
GPS TOW
BCCH Carrier
BSIC
FNm
TN
BN
GPS TOW Assist
SatID
TLM Message
Anti-Spoof
Alert
TLM Reserved

b) **Acquisition Assistance IE.** This information element is defined in subclause A.4.2.4 of 3GPP TS 44.031.

Fields of the IE
GPS TOW
BCCH Carrier
BSIC
Frame #
Timeslots #
Bit #
SVID/PRNID
Doppler (0 th order term)
Doppler (1 st order term)
Doppler Uncertainty
Code Phase
Integer Code Phase
GPS Bit number
Code Phase Search Window
Azimuth
Elevation

10.10.6 Contents of Information elements for Minimum performance testing

10.10.6.1 General

This section defines the assistance data values that shall be used for all Assisted GPS performance tests defined in clause 70.11. It is given for GPS scenarios #1, #2 and #3 where it is different for each scenario; otherwise it is marked "All" where the same value is used for all scenarios.

Where assistance data is required on a per-satellite basis, or where the values of the data also varies with time it is specified in comma-separated-variable files with suffixes XX in the GPS data perf zip file specified in A8.2, where XX is 01, 02 and 03 for GPS scenarios #1, #2 and #3 respectively. These files specify the values to be used for each satellite, indexed by satellite PRN, and, where applicable, the values to be used indexed by both time and satellite PRN.

Assistance data that is marked as "time varying" is specified and used in 80 ms increments. Interpolation between these values shall not be used.

Assistance data Information Elements and fields that are not specified shall not be used.

10.10.6.2 IE Random Offset Values

This section defines the methods for generating the random offsets that are required to be applied to one or two assistance data IEs for certain tests defined in clause 70.11.

10.10.6.2.1 GPS TOW

For every Test Instance in each TTFF test case, the IE GPS TOW shall have a random offset, relative to GPS system time, within the allowed error range of Coarse Time Assistance defined in the test case. This offset value shall have a uniform random distribution.

Note: For the Moving Scenario and Periodic Update Test Case the value of the IE GPS TOW shall be set to the nominal value, i.e. no offset shall be used.

The offset value shall be calculated by selecting the next random number from a standard uniform random number generator, in the range specified for the GPS Coarse Time assistance error range in the Test Requirements, Test parameters table for the test under consideration. The resolution used for the random number shall be 0.01, representing 10ms.

10.10.6.2.1 GPS bit number (BN or Bit #)

In addition, for every Fine Time Assistance Test Instance the IE BN or Bit # shall have a random offset, relative to the true value of the relationship between the two time references, within the allowed error range of Fine Time Assistance defined in the test case. This offset value shall have a uniform random distribution.

The offset value shall be calculated by selecting the next random number from a standard uniform random number generator with the following properties:

The range shall be the number of GSM bits whose duration is less than the range specified for the GPS Fine Time assistance error range in the Test Requirements, Test parameters table for the test under consideration.

The resolution used for the random number shall be 1, representing 1 GSM bit.

10.10.6.3 Assistance Data Reference Time

Contents of Reference Time IE

Reference Time (Fields occurring once per message)

Parameter	Units	Value/remark GPS #1	Value/remark GPS #2	Value/remark GPS #3
GPS Week	weeks	282	230	230
GPS TOW	msec	518880000. Start time. Add number of 80ms as required. (Note 1)	346080000. Start time. Add number of 80ms as required. (Note 1)	346080000. Start time. Add number of 80ms as required. (Note 1)
BCCH Carrier		ARFCN of serving BCCH	ARFCN of serving BCCH	-
BSIC		BSIC of serving BCCH	BSIC of serving BCCH	-
FNm		Present for Sensitivity Fine Time Assistance test case. Absent otherwise. Note 2	Present for Sensitivity Fine Time Assistance test case. Absent otherwise. Note 2	-
TN		Present for Sensitivity Fine Time Assistance test case. Absent otherwise. Note 2	Present for Sensitivity Fine Time Assistance test case. Absent otherwise. Note 2	-
BN		Present for Sensitivity Fine Time Assistance test case. Absent otherwise. Note 2	Present for Sensitivity Fine Time Assistance test case. Absent otherwise. Note 2	-

Note 1: GPS TOW

This is the value in ms of GPS TOW when the GPS scenario is initially started in the GPS simulator. For all TTFF test cases, each time a GPS scenario is used, the GPS start time shall be advanced by 120 seconds from the value last used so that, at the time the fix is made, it is at least 2 minutes later than the previous fix made with that scenario.

The actual value of GPS TOW to be used in the Reference Time IE (before the addition of the random offset, if applicable) shall be calculated at the time the IE is required by adding the elapsed time since the time the scenario was started in the GPS simulator to this value. The accuracy shall be such that the Maximum Test System Uncertainty for Coarse Time Assistance, specified in Table A5.5.1 of clause 70.11, shall be met.

For all TTFF test cases a random offset is then added to the value of GPS TOW as described in clause 10.10.6.2

Note 2: GSM Frame Number (FNm), Timeslot Number (TN) and Bit Number (BN)

The values of the IEs FNm, TN and BN (before the addition of the random offset) shall be calculated at the time the IE is required. The accuracy of the relationship between the two time references shall be such that the Maximum Test System Uncertainty for Fine Time Assistance, specified in Table A5.5.1 of clause 70.11, shall be met.

A random offset is then added to the value of BN as described in clause 10.10.6.2

Satellite Information

Parameter	Units	Value/remark GPS All
Number of satellites	---	9

Reference Time - GPS TOW Assist (Fields occurring once per satellite)

Parameter	Units	Value/remark GPS #1	Value/remark GPS #2	Value/remark GPS #3
SatID		PRNs: 2, 6, 10, 17, 18, 21, 26, 29, 30	PRNs: 3, 11, 14, 15, 18, 22, 23, 25, 31	PRNs: 3, 11, 14, 15, 18, 22, 23, 25, 31

Reference Time - GPS TOW Assist (Fields occurring once per satellite)

Parameter	Units	Value/remark GPS All
TLM Message	Bit string	10922
Anti-Spoof	Bit string	1
Alert	Boolean	0
TLM Reserved	Boolean	2

10.10.6.4 Assistance Data Reference Location

Contents of Reference Location IE

The uncertainty of the semi-major axis is 3 km. The uncertainty of the semi-minor axis is 3 km. The orientation of the major axis is 0 degrees. The uncertainty of the altitude information is 500 m. The confidence factor is 68%.

Reference Location

Parameter	Units	Value/remark GPS #1	Value/remark GPS #2	Value/remark GPS #3
Type of Shape	Bit field	Ellipsoid point with altitude and uncertainty Ellipsoid	Ellipsoid point with altitude and uncertainty Ellipsoid	Ellipsoid point with altitude and uncertainty Ellipsoid
Degrees of latitude	degrees	33.750005	-37.816663	-37.816663
Degrees of longitude	degrees	-84.383517	144.966670	144.966670
Altitude	m	+300	+100	+100
Uncertainty semi-major	m	3000	3000	3000
Uncertainty semi-minor	m	3000	3000	3000
Orientation of major axis	degrees	0	0	0
Uncertainty altitude	m	500	500	500
Confidence	%	68	68	68

10.10.6.5 Assistance Data Navigation Model

Contents of Navigation Model IE

Satellite Information

Parameter	Units	Value/remark GPS All
Number of satellites	---	9

Navigation Model (Fields occurring once per satellite)

Parameter	Units	Value/remark GPS #1	Value/remark GPS #2	Value/remark GPS #3
SatID	---	PRNs: 2, 6, 10, 17, 18, 21, 26, 29, 30	PRNs: 3, 11, 14, 15, 18, 22, 23, 25, 31	PRNs: 3, 11, 14, 15, 18, 22, 23, 25, 31
Satellite Status	Boolean	0 (Note)	0 (Note)	0 (Note)

Note: For consistency Satellite Status is also given in file: Navigation model XX.csv

Ephemeris and Clock Correction parameters (Fields occurring once per satellite)

Parameter	Units	Value/remark GPS All
C/A or P on L2	Boolean	See file: Navigation model XX.csv
URA Index	Boolean	See file: Navigation model XX.csv
SV Health	Boolean	See file: Navigation model XX.csv
IODC	---	See file: Navigation model XX.csv
L2 P Data Flag	Boolean	See file: Navigation model XX.csv
SF 1 Reserved	---	See file: Navigation model XX.csv
T_{GD}	sec	See file: Navigation model XX.csv
t_{oc}	sec	See file: Navigation model XX.csv
af_2	sec/sec ²	See file: Navigation model XX.csv
af_1	sec/sec	See file: Navigation model XX.csv
af_0	sec	See file: Navigation model XX.csv
C_{rs}	meters	See file: Navigation model XX.csv
Δn	semi-circles/sec	See file: Navigation model XX.csv
M_0	semi-circles	See file: Navigation model XX.csv
C_{uc}	radians	See file: Navigation model XX.csv
e	---	See file: Navigation model XX.csv
C_{us}	radians	See file: Navigation model XX.csv
$(A)^{1/2}$	meters ^{1/2}	See file: Navigation model XX.csv
t_{oe}	sec	See file: Navigation model XX.csv
Fit Interval Flag	Boolean	See file: Navigation model XX.csv
AODO	sec	See file: Navigation model XX.csv
C_{ic}	radians	See file: Navigation model XX.csv
OMEGA_0	semi-circles	See file: Navigation model XX.csv
C_{is}	radians	See file: Navigation model XX.csv
i_0	semi-circles	See file: Navigation model XX.csv
C_{rc}	meters	See file: Navigation model XX.csv
ω	semi-circles	See file: Navigation model XX.csv
OMEGA_{dot}	semi-circles/sec	See file: Navigation model XX.csv
$Idot$	semi-circles/sec	See file: Navigation model XX.csv

10.10.6.6 Assistance Data Ionospheric Model

Contents of Ionospheric Model IE

Ionospheric Model

Parameter	Units	Value/remark GPS All
α_0	seconds	4.6566129 10E-9
α_1	sec/semi-circle	1.4901161 10E-8
α_2	sec/(semi-circle) ²	-5.96046 10E-8
α_3	sec/(semi-circle) ³	-5.96046 10E-8
β_0	seconds	79872
β_1	sec/semi-circle	65536
β_2	sec/(semi-circle) ²	-65536
β_3	sec/(semi-circle) ³	-393216

10.10.6.7 Assistance Data Almanac

Contents of Almanac

Almanac (Field occurring once per message)

Parameter	Units	Value/remark GPS #1	Value/remark GPS #2	Value/remark GPS #3
WN_a	weeks	27	230	230

Satellite Information

Parameter	Units	Value/remark GPS All
Number of satellites	---	24

Almanac (Fields occurring once per satellite)

Parameter	Units	Value/remark GPS #1	Value/remark GPS #2	Value/remark GPS #3
SatID	---	PRNs: 1, 2, 4, 5, 6, 7, 9, 10, 11, 14, 15, 16, 17, 18, 19, 20, 21, 22, 24, 25, 26, 27, 29, 30	PRNs: 1, 2, 3, 4, 5, 6, 7, 8, 11, 13, 14, 15, 16, 17, 18, 20, 21, 22, 23, 25, 27, 28, 30, 31	PRNs: 1, 2, 3, 4, 5, 6, 7, 8, 11, 13, 14, 15, 16, 17, 18, 20, 21, 22, 23, 25, 27, 28, 30, 31

Almanac (Fields occurring once per satellite)

Parameter	Units	Value/remark
e	dimensionless	See file: Almanac XX.csv
t_{0a}	sec	See file: Almanac XX.csv
δi	semi-circles	See file: Almanac XX.csv
OMEGADOT	semi-circles/sec	See file: Almanac XX.csv
SV Health	Boolean	See file: Almanac XX.csv
$A^{1/2}$	meters ^{1/2}	See file: Almanac XX.csv
OMEGA_0	semi-circles	See file: Almanac XX.csv
ω	semi-circles	See file: Almanac XX.csv
M_0	semi-circles	See file: Almanac XX.csv
af_0	seconds	See file: Almanac XX.csv
af_1	sec/sec	See file: Almanac XX.csv

10.10.6.8 Assistance Data Acquisition Assistance

Contents of Acquisition Assistance IE

GPS Acquisition Assistance (Fields occurring once per message)

Parameter	Units	Value/remark GPS #1	Value/remark GPS #2	Value/remark GPS #3
GPS TOW	msec	51888000 ms. Start time. Add number of 80ms as required. (Note 1)	346080000 ms. Start time. Add number of 80ms as required. (Note 1)	346080000 ms. Start time. Add number of 80ms as required. (Note 1)
BCCH Carrier		ARFCN of serving BCCH	ARFCN of serving BCCH	Absent
BSIC		BSIC of serving BCCH	BSIC of serving BCCH	-
Frame #		Present for Sensitivity Fine Time Assistance test case. Absent otherwise. Note 2	Present for Sensitivity Fine Time Assistance test case. Absent otherwise. Note 2	-
Timeslots #		Present for Sensitivity Fine Time Assistance test case. Absent otherwise. Note 2	Present for Sensitivity Fine Time Assistance test case. Absent otherwise. Note 2	-
Bit #		Present for Sensitivity Fine Time Assistance test case. Absent otherwise. Note 2	Present for Sensitivity Fine Time Assistance test case. Absent otherwise. Note 2	-

Note 1: GPS TOW

This is the value in ms of GPS TOW when the GPS scenario is initially started in the GPS simulator. For all TTFF test cases, each time a GPS scenario is used, the GPS start time shall be advanced by 120 seconds from the value last used so that, at the time the fix is made, it is at least 2 minutes later than the previous fix made with that scenario.

The actual value of GPS TOW to be used in the Acquisition Assistance IE (before the addition of the random offset, if applicable) shall be calculated at the time the IE is required by adding the elapsed time since the time the scenario was started in the GPS simulator to this value. The accuracy shall be such that the Maximum Test System Uncertainty for Coarse Time Assistance, specified in Table A5.5.1 of clause 70.11, shall be met.

For all TTFF test cases a random offset is then added to the value of GPS TOW as described in clause 10.10.6.2

This "final GPS TOW" value is then also used to determine the value of the Acquisition Assistance parameters marked as "Time varying" in clause 10.10.6.8

Note 2: GSM Frame Number (Frame #), Timeslot Number (Timeslots #) and Bit Number (Bit #)

The values of the IEs Frame #, Timeslots # and Bit # (before the addition of the random offset) shall be calculated at the time the IE is required. The accuracy of the relationship between the two time references shall be such that the Maximum Test System Uncertainty for Fine Time Assistance, specified in Table A5.5.1 of clause 70.11, shall be met.

A random offset is then added to the value of Bit # as described in clause 10.10.6.2

Satellite Information

Parameter	Units	Value/remark GPS All
Number of satellites	---	9

GPS Acquisition Assistance (Fields occurring once per satellite)

Parameter	Units	Value/remark GPS #1	Value/remark GPS #2	Value/remark GPS #3
SVID/PRNID	---	PRNs: 2, 6, 10, 17, 18, 21, 26, 29, 30	PRNs: 3, 11, 14, 15, 18, 22, 23, 25, 31	PRNs: 3, 11, 14, 15, 18, 22, 23, 25, 31

GPS Acquisition Assistance (Fields occurring once per satellite)

Parameter	Units	Value/remark GPS All
Doppler (0 th order term)	Hz	Time varying. See file: Acquisition assist XX.csv (Note)
Doppler (1 st order term)	Hz/sec	Time varying. See file: Acquisition assist XX.csv (Note)
Doppler Uncertainty	Hz	Time varying. See file: Acquisition assist XX.csv (Note)
Code Phase	chips	Time varying. See file: Acquisition assist XX.csv (Note)
Integer Code Phase	---	Time varying. See file: Acquisition assist XX.csv (Note)
GPS Bit number	---	Time varying. See file: Acquisition assist XX.csv (Note)
Code Phase Search Window	chips	Time varying. See file: Acquisition assist XX.csv (Note)
Azimuth	deg	Time varying. See file: Acquisition assist XX.csv (Note)
Elevation	deg	Time varying. See file: Acquisition assist XX.csv (Note)

Note: Acquisition Assistance parameters

This field is "Time varying" and its value depends on the "final GPS TOW" as described in clause 10.10.6.8. The value of this field to be used shall be determined by taking the "final GPS TOW" value and selecting the nearest field value in the Acquisition assist.csv file corresponding to the value of "final current GPS TOW".

11 General tests

11.1 Verification of support and non-support of services (multiple numbering scheme or ISDN)

11.1.1 Mobile Terminated (MT) calls

11.1.1.1 Definition

This test is repeated for all Mobile Terminated Bearer Services / Teleservices according to 3GPP TS 02.02 and 3GPP TS 02.03 except Teleservices 21, 22 and 23.

11.1.1.2 Conformance requirement

1. The MS shall check the Information Elements for Bearer Capability in a received SETUP message, and if it agrees to the proposed set, it shall respond with a CALL CONFIRMED message.

3GPP TS 04.08 / 3GPP TS 24.008, subclause 5.2.2.2; 3GPP TS 04.08 / 3GPP TS 24.008, subclause 5.2.2.3.
2. The MS in the "Null" state, U0, ready to receive a SETUP shall reject a SETUP with Information Elements for Bearer Capability which are incompatible with the Bearer Services / Teleservices supported by the MS, and shall send a RELEASE COMPLETE message.

3GPP TS 04.08 / 3GPP TS 24.008, subclause 5.2.2.2; 3GPP TS 04.08 / 3GPP TS 24.008, subclause 5.2.2.3.1; 3GPP TS 07.01, subclause 8.3.1; 3GPP TS 04.08 / 3GPP TS 24.008, subclause B.3.2.

11.1.1.3 Test purpose

1. To verify that the MS, for the case of the Multinumbering scheme or ISDN, accepts a SETUP message, where the Information Elements for Bearer Capability are compatible with the Bearer Services / Teleservices declared as supported by the MS, by sending a CALL CONFIRMED message.

This is verified for all Mobile Terminated Bearer Services / Teleservices declared as supported by the MS.

2. To verify that the MS in the "Null" state, U0, when receiving a SETUP message containing incompatible Information Elements for Bearer Capability will respond with a RELEASE COMPLETE message.

This is verified for all Mobile Terminated Bearer Services / Teleservices not declared as supported by the MS.

11.1.1.4 Method of test

11.1.1.4.1 Initial conditions

For an MS with an external interface the interface shall be setup in such a way that the MS is able to successfully receive the call for the service in question. The manufacturer shall state how this is done in a PIXIT statement. The same applies to features which must be activated by MMI before an incoming call can be accepted.

The PIXIT statement for the service in question shall be consistent with the PICS statement made by the manufacturer and will result for this tests in one or several valid BC codings as presented in subclause 11.8.

The generic call set-up procedure shall be followed up to and including the reception of the CIPHERING MODE COMPLETE message from the MS.

11.1.1.4.2 Procedure

- a) For a Mobile Terminated Bearer Service / Teleservice declared as supported by the MS. The SS transmits a SETUP message.

The SETUP shall contain a single or dual BC-IE where the parameter values are arbitrarily selected among those declared as supported by the MS in PIXIT statements and corresponding to the Bearer Service / Teleservice being tested.

- b) If more than one BC-IE (or pair of) correspond to the Bearer Service / Teleservice being tested, step a) is repeated once (and only once) with another single or dual BC-IE. The BC-IE shall be chosen in such a way that as many parameters as possible are different from the previous BC-IE. In particular, if more than one value for the "Connection Element" parameter is possible, the new BC-IE shall contain a different value from the previous one for this parameter.
- c) Step a) and b) are repeated for all Bearer Services / Teleservices declared as supported by the MS.
- d) For an Mobile Terminated Bearer Service / Teleservice not declared as supported by the MS. The SS transmits SETUP. If the MS supports TS62 but not TS61, then TS61 is not tested.

The SETUP shall contain a single or dual BC-IE where the parameter values are arbitrarily selected among those defined in 3GPP TS 07.01 Annex II and corresponding to the Bearer Service / Teleservice being tested. The complete coding of the corresponding BC-IE(s) can be found in subclause 11.8.

- e) Step d) is repeated for all Bearer Services / Teleservices not declared as supported by the MS.

11.1.1.5 Test requirement

- 1) After steps a), b) and c), the MS shall send a CALL CONFIRMED message. The MS may contain a single or dual BC-IE. If present these IEs are not checked.
- 2) After steps d) and e), the MS shall send a RELEASE COMPLETE message with cause value 88 - incompatible destination.

11.1.2 Mobile Originated (MO) calls

11.1.2.1 Definition

This test is repeated for all Mobile Originated Bearer Services / Teleservices according to 3GPP TS 02.02 and 3GPP TS 02.03 except Teleservices 21, 22 and 23, which are supported by the MS.

11.1.2.2 Conformance requirement

1. The MS shall set up a call with a SETUP message containing a single or multiple BC-IE and if required by the service, a single or multiple LLC according to the actual configuration of the MS. Two bearer capabilities can be present only in the cases described in 3GPP TS 07.01.

3GPP TS 04.08 / 3GPP TS 24.008, subclause 5.2.2.2; 3GPP TS 04.08 / 3GPP TS 24.008, subclause 5.2.2.3.1; 3GPP TS 04.08 / 3GPP TS 24.008, subclause 9.3.2; 3GPP TS 07.01, subclause 8.3.3.

2. The Repeat Indicator Information Element shall be included in the SETUP message, when the in-call modification procedure is used.

3GPP TS 04.08 / 3GPP TS 24.008, subclause 9.3.2.

11.1.2.3 Test purpose

1. To verify that the MS generates a SETUP message which includes a single or multiple Bearer Capability and if required by the service, a single or multiple LLC, according to the actual configuration on the MS.

This is verified for all Mobile Originated Bearer Services / Teleservices described in 3GPP TS 07.01 and declared as supported by the MS.

2. To verify that the MS includes a correctly encoded Repeat Indicator if it includes multiple Bearer Capabilities in the SETUP message.

11.1.2.4 Method of test

11.1.2.4.1 Initial conditions

If possible, the MS shall be configured to initiate an outgoing call with a specified BC and with the corresponding LLC when the ITC value is "unrestricted digital" in the SETUP message. The manufacturer must state how this is done in a PIXIT statement. The same applies to features which must be activated by MMI before an outgoing call can be initiated.

The PIXIT statement for the service in question shall be consistent with the PICS statement made by the manufacturer and will result for this test in one valid BC coding as presented in subclause 11.8.

11.1.2.4.2 Procedure

- a) The MS shall be made to initiate a call.
- b) If the MS can be configured to send a specific BC, the test is repeated with the MS configured for all possible preferred Bearer Services and Teleservices declared as supported by the MS. The complete coding of the corresponding BC-IE(s) can be found in subclause 11.8.

11.1.2.5 Test requirement

The MS shall send a SETUP message, which shall contain the BC among those declared as supported by the MS. If the MS is configured to send a specific BC, the SETUP message shall contain this particular BC. The BC-IE(s) shall be set according to 3GPP TS 07.01. When an ITC value is set to "unrestricted digital" the MS shall include the corresponding LLC information element.

Where two BCs are contained in the SETUP message, it shall be checked that the combination is allowed, according to 3GPP TS 07.01 and that a Repeat Indicator is also included.

11.2 Verification of support of the single numbering scheme

11.2.1 Definition

-

11.2.2 Conformance requirement

1. The MS shall respond to a SETUP message containing no BC-IE with a CALL CONFIRMED message including the single or multiple Bearer Capability, according to the actual configuration of the MS. Two bearer capabilities can be present only in the cases described in 3GPP TS 07.01.

3GPP TS 04.08 / 3GPP TS 24.008, subclause 5.2.2.2; 3GPP TS 04.08 / 3GPP TS 24.008, subclause 5.2.2.3.1; 3GPP TS 04.08 / 3GPP TS 24.008, subclause 9.3.2; 3GPP TS 07.01, subclause 8.3.3.

2. The Repeat Indicator Information Element shall be included in the CALL CONFIRMED message, when the in-call modification procedure is used, and no Bearer Capability Information Element is included in the received SETUP message.

3GPP TS 04.08 / 3GPP TS 24.008, subclause 9.3.2.

11.2.3 Test purpose

1. To verify that the MS, for the case of the Single Numbering Scheme, accepts a SETUP message, where the Information Elements for Bearer Capability and Lower and Higher Layer Compatibility are not present by sending a CALL CONFIRMED message, which includes the single or multiple Bearer Capabilities, according to the actual configuration on the MS.

This is verified for one Mobile Terminated Bearer Service / Teleservice described in 3GPP TS 07.01 and declared as supported by the MS.

2. To verify that the MS includes a correctly encoded Repeat Indicator if it includes multiple Bearer Capabilities in the CALL CONFIRMED message.

11.2.4 Method of test

11.2.4.1 Initial conditions

The MS is setup to receive a call. If possible, the MS shall be configured to respond to an incoming call with a specified BC selected arbitrarily from those declared as supported by the MS, in the CALL CONFIRMED message, in reply to a SETUP message with no BC, LLC or HLC elements. The manufacturer must state how this is done in a PIXIT statement. The same applies to features which must be activated by MMI before an incoming call can be accepted.

The generic call set-up procedure shall be followed up to and including the reception of the CIPHERING MODE COMPLETE message from the MS.

The PIXIT statement for the service in question shall be consistent with the PICS statement made by the manufacturer and will result for this tests in one or several valid BC codings as presented in subclause 11.8.

11.2.4.2 Procedure

The SS transmits a SETUP message with no BC, LLC or HLC elements.

11.2.5 Test requirement

The MS shall send a CALL CONFIRMED message, which shall contain the BC among those declared as supported by the MS. If the MS is configured to respond with a specific BC, the CALL CONFIRMED message shall contain this particular BC. The BC-IE shall be coded according to 3GPP TS 07.01.

Where two BCs are contained in the CALL CONFIRMED message, it shall be checked that the combination is allowed, according to 3GPP TS 07.01 and that a Repeat Indicator is also included.

11.3 Verification of non-support of services (Advice of Charge Charging (AoCC))

11.3.1 Definition

Test procedures (a) and (b) apply to MS which support MT calls.

Test procedure (c) applies to MS which support MO calls.

Test procedure (d) applies to MS which support at least one circuit switched basic service.

11.3.2 Conformance requirement

1. An MS claiming to **not** support AoCC and in the outgoing call / U4 call delivered state, on receipt of a CONNECT message containing AoCC information shall acknowledge the CONNECT message but ignore and not acknowledge the AoCC information sent within the CONNECT.
2. An MS claiming to **not** support AoCC and in the outgoing call / U4 call delivered state, on receipt of a FACILITY message containing AoCC information shall ignore and not acknowledge the AoCC information contained within the FACILITY.
3. An MS claiming to **not** support AoCC and in the incoming call / U9 call confirmed state, on receipt of a FACILITY message containing AoCC information shall ignore and not acknowledge the AoCC information contained within the FACILITY.
4. An MS claiming to **not** support AoCC and in the U10 call active state, on receipt of a FACILITY message containing AoCC information shall ignore and not acknowledge the AoCC information contained within the FACILITY.

3GPP TS 03.86 subclauses 1.2, 1.3, 2.2 and 2.3; 3GPP TS 04.86 clause 2.

11.3.3 Test purpose

1. To verify that an MS claiming to **not** support AoCC and in the outgoing call / U4 call delivered state, on receipt of a CONNECT message containing AoCC information acknowledges the CONNECT message but ignores and does not acknowledge the AoCC information sent within the CONNECT.
2. To verify that an MS claiming to **not** support AoCC and in the outgoing call / U4 call delivered state, on receipt of a FACILITY message containing AoCC information ignores and does not acknowledge the AoCC information contained within the FACILITY.
3. To verify that an MS claiming to not support AoCC and in the incoming call / U9 call confirmed state, on receipt of a FACILITY message containing AoCC information ignores and does not acknowledge the AoCC information contained within the FACILITY.

4. To verify that an MS claiming to **not** support AoCC and in the U10 call active state, on receipt of a FACILITY message containing AoCC information ignores and does not acknowledge the AoCC information contained within the FACILITY.

11.3.4 Method of test

11.3.4.1 Initial conditions

The generic call set up procedures are followed up to and including the reception, or transmission, of the ALERTING message by the MS.

Specific PICS statements:

- Support of at least one MT circuit switched basic service (TSPC_Addinfo_MTsvc)
- Support of at least one MO circuit switched basic service (TSPC_Addinfo_MOsvc)

PIXIT Statements:

-

11.3.4.2 Procedure

- a) For an Mobile Originated call in the U4 state the SS transmits CONNECT containing AoCC information.
- b) For an Mobile Originated call in the U4 state the SS transmits FACILITY containing AoCC information.
- c) For an Mobile Terminated call in the U9 state the SS transmits a FACILITY containing AoCC information.
- d) For a call in the U10 state the SS transmits a FACILITY containing AoCC information

11.3.5 Test requirement

The MS shall ignore the AoCC information sent to it in the Facility information elements as part of the CONNECT/FACILITY messages and not send any AoCC information acknowledgement. It shall be checked for 15 s that the MS does not transmit any AoCC information acknowledgement after the receipt of AoCC information.

11.4 Verification of non-support of services (call hold)

11.4.1 Definition

-

11.4.2 Conformance requirement

An MS claiming to **not** support the Call Hold supplementary service and in the U10 call active state shall, when the appropriate Call Hold MMI command is entered:

- Fail to put the first call on hold.
- Fail to place the second call.
- Optionally provide some indication to the user of an error.

3GPP TS 02.83; 3GPP TS 04.83.

11.4.3 Test purpose

To verify that an MS claiming to **not** support the Call Hold supplementary service and in the U10 call active state, reacts in the following manner when the appropriate call hold MMI command is entered:

- MS fails to put the first call on hold.
- MS fails to place the second call.

- Optionally provides some indication to the user of an error.

11.4.4 Method of test

11.4.4.1 Initial conditions

The mobile originating generic call set up procedures shall be followed up to and including the transmission by the MS of the CONNECT ACKNOWLEDGE to place the call in the U10 call active state.

11.4.4.2 Procedure

A second directory number is entered followed by "SEND" via the MMI.

11.4.5 Test requirement

The MS shall not send any HOLD messages on the dedicated channel. This is checked for 3 s.

The MS may however send other messages.

The MS may also give the user an indication of the error that has occurred.

11.5 Verification of non-support of services (multiparty)

11.5.1 Definition

-

11.5.2 Conformance requirement

An MS claiming to not support the MultiParty supplementary service and in the U10 call active state with one call and in the held state with another call shall, when the appropriate MultiParty MMI command is entered:

- Fail to combine the three parties in a MultiParty call.
- Optionally provide some indication to the user of an error.

3GPP TS 02.83, 3GPP TS 02.84, 3GPP TS 04.83, 3GPP TS 04.84.

11.5.3 Test purpose

To verify that an MS claiming to not support the MultiParty supplementary service and in the U10 call active state with one call and another call on hold, reacts in the following manner when the appropriate MultiParty MMI command is entered:

- Fails to combine the three parties in a MultiParty call.
- Optionally provides some indication to the user of an error.

11.5.4 Method of test

11.5.4.1 Initial conditions

The mobile originating generic call set up procedures shall be followed up to and including the transmission by the MS of the CONNECT ACKNOWLEDGE to place the call in the U10 call active state. A second directory number is then entered followed by send to put the first call on hold and place a second call.

11.5.4.2 Procedure

"3" followed by "SEND" is entered via the MMI.

11.5.5 Test requirement

The MS shall not send a FACILITY message, containing the build multiparty request, on the dedicated channel. This is checked for 3 s.

The MS may however send other messages.

The MS may also give the user an indication of the error that has occurred.

11.6 Verification of non-support of feature (Fixed Dialling Number (FDN))

11.6.1 Definition

-

11.6.2 Conformance requirement

1. An MS claiming to **not** support FDN that has a SIM with FDN allocated and activated in its SIM Service Table (Service Number 3) and has FDN "enabled" shall refuse a request from the user to attempt an outgoing call.
2. An MS claiming to **not** support FDN that has a SIM with FDN allocated and activated in its SIM Service Table (Service Number 3) and has FDN "enabled" shall not respond to paging.
3. An MS claiming **not** to support FDN that has a SIM with FDN allocated and activated shall not attempt to rehabilitate the IMSI and Location Information Elementary Files of the SIM.

3GPP TS 02.07 subclause B3.2, 3GPP TS 11.11 subclause 11.2.1.

11.6.3 Test purpose

1. To verify that an MS claiming to **not** support FDN and that has a SIM with FDN allocated and activated in its SIM Service Table and has FDN "enabled". i.e. AND, IMSI and Location Information Elementary Files are Invalidated inserted, it refuses an attempt to make an outgoing call made by the user.
2. To verify that an MS claiming to **not** support FDN and that has a SIM with FDN allocated and activated in its SIM Service Table and has FDN "enabled". i.e. AND, IMSI and Location Information Elementary Files are Invalidated inserted, it does not answer to paging.
3. To verify that an MS claiming **not** to support FDN and that has a SIM with FDN allocated and activated in its SIM Service Table and has FDN "enabled". i.e. AND, IMSI and Location Information Elementary Files are Invalidated inserted, does not attempt to rehabilitate IMSI and Location Information.

11.6.4 Method of test

11.6.4.1 Initial conditions

The ME is powered off. No SIM is inserted in the ME.

11.6.4.2 Procedure

- a) A SIM with FDN allocated and activated in its SIM Service Table and has FDN "enabled" is inserted in the ME and the MS is powered on.
- b) An outgoing CM connection is attempted by the user.
- c) The MS paged with its IMSI.
- d) The MS is powered off and the SIM is examined using a suitable tool to determine if the IMSI and Location Information Elementary Files have been Rehabilitated.

11.6.5 Test requirement

- 1) in step b), the MS shall not send a CHANNEL REQUEST message.
- 2) in step c), the MS shall not send a CHANNEL REQUEST message.
- 3) in step d), the IMSI and Location Information Elementary Files shall be Invalidated.

11.7 IMEI Security

11.7.1 Conformance requirements

The IMEI shall not be changed after the ME's final production process. It shall resist tampering, i.e. manipulation and change, by any means (e.g. physical, electrical and software).

NOTE: This requirement is valid for new GSM Phase 2 and Release 96, 97, 98 and 99 MEs type approved after 1st June 2002.

3GPP TS 02.09, 3GPP TS 02.16, 3GPP TS 03.03.

11.7.2 Test purpose

To verify the conformance requirement.

11.7.3 Method of test

Not available.

11.7.4 Declaration

The manufacturer shall declare that:

- he has taken necessary and sufficient steps to ensure that any individual or organisation cannot economically change the IMEI after the ME's final production process; and
- that the IMEI resists tampering, i.e. manipulation and change, by any means (e.g. physical, electrical and software).

11.8 Coding of the Bearer Capability information element

This subclause describes the coding of the bearer capability IE in a SETUP and in a CALL CONFIRMED message according to 3GPP TS 07.01 and 3GPP TS 04.08 / 3GPP TS 24.008.

More precisely, the matter of subclause 11.8.1 is the coding of the bearer capability IE in a mobile terminating SETUP and subclause 11.8.2 deals with the coding of the bearer capability IE in a mobile originating SETUP and in a CALL CONFIRMED message.

In the whole section "x", "y" and "X" have the following meanings:

- when a field is coded with values of "x", it means that several bit combinations are authorized and the allowable ones are described in the relevant paragraph or section;
- "y" means that the value of the spare bit can be set to either 0 or 1 at the sending side and that the receiving side shall accept either of these values;
- "X" in the hexadecimal coding of the Bearer Capability IE reflects all the possible values taken by an octet taking account of the number of bits coded as "x" or "y" and their place in the octet.

11.8.1 Network to MS Direction

11.8.1.1 BS 21 to 26 - Asynchronous Service

11.8.1.1.1 BS 21

11.8.1.1.1.1 3,1 kHz Audio, Transparent

BC GSM = 04 07 AX X8 81 21 X1 4X 81

Octet 1	0	0	0	0	0	1	0	0	Information Element: Bearer Capability
Octet 2	0	0	0	0	0	1	1	1	Length
Octet 3	1	y	y	0	0	0	1	0	Extension Radio Channel Requirement: Spare Coding Standard: GSM Transfer Mode: Circuit Info. Transfer Cap.: 3,1 kHz Audio
Octet 4	1	y	1	1	1	0	0	0	Extension Spare Structure: Unstructured Duplex Mode: Full duplex Configuration: Point to Point Negotiation of Intermediate Rate Requested: No meaning Establishment: Demand
Octet 5	1	0	0	0	0	0	0	1	Extension Access Id Rate Adaptation: No Signalling Access Protocol: I.440 / I.450
Octet 6	0	0	1	0	0	0	0	1	Extension Layer 1 Id: Default User Information Layer 1 Protocol Synchronous / Asynchronous: Asynchronous
Octet 6a	0	x	0	x	0	0	0	1	Extension Number of Stop Bits, Depending of the TE Configuration Negotiation: In band Negotiation not possible Number of Data Bits, Depending of the TE Configuration User Rate: 0,3 kbit/s
Octet 6b	0	1	0	0	0	x	x	x	Extension Intermediate Rate: 8kbit/s NIC on TX: Not Required NIC on RX: Not Supported Parity, Depending of the TE Configuration
Octet 6c	1	0	0	0	0	0	0	1	Extension Connection Element: Transparent Modem Type: V.21

The following configuration is also authorized:

Structure in Octet 4:	-	0	0	-	-	-	-	-	SDU Integrity
Intermediate rate in Octet 6b:	-	1	1	-	-	-	-	-	16 kbit/s
Connection element in Octet 6c:	-	1	x	-	-	-	-	-	Both T or NT preferred

11.8.1.1.1.2 3,1 kHz Audio, Non Transparent

BC GSM = 04 0X X2 XX 81 21 X1 6X A1 (CX)

Octet 1	0	0	0	0	0	1	0	0	Information Element: Bearer Capability
Octet 2	0	0	0	0	x	x	x	x	Length (7 or 8) depending on presence of octet 7.
Octet 3	1	y	y	0	0	0	1	0	Extension Radio Channel Requirement: Spare Coding Standard: GSM Transfer Mode: Circuit Info. Transfer Cap.: 3,1 kHz Audio
Octet 4	1	y	0	0	1	0	x	0	Extension Spare Structure: SDU Integrity Duplex Mode: Full duplex Configuration: Point to Point Negotiation of Intermediate Rate Requested Establishment: Demand
Octet 5	1	0	0	0	0	0	0	1	Extension Access Id Rate Adaptation: No Signalling Access Protocol: I.440 / I.450
Octet 6	0	0	1	0	0	0	0	1	Extension Layer 1 Id: Default User Information Layer 1 Protocol Synchronous / Asynchronous: Asynchronous
Octet 6a	0	x	0	x	0	0	0	1	Extension Number of Stop Bits, Depending of the TE Configuration Negotiation: In band Negotiation not possible Number of Data Bits, Depending of the TE Configuration User Rate: 0,3 kbit/s
Octet 6b	0	1	1	0	0	x	x	x	Extension Intermediate Rate: 16kbit/s NIC on TX: Not Required NIC on RX: Not Supported Parity, Depending of the TE Configuration
Octet 6c	1	0	1	0	0	0	0	1	Extension Connection Element: Non transparent Modem Type: V.21
Octet 7 (note)	1	1	0	0	1	x	0	0	Extension Layer 2 Id. User Inform. layer 2 protocol, Depending on the TE Configuration
NOTE: Because Modem Type is V.21, Octet7 shall be present.									

Depending of the type of flow control supported by the TE, the coding of octet 7 is different. The value ISO 6429 (0 1000) means "Inband flow control" and the value COPnoFLCT (0 1100) means "No flow control".

The following configuration is also authorized:

Connection element in Octet 6c:	-	1	x	-	-	-	-	-	Both T or NT preferred
---------------------------------	---	---	---	---	---	---	---	---	------------------------

11.8.1.1.1.3 UDI, Transparent

BC GSM = 04 07 X1 X8 89 21 X1 4X 80

Octet 1	0	0	0	0	0	1	0	0	Information Element: Bearer Capability
Octet 2	0	0	0	0	0	1	1	1	Length
Octet 3	1	y	y	0	0	0	0	1	Extension Radio Channel Requirement: Spare Coding Standard: GSM Transfer Mode: Circuit Info. Transfer Cap.: UDI
Octet 4	1	y	1	1	1	0	0	0	Extension Spare Structure: Unstructured Duplex Mode: Full duplex Configuration: Point to Point Negotiation of Intermediate Rate Requested: No meaning Establishment: Demand
Octet 5	1	0	0	0	1	0	0	1	Extension Access Id Rate Adaptation: V.110 Signalling Access Protocol: I.440 / I.450
Octet 6	0	0	1	0	0	0	0	1	Extension Layer 1 Id: Default User Information Layer 1 Protocol Synchronous / Asynchronous: Asynchronous
Octet 6a	0	x	0	x	0	0	0	1	Extension Number of Stop Bits, Depending of the TE Configuration Negotiation: In band Negotiation not possible Number of Data Bits, Depending of the TE Configuration User Rate: 0,3 kbit/s
Octet 6b	0	1	0	0	0	x	x	x	Extension Intermediate Rate: 8kbit/s NIC on TX: Not Required NIC on RX: Not Supported Parity, Depending of the TE Configuration
Octet 6c	1	0	0	0	0	0	0	0	Extension Connection Element: Transparent Modem Type: None

The following configuration is also authorized:

Structure in Octet 4:	-	0	0	-	-	-	-	-	SDU Integrity
Intermediate rate in Octet 6b:	-	1	1	-	-	-	-	-	16 kbit/s
Connection element in Octet 6c:	-	1	x	-	-	-	-	-	Both T or NT preferred

11.8.1.1.4 UDI, Non Transparent

BC GSM = 04 0X X1 XX 89 21 X1 6X A0 (CX)

Octet 1	0	0	0	0	0	1	0	0	Information Element: Bearer Capability
Octet 2	0	0	0	0	x	x	x	x	Length (7 or 8) depending on presence of octet 7.
Octet 3	1	y	y	0	0	0	0	1	Extension Radio Channel Requirement : Spare Coding Standard: GSM Transfer Mode: Circuit Info. Transfer Cap.: UDI
Octet 4	1	y	0	0	1	0	x	0	Extension Spare Structure: SDU Integrity Duplex Mode: Full duplex Configuration: Point to Point Negotiation of Intermediate Rate Requested Establishment: Demand
Octet 5	1	0	0	0	1	0	0	1	Extension Access Id Rate Adaptation: V.110 Signalling Access Protocol: I.440 / I.450
Octet 6	0	0	1	0	0	0	0	1	Extension Layer 1 Id: Default User Information Layer 1 Protocol Synchronous / Asynchronous: Asynchronous
Octet 6a	0	x	0	x	0	0	0	1	Extension Number of Stop Bits, Depending of the TE Configuration Negotiation: In band Negotiation not possible Number of Data Bits, Depending of the TE Configuration User Rate: 0,3 kbit/s
Octet 6b	0	1	1	0	0	x	x	x	Extension Intermediate Rate: 16kbit/s NIC on TX: Not Required NIC on RX: Not Supported Parity, Depending of the TE Configuration
Octet 6c	1	0	1	0	0	0	0	0	Extension Connection Element: Non Transparent Modem Type: None
Octet 7 (need not be present)	1	1	0	0	1	x	0	0	Extension Layer 2 Id. User Inform. layer 2 protocol, Depending of the TE Configuration

Depending of the type of flow control supported by the TE, octet 7 is present or not. If not present, it means "outband flow control". If octet 7 is present, the value ISO 6429 (0 1000) means "Inband flow control" and the value COPnoFLCT (0 1100) means "No flow control".

The following configuration is also authorized:

Connection element in Octet 6c:	-	1	x	-	-	-	-	-	Both T or NT preferred
---------------------------------	---	---	---	---	---	---	---	---	------------------------

11.8.1.1.2 BS 22

Same as BS 21 except:

User Rate in Octet 6a:	-	-	-	-	0	0	1	0	1,2 kbit/s
If different from "none", Modem Type Octet 6c:	-	-	-	0	0	0	1	0	Modem V.22

In case of 3,1 kHz Audio non transparent service, depending of the type of flow control supported by the TE, octet 7 is present or not. If not present, it means "outband flow control".

11.8.1.1.3 BS 24

Same as BS 21 except:

	User Rate in Octet 6a:	-	-	-	-	0	0	1	1	2,4 kbit/s
If different from "none",	Modem Type Octet 6c:	-	-	-	0	0	0	1	1	Modem V.22bis

In case of 3,1 kHz Audio non transparent service, depending of the type of flow control supported by the TE, octet 7 is present or not. If not present, it means "outband flow control".

11.8.1.1.4 BS 25

Same as BS 21 except:

	User Rate in Octet 6a:	-	-	-	-	0	1	0	0	4,8 kbit/s
If different from "none",	Modem Type Octet 6c:	-	-	-	0	0	1	1	0	Modem V.32

In case of 3,1 kHz Audio non transparent service, depending of the type of flow control supported by the TE, octet 7 is present or not. If not present, it means "outband flow control".

11.8.1.1.5 BS 26

Same as BS 21 except:

	NIRR in Octet 4	-	-	-	-	-	-	0	-	no meaning
	User Rate in Octet 6a:	-	-	-	-	0	1	0	1	9,6 kbit/s
	Interm. Rate in Octet 6b:	-	1	1	-	-	-	-	-	16 kbit/s
If different from "none",	Modem Type Octet 6c:	-	-	-	0	0	1	1	0	Modem V.32

In case of 3,1kHz Audio non transparent service, depending of the type of flow control supported by the TE, octet 7 is present or not. If not present, it means "outband flow control".

11.8.1.1.6 BS 23

For MOC only.

11.8.1.2 BS 31 to 34 - Synchronous Service

11.8.1.2.1 BS 32

11.8.1.2.1.1 3,1 kHz Audio, Transparent, non-X.32 case

BC GSM = 04 07 X2 X8 81 20 13 43 83

Octet 1	0	0	0	0	0	1	0	0	Information Element: Bearer Capability
Octet 2	0	0	0	0	0	1	1	1	Length
Octet 3	1	y	y	0	0	0	1	0	Extension Radio Channel Requirement : Spare Coding Standard: GSM Transfer Mode: Circuit Info. Transfer Cap.: 3,1 kHz Audio
Octet 4	1	y	1	1	1	0	0	0	Extension Spare Structure: Unstructured Duplex Mode: Full duplex Configuration: Point to Point Negotiation of Intermediate Rate Requested: No meaning Establishment: Demand
Octet 5	1	0	0	0	0	0	0	1	Extension Access Id Rate Adaptation: No Signalling Access Protocol: I.440 / I.450
Octet 6	0	0	1	0	0	0	0	0	Extension Layer 1 Id: Default User Information Layer 1 Protocol Synchronous / Asynchronous: Synchronous
Octet 6a	0	0	0	1	0	0	1	1	Extension Number of Stop Bits: NA Negotiation: In band Negotiation not possible Number of Data Bits: NA User Rate: 2,4 kbit/s
Octet 6b	0	1	0	0	0	0	1	1	Extension Intermediate Rate: 8kbit/s NIC on TX: Not Required NIC on RX: Not Supported Parity: NA
Octet 6c	1	0	0	0	0	0	1	1	Extension Connection Element: Transparent Modem Type: V.22 bis

11.8.1.2.1.2 UDI, Transparent mode, non-X.32 case

BC GSM = 04 07 X1 X8 8X 20 13 43 80

Octet 1	0	0	0	0	0	1	0	0	Information Element: Bearer Capability
Octet 2	0	0	0	0	0	1	1	1	Length
Octet 3	1	y	y	0	0	0	0	1	Extension Radio Channel Requirement : Spare Coding Standard: GSM Transfer Mode: Circuit Info. Transfer Cap.: UDI
Octet 4	1	y	1	1	1	0	0	0	Extension Spare Structure: Unstructured Duplex Mode: Full duplex Configuration: Point to Point Negotiation of Intermediate Rate Requested: No meaning Establishment: Demand
Octet 5	1	0	0	0	1	0	x	x	Extension Access Id Rate Adaptation: V.110 Signalling Access Protocol
Octet 6	0	0	1	0	0	0	0	0	Extension Layer 1 Id: Default User Information Layer 1 Protocol Synchronous / Asynchronous: Synchronous
Octet 6a	0	0	0	1	0	0	1	1	Extension Number of Stop Bits: NA Negotiation: In band Negotiation not possible Number of Data Bits: NA User Rate: 2,4 kbit/s
Octet 6b	0	1	0	0	0	0	1	1	Extension Intermediate Rate: 8kbit/s NIC on TX: Not Required NIC on RX: Not Supported Parity: NA
Octet 6c	1	0	0	0	0	0	0	0	Extension Connection Element: Transparent Modem Type: none

If the mobile station supports only SAP I.440/450, the System Simulator sets SAP field value to::

SAP in Octet 5:	-	-	-	-	-	0	0	1	I.440/I.450
-----------------	---	---	---	---	---	---	---	---	-------------

If the MS supports only SAP X.21, SAP field is set to:

SAP in Octet 5:	-	-	-	-	-	0	1	0	X.21
-----------------	---	---	---	---	---	---	---	---	------

Else, the MS supports both values and SAP is set to:

either:

SAP in Octet 5:	-	-	-	-	-	0	0	1	I.440/I.450
-----------------	---	---	---	---	---	---	---	---	-------------

or:

SAP in Octet 5:	-	-	-	-	-	0	1	0	X.21
-----------------	---	---	---	---	---	---	---	---	------

11.8.1.2.1.3 3,1 kHz Audio, Transparent mode, X.32 case (Packet Service)

BC GSM = 04 07 X2 X8 86 20 13 43 83

Octet 1	0	0	0	0	0	1	0	0	Information Element: Bearer Capability
Octet 2	0	0	0	0	0	1	1	1	Length
Octet 3	1	y	y	0	0	0	1	0	Extension Radio Channel Requirement : Spare Coding Standard: GSM Transfer Mode: Circuit Info. Transfer Cap.: 3,1 kHz Audio
Octet 4	1	y	1	1	1	0	0	0	Extension Spare Structure: unstructured Duplex Mode: Full duplex Configuration: Point to Point Negotiation of Intermediate Rate Requested: No meaning Establishment: Demand
Octet 5	1	0	0	0	0	1	1	0	Extension Access Id Rate Adaptation: No Signalling Access Protocol: X.32
Octet 6	0	0	1	0	0	0	0	0	Extension Layer 1 Id: Default User Information Layer 1 Protocol Synchronous / Asynchronous: Synchronous
Octet 6a	0	0	0	1	0	0	1	1	Extension Number of Stop Bits: NA Negotiation: In band Negotiation not possible Number of Data Bits: NA User Rate: 2,4 kbit/s
Octet 6b	0	1	0	0	0	0	1	1	Extension Intermediate Rate: 8kbit/s NIC on TX: Not Required NIC on RX: Not Supported Parity: NA
Octet 6c	1	0	0	0	0	0	1	1	Extension Connection Element: Transparent Modem Type: V.22 bis

The following configuration is also authorized:

Structure in Octet 4:	-	0	0	-	-	-	-	-	SDU Integrity
Intermediate rate in Octet 6b:	-	1	1	-	-	-	-	-	16 kbit/s
Connection element in Octet 6c:	-	1	x	-	-	-	-	-	Both T or NT preferred
UIL2P in Octet 7	-	-	-	0	0	1	1	0	X.25

11.8.1.2.1.4 3,1 kHz Audio, Non Transparent mode, X.32 case (Packet Service)

BC GSM = 04 07 X2 XX 86 20 13 63 A3 C6

Octet 1	0	0	0	0	0	1	0	0	Information Element: Bearer Capability
Octet 2	0	0	0	0	1	0	0	0	Length
Octet 3	1	y	y	0	0	0	1	0	Extension Radio Channel Requirement : Spare Coding Standard: GSM Transfer Mode: Circuit Info. Transfer Cap.: 3,1 kHz Audio
Octet 4	1	y	0	0	1	0	x	0	Extension Spare Structure: SDU integrity Duplex Mode: Full duplex Configuration: Point to Point Negotiation of Intermediate Rate Requested Establishment: Demand
Octet 5	1	0	0	0	0	1	1	0	Extension Access Id Rate Adaptation: No Signalling Access Protocol: X.32
Octet 6	0	0	1	0	0	0	0	0	Extension Layer 1 Id: Default User Information Layer 1 Protocol Synchronous / Asynchronous: Synchronous
Octet 6a	0	0	0	1	0	0	1	1	Extension Number of Stop Bits: NA Negotiation: In band Negotiation not possible Number of Data Bits: NA User Rate: 2,4 kbit/s
Octet 6b	0	1	1	0	0	0	1	1	Extension Intermediate Rate: 16kbit/s NIC on TX: Not Required NIC on RX: Not Supported Parity: NA
Octet 6c	1	0	1	0	0	0	1	1	Extension Connection Element: Non Transparent Modem Type: V.22 bis
Octet 7	1	1	0	0	0	1	1	0	Extension Layer 2 Id. X.25

The following configuration is also authorized:

Connection element in Octet 6c:	-	1	x	-	-	-	-	-	Both T or NT preferred
---------------------------------	---	---	---	---	---	---	---	---	------------------------

11.8.1.2.1.5 UDI, Non Transparent mode, X.32 case (Packet Service)

BC GSM = 04 08 X1 XX 96 20 13 63 A0 C6

Octet 1	0	0	0	0	0	1	0	0	Information Element: Bearer Capability
Octet 2	0	0	0	0	1	0	0	0	Length
Octet 3	1	y	y	0	0	0	0	1	Extension Radio Channel Requirement : Spare Coding Standard: GSM Transfer Mode: Circuit Info. Transfer Cap.: UDI
Octet 4	1	y	0	0	1	0	x	0	Extension Spare Structure: SDU integrity Duplex Mode: Full duplex Configuration: Point to Point Negotiation of Intermediate Rate Requested Establishment: Demand
Octet 5	1	0	0	1	0	1	1	0	Extension Access Id Rate Adaptation: X.31 flagstuffing Signalling Access Protocol: X.32
Octet 6	0	0	1	0	0	0	0	0	Extension Layer 1 Id: Default User Information Layer 1 Protocol Synchronous / Asynchronous: Synchronous
Octet 6a	0	0	0	1	0	0	1	1	Extension Number of Stop Bits: NA Negotiation: In band Negotiation not possible Number of Data Bits: NA User Rate: 2,4 kbit/s
Octet 6b	0	1	1	0	0	0	1	1	Extension Intermediate Rate: 16kbit/s NIC on TX: Not Required NIC on RX: Not Supported Parity: NA
Octet 6c	1	0	1	0	0	0	0	0	Extension Connection Element: Non Transparent Modem Type: None
Octet 7	1	1	0	0	0	1	1	0	Extension Layer 2 Id. X.25

11.8.1.2.2 BS 31

For non X.32 case only, same as BS 32 except:

	User Rate in Octet 6a:	-	-	-	-	0	0	1	0	1,2 kbit/s
If different from "none",	Modem Type Octet 6c:	-	-	-	0	0	0	1	0	Modem V.22

BS31 for Packet Service does not exist.

11.8.1.2.3 BS 33

Same as BS 32 except:

	User Rate in Octet 6a:	-	-	-	-	0	1	0	0	4,8 kbit/s
If different from "none",	Modem Type Octet 6c:	-	-	-	0	0	1	1	0	Modem V.32

11.8.1.2.4 BS 34

Same as BS 32 except:

	NIRR in Octet 4	-	-	-	-	-	-	0	-	no meaning
	User Rate in Octet 6a:	-	-	-	-	0	1	0	1	9,6 kbit/s
	Interm. Rate in Octet 6b:	-	1	1	-	-	-	-	-	16 kbit/s
If different from "none",	Modem Type Octet 6c:	-	-	-	0	0	1	1	0	Modem V.32

11.8.1.3 BS 61 - Alternate Speech / Data

The first BC in the Setup message is coded "Speech": 04 01 A0.

The repeat Indicator in the Setup message is coded "Circular for successive selection (alternate)": D1.

The second BC in the Setup message is coded as described below.

11.8.1.3.1 Speech/Asynchronous Data, Transparent

BC GSM = 04 07 X2 X8 81 21 XX XX 8X

Octet 1	0	0	0	0	0	1	0	0	Information Element: Bearer Capability
Octet 2	0	0	0	0	0	1	1	1	Length
Octet 3	1	y	y	0	0	0	1	0	Extension Radio Channel Requirement : Spare Coding Standard: GSM Transfer Mode: Circuit Info. Transfer Cap.: 3,1 kHz Audio
Octet 4	1	y	1	1	1	0	0	0	Extension Spare Structure: Unstructured Duplex Mode: Full duplex Configuration: Point to Point Negotiation of Intermediate Rate Requested: No meaning Establishment: Demand
Octet 5	1	0	0	0	0	0	0	1	Extension Access Id Rate Adaptation: No Signalling Access Protocol: I.440 / I.450
Octet 6	0	0	1	0	0	0	0	1	Extension Layer 1 Id: Default User Information Layer 1 Protocol Synchronous / Asynchronous: Asynchronous
Octet 6a	0	x	0	x	x	x	x	x	Extension Number of Stop Bits, Depending of the TE Configuration Negotiation: In band Negotiation not possible Number of Data Bits, Depending of the TE Configuration User Rate
Octet 6b	0	1	x	0	0	x	x	x	Extension Intermediate Rate NIC on TX: Not Required NIC on RX: Not Supported Parity, Depending of the TE Configuration
Octet 6c	1	0	0	0	x	x	x	x	Extension Connection Element: Transparent Modem Type

Depending of the user rate supported by the MS, the user rate, the modem type and the intermediate rate change:

User Rate in Octet 6a:	-	-	-	-	0	0	0	1	0,3 kbit/s
Intermediate rate in Octet 6b:	-	1	0	-	-	-	-	-	8 kbit/s
Modem type in Octet 6c:	-	-	-	0	0	0	0	1	Modem V.21

User Rate in Octet 6a:	-	-	-	-	0	0	1	0	1,2 kbit/s
Intermediate rate in Octet 6b:	-	1	0	-	-	-	-	-	8 kbit/s
Modem type in Octet 6c:	-	-	-	0	0	0	1	0	Modem V.22

User Rate in Octet 6a:	-	-	-	-	0	0	1	1	2,4 kbit/s
Intermediate rate in Octet 6b:	-	1	0	-	-	-	-	-	8 kbit/s
Modem type in Octet 6c:	-	-	-	0	0	0	1	1	Modem V.22bis

User Rate in Octet 6a:	-	-	-	-	0	1	0	0	4,8 kbit/s
Intermediate rate in Octet 6b:	-	1	0	-	-	-	-	-	8 kbit/s
Modem type in Octet 6c:	-	-	-	0	0	1	1	0	Modem V.32

NIRR in Octet 4	-	-	-	-	-	-	0	-	no meaning
User Rate in Octet 6a:	-	-	-	-	0	1	0	1	9,6 kbit/s
Intermediate rate in Octet 6b:	-	1	1	-	-	-	-	-	16 kbit/s
Modem type in Octet 6c:	-	-	-	0	0	1	1	0	Modem V.32

The following configuration is also authorized:

Structure in Octet 4:	-	0	0	-	-	-	-	-	SDU Integrity
Intermediate rate in Octet 6b:	-	1	1	-	-	-	-	-	16 kbit/s
Connection element in Octet 6c:	-	1	x	-	-	-	-	-	Both T or NT preferred

User Information L2 Protocol (see Non Transparent service).

11.8.1.3.2 Speech/Asynchronous Data, Non Transparent

BC GSM = 04 0X X2 XX 81 21 XX 6X AX (CX)

Octet 1	0	0	0	0	0	1	0	0	Information Element: Bearer Capability
Octet 2	0	0	0	0	x	x	x	x	Length (7 or 8) depending on presence of octet 7.
Octet 3	1	y	y	0	0	0	1	0	Extension Radio Channel Requirement : Spare Coding Standard: GSM Transfer Mode: Circuit Info. Transfer Cap.: 3,1 kHz Audio
Octet 4	1	y	0	0	1	0	x	0	Extension Spare Structure: SDU Integrity Duplex Mode: Full duplex Configuration: Point to Point Negotiation of Intermediate Rate Requested Establishment: Demand
Octet 5	1	0	0	0	0	0	0	1	Extension Access Id Rate Adaptation: No Signalling Access Protocol: I.440 / I.450
Octet 6	0	0	1	0	0	0	0	1	Extension Layer 1 Id: Default User Information Layer 1 Protocol Synchronous / Asynchronous: Asynchronous
Octet 6a	0	x	0	x	x	x	x	x	Extension Number of Stop Bits, Depending of the TE Configuration Negotiation: In band Negotiation not possible Number of Data Bits, Depending of the TE Configuration User Rate
Octet 6b	0	1	1	0	0	x	x	x	Extension Intermediate Rate: 16kbit/s NIC on TX: Not Required NIC on RX: Not Supported Parity, Depending of the TE Configuration
Octet 6c	1	0	1	0	x	x	x	x	Extension Connection Element: Non transparent Modem Type
Octet 7 (may not be present)	1	1	0	0	1	x	0	0	Extension Layer 2 Id. User Inform. layer 2 protocol, Depending of the TE Configuration

Depending of the type of flow control supported by the TE, the coding of octet 7 is different. The value ISO 6429 (0 1000) means "Inband flow control" and the value COPnoFLCT (0 1100) means "No flow control". The "Outband Flow control is not allowed with V.21 modem).

Depending of the user rate supported by the MS, the user rate and the modem type change:

User Rate in Octet 6a:	-	-	-	-	0	0	0	1	0,3 kbit/s
Modem type in Octet 6c:	-	-	-	0	0	0	0	1	Modem V.21

User Rate in Octet 6a:	-	-	-	-	0	0	1	0	1,2 kbit/s
Modem type in Octet 6c:	-	-	-	0	0	0	1	0	Modem V.22

User Rate in Octet 6a:	-	-	-	-	0	0	1	1	2,4 kbit/s
Modem type in Octet 6c:	-	-	-	0	0	0	1	1	Modem V.22bis

	User Rate in Octet 6a:	-	-	-	-	0	1	0	0	4,8 kbit/s
	Modem type in Octet 6c:	-	-	-	0	0	1	1	0	Modem V.32

	NIRR in Octet 4	-	-	-	-	-	-	0	-	no meaning
	User Rate in Octet 6a:	-	-	-	-	0	1	0	1	9,6 kbit/s
	Modem type in Octet 6c:	-	-	-	0	0	1	1	0	Modem V.32

The following configuration is also authorized:

Connection element in Octet 6c:	-	1	x	-	-	-	-	-	-	Both T or NT preferred
---------------------------------	---	---	---	---	---	---	---	---	---	------------------------

11.8.1.3.3 Speech/Synchronous Data

BC GSM = 04 07 X2 X8 81 20 1X X3 8X

Octet 1	0	0	0	0	0	1	0	0	Information Element: Bearer Capability
Octet 2	0	0	0	0	0	1	1	1	Length
Octet 3	1	y	y	0	0	0	1	0	Extension Radio Channel Requirement : Spare Coding Standard: GSM Transfer Mode: Circuit Info. Transfer Cap.: 3,1 kHz Audio
Octet 4	1	y	1	1	1	0	0	0	Extension Spare Structure: Unstructured Duplex Mode: Full duplex Configuration: Point to Point Negotiation of Intermediate Rate Requested: No meaning Establishment: Demand
Octet 5	1	0	0	0	0	0	0	1	Extension Access Id Rate Adaptation: No Signalling Access Protocol: I.440 / I.450
Octet 6	0	0	1	0	0	0	0	0	Extension Layer 1 Id: Default User Information Layer 1 Protocol Synchronous / Asynchronous: Synchronous
Octet 6a	0	0	0	1	x	x	x	x	Extension Number of Stop Bits: NA Negotiation: In band Negotiation not possible Number of Data Bits: NA User Rate
Octet 6b	0	1	x	0	0	0	1	1	Extension Intermediate Rate NIC on TX: Not Required NIC on RX: Not Supported Parity: NA
Octet 6c	1	0	0	0	x	x	x	x	Extension Connection Element: Transparent Modem Type

Depending of the user rate supported by the MS, the user rate, the modem type and the intermediate rate change:

	User Rate in Octet 6a:	-	-	-	-	0	0	1	0	1,2 kbit/s
	Intermediate rate in Octet 6b:	-	1	0	-	-	-	-	-	8 kbit/s
	Modem type in Octet 6c:	-	-	-	0	0	0	1	0	Modem V.22

User Rate in Octet 6a:	-	-	-	-	0	0	1	1	2,4 kbit/s
Intermediate rate in Octet 6b:	-	1	0	-	-	-	-	-	8 kbit/s
Modem type in Octet 6c:	-	-	-	0	0	0	1	1	Modem V.22bis

User Rate in Octet 6a:	-	-	-	-	0	1	0	0	4,8 kbit/s
Intermediate rate in Octet 6b:	-	1	0	-	-	-	-	-	8 kbit/s
Modem type in Octet 6c:	-	-	-	0	0	1	1	0	Modem V.32

NIRR in Octet 4	-	-	-	-	-	-	0	-	no meaning
User Rate in Octet 6a:	-	-	-	-	0	1	0	1	9,6 kbit/s
Intermediate rate in Octet 6b:	-	1	1	-	-	-	-	-	16 kbit/s
Modem type in Octet 6c:	-	-	-	0	0	1	1	0	Modem V.32

11.8.1.4 BS 81 - Speech followed by Data

The first BC in the Setup message is coded "Speech": 04 01 A0.

The repeat Indicator in the Setup message is coded "Circular for successive selection "mode 1 alternate mode 2": D1".

The second BC in the Setup message is coded as described below.

11.8.1.4.1 Speech followed by Asynchronous Data

See subclauses 11.8.1.3.1 and 11.8.1.3.2.

11.8.1.4.2 Speech followed by Synchronous Data

See subclause 11.8.1.3.3.

11.8.1.5 TS 61 - Alternate Speech / Facsimile group 3

The first BC in the Setup message is coded "Speech": 04 01 A0.

The repeat Indicator in the Setup message is coded "Circular for successive selection (alternate)": D1.

The second BC in the Setup message is coded as described below.

11.8.1.5.1 TS 61 - Alternate Speech / Facsimile group 3, Transparent

BC GSM = 04 07 X3 X8 81 20 1X X3 80

Octet 1	0	0	0	0	0	1	0	0	Information Element: Bearer Capability
Octet 2	0	0	0	0	0	1	1	1	Length
Octet 3	1	y	y	0	0	0	1	1	Extension Radio Channel Requirement : Spare Coding Standard: GSM Transfer Mode: Circuit Info. Transfer Cap.: FAX3
Octet 4	1	y	1	1	1	0	0	0	Extension Spare Structure: Unstructured Duplex Mode: Full duplex Configuration: Point to Point Negotiation of Intermediate Rate Requested: No meaning Establishment: Demand
Octet 5	1	0	0	0	0	0	0	1	Extension Access Id Rate Adaptation: No Signalling Access Protocol: NA
Octet 6	0	0	1	0	0	0	0	0	Extension Layer 1 Id: Default User Information Layer 1 Protocol Synchronous / Asynchronous: synchronous
Octet 6a	0	0	0	1	x	x	x	x	Extension Number of Stop Bits: NA Negotiation: In band Negotiation not possible Number of Data Bits: NA User Rate
Octet 6b	0	1	x	0	0	0	1	1	Extension Intermediate Rate NIC on TX: Not Required NIC on RX: Not Supported Parity: NA
Octet 6c	1	0	0	0	0	0	0	0	Extension Connection Element: Transparent Modem Type: None

Depending of the user rate supported by the MS, the user rate and the intermediate rate change:

User Rate in Octet 6a:	-	-	-	-	0	0	1	1	2,4 kbit/s
Intermediate rate in Octet 6b:	-	1	0	-	-	-	-	-	8 kbit/s

User Rate in Octet 6a:	-	-	-	-	0	1	0	0	4,8 kbit/s
Intermediate rate in Octet 6b:	-	1	0	-	-	-	-	-	8 kbit/s

NIRR in Octet 4	-	-	-	-	-	-	0	-	no meaning
User Rate in Octet 6a:	-	-	-	-	0	1	0	1	9,6 kbit/s
Intermediate rate in Octet 6b:	-	1	1	-	-	-	-	-	16 kbit/s

11.8.1.5.2 TS 61 - Alternate Speech / Facsimile group 3, Non-Transparent

BC GSM = 04 07 X3 XX 81 20 1X 63 X0

Octet 1	0	0	0	0	0	1	0	0	Information Element: Bearer Capability
Octet 2	0	0	0	0	0	1	1	1	Length
Octet 3	1	y	y	0	0	0	1	1	Extension Radio Channel Requirement : Spare Coding Standard: GSM Transfer Mode: Circuit Info. Transfer Cap.: FAX3
Octet 4	1	y	0	0	1	0	x	0	Extension Spare Structure: SDU integrity Duplex Mode: Full duplex Configuration: Point to Point Negotiation of Intermediate Rate Requested Establishment: Demand
Octet 5	1	0	0	0	0	0	0	1	Extension Access Id Rate Adaptation: No Signalling Access Protocol: NA
Octet 6	0	0	1	0	0	0	0	0	Extension Layer 1 Id: Default User Information Layer 1 Protocol Synchronous / Asynchronous: synchronous
Octet 6a	0	0	0	1	x	x	x	x	Extension Number of Stop Bits: NA Negotiation: In band Negotiation not possible Number of Data Bits: NA User Rate
Octet 6b	0	1	1	0	0	0	1	1	Extension Intermediate Rate: 16 kbit/s NIC on TX: Not Required NIC on RX: Not Supported Parity: NA
Octet 6c	1	x	x	0	0	0	0	0	Extension Connection Element Modem Type: None

Depending of the user rate supported by the MS, the MS may have the following values:

User Rate in Octet 6a:	-	-	-	-	0	0	1	1	2,4 kbit/s
User Rate in Octet 6a:	-	-	-	-	0	1	0	0	4,8 kbit/s
User Rate in Octet 6a:	-	-	-	-	0	1	0	1	9,6 kbit/s

Depending on the support or not of both modes, Non Transparent and Transparent, the connection element field may have the following values:

Connection element in Octet 6c:	-	0	1	-	-	-	-	-	Non transparent
Connection element in Octet 6c:	-	1	x	-	-	-	-	-	Both T or NT preferred

If present, Octet 7 shall have the following value:

Octet 7	1	1	0	0	0	1	1	0	Extension Layer 2 id X.25
---------	---	---	---	---	---	---	---	---	---------------------------------

11.8.1.6 TS 62 - Automatic Facsimile group 3

The repeat Indicator in the Setup message is not available.

The BC GSM is coded as described in subclause 11.8.1.5.

11.8.2 MS to SS direction

In the whole subclause 11.8.2, "1)" and "2)" stand for:

- 1) Not applicable in a CALL CONFIRMED message.
- 2) Not applicable in a CALL CONFIRMED message responding to a SETUP message with no BC-IE (PSTN-originated call with single numbering scheme).

If the MS supports only Full Rate:

Radio Channel Requirement in Octet 3:	-	0	1	-	-	-	-	-	Full rate support only mobile station
---------------------------------------	---	---	---	---	---	---	---	---	---------------------------------------

Else

Radio Channel Requirement in Octet 3:	-	1	x	-	-	-	-	-	Dual rate mobile station
---------------------------------------	---	---	---	---	---	---	---	---	--------------------------

11.8.2.1 BS 21 to 26 - Asynchronous Service

If the MS supports only SAP I.440/I.450:

SAP in Octet 5:	-	-	-	-	-	0	0	1	I.440/I.450
-----------------	---	---	---	---	---	---	---	---	-------------

If the MS supports only SAP X.28 non dedicated PAD:

SAP in Octet 5:	-	-	-	-	-	1	0	1	X.28 nond
-----------------	---	---	---	---	---	---	---	---	-----------

Else:

SAP in Octet 5:	-	-	-	-	-	x	0	1	I.440/I.450 or X.28 nond
-----------------	---	---	---	---	---	---	---	---	--------------------------

The use of the alternative configuration "Autobauding modem type 1" in BS 22 to BS 26 is the same as indicated for BS 21 in subclauses 11.8.2.1.1.1 and 11.8.2.1.1.2.

11.8.2.1.1 BS 21

11.8.2.1.1.1 3,1 kHz Audio, Transparent

BC GSM = 04 0X X2 X8 8X 21 X1 XX X1 (CX)

Octet 1	0	0	0	0	0	1	0	0	Information Element: Bearer Capability
Octet 2	0	0	0	0	x	x	x	x	Length (7 or 8) depending on the presence of octet 7.
Octet 3	1	x	x	0	0	0	1	0	Extension Radio Channel Requirement Coding Standard: GSM Transfer Mode: Circuit Info. Transfer Cap.: 3,1 kHz Audio
Octet 4	1	y	x	x	1	0	0	0	Extension Spare Structure Duplex Mode Configuration: Point to Point Negotiation of Intermediate Rate Requested: No meaning Establishment: Demand
Octet 5	1	0	0	0	0	x	0	1	Extension Access Id Rate Adaptation: No Signalling Access Protocol
Octet 6	0	0	1	0	0	0	0	1	Extension Layer 1 Id: Default User Information Layer 1 Protocol Synchronous / Asynchronous: Asynchronous
Octet 6a	0	x	0	x	0	0	0	1	Extension Number of Stop Bits, Depending of the TE Configuration Negotiation: In band Negotiation not possible Number of Data Bits, Depending of the TE Configuration User Rate: 0,3 kbit/s
Octet 6b	0	1	x	0	0	x	x	x	Extension Intermediate Rate: 8kbit/s NIC on TX: Not Required NIC on RX: Not Supported Parity, Depending of the TE Configuration
Octet 6c	1	x	x	0	0	0	0	1	Extension Connection Element Modem Type: V.21

If the mobile station supports only Transparent mode or responds with a CALL CONFIRMED message:

Structure in Octet 4:	-	1	1	-	-	-	-	-	Unstructured
Intermediate rate in Octet 6b:	-	1	0	-	-	-	-	-	8 kbit/s
Connection element in Octet 6c:	-	0	0	-	-	-	-	-	Transparent

1) If the mobile station supports both Transparent and Non Transparent modes:

Structure in Octet 4:	-	0	0	-	-	-	-	-	SDU Integrity
Intermediate rate in Octet 6b:	-	1	1	-	-	-	-	-	16 kbit/s
Connection element in Octet 6c:	-	1	x	-	-	-	-	-	Both T or NT preferred

User Information L2 protocol in Octet 7 (see Non Transparent service)

2) The following configuration is also authorised in the SETUP message:

Connection element in Octet 6c:	-	1	x	-	-	-	-	-	Both T or NT preferred
Modem type in Octet 6c (if CE = "both"):	-	-	-	0	1	0	0	0	Autobauding Type 1

11.8.2.1.1.2 3,1 kHz Audio, Non Transparent

BC GSM = 04 0X X2 XX 8X 21 X1 6X X1 (CX)

Octet 1	0	0	0	0	0	1	0	0	Information Element: Bearer Capability
Octet 2	0	0	0	0	x	x	x	x	Length (7 or 8) depending on presence of octet 7.
Octet 3	1	x	x	0	0	0	1	0	Extension Radio Channel Requirement Coding Standard: GSM Transfer Mode: Circuit Info. Transfer Cap.: 3,1 kHz Audio
Octet 4	1	y	0	0	1	0	x	0	Extension Spare Structure: SDU Integrity Duplex Mode: Full duplex Configuration: Point to Point Negotiation of Intermediate Rate Requested Establishment: Demand
Octet 5	1	0	0	0	0	x	0	1	Extension Access Id Rate Adaptation: No Signalling Access Protocol
Octet 6	0	0	1	0	0	0	0	1	Extension Layer 1 Id: Default User Information Layer 1 Protocol Synchronous / Asynchronous: Asynchronous
Octet 6a	0	x	0	x	0	0	0	1	Extension Number of Stop Bits, Depending of the TE Configuration Negotiation: In band Negotiation not possible Number of Data Bits, Depending of the TE Configuration User Rate: 0,3 kbit/s
Octet 6b	0	1	1	0	0	x	x	x	Extension Intermediate Rate: 16kbit/s NIC on TX: Not Required NIC on RX: Not Supported Parity, Depending of the TE Configuration
Octet 6c	1	x	x	0	0	0	0	1	Extension Connection Element: NT, (Both T or Both NT) ¹⁾ Modem Type: V.21
Octet 7 (need not be present)	1	1	0	0	1	x	0	0	Extension Layer 2 Id. User Inform. layer 2 protocol, Depending on the TE Configuration

The following configuration is also authorised:

Modem type in Octet 6c:	-	-	-	0	1	0	0	0	Autobauding Type 1
-------------------------	---	---	---	---	---	---	---	---	--------------------

Depending of the type of flow control supported by the TE, the coding of octet 7 is different. The value ISO 6429 (0 1000) means "Inband flow control" and the value COPnoFLCT (0 1100) means "No flow control".

11.8.2.1.1.3 2) UDI, Transparent

BC GSM = 04 0X X1 X8 8X 21 X1 XX X0

Octet 1	0	0	0	0	0	1	0	0	Information Element: Bearer Capability
Octet 2	0	0	0	0	x	x	x	x	Length (7 or 8) depending on the presence of octet 7
Octet 3	1	x	x	0	0	0	0	1	Extension Radio Channel Requirement Coding Standard: GSM Transfer Mode: Circuit Info. Transfer Cap.: UDI
Octet 4	1	y	x	x	1	0	0	0	Extension Spare Structure Duplex Mode: Full duplex Configuration: Point to Point Negotiation of Intermediate Rate Requested: No meaning Establishment: Demand
Octet 5	1	0	0	0	1	x	0	1	Extension Access Id Rate Adaptation: V.110 Signalling Access Protocol
Octet 6	0	0	1	0	0	0	0	1	Extension Layer 1 Id: Default User Information Layer 1 Protocol Synchronous / Asynchronous: Asynchronous
Octet 6a	0	x	0	x	0	0	0	1	Extension Number of Stop Bits, Depending of the TE Configuration Negotiation: In band Negotiation not possible Number of Data Bits, Depending of the TE Configuration User Rate: 0,3 kbit/s
Octet 6b	0	1	x	0	0	x	x	x	Extension Intermediate Rate NIC on TX: Not Required NIC on RX: Not Supported Parity, Depending of the TE Configuration
Octet 6c	1	x	x	0	0	0	0	0	Extension Connection Element Modem Type: None

If the mobile station supports only Transparent mode or responds with a CALL CONFIRMED message:

Structure in Octet 4:	-	1	1	-	-	-	-	-	Unstructured
Intermediate rate in Octet 6b:	-	1	0	-	-	-	-	-	8 kbit/s
Connection element in Octet 6c:	-	0	0	-	-	-	-	-	Transparent

1) If the mobile station supports both Transparent and Non Transparent modes:

Structure in Octet 4:	-	0	0	-	-	-	-	-	SDU Integrity
Intermediate rate in Octet 6b:	-	1	1	-	-	-	-	-	16 kbit/s
Connection element in Octet 6c:	-	1	x	-	-	-	-	-	Both T or NT preferred

User Information L2 protocol in Octet 7 (see Non Transparent service).

11.8.2.1.1.4 ²⁾ UDI, Non Transparent

BC GSM = 04 0X X1 XX 8X 21 X1 6X X0 (CX)

Octet 1	0	0	0	0	0	1	0	0	Information Element: Bearer Capability
Octet 2	0	0	0	0	x	x	x	x	Length (7 or 8) depending on presence of octet 7.
Octet 3	1	x	x	0	0	0	0	1	Extension Radio Channel Requirement Coding Standard: GSM Transfer Mode: Circuit Info. Transfer Cap.: UDI
Octet 4	1	y	0	0	1	0	x	0	Extension Spare Structure: SDU Integrity Duplex Mode: Full duplex Configuration: Point to Point Negotiation of Intermediate Rate Requested Establishment: Demand
Octet 5	1	0	0	0	1	x	0	1	Extension Access Id Rate Adaptation: V.110 Signalling Access Protocol
Octet 6	0	0	1	0	0	0	0	1	Extension Layer 1 Id: Default User Information Layer 1 Protocol Synchronous / Asynchronous: Asynchronous
Octet 6a	0	x	0	x	0	0	0	1	Extension Number of Stop Bits, Depending of the TE Configuration Negotiation: In band Negotiation not possible Number of Data Bits, Depending of the TE Configuration User Rate: 0,3 kbit/s
Octet 6b	0	1	1	0	0	x	x	x	Extension Intermediate Rate: 16kbit/s NIC on TX: Not Required NIC on RX: Not Supported Parity, Depending of the TE Configuration
Octet 6c	1	x	x	0	0	0	0	0	Extension Connection Element: NT, (Both T or Both NT) ¹⁾ Modem Type: None
Octet 7 (need not be present)	1	1	0	0	1	x	0	0	Extension Layer 2 Id. User Inform. layer 2 protocol, Depending of the TE Configuration

Depending of the type of flow control supported by the TE, octet 7 is present or not. If not present, it means "outband flow control". If octet 7 is present, the value ISO 6429 (0 1000) means "Inband flow control" and the value COPnoFLCT (0 1100) means "No flow control".

11.8.2.1.2 BS 22

Same as BS 21 except:

	User Rate in Octet 6a:	-	-	-	-	0	0	1	0	1,2 kbit/s
If different from "none",	Modem Type Octet 6c:	-	-	-	0	0	0	1	0	Modem V.22

In case of 3,1 kHz Audio non transparent service, depending of the type of flow control supported by the TE, octet 7 is present or not. If not present, it means "outband flow control".

11.8.2.1.3 BS 24

Same as BS 21 except:

	User Rate in Octet 6a:	-	-	-	-	0	0	1	1	2,4 kbit/s
If different from "none",	Modem Type Octet 6c:	-	-	-	0	0	0	1	1	Modem V.22bis
							1	0	1	Modem V.26ter

In case of 3,1kHz Audio non transparent service, depending of the type of flow control supported by the TE, octet 7 is present or not. If not present, it means "outband flow control".

11.8.2.1.4 BS 25

Same as BS 21 except:

	User Rate in Octet 6a:	-	-	-	-	0	1	0	0	4,8 kbit/s
If different from "none",	Modem Type Octet 6c:	-	-	-	0	0	1	1	0	Modem V.32

In case of 3,1 kHz Audio non transparent service, depending of the type of flow control supported by the TE, octet 7 is present or not. If not present, it means "outband flow control".

11.8.2.1.5 BS 26

Same as BS 21 except:

	NIRR in Octet 4:	-	-	-	-	-	-	0	-	no meaning
	User Rate in Octet 6a:	-	-	-	-	0	1	0	1	9,6 kbit/s
	Interm. Rate in Octet 6b:	-	1	1	-	-	-	-	-	16 kbit/s
If different from "none",	Modem Type Octet 6c:	-	-	-	0	0	1	1	0	Modem V.32

In case of 3,1kHz Audio non transparent service, depending of the type of flow control supported by the TE, octet 7 is present or not. If not present, it means "outband flow control".

11.8.2.1.6 BS 23

Same as BS 21 except:

	User Rate in Octet 6a:	-	-	-	-	0	1	1	1	1,2 kbit/s/75 bit/s
If different from "none",	Modem Type Octet 6c:	-	-	-	0	0	1	0	0	Modem V.23

In case of 3,1kHz Audio non transparent service, depending of the type of flow control supported by the TE, octet 7 is present or not. If not present, it means "outband flow control".

11.8.2.2 BS 31 to 34 - Synchronous Service

11.8.2.2.1 BS 32

11.8.2.2.1.1 3,1 kHz Audio, Transparent, non-X.32 case

BC GSM = 04 07 X2 X8 81 20 13 43 83

Octet 1	0	0	0	0	0	1	0	0	Information Element: Bearer Capability
Octet 2	0	0	0	0	0	1	1	1	Length
Octet 3	1	x	x	0	0	0	1	0	Extension Radio Channel Requirement : Spare Coding Standard: GSM Transfer Mode: Circuit Info. Transfer Cap.: 3,1 kHz Audio
Octet 4	1	y	1	1	1	0	0	0	Extension Spare Structure: Unstructured Duplex Mode: Full duplex Configuration: Point to Point Negotiation of Intermediate Rate Requested: No meaning Establishment: Demand
Octet 5	1	0	0	0	0	0	0	1	Extension Access Id Rate Adaptation: No Signalling Access Protocol: I.440 / I.450
Octet 6	0	0	1	0	0	0	0	0	Extension Layer 1 Id: Default User Information Layer 1 Protocol Synchronous / Asynchronous: Synchronous
Octet 6a	0	0	0	1	0	0	1	1	Extension Number of Stop Bits: NA Negotiation: In band Negotiation not possible Number of Data Bits: NA User Rate: 2,4 kbit/s
Octet 6b	0	1	0	0	0	0	1	1	Extension Intermediate Rate: 8kbit/s NIC on TX: Not Required NIC on RX: Not Supported Parity: NA
Octet 6c	1	0	0	0	0	x	x	1	Extension Connection Element: Transparent Modem Type: V.22 bis or V.26 ter

11.8.2.2.1.2 ²⁾ UDI, Transparent mode, non-X.32 case

BC GSM = 04 07 X1 X8 8X 20 13 43 80

Octet 1	0	0	0	0	0	1	0	0	Information Element: Bearer Capability
Octet 2	0	0	0	0	0	1	1	1	Length
Octet 3	1	x	x	0	0	0	0	1	Extension Radio Channel Requirement Coding Standard: GSM Transfer Mode: Circuit Info. Transfer Cap.: UDI
Octet 4	1	y	1	1	1	0	0	0	Extension Spare Structure: Unstructured Duplex Mode: Full duplex Configuration: Point to Point Negotiation of Intermediate Rate Requested: No meaning Establishment: Demand
Octet 5	1	0	0	0	1	0	x	x	Extension Access Id Rate Adaptation: V.110 Signalling Access Protocol
Octet 6	0	0	1	0	0	0	0	0	Extension Layer 1 Id: Default User Information Layer 1 Protocol Synchronous / Asynchronous: Synchronous
Octet 6a	0	0	0	1	0	0	1	1	Extension Number of Stop Bits: NA Negotiation: In band Negotiation not possible Number of Data Bits: NA User Rate: 2,4 kbit/s
Octet 6b	0	1	0	0	0	0	1	1	Extension Intermediate Rate: 8kbit/s NIC on TX: Not Required NIC on RX: Not Supported Parity: NA
Octet 6c	1	0	0	0	0	0	0	0	Extension Connection Element: Transparent Modem Type: none

If the mobile station supports only SAP I.440/450

SAP in Octet 5:	-	-	-	-	-	0	0	1	I.440/I.450
-----------------	---	---	---	---	---	---	---	---	-------------

If the MS supports only SAP X.21

SAP in Octet 5:	-	-	-	-	-	0	1	0	X.21
-----------------	---	---	---	---	---	---	---	---	------

Else

SAP in Octet 5:	-	-	-	-	-	0	x	x	I.440/I.450 or X.21
-----------------	---	---	---	---	---	---	---	---	---------------------

11.8.2.2.1.3 3,1 kHz Audio, Transparent mode, X.32 case (Packet Service)

BC GSM = 04 0X X2 X8 86 20 13 X3 X3 (C6)

Octet 1	0	0	0	0	0	1	0	0	Information Element: Bearer Capability
Octet 2	0	0	0	0	0	1	1	1	Length
Octet 3	1	x	x	0	0	0	1	0	Extension Radio Channel Requirement Coding Standard: GSM Transfer Mode: Circuit Info. Transfer Cap.: 3,1 kHz Audio
Octet 4	1	y	x	x	1	0	0	0	Extension Spare Structure Duplex Mode: Full duplex Configuration: Point to Point Negotiation of Intermediate Rate Requested: No meaning Establishment: Demand
Octet 5	1	0	0	0	0	1	1	0	Extension Access Id Rate Adaptation: No Signalling Access Protocol: X.32
Octet 6	0	0	1	0	0	0	0	0	Extension Layer 1 Id: Default User Information Layer 1 Protocol Synchronous / Asynchronous: Synchronous
Octet 6a	0	0	0	1	0	0	1	1	Extension Number of Stop Bits: NA Negotiation: In band Negotiation not possible Number of Data Bits: NA User Rate: 2,4 kbit/s
Octet 6b	0	1	x	0	0	0	1	1	Extension Intermediate Rate NIC on TX: Not Required NIC on RX: Not Supported Parity: NA
Octet 6c	1	x	x	0	0	x	x	1	Extension Connection Element: Transparent Modem Type: V.22 bis or V.26 ter

If the mobile station supports only Transparent mode or responds with a CALL CONFIRMED message:

Structure in Octet 4:	-	1	1	-	-	-	-	-	Unstructured
Intermediate rate in Octet 6b:	-	1	0	-	-	-	-	-	8 kbit/s
Connection element in Octet 6c:	-	0	0	-	-	-	-	-	Transparent

1) If the mobile station supports both Transparent and Non Transparent modes:

Structure in Octet 4:	-	0	0	-	-	-	-	-	SDU Integrity
Intermediate rate in Octet 6b:	-	1	1	-	-	-	-	-	16 kbit/s
Connection element in Octet 6c:	-	1	x	-	-	-	-	-	Both T or NT preferred
UIL2P in Octet 7	-	-	-	0	0	1	1	0	X.25

11.8.2.2.1.4 3,1 kHz Audio, Non Transparent mode, X.32 case (Packet Service)

BC GSM = 04 08 A2 XX 86 20 13 63 X3 C6

Octet 1	0	0	0	0	0	1	0	0	Information Element: Bearer Capability
Octet 2	0	0	0	0	1	0	0	0	Length
Octet 3	1	x	x	0	0	0	1	0	Extension Radio Channel Requirement Coding Standard: GSM Transfer Mode: Circuit Info. Transfer Cap.: 3,1 kHz Audio
Octet 4	1	y	0	0	1	0	x	0	Extension Spare Structure: SDU integrity Duplex Mode: Full duplex Configuration: Point to Point Negotiation of Intermediate Rate Requested Establishment: Demand
Octet 5	1	0	0	0	0	1	1	0	Extension Access Id Rate Adaptation: No Signalling Access Protocol: X.32
Octet 6	0	0	1	0	0	0	0	0	Extension Layer 1 Id: Default User Information Layer 1 Protocol Synchronous / Asynchronous: Synchronous
Octet 6a	0	0	0	1	0	0	1	1	Extension Number of Stop Bits: NA Negotiation: In band Negotiation not possible Number of Data Bits: NA User Rate: 2,4 kbit/s
Octet 6b	0	1	1	0	0	0	1	1	Extension Intermediate Rate: 16kbit/s NIC on TX: Not Required NIC on RX: Not Supported Parity: NA
Octet 6c	1	x	x	0	0	x	x	1	Extension Connection Element: NT, (Both T or Both NT) ¹⁾ Modem Type: V.22 bis or V.26 ter
Octet 7	1	1	0	0	0	1	1	0	Extension Layer 2 Id. X.25

11.8.2.2.1.5 2) UDI, Non Transparent mode, X.32 case (Packet Service)

BC GSM = 04 08 X1 XX 96 20 13 63 A0 C6

Octet 1	0	0	0	0	0	1	0	0	Information Element: Bearer Capability
Octet 2	0	0	0	0	1	0	0	0	Length
Octet 3	1	x	x	0	0	0	0	1	Extension Radio Channel Requirement Coding Standard: GSM Transfer Mode: Circuit Info. Transfer Cap.: UDI
Octet 4	1	y	0	0	1	0	x	0	Extension Spare Structure: SDU integrity Duplex Mode: Full duplex Configuration: Point to Point Negotiation of Intermediate Rate Requested Establishment: Demand
Octet 5	1	0	0	1	0	1	1	0	Extension Access Id Rate Adaptation: X.31 flagstuffing Signalling Access Protocol: X.32
Octet 6	0	0	1	0	0	0	0	0	Extension Layer 1 Id: Default User Information Layer 1 Protocol Synchronous / Asynchronous: Synchronous
Octet 6a	0	0	0	1	0	0	1	1	Extension Number of Stop Bits: NA Negotiation: In band Negotiation not possible Number of Data Bits: NA User Rate: 2,4 kbit/s
Octet 6b	0	1	1	0	0	0	1	1	Extension Intermediate Rate: 16kbit/s NIC on TX: Not Required NIC on RX: Not Supported Parity: NA
Octet 6c	1	0	1	0	0	0	0	0	Extension Connection Element: Non Transparent Modem Type: None
Octet 7	1	1	0	0	0	1	1	0	Extension Layer 2 Id. X.25

11.8.2.2.2 BS 31

For non X.32 case only, same as BS 32 except:

	User Rate in Octet 6a:	-	-	-	-	0	0	1	0	1,2 kbit/s
If different from "none",	Modem Type Octet 6c:	-	-	-	0	0	0	1	0	Modem V.22

BS31 for Packet Service does not exist.

11.8.2.2.3 BS 33

Same as BS 32 except:

	User Rate in Octet 6a:	-	-	-	-	0	1	0	0	4,8 kbit/s
If different from "none",	Modem Type Octet 6c:	-	-	-	0	0	1	1	0	Modem V.32

11.8.2.2.4 BS 34

Same as BS 32 except:

	NIRR in Octet 4:	-	-	-	-	-	-	0	-	no meaning
	User Rate in Octet 6a:	-	-	-	-	0	1	0	1	9,6 kbit/s
	Interm. Rate in Octet 6b:	-	1	1	-	-	-	-	-	16 kbit/s
If different from "none",	Modem Type Octet 6c:	-	-	-	0	0	1	1	0	Modem V.32

11.8.2.3 BS 41 to 46 - PAD Access Asynchronous

11.8.2.3.1 ²⁾BS 41

11.8.2.3.1.1 ²⁾UDI, Transparent

BC GSM = 04 0X X1 X8 8C 21 X1 XX X0 (CX)

Octet 1	0	0	0	0	0	1	0	0	Information Element: Bearer Capability
Octet 2	0	0	0	0	0	1	1	1	Length
Octet 3	1	x	x	0	0	0	0	1	Extension Radio Channel Requirement Coding Standard: GSM Transfer Mode: Circuit Info. Transfer Cap.: UDI
Octet 4	1	y	x	x	1	0	0	0	Extension Spare Structure Duplex Mode: Full duplex Configuration: Point to Point Negotiation of Intermediate Rate Requested: No meaning Establishment: Demand
Octet 5	1	0	0	0	1	1	0	0	Extension Access Id Rate Adaptation: V.110 Signalling Access Protocol: X.28 dedicated universal NUI
Octet 6	0	0	1	0	0	0	0	1	Extension Layer 1 Id: Default User Information Layer 1 Protocol Synchronous / Asynchronous: Asynchronous
Octet 6a	0	x	0	x	0	0	0	1	Extension Number of Stop Bits, Depending of the TE Configuration Negotiation: In band Negotiation not possible Number of Data Bits, Depending of the TE Configuration User Rate: 0,3 kbit/s
Octet 6b	0	1	x	0	0	x	x	x	Extension Intermediate Rate NIC on TX: Not Required NIC on RX: Not Supported Parity, Depending of the TE Configuration
Octet 6c	1	x	x	0	0	0	0	0	Extension Connection Element Modem Type: None

If the mobile station supports only Transparent mode or responds with a CALL CONFIRMED message:

Structure in Octet 4:	-	1	1	-	-	-	-	-	Unstructured
Intermediate rate in Octet 6b:	-	1	0	-	-	-	-	-	8 kbit/s
Connection element in Octet 6c:	-	0	0	-	-	-	-	-	Transparent

1) If the mobile station supports both Transparent and Non Transparent modes:

Structure in Octet 4:	-	0	0	-	-	-	-	-	SDU Integrity
Intermediate rate in Octet 6b:	-	1	1	-	-	-	-	-	16 kbit/s
Connection element in Octet 6c:	-	1	x	-	-	-	-	-	Both T or NT preferred

User Information L2 Protocol (see Non Transparent service).

11.8.2.3.1.2 2) UDI, Non transparent

BC GSM = 04 08 X1 XX 8C 21 X1 6X X0 CX

Octet 1	0	0	0	0	0	1	0	0	Information Element: Bearer Capability
Octet 2	0	0	0	0	1	0	0	0	Length.
Octet 3	1	x	x	0	0	0	0	1	Extension Radio Channel Requirement Coding Standard: GSM Transfer Mode: Circuit Info. Transfer Cap.: UDI
Octet 4	1	y	0	0	1	0	x	0	Extension Spare Structure: SDU Integrity Duplex Mode: Full duplex Configuration: Point to Point Negotiation of Intermediate Rate Requested Establishment: Demand
Octet 5	1	0	0	0	1	1	0	0	Extension Access Id Rate Adaptation: V.110 Signalling Access Protocol: X.28 dedicated PAD, universal NUI
Octet 6	0	0	1	0	0	0	0	1	Extension Layer 1 Id: Default User Information Layer 1 Protocol Synchronous / Asynchronous: Asynchronous
Octet 6a	0	x	0	x	0	0	0	1	Extension Number of Stop Bits, Depending of the TE Configuration Negotiation: In band Negotiation not possible Number of Data Bits, Depending of the TE Configuration User Rate: 0,3 kbit/s
Octet 6b	0	1	1	0	0	x	x	x	Extension Intermediate Rate: 16kbit/s NIC on TX: Not Required NIC on RX: Not Supported Parity, Depending of the TE Configuration
Octet 6c	1	x	x	0	0	0	0	0	Extension Connection Element: NT, (Both T or Both NT) ¹⁾ Modem Type: None
Octet 7	1	1	0	0	1	x	0	0	Extension Layer 2 Id. User Inform. layer 2 protocol: Depending on the TE Configuration

Depending on the type of flow control supported by the TE, octet 7 is present or not. If not present, it means "outband flow control". If octet 7 is present, the value COPnoFLCT (01100) means "No flow control".

11.8.2.3.2 BS 42

Same as BS 41 except:

User Rate in Octet 6a:	-	-	-	-	0	0	1	0	1,2 kbit/s
------------------------	---	---	---	---	---	---	---	---	------------

11.8.2.3.3 BS 44

Same as BS 41 except:

	User Rate in Octet 6a:	-	-	-	-	0	0	1	1	2,4 kbit/s
--	------------------------	---	---	---	---	---	---	---	---	------------

11.8.2.3.4 BS 45

Same as BS 41 except:

	User Rate in Octet 6a:	-	-	-	-	0	1	0	0	4,8 kbit/s
--	------------------------	---	---	---	---	---	---	---	---	------------

11.8.2.3.5 BS 46

Same as BS 41 except:

	NIRR in Octet 4	-	-	-	-	-	-	0	-	no meaning
	User Rate in Octet 6a:	-	-	-	-	0	1	0	1	9,6 kbit/s
	Interm. Rate in Octet 6b:	-	1	1	-	-	-	-	-	16 kbit/s

11.8.2.3.6 BS 43

Same as BS 41 except:

	User Rate in Octet 6a:	-	-	-	-	0	1	1	1	1,2 kbit/s 75bit/s
--	------------------------	---	---	---	---	---	---	---	---	--------------------

11.8.2.4 BS 51 to 53 - Packet Service Synchronous

11.8.2.4.1 2) BS 51

BC GSM = 04 08 X1 X8 96 20 13 63 A0 C6

Octet 1	0	0	0	0	0	1	0	0	Information Element: Bearer Capability
Octet 2	0	0	0	0	1	0	0	0	Length
Octet 3	1	x	x	0	0	0	0	1	Extension Radio Channel Requirement Coding Standard: GSM Transfer Mode: Circuit Info. Transfer Cap.: UDI
Octet 4	1	y	0	0	1	0	0	0	Extension Spare Structure: Unstructured Duplex Mode: Full duplex Configuration: Point to Point Negotiation of Intermediate Rate Requested: No meaning Establishment: Demand
Octet 5	1	0	0	1	0	1	1	0	Extension Access Id Rate Adaptation: X.31 flag. Signalling Access Protocol: X.32
Octet 6	0	0	1	0	0	0	0	0	Extension Layer 1 Id: Default User Information Layer 1 Protocol Synchronous / Asynchronous: Synchronous
Octet 6a	0	0	0	1	0	0	1	1	Extension Number of Stop Bits: NA Negotiation: In band Negotiation not possible Number of Data Bits: NA User Rate: 2,4 kbit/s
Octet 6b	0	1	1	0	0	0	1	1	Extension Intermediate Rate: 16kbit/s NIC on TX: Not Required NIC on RX: Not Supported Parity: NA
Octet 6c	1	0	1	0	0	0	0	0	Extension Connection Element: Non Transparent Modem Type: None
Octet 7	1	1	0	0	0	1	1	0	Extension Layer 2 Id. X.25

11.8.2.4.2 BS 52

Same as BS 51 except:

User Rate in Octet 6a:	-	-	-	-	0	1	0	0	4,8 kbit/s
------------------------	---	---	---	---	---	---	---	---	------------

11.8.2.4.3 BS 53

Same as BS 51 except:

User Rate in Octet 6a:	-	-	-	-	0	1	0	1	9,6 kbit/s
------------------------	---	---	---	---	---	---	---	---	------------

11.8.2.5 BS 61 - Alternate Speech / Data

The first BC is coded as follows:

IF: speech full rate version 2 is supported by the mobile, see subclause 11.8.2.9.2;

ELSE: see subclause 11.8.2.9.1.

The repeat Indicator in the Setup message is coded "Circular for successive selection (alternate)": D1.

The second BC in the Setup message is coded as described below.

11.8.2.5.1 Speech/Asynchronous Data, Transparent

BC GSM = 04 0X X2 X8 81 21 XX XX XX (CX)

Octet 1	0	0	0	0	0	1	0	0	Information Element: Bearer Capability
Octet 2	0	0	0	0	0	1	1	1	Length
Octet 3	1	x	x	0	0	0	1	0	Extension Radio Channel Requirement Coding Standard: GSM Transfer Mode: Circuit Info. Transfer Cap.: 3,1 kHz Audio
Octet 4	1	y	x	x	1	0	0	0	Extension Spare Structure Duplex Mode: Full duplex Configuration: Point to Point Negotiation of Intermediate Rate Requested: No meaning Establishment: Demand
Octet 5	1	0	0	0	0	0	0	1	Extension Access Id Rate Adaptation: No Signalling Access Protocol: I.440 / I.450
Octet 6	0	0	1	0	0	0	0	1	Extension Layer 1 Id: Default User Information Layer 1 Protocol Synchronous / Asynchronous: Asynchronous
Octet 6a	0	x	0	x	x	x	x	x	Extension Number of Stop Bits, Depending of the TE Configuration Negotiation: In band Negotiation not possible Number of Data Bits, Depending of the TE Configuration User Rate
Octet 6b	0	1	x	0	0	x	x	x	Extension Intermediate Rate NIC on TX: Not Required NIC on RX: Not Supported Parity, Depending of the TE Configuration
Octet 6c	1	x	x	0	x	x	x	x	Extension Connection Element Modem Type

If the mobile station supports only Transparent mode or responds with a CALL CONFIRMED message:

Structure in Octet 4:	-	1	1	-	-	-	-	-	Unstructured
Intermediate rate in Octet 6b:	-	1	x	-	-	-	-	-	Depending on the user rate
Connection element in Octet 6c:	-	0	0	-	-	-	-	-	Transparent

1) If the mobile station supports both Transparent and Non Transparent modes

Structure in Octet 4:	-	0	0	-	-	-	-	-	SDU Integrity
Intermediate rate in Octet 6b:	-	1	1	-	-	-	-	-	16 kbit/s
Connection element in Octet 6c:	-	1	x	-	-	-	-	-	Both T or NT preferred

User Information L2 protocol in Octet 7 (see Non Transparent service)

Depending of the user rate supported by the MS, the user rate, the modem type and the intermediate rate change:

User Rate in Octet 6a:	-	-	-	-	0	0	0	1	0,3 kbit/s
Intermediate rate in Octet 6b:	-	1	0	-	-	-	-	-	8 kbit/s in Transparent mode
Modem type in Octet 6c:	-	-	-	0	0	0	0	1	Modem V.21

1) The following configuration is also authorised if CE = Both:

Modem type in Octet 6c:	-	-	-	0	1	0	0	0	Autobauding Type 1
-------------------------	---	---	---	---	---	---	---	---	-----------------------

User Rate in Octet 6a:	-	-	-	-	0	0	1	0	1,2 kbit/s
Intermediate rate in Octet 6b:	-	1	0	-	-	-	-	-	8 kbit/s in Transparent mode
Modem type in Octet 6c:	-	-	-	0	0	0	1	0	Modem V.22

1) The following configuration is also authorised if CE = Both:

Modem type in Octet 6c:	-	-	-	0	1	0	0	0	Autobauding Type 1
-------------------------	---	---	---	---	---	---	---	---	-----------------------

User Rate in Octet 6a:	-	-	-	-	0	0	1	1	2,4 kbit/s
Intermediate rate in Octet 6b:	-	1	0	-	-	-	-	-	8 kbit/s in Transparent mode
Modem type in Octet 6c:	-	-	-	0	0	0	1	1	Modem V.22bis
						1	0	1	Modem V.26ter

1) The following configuration is also authorised if CE = Both:

Modem type in Octet 6c:	-	-	-	0	1	0	0	0	Autobauding Type 1
-------------------------	---	---	---	---	---	---	---	---	-----------------------

User Rate in Octet 6a:	-	-	-	-	0	1	0	0	4,8 kbit/s
Intermediate rate in Octet 6b:	-	1	0	-	-	-	-	-	8 kbit/s in Transparent mode
Modem type in Octet 6c:	-	-	-	0	0	1	1	0	Modem V.32

1) The following configuration is also authorised if CE = Both:

Modem type in Octet 6c:	-	-	-	0	1	0	0	0	Autobauding Type 1
-------------------------	---	---	---	---	---	---	---	---	-----------------------

NIRR in Octet 4:	-	-	-	-	-	-	0	-	no meaning
User Rate in Octet 6a:	-	-	-	-	0	1	0	1	9,6 kbit/s
Intermediate rate in Octet 6b:	-	1	1	-	-	-	-	-	16 kbit/s in Transparent mode
Modem type in Octet 6c:	-	-	-	0	0	1	1	0	Modem V.32

1) The following configuration is also authorised if CE = Both:

	Modem type in Octet 6c:	-	-	-	0	1	0	0	0	Autobauding Type 1
	User Rate in Octet 6a:	-	-	-	-	0	1	1	1	1,2 kbits/s 75bit/2
	Intermediate rate in Octet 6b:	-	1	0	-	-	-	-	-	8 kbit/s in Transparent mode
	Modem type in Octet 6c:	-	-	-	0	0	1	0	0	Modem V.23

1) The following configuration is also authorised if CE = Both:

	Modem type in Octet 6c:	-	-	-	0	1	0	0	0	Autobauding Type 1
--	-------------------------	---	---	---	---	---	---	---	---	--------------------

11.8.2.5.2 Speech/Asynchronous Data, Non Transparent

BC GSM = 04 0X X2 XX 81 21 XX 6X XX (CX)

Octet 1	0	0	0	0	0	1	0	0	Information Element: Bearer Capability
Octet 2	0	0	0	0	x	x	x	x	Length (7 or 8) depending on presence of octet 7.
Octet 3	1	x	x	0	0	0	1	0	Extension Radio Channel Requirement Coding Standard: GSM Transfer Mode: Circuit Info. Transfer Cap.: 3,1 kHz Audio
Octet 4	1	y	0	0	1	0	x	0	Extension Spare Structure: SDU Integrity Duplex Mode: Full duplex Configuration: Point to Point Negotiation of Intermediate Rate Requested Establishment: Demand
Octet 5	1	0	0	0	0	0	0	1	Extension Access Id Rate Adaptation: No Signalling Access Protocol: I.440 / I.450
Octet 6	0	0	1	0	0	0	0	1	Extension Layer 1 Id: Default User Information Layer 1 Protocol Synchronous / Asynchronous: Asynchronous
Octet 6a	0	x	0	x	x	x	x	x	Extension Number of Stop Bits, Depending of the TE Configuration Negotiation: In band Negotiation not possible Number of Data Bits, Depending of the TE Configuration User Rate
Octet 6b	0	1	1	0	0	x	x	x	Extension Intermediate Rate: 16kbit/s NIC on TX: Not Required NIC on RX: Not Supported Parity, Depending of the TE Configuration
Octet 6c	1	x	x	0	x	x	x	x	Extension Connection Element: NT, (Both T or Both NT) ¹⁾ Modem Type
Octet 7 (may not be present)	1	1	0	0	1	x	0	0	Extension Layer 2 Id. User Inform. layer 2 protocol, Depending of the TE Configuration

Depending of the type of flow control supported by the TE, the coding of octet 7 is different. The value ISO 6429 (0 1000) means "Inband flow control" and the value COPnoFLCT (0 1100) means "No flow control". The "Outband Flow control is not allowed with V.21 modem).

Depending of the user rate supported by the MS, the user rate and the modem type change:

	User Rate in Octet 6a:	-	-	-	-	0	0	0	1	0,3 kbit/s
	Modem type in Octet 6c:	-	-	-	0	0	0	0	1	Modem V.21
		-	-	-	0	1	0	0	0	Autobauding Type 1

	User Rate in Octet 6a:	-	-	-	-	0	0	1	0	1,2 kbit/s
	Modem type in Octet 6c:	-	-	-	0	0	0	1	0	Modem V.22
		-	-	-	0	1	0	0	0	Autobauding Type 1

	User Rate in Octet 6a:	-	-	-	-	0	0	1	1	2,4 kbit/s
	Modem type in Octet 6c:	-	-	-	0	0	0	1	1	Modem V.22bis
							1	0	1	Modem V.26ter
		-	-	-	0	1	0	0	0	Autobauding Type 1

	User Rate in Octet 6a:	-	-	-	-	0	1	0	0	4,8 kbit/s
	Modem type in Octet 6c:	-	-	-	0	0	1	1	0	Modem V.32
		-	-	-	0	1	0	0	0	Autobauding Type 1

	NIRR in Octet 4:	-	-	-	-	-	-	0	-	no meaning
	User Rate in Octet 6a:	-	-	-	-	0	1	0	1	9,6 kbit/s
	Modem type in Octet 6c:	-	-	-	0	0	1	1	0	Modem V.32
		-	-	-	0	1	0	0	0	Autobauding Type 1

	User Rate in Octet 6a:	-	-	-	-	0	1	1	1	1,2 kbit/s 75bit/s
	Modem type in Octet 6c:	-	-	-	0	0	1	0	0	Modem V.23
		-	-	-	0	1	0	0	0	Autobauding Type 1

11.8.2.5.3 Speech/Synchronous Data

BC GSM = 04 07 X2 X8 81 20 1X X3 8X

Octet 1	0	0	0	0	0	1	0	0	Information Element: Bearer Capability
Octet 2	0	0	0	0	0	1	1	1	Length
Octet 3	1	x	x	0	0	0	1	0	Extension Radio Channel Requirement Coding Standard: GSM Transfer Mode: Circuit Info. Transfer Cap.: 3,1 kHz Audio
Octet 4	1	y	1	1	1	0	0	0	Extension Spare Structure: Unstructured Duplex Mode: Full duplex Configuration: Point to Point Negotiation of Intermediate Rate Requested: No meaning Establishment: Demand
Octet 5	1	0	0	0	0	0	0	1	Extension Access Id Rate Adaptation: No Signalling Access Protocol: I.440 / I.450
Octet 6	0	0	1	0	0	0	0	0	Extension Layer 1 Id: Default User Information Layer 1 Protocol Synchronous / Asynchronous: Synchronous
Octet 6a	0	0	0	1	x	x	x	x	Extension Number of Stop Bits: NA Negotiation: In band Negotiation not possible Number of Data Bits: NA User Rate
Octet 6b	0	1	x	0	0	0	1	1	Extension Intermediate Rate NIC on TX: Not Required NIC on RX: Not Supported Parity: NA
Octet 6c	1	0	0	0	x	x	x	x	Extension Connection Element: Transparent Modem Type

Depending of the user rate supported by the MS, the user rate, the modem type and the intermediate rate change:

User Rate in Octet 6a:	-	-	-	-	0	0	1	0	1,2 kbit/s
Intermediate rate in Octet 6b:	-	1	0	-	-	-	-	-	8 kbit/s
Modem type in Octet 6c:	-	-	-	0	0	0	1	0	Modem V.22

User Rate in Octet 6a:	-	-	-	-	0	0	1	1	2,4 kbit/s
Intermediate rate in Octet 6b:	-	1	0	-	-	-	-	-	8 kbit/s
Modem type in Octet 6c:	-	-	-	0	0	0	1	1	Modem V.22bis
						1	0	1	Modem V.26ter

User Rate in Octet 6a:	-	-	-	-	0	1	0	0	4,8 kbit/s
Intermediate rate in Octet 6b:	-	1	0	-	-	-	-	-	8 kbit/s
Modem type in Octet 6c:	-	-	-	0	0	1	1	0	Modem V.32

NIRR in Octet 4:	-	-	-	-	-	-	0	-	no meaning
User Rate in Octet 6a:	-	-	-	-	0	1	0	1	9,6 kbit/s
Intermediate rate in Octet 6b:	-	1	1	-	-	-	-	-	16 kbit/s
Modem type in Octet 6c:	-	-	-	0	0	1	1	0	Modem V.32

11.8.2.6 BS 81 - Speech followed by Data

The first BC is coded as follows:

IF: speech full rate version 2 is supported by the mobile, see subclause 11.8.2.9.2.

ELSE: see subclause 11.8.2.9.1.

The repeat Indicator in the Setup message is coded "Circular for successive selection 'mode 1 alternate mode 2' : D1".

The second BC in the Setup message is coded as described below.

11.8.2.6.1 Speech followed by Asynchronous Data

See subclauses 11.8.2.5.1 and 11.8.2.5.2.

11.8.2.6.2 Speech followed by Synchronous Data

See subclause 11.8.2.5.3.

11.8.2.7 TS 61 - Alternate Speech / Facsimile group 3

The first BC is coded as follows:

IF: speech full rate version 2 is supported by the mobile, see subclause 11.8.2.9.2.

ELSE: see subclause 11.8.2.9.1.

The repeat Indicator in the Setup message is coded "Circular for successive selection (alternate)": D1.

The second BC in the Setup message is coded as described below.

11.8.2.7.1 TS 61 - Alternate Speech / Facsimile group 3, Transparent

BC GSM = 04 07 X3 X8 81 20 1X X3 80

Octet 1	0	0	0	0	0	1	0	0	Information Element: Bearer Capability
Octet 2	0	0	0	0	0	1	1	1	Length
Octet 3	1	y	y	0	0	0	1	1	Extension Radio Channel Requirement: Spare Coding Standard: GSM Transfer Mode: Circuit Info. Transfer Cap.: FAX3
Octet 4	1	y	1	1	1	0	0	0	Extension Spare Structure: Unstructured Duplex Mode: Full duplex Configuration: Point to Point Negotiation of Intermediate Rate Requested: No meaning Establishment: Demand
Octet 5	1	0	0	0	0	0	0	1	Extension Access Id Rate Adaptation: No Signalling Access Protocol: NA
Octet 6	0	0	1	0	0	0	0	0	Extension Layer 1 Id: Default User Information Layer 1 Protocol Synchronous / Asynchronous: synchronous
Octet 6a	0	0	0	1	x	x	x	x	Extension Number of Stop Bits: NA Negotiation: In band Negotiation not possible Number of Data Bits: NA User Rate
Octet 6b	0	1	x	0	0	0	1	1	Extension Intermediate Rate NIC on TX: Not Required NIC on RX: Not Supported Parity: NA
Octet 6c	1	0	0	0	0	0	0	0	Extension Connection Element: Transparent Modem Type: None

Depending of the user rate supported by the MS, the user rate and the intermediate rate change:

User Rate in Octet 6a:	-	-	-	-	0	0	1	1	2,4 kbit/s
Interm. Rate in Octet 6b:	-	1	0	-	-	-	-	-	8 kbit/s

User Rate in Octet 6a:	-	-	-	-	0	1	0	0	4,8 kbit/s
Interm. Rate in Octet 6b:	-	1	0	-	-	-	-	-	8 kbit/s

NIRR in Octet 4:	-	-	-	-	-	-	0	-	no meaning
User Rate in Octet 6a:	-	-	-	-	0	1	0	1	9,6 kbit/s
Interm. Rate in Octet 6b:	-	1	1	-	-	-	-	-	16 kbit/s

11.8.2.7.2 TS 61 - Alternate Speech / Facsimile group 3, Non Transparent

BC GSM = 04 07 X3 XX 81 20 1X 63 X0 66

Octet 1	0	0	0	0	0	1	0	0	Information Element: Bearer Capability
Octet 2	0	0	0	0	0	1	1	1	Length
Octet 3	1	y	y	0	0	0	1	1	Extension Radio Channel Requirement: Spare Coding Standard: GSM Transfer Mode: Circuit Info. Transfer Cap.: FAX3
Octet 4	1	y	0	0	1	0	x	0	Extension Spare Structure: SDU Integrity Duplex Mode: Full duplex Configuration: Point to Point Negotiation of Intermediate Rate Requested Establishment: Demand
Octet 5	1	0	0	0	0	0	0	1	Extension Access Id Rate Adaptation: No Signalling Access Protocol: NA
Octet 6	0	0	1	0	0	0	0	0	Extension Layer 1 Id: Default User Information Layer 1 Protocol Synchronous / Asynchronous: synchronous
Octet 6a	0	0	0	1	x	x	x	x	Extension Number of Stop Bits: NA Negotiation: In band Negotiation not possible Number of Data Bits: NA User Rate
Octet 6b	0	1	1	0	0	0	1	1	Extension Intermediate Rate: 16 kbit/s NIC on TX: Not Required NIC on RX: Not Supported Parity: NA
Octet 6c	1	x	x	0	0	0	0	0	Extension Connection Element Modem Type: None
Octet 7	1	1	0	0	0	1	1	0	Extension Layer 2 Id X.25

The user rate supported by the MS may have the following values:

User Rate in Octet 6a:	-	-	-	-	0	0	1	1	2,4 kbit/s
------------------------	---	---	---	---	---	---	---	---	------------

User Rate in Octet 6a:	-	-	-	-	0	1	0	0	4,8 kbit/s
------------------------	---	---	---	---	---	---	---	---	------------

NIRR in Octet 4:	-	-	-	-	-	-	0	-	no meaning
User Rate in Octet 6a:	-	-	-	-	0	1	0	1	9,6 kbit/s

If present, Octet 7 shall have the following value:

UI2LP in Octet 7	-	-	-	0	0	1	1	0	X.25
------------------	---	---	---	---	---	---	---	---	------

11.8.2.8 TS 62 - Automatic Facsimile group 3

The repeat Indicator in the Setup message is not available.

The BC GSM is coded as described in subclause 11.8.2.7.

11.8.2.9 TS 11 and TS 12 - Speech

11.8.2.9.1 Support of only full/half rate speech version 1

The BC in the Setup message is coded as described below.

BC GSM = 04 01 X0

Octet 1	0	0	0	0	0	1	0	0	Information Element : Bearer Capability
Octet 2	0	0	0	0	0	0	0	1	Length
Octet 3	1	x	x	0	0	0	0	0	Extension Radio Channel Requirement Coding Standard : GSM Transfer Mode : Circuit Info. Transfer Cap. : speech

11.8.2.9.2 Support of speech full rate version 2 (Enhanced Full Rate)

This BC will be used by MS supporting EFR as the most advanced speech version. Those supporting EFR and newer codec speech version such as speech version 3, half rate speech version 2 will not use this BC.

The BC is coded as described below.

BC GSM = 04 0X X0 0X XX (8X)

Octet 1	0	0	0	0	0	1	0	0	Information Element : Bearer Capability
Octet 2	0	0	0	0	0	x	x	x	Length
Octet 3	0	x	x	0	0	0	0	0	Extension Radio Channel Requirement Coding Standard : GSM Transfer Mode : Circuit Info. Transfer Cap. : speech
Octet_3a_1	0	0	0	0	0	x	x	x	Extension Coding Spare Speech version indication
Octet_3a_2	x	0	0	0	0	x	x	x	Extension Coding Spare Speech version indication
Octet_3a_3	1	0	0	0	0	x	x	x	Extension Coding Spare Speech version indication

IF the MS supports only Full Rate:

Octet 2	0	0	0	0	0	0	1	1	Length
Radio Channel Requirement in Octet 3:	-	0	1	-	-	-	-	-	Full rate support only mobile station/preference as in octets3a_etc

Octet_3a_1	-	-	-	-	-	0	x	0	x=0 : full rate speech version 1 x=1 : full rate speech version 2
------------	---	---	---	---	---	---	---	---	--

Octet_3a_2	1	-	-	-	-	0	x	0	x=0 : full rate speech version 1 x=1 : full rate speech version 2
------------	---	---	---	---	---	---	---	---	--

The speech indication in Octet_3a_1 shall be different from the one in Octet_3a_2.

Octet_3a_3 is not present.

ELSE

Octet 2 Radio Channel Requirement in Octet 3:	0 -	0 1	0 x	0 -	0 -	1 -	0 -	0 -	Length x=0 or 1 :Dual rate mobile station/ preference as in octets3a_etc
--	--------	--------	--------	--------	--------	--------	--------	--------	---

Octet_3a_1	-	-	-	-	-	0	x	x	(0,0) :full rate speech version 1 (1,0) : full rate speech version 2 (0,1) : half rate speech version 1
------------	---	---	---	---	---	---	---	---	---

Octet_3a_2	0	-	-	-	-	0	x	x	(0,0) :full rate speech version 1 (1,0) : full rate speech version 2 (0,1) : half rate speech version 1
------------	---	---	---	---	---	---	---	---	---

Octet_3a_3	1	-	-	-	-	0	x	x	(0,0) :full rate speech version 1 (1,0) : full rate speech version 2 (0,1) : half rate speech version 1
------------	---	---	---	---	---	---	---	---	---

Each speech indication in Octet_3a_i shall be different from the one in Octet_3a_j, i≠j.

11.8.2.9.3 Support of full rate speech version 2 (EFR) and full and/or half rate speech version 3 (AMR)

The BC is coded as described below.

BC GSM: 04 0X X0 0X 0X XX (XX) (8X)

Octet 1	0	0	0	0	0	1	0	0	Information Element : Bearer Capability
Octet 2	0	0	0	0	0	x	x	x	Length
Octet 3	0	x	x	0	0	0	0	0	Extension Radio Channel Requirement Coding Standard : GSM Transfer Mode : Circuit Info. Transfer Cap. : speech
Octet_3a_1	0	0	0	0	0	x	x	x	Extension Coding Spare Speech version indication
Octet_3a_2	0	0	0	0	0	x	x	x	Extension Coding Spare Speech version indication
Octet_3a_3	x	0	0	0	0	x	x	x	Extension Coding Spare Speech version indication
Octet_3a_4	x	0	0	0	0	x	x	x	Extension Coding Spare Speech version indication
Octet_3a_5	1	0	0	0	0	x	x	x	Extension Coding Spare Speech version indication

IF the MS supports only Full Rate speech version 1 and full rate speech version 2 and full rate speech version 3:

Octet 2	0	0	0	0	0	1	0	0	Length
Radio Channel Requirement in Octet 3:	-	0	1	-	-	-	-	-	Full rate support only mobile station/preference as in octets3a_etc

Octet_3a_1	-	-	-	-	-	x	x	0	(0,0,0): full rate speech version 1 (0,1,0): full rate speech version 2 (1,0,0): full rate speech version 3
------------	---	---	---	---	---	---	---	---	---

Octet_3a_2	-	-	-	-	-	x	x	0	(0,0,0): full rate speech version 1 (0,1,0): full rate speech version 2 (1,0,0): full rate speech version 3
------------	---	---	---	---	---	---	---	---	---

Octet_3a_3	1	-	-	-	-	x	x	0	(0,0,0): full rate speech version 1 (0,1,0): full rate speech version 2 (1,0,0): full rate speech version 3
------------	---	---	---	---	---	---	---	---	---

Each speech indication in Octet_3a_i shall be different from the one in Octet_3a_j, i≠j.

ELSE IF the MS supports Full Rate speech version 1 and full rate speech version 2 and full rate speech version 3 and half rate speech version 1

Octet 2	0	0	0	0	0	1	0	1	Length
Radio Channel Requirement in Octet 3:	-	1	x	-	-	-	-	-	x=0 or 1 :Dual rate mobile station/preference as in octets3a_etc

Octet_3a_1	-	-	-	-	-	x	x	x	(0,0,0): full rate speech version 1 (0,1,0): full rate speech version 2 (1,0,0): full rate speech version 3 (0,0,1): half rate speech version 1
------------	---	---	---	---	---	---	---	---	--

Octet_3a_2	-	-	-	-	-	x	x	x	(0,0,0): full rate speech version 1 (0,1,0): full rate speech version 2 (1,0,0): full rate speech version 3 (0,0,1): half rate speech version 1
------------	---	---	---	---	---	---	---	---	--

Octet_3a_3	0	-	-	-	-	x	x	x	(0,0,0): full rate speech version 1 (0,1,0): full rate speech version 2 (1,0,0): full rate speech version 3 (0,0,1): half rate speech version 1
------------	---	---	---	---	---	---	---	---	--

Octet_3a_4	1	-	-	-	-	x	x	x	(0,0,0): full rate speech version 1 (0,1,0): full rate speech version 2 (1,0,0): full rate speech version 3 (0,0,1): half rate speech version 1
------------	---	---	---	---	---	---	---	---	--

Each speech indication in Octet_3a_i shall be different from the one in Octet_3a_j, i≠j.

ELSE IF the MS supports Full Rate speech version 1 and full rate speech version 2 and full rate speech version 3 and half rate speech version 3

Octet 2	0	0	0	0	0	1	0	1	Length
Radio Channel Requirement in Octet 3:	-	0	1	-	-	-	-	-	Dual rate mobile station/ preference as in octets3a_etc

Octet_3a_1	-	-	-	-	-	x	x	x	(0,0,0): full rate speech version 1 (0,1,0): full rate speech version 2 (1,0,0): full rate speech version 3 (1,0,1): half rate speech version 3
------------	---	---	---	---	---	---	---	---	--

Octet_3a_2	-	-	-	-	-	x	x	x	(0,0,0): full rate speech version 1 (0,1,0): full rate speech version 2 (1,0,0): full rate speech version 3 (1,0,1): half rate speech version 3
------------	---	---	---	---	---	---	---	---	--

Octet_3a_3	0	-	-	-	-	x	x	x	(0,0,0): full rate speech version 1 (0,1,0): full rate speech version 2 (1,0,0): full rate speech version 3 (1,0,1): half rate speech version 3
------------	---	---	---	---	---	---	---	---	--

Octet_3a_4	1	-	-	-	-	x	x	x	(0,0,0): full rate speech version 1 (0,1,0): full rate speech version 2 (1,0,0): full rate speech version 3 (1,0,1): half rate speech version 3
------------	---	---	---	---	---	---	---	---	--

Each speech indication in Octet_3a_i shall be different from the one in Octet_3a_j, i≠j.

ELSE IF the MS supports Full Rate speech version 1 and full rate speech version 2 and full rate speech version 3 and half rate speech version 1 and half rate speech version 3

Octet 2	0	0	0	0	0	1	1	0	Length
Radio Channel Requirement in Octet 3:	-	1	x	-	-	-	-	-	x=0 or 1 :Dual rate mobile station/preference as in octets3a_etc
Octet_3a_1	-	-	-	-	-	x	x	x	(0,0,0): full rate speech version 1 (0,1,0): full rate speech version 2 (1,0,0): full rate speech version 3 (0,0,1): half rate speech version 1 (1,0,1) half rate speech version 3
Octet_3a_2	-	-	-	-	-	x	x	x	(0,0,0): full rate speech version 1 (0,1,0): full rate speech version 2 (1,0,0): full rate speech version 3 (0,0,1): half rate speech version 1 (1,0,1) half rate speech version 3
Octet_3a_3	0	-	-	-	-	x	x	x	(0,0,0): full rate speech version 1 (0,1,0): full rate speech version 2 (1,0,0): full rate speech version 3 (0,0,1): half rate speech version 1 (1,0,1) half rate speech version 3
Octet_3a_4	0	-	-	-	-	x	x	x	(0,0,0): full rate speech version 1 (0,1,0): full rate speech version 2 (1,0,0): full rate speech version 3 (0,0,1): half rate speech version 1 (1,0,1) half rate speech version 3
Octet_3a_5	1	-	-	-	-	x	x	x	(0,0,0): full rate speech version 1 (0,1,0): full rate speech version 2 (1,0,0): full rate speech version 3 (0,0,1): half rate speech version 1 (1,0,1) half rate speech version 3

Each speech indication in Octet_3a_i shall be different from the one in Octet_3a_j, i≠j.

12 Transceiver

12.1 Conducted spurious emissions

12.1.1 MS allocated a channel

12.1.1.1 Definition

Conducted spurious emissions, when the MS has been allocated a channel, are emissions from the antenna connector at frequencies other than those of the carrier and sidebands associated with normal modulation.

12.1.1.2 Conformance requirement

1. The conducted spurious power emitted by the MS, when allocated a channel, shall be no more than the levels in table 12.1.
 - 1.1 Under normal voltage conditions; 3GPP TS 45.005, subclauses 4.3 and 4.3.3.
 - 1.2 Under extreme voltage conditions; 3GPP TS 45.005, subclauses 4.3 and 4.3.3, and clause D.2.

Table 12.1

Frequency range	Power level in dBm		
	GSM 400, GSM 700, T-GSM 810 GSM 850, GSM 900	DCS 1 800	PCS 1 900
9 kHz to 1 GHz	-36	-36	-36
1 GHz to 12,75 GHz	-30		-30
1 GHz to 1 710 MHz		-30	
1 710 MHz to 1 785 MHz		-36	
1 785 MHz to 12,75 GHz		-30	

12.1.1.3 Test purpose

- To verify that conducted spurious emissions from the MS when allocated a channel do not exceed the conformance requirements. These conducted spurious emissions will be measured in the frequency band 100 kHz to 12,75 GHz excluding the following received bands:

For GSM 400, GSM 900 and DCS 1 800:

- the band 925 MHz to 960 MHz;
- the band 1 805 MHz to 1 880 MHz;
- in addition for GSM 400 MS:
 - the band 460,4 MHz to 467,6 MHz;
 - the band 488,8 MHz to 496 MHz.

For GSM 700, T-GSM 810, GSM 850 and PCS 1 900:

- the band 747 MHz to 762 MHz;
- the band 869 MHz to 894 MHz;
- the band 1 930 MHz to 1 990 MHz.

1.1 Under normal voltage conditions.

1.2 Under extreme voltage conditions.

NOTE: The band 9 kHz to 100 kHz is not tested, because of test implementation problems.

12.1.1.4 Method of test

12.1.1.4.1 Initial conditions

A call is set up by the SS according to the generic call set up procedure on a channel in the Mid ARFCN range.

The SS commands the MS to loop back its channel decoder output to channel encoder input.

The SS sends Standard Test Signal C1.

The SS sets the MS to operate at its maximum output power.

12.1.1.4.2 Procedure

- Measurements are made in the frequency range 100 kHz to 12,75 GHz. Spurious emissions are measured at the connector of the transceiver, as the power level of any discrete signal, higher than the requirement in table 12.1 minus 6 dB, delivered into a 50 Ω load.

The measurement bandwidth based on a 5 pole synchronously tuned filter is according to table 12.2. The power indication is the peak power detected by the measuring system.

The measurement on any frequency shall be performed for at least one TDMA frame period with the exception of the idle frame.

NOTE: This ensures that both the active times (MS transmitting) and the quiet times are measured.

b) The test is repeated under extreme voltage test conditions ([annex 1, TC2.2 and TC3]).

Table 12.2

Frequency range	Frequency offset	Filter bandwidth	Approx video bandwidth
100 kHz to 50 MHz	-	10 kHz	30 kHz
50 MHz to 500 MHz excl. relevant TX band: GSM 450: 450,4 MHz to 457,6 MHz; GSM 480: 478,8 MHz to 486 MHz, and the RX bands: For GSM 400 MS: 460,4 MHz to 467,6 MHz; 488,8 MHz to 496 MHz.	-	100 kHz	300 kHz
500 MHz to 12,75 GHz, excl. relevant TX band: GSM 710: 728 MHz to 746 MHz GSM 750: 777 MHz to 792 MHz T-GSM 810: 806 MHz to 821 MHz; GSM 850: 824 MHz to 849 MHz; P-GSM: 890 MHz to 915 MHz; E-GSM: 880 MHz to 915 MHz; DCS: 1 710 MHz to 1 785 MHz, PCS 1 900: 1 850 MHz to 1 910 MHz; and the RX bands: For GSM 400 MS, GSM 900 MS and DCS 1 800 MS: 925 MHz to 960 MHz; 1 805 MHz to 1 880 MHz. For GSM 710, GSM 750, T-GSM 810, GSM 850 MS and PCS 1 900 MS: 698 MHz to 716 MHz; 747 MHz to 762 MHz; 851 MHz to 866 MHz 869 MHz to 894 MHz; 1 930 MHz to 1 990 MHz	0 to 10 MHz >= 10 MHz >= 20 MHz >= 30 MHz (offset from edge of relevant TX band)	100 kHz 300 kHz 1 MHz 3 MHz 3 MHz	300 kHz 1 MHz 3 MHz 3 MHz
relevant TX band: GSM 450: 450,4 MHz to 457,6 MHz GSM 480: 478,8 MHz to 486 MHz GSM 710: 728 MHz to 746 MHz GSM 750: 777 MHz to 792 MHz T-GSM 810: 806 MHz to 821 MHz; GSM 850: 824 MHz to 849 MHz P-GSM: 890 MHz to 915 MHz E-GSM: 880 MHz to 915 MHz DCS: 1 710 MHz to 1 785 MHz PCS 1 900: 1 850 MHz to 1 910 MHz	1,8 to 6,0 MHz > 6,0 MHz (offset from carrier)	30 kHz 100 kHz	100 kHz 300 kHz
NOTE 1: The excluded RX bands are tested in subclause 13.4. NOTE 2: The filter and video bandwidths, and frequency offsets are only correct for measurements on an MS transmitting on a channel in the Mid ARFCN range. NOTE 3: Due to practical implementation, the video bandwidth is restricted to a maximum of 3 MHz.			

12.1.1.5 Test requirement

The power of any spurious emission shall not exceed the levels given in table 12.3.

Table 12.3

Frequency range		Power level in dBm		
		GSM 400, GSM 700, T-GSM 810, GSM 850, GSM 900	DCS 1 800	PCS 1 900
100 kHz to	1 GHz	-36	-36	-36
1 GHz to	12,75 GHz	-30		-30
1 GHz to	1710 MHz		-30	
1 710 MHz to	1 785 MHz		-36	
1 785 MHz to	12,75 GHz		-30	

12.1.2 MS in idle mode

12.1.2.1 Definition

Conducted spurious emissions are any emissions from the antenna connector, when the MS is in idle mode.

12.1.2.2 Conformance requirement

1. The conducted spurious power emitted by the MS, when in idle mode, shall be no more than the levels in table 12.4.

1.1 Under normal voltage conditions; 3GPP TS 05.05, subclauses 4.3 and 4.3.3.

1.2 Under extreme voltage conditions; 3GPP TS 05.05, subclauses 4.3 and 4.3.3, and clause D.2.

Table 12.4

Frequency range		Power level in dBm	
		GSM 400, T-GSM 810, GSM 900, DCS 1 800	GSM 700, GSM 850, PCS 1 900
9 kHz to	880 MHz	-57	-57
880 MHz to	915 MHz	-59	-57
915 MHz to	1000 MHz	-57	-57
1 GHz to	1 710 MHz	-47	
1 710 MHz to	1 785 MHz	-53	
1 785 MHz to	1 900 MHz	-47	
1 900 MHz to	1980 MHz	-76	
1980 MHz to	2010 MHz	-47	
2010 MHz to	2022 MHz	-76	
2022 MHz to	2110 MHz	-47	
2110 MHz to	2170 MHz	-76	
2170 MHz	12,75 GHz	-47	
1 GHz to	1 850 MHz		-47
1 850 MHz to	1 910 MHz		-53
1 910 MHz to	12,75 GHz		-47

12.1.2.3 Test purpose

1. To verify that conducted spurious emissions, in the frequency band 100 kHz to 12,75 GHz from the MS when in idle mode do not exceed the conformance requirements.

1.1 Under normal voltage conditions.

1.2 Under extreme voltage conditions.

NOTE: The band 9 KhZ to 100 kHz is not tested, because of test implementation problems.

12.1.2.4 Method of test

12.1.2.4.1 Initial conditions

The RF power level of the BCCH shall not exceed -80 dBm in order to prevent conflicts in the frequency range 915 MHz to 1000 MHz (see Table 12.6, row 3). The BCCH message content from the serving cell shall ensure that Periodic Location Updating is not used and that page mode is continuously set to Paging Reorganization and BS_AG_BLK_RES is set to 0 so that the MS receiver will operate continually.

The CCCH_CONF shall be set to 000. 1 basic physical channel used for CCCH not combined with SDCCHs.

The BCCH allocation shall either be empty or contain only the serving cell BCCH.

NOTE: This is to ensure that the receiver does not scan other ARFCN. Scanning other ARFCN could lead to a moving in frequency of the spurious and therefore to the possibility of either not measuring a spurious emission or measuring it more than once.

The MS is in MM state "idle, updated".

12.1.2.4.2 Procedure

- a) Measurements are made in the frequency range 100 kHz to 12,75 GHz. Spurious emissions are measured as the power level of any discrete signal, higher than the requirement in table 12.4 minus 6 dB, delivered into a 50Ω load.

The measurement bandwidth based on a 5 pole synchronously tuned filter is set according to table 12.5. The power indication is the peak power detected by the measuring system.

The measurement time on any frequency shall be such that it includes the time during which the MS receives a TDMA frame containing the paging channel.

Table 12.5

Frequency range	Filter bandwidth	Video bandwidth
100 kHz to 50 MHz	10 kHz	30 kHz
50 MHz to 12,75 GHz	100 kHz	300 kHz

- b) The test is repeated under extreme voltage test conditions ([annex 1, TC2.2 and TC3]).

12.1.2.5 Test requirement

The power of any spurious emission shall not exceed the levels given in table 12.6.

Table 12.6

Frequency range		Power level in dBm	
		GSM 400, T-GSM 810 GSM 900, DCS 1 800	GSM 700, GSM 850, PCS 1 900
100 kHz to	880 MHz	-57	-57
880 MHz to	915 MHz	-59	-57
915 MHz to	1 000 MHz	-57	-57
1 GHz to	1 710 MHz	-47	
1 710 MHz to	1 785 MHz	-53	
1 785 MHz to	1 900 MHz	-47	
1 900 MHz to	1980 MHz	-76	
1980 MHz to	2010 MHz	-47	
2010 MHz to	2022 MHz	-76	
2022 MHz to	2110 MHz	-47	
2110 MHz to	2170 MHz	-76	
2170 MHz	12,75 GHz	-47	
1 GHz to	1 850 MHz		-47
1 850 MHz to	1 910 MHz		-53
1 910 MHz to	12,75 GHz		-47

12.2 Radiated spurious emissions

This test is performed either on an outdoor test site, fulfilling the requirements of [GC4 of annex 1], or in an anechoic shielded chamber, fulfilling the requirements of ([GC5 of annex 1]). Performing the measurement in the anechoic shielded chamber is preferred. The sample shall be placed at the specified height on the support.

NOTE: The test method described has been written for measurement in an anechoic shielded chamber. If an outdoor test site is used then additional precautions are necessary to ensure correct measurement. These measures are familiar to test houses which perform spurious emissions tests and are:

- Raise/lower the test antenna through the specified height range during both the emission detection and substitution parts of the test.
- Perform a qualitative pre-search in a shielded environment for test sites where the ambient RF environment can prevent the detection of spurious emissions which exceed the limit.
- Detect emissions at a more sensitive threshold to that specified in subclause 12.2.1.4 to allow for destructive interference due to ground plane reflections at the test antenna search height.

12.2.1 MS allocated a channel

12.2.1.1 Definition

Radiated spurious emissions, when the MS has been allocated a channel, are any emissions radiated by the cabinet and structure of the mobile station, including all interconnecting cables.

This is also known as "cabinet radiation".

The test applies to all types of MS with the exception of the test at extreme voltages for an MS where a practical connection, to an external power supply, is not possible.

NOTE: A "practical connection" shall be interpreted to mean it is possible to connect extreme voltages to the MS without interfering with the configuration of the MS in a way which could invalidate the test.

12.2.1.2 Conformance requirement

- The radiated spurious power emitted by the MS, when allocated a channel, shall be no more than the levels in table 12.7 under normal voltage conditions; 3GPP TS 05.05, subclauses 4.3 and 4.3.3.
- The radiated spurious power emitted by the MS, when allocated a channel, shall be no more than the levels in table 12.7 under extreme voltage conditions; 3GPP TS 05.05, subclauses 4.3 and 4.3.3, and clause D.2.

Table 12.7

Frequency range		Power level in dBm		
		GSM 400, GSM 700, T-GSM 810, GSM 850, GSM 900	DCS 1 800	PCS 1 900
30 MHz to	1 GHz	-36	-36	-36
1 GHz to	4 GHz	-30		-30
1 GHz to	1 710 MHz		-30	
1 710 MHz to	1 785 MHz		-36	
1 785 MHz to	4 GHz		-30	

12.2.1.3 Test purpose

1. To verify that radiated spurious emissions from the MS when allocated a channel do not exceed the conformance requirements under normal voltage conditions.
2. To verify that radiated spurious emissions from the MS when allocated a channel do not exceed the conformance requirements under extreme voltage conditions.

12.2.1.4 Method of test

12.2.1.4.1 Initial conditions

A call is set up by the SS according to the generic call set up procedure on a channel in the Mid ARFCN range.

NOTE: The power supply shall be connected to the MS such that the physical configuration does not change in a way that could have an effect on the measurement. In particular, the battery pack of the MS should not normally be removed. In cases where no practical connection can be made to the power supply, the MS's intended battery source shall be used.

The SS commands the MS to loop back its channel decoder output to its channel encoder input.

The SS sends Standard Test Signal C1.

The SS sets the MS to operate at its maximum output power.

12.2.1.4.2 Procedure

- a) Initially the test antenna is closely coupled to the MS and any spurious emission radiated by the MS is detected by the test antenna and receiver in the range 30 MHz to 4 GHz.

NOTE 1: This is a qualitative step to identify the frequency and presence of spurious emissions which are to be measured in subsequent steps.

- b) The test antenna separation is set to the appropriate measurement distance and at each frequency at which an emission has been detected, the MS shall be rotated to obtain maximum response and the effective radiated power of the emission determined by a substitution measurement. In case of an anechoic shielded chamber pre-calibration may be used instead of a substitution measurement.
- c) The measurement bandwidth, based on a 5 pole synchronously tuned filter, is set according to table 12.8. The power indication is the peak power detected by the measuring system.

The measurement on any frequency shall be performed for at least one TDMA frame period, with the exception of the idle frame.

NOTE 2: This ensures that both the active times (MS transmitting) and the quiet times are measured.

NOTE 3: For these filter bandwidths some difficulties may be experienced with noise floor above required measurement limit. This will depend on the gain of the test antenna, and adjustment of the measuring system bandwidth is permissible. Alternatively, for test frequencies above 900 MHz, the test antenna separation from the MS may be reduced to 1 metre.

- d) The measurements are repeated with the test antenna in the orthogonal polarization plane.

e) The test is repeated under extreme voltage test conditions (see [annex 1, TC2.2]).

Table 12.8

Frequency range	Frequency offset	Filter bandwidth	Approx video bandwidth
30 MHz to 50 MHz	-	10 kHz	30 kHz
50 MHz to 500 MHz excl. relevant TX band:	-	100 kHz	300 kHz
GSM 450: 450,4 MHz to 457,6 MHz; GSM 480: 478,8 MHz to 486 MHz 500 MHz to 4 GHz,	0 to 10 MHz	100 kHz	300 kHz
	>= 10 MHz	300 kHz	1 MHz
Excl. relevant TX band:	>= 20 MHz	1 MHz	3 MHz
GSM 710: 728 MHz to 746 MHz GSM 750: 777 MHz to 792 MHz T-GSM 810: 806MHz to 821 MHz GSM 850: 824 MHz to 849 MHz P-GSM: 890 MHz to 915 MHz; E-GSM: 880 MHz to 915 MHz; DCS: 1 710 MHz to 1 785 MHz. PCS 1 900: 1 850 MHz to 1 910 MHz	>= 30 MHz	3 MHz	3 MHz
Relevant TX band:	(offset from edge of relevant TX band)		
GSM 450: 450,4 MHz to 457,6 MHz GSM 480: 478,8 MHz to 486 MHz GSM 710: 728 MHz to 746 MHz GSM 750: 777 MHz to 792 MHz T-GSM 810: 806MHz to 821 MHz GSM 850: 824 MHz to 849 MHz P-GSM: 890 MHz to 915 MHz E-GSM: 880 MHz to 915 MHz DCS: 1 710 MHz to 1 785 MHz PCS 1 900: 1 850 MHz to 1 910 MHz	1,8 MHz to 6,0 MHz	30 kHz	100 kHz
	> 6,0 MHz	100 kHz	300 kHz
	(offset from carrier)		
NOTE 1: The filter and video bandwidths, and frequency offsets are only correct for measurements on an MS transmitting on a channel in the Mid ARFCN range.			
NOTE 2: Due to practical implementation of a SS, the video bandwidth is restricted to a maximum of 3 MHz.			

12.2.1.5 Test requirement

The power of any spurious emission shall not exceed the levels given in table 12.7.

12.2.2 MS in idle mode

12.2.2.1 Definition

Radiated spurious emissions, when the MS is in idle mode, are any emissions radiated by the cabinet and structure of the mobile station, including all interconnecting cables.

This is also known as "cabinet radiation".

The test applies to all types of MS with the exception of the test at extreme voltages for an MS where a practical connection, to an external power supply, is not possible.

NOTE: A "practical connection" shall be interpreted to mean it is possible to connect extreme voltages to the MS without interfering with the configuration of the MS in a way which could invalidate the test.

12.2.2.2 Conformance requirement

1. The radiated spurious power emitted by the MS, when in idle mode, shall be no more than the levels in table 12.9. under normal voltage conditions; 3GPP TS 05.05, subclauses 4.3 and 4.3.3.
2. The radiated spurious power emitted by the MS, when in idle mode, shall be no more than the levels in table 12.9. under extreme voltage conditions; 3GPP TS 05.05, subclauses 4.3 and 4.3.3, and clause D.2.

Table 12.9

Frequency range		Power level in dBm	
		GSM 400, T-GSM 810, GSM 900, DCS 1 800	GSM 700, GSM 850, PCS 1 900
30 MHz to	880 MHz	-57	-57
880 MHz to	915 MHz	-59	-57
915 MHz to	1 000 MHz	-57	-57
1 GHz to	1 710 MHz	-47	
1 710 MHz to	1 785 MHz	-53	
1 785 MHz to	1 900 MHz	-47	
1 900 MHz to	1980 MHz	-76	
1980 MHz to	2010 MHz	-47	
2010 MHz to	2022 MHz	-76	
2022 MHz to	2110 MHz	-47	
2110 MHz to	2170 MHz	-76	
2170 MHz to	4 GHz	-47	
1 GHz to	1 850 MHz		-47
1 850 MHz to	1 910 MHz		-53
1 910 MHz to	4GHz		-47

12.2.2.3 Test purpose

1. To verify that radiated spurious emissions from the MS when in idle mode do not exceed the requirements under normal voltage conditions.
2. To verify that radiated spurious emissions from the MS when in idle mode do not exceed the requirements under extreme voltage conditions.

12.2.2.4 Method of test

12.2.2.4.1 Initial conditions

NOTE 1: The power supply shall be connected to the MS such that the physical configuration does not change in a way that could have an effect on the measurement. In particular, the battery pack of the MS should not normally be removed. In cases where no practical connection can be made to the power supply, the MS's intended battery source shall be used.

The BCCH message content from the serving cell shall ensure that Periodic Location Updating is not used and that page mode is continuously set to Paging Reorganization and BS_AG_BLK_RES is set to 0 so that the MS receiver will operate continually.

The CCCH_CONF shall be set to 000. 1 basic physical channel used for CCCH not combined with SDCCHs.

The BCCH allocation shall either be empty or contain only the serving cell BCCH.

NOTE 2: This is to ensure that the receiver does not scan other ARFCN. Scanning other ARFCN could lead to a moving in frequency of the spurious and therefore to the possibility of either not measuring a spurious emission or measuring it more than once.

The MS is in MM state "idle, updated".

12.2.2.4.2 Procedure

- a) Initially the test antenna is closely coupled to the MS and any spurious emission radiated by the MS are detected by the test antenna and receiver in the range 30 MHz to 4 GHz.

NOTE 1: This is a qualitative step to identify the frequency and presence of spurious emissions which are to be measured in subsequent steps.

- b) The test antenna separation is set to the appropriate measurement distance and at each frequency at which a spurious emission has been detected the MS is rotated to obtain a maximum response. The effective radiated power of the emission is determined by a substitution measurement. In case of an anechoic shielded chamber pre-calibration may be used instead of a substitution measurement.

- c) The measurement bandwidth based on a 5 pole synchronously tuned filter shall be according to table 12.10. The power indication is the peak power detected by the measuring system.

The measurement time on any frequency shall be such that it includes the time during which the MS receives a TDMA frame containing the paging channel.

NOTE 2: For these filter bandwidths some difficulties may be experienced with noise floor above required measurement limit. This will depend on the gain of the test antenna, and adjustment of the measuring system bandwidth is permissible. Alternatively, for test frequencies above 900 MHz, the test antenna separation from the MS may be reduced to 1 metre.

Table 12.10

Frequency range	Filter bandwidth	Video bandwidth
30 MHz to 50 MHz	10 kHz	30 kHz
50 MHz to 4 GHz	100 kHz	300 kHz

- d) The measurements are repeated with the test antenna in the orthogonal polarization plane.

- e) The test is repeated under extreme voltage test conditions (see [Annex 1, TC2.2]).

12.2.2.5 Test requirement

The power of any spurious emission shall not exceed the levels given in table 12.9.

12.3 Conducted spurious emissions for MS supporting the R-GSM frequency band

12.3.1 MS allocated a channel

12.3.1.1 Definition

Conducted spurious emissions, when the MS has been allocated a channel, are emissions from the antenna connector at frequencies other than those of the carrier and sidebands associated with normal modulation.

12.3.1.2 Conformance requirement

- The conducted spurious power emitted by the MS, when allocated a channel, shall be no more than the levels in table 12.11.

1.1 Under normal voltage conditions; 3GPP TS 05.05, subclauses 4.3 and 4.3.3.

1.2 Under extreme voltage conditions; 3GPP TS 05.05, subclause 4.3 and 4.3.3, and clause D.2.

Table 12.11

Frequency range	Power level in dBm	
	R-GSM 900 small MS	R-GSM 900 other MS
9 kHz to 1 GHz	-36	
9 kHz to 876 MHz		-36
876 MHz to 915 MHz		-42
915 MHz to 1 GHz		-36
1 GHz to 12,75 GHz	-30	-30

12.3.1.3 Test purpose

- To verify that conducted spurious emissions, in the frequency band 100 kHz to 12,75 GHz excluding the R-GSM 900 and DCS 1 800 receive bands, from the MS when allocated a channel do not exceed the conformance requirements.

1.1 Under normal voltage conditions.

1.2 Under extreme voltage conditions.

NOTE: The band 9 kHz to 100 kHz is not tested, because of test implementation problems.

12.3.1.4 Method of test

12.3.1.4.1 Initial conditions

A call is set up by the SS according to the generic call set up procedure on a channel in the Mid ARFCN range.

The SS commands the MS to loop back its channel decoder output to channel encoder input.

The SS sends Standard Test Signal C1.

The SS sets the MS to operate at its maximum output power.

12.3.1.4.2 Procedure

- a) Measurements are made in the frequency range 100 kHz to 12,75 GHz. Spurious emissions are measured at the connector of the transceiver, as the power level of any discrete signal, higher than the requirement in table 12.11 minus 6 dB, delivered into a 50 Ω load.

The measurement bandwidth based on a 5 pole synchronously tuned filter is according to table 12.12. The power indication is the peak power detected by the measuring system.

The measurement on any frequency shall be performed for at least one TDMA frame period with the exception of the idle frame.

NOTE: This ensures that both the active times (MS transmitting) and the quiet times are measured.

- b) The test is repeated under extreme voltage test conditions ([annex 1, TC2.2 and TC3]).

Table 12.12

Frequency range	Frequency offset	Filter bandwidth	Approx video bandwidth
100 kHz to 50 MHz	-	10 kHz	30 kHz
50 MHz to 500 MHz	-	100 kHz	300 kHz
500 MHz to 12,75 GHz, excl. relevant TX band: R-GSM: 876 MHz to 915 MHz; ; , and the RX bands: 921 MHz to 960 MHz; 1 805 MHz to 1 880 MHz.	0 to 10 MHz >= 10 MHz >= 20 MHz >= 30 MHz (offset from edge of relevant TX band)	100 kHz 300 kHz 1 MHz 3 MHz	300 kHz 1 MHz 3 MHz 3 MHz
relevant TX band: R-GSM: 876 MHz to 915 MHz	1,8 MHz to 6,0 MHz > 6,0 MHz (offset from carrier)	30 kHz 100 kHz	100 kHz 300 kHz
NOTE 1: The frequency ranges 921 MHz to 960 MHz and 1 805 MHz to 1 880 MHz are excluded as these ranges are tested in subclause 13.9.			
NOTE 2: The filter and video bandwidths, and frequency offsets are only correct for measurements on an MS transmitting on a channel in the Mid ARFCN range.			
NOTE 3: Due to practical implementation, the video bandwidth is restricted to a maximum of 3 MHz.			

12.3.1.5 Test requirement

The power of any spurious emission shall not exceed the levels given in table 12.13.

Table 12.13

Frequency range		Power level in dBm	
		R-GSM 900 small MS	R-GSM 900 other MS
100 kHz to	1 GHz	-36	
100 kHz to	876 MHz		-36
876 MHz to	915 MHz		-42
915 MHz to	1 GHz		-36
1 GHz to	12,75 GHz	-30	-30

12.3.2 MS in idle mode

12.3.2.1 Definition

Conducted spurious emissions are any emissions from the antenna connector, when the MS is in idle mode.

12.3.2.2 Conformance requirement

- The conducted spurious power emitted by the MS, when in idle mode, shall be no more than the levels in table 12.14.

1.1 Under normal voltage conditions; 3GPP TS 05.05, subclauses 4.3 and 4.3.3.

1.2 Under extreme voltage conditions; 3GPP TS 05.05, subclauses 4.3 and 4.3.3, and clause D.2.

Table 12.14

Frequency range		Power level in dBm
9 kHz to	880 MHz	-57
880 MHz to	915 MHz	-59
915 MHz to	1 000 MHz	-57
1 GHz to	1 710 MHz	-47
1 710 MHz to	1 785 MHz	-53
1 785 MHz to	12,75 GHz	-47

12.3.2.3 Test purpose

- To verify that conducted spurious emissions, in the frequency band 100 kHz to 12,75 GHz from the MS when in idle mode do not exceed the conformance requirements.

1.1 Under normal voltage conditions.

1.2 Under extreme voltage conditions.

NOTE: The band 9 kHz to 100 kHz is not tested, because of test implementation problems.

12.3.2.4 Method of test

12.3.2.4.1 Initial conditions

The BCCH message content from the serving cell shall ensure that Periodic Location Updating is not used and that page mode is continuously set to Paging Reorganization and BS_AG_BLK_RES is set to 0 so that the MS receiver will operate continually.

The CCCH_CONF shall be set to 000. 1 basic physical channel used for CCCH not combined with SDCCHs.

The BCCH allocation shall either be empty or contain only the serving cell BCCH.

NOTE: This is to ensure that the receiver does not scan other ARFCN. Scanning other ARFCN could lead to a moving in frequency of the spurious and therefore to the possibility of either not measuring a spurious emission or measuring it more than once.

The MS is in MM state "idle, updated".

12.3.2.4.2 Procedure

- a) Measurements are made in the frequency range 100 kHz to 12,75 GHz. Spurious emissions are measured as the power level of any discrete signal, higher than the requirement in table 12.14 minus 6 dB, delivered into a 50 Ω load.

The measurement bandwidth based on a 5 pole synchronously tuned filter is set according to table 12.15. The power indication is the peak power detected by the measuring system.

The measurement time on any frequency shall be such that it includes the time during which the MS receives a TDMA frame containing the paging channel.

Table 12.15

Frequency range	Filter bandwidth	Video bandwidth
100 kHz to 50 MHz	10 kHz	30 kHz
50 MHz to 12,75 GHz	100 kHz	300 kHz

- b) The test is repeated under extreme voltage test conditions ([annex 1, TC2.2 and TC3]).

12.3.2.5 Test requirement

The power of any spurious emission shall not exceed the levels given in table 12.16.

Table 12.16

Frequency range	Power level in dBm
100 kHz to 880 MHz	-57
880 MHz to 915 MHz	-59
915 MHz to 1 000 MHz	-57
1 GHz to 1 710 MHz	-47
1 710 MHz to 1 785 MHz	-53
1 785 MHz to 12,75 GHz	-47

12.4 Radiated spurious emissions for MS supporting the R-GSM frequency band

This subclause applies only to MS supporting the R-GSM frequency band.

This test is performed either on an outdoor test site, fulfilling the requirements of [GC4 of annex 1], or in an anechoic shielded chamber, fulfilling the requirements of ([GC5 of annex 1]). Performing the measurement in the anechoic shielded chamber is preferred. The sample shall be placed at the specified height on the support.

NOTE: The test method described has been written for measurement in an anechoic shielded chamber. If an outdoor test site is used then additional precautions are necessary to ensure correct measurement. These measures are familiar to test houses which perform spurious emissions tests and are:

- Raise/lower the test antenna through the specified height range during both the emission detection and substitution parts of the test.
- Perform a qualitative pre-search in a shielded environment for test sites where the ambient RF environment can prevent the detection of spurious emissions which exceed the limit.
- Detect emissions at a more sensitive threshold to that specified in subclause 12.4.1.4 to allow for destructive interference due to ground plane reflections at the test antenna search height.

12.4.1 MS allocated a channel

12.4.1.1 Definition

Radiated spurious emissions, when the MS has been allocated a channel, are any emissions radiated by the cabinet and structure of the mobile station, including all interconnecting cables.

This is also known as "cabinet radiation".

The test applies to all types of MS with the exception of the test at extreme voltages for an MS where a practical connection, to an external power supply, is not possible.

NOTE: A "practical connection" shall be interpreted to mean it is possible to connect extreme voltages to the MS without interfering with the configuration of the MS in a way which could invalidate the test.

12.4.1.2 Conformance requirement

1. The radiated spurious power emitted by the MS, when allocated a channel, shall be no more than the levels in table 12.17 under normal voltage conditions; 3GPP TS 05.05, subclauses 4.3 and 4.3.3.
2. The radiated spurious power emitted by the MS, when allocated a channel, shall be no more than the levels in table 12.17 under extreme voltage conditions; 3GPP TS 05.05, subclauses 4.3 and 4.3.3, and clause D.2.

Table 12.17

Frequency range		Power level in dBm	
		R-GSM 900 small MS	R-GSM 900 other MS
30 MHz to	1 GHz	-36	
30 MHz to	876 MHz		-36
876 MHz to	915 MHz		-42
915 MHz to	1 GHz		-36
1 GHz to	4 GHz	-30	-30

12.4.1.3 Test purpose

1. To verify that radiated spurious emissions from the MS when allocated a channel do not exceed the conformance requirements under normal voltage conditions.
2. To verify that radiated spurious emissions from the MS when allocated a channel do not exceed the conformance requirements under extreme voltage conditions.

12.4.1.4 Method of test

12.4.1.4.1 Initial conditions

A call is set up by the SS according to the generic call set up procedure on a channel in the Mid ARFCN range.

NOTE: The power supply shall be connected to the MS such that the physical configuration does not change in a way that could have an effect on the measurement. In particular, the battery pack of the MS should not normally be removed. In cases where no practical connection can be made to the power supply, the MS's intended battery source shall be used.

The SS commands the MS to loop back its channel decoder output to its channel encoder input.

The SS sends Standard Test Signal C1.

The SS sets the MS to operate at its maximum output power.

12.4.1.4.2 Procedure

- a) Initially the test antenna is closely coupled to the MS and any spurious emission radiated by the MS is detected by the test antenna and receiver in the range 30 MHz to 4 GHz.

NOTE 0: This is a qualitative step to identify the frequency and presence of spurious emissions which are to be measured in subsequent steps.

- b) The test antenna separation is set to the appropriate measurement distance and at each frequency at which an emission has been detected, the MS shall be rotated to obtain maximum response and the effective radiated power of the emission determined by a substitution measurement. In case of an anechoic shielded chamber pre-calibration may be used instead of a substitution measurement.
- c) The measurement bandwidth, based on a 5 pole synchronously tuned filter, is set according to table 12.18. The power indication is the peak power detected by the measuring system.

The measurement on any frequency shall be performed for at least one TDMA frame period, with the exception of the idle frame.

NOTE 1: This ensures that both the active times (MS transmitting) and the quiet times are measured.

NOTE 2: For these filter bandwidths some difficulties may be experienced with noise floor above required measurement limit. This will depend on the gain of the test antenna, and adjustment of the measuring system bandwidth is permissible. Alternatively, for test frequencies above 900 MHz, the test antenna separation from the MS may be reduced to 1 metre.

d) The measurements are repeated with the test antenna in the orthogonal polarization plane.

e) The test is repeated under extreme voltage test conditions (see [annex 1, TC2.2]).

Table 12.18

Frequency range	Frequency offset	Filter bandwidth	Approx video bandwidth
30 MHz to 50 MHz	-	10 kHz	30 kHz
50 MHz to 500 MHz	-	100 kHz	300 kHz
500 MHz to 4 GHz,	0 to 10 MHz	100 kHz	300 kHz
	>= 10 MHz	300 kHz	1 MHz
excl. relevant TX band:	>= 20 MHz	1 MHz	3 MHz
R-GSM: 876 MHz to 915 MHz;	>= 30 MHz	3 MHz	3 MHz
	(offset from edge of relevant TX band)		
relevant TX band:			
R-GSM: 876 MHz to 915 MHz	1,8 MHz to 6,0 MHz	30 kHz	100 kHz
	> 6,0 MHz	100 kHz	300 kHz
	(offset from carrier)		
NOTE 1: The filter and video bandwidths, and frequency offsets are only correct for measurements on an MS transmitting on a channel in the Mid ARFCN range.			
NOTE 2: Due to practical implementation of a SS, the video bandwidth is restricted to a maximum of 3 MHz.			

12.4.1.5 Test requirement

The power of any spurious emission shall not exceed the levels given in table 12.17.

12.4.2 MS in idle mode

12.4.2.1 Definition

Radiated spurious emissions, when the MS is in idle mode, are any emissions radiated by the cabinet and structure of the mobile station, including all interconnecting cables.

This is also known as "cabinet radiation".

The test applies to all types of MS with the exception of the test at extreme voltages for an MS where a practical connection, to an external power supply, is not possible.

NOTE: A "practical connection" shall be interpreted to mean it is possible to connect extreme voltages to the MS without interfering with the configuration of the MS in a way which could invalidate the test.

12.4.2.2 Conformance requirement

1. The radiated spurious power emitted by the MS, when in idle mode, shall be no more than the levels in table 12.19. under normal voltage conditions; 3GPP TS 05.05, subclauses 4.3 and 4.3.3.
2. The radiated spurious power emitted by the MS, when in idle mode, shall be no more than the levels in table 12.19. under extreme voltage conditions; 3GPP TS 05.05, subclauses 4.3 and 4.3.3, and clause D.2.

Table 12.19

Frequency range		Power level in dBm
30 MHz to	880 MHz	-57
880 MHz to	915 MHz	-59
915 MHz to	1 000 MHz	-57
1 GHz to	1 710 MHz	-47
1 710 MHz to	1 785 MHz	-53
1 785 MHz to	4 GHz	-47

12.4.2.3 Test purpose

1. To verify that radiated spurious emissions from the MS when in idle mode do not exceed the requirements under normal voltage conditions.
2. To verify that radiated spurious emissions from the MS when in idle mode do not exceed the requirements under extreme voltage conditions.

12.4.2.4 Method of test

12.4.2.4.1 Initial conditions

NOTE 1: The power supply shall be connected to the MS such that the physical configuration does not change in a way that could have an effect on the measurement. In particular, the battery pack of the MS should not normally be removed. In cases where no practical connection can be made to the power supply, the MS's intended battery source shall be used.

The BCCH message content from the serving cell shall ensure that Periodic Location Updating is not used and that page mode is continuously set to Paging Reorganization and BS_AG_BLK_RES is set to 0 so that the MS receiver will operate continually.

The CCCH_CONF shall be set to 000. 1 basic physical channel used for CCCH not combined with SDCCHs.

The BCCH allocation shall either be empty or contain only the serving cell BCCH.

NOTE 2: This is to ensure that the receiver does not scan other ARFCN. Scanning other ARFCN could lead to a moving in frequency of the spurious and therefore to the possibility of either not measuring a spurious emission or measuring it more than once.

The MS is in MM state "idle, updated".

12.4.2.4.2 Procedure

- a) Initially the test antenna is closely coupled to the MS and any spurious emission radiated by the MS are detected by the test antenna and receiver in the range 30 MHz to 4 GHz.

NOTE 1: This is a qualitative step to identify the frequency and presence of spurious emissions which are to be measured in subsequent steps.

- b) The test antenna separation is set to the appropriate measurement distance and at each frequency at which a spurious emission has been detected the MS is rotated to obtain a maximum response. The effective radiated power of the emission is determined by a substitution measurement. In case of an anechoic shielded chamber pre-calibration may be used instead of a substitution measurement.
- c) The measurement bandwidth based on a 5 pole synchronously tuned filter shall be according to table 12.20. The power indication is the peak power detected by the measuring system.

The measurement time on any frequency shall be such that it includes the time during which the MS receives a TDMA frame containing the paging channel.

NOTE 2: For these filter bandwidths some difficulties may be experienced with noise floor above required measurement limit. This will depend on the gain of the test antenna, and adjustment of the measuring system bandwidth is permissible. Alternatively, for test frequencies above 900 MHz, the test antenna separation from the MS may be reduced to 1 metre.

Table 12.20

Frequency range	Filter bandwidth	Video bandwidth
30 MHz to 50 MHz	10 kHz	30 kHz
50 MHz to 4 GHz	100 kHz	300 kHz

d) The measurements are repeated with the test antenna in the orthogonal polarization plane.

e) The test is repeated under extreme voltage test conditions (see [annex 1, TC2.2]).

12.4.2.5 Test requirement

The power of any spurious emission shall not exceed the levels given in table 12.19.

13 Transmitter

13.1 Frequency error and phase error

13.1.1 Definition

The frequency error is the difference in frequency, after adjustment for the effect of the modulation and phase error, between the RF transmission from the MS and either:

- the RF transmission from the BS; or
- the nominal frequency for the ARFCN used.

The phase error is the difference in phase, after adjustment for the effect of the frequency error, between the RF transmission from the MS and the theoretical transmission according to the intended modulation.

13.1.2 Conformance requirement

1. The MS carrier frequency shall be accurate to within 0,1 ppm, or accurate to within 0,1 ppm compared to signals received from the BS. For GSM 400 MS a value of 0,2 ppm shall be used in both cases.
 - 1.1 Under normal conditions; 3GPP TS 05.10, subclause 6.1.
 - 1.2 Under vibration conditions; 3GPP TS 05.10, subclause 6.1; 3GPP TS 05.05, annex D in subclause D.2.3.
 - 1.3 Under extreme conditions; 3GPP TS 05.10, subclause 6.1; 3GPP TS 05.05, subclause 4.4; 3GPP TS 05.05, annex D in subclauses D.2.1 and D.2.2.
2. The RMS phase error (difference between the phase error trajectory and its linear regression on the active part of the time slot) for each burst shall not be greater than 5 degrees.
 - 2.1 Under normal conditions; 3GPP TS 05.05, subclause 4.6.
 - 2.2 Under vibration conditions; 3GPP TS 05.05, subclause 4.6; 3GPP TS 05.05, annex D in subclause D.2.3.
 - 2.3 Under extreme conditions; 3GPP TS 05.05, subclause 4.6; 3GPP TS 05.05, annex D in subclauses D.2.1 and D.2.2.
3. The maximum peak deviation during the useful part of each burst shall not be greater than 20 degrees.
 - 3.1 Under normal conditions; 3GPP TS 05.05, subclause 4.6.

3.2 Under vibration conditions; 3GPP TS 05.05, subclause 4.6; 3GPP TS 05.05, annex D in subclause D.2.3.

3.3 Under extreme conditions; 3GPP TS 05.05, subclause 4.6; 3GPP TS 05.05, annex D in subclauses D.2.1 and D.2.2.

13.1.3 Test purpose

1. To verify that the MS carrier frequency error does not exceed 0,1 ppm (0,2 ppm for GSM 400):

1.1 Under normal conditions.

1.2 When the MS is being vibrated.

1.3 Under extreme conditions.

NOTE: The transmit frequency accuracy of the SS is expected to be sufficient to ensure that the difference between 0,1 ppm (0,2 ppm for GSM 400) absolute and 0,1 ppm (0,2 ppm for GSM 400) compared to signals received from the BS would be small enough to be considered insignificant.

2. To verify that the RMS phase error on the useful part of the bursts transmitted by the MS does not exceed conformance requirement 2:

2.1 Under normal conditions.

2.2 When the MS is being vibrated.

2.3 Under extreme conditions.

3. To verify that the maximum phase error on the useful part of the bursts transmitted by the MS does not exceed conformance requirement 3:

3.1 Under normal conditions.

3.2 When the MS is being vibrated.

3.3 Under extreme conditions.

13.1.4 Method of test

NOTE: In order to measure the accuracy of the frequency and phase error a sampled measurement of the transmitted phase trajectory is obtained. This is compared with the theoretically expected phase trajectory. The regression line of the difference between the expected trajectory and the measured trajectory is an indication of the frequency error (assumed constant through the burst), whilst the departure of the phase differences from this trajectory is a measure of the phase error. The peak phase error is the value furthest from the regression line and the RMS phase error is the root mean square average of the phase error of all samples.

13.1.4.1 Initial conditions

A call is set up according to the Generic call setup procedure.

The SS commands the MS to hopping mode (table 6.1).

NOTE 1: It is not necessary to test in hopping mode but is done here as a simple means of making the MS change channel, it would be sufficient to test in non hopping mode and to make sure bursts are taken from a few different channels.

The SS activates ciphering mode.

NOTE 2: Ciphering mode is active during this test to give a pseudo-random bit stream to the modulator.

The SS commands the MS to complete the traffic channel loop back without signalling of erased frames (see subclause 36.2.1.1).

The SS generates Standard Test Signal C1 of annex 5.

Specific PICS statements:

- MS without vibration sensitive components (TSPC_No_Vibration_Sensitive_Components)

PIXIT Statements:

-

13.1.4.2 Procedure

- a) For one transmitted burst, the SS captures the signal as a series of phase samples over the period of the burst. These samples are evenly distributed over the duration of the burst with a minimum sampling rate of $2/T$, where T is the modulation symbol period. The received phase trajectory is then represented by this array of at least 294 samples.
- b) The SS then calculates, from the known bit pattern and the formal definition of the modulator contained in 3GPP TS 05.04, the expected phase trajectory.
- c) From a) and b) the phase trajectory error is calculated, and a linear regression line computed through this phase trajectory error. The slope of this regression line is the frequency error of the mobile transmitter relative to the simulator reference. The difference between the regression line and the individual sample points is the phase error of that point.

- c.1) The sampled array of at least 294 phase measurements is represented by the vector:

$$\varnothing_m = \varnothing_m(0) \dots \varnothing_m(n)$$

where the number of samples in the array $n+1 \geq 294$.

- c.2) The calculated array, at the corresponding sampling instants, is represented by the vector:

$$\varnothing_c = \varnothing_c(0) \dots \varnothing_c(n).$$

- c.3) The error array is represented by the vector:

$$\varnothing_e = \{\varnothing_m(0) - \varnothing_c(0)\} \dots \dots \dots \{\varnothing_m(n) - \varnothing_c(n)\} = \varnothing_e(0) \dots \varnothing_e(n).$$

- c.4) The corresponding sample numbers form a vector $t = t(0) \dots t(n)$.

- c.5) By regression theory the slope of the samples with respect to t is k where:

$$k = \frac{\sum_{j=0}^{j=n} t(j) * \varnothing_e(j)}{\sum_{j=0}^{j=n} t(j)^2}$$

- c.6) The frequency error is given by $k/(360 * \gamma)$, where γ is the sampling interval in s and all phase samples are measured in degrees.

- c.7) The individual phase errors from the regression line are given by:

$$\varnothing_e(j) - k * t(j).$$

- c.8) The RMS value \varnothing_e of the phase errors is given by:

$$\varnothing_e(\text{RMS}) = \left[\frac{\sum_{j=0}^{j=n} \{\varnothing_e(j) - k * t(j)\}^2}{n+1} \right]^{1/2}$$

- d) Steps a) to c) are repeated for 20 bursts, not necessarily contiguous.

- e) The SS instructs the MS to its maximum power control level, all other conditions remaining constant. Steps a) to d) are repeated.
- f) The SS instructs the MS to the minimum power control level, all other conditions remaining constant. Steps a) to d) are repeated.
- g) The MS is hard mounted on a vibration table and vibrated at the frequency/amplitudes specified in annex 1, TC4. During the vibration steps a) to f) are repeated.

NOTE 1: If the call is terminated when mounting the MS to the vibration table, it will be necessary to establish the initial conditions again before repeating steps a) to f).

- h) The MS is re-positioned on the vibration table in the two orthogonal planes to the plane used in step g). For each of the orthogonal planes step g) is repeated.
- i) Steps a) to f) are repeated under extreme test conditions (see annex 1, TC2.2).

NOTE 2: The series of samples taken to determine the phase trajectory could also be used, with different post-processing, to determine the transmitter burst characteristics of subclause 13.3. Although described independently, it is valid to combine the tests of subclauses 13.1 and 13.3, giving both answers from single sets of captured data.

NOTE 3: Steps g) and h) are skipped if TSPC_No_Vibration_Sensitive_Components is declared as Yes

13.1.5 Test requirements

13.1.5.1 Frequency error

For all measured bursts, the frequency error, derived in step c.6), shall be less than 0,1 ppm, except for GSM 400 MS where a value of 0,2 ppm shall be used.

13.1.5.2 Phase error

For all measured bursts, the RMS phase error, derived in step c.8), shall not exceed 5 degrees.

For all measured bursts, each individual phase error, derived in step c.7), shall not exceed 20 degrees.

13.2 Frequency error under multipath and interference conditions

13.2.1 Definition

The frequency error under multipath and interference conditions is a measure of the ability of the MS to maintain frequency synchronization with the received signal under conditions of Doppler shift, multipath reception and interference.

13.2.2 Conformance requirement

1. The MS carrier frequency error for each burst shall be accurate to within 0,1 ppm (0,2 ppm for GSM 400), or 0,1 ppm (0,2 ppm for GSM 400) compared to signals received from the BS for signal levels down to 3 dB below the reference sensitivity level.
 - 1.1 Under normal conditions; 3GPP TS 05.10, subclauses 6 and 6.1.
 - 1.2 Under extreme conditions; 3GPP TS 05.10, subclauses 6 and 6.1; 3GPP TS 05.05 annex D in subclauses D.2.1 and D.2.2.
2. The MS carrier frequency error for each burst shall be accurate to within 0,1 ppm (0,2 ppm for GSM 400), or 0,1 ppm (0,2 ppm for GSM 400) compared to signals received from the BS for 3 dB less carrier to interference ratio than the reference interference ratios (3GPP TS 05.10, subclauses 6 and 6.1).

13.2.3 Test purpose

1. To verify that the MS carrier frequency error at reference sensitivity, under conditions of multipath and Doppler shift does not exceed 0,1 ppm (0,2 ppm for GSM 400) + the frequency error due to the Doppler shift of the received signal and the assessment error in the MS.

1.1 Under normal conditions.

1.2 Under extreme conditions.

NOTE 1: Although the conformance requirement states that frequency synchronization should be maintained for input signals 3 dB below reference sensitivity. Due to the Radio Link Failure counter this test condition cannot be established. Hence all tests in this subclause are conducted at reference sensitivity level.

2. To verify that the MS carrier frequency error, under interference conditions and TUlow fading profile, does not exceed 0,1 ppm (0,2 ppm for GSM 400) + the frequency error due to the Doppler shift of the received signal and the assessment error in the MS.

NOTE 2: The test adds the effect of Doppler shift to the requirements as the conformance requirement refers to signals input to the MS receiver whereas the frequency reference for measurement will not take account of the Doppler shift.

13.2.4 Method of test

This test uses the same measurement process as test 13.1 for the MS operating under various RF conditions.

NOTE: The BA list sent on the BCCH and the SACCH will indicate at least six surrounding cells with at least one near to each band edge. It is not necessary to generate any of these BCCH but if they are provided none will be within 5 channels of the ARFCN used for the serving BCCH or TCH.

13.2.4.1 Initial conditions

The MS is brought into the idle updated state on a serving cell with BCCH in the mid ARFCN range.

13.2.4.2 Procedure

- a) The level of the serving cell BCCH is set to 10 dB above the reference sensitivity level() and the fading function set to RA. The SS waits 30 s for the MS to stabilize to these conditions. The SS is set up to capture the first burst transmitted by the MS during call establishment. A call is initiated by the SS on a channel in the mid ARFCN range as described for the generic call set up procedure but to a TCH at level 10 dB above the reference sensitivity level() and fading function set to RA.
- b) The SS calculates the frequency accuracy of the captured burst as described in test 13.1.
- c) The SS sets the serving cell BCCH and TCH to the reference sensitivity level() applicable to the type of MS, still with the fading function set to RA and then waits 30 s for the MS to stabilize to these conditions.
- d) The SS shall capture subsequent bursts from the traffic channel in the manner described in test 13.1.

NOTE: Due to the very low signal level at the MS receiver input the MS receiver is liable to error. The "looped back" bits are therefore also liable to error, and hence the SS does not know the expected bit sequence. The SS will have to demodulate the received signal to derive (error free) the transmitter burst bit pattern. Using this bit pattern the SS can calculate the expected phase trajectory according to the definition within 3GPP TS 05.04.

- e) The SS calculates the frequency accuracy of the captured burst as described in test 13.1.
- f) Steps d) and e) are repeated for 5 traffic channel bursts spaced over a period of not less than 20 s.
- g) The initial conditions are established again and steps a) to f) are repeated but with the fading function set to HT100 (HT200 for GSM 400, HT120 for GSM 700).
- h) The initial conditions are established again and steps a) to f) are repeated but with the fading function set to TU50 (TU100 for GSM 400, TU 60 for GSM 700).
- i) The initial conditions are established again and steps a) and b) are repeated but with the following differences:

- the levels of the BCCH and TCH are set to 18 dB above reference sensitivity level().
 - two further independent interfering signals are sent on the same nominal carrier frequency as the BCCH and TCH and at a level 10 dB below the level of the TCH and modulated with random data, including the midamble.
 - the fading function for all channels is set to TUlow.
- j) The SS waits 100 s for the MS to stabilize to these conditions.
- k) Repeat steps d) to f), except that at step f) the measurement period must be extended to 200 s and the number of measurements increased to 20.
- l) The initial conditions are established again and steps a) to k) are repeated for ARFCN in the Low ARFCN range.
- m) The initial conditions are established again and steps a) to k) are repeated for ARFCN in the High ARFCN range.
- n) Repeat step h) under extreme test conditions (see annex 1, TC2.2).

13.2.5 Test requirements

The frequency error, with reference to the SS carrier frequency as measured in repeats of step e), for each measured burst shall be less than the values shown in tables 13-1a and 13-1b.

Table 13-1a: Requirements for frequency error under multipath, Doppler shift and interference conditions

T-GSM 810, GSM 850 and GSM 900		DCS 1 800		PCS 1 900	
Propagation condition	Permitted frequency error	Propagation condition	Permitted frequency error	Propagation condition	Permitted frequency error
RA250	±300 Hz	RA130	±400 Hz	RA130	±420 Hz
HT100	±180 Hz	HT100	±350 Hz	HT100	±370 Hz
TU50	±160 Hz	TU50	±260 Hz	TU50	±280 Hz
TU3	±230 Hz	TU1,5	±320 Hz	TU1,5	±330 Hz

Table 13-1b: Requirements for frequency error under multipath, Doppler shift and interference conditions

GSM 450		GSM 480		GSM 700	
Propagation condition	Permitted frequency error	Propagation condition	Permitted frequency error	Propagation condition	Permitted frequency error
RA500	±300 Hz	RA500	±300 Hz	RA 300	±300 Hz
HT200	±180 Hz	HT200	±180 Hz	HT 120	±180 Hz
TU100	±160 Hz	TU100	±160 Hz	TU 60	±160 Hz
TU6	±230 Hz	TU6	±230 Hz	TU 3.6	±230 Hz

13.3 Transmitter output power and burst timing

13.3.1 Definition

The transmitter output power is the average value of the power delivered to an artificial antenna or radiated by the MS and its integral antenna, over the time that the useful information bits of one burst are transmitted.

The transmit burst timing is the envelope of the RF power transmitted with respect to time. The timings are referenced to the transition from bit 13 to bit 14 of the Training Sequence ("midamble") before differential decoding. The timing of the modulation is referenced to the timing of the received signal from the SS.

13.3.2 Conformance requirement

1. The MS maximum output power shall be as defined in 3GPP TS 05.05, subclause 4.1.1, table for GMSK modulation, according to its power class, with a tolerance of ± 2 dB under normal conditions; 3GPP TS 05.05, subclause 4.1.1, table for GMSK modulation.
2. The MS maximum output power shall be as defined in 3GPP TS 05.05, subclause 4.1.1, table for GMSK modulation, according to its power class, with a tolerance of $\pm 2,5$ dB under extreme conditions; 3GPP TS 05.05, subclause 4.1.1, table for GMSK modulation; 3GPP TS 05.05 annex D in subclauses D.2.1 and D.2.2.
3. The power control levels shall have the nominal output power levels as defined in 3GPP TS 05.05, subclause 4.1.1, from the lowest power control level up to the maximum output power corresponding to the class of the MS (for tolerance on maximum output power see conformance requirements 1), with a tolerance of ± 3 dB, ± 4 dB or ± 5 dB under normal conditions; 3GPP TS 05.05, subclause 4.1.1.
4. The power control levels shall have the nominal output power levels as defined in 3GPP TS 05.05, 4.1.1, from the lowest power control level up to the maximum output power corresponding to the class of the MS (for tolerance on maximum output power see conformance requirements 2), with a tolerance of ± 4 dB, ± 5 dB or ± 6 dB under extreme conditions; 3GPP TS 05.05, subclause 4.1.1; 3GPP TS 05.05 annex D subclauses D.2.1 and D.2.2.
5. The output power actually transmitted by the MS at consecutive power control levels shall form a monotonic sequence and the interval between power control levels shall be $2 \pm 1,5$ dB (1 ± 1 dB between power control level 30 and 31 for PCS 1 900); 3GPP TS 05.05, subclause 4.1.1.
6. The transmitted power level relative to time for a normal burst shall be within the power/time template given in 3GPP TS 05.05, annex B in figure B.1:
 - 6.1 Under normal conditions; 3GPP TS 05.05, subclause 4.5.2.
 - 6.2 Under extreme conditions; 3GPP TS 05.05, subclause 4.5.2, 3GPP TS 05.05 annex D in subclauses D.2.1 and D.2.2.
7. When accessing a cell on the RACH and before receiving the first power command during a communication on a DCCH or TCH (after an IMMEDIATE ASSIGNMENT), all GSM, class 1 and class 2 DCS 1 800 and PCS 1 900 MS shall use the power control level defined by the MS_TXPWR_MAX_CCH parameter broadcast on the BCCH of the cell, or if MS_TXPWR_MAX_CCH corresponds to a power control level not supported by the MS as defined by its power class, the MS shall act as though the closest supported power control level had been broadcast. A Class 3 DCS 1 800 MS shall use the POWER_OFFSET parameter.
8. The transmissions from the MS to the BS, measured at the MS antenna, shall be $468,75 - TA$ bit periods behind the transmissions received from the BS, where TA is the last timing advance received from the current serving BS. The tolerance on these timings shall be ± 1 bit period:
 - 8.1 Under normal conditions; 3GPP TS 05.10, subclause 6.4.
 - 8.2 Under extreme conditions; 3GPP TS 05.10, subclause 6.4, 3GPP TS 05.05 annex D in subclauses D.2.1 and D.2.2.
9. The transmitted power level relative to time for a random access burst shall be within the power/time template given in 3GPP TS 05.05, annex B in figure B.3:
 - 9.1 Under normal conditions; 3GPP TS 05.05, subclause 4.5.2.
 - 9.2 Under extreme conditions; 3GPP TS 05.05, subclause 4.5.2, 3GPP TS 05.05 annex D in subclauses D.2.1 and D.2.2.
- 10 The MS shall use a TA value of 0 for the Random Access burst sent:
 - 10.1 Under normal conditions; 3GPP TS 05.10, subclause 6.6.
 - 10.2 Under extreme conditions; 3GPP TS 05.10, subclause 6.6, 3GPP TS 05.05 annex D in subclauses D.2.1 and D.2.2.

13.3.3 Test purpose

1. To verify that the maximum output power of the MS, under normal conditions, is within conformance requirement 1.
2. To verify that the maximum output power of the MS, under extreme conditions, is within conformance requirement 2.
3. To verify that all nominal output power levels, relevant to the class of MS, are implemented in the MS and have output power levels, under normal conditions, within conformance requirement 3.
4. To verify that all nominal output levels, relevant to the class of MS, are implemented in the MS and have output power levels, under extreme conditions, within conformance requirement 4.
5. To verify that the step in the output power transmitted by the MS at consecutive power control levels is within conformance requirement 5 under normal conditions.
6. To verify that the output power relative to time, when sending a normal burst is within conformance requirement 6:
 - 6.1 Under normal conditions.
 - 6.2 Under extreme conditions.
7. To verify that the MS uses the maximum power control level according to its power class if commanded to a power control level exceeding its power class.
8. To verify that, for normal bursts, the MS transmissions to the BS are timed within conformance requirement 8:
 - 8.1 Under normal conditions.
 - 8.2 Under extreme conditions.
9. To verify that the output power relative to time, when sending an access burst is within conformance requirement 9:
 - 9.1 Under normal conditions.
 - 9.2 Under extreme conditions.
10. To verify that, for an access burst, the MS transmission to the BS is timed within conformance requirement 10:
 - 10.1 Under normal conditions.
 - 10.2 Under extreme conditions.

13.3.4 Methods of test

Two methods of test are described, separately for:

- 1) equipment fitted with a permanent antenna connector or fitted with a temporary test connector as a test fixture, and for
- 2) equipment fitted with an integral antenna, and which cannot be connected to an external antenna.

NOTE: The behaviour of the MS in the system is determined to a high degree by the antenna, and this is the only transmitter test in this EN using the integral antenna. Further studies are ongoing on improved testing on the integral antenna, taking practical conditions of MS use into account.

13.3.4.1 Method of test for equipment with a permanent or temporary antenna connector

13.3.4.1.1 Initial conditions

A call is set up by the SS according to the generic call set up procedure on a channel with ARFCN in the Mid ARFCN range, power control level set to Max power. MS TXPWR_MAX_CCH is set to the maximum value supported by the Power Class of the Mobile under test. For DCS 1 800 mobile stations the POWER_OFFSET parameter is set to 6 dB.

13.3.4.1.2 Procedure

- a) Measurement of normal burst transmitter output power.
 - The SS takes power measurement samples evenly distributed over the duration of one burst with a sampling rate of at least $2/T$, where T is the bit duration. The samples are identified in time with respect to the modulation on the burst. The SS identifies the centre of the useful 147 transmitted bits, i.e. the transition from bit 13 to bit 14 of the midamble, as the timing reference.
 - The transmitter output power is calculated as the average of the samples over the 147 useful bits. This is also used as the 0 dB reference for the power/time template.
- b) Measurement of normal burst timing delay.
 - The burst timing delay is the difference in time between the timing reference identified in a) and the corresponding transition in the burst received by the MS immediately prior to the MS transmit burst sampled.
- c) Measurement of normal burst power/time relationship.
 - The array of power samples measured in a) are referenced in time to the centre of the useful transmitted bits and in power to the 0 dB reference, both identified in a).
- d) Steps a) to c) are repeated with the MS commanded to operate on each of the nominal output power levels supported by the MS, (see tables 13-2, 13-3 and 13-4) and in step a) on one nominal output power level higher than supported by the MS.
- e) The SS commands the MS to the maximum power control level supported by the MS and steps a) to c) are repeated for ARFCN in the Low and High ranges.
- f) Measurement of access burst transmitter output power.
 - The SS causes the MS to generate an Access Burst on an ARFCN in the Mid ARFCN range, this could be either by a handover procedure or a new request for radio resource. In the case of a handover procedure the Power Level indicated in the HANDOVER COMMAND message is the maximum power control level supported by the MS. In the case of an Access Burst the MS shall use the Power Level indicated in the MS_TXPWR_MAX_CCH parameter. If the power class of the MS is DCS 1 800 Class 3, the MS shall also use the POWER_OFFSET parameter.
 - The SS takes power measurement samples evenly distributed over the duration of the access burst as described in a). However, in this case the SS identifies the centre of the useful bits of the burst by identifying the transition from the last bit of the synch sequence. The centre of the burst is then five data bits prior to this point and is used as the timing reference.
 - The transmitter output power is calculated as the average of the samples over the 87 useful bits of the burst. This is also used as the 0 dB reference for the power/time template.
- g) Measurement of access burst timing delay.
 - The burst timing delay is the difference in time between the timing reference identified in f) and the MS received data on the common control channel.
- h) Measurement of access burst power/time relationship.
 - The array of power samples measured in f) are referenced in time to the centre of the useful transmitted bits and in power to the 0 dB reference, both identified in f).
- i) Depending on the method used in step f) to cause the MS to send an Access Burst, the SS sends either a HANDOVER COMMAND with power control level set to 10 or it changes the System Information elements MS_TXPWR_MAX_CCH and for DCS 1 800 the POWER_OFFSET on the serving cell BCCH in order to limit the MS transmit power on the Access Burst to power control level 10 (+23 dBm for GSM 400, GSM 700, T-GSM 810, GSM 850, and GSM 900 or +10 dBm for DCS 1 800 and PCS 1 900) and then steps f) to h) are repeated.
- j) Steps a) to i) are repeated under extreme test conditions (annex 1, TC2.2) except that the repeats at step d) are only performed for power control level 10 and the minimum nominal output power level supported by the MS.

13.3.4.2 Method of test for equipment with an integral antenna

NOTE: If the MS is equipped with a permanent connector, such that the antenna can be disconnected and the SS be connected directly, then the method of subclause 13.3.4.1 will be applied.

The tests in this subclause are performed on an unmodified test sample.

13.3.4.2.1 Initial conditions

The MS is placed in the anechoic shielded chamber (annex 1, GC5) or on the outdoor test site, on an isolated support, in the position for normal use, at a distance of at least 3 metres from a test antenna, connected to the SS.

NOTE: The test method described has been written for measurement in an anechoic shielded chamber. If an outdoor test site is used then, in addition, it is necessary to raise/lower the test antenna through the specified height range to maximize the received power levels from both the test sample and the substitution antenna.

A call is set up by the SS according to the generic call set up procedure on a channel with ARFCN in the Mid ARFCN range, power control level set to Max power. MS_TXPWR_MAX_CCH is set to the maximum value supported by the Power Class of the Mobile under test. For DCS 1 800 mobile stations the POWER_OFFSET parameter is set to 6 dB.

13.3.4.2.2 Procedure

- a) With the initial conditions set according to subclause 13.3.4.2.1 the test procedure in subclause 13.3.4.1.2 is followed up to and including step i), except that in step a), when measurements are done at maximum power for ARFCN in the Low, Mid and High range, the measurement is made eight times with the MS rotated by $n \cdot 45$ degrees for all values of n in the range 0 to 7.

The measurements taken are received transmitter output power measurements rather than transmitter output power measurements, the output power measurement values can be derived as follows.

- b) Assessment of test site loss for scaling of received output power measurements.

The MS is replaced by a half-wave dipole, resonating at the centre frequency of the transmit band, connected to an RF generator.

The frequency of the RF signal generator is set to the frequency of the ARFCN used for the 24 measurements in step a), the output power is adjusted to reproduce the received transmitter output power averages recorded in step a).

For each indication the power, delivered by the generator (in Watts) to the half-wave dipole, is recorded. These values are recorded in the form P_{nc} , where n = MS rotation and c = channel number.

For each channel number used compute:

$$P_{ac}(\text{Watts into dipole}) = \frac{1}{8} * \sum_{n=0}^{n=7} P_{nc}$$

from which: $P_{ac}(\text{Tx dBm}) = 10 \log_{10}(P_{ac}) + 30 + 2,15$

The difference, for each of the three channels, between the actual transmitter output power averaged over the 8 measurement orientations and the received transmitter output power at orientation $n = 0$ is used to scale the received measurement results to actual transmitter output powers for all measured power control levels and ARFCN, which can then be checked against the requirements.

- c) Temporary antenna connector calibration factors (transmit).

A modified test sample equipped with a temporary antenna connector is placed in a climatic test chamber and is linked to the SS by means of the temporary antenna connector.

Under normal test conditions, the power measurement and calculation parts of steps a) to i) of 13.3.4.1.2 are repeated except that the repeats at step d) are only performed for power control level 10 and the minimum nominal output power level supported by the MS.

NOTE 1: The values noted here are related to the output transmitter carrier power levels under normal test conditions, which are known after step b). Therefore frequency dependent calibration factors that account for the effects of the temporary antenna connector can be determined.

d) Measurements at extreme test conditions.

NOTE 2: Basically the procedure for extreme conditions is:

- the power/time template is tested in the "normal" way;
- the radiated power is measured by measuring the difference with respect to the radiated power under normal test conditions.

Under extreme test conditions steps a) to i) of subclause 13.3.4.1.2 are repeated except that the repeats at step d) are only performed for power control level 10 and the minimum nominal output power level supported by the MS.

The transmitter output power under extreme test conditions is calculated for each burst type, power control level and for every frequency used by adding the frequency dependent calibration factor, determined in c), to the values obtained at extreme conditions in this step.

13.3.5 Test requirements

- a) The transmitter output power, under every combination of normal and extreme test conditions, for normal bursts and access bursts, at each frequency and for each nominal output power level applicable to the MS power class, shall be at the relevant level shown in table 13-2, table 13-3 or table 13-4 within the tolerances also shown in table 13-2, table 13-3 or table 13-4.

Bands other than DCS 1800 and PCS 1900 - begin

Table 13-2: Bands other than DCS 1800 and PCS 1900 transmitter output power for different power classes

Power class				Power control level (note2)	Transmitter output power dBm	Tolerances	
2	3	4	5			normal	extreme
.	.	.	.	2	39	±2 dB	±2,5 dB
.	.	.	.	3	37	±3 dB (note1)	±4 dB (note1)
.	.	.	.	4	35	±3 dB	±4 dB
.	.	.	.	5	33	±3 dB (note1)	±4 dB (note1)
.	.	.	.	6	31	±3 dB	±4 dB
.	.	.	.	7	29	±3 dB (note1)	±4 dB (note1)
.	.	.	.	8	27	±3 dB	±4 dB
.	.	.	.	9	25	±3 dB	±4 dB
.	.	.	.	10	23	±3 dB	±4 dB
.	.	.	.	11	21	±3 dB	±4 dB
.	.	.	.	12	19	±3 dB	±4 dB
.	.	.	.	13	17	±3 dB	±4 dB
.	.	.	.	14	15	±3 dB	±4 dB
.	.	.	.	15	13	±3 dB	±4 dB
.	.	.	.	16	11	±5 dB	±6 dB
.	.	.	.	17	9	±5 dB	±6 dB
.	.	.	.	18	7	±5 dB	±6 dB
.	.	.	.	19	5	±5 dB	±6 dB
NOTE1: When the power control level corresponds to the power class of the MS, then the tolerances shall be 2,0 dB under normal test conditions and 2,5 dB under extreme test conditions.							
NOTE2: There is no requirement to test power control levels 20-31							

Bands other than DCS 1800 and PCS 1900 - end

DCS 1 800 only - begin

Table 13-3: DCS 1 800 transmitter output power for different power classes

Power class			Power control level (note2)	Transmitter output power	Tolerances	
1	2	3			normal	extreme
		.	29	36	±2,0 dB	±2,5 dB
		.	30	34	±3,0 dB	±4,0 dB
		.	31	32	±3,0 dB	±4,0 dB
.	.	.	0	30	±3,0 dB (note1)	±4 dB (note1)
.	.	.	1	28	±3 dB	±4 dB
.	.	.	2	26	±3 dB	±4 dB
.	.	.	3	24	±3 dB (note1)	±4 dB (note1)
.	.	.	4	22	±3 dB	±4 dB
.	.	.	5	20	±3 dB	±4 dB
.	.	.	6	18	±3 dB	±4 dB
.	.	.	7	16	±3 dB	±4 dB
.	.	.	8	14	±3 dB	±4 dB
.	.	.	9	12	±4 dB	±5 dB
.	.	.	10	10	±4 dB	±5 dB
.	.	.	11	8	±4 dB	±5 dB
.	.	.	12	6	±4 dB	±5 dB
.	.	.	13	4	±4 dB	±5 dB
.	.	.	14	2	±5 dB	±6 dB
.	.	.	15	0	±5 dB	±6 dB

NOTE1: When the power control level corresponds to the power class of the MS, then the tolerances shall be 2,0 dB under normal test conditions and 2,5 dB under extreme test conditions.

NOTE2: There is no requirement to test power control levels 16-28

DCS 1 800 only – end

PCS 1 900 only - begin

Table 13-4: PCS 1 900 transmitter output power for different power classes

Power class			Power control level (note2)	Transmitter output power	Tolerances	
1	2	3			Normal	Extreme
		.	30	33	±2,0 dB	±2,5 dB
		.	31	32	±2,0 dB	±2,5 dB
.	.	.	0	30	±3,0 dB (note1)	±4 dB (note1)
.	.	.	1	28	±3 dB	±4 dB
.	.	.	2	26	±3 dB	±4 dB
.	.	.	3	24	±3 dB (note1)	±4 dB (note1)
.	.	.	4	22	±3 dB	±4 dB
.	.	.	5	20	±3 dB	±4 dB
.	.	.	6	18	±3 dB	±4 dB
.	.	.	7	16	±3 dB	±4 dB
.	.	.	8	14	±3 dB	±4 dB
.	.	.	9	12	±4 dB	±5 dB
.	.	.	10	10	±4 dB	±5 dB
.	.	.	11	8	±4 dB	±5 dB
.	.	.	12	6	±4 dB	±5 dB
.	.	.	13	4	±4 dB	±5 dB
.	.	.	14	2	±5 dB	±6 dB
.	.	.	15	0	±5 dB	±6 dB

NOTE1: When the power control level corresponds to the power class of the MS, then the tolerances shall be 2,0 dB under normal test conditions and 2,5 dB under extreme test conditions.

NOTE2: There is no requirement to test power control levels 16-29

PCS 1 900 only - end

- b) The difference between the transmitter output power at two adjacent power control levels, measured at the same frequency, shall not be less than 0,5 dB and not be more than 3,5 dB. For PCS 1 900 Class 3 the difference between the transmitter output power at power controls level 30 and 31, measured at the same frequency, shall not be less than 0 dB and not be more than 2 dB.
- c) The power/time relationship of the measured samples for normal bursts shall be within the limits of the power time template of figure 13-1 at each frequency, under every combination of normal and extreme test conditions and at each power control level measured.

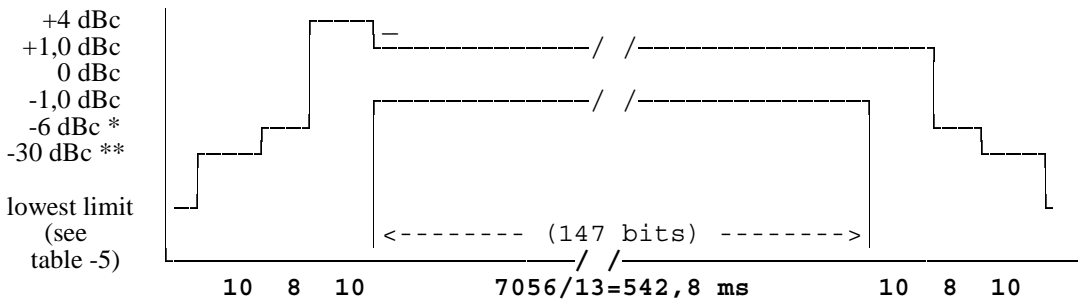

Figure 13-1: Power / time template for normal bursts

* For MS supporting bands other than DCS 1800 and PCS 1900:

- 4 dBc for power control level 16;
- 2 dBc for power control level 17;
- 1 dBc for power control levels 18 and 19.

For DCS 1 800 and PCS 1 900 MS:

- 4 dBc for power control level 11;
- 2 dBc for power control level 12;
- 1 dBc for power control levels 13, 14 and 15.

** For MS supporting bands other than DCS 1800 and PCS 1900:

- 30 dBc or -17 dBm, whichever is the higher.

For DCS 1 800 and PCS 1 900 MS:

- 30 dBc or -20 dBm, whichever is the higher.

Table 13-5: Lowest measurement limit for power / time template

	lowest limit
Bands other than DCS 1800 and PCS 1900	-59 dBc or -54 dBm whichever is the highest, except for the timeslot preceding the active slot, for which the allowed level is equal to -59 dBc or -36 dBm, whichever is the highest
DCS 1 800, PCS 1 900	-48 dBc or -48 dBm whichever is the highest

- d) All the power control levels, for the type and power class of the MS as stated by the manufacturer, shall be implemented in the MS.
- e) When the transmitter is commanded to a power control level outside of the capability corresponding to the type and power class of the MS as stated by the manufacturer, then the transmitter output power shall be within the tolerances for the closest power control level corresponding to the type and power class as stated by the manufacturer.

- f) The centre of the transmitted normal burst as defined by the transition of bits 13/14 of the midamble shall be 3 timeslot periods (1 731 μ s) \pm 1 bit period (\pm 3,69 μ s) after the centre of the corresponding received burst.
- g) The power/time relationship of the measured samples for access bursts shall be within the limits of the power time template of figure 13-2 at each frequency, under every combination of normal and extreme test conditions and at each power control level measured.

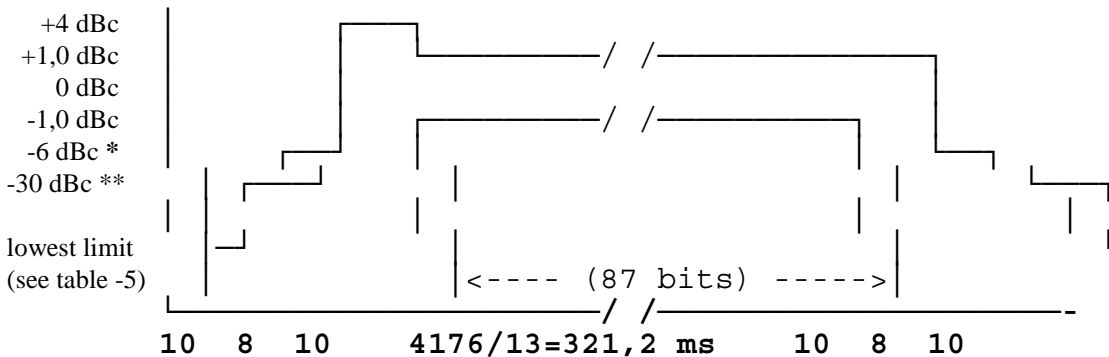

Figure 13-2: Power / time template for access burst

- * For MS supporting bands other than DCS 1800 and PCS 1900:

- 4 dBc for power control level 16;
- 2 dBc for power control level 17;
- 1 dBc for power control levels 18 and 19.

For DCS 1 800 and PCS 1 900 MS:

- 4 dBc for power control level 11;
- 2 dBc for power control level 12;
- 1 dBc for power control levels 13, 14 and 15.

- ** For MS supporting bands other than DCS 1800 and PCS 1900:

- 30 dBc or -17 dBm, whichever is the higher.

For DCS 1 800 and PCS 1 900 MS:

- 30 dBc or -20 dBm, whichever is the higher.

- h) The centre of the transmitted access burst shall be an integer number of timeslot periods less 30 bit periods relative to any CCCH midamble centre with a tolerance of \pm 1 bit period (\pm 3,69 μ s).

13.4 Output RF spectrum

13.4.1 Definition

The output RF spectrum is the relationship between the frequency offset from the carrier and the power, measured in a specified bandwidth and time, produced by the MS due to the effects of modulation and power ramping.

13.4.2 Conformance requirement

1. The level of the output RF spectrum due to modulation shall be no more than that given in 3GPP TS 05.05, subclause 4.2.1, table a1) for GSM 400, GSM 700, T_GSM 810, GSM 850 and GSM 900, table B.1) for DCS 1 800 or table C.1) for PCS 1 900, with the following lowest measurement limits:

- -36 dBm below 600 kHz offset from the carrier;

- -51 dBm for GSM 400, GSM 700, T_GSM 810, GSM 850 and GSM 900 or -56 dBm for DCS 1 800 and PCS 1 900 from 600 kHz out to less than 1 800 kHz offset from the carrier;
- -46 dBm for GSM 400, GSM 700, T_GSM 810, GSM 850 and GSM 900 or -51 dBm for DCS 1 800 and PCS 1 900 at and beyond 1 800 kHz offset from the carrier;

but with the following exceptions at up to -36 dBm:

- up to three bands of 200 kHz width centred on a frequency which is an integer multiple of 200 kHz in the combined range 600 kHz to 6000 kHz above and below the carrier;
- up to 12 bands of 200 kHz width centred on a frequency which is an integer multiple of 200 kHz at more than 6 000 kHz offset from the carrier.

1.1 Under normal conditions; 3GPP TS 05.05, subclause 4.2.1.

1.2 Under extreme conditions; 3GPP TS 05.05, subclause 4.2.1; 3GPP TS 05.05, annex D in subclauses D.2.1 and D.2.2.

2. The level of the output RF spectrum due to switching transients shall be no more than given in 3GPP TS 05.05, subclause 4.2.2, table "a) Mobile Station".

2.1 Under normal conditions; 3GPP TS 05.05, subclause 4.2.2.

2.2 Under extreme conditions; 3GPP TS 05.05, subclause 4.2.2; 3GPP TS 05.05 annex D in subclauses D.2.1 and D.2.2.

3. When allocated a channel, the power emitted by a GSM 400, GSM 900 and DCS 1 800 MS, in the band 935 MHz to 960 MHz shall be no more than -79 dBm, in the band 925 MHz to 935 MHz shall be no more than -67 dBm and in the band 1 805 MHz to 1 880 MHz shall be no more than -71 dBm except in five measurements in each of the bands 925 MHz to 960 MHz and 1 805 MHz to 1 880 MHz where exceptions at up to -36 dBm are permitted. For GSM 400 MS, in addition, the power emitted by MS, in the bands of 460,4 MHz to 467,6 MHz and 488,8 MHz to 496 MHz shall be no more than -67 dBm except in three measurements in each of the bands 460,4 MHz to 467,6 MHz and 488,8 MHz to 496 MHz where exceptions at up to -36 dBm are permitted. For GSM 700, GSM 850 and PCS 1 900 MS, the power emitted by MS, in the band of 747 MHz to 757 MHz shall be no more than -79 dBm, in the band of 757 MHz to 762 MHz shall be no more than -73 dBm, in the band 869 MHz to 894 MHz shall be no more than -79 dBm, in the band 1 930 MHz to 1 990 MHz shall be no more than -71 dBm except in five measurements in each of the bands 747 MHz to 762 MHz, 869 MHz to 894 MHz and 1 930 MHz to 1 990 MHz where exceptions at up to -36 dBm are permitted. Under normal conditions; 3GPP TS 05.05, subclause 4.3.3.

3GPP TS 45.05 subclause 2:

For T-GSM 810 the requirements for GSM 900 shall apply, apart for those parameters for which a separate requirement exists.

13.4.3 Test purpose

1. To verify that the output RF spectrum due to modulation does not exceed conformance requirement 1.
 - 1.1 Under normal conditions.
 - 1.2 Under extreme conditions.
2. To verify that the output RF spectrum due to switching transients does not exceed conformance requirement 2 when a reasonable margin is allowed for the effect of spectrum due to modulation.
 - 2.1 Under normal conditions.
 - 2.2 Under extreme conditions.
3. To verify that the MS spurious emissions in the MS receive band do not exceed conformance requirement 3.

13.4.4 Method of test

13.4.4.1 Initial conditions

A call is set up according to the generic call set up procedure.

The SS commands the MS to hopping mode. The hopping pattern includes only three channels, namely one with an ARFCN in the Low ARFCN range, a second one with an ARFCN in the Mid ARFCN range and the third one with an ARFCN in the High ARFCN range.

NOTE 1: Although the measurement is made whilst the MS is in hopping mode, each measurement is on one single channel.

NOTE 2: This test is specified in hopping mode as a simple means of making the MS change channel, it would be sufficient to test in non hopping mode and to handover the MS between the three channels tested at the appropriate time.

NOTE 3: Mid ARFCN range for GSM 900 will use the range 63-65 ARFCN

The SS commands the MS to complete the traffic channel loop back without signalling of erased frames (see subclause 36.2.1.1). This is to set a defined random pattern for the transmitter.

The SS sends Standard Test Signal C1 (annex 5) to the MS at a level of 23 dB μ Vemf().

13.4.4.2 Procedure

NOTE: When averaging is in use during frequency hopping mode, the averaging only includes bursts transmitted when the hopping carrier corresponds to the nominal carrier of the measurement.

a) In steps b) to h) the FT is equal to the hop pattern ARFCN in the Mid ARFCN range.

b) The other settings of the spectrum analyser are set as follows:

- Zero frequency scan;
- Resolution bandwidth: 30 kHz;
- Video bandwidth: 30 kHz;
- Video averaging: may be used, depending on the implementation of the test.

The video signal of the spectrum analyser is "gated" such that the spectrum generated by at least 40 of the bits 87 to 132 of the burst is the only spectrum measured. This gating may be analogue or numerical, dependent upon the design of the spectrum analyser. Only measurements during transmitted bursts on the nominal carrier of the measurement are included. The spectrum analyser averages over the gated period and over 200 or 50 such bursts, using numerical and/or video averaging.

The MS is commanded to its maximum power control level.

c) By tuning the spectrum analyser centre frequency to the measurement frequencies the power level is measured over 50 bursts at all multiples of 30 kHz offset from FT to < 1 800 kHz.

d) The resolution and video bandwidth on the spectrum analyser are adjusted to 100 kHz and the measurements are made at the following frequencies:

- on every ARFCN from 1 800 kHz offset from the carrier to the edge of the relevant transmit band for each measurement over 50 bursts;
- at 200 kHz intervals over the 2 MHz either side of the relevant transmit band for each measurement over 50 bursts.

For GSM 400 and DCS 1 800:

- at 200 kHz intervals over the band 925 MHz to 960 MHz for each measurement over 50 bursts;
- at 200 kHz intervals over the band 1 805 MHz to 1 880 MHz for each measurement over 50 bursts.

For GSM 900

- at 200 kHz intervals over the band 925 MHz to 960 MHz for each measurement over 50 bursts;
- at 200 kHz intervals over the band 1805 MHz to 1880 MHz for each measurement over 50 bursts.

In addition for GSM 400 MS:

- at 200 kHz intervals over the band 460,4 MHz to 467,6 MHz for each measurement over 50 bursts;
- at 200 kHz intervals over the band 488,8 MHz to 496 MHz for each measurement over 50 bursts.

In addition for T-GSM 810 MS:

- at 200 kHz intervals over the band 851 MHz to 866 MHz for each measurement over 50 bursts;

For GSM 700, GSM 850 and PCS 1 900:

- at 200 kHz intervals over the band 698 MHz to 716 MHz for each measurement over 50 bursts;
- at 200 kHz intervals over the band 747 MHz to 762 MHz for each measurement over 50 bursts;
- at 200 kHz intervals over the band 869 MHz to 894 MHz for each measurement over 50 bursts;
- at 200 kHz intervals over the band 1 930 MHz to 1 990 MHz for each measurement over 50 bursts.

- e) The MS is commanded to its minimum power control level. The spectrum analyser is set again as in b).
- f) By tuning the spectrum analyser centre frequency to the measurement frequencies the power level is measured over 200 bursts at the following frequencies:

FT;

FT + 100 kHz FT - 100 kHz;

FT + 200 kHz FT - 200 kHz;

FT + 250 kHz FT - 250 kHz;

FT + 200 kHz * N FT - 200 kHz * N;

where N = 2, 3, 4, 5, 6, 7, and 8;

and FT = RF channel nominal centre frequency.

- g) The spectrum analyser settings are adjusted to:

- Zero frequency scan;
- Resolution bandwidth: 30 kHz;
- Video bandwidth: 100 kHz;
- Peak hold.

The spectrum analyser gating of the signal is switched off.

The MS is commanded to its maximum power control level.

- h) By tuning the spectrum analyser centre frequency to the measurement frequencies the power level is measured at the following frequencies:

FT + 400 kHz FT - 400 kHz;

FT + 600 kHz FT - 600 kHz;

FT + 1,2 MHz FT - 1,2 MHz;

FT + 1,8 MHz FT - 1,8 MHz;

where FT = RF channel nominal centre frequency.

The duration of each measurement (at each frequency) will be such as to cover at least 10 burst transmissions at FT.

- i) Step h) is repeated for power control levels 7 and 11.
- j) Steps b), f), g) and h) are repeated with FT equal to the hop pattern ARFCN in the Low ARFCN range except that in step g) the MS is commanded to power control level 11 rather than maximum power.
- k) Steps b), f), g) and h) are repeated with FT equal to the hop pattern ARFCN in the High ARFCN range except that in step g) the MS is commanded to power control level 11 rather than maximum power.
- l) Steps a) b) f) g) and h) are repeated under extreme test conditions (annex 1, TC2.2). except that at step g) the MS is commanded to power control level 11.

13.4.5 Test requirements

For absolute measurements, performed on a temporary antenna connector, in the frequency band 450,4 MHz to 457,6 MHz, 478,8 MHz to 486 MHz, 777 MHz to 792 MHz, 824 MHz to 849 MHz, 880 MHz to 915 MHz, 1 710 MHz to 1 785 MHz, or 1 850 MHz to 1 910 MHz, the temporary antenna connector coupling factor, determined according to subclause 13.3.4.2.2 and annex 1 GC7, for the nearest relevant frequency, will be used.

For absolute measurements, performed on a temporary antenna connector, in the frequency band 925 MHz to 960 MHz, the temporary antenna connector coupling factor, will be as determined according to annex 1 GC7 for GSM 900 MS. For a GSM 400, GSM 700, T-GSM 810, GSM 850, DCS 1 800 or PCS 1 900 MS 0 dB will be assumed.

For absolute measurements, performed on a temporary antenna connector, in the frequency band 1 805 MHz to 1 880 MHz, the temporary antenna connector coupling factor, will be as determined according to annex 1 GC7 for DCS 1 800 MS. For GSM 400, GSM 700, T-GSM 810, GSM 850, GSM 900 or PCS 1 900 MS 0 dB will be assumed.

For absolute measurements, performed on a temporary antenna connector, in the frequency band 460,4 MHz to 467,6 MHz or 488,8 MHz to 496 MHz, the temporary antenna connector coupling factor, will be as determined according to annex 1 GC7 for GSM 400 MS. For a GSM 700, T-GSM 810, GSM 850, GSM 900, DCS 1800 or PCS 1 900 MS 0 dB will be assumed.

For absolute measurements, performed on a temporary antenna connector, in the frequency band 1 930 MHz to 1 990 MHz, the temporary antenna connector coupling factor, will be as determined according to annex 1 GC7 for PCS 1 900 MS. For GSM 400, GSM 700, T-GSM 810, GSM 850, GSM 900 or DCS 1 800 MS 0 dB will be assumed.

For absolute measurements, performed on a temporary antenna connector, in the frequency band 698 MHz to 762 MHz, the temporary antenna connector coupling factor, will be as determined according to annex 1 GC7 for GSM 700 MS. For a GSM 400, T-GSM 810, GSM 850, GSM 900, DCS 1800 or PCS 1 900 MS 0 dB will be assumed.

For absolute measurements, performed on a temporary antenna connector, in the frequency band 851 MHz to 866 MHz, the temporary antenna connector coupling factor, will be as determined according to annex 1 GC7 for T-GSM 810 MS. For a GSM 400, GSM 700, GSM 850, GSM 900, DCS 1800 or PCS 1 900 MS 0 dB will be assumed.

For absolute measurements, performed on a temporary antenna connector, in the frequency band 869 MHz to 894 MHz, the temporary antenna connector coupling factor, will be as determined according to annex 1 GC7 for GSM 850 MS. For a GSM 400, GSM 700, T-GSM 810, GSM 900, DCS 1800 or PCS 1 900 MS 0 dB will be assumed.

The figures in the tables below, at the listed frequencies from the carrier (kHz), are the maximum level (dB) relative to a measurement in 30 kHz bandwidth on the carrier (reference 3GPP TS 05.05 subclause 4.2.1).

- a) For the modulation sidebands out to less than 1 800 kHz offset from the carrier frequency (FT) measured in step c), f), h), j), k) and l) the measured power level in dB relative to the power level measured at FT, for all types of MS, shall not exceed the limits derived from the values shown in table 13-6 for GSM 400, GSM 700, T-GSM 810, GSM 850 and GSM 900, table 13-7 for DCS 1 800 or table 13-8 for PCS 1 900 according to the actual transmit power and frequency offset from FT. However any failures in the combined range 600 kHz to less than 1 800 kHz above and below the carrier may be counted towards the exceptions allowed in test requirements c) below.

Table 13-6: GSM 400, GSM 700, T-GSM 810, GSM 850 and GSM 900 Spectrum due to modulation out to less than 1 800 kHz offset

	power levels in dB relative to the measurement at FT				
Power level	Frequency offset (kHz)				
(dBm)	0-100	200	250	400	600 to <1800
39	+0,5	-30	-33	-60	-66
37	+0,5	-30	-33	-60	-64
35	+0,5	-30	-33	-60	-62
<= 33	+0,5	-30	-33	-60	-60
The values above are subject to the minimum absolute levels (dBm) below.					
	-36	-36	-36	-36	-51

Table 13-7: DCS 1 800 Spectrum due to modulation out to less than 1 800 kHz offset

	power levels in dB relative to the measurement at FT				
Power level	Frequency offset (kHz)				
(dBm)	0-100	200	250	400	600 to <1800
<= 36	+0,5	-30	-33	-60	-60
The values above are subject to the minimum absolute levels (dBm) below.					
	-36	-36	-36	-36	-56

Table 13-8: PCS 1 900 Spectrum due to modulation out to less than 1 800 kHz offset

	power levels in dB relative to the measurement at FT					
Power level	Frequency offset (kHz)					
(dBm)	0-100	200	250	400	600 to <1200	1200 to <1800
<= 33	+0,5	-30	-33	-60	-60	-60
The values above are subject to the minimum absolute levels (dBm) below.						
	-36	-36	-36	-36	-56	-56

NOTE 1: For frequency offsets between 100 kHz and 600 kHz the requirement is derived by a linear interpolation between the points identified in the table with linear frequency and power in dB relative.

- b) For the modulation sidebands from 1 800 kHz offset from the carrier frequency (FT) and out to 2 MHz beyond the edge of the relevant transmit band, measured in step d), the measured power level in dB relative to the power level measured at FT, shall not exceed the values shown in table 13-7 according to the actual transmit power, frequency offset from FT and system on which the MS is designed to operate. However any failures in the combined range 1 800 kHz to 6 MHz above and below the carrier may be counted towards the exceptions allowed in test requirements c) below, and any other failures may be counted towards the exceptions allowed in test requirements d) below.

Table 13-9: Spectrum due to modulation from 1 800 kHz offset to the edge of the transmit band (wideband noise)

power levels in dB relative to the measurement at FT									
GSM 400, GSM 700, T-GSM 810, GSM 850 and GSM 900				DCS 1 800			PCS 1 900		
Power Level (dBm)	Frequency offset kHz			Power level (dBm)	Frequency offset KHz		Power level (dBm)	Frequency offset kHz	
	1 800 to < 3 000	3 000 to < 6 000	>= 6 000		1 800 to < 6 000	>= 6 000		1 800 to < 6 000	>= 6 000
39	-69	-71	-77	36	-71	-79	33	-68	-76
37	-67	-69	-75	34	-69	-77	32	-67	-75
35	-65	-67	-73	32	-67	-75	30	-65	-73
<= 33	-63	-65	-71	30	-65	-73	28	-63	-71
				28	-63	-71	26	-61	-69
				26	-61	-69	<= 24	-59	-67
				<= 24	-59	-67			
The values above are subject to the minimum absolute levels (dBm) below.									
	-46	-46	-46		-51	-51		-51	-51

- c) Any failures (from a) and b) above) in the combined range 600 kHz to 6 MHz above and below the carrier should be re-checked for allowed spurious emissions. For each of the three ARFCN used, spurious emissions are allowed in up to three 200 kHz bands centred on an integer multiple of 200 kHz so long as no spurious emission exceeds -36 dBm. Any spurious emissions measured in a 30 kHz bandwidth which spans two 200 kHz bands can be counted towards either 200 kHz band, whichever minimizes the number of 200 kHz bands containing spurious exceptions.
- d) Any failures (from b) above) beyond 6 MHz offset from the carrier should be re-checked for allowed spurious emissions. For each of the three ARFCN used, up to twelve spurious emissions are allowed so long as no spurious emission exceeds -36 dBm.
- e) For GSM 400, T-GSM 810, GSM 900 and DCS 1 800 MS the spurious emissions in the bands 850 MHz to 866 MHz, 925 MHz to 935 MHz, 935 MHz to 960 MHz and 1 805 MHz to 1 880 MHz, measured in step d), shall not exceed the values shown in table 13-10 except in up to five measurements in the band 925 MHz to 960 MHz and five measurements in the band 1 805 MHz to 1 880 MHz where a level up to -36 dBm is permitted. For GSM 400 MS, in addition, the MS spurious emissions in the bands 460,4 MHz to 467,6 MHz and 488,8 MHz to 496 MHz shall not exceed the value of -67 dBm, except in up to three measurements in each of the bands 460,4 MHz to 467,6 MHz and 488,8 MHz to 496 MHz where a level up to -36 dBm is permitted. For GSM 700, GSM 850 and PCS 1 900 MS the spurious emissions in the bands 698 MHz to 716 MHz, 747 MHz to 762 MHz, 869 MHz to 894 MHz and 1 930 MHz to 1 990 MHz shall not exceed the values shown in table 13-10 except in up to five measurements in each of the bands 698 MHz to 716 MHz, 747 MHz to 762 MHz, 869 MHz to 894 MHz and 1 930 MHz to 1 990 MHz where a level up to -36 dBm is permitted.

Table 13-10: Spurious emissions in the MS receive bands

Band (MHz)	Spurious emissions level (dBm)	
	GSM 400, T-GSM 810,, GSM 900 and DCS 1 800	GSM 700, GSM 850 and PCS 1 900
460.4 – 467.6 (GSM 400 MS only)	-67	-
488.8 - 496 (GSM 400 MS only)	-67	-
850 to 866 (T-GSM 810 MS only)	-79	-
925 to 935	-67	-
935 to 960	-79	-
1 805 to 1 880	-71	-
698 to 710	-	-79
710 to 716	-	-73
747 to 757	-	-79
757 to 762	-	-73
869 to 894	-	-79
1 930 to 1 990	-	-71

- f) For the power ramp sidebands of steps h) and i) the power levels must not exceed the values shown in table 13-11 for GSM 400, GSM 700, T-GSM 810, GSM 850 and GSM 900, table 13-12 for DCS 1 800 or table 13-13 for PCS 1 900.

Table 13-11: GSM Spectrum due to switching transients

Power level	Maximum level for various offsets from carrier frequency			
	400 kHz	600 kHz	1 200 kHz	1 800 kHz
39 dBm	-13 dBm	-21 dBm	-21 dBm	-24 dBm
37 dBm	-15 dBm	-21 dBm	-21 dBm	-24 dBm
35 dBm	-17 dBm	-21 dBm	-21 dBm	-24 dBm
33 dBm	-19 dBm	-21 dBm	-21 dBm	-24 dBm
31 dBm	-21 dBm	-23 dBm	-23 dBm	-26 dBm
29 dBm	-23 dBm	-25 dBm	-25 dBm	-28 dBm
27 dBm	-23 dBm	-26 dBm	-27 dBm	-30 dBm
25 dBm	-23 dBm	-26 dBm	-29 dBm	-32 dBm
23 dBm	-23 dBm	-26 dBm	-31 dBm	-34 dBm
<= +21 dBm	-23 dBm	-26 dBm	-32 dBm	-36 dBm

Table 13-12: DCS 1 800 Spectrum due to switching transients

Power level	Maximum level for various offsets from carrier frequency			
	400 kHz	600 kHz	1200 kHz	1 800 kHz
36 dBm	-16 dBm	-21 dBm	-21 dBm	-24 dBm
34 dBm	-18 dBm	-21 dBm	-21 dBm	-24 dBm
32 dBm	-20 dBm	-22 dBm	-22 dBm	-25 dBm
30 dBm	-22 dBm	-24 dBm	-24 dBm	-27 dBm
28 dBm	-23 dBm	-25 dBm	-26 dBm	-29 dBm
26 dBm	-23 dBm	-26 dBm	-28 dBm	-31 dBm
24 dBm	-23 dBm	-26 dBm	-30 dBm	-33 dBm
22 dBm	-23 dBm	-26 dBm	-31 dBm	-35 dBm
<= +20 dBm	-23 dBm	-26 dBm	-32 dBm	-36 dBm

Table 13-13: PCS 1 900 Spectrum due to switching transients

Power level	Maximum level for various offsets from carrier frequency			
	400 kHz	600 kHz	1 200 kHz	1 800 kHz
33 dBm	-19 dBm	-22 dBm	-22 dBm	-25 dBm
32 dBm	-20 dBm	-22 dBm	-22 dBm	-25 dBm
30 dBm	-22 dBm	-24 dBm	-24 dBm	-27 dBm
28 dBm	-23 dBm	-25 dBm	-26 dBm	-29 dBm
26 dBm	-23 dBm	-26 dBm	-28 dBm	-31 dBm
24 dBm	-23 dBm	-26 dBm	-30 dBm	-33 dBm
22 dBm	-23 dBm	-26 dBm	-31 dBm	-35 dBm
<= +20 dBm	-23 dBm	-26 dBm	-32 dBm	-36 dBm

NOTE 2: These figures are different from the requirements in 3GPP TS 05.05 because at higher power levels it is the modulation spectrum which is being measured using a peak hold measurement. This allowance is given in the table.

NOTE 3: The figures for table 13-11, table 13-12 and table 13-13 assume that, using the peak hold measurement, the lowest level measurable is 8 dB above the level of the modulation specification using the 30 kHz bandwidth gated average technique for 400 kHz offset from the carrier. At 600 and 1200 kHz offset the level is 6 dB above and at 1 800 kHz offset the level is 3 dB above. The figures for 1 800 kHz have assumed the 30 kHz bandwidth spectrum due to modulation specification at <1 800 kHz.

13.5 Void

13.6 Frequency error and phase error in HSCSD multislots configurations

13.6.1 Definition

The frequency error is the difference in frequency, after adjustment for the effect of the modulation and phase error, between the RF transmission from the MS and either:

- the RF transmission from the BS; or
- the nominal frequency for the ARFCN used.

The phase error is the difference in phase, after adjustment for the effect of the frequency error, between the RF transmission from the MS and the theoretical transmission according to the intended modulation.

13.6.2 Conformance requirement

1. The MS carrier frequency shall be accurate to within 0,1 ppm, or accurate to within 0,1 ppm compared to signals received from the BS:
 - 1.1 Under normal conditions; 3GPP TS 05.10, subclause 6.1.
 - 1.2 Under vibration conditions; 3GPP TS 05.10, subclause 6.1; 3GPP TS 05.05, annex D D.2.3.
 - 1.3 Under extreme conditions; 3GPP TS 05.10, subclause 6.1; 3GPP TS 05.05, subclause 4.4; 3GPP TS 05.05, annex D in subclauses D.2.1 and D.2.2.
2. The RMS phase error (difference between the phase error trajectory and its linear regression on the active part of the time slot) for each burst shall not be greater than 5 degrees:
 - 2.1 Under normal conditions; 3GPP TS 05.05, subclause 4.6.
 - 2.2 Under vibration conditions; 3GPP TS 05.05, subclause 4.6; 3GPP TS 05.05, annex D in subclause D.2.3.
 - 2.3 Under extreme conditions; 3GPP TS 05.05, subclause 4.6; 3GPP TS 05.05, annex D in subclauses D.2.1 and D.2.2.

3. The maximum peak deviation during the useful part of each burst shall not be greater than 20 degrees.
 - 3.1 Under normal conditions; 3GPP TS 05.05, subclause 4.6.
 - 3.2 Under vibration conditions; 3GPP TS 05.05, subclause 4.6; 3GPP TS 05.05, annex D in subclause D.2.3.
 - 3.3 Under extreme conditions; 3GPP TS 05.05, subclause 4.6; 3GPP TS 05.05, annex D in subclauses D.2.1 and D.2.2.

13.6.3 Test purpose

1. To verify that in a multislot configuration the MS carrier frequency error does not exceed 0,1 ppm:
 - 1.1 Under normal conditions.
 - 1.2 When the MS is being vibrated.
 - 1.3 Under extreme conditions.

NOTE: The transmit frequency accuracy of the SS is expected to be sufficient to ensure that the difference between 0,1 ppm absolute and 0,1 ppm compared to signals received from the BS would be small enough to be considered insignificant.

2. To verify that the RMS phase error on the useful part of the bursts transmitted by the MS in a multislot configuration does not exceed conformance requirement 2:
 - 2.1 Under normal conditions.
 - 2.2 When the MS is being vibrated.
 - 2.3 Under extreme conditions.
3. To verify that the maximum phase error on the useful part of the bursts transmitted by the MS in a multislot configuration does not exceed conformance requirement 3.
 - 3.1 Under normal conditions.
 - 3.2 When the MS is being vibrated.
 - 3.3 Under extreme conditions.

13.6.4 Method of test

NOTE: In order to measure the accuracy of the frequency and phase error a sampled measurement of the transmitted phase trajectory is obtained. This is compared with the theoretically expected phase trajectory. The regression line of the difference between the expected trajectory and the measured trajectory is an indication of the frequency error (assumed constant through the burst), whilst the departure of the phase differences from this trajectory is a measure of the phase error. The peak phase error is the value furthest from the regression line and the RMS phase error is the root mean square average of the phase error of all samples.

13.6.4.1 Initial conditions

A call is set up according to the generic call setup procedure for multislot HSCSD.

The SS commands the MS to hopping mode (table 13.6.1).

NOTE 1: It is not necessary to test in hopping mode but is done here as a simple means of making the MS change channel, it would be sufficient to test in non hopping mode and to make sure bursts are taken from a few different channels.

The SS activates ciphering mode.

NOTE 2: Ciphering mode is active during this test to give a pseudo-random bit stream to the modulator.

The SS sets the MS to operate in a multislot configuration with maximum number of transmitted time slots.

The SS commands the MS to complete the traffic channel multislot loop back including signalling of erased frames.

The SS generates Standard Test Signal C1 of annex 5.

Specific PICS statements:

- MS without vibration sensitive components (TSPC_No_Vibration_Sensitive_Components)

PIXIT Statements:

-

13.6.4.2 Procedure

- a) For one transmitted burst on the last multislot subchannel, the SS captures the signal as a series of phase samples over the period of the burst. These samples are evenly distributed over the duration of the burst with a minimum sampling rate of $2/T$, where T is the modulation symbol period. The received phase trajectory is then represented by this array of at least 294 samples.
- b) The SS then calculates, from the known bit pattern and the formal definition of the modulator contained in 3GPP TS 05.04, the expected phase trajectory.
- c) From a) and b) the phase trajectory error is calculated, and a linear regression line computed through this phase trajectory error. The slope of this regression line is the frequency error of the mobile transmitter relative to the simulator reference. The difference between the regression line and the individual sample points is the phase error of that point.

- c.1) The sampled array of at least 294 phase measurements is represented by the vector:

$$\varnothing_m = \varnothing_m(0) \dots \varnothing_m(n)$$

where the number of samples in the array $n+1 \geq 294$.

- c.2) The calculated array, at the corresponding sampling instants, is represented by the vector:

$$\varnothing_c = \varnothing_c(0) \dots \varnothing_c(n).$$

- c.3) The error array is represented by the vector:

$$\varnothing_e = \{\varnothing_m(0) - \varnothing_c(0)\} \dots \dots \dots \{\varnothing_m(n) - \varnothing_c(n)\} = \varnothing_e(0) \dots \varnothing_e(n).$$

- c.4) The corresponding sample numbers form a vector $t = t(0) \dots t(n)$.

- c.5) By regression theory the slope of the samples with respect to t is k where:

$$k = \frac{\sum_{j=0}^{j=n} t(j) * \varnothing_e(j)}{\sum_{j=0}^{j=n} t(j)^2}$$

- c.6) The frequency error is given by $k/(360 \times \gamma)$, where γ is the sampling interval in s and all phase samples are measured in degrees.

- c.7) The individual phase errors from the regression line are given by:

$$\varnothing_e(j) - k \times t(j).$$

- c.8) The RMS value \varnothing_e of the phase errors is given by:

$$\varnothing_e(\text{RMS}) = \left[\frac{\sum_{j=0}^{j=n} \{\varnothing_e(j) - k * t(j)\}^2}{n+1} \right]^{\frac{1}{2}}$$

- d) Steps a) to c) are repeated for 20 bursts, not necessarily contiguous.
- e) The SS instructs the MS to its maximum power control level on each multislot subchannel, all other conditions remaining constant. Steps a) to d) are repeated.
- f) The SS instructs the MS to the minimum power control level on each multislot subchannel, all other conditions remaining constant. Steps a) to d) are repeated.
- g) The MS is hard mounted on a vibration table and vibrated at the frequency/amplitudes specified in annex 1, TC4. During the vibration steps a) to f) are repeated.

NOTE 1: If the call is terminated when mounting the MS to the vibration table, it will be necessary to establish the initial conditions again before repeating steps a) to f).

- h) The MS is re-positioned on the vibration table in the two orthogonal planes to the plane used in step g). For each of the orthogonal planes step g) is repeated.
- i) Steps a) to f) are repeated under extreme test conditions (see annex 1, TC2.2).

NOTE 2: The series of samples taken to determine the phase trajectory could also be used, with different post-processing, to determine the transmitter burst characteristics of 'Transmitter output power and burst timing in multislot configuration'. Although described independently, it is valid to combine these two tests, giving both answers from single sets of captured data.

NOTE 3: Steps g) and h) are skipped if TSPC_No_Vibration_Sensitive_Components is declared as Yes

13.6.5 Test requirements

13.6.5.1 Frequency error

For all measured bursts, the frequency error, derived in step c.6), shall be less than 10E-7.

13.6.5.2 Phase error

For all measured bursts, the RMS phase error, derived in step c.8), shall not exceed 5 degrees.

For all measured bursts, each individual phase error, derived in step c.7), shall not exceed 20 degrees.

13.7 Transmitter output power and burst timing in HSCSD configurations

13.7.1 Definition

The transmitter output power is the average value of the power delivered to an artificial antenna or radiated by the MS and its integral antenna, over the time that the useful information bits of one burst are transmitted.

The transmit burst timing is the envelope of the RF power transmitted with respect to time. The timings are referenced to the transition from bit 13 to bit 14 of the Training Sequence ("midamble") before differential decoding. The timing of the modulation is referenced to the timing of the received signal from the SS.

13.7.2 Conformance requirement

- The MS maximum output power shall be as defined in 3GPP TS 05.05, subclause 4.1.1, first table, according to its power class, with a tolerance of ± 2 dB under normal conditions; 3GPP TS 05.05, subclause 4.1.1, first table. From R99 onwards, the MS maximum output power in an uplink multislot configuration shall be as defined in

- 3GPP TS 05.05 subclause 4.1.1, sixth table, according to its power class, with a tolerance of ± 3 dB under normal conditions; 3GPP TS 05.05, subclause 4.1.1, first and sixth table. In case the MS supports the same maximum output power in an uplink multislot configuration as it supports for single slot uplink operation, the tolerance shall be ± 2 dB.
2. The MS maximum output power shall be as defined in 3GPP TS 05.05, subclause 4.1.1, first table, according to its power class, with a tolerance of $\pm 2,5$ dB under extreme conditions; 3GPP TS 05.05, subclause 4.1.1, first table; 3GPP TS 05.05 annex D in subclauses D.2.1 and D.2.2. From R99 onwards, the MS maximum output power in an uplink multislot configuration shall be as defined in 3GPP TS 05.05 subclause 4.1.1, sixth table, according to its power class, with a tolerance of ± 4 dB under extreme conditions; 3GPP TS 05.05, subclause 4.1.1, first and sixth table; 3GPP TS 05.05 annex D in subclauses D.2.1 and D.2.2. In case the MS supports the same maximum output power in an uplink multislot configuration as it supports for single slot uplink operation, the tolerance shall be $\pm 2,5$ dB.
 3. The power control levels shall have the nominal output power levels as defined in 3GPP TS 05.05, subclause 4.1.1, third table (for GSM 400, GSM 700, GSM 850 and GSM 900), fourth table (for DCS 1 800) or fifth table (for PCS 1 900), from the lowest power control level up to the maximum output power corresponding to the class of the MS (for tolerance on maximum output power see conformance requirements 1), with a tolerance of ± 3 dB, ± 4 dB or ± 5 dB under normal conditions; 3GPP TS 05.05, subclause 4.1.1, third, fourth or fifth table.
 4. The power control levels shall have the nominal output power levels as defined in 3GPP TS 05.05, subclause 4.1.1, third table (for GSM 400, GSM 700, GSM 850 and GSM 900), fourth table (for DCS 1 800) or fifth table (for PCS 1 900), from the lowest power control level up to the maximum output power corresponding to the class of the MS (for tolerance on maximum output power see conformance requirements 2), with a tolerance of ± 4 dB, ± 5 dB or ± 6 dB under extreme conditions; 3GPP TS 05.05, subclause 4.1.1, third, fourth or fifth table; 3GPP TS 05.05 annex D in subclauses D.2.1 and D.2.2.
 - 4a. From R99 onwards, the supported maximum output power for each number of uplink timeslots shall form a monotonic sequence. The maximum reduction of maximum output power from an allocation of n uplink timeslots to an allocation of $n+1$ uplink timeslots shall be equal to the difference of maximum permissible nominal reduction of maximum output power for the corresponding number of timeslots, as defined in 3GPP TS 05.05, subclause 4.1.1, sixth table.
 5. The output power actually transmitted by the MS at consecutive power control levels shall form a monotonic sequence and the interval between power control levels shall be $2 \pm 1,5$ dB (1 ± 1 dB between power control level 30 and 31 for PCS 1 900), from R99 onwards, in a multislot configuration, the first power control step down from the maximum output power is allowed to be in the range $0 \dots 2$ dB; 3GPP TS 05.05, subclause 4.1.1.
 6. The transmitted power level relative to time for a normal burst shall be within the power/time template given in 3GPP TS 05.05, annex B figure B1. In multislot configurations where the bursts in two or more consecutive time slots are actually transmitted at the same frequency, the template of annex B shall be respected at the beginning and the end of the series of consecutive bursts. The output power during the guard period between every two consecutive active timeslots shall not exceed the level allowed for the useful part of the first timeslot or the level allowed for the useful part of the second timeslot plus 3 dB, whichever is the highest:
 - 6.1 Under normal conditions; 3GPP TS 05.05, subclause 4.5.2.
 - 6.2 Under extreme conditions; 3GPP TS 05.05, subclause 4.5.2, 3GPP TS 05.05 annex D in subclauses D.2.1 and D.2.2.
 7. In multislot configurations, bidirectional subchannels shall be individually power controlled; 3GPP TS 05.08, subclause 4.2.
 8. When accessing a cell on the RACH and before receiving the first power command during a communication on a DCCH or TCH (after an IMMEDIATE ASSIGNMENT), all GSM and class 1 and class 2 DCS 1 800 and PCS 1 900 MS shall use the power control level defined by the MS_TXPWR_MAX_CCH parameter broadcast on the BCCH of the cell, or if MS_TXPWR_MAX_CCH corresponds to a power control level not supported by the MS as defined by its power class, the MS shall act as though the closest supported power control level had been broadcast. A Class 3 DCS 1 800 MS shall use the POWER_OFFSET parameter.
 9. The transmissions from the MS to the BS, measured at the MS antenna, shall be $468,75 - TA$ bit periods behind the transmissions received from the BS, where TA is the last timing advance received from the current serving BS. The tolerance on these timings shall be ± 1 bit period:

- 9.1 Under normal conditions; 3GPP TS 05.10, subclause 6.4.
- 9.2 Under extreme conditions; 3GPP TS 05.10, subclause 6.4, 3GPP TS 05.05 annex D in subclauses D.2.1 and D.2.2.
- 10. The transmitted power level relative to time for a random access burst shall be within the power/time template given in 3GPP TS 05.05, annex B figure B.3:
 - 10.1 Under normal conditions; 3GPP TS 05.05, subclause 4.5.2.
 - 10.2 Under extreme conditions; 3GPP TS 05.05, subclause 4.5.2, 3GPP TS 05.05 annex D in subclauses D.2.1 and D.2.2.
- 11 The MS shall use a TA value of 0 for the Random Access burst sent:
 - 11.1 Under normal conditions; 3GPP TS 05.10, subclause 6.6.
 - 11.2 Under extreme conditions; 3GPP TS 05.10, subclause 6.6, 3GPP TS 05.05 annex D in subclauses D.2.1 and D.2.2.

3GPP TS 45.05 subclause 2:

For T-GSM 810 the requirements for GSM 900 shall apply, apart for those parameters for which a separate requirement exists.

13.7.3 Test purpose

1. To verify that the maximum output power of the MS in HSCSD multislot configuration, under normal conditions, is within conformance requirement 1.
2. To verify that the maximum output power of the MS in HSCSD multislot configuration, under extreme conditions, is within conformance requirement 2.
3. To verify that all power control levels, relevant to the class of MS, are implemented in the MS in HSCSD multislot configuration and have output power levels, under normal conditions, within conformance requirement 3.
4. To verify that all power control levels have output power levels, under extreme conditions, within conformance requirement 4.
- 4a. From R99 onwards: to verify that the supported maximum output power for each uplink multislot configuration is within the conformance requirement 4a.
5. To verify that the step in the output power transmitted by the MS in HSCSD multislot configuration at consecutive power control levels is within conformance requirement 5 under normal conditions.
6. To verify that the output power relative to time, when sending a normal burst is within conformance requirement 6 in HSCSD multislot configuration:
 - 6.1 Under normal conditions.
 - 6.2 Under extreme conditions.
7. To verify that the MS in HSCSD multislot configuration uses the maximum power control level according to its power class if commanded to a power control level exceeding its power class.
8. To verify that, for normal bursts, the MS transmissions to the BS are timed within conformance requirement 8 in HSCSD multislot configuration:
 - 8.1 Under normal conditions.
 - 8.2 Under extreme conditions.
9. To verify that the output power relative to time, when sending an access burst is within conformance requirement 9 in HSCSD multislot configuration:
 - 9.1 Under normal conditions.

9.2 Under extreme conditions.

10. To verify that, for an access burst, the MS transmission to the BS is timed within conformance requirement 10 in HSCSD multislot configuration:

10.1 Under normal conditions.

10.2 Under extreme conditions.

11. To verify that, power is individually controlled on bidirectional HSCSD subchannels.

13.7.4 Methods of test

Two methods of test are described, separately for:

- 1) equipment fitted with a permanent antenna connector or fitted with a temporary test connector as a test fixture, and for
- 2) equipment fitted with an integral antenna, and which cannot be connected to an external antenna.

NOTE: The behaviour of the MS in the system is determined to a high degree by the antenna, and this is the only transmitter test in this EN using the integral antenna. Further studies are ongoing on improved testing on the integral antenna, taking practical conditions of MS use into account.

13.7.4.1 Method of test for equipment with a permanent or temporary antenna connector

13.7.4.1.1 Initial conditions

A call is set up by the SS according to the generic call set up procedure for HSCSD multislot configuration on a channel with ARFCN in the Mid ARFCN range, power control level set to Max power and MS to operate in its highest number of uplink slots. MS TXPWR_MAX_CCH is set to the maximum value supported by the Power Class of the Mobile under test. For DCS 1 800 mobile stations the POWER_OFFSET parameter is set to 6 dB.

13.7.4.1.2 Procedure

- a) Measurement of normal burst transmitter output power.

The SS takes power measurement samples evenly distributed over the duration of one burst with a sampling rate of at least $2/T$, where T is the bit duration. The samples are identified in time with respect to the modulation on the burst. The SS identifies the centre of the useful 147 transmitted bits, i.e. the transition from bit 13 to bit 14 of the midamble, as the timing reference.

The transmitter output power is calculated as the average of the samples over the 147 useful bits. This is also used as the 0 dB reference for the power/time template.

- b) Measurement of normal burst timing delay.

The burst timing delay is the difference in time between the timing reference identified in a) and the corresponding transition in the burst received by the MS immediately prior to the MS transmit burst sampled.

- c) Measurement of normal burst power/time relationship.

The array of power samples measured in a) are referenced in time to the centre of the useful transmitted bits and in power to the 0 dB reference, both identified in a).

- d) Steps a) to c) are repeated on each multislot subchannel with the MS commanded to operate on each of the power control levels defined, even those not supported by the MS.
- e) The SS commands the MS to the maximum power control level supported by the MS and steps a) to c) are repeated on each multislot subchannel for ARFCN in the Low and High ranges.
- f) The SS commands the MS to the maximum power control level in the first multislot subchannel allocated and to the minimum power control level in the second multislot subchannel allocated. Any further timeslots allocated are to be set to the maximum power control level. Steps a) to c) and corresponding measurements on each subchannel are repeated.

g) Measurement of access burst transmitter output power.

The SS causes the MS to generate an Access Burst on an ARFCN in the Mid ARFCN range, this could be either by a handover procedure or a new request for radio resource. In the case of a handover procedure the Power Level indicated in the HANDOVER COMMAND message is the maximum power control level supported by the MS. In the case of an Access Burst the MS shall use the Power Level indicated in the MS_TXPWR_MAX_CCH parameter. If the power class of the MS is DCS 1 800 Class 3, the MS shall also use the POWER_OFFSET parameter.

The SS takes power measurement samples evenly distributed over the duration of the access burst as described in a). However, in this case the SS identifies the centre of the useful bits of the burst by identifying the transition from the last bit of the synch sequence. The centre of the burst is then five data bits prior to this point and is used as the timing reference.

The transmitter output power is calculated as the average of the samples over the 87 useful bits of the burst. This is also used as the 0 dB reference for the power/time template.

h) Measurement of access burst timing delay.

The burst timing delay is the difference in time between the timing reference identified in g) and the MS received data on the common control channel.

i) Measurement of access burst power/time relationship.

The array of power samples measured in g) are referenced in time to the centre of the useful transmitted bits and in power to the 0 dB reference, both identified in g).

j) Depending on the method used in step g) to cause the MS to send an Access Burst, the SS sends either a HANDOVER COMMAND with power control level set to 10 or it changes the System Information elements MS_TXPWR_MAX_CCH and for DCS 1 800 the POWER_OFFSET on the serving cell BCCH in order to limit the MS transmit power on the Access Burst to power control level 10 (+23 dBm for GSM 400, GSM 700, T-GSM 810, GSM 850 and GSM 900 or +10 dBm for DCS 1 800 and PCS 1 900) and then steps g) to i) are repeated.

k) Steps a) to j) are repeated under extreme test conditions (annex 1, TC2.2) except that the repeats at step d) are only performed for power control level 10 and the minimum power control level of the MS.

13.7.4.2 Method of test for equipment with an integral antenna

NOTE: If the MS is equipped with a permanent connector, such that the antenna can be disconnected and the SS be connected directly, then the method of subclause 13.7.4.1 will be applied.

The tests in this subclause are performed on an unmodified test sample.

13.7.4.2.1 Initial conditions

The MS is placed in the anechoic shielded chamber (annex 1, GC5) or on the outdoor test site, on an isolated support, in the position for normal use, at a distance of at least 3 metres from a test antenna, connected to the SS.

NOTE: The test method described has been written for measurement in an anechoic shielded chamber. If an outdoor test site is used then, in addition, it is necessary to raise/lower the test antenna through the specified height range to maximize the received power levels from both the test sample and the substitution antenna.

A call is set up by the SS according to the generic call set up procedure on a channel with ARFCN in the Mid ARFCN range, power control level set to Max power. MS_TXPWR_MAX_CCH is set to the maximum value supported by the Power Class of the Mobile under test. For DCS 1 800 mobile stations the POWER_OFFSET parameter is set to 6 dB.

13.7.4.2.2 Procedure

a) With the initial conditions set according to subclause 13.7.4.2.1 the test procedure in subclause 13.7.4.1.2 is followed up to and including step j), except that in step a), when measurements are done at maximum power for ARFCN in the Low, Mid and High range, the measurement is made eight times with the MS rotated by $n \times 45$ degrees for all values of n in the range 0 to 7.

The measurements taken are received transmitter output power measurements rather than transmitter output power measurements, the output power measurement values can be derived as follows.

b) Assessment of test site loss for scaling of received output power measurements.

The MS is replaced by a half-wave dipole, resonating at the centre frequency of the transmit band, connected to an RF generator.

The frequency of the RF signal generator is set to the frequency of the ARFCN used for the 24 measurements in step a), the output power is adjusted to reproduce the received transmitter output power averages recorded in step a).

For each indication the power, delivered by the generator (in Watts) to the half-wave dipole, is recorded. These values are recorded in the form P_{nc} , where n = MS rotation and c = channel number.

For each channel number used compute:

$$P_{ac}(\text{Watts into dipole}) = \frac{1}{8} * \sum_{n=0}^{n=7} P_{nc}$$

from which: $P_{ac}(\text{Tx dBm}) = 10\log_{10}(P_{ac}) + 30 + 2,15$

The difference, for each of the three channels, between the actual transmitter output power averaged over the 8 measurement orientations and the received transmitter output power at orientation $n = 0$ is used to scale the received measurement results to actual transmitter output powers for all measured power control levels and ARFCN, which can then be checked against the requirements.

c) Temporary antenna connector calibration factors (transmit).

A modified test sample equipped with a temporary antenna connector is placed in a climatic test chamber and is linked to the SS by means of the temporary antenna connector.

Under normal test conditions, the power measurement and calculation parts of steps a) to j) of subclause 13.7.4.1.2 are repeated except that the repeats at step d) are only performed for power control level 10 and the minimum power control level of the MS.

NOTE 1: The values noted here are related to the output transmitter carrier power levels under normal test conditions, which are known after step b). Therefore frequency dependent calibration factors that account for the effects of the temporary antenna connector can be determined.

d) Measurements at extreme test conditions.

NOTE 2: Basically the procedure for extreme conditions is:

- the power/time template is tested in the "normal" way;
- the radiated power is measured by measuring the difference with respect to the radiated power under normal test conditions.

Under extreme test conditions steps a) to j) of subclause 13.7.4.1.2 are repeated except that the repeats at step d) are only performed for power control level 10 and the minimum power control level of the MS.

The transmitter output power under extreme test conditions is calculated for each burst type, power control level and for every frequency used by adding the frequency dependent calibration factor, determined in c), to the values obtained at extreme conditions in this step.

13.7.5 Test requirements

- a) The transmitter output power on each subchannel, under every combination of normal and extreme test conditions, for normal bursts and access bursts, at each frequency and for each power control level applicable to the MS power class, shall be at the relevant level shown in table 13.7-1, table 13.7-2 or table 13.7-3 within the tolerances also shown in table 13.7-1, table 13.7-2 or table 13.7-3.

GSM 400, GSM 700, T-GSM 810, GSM 850 and GSM 900 only - begin

Table 13.7-1: GSM 400, GSM 700, T-GSM 810, GSM 850 and GSM 900 transmitter output power for different power classes

Power class				Power control level	Transmitter output power (note 2)	Tolerances	
2	3	4	5			normal	extreme
.	.	.	.	2	39	±2 dB	±2,5 dB
.	.	.	.	3	37	±3 dB (note 1)	±4 dB (note 1)
.	.	.	.	4	35	±3 dB	±4 dB
.	.	.	.	5	33	±3 dB (note 1)	±4 dB (note 1)
.	.	.	.	6	31	±3 dB	±4 dB
.	.	.	.	7	29	±3 dB (note 1)	±4 dB (note 1)
.	.	.	.	8	27	±3 dB	±4 dB
.	.	.	.	9	25	±3 dB	±4 dB
.	.	.	.	10	23	±3 dB	±4 dB
.	.	.	.	11	21	±3 dB	±4 dB
.	.	.	.	12	19	±3 dB	±4 dB
.	.	.	.	13	17	±3 dB	±4 dB
.	.	.	.	14	15	±3 dB	±4 dB
.	.	.	.	15	13	±3 dB	±4 dB
.	.	.	.	16	11	±5 dB	±6 dB
.	.	.	.	17	9	±5 dB	±6 dB
.	.	.	.	18	7	±5 dB	±6 dB
.	.	.	.	19	5	±5 dB	±6 dB

NOTE 1: When the power control level corresponds to the power class of the MS, then the tolerances shall be 2,0 dB under normal test conditions and 2,5 dB under extreme test conditions.

NOTE 2: For R99 and Rel-4, the maximum output power in a multislot configuration may be lower within the limits defined in table 13.7-1a. From Rel-5 onwards, the maximum output power in a multislot configuration may be lower within the limits defined in table 13.7-1b.

Table 13.7-1a: R99 and Rel-4: GSM 400, GSM 700, T-GSM 810, GSM 850 and GSM 900 allowed maximum output power reduction in a multislot configuration

Number of timeslots in uplink assignment	Permissible nominal reduction of maximum output power, (dB)
1	0
2	0 to 3,0
3	1,8 to 4,8
4	3,0 to 6,0

Table 13.7-1b: From Rel-5 onwards: GSM 400, GSM 700, T-GSM 810, GSM 850 and GSM 900 allowed maximum output power reduction in a multislot configuration

Number of timeslots in uplink assignment	Permissible nominal reduction of maximum output power, (dB)
1	0
2	3,0
3	4,8
4	6,0
5	7,0
6	7,8
7	8,5
8	9,0

From R5 onwards, the actual supported maximum output power shall be in the range indicated by the parameter GMSK_MULTISLOT_POWER_PROFILE for n allocated uplink timeslots:

$$a \leq \text{MS maximum output power} \leq \min(\text{MAX_PWR}, a + 2\text{dB})$$

Where:

$$a = \min (\text{MAX_PWR}, \text{MAX_PWR} + \text{GMSK_MULTISLOT_POWER_PROFILE} - 10\log(n));$$

MAX_PWR equals to the MS maximum output power according to the relevant power class and

- GMSK_MULTISLOT_POWER_PROFILE 0 = 0 dB;
- GMSK_MULTISLOT_POWER_PROFILE 1 = 2 dB;
- GMSK_MULTISLOT_POWER_PROFILE 2 = 4 dB;
- GMSK_MULTISLOT_POWER_PROFILE 3 = 6 dB.

GSM 400, GSM 700, T-GSM 810, GSM 850 and GSM 900 only - end

DCS 1 800 only - begin

Table 13.7-2: DCS 1 800 transmitter output power for different power classes

Power class			Power control level	Transmitter output power (note 2)	Tolerances	
1	2	3		dBm	normal	extreme
.	.	.	29	36	±2,0 dB	±2,5 dB
.	.	.	30	34	±3,0 dB	±4,0 dB
.	.	.	31	32	±3,0 dB	±4,0 dB
.	.	.	0	30	±3,0 dB (note 1)	±4 dB (note 1)
.	.	.	1	28	±3 dB	±4 dB
.	.	.	2	26	±3 dB	±4 dB
.	.	.	3	24	±3 dB (note 1)	±4 dB (note 1)
.	.	.	4	22	±3 dB	±4 dB
.	.	.	5	20	±3 dB	±4 dB
.	.	.	6	18	±3 dB	±4 dB
.	.	.	7	16	±3 dB	±4 dB
.	.	.	8	14	±3 dB	±4 dB
.	.	.	9	12	±4 dB	±5 dB
.	.	.	10	10	±4 dB	±5 dB
.	.	.	11	8	±4 dB	±5 dB
.	.	.	12	6	±4 dB	±5 dB
.	.	.	13	4	±4 dB	±5 dB
.	.	.	14	2	±5 dB	±6 dB
.	.	.	15	0	±5 dB	±6 dB

NOTE 1: When the power control level corresponds to the power class of the MS, then the tolerances shall be 2,0 dB under normal test conditions and 2,5 dB under extreme test conditions.

NOTE 2: For R99 and Rel-4, the maximum output power in a multislot configuration may be lower within the limits defined in table 13.7-2a. From Rel-5 onwards, the maximum output power in a multislot configuration may be lower within the limits defined in table 13.7-2b.

Table 13.7-2a: R99 and Rel-4: DCS 1800 allowed maximum output power reduction in a multislot configuration

Number of timeslots in uplink assignment	Permissible nominal reduction of maximum output power, (dB)
1	0
2	0 to 3,0
3	1,8 to 4,8
4	3,0 to 6,0

Table 13.7-2b: From Rel-5 onwards: DCS 1800 allowed maximum output power reduction in a multislot configuration

Number of timeslots in uplink assignment	Permissible nominal reduction of maximum output power, (dB)
1	0
2	3,0
3	4,8
4	6,0
5	7,0
6	7,8
7	8,5
8	9,0

From R5 onwards, the actual supported maximum output power shall be in the range indicated by the parameter `GMSK_MULTISLOT_POWER_PROFILE` for n allocated uplink timeslots:

$$a \leq \text{MS maximum output power} \leq \min(\text{MAX_PWR}, a + 2\text{dB})$$

Where:

$$a = \min(\text{MAX_PWR}, \text{MAX_PWR} + \text{GMSK_MULTISLOT_POWER_PROFILE} - 10\log(n));$$

`MAX_PWR` equals to the MS maximum output power according to the relevant power class and

`GMSK_MULTISLOT_POWER_PROFILE 0` = 0 dB;

`GMSK_MULTISLOT_POWER_PROFILE 1` = 2 dB;

`GMSK_MULTISLOT_POWER_PROFILE 2` = 4 dB;

`GMSK_MULTISLOT_POWER_PROFILE 3` = 6 dB.

DCS 1 800 only - end

PCS 1 900 only - begin

Table 13.7-3: PCS 1 900 transmitter output power for different power classes

Power class			Power control level	Transmitter output power (note 2)	Tolerances	
1	2	3			Normal	Extreme
			30	33	±2,0 dB	±2,5 dB
			31	32	±2,0 dB	±2,5 dB
			0	30	±3,0 dB (note_1)	±4 dB (note_1)
			1	28	±3 dB	±4 dB
			2	26	±3 dB	±4 dB
			3	24	±3 dB (note_1)	±4 dB (note_1)
			4	22	±3 dB	±4 dB
			5	20	±3 dB	±4 dB
			6	18	±3 dB	±4 dB
			7	16	±3 dB	±4 dB
			8	14	±3 dB	±4 dB
			9	12	±4 dB	±5 dB
			10	10	±4 dB	±5 dB
			11	8	±4 dB	±5 dB
			12	6	±4 dB	±5 dB
			13	4	±4 dB	±5 dB
			14	2	±5 dB	±6 dB
			15	0	±5 dB	±6 dB

NOTE 1: When the power control level corresponds to the power class of the MS, then the tolerances shall be 2,0 dB under normal test conditions and 2,5 dB under extreme test conditions.

NOTE 2: For R99 and Rel-4, the maximum output power in a multislot configuration may be lower within the limits defined in table 13.7-3a. From Rel-5 onwards, the maximum output power in a multislot configuration may be lower within the limits defined in table 13.7-3b.

Table 13.7-3a: R99 and Rel-4: PCS 1900 allowed maximum output power reduction in a multislot configuration

Number of timeslots in uplink assignment	Permissible nominal reduction of maximum output power, (dB)
1	0
2	0 to 3,0
3	1,8 to 4,8
4	3,0 to 6,0

Table 13.7-3b: From Rel-5 onwards: PCS 1900 allowed maximum output power reduction in a multislot configuration

Number of timeslots in uplink assignment	Permissible nominal reduction of maximum output power, (dB)
1	0
2	3,0
3	4,8
4	6,0
5	7,0
6	7,8
7	8,5
8	9,0

From R5 onwards, the actual supported maximum output power shall be in the range indicated by the parameter GMSK_MULTISLOT_POWER_PROFILE for n allocated uplink timeslots:

$$a \leq \text{MS maximum output power} \leq \min(\text{MAX_PWR}, a + 2\text{dB})$$

Where:

$$a = \min(\text{MAX_PWR}, \text{MAX_PWR} + \text{GMSK_MULTISLOT_POWER_PROFILE} - 10\log(n));$$

MAX_PWR equals to the MS maximum output power according to the relevant power class and

GMSK_MULTISLOT_POWER_PROFILE 0 = 0 dB;

GMSK_MULTISLOT_POWER_PROFILE 1 = 2 dB;

GMSK_MULTISLOT_POWER_PROFILE 2 = 4 dB;

GMSK_MULTISLOT_POWER_PROFILE 3 = 6 dB.

PCS 1 900 only - end

- b) The difference between the transmitter output power at two adjacent power control levels, measured at the same frequency, shall not be less than 0,5 dB and not be more than 3,5 dB. For PCS 1 900 Class 3 the difference between the transmitter output power at power controls level 30 and 31, measured at the same frequency, shall not be less than 0 dB and not be more than 2 dB.

For R99 and later MS, if one or both of the adjacent output power levels are reduced according to GMSK_MULTISLOT_POWER_PROFILE X and the number of timeslots, the difference between the transmitter output power at two adjacent power control levels, measured at the same frequency, shall not be less than -1 dB and not be more than 3.5 dB.

- c) The power/time relationship of the measured samples for normal bursts shall be within the limits of the power time template of figure 13.7-2 at each frequency, under every combination of normal and extreme test conditions and at each power control level measured.

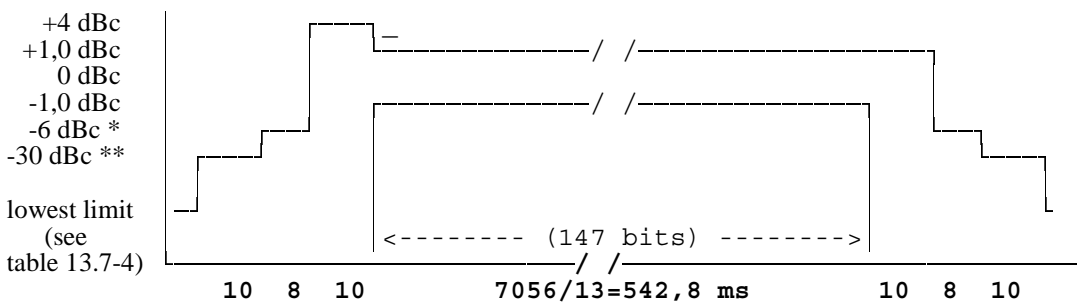

Figure 13.7-2: Power / time template for normal bursts

* For GSM 400, GSM 700, T-GSM 810, GSM 850 and GSM 900 MS:

- 4 dBc for power control level 16;
- 2 dBc for power control level 17;
- 1 dBc for power control levels 18 and 19.

For DCS 1 800 and PCS 1 900 MS:

- 4 dBc for power control level 11;
- 2 dBc for power control level 12;
- 1 dBc for power control levels 13, 14 and 15.

** For GSM 400, GSM 700, T-GSM 810, GSM 850 and GSM 900 MS:

- 30 dBc or -17 dBm, whichever is the higher.

For DCS 1 800 and PCS 1 900 MS:

- 30 dBc or -20 dBm, whichever is the higher.

Table 13.7-4: Lowest measurement limit for power / time template

	lowest limit
GSM 400, GSM 700, T-GSM 810, GSM 850, GSM 900	-59 dBc or -54 dBm whichever is the highest, except for the timeslot preceding the active slot, for which the allowed level is -59 dBc or -36 dBm, whichever is the highest
DCS 1 800, PCS 1 900	-48 dBc or -48 dBm whichever is the highest

- d) All the power control levels, for the type and power class of the MS as stated by the manufacturer, shall be implemented in the MS.
- e) When the transmitter is commanded to a power control level outside of the capability corresponding to the type and power class of the MS as stated by the manufacturer, then the transmitter output power shall be within the tolerances for the closest power control level corresponding to the type and power class as stated by the manufacturer.
- f) The centre of the transmitted normal burst as defined by the transition of bits 13/14 of the midamble shall be 3 timeslot periods (1 731 μs) ±1 bit period (±3,69 μs) after the centre of the corresponding received burst.
- g) The power/time relationship of the measured samples for access bursts shall be within the limits of the power time template of figure 13.7-3 at each frequency, under every combination of normal and extreme test conditions and at each power control level measured.

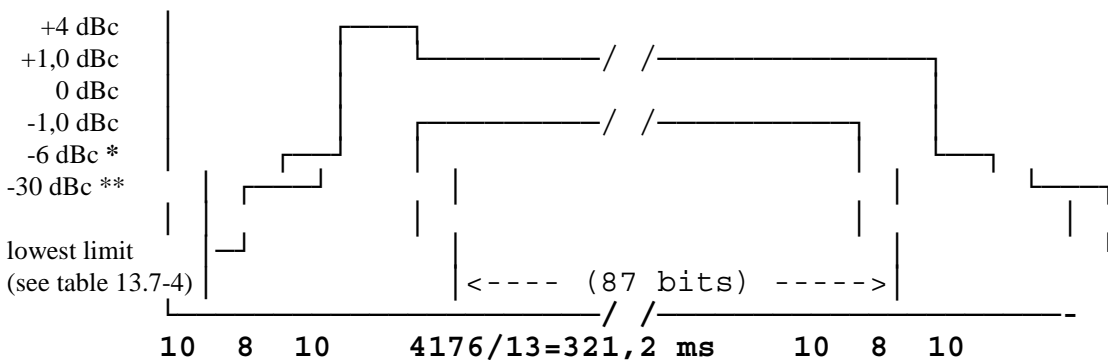

Figure 13.7-3: Power / time template for access burst

* For GSM 400, GSM 700, T-GSM 810, GSM 850 and GSM 900 MS:

- 4 dBc for power control level 16;
- 2 dBc for power control level 17;
- 1 dBc for power control levels 18 and 19.

For DCS 1 800 and PCS 1 900 MS:

- 4 dBc for power control level 11;
- 2 dBc for power control level 12;
- 1 dBc for power control levels 13, 14 and 15.

** For GSM 400, GSM 700, T-GSM 810, GSM 850 and GSM 900 MS:

- 30 dBc or -17 dBm, whichever is the higher.

For DCS 1 800 and PCS 1 900 MS:

- 30 dBc or -20 dBm, whichever is the higher.

- h) The centre of the transmitted access burst shall be an integer number of timeslot periods less 30 bit periods relative to any CCCH midamble centre with a tolerance of ± 1 bit period ($\pm 3,69 \mu\text{s}$).

13.8 Output RF spectrum in HSCSD multislot configuration

13.8.1 Definition

The output RF spectrum is the relationship between the frequency offset from the carrier and the power, measured in a specified bandwidth and time, produced by the MS due to the effects of modulation and power ramping.

13.8.2 Conformance requirement

1. The level of the output RF spectrum due to modulation shall be no more than that given in 3GPP TS 05.05, 4.2.1, table a) for GSM 400, GSM 700, GSM 850 and GSM 900, table b) for DCS 1 800 or table c) for PCS 1 900, with the following lowest measurement limits:

- -36 dBm below 600 kHz offset from the carrier;
- -51 dBm for GSM 400 and GSM 900 or -56 dBm for DCS 1 800 and PCS 1 900 from 600 kHz out to less than 1 800 kHz offset from the carrier;
- -46 dBm for GSM 400 and GSM 900 or -51 dBm for DCS 1 800 and PCS 1 900 at and beyond 1 800 kHz offset from the carrier;

but with the following exceptions at up to -36 dBm:

- up to three bands of 200 kHz width centred on a frequency which is an integer multiple of 200 kHz in the combined range 600 kHz to 6000 kHz above and below the carrier;
- up to 12 bands of 200 kHz width centred on a frequency which is an integer multiple of 200 kHz at more than 6 000 kHz offset from the carrier.

1.1 Under normal conditions; 3GPP TS 05.05, subclause 4.2.1.

1.2 Under extreme conditions; 3GPP TS 05.05, subclause 4.2.1; 3GPP TS 05.05, annex D in subclauses D.2.1 and D.2.2.

2. The level of the output RF spectrum due to switching transients shall be no more than given in 3GPP TS 05.05, subclause 4.2.2, table "a) Mobile Station".

2.1 Under normal conditions; 3GPP TS 05.05, subclause 4.2.2.

2.2 Under extreme conditions; 3GPP TS 05.05, subclause 4.2.2; 3GPP TS 05.05 annex D in subclauses D.2.1 and D.2.2.

3. When allocated a channel, the power emitted by a GSM 400, GSM 900 and DCS 1 800 MS, in the band 935 MHz to 960 MHz shall be no more than -79 dBm, in the band 925 MHz to 935 MHz shall be no more than -67 dBm and in the band 1 805 MHz to 1 880 MHz shall be no more than -71 dBm except in five measurements in each of the bands 925 MHz to 960 MHz and 1 805 MHz to 1 880 MHz where exceptions at up to -36 dBm are permitted. For GSM 400 MS, in addition, the power emitted by MS, in the bands of 460,4 MHz to 467,6 MHz and 488,8 MHz to 496 MHz shall be no more than -67 dBm except in three measurements in each of the bands 460,4 MHz to 467,6 MHz and 488,8 MHz to 496 MHz where exceptions at up to -36 dBm are permitted. For PCS 1 900 MS, the power emitted by MS, in the band 869 MHz to 894 MHz shall be no more than -79 dBm, in the band 1 930 MHz to 1 990 MHz shall be no more than -71 dBm except in five measurements in each of the bands 869 MHz to 894 MHz and 1 930 MHz to 1 990 MHz where exceptions at up to -36 dBm are permitted. For GSM 700 and GSM 850, the power emitted by MS, in the band 747 MHz to 757 MHz shall be no more than -79 dBm, in the band of 757 MHz to 762 MHz shall be no more than -73 dBm, in the band 869 MHz to 894 MHz shall be no more than -79 dBm, in the band 1 930 MHz to 1 990 MHz shall be no more than -71 dBm except in five measurements in each of the bands 747 MHz to 762 MHz, 869 MHz to 894 MHz and 1 930 MHz to 1 990 MHz where exceptions at up to -36 dBm are permitted. Under normal conditions; 3GPP TS 05.05, subclause 4.3.3.

13.8.3 Test purpose

1. To verify that the output RF spectrum due to modulation does not exceed conformance requirement 1 in the multislot configurations.
 - 1.1 Under normal conditions.
 - 1.2 Under extreme conditions.
2. To verify that the output RF spectrum due to switching transients does not exceed conformance requirement 2 in the multislot configurations when a reasonable margin is allowed for the effect of spectrum due to modulation.
 - 2.1 Under normal conditions.
 - 2.2 Under extreme conditions.
3. To verify that the MS spurious emissions in the MS receive band do not exceed conformance requirement 3 in the multislot configurations.

13.8.4 Method of test

13.8.4.1 Initial conditions

A call is set up according to the generic call set up procedure for multislot HSCSD.

The SS commands the MS to hopping mode. The hopping pattern includes only three channels, namely one with an ARFCN in the Low ARFCN range, a second one with an ARFCN in the Mid ARFCN range and the third one with an ARFCN in the High ARFCN range.

NOTE 1: Although the measurement is made whilst the MS is in hopping mode, each measurement is on one single channel.

NOTE 2: This test is specified in hopping mode as a simple means of making the MS change channel, it would be sufficient to test in non hopping mode and to handover the MS between the three channels tested at the appropriate time.

The SS sends Standard Test Signal C1 (annex 5) to the MS at a level of $23 \text{ dB}\mu\text{Vemf}(\)$.

The SS sets the MS to operate in a multislot configuration where is maximum number of transmitting timeslots. Maximum power level is set in all channels.

13.8.4.2 Procedure

NOTE: When averaging is in use during frequency hopping mode, the averaging only includes bursts transmitted when the hopping carrier corresponds to the nominal carrier of the measurement.

a) In steps b) to h) the FT is equal to the hop pattern ARFCN in the Mid ARFCN range.

b) The other settings of the spectrum analyser are set as follows:

- Zero frequency scan;
- Resolution bandwidth: 30 kHz;
- Video bandwidth: 30 kHz;
- Video averaging: may be used, depending on the implementation of the test.

The video signal of the spectrum analyser is "gated" such that the spectrum generated by at least 40 of the bits 87 to 132 of the burst in one of the active time slots is the only spectrum measured. This gating may be analogue or numerical, dependent upon the design of the spectrum analyser. Only measurements during transmitted bursts on the nominal carrier of the measurement are included. The spectrum analyser averages over the gated period and over 200 or 50 such bursts, using numerical and/or video averaging.

c) By tuning the spectrum analyser centre frequency to the measurement frequencies the power level is measured over 50 bursts at all multiples of 30 kHz offset from FT to $< 1\ 800 \text{ kHz}$.

d) The resolution and video bandwidth on the spectrum analyser are adjusted to 100 kHz and the measurements are made at the following frequencies:

- on every ARFCN from 1 800 kHz offset from the carrier to the edge of the relevant transmit band for each measurement over 50 bursts.
- at 200 kHz intervals over the 2 MHz either side of the relevant transmit band for each measurement over 50 bursts.

For GSM 400, GSM 900 and DCS 1 800:

- at 200 kHz intervals over the band 925 MHz to 960 MHz for each measurement over 50 bursts.
- at 200 kHz intervals over the band 1 805 MHz to 1 880 MHz for each measurement over 50 bursts.
- in addition for GSM 400 MS:
 - at 200 kHz intervals over the band 460,4 MHz to 467,6 MHz for each measurement over 50 bursts.
 - at 200 kHz intervals over the band 488,8 MHz to 496 MHz for each measurement over 50 bursts.

For GSM 700 and GSM 850:

- at 200 kHz intervals over the band 747 MHz to 762 MHz for each measurement over 50 bursts.
- at 200 kHz intervals over the band 869 MHz to 894 MHz for each measurement over 50 bursts.
- at 200 kHz intervals over the band 1 930 MHz to 1 990 MHz for each measurement over 50 bursts.

For PCS 1 900:

- at 200 kHz intervals over the band 869 MHz to 894 MHz for each measurement over 50 bursts.
- at 200 kHz intervals over the band 1 930 MHz to 1 990 MHz for each measurement over 50 bursts.

e) The MS is commanded to its minimum power control level. The spectrum analyser is set again as in b).

f) By tuning the spectrum analyser centre frequency to the measurement frequencies the power level is measured over 200 bursts at the following frequencies:

FT;

FT + 100 kHz FT - 100 kHz;

FT + 200 kHz FT - 200 kHz;

FT + 250 kHz FT - 250 kHz;

FT + 200 kHz * N FT - 200 kHz × N;

where N = 2, 3, 4, 5, 6, 7, and 8;

and FT = RF channel nominal centre frequency.

g) Steps a) to f) is repeated except that in step a) the spectrum analyzer is gated so that the burst of the next active time slot is measured.

h) The spectrum analyser settings are adjusted to:

- Zero frequency scan;
- Resolution bandwidth: 30 kHz;
- Video bandwidth: 100 kHz;
- Peak hold.

The spectrum analyser gating of the signal is switched off.

The MS is commanded to its maximum power control level in every transmitted time slot.

- i) By tuning the spectrum analyser centre frequency to the measurement frequencies the power level is measured at the following frequencies:

FT + 400 kHz FT - 400 kHz;

FT + 600 kHz FT - 600 kHz;

FT + 1,2 MHz FT - 1,2 MHz;

FT + 1,8 MHz FT - 1,8 MHz;

where FT = RF channel nominal centre frequency.

The duration of each measurement (at each frequency) will be such as to cover at least 10 burst transmissions at FT.

- j) Step i) is repeated for power control levels 7 and 11.
- k) Steps b), f), h) and i) are repeated with FT equal to the hop pattern ARFCN in the Low ARFCN range except that in step h) the MS is commanded to power control level 11 rather than maximum power.
- l) Steps b), f), h) and i) are repeated with FT equal to the hop pattern ARFCN in the High ARFCN range except that in step h) the MS is commanded to power control level 11 rather than maximum power.
- m) Steps a) b) f) h), and i) are repeated under extreme test conditions (annex 1, TC2.2). except that at step h) the MS is commanded to power control level 11.

13.8.5 Test requirements

For absolute measurements, performed on a temporary antenna connector, in the frequency band 450,4 MHz to 457,6 MHz, 478,8 MHz to 486 MHz, 777 MHz to 792 MHz, 824 MHz to 849 MHz, 880 MHz to 915 MHz, 1 710 MHz to 1 785 MHz or 1 850 MHz to 1 910 MHz, the temporary antenna connector coupling factor, determined according to subclause 13.3.4.2.2 and annex 1 GC7, for the nearest relevant frequency, will be used.

For absolute measurements, performed on a temporary antenna connector, in the frequency band 925 MHz to 960 MHz, the temporary antenna connector coupling factor, will be as determined according to annex 1 GC7 for GSM 900 MS. For a GSM 400, GSM 700, GSM 850 or DCS 1 800 or PCS 1 900 MS 0 dB will be assumed.

For absolute measurements, performed on a temporary antenna connector, in the frequency band 1 805 MHz to 1 880 MHz, the temporary antenna connector coupling factor, will be as determined according to annex 1 GC7 for DCS 1 800 MS. For GSM 400, GSM 700, GSM 850, GSM 900 or PCS 1 900 MS 0 dB will be assumed.

For absolute measurements, performed on a temporary antenna connector, in the frequency band 460,4 MHz to 467,6 MHz or 488,8 MHz to 496 MHz, the temporary antenna connector coupling factor, will be as determined according to annex 1 GC7 for GSM 400 MS. For a GSM 700, GSM 850, GSM 900, DCS 1 800 or PCS 1 900 MS 0 dB will be assumed.

For absolute measurements, performed on a temporary antenna connector, in the frequency band 747 MHz to 762 MHz, the temporary antenna connector coupling factor, will be as determined according to annex 1 GC7 for GSM 700 MS. For a GSM 400, GSM 850, GSM 900 or DCS 1 800 MS 0 dB will be assumed.

For absolute measurements, performed on a temporary antenna connector, in the frequency band 869 MHz to 894 MHz, the temporary antenna connector coupling factor, will be as determined according to annex 1 GC7 for GSM 850 MS. For a GSM 400, GSM 700, GSM 900 or DCS 1 800 MS 0 dB will be assumed.

For absolute measurements, performed on a temporary antenna connector, in the frequency band 1 930 MHz to 1 990 MHz, the temporary antenna connector coupling factor, will be as determined according to annex 1 GC7 for PCS 1 900 MS. For GSM 400, GSM 900 or DCS 1 800 MS 0 dB will be assumed.

The figures in the tables below, at the listed frequencies from the carrier (kHz), are the maximum level (dB) relative to a measurement in 30 kHz bandwidth on the carrier (reference 3GPP TS 05.05 subclause 4.2.1).

- a) For the modulation sidebands out to less than 1 800 kHz offset from the carrier frequency (FT) measured in step c), f), i), k), l) and m) the measured power level in dB relative to the power level measured at FT, for all types of

MS, shall not exceed the limits derived from the values shown in table 1 for GSM 400, GSM 700, GSM 850 and GSM 900, table 2 for DCS 1 800 or table 3 for PCS 1 900 according to the actual transmit power and frequency offset from FT. However any failures in the combined range 600 kHz to less than 1 800 kHz above and below the carrier may be counted towards the exceptions allowed in test requirements c) below.

Table 1: GSM 400, GSM 700, GSM 850 and GSM 900 Spectrum due to modulation out to less than 1 800 kHz offset

	power levels in dB relative to the measurement at FT				
Power level	Frequency offset (kHz)				
(dBm)	0-100	200	250	400	600 to <1 800
39	+0,5	-30	-33	-60	-66
37	+0,5	-30	-33	-60	-64
35	+0,5	-30	-33	-60	-62
<= 33	+0,5	-30	-33	-60	-60
The values above are subject to the minimum absolute levels (dBm) below.					
	-36	-36	-36	-36	-51

Table 2: DCS 1 800 Spectrum due to modulation out to less than 1 800 kHz offset

	power levels in dB relative to the measurement at FT				
Power level	Frequency offset (kHz)				
(dBm)	0-100	200	250	400	600 to <1 800
<= 36	+0,5	-30	-33	-60	-60
The values above are subject to the minimum absolute levels (dBm) below.					
	-36	-36	-36	-36	-56

Table 3: PCS 1 900 Spectrum due to modulation out to less than 1 800 kHz offset

	power levels in dB relative to the measurement at FT					
Power level	Frequency offset (kHz)					
(dBm)	0-100	200	250	400	600 to <1 200	1 200 to <1 800
<= 33	+0,5	-30	-33	-60	-60	-60
The values above are subject to the minimum absolute levels (dBm) below.						
	-36	-36	-36	-36	-56	-56

NOTE 1: For frequency offsets between 100 kHz and 600 kHz the requirement is derived by a linear interpolation between the points identified in the table with linear frequency and power in dB relative.

- b) For the modulation sidebands from 1 800 kHz offset from the carrier frequency (FT) and out to 2 MHz beyond the edge of the relevant transmit band, measured in step d), the measured power level in dB relative to the power level measured at FT, shall not exceed the values shown in table 4 according to the actual transmit power, frequency offset from FT and system on which the MS is designed to operate. However any failures in the combined range 1 800 kHz to 6 MHz above and below the carrier may be counted towards the exceptions allowed in test requirements c) below, and any other failures may be counted towards the exceptions allowed in test requirements d) below.

Table 4: Spectrum due to modulation from 1 800 kHz offset to the edge of the transmit band (wideband noise)

power levels in dB relative to the measurement at FT									
GSM 400, GSM 700, GSM 850 and GSM 900				DCS 1 800			PCS 1 900		
Power	Frequency offset			Power	Frequency offset		Power	Frequency offset	
Level	kHz			Level	KHz		level	KHz	
(dBm)	1 800 to	3 000 to	>= 6 000	(dBm)	1 800 to	>= 6 000	(dBm)	1 800 to	>= 6 000
	< 3 000	< 6 000			< 6 000			< 6 000	
39	-69	-71	-77	36	-71	-79	33	-68	-76
37	-67	-69	-75	34	-69	-77	32	-67	-75
35	-65	-67	-73	32	-67	-75	30	-65	-73
<= 33	-63	-65	-71	30	-65	-73	28	-63	-71
				28	-63	-71	26	-61	-69
				26	-61	-69	<= 24	-59	-67
				<= 24	-59	-67			
The values above are subject to the minimum absolute levels (dBm) below.									
	-46	-46	-46		-51	-51		-51	-51

- c) Any failures (from a) and b) above) in the combined range 600 kHz to 6 MHz above and below the carrier should be re-checked for allowed spurious emissions. For each of the three ARFCN used, spurious emissions are allowed in up to three 200 kHz bands centred on an integer multiple of 200 kHz so long as no spurious emission exceeds -36 dBm. Any spurious emissions measured in a 30 kHz bandwidth which spans two 200 kHz bands can be counted towards either 200 kHz band, whichever minimizes the number of 200 kHz bands containing spurious exceptions.
- d) Any failures (from b) above) beyond 6 MHz offset from the carrier should be re-checked for allowed spurious emissions. For each of the three ARFCN used, up to twelve spurious emissions are allowed so long as no spurious emission exceeds -36 dBm.
- e) For GSM 400, GSM 900 and DCS 1 800 MS spurious emissions in the bands 925 MHz to 935 MHz, 935 MHz to 960 MHz and 1 805 MHz to 1 880 MHz, measured in step d), shall not exceed the values shown in table 5 except in up to five measurements in the band 925 MHz to 960 MHz and five measurements in the band 1 805 MHz to 1 880 MHz where a level up to -36 dBm is permitted. For GSM 400 MS, in addition, the MS spurious emissions in the bands 460,4 MHz to 467,6 MHz and 488,8 MHz to 496 MHz shall not exceed the value of -67 dBm, except in up to three measurements in each of the bands 460,4 MHz to 467,6 MHz and 488,8 MHz to 496 MHz where a level up to -36 dBm is permitted. For GSM 700 and GSM 850 the spurious emissions in the bands 747 MHz to 757 MHz, 757 MHz to 762 MHz and 869 MHz to 894 MHz and 1 930 MHz to 1 990 MHz shall not exceed the values shown in table 4 except in up to five measurements in each of the bands 747 MHz to 762 MHz and 869 MHz to 894 MHz and 1 930 MHz to 1 990 MHz where a level up to -36 dBm is permitted. For PCS 1 900 MS the spurious emissions in the bands 869 MHz to 894 MHz and 1 930 MHz to 1 990 MHz shall not exceed the values shown in table 5 except in up to five measurements in each of the bands 869 MHz to 894 MHz and 1 930 MHz to 1 990 MHz where a level up to -36 dBm is permitted.

Table 5: Spurious emissions in the MS receive bands

Band (MHz)	Spurious emissions level (dBm)	
	GSM 400, GSM 900 and DCS 1 800	GSM 700, GSM 850 and PCS 1 900
925 to 935	-67	
935 to 960	-79	
1 805 to 1 880	-71	
747 to 757		-79
757 to 762		-73
869 to 894		-79
1 930 to 1 990		-71

- f) For the power ramp sidebands of steps h), i) and k) the power levels must not exceed the values shown in table 6 for GSM 400, GSM 700, GSM 850 and GSM 900, table 7 for DCS 1 800 or table 8 for PCS 1 900.

Table 6: GSM Spectrum due to switching transients

Power level	Maximum level for various offsets from carrier frequency			
	400 kHz	600 kHz	1 200 kHz	1 800 kHz
39 dBm	-13 dBm	-21 dBm	-21 dBm	-24 dBm
37 dBm	-15 dBm	-21 dBm	-21 dBm	-24 dBm
35 dBm	-17 dBm	-21 dBm	-21 dBm	-24 dBm
33 dBm	-19 dBm	-21 dBm	-21 dBm	-24 dBm
31 dBm	-21 dBm	-23 dBm	-23 dBm	-26 dBm
29 dBm	-23 dBm	-25 dBm	-25 dBm	-28 dBm
27 dBm	-23 dBm	-26 dBm	-27 dBm	-30 dBm
25 dBm	-23 dBm	-26 dBm	-29 dBm	-32 dBm
23 dBm	-23 dBm	-26 dBm	-31 dBm	-34 dBm
<= +21 dBm	-23 dBm	-26 dBm	-32 dBm	-36 dBm

Table 7: DCS 1 800 Spectrum due to switching transients

Power level	Maximum level for various offsets from carrier frequency			
	400 kHz	600 kHz	1 200 kHz	1 800 kHz
36 dBm	-16 dBm	-21 dBm	-21 dBm	-24 dBm
34 dBm	-18 dBm	-21 dBm	-21 dBm	-24 dBm
32 dBm	-20 dBm	-22 dBm	-22 dBm	-25 dBm
30 dBm	-22 dBm	-24 dBm	-24 dBm	-27 dBm
28 dBm	-23 dBm	-25 dBm	-26 dBm	-29 dBm
26 dBm	-23 dBm	-26 dBm	-28 dBm	-31 dBm
24 dBm	-23 dBm	-26 dBm	-30 dBm	-33 dBm
22 dBm	-23 dBm	-26 dBm	-31 dBm	-35 dBm
<= +20 dBm	-23 dBm	-26 dBm	-32 dBm	-36 dBm

Table 8: PCS 1 900 Spectrum due to switching transients

Power level	Maximum level for various offsets from carrier frequency			
	400 kHz	600 kHz	1 200 kHz	1 800 kHz
33 dBm	-19 dBm	-22 dBm	-22 dBm	-25 dBm
32 dBm	-20 dBm	-22 dBm	-22 dBm	-25 dBm
30 dBm	-22 dBm	-24 dBm	-24 dBm	-27 dBm
28 dBm	-23 dBm	-25 dBm	-26 dBm	-29 dBm
26 dBm	-23 dBm	-26 dBm	-28 dBm	-31 dBm
24 dBm	-23 dBm	-26 dBm	-30 dBm	-33 dBm
22 dBm	-23 dBm	-26 dBm	-31 dBm	-35 dBm
<= +20 dBm	-23 dBm	-26 dBm	-32 dBm	-36 dBm

NOTE 2: These figures are different from the requirements in 3GPP TS 05.05 because at higher power levels it is the modulation spectrum which is being measured using a peak hold measurement. This allowance is given in the table.

NOTE 3: The figures for table 6, table 7 and table 8 assume that, using the peak hold measurement, the lowest level measurable is 8 dB above the level of the modulation specification using the 30 kHz bandwidth gated average technique for 400 kHz offset from the carrier. At 600 kHz and 1 200 kHz offset the level is 6 dB above and at 1 800 kHz offset the level is 3 dB above. The figures for 1 800 kHz have assumed the 30 kHz bandwidth spectrum due to modulation specification at < 1 800 kHz.

13.9 Output RF spectrum for MS supporting the R-GSM band

13.9.1 Definition

The output RF spectrum is the relationship between the frequency offset from the carrier and the power, measured in a specified bandwidth and time, produced by the MS due to the effects of modulation and power ramping.

13.9.2 Conformance requirement

1. The level of the output RF spectrum due to modulation shall be no more than that given in 3GPP TS 05.05, subclause 4.2.1, table a) for R-GSM 900 with the following lowest measurement limits:

- -36 dBm below 600 kHz offset from the carrier;
- -51 dBm for R-GSM 900 from 600 kHz out to less than 1 800 kHz offset from the carrier;
- -46 dBm for R-GSM 900 at and beyond 1 800 kHz offset from the carrier;

but with the following exceptions at up to -36 dBm:

- up to three bands of 200 kHz width centred on a frequency which is an integer multiple of 200 kHz in the combined range 600 kHz to 6000 kHz above and below the carrier;
- up to 12 bands of 200 kHz width centred on a frequency which is an integer multiple of 200 kHz at more than 6 000 kHz offset from the carrier.

1.1 Under normal conditions; 3GPP TS 05.05, subclause 4.2.1.

1.2 Under extreme conditions; 3GPP TS 05.05, subclause 4.2.1; 3GPP TS 05.05, annex D in subclauses D.2.1 and D.2.2.

2. The level of the output RF spectrum due to switching transients shall be no more than given in 3GPP TS 05.05, subclause 4.2.2, table "a) Mobile Station:".

2.1 Under normal conditions; 3GPP TS 05.05, subclause 4.2.2.

2.2 Under extreme conditions; 3GPP TS 05.05, subclause 4.2.2; 3GPP TS 05.05 annex D in subclauses D.2.1 and D.2.2.

3. When allocated a channel, the power emitted by the MS, in the band 935 MHz to 960 MHz shall be no more than -79 dBm, in the band 925 MHz to 935 MHz shall be no more than -67 dBm, in the band 921 MHz to 925 MHz shall be no more than -60 dBm and in the band 1 805 MHz to 1 880 MHz shall be no more than -71 dBm except in five measurements in each of the bands 925 MHz to 960 MHz and 1 805 MHz to 1 880 MHz where exceptions at up to -36 dBm are permitted. Under normal conditions; 3GPP TS 05.05, subclause 4.3.3.

13.9.3 Test purpose

1. To verify that the output RF spectrum due to modulation does not exceed conformance requirement 1.

1.1 Under normal conditions.

1.2 Under extreme conditions.

2. To verify that the output RF spectrum due to switching transients does not exceed conformance requirement 2 when a reasonable margin is allowed for the effect of spectrum due to modulation.

2.1 Under normal conditions.

2.2 Under extreme conditions.

3. To verify that the MS spurious emissions in the MS receive band do not exceed conformance requirement 3.

13.9.4 Method of test

13.9.4.1 Initial conditions

A call is set up according to the generic call set up procedure.

The SS commands the MS to hopping mode. The hopping pattern includes only three channels, namely one with an ARFCN in the Low R-GSM ARFCN range, a second one with an ARFCN in the Mid ARFCN range and the third one with an ARFCN in the High ARFCN range.

NOTE 1: Although the measurement is made whilst the MS is in hopping mode, each measurement is on one single channel.

NOTE 2: This test is specified in hopping mode as a simple means of making the MS change channel, it would be sufficient to test in non hopping mode and to handover the MS between the three channels tested at the appropriate time.

The SS commands the MS to complete the traffic channel loop back without signalling of erased frames (see subclause 36.2.1.1). This is to set a defined random pattern for the transmitter.

The SS sends Standard Test Signal C1 (annex 5) to the MS at a level of $23 \text{ dB}\mu\text{Vemf}$ ().

13.9.4.2 Procedure

NOTE: When averaging is in use during frequency hopping mode, the averaging only includes bursts transmitted when the hopping carrier corresponds to the nominal carrier of the measurement.

a) In steps b) to h) the FT is equal to the hop pattern ARFCN in the Mid ARFCN range.

b) The other settings of the spectrum analyser are set as follows:

- Zero frequency scan;
- Resolution bandwidth: 30 kHz;
- Video bandwidth: 30 kHz;
- Video averaging: may be used, depending on the implementation of the test.

The video signal of the spectrum analyser is "gated" such that the spectrum generated by at least 40 of the bits 87 to 132 of the burst is the only spectrum measured. This gating may be analogue or numerical, dependent upon the design of the spectrum analyser. Only measurements during transmitted bursts on the nominal carrier of the measurement are included. The spectrum analyser averages over the gated period and over 200 or 50 such bursts, using numerical and/or video averaging.

The MS is commanded to its maximum power control level.

c) By tuning the spectrum analyser centre frequency to the measurement frequencies the power level is measured over 50 bursts at all multiples of 30 kHz offset from FT to $< 1\ 800 \text{ kHz}$.

d) The resolution and video bandwidth on the spectrum analyser are adjusted to 100 kHz and the measurements are made at the following frequencies:

- on every ARFCN from 1 800 kHz offset from the carrier to the edge of the relevant transmit band for each measurement over 50 bursts.
- at 200 kHz intervals over the 2 MHz either side of the relevant transmit band for each measurement over 50 bursts.
- at 200 kHz intervals over the band 921 MHz to 960 MHz for each measurement over 50 bursts.
- at 200 kHz intervals over the band 1 805 MHz to 1 880 MHz for each measurement over 50 bursts.

e) The MS is commanded to its minimum power control level. The spectrum analyser is set again as in b).

f) By tuning the spectrum analyser centre frequency to the measurement frequencies the power level is measured over 200 bursts at the following frequencies:

FT;

FT + 100 kHz FT - 100 kHz;

FT + 200 kHz FT - 200 kHz;

FT + 250 kHz FT - 250 kHz;

FT + 200 kHz \times N FT - 200 kHz \times N;

where $N = 2, 3, 4, 5, 6, 7,$ and 8 ;

and $FT = RF$ channel nominal centre frequency.

g) The spectrum analyser settings are adjusted to:

- Zero frequency scan;
- Resolution bandwidth: 30 kHz;
- Video bandwidth: 100 kHz;
- Peak hold.

The spectrum analyser gating of the signal is switched off.

The MS is commanded to its maximum power control level.

h) By tuning the spectrum analyser centre frequency to the measurement frequencies the power level is measured at the following frequencies:

$FT + 400$ kHz	$FT - 400$ kHz;
$FT + 600$ kHz	$FT - 600$ kHz;
$FT + 1,2$ MHz	$FT - 1,2$ MHz;
$FT + 1,8$ MHz	$FT - 1,8$ MHz;

where $FT = RF$ channel nominal centre frequency.

The duration of each measurement (at each frequency) will be such as to cover at least 10 burst transmissions at FT .

- i) Step h) is repeated for power control levels 7 and 11.
- j) Steps b), f), g) and h) are repeated with FT equal to the hop pattern ARFCN in the Low R-GSM ARFCN range except that in step g) the MS is commanded to power control level 11 rather than maximum power.
- k) Steps b), f), g) and h) are repeated with FT equal to the hop pattern ARFCN in the High ARFCN range except that in step g) the MS is commanded to power control level 11 rather than maximum power.
- l) Steps a), b), f), g) and h) are repeated under extreme test conditions (annex 1, TC2.2). except that at step g) the MS is commanded to power control level 11.

13.9.5 Test requirements

For absolute measurements, performed on a temporary antenna connector, in the frequency band 876 MHz to 915 MHz or 1 710 MHz to 1 785 MHz, the temporary antenna connector coupling factor, determined according to subclause 13.3.4.2.2 and annex 1 GC7, for the nearest relevant frequency, will be used.

For absolute measurements, performed on a temporary antenna connector, in the frequency band 921 MHz to 960 MHz, the temporary antenna connector coupling factor, will be as determined according to annex 1 GC7 for GSM 900 MS

For absolute measurements, performed on a temporary antenna connector, in the frequency band 1 805 MHz to 1 880 MHz for R-GSM 900 MS 0 dB will be assumed.

The figures in the tables below, at the listed frequencies from the carrier (kHz), are the maximum level (dB) relative to a measurement in 30 kHz bandwidth on the carrier (reference 3GPP TS 05.05 subclause 4.2.1).

- a) For the modulation sidebands out to less than 1 800 kHz offset from the carrier frequency (FT) measured in step c), f), h), j), k) and l) the measured power level in dB relative to the power level measured at FT , for all types of MS, shall not exceed the limits derived from the values shown in table 13.9-1 for R-GSM 900 according to the actual transmit power and frequency offset from FT . However any failures in the combined range 600 kHz to less than 1 800 kHz above and below the carrier may be counted towards the exceptions allowed in test requirements c) below.

Table 13.9-1a: R-GSM 900 Spectrum due to modulation out to less than 1 800 kHz offset

power levels in dB relative to the measurement at FT					
Power level (dBm)	Frequency offset (kHz)				
	0-100	200	250	400	600 to <1 800
39	+0,5	-30	-33	-60	-66
37	+0,5	-30	-33	-60	-64
35	+0,5	-30	-33	-60	-62
<= 33	+0,5	-30	-33	-60	-60
The values above are subject to the minimum absolute levels (dBm) below.					
	-36	-36	-36	-36	-51

NOTE 1: For frequency offsets between 100 kHz and 600 kHz the requirement is derived by a linear interpolation between the points identified in the table with linear frequency and power in dB relative.

- b) For the modulation sidebands from 1 800 kHz offset from the carrier frequency (FT) and out to 2 MHz beyond the edge of the relevant transmit band, measured in step d), the measured power level in dB relative to the power level measured at FT, shall not exceed the values shown in table 13.9-2 according to the actual transmit power, frequency offset from FT and system on which the MS is designed to operate. However any failures in the combined range 1 800 kHz to 6 MHz above and below the carrier may be counted towards the exceptions allowed in test requirements c) below, and any other failures may be counted towards the exceptions allowed in test requirements d) below.

Table 13.9-2: Spectrum due to modulation from 1 800 kHz offset to the edge of the transmit band (wideband noise)

Power levels in dB relative to the measurement at FT			
R-GSM 900			
Power level (dBm)	Frequency offset kHz		
	1 800 to < 3 000	3 000 to < 6 000	>= 6 000
39	-69	-71	-77
37	-67	-69	-75
35	-65	-67	-73
<= 33	-63	-65	-71
The values above are subject to the minimum absolute levels (dBm) below			
	-46	-46	-46

- c) Any failures (from a) and b) above) in the combined range 600 kHz to 6 MHz above and below the carrier should be re-checked for allowed spurious emissions. For each of the three ARFCN used, spurious emissions are allowed in up to three 200 kHz bands centred on an integer multiple of 200 kHz so long as no spurious emission exceeds -36 dBm. Any spurious emissions measured in a 30 kHz bandwidth which spans two 200 kHz bands can be counted towards either 200 kHz band, whichever minimizes the number of 200 kHz bands containing spurious exceptions.
- d) Any failures (from b) above) beyond 6 MHz offset from the carrier should be re-checked for allowed spurious emissions. For each of the three ARFCN used, up to twelve spurious emissions are allowed so long as no spurious emission exceeds -36 dBm.
- e) The MS spurious emissions in the bands 921 MHz to 925 MHz, 925 MHz to 935 MHz, 935 MHz to 960 MHz and 1 805 MHz to 1 880 MHz, measured in step d), for all types of MS, shall not exceed the values shown in table 13.9-3 except in up to five measurements in the band 925 to 960 MHz and five measurements in the band 1 805 MHz to 1 880 MHz where a level up to -36 dBm is permitted.

Table 13.9-3: Spurious emissions in the R-GSM MS receive bands

Band (MHz)	Spurious emissions level (dBm)
921 to 925	-60
925 to 935	-67
935 to 960	-79
1 805 to 1 880	-71

- f) For the power ramp sidebands of steps h) and i) the power levels must not exceed the values shown in table 13.9-4 for GSM 900.

Table 13.9-4: R-GSM Spectrum due to switching transients

Power level	Maximum level for various offsets from carrier frequency			
	400 kHz	600 kHz	1 200 kHz	1 800 kHz
39 dBm	-13 dBm	-21 dBm	-21 dBm	-24 dBm
37 dBm	-15 dBm	-21 dBm	-21 dBm	-24 dBm
35 dBm	-17 dBm	-21 dBm	-21 dBm	-24 dBm
33 dBm	-19 dBm	-21 dBm	-21 dBm	-24 dBm
31 dBm	-21 dBm	-23 dBm	-23 dBm	-26 dBm
29 dBm	-23 dBm	-25 dBm	-25 dBm	-28 dBm
27 dBm	-23 dBm	-26 dBm	-27 dBm	-30 dBm
25 dBm	-23 dBm	-26 dBm	-29 dBm	-32 dBm
23 dBm	-23 dBm	-26 dBm	-31 dBm	-34 dBm
<= +21 dBm	-23 dBm	-26 dBm	-32 dBm	-36 dBm

NOTE 2: These figures are different from the requirements in 3GPP TS 05.05 because at higher power levels it is the modulation spectrum which is being measured using a peak hold measurement. This allowance is given in the table.

NOTE 3: The figures for table 13.9-4 assume that, using the peak hold measurement, the lowest level measurable is 8 dB above the level of the modulation specification using the 30 kHz bandwidth gated average technique for 400 kHz offset from the carrier. At 600 and 1200 kHz offset the level is 6 dB above and at 1 800 kHz offset the level is 3 dB above. The figures for 1 800 kHz have assumed the 30 kHz bandwidth spectrum due to modulation specification at < 1 800 kHz.

13.10 (void)

13.11 (void)

13.12 (void)

13.13 (void)

13.14 (void)

13.15 (void)

13.16 GPRS transmitter tests

13.16.1 Frequency error and phase error in GPRS multislots configuration

13.16.1.1 Definition

The frequency error is the difference in frequency, after adjustment for the effect of the modulation and phase error, between the RF transmission from the MS and either:

- the RF transmission from the BS; or

- the nominal frequency for the ARFCN used.

The phase error is the difference in phase, after adjustment for the effect of the frequency error, between the RF transmission from the MS and the theoretical transmission according to the intended modulation.

13.16.1.2 Conformance requirement

1. The MS carrier frequency shall be accurate to within 0,1 ppm compared to signals received from the BS.
 - 1.1 Under normal conditions; 3GPP TS 05.10, subclause 6.1.
 - 1.2 Under vibration conditions; 3GPP TS 05.10, subclause 6.1; 3GPP TS 05.05, annex D subclause D.2.3.
 - 1.3 Under extreme conditions; 3GPP TS 05.10, subclause 6.1; 3GPP TS 05.05, subclause 4.4; 3GPP TS 05.05, annex D subclauses D.2.1 and D.2.2.
2. The RMS phase error (difference between the phase error trajectory and its linear regression on the active part of the time slot) for each burst shall not be greater than 5 degrees.
 - 2.1 Under normal conditions; 3GPP TS 05.05, subclause 4.6.
 - 2.2 Under vibration conditions; 3GPP TS 05.05, subclause 4.6; 3GPP TS 05.05, annex D D.2.3.
 - 2.3 Under extreme conditions; 3GPP TS 05.05, subclause 4.6; 3GPP TS 05.05, annex D D.2.1, D.2.2.
3. The maximum peak deviation during the useful part of each burst shall not be greater than 20 degrees.
 - 3.1 Under normal conditions; 3GPP TS 05.05, subclause 4.6.
 - 3.2 Under vibration conditions; 3GPP TS 05.05, subclause 4.6; 3GPP TS 05.05, annex D subclause D.2.3.
 - 3.3 Under extreme conditions; 3GPP TS 05.05, subclause 4.6; 3GPP TS 05.05, annex D subclauses D.2.1 and D.2.2.

13.16.1.3 Test purpose

1. To verify that in a multislots configuration the MS carrier frequency error does not exceed 0.1 ppm:
 - 1.1 Under normal conditions.
 - 1.2 When the MS is being vibrated.
 - 1.3 Under extreme conditions.
2. To verify that the RMS phase error on the useful parts of the bursts transmitted by the MS in a multislots configuration does not exceed conformance requirement 2:
 - 2.1 Under normal conditions.
 - 2.2 When the MS is being vibrated.
 - 2.3 Under extreme conditions.
3. To verify that the maximum phase error on the useful parts of the bursts transmitted by the MS in a multislots configuration does not exceed conformance requirement 3:
 - 3.1 Under normal conditions.
 - 3.2 When the MS is being vibrated.
 - 3.3 Under extreme conditions.

13.16.1.4 Method of the test

NOTE: In order to measure the accuracy of the frequency and phase error a sampled measurement of the transmitted phase trajectory is obtained. This is compared with the theoretically expected phase trajectory. The regression line of the difference between the expected trajectory and the measured trajectory is an indication of the frequency error (assumed constant through the burst), whilst the departure of the phase differences from this trajectory is a measure of the phase error. The peak phase error is the value furthest from the regression line and the RMS phase error is the root mean square average of the phase error of all samples.

13.16.1.4.1 Initial conditions

The test shall be run under the default GPRS conditions defined in clause 40, with power control parameter ALPHA (α) set to 0.

The SS commands the MS to hopping mode (table 13.6.1, 3GPP TS 11.10).

NOTE: It is not necessary to test in hopping mode but is done here as a simple means of making the MS change channel, it would be sufficient to test in non hopping mode and to make sure bursts are taken from a few different channels.

The MS shall be operated with it's highest number of uplink slots.

The Test Mode defined in 3GPP TS 04.14 (subclause 5.4) will be utilised. If the MS is capable of both:

Mode (a) transmitting pseudo-random data sequence in RLC data blocks;

Mode (b) transmitting looped-back RLC data blocks;

then Mode (a) will be used.

If Mode (b) is used then the SS sends the psuedo-random data sequence specified for Mode (a) on the downlink for loopback on the uplink.

Specific PICS statements:

- MS without vibration sensitive components (TSPC_No_Vibration_Sensitive_Components)

PIXIT Statements:

-

13.16.1.4.2 Procedure

- a) For one transmitted burst on the last slot of the multislot configuration, the SS captures the signal as a series of phase samples over the period of the burst. These samples are evenly distributed over the duration of the burst with a minimum sampling rate of $2/T$, where T is the modulation symbol period. The received phase trajectory is then represented by this array of at least 294 samples.
- b) The SS then calculates, from the known bit pattern and the formal definition of the modulator contained in 3GPP TS 05.04, the expected phase trajectory.
- c) From a) and b) the phase trajectory error is calculated, and a linear regression line computed through this phase trajectory error. The slope of this regression line is the frequency error of the mobile transmitter relative to the simulator reference. The difference between the regression line and the individual sample points is the phase error of that point.

- c.1) The sampled array of at least 294 phase measurements is represented by the vector:

$$\varnothing_m = \varnothing_m(0) \dots \varnothing_m(n)$$

where the number of samples in the array $n+1 \geq 294$.

- c.2) The calculated array, at the corresponding sampling instants, is represented by the vector:

$$\varnothing_c = \varnothing_c(0) \dots \varnothing_c(n).$$

- c.3) The error array is represented by the vector:

$$\varnothing_e = \{\varnothing_m(0) - \varnothing_c(0)\} \dots \dots \dots \{\varnothing_m(n) - \varnothing_c(n)\} = \varnothing_e(0) \dots \varnothing_e(n).$$

- c.4) The corresponding sample numbers form a vector $t = t(0) \dots t(n)$.

- c.5) By regression theory the slope of the samples with respect to t is k where:

$$k = \frac{\sum_{j=0}^{j=n} t(j) * \varnothing_e(j)}{\sum_{j=0}^{j=n} t(j)^2}$$

- c.6) The frequency error is given by $k/(360 * g)$, where g is the sampling interval in s and all phase samples are measured in degrees.

- c.7) The individual phase errors from the regression line are given by:

$$\varnothing_e(j) - k * t(j).$$

- c.8) The RMS value \varnothing_e of the phase errors is given by:

$$\varnothing_e(\text{RMS}) = \left[\frac{\sum_{j=0}^{j=n} \{\varnothing_e(j) - k * t(j)\}^2}{n + 1} \right]^{1/2}$$

- d) Steps a) to c) are repeated for 20 bursts, not necessarily contiguous.
- e) The SS instructs the MS to its maximum power control level by setting the power control parameter ALPHA (α) to 0 and GAMMA_TN (Γ_{CH}) for each timeslot to the desired power level in the Packet Uplink Assignment message (Closed Loop Control, see 3GPP TS 05.08, clause B.2), all other conditions remaining constant. Steps a) to d) are repeated.
- f) The SS instructs the MS to the minimum power control level, all other conditions remaining constant. Steps a) to d) are repeated.
- g) The MS is hard mounted on a vibration table and vibrated at the frequency/amplitudes specified in annex 1, TC4. During the vibration steps a) to f) are repeated.

NOTE 1: If the call is terminated when mounting the MS to the vibration table, it will be necessary to establish the initial conditions again before repeating steps a) to f).

- h) The MS is re-positioned on the vibration table in the two orthogonal planes to the plane used in step g). For each of the orthogonal planes step g) is repeated.

- i) Steps a) to f) are repeated under extreme test conditions (see annex 1, TC2.2).

NOTE 2: Steps g) and h) are skipped if TSPC_No_Vibration_Sensitive_Components is declared as Yes

13.16.1.5.1 Frequency error

For all measured bursts, the frequency error, derived in step c.6), shall be less than $10E-7$.

13.16.1.5.2 Phase error

For all measured bursts, the RMS phase error, derived in step c.8), shall not exceed 5 degrees.

For all measured bursts, each individual phase error, derived in step c.7), shall not exceed 20 degrees.

13.16.2 Transmitter output power in GPRS multislot configuration

13.16.2.1 Definition

The transmitter output power is the average value of the power delivered to an artificial antenna or radiated by the MS and its integral antenna, over the time that the useful information bits of one burst are transmitted.

13.16.2.2 Conformance requirement

1. The MS maximum output power shall be as defined in 3GPP TS 05.05, subclause 4.1.1, first table, according to its power class, with a tolerance of ± 2 dB under normal conditions; 3GPP TS 05.05, subclause 4.1.1, first table. From R99 onwards, the MS maximum output power in an uplink multislot configuration shall be as defined in 3GPP TS 05.05 subclause 4.1.1, sixth table, according to its power class, with a tolerance of ± 3 dB under normal conditions; 3GPP TS 05.05, subclause 4.1.1, first and sixth table. In case the MS supports the same maximum output power in an uplink multislot configuration as it supports for single slot uplink operation, the tolerance shall be ± 2 dB.
2. The MS maximum output power shall be as defined in 3GPP TS 05.05, subclause 4.1.1, first table, according to its power class, with a tolerance of $\pm 2,5$ dB under extreme conditions; 3GPP TS 05.05, subclause 4.1.1, first table; 3GPP TS 05.05 annex D subclauses D.2.1 and D.2.2. From R99 onwards, the MS maximum output power in an uplink multislot configuration shall be as defined in 3GPP TS 05.05 subclause 4.1.1, sixth table, according to its power class, with a tolerance of ± 4 dB under extreme conditions; 3GPP TS 05.05, subclause 4.1.1, first and sixth table; 3GPP TS 05.05 annex D in subclauses D.2.1 and D.2.2. In case the MS supports the same maximum output power in an uplink multislot configuration as it supports for single slot uplink operation, the tolerance shall be $\pm 2,5$ dB.
3. The power control levels shall have the nominal output power levels as defined in 3GPP TS 05.05, subclause 4.1.1, third table (for GSM 400, GSM 700, GSM 850 and GSM 900), fourth table (for DCS 1 800) or fifth table (for PCS 1 900), from the lowest power control level up to the maximum output power corresponding to the class of the MS (for tolerance on maximum output power see conformance requirements 1), with a tolerance of ± 3 dB, ± 4 dB or ± 5 dB under normal conditions; 3GPP TS 05.05, subclause 4.1.1, third, fourth or fifth table.
4. The power control levels shall have the nominal output power levels as defined in 3GPP TS 05.05, subclause 4.1.1, third table (for GSM 400, GSM 700, GSM 850 and GSM 900), fourth table (for DCS 1 800) or fifth table (for PCS 1 900), from the lowest power control level up to the maximum output power corresponding to the class of the MS (for tolerance on maximum output power see conformance requirements 2), with a tolerance of ± 4 dB, ± 5 dB or ± 6 dB under extreme conditions; 3GPP TS 05.05, subclause 4.1.1, third, fourth or fifth table; 3GPP TS 05.05 annex D subclauses D.2.1 and D.2.2.
- 4a. From R99 onwards, the supported maximum output power for each number of uplink timeslots shall form a monotonic sequence. The maximum reduction of maximum output power from an allocation of n uplink timeslots to an allocation of $n+1$ uplink timeslots shall be equal to the difference of maximum permissible nominal reduction of maximum output power for the corresponding number of timeslots, as defined in 3GPP TS 05.05, subclause 4.1.1, sixth table.
5. The output power actually transmitted by the MS at consecutive power control levels shall form a monotonic sequence and the interval between power control levels shall be $2 \pm 1,5$ dB (1 ± 1 dB between power control level 30 and 31 for PCS 1 900), from R99 onwards, in a multislot configuration, the first power control step down from the maximum output power is allowed to be in the range $0 \dots 2$ dB; 3GPP TS 05.05, subclause 4.1.1.
6. The transmitted power level relative to time for a normal burst shall be within the power/time template given in 3GPP TS 05.05, annex B figure B1. In multislot configurations where the bursts in two or more consecutive time slots are actually transmitted at the same frequency the template of annex B shall be respected during the useful part of each burst and at the beginning and the end of the series of consecutive bursts. The output power during the guard period between every two consecutive active timeslots shall not exceed the level allowed for the useful part of the first timeslot or the level allowed for the useful part of the second timeslot plus 3 dB, whichever is the highest:
 - 6.1 Under normal conditions; 3GPP TS 05.05, subclause 4.5.2.
 - 6.2 Under extreme conditions; 3GPP TS 05.05, subclause 4.5.2, 3GPP TS 05.05 annex D subclauses D.2.1 and D.2.2.

7. When accessing a cell on the PRACH or RACH and before receiving the first power control parameters during packet transfer on PDCH, all GSM and class 1 and class 2 DCS 1 800 and PCS 1 900 MS shall use the power control level defined by the GPRS_MS_TXPWR_MAX_CCH parameter broadcast on the PBCCH or MS_TXPWR_MAX_CCH parameter broadcast on the BCCH of the cell. When MS_TXPWR_MAX_CCH is received on the BCCH, a class 3 DCS 1800 MS shall add to it the value POWER_OFFSET broadcast on the BCCH. If MS_TXPWR_MAX_CCH or the sum defined by: MS_TXPWR_MAX_CCH plus POWER_OFFSET corresponds to a power control level not supported by the MS as defined by its power class, the MS shall act as though the closest supported power control level had been broadcast.
8. The transmitted power level relative to time for a Random Access burst shall be within the power/time template given in 3GPP TS 05.05, annex B figure B.3:
 - 8.1 Under normal conditions; 3GPP TS 05.05, subclause 4.5.2.
 - 8.2 Under extreme conditions; 3GPP TS 05.05, subclause 4.5.2, 3GPP TS 05.05 annex D subclauses D.2.1 and D.2.2.

On a multislot uplink configuration the MS may restrict the interslot output power control range to a 10 dB window, on a TDMA frame basis. On those timeslots where the ordered power level is more than 10 dB lower than the applied power level of the highest power timeslot, the MS shall transmit at a lowest possible power level within 10 dB range from the highest applied power level, if not transmitting at the actual ordered power level.

3GPP TS 45.05 subclause 2:

For T-GSM 810 the requirements for GSM 900 shall apply, apart for those parameters for which a separate requirement exists.

13.16.2.3 Test purpose

1. To verify that the maximum output power of the MS in GPRS multislot configuration, under normal conditions, is within conformance requirement 1.
2. To verify that the maximum output power of the MS in GPRS multislot configuration, under extreme conditions, is within conformance requirement 2.
3. To verify that all nominal output power levels, relevant to the class of MS, are implemented in the MS in GPRS multislot configuration and have output power levels, under normal conditions, within conformance requirement 3.
4. To verify that all nominal output power levels ,relevant to the class of MS, are implemented in the MS in GPRS multislot configuration and have output power levels, under extreme conditions, within conformance requirement 4.
- 4a. From R99 onwards: to verify that the supported maximum output power for each uplink multislot configuration is within the conformance requirement 4a.
5. To verify that the step in the output power transmitted by the MS in GPRS multislot configuration at consecutive power control levels is within conformance requirement 5 under normal conditions.
6. To verify that the output power relative to time, when sending a normal burst is within conformance requirement 6 in GPRS multislot configuration:
 - 6.1 Under normal conditions.
 - 6.2 Under extreme conditions.
7. To verify that the MS in GPRS multislot configuration uses the maximum power control level according to its power class if commanded to a power control level exceeding its power class.
8. To verify that the output power relative to time, when sending an access burst is within conformance requirement 8 in GPRS multislot configuration:
 - 8.1 Under normal conditions.
 - 8.2 Under extreme conditions.

13.16.2.4 Methods of test

Two methods of test are described, separately for:

- 1) equipment fitted with a permanent antenna connector or fitted with a temporary test connector as a test fixture; and for
- 2) equipment fitted with an integral antenna, and which cannot be connected to an external antenna.

NOTE: The behaviour of the MS in the system is determined to a high degree by the antenna, and this is the only transmitter test in this ETS using the integral antenna. Further studies are ongoing on improved testing on the integral antenna, taking practical conditions of MS use into account.

13.16.2.4.1 Method of test for equipment with a permanent or temporary antenna connector

13.16.2.4.1.1 Initial conditions

The test shall be run under the default GPRS conditions defined in clause 40.

The MS shall be operated with its highest number of uplink slots.

The Test Mode defined in 3GPP TS 04.14 (subclause 5.4) will be utilised. If the MS is capable of both:

- Mode (a) transmitting pseudo-random data sequence in RLC data blocks;
- Mode (b) transmitting looped-back RLC data blocks;

then Mode (a) will be used.

If Mode (b) is used then the SS sends the psuedo-random data sequence specified for Mode (a) on the downlink for loopback on the uplink.

The SS controls the power level by setting the concerned time slot's power control parameter ALPHA (α) to 0 and GAMMA_TN (Γ_{CH}) to the desired power level in the Packet Uplink Assignment message (Closed Loop Control, see 3GPP TS 05.08, clause B.2) GPRS_ MS TXPWR_MAX_CCH / MS TXPWR_MAX_CCH is set to the maximum value supported by the Power Class of the Mobile under test. For DCS 1 800 mobile stations the POWER_OFFSET parameter is set to 6 dB.

Specific PICS Statements:

- MS using reduced interslot dynamic range in multislot configurations (TSPC_Addinfo_Red_IntSlotRange_Mult_Conf)

PIXIT statements:

-

13.16.2.4.1.2 Procedure

- a) Measurement of normal burst transmitter output power.

The SS takes power measurement samples evenly distributed over the duration of one burst with a sampling rate of at least $2/T$, where T is the bit duration. The samples are identified in time with respect to the modulation on the burst. The SS identifies the centre of the useful 147 transmitted bits, i.e. the transition from bit 13 to bit 14 of the midamble, as the timing reference.

The transmitter output power is calculated as the average of the samples over the 147 useful bits. This is also used as the 0 dB reference for the power/time template.

- b) Measurement of normal burst power/time relationship

The array of power samples measured in a) are referenced in time to the centre of the useful transmitted bits and in power to the 0 dB reference, both identified in a).

- c) Steps a) to b) are repeated on each timeslot within the multislot configuration with the MS commanded to operate on each of the nominal output power levels defined in tables 13.16.2-1, 13.16.2-2 and 13.16.2-3, and in step a) only on one nominal output power higher than supported by the MS.

NOTE: Power control levels 0 and 1 are excluded for bands other than DCS 1800 and PCS 1900 since these power control levels can not be set by GAMMA_TN.

- d) The SS commands the MS to the maximum power control level supported by the MS and steps a) to b) are repeated on each timeslot within the multislot configuration for ARFCN in the Low and High ranges.
- e) The SS commands the MS to the maximum power control level in the first timeslot allocated within the multislot configuration and to the minimum power control level in the second timeslot allocated. Any further timeslots allocated are to be set to the maximum power control level. Steps a) to b) and corresponding measurements on each timeslot within the multislot configuration are repeated.
- f) Measurement of access burst transmitter output power

The SS causes the MS to generate an Access Burst on an ARFCN in the Mid ARFCN range, this could be either by a cell re-selection or a new request for radio resource. In the case of a cell re-selection procedure the Power Level indicated in the PSI3 message is the maximum power control level supported by the MS. In the case of an Access Burst the MS shall use the Power Level indicated in the GPRS_MS_TXPWR_MAX_CCH parameter. If the power class of the MS is DCS 1 800 Class 3 and the Power Level is indicated by the MS_TXPWR_MAX_CCH parameter, the MS shall also use the POWER_OFFSET parameter.

The SS takes power measurement samples evenly distributed over the duration of the access burst as described in a). However, in this case the SS identifies the centre of the useful bits of the burst by identifying the transition from the last bit of the synch sequence. The centre of the burst is then five data bits prior to this point and is used as the timing reference.

The transmitter output power is calculated as the average of the samples over the 87 useful bits of the burst. This is also used as the 0 dB reference for the power/time template.

- g) Measurement of access burst power/time relationship

The array of power samples measured in f) are referenced in time to the centre of the useful transmitted bits and in power to the 0 dB reference, both identified in f).

- h) Depending on the method used in step f) to cause the MS to send an Access Burst, the SS sends either a PACKET CELL CHANGE ORDER along with power control level set to 10 in PSI3 parameter GPRS_MS_TXPWR_MAX_CCH or it changes the (Packet) System Information elements (GPRS_)MS_TXPWR_MAX_CCH and for DCS 1 800 the POWER_OFFSET on the serving cell PBCCH/BCCH in order to limit the MS transmit power on the Access Burst to power control level 10 (+23 dBm for bands other than DCS 1800 and PCS 1900 or +10 dBm for DCS 1 800 and PCS 1 900) and then steps f) to g) are repeated.
- i) Steps a) to h) are repeated under extreme test conditions (annex 1, TC2.2) except that the repeats at step c) are only performed for power control level 10 and the minimum nominal output power level supported by the MS.

13.16.2.4.2 Method of test for equipment with an integral antenna

NOTE: If the MS is equipped with a permanent connector, such that the antenna can be disconnected and the SS be connected directly, then the method of subclause 13.16.2.4.1 will be applied.

The tests in this subclause are performed on an unmodified test sample.

13.16.2.4.2.1 Initial conditions

The MS is placed in the anechoic shielded chamber (annex 1, GC5) or on the outdoor test site, on an isolated support, in the position for normal use, at a distance of at least 3 metres from a test antenna, connected to the SS.

NOTE: The test method described has been written for measurement in an anechoic shielded chamber. If an outdoor test site is used then, in addition, it is necessary to raise/lower the test antenna through the specified height range to maximize the received power levels from both the test sample and the substitution antenna.

The Initial Conditions for the test are defined in subclause 13.16.2.4.1.1.

13.16.2.4.2.2 Procedure

- a) With the initial conditions set according to subclause 13.16.2.4.2.1 the test procedure in subclause 13.16.2.4.1.2 is followed up to and including step h), except that in step a), when measurements are done at maximum power for ARFCN in the Low, Mid and High range, the measurement is made eight times with the MS rotated by $n \cdot 45$ degrees for all values of n in the range 0 to 7.

The measurements taken are received transmitter output power measurements rather than transmitter output power measurements, the output power measurement values can be derived as follows.

- b) Assessment of test site loss for scaling of received output power measurements.

The MS is replaced by a half-wave dipole, resonating at the centre frequency of the transmit band, connected to an RF generator.

The frequency of the RF signal generator is set to the frequency of the ARFCN used for the 24 measurements in step a), the output power is adjusted to reproduce the received transmitter output power averages recorded in step a).

For each indication the power, delivered by the generator (in Watts) to the half-wave dipole, is recorded. These values are recorded in the form P_{nc} , where n = MS rotation and c = channel number.

For each channel number used compute:

$$P_{ac}(\text{Watts into dipole}) = \frac{1}{8} * \sum_{n=0}^{n=7} P_{nc}$$

from which: $P_{ac} (\text{Tx dBm}) = 10 \log_{10}(P_{ac}) + 30 + 2,15$

The difference, for each of the three channels, between the actual transmitter output power averaged over the 8 measurement orientations and the received transmitter output power at orientation $n = 0$ is used to scale the received measurement results to actual transmitter output powers for all measured power control levels and ARFCN, which can then be checked against the requirements.

- c) Temporary antenna connector calibration factors (transmit)

A modified test sample equipped with a temporary antenna connector is placed in a climatic test chamber and is linked to the SS by means of the temporary antenna connector.

Under normal test conditions, the power measurement and calculation parts of steps a) to j) of 13.16.2.4.1.2 are repeated except that the repeats at step d) are only performed for power control level 10 and the minimum nominal output power level supported by the MS.

NOTE 1: The values noted here are related to the output transmitter carrier power levels under normal test conditions, which are known after step b). Therefore frequency dependent calibration factors that account for the effects of the temporary antenna connector can be determined.

- d) Measurements at extreme test conditions.

NOTE 2: Basically the procedure for extreme conditions is:

- the power/time template is tested in the "normal" way;
- the radiated power is measured by measuring the difference with respect to the radiated power under normal test conditions.

Under extreme test conditions steps a) to h) of subclause 13.16.2.4.1.2 are repeated except that the repeats at step d) are only performed for power control level 10 and the minimum nominal output power level supported by the MS.

The transmitter output power under extreme test conditions is calculated for each burst type, power control level and for every frequency used by adding the frequency dependent calibration factor, determined in c), to the values obtained at extreme conditions in this step.

13.16.2.5 Test requirements

- a) The transmitter output power, under every combination of normal and extreme test conditions, for normal bursts and access bursts, at each frequency and for each power control level applicable to the MS power class, shall be at the relevant level shown in table 13.16.2-1, table 13.16.2-2 or table 13.16.2-3 within the tolerances also shown in table 13.16.2-1, table 13.16.2-2 or table 13.16.2-3.

Bands other than DCS 1800 and PCS 1900 - begin

Table 13.16.2-1: Bands other than DCS 1800 and PCS 1900 transmitter output power for different power classes

Power class					Power control level (note 4)	GAMMA_TN (Γ_{CH})	Transmitter output power (note 2,3)	Tolerances	
2	3	4	5	dBm				normal	extreme
.	.	.	.	2	0	39	±2 dB	±2,5 dB	
.	.	.	.	3	1	37	±3 dB (note 1)	±4 dB (note 1)	
.	.	.	.	4	2	35	±3 dB	±4 dB	
.	.	.	.	5	3	33	±3 dB (note 1)	±4 dB (note 1)	
.	.	.	.	6	4	31	±3 dB	±4 dB	
.	.	.	.	7	5	29	±3 dB (note 1)	±4 dB (note 1)	
.	.	.	.	8	6	27	±3 dB	±4 dB	
.	.	.	.	9	7	25	±3 dB	±4 dB	
.	.	.	.	10	8	23	±3 dB	±4 dB	
.	.	.	.	11	9	21	±3 dB	±4 dB	
.	.	.	.	12	10	19	±3 dB	±4 dB	
.	.	.	.	13	11	17	±3 dB	±4 dB	
.	.	.	.	14	12	15	±3 dB	±4 dB	
.	.	.	.	15	13	13	±3 dB	±4 dB	
.	.	.	.	16	14	11	±5 dB	±6 dB	
.	.	.	.	17	15	9	±5 dB	±6 dB	
.	.	.	.	18	16	7	±5 dB	±6 dB	
.	.	.	.	19	17	5	±5 dB	±6 dB	

NOTE1: When the power control level corresponds to the power class of the MS, then the tolerances shall be 2,0 dB under normal test conditions and 2,5 dB under extreme test conditions.

NOTE 2: For R99 and Rel-4, the maximum output power in a multislot configuration must be lower within the limits defined in table 13.16.2-1a. From Rel-5 onwards, the maximum output power in a multislot configuration may be lower within the limits defined in table 13.16.2-1b.

NOTE 3: For a MS using reduced interslot dynamic range in multislot configurations, the MS may restrict the interslot output power control range to a 10 dB window, on a TDMA frame basis. On those timeslots where the ordered power level is more than 10 dB lower than the applied power level of the highest power timeslot, the MS shall transmit at a lowest possible power level within 10 dB range from the highest applied power level, if not transmitting at the actual ordered power level.

NOTE 4: There is no requirement to test power control levels 20-31.

Table 13.16.2-1a: R99 and Rel-4: Bands other than DCS 1800 and PCS 1900 allowed maximum output power reduction in a multislot configuration

Number of timeslots in uplink assignment	Permissible nominal reduction of maximum output power, (dB)
1	0
2	0 to 3,0
3	1,8 to 4,8
4	3,0 to 6,0

Table 13.16.2-1b: From Rel-5 onwards: Bands other than DCS 1800 and PCS 1900 allowed maximum output power reduction in a multislots configuration

Number of timeslots in uplink assignment	Permissible nominal reduction of maximum output power, (dB)
1	0
2	3,0
3	4,8
4	6,0
5	7,0
6	7,8
7	8,5
8	9,0

From R5 onwards, the actual supported maximum output power shall be in the range indicated by the parameter GMSK_MULTISLOT_POWER_PROFILE for n allocated uplink timeslots:

$$a \leq \text{MS maximum output power} \leq \min(\text{MAX_PWR}, a + 2\text{dB})$$

Where:

$$a = \min(\text{MAX_PWR}, \text{MAX_PWR} + \text{GMSK_MULTISLOT_POWER_PROFILE} - 10\log(n));$$

MAX_PWR equals to the MS maximum output power according to the relevant power class and

GMSK_MULTISLOT_POWER_PROFILE 0 = 0 dB;

GMSK_MULTISLOT_POWER_PROFILE 1 = 2 dB;

GMSK_MULTISLOT_POWER_PROFILE 2 = 4 dB;

GMSK_MULTISLOT_POWER_PROFILE 3 = 6 dB.

Bands other than DCS 1800 and PCS 1900 - end

DCS 1 800 only - begin

Table 13.16.2-2: DCS 1 800 transmitter output power for different power classes

Power class			Power control level (note 4)	GAMMA_TN (Γ_{CH})	Transmitter output power (note 2,3)	Tolerances	
1	2	3			dBm	normal	extreme
.	.	.	29	0	36	±2,0 dB	±2,5 dB
.	.	.	30	1	34	±3,0 dB	±4,0 dB
.	.	.	31	2	32	±3,0 dB	±4,0 dB
.	.	.	0	3	30	±3,0 dB (note_1)	±4 dB (note_1)
.	.	.	1	4	28	±3 dB	±4 dB
.	.	.	2	5	26	±3 dB	±4 dB
.	.	.	3	6	24	±3 dB (note_1)	±4 dB (note_1)
.	.	.	4	7	22	±3 dB	±4 dB
.	.	.	5	8	20	±3 dB	±4 dB
.	.	.	6	9	18	±3 dB	±4 dB
.	.	.	7	10	16	±3 dB	±4 dB
.	.	.	8	11	14	±3 dB	±4 dB
.	.	.	9	12	12	±4 dB	±5 dB
.	.	.	10	13	10	±4 dB	±5 dB
.	.	.	11	14	8	±4 dB	±5 dB
.	.	.	12	15	6	±4 dB	±5 dB
.	.	.	13	16	4	±4 dB	±5 dB
.	.	.	14	17	2	±5 dB	±6 dB
.	.	.	15	18	0	±5 dB	±6 dB

NOTE 1: When the power control level corresponds to the power class of the MS, then the tolerances shall be 2,0 dB under normal test conditions and 2,5 dB under extreme test conditions.

NOTE 2: For R99 and Rel-4, the maximum output power in a multislot configuration must be lower within the limits defined in table 13.16.2-2a. From Rel-5 onwards, the maximum output power in a multislot configuration may be lower within the limits defined in table 13.16.2-2b.

NOTE 3: For a MS using reduced interslot dynamic range in multislot configurations, the MS may restrict the interslot output power control range to a 10 dB window, on a TDMA frame basis. On those timeslots where the ordered power level is more than 10 dB lower than the applied power level of the highest power timeslot, the MS shall transmit at a lowest possible power level within 10 dB range from the highest applied power level, if not transmitting at the actual ordered power level.

NOTE 4: There is no requirement to test power control levels 16-28.

Table 13.16.2-2a: R99 and Rel-4: DCS 1 800 allowed maximum output power reduction in a multislot configuration

Number of timeslots in uplink assignment	Permissible nominal reduction of maximum output power, (dB)
1	0
2	0 to 3,0
3	1,8 to 4,8
4	3,0 to 6,0

Table 13.16.2-2b: From Rel-5 onwards: DCS 1 800 allowed maximum output power reduction in a multislot configuration

Number of timeslots in uplink assignment	Permissible nominal reduction of maximum output power, (dB)
1	0
2	3,0
3	4,8
4	6,0
5	7,0
6	7,8
7	8,5
8	9,0

From R5 onwards, the actual supported maximum output power shall be in the range indicated by the parameter `GMSK_MULTISLOT_POWER_PROFILE` for `n` allocated uplink timeslots:

$$a \leq \text{MS maximum output power} \leq \min(\text{MAX_PWR}, a + 2\text{dB})$$

Where:

$$a = \min(\text{MAX_PWR}, \text{MAX_PWR} + \text{GMSK_MULTISLOT_POWER_PROFILE} - 10\log(n));$$

`MAX_PWR` equals to the MS maximum output power according to the relevant power class and

`GMSK_MULTISLOT_POWER_PROFILE 0` = 0 dB;

`GMSK_MULTISLOT_POWER_PROFILE 1` = 2 dB;

`GMSK_MULTISLOT_POWER_PROFILE 2` = 4 dB;

GMSK_MULTISLOT_POWER_PROFILE 3 = 6 dB.

DCS 1 800 only - end

PCS 1 900 only – begin

Table 13.16.2-3: PCS 1 900 transmitter output power for different power classes

Power class			Power control level (note 4)	GAMMA_TN (Γ_{CH})	Transmitter output power (note 2,3) dBm	Tolerances	
1	2	3				Normal	Extreme
.	.	.	30	1	33	±2,0 dB	±2,5 dB
.	.	.	31	2	32	±2,0 dB	±2,5 dB
.	.	.	0	3	30	±3,0 dB (note 1)	±4 dB (note 1)
.	.	.	1	4	28	±3 dB	±4 dB
.	.	.	2	5	26	±3 dB	±4 dB
.	.	.	3	6	24	±3 dB (note 1)	±4 dB (note 1)
.	.	.	4	7	22	±3 dB	±4 dB
.	.	.	5	8	20	±3 dB	±4 dB
.	.	.	6	9	18	±3 dB	±4 dB
.	.	.	7	10	16	±3 dB	±4 dB
.	.	.	8	11	14	±3 dB	±4 dB
.	.	.	9	12	12	±4 dB	±5 dB
.	.	.	10	13	10	±4 dB	±5 dB
.	.	.	11	14	8	±4 dB	±5 dB
.	.	.	12	15	6	±4 dB	±5 dB
.	.	.	13	16	4	±4 dB	±5 dB
.	.	.	14	17	2	±5 dB	±6 dB
.	.	.	15	18	0	±5 dB	±6 dB

NOTE 1: When the power control level corresponds to the power class of the MS, then the tolerances shall be 2,0 dB under normal test conditions and 2,5 dB under extreme test conditions.

NOTE 2: For R99 and Rel-4, the maximum output power in a multislot configuration must be lower within the limits defined in table 13.16.2-3a. From Rel-5 onwards, the maximum output power in a multislot configuration may be lower within the limits defined in table 13.16.2-3b.

NOTE 3: For a MS using reduced interslot dynamic range in multislot configurations, the MS may restrict the interslot output power control range to a 10 dB window, on a TDMA frame basis. On those timeslots where the ordered power level is more than 10 dB lower than the applied power level of the highest power timeslot, the MS shall transmit at a lowest possible power level within 10 dB range from the highest applied power level, if not transmitting at the actual ordered power level.

NOTE 4: There is no requirement to test power control levels 16-29.

Table 13.16.2-3a: R99 and Rel-4: PCS 1 900 allowed maximum output power reduction in a multislot configuration

Number of timeslots in uplink assignment	Permissible nominal reduction of maximum output power, (dB)
1	0
2	0 to 3,0
3	1,8 to 4,8
4	3,0 to 6,0

Table 13.16.2-3b: From Rel-5 onwards: PCS 1 900 allowed maximum output power reduction in a multislot configuration

Number of timeslots in uplink assignment	Permissible nominal reduction of maximum output power, (dB)
1	0
2	3,0
3	4,8
4	6,0
5	7,0
6	7,8
7	8,5
8	9,0

From R5 onwards, the actual supported maximum output power shall be in the range indicated by the parameter GMSK_MULTISLOT_POWER_PROFILE for n allocated uplink timeslots:

$$a \leq \text{MS maximum output power} \leq \min(\text{MAX_PWR}, a + 2\text{dB})$$

Where:

$$a = \min(\text{MAX_PWR}, \text{MAX_PWR} + \text{GMSK_MULTISLOT_POWER_PROFILE} - 10\log(n));$$

MAX_PWR equals to the MS maximum output power according to the relevant power class and

- GMSK_MULTISLOT_POWER_PROFILE 0 = 0 dB;
- GMSK_MULTISLOT_POWER_PROFILE 1 = 2 dB;
- GMSK_MULTISLOT_POWER_PROFILE 2 = 4 dB;

GMSK_MULTISLOT_POWER_PROFILE 3 = 6 dB.

PCS 1 900 only - end

- b) The difference between the transmitter output power at two adjacent power control levels, measured at the same frequency, shall not be less than 0,5 dB and not be more than 3,5 dB. For PCS 1 900 Class 3 the difference between the transmitter output power at power controls level 30 and 31, measured at the same frequency, shall not be less than 0 dB and not be more than 2 dB.

For R99 and Rel-4 MS, if one or both of the adjacent output power levels are reduced according to the number of timeslots, the difference between the transmitter output power at two adjacent power control levels, measured at the same frequency, shall not be less than -1dB and not be more than 3.5 dB.

For R5 onwards, if one or both of the adjacent output power levels are reduced according to GMSK_MULTISLOT_POWER_PROFILE X and the number of timeslots, the difference between the transmitter output power at two adjacent power control levels, measured at the same frequency, shall not be less than -1dB and not be more than 3.5 dB.

- c) The power/time relationship of the measured samples for normal bursts shall be within the limits of the power time template of figure 13-7-2 (3GPP TS 51.010) at each frequency, under every combination of normal and extreme test conditions and at each power control level measured.



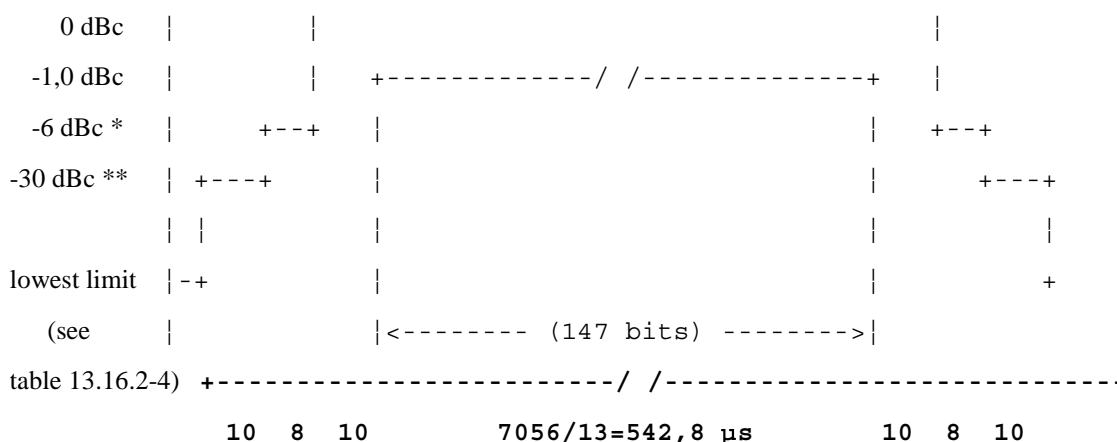

Figure 13.16.2-1: Power / time template for normal bursts

* For bands other than DCS 1800 and PCS 1900 MS:

- 4 dBc for power control level 16;
- 2 dBc for power control level 17;
- 1 dBc for power control levels 18 and 19.

For DCS 1 800 and PCS 1 900 MS:

- 4 dBc for power control level 11;
- 2 dBc for power control level 12;
- 1 dBc for power control levels 13, 14 and 15.

** For bands other than DCS 1800 and PCS 1900 MS:

- 30 dBc or -17 dBm, whichever is the higher.

For DCS 1 800 and PCS 1 900MS:

- 30 dBc or -20 dBm, whichever is the higher.

Table 13.16.2-4: Lowest measurement limit for power / time template

	lowest limit
Bands other than DCS 1800 and PCS 1900	-59 dBc or -54 dBm whichever is the highest, except for the timeslot preceding the active slot, for which the allowed level is -59 dBc or -36 dBm, whichever is the highest
DCS 1 800 PCS 1 900	-48 dBc or -48 dBm whichever is the highest

- d) All the power control levels, for the type and power class of the MS as stated by the manufacturer, shall be implemented in the MS.
- e) When the transmitter is commanded to a power control level outside of the capability corresponding to the type and power class of the MS as stated by the manufacturer, then the transmitter output power shall be within the tolerances for the closest power control level corresponding to the type and power class as stated by the manufacturer.
- f) The power/time relationship of the measured samples for access bursts shall be within the limits of the power time template of figure 13-7-3 at each frequency, under every combination of normal and extreme test conditions and at each power control level measured.

+4 dBc | | +----+

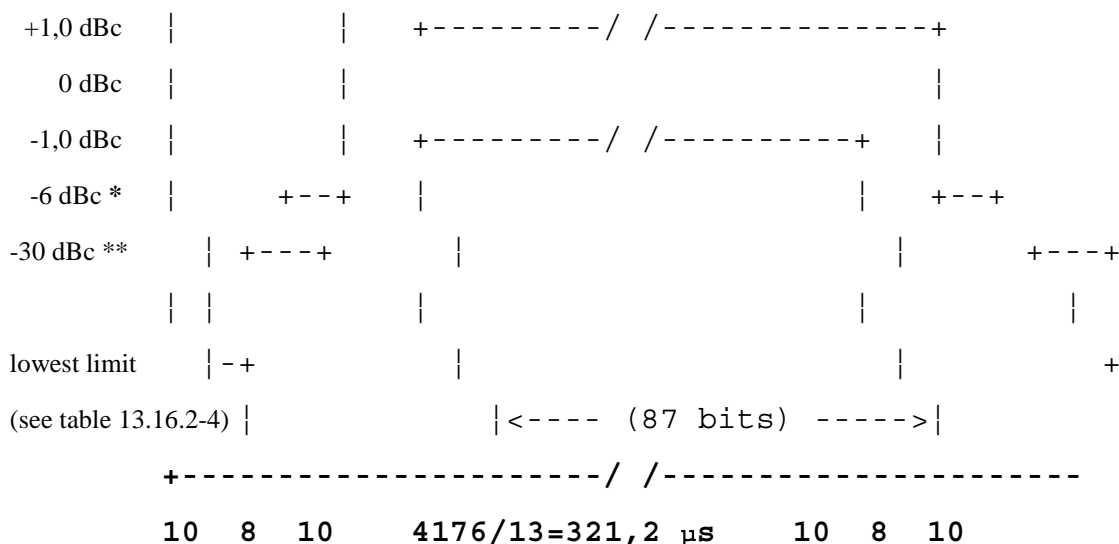

Figure 13.16.2-2: Power / time template for access burst

* For bands other than DCS 1800 and PCS 1900 MS:

- 4 dBc for power control level 16;
- 2 dBc for power control level 17;
- 1 dBc for power control levels 18 and 19.

For DCS 1 800 and PCS 1 900 MS:

- 4 dBc for power control level 11;
- 2 dBc for power control level 12;
- 1 dBc for power control levels 13, 14 and 15.

** For bands other than DCS 1800 and PCS 1900 MS:

- 30 dBc or -17 dBm, whichever is the higher.

For DCS 1 800 and PCS 1 900 MS:

- 30 dBc or -20 dBm, whichever is the higher.

13.16.3 Output RF spectrum in GPRS multislots configuration

13.16.3.1 Definition

The output RF spectrum is the relationship between the frequency offset from the carrier and the power, measured in a specified bandwidth and time, produced by the MS due to the effects of modulation and power ramping.

13.16.3.2 Conformance requirement

1. The level of the output RF spectrum due to modulation shall be no more than that given in 3GPP TS 05.05, subclause 4.2.1, table a) for GSM 400, GSM 700, GSM 850 and GSM 900, table b) for DCS 1 800 or table c) for PCS 1 900, with the following lowest measurement limits:
 - -36 dBm below 600 kHz offset from the carrier;
 - -51 dBm for GSM 400, GSM 700, GSM 850 and GSM 900 or -56 dBm for DCS 1 800 and PCS 1 900 from 600 kHz out to less than 1 800 kHz offset from the carrier;
 - -46 dBm for GSM 400, GSM 700, GSM 850 and GSM 900 or -51 dBm for DCS 1 800 and PCS 1 900 at and beyond 1 800 kHz offset from the carrier;

but with the following exceptions at up to -36 dBm:

- up to three bands of 200 kHz width centred on a frequency which is an integer multiple of 200 kHz in the combined range 600 kHz to 6 000 kHz above and below the carrier;
- up to 12 bands of 200 kHz width centred on a frequency which is an integer multiple of 200 kHz at more than 6 000 kHz offset from the carrier.

1.1 Under normal conditions; 3GPP TS 05.05, subclause 4.2.1.

1.2 Under extreme conditions; 3GPP TS 05.05, subclause 4.2.1; 3GPP TS 05.05, annex D subclauses D.2.1 and D.2.2.

2. The level of the output RF spectrum due to switching transients shall be no more than given in 3GPP TS 05.05, subclause 4.2.2, table "a) Mobile Station".

2.1 Under normal conditions; 3GPP TS 05.05, subclause 4.2.2.

2.2 Under extreme conditions; 3GPP TS 05.05, subclause 4.2.2; 3GPP TS 05.05 annex D subclause D.2.1 and D.2.2.

3. When allocated a channel, the power emitted by a GSM 400, GSM 900 and DCS 1 800 MS, in the band 935 MHz to 960 MHz shall be no more than -79 dBm, in the band 925 MHz to 935 MHz shall be no more than -67 dBm and in the band 1 805 MHz to 1 880 MHz shall be no more than -71 dBm except in five measurements in each of the bands 925 MHz to 960 MHz and 1 805 MHz to 1 880 MHz where exceptions at up to -36 dBm are permitted. For GSM 400 MS, in addition, the power emitted by MS, in the bands of 460,4 MHz to 467,6 MHz and 488,8 MHz to 496 MHz shall be no more than -67 dBm except in three measurements in each of the bands 460,4 MHz to 467,6 MHz and 488,8 MHz to 496 MHz where exceptions at up to -36 dBm are permitted. For GSM 700 and GSM 850, the power emitted by MS, in the band of 747 MHz to 757 MHz shall be no more than -79 dBm, in the band of 757 MHz to 762 MHz shall be no more than -73 dBm, in the band 869 MHz to 894 MHz shall be no more than -79 dBm, in the band 1 930 MHz to 1 990 MHz shall be no more than -71 dBm except in five measurements in each of the bands 747 MHz to 762 MHz, 869 MHz to 894 MHz and 1 930 MHz to 1 990 MHz where exceptions at up to -36 dBm are permitted. For PCS 1 900 MS, the power emitted by MS, in the band 869 MHz to 894 MHz shall be no more than -79 dBm, in the band 1 930 MHz to 1 990 MHz shall be no more than -71 dBm except in five measurements in each of the bands 869 MHz to 894 MHz and 1 930 MHz to 1 990 MHz where exceptions at up to -36 dBm are permitted. Under normal conditions; 3GPP TS 05.05, subclause 4.3.3.

13.16.3.3 Test purpose

1. To verify that the output RF spectrum due to modulation does not exceed conformance requirement 1 in the GPRS multislot configurations.

1.1 Under normal conditions.

1.2 Under extreme conditions.

2. To verify that the output RF spectrum due to switching transients does not exceed conformance requirement 2 in the GPRS multislot configurations when a reasonable margin is allowed for the effect of spectrum due to modulation.

2.1 Under normal conditions.

2.2 Under extreme conditions.

3. To verify that the MS spurious emissions in the MS receive band do not exceed conformance requirement 3 in the GPRS multislot configurations.

13.16.3.4 Method of test

13.16.3.4.1 Initial conditions

The test shall be run under the default GPRS conditions defined in clause 40, with power control parameter ALPHA (α) set to 0.

The MS shall be operated with its highest number of uplink slots.

The Test Mode defined in 3GPP TS 04.14 (subclause 5.4) will be utilised. If the MS is capable of both:

- Mode (a) transmitting pseudo-random data sequence in RLC data blocks;
- Mode (b) transmitting looped-back RLC data blocks;

then Mode (a) will be used.

If Mode (b) is used then the SS sends the pseudo-random data sequence specified for Mode (a) on the downlink for loopback on the uplink. The SS shall use a level of $23 \text{ dB}\mu\text{Vemf}$ ().

The SS commands the MS to hopping mode. The hopping pattern includes only three channels, namely one with an ARFCN in the Low ARFCN range, a second one with an ARFCN in the Mid ARFCN range and the third one with an ARFCN in the High ARFCN range.

- NOTE 1: Although the measurement is made whilst the MS is in hopping mode, each measurement is on one single channel.
- NOTE 2: This test is specified in hopping mode as a simple means of making the MS change channel, it would be sufficient to test in non hopping mode and to cell re-select the MS between the three channels tested at the appropriate time.
- NOTE 3: Mid ARFCN range for GSM 900 will use the range 63-65 ARFCN

13.16.3.4.2 Procedure

NOTE: When averaging is in use during frequency hopping mode, the averaging only includes bursts transmitted when the hopping carrier corresponds to the nominal carrier of the measurement.

- a) In steps b) to h) the FT is equal to the hop pattern ARFCN in the Mid ARFCN range.
- b) The other settings of the spectrum analyser are set as follows:
 - Zero frequency scan;
 - Resolution bandwidth: 30 kHz;
 - Video bandwidth: 30 kHz;
 - Video averaging: may be used, depending on the implementation of the test.

The video signal of the spectrum analyser is "gated" such that the spectrum generated by at least 40 of the bits 87 to 132 of the burst in one of the active time slots is the only spectrum measured. This gating may be analogue or numerical, dependent upon the design of the spectrum analyser. Only measurements during transmitted bursts on the nominal carrier of the measurement are included. The spectrum analyser averages over the gated period and over 200 or 50 such bursts, using numerical and/or video averaging.

The MS is commanded to its maximum power control level in every transmitted time slot.

- c) By tuning the spectrum analyser centre frequency to the measurement frequencies the power level is measured over 50 bursts at all multiples of 30 kHz offset from FT to $< 1\ 800 \text{ kHz}$.
- d) The resolution and video bandwidth on the spectrum analyser are adjusted to 100 kHz and the measurements are made at the following frequencies:

on every ARFCN from 1 800 kHz offset from the carrier to the edge of the relevant transmit band for each measurement over 50 bursts.

at 200 kHz intervals over the 2 MHz either side of the relevant transmit band for each measurement over 50 bursts.

For GSM 400 and DCS 1 800:

at 200 kHz intervals over the band 925 MHz to 960 MHz for each measurement over 50 bursts.

at 200 kHz intervals over the band 1 805 MHz to 1 880 MHz for each measurement over 50 bursts.

For GSM 900

at 200 kHz intervals over the band 925 MHz to 960MHz for each measurement over 50 bursts;

at 200 kHz intervals over the band 1805 MHz to 1880 MHz for each measurement over 50 bursts.

In addition for GSM 400 MS:

at 200 kHz intervals over the band 460,4 MHz to 467,6 MHz for each measurement over 50 bursts.

at 200 kHz intervals over the band 488,8 MHz to 496 MHz for each measurement over 50 bursts.

For GSM 700 and GSM 850:

at 200 kHz intervals over the band 747MHz to 762 MHz for each measurement over 50 bursts.

at 200 kHz intervals over the band 869 MHz to 894 MHz for each measurement over 50 bursts.

at 200 kHz intervals over the band 1 930 MHz to 1 990 MHz for each measurement over 50 bursts.

For PCS 1 900:

at 200 kHz intervals over the band 869 MHz to 894 MHz for each measurement over 50 bursts.

at 200 kHz intervals over the band 1 930 MHz to 1 990 MHz for each measurement over 50 bursts.

- e) The MS is commanded to its minimum power control level. The spectrum analyser is set again as in b).
- f) By tuning the spectrum analyser centre frequency to the measurement frequencies the power level is measured over 200 bursts at the following frequencies:

FT;

FT + 100 kHz FT - 100 kHz;

FT + 200 kHz FT - 200 kHz;

FT + 250 kHz FT - 250 kHz;

FT + 200 kHz * N FT - 200 kHz * N;

where N = 2, 3, 4, 5, 6, 7, and 8;

and FT = RF channel nominal centre frequency.

- g) Steps a) to f) is repeated except that in step a) the spectrum analyzer is gated so that the burst of the next active time slot is measured.

- h) The spectrum analyser settings are adjusted to:

- Zero frequency scan;
- Resolution bandwidth: 30 kHz;
- Video bandwidth: 100 kHz;
- Peak hold.

The spectrum analyser gating of the signal is switched off.

The MS is commanded to its maximum power control level in every transmitted time slot.

- i) By tuning the spectrum analyser centre frequency to the measurement frequencies the power level is measured at the following frequencies:

FT + 400 kHz FT - 400 kHz;

FT + 600 kHz FT - 600 kHz;

FT + 1,2 MHz FT - 1,2 MHz;

FT + 1,8 MHz FT - 1,8 MHz;

where FT = RF channel nominal centre frequency.

The duration of each measurement (at each frequency) will be such as to cover at least 10 burst transmissions at FT.

- j) Step i) is repeated for power control levels 7 and 11.
- k) Steps b), f), h) and i) are repeated with FT equal to the hop pattern ARFCN in the Low ARFCN range except that in step h) the MS is commanded to power control level 11 rather than maximum power.
- l) Steps b), f), h) and i) are repeated with FT equal to the hop pattern ARFCN in the High ARFCN range except that in step h) the MS is commanded to power control level 11 rather than maximum power.
- m) Steps a) b) f) h), and i) are repeated under extreme test conditions (annex 1, TC2.2). except that at step h) the MS is commanded to power control level 11.

13.16.3.5 Test requirements

For absolute measurements, performed on a temporary antenna connector, in the frequency band 450,4 MHz to 457,6 MHz, 478,8 MHz to 486 MHz, 777 MHz to 792 MHz, 824 MHz to 849 MHz, 880 MHz to 915 MHz, 1 710 MHz to 1 785 MHz, or 1 850 MHz to 1 910 MHz, the temporary antenna connector coupling factor, determined according to subclause 13.3.4.2.2 and annex 1 GC7, for the nearest relevant frequency, will be used.

For absolute measurements, performed on a temporary antenna connector, in the frequency band 925 MHz to 960 MHz, the temporary antenna connector coupling factor, will be as determined according to annex 1 GC7 for GSM 900 MS. For a GSM 400, GSM 700, GSM 850, DCS 1 800 or PCS 1 900 MS 0 dB will be assumed.

For absolute measurements, performed on a temporary antenna connector, in the frequency band 1 805 MHz to 1 880 MHz, the temporary antenna connector coupling factor, will be as determined according to annex 1 GC7 for DCS 1 800 MS. For a GSM 400, GSM 700, GSM 850, GSM 900 or PCS 1 900 MS 0 dB will be assumed.

For absolute measurements, performed on a temporary antenna connector, in the frequency band 460,4 MHz to 467,6 MHz or 488,8 to 496 MHz, the temporary antenna connector coupling factor, will be as determined according to annex 1 GC7 for GSM 400 MS. For a GSM 700, GSM 850, GSM 900, DCS 1800 or PCS 1 900 MS 0 dB will be assumed.

For absolute measurements, performed on a temporary antenna connector, in the frequency band 747 MHz to 762 MHz, the temporary antenna connector coupling factor, will be as determined according to annex 1 GC7 for GSM 700 MS. For a GSM 400, GSM 850, GSM 900 or DCS 1800 MS 0 dB will be assumed.

For absolute measurements, performed on a temporary antenna connector, in the frequency band 869 MHz to 894 MHz, the temporary antenna connector coupling factor, will be as determined according to annex 1 GC7 for GSM 850 MS. For a GSM 400, GSM 700, GSM 900 or DCS 1800 MS 0 dB will be assumed.

For absolute measurements, performed on a temporary antenna connector, in the frequency band 1 930 MHz to 1 990 MHz, the temporary antenna connector coupling factor, will be as determined according to annex 1 GC7 for PCS 1 900 MS. For GSM 400, GSM 900 or DCS 1 800 MS 0 dB will be assumed.

The figures in the tables below, at the listed frequencies from the carrier (kHz), are the maximum level (dB) relative to a measurement in 30 kHz bandwidth on the carrier (reference 3GPP TS 05.05 subclause 4.2.1).

- a) For the modulation sidebands out to less than 1 800 kHz offset from the carrier frequency (FT) measured in step c), f), i), k), l) and m) the measured power level in dB relative to the power level measured at FT, for all types of MS, shall not exceed the limits derived from the values shown in table 13.16.3-1 for GSM 400, GSM 700, GSM 850 and GSM 900, table 13.16.3-2 for DCS 1 800 or table 13.16.3-3 for PCS 1 900 according to the actual transmit power and frequency offset from FT. However any failures in the combined range 600 kHz to less than 1 800 kHz above and below the carrier may be counted towards the exceptions allowed in test requirements c) below.

Table 13.16.3-1: GSM 400, GSM 700, GSM 850 and GSM 900 Spectrum due to modulation out to less than 1 800 kHz offset

	power levels in dB relative to the measurement at FT				
Power level	Frequency offset (kHz)				
(dBm)	0-100	200	250	400	600 to < 1 800
39	+0,5	-30	-33	-60	-66
37	+0,5	-30	-33	-60	-64
35	+0,5	-30	-33	-60	-62
<= 33	+0,5	-30	-33	-60	-60
The values above are subject to the minimum absolute levels (dBm) below.					
	-36	-36	-36	-36	-51

Table 13.16.3-2: DCS 1 800 Spectrum due to modulation out to less than 1 800 kHz offset

	power levels in dB relative to the measurement at FT				
Power level	Frequency offset (kHz)				
(dBm)	0-100	200	250	400	600 to < 1 800
<= 36	+0,5	-30	-33	-60	-60
The values above are subject to the minimum absolute levels (dBm) below.					
	-36	-36	-36	-36	-56

Table 13.16.3-3: PCS 1 900 Spectrum due to modulation out to less than 1 800 kHz offset

	power levels in dB relative to the measurement at FT					
Power level	Frequency offset (kHz)					
(dBm)	0-100	200	250	400	600 to < 1 200	1 200 to < 1 800
<= 33	+0,5	-30	-33	-60	-60	-60
The values above are subject to the minimum absolute levels (dBm) below.						
	-36	-36	-36	-36	-56	-56

NOTE 1: For frequency offsets between 100 kHz and 600 kHz the requirement is derived by a linear interpolation between the points identified in the table with linear frequency and power in dB relative.

- b) For the modulation sidebands from 1 800 kHz offset from the carrier frequency (FT) and out to 2 MHz beyond the edge of the relevant transmit band, measured in step d), the measured power level in dB relative to the power level measured at FT, shall not exceed the values shown in table 13.16.3-4 according to the actual transmit power, frequency offset from FT and system on which the MS is designed to operate. However any failures in the combined range 1 800 kHz to 6 MHz above and below the carrier may be counted towards the exceptions allowed in test requirements c) below, and any other failures may be counted towards the exceptions allowed in test requirements d) below.

Table 13.16.3-4: Spectrum due to modulation from 1 800 kHz offset to the edge of the transmit band (wideband noise)

power levels in dB relative to the measurement at FT									
GSM 400, GSM 700, GSM 850 and GSM 900				DCS 1 800			PCS 1 900		
Power	Frequency offset			Power	Frequency offset		Power	Frequency offset	
Level	kHz			level	KHz		level	KHz	
(dBm)	1 800 to	3 000 to	>= 6 000	(dBm)	1 800 to	>= 6 000	(dBm)	1 800 to	>= 6 000
	< 3 000	< 6 000			< 6 000			< 6 000	
39	-69	-71	-77	36	-71	-79	33	-68	-76
37	-67	-69	-75	34	-69	-77	32	-67	-75
35	-65	-67	-73	32	-67	-75	30	-65	-73
<= 33	-63	-65	-71	30	-65	-73	28	-63	-71
				28	-63	-71	26	-61	-69
				26	-61	-69	<= 24	-59	-67
				<= 24	-59	-67			
The values above are subject to the minimum absolute levels (dBm) below.									
	-46	-46	-46		-51	-51		-51	-51

- c) Any failures (from a) and b) above) in the combined range 600 kHz to 6 MHz above and below the carrier should be re-checked for allowed spurious emissions. For each of the three ARFCN used, spurious emissions are allowed in up to three 200 kHz bands centred on an integer multiple of 200 kHz so long as no spurious emission exceeds -36 dBm. Any spurious emissions measured in a 30 kHz bandwidth which spans two 200 kHz bands can be counted towards either 200 kHz band, whichever minimizes the number of 200 kHz bands containing spurious exceptions.
- d) Any failures (from b) above) beyond 6 MHz offset from the carrier should be re-checked for allowed spurious emissions. For each of the three ARFCN used, up to twelve spurious emissions are allowed so long as no spurious emission exceeds -36 dBm.
- e) For GSM 400, GSM 900 and DCS 1 800 MS the MS spurious emissions in the bands 925 MHz to 935 MHz, 935 MHz to 960 MHz and 1 805 MHz to 1 880 MHz, measured in step d), shall not exceed the values shown in table 13.16.3-5 except in up to five measurements in the band 925 MHz to 960 MHz and five measurements in the band 1 805 MHz to 1 880 MHz where a level up to -36 dBm is permitted. For GSM 400 MS, in addition, the MS spurious emissions in the bands 460,4 MHz to 467,6 MHz and 488,8 MHz to 496 MHz shall not exceed the value of -67 dBm, except in up to three measurements in each of the bands 460,4 MHz to 467,6 MHz and 488,8 MHz to 496 MHz where a level up to -36 dBm is permitted. For GSM 700 and GSM 850 the spurious emissions in the bands 747 MHz to 757 MHz, 757 MHz to 762 MHz, 869 MHz to 894 MHz and 1 930 MHz to 1 990 MHz shall not exceed the values shown in table 13.16.3-4 except in up to five measurements in each of the bands 747 MHz to 762 MHz, 869 MHz to 894 MHz and 1 930 MHz to 1 990 MHz where a level up to -36 dBm is permitted. For PCS 1 900 MS the spurious emissions in the bands 869 MHz to 894 MHz and 1 930 MHz to 1 990 MHz shall not exceed the values shown in table 13.16.3-5 except in up to five measurements in each of the bands 869 MHz to 894 MHz and 1 930 MHz to 1 990 MHz where a level up to -36 dBm is permitted.

Table 13.16.3-5: Spurious emissions in the MS receive bands

Band (MHz)	Spurious emissions level (dBm)	
	GSM 400, GSM 900 and DCS 1 800	PCS 1 900
925 to 935	-67	
935 to 960	-79	
1805 to 1880	-71	
747 to 757		-79
757 to 762		-73
869 to 894		-79
1930 to 1990		-71

- f) For the power ramp sidebands of steps h), i) and k) the power levels must not exceed the values shown in table 13.16.3-6 for GSM 400, GSM 700, GSM 850 and GSM 900, table 13.16.3-7 for DCS 1 800 or table 13.16.3-8 for PCS 1 900.

Table 13.16.3-6: GSM Spectrum due to switching transients

Power level	Maximum level for various offsets from carrier frequency			
	400 kHz	600 kHz	1200 kHz	1 800 kHz
39 dBm	-13 dBm	-21 dBm	-21 dBm	-24 dBm
37 dBm	-15 dBm	-21 dBm	-21 dBm	-24 dBm
35 dBm	-17 dBm	-21 dBm	-21 dBm	-24 dBm
33 dBm	-19 dBm	-21 dBm	-21 dBm	-24 dBm
31 dBm	-21 dBm	-23 dBm	-23 dBm	-26 dBm
29 dBm	-23 dBm	-25 dBm	-25 dBm	-28 dBm
27 dBm	-23 dBm	-26 dBm	-27 dBm	-30 dBm
25 dBm	-23 dBm	-26 dBm	-29 dBm	-32 dBm
23 dBm	-23 dBm	-26 dBm	-31 dBm	-34 dBm
<= +21 dBm	-23 dBm	-26 dBm	-32 dBm	-36 dBm

Table 13.16.3-7: DCS 1 800 Spectrum due to switching transients

Power level	Maximum level for various offsets from carrier frequency			
	400 kHz	600 kHz	1 200 kHz	1 800 kHz
36 dBm	-16 dBm	-21 dBm	-21 dBm	-24 dBm
34 dBm	-18 dBm	-21 dBm	-21 dBm	-24 dBm
32 dBm	-20 dBm	-22 dBm	-22 dBm	-25 dBm
30 dBm	-22 dBm	-24 dBm	-24 dBm	-27 dBm
28 dBm	-23 dBm	-25 dBm	-26 dBm	-29 dBm
26 dBm	-23 dBm	-26 dBm	-28 dBm	-31 dBm
24 dBm	-23 dBm	-26 dBm	-30 dBm	-33 dBm
22 dBm	-23 dBm	-26 dBm	-31 dBm	-35 dBm
<= +20 dBm	-23 dBm	-26 dBm	-32 dBm	-36 dBm

Table 13.16.3-8: PCS 1 900 Spectrum due to switching transients

Power level	Maximum level for various offsets from carrier frequency			
	400 kHz	600 kHz	1 200 kHz	1 800 kHz
33 dBm	-19 dBm	-22 dBm	-22 dBm	-25 dBm
32 dBm	-20 dBm	-22 dBm	-22 dBm	-25 dBm
30 dBm	-22 dBm	-24 dBm	-24 dBm	-27 dBm
28 dBm	-23 dBm	-25 dBm	-26 dBm	-29 dBm
26 dBm	-23 dBm	-26 dBm	-28 dBm	-31 dBm
24 dBm	-23 dBm	-26 dBm	-30 dBm	-33 dBm
22 dBm	-23 dBm	-26 dBm	-31 dBm	-35 dBm
<= +20 dBm	-23 dBm	-26 dBm	-32 dBm	-36 dBm

NOTE 2: These figures are different from the requirements in 3GPP TS 05.05 because at higher power levels it is the modulation spectrum which is being measured using a peak hold measurement. This allowance is given in the table.

NOTE 3: The figures for table 13.16.3-6, table 13.16.3-7 and table 13.16.3-8 assume that, using the peak hold measurement, the lowest level measurable is 8 dB above the level of the modulation specification using the 30 kHz bandwidth gated average technique for 400 kHz offset from the carrier. At 600 and 1 200 kHz offset the level is 6 dB above and at 1 800 kHz offset the level is 3 dB above. The figures for 1 800 kHz have assumed the 30 kHz bandwidth spectrum due to modulation specification at < 1 800 kHz.

13.17 EGPRS transmitter tests

13.17.1 Frequency error and Modulation accuracy in EGPRS Configuration

13.17.1.1 Definition

The frequency error is the difference in frequency, after adjustment for the effect of the modulation accuracy between the RF transmission from the MS and either:

- the RF transmission from the BS; or
- the nominal frequency for the ARFCN used.

Modulation Accuracy.

For GMSK, the modulation accuracy of the transmitted signal is described as the phase accuracy (phase error) of the GMSK modulated signal. The phase error for GMSK modulation is the difference in phase, after adjustment for the effect of the frequency error, between the RF transmission from the MS and the theoretical transmission according to the intended modulation.

Since the conformance requirement, test procedure and test requirement for GMSK modulation accuracy (RMS Phase error and maximum peak deviation) are defined in subclause 13.16.1 for GPRS MS, being thereby defined also for all EGPRS MS in that section, only 8PSK modulation accuracy conformance requirement, test procedure and test requirement are defined in this subclause.

For 8-PSK, the error vector between the vector representing the transmitted signal and the vector representing the error-free modulated signal defines modulation accuracy. The magnitude of the error vector is called Error Vector Magnitude (EVM). Origin suppression is defined to be the ratio of the carrier leakage to the modulated signal.

13.17.1.2 Conformance requirement

1. The carrier frequency under 8PSK modulation shall be accurate to within 0,2 ppm for GSM 400 and 0,1 ppm for all other bands compared to signals received from the BS.
 - 1.1 Under normal conditions; 3GPP TS 05.10, subclause 6.1.
 - 1.2 Under extreme conditions; 3GPP TS 05.10, subclause 6.1; 3GPP TS 05.05, subclause 4.4; 3GPP TS 05.05, annex D subclauses D.2.1 and D.2.2.
2. The RMS EVM over the useful part of any burst of the 8-PSK modulated signal shall not exceed.
 - 2.1 9,0% Under normal conditions; 3GPP TS 05.05, subclause 4.6.2.1
 - 2.2 10,0% Under extreme conditions; 3GPP TS 05.05, subclause 4.6; 3GPP TS 05.05, annex D subclauses D.2.1 and D.2.2.
3. The peak EVM values of any burst of the 8PSK modulated signal shall be ≤ 30 %.
 - 3.1 Under normal conditions; 3GPP TS 05.05, subclause 4.6.2.3.
 - 3.2 Under extreme conditions; 3GPP TS 05.05, subclause 4.6.2.3; 3GPP TS 05.05, annex D subclauses D.2.1 and D.2.2.
4. The 95:th-percentile value of any burst of the 8-PSK modulated signal shall be ≤ 15 %.
 - 4.1 Under normal conditions; 3GPP TS 05.05, subclause 4.6.2.4.
 - 4.2 Under extreme conditions; 3GPP TS 05.05, subclause 4.6.2.4; 3GPP TS 05.05, annex D subclauses D.2.1 and D.2.2.
5. The Origin Offset Suppression for any 8PSK modulated signal shall exceed 30 dB.
 - 5.1 Under normal conditions; 3GPP TS 05.05, subclause 4.6.2.2.
 - 5.2 Under extreme conditions; 3GPP TS 05.05, subclause 4.6.2.2; 3GPP TS 05.05, annex D subclauses D.2.1 and D.2.2.

13.17.1.3 Test purpose

To verify that the carrier frequency error does not exceed conformance requirement 1:

- 1.1 Under normal conditions.
- 1.2 Under extreme conditions.

To verify that the RMS EVM over the useful part of the burst, excluding tail bits, transmitted by the MS does not exceed conformance requirement 2:

2.1 Under normal conditions.

2.2 Under extreme conditions.

To verify that the peak EVM values over the useful part of the burst, excluding tail bits, transmitted by the MS does not exceed conformance requirement 3:

3.1 Under normal conditions.

3.2 Under extreme conditions.

To verify that the 95:th percentile EVM over the useful part of any burst, excluding tail bits, does not exceed conformance requirement 4:

4.1 Under normal conditions.

4.2 Under extreme conditions.

To verify that the origin offset suppression does exceed conformance requirement 5:

5.1 Under normal conditions.

5.2 Under extreme conditions.

13.17.1.4 Method of the test

Initial conditions

The test shall be run under the default EGPRS conditions defined in clause 50, with power control parameter ALPHA (α) set to 0.

The SS shall command the MS to hopping mode (for the choice of frequencies in the frequency hopping mode, see subclause 6.2 and tables 6-1 and 6-2).

NOTE: It is not necessary to test in hopping mode but is done here as a simple means of making the MS change channel, it would be sufficient to test in non hopping mode and to make sure bursts are taken from a few different channels.

The MS shall be operated with its highest number of uplink slots.

The Test Mode defined in 3GPP TS 04.14 subclause 5.4 shall be utilised.

If the MS is capable of both:

Mode (a) transmitting pseudo-random data sequence in RLC data blocks;

Mode (b) transmitting looped-back RLC data blocks;

then Mode (a) will be used.

For the 8PSK procedure described below, the initial power value of each active timeslot shall be set to a mid-range power value.

13.17.1.4.2 Test procedure

Procedure for 8PSK Frequency error and modulation accuracy measurements

- a) For one transmitted burst on the last slot of the multislot configuration, the SS captures the transmitted signal by taking at least four samples per symbol. The transmitted signal is modeled by:

$$Y(t) = C1 \{R(t) + D(t) + C0\}W^t$$

R(t) is defined to be an ideal transmitter signal.

D(t) is the residual complex error on signal R(t).

C_0 is a constant origin offset representing carrier feedthrough.

C_1 is a complex constant representing the arbitrary phase and output power of the transmitter.

$W = e^{\alpha + j 2\pi f}$ accounts for both a frequency offset of " $2\pi f$ " radians per second phase rotation and an amplitude change of " α " nepers per second.

The symbol timing phase of $Y(t)$ is aligned with $R(t)$.

b) The SS shall generate the ideal transmitter signal as a reference. The ideal transmitter signal can be constructed from a priori knowledge of the transmitted symbols or from the demodulated symbols of the transmitted burst. In the latter case, unknown symbols shall be detected with an error rate sufficiently small to ensure the accuracy of the measurement equipment (see annex 5).

c)

c.1) The transmitted signal $Y(t)$ is compensated in amplitude, frequency and phase by multiplying with the factor:

$$W^{-t}/C_1$$

The values for W and C_1 are determined using an iterative procedure. $W(\alpha, f)$, C_1 and C_0 are chosen to minimise the RMS value of EVM on a burst-by-burst basis.

c.2) After compensation, $Y(t)$ is passed through the specified measurement filter (3GPP TS 05.05, subclause 4.6.2) to produce the signal:

$$Z(k) = S(k) + E(k) + C_0$$

where:

$S(k)$ is the ideal transmitter signal observed through the measurement filter;

$k = \text{floor}(t/T_s)$, where $T_s = 1/270.833$ kHz corresponding to the symbol times.

c.3) The error vector is defined to be:

$$E(k) = Z(k) - C_0 - S(k)$$

It is measured and calculated for each instant k over the useful part of the burst excluding tail bits. The RMS vector error is defined as:

$$\text{RMS EVM} = \sqrt{\frac{\sum_{k \in K} |E(k)|^2}{\sum_{k \in K} |S(k)|^2}}$$

c.4) Steps c.1) to c.3) are repeated with successive approximations of $W(\alpha, f)$, C_1 and C_0 until the minimum value of RMS EVM is found. The minimised value of RMS EVM and the final values for C_1 , C_0 and f are noted. (f represents the frequency error of the burst).

d) For each symbol in the useful part of the burst excluding tail bits, the SS shall calculate the error vector magnitude as:

$$\text{EVM}(k) = \sqrt{\frac{|E(k)|^2}{\frac{\sum_{k \in K} |S(k)|^2}{N}}}$$

The peak value of symbol EVM in the useful part of the burst, excluding tail bits, is noted.

e) The SS shall calculate the value for Origin Offset Suppression for the burst as:

$$OOS = \left(\frac{|C_o|^2}{\frac{1}{N} \sum_{k \in K} |S(k)|^2} \right)$$

- f) Steps a) to e) are repeated for a total of 200 bursts.
- g) The peak values of symbol EVM noted in step d) are averaged for the 200 measured bursts.
- h) The origin offset suppression values derived in step e) are averaged for the 200 measured bursts. The resulting average is converted to log format.

$$OOS(dB) = -10 \log(OOS)$$

- i) From the distribution of symbol EVM values calculated in step d) for the 200 measured bursts, the SS shall determine the 95: th percentile value.
- j) The SS instructs the MS to its maximum power control level by setting the power control parameter ALPHA (α) to 0 and GAMMA_TN (Γ_{CH}) for each timeslot to the desired power level in the Packet Uplink Assignment or Packet Timeslot Reconfigure message (Closed Loop Control, see 3GPP TS 05.08, clause B.2), all other conditions remaining constant. Steps a) to i) are repeated.
- k) The SS instructs the MS to the minimum power control level, all other conditions remaining constant. Steps a) to i) are repeated.
- l) Steps a) to i) are repeated under extreme test conditions (see annex 1, TC2.2).

13.17.1.5 Test Requirements

1. For all measured bursts, the frequency error, derived in step c.4), shall be less than $10E-7$.
2. For all measured bursts, the RMS EVM, derived in step c.3) shall not exceed 9.0 % under normal conditions and 10.0% under extreme conditions.
3. The (averaged) value of peak EVM derived in step g) shall not exceed 30 %.
4. The 95:th percentile value derived in step i) shall not exceed 15 %.
5. The origin offset suppression derived in subclause 13.17.1.4.2 step h) shall exceed 30 dB for MS.

13.17.2 Frequency error under multipath and interference conditions

13.17.2.1 Definition

The frequency error under multipath and interference conditions is a measure of the ability of the MS to maintain frequency synchronization with the received signal under conditions of Doppler shift, multipath reception and interference.

13.17.2.2 Conformance requirement

1. The MS carrier frequency error for each burst shall be accurate to within 0,1 ppm for GSM 700, GSM 850, GSM 900, DCS 1800, PCS 1 900 and 0,2 ppm for GSM 400 compared to signals received from the BS for signal levels down to 3 dB below the reference sensitivity level.
 - 1.1 Under normal conditions; 3GPP TS 05.10, subclauses 6 and 6.1.
 - 1.2 Under extreme conditions; 3GPP TS 05.10, subclauses 6 and 6.1; 3GPP TS 05.05 annex D subclauses D.2.1 and D.2.2.
2. The MS carrier frequency error for each burst shall be accurate to within 0,1 ppm, for GSM 700, GSM 850, GSM 900, DCS 1800 and PCS 1 900 and 0,2 ppm for GSM 400 compared to signals received from the BS for 3 dB less carrier to interference ratio than the reference interference ratios; 3GPP TS 05.10, subclauses 6 and 6.1.

3GPP TS 45.05 subclause 2:

For T-GSM 810 the requirements for GSM 900 shall apply, apart for those parameters for which a separate requirement exists.

13.17.2.3 Test purpose

1. To verify that the MS carrier frequency error at the PDTCH input level for reference performance, under conditions of multipath and Doppler shift does not exceed 0,1 ppm for GSM 700, T-GSM 810, GSM 850, GSM 900, DCS 1 800 and PCS 1 900 and 0,2 ppm for GSM 400 + the frequency error due to the Doppler shift of the received signal and the assessment error in the MS.

1.1 Under normal conditions.

1.2 Under extreme conditions.

NOTE 1: Although the conformance requirement states that frequency synchronization should be maintained for input signals 3 dB below PDTCH input level for reference performance. Due to the Radio Link Failure counter this test condition cannot be established. Hence all tests in this subclause are conducted at PDTCH input level for reference performance.

2. To verify that the MS carrier frequency error, under interference conditions and TUlow fading profile, does not exceed 0,1 ppm for GSM 700, T-GSM 810, GSM 850, GSM 900, DCS 1 800 and PCS 1 900 and 0,2 ppm for GSM 400 + the frequency error due to the Doppler shift of the received signal and the assessment error in the MS.

NOTE 2: The test adds the effect of Doppler shift to the requirements as the conformance requirement refers to signals input to the MS receiver whereas the frequency reference for measurement will not take account of the Doppler shift.

13.17.2.4 Method of test

This test uses the same measurement process as test 13.16.1 for GMSK modulated uplink transmission and 13.17.1 for 8PSK modulated uplink transmission for the MS operating under various RF conditions.

NOTE: The BA list sent on the BCCH will indicate at least six surrounding cells with at least one near to each band edge. It is not necessary to generate any of these BCCH but if they are provided none will be within 5 channels of the ARFCN used for the serving BCCH or PDTCH.

EGPRS Switched Radio Loopback Mode (3GPP TS 04.14, subclause 5.5) shall be utilised. This is since 8PSK modulated transmission is applied in the downlink during the test and EGPRS Switched Radio Loopback Mode is the only mandatory test mode for EGPRS MS that implements different modulations between concurrent downlink and uplink transmission. This test requires such test mode capability since an EGPRS MS is also allowed to support only GMSK modulated uplink transmission.

13.17.2.4.1 Initial conditions

The test shall be run under the default EGPRS conditions defined in clause 50 on an ARFCN in the Mid range, with power control parameter ALPHA (α) set to 0. The level of the serving cell BCCH is set to 10 dB above the input signal level at reference sensitivity performance for PDTCH/MCS-5 applicable to the type of MS and the fading function set to RA. The SS waits 30 s for the MS to stabilize to these conditions. The SS commands the MS to transmit at maximum power.

13.17.2.4.2 Procedure

- a) The SS transmits packets under static conditions, using MCS-5 coding. The SS is set up to capture the first burst transmitted by the MS during the uplink TBF. EGPRS Switched Radio Block Loop Back Mode is initiated by the SS according to the procedure defined in 3GPP TS 04.14; 5.5.1 on a PDTCH/MCS-5 channel in the mid ARFCN range. The PDTCH level is set to 10 dB above the input signal level at reference sensitivity performance for PDTCH/MCS-5 applicable to the type of MS and the fading function is set to RA. 8PSK modulated downlink transmission shall be utilised.
- b) The SS calculates the frequency accuracy of the captured burst as described in test 13.16.1 for MS capable of only GMSK modulated transmission in the uplink. For MS capable of both GMSK and 8PSK modulated transmission in the uplink the frequency accuracy of the captured burst shall be calculated as described in the test 13.17.1.

- c) The SS sets the serving cell BCCH and PDTCH to the PDTCH input signal level at reference sensitivity performance for PDTCH/MCS-5 applicable to the type of MS, still with the fading function set to RA and then waits 30 s for the MS to stabilize to these conditions.
- d) The SS shall capture subsequent bursts from the traffic channel in the manner described in test 13.16.1 or test 13.17.1.

NOTE: Due to the very low signal level at the MS receiver input the MS receiver is liable to error. The "looped back" bits are therefore also liable to error, and hence the SS does not know the expected bit sequence. The SS will have to demodulate the received signal to derive (error free) the transmitter burst bit pattern. Using this bit pattern the SS can calculate the expected phase trajectory according to the definition within 3GPP TS 05.04.

- e) The SS calculates the frequency accuracy of the captured burst as described in test 13.16.1 or test 13.17.1.
- f) Steps d) and e) are repeated for 5 traffic channel bursts spaced over a period of not less than 20 s.
- g) Both downlink and uplink TBFs are terminated. The initial conditions are established again and steps a) to f) are repeated but with the fading function set to HT200 for GSM 400, HT120 for GSM700 and HT100 for all other bands.
- h) The initial conditions are established again and steps a) to f) are repeated but with the fading function set to TU100 for GSM 400, TU60 for GSM700 and TU50 for all other bands.
- i) The initial conditions are established again and steps a) and b) are repeated but with the following differences:
- the levels of the BCCH and PDTCH are set to $-72,5 \text{ dBm} + \text{Corr}$. Corr = the correction factor for reference performance according to Spec 45.005 subclause 6.2.
 - two further independent 8-PSK modulated interfering signals are sent on the same nominal carrier frequency as the BCCH and PDTCH and at a level 20,5 dB below the level of the PDTCH and modulated with random data, including the midamble.
 - the fading function for all channels including the interfering signals is set to TULow.
- j) The SS waits 100 s for the MS to stabilize to these conditions.
- k) Repeat steps d) to f), except that at step f) the measurement period must be extended to 200 s and the number of measurements increased to 20.
- l) The initial conditions are established again and steps a) to k) are repeated for ARFCN in the Low ARFCN range.
- m) The initial conditions are established again and steps a) to k) are repeated for ARFCN in the High ARFCN range.
- n) Repeat step h) under extreme test conditions (see annex 1, TC2.2).

13.17.2.5 Test requirements

The frequency error, with reference to the SS carrier frequency as measured in repeats of step e), for each measured burst shall be less than the values shown in table 13-17-1.

Table 13-17-1: Requirements for frequency error under multipath, Doppler shift and interference conditions

GSM 400		T-GSM 810, GSM 850 and GSM 900		DCS 1 800 and PCS 1 900	
Propagation condition	Permitted frequency error	Propagation condition	Permitted frequency error	Propagation condition	Permitted frequency error
RA500	$\pm 300 \text{ Hz}$	RA250	$\pm 300 \text{ Hz}$	RA130	$\pm 400 \text{ Hz}$
HT200	$\pm 180 \text{ Hz}$	HT100	$\pm 180 \text{ Hz}$	HT100	$\pm 350 \text{ Hz}$
TU100	$\pm 160 \text{ Hz}$	TU50	$\pm 160 \text{ Hz}$	TU50	$\pm 260 \text{ Hz}$
TU6	$\pm 230 \text{ Hz}$	TU3	$\pm 230 \text{ Hz}$	TU1,5	$\pm 320 \text{ Hz}$

GSM 700	
Propagation condition	Permitted frequency error
RA 300	± 300 Hz
HT 120	± 180 Hz
TU 60	± 160 Hz
TU 3.6	± 230 Hz

13.17.3 EGPRS Transmitter output power

13.17.3.1 Definition

The transmitter output power is the average value of the power delivered to an artificial antenna or radiated by the MS and its integral antenna, over the time that the useful information bits of one burst are transmitted.

Since the conformance requirement, test procedure and test requirement of GSMK modulated signal's output power are defined in subclause 13.16.2 for GPRS MS, being thereby defined also for all EGPRS MS in that section, only 8PSK modulated signal's output power conformance requirement, test procedure and test requirements are defined in this subclause.

13.17.3.2 Conformance requirement

1. The MS maximum output power for 8-PSK modulated signal shall be as defined in 3GPP TS 05.05, subclause 4.1.1, second table, according to its power class, with a tolerances of ± 2 dB, ± 3 dB, $+3/-4$ dB defined under normal conditions in the 3GPP TS 05.05, subclause 4.1.1, second table. From R99 onwards, the MS maximum output power in an uplink multislot configuration shall be as defined in 3GPP TS 05.05 subclause 4.1.1, sixth table, according to its power class, with a tolerance of ± 3 dB under normal conditions; 3GPP TS 05.05, subclause 4.1.1, second and sixth table. In case the MS supports the same maximum output power in an uplink multislot configuration as it supports for single slot uplink operation, the tolerance shall be ± 2 dB.
2. The MS maximum output power for 8-PSK modulated signal shall be as defined in 3GPP TS 05.05, subclause 4.1.1, second table, according to its power class, with a tolerances of $\pm 2,5$ dB, ± 4 dB, $+4/-4,5$ dB defined under extreme conditions in the 3GPP TS 05.05, subclause 4.1.1, second table. From R99 onwards, the MS maximum output power in an uplink multislot configuration shall be as defined in 3GPP TS 05.05 subclause 4.1.1, sixth table, according to its power class, with a tolerance of ± 4 dB under extreme conditions; 3GPP TS 05.05, subclause 4.1.1, second and sixth table; 3GPP TS 05.05 annex D in subclauses D.2.1 and D.2.2. In case the MS supports the same maximum output power in an uplink multislot configuration as it supports for single slot uplink operation, the tolerance shall be $\pm 2,5$ dB.
3. The power control levels for 8-PSK shall have the nominal output power levels as defined in 3GPP TS 05.05, subclause 4.1.1, third table (for GSM 400, GSM 700, GSM 850 and GSM 900), fourth table (for DCS 1 800) or fifth table (for PCS 1 900), from the lowest power control level up to the maximum output power corresponding to the class of the MS (for tolerance on maximum output power see conformance requirement 1), with a tolerance of ± 2 dB, ± 3 dB, 4 dB or 5 dB under normal conditions; 3GPP TS 05.05, subclause 4.1.1, third, fourth or fifth table.
4. The power control levels for 8-PSK shall have the nominal output power levels as defined in 3GPP TS 05.05, subclause 4.1.1, third table (for GSM 400, GSM 700, GSM 850 and GSM 900), fourth table (for DCS 1 800) or fifth table (for PCS 1 900), from the lowest power control level up to the maximum output power corresponding to the class of the MS (for tolerance on maximum output power see conformance requirements 2), with a tolerance of $\pm 2,5$ dB, ± 4 dB, 5 dB or 6 dB under extreme conditions; 3GPP TS 05.05, subclause 4.1.1, third, fourth or fifth table; 3GPP TS 05.05 annex D subclauses D.2.1 and D.2.2.
- 4a. From R99 onwards, the supported maximum output power for each number of uplink timeslots shall form a monotonic sequence. The maximum reduction of maximum output power from an allocation of n uplink timeslots to an allocation of n+1 uplink timeslots shall be equal to the difference of maximum permissible nominal reduction of maximum output power for the corresponding number of timeslots, as defined in 3GPP TS 05.05, subclause 4.1.1, sixth table.
5. For 8-PSK, the output power actually transmitted by the MS at consecutive power control levels shall form a monotonic sequence and the interval between power control levels shall be $2 \pm 1,5$ dB; 3GPP TS 05.05, subclause 4.1.1, from R99 onwards, in a multislot configuration, the first power control step down from the maximum output power is allowed to be in the range 0...2 dB

6. The transmitted power level relative to time for a normal burst shall be within the power/time template given in 3GPP TS 05.05, annex B bottom figure for 8PSK modulated signal. In the case of Multislot Configurations where the bursts in two or more consecutive time slots are actually transmitted at the same frequency, the template of annex B shall be respected during the useful part of each burst and at the beginning and the end of the series of consecutive bursts. The output power during the guard period between every two consecutive active timeslots shall not exceed the level allowed for the useful part of the first timeslot, or the level allowed for the useful part of the second timeslot plus 3 dB, whichever is the highest.

6.1 Under normal conditions; 3GPP TS 05.05, subclause 4.5.2.

6.2 Under extreme conditions; 3GPP TS 05.05, subclause 4.5.2, 3GPP TS 05.05 annex D subclauses D.2.1 and D.2.2.

On a multislot uplink configuration the MS may restrict the interslot output power control range to a 10 dB window, on a TDMA frame basis. On those timeslots where the ordered power level is more than 10 dB lower than the applied power level of the highest power timeslot, the MS shall transmit at a lowest possible power level within 10 dB range from the highest applied power level, if not transmitting at the actual ordered power level.

3GPP TS 45.05 subclause 2:

For T-GSM 810 the requirements for GSM 900 shall apply, apart for those parameters for which a separate requirement exists.

13.17.3.3 Test purpose

1. To verify that the maximum output power of the 8PSK modulated signal of the EGPRS MS, under normal conditions, is within conformance requirement 1.
2. To verify that the maximum output power of the 8PSK modulated signal of the EGPRS MS, under extreme conditions, is within conformance requirement 2.
3. To verify that the maximum output power of the 8-PSK modulated signal of the EGPRS MS capable of 8PSK multislot configuration in the uplink, under normal conditions, is within conformance requirement 1.
4. To verify that the maximum output power of the 8-PSK modulated signal of the EGPRS MS capable of 8PSK multislot configuration in the uplink, under extreme conditions, is within conformance requirement 2.
- 4a. From R99 onwards: to verify that the supported maximum output power for each uplink multislot configuration is within the conformance requirement 4a.
5. To verify that all nominal output power levels, relevant to the power class of the EGPRS MS for 8PSK modulation, are implemented in the MS and have output power levels, under normal conditions, within conformance requirement 3.
6. To verify that all nominal output power levels, relevant to the power class of the EGPRS MS for 8PSK modulation, are implemented in the MS capable of 8PSK multislot configuration in the uplink and have the output power levels, under normal conditions, within conformance requirement 3.
7. To verify that all nominal output power levels, relevant to the power class of the EGPRS MS for 8PSK modulation, have output power levels, under extreme conditions, within conformance requirement 4.
8. To verify that all nominal output power levels, relevant to the power class of the EGPRS MS for 8PSK modulation, have output power levels in 8PSK multislot configuration in the uplink, under extreme conditions, within conformance requirement 4.
9. To verify that the step in the output power transmitted by the EGPRS MS at consecutive power control levels for 8PSK modulated signals is within conformance requirement 5 under normal conditions.
10. To verify that the step in the output power transmitted by the EGPRS MS capable of multislot 8PSK configuration in the uplink at consecutive power control levels for 8PSK modulated signals is within conformance requirement 5.
11. To verify that the output power relative to time, when sending a normal burst of the 8-PSK modulated signal is within conformance requirement 6:

11.1 Under normal conditions.

11.2 Under extreme conditions.

12. To verify that the output power relative to time, when sending a normal burst of 8PSK modulated signal is within conformance requirement 6 for EGPRS MS capable of 8PSK multislot configuration in the uplink:

12.1 Under normal conditions.

12.2 Under extreme conditions.

NOTE: For EGPRS MS capable of 8PSK multislot configuration in the uplink, the tests are executed only for multislot configuration.

13.17.3.4 Methods of test

Two methods of test are described, separately for:

- 1) equipment fitted with a permanent antenna connector or fitted with a temporary test connector as a test fixture; and for
- 2) equipment fitted with an integral antenna, and which cannot be connected to an external antenna.

NOTE: The behaviour of the MS in the system is determined to a high degree by the antenna, and this is the only transmitter test in this ETS using the integral antenna. Further studies are ongoing on improved testing on the integral antenna, taking practical conditions of MS use into account.

13.17.3.4.1 Method of test for equipment with a permanent or temporary antenna connector

13.17.3.4.1.1 Initial conditions

The test shall be run under the default EGPRS conditions defined in clause 50.

The Test Mode defined in 3GPP TS 04.14 subclause 5.4 shall be utilised. If the MS is capable of both:

Mode (a) transmitting pseudo-random data sequence in RLC data blocks;

Mode (b) transmitting looped-back RLC data blocks.

Then Mode (a) will be used. The SS orders the MS to transmit on the uplink with 8PSK modulation, on a mid range ARFCN, power control level set to Max power and MS to operate in its highest number of uplink slots.

The SS controls the power level by setting the concerned timeslot's power control parameter ALPHA (α) to 0 and GAMMA_TN (Γ_{CH}) to the desired power level in the Packet Uplink Assignment or Packet Time Slot Reconfigure message (Closed Loop Control, see 3GPP TS 05.08, clause B.2) GPRS_MS_TXPWR_MAX_CCH / MS_TXPWR_MAX_CCH is set to the maximum value supported by the Power Class of the Mobile under test. For DCS 1 800 mobile stations the POWER_OFFSET parameter is set to 6 dB.

Specific PICS Statements:

- MS using reduced interslot dynamic range in multislot configurations (TSPC_Addinfo_Red_IntSlotRange_Mult_Conf).

PIXIT statements:

-

13.17.3.4.1.2 Test procedure

- a) Measurement of normal burst transmitter output power

For 8PSK, power may be determined by applying the technique described for GMSK in subclause 13.16.2.4.1.2; step a) and then averaging over multiple bursts to achieve sufficient accuracy (see annex 5). Alternatively, an estimation technique based on a single burst which can be demonstrated to yield the same result as the long term average may be used. The long term average or the estimate of long term average is used as the 0dB reference for the power/time template.

- b) Measurement of normal burst power/time relationship. The array of power samples measured in a) are referenced in time to the centre of the useful transmitted symbols and in power to the 0 dB reference, both identified in a).
- c) Steps a) to b) are repeated on each timeslot within the multislot configuration with the MS commanded to operate on each of the nominal output power levels defined in tables 13.17.3-1, 13.17.3-2 and 13.17.3-3.

NOTE: Power control levels 0 and 1 are excluded for bands other than DCS 1800 and PCS 1900 since these power control levels can not be set by GAMMA_TN.

- d) The SS commands the MS to the maximum power control level supported by the MS and steps a) to b) are repeated on each timeslot within the multislot configuration for ARFCN in the Low and High ranges.
- e) The SS commands the MS to the maximum power control level in the first timeslot allocated within the multislot configuration and to the minimum power control level in the second timeslot allocated. Any further timeslots allocated are to be set to the maximum power control level. Steps a) to b) and corresponding measurements on each timeslot within the multislot configuration are repeated. This step is only applicable to MS which support more than one uplink time slot.
- f) Steps a) to e) are repeated under extreme test conditions (annex 1, TC2.2) except that the repeats at step c) are only performed for power control level 10 and the minimum nominal output power level supported by the MS.

13.17.3.4.2 Method of test for equipment with an integral antenna

NOTE: If the MS is equipped with a permanent connector, such that the antenna can be disconnected and the SS be connected directly, then the method of subclause 13.17.3.4.1 will be applied.

The tests in this subclause are performed on an unmodified test sample.

13.17.3.4.2.1 Initial conditions

The MS is placed in the anechoic shielded chamber (annex 1, GC5) or on the outdoor test site, on an isolated support, in the position for normal use, at a distance of at least 3 metres from a test antenna, connected to the SS.

NOTE: The test method described has been written for measurement in an anechoic shielded chamber. If an outdoor test site is used then, in addition, it is necessary to raise/lower the test antenna through the specified height range to maximize the received power levels from both the test sample and the substitution antenna.

The initial conditions for the MS are defined in subclause 13.17.3.4.1.1

13.17.3.4.2.2 Test procedure

- a) With the initial conditions set according to subclause 13.17.3.4.2.1 the test procedure in subclause 13.17.3.4.1.2 is followed up to and including step e), except that in step a), when measurements are done at maximum power for ARFCN in the Low, Mid and High range, the measurement is made eight times with the MS rotated by $n \cdot 45$ degrees for all values of n in the range 0 to 7.

The measurements taken are received transmitter output power measurements rather than transmitter output power measurements, the output power measurement values can be derived as follows.

- b) Assessment of test site loss for scaling of received output power measurements.

The MS is replaced by a half-wave dipole, resonating at the centre frequency of the transmit band, connected to an RF generator.

The frequency of the RF signal generator is set to the frequency of the ARFCN used for the 24 measurements in step a), the output power is adjusted to reproduce the received transmitter output power averages recorded in step a).

For each indication the power, delivered by the generator (in Watts) to the half-wave dipole, is recorded. These values are recorded in the form P_{nc} , where n = MS rotation and c = channel number.

For each channel number used compute:

$$P_{ac}(\text{Watts into dipole}) = \frac{1}{8} * \sum_{n=0}^{n=7} P_{nc}$$

from which: $P_{ac}(\text{Tx dBm}) = 10\log_{10}(P_{ac}) + 30 + 2,15$

The difference, for each of the three channels, between the actual transmitter output power averaged over the 8 measurement orientations and the received transmitter output power at orientation $n = 0$ is used to scale the received measurement results to actual transmitter output powers for all measured power control levels and ARFCN, which can then be checked against the requirements.

c) Temporary antenna connector calibration factors (transmit)

A modified test sample equipped with a temporary antenna connector is placed in a climatic test chamber and is linked to the SS by means of the temporary antenna connector.

Under normal test conditions, the power measurement and calculation parts of steps a) to e) of subclause 13.17.3.4.1.2 are repeated except that the repeats at step d) are only performed for power control level 10 and the minimum nominal output power level supported by the MS.

NOTE 1: The values noted here are related to the output transmitter carrier power levels under normal test conditions, which are known after step b). Therefore frequency dependent calibration factors that account for the effects of the temporary antenna connector can be determined.

d) Measurements at extreme test conditions.

NOTE 2: Basically the procedure for extreme conditions is:

- the power/time template is tested in the "normal" way;
- the radiated power is measured by measuring the difference with respect to the radiated power under normal test conditions.

Under extreme test conditions steps a) to e) of subclause 13.17.3.4.1.2 are repeated except that the repeats at step d) are only performed for power control level 10 and the minimum nominal output power level supported by the MS.

The transmitter output power under extreme test conditions is calculated for each burst type, power control level and for every frequency used by adding the frequency dependent calibration factor, determined in c), to the values obtained at extreme conditions in this step.

13.17.3.5 Test requirements

- a) The transmitter output power for the 8-PSK modulated signals, under every combination of normal and extreme test conditions, for normal bursts, at each frequency and for each power control level applicable to the MS power class, shall be at the relevant level shown in table 13.17.3-1 or table 13.17.3-2 within the tolerances also shown in table 13.17.3-1 or table 13.17.3-2.
- b) Void

Bands other than DCS 1800 and PCS 1900 beginning

Table 13.17.3-1: Bands other than DCS 1800 and PCS 1900 transmitter output power for different power classes 8PSK Modulated Signals

Power class			Power control level (note 3)	GAMMA_TN (Γ_{CH})	Transmitter output power (note 1,2)	Tolerances	
E1	E2	E3					
.	.	.	2-5	0-3	33	±2 dB	±2.5dB
.	.	.	6	4	31	±3 dB	±4 dB
.	.	.	7	5	29	±3 dB	±4 dB
.	.	.	8	6	27	±3 dB	±4 dB
.	.	.	9	7	25	±3 dB	±4 dB
.	.	.	10	8	23	±3 dB	±4 dB
.	.	.	11	9	21	±3 dB	±4 dB
.	.	.	12	10	19	±3 dB	±4 dB
.	.	.	13	11	17	±3 dB	±4 dB
.	.	.	14	12	15	±3 dB	±4 dB
.	.	.	15	13	13	±3 dB	±4 dB
.	.	.	16	14	11	±5 dB	±6 dB
.	.	.	17	15	9	±5 dB	±6 dB
.	.	.	18	16	7	±5 dB	±6 dB
.	.	.	19	17	5	±5 dB	±6 dB

NOTE 1: For R99 and Rel-4, the maximum output power in a multislot configuration must be lower within the limits defined in table 13.17.3-1a. From Rel-5 onwards, the maximum output power in a multislot configuration may be lower within the limits defined in table 13.17.3-1b.

NOTE 2: For a MS using reduced interslot dynamic range in multislot configurations, the MS may restrict the interslot output power control range to a 10 dB window, on a TDMA frame basis. On those timeslots where the ordered power level is more than 10 dB lower than the applied power level of the highest power timeslot, the MS shall transmit at a lowest possible power level within 10 dB range from the highest applied power level, if not transmitting at the actual ordered power level.

NOTE 3: There is no requirement to test power control levels 20-31.

Table 13.17.3-1a: R99 and Rel-4: Bands other than DCS 1800 and PCS 1900 allowed maximum output power reduction in a multislot configuration

Number of timeslots in uplink assignment	Permissible nominal reduction of maximum output power, (dB)
1	0
2	0 to 3,0
3	1,8 to 4,8
4	3,0 to 6,0

Table 13.17.3-1b: From Rel-5 onwards: Bands other than DCS 1800 and PCS 1900 allowed maximum output power reduction in a multislot configuration

Number of timeslots in uplink assignment	Permissible nominal reduction of maximum output power, (dB)
1	0
2	3,0
3	4,8
4	6,0
5	7,0
6	7,8
7	8,5
8	9,0

From R5 onwards, the actual supported maximum output power shall be in the range indicated by the parameter 8-PSK_MULTISLOT_POWER_PROFILE for n allocated uplink timeslots:

$$a \leq \text{MS maximum output power} \leq \min(\text{MAX_PWR}, a + 2\text{dB})$$

Where:

$$a = \min(\text{MAX_PWR}, \text{MAX_PWR} + 8\text{-PSK_MULTISLOT_POWER_PROFILE} - 10\log(n));$$

MAX_PWR equals to the MS maximum output power according to the relevant power class and

- 8-PSK_MULTISLOT_POWER_PROFILE 0 = 0 dB;
- 8-PSK_MULTISLOT_POWER_PROFILE 1 = 2 dB;
- 8-PSK_MULTISLOT_POWER_PROFILE 2 = 4 dB;
- 8-PSK_MULTISLOT_POWER_PROFILE 3 = 6 dB.

Bands other than DCS 1800 and PCS 1900 - end

DCS 1 800 and PCS 1 900 - beginning

Table 13.17.3-2: DCS 1 800 and PCS 1 900 transmitter output power for different power classes 8-PSK Modulated Signals

Power class			Power control level (note 3)	GAMMA_TN (Γ _{CH})	Transmitter output power (note 1,2)	Tolerances	
E1	E2	E3				NORMAL	EXTREME
.	.	.	29,0 *)	0-3 **)	30	±3 dB	±4dB
.	.	.	1	4	28	±3 dB	±4 dB
.	.	.	2	5	26	±3 dB	±4 dB
.	.	.	3	6	24	±3 dB	±4 dB
.	.	.	4	7	22	±3 dB	±4 dB
.	.	.	5	8	20	±3 dB	±4 dB
.	.	.	6	9	18	±3 dB	±4 dB
.	.	.	7	10	16	±3 dB	±4 dB
.	.	.	8	11	14	±4 dB	±4 dB
.	.	.	9	12	12	±4 dB	±5 dB
.	.	.	10	13	10	±4 dB	±5 dB
.	.	.	11	14	8	±4 dB	±5 dB
.	.	.	12	15	6	±4 dB	±5 dB
.	.	.	13	16	4	±5 dB	±5 dB
.	.	.	14	17	2	±5 dB	±6 dB
.	.	.	15	18	0	±5 dB	±6 dB

*) 30-0 for PCS 1900 **) 1-3 for PCS 1900

NOTE 1: For R99 and Rel-4, the maximum output power in a multislot configuration must be lower within the limits defined in table 13.17.3-2a. From Rel-5 onwards, the maximum output power in a multislot configuration may be lower within the limits defined in table 13.17.3-2b.

NOTE 2: For a MS using reduced interslot dynamic range in multislot configurations, the MS may restrict the interslot output power control range to a 10 dB window, on a TDMA frame basis. On those timeslots where the ordered power level is more than 10 dB lower than the applied power level of the highest power timeslot, the MS shall transmit at a lowest possible power level within 10 dB range from the highest applied power level, if not transmitting at the actual ordered power level.

NOTE 3: There is no requirement to test power control levels 16-28.

Table 13.17.3-2a: R99 and Rel-4: DCS 1 800 and PCS 1 900 allowed maximum output power reduction in a multislot configuration

Number of timeslots in uplink assignment	Permissible nominal reduction of maximum output power, (dB)
1	0
2	0 to 3,0
3	1,8 to 4,8
4	3,0 to 6,0

Table 13.17.3-2b: From Rel-5 onwards: DCS 1 800 and PCS 1 900 allowed maximum output power reduction in a multislot configuration

Number of timeslots in uplink assignment	Permissible nominal reduction of maximum output power, (dB)
1	0
2	3,0
3	4,8
4	6,0
5	7,0
6	7,8
7	8,5
8	9,0

From R5 onwards, the actual supported maximum output power shall be in the range indicated by the parameter 8-PSK_MULTISLOT_POWER_PROFILE for n allocated uplink timeslots:

$$a \leq \text{MS maximum output power} \leq \min(\text{MAX_PWR}, a + 2\text{dB})$$

Where:

$$a = \min(\text{MAX_PWR}, \text{MAX_PWR} + 8\text{-PSK_MULTISLOT_POWER_PROFILE} - 10\log(n));$$

MAX_PWR equals to the MS maximum output power according to the relevant power class and

- 8-PSK_MULTISLOT_POWER_PROFILE 0 = 0 dB;
- 8-PSK_MULTISLOT_POWER_PROFILE 1 = 2 dB;
- 8-PSK_MULTISLOT_POWER_PROFILE 2 = 4 dB;
- 8-PSK_MULTISLOT_POWER_PROFILE 3 = 6 dB.

DCS 1 800 and PCS 1 900 - end

- c) The difference between the transmitter output power at two adjacent power control levels, measured at the same frequency, shall not be less than 0,5 dB and not be more than 3,5 dB.

For R99 and Rel-4, if one or both of the adjacent output power levels are reduced according to the number of timeslots, the difference between the transmitter output power at two adjacent power control levels, measured at the same frequency, shall not be less than -1dB and not be more than 3.5 dB.

From Rel-5 onwards, if one or both of the adjacent output power levels are reduced according to 8PSK_MULTISLOT_POWER_PROFILE X and the number of timeslots, the difference between the transmitter output power at two adjacent power control levels, measured at the same frequency, shall not be less than -1dB and not be more than 3.5 dB

- d) The power/time relationship of the measured samples for normal bursts shall be within the limits of the power time template of figure 13.17.3-1 for 8-PSK at each frequency, under every combination of normal and extreme test conditions and at each power control level measured.

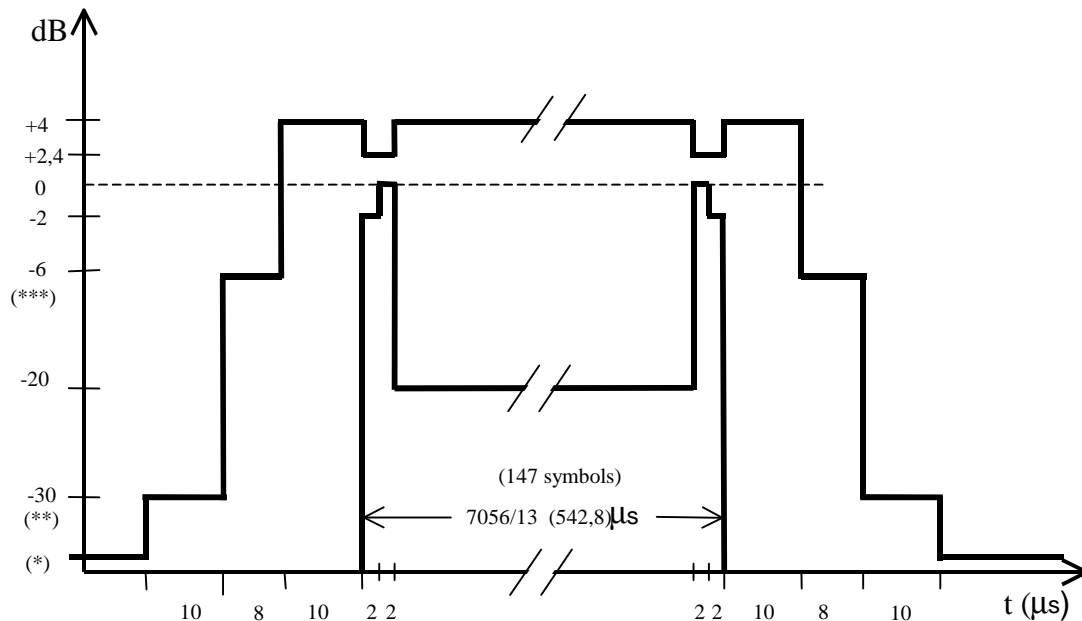

Figure 13.17.3-1: Time mask for normal duration bursts (NB) at 8-PSK modulation

- e) All the power control levels, for the type and power class of the MS as stated by the manufacturer, shall be implemented in the MS.
- f) When the transmitter is commanded to a power control level outside of the capability corresponding to the type and power class of the MS as stated by the manufacturer, then the transmitter output power shall be within the tolerances for the closest power control level corresponding to the type and power class as stated by the manufacturer.

Table 13.17.3-3: Lowest measurement limit for power / time template

(*)	For bands other than DCS 1800 and PCS 1900 MS	:	59 dBc or -54 dBm whichever is the highest, except for the timeslot preceding the active slot, for which the allowed level is -59 dBc or -36 dBm, whichever is the highest
	For DCS 1 800 MS and PCS 1 900 MS	:	-48 dBc or -48 dBm, whichever is the higher.
		:	no requirement below -30 dBc (see subclause 4.5.1).
(***)	For bands other than DCS 1800 and PCS 1900 MS	:	-4 dBc for power control level 16;
			-2 dBc for power level 17;
			-1 dBc for power level controls levels 18 and 19.
	For DCS 1 800 and PCS 1900 MS		-4dBc for power control level 11,
			-2dBc for power level 12,
			-1dBc for power control levels 13,14 and 15
(**)	For bands other than DCS 1800 and PCS 1900 MS	:	-30 dBc or -17 dBm, whichever is the higher.
	For DCS 1 800 and PCS 1900 MS		-30dBc or -20dBm, whichever is the higher.

13.17.4 Output RF spectrum in EGPRS configuration

13.17.4.1 Definition

The output RF spectrum is the relationship between the frequency offset from the carrier and the power, measured in a specified bandwidth and time, produced by the MS due to the effects of modulation and power ramping.

Since the conformance requirement, test procedure and test requirement of GSMK modulated signal's output RF spectrum are defined in subclause 13.16.3 for GPRS MS, being thereby defined also for all EGPRS MS in that section, only 8PSK modulated signal's RF output spectrum conformance requirement, test procedure and test requirements are defined in this subclause.

13.17.4.2 Conformance requirement

1. The level of the output RF spectrum due to 8PSK modulation shall be no more than that given in 3GPP TS 05.05, subclause 4.2.1, with the following lowest measurement limits:
 - -36 dBm below 600 kHz offset from the carrier;
 - -51 dBm for GSM 400, GSM 700, GSM 850 and GSM 900 or -56 dBm for DCS 1 800 and PCS 1 900 from 600 kHz out to less than 1 800 kHz offset from the carrier;
 - -46 dBm for GSM 400, GSM 700, GSM 850 and GSM 900 or -51 dBm for DCS 1 800 and PCS 1 900 at and beyond 1 800 kHz offset from the carrier;

but with the following exceptions at up to -36 dBm:

- up to three bands of 200 kHz width centred on a frequency which is an integer multiple of 200 kHz in the combined range 600 kHz to 6 000 kHz above and below the carrier;
- up to 12 bands of 200 kHz width centred on a frequency which is an integer multiple of 200 kHz at more than 6 000 kHz offset from the carrier.

1.1 Under normal conditions; 3GPP TS 05.05, subclause 4.2.1.

1.2 Under extreme conditions; 3GPP TS 05.05, subclause 4.2.1; 3GPP TS 05.05, annex D subclauses D.2.1 and D.2.2.

2. The level of the output RF spectrum due to switching transients shall be no more than given in 3GPP TS 05.05, subclause 4.2.2, table "a) Mobile Station".

2.1 Under normal conditions; 3GPP TS 05.05, subclause 4.2.2.

2.2 Under extreme conditions; 3GPP TS 05.05, subclause 4.2.2; 3GPP TS 05.05 annex D subclauses D.2.1 and D.2.2.

3. When allocated a channel, the power emitted by the GSM 400, GSM 900 and DCS 1800 MS, in the band 935 MHz to 960 MHz shall be no more than -79 dBm, in the band 925 MHz to 935 MHz shall be no more than -67 dBm and in the band 1 805 MHz to 1 880 MHz shall be no more than -71 dBm, except in five measurements in each of the bands 925 MHz to 960 MHz and 1 805 MHz to 1 880 MHz, where exceptions at up to -36 dBm are permitted. For GSM 400 mobiles, in addition, a limit of -67 dBm shall apply in the frequency bands 460,4 MHz to 467,6 MHz and 488,8 MHz to 496 MHz.

For GSM 700, GSM 850 and PCS 1 900, the power emitted by MS, in the band of 747 MHz to 757 MHz shall be no more than -79 dBm, in the band of 757 MHz to 762 MHz shall be no more than -73 dBm, in the band 869 MHz to 894 MHz shall be no more than -79 dBm, in the band 1 930 MHz to 1 990 MHz shall be no more than -71 dBm except in five measurements in each of the bands 747 MHz to 762 MHz, 869 MHz to 894 MHz and 1 930 MHz to 1 990 MHz where exceptions at up to -36 dBm are permitted; 3GPP TS 05.05, subclause 4.3.3.

13.17.4.3 Test purpose

1. To verify that the output RF spectrum due to 8PSK modulation of an EGPRS MS does not exceed conformance requirement 1.
 - 1.1 Under normal conditions.
 - 1.2 Under extreme conditions.
2. To verify that the output RF spectrum due to 8PSK modulation of an EGPRS MS does not exceed conformance requirement 1 in 8PSK uplink multislot configuration.
 - 2.1 Under normal conditions.
 - 2.2 Under extreme conditions.

3. To verify that the output RF spectrum due to switching transients of 8PSK modulated signals of an EGPRS MS does not exceed conformance requirement 2 when a reasonable margin is allowed for the effect of spectrum due to modulation.
 - 3.1 Under normal conditions.
 - 3.2 Under extreme conditions.
4. To verify that the output RF spectrum due to switching transients of 8PSK modulated signals of an EGPRS MS does not exceed conformance requirement 2 in 8PSK uplink multislot configuration when a reasonable margin is allowed for the effect of spectrum due to modulation.
 - 4.1 Under normal conditions.
 - 4.2 Under extreme conditions.
5. To verify that the MS spurious emissions in the MS receive band for 8PSK modulated signals of an EGPRS MS do not exceed conformance requirement 3.
6. To verify that the MS spurious emissions in the MS receive band for 8PSK modulated signals of an EGPRS MS do not exceed conformance requirement 3 in 8PSK uplink multislot configuration.

NOTE: For EGPRS MS capable of 8PSK multislot configuration in the uplink, the tests are executed only for multislot configuration.

13.17.4.4 Method of test

Initial conditions

The test shall be run under the default EGPRS conditions defined in clause 50, with power control parameter ALPHA (α) set to 0.

The Test Mode defined in 3GPP TS 04.14 subclause 5.4 shall be utilised. If the MS is capable of both:

- Mode (a) transmitting pseudo-random data sequence in RLC data blocks;
- Mode (b) transmitting looped-back RLC data blocks;

then Mode (a) will be used.

The SS commands the MS to transmit with its maximum number of uplink slots, with 8PSK modulation in hopping mode. The hopping pattern includes only three channels, namely one with an ARFCN in the Low ARFCN range, a second one with an ARFCN in the Mid ARFCN range and the third one with an ARFCN in the High ARFCN range.

The SS shall use a transmission level of 23 dB μ V_{emf}().

NOTE 1: Although the measurement is made whilst the MS is in hopping mode, each measurement is on one single channel.

NOTE 2: This test is specified in hopping mode as a simple means of making the MS change channel, it would be sufficient to test in non hopping mode and to cell re-select the MS between the three channels tested at the appropriate time.

NOTE 3: Mid ARFCN range for GSM 900 will use the range 63-65 ARFCN

13.17.4.4.2 Test procedure

NOTE: When averaging is in use during frequency hopping mode, the averaging only includes bursts transmitted when the hopping carrier corresponds to the nominal carrier of the measurement.

- a) In steps b) to h) the FT is equal to the hop pattern ARFCN in the Mid ARFCN range.
- b) The other settings of the spectrum analyser are set as follows:
 - Zero frequency scan;
 - Resolution bandwidth: 30 kHz;

- Video bandwidth: 30 kHz;
- Video averaging: may be used, depending on the implementation of the test.

The video signal of the spectrum analyser is "gated" such that the spectrum generated by at least 40 of the symbols 87 to 132 of the burst in one of the active time slots is the only spectrum measured. This gating may be analogue or numerical, dependent upon the design of the spectrum analyser. Only measurements during transmitted bursts on the nominal carrier of the measurement are included. The spectrum analyser averages over the gated period and over 200 or 50 such bursts, using numerical and/or video averaging.

The MS is commanded to its maximum power control level in every transmitted time slot.

- c) By tuning the spectrum analyser centre frequency to the measurement frequencies the power level is measured over 50 bursts at all multiples of 30 kHz offset from FT to < 1 800 kHz.
- d) The resolution and video bandwidth on the spectrum analyser are adjusted to 100 kHz and the measurements are made at the following frequencies:

on every ARFCN from 1 800 kHz offset from the carrier to the edge of the relevant transmit band for each measurement over 50 bursts.

at 200 kHz intervals over the 2 MHz either side of the relevant transmit band for each measurement over 50 bursts.

For GSM 400 and DCS 1 800:

at 200 kHz intervals over the band 450 MHz to 496 MHz for each measurement over 50 bursts.

at 200 kHz intervals over the band 925 MHz to 960 MHz for each measurement over 50 bursts.

at 200 kHz intervals over the band 1 805 MHz to 1 880 MHz for each measurement over 50 bursts.

For GSM 900

at 200 kHz intervals over the band 925 MHz to 960MHz for each measurement over 50 bursts;

at 200 kHz intervals over the band 1805 MHz to 1880 MHz for each measurement over 50 bursts.

For GSM 700, GSM 850 and DCS 1 900:

at 200 kHz intervals over the band 747 MHz to 762 MHz for each measurement over 50 bursts.

at 200 kHz intervals over the band 869 MHz to 894 MHz for each measurement over 50 bursts.

at 200 kHz intervals over the band 1 930 MHz to 1 990 MHz for each measurement over 50 bursts.

- e) The MS is commanded to its minimum power control level. The spectrum analyser is set again as in b).
- f) By tuning the spectrum analyser centre frequency to the measurement frequencies the power level is measured over 200 bursts at the following frequencies:

FT;

FT + 100 kHz FT - 100 kHz;

FT + 200 kHz FT - 200 kHz;

FT + 250 kHz FT - 250 kHz;

FT + 200 kHz * N FT - 200 kHz * N;

where N = 2, 3, 4, 5, 6, 7, and 8;

and FT = RF channel nominal centre frequency.

- g) Steps a) to f) is repeated except that in step a) the spectrum analyzer is gated so that the burst of the next active time slot is measured.

h) The spectrum analyser settings are adjusted to:

- Zero frequency scan;
- Resolution bandwidth: 30 kHz;
- Video bandwidth: 100 kHz;
- Peak hold.

The spectrum analyser gating of the signal is switched off.

The MS is commanded to its maximum power control level in every transmitted time slot.

i) By tuning the spectrum analyser centre frequency to the measurement frequencies the power level is measured at the following frequencies:

FT + 400 kHz FT - 400 kHz;

FT + 600 kHz FT - 600 kHz;

FT + 1,2 MHz FT - 1,2 MHz;

FT + 1,8 MHz FT - 1,8 MHz;

where FT = RF channel nominal centre frequency.

The duration of each measurement (at each frequency) will be such as to cover at least 10 burst transmissions at FT.

j) Step i) is repeated for power control levels 7 and 11.

k) Steps b), f), h) and i) are repeated with FT equal to the hop pattern ARFCN in the Low ARFCN range except that in step h) the MS is commanded to power control level 11 rather than maximum power.

l) Steps b), f), h) and i) are repeated with FT equal to the hop pattern ARFCN in the High ARFCN range except that in step h) the MS is commanded to power control level 11 rather than maximum power.

m) Steps a) b) f) h), and i) are repeated under extreme test conditions (annex 1, TC2.2). except that at step h) the MS is commanded to power control level 11.

13.17.4.5 Test requirements

For absolute measurements, performed on a temporary antenna connector, in the frequency band 450 MHz to 486 MHz or 777 MHz to 792 MHz or 824 MHz to 849 MHz or 880 MHz to 915 MHz or 1 710 MHz to 1 785 MHz or 1 850 MHz to 1 910 MHz, the temporary antenna connector coupling factor, determined according to subclause 13.3.4.2.2 and annex 1 GC7, for the nearest relevant frequency, will be used.

For absolute measurements, performed on a temporary antenna connector, in the frequency band 450 MHz to 486 MHz or 925 MHz to 960 MHz, the temporary antenna connector coupling factor, will be as determined according to annex 1 GC7 for GSM 400 or GSM 900 MS respectively. For a DCS 1 800 MS and PCS 1 900 MS 0 dB will be assumed.

For absolute measurements, performed on a temporary antenna connector, in the frequency band 1 805 MHz to 1 880 MHz, the temporary antenna connector coupling factor, will be as determined according to annex 1 GC7 for DCS 1 800 MS. For GSM 400 MS and GSM 900 MS 0 dB will be assumed.

For absolute measurements, performed on a temporary antenna connector, in the frequency band 747 MHz to 762 MHz, the temporary antenna connector coupling factor, will be as determined according to annex 1 GC7 for GSM 700 MS. For a GSM 400, GSM 850, GSM 900, DCS 1800 or PCS 1 900 MS 0 dB will be assumed.

For absolute measurements, performed on a temporary antenna connector, in the frequency band 869 to 894 MHz, the temporary antenna connector coupling factor, will be as determined according to annex 1 GC7 for GSM 850 MS. For a GSM 400, GSM 700, GSM 900, DCS 1800 or PCS 1 900 MS 0 dB will be assumed.

The figures in the tables below, at the listed frequencies from the carrier (kHz), are the maximum level (dB) relative to a measurement in 30 kHz bandwidth on the carrier (reference 3GPP TS 05.05 subclause 4.2.1).

- a) For the modulation sidebands out to less than 1 800 kHz offset from the carrier frequency (FT) measured in step c), f), i), k), l) and m) the measured power level in dB relative to the power level measured at FT, for all types of MS, shall not exceed the limits derived from the values shown in table 13.17.4-1 for GSM 400, GSM 700, GSM 850 and GSM 900 or table 13.17.4-2 for DCS 1 800 and PCS 1 900 MS, according to the actual transmit power and frequency offset from FT. However any failures in the combined range 600 kHz to less than 1 800 kHz above and below the carrier may be counted towards the exceptions allowed in test requirements c) below.

Table 13.17.4-1: GSM 400, GSM 700, GSM 850 and GSM 900 Spectrum due to modulation out to less than 1 800 kHz offset

Power level (dBm)	power levels in dB relative to the measurement at FT				
	Frequency offset (kHz)				
	0-100	200	250	400	600 to < 1 800
39	+0,5	-30	-33	-60	-66
37	+0,5	-30	-33	-60	-64
35	+0,5	-30	-33	-60	-62
<= 33	+0,5	-30	-33	-60 (note)	-60
The values above are subject to the minimum absolute levels (dBm) below.					
	-36	-36	-36	-36	-51
NOTE: For equipment supporting 8PSK, the requirement for 8-PSK modulation is -54dB.					

Table 13.17.4-2: DCS 1 800/PCS 1 900 Spectrum due to modulation out to less than 1 800 kHz offset

Power level (dBm)	power levels in dB relative to the measurement at FT				
	Frequency offset (kHz)				
	0-100	200	250	400	600 to < 1 800
<= 36	+0,5	-30	-33	-60	-60
34	+0.5	-30	-33	-60	-60
32	+0.5	-30	-33	-60	-60
30	+0.5	-30	-33	-60 (note)	-60
The values above are subject to the minimum absolute levels (dBm) below.					
	-36	-36	-36	-36	-56
NOTE: For equipment supporting 8-PSK, the requirement for 8-PSK modulation is -54dB.					

NOTE 1: For frequency offsets between 100 kHz and 600 kHz the requirement is derived by a linear interpolation between the points identified in the table with linear frequency and power in dB relative.

- b) For the modulation sidebands from 1 800 kHz offset from the carrier frequency (FT) and out to 2 MHz beyond the edge of the relevant transmit band, measured in step d), the measured power level in dB relative to the power level measured at FT, shall not exceed the values shown in table 13.17.4-3 according to the actual transmit power, frequency offset from FT and system on which the MS is designed to operate. However any failures in the combined range 1 800 kHz to 6 MHz above and below the carrier may be counted towards the exceptions allowed in test requirements c) below, and any other failures may be counted towards the exceptions allowed in test requirements d) below.

Table 13.17.4-3: Spectrum due to modulation from 1 800 kHz offset to the edge of the transmit band (wideband noise)

power levels in dB relative to the measurement at FT						
GSM 400, GSM 700, GSM 850 and GSM 900				DCS 1 800 and PCS 1 900		
Power level	Frequency offset			Power level	Frequency offset	
(dBm)	kHz			(dBm)	kHz	
	1 800 to	3 000 to	≥ 6 000		1 800 to	≥ 6 000
	< 3 000	< 6 000			< 6 000	
39	-69	-71	-77	36	-71	-79
37	-67	-69	-75	34	-69	-77
35	-65	-67	-73	32	-67	-75
≤ 33	-63	-65	-71	30	-65	-73
				28	-63	-71
				26	-61	-69
				≤ 24	-59	-67
The values above are subject to the minimum absolute levels (dBm) below.						
	-46	-46	-46		-51	-51

- c) Any failures (from a) and b) above) in the combined range 600 kHz to 6 MHz above and below the carrier should be re-checked for allowed spurious emissions. For each of the three ARFCN used, spurious emissions are allowed in up to three 200 kHz bands centred on an integer multiple of 200 kHz so long as no spurious emission exceeds -36 dBm. Any spurious emissions measured in a 30 kHz bandwidth which spans two 200 kHz bands can be counted towards either 200 kHz band, whichever minimizes the number of 200 kHz bands containing spurious exceptions.
- d) Any failures (from b) above) beyond 6 MHz offset from the carrier should be re-checked for allowed spurious emissions. For each of the three ARFCN used, up to twelve spurious emissions are allowed so long as no spurious emission exceeds -36 dBm.
- e) The MS spurious emissions in the bands 460,4 MHz to 467,6 MHz, 488,8 MHz to 496 MHz, 925 MHz to 935 MHz, 935 MHz to 960 MHz, 1 805 MHz to 1 880 MHz and 1 850 MHz to 1 910 MHz measured in step d), for all types of MS, shall not exceed the values shown in table 13.16.4-4 except in up to 3 measurements in the band 460,4 MHz to 467,6 MHz and 488,8 MHz to 496 MHz, in up to five measurements in the band 925 MHz to 960 MHz and five measurements in the band 1 805 MHz to 1 880 MHz where a level up to -36 dBm is permitted. For GSM 700, GSM 850 and PCS 1 900 the spurious emissions in the bands 747 MHz to 757 MHz, 757 MHz to 762 MHz, 869 MHz to 894 MHz and 1 930 MHz to 1 990 MHz shall not exceed the values shown in table 13.17.4-4 except in up to five measurements in each of the bands 747 MHz to 762 MHz, 869 MHz to 894 MHz and 1 930 MHz to 1 990 MHz where a level up to -36 dBm is permitted.

Table 13.17.4-4: Spurious emissions in the MS receive bands

Band (MHz)	Spurious emissions level for GSM 400, GSM 900 and DCS 1800 (dBm)	Spurious emissions level for GSM 700, GSM 850 and PCS 1 900 (dBm)
460 to 496	-67 Applicable only for GSM 400 mobiles	
925 to 935	-67	
935 to 960	-79	
1 805 to 1 880	-71	
747 to 757		-79
757 to 762		-73
869 to 894		-79
1 930 to 1 990		-71
1 850 to 1 910		Comply with FCC rules for wideband PCS services (see 3GPP TS 05.05, subclause 4.3, applicable only for PCS)

- f) For the power ramp sidebands of steps h), i) and k) the power levels must not exceed the values shown in table 13.17.4-5 for GSM 700, GSM 850 and GSM 900 or table 13.17.4-6 for DCS 1 800.

Table 13.17.4-5: GSM700, GSM 850 and GSM 900 Spectrum due to switching transients

Power level	Maximum level for various offsets from carrier frequency			
	400 kHz	600 kHz	1 200 kHz	1 800 kHz
39 dBm	-13 dBm	-21 dBm	-21 dBm	-24 dBm
37 dBm	-15 dBm	-21 dBm	-21 dBm	-24 dBm
35 dBm	-17 dBm	-21 dBm	-21 dBm	-24 dBm
33 dBm	-19 dBm	-21 dBm	-21 dBm	-24 dBm
31 dBm	-21 dBm	-23 dBm	-23 dBm	-26 dBm
29 dBm	-23 dBm	-25 dBm	-25 dBm	-28 dBm
27 dBm	-23 dBm	-26 dBm	-27 dBm	-30 dBm
25 dBm	-23 dBm	-26 dBm	-29 dBm	-32 dBm
23 dBm	-23 dBm	-26 dBm	-31 dBm	-34 dBm
<= +21 dBm	-23 dBm	-26 dBm	-32 dBm	-36 dBm

Table 13.17.4-6: DCS 1 800/PCS 1 900 Spectrum due to switching transients

Power level	Maximum level for various offsets from carrier frequency			
	400 kHz	600 kHz	1 200 kHz	1 800 kHz
36 dBm	-16 dBm	-21 dBm	-21 dBm	-24 dBm
34 dBm	-18 dBm	-21 dBm	-21 dBm	-24 dBm
32 dBm	-20 dBm	-22 dBm	-22 dBm	-25 dBm
30 dBm	-22 dBm	-24 dBm	-24 dBm	-27 dBm
28 dBm	-23 dBm	-25 dBm	-26 dBm	-29 dBm
26 dBm	-23 dBm	-26 dBm	-28 dBm	-31 dBm
24 dBm	-23 dBm	-26 dBm	-30 dBm	-33 dBm
22 dBm	-23 dBm	-26 dBm	-31 dBm	-35 dBm
<= +20 dBm	-23 dBm	-26 dBm	-32 dBm	-36 dBm

NOTE 2: These figures are different from the requirements in 3GPP TS 05.05 because at higher power levels it is the modulation spectrum which is being measured using a peak hold measurement. This allowance is given in the table.

NOTE 3: The figures for table 13.17.3-5 and table 13.17.3-6 assume that, using the peak hold measurement, the lowest level measurable is 8 dB above the level of the modulation specification using the 30 kHz bandwidth gated average technique for 400 kHz offset from the carrier. At 600 and 1 200 kHz offset the level is 6 dB above and at 1 800 kHz offset the level is 3 dB above. The figures for 1 800 kHz have assumed the 30 kHz bandwidth spectrum due to modulation specification at <1 800 kHz.

13.17.5 Void

14 Receiver

In this clause on receiver measurements, the procedures to test equipment which is fitted with a permanent antenna connector, and the procedures to test equipment which is designed to only be used with an integral antenna, are in general combined into one single test description.

Tests on Mobile Stations fitted with an integral antenna and having no means of connecting an external antenna are specified in terms of received field strength. In order to perform tests on such Mobile Stations without the need for separated access to a calibrated test site a temporary antenna connector is used as defined in annex 1 subclause 1.1.3 (General Conditions).

In practice the temporary antenna connector may be used for transmitter measurements described in clause 3, but the calibration factors determined in annex 1 will not be directly usable. The detailed calibration, when needed, for transmission tests are described in the relevant subclauses of 3.

Wherever in this subclause, for FACCH tests, the SS is required to send a Layer 3 message not requiring a Layer 3 response from the MS the message can be a TEST INTERFACE message or a STATUS message, possibly with an unknown Protocol Discriminator.

Testing philosophy

Certain assumptions concerning the functional mechanisms of GSM receivers have been made in order to define tests that will verify the receiver performance without excessive redundancy and excessive test times.

The receiver functions can be divided into:

- Analogue RF and IF stages that are affected by input levels, temperature and power supply levels.
- Demodulator that is affected by input levels and interfering signals.
- Decoders that are affected by the different logical channels and input levels.

The tests are designed to stress each of these blocks with a minimum of redundancy.

Statistical testing of receiver BER/FER performance

Error Definition

1) Frame Erasure Ratio (FER)

A frame is defined as erased if the error detection functions in the receiver, operating in accordance with 3GPP TS 05.03, indicate an error (BFI = 1). For full rate or half rate speech this is the result of the cyclic redundancy check (CRC) as well as other processing functions that cause a Bad Frame Indication (BFI). For signalling channels it is the result of the FIRE code or any other block code used. For data traffic FER is not defined.

2) Residual Bit Error Ratio (RBER).

The Residual Bit Error Ratio is defined as the Bit Error Ratio (BER) in frames which have not been declared as erased.

3) Bit Error Ratio (BER).

The Bit Error Ratio is defined as the ratio of the bits wrongly received to all data bits sent.

4) Unreliable Frame Ratio (UFR).

The Unreliable Frame Ratio is defined as the ratio of frames declared as erased (BFI=1), or unreliable (UFI=1), to the total number of frames transmitted. An unreliable frame is indicated by setting the UFI flag (UFI=1) and an erased frame is indicated by setting the BFI flag (BFI=1) (see 3GPP TS 06.21).

5) Erased SID Frame Ratio (ESIDR).

A SID Frame is erased (SID=0) when the MS does not detect a valid transmitted SID frame as a valid SID frame (SID=2), or an invalid SID frame (SID=1). The Erased SID Frame Ratio is defined as the ratio of erased SID frames (SID=0), to the total number of valid SID frames transmitted (see 3GPP TS 06.41).

6) Erased Valid SID Frame Ratio (EVSIDR).

An Erased Valid SID Frame is declared when the MS does not detect a valid transmitted SID frame as a valid SID frame (SID=2) and (BFI=0 and UFI=0). The Erased Valid SID Frame Ratio is defined as the ratio of erased valid SID frames (SID=0), or (SID=1), or ((BFI or UFI)=1), to the total number of valid SID frames transmitted (see 3GPP TS 06.41).

7) Erased Valid SID_UPDATE frame Rate associated to an adaptive speech traffic channel (EVSIDUR).

This related to the erasure of a SID_UPDATE frame related to an AMR channel (full rate or half rate) due to the failure to detect the SID_UPDATE identifier or to a due to a CRC failure.

8) Erased Valid RATSCCH Frame Rate associated to an adaptive speech traffic channel (EVRFR).

This relates to the erasure of the RATSCCH message due to the failure to detect the RATSCCH identifier or due to a CRC failure.

9) Frame error rate for the In-Band channel (TCH/AFS-INB or TCH/AHS-INB).

This related to the erasure of an AMR speech frame (full rate or half rate) due to the bad decoding of the Mode Indication in-band bits.

Test method

Each test is performed in the following manner:

- a) Set up the required test conditions.
- b) Perform the test for at least the minimum number of samples (frames, bits or bits from non erased frames) and record the number of offered samples and the number of occurred events (frame, bit or residual bit errors).
- c) Terminate the test and determine the test result ("pass" or "fail") by comparing the measured error rate against the test limit error rate.

It is permitted to run the test over more samples than the value stated for minimum number of samples. The effect of increasing the number of samples is always to give a higher probability that a good unit will pass and a lower risk that a bad unit will pass, according to the definitions of good and bad unit in this subclause.

Test criteria

The limits on number of samples and test limit error rate shall be defined in order to comply with different requirements:

- 1) to keep reasonably low the risk of passing a bad unit for each individual test;
- 2) to have high probability of passing a good unit for each individual test;
- 3) to perform measurements with a high degree of statistical significance;
- 4) to keep the test time as low as possible.

The risk of passing a bad unit (point 1) should be kept lower than 0,2 %. The performance on a full rate channel, or a half rate data channel, is generally considered "bad" if its BER (or FER) performance is 1,5 times worse than that specified in AWGN (Additive White Gaussian Noise) and 1,26 times worse than that specified in multipath environment. These values have been adopted (taking into account the expected shapes of the BER performance) in order not to pass a unit with performance worse than the specifications by more than 1 dB.

The performance on a half rate speech channel, is generally considered "bad" if the BER (or FER, or UFR) is worse than that specified, multiplied by the factors given in table 14-1. These values have been adopted (taking into account

the expected shapes of the BER performance) in order not to pass a unit with performance worse than the specifications by more than 1 dB.

Table 14-1: TCH/HS "bad" unit multiplication factors

Propagation Conditions	GSM 400, GSM 700, T-GSM 810, GSM 850 and GSM 900				DCS 1 800 and PCS 1 900			
	TUlow (No FH)	TUhigh (FH/ No FH)	HT (No FH)	RA (No FH)	TUlow (No FH)	TUhigh (FH/ No FH)	HT (No FH)	RA (No FH)
Reference sensitivity:								
TCH/HS FER		1,7				1,7		
TCH/HS class Ib (BFI=0)		2,2				2,0		
TCH/HS class II (BFI=0)		1,2	1,2	1,2		1,2	1,2	1,2
TCH/HS UFR		2,0				1,9		
TCH/HS class Ib (BFI=0 and UFI=0)		1,8				1,7		
Reference interference:								
TCH/HS FER		1,6				1,6		
TCH/HS class Ib (BFI=0)		1,8				1,8		
TCH/HS class II (BFI=0)		1,2				1,2		
TCH/HS UFR		1,6				1,6		
TCH/HS class Ib (BFI or UFI)=0		1,4				1,4		
EVSIDR	1,2				1,2			
RBBER (SID=2 and (BFI or UFI)=0)	1,3				1,3			
ESIDR	1,3				1,3			
RBBER (SID=1 or SID=2)	1,3				1,3			

The probability of passing a good unit operating on the specification limit of performance (point 2) should be at least 99,7 %.

If the error events can be assumed to be random independent variables, outputs of stationary random processes with identical Gaussian distributions, the previous figures suggest a number of events (point 3) not lower than 200 in AWGN channel and not lower than 600 in a multipath environment, and to test a BER (or FER) performance 1,22 times worse than that specified in AWGN and 1,12 times worse than that specified in a multipath environment (this corresponds to testing a performance, at the most, 0,5 dB worse than that specified).

For multipath propagation conditions the hypothesis of stationary random processes does not generally hold. In case of non frequency hopping operation mode, the radio channel may be assumed to change 10 times per wavelength of travelled distance and to be short term stationary in between. So, in this case, the required observation time for having good statistical properties should not be lower (with some rounding) than that reported in table 14-1.

Table 14-2: Minimum test time according to propagation profile

Propagation Conditions	GSM 400, GSM 700, T-GSM 810, GSM 850 and GSM 900				DCS 1 800 and PCS 1 900			
	TUlow	TUhigh	HT	RA	TUlow	TUhigh	HT	RA
Min. test time (s)	500	30	15	6	500	15	7,5	6

Tables 14-3 and 14-4 detail, for the different test conditions, the minimum number of samples required in order to meet points 1) to 3): the corresponding test time (point 4) can be consequently computed.

As can be seen in the tables, in some of the cases in which both FER and RBBER have to be tested on the same channel, the length of time for the FER measurement has been adopted for the RBBER measurement. This is longer than that required for the RBBER only according to the discussed criteria, but allows the use of a test limit error rate closer to the specified error rate while maintaining the same statistical significance. When, as is normal, it is desired to perform the FER and RBBER tests, the closer test limit error rate for the RBBER measurement can be achieved without increasing the total test time. It is always possible to extend the length of any test and further improve the statistical significance of that test.

Co-channel rejection tests with a frequency condition noted as "@ndB" are performed with the interfering frequency transmitted with an additional n dB attenuation, see 3GPP TS 45.005.

Table 14-3: Test conditions for GSM 400, GSM 700, T-GSM 810, GSM 850 and GSM 900

Type of test	Type of channel	Propagation/frequency conditions	Specified FER/ BER %	Test limit FER/ BER %	Minimum No of samples	Prob that good unit will pass %	Bad unit BER/ FER %	Risk that bad unit will pass
BFI	TCH/FS	Static	0,033	0,041	492000	99,813	0,050	0,140
	TCH/FS	Static / FH	0,033	0,041	492000	99,813	0,050	0,140
	TCH/AFS	Static	0,033	0,041	492000	99,813	0,050	0,140
	TCH/AHS	Static	0,033	0,041	492000	99,813	0,050	0,140
Sensitivity	TCH/FS	Static/FH	0,100*α	0,122*α	164000	99,717	0,150*α	0,140
	TCH/FS Class Ib	Static/FH	0,400/α	0,410/α	20000000	100,000	0,600/α	<0,001
	TCH/FS Class II	Static/FH	2,000	2,439	8200	99,714	3,000	0,001
	TCH/FS	TUhigh/No FH	6,000*α	6,742*α	8900	99,825	7,560*α	0,162
	TCH/FS Class Ib	TUhigh/No FH	0,400/α	0,420/α	1000000	99,919	0,504/α	<0,001
	TCH/FS Class II	TUhigh/No FH	8,000	8,333	120000	99,999	10,080	<0,001
	TCH/FS Class II	HT/No FH	9,000	9,333	60000	99,779	11,340	<0,001
	TCH/FS Class II	RA/No FH	7,000	7,500	24000	99,873	8,694	<0,001
	TCH/EFS	Static/FH	0,100	0,122	164000	99,758	0,150	0,171
	TCH/EFS Class Ib	Static/FH	0,100	0,110	20000000	100	0,150	<0,001
	TCH/EFS Class II	Static/FH	2,000	2,439	8200	99,753	3,000	0,168
	TCH/EFS	TUhigh/No FH	8,000	8,867	8900	99,808	10,080	0,016
	TCH/EFS Class Ib	TUhigh/No FH	0,210	0,224	1000000	99,887	0,265	<0,001
	TCH/EFS Class II	TUhigh/No FH	7,000	7,500	120000	99,999	8,820	<0,001
	TCH/EFS Class II	HT/No FH	9,000	9,350	60000	99,787	11,340	<0,001
	TCH/EFS Class II	RA/No FH	7,000	7,500	24000	99,829	8,820	<0,001
	TCH/HS (FER)	TUhigh/No FH	4,100	4,598	13050	99,776	6,970	<0,001
	TCH/HS Class Ib (BFI=0)	TUhigh/No FH	0,360	0,404	148500	99,750	0,792	<0,001
	TCH/HS Class II (BFI=0)	TUhigh/No FH	6,900	7,725	25500	100,00	8,280	0,061
	TCH/HS Class II (BFI=0)	HT/No FH	7,600	8,500	20000	100,00	9,120	0,110
TCH/HS Class II (BFI=0)	RA/No FH	6,800	7,600	20000	100,00	8,160	0,182	
"	TCH/HS (UFR)	TUhigh/No FH	5,600	6,250	9600	99,702	11,200	<0,001
	TCH/AFS-INB (FER)	TUhigh/No FH	0,034	0,047	150000	99,733	0,068	0,103
	TCH/AHS-INB (FER)	TUhigh/No FH	0,720	0,806	74000	99,728	0,907	0,191
	FACCH/F	TUhigh/No FH	8,000	8,961	6696	99,798	10,080	0,108
	FACCH/H	TUhigh/No FH	6,900	7,728	7764	99,785	8,694	0,115
	TCH/F9,6andH4,8	HT/No FH	0,700	0,778	180000	99,995	0,882	<0,001
	TCH/F4,8	HT/No FH	0,010	0,011	5350000	99,732	0,013	0,197
	TCH/F2,4	HT/No FH	0,001	0,001	11900000	99,734	0,002	<0,001
	TCH/H2,4	HT/No FH	0,010	0,011	5350000	99,732	0,013	0,197
	Input level Input level range	TCH/FS Class II	Static<-40dBm	0,010	0,012	1640000	99,716	0,015
TCH/FS Class II		Static<-15dBm	0,100	0,122	164000	99,717	0,150	0,140
TCH/FS Class II		EQ	3,000	3,250	120000	100,000	3,780	<0,001
Co-channel rejection	TCH/FS	TUlow/No FH	21,000*α	24,000*α	25000	100,000	27,720*α	<0,001
	TCH/FS Class Ib	TUlow/No FH	2,000/α	2,091/α	3300000	100,000	2,520/α	<0,001
	TCH/FS Class II	TUlow/No FH	4,000	4,300	2000000	100,000	5,040	<0,001
	TCH/FS	TUhigh/FH	3,000*α	3,371*α	17800	99,797	3,780*α	0,194
	TCH/FS Class Ib	TUhigh/FH	0,200/α	0,215/α	2000000	100,000	0,252/α	<0,001
	TCH/FS Class II	TUhigh/FH	8,000	8,333	1200000	100,000	10,080	<0,001
	TCH/EFS	TUlow/No FH	23,000	24,000	25000	99,951	27,720	<0,001
	TCH/EFS Class Ib	TUlow/No FH	0,2000	0,209	3300000	99,987	0,252	<0,001
	TCH/EFS Class II	TUlow/No FH	3,000	3,039	2000000	99,927	3,780	<0,001
	TCH/EFS	TUhigh/FH	3,000	3,357	17800	99,702	3,780	0,185
	TCH/EFS Class Ib	TUhigh/FH	0,100	0,115	2000000	100,00	0,126	<0,001
	TCH/EFS Class II	TUhigh/FH	8,000	8,333	1200000	99,998	10,08	<0,001
	TCH/AFS-INB (FER)	TUhigh/FH@-3 dB	0,160	0,189	150000	99,737	0,224	0,197
	TCH/AHS 7.95 (FER)	TUhigh/NoFH@3dB	6,700	8.44	8960			
	TCH/AHS-INB (FER)	TUhigh/No FH	0.700	0.784	76000	99.726	0.882	0.193
	O-TCH/AHS-INB (FER)	TUhigh/No FH	10.500	11.760	5102	99.822	13.230	0.089
	FACCH/F	TUlow/No FH	22,000	24,000	25000	100,000	27,720	<0,001
	FACCH/H	TUlow/No FH	22,000	24,000	25000	100,000	27,720	<0,001
	TCH/F9,6 or H4,8	TUhigh/FH	0,300	0,336	178500	99,716	0,378	0,180
	TCH/F4,8	TUhigh/FH	0,010	0,011	5350000	99,732	0,013	0,197
TCH/F2,4	TUhigh/FH	0,001	0,001	11900000	99,734	0,002	<0,001	
TCH/H2,4	TUhigh/FH	0,010	0,011	5350000	99,732	0,013	0,197	

Type of test	Type of channel	Propagation/ frequency conditions	Speci-fied FER/ BER %	Test limit FER/ BER %	Minimum No of samples	Prob that good unit will pass %	Bad unit BER/ FER %	Risk that bad unit will pass
Adjacent channel 200 kHz	TCH/FS	TUhigh/No FH	6,000* α	6,742* α	8900	99,825	7,560* α	0,162
	TCH/FS Class Ib	TUhigh/No FH	0,400/ α	0,420/ α	1000000	99,919	0,504/ α	<0,001
	TCH/FS Class II	TUhigh/No FH	8,000	8,333	600000	100,000	10,080	<0,001
	TCH/HS (FER)	TUhigh/FH	5,000	5,607	10700	99,787	8,000	<0,001
	TCH/HS Class Ib (BFI=0)	TUhigh/FH	0,290	0,325	184700	99,711	0,522	<0,001
	TCH/HS Class II (BFI=0)	TUhigh/FH	7,100	7,961	25500	100,00	8,520	0,065
	TCH/HS (UFR)	TUhigh/FH	6,100	6,834	8780	99,781	9,760	<0,001
	TCH/HS Class Ib (BFI or UFI)=0	TUhigh/FH	0,210	0,235	255000	99,715	0,294	<0,001
	EVSIDR	TUlow/No FH	21,900	24,000	25000	100,000	26,280	<0,001
	SID RBER (SID=2 and (BFI or UFI)=0)	TUlow/No FH	0,020	0,022	2678500	99,705	0,026	0,010
	ESIDR	TUlow/No FH	17,100	19,152	25000	100,000	22,230	<0,001
SID RBER (SID=1 or SID=2)	TUlow/No FH	0,500	0,560	500000	100,000	0,650	<0,001	
FACCH/F	TUhigh/No FH	9,500	10,640	5639	99,812	11,970	0,096	
Adjacent channel 400 kHz	TCH/FS	TUhigh/No FH	10,200* α	11,461* α	8900	99,995	12,852* α	0,004
	TCH/FS Class Ib	TUhigh/No FH	0,720/ α	0,756/ α	1000000	99,999	0,9077/ α	<0,001
	TCH/FS Class II	TUhigh/No FH	8,800	9,167	600000	100,000	11,088	<0,001
	FACCH/F	TUhigh/No FH	17,100	19,152	3133	99,878	21,546	<0,052
Intermod.	TCH/FS Class II	Static	2,000	2,439	8200	99,741	3,000	0,122
	FACCH/F	TUhigh/No FH	8,000	8,961	6696	99,798	10,080	0,108
Blocking and spurious resp.	TCH/FS Class II	Static	2,000	2,439	8200	99,741	4,000	<0,001
	FACCH/F	TUhigh/No FH	8,000	8,961	6696	99,798	10,080	0,108

Table 14-4: Test conditions for DCS 1 800 DCS 1 800 and PCS 1 900

Type of test	Type of channel	Propagation/ Frequency conditions	Specified	Test limit FER/BER %	Mini-mum No of samples	Prob that good unit will pass %	Bad unit FER/BER %	Risk that bad unit will pass
BFI	TCH/FS	Static	0,033	0,041	492000	99,813	0,050	0,140
	TCH/FS	Static/FH	0,033	0,041	492000	99,813	0,050	0,140
	TCH/AFS	Static/FH	0,033	0,041	492000	99,813	0,050	0,140
	TCH/AHS	Static/FH	0,033	0,041	492000	99,813	0,050	0,140
Sensitivity	TCH/FS	Static/FH	0,100* α	0,122* α	164000	99,717	0,150* α	0,140
	TCH/FS Class Ib	Static/FH	0,400/ α	0,410/ α	2000000	100,000	0,600/ α	<0,001
	TCH/FS Class II	Static/FH	2,000	2,439	8200	99,714	3,000	0,001
	TCH/FS	TUhigh/No FH	4,000* α	4,478* α	13400	99,743	5,040* α	0,133
	TCH/FS Class Ib	TUhigh/No FH	0,300/ α	0,320/ α	1500000	100,000	0,378/ α	<0,001
	TCH/FS Class II	TUhigh/No FH	8,000	8,333	60000	99,865	10,080	<0,001
	TCH/FS Class II	HT/No FH	9,000	9,333	30000	97,826	11,340	<0,001
	TCH/FS Class II	RA/No FH	7,000	7,500	24000	99,873	8,820	<0,001
	TCH/EFS	Static/FH	0,100	0,122	164000	99,758	0,150	0,171
	TCH/EFS Class Ib	Static/FH	0,100	0,110	2000000	100,00	0,150	<0,001
	TCH/EFS Class II	Static/FH	2,000	2,439	8200	99,753	3,000	0,168
	TCH/EFS	TUhigh/No FH	4,000	4,475	13400	99,701	5,040	0,179
	TCH/EFS Class Ib	TUhigh/No FH	0,120	0,130	1500000	99,979	0,151	<0,001
	TCH/EFS Class II	TUhigh/No FH	8,000	8,333	60000	99,804	10,080	<0,001
	TCH/EFS Class II	HT/No FH	9,000	9,498	30000	99,798	11,340	<0,001
	TCH/EFS Class II	RA/No FH	7,000	7,500	24000	99,829	8,820	<0,001
	TCH/HS (FER)	TUhigh/No FH	4,200	4,706	12750	99,763	7,140	<0,001
	TCH/HS Class Ib (BFI=0)	TUhigh/No FH	0,380	0,426	141000	99,706	0,760	<0,001
	TCH/HS Class II (BFI=0)	TUhigh/No FH	6,900	7,725	25500	100,00	8,280	0,061
	TCH/HS Class II (BFI=0)	HT/No FH	7,800	8,735	20000	100,00	9,360	0,114
	TCH/HS Class II (BFI=0)	RA/No FH	6,800	7,600	20000	100,00	8,160	0,182
	TCH/HS (UFR)	TUhigh/No FH	5,700	6,383	9400	99,769	10,830	<0,001
	TCH/HS Class Ib (BFI or UFI=0)	TUhigh/No FH	0,260	0,291	206000	99,712	0,442	<0,001
	TCH/AHS-INB (FER)	TUhigh/No FH	0,640	0,717	83000	99,724	0,806	0,195

Type of test	Type of channel	Propagation/ Frequency conditions	Specified	Test limit FER/BER %	Mini-mum No of samples	Prob that good unit will pass %	Bad unit FER/BER %	Risk that bad unit will pass	
„	FACCH/F	TUhigh/No FH	3,900	4,368	13736	99,752	4,914	0,140	
„	FACCH/H	TUhigh/No FH	7,200	7,752	7440	97,027	9,072	0,002]	
„	TCH/F9,6	HT/No FH	0,700	0,784	76500	99,721	0,882	0,176	
„	TCH/F4,8	HT/No FH	0,010	0,011	5350000	99,732	0,013	0,197	
„	TCH/F2,4	HT/No FH	0,001	0,001	11900000	99,734	0,002	<0,001	
Input level range	TCH/FS Class II	Static-23dBm	0,100	0,122	164000	99,717	0,150	0,140	
	TCH/FS Class II	Static<-40dBm	0,010	0,012	1640000	99,716	0,015	0,141	
	TCH/FS Class II	EQ	3,000	3,250	60000	99,981	3,780	<0,001	
Co-channel rejection	TCH/FS	TUlow/No FH	21,00* α	24,00* α	25000	100,000	26,460* α	<0,001	
	TCH/FS Class Ib	TUlow/No FH	2,000/ α	2,091/ α	3300000	100,000	2,520/ α	<0,001	
	„	TCH/FS Class II	TUlow/No FH	4,000	4,300	2000000	100,000	5,040	<0,001
	„	TCH/FS	TUhigh/FH	3,000* α	3,371* α	17800	99,797	3,780* α	0,194
	„	TCH/FS Class Ib	TUhigh/FH	0,200/ α	0,215/ α	2000000	100,000	0,252/ α	<0,001
	„	TCH/FS Class II	TUhigh/FH	8,000	8,333	1200000	100,000	10,080	<0,001
	„	TCH/EFS	TUlow/No FH	23,000	24,000	25000	99,999	26,680	<0,001
	„	TCH/EFS Class Ib	TUlow/No FH	0,200	0,209	3300000	100,000	0,252	<0,001
	„	TCH/EFS Class II	TUlow/No FH	3,000	3,039	2000000	100,000	3,780	<0,001
	„	TCH/EFS	TUhigh/FH	3,000	3,357	17800	99,815	3,780	0,185
	„	TCH/EFS Class Ib	TUhigh/FH	0,100	0,115	2000000	99,999	0,126	<0,001
	„	TCH/EFS Class II	TUhigh/FH	8,000	8,333	1200000	100,000	10,080	<0,001
	„	TCH/AFS-INB (FER)	TUlow/No FH@-3 dB	3.500	3.920	15000	99.744	4.410	0.173
	„	TCH/AFS-INB (FER)	TUhigh/FH@-3 dB	0.120	0.145	150000	99.759	0.180	0.074
	„	TCH/AHS-INB (FER)	TUhigh/No FH	0.710	0.795	75000	99.727	0.895	0.192
	„	O-TCH/HS-INB (FER)	TUhigh/No FH	11.000	12.320	4870	99.827	13.860	0.086
	„	FACCH/F	TUlow/No FH	22,000	24,000	25000	100,000	27,720	<0,001
	„	FACCH/H	TUlow/No FH	22,000	24,000	25000	100,000	27,720	<0,001
	„	TCH/F9,6 or H4,8	TUhigh/FH	0,300	0,336	178500	99,716	0,378	0,180
	„	TCH/F4,8	TUhigh/FH	0,010	0,011	5350000	99,732	0,013	0,197
„	TCH/F2,4	TUhigh/FH	0,001	0,001	11900000	99,734	0,002	<0,001	
„	TCH/H2,4	TUhigh/FH	0,010	0,011	5350000	99,732	0,013	0,197	
Adjacent channel 200 kHz	TCH/FS	TUhigh/No FH	3,000* α	3,371* α	17800	99,797	3,780* α	0,194	
	TCH/FS Class Ib	TUhigh/No FH	0,250/ α	0,270/ α	2000000	100,000	0,315/ α	<0,001	
	„	TCH/FS Class II	TUhigh/No FH	8,100	8,333	1200000	100,000	10,206	<0,001
	„	TCH/HS (FER)	TUhigh/FH	5,000	5,607	10700	99,787	8,000	<0,001
	„	TCH/HS Class Ib (BFI=0)	TUhigh/FH	0,290	0,325	184700	99,711	0,522	<0,001
	„	TCH/HS Class II (BFI=0)	TUhigh/FH	7,200	8,078	25500	100,000	8,640	0,066
	„	TCH/HS (UFR)	TUhigh/FH	6,100	6,834	8780	99,781	9,760	<0,001
	„	TCH/HS Class Ib ((BFI or UFI)=0)	TUhigh/FH	0,210	0,235	255000	99,715	0,294	<0,001
	„	EV/SIDR	TUlow/No FH	21,900	24,000	25000	100,000	26,280	<0,001
	„	SID RBER (SID=2 and (BFI or UFI)=0)	TUlow/No FH	0,020	0,022	2678500	99,705	0,026	0,010
„	ESIDR	TUlow/No FH	17,100	19,152	25000	100,000	22,230	<0,001	
„	SID RBER (SID=1 or SID=2)	TUlow/No FH	0,500	0,560	500000	100,000	0,650	<0,001	
„	FACCH/F	TUhigh/No FH	3,400	3,808	15756	99,746	4,284	0,145	
Adjacent channel 400 kHz	TCH/FS	TUhigh/No FH	5,100* α	5,714* α	10500	99,773	6,426* α	0,134	
	TCH/FS Class Ib	TUhigh/No FH	0,450/ α	0,483/ α	1200000	100,000	0,567/ α	<0,001	
	„	TCH/FS Class II	TUhigh/No FH	8,900	9,167	720000	100,000	11,214	<0,001
	„	FACCH/F	TUhigh/No FH	6,100	6,832	8782	99,777	7,686	0,122
Intermod.	TCH/FS Class II	Static	2,000	2,439	8200	99,741	3,000	0,122	
	FACCH/F	TUhigh/No FH	3,900	4,368	13736	99,752	4,914	0,140	
Blocking and spurious resp.	TCH/FS Class II	Static	2,000	2,439	8200	99,741	4,000	<0,001	
	FACCH/F	TUhigh/No FH	3,900	4,368	13736	99,752	4,914	0,140	

NOTE 1: α is a parameter which ranges from 1 to 1.6. The value of α for a RBER test on TCH/FS class Ib bits under particular measurement conditions shall be the same as that determined in the FER test on TCH/FS under the same conditions. For example, the value of α may be different for a TUhigh sensitivity test and an RA sensitivity test. The value of α is determined by dividing the measured error rate for the FER test by the value of the test limit error rate listed in the limits section of the test corresponding to $\alpha=1$; if the result of the division is lower than 1, a value of $\alpha=1$ shall be used, if the value of $\alpha > 1.6$ the FER test has failed (the normal treatment of stimulus uncertainties applies). The probabilities that a good unit will pass and the risks that a bad unit will pass, listed in the table are valid for $\alpha=1$, and would be slightly different for other values of α .

NOTE 2: In order to save time the sensitivity and co-channel rejection tests for the TCH/F2,4 channel does not comply with the above said constraints.

In fact, a bad unit which performs 2 times (instead of 1.26) worse than that specified is accounted for, so reducing the required number of events to 150, instead of 600. On the other hand, the specified RBER is in this case $10E-5$ and, on the basis of simulations and hardware validation results, doubling this RBER results in a drop in performance of less than 1 dB.

14.1 Bad frame indication

14.1.1 Bad frame indication - TCH/FS

14.1.1.1 Bad frame indication - TCH/FS - Random RF input

14.1.1.1.1 Definition

The performance of the Bad Frame Indication (BFI) is a measure of the effectiveness of the MS under DTX conditions. It includes the effect of the 3 bit Cyclic Redundancy Check (CRC) and all other processing associated with the DTX function. The BFI is measured on a full rate speech TCH (TCH/FS) by counting the number of undetected bad frames whilst the input signal is a randomly modulated carrier.

14.1.1.1.2 Conformance requirement

On a full rate speech TCH (TCH/FS) with a random RF input, the overall reception performance shall be such that, on average, less than one undetected bad speech frame (false bad frame indication) in 60 s will be measured; 3GPP TS 05.05, subclause 6.4 b

14.1.1.1.3 Test purpose

1. To verify that the BFI performance does not exceed the conformance requirement with an allowance for the statistical significance of the test.
2. To verify that on reception of a SID frame the BFI is not set.

14.1.1.1.4 Method of test

14.1.1.1.4.1 Initial conditions

A call is set up according to the generic call set up procedure on a TCH/FS with an ARFCN in the Mid ARFCN range, power control level set to maximum power.

The SS commands the MS to complete the traffic channel loop back and signal the bad frame indication.

NOTE: DTX is used during the test to prevent the MS dropping the call.

14.1.1.1.4.2 Procedure

- a) The SS simulates a BSS in DTX mode. During the period when no transmission would occur the SS transmits a GSM carrier modulated with random data at a level 11 dB above reference sensitivity level(). The SACCH is transmitted normally at a level 20 dB above reference sensitivity(). The SID frame is transmitted in its correct time interval with valid information at a level 20 dB above reference sensitivity level(). During transmission of SACCH or SID frames the random data is discontinued.

- b) The SS transmits at least the minimum number of samples of frames of TCH/FS information and checks the BFI of the looped back signal from the MS. The SS records the number of frames where the bad frame indication is not set. During transmission by the SS of SID frames the SS checks that the BFI is not set.

NOTE 1: Further explanations on the mechanism of signalling the BFI to the SS will be found in clause 36.

NOTE 2: In some cases the MS decodes half SID frames correctly even if these are not transmitted completely. Therefore, in case that a MS detects a good SID frame, the SS has to consider the received bits in detail.

14.1.1.1.5 Test requirements

The BFI performance is accepted if the measured rate of undetected bad frames does not exceed the test limit error rate:

Test limit error rate: 0,041 %;

Minimum number of samples: 492 000 (excluding SID frames).

During loop back of SID frames no BFI shall be set.

14.1.1.2 Bad frame indication - TCH/FS - Frequency hopping and downlink DTX

14.1.1.2.1 Definition

The performance of the Bad Frame Indication (BFI) is a measure of the effectiveness of the MS under DTX conditions. It includes the effect of the 3 bit Cyclic Redundancy Check (CRC) and all other processing associated with the DTX function. The BFI is measured on a full rate speech TCH (TCH/FS) by counting the number of undetected bad frames whilst the input signal is a randomly modulated carrier.

14.1.1.2.2 Conformance requirement

On a speech TCH (TCH/FS or TCH/HS), when DTX is activated with frequency hopping through C0 where bursts comprising SID frames, SACCH frames and dummy bursts are received at a level 20 dB above the reference sensitivity level and with no transmissions at the other bursts of the TCH, the overall reception performance shall be such that, on average less than one undetected bad speech frame (false bad frame indication BFI) shall be measured in one minute for MS. 3GPP TS 05.05, subclause 6.4c.

14.1.1.2.3 Test purpose

1. To verify that the BFI performance in case of frequency hopping including the C0 radio frequency does not exceed the conformance requirement with an allowance for the statistical significance of the test.
2. To verify that on reception of a SID frame the BFI is not set.

14.1.1.2.4 Method of test

14.1.1.2.4.1 Initial conditions

A call is set up according to the generic call set up procedure on a TCH/FS with a transmitted burst 20 dB above reference sensitivity. Random frequency hopping on two channels including the C0 radio frequency with ARFCNs with at least 5 channels separation shall be used, power control level set to maximum power.

The SS commands the MS to complete the traffic channel loop back and signal the bad frame indication.

NOTE: DTX is used during the test to prevent the MS dropping the call.

14.1.1.2.4.2 Procedure

- a) The SS sets downlink DTX on.
- b) The SS performs the measurement over at least the minimum number of samples of frames of TCH/FS information and checks the BFI of the looped back signal from the MS. The SS only transmits SID frames, SACCH frames and dummy bursts, with no transmission of TCH bursts. The SS records the number of frames where the bad frame indication is not set. During transmission by the SS of SID frames the SS checks that the BFI is not set.

NOTE 1: Further explanations on the mechanism of signalling the BFI to the SS will be found in clause 36.

NOTE 2: In some cases the MS decodes half SID frames correctly even if these are not transmitted completely. Therefore, in case that a MS detects a good SID frame, the SS has to consider the received bits in detail.

14.1.1.2.5 Test requirements

The BFI performance is accepted if the measured rate of undetected bad frames does not exceed the test limit error rate:

Test limit error rate: 0,041 %;

Minimum number of samples: 492 000 (excluding SID frames).

During loop back of SID frames no BFI shall be set.

14.1.2 Bad frame indication - TCH/HS

14.1.2.1 Bad frame indication - TCH/HS - Random RF input

14.1.2.1.1 Definition

The performance of the Bad Frame Indication (BFI) is a measure of the effectiveness of the MS under DTX conditions. It includes the effect of the 3 bit Cyclic Redundancy Check (CRC) and all other processing associated with the DTX function. The BFI is measured on a half rate speech TCH (TCH/HS) by counting the number of undetected bad frames whilst the input signal is a randomly modulated carrier.

14.1.2.1.2 Conformance requirement

On a half rate speech TCH (TCH/HS) with a random RF input, the overall reception performance shall be such that, on average, less than one undetected bad speech frame (false bad frame indication) in 60 seconds will be measured; 3GPP TS 05.05, subclause 6.4b.

14.1.2.1.3 Test purpose

1. To verify that the BFI performance does not exceed the conformance requirement with an allowance for the statistical significance of the test.
2. To verify that on reception of a SID frame the BFI is not set.

14.1.2.1.4 Method of test

14.1.2.1.4.1 Initial conditions

A call is set up according to the generic call set up procedure on a TCH/HS with an ARFCN in the Mid ARFCN range, power control level set to maximum power.

The SS commands the MS to complete traffic channel loop back A and signal frames detected with BFI=1 as erased.

NOTE 1: Test loop A is defined in clause 36. Frames detected with BFI=1 are signalled as erased on the uplink.

NOTE 2: DTX is used during the test to prevent the MS dropping the call.

14.1.2.1.4.2 Procedure

- a) The SS simulates a BSS in DTX mode. During the periods when no transmission would occur, the SS transmits a GSM carrier modulated with random data, at a level 11 dB above reference sensitivity level(). The SACCH is transmitted normally, at a level 20 dB above reference sensitivity(). The SID frame is transmitted in its correct time interval, with valid information, at a level 20 dB above reference sensitivity level(). During transmission of SACCH or SID frames, the random data is discontinued.
- b) The SS transmits at least the minimum number of samples of frames of TCH/HS information and checks the BFI of the looped back signal from the MS. The SS records the number of frames where the bad frame indication is not set. During transmission by the SS of SID frames the SS checks that the BFI is not set.

14.1.2.1.5 Test requirements

The BFI performance is accepted if the measured rate of undetected bad frames does not exceed the test limit error rate:

Test limit error rate: 0,041 %;

Minimum number of samples: 492 000 (excluding SID frames).

During loop back of SID frames no BFI shall be set.

14.1.2.2 Bad frame indication - TCH/HS - Frequency hopping and downlink DTX

14.1.2.2.1 Definition

The performance of the Bad Frame Indication (BFI) is a measure of the effectiveness of the MS under DTX conditions. It includes the effect of the 3 bit Cyclic Redundancy Check (CRC) and all other processing associated with the DTX function. The BFI is measured on a half rate speech TCH (TCH/HS) by counting the number of undetected bad frames whilst the input signal is a randomly modulated carrier.

14.1.2.2.2 Conformance requirement

On a half rate speech TCH (TCH/HS), when DTX is activated with frequency hopping through C0 where bursts comprising SID frames, SACCH frames and dummy bursts are received at a level 20 dB above the reference sensitivity level and with no transmissions at the other bursts of the TCH, the overall reception performance shall be such that, on average less than one undetected bad speech frame (false bad frame indication BFI) shall be measured in one minute for MS. 3GPP TS 05.05, subclause 6.4c.

14.1.2.2.3 Test purpose

1. To verify that the BFI performance in case of frequency hopping including the C0 radio frequency does not exceed the conformance requirement with an allowance for the statistical significance of the test.
2. To verify that on reception of a SID frame the BFI is not set.

14.1.2.2.4 Method of test

14.1.2.2.4.1 Initial conditions

A call is set up according to the generic call set up procedure on a TCH/HS with a transmitted burst 20 dB above reference sensitivity. Random frequency hopping on two channels including the C0 radio frequency with ARFCNs with at least 5 channels separation shall be used, power control level set to maximum power.

The SS commands the MS to complete the traffic channel loop back and signal the bad frame indication.

NOTE: DTX is used during the test to prevent the MS dropping the call.

14.1.2.2.4.2 Procedure

- a) The SS sets downlink DTX on.
- b) The SS performs the measurement over at least the minimum number of samples of frames of TCH/HS information and checks the BFI of the looped back signal from the MS. The SS only transmits SID frames, SACCH frames and dummy bursts, with no transmission of TCH bursts. The SS records the number of frames where the bad frame indication is not set. During transmission by the SS of SID frames the SS checks that the BFI is not set.

NOTE 1: Further explanations on the mechanism of signalling the BFI to the SS will be found in clause 36.

NOTE 2: In some cases the MS decodes half SID frames correctly even if these are not transmitted completely. Therefore, in case that a MS detects a good SID frame, the SS has to consider the received bits in detail.

14.1.2.2.5 Test requirements

The BFI performance is accepted if the measured rate of undetected bad frames does not exceed the test limit error rate:

Test limit error rate: 0,041 %;

Minimum number of samples: 492 000 (excluding SID frames).

During loop back of SID frames no BFI shall be set.

14.1.3 Void

14.1.4 Void

14.1.5 Bad frame indication - TCH/AFS (Speech frame)

14.1.5.1 Bad frame indication - TCH/AFS - Random RF input

14.1.5.1.1 Definition

The performance of the Bad Frame Indication (BFI) is a measure of the effectiveness of the MS. It includes the effect of the 6 bits Cyclic Redundancy Check (CRC). The BFI is measured on a full rate speech TCH (TCH/AFS) by counting the number of undetected bad frames whilst the input signal is a randomly modulated carrier.

14.1.5.1.2 Conformance requirement

On a full rate speech TCH (TCH/AFS) with a random RF input, the overall reception performance shall be such that, on average, less than one undetected bad speech frame (false bad frame indication) in 60 s will be measured, meaning a rate of 0.0333% of undetected bad speech frames; 3GPP TS 05.05, subclause 6.4b.

14.1.5.1.3 Test purpose

1. To verify that the BFI performance does not exceed the conformance requirement with an allowance for the statistical significance of the test.

14.1.5.1.4 Method of test

14.1.5.1.4.1 Initial conditions

A call is set up according to the generic call set up procedure on a TCH/AFS with an ARFCN in the Mid ARFCN range, power control level set to maximum power. The active codec set (ACS) shall consist of one codec mode as AFS 12.2.

The SS commands the MS to complete the traffic channel loop back and signal the bad frame indication.

14.1.5.1.4.2 Procedure

- a) The SS simulates a BSS with downlink DTX disabled. During the period when traffic frames would occur the SS transmits a GSM carrier modulated with random data at a level 11 dB above reference sensitivity level. The SACCH is transmitted normally at a level 20 dB above reference sensitivity. During transmission of SACCH or frames the random data is discontinued.
- b) The SS transmits at least the minimum number of samples of frames of TCH/AFS information and checks the BFI of the looped back signal from the MS. The SS records the number of frames where the bad frame indication is not set

NOTE 1: Further explanations on the mechanism of signalling the BFI to the SS will be found in clause 36.

Maximum/Minimum Duration of Test

Statistical test method

Maximum: 280 minutes (GSM 700, T-GSM 810, GSM850, GSM900, DCS1800, PCS1900).

Minimum: 7 minutes (GSM 700, T-GSM 810, GSM850, GSM900, DCS1800, PCS1900).

Non-statistical test method

Maximum/minimum: 164 minutes (GSM 700, T-GSM 810, GSM850, GSM900, DCS1800, PCS1900).

14.1.5.1.5 Test requirements

Testing the Bad Frame Indication (BFI) performance can be done either in the classical way with a fixed minimum number of samples or using statistical methods that lead to an early pass/fail decision with test time significantly reduced for MS with (BFI) performance not on the limit.

Both methods are based on a bad DUT factor $M = 1.5$.

14.1.5.1.5.1 Statistical testing of BFI performance with early decision

For more information on statistical testing of BFI performance, especially the definition of limit lines refer to Annex 6.2

Wrong decision risk F for one single error rate test:

$$F_{\text{pass}} = F_{\text{fail}} = F \quad \text{and} \quad F = 0.2\%$$

Wrong decision probability D per test step:

$$D_{\text{pass}} = D_{\text{fail}} = D \quad \text{and} \quad D = 0.0085\%$$

Parameters for limit lines:

1. $D = 0.000085$ wrong decision probability per test step.
2. $M = 1.5$ bad DUT factor
3. n_e number of (error) events. This parameter is the x-ordinate in figure 14-1.
4. n_s number of samples. The error rate is calculated from n_e and n_s .

Limit checking

For an early decision a minimum number of (error) events is necessary.

- For an early pass decision $n_e \geq 1$ (inclusive artificial error)
- For an early fail decision $n_e \geq 7$

When the target test time has been reached the test is finished and a pass/fail decision can be made.

Table 14-4a: Statistical test limits for BFI performance

BFI TCH/AFS								
	Channel	bits per sec	frames per s	Orig. BFI requirement	Derived test limit	Target number of samples	Target test time (s)	Target test time (hh:mm:ss)
AFS 12.2	frames	12200	50	0,000333	0,000411	839575	16792	04:39:52

14.1.5.1.5.2 Fixed testing of BFI performance with minimum number of samples

The BFI performance is accepted if the measured rate of undetected bad frames does not exceed the test limit error rate:

- Test limit error rate: 0,041 %;
- Minimum number of samples: 492 000

14.1.6 Bad frame indication - TCH/AHS

14.1.6.1 Bad frame indication - TCH/AHS - Random RF input

14.1.6.1.1 Definition

The performance of the Bad Frame Indication (BFI) is a measure of the effectiveness of the MS. It includes the effect of the 6-bit Cyclic Redundancy Check (CRC). The BFI is measured on a half rate speech TCH (TCH/AHS) by counting the number of undetected bad frames whilst the input signal is a randomly modulated carrier.

14.1.6.1.2 Conformance requirement

On a half rate speech TCH (TCH/AHS) with a random RF input, the overall reception performance shall be such that, on average, less than one undetected bad speech frame (false bad frame indication) in 60 s will be measured, meaning a rate of 0.0333% of undetected bad speech frames; 3GPP TS 05.05, subclause 6.4b.

14.1.6.1.3 Test purpose

1. To verify that the BFI performance does not exceed the conformance requirement with an allowance for the statistical significance of the test.

14.1.6.1.4 Method of test

14.1.6.1.4.1 Initial conditions

A call is set up according to the generic call set up procedure on a TCH/AHS with an ARFCN in the Mid ARFCN range, power control level set to maximum power. The active codec set (ACS) shall consist of one codec mode as AHS 7.95.

14.1.6.1.4.2 Procedure

- a) The SS simulates a BSS with downlink DTX disabled. During the periods when traffic frames would occur, the SS transmits a GSM carrier modulated with random data, at a level 11 dB above reference sensitivity level. The SACCH is transmitted normally, at a level 20 dB above reference sensitivity. During transmission of SACCH frames, the random data is discontinued.
- b) The SS transmits at least the minimum number of samples of frames of TCH/AHS information and checks the BFI of the looped back signal from the MS. The SS records the number of frames where the bad frame indication is not set.

Statistical test method

Maximum: 280 minutes (GSM 700, T-GSM 810, GSM850, GSM900, DCS1800, PCS1900).

Minimum: 7 minutes (GSM 700, T-GSM 810, GSM850, GSM900, DCS1800, PCS1900).

Non-statistical test method

Maximum/minimum: 164 minutes (GSM 700, T-GSM 810, GSM850, GSM900, DCS1800, PCS1900).

14.1.6.1.5 Test requirements

Testing the Bad Frame Indication (BFI) performance can be done either in the classical way with a fixed minimum number of samples or using statistical methods that lead to an early pass/fail decision with test time significantly reduced for MS with (BFI) performance not on the limit.

Both methods are based on a bad DUT factor $M = 1.5$.

14.1.6.1.5.1 Statistical testing of BFI performance with early decision

For more information on statistical testing of BFI performance, especially the definition of the limit lines refer to Annex 6.2

Wrong decision risk F for one single error rate test:

$$F_{\text{pass}} = F_{\text{fail}} = F \quad \text{and} \quad F = 0.2\%$$

Wrong decision probability D per test step:

$$D_{\text{pass}} = D_{\text{fail}} = D \quad \text{and} \quad D = 0.0085\%$$

Parameters for limit lines:

1. D = 0.000085 wrong decision probability per test step.
2. M = 1.5 bad DUT factor
3. ne number of (error) events. This parameter is the x-ordinate in figure 14-1.
4. ns number of samples. The error rate is calculated from ne and ns.

Limit checking

For an early decision a minimum number of (error) events is necessary.

For an early pass decision $ne \geq 1$ (inclusive artificial error)

For an early fail decision $ne \geq 7$

When the target test time has been reached the test is finished and a pass/fail decision can be made.

Table 14-4b: Statistical test limits for BFI performance

BFI TCH/AHS								
	Channel	bits per sec	frames per s	Orig. BFI requirement	Derived test limit	Target number of samples	Target test time (s)	Target test time (hh:mm:ss)
AHS 7.95	frames	7950	50	0,000333	0,000411	839575	16792	04:39:52

14.1.6.1.5.2 Fixed testing of BFI performance with minimum number of samples

The BFI performance is accepted if the measured rate of undetected bad frames does not exceed the test limit error rate:

Test limit error rate: 0,041 %;

Minimum number of samples: 492 000.

14.1.7 Void

14.2 Reference sensitivity

14.2.1 Reference sensitivity - TCH/FS

14.2.1.1 Definition

The reference sensitivity is the signal level at the MS receiver input at which a certain BER and FER must be achieved.

For E-GSM 900 MS this test is only performed in the P-GSM band.

14.2.1.2 Conformance requirement

1. At reference sensitivity level, the TCH/FS FER shall meet the reference sensitivity performance of table 1 in 3GPP TS 05.05 subclause 6.2.
2. At reference sensitivity level, the TCH/FS class I RBER shall meet the reference sensitivity performance of table 1 in 3GPP TS 05.05 subclause 6.2.
3. At reference sensitivity level, the TCH/FS class II RBER shall meet the reference sensitivity, performance of table 1 in 3GPP TS 05.05 subclause 6.2.

4. At reference sensitivity level, the TCH/FS class II RBER shall meet the reference sensitivity, performance of table 1 in GSM under extreme conditions; 3GPP TS 05.05 subclause 6.2 and annex D subclauses D.2.1 and D.2.2.

14.2.1.3 Test purpose

NOTE: This test is performed under STATIC propagation conditions to allow implicit testing of the ability of the MS to hop over the full band. The tests under dynamic propagation conditions are better suited to test the reference sensitivity conformance but cannot test hopping over the full band due to limited bandwidth of available fading simulators.

1. To verify that the MS does not exceed conformance requirement 1 under STATIC and TUhigh propagation conditions with an allowance for the statistical significance of the test.
2. To verify that the MS does not exceed conformance requirement 2 under STATIC and TUhigh propagation conditions with an allowance for the statistical significance of the test.
3. To verify that the MS does not exceed conformance requirement 3 under STATIC, TUhigh, RA and HT propagation conditions with an allowance for the statistical significance of the test.
4. To verify that the MS does not exceed conformance requirement 4 under STATIC and TUhigh propagation conditions with an allowance for the statistical significance of the test.

14.2.1.4 Method of test

NOTE 1: The BA list sent on the BCCH and SACCH will indicate at least six surrounding cells with at least one near to each band edge. It is not necessary to generate any of these BCCHs but, if provided the signal strengths of BCCHs shall be in the range $15 \text{ dB}\mu\text{Vemf}(\)$ to $35 \text{ dB}\mu\text{Vemf}(\)$.

NOTE 2: The ARFCN of any BCCH shall not be co-channel or on adjacent channels to the wanted traffic channel.

NOTE 3: When frequency hopping is used, the traffic channel may fall on any of the ARFCNs defined in clause 6.

14.2.1.4.1 Initial conditions

A call is set up according to the generic call set up procedure on a TCH/FS with an ARFCN in the Mid ARFCN range for GSM 400, GSM 700, T-GSM 810, GSM 850, DCS 1800 and PCS 1 900 and ARFCN 70 for GSM 900, power control level set to maximum power.

NOTE: For GSM 900 ARFCN 70 is tested since this is the 73rd harmonic of the 13 MHz clock normally used internally in a MS.

The SS transmits Standard Test Signal C1 on the traffic channel.

The SS commands the MS to create traffic channel loop back signalling erased frames.

14.2.1.4.2 Procedure

- a) The fading function is set to TUhigh.
- b) the SS sets the amplitude of the wanted signal to reference sensitivity level ().
- c) The SS compares the data of the signal that it sends to the MS with the signal which is looped back from the receiver after demodulation and decoding, and checks the frame erasure indication.
- d) The SS determines the number of residual bit error events for the bits of class II, by examining sequences of at least the minimum number of samples of consecutive bits of class II. Bits are taken only from those frames not signalled as erased.
- e) The SS determines the number of residual bit error events for the bits of the class Ib, by examining sequences of at least the minimum number of samples of consecutive bits of class Ib. Bits are only taken from those frames not signalled as erased.
- f) The SS also determines the frame erasure events by examining sequences of at least the minimum number of samples of consecutive frames and assuming a frame is received successfully, if it is not signalled as erased.

- g) Steps a) to d) are repeated under extreme test conditions.
- h) Steps a) to g) are repeated for TCH/FS with ARFCNs in the Low ARFCN range for GSM 400, GSM 700, T-GSM 810, GSM 850, DCS 1800 and PCS 1 900 and ARFCN 5 for GSM 900 and the High ARFCN range.

NOTE: For GSM 900 ARFCN 5 is tested since this is the 72nd harmonic of the 13 MHz clock normally used internally in a MS.

- i) Steps b) to d) are repeated with the SS fading function set in turn to RA and HT.
- j) Steps b) to g) are repeated, with the SS fading function set to static and the MS is commanded by the SS into hopping mode using the hopping sequence defined in clause 6.

The amplitude of the wanted signal is set according to step b). All the other time slots, except the active ones, are set to 20 dB above reference sensitivity level(). This implicitly tests adjacent time slot rejection.

14.2.1.5 Test requirements

The error rates measured for different channels and under the different propagation conditions, under any combination of normal and extreme test voltages and ambient temperatures, shall not exceed the test limit error rate values given in table 14-5 or 14-6.

Table 14-5: Limits for GSM 400, GSM 700, T-GSM 810, GSM 850 and GSM 900 sensitivity

Channels	Propagation conditions TUhigh		Propagation conditions RA		Propagation conditions HT		Static conditions	
	Test limit error rate %	Minimum No. of samples	Test limit error rate %	Minimum No. of samples	Test limit error rate %	Minimum No. of samples	Test limit error rate %	Minimum No. of samples
TCH/FS								
FER	$6,742 \cdot \alpha$	8 900					$0,122 \cdot \alpha$	164 000
class Ib(RBER)	$0,42/\alpha$	1 000 000					$0,41/\alpha$	20 000 000
class II(RBER)	8,333	120 000	7,5	24 000	9,333	60 000	2,439	8 200

Table 14-6: Limits for DCS 1 800 and PCS 1 900 sensitivity

Channels	Propagation conditions TUhigh		Propagation conditions RA		Propagation conditions HT		Static conditions	
	Test limit error rate %	Minimum No. of samples	Test limit error rate %	Minimum No. of samples	Test limit error rate %	Minimum No. of samples	Test limit error rate %	Minimum No. of samples
TCH/FS								
FER	$4,478 \cdot \alpha$	13 400					$0,122 \cdot \alpha$	164 000
class Ib(RBER)	$0,32/\alpha$	1 500 000					$0,41/\alpha$	20 000 000
class II(RBER)	8,333	60 000	7,5	24 000	9,333	30 000	2,439	8 200

Where α is a parameter which can range from 1 to 1.6. The value of α for a RBER test on TCH/FS class Ib bits under particular measurement conditions shall be the same as that determined in the FER test on TCH/FS under the same conditions.

14.2.2 Reference sensitivity - TCH/HS (Speech frames)

14.2.2.1 Definition

The reference sensitivity level is the signal level at the MS receiver input at which a certain BER and FER and UFR for speech frames must be achieved.

14.2.2.2 Conformance requirement

- At reference sensitivity level, the TCH/HS FER shall meet the reference sensitivity performance of table 1 in 3GPP TS 05.05 subclause 6.2.

- 2 At reference sensitivity level, the TCH/HS class Ib RBER (BFI=0) shall meet the reference sensitivity performance of table 1 in 3GPP TS 05.05 subclause 6.2.
- 3 At reference sensitivity level, the TCH/HS class II RBER (BFI=0) shall meet the reference sensitivity performance of table 1 in 3GPP TS 05.05 subclause 6.2.
4. At reference sensitivity level, the TCH/HS UFR shall meet the reference sensitivity performance of table 1 in 3GPP TS 05.05 subclause 6.2.
5. At reference sensitivity level, the TCH/HS class Ib RBER ((BFI or UFI)=0) shall meet the reference sensitivity performance of table 1 in 3GPP TS 05.05 subclause 6.2.

14.2.2.3 Test purpose

1. To verify that the MS does not exceed conformance requirement 1 under TUhigh propagation conditions with an allowance for the statistical significance of the test.
2. To verify that the MS does not exceed conformance requirement 2 under TUhigh propagation conditions with an allowance for the statistical significance of the test.
3. To verify that the MS does not exceed conformance requirement 3 under TUhigh, RA and HT propagation conditions with an allowance for the statistical significance of the test.
4. To verify that the MS does not exceed conformance requirement 4 under TUhigh propagation conditions with an allowance for the statistical significance of the test.
5. To verify that the MS does not exceed conformance requirement 5 under TUhigh propagation conditions with an allowance for the statistical significance of the test.

14.2.2.4 Method of test

14.2.2.4.1 Initial conditions

The BA list sent on the BCCH and SACCH indicates at least six surrounding cells, with at least one near to each band edge. It is not necessary to generate any of these BCCHs, but if provided, the signal strengths of BCCHs shall be in the range $15 \text{ dB}\mu\text{Vemf}(\)$ to $35 \text{ dB}\mu\text{Vemf}(\)$.

The ARFCN of any BCCH shall not be co-channel or on adjacent channels to the wanted traffic channel.

A call is set up according to the generic call set up procedure on a TCH/HS with an ARFCN in the mid ARFCN range, power control level set to maximum power.

The SS transmits Standard Test Signal C1 on the traffic channel.

14.2.2.4.2 Procedure

- a) The SS commands the MS to create traffic channel loop back signalling erased frames using test loop A.

NOTE 1: Test loop A is defined in clause 36. Frames detected with BFI=1 are signalled as erased on the uplink.

- b) The fading function is set to TUhigh.
- c) The SS sets the amplitude of the wanted signal to reference sensitivity level ().
- d) The SS compares the data of the signal that it sends to the MS with the signal which is looped back from the receiver after demodulation and decoding, and checks the frame erasure indication.
- e) The SS determines the number of residual bit error events for the bits of class II, by examining sequences of at least the minimum number of samples of consecutive bits of class II. Bits are taken only from those frames not signalled as erased.
- f) The SS determines the number of residual bit error events for the bits of the class Ib, by examining sequences of at least the minimum number of samples of consecutive bits of class Ib. Bits are only taken from those frames not signalled as erased.
- g) The SS also determines the frame erasure events by examining sequences of at least the minimum number of samples of consecutive frames and assuming a frame is received successfully, if it is not signalled as erased.

- h) Steps d) and e) are repeated, with the SS fading function set in turn to RA and HT.
- j) The SS increases the amplitude of the wanted signal to 20 dB above reference sensitivity level.
- k) The SS commands the MS to open test loop A and close test loop D.

NOTE 2: Test loop D is defined in clause 36. Frames marked as erased (BFI=1) or unreliable (UFI=1) are signalled to the SS on the uplink.

- l) The fading function is set to TUhigh.
- m) The SS sets the amplitude of the wanted signal to reference sensitivity level ().
- n) The SS compares the data of the signal that it sends to the MS with the signal which is looped back from the receiver after demodulation and decoding, and checks the erased/unreliable frame indication.
- p) The SS determines the number of residual bit error events for the bits of the class Ib, by examining sequences of at least the minimum number of samples of consecutive bits of class Ib. Bits are only taken from those frames not signalled as erased/unreliable.
- q) The SS also determines the unreliable frame events by examining sequences of at least the minimum number of samples of consecutive frames and assuming a frame is received successfully it is not signalled as erased/unreliable.

14.2.2.5 Test requirements

The error rates measured for different channels and under the different propagation conditions, shall not exceed the test limit error rate values given in table 14-7 or 14-8.

Table 14-7: Limits for GSM 400, GSM 700, T-GSM 810, GSM 850 and GSM 900 sensitivity

Channels	Propagation conditions TUhigh		Propagation conditions RA		Propagation conditions HT	
	Test limit error rate %	Minimum No. of samples	Test limit error rate %	Minimum No. of samples	Test limit error rate %	Minimum No. of samples
TCH/HS (FER)	4,598	13050	7,600	20000	8,500	20000
TCH/HS Class Ib (BFI=0)	0,404	148500				
TCH/HS Class II (BFI=0)	7,725	25500				
TCH/HS (UFR)	6,250	9600				
TCH/HS Class Ib ((BFI or UFI)=0)	0,269	227000				

Table 14-8: Limits for DCS 1800 and PCS 1 900 sensitivity

Channels	Propagation conditions TUhigh		Propagation conditions RA		Propagation conditions HT	
	Test limit error rate %	Minimum No. of samples	Test limit error rate %	Minimum No. of samples	Test limit error rate %	Minimum No. of samples
TCH/HS (FER)	4,706	12750	7,600	20000	8,735	20000
TCH/HS Class Ib (BFI=0)	0,426	141000				
TCH/HS Class II (BFI=0)	7,725	25500				
TCH/HS (UFR)	6,383	9400				
TCH/HS Class Ib ((BFI or UFI)=0)	0,291	206000				

14.2.3 Reference sensitivity - FACCH/F

14.2.3.1 Definition

The reference sensitivity for control channels is the signal level at the MS receiver input at which a certain FER must be achieved.

14.2.3.2 Conformance requirement.

At reference sensitivity level, the FACCH/F FER shall meet the reference sensitivity performance of table 1 in 3GPP TS 05.05 subclause 6.2.

14.2.3.3 Test purpose.

To verify that the MS does not exceed the conformance requirement under TUhigh propagation condition with an allowance for the statistical significance of the test.

14.2.3.4 Method of test

14.2.3.4.1 Initial conditions

A call is set up according to the generic call set up procedure on a TCH/F with an ARFCN in the Low ARFCN range, power control level set to maximum power.

The SS transmits Standard Test Signal C1 on the traffic channel.

14.2.3.4.2 Procedure

- a) The fading function is set to TUhigh.
- b) The SS sets the amplitude of the wanted signal to reference sensitivity level (σ).
- c) The SS sends a Layer 3 message which does not require a Layer 3 response from the MS. Due to the low signal level the MS may not be able to acknowledge the Layer 2 frame with an RR frame and the SS will repeat the Layer 2 frame. Each repeated L2 frame will be counted and will indicate a frame erasure event.
- d) The SS determines the frame erasure events during at least the minimum number of samples of FACCH/F frames.

NOTE: These frames will not be consecutive but it is expected that the statistical significance of the tests will not be unduly degraded.

14.2.3.5 Test Requirements

The error rates measured shall not exceed the test limit error rate values given in table 14-9.

Table 14-9: Limits for FACCH/F sensitivity

Channels	Type of measurements	Propagation	GSM 400, GSM 700, T-GSM 810, GSM 850 and GSM 900		DCS 1 800 and PCS 1 900	
			Test limit error rate %	Minimum No of samples	Test limit error rate %	Minimum No of samples
FACCH/F	FER	TUhigh	8,961	6696	4,368	13736

14.2.4 Reference sensitivity - FACCH/H

14.2.4.1 Definition

The reference sensitivity for control channels is the signal level at the MS receiver input at which a certain FER must be achieved.

14.2.4.2 Conformance requirement.

At reference sensitivity level, the FACCH/H FER shall meet the reference sensitivity performance of table 1 in 3GPP TS 05.05 subclause 6.2.

14.2.4.3 Test purpose.

To verify that the MS does not exceed the conformance requirement under TUhigh propagation condition with an allowance for the statistical significance of the test.

14.2.4.4 Method of test

14.2.4.4.1 Initial conditions

A call is set up according to the generic call set up procedure on TCH/HS, TCH/H4.8, TCH/H2.4 or any TCH/AHS, whichever supported by the MS, with an ARFCN in the Mid ARFCN range, power control level set to maximum power.

The SS transmits Standard Test Signal C1 on the traffic channel.

14.2.4.4.2 Procedure

- a) The fading function is set to TUhigh.
- b) The SS sets the amplitude of the wanted signal to reference sensitivity level ().
- c) The SS sends a Layer 3 message which does not require a Layer 3 response from the MS. Due to the low signal level the MS may not be able to acknowledge the Layer 2 frame with an RR frame and the SS will repeat the Layer 2 frame. Each repeated L2 frame will be counted and will indicate a frame erasure event.
- d) The SS determines the frame erasure events during at least the minimum number of samples of FACCH/H frames.

NOTE: These frames will not be consecutive but it is expected that the statistical significance of the tests will not be unduly degraded.

14.2.4.5 Test requirements

The error rates measured shall not exceed the test limit error rate values given in table 14-10.

Table 14-10: Limits for FACCH/H sensitivity

Channels	Type of measurements	Propagation	GSM 400, GSM 700, T-GSM 810, GSM 850 and GSM 900		DCS 1 800 and PCS 1 900	
			Test limit error rate %	Minimum No of samples	Test limit error rate %	Minimum No of samples
FACCH/H	FER	TUhigh	7,728		8,064	

14.2.5 Reference sensitivity - full rate data channels

14.2.5.1 Definition

The reference sensitivity for data channels is the signal level at the MS receiver input at which a certain BER must be achieved.

14.2.5.2 Conformance Requirement.

1. At reference sensitivity level, the TCH/F9,6, TCH/F4,8 and TCH/F2,4 BER shall meet the reference sensitivity performance of table 1 in 3GPP TS 05.05 subclause 6.2.

14.2.5.3 Test purpose

1. To verify that the MS does not exceed conformance requirement 1 under HT propagation condition with an allowance for the statistical significance of the test.

14.2.5.4 Method of test

14.2.5.4.1 Initial conditions

A call is set up according to the generic call set up procedure on a TCH with an ARFCN in the Mid ARFCN range. One of the supported TCH/(F9,6, F4,8, or F2,4) shall be used. The power control level is set to maximum power.

The SS transmits Standard Test Signal C1 on the traffic channel.

The SS commands the MS to create the traffic channel loop back signalling erased frames (subclause 36.2.1.1.1).

14.2.5.4.2 Procedure

- a) The fading function is set to HT.
- b) The SS sets the amplitude of the wanted signal level to reference sensitivity level ().
- c) The SS compares transmitted data with received data for at least the minimum number of samples of consecutive bits and records every error bit as an error event.
- d) The SS sets the wanted signal level to 28 dB μ V_{emf}.
- e) The SS commands the MS to open the TCH loop.
- f) The SS commands the MS to another of the supported data channels.
- g) Steps b) to f) are repeated for all supported full rate data channels.

14.2.5.5 Test requirements

The Max-events measured for different channels shall not exceed the values given in table 14-11.

Table 14-11: Limits for full rate data channel sensitivity

Channels	Type of measurements	Propagation	GSM 400, GSM 700, T-GSM 810, GSM 850 and GSM 900		DCS 1 800 and PCS 1 900	
			Test limit error rate %	Minimum No of samples	Test limit error rate %	Minimum No of samples
TCH/F9,6	BER	HT	0,778	180000	0,784	76500
TCH/F4,8	BER	HT	0,011	5350000	0,011	5350000
TCH/F2,4	BER	HT	0,001	11900000	0,001	11900000

14.2.6 Reference sensitivity - half rate data channels

14.2.6.1 Definition

The reference sensitivity for data channels is the signal level at the MS receiver input at which a certain BER must be achieved.

14.2.6.2 Conformance Requirement.

1. At reference sensitivity level, the TCH/H4,8 and TCH/H2,4 BER shall meet the reference sensitivity performance of table 1 in 3GPP TS 05.05 subclause 6.2.

14.2.6.3 Test purpose

1. To verify that the MS does not exceed conformance requirement 1 under HT propagation condition with an allowance for the statistical significance of the test.

14.2.6.4 Method of test

14.2.6.4.1 Initial conditions

A call is set up according to the generic call set up procedure on a TCH with an ARFCN in the Mid ARFCN range. One of the supported TCH/(H4,8 or H2,4) shall be used. The power control level is set to maximum power.

The SS transmits Standard Test Signal C1 on the traffic channel.

The SS commands the MS to create the traffic channel loop back signalling erased frames (subclause 36.2.1.1.1).

14.2.6.4.2 Procedure

- a) The fading function is set to HT.
- b) The SS sets the amplitude of the wanted signal level to reference sensitivity level ().

- c) The SS compares transmitted data with received data for at least the minimum number of samples of consecutive bits and records every error bit as an error event.
- d) The SS sets the wanted signal level to 28 dB μ Vemf.
- e) The SS commands the MS to open the TCH loop.
- f) The SS commands the MS to another of the supported data channels.
- g) Steps b) to f) are repeated for all supported data channels.

14.2.6.5 Test requirements

The Max-events measured for different channels shall not exceed the values given in table 14-12.

Table 14-12: Limits for half rate data channel sensitivity

			GSM 400, GSM 700, T-GSM 810, GSM 850 and GSM 900		DCS 1 800 and PCS 1 900	
Channels	Type of measurements	Propagation	Test limit error rate %	Minimum No of samples	Test limit error rate %	Minimum No of samples
TCH/H4,8	BER	HT	0,778	180000	-	-
TCH/H2,4	BER	HT	0,011	5350000	-	-

14.2.7 Reference sensitivity - TCH/EFS

14.2.7.1 Definition

The reference sensitivity is the signal level at the MS receiver input at which a certain BER and FER must be achieved.

For E-GSM 900 MS this test is only performed in the P-GSM band.

14.2.7.2 Conformance requirement

1. At reference sensitivity level, the TCH/EFS FER shall meet the reference sensitivity performance of table 1 in 3GPP TS 05.05 subclause 6.2.
2. At reference sensitivity level, the TCH/EFS class I RBER shall meet the reference sensitivity performance of table 1 in 3GPP TS 05.05 subclause 6.2.
3. At reference sensitivity level, the TCH/EFS class II RBER shall meet the reference sensitivity, performance of table 1 in 3GPP TS 05.05 subclause 6.2.
4. At reference sensitivity level, the TCH/EFS class II RBER shall meet the reference sensitivity, performance of table 1 in GSM under extreme conditions; 3GPP TS 05.05, subclause 6.2 and annex D subclauses D.2.1 and D.2.2.

14.2.7.3 Test purpose

NOTE: This test is performed under STATIC propagation conditions to allow implicit testing of the ability of the MS to hop over the full band. The tests under dynamic propagation conditions are better suited to test the reference sensitivity conformance but cannot test hopping over the full band due to limited bandwidth of available fading simulators.

1. To verify that the MS does not exceed conformance requirement 1 under STATIC and TUhigh propagation conditions with an allowance for the statistical significance of the test.
2. To verify that the MS does not exceed conformance requirement 2 under STATIC and TUhigh propagation conditions with an allowance for the statistical significance of the test.
3. To verify that the MS does not exceed conformance requirement 3 under STATIC, TUhigh, RA and HT propagation conditions with an allowance for the statistical significance of the test.
4. To verify that the MS does not exceed conformance requirement 4 under STATIC and TUhigh propagation conditions with an allowance for the statistical significance of the test.

14.2.7.4 Method of test

NOTE 1: The BA list sent on the BCCH and SACCH will indicate at least six surrounding cells with at least one near to each band edge. It is not necessary to generate any of these BCCHs but, if provided the signal strengths of BCCHs shall be in the range $15 \text{ dBmV}_{\text{emf}}(\)$ to $35 \text{ dBmV}_{\text{emf}}(\)$.

NOTE 2: The ARFCN of any BCCH shall not be co-channel or on adjacent channels to the wanted traffic channel.

NOTE 3: When frequency hopping is used, the traffic channel may fall on any of the ARFCNs defined in clause 6.

14.2.7.4.1 Initial conditions

A call is set up according to the generic call set up procedure on a TCH/EFS with an ARFCN in the Mid ARFCN range for GSM 400, GSM 700, T-GSM 810, GSM 850, DCS 1800 and PCS 1 900 and ARFCN 70 for GSM 900, power control level set to maximum power.

NOTE: For GSM 900 ARFCN 70 is tested since this is the 73rd harmonic of the 13 MHz clock normally used internally in a MS.

The SS transmits Standard Test Signal C1 on the traffic channel.

The SS commands the MS to create traffic channel loop back signalling erased frames.

14.2.7.4.2 Procedure

- a) The fading function is set to TUhigh.
- b) the SS sets the amplitude of the wanted signal to reference sensitivity level ().
- c) The SS compares the data of the signal that it sends to the MS with the signal which is looped back from the receiver after demodulation and decoding, and checks the frame erasure indication.
- d) The SS determines the number of residual bit error events for the bits of class II, by examining sequences of at least the minimum number of samples of consecutive bits of class II. Bits are taken only from those frames not signalled as erased.
- e) The SS determines the number of residual bit error events for the bits of the class Ib, by examining sequences of at least the minimum number of samples of consecutive bits of class Ib. Bits are only taken from those frames not signalled as erased.
- f) The SS also determines the frame erasure events by examining sequences of at least the minimum number of samples of consecutive frames and assuming a frame is received successfully, if it is not signalled as erased.
- g) Steps a) to d) are repeated under extreme test conditions.
- h) Steps a) to g) are repeated for TCH/EFS with ARFCNs in the Low ARFCN range for GSM 400, GSM 700, T-GSM 810, GSM 850, DCS 1800 and PCS 1 900 and ARFCN 5 for GSM 900 and the High ARFCN range.

NOTE: For GSM 900 ARFCN 5 is tested since this is the 72nd harmonic of the 13 MHz clock normally used internally in a MS.

- i) Steps b) to d) are repeated with the SS fading function set in turn to RA and HT.
- j) Steps b) to g) are repeated, with the SS fading function set to static and the MS is commanded by the SS into hopping mode using the hopping sequence defined in clause 6.

The amplitude of the wanted signal is set according to step b). All the other time slots, except the active ones, are set to 20 dB above reference sensitivity level(). This implicitly tests adjacent time slot rejection.

14.2.7.5 Test requirements

The error rates measured for different channels and under the different propagation conditions, under any combination of normal and extreme test voltages and ambient temperatures, shall not exceed the test limit error rate values given in tables 14-4 or 14-13a, 14-13b.

Table 14-13a: Limits for GSM 400, GSM 700, T-GSM 810, GSM 850 and GSM 900 sensitivity

Channels	Propagation conditions TUhigh		Propagation conditions RA		Propagation conditions HT		Static conditions	
	Test limit error rate %	Minimum No. of samples	Test limit error rate %	Minimum No. of samples	Test limit error rate %	Minimum No. of samples	Test limit error rate %	Minimum No. of samples
TCH/EFS								
FER	8,867	8900					0,122	164000
class Ib(RBER)	0,224	1000000					0,110	20000000
class II (RBER)	7,500	120000	7,500	24000	9,350	60000	2,439	8200

Table 14-13b: Limits for DCS 1 800 and PCS 1 900 sensitivity

Channels	Propagation conditions TUhigh		Propagation conditions RA		Propagation conditions HT		Static conditions	
	Test limit error rate %	Minimum No. of samples	Test limit error rate %	Minimum No. of samples	Test limit error rate %	Minimum No. of samples	Test limit error rate %	Minimum No. of samples
TCH/EFS								
FER	4,475	13400					0,122	164000
class Ib(RBER)	0,130	1500000					0,110	20000000
class II(RBER)	8,333	60000	7,500	24000	9,498	30000	2,439	8200

14.2.8 Reference sensitivity - full rate data channels in multislot configuration

14.2.8.1 Definition

The reference sensitivity for data channels is the signal level at the MS receiver input at which a certain BER must be achieved.

14.2.8.2 Conformance Requirement.

- At reference sensitivity level, the TCH/F9,6, TCH/F4,8 and TCH/F2,4 BER shall meet the reference sensitivity performance of table 1 in 3GPP TS 05.05 subclause 6.2.

14.2.8.3 Test purpose

- To verify that the MS does not exceed conformance requirement 1 in all multislot classes under HT propagation condition with an allowance for the statistical significance of the test.

14.2.8.4 Method of test

14.2.8.4.1 Initial conditions

A call is set up according to the generic call set up procedure for multislot HSCSD on a TCH with an ARFCN in the Mid ARFCN range. One of the supported TCH/(F9,6, F4,8, or F2,4) shall be used.

The SS sets the MS to operate in a worst case configuration where the overlapping of the transmitting and receiving timeslots are maximized. If it needs the use of timing advance, it is set to 63. If overlapping is not possible, transmitting and receiving timeslots should be as close as possible.

The power control level is set to maximum power.

The SS transmits Standard Test Signal C1 on all the channels.

The SS commands the MS to create the loop back of the closest channel to the transmitting timeslot.

14.2.8.4.2 Procedure

- The fading function is set to HT.
- The SS commands the MS to close the TCH loop.

- c) The SS sets the amplitude of the wanted signal level to reference sensitivity level () in all subchannels.
- d) The SS compares transmitted data with received data in all channels for at least the minimum number of samples of consecutive bits and records every error bit as an error event.
- e) The SS sets the wanted signal level to 28 dBmVemf.
- f) The SS commands the MS to open the TCH loop.
- g) The SS commands the MS to another of the supported data channels.
- h) Steps b) to g) are repeated for all supported full rate data channels.

14.2.8.5 Test requirements

The Max-events measured for different channels shall not exceed the values given in table 14-15.

Table 14-15: Limits for full rate data channel sensitivity

Channels	Type of measurements	Propagation	GSM 400, GSM 700, T-GSM 810, GSM 850 and GSM 900		DCS 1 800 and PCS 1 900	
			Test limit error rate %	Minimum No of samples	Test limit error rate %	Minimum No of samples
TCH/F9,6	BER	HT	0,778	180000	0,784	76500
TCH/F4,8	BER	HT	0,011	5350000	0,011	5350000
TCH/F2,4	BER	HT	0,001	11900000	0,001	11900000

14.2.9 Reference sensitivity - TCH/FS for MS supporting the R-GSM band

14.2.9.1 Definition

The reference sensitivity is the signal level at the MS receiver input at which a certain BER and FER must be achieved.

14.2.9.2 Conformance requirement

1. At reference sensitivity level, the TCH/FS FER shall meet the reference sensitivity performance of table 1 in 3GPP TS 05.05 subclause 6.2.
2. At reference sensitivity level, the TCH/FS class I RBER shall meet the reference sensitivity performance of table 1 in 3GPP TS 05.05 subclause 6.2.
3. At reference sensitivity level, the TCH/FS class II RBER shall meet the reference sensitivity, performance of table 1 in 3GPP TS 05.05 subclause 6.2.
4. At reference sensitivity level, the TCH/FS class II RBER shall meet the reference sensitivity, performance of table 1 in GSM under extreme conditions; 3GPP TS 05.05, subclause 6.2 and annex D subclauses D.2.1 and D.2.2.

14.2.9.3 Test purpose

NOTE: This test is performed under STATIC propagation conditions to allow implicit testing of the ability of the MS to hop over the full band. The tests under dynamic propagation conditions are better suited to test the reference sensitivity conformance but cannot test hopping over the full band due to limited bandwidth of available fading simulators.

1. To verify that the MS does not exceed conformance requirement 1 under STATIC and TUhigh propagation conditions with an allowance for the statistical significance of the test.
2. To verify that the MS does not exceed conformance requirement 2 under STATIC and TUhigh propagation conditions with an allowance for the statistical significance of the test.
3. To verify that the MS does not exceed conformance requirement 3 under STATIC, TUhigh, RA and HT propagation conditions with an allowance for the statistical significance of the test.
4. To verify that the MS does not exceed conformance requirement 4 under STATIC and TUhigh propagation conditions with an allowance for the statistical significance of the test.

14.2.9.4 Method of test

NOTE 1: The BA list sent on the BCCH and SACCH will indicate at least six surrounding cells with at least one near to each band edge. It is not necessary to generate any of these BCCHs but, if provided the signal strengths of BCCHs shall be in the range $15 \text{ dB}\mu\text{Vemf}(\)$ to $35 \text{ dB}\mu\text{Vemf}(\)$.

NOTE 2: The ARFCN of any BCCH shall not be co-channel or on adjacent channels to the wanted traffic channel.

NOTE 3: When frequency hopping is used, the traffic channel may fall on any of the ARFCNs defined in clause 6.

14.2.9.4.1 Initial conditions

A call is set up according to the generic call set up procedure on a TCH/FS with ARFCN 70 for R-GSM 900, power control level set to maximum power.

NOTE: For R-GSM 900 ARFCN 70 is tested since this is the 73rd harmonic of the 13 MHz clock normally used internally in a MS.

The SS transmits Standard Test Signal C1 on the traffic channel.

The SS commands the MS to create traffic channel loop back signalling erased frames.

14.2.9.4.2 Procedure

- a) The fading function is set to TUhigh.
- b) the SS sets the amplitude of the wanted signal to reference sensitivity level ().
- c) The SS compares the data of the signal that it sends to the MS with the signal which is looped back from the receiver after demodulation and decoding, and checks the frame erasure indication.
- d) The SS determines the number of residual bit error events for the bits of class II, by examining sequences of at least the minimum number of samples of consecutive bits of class II. Bits are taken only from those frames not signalled as erased.
- e) The SS determines the number of residual bit error events for the bits of the class Ib, by examining sequences of at least the minimum number of samples of consecutive bits of class Ib. Bits are only taken from those frames not signalled as erased.
- f) The SS also determines the frame erasure events by examining sequences of at least the minimum number of samples of consecutive frames and assuming a frame is received successfully, if it is not signalled as erased.
- g) Steps a) to d) are repeated under extreme test conditions.
- h) Steps a) to g) are repeated for TCH/FS with ARFCN 5 and 964 for R-GSM 900 and the High ARFCN range.

NOTE: For R-GSM 900 ARFCN 5 and 964 are tested since they are the 72nd and 71st harmonic of the 13 MHz clock normally used internally in a MS.i) Steps b) to d) are repeated with the SS fading function set in turn to RA and HT.

- j) Steps b) to g) are repeated, with the SS fading function set to static and the MS is commanded by the SS into hopping mode using the hopping sequence defined in clause 6.

The amplitude of the wanted signal is set according to step b). All the other time slots, except the active ones, are set to 20 dB above reference sensitivity level(). This implicitly tests adjacent time slot rejection.

14.2.9.5 Test requirements

The error rates measured for different channels and under the different propagation conditions, under any combination of normal and extreme test voltages and ambient temperatures, shall not exceed the test limit error rate values given in table 14-5b.

Table 14-5b: Limits for GSM 900 sensitivity

Channels	Propagation conditions TUhigh		Propagation conditions RA		Propagation conditions HT		Static conditions	
	Test limit error rate %	Minimum No. of samples	Test limit error rate %	Minimum No. of samples	Test limit error rate %	Minimum No. of samples	Test limit error rate %	Minimum No. of samples
TCH/FS								
FER	6,742* α	8900					0,122* α	164000
class Ib(RBER)	0,42/ α	1000000					0,41/ α	20000000
class II(RBER)	8,333	120000	7,5	24000	9,333	60000	2,439	8200

14.2.10 Reference sensitivity - TCH/AFS

14.2.10.1 Definition

The reference sensitivity is the signal level at the MS receiver input at which a certain BER and FER must be achieved.

For E-GSM 900 MS this test is only performed in the P-GSM band.

14.2.10.2 Conformance requirement

1. At reference sensitivity level, the TCH/AFS FER shall meet the reference sensitivity performance of table 1 in 3GPP TS 05.05 subclause 6.2.
2. At reference sensitivity level, the TCH/AFS class Ib RBER shall meet the reference sensitivity, performance of table 1 in 3GPP TS 05.05 subclause 6.2.

14.2.10.3 Test purpose

NOTE: This test is not performed under STATIC propagation conditions because the performance requirements are too small to be accurately measured.

1. To verify that the MS does not exceed conformance requirement 1 under TUhigh propagation conditions with an allowance for the statistical significance of the test.
2. To verify that the MS does not exceed conformance requirement 2 under TUhigh propagation conditions with an allowance for the statistical significance of the test.

14.2.10.4 Method of test

NOTE 1: The BA list sent on the BCCH and SACCH will indicate at least six surrounding cells with at least one near to each band edge. It is not necessary to generate any of these BCCHs but, if provided the signal strengths of BCCHs shall be in the range 15 dB μ Vemf() to 35 dB μ Vemf().

NOTE 2: The ARFCN of any BCCH shall not be co-channel or on adjacent channels to the wanted traffic channel.

NOTE 3: When frequency hopping is used, the traffic channel may fall on any of the ARFCNs defined in clause 6.

14.2.10.4.1 Initial conditions

A call is set up according to the generic call set up procedure on a TCH/AFS with an ARFCN in the Mid ARFCN range for GSM 400, GSM 700, T-GSM 810, GSM 850, DCS 1800 and PCS 1900 and ARFCN 70 for GSM 900, power control level set to maximum power.

NOTE: For GSM 900 ARFCN 70 is tested since this is the 73rd harmonic of the 13 MHz clock normally used internally in a MS.

The multirate configuration indicates the use of a codec set limited to 12,2 kbit/s.

The SS transmits Standard Test Signal C1 on the traffic channel.

The SS commands the MS to create traffic channel loop back signalling erased frames.

14.2.10.4.2 Procedure

- a) The fading function is set to TUhigh.
- b) the SS sets the amplitude of the wanted signal to reference sensitivity level ().
- c) The SS compares the data of the signal that it sends to the MS with the signal which is looped back from the receiver after demodulation and decoding, and checks the frame erasure indication.
- d) The SS determines the number of residual bit error events for the bits of class Ib, by examining sequences of at least the minimum number of samples of consecutive bits of class Ib. Bits are taken only from those frames not signalled as erased.
- e) The SS also determines the frame erasure events by examining sequences of at least the minimum number of samples of consecutive frames and assuming a frame is received successfully, if it is not signalled as erased.
- f) The SS uses a Channel Mode Modify procedure to change the active codec set to 10,2 kbit/s and steps a) to e) are repeated.
- g) The SS uses a Channel Mode Modify procedure to change the active codec set to 7,4 kbit/s and steps a) to e) are repeated.

Maximum/Minimum Duration of Test

Statistical test method, pre Rel-5 MS

Maximum: 31 minutes (GSM850, GSM900), 83 minutes (DCS1800, PCS1900).

Minimum: 10 minutes (GSM850, GSM900), 5 minutes (DCS1800, PCS1900).

Statistical test method, Rel -5 onwards MS

Maximum: 31 minutes (GSM850, GSM900), 278 minutes (DCS1800, PCS1900).

Minimum: 10 minutes (GSM850, GSM900), 9 minutes (DCS1800, PCS1900).

14.2.10.5 Test requirements

Testing the reference sensitivity performance is performed using statistical methods that lead to an early pass/fail decision with test time significantly reduced for MS with BER/BLER not on the limit.

For more information on statistical testing of BER/BLER performance, especially the definition of the limit lines refer to Annex 6.2

Wrong decision risk F for one single error rate test:

$$F_{\text{pass}} = F_{\text{fail}} = F \quad \text{and} \quad F = 0.2\%$$

Wrong decision probability D per test step:

$$D_{\text{pass}} = D_{\text{fail}} = D \quad \text{and} \quad D = 0.0085\%$$

Parameters for limit lines:

1. D = 0.000085 wrong decision probability per test step.
2. M = 1.5 bad DUT factor
3. ne number of (error) events.
4. ns number of samples. The error rate is calculated from ne and ns.

Limit checking

Before limit checking is valid the minimum test time due to fading needs to be considered:

Testing under multipath and interference conditions requires that at least 990 wavelengths are crossed with the speed given in the fading profile. This leads to a minimum test time depending on the frequency. No early pass/fail decision is allowed until the minimum test time due to fading has elapsed.

Table 14-36: Minimum test times due to TU high fading conditions

Full Rate 50 km/h							
Frequency	0,4	0,7	0,85	0,9	1,8	1,9	GHz
Wavelength	0,75	0,43	0,35	0,33	0,17	0,16	m
min test time	428	244	201	190	95	90	s
	0:07:08	0:04:04	0:03:21	0:03:10	0:01:35	0:01:30	hh:mm:ss

If the minimum test time due to multipath conditions exceeds the target test time, then the test runs for the minimum test time due to multipath conditions and the decision is done by comparing the result with the “derived test limit”. In this case early pass/fail decisions are obsolete.

If the target test time exceeds the minimum test time due to multipath conditions early pass/fail decisions can be headed for in order to accelerate test execution.

For an early decision a minimum number of (error) events is necessary.

For an early pass decision $n_e \geq 1$ (inclusive artificial error)

For an early fail decision $n_e \geq 7$

When the target test time has been reached the test is finished and a pass/fail decision can be made.

The error rates measured for different channels and under the different propagation conditions, under any combination of normal and extreme test voltages and ambient temperatures, shall be tested according to the values given in table 14-37 or 14-38.

Table 14-37: Statistical test limits for GSM 400, GSM 700, T-GSM 810, GSM 850 and GSM 900 sensitivity

TU high no FH								
0.4 to 0.9GHz			frames per s	Orig. BER	Derived	Target number	Target test	Target test time
	Channel	bits per sec	clas1b per s	requirement	test limit	of samples	time (s)	(hh:mm:ss)
AFS 12.2	frames	12200	50	0,049000	0,060466	5706	114	00:01:54
	Class1b	12200	8150	0,015000	0,018510	18639	2	00:00:02
AFS 10.2	frames	10200	50	0,021000	0,025914	13313	266	00:04:26
	Class1b	10200	6950	0,002300	0,002838	121556	17	00:00:17
AFS 7.4	frames	7400	50	0,004100	0,005059	68190	1364	00:22:44
	Class1b	7400	4350	0,000540	0,000666	517738	119	00:01:59

Table 14-38: Statistical test limits for DCS 1 800 and PCS 1 900 sensitivity

TU high no FH								
1.8 to 1.9 GHz			frames per s	Orig. BER	Derived	Target number	Target test	Target test time
	Channel	bits per sec	clas1b per s	requirement	test limit	of samples	time (s)	(hh:mm:ss)
AFS 12.2	frames	12200	50	Pre Rel-5:	Pre Rel-5:	Pre Rel-5:	Pre Rel-5:	Pre Rel-5:
				0,030000	0,037020	9320	186	00:03:06
	Class1b	12200	8150	Pre Rel-5:	Pre Rel-5:	Pre Rel-5:	Pre Rel-5:	Pre Rel-5:
				0,0150000	0,018510	18639	2	00:00:02
AFS 10.2	frames	10200	50	Pre Rel-5:	Pre Rel-5:	Pre Rel-5:	Pre Rel-5:	Pre Rel-5:
				0,012000	0,014808	23299	466	00:07:46
	Class1b	10200	6950	Pre Rel-5:	Pre Rel-5:	Pre Rel-5:	Pre Rel-5:	Pre Rel-5:
				0,001700	0,002098	164458	24	00:00:24
AFS 7.4	frames	7400	50	Pre Rel-5:	Pre Rel-5:	Pre Rel-5:	Pre Rel-5:	Pre Rel-5:
				0,001300	0,001604	215061	4301	01:11:41
	Class1b	7400	4350	Pre Rel-5:	Pre Rel-5:	Pre Rel-5:	Pre Rel-5:	Pre Rel-5:
				0,000360	0,000444	776607	15532	04:18:52
	Class1b	7400	4350	Pre Rel-5:	Pre Rel-5:	Pre Rel-5:	Pre Rel-5:	Pre Rel-5:
				0,000260	0,000321	1075302	247	00:04:07
	Class1b	7400	4350	Pre Rel-5:	Pre Rel-5:	Pre Rel-5:	Pre Rel-5:	Pre Rel-5:
				0,000130	0,000160	2150605	494	00:08:14

14.2.18 Reference sensitivity - TCH/AHS

14.2.18.1 Definition

The reference sensitivity level is the signal level at the MS receiver input at which a certain BER and FER for speech frames must be achieved.

14.2.18.2 Conformance requirement

- At reference sensitivity level, the TCH/AHS FER shall meet the reference sensitivity performance of table 1 in 3GPP TS 05.05 subclause 6.2.

- 2 At reference sensitivity level, the TCH/AHS class Ib RBER (BFI=0) shall meet the reference sensitivity performance of table 1 in 3GPP TS 05.05 subclause 6.2.
- 3 At reference sensitivity level, the TCH/AHS class II RBER (BFI=0) shall meet the reference sensitivity performance of table 1 in 3GPP TS 05.05 subclause 6.2.

14.2.18.3 Test purpose

1. To verify that the MS does not exceed conformance requirement 1 under TUhigh propagation conditions with an allowance for the statistical significance of the test.
2. To verify that the MS does not exceed conformance requirement 2 under TUhigh propagation conditions with an allowance for the statistical significance of the test.
3. To verify that the MS does not exceed conformance requirement 3 under TUhigh, RA and HT propagation conditions with an allowance for the statistical significance of the test.

14.2.18.4 Method of test

14.2.18.4.1 Initial conditions

The BA list sent on the BCCH and SACCH indicates at least six surrounding cells, with at least one near to each band edge. It is not necessary to generate any of these BCCHs, but if provided, the signal strengths of BCCHs shall be in the range $15 \text{ dB}\mu\text{Vemf}(\)$ to $35 \text{ dB}\mu\text{Vemf}(\)$.

The ARFCN of any BCCH shall not be co-channel or on adjacent channels to the wanted traffic channel.

A call is set up according to the generic call set up procedure on a TCH/AHS with an ARFCN in the mid ARFCN range, power control level set to maximum power.

The multirate configuration indicates the use of a codec set limited to 7,95 kbit/s.

The SS transmits Standard Test Signal C1 on the traffic channel.

14.2.18.4.2 Procedure

- a) The SS commands the MS to create traffic channel loop back signalling erased frames.

NOTE: Frames detected with BFI=1 are signalled as erased on the uplink.

- b) The fading function is set to RA.
- c) The SS sets the amplitude of the wanted signal to reference sensitivity level ($\)$.
- d) The SS compares the data of the signal that it sends to the MS with the signal which is looped back from the receiver after demodulation and decoding, and checks the frame erasure indication.
- e) The SS determines the number of residual bit error events for the bits of class II, by examining sequences of at least the minimum number of samples of consecutive bits of class II. Bits are taken only from those frames not signalled as erased.
- f) The SS determines the number of residual bit error events for the bits of the class Ib, by examining sequences of at least the minimum number of samples of consecutive bits of class Ib. Bits are only taken from those frames not signalled as erased.
- g) The SS also determines the frame erasure events by examining sequences of at least the minimum number of samples of consecutive frames and assuming a frame is received successfully, if it is not signalled as erased.
- h) The SS uses a Channel Mode Modify procedure to change the active codec set to 6,7 kbit/s and steps d) to g) are repeated.
- i) The fading function is set to HT.
- j) The SS uses a Channel Mode Modify procedure to change the active codec set to 7,4 kbit/s and steps d) to g) are repeated.

- k) The SS uses a Channel Mode Modify procedure to change the active codec set to 5,9 kbit/s and steps d) to g) are repeated.
- l) The fading function is set to TUHigh.
- m) The SS uses a Channel Mode Modify procedure to change the active codec set to 5,15 kbit/s and steps d) to g) are repeated.
- n) The SS uses a Channel Mode Modify procedure to change the active codec set to 4,75 kbit/s and steps d) to g) are repeated.

Maximum/Minimum Duration of Test

Pre Rel-5 MS

Maximum: 24 minutes (GSM850), 23 minutes (GSM900), 15 minutes (DCS1800, PCS1900).

Minimum: 23 minutes (GSM850), 22 minutes (GSM900), 12 minutes (DCS1800, PCS1900).

Rel -5 onwards MS

Maximum: 24 minutes (GSM850), 23 minutes (GSM900), 17 minutes (DCS1800, PCS1900).

Minimum: 23 minutes (GSM850), 22 minutes (GSM900), 12 minutes (DCS1800, PCS1900).

14.2.18.5 Test requirements

Testing the reference sensitivity performance is performed using statistical methods that lead to an early pass/fail decision with test time significantly reduced for MS with BER/BLER not on the limit.

For more information on statistical testing of BER/BLER performance, especially the definition of limit lines refer to Annex 6.2

Wrong decision risk F for one single error rate test:

$$F_{\text{pass}} = F_{\text{fail}} = F \text{ and } F = 0.2\%$$

Wrong decision probability D per test step:

$$D_{\text{pass}} = D_{\text{fail}} = D \text{ and } D = 0.0085\%$$

Parameters for limit lines:

1. D = 0.000085 wrong decision probability per test step.
2. M = 1.5 bad DUT factor
3. ne number of (error) events. This parameter is the x-ordinate in figure 14-1.
4. ns number of samples. The error rate is calculated from ne and ns.

Limit checking

Before limit checking is valid the minimum test time due to fading needs to be considered:

Testing under multipath and interference conditions requires that at least 990 wavelengths are crossed with the speed given in the fading profile. This leads to a minimum test time depending on the frequency range. No early pass/fail decision is allowed until the minimum test time due to fading has elapsed.

Table 14-39: Minimum test times due to TU high fading conditions

Half Rate 50 km/h							
Frequency	0,4	0,7	0,85	0,9	1,8	1,9	GHz
Wavelength	0,75	0,43	0,35	0,33	0,17	0,16	m
min test time	855	489	403	380	190	180	s
	0:14:15	0:08:09	0:06:43	0:06:20	0:03:10	0:03:00	hh:mm:ss

Table 14-40: Minimum test times due to HT 100 fading conditions

Half Rate 100 km/h							
Frequency	0,4	0,7	0,85	0,9	1,8	1,9	GHz
Wavelength	0,75	0,43	0,35	0,33	0,17	0,16	m
min test time	428	244	201	190	95	90	s
	0:07:08	0:04:04	0:03:21	0:03:10	0:01:35	0:01:30	

Table 14-x: Minimum test times due to RA 130 fading conditions

Half Rate 130 km/h							
Frequency	0,4	0,7	0,85	0,9	1,8	1,9	GHz
Wavelength	0,75	0,43	0,35	0,33	0,17	0,16	m
min test time	-	-	-	-	73	69	s
	-	-	-	-	0:01:13	0:01:09	

Table 14-41: Minimum test times due to RA 250 fading conditions

Half Rate 250 km/h							
Frequency	0,4	0,7	0,85	0,9	1,8	1,9	GHz
Wavelength	0,75	0,43	0,35	0,33	0,17	0,16	m
min test time	171	98	81	76	-	-	s
	0:02:51	0:01:38	0:01:21	0:01:16	-	-	hh:mm:ss

--	--	--	--	--	--	--	--

If the minimum test time due to multipath conditions exceeds the target test time, then the test runs for the minimum test time due to multipath conditions and the decision is done by comparing the result with the “derived test limit”. In this case early pass/fail decisions are obsolete.

If the target test time exceeds the minimum test time due to multipath conditions early pass/fail decisions can be headed for in order to accelerate test execution.

For an early decision a minimum number of (error) events is necessary.

For an early pass decision $ne \geq 1$ (inclusive artificial error)

For an early fail decision $ne \geq 7$

When the target test time has been reached the test is finished and a pass/fail decision can be made.

The error rates measured for different channels and under the different propagation conditions, under any combination of normal and extreme test voltages and ambient temperatures, shall be tested according to the values given in table 14-42 or 14-43.

Table 14-42: Statistical test limits for GSM 400, GSM 700, T-GSM 810, GSM 850 and GSM 900: fading TU high

TU high no FH								
0.4 to 0.9GHz			frames per s	Orig. BER	Derived	Target number	Target test	Target test time
			clas1b per s	requirement	test limit	of samples	time (s)	(hh:mm:ss)
	Channel	bits per sec	clas II per s					
AHS 5.15	frames	5150	50	0,025000	0,030850	11183	224	00:03:44
	Class1b	5150	2100	0,005100	0,006293	54819	26	00:00:26
	Class II	5150	600	0,063000	0,077742	4438	7	00:00:07
AHS 4.75	frames	4750	50	0,012000	0,014808	23298	466	00:07:46
	Class1b	4750	2200	0,001700	0,002098	164458	75	00:01:15
	Class II	4750	600	0,064000	0,078976	4368	7	00:00:07

Table 14-43: Statistical test limits for GSM 400, GSM 700, T-GSM 810, GSM 850 and GSM 900: fading RA 250

RA 250 no FH								
0.4 to 0.9GHz			frames per s	Orig. BER	Derived	Target number	Target test	Target test time
			clas1b per s	requirement	test limit	of samples	time (s)	(hh:mm:ss)
	Channel	bits per sec	clas II per s					
AHS 7.95	frames	7950	50					
	Class1b	7950	2800					

	Class II	7950	1800	Pre Rel-5: 0,059000 Rel-5: 0,047000	Pre Rel-5: 0,072806 Rel-5: 0,057998	Pre Rel-5: 4739 Rel-5: 5948	Pre Rel-5: 3 Rel-5: 3	Pre Rel-5: 00:00:03 Rel-5: 00:00:03
AHS 6.7	frames	6700	50					
	Class1b	6700	2750					
	Class II	6700	1200	Pre Rel-5: 0,065000 Rel-5: 0,055000	Pre Rel-5: 0,080210 Rel-5: 0,067870	Pre Rel-5: 4302 Rel-5: 5083	Pre Rel-5: 4 Rel-5: 4	Pre Rel-5: 00:00:04 Rel-5: 00:00:04

Table 14-44: Statistical test limits for GSM 400, GSM 700, T-GSM 810, GSM 850 and GSM 900: fading HT 100

HT 100 no FH								
0.4 to 0.9GHz			frames per s	Orig. BER	Derived	Target number	Target test	Target test time
			clas1b per s	requirement	test limit	of samples	time (s)	(hh:mm:ss)
	Channel	bits per sec	clas II per s					
AHS 7.4	frames	7400	50					
	Class1b	7400	2950					
	Class II	7400	1400	Pre Rel-5: 0,069000 Rel-5: 0,060000	Pre Rel-5: 0,085146 Rel-5: 0,074040	Pre Rel-5: 4052 Rel-5: 4660	Pre Rel-5: 3 Rel-5: 3	Pre Rel-5: 00:00:03 Rel-5: 00:00:03
AHS 5.9	frames	5900	50					
	Class1b	5900	2350					
	Class II	5900	800	Pre Rel-5: 0,083000 Rel-5: 0,068000	Pre Rel-5: 0,102422 Rel-5: 0,083912	Pre Rel-5: 3369 Rel-5: 4111	Pre Rel-5: 4 Rel-5: 5	Pre Rel-5: 00:00:04 Rel-5: 00:00:05

Table 14-45: Statistical test limits for DCS 1 800 and PCS 1 900 sensitivity: fading TU high

TU high no FH								
1.8 and 1.9 GHz			frames per s	Orig. BER	Derived	Target number	Target test	Target test time
			clas1b per s	requirement	test limit	of samples	time (s)	(hh:mm:ss)
	Channel	bits per sec	clas II per s					
AHS 5.15	frames	5150	50	0,026000	0,032084	10753	215	00:03:35
	Class1b	5150	2100	0,005300	0,006540	52751	25	00:00:25
	Class II	5150	600	0,063000	0,077742	4438	7	00:00:07
AHS 4.75	frames	4750	50	Pre Rel-5: 0,017000 Rel-5: 0,012000	Pre Rel-5: 0,020978 Rel-5: 0,014808	Pre Rel-5: 16446 Rel-5: 23298	Pre Rel-5: 329 Rel-5: 466	Pre Rel-5: 00:05:29 Rel-5: 00:07:46
	Class1b	4750	2200	Pre Rel-5: 0,002500 Rel-5: 0,001800	Pre Rel-5: 0,003085 Rel-5: 0,002221	Pre Rel-5: 111832 Rel-5: 155321	Pre Rel-5: 51 Rel-5: 71	Pre Rel-5: 00:00:51 Rel-5: 00:01:11
	Class II	4750	600	0,065000	0,080210	4301	7	00:00:07

Table 14-46: Statistical test limits for DCS 1 800 and PCS 1 900 sensitivity: fading RA 130

RA 130 no FH								
1.8 and 1.9 GHz			frames per s	Orig. BER	Derived	Target number	Target test	Target test time
			clas1b per s	requirement	test limit	of samples	time (s)	(hh:mm:ss)
	Channel	bits per sec	clas II per s					
AHS 7.95	frames	7950	50					
	Class1b	7950	2800					
	Class II	7950	1800	Pre Rel-5: 0,059000 Rel-5: 0,048000	Pre Rel-5: 0,072806 Rel-5: 0,059232	Pre Rel-5: 4739 Rel-5: 5825	Pre Rel-5: 3 Rel-5: 3	Pre Rel-5: 00:00:03 Rel-5: 00:00:03
AHS 6.7	frames	6700	50					
	Class1b	6700	2750					
	Class II	6700	1250	Pre Rel-5: 0,065000 Rel-5: 0,055000	Pre Rel-5: 0,080210 Rel-5: 0,067870	Pre Rel-5: 4302 Rel-5: 5083	Pre Rel-5: 3 Rel-5: 4	Pre Rel-5: 00:00:03 Rel-5: 00:00:04

Table 14-47: Statistical test limits for DCS 1 800 and PCS 1 900 sensitivity: fading HT 100

HT 100 no FH								
1.8 and 1.9 GHz			frames per s	Orig. BER	Derived	Target number	Target test	Target test time
			clas1b per s	requirement	test limit	of samples	time (s)	(hh:mm:ss)
	Channel	bits per sec	clas II per s					
AHS 7.4	frames	7400	50					
	Class1b	7400	2950					
	Class II	7400	1400	Pre Rel-5: 0,071000 Rel-5: 0,060000	Pre Rel-5: 0,087614 Rel-5: 0,074040	Pre Rel-5: 3938 Rel-5: 4660	Pre Rel-5: 3 Rel-5: 3	Pre Rel-5: 00:00:03 Rel-5: 00:00:03
AHS 5.9	frames	5900	50					
	Class1b	5900	2350					
	Class II	5900	800	Pre Rel-5: 0,084000 Rel-5: 0,068000	Pre Rel-5: 0,103656 Rel-5: 0,083912	Pre Rel-5: 3329 Rel-5: 4111	Pre Rel-5: 4 Rel-5: 5	Pre Rel-5: 00:00:04 Rel-5: 00:00:05

14.2.19 Reference sensitivity - TCH/AFS-INB

14.2.19.1 Definition

The reference sensitivity is the signal level at the MS receiver input at which a certain FER for in band signalling codewords or frames must be achieved.

For E-GSM 900 MS this test is only performed in the P-GSM band.

14.2.19.2 Conformance requirement

1. At reference sensitivity level, the TCH/AFS-INB FER shall meet the reference sensitivity performance of table 1 in 3GPP TS 45.005 subclause 6.2.

The delays associated with Loop I remain constant for all of the following circumstances:

- For a given MS implementation.
- For the duration of the MS being powered on.

3GPP TS 44.014 subclause 5.1.7a.1.

14.2.19.3 Test purpose

NOTE: This test is not performed under STATIC propagation conditions because the performance requirements are too small to be accurately measured.

1. To verify that the MS does not exceed conformance requirement 1 under TUhigh propagation conditions with an allowance for the statistical significance of the test.

14.2.19.4 Method of test

NOTE 1: The BA list sent on the BCCH and SACCH will indicate at least six surrounding cells with at least one near to each band edge. It is not necessary to generate any of these BCCHs but, if provided the signal strengths of BCCHs shall be in the range $15 \text{ dB}\mu\text{Vemf}()$ to $35 \text{ dB}\mu\text{Vemf}()$.

NOTE 2: The ARFCN of any BCCH shall not be co-channel or on adjacent channels to the wanted traffic channel.

14.2.19.4.1 Initial conditions

A call is set up according to the generic call set up procedure on a TCH/AFS with an ARFCN in the Mid ARFCN range for GSM 400, GSM 700, T-GSM 810, GSM 850, DCS 1800 and PCS 1 900 and ARFCN 70 for GSM 900, power control level set to maximum power.

NOTE: For GSM 900 ARFCN 70 is tested since this is the 73rd harmonic of the 13 MHz clock normally used internally in a MS.

The multirate configuration indicates the use of the following set of codecs modes:

Codec Mode	TCH/AFS in kbit/s
CODEC_MODE_4	12,2
CODEC_MODE_3	7,95
CODEC_MODE_2	5,9
CODEC_MODE_1	4,75

The Initial Codec Mode shall be set to the lowest codec mode (CODEC_MODE_1).

The following decision threshold and hysteresis values in terms of normalized carrier to interference ratio (C/I_{norm}), shall apply for Codec Mode Command / Request (MC, MR):

MC/MR ¹	THR_MC_Dn(MC)/ THR_MR_Dn(MR)	THR_MC_Up(MC)/ THR_MR_Up(MR)
CODEC_MODE_4	18,5 dB	+ ∞
CODEC_MODE_3	12,5 dB	20,5 dB
CODEC_MODE_2	6,5 dB	14,5 dB
CODEC_MODE_1	- ∞	8,5 dB

The SS transmits Standard Test Signal C1 on the traffic channel using the Initial Codec Mode (ICM).

The SS continuously sends a CMC corresponding to the highest codec mode (CODEC_MODE_4).

The SS commands the MS to loop back in band signaling codewords by closing a Loop I.

14.2.19.4.2 Procedure

- The fading function is set to TUhigh.
- The SS sets the amplitude of the wanted signal to reference sensitivity level ().
- The SS shall change the Codec Mode Indication and Codec Mode Command to the neighbour mode every 22 speech frames (440 ms) by following a scanning pattern (1->2->3->4->4->3->2->1). CMI should initially be increased. CMC should initially be decreased. The CMI/CMC pattern shall be repeated until the minimum required number of frame samples has been sent to the MS.
- The SS compares the in band signalling codewords/frames it sends to the MS with the in band signalling codewords/frames which are looped back from the receiver after demodulation and decoding, and checks for in band signalling (CMI/CMC) frame errors.
- The SS determines the frame error events by examining sequences of at least the minimum number of samples of consecutive frames. All frames should be considered when computing the frame error rate: those corresponding to a downlink CMI/CMC transitions and those without downlink CMI/CMC transitions.

NOTE: The delays associated with Loop I are not specified, and will be MS implementation dependant. Loop I should be considered as having two separate parts (DL CMC -> UL CMI and DL CMI -> UL CMR). The delays associated with the two parts may differ. The SS should ensure that the correctly looped inband bits are compared. The delays associated with Loop I will remain constant for the duration of the test, thus every UL frame received by the SS will have only one possible expected value.

Maximum/Minimum Duration of Test

Maximum/minimum: 50 minutes (GSM850, GSM900, DCS1800, PCS1900).

14.2.19.5 Test requirements

The frame error rates measured for different channels under any combination of normal and extreme test voltages and ambient temperatures, shall not exceed the test limit error rate values given in table 14.2.19-1 or 14.2.19-2.

Table 14.2.19-1: Limits for GSM 400, GSM 700, T-GSM 810, GSM 850 and GSM 900 sensitivity

Channels	Propagation conditions Tuhigh	
	Test limit error rate %	Minimum No. of samples
TCH/AFS-INB (FER)	0.047	150000

Table 14.2.19-2: Limits for DCS 1 800 and PCS 1 900 sensitivity

Channels	Propagation conditions TUhigh	
	Test limit error rate %	Minimum No. of samples
TCH/AFS-INB (FER)	0.015	150000

14.2.20 Reference sensitivity - TCH/AHS-INB

14.2.20.1 Definition

The reference sensitivity level is the signal level at the MS receiver input at which a certain FER for in band signalling codewords or frames must be achieved.

14.2.20.2 Conformance requirement

- At reference sensitivity level, the TCH/AHS-INB FER shall meet the reference sensitivity performance of table 1 in 3GPP TS 45.005 subclause 6.2.

The delays associated with Loop I remain constant for all of the following circumstances:

- For a given MS implementation.
- For the duration of the MS being powered on.

3GPP TS 44.014 subclause 5.1.7a.1.

14.2.20.3 Test purpose

- To verify that the MS does not exceed conformance requirement 1 under TUhigh propagation conditions with an allowance for the statistical significance of the test.

14.2.20.4 Method of test

14.2.20.4.1 Initial conditions

The BA list sent on the BCCH and SACCH indicates at least six surrounding cells, with at least one near to each band edge. It is not necessary to generate any of these BCCHs, but if provided, the signal strengths of BCCHs shall be in the range $15 \text{ dB}\mu\text{Vemf}(\)$ to $35 \text{ dB}\mu\text{Vemf}(\)$.

The ARFCN of any BCCH shall not be co-channel or on adjacent channels to the wanted traffic channel.

A call is set up according to the generic call set up procedure on a TCH/AHS with an ARFCN in the mid ARFCN range, power control level set to maximum power and with the following sets of codec modes:

Codec Mode	TCH/AHS in kbit/s
CODEC_MODE_4	7,95
CODEC_MODE_3	6,7
CODEC_MODE_2	5,9
CODEC_MODE_1	4.75

The Initial Codec Mode shall be set to the lowest codec mode (CODEC_MODE_1).

The following decision threshold and hysteresis values in terms of normalized carrier to interference ratio (C/I_{norm}), shall apply for Codec Mode Command / Request (MC, MR):

MC'/MR'	THR_MC_Dn(MC')/ THR_MR_Dn(MR')	THR_MC_Up(MC')/ THR_MR_Up(MR')
CODEC_MODE_4	16,0 dB	$+\infty$
CODEC_MODE_3	12,0 dB	18,0 dB
CODEC_MODE_2	8,0 dB	14,0 dB
CODEC_MODE_1	$-\infty$	10,0 dB

The SS transmits Standard Test Signal C1 on the traffic channel using the Initial Codec Mode (ICM).

The SS continuously sends a CMC corresponding to the highest codec mode (CODEC_MODE_4).

14.2.20.4.2 Procedure

- The SS commands the MS to loop back in band signaling codewords by closing a Loop I.

- b) The fading function is set to TUhigh.
- c) The SS sets the amplitude of the wanted signal to reference sensitivity level ().
- d) The SS shall change the Codec Mode Indication and Codec Mode Command at to the neighbour mode every 22 speech frames (440 ms) by following a scanning pattern (1->2->3->4->4->3->2->1). CMI should initially be increased. CMC should initially be decreased. The CMI/CMC pattern shall be repeated until the minimum required number of frame samples has been sent to the MS.
- e) The SS compares the in band signalling codewords/frames it sends to the MS with the in band signalling codewords/frames which are looped back from the receiver after demodulation and decoding, and checks for in band signalling (CMI/CMC) frame errors.
- f) The SS determines the frame error events by examining sequences of at least the minimum number of samples of consecutive frames. All frames should be considered when computing the frame error rate: those corresponding to a downlink CMI/CMC transitions and those without downlink CMI/CMC transitions.

NOTE: The delays associated with Loop I are not specified, and will be MS implementation dependant. Loop I should be considered as having two separate parts (DL CMC -> UL CMI and DL CMI -> UL CMC). The delays associated with the two parts may differ. The SS should ensure that the correctly looped inband bits are compared. The delays associated with Loop I will remain constant for the duration of the test, thus every UL frame received by the SS will have only one possible expected value.

Maximum/Minimum Duration of Test

Maximum/minimum: 25 minutes (GSM850, GSM900), 28 minutes (DCS1800, PCS1900).

14.2.20.5 Test requirements

The error rates measured for different channels and under the different propagation conditions, shall not exceed the test limit error rate values given in table 14.2.20-1 or 14.2.20-2.

Table 14.2.20-1: Limits for GSM 400, GSM 700, T-GSM 810, GSM 850 and GSM 900 sensitivity

Channels	Propagation conditions TUhigh	
	Test limit error rate %	Minimum No. of samples
TCH/AHS-INB (FER)	0.806	74000

Table 14.2.20-2: Limits for DCS 1800 and PCS 1 900 sensitivity

Channels	Propagation conditions TUhigh	
	Test limit error rate %	Minimum No. of samples
TCH/AHS-INB (FER)	0.717	83000

14.2.21 Reference sensitivity – O-TCH/AHS

14.2.21.1 Definition

-

14.2.21.2 Conformance requirement

For 8-PSK modulated speech channels for AMR, associated control channels and inband signalling, the minimum input signal level for which the reference performance shall be met is specified in table 1g

For all classes of MS supporting 8-PSK speech channels, an additional +2 dB adjustment applies for 8-PSK modulated speech channels.

The reference performance shall be:

For speech channels (O-TCH/AHSy) $FER \leq 1\%$

All other requirements in tables 1f and 1g shall be fulfilled at this input level for reference performance.

3GPP TS 45.005, subclause 6.2.

14.2.21.3 Test purpose

To verify that the MS does not exceed conformance requirement for FER and class 1b RBER under HT100 propagation conditions with an allowance for the statistical significance of the test, for channel combinations O-TCH/AHS10.2 and O-TCH/AHS 5.15

14.2.21.4 Method of test

14.2.21.4.1 Initial conditions

A call is set up according to the generic call set up procedure on a O-TCH/AFS with an ARFCN in the mid ARFCN range, power control level set to maximum power. RADIO_LINK_TIMEOUT is set to maximum.

The multirate configuration indicates the use of a codec set limited to 10,2 kbit/s.

The SS transmits Standard Test Signal C1 on the traffic channel (wanted signal).

The SS commands the MS to create the traffic channel loop back, signalling erased frames (subclause 36).

14.2.21.4.2 Procedure

- a) The fading function is set to HT100.
- b) The SS sets the level of the wanted signal to that indicated by C_{lev} in table 14.2.21-2 or 14.2.21-3.
- c) The SS compares the data of the signal that it sends to the MS with the signal which is looped back from the receiver after demodulation and decoding, and checks the frame erasure indication.
- d) The SS determines the number of residual bit error events for the bits of the class 1b, by examining sequences of at least the minimum number of samples of consecutive bits of class 1b. Bits are only taken from those frames not signalled as erased.
- e) The SS also determines the frame erasure events by examining sequences of at least the minimum number of samples of consecutive frames and assuming a frame is received successfully, if it is not signalled as erased.
- f) The SS uses a Channel Mode Modify procedure to change the active codec set to 5,15 kbit/s and steps b) to e) are repeated.

Maximum/Minimum Duration of Test

Maximum: 19 minutes (GSM850), 19 minutes (GSM900), 19 minutes (DCS1800), 19 minutes (PCS1900).

Minimum: 6 minutes (GSM850), 6 minutes (GSM900), 3 minutes (DCS1800), 3 minutes (PCS1900).

14.2.21.5 Test requirements

Testing should be performed using statistical methods that lead to an early pass/fail decision with test time significantly reduced for MS with FER/BER not on the limit.

For more information on statistical testing of BER/BLER performance, especially the definition of limit lines refer to Annex 7.

Wrong decision risk F for one single error rate test:

$$F_{pass} = F_{fail} = F \text{ and } F = 0.2\%$$

Wrong decision probability D per test step:

$$D_{pass} = D_{fail} = D \text{ and } D = 0.0085\%$$

Parameters for limit lines:

1. $D = 0.000085$ wrong decision probability per test step.
2. $M = 1.5$ bad DUT factor
3. n_e number of (error) events. This parameter is the x-ordinate in figure A7.1.3.1.
4. n_s number of samples. The error rate is calculated from n_e and n_s .

Limit checking

Before limit checking is valid the minimum test time due to fading needs to be considered:

Testing under multipath and interference conditions requires that at least 990 wavelengths are crossed with the speed given in the fading profile. This leads to a minimum test time depending on the frequency range. No early pass/fail decision is allowed until the minimum test time due to fading has elapsed.

Table 14.2.21-1: Minimum test times due to HT 100 fading conditions

Half Rate 100 km/h					
Frequency	0,85	0,9	1,8	1,9	GHz
Wavelength	0,35	0,33	0,17	0,16	m
min test time	201	190	95	90	s
	0:03:21	0:03:10	0:01:35	0:01:30	

If the minimum test time due to multipath conditions exceeds the target test time, then the test runs for the minimum test time due to multipath conditions and the decision is made by comparing the result with the “derived test limit”. In this case early pass/fail decisions are obsolete.

If the target test time exceeds the minimum test time due to multipath conditions early pass/fail decisions can be headed for in order to accelerate test execution.

For an early decision a minimum number of (error) events is necessary.

For an early pass decision $n_e \geq 1$ (inclusive artificial error)

For an early fail decision $n_e \geq 7$

When the target test time has been reached the test is finished and a pass/fail decision can be made.

The error rate measured in this test shall be tested according to the values given in tables 14.2.21-2 and 14.2.21.3.

Table 14.2.21-2: Statistical test limits for GSM 700, T-GSM 810, GSM 850 and GSM 900 O-TCH/AFS reference sensitivity

HT100 / No FH								
0.8 to 0.9GHz		C_{lev} (dBm)	Samples per second	Orig. BER requirement	Derived test limit	Target number of samples	Target test time (s)	Target test time (hh:mm:ss)
AHS 10.2	Frames	-91.5	50	0,010000	0,012340	27958	560	00:09:20
	Class1b		6950	0,001900	0,002345	147121	21	00:00:21
AHS 5.15	Frames	-95.0	50	0,010000	0,012340	27958	560	00:09:20
	Class1b		2700	0,001100	0,001357	254237	94	00:01:34

Table 14.2.21-3: Statistical test limits for DCS 1 800 and PCS 1 900 O-TCH/AFS reference sensitivity

HT100 / No FH								
1.8 to 1.9GHz		C _{lev} (dBm)	Samples per second	Orig. BER requirement	Derived test limit	Target number of samples	Target test time (s)	Target test time (hh:mm:ss)
AHS 10.2	Frames	-91.0	50	0,010000	0,012340	27958	560	00:09:20
	Class1b		6950	0,002000	0,002468	139789	20	00:00:20
AHS 5.15	Frames	-95.0	50	0,010000	0,012340	27958	560	00:09:20
	Class1b		2700	0,001200	0,001408	232982	86	00:01:26

14.2.22 Reference sensitivity – O-TCH/WFS

14.2.22.1 Definition

-

14.2.22.2 Conformance requirement

For 8-PSK modulated speech channels for AMR, associated control channels and inband signalling, the minimum input signal level for which the reference performance shall be met is specified in table 1g

For all classes of MS supporting 8-PSK speech channels, an additional +2 dB adjustment applies for 8-PSK modulated speech channels.

The reference performance shall be:

For speech channels (O-TCH/WFS_y) FER ≤ 1%

All other requirements in tables 1f and 1g shall be fulfilled at this input level for reference performance.

Correction values for 8-PSK modulated signals:

for GSM 400, GSM 900, GSM 850, T_GSM 810 and GSM 700 small MS	0 dB
for other GSM 400, GSM 900, GSM 850, T_GSM 810 and GSM 700 MS	-2 dB
for DCS 1 800 and PCS 1900 class 1 or class 2 MS	0 dB
for other DCS 1 800 and PCS 1900 MS	-2 dB

3GPP TS 45.005, subclause 6.2.

14.2.22.3 Test purpose

To verify that the MS does not exceed conformance requirement for FER and class 1b RBER under HT100 propagation conditions with an allowance for the statistical significance of the test, for channel combinations O-TCH/WFS15.85 and O-TCH/WFS 6.60

14.2.22.4 Method of test

14.2.22.4.1 Initial conditions

A call is set up according to the generic call set up procedure on a O-TCH/WFS with an ARFCN in the mid ARFCN range, power control level set to maximum power. RADIO_LINK_TIMEOUT is set to maximum.

The multirate configuration indicates the use of a codec set limited to 15,85 kbit/s.

The SS transmits Standard Test Signal C1 on the traffic channel (wanted signal).

The SS commands the MS to create the traffic channel loop back, signalling erased frames (subclause 36).

14.2.22.4.2 Procedure

- The fading function is set to HT100.

- b) The SS sets the level of the wanted signal to that indicated by C_{lev} in table 14.2.22-2 or 14.2.22-3. The level is corrected by the appropriate value in the table above.
- c) The SS compares the data of the signal that it sends to the MS with the signal which is looped back from the receiver after demodulation and decoding, and checks the frame erasure indication.
- d) The SS determines the number of residual bit error events for the bits of the class Ib, by examining sequences of at least the minimum number of samples of consecutive bits of class Ib. Bits are only taken from those frames not signalled as erased.
- e) The SS also determines the frame erasure events by examining sequences of at least the minimum number of samples of consecutive frames and assuming a frame is received successfully, if it is not signalled as erased.
- f) The SS uses a Channel Mode Modify procedure to change the active codec set to 6.60 kbit/s and steps b) to e) are repeated.

Maximum/Minimum Duration of Test

Maximum: 19 minutes (GSM850), 19 minutes (GSM900), 19 minutes (DCS1800), 19 minutes (PCS1900).

Minimum: 6 minutes (GSM850), 6 minutes (GSM900), 3 minutes (DCS1800), 3 minutes (PCS1900).

14.2.22.5 Test requirements

Testing should be performed using statistical methods that lead to an early pass/fail decision with test time significantly reduced for MS with FER/BER not on the limit.

For more information on statistical testing of BER/BLER performance, especially the definition of limit lines refer to Annex 7.

Wrong decision risk F for one single error rate test:

$$F_{\text{pass}} = F_{\text{fail}} = F \quad \text{and} \quad F = 0.2\%$$

Wrong decision probability D per test step:

$$D_{\text{pass}} = D_{\text{fail}} = D \quad \text{and} \quad D = 0.0085\%$$

Parameters for limit lines:

1. D = 0.000085 wrong decision probability per test step.
2. M = 1.5 bad DUT factor
3. ne number of (error) events. This parameter is the x-ordinate in figure A7.1.3.1.
4. ns number of samples. The error rate is calculated from ne and ns.

Limit checking

Before limit checking is valid the minimum test time due to fading needs to be considered:

Testing under multipath and interference conditions requires that at least 990 wavelengths are crossed with the speed given in the fading profile. This leads to a minimum test time depending on the frequency range. No early pass/fail decision is allowed until the minimum test time due to fading has elapsed.

Table 14.2.22-1: Minimum test times due to HT 100 fading conditions

Full Rate 100 km/h				
Frequency (GHz)	0,85	0,9	1,8	1,9
Wavelength (m)	0,35	0,33	0,17	0,16
min test time (s)	101	95	48	45
	0:01:41	0:01:35	0:00:48	0:00:45

If the minimum test time due to multipath conditions exceeds the target test time, then the test runs for the minimum test time due to multipath conditions and the decision is made by comparing the result with the “derived test limit”. In this case early pass/fail decisions are obsolete.

If the target test time exceeds the minimum test time due to multipath conditions early pass/fail decisions can be headed for in order to accelerate test execution.

For an early decision a minimum number of (error) events is necessary.

For an early pass decision $ne \geq 1$ (inclusive artificial error)

For an early fail decision $ne \geq 7$

When the target test time has been reached the test is finished and a pass/fail decision can be made.

The error rate measured in this test shall be tested according to the values given in tables 14.2.22-2 and 14.2.22.3

Table 14.2.22-2: Statistical test limits for GSM 700, T-GSM 810, GSM 850 and GSM 900 O-TCH/WFS reference sensitivity

HT100 / No FH								
0.8 to 0.9GHz		C _{lev} (dBm)	Samples per second	Orig. BER requirement	Derived test limit	Target number of samples	Target test time (s)	Target test time (hh:mm:ss)
WFS15.85	Frames	-95.0	50	0,010000	0,012340	27958	560	00:09:20
	Class1b		12250	0,005000	0.006170	55915	5	00:00:05
WFS 6.60	Frames	-99.5	50	0,010000	0,012340	27958	560	00:09:20
	Class1b		3900	0,002700	0.003332	103547	27	00:00:27

Table 14.2.22-3: Statistical test limits for DCS 1 800 and PCS 1 900 O-TCH/WFS reference sensitivity

HT100 / No FH								
1.8 to 1.9GHz		C _{lev} (dBm)	Samples per second	Orig. BER requirement	Derived test limit	Target number of samples	Target test time (s)	Target test time (hh:mm:ss)
WFS15.85	Frames	-95.0	50	0,010000	0,012340	27958	560	00:09:20
	Class1b		12250	0,006000	0.007404	46596	4	00:00:04
WFS 6.60	Frames	-99.5	50	0,010000	0,012340	27958	560	00:09:20
	Class1b		3900	0,003000	0.003702	69894	18	00:00:18

14.2.23 Reference sensitivity – O-TCH/WHS

14.2.23.1 Definition

-

14.2.23.2 Conformance requirement

For 8-PSK modulated speech channels for AMR, associated control channels and inband signalling, the minimum input signal level for which the reference performance shall be met is specified in table 1g

For all classes of MS supporting 8-PSK speech channels, an additional +2 dB adjustment applies for 8-PSK modulated speech channels.

The reference performance shall be:

For speech channels (O-TCH/WHSy) $FER \leq 1\%$

All other requirements in tables 1f and 1g shall be fulfilled at this input level for reference performance.

Correction values for 8-PSK modulated signals:

for GSM 400, GSM 900, GSM 850, T-GSM 810 and GSM 700 small MS	0 dB
for other GSM 400, GSM 900, GSM 850, T-GSM 810 and GSM 700 MS	-2 dB
for DCS 1 800 and PCS 1900 class 1 or class 2 MS	0 dB
for other DCS 1 800 and PCS 1900 MS	-2 dB

3GPP TS 45.005, subclause 6.2.

14.2.23.3 Test purpose

To verify that the MS does not exceed conformance requirement for FER and class 1b RBER under HT100 propagation conditions with an allowance for the statistical significance of the test, for channel combinations O-TCH/WHS12.65 and O-TCH/WHS 8.85.

14.2.23.4 Method of test

14.2.23.4.1 Initial conditions

A call is set up according to the generic call set up procedure on a O-TCH/WHS with an ARFCN in the mid ARFCN range, power control level set to maximum power. RADIO_LINK_TIMEOUT is set to maximum.

The multirate configuration indicates the use of a codec set limited to 12,65 kbit/s.

The SS transmits Standard Test Signal C1 on the traffic channel (wanted signal).

The SS commands the MS to create the traffic channel loop back, signalling erased frames (subclause 36).

14.2.23.4.2 Procedure

- The fading function is set to HT100.
- The SS sets the level of the wanted signal to that indicated by C_{lev} in table 14.2.23-2 or 14.2.23-3. The level is corrected by the appropriate value in the table above.
- The SS compares the data of the signal that it sends to the MS with the signal which is looped back from the receiver after demodulation and decoding, and checks the frame erasure indication.
- The SS determines the number of residual bit error events for the bits of the class Ib, by examining sequences of at least the minimum number of samples of consecutive bits of class Ib. Bits are only taken from those frames not signalled as erased.
- The SS also determines the frame erasure events by examining sequences of at least the minimum number of samples of consecutive frames and assuming a frame is received successfully, if it is not signalled as erased.
- The SS uses a Channel Mode Modify procedure to change the active codec set to 8.85 kbit/s and steps b) to e) are repeated.

Maximum/Minimum Duration of Test

Maximum: 19 minutes (GSM850), 19 minutes (GSM900), 19 minutes (DCS1800), 19 minutes (PCS1900).

Minimum: 7 minutes (GSM850), 7 minutes (GSM900), 3 minutes (DCS1800), 3 minutes (PCS1900).

14.2.23.5 Test requirements

Testing should be performed using statistical methods that lead to an early pass/fail decision with test time significantly reduced for MS with FER/BER not on the limit.

For more information on statistical testing of BER/BLER performance, especially the definition of limit lines refer to Annex 7.

Wrong decision risk F for one single error rate test:

$$F_{\text{pass}} = F_{\text{fail}} = F \quad \text{and} \quad F = 0.2\%$$

Wrong decision probability D per test step:

$$D_{\text{pass}} = D_{\text{fail}} = D \quad \text{and} \quad D = 0.0085\%$$

Parameters for limit lines:

1. D = 0.000085 wrong decision probability per test step.
2. M = 1.5 bad DUT factor
3. ne number of (error) events. This parameter is the x-ordinate in figure A7.1.3.1.
4. ns number of samples. The error rate is calculated from ne and ns.

Limit checking

Before limit checking is valid the minimum test time due to fading needs to be considered:

Testing under multipath and interference conditions requires that at least 990 wavelengths are crossed with the speed given in the fading profile. This leads to a minimum test time depending on the frequency range. No early pass/fail decision is allowed until the minimum test time due to fading has elapsed.

Table 14.2.23-1: Minimum test times due to HT 100 fading conditions

Half Rate 100 km/h				
Frequency (GHz)	0,85	0,9	1,8	1,9
Wavelength (m)	0,35	0,33	0,17	0,16
min test time (s)	201	190	95	90
	0:03:21	0:03:10	0:01:35	0:01:30

If the minimum test time due to multipath conditions exceeds the target test time, then the test runs for the minimum test time due to multipath conditions and the decision is made by comparing the result with the “derived test limit”. In this case early pass/fail decisions are obsolete.

If the target test time exceeds the minimum test time due to multipath conditions early pass/fail decisions can be headed for in order to accelerate test execution.

For an early decision a minimum number of (error) events is necessary.

For an early pass decision $ne \geq 1$ (inclusive artificial error)

For an early fail decision $ne \geq 7$

When the target test time has been reached the test is finished and a pass/fail decision can be made.

The error rate measured in this test shall be tested according to the values given in tables 14.2.23-2 and 14.2.23.3

Table 14.2.23-2: Statistical test limits for GSM 850 and GSM 900 O-TCH/WHS reference sensitivity

HT100 / No FH								
0.8 to 0.9GHz		C_{lev} (dBm)	Samples per second	Orig. BER requirement	Derived test limit	Target number of samples	Target test time (s)	Target test time (hh:mm:ss)
WHS12.65	Frames	-90.5	50	0,010000	0,012340	27958	560	00:09:20
	Class1b		9050	0,004000	0.004936	69895	8	00:00:08
WHS 8.85	Frames	-92.0	50	0,010000	0,012340	27958	560	00:09:20
	Class1b		5650	0,001300	0.001604	215087	38	00:00:38

Table 14.2.23-3: Statistical test limits for DCS 1 800 and PCS 1 900 O-TCH/WHS reference sensitivity

HT100 / No FH								
1.8 to 1.9GHz		C_{lev} (dBm)	Samples per second	Orig. BER requirement	Derived test limit	Target number of samples	Target test time (s)	Target test time (hh:mm:ss)
WHS12.65	Frames	-90.0	50	0,010000	0,012340	27958	560	00:09:20
	Class1b		9050	0,004400	0.005430	63536	7	00:00:07
WHS 8.85	Frames	-92.0	50	0,010000	0,012340	27958	560	00:09:20
	Class1b		5650	0,001500	0.001851	186386	33	00:00:33

14.2.24 Reference sensitivity - TCH/WFS

14.2.24.1 Definition

The reference sensitivity is the signal level at the MS receiver input at which a certain BER and FER must be achieved.

For E-GSM 900 MS this test is only performed in the P-GSM band.

14.2.24.2 Conformance requirement

At reference sensitivity level, the TCH/WFS class Ib RBER shall meet the reference sensitivity, performance of table 1f in 3GPP TS 45.005 subclause 6.2.

At reference sensitivity level, the TCH/WFS FER shall meet the reference performance stated in 3GPP TS 45.005 subclause 6.2.

The reference performance shall be:

For speech channels (TCH/WHS_y) FER ≤ 1%

The levels shall be corrected by the following values:

- **MS, GMSK modulated signals**
- for DCS 1 800 class 1 or class 2 MS +2/+4 dB**
- for DCS 1 800 class 3 MS +2 dB
- for GSM 400, GSM 900, GSM 850, T_GSM +2 dB
- 810 and GSM 700 small MS
- for other GSM 400, GSM 900, GSM 850, 0 dB
- T_GSM 810 and GSM 700 MS
- for PCS 1900 class 1 or class 2 MS +2 dB
- for other PCS 1900 MS 0 dB

** For DCS 1 800 class 1 and class 2 MS, a correction offset of +2dB shall apply for the reference sensitivity performance as specified in table 1a for the normal conditions defined in Annex D and an offset of +4 dB shall be used to determine all other MS performances.

The performance requirements for GSM 400 and GSM 700 systems are as for GSM 900 in table 1f, except that the GSM 400 MS speed is doubled from that of GSM 900, e.g. TU50 becomes TU100, and the GSM 700 MS speed is increased by a factor of 1.2, e.g. TU50 becomes TU60.

3GPP TS 45.005 subclause 6.2

For T-GSM 810 the requirements for GSM 900 shall apply, apart for those parameters for which a separate requirement exists.

3GPP TS 45.005 subclause 2

14.2.24.3 Test purpose

1. To verify that the MS does not exceed conformance requirement at the maximum implemented codec rate under propagation condition TU_{high} (for GSM700, T-GSM 810, GSM 850, GSM 900, DCS 1800 and PCS 1900) with no frequency hopping, RA_{high} with no frequency hopping (for GSM700, T-GSM 810, GSM 850 and GSM 900), HThigh with no frequency hopping (for GSM700, T-GSM 810, GSM 850, GSM 900, DCS1800 and PCS 1900), and STATIC (for GSM700, T-GSM 810, GSM 850 and GSM900) with no frequency hopping with an allowance for the statistical significance of the test.
2. To verify that the MS does not exceed conformance requirement for the remaining implemented codec rates under propagation condition TU_{high} with no frequency hopping with an allowance for the statistical significance of the test.

14.2.24.4 Method of test

NOTE 1: The BA list sent on the BCCH and SACCH will indicate at least six surrounding cells with at least one near to each band edge. It is not necessary to generate any of these BCCHs but, if provided the signal strengths of BCCHs shall be in the range 15 dB μ Vemf() to 35 dB μ Vemf().

NOTE 2: The ARFCN of any BCCH shall not be co-channel or on adjacent channels to the wanted traffic channel.

NOTE 3: When frequency hopping is used, the traffic channel may fall on any of the ARFCNs defined in clause 6.

14.2.24.4.1 Initial conditions

A call is set up according to the generic call set up procedure on a TCH/WFS with an ARFCN in the Mid ARFCN range for GSM700, T-GSM 810, GSM 850, DCS 1800 and PCS 1 900 and ARFCN 70 for GSM 900, power control level set to maximum power.

NOTE: For GSM 900 ARFCN 70 is tested since this is the 73rd harmonic of the 13 MHz clock normally used internally in a MS.

The multirate configuration indicates the use of a codec set limited to 6.60 kbit/s.

The SS transmits Standard Test Signal C1 on the traffic channel.

The SS commands the MS to create traffic channel loop back signalling erased frames.

14.2.24.4.2 Procedure

- a) The fading function is set to TU_{high}.
- b) the SS sets the amplitude of the wanted signal to reference sensitivity level from table 2f in TS 45.005 based on the current active codec set, fading function of the SS and band. The level shall be corrected by the value in the table above describing the reference performance level correction factors for packet switched channels.
- c) The SS compares the data of the signal that it sends to the MS with the signal which is looped back from the receiver after demodulation and decoding, and checks the frame erasure indication.
- d) The SS determines the number of residual bit error events for the bits of class Ib, by examining sequences of at least the minimum number of samples of consecutive bits of class Ib. Bits are taken only from those frames not signalled as erased.
- e) The SS also determines the frame erasure events by examining sequences of at least the minimum number of samples of consecutive frames and assuming a frame is received successfully, if it is not signalled as erased.
- f) The SS uses a Channel Mode Modify procedure to change the active codec set to 8.85 kbit/s and steps b) to e) are repeated.

- g) The SS uses a Channel Mode Modify procedure to change the active codec set to 12.65 kbit/s and steps b) to e) are repeated.
- h) The fading function is set to HThigh and steps b) to e) are repeated.
- i) If DCS 1800 or PCS 1900 then skip steps j) and k).
- j) The fading function is set to RAhigh and steps b) to e) are repeated.
- k) The fading function is set to STATIC and steps b) to e) are repeated.

Maximum/Minimum Duration of Test

- Maximum: 15 minutes (GSM700, GSM850, GSM900) or 10 minutes (DCS1800, PCS1900).
- Minimum: 15 minutes (GSM700, GSM850, GSM900) or 10 minutes (DCS1800, PCS1900).

14.2.24.5 Test requirements

Testing the reference sensitivity performance is performed using statistical methods that lead to an early pass/fail decision with test time significantly reduced for MS with BER/BLER not on the limit.

For more information on statistical testing of BER/BLER performance, especially the definition of the limit lines refer to Annex 6.2

Wrong decision risk F for one single error rate test:

$$F_{\text{pass}} = F_{\text{fail}} = F \quad \text{and} \quad F = 0.2\%$$

Wrong decision probability D per test step:

$$D_{\text{pass}} = D_{\text{fail}} = D \quad \text{and} \quad D = 0.0085\%$$

Parameters for limit lines:

1. D = 0.000085 wrong decision probability per test step.
2. M = 1.5 bad DUT factor
3. ne number of (error) events.
4. ns number of samples. The error rate is calculated from ne and ns.

Limit checking

Before limit checking is valid the minimum test time due to fading needs to be considered:

Testing under multipath and interference conditions requires that at least 990 wavelengths are crossed with the speed given in the fading profile. This leads to a minimum test time depending on the frequency. No early pass/fail decision is allowed until the minimum test time due to fading has elapsed.

Table 14.2.24-1: Minimum test times due to TU high fading conditions

Full Rate 50 km/h							
Frequency	0,4	0,7	0,85	0,9	1,8	1,9	GHz
Wavelength	0,75	0,43	0,35	0,33	0,17	0,16	m
min test time	428	244	201	190	95	90	s
	0:07:08	0:04:04	0:03:21	0:03:10	0:01:35	0:01:30	hh:mm:ss
Full Rate 60 km/h							
Frequency	0,4	0,7	0,85	0,9	1,8	1,9	GHz
Wavelength	0,75	0,43	0,35	0,33	0,17	0,16	m
min test time	356	204	168	158	79	75	s
	0:05:56	0:03:24	0:02:48	0:02:38	0:01:19	0:01:15	hh:mm:ss

Table 14.2.24-2: Minimum test times due to RA high fading conditions

Full Rate 250 km/h							
Frequency	0,4	0,7	0,85	0,9	1,8	1,9	GHz
Wavelength	0,75	0,43	0,35	0,33	-	-	m
min test time	86	49	40	38	-	-	S
	0:1:26	0:0:49	0:0:40	0:0:38	-	-	hh:mm:ss
Full Rate 300 km/h							
Frequency	0,4	0,7	0,85	0,9	1,8	1,9	GHz
Wavelength	0,75	0,43	0,35	0,33	-	-	m
min test time	71	41	34	32	-	-	S
	0:1:11	0:0:41	0:0:34	0:0:32	-	-	hh:mm:ss

Table 14.2.24-3: Minimum test times due to HT high fading conditions

Full Rate 100 km/h							
Frequency	0,4	0,7	0,85	0,9	1,8	1,9	GHz
Wavelength	0,75	0,43	0,35	0,33	0,17	0,16	m
min test time	214	122	101	95	48	45	S
	0:3:34	0:2:02	0:1:41	0:1:35	0:0:48	0:0:45	hh:mm:ss
Full Rate 120 km/h							
Frequency	0,4	0,7	0,85	0,9	1,8	1,9	GHz
Wavelength	0,75	0,43	0,35	0,33	-	-	m
min test time	178	102	84	79	-	-	S
	0:2:58	0:1:42	0:1:24	0:1:19	-	-	hh:mm:ss

If the minimum test time due to multipath conditions exceeds the target test time, then the test runs for the minimum test time due to multipath conditions and the decision is done by comparing the result with the “derived test limit”. In this case early pass/fail decisions are obsolete.

If the target test time exceeds the minimum test time due to multipath conditions early pass/fail decisions can be headed for in order to accelerate test execution.

For an early decision a minimum number of (error) events is necessary.

For an early pass decision $n_e \geq 1$ (inclusive artificial error)

For an early fail decision $n_e \geq 7$

When the target test time has been reached the test is finished and a pass/fail decision can be made.

The error rates measured for different channels and under the different propagation conditions shall be tested according to the values given in tables 14.2.24-4 through 14.2.24-9.

For STATIC channel conditions the target number of samples indicated in table 14.2.24-4 shall be taken.

Table 14.2.24-4: Statistical test limits for GSM 700, T-GSM 810, GSM 850 and GSM 900 STATIC

0.4 to 0.9GHz			frames per s	Orig. BER	Derived	Target number	Target test	Target test time
	Channel	Bits per sec	clas1b per s	requirement	test limit	of samples	time (s)	(hh:mm:ss)
WFS 12.65	Frames	12650	50	0.010000	0.012340	27958	560	00:09:20
	Class1b	12650	9050	0,005000	0,006170	55916	6	00:00:06

Table 14.2.24-5: Statistical test limits for GSM 700, T-GSM 810, GSM 850 and GSM 900 RA High no FH

0.4 to 0.9GHz			frames per s	Orig. BER	Derived	Target number	Target test	Target test time
	Channel	bits per sec	clas1b per s	requirement	test limit	of samples	time (s)	(hh:mm:ss)
WFS 12.65	Frames	12650	50	0.010000	0.012340	27958	560	00:09:20
	Class1b	12650	9050	0,007200	0,008885	38830	4	00:00:04

Table 14.2.24-6: Statistical test limits for GSM 700, T-GSM 810, GSM 850 and GSM 900 HT High no FH

0.4 to 0.9GHz			frames per s	Orig. BER	Derived	Target number	Target test	Target test time
	Channel	bits per sec	clas1b per s	requirement	test limit	of samples	time (s)	(hh:mm:ss)
WFS 12.65	Frames	12650	50	0.010000	0.012340	27958	560	00:09:20
	Class1b	12650	9050	0,006200	0,007651	45093	5	00:00:05

Table 14.2.24-7: Statistical test limits for GSM 700, T-GSM 810, GSM 850 and GSM 900 TU high no FH

0.4 to 0.9GHz			frames per s	Orig. BER	Derived	Target number	Target test	Target test time
	Channel	bits per sec	clas1b per s	requirement	test limit	of samples	time (s)	(hh:mm:ss)
WFS 12.65	frames	12650	50	0.010000	0.012340	27958	560	00:09:20
	Class1b	12650	9050	0,003500	0,004319	79880	9	00:00:09
WFS 8.85	frames	8850	50	0.010000	0.012340	27958	560	00:09:20
	Class1b	8850	5650	0,003800	0,004689	73573	13	00:00:13
WFS 6.60	frames	6600	50	0.010000	0.012340	27958	560	00:09:20
	Class1b	6600	3900	0,001500	0,001851	186386	48	00:00:48

Table 14.2.24-8: Statistical test limits for DCS 1 800 and PCS 1 900 HT High no FH

0.4 to 0.9GHz			frames per s	Orig. BER	Derived	Target number	Target test	Target test time
	Channel	bits per sec	clas1b per s	requirement	test limit	of samples	time (s)	(hh:mm:ss)
WFS 12.65	Frames	12650	50	0.010000	0.012340	27958	560	00:09:20
	Class1b	12650	9050	0,006600	0,008144	42360	5	00:00:05

Table 14.2.24-9: Statistical test limits for DCS 1 800 and PCS 1 900 TU high no FH

1.8 and 1.9GHz			frames per s	Orig. BER	Derived	Target number	Target test	Target test time
	Channel	bits per sec	clas1b per s	requirement	test limit	of samples	time (s)	(hh:mm:ss)
WFS 12.65	Frames	12650	50	0.010000	0.012340	27958	560	00:09:20
	Class1b	12650	9050	0,006200	0,007651	45093	5	00:00:05
WFS 8.85	Frames	8850	50	0.010000	0.012340	27958	560	00:09:20
	Class1b	8850	5650	0,005900	0,007281	47386	8	00:00:08
WFS 6.60	Frames	6600	50	0.010000	0.012340	27958	560	00:09:20
	Class1b	6600	3900	0,001700	0,002098	164458	42	00:00:42

14.2.25 Reference sensitivity – Repeated FACCH/F

14.2.25.1 Definition

The reference sensitivity for control channels is the signal level at the MS receiver input at which a certain FER must be achieved.

14.2.25.2 Conformance requirement.

For Repeated Downlink FACCH and Repeated SACCH (see 3GPP TS 44.006), the minimum input signal level for which the reference performance shall be met is specified in table 1i, according to the propagation condition and type of equipment. The performance requirements for GSM 400 and GSM 700 systems are as for GSM 900 in table 1i, except that the GSM 400 MS speed is doubled from that of GSM 900, e.g. TU50 becomes TU100, and the GSM 700 MS speed is increased by a factor of 1.2, e.g. TU50 becomes TU60.

3GPP TS 45.005 subclause 6.2.

The reference performance for Repeated Downlink FACCH and Repeated SACCH shall be FER ≤ 5%.

3GPP TS 45.005 subclause 6.2.

When calculating FER, a FACCH frame and its repetition or a SACCH frame and its repetition respectively, shall be counted as one frame and a frame erasure shall be counted when neither the FACCH frame nor its repetition or neither the SACCH frame nor its repetition respectively, could be successfully decoded.

3GPP TS 45.005 subclause 6.2.

The reference performance levels for Repeated Downlink FACCH and Repeated SACCH shall be corrected according to the values in the table below, describing the reference performance level correction factors for packet switched channels:

MS, GMSK modulated signals

- for DCS 1 800 class 1 or class 2 MS +2/+4 dB**
- for DCS 1 800 class 3 MS +2 dB
- for GSM 400 small MS, GSM 900 small MS +2 dB
- for GSM 850 small MS and GSM 700 small MS
- for other GSM 400, GSM 900 MS and GSM 850 MS and GSM 700 MS 0 dB
- for PCS 1900 class 1 or class 2 MS +2 dB
- for other PCS 1900 MS 0 dB

** For DCS 1 800 class 1 and class 2 MS, a correction offset of +2dB shall apply for the reference sensitivity performance as specified in table 1a for the normal conditions defined in Annex D and an offset of +4 dB shall be used to determine all other MS performances.

3GPP TS 45.005 subclause 6.2

For T-GSM 810 the requirements for GSM 900 shall apply, apart for those parameters for which a separate requirement exists.

3GPP TS 45.005 subclause 2.

14.2.25.3 Test purpose.

To verify that the MS does not exceed the conformance requirement under TUhigh propagation condition with an allowance for the statistical significance of the test.

14.2.25.4 Method of test

14.2.25.4.1 Initial conditions

A call is set up according to the generic call set up procedure on a TCH/F with an ARFCN in the Low ARFCN range, power control level set to maximum power.

The SS shall use Repeated FACCH for command and response frames for the duration of the test.

Each pair of FACCHs are counted as a single sample.

The SS transmits Standard Test Signal C1 on the traffic channel.

14.2.25.4.2 Procedure

- a) The fading function is set to TUhigh.
- b) The SS sets the amplitude of the wanted signal to $-104\text{dBm} + \text{Corr}$, (where Corr is the correction factor from the table above)
- c) The SS sends a Layer 3 message which does not require a Layer 3 response from the MS. Due to the low signal level the MS may not be able to acknowledge an RR frame and the L2 entity of the SS will repeat the Layer 2 frame. Each retransmitted L2 frame will be counted and will indicate a frame erasure event.
- d) The SS determines the frame erasure events during at least the minimum number of samples of FACCH/F frames.

NOTE: These frames will not be consecutive but it is expected that the statistical significance of the tests will not be unduly degraded.

Maximum/Minimum Duration of Test

Maximum: 12 minutes.

Minimum: 4 minutes (GSM700, GSM850, GSM900), 2 minutes (DCS1800, PCS900)

14.2.25.5 Test Requirements

The error rates measured shall not exceed the test limit error rate values given in table 14.2.25-2.

For more information on statistical testing of FER performance, especially the definition of limit lines refer to Annex A7.

Table 14.2.25-1: Minimum test times due to TU high fading conditions

Full Rate 50 km/h						
Frequency	0,7	0,85	0,9	1,8	1,9	GHz
Wavelength	-	0,35	0,33	0,17	0,16	m
min test time	-	201	190	95	90	s
	-	0:03:21	0:03:10	0:01:35	0:01:30	hh:mm:ss
Full Rate 60 km/h						
Frequency	0,7	0,85	0,9	1,8	1,9	GHz
Wavelength	0,43	-	-	-	-	m
min test time	204	-	-	-	-	s
	0:03:24	-	-	-	-	hh:mm:ss

Table 14.2.25-2: Test Limits for Repeated FACCH/F sensitivity

Channel	Type of measurement	Propagation condition	Original FER requirement	Derived test limit %	Target number of samples
FACCH/F	FER	TUhigh/No FH	5,00	6,17	5592

Table 14.2.25-3: Maximum test times

Maximum test time (best rate 50/3 per second) (s)	Maximum test time (best rate 50/3 per second) (hh:mm:ss)	Maximum test time (worst rate 50/6 per second) (s)	Maximum test time (worst rate 50/6 per second) (hh:mm:ss)
336	00:05:36	671	00:11:11

14.2.26 Reference sensitivity – Repeated SACCH

14.2.26.1 Definition

The reference sensitivity for control channels is the signal level at the MS receiver input at which a certain FER must be achieved.

14.2.26.2 Conformance requirement.

For Repeated Downlink FACCH and Repeated SACCH (see 3GPP TS 44.006), the minimum input signal level for which the reference performance shall be met is specified in table 1i, according to the propagation condition and type of equipment. The performance requirements for GSM 400 and GSM 700 systems are as for GSM 900 in table 1i, except that the GSM 400 MS speed is doubled from that of GSM 900, e.g. TU50 becomes TU100, and the GSM 700 MS speed is increased by a factor of 1.2, e.g. TU50 becomes TU60.

3GPP TS 45.005 subclause 6.2.

The reference performance for Repeated Downlink FACCH and Repeated SACCH shall be FER ≤ 5%.

3GPP TS 45.005 subclause 6.2.

When calculating FER, a FACCH frame and its repetition or a SACCH frame and its repetition respectively, shall be counted as one frame and a frame erasure shall be counted when neither the FACCH frame nor its repetition or neither the SACCH frame nor its repetition respectively, could be successfully decoded.

3GPP TS 45.005 subclause 6.2.

The reference performance levels for Repeated Downlink FACCH and Repeated SACCH shall be corrected according to the values in the table below, describing the reference performance level correction factors for packet switched channels:

MS, GMSK modulated signals

- for DCS 1 800 class 1 or class 2 MS +2/+4 dB**
- for DCS 1 800 class 3 MS +2 dB
- for GSM 400 small MS, GSM 900 small MS
GSM 850 small MS and GSM 700 small MS +2 dB
- for other GSM 400, GSM 900 MS and GSM
850 MS and GSM 700 MS 0 dB
- for PCS 1900 class 1 or class 2 MS +2 dB
- for other PCS 1900 MS 0 dB

** For DCS 1 800 class 1 and class 2 MS, a correction offset of +2dB shall apply for the reference sensitivity performance as specified in table 1a for the normal conditions defined in Annex D and an offset of +4 dB shall be used to determine all other MS performances.

3GPP TS 45.005 subclause 6.2

For T-GSM 810 the requirements for GSM 900 shall apply, apart for those parameters for which a separate requirement exists.

3GPP TS 45.005 subclause 2.

14.2.26.3 Test purpose.

To verify that the MS does not exceed the conformance requirement under TUhigh propagation condition with an allowance for the statistical significance of the test.

14.2.26.4 Method of test

For details on Repeated SACCH Layer 1 test method, please refer to Annex 10.

14.2.26.4.1 Initial conditions

A call is set up according to the generic call set up procedure on a TCH/F with an ARFCN in the Low ARFCN range, power control level is set to maximum power.

The SS shall use Repeated SACCH for all SACCH block on the downlink for the duration of the test.

Each pair of SACCH blocks (i.e. one Repeated SACCH block-pair) shall be counted as a single sample.

The SS shall send different PCL for each sample following Table 14.2.26-1 for the duration of the test.

The SS transmits Standard Test Signal C1 on the traffic channel

14.2.26.4.2 Procedure

- a) The fading function is set to TUhigh/NoFH.
- b) The SS sets the amplitude of the wanted signal to $-104\text{dBm} + \text{Corr}$, (where Corr is the correction factor from the table above).
- c) Following the reception of the last burst of the MS UL SACCH corresponding to the second SACCH block of a repeated SACCH interval, the SS shall compute the PCL value to use in the SS DL SACCH blocks for the next repeated SACCH interval using Table 14.2.26-1.
 - i) The first two columns of Table 14.2.26-1 are inputs, the last column is a output.
 - ii) SACCH blocks are grouped into sets of 2 consecutive SACCH blocks which is called a repeated SACCH interval.
 - iii) Last commanded PCL by SS refers to the PCL used in the DL SACCH L1 headers for repeated SACCH interval N
 - iv) Corresponding reported MS PCL refers to the PCL reported in the UL SACCH L1 header of second SACCH block on repeated SACCH interval N
 - v) Next commanded PCL by SS refers to the PCL that the SS will use in the DL SACCH L1 headers for repeated SACCH interval N+1.

Table 14.2.26-1: Power Control Level Used by SS

Last commanded PCL by SS	Corresponding Reported MS PCL	Next commanded PCL by SS
7	7	8
7	8	9
7	9	8
8	7	9
8	8	9
8	9	7
9	7	8
9	8	7
9	9	7

- d) The SS compares the MS reported PCL in the uplink SACCH L1 header of the Repeated SACCH block against the expected PCL (based on the previously commanded PCL in the downlink SACCH L1 header taking into account round-trip delays). If the MS reported PCL in the uplink SACCH L1 header is different than the expected PCL, this will invoke a frame erasure event.
- e) The SS determines the frame erasure events during at least the minimum number of samples of SACCH frames.

NOTE: These frames will be consecutive and it is expected that the statistical significance of the tests will not be unduly degraded.

Maximum/Minimum Duration of Test

Maximum: 90 minutes

Minimum: 2 minutes

14.2.26.5 Test Requirements

The error rates measured shall not exceed the test limit error rate values given in table 14.2.26-2.

For more information on statistical testing of FER performance, especially the definition of limit lines refer to Annex A7.

Table 14.2.26-2: Test Limits for Repeated SACCH sensitivity

Channel	Type of measurement	Propagation condition	Original FER requirement	Derived test limit %	Target number of samples
SACCH	FER	TUhigh/No FH	5,00	6,17	5592

Table 14.2.26-3: Maximum test times

Maximum test time (best rate 2/2 per second) (s)	Maximum test time (best rate 2/2 per second) (hh:mm:ss)
5368	01:29:28

14.2.27 Reference sensitivity - TCH/FS – DARP Phase II

14.2.27.1 Definition

The reference sensitivity is the signal level at the MS receiver input at which a certain BER and FER must be achieved.

14.2.27.2 Conformance requirement

For Downlink Advanced Receiver Performance – phase II, the minimum input signal level for which the reference performance shall be met is specified in table 1j, according to the propagation condition and type of equipment. The performance requirements for GSM 400 and GSM 700 systems are as for GSM 900 in table 1j, except that the GSM 400 MS speed is doubled from that of GSM 900, e.g. TU50 becomes TU100, and the GSM 700 MS speed is increased by a factor of 1.2, e.g. TU50 becomes TU60.

The reference performance for Downlink Advanced Receiver Performance – phase II, shall be

- For speech channels (TCH/FS, TCH/AFS_x, TCH/AHS_x) FER: ≤ 1 %
- For packet switched channels (PDTCH) BLER: ≤ 10 %

In addition for speech channels the residual class Ib BER and residual class II BER performance shall not exceed the specified values in table 1j at the corresponding signal level in dbm.

3GPP TS 45.005, subclause 6.2.

14.2.27.3 Test purpose

To verify that the MS supporting DARP Ph2 does not exceed conformance requirement for FER, Rber1b and Rber2 under TUhigh/(Corr.=0,AGI=0) and HThigh/(Corr.=0,7,AGI=-6dB) propagation conditions with an allowance for the statistical significance of the test, for channel combination TCH/FS.

14.2.27.4 Method of test

14.2.27.4.1 Initial conditions

Connect the SS to the MS antenna connectors according to Annex A1.1.6.

A call is set up according to the generic call set up procedure on a TCH/FS with an ARFCN in the Mid ARFCN range, power control level set to maximum power. RADIO_LINK_TIMEOUT is set to maximum. The SS transmits Standard Test Signal C1 on the traffic channel.

The SS commands the MS to create traffic channel loop back signalling erased frames.

Specific PICS Statements:

-

PIXIT Statements:

-

14.2.27.4.2 Procedure

- a) The fading function is set to TU high/(Corr.=0, AGI=0).
- b) the SS sets the amplitude of the wanted signal to reference sensitivity level from table 1j in TS 45.005.
- c) The SS compares the data of the signal that it sends to the MS with the signal which is looped back from the receiver after demodulation and decoding, and checks the frame erasure indication.
- d) The SS determines the number of residual bit error events for the bits of class II, by examining sequences of at least the minimum number of samples of consecutive bits of class II. Bits are taken only from those frames not signalled as erased.
- e) The SS determines the number of residual bit error events for the bits of the class Ib, by examining sequences of at least the minimum number of samples of consecutive bits of class Ib. Bits are only taken from those frames not signalled as erased.
- f) The SS also determines the frame erasure events by examining sequences of at least the minimum number of samples of consecutive frames and assuming a frame is received successfully, if it is not signalled as erased.g) Steps b) to f) are repeated with the SS fading function set in turn to HT high/(Corr.=0,7, AGI=-6dB).Maximum/Minimum Duration of Test
 - Maximum: 20 minutes (GSM700, GSM850, GSM900) or 20 minutes (DCS1800, PCS1900).
 - Minimum: 6 minutes (GSM700, GSM850, GSM900) or 3 minutes (DCS1800, PCS1900).

14.2.27.5 Test requirements

The error rates measured shall not exceed the test limit error rate values given in table 14.2.27-3 through 14.2.27-6.

For more information on statistical testing of FER and BER/BLER performance, especially the definition of limit lines refer to Annex A7.

Table 14.2.27-1: Minimum test times due to TU high fading conditions

Full Rate 50 km/h						
Frequency	0,7	0,85	0,9	1,8	1,9	GHz
Wavelength	-	0,35	0,33	0,17	0,16	M
min test time	-	201	190	95	90	S
	-	0:03:21	0:03:10	0:01:35	0:01:30	hh:mm:ss
Full Rate 60 km/h						
Frequency	0,7	0,85	0,9	1,8	1,9	GHz
Wavelength	0,43	-	-	-	-	m
min test time	204	-	-	-	-	s
	0:03:24	-	-	-	-	hh:mm:ss

Table 14.2.27-2: Minimum test times due to HT high fading conditions

Full Rate 100 km/h							
Frequency	0,4	0,7	0,85	0,9	1,8	1,9	GHz
Wavelength	0,75	0,43	0,35	0,33	0,17	0,16	m
min test time	214	122	101	95	48	45	S
	0:3:34	0:2:02	0:1:41	0:1:35	0:0:48	0:0:45	hh:mm:ss
Full Rate 120 km/h							
Frequency	0,4	0,7	0,85	0,9	1,8	1,9	GHz
Wavelength	0,75	0,43	0,35	0,33	-	-	m
min test time	178	102	84	79	-	-	S
	0:2:58	0:1:42	0:1:24	0:1:19	-	-	hh:mm:ss

Table 14.2.27-3: Statistical test limits for GSM 700, T-GSM 810, GSM 850 and GSM 900 TU high no FH/ (Corr.=0, AGI=0).

0.4 to 0.9GHz			Frames per s	Orig. BER	Derived	Target number	Target test	Target test time
	Channel	bits per sec	Class x per s	requirement	test limit	of samples	time (s)	(hh:mm:ss)
TCH/FS	FER	13000	50	0,010000	0.012340	27958	560	00:09:20
	Rber1b	13000	9100	0,000700	0,000863	399769	44	00:00:44
	Rber2	13000	3900	0,047900	0,059109	5837	2	00:00:02

Table 14.2.27-4: Statistical test limits for GSM 700, T-GSM 810, GSM 850 and GSM 900 HT high no FH/ (Corr.=0,7, AGI=-6dB).

0.4 to 0.9GHz			Frames per s	Orig. BER	Derived	Target number	Target test	Target test time
	Channel	bits per sec	Class x per s	requirement	Test limit	of samples	time (s)	(hh:mm:ss)
TCH/FS	FER	13000	50	0,010000	0.012340	27958	560	00:09:20
	Rber1b	13000	9100	0,000800	0,000987	349544	39	00:00:39
	Rber2	13000	3900	0,060900	0,075151	4591	2	00:00:02

Table 14.2.27-5: Statistical test limits for DCS 1 800 and PCS 1 900 TU high no FH/ (Corr.=0, AGI=0).

1.8 and 1.9GHz			Frames per s	Orig. BER	Derived	Target number	Target test	Target test time
	Channel	bits per sec	Class x per s	requirement	Test limit	of samples	time (s)	(hh:mm:ss)
TCH/FS	FER	13000	50	0.010000	0.012340	27958	560	00:09:20
	Rber1b	13000	9100	0,000800	0,000987	349544	39	00:00:39
	Rber2	13000	3900	0,060100	0,074163	4652	2	00:00:02

Table 14.2.27-6: Statistical test limits for DCS 1 800 and PCS 1 900 HT high no FH/ (Corr.=0,7, AGI=-6dB).

1.8 and 1.9GHz			Frames per s	Orig. BER	Derived	Target number	Target test	Target test time
	Channel	bits per sec	Class x per s	requirement	Test limit	of samples	time (s)	(hh:mm:ss)
TCH/FS	FER	13000	50	0,010000	0,012340	27958	560	00:09:20
	Rber1b	13000	9100	0,000900	0,001111	310532	35	00:00:35
	Rber2	13000	3900	0,060600	0,074780	4614	2	00:00:02

14.3 Usable receiver input level range

14.3.1 Definition

The usable receiver input level range is the range of the radio frequency input level of a specified modulated signal over which bit error ratio or frame erasure ratios stay between specified limits.

14.3.2 Conformance requirement

1. The receiver input level range requirements of 3GPP TS 05.05 subclause 6.1 for TCH/FS class II RBER under static and EQ propagation conditions shall be met:

- 1.1 Under normal conditions.
- 1.2 Under extreme conditions.

14.3.3 Test purpose

1. To verify that the MS does not exceed the conformance requirement with an allowance for the statistical significance of the test:
 - 1.1 Under normal conditions.
 - 1.2 Under extreme conditions.

14.3.4 Method of test

14.3.4.1 Initial conditions

A call is set up according to the generic call set up procedure on a TCH/FS with an ARFCN in the Mid ARFCN range, power control level set to maximum.

The SS transmits Standard Test Signal C1 on the TCH/FS.

The SS commands the MS to create traffic channel loop back signalling erased frames (subclause 36.2.1.1.2).

14.3.4.2 Procedure

- a) The SS compares the data that it sends to the MS with the signal which is looped back from the receiver after demodulation and decoding.

The SS tests the bit error ratio for the non-protected bits of TCH/FS class II, by examining sequences of at least the minimum number of samples of consecutive bits of class II. The number of error events is recorded.

- b) Step a) is repeated with the amplitude of the wanted signal increased to an input level at the receiver input of $73 \text{ dB}\mu\text{Vemf}(\)$.
- c) Step a) is repeated with the amplitude of the wanted signal increased to an input level at the receiver input of:
- | | |
|-----------|-----------------------------------|
| GSM 400 | $98 \text{ dB}\mu\text{Vemf}(\)$ |
| GSM 700 | $98 \text{ dB}\mu\text{Vemf}(\)$ |
| T-GSM 810 | $98 \text{ dB}\mu\text{Vemf}(\)$ |
| GSM 850 | $98 \text{ dB}\mu\text{Vemf}(\)$ |
| GSM 900 | $98 \text{ dB}\mu\text{Vemf}(\)$ |
| DCS 1 800 | $90 \text{ dB}\mu\text{Vemf}(\)$ |
| PCS 1 900 | $90 \text{ dB}\mu\text{Vemf}(\)$ |
- d) The SS fading function is set to EQ.
- e) Step a) is repeated with the amplitude of the wanted signal set to respectively 20 dB above reference sensitivity level() and $73 \text{ dB}\mu\text{Vemf}(\)$ at the receiver input.
- f) The test is repeated under extreme test conditions.

14.3.5 Test requirements

The error rate measured in this test shall not exceed the test limit error rate values given in table 14-14. This shall apply for any combination of normal and extreme test voltages and ambient temperature, for the different propagation conditions and for any level of input signal to the receiver.

Table 14-14: Limits for input level range

Propagation conditions	GSM 400, GSM 700, T-GSM 810, GSM 850 and GSM 900		DCS 1 800 and PCS 1 900	
	Test limit error rate %	Minimum No. of samples	Test limit error rate %	Minimum No. of samples
Static $\leq 73 \text{ dB}\mu\text{Vemf}(\)$	0,012	1640000	0,012	1 640 000
Static $98 \text{ dB}\mu\text{Vemf}(\)$	0,122	164000		
Static $90 \text{ dB}\mu\text{Vemf}(\)$			0,122	164 000
EQ	3,25	120000	3,25	60 000

14.4 Co-channel rejection

14.4.1 Co-channel rejection - TCH/FS

14.4.1.1 Definition

The co-channel rejection is a measure of the capability of the receiver to receive a wanted modulated signal without exceeding a given degradation due to the presence of an unwanted modulated signal, both signals being at the nominal frequency of the receiver.

14.4.1.2 Conformance requirement

1. At reference co-channel interference the TCH/FS FER shall meet the reference interference performance of table 2 in 3GPP TS 05.05 subclause 6.3.
2. At reference co-channel interference the TCH/FS class Ib BER shall meet the reference interference performance of table 2 in 3GPP TS 05.05 subclause 6.3.

3. At reference co-channel interference the TCH/FS class II BER shall meet the reference interference performance of table 2 in 3GPP TS 05.05 subclause 6.3.

14.4.1.3 Test purpose

1. To verify that the MS does not exceed conformance requirement 1 under propagation condition TU_{low} with no frequency hopping with an allowance for the statistical significance of the test.
2. To verify that the MS does not exceed conformance requirement 2 under propagation condition TU_{low} with no frequency hopping, with an allowance for the statistical significance of the test.
3. To verify that the MS does not exceed conformance requirement 3 under propagation condition TU_{low} with no frequency hopping with an allowance for the statistical significance of the test.
4. To verify that the non-DARP capable MS does not exceed conformance requirement 1 under propagation condition TU_{high} with frequency hopping with an allowance for the statistical significance of the test.
5. To verify that the non-DARP capable MS does not exceed conformance requirement 2 under propagation condition TU_{high} with frequency hopping with an allowance for the statistical significance of the test.
6. To verify that the non-DARP capable MS does not exceed conformance requirement 3 under propagation condition TU_{high} with frequency hopping with an allowance for the statistical significance of the test.

14.4.1.4 Method of test

14.4.1.4.1 Initial conditions

A call is set up according to the generic call set up procedure on a TCH/FS with an ARFCN in the mid ARFCN range, power control level set to maximum power.

The SS transmits Standard Test Signal C1 on the traffic channel (wanted signal).

The SS commands the MS to create the traffic channel loop back, signalling erased frames (subclause 36.1.2.1.1.1).

Specific PICS Statements:

- DARP phase 1 supported (TSPC_DARP_Phase1)
- DARP phase 2 supported (TSPC_DARP_Phase2)

PIXIT Statements:

-

14.4.1.4.2 Procedure

- a) In addition to the wanted signal, the SS produces an independent, uncorrelated interfering signal, Standard Test Signal I1 (unwanted signal).

The unwanted signal is continuous and has no fixed relationship with the bit transitions of the wanted signal. Its amplitude is 9 dB below that of the wanted signal.

The fading characteristic of the wanted and the interfering signal is TU_{low}.

- b) The SS compares the modulation of the signal that it sends to the MS with the signal which is looped back from the receiver after demodulation and decoding, and checks the frame erasure indication.
- c) The SS determines the number of residual bit error events for the bits of class II, by examining at least the minimum number of samples of consecutive bits of class II. Bits are taken only from those frames not signalled as erased.
- d) The SS determines the number of residual bit error events for the bits of the class Ib, by examining at least the minimum number of samples of consecutive bits of class Ib. Bits are only taken from those frames not signalled as erased.
- e) The SS also determines the frame erasure events by examining at least the minimum number of samples of consecutive frames and assuming a frame is received successfully it is not signalled as erased.

- f) For the non-DARP capable MS, steps a) to e) are repeated except that in step a) both the wanted and interfering signal are TU_{high} hopping and the SS commands the MS into hopping mode. A hopping pattern covering at least 10 frequencies in a range not exceeding 5 MHz is used. The hopping band is centred around an ARFCN in the Mid ARFCN range.

14.4.1.5 Test requirements

The error rate measured in this test shall not exceed the test limit error rate values given in table 14-15.

Table 14-15: Limits for co-channel rejection

Channel	Type of measurement	Propagation condition	Test limit error rate %	Minimum No. of samples
TCH/FS	FER	TU _{low} /No FH	24* α	25 000
TCH/FS Class Ib	RBER	TU _{low} /No FH	2,091/ α	3 300 000
TCH/FS Class II	RBER	TU _{low} /No FH	4,3	2 000 000
TCH/FS	FER	TU _{high} /FH	3,371* α	17 800
TCH/FS class Ib	RBER	TU _{high} /FH	0,215/ α	2 000 000
TCH/FS class II	RBER	TU _{high} /FH	8,333	1 200 000

The parameter α can range from 1 to 1.6. The value of α for the RBER test on TCH/FS class Ib bits under particular measurement conditions shall be the same as that determined in the FER test on TCH/FS under the same conditions.

14.4.2 Co-channel rejection - TCH/HS

14.4.2.1 Definition

-

14.4.2.2 Conformance requirement

1. At reference cochannel interference, the TCH/HS FER (shall meet the reference interference performance of table 2 in 3GPP TS 05.05 subclause 6.3.
2. At reference cochannel interference, the TCH/HS class Ib BER (BFI=0) shall meet the reference interference performance of table 2 in 3GPP TS 05.05 subclause 6.3.
3. At reference cochannel interference, the TCH/HS class II BER (BFI=0) shall meet the reference interference performance of table 2 in 3GPP TS 05.05 subclause 6.3.
4. At reference cochannel interference, the TCH/HS UFR shall meet the reference interference performance of table 2 in 3GPP TS 05.05 subclause 6.3.
5. At reference cochannel interference, the TCH/HS class Ib RBER ((BFI or UFI)=0) shall meet the reference interference performance of table 2 in 3GPP TS 05.05 subclause 6.3.

14.4.2.3 Test purpose

1. To verify that the MS does not exceed conformance requirement 1, under propagation conditions TU_{high} with frequency hopping, with an allowance for the statistical significance of the test.
2. To verify that the MS does not exceed conformance requirement 1, under propagation conditions TU_{high} with frequency hopping, with an allowance for the statistical significance of the test.
3. To verify that the MS does not exceed conformance requirement 1, under propagation conditions TU_{high} with frequency hopping, with an allowance for the statistical significance of the test.
4. To verify that the MS does not exceed conformance requirement 4, under propagation condition TU_{high} with frequency hopping, with an allowance for the statistical significance of the test.
5. To verify that the MS does not exceed conformance requirement 4, under propagation condition TU_{high} with frequency hopping, with an allowance for the statistical significance of the test.

14.4.2.4 Method of test

14.4.2.4.1 Initial conditions

A call is set up according to the generic call set up procedure on a TCH/HS with an ARFCN in the mid ARFCN range, power control level set to maximum power.

The SS transmits Standard Test Signal C1 on the traffic channel (wanted signal).

14.4.2.4.2 Procedure

- a) In addition to the wanted signal, the SS produces an independent, uncorrelated interfering signal, Standard Test Signal I1 (unwanted signal).

The unwanted signal is continuous and has no fixed relationship with the bit transitions of the wanted signal. Its amplitude is 9 dB below that of the wanted signal.

- b) The fading characteristic of the wanted and the interfering signal is set to TUhigh. The SS commands the MS into hopping mode. A hopping pattern covering at least 10 frequencies in a range not exceeding 5 MHz is used. The hopping pattern is centred around an ARFCN in the Mid ARFCN range.

- c) The SS commands the MS to create traffic channel loop back signalling erased frames using test loop A.

NOTE 1: Test loop A is defined in clause 36. Frames marked with BFI=1 are signalled as erased on the uplink.

- d) The SS compares the modulation of the signal that it sends to the MS with the signal which is looped back from the receiver after demodulation and decoding, and checks the frame erasure indication.

- e) The SS determines the number of residual bit error events for the bits of class II, by examining at least the minimum number of samples of consecutive bits of class II. Bits are taken only from those frames not signalled as erased.

- f) The SS determines the number of residual bit error events for the bits of the class Ib, by examining at least the minimum number of samples of consecutive bits of class Ib. Bits are only taken from those frames not signalled as erased.

- g) The SS also determines the frame erasure events by examining at least the minimum number of samples of consecutive frames and assuming a frame is received successfully it is not signalled as erased.

- h) The SS commands the MS to open test loop A and close test loop D.

NOTE 2: Test loop D is defined in clause 36. Frames marked as erased (BFI=1), or unreliable (UFI=1), are signalled to the SS on the uplink.

- j) The SS compares the data of the signal that it sends to the MS with the signal which is looped back from the receiver after demodulation and decoding, and checks the erased/unreliable frame indication.

- k) The SS determines the number of residual bit error events for the bits of the class Ib, by examining sequences of at least the minimum number of samples of consecutive bits of class Ib. Bits are only taken from those frames not signalled as erased/unreliable.

- l) The SS also determines the unreliable frame events by examining sequences of at least the minimum number of samples of consecutive frames and assuming a frame is received successfully it is not signalled as erased/unreliable.

14.4.2.5 Test requirements

The error rate measured in this test shall not exceed the test limit error rate values given in table 14-16 or table 14-17.

Table 14-16: Limits for GSM 400, GSM 700, T-GSM 810, GSM 850 and GSM 900 co-channel rejection

Channel/Type of measurement	Propagation condition	Test limit error rate %	Minimum No. of samples
TCH/HS FER	TUhigh/FH	5,607	10 700
TCH/HS Class Ib RBER (BFI=0)	TUhigh/FH	0,325	184 700
TCH/HS Class II RBER (BFI=0)	TUhigh/FH	7,961	25 500
TCH/HS UFR	TUhigh/FH	6,834	8 780
TCH/HS Class Ib RBER ((BFI or UFI)=0)	TUhigh/FH	0,235	255 000

Table 14-17: Limits for DCS 1800 and PCS 1 900 co-channel rejection

Channel/Type of measurement	Propagation condition	Test limit error rate %	Minimum No. of samples
TCH/HS FER	TUhigh/FH	5,607	10 700
TCH/HS Class Ib RBER (BFI=0)	TUhigh/FH	0,325	184 700
TCH/HS Class II RBER (BFI=0)	TUhigh/FH	7,961	25 500
TCH/HS UFR	TUhigh/FH	6,834	8 780
TCH/HS Class Ib RBER ((BFI or UFI)=0)	TUhigh/FH	0,235	255 000

14.4.3 Void

14.4.4 Co-channel rejection - FACCH/F

14.4.4.1 Definition

The co-channel rejection is a measure of the capability of the receiver to receive a wanted modulated signal without exceeding a given degradation due to the presence of an unwanted modulated signal, both signals being at the nominal frequency of the receiver.

14.4.4.2 Conformance requirement

At reference cochannel interference the FACCH/F FER shall meet the reference interference performance of table 2 in 3GPP TS 05.05 subclause 6.3).

14.4.4.3 Test purpose

To verify that the MS does not exceed the conformance requirement under propagation condition TUlow with an allowance for the statistical significance of the test.

14.4.4.4 Method of test

14.4.4.4.1 Initial conditions

A call is set up according to the generic call set up procedure on a TCH with an ARFCN in the mid ARFCN range. For MS supporting speech this shall be a TCH/FS. For MS not supporting speech one of the supported TCH/ (F9,6, F4,8, or F2,4) shall be used. The power control level is set to maximum power.

The SS transmits Standard Test Signal C1 on the traffic channel (wanted signal).

14.4.4.4.2 Procedure

- a) In addition to the wanted signal, the SS produces an independent, uncorrelated interfering signal, Standard Test Signal I1 (unwanted signal).

The unwanted signal is continuous and has no fixed relationship with the bit transitions of the wanted signal. Its amplitude is 9 dB below that of the wanted signal.

The fading characteristic of the wanted and the interfering signal is TUlow.

- d) The SS sends a Layer 3 message which does not require a Layer 3 response from the MS. Due to the co-channel interference, the MS may not be able to acknowledge the Layer 2 frame. Each repeated L2 frame indicates a frame erasure event. The SS determines the number of frame erasure events during at least the minimum number of samples of FACCH/F frames.

NOTE: These frames will not be consecutive but it is expected that the statistical significance of the tests will not be unduly degraded.

14.4.4.5 Test requirements

The error rate measured in this test shall not exceed the test limit error rate values given in table 14-19.

Table 14-19: Limits for co-channel rejection

Channel	Type of measurement	Propagation condition	Test limit error rate %	Minimum No. of samples
FACCH/F	FER	TUlow/No FH	24	25 000

14.4.5 Co-channel rejection - FACCH/H

14.4.5.1 Definition

-

14.4.5.2 Conformance requirement

At reference cochannel interference the FACCH/H FER shall meet the reference interference performance of table 2 in 3GPP TS 05.05 subclause 6.3).

14.4.5.3 Test purpose

To verify that the MS does not exceed the conformance requirement under propagation condition TUlow with an allowance for the statistical significance of the test.

14.4.5.4 Method of test

14.4.5.4.1 Initial conditions

A call is set up according to the generic call set up procedure on a TCH with an ARFCN in the mid ARFCN range. For MS supporting half rate speech this shall be a TCH/HS. For MS not supporting TCH/HS one of the supported TCH/(AHS, H4,8, or H2,4) shall be used. The power control level is set to maximum power.

The SS transmits Standard Test Signal C1 on the traffic channel (wanted signal).

14.4.5.4.2 Procedure

- a) In addition to the wanted signal, the SS produces an independent, uncorrelated interfering signal, Standard Test Signal I1 (unwanted signal).

The unwanted signal is continuous and has no fixed relationship with the bit transitions of the wanted signal. Its amplitude is 9 dB below that of the wanted signal.

The fading characteristic of the wanted and the interfering signal is TUlow.

- d) The SS sends a Layer 3 message which does not require a Layer 3 response from the MS. Due to the co-channel interference, the MS may not be able to acknowledge the Layer 2 frame. Each repeated L2 frame indicates a frame erasure event. The SS determines the number of frame erasure events during at least the minimum number of samples of FACCH/H frames.

NOTE: These frames will not be consecutive but it is expected that the statistical significance of the tests will not be unduly degrade.

14.4.5.5 Test requirements

The error rate measured in this test shall not exceed the test limit error rate values given in table 14-20.

Table 14-20: Limits for co-channel rejection

Channel	Type of measurement	Propagation condition	Test limit error rate %	Minimum No. of samples
FACCH/H	FER	TUlow/No FH	24,000	25 000

14.4.6 Co-channel rejection - TCH/EFS

14.4.6.1 Definition

The co-channel rejection is a measure of the capability of the receiver to receive a wanted modulated signal without exceeding a given degradation due to the presence of an unwanted modulated signal, both signals being at the nominal frequency of the receiver.

14.4.6.2 Conformance requirement

1. At reference co-channel interference the TCH/EFS FER shall meet the reference interference performance of table 2 in 3GPP TS 05.05 subclause 6.3.
2. At reference co-channel interference the TCH/EFS class Ib BER shall meet the reference interference performance of table 2 in 3GPP TS 05.05 subclause 6.3.
3. At reference co-channel interference the TCH/EFS class II BER shall meet the reference interference performance of table 2 in 3GPP TS 05.05 subclause 6.3.

14.4.6.3 Test purpose

1. To verify that the MS does not exceed conformance requirement 1 under propagation condition TUhigh with frequency hopping and TUlow with no frequency hopping with an allowance for the statistical significance of the test.
2. To verify that the MS does not exceed conformance requirement 2 under propagation condition TUhigh with frequency hopping and TUlow with no frequency hopping, with an allowance for the statistical significance of the test.
3. To verify that the MS does not exceed conformance requirement 3 under propagation condition TUhigh with frequency hopping and TUlow with no frequency hopping with an allowance for the statistical significance of the test.

14.4.6.4 Method of test

14.4.6.4.1 Initial conditions

A call is set up according to the generic call set up procedure on a TCH/EFS with an ARFCN in the mid ARFCN range, power control level set to maximum power.

The SS transmits Standard Test Signal C1 on the traffic channel (wanted signal).

The SS commands the MS to create the traffic channel loop back, signalling erased frames (subclause 36.1.2.1.1.1).

14.4.6.4.2 Procedure

- a) In addition to the wanted signal, the SS produces an independent, uncorrelated interfering signal, Standard Test Signal I1 (unwanted signal).

The unwanted signal is continuous and has no fixed relationship with the bit transitions of the wanted signal. Its amplitude is 9 dB below that of the wanted signal.

The fading characteristic of the wanted and the interfering signal is TUlow.

- b) The SS compares the modulation of the signal that it sends to the MS with the signal which is looped back from the receiver after demodulation and decoding, and checks the frame erasure indication.

- c) The SS determines the number of residual bit error events for the bits of class II, by examining at least the minimum number of samples of consecutive bits of class II. Bits are taken only from those frames not signalled as erased.
- d) The SS determines the number of residual bit error events for the bits of the class Ib, by examining at least the minimum number of samples of consecutive bits of class Ib. Bits are only taken from those frames not signalled as erased.
- e) The SS also determines the frame erasure events by examining at least the minimum number of samples of consecutive frames and assuming a frame is received successfully it is not signalled as erased.
- f) Steps a) to e) are repeated except that in step a) both the wanted and interfering signal are TUhigh hopping and the SS commands the MS into hopping mode. A hopping pattern covering at least 10 frequencies in a range not exceeding 5 MHz is used. The hopping pattern is centred around an ARFCN in the Mid ARFCN range.

14.4.6.5 Test requirements

The error rate measured in this test shall not exceed the test limit error rate values given in table 14-21.

Table 14-21: Limits for co-channel rejection

Channel	Type of measurement	Propagation condition	Test limit error rate %	Minimum No. of samples
TCH/EFS	FER	TUlow/No FH	24	25 000
TCH/EFS Class Ib	RBER	TUlow/No FH	0,209	3 300 000
TCH/EFS Class II	RBER	TUlow/No FH	3,039	2 000 000
TCH/EFS	FER	TUhigh/FH	3,357	17 800
TCH/EFS class Ib	RBER	TUhigh/FH	0,115	2 000 000
TCH/EFS class II	RBER	TUhigh/FH	8,333	1 200 000

14.4.7 Receiver performance in the case of frequency hopping and co-channel interference on one carrier

14.4.7.1 Definition

The GSM receiver is specified to be able to handle one out of four carriers being strongly interfered with, if frequency hopping is applied. This is used in networks to increase the capacity.

14.4.7.2 Conformance Requirement

Under the following conditions:

- a useful signal, cyclic frequency hopping over four carriers under static conditions, with equal input levels 20 dB above reference sensitivity level;
- a random, continuous, GMSK-modulated interfering signal on only one of the carriers at a level 10 dB higher than the useful signal,

the FER for TCH/FS shall be less than 5%; 3GPP TS 05.05 subclause 6.6.

14.4.7.3 Test Purpose

To verify that the MS does not exceed the conformance requirement with an allowance for the statistical significance of the test.

14.4.7.4 Method Of Test

14.4.7.4.1 Initial conditions

A call is set up according to the generic call set up procedure on a TCH/FS channel in hopping mode, power control level set to maximum power. A cyclic hop pattern covering four frequencies with a minimum carrier distance of 600 kHz is used.

The SS transmits Standard Test Signal C1 on the traffic channel with a power level 20 dB above reference sensitivity level (wanted signal). No fading is applied.

The SS commands the MS to create the traffic channel loop back, signalling erased frames.

14.4.7.4.2 Test Procedure

- a) In addition to the wanted signal, the SS produces an independent, uncorrelated interfering signal, Standard Test Signal I1 (unwanted signal) on one of the hopping frequencies of the wanted signal, and on the timeslot used by the wanted signal. The unwanted signal is continuous and has no fixed relationship with the bit transitions of the wanted signal. Its amplitude is 10 dB above that of the wanted signal. No fading characteristics are applied.
- b) The SS compares the data of the signal that it sends to the MS with the signal which is looped back from the receiver after demodulation and decoding, and checks the frame erasure indication.
- c) The SS determines the frame erasure events by examining at least the minimum number of samples of consecutive frames and assuming a frame is received successfully it is not signalled as erased.

14.4.7.5 Test requirements

The error rate measured in this test shall not exceed the test limit error rate value given in the following table.

Channel	Type of measurement	Propagation condition	Test limit error rate (%)	Minimum No. of samples
TCH/FS	FER	Static	6.1	3 300

14.4.8 Co-channel rejection - TCH/AFS

14.4.8.1 Definition

The co-channel rejection is a measure of the capability of the receiver to receive a wanted modulated signal without exceeding a given degradation due to the presence of an unwanted modulated signal, both signals being at the nominal frequency of the receiver.

14.4.8.2 Conformance requirement

1. At reference co-channel interference the TCH/AFS FER shall meet the reference interference performance of table 2 in 3GPP TS 05.05 subclause 6.3.
2. At reference co-channel interference the TCH/AFS class Ib BER shall meet the reference interference performance of table 2 in 3GPP TS 05.05 subclause 6.3.

14.4.8.3 Test purpose

1. To verify that the MS does not exceed conformance requirement 1 under propagation condition TU_{high} with frequency hopping and TU_{low} with no frequency hopping with an allowance for the statistical significance of the test.
2. To verify that the MS does not exceed conformance requirement 2 under propagation condition TU_{high} with frequency hopping and TU_{low} with no frequency hopping, with an allowance for the statistical significance of the test.

14.4.8.4 Method of test

14.4.8.4.1 Initial conditions

A call is set up according to the generic call set up procedure on a TCH/AFS with an ARFCN in the mid ARFCN range, power control level set to maximum power. RADIO_LINK_TIMEOUT is set to maximum.

The multirate configuration indicates the use of a codec set limited to 7,95 kbit/s.

The SS transmits Standard Test Signal C1 on the traffic channel (wanted signal).

The SS commands the MS to create the traffic channel loop back, signalling erased frames (subclause 36).

Specific PICS Statements:

- DARP phase 1 supported (TSPC_DARP_Phase1)
- DARP phase 2 supported (TSPC_DARP_Phase2)

PIXIT Statements:

-

14.4.8.4.2 Procedure

- a) In addition to the wanted signal, the SS produces an independent, uncorrelated interfering signal, Standard Test Signal I1 (unwanted signal).

The unwanted signal is continuous and has no fixed relationship with the bit transitions of the wanted signal. The interference ratio is set to the reference interference ratio (+9 dB), meaning that the amplitude of the interferer is 9 dB below that of the wanted signal.

The fading characteristic of the wanted and the interfering signal is TU_{low} (TU3 for T-GSM 810, GSM850 and GSM900, TU1,5 for GSM1800 and GSM1900).

- b) The SS compares the modulation of the signal that it sends to the MS with the signal which is looped back from the receiver after demodulation and decoding, and checks the frame erasure indication.
- c) The SS determines the number of residual bit error events for the bits of the class Ib, by examining at least the minimum number of samples of consecutive bits of class Ib. Bits are only taken from those frames not signalled as erased.
- d) The SS also determines the frame erasure events by examining at least the minimum number of samples of consecutive frames and assuming a frame is received successfully it is not signalled as erased.
- e) The SS uses a Channel Mode Modify procedure to change the active codec set to 5,9 kbit/s and steps b) to d) are repeated.
- f) The interference ratio is set to 3 dB below the reference interference ratio (+9 dB - 3 dB), meaning that the amplitude of the interferer is 6 dB below that of the wanted signal.
- g) The SS uses a Channel Mode Modify procedure to change the active codec set to 4,75 kbit/s and steps b) to d) are repeated.
- h) If the MS is DARP capable, the following steps are omitted.
- i) The SS commands the MS into hopping mode. A hopping pattern covering at least 10 frequencies in a range not exceeding 5 MHz is used. The hopping pattern is centred on an ARFCN in the Mid ARFCN range. The interference ratio is set to the reference interference ratio (+9 dB), meaning that the amplitude of the interferer is 9 dB below that of the wanted signal. The fading characteristic of the wanted and the interfering signal is TU_{High} (TU50 for T-GSM 810, GSM850 and GSM900, GSM1800 and GSM1900).
- j) The SS uses a Channel Mode Modify procedure to change the active codec set to 12,2 kbit/s and steps b) to d) are repeated.
- k) The SS uses a Channel Mode Modify procedure to change the active codec set to 10,2 kbit/s and steps b) to d) are repeated.
- l) The SS uses a Channel Mode Modify procedure to change the active codec set to 7,4 kbit/s and steps b) to d) are repeated.
- m) The interference ratio is set to 3 dB below the reference interference ratio (+9 dB - 3 dB), meaning that the amplitude of the interferer is 6 dB below that of the wanted signal.
- n) The SS uses a Channel Mode Modify procedure to change the active codec set to 6,7 kbit/s and steps b) to d) are repeated.
- o) The SS uses a Channel Mode Modify procedure to change the active codec set to 5,15 kbit/s and steps b) to d) are repeated.

Maximum/Minimum Duration of Test

Non-DARP MS

- Maximum: 3 hours (GSM850, GSM900), 4 hours (DCS1800, PCS1900).
- Minimum: 1 hour (GSM850, GSM900, DCS1800, PCS1900).

DARP MS

- Maximum/minimum: 42 minutes (GSM850, GSM900, DCS1800, PCS1900).

14.4.8.5 Test requirements

Testing the Co-channel interference performance is performed using statistical methods that lead to an early pass/fail decision with test time significantly reduced for MS with BER/BLER not on the limit.

For more information on statistical testing of BER/BLER performance, especially the definition of limit lines refer to Annex A7.

Wrong decision risk F for one single error rate test:

$$F_{\text{pass}} = F_{\text{fail}} = F \quad \text{and} \quad F = 0.2\%$$

Wrong decision probability D per test step:

$$D_{\text{pass}} = D_{\text{fail}} = D \quad \text{and} \quad D = 0.0085\%$$

Parameters for limit lines:

1. D = 0.000085 wrong decision probability per test step.
2. M = 1.5 bad DUT factor
3. ne number of (error) events. This parameter is the x-ordinate in figure 14-1.
4. ns number of samples. The error rate is calculated from ne and ns.

Limit checking

Before limit checking is valid the minimum test time due to fading needs to be considered:

Testing under multipath and interference conditions requires that at least 990 wavelengths are crossed for fading profiles greater than 5km/h, and 250 wavelengths are crossed for fading profiles less than or equal to 5km/h. This leads to a minimum test time depending on the frequency range. No early pass/fail decision is allowed until the minimum test time due to fading has elapsed.

Table 14-48: Minimum test times due to TU low fading conditions

Full Rate 3 km/h							
Frequency	0,4	0,7	0,85	0,9	1,8	1,9	GHz
Wavelength	0,75	0,43	0,35	0,33	-	-	m
min test time	1800	1029	847	800	-	-	S
	0:30:00	0:17:09	0:14:07	0:13:20	-	-	hh:mm:ss

Full Rate 1,5 km/h							
Frequency	0,4	0,7	0,85	0,9	1,8	1,9	GHz
Wavelength	-	-	-	-	0,17	0,16	m
min test time	-	-	-	-	800	758	s
	-	-	-	-	0:13:20	0:12:38	hh:mm:ss

Table 14-49: Minimum test times due to TU high fading conditions

Full Rate 50 km/h							
Frequency	0,4	0,7	0,85	0,9	1,8	1,9	GHz
Wavelength	0,75	0,43	0,35	0,33	0,17	0,16	m
min test time	428	244	201	190	95	90	s
	0:07:08	0:04:04	0:03:21	0:03:10	0:01:35	0:01:30	hh:mm:ss

If the minimum test time due to multipath conditions exceeds the target test time, then the test runs for the minimum test time due to multipath conditions and the decision is done by comparing the result with the “derived test limit”. In this case early pass/fail decisions are obsolete.

If the target test time exceeds the minimum test time due to multipath conditions early pass/fail decisions can be headed for in order to accelerate test execution.

For an early decision a minimum number of (error) events is necessary.

For an early pass decision $ne \geq 1$ (inclusive artificial error)

For an early fail decision $ne \geq 7$

When the target test time has been reached the test is finished and a pass/fail decision can be made.

The error rate measured in this test shall be tested according to the values given in tables 14-49 or 14-50.

Co-channel rejection tests with a frequency condition noted as "@-ndB" are performed for an interference ratio n dB below the reference interference ratio (see 3GPP TS 45.005).

Table 14-49: Statistical test limits for GSM 400, GSM 700, T-GSM 810, GSM 850 and GSM 900 TU low no FH

TU low no FH								
0.4 to 0.9GHz			frames per s	Orig. BER	Derived	Target number	Target test	Target test time
	Channel	bits per sec	clas1b per s	requirement	test limit	of samples	time (s)	(hh:mm:ss)
AFS 7.95	frames	7950	50	0,130000	0,160420	2151	43	00:00:43

	Class1b	7950	4200	0,006600	0,008144	42360	10	00:00:10
AFS 5.9	frames	5900	50	0,100000	0,123400	2796	56	00:00:56
	Class1b	5900	3150	0,003800	0,004689	73573	23	00:00:23
AFS 4.75	frames @-3dB	4750	50	0,170000	0,209780	1645	33	00:00:33
	Class1b@-3dB	4750	2800	0,006200	0,007651	45093	16	00:00:16

Table 14-50: Statistical test limits for GSM 400, GSM 700, GSM 850 and GSM 900 TU high with FH

TU high FH								
0.4 to 0.9GHz			frames per s	Orig. BER	Derived	Target number	Target test	Target test time
	Channel	bits per sec	clas1b per s	requirement	test limit	of samples	time (s)	(hh:mm:ss)
AFS 12.2	frames	12200	50	0,035000	0,043190	7988	160	00:02:40
	Class1b	12200	8150	0,017000	0,020978	16446	2	00:00:02
AFS 10.2	frames	10200	50	0,014000	0,017276	19970	399	00:06:39
	Class1b	10200	6950	0,002100	0,002591	133133	19	00:00:19
AFS 7.4	frames	7400	50	0,001600	0,001974	174737	3495	00:58:15
	Class1b	7400	4350	0,000320	0,000395	873683	201	00:03:21
AFS 6.7	Frames@ -3dB	6700	50	0,012000	0,014808	23298	466	00:07:46
	Class1b@ -3dB	6700	3950	0,006000	0,007404	46596	12	00:00:12
AFS 5.15	frames @-3dB	5150	50	0,004700	0,005800	59485	1190	00:19:50
	Class1b@-3dB	5150	2700	0,001100	0,001357	254162	94	00:01:34

Table 14-51: Statistical test limits for DCS 1 800 and PCS 1 900 TU low no FH

TU low no FH								
1.8 and 1.9GHz			frames per s	Orig. BER	Derived	Target number	Target test	Target test time
	Channel	bits per sec	clas1b per s	requirement	test limit	of samples	time (s)	(hh:mm:ss)
AFS 7.95	frames	7950	50	0,130000	0,160420	2151	43	00:00:43
	Class1b	7950	4200	0,006700	0,008268	41728	10	00:00:10
AFS 5.9	frames	5900	50	0,100000	0,123400	2796	56	00:00:56
	Class1b	5900	3150	0,003800	0,004689	73573	23	00:00:23
AFS 4.75	frames @-3dB	4750	50	0,170000	0,209780	1645	33	00:00:33
	Class1b@-3dB	4750	2800	0,006100	0,007527	45833	16	00:00:16

Table 14-52: Statistical test limits for DCS 1 800 and PCS 1 900 TU high with FH

TU high FH								
1.8 and 1.9GHz			frames per s	Orig. BER	Derived	Target number	Target test	Target test time
	Channel	bits per sec	clas1b per s	requirement	test limit	of samples	time (s)	(hh:mm:ss)
AFS 12.2	frames	12200	50	0,027000	0,033318	10355	207	00:03:27
	Class1b	12200	8150	0,016000	0,019744	17474	2	00:00:02
AFS 10.2	frames	10200	50	0,009800	0,012093	28528	571	00:09:31
	Class1b	10200	6950	0,001700	0,002098	164458	24	00:00:24
AFS 7.4	frames	7400	50	0,000830	0,001024	336842	6737	01:52:17
	Class1b	7400	4350	0,000200	0,000247	1397893	321	00:05:21
AFS 6.7	Frames @-3dB	6700	50	0,008200	0,010188	34094	682	00:11:22
	Class1b@-3dB	6700	3950	0,005100	0,006293	54819	14	00:00:14
AFS 5.15	frames @-3dB	5150	50	0,002600	0,003208	107530	2151	00:35:51
	Class1b@-3dB	5150	2700	0,000720	0,000888	388304	144	00:02:24

14.4.9 to 14.4.15 (void)

14.4.16 Co-channel rejection - TCH/AHS

14.4.16.1 Definition

-

14.4.16.2 Conformance requirement

1. At reference cochannel interference, the TCH/AHS FER shall meet the reference interference performance of table 2 in 3GPP TS 05.05 subclause 6.3.
2. At reference cochannel interference, the TCH/AHS class Ib BER (BFI=0) shall meet the reference interference performance of table 2 in 3GPP TS 05.05 subclause 6.3.
3. At reference cochannel interference, the TCH/AHS class II BER (BFI=0) shall meet the reference interference performance of table 2 in 3GPP TS 05.05 subclause 6.3.

14.4.16.3 Test purpose

1. To verify that the MS does not exceed conformance requirement 1, under propagation conditions TUhigh without frequency hopping, with an allowance for the statistical significance of the test.
2. To verify that the MS does not exceed conformance requirement 2, under propagation conditions TUhigh without frequency hopping, with an allowance for the statistical significance of the test.
3. To verify that the MS does not exceed conformance requirement 3, under propagation conditions TUhigh without frequency hopping, with an allowance for the statistical significance of the test.

14.4.16.4 Method of test

14.4.16.4.1 Initial conditions

A call is set up according to the generic call set up procedure on a TCH/AHS with an ARFCN in the mid ARFCN range, power control level set to maximum power.

The multirate configuration indicates the use of a codec set limited to 7,95 kbit/s.

The SS transmits Standard Test Signal C1 on the traffic channel (wanted signal).

14.4.16.4.2 Procedure

- a) In addition to the wanted signal, the SS produces an independent, uncorrelated interfering signal, Standard Test Signal I1 (unwanted signal).

The unwanted signal is continuous and has no fixed relationship with the bit transitions of the wanted signal. The interference ratio is set to 3 dB above the reference interference ratio (+9 dB + 3 dB), meaning that the amplitude of the interferer is 12 dB below that of the wanted signal.

b) The fading characteristic of the wanted and the interfering signal is set to TUhigh. The SS commands the MS into non hopping mode.

c) The SS commands the MS to create traffic channel loop back signalling erased frames.

NOTE: Frames marked with BFI=1 are signalled as erased on the uplink.

d) The SS compares the modulation of the signal that it sends to the MS with the signal which is looped back from the receiver after demodulation and decoding, and checks the frame erasure indication.

e) The SS determines the number of residual bit error events for the bits of class II, by examining at least the minimum number of samples of consecutive bits of class II. Bits are taken only from those frames not signalled as erased.

f) The SS determines the number of residual bit error events for the bits of the class Ib, by examining at least the minimum number of samples of consecutive bits of class Ib. Bits are only taken from those frames not signalled as erased.

g) The SS also determines the frame erasure events by examining at least the minimum number of samples of consecutive frames and assuming a frame is received successfully it is not signalled as erased.

h) The SS uses a Channel Mode Modify procedure to change the active codec set to 7,4 kbit/s and steps b) to g) are repeated.

i) The SS uses a Channel Mode Modify procedure to change the active codec set to 6,7 kbit/s and steps b) to g) are repeated.

j) The interference ratio is set to the reference interference ratio (+9 dB), meaning that the amplitude of the interferer is 9 dB below that of the wanted signal. The SS uses a Channel Mode Modify procedure to change the active codec set to 5,9 kbit/s and steps b) to g) are repeated.

k) The SS uses a Channel Mode Modify procedure to change the active codec set to 5,15 kbit/s and steps b) to g) are repeated.

l) The SS uses a Channel Mode Modify procedure to change the active codec set to 4,75 kbit/s and steps b) to g) are repeated.

Maximum/Minimum Duration of Test

Statistical test method, pre Rel-5 MS

Maximum: 40 minutes (GSM850), 38 minutes (GSM900), 20 minutes (DCS1800), 19 minutes (PCS1900).

Minimum: 40 minutes (GSM850), 38 minutes (GSM900), 19 minutes (DCS1800), 18 minutes (PCS1900).

Statistical test method, Rel-5 onwards MS

Maximum: 40 minutes (GSM850), 38 minutes (GSM900), 21 minutes (DCS1800), 20 minutes (PCS1900).

Minimum: 40 minutes (GSM850), 38 minutes (GSM900), 19 minutes (DCS1800), 18 minutes (PCS1900).

14.4.16.5 Test requirements

Testing the Co-channel interference performance is performed using statistical methods that lead to an early pass/fail decision with test time significantly reduced for MS with BER/BLER not on the limit.

For more information on statistical testing of BER/BLER performance, especially the definition of limit lines refer to Annex 6.2

Wrong decision risk F for one single error rate test:

$$F_{\text{pass}} = F_{\text{fail}} = F \quad \text{and} \quad F = 0.2\%$$

Wrong decision probability D per test step:

$$D_{\text{pass}} = D_{\text{fail}} = D \quad \text{and} \quad D = 0.0085\%$$

Parameters for limit lines:

1. D = 0.000085 wrong decision probability per test step.
2. M = 1.5 bad DUT factor
3. ne number of (error) events. This parameter is the x-ordinate in figure 14-1.
4. ns number of samples. The error rate is calculated from ne and ns.

Limit checking

Before limit checking is valid the minimum test time due to fading needs to be considered:

Testing under multipath and interference conditions requires that at least 990 wavelengths are crossed with the speed given in the fading profile. This leads to a minimum test time depending on the frequency. No early pass/fail decision is allowed until the minimum test time due to fading has elapsed.

Table 14-53: Minimum test times due to TU high fading conditions

Half Rate 50 km/h							
Frequency	0,4	0,7	0,85	0,9	1,8	1,9	GHz
Wavelenth	0,75	0,43	0,35	0,33	0,17	0,16	m
min test time	855	489	403	380	190	180	s
	0:14:15	0:08:09	0:06:43	0:06:20	0:03:10	0:03:00	

If the minimum test time due to multipath conditions exceeds the target test time, then the test runs for the minimum test time due to multipath conditions and the decision is done by comparing the result with the “derived test limit”. In this case early pass/fail decisions are obsolete.

If the target test time exceeds the minimum test time due to multipath conditions early pass/fail decisions can be headed for in order to accelerate test execution.

For an early decision a minimum number of (error) events is necessary.

For an early pass decision $ne \geq 1$ (inclusive artificial error)

For an early fail decision $ne \geq 7$

When the target test time has been reached the test is finished and a pass/fail decision can be made.

The error rate measured in this test shall be tested according to the values given in tables 14-54 or 14-55.

Co-channel rejection tests with a frequency condition noted as "+ndB" are performed for an interference ratio n dB above the reference interference ratio (see 3GPP TS 45.005).

Table 14-54: Statistical test limits for GSM 400, GSM 700, T-GSM 810, GSM 850 and GSM 900

TU high no FH								
0.4 to 0.9GHz			frames per s	Orig. BER	Derived	Target number	Target test	Target test time
	Channel	bits per sec	clas1b per s	requirement	test limit	of samples	time (s)	(hh:mm:ss)
			clas II per s					
AHS 7.95	frames @+3dB	7950	50	0,067000	0,082678	4173	83	00:01:23
	Class1b @+3dB	7950	2800	0,010000	0,012340	27958	10	00:00:10
	Class II @+3dB	7950	1800	0,032000	0,039488	8737	5	00:00:05
AHS 7.4	frames @+3dB	7400	50	0,047000	0,057998	5948	119	00:01:59
	Class1b @+3dB	7400	2950	0,005100	0,006293	54819	19	00:00:19
	Class II @+3dB	7400	1400	0,033000	0,040722	8472	6	00:00:06
AHS 6.7	frames @+3dB	6700	50	0,023000	0,028382	12156	243	00:04:03
	Class1b @+3dB	6700	2750	0,003900	0,004813	71687	26	00:00:26
	Class II @+3dB	6700	1200	0,036000	0,044424	7766	6	00:00:06
AHS 5.9	frames	5900	50	0,071000	0,087614	3938	79	00:01:19
	Class1b	5900	2350	0,005700	0,007034	49049	21	00:00:21
	Class II	5900	800	0,065000	0,080210	4301	5	00:00:05
AHS 5.15	frames	5150	50	0,033000	0,040722	8472	169	00:02:49
	Class1b	5150	2100	0,006000	0,007404	46596	22	00:00:22
	Class II	5150	600	0,069000	0,085146	4052	7	00:00:07
AHS 4.75	frames	4750	50	Pre Rel-5: 0,025000 Rel-5: 0,018000	Pre Rel-5: 0,030850 Rel-5: 0,022212	Pre Rel-5: 11184 Rel-5: 15532	Pre Rel-5: 224 Rel-5: 311	Pre Rel-5: 00:03:44 Rel-5: 00:05:11
	Class1b	4750	2200	Pre Rel-5: 0,002900 Rel-5: 0,002200	Pre Rel-5: 0,003579 Rel-5: 0,002715	Pre Rel-5: 96407 Rel-5: 127081	Pre Rel-5: 44 Rel-5: 58	Pre Rel-5: 00:00:44 Rel-5: 00:00:58
	Class II	4750	600	Pre Rel-5: 0,075000 Rel-5: 0,070000	Pre Rel-5: 0,092550 Rel-5: 0,086380	Pre Rel-5: 3228 Rel-5: 3994	Pre Rel-5: 6 Rel-5: 7	Pre Rel-5: 00:00:06 Rel-5: 00:00:07

Table 14-55: Statistical test limits for DCS 1 800 and PCS 1 900

TU high no FH								
1.8 and 1.9GHz			frames per s	Orig. BER	Derived	Target number	Target test	Target test time
			clas1b per s	requirement	test limit	of samples	time (s)	(hh:mm:ss)
	Channel	bits per sec	clas II per s					
AHS 7.95	frames @+3dB	7950	50	0,067000	0,082678	4173	83	00:01:23
	Class1b @+3dB	7950	2800	0,010000	0,012340	27958	10	00:00:10
	Class II @+3dB	7950	1800	Pre Rel-5: 0,033000 Rel-5: 0,031000	Pre Rel-5: 0,040722 Rel-5: 0,038254	Pre Rel-5: 8473 Rel-5: 9019	Pre Rel-5: 5 Rel-5: 5	Pre Rel-5: 00:00:05 Rel-5: 00:00:05
AHS 7.4	frames @+3dB	7400	50	Pre Rel-5: 0,054000 Rel-5: 0,049000	Pre Rel-5: 0,066636 Rel-5: 0,060466	Pre Rel-5: 5178 Rel-5: 5706	Pre Rel-5: 104 Rel-5: 114	Pre Rel-5: 00:01:44 Rel-5: 00:01:54
	Class1b @+3dB	7400	2950	Pre Rel-5: 0,006000 Rel-5: 0,005100	Pre Rel-5: 0,007404 Rel-5: 0,006293	Pre Rel-5: 46597 Rel-5: 54819	Pre Rel-5: 16 Rel-5: 19	Pre Rel-5: 00:00:16 Rel-5: 00:00:19
	Class II @+3dB	7400	1400	Pre Rel-5: 0,035000 Rel-5: 0,033000	Pre Rel-5: 0,043190 Rel-5: 0,040722	Pre Rel-5: 7988 Rel-5: 8472	Pre Rel-5: 6 Rel-5: 6	Pre Rel-5: 00:00:06 Rel-5: 00:00:06
AHS 6.7	frames @+3dB	6700	50	0,025000	0,030850	11183	224	00:03:44
	Class1b @+3dB	6700	2750	0,003800	0,004689	73573	27	00:00:27
	Class II @+3dB	6700	1200	Pre Rel-5: 0,039000 Rel-5: 0,035000	Pre Rel-5: 0,048126 Rel-5: 0,043190	Pre Rel-5: 7169 Rel-5: 7988	Pre Rel-5: 6 Rel-5: 7	Pre Rel-5: 00:00:06 Rel-5: 00:00:07
AHS 5.9	frames	5900	50	0,077000	0,095018	3631	73	00:01:13
	Class1b	5900	2350	0,006000	0,007404	46596	20	00:00:20
	Class II	5900	800	Pre Rel-5: 0,069000 Rel-5: 0,064000	Pre Rel-5: 0,085146 Rel-5: 0,078976	Pre Rel-5: 4052 Rel-5: 4368	Pre Rel-5: 5 Rel-5: 5	Pre Rel-5: 00:00:05 Rel-5: 00:00:05
AHS 5.15	frames	5150	50	0,038000	0,046892	7357	147	00:02:27

	Class1b	5150	2100	0,006600	0,008144	42360	20	00:00:20
	Class II	5150	600	0,068000	0,083912	4111	7	00:00:07
AHS 4.75	frames	4750	50	Pre Rel-5: 0,028000 Rel-5: 0,021000	Pre Rel-5: 0,034552 Rel-5: 0,025914	Pre Rel-5: 9985 Rel-5: 13313	Pre Rel-5: 200 Rel-5: 266	Pre Rel-5: 00:03:20 Rel-5: 00:04:26
	Class1b	4750	2200	0,002500	0,003085	111831	51	00:00:51
	Class II	4750	600	Pre Rel-5: 0,075000 Rel-5: 0,070000	Pre Rel-5: 0,09255 Rel-5: 0,086380	Pre Rel-5: 3728 Rel-5: 3994	Pre Rel-5: 6 Rel-5: 7	Pre Rel-5: 00:00:06 Rel-5: 00:00:07

14.4.16.5.2 Fixed testing of BER/BLER performance with minimum number of samples

The error rate measured in this test shall not exceed the test limit error rate values given in table 14-16 or table 14-17.

Table 14-16: Fixed limits for GSM 400, GSM 700, T-GSM 810, GSM 850 and GSM 900 co-channel rejection

Channel	Propagation condition	Test limit error rate %	Minimum No. of samples
TCH/AHS 7.95 (FER)	TUhigh/No FH@+3dB	8.44	8960
TCH/AHS 7.95 Class Ib (RBER)	TUhigh/No FH@+3dB	1.62	60000
TCH/AHS 7.95 Class II (RBER)	TUhigh/No FH@+3dB	4.032	18750
TCH/AHS 7.4 (FER)	TUhigh/No FH@+3dB	6.048	12500
TCH/AHS 7.4 Class Ib (RBER)	TUhigh/No FH@+3dB	0.643	117650
TCH/AHS 7.4 Class II (RBER)	TUhigh/No FH@+3dB	4.158	18200
TCH/AHS 6.7 (FER)	TUhigh/No FH@+3dB	2.898	23000
TCH/AHS 6.7 Class Ib (RBER)	TUhigh/No FH@+3dB	0.491	136000
TCH/AHS 6.7 Class II (RBER)	TUhigh/No FH@+3dB	4.536	15000
TCH/AHS 5.9 (FER)	TUhigh/No FH	8.946	8450
TCH/AHS 5.9 Class Ib (RBER)	TUhigh/No FH	0.718	105270
TCH/AHS 5.9 Class II (RBER)	TUhigh/No FH	8.19	9230
TCH/AHS 5.15 (FER)	TUhigh/No FH	4.158	18190
TCH/AHS 5.15 Class Ib (RBER)	TUhigh/No FH	0.756	100000
TCH/AHS 5.15 Class II (RBER)	TUhigh/No FH	8.694	8700
TCH/AHS 4.75 (FER)	TUhigh/No FH	Pre Rel-5: 3.15	Pre Rel-5: 24000
		Rel-5: 2.268	Rel-5: 33333
TCH/AHS 4.75 Class Ib (RBER)	TUhigh/No FH	Pre Rel-5: 0.365	Pre Rel-5: 206900
		Rel-5: 0.277	Rel-5: 272730
TCH/AHS 4.75 Class II (RBER)	TUhigh/No FH	Pre Rel-5: 9.45	Pre Rel-5: 8000
		Rel-5: 8.82	Rel-5: 8580

Table 14-17: Fixed limits for DCS 1800 and PCS 1 900 co-channel rejection

Channel	Propagation condition	Test limit error rate %	Minimum No. of samples
TCH/AHS 7.95 (FER)	TUhigh/No FH@+3dB	8.442	8960
TCH/AHS 7.95 Class Ib (RBER)	TUhigh/No FH@+3dB	1.26	60000
TCH/AHS 7.95 Class II (RBER)	TUhigh/No FH@+3dB	Pre Rel-5: 4.158	Pre Rel-5: 18190
		Rel-5: 3.906	Rel-5: 19355
TCH/AHS 7.4 (FER)	TUhigh/No FH@+3dB	6.804	11120
		Rel-5: 6.174	Rel-5: 12250
TCH/AHS 7.4 Class Ib (RBER)	TUhigh/No FH@+3dB	Pre Rel-5: 0.756	Pre Rel-5: 100000
		Rel-5: 0.63	Rel-5: 117730
TCH/AHS 7.4 Class II (RBER)	TUhigh/No FH@+3dB	Pre Rel-5: 4.41	Pre Rel-5: 17150
		Rel-5: 4.158	Rel-5: 18200
TCH/AHS 6.7 (FER)	TUhigh/No FH@+3dB	3.15	24000
TCH/AHS 6.7 Class Ib (RBER)	TUhigh/No FH@+3dB	0.479	157900
TCH/AHS 6.7 Class II (RBER)	TUhigh/No FH@+3dB	Pre Rel-5: 4.914	Pre Rel-5: 15390
		Rel-5: 4.41	Rel-5: 17150
TCH/AHS 5.9 (FER)	TUhigh/No FH	9.702	7800
TCH/AHS 5.9 Class Ib (RBER)	TUhigh/No FH	0.756	100000
TCH/AHS 5.9 Class II (RBER)	TUhigh/No FH	Pre Rel-5: 8.694	Pre Rel-5: 8700
		Rel-5: 8.064	Rel-5: 9375
TCH/AHS 5.15 (FER)	TUhigh/No FH	4.788	15800
TCH/AHS 5.15 Class Ib (RBER)	TUhigh/No FH	0.831	90910
TCH/AHS 5.15 Class II (RBER)	TUhigh/No FH	8.568	8830
TCH/AHS 4.75 (FER)	TUhigh/No FH	Pre Rel-5: 3.528	Pre Rel-5: 21430
		Rel-5: 2.646	Rel-5: 28580
TCH/AHS 4.75 Class Ib (RBER)	TUhigh/No FH	0.315	240000
TCH/AHS 4.75 Class II (RBER)	TUhigh/No FH	Pre Rel-5: 9.45	Pre Rel-5: 8000
		Rel-5: 8.82	Rel-5: 8580

14.4.17 Co-channel rejection - TCH/AFS-INB

14.4.17.1 Definition

The co-channel rejection is a measure of the capability of the receiver to receive a wanted modulated signal without exceeding a given degradation due to the presence of an unwanted modulated signal, both signals being at the nominal frequency of the receiver.

14.4.17.2 Conformance requirement

1. At reference co-channel interference the TCH/AFS-INB FER shall meet the reference interference performance of table 2 in 3GPP TS 45.005 subclause 6.3.

The delays associated with Loop I remain constant for all of the following circumstances:

- For a given MS implementation.
- For the duration of the MS being powered on.

3GPP TS 44.014 subclause 5.1.7a.1.

14.4.17.3 Test purpose

1. To verify that the MS does not exceed conformance requirement 1 under propagation condition TU_{high} with frequency hopping and TU_{low} with no frequency hopping with an allowance for the statistical significance of the test.

14.4.17.4 Method of test

14.4.17.4.1 Initial conditions

A call is set up according to the generic call set up procedure on a TCH/AFS with an ARFCN in the mid ARFCN range, power control level set to maximum power.

The multirate configuration indicates the use of the following set of codecs modes:

Codec Mode	TCH/AFS in kbit/s
CODEC_MODE_4	12,2
CODEC_MODE_3	7,95
CODEC_MODE_2	5,9
CODEC_MODE_1	4,75

The Initial Codec Mode shall be set to the lowest codec mode (CODEC_MODE_1).

The following decision threshold and hysteresis values in terms of normalized carrier to interference ratio (C/I_{norm}), shall apply for Codec Mode Command / Request (MC, MR):

MC'MR'	THR_MC_Dn(MC)/ THR_MR_Dn(MR)	THR_MC_Up(MC)/ THR_MR_Up(MR)
CODEC_MODE_4	18,5 dB	+ ∞
CODEC_MODE_3	12,5 dB	20,5 dB
CODEC_MODE_2	6,5 dB	14,5 dB
CODEC_MODE_1	- ∞	8,5 dB

The SS transmits Standard Test Signal C1 on the traffic channel using the Initial Codec Mode (ICM).

The SS continuously sends a CMC corresponding to the highest codec mode (CODEC_MODE_4).

The SS commands the MS to loop back in band signaling codewords by closing a Loop I.

Specific PICS Statements:

- AMR half rate speech supported (TSPC_AddInfo_Half_rate_version_3)

PIXIT Statements:

-

14.4.17.4.2 Procedure

- a) In addition to the wanted signal, the SS produces an independent, uncorrelated interfering signal, Standard Test Signal I1 (unwanted signal).

The unwanted signal is continuous and has no fixed relationship with the bit transitions of the wanted signal. Its amplitude is 6 dB below that of the wanted signal (9 dB – 3 dB less attenuation on the interfering signal).

The fading characteristic of the wanted and the interfering signal is TU_{low}.

- b) The SS shall change the Codec Mode Indication and Codec Mode Command at to the neighbour mode every 22 speech frames (440 ms) by following a scanning pattern (1->2->3->4->4->3->2->1). CMI should initially be increased. CMC should initially be decreased. The CMIC/MC shall be repeated until the minimum required number of frame samples has been sent to the MS.

- c) The SS compares the in band signalling codewords/frames it sends to the MS with the in band signalling codewords/frames which are looped back from the receiver after demodulation and decoding, and checks for in band signalling (CMI/CMC) frame errors.
- d) The SS determines the frame error events by examining sequences of at least the minimum number of samples of consecutive frames. All frames should be considered when computing the frame error rate: those corresponding to a downlink CMI/CMC transitions and those without downlink CMI/CMC transitions.
- e) If the MS does not support AMR half rate speech, then steps a) to d) are repeated except that in step a) both the wanted and interfering signal are TUhigh hopping and the SS commands the MS into hopping mode. A hopping pattern covering at least 10 frequencies in a range not exceeding 5 MHz is used. The hopping pattern is centred around an ARFCN in the Mid ARFCN range.

NOTE: The delays associated with Loop I are not specified, and will be MS implementation dependant. Loop I should be considered as having two separate parts (DL CMC -> UL CMI and DL CMI -> UL CMR). The delays associated with the two parts may differ. The SS should ensure that the correctly looped inband bits are compared. The delays associated with Loop I will remain constant for the duration of the test, thus every UL frame received by the SS will have only one possible expected value.

Maximum/Minimum Duration of Test

MS supporting AMR half rate speech:

Maximum/minimum: 14 minutes (GSM850, GSM900).

Maximum/minimum: 6 minutes (DCS1800, PCS1900).

MS not supporting AMR half rate speech:

Maximum/minimum: 72 minutes (GSM850, GSM900).

Maximum/minimum: 84 minutes (DCS1800, PCS1900).

14.4.17.5 Test requirements

The frame error rate measured in this test shall not exceed the test limit error rate values given in table 14.4.17-1 or 14.4.17-2.

Co-channel rejection tests with a frequency condition noted as "@ndB" are performed with the interfering frequency transmitted with an additional n dB attenuation, see 3GPP TS 45.005.

Table 14.4.17-1: Limits for GSM 400, GSM 700, T-GSM 810, GSM 850 and GSM 900 co-channel rejection

Channel	Propagation condition	Test limit error rate %	Minimum No. of samples
TCH/AFS-INB (FER)	TUlow/No FH@-3 dB	4.319	7988
TCH/AFS-INB (FER)	TUhigh/FH@-3 dB	0.197	174737

Table 14.4.17-2: Limits for DCS 1800 and PCS 1 900 co-channel rejection

Channel	Propagation condition	Test limit error rate %	Minimum No. of samples
TCH/AFS-INB (FER)	Tulow/No FH@-3dB	4.319	7988
TCH/AFS-INB (FER)	TUhigh/FH@-3 dB	0.148	232982

14.4.18 Co-channel rejection - TCH/AHS-INB

14.4.18.1 Definition

The co-channel rejection is a measure of the capability of the receiver to receive a wanted modulated signal without exceeding a given degradation due to the presence of an unwanted modulated signal, both signals being at the nominal frequency of the receiver.

14.4.18.2 Conformance requirement

1. At reference cochannel interference, the TCH/AHS-INB shall meet the reference interference performance of table 2 in 3GPP TS 45.005 subclause 6.3.

The delays associated with Loop I remain constant for all of the following circumstances:

- For a given MS implementation.
- For the duration of the MS being powered on.

3GPP TS 44.014 subclause 5.1.7a.1.

14.4.18.3 Test purpose

1. To verify that the MS does not exceed conformance requirement 1, under propagation conditions TU_{high} without frequency hopping, with an allowance for the statistical significance of the test.

14.4.18.4 Method of test

14.4.18.4.1 Initial conditions

A call is set up according to the generic call set up procedure on a TCH/AHS with an ARFCN in the mid ARFCN range, power control level set to maximum power.

The multirate configuration indicates the use of the following set of codecs modes:

Codec Mode	TCH/AHS in kbit/s
CODEC_MODE_4	7,95
CODEC_MODE_3	6,7
CODEC_MODE_2	5,9
CODEC_MODE_1	4.75

The Initial Codec Mode shall be set to the lowest codec mode (CODEC_MODE_1).

The following decision threshold and hysteresis values in terms of normalized carrier to interference ratio (C/I_{norm}), shall apply for Codec Mode Command / Request (MC, MR):

MC'/MR'	THR_MC_Dn(MC')/ THR_MR_Dn(MR')	THR_MC_Up(MC')/ THR_MR_Up(MR')
CODEC_MODE_4	16,0 dB	$+\infty$
CODEC_MODE_3	12,0 dB	18,0 dB
CODEC_MODE_2	8,0 dB	14,0 dB
CODEC_MODE_1	$-\infty$	10,0 dB

The SS transmits Standard Test Signal C1 on the traffic channel using the Initial Codec Mode (ICM).

The SS continuously sends a CMC corresponding to the highest codec mode (CODEC_MODE_4).

14.4.18.4.2 Procedure

- a) In addition to the wanted signal, the SS produces an independent, uncorrelated interfering signal, Standard Test Signal I1 (unwanted signal).

The unwanted signal is continuous and has no fixed relationship with the bit transitions of the wanted signal. Its amplitude is 9 dB below that of the wanted signal.

- b) The fading characteristic of the wanted and the interfering signal is set to TU_{high}. The SS commands the MS into non hopping mode.
- c) The SS commands the MS to loop back band signaling codewords by closing a Loop I.
- d) The SS shall change the Codec Mode Indication and Codec Mode Command at to the neighbour mode every 22 speech frames (440 ms) by following a scanning pattern (1->2->3->4->4->3->2->1). CMI should initially be

increased. CMC should initially be decreased. The CMICMC pattern shall be repeated until the minimum required number of frame samples has been sent to the MS.

- e) The SS compares the in band signalling codewords/frames it sends to the MS with the in band signalling codewords/frames which are looped back from the receiver after demodulation and decoding, and checks for in band signalling (CMI/CMC) frame errors.
- f) The SS determines the frame error events by examining sequences of at least the minimum number of samples of consecutive frames. All frames should be considered when computing the frame error rate: those corresponding to a downlink CMI/CMC transitions and those without downlink CMI/CMC transitions.

NOTE: The delays associated with Loop I are not specified, and will be MS implementation dependant. Loop I should be considered as having two separate parts (DL CMC -> UL CMI and DL CMI -> UL CMR). The delays associated with the two parts may differ. The SS should ensure that the correctly looped inband bits are compared. The delays associated with Loop I will remain constant for the duration of the test, thus every UL frame received by the SS will have only one possible expected value.

Maximum/Minimum Duration of Test

Maximum/minimum: 26 minutes (GSM850, GSM900), 25 minutes (DCS1800, PCS1900).

14.4.18.5 Test requirements

The frame error rate measured in this test shall not exceed the test limit error rate values given in table 14.4.18-1 or table 14.4.18-2.

Table 14.4.18-1: Limits for GSM 400, GSM 700, T-GSM 810, GSM 850 and GSM 900 co-channel rejection

Channel	Propagation condition	Test limit error rate %	Minimum No. of samples
TCH/AHS-INB (FER)	TUhigh/No FH	0.784	76000

Table 14.4.18-2: Limits for DCS 1800 and PCS 1 900 co-channel rejection

Channel	Propagation condition	Test limit error rate %	Minimum No. of samples
TCH/AHS-INB (FER)	TUhigh/No FH	0.795	75000

14.4.19 Co-channel rejection - O-TCH/AHS

14.4.19.1 Definition

-

14.4.19.2 Conformance requirement

For 8-PSK modulated channels, speech channels (AMR and AMR-WB), the minimum interference ratio for which the reference performance for cochannel interference (C/I_c) shall be met is specified in table 2k

For 8-PSK modulated speech channels (AMR and AMR-WB), ECSD channels and 8-PSK modulated packet-switched channels, the wanted input signal level shall be: $-93 \text{ dBm} + I_r + \text{Corr}$, where:

I_r = the interference ratio according to tables 2b and 2c for packets switched channels, tables 2d and 2e for ECSD and table 2k for speech (AMR and AMR-WB) and associated control channels.

Corr = the correction factor for reference performance according to subclause 6.2

For all classes of MS supporting 8-PSK speech channels, an additional +2 dB adjustment applies for 8-PSK modulated speech channels.

The reference performance is the same as defined in subclause 6.2

The reference performance shall be:

For speech channels (O-TCH/AHSy) $FER \leq 1\%$

3GPP TS 45.005, subclauses 6.2, 6.3.

14.4.19.3 Test purpose

To verify that the MS does not exceed conformance requirement for FER and class 1b RBER under TU50 propagation conditions with an allowance for the statistical significance of the test, for channel combinations O-TCH/AHS12.2, O-TCH/AHS7.95, O-TCH/AHS5.9 and O-TCH/AHS4.75.

14.4.19.4 Method of test

14.4.19.4.1 Initial conditions

A call is set up according to the generic call set up procedure on a O-TCH/AHS with an ARFCN in the mid ARFCN range, power control level set to maximum power. RADIO_LINK_TIMEOUT is set to maximum.

The multirate configuration indicates the use of a codec set limited to 12,2 kbit/s.

The SS transmits Standard Test Signal C1 on the traffic channel (wanted signal).

The SS commands the MS to create the traffic channel loop back, signalling erased frames (subclause 36).

14.4.19.4.2 Procedure

- a) In addition to the wanted signal, the SS produces an independent, uncorrelated interfering signal, Standard Test Signal I1 (unwanted signal). The unwanted signal is continuous and has no fixed relationship with the bit transitions of the wanted signal.
- b) The fading characteristic of the wanted and the interfering signals are set to TU50.
- c) The SS sets the level of the interfering signal to -91dBm .
- d) The SS sets the level of the wanted signal to that indicated by C_{lev} in table 14.4.19-2 or 14.4.19-3.
- e) The SS determines the number of residual bit error events for the bits of the class Ib, by examining sequences of at least the minimum number of samples of consecutive bits of class Ib. Bits are only taken from those frames not signalled as erased.
- f) The SS also determines the frame erasure events by examining sequences of at least the minimum number of samples of consecutive frames and assuming a frame is received successfully, if it is not signalled as erased.
- g) The SS uses a Channel Mode Modify procedure to change the active codec set to 7,95 kbit/s and steps c) to f) are repeated.
- h) The SS uses a Channel Mode Modify procedure to change the active codec set to 5,9 kbit/s and steps c) to f) are repeated.
- i) The SS uses a Channel Mode Modify procedure to change the active codec set to 4,75 kbit/s and steps c) to f) are repeated.

Maximum/Minimum Duration of Test

Maximum: 38 minutes (GSM850), 38 minutes (GSM900), 38 minutes (DCS1800), 38 minutes (PCS1900).

Minimum: 26 minutes (GSM850), 26 minutes (GSM900), 13 minutes (DCS1800), 13 minutes (PCS1900).

14.4.19.5 Test requirements

Testing should be performed using statistical methods that lead to an early pass/fail decision with test time significantly reduced for MS with FER/BER not on the limit.

For more information on statistical testing of BER/BLER performance, especially the definition of limit lines refer to Annex 7.

Wrong decision risk F for one single error rate test:

$$F_{\text{pass}} = F_{\text{fail}} = F \quad \text{and} \quad F = 0.2\%$$

Wrong decision probability D per test step:

$$D_{\text{pass}} = D_{\text{fail}} = D \quad \text{and} \quad D = 0.0085\%$$

Parameters for limit lines:

1. D = 0.000085 wrong decision probability per test step.
2. M = 1.5 bad DUT factor
3. ne number of (error) events. This parameter is the x-ordinate in figure A7.1.3.1.
4. ns number of samples. The error rate is calculated from ne and ns.

Limit checking

Before limit checking is valid the minimum test time due to fading needs to be considered:

Testing under multipath and interference conditions requires that at least 990 wavelengths are crossed with the speed given in the fading profile. This leads to a minimum test time depending on the frequency range. No early pass/fail decision is allowed until the minimum test time due to fading has elapsed.

Table 14.4.19-1: Minimum test times due to TU high fading conditions

Half Rate 50 km/h					
Frequency	0,85	0,9	1,8	1,9	GHz
Wavelength	0,35	0,33	0,17	0,16	m
min test time	403	380	190	180	s
	0:06:43	0:06:20	0:03:10	0:03:00	

If the minimum test time due to multipath conditions exceeds the target test time, then the test runs for the minimum test time due to multipath conditions and the decision is made by comparing the result with the “derived test limit”. In this case early pass/fail decisions are obsolete.

If the target test time exceeds the minimum test time due to multipath conditions early pass/fail decisions can be headed for in order to accelerate test execution.

For an early decision a minimum number of (error) events is necessary.

For an early pass decision $ne \geq 1$ (inclusive artificial error)

For an early fail decision $ne \geq 7$

When the target test time has been reached the test is finished and a pass/fail decision can be made.

The error rate measured in this test shall be tested according to the values given in tables 14.4.19-2 and 14.4.19.3

Table 14.4.19-2: Statistical test limits for T-GSM 810, GSM 850 and GSM 900 O-TCH/AHS co-chan interference

TU50 / No FH							
0.8 to 0.9GHz	C _{lev} (dBm)	Samples per second	Orig. BER requirement	Derived test limit	Target number of samples	Target test time (s)	Target test time (hh:mm:ss)

AHS 12.2	Frames	-74.5	50	0,010000	0,012340	27958	560	00:09:20
	Class1b		8150	0,003000	0,003702	93192	12	00:00:12
AHS 7.95	Frames	-76.5	50	0,010000	0,012340	27958	560	00:09:20
	Class1b		4200	0,000600	0,000740	466216	111	00:01:51
AHS 5.9	Frames	-78.0	50	0,010000	0,012340	27958	560	00:09:20
	Class1b		3150	0,001600	0,001974	174772	56	00:00:56
AHS 4.75	Frames	-79.0	50	0,010000	0,012340	27958	560	00:09:20
	Class1b		2800	0,000900	0,001111	310531	111	00:01:51

Table 14.4.19-3: Statistical test limits for DCS 1 800 and PCS 1 900 O-TCH/AHS co-chan interference

TU50 / No FH								
1.8 to 1.9GHz		C_{lev} (dBm)	Samples per second	Orig. BER requirement	Derived test limit	Target number of samples	Target test time (s)	Target test time (hh:mm:ss)
AHS 10.2	Frames	-74.5	50	0,010000	0,012340	27958	560	00:09:20
	Class1b		8150	0,003000	0,003702	93192	12	00:00:12
AHS 5.15	Frames	-76.5	50	0,010000	0,012340	27958	560	00:09:20
	Class1b		4200	0,000700	0,000864	399305	96	00:01:36
AHS 5.15	Frames	-78.5	50	0,010000	0,012340	27958	560	00:09:20
	Class1b		3150	0,001500	0,001851	186385	60	00:01:00
AHS 5.15	Frames	-79.5	50	0,010000	0,012340	27958	560	00:09:20
	Class1b		2800	0,001000	0,001234	279578	100	00:01:40

14.4.20 Co-channel rejection – O-TCH/AHS-INB

14.4.20.1 Definition

The co-channel rejection is a measure of the capability of the receiver to receive a wanted modulated signal without exceeding a given degradation due to the presence of an unwanted modulated signal, both signals being at the nominal frequency of the receiver.

14.4.20.2 Conformance requirement

- At reference cochannel interference, the O-TCH/AHS-INB shall meet the reference interference performance of table 2k in 3GPP TS 45.005 subclause 6.3.

14.4.20.3 Test purpose

- To verify that the MS does not exceed conformance requirement 1, under propagation conditions TUhigh without frequency hopping, with an allowance for the statistical significance of the test.

14.4.20.4 Method of test

14.4.20.4.1 Initial conditions

A call is set up according to the generic call set up procedure on a O-TCH/AHS with an ARFCN in the mid ARFCN range, power control level set to maximum power. RADIO_LINK_TIMEOUT is set to maximum.

The multirate configuration indicates the use of the following set of codecs modes:

Codec Mode	TCH/AHS in kbit/s
CODEC_MODE_4	7,95
CODEC_MODE_3	6,7
CODEC_MODE_2	5,9
CODEC_MODE_1	4.75

The Initial Codec Mode shall be set to the lowest codec mode (CODEC_MODE_1).

The following decision threshold and hysteresis values in terms of normalized carrier to interference ratio (C/I_{norm}), shall apply for Codec Mode Command / Request (MC, MR):

MC'/MR'	THR_MC_Dn(MC')/ THR_MR_Dn(MR')	THR_MC_Up(MC')/ THR_MR_Up(MR')
CODEC_MODE_4	16,0 dB	$+\infty$
CODEC_MODE_3	12,0 dB	18,0 dB
CODEC_MODE_2	8,0 dB	14,0 dB
CODEC_MODE_1	$-\infty$	10,0 dB

The SS transmits Standard Test Signal C1 using 8-PSK on the traffic channel using the Initial Codec Mode (ICM).

The SS continuously sends a CMC corresponding to the highest codec mode (CODEC_MODE_4).

14.4.20.4.2 Procedure

- a) In addition to the wanted signal, the SS produces an independent, uncorrelated interfering signal, Standard Test Signal I1 using 8-PSK (unwanted signal).

The unwanted signal is continuous and has no fixed relationship with the bit transitions of the wanted signal. Its amplitude is 9 dB below that of the wanted signal.

- b) The fading characteristic of the wanted and the interfering signal is set to TUhigh. The SS commands the MS into non hopping mode.
- c) The SS commands the MS to loop back band signaling codewords by closing a Loop I.
- d) The SS shall change the Codec Mode Indication and Codec Mode Command at to the neighbour mode every 22 speech frames (440 ms) by following a scanning pattern (1->2->3->4->4->3->2->1). CMI should initially be increased. CMC should initially be decreased. The CMICMC pattern shall be repeated until the minimum required number of frame samples has been sent to the MS.
- e) The SS compares the in band signalling codewords/frames it sends to the MS with the in band signalling codewords/frames which are looped back from the receiver after demodulation and decoding, and checks for in band signalling (CMI/CMC) frame errors.
- f) The SS determines the frame error events by examining sequences of at least the minimum number of samples of consecutive frames. All frames should be considered when computing the frame error rate: those corresponding to a downlink CMI/CMC transitions and those without downlink CMI/CMC transitions.

NOTE: The delays associated with Loop I are not specified, and will be MS implementation dependant. Loop I should be considered as having two separate parts (DL CMC -> UL CMI and DL CMI -> UL CMR). The delays associated with the two parts may differ. The SS should ensure that the correctly looped inband bits are compared.

Maximum/Minimum Duration of Test

Maximum/minimum: 102 seconds (GSM850, GSM900), 98 seconds (DCS1800, PCS1900).

14.4.20.5 Test requirements

The frame error rate measured in this test shall not exceed the test limit error rate values given in table 14.4.20-1 or table 14.4.20-2.

Table 14.4.20-1: Limits for GSM 400, GSM 700, T-GSM 810, GSM 850 and GSM 900 co-channel rejection

Channel	Propagation condition	Test limit error rate %	Minimum No. of samples
TCH/AHS-INB (FER)	TUhigh/No FH	11.760	5102

Table 14.4.20-2: Limits for DCS 1800 and PCS 1 900 co-channel rejection

Channel	Propagation condition	Test limit error rate %	Minimum No. of samples
TCH/AHS-INB (FER)	TUhigh/No FH	12.320	4870

14.4.21 Co-channel rejection – O-FACCH/H

14.4.21.1 Definition

-

14.4.21.2 Conformance requirement

At reference cochannel interference the O-FACCH/H FER shall meet the reference interference performance of table 2k in 3GPP TS 45.005 subclause 6.3).

14.4.21.3 Test purpose

To verify that the MS does not exceed the conformance requirement under propagation condition TUhigh with an allowance for the statistical significance of the test.

14.4.21.4 Method of test

14.4.21.4.1 Initial conditions

A call is set up according to the generic call set up procedure on a O-TCH/WHS or O-TCH/AHS (as supported by MS) with an ARFCN in the mid ARFCN range. The power control level is set to maximum power.

The SS transmits Standard Test Signal C1 on the traffic channel (wanted signal).

Specific PICS Statements:

- Support of GSM speech half rate version 4 (O-TCH/WHS) (TSPC_O-TCH_WHS)
- Support of GSM speech half rate version 6 (O-TCH/AHS) (TSPC_O-TCH_AHS)

PIXIT Statements:

-

14.4.21.4.2 Procedure

- a) In addition to the wanted signal, the SS produces an independent, uncorrelated interfering signal, Standard Test Signal I1 (unwanted signal).

The unwanted signal is continuous and has no fixed relationship with the bit transitions of the wanted signal. Its amplitude is 10 dB below that of the wanted signal for GSM 800 and GSM 900, and 9.5dB below that of the wanted signal for GSM 1800 and GSM 1900.

The fading characteristic of the wanted and the interfering signal is TU50.

- d) The SS sends a Layer 3 message which does not require a Layer 3 response from the MS. Due to the co-channel interference, the MS may not be able to acknowledge the Layer 2 frame. Each repeated L2 frame indicates a frame erasure event. The SS determines the number of frame erasure events during at least the minimum number of samples of FACCH/H frames.

NOTE: These frames will not be consecutive but it is expected that the statistical significance of the tests will not be unduly degrade.

14.4.21.5 Test requirements

Testing should be performed using statistical methods that lead to an early pass/fail decision with test time significantly reduced for MS with FER/BER not on the limit.

For more information on statistical testing of BER/BLER performance, especially the definition of limit lines refer to Annex 7.

Wrong decision risk F for one single error rate test:

$$F_{\text{pass}} = F_{\text{fail}} = F \quad \text{and} \quad F = 0.2\%$$

Wrong decision probability D per test step:

$$D_{\text{pass}} = D_{\text{fail}} = D \quad \text{and} \quad D = 0.0085\%$$

Parameters for limit lines:

1. D = 0.000085 wrong decision probability per test step
2. M = 1.5 bad DUT factor
3. ne number of (error) events. This parameter is the x-ordinate in figure A7.1.3.1.
4. ns number of samples. The error rate is calculated from ne and ns.

Limit checking

Before limit checking is valid the minimum test time due to fading needs to be considered:

Testing under multipath and interference conditions requires that at least 990 wavelengths are crossed with the speed given in the fading profile. This leads to a minimum test time depending on the frequency range. No early pass/fail decision is allowed until the minimum test time due to fading has elapsed.

Table 14.4.30-1: Minimum test times due to TU 50 fading conditions

Half Rate 50 km/h				
Frequency (GHz)	0,85	0,9	1,8	1,9
Wavelength (m)	0,35	0,33	0,17	0,16
Min test time (s)	403	380	190	180
	0:06:43	0:06:20	0:03:10	0:03:00

If the minimum test time due to multipath conditions exceeds the time taken for obtaining the minimum number of samples, then the test runs for the minimum test time due to multipath conditions and the decision is made by comparing the result with the “derived test limit”. In this case early pass/fail decisions are obsolete.

If the time taken for obtaining the minimum number of samples exceeds the minimum test time due to multipath conditions early pass/fail decisions can be headed for in order to accelerate test execution.

For an early decision a minimum number of (error) events is necessary.

For an early pass decision $ne \geq 1$ (inclusive artificial error)

For an early fail decision $ne \geq 7$

When the minimum number of samples have been obtained the test is finished and a pass/fail decision can be made.

The error rate measured in this test shall be tested according to the values given in table 14.4.30-2.

Table 14.4.30-2: Limits for co-channel rejection

Channel	Type of measurement	Propagation condition	Original BER requirement	Derived test limit	Minimum No. of samples
O-FACCH/H	FER	TUhigh/No FH	0,050000	0,061700	5592

14.4.24 Co-channel interference - O-TCH/WFS

14.4.24.1 Definition

The co-channel interference performance is a measure of the capability of the receiver to receive a wanted modulated signal without exceeding a given degradation due to the presence of an unwanted modulated signal, both signals being at the nominal frequency of the receiver.

14.4.24.2 Conformance requirement

The reference interference performance (for cochannel, C/I_c , or adjacent channel, C/I_a) in terms of frame erasure, bit error or residual bit error rates (whichever appropriate) is specified in table 2, according to the type of channel and the propagation condition. The performance requirements for GSM 400 and GSM 700 systems are as for GSM 900 in table 2, except that the GSM 400 MS speed is doubled from that of GSM 900, e.g. TU50 becomes TU100, and the GSM 700 MS speed is increased by a factor of 1.2, e.g. TU50 becomes TU60. The actual interference ratio is defined as the interference ratio for which this performance is met. The actual interference ratio shall be less than a specified limit, called the reference interference ratio. The reference interference ratio shall be, for BTS and all types of MS:

$$\text{for cochannel interference} \quad C/I_c = 9 \text{ dB}$$

For GMSK modulated channels, packet switched and ECSD and speech channels (AMR-WB), and for 8-PSK modulated channels, packet switched and ECSD and speech channels (AMR and AMR-WB), the minimum interference ratio for which the reference performance for cochannel interference (C/I_c) shall be met is specified in table 2a, 2d, 2e and 2j (GMSK), 2b and 2c, 2d and 2e, and 2k (8-PSK) respectively, according to the type of channel, the propagation condition and type of equipment.

For 8-PSK modulated speech channels (AMR and AMR-WB), ECSD channels and 8-PSK modulated packet-switched channels, the wanted input signal level shall be: $-93 \text{ dBm} + I_r + \text{Corr}$, where:

I_r = the interference ratio according to tables 2b and 2c for packets switched channels, tables 2d and 2e for ECSD and table 2k for speech (AMR and AMR-WB) and associated control channels.

Corr = the correction factor for reference performance according to subclause 6.2

The levels shall be corrected by the following values:

MS, 8-PSK modulated signals

for GSM 400, GSM 900, GSM 850 and GSM 700 small MS	0 dB
for other GSM 400, GSM 900, GSM 850 and GSM 700 MS	-2 dB
for DCS 1 800 and PCS 1900 class 1 or class 2 MS	0 dB
for other DCS 1 800 and PCS 1900 MS	-2 dB

For GMSK modulated speech channels for wideband AMR, and for 8-PSK modulated speech channels for AMR, associated control channels and inband signalling, the minimum input signal level for which the reference performance shall be met is specified in table 1f and 1g respectively for normal BTS, according to the type of channel and the propagation condition. The reference performance shall be:

$$\text{for speech channels (O-TCH/AHSy, O-TCH/WFSy, O-TCH/WHSy)} \quad \text{FER} : \leq 1\%$$

where y denotes the codec rate. All other requirements in tables 1f and 1g shall be fulfilled at this input level for reference performance.

For other equipment than normal BTS, the levels shall be corrected by the values in the table below, describing the reference performance level correction factors for packet switched channels. Furthermore, for all classes of MS supporting 8-PSK speech channels, an additional +2 dB adjustment applies for 8-PSK modulated speech channels.

For T-GSM 810 the requirements for GSM 900 shall apply, apart for those parameters for which a separate requirement exists.

3GPP 45.005 clauses 2, 6.2 and 6.3

Note: The tables 1 and 2 mentioned above can be found in 3GPP 45.005 clause 6.7

14.4.24.3 Test purpose

To verify that the MS does not exceed conformance requirement for FER and class 1b RBER under TUhigh propagation conditions with an allowance for the statistical significance of the test, for channel combinations O-TCH/WFS 8.85 and O-TCH/WFS23.85.

14.4.24.4 Method of test

14.4.24.4.1 Initial conditions

A call is set up according to the generic call set up procedure on a O-TCH/WFS with an ARFCN in the mid ARFCN range, power control level set to maximum power. RADIO_LINK_TIMEOUT is set to maximum.

The multirate configuration indicates the use of a codec set limited to 8,85 kbit/s.

The SS transmits Standard Test Signal C1 on the traffic channel (wanted signal).

The SS commands the MS to create the traffic channel loop back, signalling erased frames (subclause 36).

14.4.24.4.2 Procedure

- a) In addition to the wanted signal, the SS produces an independent, uncorrelated interfering signal, Standard Test Signal I1 (unwanted signal). The unwanted signal is continuous and has no fixed relationship with the bit transitions of the wanted signal.
- b) The fading characteristic of the wanted and the interfering signals are set to TUhigh.
- c) The SS sets the level of the interfering signal to $(-93 + \text{Corr} + 2)$ dBm (where Corr is the correction factor from 14.4.24.2). Throughout the test the C/I (interference ratio) shall be set by modifying the wanted signal.
- d) The interference ratio is set to C/Ic from table 14.4.24-2 or 14.4.24-3.
- e) The SS determines the number of residual bit error events for the bits of the class Ib, by examining sequences of at least the minimum number of samples of consecutive bits of class Ib. Bits are only taken from those frames not signalled as erased.
- f) The SS also determines the frame erasure events by examining sequences of at least the minimum number of samples of consecutive frames and assuming a frame is received successfully, if it is not signalled as erased.

The SS uses a Channel Mode Modify procedure to change the active codec set to 23.85 kbit/s and steps c) to f) are repeated.

Maximum/Minimum Duration of Test

Maximum: 20 minutes (GSM700, T-GSM 810, GSM850 and GSM900), 20 minutes (DCS1800 and PCS1900).

Minimum: 7 minutes (GSM700, T-GSM 810, GSM850 and GSM900), 4 minutes (DCS1800 and PCS1900).

14.4.24.5 Test requirements

Testing should be performed using statistical methods that lead to an early pass/fail decision with test time significantly reduced for MS with FER/BER not on the limit.

For more information on statistical testing of BER/BLER performance, especially the definition of limit lines refer to Annex 7.

Wrong decision risk F for one single error rate test:

$$F_{\text{pass}} = F_{\text{fail}} = F \quad \text{and} \quad F = 0.2\%$$

Wrong decision probability D per test step:

$$D_{\text{pass}} = D_{\text{fail}} = D \quad \text{and} \quad D = 0.0085\%$$

Parameters for limit lines:

1. D = 0.000085 wrong decision probability per test step
2. M = 1.5 bad DUT factor
3. ne number of (error) events. This parameter is the x-ordinate in figure A7.1.3.1.
4. ns number of samples. The error rate is calculated from ne and ns.

Limit checking

Before limit checking is valid the minimum test time due to fading needs to be considered:

Testing under multipath and interference conditions requires that at least 990 wavelengths are crossed with the speed given in the fading profile. This leads to a minimum test time depending on the frequency range. No early pass/fail decision is allowed until the minimum test time due to fading has elapsed.

Table 14.4.24-1: Minimum test times due to TU 50 fading conditions

Full Rate 50 km/h				
Frequency (GHz)	0,85	0,9	1,8	1,9
Wavelength (m)	0,35	0,33	0,17	0,16
Min test time (s)	201	190	95	90
	0:03:21	0:03:10	0:01:35	0:01:30

If the minimum test time due to multipath conditions exceeds the target test time, then the test runs for the minimum test time due to multipath conditions and the decision is made by comparing the result with the “derived test limit”. In this case early pass/fail decisions are obsolete.

If the target test time exceeds the minimum test time due to multipath conditions early pass/fail decisions can be headed for in order to accelerate test execution.

For an early decision a minimum number of (error) events is necessary.

For an early pass decision $ne \geq 1$ (inclusive artificial error)

For an early fail decision $ne \geq 7$

When the target test time has been reached the test is finished and a pass/fail decision can be made.

The error rate measured in this test shall be tested according to the values given in tables 14.4.24-2 and 14.4.24.3.

Table 14.4.24-2: Statistical test limits for GSM 700, T-GSM 810, GSM 850 and GSM 900 O-TCH/WHS co-channel interference

TUhigh / No FH								
0.4 to 0.9GHz		C/Ic dB	Samples per second	Orig. BER requirement	Derived test limit	Target number of samples	Target test time (s)	Target test time (hh:mm:ss)
WFS 8.85	Frames	10.5	50	0,010000	0,012340	27958	560	00:09:20
	Class1b		5650	0,002200	0,002715	127072	23	00:00:23
WFS23.85	Frames	16.0	50	0,010000	0,012340	27958	560	00:09:20
	Class1b		19450	0,001500	0,001851	186386	10	00:00:10

Table 14.4.24-3: Statistical test limits for DCS 1 800 and PCS 1 900 O-TCH/WHS co-channel interference

TUhigh / No FH								
1.8 to 1.9GHz		C/Ic dB	Samples per second	Orig. BER requirement	Derived test limit	Target number of samples	Target test time (s)	Target test time (hh:mm:ss)
WFS 8.85	Frames	9.0	50	0,010000	0,012340	27958	560	00:09:20
	Class1b		5650	0,002800	0,003455	99856	18	00:00:18
WFS23.85	Frames	14.5	50	0,010000	0,012340	27958	560	00:09:20
	Class1b		19450	0,002000	0,002468	139790	8	00:00:08

14.4.25 Co-channel interference – O-TCH/WHS

14.4.25.1 Definition

The co-channel interference performance is a measure of the capability of the receiver to receive a wanted modulated signal without exceeding a given degradation due to the presence of an unwanted modulated signal, both signals being at the nominal frequency of the receiver.

14.4.25.2 Conformance requirement

For 8-PSK modulated channels, speech channels (AMR and AMR-WB), the minimum interference ratio for which the reference performance for cochannel interference (C/Ic) shall be met is specified in table 2k

For 8-PSK modulated speech channels (AMR and AMR-WB), ECSD channels and 8-PSK modulated packet-switched channels, the wanted input signal level shall be: $-93 \text{ dBm} + I_r + \text{Corr}$, where:

I_r = the interference ratio according to tables 2b and 2c for packets switched channels, tables 2d and 2e for ECSD and table 2k for speech (AMR and AMR-WB) and associated control channels.

Corr = the correction factor for reference performance according to subclause 6.2

The levels shall be corrected by the following values:

MS, 8-PSK modulated signals

for GSM 400, GSM 900, GSM 850 and GSM 700 small MS	0 dB
for other GSM 400, GSM 900, GSM 850 and GSM 700 MS	-2 dB
for DCS 1 800 and PCS 1900 class 1 or class 2 MS	0 dB
for other DCS 1 800 and PCS 1900 MS	-2 dB

For all classes of MS supporting 8-PSK speech channels, an additional +2 dB adjustment applies for 8-PSK modulated speech channels.

The reference performance is the same as defined in subclause 6.2.

The reference performance shall be:

- for speech channels (O-TCH/AHSy, O-TCH/WFSy, O-TCH/WHSy) FER : $\leq 1\%$

where y denotes the codec rate. All other requirements in tables 1f and 1g shall be fulfilled at this input level for reference performance.

3GPP TS 45.005, subclauses 6.2, 6.3.

14.4.25.3 Test purpose

To verify that the MS does not exceed conformance requirement for FER and class 1b RBER under TU50 propagation conditions with an allowance for the statistical significance of the test, for channel combinations O-TCH/WHS12.65 and O-TCH/WHS 6.60.

14.4.25.4 Method of test

14.4.25.4.1 Initial conditions

A call is set up according to the generic call set up procedure on a O-TCH/WHS with an ARFCN in the mid ARFCN range, power control level set to maximum power. RADIO_LINK_TIMEOUT is set to maximum.

The multirate configuration indicates the use of a codec set limited to 12,65 kbit/s.

The SS transmits Standard Test Signal C1 on the traffic channel (wanted signal).

The SS commands the MS to create the traffic channel loop back, signalling erased frames (subclause 36).

14.4.25.4.2 Procedure

- a) In addition to the wanted signal, the SS produces an independent, uncorrelated interfering signal, Standard Test Signal I1 (unwanted signal). The unwanted signal is continuous and has no fixed relationship with the bit transitions of the wanted signal.
- b) The fading characteristic of the wanted and the interfering signals are set to TU50.
- c) The SS sets the level of the interfering signal to $(-93 + \text{Corr} + 2)$ dBm (where Corr is the correction factor from 14.4.25.2). Throughout the test the C/I (interference ratio) shall be set by modifying the wanted signal.
- d) The interference ratio is set to C/Ic from table 14.4.25-2 or 14.4.25-3.
- e) The SS determines the number of residual bit error events for the bits of the class Ib, by examining sequences of at least the minimum number of samples of consecutive bits of class Ib. Bits are only taken from those frames not signalled as erased.
- g) The SS also determines the frame erasure events by examining sequences of at least the minimum number of samples of consecutive frames and assuming a frame is received successfully, if it is not signalled as erased.
- h) The SS uses a Channel Mode Modify procedure to change the active codec set to 6.60 kbit/s and steps c) to f) are repeated.

Maximum/Minimum Duration of Test

Maximum: 19 minutes (GSM850), 19 minutes (GSM900), 19 minutes (DCS1800), 19 minutes (PCS1900).

Minimum: 14 minutes (GSM850), 13 minutes (GSM900), 7 minutes (DCS1800), 6 minutes (PCS1900).

14.4.25.5 Test requirements

Testing should be performed using statistical methods that lead to an early pass/fail decision with test time significantly reduced for MS with FER/BER not on the limit.

For more information on statistical testing of BER/BLER performance, especially the definition of limit lines refer to Annex 7.

Wrong decision risk F for one single error rate test:

$$F_{\text{pass}} = F_{\text{fail}} = F \quad \text{and} \quad F = 0.2\%$$

Wrong decision probability D per test step:

$$D_{\text{pass}} = D_{\text{fail}} = D \quad \text{and} \quad D = 0.0085\%$$

Parameters for limit lines:

1. D = 0.000085 wrong decision probability per test step
2. M = 1.5 bad DUT factor
3. ne number of (error) events. This parameter is the x-ordinate in figure A7.1.3.1.
4. ns number of samples. The error rate is calculated from ne and ns.

Limit checking

Before limit checking is valid the minimum test time due to fading needs to be considered:

Testing under multipath and interference conditions requires that at least 990 wavelengths are crossed with the speed given in the fading profile. This leads to a minimum test time depending on the frequency range. No early pass/fail decision is allowed until the minimum test time due to fading has elapsed.

Table 14.4.25-1: Minimum test times due to TU 50 fading conditions

Half Rate 50 km/h				
Frequency (GHz)	0,85	0,9	1,8	1,9
Wavelength (m)	0,35	0,33	0,17	0,16
Min test time (s)	403	380	190	180
	0:06:43	0:06:20	0:03:10	0:03:00

If the minimum test time due to multipath conditions exceeds the target test time, then the test runs for the minimum test time due to multipath conditions and the decision is made by comparing the result with the “derived test limit”. In this case early pass/fail decisions are obsolete.

If the target test time exceeds the minimum test time due to multipath conditions early pass/fail decisions can be headed for in order to accelerate test execution.

For an early decision a minimum number of (error) events is necessary.

For an early pass decision $ne \geq 1$ (inclusive artificial error)

For an early fail decision $ne \geq 7$

When the target test time has been reached the test is finished and a pass/fail decision can be made.

The error rate measured in this test shall be tested according to the values given in tables 14.4.25-2 and 14.4.25.3.

Table 14.4.25-2: Statistical test limits for T-GSM 810, GSM 850 and GSM 900 O-TCH/WHS co-channel interference

TU50 / No FH								
0.8 to 0.9GHz		C/lc dB	Samples per second	Orig. BER requirement	Derived test limit	Target number of samples	Target test time (s)	Target test time (hh:mm:ss)
WHS12.65	Frames	17.0	50	0,010000	0,012340	27958	560	00:09:20
	Class1b		9050	0,002700	0,003332	103542	12	00:00:12
WHS 6.60	Frames	13.5	50	0,010000	0,012340	27958	560	00:09:20
	Class1b		3900	0,001200	0,001481	232951	60	00:01:00

Table 14.4.25-3: Statistical test limits for DCS 1 800 and PCS 1 900 O-TCH/WHS co-channel interference

TU50 / No FH								
1.8 to 1.9GHz		C/Ic dB	Samples per second	Orig. BER requirement	Derived test limit	Target number of samples	Target test time (s)	Target test time (hh:mm:ss)
WHS12.65	Frames	16.5	50	0,010000	0,012340	27958	560	00:09:20
	Class1b		9050	0,003000	0,003702	93193	11	00:00:11
WHS 6.60	Frames	13.0	50	0,010000	0,012340	27958	560	00:09:20
	Class1b		3900	0,001200	0,001481	232951	60	00 :01:00

14.4.26 Co-channel rejection - O-TCH/WFS-INB

14.4.26.1 Definition

The co-channel rejection is a measure of the capability of the receiver to receive a wanted modulated signal without exceeding a given degradation due to the presence of an unwanted modulated signal, both signals being at the nominal frequency of the receiver.

14.4.26.2 Conformance requirement

For GMSK modulated speech channels for wideband AMR, and for 8-PSK modulated speech channels for AMR, associated control channels and inband signalling, the minimum input signal level for which the reference performance shall be met is specified in table 1f and 1g respectively for normal BTS, according to the type of channel and the propagation condition. The reference performance shall be:

- for speech channels (TCH/WFSy) FER : $\leq 1\%$
- for speech channels (O-TCH/AHSy, O-TCH/WFSy, O-TCH/WHSy) FER : $\leq 1\%$
- for fast associated control channels (O-FACCH/F, O-FACCH/H) FER : $\leq 5\%$
- for inband signalling channels (TCH/WFS-INB, O-TCH/AHS-INB, O-TCH/WFS-INB, O-TCH/WHS-INB) FER : $\leq 0,5\%$
- for EVSIDUR and EVRFR FER : $\leq 1\%$

where y denotes the codec rate. All other requirements in tables 1f and 1g shall be fulfilled at this input level for reference performance.

For other equipment than normal BTS, the levels shall be corrected by the values in the table below, describing the reference performance level correction factors for packet switched channels. Furthermore, for all classes of MS supporting 8-PSK speech channels, an additional +2 dB adjustment applies for 8-PSK modulated speech channels.

3GPP TS 45.005; Subclause 6.2

The reference interference performance (for cochannel, C/Ic, or adjacent channel, C/Ia) in terms of frame erasure, bit error or residual bit error rates (whichever appropriate) is specified in table 2, according to the type of channel and the propagation condition. The performance requirements for GSM 400 and GSM 700 systems are as for GSM 900 in table 2, except that the GSM 400 MS speed is doubled from that of GSM 900, e.g. TU50 becomes TU100, and the GSM 700 MS speed is increased by a factor of 1.2, e.g. TU50 becomes TU60. The actual interference ratio is defined as the interference ratio for which this performance is met. The actual interference ratio shall be less than a specified limit, called the reference interference ratio. The reference interference ratio shall be, for BTS and all types of MS:

- for cochannel interference C/Ic = 9 dB
- for adjacent (200 kHz) interference C/Ia1 = -9 dB

- for adjacent (400 kHz) interference $C/I_{a2} = -41$ dB
- for adjacent (600 kHz) interference $C/I_{a3} = -49$ dB

For 8-PSK modulated speech channels (AMR and AMR-WB), ECSD channels and 8-PSK modulated packet-switched channels, the wanted input signal level shall be: -93 dBm + Ir + Corr, where:

Ir = the interference ratio according to tables 2b and 2c for packets switched channels, tables 2d and 2e for ECSD and table 2k for speech (AMR and AMR-WB) and associated control channels.

Corr = the correction factor for reference performance according to subclause 6.2

The levels shall be corrected by the following values:

MS, 8-PSK modulated signals

for GSM 400, GSM 900, GSM 850 and GSM 700 small MS	0 dB
for other GSM 400, GSM 900, GSM 850 and GSM 700 MS	-2 dB
for DCS 1 800 and PCS 1900 class 1 or class 2 MS	0 dB
for other DCS 1 800 and PCS 1900 MS	-2 dB

3GPP TS 45.005; Subcluse 6.3

The delays associated with Loop I remain constant for all of the following circumstances:

- For a given MS implementation.
- For the duration of the MS being powered on.

3GPP TS 44.014 subclause 5.1.7a.1.

14.4.26.3 Test purpose

To verify that the MS does not exceed conformance requirement under propagation condition TU high without frequency hopping with an allowance for the statistical significance of the test.

14.4.26.4 Method of test

14.4.26.4.1 Initial conditions

A call is set up according to the generic call set up procedure on O-TCH/WFS with an ARFCN in the mid ARFCN range, power control level set to maximum power.

The multirate configuration indicates the use of the following set of codecs modes:

Codec Mode	O-TCH/WFS in kbit/s
CODEC_MODE_4	23,85
CODEC_MODE_3	12,65
CODEC_MODE_2	8,85
CODEC_MODE_1	6,60

The Initial Codec Mode shall be set to the lowest codec mode (CODEC_MODE_1).

The following decision threshold and hysteresis values in terms of normalised carrier to interference ratio (C/I_{norm}), shall apply for Codec Mode Command / Request (MC, MR):

MC'/MR'	THR_MC_Dn(MC)/ THR_MR_Dn(MR)	THR_MC_Up(MC)/ THR_MR_Up(MR)
CODEC_MODE_4	18,5 dB	+∞
CODEC_MODE_3	12,5 dB	20,5 dB
CODEC_MODE_2	6,5 dB	14,5 dB
CODEC_MODE_1	~∞	8,5 dB

The SS transmits Standard Test Signal C1 on the traffic channel using the Initial Codec Mode (ICM).

The SS continuously sends a CMC corresponding to the highest codec mode (CODEC_MODE_4).

The SS commands the MS to loop back in band signalling codewords by closing a Loop I.

14.4.26.4.2 Procedure

- a) In addition to the wanted signal, the SS produces an independent, uncorrelated interfering signal, Standard Test Signal I1 (unwanted signal).

The unwanted signal is continuous and has no fixed relationship with the bit transitions of the wanted signal. Its amplitude is set to $(-93 + \text{Corr} + 2)$ dBm (where Corr is the correction factor from 14.4.26.2). The C/I (interference ratio) shall be set by modifying the wanted signal..

The interference ratios C/Ic for the specific frequency bands are set according table 14.4.26-1 or 14.4.26-2.

The fading characteristic of the wanted and the interfering signal is TU high.

- b) The SS shall change the Codec Mode Indication and Codec Mode Command at to the neighbour mode every 22 speech frames (440 ms) by following a scanning pattern (1->2->3->4->4->3->2->1). CMI should initially be increased. CMC should initially be decreased. The CMI/CMC shall be repeated until the minimum required number of frame samples has been sent to the MS.
- c) The SS compares the in band signalling codewords/frames it sends to the MS with the in band signalling codewords/frames which are looped back from the receiver after demodulation and decoding, and checks for in band signalling (CMI/CMC) frame errors.
- d) The SS determines the frame error events by examining sequences of at least the minimum number of samples of consecutive frames. All frames should be considered when computing the frame error rate: those corresponding to a downlink CMI/CMC transitions and those without downlink CMI/CMC transitions.

NOTE: The delays associated with Loop I are not specified, and will be MS implementation dependant. Loop I should be considered as having two separate parts (DL CMC -> UL CMI and DL CMI -> UL CMC). The delays associated with the two parts may differ. The SS should ensure that the correctly looped inband bits are compared. The delays associated with Loop I will remain constant for the duration of the test, thus every UL frame received by the SS will have only one possible expected value.

Maximum/Minimum Duration of Test

Maximum/minimum: 19 minutes.

14.4.26.5 Test requirements

The frame error rate measured in this test shall not exceed the test limit error rate values given in table 14.4.26-1.

Table 14.4.26-1: Limits for T-GSM 810, GSM 850 and GSM 950 O-TCH/WFS-INB co-channel rejection

Channel	Propagation condition	C/Ic dB	Test limit error rate %	Minimum No. of samples
O-TCH/WFS-INB (FER)	TU high/No FH	7.0	0.617	55916

Table 14.4.26-2: Limits for DCS 1800 and PCS 1900 O-TCH/WFS-INB co-channel rejection

Channel	Propagation condition	C/Ic dB	Test limit error rate %	Minimum No. of samples
O-TCH/WFS-INB (FER)	TU high/No FH	6.5	0.617	55916

14.4.27 Void

14.4.28 Co-channel rejection - TCH/WFS

14.4.28.1 Definition

The co-channel rejection is a measure of the capability of the receiver to receive a wanted modulated signal without exceeding a given degradation due to the presence of an unwanted modulated signal, both signals being at the nominal frequency of the receiver.

14.4.28.2 Conformance requirement

At reference co-channel interference the TCH/WFS class Ib BER shall meet the reference interference performance of table 2j in 3GPP TS 45.005 subclause 6.3.

The performance requirements for GSM 400 and GSM 700 systems are as for GSM 900 in table 2j, except that the GSM 400 MS speed is doubled from that of GSM 900, e.g. TU50 becomes TU100, and the GSM 700 MS speed is increased by a factor of 1.2, e.g. TU50 becomes TU60.

For packet switched and AMR-WB speech, GMSK modulated channels the wanted input signal level shall be: $-93 \text{ dBm} + I_r + \text{Corr}$, where:

I_r = the interference ratio according to table 2a and table 2j for the packet switched and AMR-WB speech channels respectively

Corr = the correction factor for reference performance according to subclause 6.2.

3GPP TS 45.005 subclause 6.3

The levels shall be corrected by the following values:

MS, GMSK modulated signals

- for DCS 1 800 class 1 or class 2 MS +2/+4 dB**
- for DCS 1 800 class 3 MS +2 dB
- for GSM 400 small MS, GSM 900 small MS
GSM 850 small MS and GSM 700 small MS +2 dB
- for other GSM 400, GSM 900 MS and GSM
850 MS and GSM 700 MS 0 dB
- for PCS 1900 class 1 or class 2 MS +2 dB
- for other PCS 1900 MS 0 dB

** For DCS 1 800 class 1 and class 2 MS, a correction offset of +2dB shall apply for the reference sensitivity performance as specified in table 1a for the normal conditions defined in Annex D and an offset of +4 dB shall be used to determine all other MS performances.

3GPP TS 45.005 subclause 6.2

For T-GSM 810 the requirements for GSM 900 shall apply, apart for those parameters for which a separate requirement exists.

3GPP TS 45.005 subclause 2

14.4.28.3 Test purpose

1. To verify that the MS does not exceed conformance requirement at the maximum implemented codec rate under propagation condition TUhigh (for GSM 700, T-GSM 810, GSM 850, GSM 900, DCS 1800 and PSC 1900) with no frequency hopping, RAhigh with no frequency hopping (for GSM 700, T-GSM 810, GSM 850 and GSM 900), and TULow (for GSM 700, T-GSM 810, GSM 850 and GSM900) with no frequency hopping with an allowance for the statistical significance of the test.

2. To verify that the MS does not exceed conformance requirement for the remaining implemented codec rates under propagation condition TU_{high} with no frequency hopping with an allowance for the statistical significance of the test.

14.4.28.4 Method of test

14.4.28.4.1 Initial conditions

A call is set up according to the generic call set up procedure on a TCH/WFS with an ARFCN in the mid ARFCN range, power control level set to maximum power. RADIO_LINK_TIMEOUT is set to maximum.

The multirate configuration indicates the use of a codec set limited to 6.60 kbit/s.

The SS transmits Standard Test Signal C1 on the traffic channel (wanted signal).

The SS commands the MS to create the traffic channel loop back, signalling erased frames (subclause 36).

Specific PICS statements:

- TSPC_Type_SmallMS
- TSPC_Type_DCS_Class1
- TSPC_Type_DCS_Class2
- TSPC_Type_DCS_Class3
- TSPC_Type_PCS_Class1
- TSPC_Type_PCS_Class2

PIXIT statements:

-

14.4.28.4.2 Procedure

- a) In addition to the wanted signal, the SS produces an independent, uncorrelated interfering signal, Standard Test Signal I1 (unwanted signal).

The unwanted signal is continuous and has no fixed relationship with the bit transitions of the wanted signal. The unwanted signal shall be set to $(-93 + \text{Corr})$ dB (where Corr is the correction factor from 14.4.28.2). Throughout the test the C/I (interference ratio) shall be set by modifying the wanted signal.

The interference ratio is set to C/I_c from table 14.4.28-6 or 14.4.28-7.

The fading characteristic of the wanted and the interfering signal is TU_{High} non-hopping (TU50 for T-GSM 810, GSM 850 and GSM 900, TU60 for GSM 700).

- b) The SS compares the modulation of the signal that it sends to the MS with the signal which is looped back from the receiver after demodulation and decoding, and checks the frame erasure indication.
- c) The SS determines the number of residual bit error events for the bits of the class Ib, by examining at least the minimum number of samples of consecutive bits of class Ib. Bits are only taken from those frames not signalled as erased.
- d) The SS also determines the frame erasure events by examining at least the minimum number of samples of consecutive frames and assuming a frame is received successfully if it is not signalled as erased.
- e) The SS uses a Channel Mode Modify procedure to change the active codec set to 8.85 kbit/s, and the interference ratio is adjust to C/I_c from table 14.4.28-6 or 14.4.28-7. Steps b) to d) are repeated.
- f) The SS uses a Channel Mode Modify procedure to change the active codec set to 12.65 kbit/s, and the interference radio adjust to C/I_c from table 14.4.28-6 or 14.4.28-7.. Steps b) to d) are repeated.
- h) If DCS 1800 or PCS 1900 then skip steps i) and j).

- i) The fading characteristic of the wanted and the interfering signal is set to TULow non-hopping (TU3 for T-GSM 810, GSM 850 and GSM 900, TU3.6 for GSM 700), and the interference ratio adjusted to C/Ic from table 14.4.28-4. Steps b) to d) are repeated.
- j) The fading characteristic of the wanted and the interfering signal is set to RAHigh non-hopping (RA250 for T-GSM 810, GSM 850 and GSM 900, RA300 for GSM 700) and the interference ratio adjusted to C/Ic from table 14.4.28-5. Steps b) to d) are repeated.

Maximum/Minimum Duration of Test

- Maximum: 30 minutes (GSM 700), 25 minutes (GSM850, GSM900) or 5 minutes (DCS1800, PCS1900).
- Minimum: 30 minutes (GSM 700), 25 minutes, (GSM850, GSM900) or 5 minutes (DCS1800, PCS1900).

14.4.28.5 Test requirements

Testing the Co-channel interference performance is performed using statistical methods that lead to an early pass/fail decision with test time significantly reduced for MS with BER/BLER not on the limit.

For more information on statistical testing of BER/BLER performance, especially the definition of limit lines refer to Annex A7.

Wrong decision risk F for one single error rate test:

$$F_{\text{pass}} = F_{\text{fail}} = F \quad \text{and} \quad F = 0.2\%$$

Wrong decision probability D per test step:

$$D_{\text{pass}} = D_{\text{fail}} = D \quad \text{and} \quad D = 0.0085\%$$

Parameters for limit lines:

1. D = 0.000085 wrong decision probability per test step.
2. M = 1.5 bad DUT factor
3. ne number of (error) events. This parameter is the x-ordinate in figure 14-1.
4. ns number of samples. The error rate is calculated from ne and ns.

Limit checking

Before limit checking is valid the minimum test time due to fading needs to be considered:

Testing under multipath and interference conditions requires that at least 990 wavelengths are crossed for fading profiles greater than 5km/h, and 250 wavelengths are crossed for fading profiles less than or equal to 5km/h. This leads to a minimum test time depending on the frequency range. No early pass/fail decision is allowed until the minimum test time due to fading has elapsed.

Table 14.4.28-1: Minimum test times due to TU low fading conditions

Full Rate 3 km/h							
Frequency	0,4	0,7	0,85	0,9	1,8	1,9	GHz
Wavelength	0,75	0,43	0,35	0,33	-	-	m
min test time	1800	1029	847	800	-	-	S
	0:30:00	0:17:09	0:14:07	0:13:20	-	-	hh:mm:ss
Full Rate 3.6km/h							
Frequency	0,4	0,7	0,85	0,9	1,8	1,9	GHz
Wavelength	0,75	0,43	0,35	0,33	-	-	m
min test time	1500	857	706	667	-	-	S
	0:25:00	0:14:17	0:11:46	0:11:07	-	-	hh:mm:ss

Table 14.4.28-2: Minimum test times due to TU high fading conditions

Full Rate 50 km/h							
Frequency	0,4	0,7	0,85	0,9	1,8	1,9	GHz
Wavelength	0,75	0,43	0,35	0,33	0,17	0,16	m
min test time	428	244	201	190	95	90	s
	0:07:08	0:04:04	0:03:21	0:03:10	0:01:35	0:01:30	hh:mm:ss
Full Rate 60 km/h							
Frequency	0,4	0,7	0,85	0,9	1,8	1,9	GHz
Wavelength	0,75	0,43	0,35	0,33	0,17	0,16	m
min test time	356	204	168	158	79	75	s
	0:05:56	0:03:24	0:02:48	0:02:38	0:01:19	0:01:15	hh:mm:ss

Table 14.4.28-3: Minimum test times due to RA high fading conditions

Full Rate 250 km/h							
Frequency	0,4	0,7	0,85	0,9	1,8	1,9	GHz
Wavelength	0,75	0,43	0,35	0,33	-	-	m
min test time	86	49	40	38	-	-	S
	0:1:26	0:0:49	0:0:40	0:0:38	-	-	hh:mm:ss
Full Rate 300 km/h							
Frequency	0,4	0,7	0,85	0,9	1,8	1,9	GHz
Wavelength	0,75	0,43	0,35	0,33	-	-	m
min test time	71	41	34	32	-	-	S
	0:1:11	0:0:41	0:0:34	0:0:32	-	-	hh:mm:ss

If the minimum test time due to multipath conditions exceeds the target test time, then the test runs for the minimum test time due to multipath conditions and the decision is done by comparing the result with the “derived test limit”. In this case early pass/fail decisions are obsolete.

If the target test time exceeds the minimum test time due to multipath conditions early pass/fail decisions can be headed for in order to accelerate test execution.

For an early decision a minimum number of (error) events is necessary.

For an early pass decision $ne \geq 1$ (inclusive artificial error)

For an early fail decision $ne \geq 7$

When the target test time has been reached the test is finished and a pass/fail decision can be made.

The error rate measured in this test shall be tested according to the values given in tables 14.4.28-4 through 14.4.28-7.

Table 14.4.28-4: Statistical test limits for GSM 700, T-GSM 810, GSM 850 and GSM 900 TU low no FH

0.4 to 0.9GHz		C/lc (dB)	Samples per second	Orig. BER requirement	Derived test limit	Target number of samples	Target test time (s)	Target test time (hh:mm:ss)
WFS 12.65	frames	21.5	50	0,010000	0,012340	27958	560	00:09:20
	Class1b	(as frames)	9050	0,000800	0,000987	349473	39	00:00:39

Table 14.4.28-5: Statistical test limits for GSM 700, T-GSM 810, GSM 850 and GSM 900 RA High no FH

0.4 to 0.9GHz		C/lc (dB)	Samples per second	Orig. BER requirement	Derived test limit	Target number of samples	Target test time (s)	Target test time (hh:mm:ss)
WFS 12.65	frames	21.5	50	0,010000	0,012340	27958	560	00:09:20
	Class1b	(as frames)	9050	0,006300	0,007774	44378	5	00:00:05

Table 14.4.28-6: Statistical test limits for GSM 700, T-GSM 810, GSM 850 and GSM 900 TU high no FH

0.4 to 0.9GHz		C/lc (dB)	Samples per second	Orig. BER requirement	Derived test limit	Target number of samples	Target test time (s)	Target test time (hh:mm:ss)
WFS 12.65	frames	14.5	50	0,010000	0,012340	27958	560	00:09:20
	Class1b	(as frames)	9050	0,004000	0,004936	69895	8	00:00:08
WFS 8.85	frames	11.5	50	0,010000	0,012340	27958	560	00:09:20
	Class1b	(as frames)	5650	0,004200	0,005183	66566	12	00:00:12
WFS 6.60	frames	10.5	50	0,010000	0,012340	27958	560	00:09:20
	Class1b	(as frames)	3900	0,001600	0,001974	174737	45	00:00:45

Table 14.4.28-7: Statistical test limits for DCS 1 800 and PCS 1 900 TU high no FH

0.4 to 0.9GHz		C/lc (dB)	Samples per second	Orig. BER requirement	Derived test limit	Target number of samples	Target test time (s)	Target test time (hh:mm:ss)
WFS 12.65	frames	14.5	50	0,010000	0,012340	27958	560	00:09:20
	Class1b	(as frames)	9050	0,006300	0,007774	44378	5	00:00:05
WFS 8.85	frames	11.5	50	0,010000	0,012340	27958	560	00:09:20
	Class1b	(as frames)	5650	0,006400	0,007898	43684	8	00:00:08
WFS 6.60	frames	10.5	50	0,010000	0,012340	27958	560	00:09:20
	Class1b	(as frames)	3900	0,002700	0,003332	103548	27	00:00:27

14.4.29 Co-channel interference - TCH/WFS-INB

14.4.29.1 Definition

The co-channel interference is a measure of the capability of the receiver to receive a wanted modulated signal without exceeding a given degradation due to the presence of an unwanted modulated signal, both signals being at the nominal frequency of the receiver.

14.4.29.2 Conformance requirement

At reference co-channel interference the TCH/WFS-INB FER shall meet the reference interference performance of TCH/AFS-INB FER, as stated in NOTE 5 in table 2j in 3GPP TS 45.005 subclause 6.3.

The delays associated with Loop I remain constant for all of the following circumstances:

- For a given MS implementation.
- For the duration of the MS being powered on.

NOTE: While a Loop I is active, it is expected that the SS transmit a valid downlink signal including speech frames channel encoded according to the DL CMI.

3GPP TS 44.014 subclause 5.1.7a.1.

The performance requirements for GSM 400 and GSM 700 systems are as for GSM 900 in table 2j, except that the GSM 400 MS speed is doubled from that of GSM 900, e.g. TU50 becomes TU100, and the GSM 700 MS speed is increased by a factor of 1.2, e.g. TU50 becomes TU60.

3GPP TS 45.005 subclause 6.3

For T-GSM 810 the requirements for GSM 900 shall apply, apart for those parameters for which a separate requirement exists.

3GPP TS 45.005 subclause 2.

14.4.29.3 Test purpose

1. To verify that the MS does not exceed conformance requirement at the maximum implemented codec rate under propagation condition TU_{high} (for GSM 700, T-GSM 810, GSM 850, GSM 900, DCS 1800 and PSC 1900) with no frequency hopping with an allowance for the statistical significance of the test.
2. To verify that the MS does not exceed conformance requirement for the remaining implemented codec rates under propagation condition TU_{high} with no frequency hopping with an allowance for the statistical significance of the test.

14.4.29.4 Method of test

14.4.29.4.1 Initial conditions

A call is set up according to the generic call set up procedure on a TCH/WFS with an ARFCN in the mid ARFCN range, power control level set to maximum power.

The multirate configuration indicates the use of the following set of codecs modes:

Codec Mode	TCH/WFS in kbit/s
CODEC_MODE_3	12.65
CODEC_MODE_2	8.85
CODEC_MODE_1	6.6

The Initial Codec Mode shall be set to the lowest codec mode (CODEC_MODE_1).

The following decision threshold and hysteresis values in terms of normalized carrier to interference ratio (C/I_{norm}), shall apply for Codec Mode Command / Request (MC, MR):

MC/MR'	THR_MC_Dn(MC)/ THR_MR_Dn(MR)	THR_MC_Up(MC)/ THR_MR_Up(MR)
CODEC_MODE_3	18,5 dB	+ ∞
CODEC_MODE_2	12,5 dB	20,5 dB
CODEC_MODE_1	- ∞	14.5 dB

The SS transmits Standard Test Signal C1 on the traffic channel using the Initial Codec Mode (ICM).

The SS continuously sends a CMC corresponding to the highest codec mode (CODEC_MODE_3).

The SS commands the MS to loop back in band signaling codewords by closing a Loop I.

Specific PICS Statements

-

PIXIT Statements

-

14.4.29.4.2 Procedure

- a) In addition to the wanted signal, the SS produces an independent, uncorrelated interfering signal, Standard Test Signal II (unwanted signal).

The unwanted signal is continuous and has no fixed relationship with the bit transitions of the wanted signal. Its amplitude is 6 dB below that of the wanted signal (9 dB – 3 dB less attenuation on the interfering signal).

The fading characteristic of the wanted and the interfering signal is TUHigh non-hopping (TU50 for T-GSM 810, GSM 850 and GSM 900, TU60 for GSM 700).

- b) The SS shall change the Codec Mode Indication and Codec Mode Command at to the neighbour mode every 22 speech frames (440 ms) by following a scanning pattern (1->2->3->3->2->1). CMI should initially be increased. CMC should initially be decreased. The CMI/CMC shall be repeated until the minimum required number of frame samples has been sent to the MS.
- c) The SS compares the in band signalling codewords/frames it sends to the MS with the in band signalling codewords/frames which are looped back from the receiver after demodulation and decoding, and checks for in band signalling (CMI/CMC) frame errors.
- d) The SS determines the frame error events by examining sequences of at least the minimum number of samples of consecutive frames. All frames should be considered when computing the frame error rate: those corresponding to a downlink CMI/CMC transitions and those without downlink CMI/CMC transitions.

NOTE: The delays associated with Loop I are not specified, and will be MS implementation dependant. Loop I should be considered as having two separate parts (DL CMC -> UL CMI and DL CMI -> UL CMR). The delays associated with the two parts may differ. The SS should ensure that the correctly looped inband bits are compared. The delays associated with Loop I will remain constant for the duration of the test, thus every UL frame received by the SS will have only one possible expected value.

Maximum/Minimum Duration of Test

Maximum/minimum: 45 minutes (GSM 700, GSM850, GSM900).

Maximum/minimum: 80 minutes (DCS1800, PCS1900).

14.4.29.5 Test requirements

The frame error rate measured in this test shall not exceed the test limit error rate values given in table 14.4.29-1 or 14.4.29-2.

Co-channel rejection tests with a frequency condition noted as "@ndB" are performed with the interfering frequency transmitted with an additional n dB attenuation, see 3GPP TS 45.005.

Table 14.4.29-1: Limits for GSM 400, GSM 700, T-GSM 810, GSM 850 and GSM 900 co-channel rejection

Channel	Propagation condition	Test limit error rate %	Minimum No. of samples
TCH/WFS-INB (FER)	TUhigh/No FH@-3 dB	0.271	127081

Table 14.4.29-2: Limits for DCS 1800 and PCS 1 900 co-channel rejection

Channel	Propagation condition	Test limit error rate %	Minimum No. of samples
TCH/WFS-INB (FER)	TUhigh/No FH@-3 dB	0.148	232982

14.4.30 Co-channel interference - O-FACCH/F

14.4.30.1 Definition

The co-channel interference performance is a measure of the capability of the receiver to receive a wanted modulated signal without exceeding a given degradation due to the presence of an unwanted modulated signal, both signals being at the nominal frequency of the receiver.

14.4.30.2 Conformance requirement

The reference interference performance (for cochannel, C/I_c , or adjacent channel, C/I_a) in terms of frame erasure, bit error or residual bit error rates (whichever appropriate) is specified in table 2, according to the type of channel and the propagation condition. The performance requirements for GSM 400 and GSM 700 systems are as for GSM 900 in table 2, except that the GSM 400 MS speed is doubled from that of GSM 900, e.g. TU50 becomes TU100, and the GSM 700 MS speed is increased by a factor of 1.2, e.g. TU50 becomes TU60. The actual interference ratio is defined as the interference ratio for which this performance is met.

For GMSK modulated channels, packet switched and ECSD and speech channels (AMR-WB), and for 8-PSK modulated channels, packet switched and ECSD and speech channels (AMR and AMR-WB), the minimum interference ratio for which the reference performance for cochannel interference (C/I_c) shall be met is specified in table 2a, 2d, 2e and 2j (GMSK), 2b and 2c, 2d and 2e, and 2k (8-PSK) respectively, according to the type of channel, the propagation condition and type of equipment.

For 8-PSK modulated speech channels (AMR and AMR-WB), ECSD channels and 8-PSK modulated packet-switched channels, the wanted input signal level shall be: $-93 \text{ dBm} + I_r + \text{Corr}$, where:

I_r = the interference ratio according to tables 2b and 2c for packets switched channels, tables 2d and 2e for ECSD and table 2k for speech (AMR and AMR-WB) and associated control channels.

Corr = the correction factor for reference performance according to subclause 6.2

For GMSK modulated speech channels for wideband AMR, and for 8-PSK modulated speech channels for AMR, associated control channels and inband signalling, the minimum input signal level for which the reference performance shall be met is specified in table 1f and 1g respectively for normal BTS, according to the type of channel and the propagation condition. The reference performance shall be:

- for fast associated control channels (O-FACCH/F, FER : $\leq 5\%$
O-FACCH/H)

For other equipment than normal BTS, the levels shall be corrected by the values in the table below, describing the reference performance level correction factors for packet switched channels. Furthermore, for all classes of MS supporting 8-PSK speech channels, an additional +2 dB adjustment applies for 8-PSK modulated speech channels.

3GPP 45.005 clauses 6.2 and 6.3

Note: The tables 1 and 2 mentioned above can be found in 3GPP 45.005 clause 6.7

14.4.30.3 Test purpose

To verify that the MS does not exceed the conformance requirement under propagation condition TUlow with an allowance for the statistical significance of the test, for channel combinations O-TCH/WFS 12.65.

14.4.30.4 Method of test

14.4.30.4.1 Initial conditions

A call is set up according to the generic call set up procedure on a O-TCH/WFS with an ARFCN in the mid ARFCN range, power control level set to maximum power.

The multirate configuration indicates the use of a codec set limited to 12,65 kbit/s.

The SS transmits Standard Test Signal C1 on the traffic channel (wanted signal).

14.4.30.4.2 Procedure

- a) In addition to the wanted signal, the SS produces an independent, uncorrelated interfering signal, Standard Test Signal I1 (unwanted signal).

The unwanted signal is continuous and has no fixed relationship with the bit transitions of the wanted signal. Its amplitude is 15,5 dB below that of the wanted signal.

The fading characteristic of the wanted and the interfering signal is TUlow.

- d) The SS sends a Layer 3 message which does not require a Layer 3 response from the MS. Due to the co-channel interference, the MS may not be able to acknowledge the Layer 2 frame. Each repeated L2 frame indicates a frame erasure event. The SS determines the number of frame erasure events during at least the minimum number of samples of FACCH/F frames.

NOTE: These frames will not be consecutive but it is expected that the statistical significance of the tests will not be unduly degraded.

14.4.30.5 Test requirements

The error rate measured in this test shall not exceed the test limit error rate values given in table 14.4.30-1.

Table 14.4.30-1: Limits for co-channel rejection

Channel	Type of measurement	Propagation condition	Test limit error rate %	Minimum No. of samples
O-FACCH/F	FER	TUlow/No FH	18	25 000

14.4.31 Co-channel rejection – Repeated FACCH/F

14.4.31.1 Definition

The co-channel rejection is a measure of the capability of the receiver to receive a wanted modulated signal without exceeding a given degradation due to the presence of an unwanted modulated signal, both signals being at the nominal frequency of the receiver.

14.4.31.2 Conformance requirement

The reference performance for Repeated Downlink FACCH and Repeated SACCH shall be $FER \leq 5\%$.

3GPP TS 45.005 subclause 6.2

When calculating FER, a FACCH frame and its repetition or a SACCH frame and its repetition respectively, shall be counted as one frame and a frame erasure shall be counted when neither the FACCH frame nor its repetition or neither the SACCH frame nor its repetition respectively, could be successfully decoded.

3GPP TS 45.005 subclause 6.2.

For Repeated Downlink FACCH and Repeated SACCH (see 3GPP TS 44.006), the minimum interference ratio for which the reference performance for cochannel interference (C/I_c) shall be met is specified in table 2p according to the propagation condition and type of equipment. The performance requirements for GSM 400 and GSM 700 systems are as for GSM 900 in table 2a, 2b, 2c, 2d, 2e, 2j, 2k, 2m and 2p except that the GSM 400 MS speed is doubled from that of GSM 900, e.g. TU50 becomes TU100, and the GSM 700 MS speed is increased by a factor of 1.2, e.g. TU50 becomes TU60.

3GPP TS 45.005 subclause 6.3

For Repeated Downlink FACCH and Repeated SACCH (see 3GPP TS 44.006), the wanted input signal level shall be: - 93 dBm + Ir + Corr, where:

Ir = the interference ratio according to table 2p.

Corr = the correction factor for reference performance according to subclause 6.2

3GPP TS 45.005 subclause 6.3

The levels shall be corrected by the following values:

MS, GMSK modulated signals

- for DCS 1 800 class 1 or class 2 MS +2/+4 dB**
- for DCS 1 800 class 3 MS +2 dB
- for GSM 400 small MS, GSM 900 small MS
GSM 850 small MS and GSM 700 small MS +2 dB
- for other GSM 400, GSM 900 MS and GSM
850 MS and GSM 700 MS 0 dB
- for PCS 1900 class 1 or class 2 MS +2 dB
- for other PCS 1900 MS 0 dB

** For DCS 1 800 class 1 and class 2 MS, a correction offset of +2dB shall apply for the reference sensitivity performance as specified in table 1a for the normal conditions defined in Annex D and an offset of +4 dB shall be used to determine all other MS performances.

3GPP TS 45.005 subclause 6.2

For T-GSM 810 the requirements for GSM 900 shall apply, apart for those parameters for which a separate requirement exists.

3GPP TS 45.005 subclause 2.

14.4.31.3 Test purpose

To verify that the MS does not exceed the conformance requirements under propagation condition TUhigh with an allowance for the statistical significance of the test.

14.4.31.4 Method of test

14.4.31.4.1 Initial conditions

A call is set up according to the generic call set up procedure on a TCH with an ARFCN in the mid ARFCN range. For MS supporting speech this shall be a TCH/FS. For MS not supporting speech one of the supported TCH/ (F9,6, F4,8, or F2,4) shall be used. The power control level is set to maximum power.

The SS shall use Repeated FACCH for command and response frames for the duration of the test.

Each pair of FACCHs are counted as a single sample.

The SS transmits Standard Test Signal C1 on the traffic channel (wanted signal).

Specific PICS statements:

- TSPC_Type_SmallMS
- TSPC_Type_DCS_Class1
- TSPC_Type_DCS_Class2
- TSPC_Type_DCS_Class3
- TSPC_Type_PCS_Class1
- TSPC_Type_PCS_Class2

PIXIT statements:

-

14.4.31.4.2 Procedure

- a) In addition to the wanted signal, the SS produces an independent, uncorrelated interfering signal, Standard Test Signal I1 (unwanted signal).

The unwanted signal is continuous and has no fixed relationship with the bit transitions of the wanted signal. The unwanted signal shall be set to $(-93 + \text{Corr})$ dB (where Corr is the correction factor from the table above). Throughout the test the C/I (interference ratio) shall be set by modifying the wanted signal.

The fading characteristic of the wanted and the interfering signal is TUhigh.

- b) The SS sends a Layer 3 message which does not require a Layer 3 response from the MS. Due to the co-channel interference, the MS may not be able to acknowledge an RR frame and the L2 entity of the SS will repeat the Layer 2 frame. Each retransmitted L2 frame indicates a frame erasure event. The SS determines the number of frame erasure events during at least the minimum number of samples of FACCH/F frames.

NOTE: These frames will not be consecutive but it is expected that the statistical significance of the tests will not be unduly degraded.

Maximum/Minimum Duration of Test

Maximum: 12 minutes.

Minimum: 4 minutes (GSM700, GSM850, GSM900), 2 minutes (DCS1800, PCS900)

14.4.31.5 Test requirements

The error rate measured in this test shall not exceed the test limit error rate values given in table 14.4.31-2

For more information on statistical testing of FER performance, especially the definition of limit lines refer to Annex A7.

Table 14.4.31-1: Minimum test times due to TU high fading conditions

Full Rate 50 km/h						
Frequency	0,7	0,85	0,9	1,8	1,9	GHz
Wavelength	-	0,35	0,33	0,17	0,16	m
min test time	-	201	190	95	90	s
	-	0:03:21	0:03:10	0:01:35	0:01:30	hh:mm:ss
Full Rate 60 km/h						
Frequency	0,7	0,85	0,9	1,8	1,9	GHz
Wavelength	0,43	-	-	-	-	m
min test time	204	-	-	-	-	s
	0:03:24	-	-	-	-	hh:mm:ss

Table 14.4.31-2: Test Limits for Repeated FACCH/F sensitivity

Channel	Type of measurement	Propagation condition	Original FER requirement	Derived test limit %	Target number of samples
FACCH/F	FER	TUhigh/No FH	5,00	6,17	5592

Table 14.4.31-3: Maximum test times

Maximum test time (best rate 50/3 per second) (s)	Maximum test time (best rate 50/3 per second) (hh:mm:ss)	Maximum test time (worst rate 50/6 per second) (s)	Maximum test time (worst rate 50/6 per second) (hh:mm:ss)
336	00:05:36	671	00:11:11

14.4.32 Co-channel rejection – Repeated SACCH

14.4.32.1 Definition

The co-channel rejection is a measure of the capability of the receiver to receive a wanted modulated signal without exceeding a given degradation due to the presence of an unwanted modulated signal, both signals being at the nominal frequency of the receiver.

14.4.32.2 Conformance requirement

The reference performance for Repeated Downlink FACCH and Repeated SACCH shall be $FER \leq 5\%$.

3GPP TS 45.005 subclause 6.2

When calculating FER, a FACCH frame and its repetition or a SACCH frame and its repetition respectively, shall be counted as one frame and a frame erasure shall be counted when neither the FACCH frame nor its repetition or neither the SACCH frame nor its repetition respectively, could be successfully decoded.

3GPP TS 45.005 subclause 6.2.

For Repeated Downlink FACCH and Repeated SACCH (see 3GPP TS 44.006), the minimum interference ratio for which the reference performance for cochannel interference (C/Ic) shall be met is specified in table 2p according to the propagation condition and type of equipment. The performance requirements for GSM 400 and GSM 700 systems are as for GSM 900 in table 2a, 2b, 2c, 2d, 2e, 2j, 2k, 2m and 2p except that the GSM 400 MS speed is doubled from that of GSM 900, e.g. TU50 becomes TU100, and the GSM 700 MS speed is increased by a factor of 1.2, e.g. TU50 becomes TU60.

3GPP TS 45.005 subclause 6.3

For Repeated Downlink FACCH and Repeated SACCH (see 3GPP TS 44.006), the wanted input signal level shall be: -93 dBm + Ir + Corr, where:

Ir = the interference ratio according to table 2p.

Corr = the correction factor for reference performance according to subclause 6.2

3GPP TS 45.005 subclause 6.3

The levels shall be corrected by the following values:

<u>MS, GMSK modulated signals</u>		
-	for DCS 1 800 class 1 or class 2 MS	+2/+4 dB**
-	for DCS 1 800 class 3 MS	+2 dB
-	for GSM 400 small MS, GSM 900 small MS GSM 850 small MS and GSM 700 small MS	+2 dB
-	for other GSM 400, GSM 900 MS and GSM 850 MS and GSM 700 MS	0 dB
	for PCS 1900 class 1 or class 2 MS	+2 dB
	for other PCS 1900 MS	0 dB

** For DCS 1 800 class 1 and class 2 MS, a correction offset of +2dB shall apply for the reference sensitivity performance as specified in table 1a for the normal conditions defined in Annex D and an offset of +4 dB shall be used to determine all other MS performances.

3GPP TS 45.005 subclause 6.2

For T-GSM 810 the requirements for GSM 900 shall apply, apart for those parameters for which a separate requirement exists.

3GPP TS 45.005 subclause 2.

14.4.32.3 Test purpose

To verify that the MS does not exceed the conformance requirements under propagation condition TUhigh with an allowance for the statistical significance of the test.

14.4.32.4 Method of test

For details on Repeated SACCH Layer 1 test method, please refer to Annex 10.

14.4.32.4.1 Initial conditions

A call is set up according to the generic call set up procedure on a TCH with an ARFCN in the mid ARFCN range. For MS supporting speech this shall be a TCH/FS. For MS not supporting speech one of the supported TCH/ (F9,6, F4,8, or F2,4) shall be used. The power control level is set to maximum power.

The SS shall use Repeated SACCH for all SACCH block on the downlink for the duration of the test.

Each pair of SACCH blocks (i.e. one Repeated SACCH block-pair) shall be counted as a single sample.

The SS shall send different PCL for each sample following Table 14.4.32-1 for the duration of the test.

The SS transmits Standard Test Signal C1 on the traffic channel (wanted signal).

Specific PICS statements:

- TSPC_Type_SmallMS
- TSPC_Type_DCS_Class1
- TSPC_Type_DCS_Class2
- TSPC_Type_DCS_Class3
- TSPC_Type_PCS_Class1
- TSPC_Type_PCS_Class2

PIXIT statements:

-

14.4.32.4.2 Procedure

- a) In addition to the wanted signal, the SS produces an independent, uncorrelated interfering signal, Standard Test Signal I1 (unwanted signal).

The unwanted signal is continuous and has no fixed relationship with the bit transitions of the wanted signal. The unwanted signal shall be set to $(-93 + \text{Corr})$ dB (where Corr is the correction factor from 14.4.32.2). Throughout the test the C/I (interference ratio) shall be set by modifying the wanted signal.

The fading characteristic of the wanted and the interfering signal is TUhigh/NoFH.

- b) Following the reception of the last burst of the MS UL SACCH corresponding to the second SACCH block of a repeated SACCH interval, the SS shall compute the PCL value to use in the SS DL SACCH blocks for the next repeated SACCH interval using Table 14.4.32-1.
- i) The first two columns of Table 14.4.32-1 are inputs, the last column is a output.
 - ii) SACCH blocks are grouped into sets of 2 consecutive SACCH blocks which is called a repeated SACCH interval.
 - iii) Last commanded PCL by SS refers to the PCL used in the DL SACCH L1 headers for repeated SACCH interval N
 - iv) Corresponding reported MS PCL refers to the PCL reported in the UL SACCH L1 header of second SACCH block on repeated SACCH interval N
 - v) Next commanded PCL by SS refers to the PCL that the SS will use in the DL SACCH L1 headers for repeated SACCH interval N+1..

Table 14.4.32-1: Power Control Level Used by SS

Last commanded PCL by SS	Corresponding Reported MS PCL	Next commanded PCL by SS
7	7	8
7	8	9
7	9	8
8	7	9
8	8	9
8	9	7
9	7	8
9	8	7
9	9	7

c) The SS compares the MS reported PCL in the uplink SACCH L1 header of the Repeated SACCH block against the expected PCL (based on the previously commanded PCL in the downlink SACCH L1 header taking into account round-trip delays). If the MS reported PCL in the uplink SACCH L1 header is different than the expected PCL, this will invoke a frame erasure event.

d) The SS determines the frame erasure events during at least the minimum number of samples of SACCH frames.

NOTE: These frames will be consecutive and it is expected that the statistical significance of the tests will not be unduly degraded.

Maximum/Minimum Duration of Test

Maximum: 90 minutes

Minimum: 2 minutes

14.4.32.5 Test requirements

The error rate measured in this test shall not exceed the test limit error rate values given in table 14.4.32-2.

For more information on statistical testing of FER performance, especially the definition of limit lines refer to Annex A7.

Table 14.4.32-2: Test Limits for Repeated SACCH sensitivity

Channel	Type of measurement	Propagation condition	Original FER requirement	Derived test limit %	Target number of samples
SACCH	FER	TUhigh/No FH	5,00	6,17	5592

Table 14.4.32-3: Minimum/Maximum test times

Minimum test time (best rate 2/2 per second) (s)	Minimum test time (best rate 2/2 per second) (hh:mm:ss)
5368	01:29:28

14.5 Adjacent channel rejection

14.5.1 Adjacent channel rejection - speech channels

14.5.1.1 TCH/FS

14.5.1.1.1 Definition

The adjacent channel selectivity is a measure of the capability of the receiver to receive a wanted modulated signal without exceeding a given degradation due to the presence of an unwanted signal in the adjacent channel.

The adjacent channel can be adjacent in the RF spectrum or in time. There are therefore two types of adjacent channel selectivity:

- 1) Adjacent RF channel selectivity which is specifically tested in this subclause.
- 2) Adjacent Time Slot selectivity, which is implicitly tested in test 14.2.1.

14.5.1.1.2 Conformance requirement

1. With adjacent channel interference at 200 kHz above and below the wanted signal and signal level 9 dB above the wanted signal level:
 - 1.1 For a TUhigh faded wanted signal and a TUhigh adjacent channel interferer, the FER for TCH/FS shall be within the requirements of table 2 in 3GPP TS 05.05 subclause 6.3.
 - 1.2 For a TUhigh faded wanted signal and a TUhigh adjacent channel interferer, the Class Ib RBER shall be within the requirements of table 2 in 3GPP TS 05.05 subclause 6.3.
 - 1.3 For a TUhigh faded wanted signal and a TUhigh adjacent channel interferer, the Class II RBER shall be within the requirements of table 2 in 3GPP TS 05.05 subclause 6.3.
 - 1.4 For a TUhigh faded wanted signal and a TUhigh adjacent channel interferer, the Class II RBER shall be within the requirements of table 2 in 3GPP TS 05.05 under extreme test conditions; 3GPP TS 05.05 subclause 6.3 and annex D subclauses D.2.1 and D.2.2.
2. For adjacent channel interference at 400 kHz above and below the wanted signal frequency and signal level 41 dB above the wanted signal level:
 - 2.1 For a TUhigh faded wanted signal and a static adjacent channel interferer, the FER for TCH/FS shall be better than:

GSM 400, GSM 700, GSM 850 and GSM 900:	10,2* α %; 3GPP TS 05.05, subclause 6.3;
DCS 1 800 and PCS 1 900:	5,1* α %; 3GPP TS 05.05, subclause 6.3.
 - 2.2 For a TUhigh faded wanted signal and a static adjacent channel interferer, the Class Ib RBER shall be better than:

GSM 400, GSM 700, GSM 850 and GSM 900:	0,72/ α %; 3GPP TS 05.05, subclause 6.3;
DCS 1 800 and PCS 1 900:	0,45/ α %; 3GPP TS 05.05, subclause 6.3.
 - 2.3 For a TUhigh faded wanted signal and a static adjacent channel interferer, the Class II RBER shall be better than:

GSM 400, GSM 700, GSM 850 and GSM 900:	8,8 %; 3GPP TS 05.05, subclause 6.3;
DCS 1 800 and PCS 1 900:	8,9 %; 3GPP TS 05.05, subclause 6.3.
 - 2.4 For a TUhigh faded wanted signal and a static adjacent channel interferer, the Class II RBER shall be better than:

GSM 400, GSM 700, GSM 850 and GSM 900:	8,8 %;
DCS 1 800 and PCS 1 900:	8,9 %.

under extreme test conditions; 3GPP TS 05.05, subclause 6.3, annex D subclauses D.2.1 and D.2.2.

3GPP TS 45.05 subclause 2:

For T-GSM 810 the requirements for GSM 900 shall apply, apart for those parameters for which a separate requirement exists.

14.5.1.1.3 Test purpose

1 To verify that with a TUhigh adjacent channel interferer at 200 kHz above and below the wanted TUhigh signal frequency and signal level 9 dB above the wanted signal level:

1.1 Conformance requirement 1.1 is met with an allowance for the statistical significance of the test.

1.2 Conformance requirement 1.2 is met with an allowance for the statistical significance of the test.

1.3 Conformance requirement 1.3 is met with an allowance for the statistical significance of the test.

1.4 Conformance requirement 1.4 is met with an allowance for the statistical significance of the test.

2. To verify that with a static adjacent channel interferer at 400 kHz above and below a TUhigh wanted signal frequency and signal level 41 dB above the wanted signal level:

2.1 Conformance requirement 2.1 is met with an allowance for the statistical significance of the test.

2.2 Conformance requirement 2.2 is met with an allowance for the statistical significance of the test.

2.3 Conformance requirement 2.3 is met with an allowance for the statistical significance of the test.

2.4 Conformance requirement 2.4 is met with an allowance for the statistical significance of the test.

14.5.1.1.4 Method of test

14.5.1.1.4.1 Initial conditions

A call is set up according to the generic call set up procedure on a TCH/FS with an ARFCN in the mid ARFCN range, power control level set to maximum power.

The SS commands the MS to create the traffic channel loop back signalling erased frames.

The SS transmits Standard Test Signal C1 on the TCH (wanted signal).

14.5.1.1.4.2 Procedure

a) In addition to the wanted signal, the SS transmits an independent, uncorrelated interfering signal, Standard Test Signal I1 (unwanted signal).

The unwanted signal is continuous and has no fixed relationship with the bit transitions of the wanted signal.

The fading characteristic of the wanted and the unwanted signal is set to TUhigh.

The unwanted signal is transmitted at a nominal frequency 200 kHz above the nominal frequency of the wanted signal. Its amplitude is set to 9dB above that of the wanted signal.

b) The SS compares the data of the signal that it sends to the MS with the signal which is looped back from the receiver after demodulation and decoding, and checks the frame erasure indication.

c) The SS tests the frame erasure compliance for the TCH/FS by examining at least the minimum number of samples of consecutive frames. The number of frame erasure events is recorded.

d) The SS determines the number of residual bit error events for the bits of the class Ib and class II, by examining sequences of at least the minimum number of samples of consecutive bits of class Ib and class II, Bits are only taken from those frames for which no bad frame indication was given.

e) The measurement of steps c) and d) is repeated with the unwanted signal on a frequency at the same displacement from, but below, the frequency of the wanted signal.

- f) The measurement of steps c) to e) shall be repeated for a displacement of the unwanted signal of 400 kHz, and with the amplitude of the unwanted signal 41 dB above the level of the wanted input signal, and the unwanted signal static.
- g) Steps c) to f) are repeated for class II BER under extreme test conditions.

14.5.1.1.5 Test requirements

Table 14-22: Limits for adjacent channel selectivity

Interference at	Channel	Type of measurement	GSM 400, GSM 700, T-GSM 810, GSM 850 and GSM 900		DCS 1 800 and PCS 1 900	
			Test limit error rate %	Minimum No. of samples	Test limit error rate %	Minimum No. of samples
200 kHz	TCH/FS class Ib class II	FER	$6,742 \cdot \alpha$	8 900	$3,371 \cdot \alpha$	17 800
		RBER	$0,420/\alpha$	1 000 000	$0,270/\alpha$	2 000 000
		RBER	8,333	600 000	8,333	1 200 000
400 kHz	TCH/FS class Ib class II	FER	$11,461 \cdot \alpha$	8 900	$5,714 \cdot \alpha$	10 500
		RBER	$0,756/\alpha$	1 000 000	$0,483/\alpha$	1 200 000
		RBER	9,167	600 000	9,167	720 000

The error rates measured in this test shall not exceed the test limit error rate given in table 14-22. This shall apply for any combination of normal and extreme test voltages and ambient temperature, and with the interfering signals at either side of the wanted frequency.

The parameter α can range from 1 to 1,6. The value of α for the RBER test on TCH/FS class Ib bits under particular measurement conditions shall be the same as that determined in the FER test on TCH/FS under the same conditions.

NOTE: A static unwanted signal is used to avoid a potential problem with the implementation of the fading simulator.

14.5.1.2 TCH/AFS

14.5.1.2.1 Definition

The adjacent channel selectivity is a measure of the capability of the receiver to receive a wanted modulated signal without exceeding a given degradation due to the presence of an unwanted signal in the adjacent channel.

The adjacent channel can be adjacent in the RF spectrum or in time. There are therefore two types of adjacent channel selectivity:

- 1) Adjacent RF channel selectivity, which is specifically tested in this subclause.
- 2) Adjacent Time Slot selectivity, which is not tested in this subclause.

14.5.1.2.2 Conformance requirement

1. With adjacent channel interference at 200 kHz above and below the wanted signal and signal level 9 dB above the wanted signal level:
 - 1.1 For a TUhigh faded wanted signal and a TUhigh adjacent channel interferer, the FER for TCH/AFS shall be within the requirements of table 2 in 3GPP TS 05.05; 3GPP TS 05.05, 6.3.
 - 1.2 For a TUhigh faded wanted signal and a TUhigh adjacent channel interferer, the Class Ib and Class II RBER shall be within the requirements of table 2 in 3GPP TS 05.05; 3GPP TS 05.05, 6.3.
2. For adjacent channel interference at 400 kHz above and below the wanted signal frequency and signal level 41 dB above the wanted signal level:
 - 2.1 For a TUhigh faded wanted signal and a TUhigh adjacent channel interferer, the FER for TCH/AFS shall be within the requirements of table 2 in 3GPP TS 05.05; 3GPP TS 05.05, 6.3.

1.2 For a TUhigh faded wanted signal and a TUhigh adjacent channel interferer, the Class Ib and Class II RBER shall be within the requirements of table 2 in 3GPP TS 05.05; 3GPP TS 05.05, 6.3.

14.5.1.2.3 Test purpose

- 1 To verify that with a TUhigh adjacent channel interferer at 200 kHz above and below the wanted TUhigh signal frequency and the interfering signal at a level resulting in the specified interference ratio:
 - 1.1 Conformance requirement 1.1 is met with an allowance for the statistical significance of the test.
 - 1.2 Conformance requirement 1.2 is met with an allowance for the statistical significance of the test.
- 2 To verify that with a TUhigh adjacent channel interferer at 400 kHz above and below a TUhigh wanted signal frequency and the interfering signal at a level resulting in the specified interference ratio:
 - 2.1 Conformance requirement 2.1 is met with an allowance for the statistical significance of the test.
 - 2.2 Conformance requirement 2.2 is met with an allowance for the statistical significance of the test.

14.5.1.2.4 Method of test

14.5.1.2.4.1 Initial conditions

A call is set up according to the generic call set up procedure on a TCH/AFS with an ARFCN in the mid ARFCN range, power control level set to maximum power.

The multirate configuration indicates the use of a codec set limited to 12.2 kbit/s.

The SS commands the MS to create the traffic channel loop back signalling erased frames.

The SS transmits Standard Test Signal C1 on the TCH (wanted signal).

14.5.1.2.4.2 Procedure

- a) In addition to the wanted signal, the SS transmits an independent, uncorrelated interfering signal, Standard Test Signal I1 (unwanted signal).

The unwanted signal is continuous and has no fixed relationship with the bit transitions of the wanted signal.

The fading characteristic of the wanted and the unwanted signal is set to TUHigh.

The unwanted signal is transmitted at a nominal frequency 200 kHz above the nominal frequency of the wanted signal. Its amplitude is set according to the specified reference interference ratio (-9 dB for 200 kHz offset), meaning 9 dB above that of the wanted signal.
- b) The SS compares the data of the signal that it sends to the MS with the signal which is looped back from the receiver after demodulation and decoding, and checks the frame erasure indication.
- c) The SS tests the frame erasure compliance for the TCH/AFS by examining at least the minimum number of samples of consecutive frames. The number of frame erasure events is recorded.
- d) The SS determines the number of residual bit error events for the bits of the class Ib, by examining sequences of at least the minimum number of samples of consecutive bits of class Ib, Bits are only taken from those frames for which no bad frame indication was given.
- e) The unwanted signal is moved to a nominal frequency 200 kHz below the nominal frequency of the wanted signal. Its amplitude is set according to the specified reference interference ratio (-9 dB-3 dB for 200 kHz offset), meaning 12 dB above that of the wanted signal.
- f) The SS uses a Channel Mode Modify procedure to change the active codec set to 7.95 kbit/s and steps b) to d) are repeated.
- g) The unwanted signal is moved to a nominal frequency 400 kHz above the nominal frequency of the wanted signal. Its amplitude is set to 3 dB below the reference interference ratio ((-41 dB - 3 dB) for 400 kHz offset), meaning 44 dB above that of the wanted signal.

- h) The SS uses a Channel Mode Modify procedure to change the active codec set to 5.9 kbit/s and steps b) to d) are repeated.
- i) The unwanted signal is moved to a nominal frequency 400 kHz below the nominal frequency of the wanted signal. Its amplitude is set to 3 dB below the reference interference ratio ((-41 dB - 3 dB) for 400 kHz offset), meaning 44 dB above that of the wanted signal.
- j) The SS uses a Channel Mode Modify procedure to change the active codec set to 4.75 kbit/s and steps b) to d) are repeated.

Maximum/Minimum Duration of Test

Pre Rel-5 MS

Maximum: 16 minutes (GSM850, GSM900), 42 minutes (DCS1800, PCS1900).

Minimum: 14 minutes (GSM850, GSM900), 7 minutes (DCS1800, PCS1900).

Rel -5 onwards MS

Maximum: 23 minutes (GSM850, GSM900), 125 minutes (DCS1800, PCS1900).

Minimum: 14 minutes (GSM850, GSM900), 17 minutes (DCS1800, PCS1900).

14.5.1.2.5 Test requirements

Testing the adjacent channel interference performance is performed using statistical methods that lead to an early pass/fail decision with test time significantly reduced for MS with BER/BLER not on the limit.

For more information on statistical testing of BER/BLER performance, especially the definition of the limit lines refer to Annex 6.2

Wrong decision risk F for one single error ratio test:

$$F_{\text{pass}} = F_{\text{fail}} = F \quad \text{and} \quad F = 0.2\%$$

Wrong decision probability D per test step:

$$D_{\text{pass}} = D_{\text{fail}} = D \quad \text{and} \quad D = 0.0085\%$$

Parameters for limit lines:

1. D = 0.000085 wrong decision probability per test step.
2. M = 1.5 bad DUT factor
3. ne number of (error) events.
4. ns number of samples. The error rate is calculated from ne and ns.

Limit checking

Before limit checking is valid the minimum test time due to fading needs to be considered:

Testing under multipath and interference conditions requires that at least 990 wavelengths are crossed with the speed given in the fading profile. This leads to a minimum test time depending on the frequency range. No early pass/fail decision is allowed until the minimum test time due to fading has elapsed.

Table 14-56: Minimum test times due to TU high fading conditions

Full Rate 50 km/h							
Frequency	0,4	0,7	0,85	0,9	1,8	1,9	GHz
Wavelength	0,75	0,43	0,35	0,33	0,17	0,16	m
990 Waves	743	424	349	330	165	156	m
min net test time	53	31	25	24	12	11	s @ 50km/h
min test time	428	244	201	190	95	90	s
	0:07:08	0:04:04	0:03:21	0:03:10	0:01:35	0:01:30	hh:mm:ss

If the minimum test time due to multipath conditions exceeds the target test time, then the test runs for the minimum test time due to multipath conditions and the decision is done by comparing the result with the “derived test limit”. In this case early pass/fail decisions are obsolete.

If the target test time exceeds the minimum test time due to multipath conditions early pass/fail decisions can be headed for in order to accelerate test execution.

For an early decision a minimum number of (error) events is necessary.

For an early pass decision $ne \geq 1$ (inclusive artificial error)

For an early fail decision $ne \geq 7$

When the target test time has been reached the test is finished and a pass/fail decision can be made.

The error rates measured for different channels and under the different propagation conditions, under any combination of normal and extreme test voltages and ambient temperatures, shall be tested according to the values given in table 14-57 or 14-58. Adjacent channel rejection tests with a frequency condition noted as “@-ndB” are performed for an interference ratio n dB below the reference interference ratio (see 3GPP TS 05.05). Where an entry in the table is ‘-’, this combination should not be tested.

Table 14-57: Statistical test limits for GSM 400, GSM 700, T-GSM 810, GSM 850 and GSM 900 adjacent channel rejection

TU high no FH								
0.4 to 0.9GHz			frames per s	Orig. BER	Derived	Target number	Target test	Target test time
	Channel	bits per sec	clas1b per s	requirement	test limit	of samples	time (s)	(hh:mm:ss)
AFS 12.2	frames	12200	50	0,060000	0,074040	4660	93	00:01:33
	Class1b	12200	8150	0,017000	0,020978	16446	2	00:00:02
AFS 7.95	frames @-3dB	7950	50	Pre Rel-5:	Pre Rel-5:	Pre Rel-5:	Pre Rel-5:	Pre Rel-5:
				0,075000	0,092550	3728	75	00:01:15
				Rel-5:	Rel-5:	Rel-5:	Rel-5:	Rel-5:
				0,053000	0,065402	5275	106	00:01:46
	Class1b @-3dB	7950	4200	Pre Rel-5:	Pre Rel-5:	Pre Rel-5:	Pre Rel-5:	Pre Rel-5:
				0,015000	0,018510	18639	4	00:00:04
				Rel-5:	Rel-5:	Rel-5:	Rel-5:	Rel-5:

				0,010000	0,012340	27958	7	00:00:07
AFS 5.9	frames @-3dB	5900	50	Pre Rel-5: 0,032000 Rel-5: 0,020000	Pre Rel-5: 0,039488 Rel-5: 0,024680	Pre Rel-5: 8737 Rel-5: 13979	Pre Rel-5: 175 Rel-5: 280	Pre Rel-5: 00:02:55 Rel-5: 00:04:40
	Class1b @-3dB	5900	3150	Pre Rel-5: 0,002900 Rel-5: 0,002300	Pre Rel-5: 0,003579 Rel-5: 0,002838	Pre Rel-5: 96407 Rel-5: 121556	Pre Rel-5: 31 Rel-5: 39	Pre Rel-5: 00:00:31 Rel-5: 00:00:39
AFS 4.75	frames @-3dB	4750	50	Pre Rel-5: 0,017000 Rel-5: 0,008200	Pre Rel-5: 0,020978 Rel-5: 0,010119	Pre Rel-5: 16446 Rel-5: 34095	Pre Rel-5: 329 Rel-5: 682	Pre Rel-5: 00:05:29 Rel-5: 00:11:22
	Class1b @-3dB	4750	2800	Pre Rel-5: 0,001500 Rel-5: 0,001100	Pre Rel-5: 0,001851 Rel-5: 0,001357	Pre Rel-5: 186386 Rel-5: 254162	Pre Rel-5: 67 Rel-5: 91	Pre Rel-5: 00:01:07 Rel-5: 00:01:31

Table 14-58: Statistical test limits for DCS 1 800 and PCS 1 900 adjacent channel rejection

TU high no FH								
1.8 to 1.9 GHz			frames per s	Orig. BER	Derived	Target number	Target test	Target test time
	Channel	bits per sec	clas1b per s	requirement	test limit	of samples	time (s)	(hh:mm:ss)
AFS 12.2	frames	12200	50	Pre Rel-5: 0,035000 Rel-5: 0,027000	Pre Rel-5: 0,043190 Rel-5: 0,033318	Pre Rel-5: 7898 Rel-5: 10355	Pre Rel-5: 160 Rel-5: 207	Pre Rel-5: 00:02:40 Rel-5: 00:03:27
	Class1b	12200	8150	Pre Rel-5: 0,018000 Rel-5: 0,016000	Pre Rel-5: 0,022212 Rel-5: 0,019744	Pre Rel-5: 15533 Rel-5: 17474	Pre Rel-5: 2 Rel-5: 2	Pre Rel-5: 00:00:02 Rel-5: 00:00:02
AFS 7.95	frames @-3dB	7950	50	Pre Rel-5: 0,034000 Rel-5: 0,020000	Pre Rel-5: 0,041956 Rel-5: 0,024680	Pre Rel-5: 8223 Rel-5: 13979	Pre Rel-5: 164 Rel-5: 280	Pre Rel-5: 00:02:44 Rel-5: 00:04:40
	Class1b @-3dB	7950	4200	Pre Rel-5: 0,007800 Rel-5:	Pre Rel-5: 0,009625 Rel-5:	Pre Rel-5: 35844 Rel-5:	Pre Rel-5: 9 Rel-5:	Pre Rel-5: 00:00:09 Rel-5:

				0,006800	0,008391	41115	10	00:00:10
AFS 5.9	frames @-3dB	5900	50	Pre Rel-5: 0,010000 Rel-5: 0,004100	Pre Rel-5: 0,012340 Rel-5: 0,005059	Pre Rel-5: 27958 Rel-5: 68190	Pre Rel-5: 559 Rel-5: 1364	Pre Rel-5: 00:09:19 Rel-5: 00:22:44
	Class1b @-3dB	5900	3150	Pre Rel-5: 0,001200 Rel-5: 0,000790	Pre Rel-5: 0,001481 Rel-5: 0,000975	Pre Rel-5: 232983 Rel-5: 353897	Pre Rel-5: 74 Rel-5: 112	Pre Rel-5: 00:01:14 Rel-5: 00:01:52
AFS 4.75	frames @-3dB	4750	50	Pre Rel-5: 0,003500 Rel-5: 0,001000	Pre Rel-5: 0,004319 Rel-5: 0,001234	Pre Rel-5: 79880 Rel-5: 279579	Pre Rel-5: 1598 Rel-5: 5592	Pre Rel-5: 00:26:38 Rel-5: 01:33:12
	Class1b @-3dB	4750	2800	Pre Rel-5: 0,000330 Rel-5: 0,000210	Pre Rel-5: 0,000407 Rel-5: 0,000259	Pre Rel-5: 847208 Rel-5: 1331327	Pre Rel-5: 303 Rel-5: 475	Pre Rel-5: 00:05:03 Rel-5: 00:07:55

14.5.1.3 TCH/AHS

14.5.1.3.1 Definition

The adjacent channel selectivity is a measure of the capability of the receiver to receive a wanted modulated signal without exceeding a given degradation due to the presence of an unwanted signal in the adjacent channel.

The adjacent channel can be adjacent in the RF spectrum or in time. There are therefore two types of adjacent channel selectivity:

- 1) Adjacent RF channel selectivity which is specifically tested in this subclause.
- 2) Adjacent Time Slot selectivity, which is not tested in this subclause.

14.5.1.3.2 Conformance requirement

1. With adjacent channel interference at 200 kHz above and below the wanted signal and signal level 9 dB above the wanted signal level:
 - 1.1 For a TUhigh faded wanted signal and a TUhigh adjacent channel interferer, the FER for TCH/AHS shall be within the requirements of table 2 in 3GPP TS 05.05; 3GPP TS 05.05, 6.3.
 - 1.2 For a TUhigh faded wanted signal and a TUhigh adjacent channel interferer, the Class Ib and Class II RBER shall be within the requirements of table 2 in 3GPP TS 05.05; 3GPP TS 05.05, 6.3.
2. For adjacent channel interference at 400 kHz above and below the wanted signal frequency and signal level 41 dB above the wanted signal level:
 - 2.1 For a TUhigh faded wanted signal and a TUhigh adjacent channel interferer, the FER for TCH/AHS shall be within the requirements of table 2 in 3GPP TS 05.05; 3GPP TS 05.05, 6.3.
 - 2.2 For a TUhigh faded wanted signal and a TUhigh adjacent channel interferer, the Class Ib and Class II RBER shall be within the requirements of table 2 in 3GPP TS 05.05; 3GPP TS 05.05, 6.3.

14.5.1.3.3 Test purpose

- 1 To verify that with a TUhigh adjacent channel interferer at 200 kHz above and below the wanted TUhigh signal frequency and the interfering signal at a level resulting in the specified interference ratio:
 - 1.1 Conformance requirement 1.1 is met with an allowance for the statistical significance of the test.
 - 1.2 Conformance requirement 1.2 is met with an allowance for the statistical significance of the test.
- 2 To verify that with a TUhigh adjacent channel interferer at 400 kHz above and below a TUhigh wanted signal frequency and the interfering signal at a level resulting in the specified interference ratio:
 - 2.1 Conformance requirement 2.1 is met with an allowance for the statistical significance of the test.
 - 2.2 Conformance requirement 2.2 is met with an allowance for the statistical significance of the test.

14.5.1.3.4 Method of test

14.5.1.3.4.1 Initial conditions

A call is set up according to the generic call set up procedure on a TCH/AHS with an ARFCN in the mid ARFCN range, power control level set to maximum power.

The multirate configuration indicates the use of a codec set limited to 7,4 kbit/s.

The SS commands the MS to create the traffic channel loop back signalling erased frames.

The SS transmits Standard Test Signal C1 on the TCH (wanted signal).

14.5.1.3.4.2 Procedure

- a) In addition to the wanted signal, the SS transmits an independent, uncorrelated interfering signal, Standard Test Signal I1 (unwanted signal).

The unwanted signal is continuous and has no fixed relationship with the bit transitions of the wanted signal.

The fading characteristic of the wanted and the unwanted signal is set to TUHigh.

The unwanted signal is transmitted at a nominal frequency 200 kHz above the nominal frequency of the wanted signal. The interference ratio is set to 3 dB above the reference interference ratio (-9 dB + 3 dB), meaning that the amplitude of the interferer is set to 6 dB above that of the wanted signal.
- b) The SS compares the data of the signal that it sends to the MS with the signal which is looped back from the receiver after demodulation and decoding, and checks the frame erasure indication.
- c) The SS tests the frame erasure compliance for the TCH/AHS by examining at least the minimum number of samples of consecutive frames. The number of frame erasure events is recorded.
- d) The SS determines the number of residual bit error events for the bits of the class Ib, by examining sequences of at least the minimum number of samples of consecutive bits of class Ib, Bits are only taken from those frames for which no bad frame indication was given.
- e) The unwanted signal is moved to a nominal frequency 200 kHz below the nominal frequency of the wanted signal. The interference ratio is set to 3 dB above the reference interference ratio (-9 dB + 3 dB), meaning that the amplitude of the interferer is set to 6 dB above that of the wanted signal
- f) The SS uses a Channel Mode Modify procedure to change the active codec set to 6.7 kbit/s and steps b) to d) are repeated
- g) The unwanted signal is moved to a nominal frequency 400 kHz above the nominal frequency of the wanted signal. Its amplitude is set to the reference interference ratio (-41 dB for 400 kHz offset), meaning 41 dB above that of the wanted signal.
- h) The SS uses a Channel Mode Modify procedure to change the active codec set to 5.15 kbit/s and steps b) to d) are repeated.

- i) The unwanted signal is moved to a nominal frequency 400 kHz below the nominal frequency of the wanted signal. Its amplitude is set to the reference interference ratio (-41 dB for 400 kHz offset), meaning 41 dB above that of the wanted signal.
- j) The SS uses a Channel Mode Modify procedure to change the active codec set to 4.75 kbit/s and steps b) to d) are repeated.

Maximum/Minimum Duration of Test

Pre Rel-5 MS

Maximum: 27 minutes (GSM850), 26 minutes (GSM900), 14 minutes (DCS1800, PCS1900).

Minimum: 27 minutes (GSM850), 26 minutes (GSM900), 13 minutes (DCS1800), 12 minutes (PCS1900).

Rel -5 onwards MS

Maximum: 27 minutes (GSM850), 26 minutes (GSM900), 15 minutes (DCS1800, PCS1900).

Minimum: 27 minutes (GSM850), 26 minutes (GSM900), 13 minutes (DCS1800), 12 minutes (PCS1900).

14.5.1.3.5 Test requirements

Testing the adjacent channel interference performance is performed using statistical methods that lead to an early pass/fail decision with test time significantly reduced for MS with BER/BLER not on the limit.

For more information on statistical testing of BER/BLER performance, especially the definition of the limit lines refer to Annex 6.2

Wrong decision risk F for one single error ratio test:

$$F_{\text{pass}} = F_{\text{fail}} = F \quad \text{and} \quad F = 0.2\%$$

Wrong decision probability D per test step:

$$D_{\text{pass}} = D_{\text{fail}} = D \quad \text{and} \quad D = 0.0085\%$$

Parameters for limit lines:

1. D = 0.000085 wrong decision probability per test step.
2. M = 1.5 bad DUT factor
3. ne number of (error) events.
4. ns number of samples. The error rate is calculated from ne and ns.

Limit checking

Before limit checking is valid the minimum test time due to fading needs to be considered:

Testing under multipath and interference conditions requires that at least 990 wavelengths are crossed with the speed given in the fading profile. This leads to a minimum test time depending on the frequency range. No early pass/fail decision is allowed until the minimum test time due to fading has elapsed.

Table 14-59: Minimum test times due to TU high fading conditions

Half Rate 50 km/h						
Frequency	0,4	0,7	0,85	0,9	1,8	1,9 GHz

Wavelength	0,75	0,43	0,35	0,33	0,17	0,16	m
990 Waves	743	424	349	330	165	156	m
min net test time	53	31	25	24	12	11	s @ 50km/h
min test time	855	489	403	380	190	180	s
	0:14:15	0:08:09	0:06:43	0:06:20	0:03:10	0:03:00	hh.mm:ss

If the minimum test time due to multipath conditions exceeds the target test time, then the test runs for the minimum test time due to multipath conditions and the decision is done by comparing the result with the "derived test limit". In this case early pass/fail decisions are obsolete.

If the target test time exceeds the minimum test time due to multipath conditions early pass/fail decisions can be headed for in order to accelerate test execution.

For an early decision a minimum number of (error) events is necessary.

For an early pass decision $ne \geq 1$ (inclusive artificial error)

For an early fail decision $ne \geq 7$

When the target test time has been reached the test is finished and a pass/fail decision can be made.

The error rates measured for different channels and under the different propagation conditions, under any combination of normal and extreme test voltages and ambient temperatures, shall be tested according to the values given in table 14-60 or 14-61. Adjacent channel rejection tests with a frequency condition noted as "+ndB" are performed for an interference ratio n dB above the reference interference ratio (see 3GPP TS 05.05).

Table 14-60: Statistical test limits for GSM 400, GSM 700, T-GSM 810, GSM 850 and GSM 900 adjacent channel rejection

TU high no FH								
0.4 to 0.9GHz			frames per s	Orig. BER	Derived	Target number	Target test	Target test time
			clas1b per s	requirement	test limit	of samples	time (s)	(hh:mm:ss)
	Channel	bits per sec	clas II per s					
AHS 7.4	frames @+3dB	7400	50	0,048000	0,059232	5825	116	00:01:56
	Class1b @+3dB	7400	2950	0,005100	0,006293	54819	19	00:00:19
	Class II @+3dB	7400	1400	0,033000	0,040722	8472	6	00:00:06
AHS 6.7	frames @+3dB	6700	50	0,023000	0,028382	12156	243	00:04:03
	Class1b @+3dB	6700	2750	0,003900	0,004813	71687	26	00:00:26
	Class II @+3dB	6700	1200	0,036000	0,044424	7766	6	00:00:06
AHS 5.15	frames	5150	50	0,033000	0,040722	8472	169	00:02:49
	Class1b	5150	2100	0,006000	0,007404	46596	22	00:00:22
	Class II	5150	600	0,069000	0,085146	4052	7	00:00:07
AHS 4.75	frames	4750	50	Pre Rel-5:	Pre Rel-5:	Pre Rel-5:	Pre Rel-5:	Pre Rel-5:

				0,025000 Rel-5: 0,018000	0,030850 Rel-5: 0,022212	11184 Rel-5: 15532	224 Rel-5: 311	00:03:44 Rel-5: 00:05:11
	Class1b	4750	2200	Pre Rel-5: 0,002900 Rel-5: 0,002200	Pre Rel-5: 0,003579 Rel-5: 0,002715	Pre Rel-5: 96407 Rel-5: 127081	Pre Rel-5: 44 Rel-5: 58	Pre Rel-5: 00:00:44 Rel-5: 00:00:58
	Class II	4750	600	Pre Rel-5: 0,075000 Rel-5: 0,070000	Pre Rel-5: 0,092550 Rel-5: 0,086380	Pre Rel-5: 3728 Rel-5: 3994	Pre Rel-5: 6 Rel-5: 7	Pre Rel-5: 00:00:06 Rel-5: 00:00:07

Table 14-61: Statistical test limits for DCS 1 800 and PCS 1 900 adjacent channel rejection

TU high no FH								
1.8 and 1.9 GHz			frames per s	Orig. BER	Derived	Target number	Target test	Target test time
			clas1b per s	requirement	test limit	of samples	time (s)	(hh:mm:ss)
	Channel	bits per sec	clas II per s					
AHS 7.4	frames @+3dB	7400	50	Pre Rel-5: 0,054000 Rel-5: 0,049000	Pre Rel-5: 0,066636 Rel-5: 0,060466	Pre Rel-5: 5178 Rel-5: 5706	Pre Rel-5: 104 Rel-5: 114	Pre Rel-5: 00:01:44 Rel-5: 00:01:54
	Class1b @+3dB	7400	2950	Pre Rel-5: 0,006000 Rel-5: 0,005100	Pre Rel-5: 0,007404 Rel-5: 0,006293	Pre Rel-5: 46597 Rel-5: 54819	Pre Rel-5: 16 Rel-5: 19	Pre Rel-5: 00:00:16 Rel-5: 00:00:19
	Class II @+3dB	7400	1400	Pre Rel-5: 0,035000 Rel-5: 0,033000	Pre Rel-5: 0,043190 Rel-5: 0,040722	Pre Rel-5: 7988 Rel-5: 8472	Pre Rel-5: 6 Rel-5: 6	Pre Rel-5: 00:00:06 Rel-5: 00:00:06
AHS 6.7	frames @+3dB	6700	50	0,025000	0,030850	11183	224	00:03:44
	Class1b @+3dB	6700	2750	0,003800	0,004689	73573	27	00:00:27
	Class II @+3dB	6700	1200	Pre Rel-5: 0,039000 Rel-5: 0,035000	Pre Rel-5: 0,048126 Rel-5: 0,043190	Pre Rel-5: 7169 Rel-5: 7988	Pre Rel-5: 6 Rel-5: 6	Pre Rel-5: 00:00:06 Rel-5: 00:00:06
AHS 5.15	frames	5150	50	0,038000	0,046892	7357	147	00:02:27

	Class1b	5150	2100	0,006600	0,008144	42360	20	00:00:20
	Class II	5150	600	0,068000	0,083912	4111	7	00:00:07
AHS 4.75	frames	4750	50	Pre Rel-5: 0,028000 Rel-5: 0,021000	Pre Rel-5: 0,034552 Rel-5: 0,025914	Pre Rel-5: 9985 Rel-5: 13313	Pre Rel-5: 200 Rel-5: 266	Pre Rel-5: 00:03:20 Rel-5: 00:04:26
	Class1b	4750	2200	0,002500	0,003085	111831	51	00:00:51
	Class II	4750	600	Pre Rel-5: 0,075000 Rel-5: 0,070000	Pre Rel-5: 0,09255 Rel-5: 0,086380	Pre Rel-5: 3728 Rel-5: 3994	Pre Rel-5: 6 Rel-5: 7	Pre Rel-5: 00:00:06 Rel-5: 00:00:07

14.5.1.4 O-TCH/AHS

14.5.1.4.1 Definition

-

14.5.1.4.2 Conformance requirement

For 8-PSK modulated channels, speech channels (AMR and AMR-WB), the minimum interference ratio for which the reference performance for cochannel interference (C/I_c) shall be met is specified in table 2k

The corresponding interference ratio for adjacent channel interference shall be:

Modulation of wanted signal				GMSK	8-PSK
-	for adjacent (200 kHz) interference	C/I _{a1}	=	C/I _c - 18 dB	See table 2l for speech, see tables 2f, 2g, 2h, 2i and 2n for other channels
-	for adjacent (400 kHz) interference	C/I _{a2}	=	C/I _c - 50 dB	C/I _c - 50 dB
-	for adjacent (600 kHz) interference	C/I _{a3}	=	C/I _c - 58 dB	C/I _c - 58 dB

For 8-PSK modulated speech channels (AMR and AMR-WB), ECSD channels and 8-PSK modulated packet-switched channels, the wanted input signal level shall be: - 93 dBm + I_r + Corr, where:

I_r = the interference ratio according to tables 2b and 2c for packets switched channels, tables 2d and 2e for ECSD and table 2k for speech (AMR and AMR-WB) and associated control channels.

Corr = the correction factor for reference performance according to subclause 6.2

For adjacent channel performance, the wanted input signal level shall be set to the value calculated using the formulas above for cochannel performance.

For all classes of MS supporting 8-PSK speech channels, an additional +2 dB adjustment applies for 8-PSK modulated speech channels.

The reference performance is the same as defined in subclause 6.2

The reference performance shall be:

For speech channels (O-TCH/AHSy) FER ≤ 1%

3GPP TS 45.005, subclauses 6.2, 6.3.

14.5.1.4.3 Test purpose

To verify that the MS does not exceed conformance requirement for FER and class 1b RBER under TU50 propagation conditions with an allowance for the statistical significance of the test, for channel combinations O-TCH/AHS7.4, O-TCH/AHS6.7.

14.5.1.4.4 Method of test

14.5.1.4.4.1 Initial conditions

A call is set up according to the generic call set up procedure on a O-TCH/AHS with an ARFCN in the mid ARFCN range, power control level set to maximum power. RADIO_LINK_TIMEOUT is set to maximum.

The multirate configuration indicates the use of a codec set limited to 7,4 kbit/s.

The SS transmits Standard Test Signal C1 on the traffic channel (wanted signal).

The SS commands the MS to create the traffic channel loop back, signalling erased frames (subclause 36).

14.5.1.4.4.2 Procedure

- a) In addition to the wanted signal, the SS produces an independent, uncorrelated interfering signal, Standard Test Signal I1 (unwanted signal) at a nominal frequency 400KHz above that of the wanted signal. The unwanted signal is continuous and has no fixed relationship with the bit transitions of the wanted signal.
- b) The fading characteristic of the wanted and the interfering signals are set to TU50.
- c) The SS sets the level of the interfering signal to -27dBm .
- d) The SS sets the level of the wanted signal to -77dBm .
- e) The SS determines the number of residual bit error events for the bits of the class Ib, by examining sequences of at least the minimum number of samples of consecutive bits of class Ib. Bits are only taken from those frames not signalled as erased.
- f) The SS also determines the frame erasure events by examining sequences of at least the minimum number of samples of consecutive frames and assuming a frame is received successfully, if it is not signalled as erased.
- g) The SS moves the interfering signal to a nominal frequency 200KHz below that of the wanted signal.
- h) The SS sets the level of the interfering signal to -73dBm .
- i) The SS uses a Channel Mode Modify procedure to change the active codec set to 6,7 kbit/s.
- j) The SS sets the level of the wanted signal to that indicated by C_{lev} in table 14.5.1.4-2 or 14.5.1.4-3.
- k) Steps e) to f) are repeated.

Maximum/Minimum Duration of Test

Maximum: 19 minutes (GSM850), 19 minutes (GSM900), 19 minutes (DCS1800), 19 minutes (PCS1900).

Minimum: 14 minutes (GSM850), 13 minutes (GSM900), 7 minutes (DCS1800), 6 minutes (PCS1900).

14.5.1.4.5 Test requirements

Testing should be performed using statistical methods that lead to an early pass/fail decision with test time significantly reduced for MS with FER/BER not on the limit.

For more information on statistical testing of BER/BLER performance, especially the definition of limit lines refer to Annex 7.

Wrong decision risk F for one single error rate test:

$$F_{\text{pass}} = F_{\text{fail}} = F \quad \text{and} \quad F = 0.2\%$$

Wrong decision probability D per test step:

$$D_{\text{pass}} = D_{\text{fail}} = D \quad \text{and} \quad D = 0.0085\%$$

Parameters for limit lines:

1. $D = 0.000085$ wrong decision probability per test step.
2. $M = 1.5$ bad DUT factor
3. n_e number of (error) events. This parameter is the x-ordinate in figure A7.1.3.1.
4. n_s number of samples. The error rate is calculated from n_e and n_s .

Limit checking

Before limit checking is valid the minimum test time due to fading needs to be considered:

Testing under multipath and interference conditions requires that at least 990 wavelengths are crossed with the speed given in the fading profile. This leads to a minimum test time depending on the frequency range. No early pass/fail decision is allowed until the minimum test time due to fading has elapsed.

Table 14.5.1.4-1: Minimum test times due to TU high fading conditions

Half Rate 50 km/h					
Frequency	0,85	0,9	1,8	1,9	GHz
Wavelength	0,35	0,33	0,17	0,16	m
min test time	403	380	190	180	s
	0:06:43	0:06:20	0:03:10	0:03:00	

If the minimum test time due to multipath conditions exceeds the target test time, then the test runs for the minimum test time due to multipath conditions and the decision is made by comparing the result with the “derived test limit”. In this case early pass/fail decisions are obsolete.

If the target test time exceeds the minimum test time due to multipath conditions early pass/fail decisions can be headed for in order to accelerate test execution.

For an early decision a minimum number of (error) events is necessary.

For an early pass decision $n_e \geq 1$ (inclusive artificial error)

For an early fail decision $n_e \geq 7$

When the target test time has been reached the test is finished and a pass/fail decision can be made.

The error rate measured in this test shall be tested according to the values given in tables 14.5.1.4-2 and 14.5.1.4.3

Table 14.5.1.4-2: Statistical test limits for T-GSM 810, GSM 850 and GSM 900 O-TCH/AHS adj-chan interference

TU50 / No FH								
0.8 to 0.9GHz		C_{lev} (dBm)	Samples per second	Orig. BER requirement	Derived test limit	Target number of samples	Target test time (s)	Target test time (hh:mm:ss)
O-TCH/AHS 7.4	Frames	n/a	50	0,010000	0,012340	27958	560	00:09:20
	Class1b		3950	0,001500	0.001851	186385	48	00:00:48
O-TCH/	Frames	-77.5	50	0,010000	0,012340	27958	560	00:09:20

AHS 6.7	Class1b		3950	0,001500	0,001851	186385	48	00:00:48
---------	---------	--	------	----------	----------	--------	----	----------

Table 14.5.1.4-3: Statistical test limits for DCS 1 800 and PCS 1 900 O-TCH/AHS adj-chan interference

TU50 / No FH								
1.8 to 1.9GHz		C_{lev} (dBm)	Samples per second	Orig. BER requirement	Derived test limit	Target number of samples	Target test time (s)	Target test time (hh:mm:ss)
O-TCH/AHS 7.4	Frames	n/a	50	0,010000	0,012340	27958	560	00:09:20
	Class1b		3950	0,001700	0,002098	164442	42	00:00:42
O-TCH/AHS 6.7	Frames	-78.0	50	0,010000	0,012340	27958	560	00:09:20
	Class1b		3950	0,001500	0,001851	186385	48	00:00:48

14.5.1.5 O-TCH/WFS

14.5.1.5.1 Definition

The adjacent channel selectivity is a measure of the capability of the receiver to receive a wanted modulated signal without exceeding a given degradation due to the presence of an unwanted signal in the adjacent channel.

The adjacent channel can be adjacent in the RF spectrum or in time. There are therefore two types of adjacent channel selectivity:

- 1) Adjacent RF channel selectivity, which is specifically tested in this subclause.
- 2) Adjacent Time Slot selectivity, which is not tested in this subclause.

14.5.1.5.2 Conformance requirement

The reference interference performance (for cochannel, C/I_c , or adjacent channel, C/I_a) in terms of frame erasure, bit error or residual bit error rates (whichever appropriate) is specified in table 2, according to the type of channel and the propagation condition. The actual interference ratio is defined as the interference ratio for which this performance is met. The actual interference ratio shall be less than a specified limit, called the reference interference ratio.

For equipment supporting 8-PSK, and for MS indicating support for Downlink Advanced Receiver Performance – phase I (see 3GPP TS 24.008), the applicable requirements in table 2a, 2b, 2c, 2d, 2e, 2f, 2g, 2h, 2i, 2j, 2k, 2l, 2m, 2n and 2p apply for both GMSK and 8-PSK modulated interfering signals. The corresponding interference ratio for adjacent channel interference shall be:

<u>Modulation of wanted signal</u>				<u>GMSK</u>	<u>8-PSK</u>
- for adjacent (200 kHz) interference	C/I_{a1}	=	$C/I_c - 18$ dB		See table 2l for speech, see tables 2f, 2g, 2h, 2i and 2n for other channels
- for adjacent (400 kHz) interference	C/I_{a2}	=	$C/I_c - 50$ dB		$C/I_c - 50$ dB
- for adjacent (600 kHz) interference	C/I_{a3}	=	$C/I_c - 58$ dB		$C/I_c - 58$ dB

NOTE: The C/I_{a3} figure is given for information purposes and will not require testing. It was calculated for the case of an equipment with an antenna connector, operating at output power levels of +33 dBm and below. Rejection of signals at 600 kHz is specified in subclause 5.1.

For 8-PSK modulated speech channels (AMR and AMR-WB), ECSD channels and 8-PSK modulated packet-switched channels, the wanted input signal level shall be: -93 dBm + I_r + Corr, where:

I_r = the interference ratio according to tables 2b and 2c for packets switched channels, tables 2d and 2e for ECSD and table 2k for speech (AMR and AMR-WB) and associated control channels.

Corr = the correction factor for reference performance according to subclause 6.2

The levels shall be corrected by the following values:

MS, 8-PSK modulated signals

for GSM 400, GSM 900, GSM 850 and GSM 700 small MS	0 dB
for other GSM 400, GSM 900, GSM 850 and GSM 700 MS	-2 dB
for DCS 1 800 and PCS 1900 class 1 or class 2 MS	0 dB
for other DCS 1 800 and PCS 1900 MS	-2 dB

For GMSK modulated speech channels for wideband AMR, and for 8-PSK modulated speech channels for AMR, associated control channels and inband signalling, the minimum input signal level for which the reference performance shall be met is specified in table 1f and 1g respectively for normal BTS, according to the type of channel and the propagation condition. The reference performance shall be:

- for speech channels (O-TCH/AHSy, O-TCH/WFSy, O-TCH/WHSy) FER : $\leq 1\%$

For other equipment than normal BTS, the levels shall be corrected by the values in the table below, describing the reference performance level correction factors for packet switched channels. Furthermore, for all classes of MS supporting 8-PSK speech channels, an additional +2 dB adjustment applies for 8-PSK modulated speech channels. For T-GSM 810 the requirements for GSM 900 shall apply, apart for those parameters for which a separate requirement exists.

3GPP 45.005 clauses 2, 6.2 and 6.3

Note: The tables 1 and 2 mentioned above can be found in 3GPP 45.005 clause 6.7

14.5.1.5.3 Test purpose

- 1 To verify that with a TUhigh adjacent channel interferer at 200 kHz above and below the wanted TUhigh signal frequency and the interfering signal at a level resulting in the specified interference ratio the MS does not exceed conformance requirements in tables 14.5.1.5-2/3 with an allowance for the statistical significance of the test.
- 2 To verify that with a TUhigh adjacent channel interferer at 400 kHz above and below a TUhigh wanted signal frequency and the interfering signal at a level resulting in the specified interference ratio the MS does not exceed conformance requirements in tables 14.5.1.5-2/3 with an allowance for the statistical significance of the test.

14.5.1.5.4 Method of test

14.5.1.5.4.1 Initial conditions

A call is set up according to the generic call set up procedure on a O-TCH/WFS with an ARFCN in the mid ARFCN range, power control level set to maximum power.

The multirate configuration indicates the use of a codec set limited to 15.85 kbit/s.

The SS commands the MS to create the traffic channel loop back signalling erased frames.

The SS transmits Standard Test Signal C1 on the O-TCH (wanted signal) with an amplitude of $-93 \text{ dBm} + I_r + \text{Corr} + 2 \text{ dB}$, where I_r equals C/I_c in table.14.5.1.5-2/3 and the values for Corr are as stated above.

14.5.1.5.4.2 Procedure

- a) In addition to the wanted signal, the SS transmits an independent, uncorrelated interfering signal, Standard Test Signal I1 (unwanted signal).

The unwanted signal is continuous and has no fixed relationship with the bit transitions of the wanted signal.

The fading characteristic of the wanted and the unwanted signal is set to TUHigh.

The unwanted signal is transmitted at a nominal frequency of 200 kHz above the nominal frequency of the wanted signal. The interference ratio is set to C/I_{a1} from table 14.5.1.5-4.

- b) The SS compares the data of the signal that it sends to the MS with the signal which is looped back from the receiver after demodulation and decoding, and checks the frame erasure indication.
- c) The SS tests the frame erasure compliance for the O-TCH/WFS by examining at least the minimum number of samples of consecutive frames. The number of frame erasure events is recorded.
- d) The SS determines the number of residual bit error events for the bits of the class Ib, by examining sequences of at least the minimum number of samples of consecutive bits of class Ib, Bits are only taken from those frames for which no bad frame indication was given.
- e) The unwanted signal is moved to a nominal frequency 200 kHz below the nominal frequency of the wanted signal.
- f) The SS uses a Channel Mode Modify procedure to change the active codec set to 12.65 kbit/s and the wanted signal level is set accordingly. The interference ratio is set to C/I_{a1} from table 14.5.1.5-4 and steps b) to d) are repeated.
- g) The unwanted signal is moved to a nominal frequency 400 kHz above the nominal frequency of the wanted signal.
- h) The SS uses a Channel Mode Modify procedure to change the active codec set to 8.85 kbit/s and the wanted signal level is set accordingly. The interference ratio is set to $(C/I_c - 50\text{dB})$, i.e. the amplitude of the unwanted signal is set to $(50\text{ dB} - C/I_c)$ above that of the wanted signal, (C/I_c is the co-channel interference ratio from table 14.5.1.5-2 and 14.5.1.5-3). Steps b) to d) are repeated.
- i) The unwanted signal is moved to a nominal frequency 400 kHz below the nominal frequency of the wanted signal.
- j) The SS uses a Channel Mode Modify procedure to change the active codec set to 6.60 kbit/s and the wanted signal level is set accordingly. The interference ratio is set to $(C/I_c - 50\text{dB})$, i.e. the amplitude of the unwanted signal is set to $(50\text{ dB} - C/I_c)$ above that of the wanted signal, (C/I_c is the co-channel interference ratio from table 14.5.1.5-2 and 14.5.1.5-3). Steps b) to d) are repeated.

Maximum/Minimum Duration of Test

Maximum: 14 minutes (GSM700, T-GSM 810, GSM850 and GSM900), 7 minutes (DCS1800 and PCS1900).

Minimum: 14 minutes (GSM700, T-GSM 810, GSM850 and GSM900), 7 minutes (DCS1800 and PCS1900).

14.5.1.5.5 Test requirements

Testing the adjacent channel interference performance is performed using statistical methods that lead to an early pass/fail decision with test time significantly reduced for MS with BER/BLER not on the limit.

For more information on statistical testing of BER/BLER performance, especially the definition of the limit lines refer to Annex 6.2

Wrong decision risk F for one single error ratio test:

$$F_{\text{pass}} = F_{\text{fail}} = F \quad \text{and} \quad F = 0.2\%$$

Wrong decision probability D per test step:

$$D_{\text{pass}} = D_{\text{fail}} = D \quad \text{and} \quad D = 0.0085\%$$

Parameters for limit lines:

1. D = 0.000085 wrong decision probability per test step.

- 2. $M = 1.5$ bad DUT factor
- 3. n_e number of (error) events.
- 4. n_s number of samples. The error rate is calculated from n_e and n_s .

Limit checking

Before limit checking is valid the minimum test time due to fading needs to be considered:

Testing under multipath and interference conditions requires that at least 990 wavelengths are crossed with the speed given in the fading profile. This leads to a minimum test time depending on the frequency range. No early pass/fail decision is allowed until the minimum test time due to fading has elapsed.

Table 14.5.1.5-1: Minimum test times due to TU high fading conditions

Full Rate 50 km/h							
Frequency	0,4	0,7	0,85	0,9	1,8	1,9	GHz
Wavelength	0,75	0,43	0,35	0,33	0,17	0,16	m
990 Waves	743	424	349	330	165	156	m
min net test time	53	31	25	24	12	11	s @ 50km/h
min test time	428	244	201	190	95	90	s
	0:07:08	0:04:04	0:03:21	0:03:10	0:01:35	0:01:30	hh:mm:ss

If the minimum test time due to multipath conditions exceeds the target test time, then the test runs for the minimum test time due to multipath conditions and the decision is done by comparing the result with the “derived test limit”. In this case early pass/fail decisions are obsolete.

If the target test time exceeds the minimum test time due to multipath conditions early pass/fail decisions can be headed for in order to accelerate test execution.

For an early decision a minimum number of (error) events is necessary.

For an early pass decision $n_e \geq 1$ (inclusive artificial error)

For an early fail decision $n_e \geq 7$

When the target test time has been reached the test is finished and a pass/fail decision can be made.

The error rates measured for different channels and under the different propagation conditions, under any combination of normal and extreme test voltages and ambient temperatures, shall be tested according to the values given in table 14.5.1.5-2 or 14.5.1.5-3. Adjacent channel rejection tests with a frequency condition noted as “@-ndB” are performed for an interference ratio n dB below the reference interference ratio (see 3GPP TS 05.05). Where an entry in the table is ‘-’, this combination should not be tested.

Table 14.5.1.5-2: Statistical test limits for GSM 710, T-GSM 810, GSM 850 and GSM 900 adjacent channel rejection

TU high no FH,								
0.4 to 0.9GHz		C/Ic (dB)	samples per s	Orig. BER/FER requirement	Derived test limit	Target number of samples	Target test time (s)	Target test time (hh:mm:ss)
WFS15.85	frames	13.5	50	0,010000	0,012340	27958	560	00:09:20
	Class1b		12250	0,004500	0,005553	62129	5	00:00:05
WFS12.65	frames	11.5	50	0,010000	0,012340	27958	560	00:09:20
	Class1b		9050	0,003500	0,004319	79880	9	00:00:09
WFS 8.85	frames	10.5	50	0,010000	0,012340	27958	560	00:09:20
	Class1b		5650	0,003500	0,004319	79880	15	00:00:15
WFS 6.60	frames	9.5	50	0,010000	0,012340	27958	560	00:09:20
	Class1b		3900	0,001500	0,001851	186386	48	00:00:48

Table 14.5.1.5-3: Statistical test limits for DCS 1800 and PCS 1900 adjacent channel rejection

TU high no FH								
1.8 to 1.9GHz		C/Ic (dB)	samples per s	Orig. BER/FER requirement	Derived test limit	Target number of samples	Target test time (s)	Target test time (hh:mm:ss)
WFS15.85	frames	12.0	50	0,010000	0,012340	27958	560	00:09:20
	Class1b		12250	0,005000	0,006170	55916	5	00:00:05
WFS12.65	frames	10.5	50	0,010000	0,012340	27958	560	00:09:20
	Class1b		9050	0,003600	0,004442	77668	9	00:00:09
WFS 8.85	frames	9.0	50	0,010000	0,012340	27958	560	00:09:20
	Class1b		5650	0,004200	0,005183	66564	12	00:00:12
WFS 6.60	frames	8.0	50	0,010000	0,012340	27958	560	00:09:20
	Class1b		3900	0,002000	0,002468	139790	36	00:00:36

Table 14.5.1.5-4: Adjacent channel interference ratio C/Ia1 for 8PSK-modulated WB-AMR channels

Type of Channel		GSM 850 and GSM 900		DCS 1 800 & PCS 1 900	
		Propagation condition			
		TU50(no FH)		TU50(no FH)	
O-TCH/ WFS15.85	dB	-5		-5.5	
O-TCH/ WFS12.65	dB	-7		-7.5	

14.5.1.6 Adjacent channel interference O-TCH/WHS

14.5.1.6.1 Definition

-

14.5.1.6.2 Conformance requirement

For 8-PSK modulated channels, speech channels (AMR and AMR-WB), the minimum interference ratio for which the reference performance for cochannel interference (C/Ic) shall be met is specified in table 2k

The corresponding interference ratio for adjacent channel interference shall be:

Modulation of wanted signal				GMSK	8-PSK
-	for adjacent (200 kHz) interference	C/la1	=	C/lc - 18 dB	See table 2l for speech, see tables 2f, 2g, 2h, 2i and 2n for other channels
-	for adjacent (400 kHz) interference	C/la2	=	C/lc - 50 dB	C/lc -50 dB
-	for adjacent (600 kHz) interference	C/la3	=	C/lc - 58 dB	C/lc -58 dB

For 8-PSK modulated speech channels (AMR and AMR-WB), ECSD channels and 8-PSK modulated packet-switched channels, the wanted input signal level shall be: $-93 \text{ dBm} + Ir + \text{Corr}$, where:

Ir = the interference ratio according to tables 2b and 2c for packets switched channels, tables 2d and 2e for ECSD and table 2k for speech (AMR and AMR-WB) and associated control channels.

Corr = the correction factor for reference performance according to subclause 6.2

The levels shall be corrected by the following values:

MS, 8-PSK modulated signals

for GSM 400, GSM 900, GSM 850 and GSM 700 small MS	0 dB
for other GSM 400, GSM 900, GSM 850 and GSM 700 MS	-2 dB
for DCS 1 800 and PCS 1900 class 1 or class 2 MS	0 dB
for other DCS 1 800 and PCS 1900 MS	-2 dB

For adjacent channel performance, the wanted input signal level shall be set to the value calculated using the formulas above for cochannel performance.

For all classes of MS supporting 8-PSK speech channels, an additional +2 dB adjustment applies for 8-PSK modulated speech channels.

The reference performance is the same as defined in subclause 6.2

The reference performance shall be:

For speech channels (O-TCH/WHS_y) $\text{FER} \leq 1\%$

3GPP TS 45.005, subclauses 6.2, 6.3.

14.5.1.6.3 Test purpose

To verify that the MS does not exceed conformance requirement for FER and class 1b RBER under TU50 propagation conditions with an allowance for the statistical significance of the test, for channel combinations O-TCH/WHS8.85, O-TCH/WHS6.6.

14.5.1.6.4 Method of test

14.5.1.6.4.1 Initial conditions

A call is set up according to the generic call set up procedure on a O-TCH/WHS with an ARFCN in the mid ARFCN range, power control level set to maximum power. RADIO_LINK_TIMEOUT is set to maximum.

The multirate configuration indicates the use of a codec set limited to 8,85 kbit/s.

The SS transmits Standard Test Signal C1 on the traffic channel (wanted signal) with an amplitude of $-93 \text{ dBm} + Ir + \text{Corr} + 2 \text{ dB}$, where Ir equals C/lc in table 14.5.1.6-2 and the values for Corr are as stated above.

The SS commands the MS to create the traffic channel loop back, signalling erased frames (subclause 36).

14.5.1.6.4.2 Procedure

- In addition to the wanted signal, the SS produces an independent, uncorrelated interfering signal, Standard Test Signal I1 (unwanted signal) at a nominal frequency 400KHz above that of the wanted signal. The unwanted signal is continuous and has no fixed relationship with the bit transitions of the wanted signal.

- b) The fading characteristic of the wanted and the interfering signals are set to TU50.
- c) The interference ratio is set to $(C/I_c - 50\text{dB})$, i.e. the amplitude of the unwanted signal is set to $(50\text{ dB} - C/I_c)$ above that of the wanted signal, (C/I_c is the co-channel interference ratio from table 14.5.1.6-2).
- d) The SS determines the number of residual bit error events for the bits of the class Ib, by examining sequences of at least the minimum number of samples of consecutive bits of class Ib. Bits are only taken from those frames not signalled as erased.
- e) The SS also determines the frame erasure events by examining sequences of at least the minimum number of samples of consecutive frames and assuming a frame is received successfully, if it is not signalled as erased.
- f) The SS moves the interfering signal to a nominal frequency 200KHz below that of the wanted signal.
- g) The SS uses a Channel Mode Modify procedure to change the active codec set to 6,6 kbit/s.
- h) The SS sets the level of the wanted signal accordingly.
- i) The interference ratio is set to C/I_{a1} from table 14.5.1.6-2.
- j) Steps d) to e) are repeated.

Maximum/Minimum Duration of Test

Maximum: 19 minutes (GSM850), 19 minutes (GSM900), 19 minutes (DCS1800), 19 minutes (PCS1900).

Minimum: 14 minutes (GSM850), 13 minutes (GSM900), 7 minutes (DCS1800), 6 minutes (PCS1900).

14.5.1.6.5 Test requirements

Testing should be performed using statistical methods that lead to an early pass/fail decision with test time significantly reduced for MS with FER/BER not on the limit.

For more information on statistical testing of BER/BLER performance, especially the definition of limit lines refer to Annex 7.

Wrong decision risk F for one single error rate test:

$$F_{\text{pass}} = F_{\text{fail}} = F \quad \text{and} \quad F = 0.2\%$$

Wrong decision probability D per test step:

$$D_{\text{pass}} = D_{\text{fail}} = D \quad \text{and} \quad D = 0.0085\%$$

Parameters for limit lines:

1. D = 0.000085 wrong decision probability per test step.
2. M = 1.5 bad DUT factor
3. ne number of (error) events. This parameter is the x-ordinate in figure A7.1.3.1.
4. ns number of samples. The error rate is calculated from ne and ns.

Limit checking

Before limit checking is valid the minimum test time due to fading needs to be considered:

Testing under multipath and interference conditions requires that at least 990 wavelengths are crossed with the speed given in the fading profile. This leads to a minimum test time depending on the frequency range. No early pass/fail decision is allowed until the minimum test time due to fading has elapsed.

Table 14.5.1.6-1: Minimum test times due to TU high fading conditions

Half Rate 50 km/h					
Frequency	0,85	0,9	1,8	1,9	GHz
Wavelength	0,35	0,33	0,17	0,16	M
min test time	403	380	190	180	S
	0:06:43	0:06:20	0:03:10	0:03:00	

If the minimum test time due to multipath conditions exceeds the target test time, then the test runs for the minimum test time due to multipath conditions and the decision is made by comparing the result with the “derived test limit”. In this case early pass/fail decisions are obsolete.

If the target test time exceeds the minimum test time due to multipath conditions early pass/fail decisions can be headed for in order to accelerate test execution.

For an early decision a minimum number of (error) events is necessary.

For an early pass decision $n_e \geq 1$ (inclusive artificial error)

For an early fail decision $n_e \geq 7$

When the target test time has been reached the test is finished and a pass/fail decision can be made.

The error rate measured in this test shall be tested according to the values given in tables 14.5.1.6-2 and 14.5.1.6.3

Table 14.5.1.6-2: Statistical test limits for GSM 850 and GSM 900 O-TCH/WHS adj-chan interference

TU high no FH		C/la1 (dB)	C/lc (dB)	Samples per second	Orig. BER requirement	Derived test limit	Target number of samples	Target test time (s)	Target test time (hh:mm:ss)
O-TCH/ WHS 8.85	Frames	-	15.0	50	0,010000	0,012340	27958	560	00:09:20
	Class1b			5650	0,001100	0,001357	254237	45	00:00:45
O-TCH/ WHS 6.60	Frames	-5.0	13.5	50	0,010000	0,012340	27958	560	00:09:20
	Class1b			3900	0,001500	0,001851	186386	48	00:00:48

Table 14.5.1.6-3: Statistical test limits for DCS 1 800 and PCS 1 900 O-TCH/WHS adj-chan interference

TU high no FH		C/la1 (dB)	C/lc (dB)	Samples per second	Orig. BER requirement	Derived test limit	Target number of samples	Target test time (s)	Target test time (hh:mm:ss)
O-TCH/ WHS 8.85	Frames	-	14.5	50	0,010000	0,012340	27958	560	00:09:20
	Class1b			5650	0,001200	0,001481	232951	42	00:00:42
O-TCH/ WHS 6.60	Frames	-5.0	13.0	50	0,010000	0,012340	27958	560	00:09:20
	Class1b			3900	0,001600	0,001974	174772	45	00:00:45

14.5.1.7 TCH/WFS Adjacent Channel Interference

14.5.1.7.1 Definition

The adjacent channel selectivity is a measure of the capability of the receiver to receive a wanted modulated signal without exceeding a given degradation due to the presence of an unwanted signal in the adjacent channel.

The adjacent channel can be adjacent in the RF spectrum or in time. There are therefore two types of adjacent channel selectivity:

- 1) Adjacent RF channel selectivity, which is specifically tested in this subclause.
- 2) Adjacent Time Slot selectivity, which is not tested in this subclause.

14.5.1.7.2 Conformance requirement

At reference adjacent channel interference the TCH/WFS class Ib BER shall meet the reference interference performance of table 2j in 3GPP TS 45.005 subclause 6.3.

At reference adjacent channel interference the TCH/WFS FER shall meet the reference performance stated in 3GPP TS 45.005 subclause 6.2.

The reference performance shall be:

For speech channels (TCH/WFS_y) FER ≤ 1%

The performance requirements for GSM 400 and GSM 700 systems are as for GSM 900 in table 2j, except that the GSM 400 MS speed is doubled from that of GSM 900, e.g. TU50 becomes TU100, and the GSM 700 MS speed is increased by a factor of 1.2, e.g. TU50 becomes TU60.

For packet switched and AMR-WB speech, GMSK modulated channels the wanted input signal level shall be: -93 dBm + Ir + Corr, where:

Ir = the interference ratio according to table 2a and table 2j for the packet switched and AMR-WB speech channels respectively

Corr = the correction factor for reference performance according to subclause 3GPP TS 45.005 subclause 6.2.

The corresponding interference ratio for adjacent channel interference shall be:

Modulation of wanted signal		GMSK
- for adjacent (200 kHz) interference	C/Ia1 =	C/Ic - 18 dB
- for adjacent (400 kHz) interference	C/Ia2 =	C/Ic - 50 dB

For T-GSM 810 the requirements for GSM 900 shall apply, apart for those parameters for which a separate requirement exists.

Reference: 3GPP TS 45.005 Subclause 2, 6.3

The levels shall be corrected by the following values:

MS, GMSK modulated signals	
- for DCS 1 800 class 1 or class 2 MS	+2/+4 dB**
- for DCS 1 800 class 3 MS	+2 dB
- for GSM 400 small MS, GSM 900 small MS GSM 850 small MS and GSM 700 small MS	+2 dB
- for other GSM 400, GSM 900 MS and GSM 850 MS and GSM 700 MS	0 dB
- for PCS 1900 class 1 or class 2 MS	+2 dB
- for other PCS 1900 MS	0 dB

** For DCS 1 800 class 1 and class 2 MS, a correction offset of +2dB shall apply for the reference sensitivity performance as specified in table 1a for the normal conditions defined in Annex D and an offset of +4 dB shall be used to determine all other MS performances.

3GPP TS 45.005 Subclause 6.2

14.5.1.7.3 Test purpose

To verify that with an adjacent channel interferer at 200 kHz and at 400kHz above and below the wanted signal the MS does not exceed conformance requirements in tables 14.5.1.7-3/4 for three given codec rates under propagation condition TU_{high} (for GSM 400, GSM 700, T-GSM 810, GSM 850, GSM 900, DCS 1800 and PCS 1900) with no frequency hopping, with an allowance for the statistical significance of the test.

14.5.1.7.4 Method of Test

14.5.1.7.4.1 Initial conditions

A call is set up according to the generic call set up procedure on TCH/WFS with an ARFCN in the mid ARFCN range, power control level set to maximum power.

The multirate configuration indicates the use of a codec set limited to 12.65 kbit/s.

The SS commands the MS to create the traffic channel loop back signalling erased frames.

The SS transmits Standard Test Signal C1 on the TCH (wanted signal) with an amplitude of $-93 \text{ dBm} + I_r + \text{Corr}$, where I_r equals C/I_c in table.14.5.1.7-2 and the values for Corr are as stated above

14.5.1.7.4.2 Procedure

- a) In addition to the wanted signal, the SS transmits an independent, uncorrelated interfering signal, Standard Test Signal I1 (unwanted signal).

The unwanted signal is continuous and has no fixed relationship with the bit transitions of the wanted signal.

The interference ratio shall be set to $(C/I_c - 18 \text{ dB})$ for adjacent channel interference of 200 kHz and $(C/I_c - 50 \text{ dB})$ for adjacent channel interference of 400 kHz respectively. The co-channel interference values C/I_c can be found in table 14.5.1.7-2.

The fading characteristic of the wanted and the unwanted signal is set to TUHigh.

The unwanted signal is transmitted at a nominal frequency of 200 kHz above the nominal frequency of the wanted signal. The interference ratio is set to $(C/I_c - 18 \text{ dB})$, i.e. the amplitude of the unwanted signal is set to $(18 \text{ dB} - C/I_c)$ above that of the wanted signal.

- b) The SS compares the data of the signal that it sends to the MS with the signal which is looped back from the receiver after demodulation and decoding, and checks the frame erasure indication.
- c) The SS tests the frame erasure compliance for the TCH/WFS by examining at least the minimum number of samples of consecutive frames. The number of frame erasure events is recorded.
- d) The SS determines the number of residual bit error events for the bits of the class Ib, by examining sequences of at least the minimum number of samples of consecutive bits of class Ib, Bits are only taken from those frames for which no bad frame indication was given.
- e) The unwanted signal is moved to a nominal frequency of 200 kHz below the nominal frequency of the wanted signal. The interference ratio is set to $(C/I_c - 18 \text{ dB})$, i.e. the amplitude of the unwanted signal is set to $(18 \text{ dB} - C/I_c)$ above that of the wanted signal.
- f) The SS uses a Channel Mode Modify procedure to change the active codec set to 8.85 kbit/s. The wanted signal level is set accordingly and steps b) to d) are repeated.
- g) The unwanted signal is moved to a nominal frequency of 400 kHz above the nominal frequency of the wanted signal. The interference ratio is set to $(C/I_c - 50 \text{ dB})$, i.e. the amplitude of the unwanted signal is set to $(50 \text{ dB} - C/I_c)$ above that of the wanted signal.
- h) The SS uses a Channel Mode Modify procedure to change the active codec set to 6.60 kbit/s. The wanted signal level is set accordingly and steps b) to d) are repeated.
- i) The unwanted signal is moved to a nominal frequency of 400 kHz below the nominal frequency of the wanted signal. The interference ratio is set to $(C/I_c - 50 \text{ dB})$, i.e. the amplitude of the unwanted signal is set to $(50 \text{ dB} - C/I_c)$ above that of the wanted signal. Steps b) to d) are repeated.

Maximum/Minimum Duration of Test

Maximum: 5 minutes (GSM850, GSM900), 23 minutes (DCS1800, PCS1900).

Minimum: 2 minutes (GSM850, GSM900), 4 minutes (DCS1800, PCS1900).

14.5.1.7.5 Test requirements

Testing the adjacent channel interference performance is performed using statistical methods that lead to an early pass/fail decision with test time significantly reduced for MS with BER/BLER not on the limit.

For more information on statistical testing of BER/BLER performance, especially the definition of the limit lines refer to Annex 6.2

Wrong decision risk F for one single error ratio test:

$$F_{\text{pass}} = F_{\text{fail}} = F \quad \text{and} \quad F = 0.2\%$$

Wrong decision probability D per test step:

$$D_{\text{pass}} = D_{\text{fail}} = D \quad \text{and} \quad D = 0.0085\%$$

Parameters for limit lines:

1. D = 0.000085 wrong decision probability per test step.
2. M = 1.5 bad DUT factor
3. ne number of (error) events.
4. ns number of samples. The error rate is calculated from ne and ns.

Limit checking

Before limit checking is valid the minimum test time due to fading needs to be considered:

Testing under multipath and interference conditions requires that at least 990 wavelengths are crossed with the speed given in the fading profile. This leads to a minimum test time depending on the frequency range. No early pass/fail decision is allowed until the minimum test time due to fading has elapsed.

Table 14.5.1.7-1: Minimum test times due to TU high fading conditions

Frequency	0,4	0,7	0,85	0,9	1,8	1,9	GHz
Wavelength	0,75	0,43	0,35	0,33	0,17	0,16	m
min test time	428	244	201	190	95	90	s
	0:07:08	0:04:04	0:03:21	0:03:10	0:01:35	0:01:30	hh:mm:ss

If the minimum test time due to multipath conditions exceeds the target test time, then the test runs for the minimum test time due to multipath conditions and the decision is done by comparing the result with the “derived test limit”. In this case early pass/fail decisions are obsolete.

If the target test time exceeds the minimum test time due to multipath conditions early pass/fail decisions can be headed for in order to accelerate test execution.

For an early decision a minimum number of (error) events is necessary.

For an early pass decision $n_e \geq 1$ (inclusive artificial error)

For an early fail decision $n_e \geq 7$

When the target test time has been reached the test is finished and a pass/fail decision can be made.

Table 14.5.1.7-2: Co-channel interference ratio C/Ic for GMSK-modulated WB-AMR channels

Type of Channel		GSM 850 and GSM 900		DCS 1 800 & PCS 1 900	
		Propagation condition			
		TU50(no FH)		TU50(no FH)	
TCH/ WFS12.65	dB	14.5		13.0	
TCH/ WFS8.85	dB	11.5		10.0	
TCH/ WFS6.60	dB	10.5		9.0	

Table 14.5.1.7-3: Statistical test limits for GSM 700, T-GSM 810, GSM 850 and GSM 900 adjacent channel rejection

0.4 to 0.9GHz			frames per s	Orig. BER	Derived	Target number	Target test	Target test time
	Channel	bits per sec	clas1b per s	requirement	test limit	of samples	time (s)	(hh:mm:ss)
WFS 12.65	frames	12650	50	0,010000	0,012340	27958	560	00:09:20
	Class1b	12650	9050	0,004000	0,004936	69895	8	00:00:08
WFS 8.85	frames	8850	50	0,010000	0,012340	27958	560	00:09:20
	Class1b	8850	5650	0,004200	0,005183	66566	12	00:00:12
WFS 6.60	frames	6600	50	0,010000	0,012340	27958	560	00:09:20
	Class1b	6600	3900	0,001600	0,001974	174737	45	00:00:45

Table 14.5.1.7-3: Statistical test limits for DCS 1 800 and PCS 1 900 adjacent channel rejection

TU high no FH								
1.8 and 1.9GHz			frames per s	Orig. BER	Derived	Target number	Target test	Target test time
	Channel	bits per sec	clas1b per s	requirement	test limit	of samples	time (s)	(hh:mm:ss)
WFS 12.65	frames	12650	50	0,010000	0,012340	27958	560	00:09:20
	Class1b	12650	9050	0,006300	0,007774	44378	5	00:00:05
WFS 8.85	frames	8850	50	0,010000	0,012340	27958	560	00:09:20
	Class1b	8850	5650	0,006400	0,007898	43684	8	00:00:08
WFS 6.60	frames	6600	50	0,010000	0,012340	27958	560	00:09:20
	Class1b	6600	3900	0,002700	0,003332	103548	27	00:00:27

14.5.2 Adjacent channel rejection - control channels

14.5.2.1 Definition

The adjacent channel selectivity is a measure of the capability of the receiver to receive a wanted modulated signal without exceeding a given degradation due to the presence of an unwanted signal in the adjacent channel.

The adjacent channel can be the adjacent in the RF spectrum or in time. There are therefore two types of adjacent channel selectivity:

- 1) Adjacent RF channel selectivity which is specifically tested in this subclause.
- 2) Adjacent Time Slot selectivity, which is implicitly tested in test 14.2.1.

14.5.2.2 Conformance requirement

1. For adjacent channel interference at 200 kHz above and below the wanted signal frequency and signal level 9 dB above the wanted signal level:
 - 1.1 For a TUhigh faded wanted signal and a TUhigh adjacent channel interferer, the FER for the FACCH/F does not exceed the requirements of table 2 in 3GPP TS 05.05 subclause 6.3.
 - 1.2 For a TUhigh faded wanted signal and a TUhigh adjacent channel interferer, the FER for the FACCH/F does not exceed the requirements of table 2 in 3GPP TS 05.05 under extreme test conditions; 3GPP TS 05.05 subclause 6.3, annex D subclauses D.2.1 and D.2.2.
2. With adjacent channel interference at 400 kHz above and below the wanted signal frequency and signal level 41 dB above the wanted signal level:
 - 2.1 For a TUhigh faded wanted signal and a static adjacent channel interferer, the FER for the FACCH/F shall be better than:

GSM 400, GSM 700, GSM 850 and GSM 900: 17,1 %; 3GPP TS 05.05, subclause 6.3;

DCS 1 800 and PCS 1 900: 6,1 %; 3GPP TS 05.05, subclause 6.3.

2.2 For a TUhigh faded wanted signal and a static adjacent channel interferer, the FACCH/F shall be better than:

GSM 400, GSM 700, GSM 850 and GSM 900: 17,1 %;

DCS 1 800 and PCS 1 900: 6,1 %.

under extreme test conditions; 3GPP TS 05.05, subclause 6.3, annex D subclauses D.2.1 and D.2.2.

3GPP TS 45.05 subclause 2:

For T-GSM 810 the requirements for GSM 900 shall apply, apart for those parameters for which a separate requirement exists.

14.5.2.3 Test purpose

- 1 To verify that with TUhigh adjacent channel interference at 200 kHz above and below a TUhigh wanted signal frequency and signal level 9 dB above the wanted signal level:
 - 1.1 Conformance requirement 1.1 is met with an allowance for the statistical significance of the test.
 - 1.2 Conformance requirement 1.2 is met with an allowance for the statistical significance of the test.
2. To verify that with static adjacent channel interference at 400 kHz above and below a TUhigh wanted signal frequency and signal level 41 dB above the wanted signal level:
 - 2.1 Conformance requirement 2.1 is met with an allowance for the statistical significance of the test.
 - 2.2 Conformance requirement 2.2 is met with an allowance for the statistical significance of the test.

14.5.2.4 Method of test

14.5.2.4.1 Initial conditions

A call is set up according to the generic call set up procedure on a TCH in the mid ARFCN range. Any one of the supported TCH/(F9,6, F4,8, or F2,4) shall be used.

The SS transmits the Standard Test Signal C1 on the TCH (wanted signal).

14.5.2.4.2 Procedure

- a) In addition to the wanted signal, the SS transmits an independent, uncorrelated interfering signal, Standard Test Signal I1 (unwanted signal).

The unwanted signal is continuous and has no fixed relationship with the bit transitions of the wanted signal. The fading characteristic of the wanted and the unwanted signal is TUhigh.

The unwanted signal is transmitted at a nominal frequency 200 kHz above the nominal frequency of the wanted signal. Its amplitude is set to 9dB above that of the wanted signal.

- b) The SS sends a Layer 3 message which does not require a Layer 3 response from the MS. Due to the adjacent channel interference, the MS may not be able to acknowledge the Layer 2 frame. Each repeated L2 frame indicates a frame erasure event. The SS determines the number of frame erasure events during at least the minimum number of samples of FACCH/F frames.

NOTE: These frames will not be consecutive but it is expected that the statistical significance of the tests will not be unduly degraded.

- c) The measurement of step b) is repeated with the unwanted signal on a frequency at the same displacement from, but below, the frequency of the wanted signal.
- d) The measurement of steps a) to c) is repeated for a displacement of the unwanted signal of 400 kHz, and with the amplitude of the unwanted signal 41 dB above the level of the wanted input signal, and the unwanted signal static.
- e) Steps a) to d) are repeated under extreme test conditions.

14.5.2.5 Test requirements

Table 14-23: Limits for adjacent channel selectivity

Interference at	Channel	Type of measurement	Test limit error rate %	Minimum No. of samples	Test limit error rate %	Minimum No. of samples
200 kHz	FACCH/F	FER	10,640	5 639	3,808	15 756
400 kHz	FACCH/F	FER	19,152	3 133	6,832	8 782

The error rates measured in this test shall not exceed the test limit error rates given in table 14-23. This shall apply for any combination of normal and extreme test voltages and ambient temperature, and with the interfering signals at either side of the wanted frequency.

NOTE: A static unwanted signal is used to avoid a potential problem with the noise floor of the fading simulator.

14.6 Intermodulation rejection

14.6.1 Intermodulation rejection - speech channels

14.6.1.1 Definition

The intermodulation rejection is a measure of the capability of the receiver to receive a wanted modulated signal without exceeding a given degradation due to the presence of two or more unwanted signals with a specific frequency relationship to the wanted signal frequency.

For E-GSM 900 and R-GSM 900 MS this test is only performed in the P-GSM band.

14.6.1.2 Conformance requirement

In the presence of two unwanted signals with a specific frequency relationship to the wanted signal frequency the Class II RBER for TCH/FS shall meet the reference sensitivity performance of table 1 in 3GPP TS 05.05 subclause 5.3.

14.6.1.3 Test purpose

To verify that the MS does not exceed the conformance requirement with an allowance for the statistical significance of the test.

14.6.1.4 Method of test

NOTE: The measurements address the third order intermodulation, which represents the most serious case.

14.6.1.4.1 Initial conditions

A call is set up according to the generic call set up procedure on a TCH with an ARFCN in the Mid ARFCN range, power control level set to maximum power.

The SS transmits Standard Test Signal C1 on the traffic channel.

14.6.1.4.2 Procedure

- The amplitude of the wanted signal is set to 4 dB above the reference sensitivity level (see table 14-24).
- The SS commands the MS to create the loop back facility signalling erased frames.
- The SS produces a static wanted signal, and two static interfering (unwanted) signals at the same time. There is no correlation in the modulation between the signals.

The first interfering signal is on a frequency equal to the centre frequency of an ARFCN four above that of the receiver. This signal is static and unmodulated.

The second interfering signal is on an ARFCN eight above that of the receiver. This signal is static, continuous and modulated by random data.

The amplitude of both the interfering signals is set according to table 14-24.

- d) The SS compares the data of the signal that it sends to the MS with the signal which is looped back from the receiver after demodulation and decoding, and checks the frame erasure indication.

The SS tests the RBER compliance of class II bits by examining at least the minimum number of samples of consecutive bits. Bits only taken from those frames which do not signal frame erasure. The number of error events is recorded.

- e) The measurement of step d) is repeated with the two unwanted signals having frequencies corresponding to ARFCN four and eight below the ARFCN of the wanted signal.
- f) Steps b) to e), are repeated but with the receiver operating on an ARFCN in the Low ARFCN range.
- g) Steps b) to e), are repeated but with the receiver operating on an ARFCN in the High ARFCN range.
- h) Steps a) to g) are repeated under extreme test conditions.

Table 14-24: Intermodulation test signal levels

	GSM 400, GSM 700, T-GSM 810, GSM 850 and GSM 900		DCS 1 800		PCS 1 900
	Small MS	Other MS	Class 1 and 2	Class 3	
WANTED SIGNAL dB μ Vemf()	15	13	17	15	15
FIRST INTERFERER dB μ Vemf()	64	74	64	68	64
SECOND INTERFERER dB μ Vemf()	63	63	64	68	64

NOTE: Some of the levels in table 14-24 are different to those specified in 3GPP TS 05.05 due to the consideration of the effect of modulation sideband noise from the second interferer.

14.6.1.5 Test requirements

The error rate measured in this test shall not exceed the test limit error rate values given in table 14-25.

This shall apply under normal condition and under any combination of normal and extreme test voltages and ambient temperature, and with the two interfering signals at either side of the wanted frequency.

Table 14-25: Limits for intermodulation rejection

Channel	Propagation conditions	Type of measurement	Test limit error rate %	Minimum No. of samples
TCH/FS Class II	Static	RBER	2,439	8 200

14.6.2 Intermodulation rejection - control channels

14.6.2.1 Definition

The intermodulation rejection is a measure of the capability of the receiver to receive a wanted modulated signal without exceeding a given degradation due to the presence of two or more unwanted signals with a specific frequency relationship to the wanted signal frequency.

For E-GSM 900 and R-GSM 900 MS this test is only performed in the P-GSM band.

14.6.2.2 Conformance requirement

In the presence of two unwanted signals with a specific frequency relationship to the wanted signal frequency the FER for FACCH/F shall meet the reference sensitivity performance of table 1 in 3GPP TS 05.05 subclause 5.3.

14.6.2.3 Test purpose

To verify that the MS does not exceed the conformance requirement with an allowance for the statistical significance of the test.

14.6.2.4 Method of test

NOTE: The measurements address the third order intermodulation, which represents the most serious case.

14.6.2.4.1 Initial conditions

A call is set up according to the generic call set up procedure on a TCH with an ARFCN in the Mid ARFCN range, power control level set to maximum.

The SS transmits Standard Test Signal C1 on the traffic channel. The amplitude of the wanted signal is set to 4 dB above the reference sensitivity level (see table 14-25).

14.6.2.4.2 Procedure

- a) The SS produces a TUhigh wanted signal, and two static interfering (unwanted) signals at the same time. There is no correlation in the modulation between the signals.

The first interfering signal is on a frequency equal to the centre frequency of an ARFCN four above that of the receiver. This signal is static and unmodulated.

The second interfering signal is on an ARFCN eight above that of the receiver. This signal is static, continuous and modulated by random data.

The amplitude of both the interfering signals is set according to table 14-26.

- b) The SS sends a Layer 3 message which does not require a Layer 3 response from the MS. The SS determines the number of frame erasure events during at least the minimum number of samples of FACCH/F frames.

NOTE: These frames will not be consecutive but it is expected that the statistical significance of the tests will not be unduly degraded.

- c) The measurement of step b) is repeated with the two unwanted signals having frequencies corresponding to ARFCN four and eight below the ARFCN of the wanted signal.
- d) Steps a) to c), are repeated but with the receiver operating on an ARFCN in the Low ARFCN range.
- e) Steps a) to c), are repeated but with the receiver operating on an ARFCN in the High ARFCN range.
- f) Steps a) to e) are repeated under extreme test conditions.

Table 14-26: Intermodulation test signal levels

	GSM 400, GSM 700, T-GSM 810, GSM 850 and GSM 900		DCS 1 800		PCS 1 900
	Small MS	Other MS	Class 1 and 2	Class 3	
WANTED SIGNAL dB μ Vemf()	15	13	17	15	15
FIRST INTERFERER dB μ Vemf()	64	74	64	68	64
SECOND INTERFERER dB μ Vemf()	63	63	64	68	64

NOTE: Some of the levels in table 14-26 are different to those specified in 3GPP TS 05.05 due to the consideration of the effect of modulation sideband noise from the second interferer.

14.6.2.5 Test requirements

The error rate measured in this test shall not exceed the test limit error rate values given in table 14-27.

This shall apply under normal condition and under any combination of normal and extreme test voltages and ambient temperature, and with the two interfering signals at either side of the wanted frequency.

Table 14-27: Limits for intermodulation rejection

			GSM 400, GSM 700, T-GSM 810, GSM 850 and GSM 900		DCS 1 800 and PCS 1 900	
Channel	Propagation conditions	Type of measurement	Test limit error rate %	Minimum No. of max-samples	Test limit error rate %	Min No. of max-samples
FACCH/F	TUhigh/No FH	FER	8,961	6 696	4,368	13 736

14.7 Blocking and spurious response

14.7.1 Blocking and spurious response - speech channels

14.7.1.1 Definition

Blocking is a measure of the ability of the receiver to receive a modulated wanted input signal in the presence of an unwanted input signal, on frequencies other than those of the spurious responses or the adjacent channels, without exceeding a given degradation.

14.7.1.2 Conformance requirement

1. The blocking characteristics of the receiver are specified separately for in-band and out-of-band performance as identified in 3GPP TS 05.05 subclause 5.1.

The reference sensitivity performance as specified in table 1 of 3GPP TS 05.05 shall be met when the following signals are simultaneously input to the receiver:

- a useful signal at frequency f_0 , 3 dB above the reference sensitivity level as specified in 3GPP TS 05.05 subclause 6.2;
- a continuous, static sine wave signal at a level as in the table of 3GPP TS 05.05 subclause 5.1 and at a frequency (f) which is an integer multiple of 200 kHz;

with the following exceptions, called spurious response frequencies:

- a) GSM 700, GSM 850 and GSM 900: in band, for a maximum of six occurrences (which if grouped shall not exceed three contiguous occurrences per group);

DCS 1 800: in band, for a maximum of twelve occurrences (which if grouped shall not exceed three contiguous occurrences per group);

PCS 1 900: in band, for a maximum of twelve occurrences (which if grouped shall not exceed three contiguous occurrences per group);

GSM 400: in band, for a maximum of three occurrences;

- b) out of band, for a maximum of 24 occurrences (which if below f_0 and grouped shall not exceed three contiguous occurrences per group).

where the above performance shall be met when the continuous sine wave signal (f) is set to a level of 70 dB μ V (emf) (i.e. -43 dBm). 3GPP TS 05.05, subclause 5.1.

3GPP TS 45.05 subclause 2:

For T-GSM 810 the requirements for GSM 900 shall apply, apart for those parameters for which a separate requirement exists.

14.7.1.3 Test purpose

1. To verify that the in band blocking performance is met without exceeding the total number of allowed in band spurious responses. An allowance is made for the statistical significance of the test.

2. To verify that at selected out of band frequencies, the out of band blocking performance is met without exceeding the total number of allowed out of band spurious responses. An allowance is made for the statistical significance of the test.

NOTE: Not all of the possible out of band frequencies are tested as this results in excessive test time. However, the total number of out of band spurious responses, specified in 3GPP TS 05.05, are allowed to ensure a fair test of the MS.

14.7.1.4 Method of test

14.7.1.4.1 Initial conditions

A call is set up according to the generic call set up procedure, except the BCCH frequency list shall be empty, on a TCH with an arbitrary ARFCN in the range supported by the MS. The power control level is set to maximum power. The ARFCN of the BCCH shall be the same - or at an offset of +/- 2 channels, than that of the ARFCN for the TCH.

The SS transmits Standard Test Signal C1 on the traffic channel. (TCH frequency FR).

The SS commands the MS to create traffic channel loop back signalling erased frames.

14.7.1.4.2 Procedure

- a) The SS produces a static wanted signal and a static interfering signal at the same time. The amplitude of the wanted signal is set to 4 dB above the reference sensitivity level.
- b) The unwanted signal is a C.W. signal (Standard test signal IO) of frequency FB. It is applied in turn on the subset of frequencies calculated in step c) in the overall range 100 kHz to 12,75 GHz, where FB is an integer multiple of 200 kHz.

However, frequencies in the range $FR \pm 600$ kHz are excluded.

NOTE: Allowance must be made for possible spurious signals arising from the SS. These are particularly likely at sub harmonic frequencies nFB where $n = 2, 3, 4, 5$, etc.

- c) The frequencies at which the test is performed (adjusted to an integer multiple of 200 kHz channels most closely approximating the absolute frequency of the calculated blocking signal frequency) are the combined frequencies from i), ii) and iii) below:-

- i) The total frequency range formed by:

GSM 400 the frequencies between $F_{10} + (IF_1 + IF_2 + \dots + IF_n + 3,6 \text{ MHz})$

and $F_{10} - (IF_1 + IF_2 + \dots + IF_n + 3,6 \text{ MHz})$.

GSM 700 and T-GSM 810 the frequencies between $F_{10} + (IF_1 + IF_2 + \dots + IF_n + 7,5 \text{ MHz})$

and $F_{10} - (IF_1 + IF_2 + \dots + IF_n + 7,5 \text{ MHz})$.

GSM 850 and P-GSM 900 the frequencies between $F_{10} + (IF_1 + IF_2 + \dots + IF_n + 12,5 \text{ MHz})$

and $F_{10} - (IF_1 + IF_2 + \dots + IF_n + 12,5 \text{ MHz})$.

E-GSM 900 the frequencies between $F_{10} + (IF_1 + IF_2 + \dots + IF_n + 17,5 \text{ MHz})$

and $F_{10} - (IF_1 + IF_2 + \dots + IF_n + 17,5 \text{ MHz})$.

DCS 1 800 the frequencies between $F_{10} + (IF_1 + IF_2 + \dots + IF_n + 37,5 \text{ MHz})$

and $F_{10} - (IF_1 + IF_2 + \dots + IF_n + 37,5 \text{ MHz})$.

PCS 1 900 the frequencies between $F_{10} + (IF_1 + IF_2 + \dots + IF_n + 30,0 \text{ MHz})$

and $F_{10} - (IF_1 + IF_2 + \dots + IF_n + 30,0 \text{ MHz})$.

and

the frequencies +100 MHz and -100 MHz from the edge of the relevant receive band.

Measurements are made at 200 kHz intervals.

ii) The three frequencies IF_1 , $IF_1 + 200$ kHz, $IF_1 - 200$ kHz.

iii) The frequencies:

$mF_{lo} + IF_1$;

$mF_{lo} - IF_1$;

mFR ;

where m is all positive integers greater than or equal to 2 such that either sum lies in the range 100 kHz to 12,75 GHz.

The frequencies in step ii) and iii) lying in the range of frequencies defined by step i) above need not be repeated.

Where:

F_{lo} - local oscillator applied to first receiver mixer

$IF_1 \dots IF_n$ - are the n intermediate frequencies

F_{lo} , IF_1 , $IF_2 \dots IF_n$ - shall be declared by the manufacturer in the PIXIT statement 3GPP TS 51.010-1 annex 3.

d) The level of the unwanted signal is set according to table 14-28.

Table 14-28a: Level of unwanted signals

FREQUENCY	GSM 900		DCS 1 800
	Small MS	Other MS	
	LEVEL IN dB μ Vemf()		
FR \pm 600 kHz to FR \pm 800 kHz	70	75	70
FR \pm 800 kHz to FR \pm 1,6 MHz	70	80	70
FR \pm 1,6 MHz to FR \pm 3 MHz	80	90	80
915 MHz to FR - 3 MHz	90	90	-
FR + 3 MHz to 980 MHz	90	90	-
1 785 MHz to FR - 3 MHz	-	-	87
FR + 3 MHz to 1 920 MHz	-	-	87
835 MHz to < 915 MHz	113	113	
> 980 MHz to 1 000 MHz	113	113	
100 kHz to < 835 MHz	90	90	
> 1 000 MHz to 12,75 GHz	90	90	
100 kHz to 1 705 MHz	-	-	113
> 1 705 MHz to < 1 785 MHz	-	-	101
> 1 920 MHz to 1 980 MHz	-	-	101
> 1 980 MHz to 12,75 GHz	-	-	90

Table 14-28b: Level of unwanted signals

FREQUENCY	GSM 450		GSM 480	
	Small MS	Other MS	Small MS	Other MS
	LEVEL IN dB μ Vemf()			
FR \pm 600 kHz to FR \pm 800 kHz	70	75	70	75
FR \pm 800 kHz to FR \pm 1,6 MHz	70	80	70	80
FR \pm 1,6 MHz to FR \pm 3 MHz	80	90	80	90
457,6 MHz to FR - 3 MHz	90	90	-	-
FR + 3 MHz to 473,6 MHz	90	90	-	-
486 MHz to FR - 3 MHz	-	-	90	90
FR + 3 MHz to 502 MHz	-	-	90	90
100 kHz to < 457,6 MHz	113	113	-	-
> 473,6 MHz to 12,75 GHz	113	113	-	-
100 kHz to < 486 MHz	-	-	113	113
> 502 MHz to 12,75 GHz	-	-	113	113

Table 14-28c: Level of unwanted signals

FREQUENCY	PCS 1 900 LEVEL IN dB μ Vemf()
FR \pm 600 kHz to FR \pm 800 kHz	70
FR \pm 800 kHz to FR \pm 1,6 MHz	70
FR \pm 1,6 MHz to FR \pm 3 MHz	80
1 910 MHz to FR - 3 MHz	87
FR + 3 MHz to 2 010 MHz	87
100 kHz to 1 830 MHz	113
> 1 830 MHz to < 1 910 MHz	101
> 2 010 MHz to 2 070 MHz	101
> 2 070 MHz to 12,75 GHz	90

Table 14-28d: Level of unwanted signals

FREQUENCY	GSM 710	GSM 750	T-GSM 810	GSM 850
	LEVEL IN dB μ Vemf()			
FR \pm 600 kHz to FR \pm 800 kHz	70	70	70	70
FR \pm 800 kHz to FR \pm 1,6 MHz	70	70	70	70
FR \pm 1,6 MHz to FR \pm 3 MHz	80	80	80	80
678 MHz to FR - 3 MHz	90	-	-	-
FR + 3 MHz to 728 MHz	90	-	-	-
727 MHz to FR - 3 MHz	-	90	-	-
FR + 3 MHz to 777 MHz	-	90	-	-
831 MHz to FR - 3 MHz	-	-	90	-
FR + 3 MHz to 886 MHz	-	-	90	-
849 MHz to FR - 3 MHz	-	-	-	90
FR + 3 MHz to 914 MHz	-	-	-	90
678 MHz to FR - 3 MHz	113	-	-	-
FR + 3 MHz to 728 MHz	113	-	-	-
100 kHz to < 727 MHz	-	113	-	-
> 777 MHz to 12,75 GHz	-	113	-	-
100 kHz to 831 MHz	-	-	113	-
> 886 MHz to 12,75 MHz	-	-	113	-
100 kHz to < 849 MHz	-	-	-	113
> 914 MHz to 12,75 GHz	-	-	-	113

NOTE 1: These values differ from 3GPP TS 05.05 because of practical generator limits in the SS.

NOTE 2: For an E-GSM 900 MS the level of the unwanted signal in the band 905 MHz to < 915 MHz is relaxed to 108 dB μ Vemf().

NOTE 3: For a GSM 450 small MS the level of the unwanted signal in the band 450,4 MHz to < 457,6 MHz is relaxed to 108 dBuVemf(). For a GSM 480 small MS the level of the unwanted signal in the band 478,8 MHz to < 486 MHz is relaxed to 108 dBuVemf().

- e) The SS compares the data of the signal that it sends to the MS with the signal which is looped back from the receiver after demodulation and decoding, and checks the frame erasure indication.

The SS tests the RBER compliance for the bits of class II, by examining sequences of at least the minimum number of samples of consecutive bits of class II, where bits are taken only from those frames for which no bad frame indication was given. The number of error events is recorded.

If a failure is indicated it is noted and counted towards the allowed exemption totals.

In the case of failures discovered at the predicted frequencies at steps f ii), iii) or iv) the test is repeated on the adjacent channels ± 200 kHz away. If either of these two frequencies fail then the next channel 200 kHz beyond is also tested. This process is repeated until all channels constituting the group of failures is known.

14.7.1.5 Test requirements

The error rate measured in this test shall not exceed the conformance requirement. Testing the conformance requirement can be done either in the classical way with a fixed minimum number of samples (refer to section 14.7.1.5.2) or using statistical methods that lead to an early pass/fail decision with test time significantly reduced for MS with performance not on the limit (refer to section 14.7.1.5.1). Both methods are based on a bad DUT factor $M = 1.5$.

This shall apply under normal test voltage and ambient temperature, and with the interfering signal at any frequency in the range specified.

The following exceptions are allowed:

- | | |
|----------|---|
| GSM 450: | A maximum of three failures in the frequency band 457,6 MHz to 473,6 MHz.

A maximum of 24 failures in the combined bands 100 kHz to 457,6 MHz and 473,6 MHz to 12,75 GHz (which, if below FR and grouped, shall not exceed three 200 kHz channels per group). |
| GSM 480: | A maximum of three failures in the frequency band 486 MHz to 502 MHz.

A maximum of 24 failures in the combined bands 100 kHz to 486 MHz and 502 MHz to 12,75 GHz (which, if below FR and grouped, shall not exceed three 200 kHz channels per group). |
| GSM 710: | A maximum of six failures in the frequency band 678 MHz to 728 MHz (which, if grouped, shall not exceed three 200 kHz channels per group).

A maximum of 24 failures in the combined bands 100 kHz to 678 MHz and 728 MHz to 12,75 GHz (which, if below FR and grouped, shall not exceed three 200 kHz channels per group). |
| GSM 750: | A maximum of six failures in the frequency band 727 MHz to 782 MHz (which, if grouped, shall not exceed three 200 kHz channels per group).

A maximum of 24 failures in the combined bands 100 kHz to 727 MHz and 782 MHz to 12,75 GHz (which, if below FR and grouped, shall not exceed three 200 kHz channels per group). |
| GSM 810: | A maximum of six failures in the frequency band 831 MHz to 886 MHz (which, if grouped, shall not exceed three 200 kHz channels per group).

A maximum of 24 failures in the combined bands 100 kHz to 831 MHz and 886 MHz to 12,75 GHz (which, if below FR and grouped, shall not exceed three 200 kHz channels per group). |
| GSM 850: | A maximum of six failures in the frequency band 849 MHz to 914 MHz (which, if grouped, shall not exceed three 200 kHz channels per group).

A maximum of 24 failures in the combined bands 100 kHz to 849 MHz and 914 MHz to 12,75 GHz (which, if below FR and grouped, shall not exceed three 200 kHz channels per group). |
| GSM 900: | A maximum of six failures in the frequency band 915 MHz to 980 MHz (which, if grouped, shall not exceed three 200 kHz channels per group). |

A maximum of 24 failures in the combined bands 100 kHz to 915 MHz and 980 MHz to 12,75 GHz (which, if below FR and grouped, shall not exceed three 200 kHz channels per group).

DCS 1 800: A maximum of twelve failures in the band 1 785 MHz to 1 920 MHz (which, if grouped, shall not exceed three 200 kHz channels per group).

A maximum of 24 in the combined bands 100 kHz to 1 785 MHz and 1 920 MHz to 12,75 GHz (which, if below FR and grouped, shall not exceed three 200 kHz channels per group).

PCS 1 900: A maximum of twelve failures in the band 1 910 MHz to 2 010 MHz (which, if grouped, shall not exceed three 200 kHz channels per group).

A maximum of 24 in the combined bands 100 kHz to 1 910 MHz and 2 010 MHz to 12,75 GHz (which, if below FR and grouped, shall not exceed three 200 kHz channels per group).

If the number of failures do not exceed the maximum allowed figures stated above, the test of 14.7.1.4 is repeated at the frequencies at which the failures occurred. The level of the unwanted signal is set to 70 dB μ Vemf() and the performance requirement is once again that stated in the table above.

The number of Error Events recorded in this test shall not exceed the test limit error rate values given below, when using either the accelerated BER method or the maximum number of samples. No failures are allowed at this lower unwanted signal level.

14.7.1.5.1 Statistical testing of blocking and spurious response performance with early decision

For more information on statistical testing of blocking and spurious response performance, especially the definition of limit lines refer to Annex 7.

Wrong decision risk F for one single error rate test:

$F_{\text{pass}} \neq F_{\text{fail}}$ As the blocking test case comprises of many BER tests the wrong decision risk for a fail decision of one single error rate test must be smaller than the wrong decision risk for a pass decision to avoid an increased probability of an erroneous fail decision.

$F_{\text{pass}} = 0.2\%$

$F_{\text{fail}} = 0.02\%$

Wrong decision probability D per test step:

$D_{\text{pass}} \neq D_{\text{fail}}$

$D_{\text{pass}} = 0.0085\%$

$D_{\text{fail}} = 0.00085\%$

Parameters for limit lines:

1. $D_{\text{pass}} = 0.0085\%$ wrong decision probability per test step for early pass decision.

$D_{\text{fail}} = 0.00085\%$ wrong decision probability per test step for early fail decision.

2. $M = 1.5$ bad DUT factor

3. n_e number of (error) events.

4. n_s number of samples. The error rate is calculated from n_e and n_s .

Limit checking

For an early decision a minimum number of measured (error) events is necessary.

For an early pass decision $n_e \geq 1$

For an early fail decision $n_e \geq 8$

When the target test time has been reached the test is finished and a pass/fail decision can be made.

The statistical test limits for blocking performance with early decision are given in Table 14-29a

Table 14-29a: Statistical test limits for blocking performance

Channel	bits per s	Orig. RBER requirement	Derived test limit	Target number of samples	Target test time (s)	Target test time (hh:mm:ss)
TCH/FS Class II	3900	0,020000	0,024680	13979	4	00:00:04

14.7.1.5.2 Fixed testing of blocking and spurious response performance with minimum number of samples

The fixed testing of the conformance requirement is done using the minimum number of samples and the limit RBER given in table 14-29c

Table 14-29c: Limits for blocking

Channel	Type of measurement	Test limit error rate %	Minimum number of samples
TCH/FS Class II	RBER	2,439	8 200

14.7.2 Blocking and spurious response - control channels

14.7.2.1 Definition

Blocking is a measure of the ability of the receiver to receive a modulated wanted input signal in the presence of an unwanted input signal, on frequencies other than those of the spurious responses or the adjacent channels, without exceeding a given degradation.

14.7.2.2 Conformance requirement

1. The blocking characteristics of the receiver are specified separately for in-band and out-of-band performance as identified in 3GPP TS 05.05 subclause 5.1.

The reference sensitivity performance as specified in table 1 of 3GPP TS 05.05 shall be met when the following signals are simultaneously input to the receiver:

- a useful signal at frequency f_0 , 3 dB above the reference sensitivity level as specified in 3GPP TS 05.05 subclause 6.2;
- a continuous, static sine wave signal at a level as in the table of 3GPP TS 05.05 subclause 5.1 and at a frequency (f) which is an integer multiple of 200 kHz.

with the following exceptions, called spurious response frequencies:

- a) GSM 700, GSM 850 or GSM 900: in band, for a maximum of six occurrences (which if grouped shall not exceed three contiguous occurrences per group);
 - DCS 1 800: in band, for a maximum of twelve occurrences (which if grouped shall not exceed three contiguous occurrences per group);
 - PCS 1 900: in band, for a maximum of twelve occurrences (which if grouped shall not exceed three contiguous occurrences per group);
 - GSM 400: in band, for a maximum of three occurrences;
- b) out of band, for a maximum of 24 occurrences (which if below f_0 and grouped shall not exceed three contiguous occurrences per group).

where the above performance shall be met when the continuous sine wave signal (f) is set to a level of 70 dB μ V (emf) (i.e. -43 dBm). 3GPP TS 05.05, subclause 5.1.

14.7.2.3 Test purpose

1. To verify that the in band blocking performance is met without exceeding the total number of allowed in band spurious responses. An allowance is made for the statistical significance of the test.
2. To verify that at selected out of band frequencies, the out of band blocking performance is met without exceeding the total number of allowed out of band spurious responses. An allowance is made for the statistical significance of the test.

NOTE: Not all of the possible out of band frequencies are tested as this results in excessive test time. However, the total number of out of band spurious responses, specified in 3GPP TS 05.05, are allowed to ensure a fair test of the MS.

14.7.2.4 Method of test

14.7.2.4.1 Initial conditions

A call is set up according to the generic call set up procedure, except the BCCH frequency list shall be empty, on a TCH with an arbitrary ARFCN in the range supported by the MS. The power control level is set to maximum power. The ARFCN of the BCCH shall be the same - or at an offset of +/- 2 channels, than that of the ARFCN for the TCH.

The SS transmits Standard Test Signal C1 on the traffic channel. (TCH frequency FR).

14.7.2.4.2 Procedure

- a) The SS sends a Layer 3 message which does not require a Layer 3 response from the MS. Due to interfering signals, the MS may not be able to acknowledge the Layer 2 frame. Frame erasures are indicated by repeated L2 frames.
- b) The SS is set to produce a TUhigh wanted signal and a static interfering signal at the same time. The SS sets the amplitude of the wanted signal to 4 dB above the reference sensitivity level.
- c) The unwanted signal is a C.W. signal (Standard test signal IO) of frequency FB. It is applied in turn on the subset of frequencies calculated at step f) in the overall range 100 kHz to 12,75 GHz, where FB is an integer multiple of 200 kHz.

However, frequencies in the range $FR \pm 600$ kHz are excluded.

NOTE: Allowance must be made for possible spurious signals arising from the SS. These are particularly likely at sub harmonic frequencies nFB where $n = 2, 3, 4, 5$, etc.

- d) The frequencies at which the test is performed (adjusted to an integer multiple of 200 kHz channels most closely approximating the absolute frequency of the calculated blocking signal frequency) are the combined frequencies from i), ii) and iii) which follow:

- i) The total frequency range formed by:-

GSM 400 the frequencies between $F_{10} + (IF_1 + IF_2 + \dots + IF_n + 3,6 \text{ MHz})$
and $F_{10} - (IF_1 + IF_2 + \dots + IF_n + 3,6 \text{ MHz})$.

GSM 700 the frequencies between $F_{10} + (IF_1 + IF_2 + \dots + IF_n + 7,5 \text{ MHz})$
and $F_{10} - (IF_1 + IF_2 + \dots + IF_n + 7,5 \text{ MHz})$.

GSM 850 the frequencies between $F_{10} + (IF_1 + IF_2 + \dots + IF_n + 12,5 \text{ MHz})$
and $F_{10} - (IF_1 + IF_2 + \dots + IF_n + 12,5 \text{ MHz})$.

P-GSM 900 the frequencies between $F_{10} + (IF_1 + IF_2 + \dots + IF_n + 12,5 \text{ MHz})$
and $F_{10} - (IF_1 + IF_2 + \dots + IF_n + 12,5 \text{ MHz})$.

E-GSM 900 the frequencies between $F_{10} + (IF_1 + IF_2 + \dots + IF_n + 17,5 \text{ MHz})$
and $F_{10} - (IF_1 + IF_2 + \dots + IF_n + 17,5 \text{ MHz})$.

DCS 1 800 the frequencies between $F_{10} + (IF_1 + IF_2 + \dots + IF_n + 37,5 \text{ MHz})$
and $F_{10} - (IF_1 + IF_2 + \dots + IF_n + 37,5 \text{ MHz})$.

PCS 1 900 the frequencies between $F_{10} + (IF_1 + IF_2 + \dots + IF_n + 30,0 \text{ MHz})$
and $F_{10} - (IF_1 + IF_2 + \dots + IF_n + 30,0 \text{ MHz})$.

and

the frequencies +100 MHz and -100 MHz from the edge of the relevant receive band.

Measurement are made at 200 kHz intervals.

ii) The three frequencies IF_1 , $IF_1 + 200 \text{ kHz}$, $IF_1 - 200 \text{ kHz}$.

iii) The frequencies:

$mF_{10} + IF_1$;

$mF_{10} - IF_1$;

mFR ;

where m is all positive integers greater than or equal to 2 such that either sum lies in the range 100 kHz to 12,75 GHz.

The frequencies in step ii) and iii) lying in the range of frequencies defined by step i) above need not be repeated.

Where:

F_{10} - local oscillator applied to first receiver mixer

$IF_1 \dots IF_n$ - are the n intermediate frequencies

F_{10} , IF_1 , $IF_2 \dots IF_n$ - shall be declared by the manufacturer in the PIXIT statement
3GPP TS 51.010-1 annex 3.

e) The level of the unwanted signal is set according to table 14-30.

Table 14-30a: Level of unwanted signals

FREQUENCY	GSM 900		DCS 1 800
	Small MS	Other MS	
	LEVEL IN $\text{dB}\mu\text{Vemf}(\text{)}$		
FR $\pm 600 \text{ kHz}$ to FR $\pm 800 \text{ kHz}$	70	75	70
FR $\pm 800 \text{ kHz}$ to FR $\pm 1,6 \text{ MHz}$	70	80	70
FR $\pm 1,6 \text{ MHz}$ to FR $\pm 3 \text{ MHz}$	80	90	80
915 MHz to FR - 3 MHz	90	90	-
FR + 3 MHz to 980 MHz	90	90	-
1785 MHz to FR - 3 MHz	-	-	87
FR + 3 MHz to 1 920 MHz	-	-	87
835 MHz to < 915 MHz	113	113	
> 980 MHz to 1 000 MHz	113	113	
100 kHz to < 835 MHz	90	90	
> 1 000 MHz to 12,75 GHz	90	90	
100 kHz to 1 705 MHz	-	-	113
> 1 705 MHz to < 1 785 MHz	-	-	101
> 1 920 MHz to 1 980 MHz	-	-	101
> 1 980 MHz to 12,75 GHz	-	-	90

Table 14-30b: Level of unwanted signals

FREQUENCY	GSM 450		GSM 480	
	Small MS	Other MS	Small MS	Other MS
	LEVEL IN dB μ Vemf()			
FR \pm 600 kHz to FR \pm 800 kHz	70	75	70	75
FR \pm 800 kHz to FR \pm 1,6 MHz	70	80	70	80
FR \pm 1,6 MHz to FR \pm 3 MHz	80	90	80	90
457,6 MHz to FR - 3 MHz	90	90	-	-
FR + 3 MHz to 473,6 MHz	90	90	-	-
486 MHz to FR - 3 MHz	-	-	90	90
FR + 3 MHz to 502 MHz	-	-	90	90
100 kHz to < 457,6 MHz	113	113	-	-
> 473,6 MHz to 12,75 GHz	113	113	-	-
100 kHz to < 486 MHz	-	-	113	113
> 502 MHz to 12,75 GHz	-	-	113	113

Table 14-30c: Level of unwanted signals

FREQUENCY	PCS 1 900 LEVEL IN dB μ Vemf()
FR \pm 600 kHz to FR \pm 800 kHz	70
FR \pm 800 kHz to FR \pm 1,6 MHz	70
FR \pm 1,6 MHz to FR \pm 3 MHz	80
1 910 MHz to FR - 3 MHz	87
FR + 3 MHz to 2 010 MHz	87
100 kHz to 1 830 MHz	113
> 1 830 MHz to < 1 910 MHz	101
> 2 010 MHz to 2 070 MHz	101
> 2 070 MHz to 12,75 GHz	90

Table 14-30d: Level of unwanted signals

FREQUENCY	GSM 710	GSM 750	T-GSM 810	GSM 850
	LEVEL IN dB μ Vemf()			
FR \pm 600 kHz to FR \pm 800 kHz	70	70	70	70
FR \pm 800 kHz to FR \pm 1,6 MHz	70	70	70	70
FR \pm 1,6 MHz to FR \pm 3 MHz	80	80	80	80
678 MHz to FR - 3 MHz	90	-	-	-
FR + 3 MHz to 728 MHz	90	-	-	-
727 MHz to FR - 3 MHz	-	90	-	-
FR + 3 MHz to 777 MHz	-	90	-	-
831 MHz to FR - 3 MHz	-	-	90	-
FR + 3 MHz to 886 MHz	-	-	90	-
849 MHz to FR - 3 MHz	-	-	-	90
FR + 3 MHz to 914 MHz	-	-	-	90
678 MHz to FR - 3 MHz	113	-	-	-
FR + 3 MHz to 728 MHz	113	-	-	-
100 kHz to < 727 MHz	-	113	-	-
> 782 MHz to 12,75 GHz	-	113	-	-
100 kHz to 831 MHz	-	-	113	-
> 886 MHz to 12,75 MHz	-	-	113	-
100 kHz to < 849 MHz	-	-	-	113
> 914 MHz to 12,75 GHz	-	-	-	113

NOTE 1: These values differ from 3GPP TS 05.05 because of practical generator limits in the SS.

NOTE 2: For an E-GSM 900 MS the level of the unwanted signal in the band 905 MHz to < 915 MHz is relaxed to 108 dB μ Vemf().

NOTE 3: For a GSM 450 small MS the level of the unwanted signal in the band 450,4 MHz to <457,6 MHz is relaxed to 108 dBuVemf(). For a GSM 480 small MS the level of the unwanted signal in the band 478,8 MHz to <486 MHz is relaxed to 108 dBuVemf().

- f) The SS determines the number of frame erasure events during at least the minimum number of samples. If a failure is indicated, it is noted and counted towards the allowed exemption total.

In the case of failures discovered at the predicted frequencies at steps f ii), iii) or iv) the test is repeated on the adjacent channels ± 200 kHz away. If either of these two frequencies fail then the next channel 200 kHz beyond is also be tested. This process is repeated until all channels constituting the group of failures is known.

14.7.2.5 Test requirements

The error rate measured in this test shall not exceed the test limit error rate given in table 14-31.

This shall apply under normal test voltage and ambient temperature, and with the interfering signal at any frequency in the range specified.

Table 14-31: Limits for blocking

Channel	Type of measurement	GSM 400 and GSM 900		DCS 1 800 and PCS 1 900	
		Test limit error rate	Minimum No. of samples	Test limit error rate	Minimum No. of samples
FACCH/F	FER	8,961	6 696	4,368	13 736

The following exceptions are allowed:

- GSM 450:** A maximum of three failures in the frequency band 457,6 MHz to 473,6 MHz.
A maximum of 24 failures in the combined bands 100 kHz to 457,6 MHz and 473,6 MHz to 12,75 GHz (which, if below FR and grouped, shall not exceed three 200 kHz channels per group).
- GSM 480:** A maximum of three failures in the frequency band 486 MHz to 502 MHz.
A maximum of 24 failures in the combined bands 100 kHz to 486 MHz and 502 MHz to 12,75 GHz (which, if below FR and grouped, shall not exceed three 200 kHz channels per group).
- GSM 710:** A maximum of six failures in the frequency band 678 MHz to 728 MHz (which, if grouped, shall not exceed three 200 kHz channels per group).
A maximum of 24 failures in the combined bands 100 kHz to 678 MHz and 728 MHz to 12,75 GHz (which, if below FR and grouped, shall not exceed three 200 kHz channels per group).
- GSM 750:** A maximum of six failures in the frequency band 727 MHz to 782 MHz (which, if grouped, shall not exceed three 200 kHz channels per group).
A maximum of 24 failures in the combined bands 100 kHz to 727 MHz and 782 MHz to 12,75 GHz (which, if below FR and grouped, shall not exceed three 200 kHz channels per group).
- T-GSM 810:** A maximum of six failures in the frequency band 831 MHz to 886 MHz (which, if grouped, shall not exceed three 200 kHz channels per group).
A maximum of 24 failures in the combined bands 100 kHz to 831 MHz and 886 MHz to 12,75 GHz (which, if below FR and grouped, shall not exceed three 200 kHz channels per group).
- GSM 850:** A maximum of six failures in the frequency band 849 MHz to 914 MHz (which, if grouped, shall not exceed three 200 kHz channels per group).
A maximum of 24 failures in the combined bands 100 kHz to 849 MHz and 914 MHz to 12,75 GHz (which, if below FR and grouped, shall not exceed three 200 kHz channels per group).
- GSM 900:** A maximum of six failures in the band 915 MHz to 980 MHz (which, if grouped, shall not exceed three 200 kHz channels per group).

A maximum of 24 in the combined bands 100 kHz to 915 MHz and 980 MHz to 12,75 GHz (which, if below FR and grouped, shall not exceed three 200 kHz channels per group).

DCS 1 800: A maximum of twelve failures in the band 1785 MHz to 1 920 MHz (which, if grouped, shall not exceed three 200 kHz channels per group).

A maximum of 24 in the combined bands 100 kHz to 1785 MHz and 1 920 MHz to 12,75 GHz (which, if below FR and grouped, shall not exceed three 200 kHz channels per group).

PCS 1 900: A maximum of twelve failures in the band 1 910 MHz to 2 010 MHz (which, if grouped, shall not exceed three 200 kHz channels per group).

A maximum of 24 in the combined bands 100 kHz to 1 910 MHz and 2 010 MHz to 12,75 GHz (which, if below FR and grouped, shall not exceed three 200 kHz channels per group).

If the number of failures do not exceed the maximum allowed figures stated above, the test of 14.7.2.4 is repeated at the frequencies at which the failures occurred. The level of the unwanted signal is set to $70 \text{ dB}\mu\text{Vemf}(\)$ and the performance requirement is once again that stated above.

The number of Error Events recorded in this test shall not exceed the test limit error rate values given above, when using the maximum number of samples.

No failures are allowed at this lower unwanted signal level.

14.7.3 Blocking and spurious response - speech channels for MS supporting the R-GSM band

14.7.3.1 Definition

Blocking is a measure of the ability of the receiver to receive a modulated wanted input signal in the presence of an unwanted input signal, on frequencies other than those of the spurious responses or the adjacent channels, without exceeding a given degradation.

14.7.3.2 Conformance requirement

1. The blocking characteristics of the receiver are specified separately for in-band and out-of-band performance as identified in 3GPP TS 05.05 subclause 5.1.

The reference sensitivity performance as specified in table 1 of 3GPP TS 05.05 shall be met when the following signals are simultaneously input to the receiver:

- a useful signal at frequency f_0 , 3 dB above the reference sensitivity level as specified in 3GPP TS 05.05 subclause 6.2;
- a continuous, static sine wave signal at a level as in the table of 3GPP TS 05.05 subclause 5.1 and at a frequency (f) which is an integer multiple of 200 kHz.

With the following exceptions, called spurious response frequencies:

- a) R-GSM 900: in band, for a maximum of six occurrences (which if grouped shall not exceed three contiguous occurrences per group);
- b) out of band, for a maximum of 24 occurrences (which if below f_0 and grouped shall not exceed three contiguous occurrences per group).

Where the above performance shall be met when the continuous sine wave signal (f) is set to a level of $70 \text{ dB}\mu\text{V}$ (emf) (i.e. -43 dBm). 3GPP TS 05.05, subclause 5.1.

14.7.3.3 Test purpose

1. To verify that the in band blocking performance is met without exceeding the total number of allowed in band spurious responses. An allowance is made for the statistical significance of the test.

2. To verify that at selected out of band frequencies, the out of band blocking performance is met without exceeding the total number of allowed out of band spurious responses. An allowance is made for the statistical significance of the test.

NOTE: Not all of the possible out of band frequencies are tested as this results in excessive test time. However, the total number of out of band spurious responses, specified in 3GPP TS 05.05, are allowed to ensure a fair test of the MS.

14.7.3.4 Method of test

14.7.3.4.1 Initial conditions

A call is set up according to the generic call set up procedure, except the BCCH frequency list shall be empty, on a TCH with an arbitrary ARFCN in the range supported by the MS. The power control level is set to maximum power. The ARFCN of the BCCH shall be the same - or at an offset of +/- 2 channels, than that of the ARFCN for the TCH.

The SS transmits Standard Test Signal C1 on the traffic channel. (TCH frequency FR).

The SS commands the MS to create traffic channel loop back signalling erased frames.

14.7.3.4.2 Procedure

- a) The SS produces a static wanted signal and a static interfering signal at the same time. The amplitude of the wanted signal is set to 4 dB above the reference sensitivity level.
- b) The unwanted signal is a C.W. signal (Standard test signal IO) of frequency FB. It is applied in turn on the subset of frequencies calculated in step c) in the overall range 100 kHz to 12,75 GHz, where FB is an integer multiple of 200 kHz.

However, frequencies in the range $FR \pm 600$ kHz are excluded.

NOTE: Allowance must be made for possible spurious signals arising from the SS. These are particularly likely at sub harmonic frequencies nFB where $n = 2, 3, 4, 5$, etc.

- c) The frequencies at which the test is performed (adjusted to an integer multiple of 200 kHz channels most closely approximating the absolute frequency of the calculated blocking signal frequency) are the combined frequencies from i), ii) and iii) below:-

- i) The total frequency range formed by:-

R-GSM 900 the frequencies between $F_{10} + (IF_1 + IF_2 + \dots + IF_n + 19,5 \text{ MHz})$

and $F_{10} - (IF_1 + IF_2 + \dots + IF_n + 19,5 \text{ MHz})$.

And the frequencies +100 MHz and -100 MHz from the edge of the relevant receive band.

Measurements are made at 200 kHz intervals.

- ii) The three frequencies IF_1 , $IF_1 + 200$ kHz, $IF_1 - 200$ kHz.

- iii) The frequencies:

$mF_{10} + IF_1$;

$mF_{10} - IF_1$;

mFR ;

where m is all positive integers greater than or equal to 2 such that either sum lies in the range 100 kHz to 12,75 GHz.

The frequencies in step ii) and iii) lying in the range of frequencies defined by step i) above need not be repeated.

Where:

F_{10} - local oscillator applied to first receiver mixer

$IF_1 \dots IF_n$ - are the n intermediate frequencies

$F_{lo}, IF_1, IF_2 \dots IF_n$ - shall be declared by the manufacturer in the PIXIT statement
3GPP TS 51.010-1 annex 3.

d) The level of the unwanted signal is set according to table 14-28b.

Table 14-28b: Level of unwanted signals for R-GSM MS

FREQUENCY	R-GSM 900	
	Small MS	Other MS
	LEVEL IN dB μ Vemf()	
FR \pm 600 kHz to FR \pm 800 kHz	70	75
FR \pm 800 kHz to FR \pm 1,6 MHz	70	80
FR \pm 1,6 MHz to FR \pm 3 MHz	80	90
915 MHz to FR - 3 MHz	90	90
FR + 3 MHz to 980 MHz	90	90
1 785 MHz to FR - 3 MHz	-	-
FR + 3 MHz to 1 920 MHz	-	-
835 MHz to < 876 MHz	113	113
876 MHz to 880 MHz	106	113
880 MHz to 915 MHz	106	108
> 980 MHz to 1 000 MHz	113	113
100 kHz to < 835 MHz	90	90
> 1 000 MHz to 12,75 GHz	90	90

NOTE: These values differ from 3GPP TS 05.05 because of practical generator limits in the SS.

e) The SS compares the data of the signal that it sends to the MS with the signal which is looped back from the receiver after demodulation and decoding, and checks the frame erasure indication.

The SS tests the RBER compliance for the bits of class II, by examining sequences of at least the minimum number of samples of consecutive bits of class II, where bits are taken only from those frames for which no bad frame indication was given. The number of error events is recorded.

If a failure is indicated it is noted and counted towards the allowed exemption totals.

In the case of failures discovered at the predicted frequencies at steps f ii), iii) or iv) the test is repeated on the adjacent channels \pm 200 kHz away. If either of these two frequencies fail then the next channel 200 kHz beyond is also tested. This process is repeated until all channels constituting the group of failures is known.

14.7.3.5 Test requirements

The error rate measured in this test shall not exceed the test limit error rate values given in table 14-29b.

This shall apply under normal test voltage and ambient temperature, and with the interfering signal at any frequency in the range specified.

Table 14-29b: Limits for blocking

Channel	Type of measurement	Test limit error rate %	Minimum number of samples
TCH/FS Class II	RBER	2,439	8 200

The following exceptions are allowed:

R-GSM 900: A maximum of six failures in the frequency band 915 MHz to 980 MHz (which, if grouped, shall not exceed three 200 kHz channels per group).

A maximum of 24 failures in the combined bands 100 kHz to 915 MHz and 980 MHz to 12,75 GHz (which, if below FR and grouped, shall not exceed three 200 kHz channels per group).

If the number of failures do not exceed the maximum allowed figures stated above, the test of 14.7.3.4 is repeated at the frequencies at which the failures occurred. The level of the unwanted signal is set to $70 \text{ dB}\mu\text{Vemf}(\)$ and the performance requirement is once again that that stated in the table above.

The number Error rate measured in this test shall not exceed the test limit error rate values given in table 14-29b.

No failures are allowed at this lower unwanted signal level.

14.7.4 Blocking and spurious response - control channels for MS supporting the R-GSM band

14.7.4.1 Definition

Blocking is a measure of the ability of the receiver to receive a modulated wanted input signal in the presence of an unwanted input signal, on frequencies other than those of the spurious responses or the adjacent channels, without exceeding a given degradation.

14.7.4.2 Conformance requirement

1. The blocking characteristics of the receiver are specified separately for in-band and out-of-band performance as identified in 3GPP TS 05.05 subclause 5.1.

The reference sensitivity performance as specified in table 1 of 3GPP TS 05.05 shall be met when the following signals are simultaneously input to the receiver:

- a useful signal at frequency f_0 , 3 dB above the reference sensitivity level as specified in 3GPP TS 05.05 subclause 6.2;
- a continuous, static sine wave signal at a level as in the table of 3GPP TS 05.05 subclause 5.1 and at a frequency (f) which is an integer multiple of 200 kHz.

With the following exceptions, called spurious response frequencies:-

- a) R-GSM 900: in band, for a maximum of six occurrences (which if grouped shall not exceed three contiguous occurrences per group);
- b) out of band, for a maximum of 24 occurrences (which if below f_0 and grouped shall not exceed three contiguous occurrences per group).

Where the above performance shall be met when the continuous sine wave signal (f) is set to a level of $70 \text{ dB}\mu\text{V}$ (emf) (i.e. -43 dBm). 3GPP TS 05.05, subclause 5.1.

14.7.4.3 Test purpose

1. To verify that the in band blocking performance is met without exceeding the total number of allowed in band spurious responses. An allowance is made for the statistical significance of the test.
2. To verify that at selected out of band frequencies, the out of band blocking performance is met without exceeding the total number of allowed out of band spurious responses. An allowance is made for the statistical significance of the test.

NOTE: Not all of the possible out of band frequencies are tested as this results in excessive test time. However, the total number of out of band spurious responses, specified in 3GPP TS 05.05, are allowed to ensure a fair test of the MS.

14.7.4.4 Method of test

14.7.4.4.1 Initial conditions

A call is set up according to the generic call set up procedure, except the BCCH frequency list shall be empty, on a TCH with an arbitrary ARFCN in the range supported by the MS. The power control level is set to maximum power. The ARFCN of the BCCH shall be the same - or at an offset of ± 2 channels, than that of the ARFCN for the TCH.

The SS transmits Standard Test Signal C1 on the traffic channel. (TCH frequency FR).

14.7.4.4.2 Procedure

- a) The SS sends a Layer 3 message which does not require a Layer 3 response from the MS. Due to interfering signals, the MS may not be able to acknowledge the Layer 2 frame. Frame erasures are indicated by repeated L2 frames.
- b) The SS is set to produce a TUhigh wanted signal and a static interfering signal at the same time. The SS sets the amplitude of the wanted signal to 4 dB above the reference sensitivity level.
- c) The unwanted signal is a C.W. signal (Standard test signal IO) of frequency FB. It is applied in turn on the subset of frequencies calculated at step f) in the overall range 100 kHz to 12,75 GHz, where FB is an integer multiple of 200 kHz.

However, frequencies in the range $FR \pm 600$ kHz are excluded.

NOTE: Allowance must be made for possible spurious signals arising from the SS. These are particularly likely at sub harmonic frequencies nFB where $n = 2, 3, 4, 5$, etc.

- d) The frequencies at which the test is performed (adjusted to an integer multiple of 200 kHz channels most closely approximating the absolute frequency of the calculated blocking signal frequency) are the combined frequencies from i), ii) and iii) which follow:

- i) The total frequency range formed by:-

R-GSM 900 the frequencies between $F_{lo} + (IF_1 + IF_2 + \dots + IF_n + 19,5 \text{ MHz})$

and $F_{lo} - (IF_1 + IF_2 + \dots + IF_n + 19,5 \text{ MHz})$.

and

the frequencies +100 MHz and -100 MHz from the edge of the relevant receive band.

Measurement are made at 200 kHz intervals.

- ii) The three frequencies IF_1 , $IF_1 + 200$ kHz, $IF_1 - 200$ kHz.

- iii) The frequencies:

$mF_{lo} + IF_1$;

$mF_{lo} - IF_1$;

mFR ;

where m is all positive integers greater than or equal to 2 such that either sum lies in the range 100 kHz to 12,75 GHz.

The frequencies in step ii) and iii) lying in the range of frequencies defined by step i) above need not be repeated.

Where:

F_{lo} - local oscillator applied to first receiver mixer

$IF_1 \dots IF_n$ - are the n intermediate frequencies

F_{lo} , IF_1 , $IF_2 \dots IF_n$ - shall be declared by the manufacturer in the PIXIT statement 3GPP TS 51.010-1 annex 3.

- e) The level of the unwanted signal is set according to table 14-30b.

Table 14-30b: Level of unwanted signals

FREQUENCY	GSM 900	
	Small MS	Other MS
	LEVEL IN dB μ Vemf()	
FR \pm 600 kHz to FR \pm 800 kHz	70	75
FR \pm 800 kHz to FR \pm 1,6 MHz	70	80
FR \pm 1,6 MHz to FR \pm 3 MHz	80	90
915 MHz to FR - 3 MHz	90	90
FR + 3 MHz to 980 MHz	90	90
835 MHz to < 876 MHz	113	113
876 MHz to 880 MHz	106	113
880 MHz to 915 MHz	106	108
> 980 MHz to 1 000 MHz	113	113
100 kHz to < 835 MHz	90	90
>1000 MHz to 12,75 GHz	90	90

NOTE: These values differ from 3GPP TS 05.05 because of practical generator limits in the SS.

- f) The SS determines the number of frame erasure events during at least the minimum number of samples. If a failure is indicated, it is noted and counted towards the allowed exemption total.

In the case of failures discovered at the predicted frequencies at steps f ii), iii) or iv) the test is repeated on the adjacent channels \pm 200 kHz away. If either of these two frequencies fail then the next channel 200 kHz beyond is also be tested. This process is repeated until all channels constituting the group of failures is known.

14.7.4.5 Test requirements

The error rate measured in this test shall not exceed the test limit error rate given in table 14-31b.

This shall apply under normal test voltage and ambient temperature, and with the interfering signal at any frequency in the range specified.

Table 14-31b: Limits for blocking

Channel	Type of measurement	GSM 900		DCS 1 800	
		Test limit error rate	Minimum No. of samples	Test limit error rate	Minimum No. of samples
FACCH/F	FER	8,961	6 696	4,368	13 736

The following exceptions are allowed:

- R-GSM 900: A maximum of six failures in the band 915 MHz to 980 MHz (which, if grouped, shall not exceed three 200 kHz channels per group).

A maximum of 24 in the combined bands 100 kHz to 915 MHz and 980 MHz to 12,75 GHz (which, if below FR and grouped, shall not exceed three 200 kHz channels per group).

If the number of failures do not exceed the maximum allowed figures stated above, the test of 14.7.4.4 is repeated at the frequencies at which the failures occurred. The level of the unwanted signal is set to 70 dB μ Vemf() and the performance requirement is once again that stated above.

The number of Error Events recorded in this test shall not exceed the test limit error rate values given above, when using the maximum number of samples.

No failures are allowed at this lower unwanted signal level.

14.8 AM suppression

14.8.1 AM suppression - speech channels

14.8.1.1 Definition

AM suppression is a measure of the ability of the receiver to receive a modulated wanted input signal in the presence of an unwanted TDMA modulated interferer.

14.8.1.2 Conformance requirement

The reference sensitivity performance as specified in table 1 shall be met when the following signals are simultaneously input to the receiver:

- a useful signal at frequency f_0 , 3 dB above the reference sensitivity level as specified in 3GPP TS 05.05 subclause 5.2.
- a single frequency (f), in the relevant receive band, $|f - f_0| \geq 6\text{MHz}$, which is an integer multiple of 200 kHz, a GSM TDMA signal modulated by any 148-bits subsequence of the 511-bits pseudo random bit sequence, defined in ITU-T Recommendation O.153 fascicle IV.4, at a level as defined in the table below. The interferer shall have one timeslot active and the frequency shall be at least 2 channels separated from any identified spurious responses. The transmitted bursts shall be synchronized to but, delayed in time between 61 and 86 bit periods relative to the bursts of the wanted signal. 3GPP TS 05.05, subclause 5.2.

MS type	Signal level
GSM 400	-31 dBm
GSM 700	-31 dBm
GSM 850	-31 dBm
GSM 900	-31 dBm
DCS 1 800	-29 / -31 dBm (note)
PCS 1 900	-31 dBm
NOTE: The -31 dBm level shall apply to DCS 1 800 class 1 and class 2 MS meeting the -102 dBm reference sensitivity level requirement according to 3GPP TS 05.05, subclause 6.2.	

3GPP TS 45.05 subclause 2:

For T-GSM 810 the requirements for GSM 900 shall apply, apart for those parameters for which a separate requirement exists.

14.8.1.3 Test purpose

To verify that the AM suppression performance of the MS meets the conformance requirement with an allowance for the statistical significance of the test.

14.8.1.4 Method of test

14.8.1.4.1 Initial conditions

A call is set up according to the generic call set up procedure, on a TCH/FS with an ARFCN in the mid ARFCN range. The power control level is set to maximum power.

The SS transmits standard Test Signal C1 on the traffic channel (TCH frequency FR).

The SS commands the MS to create traffic channel loop back signalling erased frames.

This test is performed after test 14.7.

14.8.1.4.2 Procedure

- a) The SS produces a static wanted signal with an amplitude 4 dB above reference sensitivity level.
- b) The SS produces an interfering signal as described below:

- static fading profile;
- at an in band frequency greater than 6 MHz separated from FR and separated by at least two ARFCNs from any spurious responses.

NOTE: Spurious responses are identified by test cases 14.7.1 and 14.7.2.

- at a level as described in table 14-32.
- GSM TDMA modulated by random data with one timeslot active.
- synchronized to, but delayed between 61 and 86 bit periods to the bursts of the wanted signal.

Table 14-32: Interferer signal level

MS type	Signal level (dB μ Vemf)
GSM 400	82
GSM 700	82
T-GSM 810	82
GSM 850	82
GSM 900	82
DCS 1 800	82/84
PCS 1 900	82
NOTE: The 82 dB μ Vemf (ie. -31 dBm) level shall apply to DCS 1 800 class 1 and class 2 MS meeting the -102 dBm reference sensitivity level requirement according to 3GPP TS 05.05, subclause 6.2.	

- c) The SS compares the data of the signal that it sends to the MS with the signal which is looped back from the receiver after demodulation and decoding, and checks the frame erasure indication.
- d) The SS tests the RBER compliance of class II bits by examining at least the minimum number of samples of consecutive bits. Bits only taken from those frames which do not signal frame erasure. The number of error events is recorded.

14.8.1.5 Test requirements

The error rates measured in this test shall not exceed the test limit error rate values given in table 14.27.

Table 14-33: Limits for AM suppression

Channel	Propagation conditions	Type of measurement	Test limit error rate %	Minimum No. of samples
TCH/FS Class II	Static	RBER	2,439	8 200

14.8.2 AM suppression - control channels

14.8.2.1 Definition

AM suppression is a measure of the ability of the receiver to receive a modulated wanted input signal in the presence of an unwanted TDMA modulated interferer.

14.8.2.2 Conformance requirement

The reference sensitivity performance as specified in table 1 shall be met when the following signals are simultaneously input to the receiver:

- a useful signal at frequency f_0 , 3 dB above the reference sensitivity level as specified in 3GPP TS 05.05 subclause 5.2.
- a single frequency (f), in the relevant receive band, $|f - f_0| \geq 6\text{MHz}$, which is an integer multiple of 200 kHz, a GSM TDMA signal modulated by any 148-bits subsequence of the 511-bits pseudo random bit sequence, defined in ITU-T Recommendation O.153 fascicle IV.4, at a level as defined in the table below. The interferer

shall have one timeslot active and the frequency shall be at least 2 channels separated from any identified spurious responses. The transmitted bursts shall be synchronized to but, delayed in time between 61 and 86 bit periods relative to the bursts of the wanted signal. 3GPP TS 05.05, subclause 5.2.

MS type	Signal level
GSM 400	-31 dBm
GSM 700	-31 dBm
GSM 850	-31 dBm
GSM 900	-31 dBm
DCS 1 800	-29 / -31 dBm (note)
PCS 1 900	-31 dBm
NOTE: The -31 dBm level shall apply to DCS 1 800 class 1 and class 2 MS meeting the -102 dBm reference sensitivity level requirement according to 3GPP TS 05.05, subclause 6.2.	

3GPP TS 45.05 subclause 2:

For T-GSM 810 the requirements for GSM 900 shall apply, apart for those parameters for which a separate requirement exists.

14.8.2.3 Test purpose

To verify that the AM suppression performance of the MS meets the conformance requirement with an allowance for the statistical significance of the test.

14.8.2.4 Method of test

14.8.2.4.1 Initial conditions

A call is set up according to the generic call set up procedure, on a TCH with an ARFCN in the mid ARFCN range. The power control level is set to maximum power.

The SS transmits standard Test Signal C1 on the traffic channel (TCH frequency FR).

This test is performed after test 14.7.

14.8.2.4.2 Procedure

- a) The SS produces a TUhigh wanted signal with an amplitude 4 dB above reference sensitivity level.
- b) The SS produces an interfering signal as described below:
 - static fading profile;
 - t an in band frequency greater than 6 MHz separated from FR and separated by at least two ARFCNs from any spurious responses.

NOTE: Spurious responses are identified by test cases 14.7.1 and 14.7.2.

- at a level as described in table 14-34.
- GSM TDMA modulated by random data with one timeslot active.
- synchronized to, but delayed between 61 and 86 bit periods to the bursts of the wanted signal.

Table 14-34: Interferer signal level

MS type	Signal level (dB μ Vemf)
GSM 400	82
GSM 700	82
T-GSM 810	82
GSM 850	82
GSM 900	82
DCS 1 800	82/84
PCS 1 900	82
NOTE: The 82 dB μ Vemf (ie. -31 dBm) level shall apply to DCS 1 800 class 1 and class 2 MS meeting the -102 dBm reference sensitivity level requirement according to 3GPP TS 05.05, subclause 6.2.	

- c) The SS sends the status message. Due to interfering signals, the MS may not be able acknowledge the Layer 2 frame. Frame erasures are indicated by repeated L2 frames.
- d) The SS determines the number of frame erasure events during at least the minimum number of samples. If a failure is indicated, it is noted and counted towards the allowed exemption total.

14.8.2.5 Test requirements

The error rates measured in this test shall not exceed the test limit error rate values given in table 14.35.

Table 14-35: Limits for AM suppression

Channel	Propagation conditions	Type of measurement	GSM 400, GSM 700, T-GSM 810, GSM 850 and GSM 900		DCS 1 800 and PCS 1 900	
			Test limit error rate %	Minimum No. of max-samples	Test limit error rate %	Min No. of max-samples
FACCH/F	TUhigh/No FH	FER	8,961	6 696	4,368	13 736

14.9 Paging performance at high input levels

14.9.1 Definition

The paging performance at high input levels is the signal level at the MS receiver input at which a certain FER for the PCH must be achieved.

14.9.2 Conformance requirement

The paging performance at high input levels requirements of 3GPP TS 05.05 subclause 6.5 a) for PCH under static propagation conditions shall be met from 20 dB above reference sensitivity level up to -15 dBm for GSM 400, GSM 700, GSM 850 and GSM 900 and -23 dBm for DCS 1 800 and PCS 1 900.

3GPP TS 45.05 subclause 2:

For T-GSM 810 the requirements for GSM 900 shall apply, apart for those parameters for which a separate requirement exists.

14.9.3 Test purpose

To verify that the MS does not exceed the conformance requirement with an allowance for the statistical significance of the test.

14.9.4 Method of test

14.9.4.1 Initial conditions

System Simulator:

1 cell, Tx-Integer = 3, MAX RETRANS is set to minimum. The CCCH is combined with SDCCH.

BS_PA_MFRMS = 9 to achieve worst case sleep mode (DRX). The signal level at the receiver input is set to:

GSM 400: -15 dBm;
GSM 700: -15 dBm;
GSM 850: -15 dBm;
T-GSM 810: -15 dBm;
GSM 900: -15 dBm;
DCS 1800: -23 dBm;
PCS 1 900: -23 dBm.

Mobile Station:

The MS has a valid TMSI. It is "idle updated". The MS should have been powered up immediately before running the test, i.e. if a Location update is necessary the MS must be switched off and on again.

14.9.4.2 Procedure

The MS is paged and the SS starts timer T3113. If a CHANNEL REQUEST is received before expiry of T3113 the SS sends an IMMEDIATE ASSIGNMENT REJECT. The sequence is performed 4 times.

Between two consecutive executions the SS must wait for an amount of time which is enough to guarantee that the MS is in service (listening to its paging subchannel).

14.9.5 Test requirements

If the MS answers all pagings with a CHANNEL REQUEST the requirements are met.

NOTE: The probability for a good MS to fail this test is less than 1 %.

14.10 Performance of the Codec Mode Request Generation for Adaptive Multi-Rate Codecs

14.10.1 Performance of the Codec Mode Request Generation – TCH/AFS

14.10.1.1 Definition

When a traffic channel supporting an Adaptive Multi-Rate speech codec is activated, the Codec Mode Request is sent by MS in band every other speech frame to indicate to the Network the recommended codec mode of the ACS to use on the downlink.

14.10.1.2 Conformance Requirement

For TULow channel conditions with ideal frequency hopping without DTX activated, the MS shall produce Codec Mode Requests with the following accuracy:

Requirement 1: When a carrier to interferer ratio 4 dB higher than a defined upper threshold is applied to the antenna connector, the MS shall request a higher mode with a probability exceeding 90%. This shall be measured immediately after a settling-time of 200 ms.

Requirement 2: When a carrier to interferer ratio 4 dB lower than a defined lower threshold is applied to the antenna connector, the MS shall request a lower mode with a probability exceeding 90%. This shall be measured immediately after a settling-time of 200 ms.

If required, the above test levels shall be reduced by the fixed normalization factor defined in sub-clause 3.3.1 of TS 45.009 to account for potential improved receiver performances.

Note: Ideal frequency hopping assumes perfect decorrelation between bursts. For the propagation profile TU3, this is not easily achievable due to the high number of hopping frequencies required. Therefore, performance tests should be performed under ideal frequency hopping conditions for the following propagation profiles: TU50 for GSM900 and GSM850, TU25 for DCS1800 and PCS1900, TU100 for GSM400, and TU60 for GSM700.

3GPP TS 45.05 subclause 2:

For T-GSM 810 the requirements for GSM 900 shall apply, apart for those parameters for which a separate requirement exists.

14.10.1.3 Test Purpose

1. To verify that the MS does not exceed conformance requirement 1 under TUHigh and frequency hopping propagation conditions without DTX with an allowance for the statistical significance of the test.
2. To verify that the MS does not exceed conformance requirement 2 under TUHigh and frequency hopping propagation conditions without DTX with an allowance for the statistical significance of the test.
3. To implicitly verify the correct implementation of the AMR Thresholds and Hysteresis parameters received in either an ASSIGNMENT COMMAND or MODE MODIFY procedure, or through an AMR_CONFIG_REQ or THRESH_REQ message carried in a RATSCCH.

NOTE: This would normally be performed as a signalling test, however due to the complex layer 1 requirements it is verified here. Any future modification or Change Request on this section should take into account this additional test objective.

14.10.1.4 Method of Test

14.10.1.4.1 Initial conditions

A call is set up according to the generic call set up procedure on a TCH/AFS with a hopping pattern in the Mid ARFCN range and covering at least 10 frequencies not exceeding 5 MHz. DTX shall not be activated. Power control level shall be set to maximum power.

The initial configuration indicates the use of the 12.2 mode of AMR only.

The SS transmits Standard Test Signal C1 on the traffic channel.

In addition to the wanted signal, the SS produces an independent, uncorrelated interfering signal, Standard Test Signal I1 (unwanted signal).

- The unwanted signal is continuous and has no fixed relationship with the bit transitions of the wanted signal. Initially, the unwanted signal is switched off.
- The fading characteristic of the wanted and the interfering signal is TUHigh.

NOTE 1: The fading characteristics shall be TU50 for GSM900, T-GSM 810 and GSM850, TU25 for DCS1800 and PCS1900, TU100 for GSM400, and TU60 for GSM700.

Specific PICS Statements:

-

PIXIT Statements:

- AMR C/I normalization factor.

14.10.1.4.2 Procedure

INITIAL CONFIG:

- 1a) The SS uses a Channel Mode Modify procedure to change the active codec set to the following set:

Codec Mode	TCH/AFS in kbit/s
CODEC_MODE_4	10,2
CODEC_MODE_3	7.4
CODEC_MODE_2	6,7
CODEC_MODE_1	5,15

With Initial Codec Mode unspecified, thus the default ICM rule being used and the following decision thresholds and hysteresis values:

MC'MR'	THR_MC_Dn(MC)/ THR_MR_Dn(MR)	THR_MC_Up(MC)/ THR_MR_Up(MR)
CODEC_MODE_4	Thr1d = 17.5 dB	+ ∞
CODEC_MODE_3	Thr2d = 14.5 dB	Thr1u = 19.5 dB
CODEC_MODE_2	Thr3d = 12.5 dB	Thr2u = 16.5 dB
CODEC_MODE_1	- ∞	Thr3u = 14.5 dB

The SS uses the expected Initial Codec Mode (default rule) after sending the mode modify message and commands the MS through the CMC field to use the Initial Codec Mode as well. The SS waits for the MS to change the uplink codec to the expected Initial Codec Mode (default rule).

- 1b) The SS then sends an AMR_CONF_REQ through a RATSCCH message commanding the MS to use the following ACS:

Codec Mode	TCH/AFS in kbit/s
CODEC_MODE_3	12,2
CODEC_MODE_2	7.95
CODEC_MODE_1	4,75

With the Initial Codec Mode set to the 12.2 kbit/s mode and the following decision thresholds and hysteresis values:

MC'MR'	THR_MC_Dn(MC)/ THR_MR_Dn(MR)	THR_MC_Up(MC)/ THR_MR_Up(MR)
CODEC_MODE_3	Thr1d = 12.5 dB	+ ∞
CODEC_MODE_2	Thr2d = 6.5 dB	Thr1u = 14.5 dB
CODEC_MODE_1	- ∞	Thr2u = 8.5 dB

The SS switches the downlink codec to the Initial Codec Mode 12 frames after sending the AMR_CONF_REQ message and commands the MS through the CMC field to use the requested Initial Codec Mode. The SS waits for the MS to change the uplink codec to the expected Initial Codec Mode, 12 frames after receiving the ACK_OK message.

The SS waits until the MS indicates in the CMR that the 12.2 kbit/s is the recommended downlink codec mode.

If the MS never reaches that point then the test is failed.

The downlink radio environment is altered so that the carrier to interference ratio is set to 4 dB above the highest of the upwards thresholds Thr1u. The SS waits 500ms.

- 1c) The downlink radio environment is altered so that the carrier to interference ratio is reduced to 4 dB below the highest of the downwards thresholds Thr1d. The SS increments the counter for 'C/I decreases below thresholds'.
- 1d) The SS checks the CMR received from the MS 200ms after the carrier to interference has been altered. If the CMR indicates that the MS recommends to use the 7.95 kbit/s or a lower codec mode in the downlink, then the SS should increment the successful C/I decrease event counter. Otherwise, the SS should increment the unsuccessful C/I decrease event counter.
- 1e) The SS switches the downlink codec mode to 7.95 kbit/s and waits for 0.5s.

- 1f) The downlink radio environment is altered so that the carrier to interference ratio is reduced to 4 dB below the lowest of the downwards thresholds Thr2d. The SS increments the counter for 'C/I decreases below thresholds'.
- 1g) The SS checks the CMR received from the MS 200ms after the carrier to interference has been altered. If the CMR indicates that the MS recommends to use the 4.75 kbit/s codec mode in the downlink, then the SS should increment the successful C/I decrease event counter. Otherwise, the SS should increment the unsuccessful C/I decrease event counter.
- 1h) The SS switches the downlink codec mode to 4.75 kbit/s and waits for 0.5s.
- 1i) The downlink radio environment is altered so that the carrier to interference ratio is increased to 4 dB above the lowest of the upwards thresholds Thr2u. The SS increments the counter for 'C/I increases above thresholds'.
- 1j) The SS checks the CMR received from the MS 200ms after the carrier to interference has been altered. If the CMR indicates that the MS recommends to use the 7.95 kbit/s or a higher codec mode in the downlink, then the SS should increment the successful C/I increase event counter. Otherwise, the SS should increment the unsuccessful C/I increase event counter.
- 1k) The SS switches the downlink codec mode to 7.95 kbit/s and waits for 0.5s.
- 1l) The downlink radio environment is altered so that the carrier to interference ratio is increased to 4 dB above the highest of the upwards thresholds Thr1u. The SS increments the counter for 'C/I increases above thresholds'.
- 1m) The SS checks the CMR received by the MS 200ms after the carrier to interference has been altered. If the CMR indicates that the MS recommends to use 12.2 kbit/s in the downlink, then the SS should increment the successful C/I increase event counter. Otherwise, the SS should increment the unsuccessful C/I increase event counter.
- 1n) The SS switches the downlink codec mode to 12.2 kbit/s and waits for 0.5s.
- 1o) The SS repeats steps 1c) to 1n) until 500 samples of C/I increases and 500 samples of C/I decreases have been recorded.

STEP 2:

- 2a) The unwanted signal is removed.

The SS then sends an AMR_CONF_REQ through a RATSCCH message commanding the MS to use the following ACS:

Codec Mode	TCH/AFS in kbit/s
CODEC_MODE_4	10,2
CODEC_MODE_3	7.4
CODEC_MODE_2	6,7
CODEC_MODE_1	5,15

With the Initial Codec Mode set to any mode and the following decision thresholds and hysteresis values:

MC/MR'	THR_MC_Dn(MC)/ THR_MR_Dn(MR)	THR_MC_Up(MC)/ THR_MR_Up(MR)
CODEC_MODE_4	Thr1d = 17.5 dB	+ ∞
CODEC_MODE_3	Thr2d = 14.5 dB	Thr1u = 19.5 dB
CODEC_MODE_2	Thr3d = 12.5 dB	Thr2u = 16.5 dB
CODEC_MODE_1	- ∞	Thr3u = 14.5 dB

The SS switches the downlink codec to the Initial Codec Mode 12 frames after sending the AMR_CONF_REQ message and commands the MS through the CMC field to use the requested Initial Codec Mode. The SS waits for the MS to change the uplink codec to the expected Initial Codec Mode, 12 frames after receiving the ACK_OK message.

- 2b) The SS uses a Channel Mode Modify procedure to change the active codec set to the following set:

Codec Mode	TCH/AFS in kbit/s
CODEC_MODE_3	12,2
CODEC_MODE_2	7,95
CODEC_MODE_1	4,75

With the Initial Codec Mode set to the 12.2 kbit/s mode and the following decision thresholds and hysteresis values:

MC'MR'	THR_MC_Dn(MC)/ THR_MR_Dn(MR)	THR_MC_Up(MC)/ THR_MR_Up(MR)
CODEC_MODE_3	Thr1d = 11.5 dB	+ ∞
CODEC_MODE_2	Thr2d = 5.5 dB	Thr1u = 13.5 dB
CODEC_MODE_1	- ∞	Thr2u = 7.5 dB

The SS switches the downlink codec to the Initial Codec Mode after sending the mode modify message and commands the MS through the CMC field to use the Initial Codec Mode as well. The SS waits for the MS to change the uplink codec to the expected Initial Codec Mode.

The SS waits until the MS indicates in the CMR that the 12.2 kbit/s is the recommended downlink codec mode.

If the MS never reaches that point then the test is failed.

The downlink radio environment is altered so that the carrier to interference ratio is set to 4 dB above the highest of the upwards thresholds Thr1u. The SS waits 500ms

- 2c) The SS repeats steps 1c) to 1n) until 500 samples of C/I increases and 500 samples of C/I decreases have been recorded.

STEP 3:

- 3a) The unwanted signal is removed.

The SS then sends an AMR_CONF_REQ through a RATSCCH message commanding the MS to use the AMR 7.95 kbit/s mode only:

The SS switches the downlink codec to the 7.95 mode 12 frames after sending the AMR_CONF_REQ message and commands the MS through the CMC field to use the requested codec. The SS waits for the MS to change the uplink codec to the expected codec, 12 frames after receiving the ACK_OK message.

- 3b) The SS uses a Channel Mode Modify procedure to change the active codec set to the following set:

Codec Mode	TCH/AFS in kbit/s
CODEC_MODE_3	12,2
CODEC_MODE_2	7,95
CODEC_MODE_1	4,75

With the Initial Codec Mode set to the 12.2 kbit/s mode and the following decision thresholds and hysteresis values:

MC'MR'	THR_MC_Dn(MC)/ THR_MR_Dn(MR)	THR_MC_Up(MC)/ THR_MR_Up(MR)
CODEC_MODE_3	Thr1d = 18.5 dB	+ ∞
CODEC_MODE_2	Thr2d = 10.5 dB	Thr1u = 20.5 dB
CODEC_MODE_1	- ∞	Thr2u = 12.5 dB

The SS switches the downlink codec to the Initial Codec Mode after sending the mode modify message and commands the MS through the CMC field to use the Initial Codec Mode as well. The SS waits for the MS to change the uplink codec to the expected Initial Codec Mode

The SS waits until the MS indicates in the CMR that the 12.2 kbit/s is the recommended downlink codec mode.

If the MS never reaches that point then the test is failed.

- 3c) The SS then sends a THRESH_REQ through a RATSCCH message commanding the MS to modify the Thresholds and Hysteresis to the following values:

MC'MR'	THR_MC_Dn(MC)/ THR_MR_Dn(MR)	THR_MC_Up(MC)/ THR_MR_Up(MR)
CODEC_MODE_3	Thr1d = 13.5 dB	+ ∞
CODEC_MODE_2	Thr2d = 7.5 dB	Thr1u = 15.5 dB
CODEC_MODE_1	- ∞	Thr2u = 9.5 dB

The SS waits 12 frames after receiving the ACK_OK message.

- 3d) The SS waits until the MS indicates in the CMR that the 12.2 kbit/s is the recommended downlink codec mode.

If the MS never reaches that point then the test is failed.

The downlink radio environment is altered so that the carrier to interference ratio is set to 4 dB above the highest of the upwards thresholds Thr1u. The SS waits 500ms

- 3e) The SS repeats steps 1c) to 1n) until 500 samples of C/I increases and 500 samples of C/I decreases have been recorded.

STEP 4:

- 4a) The unwanted signal is removed.

The SS uses a Channel Mode Modify procedure commanding the MS to use the AMR 10.2 kbit/s mode only:

The SS waits for the MS to change the uplink codec to the 10.2 kbit/s mode.

- 4b) The SS then sends an AMR_CONF_REQ through a RATSCCH message commanding the MS to use the following ACS:

Codec Mode	TCH/AFS in kbit/s
CODEC_MODE_3	12,2
CODEC_MODE_2	7,95
CODEC_MODE_1	4,75

With the Initial Codec Mode set to the 12.2 kbit/s mode and the following decision thresholds and hysteresis values:

MC'MR'	THR_MC_Dn(MC)/ THR_MR_Dn(MR)	THR_MC_Up(MC)/ THR_MR_Up(MR)
CODEC_MODE_3	Thr1d = 12.5 dB	+ ∞
CODEC_MODE_2	Thr2d = 6.5 dB	Thr1u = 14.5 dB
CODEC_MODE_1	- ∞	Thr2u = 8.5 dB

The SS switches the downlink codec to the Initial Codec Mode 12 frames after sending the AMR_CONF_REQ message and commands the MS through the CMC field to use the requested Initial Codec Mode. The SS waits for the MS to change the uplink codec to the expected Initial Codec Mode, 12 frames after receiving the ACK_OK message.

The SS waits until the MS indicates in the CMR that the 12.2 kbit/s is the recommended downlink codec mode.

If the MS never reaches that point then the test is failed.

The downlink radio environment is altered so that the carrier to interference ratio is set to 4 dB above the highest of the upwards thresholds Thr1u. The SS waits 500ms

- 4c) The SS repeats steps 1c) to 1n) until 500 samples of C/I increases and 500 samples of C/I decreases have been recorded.

NOTE: The core specifications state that an MS shall respond to a change of C/I within 200ms. The core specifications place no bounds on magnitude or rate of change of C/I. For this test the magnitude of change is bounded by THRESH and HYST selection, and the rate of change is bounded by the 500ms wait periods. These bounds are selected to ensure an MS implementation is not adversely biased by this test.

Maximum/Minimum Duration of Test

Maximum/minimum: 54 minutes (GSM850, GSM900, DCS1800, PCS1900).

14.10.1.5 Test requirements

The requirement and minimum set of samples shall not exceed the values given in the following table for each set of thresholds.

Event	Maximum allowed error rate	Minimum No. of samples
C/I increases over Thresholds	11%	2000
C/I decreases below Thresholds	11%	2000

14.10.2 Performance of the Codec Mode Request Generation – TCH/AHS

14.10.2.1 Definition

When a traffic channel supporting an Adaptive Multi-Rate speech codec is activated, the Codec Mode Request is sent by MS in band every other speech frame to indicate to the Network the recommended codec mode of the ACS to use on the downlink.

14.10.2.2 Conformance Requirement

For TULow channel conditions with ideal frequency hopping without DTX activated, the MS shall produce Codec Mode Requests with the following accuracy:

Requirement 1: When a carrier to interferer ratio 4 dB higher than a defined upper threshold is applied to the antenna connector, the MS shall request a higher mode with a probability exceeding 90%. This shall be measured immediately after a settling-time of 200 ms.

Requirement 2: When a carrier to interferer ratio 4 dB lower than a defined lower threshold is applied to the antenna connector, the MS shall request a lower mode with a probability exceeding 90%. This shall be measured immediately after a settling-time of 200 ms.

If required, the above test levels shall be reduced by the fixed normalization factor defined in sub-clause 3.3.1 of TS 45.009 to account for potential improved receiver performances.

Note: Ideal frequency hopping assumes perfect decorrelation between bursts. For the propagation profile TU3, this is not easily achievable due to the high number of hopping frequencies required. Therefore, performance tests should be performed under ideal frequency hopping conditions for the following propagation profiles: TU50 for GSM900 and GSM850, TU25 for DCS1800 and PCS1900, TU100 for GSM400, and TU60 for GSM700.

3GPP TS 45.05 subclause 2:

For T-GSM 810 the requirements for GSM 900 shall apply, apart for those parameters for which a separate requirement exists.

14.10.2.3 Test Purpose

1. To verify that the MS does not exceed conformance requirement 1 under TULow and frequency hopping propagation conditions without DTX with an allowance for the statistical significance of the test.

2. To verify that the MS does not exceed conformance requirement 2 under TUHigh and frequency hopping propagation conditions without DTX with an allowance for the statistical significance of the test.
3. To implicitly verify the correct implementation of the AMR Thresholds and Hysteresis parameters received in either an ASSIGNMENT COMMAND or MODE MODIFY procedure, or through an AMR_CONFIG_REQ or and in a AMR_CONFIG_REQ message carried in a RATSCCH.

NOTE: This would normally be performed as a signalling test, however due to the complex layer 1 requirements it is verified here. Any future modification or Change Request on this section should take into account this additional test objective.

14.10.2.4 Method of Test

14.10.2.4.1 Initial conditions

A call is set up according to the generic call set up procedure on a TCH/AHS with a hopping pattern in the Mid ARFCN range and covering at least 10 frequencies not exceeding 5 MHz. DTX shall not be activated. Power control level shall be set to maximum power.

The initial configuration indicates the use of the 7.95 mode of AMR only.

The SS transmits Standard Test Signal C1 on the traffic channel.

In addition to the wanted signal, the SS produces an independent, uncorrelated interfering signal, Standard Test Signal I1 (unwanted signal).

- The unwanted signal is continuous and has no fixed relationship with the bit transitions of the wanted signal. Initially, the unwanted signal is switched off.
- The fading characteristic of the wanted and the interfering signal is TUHigh.

NOTE 1: The fading characteristics shall be TU50 for GSM900, T-GSM 810 and GSM850, TU25 for DCS1800 and PCS1900, TU100 for GSM400, and TU60 for GSM700.

Specific PICS Statements:

-

PIXIT Statements:

- AMR C/I normalization factor.

14.10.2.4.2 Procedure

INITIAL CONFIG:

- 1a) The SS uses a Channel Mode Modify procedure to change the active codec set to the following set:

Codec Mode	TCH/AHS in kbit/s
CODEC_MODE_4	7.4
CODEC_MODE_3	6.7
CODEC_MODE_2	5.15
CODEC_MODE_1	4.75

With Initial Codec Mode unspecified, thus the default ICM rule being used and the following decision thresholds and hysteresis values:

MC/MR'	THR_MC_Dn(MC)/ THR_MR_Dn(MR)	THR_MC_Up(MC)/ THR_MR_Up(MR)
CODEC_MODE_4	Thr1d = 17.5 dB	+ ∞
CODEC_MODE_3	Thr2d = 14.5 dB	Thr1u = 19.5 dB
CODEC_MODE_2	Thr3d = 12.5 dB	Thr2u = 16.5 dB
CODEC_MODE_1	- ∞	Thr3u = 14.5 dB

The SS uses the expected Initial Codec Mode (default rule) after sending the mode modify message and commands the MS through the CMC field to use the Initial Codec Mode as well. The SS waits for the MS to change the uplink codec to the expected Initial Codec Mode (default rule).

- 1b) The SS then sends an AMR_CONF_REQ through a RATSCCH message commanding the MS to use the following ACS:

Codec Mode	TCH/AHS in kbit/s
CODEC_MODE_3	7.95
CODEC_MODE_2	6.7
CODEC_MODE_1	4,75

With the Initial Codec Mode set to the 7.95 kbit/s mode and the following decision thresholds and hysteresis values:

MC/MR'	THR_MC_Dn(MC)/ THR_MR_Dn(MR)	THR_MC_Up(MC)/ THR_MR_Up(MR)
CODEC_MODE_3	Thr1d = 14.0 dB	+ ∞
CODEC_MODE_2	Thr2d = 10.0 dB	Thr1u = 16.0 dB
CODEC_MODE_1	- ∞	Thr2u = 12.0 dB

The SS switches the downlink codec to the Initial Codec Mode 12 frames after sending the AMR_CONF_REQ message and commands the MS through the CMC field to use the requested Initial Codec Mode. The SS waits for the MS to change the uplink codec to the expected Initial Codec Mode, 12 frames after receiving the ACK_OK message.

The SS waits until the MS indicates in the CMR that the 7.95 kbit/s is the recommended downlink codec mode.

If the MS never reaches that point then the test is failed.

The downlink radio environment is altered so that the carrier to interference ratio is set to 4 dB above the highest of the upwards thresholds Thr1u. The SS waits 1 second.

- 1c) The downlink radio environment is altered so that the carrier to interference ratio is reduced to 4 dB below the highest of the downwards thresholds Thr1d. The SS increments the counter for 'C/I decreases below thresholds'.
- 1d) The SS checks the CMR received from the MS 200ms after the carrier to interference has been altered. If the CMR indicates that the MS recommends to use the 6.7 kbit/s or a lower codec mode in the downlink, then the SS should increment the successful C/I decrease event counter. Otherwise, the SS should increment the unsuccessful C/I decrease event counter.
- 1e) The SS switches the downlink codec mode to 6.7 kbit/s and waits for 0.5s.
- 1f) The downlink radio environment is altered so that the carrier to interference ratio is reduced to 4 dB below the lowest of the downwards thresholds Thr2d. The SS increments the counter for 'C/I decreases below thresholds'.
- 1g) The SS checks the CMR received from the MS 200ms after the carrier to interference has been altered. If the CMR indicates that the MS recommends to use the 4.75 kbit/s codec mode in the downlink, then the SS should increment the successful C/I decrease event counter. Otherwise, the SS should increment the unsuccessful C/I decrease event counter.
- 1h) The SS switches the downlink codec mode to 4.75 kbit/s and waits for 0.5s.
- 1i) The downlink radio environment is altered so that the carrier to interference ratio is increased to 4 dB above the lowest of the upwards thresholds Thr2u. The SS increments the counter for 'C/I increases above thresholds'.
- 1j) The SS checks the CMR received from the MS 200ms after the carrier to interference has been altered. If the CMR indicates that the MS recommends to use the 6.7 kbit/s or a higher codec mode in the downlink, then

the SS should increment the successful C/I increase event counter. Otherwise, the SS should increment the unsuccessful C/I increase event counter.

- 1k) The SS switches the downlink codec mode to 6.7 kbit/s and waits for 0.5s.
- 1l) The downlink radio environment is altered so that the carrier to interference ratio is increased to 4 dB above the highest of the upwards thresholds Thr1u. The SS increments the counter for 'C/I increases above thresholds'.
- 1m) The SS checks the CMR received from the MS 200ms after the carrier to interference has been altered. If the CMR indicates that the MS recommends to use 7.95 kbit/s in the downlink, then the SS should increment the successful C/I increase event counter. Otherwise, the SS should increment the unsuccessful C/I increase event counter.
- 1n) The SS switches the downlink codec mode to 7.95 kbit/s and waits for 0.5s.
- 1o) The SS repeat steps 1c) to 1n) until 500 samples of C/I increases and 500 samples of C/I decreases samples have been recorded.

STEP 2:

- 2a) The unwanted signal is removed.

The SS then send an AMR_CONF_REQ through a RATSCCH message commanding the MS to use the following ACS:

Codec Mode	TCH/AHS in kbit/s
CODEC_MODE_4	7.4
CODEC_MODE_3	6.7
CODEC_MODE_2	5.15
CODEC_MODE_1	4.75

With the Initial Codec Mode set to any mode.

and the following decision thresholds and hysteresis values:

MC'MR'	THR_MC_Dn(MC)/ THR_MR_Dn(MR)	THR_MC_Up(MC)/ THR_MR_Up(MR)
CODEC_MODE_4	Thr1d = 17.5 dB	+ ∞
CODEC_MODE_3	Thr2d = 14.5 dB	Thr1u = 19.5 dB
CODEC_MODE_2	Thr3d = 12.5 dB	Thr2u = 16.5 dB
CODEC_MODE_1	- ∞	Thr3u = 14.5 dB

The SS switches the downlink codec to the Initial Codec Mode 12 frames after sending the AMR_CONF_REQ message and commands the MS through the CMC field to use the requested Initial Codec Mode. The SS waits for the MS to change the uplink codec to the expected Initial Codec Mode, 12 frames after receiving the ACK_OK message.

- 2b) The SS uses a Channel Mode Modify procedure to change the active codec set to the following set:

Codec Mode	TCH/AHS in kbit/s
CODEC_MODE_3	7.95
CODEC_MODE_2	6.7
CODEC_MODE_1	4,75

With the Initial Codec Mode set to the 7.95 kbit/s mode and the following decision thresholds and hysteresis values:

MC/MR'	THR_MC_Dn(MC)/ THR_MR_Dn(MR)	THR_MC_Up(MC)/ THR_MR_Up(MR)
CODEC_MODE_3	Thr1d = 13.0 dB	+ ∞
CODEC_MODE_2	Thr2d = 9 dB	Thr1u = 15.0 dB
CODEC_MODE_1	- ∞	Thr2u = 11.0 dB

The SS switches the downlink codec to the Initial Codec Mode after sending the mode modify message and commands the MS through the CMC field to use the Initial Codec Mode as well. The SS waits for the MS to change the uplink codec to the expected Initial Codec Mode.

The SS waits until the MS indicates in the CMR that the 7.95 kbit/s is the recommended downlink codec mode.

If the MS never reaches that point then the test is failed.

The downlink radio environment is altered so that the carrier to interference ratio is set to 4 dB above the highest of the upwards thresholds Thr1u. The SS waits 500ms

- 2c) The SS repeats steps 1c) to 1n) until 500 samples of C/I increases and 500 samples of C/I decreases have been recorded.

STEP 3:

- 3a) The unwanted signal is removed.

The SS then sends an AMR_CONF_REQ through a RATSCCH message commanding the MS to use the AMR 6.7 kbit/s mode only:

The SS switches the downlink codec to the 6.7 mode 12 frames after sending the AMR_CONF_REQ message and commands the MS through the CMC field to use the requested codec. The SS waits for the MS to change the uplink codec to the expected codec, 12 frames after receiving the ACK_OK message.

- 3b) The SS uses a Channel Mode Modify procedure to change the active codec set to the following set:

Codec Mode	TCH/AHS in kbit/s
CODEC_MODE_3	7.95
CODEC_MODE_2	6.7
CODEC_MODE_1	4,75

With the Initial Codec Mode set to the 7.95 kbit/s mode and the following decision thresholds and hysteresis values:

MC/MR'	THR_MC_Dn(MC)/ THR_MR_Dn(MR)	THR_MC_Up(MC)/ THR_MR_Up(MR)
CODEC_MODE_3	Thr1d = 18.5 dB	+ ∞
CODEC_MODE_2	Thr2d = 10.5 dB	Thr1u = 20.5 dB
CODEC_MODE_1	- ∞	Thr2u = 12.5 dB

The SS switches the downlink codec to the Initial Codec Mode after sending the mode modify message and commands the MS through the CMC field to use the Initial Codec Mode as well. The SS waits for the MS to change the uplink codec to the expected Initial Codec Mode

The SS waits until the MS indicates in the CMR that the 7.95 kbit/s is the recommended downlink codec mode.

If the MS never reaches that point then the test is failed.

- 3c) The SS then sends a THRESH_REQ through a RATSCCH message commanding the MS to modify the Thresholds and Hysteresis to the following values:

MC/MR'	THR_MC_Dn(MC)/ THR_MR_Dn(MR)	THR_MC_Up(MC)/ THR_MR_Up(MR)
CODEC_MODE_3	Thr1d = 15.0 dB	+ ∞
CODEC_MODE_2	Thr2d = 11.0 dB	Thr1u = 17.0 dB
CODEC_MODE_1	- ∞	Thr2u = 13.0 dB

The SS waits 12 frames after receiving the ACK_OK message.

- 3d) The SS waits until the MS indicates in the CMR that the 7.95 kbit/s is the recommended downlink codec mode.

If the MS never reaches that point then the test is failed.

The downlink radio environment is altered so that the carrier to interference ratio is set to 4 dB above the highest of the upwards thresholds Thr1u. The SS waits 500ms

- 3e) The SS repeats steps 1c) to 1n) until 500 samples of C/I increases and 500 samples of C/I decreases have been recorded.

STEP 4:

- 4a) The unwanted signal is removed.

The SS uses a Channel Mode Modify procedure commanding the MS to use the AMR 5.15 kbit/s mode only:

The SS waits for the MS to change the uplink codec to the 5.15 kbit/s mode.

- 4b) The SS then sends an AMR_CONF_REQ through a RATSCCH message commanding the MS to use the following ACS:

Codec Mode	TCH/AHS in kbit/s
CODEC_MODE_3	7.95
CODEC_MODE_2	6.7
CODEC_MODE_1	4,75

With the Initial Codec Mode set to the 7.95 kbit/s mode and the following decision thresholds and hysteresis values:

MC/MR'	THR_MC_Dn(MC)/ THR_MR_Dn(MR)	THR_MC_Up(MC)/ THR_MR_Up(MR)
CODEC_MODE_3	Thr1d = 14.0 dB	+ ∞
CODEC_MODE_2	Thr2d = 10.0 dB	Thr1u = 16.0 dB
CODEC_MODE_1	- ∞	Thr2u = 12.0 dB

The SS switches the downlink codec to the Initial Codec Mode 12 frames after sending the AMR_CONF_REQ message and commands the MS through the CMC field to use the requested Initial Codec Mode. The SS waits for the MS to change the uplink codec to the expected Initial Codec Mode, 12 frames after receiving the ACK_OK message.

The SS waits until the MS indicates in the CMR that the 7.95 kbit/s is the recommended downlink codec mode.

If the MS never reaches that point then the test is failed.

The downlink radio environment is altered so that the carrier to interference ratio is set to 4 dB above the highest of the upwards thresholds Thr1u. The SS waits 500ms

- 4c) The SS repeats steps 1c) to 1n) until 500 samples of C/I increases and 500 samples of C/I decreases have been recorded.

NOTE: The core specifications state that an MS shall respond to a change of C/I within 200ms. The core specifications place no bounds on magnitude or rate of change of C/I. For this test the magnitude of change is bounded by THRESH and HYST selection, and the rate of change is bounded by the 500ms wait periods. These bounds are selected to ensure an MS implementation is not adversely biased by this test.

Maximum/Minimum Duration of Test

Maximum/minimum: 54 minutes (GSM850, GSM900, DCS1800, PCS1900).

14.10.2.5 Test requirements

The requirement and minimum set of samples shall not exceed the values given in the following table for each set of thresholds.

Event	Maximum allowed error rate	Minimum No. of samples
C/I increases over Thresholds	11%	2000
C/I decreases below Thresholds	11%	2000

14.10.3 Performance of the Codec Mode Request Generation – TCH/AFS - improved RX

14.10.3.1 Definition

When a traffic channel supporting an Adaptive Multi-Rate speech codec is activated, the Codec Mode Request is sent by MS in band every other speech frame to indicate to the Network the recommended codec mode of the ACS to use on the downlink.

14.10.3.2 Conformance Requirement

For TULow channel conditions with ideal frequency hopping without DTX activated, the MS shall produce Codec Mode Requests with the following accuracy:

Requirement 1: When a carrier to interferer ratio 4 dB higher than a defined upper threshold is applied to the antenna connector, the MS shall request a higher mode with a probability exceeding 90%. This shall be measured immediately after a settling-time of 200 ms.

Requirement 2: When a carrier to interferer ratio 4 dB lower than a defined lower threshold is applied to the antenna connector, the MS shall request a lower mode with a probability exceeding 90%. This shall be measured immediately after a settling-time of 200 ms.

The above test levels shall be reduced by the normalization factor defined in sub-clause 3.3.1 of TS 45.009 to account for improved receiver performances, specified in 14.10.3.4.1 below.

Note: Ideal frequency hopping assumes perfect decorrelation between bursts. For the propagation profile TU3, this is not easily achievable due to the high number of hopping frequencies required. Therefore, performance tests should be performed under ideal frequency hopping conditions for the following propagation profiles: TU50 for GSM900 and GSM850, TU25 for DCS1800 and PCS1900, TU100 for GSM400, and TU60 for GSM700.

3GPP TS 45.05 subclause 2:

For T-GSM 810 the requirements for GSM 900 shall apply, apart for those parameters for which a separate requirement exists.

14.10.3.3 Test Purpose

1. To verify that the MS does not exceed conformance requirement 1 under TULow and frequency hopping propagation conditions without DTX with an allowance for the statistical significance of the test.
2. To verify that the MS does not exceed conformance requirement 2 under TULow and frequency hopping propagation conditions without DTX with an allowance for the statistical significance of the test.

3. To implicitly verify the correct implementation of the AMR Thresholds and Hysteresis parameters received in either an ASSIGNMENT COMMAND or MODE MODIFY procedure, or through an AMR_CONFIG_REQ or THRESH_REQ message carried in a RATSCCH.

NOTE: This would normally be performed as a signalling test, however due to the complex layer 1 requirements it is verified here. Any future modification or Change Request on this section should take into account this additional test objective.

NOTE: The C/I values used throughout this test have been carefully selected to ensure no values above 16dB are signalled, low C/I values will not conflict with the synchronisation requirements in TS 45.010, and also to ensure the C/I values are shared between upward and downward applications. Any future modification or Change Request on this section should take into account these aspects.

14.10.3.4 Method of Test

14.10.3.4.1 Initial conditions

A call is set up according to the generic call set up procedure on a TCH/AFS with a hopping pattern in the Mid ARFCN range and covering at least 10 frequencies not exceeding 5 MHz. DTX shall not be activated. Power control level shall be set to maximum power.

The initial configuration indicates the use of the 12.2 mode of AMR only.

The SS transmits Standard Test Signal C1 on the traffic channel.

In addition to the wanted signal, the SS produces an independent, uncorrelated interfering signal, Standard Test Signal I1 (unwanted signal).

- The unwanted signal is continuous and has no fixed relationship with the bit transitions of the wanted signal. Initially, the unwanted signal is switched off.
- The fading characteristic of the wanted and the interfering signal is TUHigh.

NOTE 1: The fading characteristics shall be TU50 for GSM900, T-GSM 810 and GSM850, TU25 for DCS1800 and PCS1900, TU100 for GSM400, and TU60 for GSM700.

Specific PICS Statements:

-

PIXIT Statements:

- AMR C/I normalization factors (AFS DARP) as follows:

Required additional information PIXIT
CI_NORM_AFS_DARP_2dB
CI_NORM_AFS_DARP_3dB
CI_NORM_AFS_DARP_4dB
CI_NORM_AFS_DARP_6dB
CI_NORM_AFS_DARP_8dB
CI_NORM_AFS_DARP_10dB
CI_NORM_AFS_DARP_11dB
CI_NORM_AFS_DARP_12dB
CI_NORM_AFS_DARP_14dB
CI_NORM_AFS_DARP_17dB
CI_NORM_AFS_DARP_19dB
CI_NORM_AFS_DARP_20dB

14.10.3.4.2 Procedure

INITIAL CONFIG:

- 1a) The SS uses a Channel Mode Modify procedure to change the active codec set to the following set:

Codec Mode	TCH/AFS in kbit/s
CODEC_MODE_4	10,2
CODEC_MODE_3	7,4
CODEC_MODE_2	6,7
CODEC_MODE_1	5,15

With Initial Codec Mode unspecified, thus the default ICM rule being used and the following decision thresholds and hysteresis values:

MC'MR'	THR_MC_Dn(MC)/ THR_MR_Dn(MR)	THR_MC_Up(MC)/ THR_MR_Up(MR)
CODEC_MODE_4	Thr1d = 17.5 dB	+ ∞
CODEC_MODE_3	Thr2d = 14.5 dB	Thr1u = 19.5 dB
CODEC_MODE_2	Thr3d = 12.5 dB	Thr2u = 16.5 dB
CODEC_MODE_1	- ∞	Thr3u = 14.5 dB

The SS uses the expected Initial Codec Mode (default rule) after sending the mode modify message and commands the MS through the CMC field to use the Initial Codec Mode as well. The SS waits for the MS to change the uplink codec to the expected Initial Codec Mode (default rule).

- 1b) The SS then sends an AMR_CONF_REQ through a RATSCCH message commanding the MS to use the following ACS:

Codec Mode	TCH/AFS in kbit/s
CODEC_MODE_3	12,2
CODEC_MODE_2	7,95
CODEC_MODE_1	4,75

With the Initial Codec Mode set to the 12.2 kbit/s mode and the following decision thresholds and hysteresis values:

MC'MR'	THR_MC_Dn(MC)/ THR_MR_Dn(MR)	THR_MC_Up(MC)/ THR_MR_Up(MR)
CODEC_MODE_3	Thr1d = 15.0 dB	+ ∞
CODEC_MODE_2	Thr2d = 6.0 dB	Thr1u = 15.0 dB
CODEC_MODE_1	- ∞	Thr2u = 6.0 dB

The SS switches the downlink codec to the Initial Codec Mode 12 frames after sending the AMR_CONF_REQ message and commands the MS through the CMC field to use the requested Initial Codec Mode. The SS waits for the MS to change the uplink codec to the expected Initial Codec Mode, 12 frames after receiving the ACK_OK message.

The SS waits until the MS indicates in the CMR that the 12.2 kbit/s is the recommended downlink codec mode.

If the MS never reaches that point then the test is failed.

The downlink radio environment is altered so that the carrier to interference ratio is set Thr1u + 4dB - CI_NORM_AFS_DARP_19dB. The SS waits 500ms.

- 1c) The downlink radio environment is altered so that the carrier to interference ratio is reduced to Thr1d - 4dB - CI_NORM_AFS_DARP_11dB. The SS increments the counter for 'C/I decreases below thresholds'.
- 1d) The SS checks the CMR received from the MS 200ms after the carrier to interference has been altered. If the CMR indicates that the MS recommends to use the 7.95 kbit/s or a lower codec mode in the downlink, then the SS should increment the successful C/I decrease event counter. Otherwise, the SS should increment the unsuccessful C/I decrease event counter.
- 1e) The SS switches the downlink codec mode to 7.95 kbit/s and waits for 0.5s.

- 1f) The downlink radio environment is altered so that the carrier to interference ratio is reduced to $\text{Thr2d} - 4\text{dB} - \text{CI_NORM_AFS_DARP_2dB}$. The SS increments the counter for 'C/I decreases below thresholds'.
- 1g) The SS checks the CMR received from the MS 200ms after the carrier to interference has been altered. If the CMR indicates that the MS recommends to use the 4.75 kbit/s codec mode in the downlink, then the SS should increment the successful C/I decrease event counter. Otherwise, the SS should increment the unsuccessful C/I decrease event counter.
- 1h) The SS switches the downlink codec mode to 4.75 kbit/s and waits for 0.5s.
- 1i) The downlink radio environment is altered so that the carrier to interference ratio is increased to $\text{Thr2u} + 4\text{dB} - \text{CI_NORM_AFS_DARP_10dB}$. The SS increments the counter for 'C/I increases above thresholds'.
- 1j) The SS checks the CMR received from the MS 200ms after the carrier to interference has been altered. If the CMR indicates that the MS recommends to use the 7.95 kbit/s or a higher codec mode in the downlink, then the SS should increment the successful C/I increase event counter. Otherwise, the SS should increment the unsuccessful C/I increase event counter.
- 1k) The SS switches the downlink codec mode to 7.95 kbit/s and waits for 0.5s.
- 1l) The downlink radio environment is altered so that the carrier to interference ratio is increased to $\text{Thr1u} + 4\text{dB} - \text{CI_NORM_AFS_DARP_19dB}$. The SS increments the counter for 'C/I increases above thresholds'.
- 1m) The SS checks the CMR received by the MS 200ms after the carrier to interference has been altered. If the CMR indicates that the MS recommends to use 12.2 kbit/s in the downlink, then the SS should increment the successful C/I increase event counter. Otherwise, the SS should increment the unsuccessful C/I increase event counter.
- 1n) The SS switches the downlink codec mode to 12.2 kbit/s and waits for 0.5s.
- 1o) The SS repeats steps 1c) to 1n) until 500 samples of C/I increases and 500 samples of C/I decreases have been recorded.

STEP 2:

- 2a) The unwanted signal is removed.

The SS then sends an AMR_CONF_REQ through a RATSCCH message commanding the MS to use the following ACS:

Codec Mode	TCH/AFS in kbit/s
CODEC_MODE_4	10,2
CODEC_MODE_3	7,4
CODEC_MODE_2	6,7
CODEC_MODE_1	5,15

With the Initial Codec Mode set to any mode and the following decision thresholds and hysteresis values:

MC/MR'	THR_MC_Dn(MC)/ THR_MR_Dn(MR)	THR_MC_Up(MC)/ THR_MR_Up(MR)
CODEC_MODE_4	Thr1d = 17.5 dB	+ ∞
CODEC_MODE_3	Thr2d = 14.5 dB	Thr1u = 19.5 dB
CODEC_MODE_2	Thr3d = 12.5 dB	Thr2u = 16.5 dB
CODEC_MODE_1	- ∞	Thr3u = 14.5 dB

The SS switches the downlink codec to the Initial Codec Mode 12 frames after sending the AMR_CONF_REQ message and commands the MS through the CMC field to use the requested Initial Codec Mode. The SS waits for the MS to change the uplink codec to the expected Initial Codec Mode, 12 frames after receiving the ACK_OK message.

- 2b) The SS uses a Channel Mode Modify procedure to change the active codec set to the following set:

Codec Mode	TCH/AFS in kbit/s
CODEC_MODE_3	12,2
CODEC_MODE_2	7.95
CODEC_MODE_1	4,75

With the Initial Codec Mode set to the 12.2 kbit/s mode and the following decision thresholds and hysteresis values:

MC/MR'	THR_MC_Dn(MC)/ THR_MR_Dn(MR)	THR_MC_Up(MC)/ THR_MR_Up(MR)
CODEC_MODE_3	Thr1d = 12.0 dB	+ ∞
CODEC_MODE_2	Thr2d = 8.0 dB	Thr1u = 13.0 dB
CODEC_MODE_1	- ∞	Thr2u = 8.0 dB

The SS switches the downlink codec to the Initial Codec Mode after sending the mode modify message and commands the MS through the CMC field to use the Initial Codec Mode as well. The SS waits for the MS to change the uplink codec to the expected Initial Codec Mode.

The SS waits until the MS indicates in the CMR that the 12.2 kbit/s is the recommended downlink codec mode.

If the MS never reaches that point then the test is failed.

The downlink radio environment is altered so that the carrier to interference ratio is set to Thr1u + 4dB - CI_NORM_AFS_DARP_17dB. The SS waits 500ms

- 2c) The downlink radio environment is altered so that the carrier to interference ratio is reduced to Thr1d – 4dB - CI_NORM_AFS_DARP_8dB. The SS increments the counter for ‘C/I decreases below thresholds’.
- 2d) The SS checks the CMR received from the MS 200ms after the carrier to interference has been altered. If the CMR indicates that the MS recommends to use the 7.95 kbit/s or a lower codec mode in the downlink, then the SS should increment the successful C/I decrease event counter. Otherwise, the SS should increment the unsuccessful C/I decrease event counter.
- 2e) The SS switches the downlink codec mode to 7.95 kbit/s and waits for 0.5s.
- 2f) The downlink radio environment is altered so that the carrier to interference ratio is reduced to Thr2d – 4dB - CI_NORM_AFS_DARP_4dB. The SS increments the counter for ‘C/I decreases below thresholds’.
- 2g) The SS checks the CMR received from the MS 200ms after the carrier to interference has been altered. If the CMR indicates that the MS recommends to use the 4.75 kbit/s codec mode in the downlink, then the SS should increment the successful C/I decrease event counter. Otherwise, the SS should increment the unsuccessful C/I decrease event counter.
- 2h) The SS switches the downlink codec mode to 4.75 kbit/s and waits for 0.5s.
- 2i) The downlink radio environment is altered so that the carrier to interference ratio is increased to Thr2u + 4dB - CI_NORM_AFS_DARP_12dB. The SS increments the counter for ‘C/I increases above thresholds’.
- 2j) The SS checks the CMR received from the MS 200ms after the carrier to interference has been altered. If the CMR indicates that the MS recommends to use the 7.95 kbit/s or a higher codec mode in the downlink, then the SS should increment the successful C/I increase event counter. Otherwise, the SS should increment the unsuccessful C/I increase event counter.
- 2k) The SS switches the downlink codec mode to 7.95 kbit/s and waits for 0.5s.
- 2l) The downlink radio environment is altered so that the carrier to interference ratio is increased to Thr1u + 4dB - CI_NORM_AFS_DARP_17dB. The SS increments the counter for ‘C/I increases above thresholds’.
- 2m) The SS checks the CMR received by the MS 200ms after the carrier to interference has been altered. If the CMR indicates that the MS recommends to use 12.2 kbit/s in the downlink, then the SS should increment the successful C/I increase event counter. Otherwise, the SS should increment the unsuccessful C/I increase event counter.

- 2n) The SS switches the downlink codec mode to 12.2 kbit/s and waits for 0.5s.
- 2o) The SS repeats steps 2c) to 2n) until 500 samples of C/I increases and 500 samples of C/I decreases have been recorded.

STEP 3:

- 3a) The unwanted signal is removed.

The SS then sends an AMR_CONF_REQ through a RATSCCH message commanding the MS to use the AMR 7.95 kbit/s mode only:

The SS switches the downlink codec to the 7.95 mode 12 frames after sending the AMR_CONF_REQ message and commands the MS through the CMC field to use the requested codec. The SS waits for the MS to change the uplink codec to the expected codec, 12 frames after receiving the ACK_OK message.

- 3b) The SS uses a Channel Mode Modify procedure to change the active codec set to the following set:

Codec Mode	TCH/AFS in kbit/s
CODEC_MODE_3	12,2
CODEC_MODE_2	7.95
CODEC_MODE_1	4,75

With the Initial Codec Mode set to the 12.2 kbit/s mode and the following decision thresholds and hysteresis values:

MC'MR'	THR_MC_Dn(MC)/ THR_MR_Dn(MR)	THR_MC_Up(MC)/ THR_MR_Up(MR)
CODEC_MODE_3	Thr1d = 18.5 dB	+ ∞
CODEC_MODE_2	Thr2d = 10.5 dB	Thr1u = 20.5 dB
CODEC_MODE_1	- ∞	Thr2u = 12.5 dB

The SS switches the downlink codec to the Initial Codec Mode after sending the mode modify message and commands the MS through the CMC field to use the Initial Codec Mode as well. The SS waits for the MS to change the uplink codec to the expected Initial Codec Mode

The SS waits until the MS indicates in the CMR that the 12.2 kbit/s is the recommended downlink codec mode.

If the MS never reaches that point then the test is failed.

- 3c) The SS then sends a THRESH_REQ through a RATSCCH message commanding the MS to modify the Thresholds and Hysteresis to the following values:

MC'MR'	THR_MC_Dn(MC)/ THR_MR_Dn(MR)	THR_MC_Up(MC)/ THR_MR_Up(MR)
CODEC_MODE_3	Thr1d = 14.0 dB	+ ∞
CODEC_MODE_2	Thr2d = 10.0 dB	Thr1u = 16.0 dB
CODEC_MODE_1	- ∞	Thr2u = 10.0 dB

The SS waits 12 frames after receiving the ACK_OK message.

- 3d) The SS waits until the MS indicates in the CMR that the 12.2 kbit/s is the recommended downlink codec mode.

If the MS never reaches that point then the test is failed.

The downlink radio environment is altered so that the carrier to interference ratio is set to Thr1u + 4dB - CI_NORM_AFS_DARP_20dB. The SS waits 500ms

- 3e) The downlink radio environment is altered so that the carrier to interference ratio is reduced to Thr1d - 4dB - CI_NORM_AFS_DARP_10dB. The SS increments the counter for 'C/I decreases below thresholds'.

- 3f) The SS checks the CMR received from the MS 200ms after the carrier to interference has been altered. If the CMR indicates that the MS recommends to use the 7.95 kbit/s or a lower codec mode in the downlink, then the SS should increment the successful C/I decrease event counter. Otherwise, the SS should increment the unsuccessful C/I decrease event counter.
- 3g) The SS switches the downlink codec mode to 7.95 kbit/s and waits for 0.5s.
- 3h) The downlink radio environment is altered so that the carrier to interference ratio is reduced to $\text{Thr2d} - 4\text{dB} - \text{CI_NORM_AFS_DARP_6dB}$. The SS increments the counter for 'C/I decreases below thresholds'.
- 3i) The SS checks the CMR received from the MS 200ms after the carrier to interference has been altered. If the CMR indicates that the MS recommends to use the 4.75 kbit/s codec mode in the downlink, then the SS should increment the successful C/I decrease event counter. Otherwise, the SS should increment the unsuccessful C/I decrease event counter.
- 3j) The SS switches the downlink codec mode to 4.75 kbit/s and waits for 0.5s.
- 3k) The downlink radio environment is altered so that the carrier to interference ratio is increased to $\text{Thr2u} + 4\text{dB} - \text{CI_NORM_AFS_DARP_14dB}$. The SS increments the counter for 'C/I increases above thresholds'.
- 3l) The SS checks the CMR received from the MS 200ms after the carrier to interference has been altered. If the CMR indicates that the MS recommends to use the 7.95 kbit/s or a higher codec mode in the downlink, then the SS should increment the successful C/I increase event counter. Otherwise, the SS should increment the unsuccessful C/I increase event counter.
- 3m) The SS switches the downlink codec mode to 7.95 kbit/s and waits for 0.5s.
- 3n) The downlink radio environment is altered so that the carrier to interference ratio is increased to $\text{Thr1u} + 4\text{dB} - \text{CI_NORM_AFS_DARP_20dB}$. The SS increments the counter for 'C/I increases above thresholds'.
- 3o) The SS checks the CMR received by the MS 200ms after the carrier to interference has been altered. If the CMR indicates that the MS recommends to use 12.2 kbit/s in the downlink, then the SS should increment the successful C/I increase event counter. Otherwise, the SS should increment the unsuccessful C/I increase event counter.
- 3p) The SS switches the downlink codec mode to 12.2 kbit/s and waits for 0.5s.
- 3q) The SS repeats steps 3e) to 3p) until 500 samples of C/I increases and 500 samples of C/I decreases have been recorded.

STEP 4:

- 4a) The unwanted signal is removed.

The SS uses a Channel Mode Modify procedure commanding the MS to use the AMR 10.2 kbit/s mode only:

The SS waits for the MS to change the uplink codec to the 10.2 kbit/s mode.

- 4b) The SS then sends an AMR_CONF_REQ through a RATSCCH message commanding the MS to use the following ACS:

Codec Mode	TCH/AFS in kbit/s
CODEC_MODE_3	12,2
CODEC_MODE_2	7.95
CODEC_MODE_1	4,75

With the Initial Codec Mode set to the 12.2 kbit/s mode and the following decision thresholds and hysteresis values:

MC'MR'	THR_MC_Dn(MC)/ THR_MR_Dn(MR)	THR_MC_Up(MC)/ THR_MR_Up(MR)
CODEC_MODE_3	Thr1d = 16.0 dB	+ ∞
CODEC_MODE_2	Thr2d = 7.0 dB	Thr1u = 16.0 dB
CODEC_MODE_1	- ∞	Thr2u = 7.0 dB

The SS switches the downlink codec to the Initial Codec Mode 12 frames after sending the AMR_CONF_REQ message and commands the MS through the CMC field to use the requested Initial Codec Mode. The SS waits for the MS to change the uplink codec to the expected Initial Codec Mode, 12 frames after receiving the ACK_OK message.

The SS waits until the MS indicates in the CMR that the 12.2 kbit/s is the recommended downlink codec mode.

If the MS never reaches that point then the test is failed.

The downlink radio environment is altered so that the carrier to interference ratio is set to Thr1u + 4dB - CI_NORM_AFS_DARP_20dB. The SS waits 500ms

- 4c) The downlink radio environment is altered so that the carrier to interference ratio is reduced to Thr1d – 4dB - CI_NORM_AFS_DARP_12dB. The SS increments the counter for ‘C/I decreases below thresholds’.
- 4d) The SS checks the CMR received from the MS 200ms after the carrier to interference has been altered. If the CMR indicates that the MS recommends to use the 7.95 kbit/s or a lower codec mode in the downlink, then the SS should increment the successful C/I decrease event counter. Otherwise, the SS should increment the unsuccessful C/I decrease event counter.
- 4e) The SS switches the downlink codec mode to 7.95 kbit/s and waits for 0.5s.
- 4f) The downlink radio environment is altered so that the carrier to interference ratio is reduced to Thr2d – 4dB - CI_NORM_AFS_DARP_3dB. The SS increments the counter for ‘C/I decreases below thresholds’.
- 4g) The SS checks the CMR received from the MS 200ms after the carrier to interference has been altered. If the CMR indicates that the MS recommends to use the 4.75 kbit/s codec mode in the downlink, then the SS should increment the successful C/I decrease event counter. Otherwise, the SS should increment the unsuccessful C/I decrease event counter.
- 4h) The SS switches the downlink codec mode to 4.75 kbit/s and waits for 0.5s.
- 4i) The downlink radio environment is altered so that the carrier to interference ratio is increased to Thr2u + 4dB - CI_NORM_AFS_DARP_11dB. The SS increments the counter for ‘C/I increases above thresholds’.
- 4j) The SS checks the CMR received from the MS 200ms after the carrier to interference has been altered. If the CMR indicates that the MS recommends to use the 7.95 kbit/s or a higher codec mode in the downlink, then the SS should increment the successful C/I increase event counter. Otherwise, the SS should increment the unsuccessful C/I increase event counter.
- 4k) The SS switches the downlink codec mode to 7.95 kbit/s and waits for 0.5s.
- 4l) The downlink radio environment is altered so that the carrier to interference ratio is increased to Thr1u + 4dB - CI_NORM_AFS_DARP_20dB. The SS increments the counter for ‘C/I increases above thresholds’.
- 4m) The SS checks the CMR received by the MS 200ms after the carrier to interference has been altered. If the CMR indicates that the MS recommends to use 12.2 kbit/s in the downlink, then the SS should increment the successful C/I increase event counter. Otherwise, the SS should increment the unsuccessful C/I increase event counter.
- 4n) The SS switches the downlink codec mode to 12.2 kbit/s and waits for 0.5s.
- 4o) The SS repeats steps 4c) to 4n) until 500 samples of C/I increases and 500 samples of C/I decreases have been recorded.

NOTE: The core specifications state that an MS shall respond to a change of C/I within 200ms. The core specifications place no bounds on magnitude or rate of change of C/I. For this test the magnitude of change is bounded by THRESH and HYST selection, and the rate of change is bounded by the 500ms wait periods. These bounds are selected to ensure an MS implementation is not adversely biased by this test.

Maximum/Minimum Duration of Test

Maximum/minimum: 54 minutes (GSM850, GSM900, DCS1800, PCS1900).

14.10.3.5 Test requirements

The requirement and minimum set of samples shall not exceed the values given in the following table for each set of thresholds.

Event	Maximum allowed error rate	Minimum No. of samples
C/I increases over Thresholds	11%	2000
C/I decreases below Thresholds	11%	2000

14.10.4 Performance of the Codec Mode Request Generation – TCH/AHS – improved RX

14.10.4.1 Definition

When a traffic channel supporting an Adaptive Multi-Rate speech codec is activated, the Codec Mode Request is sent by MS in band every other speech frame to indicate to the Network the recommended codec mode of the ACS to use on the downlink.

14.10.4.2 Conformance Requirement

For TULow channel conditions with ideal frequency hopping without DTX activated, the MS shall produce Codec Mode Requests with the following accuracy:

Requirement 1: When a carrier to interferer ratio 4 dB higher than a defined upper threshold is applied to the antenna connector, the MS shall request a higher mode with a probability exceeding 90%. This shall be measured immediately after a settling-time of 200 ms.

Requirement 2: When a carrier to interferer ratio 4 dB lower than a defined lower threshold is applied to the antenna connector, the MS shall request a lower mode with a probability exceeding 90%. This shall be measured immediately after a settling-time of 200 ms.

The above test levels shall be reduced by the normalization factor defined in sub-clause 3.3.1 of TS 45.009 to account for improved receiver performances, specified in 14.10.3.4.1 below.

Note: Ideal frequency hopping assumes perfect decorrelation between bursts. For the propagation profile TU3, this is not easily achievable due to the high number of hopping frequencies required. Therefore, performance tests should be performed under ideal frequency hopping conditions for the following propagation profiles: TU50 for GSM900 and GSM850, TU25 for DCS1800 and PCS1900, TU100 for GSM400, and TU60 for GSM700.

3GPP TS 45.05 subclause 2:

For T-GSM 810 the requirements for GSM 900 shall apply, apart for those parameters for which a separate requirement exists.

14.10.4.3 Test Purpose

1. To verify that the MS does not exceed conformance requirement 1 under TULow and frequency hopping propagation conditions without DTX with an allowance for the statistical significance of the test.
2. To verify that the MS does not exceed conformance requirement 2 under TULow and frequency hopping propagation conditions without DTX with an allowance for the statistical significance of the test.
3. To implicitly verify the correct implementation of the AMR Thresholds and Hysteresis parameters received in either an ASSIGNMENT COMMAND or MODE MODIFY procedure, or through an AMR_CONFIG_REQ or and in a AMR_CONFIG_REQ message carried in a RATSCCH.

NOTE: This would normally be performed as a signalling test, however due to the complex layer 1 requirements it is verified here. Any future modification or Change Request on this section should take into account this additional test objective.

NOTE: The C/I values used throughout this test have been carefully selected to ensure no values above 16dB are signalled, low C/I values will not conflict with the synchronisation requirements in TS 45.010, and also to ensure the C/I values are shared between upward and downward applications. Any future modification or Change Request on this section should take into account these aspects.

14.10.4.4 Method of Test

14.10.4.4.1 Initial conditions

A call is set up according to the generic call set up procedure on a TCH/AHS with a hopping pattern in the Mid ARFCN range and covering at least 10 frequencies not exceeding 5 MHz. DTX shall not be activated. Power control level shall be set to maximum power.

The initial configuration indicates the use of the 7.95 mode of AMR only.

The SS transmits Standard Test Signal C1 on the traffic channel.

In addition to the wanted signal, the SS produces an independent, uncorrelated interfering signal, Standard Test Signal I1 (unwanted signal).

- The unwanted signal is continuous and has no fixed relationship with the bit transitions of the wanted signal. Initially, the unwanted signal is switched off.
- The fading characteristic of the wanted and the interfering signal is TUHigh.

NOTE 1: The fading characteristics shall be TU50 for GSM900, T-GSM 810 and GSM850, TU25 for DCS1800 and PCS1900, TU100 for GSM400, and TU60 for GSM700.

Specific PICS Statements:

-

PIXIT Statements:

- AMR C/I normalization factors (AHS DARP) as follows:

Required additional information PIXIT
CI_NORM_AHS_DARP_4dB
CI_NORM_AHS_DARP_6dB
CI_NORM_AHS_DARP_7dB
CI_NORM_AHS_DARP_10dB
CI_NORM_AHS_DARP_12dB
CI_NORM_AHS_DARP_13dB
CI_NORM_AHS_DARP_16dB
CI_NORM_AHS_DARP_17dB
CI_NORM_AHS_DARP_20dB
CI_NORM_AHS_DARP_21dB

14.10.4.4.2 Procedure

INITIAL CONFIG:

- 1a) The SS uses a Channel Mode Modify procedure to change the active codec set to the following set:

Codec Mode	TCH/AHS in kbit/s
CODEC_MODE_4	7.4
CODEC_MODE_3	6.7
CODEC_MODE_2	5.15
CODEC_MODE_1	4.75

With Initial Codec Mode unspecified, thus the default ICM rule being used and the following decision thresholds and hysteresis values:

MC/MR'	THR_MC_Dn(MC)/ THR_MR_Dn(MR)	THR_MC_Up(MC)/ THR_MR_Up(MR)
CODEC_MODE_4	Thr1d = 17.5 dB	+ ∞
CODEC_MODE_3	Thr2d = 14.5 dB	Thr1u = 19.5 dB
CODEC_MODE_2	Thr3d = 12.5 dB	Thr2u = 16.5 dB
CODEC_MODE_1	- ∞	Thr3u = 14.5 dB

The SS uses the expected Initial Codec Mode (default rule) after sending the mode modify message and commands the MS through the CMC field to use the Initial Codec Mode as well. The SS waits for the MS to change the uplink codec to the expected Initial Codec Mode (default rule).

- 1b) The SS then sends an AMR_CONF_REQ through a RATSCCH message commanding the MS to use the following ACS:

Codec Mode	TCH/AHS in kbit/s
CODEC_MODE_3	7.95
CODEC_MODE_2	6.7
CODEC_MODE_1	4,75

With the Initial Codec Mode set to the 7.95 kbit/s mode and the following decision thresholds and hysteresis values:

MC/MR'	THR_MC_Dn(MC)/ THR_MR_Dn(MR)	THR_MC_Up(MC)/ THR_MR_Up(MR)
CODEC_MODE_3	Thr1d = 14.0 dB	+ ∞
CODEC_MODE_2	Thr2d = 8.0 dB	Thr1u = 16.0 dB
CODEC_MODE_1	- ∞	Thr2u = 9.0 dB

The SS switches the downlink codec to the Initial Codec Mode 12 frames after sending the AMR_CONF_REQ message and commands the MS through the CMC field to use the requested Initial Codec Mode. The SS waits for the MS to change the uplink codec to the expected Initial Codec Mode, 12 frames after receiving the ACK_OK message.

The SS waits until the MS indicates in the CMR that the 7.95 kbit/s is the recommended downlink codec mode.

If the MS never reaches that point then the test is failed.

The downlink radio environment is altered so that the carrier to interference ratio is set to Thr1u + 4dB - CI_NORM_AHS_DARP_20dB. The SS waits 1 second.

- 1c) The downlink radio environment is altered so that the carrier to interference ratio is reduced to Thr1d - 4dB - CI_NORM_AHS_DARP_10dB. The SS increments the counter for 'C/I decreases below thresholds'.
- 1d) The SS checks the CMR received from the MS 200ms after the carrier to interference has been altered. If the CMR indicates that the MS recommends to use the 6.7 kbit/s or a lower codec mode in the downlink, then the SS should increment the successful C/I decrease event counter. Otherwise, the SS should increment the unsuccessful C/I decrease event counter.
- 1e) The SS switches the downlink codec mode to 6.7 kbit/s and waits for 0.5s.
- 1f) The downlink radio environment is altered so that the carrier to interference ratio is reduced to Thr2d - 4dB - CI_NORM_AHS_DARP_4dB. The SS increments the counter for 'C/I decreases below thresholds'.
- 1g) The SS checks the CMR received from the MS 200ms after the carrier to interference has been altered. If the CMR indicates that the MS recommends to use the 4.75 kbit/s codec mode in the downlink, then the SS should increment the successful C/I decrease event counter. Otherwise, the SS should increment the unsuccessful C/I decrease event counter.
- 1h) The SS switches the downlink codec mode to 4.75 kbit/s and waits for 0.5s.

- 1i) The downlink radio environment is altered so that the carrier to interference ratio is increased to Thr2u + 4dB - CI_NORM_AHS_DARP_13dB. The SS increments the counter for 'C/I increases above thresholds'.
- 1j) The SS checks the CMR received from the MS 200ms after the carrier to interference has been altered. If the CMR indicates that the MS recommends to use the 6.7 kbit/s or a higher codec mode in the downlink, then the SS should increment the successful C/I increase event counter. Otherwise, the SS should increment the unsuccessful C/I increase event counter.
- 1k) The SS switches the downlink codec mode to 6.7 kbit/s and waits for 0.5s.
- 1l) The downlink radio environment is altered so that the carrier to interference ratio is increased to Thr1u + 4dB - CI_NORM_AHS_DARP_20dB. The SS increments the counter for 'C/I increases above thresholds'.
- 1m) The SS checks the CMR received from the MS 200ms after the carrier to interference has been altered. If the CMR indicates that the MS recommends to use 7.95 kbit/s in the downlink, then the SS should increment the successful C/I increase event counter. Otherwise, the SS should increment the unsuccessful C/I increase event counter.
- 1n) The SS switches the downlink codec mode to 7.95 kbit/s and waits for 0.5s.
- 1o) The SS repeat steps 1c) to 1n) until 500 samples of C/I increases and 500 samples of C/I decreases samples have been recorded.

STEP 2:

- 2a) The unwanted signal is removed.

The SS then send an AMR_CONF_REQ through a RATSCCH message commanding the MS to use the following ACS:

Codec Mode	TCH/AHS in kbit/s
CODEC_MODE_4	7.4
CODEC_MODE_3	6.7
CODEC_MODE_2	5.15
CODEC_MODE_1	4.75

With the Initial Codec Mode set to any mode.

and the following decision thresholds and hysteresis values:

MC/MR'	THR_MC_Dn(MC)/ THR_MR_Dn(MR)	THR_MC_Up(MC)/ THR_MR_Up(MR)
CODEC_MODE_4	Thr1d = 17.5 dB	+ ∞
CODEC_MODE_3	Thr2d = 14.5 dB	Thr1u = 19.5 dB
CODEC_MODE_2	Thr3d = 12.5 dB	Thr2u = 16.5 dB
CODEC_MODE_1	- ∞	Thr3u = 14.5 dB

The SS switches the downlink codec to the Initial Codec Mode 12 frames after sending the AMR_CONF_REQ message and commands the MS through the CMC field to use the requested Initial Codec Mode. The SS waits for the MS to change the uplink codec to the expected Initial Codec Mode, 12 frames after receiving the ACK_OK message.

- 2b) The SS uses a Channel Mode Modify procedure to change the active codec set to the following set:

Codec Mode	TCH/AHS in kbit/s
CODEC_MODE_3	7.95
CODEC_MODE_2	6.7
CODEC_MODE_1	4,75

With the Initial Codec Mode set to the 7.95 kbit/s mode and the following decision thresholds and hysteresis values:

MC/MR'	THR_MC_Dn(MC)/ THR_MR_Dn(MR)	THR_MC_Up(MC)/ THR_MR_Up(MR)
CODEC_MODE_3	Thr1d = 14.0 dB	+ ∞
CODEC_MODE_2	Thr2d = 8 dB	Thr1u = 16.0 dB
CODEC_MODE_1	- ∞	Thr2u = 8.0 dB

The SS switches the downlink codec to the Initial Codec Mode after sending the mode modify message and commands the MS through the CMC field to use the Initial Codec Mode as well. The SS waits for the MS to change the uplink codec to the expected Initial Codec Mode.

The SS waits until the MS indicates in the CMR that the 7.95 kbit/s is the recommended downlink codec mode.

If the MS never reaches that point then the test is failed.

The downlink radio environment is altered so that the carrier to interference ratio is set to Thr1u + 4dB - CI_NORM_AHS_DARP_20dB. The SS waits 500ms

- 2c) The downlink radio environment is altered so that the carrier to interference ratio is reduced to Thr1d - 4dB - CI_NORM_AHS_DARP_10dB. The SS increments the counter for 'C/I decreases below thresholds'.
- 2d) The SS checks the CMR received from the MS 200ms after the carrier to interference has been altered. If the CMR indicates that the MS recommends to use the 6.7 kbit/s or a lower codec mode in the downlink, then the SS should increment the successful C/I decrease event counter. Otherwise, the SS should increment the unsuccessful C/I decrease event counter.
- 2e) The SS switches the downlink codec mode to 6.7 kbit/s and waits for 0.5s.
- 2f) The downlink radio environment is altered so that the carrier to interference ratio is reduced to Thr2d - 4dB - CI_NORM_AHS_DARP_4dB. The SS increments the counter for 'C/I decreases below thresholds'.
- 2g) The SS checks the CMR received from the MS 200ms after the carrier to interference has been altered. If the CMR indicates that the MS recommends to use the 4.75 kbit/s codec mode in the downlink, then the SS should increment the successful C/I decrease event counter. Otherwise, the SS should increment the unsuccessful C/I decrease event counter.
- 2h) The SS switches the downlink codec mode to 4.75 kbit/s and waits for 0.5s.
- 2i) The downlink radio environment is altered so that the carrier to interference ratio is increased to Thr2u + 4dB - CI_NORM_AHS_DARP_12dB. The SS increments the counter for 'C/I increases above thresholds'.
- 2j) The SS checks the CMR received from the MS 200ms after the carrier to interference has been altered. If the CMR indicates that the MS recommends to use the 6.7 kbit/s or a higher codec mode in the downlink, then the SS should increment the successful C/I increase event counter. Otherwise, the SS should increment the unsuccessful C/I increase event counter.
- 2k) The SS switches the downlink codec mode to 6.7 kbit/s and waits for 0.5s.
- 2l) The downlink radio environment is altered so that the carrier to interference ratio is increased to Thr1u + 4dB - CI_NORM_AHS_DARP_20dB. The SS increments the counter for 'C/I increases above thresholds'.
- 2m) The SS checks the CMR received from the MS 200ms after the carrier to interference has been altered. If the CMR indicates that the MS recommends to use 7.95 kbit/s in the downlink, then the SS should increment the successful C/I increase event counter. Otherwise, the SS should increment the unsuccessful C/I increase event counter.
- 2n) The SS switches the downlink codec mode to 7.95 kbit/s and waits for 0.5s.
- 2o) The SS repeats steps 2c) to 2n) until 500 samples of C/I increases and 500 samples of C/I decreases have been recorded.

STEP 3:

- 3a) The unwanted signal is removed.

The SS then sends an AMR_CONF_REQ through a RATSCCH message commanding the MS to use the AMR 6.7 kbit/s mode only:

The SS switches the downlink codec to the 6.7 mode 12 frames after sending the AMR_CONF_REQ message and commands the MS through the CMC field to use the requested codec. The SS waits for the MS to change the uplink codec to the expected codec, 12 frames after receiving the ACK_OK message.

- 3b) The SS uses a Channel Mode Modify procedure to change the active codec set to the following set:

Codec Mode	TCH/AHS in kbit/s
CODEC_MODE_3	7.95
CODEC_MODE_2	6.7
CODEC_MODE_1	4,75

With the Initial Codec Mode set to the 7.95 kbit/s mode and the following decision thresholds and hysteresis values:

MC'MR'	THR_MC_Dn(MC)/ THR_MR_Dn(MR)	THR_MC_Up(MC)/ THR_MR_Up(MR)
CODEC_MODE_3	Thr1d = 18.5 dB	+ ∞
CODEC_MODE_2	Thr2d = 10.5 dB	Thr1u = 20.5 dB
CODEC_MODE_1	- ∞	Thr2u = 12.5 dB

The SS switches the downlink codec to the Initial Codec Mode after sending the mode modify message and commands the MS through the CMC field to use the Initial Codec Mode as well. The SS waits for the MS to change the uplink codec to the expected Initial Codec Mode

The SS waits until the MS indicates in the CMR that the 7.95 kbit/s is the recommended downlink codec mode.

If the MS never reaches that point then the test is failed.

- 3c) The SS then sends a THRESH_REQ through a RATSCCH message commanding the MS to modify the Thresholds and Hysteresis to the following values:

MC'MR'	THR_MC_Dn(MC)/ THR_MR_Dn(MR)	THR_MC_Up(MC)/ THR_MR_Up(MR)
CODEC_MODE_3	Thr1d = 16.0 dB	+ ∞
CODEC_MODE_2	Thr2d = 11.0 dB	Thr1u = 17.0 dB
CODEC_MODE_1	- ∞	Thr2u = 13.0 dB

The SS waits 12 frames after receiving the ACK_OK message.

- 3d) The SS waits until the MS indicates in the CMR that the 7.95 kbit/s is the recommended downlink codec mode.

If the MS never reaches that point then the test is failed.

The downlink radio environment is altered so that the carrier to interference ratio is set to Thr1u + 4dB - CI_NORM_AHS_DARP_21dB. The SS waits 500ms

- 3e) The downlink radio environment is altered so that the carrier to interference ratio is reduced to Thr1d - 4dB - CI_NORM_AHS_DARP_12dB. The SS increments the counter for 'C/I decreases below thresholds'.
- 3f) The SS checks the CMR received from the MS 200ms after the carrier to interference has been altered. If the CMR indicates that the MS recommends to use the 6.7 kbit/s or a lower codec mode in the downlink, then the SS should increment the successful C/I decrease event counter. Otherwise, the SS should increment the unsuccessful C/I decrease event counter.
- 3g) The SS switches the downlink codec mode to 6.7 kbit/s and waits for 0.5s.

- 3h) The downlink radio environment is altered so that the carrier to interference ratio is reduced to Thr2d - 4dB - CI_NORM_AHS_DARP_7dB. The SS increments the counter for 'C/I decreases below thresholds'.
- 3i) The SS checks the CMR received from the MS 200ms after the carrier to interference has been altered. If the CMR indicates that the MS recommends to use the 4.75 kbit/s codec mode in the downlink, then the SS should increment the successful C/I decrease event counter. Otherwise, the SS should increment the unsuccessful C/I decrease event counter.
- 3j) The SS switches the downlink codec mode to 4.75 kbit/s and waits for 0.5s.
- 3k) The downlink radio environment is altered so that the carrier to interference ratio is increased to Thr2u + 4dB - CI_NORM_AHS_DARP_17dB. The SS increments the counter for 'C/I increases above thresholds'.
- 3l) The SS checks the CMR received from the MS 200ms after the carrier to interference has been altered. If the CMR indicates that the MS recommends to use the 6.7 kbit/s or a higher codec mode in the downlink, then the SS should increment the successful C/I increase event counter. Otherwise, the SS should increment the unsuccessful C/I increase event counter.
- 3m) The SS switches the downlink codec mode to 6.7 kbit/s and waits for 0.5s.
- 3n) The downlink radio environment is altered so that the carrier to interference ratio is increased to Thr1u + 4dB - CI_NORM_AHS_DARP_21dB. The SS increments the counter for 'C/I increases above thresholds'.
- 3o) The SS checks the CMR received from the MS 200ms after the carrier to interference has been altered. If the CMR indicates that the MS recommends to use 7.95 kbit/s in the downlink, then the SS should increment the successful C/I increase event counter. Otherwise, the SS should increment the unsuccessful C/I increase event counter.
- 3p) The SS switches the downlink codec mode to 7.95 kbit/s and waits for 0.5s.
- 3q) The SS repeats steps 3e) to 3p) until 500 samples of C/I increases and 500 samples of C/I decreases have been recorded.

STEP 4:

- 4a) The unwanted signal is removed.

The SS uses a Channel Mode Modify procedure commanding the MS to use the AMR 5.15 kbit/s mode only:

The SS waits for the MS to change the uplink codec to the 5.15 kbit/s mode.

- 4b) The SS then sends an AMR_CONF_REQ through a RATSCCH message commanding the MS to use the following ACS:

Codec Mode	TCH/AHS in kbit/s
CODEC_MODE_3	7.95
CODEC_MODE_2	6.7
CODEC_MODE_1	4,75

With the Initial Codec Mode set to the 7.95 kbit/s mode and the following decision thresholds and hysteresis values:

MC/MR'	THR_MC_Dn(MC)/ THR_MR_Dn(MR)	THR_MC_Up(MC)/ THR_MR_Up(MR)
CODEC_MODE_3	Thr1d = 17.0 dB	+ ∞
CODEC_MODE_2	Thr2d = 10.0 dB	Thr1u = 17.0 dB
CODEC_MODE_1	- ∞	Thr2u = 12.0 dB

The SS switches the downlink codec to the Initial Codec Mode 12 frames after sending the AMR_CONF_REQ message and commands the MS through the CMC field to use the requested Initial Codec Mode. The SS waits for the MS to change the uplink codec to the expected Initial Codec Mode, 12 frames after receiving the ACK_OK message.

The SS waits until the MS indicates in the CMR that the 7.95 kbit/s is the recommended downlink codec mode.

If the MS never reaches that point then the test is failed.

The downlink radio environment is altered so that the carrier to interference ratio is set to $\text{Thr1u} + 4\text{dB} - \text{CI_NORM_AHS_DARP_21dB}$. The SS waits 500ms

- 4c) The downlink radio environment is altered so that the carrier to interference ratio is reduced to $\text{Thr1d} - 4\text{dB} - \text{CI_NORM_AHS_DARP_13dB}$. The SS increments the counter for 'C/I decreases below thresholds'.
- 4d) The SS checks the CMR received from the MS 200ms after the carrier to interference has been altered. If the CMR indicates that the MS recommends to use the 6.7 kbit/s or a lower codec mode in the downlink, then the SS should increment the successful C/I decrease event counter. Otherwise, the SS should increment the unsuccessful C/I decrease event counter.
- 4e) The SS switches the downlink codec mode to 6.7 kbit/s and waits for 0.5s.
- 4f) The downlink radio environment is altered so that the carrier to interference ratio is reduced to $\text{Thr2d} - 4\text{dB} - \text{CI_NORM_AHS_DARP_6dB}$. The SS increments the counter for 'C/I decreases below thresholds'.
- 4g) The SS checks the CMR received from the MS 200ms after the carrier to interference has been altered. If the CMR indicates that the MS recommends to use the 4.75 kbit/s codec mode in the downlink, then the SS should increment the successful C/I decrease event counter. Otherwise, the SS should increment the unsuccessful C/I decrease event counter.
- 4h) The SS switches the downlink codec mode to 4.75 kbit/s and waits for 0.5s.
- 4i) The downlink radio environment is altered so that the carrier to interference ratio is increased to $\text{Thr2u} + 4\text{dB} - \text{CI_NORM_AHS_DARP_16dB}$. The SS increments the counter for 'C/I increases above thresholds'.
- 4j) The SS checks the CMR received from the MS 200ms after the carrier to interference has been altered. If the CMR indicates that the MS recommends to use the 6.7 kbit/s or a higher codec mode in the downlink, then the SS should increment the successful C/I increase event counter. Otherwise, the SS should increment the unsuccessful C/I increase event counter.
- 4k) The SS switches the downlink codec mode to 6.7 kbit/s and waits for 0.5s.
- 4l) The downlink radio environment is altered so that the carrier to interference ratio is increased to $\text{Thr1u} + 4\text{dB} - \text{CI_NORM_AHS_DARP_21dB}$. The SS increments the counter for 'C/I increases above thresholds'.
- 4m) The SS checks the CMR received from the MS 200ms after the carrier to interference has been altered. If the CMR indicates that the MS recommends to use 7.95 kbit/s in the downlink, then the SS should increment the successful C/I increase event counter. Otherwise, the SS should increment the unsuccessful C/I increase event counter.
- 4n) The SS switches the downlink codec mode to 7.95 kbit/s and waits for 0.5s.
- 4o) The SS repeats steps 4c) to 4n) until 500 samples of C/I increases and 500 samples of C/I decreases have been recorded.

NOTE: The core specifications state that an MS shall respond to a change of C/I within 200ms. The core specifications place no bounds on magnitude or rate of change of C/I. For this test the magnitude of change is bounded by THRESH and HYST selection, and the rate of change is bounded by the 500ms wait periods. These bounds are selected to ensure an MS implementation is not adversely biased by this test.

Maximum/Minimum Duration of Test

Maximum/minimum: 54 minutes (GSM850, GSM900, DCS1800, PCS1900).

14.10.4.5 Test requirements

The requirement and minimum set of samples shall not exceed the values given in the following table for each set of thresholds.

Event	Maximum allowed error rate	Minimum No. of samples
C/I increases over Thresholds	11%	2000
C/I decreases below Thresholds	11%	2000

14.10.5 Performance of the Codec Mode Request Generation – O-TCH/AHS

14.10.5.1 Definition

When a traffic channel supporting an Adaptive Multi-Rate speech codec is activated, the Codec Mode Request is sent by MS in band every other speech frame to indicate to the Network the recommended codec mode of the ACS to use on the downlink.

14.10.5.2 Conformance Requirement

For TULow channel conditions with ideal frequency hopping without DTX activated, the MS shall produce Codec Mode Requests with the following accuracy:

Requirement 1: When a carrier to interferer ratio 4 dB higher than a defined upper threshold is applied to the antenna connector, the MS shall request a higher mode with a probability exceeding 90%. This shall be measured immediately after a settling-time of 200 ms.

Requirement 2: When a carrier to interferer ratio 4 dB lower than a defined lower threshold is applied to the antenna connector, the MS shall request a lower mode with a probability exceeding 90%. This shall be measured immediately after a settling-time of 200 ms.

If required, the above test levels shall be reduced by the fixed normalization factor defined in sub-clause 3.3.1 of TS 45.009 to account for potential improved receiver performances.

Note: Ideal frequency hopping assumes perfect decorrelation between bursts. For the propagation profile TU3, this is not easily achievable due to the high number of hopping frequencies required. Therefore, performance tests should be performed under ideal frequency hopping conditions for the following propagation profiles: TU50 for GSM900 and GSM850, TU25 for DCS1800 and PCS1900, TU100 for GSM400, and TU60 for GSM700.

3GPP TS 45.05 subclause 2:

For T-GSM 810 the requirements for GSM 900 shall apply, apart for those parameters for which a separate requirement exists.

14.10.5.3 Test Purpose

1. To verify that the MS does not exceed conformance requirement 1 under TUIHigh and frequency hopping propagation conditions without DTX with an allowance for the statistical significance of the test.
2. To verify that the MS does not exceed conformance requirement 2 under TUIHigh and frequency hopping propagation conditions without DTX with an allowance for the statistical significance of the test.
3. To implicitly verify the correct implementation of the AMR Thresholds and Hysteresis parameters received in either an ASSIGNMENT COMMAND or MODE MODIFY procedure, or through an AMR_CONFIG_REQ or THRESH_REQ message carried in a RATSCCH.

NOTE: This would normally be performed as a signalling test, however due to the complex layer 1 requirements it is verified here. Any future modification or Change Request on this section should take into account this additional test objective.

14.10.5.4 Method of Test

14.10.5.4.1 Initial conditions

A call is set up according to the generic call set up procedure on a O-TCH/AHS with a hopping pattern in the Mid ARFCN range and covering at least 10 frequencies not exceeding 5 MHz. DTX shall not be activated. Power control level shall be set to maximum power.

The initial configuration indicates the use of the 12.2 mode of AMR only.

The SS transmits Standard Test Signal C1 on the traffic channel.

In addition to the wanted signal, the SS produces an independent, uncorrelated interfering signal, Standard Test Signal II (unwanted signal).

- The unwanted signal is continuous and has no fixed relationship with the bit transitions of the wanted signal. Initially, the unwanted signal is switched off.
- The fading characteristic of the wanted and the interfering signal is TUHigh.

NOTE 1: The fading characteristics shall be TU50 for GSM900, T-GSM 810 and GSM850, TU25 for DCS1800 and PCS1900, TU100 for GSM400, and TU60 for GSM700.

Specific PICS Statements:

-

PIXIT Statements:

- AMR C/I normalization factor.

14.10.5.4.2 Procedure

INITIAL CONFIG:

- 1a) The SS uses a Channel Mode Modify procedure to change the active codec set to the following set:

Codec Mode	O-TCH/AHS in kbit/s
CODEC_MODE_4	10,2
CODEC_MODE_3	7,4
CODEC_MODE_2	6,7
CODEC_MODE_1	5,15

With Initial Codec Mode unspecified, thus the default ICM rule being used and the following decision thresholds and hysteresis values:

MC'MR'	THR_MC_Dn(MC)/ THR_MR_Dn(MR)	THR_MC_Up(MC)/ THR_MR_Up(MR)
CODEC_MODE_4	Thr1d = 17.5 dB	+ ∞
CODEC_MODE_3	Thr2d = 14.5 dB	Thr1u = 19.5 dB
CODEC_MODE_2	Thr3d = 12.5 dB	Thr2u = 16.5 dB
CODEC_MODE_1	- ∞	Thr3u = 14.5 dB

The SS uses the expected Initial Codec Mode (default rule) after sending the mode modify message and commands the MS through the CMC field to use the Initial Codec Mode as well. The SS waits for the MS to change the uplink codec to the expected Initial Codec Mode (default rule).

- 1b) The SS then sends an AMR_CONF_REQ through a RATSCCH message commanding the MS to use the following ACS:

Codec Mode	O-TCH/AHS in kbit/s
CODEC_MODE_3	12,2
CODEC_MODE_2	7,95
CODEC_MODE_1	4,75

With the Initial Codec Mode set to the 12.2 kbit/s mode and the following decision thresholds and hysteresis values:

MC/MR'	THR_MC_Dn(MC)/ THR_MR_Dn(MR)	THR_MC_Up(MC)/ THR_MR_Up(MR)
CODEC_MODE_3	Thr1d = 12.5 dB	+ ∞
CODEC_MODE_2	Thr2d = 6.5 dB	Thr1u = 14.5 dB
CODEC_MODE_1	- ∞	Thr2u = 8.5 dB

The SS switches the downlink codec to the Initial Codec Mode 12 frames after sending the AMR_CONF_REQ message and commands the MS through the CMC field to use the requested Initial Codec Mode. The SS waits for the MS to change the uplink codec to the expected Initial Codec Mode, 12 frames after receiving the ACK_OK message.

The SS waits until the MS indicates in the CMR that the 12.2 kbit/s is the recommended downlink codec mode.

If the MS never reaches that point then the test is failed.

The downlink radio environment is altered so that the carrier to interference ratio is set to 4 dB above the highest of the upwards thresholds Thr1u. The SS waits 500ms.

- 1c) The downlink radio environment is altered so that the carrier to interference ratio is reduced to 4 dB below the highest of the downwards thresholds Thr1d. The SS increments the counter for 'C/I decreases below thresholds'.
- 1d) The SS checks the CMR received from the MS 200ms after the carrier to interference has been altered. If the CMR indicates that the MS recommends to use the 7.95 kbit/s or a lower codec mode in the downlink, then the SS should increment the successful C/I decrease event counter. Otherwise, the SS should increment the unsuccessful C/I decrease event counter.
- 1e) The SS switches the downlink codec mode to 7.95 kbit/s and waits for 0.5s.
- 1f) The downlink radio environment is altered so that the carrier to interference ratio is reduced to 4 dB below the lowest of the downwards thresholds Thr2d. The SS increments the counter for 'C/I decreases below thresholds'.
- 1g) The SS checks the CMR received from the MS 200ms after the carrier to interference has been altered. If the CMR indicates that the MS recommends to use the 4.75 kbit/s codec mode in the downlink, then the SS should increment the successful C/I decrease event counter. Otherwise, the SS should increment the unsuccessful C/I decrease event counter.
- 1h) The SS switches the downlink codec mode to 4.75 kbit/s and waits for 0.5s.
- 1i) The downlink radio environment is altered so that the carrier to interference ratio is increased to 4 dB above the lowest of the upwards thresholds Thr2u. The SS increments the counter for 'C/I increases above thresholds'.
- 1j) The SS checks the CMR received from the MS 200ms after the carrier to interference has been altered. If the CMR indicates that the MS recommends to use the 7.95 kbit/s or a higher codec mode in the downlink, then the SS should increment the successful C/I increase event counter. Otherwise, the SS should increment the unsuccessful C/I increase event counter.
- 1k) The SS switches the downlink codec mode to 7.95 kbit/s and waits for 0.5s.
- 1l) The downlink radio environment is altered so that the carrier to interference ratio is increased to 4 dB above the highest of the upwards thresholds Thr1u. The SS increments the counter for 'C/I increases above thresholds'.
- 1m) The SS checks the CMR received by the MS 200ms after the carrier to interference has been altered. If the CMR indicates that the MS recommends to use 12.2 kbit/s in the downlink, then the SS should increment the successful C/I increase event counter. Otherwise, the SS should increment the unsuccessful C/I increase event counter.
- 1n) The SS switches the downlink codec mode to 12.2 kbit/s and waits for 0.5s.

- 1o) The SS repeats steps 1c) to 1n) until 500 samples of C/I increases and 500 samples of C/I decreases have been recorded.

STEP 2:

- 2a) The unwanted signal is removed.

The SS then sends an AMR_CONF_REQ through a RATSCCH message commanding the MS to use the following ACS:

Codec Mode	O-TCH/AHS in kbit/s
CODEC_MODE_4	10,2
CODEC_MODE_3	7.4
CODEC_MODE_2	6,7
CODEC_MODE_1	5,15

With the Initial Codec Mode set to any mode and the following decision thresholds and hysteresis values:

MC'MR'	THR_MC_Dn(MC)/ THR_MR_Dn(MR)	THR_MC_Up(MC)/ THR_MR_Up(MR)
CODEC_MODE_4	Thr1d = 17.5 dB	+ ∞
CODEC_MODE_3	Thr2d = 14.5 dB	Thr1u = 19.5 dB
CODEC_MODE_2	Thr3d = 12.5 dB	Thr2u = 16.5 dB
CODEC_MODE_1	- ∞	Thr3u = 14.5 dB

The SS switches the downlink codec to the Initial Codec Mode 12 frames after sending the AMR_CONF_REQ message and commands the MS through the CMC field to use the requested Initial Codec Mode. The SS waits for the MS to change the uplink codec to the expected Initial Codec Mode, 12 frames after receiving the ACK_OK message.

- 2b) The SS uses a Channel Mode Modify procedure to change the active codec set to the following set:

Codec Mode	O-TCH/AHS in kbit/s
CODEC_MODE_3	12,2
CODEC_MODE_2	7.95
CODEC_MODE_1	4,75

With the Initial Codec Mode set to the 12.2 kbit/s mode and the following decision thresholds and hysteresis values:

MC'MR'	THR_MC_Dn(MC)/ THR_MR_Dn(MR)	THR_MC_Up(MC)/ THR_MR_Up(MR)
CODEC_MODE_3	Thr1d = 11.5 dB	+ ∞
CODEC_MODE_2	Thr2d = 5.5 dB	Thr1u = 13.5 dB
CODEC_MODE_1	- ∞	Thr2u = 7.5 dB

The SS switches the downlink codec to the Initial Codec Mode after sending the mode modify message and commands the MS through the CMC field to use the Initial Codec Mode as well. The SS waits for the MS to change the uplink codec to the expected Initial Codec Mode.

The SS waits until the MS indicates in the CMR that the 12.2 kbit/s is the recommended downlink codec mode.

If the MS never reaches that point then the test is failed.

The downlink radio environment is altered so that the carrier to interference ratio is set to 4 dB above the highest of the upwards thresholds Thr1u. The SS waits 500ms

- 2c) The SS repeats steps 1c) to 1n) until 500 samples of C/I increases and 500 samples of C/I decreases have been recorded.

STEP 3:

- 3a) The unwanted signal is removed.

The SS then sends an AMR_CONF_REQ through a RATSCCH message commanding the MS to use the AMR 7.95 kbit/s mode only:

The SS switches the downlink codec to the 7.95 mode 12 frames after sending the AMR_CONF_REQ message and commands the MS through the CMC field to use the requested codec. The SS waits for the MS to change the uplink codec to the expected codec, 12 frames after receiving the ACK_OK message.

- 3b) The SS uses a Channel Mode Modify procedure to change the active codec set to the following set:

Codec Mode	O-TCH/AHS in kbit/s
CODEC_MODE_3	12,2
CODEC_MODE_2	7.95
CODEC_MODE_1	4,75

With the Initial Codec Mode set to the 12.2 kbit/s mode and the following decision thresholds and hysteresis values:

MC/MR'	THR_MC_Dn(MC)/ THR_MR_Dn(MR)	THR_MC_Up(MC)/ THR_MR_Up(MR)
CODEC_MODE_3	Thr1d = 18.5 dB	+ ∞
CODEC_MODE_2	Thr2d = 10.5 dB	Thr1u = 20.5 dB
CODEC_MODE_1	- ∞	Thr2u = 12.5 dB

The SS switches the downlink codec to the Initial Codec Mode after sending the mode modify message and commands the MS through the CMC field to use the Initial Codec Mode as well. The SS waits for the MS to change the uplink codec to the expected Initial Codec Mode

The SS waits until the MS indicates in the CMR that the 12.2 kbit/s is the recommended downlink codec mode.

If the MS never reaches that point then the test is failed.

- 3c) The SS then sends a THRESH_REQ through a RATSCCH message commanding the MS to modify the Thresholds and Hysteresis to the following values:

MC/MR'	THR_MC_Dn(MC)/ THR_MR_Dn(MR)	THR_MC_Up(MC)/ THR_MR_Up(MR)
CODEC_MODE_3	Thr1d = 13.5 dB	+ ∞
CODEC_MODE_2	Thr2d = 7.5 dB	Thr1u = 15.5 dB
CODEC_MODE_1	- ∞	Thr2u = 9.5 dB

The SS waits 12 frames after receiving the ACK_OK message.

- 3d) The SS waits until the MS indicates in the CMR that the 12.2 kbit/s is the recommended downlink codec mode.

If the MS never reaches that point then the test is failed.

The downlink radio environment is altered so that the carrier to interference ratio is set to 4 dB above the highest of the upwards thresholds Thr1u. The SS waits 500ms

- 3e) The SS repeats steps 1c) to 1n) until 500 samples of C/I increases and 500 samples of C/I decreases have been recorded.

STEP 4:

- 4a) The unwanted signal is removed.

The SS uses a Channel Mode Modify procedure commanding the MS to use the AMR 10.2 kbit/s mode only:

The SS waits for the MS to change the uplink codec to the 10.2 kbit/s mode.

- 4b) The SS then sends an AMR_CONF_REQ through a RATSCCH message commanding the MS to use the following ACS:

Codec Mode	O-TCH/AHS in kbit/s
CODEC_MODE_3	12,2
CODEC_MODE_2	7,95
CODEC_MODE_1	4,75

With the Initial Codec Mode set to the 12.2 kbit/s mode and the following decision thresholds and hysteresis values:

MC'MR'	THR_MC_Dn(MC)/ THR_MR_Dn(MR)	THR_MC_Up(MC)/ THR_MR_Up(MR)
CODEC_MODE_3	Thr1d = 12.5 dB	+ ∞
CODEC_MODE_2	Thr2d = 6.5 dB	Thr1u = 14.5 dB
CODEC_MODE_1	- ∞	Thr2u = 8.5 dB

The SS switches the downlink codec to the Initial Codec Mode 12 frames after sending the AMR_CONF_REQ message and commands the MS through the CMC field to use the requested Initial Codec Mode. The SS waits for the MS to change the uplink codec to the expected Initial Codec Mode, 12 frames after receiving the ACK_OK message.

The SS waits until the MS indicates in the CMR that the 12.2 kbit/s is the recommended downlink codec mode.

If the MS never reaches that point then the test is failed.

The downlink radio environment is altered so that the carrier to interference ratio is set to 4 dB above the highest of the upwards thresholds Thr1u. The SS waits 500ms

- 4c) The SS repeats steps 1c) to 1n) until 500 samples of C/I increases and 500 samples of C/I decreases have been recorded.

NOTE: The core specifications state that an MS shall respond to a change of C/I within 200ms. The core specifications place no bounds on magnitude or rate of change of C/I. For this test the magnitude of change is bounded by THRESH and HYST selection, and the rate of change is bounded by the 500ms wait periods. These bounds are selected to ensure an MS implementation is not adversely biased by this test.

Maximum/Minimum Duration of Test

Maximum/minimum: 54 minutes (GSM850, GSM900, DCS1800, PCS1900).

14.10.5.5 Test requirements

The requirement and minimum set of samples shall not exceed the values given in the following table for each set of thresholds.

Event	Maximum allowed error rate	Minimum No. of samples
C/I increases over Thresholds	11%	2000
C/I decreases below Thresholds	11%	2000

14.10.6 Performance of the Codec Mode Request Generation – O-TCH/WFS

14.10.6.1 Definition

When a traffic channel supporting an Adaptive Multi-Rate speech codec is activated, the Codec Mode Request is sent by MS in band every other speech frame to indicate to the Network the recommended codec mode of the ACS to use on the downlink.

14.10.6.2 Conformance Requirement

For TU3 channel conditions with ideal frequency hopping without DTX activated in GSM900 and GSM850, the MS shall produce Codec Mode Requests with the following accuracy:

- When a carrier to interferer ratio 4 dB higher than a defined upper threshold is applied to the antenna connector, the MS shall request a higher mode with a probability exceeding 90%. This shall be measured immediately after a settling-time of 200 ms.
- When a carrier to interferer ratio 4 dB lower than a defined lower threshold is applied to the antenna connector, the MS shall request a lower mode with a probability exceeding 90%. This shall be measured immediately after a settling-time of 200 ms.

If required, the above test levels shall be reduced by the normalization factor defined in sub-clause 3.3.1 to account for potential improved receiver performances.

For other frequency bands, the propagation profile should be adjusted to: TU1.5 for DCS1800 and PCS1900, TU6 for GSM400 and TU3.6 for GSM700.

Note 1: Ideal frequency hopping assumes perfect decorrelation between bursts. For the propagation profile TU3, this is not easily achievable due to the high number of hopping frequencies required. Therefore, performance tests should be performed under ideal frequency hopping conditions for the following propagation profiles: TU50 for GSM900 and GSM850, TU25 for DCS1800 and PCS1900, TU100 for GSM400, and TU60 for GSM700.

3GPP TS 45.009, subclause 3.3.3.3

14.10.6.3 Test Purpose

1. To verify that the MS does not exceed the conformance requirements (for producing codec request) under TU High and frequency hopping propagation conditions without DTX with an allowance for the statistical significance of the test.
2. To implicitly verify the correct implementation of the AMR Thresholds and Hysteresis parameters received in either an ASSIGNMENT COMMAND or MODE MODIFY procedure, or through an AMR_CONFIG_REQ or THRESH_REQ message carried in a RATSCCH.

NOTE: This would normally be performed as a signalling test, however due to the complex layer 1 requirements it is verified here. Any future modification or Change Request on this section should take into account this additional test objective.

14.10.6.4 Method of Test

14.10.6.4.1 Initial conditions

A call is set up according to the generic call set up procedure on a O-TCH/WFS with a hopping pattern in the Mid ARFCN range and covering at least 10 frequencies not exceeding 5 MHz. DTX shall not be activated. Power control level shall be set to maximum power.

The initial configuration indicates the use of the 12.65 mode of AMR only.

The SS transmits Standard Test Signal C1 on the traffic channel.

In addition to the wanted signal, the SS produces an independent, uncorrelated interfering signal, Standard Test Signal I1 (unwanted signal).

- The unwanted signal is continuous and has no fixed relationship with the bit transitions of the wanted signal. Initially, the unwanted signal is switched off.
- The fading characteristic of the wanted and the interfering signal is TU High.

NOTE 1: The fading characteristics shall be TU50 for GSM900 and GSM850, TU25 for DCS1800 and PCS1900, TU100 for GSM400, and TU60 for GSM700..

Specific PICS Statements:

-

PIXIT Statements:

- O-TCH/F C/I normalisation factor

14.10.6.4.2 Procedure

INITIAL CONFIG:

1a) The SS uses a Channel Mode Modify procedure to change the active codec set to the following set:

Codec Mode	O-TCH/WFS in kbit/s
CODEC_MODE_4	23,85
CODEC_MODE_3	12,65
CODEC_MODE_2	8,85
CODEC_MODE_1	6,6

With Initial Codec Mode unspecified, thus the default ICM rule being used and the following decision thresholds and hysteresis values:

MC'/MR'	THR_MC_Dn(MC)/ THR_MR_Dn(MR)	THR_MC_Up(MC)/ THR_MR_Up(MR)
CODEC_MODE_4	Thr1d = 17.5 dB	+ ∞
CODEC_MODE_3	Thr2d = 14.5 dB	Thr1u = 19.5 dB
CODEC_MODE_2	Thr3d = 12.5 dB	Thr2u = 16.5 dB
CODEC_MODE_1	- ∞	Thr3u = 14.5 dB

The SS uses the expected Initial Codec Mode (default rule) after sending the mode modify message and commands the MS through the CMC field to use the Initial Codec Mode as well. The SS waits for the MS to change the uplink codec to the expected Initial Codec Mode (default rule).

1b) The SS then sends an AMR_CONF_REQ through a RATSCCH message commanding the MS to use the following ACS:

Codec Mode	O-TCH/WFS in kbit/s
CODEC_MODE_3	12,65
CODEC_MODE_2	8,85
CODEC_MODE_1	6,6

With the Initial Codec Mode set to the 12.65 kbit/s mode and the following decision thresholds and hysteresis values:

MC'/MR'	THR_MC_Dn(MC)/ THR_MR_Dn(MR)	THR_MC_Up(MC)/ THR_MR_Up(MR)
CODEC_MODE_3	Thr1d = 12.5 dB	+ ∞
CODEC_MODE_2	Thr2d = 6.5 dB	Thr1u = 14.5 dB
CODEC_MODE_1	- ∞	Thr2u = 8.5 dB

The SS switches the downlink codec to the Initial Codec Mode 12 frames after sending the AMR_CONF_REQ message and commands the MS through the CMC field to use the requested Initial

Codec Mode. The SS waits for the MS to change the uplink codec to the expected Initial Codec Mode, 12 frames after receiving the ACK_OK message.

The SS waits until the MS indicates in the CMR that the 12.65 kbit/s is the recommended downlink codec mode.

If the MS never reaches that point then the test is failed.

The downlink radio environment is altered so that the carrier to interference ratio is set to 4 dB above the highest of the upwards thresholds Thr1u. The SS waits 500ms.

- 1c) The downlink radio environment is altered so that the carrier to interference ratio is reduced to 4 dB below the highest of the downwards thresholds Thr1d. The SS increments the counter for 'C/I decreases below thresholds'.
- 1d) The SS checks the CMR received from the MS 200ms after the carrier to interference has been altered. If the CMR indicates that the MS recommends to use the 8.85 kbit/s or a lower codec mode in the downlink, then the SS should increment the successful C/I decrease event counter. Otherwise, the SS should increment the unsuccessful C/I decrease event counter.
- 1e) The SS switches the downlink codec mode to 8.85 kbit/s and waits for 0.5s.
- 1f) The downlink radio environment is altered so that the carrier to interference ratio is reduced to 4 dB below the lowest of the downwards thresholds Thr2d. The SS increments the counter for 'C/I decreases below thresholds'.
- 1g) The SS checks the CMR received from the MS 200ms after the carrier to interference has been altered. If the CMR indicates that the MS recommends to use the 6.6 kbit/s codec mode in the downlink, then the SS should increment the successful C/I decrease event counter. Otherwise, the SS should increment the unsuccessful C/I decrease event counter.
- 1h) The SS switches the downlink codec mode to 6.6 kbit/s and waits for 0.5s.
- 1i) The downlink radio environment is altered so that the carrier to interference ratio is increased to 4 dB above the lowest of the upwards thresholds Thr2u. The SS increments the counter for 'C/I increases above thresholds'.
- 1j) The SS checks the CMR received from the MS 200ms after the carrier to interference has been altered. If the CMR indicates that the MS recommends to use the 8.85 kbit/s or a higher codec mode in the downlink, then the SS should increment the successful C/I increase event counter. Otherwise, the SS should increment the unsuccessful C/I increase event counter.
- 1k) The SS switches the downlink codec mode to 8.85 kbit/s and waits for 0.5s.
- 1l) The downlink radio environment is altered so that the carrier to interference ratio is increased to 4 dB above the highest of the upwards thresholds Thr1u. The SS increments the counter for 'C/I increases above thresholds'.
- 1m) The SS checks the CMR received by the MS 200ms after the carrier to interference has been altered. If the CMR indicates that the MS recommends to use 12.65 kbit/s in the downlink, then the SS should increment the successful C/I increase event counter. Otherwise, the SS should increment the unsuccessful C/I increase event counter.
- 1n) The SS switches the downlink codec mode to 12.65 kbit/s and waits for 0.5s.
- 1o) The SS repeats steps 1c) to 1n) until 500 samples of C/I increases and 500 samples of C/I decreases have been recorded.

STEP 2:

- 2a) The unwanted signal is removed.

The SS then sends an AMR_CONF_REQ through a RATSCCH message commanding the MS to use the following ACS:

Codec Mode	O-TCH/WFS in kbit/s
CODEC_MODE_2	8,85
CODEC_MODE_1	6,6

With the Initial Codec Mode set to any mode and the following decision thresholds and hysteresis values:

MC/MR'	THR_MC_Dn(MC)/ THR_MR_Dn(MR)	THR_MC_Up(MC)/ THR_MR_Up(MR)
CODEC_MODE_2	Thr3d = 12.5 dB	+ ∞
CODEC_MODE_1	- ∞	Thr3u = 14.5 dB

The SS switches the downlink codec to the Initial Codec Mode 12 frames after sending the AMR_CONF_REQ message and commands the MS through the CMC field to use the requested Initial Codec Mode. The SS waits for the MS to change the uplink codec to the expected Initial Codec Mode, 12 frames after receiving the ACK_OK message.

2b) The SS uses a Channel Mode Modify procedure to change the active codec set to the following set:

Codec Mode	O-TCH/WFS in kbit/s
CODEC_MODE_3	12,65
CODEC_MODE_2	8,85
CODEC_MODE_1	6,6

With the Initial Codec Mode set to the 12.65 kbit/s mode and the following decision thresholds and hysteresis values:

MC/MR'	THR_MC_Dn(MC)/ THR_MR_Dn(MR)	THR_MC_Up(MC)/ THR_MR_Up(MR)
CODEC_MODE_3	Thr1d = 11.5 dB	+ ∞
CODEC_MODE_2	Thr2d = 5.5 dB	Thr1u = 13.5 dB
CODEC_MODE_1	- ∞	Thr2u = 7.5 dB

The SS switches the downlink codec to the Initial Codec Mode after sending the mode modify message and commands the MS through the CMC field to use the Initial Codec Mode as well. The SS waits for the MS to change the uplink codec to the expected Initial Codec Mode.

The SS waits until the MS indicates in the CMR that the 12.65 kbit/s is the recommended downlink codec mode.

If the MS never reaches that point then the test is failed.

The downlink radio environment is altered so that the carrier to interference ratio is set to 4 dB above the highest of the upwards thresholds Thr1u. The SS waits 500ms

2c) The SS repeats steps 1c) to 1n) until 500 samples of C/I increases and 500 samples of C/I decreases have been recorded.

STEP 3:

3a) The unwanted signal is removed.

The SS then sends an AMR_CONF_REQ through a RATSCCH message commanding the MS to use the AMR 8.85 kbit/s mode only:

The SS switches the downlink codec to the 8.85 mode 12 frames after sending the AMR_CONF_REQ message and commands the MS through the CMC field to use the requested codec. The SS waits for the MS to change the uplink codec to the expected codec, 12 frames after receiving the ACK_OK message.

3b) The SS uses a Channel Mode Modify procedure to change the active codec set to the following set:

Codec Mode	O-TCH/WFS in kbit/s
CODEC_MODE_3	12,65
CODEC_MODE_2	8,85
CODEC_MODE_1	6,6

With the Initial Codec Mode set to the 12.65 kbit/s mode and the following decision thresholds and hysteresis values:

MC'/MR'	THR_MC_Dn(MC)/ THR_MR_Dn(MR)	THR_MC_Up(MC)/ THR_MR_Up(MR)
CODEC_MODE_3	Thr1d = 18.5 dB	+ ∞
CODEC_MODE_2	Thr2d = 10.5 dB	Thr1u = 20.5 dB
CODEC_MODE_1	- ∞	Thr2u = 12.5 dB

The SS switches the downlink codec to the Initial Codec Mode after sending the mode modify message and commands the MS through the CMC field to use the Initial Codec Mode as well. The SS waits for the MS to change the uplink codec to the expected Initial Codec Mode

The SS waits until the MS indicates in the CMR that the 12.65 kbit/s is the recommended downlink codec mode.

If the MS never reaches that point then the test is failed.

- 3c) The SS then sends a THRESH_REQ through a RATSCCH message commanding the MS to modify the Thresholds and Hysteresis to the following values:

MC'/MR'	THR_MC_Dn(MC)/ THR_MR_Dn(MR)	THR_MC_Up(MC)/ THR_MR_Up(MR)
CODEC_MODE_3	Thr1d = 13.5 dB	+ ∞
CODEC_MODE_2	Thr2d = 7.5 dB	Thr1u = 15.5 dB
CODEC_MODE_1	- ∞	Thr2u = 9.5 dB

The SS waits 12 frames after receiving the ACK_OK message.

- 3d) The SS waits until the MS indicates in the CMR that the 12.65 kbit/s is the recommended downlink codec mode.

If the MS never reaches that point then the test is failed.

The downlink radio environment is altered so that the carrier to interference ratio is set to 4 dB above the highest of the upwards thresholds Thr1u. The SS waits 500ms

- 3e) The SS repeats steps 1c) to 1n) until 500 samples of C/I increases and 500 samples of C/I decreases have been recorded.

STEP 4:

- 4a) The unwanted signal is removed.

- The SS uses a Channel Mode Modify procedure commanding the MS to use the AMR 8.85 kbit/s mode only:
- The SS waits for the MS to change the uplink codec to the 8.85 kbit/s mode.

- 4b) The SS then sends an AMR_CONF_REQ through a RATSCCH message commanding the MS to use the following ACS:

Codec Mode	O-TCH/WFS in kbit/s
CODEC_MODE_3	12,65
CODEC_MODE_2	8,85
CODEC_MODE_1	6,6

With the Initial Codec Mode set to the 12.65 kbit/s mode and the following decision thresholds and hysteresis values:

MC/MR'	THR_MC_Dn(MC)/ THR_MR_Dn(MR)	THR_MC_Up(MC)/ THR_MR_Up(MR)
CODEC_MODE_3	Thr1d = 12.5 dB	+ ∞
CODEC_MODE_2	Thr2d = 6.5 dB	Thr1u = 14.5 dB
CODEC_MODE_1	- ∞	Thr2u = 8.5 dB

The SS switches the downlink codec to the Initial Codec Mode 12 frames after sending the AMR_CONF_REQ message and commands the MS through the CMC field to use the requested Initial Codec Mode. The SS waits for the MS to change the uplink codec to the expected Initial Codec Mode, 12 frames after receiving the ACK_OK message.

The SS waits until the MS indicates in the CMR that the 12.65 kbit/s is the recommended downlink codec mode.

If the MS never reaches that point then the test is failed.

The downlink radio environment is altered so that the carrier to interference ratio is set to 4 dB above the highest of the upwards thresholds Thr1u. The SS waits 500ms

4c) The SS repeats steps 1c) to 1n) until 500 samples of C/I increases and 500 samples of C/I decreases have been recorded.

NOTE: The core specifications state that an MS shall respond to a change of C/I within 200ms. The core specifications place no bounds on magnitude or rate of change of C/I. For this test the magnitude of change is bounded by THRESH and HYST selection, and the rate of change is bounded by the 500ms wait periods. These bounds are selected to ensure an MS implementation is not adversely biased by this test.

Maximum/Minimum Duration of Test

Maximum/minimum: 54 minutes.

14.10.6.5 Test requirements

The requirement and minimum set of samples shall not exceed the values given in the following table for each set of thresholds.

Event	Maximum allowed error rate	Minimum No. of samples
C/I increases over Thresholds	11%	2000
C/I decreases below Thresholds	11%	2000

14.10.7 Performance of the Codec Mode Request Generation – O-TCH/WHS

14.10.7.1 Definition

When a traffic channel supporting an Adaptive Multi-Rate speech codec is activated, the Codec Mode Request is sent by MS in band every other speech frame to indicate to the Network the recommended codec mode of the ACS to use on the downlink.

14.10.7.2 Conformance Requirement

For TULow channel conditions with ideal frequency hopping without DTX activated, the MS shall produce Codec Mode Requests with the following accuracy:

Requirement 1: When a carrier to interferer ratio 4 dB higher than a defined upper threshold is applied to the antenna connector, the MS shall request a higher mode with a probability exceeding 90%. This shall be measured immediately after a settling-time of 200 ms.

Requirement 2: When a carrier to interferer ratio 4 dB lower than a defined lower threshold is applied to the antenna connector, the MS shall request a lower mode with a probability exceeding 90%. This shall be measured immediately after a settling-time of 200 ms.

If required, the above test levels shall be reduced by the fixed normalization factor defined in sub-clause 3.3.1 of TS 45.009 to account for potential improved receiver performances.

Note: Ideal frequency hopping assumes perfect decorrelation between bursts. For the propagation profile TU3, this is not easily achievable due to the high number of hopping frequencies required. Therefore, performance tests should be performed under ideal frequency hopping conditions for the following propagation profiles: TU50 for GSM900 and GSM850, TU25 for DCS1800 and PCS1900, TU100 for GSM400, and TU60 for GSM700.

14.10.7.3 Test Purpose

1. To verify that the MS does not exceed conformance requirement 1 under TUHigh and frequency hopping propagation conditions without DTX with an allowance for the statistical significance of the test.
2. To verify that the MS does not exceed conformance requirement 2 under TUHigh and frequency hopping propagation conditions without DTX with an allowance for the statistical significance of the test.
3. To implicitly verify the correct implementation of the AMR Thresholds and Hysteresis parameters received in either an ASSIGNMENT COMMAND or MODE MODIFY procedure, or through an AMR_CONFIG_REQ or THRESH_REQ message carried in a RATSCCH.

NOTE: This would normally be performed as a signalling test, however due to the complex layer 1 requirements it is verified here. Any future modification or Change Request on this section should take into account this additional test objective.

14.10.7.4 Method of Test

14.10.7.4.1 Initial conditions

A call is set up according to the generic call set up procedure on a O-TCH/WHS with a hopping pattern in the Mid ARFCN range and covering at least 10 frequencies not exceeding 5 MHz. DTX shall not be activated. Power control level shall be set to maximum power.

The initial configuration indicates the use of the 12.65 mode of AMR only.

The SS transmits Standard Test Signal C1 on the traffic channel.

In addition to the wanted signal, the SS produces an independent, uncorrelated interfering signal, Standard Test Signal I1 (unwanted signal).

- The unwanted signal is continuous and has no fixed relationship with the bit transitions of the wanted signal. Initially, the unwanted signal is switched off.
- The fading characteristic of the wanted and the interfering signal is TUHigh.

NOTE 1: The fading characteristics shall be TU50 for GSM900 and GSM850, TU25 for DCS1800 and PCS1900, TU100 for GSM400, and TU60 for GSM700..

Specific PICS Statements:

-

PIXIT Statements:

- AMR C/I normalization factor.

14.10.7.4.2 Procedure

INITIAL CONFIG:

- 1a) The SS uses a Channel Mode Modify procedure to change the active codec set to the following set:

Codec Mode	O-TCH/WHS in kbit/s
CODEC_MODE_2	8,85
CODEC_MODE_1	6,6

With Initial Codec Mode unspecified, thus the default ICM rule being used and the following decision thresholds and hysteresis values:

MC/MR'	THR_MC_Dn(MC)/ THR_MR_Dn(MR)	THR_MC_Up(MC)/ THR_MR_Up(MR)
CODEC_MODE_2	Thr3d = 12.5 dB	+ ∞
CODEC_MODE_1	- ∞	Thr3u = 14.5 dB

The SS uses the expected Initial Codec Mode (default rule) after sending the mode modify message and commands the MS through the CMC field to use the Initial Codec Mode as well. The SS waits for the MS to change the uplink codec to the expected Initial Codec Mode (default rule).

- 1b) The SS then sends an AMR_CONF_REQ through a RATSCCH message commanding the MS to use the following ACS:

Codec Mode	O-TCH/WHS in kbit/s
CODEC_MODE_3	12,65
CODEC_MODE_2	8,85
CODEC_MODE_1	6,6

With the Initial Codec Mode set to the 12.65 kbit/s mode and the following decision thresholds and hysteresis values:

MC/MR'	THR_MC_Dn(MC)/ THR_MR_Dn(MR)	THR_MC_Up(MC)/ THR_MR_Up(MR)
CODEC_MODE_3	Thr1d = 12.5 dB	+ ∞
CODEC_MODE_2	Thr2d = 6.5 dB	Thr1u = 14.5 dB
CODEC_MODE_1	- ∞	Thr2u = 8.5 dB

The SS switches the downlink codec to the Initial Codec Mode 12 frames after sending the AMR_CONF_REQ message and commands the MS through the CMC field to use the requested Initial Codec Mode. The SS waits for the MS to change the uplink codec to the expected Initial Codec Mode, 12 frames after receiving the ACK_OK message.

The SS waits until the MS indicates in the CMR that the 12.65 kbit/s is the recommended downlink codec mode.

If the MS never reaches that point then the test is failed.

The downlink radio environment is altered so that the carrier to interference ratio is set to 4 dB above the highest of the upwards thresholds Thr1u. The SS waits 500ms.

- 1c) The downlink radio environment is altered so that the carrier to interference ratio is reduced to 4 dB below the highest of the downwards thresholds Thr1d. The SS increments the counter for 'C/I decreases below thresholds'.
- 1d) The SS checks the CMR received from the MS 200ms after the carrier to interference has been altered. If the CMR indicates that the MS recommends to use the 8.85 kbit/s or a lower codec mode in the downlink, then the SS should increment the successful C/I decrease event counter. Otherwise, the SS should increment the unsuccessful C/I decrease event counter.
- 1e) The SS switches the downlink codec mode to 8.85 kbit/s and waits for 0.5s.
- 1f) The downlink radio environment is altered so that the carrier to interference ratio is reduced to 4 dB below the lowest of the downwards thresholds Thr2d. The SS increments the counter for 'C/I decreases below thresholds'.

- 1g) The SS checks the CMR received from the MS 200ms after the carrier to interference has been altered. If the CMR indicates that the MS recommends to use the 6.6 kbit/s codec mode in the downlink, then the SS should increment the successful C/I decrease event counter. Otherwise, the SS should increment the unsuccessful C/I decrease event counter.
- 1h) The SS switches the downlink codec mode to 6.6 kbit/s and waits for 0.5s.
- 1i) The downlink radio environment is altered so that the carrier to interference ratio is increased to 4 dB above the lowest of the upwards thresholds Thr2u. The SS increments the counter for 'C/I increases above thresholds'.
- 1j) The SS checks the CMR received from the MS 200ms after the carrier to interference has been altered. If the CMR indicates that the MS recommends to use the 8.85 kbit/s or a higher codec mode in the downlink, then the SS should increment the successful C/I increase event counter. Otherwise, the SS should increment the unsuccessful C/I increase event counter.
- 1k) The SS switches the downlink codec mode to 8.85 kbit/s and waits for 0.5s.
- 1l) The downlink radio environment is altered so that the carrier to interference ratio is increased to 4 dB above the highest of the upwards thresholds Thr1u. The SS increments the counter for 'C/I increases above thresholds'.
- 1m) The SS checks the CMR received by the MS 200ms after the carrier to interference has been altered. If the CMR indicates that the MS recommends to use 12.65 kbit/s in the downlink, then the SS should increment the successful C/I increase event counter. Otherwise, the SS should increment the unsuccessful C/I increase event counter.
- 1n) The SS switches the downlink codec mode to 12.65 kbit/s and waits for 0.5s.
- 1o) The SS repeats steps 1c) to 1n) until 500 samples of C/I increases and 500 samples of C/I decreases have been recorded.

STEP 2:

- 2a) The unwanted signal is removed.

The SS then sends an AMR_CONF_REQ through a RATSCCH message commanding the MS to use the following ACS:

Codec Mode	O-TCH/WHS in kbit/s
CODEC_MODE_2	8,85
CODEC_MODE_1	6,6

With the Initial Codec Mode set to any mode and the following decision thresholds and hysteresis values:

MC/MR'	THR_MC_Dn(MC)/ THR_MR_Dn(MR)	THR_MC_Up(MC)/ THR_MR_Up(MR)
CODEC_MODE_2	Thr3d = 12.5 dB	+ ∞
CODEC_MODE_1	- ∞	Thr3u = 14.5 dB

The SS switches the downlink codec to the Initial Codec Mode 12 frames after sending the AMR_CONF_REQ message and commands the MS through the CMC field to use the requested Initial Codec Mode. The SS waits for the MS to change the uplink codec to the expected Initial Codec Mode, 12 frames after receiving the ACK_OK message.

- 2b) The SS uses a Channel Mode Modify procedure to change the active codec set to the following set:

Codec Mode	O-TCH/WHS in kbit/s
CODEC_MODE_3	12,65
CODEC_MODE_2	8,85
CODEC_MODE_1	6,6

With the Initial Codec Mode set to the 12.2 kbit/s mode and the following decision thresholds and hysteresis values:

MC'MR'	THR_MC_Dn(MC)/ THR_MR_Dn(MR)	THR_MC_Up(MC)/ THR_MR_Up(MR)
CODEC_MODE_3	Thr1d = 11.5 dB	+ ∞
CODEC_MODE_2	Thr2d = 5.5 dB	Thr1u = 13.5 dB
CODEC_MODE_1	- ∞	Thr2u = 7.5 dB

The SS switches the downlink codec to the Initial Codec Mode after sending the mode modify message and commands the MS through the CMC field to use the Initial Codec Mode as well. The SS waits for the MS to change the uplink codec to the expected Initial Codec Mode.

The SS waits until the MS indicates in the CMR that the 12.65 kbit/s is the recommended downlink codec mode.

If the MS never reaches that point then the test is failed.

The downlink radio environment is altered so that the carrier to interference ratio is set to 4 dB above the highest of the upwards thresholds Thr1u. The SS waits 500ms

2c) The SS repeats steps 1c) to 1n) until 500 samples of C/I increases and 500 samples of C/I decreases have been recorded.

STEP 3:

3a) The unwanted signal is removed.

The SS then sends an AMR_CONF_REQ through a RATSCCH message commanding the MS to use the AMR 8.85 kbit/s mode only:

The SS switches the downlink codec to the 8.85 mode 12 frames after sending the AMR_CONF_REQ message and commands the MS through the CMC field to use the requested codec. The SS waits for the MS to change the uplink codec to the expected codec, 12 frames after receiving the ACK_OK message.

3b) The SS uses a Channel Mode Modify procedure to change the active codec set to the following set:

Codec Mode	O-TCH/WHS in kbit/s
CODEC_MODE_3	12,65
CODEC_MODE_2	8,85
CODEC_MODE_1	6,6

With the Initial Codec Mode set to the 12.65 kbit/s mode and the following decision thresholds and hysteresis values:

MC'MR'	THR_MC_Dn(MC)/ THR_MR_Dn(MR)	THR_MC_Up(MC)/ THR_MR_Up(MR)
CODEC_MODE_3	Thr1d = 18.5 dB	+ ∞
CODEC_MODE_2	Thr2d = 10.5 dB	Thr1u = 20.5 dB
CODEC_MODE_1	- ∞	Thr2u = 12.5 dB

The SS switches the downlink codec to the Initial Codec Mode after sending the mode modify message and commands the MS through the CMC field to use the Initial Codec Mode as well. The SS waits for the MS to change the uplink codec to the expected Initial Codec Mode

The SS waits until the MS indicates in the CMR that the 12.65 kbit/s is the recommended downlink codec mode.

If the MS never reaches that point then the test is failed.

3c) The SS then sends a THRESH_REQ through a RATSCCH message commanding the MS to modify the Thresholds and Hysteresis to the following values:

MC/MR'	THR_MC_Dn(MC)/ THR_MR_Dn(MR)	THR_MC_Up(MC)/ THR_MR_Up(MR)
CODEC_MODE_3	Thr1d = 13.5 dB	+ ∞
CODEC_MODE_2	Thr2d = 7.5 dB	Thr1u = 15.5 dB
CODEC_MODE_1	- ∞	Thr2u = 9.5 dB

The SS waits 12 frames after receiving the ACK_OK message.

3d) The SS waits until the MS indicates in the CMR that the 12.65 kbit/s is the recommended downlink codec mode.

If the MS never reaches that point then the test is failed.

The downlink radio environment is altered so that the carrier to interference ratio is set to 4 dB above the highest of the upwards thresholds Thr1u. The SS waits 500ms

3e) The SS repeats steps 1c) to 1n) until 500 samples of C/I increases and 500 samples of C/I decreases have been recorded.

STEP 4:

4a) The unwanted signal is removed.

- The SS uses a Channel Mode Modify procedure commanding the MS to use the AMR 8.85 kbit/s mode only:
- The SS waits for the MS to change the uplink codec to the 8.85 kbit/s mode.

4b) The SS then sends an AMR_CONF_REQ through a RATSCCH message commanding the MS to use the following ACS:

Codec Mode	O-TCH/WHS in kbit/s
CODEC_MODE_3	12,65
CODEC_MODE_2	8,85
CODEC_MODE_1	6,6

With the Initial Codec Mode set to the 12.65 kbit/s mode and the following decision thresholds and hysteresis values:

MC/MR'	THR_MC_Dn(MC)/ THR_MR_Dn(MR)	THR_MC_Up(MC)/ THR_MR_Up(MR)
CODEC_MODE_3	Thr1d = 12.5 dB	+ ∞
CODEC_MODE_2	Thr2d = 6.5 dB	Thr1u = 14.5 dB
CODEC_MODE_1	- ∞	Thr2u = 8.5 dB

The SS switches the downlink codec to the Initial Codec Mode 12 frames after sending the AMR_CONF_REQ message and commands the MS through the CMC field to use the requested Initial Codec Mode. The SS waits for the MS to change the uplink codec to the expected Initial Codec Mode, 12 frames after receiving the ACK_OK message.

The SS waits until the MS indicates in the CMR that the 12.65 kbit/s is the recommended downlink codec mode.

If the MS never reaches that point then the test is failed.

The downlink radio environment is altered so that the carrier to interference ratio is set to 4 dB above the highest of the upwards thresholds Thr1u. The SS waits 500ms

4c) The SS repeats steps 1c) to 1n) until 500 samples of C/I increases and 500 samples of C/I decreases have been recorded.

NOTE: The core specifications state that an MS shall respond to a change of C/I within 200ms. The core specifications place no bounds on magnitude or rate of change of C/I. For this test the magnitude of change is bounded by THRESH and HYST selection, and the rate of change is bounded by the 500ms wait periods. These bounds are selected to ensure an MS implementation is not adversely biased by this test.

Maximum/Minimum Duration of Test

Maximum/minimum: 54 minutes (GSM850, GSM900, DCS1800, PCS1900).

14.10.7.5 Test requirements

The requirement and minimum set of samples shall not exceed the values given in the following table for each set of thresholds.

Event	Maximum allowed error rate	Minimum No. of samples
C/I increases over Thresholds	11%	2000
C/I decreases below Thresholds	11%	2000

14.10.8 Performance of the Codec Mode Request Generation – TCH/WFS

14.10.8.1 Definition

When a traffic channel supporting a WB-AMR speech codec is activated, the Codec Mode Request is sent by MS in band every other speech frame to indicate to the Network the recommended codec mode of the ACS to use on the downlink.

14.10.8.2 Conformance Requirement

For TU3 channel conditions with ideal frequency hopping without DTX activated in GSM900 and GSM850, the MS shall produce Codec Mode Requests with the following accuracy:

- When a carrier to interferer ratio 4 dB higher than a defined upper threshold is applied to the antenna connector, the MS shall request a higher mode with a probability exceeding 90%. This shall be measured immediately after a settling-time of 200 ms.
- When a carrier to interferer ratio 4 dB lower than a defined lower threshold is applied to the antenna connector, the MS shall request a lower mode with a probability exceeding 90%. This shall be measured immediately after a settling-time of 200 ms.

If required, the above test levels shall be reduced by the normalization factor defined in sub-clause 3.3.1 to account for potential improved receiver performances.

For other frequency bands, the propagation profile should be adjusted to: TU1.5 for DCS1800 and PCS1900, TU6 for GSM400 and TU3.6 for GSM700.

Note 1: Ideal frequency hopping assumes perfect decorrelation between bursts. For the propagation profile TU3, this is not easily achievable due to the high number of hopping frequencies required. Therefore, performance tests should be performed under ideal frequency hopping conditions for the following propagation profiles: TU50 for GSM900 and GSM850, TU25 for DCS1800 and PCS1900, TU100 for GSM400, and TU60 for GSM700.

3GPP TS 45.009 subclause 3.3.3.3

For T-GSM 810 the requirements for GSM 900 shall apply, apart for those parameters for which a separate requirement exists.

3GPP TS 45.005 subclause 2

14.10.8.3 Test Purpose

1. To verify that the MS does not exceed conformance requirement (for producing codec request) under TUHigh and frequency hopping propagation conditions without DTX with an allowance for the statistical significance of the test.
2. To implicitly verify the correct implementation of the WB-AMR Thresholds and Hysteresis parameters received in either an ASSIGNMENT COMMAND or MODE MODIFY procedure, or through an AMR_CONFIG_REQ or THRESH_REQ message carried in a RATSCCH.

NOTE: This would normally be performed as a signalling test, however due to the complex layer 1 requirements it is verified here. Any future modification or Change Request on this section should take into account this additional test objective.

14.10.8.4 Method of Test

14.10.8.4.1 Initial conditions

A call is set up according to the generic call set up procedure on a TCH/WFS with a hopping pattern in the Mid ARFCN range and covering at least 10 frequencies not exceeding 5 MHz. DTX shall not be activated. Power control level shall be set to maximum power.

The initial configuration indicates the use of the 12.65 mode of AMR only.

The SS transmits Standard Test Signal C1 on the traffic channel.

In addition to the wanted signal, the SS produces an independent, uncorrelated interfering signal, Standard Test Signal II (unwanted signal).

- The unwanted signal is continuous and has no fixed relationship with the bit transitions of the wanted signal. Initially, the unwanted signal is switched off.
- The fading characteristic of the wanted and the interfering signal is TUHigh.

NOTE 1: The fading characteristics shall be TU50 for GSM900, T-GSM 810 and GSM850, TU25 for DCS1800 and PCS1900, TU100 for GSM400, and TU60 for GSM700.

Specific PICS Statements:

-

PIXIT Statements:

TCH/WFS C/I normalization factor

14.10.8.4.2 Procedure

STEP 1

- 1a) The SS uses a Channel Mode Modify procedure to change the active codec set to the following set:

Codec Mode	TCH/WFS in kbit/s
CODEC_MODE_3	12,65
CODEC_MODE_2	8,85
CODEC_MODE_1	6,6

With Initial Codec Mode unspecified, thus the default ICM rule being used and the following decision thresholds and hysteresis values:

MC/MR'	THR_MC_Dn(MC)/ THR_MR_Dn(MR)	THR_MC_Up(MC)/ THR_MR_Up(MR)
CODEC_MODE_3	18.5 dB	+ ∞
CODEC_MODE_2	12.5 dB	20.5 dB
CODEC_MODE_1	- ∞	14.5 dB

The SS uses the expected Initial Codec Mode (default rule) after sending the mode modify message and commands the MS through the CMC field to use the Initial Codec Mode as well. The SS waits for the MS to change the uplink codec to the expected Initial Codec Mode (default rule).

- 1b) The SS then sends an AMR_CONF_REQ through a RATSCCH message commanding the MS to use the following ACS:

Codec Mode	TCH/WFS in kbit/s
CODEC_MODE_3	12,65
CODEC_MODE_2	8,85
CODEC_MODE_1	6,6

With the Initial Codec Mode set to the 12.65 kbit/s mode and the following decision thresholds and hysteresis values:

MC/MR'	THR_MC_Dn(MC)/ THR_MR_Dn(MR)	THR_MC_Up(MC)/ THR_MR_Up(MR)
CODEC_MODE_3	Thr1d = 12.5 dB	+ ∞
CODEC_MODE_2	Thr2d = 6.5 dB	Thr1u = 14.5 dB
CODEC_MODE_1	- ∞	Thr2u = 8.5 dB

The SS switches the downlink codec to the Initial Codec Mode 12 frames after sending the AMR_CONF_REQ message and commands the MS through the CMC field to use the requested Initial Codec Mode. The SS waits for the MS to change the uplink codec to the expected Initial Codec Mode, 12 frames after receiving the ACK_OK message.

The SS waits until the MS indicates in the CMR that the 12.65 kbit/s is the recommended downlink codec mode.

If the MS never reaches that point then the test is failed.

The downlink radio environment is altered so that the carrier to interference ratio is set to 4 dB above the highest of the upwards thresholds Thr1u. The SS waits 500ms.

- 1c) The downlink radio environment is altered so that the carrier to interference ratio is reduced to 4 dB below the highest of the downwards thresholds Thr1d. The SS increments the counter for 'C/I decreases below thresholds'.
- 1d) The SS checks the CMR received from the MS 200ms after the carrier to interference has been altered. If the CMR indicates that the MS recommends to use the 8.85 kbit/s or a lower codec mode in the downlink, then the SS should increment the successful C/I decrease event counter. Otherwise, the SS should increment the unsuccessful C/I decrease event counter.
- 1e) The SS switches the downlink codec mode to 8.85 kbit/s and waits for 0.5s.
- 1f) The downlink radio environment is altered so that the carrier to interference ratio is reduced to 4 dB below the lowest of the downwards thresholds Thr2d. The SS increments the counter for 'C/I decreases below thresholds'.
- 1g) The SS checks the CMR received from the MS 200ms after the carrier to interference has been altered. If the CMR indicates that the MS recommends to use the 6.6 kbit/s codec mode in the downlink, then the SS should increment the successful C/I decrease event counter. Otherwise, the SS should increment the unsuccessful C/I decrease event counter.
- 1h) The SS switches the downlink codec mode to 8.85 kbit/s and waits for 0.5s.

- li) The downlink radio environment is altered so that the carrier to interference ratio is increased to 4 dB above the highest of the upwards thresholds Thr_{1u}. The SS increments the counter for 'C/I increases above thresholds'.
- lj) The SS checks the CMR received by the MS 200ms after the carrier to interference has been altered. If the CMR indicates that the MS recommends to use 12.65 kbit/s in the downlink, then the SS should increment the successful C/I increase event counter. Otherwise, the SS should increment the unsuccessful C/I increase event counter.
- lk) The SS switches the downlink codec mode to 12.65 kbit/s and waits for 0.5s.
- ll) The SS repeats steps 1c) to 1k) until 500 samples of C/I increases and 500 samples of C/I decreases have been recorded.

STEP 2:

- 2a) The unwanted signal is removed.

The SS then sends an AMR_CONF_REQ through a RATSCCH message commanding the MS to use the following ACS:

Codec Mode	TCH/WFS in kbit/s
CODEC_MODE_3	12,65
CODEC_MODE_2	8,85
CODEC_MODE_1	6,6

With the Initial Codec Mode set to any mode and the following decision thresholds and hysteresis values:

MC'MR'	THR_MC_Dn(MC)/ THR_MR_Dn(MR)	THR_MC_Up(MC)/ THR_MR_Up(MR)
CODEC_MODE_3	18.5 dB	+ ∞
CODEC_MODE_2	12.5 dB	20.5 dB
CODEC_MODE_1	- ∞	14.5 dB

The SS switches the downlink codec to the Initial Codec Mode 12 frames after sending the AMR_CONF_REQ message and commands the MS through the CMC field to use the requested Initial Codec Mode. The SS waits for the MS to change the uplink codec to the expected Initial Codec Mode, 12 frames after receiving the ACK_OK message.

- 2b) The SS uses a Channel Mode Modify procedure to change the active codec set to the following set:

Codec Mode	TCH/WFS in kbit/s
CODEC_MODE_3	12,65
CODEC_MODE_2	8,85
CODEC_MODE_1	6,6

With the Initial Codec Mode set to the 12.65 kbit/s mode and the following decision thresholds and hysteresis values:

MC'MR'	THR_MC_Dn(MC)/ THR_MR_Dn(MR)	THR_MC_Up(MC)/ THR_MR_Up(MR)
CODEC_MODE_3	Thr1d = 11.5 dB	+ ∞
CODEC_MODE_2	Thr2d = 5.5 dB	Thr1u = 13.5 dB
CODEC_MODE_1	- ∞	Thr2u = 7.5 dB

The SS switches the downlink codec to the Initial Codec Mode after sending the mode modify message and commands the MS through the CMC field to use the Initial Codec Mode as well. The SS waits for the MS to change the uplink codec to the expected Initial Codec Mode.

The SS waits until the MS indicates in the CMR that the 12.65 kbit/s is the recommended downlink codec mode.

If the MS never reaches that point then the test is failed.

The downlink radio environment is altered so that the carrier to interference ratio is set to 4 dB above the highest of the upwards thresholds Thr1u. The SS waits 500ms

- 2c) The SS repeats steps 1c) to 1k) until 500 samples of C/I increases and 500 samples of C/I decreases have been recorded.

STEP 3:

- 3a) The unwanted signal is removed.

The SS then sends an AMR_CONF_REQ through a RATSCCH message commanding the MS to use the AMR 8.85 kbit/s mode only:

The SS switches the downlink codec to the 8.85 kbit/s mode 12 frames after sending the AMR_CONF_REQ message and commands the MS through the CMC field to use the requested codec. The SS waits for the MS to change the uplink codec to the expected codec, 12 frames after receiving the ACK_OK message.

- 3b) The SS uses a Channel Mode Modify procedure to change the active codec set to the following set:

Codec Mode	TCH/WFS in kbit/s
CODEC_MODE_3	12,65
CODEC_MODE_2	8,85
CODEC_MODE_1	6,6

With the Initial Codec Mode set to the 12.65 kbit/s mode and the following decision thresholds and hysteresis values:

MC/MR'	THR_MC_Dn(MC)/ THR_MR_Dn(MR)	THR_MC_Up(MC)/ THR_MR_Up(MR)
CODEC_MODE_3	Thr1d = 18.5 dB	+ ∞
CODEC_MODE_2	Thr2d = 10.5 dB	Thr1u = 20.5 dB
CODEC_MODE_1	- ∞	Thr2u = 12.5 dB

The SS switches the downlink codec to the Initial Codec Mode after sending the mode modify message and commands the MS through the CMC field to use the Initial Codec Mode as well. The SS waits for the MS to change the uplink codec to the expected Initial Codec Mode

The SS waits until the MS indicates in the CMR that the 12.65 kbit/s is the recommended downlink codec mode.

If the MS never reaches that point then the test is failed.

- 3c) The SS then sends a THRESH_REQ through a RATSCCH message commanding the MS to modify the Thresholds and Hysteresis to the following values:

MC/MR'	THR_MC_Dn(MC)/ THR_MR_Dn(MR)	THR_MC_Up(MC)/ THR_MR_Up(MR)
CODEC_MODE_3	Thr1d = 13.5 dB	+ ∞
CODEC_MODE_2	Thr2d = 7.5 dB	Thr1u = 15.5 dB
CODEC_MODE_1	- ∞	Thr2u = 9.5 dB

The SS waits 12 frames after receiving the ACK_OK message.

- 3d) The SS waits until the MS indicates in the CMR that the 12.65 kbit/s is the recommended downlink codec mode.

If the MS never reaches that point then the test is failed.

The downlink radio environment is altered so that the carrier to interference ratio is set to 4 dB above the highest of the upwards thresholds Thr1u. The SS waits 500ms

- 3e) The SS repeats steps 1c) to 1k) until 500 samples of C/I increases and 500 samples of C/I decreases have been recorded.

STEP 4:

- 4a) The unwanted signal is removed.

The SS uses a Channel Mode Modify procedure commanding the MS to use the AMR 8.85 kbit/s mode only:

The SS waits for the MS to change the uplink codec to the 8.85 kbit/s mode.

- 4b) The SS then sends an AMR_CONF_REQ through a RATSCCH message commanding the MS to use the following ACS:

Codec Mode	TCH/WFS in kbit/s
CODEC_MODE_3	12,65
CODEC_MODE_2	8,85
CODEC_MODE_1	6,6

With the Initial Codec Mode set to the 12.65 kbit/s mode and the following decision thresholds and hysteresis values:

MC'MR'	THR_MC_Dn(MC)/ THR_MR_Dn(MR)	THR_MC_Up(MC)/ THR_MR_Up(MR)
CODEC_MODE_3	Thr1d = 12.5 dB	+ ∞
CODEC_MODE_2	Thr2d = 6.5 dB	Thr1u = 14.5 dB
CODEC_MODE_1	- ∞	Thr2u = 8.5 dB

The SS switches the downlink codec to the Initial Codec Mode 12 frames after sending the AMR_CONF_REQ message and commands the MS through the CMC field to use the requested Initial Codec Mode. The SS waits for the MS to change the uplink codec to the expected Initial Codec Mode, 12 frames after receiving the ACK_OK message.

The SS waits until the MS indicates in the CMR that the 12.65 kbit/s is the recommended downlink codec mode.

If the MS never reaches that point then the test is failed.

The downlink radio environment is altered so that the carrier to interference ratio is set to 4 dB above the highest of the upwards thresholds Thr1u. The SS waits 500ms

- 4c) The SS repeats steps 1c) to 1k) until 500 samples of C/I increases and 500 samples of C/I decreases have been recorded.

Maximum/Minimum Duration of Test

Maximum/minimum: 54 minutes.

14.10.8.5 Test requirements

The requirement and minimum set of samples shall not exceed the values given in the following table for each set of thresholds.

Event	Maximum allowed error rate	Minimum No. of samples
C/I increases over Thresholds	11%	2000
C/I decreases below Thresholds	11%	2000

14.10.9 Performance of the Codec Mode Request Generation – TCH/WFS - improved RX

14.10.9.1 Definition

When a traffic channel supporting an Adaptive Multi-Rate speech codec version 5 is activated, the Codec Mode Request is sent by MS in band every other speech frame to indicate to the Network the recommended codec mode of the ACS to use on the downlink.

14.10.9.2 Conformance Requirement

3GPP TS 45.009 subclause 3.3.3.3:

For TU3 channel conditions with ideal frequency hopping without DTX activated in GSM900 and GSM850, the MS shall produce Codec Mode Requests with the following accuracy:

- When a carrier to interferer ratio 4 dB higher than a defined upper threshold is applied to the antenna connector, the MS shall request a higher mode with a probability exceeding 90%. This shall be measured immediately after a settling-time of 200 ms.
- When a carrier to interferer ratio 4 dB lower than a defined lower threshold is applied to the antenna connector, the MS shall request a lower mode with a probability exceeding 90%. This shall be measured immediately after a settling-time of 200 ms.

If required, the above test levels shall be reduced by the normalization factor defined in sub-clause 3.3.1 to account for potential improved receiver performances.

For other frequency bands, the propagation profile should be adjusted to: TU1.5 for DCS1800 and PCS1900, TU6 for GSM400 and TU3.6 for GSM700.

Note 1: Ideal frequency hopping assumes perfect decorrelation between bursts. For the propagation profile TU3, this is not easily achievable due to the high number of hopping frequencies required. Therefore, performance tests should be performed under ideal frequency hopping conditions for the following propagation profiles: TU50 for GSM900 and GSM850, TU25 for DCS1800 and PCS1900, TU100 for GSM400, and TU60 for GSM700.

Note 2: Receivers with improved performance may exceed the minimum requirements reflected by the normalisation factor defined in sub-clause 3.3.1. The normalisation factor, reflecting the improved performance, may depend on the carrier to interference ratio (C/I). Therefore, the conformance test of these receivers may require normalisation factors to be provided for each nominal C/I of the test.

3GPP TS 45.005 subclause 2:

For T-GSM 810 the requirements for GSM 900 shall apply, apart for those parameters for which a separate requirement exists.

14.10.9.3 Test Purpose

1. To verify that the MS does not exceed conformance requirements for producing codec mode request under TUHigh and frequency hopping propagation conditions without DTX with an allowance for the statistical significance of the test.
2. To implicitly verify the correct implementation of the AMR Thresholds and Hysteresis parameters received in either an ASSIGNMENT COMMAND or MODE MODIFY procedure, or through an AMR_CONFIG_REQ or THRESH_REQ message carried in a RATSCCH.

NOTE: This would normally be performed as a signalling test, however due to the complex layer 1 requirements it is verified here. Any future modification or Change Request on this section should take into account this additional test objective.

NOTE: The C/I values used throughout this test have been carefully selected to ensure no values above 16dB are signalled, low C/I values will not conflict with the synchronisation requirements in TS 45.010, and also to ensure the C/I values are shared between upward and downward applications. Any future modification or Change Request on this section should take into account these aspects.

14.10.9.4 Method of Test

14.10.9.4.1 Initial conditions

A call is set up according to the generic call set up procedure on a TCH/WFS with a hopping pattern in the Mid ARFCN range and covering at least 10 frequencies not exceeding 5 MHz. DTX shall not be activated. Power control level shall be set to maximum power.

The initial configuration indicates the use of the 12.65 mode of AMR only.

The SS transmits Standard Test Signal C1 on the traffic channel.

In addition to the wanted signal, the SS produces an independent, uncorrelated interfering signal, Standard Test Signal I1 (unwanted signal).

- The unwanted signal is continuous and has no fixed relationship with the bit transitions of the wanted signal. Initially, the unwanted signal is switched off.
- The fading characteristic of the wanted and the interfering signal is TUHigh.

NOTE 1: The fading characteristics shall be TU50 for GSM900, T-GSM 810 and GSM850, TU25 for DCS1800 and PCS1900, TU100 for GSM400, and TU60 for GSM700.

Specific PICS Statements

-

PIXIT Statements

TCH/WFS C/I normalization factors (TCH/WFS DARP) as follows:

Required additional information (PIXIT)
CI_NORM_WFS_DARP_2dB
CI_NORM_WFS_DARP_3dB
CI_NORM_WFS_DARP_4dB
CI_NORM_WFS_DARP_6dB
CI_NORM_WFS_DARP_8dB
CI_NORM_WFS_DARP_10dB
CI_NORM_WFS_DARP_11dB
CI_NORM_WFS_DARP_12dB
CI_NORM_WFS_DARP_14dB
CI_NORM_WFS_DARP_17dB
CI_NORM_WFS_DARP_19dB
CI_NORM_WFS_DARP_20dB

14.10.9.4.2 Procedure

STEP 1:

1a) The SS uses a Channel Mode Modify procedure to change the active codec set to the following set:

Codec Mode	TCH/WFS in kbit/s
CODEC_MODE_3	12,65
CODEC_MODE_2	8,85
CODEC_MODE_1	6,6

With Initial Codec Mode unspecified, thus the default ICM rule being used and the following decision thresholds and hysteresis values:

MC/MR'	THR_MC_Dn(MC)/ THR_MR_Dn(MR)	THR_MC_Up(MC)/ THR_MR_Up(MR)
CODEC_MODE_3	Thr1d = 17.5 dB	+ ∞
CODEC_MODE_2	Thr3d = 12.5 dB	Thr2u = 16.5 dB
CODEC_MODE_1	- ∞	Thr3u = 14.5 dB

The SS uses the expected Initial Codec Mode (default rule) after sending the mode modify message and commands the MS through the CMC field to use the Initial Codec Mode as well. The SS waits for the MS to change the uplink codec to the expected Initial Codec Mode (default rule).

- 1b) The SS then sends an AMR_CONF_REQ through a RATSCCH message commanding the MS to use the following ACS:

Codec Mode	TCH/WFS in kbit/s
CODEC_MODE_3	12,65
CODEC_MODE_2	8,85
CODEC_MODE_1	6,6

With the Initial Codec Mode set to the 12.65 kbit/s mode and the following decision thresholds and hysteresis values:

MC/MR'	THR_MC_Dn(MC)/ THR_MR_Dn(MR)	THR_MC_Up(MC)/ THR_MR_Up(MR)
CODEC_MODE_3	Thr1d = 15.0 dB	+ ∞
CODEC_MODE_2	Thr2d = 6.0 dB	Thr1u = 15.0 dB
CODEC_MODE_1	- ∞	Thr2u = 6.0 dB

The SS switches the downlink codec to the Initial Codec Mode 12 frames after sending the AMR_CONF_REQ message and commands the MS through the CMC field to use the requested Initial Codec Mode. The SS waits for the MS to change the uplink codec to the expected Initial Codec Mode, 12 frames after receiving the ACK_OK message.

The SS waits until the MS indicates in the CMR that the 12.65 kbit/s is the recommended downlink codec mode.

If the MS never reaches that point then the test is failed.

The downlink radio environment is altered so that the carrier to interference ratio is set Thr1u + 4dB - CI_NORM_AFS_DARP_19dB. The SS waits 500ms.

- 1c) The downlink radio environment is altered so that the carrier to interference ratio is reduced to Thr1d - 4dB - CI_NORM_AFS_DARP_11dB. The SS increments the counter for 'C/I decreases below thresholds'.
- 1d) The SS checks the CMR received from the MS 200ms after the carrier to interference has been altered. If the CMR indicates that the MS recommends to use the 7.95 kbit/s or a lower codec mode in the downlink, then the SS should increment the successful C/I decrease event counter. Otherwise, the SS should increment the unsuccessful C/I decrease event counter.
- 1e) The SS switches the downlink codec mode to 8.85 kbit/s and waits for 0.5s.
- 1f) The downlink radio environment is altered so that the carrier to interference ratio is reduced to Thr2d - 4dB - CI_NORM_AFS_DARP_2dB. The SS increments the counter for 'C/I decreases below thresholds'.
- 1g) The SS checks the CMR received from the MS 200ms after the carrier to interference has been altered. If the CMR indicates that the MS recommends to use the 6.6 kbit/s codec mode in the downlink, then the SS should increment the successful C/I decrease event counter. Otherwise, the SS should increment the unsuccessful C/I decrease event counter.
- 1h) The SS switches the downlink codec mode to 6.6 kbit/s and waits for 0.5s.
- 1i) The downlink radio environment is altered so that the carrier to interference ratio is increased to Thr2u + 4dB - CI_NORM_AFS_DARP_10dB. The SS increments the counter for 'C/I increases above thresholds'.

- 1j) The SS checks the CMR received from the MS 200ms after the carrier to interference has been altered. If the CMR indicates that the MS recommends to use the 8.85 kbit/s or a higher codec mode in the downlink, then the SS should increment the successful C/I increase event counter. Otherwise, the SS should increment the unsuccessful C/I increase event counter.
- 1k) The SS switches the downlink codec mode to 8.85 kbit/s and waits for 0.5s.
- 1l) The downlink radio environment is altered so that the carrier to interference ratio is increased to $\text{Thr1u} + 4\text{dB} - \text{CI_NORM_AFS_DARP_19dB}$. The SS increments the counter for 'C/I increases above thresholds'.
- 1m) The SS checks the CMR received by the MS 200ms after the carrier to interference has been altered. If the CMR indicates that the MS recommends to use 12.65 kbit/s in the downlink, then the SS should increment the successful C/I increase event counter. Otherwise, the SS should increment the unsuccessful C/I increase event counter.
- 1n) The SS switches the downlink codec mode to 12.65 kbit/s and waits for 0.5s.
- 1o) The SS repeats steps 1c) to 1n) until 500 samples of C/I increases and 500 samples of C/I decreases have been recorded.

STEP 2:

- 2a) The unwanted signal is removed.

The SS then sends an AMR_CONF_REQ through a RATSCCH message commanding the MS to use the following ACS:

Codec Mode	TCH/WFS in kbit/s
CODEC_MODE_3	12,65
CODEC_MODE_2	8,85
CODEC_MODE_1	6,6

With the Initial Codec Mode set to any mode and the following decision thresholds and hysteresis values:

MC/MR'	THR_MC_Dn(MC)/ THR_MR_Dn(MR)	THR_MC_Up(MC)/ THR_MR_Up(MR)
CODEC_MODE_3	Thr1d = 17.5 dB	+ ∞
CODEC_MODE_2	Thr2d = 12.5 dB	Thr1u = 16.5 dB
CODEC_MODE_1	- ∞	Thr2u = 14.5 dB

The SS switches the downlink codec to the Initial Codec Mode 12 frames after sending the AMR_CONF_REQ message and commands the MS through the CMC field to use the requested Initial Codec Mode. The SS waits for the MS to change the uplink codec to the expected Initial Codec Mode, 12 frames after receiving the ACK_OK message.

- 2b) The SS uses a Channel Mode Modify procedure to change the active codec set to the following set:

Codec Mode	TCH/WFS in kbit/s
CODEC_MODE_3	12,65
CODEC_MODE_2	8,85
CODEC_MODE_1	6,6

With the Initial Codec Mode set to the 12.65 kbit/s mode and the following decision thresholds and hysteresis values:

MC/MR'	THR_MC_Dn(MC)/ THR_MR_Dn(MR)	THR_MC_Up(MC)/ THR_MR_Up(MR)
CODEC_MODE_3	Thr1d = 12.0 dB	+ ∞
CODEC_MODE_2	Thr2d = 8.0 dB	Thr1u = 13.0 dB
CODEC_MODE_1	- ∞	Thr2u = 8.0 dB

The SS switches the downlink codec to the Initial Codec Mode after sending the mode modify message and commands the MS through the CMC field to use the Initial Codec Mode as well. The SS waits for the MS to change the uplink codec to the expected Initial Codec Mode.

The SS waits until the MS indicates in the CMR that the 12.65 kbit/s is the recommended downlink codec mode.

If the MS never reaches that point then the test is failed.

The downlink radio environment is altered so that the carrier to interference ratio is set to Thr1u + 4dB - CI_NORM_AFS_DARP_17dB. The SS waits 500ms

- 2c) The downlink radio environment is altered so that the carrier to interference ratio is reduced to Thr1d – 4dB - CI_NORM_AFS_DARP_8dB. The SS increments the counter for ‘C/I decreases below thresholds’.
- 2d) The SS checks the CMR received from the MS 200ms after the carrier to interference has been altered. If the CMR indicates that the MS recommends to use the 8.85 kbit/s or a lower codec mode in the downlink, then the SS should increment the successful C/I decrease event counter. Otherwise, the SS should increment the unsuccessful C/I decrease event counter.
- 2e) The SS switches the downlink codec mode to 8.85 kbit/s and waits for 0.5s.
- 2f) The downlink radio environment is altered so that the carrier to interference ratio is reduced to Thr2d – 4dB - CI_NORM_AFS_DARP_4dB. The SS increments the counter for ‘C/I decreases below thresholds’.
- 2g) The SS checks the CMR received from the MS 200ms after the carrier to interference has been altered. If the CMR indicates that the MS recommends to use the 6.6 kbit/s codec mode in the downlink, then the SS should increment the successful C/I decrease event counter. Otherwise, the SS should increment the unsuccessful C/I decrease event counter.
- 2h) The SS switches the downlink codec mode to 6.6 kbit/s and waits for 0.5s.
- 2i) The downlink radio environment is altered so that the carrier to interference ratio is increased to Thr2u + 4dB - CI_NORM_AFS_DARP_12dB. The SS increments the counter for ‘C/I increases above thresholds’.
- 2j) The SS checks the CMR received from the MS 200ms after the carrier to interference has been altered. If the CMR indicates that the MS recommends to use the 8.85 kbit/s or a higher codec mode in the downlink, then the SS should increment the successful C/I increase event counter. Otherwise, the SS should increment the unsuccessful C/I increase event counter.
- 2k) The SS switches the downlink codec mode to 8.85 kbit/s and waits for 0.5s.
- 2l) The downlink radio environment is altered so that the carrier to interference ratio is increased to Thr1u + 4dB - CI_NORM_AFS_DARP_17dB. The SS increments the counter for ‘C/I increases above thresholds’.
- 2m) The SS checks the CMR received by the MS 200ms after the carrier to interference has been altered. If the CMR indicates that the MS recommends to use 12.65 kbit/s in the downlink, then the SS should increment the successful C/I increase event counter. Otherwise, the SS should increment the unsuccessful C/I increase event counter.
- 2n) The SS switches the downlink codec mode to 12.65 kbit/s and waits for 0.5s.
- 2o) The SS repeats steps 2c) to 2n) until 500 samples of C/I increases and 500 samples of C/I decreases have been recorded.

STEP 3:

- 3a) The unwanted signal is removed.

The SS then sends an AMR_CONF_REQ through a RATSCCH message commanding the MS to use the AMR 8.85 kbit/s mode only:

The SS switches the downlink codec to the 8.85 mode 12 frames after sending the AMR_CONF_REQ message and commands the MS through the CMC field to use the requested codec. The SS waits for the MS to change the uplink codec to the expected codec, 12 frames after receiving the ACK_OK message.

3b) The SS uses a Channel Mode Modify procedure to change the active codec set to the following set:

Codec Mode	TCH/WFS in kbit/s
CODEC_MODE_3	12,65
CODEC_MODE_2	8,85
CODEC_MODE_1	6,6

With the Initial Codec Mode set to the 12.65 kbit/s mode and the following decision thresholds and hysteresis values:

MC'/MR'	THR_MC_Dn(MC)/ THR_MR_Dn(MR)	THR_MC_Up(MC)/ THR_MR_Up(MR)
CODEC_MODE_3	Thr1d = 18.5 dB	+ ∞
CODEC_MODE_2	Thr2d = 10.5 dB	Thr1u = 20.5 dB
CODEC_MODE_1	- ∞	Thr2u = 12.5 dB

The SS switches the downlink codec to the Initial Codec Mode after sending the mode modify message and commands the MS through the CMC field to use the Initial Codec Mode as well. The SS waits for the MS to change the uplink codec to the expected Initial Codec Mode

The SS waits until the MS indicates in the CMR that the 12.65 kbit/s is the recommended downlink codec mode.

If the MS never reaches that point then the test is failed.

3c) The SS then sends a THRESH_REQ through a RATSCCH message commanding the MS to modify the Thresholds and Hysteresis to the following values:

MC'/MR'	THR_MC_Dn(MC)/ THR_MR_Dn(MR)	THR_MC_Up(MC)/ THR_MR_Up(MR)
CODEC_MODE_3	Thr1d = 14.0 dB	+ ∞
CODEC_MODE_2	Thr2d = 10.0 dB	Thr1u = 16.0 dB
CODEC_MODE_1	- ∞	Thr2u = 10.0 dB

The SS waits 12 frames after receiving the ACK_OK message.

3d) The SS waits until the MS indicates in the CMR that the 12.65 kbit/s is the recommended downlink codec mode.

If the MS never reaches that point then the test is failed.

The downlink radio environment is altered so that the carrier to interference ratio is set to Thr1u + 4dB - CI_NORM_AFS_DARP_20dB. The SS waits 500ms

3e) The downlink radio environment is altered so that the carrier to interference ratio is reduced to Thr1d - 4dB - CI_NORM_AFS_DARP_10dB. The SS increments the counter for 'C/I decreases below thresholds'.

3f) The SS checks the CMR received from the MS 200ms after the carrier to interference has been altered. If the CMR indicates that the MS recommends to use the 8.85 kbit/s or a lower codec mode in the downlink, then the SS should increment the successful C/I decrease event counter. Otherwise, the SS should increment the unsuccessful C/I decrease event counter.

3g) The SS switches the downlink codec mode to 8.85 kbit/s and waits for 0.5s.

3h) The downlink radio environment is altered so that the carrier to interference ratio is reduced to Thr2d - 4dB - CI_NORM_AFS_DARP_6dB. The SS increments the counter for 'C/I decreases below thresholds'.

3i) The SS checks the CMR received from the MS 200ms after the carrier to interference has been altered. If the CMR indicates that the MS recommends to use the 6.6 kbit/s codec mode in the downlink, then the SS should increment the successful C/I decrease event counter. Otherwise, the SS should increment the unsuccessful C/I decrease event counter.

3j) The SS switches the downlink codec mode to 6.6 kbit/s and waits for 0.5s.

- 3k) The downlink radio environment is altered so that the carrier to interference ratio is increased to $\text{Thr}_{2u} + 4\text{dB} - \text{CI_NORM_AFS_DARP}_{14\text{dB}}$. The SS increments the counter for 'C/I increases above thresholds'.
- 3l) The SS checks the CMR received from the MS 200ms after the carrier to interference has been altered. If the CMR indicates that the MS recommends to use the 8.85 kbit/s or a higher codec mode in the downlink, then the SS should increment the successful C/I increase event counter. Otherwise, the SS should increment the unsuccessful C/I increase event counter.
- 3m) The SS switches the downlink codec mode to 8.85 kbit/s and waits for 0.5s.
- 3n) The downlink radio environment is altered so that the carrier to interference ratio is increased to $\text{Thr}_{1u} + 4\text{dB} - \text{CI_NORM_AFS_DARP}_{20\text{dB}}$. The SS increments the counter for 'C/I increases above thresholds'.
- 3o) The SS checks the CMR received by the MS 200ms after the carrier to interference has been altered. If the CMR indicates that the MS recommends to use 12.65 kbit/s in the downlink, then the SS should increment the successful C/I increase event counter. Otherwise, the SS should increment the unsuccessful C/I increase event counter.
- 3p) The SS switches the downlink codec mode to 12.65 kbit/s and waits for 0.5s.
- 3q) The SS repeats steps 3e) to 3p) until 500 samples of C/I increases and 500 samples of C/I decreases have been recorded.

STEP 4:

- 4a) The unwanted signal is removed.

The SS uses a Channel Mode Modify procedure commanding the MS to use the WFS 8.85 kbit/s mode only:

The SS waits for the MS to change the uplink codec to the 8.85 kbit/s mode.

- 4b) The SS then sends an AMR_CONF_REQ through a RATSCCH message commanding the MS to use the following ACS:

Codec Mode	TCH/WFS in kbit/s
CODEC_MODE_3	12,65
CODEC_MODE_2	8,85
CODEC_MODE_1	6,6

With the Initial Codec Mode set to the 12.65 kbit/s mode and the following decision thresholds and hysteresis values:

MC/MR'	THR_MC_Dn(MC)/ THR_MR_Dn(MR)	THR_MC_Up(MC)/ THR_MR_Up(MR)
CODEC_MODE_3	Thr1d = 16.0 dB	+ ∞
CODEC_MODE_2	Thr2d = 7.0 dB	Thr1u = 16.0 dB
CODEC_MODE_1	- ∞	Thr2u = 7.0 dB

The SS switches the downlink codec to the Initial Codec Mode 12 frames after sending the AMR_CONF_REQ message and commands the MS through the CMC field to use the requested Initial Codec Mode. The SS waits for the MS to change the uplink codec to the expected Initial Codec Mode, 12 frames after receiving the ACK_OK message.

The SS waits until the MS indicates in the CMR that the 12.65 kbit/s is the recommended downlink codec mode.

If the MS never reaches that point then the test is failed.

The downlink radio environment is altered so that the carrier to interference ratio is set to $\text{Thr}_{1u} + 4\text{dB} - \text{CI_NORM_AFS_DARP}_{20\text{dB}}$. The SS waits 500ms

- 4c) The downlink radio environment is altered so that the carrier to interference ratio is reduced to $\text{Thr}_{1d} - 4\text{dB} - \text{CI_NORM_AFS_DARP}_{12\text{dB}}$. The SS increments the counter for 'C/I decreases below thresholds'.

- 4d) The SS checks the CMR received from the MS 200ms after the carrier to interference has been altered. If the CMR indicates that the MS recommends to use the 8.85 kbit/s or a lower codec mode in the downlink, then the SS should increment the successful C/I decrease event counter. Otherwise, the SS should increment the unsuccessful C/I decrease event counter.
- 4e) The SS switches the downlink codec mode to 8.85 kbit/s and waits for 0.5s.
- 4f) The downlink radio environment is altered so that the carrier to interference ratio is reduced to Thr2d – 4dB - CI_NORM_AFS_DARP_3dB. The SS increments the counter for ‘C/I decreases below thresholds’.
- 4g) The SS checks the CMR received from the MS 200ms after the carrier to interference has been altered. If the CMR indicates that the MS recommends to use the 6.6 kbit/s codec mode in the downlink, then the SS should increment the successful C/I decrease event counter. Otherwise, the SS should increment the unsuccessful C/I decrease event counter.
- 4h) The SS switches the downlink codec mode to 6.6 kbit/s and waits for 0.5s.
- 4i) The downlink radio environment is altered so that the carrier to interference ratio is increased to Thr2u + 4dB - CI_NORM_AFS_DARP_11dB. The SS increments the counter for ‘C/I increases above thresholds’.
- 4j) The SS checks the CMR received from the MS 200ms after the carrier to interference has been altered. If the CMR indicates that the MS recommends to use the 8.85 kbit/s or a higher codec mode in the downlink, then the SS should increment the successful C/I increase event counter. Otherwise, the SS should increment the unsuccessful C/I increase event counter.
- 4k) The SS switches the downlink codec mode to 8.85 kbit/s and waits for 0.5s.
- 4l) The downlink radio environment is altered so that the carrier to interference ratio is increased to Thr1u + 4dB - CI_NORM_AFS_DARP_20dB. The SS increments the counter for ‘C/I increases above thresholds’.
- 4m) The SS checks the CMR received by the MS 200ms after the carrier to interference has been altered. If the CMR indicates that the MS recommends to use 12.65 kbit/s in the downlink, then the SS should increment the successful C/I increase event counter. Otherwise, the SS should increment the unsuccessful C/I increase event counter.
- 4n) The SS switches the downlink codec mode to 12.65 kbit/s and waits for 0.5s.
- 4o) The SS repeats steps 4c) to 4n) until 500 samples of C/I increases and 500 samples of C/I decreases have been recorded.

NOTE: The core specifications state that an MS shall respond to a change of C/I within 200ms. The core specifications place no bounds on magnitude or rate of change of C/I. For this test the magnitude of change is bounded by THRESH and HYST selection, and the rate of change is bounded by the 500ms wait periods. These bounds are selected to ensure an MS implementation is not adversely biased by this test.

Maximum/Minimum Duration of Test

Maximum/minimum: 54 minutes.

14.10.9.5 Test requirements

The requirement and minimum set of samples shall not exceed the values given in the following table for each set of thresholds.

Event	Maximum allowed error rate	Minimum No. of samples
C/I increases over Thresholds	11%	2000
C/I decreases below Thresholds	11%	2000

14.11 DARP Phase 1 Speech bearer tests

14.11.1 TCH/FS

14.11.1.1 DTS-1

14.11.1.1.1 Definition

The DARP reference test scenarios define a set of interfering signals and corresponding performance limits. These tests are a measure of the capability of the DARP receiver to receive a wanted modulated signal without exceeding a given degradation due to the presence of these specific unwanted modulated signals.

14.11.1.1.2 Conformance requirement

1. MS indicating support for Downlink Advanced Receiver Performance – phase I (see 3GPP TS 24.008) shall fulfil the requirements in table 2o for wanted signals on GMSK modulated channels under TU50 no FH propagation conditions and GMSK modulated interferers for the test scenarios defined in annex L. The reference performance shall be:
 - For speech channels (TCH/FS) FER: $\leq 1\%$
2. The values in table 2o are given as the C/I1 ratio, where C is the power level of the wanted signal and I1 is the power level of the dominant co-channel interferer (Co-channel 1, see annex L). In addition for speech channels the residual class Ib BER and residual class II BER performance shall not exceed the specified values in table 2o at the corresponding C/I1.

3GPP TS 45.005, subclause 6.3

14.11.1.1.3 Test purpose

To verify that the MS does not exceed the first conformance requirement for TCH/FS under propagation condition TUhigh with an allowance for the statistical significance of the test.

To verify that the MS does not exceed the second conformance requirement for TCH/FS under propagation condition TUhigh with an allowance for the statistical significance of the test.

14.11.1.1.4 Method of test

14.11.1.1.4.1 Initial conditions

A call is set up according to the generic call set up procedure on a TCH/FS with an ARFCN in the mid ARFCN range, power control level set to maximum power. RADIO_LINK_TIMEOUT is set to maximum.

The SS transmits Standard Test Signal C1 on the traffic channel (wanted signal).

The SS commands the MS to create the traffic channel loop back, signalling erased frames (subclause 36).

14.11.1.1.4.2 Procedure

- a) In addition to the wanted signal, the SS produces an independent, uncorrelated interfering signal, Standard Test Signal I1 (unwanted signal).

The unwanted signal is continuous and has no fixed relationship with the bit transitions of the wanted signal. The interfering signal level is set to -80 dBm.

The fading characteristic of the wanted and the interfering signal is TUHigh.

- b) The SS sets the level of the wanted signal to that indicated by C_{lev} in table 14.11.1-2 or 14.11.1-3.
- c) The SS compares the modulation of the signal that it sends to the MS with the signal which is looped back from the receiver after demodulation and decoding, and checks the frame erasure indication.
- d) The SS determines the number of residual bit error events for the bits of the class Ib, by examining at least the minimum number of samples of consecutive bits of class Ib. Bits are only taken from those frames not signalled as erased.

- e) The SS also determines the number of residual bit error events for the bits of the class II, by examining at least the minimum number of samples of consecutive bits of class II. Bits are only taken from those frames not signalled as erased.
- f) The SS also determines the frame erasure events by examining at least the minimum number of samples of consecutive frames and assuming a frame is received successfully it is not signalled as erased.

Maximum/Minimum Duration of Test

Maximum: 10 minutes (GSM850), 10 minutes (GSM900), 10 minutes (DCS1800), 10 minutes (PCS1900).

Minimum: 4 minutes (GSM850), 4 minutes (GSM900), 2 minutes (DCS1800), 2 minutes (PCS1900).

14.11.1.1.5 Test requirements

Testing should be performed using statistical methods that lead to an early pass/fail decision with test time significantly reduced for MS with FER/BER not on the limit.

For more information on statistical testing of BER/BLER performance, especially the definition of limit lines refer to Annex 7 (A7.1.3.2)

Wrong decision risk F for one single error rate test:

$$F_{\text{pass}} = F_{\text{fail}} = F \quad \text{and} \quad F = 0.2\%$$

Wrong decision probability D per test step:

$$D_{\text{pass}} = D_{\text{fail}} = D \quad \text{and} \quad D = 0.0085\%$$

Parameters for limit lines:

1. D = 0.000085 wrong decision probability per test step.
2. M = 1.5 bad DUT factor
3. ne number of (error) events. This parameter is the x-ordinate in figure Annex 7 figure A7.1.3.1.
4. ns number of samples. The error rate is calculated from ne and ns.

Limit checking

Before limit checking is valid the minimum test time due to fading needs to be considered:

Testing under multipath and interference conditions requires that at least 990 wavelengths are crossed with the speed given in the fading profile. This leads to a minimum test time depending on the frequency range. No early pass/fail decision is allowed until the minimum test time due to fading has elapsed.

Table 14.11.1-1: Minimum test times due to TU high fading conditions

Full Rate 50 km/h				
Frequency	0,85	0,9	1,8	1,9 GHz
Wavelength	0,35	0,33	0,17	0,16 m
Min test time	201	190	95	90 s
	0:03:21	0:03:10	0:01:35	0:01:30 hh:mm:ss

If the minimum test time due to multipath conditions exceeds the target test time, then the test runs for the minimum test time due to multipath conditions and the decision is made by comparing the result with the “derived test limit”. In this case early pass/fail decisions are obsolete.

If the target test time exceeds the minimum test time due to multipath conditions early pass/fail decisions can be headed for in order to accelerate test execution.

For an early decision a minimum number of (error) events is necessary.

For an early pass decision $ne \geq 1$ (inclusive artificial error)

For an early fail decision $n_e \geq 7$

When the target test time has been reached the test is finished and a pass/fail decision can be made.

The error rate measured in this test shall be tested according to the values given in tables 14.11.1-2 or 14.11.1-3.

Table 14.11.1-2: Statistical test limits for GSM 850 and GSM 900 TCH/FS DARP DTS-1

DTS-1								
0.8 to 0.9GHz		C_{lev} (dBm)	Samples per second	Orig. BER requirement	Derived test limit	Target number of samples	Target test time (s)	Target test time (hh:mm:ss)
FS	Frames	-75.5	50	0,010000	0,012340	27958	560	00:09:20
	Class Ib	(as frames)	6600	0,001000	0,001234	279580	43	00:00:43
	Class II	(as frames)	3900	0,046000	0,056764	6078	2	00:00:02

Table 14.11.1-3: Statistical test limits for DCS 1 800 and PCS 1 900 TCH/AFS DARP DTS-1

DTS-1								
1.8 to 1.9GHz		C_{lev} (dBm)	Samples per second	Orig. BER requirement	Derived test limit	Target number of samples	Target test time (s)	Target test time (hh:mm:ss)
FS	Frames	-76.5	50	0,010000	0,012340	27958	560	00:09:20
	Class Ib	(as frames)	6600	0,001000	0,001234	279580	43	00:00:43
	Class II	(as frames)	3900	0,053000	0,065402	5276	2	00:00:02

14.11.2 TCH/AFS

14.11.2.1 DTS-1

14.11.2.1.1 Definition

The DARP reference test scenarios define a set of interfering signals and corresponding performance limits. These tests are a measure of the capability of the DARP receiver to receive a wanted modulated signal without exceeding a given degradation due to the presence of these specific unwanted modulated signals.

14.11.2.1.2 Conformance requirement

- MS indicating support for Downlink Advanced Receiver Performance – phase I (see 3GPP TS 24.008) shall fulfil the requirements in table 2o for wanted signals on GMSK modulated channels under TU50 no FH propagation conditions and GMSK modulated interferers for the test scenarios defined in annex L. The reference performance shall be:
 - For speech channels (TCH/FS, TCH/AFS_x, TCH/AHS_x) FER: $\leq 1\%$
- The values in table 2o are given as the C/I1 ratio, where C is the power level of the wanted signal and I1 is the power level of the dominant co-channel interferer (Co-channel 1, see annex L). In addition for speech channels the residual class Ib BER and residual class II BER performance shall not exceed the specified values in table 2o at the corresponding C/I1.

3GPP TS 45.005, subclause 6.3

14.11.2.1.3 Test purpose

To verify that the MS does not exceed the first conformance requirement for TCH/AFS under propagation condition TU_{high} with an allowance for the statistical significance of the test.

To verify that the MS does not exceed the second conformance requirement for TCH/AFS under propagation condition TU_{high} with an allowance for the statistical significance of the test for class Ib BER.

14.11.2.1.4 Method of test

14.11.2.1.4.1 Initial conditions

A call is set up according to the generic call set up procedure on a TCH/AFS with an ARFCN in the mid ARFCN range, power control level set to maximum power. RADIO_LINK_TIMEOUT is set to maximum.

The multirate configuration indicates the use of a codec set limited to 12,2 kbit/s.

The SS transmits Standard Test Signal C1 on the traffic channel (wanted signal), with training sequence code (TSC) = 0.

The SS commands the MS to create the traffic channel loop back, signalling erased frames (subclause 36).

14.11.2.1.4.2 Procedure

- a) In addition to the wanted signal, the SS produces an independent, uncorrelated interfering signal, Standard Test Signal I1 (unwanted signal).

The unwanted signal is continuous and has no fixed relationship with the bit transitions of the wanted signal. The interfering signal level is set to -80 dBm.

The fading characteristic of the wanted and the interfering signal is TU_{High}.

- b) The SS sets the level of the wanted signal to that indicated by C_{lev} in table 14-63 or 14-64.
- c) The SS compares the modulation of the signal that it sends to the MS with the signal which is looped back from the receiver after demodulation and decoding, and checks the frame erasure indication.
- d) The SS determines the number of residual bit error events for the bits of the class Ib, by examining at least the minimum number of samples of consecutive bits of class Ib. Bits are only taken from those frames not signalled as erased.
- e) The SS also determines the frame erasure events by examining at least the minimum number of samples of consecutive frames and assuming a frame is received successfully it is not signalled as erased.
- f) The SS uses a Channel Mode Modify procedure to change the active codec set to 10,2 kbit/s and steps b) to e) are repeated.
- g) The SS uses a Channel Mode Modify procedure to change the active codec set to 7,95 kbit/s and steps b) to e) are repeated.
- h) The SS uses a Channel Mode Modify procedure to change the active codec set to 7,4 kbit/s and steps b) to e) are repeated.
- i) The SS uses a Channel Mode Modify procedure to change the active codec set to 6,7 kbit/s and steps b) to e) are repeated.
- j) The SS uses a Channel Mode Modify procedure to change the active codec set to 5,9 kbit/s and steps b) to e) are repeated.
- k) The SS uses a Channel Mode Modify procedure to change the active codec set to 5,15 kbit/s and steps b) to e) are repeated.
- l) The SS uses a Channel Mode Modify procedure to change the active codec set to 4,75 kbit/s and steps b) to e) are repeated.

Maximum/Minimum Duration of Test

Maximum: 75 minutes (GSM850), 75 minutes (GSM900), 75 minutes (DCS1800), 75 minutes (PCS1900).

Minimum: 27 minutes (GSM850), 26 minutes (GSM900), 13 minutes (DCS1800), 12 minutes (PCS1900).

14.11.2.1.5 Test requirements

Testing should be performed using statistical methods that lead to an early pass/fail decision with test time significantly reduced for MS with FER/BER not on the limit.

For more information on statistical testing of BER/BLER performance, especially the definition of limit lines refer to Annex 7.

Wrong decision risk F for one single error rate test:

$$F_{\text{pass}} = F_{\text{fail}} = F \quad \text{and} \quad F = 0.2\%$$

Wrong decision probability D per test step:

$$D_{\text{pass}} = D_{\text{fail}} = D \quad \text{and} \quad D = 0.0085\%$$

Parameters for limit lines:

1. D = 0.000085 wrong decision probability per test step.
2. M = 1.5 bad DUT factor
3. ne number of (error) events. This parameter is the x-ordinate in figure A7.1.3.2.
4. ns number of samples. The error rate is calculated from ne and ns.

Limit checking

Before limit checking is valid the minimum test time due to fading needs to be considered:

Testing under multipath and interference conditions requires that at least 990 wavelengths are crossed with the speed given in the fading profile. This leads to a minimum test time depending on the frequency range. No early pass/fail decision is allowed until the minimum test time due to fading has elapsed.

Table 14-62: Minimum test times due to TU high fading conditions

Full Rate 50 km/h					
Frequency	0,85	0,9	1,8	1,9	GHz
Wavelength	0,35	0,33	0,17	0,16	m
min test time	201	190	95	90	s
	0:03:21	0:03:10	0:01:35	0:01:30	hh:mm:ss

If the minimum test time due to multipath conditions exceeds the target test time, then the test runs for the minimum test time due to multipath conditions and the decision is made by comparing the result with the “derived test limit”. In this case early pass/fail decisions are obsolete.

If the target test time exceeds the minimum test time due to multipath conditions early pass/fail decisions can be headed for in order to accelerate test execution.

For an early decision a minimum number of (error) events is necessary.

For an early pass decision $ne \geq 1$ (inclusive artificial error)

For an early fail decision $ne \geq 7$

When the target test time has been reached the test is finished and a pass/fail decision can be made.

The error rate measured in this test shall be tested according to the values given in tables 14-63 or 14-64.

Table 14-63: Statistical test limits for GSM 850 and GSM 900 TCH/AFS DARP DTS-1

DTS-1								
0.8 to 0.9GHz		C _{lev} (dBm)	Samples per second	Orig. BER requirement	Derived test limit	Target number of samples	Target test time (s)	Target test time (hh:mm:ss)
AFS 12.2	Frames	-75.0	50	0,010000	0,012340	27958	560	00:09:20
	Class1b	(as frames)	8150	0,006000	0,007404	46596	6	00:00:06
AFS 10.2	Frames	-76.5	50	0,010000	0,012340	27958	560	00:09:20
	Class1b	(as frames)	6950	0,002000	0,002468	139789	20	00:00:20
AFS 7.95	Frames	-78.5	50	0,010000	0,012340	27958	560	00:09:20
	Class1b	(as frames)	4200	0,003500	0,004319	79879	19	00:00:19
AFS 7.4	Frames	-78.5	50	0,010000	0,012340	27958	560	00:09:20
	Class1b	(as frames)	4350	0,002000	0,002468	139789	32	00:00:32
AFS 6.7	Frames	-80.0	50	0,010000	0,012340	27958	560	00:09:20
	Class1b	(as frames)	3950	0,005000	0,006170	55915	14	00:00:14
AFS 5.9	Frames	-80.0	50	0,010000	0,012340	27958	560	00:09:20
	Class1b	(as frames)	3150	0,002000	0,002468	139789	44	00:00:44
AFS 5.15	Frames	-81.0	50	0,010000	0,012340	27958	560	00:09:20
	Class1b	(as frames)	2700	0,002100	0,002591	133153	49	00:00:49
AFS 4.75	Frames	-81.5	50	0,010000	0,012340	27958	560	00:09:20
	Class1b	(as frames)	2800	0,001500	0,001851	186385	66	00:01:06

Table 14-64: Statistical test limits for DCS 1 800 and PCS 1 900 TCH/AFS DARP DTS-1

DTS-1								
1.8 to 1.9GHz		C _{lev} (dBm)	Samples per second	Orig. BER requirement	Derived test limit	Target number of samples	Target test time (s)	Target test time (hh:mm:ss)
AFS 12.2	Frames	-76.0	50	0,010000	0,012340	27958	560	00:09:20
	Class1b	(as frames)	8150	0,008700	0,010736	32134	4	00:00:04
AFS 10.2	Frames	-77.0	50	0,010000	0,012340	27958	560	00:09:20
	Class1b	(as frames)	6950	0,002000	0,002468	139789	20	00:00:20
AFS 7.95	Frames	-79.5	50	0,010000	0,012340	27958	560	00:09:20
	Class1b	(as frames)	4200	0,003600	0,004442	77667	18	00:00:18
AFS 7.4	Frames	-79.5	50	0,010000	0,012340	27958	560	00:09:20
	Class1b	(as frames)	4350	0,002000	0,002468	139789	32	00:00:32
AFS 6.7	Frames	-80.5	50	0,010000	0,012340	27958	560	00:09:20
	Class1b	(as frames)	3950	0,007000	0,008638	39939	10	00:00:10

AFS 5.9	Frames	-81.0	50	0,010000	0,012340	27958	560	00:09:20
	Class1b	(as frames)	3150	0,002000	0,002468	139789	44	00:00:44
AFS 5.15	Frames	-81.5	50	0,010000	0,012340	27958	560	00:09:20
	Class1b	(as frames)	2700	0,002500	0,003085	111831	41	00:00:41
AFS 4.75	Frames	-82.0	50	0,010000	0,012340	27958	560	00:09:20
	Class1b	(as frames)	2800	0,001500	0,001851	186385	66	00:01:06

14.11.2.2 DTS-4

14.11.2.2.1 Definition

The DARP reference test scenarios define a set of interfering signals and corresponding performance limits. These tests are a measure of the capability of the DARP receiver to receive a wanted modulated signal without exceeding a given degradation due to the presence of these specific unwanted modulated signals.

14.11.2.2.2 Conformance requirement

1. MS indicating support for Downlink Advanced Receiver Performance – phase I (see 3GPP TS 24.008) shall fulfil the requirements in table 2o for wanted signals on GMSK modulated channels under TU50 no FH propagation conditions and GMSK modulated interferers for the test scenarios defined in annex L. The reference performance shall be:

– For speech channels (TCH/FS, TCH/AFS_x, TCH/AHS_x) FER: ≤ 1 %

2. The values in table 2o are given as the C/I1 ratio, where C is the power level of the wanted signal and I1 is the power level of the dominant co-channel interferer (Co-channel 1, see annex L). In addition for speech channels the residual class Ib BER and residual class II BER performance shall not exceed the specified values in table 2o at the corresponding C/I1.

3GPP TS 45.005, subclause 6.3

14.11.2.2.3 Test purpose

To verify that the MS does not exceed the first conformance requirement for TCH/AFS under propagation condition TU_{high} with an allowance for the statistical significance of the test.

To verify that the MS does not exceed the second conformance requirement for TCH/AFS under propagation condition TU_{high} with an allowance for the statistical significance of the test.

14.11.2.2.4 Method of test

14.11.2.2.4.1 Initial conditions

A call is set up according to the generic call set up procedure on a TCH/AFS with an ARFCN in the mid ARFCN range, power control level set to maximum power. RADIO_LINK_TIMEOUT is set to maximum.

The multirate configuration indicates the use of a codec set limited to 12,2 kbit/s.

The SS transmits Standard Test Signal C1 on the traffic channel (wanted signal), with training sequence code (TSC) = 0.

The SS commands the MS to create the traffic channel loop back, signalling erased frames (subclause 36).

14.11.2.2.4.2 Procedure

- a) In addition to the wanted signal, the SS produces one further interfering signal to produce scenario DTS-4.

A signal of type I5 using the same ARFCN as C1, with fading characteristics of TU_{high}, and signal level of -77 dBm.

- b) The SS sets the level of the wanted signal to that indicated by C_{lev} in table 14.11.2.2-2 or 14-11.2.2-3.

- c) The SS compares the modulation of the signal that it sends to the MS with the signal which is looped back from the receiver after demodulation and decoding, and checks the frame erasure indication.
- d) The SS determines the number of residual bit error events for the bits of the class Ib, by examining at least the minimum number of samples of consecutive bits of class Ib. Bits are only taken from those frames not signalled as erased.
- e) The SS also determines the frame erasure events by examining at least the minimum number of samples of consecutive frames and assuming a frame is received successfully it is not signalled as erased.
- f) The SS uses a Channel Mode Modify procedure to change the active codec set to 5,9 kbit/s and steps b) to e) are repeated.

Maximum/Minimum Duration of Test

Maximum: 19 minutes (GSM850), 19 minutes (GSM900), 19 minutes (DCS1800), 19 minutes (PCS1900).

Minimum: 7 minutes (GSM850), 6 minutes (GSM900), 3 minutes (DCS1800), 3 minutes (PCS1900).

14.11.2.2.5 Test requirements

Testing should be performed using statistical methods that lead to an early pass/fail decision with test time significantly reduced for MS with FER/BER not on the limit.

For more information on statistical testing of BER/BLER performance, especially the definition of limit lines refer to Annex 7.

Wrong decision risk F for one single error rate test:

$$F_{\text{pass}} = F_{\text{fail}} = F \quad \text{and} \quad F = 0.2\%$$

Wrong decision probability D per test step:

$$D_{\text{pass}} = D_{\text{fail}} = D \quad \text{and} \quad D = 0.0085\%$$

Parameters for limit lines:

1. D = 0.000085 wrong decision probability per test step.
2. M = 1.5 bad DUT factor
3. ne number of (error) events. This parameter is the x-ordinate in figure A7.1.3.1.
4. ns number of samples. The error rate is calculated from ne and ns.

Limit checking

Before limit checking is valid the minimum test time due to fading needs to be considered:

Testing under multipath and interference conditions requires that at least 990 wavelengths are crossed with the speed given in the fading profile. This leads to a minimum test time depending on the frequency range. No early pass/fail decision is allowed until the minimum test time due to fading has elapsed.

Table 14.11.2.2-1: Minimum test times due to TU 50 fading conditions

Full Rate 50 km/h					
Frequency	0,85	0,9	1,8	1,9	GHz
Wavelength	0,35	0,33	0,17	0,16	m
min test time	201	190	95	90	s
	0:03:21	0:03:10	0:01:35	0:01:30	hh:mm:ss

If the minimum test time due to multipath conditions exceeds the target test time, then the test runs for the minimum test time due to multipath conditions and the decision is made by comparing the result with the “derived test limit”. In this case early pass/fail decisions are obsolete.

If the target test time exceeds the minimum test time due to multipath conditions early pass/fail decisions can be headed for in order to accelerate test execution.

For an early decision a minimum number of (error) events is necessary.

For an early pass decision $ne \geq 1$ (inclusive artificial error)

For an early fail decision $ne \geq 7$

When the target test time has been reached the test is finished and a pass/fail decision can be made.

The error rate measured in this test shall be tested according to the values given in tables 14.11.2.2-2 or 14.11.2.2-3.

Table 14.11.2.2-2: Statistical test limits for GSM 850 and GSM 900 TCH/AFS DARP DTS-4

DTS-4								
0.8 to 0.9GHz		C_{lev} (dBm)	Samples per second	Orig. BER requirement	Derived test limit	Target number of samples	Target test time (s)	Target test time (hh:mm:ss)
AFS 12.2	Frames	-73.5	50	0,010000	0,012340	27958	560	00:09:20
	Class1b	(as frames)	8150	0,008000	0,009872	34947	5	00:00:05
AFS 5.9	Frames	-79.0	50	0,010000	0,012340	27958	560	00:09:20
	Class1b	(as frames)	3150	0,001600	0,001974	174772	56	00:00:56

Table 14.11.2.2-3: Statistical test limits for DCS 1 800 and PCS 1 900 TCH/AFS DARP DTS-4

DTS-4								
1.8 to 1.9GHz		C_{lev} (dBm)	Samples per second	Orig. BER requirement	Derived test limit	Target number of samples	Target test time (s)	Target test time (hh:mm:ss)
AFS 12.2	Frames	-74.0	50	0,010000	0,012340	27958	560	00:09:20
	Class1b	(as frames)	8150	0,009500	0,011723	29429	4	00:00:04
AFS 5.9	Frames	-80.0	50	0,010000	0,012340	27958	560	00:09:20
	Class1b	(as frames)	3150	0,002100	0,002491	138498	44	00:00:44

14.11.2.3 DTS-2/3/5

14.11.2.3.1 Definition

The DARP reference test scenarios define a set of interfering signals and corresponding performance limits. These tests are a measure of the capability of the DARP receiver to receive a wanted modulated signal without exceeding a given degradation due to the presence of these specific unwanted modulated signals.

14.11.2.3.2 Conformance requirement

- MS indicating support for Downlink Advanced Receiver Performance – phase I (see 3GPP TS 24.008) shall fulfil the requirements in table 2o for wanted signals on GMSK modulated channels under TU50 no FH propagation conditions and GMSK modulated interferers for the test scenarios defined in annex L. The reference performance shall be:

- For speech channels (TCH/FS, TCH/AFS_x, TCH/AHS_x) FER: ≤ 1 %

2. The values in table 2o are given as the C/I1 ratio, where C is the power level of the wanted signal and I1 is the power level of the dominant co-channel interferer (Co-channel 1, see annex L).
In addition for speech channels the residual class Ib BER and residual class II BER performance shall not exceed the specified values in table 2o at the corresponding C/I1.

3GPP TS 45.005, subclause 6.3

14.11.2.3.3 Test purpose

To verify that the MS does not exceed the first conformance requirement for TCH/AFS under propagation condition TU_{high} with an allowance for the statistical significance of the test.

To verify that the MS does not exceed the second conformance requirement for TCH/AFS under propagation condition TU_{high} with an allowance for the statistical significance of the test.

14.11.2.3.4 Method of test

14.11.2.3.4.1 Initial conditions

A call is set up according to the generic call set up procedure on a TCH/AFS with an ARFCN in the mid ARFCN range, power control level set to maximum power. RADIO_LINK_TIMEOUT is set to maximum.

The multirate configuration indicates the use of a codec set limited to 10,2 kbit/s.

The SS transmits Standard Test Signal C1 on the traffic channel (wanted signal), with training sequence code (TSC) = 0.

The SS commands the MS to create the traffic channel loop back, signalling erased frames (subclause 36).

14.11.2.3.4.2 Procedure

- a) In addition to the wanted signal, the SS produces a further four interfering signals to produce scenario DTS-2.
 - A signal of type I1 using the same ARFCN as C1, with fading characteristics of TU_{High}, and signal level of -80 dBm.
 - A signal of type I1 using the same ARFCN as C1, with fading characteristics of TU_{High}, and signal level of -90 dBm.
 - A signal of type I1 using an ARFCN one higher than C1, with fading characteristics of TU_{High}, and signal level of -77 dBm.
 - A signal of type I3 using the same ARFCN as C1, and signal level of -97 dBm.
- b) The SS sets the level of the wanted signal to that indicated by C_{lev} in table 14.11.2.3-2 or 14.11.2.3-3, and sets the fading characteristic of the signal to TU_{High}.
- c) The SS compares the modulation of the signal that it sends to the MS with the signal which is looped back from the receiver after demodulation and decoding, and checks the frame erasure indication.
- d) The SS determines the number of residual bit error events for the bits of the class Ib, by examining at least the minimum number of samples of consecutive bits of class Ib. Bits are only taken from those frames not signalled as erased.
- e) The SS also determines the frame erasure events by examining at least the minimum number of samples of consecutive frames and assuming a frame is received successfully it is not signalled as erased.
- f) The SS uses a Channel Mode Modify procedure to change the active codec set to 4,75 kbit/s and steps b) to e) are repeated.
- g) The SS discontinues all interfering signals.
- h) In addition to the wanted signal, the SS produces a further four interfering signals to produce scenario DTS-3.

A signal of type I4 using the same ARFCN as C1, with fading characteristics of TUHigh, and signal level of -80 dBm.

A signal of type I1 using the same ARFCN as C1, with fading characteristics of TUHigh, and signal level of -90 dBm.

A signal of type I1 using an ARFCN one lower than C1, with fading characteristics of TUHigh, and signal level of -77 dBm.

A signal of type I3 using the same ARFCN as C1, and signal level of -97 dBm.

i) The SS uses a Channel Mode Modify procedure to change the active codec set to 7,95 kbit/s and steps b) to e) are repeated.

j) The SS uses a Channel Mode Modify procedure to change the active codec set to 5,15 kbit/s and steps b) to e) are repeated.

k) The SS discontinues all interfering signals.

l) In addition to the wanted signal, the SS produces a further four interfering signals to produce scenario DTS-5.

A signal of type I5 using the same ARFCN as C1, with fading characteristics of TUHigh, and signal level of -77 dBm.

A signal of type I1 using the same ARFCN as C1, with fading characteristics of TUHigh, and signal level of -90 dBm.

A signal of type I1 using an ARFCN one higher than C1, with fading characteristics of TUHigh, and signal level of -77 dBm.

A signal of type I3 using the same ARFCN as C1, and signal level of -97 dBm.

m) The SS uses a Channel Mode Modify procedure to change the active codec set to 12,2 kbit/s and steps b) to e) are repeated.

n) The SS uses a Channel Mode Modify procedure to change the active codec set to 5,9 kbit/s and steps b) to e) are repeated.

Maximum/Minimum Duration of Test

Maximum: 56 minutes (GSM850), 56 minutes (GSM900), 56 minutes (DCS1800), 56 minutes (PCS1900).

Minimum: 20 minutes (GSM850), 19 minutes (GSM900), 10 minutes (DCS1800), 9 minutes (PCS1900).

14.11.2.3.5 Test requirements

Testing should be performed using statistical methods that lead to an early pass/fail decision with test time significantly reduced for MS with FER/BER not on the limit.

For more information on statistical testing of BER/BLER performance, especially the definition of limit lines refer to Annex 7.

Wrong decision risk F for one single error rate test:

$$F_{\text{pass}} = F_{\text{fail}} = F \quad \text{and} \quad F = 0.2\%$$

Wrong decision probability D per test step:

$$D_{\text{pass}} = D_{\text{fail}} = D \quad \text{and} \quad D = 0.0085\%$$

Parameters for limit lines:

1. D = 0.000085 wrong decision probability per test step.
2. M = 1.5 bad DUT factor
3. ne number of (error) events. This parameter is the x-ordinate in figure A7.1.3.1.

4. n_s number of samples. The error rate is calculated from n_e and n_s .

Limit checking

Before limit checking is valid the minimum test time due to fading needs to be considered:

Testing under multipath and interference conditions requires that at least 990 wavelengths are crossed with the speed given in the fading profile. This leads to a minimum test time depending on the frequency range. No early pass/fail decision is allowed until the minimum test time due to fading has elapsed.

Table 14.11.2.3-1: Minimum test times due to TU 50 fading conditions

Full Rate 50 km/h					
Frequency	0,85	0,9	1,8	1,9	GHz
Wavelength	0,35	0,33	0,17	0,16	m
min test time	201	190	95	90	s
	0:03:21	0:03:10	0:01:35	0:01:30	hh:mm:ss

If the minimum test time due to multipath conditions exceeds the target test time, then the test runs for the minimum test time due to multipath conditions and the decision is made by comparing the result with the “derived test limit”. In this case early pass/fail decisions are obsolete.

If the target test time exceeds the minimum test time due to multipath conditions early pass/fail decisions can be headed for in order to accelerate test execution.

For an early decision a minimum number of (error) events is necessary.

For an early pass decision $n_e \geq 1$ (inclusive artificial error)

For an early fail decision $n_e \geq 7$

When the target test time has been reached the test is finished and a pass/fail decision can be made.

The error rate measured in this test shall be tested according to the values given in tables 14.11.2.3-2 or 14.11.2.3-3.

Table 14.11.2.3-2: Statistical test limits for GSM 850 and GSM 900 TCH/AFS DARP DTS-2/3/5

DTS-2/3/5								
0.8 to 0.9GHz		C_{lev} (dBm)	Samples per second	Orig. BER requirement	Derived test limit	Target number of samples	Target test time (s)	Target test time (hh:mm:ss)
AFS 10.2	Frames	-71.5	50	0,010000	0,012340	27958	560	00:09:20
	DTS-2	(as frames)	6950	0,001500	0,001851	186385	27	00:00:27
AFS 4.75	Frames	-75.5	50	0,010000	0,012340	27958	560	00:09:20
	DTS-2	(as frames)	2800	0,001500	0,001851	186385	67	00:01:07
AFS 7.95	Frames	-72.5	50	0,010000	0,012340	27958	560	00:09:20
	DTS-3	(as frames)	4200	0,002800	0,003455	99855	24	00:00:24
AFS 5.15	Frames	-74.5	50	0,010000	0,012340	27958	560	00:09:20
	DTS-3	(as frames)	2700	0,002500	0,003085	111831	42	00:00:42
AFS 12.2	Frames	-70.0	50	0,010000	0,012340	27958	560	00:09:20

DTS-5	Class1b	(as frames)	8150	0,007000	0,008638	39939	5	00:00:05
AFS 5.9	Frames	-74.5	50	0,010000	0,012340	27958	560	00:09:20
DTS-5	Class1b	(as frames)	3150	0,002000	0,002468	139789	45	00:00:45

Table 14.11.2.3-3: Statistical test limits for DCS 1 800 and PCS 1 900 TCH/AFS DARP DTS-2/3/5

DTS-2/3/5								
1.8 to 1.9GHz		C _{lev} (dBm)	Samples per second	Orig. BER requirement	Derived test limit	Target number of samples	Target test time (s)	Target test time (hh:mm:ss)
AFS 10.2	Frames	-72.5	50	0,010000	0,012340	27958	560	00:09:20
DTS-2	Class1b	(as frames)	6950	0,002000	0,002468	139789	21	00:00:21
AFS 4.75	Frames	-77.0	50	0,010000	0,012340	27958	560	00:09:20
DTS-2	Class1b	(as frames)	2800	0,002000	0,002468	139789	50	00:00:50
AFS 7.95	Frames	-73.5	50	0,010000	0,012340	27958	560	00:09:20
DTS-3	Class1b	(as frames)	4200	0,004000	0,004936	69894	17	00:00:17
AFS 5.15	Frames	-75.5	50	0,010000	0,012340	27958	560	00:09:20
DTS-3	Class1b	(as frames)	2700	0,002500	0,003085	111831	42	00:00:42
AFS 12.2	Frames	-71.0	50	0,010000	0,012340	27958	560	00:09:20
DTS-5	Class1b	(as frames)	8150	0,011000	0,013574	25416	4	00:00:04
AFS 5.9	Frames	-76.0	50	0,010000	0,012340	27958	560	00:09:20
DTS-5	Class1b	(as frames)	3150	0,002200	0,002715	127071	41	00:00:41

14.11.3 TCH/AHS

14.11.3.1 DTS-1

14.11.3.1.1 Definition

The DARP reference test scenarios define a set of interfering signals and corresponding performance limits. These tests are a measure of the capability of the DARP receiver to receive a wanted modulated signal without exceeding a given degradation due to the presence of these specific unwanted modulated signals.

14.11.3.1.2 Conformance requirement

- MS indicating support for Downlink Advanced Receiver Performance – phase I (see 3GPP TS 24.008) shall fulfil the requirements in table 2o for wanted signals on GMSK modulated channels under TU50 no FH propagation conditions and GMSK modulated interferers for the test scenarios defined in annex L. The reference performance shall be:
 - For speech channels (TCH/FS, TCH/AFS_x, TCH/AHS_x) FER: ≤ 1 %
- The values in table 2o are given as the C/I1 ratio, where C is the power level of the wanted signal and I1 is the power level of the dominant co-channel interferer (Co-channel 1, see annex L). In addition for speech channels the residual class Ib BER and residual class II BER performance shall not exceed the specified values in table 2o at the corresponding C/I1.

3GPP TS 45.005, subclause 6.3

14.11.3.1.3 Test purpose

To verify that the MS does not exceed the first conformance requirement for TCH/AHS under propagation condition TU_{high} with an allowance for the statistical significance of the test.

To verify that the MS does not exceed the second conformance requirement for TCH/AHS under propagation condition TU_{high} with an allowance for the statistical significance of the test.

14.11.3.1.4 Method of test

14.11.3.1.4.1 Initial conditions

A call is set up according to the generic call set up procedure on a TCH/AHS with an ARFCN in the mid ARFCN range, power control level set to maximum power. RADIO_LINK_TIMEOUT is set to maximum.

The multirate configuration indicates the use of a codec set limited to 7,95 kbit/s.

The SS transmits Standard Test Signal C1 on the traffic channel (wanted signal), with training sequence code (TSC) = 0.

The SS commands the MS to create the traffic channel loop back, signalling erased frames (subclause 36).

14.11.3.1.4.2 Procedure

- a) In addition to the wanted signal, the SS produces one further interfering signal to produce scenario DTS-1.

A signal of type II using the same ARFCN as C1, with fading characteristics of TU_{High}, and signal level of -80 dBm.

- b) The SS sets the level of the wanted signal to that indicated by C_{lev} in table 14.11.3.1-2 or 14.11.3.1-3.
- c) The SS compares the modulation of the signal that it sends to the MS with the signal which is looped back from the receiver after demodulation and decoding, and checks the frame erasure indication.
- d) The SS determines the number of residual bit error events for the bits of the class Ib and II, by examining at least the minimum number of samples of consecutive bits of class Ib and II. Bits are only taken from those frames not signalled as erased.
- e) The SS also determines the frame erasure events by examining at least the minimum number of samples of consecutive frames and assuming a frame is received successfully if it is not signalled as erased.
- f) The SS uses a Channel Mode Modify procedure to change the active codec set to 7,4 kbit/s and steps b) to e) are repeated.
- g) The SS uses a Channel Mode Modify procedure to change the active codec set to 6,7 kbit/s and steps b) to e) are repeated.
- h) The SS uses a Channel Mode Modify procedure to change the active codec set to 5,9 kbit/s and steps b) to e) are repeated.
- i) The SS uses a Channel Mode Modify procedure to change the active codec set to 5,15 kbit/s and steps b) to e) are repeated.
- m) The SS uses a Channel Mode Modify procedure to change the active codec set to 4,75 kbit/s and steps b) to e) are repeated.

Maximum/Minimum Duration of Test

Maximum: 56 minutes (GSM850), 56 minutes (GSM900), 56 minutes (DCS1800), 56 minutes (PCS1900).

Minimum: 41 minutes (GSM850), 38 minutes (GSM900), 19 minutes (DCS1800), 18 minutes (PCS1900).

14.11.3.1.5 Test requirements

Testing should be performed using statistical methods that lead to an early pass/fail decision with test time significantly reduced for MS with FER/BER not on the limit.

For more information on statistical testing of BER/BLER performance, especially the definition of limit lines refer to Annex 7.

Wrong decision risk F for one single error rate test:

$$F_{\text{pass}} = F_{\text{fail}} = F \quad \text{and} \quad F = 0.2\%$$

Wrong decision probability D per test step:

$$D_{\text{pass}} = D_{\text{fail}} = D \quad \text{and} \quad D = 0.0085\%$$

Parameters for limit lines:

1. D = 0.000085 wrong decision probability per test step.
2. M = 1.5 bad DUT factor
3. ne number of (error) events. This parameter is the x-ordinate in figure A7.1.3.2.
4. ns number of samples. The error rate is calculated from ne and ns.

Limit checking

Before limit checking is valid the minimum test time due to fading needs to be considered:

Testing under multipath and interference conditions requires that at least 990 wavelengths are crossed with the speed given in the fading profile. This leads to a minimum test time depending on the frequency range. No early pass/fail decision is allowed until the minimum test time due to fading has elapsed.

Table 14.11.3.1-1: Minimum test times due to TU high fading conditions

Half Rate 50 km/h					
Frequency	0,85	0,9	1,8	1,9	GHz
Wavelength	0,35	0,33	0,17	0,16	m
min test time	403	380	190	180	s
	0:06:43	0:06:20	0:03:10	0:03:00	hh:mm:ss

If the minimum test time due to multipath conditions exceeds the target test time, then the test runs for the minimum test time due to multipath conditions and the decision is made by comparing the result with the “derived test limit”. In this case early pass/fail decisions are obsolete.

If the target test time exceeds the minimum test time due to multipath conditions early pass/fail decisions can be headed for in order to accelerate test execution.

For an early decision a minimum number of (error) events is necessary.

For an early pass decision $ne \geq 1$ (inclusive artificial error)

For an early fail decision $ne \geq 7$

When the target test time has been reached the test is finished and a pass/fail decision can be made.

The error rate measured in this test shall be tested according to the values given in tables 14.11.3.1-2 or 14.11.3.1-3.

Table 14-11.3.1-2: Statistical test limits for GSM 850 and GSM 900 TCH/AHS DARP DTS-1

DTS-1								
0.8 to 0.9GHz		C _{lev} (dBm)	Samples per second	Orig. BER requirement	Derived test limit	Target number of samples	Target test time (s)	Target test time (hh:mm:ss)
AHS 7.95	Frames	-71.0	50	0.010000	0.012340	27959	560	0:09:20

	Class1b	(as frames)	2800	0.003500	0.004319	79881	29	0:00:29
	Class II	(as frames)	1800	0.018000	0.022212	15533	9	0:00:09
AHS 7.4	Frames	-71.5	50	0.010000	0.012340	27959	560	0:09:20
	Class1b	(as frames)	2950	0.002500	0.003085	111832	38	0:00:38
	Class II	(as frames)	1400	0.022000	0.027148	12709	10	0:00:10
AHS 6.7	Frames	-73.0	50	0.010000	0.012340	27959	560	0:09:20
	Class1b	(as frames)	2750	0.002500	0.003085	111832	41	0:00:41
	Class II	(as frames)	1200	0.029000	0.035786	9642	9	0:00:09
AHS 5.9	Frames	-74.0	50	0.010000	0.012340	27959	560	0:09:20
	Class1b	(as frames)	2350	0.001500	0.001851	186387	80	0:01:20
	Class II	(as frames)	800	0.037000	0.045658	7557	10	0:00:10
AHS 5.15	Frames	-75.5	50	0.010000	0.012340	27959	560	0:09:20
	Class1b	(as frames)	2100	0.002500	0.003085	111832	54	0:00:54
	Class II	(as frames)	600	0.049000	0.060466	5707	10	0:00:10
AHS 4.75	Frames	-77.0	50	0.010000	0.012340	27959	560	0:09:20
	Class1b	(as frames)	2200	0.002000	0.002468	139790	64	0:01:04
	Class II	(as frames)	600	0.065000	0.080210	4302	8	0:00:08

Table 14-11.3.1-3: Statistical test limits for DCS 1 800 and PCS 1 900 TCH/AHS DARP DTS-1

DTS-1								
1.8 to 1.9GHz		C _{lev} (dBm)	Samples per second	Orig. BER requirement	Derived test limit	Target number of samples	Target test time (s)	Target test time (hh:mm:ss)
AHS 7.95	Frames	-70.0	50	0.010000	0.012340	27959	560	0:09:20
	Class1b	(as frames)	2800	0.003500	0.004319	79881	29	0:00:29
	Class II	(as frames)	1800	0.017000	0.020978	16447	10	0:00:10
AHS 7.4	Frames	-71.0	50	0.010000	0.012340	27959	560	0:09:20
	Class1b	(as frames)	2950	0.002000	0.002468	139790	48	0:00:48
	Class II	(as frames)	1400	0.021000	0.025914	13314	10	0:00:10
AHS 6.7	Frames	-72.5	50	0.010000	0.012340	27959	560	0:09:20
	Class1b	(as frames)	2750	0.002500	0.003085	111832	41	0:00:41
	Class II	(as frames)	1200	0.032000	0.039488	8738	8	0:00:08
AHS 5.9	Frames	-74.0	50	0.010000	0.012340	27959	560	0:09:20
	Class1b	(as frames)	2350	0.001500	0.001851	186387	80	0:01:20
	Class II	(as frames)	800	0.038000	0.046892	7358	10	0:00:10
AHS 5.15	Frames	-75.0	50	0.010000	0.012340	27959	560	0:09:20
	Class1b	(as frames)	2100	0.003100	0.003825	90188	43	0:00:43
	Class II	(as frames)	600	0.050000	0.061700	5593	10	0:00:10

AHS 4.75	Frames	-76.5	50	0.010000	0.012340	27959	560	0:09:20
	Class1b	(as frames)	2200	0.002000	0.002468	139790	64	0:01:04
	Class II	(as frames)	600	0.067000	0.082678	4174	7	0:00:07

14.11.3.2 Void

14.11.3.3 DTS-2/3

14.11.3.3.1 Definition

The DARP reference test scenarios define a set of interfering signals and corresponding performance limits. These tests are a measure of the capability of the DARP receiver to receive a wanted modulated signal without exceeding a given degradation due to the presence of these specific unwanted modulated signals.

14.11.3.3.2 Conformance requirement

3. MS indicating support for Downlink Advanced Receiver Performance – phase I (see 3GPP TS 24.008) shall fulfil the requirements in table 2o for wanted signals on GMSK modulated channels under TU50 no FH propagation conditions and GMSK modulated interferers for the test scenarios defined in annex L. The reference performance shall be:

– For speech channels (TCH/FS, TCH/AFS_x, TCH/AHS_x) FER: $\leq 1\%$

4. The values in table 2o are given as the C/I1 ratio, where C is the power level of the wanted signal and I1 is the power level of the dominant co-channel interferer (Co-channel 1, see annex L). In addition for speech channels the residual class Ib BER and residual class II BER performance shall not exceed the specified values in table 2o at the corresponding C/I1.

3GPP TS 45.005, subclause 6.3

14.11.3.3.3 Test purpose

To verify that the MS does not exceed the first conformance requirement for TCH/AHS under propagation condition TU_{high} with an allowance for the statistical significance of the test.

To verify that the MS does not exceed the second conformance requirement for TCH/AHS under propagation condition TU_{high} with an allowance for the statistical significance of the test.

14.11.3.3.4 Method of test

14.11.3.3.4.1 Initial conditions

A call is set up according to the generic call set up procedure on a TCH/AHS with an ARFCN in the mid ARFCN range, power control level set to maximum power. RADIO_LINK_TIMEOUT is set to maximum.

The multirate configuration indicates the use of a codec set limited to 7,4 kbit/s.

The SS transmits Standard Test Signal C1 on the traffic channel (wanted signal), with training sequence code (TSC) = 0.

The SS commands the MS to create the traffic channel loop back, signalling erased frames (subclause 36).

14.11.3.3.4.2 Procedure

- a) In addition to the wanted signal, the SS produces a further four interfering signals to produce scenario DTS-2.
- A signal of type I1 using the same ARFCN as C1, with fading characteristics of TUHigh, and signal level of -80 dBm.
 - A signal of type I1 using the same ARFCN as C1, with fading characteristics of TUHigh, and signal level of -90 dBm.
 - A signal of type I1 using an ARFCN one higher than C1, with fading characteristics of TUHigh, and signal level of -77 dBm.
 - A signal of type I3 using the same ARFCN as C1, and signal level of -97 dBm.
- b) The SS sets the level of the wanted signal to that indicated by C_{lev} in table 14.11.3.3-2 or 14.11.3.3-3, and sets the fading characteristic of the signal to TUHigh..
- c) The SS compares the modulation of the signal that it sends to the MS with the signal which is looped back from the receiver after demodulation and decoding, and checks the frame erasure indication.
- d) The SS determines the number of residual bit error events for the bits of the class Ib and II, by examining at least the minimum number of samples of consecutive bits of class Ib and II. Bits are only taken from those frames not signalled as erased.
- e) The SS also determines the frame erasure events by examining at least the minimum number of samples of consecutive frames and assuming a frame is received successfully if it is not signalled as erased.
- n) The SS uses a Channel Mode Modify procedure to change the active codec set to 4,75 kbit/s and steps b) to e) are repeated.
- o) The SS discontinues all interfering signals.
- p) In addition to the wanted signal, the SS produces a further four interfering signals to produce scenario DTS-3.
- A signal of type I4 using the same ARFCN as C1, with fading characteristics of TUHigh, and signal level of -80 dBm.
 - A signal of type I1 using the same ARFCN as C1, with fading characteristics of TUHigh, and signal level of -90 dBm.
 - A signal of type I1 using an ARFCN one lower than C1, with fading characteristics of TUHigh, and signal level of -77 dBm.
 - A signal of type I3 using the same ARFCN as C1, and signal level of -97 dBm.
- q) The SS uses a Channel Mode Modify procedure to change the active codec set to 6,7 kbit/s and steps b) to e) are repeated.
- r) The SS uses a Channel Mode Modify procedure to change the active codec set to 5,15 kbit/s and steps b) to e) are repeated.

Maximum/Minimum Duration of Test

Maximum: 38 minutes (GSM850), 38 minutes (GSM900), 38 minutes (DCS1800), 38 minutes (PCS1900).

Minimum: 27 minutes (GSM850), 26 minutes (GSM900), 13 minutes (DCS1800), 12 minutes (PCS1900).

14.11.3.3.5 Test requirements

Testing should be performed using statistical methods that lead to an early pass/fail decision with test time significantly reduced for MS with FER/BER not on the limit.

For more information on statistical testing of BER/BLER performance, especially the definition of limit lines refer to Annex 7.

Wrong decision risk F for one single error rate test:

$$F_{\text{pass}} = F_{\text{fail}} = F \quad \text{and} \quad F = 0.2\%$$

Wrong decision probability D per test step:

$$D_{\text{pass}} = D_{\text{fail}} = D \quad \text{and} \quad D = 0.0085\%$$

Parameters for limit lines:

1. D = 0.000085 wrong decision probability per test step.
2. M = 1.5 bad DUT factor
3. ne number of (error) events. This parameter is the x-ordinate in figure A7.1.3.1.
4. ns number of samples. The error rate is calculated from ne and ns.

Limit checking

Before limit checking is valid the minimum test time due to fading needs to be considered:

Testing under multipath and interference conditions requires that at least 990 wavelengths are crossed with the speed given in the fading profile. This leads to a minimum test time depending on the frequency range. No early pass/fail decision is allowed until the minimum test time due to fading has elapsed.

Table 14.11.3.3-1: Minimum test times due to TU 50 fading conditions

Half Rate 50 km/h					
Frequency	0,85	0,9	1,8	1,9	GHz
Wavelength	0,35	0,33	0,17	0,16	m
min test time	403	380	190	180	s
	0:06:43	0:06:20	0:03:10	0:03:00	hh:mm:ss

If the minimum test time due to multipath conditions exceeds the target test time, then the test runs for the minimum test time due to multipath conditions and the decision is made by comparing the result with the “derived test limit”. In this case early pass/fail decisions are obsolete.

If the target test time exceeds the minimum test time due to multipath conditions early pass/fail decisions can be headed for in order to accelerate test execution.

For an early decision a minimum number of (error) events is necessary.

For an early pass decision $ne \geq 1$ (inclusive artificial error)

For an early fail decision $ne \geq 7$

When the target test time has been reached the test is finished and a pass/fail decision can be made.

The error rate measured in this test shall be tested according to the values given in tables 14.11.3.3-2 or 14.11.3.3-3.

Table 14.11.3.3-2: Statistical test limits for GSM 850 and GSM 900 TCH/AHS DARP DTS-2/3

DTS-2/3								
0.8 to 0.9GHz		C _{lev} (dBm)	Samples per second	Orig. BER requirement	Derived test limit	Target number of samples	Target test time (s)	Target test time (hh:mm:ss)
AHS 7.4	Frames	-67.5	50	0.010000	0.012340	27959	560	0:09:20
DTS-2	Class1b	(as frames)	2950	0.002000	0.002468	139790	48	0:00:48

	Class II	(as frames)	1400	0.019000	0.023446	14716	11	0:00:11
AHS 4.75	Frames	-72.5	50	0.010000	0.012340	27959	560	0:09:20
DTS-2	Class1b	(as frames)	2200	0.002500	0.003085	111832	51	0:00:51
	Class II	(as frames)	600	0.058000	0.071572	4821	9	0:00:09
AHS 6.7	Frames	-68.0	50	0.010000	0.012340	27959	560	0:09:20
DTS-3	Class1b	(as frames)	2750	0.002500	0.003085	111832	41	0:00:41
	Class II	(as frames)	1200	0.025000	0.030850	11184	10	0:00:10
AHS 5.15	Frames	-70.0	50	0.010000	0.012340	27959	560	0:09:20
DTS-3	Class1b	(as frames)	2100	0.003000	0.003702	93194	45	0:00:45
	Class II	(as frames)	600	0.048000	0.059232	5826	10	0:00:10

Table 14.11.3.3-3: Statistical test limits for DCS 1 800 and PCS 1 900 TCH/AHS DARP DTS-2/3

DTS-2/3								
1.8 to 1.9GHz		C _{lev} (dBm)	Samples per second	Orig. BER requirement	Derived test limit	Target number of samples	Target test time (s)	Target test time (hh:mm:ss)
AHS 7.4	Frames	-67.0	50	0.010000	0.012340	27959	560	0:09:20
DTS-2	Class1b	(as frames)	2950	0.002000	0.002468	139790	48	0:00:48
	Class II	(as frames)	1400	0.019000	0.023446	14716	11	0:00:11
AHS 4.75	Frames	-72.0	50	0.010000	0.012340	27959	560	0:09:20
DTS-2	Class1b	(as frames)	2200	0.002500	0.003085	111832	51	0:00:51
	Class II	(as frames)	600	0.059000	0.072806	4740	8	0:00:08
AHS 6.7	Frames	-67.5	50	0.010000	0.012340	27959	560	0:09:20
DTS-3	Class1b	(as frames)	2750	0.002500	0.003085	111832	41	0:00:41
	Class II	(as frames)	1200	0.025000	0.030850	11184	10	0:00:10
AHS 5.15	Frames	-70.0	50	0.010000	0.012340	27959	560	0:09:20
DTS-3	Class1b	(as frames)	2100	0.003000	0.003702	93194	45	0:00:45
	Class II	(as frames)	600	0.044000	0.054296	6355	11	0:00:11

14.12 DARP Phase 1 Signalling bearer tests

14.12.1 FACCH/F

14.12.1.1 FACCH – DTS-1

14.12.1.1.1 Definition

The DARP reference test scenarios define a set of interfering signals and corresponding performance limits. These tests are a measure of the capability of the DARP receiver to receive a wanted modulated signal without exceeding a given degradation due to the presence of these specific unwanted modulated signals.

14.12.1.1.2 Conformance requirement

1. MS indicating support for Downlink Advanced Receiver Performance – phase I (see 3GPP TS 24.008) shall fulfil the requirements in table 2o for wanted signals on GMSK modulated channels under TU50 no FH propagation conditions and GMSK modulated interferers for the test scenarios defined in annex L. The reference performance shall be:
 - For signalling channels (FACCH/F, SDCCH) FER: $\leq 5 \%$
2. The values in table 2o are given as the C/I1 ratio, where C is the power level of the wanted signal and I1 is the power level of the dominant co-channel interferer (Co-channel 1, see annex L).

3GPP TS 45.005, subclause 6.3

14.12.1.1.3 Test purpose

To verify that the MS does not exceed the first conformance requirement for FACCH/F under propagation condition TUhigh with an allowance for the statistical significance of the test.

To verify that the MS does not exceed the second conformance requirement for FACCH/F under propagation condition TUhigh with an allowance for the statistical significance of the test.

14.12.1.1.4 Method of test

14.12.1.1.4.1 Initial conditions

A call is set up according to the generic call set up procedure on a TCH with an ARFCN in the mid ARFCN range. For MS supporting speech this shall be a TCH/FS. For MS not supporting speech one of the supported TCH/ (F9,6, F4,8 or F2,4) shall be used. The power control level set to maximum power. RADIO_LINK_TIMEOUT is set to maximum.

The SS transmits Standard Test Signal C1 on the traffic channel (wanted signal).

14.12.1.1.4.2 Procedure

- a) In addition to the wanted signal, the SS produces an independent, uncorrelated interfering signal, Standard Test Signal I1 (unwanted signal).

The unwanted signal is continuous and has no fixed relationship with the bit transitions of the wanted signal. The interfering signal level is set to -80 dBm.

The fading characteristic of the wanted and the interfering signal is TUHigh.

- b) The SS sets the level of the wanted signal to that indicated by C_{lev} in table 14-12.1.1.4.2 (GSM 900 / 850) and table 14-12.1.1.4.3 (DCS 1800 / 1900).
- c) The SS sends a Layer 3 message which does not require a Layer 3 response from the MS. Each repeated L2 frame indicates a frame erasure event.
- d) The SS determines the number of frame erasure events during at least the minimum number of samples of FACCH/F frames.

NOTE: These frames will not be consecutive but it is expected that the statistical significance of the tests will not be unduly degraded.

14.12.1.1.4.3 Test requirements

Testing should be performed using statistical methods that lead to an early pass/fail decision with test time significantly reduced for MS with FER/BER not on the limit.

For more information on statistical testing of BER/BLER performance, especially the definition of limit lines refer to Annex 7 (A7.1.3.2)

Wrong decision risk F for one single error rate test:

$$F_{\text{pass}} = F_{\text{fail}} = F \quad \text{and} \quad F = 0.2\%$$

Wrong decision probability D per test step:

$$D_{\text{pass}} = D_{\text{fail}} = D \quad \text{and} \quad D = 0.0085\%$$

Parameters for limit lines:

1. $D = 0.000085$ wrong decision probability per test step.
2. $M = 1.5$ bad DUT factor
3. n_e number of (error) events. This parameter is the x-ordinate in figure 14-1.
4. n_s number of samples. The error rate is calculated from n_e and n_s .

Limit checking

Before limit checking is valid the minimum test time due to fading needs to be considered:

Testing under multipath and interference conditions requires that at least 990 wavelengths are crossed with the speed given in the fading profile. This leads to a minimum test time depending on the frequency range. No early pass/fail decision is allowed until the minimum test time due to fading has elapsed.

Table 14-12.1.1.4.1: Minimum test times due to TU high fading conditions

Full Rate 50 km/h					
Frequency	0,85	0,9	1,8	1,9	GHz
Wavelength	0,35	0,33	0,17	0,16	M
min test time	403	380	190	180	S
	0:06:43	0:06:20	0:03:10	0:03:00	hh:mm:ss

If the minimum test time due to multipath conditions exceeds the target test time, then the test runs for the minimum test time due to multipath conditions and the decision is made by comparing the result with the “derived test limit”. In this case early pass/fail decisions are obsolete.

If the target test time exceeds the minimum test time due to multipath conditions early pass/fail decisions can be headed for in order to accelerate test execution.

For an early decision a minimum number of (error) ETS is necessary.

For an early pass decision $n_e \geq 1$ (inclusive artificial error).

For an early fail decision $n_e \geq 7$.

When the target test time has been reached the test is finished and a pass/fail decision can be made.

The error rate measured in this test shall be tested according to the values given in table 14-12.1.1.4.2

Table 14-12.1.1.4.2: Statistical test limits for FACCH/F DARP DTS-1 (GSM 900 / 850)

DTS-1								
		C_{lev} (dBm)	Samples per second	Orig. BER requirement	Derived test limit	Target number of samples	Target test time (s)	Target test time (hh:mm:ss)
FACCH/F	Frames	-77.0	5	0,050000	0,061700	5592	1119	00:18:39

Table 14-12.1.1.4.3: Statistical test limits for FACCH/F DARP DTS-1 (DCS 1800 / 1900)

DTS-1		C_{lev} (dBm)	Samples per second	Orig. BER requirement	Derived test limit	Target number of samples	Target test time (s)	Target test time (hh:mm:ss)
FACCH/F	Frames	-77.0	5	0,050000	0,061700	5592	1119	00:18:39

14.12.1.2 FACCH – DTS-2-3

14.12.1.2.1 Definition

The DARP reference test scenarios define a set of interfering signals and corresponding performance limits. These tests are a measure of the capability of the DARP receiver to receive a wanted modulated signal without exceeding a given degradation due to the presence of these specific unwanted modulated signals.

14.12.1.2.2 Conformance requirement

- MS indicating support for Downlink Advanced Receiver Performance – phase I (see 3GPP TS 24.008) shall fulfil the requirements in table 2o for wanted signals on GMSK modulated channels under TU50 no FH propagation conditions and GMSK modulated interferers for the test scenarios defined in annex L. The reference performance shall be:
 - For signalling channels (FACCH/F, SDCCH) FER: $\leq 5\%$
- The values in table 2o are given as the C/I1 ratio, where C is the power level of the wanted signal and I1 is the power level of the dominant co-channel interferer (Co-channel 1, see annex L).

3GPP TS 45.005, subclause 6.3

14.12.1.2.3 Test purpose

To verify that the MS does not exceed the first conformance requirement for FACCH/F under propagation condition TUhigh with an allowance for the statistical significance of the test.

To verify that the MS does not exceed the second conformance requirement for FACCH/F under propagation condition TUhigh with an allowance for the statistical significance of the test.

14.12.1.2.4 Method of test

14.12.1.2.4.1 Initial conditions

A call is set up according to the generic call set up procedure on a TCH with an ARFCN in the mid ARFCN range. For MS supporting speech this shall be a TCH/FS. For MS not supporting speech one of the supported TCH/ (F9,6, F4,8 or F2,4) shall be used. The power control level set to maximum power. RADIO_LINK_TIMEOUT is set to maximum.

The SS transmits Standard Test Signal C1 on the traffic channel (wanted signal).

14.12.1.2.4.2 Procedure

- a) In addition to the wanted signal, the SS produces a further four interfering signals to produce scenario DTS-2.

A signal of type I1 using the same ARFCN as C1, with fading characteristics of TUHigh, and signal level of -80 dBm.

A signal of type I1 using the same ARFCN as C1, with fading characteristics of TUHigh, and signal level of -90 dBm.

A signal of type I1 using an ARFCN one higher than C1, with fading characteristics of TUHigh, and signal level of -77 dBm.

A signal of type I3 using the same ARFCN as C1, and signal level of -97 dBm.

- b) The SS sets the level of the wanted signal to that indicated by C_{lev} in table 14-12.1.2.4.2 (GSM 900 / 850) and table 14-12.1.2.4.4 (DCS 1800 / 1900).
- c) The SS sends a Layer 3 message which does not require a Layer 3 response from the MS. Each repeated L2 frame indicates a frame erasure event.
- d) The SS determines the number of frame erasure events during at least the minimum number of samples of FACCH/F frames.

NOTE: These frames will not be consecutive but it is expected that the statistical significance of the tests will not be unduly degraded.

- e) The SS discontinues all interfering signals.

- f) In addition to the wanted signal, the SS produces a further four interfering signals to produce scenario DTS-3.

A signal of type I4 using the same ARFCN as C1, with fading characteristics of TUHigh, and signal level of -80 dBm.

A signal of type I1 using the same ARFCN as C1, with fading characteristics of TUHigh, and signal level of -90 dBm.

A signal of type I1 using an ARFCN one lower than C1, with fading characteristics of TUHigh, and signal level of -77 dBm.

A signal of type I3 using the same ARFCN as C1, and signal level of -97 dBm.

- g) The SS sets the level of the wanted signal to that indicated by C_{lev} in table 14-12.1.2.4.3 (GSM 900 / 850) and table 14-12.1.2.4.5 (DCS 1800 / 1900).

- h) The SS sends a Layer 3 message which does not require a Layer 3 response from the MS. Each repeated L2 frame indicates a frame erasure event.

- i) The SS determines the number of frame erasure events during at least the minimum number of samples of FACCH/F frames.

NOTE: These frames will not be consecutive but it is expected that the statistical significance of the tests will not be unduly degraded.

14.12.1.2.4.3 Test requirements

Testing should be performed using statistical methods that lead to an early pass/fail decision with test time significantly reduced for MS with FER/BER not on the limit.

For more information on statistical testing of BER/BLER performance, especially the definition of limit lines refer to Annex 6.2.

Wrong decision risk F for one single error rate test:

$$F_{pass} = F_{fail} = F \quad \text{and} \quad F = 0.2\%$$

Wrong decision probability D per test step:

$$D_{\text{pass}} = D_{\text{fail}} = D \quad \text{and} \quad D = 0.0085\%$$

Parameters for limit lines:

1. $D = 0.000085$ wrong decision probability per test step.
2. $M = 1.5$ bad DUT factor
3. n_e number of (error) events. This parameter is the x-ordinate in figure 14-1.
4. n_s number of samples. The error rate is calculated from n_e and n_s .

Limit checking

Before limit checking is valid the minimum test time due to fading needs to be considered:

Testing under multipath and interference conditions requires that at least 990 wavelengths are crossed with the speed given in the fading profile. This leads to a minimum test time depending on the frequency range. No early pass/fail decision is allowed until the minimum test time due to fading has elapsed.

Table 14-12.1.2.4.1: Minimum test times due to TU high fading conditions

Full Rate 50 km/h					
Frequency	0,85	0,9	1,8	1,9	GHz
Wavelength	0,35	0,33	0,17	0,16	M
min test time	403	380	190	180	S
	0:06:43	0:06:20	0:03:10	0:03:00	hh:mm:ss

If the minimum test time due to multipath conditions exceeds the target test time, then the test runs for the minimum test time due to multipath conditions and the decision is made by comparing the result with the “derived test limit”. In this case early pass/fail decisions are obsolete.

If the target test time exceeds the minimum test time due to multipath conditions early pass/fail decisions can be headed for in order to accelerate test execution.

For an early decision a minimum number of (error) events is necessary.

For an early pass decision $n_e \geq 1$ (inclusive artificial error)

For an early fail decision $n_e \geq 7$

When the target test time has been reached the test is finished and a pass/fail decision can be made.

The error rate measured in this test shall be tested according to the values given in tables 14-12.1.2.4.2 and 14-12.1.2.4.3.

Table 14-12.1.2.4.2: Statistical test limits for FACCH/F DARP DTS-2 (GSM 900 / 850)

DTS-2								
		C_{lev} (dBm)	Samples per second	Orig. BER requirement	Derived test limit	Target number of samples	Target test time (s)	Target test time (hh:mm:ss)
FACCH/F	Frames	-72.0	5	0,050000	0,061700	5592	1119	00:18:39

Table 14-12.1.2.4.3: Statistical test limits for FACCH/F DARP DTS-3 (GSM 900 / 850)

DTS-3								
		C_{lev} (dBm)	Samples per second	Orig. BER requirement	Derived test limit	Target number of samples	Target test time (s)	Target test time (hh:mm:ss)
FACCH/F	Frames	-71.0	5	0,050000	0,061700	5592	1119	00:18:39

Table 14-12.1.2.4.4: Statistical test limits for FACCH/F DARP DTS-2 (DCS 1800 / 1900)

DTS-2								
		C_{lev} (dBm)	Samples per second	Orig. BER requirement	Derived test limit	Target number of samples	Target test time (s)	Target test time (hh:mm:ss)
FACCH/F	Frames	-72,5-	5	0,050000	0,061700	5592	1119	00:18:39

Table 14-12.1.2.4.5: Statistical test limits for FACCH/F DARP DTS-3 (DCS 1800 / 1900)

DTS-3								
		C_{lev} (dBm)	Samples per second	Orig. BER requirement	Derived test limit	Target number of samples	Target test time (s)	Target test time (hh:mm:ss)
FACCH/F	Frames	-72,0	5	0,050000	0,061700	5592	1119	00:18:39

14.13 (void)

14.14 (void)

14.15 (void)

14.16 GPRS receiver tests

Statistical testing of receiver BLER performance

Error Definition

Block Error Ratio (BLER):

The Block Error Ratio is the ratio of blocks received in error to the total number of received blocks, where a block is defined as received in error if the error detection functions in the receiver, operating in accordance with 3GPP TS 05.03, indicate an error as a the result of the Block Check Sequence (BCS).

For USF the Block Error Ratio is the ratio of incorrectly interpreted USF to the total number of received USF.

Test criteria

In the receiver tests for circuit switched channels, test error rates have been defined in order not to pass MS with a performance worse than the specification by 1 dB, with tests to be performed at the sensitivity and interference levels defined in 3GPP TS 05.05. For circuit switched channels 3GPP TS 05.05 defines the error rates at a fixed sensitivity or interference level.

For packet switched channels 3GPP TS 05.05 defines the receive or interference level at which a fixed Block Error Ratio is met. Therefore, for GPRS the receiver is tested with a 1 dB offset in the receive level and the interference level.

If the error events can be assumed to be random independent variables, outputs of stationary random processes with identical Gaussian distributions, the previous figures suggest a number of events not lower than 200 in AWGN channel and not lower than 600 in a multipath environment.

For multipath propagation conditions the hypothesis of stationary random processes does not generally hold. In case of non frequency hopping operation mode, the radio channel may be assumed to change 10 times per wavelength of travelled distance and to be short term stationary in between. So, in this case, the required observation time for having good statistical properties should not be lower (with some rounding) than that reported in table 14.16-1.

Table 14.16-1: Minimum test time according to propagation profile

Propagation Conditions	GSM 400, GSM 700, T-GSM 810, GSM 850 and GSM 900				DCS 1 800 and PCS 1 900			
	TUlow	TUhigh	HT	RA	TUlow	TUhigh	HT	RA
Min. test time (s)	500	30	15	6	500	15	7,5	6

Table 14.16-2 details, for the different test conditions, the minimum number of blocks required in order to meet points 1) to 3): the corresponding test time (point 4) can be consequently computed.

Table 14.16-2: Test conditions

Type of test	Type of sub-test	Propagation/frequency conditions	Specified BLER %	Minimum No of blocks
Sensitivity	PDTCH/CS-1	static	10	2000
"	PDTCH/CS-1	TUhigh/no FH	10	6000
"	PDTCH/CS-1	TUhigh/FH	10	6000
"	PDTCH/CS-1	RA/no FH	10	6000
"	PDTCH/CS-1	HT/no FH	10	6000
"	PDTCH/CS-2	static	10	2000
"	PDTCH/CS-2	TUhigh/no FH	10	6000
"	PDTCH/CS-2	TUhigh/FH	10	6000
"	PDTCH/CS-2	RA/no FH	10	6000
"	PDTCH/CS-2	HT/no FH	10	6000
"	PDTCH/CS-3	static	10	2000
"	PDTCH/CS-3	TUhigh/no FH	10	6000
"	PDTCH/CS-3	TUhigh/FH	10	6000
"	PDTCH/CS-3	RA/no FH	10	6000
"	PDTCH/CS-3	HT/no FH	10	6000
"	PDTCH/CS-4	static	10	2000
"	PDTCH/CS-4	TUhigh/no FH	10	6000
"	PDTCH/CS-4	TUhigh/FH	10	6000
"	USF/CS-1	static	1	20000
"	USF/CS-1	TUhigh/no FH	1	60000
"	USF/CS-1	TUhigh/FH	1	60000
"	USF/CS-1	RA/no FH	1	60000
"	USF/CS-1	HT/no FH	1	60000
"	USF/CS-2/CS-3/CS-4	static	1	20000
"	USF/CS-2/CS-3/CS-4	TUhigh/noFH	1	60000
"	USF/CS-2/CS-3/CS-4	TUhigh/FH	1	60000
"	USF/CS-2/CS-3/CS-4	RA/no FH	1	60000
"	USF/CS-2/CS-3/CS-4	HT/no FH	1	60000
Co-channel	PDTCH/CS-1	TUlow/no FH	10	6000, but minimum of 500s
"	PDTCH/CS-1	TUhigh/no FH	10	6000
"	PDTCH/CS-1	TUhigh/FH	10	6000
"	PDTCH/CS-1	RA/no FH	10	6000
"	PDTCH/CS-2	TUlow/no FH	10	6000, but minimum of 500s
"	PDTCH/CS-2	TUhigh/no FH	10	6000
"	PDTCH/CS-2	TUhigh/FH	10	6000
"	PDTCH/CS-2	RA/no FH	10	6000
"	PDTCH/CS-3	TUlow/no FH	10	6000, but minimum of 500s
"	PDTCH/CS-3	TUhigh/no FH	10	6000
"	PDTCH/CS-3	TUhigh/FH	10	6000
"	PDTCH/CS-3	RA/no FH	10	6000
"	PDTCH/CS-4	TUlow/no FH	10	6000, but minimum of 500s
"	PDTCH/CS-4	TUhigh/no FH	10	6000
"	PDTCH/CS-4	TUhigh/FH	10	6000
"	USF/CS-1	TUlow/no FH	1	60000
"	USF/CS-1	TUhigh/no FH	1	60000
"	USF/CS-1	TUhigh/FH	1	60000
"	USF/CS-1	RA/no FH	1	60000
"	USF/CS-2/CS-3/CS-4	TUlow/no FH	1	60000
"	USF/CS-2/CS-3/CS-4	TUhigh/no FH	1	60000
"	USF/CS-2/CS-3/CS-4	TUhigh/FH	1	60000
"	USF/CS-2/CS-3/CS-4	RA/no FH	1	60000
NOTE 1: For PDTCH sub-tests under fading conditions, the number of RLC blocks indicated above shall be transmitted on each downlink timeslot of the multislot configuration.				
NOTE 2: For USF sub-tests under fading conditions, the number of RLC blocks indicated above shall be per uplink timeslot of the multislot configuration.				

14.16.1 Minimum Input level for Reference Performance

14.16.1.1 Definition

The minimum input level is the signal level at the MS receiver input at which a certain BLER is met.

14.16.1.2 Conformance requirement

- The block error rate (BLER) performance shall not exceed 10 % at input levels according to the table below.

Type of channel		Propagation conditions				
		static	TUhigh (no FH)	TUhigh (ideal FH)	RA (no FH)	HT (no FH)
GSM 400, GSM 700, GSM 850 and GSM 900						
PDTCH/CS-1	dBm	-104	-104	-104	-104	-103
PDTCH/CS-2	dBm	-104	-100	-101	-101	-99
PDTCH/CS-3	dBm	-104	-98	-99	-98	-96
PDTCH/CS-4	dBm	-101	-90	-90	*	*
DCS 1 800 and PCS 1 900						
PDTCH/CS-1	dBm	-104	-104	-104	-104	-103
PDTCH/CS-2	dBm	-104	-100	-100	-101	-99
PDTCH/CS-3	dBm	-104	-98	-98	-98	-94
PDTCH/CS-4	dBm	-101	-88	-88	*	*

The input levels given in the above Table are referenced to normal GSM 900 MS, and have to be corrected by the following values for other MS:

GSM 400, GSM 700, GSM 850 and GSM 900 small MS	+2 dB
DCS 1800 class 1 or 2 MS	+2/+4 dB**
DCS 1800 class 3 and PCS 1 900 class 1 or 2 MS	+2 dB
PCS 1 900 class 3 MS	0 dB

** For all DCS 1 800 class 1 and class 2 MS, a correction offset of +2dB shall apply for the reference sensitivity performance as specified in table 1a for the normal conditions defined in Annex D and an offset of +4 dB shall be used to determine all other MS performances.

3GPP TS 05.05, table 1a; 3GPP TS 05.05, subclause 6.2.

- The block error rate (BLER) performance shall not exceed 1 % at input levels according to the table below.

Type of channel		Propagation conditions				
		static	TUhigh (no FH)	TUhigh (ideal FH)	RA (no FH)	HT (no FH)
GSM 400, GSM 700, GSM 850 and GSM 900						
USF/CS-1	dBm	< -104	-101	-103	-103	-101
USF/CS-2 to 4	dBm	< -104	-103	-104	-104	-104
DCS 1 800 and PCS 1 900						
USF/CS-1	dBm	< -104	-103	-103	-103	-101
USF/CS-2 to 4	dBm	< -104	-104	-104	-104	-103

The input levels given in the above Table are referenced to normal GSM 900 MS, and have to be corrected by the following values for other MS:

GSM 400, GSM 700, GSM 850 and GSM 900 small MS	+2 dB
DCS 1800 class 1 or 2 MS	+2/+4 dB**
DCS 1800 class 3 and PCS 1 900 class 1 or 2 MS	+2 dB

PCS 1 900 class 3 MS

0 dB

** For all DCS 1 800 class 1 and class 2 MS, a correction offset of +2dB shall apply for the reference sensitivity performance as specified in table 1a for the normal conditions defined in Annex D and an offset of +4 dB shall be used to determine all other MS performances.

3GPP TS 05.05, table 1a; 3GPP TS 05.05, subclause 6.2.

3. The BLER shall not exceed the the conformance requirements given in 1. - 2. under extreme conditions; 3GPP TS 05.05, subclause 6.2 and annex D subclauses D.2.1 and D.2.2.

4. The reference sensitivity performance specified above need not be met in the following cases:

for MS at the static channel, if the received level on either of the two adjacent timeslots to the wanted exceed the wanted timeslot by more than 20 dB;

for MS on a multislot configuration, if the received level on any of the timeslots belonging to the same multislot configuration as the wanted time slot, exceed the wanted time slot by more than 6 dB;

The interfering adjacent time slots shall be static with valid GSM signals in all cases;

3GPP TS 05.05, subclause 6.2.

5) For an MS allocated a USF on a PDCH with a random RF input or a valid PDCH signal with a random USF not equal to the allocated USF, the overall reception shall be such that the MS shall detect the allocated USF in less than 1% of the radio blocks. This requirement shall be met for all input levels up to -40 dBm.

3GPP TS 05.05, subclause 6.4

3GPP TS 45.05 subclause 2:

For T-GSM 810 the requirements for GSM 900 shall apply, apart for those parameters for which a separate requirement exists.

14.16.1.3 Test purpose

NOTE: This test is performed under STATIC propagation conditions to allow implicit testing of the ability of the MS to hop over the full band. The tests under dynamic propagation conditions are better suited to test the minimum input level for reference BLER performance conformance but cannot test hopping over the full band due to limited bandwidth of available fading simulators.

1. To verify that that the MS sends a Packet Not Acknowledge in the Packet Downlink Ack/Nack in case of a the Block Check Sequence indicating a Block Error.
2. To verify that the MS does not exceed conformance requirement 1 for CS-3 and CS-4 under STATIC, TUhigh, HT and RA propagation conditions with an allowance for the statistical significance of the test.
3. To verify that the MS does not exceed conformance requirement 2 under HT propagation conditions with an allowance for the statistical significance of the test.
4. To verify that the MS does not exceed conformance requirement 3 under STATIC, TUhigh, HT and RA propagation conditions for the PDTCH, and HT propagation conditions for the USF, with an allowance for the statistical significance of the test.
5. To verify that the MS meets the conformance requirements also 1 and 2 for the conditions allowed by conformance requirement 4, with an allowance for the statistical significance of the test.
6. To verify that the MS meets conformance requirement 5, with an allowance for the statistical significance of the test.

14.16.1.4 Method of test

14.16.1.4.1 Initial conditions

NOTE 1: The BA list sent on the BCCH and SACCH will indicate at least six surrounding cells with at least one near to each band edge. It is not necessary to generate any of these BCCHs but, if provided the signal strengths of BCCHs shall be in the range $15 \text{ dB}\mu\text{Vemf}(\)$ to $35 \text{ dB}\mu\text{Vemf}(\)$. Surrounding cell signal levels and cell reselection parameters are set so that the MS will not try a cell reselection.

NOTE 2: The ARFCN of any BCCH shall not be co-channel or on adjacent channels to the wanted traffic channel.

NOTE 3: When frequency hopping is used, the traffic channel may fall on any of the ARFCNs defined in clause 6.

NOTE 4: The PSI1 message is included in the PACCH when the MS is in packet transfer mode. The PBCCH_CHANGE_MARK value in PSI1 is not changed. This, together with preventing cell reselection as per Note 1, ensures that the MS is highly unlikely to suspend the TBF (3GPP TS 04.60 subclause 5.5.1.4.2 Suspension of operation to receive system operation), and thus making the effect of TBF suspension statistically insignificant for the test result.

A call is set up according to the generic call set up procedure for packet switched on an ARFCN in the Mid range, on the maximum number of receive timeslots, with the MS transmitting at maximum power. The power control parameter ALPHA (α) is set to 0.

For the ACK/NACK BLER and the BCS BLER parts of the test case, a downlink TBF will be established.

For the USF BLER parts of the test case the Test Mode defined in 3GPP TS 04.14 (subclause 5.4) will be used for uplink TBF. If the MS is capable of both:

Mode (a) transmitting pseudo-random data sequence in RLC data blocks;

Mode (b) transmitting looped-back RLC data blocks;

then Mode (a) will be used.

If Mode (b) is used then the SS sends the pseudo-random data sequence specified for Mode (a) on the downlink for loopback on the uplink.

14.16.1.4.2 Procedure

- a) The SS transmits packets under Static propagation conditions, using CS-3 coding at a level of 1 dB above the level given in conformance reference 1. Out of the 400 blocks transmitted by the SS, 20 blocks are sent with incorrect BCS, at (pseudo) random positions. The SS checks, for the blocks it transmitted with incorrect BCS, whether or not the MS Packet Downlink Ack/Nack as sent by the MS indicates these blocks as not acknowledged.
- b) The SS transmits packets under static conditions, with the MS commanded to hopping mode using the hopping sequence used in clause 6, and using CS-3 coding to the MS on all allocated timeslots, at a level of 1 dB above the level given in the table in conformance requirement 1. On the time slots not allocated to the MS, the SS transmits at a level of 20 dB above above the level given in the table in conformance requirement 1. This implicitly tests adjacent time slot rejection.
- c) The SS counts the number of blocks transmitted with CS-3 and the number of these blocks not acknowledged based on the content of the Ack/Nack Description information element (see 3GPP TS 04.60, subclause 12.3) in the Packet Downlink Ack/Nack as sent from the MS to the SS on the PACCH.

NOTE: Due to the error rates related to the USF, the MS is likely to occasionally miss its USF for transmitting the Packet Downlink Ack/Nack. As this requirement is not verified in this part of the test, the SS then again assigns uplink resources so the MS can sent this message.

- d) Once the number of blocks transmitted with CS-3 as counted in step c) reaches or exceeds the minimum number of blocks as given in table 14-16.2, the SS calculates the Block error ratio. The SS resets both counters.
- e) The SS repeats step b) to d) with the following four fading conditions and hopping modes: TUhigh/noFH, TUhigh/FH, HT/noFH and RA/noFH. For these tests with fading channels, the SS does not transmit on the timeslots not allocated to the MS.

- f) The SS repeats steps b) to d) using CS-4 coding with the following three fading conditions: Static/FH, TUhigh/noFH and TUhigh/FH. For these tests with fading channels, the SS does not transmit on the timeslots not allocated to the MS.
- g) The SS repeats steps b) to f) under extreme test conditions.
- h) This step is only performed for a multislot MS. The SS establishes the normal test conditions with the exceptions in the parameter settings of Packet Downlink Assignment message:
- P0 = 14 dBm;
 - BTS_PWR_CTRL_MODE = Mode A;
 - PR_MODE = B.

Furthermore, the SS has to set the PR fields in the MAC headers of each downlink RLC data block to correspond the applied downlink power level, as defined below. The SS repeats steps b) to d) with only one of the active timeslots at 1 dB above the level at which the reference sensitivity performance shall be met, and all other timeslots belonging to the same multislot configuration at a level of 6 dB above this timeslot.

- i) The SS establishes the normal test conditions, and sets the fading function to HT/noFH.
- j) The SS sets the value of the USF/CS-1 such as to allocate the uplink to the MS, transmitting at a level of 1 dB above the level given in the table in conformance requirement 2.
- k) The SS counts the number of times the USF is allocated to the MS, and the number of times the MS does not transmit while being allocated the uplink.
- l) Once the number of USF/CS-1 allocating the uplink for the MS as counted in step k) reaches or exceeds the minimum number of blocks as given in table 14-16.2, the SS calculates the Block error ratio. The SS resets both counters.
- m) The SS repeats steps j) to l) using USF/CS2 to 4 coding.
- NOTE: Since coding for USF-bits is identical for CS2 and CS3, it's not required to perform the step for both of those CS.
- n) The SS repeats steps i) to m) under extreme test conditions.
- o) The SS establishes normal test condition and a static channel. The SS sets the value of the USF/CS-1 to all values randomly, with the exception of the one allocated to the MS, transmitting at 3 dB below the level at which reference performance shall be met, and counts the number of times the MS transmits on the uplink. This is done for 2 000 blocks.

14.16.1.5 Test requirements

In step a) the Packet Downlink Ack/Nack as sent by the MS shall indicate every block transmitted by the SS with incorrect BCS as not acknowledged.

The block error ratio, as calculated by the SS for different channels and under the different propagation conditions, under any combination of normal and extreme test voltages and ambient temperatures, shall not exceed the conformance requirement.

In step o) the MS shall transmit no more than 25 times.

In the case when downlink power control is not used and the output power used on the transmitted blocks is not equal to (BCCH level – Pb) then the MS is not required to fulfil 3GPP TS 05.05 requirements for the first 25 blocks addressed to this MS (3GPP TS 05.08, subclause 10.2.2).

NOTE: This is stated in the Rel 99 version of 3GPP TS 05.08.

14.16.2 Co-channel rejection

14.16.2.1 Co-channel rejection for packet channels

14.16.2.1.1 Definition

The co-channel rejection is a measure of the capability of the receiver to receive a wanted modulated signal without exceeding a given degradation due to the presence of an unwanted modulated signal, both signals being at the nominal frequency of the receiver.

14.16.2.1.2 Conformance requirement

1. The block error rate (BLER) performance shall not exceed 10 % at co-channel interference ratios (C/I_c) exceeding those according to the table below.

Type of channel	Propagation conditions				
	TUlow (no FH)	TUhigh (no FH)	TUhigh (ideal FH)	RA (no FH)	
GSM 400, GSM 700, GSM 850 and GSM 900					
PDTCH/CS-1	dB	13	10	9	9
PDTCH/CS-2	dB	15	14	13	13
PDTCH/CS-3	dB	16	16	15	16
PDTCH/CS-4	dB	21	24	24	-
DCS 1 800 and PCS 1 900					
PDTCH/CS-1	dB	13	9	9	9
PDTCH/CS-2	dB	15	13	13	13
PDTCH/CS-3	dB	16	16	16	16
PDTCH/CS-4	dB	21	27	27	-

3GPP TS 05.05, table 2a; 3GPP TS 05.05, subclause 6.2.

2. The block error rate (BLER) performance shall not exceed 1 % at co-channel interference ratios (C/I_c) exceeding those according to the table below.

Type of channel	Propagation conditions				
	TUlow (no FH)	TUhigh (no FH)	TUhigh (ideal FH)	RA (no FH)	
GSM 400, GSM 700, GSM 850 and GSM 900					
USF/CS-1	dB	19	12	10	10
USF/CS-2 to 4	dB	18	10	9	8
DCS 1 800 and PCS 1 900					
USF/CS-1	dB	19	10	10	10
USF/CS-2 to 4	dB	18	9	9	7

3GPP TS 45.05 subclause 2:

For T-GSM 810 the requirements for GSM 900 shall apply, apart for those parameters for which a separate requirement exists.

14.16.2.1.3 Test purpose

1. To verify that the MS does not exceed conformance requirement 1 under propagation condition TUlow/no FH, TUhigh/noFH, TUhigh/FH and RA/no FH with an allowance for the statistical significance of the test.
2. To verify that the MS does not exceed conformance requirement 2 under propagation condition TUhigh/noFH, with an allowance for the statistical significance of the test.

14.16.2.1.4 Method of test

14.16.2.1.4.1 Initial conditions

A call is set up according to the generic call set up procedure with an ARFCN in the mid ARFCN range, power control level set to maximum power. The power control parameter ALPHA (α) is set to 0.

The SS transmits Standard Test Signal C1.

In addition to this wanted signal (C), the SS produces an independent, uncorrelated interfering signal (I).

This unwanted signal is random, continuous and GSM-modulated, and has no fixed relationship with the bit transitions of the wanted signal.

For the ACK/NACK BLER and the BCS BLER parts of the test case, a downlink TBF will be established.

For the USF BLER parts of the test case the Test Mode defined in GSM Rec. 4.14 (para 5.4) will be used for uplink TBF. If the MS is capable of both:

Mode (a) transmitting pseudo-random data sequence in RLC data blocks;

Mode (b) transmitting looped-back RLC data blocks;

then Mode (a) will be used.

If Mode (b) is used then the SS sends the pseudo-random data sequence specified for Mode (a) on the downlink for loopback on the uplink.

Specific PICS statements:

- Support of DARP Phase 1 (TSPC_DARP_Phase1)

PIXIT Statements:

-

14.16.2.1.4.2 Procedure

- a) The SS transmits packets using CS-1 coding to the MS on all allocated timeslots.
- b) The fading characteristic of the wanted and the interfering signal is TUlow, no FH applies.
- c) The co-channel interference ratio is set to 1 dB above the ratio given in the table in conformance requirement 1. The interferer shall have the same frequency hopping sequence as the wanted signal, as well as be subject to the same fading profile.
- d) The SS counts the number of blocks transmitted with current coding scheme and the number of these blocks not acknowledged based on the content of the Ack/Nack Description information element (see 3GPP TS 04.60, subclause 12.3) in the Packet Downlink Ack/Nack as sent from the MS to the SS on the PACCH.

NOTE: Due to the error rates related to the USF, the MS is likely to occasionally miss its USF for transmitting the Packet Downlink Ack/Nack. As this requirement is not verified in this part of the test, the SS then again assigns uplink resources so the MS can send this message.

- e) Once the number of blocks transmitted with the current coding scheme as counted in step d) reaches or exceeds the minimum number of blocks as given in table 14.16-2, the SS calculates the Block error ratio. The SS resets both counters.
- f) In the case of CS-1 the SS repeats step c) to e) with the fading conditions and hopping modes: TUhigh/FH, and RA/noFH and, if the MS does not support DARP phase 1 also with TUhigh/noFH fading condition. In the case of CS-2 the SS repeats step c) to e) with the fading condition and hopping mode RA/no FH only. In the case of CS-3 the SS repeats step c) to e) with the fading condition and hopping mode TUhigh/FH only. In the case of CS-4 and the MS does not support DARP phase 1 the SS repeats step c) to e) with the fading condition and hopping modes: TUhigh/noFH.
- g) The SS repeats the steps b) to f) for each of the coding schemes CS-2, CS-3 and CS-4.

- h) The SS sets the fading function to TUhigh/noFH.
- i) The SS sets the value of the USF/CS-1 such as to allocate the uplink to the MS, using a co-channel interference level of 1 dB above the level given in the table in conformance requirement 2.
- j) The SS counts the number of times the USF is allocated to the MS, and the number of times the MS does not transmit while being allocated the uplink.
- k) Once the number of USF/CS-1 allocating the uplink for the MS as counted in step j) reaches or exceeds the minimum number of blocks as given in table 14.16-2, the SS calculates the Block error ratio. The SS resets both counters.
- l) The SS repeats steps i) to k) using USF/CS2 coding.

14.16.2.1.5 Test requirements

The block error ratio, as calculated by the SS for different channels and under the different propagation conditions, shall not exceed the conformance requirement.

NOTE: The wanted signal levels derived from calculations using 3GPP TS 45.005 subclause 6.3 together with subclause 14.16.2.1.4.2 c) shall be set according to the table below.

Type of channel		Propagation conditions			
		TUlow (no FH)	TUhigh (no FH)	TUhigh (ideal FH)	RA (no FH)
GSM 400, GSM 700, T-GSM 810, GSM 850 and GSM 900 Small Ms (see note (1))					
PDTCH/CS-1	dBm	-77	-80	-81	-81
PDTCH/CS-2	dBm	-75	-76	-77	-77
PDTCH/CS-3	dBm	-74	-74	-75	-74
PDTCH/CS-4	dBm	-69	-66	-66	-
DCS 1 800 and PCS 1 900 (class 1 and 2) (see note (2))					
PDTCH/CS-1	dBm	-77	-81	-81	-81
PDTCH/CS-2	dBm	-75	-77	-77	-77
PDTCH/CS-3	dBm	-74	-74	-74	-74
PDTCH/CS-4	dBm	-69	-63	-63	-
NOTE 1: For other GSM 400, GSM 900, T-GSM 810, GSM 850 and GSM 700 MS the values in the table above should be decreased by 2 dBm.					
NOTE 2: For other classes of PCS 1 900 MS the values in the above table should be decreased by 2 dBm. For DCS 1 800 MS under extreme conditions the values in the above table should be increased by 2 dBm.					

14.16.3 Acknowledged mode / Downlink TBF / I_LEVEL measurement report

14.16.3.1 Conformance requirements

The PACKET DOWNLINK ACK/NACK message contains a Channel Quality Report (see 3GPP TS 05.08). The optional I_LEVEL measurement results shall be included in at least every other PACKET DOWNLINK ACK/NACK message.

The accuracy of the received signal level and interference measurements shall be as defined in subclause 8.1.2. The measured signal strength values shall be mapped to the reported C values as defined for RXLEV in subclause 8.1.4. If included in a PACKET MEASUREMENT REPORT message, the measured interference level, γ_{CH} , shall be mapped to a reported I_LEVEL as defined for RXLEV in subclause 8.1.4. If included in a PACKET DOWNLINK ACK/NACK or a PACKET RESOURCE REQUEST message, the measured interference level, γ_{CH} , shall be mapped to a reported I_LEVEL value between 0 and 15, relative to reported C value as follows:

I_LEVEL 0 = interference level is greater than C
 I_LEVEL 1 = interference level is less than or equal to C and greater than C - 2 dB
 I_LEVEL 2 = interference level is less than or equal to C - 2 dB and greater than C - 4 dB
 :
 :
 I_LEVEL 14 = interference level is less than or equal to C - 26 dB and greater than C - 28 dB
 I_LEVEL 15 = interference level is less than or equal to C - 28 dB

14.16.3.2 References

3GPP TS 04.60, 3GPP TS 44.060, subclause 8.1.2.2.

3GPP TS 05.08, 3GPP TS 45.008, subclauses 10.3

14.16.3.3 Test purpose

To verify that correct I_LEVEL measurement results are included in at least every other PACKET DOWNLINK ACK/NACK message.

14.16.3.4 Method of test

14.16.3.5 Initial Conditions

System Simulator:

- 1) cell, default setting, PBCCH not present. The power control parameter ALPHA (α) is set to 0.
- 2) The level of the serving cell BCCH and of the PDTCH is set to 30 dB above the reference sensitivity level which is specified in 3GPP TS 05.05. For instance for class 2 or 3 MS, in GSM 900 MS, the level of the serving cell BCCH and of the PDTCH shall be set to $-104 \text{ dBm} + 30\text{dB} = -74\text{dBm}$.
- 3) PC_MEAS_CHAN indicates that the MS shall measure the received signal level of each radio block on one of the PDCH monitored by the MS for PACCH.
- 4) The interference filter parameter N_AVG_I is set to 3 (coded value 0011)
- 5) The C value filter parameter T_AVG_T is set to 15 (coded 01111).
- 6) Normal conditions as defined in Annex D of 3GPP TS 05.05 are applied.

Mobile Station:

The MS is GPRS updated with a P-TMSI allocated, SPLIT PG CYCLE negotiated and the test PDP Context2 activated.

14.16.3.6 Void

14.16.3.7 Test Procedure

In addition to the wanted signal on PDTCH, the SS produces an uncorrelated co-channel interfering signal, GMSK modulated: the unwanted signal is sent during idle frames of PDTCH of the wanted signal, and has no fixed relationship with the bit transitions of the wanted signal.

This interfering signal is sent on the same nominal carrier frequency as the PACCH and PDTCH and at a level x dB above the level of the PDTCH and modulated with random data.

x is a random value in [1 dB; -29 dB] in steps of 2 dB, negative values of x meaning that the resulting interference level is below the level of the PDTCH.

For instance, for GSM 900 MS, the resulting interference level depends on the x random value as follows:

x	Interference level
1 dB	-73 dBm
-1 dB	-75 dBm
-3 dB	-77 dBm
-5 dB	-79 dBm
-7 dB	-81 dBm
-9 dB	-83 dBm
-11 dB	-85 dBm
-13 dB	-87 dBm
-15 dB	-89 dBm
-17 dB	-91 dBm
-19 dB	-93 dBm
-21 dB	-95 dBm
-23 dB	-97 dBm
-25 dB	-99 dBm
-27 dB	-101 dBm
-29 dB	-103 dBm

Note: Values of the reference sensitivity level for every frequencies are defined in “3GPP TS 05.05.

- a) The SS establishes a downlink TBF and sends RLC data blocks.
- b) The MS is polled every 12 RLC data block by setting the S/P bit.
- c) The SS verifies that a correct I_level parameter is included in the Channel Quality report of at least every other two Packet Downlink Ack/Nack messages.
- d) The SS verifies that the reported value of I_level is correct: the measured interference level is mapped to a reported I_LEVEL value between 0 and 15, relative to reported C value as follows (as stated in 3GPP TS 05.08, subclauses 10.3), level resulting from the value of x:

x	I_LEVEL
1 dB	0
-1 dB	1
-3 dB	2
-5 dB	3
-7 dB	4
-9 dB	5
-11 dB	6
-13 dB	7
-15 dB	8
-17 dB	9
-19 dB	10
-21 dB	11
-23 dB	12
-25 dB	13
-27 dB	14
-29 dB	15

The accuracy of the interference measurement shall fulfill the requirement as defined in 3GPP TS 05.08, subclauses 8.1.2:

the R.M.S received signal level at the receiver input shall be measured by the MS and the BSS over the full range of -110 dBm to -48 dBm with an absolute accuracy of ± 4 dB from -110 dBm to -70 dBm under normal conditions and ± 6 dB over the full range under both normal and extreme conditions.

Thus, for GSM 900 MS, the resulting tolerance is ± 4 dB for every value of the x random variable.

14.16.4 DARP Phase 1 GPRS tests

14.16.4.1 Synchronous single co-channel interferer (DTS-1)

14.16.4.1.1 Definition

The DARP reference test scenario DTS-1 for a single synchronous co-channel interferer defines an interfering signal and corresponding performance limits. This test is a measure of the capability of the DARP receiver to receive a wanted modulated signal without exceeding a given degradation due to the presence of this specific unwanted signals.

14.16.4.1.2 Conformance requirement

MS indicating support for Downlink Advanced Receiver Performance – phase I (see 3GPP TS 24.008) shall fulfil the requirements in table 2o for wanted signals on GMSK modulated channels under TU50 no FH propagation conditions and GMSK modulated interferers for the test scenarios defined in annex L. The reference performance shall be:

- For packet switched channels (PDTCH) BLER: $\leq 10\%$

The values in table 2o are given as the C/I1 ratio, where C is the power level of the wanted signal and I1 is the power level of the dominant co-channel interferer (Co-channel 1, see annex L).

3GPP TS 45.005; clause 6.3.

Reference Test Scenarios for Synchronous single co-channel interferer

Reference Test Scenario	Interfering Signal	Interferer relative power level	TSC	Interferer Delay range
DTS-1	Co-channel 1	0 dB	none	no delay

3GPP TS 45.005; Annex L.

GSM 900 and GSM 850	
Propagation condition	DTS-1, TU50 no FH
Type of channel	C/I
PDTCH CS-1	3 dB
PDTCH CS-2	6 dB
PDTCH CS-3	8,5 dB
PDTCH CS-4	19,5 dB

DCS 1 800 & PCS 1900	
Propagation condition	DTS-1, TU50 no FH
Type of channel	C/I
PDTCH CS-1	2,5 dB
PDTCH CS-2	6 dB
PDTCH CS-3	9 dB
PDTCH CS-4	22 dB

3GPP TS 45.005; table 2o (extracts).

For T-GSM 810 the requirements for GSM 900 shall apply, apart for those parameters for which a separate requirement exists.

3GPP TS 45.005; subclause 2

14.16.4.1.3 Test purpose

To verify that the MS does not exceed conformance requirement for different coding schemes and under the propagation condition TU50/noFH with an allowance for the statistical significance of the test.

14.16.4.1.4 Test method

14.16.4.1.4.1 Initial condition

A call is set up according to the generic call set up procedure with an ARFCN in the mid ARFCN range, power control level set to maximum power. The power control parameter ALPHA (α) is set to 0.

The SS establish a downlink TBF.

The SS transmits Standard Test Signal C1 with TSC 0.

In addition to this wanted signal (C1), the SS produces an independent, uncorrelated interfering signal (I1). This unwanted signal is random, continuous and GSM-modulated and has no fixed relationship with the bit transitions of the wanted signal.

14.16.4.1.4.2 Procedure

- a) The co-channel interferer signal I1 (unwanted signal) is set to -80 dBm.
- b) The fading characteristic of the wanted signal C1 and the interferer signal I1 is set to TU High. No FH applies.
- c) The SS transmits packets using CS-1 coding to the MS on all allocated timeslots.
- d) The SS sets the level of the wanted signal 1dB above the value according the Table 14.16.4.1.5-1 and Table 14.16.4.1.5-2.
- e) The SS counts the number of blocks transmitted with current coding scheme and the number of these blocks not acknowledged based on the content of the Ack/Nack Description information element (see 3GPP TS 04.60, sub clause 12.3) in the Packet Downlink Ack/Nack as sent from the MS to the SS on the PACCH.
- f) Once the number of blocks transmitted with the current coding scheme as counted in step (e) reaches or exceeds the minimum number of blocks as given in table 14.16-2 the SS calculates the Block error ratio. The SS resets both counters.
- f) The SS repeats the steps c) to f) for each of the coding schemes CS-2, CS-3 and CS-4.

14.16.4.1.5 Test requirement

The block error ratio, as calculated by the SS for different channels under the TU High propagation conditions, shall not exceed the conformance requirement.

NOTE: The wanted signal levels derived from calculations using 3GPP TS 45.005 table 2o.

Table 14.16.4.1.5-1

GSM 900 and GSM 850		
PDTCH CS-1	C/dBm	- 77.0
PDTCH CS-2	C/dBm	- 74.0
PDTCH CS-3	C/dBm	- 71.5
PDTCH CS-4	C/dBm	- 60.5

Table 14.16.4.1.5-2

DCS 1 800 & PCS 1900		
PDTCH CS-1	C/dBm	- 77.5
PDTCH CS-2	C/dBm	- 74.0
PDTCH CS-3	C/dBm	- 71.0
PDTCH CS-4	C/dBm	- 58.0

14.16.4.2 Synchronous multiple interferers (DTS-2 / DTS-3)

14.16.4.2.1 Definition

The DARP reference test scenarios DTS-2 and DTS-3 for multiple synchronous interferers define a set of interfering signals and the corresponding performance limits. These tests are a measure of the capability of the DARP receiver to receive a wanted modulated signal without exceeding a given degradation due to the presence of these specific unwanted signals.

14.16.4.2.2 Conformance requirement

The block error rate (BLER) performance for PDTCH / CS-1 to CS-4 shall not exceed 10 % at the multiple interference ratios (C/I_c) according to table 14.16.4.2.2-1.

Table 14.16.4.2.2-1: Reference Test Scenarios for synchronous multiple interferers

Reference Test Scenario	Interfering Signal	Interferer relative power level	TSC	Interferer Delay range
DTS-2	Co-channel 1	0 dB	none	no delay
	Co-channel 2	-10 dB	none	no delay
	Adjacent 1	3 dB	none	no delay
	AWGN	-17 dB	-	-
DTS-3	Co-channel 1	0 dB	random	-1 to +4 symbols
	Co-channel 2	-10 dB	none	no delay
	Adjacent 1	3 dB	none	no delay
	AWGN	-17 dB	-	-

The values in Table 14.16.4.2.2-2 and Table 14.16.4.2.2-3 are given as the C/I_1 ratio, where C is the power level of the wanted signal and I_1 is the power level of the dominant co-channel interferer (3GPP TS 45.005, annex L).

Table 14.16.4.2.2-2

GSM 900 and GSM 850		
Propagation condition	TU50 no FH	
Type of channel	C/I	
	DTS-2	DTS-3
PDTCH CS-1	8 dB	8,5 dB
PDTCH CS-2	10,5 dB	11 dB
PDTCH CS-3	13 dB	13,5 dB
PDTCH CS-4	22 dB	22,5 dB

Table 14.16.4.2.2-3

DCS 1 800 & PCS 1900		
Propagation condition	TU50 no FH	
Type of channel	C/I	
	DTS-2	DTS-3
PDTCH CS-1	7 dB	8 dB
PDTCH CS-2	10,5 dB	11 dB
PDTCH CS-3	12,5 dB	13 dB
PDTCH CS-4	23,5 dB	24 dB

Reference 3GPP TS 45.005, annex L, table 2o

14.16.4.2.3 Test purpose

To verify that the MS does not exceed the conformance requirement for different coding schemes under the propagation condition TU50/noFH with an allowance for the statistical significance of the test.

14.16.4.2.4 Test method

14.16.4.2.4.1 Initial condition

A call is set up according to the generic call set up procedure for packet switched on an ARFCN in the Mid range, on the maximum number of receive timeslots which the MS is capable to support, The MS is transmitting at maximum power. The power control parameter ALPHA (α) is set to 0.

The SS establish a downlink TBF.

The SS transmits Standard Test Signal C1 with TSC 0.

In addition to this wanted signal (C1), the SS produces multiple interfering signals for DTS-2 or DTS-3 scenarios as appropriate for the test procedure.

These interferers are:

Identical interferer for DTS-2 and DTS-3:

- Co-channel 2 (I_{CoCh2}): Synchronous co-channel interferer of type I1 as specified in TS 51.010 annex 5.2
- Adjacent 1 (I_{AdjCh1}): Adjacent channel interferer of type I1 as specified in TS 51.010 annex 5.2
- AWGN (I_{AWGN}): AWGN interferer of type I3 as specified in TS51.010 annex 5.2

DTS-2 specific interferer:

- Co-channel 1 (I_{CoCh1}): Synchronous co-channel interferer of type I1 as specified in TS 51.010 annex 5.2

DTS-3 specific interferer:

- Co-channel 1 (I_{CoCh1}): Delayed co-channel interferer of type I4 as specified in TS 51.010 annex 5.2.

14.16.4.2.4.2 Test Procedure

14.16.4.2.4.3 DTS-2 Procedure

- a) The DTS-2 co-channel interferer signal I_{CoCh1} is configured according to DTS-2 configuration.
- b) The co-channel interferer signal I_{CoCh1} set to -80 dBm.
- c) The power levels of the interferers I_{CoCh2} , I_{AdjCh1} , and I_{AWGN} are set according to table 14.16.4.2.2-1. The power levels are defined relative to I_{CoCh1} .
- d) The fading characteristics of the wanted signal C1 and the interferer signals I_{CoCh1} , I_{CoCh2} , and I_{AdjCh1} are set to TU High. No FH applies.
- e) The SS transmits packets using CS-1 coding on all allocated timeslots.
- f) The SS sets the level of the wanted signal C1 1 dB above the value according to Table 14.16.4.2.5-1 and Table 14.16.4.2.5-2.
- g) The SS counts the number of blocks transmitted with current coding scheme and the number of these blocks not acknowledged based on the content of the Ack/Nack Description information element (see 3GPP TS 04.60, sub clause 12.3) in the Packet Downlink Ack/Nack as sent from the MS to the SS on the PACCH.
- h) Once the number of blocks transmitted with the current coding scheme as counted in step (e) reaches or exceeds the minimum number of blocks as given in table 14.16-2 the SS calculates the Block error ratio. The SS resets both counters.
- i) SS repeats the steps (e) to (h) for each of the coding schemes CS-2, CS-3 and CS-4.

14.16.4.2.4.4 DTS-3 Procedure

- a) The DTS-3 co-channel interferer signal I_{CoCh1} is configured according to DTS-3 configuration.
- b) The SS repeats the steps (b) to (i) identical to the DTS-2 procedure

14.16.4.2.5 Test requirement

The block error ratio, as calculated by the SS for different channels and under the TU High propagation conditions, shall not exceed the conformance requirement.

NOTE: The wanted signal levels derived from calculations using 3GPP TS 45.005 (table 2o, annex L) , shall be set according to the table below.

Table 14.16.4.2.5-1

GSM 900 and GSM 850			
Type of channel		DARP Test Scenario	
		DTS-2	DTS-3
PDTCH CS-1	C/dBm	- 72,0	-71,5
PDTCH CS-2	C/dBm	- 69,5	-69,0
PDTCH CS-3	C/dBm	-67,0	-66,5
PDTCH CS-4	C/dBm	-58,0	-57,5

Table 14.16.4.2.5-2

DCS 1 800 & PCS 1900			
Type of channel		DARP Test Scenario	
		DTS-2	DTS-3
PDTCH CS-1	C/dBm	- 73,0	- 72,0
PDTCH CS-2	C /dBm	- 69,5	- 69,0
PDTCH CS-3	C /dBm	- 67,5	- 67,0
PDTCH CS-4	C /dBm	- 56,5	- 56,0

14.16.5 DARP Phase II GPRS tests

14.16.5.1 Synchronous single co-channel interferer (DTS-1)

14.16.5.1.1 Definition

The DARP phase II reference test scenario DTS-1 for a single synchronous co-channel interferer defines an interfering signal and corresponding performance limits. This test is a measure of the capability of the DARP phase II receivers to receive a wanted modulated signal without exceeding a given degradation due to the presence of this specific unwanted signal.

14.16.5.1.2 Conformance requirement

MS indicating support for Downlink Advanced Receiver Performance – phase II (see 3GPP TS 24.008) shall fulfil the requirements in table 2q for the test scenarios defined in annex N

The reference performance shall be:

- For packet switched channels (PDTCH) BLER:≤ 10 %

The values in table 2q are given as the C/I1 ratio, where C is the power level of the wanted signal and I1 is the power level of the dominant co-channel interferer (Co-channel 1, see annex N).

3GPP TS 45.005; clause 6.3.

Reference Test Scenario for synchronous single co-channel interferer

Reference Test Scenario	Interfering Signal	Interferer relative power level	TSC	Interferer Delay range
DTS-1	Co-channel 1	0 dB	none	no delay

3GPP TS 45.005; Annex N.

GSM 900 and GSM 850	
Propagation condition: TU50 (no FH)	
Correlation=0; AGI=0 dB	
PDTCH CS-1	-12,5 dB
PDTCH CS-2	-9,5 dB
PDTCH CS-3	-8,0 dB
PDTCH CS-4	0,0 dB

GSM 1800 and GSM 1900	
Propagation condition: TU50 (no FH)	
Correlation=0; AGI=0 dB	
PDTCH CS-1	-12,0 dB
PDTCH CS-2	-9,0 dB
PDTCH CS-3	-7,0 dB
PDTCH CS-4	4,5 dB

3GPP TS 45.005; table 2q (excerpt for DTS-1).

For T-GSM 810 the requirements for GSM 900 shall apply, apart for those parameters for which a separate requirement exists.

3GPP TS 45.005; sub clause 2

14.16.5.1.3 Test purpose

To verify that the MS does not exceed conformance requirement for different coding schemes and under the propagation condition TU50/noFH with an allowance for the statistical significance of the test.

14.16.5.1.4 Test method

14.16.5.1.4.1 Initial condition

The SS is configured as defined in annex N.2 picture N.2.2 of 3GPP 45.005

The diversity parameter for the antenna correlation is set to 0 and the antenna gain imbalance (AGI) is set to 0 dB

A call is set up according to the generic call set up procedure with an ARFCN in the mid ARFCN range on the maximum number of receive timeslots which the MS is capable to support. The power control level set to maximum power.

The power control parameter ALPHA (α) is set to 0.

The SS establish a downlink TBF.

The SS transmits Standard Test Signal C1 with TSC 0.

In addition to this wanted signal (C1), the SS produces an independent, uncorrelated interfering signal (I1). This unwanted signal is random, continuous and GSM-modulated and has no fixed relationship with the bit transitions of the wanted signal.

14.16.5.1.4.2 Procedure

- The co-channel interferer signal I1 (unwanted signal) is set to -70 dBm.
- The fading characteristic of the wanted signal C1 and the interferer signal I1 is set to TU High. No FH applies.
- The SS transmits packets using CS-1 coding to the MS on all allocated timeslots.
- The SS sets the level of the wanted signal 1dB above the value according the Table 14.16.5.1.5-1 and Table 14.16.5.1.5-2.
- The SS transmits the number of blocks with current coding scheme accordingly with table 14.16-2 and counts the BLER based on the content of the ACK/NACK Description information element (see 3GPP TS 04.60, sub

clause 12.3) in the Packet Downlink ACK/NACK as sent from the MS to the SS on the PACCH. The SS resets both counters.

- f) The SS repeats the steps (c) to (e) for each of the coding schemes CS-2, CS-3 and CS-4.

14.16.5.1.5 Test requirement

The block error ratio, as calculated by the SS for different channels under the TU High propagation conditions, shall not exceed the conformance requirement.

NOTE: The wanted signal levels derived from calculations using 3GPP TS 45.005 table 2q shall be set according to the table below.

Table 14.16.5.1.5-1

GSM 900 and GSM 850		
PDTCH CS-1	C/dBm	-82,5
PDTCH CS-2	C/dBm	-79,5
PDTCH CS-3	C/dBm	-78,0
PDTCH CS-4	C/dBm	-70,0

Table 14.16.5.1.5-2

DCS 1 800 & PCS 1900		
PDTCH CS-1	C/dBm	-82,0
PDTCH CS-2	C/dBm	-79,0
PDTCH CS-3	C/dBm	-77,0
PDTCH CS-4	C/dBm	-65,5

14.16.5.2 Multiple interferers (DTS-2 / DTS-5)

14.16.5.2.1 Definition

The DARP phase II reference test scenarios DTS-2 and DTS-5 for multiple interferers define a set of interfering signals and the corresponding performance limits. These tests are a measure of the capability of the DARP phase II receivers to receive a wanted modulated signal without exceeding a given degradation due to the presence of these specific unwanted signals.

14.16.5.2.2 Conformance requirement

MS indicating support for Downlink Advanced Receiver Performance – phase II (see 3GPP TS 24.008) shall fulfil the requirements in table 2q for the test scenarios defined in annex N

The reference performance shall be:

- For packet switched channels (PDTCH) BLER: ≤ 10 %

The values in table 2q are given as the C/I1 ratio, where C is the power level of the wanted signal and I1 is the power level of the dominant co-channel interferer (Co-channel 1, see annex N).

3GPP TS 45.005; clause 6.3.

Reference Test Scenarios for synchronous multiple interferers

Reference Test Scenario	Interfering Signal	Interferer relative power level	TSC	Interferer Delay range
DTS-2	Co-channel 1	0 dB	none	no delay
	Co-channel 2	-10 dB	none	no delay
	Adjacent 1	3 dB	none	no delay
	AWGN	-17 dB	-	-

Reference Test Scenario for asynchronous multiple interferers

Reference Test Scenario	Interfering Signal	Interferer relative power level	TSC	Interferer Delay
DTS-5	Co-channel 1 Co-channel 2 Adjacent 1 AWGN	0 dB ^{*)} -10 dB 3 dB -17 dB	none none none -	74 symbols no delay no delay -
*) The power of the delayed interferer burst, averaged over the active part of the wanted signal burst. The power of the delayed interferer burst, averaged over the active part of the delayed interferer burst is 3 dB higher.				

3GPP TS 45.005; Annex N.

GSM 900 and GSM 850		
Propagation condition: TU50 (no FH)		
Correlation=0; AGI=0 dB		
Channel type	C/I	
	DTS-2	DTS-5
PDTCH CS-1	0,5	0,5
PDTCH CS-2	3,0	3,5
PDTCH CS-3	5,0	5,5
PDTCH CS-4	12,0	13,0

GSM 1800 and PCS 1900		
Propagation condition: TU50 (no FH)		
Correlation=0; AGI=0 dB		
Channel type	C/I	
	DTS-2	DTS-5
PDTCH CS-1	0,0	0,0
PDTCH CS-2	3,0	3,0
PDTCH CS-3	4,5	5,0
PDTCH CS-4	12,5	13,5

3GPP TS 45.005 table 2q (excerpt for DTS-2 and DTS-5)

For T-GSM 810 the requirements for GSM 900 shall apply, apart for those parameters for which a separate requirement exists.

3GPP TS 45.005; sub clause 2

14.16.5.2.3 Test purpose

To verify that the MS does not exceed the conformance requirement for different coding schemes under the propagation condition TU50/noFH with an allowance for the statistical significance of the test.

14.16.5.2.4 Test method

14.16.5.2.4.1 Initial condition

The SS is configured for a single input and dual output configuration (SIDO) as defined in annex N.2.2 picture N.2.2 of 3GPP 45.005

The diversity parameter for the antenna correlation is set to 0 and the antenna gain imbalance (AGI) is set to 0 dB

A call is set up according to the generic call set up procedure for packet switched on an ARFCN in the Mid range, on the maximum number of receive timeslots which the MS is capable to support, The MS is transmitting at maximum power. The power control parameter ALPHA (α) is set to 0.

The SS establish a downlink TBF.

The SS transmits Standard Test Signal C1 with TSC 0.

In addition to this wanted signal (C1), the SS produces multiple interfering signals for DTS-2 or DTS-5 scenarios as appropriate for the test procedure.

These interferers are:

Identical interferer types for DTS-2 and DTS-5:

- Co-channel 2 (I_{CoCh2}): Synchronous co-channel interferer of type I1 as specified in TS 51.010 annex 5.2
- Adjacent 1 (I_{AdjCh1}): Adjacent channel interferer of type I1 as specified in TS 51.010 annex 5.2
- AWGN (I_{AWGN}): AWGN interferer of type I3 as specified in TS 51.010 annex 5.2

DTS-2 specific interferer:

- Co-channel 1 (I_{CoCh1}): Synchronous co-channel interferer of type I1 as specified in TS 51.010 annex 5.2

DTS-5 specific interferer:

- Co-channel 1 (I_{CoCh1}): Delayed co-channel interferer of type I5 as specified in TS 51.010 annex 5.2.

14.16.5.2.4.2 Test Procedure

14.16.5.2.4.2.1 DTS-2 Procedure

- a) The DTS-2 co-channel interferer signal I_{CoCh1} is configured according to the DTS-2 configuration.
- b) The co-channel interferer signal I_{CoCh1} set to -70 dBm.
- c) The power levels of the interferers I_{CoCh2} , I_{AdjCh1} , and I_{AWGN} are set according to table 14.16.5.2.21. The power levels are defined relative to I_{CoCh1} .
- d) The fading characteristics of the wanted signal C1 and the interferer signals I_{CoCh1} , I_{CoCh2} , and I_{AdjCh1} are set to TU High. No FH applies.
- e) The SS transmits packets using CS-1 coding on all allocated timeslots.
- f) The SS sets the level of the wanted signal C1 1 dB above the value according to table 14.16.5.2.5-1 and table 14.16.5.2.5-2.
- g) The SS transmits the number of blocks with current coding scheme accordingly with table 14.16-2 and counts the BLER based on the content of the ACK/NACK Description information element (see 3GPP TS 04.60, sub clause 12.3) in the Packet Downlink ACK/NACK as sent from the MS to the SS on the PACCH. The SS resets both counters.
- h) The SS repeats the steps (e) to (g) for each of the coding schemes CS-2, CS-3 and CS-4.

14.16.5.2.4.2.2 DTS-5 Procedure

- a) The DTS-5 co-channel interferer signal I_{CoCh1} is configured according to DTS-5 configuration.
- b) The SS repeats the steps (b) to (h) identical to the DTS-2 procedure

14.16.5.2.5 Test requirement

The block error ratio calculated by the SS for different channels and under the TU High propagation conditions, shall not exceed the conformance requirement.

NOTE: The wanted signal levels derived from calculations using 3GPP TS 45.005 table 2q, shall be set according to the table below.

Table 14.16.5.2.5-1

GSM 900 and GSM 850			
Type of channel		DARP II Test Scenario	
		DTS-2	DTS-5
PDTCH CS-1	C/dBm	-69,5	-69,5
PDTCH CS-2	C/dBm	-67,0	-66,5
PDTCH CS-3	C/dBm	-65,0	-64,5
PDTCH CS-4	C/dBm	-58,0	-57,0

Table 14.16.5.2.5-2

DCS 1 800 & PCS 1900			
Type of channel		DARP II Test Scenario	
		DTS-2	DTS-5
PDTCH CS-1	C/dBm	-70,0	-70,0
PDTCH CS-2	C /dBm	-67,0	-67,0
PDTCH CS-3	C /dBm	-65,5	-65,0
PDTCH CS-4	C /dBm	-57,5	-56,5

14.18 EGPRS receiver tests

Statistical testing of receiver BLER performance

Error Definition

Block Error Ratio (BLER):

The Block Error Ratio is the ratio of blocks received in error to the total number of received blocks, where a block is defined as received in error if the error detection functions in the receiver, operating in accordance with 3GPP TS 05.03, indicate an error as the result of the Block Check Sequence (BCS).

For USF the Block Error Ratio is the ratio of incorrectly interpreted USF to the total number of received USF.

Test criteria

In the receiver tests for circuit switched channels, test error rates have been defined in order not to pass MS with a performance worse than the specification by 1 dB, with tests to be performed at the sensitivity and interference levels defined in 3GPP TS 05.05. For circuit switched channels 3GPP TS 05.05 defines the error rates at a fixed sensitivity or interference level.

For packet switched channels 3GPP TS 05.05 defines the receive or interference level at which a fixed Block Error Ratio is met. Therefore, for EGPRS the receiver is tested with a 1 dB offset in the receive level and the interference level.

If the error events can be assumed to be random independent variables, outputs of stationary random processes with identical Gaussian distributions, the previous figures suggest a number of events not lower than 200 in AWGN channel and not lower than 600 in a multipath environment.

For multipath propagation conditions the hypothesis of stationary random processes does not generally hold. In case of non frequency hopping operation mode, the radio channel may be assumed to change 10 times per wavelength of travelled distance and to be short term stationary in between. So, in this case, the required observation time for having good statistical properties should not be lower (with some rounding) than that reported in table 14.18-1.

Table 14.18-1: Minimum test time according to propagation profile

Propagation Conditions	GSM 400, GSM 700, GSM 850 and GSM 900				DCS 1 800 and PCS 1 900			
	TUlow	TUhigh	HT	RA	TUlow	TUhigh	HT	RA
Min. test time (s)	500	30	15	6	500	15	7,5	6

Table 14.18-2 details, for the different test conditions, the minimum number of blocks required in order to meet points 1) to 3): the corresponding test time (point 4) can be consequently computed.

Table 14.18-2: Test conditions

Type of test	Type of sub-test	Propagation/ frequency conditions	Specified BLER %	Minimum No of RLC blocks
Sensitivity	PDTCH/MCS-1 to 4	static	10	2 000
"	PDTCH/MCS-1 to 4	TUhigh/no FH	10	6 000
"	PDTCH/MCS-1 to 4	TUhigh/FH	10	6 000
"	PDTCH/MCS-1 to 4	RA/no FH	10	6 000
"	PDTCH/MCS-1 to 4	HT/no FH	10	6 000
"	PDTCH/MCS-5 to 9	static	10	2 000
"	PDTCH/MCS-5 to 9	TUhigh/no FH	10 or 30	6 000 or 2 000
"	PDTCH/MCS-5 to 9	TUhigh/FH	10 or 30	6 000 or 2 000
"	PDTCH/MCS-5 to 9	RA/noFH	10 or 30	6 000 or 2 000
"	PDTCH/MCS-5 to 9	HT/noFH	10 or 30	6 000 or 2 000
"	USF/MCS-1 to 4	static	1	20 000
"	USF/MCS-1 to 4	TUhigh/no FH	1	60 000
"	USF/MCS-1 to 4	TUhigh/FH	1	60 000
"	USF/MCS-1 to 4	RA/no FH	1	60 000
"	USF/MCS-1 to 4	HT/no FH	1	60 000
"	USF/MCS-5 to 9	static	1	20 000
"	USF/MCS-5 to 9	Tuhigh/noFH	1	60 000
"	USF/MCS-5 to 9	Tuhigh/FH	1	60 000
"	USF/MCS-5 to 9	RA/no FH	1	60 000
"	USF/MCS-5 to 9	HT/no FH	1	60 000
Co-channel	PDTCH/MCS-1 to 4	TUlow/no FH	10	6 000, but minimum of 500 s
"	PDTCH/MCS-1 to 4	TUhigh/no FH	10	6 000
"	PDTCH/MCS-1 to 4	TUhigh/FH	10	6 000
"	PDTCH/MCS-1 to 4	RA/no FH	10	6 000
"	PDTCH/MCS-5 to 9	TUlow/no FH	10 or 30	6 000 or 2 000, but minimum of 500 s
"	PDTCH/MCS-5 to 9	TUhigh/no FH	10 or 30	6 000 or 2 000
"	PDTCH/MCS-5 to 9	TUhigh/FH	10 or 30	6 000 or 2 000
"	PDTCH/MCS-5 to 9	RA/no FH	10 or 30	6 000 or 2 000
"	USF/MCS-1 to 4	TUlow/no FH	1	60 000
"	USF/MCS-1 to 4	TUhigh/no FH	1	60 000
"	USF/MCS-1 to 4	TUhigh/FH	1	60 000
"	USF/MCS-1 to 4	RA/no FH	1	60 000
"	USF/MCS-5 to 9	TUlow/no FH	1	60 000
"	USF/MCS-5 to 9	TUhigh/no FH	1	60 000
"	USF/MCS-5 to 9	TUhigh/FH	1	60 000
"	USF/MCS-5 to 9	RA/no FH	1	60 000
Adjacent Channel 200kHz	PDTCH/MCS-1 to 4	TUlow/No FH	10	6 000
"	PDTCH/MCS-1 to 4	TUhigh/NoFH	10	6 000
"	PDTCH/MSC-5 to 9	TUlow/No FH	10 or 30	6 000 or 2 000
"	PDTCH/MSC-5 to 9	TUhigh/No FH	10 or 30	6 000 or 2 000
"	USF/MCS-1 to 4	TUlow/No FH	1	60 000
"	USF/MCS-1 to 4	TUhigh/No FH	1	60 000
"	USF/MCS-5 to 9	TUlow/No FH	1	60 000
"	USF/MCS-5 to 9	TUhigh/No FH	1	60 000

Type of test	Type of sub-test	Propagation/ frequency conditions	Specified BLER %	Minimum No of RLC blocks
Adjacent Channel 400kHz " " "	PDTCH/MCS-1 to 4	TUhigh/No FH	10	6 000
	PDTCH/MCS-5 to 9	TUhigh/No FH	10 or 30	6 000 or 2 000
	USF/MCS-1 to 4	TUhigh/No FH	1	60 000
	USF/MCS-5 to 9	TUhigh/No FH	1	60 000
Intermodulation Rejection " " "	PDTCH/MCS-1 to 4	static	10	2 000
	PDTCH/MCS-5 to 9	static	10	2 000
	USF/MCS-1 to 4	static	1	20 000
	USF/MCS-1 to 9	static	1	20 000
Blocking and Spurious " " "	PDTCH/MCS-1 to 4	static	10	6 000
	PDTCH/MCS-5 to 9	static	10 or 30	6 000 or 2 000
	USF/MCS-1 to 4	static	1	60 000
	USF/MCS-5 to 9	static	1	60 000

NOTE 1: For MCS-7, 8 and 9 the BLER of 10 % or 30 % is specified in the conformance requirements. For MCS-5 to 6 a BLER of 10 % is always applied.

NOTE 2: For PDTCH sub-tests under fading conditions the number of RLC blocks indicated above shall be transmitted on each downlink timeslot of the multislot configuration.

NOTE 3: For USF sub-tests under fading conditions, the number of RLC blocks indicated above shall be per uplink timeslot of the multislot configuration.

14.18.1 Minimum Input level for Reference Performance

14.18.1.1 Definition

The minimum input level is the signal level at the MS receiver input at which a certain BLER is met.

14.18.1.2 Conformance requirement

- The block error rate (BLER) performance for PDTCH/MCS1 to 4 shall not exceed 10 % at input levels according to the table 14.18-3a; and for PDTCH/MCS5 to 9 shall not exceed 10 % or 30 % depending on Coding Schemes at input levels according to the table 14.18-3b.

Table 14.18-3a: PDTCH Sensitivity Input Level for GMSK modulation

Type of Channel	Propagation conditions					
	static	TUhigh (no FH)	TUhigh (ideal FH)	RA (no FH)	HT (no FH)	
GSM 400, GSM 700, GSM 850 and GSM 900						
PDTCH/MCS-1	dBm	-104	-102,5	-103	-103	-102
PDTCH/MCS-2	dBm	-104	-100,5	-101	-100,5	-100
PDTCH/MCS-3	dBm	-104	-96,5	-96,5	-92,5	-95,5
PDTCH/MCS-4	dBm	-101,5	-91	-91	(note)	(note)
DCS 1 800 and PCS 1 900						
PDTCH/MCS-1	dBm	-104	-102,5	-103	-103	-101,5
PDTCH/MCS-2	dBm	-104	-100,5	-101	-100,5	-99,5
PDTCH/MCS-3	dBm	-104	-96,5	-96,5	-92,5	-94,5
PDTCH/MCS-4	dBm	-101,5	-90,5	-90,5	(note)	(note)

NOTE: PDTCH/MCS-4 can not meet the reference performance for some propagation conditions.

The input levels given in the above Table are applicable to GSM 400, GSM 700, GSM 850, GSM 900 and PCS 1 900 MS, and have to be corrected by the following values for the following classes of MS:

GSM 400 small MS	+2 dB;
GSM 700, GSM 850, GSM 900 small MS	+2 dB;
DCS 1800 class 1 or 2 MS	+2/+4 dB**;
DCS 1800 class 3 MS	+2 dB;
PCS 1 900 class 1 or 2 MS	+2 dB.

** For all DCS 1 800 class 1 and class 2 MS, a correction offset of +2dB shall apply for the reference sensitivity performance as specified in table 1a for the normal conditions defined in Annex D and an offset of +4 dB shall be used to determine all other MS performances.

3GPP TS 05.05, table 1a; 3GPP TS 05.05, subclause 6.2.

Table 14.18-3b: PDTCH Sensitivity Input Level for MS for 8-PSK modulation

GSM 400, GSM 700, GSM 850 and GSM 900						
Type of channel		Propagation conditions				
		static	TUhigh (no FH)	TUhigh (ideal FH)	RA (no FH)	HT (no FH)
PDTCH/MCS-5	dBm	-98	-93	-94	-93	-92
PDTCH/MCS-6	dBm	-96	-91	-91,5	-88	-89
PDTCH/MCS-7	dBm	-93	-84	-84	(note 2)	-83 (note 3)
PDTCH/MCS-8	dBm	-90,5	-83 (note 3)	-83 (note 3)	(note 2)	(note 2)
PDTCH/MCS-9	dBm	-86	-78,5 (note 3)	-78,5 (note 3)	(note 2)	(note 2)
DCS 1 800 and PCS 1 900						
Type of channel		Propagation conditions				
		static	TUhigh (no FH)	TUhigh (ideal FH)	RA (no FH)	HT (no FH)
PDTCH/MCS-5	dBm	-98	-93,5	-93,5	-93	-89,5
PDTCH/MCS-6	dBm	-96	-91	-91	-88	-83,5
PDTCH/MCS-7	dBm	-93	-81,5	-80,5	(note 2)	(note 2)
PDTCH/MCS-8	dBm	-90,5	-80 (note 3)	-80 (note 3)	(note 2)	(note 2)
PDTCH/MCS-9	dBm	-86	(note 2)	(note 2)	(note 2)	(note 2)
NOTE 1: Ideal FH case assumes perfect decorrelation between bursts. This case may only be tested if such a decorrelation is ensured in the test. For TUhigh (ideal FH), sufficient decorrelation may be achieved with 4 frequencies spaced over 5 MHz.						
NOTE 2: PDTCH for MCS-x can not meet the reference performance for some propagation conditions.						
NOTE 3: Performance is specified at 30% BLER for some cases.						

The input levels given in the above Table are applicable to Class 4 or Class 5 MS for GSM 400, GSM 700, GSM 850 and GSM 900 and to Class 1 or Class 2 MS for DCS 1 800 and PCS 1 900. For all other MS the input levels have to be corrected by the value of -2 dB.

3GPP TS 05.05, tables 1c; 3GPP TS 05.05, subclause 6.2

- The block error rate (BLER) performance for USF/MCS1 to 9 shall not exceed 1 % at input levels according to the tables 14.18-4a and 14.18-4b.

Table 14.18-4a: USF Sensitivity Input Level for GMSK modulation

Type of channel	Propagation conditions					
	static	TUhigh (no FH)	TUhigh (ideal FH)	RA (no FH)	HT (no FH)	
GSM 400, GSM 700, GSM 850 and GSM 900						
USF/MCS-1 to 4	dBm	-104	-102,5	-104	-104	-102,5
DCS 1 800 and PCS 1 900						
USF/MCS-1 to 4	dBm	-104	-104	-104	-104	-102,5

The input levels given in the above Table are applicable to GSM 400, GSM 700, GSM 850, GSM 900 and PCS 1 900 MS, and have to be corrected by the following values for the following classes of MS:

GSM 400 small MS	+2 dB;
GSM 700, GSM 850 and GSM 900 small MS	+2 dB;
DCS 1800 class 1 or 2 MS	+2/+4 dB**;
DCS 1800 class 3 MS	+2 dB;
PCS 1 900 class 1 or 2 MS	+2 dB.

** For all DCS 1 800 class 1 and class 2 MS, a correction offset of +2dB shall apply for the reference sensitivity performance as specified in table 1a for the normal conditions defined in Annex D and an offset of +4 dB shall be used to determine all other MS performances.

3GPP TS 05.05, table 1a; 3GPP TS 05.05, subclause 6.2.

Table 14.18-4b: USF Sensitivity Input Level for 8-PSK modulation

Type of Channel	Propagation conditions					
	static	TUhigh (no FH)	TUhigh (ideal FH)	RA (no FH)	HT (no FH)	
GSM 400, GSM 700, GSM 850 and GSM 900						
USF/MCS-5 to 9	dBm	-102	-97,5	-99	-100	-99
DCS 1 800 and PCS 1 900						
USF/MCS-5 to 9	dBm	-102	-99	-99	-100	-99

The input levels given in the above Table are applicable to Class 4 or Class 5 MS for GSM 400, GSM 700, GSM 850 and GSM 900 and to Class 1 or Class 2 MS for DCS 1 800 and PCS 1 900. For all other MS the input levels have to be corrected by the value of -2 dB.

3GPP TS 05.05, table 1c; 3GPP TS 05.05, subclause 6.2

- The BLER shall not exceed the conformance requirements given in 1. and 2. under extreme conditions; 3GPP TS 05.05, subclause 6.2 and annex D subclauses D.2.1 and D.2.2.

- The reference sensitivity performance specified above need not be met in the following cases:

For MS at the static channel, if the received level on either of the two adjacent timeslots to the wanted exceed the wanted timeslot by more than 20 dB.

For MS on a multislot configuration, if the received level on any of the timeslots belonging to the same multislot configuration as the wanted time slot, exceed the wanted time slot by more than 6 dB.

The interfering adjacent time slots shall be static with valid GSM signals in all cases.

3GPP TS 05.05, subclause 6.2.

- For an MS allocated a USF on a PDCH with a random RF input or a valid PDCH signal with a random USF not equal to the allocated USF, the overall reception shall be such that the MS shall detect the allocated USF in less than 1 % of the radio blocks for GMSK modulated signals and 1 % for 8-PSK modulated signals. This

requirement shall be met for all input levels up to -40 dBm for GMSK modulated signals and up to -40 dBm for 8-PSK modulated signals.

3GPP TS 05.05, subclause 6.4

3GPP TS 45.05 subclause 2:

For T-GSM 810 the requirements for GSM 900 shall apply, apart for those parameters for which a separate requirement exists.

14.18.1.3 Test purpose

1. To verify that the MS sends a Packet Not Acknowledge in the Packet Downlink Ack/Nack in case of the Block Check Sequence indicating a Block Error.
2. To verify that the MS does not exceed conformance requirement 1 for PDTCH with different coding schemes and under different propagation conditions with an allowance for the statistical significance of the test.
3. To verify that the MS does not exceed conformance requirement 2 under HT propagation conditions with an allowance for the statistical significance of the test.
4. To verify that the MS does not exceed conformance requirement 3 under STATIC, TUhigh, HT and RA propagation conditions for the PDTCH, and under HT propagation conditions for the USF, with an allowance for the statistical significance of the test.
5. To verify that the MS meets the conformance requirements also 1 and 2 for the conditions allowed by conformance requirement 4, with an allowance for the statistical significance of the test.
6. To verify that the MS meets conformance requirement 5, with an allowance for the statistical significance of the test.

14.18.1.4 Method of test

Initial conditions

NOTE 1: The BA list sent on the BCCH will indicate at least six surrounding cells with at least one near to each band edge. It is not necessary to generate any of these BCCHs but, if provided the signal strengths of BCCHs shall be in the range $15 \text{ dB}\mu\text{Vemf}(\)$ to $35 \text{ dB}\mu\text{Vemf}(\)$. Surrounding cell signal levels and cell reselection parameters are set so that the MS will not try a cell reselection.

NOTE 2: The ARFCN of any BCCH shall not be co-channel or on adjacent channels to the wanted traffic channel.

NOTE 3: When frequency hopping is used under static conditions, the traffic channel may fall on any of the ARFCNs defined in clause 6. When frequency hopping is used under non-static conditions any ARFCNs shall be chosen.

NOTE 4: The PSI1 message is included in the PACCH when the MS is in packet transfer mode. The PBCCH_CHANGE_MARK value in PSI1 is not changed. This, together with preventing cell reselection as per Note 1, ensures that the MS is highly unlikely to suspend the TBF (3GPP TS 04.60 subclause 5.5.1.4.2 Suspension of operation to receive system operation), and thus making the effect of TBF suspension statistically insignificant for the test result.

For both GMSK and 8-PSK modulations, a downlink TBF is set up according to the generic procedure specified in clause 40 for packet switched on an ARFCN in the Mid range. The power control parameter ALPHA (α) is set to 0. The SS shall transmit on the maximum number of receive timeslots. The SS commands the MS to transmit at maximum power.

Test procedure

For GMSK Modulation:

- a) The SS transmits packets under static conditions, using MCS-4 coding at a level of 1 dB above the level given in conformance reference 1. Out of the 400 blocks transmitted by the SS, 20 blocks are sent with incorrect BCS, at (pseudo) random positions. The SS checks, for the blocks it transmitted with incorrect BCS, whether or not the MS Packet Downlink Ack/Nack as sent by the MS indicates these blocks as not acknowledged.

- b) The SS transmits packets under static conditions, with the MS commanded to hopping mode using the hopping sequence used in clause 6, and using MCS-4 coding to the MS on all allocated timeslots, at a level of 1 dB above the level given in the table in conformance requirement 1. On the time slots not allocated to the MS, the SS transmits at a level of 20 dB above the level given in the table in conformance requirement 1. This implicitly tests adjacent time slot rejection.
- c) The SS counts the number of blocks transmitted with MCS-4 and the number of these blocks not acknowledged based on the content of the Ack/Nack Description information element (see 3GPP TS 04.60, subclause 12.3) in the Packet Downlink Ack/Nack as sent from the MS to the SS on the PACCH.

NOTE 5: Due to the error rates related to the USF, the MS is likely to occasionally miss its USF for transmitting the Packet Downlink Ack/Nack. As this requirement is not verified in this part of the test, the SS then again assigns uplink resources so the MS can send this message.

- d) Once the number of blocks transmitted with MCS-4 as counted in step c) reaches or exceeds the minimum number of blocks as given in table 14-18-2, the SS calculates the Block error ratio. The SS resets both counters.
- e) The SS repeats step b) to d) with the following two fading conditions and hopping modes: TUhigh/noFH and TUhigh/FH. For these tests with fading channels, the SS does not transmit on the timeslots not allocated to the MS.
- f) The SS repeats steps b) to d) using MCS-3 coding with RA/No FH, MCS-2 coding with HT/No FH and MCS-1 coding with TUhigh/No FH. For these tests, the SS does not transmit on the timeslots not allocated to the MS.
- g) The SS repeats steps b) to e) under extreme test conditions for MCS-4 coding only.
- h) This step is only performed for a multislot MS. The SS establishes the normal test conditions with the exceptions in the parameter settings of Packet Downlink Assignment message:
 - P0 = 14 dB;
 - BTS_PWR_CTRL_MODE = Mode A;
 - PR_MODE = B.

Furthermore, the SS has to set the PR fields in the MAC headers of each downlink RLC data block to correspond the applied downlink power level, as defined below. The SS repeats steps b) to d) with only one of the active timeslots at 1 dB above the level at which the reference sensitivity performance shall be met, and all other timeslots belonging to the same multislot configuration at a level of 6 dB above this timeslot.

- i) The SS establishes the normal test conditions, and sets the fading function to HT/noFH. An uplink TBF shall be established.
- j) The SS sets the value of the USF/MCS-1 such as to allocate the uplink to the MS, transmitting at a level of 1 dB above the level given in the table in conformance requirement 2.
- k) The SS counts the number of times the USF is allocated to the MS, and the number of times the MS does not transmit while being allocated the uplink.
- l) Once the number of USF/MCS-1 allocating the uplink for the MS as counted in step k) reaches or exceeds the minimum number of blocks as given in table 14-18-2, the SS calculates the Block error ratio. The SS resets both counters
- m) The SS repeats steps i) to l) under extreme test conditions using MCS-4 coding.
- n) The SS establishes normal test condition and a static channel. The SS sets the value of the USF/MCS-1 to all values randomly, with the exception of the one allocated to the MS, transmitting at 3 dB below the level at which reference performance shall be met, and counts the number of times the MS transmits on the uplink. This is done for 2 000 blocks.

For 8-PSK Modulation:

- a) The SS transmits packets under static conditions, using MCS-8 coding at a level of 1 dB above the level given in conformance reference 1. Out of the 400 blocks transmitted by the SS, 20 blocks are sent with incorrect BCS, at (pseudo) random positions. The SS checks, for the blocks it transmitted with incorrect BCS, whether or not the MS Packet Downlink Ack/Nack as sent by the MS indicates these blocks as not acknowledged.

- b) The SS transmits packets under static conditions, with the MS commanded to hopping mode using the hopping sequence used in clause 6, and using MCS-8 coding to the MS on all allocated timeslots, at a level of 1 dB above the level given in the table in conformance requirement 1. On the time slots not allocated to the MS, the SS transmits at a level of 20 dB above the level given in the table in conformance requirement 1. This implicitly tests adjacent time slot rejection.
- c) The SS counts the number of blocks transmitted with MCS-8 and the number of these blocks not acknowledged based on the content of the Ack/Nack Description information element (see 3GPP TS 04.60, subclause 12.3) in the Packet Downlink Ack/Nack as sent from the MS to the SS on the PACCH.

NOTE 6: Due to the error rates related to the USF, the MS is likely to occasionally miss its USF for transmitting the Packet Downlink Ack/Nack. As this requirement is not verified in this part of the test, the SS then again assigns uplink resources so the MS can send this message.

- d) Once the number of blocks transmitted with MCS-8 as counted in step c) reaches or exceeds the minimum number of blocks as given in table 14-18-2, the SS calculates the Block error ratio. The SS resets both counters.
- e) The SS repeats step b) to d) with the following two fading conditions and hopping modes: TUhigh/noFH and TUhigh/FH. For these tests with fading channels, the SS does not transmit on the timeslots not allocated to the MS.
- f) The SS repeats steps b) to d) using MCS-9 with static condition, MCS-7 with TUhigh/FH, MSC-6 with HT/No FH and MSC-5 with RA/No FH. For these tests, the SS does not transmit on the timeslots not allocated to the MS.
- g) The SS repeats steps b) to e) under extreme test conditions for MCS-8 coding only.
- h) This step is only performed for a multislot MS. The SS establishes the normal test conditions with the exceptions in the parameter settings of Packet Downlink Assignment message:
 - $P_0 = 14$ dB;
 - $BTS_PWR_CTRL_MODE = Mode A$;
 - $PR_MODE = B$.

Furthermore, the SS has to set the PR fields in the MAC headers of each downlink RLC data block to correspond the applied downlink power level, as defined below. The SS repeats steps b) to d) with only one of the active timeslots at 1 dB above the level at which the reference sensitivity performance shall be met, and all other timeslots belonging to the same multislot configuration at a level of 6 dB above this timeslot.

- i) The SS establishes the normal test conditions, and sets the fading function to HT/noFH. An uplink TBF shall be established.
- j) The SS sets the value of the USF/MCS-5 such as to allocate the uplink to the MS, transmitting at a level of 1 dB above the level given in the table in conformance requirement 2.
- k) The SS counts the number of times the USF is allocated to the MS, and the number of times the MS does not transmit while being allocated the uplink.
- l) Once the number of USF/MCS-5 allocating the uplink for the MS as counted in step k) reaches or exceeds the minimum number of blocks as given in table 14-18-2, the SS calculates the Block error ratio. The SS resets both counters.
- m) The SS repeats steps j) to l) under extreme test conditions using MCS-9 coding.
- n) The SS establishes normal test condition and a static channel. The SS sets the value of the USF/MCS-5 to all values randomly, with the exception of the one allocated to the MS, transmitting at 3 dB below the level at which reference performance shall be met, and counts the number of times the MS transmits on the uplink. This is done for 2 000 blocks.

14.18.1.5 Test requirements

In step a) the Packet Downlink Ack/Nack as sent by the MS shall indicate every block transmitted by the SS with incorrect BCS as not acknowledged.

The block error ratio, as calculated by the SS for different channels and under the different propagation conditions, under any combination of normal and extreme test voltages and ambient temperatures, shall not exceed the conformance requirement.

In step n) for both GMSK modulation and 8-PSK modulation the MS shall transmit no more than 25 times.

In the case when downlink power control is not used and the output power used on the transmitted blocks is not equal to (BCCH level – P_b) then the MS is not required to fulfil 3GPP TS 05.05 requirements for the first 25 blocks addressed to this MS (3GPP TS 05.08, subclause 10.2.2).

14.18.2 Co-channel rejection

14.18.2.1 Definition

The co-channel rejection is a measure of the capability of the receiver to receive a wanted modulated signal without exceeding a given degradation due to the presence of an unwanted modulated signal, both signals being at the nominal frequency of the receiver. "Wanted signal" in this test is the signal generated by the transmitted RLC data blocks.

14.18.2.2 Conformance requirement

1. The block error rate (BLER) performance for PDTCH/MCS1 to 4 shall not exceed 10 % at co-channel interference ratios (C/I_c) exceeding those according to the table 14.18-5a; and for PDTCH/MCS5 to 9 shall not exceed 10 % or 30 % depending on Coding Schemes at co-channel interference ratios (C/I_c) exceeding those according to the table 14.18-5b.

Table 14.18-5a: PDTCH Co-channel Interference Ratio for GMSK modulation

Type of channel	Propagation conditions				
	TUlow (no FH)	TUhigh (no FH)	TUhigh (ideal FH)	RA (no FH)	
GSM 400, GSM 700, GSM 850 and GSM 900					
PDTCH/MCS-1	dB	13	10,5	9,5	10
PDTCH/MCS-2	dB	15	12,5	12	12
PDTCH/MCS-3	dB	16,5	17	17	19
PDTCH/MCS-4	dB	19	22	22	(note)
DCS 1 800 and PCS 1 900					
PDTCH/MCS-1	dB	13	10	9,5	10
PDTCH/MCS-2	dB	15	12	12	12
PDTCH/MCS-3	dB	16,5	17	18	19
PDTCH/MCS-4	dB	19	23	23	(note)
NOTE: PDTCH/MCS-4 can not meet the reference performance for some propagation condition.					

3GPP TS 05.05, table 2a; 3GPP TS 05.05, subclause 6.3.

Table 14.18-5b: Cochannel interference ratio for MS at reference performance for 8-PSK modulation

GSM 400, GSM 700, GSM 850 and GSM 900					
Type of channel		Propagation conditions			
		TUlow (no FH)	TUhigh (no FH)	TUhigh (ideal FH)	RA (no FH)
PDTCH/MCS-5	dB	19,5	15,5	14,5	16,5
PDTCH/MCS-6	dB	21,5	18	17,5	21
PDTCH/MCS-7	dB	26,5	25	24.5	(note 1)
PDTCH/MCS-8	dB	30,5	25,5 (note 2)	25,5**	(note 1)
PDTCH/MCS-9	dB	25,5 (note 2)	30,5 (note 2)	30,5**	(note 1)
DCS 1800 and PCS 1 900					
Type of channel		Propagation conditions			
		TUlow (no FH)	TUhigh (no FH)	TUhigh (ideal FH)	RA (no FH)
PDTCH/MCS-5	dB	19,5	15	15,5	16,5
PDTCH/MCS-6	dB	21,5	18	18,5	21
PDTCH/MCS-7	dB	26,5	27,5	28	(note 1)
PDTCH/MCS-8	dB	30,5	29,5 (note 2)	29 (note 2)	(note 1)
PDTCH/MCS-9	dB	25,5 (note 2)	(note 1)	(note 1)	(note 1)

NOTE 1: PDTCH/MCS-x can not meet the reference performance for some propagation condition.
NOTE 2: Performance is specified at 30% BLER for some cases.

3GPP TS 05.05, table 2c and subclause 6.3.

- The block error rate (BLER) performance for USF/MCS1 to 9 shall not exceed 1 % at co-channel interference ratios (C/I_c) exceeding those according to the tables 14.18-6a and 14.18-6b.

Table 14.18-6a: USF Co-channel Interference Ratio for GMSK modulation

Type of channel		Propagation conditions			
		TUlow (no FH)	TUhigh (no FH)	TUhigh (ideal FH)	RA (no FH)
GSM 400, GSM 700, GSM 850 and GSM 900					
USF/MCS-1 to 4	dB	18	11	9,5	9,5
DCS 1 800 and PCS 1 900					
USF/MCS-1 to 4	dB	18	9,5	9,5	9,5

3GPP TS 05.05, tables 2a.

Table 14.18-6b: USF Co-channel Interference Ratio for 8-PSK modulation

Type of channel		Propagation conditions			
		TUlow (no FH)	TUhigh (no FH)	TUhigh (ideal FH)	RA (no FH)
GSM 400, GSM 700, GSM 850 and GSM 900					
USF/MCS-5 to 9	dB	17	11,5	9	9
DCS 1 800 and PCS 1 900					
USF/MCS-5 to 9	dB	17	10	9	9

3GPP TS 05.05, Tables 2c.

3GPP TS 45.05 subclause 2:

For T-GSM 810 the requirements for GSM 900 shall apply, apart for those parameters for which a separate requirement exists.

14.18.2.3 Test purpose

1. To verify that the MS does not exceed conformance requirement 1 for different coding schemes and under different propagation conditions with an allowance for the statistical significance of the test.
2. To verify that the MS does not exceed conformance requirement 2 under propagation condition TUhigh/noFH, with an allowance for the statistical significance of the test.

14.18.2.4 Method of test

Initial conditions

For both GMSK and 8-PSK modulations, a downlink TBF is set up according to the generic procedure specified in clause 40 for packet switched with an ARFCN in the mid ARFCN range, power control level set to maximum power. The power control parameter ALPHA (α) is set to 0.

The SS transmits EGPRS RLC data blocks containing random data. In addition to these data blocks, the SS produces an independent, uncorrelated interfering signal (I1).

Specific PICS statements:

- Support of DARP Phase 1 (TSPC_DARP_Phase1)

PIXIT Statements:

-

Test procedure

For GMSK Modulation:

- a) The SS transmits packets on PDTCH using MCS-4 coding to the MS on all allocated timeslots.
- b) The fading characteristic of the wanted signal and the interfering signal is TULow, no FH applies.
- c) The co-channel interference ratio is set to 1 dB above the ratio given in the table in conformance requirement 1. The interferer shall have the same frequency hopping sequence as the wanted signal, as well as be subject to the same fading profile.
- d) The SS counts the number of blocks transmitted with current coding scheme and the number of these blocks not acknowledged based on the content of the Ack/Nack Description information element (see 3GPP TS 04.60, subclause 12.3) in the Packet Downlink Ack/Nack as sent from the MS to the SS on the PACCH.

NOTE 1: Due to the error rates related to the USF, the MS is likely to occasionally miss its USF for transmitting the Packet Downlink Ack/Nack. As this requirement is not verified in this part of the test, the SS then again assigns uplink resources so the MS can send this message.

- e) Once the number of blocks transmitted with the current coding scheme as counted in step d) reaches or exceeds the minimum number of blocks as given in table 14-18-2, the SS calculates the Block error ratio. The SS resets both counters.
- f) If the MS does not support DARP phase 1 the SS repeats step c) to e) with the TUhigh/noFH fading condition
- g) The SS repeats the steps c) to e) for the coding schemes, MCS-2 with TUhigh/FH and for MCS-1 with RA/noFH and, if the MS does not support DARP phase 1, also the coding scheme MCS-3 with TUhigh/noFH.
- h) The SS establishes the normal test conditions, and sets the fading function to TUhigh/noFH. An uplink TBF shall be established.
- i) The SS sets the value of the USF/MCS-4 such as to allocate the uplink to the MS, using a co-channel interference ratio of 1 dB above the ratio given in the table in conformance requirement 2.
- j) The SS counts the number of times the USF is allocated to the MS, and the number of times the MS does not transmit while being allocated the uplink.

- k) Once the number of USF/MCS-4 allocating the uplink for the MS as counted in step j) reaches or exceeds the minimum number of blocks as given in table 14-18-2, the SS calculates the Block error ratio. The SS resets both counters.

For 8-PSK Modulation:

- a) The SS transmits packets on PDTCH using MCS-8 coding to the MS on all allocated timeslots.
- b) The fading characteristic of the wanted signal and the interfering signal is TUlow, no FH applies.
- c) The co-channel interference ratio is set to 1 dB above the ratio given in the table in conformance requirement 1. The interferer shall have the same frequency hopping sequence as the wanted signal, as well as be subject to the same fading profile.
- d) The SS counts the number of blocks transmitted with current coding scheme and the number of these blocks not acknowledged based on the content of the Ack/Nack Description information element (see 3GPP TS 04.60, subclause 12.3) in the Packet Downlink Ack/Nack as sent from the MS to the SS on the PACCH.

NOTE 2: Due to the error rates related to the USF, the MS is likely to occasionally miss its USF for transmitting the Packet Downlink Ack/Nack. As this requirement is not verified in this part of the test, the SS then again assigns uplink resources so the MS can send this message.

- e) Once the number of blocks transmitted with the current coding scheme as counted in step d) reaches or exceeds the minimum number of blocks as given in table 14-18-2, the SS calculates the Block error ratio. The SS resets both counters.
- f) The SS repeats step c) to e) with the TUhigh/noFH fading condition.
- g) The SS repeats steps c) to e) for MCS-9 with TUlow/NoFH, MCS-7 with TUhigh/noFH, MCS-6 with TUhigh/FH and MSC-5 with RA/noFH.
- h) The SS sets the fading function to TUhigh/noFH. An uplink TBF shall be established.
- i) The SS sets the value of the USF/MCS-9 such as to allocate the uplink to the MS, using a co-channel interference ratio of 1 dB above the ratio given in the table in conformance requirement 2.
- j) The SS counts the number of times the USF is allocated to the MS, and the number of times the MS does not transmit while being allocated the uplink.
- k) Once the number of USF/MCS-9 allocating the uplink for the MS as counted in step j) reaches or exceeds the minimum number of blocks as given in table 14-18-2, the SS calculates the Block error ratio. The SS resets both counters.

14.18.2.5 Test requirements

The block error ratio, as calculated by the SS for different channels and under the different propagation conditions, shall not exceed the conformance requirement.

14.18.3 Adjacent channel rejection

14.18.3.1 Definition

The adjacent channel selectivity is a measure of the capability of the receiver to receive wanted data packets without exceeding a given degradation due to the presence of an interfering signal (I1) in the adjacent channel. "Wanted signal" in this test is the signal generated by the transmitted RLC data blocks.

The adjacent channel can be the adjacent in the RF spectrum or in time. There are therefore two types of adjacent channel selectivity:

- 1) Adjacent RF channel selectivity which is specifically tested in this subclause.
- 2) Adjacent Time Slot selectivity, which is implicitly tested in test 14.18.2.

14.18.3.2 Conformance requirement

1. For GMSK modulation, under adjacent channel interference at 200 kHz above and below the wanted signal frequency and at the adjacent interference ratio (C/I_{a1}) exceeding $C/I_c - 18$ dB where C/I_c is the co-channel interference ratio specified in table 14.18-5a for PDTCH and table 14.18-6a for USF channels.
 - 1.1 For a TU_{high} faded wanted signal and a TU_{high} adjacent channel interferer, The block error rate (BLER) performance for PDTCH/MCS-1 to 4 shall not exceed 10 %; 3GPP TS 05.05, subclause 6.2.
 - 1.2 For a TU_{high} faded wanted signal and a TU_{high} adjacent channel interferer, The block error rate (BLER) performance for USF/MSC-1 to 4 shall not exceed 1 %; 3GPP TS 05.05, subclause 6.2.
- For 8-PSK modulation, under adjacent channel interference at 200 kHz above and below the wanted signal frequency and at the adjacent interference ratio (C/I_{a1}) specified in table 14.18-7a.
 - 1.3 For a TU_{high} faded wanted signal and a TU_{high} adjacent channel interferer, The block error rate (BLER) performance for PDTCH/MCS-5 to 9 shall not exceed 10 % or 30 % depending on Coding Scheme; 3GPP TS 05.05, subclause 6.2.
 - 1.4 For a TU_{high} faded wanted signal and a TU_{high} adjacent channel interferer, The block error rate (BLER) performance for USF/MSC-5 to 9 shall not exceed 1 %; 3GPP TS 05.05, subclause 6.2.

Table 14.18-7a: Adjacent channel interference ratio for MS at reference performance for 8-PSK modulation

GSM 400, GSM 700, GSM 850 and GSM 900						
Type of channel		Propagation conditions				
		TU _{low} (no FH)	TU _{low} (ideal FH)	TU _{high} (no FH)	TU _{high} (ideal FH)	RA (no FH)
PDTCH/MCS-5	dB	2,5	-2	-1	-2	1
PDTCH/MCS-6	dB	5,5	0,5	2	1	6,5
PDTCH/MCS-7	dB	10,5	8	10	9	(note 1)
PDTCH/MCS-8	dB	15,5	9 (note 2)	11 (note 2)	10,5 (note 2)	(note 1)
PDTCH/MCS-9	dB	10 (note 2)	12,5 (note 2)	17 (note 2)	15,5 (note 2)	(note 1)
USF/MCS-5 to 9	dB	-1	-8,5	-8	-9,5	-9
DCS 1 800 and PCS 1 900						
Type of channel		Propagation conditions				
		TU _{low} (no FH)	TU _{low} (ideal FH)	TU _{high} (no FH)	TU _{high} (ideal FH)	RA (no FH)
PDTCH/MCS-5	dB	2,5	-2	-2	-1,5	1
PDTCH/MCS-6	dB	5,5	0,5	1,5	1,5	6,5
PDTCH/MCS-7	dB	10,5	8	12,5	12	(note 1)
PDTCH/MCS-8	dB	15,5	9 (note 2)	16 (note 2)	15,5 (note 2)	(note 1)
PDTCH/MCS-9	dB	10 (note 2)	12,5 (note 2)	(note 1)	(note 1)	(note 1)
USF/MCS-5 to 9	dB	-1	-8,5	-9	-9,5	-9
NOTE1: PDTCH for MCS-x can not meet the reference performance for some propagation conditions.						
NOTE 2: Performance is specified at 30% BLER for some cases.						

3GPP TS 05.05, table 2g and sublcuase 6.3.

2. For both GMSK and 8-PSK modulations, under adjacent channel interference conditions with interfering signals at 400 kHz above and below the wanted signal frequency and at the adjacent interference ratio (C/I_{a2}) exceeding $C/I_c - 50$ dB.
 - 2.1 For a TU_{high} faded wanted signal and a TU_{high} adjacent channel interferer, The block error rate (BLER) performance for PDTCH/MCS-1 to 4 shall not exceed 10 % for GMSK modulation; and for PDTCH/MCS-5 to 9 shall not exceed 10 % or 30 % depending on Coding Schemes; 3GPP TS 05.05, subclause 6.2.
 - 2.2 For a TU_{high} faded wanted signal and a TU_{high} adjacent channel interferer, The block error rate (BLER) performance for USF/MSC-1 to 9 shall not exceed 1 %; 3GPP TS 05.05, subclause 6.2.

C/I_c is the co-channel interference ratio. For a PDTCH with GMSK modulation C/I_c is specified in table 14.18-5a; for a PDTCH with 8-PSK modulation C/I_c is specified in table 14.18-5b, for a USF with GMSK

modulation C/Ic is specified in tables 14.18-6a; and for USF with 8-PSK modulation C/Ic is specified in table 14.18-6b. 3GPP TS 05.05, subclause 6.3.

3. The BLER shall not exceed the conformance requirements given in 1. and 2. under extreme conditions; 3GPP TS 05.05, subclause 6.2 and annex D subclauses D.2.1 and D.2.2.

3GPP TS 45.05 subclause 2:

For T-GSM 810 the requirements for GSM 900 shall apply, apart for those parameters for which a separate requirement exists.

14.18.3.3 Test purpose

- 1 To verify that the conformance requirements 1.1, 1.2, 1.3 and 1.4 are met with an allowance for the statistical significance of the test in the presence of a GMSK modulated adjacent channel interferer under propagation condition TUhigh at 200 kHz above and below the wanted signal frequency.
- 2 To verify that the conformance requirements 2.1 and 2.2 are met with an allowance for the statistical significance of the test in the presence of a GMSK modulated adjacent channel interferer under propagation condition TUhigh at 400 kHz above and below the wanted signal frequency.
3. To verify that Conformance Requirements are met under extreme conditions.

14.18.3.4 Method of test

Initial conditions

For both GMSK and 8-PSK modulations, a downlink TBF is set up according to the generic procedure specified in clause 40 for packet switched with an ARFCN in the mid ARFCN range, power control level set to maximum power. The power control parameter ALPHA (α) is set to 0. The SS transmits EGPRS RLC data blocks containing random data. In addition to the wanted test signal, the SS transmits an independent, uncorrelated interfering signal Standard Test Signal (II). This unwanted signal is random, continuous and GMSK-modulated, and has no fixed relationship with the bit transitions of the wanted signal.

The fading characteristic of the wanted and the interfering signal is TUhigh/noFH

Test procedure

For GMSK Modulation:

- a) The SS transmits packets on PDTCH using MCS-1 coding to the MS on all allocated timeslots.
- b) The SS transmits the unwanted signal at a nominal frequency 200kHz above the nominal frequency of the wanted signal. Its amplitude is set to achieve the adjacent interference ratio 1dB above that specified in the conformance requirements.
- c) The SS counts the number of blocks transmitted with current coding scheme and the number of these blocks not acknowledged based on the content of the Ack/Nack Description information element (see 3GPP TS 04.60, subclause 12.3) in the Packet Downlink Ack/Nack as sent from the MS to the SS on the PACCH.

NOTE 1: Due to the error rates related to the USF, the MS is likely to occasionally miss its USF for transmitting the Packet Downlink Ack/Nack. As this requirement is not verified in this part of the test, the SS then again assigns uplink resources so the MS can send this message.

- d) Once the number of blocks transmitted with the current coding scheme as counted in step c) reaches or exceeds the minimum number of blocks as given in table 14-18-2, the SS calculates the Block error ratio. The SS resets both counters.
- e) The SS repeats steps c) and d) with the unwanted signal transmitted at a nominal frequency 200 kHz below the nominal frequency of the wanted signal and its amplitude is set to achieve the adjacent interference ratio 1dB above that specified in the conformance requirements.
- f) The SS repeats steps c) and d) with the unwanted signal transmitted at a nominal frequency 400 kHz above the nominal frequency of the wanted signal and its amplitude is set to achieve the adjacent interference ratio 1dB above that specified in the conformance requirements.

- g) The SS repeats steps c) and d) with the unwanted signal transmitted at a nominal frequency 400 kHz below the nominal frequency of the wanted signal and its amplitude is set to achieve the adjacent interference ratio 1dB above that specified in the conformance requirements.
- h) The SS repeats steps b) to g) for each of the coding schemes MCS-2 to 4.
- i) The SS repeats steps a) to g) under extreme test conditions for MCS-4 coding scheme only.
- j) The SS establishes the normal test conditions. An uplink TBF shall be established.
- k) The SS sets the value of the USF/MCS-1 such as to allocate the uplink to the MS.
- l) The SS transmits the unwanted signal at a nominal frequency 200 kHz above the nominal frequency of the wanted signal. Its amplitude is set to achieve the adjacent interference ratio 1dB above that specified in the conformance requirements.
- m) The SS counts the number of times the USF is allocated to the MS, and the number of times the MS does not transmit while being allocated the uplink.
- n) Once the number of USF/MCS-1 allocating the uplink for the MS as counted in step m) reaches or exceeds the minimum number of blocks as given in table 14.18-2, the SS calculates the Block error ratio. The SS resets both counters.
- o) The SS repeats steps m) and n) with the unwanted signal transmitted at a nominal frequency 200 kHz below the nominal frequency of the wanted signal and its amplitude is set at to achieve the adjacent interference ratio 1dB above that specified in the conformance requirements.
- p) The SS repeats steps m) and n) with the unwanted signal transmitted at a nominal frequency 400 kHz above the nominal frequency of the wanted signal and its amplitude is set to achieve the adjacent interference ratio 1dB above that specified in the conformance requirements.
- q) The SS repeats steps m) and n) with the unwanted signal transmitted at a nominal frequency 400 kHz below the nominal frequency of the wanted signal and its amplitude is set to achieve the adjacent interference ratio 1dB above that specified in the conformance requirements.
- r) The SS repeats steps k) to q) under extreme test conditions for coding scheme USF/MCS-4.

For 8-PSK Modulation:

- a) The SS transmits packets on PDTCH using MCS-5 coding to the MS on all allocated timeslots.
- b) The SS transmits the unwanted signal at a nominal frequency 200 kHz above the nominal frequency of the wanted signal. Its amplitude is set to achieve the adjacent interference ratio 1dB above that specified in the conformance requirements.
- c) The SS counts the number of blocks transmitted with current coding scheme and the number of these blocks not acknowledged based on the content of the Ack/Nack Description information element (see 3GPP TS 04.60, subclause 12.3) in the Packet Downlink Ack/Nack as sent from the MS to the SS on the PACCH.

NOTE 2: Due to the error rates related to the USF, the MS is likely to occasionally miss its USF for transmitting the Packet Downlink Ack/Nack. As this requirement is not verified in this part of the test, the SS then again assigns uplink resources so the MS can send this message.

- d) Once the number of blocks transmitted with the current coding scheme as counted in step c) reaches or exceeds the minimum number of blocks as given in table 14-18-2, the SS calculates the Block error ratio. The SS resets both counters.
- e) The SS repeats steps c) and d) with the unwanted signal transmitted at a nominal frequency 200 kHz below the nominal frequency of the wanted signal and its amplitude is set to achieve the adjacent interference ratio 1dB above that specified in the conformance requirements.
- f) The SS repeats steps c) and d) with the unwanted signal transmitted at a nominal frequency 400 kHz above the nominal frequency of the wanted signal and its amplitude is set to achieve the adjacent interference ratio 1dB above that specified in the conformance requirements.

- g) The SS repeats steps c) and d) with the unwanted signal transmitted at a nominal frequency 400 kHz below the nominal frequency of the wanted signal and its amplitude is set to achieve the adjacent interference ratio 1dB above that specified in the conformance requirements.
- h) The SS repeats steps b) to g) for each of the coding schemes MCS-6 to 8 and for the coding scheme MCS-9 with the TU low fading condition for both the wanted and the interfering signal.
- i) The SS repeats steps a) to h) under extreme test conditions for coding scheme MCS-9 only.
- j) The SS establishes the normal test conditions. An uplink TBF shall be established.
- k) The SS sets the value of the USF/MCS-5 such as to allocate the uplink to the MS.
- l) The SS transmits the unwanted signal at a nominal frequency 200 kHz above the nominal frequency of the wanted signal. Its amplitude is set to achieve the adjacent interference ratio 1dB above that specified in the conformance requirements.
- m) The SS counts the number of times the USF is allocated to the MS, and the number of times the MS does not transmit while being allocated the uplink.
- n) Once the number of USF/MCS-5 allocating the uplink for the MS as counted in step m) reaches or exceeds the minimum number of blocks as given in table 14-18-2, the SS calculates the Block error ratio. The SS resets both counters.
- o) The SS repeats steps m) and n) with the unwanted signal transmitted at a nominal frequency 200 kHz below the nominal frequency of the wanted signal and its amplitude is set to achieve the adjacent interference ratio 1dB above that specified in the conformance requirements.
- p) The SS repeats steps m) and n) with the unwanted signal transmitted at a nominal frequency 400 kHz above the nominal frequency of the wanted signal and its amplitude is set to achieve the adjacent interference ratio 1dB above that specified in the conformance requirements.
- q) The SS repeats steps m) and n) with the unwanted signal transmitted at a nominal frequency 400 kHz below the nominal frequency of the wanted signal and its amplitude is set to achieve the adjacent interference ratio 1dB above that specified in the conformance requirements.
- r) The SS repeats steps k) to q) under extreme test conditions for coding scheme MCS-9.

14.18.3.5 Test requirements

The block error ratio, as calculated by the SS for different channels with different coding schemes and under TUhigh propagation condition, under any combination of normal and extreme test voltages and ambient temperatures, shall not exceed the conformance requirement.

Testing of the conformance requirement for USF/MCS (1-9) can be done either with fixed minimum number of samples or based on the statistical test method that lead to an early pass/fail decision with test time significantly reduced for MS with BLER not on the limit.

14.18.3.5.1 Fixed limit test with minimum number of samples

The fixed testing of the conformance requirement is done using the minimum number of samples and the limit BLER given in table 14.18-2.

14.18.3.5.2 Statistical test with early pass / fail decision

Specific details on statistical testing of BER/BLER performance are defined in Annex 7.

Minimum test time due to fading conditions has to be considered before checking the conformance limits. The minimum test time for the specific fading condition are specified in the table 14.18.3.5-1.

Table 14.18.3.5-1: Minimum test time due to TU high fading conditions

TU high						
Frequency /MHz	400	700	850	900	1800	1900
Wave length / m	0,75	0,43	0,35	0,33	0,17	0,16
Min. Test time /s	214	204	201	190	95	90
hh:mm:ss	00:03:34	00:03:24	00:03:21	00:03:10	00:01:35	00:01:30

The statistical testing of the conformance requirement is done based on table 14.18.3.5-2. The table shows the values for MS with a single slot configuration. For MS multi slot configuration the number of blocks has to be increased accordingly.

Table 14.18.3.5-2: Statistical limits for adjacent channel rejection

GSM 400, GSM 700, GSM 850, GSM 900, DCS 1800 and PCS 1900						
Channel types	Block per s	Org. BLER requirement	Derived test limit	Target number of samples	Target test time /s	Target test time /hh:mm:ss
USF/MCS-1 to 9	50	0,01	0,01234	27958	559	00:09:19

14.18.4 Intermodulation rejection

14.18.4.1 Definition

The intermodulation rejection is a measure of the capability of the receiver to receive a wanted modulated signal without exceeding a given degradation due to the presence of two or more unwanted signals with a specific frequency relationship to the wanted signal frequency. "Wanted signal" in this test is the signal generated by the transmitted RLC data blocks.

14.18.4.2 Conformance requirement

In the presence of two unwanted signals with a specific frequency relationship to the wanted signal frequency in both GMSK and 8-PSK modulations

1. The block error rate (BLER) performance for PDTCH/MCS1 to 4 shall not exceed 10 % and for PDTCH/MCS5 to 9 shall not exceed 10 % or 30 % depending on Coding Schemes; 3GPP TS 05.05, subclause 6.2.
2. The block error rate (BLER) performance for USF/MSC-1 to 9 shall not exceed 1 %; 3GPP TS 05.05, subclause 6.2.
3. The BLER shall not exceed the conformance requirements given in 1. - 2. under extreme conditions; 3GPP TS 05.05, subclause 6.2 and annex D subclauses D.2.1 and D.2.2.

14.18.4.3 Test purpose

1. To verify that the MS does not exceed the conformance requirements for different channels and coding schemes under the static condition with an allowance for the statistical significance of the test.
2. To verify that Conformance Requirements are met under extreme conditions.

14.18.4.4 Method of test

NOTE: The measurements address the third order intermodulation, which represents the most serious case.

Initial conditions

For both GMSK and 8-PSK modulations, a downlink TBF is set up according to the generic procedure specified in clause 40 for packet switched with an ARFCN in the Mid ARFCN range, power control level set to maximum. The power control parameter ALPHA (α) is set to 0.

The SS transmits EGPRS RLC data blocks containing random data. The amplitude of the wanted signal is set to 4 dB above the reference sensitivity level with appropriate correction value as specified in table 14.18-3a for GMSK modulation and table 14.18-3b for 8-PSK modulation for PDTCH channel and in tables 14.18-4a for GMSK modulation and 14.18-4b for 8-PSK modulation for USF channel.

In addition to the static wanted test signal, the SS transmits two static interfering (unwanted) signals at the same time. There is no correlation in the modulation between the signals.

Test procedure

For GMSK modulation:

- a) The SS transmits packets on PDTCH using MCS-4 coding to the MS on all allocated timeslots.
- b) The first interfering signal is on a frequency equal to the centre frequency of an ARFCN four above the ARFCN of the wanted signal. This signal is static, continuous and unmodulated.
- c) The second interfering signal is on an ARFCN eight above the ARFCN of the wanted signal. This signal is static, continuous and GMSK modulated by random data (I1).

The amplitude of both the interfering signals is set according to table 14.18-8.

- d) The SS counts the number of blocks transmitted with current coding scheme and the number of these blocks not acknowledged based on the content of the Ack/Nack Description information element (see 3GPP TS 04.60, subclause 12.3) in the Packet Downlink Ack/Nack as sent from the MS to the SS on the PACCH.

NOTE 1: Due to the error rates related to the USF, the MS is likely to occasionally miss its USF for transmitting the Packet Downlink Ack/Nack. As this requirement is not verified in this part of the test, the SS then again assigns uplink resources so the MS can send this message.

- e) Once the number of blocks transmitted with the current coding scheme as counted in step d) reaches or exceeds the minimum number of blocks as given in table 14-18-2, the SS calculates the Block error ratio. The SS resets both counters.
- f) The SS repeats steps d) and e) with the two unwanted signals having frequencies corresponding to ARFCN four and eight below the ARFCN of the wanted signal.
- g) The SS repeats steps a) to f) with the receiver operating on an ARFCN in the Low ARFCN.
- h) The SS repeats steps a) to f) with the receiver operating on an ARFCN in the High ARFCN range.
- i) The SS repeats steps a) to f) for each of the coding schemes MCS-1 to 3.
- j) Steps a) to h) are repeated under extreme test conditions for MCS-4 only.
- k) The SS establishes the normal test conditions. An uplink TBF shall be established.
- l) The SS sets the value of the USF/MCS-4 such as to allocate the uplink to the MS.
- m) The first interfering signal is on a frequency equal to the centre frequency of an ARFCN four above the ARFCN of the wanted signal. This signal is static, continuous and unmodulated.
- n) The second interfering signal is on an ARFCN eight above the ARFCN of the wanted signal. This signal is static, continuous and GMSK modulated by random data (I1).

The amplitude of both the interfering signals is set according to table 14.18-8.

- o) The SS counts the number of times the USF is allocated to the MS, and the number of times the MS does not transmit while being allocated the uplink.
- p) Once the number of USF/MCS-4 allocating the uplink for the MS as counted in step o) reaches or exceeds the minimum number of blocks as given in table 14-18-2, the SS calculates the Block error ratio. The SS resets both counters.
- q) The SS repeats steps o) and p) with the two unwanted signals having frequencies corresponding to ARFCN four and eight below the ARFCN of the wanted signal.
- r) The SS repeats steps l) to q) with the receiver operating on an ARFCN in the Low ARFCN.
- s) The SS repeats steps l) to q) with the receiver operating on an ARFCN in the High ARFCN range.
- t) The SS repeats steps l) to s) under extreme test conditions for MCS-4.

For 8-PSK Modulation:

- a) The SS transmits packets on PDTCH using MCS-9 coding to the MS on all allocated timeslots.
- b) The first interfering signal is on a frequency equal to the centre frequency of an ARFCN four above the ARFCN of the wanted signal. This signal is static, continuous and unmodulated.
- c) The second interfering signal is on an ARFCN eight above the ARFCN of the wanted signal. This signal is static, continuous and GMSK modulated by random data (I1).

The amplitude of both the interfering signals is set according to table 14.18-8.

- d) The SS counts the number of blocks transmitted with current coding scheme and the number of these blocks not acknowledged based on the content of the Ack/Nack Description information element (see 04.60, 12.3) in the Packet Downlink Ack/Nack as sent from the MS to the SS on the PACCH.

NOTE 2: Due to the error rates related to the USF, the MS is likely to occasionally miss its USF for transmitting the Packet Downlink Ack/Nack. As this requirement is not verified in this part of the test, the SS then again assigns uplink resources so the MS can send this message.

- e) Once the number of blocks transmitted with the current coding scheme as counted in step d) reaches or exceeds the minimum number of blocks as given in table 14.18-2, the SS calculates the Block error ratio. The SS resets both counters.
- f) The SS repeats steps d) and e) with the two unwanted signals having frequencies corresponding to ARFCN four and eight below the ARFCN of the wanted signal.
- g) The SS repeats steps a) to f) with the receiver operating on an ARFCN in the Low ARFCN.
- h) The SS repeats steps a) to f) with the receiver operating on an ARFCN in the High ARFCN range.
- i) The SS repeats steps a) to f) for each of the coding schemes MCS-5,6,7 and 8 with the receiver operating on an ARFCN in the Middle ARFCN range.
- j) The SS repeats steps a) to h) under extreme test conditions for MCS-9 only.
- k) The SS establishes the normal test conditions. An uplink TBF shall be established.
- l) The SS sets the value of the USF/MCS-9 such as to allocate the uplink to the MS.
- m) The first interfering signal is on a frequency equal to the centre frequency of an ARFCN four above the ARFCN of the wanted signal. This signal is static, continuous and unmodulated.
- n) The second interfering signal is on an ARFCN eight above the ARFCN of the wanted signal. This signal is static, continuous and GMSK modulated by random data (I1).

The amplitude of both the interfering signals is set according to table 14.18-8.

- o) The SS counts the number of times the USF is allocated to the MS, and the number of times the MS does not transmit while being allocated the uplink.
- p) Once the number of USF/MCS-9 allocating the uplink for the MS as counted in step o) reaches or exceeds the minimum number of blocks as given in table 14.18-2, the SS calculates the Block error ratio. The SS resets both counters.
- q) The SS repeats steps o) and p) with the two unwanted signals having frequencies corresponding to ARFCN four and eight below the ARFCN of the wanted signal.
- r) The SS repeats steps l) to q) with the receiver operating on an ARFCN in the Low ARFCN
- s) The SS repeats steps l) to q) with the receiver operating on an ARFCN in the High ARFCN range.
- t) The SS repeats steps l) to s) under extreme test conditions for MCS-9 only.

Table 14.18-8: Intermodulation interfering test signal levels

	GSM 400, GSM 700, T-GSM 810, GSM 850, GSM 900, PCS 1 900		DCS 1 800	
	Small MS	Other MS	Class 1 and 2	Class 3
FIRST INTERFERER dB μ Vemf()	64	74	64	68
SECOND INTERFERER dB μ Vemf()	63	63	64	68

NOTE: Some of the levels in table 14.18-8 are different to those specified in 3GPP TS 05.05 due to the consideration of the effect of modulation sideband noise from the second interferer.

14.18.4.5 Test requirements

The block error ratio, as calculated by the SS for different channels with different coding schemes and under static condition, under any combination of normal and extreme test voltages and ambient temperatures, shall not exceed the conformance requirement.

14.18.5 Blocking and spurious response

14.18.5.1 Definition

Blocking is a measure of the ability of the receiver to receive a modulated wanted input signal in the presence of an unwanted input signal, on frequencies other than those of the spurious responses or the adjacent channels, without exceeding a given degradation. "Wanted signal" in this test is the signal generated by the transmitted RLC data blocks.

14.18.5.2 Conformance requirement

- The blocking characteristics of the receiver are specified separately for in-band and out-of-band performance as identified in 3GPP TS 05.05 subclause 5.1.
- The block error rate (BLER) performance for PDTCH/MCS1 to 4 shall not exceed 10 % and for PDTCH/MCS5 to 9 shall not exceed 10 % or 30 % depending on Coding Schemes and for USF/MCS1 to 9 shall not exceed 1 % when the following signals are simultaneously input to the receiver; 3GPP TS 05.05, subclause 6.2:
 - a useful signal at frequency f_0 , 3 dB above the reference sensitivity level specified in table 14.18-3a for GMSK modulation and table 14.18-3b for 8-PSK modulation for PDTCH channels; and in tables 14.18-4a for GMSK modulation and 14.18-4b for 8-PSK modulation for USF channel with correction values as specified in 3GPP TS 05.05 subclause 6.2;
 - a continuous, static sine wave unwanted signal at a level as in the table 14.18-9 below and at a frequency (f) which is an integer multiple of 200 kHz.

with the following exceptions, called spurious response frequencies:

- GSM 400: inband, for a maximum of three occurrences. 3GPP TS 05.05, subclause 5.1.

GSM 700, GSM 850 or GSM 900: in band, for a maximum of six occurrences (which if grouped shall not exceed three contiguous occurrences per group). 3GPP TS 05.05, subclause 5.1.

DCS 1 800 and PCS 1 900: in band, for a maximum of twelve occurrences (which if grouped shall not exceed three contiguous occurrences per group). 3GPP TS 05.05, subclause 5.1.

- out of band, for a maximum of 24 occurrences (which if below f_0 and grouped shall not exceed three contiguous occurrences per group). 3GPP TS 05.05, subclause 5.1.

where the above performance shall be met when the continuous sine wave signal (f) is set to a level of 70 dB μ V (emf) (i.e. -43 dBm). 3GPP TS 05.05, subclause 5.1.

14.18.5.3 Test purpose

- To verify that the in band blocking performance is met without exceeding the total number of allowed in band spurious responses. An allowance is made for the statistical significance of the test.

2. To verify that at selected out of band frequencies, the out of band blocking performance is met without exceeding the total number of allowed out of band spurious responses. An allowance is made for the statistical significance of the test.

NOTE: Not all of the possible out of band frequencies are tested as this results in excessive test time. However, the total number of out of band spurious responses, specified in 3GPP TS 05.05, are allowed to ensure a fair test of the MS.

14.18.5.4 Method of test

Initial conditions

A call is set up according to the generic call set up procedure, except the BCCH frequency list shall be empty, on a TCH with an arbitrary ARFCN in the range supported by the MS. The power control level is set to maximum power. The ARFCN of the BCCH shall be the same - or at an offset of +/- 2 channels, than that of the ARFCN for the TCH.

The SS transmits EGPRS RLC data blocks containing random data.

In addition to the wanted Test Signal, the SS transmit a static unmodulated continuous interfering signal (Standard Test Signal I0).

Test procedure

For GMSK Modulation:

- a) The SS is set to produce a static GMSK wanted signal and a static interfering signal at the same time. The SS sets the amplitude of the wanted signal to 4 dB above the reference sensitivity level specified in table 14.18-3a for PDTCH channel and in table 14.18-4a for USF channel with correction values as specified in 3GPP TS 05.05 subclause 6.2.
- b) The SS transmits packets on PDTCH using MCS-4 coding to MS on all allocated timeslots.
- c) The unwanted signal is of frequency FB. It is applied in turn on the subset of frequencies calculated at step d) in the overall range 100 kHz to 12,75 GHz, where FB is an integer multiple of 200 kHz.

However, frequencies in the range $FR \pm 600$ kHz are excluded.

NOTE: Allowance must be made for possible spurious signals arising from the SS. These are particularly likely at sub harmonic frequencies nFB where $n = 2, 3, 4, 5$, etc.

- d) The frequencies at which the test is performed (adjusted to an integer multiple of 200 kHz channels most closely approximating the absolute frequency of the calculated blocking signal frequency) are the combined frequencies from i), ii) and iii) which follow:

- i) The total frequency range formed by:

GSM 400 the frequencies between $F_{10} + (IF_1 + IF_2 + \dots + IF_n + 3,6 \text{ MHz})$
and $F_{10} - (IF_1 + IF_2 + \dots + IF_n + 3,6 \text{ MHz})$.

GSM 700 the frequencies between $F_{10} + (IF_1 + IF_2 + \dots + IF_n + 7,5 \text{ MHz})$
and $F_{10} - (IF_1 + IF_2 + \dots + IF_n + 7,5 \text{ MHz})$.

GSM 850 the frequencies between $F_{10} + (IF_1 + IF_2 + \dots + IF_n + 12,5 \text{ MHz})$
and $F_{10} - (IF_1 + IF_2 + \dots + IF_n + 12,5 \text{ MHz})$.

P-GSM 900: the frequencies between $F_{10} + (IF_1 + IF_2 + \dots + IF_n + 12,5 \text{ MHz})$
and $F_{10} - (IF_1 + IF_2 + \dots + IF_n + 12,5 \text{ MHz})$.

E-GSM 900: the frequencies between $F_{10} + (IF_1 + IF_2 + \dots + IF_n + 17,5 \text{ MHz})$
and $F_{10} - (IF_1 + IF_2 + \dots + IF_n + 17,5 \text{ MHz})$.

DCS 1 800: the frequencies between $F_{10} + (IF_1 + IF_2 + \dots + IF_n + 37,5 \text{ MHz})$

and $F_{lo} - (IF_1 + IF_2 + \dots + IF_n + 37,5 \text{ MHz})$.

PCS 1 900: the frequencies between $F_{lo} + (IF_1 + IF_2 + \dots + IF_n + 30 \text{ MHz})$

and $F_{lo} - (IF_1 + IF_2 + \dots + IF_n + 30 \text{ MHz})$.

and

the frequencies +100 MHz and -100 MHz from the edge of the relevant receive band.

Measurement are made at 200 kHz intervals.

ii) The three frequencies IF_1 , $IF_1 + 200 \text{ kHz}$, $IF_1 - 200 \text{ kHz}$.

iii) The frequencies:

$mF_{lo} + IF_1$;

$mF_{lo} - IF_1$;

mFR ;

where m is all positive integers greater than or equal to 2 such that either sum lies in the range 100 kHz to 12,75 GHz.

The frequencies in step ii) and iii) lying in the range of frequencies defined by step i) above need not be repeated.

Where:

F_{lo} - local oscillator applied to first receiver mixer

$IF_1 \dots IF_n$ - are the n intermediate frequencies

F_{lo} , IF_1 , $IF_2 \dots IF_n$ - shall be declared by the manufacturer in the PIXIT statement 3GPP TS 51.010-1 annex 3.

e) The level of the unwanted signal is set according to table 14.18-9.

Table 14.18-9a: Level of unwanted signals

	GSM450		GSM480		GSM 900		DCS 1 800	PCS 1 900
	Small MS	Other MS	Small MS	Other MS	Small MS	Other MS		
FREQUENCY	LEVEL IN dB_μVemf()							
FR ±600 kHz to FR ±800 kHz	70	75	70	75	70	75	70	70
FR ±800 kHz to FR ±1,6 MHz	70	80	70	80	70	80	70	70
FR ±1,6 MHz to FR ±3 MHz	80	90	80	90	80	90	80	80
457,6 MHz to FR - 3 MHz	90	90	-	-	-	-	-	-
FR + 3 MHz to 473,6 MHz	90	90	-	-	-	-	-	-
486 MHz to FR - 3MHz	-	-	90	90	-	-	-	-
FR + 3MHz to 502 MHz	-	-	90	90	-	-	-	-
915 MHz to FR - 3 MHz	-	-	-	-	90	90	-	-
FR + 3 MHz to 980 MHz	-	-	-	-	90	90	-	-
1 785 MHz to FR - 3 MHz	-	-	-	-	-	-	87	-
FR + 3 MHz to 1 920 MHz	-	-	-	-	-	-	87	-
1 910 MHz to FR - 3 MHz	-	-	-	-	-	-	-	87
FR + 3 MHz to 2 010 MHz	-	-	-	-	-	-	-	87
100 kHz to < 457,6 MHz	113	113	-	-	-	-	-	-
> 473,6MHz to 12,750 MHz	113	113	-	-	-	-	-	-
100 kHz to < 486 MHz	-	-	113	113	-	-	-	-
> 502 MHz to 12,750 MHz	-	-	113	113	-	-	-	-
835 MHz to < 915 MHz	-	-	-	-	113	113	-	-
> 980 MHz to 1 000 MHz	-	-	-	-	113	113	-	-
100 kHz to < 835 MHz	-	-	-	-	113	113	-	-
> 1 000 MHz to 12,750 MHz	-	-	-	-	113	113	-	-
100 kHz to 1 705 MHz	-	-	-	-	-	-	113	-
> 1 705 MHz to < 1 785 MHz	-	-	-	-	-	-	101	-
> 1 920 MHz to 1 980 MHz	-	-	-	-	-	-	101	-
> 1 980 MHz to 12,750 MHz	-	-	-	-	-	-	113	-
100 kHz to < 1 830 MHz	-	-	-	-	-	-	-	113
1 830 MHz to < 1 910 MHz	-	-	-	-	-	-	-	101
> 2 010 MHz to 2 070 MHz	-	-	-	-	-	-	-	101
> 2 070 MHz to 12,750 MHz	-	-	-	-	-	-	-	113

Table 14-18-9b: Level of unwanted signals

FREQUENCY	GSM 710	GSM 750	T-GSM 810	GSM 850
	LEVEL IN dB μ Vemf()			
FR \pm 600 kHz to FR \pm 800 kHz	70	70	70	70
FR \pm 800 kHz to FR \pm 1,6 MHz	70	70	70	70
FR \pm 1,6 MHz to FR \pm 3 MHz	80	80	80	80
678 MHz to FR - 3 MHz	90	-	-	-
FR + 3 MHz to 728 MHz	90	-	-	-
727 MHz to FR - 3 MHz	-	90	-	-
FR + 3 MHz to 777 MHz	-	90	-	-
831 MHz to FR - 3 MHz	-	-	90	-
FR + 3 MHz to 886 MHz	-	-	90	-
849 MHz to FR - 3 MHz	-	-	-	90
FR + 3 MHz to 914 MHz	-	-	-	90
678 MHz to FR - 3 MHz	113	-	-	-
FR + 3 MHz to 728 MHz	113	-	-	-
100 kHz to < 727 MHz	-	113	-	-
> 777 MHz to 12,75 GHz	-	113	-	-
100 kHz to 831 MHz	-	-	113	-
> 886 MHz to 12,75 MHz	-	-	113	-
100 kHz to < 849 MHz	-	-	-	113
> 914 MHz to 12,75 GHz	-	-	-	113

NOTE 1: For E-GSM 900 MS the level of the unwanted signal in the band 905 MHz to 915 MHz is relaxed to 108 dB μ Vemf(). 3GPP TS 05.05, subclause 5.1.

NOTE 2: a) For R-GSM 900 MS the level of the unwanted signal in the band 880 MHz to 915 MHz is relaxed to 108 dB μ Vemf(). 3GPP TS 05.05, subclause 5.1.

b) For R-GSM 900 small MS the level of the unwanted signal in the band 876 MHz to 915 MHz is relaxed to 106 dB μ Vemf(). 3GPP TS 05.05, subclause 5.1.

NOTE 3: a) For GSM 450 small MS the level of the unwanted signal in the band 450,4 MHz to 457,6 MHz is relaxed to 108 dB μ Vemf(). 3GPP TS 05.05, subclause 5.1.

b) For GSM 480 small MS the level of the unwanted signal in the band 478,8 MHz to 486 MHz is relaxed to 108 dB μ Vemf(). 3GPP TS 05.05, subclause 5.1.

f) The SS counts the number of blocks transmitted with current coding scheme and the number of these blocks not acknowledged based on the content of the Ack/Nack Description information element (see 3GPP TS 04.60, subclause 12.3) in the Packet Downlink Ack/Nack as sent from the MS to the SS on the PACCH.

NOTE 1: Due to the error rates related to the USF, the MS is likely to occasionally miss its USF for transmitting the Packet Downlink Ack/Nack. As this requirement is not verified in this part of the test, the SS then again assigns uplink resources so the MS can send this message.

g) Once the number of blocks transmitted with the current coding scheme as counted in step f) reaches or exceeds the minimum number of blocks as given in table 14.18-2, the SS calculates the Block error ratio. The SS resets both counters.

If a failure is indicated, it is noted and counted towards the allowed exemption total. In the case of failures discovered at the predicted frequencies at steps d i), ii) or iii) the test is repeated on the adjacent channels \pm 200 kHz away. If either of these two frequencies fail then the next channel 200 kHz beyond is also be tested. This process is repeated until all channels constituting the group of failures is known.

h) The SS sets the value of the USF/MCS-4 such as to allocate the uplink to the MS.

i) The unwanted signal is of frequency FB. It is applied in turn on the subset of frequencies calculated at step d) in the overall range 100 kHz to 12,75 GHz, where FB is an integer multiple of 200 kHz.

However, frequencies in the range FR \pm 600 kHz are excluded.

NOTE 2: Allowance must be made for possible spurious signals arising from the SS. These are particularly likely at sub harmonic frequencies nFB where $n = 2, 3, 4, 5$, etc.

- j) The level of the unwanted signal is set according to table 14.18-9.
- k) The SS counts the number of times the USF is allocated to the MS, and the number of times the MS does not transmit while being allocated the uplink.
- l) Once the number of USF/MCS-4 allocating the uplink for the MS as counted in step k) reaches or exceeds the minimum number of blocks as given in table 14.18-2, the SS calculates the Block error ratio. The SS resets both counters. If a failure is indicated, it is noted and counted towards the allowed exemption total.

In the case of failures discovered at the predicted frequencies at steps d i), ii) or iii) the test is repeated on the adjacent channels ± 200 kHz away. If either of these two frequencies fail then the next channel 200 kHz beyond is also be tested. This process is repeated until all channels constituting the group of failures is known.

For 8-PSK Modulation:

- a) The SS is set to produce a static 8-PSK wanted signal and a static interfering signal at the same time. The SS sets the amplitude of the wanted signal to 4 dB above the reference sensitivity level specified in table 14.18-3b for PDTCH channel and in table 14.18-4b for USF channel with correction values as specified in 3GPP TS 05.05 subclause 6.2;
- b) The SS transmits packets on PDTCH using MCS-9 coding to MS on all allocated timeslots.
- c) The unwanted signal is of frequency FB. It is applied in turn on the subset of frequencies calculated at step d) in the overall range 100 kHz to 12,75 GHz, where FB is an integer multiple of 200 kHz.

However, frequencies in the range $FR \pm 600$ kHz are excluded.

NOTE 3: Allowance must be made for possible spurious signals arising from the SS. These are particularly likely at sub harmonic frequencies nFB where $n = 2, 3, 4, 5$, etc.

- d) The frequencies at which the test is performed (adjusted to an integer multiple of 200 kHz channels most closely approximating the absolute frequency of the calculated blocking signal frequency) are the combined frequencies from i), ii) and iii) which follow:

- i) The total frequency range formed by:

GSM 400 the frequencies between $F_{lo} + (IF_1 + IF_2 + \dots + IF_n + 3,6 \text{ MHz})$
and $F_{lo} - (IF_1 + IF_2 + \dots + IF_n + 3,6 \text{ MHz})$.

GSM 700 the frequencies between $F_{lo} + (IF_1 + IF_2 + \dots + IF_n + 7,5 \text{ MHz})$
and $F_{lo} - (IF_1 + IF_2 + \dots + IF_n + 7,5 \text{ MHz})$.

GSM 850 the frequencies between $F_{lo} + (IF_1 + IF_2 + \dots + IF_n + 12,5 \text{ MHz})$
and $F_{lo} - (IF_1 + IF_2 + \dots + IF_n + 12,5 \text{ MHz})$.

P-GSM 900: the frequencies between $F_{lo} + (IF_1 + IF_2 + \dots + IF_n + 12,5 \text{ MHz})$
and $F_{lo} - (IF_1 + IF_2 + \dots + IF_n + 12,5 \text{ MHz})$.

E-GSM 900: the frequencies between $F_{lo} + (IF_1 + IF_2 + \dots + IF_n + 17,5 \text{ MHz})$
and $F_{lo} - (IF_1 + IF_2 + \dots + IF_n + 17,5 \text{ MHz})$.

DCS 1 800: the frequencies between $F_{lo} + (IF_1 + IF_2 + \dots + IF_n + 37,5 \text{ MHz})$
and $F_{lo} - (IF_1 + IF_2 + \dots + IF_n + 37,5 \text{ MHz})$.

PCS 1 900: the frequencies between $F_{lo} + (IF_1 + IF_2 + \dots + IF_n + 30 \text{ MHz})$
and $F_{lo} - (IF_1 + IF_2 + \dots + IF_n + 30 \text{ MHz})$.

and

the frequencies +100 MHz and -100 MHz from the edge of the relevant receive band.

Measurement are made at 200 kHz intervals.

ii) The three frequencies IF_1 , $IF_1 + 200$ kHz, $IF_1 - 200$ kHz.

iii) The frequencies:

$mF_{lo} + IF_1$;

$mF_{lo} - IF_1$;

mFR ;

where m is all positive integers greater than or equal to 2 such that either sum lies in the range 100 kHz to 12,75 GHz.

The frequencies in step ii) and iii) lying in the range of frequencies defined by step i) above need not be repeated.

Where:

F_{lo} - local oscillator applied to first receiver mixer

$IF_1 \dots IF_n$ - are the n intermediate frequencies

$F_{lo}, IF_1, IF_2 \dots IF_n$ - shall be declared by the manufacturer in the PIXIT statement
3GPP TS 51.010-1 annex 3.

e) The level of the unwanted signal is set according to table 14.18-9.

f) The SS counts the number of blocks transmitted with current coding scheme and the number of these blocks not acknowledged based on the content of the Ack/Nack Description information element (see 04.60, 12.3) in the Packet Downlink Ack/Nack as sent from the MS to the SS on the PACCH.

NOTE 4: Due to the error rates related to the USF, the MS is likely to occasionally miss its USF for transmitting the Packet Downlink Ack/Nack. As this requirement is not verified in this part of the test, the SS then again assigns uplink resources so the MS can send this message.

g) Once the number of blocks transmitted with the current coding scheme as counted in step f) reaches or exceeds the minimum number of blocks as given in table 14.18-2, the SS calculates the Block error ratio. The SS resets both counters. If a failure is indicated, it is noted and counted towards the allowed exemption total.

In the case of failures discovered at the predicted frequencies at steps d i), ii) or iii) the test is repeated on the adjacent channels ± 200 kHz away. If either of these two frequencies fail then the next channel 200 kHz beyond is also be tested. This process is repeated until all channels constituting the group of failures is known.

h) The SS sets the value of the USF/MCS-9 such as to allocate the uplink to the MS.

j) The unwanted signal is of frequency FB . It is applied in turn on the subset of frequencies calculated at step d) in the overall range 100 kHz to 12,75 GHz, where FB is an integer multiple of 200 kHz.

However, frequencies in the range $FR \pm 600$ kHz are excluded.

NOTE 5: Allowance must be made for possible spurious signals arising from the SS. These are particularly likely at sub harmonic frequencies nFB where $n = 2, 3, 4, 5$, etc.

k) The level of the unwanted signal is set according to table 14.18-9.

l) The SS counts the number of times the USF is allocated to the MS, and the number of times the MS does not transmit while being allocated the uplink.

m) Once the number of USF/MCS-9 allocating the uplink for the MS as counted in step l) reaches or exceeds the minimum number of blocks as given in table 14.18-2, the SS calculates the Block error ratio. The SS resets both counters. If a failure is indicated, it is noted and counted towards the allowed exemption total.

In the case of failures discovered at the predicted frequencies at steps d i), ii) or iii) the test is repeated on the adjacent channels ± 200 kHz away. If either of these two frequencies fail then the next channel 200 kHz beyond is also be tested. This process is repeated until all channels constituting the group of failures is known.

14.18.5.5 Test requirements

The block error ratio as calculated by the SS for different channels and coding schemes shall not exceed the conformance requirement. Testing the conformance requirement can be done either in the classical way with a fixed minimum number of samples (refer to section 14.18.5.5.2) or using statistical methods that lead to an early pass/fail decision with test time significantly reduced for MS with performance not on the limit (refer to section 14.18.5.5.1). Both methods are based on a bad DUT factor $M = 1.5$.

This shall apply under normal test voltage and ambient temperature, and with the interfering signal at any frequency in the range specified.

The following exceptions are allowed:

- GSM 400:** A maximum of three failures in the band 457,6 MHz to 473,6 MHz for GSM450 and in the band 486,0 MHz to 502,0 MHz for GSM480
- A maximum of 24 in the combined bands 100 kHz to 457,6 MHz and 473,6 MHz to 12,75 GHz for GSM 450 and in the combined bands 100 kHz to 486,0 MHz and 502,0 MHz to 12,75 GHz for GSM 480 (which, if below FR and grouped, shall not exceed three 200 kHz channels per group).
- GSM 710:** A maximum of six failures in the frequency band 678 MHz to 728 MHz (which, if grouped, shall not exceed three 200 kHz channels per group).
- A maximum of 24 failures in the combined bands 100 kHz to 678 MHz and 728 MHz to 12,75 GHz (which, if below FR and grouped, shall not exceed three 200 kHz channels per group).
- GSM 750:** A maximum of six failures in the frequency band 727 MHz to 782 MHz (which, if grouped, shall not exceed three 200 kHz channels per group).
- A maximum of 24 failures in the combined bands 100 kHz to 727 MHz and 782 MHz to 12,75 GHz (which, if below FR and grouped, shall not exceed three 200 kHz channels per group).
- GSM 810:** A maximum of six failures in the frequency band 831 MHz to 886 MHz (which, if grouped, shall not exceed three 200 kHz channels per group).
- A maximum of 24 failures in the combined bands 100 kHz to 831 MHz and 886 MHz to 12,75 GHz (which, if below FR and grouped, shall not exceed three 200 kHz channels per group).
- GSM 850:** A maximum of six failures in the frequency band 849 MHz to 914 MHz (which, if grouped, shall not exceed three 200 kHz channels per group).
- A maximum of 24 failures in the combined bands 100 kHz to 849 MHz and 914 MHz to 12,75 GHz (which, if below FR and grouped, shall not exceed three 200 kHz channels per group).
- GSM 900:** A maximum of six failures in the band 915 MHz to 980 MHz (which, if grouped, shall not exceed three 200 kHz channels per group).
- A maximum of 24 in the combined bands 100 kHz to 915 MHz and 980 MHz to 12,75 GHz (which, if below FR and grouped, shall not exceed three 200 kHz channels per group).
- DCS 1 800:** A maximum of twelve failures in the band 1 785 MHz to 1 920 MHz (which, if grouped, shall not exceed three 200 kHz channels per group).
- A maximum of 24 in the combined bands 100 kHz to 1 785 MHz and 1 920 MHz to 12,75 GHz (which, if below FR and grouped, shall not exceed three 200 kHz channels per group).
- PCS 1 900:** A maximum of twelve failures in the band 1 910 MHz to 2 010 MHz (which, if grouped, shall not exceed three 200 kHz channels per group).
- A maximum of 24 in the combined bands 100 kHz to 1 910 MHz and 2 010 MHz to 12,75 GHz (which, if below FR and grouped, shall not exceed three 200 kHz channels per group).

If the number of failures do not exceed the maximum allowed figures stated above, the test of 14.18.5.4 is repeated at the frequencies at which the failures occurred. The level of the unwanted signal is set to 70 dBuVemf() and the performance requirement is once again that stated above.

The number of Error Events recorded in this test shall not exceed the test limit error rate values given above, when using either the accelerated BLER method or the maximum number of samples.

No failures are allowed at this lower unwanted signal level.

14.18.5.5.1 Statistical testing of blocking and spurious response performance with early decision

For more information on statistical testing of blocking and spurious response performance, especially the definition of limit lines refer to Annex 7.

Wrong decision risk F for one single error rate test:

$F_{\text{pass}} \neq F_{\text{fail}}$ As the blocking test case comprises of many BLER tests the wrong decision risk for a fail decision of one single error rate test must be smaller than the wrong decision risk for a pass decision to avoid an increased probability of an erroneous fail decision.

$$F_{\text{pass}} = 0.2\%$$

$$F_{\text{fail}} = 0.02\%$$

Wrong decision probability D per test step:

$$D_{\text{pass}} \neq D_{\text{fail}}$$

$$D_{\text{pass}} = 0.0085\%$$

$$D_{\text{fail}} = 0.00085\%$$

Parameters for limit lines:

1. $D_{\text{pass}} = 0.0085\%$ wrong decision probability per test step for early pass decision.
- $D_{\text{fail}} = 0.00085\%$ wrong decision probability per test step for early fail decision.
2. $M = 1.5$ bad DUT factor
3. n_e number of (error) events.
4. n_s number of samples. The error rate is calculated from n_e and n_s .

Limit checking

For an early decision a minimum number of measured (error) events is necessary.

For an early pass decision $n_e \geq 1$

For an early fail decision $n_e \geq 8$

When the target test time has been reached the test is finished and a pass/fail decision can be made.

The statistical testing of the conformance requirement is done using table 14.18.5-1.

Table 14.18.5-1: Statistical test limits for blocking performance of EGPRS mobiles

Blocking and spurious response for EGPRS mobiles						
		Orig. BLER	Derived	Target	Target	Target test time
	blocks per s	requirement	test limit	number of samples	test time (s)	(hh:mm:ss)
One time slot:						
PDTCH/MCS-4	50	0,100000	0,125100	3221	64	00:01:04
USF/MCS-4	50	0,010000	0,012510	32214	644	00:10:44
PDTCH/MCS-9	50	0,100000	0,125100	3221	64	00:01:04
USF/MCS-9	50	0,010000	0,012510	32214	644	00:10:44
Two time slots:						
PDTCH/MCS-4	100	0,100000	0,125100	3221	32	00:00:32
USF/MCS-4	100	0,010000	0,012510	32214	322	00:05:22
PDTCH/MCS-9	100	0,100000	0,125100	3221	32	00:00:32
USF/MCS-9	100	0,010000	0,012510	32214	322	00:05:22
Three time slots						
PDTCH/MCS-4	150	0,100000	0,125100	3221	21	00:00:21
USF/MCS-4	150	0,010000	0,012510	32214	215	00:03:35
PDTCH/MCS-9	150	0,100000	0,125100	3221	21	00:00:21
USF/MCS-9	150	0,010000	0,012510	32214	215	00:03:35
Four time slots						
PDTCH/MCS-4	200	0,100000	0,125100	3221	16	00:00:16
USF/MCS-4	200	0,010000	0,012510	32214	161	00:02:41
PDTCH/MCS-9	200	0,100000	0,125100	3221	16	00:00:16
USF/MCS-9	200	0,010000	0,012510	32214	161	00:02:41

14.18.5.2 Fixed testing of blocking and spurious response performance with minimum number of samples

The fixed testing of the conformance requirement is done using the minimum number of samples and the limit BLER given in table 14.18-2.

14.18.6 EGPRS Usable receiver input level range

14.18.6.1 Definition

The usable receiver input level range is the range of the radio frequency input level of a specified modulated signal over which bit error ratio stay between specified limits.

14.18.6.2 Conformance requirement

1. The receiver input level range requirements of 3GPP TS 05.05 subclause 6.1 for raw data bits of GMSK modulation under static and EQ propagation conditions shall be met:
 - 1.1 Under normal conditions.
 - 1.2 Under extreme conditions.
2. The receiver input level range requirements of 3GPP TS 05.05 subclause 6.1 for raw data bits of 8PSK modulation under static condition shall be met:
 - 2.1 Under normal conditions.
 - 2.2 Under extreme conditions.
3. The receiver input level range requirements of 3GPP TS 05.05 subclause 6.1 for raw data bits of 8PSK modulation with random frequency offset under static condition shall be met:

3.1 Under normal conditions.

3.2 Under extreme conditions.

14.18.6.3 Test purpose

1. To verify that the MS does not exceed the conformance requirement with an allowance for the statistical significance of the test.

1.1 Under normal conditions.

1.2 Under extreme conditions.

14.18.6.4 Test Method

Initial Conditions

The MS is assumed to be EGPRS attached. The power control parameter ALPHA (α) is set to 0.

The SS establishes a downlink TBF on one timeslot.

The SS commands the MS to request an establishment of the TBF Uplink and to create a channel loop back after demodulation and before decoding. This is achieved by the EGPRS Switched Radio Loopback Mode (3GPP TS 04.14/44.014, subclause 5.5)

Test Procedure

For GMSK Modulation:

- a) The SS shall transmit the pseudo-random data using the standard GMSK-modulated test signal in the Mid ARFCN range and the input level at the receiver input shall be 20 dB above the Reference Sensitivity Level.
- b) The SS compares the data that it sends to the MS with the data which is looped back from the receiver after demodulation and before decoding.

The SS tests the bit error ratio for the data bits, by examining sequences of at least the minimum number of samples specified in the test requirements. The number of error events is recorded.

- c) Step b) is repeated with the input level at the receiver input increased to 73 dB μ Vemf().
- d) Step b) is repeated with the input level at the receiver input increased to the following values:
 For GSM 400, GSM 700, T-GSM 810, GSM 850 and GSM 900: 98 dB μ Vemf().
 For DCS 1 800 and PCS 1 900: 90 dB μ Vemf().
- e) The SS fading function is set to EQ.
- f) Step b) is repeated with the input level at the receiver input set to 20dB above the reference sensitivity level() and then increased to 73 dB μ Vemf().
- g) Steps a) to f) are repeated under extreme test conditions.

For 8PSK Modulation:

- a) The SS shall transmit the pseudo-random data using the standard 8PSK-modulated test signal in the Mid ARFCN range and the input level at the receiver input shall be -82 dBm, which level is subject to adjustment according to correction table in subclause 6.2. of 3GPP TS 05.05/45.005. For an EGPRS MS that only supports GMSK modulation in the uplink, a GMSK-modulated signal will be used for UL transmission.

- b) The SS compares the data that it sends to the MS with the data which is looped back from the receiver after demodulation and before decoding.

The SS tests the bit error ratio for the data bits, by examining sequences of at least the minimum number of samples specified in the test requirements. The number of error events is recorded.

- c) Step b) is repeated with the input level at the receiver input increased to 73 dB μ Vemf().

- d) Step b) is repeated with the input level at the receiver input increased to 87 dB μ Vemf().
- e) Steps a) to d) are repeated under extreme test conditions.

For 8PSK Modulation with random frequency offset:

- a) The SS shall transmit the pseudo-random data using the standard 8PSK-modulated test signal with random frequency offset within 0,1ppm in the Mid ARFCN range and the input level at the receiver input shall be -82 dBm, which level is subject to adjustment according to correction table in subclause 6.2. of 3GPP TS 05.05/45.005. For an EGPRS MS that only supports GMSK modulation in the uplink, a GMSK-modulated signal will be used for UL transmission.
- b) The SS compares the data that it sends to the MS with the data which is looped back from the receiver after demodulation and before decoding.

The SS tests the bit error ratio for the data bits, by examining sequences of at least the minimum number of samples specified in the test requirements. The number of error events is recorded.

- c) Step b) is repeated with the input level at the receiver input increased to 73 dB μ Vemf().
- d) Step a) to c) are repeated under extreme test conditions.

14.18.6.5 Test Requirements

The error rate measured in this test shall not exceed the test limit error rate values given in table 14.18-10. This shall apply for any combination of normal and extreme test voltages and ambient temperature, for the different propagation conditions and for any level of input signal to the receiver.

Table 14.18-10: Limits for input level range

			GSM 400, GSM 700, T-GSM 810, GSM 850 and GSM 900		DCS 1 800 and PCS 1 900	
Type of test signals	Type of measurement	Propaga-tion Conditions	Test limit Error rate %	Minimum No. of samples	Test limit Error rate %	Minimum No. of samples
GMSK	BER	Static <= 73dB μ Vemf()	0,012	1 640 000	0,012	1 640 000
		Static <= 98dB μ Vemf()	0,122	164 000	0,122	164 000
		Static <= 90dB μ Vemf()) EQ	3,25	120 000		
8PSK	BER	Static<= 73dB μ Vemf()	0,012	1 640 000	0,012	1 640 000
		Static <= 87dB μ Vemf())	0,122	164 000	0,122	164 000
8PSK with frequency offset within 0,1 ppm	BER	Static <= 73dB μ Vemf())	0,012	1 640 000	0,122	164 000

14.18.7 Incremental Redundancy Performance

14.18.7.1 Definition

In Incremental Redundancy RLC mode, soft information from multiple, differently punctured versions of an RLC data block may be used when decoding the RLC data block. This significantly increases the link performance.

14.18.7.2 Conformance requirement

An EGPRS capable MS shall, under the conditions stated in the table below, achieve a long-term throughput of 20 kbps per time slot (see NOTE) measured between LLC and RLC/MAC layer.

Propagation conditions	Static, input level –97.0 dBm
Modulation and Coding Scheme	MCS-9
Acknowledgements polling period	32 RLC data blocks
Roundtrip time	120 ms
Number of timeslots	Maximum capability of the MS
Transmit window size	Maximum for the MS timeslot capability

NOTE: This corresponds to an equivalent block error rate of approximately 0.66 using the prescribed MCS-9.

3GPP TS 05.05, subclause 6.7 (3GPP 45.005, subclause 6.7).

14.18.7.3 Test purpose

To verify that the EGPRS MS can operate in Incremental Redundancy RLC mode for a sufficiently long time and that it achieves a long-term throughput of 20 kbps per timeslot, measured between LLC and RLC/MAC layer, under the conditions defined in conformance requirement.

14.18.7.4 Method of test

The SS establishes a downlink TBF in Incremental Redundancy RLC mode, beginning on a Mid ARFCN Range, under the conditions defined in the conformance requirement. The downlink data transfer is proceeded with random payload data according to the Incremental Redundancy RLC mode procedures using MCS-9. The throughput between LLC and RLC/MAC layer is determined by the SS on the basis of the amount of successfully delivered LLC data, i.e. the amount of data bits in acknowledged RLC data blocks in the correct order without gaps representing LLC or higher layer data. The long-term throughput is determined until at least 6000 RLC data blocks have been send from RLC/MAC layer to the LLC layer within the MS. The test is repeated in Low and High ARFCN range.

If the END_OF_WINDOW bit in the ack/nack message is not set, the SS shall poll the MS for the next partial bitmap irrespective of the polling period.

If the MS is setting the MS OUT OF MEMORY BIT to 1 in the EGPRS Packet Downlink ACK/NACK message the SS should take care that only NACKED RLC data blocks are retransmitted with MCS 9 and if the MS sets again the MS OUT OF MEMORY BIT to 0 the SS can continue transmitting also new data with MCS 9.

Initial conditions

The SS establishes a downlink EGPRS TBF in Incremental Redundancy RLC mode according to the generic procedures defined in sect. 50, on a Mid ARFCN Range. For the TBF, the SS allocates the maximum number of timeslots according to the multislot capability of the MS under test, applies MCS-9 as the Modulation and Coding Scheme and the maximum RLC downlink window size the number of used time slots allows for the data transfer. The SS commands the MS to use maximum transmit power in the uplink, decreases the transmit power to –96 dBm in the downlink and preserves the fading conditions as static. The power control parameter ALPHA (α) is set to 0.

Procedure

- a) Using MSC-9 with Puncturing Scheme 1 (PS1), the SS continues the EGPRS TBF in the downlink by transmitting RLC data blocks with valid Block Sequence Numbers (BSN) within the RLC downlink window of maximum size according to MS's multislot class, and polls the MS for acknowledgements after every polling period of 32 RLC data blocks.
- b) The SS updates its associated acknowledge state array V(B) according to the ack/nack bitmap in the EGPRS Downlink Ack/Nack message transmitted by the MS as a response to polling and shifts the RLC downlink window accordingly.
- c) While continuing the transmission of further RLC data blocks with PS1, the SS retransmits, after a delay that corresponds to a round trip time of 120ms, all unacknowledged RLC data blocks with PS2 starting from the oldest unacknowledged RLC blocks.
- d) The SS repeats the steps a) to c). For retransmissions of RLC data blocks that have already been retransmitted with PS2, the SS applies PS3 for such blocks and further again PS1 and PS2 in cyclic manner if necessary.
- e) Steps a) to d) are repeated until at least 6000 RLC data blocks are transmitted from RLC to LLC layer within the MS, but never more then 18000 RLC data blocks from SS to MS.

Note: If the MS needs more than 18000 RLC data blocks received to send 6000 RLC blocks up to the LLC layer it will never fulfil the conformance requirements.

- f) The SS calculates the data throughput per time slot between RLC/MAC and LLC layers on the basis of successfully transmitted LLC-data during steps a) to e). For this the lower end of the RLC downlink window can be used to measure the progress of the transmission in terms of amount of data passed on to the LLC.

If n is the number of timeslots, x the position of the lower end of the RLC downlink window, and t is the duration from the beginning of the transmission of RLC data blocks to reaching the stop condition, then the average throughput per timeslot is $(x \cdot 592 \text{ bit})/(n \cdot t)$.

- g) Steps a) to f) are repeated at Low and High ARFCN ranges.

Test requirements

The long-term throughput per time slot as a result of step f) of the test procedure shall equal or exceed 20kbps on low, mid and high ARFCN range.

14.18.8 DARP Phase 1 EGPRS tests

14.18.8.1 Synchronous single co-channel interferer (DTS-1)

14.18.8.1.1 Definition

The DARP reference test scenario DTS-1 for a single synchronous co-channel interferer defines an interfering signal and corresponding performance limits. This test is a measure of the capability of the DARP receiver to receive a wanted modulated signal without exceeding a given degradation due to the presence of this specific unwanted signals.

14.18.8.1.2 Conformance requirement

MS indicating support for Downlink Advanced Receiver Performance – phase I (see 3GPP TS 24.008) shall fulfil the requirements in table 2o for wanted signals on GMSK modulated channels under TU50 no FH propagation conditions and GMSK modulated interferers for the test scenarios defined in annex L. The reference performance shall be:

- For packet switched channels (PDTCH) BLER: $\leq 10 \%$

The values in table 2o are given as the C/I1 ratio, where C is the power level of the wanted signal and I1 is the power level of the dominant co-channel interferer (Co-channel 1, see annex L).

3GPP TS 45.005; clause 6.3.

Reference Test Scenarios for Synchronous single co-channel interferer

Reference Test Scenario	Interfering Signal	Interferer relative power level	TSC	Interferer Delay range
DTS-1	Co-channel 1	0 dB	none	no delay

3GPP TS 45.005; Annex L.

GSM 900 and GSM 850	
Propagation condition	TU50 no FH
Type of channel	C/I
PDTCH MCS-1	3,5 dB
PDTCH MCS-2	5,5 dB
PDTCH MCS-3	11 dB
PDTCH MCS-4	18 dB

DCS 1 800 & PCS 1900	
Propagation condition	TU50 no FH
Type of channel	C/I
PDTCH MCS-1	3,5 dB
PDTCH MCS-2	6,5 dB
PDTCH MCS-3	11,5 dB
PDTCH MCS-4	19,5 dB

3GPP TS 45.005; table 2o (extracts)

For T-GSM 810 the requirements for GSM 900 shall apply, apart for those parameters for which a separate requirement exists.

3GPP TS 45.005; subclause 2

14.18.8.1.3 Test purpose

To verify that the MS does not exceed conformance requirement for different coding schemes and under the propagation condition TU50/noFH with an allowance for the statistical significance of the test.

14.18.8.1.4 Test method

14.18.8.1.4.1 Initial condition

A downlink TBF is established according to the generic call set up procedure with an ARFCN in the mid ARFCN range, power control level set to maximum power. The power control parameter ALPHA (α) is set to 0.

The SS establish a downlink TBF.

The SS transmits Standard Test Signal C1 with TSC 0.

In addition to this wanted signal (C1), the SS produces an independent, uncorrelated interfering signal (I1). This unwanted signal is random, continuous and GSM-modulated and has no fixed relationship with the bit transitions of the wanted signal.

14.18.8.1.4.2 Procedure

- a) The co-channel interferer signal I1 (unwanted signal) is set to -80 dBm.
- b) The fading characteristic of the wanted signal C1 and the interferer signal I1 is set to TU High. No FH applies.
- c) The SS transmits packets using MCS-1 coding to the MS on all allocated timeslots.
- d) The SS sets the level of the wanted signal 1 dB above the value according to table 14.18.8.1.4.3-1 and table 14.18.8.1.4.3-2.
- e) The SS counts the number of blocks transmitted with current coding scheme and the number of these blocks not acknowledged based on the content of the Ack/Nack Description information element (see 3GPP TS 04.60, sub clause 12.3) in the Packet Downlink Ack/Nack as sent from the MS to the SS on the PACCH.
- f) Once the number of blocks transmitted with the current coding scheme as counted in step (e) reaches or exceeds the minimum number of blocks as given in table 14.18-2 the SS calculates the Block error ratio. The SS resets both counters.
- g) The SS repeats the steps (c) to f) for each of the coding schemes MCS-2, MCS-3 and MCS-4

14.18.8.1.4.3 Test requirement

The block error ratio, as calculated by the SS for different channels under the TU High propagation conditions, shall not exceed the conformance requirement.

NOTE: The wanted signal levels derived from calculations using 3GPP TS 45.005 table 2o shall be set according to the table 14.18.8.1.4.3-1 and 14.18.8.1.4.3-2.

Table 14.18.8.1.4.3-1

GSM 900, T-GSM 810 and GSM 850		
PDTCH MCS-1	C/dBm	- 76,5
PDTCH MCS-2	C/dBm	- 74,5
PDTCH MCS-3	C/dBm	- 69,0
PDTCH MCS-4	C/dBm	- 62,0

Table 14.18.8.1.4.3-2

DCS 1 800 & PCS 1900		
PDTCH MCS-1	C/dBm	- 76,5
PDTCH MCS-2	C/dBm	- 73,5
PDTCH MCS-3	C/dBm	- 68,5
PDTCH MCS-4	C/dBm	- 60,5

14.18.8.2 Synchronous single co-channel interferer (DTS-2 / DTS-3)

14.18.8.2.1 Definition

The DARP reference test scenarios DTS-2 and DTS-3 for multiple synchronous interferers define a set of interfering signals and the corresponding performance limits. These tests are a measure of the capability of the DARP receiver to receive a wanted modulated signal without exceeding a given degradation due to the presence of these specific unwanted signals.

14.18.8.2.2 Conformance requirement

The block error rate (BLER) performance for PDTCH / CS-1 to CS-4 shall not exceed 10 % at the multiple interference ratios (C/I_c) according to table 14.18.8.2.2-1.

Table 14.18.8.2.2-1 Reference Test Scenarios for synchronous multiple interferers

Reference Test Scenario	Interfering Signal	Interferer relative power level	TSC	Interferer Delay range
DTS-2	Co-channel 1	0 dB	none	no delay
	Co-channel 2	-10 dB	none	no delay
	Adjacent 1	3 dB	none	no delay
	AWGN	-17 dB	-	-
DTS-3	Co-channel 1	0 dB	random	-1 to +4 symbols
	Co-channel 2	-10 dB	none	no delay
	Adjacent 1	3 dB	none	no delay
	AWGN	-17 dB	-	-

The values in table 14.18.8.2.2-2 and table 14.18.8.2.2-3 are given as the C/I_1 ratio, where C is the power level of the wanted signal and I_1 is the power level of the dominant co-channel interferer (3GPP TS 45.005, annex L).

Table 14.18.8.2.2-2

GSM 900 and GSM 850		
Propagation condition	TU50 no FH	
Type of channel	C/I	
	DTS-2	DTS-3
PDTCH MCS-1	9,5 dB	10,5 dB
PDTCH MCS-2	11 dB	12 dB
PDTCH MCS-3	15 dB	15,5 dB
PDTCH MCS-4	20 dB	21 dB

Table 14.18.8.2.2-3

DCS 1 800 & PCS 1900		
Propagation condition	TU50 no FH	
Type of channel	C/I	
	DTS-2	DTS-3
PDTCH MCS-1	9 dB	10 dB
PDTCH MCS-2	11 dB	11,5 dB
PDTCH MCS-3	15 dB	15,5 dB
PDTCH MCS-4	22 dB	22,5 dB

Reference 3GPP TS 45.005, annex L, table 2o

3GPP TS 45.05 subclause 2:

For T-GSM 810 the requirements for GSM 900 shall apply, apart for those parameters for which a separate requirement exists.

14.18.8.2.3 Test purpose

To verify that the MS does not exceed the conformance requirement for different PDTCH / MSC 1-4 coding schemes under the propagation condition TU50/noFH with an allowance for the statistical significance of the test.

14.18.8.2.4 Test method

14.18.8.2.4.1 Initial condition

A TBF is established according to the generic call set up procedure for packet switched on an ARFCN in the Mid range, on the maximum number of receive timeslots which the MS is capable to support, The MS is transmitting at maximum power. The power control parameter ALPHA (α) is set to 0.

The SS establish a downlink TBF.

The SS transmits Standard Test Signal C1 with TSC 0.

In addition to this wanted signal (C1), the SS produces multiple interfering signals for DTS-2 or DTS-3 scenarios as appropriate for the test procedure.

These interferers are:

Identical interferer for DTS-2 and DTS-3:

- Co-channel 2 (I_{CoCh2}): Synchronous co-channel interferer of type I1 as specified in TS 51.010 annex 5.2
- Adjacent 1 (I_{AdjCh1}): Adjacent channel interferer of type I1 as specified in TS 51.010 annex 5.2
- AWGN (I_{AWGN}): AWGN interferer of type I3 as specified in TS51.010 annex 5.2

DTS-2 specific interferer:

- Co-channel 1 (I_{CoCh1}): Synchronous co-channel interferer of type I1 as specified in TS 51.010 annex 5.2

DTS-3 specific interferer:

- Co-channel 1 (I_{CoCh1}): Delayed co-channel interferer of type I4 as specified in TS 51.010 annex 5.2.

14.18.8.2.4.2 Test procedure

14.18.8.2.4.3 DTS-2 procedure

- a) The DTS-2 co-channel interferer signal I_{CoCh1} is configured according to DTS-2 configuration.
- b) The co-channel interferer signal I_{CoCh1} set to -80 dBm.

- c) The power levels of the interferers I_{CoCh2} , I_{AdjCh1} , and I_{AWGN} are set according to table 14.18.8.2.2-1. The power levels are defined relative to I_{CoCh1} .
- d) The fading characteristics of the wanted signal C1 and the interferer signals I_{CoCh1} , I_{CoCh2} , and I_{AdjCh1} are set to TU High. No FH applies.
- e) The SS transmits packets using MCS-1 coding on all allocated timeslots.
- f) The SS sets the level of the wanted signal C1 1 dB above the level according to table 14.18.8.2.4.5-1 and table 14.18.8.2.4.5-2.
- g) The SS counts the number of blocks transmitted with current coding scheme and the number of these blocks not acknowledged based on the content of the Ack/Nack Description information element (see 3GPP TS 04.60, sub clause 12.3) in the Packet Downlink Ack/Nack as sent from the MS to the SS on the PACCH.
- h) Once the number of blocks transmitted with the current coding scheme as counted in step (e) reaches or exceeds the minimum number of blocks as given in table 14.18-2 the SS calculates the Block error ratio. The SS resets both counters.
- i) SS repeats the steps (e) to (h) for each of the coding schemes MCS-2, MCS-3 and MCS-4.

14.18.8.2.4.4 Test method

- a) The DTS-3 co-channel interferer signal I_{CoCh1} is configured according to DTS-3 configuration.
- b) The SS repeats the steps (b) to (h) identical to the DTS-2 procedure

14.18.8.2.4.5 Test requirement

The block error ratio, as calculated by the SS for different channels and under the TU High propagation conditions, shall not exceed the conformance requirement.

NOTE: The wanted signal levels derived from calculations using 3GPP TS 45.005 (table 2o, annex L) , shall be set according to the table below.

Table 14.18.8.2.4.5-1

GSM 900, T-GSM 810 and GSM 850			
Type of channel		DARP Test Scenario	
		DTS-2	DTS-3
PDTCH MCS-1	C/dBm	- 70,5	- 69,5
PDTCH MCS-2	C/dBm	- 69,0	- 68,0
PDTCH MCS-3	C/dBm	- 65,0	- 64,5
PDTCH MCS-4	C/dBm	- 60,0	- 59,0

Table 14.18.8.2.4.5-2

DCS 1 800 & PCS 1900			
Type of channel		DARP Test Scenario	
		DTS-2	DTS-3
PDTCH MCS-1	C/dBm	- 71,0	- 70,0
PDTCH MCS-2	C /dBm	- 69,0	- 68,5
PDTCH MCS-3	C /dBm	- 65,0	- 64,5
PDTCH MCS-4	C /dBm	- 58,0	- 57,5

14.18.9 DARP Phase II EGPRS tests

14.18.9.1 Synchronous single co-channel interferer (DTS-1)

14.18.9.1.1 Definition

The DARP phase II reference test scenario DTS-1 for a single synchronous co-channel interferer defines an interfering signal and corresponding performance limits. This test is a measure of the capability of the DARP phase II receivers to receive a wanted modulated signal without exceeding a given degradation due to the presence of this specific unwanted signal.

14.18.9.1.2 Conformance requirement

MS indicating support for Downlink Advanced Receiver Performance – phase II (see 3GPP TS 24.008) shall fulfil the requirements in table 2q for the test scenarios defined in annex N

The reference performance shall be:

- For packet switched channels (PDTCH) BLER: ≤ 10 %

The values in table 2q are given as the C/I1 ratio, where C is the power level of the wanted signal and I1 is the power level of the dominant co-channel interferer (Co-channel 1, see annex N).

3GPP TS 45.005; clause 6.3.

Reference Test Scenario for synchronous single co-channel interferer

Reference Test Scenario	Interfering Signal	Interferer relative power level	TSC	Interferer Delay range
DTS-1	Co-channel 1	0 dB	none	no delay

3GPP TS 45.005; Annex N.

GSM 900 and GSM 850	
Propagation condition: TU50 (no FH)	
Correlation=0; AGI=0 dB	
PDTCH MCS-1	-11,5 dB
PDTCH MCS-2	-10,0 dB
PDTCH MCS-3	-6,5 dB
PDTCH MCS-4	-1,0 dB

GSM 1800 and GSM 1900	
Propagation condition: TU50 (no FH)	
Correlation=0; AGI=0 dB	
PDTCH MCS-1	-10,5 dB
PDTCH MCS-2	-8,5 dB
PDTCH MCS-3	-4,5 dB
PDTCH MCS-4	2,0 dB

3GPP TS 45.005; table 2q (excerpt for DTS-1).

For T-GSM 810 the requirements for GSM 900 shall apply, apart for those parameters for which a separate requirement exists.

3GPP TS 45.005; sub clause 2

14.18.9.1.3 Test purpose

To verify that the MS does not exceed conformance requirement for different coding schemes and under the propagation condition TU50/noFH with an allowance for the statistical significance of the test.

14.18.9.1.4 Test method

14.18.9.1.4.1 Initial condition

The SS is configured as defined in annex N.2 picture N.2.2 of 3GPP 45.005

The diversity parameter for the antenna correlation is set to 0 and the antenna gain imbalance (AGI) is set to 0 dB

A call is set up according to the generic call set up procedure with an ARFCN in the mid ARFCN range on the maximum number of receive timeslots which the MS is capable to support. The power control level set to maximum power.

The power control parameter ALPHA (α) is set to 0.

The SS establish a downlink TBF.

The SS transmits Standard Test Signal C1 with TSC 0.

In addition to this wanted signal (C1), the SS produces an independent, uncorrelated interfering signal (I1). This unwanted signal is random, continuous and GSM-modulated and has no fixed relationship with the bit transitions of the wanted signal.

14.18.9.1.4.2 Procedure

- a) The co-channel interferer signal I1 (unwanted signal) is set to -70 dBm.
- b) The fading characteristic of the wanted signal C1 and the interferer signal I1 is set to TU High. No FH applies.
- c) The SS transmits packets using MCS-1 coding to the MS on all allocated timeslots.
- d) The SS sets the level of the wanted signal 1dB above the value according the Table 14.18.9.1.5-1 and Table 14.18.9.1.5-2.
- e) The SS transmits the number of blocks with current coding scheme accordingly with table 14.16-2 and counts the BLER based on the content of the ACK/NACK Description information element (see 3GPP TS 04.60, sub clause 12.3) in the Packet Downlink ACK/NACK as sent from the MS to the SS on the PACCH. The SS resets both counters.
- f) The SS repeats the steps (c) to (e) for each of the coding schemes MCS-2 to MCS-4

14.18.9.1.5 Test requirement

The block error ratio, as calculated by the SS for different channels under the TU High propagation conditions, shall not exceed the conformance requirement.

NOTE: The wanted signal levels derived from calculations using 3GPP TS 45.005 table 2q shall be set according to the table below.

Table 14.18.9.1.5-1

GSM 900 and GSM 850		
PDTCH MCS-1	C/dBm	-81,5
PDTCH MCS-2	C/dBm	-80,0
PDTCH MCS-3	C/dBm	-76,5
PDTCH MCS-4	C/dBm	-71,0

Table 14.18.9.1.5-2

DCS 1 800 & PCS 1900		
PDTCH MCS-1	C/dBm	-80,5
PDTCH MCS-2	C/dBm	-78,5
PDTCH MCS-3	C/dBm	-74,5
PDTCH MCS-4	C/dBm	-68,0

14.18.9.2 Synchronous single co-channel interferer (DTS-1b)

14.18.9.2.1 Definition

The DARP phase II reference test scenario DTS-1 for a single synchronous co-channel interferer defines an interfering signal and corresponding performance limits. This test is a measure of the capability of the DARP phase II receivers to receive a wanted modulated signal without exceeding a given degradation due to the presence of this specific unwanted signal.

14.18.9.2.2 Conformance requirement

MS indicating support for Downlink Advanced Receiver Performance – phase II (see 3GPP TS 24.008) shall fulfil the requirements in table 2q for the test scenarios defined in annex N

The reference performance shall be:

- For packet switched channels (PDTCH) BLER: ≤ 10 %

The values in table 2q are given as the C/I1 ratio, where C is the power level of the wanted signal and I1 is the power level of the dominant co-channel interferer (Co-channel 1, see annex N).

3GPP TS 45.005; clause 6.3.

Reference Test Scenario for synchronous single co-channel interferer

Reference Test Scenario	Interfering Signal	Interferer relative power level	TSC	Interferer Delay range
DTS-1b	Co-channel 1 8PSK	0 dB	none	no delay

3GPP TS 45.005; Annex N.

GSM 900 and GSM 850	
Propagation condition: TU50 (no FH)	
Correlation=0; AGI=0 dB	
PDTCH MCS-5	-6,5 dB
PDTCH MCS-6	-4,0 dB
PDTCH MCS-7	1,5 dB
PDTCH MCS-8	1,5** dB
PDTCH MCS-9	6,0** dB

GSM 1800 and GSM 1900	
Propagation condition: TU50 (no FH)	
Correlation=0; AGI=0 dB	
PDTCH MCS-5	-6,0 dB
PDTCH MCS-6	-3,5 dB
PDTCH MCS-7	3,0 dB
PDTCH MCS-8	5,0** dB
PDTCH MCS-9	12,0** dB

NOTE: Performance is specified at 30% BLER for those cases identified with mark “**

NOTE 1: DARP Test Scenario 1 (DTS-1) is similar to testing of co-channel interference for non-DARP receivers with essentially at least as stringent requirements under TU50noFH propagation conditions. DTS-1b utilizes an 8-PSK modulated interferer and is to be applied for MCS5-MCS9.

3GPP TS 45.005; table 2q (excerpt for DTS-1b).

For T-GSM 810 the requirements for GSM 900 shall apply, apart for those parameters for which a separate requirement exists.

3GPP TS 45.005; sub clause 2

14.18.9.2.3 Test purpose

To verify that the MS does not exceed conformance requirement for different coding schemes and under the propagation condition TU50/noFH with an allowance for the statistical significance of the test.

14.18.9.2.4 Test method

14.18.9.2.4.1 Initial condition

The SS is configured as defined in annex N.2 picture N.2.2 of 3GPP 45.005.

The diversity parameter for the antenna correlation is set to 0 and the antenna gain imbalance (AGI) is set to 0 dB

A call is set up according to the generic call set up procedure with an ARFCN in the mid ARFCN range on the maximum number of receive timeslots which the MS is capable to support. The power control level set to maximum power.

The power control parameter ALPHA (α) is set to 0.

The SS establish a downlink TBF.

The SS transmits Standard Test Signal C1 with TSC 0.

In addition to this wanted signal (C1), the SS produces an independent, uncorrelated interfering signal (I1). This unwanted signal is random, continuous and GSM-modulated and has no fixed relationship with the bit transitions of the wanted signal.

14.18.9.2.4.2 Procedure

- a) The co-channel interferer signal I1 (unwanted signal) is set to -70 dBm.
- b) The fading characteristic of the wanted signal C1 and the interferer signal I1 is set to TU High. No FH applies.
- c) The SS transmits packets using MCS-5 coding to the MS on all allocated timeslots.
- d) The SS sets the level of the wanted signal 1dB above the value according the Table 14.18.9.2.5-1 and Table 14.18.9.2.5-2.
- e) The SS transmits the number of blocks with current coding scheme accordingly with table 14.16-2 and counts the BLER based on the content of the ACK/NACK Description information element (see 3GPP TS 04.60, sub clause 12.3) in the Packet Downlink ACK/NACK as sent from the MS to the SS on the PACCH. The SS resets both counters.
- f) The SS repeats the steps (c) to (e) for each of the coding schemes MCS-6 to MCS-9

14.18.9.2.5 Test requirement

The block error ratio, as calculated by the SS for different channels under the TU High propagation conditions, shall not exceed the conformance requirement.

NOTE: The wanted signal levels derived from calculations using 3GPP TS 45.005 table 2q shall be set according to the table below.

Table 14.18.9.2.5-1

GSM 900 and GSM 850		
PDTCH MCS-5	C/dBm	-76,5
PDTCH MCS-6	C/dBm	-74,0
PDTCH MCS-7	C/dBm	-68,5
PDTCH MCS-8	C/dBm	-68,5
PDTCH MCS-9	C/dBm	-64,0

Table 14.18.9.2.5-2

DCS 1 800 & PCS 1900		
PDTCH MCS-5	C/dBm	-76,0
PDTCH MCS-6	C/dBm	-73,5
PDTCH MCS-7	C/dBm	-67,0
PDTCH MCS-8	C/dBm	-65,0
PDTCH MCS-9	C/dBm	-58,0

14.18.9.3 Multiple interferers (DTS-2 / DTS-5)

14.18.9.3.1 Definition

The DARP phase II reference test scenarios DTS-2 and DTS-5 for multiple interferers define a set of interfering signals and the corresponding performance limits. These tests are a measure of the capability of the DARP phase II receivers to receive a wanted modulated signal without exceeding a given degradation due to the presence of these specific unwanted signals.

14.18.9.3.2 Conformance requirement

MS indicating support for Downlink Advanced Receiver Performance – phase II (see 3GPP TS 24.008) shall fulfil the requirements in table 2q for the test scenarios defined in annex N

The reference performance shall be:

- For packet switched channels (PDTCH) BLER: ≤ 10 %

The values in table 2q are given as the C/I1 ratio, where C is the power level of the wanted signal and I1 is the power level of the dominant co-channel interferer (Co-channel 1, see annex N).

3GPP TS 45.005; clause 6.3.

Reference Test Scenarios for synchronous multiple interferers

Reference Test Scenario	Interfering Signal	Interferer relative power level	TSC	Interferer Delay range
DTS-2	Co-channel 1	0 dB	none	no delay
	Co-channel 2	-10 dB	none	no delay
	Adjacent 1	3 dB	none	no delay
	AWGN	-17 dB	-	-

Reference Test Scenario for asynchronous multiple interferers

Reference Test Scenario	Interfering Signal	Interferer relative power level	TSC	Interferer Delay
DTS-5	Co-channel 1	0 dB ^{*)}	none	74 symbols
	Co-channel 2	-10 dB	none	no delay
	Adjacent 1	3 dB	none	no delay
	AWGN	-17 dB	-	-
^{*)} The power of the delayed interferer burst, averaged over the active part of the wanted signal burst. The power of the delayed interferer burst, averaged over the active part of the delayed interferer burst is 3 dB higher.				

3GPP TS 45.005; Annex N.

GSM 900 and GSM 850		
Propagation condition: TU50 (no FH)		
Correlation=0; AGI=0 dB		
Channel type	C/I	
	DTS-2	DTS-5
PDTCH MCS-1	1,0	1,5
PDTCH MCS-2	2,5	2,5
PDTCH 'MCS-3	6,0	6,0
PDTCH MCS-4	11,0	12,5
PDTCH MCS-5	7,0	8,0
PDTCH MCS-6	9,0	10,5
PDTCH MCS-7	13,5	15,0
PDTCH MCS-8	20,0	20,5
PDTCH MCS-9	23,5	26,5

DCS 1800 and PCM 1900		
Propagation condition: TU50 (no FH)		
Correlation=0; AGI=0 dB		
Channel type	C/I	
	DTS-2	DTS-5
PDTCH MCS-1	1,0	1,0
PDTCH MCS-2	2,5	2,5
PDTCH 'MCS-3	6,0	6,0
PDTCH MCS-4	11,1	13,0
PDTCH MCS-5	6,5	7,5
PDTCH MCS-6	8,5	9,5
PDTCH MCS-7	14,0	15,0
PDTCH MCS-8	20,5	22,0
PDTCH MCS-9	25,0	25,5

3GPP TS 45.005 table 2q (excerpt for DTS-2 and DTS-5)

For T-GSM 810 the requirements for GSM 900 shall apply, apart for those parameters for which a separate requirement exists.

3GPP TS 45.005; sub clause 2

14.18.9.3.3 Test purpose

To verify that the MS does not exceed the conformance requirement for different coding schemes under the propagation condition TU50/noFH with an allowance for the statistical significance of the test.

14.18.9.3.4 Test method

14.18.9.3.4.1 Initial condition

The SS is configured as defined in annex N.2 picture N.2.2 of 3GPP 45.005.

The diversity parameter for the antenna correlation is set to 0 and the antenna gain imbalance (AGI) is set to 0 dB

A call is set up according to the generic call set up procedure for packet switched on an ARFCN in the Mid range, on the maximum number of receive timeslots which the MS is capable to support, The MS is transmitting at maximum power. The power control parameter ALPHA (α) is set to 0.

The SS establish a downlink TBF.

The SS transmits Standard Test Signal C1 with TSC 0.

In addition to this wanted signal (C1), the SS produces multiple interfering signals for DTS-2 or DTS-5 scenarios as appropriate for the test procedure.

These interferers are:

Identical interferer types for DTS-2 and DTS-5:

- Co-channel 2 (I_{CoCh2}): Synchronous co-channel interferer of type I1 as specified in TS 51.010 annex 5.2
- Adjacent 1 (I_{AdjCh1}): Adjacent channel interferer of type I1 as specified in TS 51.010 annex 5.2
- AWGN (I_{AWGN}): AWGN interferer of type I3 as specified in TS 51.010 annex 5.2

DTS-2 specific interferer:

- Co-channel 1 (I_{CoCh1}): Synchronous co-channel interferer of type I1 as specified in TS 51.010 annex 5.2

DTS-5 specific interferer:

- Co-channel 1 (I_{CoCh1}): Delayed co-channel interferer of type I5 as specified in TS 51.010 annex 5.2.

14.18.9.3.4.2 Test Procedure

14.18.9.3.4.2.1 DTS-2 Procedure

- a) The DTS-2 co-channel interferer signal I_{CoCh1} is configured according to the DTS-2 configuration.
- b) The co-channel interferer signal I_{CoCh1} set to -70 dBm.
- c) The power levels of the interferers I_{CoCh2} , I_{AdjCh1} , and I_{AWGN} are set according to table 14.18.9.3.21. The power levels are defined relative to I_{CoCh1} .
- d) The fading characteristics of the wanted signal C1 and the interferer signals I_{CoCh1} , I_{CoCh2} , and I_{AdjCh1} are set to TU High. No FH applies.
- e) The SS transmits packets using MCS-1 coding on all allocated timeslots.
- f) The SS sets the level of the wanted signal C1 1 dB above the value according to table 14.18.9.3.5-1 and table 14.18.9.3.5-2.
- g) The SS transmits the number of blocks with current coding scheme accordingly with table 14.16-2 and counts the BLER based on the content of the ACK/NACK Description information element (see 3GPP TS 04.60, sub clause 12.3) in the Packet Downlink ACK/NACK as sent from the MS to the SS on the PACCH. The SS resets both counters.
- h) The SS repeats the steps (e) to (h) for each of the coding schemes MCS-2 to MSC-9.

14.18.9.3.4.2.2 DTS-5 Procedure

- a) The DTS-5 co-channel interferer signal I_{CoCh1} is configured according to DTS-5 configuration.
- b) The SS repeats the steps (b) to (i) identical to the DTS-2 procedure

14.18.9.3.5 Test requirement

The block error ratio calculated by the SS for different channels and under the TU High propagation conditions, shall not exceed the conformance requirement.

NOTE: The wanted signal levels derived from calculations using 3GPP TS 45.005 table 2q, shall be set according to the table below.

Table 14.18.9.3.5-1

GSM 900 and GSM 850			
Type of channel		DARP II Test Scenario	
		DTS-2	DTS-5
PDTCH MCS-1	C/dBm	-69,0	-68,5
PDTCH MCS-2	C/dBm	-67,5	-67,5
PDTCH MCS-3	C/dBm	-64,0	-64,0
PDTCH MCS-4	C/dBm	-59,0	-57,5
PDTCH MCS-5	C/dBm	-63,0	-62,0
PDTCH MCS-6	C/dBm	-61,0	-59,5
PDTCH MCS-7	C/dBm	-56,5	-55,0
PDTCH MCS-8	C/dBm	-50,0	-49,5
PDTCH MCS-9	C/dBm	-46,5	-43,5

Table 14.18.9.3.5-2

DCS 1 800 & PCS 1900			
Type of channel		DARP II Test Scenario	
		DTS-2	DTS-5
PDTCH MCS-1	C/dBm	-69,0	-69,0
PDTCH MCS-2	C /dBm	-67,5	-67,5
PDTCH MCS-3	C /dBm	-64,0	-64,0
PDTCH MCS-4	C /dBm	-58,5	-57,0
PDTCH MCS-5	C/dBm	-63,5	-62,5
PDTCH MCS-6	C/dBm	-61,5	-60,5
PDTCH MCS-7	C/dBm	-56,0	-55,0
PDTCH MCS-8	C/dBm	-49,5	-48,0
PDTCH MCS-9	C/dBm	-45,0	-44,5

14.19 DARP Phase II Speech bearer tests

14.19.1 TCH/FS

14.19.1.1 DTS-1

14.19.1.1.1 Definition

DARP Phase II, also referred as Mobile Station Receiver Diversity is a feature where the MS uses two receive antennas in order to improve performance under non-interfering and interfering scenarios.

The DARP Phase II reference test scenarios define a set of interfering signals and corresponding performance limits. These tests are a measure of the capability of the DARP Phase II receiver to receive a wanted modulated signal without exceeding a given degradation due to the presence of these specific unwanted modulated signals.

14.19.1.1.2 Conformance requirement

- MS indicating support for Downlink Advanced Receiver Performance – phase II (see 3GPP TS 24.008) shall fulfil the requirements in table 2q for the test scenarios defined in annex N. The reference performance shall be:
 - For speech channels (TCH/FS, TCH/AFS_x, TCH/AHS_x) FER: $\leq 1\%$
- The values in table 2q are given as the C/I1 ratio, where C is the power level of the wanted signal and I1 is the power level of the dominant co-channel interferer (Co-channel 1, see annex N). In addition for speech channels the residual class Ib BER and residual class II BER performance shall not exceed the specified values in table 2q at the corresponding C/I1.

3GPP TS 45.005, subclause 6.3

For T-GSM 810 the requirements for GSM 900 shall apply, apart for those parameters for which a separate requirement exists.

3GPP TS 45.005; sub clause 2

14.19.1.1.3 Test purpose

To verify that the MS does not exceed the first conformance requirement for TCH/FS under propagation condition TU_{high} with an allowance for the statistical significance of the test.

To verify that the MS does not exceed the second conformance requirement for TCH/FS under propagation condition TU_{high} with an allowance for the statistical significance of the test.

14.19.1.1.4 Method of test

14.19.1.1.4.1 Initial conditions

A call is set up according to the generic call set up procedure on a TCH/FS with an ARFCN in the mid ARFCN range, power control level set to maximum power. RADIO_LINK_TIMEOUT is set to maximum.

The SS transmits Standard Test Signal C1 on the traffic channel (wanted signal).

The SS commands the MS to create the traffic channel loop back, signalling erased frames (subclause 36).

14.19.1.1.4.2 Procedure

- a) In addition to the wanted signal, the SS produces an independent, uncorrelated interfering signal, Standard Test Signal I1 (unwanted signal).

The unwanted signal is continuous and has no fixed relationship with the bit transitions of the wanted signal. The interfering signal level is set to -70 dBm.

The fading characteristic of the wanted and the interfering signal is TU_{High}. Antenna correlation is 0 and antenna gain imbalance is 0dB.

- b) The SS sets the level of the wanted signal to that indicated by C_{lev} in table 14.19.1-2 or 14.19.1-3.
- c) The SS compares the modulation of the signal that it sends to the MS with the signal which is looped back from the receiver after demodulation and decoding, and checks the frame erasure indication.
- d) The SS determines the number of residual bit error events for the bits of the class Ib, by examining at least the minimum number of samples of consecutive bits of class Ib. Bits are only taken from those frames not signalled as erased.
- e) The SS also determines the number of residual bit error events for the bits of the class II, by examining at least the minimum number of samples of consecutive bits of class II. Bits are only taken from those frames not signalled as erased.
- f) The SS also determines the frame erasure events by examining at least the minimum number of samples of consecutive frames and assuming a frame is received successfully it is not signalled as erased.

Maximum/Minimum Duration of Test

Maximum: 10 minutes (GSM850), 10 minutes (GSM900), 10 minutes (DCS1800), 10 minutes (PCS1900).

Minimum: 4 minutes (GSM850), 4 minutes (GSM900), 2 minutes (DCS1800), 2 minutes (PCS1900).

14.19.1.1.5 Test requirements

Testing should be performed using statistical methods that lead to an early pass/fail decision with test time significantly reduced for MS with FER/BER not on the limit.

For more information on statistical testing of BER/BLER performance, especially the definition of limit lines refer to Annex 7 (A7.1.3.2)

Wrong decision risk F for one single error rate test:

$$F_{\text{pass}} = F_{\text{fail}} = F \quad \text{and} \quad F = 0.2\%$$

Wrong decision probability D per test step:

$$D_{\text{pass}} = D_{\text{fail}} = D \quad \text{and} \quad D = 0.0085\%$$

Parameters for limit lines:

1. $D = 0.000085$ wrong decision probability per test step.
2. $M = 1.5$ bad DUT factor
3. n_e number of (error) events. This parameter is the x-ordinate in figure Annex 7 figure A7.1.3.1.
4. n_s number of samples. The error rate is calculated from n_e and n_s .

Limit checking

Before limit checking is valid the minimum test time due to fading needs to be considered:

Testing under multipath and interference conditions requires that at least 990 wavelengths are crossed with the speed given in the fading profile. This leads to a minimum test time depending on the frequency range. No early pass/fail decision is allowed until the minimum test time due to fading has elapsed.

Table 14.19.1-1: Minimum test times due to TU high fading conditions

Full Rate 50 km/h				
Frequency	0,85	0,9	1,8	1,9 GHz
Wavelength	0,35	0,33	0,17	0,16 m
Min test time	201	190	95	90 s
	0:03:21	0:03:10	0:01:35	0:01:30 hh:mm:ss

If the minimum test time due to multipath conditions exceeds the target test time, then the test runs for the minimum test time due to multipath conditions and the decision is made by comparing the result with the “derived test limit”. In this case early pass/fail decisions are obsolete.

If the target test time exceeds the minimum test time due to multipath conditions early pass/fail decisions can be headed for in order to accelerate test execution.

For an early decision a minimum number of (error) events is necessary.

For an early pass decision $n_e \geq 1$ (inclusive artificial error)

For an early fail decision $n_e \geq 7$

When the target test time has been reached the test is finished and a pass/fail decision can be made.

The error rate measured in this test shall be tested according to the values given in tables 14.19.1-2 or 14.19.1-3.

Table 14.19.1-2: Statistical test limits for GSM 850 and GSM 900 TCH/FS DARP Phase II DTS-1

DTS-1								
0.8 to 0.9GHz		C_{lev} (dBm)	Samples per second	Orig. BER requirement	Derived test limit	Target number of samples	Target test time (s)	Target test time (hh:mm:ss)
FS	Frames	-82	50	0,010000	0,0123400	27958	560	00:09:20
	Class I	(as frames)	9100	0,000600	0,0007404	465965	51	00:00:51
	Class II	(as frames)	3900	0,053700	0,0662658	5207	2	00:00:02

Table 14.19.1-3: Statistical test limits for DCS 1 800 and PCS 1 900 TCH/FS DARP Phase II DTS-1

DTS-1								
1.8 to 1.9GHz		C_{lev} (dBm)	Samples per second	Orig. BER requirement	Derived test limit	Target number of samples	Target test time (s)	Target test time (hh:mm:ss)
FS	Frames	-81.5	50	0,010000	0,0123400	27958	560	00:09:20
	Class Ib	(as frames)	9100	0,000800	0,0009872	349474	39	00:00:39
	Class II	(as frames)	3900	0,058600	0,0723124	4771	2	00:00:02

14.19.2 TCH/AFS

14.19.2.1 DTS-1

14.19.2.1.1 Definition

DARP Phase II, also referred as Mobile Station Receiver Diversity is a feature where the MS uses two receive antennas in order to improve performance under non-interfering and interfering scenarios.

The DARP Phase II reference test scenarios define a set of interfering signals and corresponding performance limits. These tests are a measure of the capability of the DARP Phase II receiver to receive a wanted modulated signal without exceeding a given degradation due to the presence of these specific unwanted modulated signals.

14.19.2.1.2 Conformance requirement

1. MS indicating support for Downlink Advanced Receiver Performance – phase II (see 3GPP TS 24.008) shall fulfil the requirements in table 2q for the test scenarios defined in annex N. The reference performance shall be:
 - For speech channels (TCH/FS, TCH/AFS_x, TCH/AHS_x) FER: ≤ 1 %
2. The values in table 2q are given as the C/I1 ratio, where C is the power level of the wanted signal and I1 is the power level of the dominant co-channel interferer (Co-channel 1, see annex N). In addition for speech channels the residual class Ib BER and residual class II BER performance shall not exceed the specified values in table 2q at the corresponding C/I1.

3GPP TS 45.005, subclause 6.3

For T-GSM 810 the requirements for GSM 900 shall apply, apart for those parameters for which a separate requirement exists.

3GPP TS 45.005; sub clause 2

14.19.2.1.3 Test purpose

To verify that the MS does not exceed the first conformance requirement for TCH/AFS under propagation condition TU_{high} with an allowance for the statistical significance of the test.

To verify that the MS does not exceed the second conformance requirement for TCH/AFS under propagation condition TU_{high} with an allowance for the statistical significance of the test for class Ib BER.

14.19.2.1.4 Method of test

14.19.2.1.4.1 Initial conditions

A call is set up according to the generic call set up procedure on a TCH/AFS with an ARFCN in the mid ARFCN range, power control level set to maximum power. RADIO_LINK_TIMEOUT is set to maximum.

The multirate configuration indicates the use of a codec set limited to 12,2 kbit/s.

The SS transmits Standard Test Signal C1 on the traffic channel (wanted signal), with training sequence code (TSC) = 0.

The SS commands the MS to create the traffic channel loop back, signalling erased frames (subclause 36).

14.19.2.1.4.2 Procedure

- a) In addition to the wanted signal, the SS produces an independent, uncorrelated interfering signal, Standard Test Signal II (unwanted signal).

The unwanted signal is continuous and has no fixed relationship with the bit transitions of the wanted signal. The interfering signal level is set to -70 dBm.

The fading characteristic of the wanted and the interfering signal is TUHigh. Antenna correlation is 0 and antenna gain imbalance is 0dB.

- b) The SS sets the level of the wanted signal to that indicated by C_{lev} in table 14.19.2-2 or 14.19.2-3.
- c) The SS compares the modulation of the signal that it sends to the MS with the signal which is looped back from the receiver after demodulation and decoding, and checks the frame erasure indication.
- d) The SS determines the number of residual bit error events for the bits of the class Ib, by examining at least the minimum number of samples of consecutive bits of class Ib. Bits are only taken from those frames not signalled as erased.
- e) The SS also determines the frame erasure events by examining at least the minimum number of samples of consecutive frames and assuming a frame is received successfully it is not signalled as erased.
- f) The SS uses a Channel Mode Modify procedure to change the active codec set to 7,4 kbit/s and steps b) to e) are repeated.
- g) The SS uses a Channel Mode Modify procedure to change the active codec set to 5,9 kbit/s and steps b) to e) are repeated.

Maximum/Minimum Duration of Test

Maximum: 28 minutes (GSM850), 28 minutes (GSM900), 28 minutes (DCS1800), 28 minutes (PCS1900).

Minimum: 11 minutes (GSM850), 10 minutes (GSM900), 5 minutes (DCS1800), 5 minutes (PCS1900).

14.19.2.1.5 Test requirements

Testing should be performed using statistical methods that lead to an early pass/fail decision with test time significantly reduced for MS with FER/BER not on the limit.

For more information on statistical testing of BER/BLER performance, especially the definition of limit lines refer to Annex 7.

Wrong decision risk F for one single error rate test:

$$F_{pass} = F_{fail} = F \quad \text{and} \quad F = 0.2\%$$

Wrong decision probability D per test step:

$$D_{pass} = D_{fail} = D \quad \text{and} \quad D = 0.0085\%$$

Parameters for limit lines:

1. D = 0.000085 wrong decision probability per test step.
2. M = 1.5 bad DUT factor
3. ne number of (error) events. This parameter is the x-ordinate in figure A7.1.3.2.
4. ns number of samples. The error rate is calculated from ne and ns.

Limit checking

Before limit checking is valid the minimum test time due to fading needs to be considered:

Testing under multipath and interference conditions requires that at least 990 wavelengths are crossed with the speed given in the fading profile. This leads to a minimum test time depending on the frequency range. No early pass/fail decision is allowed until the minimum test time due to fading has elapsed.

Table 14.19.2-1: Minimum test times due to TU high fading conditions

Full Rate 50 km/h					
Frequency	0,85	0,9	1,8	1,9	GHz
Wavelength	0,35	0,33	0,17	0,16	m
min test time	201	190	95	90	s
	0:03:21	0:03:10	0:01:35	0:01:30	hh:mm:ss

If the minimum test time due to multipath conditions exceeds the target test time, then the test runs for the minimum test time due to multipath conditions and the decision is made by comparing the result with the “derived test limit”. In this case early pass/fail decisions are obsolete.

If the target test time exceeds the minimum test time due to multipath conditions early pass/fail decisions can be headed for in order to accelerate test execution.

For an early decision a minimum number of (error) events is necessary.

For an early pass decision $ne \geq 1$ (inclusive artificial error)

For an early fail decision $ne \geq 7$

When the target test time has been reached the test is finished and a pass/fail decision can be made.

The error rate measured in this test shall be tested according to the values given in tables 14-63 or 14-64.

Table 14.19.2-2: Statistical test limits for GSM 850 and GSM 900 TCH/AFS DARP Phase II DTS-1

DTS-1								
0.8 to 0.9GHz		C_{lev} (dBm)	Samples per second	Orig. BER requirement	Derived test limit	Target number of samples	Target test time (s)	Target test time (hh:mm:ss)
AFS 12.2	Frames	-81.0	50	0,010000	0,012340	27958	560	00:09:20
	Class1b	(as frames)	8150	0,006900	0,0085146	40519	5	00:00:05
AFS 7.4	Frames	-83.5	50	0,010000	0,012340	27958	560	00:09:20
	Class1b	(as frames)	4350	0,002100	0,0025914	133133	31	00:00:31
AFS 5.9	Frames	-85.0	50	0,010000	0,012340	27958	560	00:09:20
	Class1b	(as frames)	3150	0,001700	0,0020978	164459	53	00:00:53

Table 14.19.2-3: Statistical test limits for DCS 1800 and PCS 1900 TCH/AFS DARP Phase II DTS-1

DTS-1								
1.8 to 1.9GHz		C_{lev} (dBm)	Samples per second	Orig. BER requirement	Derived test limit	Target number of samples	Target test time (s)	Target test time (hh:mm:ss)
AFS 12.2	Frames	-80.5	50	0,010000	0,012340	27958	560	00:09:20
	Class1b	(as frames)	8150	0,008400	0,0103656	33284	5	00:00:05
AFS 7.4	Frames	-83.5	50	0,010000	0,012340	27958	560	00:09:20
	Class1b	(as frames)	4350	0,001800	0,0022212	155322	36	00:00:36
AFS 5.9	Frames	-84.5	50	0,010000	0,012340	27958	560	00:09:20
	Class1b	(as frames)	3150	0,002000	0,002468	139790	45	00:00:45

14.19.2.2 DTS-2/5

14.19.2.2.1 Definition

DARP Phase II, also referred as Mobile Station Receiver Diversity is a feature where the MS uses two receive antennas in order to improve performance under non-interfering and interfering scenarios.

The DARP Phase II reference test scenarios define a set of interfering signals and corresponding performance limits. These tests are a measure of the capability of the DARP Phase II receiver to receive a wanted modulated signal without exceeding a given degradation due to the presence of these specific unwanted modulated signals.

14.19.2.2.2 Conformance requirement

1. MS indicating support for Downlink Advanced Receiver Performance – phase II (see 3GPP TS 24.008) shall fulfil the requirements in table 2q for the test scenarios defined in annex N. The reference performance shall be:
 - For speech channels (TCH/FS, TCH/AFS_x, TCH/AHS_x) FER: $\leq 1\%$
2. The values in table 2q are given as the C/I1 ratio, where C is the power level of the wanted signal and I1 is the power level of the dominant co-channel interferer (Co-channel 1, see annex N).
In addition for speech channels the residual class Ib BER and residual class II BER performance shall not exceed the specified values in table 2q at the corresponding C/I1.

3GPP TS 45.005, subclause 6.3

For T-GSM 810 the requirements for GSM 900 shall apply, apart for those parameters for which a separate requirement exists.

3GPP TS 45.005; sub clause 2

14.19.2.2.3 Test purpose

To verify that the MS does not exceed the first conformance requirement for TCH/AFS under propagation condition TU_{high} with an allowance for the statistical significance of the test.

To verify that the MS does not exceed the second conformance requirement for TCH/AFS under propagation condition TU_{high} with an allowance for the statistical significance of the test.

14.19.2.2.4 Method of test

14.19.2.2.4.1 Initial conditions

A call is set up according to the generic call set up procedure on a TCH/AFS with an ARFCN in the mid ARFCN range, power control level set to maximum power. RADIO_LINK_TIMEOUT is set to maximum.

The multirate configuration indicates the use of a codec set limited to 7,4 kbit/s.

The SS transmits Standard Test Signal C1 on the traffic channel (wanted signal), with training sequence code (TSC) = 0.

The SS commands the MS to create the traffic channel loop back, signalling erased frames (subclause 36).

14.19.2.2.4.2 Procedure

- a) In addition to the wanted signal, the SS produces a further four interfering signals to produce scenario DTS-2.
- A signal of type I1 using the same ARFCN as C1, with fading characteristics of TUHigh, and signal level of -70 dBm.
- A signal of type I1 using the same ARFCN as C1, with fading characteristics of TUHigh, and signal level of -80 dBm.
- A signal of type I1 using an ARFCN one higher than C1, with fading characteristics of TUHigh, and signal level of -67 dBm.
- A signal of type I3 using the same ARFCN as C1, and signal level of -87 dBm.
- b) The SS sets the level of the wanted signal to that indicated by C_{lev} in table 14.19.2.2-2 or 14.19.2.2-3, and sets the fading characteristic of the signal to TUHigh. Antenna correlation is set to 0 and antenna gain imbalance is set to 0dB.
- c) The SS compares the modulation of the signal that it sends to the MS with the signal which is looped back from the receiver after demodulation and decoding, and checks the frame erasure indication.
- d) The SS determines the number of residual bit error events for the bits of the class Ib, by examining at least the minimum number of samples of consecutive bits of class Ib. Bits are only taken from those frames not signalled as erased.
- e) The SS also determines the frame erasure events by examining at least the minimum number of samples of consecutive frames and assuming a frame is received successfully it is not signalled as erased.
- f) The SS uses a Channel Mode Modify procedure to change the active codec set to 5,9 kbit/s and steps b) to e) are repeated.
- g) The SS discontinues all interfering signals.
- h) In addition to the wanted signal, the SS produces a further four interfering signals to produce scenario DTS-5.
- A signal of type I5 using the same ARFCN as C1, with fading characteristics of TUHigh, and signal level of -67 dBm.
- A signal of type I1 using the same ARFCN as C1, with fading characteristics of TUHigh, and signal level of -80 dBm.
- A signal of type I1 using an ARFCN one higher than C1, with fading characteristics of TUHigh, and signal level of -67 dBm.
- A signal of type I3 using the same ARFCN as C1, and signal level of -87 dBm.
- i) The SS uses a Channel Mode Modify procedure to change the active codec set to 12,2 kbit/s and steps b) to e) are repeated.

Maximum/Minimum Duration of Test

Maximum: 28 minutes (GSM850), 28 minutes (GSM900), 28 minutes (DCS1800), 28 minutes (PCS1900).

Minimum: 10 minutes (GSM850), 10 minutes (GSM900), 5 minutes (DCS1800), 5 minutes (PCS1900).

14.19.2.2.5 Test requirements

Testing should be performed using statistical methods that lead to an early pass/fail decision with test time significantly reduced for MS with FER/BER not on the limit.

For more information on statistical testing of BER/BLER performance, especially the definition of limit lines refer to Annex 7.

Wrong decision risk F for one single error rate test:

$$F_{\text{pass}} = F_{\text{fail}} = F \quad \text{and} \quad F = 0.2\%$$

Wrong decision probability D per test step:

$$D_{\text{pass}} = D_{\text{fail}} = D \quad \text{and} \quad D = 0.0085\%$$

Parameters for limit lines:

1. D = 0.000085 wrong decision probability per test step.
2. M = 1.5 bad DUT factor
3. ne number of (error) events. This parameter is the x-ordinate in figure A7.1.3.1.
4. ns number of samples. The error rate is calculated from ne and ns.

Limit checking

Before limit checking is valid the minimum test time due to fading needs to be considered:

Testing under multipath and interference conditions requires that at least 990 wavelengths are crossed with the speed given in the fading profile. This leads to a minimum test time depending on the frequency range. No early pass/fail decision is allowed until the minimum test time due to fading has elapsed.

Table 14.19.2.2-1: Minimum test times due to TU 50 fading conditions

Full Rate 50 km/h					
Frequency	0,85	0,9	1,8	1,9	GHz
Wavelength	0,35	0,33	0,17	0,16	m
min test time	201	190	95	90	s
	0:03:21	0:03:10	0:01:35	0:01:30	hh:mm:ss

If the minimum test time due to multipath conditions exceeds the target test time, then the test runs for the minimum test time due to multipath conditions and the decision is made by comparing the result with the “derived test limit”. In this case early pass/fail decisions are obsolete.

If the target test time exceeds the minimum test time due to multipath conditions early pass/fail decisions can be headed for in order to accelerate test execution.

For an early decision a minimum number of (error) events is necessary.

For an early pass decision $ne \geq 1$ (inclusive artificial error)

For an early fail decision $ne \geq 7$

When the target test time has been reached the test is finished and a pass/fail decision can be made.

The error rate measured in this test shall be tested according to the values given in tables 14.19.2.2-2 or 14.19.2.2-3.

Table 14.19.2.2-2: Statistical test limits for GSM 850 and GSM 900 TCH/AFS DARP Phase II DTS-2/5

DTS-2/5								
0.8 to 0.9GHz		Clev (dBm)	Samples per second	Orig. BER requirement	Derived test limit	Target number of samples	Target test time (s)	Target test time (hh:mm:ss)
AFS 7.4 DTS-2	Frames	-70	50	0,010000	0,012340	27958	560	00:09:20
	Class1b	(as frames)	4350	0,001500	0,001851	186386	43	00:00:43
AFS 5.9 DTS-2	Frames	-71.5	50	0,010000	0,012340	27958	560	00:09:20
	Class1b	(as frames)	3150	0,001600	0,0019744	174737	56	00:00:56
AFS 12.2 DTS-5	Frames	-67.5	50	0,010000	0,012340	27958	560	00:09:20
	Class1b	(as frames)	8150	0,006700	0,0082678	41729	6	00:00:06

Table 14.19.2.2-3: Statistical test limits for DCS 1800 and PCS 1900 TCH/AFS DARP Phase II DTS-2/5

DTS-2/5								
1.8 to 1.9GHz		C_{lev} (dBm)	Samples per second	Orig. BER requirement	Derived test limit	Target number of samples	Target test time (s)	Target test time (hh:mm:ss)
AFS 7.4 DTS-2	Frames	-71	50	0,010000	0,012340	27958	560	00:09:20
	Class1b	(as frames)	4350	0,001800	0,0022212	155322	36	00:00:36
AFS 5.9 DTS-2	Frames	-72	50	0,010000	0,012340	27958	560	00:09:20
	Class1b	(as frames)	3150	0,001800	0,0022212	155322	50	00:00:50
AFS 12.2 DTS-5	Frames	-68.5	50	0,010000	0,012340	27958	560	00:09:20
	Class1b	(as frames)	8150	0,009400	0,0115996	29743	4	00:00:04

14.19.3 TCH/AHS

14.19.3.1 DTS-1

14.19.3.1.1 Definition

DARP Phase II, also referred as Mobile Station Receiver Diversity is a feature where the MS uses two receive antennas in order to improve performance under non-interfering and interfering scenarios.

The DARP Phase II reference test scenarios define a set of interfering signals and corresponding performance limits. These tests are a measure of the capability of the DARP Phase II receiver to receive a wanted modulated signal without exceeding a given degradation due to the presence of these specific unwanted modulated signals.

14.19.3.1.2 Conformance requirement

- MS indicating support for Downlink Advanced Receiver Performance – phase II (see 3GPP TS 24.008) shall fulfil the requirements in table 2q for the test scenarios defined in annex N. The reference performance shall be:
 - For speech channels (TCH/FS, TCH/AFS_x, TCH/AHS_x) FER: $\leq 1\%$
- The values in table 2q are given as the C/I1 ratio, where C is the power level of the wanted signal and I1 is the power level of the dominant co-channel interferer (Co-channel 1, see annex N).
In addition for speech channels the residual class Ib BER and residual class II BER performance shall not exceed the specified values in table 2q at the corresponding C/I1.

3GPP TS 45.005, subclause 6.3

For T-GSM 810 the requirements for GSM 900 shall apply, apart for those parameters for which a separate requirement exists.

3GPP TS 45.005; sub clause 2

14.19.3.1.3 Test purpose

To verify that the MS does not exceed the first conformance requirement for TCH/AHS under propagation condition TU_{high} with an allowance for the statistical significance of the test.

To verify that the MS does not exceed the second conformance requirement for TCH/AHS under propagation condition TU_{high} with an allowance for the statistical significance of the test.

14.19.3.1.4 Method of test

14.19.3.1.4.1 Initial conditions

A call is set up according to the generic call set up procedure on a TCH/AHS with an ARFCN in the mid ARFCN range, power control level set to maximum power. RADIO_LINK_TIMEOUT is set to maximum.

The multirate configuration indicates the use of a codec set limited to 7,4 kbit/s.

The SS transmits Standard Test Signal C1 on the traffic channel (wanted signal), with training sequence code (TSC) = 0.

The SS commands the MS to create the traffic channel loop back, signalling erased frames (subclause 36).

14.19.3.1.4.2 Procedure

- a) In addition to the wanted signal, the SS produces one further interfering signal to produce scenario DTS-1.
- A signal of type II using the same ARFCN as C1, with fading characteristics of TUHigh, and signal level of -70 dBm.
- The fading characteristic of the wanted signal is TUHigh. Antenna correlation is 0 and antenna gain imbalance is 0dB.
- b) The SS sets the level of the wanted signal to that indicated by C_{lev} in table 14.19.3.1-2 or 14.19.3.1-3.
- c) The SS compares the modulation of the signal that it sends to the MS with the signal which is looped back from the receiver after demodulation and decoding, and checks the frame erasure indication.
- d) The SS determines the number of residual bit error events for the bits of the class Ib and II, by examining at least the minimum number of samples of consecutive bits of class Ib and II. Bits are only taken from those frames not signalled as erased.
- e) The SS also determines the frame erasure events by examining at least the minimum number of samples of consecutive frames and assuming a frame is received successfully if it is not signalled as erased.
- f) The SS uses a Channel Mode Modify procedure to change the active codec set to 5,9 kbit/s and steps b) to e) are repeated.

Maximum/Minimum Duration of Test

Maximum: 19 minutes (GSM850), 19 minutes (GSM900), 19 minutes (DCS1800), 19 minutes (PCS1900).

Minimum: 14 minutes (GSM850), 13 minutes (GSM900), 7 minutes (DCS1800), 6 minutes (PCS1900).

14.19.3.1.5 Test requirements

Testing should be performed using statistical methods that lead to an early pass/fail decision with test time significantly reduced for MS with FER/BER not on the limit.

For more information on statistical testing of BER/BLER performance, especially the definition of limit lines refer to Annex 7.

Wrong decision risk F for one single error rate test:

$$F_{pass} = F_{fail} = F \quad \text{and} \quad F = 0.2\%$$

Wrong decision probability D per test step:

$$D_{pass} = D_{fail} = D \quad \text{and} \quad D = 0.0085\%$$

Parameters for limit lines:

1. D = 0.000085 wrong decision probability per test step.
2. M = 1.5 bad DUT factor
3. ne number of (error) events. This parameter is the x-ordinate in figure A7.1.3.2.
4. ns number of samples. The error rate is calculated from ne and ns.

Limit checking

Before limit checking is valid the minimum test time due to fading needs to be considered:

Testing under multipath and interference conditions requires that at least 990 wavelengths are crossed with the speed given in the fading profile. This leads to a minimum test time depending on the frequency range. No early pass/fail decision is allowed until the minimum test time due to fading has elapsed.

Table 14.19.3.1-1: Minimum test times due to TU high fading conditions

Half Rate 50 km/h					
Frequency	0,85	0,9	1,8	1,9	GHz
Wavelength	0,35	0,33	0,17	0,16	m
min test time	403	380	190	180	s
	0:06:43	0:06:20	0:03:10	0:03:00	hh:mm:ss

If the minimum test time due to multipath conditions exceeds the target test time, then the test runs for the minimum test time due to multipath conditions and the decision is made by comparing the result with the “derived test limit”. In this case early pass/fail decisions are obsolete.

If the target test time exceeds the minimum test time due to multipath conditions early pass/fail decisions can be headed for in order to accelerate test execution.

For an early decision a minimum number of (error) events is necessary.

For an early pass decision $ne \geq 1$ (inclusive artificial error)

For an early fail decision $ne \geq 7$

When the target test time has been reached the test is finished and a pass/fail decision can be made.

The error rate measured in this test shall be tested according to the values given in tables 14.19.3.1-2 or 14.19.3.1-3.

Table 14.19.3.1-2: Statistical test limits for GSM 850 and GSM 900 TCH/AHS DARP Phase II DTS-1

DTS-1								
0.8 to 0.9GHz		C_{lev} (dBm)	Samples per second	Orig. BER requirement	Derived test limit	Target number of samples	Target test time (s)	Target test time (hh:mm:ss)
AHS 7.4	Frames	-77.5	50	0.010000	0.012340	27959	560	0:09:20
	Class1b	(as frames)	2950	0.004000	0,004936	69895	24	0:00:24
	Class II	(as frames)	1400	0.018800	0,0231992	14872	11	0:00:11
AHS 5.9	Frames	-79.5	50	0.010000	0.012340	27959	560	0:09:20
	Class1b	(as frames)	2350	0.005100	0,0062934	54820	24	0:00:24
	Class II	(as frames)	800	0.032700	0,0403518	8550	11	0:00:11

Table 14.19.3.1-3: Statistical test limits for DCS 1 800 and PCS 1 900 TCH/AHS DARP Phase II DTS-1

DTS-1								
1.8 to 1.9GHz		C_{lev} (dBm)	Samples per second	Orig. BER requirement	Derived test limit	Target number of samples	Target test time (s)	Target test time (hh:mm:ss)
AHS 7.4	Frames	-77.0	50	0.010000	0.012340	27959	560	0:09:20
	Class1b	(as frames)	2950	0.005700	0,0070338	49049	17	0:00:17
	Class II	(as frames)	1400	0.021100	0,0260374	13251	10	0:00:10
AHS 5.9	Frames	-79.0	50	0.010000	0.012340	27959	560	0:09:20
	Class1b	(as frames)	2350	0.006200	0,0076508	45094	20	0:00:20
	Class II	(as frames)	800	0.035600	0,0439304	7854	10	0:00:10

14.19.3.2 DTS-2

14.19.3.2.1 Definition

DARP Phase II, also referred as Mobile Station Receiver Diversity is a feature where the MS uses two receive antennas in order to improve performance under non-interfering and interfering scenarios.

The DARP Phase II reference test scenarios define a set of interfering signals and corresponding performance limits. These tests are a measure of the capability of the DARP Phase II receiver to receive a wanted modulated signal without exceeding a given degradation due to the presence of these specific unwanted modulated signals.

14.19.3.2.2 Conformance requirement

1. MS indicating support for Downlink Advanced Receiver Performance – phase II (see 3GPP TS 24.008) shall fulfil the requirements in table 2q for the test scenarios defined in annex N. The reference performance shall be:
 - For speech channels (TCH/FS, TCH/AFSx, TCH/AHSx) FER: $\leq 1\%$
2. The values in table 2q are given as the C/I1 ratio, where C is the power level of the wanted signal and I1 is the power level of the dominant co-channel interferer (Co-channel 1, see annex N). In addition for speech channels the residual class Ib BER and residual class II BER performance shall not exceed the specified values in table 2q at the corresponding C/I1.

3GPP TS 45.005, subclause 6.3.

For T-GSM 810 the requirements for GSM 900 shall apply, apart for those parameters for which a separate requirement exists.

3GPP TS 45.005; sub clause 2

14.19.3.2.3 Test purpose

To verify that the MS does not exceed the first conformance requirement for TCH/AHS under propagation condition TUhigh with an allowance for the statistical significance of the test.

To verify that the MS does not exceed the second conformance requirement for TCH/AHS under propagation condition TUhigh with an allowance for the statistical significance of the test.

14.19.3.2.4 Method of test

14.19.3.2.4.1 Initial conditions

A call is set up according to the generic call set up procedure on a TCH/AHS with an ARFCN in the mid ARFCN range, power control level set to maximum power. RADIO_LINK_TIMEOUT is set to maximum.

The multirate configuration indicates the use of a codec set limited to 7,4 kbit/s.

The SS transmits Standard Test Signal C1 on the traffic channel (wanted signal), with training sequence code (TSC) = 0.

The SS commands the MS to create the traffic channel loop back, signalling erased frames (subclause 36).

14.19.3.2.4.2 Procedure

- a) In addition to the wanted signal, the SS produces a further four interfering signals to produce scenario DTS-2.
 - A signal of type I1 using the same ARFCN as C1, with fading characteristics of TUHigh, and signal level of -70 dBm.
 - A signal of type I1 using the same ARFCN as C1, with fading characteristics of TUHigh, and signal level of -80 dBm.
 - A signal of type I1 using an ARFCN one higher than C1, with fading characteristics of TUHigh, and signal level of -67 dBm.
 - A signal of type I3 using the same ARFCN as C1, and signal level of -87 dBm.
- b) The SS sets the level of the wanted signal to that indicated by Clev in table 14.19.3.2-2 or 14.19.3.2-3, and sets the fading characteristic of the signal to TUHigh. Antenna correlation is set to 0 and antenna gain imbalance is set to 0dB.
- c) The SS compares the modulation of the signal that it sends to the MS with the signal which is looped back from the receiver after demodulation and decoding, and checks the frame erasure indication.

- d) The SS determines the number of residual bit error events for the bits of the class Ib and II, by examining at least the minimum number of samples of consecutive bits of class Ib and II. Bits are only taken from those frames not signalled as erased.
- e) The SS also determines the frame erasure events by examining at least the minimum number of samples of consecutive frames and assuming a frame is received successfully if it is not signalled as erased.
- f) The SS uses a Channel Mode Modify procedure to change the active codec set to 5,9 kbit/s and steps b) to e) are repeated.

Maximum/Minimum Duration of Test

Maximum: 19 minutes (GSM850), 19 minutes (GSM900), 19 minutes (DCS1800), 19 minutes (PCS1900).

Minimum: 14 minutes (GSM850), 13 minutes (GSM900), 7 minutes (DCS1800), 6 minutes (PCS1900).

14.19.3.2.5 Test requirements

Testing should be performed using statistical methods that lead to an early pass/fail decision with test time significantly reduced for MS with FER/BER not on the limit.

For more information on statistical testing of BER/BLER performance, especially the definition of limit lines refer to Annex 7.

Wrong decision risk F for one single error rate test:

$$F_{\text{pass}} = F_{\text{fail}} = F \quad \text{and} \quad F = 0.2\%$$

Wrong decision probability D per test step:

$$D_{\text{pass}} = D_{\text{fail}} = D \quad \text{and} \quad D = 0.0085\%$$

Parameters for limit lines:

1. D = 0.000085 wrong decision probability per test step.
2. M = 1.5 bad DUT factor
3. ne number of (error) events. This parameter is the x-ordinate in figure A7.1.3.1.
4. ns number of samples. The error rate is calculated from ne and ns.

Limit checking

Before limit checking is valid the minimum test time due to fading needs to be considered:

Testing under multipath and interference conditions requires that at least 990 wavelengths are crossed with the speed given in the fading profile. This leads to a minimum test time depending on the frequency range. No early pass/fail decision is allowed until the minimum test time due to fading has elapsed.

Table 14.19.3.2-1: Minimum test times due to TU 50 fading conditions

Half Rate 50 km/h					
Frequency	0,85	0,9	1,8	1,9	GHz
Wavelength	0,35	0,33	0,17	0,16	m
min test time	403	380	190	180	s
	0:06:43	0:06:20	0:03:10	0:03:00	hh:mm:ss

If the minimum test time due to multipath conditions exceeds the target test time, then the test runs for the minimum test time due to multipath conditions and the decision is made by comparing the result with the "derived test limit". In this case early pass/fail decisions are obsolete.

If the target test time exceeds the minimum test time due to multipath conditions early pass/fail decisions can be headed for in order to accelerate test execution.

For an early decision a minimum number of (error) events is necessary.

For an early pass decision $n_e \geq 1$ (inclusive artificial error)

For an early fail decision $n_e \geq 7$

When the target test time has been reached the test is finished and a pass/fail decision can be made.

The error rate measured in this test shall be tested according to the values given in tables 14.19.3.2-2 or 14.19.3.2-3.

Table 14.19.3.2-2: Statistical test limits for GSM 850 and GSM 900 TCH/AHS DARP Phase II DTS-2

DTS-2								
0.8 to 0.9GHz		C_{lev} (dBm)	Samples per second	Orig. BER requirement	Derived test limit	Target number of samples	Target test time (s)	Target test time (hh:mm:ss)
AHS 7.4 DTS-2	Frames	-65.5	50	0.010000	0.012340	27959	560	0:09:20
	Class1b	(as frames)	2950	0.005000	0,00617	55916	19	0:00:19
	Class II	(as frames)	1400	0.022500	0,027765	12426	9	0:00:09
AHS 5.9 DTS-2	Frames	-67	50	0.010000	0.012340	27959	560	0:09:20
	Class1b	(as frames)	2350	0.006400	0,0078976	43685	19	0:00:19
	Class II	(as frames)	800	0.038500	0.071572	4821	9	0:00:09

Table 14.19.3.2-3: Statistical test limits for DCS 1800 and PCS 1900 TCH/AHS DARP Phase II DTS-2

DTS-2								
1.8 to 1.9GHz		C_{lev} (dBm)	Samples per second	Orig. BER requirement	Derived test limit	Target number of samples	Target test time (s)	Target test time (hh:mm:ss)
AHS 7.4 DTS-2	Frames	-65.5	50	0.010000	0.012340	27959	560	0:09:20
	Class1b	(as frames)	2950	0.005200	0,0064168	53766	19	0:00:19
	Class II	(as frames)	1400	0.022700	0,0280118	12317	9	0:00:09
AHS 5.9 DTS-2	Frames	-67	50	0.010000	0.012340	27959	560	0:09:20
	Class1b	(as frames)	2350	0.007000	0,008638	39940	17	0:00:17
	Class II	(as frames)	800	0.037500	0,046275	7456	10	0:00:10

15 Timing advance and absolute delay

15.1 GSM Timing advance and absolute delay

15.1.1 Definition

Timing advance (TA) is a time offset in bits as sent to the MS by the BS. The MS shall advance its transmissions to the BS by the timing advance relative to 3 timeslots behind transmissions received from the BS.

The absolute delay is the delay between a common burst reference point within the received and the transmitted RF burst.

NOTE: For normal or dummy bursts, the common burst reference point is defined to be the transition from bit 13 to bit 14 of the midamble. For an access burst it is defined to be the transition from bit 48 to bit 49 of the burst.

Equivalently the delay can be referenced to the modulator input vs. the demodulator output or to the differential encoder input vs. the differential decoder output, provided the measured delay is corrected for the additional delays in the signal path.

15.1.2 Conformance requirement

- 1) The random access burst transmission, measured at the MS antenna, shall use a TA of 0, and therefore be 3 timeslots behind the transmissions received from the BTS, with an absolute tolerance of ± 1 bit period.

3GPP TS 05.10, subclauses 6.4 and 6.6.

- 2) The normal burst transmission, measured at the MS antenna, shall be 3 timeslots - TA behind the transmissions received from the BTS, with an absolute tolerance of ± 1 bit period.

3GPP TS 05.10, subclause 6.4.

- 3) When the MS receives a new value of TA on the SACCH, it shall implement the new value of TA at the first TDMA frame belonging to the next reporting period, after the SACCH frame containing the new TA value.

3GPP TS 05.10, subclause 6.5.

- 4) The MS shall signal the used TA to the BS, in the L1 header of the uplink SACCH message.

3GPP TS 05.10, subclause 6.4, 3GPP TS 04.04, subclause 7.2.

15.1.3 Test purpose

- 1) To verify that the MS uses a TA value of 0 for the access burst.
- 2) To verify that the MS meets the absolute receive/transmit delay requirement for the access burst.
- 3) To verify that the MS meets the absolute receive/transmit delay requirement for normal bursts.
- 4) To verify that the MS implements a new timing advance value as signalled on the SACCH as in the requirement.
- 5) To verify that the MS sends the TA used on the uplink SACCH as in the requirement.

15.1.4 Method of test

15.1.4.1 Initial conditions

The SS sends "MAXRETRANS = 7" and "TX-INTEGGER = 3" on the BCCH.

The MS is brought into MM state "idle, updated".

15.1.4.2 Procedure

- a) The SS pages the MS after 10 s.

- b) The SS does not respond to the first 7 CHANNEL REQUEST messages from the MS. The SS responds to the 8th CHANNEL REQUEST from the MS on the RACH by sending an IMMEDIATE ASSIGNMENT message, with TA set to 0.
- c) The SS continues to set up a call according to the generic call set up procedure.
- d) The SS signals the TA values 10, 20, 30, 40, 50, 60, 63, and one random value other than these values to the MS in consecutive SACCH blocks.

For GSM 400 MS, the SS signals the TA values 35, 70, 105, 140, 175, 210, 219, and one random value other than these values to the MS in consecutive SACCH blocks.

The SS determines the TA value set in the L1 header on the uplink SACCH for each timing advance.

The SS measures the absolute delay for all bursts.

15.1.5 Test requirement

The measured receive/transmit delay for each burst shall equal the following nominal values with an absolute tolerance of ± 1 bit period:

access bursts: 3 timeslots (= 45/26 ms).

normal bursts: 3 timeslots (= 45/26 ms) minus the last TA value received from the SS.

The MS shall use the new timing advance at the first TDMA frame belonging to the next reporting period after the SACCH frame containing the new TA value.

The TA field in the uplink SACCH L1 header shall contain to the most recently ordered TA value.

15.2 Void

15.3 Void

15.4 Void

15.5 Void

15.6 GPRS Timing advance and absolute delay

15.6.1 Definition

Timing advance (TA) is a time offset in bits as sent to the MS by the BS. The MS shall advance its transmissions to the BS by the timing advance relative to 3 timeslots behind transmissions received from the BS.

The absolute delay is the delay between a common burst reference point within the received and the transmitted RF burst.

The timing advance procedure is used to derive the correct value for timing advance that the MS has to use for the uplink transmission of radio blocks.

The timing advance procedure comprises two parts:

- initial timing advance estimation;
- continuous timing advance update.

NOTE: For normal or dummy bursts, the common burst reference point is defined to be the transition from bit 13 to bit 14 of the midamble. For an access burst it is defined to be the transition from bit 48 to bit 49 of the burst.

Equivalently the delay can be referenced to the modulator input vs. the demodulator output or to the differential encoder input vs. the differential decoder output, provided the measured delay is corrected for the additional delays in the signal path.

15.6.2 Conformance requirement

- 1) The random access burst transmission, measured at the MS antenna, shall use a TA of 0, and therefore be 3 timeslots behind the transmissions received from the BTS, with an absolute tolerance of ± 1 bit period.

3GPP TS 05.10, subclauses 6.4 and 6.6.

- 2) The normal burst transmission, measured at the MS antenna, shall be 3 timeslots - TA behind the transmissions received from the BTS, with an absolute tolerance of ± 1 bit period. In case of a multislot configuration, the MS shall use a common timebase for transmission of all channels. In this case, the MS may optionally use a timeslot length of 157 bit periods on timeslots $TN = 0$ and 4, and 156 bit periods on timeslots with $TN = 1, 2, 3, 5, 6$ and 7, rather than 156.25 bit periods on all timeslots. In case of a packet switched multislot configuration the common timebase shall be derived from all timeslots monitored by the MS. In this case, the MS may assume that the BTS uses a timeslot length of 156.25 bit periods on all timeslots

3GPP TS 05.10, subclause 6.4.

- 3) For an MS in Packet transfer mode, except MS class A in dedicated mode:

Within the packet resource assignments (see 3GPP TS 04.08 / 3GPP TS 24.008 and 3GPP TS 04.60) for uplink or downlink messages the MS gets the Timing Advance Index (TAI). The MS shall send access bursts on the subchannel defined by the TAI on the PTCCH using $TA=0$.

3GPP TS 05.10, subclause 6.5.2.

- 4) For an MS in Packet transfer mode, except MS class A in dedicated mode:

When the MS receives the updated value of TA from the BTS on the downlink PTCCH, it shall always use the last received TA value for the uplink transmission.

3GPP TS 05.10, subclause 6.5.2.

- 5) For an MS in Packet transfer mode, except MS class A in dedicated mode:

Upon initiation of the continuous timing advance procedure the MS shall disregard the TA values on PTCCH until it has sent its first access burst on PTCCH.

3GPP TS 05.10, subclause 6.5.2.

- 6) For an MS in Packet transfer mode, except MS class A in dedicated mode:

The network may request the MS to send 4 access bursts to calculate a new TA value. For this purpose the network sets the system information element `CONTROL_ACK_TYPE` to indicate that the MS is to respond with a `PACKET_CONTROL_ACKNOWLEDGEMENT` consisting of 4 access bursts (see 3GPP TS 04.60), and sends a `PACKET_POLLING_REQUEST` to the MS. In this case, the MS shall transmit 4 consecutive access bursts on the assigned resources.

3GPP TS 05.10, subclause 6.5.2.

- 7) For an MS in Packet transfer mode, except MS class A in dedicated mode:

If the MS receives a resource assignment or power control/timing advance message (see 3GPP TS 04.60), the MS shall use the included TA value until it receives a new value on PTCCH.

3GPP TS 05.10, subclause 6.5.2.

- 8) For an MS in Packet idle mode, except MS class A in dedicated mode:

If the MS receive a packet downlink assignment (see 3GPP TS 04.08 / 3GPP TS 24.008 and 3GPP TS 04.60) indicating to the MS that it can only start the uplink transmission on PDTCH after the timing advance is obtained by a Packet Power Control/Timing Advance message, the MS shall start the packet transfer after the TA value is received on the PACCH.

3GPP TS 05.10, subclause 6.5.2.

- 9) For an MS in Packet transfer mode, except MS class A in dedicated mode:

If the MS receives a packet resource assignment (see 3GPP TS 04.08 / 3GPP TS 24.008 and 3GPP TS 04.60) indicating that a default timing advance shall be used, the MS shall not use the continuous timing advance procedure.

3GPP TS 05.10, subclause 6.5.2.

10) For an MS in Packet transfer mode, except MS class A in dedicated mode:

When the MS receives a new or updated TA value on the downlink PTCCH or downlink PACCH, the MS shall be ready to transmit using the new TA value within 40 ms of the end of the last timeslot of the message block containing the new TA value.

3GPP TS 05.10, subclause 6.9.

NOTE: A MS class A in dedicated mode has to follow the procedures described in 3GPP TS 05.10 subclause 6.5.1.

15.6.3 Test purpose

- 1) To verify that the MS uses a TA value of 0 for the access burst.
- 2) To verify that the MS meets the absolute receive/transmit delay requirement for the access burst.
- 3) To verify that the MS meets the absolute receive/transmit delay requirement for normal bursts.
- 4) To verify that an MS in Packet transfer mode, except for a GPRS Class A MS in dedicated mode, when it receives an updated value of TA from the BTS on the downlink PTCCH, uses the last received TA value for the uplink transmission, respecting conformance requirement 10.
- 5) To verify that an MS in Packet transfer mode, except for a GPRS Class A MS in dedicated mode, upon initiation of the continuous timing advance procedure shall disregard the TA values on PTCCH until it has sent its first access burst on PTCCH.
- 6) To verify that an MS in Packet transfer mode, except for a GPRS Class A MS in dedicated mode, if it receives a packet polling message as defined in conformance requirement 6, sends 4 access bursts on a network assigned uplink resource.
- 7) To verify that an MS in Packet transfer mode, except for a GPRS Class A MS in dedicated mode, if it receives a resource assignment or power control/timing advance message (see 3GPP TS 04.60), uses the included TA value until it receives a new value on PTCCH.
- 8) To verify that an MS in Packet idle mode, except for a GPRS Class A MS in dedicated mode, if it receives a packet downlink assignment (see 3GPP TS 04.08 / 3GPP TS 24.008 and 3GPP TS 04.60) indicating to the MS that it can only start the uplink transmission on PDTCH after the timing advance is obtained by the continuous update procedure or a Packet Power Control/Timing Advance message, it starts the packet transfer after the TA value is received from the SS.
- 9) To verify that an MS in Packet transfer mode, except for a GPRS Class A MS in dedicated mode, if it receives a packet resource assignment (see 3GPP TS 04.08 / 3GPP TS 24.008 and 3GPP TS 04.60) indicating that a default timing advance shall be used, does not use the continuous timing advance procedure.

15.6.4 Method of test

15.6.4.1 Initial conditions

The test shall be run under the default GPRS conditions defined in clause 40.

The SS sets the Packet System Information 1 parameter CONTROL_ACK_TYPE to "0".

The MS is brought into packet idle mode.

The MS shall be PDP context activated.

NOTE: The Test Requirements (15.6.5) are based on a One Phase Packet Access protocol, see 3GPP TS 04.60.

15.6.4.2 Procedure

- a) The SS pages MS on the PPCH. The SS measures the receive/transmit delay for each burst. The SS then sends a Packet Access Reject message.
- b) The MS is made to send a Packet Channel Request by triggering the MS to send a minimum of 6000 octets. The SS transmits a packet resource assignment to the MS with a valid TAI. The SS transmits a TA value on the PTCCH for this TAI which is neither 0 nor 1. The SS measures the receive/transmit delay for several bursts, using the conditions defined in Conformance requirement 10).
- c) The SS transmits a number of different TA values on the PTCCH for the TAI assigned to the MS. The SS also changes the TA values on the PTCCH for the other TAI in such a way that there is no correlation between TA values. The SS measures the receive/transmit delay for several bursts, using the conditions defined in Conformance requirement 10).
- d) The SS transmits a new TA value, different by more than 1 from the previously transmitted one, in such a way that the MS can only correctly receive the last (4th) occurrence of the new TA value. The SS measures the receive/transmit delay for several bursts after the 4th (and correctly received) TA transmission, using the conditions defined in Conformance requirement 10).
- e) The MS is made to send a Packet Channel Request by triggering the MS to send a minimum of 6000 octets. The SS responds with a Packet Queuing Notification. After 4 s the SS sends a Packet Polling, addressing the MS with its Temporary Queuing Identity. The SS measures the receive/transmit delay for each of the 4 access bursts after the Packet Polling message is sent.

NOTE: The wait must be less than 5 seconds, see 3GPP TS 04.60 subclause 7.1.2.2.2., timer T3162.

- f) The SS sends a Packet Uplink Assignment to the MS with valid TIMING_ADVANCE_INDEX, TIMING_ADVANCE_TIMESLOT_NUMBER, and TIMING_ADVANCE_VALUE. As part of the subsequent continuous timing advance update procedure, the SS sends a timing advance value on the downlink PTCCH for the MS, that is different from the TIMING_ADVANCE_VALUE in the Packet Uplink Assignment. The SS measures the receive/transmit delay for several bursts, once after the Packet Uplink Assignment is sent, and once after the MS should be using the updated TA, using the conditions defined in Conformance requirement 10).
- g) The MS is brought back to Packet idle mode. The SS sends a Packet Downlink Assignment to the MS with no valid Timing Advance included. The SS polls the MS by sending an RLC Block. The SS waits 2 seconds and then sends a PACKET POWER CONTROL/TIMING ADVANCE message with valid timing advance information. The SS sends further RLC Blocks. The SS measures the receive/transmit delay for several bursts.
- h) The MS is made to send a Packet Channel Request by triggering the MS to send a minimum of 6000 octets. The SS sends a Packet Uplink Assignment to the MS with TIMING_ADVANCE_VALUE set to a value different from the last one ordered on the PTCCH, and the TIMING_ADVANCE_INDEX and TIMING_ADVANCE_TIMESLOT_NUMBER fields not present. The SS continues to transmit TA values on the PTCCH. These shall be different from the TA value TIMING_ADVANCE_VALUE in the Packet Uplink Assignment. The SS measures the receive/transmit delay for several bursts, once after the transmission of the Packet Uplink Assignment, and once after the SS transmits the new TA using the continuous update procedure for the TAI chosen in step g), using the conditions defined in Conformance requirement 10).

15.6.5 Test requirement

The measured receive/transmit delay for each burst shall equal the following nominal values with an absolute tolerance of ± 1 bit period.

access bursts: 3 timeslots (= 45/26 ms).

normal bursts: 3 timeslots (= 45/26 ms) minus the last TA value received from the SS.

In step a) the MS shall transmit an access burst on the PRACH.

In step b) the MS shall send access bursts on the PTCCH on the subchannel defined by the TAI with TA = 0.

In step c) the MS shall use the updated TA values.

In step d) the MS shall use the updated TA value.

In step e) the MS shall transmit 4 access bursts.

In step f) the MS shall use the TIMING_ADVANCE_VALUE in the Packet Uplink Assignment first, and change to the Timing Advance value transmitted on the downlink PTCCH in response to the sending of an access burst on the uplink PTCCH.

In step g) the MS shall not transmit on the allocated resources before it received a Timing Advance value via a PACKET POWER CONTROL/TIMING ADVANCE message on the downlink PACCH.

In step h) the last TA value received from the SS is the TIMING_ADVANCE_VALUE in the Packet Uplink Assignment.

15.7 ECSD Timing advance and absolute delay

15.7.1 Definition

Timing advance (TA) is a time offset in symbols as sent to the MS by the BS. The MS shall advance its transmissions to the BS by the timing advance relative to 3 timeslots behind transmissions received from the BS.

The absolute delay is the delay between a common burst reference point within the received and the transmitted RF burst.

NOTE: For normal bursts for GMSK modulation, the common burst reference point is defined to be the transition from bit 13 to bit 14 of the midamble. For normal bursts for 8-PSK modulation, the common burst reference point is defined to be the transition from symbol 13 to symbol 14 of the midamble. For an access burst it is defined to be the transition from bit 48 to bit 49 of the burst.

Equivalently the delay can be referenced to the modulator input vs. the demodulator output or to the differential encoder input vs. the differential decoder output, provided the measured delay is corrected for the additional delays in the signal path.

15.7.2 Conformance requirement

- 1) The random access burst transmission, measured at the MS antenna, shall use a TA of 0, and therefore be 3 timeslots behind the transmissions received from the BTS, with an absolute tolerance of ± 1 symbol period.

3GPP TS 05.10, subclauses 6.4 and 6.6.

- 2) The normal burst transmission, measured at the MS antenna, shall be 3 timeslots - TA behind the transmissions received from the BTS, with an absolute tolerance of ± 1 symbol period. In case of a multislot configuration, the MS shall use a common timebase for transmission of all channels. In this case, the MS may optionally use a timeslot length of 157 symbol periods on timeslots $TN = 0$ and 4, and 156 symbol periods on timeslots with $TN = 1, 2, 3, 5, 6$ and 7, rather than 156,25 symbol periods on all timeslots. In case of a circuit switched multislot configuration, the common timebase shall be derived from the main channel and the TA values received on other channels shall be neglected.

3GPP TS 05.10, subclause 6.4.

- 3) When the MS receives a new value of TA on the SACCH, it shall implement the new value of TA at the first TDMA frame belonging to the next reporting period, after the SACCH frame containing the new TA value.

3GPP TS 05.10, subclause 6.5.1

- 4) The MS shall signal the used TA to the BS, in the L1 header of the uplink SACCH message.

3GPP TS 05.10, subclause 6.5.1, 3GPP TS 04.04, subclause 7.2.

15.7.3 Test purpose

- 1) To verify that the MS uses a TA value of 0 for the access burst.
- 2) To verify that the MS meets the absolute receive/transmit delay requirement for the access burst.
- 3) To verify that the MS meets the absolute receive/transmit delay requirement for normal bursts.
- 4) To verify that the MS implements a new timing advance value as signalled on the SACCH as in the requirement.

- 5) To verify that the MS sends the TA used on the uplink SACCH as in the requirement.
- 6) To verify that a multislot capable MS operates in accordance with the conformance requirement 2.

15.7.4 Method of test

Initial conditions

The SS sends "MAXRETRANS = 7" and "TX-INTEGGER = 3" on the BCCH.

The MS is brought into MM state "idle, updated".

Procedure

- a) The SS pages the MS after 10 s.
- b) The SS does not respond to the first 7 CHANNEL REQUEST messages from the MS. The SS responds to the 8th CHANNEL REQUEST from the MS on the RACH by sending an IMMEDIATE ASSIGNMENT message, with TA set to 0.
- c) The SS continues to set up a call according to the generic call set up procedure for ECSD. In the case of a multislot capable MS, the call is set up according to the generic call set up procedure for multislot configuration for ECSD and the SS commands the MS to operate with maximum number of both uplink and downlink timeslots according to the multislot class of the MS. In the case of class A ECSD MS, 8-PSK modulated channels shall be used in the downlink. In the case of class B ECSD MS, GMSK modulated channels shall be used in the downlink and 8-PSK modulated channels in the uplink.
- d) The SS signals the TA values 10, 20, 30, 40, 50, 60, 63, and one random value other than these values to the MS in consecutive SACCH blocks.

For GSM 400 MS, the SS signals the TA values 35, 70, 105, 140, 175, 210, 219, and one random value other than these values to the MS in consecutive SACCH blocks.

In the case of a multislot capable MS, the TA values defined above are signalled on the main channel of the multislot configuration, and on the subchannels TA values different from those ones are signalled.

The SS determines the TA value set in the L1 header on the uplink SACCH for each timing advance.

The SS measures the absolute delay for all bursts.

15.7.5 Test requirement

The measured receive/transmit delay for each burst shall equal the following nominal values with an absolute tolerance of ± 1 symbol period:

access bursts: 3 timeslots (= 45/26 ms).

normal bursts: 3 timeslots (= 45/26 ms) minus the last TA value received from the SS.

The MS shall use the new timing advance at the first TDMA frame belonging to the next reporting period after the SACCH frame containing the new TA value.

The TA field in the uplink SACCH L1 header shall contain to the most recently ordered TA value.

The multislot capable MS shall use a common TA value for all uplink channels, derived from the main downlink channel of the multislot configuration. The TA value in the uplink SACCH L1 header shall be that one.

15.8 EGPRS timing advance and absolute delay

15.8.1 Definition

Timing advance (TA) is a time offset in symbols as sent to the MS by the BS. The MS shall advance its transmissions to the BS by the timing advance relative to 3 timeslots behind transmissions received from the BS.

The absolute delay is the delay between a common burst reference point within the received and the transmitted RF burst.

The timing advance procedure is used to derive the correct value for timing advance that the MS has to use for the uplink transmission of radio blocks.

The timing advance procedure comprises two parts:

- initial timing advance estimation;
- continuous timing advance update.

NOTE: For normal bursts for GMSK modulation, the common burst reference point is defined to be the transition from bit 13 to bit 14 of the midamble. For normal bursts for 8-PSK modulation, the common burst reference point is defined to be the transition from symbol 13 to symbol 14 of the midamble. For an access burst it is defined to be the transition from bit 48 to bit 49 of the burst.

Equivalently the delay can be referenced to the modulator input vs. the demodulator output or to the differential encoder input vs. the differential decoder output, provided the measured delay is corrected for the additional delays in the signal path.

15.8.2 Conformance requirement

- 1) The random access burst transmission, measured at the MS antenna, shall use a TA of 0, and therefore be 3 timeslots behind the transmissions received from the BTS, with an absolute tolerance of ± 1 symbol period.

3GPP TS 05.10, subclauses 6.4 and 6.6.

- 2) The normal burst transmission, measured at the MS antenna, shall be 3 timeslots - TA behind the transmissions received from the BTS, with an absolute tolerance of ± 1 symbol period. In case of a multislot configuration, the MS shall use a common timebase for transmission of all channels. In this case, the MS may optionally use a timeslot length of 157 symbol periods on timeslots $TN = 0$ and 4, and 156 symbol periods on timeslots with $TN = 1, 2, 3, 5, 6$ and 7, rather than 156.25 symbol periods on all timeslots. In case of a packet switched multislot configuration the common timebase shall be derived from all timeslots monitored by the MS. In this case, the MS may assume that the BTS uses a timeslot length of 156.25 symbol periods on all timeslots

3GPP TS 05.10, subclause 6.4.

- 3) For an MS in Packet transfer mode, except MS class A in dedicated mode:

Within the packet resource assignments (see 3GPP TS 04.08 / 3GPP TS 24.008 and 3GPP TS 04.60) for uplink or downlink messages the MS gets the Timing Advance Index (TAI). The MS shall send access bursts on the subchannel defined by the TAI on the PTCCH using $TA=0$.

3GPP TS 05.10, subclause 6.5.2.

- 4) For an MS in Packet transfer mode, except MS class A in dedicated mode:

When the MS receives the updated value of TA from the BTS on the downlink PTCCH, it shall always use the last received TA value for the uplink transmission.

3GPP TS 05.10, subclause 6.5.2.

- 5) For an MS in Packet transfer mode, except MS class A in dedicated mode:

Upon initiation of the continuous timing advance procedure the MS shall disregard the TA values on PTCCH until it has sent its first access burst on PTCCH.

3GPP TS 05.10, subclause 6.5.2.

- 6) For an MS in Packet transfer mode, except MS class A in dedicated mode:

The network may request the MS to send 4 access bursts to calculate a new TA value. For this purpose the network sets the system information element `CONTROL_ACK_TYPE` to indicate that the MS is to respond with a `PACKET_CONTROL_ACKNOWLEDGEMENT` consisting of 4 access bursts (see 3GPP TS 04.60), and sends a `PACKET_POLLING_REQUEST` to the MS. In this case, the MS shall transmit 4 consecutive access bursts on the assigned resources.

3GPP TS 05.10, subclause 6.5.2.

- 7) For an MS in Packet transfer mode, except MS class A in dedicated mode:

If the MS receives a resource assignment or power control/timing advance message (see 3GPP TS 04.60), the MS shall use the included TA value until it receives a new value on PTCCH.

3GPP TS 05.10, subclause 6.5.2.

- 8) For an MS in Packet transfer mode, except MS class A in dedicated mode:

If the MS receive a packet resource assignment (see 3GPP TS 04.08 / 3GPP TS 24.008 and 3GPP TS 04.60) indicating to the MS that it can only start the uplink transmission on PDTCH after the timing advance is obtained by the continuous update procedure, the MS shall start the packet transfer after the TA value is received on the PTCCH.

3GPP TS 05.10, subclause 6.5.2.

- 9) For an MS in Packet transfer mode, except MS class A in dedicated mode:

If the MS receives a packet resource assignment (see 3GPP TS 04.08 / 3GPP TS 24.008 and 3GPP TS 04.60) indicating that a default timing advance shall be used, the MS shall not use the continuous timing advance procedure.

3GPP TS 05.10, subclause 6.5.2.

- 10) For an MS in Packet transfer mode, except MS class A in dedicated mode:

When the MS receives a new or updated TA value on the downlink PTCCH or downlink PACCH, the MS shall be ready to transmit using the new TA value within 40 ms of the end of the last timeslot of the message block containing the new TA value.

3GPP TS 05.10, subclause 6.9.

NOTE: A MS class A in dedicated mode has to follow the procedures described in 3GPP TS 05.10 subclause 6.5.1.

15.8.3 Test purpose

- 1) To verify that the MS uses a TA value of 0 for the access burst.
- 2) To verify that the MS meets the absolute receive/transmit delay requirement for the access burst.
- 3) To verify that the MS meets the absolute receive/transmit delay requirement for normal bursts in accordance with the conformance requirement 2.
- 4) To verify that an MS in Packet transfer mode, except for an MS Class A in dedicated mode, when it receives an updated value of TA from the BTS on the downlink PTCCH, uses the last received TA value for the uplink transmission, respecting conformance requirement 10.
- 5) To verify that an MS in Packet transfer mode, except for an MS Class A in dedicated mode, upon initiation of the continuous timing advance procedure shall disregard the TA values on PTCCH until it has sent its first access burst on PTCCH.
- 6) To verify that an MS in Packet transfer mode, except for an MS Class A in dedicated mode, if it receives a packet polling message as defined in conformance requirement 6, sends 4 access bursts on a network assigned uplink resource.
- 7) To verify that an MS in Packet transfer mode, except for an MS Class A in dedicated mode, if it receives a resource assignment or power control/timing advance message (see 3GPP TS 04.60), uses the included TA value until it receives a new value on PTCCH.
- 8) To verify that an MS in Packet transfer mode, except for an MS Class A in dedicated mode, if it receives a packet resource assignment (see 3GPP TS 04.08 / 3GPP TS 24.008 and 3GPP TS 04.60) indicating to the MS that it can only start the uplink transmission on PDTCH after the timing advance is obtained by the continuous update procedure, it starts the packet transfer after the TA value is received on the PTCCH respecting conformance requirement 10.

- 9) To verify that an MS in Packet transfer mode, except for an MS Class A in dedicated mode, if it receives a packet resource assignment (see 3GPP TS 04.08 / 3GPP TS 24.008 and 3GPP TS 04.60) indicating that a default timing advance shall be used, does not use the continuous timing advance procedure.

15.8.4 Method of test

Initial conditions

The SS sets the System Information parameter CONTROL_ACK_TYPE to "0".

The MS is GPRS Attached and PDP context activated.

NOTE:

EGPRS PACKET CHANNEL REQUEST shall be used in the following cases

- a. If Release of EGPRS supported is Release 4 or above.
- b. If Support of EGPRS Packet Access enhancement is True for a R99 MS.

PACKET CHANNEL REQUEST shall be used if support of EGPRS Packet Access enhancement is False for a R99 MS.

Procedure

- a) The SS pages MS on the PPCH or PCH. The SS measures the receive/transmit delay for each burst. MS may send EGPRS PACKET CHANNEL REQUEST or PACKET CHANNEL REQUEST (See note). The SS then completes the uplink TBF to receive the Page response.
- b) The MS is made to send an EGPRS Packet Channel Request by triggering the MS to send a minimum of 6000 octets. The SS transmits a packet resource assignment to the MS with a valid TAI and EGPRS channel coding command as MCS-5. The SS transmits a TA value on the PTCCH for this TAI which is neither 0 nor 1. The SS measures the receive/transmit delay for each burst.
- c) The SS transmits a number of different TA values on the PTCCH for the TAI assigned to the MS. The SS also changes the TA values on the PTCCH for the other TAI in such a way that there is no correlation between TA values. The SS measures the receive/transmit delay for each burst.
- d) The SS transmits a new TA value, different by more than 1 from the previously transmitted one, in such a way that the MS can only correctly receive the last (4th) occurrence of the new TA value. The SS measures the receive/transmit delay for each burst. The uplink TBF is terminated.
- e) If PBCCH is present: the MS is made to send an EGPRS Packet Channel Request by triggering the MS to send a minimum of 6000 octets. The SS responds with a Packet Queuing Notification. After 4 s the SS sends a Packet Polling, addressing the MS with its Temporary Queuing Identity. The SS measures the receive/transmit delay for each of the 4 access burst.

NOTE: The wait must be less than 5 seconds, see 3GPP TS 04.60 subclause 7.1.2.2.2., timer T3162.

If the PBCCH is not present: the SS sends a Packet Polling addressing the MS with its Temporary Logical Link Identifier. The SS measures the receive/transmit delay for each of the 4 access burst.

- f) The SS sends a Packet Uplink Assignment to the MS with valid TIMING_ADVANCE_INDEX, TIMING_ADVANCE_TIMESLOT_NUMBER, TIMING_ADVANCE_VALUE and EGPRS channel coding command as MCS-5. As part of the subsequent continuous timing advance update procedure, the SS sends a timing advance value on the downlink PTCCH for the MS, that is different from the TIMING_ADVANCE_VALUE in the Packet Uplink Assignment. The SS measures the receive/transmit delay for several bursts, once before the MS should be using the updated TA and once after the MS should be using the updated TA, using the conditions defined in Conformance requirement 10).
- g) The MS is brought back to Packet idle mode. The SS sends a Packet Downlink Assignment to the MS with no valid Timing Advance included. The SS polls the MS by sending an RLC Block coded with MCS-5. The SS waits 2 seconds and then sends a PACKET POWER CONTROL/TIMING ADVANCE message with valid timing advance information. The SS sends further RLC Blocks. The SS measures the receive/transmit delay for several bursts.

- h) The MS is made to send an EGPRS PACKET Channel Request by triggering the MS to send a minimum of 6000 octets. The SS sends a Packet Uplink Assignment to the MS with TIMING_ADVANCE_VALUE set to a value different from the last one ordered on the PTCCH, EGPRS channel coding command as MCS-5 and the TIMING_ADVANCE_INDEX and TIMING_ADVANCE_TIMESLOT_NUMBER fields not present. The SS continues to transmit TA values on the PTCCH. These shall be different from the TA value TIMING_ADVANCE_VALUE in the Packet Uplink Assignment. The SS measures the receive/transmit delay for several bursts once after the transmission of the Packet Uplink Assignment, and once after the SS transmits the new TA using the continuous update procedure for the TAI chosen in step g), using the conditions defined in Conformance requirement 10).

15.8.4.3 Test requirement

The measured receive/transmit delay for each burst shall equal the following nominal values with an absolute tolerance of ± 1 symbol period.

access bursts: 3 timeslots (= 45/26 ms).

normal bursts: 3 timeslots (= 45/26 ms) minus the last TA value received from the SS.

In step a) the MS shall transmit an access burst on the PRACH or RACH.

In step b) the MS shall send access bursts on the PTCCH on the subchannel defined by the TAI with TA = 0.

In step c) the MS shall use the updated TA values.

In step d) the MS shall use the updated TA value.

In step e) the MS shall transmit 4 access bursts.

In step f) the MS shall use the TIMING_ADVANCE_VALUE in the Packet Uplink Assignment first, and change to the Timing Advance value transmitted on the downlink PTCCH in response to the sending of an access burst on the uplink PTCCH.

In step g) the MS shall not transmit Normal Bursts on the allocated resources before it received a Timing Advance value via a PACKET POWER CONTROL/TIMING ADVANCE message on the downlink PACCH.

In step h) the last TA value received from the SS is the TIMING_ADVANCE_VALUE in the Packet Uplink Assignment.

15.9 Timing Advance whilst in DTM

15.9.1 Conformance requirements

A MS class A in dedicated or dual transfer mode shall the procedures described in sub-clause 6.5.1.

When the MS receives a new value of TA from the BTS on the SACCH, it shall implement the new value of TA at the first TDMA frame belonging to the next reporting period (as defined in 3GPP TS 05.08), after the SACCH frame containing the new TA value. On channels used for a voice group call, the TA value sent by the BTS applies only to an MS currently allocated the uplink.

The MS shall signal the used TA to the BTS on the SACCH.

A mobile station in DTM shall disable the timing advance features for the GPRS side:

- the mobile station shall inhibit the transmission of timing advance access bursts;
- the mobile station shall ignore the reception of GPRS timing advance messages, if any.

References

3GPP TS 05.10/45.010 sub-clauses 6.5.2, 6.5.1

3GPP TS 03.55 sub-clauses 5.1

15.9.2 Test purpose

To verify that the MS disregards any PS timing advance information that it receives and only uses CS TA information.

15.9.3 Method of test

Initial Conditions

System Simulator:

1 cell, DTM supported.

Mobile Station:

The MS is in the active state (U10) of a call.

The MS is GPRS idle with a P-TMSI allocated and the PDP context 1 activated.

Specific PICS Statement(s):

- DTM/GPRS Multislot Class 5 (TSPC_DTM_GPRS_Multislot_Class_5)
- DTM/GPRS Multislot Class 9 (TSPC_DTM_GPRS_Multislot_Class_9)

PIXIT Statements:

-

Test Procedure

The MS is triggered to initiate packet uplink transfer data and sends a DTM REQUEST message to the SS. On receiving the DTM REQUEST message, requesting uplink resources, the SS assigns the MS PS resources in a timeslot adjoining the CS resource. The SS accomplishes the resource assignment by passing a PACKET ASSIGNMENT message to the MS. Once the SS has verified that the MS is correctly sending RLC data blocks to the SS, the SS starts to vary the TA ordered by both PS and CS signalling.

The SS signals the TA values 10, 20, 30, 40, 50, 60, 63, and one random value other than these values to the MS in consecutive SACCH blocks.

The SS then signals the TA values of 10, 20, 30, 40, 50 on the PS domain to the MS.

The SS then sends a PACKET POWER / TIMING ADVANCE message to the MS, ordering the MS to change the TA to a random value (different from previous value) and verifies that the MS does not change the TA of transmissions.

Test requirement

The measured receive/transmit delay for each burst shall equal the following nominal values with an absolute tolerance of ± 1 bit period:

normal bursts: 3 timeslots (= 45/26 ms) minus the last TA value received from the SS.

The MS shall use the new CS TA at the first opportunity, but shall not change the TA of the MS for any TA received in signalling on the PTCCH

Maximum Duration of Test

5 minutes

Expected Sequence

Step	Direction	Message	Comments
1	MS		MS in state U10 of Call on Timeslot N (chosen arbitrarily) with Channel Type = TCH/F.
2	MS		Trigger the MS to initiate an uplink packet transfer containing 3k octets.
3	MS->SS	DTM REQUEST	
4	SS->MS	PACKET ASSIGNMENT	Assigning uplink resources on timeslot $(N \pm 1) \text{ MOD } 8$. Including timing advance index (arbitrarily chosen)
5	MS<->SS	{ Uplink data transfer }	Macro – 1k octets
5A			The SS schedules the TA values 10, 20, 30, 40, 50, 60, 63, and one random value other than these values to the MS in consecutive SACCH blocks. The SS then schedules the TA values of 10, 20, 30, 40, 50 on the downlink PTCCH. After scheduling each TA value on PTCCH/D, assign a valid USF to receive uplink RLC data block.
6	SS->MS	PACKET POWER / TIMING ADVANCE	
7	MS->SS	RLC UPLINK DATA	
8	MS->SS	RLC UPLINK DATA	
9	SS		Verifies that MS has not implemented the TA ordered in the PACKET POWER / TIMING ADVANCE message.
10		{ Uplink Data Transfer }	Macro - Completion of the Data.

Specific Message Contents:

PACKET POWER CONTROL/TIMING ADVANCE message:

MESSAGE_TYPE	000101
Global Packet Timing Advance - {0 1<TIMING_ADVANCE_VALUE>} - TIMING_ADVANCE_VALUE - {0 1<TIMING_ADVANCE_INDEX>} <TIMING_ADVANCE_TIMESLOT_NUMBER>	1 Random value (different from previous value) 0 (no TIMING_ADVANCE_INDEX)

16 Reception time tracking speed

16.1 Definition

Reception time tracking speed is the speed at which the MS adapts its transmit time to a change in the timing of the received signal.

16.2 Conformance requirement

If the MS determines that the timing difference with signals received from the BS exceeds 2 μs , the MS shall adjust its timebase in steps of 1/4 bit period, in intervals not less than 1 s and not greater than 2 s until the timing difference is less than 1/2 bit period at 3 dB below reference sensitivity and 3 dB less carrier to interference ratio than the reference interference ratios.

3GPP TS 05.10, subclauses 6 and 6.2.

16.3 Test purpose

- 1) To verify that the MS adapts its transmit time to the timing of the received signal as in the conformance requirement under TUHigh propagation conditions at 2 dB above reference sensitivity level().
- 2) To verify that the MS adapts its transmit time to the timing of the received signal as in the conformance requirement under RA propagation conditions at 2 dB above reference sensitivity level().

NOTE: This test is performed at a level higher than in the conformance requirement because of test implementation problems.

16.4 Method of test

16.4.1 Initial conditions

The SS sets up a call according to the generic call set up procedure on a channel in the Mid ARFCN range.

The SS sets TUHigh.

16.4.2 Procedure

- a) After 10 s the SS sets the input signal level to 2 dB above reference sensitivity level().
- b) For the last second before step c) the SS takes an average receive/transmit delay of all bursts in that 1 s.
- c) The SS increases the delay of the transmitted signal to the MS by a 2 bit step (about 7,4 μ s) and keeps this delay for 20 s.
- d) The SS measures the absolute receive/transmit delay for each burst.
- e) The SS increases the input signal level to 5 dB above reference sensitivity level() and sets propagation condition RA.
- f) The SS repeats steps a) to d).

16.5 Test requirement

The MS shall adjust the timing of its transmit burst back to the correct receive/transmit timing delay. All burst timings shall be within the shaded part of figure 16.1.

bits change
of transmit
timing

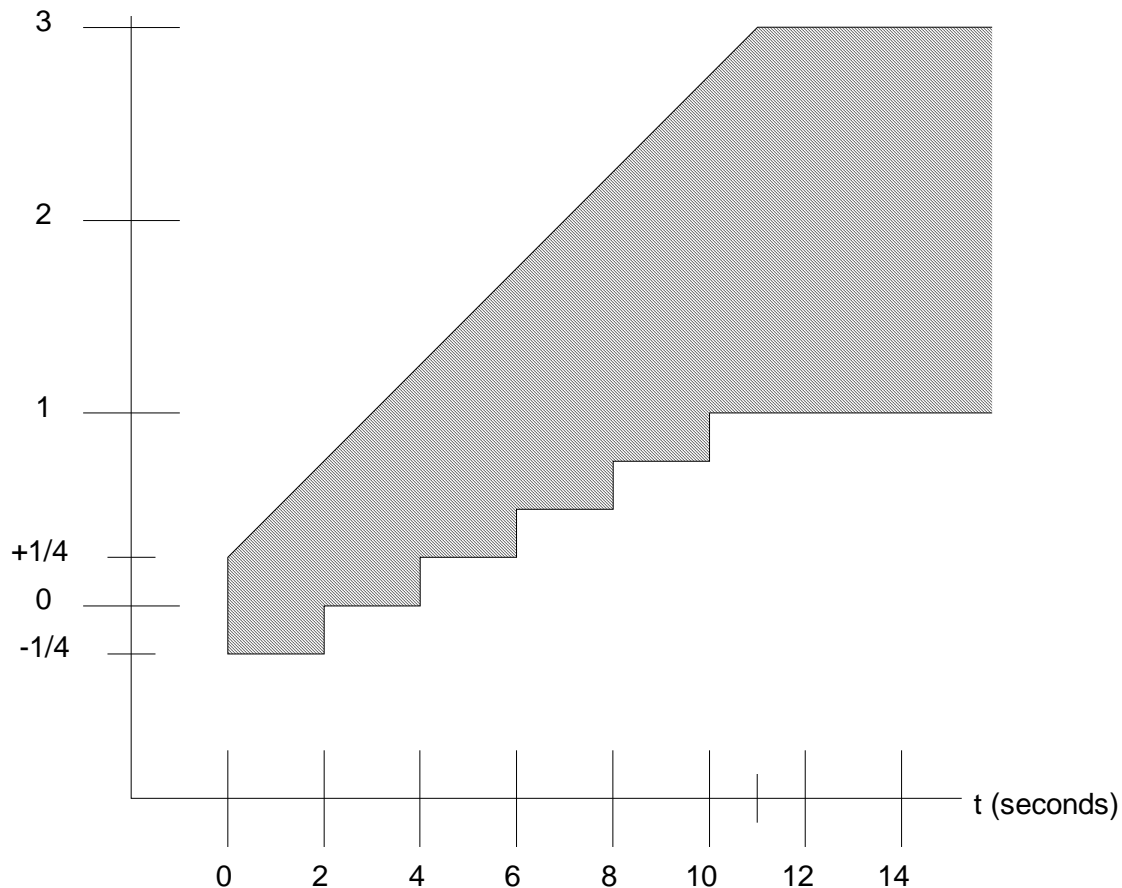

NOTE: $t = 0$ is the time at which the SS makes the transmission timing step change in c) of subclause 16.4.2.

Figure 16.1

17 Access times during handover

17.1 Intra cell channel change

17.1.1 Definition

The access times are:

- the time between either receipt by the MS of the last timeslot of the message block containing an ASSIGNMENT COMMAND or HANDOVER COMMAND and the time it has to be ready to transmit on the new channel; and
- the time between the end of the last complete speech or data frame or message block sent on the old channel and the time the MS is ready to transmit on the new channel.

For E-GSM 900 and R-GSM 900 MS this test is performed in the P-GSM band (see table 3.3 P-GSM 900ARFCN ranges).

17.1.2 Conformance requirement

- 1) When for an intracell channel change, the MS receives an ASSIGNMENT COMMAND command or a HANDOVER COMMAND it shall be ready to transmit on the new channel within 120 ms of the last timeslot of the message block containing the command.

3GPP TS 05.10, subclause 6.8.

- 2) For an intracell channel change, the time between the end of the last complete speech or data frame or message block sent on the old channel and the time the MS is ready to transmit on the new channel shall be less than 20 ms.

3GPP TS 05.10, subclause 6.8.

17.1.3 Test purpose

- 1) To verify that the MS, when commanded to perform an intracell channel change to a new ARFCN and/or a new timeslot number within the same cell, if the starting time is not used in the ASSIGNMENT COMMAND, is ready to transmit on the new channel within 120 ms of the last timeslot containing the ASSIGNMENT COMMAND.
- 2) To verify that the MS, when commanded to perform an intracell channel change to a new ARFCN and/or a new timeslot number within the same cell, if the starting time is not used in the ASSIGNMENT COMMAND, is ready to transmit on the new channel within 20 ms of the last complete speech/data frame or message block sent on the old channel.

17.1.4 Method of test

17.1.4.1 Initial conditions

The SS sets up a call according to the generic call set up procedure on a channel in the Low ARFCN range on timeslot 1.

17.1.4.2 Procedure

- a) The SS sends an ASSIGNMENT COMMAND to the MS allocating a channel in the high ARFCN range on timeslot 2, and with a power command of 7. These old and new carriers have a relative frequency tolerance of 0, and a relative timing tolerance of 1/4 bit.
- b) The SS, after it has sent the ASSIGNMENT COMMAND, measures the reception time of bursts received on the new channel, and the time at which transmission ceases on the old channel.

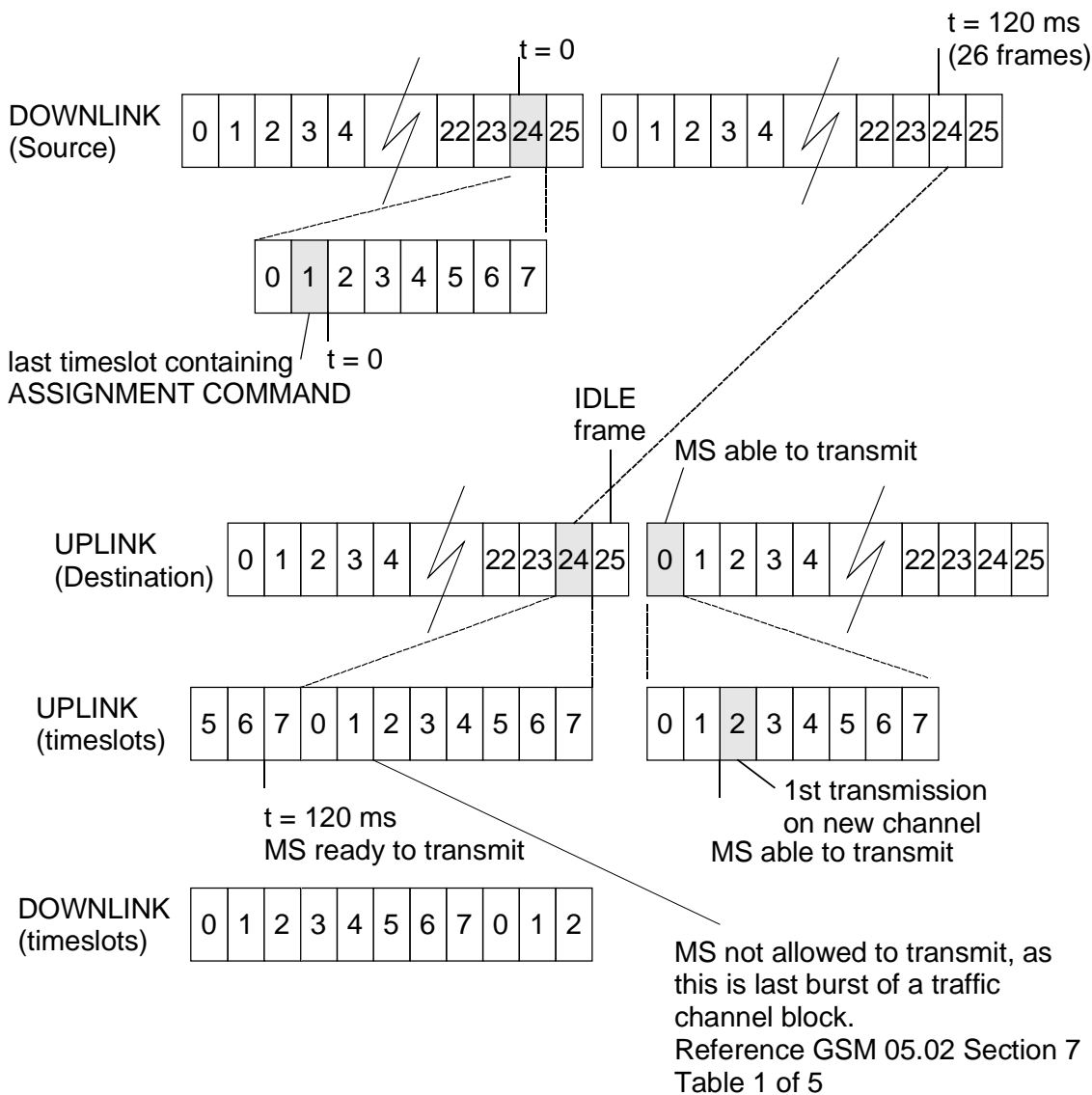

Timing difference between Downlink and Uplink is 3 timeslots.

Relative timing difference between the 2 carriers is a $1/4$ bit period.

Maximum time to first transmission on the new channel is 131 ms (120ms + 2 frames + 3 timeslots + $1/4$ bit period)

Figure 17-1: Access time - Intra cell channel change (Test Requirement 1)

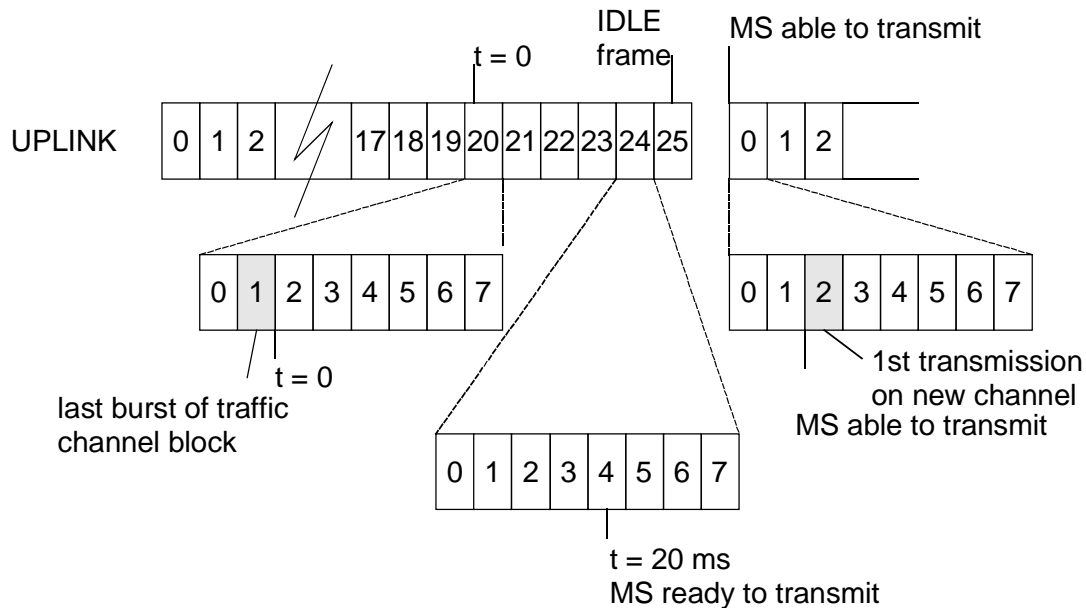

Figure 17-2: Access time - Intra cell channel change (Test Requirement 2)

17.1.5 Test requirement

- 1) The MS shall transmit its first burst on the new channel within 131 ms from the last timeslot of the message block containing the ASSIGNMENT COMMAND.

NOTE 1: The requirement time of 120 ms, at which the MS shall be ready to transmit, will expire right at the beginning of a new downlink burst on timeslot 2, which will be the last burst of a traffic channel block. The following frame could be an IDLE frame and the MS would then transmit in the next frame. Taking into account the 3 timeslot shift between up and downlink, and the 1/4 bit relative timing tolerance between the carriers, means that the MS may first transmit on the new channel after 131 ms (120 ms + 2 frames + 3 timeslots + 1/4 bit period). See figure 17-1.

- 2) The MS shall transmit its first burst on the new channel within 27,7 ms from the last complete speech or data frame or message block sent on the old channel.

NOTE 2: The requirement time of 20 ms, at which the MS shall be ready to transmit, will expire at just over 4 frames after the sending of the last bit on the old channel. The next frame could be an IDLE frame and the MS would then transmit in the following frame. This equates to 6 frames so in the worst case, including the 1/4 bit relative timing tolerance between the carriers, the MS may take 27,7 ms before starting transmissions on the new channel.

17.2 Inter cell handover

17.2.1 Definition

The access times are:

- the time between receipt by the MS of the last timeslot of the message block containing a HANDOVER COMMAND and the time it has to be ready to transmit on the new channel; and
- the time between the end of the last complete speech or data frame or message block sent on the old channel and the time the MS is ready to transmit on the new channel.

17.2.2 Conformance requirement

- 1) When the MS receives a HANDOVER COMMAND it shall be ready to transmit on the new channel within 120 ms of the last timeslot of the message block containing the HANDOVER COMMAND.

3GPP TS 05.10, subclause 6.8

- 2) The time between the end of the last complete speech or data frame or message block sent on the old channel and the time the MS is ready to transmit on the new channel shall be less than 20 ms.

3GPP TS 05.10, subclause 6.8.

- 3) When the MS receives a new TA value in response to a handover access burst, the MS shall be ready to transmit using the new TA value within 40 ms of the end of the last timeslot of the message block containing the new TA.

3GPP TS 05.10, subclause 6.9.

- 4) The MS shall use a TA value of 0 for the handover access bursts sent.

3GPP TS 05.10, subclause 6.6.

17.2.3 Test purpose

- 1) To verify that the MS, when commanded to handover on a new ARFCN and a new timeslot number in a new, not synchronized cell, starting time not used in the HANDOVER COMMAND, will be ready to transmit on the new channel within 120 ms of the last timeslot containing the HANDOVER COMMAND.
- 2) To verify that the MS, when commanded to handover on a new ARFCN and a new timeslot number in a new, not synchronized cell, starting time not used in the HANDOVER COMMAND, will be ready to transmit on the new channel within 20 ms of the last complete speech or data frame or message block sent on the old channel.
- 3) To verify that the MS, when it receives a new TA value in response to a handover access burst, is ready to transmit using the new TA value within 50 ms of the end of the last timeslot of the message block containing the new TA value.
- 4) To verify that the MS uses a TA value of 0 for the handover access burst sent.

17.2.4 Method of test

17.2.4.1 Initial conditions

The SS establishes two non-synchronized cells, A and B, under ideal radio conditions. A is the old cell and B is the target for the handover.

The SS uses two traffic channels with the following properties:

Band	Cell A			Cell B		
	TN	ARFCN	Offset (Hz)	TN	ARFCN	Offset (Hz)
GSM 450	2	259	+240	0	293	-240
GSM 480	2	306	+260	0	340	-260
GSM 710	2	438	+244	0	511	-244
GSM 750	2	438	+250	0	511	-250
T-GSM 810	2	438	+244	0	511	-244
GSM 850	2	128	+252	0	251	-252
GSM 900	2	1	+267	0	124	-267
DCS 1800	2	512	+320	0	885	-320
PCS 1900	2	512	+366	0	810	-366

NOTE 1: In each band, Cell A uses the lowest and Cell B the highest allowed carrier. For GSM710 and T-GSM810 the ARFCNs above are based on the values below (see 3GPP TS 45.005, 3GPP TS 44.018) to achieve the same result.

Parameter	3GPP TS 04.08 / 3GPP TS 44.018 reference	Abbr.	Normal Setting
GSM_Band (4 bit field)	10.5.2.11b	-	0110 – GSM 710 Or 0111 – T-GSM 810
ARFCN_FIRST	10.5.2.11b	-	1
BAND_OFFSET	10.5.2.11b	-	438
ARFCN_RANGE	10.5.2.11b	-	90

NOTE 2: The offset is representing worst cases:

for Doppler shift due to a velocity chosen according to the band:

Band	Velocity (kph)
GSM 450, GSM 480	500
GSM 710, GSM 750	300
T-GSM 810, GSM 850, GSM 900	250
DCS 1800, PCS 1900	130

and a frequency inaccuracy of 0,05 ppm.

The BCCH for the two cells have the following differences in timing:

Timer T1	50;
Timer T2	15;
Timer T3	40;
1/4 bit number	17;
Timeslots	2.

The SS sets up a call according to the generic call set up procedure on the channel in cell A.

17.2.4.2 Procedure

- The SS sends a HANOVER COMMAND on the main DCCH on cell A ordering the MS to go to the channel in cell B. The power command is set to 7.
- After the SS has sent HANOVER COMMAND it measures the reception time of bursts received on the new channel and the time at which transmission ceases on the old channel.
- The SS also measures the absolute transmit/receive delay for the access bursts on the new channel.
- The SS sends the PHYSICAL INFORMATION with TA set to 50. The SS then measures the reception time and absolute delay of the bursts transmitted on the new cell.

17.2.5 Test requirement

- The MS shall transmit its first burst on cell B within 142,6 ms from the last timeslot of the message block containing the HANOVER COMMAND.

NOTE 1: The requirement time of 120 ms, at which the MS shall be ready to transmit, will expire right at the end of the last burst of a downlink traffic channel block on the old channel. Due to the two timeslot difference in cell timing, the two timeslots difference in the channel allocation and the 15 frames difference in multiframe timing, this point could occur 2,5 frames before the end of the last burst of a downlink traffic channel block on the new channel. The following frame could be an IDLE frame and the MS would then transmit in the next frame. Taking into account the three timeslot shift between up and downlink, and the 17 1/4 bit periods timing difference between the two carriers, means that the MS may first transmits on the new channel after 142,6 ms (120 ms + 2,5 frames + 2 frames + 3 timeslots + 17 1/4 bit periods).

- The MS shall transmit its first burst on cell B within 39,2 ms from the last complete speech or data frame or message block sent on cell A.

NOTE 2: The requirement time of 20 ms, at which the MS shall be ready to transmit, will expire at just over 4 frames after the sending of the last bit on the old channel. Due to the two timeslot difference in cell timing, the two timeslots difference in the channel allocation and the 15 frames difference in multiframe timing, this point could occur 2 frames before the end of the last burst of an uplink traffic channel block on the new channel. The following frame could be an IDLE frame and the MS would then transmit in the next frame. This equates to 8,5 frames so in the worst case the MS may take 39,2 ms between cessation of transmission on the old channel and transmission beginning on the new channel.

- 3) The MS shall transmit using the TA value in the PHYSICAL INFORMATION within 50 ms from the end of the last timeslot of the message block containing the new TA value.
- 4) The measured absolute delay for the access bursts in steps c) and d) shall equal 3 timeslots (=45/26 ms), with an absolute tolerance of ± 1 bit.

18 Temporary reception gaps

18.1 Temporary reception gaps, single slot

18.1.1 Definition

A temporary reception gap is a limited period of time in which the RF reception is interrupted. During this gap the MS shall maintain the frequency and timing of its transmission within specifications.

18.1.2 Conformance requirement

- 1) During a temporary total loss of signal, of up to 64 SACCH block periods, the MS shall update its timebase with a clock which is accurate to within 0,2 ppm, or to within 0,2 ppm of the signals previously received from the BTS. The MS shall use the same frequency source for both RF frequency generation and clocking the timebase.

3GPP TS 05.10, subclauses 6.1 and 6.7.

- 2) The MS shall time its transmissions to the BTS according to signals received from the BTS. The MS transmissions to the BTS, measured at the MS antenna, shall be 3 timeslots - TA behind the transmissions received from the BTS, where TA is the last timing advance received from the current serving BTS.

3GPP TS 05.10, subclause 6.4.

- 3) During a temporary total loss of signal, of up to 64 SACCH block periods, the MS shall update its timebase with a clock which is accurate to within 0,2 ppm, or to within 0,2 ppm of the signals previously received from the BTS.

3GPP TS 05.10, subclause 6.7.

18.1.3 Test purpose

- 1) To verify that, during a temporary total loss of signal of up to 63 SACCH block periods, the MS carrier frequency is accurate to within 0,2 ppm of the signals previously received from the BTS.
- 2) To verify that, the MS transmissions to the BTS, measured at the MS antenna, is 3 timeslots behind the transmissions received from the BTS, with a tolerance of ± 1 bit period.
- 3) To verify that, during a temporary total loss of signal, of up to 63 SACCH block periods, the MS transmission timing may have drifted resulting in an error not greater than $\pm 6,048 \mu\text{s}$ (0,2 ppm of 63 SACCH blocks).

18.1.4 Method of test

18.1.4.1 Initial conditions

The SS signals RADIO_LINK_TIMEOUT = 64 and "DTX OFF" on the BCCH.

The MS is brought into MM state "idle, updated".

After 10 s, the SS continues to set up a call according to the generic call set up procedure.

18.1.4.2 Procedure

- a) The SS, in a TDMA frame immediately following the transmission of a complete SACCH block, removes the downlink signal for 63 SACCH blocks.

NOTE: This gives the maximum temporary reception gap.

- b) The SS measures the frequency and timing of the MS transmissions immediately before, and at least 5 times at approximately equally spaced intervals during the gap, one of these measurements being at the end of the gap.

- c) The SS resumes transmission for a period sufficient to allow the MS reception of 1 SACCH block.
- d) The SS again removes downlink transmission for a period equal to at least 3 SACCH blocks. The SS measures the frequency and timing of the MS transmissions immediately before and during this second reception gap.

18.1.5 Test requirement

- 1) The MS carrier frequency shall be accurate to within 0,2 ppm compared to signals received from the SS.
- 2) At the start of the first reception gap the MS receive/transmit delay timing shall be 3 timeslots \pm 1 bit.

NOTE: The SS determines the error from the first measurement of MS transmission frequency and timing.

- 3) During the second reception gap the MS shall maintain transmission for a period up to but not exceeding 3 SACCH blocks.
- 4) During the first, maximum, reception gap the MS transmission timing may have drifted resulting in an error of not greater than $\pm 6,048 \mu\text{s}$.

NOTE: The SS determines the error at the start of the reception gap from the first measurement of MS transmission frequency and timing.

18.2 Temporary reception gaps in HSCSD multislots configurations

18.2.1 Definition

A temporary reception gap is a limited period of time in which the RF reception is interrupted. During this gap the MS shall maintain the frequency and timing of its transmission within specifications.

18.2.2 Conformance requirement

- 1) During a temporary total loss of signal, of up to 64 SACCH block periods, the MS shall update its timebase with a clock which is accurate to within 0,2 ppm, or to within 0,2 ppm of the signals previously received from the BTS. The MS shall use the same frequency source for both RF frequency generation and clocking the timebase.

3GPP TS 05.10, subclauses 6.7 and 6.1.

- 2) The MS shall time its transmissions to the BTS according to signals received from the BTS. The MS transmissions to the BTS, measured at the MS antenna, shall be 3 timeslots - TA behind the transmissions received from the BTS, where TA is the last timing advance received from the current serving BTS.

3GPP TS 05.10, subclause 6.4.

- 3) During a temporary total loss of signal, of up to 64 SACCH block periods, the MS shall update its timebase with a clock which is accurate to within 0,2 ppm, or to within 0,2 ppm of the signals previously received from the BTS.

3GPP TS 05.10, subclause 6.7.

18.2.3 Test purpose

- 1) To verify that, during a temporary total loss of signal of up to 63 SACCH block periods on the main multislots channel, the MS carrier frequency is accurate to within 0,2 ppm of the signals previously received from the BTS.
- 2) To verify that, the MS transmissions to the BTS, measured at the MS antenna, is 3 timeslots behind the transmissions received from the BTS, with a tolerance of ± 1 bit period.
- 3) To verify that, during a temporary total loss of signal, of up to 63 SACCH block periods on the main multislots channel, the MS transmission timing may have drifted resulting in an error not greater than $\pm 6,048 \mu\text{s}$ (0,2 ppm of 63 SACCH blocks).
- 4) To verify that, during a temporary loss of more than 64 SACCH block periods on other than the main channel in symmetric configuration, the MS meet the requirements 1, 2 and 3.

18.2.4 Method of test

18.2.4.1 Initial conditions

The SS signals RADIO_LINK_TIMEOUT = 64 and "DTX OFF" on the BCCH.

The MS is brought into MM state "idle, updated".

After 10 s, the SS continues to set up a call according to the generic call set up procedure for multislot HSCSD.

The SS commands the MS to operate in a highest possible asymmetric configuration, with a maximum number of downlink timeslots.

18.2.4.2 Procedure

- a) The SS, in a TDMA frame immediately following the transmission of a complete SACCH block, removes the downlink signal for 63 SACCH blocks of the main channel.

NOTE: This gives the maximum temporary reception gap.

- b) The SS measures the frequency and timing of the MS transmissions immediately before, and at least 5 times at approximately equally spaced intervals during the gap, one of these measurements being at the end of the gap.
- c) The SS resumes transmission for a period sufficient to allow the MS reception of 1 SACCH block.
- d) The SS again removes downlink transmission for a period equal to at least 3 SACCH blocks of the main channel. The SS measures the frequency and timing of the MS transmissions immediately before and during this second reception gap.
- e) SS signals RADIO_LINK_TIMEOUT=64 and commands the MS to operate in a highest possible symmetric multislot configuration, with a maximum number of uplink timeslots.
- f) For a symmetric multislot configuration steps a) and b) are repeated with the exception that a 69 SACCH blocks are removed from a channel other than the main channel.

18.2.5 Test requirement

- 1) The MS carrier frequency shall be accurate to within 0,2 ppm compared to signals received from the SS.
- 2) The receive/transmit delay timing shall be 3 timeslots \pm 1 bit.
- 3) During the second reception gap the MS shall maintain transmission for a period up to but not exceeding 3 SACCH blocks.
- 4) During the first, maximum, reception gap the MS transmission timing may have drifted resulting in an error of not greater than $\pm 6,048 \mu\text{s}$.
- 5) During the last reception gap, the MS shall maintain transmission.

NOTE: The SS determines the error at the start of the reception gap from the first measurement of MS transmission frequency and timing.

19 Channel release after unrecoverable errors

NOTE: It is not possible to explicitly verify the correct functioning of all aspects of the radio link failure algorithm in the MS. Therefore 3 tests are used to implicitly verify correct implementation.

19.1 Channel release after unrecoverable errors - 1

19.1.1 Definition

Channel release after unrecoverable errors is a procedure to abort the call if the radio link has been severely corrupted for some time, according to a link failure criterion.

19.1.2 Conformance requirement

- 1) If the MS is unable to decode a SACCH message, the radio link counter *S* is decreased by 1. In the case of a successful reception of a SACCH message *S* is increased by 2. In any case *S* shall not exceed the value of RADIO_LINK_TIMEOUT. If *S* reaches 0 a radio link failure shall be declared.

3GPP TS 05.08, subclause 5.2.

- 2) The MS shall continue transmitting as normal on the uplink until *S* reaches 0.

3GPP TS 05.08, subclause 5.2.

- 3) The algorithm shall start after the assignment of a dedicated channel and *S* shall be initialized to RADIO_LINK_TIMEOUT.

3GPP TS 05.08, subclause 5.2.

- 4) (Re-)initialization and start of the algorithm shall be done whenever the MS switches to a new channel (this includes the old channel in assignment and handover failure cases), at the latest when the main signalling link (see 3GPP TS 04.08 / 3GPP TS 44.018) has been established.

3GPP TS 05.08, subclause 5.2.

19.1.3 Test purpose

- 1) To verify correct handling of the radio link counter *S*.
- 2) To verify that the MS that is transmitting continues to transmit as normal on the uplink until *S* reaches 0.
- 3) To verify that the algorithm starts after the assignment of a dedicated channel, with *S* initialized to RADIO_LINK_TIMEOUT.
- 4) To verify that the MS declares RADIO_LINK_FAILURE, and clears the RR connection when *S* = 0.

19.1.4 Method of test

19.1.4.1 Initial conditions

The SS sends a randomly chooses value *N* for the parameter RADIO_LINK_TIMEOUT on the BCCH. CALL RE-ESTABLISHMENT is not allowed.

19.1.4.2 Procedure

- a) A MS originated call is set up according to the generic call set up procedure.
- b) The SS sends 32 error free SACCH messages, followed by *N* SACCH messages that contain unrecoverable errors, and then continuously sends error free SACCH messages.

NOTE: The SS shall continue sending error free SACCH messages for a time that allows the MS to release the RR connection.

- c) The SS sets *N* to a different but randomly chosen value, and broadcasts this on the BCCH. The SS repeats steps a) to b).

19.1.5 Test requirement

After receiving the *N* SACCH messages with unrecoverable errors, the MS shall abort the RR-connection, i.e. there is no more MS activity on the SACCH channel.

19.2 Channel release after unrecoverable errors - 2

19.2.1 Definition

Channel release after unrecoverable errors is a procedure to abort the call if the radio link has been severely corrupted for some time, according to a link failure criterion.

19.2.2 Conformance requirement

- 1) If the MS is unable to decode a SACCH message, the radio link counter *S* is decreased by 1. In the case of a successful reception of a SACCH message *S* is increased by 2. In any case *S* shall not exceed the value of RADIO_LINK_TIMEOUT. If *S* reaches 0 a radio link failure shall be declared.

3GPP TS 05.08, subclause 5.2.

- 2) The MS shall continue transmitting as normal on the uplink until *S* reaches 0.

3GPP TS 05.08, subclause 5.2.

- 3) The algorithm shall start after the assignment of a dedicated channel and *S* shall be initialized to RADIO_LINK_TIMEOUT.

3GPP TS 05.08, subclause 5.2.

- 4) (Re-)initialization and start of the algorithm shall be done whenever the MS switches to a new channel (this includes the old channel in assignment and handover failure cases), at the latest when the main signalling link (see 3GPP TS 04.08 / 3GPP TS 44.018) has been established.

3GPP TS 05.08, subclause 5.2.

19.2.3 Test purpose

- 1) To verify correct handling of the radio link counter *S*.
- 2) To verify that the MS that is transmitting continues to transmit as normal on the uplink until *S* reaches 0.
- 3) To verify that the algorithm starts after the assignment of a dedicated channel, with *S* initialized to RADIO_LINK_TIMEOUT.

19.2.4 Method of test

19.2.4.1 Initial conditions

The SS sends a randomly chooses value *N* for the parameter RADIO_LINK_TIMEOUT on the BCCH. CALL RE-ESTABLISHMENT is not allowed.

19.2.4.2 Procedure

- a) A MS originated call is set up according to the generic call set up procedure.
- b) The SS sends 2 SACCH messages with unrecoverable errors followed by one error free SACCH message. This step is repeated 64 times.
- c) The SS sets *N* to a different but randomly chosen value, and broadcasts this on the BCCH. The SS repeats steps a) to b).

19.2.5 Test requirement

The MS shall not abort the RR-connection.

19.3 Channel release after unrecoverable errors - 3

19.3.1 Definition

Channel release after unrecoverable errors is a procedure to abort the call if the radio link has been severely corrupted for some time, according to a link failure criterion.

19.3.2 Conformance requirements

- 1) If the MS is unable to decode a SACCH message, the radio link counter *S* is decreased by 1. In the case of a successful reception of a SACCH message *S* is increased by 2. In any case *S* shall not exceed the value of RADIO_LINK_TIMEOUT. If *S* reaches 0 a radio link failure shall be declared.

3GPP TS 05.08, subclause 5.2.

- 2) The MS shall continue transmitting as normal on the uplink until S reaches 0.

3GPP TS 05.08, subclause 5.2.

- 3) The algorithm shall start after the assignment of a dedicated channel and S shall be initialized to RADIO_LINK_TIMEOUT.

3GPP TS 05.08, subclause 5.2.

- 4) (Re-)initialization and start of the algorithm shall be done whenever the MS switches to a new channel (this includes the old channel in assignment and handover failure cases), at the latest when the main signalling link (see 3GPP TS 04.08 / 3GPP TS 44.018) has been established.

3GPP TS 05.08, subclause 5.2.

19.3.3 Test purpose

- 1) To verify correct handling of the radio link counter S.
- 2) To verify that the MS that is transmitting continues to transmit as normal on the uplink until S reaches 0.
- 3) To verify that the algorithm starts after the assignment of a dedicated channel, with S initialized to RADIO_LINK_TIMEOUT.
- 4) To verify that the MS declares RADIO_LINK_FAILURE, and clears the RR connection when S = 0.

19.3.4 Method of test

19.3.4.1 Initial conditions

The SS sends a randomly chooses value N for the parameter RADIO_LINK_TIMEOUT on the BCCH. CALL RE_ESTABLISHMENT is not allowed.

19.3.4.2 Procedure

- a) A MS originated call is set up according to the generic call set up procedure.
- b) The SS sends 32 error free SACCH messages, followed by 3 SACCH messages with unrecoverable errors, and the sends 1 error free SACCH message. This step is repeated N - 2 times.
- c) The SS shall continuously send error free SACCH messages.

NOTE: The SS shall continue sending error free SACCH messages for a time that allows the MS to release the RR connection.

- d) The SS sets N to a different but randomly chosen value, and broadcasts this on the BCCH. The SS repeats steps a) to c).

19.3.5 Test requirement

After receiving the $3 \times (N - 2)$ erroneous SACCH messages the MS shall abort the RR-connection, i.e. there is no more activity on the SACCH channel.

20 Cell selection and reselection

In the following paragraphs some explanatory text is given concerning the nature of the tests in this clause and the general behaviour of the SS is described.

Since the conformance requirements of most of the tests in this clause cannot be tested explicitly, testing is done implicitly by testing the MS behaviour from its responses to the SS.

The SS transmits one BCCH carrier per cell as indicated in the initial conditions for each test. These are referred to as carrier 1, carrier 2, etc. Each of these cell control channels are non-combined with SDCCHs. For tests in section 20.1 to 20.21, it is assumed that the SS can simultaneously transmit seven BCCH carriers and monitor three random access channels. For all other tests, unless explicitly stated otherwise, it is assumed that the SS can simultaneously transmit 7

BCCH or PBCCH carriers and monitor all RACH and PRACH channels for Cell Selection Testing and all adjacent RACH and PRACH channels for Cell Reselection. For multiband tests it is assumed that at least one of the BCCH carriers and one of the monitored random access channels is in a different frequency band from the others. In some cases, a test is performed in multiple stages in order that the requirements can be tested within the above constraints.

For any MS all the carriers are in its supported band(s) of operation. For an E-GSM mobile station at least one of the carriers is in the extension band and one of the carriers is in the primary band. Note: For an MS supporting Stored List Cell Selection it is necessary to ensure that the SIM does not contain any of the ARFCN's used by each individual Test, otherwise the Test Purpose will not be met as the MS will apply different rules compared to Normal Cell Selection. This can be achieved by either editing the SIM card or initially updating the MS in a cell with no BA in the list. This must apply to all tests in section 20.

Unless otherwise stated in the method of test, in all of the tests of this clause:

- The SS is continuously paging the MS on all carriers at the start of the test and does not respond to RACH requests from the MS. Where a test specifies that the MS is not paged on a particular carrier, only idle paging is transmitted according to 3GPP TS 04.08 / 3GPP TS 44.018, subclause 3.2.2.2.
- The default values of the system information data fields given in table 20.1 are used.
- The SIM is in the idle updated state in the default location area with a TMSI assigned at the beginning of each test.
- The ARFCNs used for the carriers in each test are chosen from those in table 20.1 with adjacent carriers separated by a minimum of three channels.

The absolute accuracy of the MS signal level measurements is assumed to be ± 6 dB. A difference of at least 8 dB is allowed for cases of discrimination between C1 or C2 values and 0.

The relative accuracy of the MS signal level measurements is assumed to be ± 3 dB for the signal levels used in the tests of this clause, except for subclause 20.20, where the relative accuracy is assumed to be ± 5 dB if the measurements are on different frequency bands. A difference of at least 5 dB is allowed for cases of discrimination between C1 or C2 values on different carriers, except for subclause 20.20, where a difference of at least 10 dB is allowed if the measurements are on different frequency bands.

NOTE 1: The accuracy of MS signal level measurements is specified in 3GPP TS 05.08. For all of the tests in this clause, the signal levels used are greater than 1 dB above reference sensitivity level.

NOTE 2: The tolerance on timers specified in 3GPP TS 05.08 is ± 10 % except for PENALTY_TIME where it is ± 2 s. In the tests of this clause, the test requirements include these tolerances. Consequently, the times stated in the test requirement sometimes differ from the corresponding timer in the conformance requirement.

Where pulsed signals are specified, the SS tolerance on pulse width is ± 2 % and the SS tolerance on power level ± 1 dB.

Table 20.1: Default values of the system information fields

Parameter	3GPP TS 04.08 / 3GPP TS 44.018 reference	Abbr.	Normal Setting
Cell channel description	10.5.2.1	-	Any values
MAX retrans	10.5.2.29	-	1
TX-integer	10.5.2.29	-	Any value
CELL_BAR_QUALIFY	10.5.2.35	CBQ	0
CELL_BAR_ACCESS	10.5.2.29	CBA	0 (not barred)
AC CN	10.5.2.29	AC	All 0
RE	10.5.2.29	RE	0 (re-establishment allowed)
NCC	10.5.2.2	NCC	Any value
Cell Identity	10.5.1.1	-	Any value
MCC, MNC	10.5.1.3	PLMN	MS Home PLMN
LAC	10.5.1.3	LAC	1111 (Hex)
ATT	10.5.2.11	-	0 (Attach/Detach not allowed)
BS_AG_BLKES_RES	10.5.2.11	-	Any values
CCCH_CONF	10.5.2.11	-	1 basic physical channel used for CCCH, non-combined with SDCCHs.
T3212	10.5.2.11	-	Any values
BS_PA_MFRMS	10.5.2.11	BPM	5 frames

Parameter	3GPP TS 04.08 / 3GPP TS 44.018 reference	Abbr.	Normal Setting
Cell Options	10.5.2.3	-	Any values
CELL_RESELECT_HYSTERESIS	10.5.2.4	CRH	4 dB
MS_TXPWR_MAX_CCH	10.5.2.4	MTMC	Max. output power of MS
RXLEV_ACCESS_MIN	10.5.2.4	RAM	-90 dBm
CELL_RESELECT_OFFSET	10.5.2.35	CRO	0
TEMPORARY_OFFSET	10.5.2.35	TO	0
PENALTY_TIME	10.5.2.35	PT	0
Power Offset	10.5.2.35	PO	0
BA ARFCN	10.5.2.22	BA	All 0 except values in Table 20.1a or 20.1b

Table 20.1a: ARFCNs for Single Band Tests

Band	ARFCNs	broadcast in SYSTEM INFORMATION type
GSM 450	259, 263, 269, 275, 279, 283, 287, 292	SI2
GSM 480	306, 310, 316, 322, 326, 330, 334, 339	SI2
GSM 710	441, 446, 452, 455, 461, 462, 466, 470, 477, 485, 493, 511	SI2
GSM 750	441, 446, 452, 455, 461, 462, 466, 470, 477, 485, 493, 511	SI2
T-GSM 810	441, 446, 452, 455, 461, 462, 466, 470, 477, 485, 493, 511	SI2
GSM 850	130, 136, 145, 152, 168, 170, 176, 177, 181, 185, 189, 193, 197, 207, 219, 251	SI2
GSM 900	both P-GSM and E-GSM ARFCNs are broadcast: GSM: 3, 9, 18, 25, 41, 43, 49, 50, 54, 58, 62, 66, 70, 80, 92, 124 E-GSM: 985, 989, 995, 1010, 1014	SI2 SI2bis
DCS 1800	512, 543, 568, 589, 602, 641, 662, 683, 696, 711, 732, 754, 794, 851, 870, 871, 872, 884	SI2
PCS1900	512, 543, 568, 589, 602, 629, 641, 653, 662, 683, 696, 711, 727, 732, 754, 777, 794, 809	SI2

Table 20.1b: ARFCNs for Multiband Tests

Band	ARFCNs	broadcast in SYSTEM INFORMATION type
GSM 450	259, 263, 269, 275, 279, 283, 287, 292	SI2 (GSM 450 cell) & SI2ter (other band cell)
GSM 480	306, 310, 316, 322, 326, 330, 334, 339	SI2 (GSM 480 cell) & SI2ter (other band cell)
GSM 710	441, 452, 461, 477, 493, 511	SI2 (GSM 710 cell) & SI2ter (other band cell)
GSM 750	441, 452, 461, 477, 493, 511	SI2 (GSM 750 cell) & SI2ter (other band cell)
T-GSM 810	441, 452, 461, 477, 493, 511	SI2 (T-GSM 810 cell) & SI2ter (other band cell)
GSM 850	136, 152, 170, 177, 185, 193, 207, 251	SI2 (GSM 850 cell) & SI2ter (other band cell)
GSM 900	3, 18, 41, 49, 62, 70, 92, 124	SI2 (GSM 900 cell) & SI2ter (other band cell)
DCS 1800	512, 568, 602, 662, 696, 732, 794, 870	SI2 (DCS 1800 cell) & SI2ter (other band cell)
PCS 1900	512, 568, 602, 641, 662, 696, 727, 754	SI2 (PCS 1900 cell) & SI2ter (other band cell)

Table 20.1c: MNC values

Band	MNC value
GSM400, GSM900, DCS1800	01
Otherwise	011

For GSM 710 and T-GSM 810 Bands ARFCNs are defined using Dynamic Mapping: Information about dynamic mapping is provided by System Information type 15 or Packet System Information type 8 if PBCCH exists, and optionally by System Information type 14. The required parameters are as defined in Table 20.1d.

Table 20.1d: ARFCNs for GSM710, T-GSM 810

Parameter	3GPP TS 04.08 / 3GPP TS 44.018 reference	Abbr.	Normal Setting
-----------	--	-------	----------------

Parameter	3GPP TS 04.08 / 3GPP TS 44.018 reference	Abbr.	Normal Setting
GSM_Band (4 bit field)	10.5.2.11b	-	0110 – GSM 710 Or 0111 – T-GSM 810
ARFCN_FIRST	10.5.2.11b	-	1
BAND_OFFSET	10.5.2.11b	-	438
ARFCN_RANGE	10.5.2.11b	-	90

Unless otherwise specified all tests in clauses 20.1 to 20.15 are applicable for all MSs supporting the bands identified in Table 20.1a

20.1 Cell selection

20.1.1 Definition

Cell selection is a process in which a MS, whenever a new PLMN is selected, attempts to find a suitable cell of that PLMN to camp on. Two methods of searching for a suitable cell are possible, normal cell selection and stored list cell selection. The process ensures that the MS is camped on a cell from which it can reliably decode downlink data and with which it has a high probability of communications on the uplink. Once the MS is camped on a cell, access to the network is allowed.

20.1.2 Conformance requirement

1. The MS shall be able to select the correct (fourth strongest) cell and be able to respond to paging on that cell within 30 s of switch on, when the three strongest cells are not suitable. This assumes a valid SIM, with PIN disabled and ideal radio conditions; 3GPP TS 05.08, subclause 6.1.
2. There are various requirements that a cell must satisfy before an MS can perform normal camping on it:
 - 2.1 (i) It should be a cell of the selected PLMN
 - 2.2 (ii) It should not be "barred" (see subclause 3.5.1)
 - 2.3 (iv) The radio path loss between MS and BTS must be below a threshold set by the PLMN operator. This is estimated as shown in subclause 3.6.

3GPP TS 03.22, subclause 3.2.1.

NOTE: Criteria (iii) is not applicable for Cell Selection.

3. Initially the MS looks for a cell which satisfies these 4 constraints ("suitable cell") by checking cells in descending order of received signal strength. If a suitable cell is found, the MS camps on it; 3GPP TS 03.22, subclause 3.2.1.
4. The MS shall be able to calculate correctly the path loss criterion parameter $C1$, used for cell selection and reselection; 3GPP TS 05.08, subclause 6.4.

20.1.3 Test purpose

1. To verify that the MS meets conformance requirement 1.
2. To verify that:
 - 2.1 The MS does not select a cell of a PLMN which is not the selected PLMN.
 - 2.2 The MS does not select a cell which is "barred".
 - 2.3 The MS does not select a cell with $C1 < 0$.
3. To verify that the MS selects suitable cells in descending order of received signal strength.
4. To verify that the MS does not select a cell with $C1 < 0$.

20.1.4 Method of test

20.1.4.1 Initial conditions

Parameters changed from the default values in table 20.1.

Parameter	Carrier 1	Carrier 2	Carrier 3	Carrier 4	Carrier 5	Carrier 6
RF Signal Level (dB μ V emf() / dBm)	48 / -65	38 / -75	43 / -70	33 / -80	28 / -85	OFF
CBA	1	0	0	0	0	
RXLEV_ACCESS_MIN (dBm)	-90	-67	-90	-88	-98	
MNC			See Table 20.1c			
MCC			002			
C1	25	-8	20	8	13	
C2	25	-8	20	8	13	

For an E-GSM MS carrier 2 and carrier 4 ARFCNs are chosen in the E-GSM band, carrier 1 and carrier 3 ARFCNs in the P-GSM band.

20.1.4.2 Procedure

- a) The SS activates the carriers and monitors carriers 2, 4 and 5 for RA requests from the MS.
- b) The MS is switched on.
- c) The MS is switched off.
- d) The SS monitors carriers 1 and 3 for RA requests from the MS.
- e) The MS is switched on.

20.1.5 Test requirements

- 1) After step b), the first response from the MS shall be on carrier 4 within 33 s. There shall be no response from the MS on carrier 2.
- 2) After step e), there shall be no response from the MS on either carrier 1 or carrier 3 within 33 s.

20.2 Cell selection with varying signal strength values

20.2.1 Definition

For definition see conformance requirement.

20.2.2 Conformance requirement

1. The MS shall:

The MS shall search all RF channels within its bands of operation, take readings of received RF signal level on each RF channel, and calculate the RLA_C for each. The averaging is based on at least five measurement samples per RF carrier spread over 3 to 5 s, the measurement samples from the different RF carriers being spread evenly during this period.

3GPP TS 05.08 / 3GPP TS 45.008, subclause 6.2.

1.1 The MS shall search all RF channels within its bands of operation, take readings of received RF signal level on each RF channel, and calculate the RLA_C for each.

1.2 The averaging is based on at least five measurement samples per RF carrier spread over 3 to 5 s, ...

1.3 the measurement samples from the different RF carriers being spread evenly during this period.

2. These quantities termed the "received level averages" (RLA_C), shall be unweighted averages of the received signal levels measured in dBm..

GSM 05.08 / 3GPP TS 45.008, subclause 6.1.

20.2.3 Test purpose

1. To verify that:
 - 1.1 The MS meets conformance requirement 1.1.
 - 1.2 The MS meets conformance requirement 1.2.
 - 1.3 The MS meets conformance requirement 1.3.
2. To verify that the MS meets conformance requirement 2.

20.2.4 Method of test

20.2.4.1 Initial conditions

Parameters changed from the default values in table 20.1.

Parameter	Carrier 1	Carrier 2	Carrier 3	Carrier 4	Carrier 5	Carrier 6
RF Signal Level (dB μ V emf() / dBm)	23 / -90	58 / -55	OFF	OFF	OFF	OFF
RXLEV_ACCESS_MIN (dB μ V emf() / dBm)	13 / -100	13 / -100				
C1	10	53				

For an E-GSM MS carrier 1 ARFCN is chosen in the E-GSM band.

Specific PICS Statements:

-

PIXIT statements:

- averaging time T_{av}

20.2.4.2 Procedure

- a) The SS transmits on carriers 1 and 2. After a period of $b \times T_{av}$ carrier 2 reduces its transmit level to -85 dBm (28 dB μ V emf()). After a further period of $a \times T_{av}$, carrier 2 increases its transmit level again to -55 dBm (58 dB μ V emf()). Switching of carrier 2 continues with these levels and duty cycle until the end of the test.

T_{av} is the averaging time declared by the manufacturer.

The parameters a and b are chosen according to the following rules:

$$(a + b) \times T_{av} > T_{av}$$

$$0 < a \times T_{av} < 2/3 \times T_{av}$$

$$0,5 \times T_{av} < b \times T_{av} < T_{av}$$

In the equations < and > means at least one TDMA frame less or greater than the given value.

While satisfying the conditions given above:

a is chosen to be as close as possible to 2/3.

b is chosen to be as close as possible to 0,5.

- b) The MS is switched on.
- c) The SS monitors all RA requests from MS on carriers 1 and 2.

20.2.5 Test requirements

In step c), the first response from the MS shall be on carrier 2 within 33 s.

NOTE 1: With the selected duty cycle it can be guaranteed that a "good" MS passes the test even at the worst case situations. The minimum averaged value of carrier 2 is in any case higher or equal to -75 dBm which is still 6 dB above carrier 1's level (for a "good" MS).

NOTE 2: With the selected levels and duty cycle the probability that a "bad" MS (i.e. MS that averages over shorter period than 3 s) fails the test is maximized. However, it can not be guaranteed that all the MSs not fulfilling the conformance requirement of averaging or uniform sampling will fail this test.

20.3 Basic cell reselection

20.3.1 Definition

While camped on a cell of the selected PLMN the MS may need to select a different cell in order to fulfil the normal service state. This ensures that the MS is camped on a cell from which it can reliably decode downlink data and with which it has a high probability of communications on the uplink.

20.3.2 Conformance requirement

1. While camped on a cell of the selected PLMN ("camped normally"), the MS may need to select a different cell ("normal cell reselection" state). The following events trigger a cell reselection:

1.1 (iii) The cell camped on (current serving cell) has become barred.

1.2 (iv) There is a better cell (in terms of the path loss criterion C2) in the same LA, or a much better cell in another LA of the selected PLMN (using the CRH parameter).

The MS will then reselect a new cell in order to fulfil the process goal.; 3GPP TS 03.22, subclause 4.5.

NOTE 1: Criterion (i) is tested in subclause 20.8 (Cell reselection when $C1(\text{serving cell}) < 0$ for 5 s).

NOTE 2: Criterion (ii) is tested subclause 20.16 (Downlink signalling failure).

NOTE 3: Criterion (v) is tested in subclause 20.6 (Cell reselection timings).

2. There are various requirements that a cell must satisfy before an MS can perform normal camping on it:

2.1 (ii) It should not be "barred".

2.2 (iv) The radio path loss between MS and BTS must be below a threshold set by the PLMN operator.
3GPP TS 03.22, subclause 3.2.1.

NOTE 4: Criterion (i) is not relevant for cell reselection and for cell selection it is tested in subclause 20.1.

NOTE 5: Criterion (iv) refers to the C1 parameter.

3. The MS shall be able to calculate correctly the path loss criterion parameter C2 used for cell reselection;
3GPP TS 05.08, subclause 6.4.

4. At least every 5 s the MS shall calculate the value of C1 and C2 for the serving cell and recalculate C1 and C2 values for non serving cells (if necessary). The MS shall then check whether:

i) The path loss criterion (C1) for current serving cell falls below zero for a period of 5 s. This indicates that the path loss to the cell has become too high.

ii) The calculated value of C2 for a non-serving suitable cell exceeds the value of C2 for the serving cell for a period of 5 seconds, except;

- a) in the case of the new cell being in a different location area or, for a GPRS MS, in a different routing area or always for a GPRS MS in ready state in which case the C2 value for the new cell shall exceed the C2 value of the serving cell by at least CELL_RESELECT_HYSTERESIS dB as defined by the BCCH data from the current serving cell, for a period of 5 seconds; or
- b) in case of a cell reselection occurring within the previous 15 seconds in which case the C2 value for the new cell shall exceed the C2 value of the serving cell by at least 5 dB for a period of 5 seconds.

This indicates that it is a better cell.

3GPP TS 05.08 / 3GPP TS 45.008, subclause 6.6.2.

5. The MS shall attempt to decode the full BCCH data of the serving cell at least every 30 s; 3GPP TS 05.08, subclause 6.6.1.

20.3.3 Test purpose

1. To verify that:
 - 1.1 The MS meets conformance requirement 1.1.
 - 1.2 The MS meets conformance requirement 1.2.
2. To verify that:
 - 2.1 The MS does not reselect a cell which is barred.
 - 2.2 The MS does not reselect a cell which has a C1 < 0.
3. To verify that the MS calculates the C2 parameter correctly when the CELL_RESELECT_OFFSET, TEMPORARY_OFFSET and PENALTY_TIME parameters are not used.
4. To verify that the MS takes into account the CELL_RESELECT_HYSTERESIS parameter when reselecting a cell in a different location area.
5. To verify that the MS decodes the CELL_BAR_ACCESS and CELL_BAR_QUALIFY parameters from the BCCH every 30 s.

20.3.4 Method of test

20.3.4.1 Initial conditions

Parameters changed from the default values in table 20.1.

Parameter	Carrier 1	Carrier 2	Carrier 3	Carrier 4	Carrier 5	Carrier 6
RF Signal Level (dB μ V emf) / dBm)	43 / -70	33 / -80	43 / -70	38 / -75	38 / -75	
RXLEV_ACCESS_MIN (dBm)	-85	-90	-90	-85	-67	
CRH	10 dB					
LAC			different from other carriers			
CBA				1		
CBQ				0		
C1	15	10	20	10	-8	
C2	15	10	20	10	-8	

The BA(BCCH) list only contains the ARFCNs of the carriers used during the test.

20.3.4.2 Procedure

- a) The SS activates carriers 1, 2, 4 and 5. The MS is not paged on carrier 1. The SS monitors carriers 2, 4 and 5 for RA requests from the MS.
- b) The MS is switched on.
- c) The SS stops paging on all carriers except carrier 2. The level of carrier 2 is increased to 43 dB μ V_{emf} (C2 becomes 20 dB), and the SS monitors carrier 2 for RA requests from the MS.
- d) When the SS receives a response from the MS on carrier 2, it stops paging the MS on this carrier.
- e) The MS is switched off.
- f) The SS is reconfigured and sets CBA = 1 on carriers 1 and 5.
- g) The MS is switched on.
- h) After 33 s, the SS starts paging continuously on carrier 1 and sets CBA=1 on carrier 2 and CBA=0 on carriers 1, 4 and 5.
- i) When the SS receives a response on carrier 1, it stops paging the MS and waits for 25 s. (The MS should reselect and camp onto carrier 1).
- j) The SS activates carrier 3, pages the MS continuously on this carrier and monitors carrier 3 for RA requests from the MS.
- k) The SS increases the level of carrier 3 to 53 dB μ V_{emf} (C2 increases to 30 dB.).

20.3.5 Test requirements

- 1) After step b), there shall be no response from the MS on carriers 2, 4, or 5 within 50 s.
- 2) In step c), the MS shall respond on carrier 2 within 20 s of increasing the level of carrier 2.

NOTE 1: 5 s to perform running average, 10 s to detect C2 differences, 2,4 s to read BCCH of carrier 2, 1 s to perform RA. Total 18,4 s, allow 20 s.

- 3) In step h), the MS shall respond on carrier 1 within 50 s of setting CBA=1 on carrier 2.

NOTE 2: 33 s for the MS to read the BCCH of carrier 2 (30 s + 10 %), 15 s for the MS to reselect cell 1, since the MS already has a running average on carrier 1, allow 50 s.

- 4) After step j), there shall be no response from the MS within 50 s.
- 5) After step k), the MS shall respond on carrier 3 within 20 s.

20.4 Cell reselection using TEMPORARY_OFFSET, CELL_RESELECT_OFFSET, POWER_OFFSET and PENALTY_TIME parameters

20.4.1 Definition

void

20.4.2 Conformance requirement

1. The MS shall be able to calculate correctly the path loss criterion parameter C2 used for cell reselection; 3GPP TS 05.08, subclause 6.4.

20.4.3 Test purpose

1. To verify that the MS calculates the C2 parameter correctly when the CELL_RESELECT_OFFSET, TEMPORARY_OFFSET and PENALTY_TIME parameters are used.

2. To verify DCS 1 800 MS correctly calculate the C2 parameter when the POWER_OFFSET parameter is present.

20.4.4 Method of test

20.4.4.1 Initial conditions

Parameters changed from the default values in table 20.1.

Parameter	Carrier 1	Carrier 2	Carrier 3	Carrier 4	Carrier 5	Carrier 6
RF Signal Level (dB μ V emf() / dBm)	53 / -60	43 / -70	48 / -65	48 / -65		
RXLEV_ACCESS_MIN (dBm)	-80	-100	-85	-85		
PT		11111	40 s	60 s		
CRO		16 dB	20 dB	20 dB		
TO			20 dB	20 dB		
K = 1						
C1	20	30	20	20		
C2	20	14	20 - > 40	20 - > 40		
K = 2 (DCS1800 Class 3 MS only)						
POWER_OFFSET	0	2	6	6		

The BA(BCCH) list only contains the ARFCNs of the carriers used during the test.

Specific PICS statements:

- Support of DCS Power Class 3 (TSPC_Type_DCS_Class3)

PIXIT Statements:

-

20.4.4.2 Procedure

For testing of all types of MS, the test procedure is performed for execution counter K = 1. For testing of DCS 1 800 Class 3 MS, the test procedure is performed for execution counter K = 1 and 2:

On execution counter K = 1, the POWER_OFFSET Parameter is not present.

On execution counter K = 2, the POWER_OFFSET parameter is present.

- a) The SS activates carriers 1 and 2. The MS is not paged on carrier 1. The SS monitors carrier 2 for RA requests from the MS.
- b) The MS is switched on.
- c) The SS increases the level of carrier 2 to 54 dB μ Vemf (C2 becomes 25 dB).
- d) When the SS receives a response on carrier 2, the SS stops paging on that carrier and waits for 20 s (The MS should reselect and camp onto carrier 2).
- e) The SS activates carriers 3 and 4 and continuously pages the MS on these carriers. The SS monitors carriers 3 and 4 for RA requests from the MS.

20.4.4.3 Requirements

For execution counter K = 1 and K = 2.

- 1) After step b), there shall be no response from the MS on carrier 2 within 50 s.
- 2) After step c), the MS shall respond on carrier 2 within 20 s of increasing the level of carrier 2.
- 3) After step e), there shall be no response from the MS on carrier 3 within 38 s of activating the carriers but, the MS shall respond on carrier 3 within 90 s. The response on carrier 3 shall be before any response on carrier 4.

NOTE: Minimum time of 38 s set by penalty timer on carrier 3 less 2 s tolerance. Maximum time, total of 33 s to read BCCH of carrier 3, 42 s for expiry of penalty timer on carrier 3, 15 s for reselection, since the MS will already have running averages on carriers 3 and 4, when the penalty timers expire, allow 90 s.

20.5 Cell reselection using parameters transmitted in the System Information type 2bis, type 2ter, type 7 and type 8 messages

20.5.1 Definition

System information (SI) type 7 and 8 are transmitted on the BCCH Ext when the system information type 4 message does not contain all information needed for cell selection.

The system information type 2 bis message is used when the system information type 2 message does not contain all neighbour cell ARFCNs.

The system information type 2 ter message is used when system information type 2 messages broadcast by one cell which are system information 2 or both system information 2 and 2bis do not contain all neighbour cell ARFCNs.

Test purpose 2 is not applicable for P-GSM MS. This is reflected in initial conditions step d).

Test purpose 4 is only applicable to an E-GSM MS. This is reflected in initial conditions step f), test procedures d) and e) and test requirements clause 3).

20.5.2 Conformance requirement

1. The MS shall be able to calculate correctly the path loss criterion parameter C2 used for cell reselection. 3GPP TS 05.08, subclause 6.4.
2. Whilst in idle mode, an MS shall continue to monitor all BCCH carriers as indicated by the BCCH allocation. 3GPP TS 05.08, subclause 6.6.1.
3. Mobile stations shall treat all ARFCNs in the set {0, 1, 2 ... 1023} as valid ARFCN values even if the mobile station is unable to transmit or receive on that ARFCN. 3GPP TS 04.08 / 3GPP TS 44.018, subclause 10.5.2.1b.
4. An E-GSM MS shall correctly decode parameters transmitted in the system information type 2 ter message. 3GPP TS 04.08 / 3GPP TS 44.018, subclause 9.1.34.

20.5.3 Test purpose

1. To verify that the MS correctly calculates the C2 criterion when the parameters affecting cell reselection are transmitted in the system information type 7 and 8 messages.
2. To verify that E-GSM, DCS 1 800 and PCS 1 900 MS decode parameters transmitted in the system information type 2 bis message.
3. To verify that the MS treats ARFCNs as valid ARFCNs even if the MS is unable to transmit or receive on that ARFCN.
4. To verify that an E-GSM mobile correctly decode parameters transmitted in the system information type 2 ter message.

20.5.4 Method of test

20.5.4.1 Initial conditions

- a) Parameters changed from the default values in table 20.1.

Parameter	Carrier 1	Carrier 2	Carrier 3 (note)	Carrier 4	Carrier 5	Carrier 6
RF Signal Level (dB μ V emf() / dBm)	53 / -60	32 / -81	40 / -73	OFF	OFF	OFF
RXLEV_ACCESS_MI N (dB μ V emf() / dBm)	23 / -90	23 / -90	30 / -83			
BS_AG_BLKs_RES PT	1	1	1			
CRO		0	0			
TO		16 dB	10 dB			
		0 dB	0 dB			
C1	30	9	10			
C2	30	25	20			

NOTE: Carrier 3 is off for P-GSM, DCS 1800 and PCS 1 900 MS. Carrier 3 is only required for E-GSM MS.

The BA(BCCH) list only contains the ARFCNs of the carriers used during the test and the ARFCNs specified in d) below.

- b) The ARFCNs of carriers 1, 2 and 3 are chosen from those in table 20.1a.
- c) The cell reselection parameters PENALTY_TIME, CELL_RESELECT_OFFSET and TEMPORARY_OFFSET are transmitted in the SI3, SI7 and SI8 messages on carrier 2. They are not transmitted in SI4 and the ADDITIONAL RESELECT PARAM IND parameter is set to 1.
- d) The SI2bis message is transmitted on carrier 1 and contains the ARFCN of carrier 2 and ARFCNs 43, 70, 500, 550, 990 and 995. The ARFCN of carrier 2 is transmitted in the SI2 message only for an MS supporting only P-GSM..
- e) Carriers 1 and 2 are synchronized, but staggered in frame number so that the transmission of the SI3 message on carrier 2, coincides with the paging block which the MS is listening to on carrier 1.

NOTE: Under these conditions, the MS can only decode the parameters affecting cell reselection from the SI7 or SI8 messages.

To achieve this, the following conditions are used:

- BS_PA_MFRMS = 4;
 - IMSI mod 1000 = 12;
 - FN carrier 1 = FN carrier 2-21, for simultaneously transmitted frames.
- f) For an E-GSM MS, the SI3 message on carrier 2 indicates that SI2ter is used on carrier 2. SI2ter message contains the ARFCN of carrier 3 and ARFCNs 45, 76, 891, 905. The ARFCN of carrier 3 is transmitted neither in the SI2 nor in the SI2bis messages on carriers 1 and 2.

20.5.4.2 Test Procedure

- a) The SS activates the channels. The MS is not paged on carrier 1.
- b) The MS is switched on.
- c) After 50 s, the SS increases the level of carrier 2 to 42 dB μ Vemf().
- d) For an E-GSM MS only, when the SS receives a response on carrier 2, the SS stops paging on that carrier and after 30 s, the SS increases the level of carrier 3 to 60 dB μ Vemf().

20.5.5 Test Requirements

- 1) After step b), there shall be no response from the MS on carrier 2. For an E-GSM MS there shall also be no response on carrier 3.
- 2) After increasing the level of carrier 2 in step c), the MS shall respond on carrier 2 within 20 s.
- 3) After increasing the level of carrier 3 in step d), an E-GSM mobile shall respond on carrier 3 within 20 s.

20.6 Cell reselection timings

20.6.1 Definition

void

20.6.2 Conformance requirement

1. At least every 5 s the MS shall calculate the value of C1 and C2 for the serving cell and recalculate C1 and C2 values for non serving cells (if necessary). The MS shall then check whether:
 - 1.1 ii) The calculated value of C2 for a non-serving suitable cell exceeds the value of C2 for the serving cell for a period of 5 s.
 - 1.2 Cell reselection for any other reason (see 3GPP TS 03.22) shall take place immediately, but the cell that the MS was camped on shall not be returned to within 5 s if another suitable cell can be found.

3GPP TS 05.08, subclause 6.6.2.

20.6.3 Test purpose

1. To verify that:
 - 1.1 The MS does not perform a cell reselection when the C2 value for a non serving cell does not exceed the C2 value of the serving cell for a period of at least 5 s.
 - 1.2 When the MS performs an immediate cell reselection due to an unsuccessful random access attempt, the cell that the MS was camped onto is not returned to within 5 s when another suitable cell exists.

20.6.4 Method of test

20.6.4.1 Initial conditions

Parameters changed from the default values in table 20.1.

Parameter	Carrier 1	Carrier 2	Carrier 3	Carrier 4	Carrier 5	Carrier
RF Signal Level (dB μ V emf() / dBm)	56 / -57	46 / -67	OFF	OFF	OFF	OFF
RXLEV_ACCESS_MIN (dB μ V emf() / dBm)	29 / -84	33 / -80				
Max. Retrans	00	00				
C1	27	13				
C2	27	13				

Below is an alternative table of parameters for use with test equipment that cannot reach the upper RF levels as specified in the table above. These carrier levels are reduced by 5 dB and will not effect the purpose of the test case.

Parameter	Carrier 1	Carrier 2	Carrier 3	Carrier 4	Carrier 5	Carrier
RF Signal Level (dB μ V emf() / dBm)	51 / -62	41 / -72	OFF	OFF	OFF	OFF
RXLEV_ACCESS_MIN (dB μ V emf() / dBm)	24 / -89	28 / -85				
Max. Retrans	00	00				
C1	27	13				
C2	27	13				

The BA(BCCH) list only contains 5 ARFCNs including the ARFCNs of the carriers used during the test.

NOTE: With 5 ARFCNs in the BA(BCCH) list and BS_PA_MFRMS=5 (default value) the MS will maintain a running average on surrounding cells over a period of 5 s.

20.6.4.2 Procedure

- a) The SS activates the channels. The MS is not paged on any of the carriers.
- b) The MS is switched on.
- c) After 50 s, the SS starts paging continuously on carriers 1 and 2 for 20 s. The SS monitors carriers 1 and 2 for RA requests from the MS.
- d) The SS stops paging on carriers 1 and 2 and waits for 20 s. (The MS should revert to carrier 1 due to cell reselection.)
- e) The SS starts paging continuously on carrier 2.
- f) The SS increases the transmit level of carrier 2 by 20 dB for a period of 4 s and then reduces the level back to the original value.
- g) The SS increases the transmit level of carrier 2 by 20 dB and waits for the MS to access on carrier 2.

20.6.5 Test requirements

- 1) In step c), the MS shall transmit 2 RA requests on carrier 1 followed by 2 RA requests on carrier 2. Subsequent RA requests on either carrier shall not occur within 4,5 s of the second RA request on that carrier.
- 2) In step f), there shall be no access on carrier 2 within 34 seconds of increasing the level of carrier 2.
- 3) After step g), the MS shall respond on carrier 2.

20.7 Priority of cells

20.7.1 Definition

In general, cell prioritization is a means of encouraging MSs to select some suitable cells in preference to others.

20.7.2 Conformance requirement

1. During cell selection a cell with low priority indication will only be selected if a suitable cell of normal priority cannot be found; 3GPP TS 03.22, subclause 3.5.2.1.
- 2.

Table 1a: Parameters affecting cell priority for cell selection

CELL_BAR_QUALIFY	CELL_BAR_ACCESS	Cell selection priority	Status for cell reselection
0	0	normal	normal
0	1	barred	barred
1	0	low	normal (see note 2)
1	1	low	normal (see note 2)

3GPP TS 05.08, table 1.a.

3. If all the following conditions are met then the "Cell selection priority" and the "Status for cell reselection" shall be set to normal:
 - the cell belongs to the MS HPLMN;
 - the MS is in cell test operation mode;
 - the CELL_BAR_ACCESS is set to "1";
 - the CELL_BAR_QUALIFY is set to "0";
 - the Access Control class 15 is barred.

3GPP TS 05.08, table 1.a.

20.7.3 Test purpose

1. To verify that the MS does not select a cell of low priority when a suitable cell of normal priority exists with a lower received signal strength.
2. To verify that the MS takes into account CELL_BAR_ACCESS and CELL BAR _QUALIFY when performing cell selection and reselection.
3. To verify that the MS meets conformance requirement 3.

20.7.4 Method of test

20.7.4.1 Initial conditions

Parameters changed from Default values table 20.1

Parameter	Carrier 1	Carrier 2	Carrier 3	Carrier 4	Carrier 5	Carrier 6
RF Signal Level (dB μ V emf() / dBm)	33 / -80	43 / -70	33 / -80	23 / -90	OFF	OFF
RXLEV_ACCESS_MIN (dB μ V emf() / dBm)	3 / -110	23 / -90	13 / -100	13 / -100		
CBA	0	1	1	0		
CBQ	1	1	0	0		
Access class 15	barred	barred	barred	barred		
C1	30	20	20	10		

20.7.4.2 Procedure

- a) The SS activates the carriers and monitors for RA requests from the MS on carriers 1, 2, and 4.
- b) The MS is switched on.
- c) The MS is switched off. The SS deactivates the carriers.
- d) The MS is placed in cell test operation mode.

NOTE: Cell test mode is a mode of operation defined in SIM administrative data field.

- e) The SS activates the carriers and monitors for RA requests from the MS on carriers 1, 2, and 3.
- f) The MS is switched on.

20.7.5 Test requirements

- 1) After step b), the first response from the MS shall be on carrier 4 within 33 s, followed by a response on carrier 1 before a response (if any) on carrier 2 within 50 s.
- 2) After step f), the first response from the MS shall be on carrier 3 within 33 s, followed by a response on carrier 1 before a response (if any) on carrier 2 within 50 s.

20.8 Cell reselection when C1 (serving cell) < 0 for 5 s

20.8.1 Definition

void

20.8.2 Conformance requirement

1. At least every 5 s the MS shall calculate the value of C1 and C2 for the serving cell and recalculate C1 and C2 values for non serving cells (if necessary). The MS shall then check whether:
 - i) The path loss criterion (C1) for current serving cell falls below zero for a period of 5 s. This indicates that the path loss to the cell has become too high. 3GPP TS 05.08, subclause 6.6.2.

2. While camped on a cell of the selected PLMN ("camped normally"), the MS may need to select a different cell ("normal cell reselection" state). The following events trigger a cell reselection:
 - (i) The path loss criterion parameter C1 (see subclause 3.6) indicates that the path loss to the cell has become too high. 3GPP TS 03.22, subclause 4.5.

20.8.3 Test purpose

1. To verify that the MS meets conformance requirement 1.
2. To verify that the MS meets conformance requirement 2.

20.8.4 Method of test

20.8.4.1 Initial conditions

Parameters changed from Default values table 20.1.

Parameter	Carrier 1	Carrier 2	Carrier 3	Carrier 4	Carrier 5	Carrier 6
RF Signal Level (dB μ V emf() / dBm)	63 / -50	33 / -80	OFF	OFF	OFF	OFF
RXLEV_ACCESS_MIN (dB μ V emf() / dBm)	43 / -70	23 / -90				
CRO	30 dB					
TO	0					
PT	0					
C1	20	10				
C2	50	10				

NOTE: With BS_PA_MFRMS = 5 (default value), the averaging time of the MS on the serving cell BCCH is 5,9 s.

20.8.4.2 Procedure

- a) The SS activates the carriers. The MS is not paged on carrier 1. The SS monitors carriers 1 and 2 for RA requests from the MS.
- b) The MS is switched on.
- c) The SS reduces signal level on carrier 1 to -80 dBm / 33 dB μ V emf() for 4 s. Then, the SS raises the level back to -50 dBm / 63 dB μ V emf(). (C1 becomes -10 dB and C2, 20 dB during this period).
- d) The SS reduces signal level on carrier 1 to -80 dBm / 33 dB μ V emf()

20.8.5 Test requirements

- 1) After step b), there shall be no access on carrier 1 or carrier 2, within 50 s.
- 2) After step c), there shall be no access on carrier 2 within 30 s.
- 3) After step d), the MS shall access on carrier 2 within 20 s.

20.9 Running average of the surrounding cell BCCH carrier signal levels

20.9.1 Definition

void

20.9.2 Conformance requirement

1. Whilst in idle mode an MS shall continue to monitor all BCCH carriers as indicated by the BCCH allocation (BA - See table 1). A running average of received signal level (RLA_C) in the preceding 5 to:

$$- \text{Max. } \{5, ((5 \times N + 6) \text{ DIV } 7) * \text{BS_PA_MFRMS} / 4\};$$

seconds shall be maintained for each carrier in the BCCH allocation. N is the number of non-serving cell BCCH carriers in BA and the parameter BS_PA_MFRMS is defined in 3GPP TS 45.002; 3GPP TS 45.008, subclause 6.6.1.

2. The same number of measurement samples shall be taken for all non-serving cell BCCH carriers of the BA list, and the samples allocated to each carrier shall as far as possible be uniformly distributed over each evaluation period. 3GPP TS 05.08 / 3GPP TS 45.008, subclause 6.6.1

20.9.3 Test purpose

1. To verify that if the MS calculates a received level average (over 5 s) for a non-serving suitable cell which results in the value of C2 exceeding the value of C2 for the serving cell, then cell reselection takes place to the non-serving cell.
2. To verify that by using suitable varying levels of signal strength for non serving cells, the MS samples on non serving cell BCCH carriers are as far as possible distributed uniformly over each evaluation period.

20.9.4 Method of test

20.9.4.1 Initial conditions

Parameters changed from Default values table 20.1.

Parameter	Carrier 1	Carrier 2	Carrier 3	Carrier 4	Carrier 5	Carrier 6
RF Signal Level (dBμV emf() / dBm)	53 / -60	33 / -80	OFF	OFF	OFF	OFF
RXLEV_ACCESS_MIN (dBμV emf() / dBm)	23 / -90	23 / -90				
C1	30	10				
C2	30	10				

BS_PA_MFRMS is set to 4 for this test.

The BA(BCCH) list only contains 7 ARFCNs including the ARFCNs of the carriers used during the test.

NOTE: With 7 ARFCNs in the BA(BCCH) list and BS_PA_MFRMS=4 the MS will maintain a running average on surrounding cells over a period of 5 s.

20.9.4.2 Procedure

- a) The SS activates the carriers. The MS is not paged on carrier 1. The SS monitors carriers 1 and 2.
- b) The MS is switched on.
- c) The SS starts switching the level of carrier 2 between -80 dBm and -57 dBm every 2,7 s and continues to do so until the end of the test.
- d) The SS decreases the level of carrier 1 to -76 dBm.

NOTE: As a result of the switching in levels, the running average on carrier 2 will be between -66 dBm and -71dBm, assuming that samples are distributed over five consecutive paging blocks.

20.9.5 Test requirements

- 1) After step b), there shall be no access from the MS on carrier 1 or carrier 2, within 50 s.
- 2) After step c), there shall be no access from the MS on carrier 1 or 2 within 25 s.

NOTE: Any potential access on is likely to occur within 20 s.

- 3) After step d), the MS shall access on carrier 2 within 20 s.

20.10 Running average of the serving cell BCCH carrier signal level

20.10.1 Definition

The MS is required to monitor continuously the BCCH carrier signal level of the serving cell (and to compare it to the BCCH carrier signal levels of the non-serving cells) to guarantee that it is camped on the most suitable cell.

20.10.2 Conformance requirement

1. For the serving cell, receive level measurement samples shall be taken at least for each paging block of the MS. The RLA_C shall be a running average determined using samples collected over a period of 5 s to Max {5s, five consecutive paging blocks of that MS}. New sets of RLA_C values shall be calculated as often as possible.; 3GPP TS 45.008, subclause 6.6.1.

20.10.3 Test purpose

1. To verify that by using suitable varying levels of signal strength for the serving cell, the MS performs a running average over 5 consecutive paging blocks.

20.10.4 Method of test

20.10.4.1 Initial conditions

Parameters changed from Default values table 20.1.

Parameter	Carrier 1	Carrier 2	Carrier 3	Carrier 4	Carrier 5	Carrier 6
RF signal level (dB μ V emf() / dBm)	63 / -50	39 / -74	OFF	OFF	OFF	OFF
RXLEV_ACCESS_MIN (dB μ V emf() / dBm)	23 / -90	23 / -90				
C1	40	16				
C2	40	16				

NOTE: With BS_PA_MFRMS = 5 (default value), the averaging time of the MS on the serving cell BCCH is 5,9 s.

20.10.4.2 Procedure

- a) The SS activates the carriers. The MS is not paged on carrier 1. The SS monitors carriers 1 and 2 for RA requests from the MS.
- b) The MS is switched on.
- c) After 50 s the SS starts switching the level of carrier 1 between -80 dBm and -50 dBm every 3 s.

NOTE: As a result of the switching in levels, the running average on carrier 1 will be between -62 dBm and -68 dBm over five consecutive paging blocks.

- d) The SS increases the level of carrier 2 to -56 dBm.

20.10.5 Test requirement

- 1) After step c), the MS shall not access on carrier 2, within 25 s.
- 2) After step d), the MS shall access on carrier 2, within 30 s.

NOTE: 13,75 s to perform running average, 10 s to detect C2 differences, 2,4 s to read BCCH of carrier 2, 1 s to perform RA. Total 27,15 s, allow 30 s.

20.11 Updating the list of six strongest neighbour carriers and decoding the BCCH information of a new carrier on the list

20.11.1 Definition

void

20.11.2 Conformance requirement

1. The list of the 6 strongest non-serving carriers shall be updated at least as often as the duration of the running average defined for measurements on the BCCH allocation and may be updated more frequently; 3GPP TS 05.08, subclause 6.6.1.
2. When the MS recognizes that a new BCCH carrier has become one of the 6 strongest, the BCCH data shall be decoded for the new carrier within 30 s; 3GPP TS 05.08, subclause 6.6.1.

20.11.3 Test purpose

1. To verify that MS meets conformance requirement 1.
2. To verify that MS meets conformance requirement 2.

20.11.4 Method of test

20.11.4.1 Initial conditions

Six BCCH carriers are established with the system information contents of table 20.1.

Parameters changed from Default values table 20.1.

Parameter	Carrier 1	Carrier 2	Carrier 3	Carrier 4	Carrier 5	Carrier 6	Carrier 7
RF signal level (dB μ V emf ()/dBm)	53 / -60	48 / -65	43 / -70	38 / -75	33 / -80	33 / -80	38 / -75
RXLEV_ACCESS_MIN	-90	-90	-90	-90	-90	-90	-110
C1	30	25	20	15	10	10	35
C2	30	25	20	15	10	10	35

The BA(BCCH) list contains only eight ARFCNs and includes those of carriers 1 to 7.

BS_PA_MFRMS is set to 3 during this test.

NOTE: The combination of 8 carriers on the BA list and BS_PA_MFRMS = 3 leads to averaging time of 5 s. Hence 5 s is also the updating time of the list of six strongest neighbour carriers.

20.11.4.2 Procedure

- a) The SS activates carriers 1 to 6. The MS is not paged on any of the carriers.
- b) The MS is switched on.
- c) After 60 s, the SS activates carrier 7 and pages the MS continuously on this carrier. The SS monitors carrier 7 for RA requests from the MS.

20.11.5 Test requirements

- 1) The MS shall access on carrier 7 within 55 s of activating carrier 7.

NOTE: 5,5 s to notice new strongest carrier in top 6 (because the updating time for six strongest is 5 s (+10 %)), 33 s to read BCCH, 15 s for reselection, since the MS has already performed the running average on the new strongest carrier, allow 55 s.

20.12 Decoding the BCCH information of the neighbour carriers on the list of six strongest neighbour carriers

20.12.1 Definition

void

20.12.2 Conformance requirement

1. The MS shall attempt to decode the BCCH data block that contains the parameters affecting cell reselection for each of the 6 strongest non-serving cell BCCH carriers at least every 5 minutes; 3GPP TS 05.08, subclause 6.6.1.

NOTE: Verification of cell reselection as implicitly tested here is performed in subclause 20.3.

20.12.3 Test purpose

1. To verify that the MS decodes the BCCH data block that contains the parameters affecting cell reselection for a non-serving cell BCCH carrier, (which is in the list of six strongest neighbour cells), at least every 5 minutes. This is achieved by changing the BCCH data such that the value of C2 for the non serving cell exceeds the value of C2 for the serving cell, and observing that the MS performs cell reselection within 5 minutes plus the time allowed for cell reselection after the change of the BCCH data.

20.12.4 Method of test

20.12.4.1 Initial conditions

Parameters changed from Default values table 20.1.

Parameter	Carrier 1	Carrier 2	Carrier 3	Carrier 4	Carrier 5	Carrier 6
RF signal level (dB μ V emf() / dBm)	38 / -75	33 / -80	OFF	OFF	OFF	OFF
C1	15	10				
C2	15	10				

20.12.4.2 Procedure

- a) The SS activates the carriers. The MS is not paged on carrier 1. The SS monitors carriers 1 and 2.
- b) The MS is switched on.
- c) The SS changes the RXLEV_ACCESS_MIN in the BCCH data of carrier 2 to be -100 dBm.

NOTE: With the above change the C2 of carrier 2 becomes 20 whereas the C2 of carrier 1 stays at 15.

20.12.5 Test requirements

- 1) After step b), there shall be no access from the MS on carrier 1 or carrier 2 within 50 s.
- 2) After step c), the MS shall access on carrier 2 within 345 s of the change in the BCCH data of carrier 2.

NOTE: 330 s for decode of BCCH of carrier 2 (300 s +10 %), 15 s for reselection of carrier 2, since the MS already has a running average on carrier 2.

20.13 Decoding the BSIC of the neighbour carriers on the list of six strongest neighbour carriers

20.13.1 Definition

-20.13.2 Conformance requirement

1. The MS shall attempt to check the BSIC for each of the 6 strongest non-serving cell BCCH carriers at least every 30 s, to confirm that it is monitoring the same cell. If a change of BSIC is detected then the carrier shall be treated as a new carrier and the BCCH data redetermined; 3GPP TS 05.08, subclause 6.6.1.

NOTE: Verification of cell reselection as implicitly tested here is performed in subclause 20.3.

20.13.3 Test purpose

1. To verify that the MS will check the BSIC of the non-serving cell, which is in the list of six strongest neighbour cells, by changing the BSIC and the BCCH data of the non-serving cell such that the value of C2 for that cell exceeds the value of C2 of the serving cell, and observing that the MS performs cell reselection within the time allowed to check the BSIC, redetermine the BCCH data and perform cell reselection.

20.13.4 Method of test

20.13.4.1 Initial conditions

Parameters changed from Default values table 20.1.

Parameter	Carrier 1	Carrier 2	Carrier 3	Carrier 4	Carrier 5	Carrier 6
RF signal level (dB μ V emf() / dBm)	38 / -75	33 / -80	OFF	OFF	OFF	OFF
C1	15	10				
C2	15	10				

20.13.4.2 Procedure

- a) The SS activates the carriers. The MS is not paged on carrier 1. The SS monitors carriers 1 and 2.
- b) The MS is switched on.
- c) The SS changes the BSIC of carrier 2 by changing the Base Station Colour Code (BCC) part of the BSIC. The SS also changes the RXLEV_ACCESS_MIN in the BCCH data of carrier 2 to be -100 dBm.

NOTE: With the above change to the BCCH data the C2 of carrier 2 becomes 20 whereas the C2 of carrier 1 stays at 15.

20.13.5 Test requirements

- 1) In step b), there shall be no access from the MS on carrier 1 or carrier 2 within 50 s.
- 2) After step c), the MS shall access on carrier 2 within 85 s of the change in the BSIC value (and BCCH data) of carrier 2.

NOTE: 33 s for check of BSIC on carrier 2, 33 s for decode of BCCH of carrier 2, 15 s for reselection of carrier 2, since the MS already has a running average on carrier 2, allow 85 s.

20.14 Emergency calls

20.14.1 Definition

-

20.14.2 Conformance requirement

1. In this mode, only emergency calls may be made

3GPP TS 45.008, subclause 6.8.

2. When in the limited service state (see 3GPP TS 43.022) the aim is to gain normal service rapidly and the following tasks shall be performed, depending on the conditions, as given in the table below:

- a) The MS shall monitor the received signal level of all RF channels within its bands of operation, and search for a BCCH carrier which has $C1 > 0$ and which is not barred. When such a carrier is found, the MS shall camp on that cell, irrespective of the PLMN identity.

3GPP TS 45.008, subclause 6.8.

3. c) The MS shall perform cell reselection at least among the cells of the PLMN of the cell on which the MS has camped, according to the algorithm of 3GPP TS 43.022, except that a zero value of CELL_RESELECT_HYSTERESIS shall be used.

3GPP TS 45.008, subclause 6.8.

20.14.3 Test purpose

- To verify that the MS shall be able to initiate emergency calls when no suitable cells of the selected PLMN are available, but at least one acceptable cell is available.
- To verify that the MS selects a cell with $C1 > 0$ and $CBA = 0$ when no suitable cells of the selected PLMN are available.
- To verify that the MS, when performing cell reselection in the limited service state, uses $CELL_RESELECT_HYSTERESIS = 0$.

20.14.4 Method of test

20.14.4.1 Initial conditions

Parameters changed from Default values table 20.1.

Parameter	Carrier 1	Carrier 2	Carrier 3	Carrier 4	Carrier 5	Carrier 6
RF signal level (dB μ V emf) / dBm)	38 / -75	33 / -80	33 / -80	OFF	OFF	OFF
RXLEV_ACCESS_MIN (dB μ V emf) / dBm)	23 / -90	43 / -70	23 / -90			
CELL_BAR_ACCESS MCC,MNC	1 (barred) forbidden	0 forbidden	0 forbidden			
CELL_RESELECT_HYST	0	0	14 dB			
C1	15	-10	10			

NOTE: All the BCCH carriers belong to the same PLMN, which is not the MS's home PLMN and is in the SIM's forbidden PLMN's list.

20.14.4.2 Procedure

- The SS activates the carriers. The SS monitors for RA attempts from the MS on carriers 1, 2 and 3 for the duration of the test. In order to prevent the MS from answering to paging only idle-paging is sent on all channels.
- The MS is switched on.
- 50 s after switch on, an emergency call is initiated on the MS.
- The SS changes the CBA of carrier 1 to 0.

NOTE 1: The MS should reselect to carrier 1 because it should not take into account the CELL_RESELECT_HYST value of 14 but use 0 instead.

- After 345 s an emergency call is initiated on the MS.

NOTE 2: 330 s to detect change of BCCH data, 15 s to perform reselection of carrier 1, since the MS already has a running average on carrier 1.

20.14.5 Test requirements

- 1) In step c), the first access by the MS shall be on carrier 3.
- 2) In step e), the first access from the MS shall be on carrier 1.

20.15 Cell reselection due to MS rejection "LA not allowed"

20.15.1 Definition

While camped on a cell of the selected PLMN the MS may need to select a different cell in order to fulfil the normal service state. This ensures that the MS is camped on a cell from which it can reliably decode downlink data and with which it has a high probability of communications on the uplink.

This process goes on while camping on a cell which pertains to an LA which is placed in the list of "forbidden LAIs for regional provision of service".

20.15.2 Conformance requirement

1. In response to a registration attempt, when receiving an LU reject with cause value "LA not allowed", the MS stores this LAI in a list of "forbidden LAIs for regional provision of service", to prevent repeated attempts to access a cell of the forbidden LA, 3GPP TS 03.22, subclause 3.3.
2. If the MS has received the cause 'LA not allowed', it shall ignore this fact when selecting a cell to camp on, i.e. it shall not reject a cell for camping on because that cell is part of a LA where this cause has been received, 3GPP TS 03.22, subclause 3.5.4.
3. In response to a registration attempt, when receiving an LU reject with cause value "LA not allowed", the MS continues to perform normal cell-reselection, 3GPP TS 03.22, subclause 4.4.2
4. A new LU attempt shall only be performed when a new LA (or new PLMN) is entered according to the cell reselection procedure, 3GPP TS 03.22, subclause 3.3 and figure 4.

NOTE: LA stands for "Location Area" and LU stands for "Location Update".

20.15.3 Test purpose

1. To verify that if an LU is rejected with cause "LA not allowed" that the LAI of that cell is written into a forbidden list which prevents the MS from performing LU onto another cell in that LA. This is verified indirectly in test purposes 2,3 and 4.
2. To verify that the MS will not reject a cell for camping on because that cell is part of a LA in the list of "forbidden LAIs for regional provision of service". This is verified indirectly by making the MS attempt an emergency call and checking that the channel request message is transmitted on the correct cell.
3. To verify that the MS when receiving an LU reject with cause value "LA not allowed", the MS continues to perform normal cell-reselection:

Cell reselection is triggered if there is a better cell (in terms of the path loss criterion C2) in the same LA, or a much better cell in another LA of the selected PLMN (using the CRH parameter). 3GPP TS 03.22, subclauses 3.4 and 4.5.

4. To verify that a new LU attempt will be performed when a new LA (or new PLMN) is entered, 3GPP TS 03.22, subclause 3.3 and figure 4.

20.15.4 Method of test

20.15.4.1 Initial conditions

Parameters changed from Default values table 20.1.

Parameter	Carrier 1	Carrier 2	Carrier 3	Carrier 4	Carrier 5	Carrier 6
RF Signal Level (dB μ V emf() / dBm)	63 / -50	54 / -59	44 / -69	OFF	OFF	OFF
RXLEV_ACCESS_MIN (dB μ V emf() / dBm)	53 / -60	35 / -78	29 / -84			
CRH	14	0	10			
LAC	H1111	H2222	H1111			
ATT	1	1	1			
C1	10	19	15			
C2	10	19	15			

20.15.4.2 Procedure

- The SS activates the carriers. The SS monitors all RA requests from MS on carriers 1, 2 and 3 until step e) has been completed. Only idle-paging is sent on all channels.
- The MS is switched on.
- When the MS performs an IMSI attach onto carrier 1, the SS shall reject it with cause "LA not allowed".
- 30 s after the MS has returned to idle mode (channel release after LU reject), the MS is manually commanded to set up an emergency call.

NOTE 1: C2 of carrier 3 > C2 of carrier 1. Carriers 1 and 3 belong to the same LA.

- The SS rejects the CM service request from the MS, with a CM service reject message with cause value #17 (Network Failure).

NOTE 2: Cause values #4 (IMSI unknown in VLR) or #6 (Illegal ME) lead to unwanted behaviour of the mobile.

- 10 s after the MS has returned to idle mode (channel release after CM service reject), the SS increases the level of carrier 2 to 65 dB μ V emf().

NOTE 3: C2 of carrier 2 = 30, now larger than C2 of carrier 3 + CRH.

- The SS shall accept any LU on carrier 2.

20.15.5 Test requirements

- After step b), the MS shall respond on carrier 1 within 33 s.
- In step d), the MS shall access on carrier 3 with a channel request message, within 15 s of being commanded to set up the emergency call.
- After increasing the level of carrier 2 in step f), the MS shall reselect and access onto carrier 2 requesting an LU within 30 s.

NOTE: 13,75 s to perform running average, 10 s to detect C2 differences, 2,4 s to read BCCH of carrier 2, 1 s to perform RA. Total 27,15 s, allow 30 s.

20.16 Downlink signalling failure

20.16.1 Definition

See conformance requirement.

20.16.2 Conformance requirement

The downlink signalling failure criterion is based on the downlink signalling failure counter DSC.

- When the MS camps on a cell, DSC shall be initialized to a value equal to the nearest integer to 90/N where N is the BS_PA_MFRMS parameter for that cell (see 3GPP TS 05.02).
- Thereafter, whenever the MS attempts to decode a message in its paging subchannel; if a message is successfully decoded DSC is increased by 1, (however never beyond the nearest integer to 90/N).

3. Whenever the MS can not successfully decode a message in its paging subchannel the DSC is decreased by 4.
4. When DSC reaches 0, a downlink signalling failure shall be declared. A downlink signalling failure shall result in cell reselection, 3GPP TS 03.22, subclause 4.5 (ii) and 3GPP TS 05.08, subclause 6.5.

NOTE: The network sends the paging subchannel for a given MS every BS_PA_MFRMS multiframes. The requirement for network transmission on the paging subchannel is specified in 3GPP TS 04.08 / 3GPP TS 44.018. The MS is required to attempt to decode a message every time its paging subchannel is sent.

20.16.3 Test purpose

1. To verify that the MS initializes the DSC counter in accordance with the conformance requirement. This is verified indirectly.
2. To verify that whenever the MS successfully decodes a message on paging subchannel, the DSC is increased by 1, (however never beyond the nearest integer to $90/N$). This is verified indirectly.
3. To verify that whenever the MS can not successfully decode a message on paging subchannel, the DSC decreased by 4. This is verified indirectly.
4. To verify that when the DSC reaches 0, a downlink signalling failure shall be declared and the MS will perform cell reselection.

20.16.4 Method of test

20.16.4.1 Initial conditions

Two BCCH carriers are established with the system information contents of table 20.1.

Parameters changed from Default values table 20.1.

Parameter	Carrier 1	Carrier 2	Carrier 3	Carrier 4	Carrier 5	Carrier 6
RF signal level (dB μ V emf() / dBm)	43 / -70	33 / -80	OFF	OFF	OFF	OFF
C1 = C2	20	10				

NOTE: The DSC counter will have a value 18 (90/5).

20.16.4.2 Procedure

- a) The MS is switched on. On carrier 1 valid layer 3 messages shall be sent in the paging blocks, but not paging the MS (idle paging). On carrier 2 the MS is paged continuously in all paging blocks.
- b) After 40 s the SS sends corrupted data (using random data, wrong parity bits see 3GPP TS 05.03, subclauses 4.3 and 4.1.2 or other lower layer error) in four successive paging blocks to carrier 1 and then reverts to sending normal data.

NOTE 1: Sending corrupted, i.e. non-decodable data on four successive paging blocks should decrease the DSC to 2.

- c) The SS monitors all accesses on both carriers for 30 s.
- d) The SS sends corrupted data in five successive paging blocks to carrier 1 and then reverts to sending normal data.

NOTE 2: Sending random, data on five successive paging blocks should decrease the DSC to < 0 and cause a cell reselection.

- e) The SS monitors all accesses on both carriers for 30 s.

20.16.5 Test requirements

- 1) There shall be no access to carrier 2 in test steps a) and c).
- 2) The MS shall access on carrier 2 at test step e) within 15 s.

20.17 Cell selection if no suitable cell found in 10 s

20.17.1 Definition

See conformance requirement.

20.17.2 Conformance requirement

If no suitable cell is found in cell reselection process within 10 s, the cell selection algorithm of 3GPP TS 03.22 shall be performed, 3GPP TS 05.08, subclause 6.6.2.

20.17.3 Test purpose

To verify that the MS fulfils the conformance requirement.

20.17.4 Method of test

20.17.4.1 Initial conditions

One BCCH carrier is established with the system information contents of table 20.1.

Parameters changed from Default values table 20.1.

Parameter	Carrier 1	Carrier 2	Carrier 3	Carrier 4	Carrier 5	Carrier 6
RF signal level (dB μ V emf() / dBm)	43 / -70	OFF	OFF	OFF	OFF	OFF
C1 = C2	20					

20.17.4.2 Procedure

- a) The MS is switched on. Idle paging is sent on carrier 1.
- b) After the MS indicates service the SS reduces the transmit level of carrier 1 to 13 dB μ V emf() (so that C1 of carrier 1 becomes -10) and turns on a new carrier (carrier 2) at a level of 33 dB μ V emf(). Carrier 2 shall not be in the MS BA list (i.e. it shall not be one of the carriers that MS has been monitoring after camped on carrier 1).
- c) The SS shall monitor all accesses on carriers 1 and 2 for 60 s.

NOTE: The access on carrier 2 should not take longer than 50 s. (5 s to rxlev averages, 5 s for C1 < 0 duration, 10 s for searching another suitable cell, 30 s for cell selection), 60 s is a safe time to wait.

20.17.5 Test requirements

The MS shall access on carrier 2 at test step c) within 60 s.

20.18 Cell reselection due to MS rejection "Roaming not allowed in this LA"

20.18.1 Definition

While camped on a cell of the selected PLMN the MS may need to select a different cell in order to fulfil the normal service state. This ensures that the MS is camped on a cell from which it can reliably decode downlink data and with which it has a high probability of communications on the uplink.

The MS looks for suitable neighbour cells which satisfies 4 constraints including that It should not be in an LA which is in the list of "forbidden LAs for roaming".

20.18.2 Conformance requirement

1. To prevent repeated attempts to have roaming service on a not allowed LA, when the MS is informed that an LA is forbidden, the LA is added to a list of "forbidden LAs for roaming" which is stored in the MS, 3GPP TS 03.22; subclause 3.1.
2. If the MS has received the cause "Roaming not allowed in this LA", in response to a LU attempt, the Network Selection Procedure shall be started, 3GPP TS 03.22; subclause 4.3.3 L3, 3GPP TS 04.08 / 3GPP TS 24.008, subclause 4.4.4.7.
3. The MS can only perform camping on a suitable cell, which:
 - should not be in an LA which is in the list of "forbidden LAs for roaming" 3GPP TS 03.22, subclause 3.2.1.

NOTE: LA stands for "Location Area" and LU stands for "Location Update".

20.18.3 Test purpose

1. To verify that if an LU is rejected with cause "Roaming not allowed in this LA", that the LAI of that cell is written into a forbidden list which prevents the MS from camping onto any cell in that LA.
2. To verify that if the MS has received the cause "Roaming not allowed in this LA", in response to a LU attempt, the Network Selection Procedure is initiated. This is verified indirectly by test purpose 3, in that the new LA is accessed as part of cell selection, hence CRH is disregarded.
3. To verify that if an LU is rejected, when attempting LU in a LA with LAI = LAI1, with cause "Roaming not allowed in this LA" and only cells of the selected PLMN are available, the MS will only camp and attempt LU in any LA with LAI <> LAI1.

20.18.4 Method of test

20.18.4.1 Initial conditions

Parameters changed from Default values table 20.1.

Parameter	Carrier 1	Carrier 2	Carrier 3	Carrier 4	Carrier 5	Carrier 6
RF Signal Level (dBμV emf() / dBm)	63 / -50	53 / -60	OFF	OFF	OFF	OFF
RXLEV_ACCESS_MIN (dBμV emf() / dBm)	23 / -90	23 / -90				
MNC	MNC <> HPLMN	MNC <> HPLMN				
MCC	MCC of HPLMN	MCC of HPLMN				
CRH	0	0				
LAC	H1111	H2222				
ATT	1	1				
C1	40	30				
C2	40	30				

20.18.4.2 Procedure

- a) The MS is switched on. Idle paging is sent on all carriers.
- b) The SS monitors all RA requests from MS on carriers 1 and 2.
- c) When the MS performs an IMSI attach onto carrier 1, the SS shall reject it with cause "Roaming not allowed in this LA".
- d) The SS shall accept any LU on carrier 2.
- e) The SS monitors all RA requests from MS on carriers 1 to 2.

20.18.5 Test requirements

- 1) The MS should respond on carrier 1 within 33 s of switch on.
- 2) After LU reject, the MS shall initiate the Network Selection Procedure and access onto Carrier 2 as part of cell selection within 33 s from returning to idle mode after the LU reject.

NOTE: The timing requirement in b) is given only for testing purposes only. No timing requirements are defined for the Network Selection Procedure, but the time allowed for cell selection (see 20.1) should be adequate.

- 3) After the LU reject on carrier 1, there shall be no more access attempts on this carrier.

20.19 Cell selection on release of SDCCH and TCH

20.19.1 Definition

Void.

20.19.2 Conformance requirement

1. When the SS releases a TCH or SDCCH and returns to idle mode, it shall, as quickly as possible camp on the BCCH carrier of the cell whose channel has just been released. If the full BCCH data for that cell was not decoded in the preceding 30 s, the MS shall then attempt to decode the full BCCH data. Until the MS has decoded the BCCH data required for determining the paging group, it shall also monitor all paging blocks on timeslot 0 of the BCCH carrier for possible paging messages that might address it. If the MS receives a page before having decoded the full BCCH data for the cell, the MS shall store the page and respond once the full BCCH data has been decoded, provided that the cell is not barred and the MSs access class is allowed.
3GPP TS 05.08, subclause 6.7.

20.19.3 Test purpose

1. To verify that on release of a TCH or an SDCCH, the MS camps as quickly as possible on the BCCH carrier of the cell whose channel has just been released.

NOTE: This is implicitly tested by the MS responding to a paging request. The decoding of BCCH data cannot be explicitly tested. However, the MS shall monitor for paging messages which may address it if it decodes the BCCH.

20.19.4 Method of test

20.19.4.1 Initial conditions

- a) Parameters changed from default values in table 20.1.

Parameter	Carrier 1	Carrier 2	Carrier 3	Carrier 4	Carrier 5	Carrier 6
RF Signal Level (dBmV emf() / dBm)	53 / -60	33 / -80	OFF	OFF	OFF	OFF
RXLEV_ACCESS_MIN (dBmV emf() / dBm)	23 / -90	23 / -90				
BS_PA_MFRMS	2	2				
ATT	1					
C1	30	10				
C2	30	10				

- b) Carrier 1 is configured to have a combined control channel.
- c) Carrier 2 is configured to have a non combined control channel.

20.19.4.2 Test procedure

- a) The SS activates the carriers. No paging messages are transmitted on carrier 1 or carrier 2.
- b) The MS is switched on.
- c) In response to the MS access for IMSI attach, the SS allocates a combined SDDCH/4, accepts the IMSI attach procedure and then releases the link. After 0,5 s but within 1 second of transmitting the UA frame on completion of the IMSI attach procedure, the SS transmits a single PAGING REQUEST in the appropriate paging block of the MS on carrier 1.
- d) When the MS responds to paging, the SS establishes a call on a traffic channel.
- e) The SS increases the level of carrier 2 to 63 dBmV emf().
- f) After 10 s the SS performs a handover to another TCH, with the parameters of carrier 2 indicated in the CELL DESCRIPTION information element of the HANDOVER COMMAND message.
- g) After a further 10 s, the SS clears down the call. After 0,5 s but within 1 second of transmitting the UA frame, the SS transmits a single PAGING REQUEST on carrier 2 in the appropriate paging block of the MS.

20.19.5 Test requirements

- 1) After step b) the MS shall access in order to commence an IMSI attach procedure on carrier 1 within 33 s.
- 2) In step c), the MS shall respond to paging within 3 seconds of transmitting the PAGING REQUEST.
- 3) In step g), the MS shall respond to paging within 3 seconds of transmitting the PAGING REQUEST.

20.20 Multiband cell selection and reselection

20.20.1 Multiband cell selection and reselection / Cell Selection

20.20.1.1 Definition

Multiband cell selection is a process in which a multiband MS, whenever a new PLMN is selected, attempts to find a suitable cell of that PLMN to camp on, irrespective of frequency band. Two methods of searching for a suitable cell are possible, normal cell selection and stored list cell selection. The process ensures that the MS is camped on a cell from which it can reliably decode downlink data and with which it has a high probability of communications on the uplink. Once the MS is camped on a cell, access to the network is allowed.

20.20.1.2 Conformance requirement

1. The MS shall search all RF channels within its bands of operation, take readings of received RF signal level on each RF channel, and calculate the RLA_C for each. The averaging is based on at least five measurement samples per RF carrier spread over 3 to 5 s, the measurement samples from the different RF carriers being spread evenly during this period.

A multi band MS shall search all channels within its bands of operation as specified above. The number of channels searched will be the sum of channels on each band of operation.

3GPP TS 45.008, subclause 6.2.
2. ... the MS shall be able to select the correct (fourth strongest) cell and be able to respond to paging on that cell within 30 s of switch on, when the three strongest cells are not suitable. This assumes a valid SIM, with PIN disabled and ideal radio conditions; 3GPP TS 05.08, subclause 6.1.
3. There are various requirements that a cell must satisfy before an MS can perform normal camping on it:
 - 3.1 (i) It should be a cell of the selected PLMN
 - 3.2 (ii) It should not be "barred" (see subclause 3.5.1)

3.3 (iv) The radio path loss between MS and BTS must be below a threshold set by the PLMN operator. This is estimated as shown in subclause 3.6.

3GPP TS 03.22, subclause 3.2.1.

NOTE: Criteria (iii) is not applicable for Cell Selection

4. Initially the MS looks for a cell which satisfies these 4 constraints ("suitable cell") by checking cells in descending order of received signal strength. If a suitable cell is found, the MS camps on it; 3GPP TS 03.22, subclause 3.2.1.
5. The MS shall be able to calculate correctly the path loss criterion parameter C1, used for cell selection and reselection; 3GPP TS 05.08, subclause 6.4.

20.20.1.3 Test purpose

1. To verify that the MS meets conformance requirement 1.
2. To verify that the MS meets conformance requirement 2 in a multiband environment.
3. To verify that:
 - 3.1 The MS does not select a cell of a PLMN which is not the selected PLMN.
 - 3.2 The MS does not select a cell which is "barred".
 - 3.3 The MS does not select a cell with $C1 < 0$.
4. To verify that the MS selects suitable cells in descending order of received signal strength, irrespective of frequency band.
5. To verify that the MS does not select a cell with $C1 < 0$.

20.20.1.4 Method of test

20.20.1.4.1 Initial conditions

Parameters changed from the default values in table 20.1.

Parameter	Carrier 1	Carrier 2	Carrier 3	Carrier 4	Carrier 5	Carrier 6
RF Signal Level (dBmV emf() / dBm)	48 / -65	36 / -77	43 / -70	33 / -80	23 / -90	OFF
CBA	1	0	0	0	0	
RXLEV_ACCESS_MIN (dBm)	-90	-69	-90	-88	-98	
MNC			See Table 20.1c		See Table 20.1c	
MCC			002			
MS_TXPWR_MAX_CCH	7	7		7		
C1	25	-8	20	8	8	
C2	25	-8	20	8	8	

Carrier 1, carrier 2 and carrier 4 ARFCNs are chosen in the lower band, carrier 3 and carrier 5 ARFCNs in the higher band.

20.20.1.4.2 Procedure

- a) The SS activates the carriers and monitors carriers 2, 4 and 5 for RA requests from the MS.
- b) The MS is switched on.
- c) The MS is switched off.
- d) The SS monitors carriers 1 and 3 for RA requests from the MS.
- e) The MS is switched on.

- f) The MS is switched off.
- g) The SS is reconfigured and sets MCC of carrier 3 to 001 (same as the other carriers).
- h) The SS activates the carriers and monitors carriers 3, 4 and 5 for RA requests from the MS.
- i) The MS is switched on.
- j) The MS is switched off.
- k) For multiband MS supporting three or more bands all valid combinations of two bands shall be tested using the steps from a) to j). The valid combinations are indicated in sub-clause 26.11.6 Multiband signalling / Default messages contents.

20.20.1.4.3 Specific PICS statement(s)

- Support for stored list cell selection Yes/No (TSPC_AddInfo_StoredListCellSel)

20.20.1.4.4 PIXIT Statements

-

20.20.1.5 Test requirements

- 1) After step b), the first response from the MS shall be on carrier 4 within 33 s. If the MS supports stored list cell selection MS may be also on carrier 5. There shall be no response from the MS on carrier 2.
- 2) After step e), there shall be no response from the MS on either carrier 1 or carrier 3 within 33 s.
- 3) After step i), the first response from the MS shall be on carrier 3 within 33 s. If the MS supports stored list cell selection the first response may be also on carrier 4 or carrier 5.

20.20.2 Multiband cell selection and reselection / Cell reselection

20.20.2.1 Definition

While camped on a cell of the selected PLMN the multiband MS may need to select a different cell (irrespective of frequency band used) in order to fulfil the normal service state. This ensures that the MS is camped on a cell from which it can reliably decode downlink data and with which it has a high probability of communications on the uplink.

20.20.2.2 Conformance requirement

1. The list of the 6 strongest non-serving carriers shall be updated at least as often as the duration of the running average defined for measurements on the BCCH allocation and may be updated more frequently; 3GPP TS 05.08, subclause 6.6.1.
2. When the MS recognizes that a new BCCH carrier has become one of the 6 strongest, the BCCH data shall be decoded for the new carrier within 30 s; 3GPP TS 05.08, subclause 6.6.1.
3. The MS shall be able to calculate correctly the path loss criterion parameter C2 used for cell reselection; 3GPP TS 05.08, subclause 6.4.

20.20.2.3 Test purpose

1. To verify that MS meets conformance requirement 1.
2. To verify that MS meets conformance requirement 2.
3. To verify that the MS calculates the C2 parameter correctly when the CELL_RESELECT_OFFSET, and PENALTY_TIME parameters are used to give different priorities to different frequency bands.

20.20.2.4 Method of test

20.20.2.4.1 Initial conditions

Six BCCH carriers are established with the system information contents of table 20.1.

Parameters changed from Default values table 20.1.

Parameter	Carrier 1	Carrier 2	Carrier 3	Carrier 4	Carrier 5	Carrier 6	Carrier 7
RF signal level (dBmV emf ()/dBm)	53 / -60	48 / -65	43 / -70	38 / -75	33 / -80	33 / -80	43 / -70
RXLEV_ACCESS_MIN (dBm)	-90	-90	-90	-90	-90	-90	-110
PT							11111
CRO							20 dB
MS_TXPWR_MAX_CCH	7	7	7				
C1	30	25	20	15	10	10	40
C2	30	25	20	15	10	10	20

Carrier 1, 2 and 3 ARFCNs are chosen in the lower band, carrier 4, 5, 6 and 7 ARFCNs in the higher band.

The BA(BCCH) list contains only eight ARFCNs and includes those of carriers 1 to 7.

BS_PA_MFRMS is set to 3 during this test.

NOTE: The combination of 8 carriers on the BA list and BS_PA_MFRMS = 3 leads to averaging time of 5 s.
Hence 5 s is also the updating time of the list of six strongest neighbour carriers.

20.20.2.4.2 Procedure

- a) The SS activates carriers 1 to 6. The MS is not paged on any of the carriers.
- b) The MS is switched on.
- c) After 60 s, the SS deactivates carrier 4 and activates carrier 7 and pages the MS continuously on carrier 7. The SS monitors carrier 7 for RA requests from the MS.
- d) The MS is switched off.
- e) The SS is reconfigured and sets PT = 0 and CRO = 0 on carrier 7 (thus increasing C2 to 40 dB).
- f) The SS activates carriers 1 to 6. The MS is not paged on any of the carriers.
- g) The MS is switched on.
- h) After 60 s, the SS deactivates carrier 4 and activates carrier 7 and pages the MS continuously on carrier 7. The SS monitors carrier 7 for RA requests from the MS.
- i) 20 s after receiving an RA request on carrier 7 the SS sets PT = 11111 and CRO = 20 dB on carrier 7 (thus decreasing C2 to 20dB), stops paging on carrier 7, and pages the MS continuously on carrier 1. The SS monitors carrier 1 for RA requests from the MS.
- j) The MS is switched off.
- k) For multiband MS supporting three or more bands all valid combinations of two bands shall be tested using the steps from a) to j). The valid combinations are indicated in sub-clause 26.11.6 Multiband signalling / Default messages contents.

20.20.2.5 Test requirements

- 1) After step c) there shall be no response from the MS on carrier 7 within 55 s of activating carrier 7.
- 2) After step h) the MS shall access on carrier 7 within 55 s of activating carrier 7.

NOTE: 5,5 s to notice new strongest carrier in top 6 (because the updating time for six strongest is 5 s (+10 %)), 33 s to read BCCH, 15 s for reselection, since the MS has already performed the running average on the new strongest carrier, allow 55 s.

- 3) After step i) the MS shall access on carrier 1 within 55 s of setting PT and CRO on carrier 7.

20.21 R-GSM cell selection and reselection

In the following paragraphs some explanatory text is given concerning the nature of the tests in this subclause and the general behaviour of the SS is described.

Since the conformance requirements of most of the tests in this subclause cannot be tested explicitly, testing is done implicitly by testing the MS behaviour from its responses to the SS.

The SS transmits one BCCH carrier per cell as indicated in the initial conditions for each test. These are referred to as carrier 1, carrier 2, etc. It is assumed that the SS can simultaneously transmit seven BCCH carriers and monitor three random access channels. For multiband tests it is assumed that at least one of the BCCH carriers and one of the monitored random access channels is in a different frequency band from the others. In some cases, a test is performed in multiple stages in order that the requirements can be tested within the above constraints.

For any MS all the carriers are in its supported band(s) of operation. For an R-GSM mobile station at least one of the carriers is chosen between ARFCN 955-974 and one of the carriers is in the primary band.

Unless otherwise stated in the method of test, in all of the tests of this subclause:

- The SS is continuously paging the MS on all carriers at the start of the test and does not respond to RACH requests from the MS. Where a test specifies that the MS is not paged on a particular carrier, only idle paging is transmitted according to 3GPP TS 04.08 / 3GPP TS 44.018, subclause 3.2.2.2.
- The default values of the system information data fields given in table 20.21.1 are used.
- The SIM is in the idle updated state in the default location area with a TMSI assigned at the beginning of each test.
- The ARFCNs used for the carriers in each test are chosen from those in table 20.21.1 with adjacent carriers separated by a minimum of three channels.

The absolute accuracy of the MS signal level measurements is assumed to be ± 6 dB. A difference of at least 8 dB is allowed for cases of discrimination between C1 or C2 values and 0.

The relative accuracy of the MS signal level measurements is assumed to be ± 3 dB for the signal levels used in the tests of this subclause, except for subclause 20.20, where the relative accuracy is assumed to be ± 5 dB if the measurements are on different frequency bands. A difference of at least 5 dB is allowed for cases of discrimination between C1 or C2 values on different carriers, except for subclause 20.20, where a difference of at least 10 dB is allowed if the measurements are on different frequency bands.

NOTE 1: The accuracy of MS signal level measurements is specified in 3GPP TS 05.08. For all of the tests in this subclause, the signal levels used are greater than 1 dB above reference sensitivity level.

NOTE 2: The tolerance on timers specified in 3GPP TS 05.08 is ± 10 % except for PENALTY_TIME where it is ± 2 s. In the tests of this subclause, the test requirements include these tolerances. Consequently, the times stated in the test requirement sometimes differ from the corresponding timer in the conformance requirement.

Where pulsed signals are specified, the SS tolerance on pulse width is ± 2 % and the SS tolerance on power level ± 1 dB.

Table 20.21.1: Default values of the system information fields

Parameter	3GPP TS 04.08 / 3GPP TS 44.018 reference	Abbr.	Normal Setting
Cell channel description	10.5.2.1	-	Any values
MAX retrans	10.5.2.29	-	1
TX-integer	10.5.2.29	-	Any value
CELL_BAR_QUALIFY	10.5.2.35	CBQ	0
CELL_BAR_ACCESS	10.5.2.29	CBA	0 (not barred)
AC CN	10.5.2.29	AC	All 0
RE	10.5.2.29	RE	0 (re-establishment allowed)
NCC	10.5.2.2	NCC	Any value
Cell Identity	10.5.1.1	-	Any value
MCC, MNC	10.5.1.3	PLMN	MS Home PLMN
LAC	10.5.1.3	LAC	1111 (Hex)
ATT	10.5.2.11	-	0 (Attach/Detach not allowed)
BS_AG_BLK_RES	10.5.2.11	-	Any values
T3212	10.5.2.11	-	Any values
BS_PA_MFRMS	10.5.2.11	BPM	5 frames
Cell Options	10.5.2.3	-	Any values
CELL_RESELECT_HYSTERESIS	10.5.2.4	CRH	4 dB
MS_TXPWR_MAX_CCH	10.5.2.4	MTMC	Max. output power of MS
RXLEV_ACCESS_MIN	10.5.2.4	RAM	-90 dBm
CELL_RESELECT_OFFSET	10.5.2.35	CRO	0
TEMPORARY_OFFSET	10.5.2.35	TO	0
PENALTY_TIME	10.5.2.35	PT	0
Power Offset	10.5.2.35	PO	0
BA ARFCN	10.5.2.22	BA	All 0 except values in Table 20.21.1a or 20.21.1b

Table 20.21.1a: ARFCNs for Single Band Tests

Band	ARFCNs	broadcast in SYSTEM INFORMATION type
GSM 450	259, 263, 269, 275, 279, 283, 287, 292	SI2
GSM 480	306, 310, 316, 322, 326, 330, 334, 339	SI2
GSM 710	441, 446, 452, 455, 461, 462, 466, 470, 477, 485, 493, 511	SI2
GSM 750	441, 446, 452, 455, 461, 462, 466, 470, 477, 485, 493, 511	SI2
T-GSM 810	441, 446, 452, 455, 461, 462, 466, 470, 477, 485, 493, 511	SI2
GSM 850	130, 136, 145, 152, 168, 170, 176, 177, 181, 185, 189, 193, 197, 207, 219, 251	SI2
GSM 900	both P-GSM and R-GSM ARFCNs are broadcast: GSM: 3, 9, 18, 25, 41, 43, 49, 50, 54, 58, 62, 66, 70, 80, 92, 124 R-GSM: 956, 960, 969, 985, 989, 995, 1010, 1014	SI2 SI2bis
DCS 1800	512, 543, 568, 589, 602, 641, 662, 683, 696, 711, 732, 754, 794, 851, 870, 871, 872, 884	SI2
PCS 1900	512, 543, 568, 589, 602, 629, 641, 653, 662, 683, 696, 711, 727, 732, 754, 777, 794, 809	SI2

Table 20.21.1b: ARFCNs for Multiband Tests

Band	ARFCNs	broadcast in SYSTEM INFORMATION type
GSM 900	3, 18, 41, 49, 62, 70, 92, 124	SI2 (GSM 900 cell) & SI2ter (DCS 1800 cell)
DCS 1800	512, 568, 602, 662, 696, 732, 794, 870	SI2 (DCS 1800 cell) & SI2ter (GSM 900 cell)

20.21.1 R-GSM cell selection

20.21.1.1 Definition

Cell selection is a process in which a MS, whenever a new PLMN is selected, attempts to find a suitable cell of that PLMN to camp on. Two methods of searching for a suitable cell are possible, normal cell selection and stored list cell selection. The process ensures that the MS is camped on a cell from which it can reliably decode downlink data and with which it has a high probability of communications on the uplink. Once the MS is camped on a cell, access to the network is allowed.

20.21.1.2 Conformance requirement

1. ... the MS shall be able to select the correct (fourth strongest) cell and be able to respond to paging on that cell within 30 s of switch on, when the three strongest cells are not suitable. This assumes a valid SIM, with PIN disabled and ideal radio conditions; 3GPP TS 05.08, subclause 6.1.
2. There are various requirements that a cell must satisfy before an MS can perform normal camping on it:
 - 2.1 (i) It should be a cell of the selected PLMN.
 - 2.2 (ii) It should not be "barred" (see subclause 3.5.1).
 - 2.3 (iv) The radio path loss between MS and BTS must be below a threshold set by the PLMN operator. This is estimated as shown in subclause 3.6.

3GPP TS 03.22, subclause 3.2.1.

NOTE: Criteria (iii) is not applicable for Cell Selection.

3. Initially the MS looks for a cell which satisfies these 4 constraints ("suitable cell") by checking cells in descending order of received signal strength. If a suitable cell is found, the MS camps on it; 3GPP TS 03.22, subclause 3.2.1.
4. The MS shall be able to calculate correctly the path loss criterion parameter C1, used for cell selection and reselection; 3GPP TS 05.08, subclause 6.4.

20.21.1.3 Test purpose

1. To verify that the MS meets conformance requirement 1.
2. To verify that:
 - 2.1 The MS does not select a cell of a PLMN which is not the selected PLMN.
 - 2.2 The MS does not select a cell which is "barred".
 - 2.3 The MS does not select a cell with $C1 < 0$.
3. To verify that the MS selects suitable cells in descending order of received signal strength.
4. To verify that the MS does not select a cell with $C1 < 0$.

20.21.1.4 Method of test

20.21.1.4.1 Initial conditions

Parameters changed from the default values in table 20.21.1.

Parameter	Carrier 1	Carrier 2	Carrier 3	Carrier 4	Carrier 5	Carrier 6
RF Signal Level (dB μ V emf() / dBm)	48 / -65	38 / -75	43 / -70	33 / -80	28 / -85	OFF
CBA	1	0	0	0	0	
RXLEV_ACCESS_MIN (dBm)	-90	-67	-90	-88	-98	
MNC			See Table 20.1c			
MCC			002			
C1	25	-8	20	8	13	
C2	25	-8	20	8	13	

Carrier 2 and carrier 4 are chosen between ARFCN 955 - 974. Carrier 1 is chosen between 975 - 1 023, 0; and carrier 3 remains in the P-GSM band.

20.21.1.4.2 Procedure

- a) The SS activates the carriers and monitors carriers 2, 4 and 5 for RA requests from the MS.

- b) The MS is switched on.
- c) The MS is switched off.
- d) The SS monitors carriers 1 and 3 for RA requests from the MS.
- e) The MS is switched on.

20.21.1.5 Test requirements

- 1) After step b), the first response from the MS shall be on carrier 4 within 33 s. There shall be no response from the MS on carrier 2.
- 2) After step e), there shall be no response from the MS on either carrier 1 or carrier 3 within 33 s.

20.21.2 R-GSM cell selection with varying signal strength values

20.21.2.1 Definition

For definition see conformance requirement.

20.21.2.2 Conformance requirement

- 1. The MS shall:

The MS shall search all RF channels within its bands of operation, take readings of received RF signal level on each RF channel, and calculate the RLA_C for each. The averaging is based on at least five measurement samples per RF carrier spread over 3 to 5 s, the measurement samples from the different RF carriers being spread evenly during this period.

3GPP TS 05.08 / 3GPP TS 45.008, subclause 6.2.

- 1.1 The MS shall search all RF channels in the system (194 ARFCNs for R-GSM), take readings of received RF signal strength on each RF channel, and calculate the received level average for each.
- 1.2 The averaging is based on at least five measurement samples per RF carrier spread over T_{av} (3 s to 5 s).
- 1.3 The measurement samples from the different RF carriers being spread evenly during this period.
- 2. These quantities termed the "received level averages" (RLA_C), shall be unweighted averages of the received signal levels measured in dBm.

3GPP TS 05.08 / 3GPP TS 45.008, subclause 6.1.

20.21.2.3 Test purpose

- 1. To verify that:
 - 1.1 The MS meets conformance requirement 1.1.
 - 1.2 The MS meets conformance requirement 1.2.
 - 1.3 The MS meets conformance requirement 1.3.
- 2 To verify that the MS meets conformance requirement 2.

20.21.2.4 Method of test

20.21.2.4.1 Initial conditions

Parameters changed from the default values in table 20.21.1.

Parameter	Carrier 1	Carrier 2	Carrier 3	Carrier 4	Carrier 5	Carrier 6
RF Signal Level (dB μ V emf() / dBm)	23 / -90	58 / -55	OFF	OFF	OFF	OFF
RXLEV_ACCESS_MIN (dB μ V emf() / dBm)	13 / -100	13 / -100				
C1	10	53				

Carrier 1 is chosen between ARFCN 955 - 974.

Specific PICS Statements:

-

PIXIT statements:

- averaging time T_{av}

20.21.2.4.2 Procedure

- a) The SS transmits on carriers 1 and 2. After a period of $b \times T_{av}$ carrier 2 reduces its transmit level to -85 dBm (28 dB μ V emf()). After a further period of $a \times T_{av}$, carrier 2 increases its transmit level again to -55 dBm (58 dB μ V emf()). Switching of carrier 2 continues with these levels and duty cycle until the end of the test.

T_{av} is the averaging time declared by the manufacturer.

The parameters a and b are chosen according to the following rules:

$$(a + b) \times T_{av} > T_{av}$$

$$0 < a \times T_{av} < 2/3 \times T_{av}$$

$$0,5 \times T_{av} < b \times T_{av} < T_{av}$$

In the equations $<$ and $>$ means at least one TDMA frame less or greater than the given value.

While satisfying the conditions given above:

a is chosen to be as close as possible to 2/3.

b is chosen to be as close as possible to 0,5.

- b) The MS is switched on.
c) The SS monitors all RA requests from MS on carriers 1 and 2.

20.21.2.5 Test requirements

In step c), the first response from the MS shall be on carrier 2 within 33 s.

NOTE 1: With the selected duty cycle it can be guaranteed that a "good" MS passes the test even at the worst case situations. The minimum averaged value of carrier 2 is in any case higher or equal to -75 dBm which is still 6 dB above carrier 1's level (for a "good" MS).

NOTE 2: With the selected levels and duty cycle the probability that a "bad" MS (i.e. MS that averages over shorter period than 3 s) fails the test is maximized. However, it can not be guaranteed that all the MSs not fulfilling the conformance requirement of averaging or uniform sampling will fail this test.

20.21.3 R-GSM basic cell reselection

20.21.3.1 Definition

While camped on a cell of the selected PLMN the MS may need to select a different cell in order to fulfil the normal service state. This ensures that the MS is camped on a cell from which it can reliably decode downlink data and with which it has a high probability of communications on the uplink.

20.21.3.2 Conformance requirement

1. While camped on a cell of the selected PLMN ("camped normally"), the MS may need to select a different cell ("normal cell reselection" state). The following events trigger a cell reselection:

1.1 (iii) The cell camped on (current serving cell) has become barred.

1.2 (iv) There is a better cell (in terms of the path loss criterion C2) in the same LA, or a much better cell in another LA of the selected PLMN (using the CRH parameter).

The MS will then reselect a new cell in order to fulfil the process goal.; 3GPP TS 03.22, subclause 4.5.

NOTE 1: Criterion (i) is tested in subclause 20.21.8 (Cell reselection when $C1(\text{serving cell}) < 0$ for 5 s).

NOTE 2: Criterion (ii) is tested subclause 20.21.16 (Downlink signalling failure).

NOTE 3: Criterion (v) is tested in subclause 20.21.6 (Cell reselection timings).

2. There are various requirements that a cell must satisfy before an MS can perform normal camping on it:

2.1 (ii) It should not be "barred".

2.2 (iv) The radio path loss between MS and BTS must be below a threshold set by the PLMN operator. 3GPP TS 03.22, subclause 3.2.1.

NOTE 4: Criterion (i) is not relevant for cell reselection and for cell selection it is tested in subclause 20.21.1.

NOTE 5: Criterion (iv) refers to the C1 parameter.

3. The MS shall be able to calculate correctly the path loss criterion parameter C2 used for cell reselection; 3GPP TS 05.08, subclause 6.4.

4. At least every 5 s the MS shall calculate the value of C1 and C2 for the serving cell and recalculate C1 and C2 values for non serving cells (if necessary). The MS shall then check whether:

i) The path loss criterion (C1) for current serving cell falls below zero for a period of 5 s. This indicates that the path loss to the cell has become too high.

ii) The calculated value of C2 for a non-serving suitable cell exceeds the value of C2 for the serving cell for a period of 5 s, except in the case of the new cell being in a different location area in which case the C2 value for the new cell shall exceed the C2 value of the serving cell by at least CELL_RESELECT_HYSTERESIS dB as defined by the BCCH data from the current serving cell, for a period of 5 s. This indicates that it is a better cell. 3GPP TS 05.08, subclause 6.6.2.

5. The MS shall attempt to decode the full BCCH data of the serving cell at least every 30 s; 3GPP TS 05.08, subclause 6.6.1.

20.21.3.3 Test purpose

1. To verify that:

1.1 The MS meets conformance requirement 1.1.

1.2 The MS meets conformance requirement 1.2.

2. To verify that:
 - 2.1 The MS does not reselect a cell which is barred.
 - 2.2 The MS does not reselect a cell which has a $C1 < 0$.
3. To verify that the MS calculates the C2 parameter correctly when the CELL_RESELECT_OFFSET, TEMPORARY_OFFSET and PENALTY_TIME parameters are not used.
4. To verify that the MS takes into account the CELL_RESELECT_HYSTERESIS parameter when reselecting a cell in a different location area.
5. To verify that the MS decodes the CELL_BAR_ACCESS and CELL_BAR_QUALIFY parameters from the BCCH every 30 s.

20.21.3.4 Method of test

20.21.3.4.1 Initial conditions

Parameters changed from the default values in table 20.21.1.

Parameter	Carrier 1	Carrier 2	Carrier 3	Carrier 4	Carrier 5	Carrier 6
RF Signal Level (dB μ V emf() / dBm)	43 / -70	33 / -80	43 / -70	38 / -75	38 / -75	
RXLEV_ACCESS_MIN (dBm)	-85	-90	-90	-85	-67	
CRH	10 dB					
LAC			different from other carriers			
CBA				1		
CBQ				0		
C1	15	10	20	10	-8	
C2	15	10	20	10	-8	

The BA(BCCH) list only contains the ARFCNs of the carriers used during the test.

20.21.3.4.2 Procedure

- a) The SS activates carriers 1, 2, 4 and 5. The MS is not paged on carrier 1. The SS monitors carriers 2, 4 and 5 for RA requests from the MS.
- b) The MS is switched on.
- c) The SS stops paging on all carriers except carrier 2. The level of carrier 2 is increased to 43 dB μ Vemf (C2 becomes 20 dB), and the SS monitors carrier 2 for RA requests from the MS.
- d) When the SS receives a response from the MS on carrier 2, it stops paging the MS on this carrier.
- e) The MS is switched off.
- f) The SS is reconfigured and sets CBA = 1 on carriers 1 and 5.
- g) The MS is switched on.
- h) After 33 s, the SS starts paging continuously on carrier 1 and sets CBA=1 on carrier 2 and CBA=0 on carriers 1, 4 and 5.
- i) When the SS receives a response on carrier 1, it stops paging the MS and waits for 25 s. (The MS should reselect and camp onto carrier 1).
- j) The SS activates carrier 3, pages the MS continuously on this carrier and monitors carrier 3 for RA requests from the MS.
- k) The SS increases the level of carrier 3 to 53 dB μ Vemf (C2 increases to 30 dB).

20.21.3.5 Test requirements

- 1) After step b), there shall be no response from the MS on carriers 2, 4, or 5 within 50 s.
- 2) In step c), the MS shall respond on carrier 2 within 20 s of increasing the level of carrier 2.

NOTE 1: 5 s to perform running average, 10 s to detect C2 differences, 2,4 s to read BCCH of carrier 2, 1 s to perform RA. Total 18,4 s, allow 20 s.

- 3) In step h), the MS shall respond on carrier 1 within 50 s of setting CBA=1 on carrier 2.

NOTE 2: 33 s for the MS to read the BCCH of carrier 2 (30 s + 10 %), 15 s for the MS to reselect cell 1, since the MS already has a running average on carrier 1, allow 50 s.

- 4) After step j), there shall be no response from the MS within 50 s.
- 5) After step k), the MS shall respond on carrier 3 within 20 s.

20.21.4 R-GSM cell reselection using TEMPORARY_OFFSET, CELL_RESELECT_OFFSET, POWER_OFFSET and PENALTY_TIME parameters

20.21.4.1 Definition

Void.

20.21.4.2 Conformance requirement

1. The MS shall be able to calculate correctly the path loss criterion parameter C2 used for cell reselection; 3GPP TS 05.08, subclause 6.4.

20.21.4.3 Test purpose

1. To verify that the MS calculates the C2 parameter correctly when the CELL_RESELECT_OFFSET, TEMPORARY_OFFSET and PENALTY_TIME parameters are used.
2. To verify DCS 1 800 MS correctly calculate the C2 parameter when the POWER_OFFSET parameter is present.

20.21.4.4 Method of test

20.21.4.4.1 Initial conditions

Parameters changed from the default values in table 20.21.1.

Parameter	Carrier 1	Carrier 2	Carrier 3	Carrier 4	Carrier 5	Carrier 6
RF Signal Level (dB μ V emf() / dBm)	53 / -60	43 / -70	48 / -65	48 / -65		
RXLEV_ACCESS_MIN (dBm)	-80	-100	-85	-85		
PT		11111	40 s	60 s		
CRO		16 dB	20 dB	20 dB		
TO			20 dB	20 dB		
K = 1						
C1	20	30	20	20		
C2	20	14	20 -> 40	20 -> 40		
K = 2 (DCS1800 Class 3 MS only)						
POWER_OFFSET	0	2	6	6		

The BA(BCCH) list only contains the ARFCNs of the carriers used during the test.

20.21.4.4.2 Procedure

For testing of GSM MS, the test procedure is performed for execution counter K = 1.

For testing of DCS 1 800 MS, the test procedure is performed for execution counter K = 1 and 2:

On execution counter K = 1, the POWER_OFFSET Parameter is not present.

On execution counter K = 2, the POWER_OFFSET parameter is present.

- a) The SS activates carriers 1 and 2. The MS is not paged on carrier 1. The SS monitors carrier 2 for RA requests from the MS.
- b) The MS is switched on.
- c) The SS increases the level of carrier 2 to 54 dB μ V_{emf} (C2 becomes 25 dB).
- d) When the SS receives a response on carrier 2, the SS stops paging on that carrier and waits for 20 s (The MS should reselect and camp onto carrier 2).
- e) The SS activates carriers 3 and 4 and continuously pages the MS on these carriers. The SS monitors carriers 3 and 4 for RA requests from the MS.

20.21.4.4.3 Requirements

For execution counter K = 1 and K = 2.

- 1) After step b), there shall be no response from the MS on carrier 2 within 50 s.
- 2) After step c), the MS shall respond on carrier 2 within 20 s of increasing the level of carrier 2.
- 3) After step e), there shall be no response from the MS on carrier 3 within 38 s of activating the carriers but, the MS shall respond on carrier 3 within 90 s. The response on carrier 3 shall be before any response on carrier 4.

NOTE: Minimum time of 38 s set by penalty timer on carrier 3 less 2 s tolerance. Maximum time, total of 33 s to read BCCH of carrier 3, 42 s for expiry of penalty timer on carrier 3, 15 s for reselection, since the MS will already have running averages on carriers 3 and 4, when the penalty timers expire, allow 90 s.

20.21.5 R-GSM cell reselection using parameters transmitted in the System Information type 2bis, type 2ter, type 7 and type 8 messages

20.21.5.1 Definition

System information (SI) type 7 and 8 are transmitted on the BCCH Ext when the system information type 4 message does not contain all information needed for cell selection.

The system information type 2 bis message is used when the system information type 2 message does not contain all neighbour cell ARFCNs.

The system information type 2 ter message is used when system information type 2 messages broadcast by one cell which are system information 2 or both system information 2 and 2bis do not contain all neighbour cell ARFCNs.

20.21.5.2 Conformance requirement

1. The MS shall be able to calculate correctly the path loss criterion parameter C2 used for cell reselection. 3GPP TS 05.08, subclause 6.4.
2. Whilst in idle mode, an MS shall continue to monitor all BCCH carriers as indicated by the BCCH allocation. 3GPP TS 05.08, subclause 6.6.1.
3. Mobile stations shall treat all ARFCNs in the set {0, 1, 2 ... 1 023} as valid ARFCN values even if the mobile station is unable to transmit or receive on that ARFCN. 3GPP TS 04.08 / 3GPP TS 44.018, subclause 10.5.2.1b.
4. The MS shall correctly decodes parameters transmitted in the system information type 2 ter message. 3GPP TS 04.08 / 3GPP TS 44.018, subclause 9.1.34.

20.21.5.3 Test purpose

1. To verify that the MS correctly calculates the C2 criterion when the parameters affecting cell reselection are transmitted in the system information type 7 and 8 messages.
2. To verify that the MS decodes parameters transmitted in the system information type 2 bis message.
3. To verify that the MS treats ARFCNs as valid ARFCNs even if the MS is unable to transmit or receive on that ARFCN.
4. To verify that the MS correctly decodes parameters transmitted in the system information type 2 ter message.

20.21.5.4 Method of test

20.21.5.4.1 Initial conditions

- a) Parameters changed from the default values in table 20.21.1.

Parameter	Carrier 1	Carrier 2	Carrier 3	Carrier 4	Carrier 5	Carrier 6
RF Signal Level (dB μ V emf() / dBm)	53 / -60	32 / -81	40 / -73	OFF	OFF	OFF
RXLEV_ACCESS_MIN (dB μ V emf() / dBm)	23 / -90	23 / -90	30 / -83			
BS_AG_BLK_RES	1	1	1			
PT		0	0			
CRO		16 dB	10 dB			
TO		0 dB	0 dB			
C1	30	9	10			
C2	30	25	20			

- b) The ARFCNs of carriers 1, 2 and 3 are chosen from those in table 20.21.1 with carrier 3 chosen between ARFCN 955 - 974.
- c) The cell reselection parameters PENALTY_TIME, CELL_RESELECT_OFFSET and TEMPORARY_OFFSET are transmitted in the SI3, SI7 and SI8 messages on carrier 2. They are not transmitted in SI4 and the ADDITIONAL RESELECT PARAM IND parameter is set to 1.
- d) The SI2bis message is transmitted on carrier 1 and contains the ARFCN of carrier 2 and ARFCNs 43, 70, 500, 550, 958, 963, 990 and 995. The ARFCN of carrier 2 is not transmitted in the SI2 message.
- e) Carriers 1 and 2 are synchronized, but staggered in frame number so that the transmission of the SI3 message on carrier 2, coincides with the paging block which the MS is listening to on carrier 1.

NOTE: Under these conditions, the MS can only decode the parameters affecting cell reselection from the SI7 or SI8 messages.

To achieve this, the following conditions are used:

- BS_PA_MFRMS = 4;
 - IMSI mod 1000 = 12;
 - FN carrier 1 = FN carrier 2-21, for simultaneously transmitted frames.
- f) The SI3 message on carrier 2 indicates that SI2ter is used on carrier 2. SI2ter message contains the ARFCN of carrier 3 and ARFCNs 45, 76, 891, 905. The ARFCN of carrier 3 is transmitted neither in the SI2 nor in the SI2bis messages on carriers 1 and 2.

20.21.5.4.2 Test Procedure

- a) The SS activates the channels. The MS is not paged on carrier 1.
- b) The MS is switched on.
- c) After 50 s, the SS increases the level of carrier 2 to 42 dB μ Vemf().

- d) When the SS receives a response on carrier 2, the SS stops paging on that carrier and after 30 s, the SS increases the level of carrier 3 to 60 dB μ V_{emf}().

20.21.5.5 Test Requirements

- 1) After step b), there shall be no response from the MS on carrier 2. There shall also be no response on carrier 3.
- 2) After increasing the level of carrier 2 in step c), the MS shall respond on carrier 2 within 33 s.
- 3) After increasing the level of carrier 3 in step d), the mobile shall respond on carrier 3 within 35 s.

20.21.6 R-GSM cell reselection timings

20.21.6.1 Definition

Void.

20.21.6.2 Conformance requirement

1. At least every 5 s the MS shall calculate the value of C1 and C2 for the serving cell and recalculate C1 and C2 values for non serving cells (if necessary). The MS shall then check whether:
 - 1.1 ii) The calculated value of C2 for a non-serving suitable cell exceeds the value of C2 for the serving cell for a period of 5 s.
 - 1.2 In case ii) above, cell reselection shall not take place if there was a cell reselection within the previous 15 s.
 - 1.3 Cell reselection for any other reason (see 3GPP TS 03.22) shall take place immediately, but the cell that the MS was camped on shall not be returned to within 5 s if another suitable cell can be found.

3GPP TS 05.08, subclause 6.6.2.

20.21.6.3 Test purpose

1. To verify that:
 - 1.1 The MS does not perform a cell reselection when the C2 value for a non serving cell does not exceed the C2 value of the serving cell for a period of at least 5 s.
 - 1.2 The MS meets conformance requirement 1.2 with an allowance for the uncertainty of the test.
 - 1.3 When the MS performs an immediate cell reselection due to an unsuccessful random access attempt, the cell that the MS was camped onto is not returned to within 5 s when another suitable cell exists.

20.21.6.4 Method of test

20.21.6.4.1 Initial conditions

Parameters changed from the default values in table 20.21.1.

Parameter	Carrier 1	Carrier 2	Carrier 3	Carrier 4	Carrier 5	Carrier
RF Signal Level (dB μ V _{emf} () / dBm)	56 / -57	46 / -67	OFF	OFF	OFF	OFF
RXLEV_ACCESS_MIN (dB μ V _{emf} () / dBm)	29 / -84	33 / -80				
Max. Retrans	00	00				
C1	27	13				
C2	27	13				

Below is an alternative table of parameters for use with test equipment that cannot reach the upper RF levels as specified in the table above. These carrier levels are reduced by 5 dB and will not effect the purpose of the test case:

Parameter	Carrier 1	Carrier 2	Carrier 3	Carrier 4	Carrier 5	Carrier 6
RF Signal Level (dB μ V emf() / dBm)	51 / -62	41 / -72	OFF	OFF	OFF	OFF
RXLEV_ACCESS_MIN (dB μ V emf() / dBm)	24 / -89	28 / -85				
Max. Retrans	00	00				
C1	27	13				
C2	27	13				

The BA(BCCH) list only contains 5 ARFCNs including the ARFCNs of the carriers used during the test.

NOTE: With 5 ARFCNs in the BA(BCCH) list and BS_PA_MFRMS=5 (default value) the MS will maintain a running average on surrounding cells over a period of 5 s.

20.21.6.4.2 Procedure

- a) The SS activates the channels. The MS is not paged on any of the carriers.
- b) The MS is switched on.
- c) After 50 s, the SS starts paging continuously on carriers 1 and 2 for 20 s. The SS monitors carriers 1 and 2 for RA requests from the MS.
- d) The SS stops paging on carriers 1 and 2 and waits for 20 s. (The MS should revert to carrier 1 due to cell reselection.)
- e) The SS starts paging continuously on carrier 2.
- f) The SS increases the transmit level of carrier 2 by 20 dB for a period of 4 s and then reduces the level back to the original value.
- g) The SS increases the transmit level of carrier 2 by 20dB and waits for the MS to access on carrier 2. The SS records the time t from the increase in the level of carrier 2 to the first response from the MS.
- h) The SS stops paging on carrier 2 and decreases the transmit level of carrier 2 back to the original value.
- j) The SS waits 20 s. (The MS should revert to carrier 1 due to cell reselection.)
- k) The SS increases the transmit level of carrier 2 by 20 dB. After $t+2$ s, the SS starts paging continuously on carrier 1 and reduces the level of carrier 2 back to the original level.

20.21.6.5 Test requirements

- 1) In step c), the MS shall transmit 2 RA requests on carrier 1 followed by 2 RA requests on carrier 2. Subsequent RA requests on carrier 1 shall not occur within 4,5 s of the second RA request on carrier 1.
- 2) In step f), there shall be no access on carrier 2 within 34 seconds of increasing the level of carrier 2.
- 3) After step g), the MS shall respond on carrier 2.
- 4) In step k), there shall be no response on carrier 1 within 11 s after the level of carrier 2 is reduced back to the original level.

NOTE: The 11 s is derived from $(t+15)$ seconds minimum cell reselection timer minus $(t+2)$ seconds from the start of step k) up to the reduction of the level of carrier 2. A further 2 s are subtracted to cover for any uncertainty introduced by the RA process occurring after step g).

20.21.7 R-GSM priority of cells

20.21.7.1 Definition

In general, cell prioritization is a means of encouraging MSs to select some suitable cells in preference to others.

20.21.7.2 Conformance requirement

1. During cell selection a cell with low priority indication will only be selected if a suitable cell of normal priority cannot be found; 3GPP TS 03.22, subclause 3.5.2.1.
- 2.

Table 1a: Parameters affecting cell priority for cell selection

CELL_BAR_QUALIFY	CELL_BAR_ACCESS	Cell selection priority	Status for cell reselection
0	0	normal	normal
0	1	barred	barred
1	0	low	normal (see note 2)
1	1	low	normal (see note 2)

3GPP TS 05.08, table 1.a.

3. If all the following conditions are met then the "Cell selection priority" and the "Status for cell reselection" shall be set to normal:
 - the cell belongs to the MS HPLMN;
 - the MS is in cell test operation mode;
 - the CELL_BAR_ACCESS is set to "1";
 - the CELL_BAR_QUALIFY is set to "0";
 - the Access Control class 15 is barred.

3GPP TS 05.08, table 1.a.

20.21.7.3 Test purpose

1. To verify that the MS does not select a cell of low priority when a suitable cell of normal priority exists with a lower received signal strength.
2. To verify that the MS takes into account CELL_BAR_ACCESS and CELL BAR _QUALIFY when performing cell selection and reselection.
3. To verify that the MS meets conformance requirement 3.

20.21.7.4 Method of test

20.21.7.4.1 Initial conditions

Parameters changed from Default values table 20.21.1.

Parameter	Carrier 1	Carrier 2	Carrier 3	Carrier 4	Carrier 5	Carrier 6
RF Signal Level (dB μ V emf) / dBm)	33 / -80	43 / -70	33 / -80	23 / -90	OFF	OFF
RXLEV_ACCESS_MIN (dB μ V emf) / dBm)	3 / -110	23 / -90	13 / -100	13 / -100		
CBA	0	1	1	0		
CBQ	1	1	0	0		
Access class 15	barred	barred	barred	barred		
C1	30	20	20	10		

20.21.7.4.2 Procedure

- a) The SS activates the carriers and monitors for RA requests from the MS on carriers 1, 2, and 4.
- b) The MS is switched on.
- c) The MS is switched off. The SS deactivates the carriers.

d) The MS is placed in cell test operation mode.

NOTE: Cell test mode is a mode of operation defined in SIM administrative data field.

e) The SS activates the carriers and monitors for RA requests from the MS on carriers 1, 2, and 3.

f) The MS is switched on.

20.21.7.5 Test requirements

- 1) After step b), the first response from the MS shall be on carrier 4 within 33 s, followed by a response on carrier 1 before a response (if any) on carrier 2 within 50 s.
- 2) After step f), the first response from the MS shall be on carrier 3 within 33 s, followed by a response on carrier 1 before a response (if any) on carrier 2 within 50 s.

20.21.8 R-GSM cell reselection when C1 (serving cell) < 0 for 5 s

20.21.8.1 Definition

Void.

20.21.8.2 Conformance requirement

1. At least every 5 s the MS shall calculate the value of C1 and C2 for the serving cell and recalculate C1 and C2 values for non serving cells (if necessary). The MS shall then check whether:
 - i) The path loss criterion (C1) for current serving cell falls below zero for a period of 5 s. This indicates that the path loss to the cell has become too high. 3GPP TS 05.08, subclause 6.6.2.
2. While camped on a cell of the selected PLMN ("camped normally"), the MS may need to select a different cell ("normal cell reselection" state). The following events trigger a cell reselection:
 - i) The path loss criterion parameter C1 (see subclause 3.6) indicates that the path loss to the cell has become too high.; 3GPP TS 03.22, subclause 4.5.

20.21.8.3 Test purpose

1. To verify that the MS meets conformance requirement 1.
2. To verify that the MS meets conformance requirement 2.

20.21.8.4 Method of test

20.21.8.4.1 Initial conditions

Parameters changed from Default values table 20.21.1.

Parameter	Carrier 1	Carrier 2	Carrier 3	Carrier 4	Carrier 5	Carrier 6
RF Signal Level (dB μ V emf() / dBm)	63 / -50	33 / -80	OFF	OFF	OFF	OFF
RXLEV_ACCESS_MIN (dB μ V emf() / dBm)	43 / -70	23 / -90				
CRO	30 dB					
TO	0					
PT	0					
C1	20	10				
C2	50	10				

NOTE: With BS_PA_MFRMS = 5 (default value), the averaging time of the MS on the serving cell BCCH is 5,9 s.

20.21.8.4.2 Procedure

- a) The SS activates the carriers. The MS is not paged on carrier 1. The SS monitors carriers 1 and 2 for RA requests from the MS.
- b) The MS is switched on.
- c) The SS reduces signal level on carrier 1 to -80 dBm / 33 dB μ V emf() for 4 s. Then, the SS raises the level back to -50 dBm / 63 dB μ V emf(). (C1 becomes -10 dB and C2, 20 dB during this period).
- d) The SS reduces signal level on carrier 1 to -80 dBm / 33 dB μ V emf().

20.21.8.5 Test requirements

- 1) After step b), there shall be no access on carrier 1 or carrier 2, within 50 s.
- 2) After step c), there shall be no access on carrier 2 within 30 s.
- 3) After step d), the MS shall access on carrier 2 within 20 s.

20.21.9 R-GSM running average of the surrounding cell BCCH carrier signal levels

20.21.9.1 Definition

Void.

20.21.9.2 Conformance requirement

1. Whilst in idle mode an MS shall continue to monitor all BCCH carriers as indicated by the BCCH allocation (BA - See table 1). A running average of received level in the preceding 5 to:
 - $\text{Max. } \{5, ((5 \times N + 6) \text{ DIV } 7) \times \text{BS_PA_MFRMS} / 4\}$
 - seconds shall be maintained for each carrier in the BCCH allocation. N is the number of non-serving cell BCCH carriers in BA and the parameter BS_PA_MFRMS is defined in 3GPP TS 05.02; 3GPP TS 05.08, subclause 6.6.1.
2. The same number of measurement samples shall be taken for all non-serving cell BCCH carriers of the BA list, and the samples allocated to each carrier shall as far as possible be uniformly distributed over each evaluation period.; 3GPP TS 05.08, subclause 6.6.1

20.21.9.3 Test purpose

1. To verify that if the MS calculates a received level average (over 5 s) for a non-serving suitable cell which results in the value of C2 exceeding the value of C2 for the serving cell, then cell reselection takes place to the non-serving cell.
2. To verify that by using suitable varying levels of signal strength for non serving cells, the MS samples on non serving cell BCCH carriers are as far as possible distributed uniformly over each evaluation period.

20.21.9.4 Method of test

20.21.9.4.1 Initial conditions

Parameters changed from Default values table 20.21.1.

Parameter	Carrier 1	Carrier 2	Carrier 3	Carrier 4	Carrier 5	Carrier 6
RF Signal Level (dB μ V emf() / dBm)	53 / -60	33 / -80	OFF	OFF	OFF	OFF
RXLEV_ACCESS_MIN (dB μ V emf() / dBm)	23 / -90	23 / -90				
C1	30	10				
C2	30	10				

BS_PA_MFRMS is set to 4 for this test.

The BA(BCCH) list only contains 7 ARFCNs including the ARFCNs of the carriers used during the test.

NOTE: With 7 ARFCNs in the BA(BCCH) list and BS_PA_MFRMS=4 the MS will maintain a running average on surrounding cells over a period of 5 s.

20.21.9.4.2 Procedure

- a) The SS activates the carriers. The MS is not paged on carrier 1. The SS monitors carriers 1 and 2.
- b) The MS is switched on.
- c) The SS starts switching the level of carrier 2 between -80 dBm and -57 dBm every 2,7 s and continues to do so until the end of the test.
- d) The SS decreases the level of carrier 1 to -76 dBm.

NOTE: As a result of the switching in levels, the running average on carrier 2 will be between -66dBm and -71dBm, assuming that samples are distributed over five consecutive paging blocks.

20.21.9.5 Test requirements

- 1) After step b), there shall be no access from the MS on carrier 1 or carrier 2, within 50 s.
- 2) After step c), there shall be no access from the MS on carrier 1 or 2 within 25 s.

NOTE: Any potential access on is likely to occur within 20 s.

- 3) After step d), the MS shall access on carrier 2 within 20 s.

20.21.10 R-GSM running average of the serving cell BCCH carrier signal level

20.21.10.1 Definition

The MS is required to monitor continuously the BCCH carrier signal level of the serving cell (and to compare it to the BCCH carrier signal levels of the non-serving cells) to guarantee that it is camped on the most suitable cell.

20.21.10.2 Conformance requirement

1. For the serving cell, receive level measurement samples shall be taken at least for each paging block of the MS. The receive level average shall be a running average determined using samples collected over a period of 5 s or five consecutive paging blocks of that MS, whichever is the greater period. New receiving level average values shall be calculated as often as possible. 3GPP TS 05.08, subclause 6.6.1.

20.21.10.3 Test purpose

1. To verify that by using suitable varying levels of signal strength for the serving cell, the MS performs a running average over 5 consecutive paging blocks.

20.21.10.4 Method of test

20.21.10.4.1 Initial conditions

Parameters changed from Default values table 20.21.1.

Parameter	Carrier 1	Carrier 2	Carrier 3	Carrier 4	Carrier 5	Carrier 6
RF signal level (dB μ V emf() / dBm)	63 / -50	39 / -74	OFF	OFF	OFF	OFF
RXLEV_ACCESS_MIN (dB μ V emf() / dBm)	23 / -90	23 / -90				
C1	40	16				
C2	40	16				

NOTE: With BS_PA_MFRMS = 5 (default value), the averaging time of the MS on the serving cell BCCH is 5,9 s.

20.21.10.4.2 Procedure

- The SS activates the carriers. The MS is not paged on carrier 1. The SS monitors carriers 1 and 2 for RA requests from the MS.
- The MS is switched on.
- After 50 s the SS starts switching the level of carrier 1 between -80 dBm and -50 dBm every 3 s.

NOTE: As a result of the switching in levels, the running average on carrier 1 will be between -62 dBm and -68 dBm over five consecutive paging blocks.

- The SS increases the level of carrier 2 to -56 dBm.

20.21.10.5 Test requirement

- After step c), the MS shall not access on carrier 2, within 25 s.
- After step d), the MS shall access on carrier 2, within 30 s.

NOTE: 13,75 s to perform running average, 10 s to detect C2 differences, 2,4 s to read BCCH of carrier 2, 1 s to perform RA. Total 27,15 s, allow 30 s.

20.21.11 Updating the list of six strongest neighbour carriers and decoding the BCCH information of a new carrier on the list

20.21.11.1 Definition

Void.

20.21.11.2 Conformance requirement

- The list of the 6 strongest non-serving carriers shall be updated at least as often as the duration of the running average defined for measurements on the BCCH allocation and may be updated more frequently; 3GPP TS 05.08, subclause 6.6.1.
- When the MS recognizes that a new BCCH carrier has become one of the 6 strongest, the BCCH data shall be decoded for the new carrier within 30 s; 3GPP TS 05.08, subclause 6.6.1.

20.21.11.3 Test purpose

- To verify that MS meets conformance requirement 1.
- To verify that MS meets conformance requirement 2.

20.21.11.4 Method of test

20.21.11.4.1 Initial conditions

Six BCCH carriers are established with the system information contents of table 20.21.1.

Parameters changed from Default values table 20.21.1.

Parameter	Carrier 1	Carrier 2	Carrier 3	Carrier 4	Carrier 5	Carrier 6	Carrier 7
RF signal level (dB μ V emf ()/dBm)	53 / -60	48 / -65	43 / -70	38 / -75	33 / -80	33 / -80	38 / -75
RXLEV_ACCESS_MIN	-90	-90	-90	-90	-90	-90	-110
C1	30	25	20	15	10	10	35
C2	30	25	20	15	10	10	35

The BA(BCCH) list contains only eight ARFCNs and includes those of carriers 1 to 7.

BS_PA_MFRMS is set to 3 during this test.

NOTE: The combination of 8 carriers on the BA list and BS_PA_MFRMS = 3 leads to averaging time of 5 s. Hence 5 s is also the updating time of the list of six strongest neighbour carriers.

20.21.11.4.2 Procedure

- The SS activates carriers 1 to 6. The MS is not paged on any of the carriers.
- The MS is switched on.
- After 60 s, the SS activates carrier 7 and pages the MS continuously on this carrier. The SS monitors carrier 7 for RA requests from the MS.

20.21.11.5 Test requirements

- The MS shall access on carrier 7 within 55 s of activating carrier 7.

NOTE: 5,5 s to notice new strongest carrier in top 6 (because the updating time for six strongest is 5 s (+10 %)), 33 s to read BCCH, 15 s for reselection, since the MS has already performed the running average on the new strongest carrier, allow 55 s.

20.21.12 R-GSM decoding the BCCH information of the neighbour carriers on the list of six strongest neighbour carriers

20.21.12.1 Definition

Void.

20.21.12.2 Conformance requirement

- The MS shall attempt to decode the BCCH data block that contains the parameters affecting cell reselection for each of the 6 strongest non-serving cell BCCH carriers at least every 5 minutes; 3GPP TS 05.08, subclause 6.6.1.

NOTE: Verification of cell reselection as implicitly tested here is performed in subclause 20.21.3.

20.21.12.3 Test purpose

- To verify that the MS decodes the BCCH data block that contains the parameters affecting cell reselection for a non-serving cell BCCH carrier, (which is in the list of six strongest neighbour cells), at least every 5 minutes. This is achieved by changing the BCCH data such that the value of C2 for the non serving cell exceeds the value of C2 for the serving cell, and observing that the MS performs cell reselection within 5 minutes plus the time allowed for cell reselection after the change of the BCCH data.

20.21.12.4 Method of test

20.21.12.4.1 Initial conditions

Parameters changed from Default values table 20.21.1.

Parameter	Carrier 1	Carrier 2	Carrier 3	Carrier 4	Carrier 5	Carrier 6
RF signal level (dB μ V emf() / dBm)	38 / -75	33 / -80	OFF	OFF	OFF	OFF
C1	15	10				
C2	15	10				

20.21.12.4.2 Procedure

- The SS activates the carriers. The MS is not paged on carrier 1. The SS monitors carriers 1 and 2.
- The MS is switched on.
- The SS changes the RXLEV_ACCESS_MIN in the BCCH data of carrier 2 to be -100 dBm.

NOTE: With the above change the C2 of carrier 2 becomes 20 whereas the C2 of carrier 1 stays at 15.

20.21.12.5 Test requirements

- 1) After step b), there shall be no access from the MS on carrier 1 or carrier 2 within 50 s.
- 2) After step c), the MS shall access on carrier 2 within 345 s of the change in the BCCH data of carrier 2.

NOTE: 330 s for decode of BCCH of carrier 2 (300 s +10 %), 15 s for reselection of carrier 2, since the MS already has a running average on carrier 2.

20.21.13 R-GSM decoding the BSIC of the neighbour carriers on the list of six strongest neighbour carriers

20.21.13.1 Definition

Void.

20.21.13.2 Conformance requirement

1. The MS shall attempt to check the BSIC for each of the 6 strongest non-serving cell BCCH carriers at least every 30 s, to confirm that it is monitoring the same cell. If a change of BSIC is detected then the carrier shall be treated as a new carrier and the BCCH data redetermined; 3GPP TS 05.08, subclause 6.6.1.

NOTE: Verification of cell reselection as implicitly tested here is performed in subclause 20.21.3.

20.21.13.3 Test purpose

1. To verify that the MS will check the BSIC of the non-serving cell, which is in the list of six strongest neighbour cells, by changing the BSIC and the BCCH data of the non-serving cell such that the value of C2 for that cell exceeds the value of C2 of the serving cell, and observing that the MS performs cell reselection within the time allowed to check the BSIC, redetermine the BCCH data and perform cell reselection.

20.21.13.4 Method of test

20.21.13.4.1 Initial conditions

Parameters changed from Default values table 20.21.1.

Parameter	Carrier 1	Carrier 2	Carrier 3	Carrier 4	Carrier 5	Carrier 6
RF signal level (dB μ V emf() / dBm)	38 / -75	33 / -80	OFF	OFF	OFF	OFF
C1	15	10				
C2	15	10				

20.21.13.4.2 Procedure

- a) The SS activates the carriers. The MS is not paged on carrier 1. The SS monitors carriers 1 and 2.
- b) The MS is switched on.
- c) The SS changes the BSIC of carrier 2 by changing the Base Station Colour Code (BCC) part of the BSIC. The SS also changes the RXLEV_ACCESS_MIN in the BCCH data of carrier 2 to be -100 dBm.

NOTE: With the above change to the BCCH data the C2 of carrier 2 becomes 20 whereas the C2 of carrier 1 stays at 15.

20.21.13.5 Test requirements

- 1) In step b), there shall be no access from the MS on carrier 1 or carrier 2 within 50 s.
- 2) After step c), the MS shall access on carrier 2 within 85 s of the change in the BSIC value (and BCCH data) of carrier 2.

NOTE: 33 s for check of BSIC on carrier 2, 33 s for decode of BCCH of carrier 2, 15 s for reselection of carrier 2, since the MS already has a running average on carrier 2, allow 85 s.

20.21.14 R-GSM emergency calls

20.21.14.1 Definition

-

20.21.14.2 Conformance requirement

1. When in a limited service state, the MS shall be able to initiate emergency calls; 3GPP TS 05.08, subclause 6.8.
2. When in a limited service state and if not camped on a cell, the MS shall monitor the signal strength of all 194 RF channels, and search for a BCCH carrier which has $C1 > 0$ and which is not barred. When such a carrier is found, the MS shall camp on that cell, irrespective of the PLMN identity; 3GPP TS 05.08, subclause 6.8.
3. The MS shall perform cell reselection at least among the cells of the PLMN of the cell on which the MS has camped, according to the algorithm of 3GPP TS 03.22, subclauses 4.5 and 3.7, except that a zero value of CELL_RESELECT_HYSTERESIS shall be used; 3GPP TS 05.08, subclause 6.8.

20.21.14.3 Test purpose

1. To verify that the MS shall be able to initiate emergency calls when no suitable cells of the selected PLMN are available, but at least one acceptable cell is available.
2. To verify that the MS selects a cell with $C1 > 0$ and $CBA = 0$ when no suitable cells of the selected PLMN are available.
3. To verify that the MS, when performing cell reselection in the limited service state, uses $CELL_RESELECT_HYSTERESIS = 0$.

20.21.14.4 Method of test

20.21.14.4.1 Initial conditions

Parameters changed from Default values table 20.21.1.

Parameter	Carrier 1	Carrier 2	Carrier 3	Carrier 4	Carrier 5	Carrier 6
RF signal level (dB μ V emf() / dBm)	38 / -75	33 / -80	33 / -80	OFF	OFF	OFF
RXLEV_ACCESS_MIN (dB μ V emf() / dBm)	23 / -90	43 / -70	23 / -90			
CELL_BAR_ACCESS MCC,MNC	1 (barred) forbidden	0 forbidden	0 forbidden			
CELL_RESELECT_HYST	0	0	14 dB			
C1	15	-10	10			

NOTE: All the BCCH carriers belong to the same PLMN, which is not the MS's home PLMN and is in the SIM's forbidden PLMN's list.

20.21.14.4.2 Procedure

- a) The SS activates the carriers. The SS monitors for RA attempts from the MS on carriers 1, 2 and 3 for the duration of the test.
- b) The MS is switched on.
- c) 50 s after switch on, an emergency call is initiated on the MS.
- d) The SS changes the CBA of carrier 1 to 0.

NOTE 1: The MS should reselect to carrier 1 because it should not take into account the CELL_RESELECT_HYST value of 14 but use 0 instead.

e) After 345 s an emergency call is initiated on the MS.

NOTE 2: 330 s to detect change of BCCH data, 15 s to perform reselection of carrier 1, since the MS already has a running average on carrier 1.

20.21.14.5 Test requirements

- 1) In step c), the first access by the MS shall be on carrier 3.
- 2) In step e), the first access from the MS shall be on carrier 1.

20.21.15 R-GSM cell reselection due to MS rejection "LA not allowed"

20.21.15.1 Definition

While camped on a cell of the selected PLMN the MS may need to select a different cell in order to fulfil the normal service state. This ensures that the MS is camped on a cell from which it can reliably decode downlink data and with which it has a high probability of communications on the uplink.

This process goes on while camping on a cell which pertains to an LA which is placed in the list of "forbidden LAIs for regional provision of service".

20.21.15.2 Conformance requirement

1. In response to a registration attempt, when receiving an LU reject with cause value "LA not allowed", the MS stores this LAI in a list of "forbidden LAIs for regional provision of service", to prevent repeated attempts to access a cell of the forbidden LA, 3GPP TS 03.22, subclause 3.3.
2. If the MS has received the cause 'LA not allowed', it shall ignore this fact when selecting a cell to camp on, i.e. it shall not reject a cell for camping on because that cell is part of a LA where this cause has been received, 3GPP TS 03.22, subclause 3.5.4.
3. In response to a registration attempt, when receiving an LU reject with cause value "LA not allowed", the MS continues to perform normal cell-reselection, 3GPP TS 03.22, subclause 4.4.2
4. A new LU attempt shall only be performed when a new LA (or new PLMN) is entered according to the cell reselection procedure, 3GPP TS 03.22, subclause 3.3 and figure 4.

NOTE: LA stands for "Location Area" and LU stands for "Location Update".

20.21.15.3 Test purpose

1. To verify that if an LU is rejected with cause "LA not allowed" that the LAI of that cell is written into a forbidden list which prevents the MS from performing LU onto another cell in that LA. This is verified indirectly in test purposes 2, 3 and 4.
2. To verify that the MS will not reject a cell for camping on because that cell is part of a LA in the list of "forbidden LAIs for regional provision of service". This is verified indirectly by making the MS attempt an emergency call and checking that the channel request message is transmitted on the correct cell.
3. To verify that the MS when receiving an LU reject with cause value "LA not allowed", the MS continues to perform normal cell-reselection:

Cell reselection is triggered if there is a better cell (in terms of the path loss criterion C2) in the same LA, or a much better cell in another LA of the selected PLMN (using the CRH parameter). 3GPP TS 03.22, subclauses 3.4 and 4.5.

4. To verify that a new LU attempt will be performed when a new LA (or new PLMN) is entered, 3GPP TS 03.22, subclause 3.3 and figure 4.

20.21.15.4 Method of test

20.21.15.4.1 Initial conditions

Parameters changed from Default values table 20.21.1.

Parameter	Carrier 1	Carrier 2	Carrier 3	Carrier 4	Carrier 5	Carrier 6
RF Signal Level (dB μ V emf() / dBm)	63 / -50	54 / -59	44 / -69	OFF	OFF	OFF
RXLEV_ACCESS_MIN (dB μ V emf() / dBm)	53 / -60	35 / -78	29 / -84			
CRH	14	0	10			
LAC	H1111	H2222	H1111			
ATT	1	1	1			
C1	10	19	15			
C2	10	19	15			

20.21.15.4.2 Procedure

- The SS activates the carriers. The SS monitors all RA requests from MS on carriers 1, 2 and 3 until step e) has been completed. Only idle-paging is sent on all channels.
- The MS is switched on.
- When the MS performs an IMSI attach onto carrier 1, the SS shall reject it with cause "LA not allowed".
- 30 s after the MS has returned to idle mode (channel release after LU reject), the MS is manually commanded to set up an emergency call.

NOTE 1: C2 of carrier 3 > C2 of carrier 1. Carriers 1 and 3 belong to the same LA.

- The SS rejects the CM service request from the MS, with a CM service reject message with cause value #17 (Network Failure).

NOTE 2: Cause values #4 (IMSI unknown in VLR) or #6 (Illegal ME) lead to unwanted behaviour of the mobile.

- 10 s after the MS has returned to idle mode (channel release after CM service reject), the SS increases the level of carrier 2 to 65 dB μ V emf().

NOTE 3: C2 of carrier 2 = 30, now larger than C2 of carrier 3 + CRH.

- The SS shall accept any LU on carrier 2.

20.21.15.5 Test requirements

- After step b), the MS shall respond on carrier 1 within 33 s.
- In step d), the MS shall access on carrier 3 with a channel request message, within 15 s of being commanded to set up the emergency call.
- After increasing the level of carrier 2 in step f), the MS shall reselect and access onto carrier 2 requesting an LU within 30 s.

NOTE: 13,75 s to perform running average, 10 s to detect C2 differences, 2,4 s to read BCCH of carrier 2, 1 s to perform RA. Total 27,15 s, allow 30 s.

20.21.16 R-GSM downlink signalling failure

20.21.16.1 Definition

See conformance requirement.

20.16.2 Conformance requirement

The downlink signalling failure criterion is based on the downlink signalling failure counter DSC.

- When the MS camps on a cell, DSC shall be initialized to a value equal to the nearest integer to $90/N$ where N is the BS_PA_MFRMS parameter for that cell (see 3GPP TS 05.02).
- Thereafter, whenever the MS attempts to decode a message in its paging subchannel; if a message is successfully decoded DSC is increased by 1, (however never beyond the nearest integer to $90/N$).

3. Whenever the MS can not successfully decode a message in its paging subchannel the DSC is decreased by 4.
4. When DSC reaches 0, a downlink signalling failure shall be declared. A downlink signalling failure shall result in cell reselection, 3GPP TS 03.22, subclause 4.5 (ii) and 3GPP TS 05.08, subclause 6.5.

NOTE: The network sends the paging subchannel for a given MS every BS_PA_MFRMS multiframes. The requirement for network transmission on the paging subchannel is specified in 3GPP TS 04.08 / 3GPP TS 44.018. The MS is required to attempt to decode a message every time its paging subchannel is sent.

20.21.16.3 Test purpose

1. To verify that the MS initializes the DSC counter in accordance with the conformance requirement. This is verified indirectly.
2. To verify that whenever the MS successfully decodes a message on paging subchannel, the DSC is increased by 1, (however never beyond the nearest integer to $90/N$). This is verified indirectly.
3. To verify that whenever the MS can not successfully decode a message on paging subchannel, the DSC decreased by 4. This is verified indirectly.
4. To verify that when the DSC reaches 0, a downlink signalling failure shall be declared and the MS will perform cell reselection.

20.21.16.4 Method of test

20.21.16.4.1 Initial conditions

Two BCCH carriers are established with the system information contents of table 20.21.1.

Parameters changed from Default values table 20.21.1.

Parameter	Carrier 1	Carrier 2	Carrier 3	Carrier 4	Carrier 5	Carrier 6
RF signal level (dB μ V emf() / dBm)	43 / -70	33 / -80	OFF	OFF	OFF	OFF
C1 = C2	20	10				

NOTE: The DSC counter will have a value 18 ($90/5$).

20.21.16.4.2 Procedure

- a) The MS is switched on. On carrier 1 valid layer 3 messages shall be sent in the paging blocks, but not paging the MS (idle paging). On carrier 2 the MS is paged continuously in all paging blocks.
- b) After 40 s the SS sends corrupted data (using random data, wrong parity bits see 3GPP TS 05.03, subclauses 4.3 and 4.1.2 or other lower layer error) in four successive paging blocks to carrier 1 and then reverts to sending normal data.

NOTE 1: Sending corrupted, i.e. non-decodable data on four successive paging blocks should decrease the DSC to 2.

- c) The SS monitors all accesses on both carriers for 30 s.
- d) The SS sends corrupted data in five successive paging blocks to carrier 1 and then reverts to sending normal data.

NOTE 2: Sending random, data on five successive paging blocks should decrease the DSC to < 0 and cause a cell reselection.

- e) The SS monitors all accesses on both carriers for 30 s.

20.21.16.5 Test requirements

- 1) There shall be no access to carrier 2 in test steps a) and c).
- 2) The MS shall access on carrier 2 at test step e) within 15 s.

20.21.17 R-GSM cell selection if no suitable cell found in 10 s

20.21.17.1 Definition

See conformance requirement.

20.21.17.2 Conformance requirement

If no suitable cell is found in cell reselection process within 10 s, the cell selection algorithm of 3GPP TS 03.22 shall be performed, 3GPP TS 05.08; subclause 6.6.2.

20.21.17.3 Test purpose

To verify that the MS fulfils the conformance requirement.

20.21.17.4 Method of test

20.21.17.4.1 Initial conditions

One BCCH carrier is established with the system information contents of table 20.21.1.

Parameters changed from Default values table 20.21.1.

Parameter	Carrier 1	Carrier 2	Carrier 3	Carrier 4	Carrier 5	Carrier 6
RF signal level (dB μ V emf() / dBm)	43 / -70	OFF	OFF	OFF	OFF	OFF
C1 = C2	20					

20.21.17.4.2 Procedure

- a) The MS is switched on. Idle paging is sent on carrier 1.
- b) After the MS indicates service the SS reduces the transmit level of carrier 1 to 13 dB μ V emf() (so that C1 of carrier 1 becomes -10) and turns on a new carrier (carrier 2) at a level of 33 dB μ V emf(). Carrier 2 shall not be in the MS BA list (i.e. it shall not be one of the carriers that MS has been monitoring after camped on carrier 1).
- c) The SS shall monitor all accesses on carriers 1 and 2 for 60 s.

NOTE: The access on carrier 2 should not take longer than 50 s. (5 s to rxlev averages, 5 s for C1 < 0 duration, 10 s for searching another suitable cell, 30 s for cell selection), 60 s is a safe time to wait.

20.21.17.5 Test requirements

The MS shall access on carrier 2 at test step c) within 60 s.

20.21.18 R-GSM cell reselection due to MS rejection "Roaming not allowed in this LA"

20.21.18.1 Definition

While camped on a cell of the selected PLMN the MS may need to select a different cell in order to fulfil the normal service state. This ensures that the MS is camped on a cell from which it can reliably decode downlink data and with which it has a high probability of communications on the uplink.

The MS looks for suitable neighbour cells which satisfies 4 constraints including that It should not be in an LA which is in the list of "forbidden LAs for roaming".

20.21.18.2 Conformance requirement

1. To prevent repeated attempts to have roaming service on a not allowed LA, when the MS is informed that an LA is forbidden, the LA is added to a list of "forbidden LAs for roaming" which is stored in the MS, 3GPP TS 03.22, subclause 3.1.

2. If the MS has received the cause "Roaming not allowed in this LA", in response to a LU attempt, the Network Selection Procedure shall be started, 3GPP TS 03.22; subclause 4.3.3 L3, 3GPP TS 04.08 / 3GPP TS 24.008; subclause 4.4.4.7.
3. The MS can only perform camping on a suitable cell, which:
 - should not be in an LA which is in the list of "forbidden LAs for roaming" 3GPP TS 03.22, subclause 3.2.1.

NOTE: LA stands for "Location Area" and LU stands for "Location Update".

20.21.18.3 Test purpose

1. To verify that if an LU is rejected with cause "Roaming not allowed in this LA", that the LAI of that cell is written into a forbidden list which prevents the MS from camping onto any cell in that LA.
2. To verify that if the MS has received the cause "Roaming not allowed in this LA", in response to a LU attempt, the Network Selection Procedure is initiated. This is verified indirectly by test purpose 3, in that the new LA is accessed as part of cell selection, hence CRH is disregarded.
3. To verify that if an LU is rejected, when attempting LU in a LA with LAI = LAI1, with cause "Roaming not allowed in this LA" and only cells of the selected PLMN are available, the MS will only camp and attempt LU in any LA with LAI \neq LAI1.

20.21.18.4 Method of test

20.21.18.4.1 Initial conditions

Parameters changed from Default values table 20.21.1.

Parameter	Carrier 1	Carrier 2	Carrier 3	Carrier 4	Carrier 5	Carrier 6
RF Signal Level (dB μ V emf() / dBm)	63 / -50	53 / -60	OFF	OFF	OFF	OFF
RXLEV_ACCESS_MIN (dB μ V emf() / dBm)	23 / -90	23 / -90				
MNC	MNC \neq HPLMN	MNC \neq HPLMN				
MCC	MCC of HPLMN	MCC of HPLMN				
CRH	0	0				
LAC	H1111	H2222				
ATT	1	1				
C1	40	30				
C2	40	30				

20.21.18.4.2 Procedure

- a) The MS is switched on. Idle paging is sent on all carriers.
- b) The SS monitors all RA requests from MS on carriers 1 and 2.
- c) When the MS performs an IMSI attach onto carrier 1, the SS shall reject it with cause "Roaming not allowed in this LA".
- d) The SS shall accept any LU on carrier 2.
- e) The SS monitors all RA requests from MS on carriers 1 to 2.

20.21.18.5 Test requirements

- 1) The MS should respond on carrier 1 within 33 s of switch on.
- 2) After LU reject, the MS shall initiate the Network Selection Procedure and access onto Carrier 2 as part of cell selection within 33 s from returning to idle mode after the LU reject.

NOTE: The timing requirement in b) is given only for testing purposes only. No timing requirements are defined for the Network Selection Procedure, but the time allowed for cell selection (see 20.21.1) should be adequate.

- 3) After the LU reject on carrier 1, there shall be no more access attempts on this carrier.

20.21.19R-GSM cell selection on release of SDCCH and TCH

20.21.19.1 Definition

20.21.19.2 Conformance requirement

1. When the SS releases a TCH or SDCCH and returns to idle mode, it shall, as quickly as possible camp on the BCCH carrier of the cell whose channel has just been released. If the full BCCH data for that cell was not decoded in the preceding 30 s, the MS shall then attempt to decode the full BCCH data. Until the MS has decoded the BCCH data required for determining the paging group, it shall also monitor all paging blocks on timeslot 0 of the BCCH carrier for possible paging messages that might address it. If the MS receives a page before having decoded the full BCCH data for the cell, the MS shall store the page and respond once the full BCCH data has been decoded, provided that the cell is not barred and the MS's access class is allowed. 3GPP TS 05.08, subclause 6.7.

20.21.19.3 Test purpose

1. To verify that on release of a TCH or an SDCCH, the MS camps as quickly as possible on the BCCH carrier of the cell whose channel has just been released.

NOTE: This is implicitly tested by the MS responding to a paging request. The decoding of BCCH data cannot be explicitly tested. However, the MS shall monitor for paging messages which may address it if it decodes the BCCH.

20.21.19.4 Method of test

20.21.19.4.1 Initial conditions

- a) Parameters changed from default values in table 20.21.1.

Parameter	Carrier 1	Carrier 2	Carrier 3	Carrier 4	Carrier 5	Carrier 6
RF Signal Level (dBmV emf() / dBm)	53 / -60	33 / -80	OFF	OFF	OFF	OFF
RXLEV_ACCESS_MIN (dBmV emf() / dBm)	23 / -90	23 / -90				
BS_PA_MFRMS	2	2				
ATT	1					
C1	30	10				
C2	30	10				

- b) Carrier 1 is configured to have a combined control channel.
 c) Carrier 2 is configured to have a non combined control channel.

20.21.19.4.2 Test procedure

- a) The SS activates the carriers. No paging messages are transmitted on carrier 1 or carrier 2.
- b) The MS is switched on.
- c) In response to the MS access for IMSI attach, the SS allocates a combined SDDCH/4, accepts the IMSI attach procedure and then releases the link. After 0,5 s but within 1 s of transmitting the UA frame on completion of the IMSI attach procedure, the SS transmits a single PAGING REQUEST in the appropriate paging block of the MS on carrier 1.
- d) When the MS responds to paging, the SS establishes a call on a traffic channel.
- e) The SS increases the level of carrier 2 to 63 dBmV emf().
- f) After 10 s the SS performs a handover to another TCH, with the parameters of carrier 2 indicated in the CELL DESCRIPTION information element of the HANDOVER COMMAND message.

- g) After a further 10 s, the SS clears down the call. After 0,5 s but within 1 second of transmitting the UA frame, the SS transmits a single PAGING REQUEST on carrier 2 in the appropriate paging block of the MS.

20.21.19.5 Test requirements

- 1) After step b) the MS shall access in order to commence an IMSI attach procedure on carrier 1 within 33 s.
- 2) In step c), the MS shall respond to paging within 3 seconds of transmitting the PAGING REQUEST.
- 3) In step g), the MS shall respond to paging within 3 seconds of transmitting the PAGING REQUEST.

20.22 GPRS Cell Selection and Reselection

The absolute accuracy of the MS signal level measurements is assumed to be ± 6 dB. A difference of at least 8 dB is allowed for cases of discrimination between C1, C31, C32 values and 0.

The relative accuracy of the MS signal level measurements is assumed to be ± 3 dB for the signal levels used in the tests of this subclause. A difference of at least 5 dB is allowed for cases of discrimination between C1 and C31 and C32 values on different carriers.

NOTE 1: The accuracy of MS signal level measurements is specified in 3GPP TS 05.08. For all of the tests in this subclause, the signal levels used are greater than 1 dB above reference sensitivity level.

NOTE 2: The tolerance on timers specified in 3GPP TS 05.08 is ± 10 % except for PENALTY_TIME where it is ± 2 s. In the tests of this subclause, the test requirements include these tolerances. Consequently, the times stated in the test requirement sometimes differ from the corresponding timer in the conformance requirement.

Where pulsed signals are specified, the SS tolerance on pulse width is ± 2 % and the SS tolerance on power level ± 1 dB.

The cell re-selection tests defined in the subclauses 20.22.2 to 20.22.7 apply to the MSs attached to GPRS if a PBCCH exists in the serving cell. The cell re-selection test defined in the subclause 20.22.9 applies to the MSs attached to GPRS when no PBCCH exists in the serving cell. Otherwise the MS shall perform cell re-selection according to the idle mode procedures defined in clause 6 of 3GPP TS 05.08 and therefore tests defined in clause 20 of TS 51.010 apply.

The support of GPRS shall be indicated in SYSTEM INFORMATION TYPE 3 message. In addition, the support of GPRS shall be indicated in either SYSTEM INFORMATION TYPE 4 or SYSTEM INFORMATION TYPE 7 and 8 messages. If GPRS is supported, SYSTEM INFORMATION TYPE 13 message shall be sent. SI 13 message shall not be sent if GPRS is not supported (3GPP TS 04.08 / 3GPP TS 44.018, subclause 3.2.2.1. Additional requirements for the broadcast of system information in a cell supporting GPRS are specified in 3GPP TS 04.60. The GPRS support is indicated by the presence of the field GPRS Indicator in the SI Rest Octets (3GPP TS 04.08 / 3GPP TS 44.018, subclauses 10.5.2.34; 10.5.2.35, 10.5.2.36 and 10.5.2.37).

The following definitions are applicable to tests 20.22.1 to 20.22.31:

- Carrier X supports GPRS : the SS includes the field GPRS Indicator in SI 3 Rest Octets and in SI 4 Rest Octets.
- The SS enables GPRS on carrier X : the SS starts including the field GPRS Indicator in SI 3 Rest Octets and in SI 4 Rest Octets.
- The SS disables GPRS on carrier X : the SS stops including the field GPRS Indicator in SI 3 Rest Octets and in SI 4 Rest Octets.

Unless otherwise stated in the method of test, in all of the tests of this subclause:

- The SIM is in the idle updated state in the default registration area with a TMSI and PTMSI assigned at the beginning of each test.
- By default idle paging is transmitted on the PCH according to 3GPP TS 04.08 / 3GPP TS 44.018, subclause 3.2.2.2.
- Where MS paging is specified within a test, TMSI is to be used on CCCH and PTMSI on PCCCH
- All carriers support GPRS on BCCH without a separate PBCCH channel.

- The scheduling parameters BS_PBCCH_BLKs and PSI1_REPEAT_PERIOD shall be selected such that a complete set of consistent PSI messages can be decoded within 8 multiframes (8 * 52 frames / 2 seconds).
- The Scheduling of System Information should be such that a complete set of consistent SI messages, including SI13 were applicable, can be decoded within 8 multiframes (8 × 51 frames).
- The MS is configured to automatically attach to GPRS at switch on by using the PICS/PIXIT Statement "Automatic GPRS attach procedure at switch on or power on Yes/No" as in GPRS Attach procedure tests (see subclause 44.2.1). For MS that does attach at power on, the SS shall accept access request with cause 'MM procedure' in the case of PRACH and 'one phase access' in the case of RACH in determining test verdict where applicable.
- The network simulation settings as specified in section 40 shall be applied unless otherwise stated in section 20.22.

Table 20.22.1: Default values of the system information fields

Parameter	3GPP TS 04.60 reference	Abbr.	Normal Setting
PRIORITY_CLASS	11.2.20	PC	1
C31_HYST	11.2.20	C31H	0
RA_RESELECT_HYSTERESIS	11.2.20	RARH	0 dB
HCS_THR	11.2.20	HT	-110dBm
GPRS_RESELECT_OFFSET	11.2.20	GRO	0 dB
NC_REPORTING_PERIOD_I	11.2.23	RP	61.44s
NETWORK_CONTROL_ORDER	11.2.23	NCO	NCO
GPRS_CELL_RESELECT_HYST	11.2.20	GCRH	0 dB
GPRS_TEMPORARY_OFFSET	11.2.20	GTO	0 db
GPRS_PENALTY_TIME	11.2.20	GPT	10s
GPRS_MS_TXPWR_MAX_CCH	11.2.20	GMTMC	Max. output power of MS
GPRS_RXLEV_ACCESS_MIN	11.2.20	GRAM	-90 dBm
C32_QUAL	11.2.20	C32Q	0
BA(GPRS) ARFCN	11.2.20	BA	All 0 except values in Table 20.22.1a (broadcast in PACKET SYSTEM INFORMATION type 3 and 3bis in case of PBCCH present and in SYSTEM INFORMATION TYPE 2 and 2bis if PBCCH is absent.)

Table 20.22.1a: ARFCNs for Single Band Tests

Band	ARFCNs
GSM 450	259, 263, 269, 275, 279, 283, 287, 292
GSM 480	306, 310, 316, 322, 326, 330, 334, 339
GSM 710	441, 446, 452, 455, 461, 462, 466, 470, 477, 485, 493, 511
GSM 750	441, 446, 452, 455, 461, 462, 466, 470, 477, 485, 493, 511
T-GSM 810	441, 446, 452, 455, 461, 462, 466, 470, 477, 485, 493, 511
GSM 850	130, 136, 145, 152, 168, 170, 176, 177, 181, 185, 189, 193, 197, 207, 219, 251
GSM 900	both P-GSM and E-GSM ARFCNs are broadcast: GSM: 3, 9, 18, 25, 41, 43, 49, 50, 54, 58, 62, 66, 70, 80, 92, 124 E-GSM: 985, 989, 995, 1010, 1014
DCS 1800	512, 543, 568, 589, 602, 641, 662, 683, 696, 711, 732, 754, 794, 851, 870, 871, 872, 884
PCS1900	512, 543, 568, 589, 602, 629, 641, 653, 662, 683, 696, 711, 727, 732, 754, 777, 794, 809

20.22.1 Cell selection

20.22.1.1 Definition

Cell selection is a process in which an MS, whenever a new PLMN is selected, attempts to find a suitable cell of that PLMN to camp on. Two methods of searching for a suitable cell are possible, normal cell selection and stored list cell selection. The process ensures that the MS is camped on a cell from which it can reliably decode downlink data and with which it has a high probability of communications on the uplink. Once the MS is camped on a cell, access to the network is allowed.

20.22.1.2 Conformance requirement

1. ... the MS shall be able to select the correct (fourth strongest) cell and be able to respond to paging on that cell within 30 seconds of switch on, when the three strongest cells are not suitable. This assumes a valid SIM with PIN disabled and ideal radio conditions

3GPP TS 05.08 / 3GPP TS 45.008, subclause 6.1.

2. There are various requirements that a cell must satisfy before an MS can perform normal camping on it:

2.1 (i) It should be a cell of the selected PLMN

2.2 (ii) It should not be "barred" (see subclause 3.5.1)

2.3 (iii) It should not be in an LA which is in the list of "forbidden LAs for roaming";

2.4 (iv) The radio path loss between MS and BTS must be below a threshold set by the PLMN operator. This is estimated as shown in subclause 3.6. 3GPP TS 03.22, subclause 3.2.1.

NOTE: Criteria 2.3 (iii) is not applicable for Cell Selection.

3. Initially the MS looks for a cell which satisfies these 4 constraints ("suitable cell") by checking cells in descending order of received signal strength. If a suitable cell is found, the MS camps on it, 3GPP TS 03.22, subclause 3.2.1.
4. The MS shall be able to calculate correctly the path loss criterion parameter C1, used for cell selection and reselection, 3GPP TS 05.08, subclause 6.4.

20.22.1.3 Test purpose

1. To verify that the MS meets conformance requirement 1. even when one of the other cells supports GPRS.
2. To verify that:
 - 2.1 The MS does not select a cell of a PLMN, which is not the selected PLMN.
 - 2.2 The MS does not select a cell which is "barred".
 - 2.4 The MS does not select a cell with $C1 < 0$.
3. To verify that the MS selects suitable cells in descending order of received signal strength.
4. To verify that the MS does not select a cell with $C1 < 0$.

20.22.1.4 Method of test

20.22.1.4.1 Initial conditions

Parameters changed from the default values in table 20.22.1.

Parameter	Cell A	Cell B		Cell C	Cell D	Cell E
	Carrier 1	Carrier 2	Carrier 6	Carrier 3	Carrier 4	Carrier 5
Channel Type Carried	BCCH	BCCH	PBCCH	BCCH	BCCH	BCCH
RF Signal Level (dBm)	-75	-80	-80	-70	-60	-70
Serving Cell parameters						
CBA	0	0	--	0	1	0
RXLEV_ACCESS_MIN (dBm)	-90	Default	--	-90	-90	-60
GPRS_RXLEV_ACCESS_MIN	--	--	-90	--	--	--
MNC	Default	Default	Default	See Table 20.1c	Default	Default
MCC	Default	Default	Default	002	Default	Default
Neighbour Cell parameters						
GPRS_RXLEV_ACCESS_MIN	Default	-90	--	Default	Default	Default
C1	15	10		20	30	-10

NOTE 1: For an E-GSM MS carrier 1 and carrier 5 ARFCNs are chosen in the E-GSM band, carrier 3 and carrier 4 ARFCNs in the P-GSM band.

NOTE 2: Carrier 2 is the BCCH carrier which broadcasts the position of the PBCCH channel in the cell (carrier 6).

NOTE 3: Carriers 1, 3, 4 and 5 do not support GPRS.

NOTE 4: Serving Cell Parameters are coded and transmitted on the specified Channel Type whilst Neighbour Cell Parameters are coded and transmitted on the PBCCH, but refer to the Neighbour BCCH carriers.

20.22.1.4.2 Procedure

- a) The SS activates and pages on the MS on all carriers. All Carriers are monitored for RA requests from the MS.
- b) The MS is switched on.

20.22.1.5 Test requirements

- 1) After step b), the first response from the MS shall be on carrier 1 within 33 s. There shall be no response from the MS on any other carrier.

20.22.2 Cell reselection in Packet Idle mode

20.22.2.1 Definition

-

20.22.2.2 Conformance requirement

1. At least for every new sample or every second, whichever is the greatest, the MS shall update RLA_P and calculate the value of C1, C31 and C32 for the serving cell and the non-serving cells; 3GPP TS 05.08, subclause 10.1.2 The MS shall make a cell re-selection if:

- (i) The path loss criterion parameter (C1) for the serving cell falls below zero.
- (ii) A non-serving suitable cell (see 3GPP TS 03.22) is evaluated to be better than the serving cell. The best cell is the cell with the highest value of C32 among:

- those cells that have the highest PRIORITY_CLASS among those that fulfil the criterion $C31 \geq 0$; or
- all cells, if no cells fulfil the criterion $C31 \geq 0$.

If the parameter C32_QUAL is set, positive GPRS_RESELECT_OFFSET values shall only be applied to the neighbour cell with the highest RLA_P value of those cells for which C32 is compared above.

PRIORITY_CLASS and C32_QUAL are broadcast on PBCCH of the serving cell.

When evaluating the best cell, the following hysteresis values shall be subtracted from the C32 value for the neighbour cells:

- in standby state, if the new cell is in the same routing area: 0.
- in ready state, if the new cell is in the same routing area:
 - GPRS_CELL_RESELECT_HYSTERESIS. If the parameter C31_HYST is set,;
 - GPRS_CELL_RESELECT_HYSTERESIS shall also be subtracted from the C31 value for the neighbour cells.
- in standby or ready state, if the new cell is in a different routing area:
 - RA_RESELECT_HYSTERESIS.
- in case of a cell re-selection occurred within the previous 15 s: 5 dB.
 - GPRS_CELL_RESELECT_HYSTERESIS, C31_HYST and RA_RESELECT_HYSTERESIS are broadcast on PBCCH of the serving cell.

20.22.2.3 Test purpose

To verify that the MS reselects the correct cell based on the C32 parameter when GPRS_RESELECT_OFFSET, TEMPORARY_OFFSET and PENALTY_TIME parameters are transmitted in the System information messages.

1. To verify MS does not reselect on the basis of C31 as there are no HCS threshold values transmitted in the System information messages.

20.22.2.4 Method of test

20.22.2.4.1 Initial conditions

Parameters changed from the default values in table 20.22.1.

Parameter	Cell A		Cell B		Cell C	
	Carrier 1	Carrier 4	Carrier 5	Carrier 2	Carrier 3	Carrier 6
Channel Type Carried	BCCH	PBCCH	BCCH	PBCCH	BCCH	PBCCH
RF Signal Level (dBm)	-65	-65	-60	-60	-70	-70
Serving Cell Parameters						
GPRS_RXLEV_ACCESS_MIN (dBm)	--	-85	--	-90	--	-100
Neighbour Cell Parameters						
GPRS_RXLEV_ACCESS_MIN (dBm)	-85	--	-90	--	-100	--
GPT	40 s	--	Default	--	Default	--
GRO	20 dB	--	-20 dB	--	-20 dB	--
GTO	20 dB	--	Default	--	Default	--
C1	20	--	30	--	30	--
C32	20-40	--	30	--	10	--

NOTE 1: The BA(GPRS) list only contains the ARFCNs of the carriers used during the test.

NOTE 2: The HCS structure is omitted from the packet system information messages.

NOTE 3: Carrier 5 is the BCCH carrier which broadcasts the position of the PBCCH channel in the cell (Carrier 2).
Carrier 3 is the BCCH carrier which broadcasts the position of the PBCCH channel in the cell (Carrier 6).
Carrier 1 is the BCCH carrier which broadcasts the position of the PBCCH channel in the cell (Carrier 4).

NOTE 4: Serving Cell Parameters are coded and transmitted on the specified Channel Type whilst Neighbour Cell Parameters are coded and transmitted on the PBCCH, but refer to the Neighbour BCCH carriers.

20.22.2.4.2 Procedure

- a) The SS activates carriers 2 and 5.
- b) The MS is switched on and completes GPRS Attach (ready timer deactivated) on Carrier 2.
- c) The SS activates carriers 1, 4, 3 and 6. The MS is paged on carriers 4, 3 and 6. The SS monitors carriers 4 and 3 for RA requests from the MS.

20.22.2.5 Test Requirements

- 1) After step b) the SS should ensure that the MS final state is in Packet Idle mode on carrier 2.
- 2) After step c) there should be no response on carrier 4 within 38 s of activating the carrier but MS should respond on carrier 4 within 50 s plus Max{10s, 14 consecutive paging blocks of that MS} of activating the carrier.

NOTE: Minimum time of 38 s set by penalty timer on carrier 4 less 2 s tolerance. Maximum time includes Max{10s, 14 consecutive paging blocks of that MS} to read BSIC on carrier 1, 40 s + 2 s tolerance for expiry of penalty timer on carrier 4, 2 s to decode BCCH on carrier 1 (taking into account the Scheduling of System Information requirement from setion 20.22), 2 s to decode PBCCH on carrier 4 (taking into account the Scheduling of Packet System Information requirement from setion 20.22), 1 s for reselection, since the MS will already have running averages on carrier 1, when the penalty timers expire, additional time for update of NB-list in the mobile, allow at least 50 s plus Max{10s, 14 consecutive paging blocks of that MS}.

20.22.3 Priority of cells

20.22.3.1 Definition

-

20.22.3.2 Conformance requirement

At least for every new sample or every second, whichever is the greatest, the MS shall update RLA_P and calculate the value of C1, C31 and C32 for the serving cell and the non-serving cells; 3GPP TS 05.08, subclause 10.1.2. The MS shall make a cell re-selection if:

- (i) The path loss criterion parameter (C1) for the serving cell falls below zero.
- (ii) A non-serving suitable cell (see 3GPP TS 03.22) is evaluated to be better than the serving cell. The best cell is the cell with the highest value of C32 among:
 - those cells that have the highest PRIORITY_CLASS among those that fulfil the criterion $C31 \geq 0$; or
 - all cells, if no cells fulfil the criterion $C31 \geq 0$.

If the parameter C32_QUAL is set, positive GPRS_RESELECT_OFFSET values shall only be applied to the neighbour cell with the highest RLA_P value of those cells for which C32 is compared above.

PRIORITY_CLASS and C32_QUAL are broadcast on PBCCH of the serving cell.

When evaluating the best cell, the following hysteresis values shall be subtracted from the C32 value for the neighbour cells:

- in standby state, if the new cell is in the same routing area: 0.
- in ready state, if the new cell is in the same routing area:
 - GPRS_CELL_RESELECT_HYSTERESIS. If the parameter C31_HYST is set;
 - GPRS_CELL_RESELECT_HYSTERESIS shall also be subtracted from the C31 value for the neighbour cells.
- in standby or ready state, if the new cell is in a different routing area:
 - RA_RESELECT_HYSTERESIS.
- in case of a cell re-selection occurred within the previous 15 s: 5 dB.
 - GPRS_CELL_RESELECT_HYSTERESIS, C31_HYST and RA_RESELECT_HYSTERESIS are broadcast on PBCCH of the serving cell.

20.22.3.3 Test purpose

1. To verify that the MS reselects to the correct cell by calculating C31 correctly when C31_HYST is set on the network.

20.22.3.4 Method of Test

20.22.3.4.1 Initial Conditions

Parameters changed from the default values in table 20.22.1.

Parameter	Cell A		Cell B	Cell C	Cell D	Cell E
	Carrier 1	Carrier 2	Carrier 3	Carrier 4	Carrier 5	Carrier 6
Channel Type Carried	BCCH	PBCCH	BCCH	BCCH	BCCH	BCCH
RF Signal Level (dBm)	-60	-60	-80	-64	-70	-70
Serving Cell Parameters						
GPRS_RXLEV_ACCESS_MIN (dBm)	--	-100	--	--	--	--
C31_HYST	--	1	--	--	--	--
Priority Class	--	3	--	--	--	--
HCS_THR	--	-90	--	--	--	--
GCRH	--	6	--	--	--	--
Neighbour Cell Parameters						
GPRS_RXLEV_ACCESS_MIN (dBm)	-100	--	-100	-92	-100	-102
Priority Class	3	--	3	3	3	1
GRO	Default	--	10	4	10	16
HCS_THR	-90	--	-70	-80	-86	-86
C1	40 to 15	--	20	28	30	32
C31	30 to 5	--	-16	10	10	10
C32	40 to 15	--	24	26	34	42

NOTE 1: GRO = GPRS_RESELECT_OFFSET, GCRH = GPRS_CELL_RESELECT_HYSTERESIS, RARH = RA_RESELECT_HYSTERESIS.

NOTE 2: The BA(GPRS) list only contains the ARFCNs of the carriers used during the test. The HCS structure is transmitted in the Packet system information messages.

NOTE 3: Carrier 1 is the BCCH carrier which broadcasts the position of the PBCCH channel in the cell (carrier 2.)

NOTE 4: Carrier 2 (PBCCH) broadcasts settings for carriers 3 to 6. Calculations of C31 and C32 are based on the MS attached to carrier 2.

NOTE 5: Serving Cell Parameters are coded and transmitted on the specified Channel Type whilst Neighbour Cell Parameters are coded and transmitted on the PBCCH, but refer to the Neighbour BCCH carriers.

20.22.3.4.2 Procedure

- The SS activates carriers 1 and 2. The MS is switched on and completes GPRS Attach procedure (ready timer deactivated) on carrier 2.
- The SS activates carriers 3, 4, 5 and 6. The SS waits until MS has completed the running average of the BA(GPRS). Time allowed is max(10s, 14 consecutive paging blocks of the MS).
- The RF level of carriers 1 and 2 are reduced to -85 dBm (C1 = decreases to 15).

20.22.3.5 Test Requirements

After step c) the MS should respond on carrier 5. (Carrier 3 should be rejected as $C31 < 0$, carrier 6 has a lower priority class than carrier 4 and carrier 5 so is rejected, even though $C32 = 40$, out of carrier 4 and 5, carrier 5 has highest C32 value.

NOTE: Time allowed includes $\text{Max}\{5\text{s}, 5 \text{ consecutive paging blocks of the MS}\}$ for MS to determine C32 on neighbour cell is higher, 2 seconds to decode BCCH and 1 sec for re-selection.

20.22.4 Cell re-selection with cells in different routing area

20.22.4.1 Definition

-

20.22.4.2 Conformance requirement

At least for every new sample or every second, whichever is the greatest, the MS shall update RLA_P and calculate the value of C1, C31 and C32 for the serving cell and the non-serving cells; 3GPP TS 05.08, subclause 10.1.2. The MS shall make a cell re-selection if:

- (i) The path loss criterion parameter (C1) for the serving cell falls below zero.
- (ii) A non-serving suitable cell (see 3GPP TS 03.22) is evaluated to be better than the serving cell. The best cell is the cell with the highest value of C32 among;
- those cells that have the highest PRIORITY_CLASS among those that fulfil the criterion $C31 \geq 0$; or
 - all cells, if no cells fulfil the criterion $C31 \geq 0$.

If the parameter C32_QUAL is set, positive GPRS_RESELECT_OFFSET values shall only be applied to the neighbour cell with the highest RLA_P value of those cells for which C32 is compared above.

PRIORITY_CLASS and C32_QUAL are broadcast on PBCCH of the serving cell.

When evaluating the best cell, the following hysteresis values shall be subtracted from the C32 value for the neighbour cells:

- in standby state, if the new cell is in the same routing area: 0.
- in ready state, if the new cell is in the same routing area:
 - GPRS_CELL_RESELECT_HYSTERESIS. If the parameter C31_HYST is set;
 - GPRS_CELL_RESELECT_HYSTERESIS shall also be subtracted from the C31 value for the neighbour cells.
- in standby or ready state, if the new cell is in a different routing area:
 - RA_RESELECT_HYSTERESIS.
- in case of a cell re-selection occurred within the previous 15 s: 5 dB.
 - GPRS_CELL_RESELECT_HYSTERESIS, C31_HYST and RA_RESELECT_HYSTERESIS are broadcast on PBCCH of the serving cell.

20.22.4.3 Test purpose

To verify that the MS reselects to the correct cell by calculating C32 correctly when one of the cells is in a different routing area.

20.22.4.4 Method of Test

20.22.4.4.1 Initial Conditions

Parameters changed from the default values in table 20.22.1.

Parameter	Cell A		Cell B		Cell C	
	Carrier 1	Carrier 2	Carrier 3	Carrier 4	Carrier 5	Carrier 6
Channel Type Carried	BCCH	PBCCH	BCCH	PBCCH	PBCCH	BCCH
RF Signal Level (dBm)	-60	-60	-70	-70	-70	-70
Serving Cell Parameters						
RA COLOUR	1	--	1	--	--	2
GPRS_RXLEV_ACCESS_MIN (dBm)	--	-100	--	-100	100	--
GCRH	--	4	--	Default	Default	--
RARH	--	14	--	14	Default	--
Neighbour Cell Parameters						
GPRS_RXLEV_ACCESS_MIN (dBm)	-100	--	-100	--	--	-100
GRO	Default	--		--	--	6
C1	40	--	30	--	--	30
C32	40	--	30	--	--	22

NOTE 1: GRO = GPRS_RESELECT_OFFSET, GCRH = GPRS_CELL_RESELECT_HYSTERESIS, RARH = RA_RESELECT_HYSTERESIS.

NOTE 2: The BA(GPRS) list only contains the ARFCNs of the carriers used during the test. The HCS structure is omitted from the packet system information messages on all the cells. Therefore C31 is not used.

NOTE 3: Carrier 1 is the BCCH carrier which broadcasts the position of the PBCCH channel in the cell (carrier 2)
Carrier 3 is the BCCH carrier which broadcasts the position of the PBCCH channel in the cell (carrier 4)
Carrier 6 is the BCCH carrier which broadcasts the position of the PBCCH channel in the cell (carrier 5).

NOTE 4: The calculated values of C32 are based on the MS attached to Carrier 2

NOTE 5: Serving Cell Parameters are coded and transmitted on the specified Channel Type whilst Neighbour Cell Parameters are coded and transmitted on the PBCCH, but refer to the Neighbour BCCH carriers.

20.22.4.4.2 Procedure

- a) The SS activates Carriers 1 and 2. The MS is switched on and completes GPRS Attach procedure (ready timer deactivated) on carrier 2.
- b) The SS activates Carriers 3, 4, 5 and 6. The SS waits until MS has completed the running average of the BA(GPRS). Time allowed is max(10s, 14 consecutive paging blocks of the MS).
- c) The RF level of carriers 1 and 2 are reduced to -85 dBm (C1 = decreases to 15).

20.22.4.5 Test Requirements

After step c) the MS should respond on carrier 4. (Carrier 5 C32=22 if RA_RESELECT_HYSTERESIS is used correctly by MS otherwise it will be 36 and MS will select carrier 5 incorrectly)

Note: Time allowed includes Max{5s, 5 consecutive paging blocks of the MS} for MS to determine C32 on neighbour cell is higher, 2 seconds to decode BCCH, 2 sec to decode PSI1, 2 sec to decode PBCCH and 1 sec for re-selection.

20.22.5 Network controlled Cell re-selection in Idle Mode

20.22.5.1 Definition

-

20.22.5.2 Conformance requirement

1. A cell re-selection command may be sent from the network to an MS. When the MS receives the command, it shall immediately re-select the cell according to the included cell description and change the network control mode according to the command (3GPP TS 04. 60, GSM05.08, subclause 10.1.4).

20.22.5.3 Test purpose

To verify the MS can correctly interpret the network control commands and reselect to the correct cell.

20.22.5.4 Method of Test

20.22.5.4.1 Initial Conditions

Parameters changed from the default values in table 20.22.1.

Parameter	Cell A		Cell B	Cell C		NOTE	
	Carrier 1	Carrier 2	Carrier 3	Carrier 4	Carrier 5		
Channel Type Carried	BCCH	PBCCH	BCCH	BCCH	PBCCH	NOTE 1:	The
RF Signal Level (dBm)	-60	-60	-80	-70	-70		
Serving Cell Parameters						NOTE 2:	Carr
GPRS_RXLEV_ACCESS_MIN (dBm)	--	-100	--	--	-100		
NETWORK_CONTROL_ORDER		NC2	NC0		NC2		
NC_REPORTING_PERIOD_T (s)		7.68	--		7.68	NOTE 3:	Serv
NC_REPORTING_PERIOD_I (s)		30.72			30.72		
Neighbour Cell Parameters							
GPRS_RXLEV_ACCESS_MIN (dBm)	-100	--	-100	-100	--		
C1	40-20	--	20-40	30	--		
C32	40-20	--	20-40	30	--		

20.22.5.4.2 Procedure

- The MS is switched on and completes GPRS Attach procedure (ready timer deactivated) on carrier 2. SS waits till either the measurement of cell B and C are reported in PACKET MEASUREMENT REPORT or a timer set to $\max(10s, 14 \text{ consecutive Paging Blocks of the MS}) + 10\%$ expires.
- The RF level of carriers 1 and 2 are reduced to -80 dBm. (C32 becomes 20).
- The SS waits 15 s after the RF level of carriers 1 and 2 are reduced before sending Packet Cell Change Order, with the IMMEDIATE_REL bit set to FALSE, to the MS to select carrier 4. The MS shall complete Cell Update procedure on carrier 5.
- The RF level of carrier 3 is increased to -60 dBm. (C32 becomes 40).
- The SS waits Y s (see the note below) after increasing the RF level of carrier 3 before the Network Control Order is changed to NC0 on carriers 4 and 5 by sending Packet Measurement Order.

Note: Y sec is $\text{Max}\{5s, 5 \text{ consecutive paging blocks of the MS}\}$.

20.22.5.5 Test Requirements

- After step b) there should be no response on carriers 3, 4 or 5.
- After step c) there should be a response on carrier 5.

Note: Time allowed includes 2 seconds to decode BCCH, 2 sec to decode PSI1, 2 sec to decode PBCCH and 5 sec for re-selection.

- After step d) there should be no response on carriers 1, 2, 3.
- After step e) there should be a response on carrier 3 within x s (see Note) of the SS sending the Packet Measurement Order.

Note: Time allowed includes 1 paging block of the MS + 2 seconds to decode BCCH + 1s for reselection + 1s tolerance.

20.22.6 Cell reselection timings

20.22.6.1 Definition

-

20.22.6.2 Conformance requirement

At least for every sample or every second, whichever is greatest, the MS shall calculate the value of C1, C31 and C32 for the serving cell and recalculate C1, C31 and C32 values for non serving cells (if necessary). The MS shall make a cell re-selection if:

- The path loss criterion parameter (C1) for the serving cells falls below zero.

20.22.6.3 Test purpose

1. To verify that the MS meets conformance requirement 6.2 (i) within time allowed.

20.22.6.4 Method of Test

20.22.6.4.1 Initial Conditions

Parameters changed from the default values in table 20.22.1.

Parameter	Cell A		Cell B	
	Carrier 1	Carrier 2	Carrier 3	Carrier 4
Channel Type Carried	BCCH	PBCCH	BCCH	PBCCH
RF Signal Level (dBm)	-60	-60	-70	-70
Serving Cell Parameters				
GPRS_RXLEV_ACCESS_MIN (dBm)	--	-90	--	-100
Neighbour Cell Parameters				
GPRS_RXLEV_ACCESS_MIN (dBm)	-90	--	-100	--
GRO	Default	--	-28	--
C1	30	--	30	--
C32	30	--	2	--

NOTE 1: The HCS structure is omitted from the system information messages on all the cells. Therefore C31 is not used.

NOTE 2: Carriers 1 and 3 are the BCCH carriers which broadcast the position of the PBCCH channel in the cell (carriers 2 and 4).

NOTE 3: Serving Cell Parameters are coded and transmitted on the specified Channel Type whilst Neighbour Cell Parameters are coded and transmitted on the PBCCH, but refer to the Neighbour BCCH carriers.

20.22.6.4.2 Procedure

- a) The SS activates carriers 1 and 2. The MS is switched on and brought into Packet Idle Mode on carrier 2.
- b) The SS activates all remaining carriers and pages the MS on carrier 4. The SS starts to monitor carriers 3 and 4 for responses from the MS.
- c) The SS waits 30 s before the RF level of carriers 1 and 2 are reduced to -100 dBm for X seconds, where X = repetition of paging blocks in seconds \times 2. (During this period C1 becomes -10). Then the SS raises the level back to -60 dBm. The SS waits 20 s.
- d) The SS reduces the RF level on carriers 1 and 2 to -100dBm.

20.22.6.5 Test Requirements

- 1) After step c) there shall be no access on carrier 3 or carrier 4.
- 2) After step d) there shall be access on carrier 4 (see note below).

Note: Time allowed includes Max{5s, 5 consecutive paging blocks of the MS} for MS to determine C1 is less than zero, 2 seconds to decode BCCH, 2 sec to decode PSI1, 2 sec to decode PBCCH and 1 sec for re-selection.

20.22.7 Downlink signalling failure

20.22.7.1 Definition

-

20.22.7.2 Conformance requirement

The downlink signalling failure criterion is based on the downlink signalling failure counter DSC.

1. If DRX period split is supported, DSC shall be initialised to a value equal to the nearest integer to $\max(10, 90/64 \times \text{SPLIT_PG_CYCLE})$ where SPLIT_PG_CYCLE is a parameter given by the MS at GPRS attach (see 3GPP TS 05.02).
2. Thereafter, whenever the MS attempts to decode a message in its paging subchannel; if a message is successfully decoded DSC is increased by 1, however never beyond the max value defined in 1.
3. Whenever the MS can not successfully decode a message in its paging subchannel the DSC is decreased by 4.
4. When DSC reaches 0, a downlink signalling failure shall be declared. A downlink signalling failure shall result in cell reselection, 3GPP TS 03.22, subclause 4.5 (ii) and 3GPP TS 05.08, subclause 6.5

NOTE: The network sends the paging subchannel for a given MS every $64/\text{SPLIT_PG_CYCLE}$ multiframes . The requirement for network transmission on the paging subchannel is specified in 3GPP TS 04.08 / 3GPP TS 44.018. The MS is required to attempt to decode a message every time its paging subchannel is sent.

20.22.7.3 Test purpose

1. To verify that the MS initialises the DSC counter in accordance with the conformance requirement. This is verified indirectly.
2. To verify that whenever the MS successfully decodes a message on paging subchannel, the DSC is increased by 1, (however never beyond the nearest integer to max defined in subclause 16.2.1). This is verified indirectly.
- 3 To verify that whenever the MS can not successfully decode a message on paging subchannel, the DSC decreased by 4. This is verified indirectly.
4. To verify that when the DSC reaches 0, a downlink signalling failure shall be declared and the MS will perform cell reselection.

20.22.7.4 Method of Test

20.22.7.4.1 Initial Conditions

Parameters changed from the default values in table 20.22.1.

Parameter	Cell A		Cell B	
	Carrier 1	Carrier 2	Carrier 3	Carrier 4
Channel Type Carried	BCCH	PBCCH	BCCH	PBCCH
RF Signal Level (dBμV emf) / dBm	-65	-65	-60	-60
Serving Cell Parameters				
GPRS_RXLEV_ACCESS_MIN (dBm)	--	-95	--	-100
Neighbour Cell Parameters				
GPRS_RXLEV_ACCESS_MIN (dBm)	-95	--	-100	--
C1	30	--	40	--
C32	30	--	40	--

NOTE 1: The HCS structure is omitted from the system information messages on all the cells. Therefore C31 is not used.

NOTE 2: The SS shall use the SPLIT_PG_CYCLE which the MS defines in the Attach Request. The SS shall calculate the DSC, which the MS uses, based upon the received SPLIT_PG_CYCLE. I.e. if the MS uses SPLIT_PG_CYCLE = 4, the SS shall use DSC = 10 and paging blocks shall occur every 832 frames or 3,84 s.

NOTE 3: Carriers 1 and 3 are BCCH carriers which broadcast the position of the PBCCH channel in the cell (carriers 2 and 4).

NOTE 4: Serving Cell Parameters are coded and transmitted on the specified Channel Type whilst Neighbour Cell Parameters are coded and transmitted on the PBCCH, but refer to the Neighbour BCCH carriers.

20.22.7.4.2 Procedure

- a) The SS activates carriers 3 and 4. On carrier 4 valid layer 3 messages shall be sent in the paging blocks, but not paging the MS. The MS is switched on and brought into Packet Idle Mode on carrier 4. The SS activates all remaining carriers and on carrier 2 the MS is paged continuously in all paging blocks.
- b) After 40 s the SS sends corrupted data (using random data, wrong parity bits see 3GPP TS 05.03, subclauses 4.3 and 4.1.2 or other lower layer error) in N successive paging blocks on carrier 4 and then reverts to sending normal data.

NOTE 1: Sending corrupted, i.e. non-decodable data on N successive paging blocks should decrease the DSC to 1 to 4 depending upon the value of DSC.

NOTE 2: N is rounded off to the nearest higher integer of $((DSC / 4) - 1)$

- c) The SS monitors all accesses on both carriers for X s, where $X = DSC \times$ repetition of paging blocks in seconds (Allows the DSC counter to go back to maximum).
- d) The SS sends corrupted data in successive paging blocks on carrier 4 until $DCS < 0$ and then reverts to sending normal data..

NOTE 2: Sending corrupted, data in successive paging blocks should decrease the DSC to < 0 (or below 0) and cause a cell reselection.

- e) The SS monitors all accesses on both carriers for 30 s.

20.22.7.5 Test requirements

- 1) There shall be no access on carriers 1 or 2 after step b).
- 2) The MS shall access on carrier 2 at test step e) within 7 s. (The time 7 should be measured from the transmission of the last complete successive paging block with errors. Given time of 7 sec includes: 2s to decode BCCH, 2s to synchronise to PSI1, 2s to decode PBCCH and 1 sec tolerance).

20.22.8 Cell selection when the best cell does not support GPRS

20.22.8.1 Definition

Cell selection is a process in which an MS, whenever a new PLMN is selected, attempts to find a suitable cell of that PLMN to camp on. Two methods of searching for a suitable cell are possible, normal cell selection and stored list cell selection. The process ensures that the MS is camped on a cell from which it can reliably decode downlink data and with which it has a high probability of communications on the uplink. The support of GPRS is not a condition to select a cell. Once the MS is camped on a cell, access to the network is allowed.

20.22.8.2 Conformance requirement

1. ... the MS shall be able to select the correct (fourth strongest) cell and be able to respond to paging on that cell within 30 seconds of switch on, when the three strongest cells are not suitable. This assumes a valid SIM with PIN disabled and ideal radio conditions
3GPP TS 05.08 / 3GPP TS 45.008, subclause 6.1.
2. There are various requirements that a cell must satisfy before an MS can perform normal camping on it:
 - 2.1 (i) It should be a cell of the selected PLMN;
 - 2.2 (ii) It should not be "barred" (see subclause 3.5.1);
 - 2.3 (iii) It should not be in an LA which is in the list of "forbidden LAs for roaming";
 - 2.4 (iv) The radio path loss between MS and BTS must be below a threshold set by the PLMN operator. This is estimated as shown in subclause 3.6. 3GPP TS 03.22, subclause 3.2.1.

NOTE: Criteria 2.3 (iii) is not applicable for Cell Selection.

3. Initially the MS looks for a cell which satisfies these 4 constraints ("suitable cell") by checking cells in descending order of received signal strength. If a suitable cell is found, the MS camps on it, 3GPP TS 03.22, subclause 3.2.1.
4. The MS shall be able to calculate correctly the path loss criterion parameter C1, used for cell selection and reselection, 3GPP TS 05.08, subclause 6.4.

20.22.8.3 Test purpose

1. To verify that the MS meets conformance requirement 1. even when one of the other cells supports GPRS.
2. To verify that:
 - 2.1 The MS does not select a cell of a PLMN, which is not the selected PLMN.
 - 2.2 The MS does not select a cell which is "barred".
 - 2.4 The MS does not select a cell with $C1 < 0$.
3. To verify that the MS selects suitable cells in descending order of received signal strength.
4. To verify that the MS does not select a cell with $C1 < 0$.

20.22.8.4 Method of test

20.22.8.4.1 Initial conditions

Parameters changed from the default values in table 20.22.1.

Parameter	Cell A	Cell B	Cell C	Cell D	Cell E
	Carrier 1	Carrier 2	Carrier 3	Carrier 4	Carrier 5
Channel Type Carried	BCCH	BCCH	BCCH	BCCH	BCCH
RF Signal Level (dBm)	-75	-80	-70	-60	-70
GPRS Support	N	Y	N	N	N
CBA	0	0	0	1	0
RXLEV_ACCESS_MIN (dBm)	-90	-90	-90	-90	-60
GPRS_RXLEV_ACCESS_MIN	--	--	--	--	--
MNC	Default	Default	See Table 20.1c	Default	Default
MCC	Default	Default	002	Default	Default
C1	15	10	20	30	-10

NOTE 1: For an E-GSM MS carrier 1 and carrier 5 ARFCNs are chosen in the E-GSM band, carrier 3 and carrier 4 ARFCNs in the P-GSM band.

NOTE 2: Carrier 2 supports GPRS without PBCCH channel in the cell.

NOTE 3: Carriers 1, 3, 4 and 5 do not support GPRS.

20.22.8.4.2 Procedure

- a) The SS activates and pages on the MS on all carriers. All Carriers are monitored for RA requests from the MS.
- b) The MS is switched on.

20.22.8.5 Test requirements

- 1) After step b), the first response from the MS shall be on carrier 1 within 33 s. There shall be no response from the MS on any other carrier.

20.22.9 Cell reselection when the best cell does not support GPRS

20.22.9.1 Definition

While camped on a cell of the selected PLMN the MS may need to select a different cell in order to fulfil the normal service state. This ensures that the MS is camped on a cell from which it can reliably decode downlink data and with which it has a high probability of communications on the uplink. The target cell should be reselected despite it does not support GPRS.

20.22.9.2 Conformance requirement

1. While camped on a cell of the selected PLMN ("camped normally"), the MS may need to select a different cell ("normal cell reselection" state). The following events trigger a cell reselection:

1.1 (iii) The cell camped on (current serving cell) has become barred.

1.2 (iv) There is a better cell (in terms of the path loss criterion C2) in the same LA, or a much better cell in another LA of the selected PLMN (using the CRH parameter).

The MS will then reselect a new cell in order to fulfil the process goal.; 3GPP TS 03.22, subclause 4.5.

NOTE 1: Criterion (i) is tested in subclause 20.8 (Cell reselection when $C1(\text{serving cell}) < 0$ for 5 s).

NOTE 2: Criterion (ii) is tested subclause 20.16 (Downlink signalling failure).

NOTE 3: Criterion (v) is tested in subclause 20.6 (Cell reselection timings).

2. There are various requirements that a cell must satisfy before an MS can perform normal camping on it:

2.1 (ii) It should not be "barred".

2.2 (iv) The radio path loss between MS and BTS must be below a threshold set by the PLMN operator. 3GPP TS 03.22, subclause 3.2.1.

NOTE 4: Criterion (i) is not relevant for cell reselection and for cell selection it is tested in subclause 20.1.

NOTE 5: Criterion (iv) refers to the C1 parameter.

3. The MS shall be able to calculate correctly the path loss criterion parameter C2 used for cell reselection; 3GPP TS 05.08, subclause 6.4.

4. At least every 5 s the MS shall calculate the value of C1 and C2 for the serving cell and recalculate C1 and C2 values for non serving cells (if necessary). The MS shall then check whether:

i) The path loss criterion (C1) for current serving cell falls below zero for a period of 5 s. This indicates that the path loss to the cell has become too high.

ii) The calculated value of C2 for a non-serving suitable cell exceeds the value of C2 for the serving cell for a period of 5 s, except in the case of the new cell being in a different location area or, for a GPRS MS, in a different routing area or always for a GPRS MS in ready state in which case the C2 value for the new cell shall exceed the C2 value of the serving cell by at least `CELL_RESELECT_HYSTERESIS` dB as defined by the BCCH data from the current serving cell, for a period of 5 seconds. This indicates that it is a better cell. 3GPP TS 05.08, subclause 6.6.2.

5. The MS shall attempt to decode the full BCCH data of the serving cell at least every 30 s; 3GPP TS 05.08, subclause 6.6.1.

20.22.9.3 Test purpose

20.22.9.3.1 Test purpose for procedure 1

1. To verify that:

1.1 The MS meets conformance requirement 1.1.

1.2 The MS meets conformance requirement 1.2.

2. To verify that:
 - 2.1 The MS does not reselect a cell which is barred.
 - 2.2 The MS does not reselect a cell which has a $C1 < 0$.
 - 2.3 The MS does reselect a cell even if does not support GPRS.
 - 2.4 The MS keeps camping on the serving cell despite it does not support GPRS and there is a non-serving suitable cell with a lower $C2$ that supports GPRS.
 - 2.5 The MS does not attempt to attach to GPRS when camping on a cell that does not support GPRS despite there is a non-serving suitable cell with a lower $C2$ that supports GPRS.
3. To verify that the MS takes into account the `CELL_RESELECT_HYSTERESIS` parameter when reselecting a cell in a different location area or if MS in Ready State, whether this cell supports GPRS or not.

Method of test for procedure 1

Initial Condition

Parameters changed from the default values in table 20.22.1.

Parameter	Carrier 1	Carrier 2	Carrier 3	Carrier 4
Channel Type Carried	BCCH	BCCH	BCCH	BCCH
RF Signal Level (dB μ V emf) / dBm	43 / -70	33 / -80	38 / -75	38 / -75
GPRS Support	Y	N	N	N
RXLEV_ACCESS_MIN (dBm)	-85	-90	-85	-67
CRH	10 dB	Default	Default	Default
LAC	Default	Default	Default	Default
CBA	Default	Default	1	Default
CBQ	Default	Default	0	Default
C1	15	10	10	-8
C2	15	10	10	-8

NOTE 1: Carrier 1 support GPRS without PBCCH channel in the cell.

NOTE 2: Carriers 2, 3 and 4 do not support GPRS.

The BA(BCCH) list only contains the ARFCNs of the carriers used during the test.

Procedure

- a) The SS activates carriers 1, 2, 3 and 4 with paging enabled on Carriers 2, 3 and 4.
- b) The MS is switched on.
- c) The MS should select and camp onto carrier 1 and complete the GPRS Attach procedure (Ready Timer deactivated).
- d) The SS disables GPRS on carrier 1 and enables GPRS on carrier 2.
- e) The SS enables GPRS on carrier 1 and disables GPRS on carrier 2.
- f) The level of carrier 2 is increased to 43 dB μ Vemf ($C2$ becomes 20 dB), and the SS monitors carrier 2 for RA requests from the MS.
- g) The level of carrier 2 is increased to 53 dB μ Vemf ($C2$ becomes 30 dB), and the SS monitors carrier 2 for RA requests from the MS.

Test requirements

- 1) After step c), there shall be no response from the MS on carriers 2, 3, or 4 within 50 s.

NOTE 1: 33 s for the MS to read the BCCH of carrier 2 (30 s + 10 %), 15 s for the MS to reselect another cell, since the MS already has a running average on carrier 1, allow 50 s.

2) After step d), there shall be no response from the MS on carriers 2, 3, or 4 within 345 s.

NOTE 2: 330 s for the MS to read the BCCH of carrier 2 (300 s + 10 %), 15 s for the MS to reselect another cell, since the MS already has a running average on carrier 1.

3) After step e), there shall be no response from the MS on carriers 2, 3, or 4 within 345 s.

4) After step f), there shall be no response from the MS on carriers 2, 3, or 4 within 50 s.

5) In step g), the MS shall respond on carrier 2 within 20 s of increasing the level of carrier 2.

NOTE 3: 5 s to perform running average, 10 s to detect C2 differences, 2,4 s to read BCCH of carrier 2, 1 s to perform RA. Total 18,4 s, allow 20 s.

20.22.9.3.2 Test purpose for procedure 2

2.1 To verify that the MS does not camp on a barred cell.

4. To verify that the MS decodes the CELL_BAR_ACCESS parameter from the BCCH every 30 s.

Method of test for procedure 2

Initial Condition

Parameters changed from the default values in table 20.22.1.

Parameter	Carrier 1	Carrier 2	Carrier 3	Carrier 4
Channel Type Carried	BCCH	BCCH	BCCH	BCCH
RF Signal Level (dBμV emf() / dBm)	38 / -75	43 / -70	43 / -70	38 / -75
GPRS Support	N	Y	Y	N
RXLEV_ACCESS_MIN (dBm)	-85	-90	-90	-85
LAC	Default	Default	different from other carriers	Default
CBA	Default	Default	1	1
CBQ	Default	Default	Default	0
C1	10	20	20	10
C2	10	20	20	10

NOTE 1: Carrier 2 and 3 support GPRS without PBCCH channel in the cell.

NOTE 2: Carriers 1 and 4 do not support GPRS.

The BA(BCCH) list only contains the ARFCNs of the carriers used during the test.

Procedure

a) The SS activates all carriers with paging enabled on Carriers 1, 3 and 4. The MS is switched on. The MS should select and camp onto carrier 2 and complete the GPRS Attach procedure (Ready Timer deactivated).

b) After 33 s, the SS sets CBA = 1 on carrier 2.

Test requirements

1) In step b), the MS shall access Carrier 1 within 50 s of setting CBA=1 on carrier 2.

20.22.10 Cell Selection-Search for Suitable Cell/ cell priority

20.22.10.1 Definition

-

20.22.10.2 Conformance requirement

For normal service, the MS has to camp on suitable cell. The choice of such a suitable cell for the purpose of receiving normal service is referred to as "normal camping". If a suitable cell is found, the MS camps on it and performs any

registration necessary. Cells can have two levels of priority, suitable cells which are of low priority are only camped on if there are no other suitable cells of normal priority (3GPP TS 03.22, subclause 3.5.2).

20.22.10.3 Test purpose

To verify that the MS selects cells of Normal priority even though there is a stronger suitable cell of low priority. Thus it verifies that PBCCH presence does not degrade the MS functionality.

20.22.10.4 Method of test

Initial conditions

Parameter	Cell 1		Cell 2	
	Carrier1	Carrier2	Carrier3	Carrier4
Channel Type carried	BCCH	PBCCH	BCCH	PBCCH
RF Signal Level (dBm)	-70	-70	-80	-80
Serving Cell Parameters				
RXLEV_ACCESS_MIN (dBm)	-90	--	-90	--
GPRS_RXLEV_ACCESS_MIN (dBm)	--	-90	--	-90
CELL_BAR_QUALIFY	1	--	0	--
C1	20	--	10	--

NOTE 1: Carrier 1 and carrier 3 are the BCCH Carriers which broadcasts the position of the PBCCH channel in the cell (carrier 2 and carrier 4).

NOTE 2: Serving Cell Parameters are coded and transmitted on the specified Channel Type

NOTE 3: Cell Bar Qualify is transmitted on BCCH.CBQ = 1, low priority and CBQ = 0 is normal priority.

Procedure

- a) The SS activates all Carriers.
- b) MS is Switched on.

20.22.10.5 Test Requirements

- 1) After Step b) the response from the MS shall be on Carrier 4 within 33s.

NOTE: Cell 1 BCCH carrier is stronger, but has low priority, So MS should camp on Cell 2.

20.22.11 Cell Selection/No normal priority cell

20.22.11.1 Definition

-

20.22.11.2 Conformance requirement

Cells can have two levels of priority, suitable cells which are of low priority are only camped on if there are no other suitable cells of normal priority (3GPP TS 03.22 subclause 3.2.1).

20.22.11.3 Test purpose

To verify that the MS camps on a cell of low priority when no suitable cells of normal priority are available. Thus it verifies that PBCCH presence does not degrade the MS functionality.

20.22.11.4 Method of test

Initial conditions

Parameter	Cell 1		Cell 2	
	Carrier1	Carrier2	Carrier3	Carrier4
Channel Type carried	BCCH	PBCCH	BCCH	PBCCH
RF Signal Level (dBm)	-80	-80	-100	-100
Serving Cell Parameters				
RXLEV_ACCESS_MIN (dBm)	-90	--	-90	--
GPRS_RXLEV_ACCESS_MIN (dBm)	--	-90	--	-90
CELL_BAR_QUALIFY	1	--	0	--
C1	10	--	-10	--

NOTE 1: Carrier 1 and Carrier 3 are the BCCH Carriers which broadcasts the position of the PBCCH channels in the cell (carrier 2 and carrier 4).

NOTE 2: Serving Cell Parameters are coded and transmitted on the specified Channel Type

NOTE 3: Cell Bar Qualify is transmitted on BCCH.CBQ = 1, low priority and CBQ = 0 is normal priority.

Procedure

- a) The SS activates all the Carriers.
- b) MS is switched on.

20.22.11.5 Test Requirements

- 1) After Step b) the first response from the MS shall be on Carrier 2 within 33 s.

NOTE: Cell 1 BCCH carrier is stronger, but has low priority, So MS should camp on Carrier 2 (PBCCH carrier on Cell 1).

20.22.12 Cell Selection on "LA Not Allowed"

20.22.12.1 Definition

-

20.22.12.2 Conformance requirement

If the MS has received the cause "LA Not Allowed" it shall ignore this fact when selecting a cell to camp on (3GPP TS 03.22, subclause 3.2.1).

20.22.12.3 Test purpose

To verify that the MS does not reject a cell because the cell is a part of the LA for which it has received the cause "LA Not Allowed".

NOTE: During GPRS Attach, the MS receives an ATTACH REJECT message with cause 'LA not allowed'. The MS shall then camp on any acceptable cell and shall be able to make emergency calls.

20.22.12.4 Method of test

Initial conditions

Parameter	Cell 1		Cell 2	
	Carrier1	Carrier2	Carrier3	Carrier4
Channel Type carried	BCCH	PBCCH	BCCH	PBCCH
RF Signal Level (dBm)	-60	-60	-75	-75
Serving Cell Parameters				
RXLEV_ACCESS_MIN (dBm)	-90	--	-90	--
CELL_BAR_ACCESS	0	--	1	--
LAC	Default	--	Default	--
GPRS_LEV_ACCESS_MIN (dBm)	--	-90	--	-90
C1	30	--	15	--

NOTE 1: Carrier 1 and carrier 3 are the BCCH Carriers which broadcasts the position of the PBCCH channel in the cell (carrier 2 and carrier 4).

NOTE 2: Serving Cell Parameters are coded and transmitted on the specified Channel Type

20.22.12.4.2 Procedure

- a) The SS activates all the Carriers.
- b) MS is Switched on.
- c) The SS sends an Attach Reject Message on Cell 1 with cause as "LA not allowed".
- d) The MS is manually commanded to set up an emergency call.

20.22.12.5 Test Requirements

- 1) After Step b) the response shall be on Carrier 2.
- 2) In step d), the MS shall access on carrier 1 with a channel request message, within 15 s of being commanded to set up the emergency call.

NOTE: Cell 2 is barred and hence it is not suitable for Camping.

20.22.13 Cell Reselection based on C32 quality

20.22.13.1 Definition

-

20.22.13.2 Conformance requirement

At least for every new sample or every second, whichever is the greatest, the MS shall update RLA_P and calculate the value of C1, C31 and C32 for the serving cell and the non-serving cells; (3GPP TS 05.08, subclause 10.1.2). The MS shall make a cell re-selection if:

- a. The path loss criterion parameter (C1) for the serving cell falls below zero.
- b. A non-serving suitable cell (see 3GPP TS 03.22) is evaluated to be better than the serving cell. The best cell is the cell with highest value of C32 among:
 - those cells that have the highest PRIORITY_CLASS among those that fulfill the criterion $C31 \geq 0$; or
 - all cells, if no cells fulfill the criterion $C31 \geq 0$;
 - if the parameter C32_QUAL is set, positive GRPS_RESELECT_OFFSET values shall be only be applied to the neighbour cell with the highest RLA_P value of those cells for which C32 is compared above.

PRIORITY_CLASS and C32_QUAL are broadcast on PBCCH of the serving cell.

When evaluating the best cell, the following hysteresis values shall be subtracted from the C32 value for the neighbour cells:

- in standby state, if the new cell is in the same routing area: 0.
- in ready state, if the new cell is in the same routing area:
 - GPRS_CELL_RESELECT_HYSTERE SIS.If the parameter C31_HYST is set;
 - GPRS_CELL_RESELECT_HYSTE RESIS shall also be subtracted from the C31 value for the neighbour cells.
- in standby or ready state, if the new cell is in a different routing area:
 - RA_RESELECT_HYSTERESIS.
- in case of a cell re-selection occurred within the previous 15 s: 5 dB.

GPRS_CELL_RESELECT_HYSTERE SIS, C31_HYST and RA_RESELECT_HYSTERESIS are broadcast on PBCCH of the serving cell (3GPP TS 05.08 subclauses 10.1, 3GPP TS 05.08 10.1.2 and 10.1.3).

20.22.13.3 Test purpose

To verify that if C32_QUAL is set, positive GPRS_RESELECT_OFFSET values shall only be applied for the neighbour cells with the highest RLA value of those cells for which C32 is compared, Otherwise positive GRO shall be applied for all the neighbour cells.

20.22.13.4 Method of test

Initial conditions

Parameter	Cell 1		Cell 2		Cell 3	
	Carrier1	Carrier2	Carrier3	Carrier4	Carrier5	Carrier6
Channel Type carried	BCCH	PBCCH	BCCH	PBCCH	BCCH	PBCCH
RF Signal Level (dBm)	-50 to -75	-50 to -75	-60	-60	-65	-65
Serving Cell Parameters						
RXLEV_ACCESS_MIN (dBm)	-90	--	-90	--	-90	--
GPRS_RXLEV_ACCESS_MIN (dBm)	--	-90	--	-90	--	-90
GPRS_PRIORITY_CLASS	--	1	--	1	--	1
GPRS_HCS_THR (dBm)	--	-90	--	-80	--	-80
C32_QUAL	--	1	--	0	--	0
Neighbour Cell Parameters						
GPRS_RESELECT_OFFSET (dB)	Default	--	2	--	10	--
GPRS_PRIORITY_CLASS	1	--	1	--	1	--
GPRS_HCS_THR (dBm)	-90	--	-80	--	-80	--
C1	40 to 15	--	30	--	25	--
C31	40 to 15	--	20	--	15	--
C32	40 to 15	--	32	--	25	--

NOTE 1: All cells shall be in the same routing area.

NOTE 2: Carrier 1, carrier 3 and carrier 5 are the BCCH Carriers which broadcasts the position of the PBCCH channels in the cell (carrier 2, carrier 4 and carrier 6).

NOTE 3: Serving Cell Parameters are coded and transmitted on the specified Channel Type whilst Neighbour Cell Parameters are coded and transmitted on the PBCCH, but refer to the neighbouring BCCH carriers

20.22.13.4.2 Procedure

- a) The SS activates all carriers. The MS is paged continuously on Carriers 4 and 6.
- b) MS is switched on.

- c) GPRS attach procedure is completed by SS. The SS waits 20s.
- d) The RF level of Carrier 1 and 2 is decreased to -75 so that C32 (Cell 1) is lesser than that of the other cells.

20.22.13.5 Test Requirements

- 1) The MS shall camp on Cell 1 within 33 s after step b).
- 2) The MS is GPRS Attached after step c).
- 3) The MS shall respond to continuous paging with a Packet Channel Request on Carrier 4 within $7s + \max(5s, 5 \text{ consecutive paging blocks of that MS})$. (time allowed includes 2s to decode BCCH on Carrier 3, 2s for PSII decoding, 2s to decode PBCCH on Carrier 4 and 1s for reselection) .

NOTE 1: $C32(n) = C1(n) + \text{GRO}$ {n is the neighboring cells}.

NOTE 2: If C32_QUAL is set on PBCCH then this positive GRO is added to only highest RLA_P, i.e. to Carrier4. So Cell 2 is selected. If C32_QUAL was not set, then GRO is added to all the carriers. So Carrier 6 would have been more suitable.

20.22.14 Void

20.22.15 Cell Reselection/ ready state / no reselection

20.22.15.1 Definition

-

20.22.15.2 Conformance requirement

At least every 5 s, the MS shall calculate the value of C1 and C2 for the serving cell and recalculate C1 and C2 values for non-serving cells (if necessary). 3GPP TS 05.08 subclause 6.6.2.

The MS shall then check whether:

- i) the path loss criterion (C1) for the current serving cell falls below zero for a period of 5 s. This indicates that the path loss to the cell has become too high.
- ii) The calculated value of C2 for a non-serving suitable cell exceeds the value of C2 for the serving cell for a period of 5 s except:
 - a) in the case of a new cell being in a different Location Area or, for a GPRS MS, in a different routing area or always for a GPRS MS in ready state in which case the C2 value for the new cell shall exceed the C2 value of the serving cell by at least CELL_RESELECT_HYSTERESIS dB as defined by the BCCH data from the current serving cell, for a period of 5 s.

20.22.15.3 Test purpose

To verify that the MS does not reselect because of a C2 criteria when GMM is in ready state (MS GPRS attached) and when the C2 value for adjacent cell exceeds the C2 value of the serving cell by at least CELL_RESELECT_HYSTERESIS dB for a period of less than 5 s.

NOTE: The serving cell C2 decreases before mobile is out of ready state with the following conditions.

- a) $C2(\text{Serving}) + \text{CELL_RESELECT_HYSTERESIS} > C2(\text{Adjacent})$.
- b) $C2(\text{Serving}) + \text{CELL_RESELECT_HYSTERESIS} < C2(\text{Adjacent})$ for < 5 s.

20.22.15.4 Method of Test

Initial Conditions

Parameters changed from the default values in table 20.22.1.

Parameter	Cell 1	Cell 2
	Carrier1	Carrier2
Channel Type carried	BCCH	BCCH
RF Signal Level (dBm)	-55 to -75	-60
RXLEV_ACCESS_MIN (dBm)	-90	-90
CRH	10	Default
C2	35 to 15	30

NOTE 1: MS must be configured to Initiate GPRS Attach on Power On.

NOTE 2: Cell reselection criteria from the above parameters:

$$[C2(s)+CRH = 25] < [C2(n) = 30]$$

for a period of less than 5 s, where 's' denotes the serving cell and 'n' denotes the non-serving cell. After 5 s, C2 of serving cell goes back to the original higher value.

$$[C2(s)+CRH = 45] > [C2(n) = 30]$$

NOTE 3: Each Cell Supports GPRS without PBCCH

20.22.15.4.2 Procedure

- a) The SS activates both carriers. The MS is paged continuously on Carrier 2.
- b) MS is switched on.
- c) The SS completes the GPRS Attach procedure (Ready Timer deactivated).
- d) The C2 value for carrier 1 is decreased by 20 dB for < 5 s.

20.22.15.5 Test requirements

- 1) The MS shall camp on carrier 1 within 33 s after step b), and initiate the GPRS Attach procedure.
- 2) The MS is in GMM Ready State after step c).
- 3) After step d) there shall be no access on Carrier 2 for 50s.

20.22.16 Cell Reselection/ ready state/ Reselection and Cell update procedure

20.22.16.1 Definition

-

20.22.16.2 Conformance requirement

The MS is required to perform the following measurements to ensure that the path loss criterion to the serving cell is acceptable.(3GPP TS 05.08 subclause 6.6.2).

At least every 5s the MS shall calculate the value of C1 and C2 for the serving cell and re-calculate C1 and C2 values for non serving cells (if necessary). The MS shall then check whether:

- 1) The path loss criterion (C1) for current serving cell falls below zero for a period of 5 s. This indicates that the path loss to the cell has become too high.
- 2) The calculated value of C2 for non -serving suitable cell exceeds the value of C2 for the serving cell for a period of 5 s, except:
 - a) in the case of new cell being in a different location area, for a GPRS MS, in a different routing area or always for a GPRS Ms in ready state in which case the C2 value for the new cell shall exceed the C2 value of the serving cell by at least CELL_RESELECT_HYSTERSIS dB as defined by the BCCH data from the current serving cell, for a period of 5 s; or

- b) in case of a cell reselection occurring within the previous 15 s in which case the C2 value for the new cell shall exceed the C2 value of the serving cell by at least 5dB for a period of 5 s.

This indicates that it is a better cell.

A cell update takes place when the MS enters a new cell inside the current RA and the MS is in READY state. If the RA has changed, a routing area update is executed instead of a cell update (3GPP TS 03.60 subclause 6.9.11).

20.22.16.3 Test purpose

1. To verify that the MS reselects an adjacent cell because of a C2 criteria when GMM is in ready state (MS GPRS attached) and when the C2 value for adjacent cell exceeds the C2 value of the serving cell by at least CELL_RESELECT_HYSTERESIS dB for a period of 5 s.
2. To verify that the MS performs the cell update procedure (when the cell is in the same Routing Area) and $C2(\text{Serving}) + \text{CELL_RESELECT_HYSTERESIS} < C2(\text{Adjacent})$ for at least 5 s.

20.22.16.4 Method of Test

Initial Conditions

Parameters changed from the default values in table 20.22.1.

Parameter	Cell 1	Cell 2
	Carrier1	Carrier2
Channel Type carried	BCCH	BCCH
RF Signal Level (dBm)	-60 to -75	-65
RXLEV_ACCESS_MIN (dBm)	-90	-90
CRH (dB)	6	Default
C2	30 to 15	25

NOTE 1: Cell reselection criteria from the above parameters:

$$[C2(s) = 15] < [C2(n) = 25] \text{ for a period } > 5 \text{ s.}$$

$$[C2(s) + \text{CRH} = 21] < [C2(n) = 25] \text{ for a period } > 5 \text{ s.}$$

NOTE 2: Each Cell Supports GPRS without PBCCH

Procedure

- a) The SS activates both carriers.
- b) MS is switched on.
- c) The SS completes the GPRS Attach procedure (Ready Timer deactivated). The SS waits 20s.
- d) The C2 value for carrier 1 is decreased by 15 dB.

20.22.16.5 Test requirements

- 1) The MS shall camp on carrier 1 within 33 s after step b) and initiate a GPRS Attach procedure.
- 2) The MS is in GMM ready state after step c).
- 3) After step d) the MS shall initiate the Cell Update procedure on Carrier 2 within 22s.

NOTE 1: Time allowed includes 5.9s to perform running average on Carrier 1 (based on BS_PA_MFRMS of 5), 5s to update C2, 5s to check the C2 value for adjacent cell exceeds the C2 value of the serving cell by at least CELL_RESELECT_HYSTERESIS, 2.4s to decode BCCH carrier, 1s for reselection and 10% timer tolerance.

20.22.17 C2 reselection in another RA - no cell reselection

20.22.17.1 Definition

-

20.22.17.2 Conformance requirement

The MS is required to perform the following measurements to ensure that the path loss criterion to the serving cell is acceptable.(3GPP TS 05.08 subclause 6.6.2)

At least every 5 s the MS shall calculate the value of C1 and C2 for the serving cell and re-calculate C1 and C2 values for non serving cells(if necessary).The MS shall then check whether:

- 1) The path loss criterion (C1) for current serving cell falls below zero for a period of 5 s. This indicates that the path loss to the cell has become too high.
- 2) The calculated value of C2 for non -serving suitable cell exceeds the value of C2 for the serving cell for a period of 5 s, except:
 - a) in the case of new cell being in a different location area, for a GPRS MS, in a different routing area or always for a GPRS Ms in ready state in which case the C2 value for the new cell shall exceed the C2 value of the serving cell by at least CELL_RESELECT_HYSTERESIS dB as defined by the BCCH data from the current serving cell, for a period of 5 s; or
 - b) in case of a cell reselection occurring within the previous 15 s in which case the C2 value for the new cell shall exceed the C2 value of the serving cell by at least 5dB for a period of 5 s.

This indicates that it is a better cell.

A cell update takes place when the MS enters a new cell inside the current RA and the MS is in READY state. If the RA has changed, a routing area update is executed instead of a cell update (3GPP TS 03.60 subclause 6.9.11).

20.22.17.3 Test purpose

To verify that the MS does not reselecting an adjacent cell when the cell is in a routing area different from the serving cell's one and when the C2 value for the adjacent cell does not exceed the C2 value of the serving cell for a period of 5 s by at least CRH dB.

20.22.17.4 Method of Test

Initial Conditions

Parameter	Cell 1	Cell 2	Cell 3	Cell 4
	Carrier1	Carrier2	Carrier3	Carrier4
Channel Type carried	BCCH	BCCH	BCCH	BCCH
RF Signal (dBm)	-60 to -80	-65	-75	-75
CBA	0	0	0	0
RXLEV_ACCESS_MIN (dBm)	-100	-100	-100	-100
CRH (dB)	+10	Default	Default	Default
C1	40 to 20	35	25	25
C2	40 to 20	35	25	25

NOTE 1: Carrier 1 and carrier 3 are in same routing area, carrier 2 and carrier 4 are in different routing area from carriers 1 and 3.

NOTE 2: Each Cell Supports GPRS without PBCCH

20.22.17.4.2 Procedure

- a) The SS activates all carriers. The MS is continuously paged on Carriers 2, 3 and 4.
- b) MS is switched ON.

- c) The SS shall complete the GPRS attach procedure (Ready timer deactivated). The SS waits 20s.
- d) Decrease the RF level of Carrier 1 such that the following conditions are met for a period of less than 5 s.
 - $C2(\text{adjacent}) > C2(\text{Serving});$
 - $C2 + CRH(\text{serving cell}) < C2(\text{adjacent cell}).$

20.22.17.5 Test requirements

- 1) MS shall camp on Carrier 1 after step b) and initiate a GPRS attach procedure within 33s.
- 2) The MS is in GMM ready state after step c).
- 3) After step d) there shall be no access on Carriers 2, 3 or 4 for 50s.

20.22.18 C2 reselection in another Routing Area - Routing Area Update

20.22.18.1 Definition

-

20.22.18.2 Conformance requirement

The MS is required to perform the following measurements to ensure that the path loss criterion to the serving cell is acceptable.(3GPP TS 05.08 subclause 6.6.2)

At least every 5 s the MS shall calculate the value of C1 and C2 for the serving cell and re-calculate C1 and C2 values for non serving cells(if necessary).The MS shall then check whether:

- 1) The path loss criterion (C1) for current serving cell falls below zero for a period of 5 s. This indicates that the path loss to the cell has become too high.
- 2) The calculated value of C2 for non -serving suitable cell exceeds the value of C2 for the serving cell for a period of 5 s, except:
 - a) in the case of new cell being in a different location area, for a GPRS MS, in a different routing area or always for a GPRS Ms in ready state in which case the C2 value for the new cell shall exceed the C2 value of the serving cell by at least CELL_RESELECT_HYSTERSIS dB as defined by the BCCH data from the current serving cell, for a period of 5 s; or
 - b) in case of a cell reselection occurring within the previous 15 s in which case the C2 value for the new cell shall exceed the C2 value of the serving cell by at least 5 dB for a period of 5 s.

This indicates that it is a better cell.

A cell update takes place when the MS enters a new cell inside the current RA and the MS is in READY state. If the RA has changed, a routing area update is executed instead of a cell update (3GPP TS 03.60 subclause 6.9.11).

20.22.18.3 Test purpose

1. To Verify that when the MS is in ready state, the MS reselects an adjacent cell when the cell is in a routing area different from the serving cell's one and when the C2 value for the adjacent cell exceed the C2 value of the serving cell for a period of 5 s by at least CRH dB.
2. To verify that the MS performs the Normal Routing Area Update procedure.

20.22.18.4 Method of Test

Initial Conditions:

	Cell 1	Cell 2	Cell 3	Cell4
Parameter	Carrier1	Carrier2	Carrier3	Carrier4
Channel Type carried	BCCH	BCCH	BCCH	BCCH
RF Signal (dBm)	-60 to -80	-65	-75	-75
CBA	0	0	0	0
RXLEV_ACCESS_MIN (dBm)	-100	-100	-100	-100
CRH (dB)	+10	Default	Default	Default
C1	40 to 20	35	25	25
C2	40 to 20	35	25	25

NOTE 1: Carrier 1 and carrier 3 are in same routing area.

NOTE 2: Carrier 2 and carrier 4 are in different routing area from carrier 1 and carrier 3.

NOTE 3: Each Cell Supports GPRS without PBCCH

20.22.18.4.2 Procedure

- a) The SS activates all carriers.
- b) MS is switched ON.
- c) SS Completes the GPRS attach procedure (Ready timer deactivated).
- d) The RF level of Carrier 1 is decreased to -80 dBm such that the following condition is met:
 - $C2(\text{-serving}) + CRH < C2(\text{adjacent cell})$.

20.22.18.5 Test requirements

- 1) MS shall camp on Carrier 1 after step b) and initiate a GPRS attach procedure within 33s.
- 2) The MS is in GMM ready state after step c). The SS waits 20s.
- 3) After step d) the MS shall reselect to carrier 2 within 22s. The MS shall initiate the Routing Area Update procedure.

NOTE 1: Time allowed includes 5.9s to perform running average on Carrier 1 (based on BS_PA_MFRMS of 5), 5s to update C2, 5s to check the C2 value for adjacent cell exceeds the C2 value of the serving cell by at least CELL_RESELECT_HYSTERESIS, 2.4s to decode BCCH carrier, 1s for reselection and 10% timer tolerance.

20.22.19 Borders between routing areas - reselection of a GPRS cell in a homogenous network

20.22.19.1 Definition

-

20.22.19.2 Conformance requirement

The MS is required to perform the following measurements (see 3GPP TS 03.22) to ensure that the path loss criterion to the serving cell is acceptable.

At least every 5s the MS shall calculate the value of C1 and C2 for the serving cell and re-calculate C1 and C2 values for non serving cells(if necessary).The MS shall then check whether:

- 1) The path loss criterion (C1) for current serving cell falls below zero for a period of 5 s. This indicates that the path loss to the cell has become too high.

- 2) The calculated value of C2 for non-serving suitable cell exceeds the value of C2 for the serving cell for a period of 5 s, except:
- in the case of new cell being in a different location area, for a GPRS MS, in a different routing area or always for a GPRS Ms in ready state in which case the C2 value for the new cell shall exceed the C2 value of the serving cell by at least CELL_RESELECT_HYSTERISIS (CRH) dB as defined by the BCCH data from the current serving cell, for a period of 5 s; or
 - in case of a cell reselection occurring within the previous 15 s in which case the C2 value for the new cell shall exceed the C2 value of the serving cell by at least 5dB for a period of 5 s.

This indicates that it is a better cell.

Reference: 3GPP TS 05.08, section 6.6.2.

20.22.19.3 Test purpose

To Verify that the MS does not reselect a cell in a different routing area when another one is suitable in the same routing area even if C2 is lower.

20.22.19.4 Method of Test

Initial Conditions

Parameter	Cell 1	Cell 2	Cell 3	Cell 4
	Carrier1	Carrier2	Carrier3	Carrier4
Channel Type carried	BCCH	BCCH	BCCH	BCCH
RF Signal (dBm)	-60 to -75	-65	-70	-80
CBA	0	0	0	0
RXLEV_ACCESS_MIN (dBm)	-100	-100	-100	-100
CRH	+14	Default	+14	Default
C1	40 to 25-	35	30	20
C2	40 to 25-	35	30	20

NOTE 1: Carrier 1 and carrier 3 are in same routing area.

NOTE 2: Carrier 2 and carrier 4 are in different routing area then carrier 1 and carrier 3.

NOTE 3: Each Cell Supports GPRS without PBCCH

NOTE 4: The Ready Timer length should be set to 0 so that the MS immediately enters the GMM Standby State on completion of the GPRS Attach (ref. 03.60, 6.2.1).

20.22.19.4.2 Procedure

- The SS activates all carriers. The MS is paged continuously on Carriers 2, 3 and 4.
- MS is switched ON.
- The SS completes the GPRS attach procedure.
- The RF level of Carrier 1 is decreased such that C1 is 25 for 5 s.

20.22.19.5 Test requirements

- The MS shall camp on carrier 1 after step b) and initiate the GPRS attach procedure.
- The MS is in GMM Standby State after Step c).
- After step d) the MS shall reselect to carrier 3 as:

$$(C2(\text{Carrier 1}) + \text{CRH} = 39) > (C2(\text{Carrier 2}) = 35)$$

$$(C2(\text{Carrier } 1) = 25) < (C2(\text{Carrier } 3) = 30)$$

The MS should respond to Paging on Carrier 3 only within 30s.

NOTE: Time allowed includes 18.75s running average of neighbour cells (based on max BA list of 20 specified in 20.22 for an E-GSM MS), 5s to update C2, 2.4s to decode BCCH, 1s to reselect and 10% tolerance. Allow 30s.

20.22.20 Void

20.22.21 Void

20.22.22 Cell Reselection with cells in different Routing area - Cell Reselection on CCCH - PBCCH not present

20.22.22.1 Definition

-

20.22.22.2 Conformance requirement

At least for every new sample or every second, whichever is the greatest, the MS shall update RLA_P and calculate the value of C1, C31 and C32 for the serving cell and the non-serving cells; 3GPP TS 05.08, subclause 10.1.2. The MS shall make a cell re-selection if:

- a. The path loss criterion parameter (C1) for the serving cell falls below zero.
- b. A non-serving suitable cell (see 3GPP TS 03.22) is evaluated to be better than the serving cell. The best cell is the cell with highest value of C32 among:
 - Those cells that have the highest PRIORITY_CLASS among those that fulfill the criterion $C31 \geq 0$; or
 - All cells, if no cells fulfill the criterion $C31 \geq 0$;
 - If the parameter C32_QUAL is set, positive GRPS_RESELECT_OFFSET values shall be only be applied to the neighbor cell with the highest RLA_P value of those cells for which C32 is compared above.

PRIORITY_CLASS and C32_QUAL are broadcast on PBCCH of the serving cell.

When evaluating the best cell, the following hysteresis values shall be subtracted from the C32 value for the neighbor cells:

- in standby state, if the new cell is in the same routing area: 0.
- in ready state, if the new cell is in the same routing area:
 - GPRS_CELL_RESELECT_HYSTERESIS. If the parameter C31_HYST is set;
 - GPRS_CELL_RESELECT_HYSTERESIS shall also be subtracted from the C31 value for the neighbour cells.
- in standby or ready state, if the new cell is in a different routing area:
 - RA_RESELECT_HYSTERESIS.
- in case of a cell re-selection occurred within the previous 15 s: 5 dB.
 - GPRS_CELL_RESELECT_HYSTERESIS, C31_HYST and RA_RESELECT_HYSTERESIS are broadcast on PBCCH of the serving cell.

The cell re-selection procedures defined in subclauses 10.1.1 to 10.1.3 (of 3GPP TS 05.08) apply to the MS attached to GPRS if a PBCCH exists in the serving cell. These procedures shall also apply for cells for which GPRS cell re-selection parameters are provided to the MS in a Packet Cell Change Order or Packet Measurement Order message.

Otherwise the MS shall perform cell re-selection according to the idle mode procedures defined in clause 6 of 3GPP TS 05.08.

20.22.22.3 Test purpose

To verify that the MS reselects to the correct cell by calculating C32 correctly when one of the cells is in a different routing area. When the MS is in the Standby or ready state, on triggering of a reselection, when it considers a suitable cell which happens to be in a different Routing Area, the C32 value of the new cell must be reduced by RARH for comparison.

20.22.22.4 Method of test

Initial conditions

Parameter	Cell 1	Cell 2	Cell 3
	Carrier1	Carrier2	Carrier3
Channel Type carried	BCCH	BCCH	BCCH
RF Signal (dBm)	-60 to -80	-65	-70
GPRS_RXLEV_ACCESS_MIN (dBm)	-90	-90	-90
RA COLOUR	001	010	001
RARH (dB)	10	Default	Default
GPRS_PRIORITY_CLASS		0	0
GPRS_HCS_THR		-90	-90
C1	30 to 10	25	20
C31	0	25	20
C32	30 to 10	15	20

NOTE 1: The BA(BCCH) list only contains the ARFCNs of the carriers used during the test.

NOTE 2: The value of RXLEV_ACCESS_MIN is obtained from the SI messages for reselection. NOTE 3: When a neighbouring cell belongs to a different RA, RARH value is deduced from its C32 value during reselection, if the MS is in Standby or Ready state. In absence of PBCCH, when RARH is not available, CRH (from SI messages on BCCH) is used instead (3GPP TS 05.08 subclause 10.1.1).

NOTE 3: GPRS reselection parameters for carrier 1 shall be converted from the idle mode cell reselection parameters received on System Information 4 on BCCH according to 3GPP TS 05.08 table 3a.

20.22.22.4.2 Procedure

- All the carriers are activated and MS is switched ON. The MS is paged continuously on Carriers 2 and 3.
- SS completes the GPRS Attach procedure. (Ready Timer is set to default.)
- Send GPRS reselection parameters through Packet Measurement Order message.
- SS waits until MS goes into Standby Mode (expiry of Ready Timer). The RF level of carrier 1 is reduced to -80dBm, hence Reselection is triggered.

20.22.22.5 Test Requirements

- After step a) the MS camps on Carrier 1 and initiates the GPRS Attach procedure.
- After step d) the MS should respond on Carrier 3 within 11s.

NOTE 1: Time allowed includes 5.9s to perform running average on Carrier 1 (based on BS_PA_MFRMS of 5), 2.4s to decode BCCH carrier, 1s for reselection and 10% timer tolerance.

20.22.23 Void

20.22.24 Void

20.22.25 Void

20.22.26 Void

20.22.27 Void

20.22.28 Void

20.22.29 Packet Measurement order procedure / Downlink transfer / Normal case/ 3G cell reselection dedicated parameters

20.22.29.1 Conformance requirement

For a multi-RAT MS, cells or frequencies with other radio access technologies may be included in 3G Cell Reselection list (see 3GPP TS 04.18). The network controls the measurements for reselection of these cells by the parameter *Qsearch_I* broadcast on BCCH. *Qsearch_I* defines a threshold and also indicates whether these measurements shall be performed when *RLA_C* (see subclause 6.6.1) of the serving cell is below or above the threshold. These measurements may be performed less frequently than measurements of GSM cells as described in subclause 6.6.1, in order to conserve MS power.

The MS shall be able to identify and select a new best UTRAN cell on a frequency, which is part of the 3G Cell Reselection list, within 30 seconds after it has been activated under the condition that there is only one UTRAN frequency in the list and under good radio conditions. For test purposes the following radio conditions can be used: Serving GSM cell at *RXLEV*= -70 dBm, with 6 GSM neighbours at *RXLEV*= -75 dBm. Then either an UTRAN FDD neighbour cell or an UTRAN TDD neighbour cell is switched on. The radio conditions for the UTRAN FDD cell are as follows (see TS 25.101 for definitions):

Parameter	Unit	UTRAN FDD Cell
<i>CPICH_Ec/Ior</i>	dB	-10
<i>PCCPCH_Ec/Ior</i>	dB	-12
<i>SCH_Ec/Ior</i>	dB	-12
<i>PICH_Ec/Ior</i>	dB	-15
<i>DPCH_Ec/Ior</i>	dB	-∞
<i>OCNS_Ec/Ior</i>	dB	-0.94
\hat{I}_{or}/I_{oc}	dB	10
<i>I_{oc}</i>	dBm/3.84 MHz	-70
<i>CPICH_Ec/Io</i>	dB	-10.4
<i>CPICH_RSCP</i>	dBm	-70
<i>FDD_Qoffset</i>	integer	5 (-12dB)
<i>FDD_Qmin</i>	integer	7 (-12 dB)
<i>Qsearch_I</i>	integer	7 (search always)
Propagation Condition	AWGN	

The radio conditions for the UTRAN TDD cell (3.84 Mcps) are as follows (see 3GPP TS 25.123 for definitions and for the values of the remaining configuration parameters):

Parameter	Unit	UTRA TDD Cell (3.84 Mcps)	
<i>Timeslot Number</i>		0	8
<i>P-CCPCH_Ec/Ior</i>	dB	-3	
<i>SCH_Ec/Ior</i>	dB	-9	-9
<i>SCH_t_offset</i>	integer	0	0
<i>PICH_Ec/Ior</i>	dB		-3
<i>OCNS_Ec/Ior</i>	dB	-3.12	-3.12
<i>PCCPCH RSCP</i>	dBm	-70	-70
<i>TDD_Qoffset</i>	integer	5 (-12 dB)	
<i>Qsearch_I</i>	integer	7 (search always)	
Propagation Condition	AWGN		

NOTE: On timeslot 8 the P-CCPCH is not transmitted; on that timeslot, the PCCPCH RSCP defines the power level of the beacon channel.

The allowed time is increased by 30 seconds for each additional UTRAN frequency in the 3G Cell Reselection list. However, multiple UTRAN cells on the same frequency in the list does not increase the allowed time.

A multi-RAT MS shall be able to monitor 64 UTRAN cells, divided into (depending on the MS capability):

- FDD cells on up to 3 FDD frequencies, with a maximum of 32 cells per frequency; and/or
- TDD cells on up to 3 TDD frequencies with a maximum of 32 cells per frequency.

The MS shall attempt to read and store UTRAN predefined configurations using the rules defined in 3GPP TS 25.331 with the following exceptions:

- The MS shall build a list of at most 16 predefined configurations, read from the BCCH of the identified UTRAN cells of equivalent PLMNs.
- After PLMN selection (see 3GPP TS 23.122), the MS shall delete any old list of predefined configurations and as soon as possible attempt to read the predefined configurations from one identified UTRAN cell of the selected PLMN or of an equivalent PLMN.
- The MS shall attempt to update the list of predefined configurations every 60 minutes.

In case of a conflict with GSM tasks, the GSM tasks take precedence.

NOTE: Instead of reading new predefined configurations from a PLMN, the MS may use previously received predefined configurations for that PLMN according to the rules in 3GPP TS 25.331.

The MS shall report the list of predefined configurations in the UTRAN CLASSMARK CHANGE message (see 3GPP TS 04.18).

References

3GPP TS 05.08, subclause 6.6.4

20.22.29.2 Test Purpose

To verify that the 3G search parameters and neighbour cell description are correctly used by the in order to reselect a 3G cell.

To verify that the individual parameters are used by the MS instead of broadcast 3G cell reselection parameters when the MS receives a PACKET MEASUREMENT ORDER message.

20.22.29.3 Method of test

Initial conditions

System Simulator:

1 GSM/GPRS cell, operating in NC0, 1 UTRAN neighbour cell.

Parameter	Unit	Cell 1 (GSM)
Test Channel		1
RF Signal Level	dBm	-70

Parameter	Unit	Cell 2 (UTRAN)
Test Channel		1
CPICH_Ec (FDD)	dBm / 3.84 MHz	OFF to -70

- 3GPP TS 34.108, subclause 6.1 shall be referenced for default parameters of UTRAN Cell.
- 3GPP TS 34.123-3, subclause 8.3.2 shall be referenced for configuring channels on UTRAN Cell.

Mobile Station:

MS is in Packet Idle mode and GPRS attached.

PDP context established.

Foreseen final state of the MS

- MS is in Packet Idle mode.

Test procedure

The GSM/GPRS cell operates in NC0. The MS is brought into downlink packet transfer mode on GSM carrier. The SS sends a PACKET MEASUREMENT ORDER message, setting Qsearch_P to "Never". The SS activates UTRAN carrier with higher RF signal strength than GSM carrier. The MS shall stay camping in the cell of Carrier 1. During the transfer, the SS sends a PACKET MEASUREMENT ORDER message, setting 3G search to "Always".

The GPRS 3G Cell Reselection list includes UTRAN frequencies.

The MS then reselects (see TS 25.304) a UTRAN cell when its measured RSCP value exceeds the value of RLA_P for the serving cell by the value FDD_GPRS_Qoffset for a period of 5 seconds and the UTRAN cell measured Ec/No value is equal or greater than the value FDD_Qmin, where FDD_Qmin and FDD_Qoffset are broadcast on BCCH of the serving cell.

The UTRAN neighbour cell is suitable and the parameters required to determine if it is suitable are broadcast on BCCH of the UTRAN cell.

Maximum duration of the test

3 minutes

Expected Sequence

Step	Direction	Message	Comments
1	MS		The MS is GPRS attached and has activated a PDP context (see PICS) on GSM carrier.
2	SS -> MS	IMMEDIATE ASSIGNMENT	Sent on a PCH block corresponding to the MS's paging group, including a packet downlink assignment with correct TLLI. Triggers the MS to monitor the assigned PDCH. With a valid RRBP.
3	MS -> SS	PACKET CONTROL ACK	MS acknowledges on PACCH the IMMEDIATE ASSIGNMENT
4	SS->MS	PACKET MEASUREMENT ORDER	Sent on PACCH of GSM carrier PMO message contains Qsearch_P set to "Never". Note: NETWORK_CONTROL_ORDER still indicates NC0
5	SS->MS	Void	SS sends downlink data,
6			
7			
8			Activate UTRAN carrier setting the CPICH Ec level to -70 dBm / 3.84 MHz Repetition of step 5 for 15 secs during which TBF is maintained
9	SS->MS	PACKET MEASUREMENT ORDER	The SS verifies that no RRC CONNECTION REQUEST is received from the MS Sent on PACCH of GSM carrier; the PMO message contains Qsearch_P set to "Always". Note: NETWORK_CONTROL_ORDER still indicates NC0
10			Repetition of step 5 for 30 secs during which TBF is maintained. Check that after 15s, the MS does not camp any more on the GSM cell: the MS stops sending PACKET DOWNLINK ACK/NACK messages when requested.
11	MS -> SS	RRC CONNECTION REQUEST	Verify that the MS has reselected the UTRAN carrier. The SS verifies that the time between the end of Step 9 and the RRC CONNECTION REQUEST is between 5 secs and 30 secs.

Specific message contents

IMMEDIATE ASSIGNMENT in step 2

As in section 41.2.6.1.

SYSTEM INFORMATION TYPE 2quarter (Instance 1 of 1)

MESSAGE_TYPE	00000111
MP_CHANGE_MARK	0
SI2quarter_INDEX	0000
SI2quarter_COUNT	0000
3G Neighbour Cells Description	
UTRAN FDD Description	
Repeated UTRAN FDD Neighbour Cells	
FDD-ARFCN	
FDD_Indic0	0 See TS 34.108, clause 6.1.5, table 6.1.1,(Parameter UTRA RF Channel Number)
NR_OF_FDD_CELLS	Set to 0
GPRS 3G MEASUREMENT Parameters Description	Set to 1
Qsearch_P	Set to 7: always search for 3G cells..

<p>3G_SEARCH_PRIO</p> <p>3G MEASUREMENT Parameters Description</p> <p>Qsearch_I</p> <p>FDD_Qoffset</p> <p>FDD_Qmin</p>	<p>Indicates if 3G cells may be searched when BSIC decoding is required. Set to 1 = yes</p> <p>Set to 7: always search for 3G cells..</p> <p>Applies an offset to RLA_P for cell re-selection to access technology/mode: -12dB.</p> <p>Minimum threshold for E_c/N_0 for UTRAN FDD cell re-selection: -12 dB.</p>
--	--

PACKET MEASUREMENT ORDER in step 4:

MESSAGE_TYPE	0000 11
PAGE_MODE	00 Normal Paging
TLLI	10 (address is TLLI)
-	Same as the value received from MS
PMO_INDEX	0 0 0 first message
PMO_COUNT	0 0 0 one message expected
{ 0 1 < NC Measurement Parameters > }	1 NC Measurement Parameters available
NC Measurement Parameters	
NETWORK_CONTROL_ORDER	0 0 NC0
{ 0 1 < NC_NON_DRX_PERIOD	1 Additional NC parameters available
< NC_REPORTING_PERIOD_I	NC_NON_DRX_PERIOD = 000
< NC_REPORTING_PERIOD_T > }	(No non-DRX mode after a measurement report has been sent)
	NC_REPORTING_PERIOD_I = 111
	(61.44 sec)
	NC_REPORTING_PERIOD_T = 011
	(3.84 sec)
{ 0 1 < NC_FREQUENCY_LIST > }	1 NC Frequency list struct available
{ 0 1 { < NR_OF_REMOVED_FREQ > }	0 no NC Frequency removed
{ 1 < List of added Frequency > }	1 List of added Frequency available
List of added Frequency	
< START_FREQUENCY >	BCCH ARFCN of Cell BBSIC of Cell B1 cell
< BSIC >	selection parameters present
{ 0 1 < Cell selection params > }	
Cell selection params	
< CELL_BAR_ACCESS_2 >	0
< EXC_ACC >	1
< SAME_RA_AS_SERVING_CELL >	1
{ 0 1 < GPRSPower information >	1 GPRS power info present
< GPRS_RXLEV_ACCESS_MIN >	011111 -- -80 dBm
< GPRS_MS_TXPWR_MAX_CCH > }	01010
{ 0 1 < GPRS Selection Info >	1 GPRS Selection Info present
< GPRS_TEMPORARY_OFFSET >	000
< GPRS_PENALTY_TIME : bit (5) > }	00000
{ 0 1 < GPRS Reselection Info > }	1 GPRS Reselection Info present
< GPRS_RESELECT_OFFSET > }	10000
{ 0 1 < HCS parameter Info > }	1 HCS parameter Info present
< PRIORITY_CLASS >	001
< HCS_THR >	10100
{ 0 1 < SI13 PBCCH LOCATION Info > } ;	0 No SI13 PBCCH LOCATION Info present
Frequency Info continued	
< NR_OF_FREQUENCIES >	00010
< FREQ_DIFF_LENGTH : bit (3) >	000
< FREQUENCY_DIFF >	1
< BSIC >	BSIC of Cell B0 no cell selection parameters present
{ 0 1 < Cell selection params > }	1
< FREQUENCY_DIFF >	BSIC of Cell B0 no cell selection parameters present
< BSIC >	present
{ 0 1 < Cell selection params > }	Ending repetition of < List of added Frequency >
0;	0 No EXT Measurement Parameters present
{ 0 1 < EXT Measurement Parameters > }	1 Additions in release 98
{ null 0 bit** 1 Additions in release 98 > }	0 No LSA parameters present
{ 0 1 < LSA Parameters > }	1 Additions in release 99
{ null 0 bit** 1 Additions in release 99 > }	1 ENH Measurement Parameters present
{ 0 1 < ENH Measurement Parameters > }	
ENH Measurement Parameters	
{ 0 < BA_IND Info 1 < PSI3_CHANGE_MARK > }	0
< BA_IND >	0 3G Neighbour Cell Description not present
< 3G_BA_IND >	0 GPRS REP PRIORITY Description not present
< PMO_IND >	0 GPRS MEAS Parameters Description not present
< REPORT_TYPE >	1 GPRS 3G MEASParameters Description present
< REPORTING_RATE >	1111 -- never
< INVALID_BSIC_REPORTING >	1
{ 0 1 < 3G Neighbour Cell Description > }	0 FDD_REP_QUANT Info not present
{ 0 1 < GPRS REP PRIORITY Description > }	0 FDD_REPORTING_OFFSET Info not present
{ 0 1 < GPRS MEASUREMENT Parameters Description	

<pre> > } { 0 1 < GPRS 3G MEASUREMENT Parameters Description > } < Qsearch_P > < 3G_SEARCH_Prio > { 0 1 < FDD_REP_QUANT Info > } { 0 1 < FDD_REPORTING_OFFSET Info > } { 0 1 < TDD_MULTIRAT_REPORTING Info > } { 0 1 < TDD_REPORTING_OFFSET Info > } { 0 1 < CDMA2000_MULTIRAT_REPORTING Info > } { 0 1 < CDMA2000_REPORTING_OFFSET Info > } { null 0 bit** 1 Additions in release R4 > < padding bits > </pre>	<pre> 0 TDD_MULTIRAT_REPORTING Info not present 0 TDD_REPORTING_OFFSET Info not present 0 CDMA 2000_MULTIRAT_REPORTING info not present 0 CDMA2000_REPORTING_OFFSET Info not present - Spare Padding </pre>
---	---

PACKET MEASUREMENT ORDER in step 9:

Same as PACKET MEASUREMENT ORDER in step 4, except:

Qsearch_P	Set to 7 ("Always")
-----------	---------------------

20.22.30 Cell Reselection/usage of BA(GPRS)

20.22.30.1 Cell Reselection/usage of BA(GPRS)/ Most suitable cell not in BA(GPRS)

20.22.30.1.1 Conformance requirement

Whilst in packet idle mode (see 03.64) an MS shall continuously monitor all BCCH carriers as indicated by the BA(GPRS) list and the BCCH carrier of the serving cell. References

3GPP TS 05.08, subclause 10.1.1.1

20.22.30.1.2 Test Purpose

To verify that the MS uses the BA(GPRS) list for the reselection and measurement. If the most suitable cell is not in the BA(GPRS) list, then it is not considered for the reselection.

20.22.30.1.3 Method of test

Initial conditions

Parameter	Cell A		Cell B	Cell C
	Carrier 1	Carrier 2	Carrier 3	Carrier 4
Channel Type Carried	BCCH	PBCCH	BCCH	BCCH
RF Signal Level (dBm)	-60	-60	-70	-70
RXLEV_ACCESS_MIN (dBm)	-85		-85	-85
Serving Cell Parameters				
GPRS_RXLEV_ACCESS_MIN (dBm)	--	-85		
NETWORK_CONTROL_ORDER		NC2	NC2	NC2
NC_REPORTING_PERIOD_I		3.84 sec	Default	Default
Neighbour Cell Parameters				
GPRS_RXLEV_ACCESS_MIN (dBm)	-85	--	-85	--
C1	25 to -10	--	15	35
C32	25 to -10	--	15	35

NOTE 1: All cells support GPRS. Cell A support PCCCH. Cell B and C does not support PCCCH in the cell.

NOTE 2: Carrier 4 is not a part of BA(GPRS) on carrier 2. Carrier 3 is part of BA(GPRS) on carrier 2.

Procedure

- a) The SS activates Carriers 1,2,3 and 4.

- b) MS is switched ON.
- c) The MS shall complete the GPRS attach procedure on carrier 2(Ready Timer deactivated).
- d) SS increases the signal strength of cell C to -50dBm.
- e) SS receives measurement report till the measurement of Carrier 3 (cell B) are included in it.
- f) SS sends a PACKET MEASUREMENT ORDER changing the NC mode to NC0.
- g) SS reduces the signal strength of cell A to -95 dBm.

20.22.30.1.4 Test Requirements

- 1) MS shall camp on Carrier 2 after step b) and initiate the attach procedure.
- 2) In step e), MS should not include the measurements of Carrier 4 in the measurement reports. This is checked up to Max{5s, 5 consecutive paging blocks of that MS} to ensure the MS has completed the running average measurements of the neighbour cells.
- 3) In step f), SS checks that the MS stays on carrier 2, and does not reselect to carrier 4, even though carrier 4 is better than carrier 2 for a period of 5s + Max{5s, 5 consecutive paging blocks of the MS}.
- 4) In step g), the MS shall respond on carrier 3 even though the carrier 4 is better than carrier 3 for reselection, as carrier 4 is not a part of BA(GPRS). The response should be within the time given in the note below.

Note: Time allowed includes Max{5s, 5 consecutive paging blocks of the MS} for MS to determine C32 of cell C is greater than cell A, 2 seconds to decode BCCH and 1 sec for re-selection.

20.22.30.2 Cell Reselection / usage of BA(GPRS) / Change of BA(GPRS)

Whilst in packet idle mode (see 03.64) an MS shall continuously monitor all BCCH carriers as indicated by the BA(GPRS) list and the BCCH carrier of the serving cell.

References

3GPP TS 05.08, subclause 10.1.1.1.

20.22.30.2.2 Test Purpose

To verify that if the BA(GPRS) list is changed in the broadcast, MS uses the new BA(GPRS).

20.22.30.2.3 Method of test

Initial conditions

Parameter	Cell A		Cell B	Cell C
	Carrier 1	Carrier 2	Carrier 3	Carrier 4
Channel Type Carried	BCCH	PBCCH	BCCH	BCCH
RF Signal Level (dBm)	-60	-60	-70	-70
Serving Cell Parameters				
GPRS_RXLEV_ACCESS_MIN (dBm)	--	-90		
NETWORK_CONTROL_ORDER		NC2	NC2	NC2
NC_REPORTING_PERIOD_I		3.84 sec	Default	Default
Neighbour Cell Parameters				
GPRS_RXLEV_ACCESS_MIN (dBm)	-90	--	-90	-90
C1	30	--	20	20
C32	30	--	20	20

NOTE 1: All cells support GPRS. Cell A support PCCCH. Cell B and C does not support PCCCH in the cell.

NOTE 2: Carrier 4 is not a part of BA(GPRS) on carrier 2. Carrier 3 is part of BA(GPRS) on carrier 2.

Procedure

- a) The SS activates Carriers 1,2,3 and4 .

- b) MS is switched ON.
- c) The SS shall complete the GPRS attach procedure on Carrier 2(Ready Timer deactivated).
- d) The SS increases the signal strength of cell C to -50dBm.
- e) SS receives NC measurement report till the measurement of Carrier 3(Cell B) are included in the PACKET MEASUREMENT REPORT.
- f) SS changes the broadcast information to include carrier 4 as a part of the BA(GPRS) on the carrier 2.
- g) SS receives NC measurement report till the measurements of Carrier 3 (Cell B) and Carrier 4 (Cell C) are included in the PACKET MEASUREMENT REPORT.
- h) SS sends a PACKET MEASUREMENT ORDER changing the NC mode to NC0. PACKET MEASUREMENT ORDER must be sent within NC_REPORTING_PERIOD_I from receiving latest PACKET MEASUREMENT REPORT.

20.22.30.2.4 Test Requirements

- 1) MS shall camp on Carrier 2 after step b) and initiate the attach procedure.
- 2) In step e), MS should not include the measurements of Carrier 4 in the measurement reports This is verified up to Max{5s, 5 consecutive paging blocks of that MS} to ensure the MS has completed the running average measurements of the neighbour cells.
- 3) In step g), SS checks that the MS stays on carrier 2 for a minimum period of $8 * 52$ Multiframes (complete update of PBCCH content) + Max{5s, 5 consecutive paging blocks of the MS} (for MS to update running average) + 5s (to give erroneous MS time to reselect).
- 4) After step h), the MS shall respond on carrier 4 within the time given in the note below.

Note: Time allowed includes Max{5s, 5 consecutive paging blocks of the MS} for MS to determine C32 of cell C is greater than cell A, 2 seconds to decode BCCH and 1 sec for re-selection.

20.22.30.3 Cell Reselection/usage of BA(GPRS)/ Measurement on first 32 entries.

20.22.30.3.1 Conformance requirement

Whilst in packet idle mode (see 03.64) an MS shall continuously monitor all BCCH carriers as indicated by the BA(GPRS) list and the BCCH carrier of the serving cell.

The GSM Neighbour Cell list may contain up to 96 GSM Neighbour Cells. The total number of GSM frequencies to measure shall not exceed 32. If the list includes more than 32 frequencies, the MS shall only measure the 32 frequencies with the lowest indices.

References

3GPP TS 05.08, subclause 10.1.1.1

3GPP TS 04.60, subclause 5.6.3.2

20.22.30.3.2 Test Purpose

To verify that if the BA(GPRS) includes more than 32 frequencies in that case MS shall only measure the 32 frequencies with lowest indices.

20.22.30.2.3 Method of test

Initial conditions

Parameter	Cell A		Cell B	Cell C
	Carrier 1	Carrier 2	Carrier 3	Carrier 4
Channel Type Carried	BCCH	PBCCH	BCCH	BCCH
RF Signal Level (dBm)	-60	-60	-70	-70
Serving Cell Parameters				
GPRS_RXLEV_ACCESS_MIN (dBm)	--	-90	-90	-90
NETWORK_CONTROL_ORDER		NC2	NC2	NC2
NC_REPORTING_PERIOD_I		3.84 sec	Default	Default
Neighbour Cell Parameters				
GPRS_RXLEV_ACCESS_MIN (dBm)	-90	--	-90	-90
C1	30	--	20	20
C32	30	--	20	20

NOTE 1: All cells support GPRS. Cell A support PCCCH. Cell B and C does not support PCCCH in the cell.

NOTE 2: Carrier 3 is 32nd while carrier 4 is 33rd in the BA(GPRS) on carrier 2.

Procedure

- The SS activates all carriers.
- MS is switched ON.
- The MS shall complete the GPRS attach procedure (Ready Timer deactivated) on carrier 2.
- SS receives 25 NC measurement reports in idle mode.

20.22.30.3.4 Test Requirements

- After step b) MS shall camp on carrier 2 and initiate the attach procedure.
- In step d), SS checks that the MS includes measurements of carrier 3 in the PACKET MEASUREMENT REPORT while the measurements of carrier 4 are not included in any of the measurement reports.

20.22.31 Network controlled cell reselection / Transfer mode

20.22.31.1 Network controlled cell reselection / Downlink transfer / Normal case/
Location and Routing Area Update/ NMO I

20.22.31.1.1 Conformance requirement

When a cell reselection is initiated by the network for an individual mobile station, the cell change order procedure is started by sending a PACKET CELL CHANGE ORDER message to the mobile station on the PCCCH or PACCH.

Upon receipt of the PACKET CELL CHANGE ORDER message the mobile station shall start timer T3174.

When a cell reselection is made controlled by the network, the mobile station shall act upon the IMMEDIATE_REL value which has been received in the Packet Cell Change Order: if required, the mobile station shall abort any TBF in progress by immediately ceasing to decode the downlink, ceasing to transmit on the uplink, stopping all RLC/MAC timers except for timers related to measurement reporting. The mobile station shall then switch to the identified specified new cell and shall obey the relevant RLC/MAC procedures on this new cell.

To initiate a combined routing area updating procedure the MS sends the message ROUTING AREA UPDATE REQUEST to the network, starts timer T3330 and changes to state GMM-ROUTING-UPDATING-INITIATED and MM LOCATION UPDATING PENDING. The value of the update type IE in the message shall indicate "combined RA/LA updating". If for the last attempt to update the registration of the location area

a MM specific procedure was performed, the value of the update type IE in the ROUTING AREA UPDATE REQUEST message shall indicate "combined RA/LA updating with IMSI attach". Furthermore the MS shall include the TMSI status IE if no valid TMSI is available.

20.22.31.1.2 References

3GPP TS 04.60, subclauses 8.4 and 5.5.1.1.

3GPP TS 04.08 / 3GPP TS 24.008 subclause 4.7.5.2.

20.22.31.1.3 Test Purpose

To test the behaviour of the MS when the network triggers a Packet Cell Change Order to a cell belonging to another routing area, whereas the network mode of operation I is active, i.e:

To verify that the MS switches to the new cell under network control.

To verify that the MS performs the Combined Routing Area Update procedure.

20.22.31.1.4 Method of test

Initial conditions

System simulator:

All 5 carriers should be activated.

Parameters changed from the default values in table 20.22.1.

Parameter	Cell A		Cell B	Cell C	
	Carrier 1	Carrier 2	Carrier 3	Carrier 4	Carrier 5
Channel Type Carried	BCCH	PBCCH	BCCH	BCCH	PBCCH
RF Signal Level (dBm)	-60	-60	-80	-70	-70
Serving Cell Parameters					
GPRS_RXLEV_ACCESS_MIN (dBm)	--	-100	--	--	-100
NETWORK_CONTROL_ORDER	NC2	NC2	NC2	NC2	NC2
NC_REPORTING_PERIOD_T (s)	0,96	0,96	--	0,96	0,96
Network Mode of Operation	NMO 1	NMO 1	NMO 1	NMO 1	NMO 1
RAC	Default	Default	Default	Different to default	Same as carrier 4
LAC	Default	Default	Default	Different to default	Same as carrier 4
Neighbour Cell Parameters					
GPRS_RXLEV_ACCESS_MIN (dBm)	-100	--	-100	-100	--
C1	40-20	--	20-40	30	--
C32	40-20	--	20-40	30	--

20.22.31.1.5 void

20.22.31.1.6 Foreseen final state of the MS

- MS is in Transfer mode on carrier 5.

20.22.31.1.7 Test procedure

- The MS is switched on and completes GPRS Attach procedure (ready timer deactivated) on carrier 2. MS is PDP context activated and brought into packet transfer mode.
- The RF level of carriers 1 and 2 are reduced to -80 dBm. (C32 becomes 20).
- The SS waits 15 s after the RF level of carriers 1 and 2 are reduced before sending Packet Cell Change Order, with the IMMEDIATE_REL bit set to FALSE, to the MS to select carrier 4. The MS shall complete a combined RA/LA update procedure on carrier 5.

- d) The RF level of carrier 3 is increased to -60 dBm. (C32 becomes 40).
- e) The SS waits 15 s after increasing the RF level of carrier 3 to ensure no RA update takes place on carriers 1, 2 and 3.

NOTE: During the TBF, T3158 may expire and thus PACKET MEASUREMENT REPORT could be sent at any time while the downlink transfer is in progress. The SS shall be prepared for this.

20.22.31.1.8 Test Requirements

- 1) After step b) there should be no response (RA update or cell update) on carriers 3, 4 or 5.
- 2) After step c) there should be a response on carrier 5. Since the LA update is combined with the RA update, there should be no LA update on carrier 4.

Note: Time allowed includes 2 seconds to decode BCCH, 2 sec to decode PSII, 2 sec to decode PBCCH and 5 sec for re-selection.

- 3) After step d) there should be no response on carriers 1, 2, 3.

Note: Time allowed includes max(1 second, 1 paging block of the MS) + 2 seconds to decode BCCH + 1s for reselection + 1s tolerance.

20.22.31.1.9 Maximum duration of the test

4 minutes

20.22.31.2 Network controlled cell reselection / Downlink transfer / Normal case/ Location and Routing Area Update/ NMO II

20.22.31.2.1 Conformance requirement

When a cell reselection is initiated by the network for an individual mobile station, the cell change order procedure is started by sending a PACKET CELL CHANGE ORDER message to the mobile station on the PCCCH or PACCH.

Upon receipt of the PACKET CELL CHANGE ORDER message the mobile station shall start timer T3174.

When a cell reselection is made controlled by the network, the mobile station shall act upon the IMMEDIATE_REL value which has been received in the Packet Cell Change Order: if required, the mobile station shall abort any TBF in progress by immediately ceasing to decode the downlink, ceasing to transmit on the uplink, stopping all RLC/MAC timers except for timers related to measurement reporting. The mobile station shall then switch to the identified specified new cell and shall obey the relevant RLC/MAC procedures on this new cell.

To initiate the normal routing area updating procedure, the MS sends the message ROUTING AREA UPDATE REQUEST to the network, starts timer T3330 and changes to state GMM-ROUTING-AREA-UPDATING-INITIATED. The message ROUTING AREA UPDATE REQUEST shall contain the P-TMSI signature when received within a previous ATTACH ACCEPT or ROUTING AREA UPDATE ACCEPT message.

If the routing area updating request has been accepted by the network, a ROUTING AREA UPDATE ACCEPT message shall be sent to the MS. The network may assign a new P-TMSI and/or a new P-TMSI signature for the MS. If a new P-TMSI and/or P-TMSI signature have been assigned to the MS, it/they shall be included in the ROUTING AREA UPDATE ACCEPT message together with the routing area identification.

If the network operates in mode II or III, then a GPRS-attached MS that has the capability to be simultaneously GPRS-attached and IMSI-attached shall perform the (non-combined) Routing Area Update procedures, and either:

- access the non-GPRS common control channels for CS operation (the way that CS operation is performed in parallel with GPRS operation is an MS implementation issue outside the scope of the present document); or

- if CS operation is not desired, depending on system information that defines whether or not explicit detach shall be used, either:
 - avoid all CS signalling (in which case the MS may be implicitly IMSI detached after a while); or
 - perform an explicit IMSI detach via the non-GPRS common control channels (if the MS was already IMSI-attached).

20.22.31.2.2 References

3GPP TS 04.60, subclauses 8.4 and 5.5.1.1.

3GPP TS 04.08 / 3GPP TS 24.008 subclause 4.7.5.1.

3GPP TS 03.60, subclause 6.5

20.22.31.2.3 Test Purpose

To test the behaviour of the MS when the network triggers a Packet Cell Change Order to a cell belonging to another routing area, whereas the network mode of operation II is active, i.e:

To verify that the cell change order procedure is started when the MS receives a PACKET CELL CHANGE ORDER message.

To verify that the MS switches to the new cell under network control.

To verify that the MS performs separate Normal Location and Routing Area Update procedures.

20.22.31.2.4 Method of test

Initial conditions

System simulator:

Parameters changed from the default values in table 20.22.1.

Parameter	Cell A		Cell B	Cell C	
	Carrier 1	Carrier 2	Carrier 3	Carrier 4	Carrier 5
Channel Type Carried	BCCH	PBCCH	BCCH	BCCH	PBCCH
RF Signal Level (dBm)	-60	-60	-80	-70	-70
Serving Cell Parameters					
GPRS_RXLEV_ACCESS_MIN (dBm)	--	-100	--	--	-100
NETWORK_CONTROL_ORDER	NC2	NC2	NC2	NC2	NC2
NC_REPORTING_PERIOD_T (s)	0,96	0,96	--	0,96	0,96
Network Mode of Operation	NMO 2	NMO 2	NMO 2	NMO 2	NMO 2
RAC	Default	Default	Default	Different to default	Same as carrier 4
LAC	Default	Default	Default	Different to default	Same as carrier 4
Neighbour Cell Parameters					
GPRS_RXLEV_ACCESS_MIN (dBm)	-100	--	-100	-100	--
C1	40-20	--	20-40	30	--
C32	40-20	--	20-40	30	--

20.22.31.2.5 void

20.22.31.2.6 Foreseen final state of the MS

- MS is in Transfer mode on carrier 5.

20.22.31.2.7 Test procedure

- a) The MS is switched on and completes GPRS Attach procedure (ready timer deactivated) on carrier 2. MS is PDP context activated and brought into packet transfer mode.

- b) The RF level of carriers 1 and 2 are reduced to -80 dBm. (C32 becomes 20).
- c) The SS waits 15 s after the RF level of carriers 1 and 2 are reduced before sending Packet Cell Change Order, with the IMMEDIATE_REL bit set to FALSE, to the MS to select carrier 4. The MS shall complete Routing Area Update procedure on carrier 5 and Location Update procedure on carrier 4.
- d) The RF level of carrier 3 is increased to -60 dBm. (C32 becomes 40).
- e) The SS waits 15 s after increasing the RF level of carrier 3 to ensure no RA update takes place on carriers 1, 2 and 3.

NOTE: During the TBF, T3158 may expire and thus PACKET MEASUREMENT REPORT could be sent at any time while the downlink transfer is in progress. The SS shall be prepared for this.

NOTE: In step c), since the order of LA and RA updates is not being tested, the SS shall be prepared for initial procedure being on carrier 4 or 5.

20.22.31.2.8 Test Requirements

- 1) After step b) there should be no response on carriers 3, 4 or 5.
- 2) After step c) there should be a response on carrier 4 and on carrier 5 (the order in which the LA and RA updates occur is not the subject of this test).

Note: Time allowed includes 2 seconds to decode BCCH, 2 sec to decode PSII, 2 sec to decode PBCCH and 5 sec for re-selection.

20.22.31.2.9 Maximum duration of the test

4 minutes

20.23 COMPACT Cell Selection and Reselection

The absolute accuracy of the MS signal level measurements is assumed to be ± 6 dB. A difference of at least 8 dB is allowed for cases of discrimination between C1, C31, C32 values and 0.

The relative accuracy of the MS signal level measurements is assumed to be ± 3 dB for the signal levels used in the tests of this subclause. A difference of at least 5 dB is allowed for cases of discrimination between C1 and C31 and C32 values on different carriers.

NOTE 1: The accuracy of MS signal level measurements is specified in 3GPP TS 05.08. For all of the tests in this subclause, the signal levels used are greater than 1 dB above reference sensitivity level.

NOTE 2: The tolerance on timers specified in 3GPP TS 05.08 is ± 10 % except for PENALTY_TIME where it is ± 2 s. In the tests of this subclause, the test requirements include these tolerances. Consequently, the times stated in the test requirement sometimes differ from the corresponding timer in the conformance requirement.

Where pulsed signals are specified, the SS tolerance on pulse width is ± 2 % and the SS tolerance on power level ± 1 dB.

The cell re-selection tests defined in the following subclauses applies to the MSs attached to EGPRS if a CPBCCCH exists in the serving cell. Otherwise the MS shall perform cell re-selection according to the idle mode procedures defined in clause 6 or clause 10 of 3GPP TS 05.08 and therefore tests defined in clause 20 or subclause 20.22 of 3GPP TS 11.10 apply respectively.

Unless otherwise stated in the method of test, in all of the tests of this subclause:

- The SIM is in the idle updated state in the default registration area with a PTMSI assigned at the beginning of each test.
- All carriers support COMPACT.
- The Scheduling of Packet System information should be such that a complete set of consistent PSI messages can be decoded within 8 multiframe.
- The mobile station supports COMPACT.

- The mobile station is either packet data only capable or it does not support GSM CS services.
- Time Group 0 is used to send CPBCCH / CPCCCH blocks for all ARFCN values (one active timegroup/carrier).
- 1 CPBCCH block and 3 CPPCH blocks are allocated in all timegroups (N_CCCH_NH = 4).
- All cells must be timeslot and frame synchronized to each other.

Table 20.23.1: Default values of the system information fields

Parameter	3GPP TS 04.6 0 reference	Abbr.	Normal Setting
PRIORITY_CLASS	11.2.20	PC	1
C31_HYST	11.2.20	C31H	0
RA_RESELECT_HYSTERESIS	11.2.20	RARH	0 dB
HCS_THR	11.2.20	HT	-110 dBm
GPRS_RESELECT_OFFSET	11.2.20	GRO	0 dB
REPORTING_PERIOD	11.2.23	RP	60s
NETWORK_CONTROL_ORDER	11.2.23	NCO	NCO
GPRS_CELL_RESELECT_HYST	11.2.20	GCRH	0 dB
GPRS_TEMPORARY_OFFSET	11.2.20	GTO	0 db
GPRS_PENALTY_TIME	11.2.20	GPT	0 s
SPLIT_PG_CYCLE	5.5.1.5	SPGC	0
GPRS_CELL_RESELECT_HYSTERESIS	11.2.20	GCRH	4 dB
GPRS_MS_TXPWR_MAX_CCH	11.2.20	GMTMC	Max. output power of MS
GPRS_RXLEV_ACCESS_MIN	11.2.20	GRAM	-90 dBm
C32_QUAL	11.2.20	C32Q	0
BA(GPRS) ARFCN	11.2.20	BA	All 0 except ARFCNs in Table 20.23.1a (broadcast in PACKET SYSTEM INFORMATION type 3):
GUAR_CONSTANT_PWR_BLKs	11.2.20	GCPB	0
CELL_BAR_ACCESS_2	11.2.20	CBA2	0
Cell Bar Qualify 2	11.2.20	CBQ2	0

Table 20.23.1a: ARFCNs

Band	ARFCNs
GSM 450	259, 263, 269, 275, 279, 283, 287, 292
GSM 480	306, 310, 316, 322, 326, 330, 334, 339
GSM 710	441, 446, 452, 455, 461, 462, 466, 470, 477, 485, 493, 511
GSM 750	441, 446, 452, 455, 461, 462, 466, 470, 477, 485, 493, 511
T-GSM 810	441, 446, 452, 455, 461, 462, 466, 470, 477, 485, 493, 511
GSM 850	130, 136, 145, 152, 168, 170, 176, 177, 181, 185, 189, 193, 197, 207, 219, 251
GSM 900	both P-GSM and E-GSM ARFCNs are broadcast: GSM: 3, 9, 18, 25, 41, 43, 49, 50, 54, 58, 62, 66, 70, 80, 92, 124 E-GSM: 985, 989, 995, 1010, 1014
DCS 1800	512, 543, 568, 589, 602, 641, 662, 683, 696, 711, 732, 754, 794, 851, 870, 871, 872, 884
PCS1900	512, 543, 568, 589, 602, 641, 662, 683, 696, 711, 732, 754, 790, 791, 792, 809

20.23.1 Cell selection

20.23.1.1 Definition

Cell selection is a process in which an MS, whenever a new PLMN is selected, attempts to find a suitable cell of that PLMN to camp on. Two methods of searching for a suitable cell are possible, normal cell selection and stored list cell selection. The process ensures that the MS is camped on a cell from which it can reliably decode downlink data and with which it has a high probability of communications on the uplink. Once the MS is camped on a cell, access to the network is allowed.

20.23.1.2 Conformance requirement

1. The MS shall be able to select the strongest COMPACT cell within 120 s of switch on. This assumes a valid SIM, with PIN disabled and ideal radio conditions.

2. There are various requirements that a cell must satisfy before an MS can perform normal camping on it:
 - 2.1 (i) It should be a cell of the selected PLMN.
 - 2.2 (ii) It should not be "barred" (see 3GPP TS 03.22 subclause 3.5.1).
 - 2.3 (iii) It should not be in an LA which is in the list of "forbidden LAs for roaming".
 - 2.4 (iv) The radio path loss between MS and BTS must be below a threshold set by the PLMN operator. This is estimated as shown in subclause 3.6. (3GPP TS 03.22, subclause 3.2.1)

NOTE: Criteria 2.3 (iii) is not applicable for Cell Selection.

3. Initially the MS looks for a cell which satisfies these 4 constraints ("suitable cell") by checking cells in descending order of received signal strength. If a suitable cell is found, the MS camps on it, 3GPP TS 03.22, subclause 3.2.1.
4. The MS shall be able to calculate correctly the path loss criterion parameter C1, used for cell selection and reselection, 3GPP TS 05.08, subclause 12.3.4.

20.23.1.3 Test purpose

1. To verify that the MS meets conformance requirement 1. when all cells support COMPACT.
2. To verify that:
 - 2.1 The MS does not select a cell of a PLMN, which is not the selected PLMN.
 - 2.2 The MS does not select a cell which is "barred".
 - 2.3 The MS does not select a cell with $C1 < 0$.
3. To verify that the MS selects suitable cells in descending order of received signal strength.
4. To verify that the MS does not select a cell with $C1 < 0$.

20.23.1.4 Method of test

Initial conditions

Parameters changed from the default values in table 20.23.1.

Parameter	Carrier 1	Carrier 2	Carrier 3	Carrier 4	Carrier 5	Carrier 6
RF Signal Level (dBm)	-75	-80	-70	-60	-70	-80
CBA2	0	0	0	1	0	
RXLEV_ACCESS_MIN (dBm)						-90
GPRS_RXLEV_ACCESS_MIN	-90	-90	-90	-90	-60	
MNC			See Table 20.1c			
MCC			002			
C1	15	10	20	30	-10	10

NOTE 1: For an E-GSM MS carrier 1 and carrier 5 ARFCNs are chosen in the E-GSM band, carrier 3 and carrier 4 ARFCNs in the P-GSM band.

NOTE 2: Carrier 6 is GSM BCCH and do not support GPRS/EGPRS.

Procedure

- a) The SS activates and pages on the MS on all carriers. All Carriers are monitored for RA requests from the MS.
- b) The MS is switched on.

20.23.1.5 Test requirements

- 1) After step b), the first response from the MS shall be on carrier 1 within 123 s. There shall be no response from the MS on any other carrier.

20.23.2 Cell reselection in Packet Idle mode

20.23.2.1 Definition

-

20.23.2.2 Conformance requirement

At least for every new sample or every second, whichever is the greatest, the MS shall update RLA_P and calculate the value of $C1$, $C31$ and $C32$ for the serving cell and the non-serving cells; 3GPP TS 05.08, subclause 10.1.2 The MS shall make a cell re-selection if:

- (i) The path loss criterion parameter ($C1$) for the serving cell falls below zero.
- (ii) A non-serving suitable cell (see 3GPP TS 03.22) is evaluated to be better than the serving cell. The best cell is the cell with the highest value of $C32$ among:
 - those cells that have the highest $PRIORITY_CLASS$ among those that fulfil the criterion $C31 \geq 0$; or
 - all cells, if no cells fulfil the criterion $C31 \geq 0$;
 - if the parameter $C32_QUAL$ is set, positive $GPRS_RESELECT_OFFSET$ values shall only be applied to the neighbour cell with the highest RLA_P value of those cells for which $C32$ is compared above.

$PRIORITY_CLASS$ and $C32_QUAL$ are broadcast on CPBCCCH of the serving cell.

When evaluating the best cell, the following hysteresis values shall be subtracted from the $C32$ value for the neighbour cells:

- in standby state, if the new cell is in the same routing area: 0.
- in ready state, if the new cell is in the same routing area:
 - $GPRS_CELL_RESELECT_HYSTERESIS$. If the parameter $C31_HYST$ is set;
 - $GPRS_CELL_RESELECT_HYSTERESIS$ shall also be subtracted from the $C31$ value for the neighbour cells.
- in standby or ready state, if the new cell is in a different routing area:
 - $RA_RESELECT_HYSTERESIS$.
- in case of a cell re-selection occurred within the previous 15 s: 5 dB.
 - $GPRS_CELL_RESELECT_HYSTERESIS$, $C31_HYST$ and $RA_RESELECT_HYSTERESIS$ are broadcast on CPBCCCH of the serving cell.

20.23.2.3 Test purpose

To verify that the MS reselects the correct cell based on the $C32$ parameter when $GPRS_RESELECT_OFFSET$, $TEMPORARY_OFFSET$ and $PENALTY_TIME$ parameters are transmitted in the System information messages.

1. To verify MS does not reselect on the basis of $C31$ as there are no HCS threshold values transmitted in the System information messages.

20.23.2.4 Method of test

Initial conditions

Parameters changed from the default values in table 20.23.1.

Parameter	Carrier 1	Carrier 2	Carrier 3	Carrier 4
RF Signal Level (dBm)	-70	-70	-65	-60
GPRS_RXLEV_ACCESS_MIN (dBm)	-90	-100	-85	-90
GPT			40 s	
GRO		-20 dB	20 dB	
GTO			20 dB	
C1	20	30	20	30
C32	20	10	20-40	30

NOTE 1: The BA(GPRS) list only contains the ARFCNs of the carriers used during the test.

NOTE 2: The HCS structure is omitted from the packet system information messages.

Procedure

- a) The SS activates carriers 1 and 4. The MS is paged on Carriers 1 and 4. The SS starts monitoring carriers 1 and 4 for RA requests from the MS.
- b) The MS is switched on.
- c) The SS activates carriers 2 and 3. The MS is paged on both carriers. The SS monitors carriers 2 and 3 for RA requests from the MS.

20.23.2.5 Test Requirements

- 1) After step b) there should be a response on carrier 4 within 123 s.

NOTE 1: The SS should ensure that the MS final state is in Packet Idle mode on carrier 4.

- 2) After step c) there should be no response on carrier 3 within 38 s of activating the carrier but MS should respond on carrier 3 within 50 s of activating the carrier.

NOTE 2: Minimum time of 38 s set by penalty timer on carrier 4 less 2 second tolerance. Maximum time includes 42 s (40 s + 2 s tolerance) for expiry of penalty timer on carrier 4, 2 s to decode CPBCCCH, 1 s for reselection, since the MS will already have running averages on carrier 4, when the penalty timers expire, allow 50 s.

20.23.3 Priority of cells

20.23.3.1 Definition

-

20.23.3.2 Conformance requirement

At least for every new sample or every second, whichever is the greatest, the MS shall update RLA_P and calculate the value of C1, C31 and C32 for the serving cell and the non-serving cells; 3GPP TS 05.08, subclause 10.1.2 The MS shall make a cell re-selection if:

- (i) The path loss criterion parameter (C1) for the serving cell falls below zero.
- (ii) A non-serving suitable cell (see 3GPP TS 03.22) is evaluated to be better than the serving cell. The best cell is the cell with the highest value of C32 among:
 - those cells that have the highest PRIORITY_CLASS among those that fulfil the criterion $C31 \geq 0$; or
 - all cells, if no cells fulfil the criterion $C31 \geq 0$;

- if the parameter C32_QUAL is set, positive GPRS_RESELECT_OFFSET values shall only be applied to the neighbour cell with the highest RLA_P value of those cells for which C32 is compared above.

PRIORITY_CLASS and C32_QUAL are broadcast on CPBCCCH of the serving cell.

When evaluating the best cell, the following hysteresis values shall be subtracted from the C32 value for the neighbour cells:

- in standby state, if the new cell is in the same routing area: 0.
- in ready state, if the new cell is in the same routing area:
 - GPRS_CELL_RESELECT_HYSTERESIS. If the parameter C31_HYST is set;
 - GPRS_CELL_RESELECT_HYSTERESIS shall also be subtracted from the C31 value for the neighbour cells.
- in standby or ready state, if the new cell is in a different routing area:
 - RA_RESELECT_HYSTERESIS.
- in case of a cell re-selection occurred within the previous 15 s: 5 dB.
 - GPRS_CELL_RESELECT_HYSTERESIS, C31_HYST and RA_RESELECT_HYSTERESIS are broadcast on CPBCCCH of the serving cell.

20.23.3.3 Test purpose

1. To verify that the MS reselects to the correct cell by calculating C31 correctly when C31_HYST is set on the network.

20.23.3.4 Method of Test

Initial Conditions

Parameters changed from the default values in table 20.23.1.

Parameter	Carrier 1	Carrier 2	Carrier 3	Carrier 4	Carrier 5
RF Signal Level (dBm)	-60	-80	-65	-70	-70
GPRS_RXLEV_ACCESS_MIN (dBm) C31_HYST = 1	-100	-100	-95	-100	-102
Priority Class	1	1	1	1	3
GRO		10	4	10	14
HCS_THR	-90	-70	-76	-80	-80
GCRH	10				
C1	40 to 15	20	30	30	32
C31	20 to 5	-10	11	10	10
C32	40 to 15	20	24	30	36

NOTE 1: GRO = GPRS_RESELECT_OFFSET, GCRH = GPRS_CELL_RESELECT_HYSTERESIS, RARH = RA_RESELECT_HYSTERESIS.

NOTE 2: The BA(GPRS) list only contains the ARFCNs of the carriers used during the test. The HCS structure is transmitted in the Packet system information messages.

Procedure

- a) The MS is switched on and a downlink TBF is set-up on carrier 1.
- b) The SS waits 10 s.
- c) The RF level of Carrier 1 is reduced to -85 dBm (C1=decreases to 15).

20.23.3.5 Test Requirements

After step c) the MS should respond on carrier 4 within 10 s. (Carrier 2 should be rejected as $C31 < 0$, Carrier 5 has a lower priority class than Carrier 3 and Carrier 4 so is rejected, even though $C32 = 36$, out of carrier 3 and 4, Carrier 4 has highest $C32$ value.

NOTE: Time allowed includes 5 s for MS to determine $C32$ on neighbour cell is higher, 2 s to decode CPBCCCH and 1 s for re-selection.

20.23.4 Cell re-selection with cells in different routing area

20.23.4.1 Definition

-

20.23.4.2 Conformance requirement

At least for every new sample or every second, whichever is the greatest, the MS shall update RLA_P and calculate the value of $C1$, $C31$ and $C32$ for the serving cell and the non-serving cells; 3GPP TS 05.08, subclause 10.1.2 The MS shall make a cell re-selection if:

- (i) The path loss criterion parameter ($C1$) for the serving cell falls below zero.
- (ii) A non-serving suitable cell (see 3GPP TS 03.22) is evaluated to be better than the serving cell. The best cell is the cell with the highest value of $C32$ among:
 - those cells that have the highest $PRIORITY_CLASS$ among those that fulfil the criterion $C31 \geq 0$; or
 - all cells, if no cells fulfil the criterion $C31 \geq 0$;
 - if the parameter $C32_QUAL$ is set, positive $GPRS_RESELECT_OFFSET$ values shall only be applied to the neighbour cell with the highest RLA_P value of those cells for which $C32$ is compared above.

$PRIORITY_CLASS$ and $C32_QUAL$ are broadcast on CPBCCCH of the serving cell.

When evaluating the best cell, the following hysteresis values shall be subtracted from the $C32$ value for the neighbour cells:

- in standby state, if the new cell is in the same routing area: 0.
- in ready state, if the new cell is in the same routing area:
 - $GPRS_CELL_RESELECT_HYSTERESIS$. If the parameter $C31_HYST$ is set;
 - $GPRS_CELL_RESELECT_HYSTERESIS$ shall also be subtracted from the $C31$ value for the neighbour cells.
- in standby or ready state, if the new cell is in a different routing area:
 - $RA_RESELECT_HYSTERESIS$.
- in case of a cell re-selection occurred within the previous 15 s: 5 dB.
 - $GPRS_CELL_RESELECT_HYSTERESIS$, $C31_HYST$ and $RA_RESELECT_HYSTERESIS$ are broadcast on CPBCCCH of the serving cell.

20.23.4.3 Test purpose

To verify that the MS reselects to the correct cell by calculating $C32$ correctly when one of the cells is in a different routing area.

20.23.4.4 Method of Test

Initial Conditions

Parameters changed from the default values in table 20.23.1.

Parameter	Carrier 1	Carrier 2	Carrier 3	Carrier 4	Carrier 5
RF Signal Level (dBm)	-60	-70	-70	-70	-70
RAI				Different	
GPRS_RXLEV_ACCESS_MIN (dBm)	-100	-80	-100	-100	-80
GRO		4	4	6	4
GCRH	4				
RARH	14				
C1	40 to 15	10	30	30	10
C32	40 to 15	14	34	22	14

NOTE 1: GRO = GPRS_RESELECT_OFFSET, GCRH = GPRS_CELL_RESELECT_HYSTERESIS, RARH = RA_RESELECT_HYSTERESIS.

NOTE 2: The BA(GPRS) list only contains the ARFCNs of the carriers used during the test. The HCS structure is transmitted in the Packet system information messages.

Procedure

- The MS is switched on and a downlink TBF is set-up on carrier 1.
- The SS waits 10 s.
- The RF level of Carrier 1 is reduced to -85 dBm (C1=decreases to 15).

20.23.4.5 Test Requirements

After step c) the MS should respond on carrier 3 within 10 s. (Carrier 4 C32=22 if RA_RESELECT_HYSTERESIS is used correctly by MS otherwise it will be 36 and MS will select carrier 4 incorrectly.)

NOTE: Time allowed includes 5 s for MS to determine C32 on neighbour cell is higher, 2 s to decode CPBCCCH and 1 s for re-selection.

20.23.5 Network controlled Cell re-selection in Transfer Mode

20.23.5.1 Definition

-

20.23.5.2 Conformance requirement

- A cell re-selection command may be sent from the network to an MS. When the MS receives the command, it shall immediately re-select the cell according to the included cell description and change the network control mode according to the command (3GPP TS 04. 60, 3GPP TS 05.08 subclause 10.1.4).

20.23.5.3 Test purpose

To verify the MS can correctly interpret the network control commands and reselect to the correct cell.

20.23.5.4 Method of Test

Initial Conditions

Parameters changed from the default values in table 20.23.1.

Parameter	Carrier 1	Carrier 2	Carrier 3
RF Signal Level (dBm)	-60	-80	-70
GPRS_RXLEV_ACCESS_MIN (dBm)	-100	-100	-100
NETWORK_CONTROL_ORDER	NC2	NC0	NC2
NC_REPORTING PERIOD_T (s)	0,96		0,96
C1	40-20	20-40	30
C32	40-20	20-40	30

NOTE: The HCS structure is omitted from the packet system information messages on all the cells. Therefore C31 is not used.

Procedure

- a) The MS is switched on and a downlink TBF is set up on carrier 1.
- b) The RF level of carrier 1 is reduced to –80 dBm. (C32 becomes 20).
- c) The SS waits 15 s after the RF level of carrier 1 is reduced before sending a reselect command to the MS to select carrier 3.
- d) The RF level of carrier 2 is increased to –60 dBm. (C32 becomes 40).
- e) The SS waits 15 s after increasing the RF level of carrier 2 before the Network Control Order is changed to NC0 on carrier 3. The SS sends a RESET command to the MS.

20.23.5.5 Test Requirements

- 1) After step b) there should be no response on carriers 2 or 3.
- 2) After step c) there should be a response on carrier 3 within 5 s of the re-select command. (The 3 s = 2 s for CPBCCCH decoding + 1 s for re-selection + tolerance.)
- 3) After step d) there should be no response on carriers 1 or 2.
- 4) After step e) there should be a response on carrier 2 within 3 s of the SS sending the RESET command. (The 3s = 2s for CPBCCCH decoding + 1s for re-selection + tolerance.)

20.23.6 Cell reselection timings

20.23.6.1 Definition

-

20.23.6.2 Conformance requirement

At least for every sample or every second, whichever is greatest, the MS shall calculate the value of C1, C31 and C32 for the serving cell and recalculate C1, C31 and C32 values for non serving cells (if necessary). The MS shall make a cell re-selection if:

- i) The path loss criterion parameter (C1) for the serving cells falls below zero.

20.23.6.3 Test purpose

1. To verify that the MS meets conformance requirement 6.2 (i) within time allowed.

20.23.6.4 Method of Test

Initial Conditions

Parameters changed from the default values in table 20.23.1.

Parameter	Carrier 1	Carrier 2
RF Signal Level (dBm)	-60	-70
GPRS_RXLEV_ACCESS_MIN (dBm)	-90	-100
GRO		-28
SPLIT_PG_CYCLE	4	4
C1	30	30
C32	30	2

NOTE 1: The HCS structure is omitted from the system information messages on all the cells. Therefore C31 is not used.

NOTE 2: The RLA_P should be updated every 3,84 s with SPLIT_PG_CYCLE = 4.

Procedure

- a) The SS activates both carriers and pages the MS on carrier 2. The SS starts to monitor carrier 2 for responses from the MS.
- b) The MS is switched on.
- c) The SS waits 120 s before the RF level of carrier 1 is reduced to -100 dBm for 8 s. (During this period C1 becomes -10). Then the SS raises the level back to -60 dBm. The SS waits 20 s.
- d) The SS reduces the RF level on carrier 1 to -100 dBm.

20.23.6.5 Test Requirements

- 1) After step c) there shall be no access on carrier 2.
- 2) After step d) there shall be access on carrier 2 within 23 s (allow 20 s for c1 average to reach -10 + 2s to decode CPBCCCH).

20.23.7 Downlink signalling failure

20.23.7.1 Definition

-

20.23.7.2 Conformance requirement

The downlink signalling failure criterion is based on the downlink signalling failure counter DSC.

1. If DRX period split is supported, DSC shall be initialised to a value equal to the nearest integer to $\max(10, 90/64 \times \text{SPLIT_PG_CYCLE})$ where SPLIT_PG_CYCLE is an parameter defined at GPRS attach (see 3GPP TS 05.02).
2. Thereafter, whenever the MS attempts to decode a message in its paging subchannel; if a message is successfully decoded DSC is increased by 1, however never beyond the max value defined in 1.
3. Whenever the MS can not successfully decode a message in its paging subchannel the DSC is decreased by 4.
4. When DSC reaches 0, a downlink signalling failure shall be declared. A downlink signalling failure shall result in cell reselection, 3GPP TS 03.22, subclause 4.5 (ii) and 3GPP TS 05.08, subclause 6.5.

NOTE: The network sends the paging subchannel for a given MS every $64/\text{SPLIT_PG_CYCLE}$ multiframes . The requirement for network transmission on the paging subchannel is specified in 3GPP TS 04.08 / 3GPP TS 44.018. The MS is required to attempt to decode a message every time its paging subchannel is sent.

20.23.7.3 Test purpose

1. To verify that the MS initialises the DSC counter in accordance with the conformance requirement. This is verified indirectly.
2. To verify that whenever the MS successfully decodes a message on paging subchannel, the DSC is increased by 1, (however never beyond the nearest integer to max defined in subclause 16.2.1). This is verified indirectly.
3. To verify that whenever the MS can not successfully decode a message on paging subchannel, the DSC decreased by 4. This is verified indirectly.
4. To verify that when the DSC reaches 0, a downlink signalling failure shall be declared and the MS will perform cell reselection.

20.23.7.4 Method of Test

Initial Conditions

Parameters changed from the default values in table 20.23.1.

Parameter	Carrier 1	Carrier 2
RF Signal Level (dB μ V emf() / dBm)	-65	-60
GPRS_RXLEV_ACCESS_MIN (dBm)	-95	-100
SPLIT_PG_CYCLE	4	4
C1	30	40
C32	30	40

NOTE 1: The HCS structure is omitted from the system information messages on all the cells. Therefore C31 is not used.

NOTE 2: With SPLIT_PG_CYCLE=4 DSC should be set to 10, Paging blocks occur every 832 frames or 3,84 s.

Procedure

- The MS is switched on. On carrier 2 valid layer 3 messages shall be sent in the paging blocks, but not paging the MS. On carrier 1 the MS is paged continuously in all paging blocks.
- After 40 s the SS sends corrupted data (using random data, wrong parity bits see 3GPP TS 05.03, subclauses 4.3 and 4.1.2 or other lower layer error) in 2 successive paging blocks on carrier 2 and then reverts to sending normal data.

NOTE 1: Sending corrupted, i.e. non-decodable data on 2 successive paging blocks should decrease the DSC to 2.

- The SS monitors all accesses on both carriers for 40 s. (Allows the DSC counter to go back to maximum of 10, paging block every 3,84 s.)
- The SS sends corrupted data in 3 successive paging blocks on carrier 2 and then reverts to sending normal data..

NOTE 2: Sending corrupted, data on 3 successive paging blocks should decrease the DSC to < 0 (-2) and cause a cell reselection.

- The SS monitors all accesses on both carriers for 30 s.

20.23.7.5 Test requirements

- There shall be no access on carrier 1 after step b).
- The MS shall access on carrier 1 at test step e) within 3 s. (The time should be measured from the transmission of the complete 3rd successive paging block with errors and allows 2 secs for decoding CPBCCCH).

20.23.8 COMPACT Cell re-selection when target cell is BCCH supporting EGPRS and different routing area

20.23.8.1 Definition

-

20.23.8.2 Conformance requirement

At least for every new sample or every second, whichever is the greatest, the MS shall update RLA_P and calculate the value of C1, C31 and C32 for the serving cell and the non-serving cells; 3GPP TS 05.08, subclause 10.1.2 The MS shall make a cell re-selection if:

- The path loss criterion parameter (C1) for the serving cell falls below zero.
- A non-serving suitable cell (see 3GPP TS 03.22) is evaluated to be better than the serving cell. The best cell is the cell with the highest value of C32 among:
 - those cells that have the highest PRIORITY_CLASS among those that fulfil the criterion $C31 \geq 0$; or
 - all cells, if no cells fulfil the criterion $C31 \geq 0$;

- if the parameter C32_QUAL is set, positive GPRS_RESELECT_OFFSET values shall only be applied to the neighbour cell with the highest RLA_P value of those cells for which C32 is compared above.

PRIORITY_CLASS and C32_QUAL are broadcast on CPBCCCH of the serving cell.

When evaluating the best cell, the following hysteresis values shall be subtracted from the C32 value for the neighbour cells:

- in standby state, if the new cell is in the same routing area: 0.
- in ready state, if the new cell is in the same routing area:
 - GPRS_CELL_RESELECT_HYSTERESIS. If the parameter C31_HYST is set;
 - GPRS_CELL_RESELECT_HYSTERESIS shall also be subtracted from the C31 value for the neighbour cells.
- in standby or ready state, if the new cell is in a different routing area:
 - RA_RESELECT_HYSTERESIS.
- in case of a cell re-selection occurred within the previous 15 s: 5 dB.
 - GPRS_CELL_RESELECT_HYSTERESIS, C31_HYST and RA_RESELECT_HYSTERESIS are broadcast on CPBCCCH of the serving cell.

20.23.8.3 Test purpose

To verify that the MS is able to reselect a correct cell when target cell is non COMPACT cell supporting EGPRS.

20.23.8.4 Method of Test

Initial Conditions

Parameters changed from the default values in table 20.23.1.

Parameter	Carrier 1	Carrier 2	Carrier 3	Carrier 4	Carrier 5
RF Signal Level (dBm)	-60	-70	-70	-65	-70
RAI				Different	
GPRS_RXLEV_ACCESS_MIN (dBm)	-100	-80	-100	-100	-80
GRO		4	4	6	4
GCRH	4				
RARH	6				
C1	40 to 15	10	30	35	10
C32	40 to 15	10	30	35	10

NOTE 1: GRO = GPRS_RESELECT_OFFSET, GCRH = GPRS_CELL_RESELECT_HYSTERESIS, RARH = RA_RESELECT_HYSTERESIS.

NOTE 2: The BA(GPRS) list only contains the ARFCNs of the carriers used during the test. The HCS structure is transmitted in the Packet system information messages.

NOTE 3: Carrier 4 is continuous GSM BCCH supporting EGPRS.

Procedure

- The MS is switched on and a downlink TBF is set-up on carrier 1.
- The SS waits 10 s.
- The RF level of Carrier 1 is reduced to -85 dBm (C1 = decreases to 15).

20.23.8.5 Test Requirements

- After step c) the MS should respond on carrier 4 within 10 s. (Carrier 4 C32=35 if RA_RESELECT_HYSTERESIS is used correctly by MS.)

NOTE: Time allowed includes 5 s for MS to determine C32 on neighbour cell is higher, 2 s to decode CPBCCCH and 1 s for re-selection.

20.23.9 Cell re-selection when target cell is COMPACT CPBCCCH in different routing area

20.23.9.1 Definition

-

20.23.9.2 Conformance requirement

At least for every new sample or every second, whichever is the greatest, the MS shall update RLA_P and calculate the value of C1, C31 and C32 for the serving cell and the non-serving cells; 3GPP TS 05.08, subclause 10.1.2 The MS shall make a cell re-selection if:

- (i) The path loss criterion parameter (C1) for the serving cell falls below zero.
- (ii) A non-serving suitable cell (see 3GPP TS 03.22) is evaluated to be better than the serving cell. The best cell is the cell with the highest value of C32 among:
 - those cells that have the highest PRIORITY_CLASS among those that fulfil the criterion $C31 \geq 0$; or
 - all cells, if no cells fulfil the criterion $C31 \geq 0$;
 - if the parameter C32_QUAL is set, positive GPRS_RESELECT_OFFSET values shall only be applied to the neighbour cell with the highest RLA_P value of those cells for which C32 is compared above.

PRIORITY_CLASS and C32_QUAL are broadcast on PBCCH of the serving cell.

When evaluating the best cell, the following hysteresis values shall be subtracted from the C32 value for the neighbour cells:

- in standby state, if the new cell is in the same routing area: 0.
- in ready state, if the new cell is in the same routing area:
 - GPRS_CELL_RESELECT_HYSTERESIS. If the parameter C31_HYST is set;
 - GPRS_CELL_RESELECT_HYSTERESIS shall also be subtracted from the C31 value for the neighbour cells.
- in standby or ready state, if the new cell is in a different routing area:
 - RA_RESELECT_HYSTERESIS.
- in case of a cell re-selection occurred within the previous 15 s: 5 dB.
 - GPRS_CELL_RESELECT_HYSTERESIS, C31_HYST and RA_RESELECT_HYSTERESIS are broadcast on PBCCH of the serving cell.

20.23.9.3 Test purpose

To verify that the MS reselects to the correct cell by calculating C32 correctly when the target cells are supporting COMPACT.

20.23.9.4 Method of Test

Initial Conditions

Parameters changed from the default values in table 20.23.1.

Parameter	Carrier 1	Carrier 2	Carrier 3	Carrier 4	Carrier 5	Carrier 6
RF Signal Level (dBm)	-60	-60	-70	-70	-65	-70
RAI					Different	
GPRS_RXLEV_ACCESS_MIN (dBm)	-100	-100	-80	-100	-100	-80
GRO			4	4	6	4
GCRH	4					
RARH	6					
C1	40 to 15		10	30	35	10
C32	40 to 15		10	30	35	10

NOTE 1: GRO = GPRS_RESELECT_OFFSET, GCRH = GPRS_CELL_RESELECT_HYSTERESIS, RARH = RA_RESELECT_HYSTERESIS.

NOTE 2: The BA(GPRS) list only contains the ARFCNs of the carriers used during the test. The HCS structure is transmitted in the Packet system information messages.

NOTE 3: Carrier 1 is the BCCH carrier which broadcasts the position of the PBCCH channel supporting EGPRS in the cell (Carrier 2).

NOTE 4: Carriers 3, 4 and 6 are continuous GSM BCCH's supporting EGPRS.

Procedure

- The MS is switched on and a downlink TBF is set-up on carrier 2.
- The SS waits 10 s.
- The RF level of Carriers 1 and 2 are reduced to -85 dBm (C1 = decreases to 15).

20.23.9.5 Test Requirements

After step c) the MS should respond on carrier 5 within 10 s. (Carrier 5 C32=35 if RA_RESELECT_HYSTERESIS is used correctly by MS.)

NOTE: Time allowed includes 5 s for MS to determine C32 on neighbour cell is higher, 2 s to decode CPBCCH and 1 s for re-selection.

20.24 SoLSA Cell Selection and Reselection

All GSM test cases presented in 3GPP TS 11.10 clause 20 are applicable for SoLSA ME with or without LSA SIM. Nevertheless, if LSA SIM are used, it must be checked that no LSA subscription matches the information broadcast by the cell. Otherwise, test cases dealing with cell reselection would fail.

The cell re-selection tests defined in the following sections apply to the SoLSA MS if an LSA support exists in the serving cell. Otherwise the SoLSA MS shall perform cell re-selection according to the idle mode procedures defined in clause 6 of 3GPP TS 05.08.

The SS transmits one BCCH carrier per cell as indicated in the initial conditions for each test. These are referred to as carrier 1, carrier 2, etc. Each of these cell control channels are non-combined with SDCCHs. It is assumed that the SS can simultaneously transmit seven BCCH carriers and monitor three random access channels. In some cases, a test is performed in multiple stages in order that the requirements can be tested within the above constraints.

For any SoLSA MS all the carriers are in its supported band(s) of operation. For an E-GSM mobile station at least one of the carriers is in the extension band and one of the carriers is in the primary band.

Unless otherwise stated in the method of test, in all of the tests of this subclause:

- The SS is continuously paging the SoLSA MS on all carriers at the start of the test and does not respond to RACH requests from the SoLSA MS. Where a test specifies that the SoLSA MS is not paged on a particular carrier, only idle paging is transmitted according to 3GPP TS 04.18, subclause 3.2.2.2.
- The default values of the system information data fields given in table 20.24.1 are used.

- The SIM is in the idle updated state in the default location area with a TMSI assigned at the beginning of each test.
- The ARFCNs used for the carriers in each test are chosen from those in table 20.24.1 with adjacent carriers separated by a minimum of three channels.

The absolute accuracy of the SoLSA MS signal level measurements is assumed to be ± 6 dB. A difference of at least 8 dB is allowed for cases of discrimination between C1, C2 or C4 values and 0.

The relative accuracy of the SoLSA MS signal level measurements is assumed to be ± 3 dB for the signal levels used in the tests of this subclause. A difference of at least 5 dB is allowed for cases of discrimination between C1, C2 or C4 values on different carriers.

NOTE 1: The accuracy of SoLSA MS signal level measurements is specified in 3GPP TS 05.08. For all of the tests in this subclause, the signal levels used are greater than 1 dB above reference sensitivity level.

NOTE 2: The tolerance on timers specified in 3GPP TS 05.08 is ± 10 % except for PENALTY_TIME where it is ± 2 s. In the tests of this subclause, the test requirements include these tolerances. Consequently, the times stated in the test requirement sometimes differ from the corresponding timer in the conformance requirement.

Where pulsed signals are specified, the SS tolerance on pulse width is ± 2 % and the SS tolerance on power level ± 1 dB.

NOTE 3: Additional to the abbreviations and definitions in 3GPP TR 21.905 the following definitions are used within this subclause.

Definitions

LSA cell	A cell in which SoLSA features are possible
LSA only SIM	A SIM with LSA only access
LSA SIM	A SIM with SoLSA files
Normal LSA cell	An LSA cell which is not an LSA exclusive access cell
Normal LSA SIM	An LSA SIM which is not an LSA only SIM
SoLSA ME	An ME supporting SoLSA
SoLSA MS	A SoLSA ME with LSA SIM

Table 20.24.1: Default values of the system information fields

Parameter	Reference	Abbr.	Normal Setting
Cell channel description	3GPP TS 04.18, 10.5.2.1b	-	Any values
MAX retrans	3GPP TS 04.18, 10.5.2.29	-	1
TX-integer	3GPP TS 04.18, 10.5.2.29	-	Any value
CELL_BAR_QUALIFY	3GPP TS 04.18, 10.5.2.35	CBQ	0
CELL_BAR_ACCESS	3GPP TS 04.18, 10.5.2.29	CBA	0 (not barred)
AC CN	3GPP TS 04.18, 10.5.2.29	AC	All 0
RE	3GPP TS 04.18, 10.5.2.29	RE	0 (re-establishment allowed)
NCC	3GPP TS 04.18, 10.5.2.2	NCC	Any value
Cell Identity	3GPP TS 24.008, 10.5.1.1	CI	Any values
MCC, MNC	3GPP TS 24.008, 10.5.1.3	PLMN	MS Home PLMN
MCC_ESC, MNC_ESC	3GPP TS 23.003, 4.1	escape PLMN	MCC = 901, MNC = 08
LAC	3GPP TS 24.008, 10.5.1.3	LAC	Any value
ATT	3GPP TS 04.18, 10.5.2.11	-	0 (Attach/Detach not allowed)
BS_AG_BLK_RES	3GPP TS 04.18, 10.5.2.11	-	Any values
CCCH_CONF	3GPP TS 04.18, 10.5.2.11	-	1 basic physical channel used for CCCH, non-combined with SDCCHs.
T3212	3GPP TS 04.18, 10.5.2.11	-	Any values
BS_PA_MFRMS	3GPP TS 04.18, 10.5.2.11	BPM	5 frames
Cell Options	3GPP TS 04.18, 10.5.2.3	-	Any values
CELL_RESELECT_HYSTERESIS	3GPP TS 04.18, 10.5.2.4	CRH	4 dB
MS_TXPWR_MAX_CCH	3GPP TS 04.18, 10.5.2.4	MTMC	Max. output power of MS
RXLEV_ACCESS_MIN	3GPP TS 04.18, 10.5.2.4	RAM	-90 dBm
CELL_RESELECT_OFFSET	3GPP TS 04.18, 10.5.2.35	CRO	0
TEMPORARY_OFFSET	3GPP TS 04.18, 10.5.2.35	TO	0
PENALTY_TIME	3GPP TS 04.18, 10.5.2.35	PT	0

Parameter	Reference	Abbr.	Normal Setting
Power Offset	3GPP TS 04.18, 10.5.2.35	PO	0
BA ARFCN	3GPP TS 04.18, 10.5.2.22	BA	All 0 except:
LSA Identifier	3GPP TS 24.008, 10.5.3.11	LSA ID	Any value
LSA Offset	3GPP TS 04.18, 10.5.2.35; 3GPP TS 05.08, 9. table 1	LSA_OFFSET	0
Priority Threshold	3GPP TS 04.18, 10.5.2.35 3GPP TS 05.08, 9 and table 1	PRIO_THR	0

Table 20.24.1a: ARFCNs for Single Band Tests

Band	ARFCNs	broadcast in SYSTEM INFORMATION type
GSM 450	259, 263, 269, 275, 279, 283, 287, 292	SI2
GSM 480	306, 310, 316, 322, 326, 330, 334, 339	SI2
GSM 710	441, 446, 452, 455, 461, 462, 466, 470, 477, 485, 493, 511	SI2
GSM 750	441, 446, 452, 455, 461, 462, 466, 470, 477, 485, 493, 511	SI2
T-GSM 810	441, 446, 452, 455, 461, 462, 466, 470, 477, 485, 493, 511	SI2
GSM 850	130, 136, 145, 152, 168, 170, 176, 177, 181, 185, 189, 193, 197, 207, 219, 251	SI2
GSM 900	both P-GSM and E-GSM ARFCNs are broadcast: GSM: 3, 9, 18, 25, 41, 43, 49, 50, 54, 58, 62, 66, 70, 80, 92, 124 E-GSM: 985, 989, 995, 1010, 1014	SI2 SI2bis
DCS 1800	512, 543, 568, 589, 602, 641, 662, 683, 696, 711, 732, 754, 794, 851, 870, 871, 872, 884	SI2
PCS1900	512, 543, 568, 589, 602, 641, 662, 683, 696, 711, 732, 754, 794	SI2

Table 20.24.1b: ARFCNs for Multiband Tests

Band	ARFCNs	broadcast in SYSTEM INFORMATION type
GSM 450	259, 263, 269, 275, 279, 283, 287, 292	SI2 (GSM 450 cell) & SI2ter (other band cell)
GSM 480	306, 310, 316, 322, 326, 330, 334, 339	SI2 (GSM 480 cell) & SI2ter (other band cell)
GSM 710	441, 452, 461, 477, 493, 511	SI2 (GSM 710 cell) & SI2ter (other band cell)
GSM 750	441, 452, 461, 477, 493, 511	SI2 (GSM 750 cell) & SI2ter (other band cell)
T-GSM 810	441, 452, 461, 477, 493, 511	SI2 (T-GSM 810 cell) & SI2ter (other band cell)
GSM 850	136, 152, 170, 177, 185, 193, 207, 251	SI2 (GSM 850 cell) & SI2ter (other band cell)
GSM 900	3, 18, 41, 49, 62, 70, 92, 124	SI2 (GSM 900 cell) & SI2ter (other band cell)
DCS 1800	512, 568, 602, 662, 696, 732, 794, 870	SI2 (DCS 1800 cell) & SI2ter (other band cell)
PCS 1900	512, 568, 602, 662, 696, 732, 794	SI2 (PCS 1900 cell) & SI2ter (other band cell)

Default values of the SIM card

The "LSA only access indicator" byte of file EF_{SAI} on the SIM card shall be disabled unless otherwise stated (see subclause 20.24).

General initial conditions:

1. Following LSA shall be defined in the fields of the EF_{SLL} (3GPP TS 11.11, subclause 10.4.1.2) and in the LSA descriptor files (GSM 11.11, subclause 10.4.1.3) on the SIM card used for testing.

	LSA ID	CI	LAC	LAC + CI	PLMN code (see NOTE)	LSA Priority	Idle mode support	LSA indication for idle mode
LSA1	54 66.001				HPLMN	0	On	Off
LSA2	66.000				HPLMN	0	Off	On
LSA3	9.000.000			2 + [250..254]	HPLMN	8	On	On
LSA4	9.000.001				HPLMN	8	Off	Off
LSA5	30.000	[256..260]			HPLMN	15	On	On
LSA6	5		1		HPLMN	7	On	On
LSA7	100		10	3 + 500	HPLMN	0	On	On
LSA8	9.000.001				VPLMN	15	On	On
LSA9	54				VPLMN	8	On	On

NOTE: VPLMN is a set of values for MCC and MNC for the LSA which shall not be in the list of the forbidden PLMNs on the SIM card.

2. List of values, that shall not be found in the SIM card, in order to be sure that the SoLSA MS is not subscribed to the LSA defined by the current carrier.

	LSA ID	CI	LAC	LAC + CI
LSA value	[250..255]	[5000..5005]	5	5 + [5000..5005]

3. The initial condition "escape PLMN" is set to "Yes" in the following tables of this subclause, in case of testing with an LSA exclusive access cell.

General Remark

1) Elementary File EF_{SLL} (3GPP TS 11.11, subclause 10.4.1.2)

The information regarding 'idle mode support' and 'LSA indication for idle mode' is contained on the SIM card, in the Elementary File EF_{SLL} SoLSA LSA List (identifier '4F31') and, more precisely, in the 'Configuration Parameters' byte.

File EF_{SLL} is represented in the table below, from 3GPP TS 11.11, subclause 10.4.1.2.

Each LSA is described by one record that is linked to an LSA Descriptor file. Each record contains information of the PLMN, priority of the LSA, information about the subscription and may also contain a text string and/or an icon that identifies the LSA to the user. The text string can be edited by the user.

Identifier: '4F31'		Structure: linear fixed		Optional
Record length: X + 10 bytes		Update activity: low		
Access Conditions:				
READ		CHV1		
UPDATE		CHV1		
INVALIDATE		ADM		
REHABILITATE		ADM		
Bytes	Description		M/O	Length
1 to X	LSA name		O	X bytes
X+1	Configuration parameters		M	1 byte
X+2	RFU		M	1 byte
X+3	Icon Identifier		M	1 byte
X+4	Priority		M	1 byte
X+5 to X+7	PLMN code		M	3 bytes
X+8 to X+9	LSA Descriptor File Identifier		M	2 byte
X+10	LSA Descriptor Record Identifier		M	1 byte

- Configuration parameters

Contents: Icon qualifier, control of idle mode support and control of LSA indication for idle mode.

Coding:

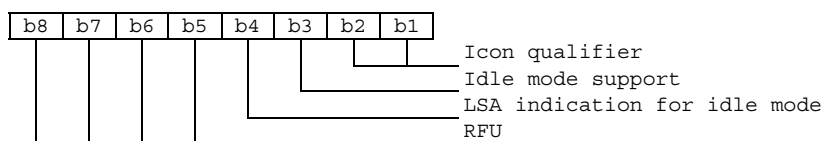

Idle mode support:

Contents: The idle mode support is used to indicate whether the ME shall favour camping on the LSA cells in idle mode.

b3 = 0: Idle mode support disabled
 b3 = 1: Idle mode support enabled

LSA indication for idle mode:

Contents: The LSA indication for idle mode is used to indicate whether or not the ME shall display the LSA name when the ME is camped on a cell within the LSA.

b4 = 0: LSA indication for idle mode disabled
 b4 = 1: LSA indication for idle mode enabled

- Priority

Contents: Priority of the LSA which gives the ME the preference of this LSA relative to the other LSAs.

Coding:

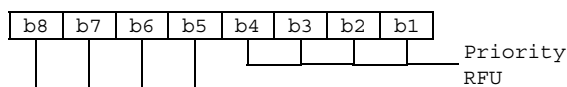

'0' is lowest priority, 'F' is highest.

- PLMN code

Contents: MCC + MNC for the LSA.

Coding: according to 3GPP TS 04.08 [15] / 3GPP TS 24.008 and EF_{LOCI}.

- LSA Descriptor File Identifier:

Contents: these bytes identify the EF which contains the LSA Descriptors forming the LSA.

Coding: byte X+8: high byte of the LSA Descriptor file;
 byte X+9: low byte of the LSA Descriptor file.

- LSA Descriptor Record Identifier:

Contents: this byte identifies the number of the first record in the LSA Descriptor file forming the LSA.

Coding: binary.

2) Elementary Files "LSA Descriptor File" (3GPP TS 11.11, subclause 10.4.1.3)

The information regarding the LSA identification is contained on the SIM card in the LSA descriptor files, more precisely in the byte 'LSA descriptor type and number' (see table below, from 3GPP TS 11.11, subclause 10.4.1.3).

Residing under DF_{SoLSA}, there may be several LSA Descriptor files. These EFs contains one or more records again containing LSA Descriptors forming the LSAs. LSAs can be described in four different ways. As a list of LSA IDs, as a list of LAC + CIs, as a list of CIs or as a list of LACs. As the basic elements (LSA ID, LAC + CI, CI and LAC) of the four types of lists are of different length, they can not be mixed within one record.

Different records may contain different kinds of lists within the EFs.

Identifier: '4FXX'		Structure: linear fixed		Optional
Record length: n*X+2 bytes		Update activity: low		
Access Conditions:				
READ		CHV1		
UPDATE		ADM		
INVALIDATE		ADM		
REHABILITATE		ADM		
Bytes	Description	M/O	Length	
1	LSA descriptor type and number	M	1 byte	
2 to X+1	1 st LSA Descriptor	M	X bytes	
X+2 to 2X+1	2 nd LSA Descriptor	M	X bytes	
(n-1)*X+2 to n*X+1	n th LSA Descriptor	M	X bytes	
n*X+2	Record Identifier	M	1 byte	

- LSA descriptor type and number:

Contents: The LSA descriptor type gives the format of the LSA descriptor and the number of valid LSA Descriptors within the record.

Coding:

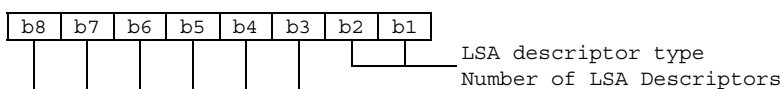

The bit 1 and bit 2 of the first byte of the LSA descriptor file identify the LSA descriptor type.

- LSA descriptor type:

Contents: Gives the format of the LSA Descriptors.

- b2, b1: 00: LSA ID. identification of the LSA is done by means of the LSA ID
- 01: LAC + CI identification of the LSA is done by means of the LAC + CI
- 10: CI identification of the LSA is done by means of the CI
- 11: LAC identification of the LSA is done by means of the LAC

3) Elementary File EF_{SAI} (3GPP TS 11.11, subclause 10.4.1.1)

This EF contains the 'LSA only access indicator'. This EF shall always be allocated if DF_{SoLSA} is present.

If the indicator is set, the network will prevent terminated and/or originated calls when the MS is camped in cells that are not included in the list of allowed LSAs in EF_{SLL}. Emergency calls are, however, always allowed.

The EF also contains a text string which may be displayed when the MS is out of the served area(s).

Identifier: '4F30'		Structure: transparent		Optional
File size: X + 1 bytes		Update activity: low		
Access Conditions:				
READ		CHV1		
UPDATE		ADM		
INVALIDATE		ADM		
REHABILITATE		ADM		
Bytes	Description	M/O	Length	
1	LSA only access indicator	M	1 byte	
2 to X+1	LSA only access indication text	M	X bytes	

- LSA only access indicator

Contents: indicates whether the MS is restricted to use LSA cells only or not.

Coding:

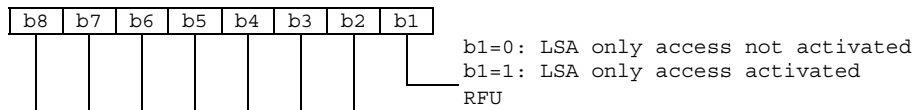

- LSA only access indication text

Contents: text to be displayed by the ME when it's out of LSA area.

20.24.1 SoLSA Cell Selection suitable cell

20.24.1.1 Definition

SoLSA Cell selection is a process in which a SoLSA MS, whenever a new PLMN is selected, attempts to find a "suitable cell" of that PLMN to camp on. Two methods of searching for a "suitable cell" are possible, normal cell selection and stored list cell selection. The process ensures that the SoLSA MS is camped on a cell from which it can reliably decode downlink data and with which it has a high probability of communications on the uplink. Once the SoLSA MS is camped on a cell, access to the network is allowed.

20.24.1.2 Conformance requirement

1. The SoLSA MS shall be able to select the strongest "suitable cell" and be able to respond to paging on that cell within 30 s of switch on. This requires a valid normal LSA SIM with PIN disabled and ideal radio conditions; 3GPP TS 05.08, subclause 6.1. And it requires a list of LSAs for the subscriber stored on the SIM; 3GPP TS 11.11, subclause 10.4.1.2.

NOTE 1: For camping on an LSA cell the LSA subscription is not necessary except for camping on an LSA exclusive access cell; 3GPP TS 03.73, subclause 11.4.2.

NOTE 2: There should be no extra delay in cell selection procedure; 3GPP TS 02.43, subclause 4.2.2.

2. There are various requirements that a cell must satisfy before a SoLSA MS can perform normal camping on it:

2.1 (i) It should be a cell of the selected PLMN.

2.2 (ii) It should not be "barred".

2.3 (iv) The radio path loss between SoLSA MS and BTS must be below a threshold set by the PLMN operator.

2.4 (v) It should not be an LSA exclusive access cell to which the SoLSA MS does not subscribe.

3GPP TS 03.22, subclause 3.2.1.

NOTE 3: Criteria (iii) is not applicable for Cell Selection.

3. Initially the SoLSA MS looks for a cell which satisfies these 5 constraints ("suitable cell") by checking cells in descending order of received signal strength. If a "suitable cell" is found, the SoLSA MS camps on it; 3GPP TS 03.22, subclause 3.2.1.

4. The SoLSA MS shall be able to calculate correctly the path loss criterion parameter C1, used for cell selection and reselection; 3GPP TS 05.08, subclause 6.4.

5. The LSA identification shall be stored on the SIM card in the LSA descriptor files. LSAs can be described in four different ways; 3GPP TS 11.11, subclause 10.4.1.3:

- as a list of LSA IDs (3 bytes);
- as a list of LAC + CIs (4 bytes);
- as a list of CIs (2 bytes);
- as a list of LACs (2 bytes); or
- as a combination of the lists above.

20.24.1.3 Test purpose

The SoLSA MS shall be able to select a "suitable cell" according to the normal cell selection criteria. The identification of the LSA is done by using the LSA ID, the CI, the LAC or the LAC + CI.

20.24.1.4 Method of tests

20.24.1.4.1 SoLSA Cell Selection suitable cell / LSA identified by LSA ID

20.24.1.4.1.1 Initial conditions

- a) Identification of the LSA by means of LSA ID (see subclause 20.24).
- b) Parameters changed from the default values in table 20.24.1; further initial conditions.

Parameter/condition	Carrier 1	Carrier 2	Carrier 3	Carrier 4
RF Signal Level (dB μ V emf() / dBm)	43/-70	13/-100	53/-60	63/-50
CBA	0	0	1	0
RXLEV_ACCESS_MIN (dBm)	-90	-90	-90	-90
MNC				1
MCC				002
C1	20	-10	30	40
LSA ID	66.001	66.001	66.001	66.001
LAC	5	5	5	5
CI	5.000	5.001	5.002	5.003
Matching LSA on SIM	LSA1	LSA1	LSA1	-
Escape PLMN	No	No	No	No

- c) Parameters changed from the default values in table 20.24.1; further initial conditions (for test procedure step g)

Parameter/condition	Carrier 1	Carrier 2	Carrier 3	Carrier 4
RF Signal Level (dB μ V emf() / dBm)	43/-70	13/-100	53/-60	OFF
CBA	0	0	1	
RXLEV_ACCESS_MIN (dBm)	-90	-90	-90	
C1	20	-10	30	
LSA ID	250	66.001	250	
LAC	5	5	5	
CI	5.000	5.001	5.002	
Matching LSA on SIM	-	LSA1	-	
Escape PLMN	Yes	Yes	No	

20.24.1.4.1.2 Test Procedure

- a) The SS activates all carriers according to table b) and monitors carriers 1, 2 and 4 for RA requests from the SoLSA MS.
- b) The SoLSA MS is switched on.
- c) The SoLSA MS is switched off.
- d) The SS monitors carrier 3 for RA requests from the SoLSA MS.
- e) The SoLSA MS is switched on.
- f) The SoLSA MS is switched off.
- g) The SS is reconfigured according to table c). The SS monitors carriers 1, 2 and 3 for RA requests from the SoLSA MS.
- h) The SoLSA MS is switched on.
- i) The SoLSA MS is switched off.

- j) The SS is reconfigured and the level of carrier 2 increases to 33 dB μ V / - 80 dBm (C1 increases to 10 dBm). The SS monitors carriers 1, 2 and 3 for RA requests from the SoLSA MS.
- k) The SoLSA MS is switched on.

20.24.1.4.1.3 void

20.24.1.4.1.4 Test Requirements

- 1) After step b), the first response from the SoLSA MS shall be received on carrier 1 within 50 s. There shall be no response from the SoLSA MS on the other monitored carriers.

NOTE 1: 33 s for cell selection, 10 s for communicating the data between SIM and ME, 5 s for search of a matching LSA on SIM: allow 50 s.

- 2) There shall be no response from the SoLSA MS on the monitored carrier after step e) within 60 s.

NOTE 2: Any potential access is likely to occur within 50 s.

- 3) After step h), there shall be no response from the SoLSA MS on the monitored carriers within 60 s (carrier 1 is not fulfilling conformance requirement 2.4).

- 4) After step k), the first response from the SoLSA MS shall be received on carrier 2 within 50 s. There shall be no response from the SoLSA MS on the other monitored carriers.

20.24.1.4.2 SoLSA Cell Selection suitable cell / LSA identified by LAC + CI

20.24.1.4.2.1 Initial conditions

- a) Identification of the LSA by means of LAC + CI (see subclause 20.24. General remark 2).
- b) Parameters changed from the default values in table 20.24.1; further initial conditions.

Parameter/condition	Carrier 1	Carrier 2	Carrier 3	Carrier 4
RF Signal Level (dB μ V emf() / dBm)	43/-70	13/-100	53/-60	63/-50
CBA	0	0	1	0
RXLEV_ACCESS_MIN (dBm)	-90	-90	-90	-90
MNC				1
MCC				002
C1	20	-10	30	40
LSA ID	250	250	250	250
LAC	2	2	2	2
CI	250	251	252	253
Matching LSA on SIM	LSA3	LSA3	LSA3	-
Escape PLMN	No	No	No	No

- c) Parameters changed from the default values in table 20.24.1; further initial conditions (for test procedure step g).

Parameter/condition	Carrier 1	Carrier 2	Carrier 3	Carrier 4
RF Signal Level (dB μ V emf() / dBm)	43/-70	13/-100	53/-60	OFF
CBA	0	0	1	
RXLEV_ACCESS_MIN (dBm)	-90	-90	-90	
C1	20	-10	30	
LSA ID	250	250	250	
LAC	2	2	5	
CI	5000	250	251	
Matching LSA on SIM	-	LSA3	-	
Escape PLMN	Yes	Yes	No	

20.24.1.4.2.2 Test Procedure

- a) The SS activates all carriers according to table b) and monitors carriers 1, 2 and 4 for RA requests from the SoLSA MS.

- b) The SoLSA MS is switched on.
- c) The SoLSA MS is switched off.
- d) The SS monitors carrier 3 for RA requests from the SoLSA MS.
- e) The SoLSA MS is switched on.
- f) The SoLSA MS is switched off.
- g) The SS is reconfigured according to table c). The SS monitors carriers 1, 2 and 3 for RA requests from the SoLSA MS.
- h) The SoLSA MS is switched on.
- i) The SoLSA MS is switched off.
- j) The SS is reconfigured and the level of carrier 2 increases to 33 dB μ V / - 80 dBm (C1 increases to 10 dBm). The SS monitors carriers 1, 2 and 3 for RA requests from the SoLSA MS.
- k) The SoLSA MS is switched on.

20.24.1.4.2.3 void

20.24.1.4.2.4 Test Requirements

- 1) After step b), the first response from the SoLSA MS shall be received on carrier 1 within 50 s. There shall be no response from the SoLSA MS on the other monitored carriers.
- 2) There shall be no response from the SoLSA MS on the monitored carrier after step e) within 60 s.

NOTE: Any potential access is likely to occur within 50 s.

- 3) After step h), there shall be no response from the SoLSA MS on the monitored carriers within 60 s.
- 4) After step k), the first response from the SoLSA MS shall be received on carrier 2 within 50 s. There shall be no response from the SoLSA MS on the other monitored carriers.

20.24.1.4.3 SoLSA Cell Selection suitable cell / LSA identified by CI

20.24.1.4.3.1 Initial conditions

- a) Identification of the LSA by means of CI (see subclause 20.24. General remark 2).
- b) Parameters changed from the default values in table 20.24.1; further initial conditions.

Parameter/condition	Carrier 1	Carrier 2	Carrier 3	Carrier 4
RF Signal Level (dB μ V emf() / dBm)	43/-70	13/-100	53/-60	63/-50
CBA	0	0	1	0
RXLEV_ACCESS_MIN (dBm)	-90	-90	-90	-90
MNC				1
MCC				002
C1	20	-10	30	40
LSA ID	250	250	250	250
LAC	5	5	5	5
CI	257	258	259	260
Matching LSA on SIM	LSA5	LSA5	LSA5	-
Escape PLMN	No	No	No	No

- c) Parameters changed from the default values in table 20.24.1; further initial conditions (for test procedure step g).

Parameter/condition	Carrier 1	Carrier 2	Carrier 3	Carrier 4
RF Signal Level (dB μ V emf() / dBm)	43/-70	13/-100	53/-60	OFF
CBA	0	0	1	
RXLEV_ACCESS_MIN (dBm)	-90	-90	-90	
C1	20	-10	30	
LSA ID	250	250	250	
LAC	5	5	5	
CI	5.000	258	5.001	
Matching LSA on SIM	-	LSA5	-	
Escape PLMN	Yes	Yes	No	

20.24.1.4.3.2 Test Procedure

- a) The SS activates all carriers according to table b) and monitors carriers 1, 2 and 4 for RA requests from the SoLSA MS.
- b) The SoLSA MS is switched on.
- c) The SoLSA MS is switched off.
- d) The SS monitors carrier 3 for RA requests from the SoLSA MS.
- e) The SoLSA MS is switched on.
- f) The SoLSA MS is switched off.
- g) The SS is reconfigured according to table c). The SS monitors carriers 1, 2 and 3 for RA requests from the SoLSA MS.
- h) The SoLSA MS is switched on.
- i) The SoLSA MS is switched off.
- j) The SS is reconfigured and the level of carrier 2 increases to 33 dB μ V / -80 dBm (C1 increases to 10 dBm). The SS monitors carriers 1, 2 and 3 for RA requests from the SoLSA MS.
- k) The SoLSA MS is switched on.

20.24.1.4.3.3 void

20.24.1.4.3.4 Test Requirements

- 1) After step b), the first response from the SoLSA MS shall be received on carrier 1 within 50 s. There shall be no response from the SoLSA MS on the other monitored carriers.
- 2) There shall be no response from the SoLSA MS on the monitored carrier after step e) within 60 s.

NOTE: Any potential access is likely to occur within 50 s.

- 3) After step h), there shall be no response from the SoLSA MS on the monitored carriers within 60 s.
- 4) After step k), the first response from the SoLSA MS shall be received on carrier 2 within 50 s. There shall be no response from the SoLSA MS on the other monitored carriers.

20.24.1.4.4 SoLSA Cell Selection suitable cell / LSA identified by LAC

20.24.1.4.4.1 Initial conditions

- a) Identification of the LSA by means of LAC (see subclause 20.24. General remark 2).
- b) Parameters changed from the default values in table 20.24.1; further initial conditions.

Parameter/condition	Carrier 1	Carrier 2	Carrier 3	Carrier 4
RF Signal Level (dB μ V emf() / dBm)	43/-70	13/-100	53/-60	63/-50
CBA	0	0	1	0
RXLEV_ACCESS_MIN (dBm)	-90	-90	-90	-90
MNC				1
MCC				002
C1	20	-10	30	40
LSA ID	250	250	250	250
LAC	1	1	1	1
CI	5.000	5.001	5.002	5.003
Matching LSA on SIM	LSA6	LSA6	LSA6	-
Escape PLMN	No	No	No	No

c) Parameters changed from the default values in table 20.24.1; further initial conditions (for test procedure step g).

Parameter/condition	Carrier 1	Carrier 2	Carrier 3	Carrier 4
RF Signal Level (dB μ V emf() / dBm)	43/-70	13/-100	53/-60	OFF
CBA	0	0	1	
RXLEV_ACCESS_MIN (dBm)	-90	-90	-90	
C1	20	-10	30	
LSA ID	250	250	250	
LAC	5	1	5	
CI	5.000	5.001	5.002	
Matching LSA on SIM	-	LSA6	-	
Escape PLMN	Yes	Yes	No	

20.24.1.4.4.2 Test Procedure

- a) The SS activates all carriers according to table b) and monitors carriers 1, 2 and 4 for RA requests from the SoLSA MS.
- b) The SoLSA MS is switched on.
- c) The SoLSA MS is switched off.
- d) The SS monitors carrier 3 for RA requests from the SoLSA MS.
- e) The SoLSA MS is switched on.
- f) The SoLSA MS is switched off.
- g) The SS is reconfigured according to table c). The SS monitors carriers 1, 2 and 3 for RA requests from the SoLSA MS.
- h) The SoLSA MS is switched on.
- i) The SoLSA MS is switched off.
- j) The SS is reconfigured and the level of carrier 2 increases to 33 dB μ V / -80 dBm (C1 increases to 10 dBm). The SS monitors carriers 1, 2 and 3 for RA requests from the SoLSA MS.
- k) The SoLSA MS is switched on.

20.24.1.4.4.3 void

20.24.1.4.4.4 Test Requirements

- 1) After step b), the first response from the SoLSA MS shall be received on carrier 1 within 50 s. There shall be no response from the SoLSA MS on the other monitored carriers.
- 2) There shall be no response from the SoLSA MS on the monitored carrier after step e) within 60 s.

NOTE: Any potential access is likely to occur within 50 s.

- 3) After step h), there shall be no response from the SoLSA MS on the monitored carriers within 60 s.
- 4) After step k), the first response from the SoLSA MS shall be received on carrier 2 within 50 s. There shall be no response from the SoLSA MS on the other monitored carriers.

20.24.2 SoLSA Cell (Re)Selection Emergency Call

20.24.2.1 Definition

-

20.24.2.2 Conformance requirement

1. The SoLSA MS shall be able to initiate emergency calls when no "suitable cells" of the selected PLMN are available, but at least one acceptable cell is available. The SoLSA MS is in limited service state. An LSA exclusive access cell is "suitable" only if the LSA of the cell is one of the allowed LSA according to the SIM. Emergency calls are always allowed if no cells are found suitable; 3GPP TS 03.73, subclause 11.4.2.
2. When in a limited service state and if not camped on a cell, the MS shall monitor the received signal level of all RF channels within its band of operation, and search for a BCCH carrier which has $C1 > 0$ and which is not barred. When such a carrier is found, the MS shall camp on that cell, irrespective of the PLMN identity; 3GPP TS 05.08, subclause 6.8.
3. The MS shall perform cell reselection at least among the cells of the PLMN of the cell on which the MS has camped, according to the algorithm of 3GPP TS 03.22, except that a zero value of CELL_RESELECT_HYSTERESIS shall be used.

20.24.2.3 Test purpose

1. To verify that the SoLSA MS shall be able to initiate emergency calls when no "suitable cells" of selected PLMN are available, but at least one acceptable cell is available. The available cells are:
 - a) LSA exclusive access cells of the selected PLMN with no LSA subscription.
 - b) Normal LSA cell of forbidden PLMN.
2. To verify that the MS selects a cell with $C1 > 0$ and $CBA = 0$ when no suitable cells of the selected PLMN are available.
3. To verify that the MS, when performing cell reselection in the limited service state, uses $CELL_RESELECT_HYSTERESIS = 0$, 3GPP TS 05.08, subclause 6.8.

20.24.2.4 Method of test

20.24.2.4.1 Initial conditions

- a) Parameters changed from the default values in table 20.24.1; further initial conditions for LSA exclusive access cell.

Parameter/condition	Carrier 1	Carrier 2	Carrier 3	Carrier 4
RF Signal Level (db μ V emf) / dBm)	38 / -75	23 / -90	33 / -80	OFF
RXLEV_ACCESS_MIN (dBm)	-90	-80	-90	
CBA	1 (barred)	0	0	
MCC, MNC	Home PLMN	Home PLMN	Home PLMN	
CRH (dB)	0	0	14	
C1	15	-10	10	
LSA_ID	250	251	252	
LAC	5	5	5	
CI	5000	5001	5002	
Matching LSA on SIM	-	-	-	
Escape PLMN	Yes	Yes	Yes	

- b) Parameters changed from the default values in table 20.24.1; further initial conditions for normal LSA cell.

Parameter/condition	Carrier 1	Carrier 2	Carrier 3	Carrier 4
RF Signal Level (dBµV emf() / dBm)	38/ -75	23 / -90	33 / -80	OFF
RXLEV_ACCESS_MIN (dBm)	-90	-80	-90	
CBA	1 (barred)	0	0	
MCC, MNC	forbidden	forbidden	forbidden	
CRH (dB)	0	0	14	
C1	15	-10	10	
LSA_ID	250	251	252	
LAC	5	5	5	
CI	5000	5001	5002	
Matching LSA on SIM	-	-	-	
Escape PLMN	No	No	No	

NOTE: All the BCCH carriers belong to the same PLMN, which is not the MS's home PLMN and which is in the SIM's forbidden PLMN list.

Run the following test procedure twice by using two different sets of initial conditions:

- using initial conditions a);
- using initial conditions b).

20.24.2.4.2 Test Procedure

- a) The SS activates the carriers. The SS monitors carriers 1, 2 and 3 for RA requests for the duration of the test.
- b) The SoLSA MS is switched on.
- c) 60 s after switch on, an emergency call is initiated on the SoLSA MS.
- d) The SS changes the CBA of carrier 1 to 0.

NOTE 1: The MS should reselect carrier 1 because it should not take into account the CRH value of 14 but use 0 instead.

- e) After 350 s an emergency call is initiated on the SoLSA MS.

NOTE 2: 330 s to detect change of BCCH data on neighbour cell, 15 s to perform reselection of carrier 1 since the SoLSA MS already has a running average on carrier 1, 5 s for search of a matching LSA on SIM.

20.24.2.4.3 void

20.24.2.4.4 Test requirements

- 1) In step c), the first access of the SoLSA MS shall be on carrier 3.
- 2) In step e), the first access of the SoLSA MS shall be on carrier 1.

20.24.3 SoLSA Cell Reselection / idle mode support enabled

General Remark

The identification of the LSA is done by means of the LSA ID, see General Remark 2) in subclause 20.24.

20.24.3.1 General conformance requirement

1. There are various requirements that a cell must satisfy before a SoLSA MS can perform normal camping on it:
 - i) It should be a cell of the selected PLMN.
 - ii) It should not be "barred".
 - iii) It should not be in an LA which is in the list of "forbidden LA for roaming".
 - iv) The radio path loss between SoLSA MS and BTS must be below a threshold set by the PLMN operator.

v) It should not be an LSA exclusive access cell to which the SoLSA MS does not subscribe.

3GPP TS 03.22, subclause 3.2.1.

2. While camped on a cell of the selected PLMN ("camped normally"), the SoLSA MS may need to select a different cell ("normal cell reselection" state). The following events trigger a cell reselection:

- The cell camped on (current serving cell) has become barred.
- There is a better cell (in terms of the path loss criterion C2) in the same LA, or a much better cell in another LA of the selected PLMN (using the CRH parameter).
- The SoLSA MS will then reselect a new cell in order to fulfil the process goal.

3GPP TS 03.22, subclause 4.5.

3. At least for every new sample or every second, whichever is the greatest, the SoLSA MS calculates the value of C1, C2 and C4 for the serving cell and the non-serving cells. The SoLSA MS shall make a cell reselection if:

- i) The path loss criterion parameter (C1) for the serving cell falls below zero for a period of 5 s.
- ii) A non-serving suitable cell (see 3GPP TS 03.22) is evaluated to be better than the serving cell for a period of 5 s. The best cell is:
 - the cell with the highest value of $C2 + LSA_OFFSET$ among those cells that have highest LSA priority among those that fulfil the criteria $C4 \geq 0$; or
 - the cell with the highest value of C2 among all cells, if no cell fulfil the criterion $C4 \geq 0$.

LSA_OFFSET and LSA ID(s) are broadcast on BCCH. LSA priority is defined by the list of LSAs for the subscriber stored on the SIM. Cells with no LSA priority, e.g. non-LSA cells, are given LSA priority lower than 0. If no LSA_OFFSET parameter is broadcast, LSA_OFFSET shall be set to 0.

When evaluating the best cell, the following hysteresis values shall be subtracted from the C2 value for the neighbour cells:

- if the new cell is in the same location area: 0.
- if the new cell is in a different location area:
 - CELL_RESELECT_HYSTERESIS, which is broadcast on BCCH of the serving cell.
- in case of a cell reselection occurred within the previous 15 s: 5 dB.

3GPP TS 05.08, subclause 6.6.3.

4. Cell reselection for any other reason shall take place immediately, but the cell that the SoLSA MS was camped on shall not be returned to within 5 s if another suitable cell can be found. If valid receive level averages are not available, the SoLSA MS shall wait until these values are available and then perform the cell reselection if it is still required. The SoLSA MS may accelerate the measurement procedure within the requirements in 3GPP TS 05.08, subclause 6.6.1 to minimise the cell reselection delay. 3GPP TS 05.08, subclause 6.6.3.

5. If no suitable cell is found within 10 s, the cell selection algorithm of 3GPP TS 03.22 shall be performed. Since information concerning a number of channels is already known to the SoLSA MS, it may assign high priority to measurements on the strongest carriers from which it has not previously made attempts to obtain BCCH information, and omit repeated measurements on the known ones. 3GPP TS 05.08, subclause 6.6.3.

6. At least every 5 s the MS shall calculate the value of C1 and C2 for the serving cell and re-calculate C1 and C2 values for non serving cells (if necessary). The MS shall then check whether:

- i) The path loss criterion (C1) for current serving cell falls below zero for a period of 5 s. This indicates that the path loss to the cell has become too high.
- ii) The calculated value of C2 for a non-serving suitable cell exceeds the value of C2 for the serving cell for a period of 5 s, except;

- a) in the case of the new cell being in a different location area or, for a GPRS MS, in a different routing area or always for a GPRS MS in ready state in which case the C2 value for the new cell shall exceed the C2 value of the serving cell by at least CELL_RESELECT_HYSTERESIS dB as defined by the BCCH data from the current serving cell, for a period of 5 s; or
- b) in case of a cell reselection occurring within the previous 15 s in which case the C2 value for the new cell shall exceed the C2 value of the serving cell by at least 5 dB for a period of 5 s.

This indicates that it is a better cell.

3GPP TS 05.08, subclause 6.6.2.

7. The SoLSA MS shall attempt to decode the full BCCH data of the serving cell at least every 30 s; 3GPP TS 05.08, subclause 6.6.1.
8. The signal strength threshold criterion parameter C4 is used to determine whether prioritised LSA cell reselection shall apply and is defined by:

$$C4 = A - \text{PRIO_THR}$$

where

$$A = \text{RLA_C} - \text{RXLEV_ACCESS_MIN}$$

and PRIO_THR is the signal threshold for applying LSA reselection. PRIO_THR is broadcast on the BCCH. If the idle mode support is disabled for the LSA (3GPP TS 11.11, subclause 10.4.1.2) or if the cell does not belong to any LSA to which the MS is subscribed or if no PRIO_THR parameter is broadcast, PRIO_THR shall be set to ∞ .

3GPP TS 05.08, subclause 6.4.

9. The LSA identification is stored on the SIM card within the descriptor file for the LSA. 3GPP TS 11.11, subclause 10.4.1.3.

20.24.3.2 SoLSA Cell Reselection / idle mode support enabled / LSA Priority

20.24.3.2.1 Definition

While camped on a cell of the selected PLMN the SoLSA MS may need to select a different cell in order to fulfil the normal service state. This ensures that the SoLSA MS is camped on a cell from which it can reliably decode downlink data and with which it has a high probability of communications on the uplink.

Idle mode support for SoLSA on the SIM card is enabled (see General Remark 1. in subclause 20.24).

20.24.3.2.2 Conformance requirement

1. While camped on a cell of the selected PLMN ("camped normally"), the SoLSA MS may need to select a different cell ("normal cell reselection" state). The following events trigger a cell reselection:
 - The cell camped on (current serving cell) has become barred.
 - There is a better cell (in terms of the path loss criterion C2) in the same LA.
 - The SoLSA MS will then reselect a new cell in order to fulfil the process goal.

3GPP TS 03.22, subclause 4.5.

2. A SoLSA MS with SIM indicating LSA subscription shall always try to reselect the cell with highest LSA priority according to the information stored on the SIM. 3GPP TS 03.73, subclause 11.4.2.

20.24.3.2.3 Test purpose

To verify that the SoLSA MS when idle mode support for SoLSA on the SIM card is enabled shall favour camping on those LSA cells with the highest LSA priority the SoLSA MS is subscribed to.

20.24.3.2.4 Method of test

20.24.3.2.4.1 Initial conditions

- a) Identification of the LSA by means of LSA ID (see subclause 20.24. General remark 2).
- b) Parameters changed from the default values in table 20.24.1.

Parameter	Carrier 1	Carrier 2	Carrier 3	Carrier 4
RF Signal Level (dB μ V emf() / dBm)	63/ -50	53/ -60	33 / -80	OFF
CBA	0	0	0	
RXLEV_ACCESS_MIN (dBm)	-90	-90	-90	
LAC				
C1	40	30	10	
C2	40	30	10	
C4	40	30	10	
LSA IDs	66.001	9.000.000	30.000	
	250	66.001	66.001	
	251	250	9.000.000	
	252	251	250	
LAC	5	5	5	
CI	5000	5001	5002	

- c) Further initial conditions (Carrier 1-3 are normal LSA cells).

Parameter	Carrier 1	Carrier 2	Carrier 3	Carrier 4
Matching LSA on SIM	LSA1	LSA1, LSA3	LSA1, LSA3, LSA5	
Escape PLMN	No	No	No	

- d) Further initial conditions (Carrier 1-3 are LSA exclusive access cells).

Parameter	Carrier 1	Carrier 2	Carrier 3	Carrier 4
Matching LSA on SIM	LSA1	LSA1, LSA3	LSA1, LSA3, LSA5	
Escape PLMN	Yes	Yes	Yes	

Run the following test procedure twice by using two different sets of initial conditions:

- using initial conditions a), b) and c);
- using initial conditions a), b) and d).

20.24.3.2.4.2 Test Procedure

- a) The SS activates carriers 1, 2 and 3 and monitors these carriers for RA requests from the SoLSA MS.
- b) The SoLSA MS is switched on.
- c) After approx. 60 s the SS is reconfigured and carrier 3 becomes barred (CBA = 1) in order to give the MS the time to perform cell reselection on carrier 3.
- d) The SS is reconfigured and the level of carrier 2 is decreased to 13 dB μ Vemf() / -100 dBm. (C2 decreases to -10 dB).

20.24.3.2.4.3 void

20.24.3.2.4.4 Test Requirements

- 1) After step b), the first response from the SoLSA MS shall be received on carrier 1 (highest C1) within 50 s (Cell Selection).

NOTE 1: 33 s for the MS to read the BCCH of carrier 3 (30 s + 10 %), 10 s for communicating the data between SIM and ME, 5 s for search of a matching LSA on SIM. Total 48 s, allow 50 s.

- 2) The following response from the SoLSA MS shall be received on carrier 3 within 25 s after the first response on carrier 1 (Reselection, highest LSA Priority (15)).

NOTE 2: 5 s for the running average, 10 s to detect C2 differences, 2,4 s to read BCCH of carrier 1, 1 s to perform RA, 5 s for search of a matching LSA on SIM. Total 23,4 s, allow 25 s.

- 3) After step c), there shall be response from the SoLSA MS on carrier 2 within 55 s after carrier 3 has been barred (Highest LSA Priority on the SIM (8)).

NOTE 3: 30 s for the MS to read the BCCH of carrier 3, 20 s to reselect carrier 2, 5 s for search of a matching LSA on SIM: total 55 s.

- 4) After step d), there shall be response from the SoLSA MS on carrier 1 within 25 s after carrier 2 has been reconfigured.

NOTE 4: 5 s for the running average, 10 s to detect C2 differences, 2,4 s to read BCCH of carrier 1, 1 s to perform RA, 5 s for search of a matching LSA on SIM. Total 23,4 s, allow 25 s.

20.24.3.3 SoLSA Cell Reselection / idle mode support enabled / LSA Priority / different location area

20.23.3.3.1 Definition

While camped on a cell of the selected PLMN the SoLSA MS may need to select a different cell in order to fulfil the normal service state. This ensures that the SoLSA MS is camped on a cell from which it can reliably decode downlink data and with which it has a high probability of communications on the uplink.

Idle mode support for SoLSA on the SIM card is enabled (See General Remark 1. of subclause 20.24).

20.24.3.3.2 Conformance requirement

1. While camped on a cell of the selected PLMN ("camped normally"), the SoLSA MS may need to select a different cell ("normal cell reselection" state). The following events trigger a cell reselection:
 - The cell camped on (current serving cell) has become barred.
 - There is a better cell (in terms of the path loss criterion C2) in the same LA, or a much better cell in another LA of the selected PLMN (using the CRH parameter).
 - The SoLSA MS will then reselect a new cell in order to fulfil the process goal.

3GPP TS 03.22, subclause 4.5.
2. A SoLSA MS with SIM indicating LSA subscription shall always try to reselect the cell with highest LSA priority according to the information stored on the SIM. 3GPP TS 03.73, subclause 11.4.2.
3. The LSA identification shall be stored on the SIM card in the LSA descriptor files (EF). LSAs can be described in four different ways (see 3GPP TS 11.11, subclause 10.4.1.3):
 - as a list of LSA IDs (3 bytes);
 - as a list of LAC + CIs (4 bytes);
 - as a list of CIs (2 bytes);
 - as a list of LACs (2 bytes); or
 - as a combination of the lists above.

20.24.3.3.3 Test purpose

To verify that the SoLSA MS when idle mode support for SoLSA on the SIM card is enabled shall favour camping on those LSA cells with the highest C2 among those cells with the highest LSA priority the SoLSA MS is subscribed to even if the cell belongs to a different location area.

20.24.3.3.4 Method of test

20.24.3.3.4.1 Initial conditions

- a) Identification of the LSA by means of LSA ID (see subclause 20.24. General remark 2).
- b) Parameters changed from the default values in table 20.24.1.

Parameter	Carrier 1	Carrier 2	Carrier 3	Carrier 4
RF Signal Level (dB μ V emf() / dBm)	43/ -70	33/ -80	33 / -80	13 / -100
CBA	0	0	0	0
RXLEV_ACCESS_MIN (dBm)	-90	-90	-90	-90
CRH (dB)	10	10	10	10
C1	20	10	10	-10
C2	20	10	10	-10
C4	20	10	10	-10
LSA ID	54	54	54	30.000
LAC	5	5	3	3
CI	5000	5001	5002	5003

- c) Further initial conditions (Carrier 1-3 are normal LSA cells).

Parameter	Carrier 1	Carrier 2	Carrier 3	Carrier 4
Matching LSA on SIM	LSA1	LSA1	LSA1	LSA5
Escape PLMN	No	No	No	No

- d) Further initial conditions (Carrier 1-3 are LSA exclusive access cells).

Parameter	Carrier 1	Carrier 2	Carrier 3	Carrier 4
Matching LSA on SIM	LSA1	LSA1	LSA1	LSA5
Escape PLMN	Yes	Yes	Yes	Yes

- e) Identification of the LSA by means of:

- LSA ID on Carrier 1;
- LAC + CI on Carrier 2;
- LAC on Carrier 3;
- CI on carrier 4.

(see subclause 20.24. General remark 2.)

- f) Parameters changed from the default values in table 20.24.1.

Parameter	Carrier 1	Carrier 2	Carrier 3	Carrier 4
RF Signal Level (dB μ V emf() / dBm)	43/ -70	33/ -80	33 / -80	13 / -100
CBA	0	0	0	0
RXLEV_ACCESS_MIN (dBm)	-90	-90	-90	-90
CRH (dB)	10	10	10	10
C1	20	10	10	-10
C2	20	10	10	-10
C4	20	10	10	-10
LSA ID	100	250	250	250
LAC	3	3	10	5
CI	5000	500	5002	256

- g) Further initial conditions (Carrier 1-4 are normal LSA cells).

Parameter	Carrier 1	Carrier 2	Carrier 3	Carrier 4
Matching LSA on SIM	LSA7	LSA7	LSA7	LSA5
Escape PLMN	No	No	No	No

h) Further initial conditions (Carrier 1-4 are LSA exclusive access cells).

Parameter	Carrier 1	Carrier 2	Carrier 3	Carrier 4
Matching LSA on SIM	LSA7	LSA7	LSA7	LSA5
Escape PLMN	Yes	Yes	Yes	Yes

Run the following test procedure twice by using four different sets of initial conditions:

- using initial conditions a), b) and c);
- using initial conditions a), b) and d);
- using initial conditions e), f) and g);
- using initial conditions e), f) and h).

20.24.3.3.4.2 Test Procedure

- a) The SS activates carriers 1, 2 and 3 and monitors these carriers for RA requests from the SoLSA MS. Carrier 4 is switched off.
- b) The SoLSA MS is switched on.
- c) The SS is reconfigured and the level of carrier 3 is increased to 63 dB μ V emf() / -50 dBm (C2 increases to 40 dB).
- d) The SS is reconfigured and the level of carrier 2 is increased to 63 dB μ V emf() / -50 dBm (C2 increases to 40 dB).
- e) The SS is reconfigured and carrier 3 becomes barred (CBA = 1).
- f) The SS activates carrier 4 and monitors carriers 1, 2 and 4. Carrier 3 is switched off.
- g) The SS is reconfigured and the level of carrier 4 is increased to 33 dB μ V emf () / -80 dBm (C2 increases to 10 dB).

20.24.3.3.4.3 void

20.24.3.3.4.4 Test Requirements

- 1) After step b), the first response from the SoLSA MS shall be received on carrier 1 within 50 s. (Cell Selection, highest C1). There shall be no response from the SoLSA MS on any other carrier within 35 s after first response on carrier 1.

NOTE 1: Any potential access is likely to occur within 25 s.

- 2) After step c), there shall be response from the SoLSA MS on carrier 3 within 25 s after increasing the level of carrier 3 (now highest C2 (C2-CRH), for cells with C4 > 0).
- 3) After step d), there shall be no response from the SoLSA MS on carrier 2 within 35 s after increasing the level of carrier 2 (still highest C2/C2-CRH for carrier 3).

NOTE 2: Any potential access is likely to occur within 25 s.

- 4) After step e), there shall be response from the SoLSA MS on carrier 2 within 55 s after carrier 3 becomes barred.
- 5) After step f), there shall be no response from the SoLSA MS on carrier 4 within 60 s after carrier 4 is switched on (Highest LSA Priority (15), but C2 < 0).
- 6) After step g), there shall be response from the SoLSA MS on carrier 4 within 25 s after increasing level of carrier 4 (not highest C2, but C4 > 0 and highest LSA Priority (15) on the SIM).

20.24.3.4 SoLSA Cell Reselection / idle mode support enabled / Priority Threshold

20.24.3.4.1 Definition

While camped on a cell of the selected PLMN the SoLSA MS may need to select a different cell in order to fulfil the normal service state. This ensures that the SoLSA MS is camped on a cell from which it can reliably decode downlink data and with which it has a high probability of communications on the uplink.

Idle mode support for SoLSA on the SIM card is enabled (see General Remark 1 in subclause 20.24).

20.24.3.4.2 Conformance requirement

The SoLSA MS shall be able to calculate correctly the signal strength threshold criterion parameter C4 which is to determine whether prioritised LSA cell reselection shall apply.

The signal strength threshold criterion parameter C4 is used to determine whether prioritised LSA cell reselection shall apply and is defined by:

$$C4 = A - \text{PRIO_THR}$$

Where:

A is defined as above and PRIO_THR is the signal threshold for applying LSA reselection. PRIO_THR is broadcast on the BCCH. If the idle mode support is disabled for the LSA (see 3GPP TS 11.11) or if the cell does not belong to any LSA to which the MS is subscribed or if no PRIO_THR parameter is broadcast, PRIO_THR shall be set to ∞ .

3GPP TS 05.08, subclause 6.4.

20.24.3.4.3 SoLSA Cell Reselection / idle mode support enabled / Priority Threshold any value

20.24.3.4.3.1 Test purpose

To verify that the SoLSA MS is able to reselect cells correctly according to parameter PRIO_THR. (parameter C4 criterion).

20.24.3.4.3.2 Method of test

20.24.3.4.3.2.1 Initial conditions

- Identification of the LSA by means of LSA ID (see subclause 20.24. General remark 2.)
- Parameters changed from the default values in table 20.24.1.

Parameter	Carrier 1	Carrier 2	Carrier 3	Carrier 4
RF Signal Level (dB μ V emf() / dBm)	47 / -66	55 / -58	63 / -50	OFF
CBA	0	0	0	
RXLEV_ACCESS_MIN (dBm)	-90	-90	-90	
C1	15	25	40	
C2	15	25	40	
PRIO_THR (level / dB)	1 / 6	6 / 36	2 / 12	
C4	9	-11	28	
LSA ID	66.001	9.000.000	30.000	
LAC	5	5	5	
CI	5000	5001	5002	

NOTE: The level of PRIO_THR is evaluated according to 3GPP TS 05.08, clause 9 and table 1.

- Further initial conditions (Carrier 1-3 are normal LSA cells).

Parameter	Carrier 1	Carrier 2	Carrier 3	Carrier 4
Matching LSA on SIM	LSA1	LSA3	LSA5	
Escape PLMN	No	No	No	

d) Further initial conditions (Carrier 1-3 are LSA exclusive access cells).

Parameter	Carrier 1	Carrier 2	Carrier 3	Carrier 4
Matching LSA on SIM	LSA1	LSA3	LSA5	
Escape PLMN	Yes	Yes	Yes	

Run the following test procedure twice by using two different sets of initial conditions:

- using initial conditions a), b) and c);
- using initial conditions a), b) and d).

20.24.3.4.3.2.2 Test Procedure

- a) The SS activates carriers 1, 2 and 3 and monitors these carriers for RA requests from the SoLSA MS.
- b) The SoLSA MS is switched on.
- c) Carrier 3 is barred (CBA = 1).
- d) The PRIO_THR value of carrier 2 is set to 0 dB (level 0).
- e) The PRIO_THR value of carrier 2 is set to 36 dB (level 6).

20.24.3.4.3.2.3 void

20.24.3.4.3.2.4 Test Requirements

- 1) After step b), the first response from the SoLSA MS shall be received on carrier 3 within 50 s after switch on.
- 2) After step c), the SoLSA MS shall respond on carrier 1 within 55 s after barring of carrier 3 (Highest Priority + C4 > 0).
- 3) After step d), the SoLSA MS shall respond on carrier 2 within 55 s after changing the PRIO_THR value of carrier 2 (C4 > 0 + Highest C2+LSA_OFFSET).
- 4) After step e), the SoLSA MS shall respond on carrier 1 within 55 s after changing the PRIO_THR value of carrier 2 (C4 > 0, Highest priority).

20.24.3.4.4 SoLSA Cell Reselection / idle mode support enabled / Priority Threshold infinite

20.24.3.4.4.1 Test purpose

To verify that the SoLSA MS is able to reselect cells correctly according to parameter C2 among those cell not fulfilling C4 ≥ 0.

20.24.3.4.4.2 Method of test

20.24.3.4.4.2.1 Initial conditions

- a) Identification of the LSA by means of LSA ID (see subclause 20.24. General remark 2).
- b) Parameters changed from the default values in table 20.24.1.

Parameter	Carrier 1	Carrier 2	Carrier 3	Carrier 4
RF Signal Level (dBμV emf() / dBm)	63 / -50	53 / -60	58 / -55	31 / -82

CBA	0	0	0	0
RXLEV_ACCESS_MIN (dBm)	-90	-90	-90	-90
CRH (dB)	10			
PRI0_THR (level / dB)	7 / 'infinite'	7 / 'infinite'	7 / 'infinite'	
C1	40	30	35	8
C2	40	30	35	8
C4	<0	<0	<0	8
LSA_OFFSET (level / dB)		5 / 32		
LSA ID	66.001	66.001	9.000.000	30.000
LAC	5	5	3	3
CI	5000	5001	5002	5003

c) Further initial conditions (Carrier 1-4 are normal LSA cells).

Parameter	Carrier 1	Carrier 2	Carrier 3	Carrier 4
Matching LSA on SIM	LSA1	LSA1	LSA3	LSA5
Escape PLMN	No	No	No	No

d) Further initial conditions (Carrier 1-4 are LSA exclusive access cells).

Parameter	Carrier 1	Carrier 2	Carrier 3	Carrier 4
Matching LSA on SIM	LSA1	LSA1	LSA3	LSA5
Escape PLMN	Yes	Yes	Yes	Yes

Run the following test procedure twice by using two different sets of initial conditions:

- using initial conditions a), b) and c);
- using initial conditions a), b) and d).

20.24.3.4.4.2.2 Test Procedure

- a) The SS activates carriers 1, 2 and 3 and monitors these carriers for RA requests from the SoLSA MS. Carrier 4 is switched off.
- b) The SoLSA MS is switched on.
- c) The SS is reconfigured and the level of carrier 1 is decreased to 33 dB μ V emf() / -80 dBm (C2 of carrier 1 becomes 10).
- d) The SS is reconfigured and the level of carrier 3 is increased to 63 dB μ V emf() / -50 dBm (C2 of carrier 3 becomes 40).
- e) Carrier 1 is switched off. Carrier 4 is switched on. The SS monitors carriers 2, 3 and 4.

20.24.3.4.4.2.3 void

20.24.3.4.4.2.4 Test Requirements

- 1) After step b), the first response from the SoLSA MS shall be received on carrier 1 within 50 s. There shall be no response from the SoLSA MS on any other carrier within 35 s after the first response on carrier 1.

NOTE 1: Any potential access is likely to occur within 25 s.

- 2) After step c), there shall be response from the SoLSA MS on carrier 2 within 25 s after carrier 1 has been reconfigured (Highest C2/C2-CRH).
- 3) After step d), there shall be response on carrier 3 within 25 s after carrier 2 has been reconfigured (Highest C2/C2-CRH).
- 4) After step e), there shall be response on carrier 4 within 60 s after the system has been reconfigured (idle mode support enabled for carrier 4).

NOTE: 5,5 s to notice new strongest carriers on top 6 (because the updating time for the 6 strongest is 5 s ($\pm 10\%$)), 33 s to read BCCH, 15 s for reselection, 5 s for search of a matching LSA on SIM. Allow 60 s.

20.24.3.5 SoLSA Cell Reselection / idle mode support enabled / LSA Priority / LSA_OFFSET

20.24.3.5.1 Definition

While camped on a cell of the selected PLMN the SoLSA MS may need to select a different cell in order to fulfil the normal service state. This ensures that the SoLSA MS is camped on a cell from which it can reliably decode downlink data and with which it has a high probability of communications on the uplink.

20.24.3.5.2 Conformance requirement

While performing cell reselection, the SoLSA MS shall be able to calculate correctly the signal strength threshold criterion parameter consisting of $C2 + LSA_OFFSET$ to determine which LSA cell shall be selected among those having the same LSA priority; 3GPP TS 05.08, subclause 6.6.3.

20.24.3.5.3 Test Purpose

To verify that the SoLSA MS shall be able to reselect the cell with the highest value of $C2 + LSA_OFFSET$ among those cells that have highest LSA priority and fulfil the criteria $C4 \geq 0$.

20.24.3.5.4 Method of test

20.24.3.5.4.1 Initial conditions

a) Identification of the LSA by means of LSA ID (see subclause 20.24. General remark 2).

b) Parameters changed from the default values in table 20.24.1.

Parameter	Carrier 1	Carrier 2	Carrier 3	Carrier 4
RF Signal Level (dB μ V emf() / dBm)	63 / -50	43 / -70	33 / -80	OFF
CBA	0	0	0	
RXLEV_ACCESS_MIN (dBm)	-90	-90	-90	
C1	40	20	10	
C2	40	20	10	
C4	40	20	10	
LSA_OFFSET (level / dB)	0 / 0	1 / 4	4 / 24	
LSA ID	30.000	66.001	66.001	
LAC	5	5	5	
CI	5000	5001	5002	

NOTE: The level of LSA_OFFSET is evaluated according to 3GPP TS 05.08, clause 9 and table 1.

c) Further initial conditions (Carrier 1-3 are normal LSA cells).

Parameter	Carrier 1	Carrier 2	Carrier 3	Carrier 4
Matching LSA on SIM	LSA5	LSA1	LSA1	
Escape PLMN	No	No	No	

d) Further initial conditions (Carrier 1-3 are LSA exclusive access cells).

Parameter	Carrier 1	Carrier 2	Carrier 3	Carrier 4
Matching LSA on SIM	LSA5	LSA1	LSA1	
Escape PLMN	Yes	Yes	Yes	

Run the following test procedure twice by using two different sets of initial conditions:

- using initial conditions a), b) and c);
- using initial conditions a), b) and d).

20.24.3.5.4.2 Test Procedure

- a) The SS activates carriers 1, 2 and 3 and monitors these carriers for RA requests from the SoLSA MS.
- b) The SoLSA MS is switched on.
- c) Carrier 1 is barred (CBA = 1).
- d) Carrier 3 is barred (CBA = 1).

20.24.3.5.4.3 void

20.24.3.5.4.4 Test Requirements

- 1) After step b), the first response from the SoLSA MS shall be received on carrier 1 after 50 s. (highest value of C1). There shall be no response from the SoLSA MS on other carriers within 35s after the first response sent on carrier 1.

NOTE: Any potential access is likely to occur within 25 s.

- 2) After step c), the SoLSA MS shall respond on carrier 3 within 55 s after carrier 1 becomes barred. (same priority as for LSA on carrier 2 but highest value of C2+LSA_OFFSET).
- 3) After step d), the SoLSA MS shall respond on carrier 2 within 55 s after carrier 3 becomes barred.

20.24.3.6 SoLSA Cell Reselection / idle mode support enabled / LSA Priority / cell combinations

20.24.3.6.1 Definition

-

20.24.3.6.2 Conformance requirement

1. While camped on a cell of the selected PLMN ("camped normally"), the SoLSA MS may need to select a different cell ("normal cell reselection" state). The following events trigger a cell reselection:

- The cell camped on (current serving cell) has become barred.
- There is a better cell (in terms of the path loss criterion C2) in the same LA.
- The MS will then reselect a new cell in order to fulfil the process goal.

3GPP TS 03.22, subclause 4.5.

2. The SoLSA MS shall reselect the correct cell when subscription for normal LSA cells and LSA exclusive access cells varies; GSM 03.73, subclauses 4.3.1 and 4.3.3.

The setting of the LSA only bit on the SIM shall not influence the behaviour of the cell reselection: for subscribers with LSA only access call unrelated service requests are accepted even outside of the allowed LSAs. 3GPP TS 03.73, subclause 4.5.4.

3. When MS is out of the allowed LSA it shall be registered in PLMN but indicate subscriber/service specific "out of LSA area" notification. It shall be a network controlled function to prevent terminated or/and originated calls. Emergency calls are however always allowed. 3GPP TS 02.11, subclause 5.3.

20.24.3.6.3 Test purpose

To verify that the SoLSA MS shall reselect the correct cell when subscription for normal LSA cells and LSA exclusive access cells varies. The setting of LSA only bit on the SIM shall not influence the behaviour of the cell reselection.

20.24.3.6.4 Method of tests

20.24.3.6.4.1 Initial conditions

- a) Parameters changed from the default values in table 20.24.1.

Parameter	Carrier 1	Carrier 2	Carrier 3	Carrier 4
RF Signal Level (dB μ V emf) / dBm)	53/ -60	43/ -70	63 / -50	OFF
CBA	0	0	0	
RXLEV_ACCESS_MIN (dBm)	-90	-90	-90	
C1	30	20	40	
C2	30	20	40	
C4	30	20	<0	

b) Further parameters changed from the default values in table 20.24.1; further initial conditions.

Parameter/condition	Carrier 1	Carrier 2	Carrier 3	Carrier 4
LSA ID	9.000.000	30.000	250	
LAC	5	5	5	
CI	5000	5001	5002	
Matching LSA on SIM	LSA3	LSA5	-	
Escape PLMN	Yes	No	No	

c) Further parameters changed from the default values in table 20.24.1; further initial conditions.

Parameter/condition	Carrier 1	Carrier 2	Carrier 3	Carrier 4
LSA ID	250	9.000.000	250	
LAC	5	5	5	
CI	5000	5001	5002	
Matching LSA on SIM	-	LSA3	-	
Escape PLMN	No	Yes	No	

d) Further parameters changed from the default values in table 20.24.1; further initial conditions.

Parameter/condition	Carrier 1	Carrier 2	Carrier 3	Carrier 4
LSA ID	250	30.000	250	
LAC	5	5	5	
CI	5000	5001	5002	
Matching LSA on SIM	-	LSA5	-	
Escape PLMN	No	No	Yes	

e) Further parameters changed from the default values in table 20.24.1; further initial conditions.

Parameter/condition	Carrier 1	Carrier 2	Carrier 3	Carrier 4
LSA ID	250	250	250	
LAC	5	5	5	
CI	5000	5001	5002	
Matching LSA on SIM	-	-	-	
Escape PLMN	Yes	No	No	

f) Identification of the LSA by means of LSA ID (see subclause 20.24. General remark 2).

Run the following test procedures twice using two different sets of initial conditions:

- with an LSA only SIM;
- with a normal LSA SIM.

20.24.3.6.4.2.1 Test Procedure

Using conditions from table a), b) and f).

- a) The SS activates the carriers 1, 2, 3 and monitors these carriers for RA requests from the SoLSA MS.
- b) The SoLSA MS is switched on.
- c) The SS is reconfigured and carrier 3 becomes barred (CBA = 1).

- d) The SS is reconfigured and carrier 2 becomes barred (CBA = 1) and carrier 3 becomes not barred (CBA = 0).

20.24.3.6.4.2.2 void

20.24.3.6.4.2.3 Test Requirements

- 1) After step b), the first response from the SoLSA MS shall be received on carrier 3 within 50 s. There shall be no response from the SoLSA MS on any other carrier within 35 s after the first response on carrier 3.

NOTE 1: Any potential access is likely to occur within 35 s.

- 2) After step c), there shall be response from the SoLSA MS on carrier 2 within 60 s after activating of carriers 2 and 3. (Highest LSA Priority on the SIM (15) for $C4 \geq 0$ in the present subscription).

NOTE 2: 5,5 s to notice new strongest carriers on top 6 (because the updating time for the 6 strongest is 5 s ($\pm 10\%$)), 33 s to read BCCH, 15 s for reselection, 5 s for search of a matching LSA on SIM. Allow 60 s.

- 3) After step d), there shall be response from SoLSA MS on carrier 1 within 55 s after carrier 2 has become barred (highest priority (8) with $C4 \geq 0$).

20.24.3.6.4.3.1 Test Procedure

Using conditions from table a), c) and f).

- a) The SS activates carrier 1 and monitors that carrier for RA requests from the SoLSA MS. Carrier 2 and 3 are switched off.
- b) The SoLSA MS is switched on.
- c) The SS activates the carriers 2 and 3 (carrier 1 is still switched on) and monitors carriers 1, 2 and 3 for RA requests from the SoLSA MS.
- d) The SS is reconfigured and the carrier 2 becomes barred (CBA = 1).

20.24.3.6.4.3.2 void

20.24.3.6.4.3.3 Test Requirements

- 1) After step b), the first response from the SoLSA MS shall be received on carrier 1 within 50 s.
- 2) After step c), there shall be response from the SoLSA MS on carrier 2 after 60 s (highest LSA Priority on the SIM (8) with $C4 \geq 0$).
- 3) After step d), there shall be response from SoLSA MS on carrier 3 within 55 s after carrier 2 becomes barred (no subscription, Highest C2).

20.24.3.6.4.4.1 Test Procedure

Using conditions from table a), d) and f).

- a) The SS activates the carrier 1 and monitors that carrier for RA requests from the SoLSA MS. Carrier 2 and 3 are switched off.
- b) The SoLSA MS is switched on.
- c) The SS activates the carriers 2 and 3 (carrier 1 is still switched on) and monitors carriers 1, 2 and 3 for RA requests from the SoLSA MS.
- d) The SS is reconfigured and carrier 2 becomes barred (CBA = 1).

20.24.3.6.4.4.2 void

20.24.3.6.4.4.3 Test Requirements

- 1) After step b), the first response from the SoLSA MS shall be received on carrier 1 within 50 s.

- 2) After step c), there shall be response from the SoLSA MS on carrier 2 after 60 s after carrier 2 and 3 were switched on (LSA with highest Priority (15)).
- 3) After step d), there shall be response from SoLSA MS on carrier 1 within 55 s after carrier 2 has become barred (Carrier 3 is an LSA exclusive access cell with no matching subscription).

20.24.3.6.4.5.1 Test Procedure

Using conditions from table a),e) and f).

- a) The SS activates carriers 1 and 3 and monitors these for RA requests from the SoLSA MS.
- b) The SoLSA MS is switched on.
- c) The SS activates carrier 2 and carrier 3 becomes barred. (CBA = 1).
- d) The SS is reconfigured and carrier 2 becomes barred. (CBA = 1).

20.24.3.6.4.5.2 void

20.24.3.6.4.5.3 Test Requirements

- 1) After step b), the first response from the SoLSA MS shall be received on carrier 3 within 50 s (Carrier 1 is an LSA exclusive access cell with no matching subscription).
- 2) After step c), there shall be response from the SoLSA MS on carrier 2 within 55 s.
- 3) After step d), there shall be no paging response from SoLSA MS on any carrier (Carrier 2 and 3 are barred, carrier 1 is an exclusive access cell, the SoLSA MS is in the limited state) within 65 s.

NOTE: Any potential access is likely to occur quicker.

20.24.3.7 SoLSA Cell Reselection / roaming

20.24.3.7.1 Definition

While camped on a cell of the selected PLMN the SoLSA MS may need to select a different cell in order to fulfil the normal service state. This ensures that the SoLSA MS is camped on a cell from which it can reliably decode downlink data and with which it has a high probability of communications on the uplink.

Idle mode support for SoLSA on the SIM card is enabled (see General Remark 1. in subclause 20.24).

20.24.3.7.2 Conformance requirement

1. While camped on a cell of the selected PLMN ("camped normally"), the SoLSA MS may need to select a different cell ("normal cell reselection" state). The following events trigger a cell reselection:
 - There is a better cell (in terms of the path loss criterion C2) in the same LA.
 - The SoLSA MS will then reselect a new cell in order to fulfil the process goal.3GPP TS 03.22, subclause 4.5.
2. A SoLSA MS with SIM indicating LSA subscription shall always try to reselect the cell with highest LSA priority according to the information stored on the SIM. 3GPP TS 03.73, subclause 11.4.2.

20.24.3.7.3 Test Purpose

To verify that the SoLSA MS when idle mode support for SoLSA on the SIM card is enabled shall favour camping on those LSA cells with the highest LSA priority the SoLSA MS is subscribed to even if subscriber is outside of his HPLMN.

20.24.3.7.4 Method of test

20.24.3.7.4.1 Initial conditions

- a) Identification of the LSA by means of LSA ID (see subclause 20.24 General remark 2.).
- b) Parameters changed from the default values in table 20.24.1.

Parameter	Carrier 1	Carrier 2	Carrier 3	Carrier 4
RF Signal Level (dB μ V emf() / dBm)	43/-70	53/-60	33/-80	63/-50
RXLEV_ACCESS_MIN (dBm)	-90	-90	-90	-90
MCC, MNC	VPLMN	VPLMN	VPLMN	VPLMN
C1	20	30	10	40
C2	20	30	10	40
C4	20	<0	10	40
LSA ID	9.000.000	-	9.000.001	54
LAC	5	5	5	5
CI	5000	5001	5002	5003

- c) Further initial conditions (Carrier 1-3 are normal LSA cells).

Parameter	Carrier 1	Carrier 2	Carrier 3	Carrier 4
Matching LSA on SIM	-	-	LSA8	LSA9
Escape PLMN	No	No	No	No

- d) Further initial conditions (Carrier 1-3 are LSA exclusive access cells).

Parameter	Carrier 1	Carrier 2	Carrier 3	Carrier 4
Matching LSA on SIM	-	-	LSA8	LSA9
Escape PLMN	Yes	Yes	Yes	Yes

Run the following test procedure twice by using two different sets of initial conditions:

- using initial conditions a), b) and c);
- using initial conditions a), b) and d).

20.24.3.7.4.2 Test Procedure

- a) The SS activates carrier 1 and carrier 2, pages the MS on these carriers and monitors these for RA requests from the SoLSA MS. Carriers 3 and 4 are switched off.
- b) The SoLSA MS is switched on.
- c) After approx. 60 s the SS is reconfigured and level of carrier 2 decreases to 33 dB μ V/-80dBm (C2 decreases to 10). The SS monitors carriers 1 and 2 for RA requests from the SoLSA MS.
- d) The SS activates carriers 3 and 4. The SS pages the MS on carriers 3 and 4, and monitors these carriers for RA requests from the SoLSA MS.
- e) The SS is reconfigured and carrier 3 becomes barred (CBA = 1). The SS pages the MS on carrier 4, and monitors this carrier for RA requests from the SoLSA MS.

20.24.3.7.4.3 void

20.24.3.7.4.4 Test Requirements

- 1) After step b), the first response from the SoLSA MS shall be received on carrier 2 within 50 s.
- 2) After step c), there shall be response from the SoLSA MS on carrier 1 within 25 s after decreasing the level of carrier 2 (highest C2).

- 3) After step d), there shall be response from the SoLSA MS on carrier 3 within 55 s (highest priority on the SIM card for matching LSA subscription).
- 4) After step e), there shall be response from the SoLSA MS on carrier 4 within 55 s.

20.24.4 SoLSA Cell Reselection / idle mode support / any value

General Remark

Definition of "idle mode support" is given in subclause 20.24 General Remark 1.

"Idle mode support" is only controlling if 'favouring' shall be done at cell reselection. It does not disable the LSA subscription.

20.24.4.1 Definition

While camped on a cell of the selected PLMN a SoLSA MS may need to select a different cell in order to fulfil the normal service state. This ensures that the SoLSA MS is camped on a cell from which it can reliably decode downlink data and with which it has a high probability of communications on the uplink.

20.24.4.2 Conformance requirement

1. While camped on a cell of the selected PLMN ("camped normally"), the SoLSA MS may need to select a different cell ("normal cell reselection" state). The following events trigger a cell reselection:
 - The cell camped on (current serving cell) has become barred.
 - There is a better cell (in terms of the path loss criterion C2) in the same LA, or a much better cell in another LA of the selected PLMN (using the CRH parameter).
 - The SoLSA MS will then reselect a new cell in order to fulfil the process goal.

3GPP TS 03.22, subclause 4.5.

20.24.4.3 Test purpose

To verify that the SoLSA MS shall not favour camping on the LSA for which support in idle mode is disabled.

20.24.4.4 Method of test

20.24.4.5 Initial conditions

- a) Identification of the LSA by means of LSA ID (see subclause 20.24. General remark 2).
- b) Parameters changed from the default values in table 20.24.1.

Parameter	Carrier 1	Carrier 2	Carrier 3	Carrier 4
RF Signal Level (dB μ V emf() / dBm)	63/ -50	53/-60	58/-55	31 / -82
CBA	0	0	0	0
RXLEV_ACCESS_MIN (dBm)	-90	-90	-90	-90
CRH (dB)	10			
C1	40	30	35	8
C2	40	30	35	8
C4	40	30	35	8
LSA ID	66.000	66.000	9.000.001	5
LAC	5	5	3	3
CI	5000	5001	5002	5003

c) Further initial conditions (Carrier 1-4 are normal LSA cells).

Parameter	Carrier 1	Carrier 2	Carrier 3	Carrier 4
Idle mode support enabled	No	No	No	Yes
Matching LSA on SIM	LSA2	LSA2	LSA4	LSA6
Escape PLMN	No	No	No	No

d) Further initial conditions (Carrier 1-4 are LSA exclusive access cells).

Parameter	Carrier 1	Carrier 2	Carrier 3	Carrier 4
Idle mode support enabled	No	No	No	Yes
Matching LSA on SIM	LSA2	LSA2	LSA4	LSA6
Escape PLMN	Yes	Yes	Yes	Yes

Run the following test procedure twice by using two different sets of initial conditions:

- using initial conditions a), b) and c);
- using initial conditions a), b) and d).

20.24.4.6 Test Procedure

- a) The SS activates carriers 1, 2 and 3 and monitors these carriers for RA requests from the SoLSA MS. Carrier 4 is switched off.
- b) The SoLSA MS is switched on.
- c) The SS is reconfigured and the level of carrier 1 is decreased to 33 dB μ V emf() / -80 dBm (C2 of carrier 1 becomes 10).
- d) The SS is reconfigured and the level of carrier 3 is increased to 63 dB μ V emf() / -50 dBm (C2 of carrier 3 becomes 40).
- e) Carrier 1 is switched off. Carrier 4 is switched on. The SS monitors carriers 2, 3 and 4.

20.24.4.7 void

20.24.4.8 Test Requirements

- 1) After step b), the first response from the SoLSA MS shall be received on carrier 1 within 50 s. There shall be no response from the SoLSA MS on any other carrier within 35 s after the first response on carrier 1.

NOTE 1: Any potential access is likely to occur within 25 s.

- 2) After step c), there shall be response from the SoLSA MS on carrier 2 within 25 s after carrier 1 has been reconfigured (Highest C2/C2-CRH).
- 3) After step d), there shall be response on carrier 3 within 25 s after carrier 3 has been reconfigured (Highest C2/C2-CRH).
- 4) After step e), there shall be response on carrier 4 within 60 s after the system has been reconfigured (idle mode support enabled for carrier 4).

NOTE 2: 5,5 s to notice new strongest carriers on top 6 (because the updating time for the 6 strongest is 5 s ($\pm 10\%$)), 33 s to read BCCH, 15 s for reselection, 5 s for search of a matching LSA on SIM. Allow 60 s.

20.24.5 SoLSA Cell Reselection / LSA indication for idle mode

General Remark

Definition of "LSA indication for idle mode" is given in subclause 20.24 General Remark 1.

"LSA indication for idle mode" is only controlling if indication of the LSA name shall be done. It has no influence on the LSA subscription.

20.24.5.1 General Definition

The SoLSA MS in idle mode may inform the user whether or not the serving cell belongs to the subscribed LSA.

- The indication is dependent on the setting of the idle mode indication bit on the SIM card for that LSA.
- The indication is independent from the setting of the LSA idle mode support bit on the SIM card for that LSA (see subclause 20.24 General Remark 1).

20.24.5.2 General conformance requirement

1. The service subscriber can define a name (alphanumeric name, icon, etc) for each of her allowed LSAs. The MS will, in idle mode and if required by the user, indicate to the user the current LSA. The indication may be the name of the current LSA, as set by the user. The form of display and indication are left to manufacturer's choice. 3GPP TS 03.73, subclause 4.3.2.
2. In addition to indicate the registered PLMN, an MS with subscription for an LSA in the registered PLMN shall indicate this LSA when it is available. The indication towards the user is optional and may be done by displaying the stored LSA name that corresponds to the ID of the current LSA. An MS with LSA only access subscription may also give an indication towards the user, when the no subscribed LSAs are available to the user. The indication is optional and may be done by displaying the LSA only access text stored in the SIM. 3GPP TS 03.73, subclause 11.8.1.

20.24.5.3 SoLSA Cell Reselection / LSA indication for idle mode / idle mode support enabled

20.24.5.3.1 Definition

See general Definition of this subclause.

20.24.5.3.2 Conformance requirement

1. When both idle mode support and idle mode indication are enabled on the SIM card, the SoLSA MS shall display the name (which was defined by the service subscriber) of the current LSA to the user.
2. When idle mode support is enabled and idle mode indication is disabled on the SIM card, it is expected that the SoLSA MS does not display the LSA name (which was defined by the service subscriber) of the current LSA to the user.

3GPP TS 03.73, subclause 4.3.2; 3GPP TS 03.73, subclause 11.8.1; 3GPP TS 11.11, subclause 10.4.1.2.

20.24.5.3.3 Test Purpose

1. To verify that if idle mode indication bit on the SIM card is enabled for the LSA, the SoLSA MS supports the LSA indication. The LSA name (text/icon) shall be displayed on the SoLSA MS.
2. To verify that if idle mode indication bit on the SIM card is disabled for the LSA the SoLSA MS does not support the LSA indication.

20.24.5.3.4 Method of test

20.24.5.3.4.1 Initial conditions

- a) Identification of the LSA by means of LSA ID (see subclause 20.24. General remark 2).
- b) Parameters changed from the default values in table 20.24.1; further initial conditions.

Parameter/condition	Carrier 1	Carrier 2	Carrier 3	Carrier 4
RF Signal Level (dB μ V emf() / dBm)	43/-70	53/-60	33/-80	OFF
RXLEV_ACCESS_MIN (dBm)	-90	-90	-90	
C1	20	30	10	
C2	20	30	10	
LSA ID	-	66.001	9.000.000	
LAC	5	5	5	
CI	5000	5001	5002	
Matching LSA on SIM	-	LSA1	LSA3	
Escape PLMN	No	No	No	

20.24.5.3.4.2 Test Procedure

- a) The SS activates carrier 1, pages the MS on this carrier and monitors it for RA requests from the SoLSA MS. Carrier 2 and 3 are switched off.
- b) The SoLSA MS is switched on.
- c) Carrier 2 and Carrier 3 are switched on. The SS pages the MS on carriers 1, 2 and 3, and monitors these carriers for RA requests from the SoLSA MS.
- d) The SS is reconfigured and carrier 3 becomes barred (CBA = 1). The SS pages the MS on carriers 1, 2 and 3, and monitors these carriers for RA requests from the SoLSA MS.
- e) The SS is reconfigured and sets CBA = 0 on carrier 3. The SS pages the MS on carriers 1, 2 and 3 and monitors these carriers for RA requests from the SoLSA MS.

20.24.5.3.4.3a Specific PICS statements

-20.24.5.3.4.3b PIXIT statements

- Interface to the human user (p1=Y/N).
- Way to indicate the identity of the current LSA to the human user (only applicable if the SoLSA MS has an interface to the human user).
- Way to indicate the change of the current LSA to the human user (only applicable if the SoLSA MS has an interface to the human user).

20.24.5.3.4.4 Test Requirements

- 1) After step b), the first response from the SoLSA MS shall be received on carrier 1 within 50 s. There shall be no LSA indication on the SoLSA MS (No LSA).
- 2) After step c), there shall be response from the SoLSA MS on carrier 3 within 25 s (highest LSA Priority (8) on the SIM card). An LSA indication is expected on the SoLSA MS.
- 3) After step d), there shall be response from the SoLSA MS on carrier 2 within 55 s. There shall be no indication on the SoLSA MS (highest LSA Priority on the SIM card, no indication on the SIM card).
- 4) After step e), there shall be response from the SoLSA MS on carrier 3 within 55 s (LSA carrier on the SIM card). An LSA indication is expected on the SoLSA MS (idle mode indication for that LSA is enabled).

20.24.5.4 SoLSA Cell Reselection / LSA indication for idle mode / idle mode support disabled

20.24.5.4.1 Definition

See general Definition of this subclause.

20.24.5.4.2 Conformance requirement

1. When idle mode support is disabled and idle mode indication is enabled on the SIM card, it is expected that the SoLSA MS displays the LSA name (which was defined by the service subscriber) of the current LSA to the user.
2. When idle mode support is disabled and idle mode indication is disabled on the SIM card, the SoLSA MS shall not display the LSA name (which was defined by the service subscriber) of the current LSA to the user.

3GPP TS 03.73, subclause 4.3.2; 3GPP TS 03.73, subclause 11.8.1; 3GPP TS 11.11, 1subclause 0.4.1.2.

20.24.5.4.3 Test Purpose

To verify that when idle mode support is disabled, the SoLSA MS shall display the LSA name in dependence from the idle mode indication bit.

20.24.5.4.4 Method of test

20.24.5.4.4.1 Initial conditions

- a) Identification of the LSA by means of LSA ID (see subclause 20.24. General remark 2).
- b) Parameters changed from the default values in table 20.24.1; further initial conditions.

Parameter/condition	Carrier 1	Carrier 2	Carrier 3	Carrier 4
RF Signal Level (dB μ V emf() / dBm)	43/-70	53/-60	33/-80	OFF
CBA	0	0	0	
RXLEV_ACCESS_MIN (dBm)	-90	-90	-90	
C1	20	30	10	
C2	20	30	10	
LSA ID	250	66.000	9.000.001	
LAC	5	5	5	
CI	5000	5001	5002	
Matching LSA on SIM	-	LSA2	LSA4	
Escape PLMN	No	No	No	

20.24.5.4.4.2 Test Procedure

- a) The SS activates carrier 1, pages this carrier and monitors it for RA requests from the SoLSA MS. Carriers 2 and 3 are switched off.
- b) The SoLSA MS is switched on.
- c) Carrier 2 and carrier 3 are switched on. The SS pages the MS on carriers 1, 2 and 3, and monitors these carriers for RA requests from the SoLSA MS.
- d) The SS is reconfigured and the level of carrier 3 increases to 63 dB μ Vemf / -50dBm (C2 increases to 40 dB).
- e) The SS is reconfigured and the level of carrier 3 decreases to 33 dB μ Vemf0,1,0 /- 80dBm (C2 decreases to 10 dB).

20.24.5.4.4.3a Specific PICS statements

-

20.24.5.4.4.3b PIXIT statements

- Interface to the human user (p1=Y/N).
- Way to indicate the identity of the current LSA to the human user (only applicable if the SoLSA MS has an interface to the human user).
- Way to indicate the change of the current LSA to the human user (only applicable if the SoLSA MS has an interface to the human user).

20.24.5.4.4.4 Test Requirements

- 1) After step b), the first response from the SoLSA MS shall be received on carrier 1 within 50 s. There shall be no LSA indication on the SoLSA MS.
- 2) After step c), there shall be response from the SoLSA MS on carrier 2 within 25 s (highest C2). An LSA indication is expected on the SoLSA MS.
- 3) After step d), there shall be response from the SoLSA MS on carrier 3 within 25 s (highest C2). There shall be no LSA indication on the SoLSA MS.
- 4) After step e), there shall be response from the SoLSA MS on carrier 2 within 25 s (highest C2). An LSA indication is expected on the SoLSA MS.

20.25 Intersystem Cell Reselection

The default parameters for the GSM/GPRS cell, the accuracy of the MS signal measurements and tolerance of timers, are given in TS 51.010 section 20.22.

The default parameters and tolerances of the UTRAN cells are specified in TS 34.108.

20.25.1 Definition of system information messages

SYSTEM INFORMATION TYPE 3 REST OCTETS

- SI2q indicated on BCCH Norm

SYSTEM INFORMATION TYPE 2QUATER

Information Element	Value/remark
< RR management Protocol Discriminator bit (4) >	'0110'B
< Skip Indicator : bit (4) >	'0000'B
< Message type : bit (8) >	'0000 0111'B
< SI2 quarter Rest Octets >	
< BA_IND : bit >	0
< 3G_BA_IND : bit >	0
< MP_CHANGE_MARK : bit >	0
< SI2quater_INDEX : bit (4) >	'0000'B
< SI2quater_COUNT : bit (4) >	'0000'B
0 1 < Measurement_Parameters Description >	0
0 1 < GPRS_Real Time Difference Description >	0
0 1 < GPSR_BSIC Description >	0
0 1 < GPRS_REPORT PRIORITY Description >	0
0 1 < GPRS_Measurement_Parameters Description >	0
0 1 < NC Measurement Parameters >	0
0 1 < extension length >	0
0 1 < 3G Neighbour Cell Description >	1
0 1 < Index_Start_3G : bit (7) >	0
0 1 < Absolute_Index_Start_EMR : bit (7) >	0
0 1 < UTRAN FDD Description >	1
0 1 < Bandwidth_FDD : bit (3) >	0
1 < Repeated UTRAN FDD Neighbour Cells > ** 0	1
0 < FDD-ARFCN : bit (14) >	0 See TS 34.108, clause 6.1.5, table 6.1.1
< FDD_Indic0 : bit >	0
< NR_OF_FDD_CELLS : bit (5) >	'00001'B
< FDD_CELL_INFORMATION Field >	10 bits Scrambling code according to TS 34.108, clause 6.1.4, Default settings for cell No.1
1 < Repeated UTRAN FDD Neighbour Cells > ** 0	0
0 1 < UTRAN TDD Description >	0
0 1 < 3G MEASUREMENT Parameters Description >	1
< Qsearch_I : bit (4) >	'0111'B (Always)
< Qsearch_C_Initial : bit (1) >	0
0 1 < FDD_Qoffset : bit (4) >	1 '0000'B (Always select a cell if acceptable)
< FDD_REP_QUANT : bit (1) >	0
< FDD_MULTIRAT_REPORTING : bit (2) >	'01'B
< FDD_Qmin : bit (3) >	'111'B (-12 dB)
0 1 < TDD_Qoffset : bit (4) >	0
0 1 < GPRS_3G_MEASUREMENT Parameters Description >	1
< Qsearch_P : bit (4) >	'0111'B (Always)
< 3G_SEARCH_PRIO : bit >	0
0 1 < FDD_REP_QUANT : bit >	0
0 1 < FDD_REPORTING_OFFSET : bit (3) >	0
0 1 < TDD_MULTIRAT_REPORTING : bit (2) >	0
0 1 < TDD_REPORTING_OFFSET : bit (3) >	0

20.25.2 Intersystem Cell Reselection/Idle Mode/FDD_Qmin

20.25.2.1 Conformance requirement

If the 3G Cell Reselection list includes UTRAN frequencies, the MS shall, at least every 5 s update the value RLA_C for the serving cell and each of the at least 6 strongest non-serving GSM cells.

The MS shall then reselect a suitable (see TS 25.304) UTRAN cell if its measured RSCP value exceeds the value of RLA_C for the serving cell and all of the suitable (see 3GPP TS 03.22) non-serving GSM cells by the value XXX_Qoffset for a period of 5 seconds and, for FDD, the UTRAN cells measured Ec/No value is equal or greater than

the value FDD_Qmin. In case of a cell reselection occurring within the previous 15 seconds, XXX_Qoffset is increased by 5 dB.

Table 1: Radio sub-system link control parameters

Parameter name	Description	Range	Bits	Channel
FDD_Qmin	A minimum threshold for Ec/No for UTRAN FDD cell re-selection, 0= -20dB, 1= -6dB, 2= -18dB, 3= -8dB, 4= -16dB, 5= -10dB, 6= -14dB, 7= -12dB. Default value= -12dB.	0-7	3	BCCH D/L

References:

3GPP TS 05.08, subclause 6.6.5 and 9

20.25.2.2 Test purpose

To verify that the MS uses the FDD_Qmin parameter at cell re-selection from GSM to UTRAN while in GSM Idle Mode.

20.25.2.3 Method of test

Initial conditions

Parameter	Cell 1	Cell 2
	Carrier1	Carrier2
Channel Type carried	BCCH	BCH
Signal Level (dBm)	-50	Off to -48
Ec/No (dB)	-	-6>dB>-16

NOTE 1: MS is IMSI updated on Cell 1.

NOTE 2: Carrier 1 is the BCCH carrier, GPRS not present.

NOTE 3: Carrier 2 is the UTRAN FDD cell configured according to TS 34.108, clause 6.1.4, Default settings for cell No.1

NOTE 4: Serving Cell Parameters are coded and transmitted on the specified Channel Type

NOTE 5: Carriers should have a relative accuracy of ± 2 dB.

NOTE 6: When executing the test in FDD band II or FDD band VIII carrier 2 shall use the high range UARFCN, defined in TS 3GPP 34.108 clause 5.1.1. This is to avoid the FDD band overlapping with the GSM band under test.

SYSTEM INFORMATION TYPE 3 REST OCTETS

- GPRS **not** indicated

SYSTEM INFORMATION TYPE 4 REST OCTETS

- GPRS **not** indicated

SYSTEM INFORMATION TYPE 2QUATER

Information Element	Value/remark
< MP_CHANGE_MARK : bit (1)>	0
< FDD_Qmin : bit (3) >	'001'B (-6 dB)

Test procedure

The MS is camping on the GSM cell and has received a 3G Neighbour Cell list in the 3G_NEIGHBOUR_CELL description in System Information Type 2quater. The FDD_Qmin in the 3G_MEASUREMENT_PARAMETERS description is set to -6 dB.

It is verified for 30 sec that no Cell Reselection to the UTRAN cell is performed.

System Information 2quater is updated with FDD_Qmin in the 3G_MEASUREMENT_PARAMETERS description set to -16 dB.

It is verified that a Cell Reselection to UTRAN is performed within 45 secs when UE receives and acts on revised SI2quater and the UTRAN cell Ec/No gets greater than FDD_Qmin. (45 secs = 30 secs period of SI reading + 5 secs for UE to receive and decode SI2quater +2*5sec, where 5 sec is the maximum time between 2 consecutive UTRAN measurements.)

Maximum duration of the test

2 minutes

Expected sequence

Step	Direction	Message	Comments
1	SS		Carrier 2 is activated with $-6 > Ec/No > -16$ (dB)
2	SS <->MS		Verify that no cell reselection is performed to Carrier 2 for 30 sec.
3	SS	SYSTEM INFORMATION TYPE 2QUATER	See specific contents below.
4	MS -> SS	RRC CONNECTION REQUEST	Verify that the MS reselects to Carrier 2 within 45 secs from Step 3. Establishment cause shall be "interRAT-CellReselection"

Specific message contents

SYSTEM INFORMATION TYPE 2QUATER in Step 3

Information Element	Value/remark
< MP_CHANGE_MARK : bit (1)>	1
< FDD_Qmin : bit (3) >	'100'B (-16 dB)

20.25.3 Intersystem Cell Reselection/Idle Mode/FDD_Qoffset

20.25.3.1 Conformance requirement

If the 3G Cell Reselection list includes UTRAN frequencies, the MS shall, at least every 5 s update the value RLA_C for the serving cell and each of the at least 6 strongest non-serving GSM cells.

The MS shall then reselect a suitable (see TS 25.304) UTRAN cell if its measured RSCP value exceeds the value of RLA_C for the serving cell and all of the suitable (see 3GPP TS 03.22) non-serving GSM cells by the value XXX_Qoffset for a period of 5 seconds and, for FDD, the UTRAN cells measured Ec/No value is equal or greater than the value FDD_Qmin. In case of a cell reselection occurring within the previous 15 seconds, XXX_Qoffset is increased by 5 dB.

Table 1: Radio sub-system link control parameters

Parameter name	Description	Range	Bits	Channel
FDD_Qoffset	Applies an offset to RLA_C for cell re-selection to access technology/mode FDD 0 = -∞ (always select a cell if acceptable), 1 = -28 dB, 2 = -24 dB, ... , 15 = 28 dB. Default value = 0 dB.	0-15	4	BCCH D/L

Power Spectral Density: The units of Power Spectral Density (PSD) are extensively used in this document. PSD is a function of power versus frequency and when integrated across a given bandwidth, the function represents the mean power in such a bandwidth.

References:

3GPP TS 05.08, subclause 6.6.5 and 9; TS 25.101 subclause 3.1.

20.25.3.2 Test purpose

To verify that the MS uses the FDD_Qoffset parameter at cell re-selection from GSM/GPRS to UTRAN while in Idle Mode.

20.25.3.3 Method of test

Initial conditions

Parameter	Unit	Cell 1 (GSM)
Test Channel		1
RF Signal Level	dBm	-75
RXLEV_ACCESS_MIN	dBm	-100
FDD_Qoffset	dBm	20

Parameter	Unit	Cell 2 (UTRAN)
Test Channel		1
CPICH_Ec (FDD)	dBm / 3.84 MHz	OFF to -60 to -50

NOTE 1: MS is IMSI updated on Cell 1.

NOTE 2: Carrier 1 is the BCCH carrier, GPRS not present.

NOTE 3: Carrier 2 is the UTRAN FDD cell configured according to TS 34.108, clause 6.1.4, Default settings for cell No.1

NOTE 4: Serving Cell Parameters are coded and transmitted on the specified Channel Type.

NOTE 5: Carriers should have a relative accuracy of ± 3 dB.

NOTE 6: When executing the test in FDD band II or FDD band VIII carrier 2 shall use the high range UARFCN, defined in TS 3GPP 34.108 clause 5.1.1. This is to avoid the FDD band overlapping with the GSM band under test.

SYSTEM INFORMATION TYPE 3 REST OCTETS

- SI2q indicated on BCCH extended
- GPRS **not** indicated

SYSTEM INFORMATION TYPE 4 REST OCTETS

- GPRS **not** indicated

SYSTEM INFORMATION TYPE 2QUATER

Information Element	Value/remark
0 1 < FDD_Qoffset : bit (4) >	1 '1101'B (20 dB)

Test procedure

The MS is camping on the GSM cell and has received a 3G Neighbour Cell list in the 3G_NEIGHBOUR_CELL description in System Information Type 2quater. The FDD_Qoffset in the 3G_MEASUREMENT_PARAMETERS description is set to 20 dB.

It is verified for 30 sec that no Cell Reselection to the UTRAN cell is performed.

The UTRAN cell CPICH Ec is increased to -50 dBm / 3.84 MHz and therefore, The mean power of the CPICH Ec integrated across 3.84 MHz bandwidth is -50 dBm

It is verified that a Cell Reselection to UTRAN CPICH Ec is performed within 15.4 sec when the UTRAN cell mean power of the CPICH Ec integrated across 3.84 MHz gets greater than the GSM cell $RLA_C + FDD_Qoffset$. (15.4 sec = $2*5$ sec, where 5 sec is the maximum time between 2 consecutive UTRAN measurements, with 4 seconds to read the SIBs plus 10% tolerance overall)

Maximum duration of the test

2 minutes

Expected sequence

Step	Direction	Message	Comments
1	SS		Carrier 2 is activated
2	SS		Verify that the MS does not reselect to Carrier 2 for 30 sec.
3	SS		Increase power of Carrier 2 to -50 dBm.
4	MS -> SS	RRC CONNECTION REQUEST	Verify that the MS reselects to Carrier 2 within 15.4 sec from Step 3. Establishment cause shall be "interRAT-CellReselection"

Specific message contents

None

20.25.4 Intersystem Cell Reselection/Idle Mode/Qsearch_I

20.25.4.1 Conformance requirement

If the 3G Cell Reselection list includes UTRAN frequencies, the MS shall, at least every 5 s update the value RLA_C for the serving cell and each of the at least 6 strongest non-serving GSM cells.

The MS shall then reselect a suitable (see TS 25.304) UTRAN cell if its measured RSCP value exceeds the value of RLA_C for the serving cell and all of the suitable (see 3GPP TS 03.22) non-serving GSM cells by the value $XXX_Qoffset$ for a period of 5 seconds and, for FDD, the UTRAN cells measured Ec/No value is equal or greater than the value FDD_Qmin . In case of a cell reselection occurring within the previous 15 seconds, $XXX_Qoffset$ is increased by 5 dB.

Table 1: Radio sub-system link control parameters

Parameter name	Description	Range	Bits	Channel
Qsearch_I	Search for 3G cells if signal level is below (0-7) or above (8-15) threshold 0 = -98 dBm, 1 = -94 dBm, ... , 6 = -74 dBm, 7 = ∞ (always) 8 = -78 dBm, 9 = -74 dBm, ... , 14 = -54 dBm, 15 = ∞ (never). Default value = ∞ (never).	0-15	4	BCCH D/L

References:

3GPP TS 05.08, subclause 6.6.5 and 9

20.25.4.2 Test purpose

To verify that the MS uses the Qsearch_I parameter at cell re-selection from GSM to UTRAN while in Idle Mode.

20.25.4.3 Method of test

Initial conditions

Parameter	Unit	Cell 1 (GSM)
Test Channel		1
RF Signal Level	dBm	-60 to -77
RXLEV_ACCESS_MIN	dBm	-100
MP_CHANGE_MARK		0
Qsearch_I		15 to 6

Parameter	Unit	Cell 2 (UTRAN)
Test Channel		1
CPICH_Ec (FDD)	dBm / 3.84 MHz	OFF to -50

NOTE 1: MS is IMSI attached on Cell 1.
If MS supports GPRS, then MS is GPRS attached on cell 1.

NOTE 2: Carrier 1 is the BCCH carrier, PBCCH not present, NC0.

NOTE 3: Carrier 2 is the UTRAN FDD cell configured according to TS 34.108, clause 6.1.4, Default settings for cell No.1

NOTE 4: Serving Cell Parameters are coded and transmitted on the specified Channel Type

NOTE 5: Carriers should have a relative accuracy of ± 3 dB.

SYSTEM INFORMATION TYPE 2QUATER

Information Element	Value/remark
< Qsearch_I : bit (4) >	'1111'B (Never)
< Qsearch_P : bit (4) >	'0111'B (Always)

Test procedure

The MS is camping on the GSM cell and has received a 3G Neighbour Cell list in the 3G_NEIGHBOUR_CELL description in System Information Type 2quater. Qsearch_I in the 3G_MEASUREMENT_PARAMETERS description indicates that no 3G measurements shall be performed.

It is verified for 30 sec that no Cell Reselection to the UTRAN cell is performed.

The SS broadcast a new System Information Type 2quater with an updated Qsearch_I indicating that 3G measurements shall be performed when the strongest GSM cell RLA_C is below -74 dBm.

It is verified for 65 sec that no Cell Reselection to the UTRAN cell is performed. (Maximum 30 sec for SI reading + 5 sec for System Information 2quater reading + 30 sec to find the UTRAN.)

The GSM cell RLA_C is decreased to -77 dBm.

It is verified that a Cell Reselection to UTRAN is performed within 30 sec.

Maximum duration of the test

4 minutes

Expected sequence

Step	Direction	Message	Comments
1	SS		Carrier 2 is activated on -50 dBm
2	SS		Verify that no cell reselection is performed to Carrier 2 for 30 sec.
3	SS	SYSTEM INFORMATION 2QUATER	See specific contents below. Verify that no cell reselection is performed to Carrier 2 for 65 sec.
3a	SS	SYSTEM INFORMATION TYPE 13	
4	SS		
5	SS		
6	MS -> SS	RRC CONNECTION REQUEST	Reduce power of Carrier 1 to -77 dBm. Verify that the MS reselects to Carrier 2 within 30 sec. Establishment cause shall be "interRAT-CellReselection"

Specific message contents

SYSTEM INFORMATION 2QUATER in Step 3

< MP_CHANGE_MARK : bit >	1
0 1 < 3G_MEASUREMENT Parameters Description >	0
< Qsearch_I : bit (4) >	'0110'B (-74 dBm)
< Qsearch_C_Initial : bit (1) >	0
0 1 < FDD_Qoffset : bit (4) >	0
0 1 < TDD_Qoffset : bit (4) >	0

SYSTEM INFORMATION Type 13 in Step 3a

Information Element	Value/remark
< BCCH_CHANGE_MARK : bit (3) >	'001'B
< SI_CHANGE_FIELD : bit (4) >	'0010'B (Update of SI2, SI2 bis or SI2 ter message or any instance of SI2quater messages)

21 Received signal measurements

For evaluating the reception quality (the basis for handover and power control) the following two criteria are used:

- signal strength (RXLEV);
- signal quality (RXQUAL).

Unless otherwise specified all tests in clauses 21.1 to 21.4 are applicable for all MSs supporting the bands referred to in clause 1.

21.1 Signal strength

21.1.1 Definition

The MS reports RXLEV values related to the apparent received RF signal strength. It is necessary for these levels to attain sufficient accuracy for the correct functioning of the system.

21.1.2 Conformance requirement

1. The RMS received signal level at the receiver input shall be measured by the MS over the full range of -110 dBm to -48 dBm with a relative accuracy between signals with levels up to 20 dB difference according to table 21-1
 - 1.1 under normal conditions, 3GPP TS 05.08, subclause 8.1.2 and 3GPP TS 05.05, subclause 6.2.
 - 1.2 under extreme conditions, 3GPP TS 05.08, subclause 8.1.2, 3GPP TS 05.05, subclauses D.1 and D.2.

Table 21-1: Tolerance for relative accuracy of receive signal measurement

Absolute level of lower level signal dBm						Tolerance dB			
GSM Small MS	GSM Other MS	DCS 1800 Class 1&2	DCS 1800 Class 3	PCS 1900 Class 1&2	PCS 1900 Other MS	Lower limit		Upper limit	
						Single	Multi	Single	Multi
≥ -88	≥ -90	≥ -86	≥ -88	≥ -88	≥ -90	2	4	2	4
≥ -101	≥ -103	≥ -99	≥ -101	≥ -101	≥ -103	3	5	2	5
< -101	< -103	< -99	< -101	< -101	< -103	4	6	2	6

Single means that the measurements are on the same or different RF channel within the same frequency band.

Multi means that the measurements are on different RF channel on different frequency bands.

For measurements between ARFCN in different bands the 'Absolute level of lower level signal' column for the band including the lower level signal shall be used to determine which tolerance applies.

At extreme temperature conditions an extra 2 dB shall be added to the Multi limits in above table.

2. The RMS received signal level at the receiver input shall be measured with an absolute accuracy of ± 4 dB from -110 dBm to -70 dBm under normal conditions; 3GPP TS 05.08, subclause 8.1.2.
3. The RMS received signal level at the receiver input shall be measured with an absolute accuracy of ± 6 dB over the full range of -110 dBm to -48 dBm under both normal and extreme conditions; 3GPP TS 05.08, subclause 8.1.2.
4. If the received signal level falls below the reference sensitivity level for the type of MS then the MS shall report a level between the reference sensitivity level and the actual received level, but with the tolerances given in conformance requirements 2. and 3. above.
5. The measured signal level shall be mapped to an RXLEV value between 0 and 63 as specified in 3GPP TS 05.08, subclause 8.1.4.

21.1.3 Test purpose

1. To verify that the RXLEV reported by the MS does not exceed conformance requirement 1.
 - 1.1 under normal conditions;
 - 1.2 under extreme conditions.
2. To verify that the RXLEV reported by the MS does not exceed conformance requirement 2 under normal conditions.
3. To verify that the RXLEV reported by the MS does not exceed conformance requirement 3 under extreme conditions and under normal conditions from -48 dBm to -70 dBm.
4. To verify that the RXLEV reported by the MS does not exceed conformance requirement 4.

NOTE: Conformance requirement 5 is inherently tested in each of the test purposes 1. to 4.

21.1.4 Method of test

21.1.4.1 Initial conditions

The SS is set to produce the BCCH of the serving cell at $63 \text{ dB}\mu\text{Vemf}(\)$ and the BCCHs of 6 surrounding cells at $28 \text{ dB}\mu\text{Vemf}(\)$. The BCCH of the serving cell indicates these BCCHs, but not the BCCH of the serving cell. The ARFCN of the serving cell BCCH is chosen so as not to interfere with the other channels as shown in table 21-2. The fading profile for the BCCHs of the serving and surrounding cells will be set to static.

After 30 s, a call is set up according to the generic call set up procedure to an ARFCN, within the supported band of operation. The SACCH indicates the same surrounding cell BCCHs as the BCCH of the serving cell.

NOTE: The 30 s is to allow the MS to scan and find all BCCHs.

21.1.4.2 Procedure

- a) The levels of the TCH and BCCHs are set according to table 21-2 step 1. The SS waits 20 s before continuing.

Table 21-2: Signal levels at receiver input in dB μ Vemf()

	ARFCN	TCH	BCCH1	BCCH2	BCCH3	BCCH4	BCCH5	BCCH6
Step	GSM 450	259	276	293	264	269	281	288
	GSM 480	306	323	340	311	316	328	335
	GSM 900:	1	62	124	20	40	80	100
	DCS 1 800	512	700	885	585	660	790	835
	PCS 1 900	512	700	805	585	660	790	550
	450/900	259	124	276	293	269	288	1
	480/900	306	124	323	340	316	335	1
	450/1 800	259	885	276	293	269	288	512
	480/1 800	306	885	323	340	316	335	512
	900/1 800	1	885	62	124	40	100	512
	450/900/1 800	259	124	276	885	293	1	512
	480/900/1 800	306	124	323	885	340	1	512
	GSM 850	128	189	251	150	170	210	230
	GSM 710	438	475	511	440	455	485	500
	T-GSM 810	438	475	511	440	455	485	500
	GSM 750	438	475	511	440	455	485	500
	750/850	438	251	475	511	455	485	128
1 + m \times 21		64,5 - m \times 10	64,5 - m \times 10	64,5 - m \times 10	64,5 - m \times 10	64,5 - m \times 10	64,5 - m \times 10	64,5 - m \times 10
2 + m \times 21		54,5 - m \times 10	63,5 - m \times 10	54,5 - m \times 10	54,5 - m \times 10	54,5 - m \times 10	54,5 - m \times 10	54,5 - m \times 10
3 + m \times 21		54,5 - m \times 10	62,5 - m \times 10	44,5 - m \times 10	44,5 - m \times 10	44,5 - m \times 10	44,5 - m \times 10	44,5 - m \times 10
.		44,5 - m \times 10	44,5 - m \times 10
17 + m \times 21		54,5 - m \times 10	44,5 - m \times 10	44,5 - m \times 10
18 + m \times 21		44,5 - m \times 10	44,5 - m \times 10	44,5 - m \times 10
.		44,5 - m \times 10	44,5 - m \times 10
21 + m \times 21		44,5 - m \times 10	44,5 - m \times 10	44,5 - m \times 10	44,5 - m \times 10	44,5 - m \times 10	44,5 - m \times 10	44,5 - m \times 10

m = 0, 1, 2, 3, 4.

- b) The measurement is done in 105 steps. The initial signal levels of the TCH of the serving cell and the BCCHs of the surrounding cells are adjusted according to table 21-2. At each step the SS keeps the signal levels stable for one reporting period, except at steps 21 + m \times 21 where the level is held stable for 1,75 reporting periods. The RXLEV value for the period in which the change occurs (reported in the following period) is discarded. The SS records the RXLEV values reported for the surrounding cell BCCHs in steps 1 + m \times 21 and 21 + m \times 21. The RXLEV values for BCCH 1 are recorded by the SS for all 105 steps.

NOTE: This extension at steps 21 + m \times 21 is to allow an extra quarter reporting period for the MS to stabilize for steps 1 + m \times 21.

At steps 1 to 30 the SS simulates a base station with DTX off and at steps 31 to 105 the SS simulates a base station with DTX on.

At steps 1 to 30 the SS checks the accuracy of the measured signal strength of TCH by checking the values of the parameters RXLEV_FULL and RXLEV_SUB. At steps 31 to 105 the SS shall check only the value of the parameter RXLEV_SUB.

At step 64, within every 480 ms reporting period, out of the 4 SACCH and 8 SID timeslots the SS transmits the first six active timeslots of the TCH with signal level 39,5 dB μ Vemf() and the last six active timeslots of the TCH with signal level 29,5 dB μ Vemf().

- c) Step b) is repeated under extreme conditions (annex 1, TC2,2 and TC3).

21.1.5 Test requirements

21.1.5.1 Relative accuracy of measurements on different ARFCN

For normal and each of the 4 extreme conditions tested the following applies:

- a) For each of the steps 1, 21, 22, 42, 43 and 64, of the 7 reported RXLEV values checked, the difference between the minimum reported RXLEV value and the maximum reported RXLEV value shall be no more than 4 if the measurements are on the same or on different RF channel within the same frequency band and no more than 8 (12 for extreme temperature conditions) if the measurements are on different frequency bands.
- b) For each of the steps 63 and 85, of the 7 reported RXLEV values checked, the difference between the minimum reported RXLEV value and the maximum reported RXLEV value shall be no more than 5 for small MS, DCS 1 800 and PCS 1 900 (Class 1 and 2) MS or 4 for other MS if the measurements are on the same or on different RF channel within the same frequency band and no more than 9 for small MS, DCS 1 800 and PCS 1 900 (Class 1 and 2) MS or 8 for other MS and other PCS 1 900 MS (13 and 12 for extreme temperature conditions) if the measurements are on different frequency bands.
- c) For step 84, of the 7 reported RXLEV values checked, the difference between the minimum reported RXLEV value and the maximum reported RXLEV value shall be no more than 5 if the measurements are on the same or on different RF channel within the same frequency band and no more than 9 (13 for extreme temperature conditions) if the measurements are on different frequency bands.
- d) For step 105, of the reported RXLEV values checked, the difference between the minimum reported RXLEV value and the maximum reported RXLEV value shall be no more than 6 if the measurements are on the same or on different RF channel within the same frequency band and no more than 10 (14 for extreme temperature conditions) if the measurements are on different frequency bands.

NOTE: It is not mandatory for the MS to report any of the BCCHs in step 105.

21.1.5.2 Relative accuracy at a single frequency (BCCH1)

For normal and each of the 4 extreme conditions tested the following applies:

For: $n \leq 21$ and $RXLEV_1 = 63$

$RXLEV_n - (63 - n + r)$ shall be between:

-2 and +2

NOTE 1: This formula allows for an MS with an absolute accuracy worse than +0,5 dB and therefore reporting an RXLEV of 63 for more than one step. The formula checks the relative accuracy from the lowest input level for which the MS last reports RXLEV of 63.

Otherwise:

$RXLEV_{(m*21+1)} - RXLEV_{(m*21+n)} - n + 1$ shall be between:

-2 and +2

for steps 2 to 62 and 65 to 71 for DCS 1 800 class 1/2 MS; or steps 2 to 62 and 65 to 73 for DCS 1 800 class 3, PCS 1 900 (Class 1&2) and Small GSM MS; or 2 to 75 for other MS and other PCS 1 900 MS.

-3 and +2

for steps 63 and 72 to 96 for DCS 1 800 class 1/2 MS; or steps 63 and 74 to 98 for DCS 1 800 class 3, PCS 1 900 (Class 1 and 2) and Small GSM MS; or

76 to 100 for other MS and other PCS 1 900 MS.

-4 and +2

for steps 97 to 105 for DCS 1 800 class 1/2 MS; or steps 99 to 105 for DCS 1 800 class 3, PCS 1 900 (Class 1 and 2) and Small GSM MS; or 101 to 105 for other MS and other PCS 1 900 MS.

where: $1 < n \leq 21$ and $0 \leq m \leq 4$ as identified in table 21-2, and r is the number of the last step where RXLEV of 63 was reported.

NOTE 2: It is not mandatory for the MS to report BCCH1 for steps greater than 99 for GSM 400, GSM 700, GSM 850, T_GSM 810 or GSM 900 Small MS or 101 for other GSM and other PCS 1 900 MS or 97 for a DCS 1 800 Class 1 or Class 2 MS and 99 for DCS 1 800 Class 3 and PCS 1 900 (Class 1 and 2) MS. If the MS reports a level and the upper limit for this step in the above formula implies a level below the reference sensitivity level for the type of MS, then the upper limit shall be considered as equal to a value corresponding to the reference sensitivity level.

21.1.5.3 Absolute accuracy

For each BCCH reported, $|RXLEV_{MS} + m \times 10 - 62|$ shall be no more than:

- 4 for steps 64 and 85 under normal conditions.
- 6 for steps 64 and 85 under extreme conditions.
- 6 for steps 1, 22 and 43 under normal and extreme conditions.

where: $0 \leq m \leq 4$ as identified in table 21-2.

21.2 Signal strength selectivity

21.2.1 Definition

The signal strength selectivity is a measure of the ability of the signal strength measuring part of the MS to discriminate against RF power from adjacent ARFCN. The RXLEV selectivity figure corresponds to the amount by which the adjacent channel power shall be attenuated.

21.2.2 Conformance requirement

The selectivity of the received signal measurement shall be as follows:

- for adjacent (200 kHz) channel; ≥ 16 dB;
- for adjacent (400 kHz) channel; ≥ 48 dB;
- for adjacent (600 kHz) channel; ≥ 56 dB.

3GPP TS 05.08, subclause 8.1.2.

21.2.3 Test purpose

To verify that the MS meets the conformance requirement at the 200 kHz adjacent channel above and below the wanted.

21.2.4 Method of test

21.2.4.1 Initial conditions

For GSM 450:

A call is set up according to the generic call set up procedure on ARFCN 269 and with surrounding cell BCCH3 indicated in the BA list at ARFCN 281.

The RF level of the TCH and BCCH3 is set to 20 dB above reference sensitivity level().

BCCH1 and 2 at ARFCN 270 and 280 are off.

These conditions are kept for 30 s to ensure the MS has time to decode the BCCH.

For GSM 480:

A call is set up according to the generic call set up procedure on ARFCN 316 and with surrounding cell BCCH3 indicated in the BA list at ARFCN 328.

The RF level of the TCH and BCCH3 is set to 20 dB above reference sensitivity level().

BCCH1 and 2 at ARFCN 317 and 327 are off.

These conditions are kept for 30 s to ensure the MS has time to decode the BCCH.

For GSM 710, GSM 750, T-GSM 810:

A call is set up according to the generic call set up procedure on ARFCN 450 and with surrounding cell BCCH3 indicated in the BA list at ARFCN 485.

The RF level of the TCH and BCCH3 is set to 20 dB above reference sensitivity level().

BCCH1 and 2 at ARFCN 451 and 484 are off.

These conditions are kept for 30 s to ensure the MS has time to decode the BCCH.

For GSM 850:

A call is set up according to the generic call set up procedure on ARFCN 170 and with surrounding cell BCCH3 indicated in the BA list at ARFCN 210.

The RF level of the TCH and BCCH3 is set to 20 dB above reference sensitivity level().

BCCH1 and 2 at ARFCN 171 and 209 are off.

These conditions are kept for 30 s to ensure the MS has time to decode the BCCH.

For GSM 900:

A call is set up according to the generic call set up procedure on ARFCN 40 and with surrounding cell BCCH3 indicated in the BA list at ARFCN 80.

The RF level of the TCH and BCCH3 is set to 20 dB above reference sensitivity level().

BCCH1 and 2 at ARFCN 41 and 79 are off.

These conditions are kept for 30 s to ensure the MS has time to decode the BCCH.

For DCS 1 800 and PCS 1 900:

A call is set up according to the generic call set up procedure on ARFCN 690 and with surrounding cell BCCH3 indicated in the BA list at ARFCN 790.

The RF level of the TCH and BCCH3 is set to 20 dB above reference sensitivity level().

BCCH1 and 2 at ARFCN 691 and 789 are off.

These conditions are kept for 30 s to ensure the MS has time to decode the BCCH.

21.2.4.2 Procedure

- a) The SS records the RXLEV values reported for the TCH and BCCH3.
- b) BCCH1 and 2 are set to 9 dB above the signal level of the TCH and BCCH3.

NOTE: The first adjacent channel interference requirement limits the level of BCCHs 1 and 2 to 9 dB. This ensures that the MS can maintain the call, and read BCCH3.

- c) These conditions are kept for 30 s.
- d) The SS records the RXLEV values reported for the TCH and BCCH3.

21.2.5 Test requirements

The values of RXLEV recorded in step d) shall be no more than 1 above the values recorded in step a).

NOTE: This one change in the reported value of RXLEV is calculated as follows: The level of the first adjacent interfering signal is such that C/I is -9 dB. With an RXLEV selectivity for the first adjacent channel of 16 dB, the power from the adjacent channel is equal to -7 dB with respect to the power level of the useful signal. The increase in power therefore is equal to $10\log(1 + 10^{-0.7}) = 0,71$ dB. Thus, the value of RXLEV could increase by 1.

21.3 Signal quality under static conditions

In order to have a testing performance corresponding to that in clause 14 for high error rates, the multiplication factor of the tested error rate with respect to the specified error rate have been increased. The following figures have been used (static propagation conditions):

Specified error rate	Multiplication factor	min. Max-events
≤ 25 %	1,22	200
30 - 40 %	1,15	300
> 40 %	1,1	400

21.3.1 Signal quality under static conditions - TCH/FS no DTX

21.3.1.1 Definition

The MS must be capable of measuring the received signal quality, which is specified in terms of bit error ratio (BER) before channel decoding averaged over the reporting period of length of one SACCH multiframe defined in subclause 8.4 of 3GPP TS 05.08. The MS has to map this BER into RXQUAL values using the coding scheme defined in subclause 8.2.4 of 3GPP TS 05.08. The error assessment is based on 104 TDMA frames: RXQUAL_FULLL.

21.3.1.2 Conformance requirement

1. The received signal quality shall be measured by the MS in a manner that can be related to an equivalent average BER before channel decoding (i.e. chip error ratio), assessed over the reporting period of one SACCH multiframe. When the quality is assessed over the full-set of frames, eight levels of RXQUAL are defined and shall be mapped to the equivalent BER before channel decoding as per the table in 3GPP TS 05.08, subclauses 8.2.2 and 8.2.4.
2. The reported parameters (RXQUAL) shall be the received signal quality, averaged over the reporting period of length one SACCH multiframe; 3GPP TS 05.08, subclause 8.2.3.

21.3.1.3 Test purpose

1. To verify, under static propagation conditions, that the received signal quality is measured and mapped to the eight levels of RXQUAL_FULLL by the MS in a manner that can be related to an equivalent average BER before channel decoding (i.e. chip error ratio), assessed over the reporting period of one SACCH multiframe. The probability that the correct RXQUAL band is reported shall meet the values given in as per the table in 3GPP TS 05.08, subclause 8.2.4.
2. To verify that the reported parameters (RXQUAL) are the received signal quality, averaged over the reporting period of length one SACCH multiframe.

21.3.1.4 Method of test

21.3.1.4.1 Initial conditions

A call is set up by the SS according to the generic call set up procedure on a full rate speech channel in the mid ARFCN range. The RADIO_LINK_TIMEOUT parameter value is set to maximum.

Specific PICS Statements:

-

PIXIT Statements:

- Loop C delay Full rate

The SS commands the MS to establish the TCH burst-by-burst loop (C), see subclause 36.

The SS produces a wanted signal and an independent uncorrelated interfering (unwanted) signal, both with static propagation characteristics. The wanted signal is the standard test signal C1. It is at the nominal frequency of the receiver and its level is 28 dBμVemf(-85 dBm). The unwanted signal is the standard test signal I1, on the same timeslot on a nominal frequency 200 kHz above the nominal frequency of the wanted signal.

21.3.1.4.2 Procedure

- a) The SS sets the level of the unwanted signal at a value for which the BER of the looped back bursts, averaged over the reporting period as defined in 3GPP TS 05.08, subclause 8.4 is covered by one of the cases 1 to 13 of table 21.3.1.5.
- b) The SS verifies that the MS reports RXQUAL and whether or not the reported level is correct by comparison with the RXQUAL level of the corresponding looped back bursts. The SS increases a sample counter(i), and then an event counter(i) for each incorrect MS reported RXQUAL level, where i corresponds to the case determined by the BER of the looped back bursts (table 21.3.1.5). The SS shall take 10 samples.
- c) If the previous RXQUAL_n ≥ 6 the SS shall set the unwanted signal to a level that ensures SACCH bursts will be successfully received by the MS. The SS shall wait 7 SACCH multiframe periods. The SS shall reapply the unwanted signal, then wait 1 SACCH multiframe period ^{*2}
- d) The SS shall increase the level of the unwanted signal in small steps^{*1}, after each level change repeating steps (b) and (c) until case 14 is reached.
- e) The SS shall decrease the level of the unwanted signal in small steps^{*1}, after each level change repeating step (b) and (c) until case 0 is reached.
- f) Steps b) through e) should be repeated until the total number of samples, $\sum_{i=0..14}(\text{sample counter}(i))$ is a minimum of 3300 (minimum total events(200)/minimum test limit(0.061)).
- g) The SS removes the unwanted signal and releases the call.

^{*1} NOTE: It is intended that the small steps are ~0.2dB, however the accuracy and linearity of these steps is inconsequential to the outcome of the test. It is intended that the test will be performed over a range of C/I which are representative of the normal operational range of the MS.

^{*2} NOTE: This special case for poor RF conditions is intended to ensure that the RADIO_LINK_TIMEOUT does not expire. The values have been selected to guarantee a net SACCH/T FER less than 62% (effective limit before failure ~67%).

^{*3} NOTE: When testing RXQUAL_SUB, on a full rate speech channel, the MS has approximately twice as many bits as the SS to assess BER. The MS has both SID and SACCH bits, whereas the SS only has the looped back SID bits. Therefore it is only tested that the MS uses the correct frames for RXQUAL_SUB reporting by checking both RXQUAL_SUB and RXQUAL_FULL reports. No quantitative assessment is done.

Maximum Duration of Test

40 minutes.

21.3.1.5 Test requirements

The sets of test results for sample counter (i) and event counter (i) should be combined as follows.

$$\sum_{i=0..14} ((\text{event counter } i * 100) / \text{test limit } i)$$

$$\sum_{i=0..14} (\text{sample counter } i)$$

A result of <1 is a pass, ≥ 1 is a fail

Table 21.3.1.5: Test criteria and limits for RXQUAL_FULL errors for TCH/FS

Case (i)	BER estimated by MS/SS (all applicable bursts) (%)	Expected RXQUAL (RXQUAL_)	Test limit DTX Off (%)
0	<0.1	0	12.2
1	>=0.1, <0.26	0, 1	30.5
2	>=0.26, <0.3	1	30.5
3	>=0.3, <0.51	1, 2	30.5
4	>=0.51, <0.64	2	18.3
5	>=0.64, <1.0	2, 3	18.3
6	>=1.0, <1.3	3	12.2
7	>=1.3, <1.9	3, 4	12.2
8	>=1.9, <2.7	4	12.2
9	>=2.7, <3.8	4, 5	12.2
10	>=3.8, <5.4	5	6.1
11	>=5.4, <7.6	5, 6	6.1
12	>=7.6, <11.0	6	6.1
13	>=11.0, <15.0	6, 7	6.1
14	>=15.0	7	6.1

21.3.2 Signal quality under static conditions - TCH/HS

21.3.2.1 Definition

The MS shall be capable of measuring the received signal quality, which is specified in terms of bit error ratio (BER) before channel decoding averaged over the reporting period of length of one SACCH multiframe defined in subclause 8.4 of 3GPP TS 05.08. The MS shall map this BER into RXQUAL values using the coding scheme defined in subclause 8.2.4 of 3GPP TS 05.08. For the half rate channel without downlink DTX, the error assessment is based on 52 TDMA frames: RXQUAL_FULL. In case downlink DTX is used, the assessment is based on 12 TDMA frames: RXQUAL_SUB.

21.3.2.2 Conformance requirement

1. The received signal quality shall be measured by the MS in a manner that can be related to an equivalent average BER before channel decoding (i.e. chip error ratio), assessed over the reporting period of one SACCH multiframe. When the quality is assessed over the full-set and sub-set of frames, eight levels of RXQUAL are defined and shall be mapped to the equivalent BER before channel decoding as per the table in 3GPP TS 05.08, subclauses 8.2.2 and 8.2.4.
2. The reported parameters (RXQUAL) shall be the received signal quality, averaged over the reporting period of length one SACCH multiframe; 3GPP TS 05.08, subclause 8.2.3.

21.3.2.3 Test purpose

1. To verify, under static propagation conditions, that the received signal quality is measured and mapped to the eight levels of RXQUAL_FULL by the MS in a manner that can be related to an equivalent average BER before channel decoding (i.e. chip error ratio), assessed over the reporting period of one SACCH multiframe. The probability that the correct RXQUAL band is reported shall meet the values given as per the table in 3GPP TS 05.08, subclause 8.2.4.
2. To verify that the reported parameters (RXQUAL) are the received signal quality, averaged over the reporting period of length one SACCH multiframe.

21.3.2.4 Method of test

21.3.2.4.1 Initial conditions

A call is set up by the SS according to the generic call set up procedure on a half rate speech channel in the mid ARFCN range. The RADIO_LINK_TIMEOUT parameter value is set to maximum.

Specific PICS Statements:

-

PIXIT Statements:

- Loop C delay Half rate

The SS commands the MS to establish the TCH burst-by-burst loop (loop C), see subclause 36.

The SS produces a wanted signal and an independent uncorrelated interfering (unwanted) signal, both with static propagation characteristics. The wanted signal is the standard test signal C1. It is at the nominal frequency of the receiver and its level is 28 dB μ V_{emf} (-85 dBm). The unwanted signal is the standard test signal I1, on the same timeslot on a nominal frequency 200 kHz above the nominal frequency of the wanted signal.

The SS sets downlink DTX off.

21.3.2.4.2 Procedure

- a) The SS sets the level of the unwanted signal such that the BER of the looped back bursts, averaged over the reporting period as defined in 3GPP TS 05.08, subclause 8.4, is covered by one of the cases 1 to 13 of table 21.3.2.5.
- b) The SS verifies that the MS reports RXQUAL and whether or not the reported level is correct by comparison with the RXQUAL level of the corresponding looped back bursts. The SS increases a sample counter(i), and then an event counter(i) for each incorrect MS reported RXQUAL level, where i corresponds to the case determined by the BER of the looped back bursts (table 21.3.2.5). The SS shall take 10 samples.
- c) If the previous RXQUAL_n >= 6 the SS shall set the unwanted signal to a level that ensures SACCH bursts will be successfully received by the MS. The SS shall wait 7 SACCH multiframe periods. The SS shall reapply the unwanted signal, then wait 1 SACCH multiframe period *²
- d) The SS shall increase the level of the unwanted signal in small steps*¹, after each level change repeating step (b) until case 14 is reached.
- e) The SS shall decrease the level of the unwanted signal in small steps*¹, after each level change repeating step (b) until case 0 is reached.
- f) Steps d) and e) should be repeated until the total number of samples, $\sum_{i=0..14}(\text{sample counter}(i))$ is a minimum of 3300.
- g) The SS releases the call

*¹ NOTE: It is intended that the small steps are ~0.2dB, however the accuracy and linearity of these steps is inconsequential to the outcome of the test. It is intended that the test will be performed over a range of C/I which are representative of the normal operational range of the MS.

*² NOTE: This special case for poor RF conditions is intended to ensure that the RADIO_LINK_TIMEOUT does not expire. The values have been selected to guarantee a net SACCH/T FER less than 62% (effective limit before failure ~67%).

Maximum Duration of Test

40 minutes.

21.3.2.5 Test requirements

The sets of test results for sample counter (i) and event counter (i) should be combined as follows.

$$\sum_{i=0..14} ((\text{event counter } i * 100) / \text{test limit } i)$$

$$\sum_{i=0..14} (\text{sample counter } i)$$

A result of <1 is a pass, >=1 is a fail.

Table 21.3.2.5: Test criteria and limits for RXQUAL_FULL for TCH/AHS

Case (i)	BER estimated by MS/SS (all applicable bursts) (%)	Expected RXQUAL (RXQUAL_)	Test limit DTX Off (%)
0	<0.1	0	12.2
1	>=0.1, <0.26	0, 1	46
2	>=0.26, <0.3	1	46
3	>=0.3, <0.51	1, 2	46
4	>=0.51, <0.64	2	34.5
5	>=0.64, <1.0	2,3	34.5
6	>=1.0, <1.3	3	18.3
7	>=1.3, <1.9	3, 4	18.3
8	>=1.9, <2.7	4	18.3
9	>=2.7, <3.8	4, 5	18.3
10	>=3.8, <5.4	5	6.1
11	>=5.4, <7.6	5, 6	6.1
12	>=7.6, <11.0	6	6.1
13	>=11.0, <15.0	6, 7	6.1
14	>=15.0	7	6.1

21.3.3 Signal quality under static conditions - TCH/AFS – DTX off

21.3.3.1 Definition

The MS must be capable of measuring the received signal quality, which is specified in terms of bit error ratio (BER) before channel decoding averaged over the reporting period of length of one SACCH multiframe defined in subclause 8.4 of 3GPP TS 05.08. The MS has to map this BER into RXQUAL values using the coding scheme defined in subclause 8.2.4 of 3GPP TS 05.08. For the full rate channel without downlink DTX, the error assessment is based on 104 TDMA frames: RXQUAL_FULL.

21.3.3.2 Conformance requirement

1. The received signal quality shall be measured by the MS in a manner that can be related to an equivalent average BER before channel decoding (i.e. chip error ratio), assessed over the reporting period of one SACCH multiframe. When the quality is assessed over the full-set and sub-set of frames, eight levels of RXQUAL are defined and shall be mapped to the equivalent BER before channel decoding as per the table in 3GPP TS 05.08, subclauses 8.2.2 and 8.2.4.
2. The reported parameters (RXQUAL) shall be the received signal quality, averaged over the reporting period of length one SACCH multiframe; 3GPP TS 05.08, subclause 8.2.3.

21.3.3.3 Test purpose

1. To verify, under static propagation conditions, that the received signal quality is measured and mapped to the eight levels of RXQUAL_FULL by the MS in a manner that can be related to an equivalent average BER before channel decoding (i.e. chip error ratio), assessed over the reporting period of one SACCH multiframe. The probability that the correct RXQUAL band is reported shall meet the values given by the table in 3GPP TS 05.08, subclause 8.2.4.
2. To verify that the reported parameters (RXQUAL) are the received signal quality, averaged over the reporting period of length one SACCH multiframe.

21.3.3.4 Method of test

21.3.3.4.1 Initial conditions

A call is set up according to the generic call set up procedure on a TCH/AFS with an ARFCN in the Mid ARFCN range, power control level set to maximum power. The RADIO_LINK_TIMEOUT parameter value is set to maximum.

Specific PICS Statements:

-

PIXIT Statements:

- Loop C delay Full rate

The multirate configuration indicates the use of the following set of codecs modes:

Codec Mode	TCH/AFS in kbit/s
CODEC_MODE_4	12,2
CODEC_MODE_3	7,95
CODEC_MODE_2	5,9
CODEC_MODE_1	4,75

The Initial Codec Mode shall be set to the lowest codec mode (CODEC_MODE_1).

The SS sends a CMC and CMI corresponding to the lowest codec mode (CODEC_MODE_1).

The SS produces a wanted signal and an independent uncorrelated interfering (unwanted) signal, both with static propagation characteristics. The SS transmits the wanted signal (Standard Test Signal C1) on the traffic channel at the nominal frequency of the receiver and its level is nominally 28 dB μ Vemf (-85 dBm). The unwanted signal is the standard test signal I1, on the same timeslot on a nominal frequency 200 kHz above the nominal frequency of the wanted signal.

The SS commands the MS to establish the TCH burst-by-burst loop, see subclause 36.

21.3.3.4.2 Procedure

- a) The SS sets the level of the unwanted signal such that the BER of the looped back bursts, averaged over the reporting period as defined in 3GPP TS 05.08, subclause 8.4, is covered by one of the cases 1 to 13 of table 21.3.3.5.
- b) The SS verifies that the MS reports RXQUAL and whether or not the reported level is correct by comparison with the RXQUAL level of the corresponding looped back bursts. The SS increases a sample counter(i), and then an event counter(i) for each incorrect MS reported RXQUAL level, where i corresponds to the case determined by the BER of the looped back bursts (table 21.3.3.5). The SS shall take 10 samples.
- c) When $\sum_{i=0..14}(\text{sample counter}(i)) = 800$ the CMI shall be changed to indicate CODEC_MODE_2, at 1600 CMI = CODEC_MODE_3, and at 2400 CMI = CODEC_MODE_4.
- d) If the previous $\text{RXQUAL}_n \geq 6$ the SS shall set the unwanted signal to a level that ensures SACCH bursts will be successfully received by the MS. The SS shall wait 7 SACCH multiframe periods. The SS shall reapply the unwanted signal, then wait 1 SACCH multiframe period *²
- e) The SS shall increase the level of the unwanted signal in small steps*¹, after each level change repeating steps (b) and (c) until case 14 is reached.
- f) The SS shall decrease the level of the unwanted signal in small steps*¹, after each level change repeating step (b) and (c) until case 0 is reached.
- g) Steps d) and e) should be repeated until the total number of samples, $\sum_{i=0..14}(\text{sample counter}(i))$ is a minimum of 3300.
- h) The SS releases the call

*¹ NOTE: It is intended that the small steps are ~0.2dB, however the accuracy and linearity of these steps is inconsequential to the outcome of the test. It is intended that the test will be performed over a range of C/I which are representative of the normal operational range of the MS.

*² NOTE: This special case for poor RF conditions is intended to ensure that the RADIO_LINK_TIMEOUT does not expire. The values have been selected to guarantee a net SACCH/T FER less than 62% (effective limit before failure ~67%).

Maximum Duration of Test

40 minutes.

21.3.3.5 Test requirements

The sets of test results for sample counter (i) and event counter (i) should be combined as follows.

$$\sum_{i=0..14} ((\text{event counter } i * 100) / \text{test limit } i)$$

$$\sum_{i=0..14} (\text{sample counter } i)$$

A result of <1 is a pass, >=1 is a fail.

Table 21.3.3.5: Test criteria and limits for RXQUAL_FULL for TCH/AFS

Case (i)	BER estimated by MS/SS (all applicable bursts) (%)	Expected RXQUAL (RXQUAL_)	Test limit DTX Off (%)
0	<0.1	0	12.2
1	>=0.1, <0.26	0, 1	30.5
2	>=0.26, <0.3	1	30.5
3	>=0.3, <0.51	1, 2	30.5
4	>=0.51, <0.64	2	18.3
5	>=0.64, <1.0	2,3	18.3
6	>=1.0, <1.3	3	12.2
7	>=1.3, <1.9	3, 4	12.2
8	>=1.9, <2.7	4	12.2
9	>=2.7, <3.8	4, 5	12.2
10	>=3.8, <5.4	5	6.1
11	>=5.4, <7.6	5, 6	6.1
12	>=7.6, <11.0	6	6.1
13	>=11.0, <15.0	6, 7	6.1
14	>=15.0	7	6.1

21.3.4 Signal quality under static conditions - TCH/AHS - DTX Off

21.3.4.1 Definition

The MS shall be capable of measuring the received signal quality, which is specified in terms of bit error ratio (BER) before channel decoding averaged over the reporting period of length of one SACCH multiframe defined in subclause 8.4 of 3GPP TS 05.08. The MS shall map this BER into RXQUAL values using the coding scheme defined in subclause 8.2.4 of 3GPP TS 05.08. For the half rate channel without downlink DTX, the error assessment is based on 52 TDMA frames: RXQUAL_FULL.

21.3.4.2 Conformance requirement

1. The received signal quality shall be measured by the MS in a manner that can be related to an equivalent average BER before channel decoding (i.e. chip error ratio), assessed over the reporting period of one SACCH multiframe. When the quality is assessed over the full-set and sub-set of frames, eight levels of RXQUAL are defined and shall be mapped to the equivalent BER before channel decoding as per the table in 3GPP TS 05.08, subclauses 8.2.2 and 8.2.4.
2. The reported parameters (RXQUAL) shall be the received signal quality, averaged over the reporting period of length one SACCH multiframe; 3GPP TS 05.08, subclause 8.2.3.

21.3.4.3 Test purpose

1. To verify, under static propagation conditions, that the received signal quality is measured and mapped to the eight levels of RXQUAL_FULL by the MS in a manner that can be related to an equivalent average BER before channel decoding (i.e. chip error ratio), assessed over the reporting period of one SACCH multiframe. The probability that the correct RXQUAL band is reported shall meet the values given by the table in 3GPP TS 05.08, subclause 8.2.4.
2. To verify that the reported parameters (RXQUAL) are the received signal quality, averaged over the reporting period of length one SACCH multiframe.

21.3.4.4 Method of test

21.3.4.4.1 Initial conditions

A call is set up according to the generic call set up procedure on a TCH/AHS with an ARFCN in the Mid ARFCN range, power control level set to maximum power. The RADIO_LINK_TIMEOUT parameter value is set to maximum.

Specific PICS Statements:

-

PIXIT Statements:

- Loop C delay Half rate

The multirate configuration indicates the use of the following set of codecs modes:

Codec Mode	TCH/AHS in kbit/s
CODEC_MODE_3	7.95
CODEC_MODE_2	6.7
CODEC_MODE_1	4,75

The Initial Codec mode (ICM) shall be set to the lowest codec mode (CODEC_MODE_1).

The SS continuously sends a CMC corresponding to the lowest codec mode (CODEC_MODE_1).

The SS produces a wanted signal and an independent uncorrelated interfering (unwanted) signal, both with static propagation characteristics. The SS transmits the wanted signal (Standard Test Signal C1 on the traffic channel using the Initial Codec Mode (ICM) at the nominal frequency of the receiver and its level is 28 dB μ Vemf (-85 dBm). The unwanted signal is the standard test signal I1, on the same timeslot on a nominal frequency 200 kHz above the nominal frequency of the wanted signal.

The SS commands the MS to establish the TCH burst-by-burst loop, see subclause 36.

The SS sets downlink DTX off.

21.3.4.4.2 Procedure

- a) The SS sets the level of the unwanted signal such that the BER of the looped back bursts, averaged over the reporting period as defined in 3GPP TS 05.08, subclause 8.4, is covered by one of the cases 1 to 13 of table 21.3.4.5.
- b) The SS verifies that the MS reports RXQUAL and whether or not the reported level is correct by comparison with the RXQUAL level of the corresponding looped back bursts. The SS increases a sample counter(i), and then an event counter(i) for each incorrect MS reported RXQUAL level, where i corresponds to the case determined by the BER of the looped back bursts (table 21.3.4.5). The SS shall take 10 samples.
- c) When $\sum_{i=0..14}(\text{sample counter}(i)) = 1100$ the CMI shall be changed to indicate CODEC_MODE_2, at 2200 CMI = CODEC_MODE_3.
- d) If the previous $\text{RXQUAL}_n \geq 6$ the SS shall set the unwanted signal to a level that ensures SACCH bursts will be successfully received by the MS. The SS shall wait 7 SACCH multiframe periods. The SS shall reapply the unwanted signal, then wait 1 SACCH multiframe period *²
- e) The SS shall increase the level of the unwanted signal in small steps*¹, after each level change repeating steps (b) and (c) until case 14 is reached.
- f) The SS shall decrease the level of the unwanted signal in small steps*¹, after each level change repeating step (b) and (c) until case 0 is reached.
- g) Steps d) and e) should be repeated until the total number of samples, $\sum_{i=0..14}(\text{sample counter}(i))$ is a minimum of 3300.
- h) The SS releases the call

*¹ NOTE: It is intended that the small steps are ~0.2dB, however the accuracy and linearity of these steps is inconsequential to the outcome of the test. It is intended that the test will be performed over a range of C/I which are representative of the normal operational range of the MS.

*² NOTE: This special case for poor RF conditions is intended to ensure that the RADIO_LINK_TIMEOUT does not expire. The values have been selected to guarantee a net SACCH/T FER less than 62% (effective limit before failure ~67%).

Maximum Duration of Test

40 minutes.

21.3.4.5 Test requirements

The sets of test results for sample counter (i) and event counter (i) should be combined as follows.

$$\sum_{i=0..14} ((\text{event counter}_i * 100) / \text{test limit}_i)$$

$$\sum_{i=0..14} (\text{sample counter}_i)$$

A result of <1 is a pass, >=1 is a fail.

Table 21.3.4.5: Test criteria and limits for RXQUAL_FULL for TCH/AHS

Case (i)	BER estimated by MS/SS (all applicable bursts) (%)	Expected RXQUAL (RXQUAL_)	Test limit DTX Off (%)
0	<0.1	0	12.2
1	>=0.1, <0.26	0, 1	46
2	>=0.26, <0.3	1	46
3	>=0.3, <0.51	1, 2	46
4	>=0.51, <0.64	2	34.5
5	>=0.64, <1.0	2,3	34.5
6	>=1.0, <1.3	3	18.3
7	>=1.3, <1.9	3, 4	18.3
8	>=1.9, <2.7	4	18.3
9	>=2.7, <3.8	4, 5	18.3
10	>=3.8, <5.4	5	6.1
11	>=5.4, <7.6	5, 6	6.1
12	>=7.6, <11.0	6	6.1
13	>=11.0, <15.0	6, 7	6.1
14	>=15.0	7	6.1

21.3.5 Signal quality under static conditions - TCH/AFS – DTX on

21.3.5.1 Definition

The MS must be capable of measuring the received signal quality, which is specified in terms of bit error ratio (BER) before channel decoding averaged over the reporting period of length of one SACCH multiframe defined in subclause 8.4 of 3GPP TS 05.08. The MS has to map this BER into RXQUAL values using the coding scheme defined in subclause 8.2.4 of 3GPP TS 05.08. In case downlink DTX is used, the assessment is based on a subset of TDMA frames containing SID_UPDATE frames and SACCH frames: RXQUAL_SUB. On TCH/AFS and TCH/AHS, there is no fixed subset of TDMA frames that will always be transmitted during DTX, however a SID_UPDATE will be transmitted every 8 speech frames. A detection algorithm is required in the receiver which informs about whether a SID_UPDATE (see 3GPP TS 05.03 and 3GPP TS 06.93) frame was transmitted (and thus can be used for quality and signal level estimation) or not.

21.3.5.2 Conformance requirement

1. The received signal quality shall be measured by the MS in a manner that can be related to an equivalent average BER before channel decoding (i.e. chip error ratio), assessed over the reporting period of one SACCH multiframe. When the quality is assessed over the full-set and sub-set of frames, eight levels of RXQUAL are

defined and shall be mapped to the equivalent BER before channel decoding as per the table in 3GPP TS 05.08, subclauses 8.2.2 and 8.2.4.

2. The reported parameters (RXQUAL) shall be the received signal quality, averaged over the reporting period of length one SACCH multiframe; 3GPP TS 05.08, subclause 8.2.3.

21.3.5.3 Test purpose

1. To verify that, for downlink DTX, the reported parameter RXQUAL_SUB is the received signal quality, averaged over the correct frames (SID_UPDATE and SACCH), mapped by the MS to the eight levels RXQUAL scale in a manner that can be related to an equivalent average BER before channel decoding assessed over the reporting period of one SACCH multiframe. The probability that the correct RXQUAL band is reported shall meet the values given by the table in 3GPP TS 05.08, subclause 8.2.4.
2. To verify that the reported parameters (RXQUAL) are the received signal quality, averaged over the reporting period of length one SACCH multiframe.

21.3.5.4 Method of test

21.3.5.4.1 Initial conditions

A call is set up according to the generic call set up procedure on a TCH/AFS with an ARFCN in the Mid ARFCN range, power control level set to maximum power. The RADIO_LINK_TIMEOUT parameter value is set to maximum.

Specific PICS Statements:

-

PIXIT Statements:

- Loop C delay Full rate

The multirate configuration indicates the use of the following set of codecs modes:

Codec Mode	TCH/AFS in kbit/s
CODEC_MODE_4	12,2
CODEC_MODE_3	7,95
CODEC_MODE_2	5,9
CODEC_MODE_1	4,75

The Initial Codec Mode shall be arbitrarily set to one of the codec modes of the codec set. *³

The SS sends a CMC and CMI corresponding to the initial codec mode selection.

The SS produces a wanted signal and an independent uncorrelated interfering (unwanted) signal, both with static propagation characteristics. The SS transmits the wanted signal (Standard Test Signal C1) on the traffic channel at the nominal frequency of the receiver and its level is nominally 28 dB μ V_{emf} (-85 dBm). The unwanted signal is the standard test signal I1, on the same timeslot on a nominal frequency 200 kHz above the nominal frequency of the wanted signal.

The SS commands the MS to establish the TCH burst-by-burst loop, see subclause 36.

The SS sets downlink DTX on.

21.3.5.4.2 Procedure

- a) The SS sets the level of the unwanted signal such that the BER of the looped back bursts, averaged over the reporting period as defined in 3GPP TS 05.08, subclause 8.4, is covered by one of the cases 1 to 13 of table 21.3.5.5.
- b) The SS verifies that the MS reports RXQUAL and whether or not the reported level is correct by comparison with the RXQUAL level of the corresponding looped back bursts. The SS increases a sample counter(i), and then an event counter(i) for each incorrect MS reported RXQUAL level, where i corresponds to the case determined by the BER of the looped back bursts (table 21.3.5.5). The SS shall take 10 samples.

- c) If the previous $RXQUAL_n \geq 6$ the SS shall set the unwanted signal to a level that ensures SACCH bursts will be successfully received by the MS. The SS shall wait 7 SACCH multiframe periods. The SS shall reapply the unwanted signal, then wait 1 SACCH multiframe period ^{*2}
- d) The SS shall increase the level of the unwanted signal in small steps^{*1}, after each level change repeating step (b) and (c) until case 14 is reached.
- e) The SS shall decrease the level of the unwanted signal in small steps^{*1}, after each level change repeating step (b) and (c) until case 0 is reached.
- f) Steps c) and d) should be repeated until the total number of samples, $\sum_{i=0..14}(\text{sample counter}(i))$ is a minimum of 1100.
- g) The SS releases the call

^{*1} NOTE: It is intended that the small steps are ~0.2dB, however the accuracy and linearity of these steps is inconsequential to the outcome of the test. It is intended that the test will be performed over a range of C/I which are representative of the normal operational range of the MS.

^{*2} NOTE: This special case for poor RF conditions is intended to ensure that the RADIO_LINK_TIMEOUT does not expire. The values have been selected to guarantee a net SACCH/T FER less than 62% (effective limit before failure ~67%).

^{*3} NOTE: Using varying codec modes does not improve the test depth because the channel coding of the SID_UPDATE frames are identical for all codec modes. (TS 3GPP 45.003).

Maximum Duration of Test

15 minutes.

21.3.5.5 Test requirements

The sets of test results for sample counter (i) and event counter (i) should be combined as follows.

$$\sum_{i=0..14} ((\text{event counter}_i * 100) / \text{test limit}_i)$$

$$\sum_{i=0..14} (\text{sample counter}_i)$$

A result of <1 is a pass, >=1 is a fail.

Table 21.3.5.5: Test criteria and limits for RXQUAL_SUB for TCH/AFS

Case (i)	BER measured by SS (12 of 16 bursts) (%)	Assumed BER estimated by MS (16 of 16 bursts) (%)	Expected RXQUAL (RXQUAL_)	Test limit (%)
0	<0.05	<0.11	0,	40.25
1	>=0.05, <0.2	>=0.055, <0.256	0, 1	71.5
2	>=0.2, <0.4	>=0.164, <0.475	0, 1, 2	71.5
3	>=0.4, <0.5	>=0.329, <0.548	1, 2	71.5
4	>=0.5, <0.8	>=0.384, <0.914	1, 2, 3	71.5
5	>=0.8, <0.9	>=0.603, <1.096	2, 3	60.5
6	>=0.9, <1.5	>=0.713, <1.827	2, 3, 4	60.5
7	>=1.5, <1.8	>=1.151, <2.193	3, 4	60.5
8	>=1.8, <3.0	>=1.371, <3.746	3, 4, 5	60.5
9	>=3.0, <3.6	>=2.303, <4.477	4, 5	46
10	>=3.6, <6.0	>=2.741, <7.493	4, 5, 6	46
11	>=6.0, <7.3	>=4.550, <9.046	5, 6	34.5
12	>=7.3, <12.1	>=5.482, <15.077	5, 6, 7	34.5
13	>=12.1, <24.15	>=9.101, <30.154	6, 7	24.4
14	>=24.15	>=18.147	7	18.3

21.3.6 Signal quality under static conditions - TCH/AHS – DTX On

21.3.6.1 Definition

The MS must be capable of measuring the received signal quality, which is specified in terms of bit error ratio (BER) before channel decoding averaged over the reporting period of length of one SACCH multiframe defined in subclause 8.4 of 3GPP TS 05.08. The MS has to map this BER into RXQUAL values using the coding scheme defined in subclause 8.2.4 of 3GPP TS 05.08. In case downlink DTX is used, the assessment is based on a subset of TDMA frames containing SID_UPDATE frames and SACCH frames: RXQUAL_SUB. On TCH/AHS, there is no fixed subset of TDMA frames that will always be transmitted during DTX, however a SID_UPDATE will be transmitted every 8 speech frames. A detection algorithm is required in the receiver that informs about whether a SID_UPDATE (see 3GPP TS 05.03 and 3GPP TS 06.93) frame was transmitted (and thus can be used for quality and signal level estimation) or not.

21.3.6.2 Conformance requirement

1. The received signal quality shall be measured by the MS in a manner that can be related to an equivalent average BER before channel decoding (i.e. chip error ratio), assessed over the reporting period of one SACCH multiframe. When the quality is assessed over the full-set and sub-set of frames, eight levels of RXQUAL are defined and shall be mapped to the equivalent BER before channel decoding as per the table in 3GPP TS 05.08, subclauses 8.2.2 and 8.2.4.
2. The reported parameters (RXQUAL) shall be the received signal quality, averaged over the reporting period of length one SACCH multiframe; 3GPP TS 05.08, subclause 8.2.3.

21.3.6.3 Test purpose

1. To verify that, for downlink DTX, the reported parameter RXQUAL_SUB is the received signal quality, averaged over the correct frames (SID_UPDATE and SACCH), mapped by the MS to the eight levels RXQUAL scale in a manner that can be related to an equivalent average BER before channel decoding assessed over the reporting period of one SACCH multiframe. The probability that the correct RXQUAL band is reported shall meet the values given by the table in 3GPP TS 05.08, subclause 8.2.4.
2. To verify that the reported parameters (RXQUAL) are the received signal quality averaged over the reporting period of length one SACCH multiframe.

21.3.6.4 Method of test

21.3.6.4.1 Initial conditions

A call is set up according to the generic call set up procedure on a TCH/AHS with an ARFCN in the Mid ARFCN range, power control level set to maximum power. The RADIO_LINK_TIMEOUT parameter value is set to maximum.

Specific PICS Statements:

-

PIXIT Statements:

- Loop C delay Half rate

The multirate configuration indicates the use of the following set of codecs modes:

Codec Mode	TCH/AHS in kbit/s
CODEC_MODE_3	7.95
CODEC_MODE_2	6.7
CODEC_MODE_1	4,75

The Initial Codec Mode shall be arbitrarily set to one of the codec modes of the codec set. *³

The SS sends a CMC and CMI corresponding to the initial codec mode selection.

The SS produces a wanted signal and an independent uncorrelated interfering (unwanted) signal, both with static propagation characteristics. The SS transmits the wanted signal (Standard Test Signal C1) on the traffic channel at the nominal frequency of the receiver and its level is nominally 28 dBµVemf (-85 dBm). The unwanted signal is the

standard test signal I1, on the same timeslot on a nominal frequency 200 kHz above the nominal frequency of the wanted signal.

The SS commands the MS to establish the TCH burst-by-burst loop, see subclause 36.

The SS sets downlink DTX on.

21.3.6.4.2 Procedure

- a) The SS sets the level of the unwanted signal such that the BER of the looped back bursts, averaged over the reporting period as defined in 3GPP TS 05.08, subclause 8.4, is covered by one of the cases 1 to 13 of table 21.3.6.5.
- b) The SS verifies that the MS reports RXQUAL and whether or not the reported level is correct by comparison with the RXQUAL level of the corresponding looped back bursts. The SS increases a sample counter(i), and then an event counter(i) for each incorrect MS reported RXQUAL level, where i corresponds to the case determined by the BER of the looped back bursts (table 21.3.6.5). The SS shall take 10 samples.
- c) If the previous RXQUAL_n >= 6 the SS shall set the unwanted signal to a level that ensures SACCH bursts will be successfully received by the MS. The SS shall wait 7 SACCH multiframe periods. The SS shall reapply the unwanted signal, then wait 1 SACCH multiframe period ^{*2}
- d) The SS shall increase the level of the unwanted signal in small steps^{*1}, after each level change repeating step (b) and (c) until case 14 is reached.
- e) The SS shall decrease the level of the unwanted signal in small steps^{*1}, after each level change repeating step (b) and (c) until case 0 is reached.
- f) Steps c) and d) should be repeated until the total number of samples, $\sum_{i=0..14}(\text{sample counter}(i))$ is a minimum of 1200.
- g) The SS releases the call

^{*1} NOTE: It is intended that the small steps are ~0.2dB, however the accuracy and linearity of these steps is inconsequential to the outcome of the test. It is intended that the test will be performed over a range of C/I which are representative of the normal operational range of the MS.

^{*2} NOTE: This special case for poor RF conditions is intended to ensure that the RADIO_LINK_TIMEOUT does not expire. The values have been selected to guarantee a net SACCH/T FER less than 62% (effective limit before failure ~67%).

^{*3} NOTE: Using varying codec modes does not improve the test depth because the channel coding of the SID_UPDATE frames are identical for all codec modes. (TS 3GPP 45.003).

Maximum Duration of Test

17 minutes.

21.3.6.5 Test requirements

The sets of test results for sample counter (i) and event counter (i) should be combined as follows.

$$\sum_{i=0..14} ((\text{event counter } i * 100) / \text{test limit } i)$$

$$\sum_{i=0..14} (\text{sample counter } i)$$

A result of <1 is a pass, >=1 is a fail.

Table 21.3.6.5: Test criteria and limits for RXQUAL_SUB for TCH/AHS

Case (i)	BER measured by SS (12 of 16 bursts) (%)	Assumed BER estimated by MS (16 of 16 bursts) (%)	Expected RXQUAL (RXQUAL_)	Test limit (%)
0	<0.05	<0.11	0,	40.25
1	>=0.05, <0.2	>=0.055, <0.256	0, 1	71.5
2	>=0.2, <0.4	>=0.164, <0.475	0, 1, 2	71.5
3	>=0.4, <0.5	>=0.329, <0.548	1, 2	71.5
4	>=0.5, <0.8	>=0.384, <0.914	1, 2, 3	71.5
5	>=0.8, <0.9	>=0.603, <1.096	2, 3	60.5
6	>=0.9, <1.5	>=0.713, <1.827	2, 3, 4	60.5
7	>=1.5, <1.8	>=1.151, <2.193	3, 4	60.5
8	>=1.8, <3.0	>=1.371, <3.746	3, 4, 5	60.5
9	>=3.0, <3.6	>=2.303, <4.477	4, 5	46
10	>=3.6, <6.0	>=2.741, <7.493	4, 5, 6	46
11	>=6.0, <7.3	>=4.550, <9.046	5, 6	34.5
12	>=7.3, <12.1	>=5.482, <15.077	5, 6, 7	34.5
13	>=12.1, <24.15	>=9.101, <30.154	6, 7	24.4
14	>=24.15	>=18.147	7	18.3

21.4 Signal quality under TUhigh propagation conditions

In order to have a testing performance corresponding to that in clause 14 for high error rates, the multiplication factor of the tested error rate with respect to the specified error rate have been increased. The following figures have been used (TUHigh propagation conditions):

Specified error rate	Multiplication factor	min. Max-events
≤ 25 %	1,22	200
30 - 40 %	1,15	300
> 40 %	1,1	400

21.4.1 Signal quality under TUhigh propagation conditions - TCH/FS

21.4.1.1 Definition

The MS must be capable of measuring the received signal quality, which is specified in terms of bit error ratio (BER) before channel decoding averaged over the reporting period of length of one SACCH multiframe defined in subclause 8.4 of 3GPP TS 05.08. The MS has to map this BER into RXQUAL values using the coding scheme defined in subclause 8.2.4 of 3GPP TS 05.08. For the full rate channel without downlink DTX, the error assessment is based on 104 TDMA frames: RXQUAL_FULL.

21.4.1.2 Conformance requirement

1. The received signal quality shall be measured by the MS in a manner that can be related to an equivalent average BER before channel decoding (i.e. chip error ratio), assessed over the reporting period of 1 SACCH multiframe. The assessed equivalent BER before channel decoding shall be mapped to the eight levels of RXQUAL using the coding scheme defined in subclause 8.2.4 of 3GPP TS 05.08 subclauses 8.2.2 and 8.2.4.
2. The reported parameters (RXQUAL) shall be the received signal quality, averaged over the reporting period of length one SACCH multiframe.

3GPP TS 05.08, subclause 8.2.3.

21.4.1.3 Test purpose

1. To verify, under TUhigh conditions, that the received signal quality is measured and reported to the eight levels of RXQUAL_FULL by the MS in a manner that can be related to an equivalent average BER before channel decoding (i.e. chip error ratio), assessed over the reporting period of length one SACCH multiframe for the TCH/FS. The probability that the correct RXQUAL band is reported shall meet the values given as per the table in 3GPP TS 05.08 subclause 8.2.

2. To verify that the reported parameters (RXQUAL) is the received signal quality, averaged over the reporting period of length one SACCH multiframe.

21.4.1.4 Method of test

21.4.1.4.1 Initial conditions

The SS sets up a call according to the generic call set up procedure on a full rate speech channel in the mid ARFCN range. The RADIO_LINK_TIMEOUT parameter is set to maximum.

Specific PICS Statements:

-

PIXIT Statements:

- Loop C delay Full rate

The SS commands the MS to establish the TCH burst-by-burst loop (C), see subclause 36.

The SS produces the standard test signal C1, with TUhigh propagation profile. It shall be at the nominal frequency of the receiver at a level of 28 dB μ Vemf (-85 dBm).

The SS also generates an independent, uncorrelated interfering (unwanted) signal with TUhigh propagation profile. The unwanted signal is the standard test signal I1, on the same timeslot and same ARFCN of the wanted signal.

21.4.1.4.2 Procedure

- a) The SS sets the level of the unwanted signal such that the BER of the looped back bursts, averaged over the reporting period as defined in 3GPP TS 05.08, subclause 8.4, is covered by one of the cases 1 to 13 of table 21.4.1.5.
- b) The SS verifies that the MS reports RXQUAL and whether or not the reported level is correct by comparison with the RXQUAL level of the corresponding looped back bursts. The SS increases a sample counter(i), and then an event counter(i) for each incorrect MS reported RXQUAL level, where i corresponds to the case determined by the BER of the looped back bursts (table 21.4.1.5). The SS shall take 10 samples.
- c) If the previous RXQUAL_n \geq 6 the SS shall set the unwanted signal to a level that ensures SACCH bursts will be successfully received by the MS. The SS shall wait 7 SACCH multiframe periods. The SS shall reapply the unwanted signal, then wait 1 SACCH multiframe period ^{*2}
- d) The SS shall increase the level of the unwanted signal in small steps^{*1}, after each level change repeating steps (b) and (c) until case 14 is reached.
- e) The SS shall decrease the level of the unwanted signal in small steps^{*1}, after each level change repeating step (b) and (c) until case 0 is reached.
- f) Steps b) through e) should be repeated until the total number of samples, $\sum_{i=0..14}(\text{sample counter}(i))$ is a minimum of 1650 (minimum total events(200)/minimum test limit(0.122)).
- g) The SS removes the unwanted signal and releases the call.

^{*1} NOTE: It is intended that the small steps are ~0.2dB, however the accuracy and linearity of these steps is inconsequential to the outcome of the test. It is intended that the test will be performed over a range of C/I which are representative of the normal operational range of the MS.

^{*2} NOTE: This special case for poor RF conditions is intended to ensure that the RADIO_LINK_TIMEOUT does not expire. The values have been selected to guarantee a net SACCH/T FER less than 62% (effective limit before failure ~67%).

Maximum Duration of Test

14 minutes.

21.4.1.5 Test requirements

The sets of test results for sample counter (i) and event counter (i) should be combined as follows.

$$\sum_{i=0..14} ((\text{event counter}_i * 100) / \text{test limit}_i)$$

$$\sum_{i=0..14} (\text{sample counter}_i)$$

A result of <1 is a pass, >=1 is a fail.

Table 21.4.1.5: Test criteria and limits for RXQUAL FULL errors for TCH/FS

Case (i)	BER estimated by MS/SS (all applicable bursts) (%)	Expected RXQUAL (RXQUAL_)	Test limit
0	<0.1	0, 1	18.3
1	>=0.1, <0.26	0, 1, 2	18.3
2	>=0.26, <0.3	0, 1, 2	18.3
3	>=0.3, <0.51	0, 1, 2, 3	18.3
4	>=0.51, <0.64	1, 2, 3	18.3
5	>=0.64, <1.0	1, 2, 3, 4	30.5
6	>=1.0, <1.3	2, 3, 4	30.5
7	>=1.3, <1.9	2, 3, 4, 5	30.5
8	>=1.9, <2.7	3, 4, 5	30.5
9	>=2.7, <3.8	3, 4, 5, 6	30.5
10	>=3.8, <5.4	4, 5, 6	12.2
11	>=5.4, <7.6	4, 5, 6, 7	12.2
12	>=7.6, <11.0	5, 6, 7	12.2
13	>=11.0, <15.0	5, 6, 7	12.2
14	>=15.0	6, 7	12.2

21.4.2 Signal quality under TUhigh propagation conditions - TCH/AFS

21.4.2.1 Definition

The MS shall be capable of measuring the received signal quality, which is specified in terms of bit error ratio (BER) before channel decoding averaged over the reporting period of length of one SACCH multiframe defined in subclause 8.4 of 3GPP TS 05.08. The MS shall map this BER into RXQUAL values using the coding scheme defined in subclause 8.2.4 of 3GPP TS 05.08. For the full rate channel without downlink DTX, the error assessment is based on 104 TDMA frames: RXQUAL_FULL.

21.4.2.2 Conformance requirement

1. The received signal quality shall be measured by the MS in a manner that can be related to an equivalent average BER before channel decoding (i.e. chip error ratio), assessed over the reporting period of 1 SACCH multiframe. The assessed equivalent BER before channel decoding shall be mapped to the eight levels of RXQUAL using the coding scheme defined in subclause 8.2.4 of 3GPP TS 05.08 subclauses 8.2.2 and 8.2.4.
2. The reported parameters (RXQUAL) shall be the received signal quality, averaged over the reporting period of length one SACCH multiframe; 3GPP TS 05.08, subclause 8.2.3.

21.4.2.3 Test purpose

1. To verify, under TUhigh conditions, that the received signal quality is measured and reported to the eight levels of RXQUAL_FULL by the MS in a manner that can be related to an equivalent average BER before channel decoding (i.e. chip error ratio), assessed over the reporting period of length one SACCH multiframe for the TCH/AFS. The probability that the correct RXQUAL band is reported shall meet the values given by the table in 3GPP TS 05.08 subclause 8.2.
2. To verify that the reported parameters (RXQUAL) is the received signal quality, averaged over the reporting period of length one SACCH multiframe.

21.4.2.4 Method of test

21.4.2.4.1 Initial conditions

A call is set up according to the generic call set up procedure on a TCH/AFS with an ARFCN in the Mid ARFCN range, power control level set to maximum power. The RADIO_LINK_TIMEOUT parameter value is set to maximum.

Specific PICS Statements:

-

PIXIT Statements:

- Loop C delay Full rate

The multirate configuration indicates the use of the following set of codecs modes:

Codec Mode	TCH/AFS in kbit/s
CODEC_MODE_4	12,2
CODEC_MODE_3	7,95
CODEC_MODE_2	5,9
CODEC_MODE_1	4,75

The Initial Codec Mode shall be set to the lowest codec mode (CODEC_MODE_1).

The SS sends a CMC and CMI corresponding to the lowest codec mode (CODEC_MODE_1).

The SS produces a wanted signal and an independent uncorrelated interfering (unwanted) signal, both with TUhigh propagation characteristics. The SS transmits the wanted signal (Standard Test Signal C1) on the traffic channel, with TUhigh propagation profile, at the nominal frequency of the receiver at a level of 28 dB μ Vemf (-85 dBm). The unwanted signal is the standard test signal I1, on the same timeslot and on same ARFCN of the wanted signal.

The SS commands the MS to establish the TCH burst-by-burst loop (C), see subclause 36.

21.4.2.4.2 Procedure

- a) The SS sets the level of the unwanted signal such that the BER of the looped back bursts, averaged over the reporting period as defined in 3GPP TS 05.08, subclause 8.4, is covered by one of the cases 1 to 13 of table 21.4.2.5.
- b) The SS verifies that the MS reports RXQUAL and whether or not the reported level is correct by comparison with the RXQUAL level of the corresponding looped back bursts. The SS increases a sample counter(i), and then an event counter(i) for each incorrect MS reported RXQUAL level, where i corresponds to the case determined by the BER of the looped back bursts (table 21.4.2.5). The SS shall take 10 samples.
- c) When $\sum_{i=0..14}(\text{sample counter}(i)) = 400$ the CMI shall be changed to indicate CODEC_MODE_2, at 800 CMI = CODEC_MODE_3, and at 1200 CMI = CODEC_MODE_4.
- d) If the previous RXQUAL_n ≥ 6 the SS shall set the unwanted signal to a level that ensures SACCH bursts will be successfully received by the MS. The SS shall wait 7 SACCH multiframe periods. The SS shall reapply the unwanted signal, then wait 1 SACCH multiframe period *²
- e) The SS shall increase the level of the unwanted signal in small steps*¹, after each level change repeating steps (b) and (c) until case 14 is reached.
- f) The SS shall decrease the level of the unwanted signal in small steps*¹, after each level change repeating step (b) and (c) until case 0 is reached.
- g) Steps d) and e) should be repeated until the total number of samples, $\sum_{i=0..14}(\text{sample counter}(i))$ is a minimum of 1650.
- h) The SS releases the call.

*¹ NOTE: It is intended that the small steps are ~0.2dB, however the accuracy and linearity of these steps is inconsequential to the outcome of the test. It is intended that the test will be performed over a range of C/I which are representative of the normal operational range of the MS.

*² NOTE: This special case for poor RF conditions is intended to ensure that the RADIO_LINK_TIMEOUT does not expire. The values have been selected to guarantee a net SACCH/T FER less than 62% (effective limit before failure ~67%).

Maximum Duration of Test

14 minutes.

21.4.2.5 Test requirements

The sets of test results for sample counter (i) and event counter (i) should be combined as follows.

$$\sum_{i=0..14} ((\text{event counter } i * 100) / \text{test limit } i)$$

$$\sum_{i=0..14} (\text{sample counter } i)$$

A result of <1 is a pass, >=1 is a fail.

Table 21.4.2.5: Test criteria and limits for RXQUAL FULL errors for TCH/AFS

Case (i)	BER estimated by MS/SS (all applicable bursts) (%)	Expected RXQUAL (RXQUAL_)	Test limit
0	<0.1	0, 1	18.3
1	>=0.1, <0.26	0, 1, 2	18.3
2	>=0.26, <0.3	0, 1, 2	18.3
3	>=0.3, <0.51	0, 1, 2, 3	18.3
4	>=0.51, <0.64	1, 2, 3	18.3
5	>=0.64, <1.0	1, 2, 3, 4	30.5
6	>=1.0, <1.3	2, 3, 4	30.5
7	>=1.3, <1.9	2, 3, 4, 5	30.5
8	>=1.9, <2.7	3, 4, 5	30.5
9	>=2.7, <3.8	3, 4, 5, 6	30.5
10	>=3.8, <5.4	4, 5, 6	12.2
11	>=5.4, <7.6	4, 5, 6, 7	12.2
12	>=7.6, <11.0	5, 6, 7	12.2
13	>=11.0, <15.0	5, 6, 7	12.2
14	>=15.0	6, 7	12.2

21.4.3 Signal quality under TUhigh propagation conditions - TCH/AHS

21.4.3.1 Definition

The MS shall be capable of measuring the received signal quality, which is specified in terms of bit error ratio (BER) before channel decoding averaged over the reporting period of length of one SACCH multiframe defined in subclause 8.4 of 3GPP TS 05.08. The MS shall map this BER into RXQUAL values using the coding scheme defined in subclause 8.2.4 of 3GPP TS 05.08. For the half rate channel without downlink DTX, the error assessment is based on 52 TDMA frames: RXQUAL_FULL.

21.4.3.2 Conformance requirement

1. The received signal quality shall be measured by the MS in a manner that can be related to an equivalent average BER before channel decoding (i.e. chip error ratio), assessed over the reporting period of 1 SACCH multiframe. The assessed equivalent BER before channel decoding shall be mapped to the eight levels of RXQUAL using the coding scheme defined in subclause 8.2.4 of 3GPP TS 05.08 subclauses 8.2.2 and 8.2.4.
2. The reported parameters (RXQUAL) shall be the received signal quality, averaged over the reporting period of length one SACCH multiframe; 3GPP TS 05.08, subclause 8.2.3.

21.4.3.3 Test purpose

1. To verify, under TUhigh conditions, that the received signal quality is measured and reported to the eight levels of RXQUAL_FULL by the MS in a manner that can be related to an equivalent average BER before channel decoding (i.e. chip error ratio), assessed over the reporting period of length one SACCH multiframe for the TCH/AHS. The probability that the correct RXQUAL band is reported shall meet the values given by the table in 3GPP TS 05.08 subclause 8.2.

2. To verify that the reported parameters (RXQUAL) is the received signal quality, averaged over the reporting period of length one SACCH multiframe.

21.4.3.4 Method of test

21.4.3.4.1 Initial conditions

A call is set up according to the generic call set up procedure on a TCH/AHS with in the Mid ARFCN range, power control level set to maximum power. The RADIO_LINK_TIMEOUT parameter value is set to maximum.

Specific PICS Statements:

-

PIXIT Statements:

- Loop C delay Half rate

The multirate configuration indicates the use of the following set of codecs modes:

Codec Mode	TCH/AHS in kbit/s
CODEC_MODE_3	7.95
CODEC_MODE_2	6.7
CODEC_MODE_1	4,75

The Initial Codec mode (ICM) shall be set to the lowest codec mode (CODEC_MODE_1).

The SS sends a CMC and CMI corresponding to the lowest codec mode (CODEC_MODE_1).

The SS produces a wanted signal and an independent uncorrelated interfering (unwanted) signal, both with TUhigh propagation characteristics. The SS transmits the wanted signal (Standard Test Signal C1) on the traffic channel, with TUhigh propagation profile, at the nominal frequency of the receiver at a level of 28 dBμVemf (-85 dBm). The unwanted signal is the standard test signal I1, on the same timeslot and on same ARFCN of the wanted signal.

The SS commands the MS to establish the TCH burst-by-burst loop, see subclause 36.

21.4.3.4.2 Procedure

- a) The SS sets the level of the unwanted signal such that the BER of the looped back bursts, averaged over the reporting period as defined in 3GPP TS 05.08, subclause 8.4, is covered by one of the cases 1 to 13 of table 21.4.3.5.
- b) The SS verifies that the MS reports RXQUAL and whether or not the reported level is correct by comparison with the RXQUAL level of the corresponding looped back bursts. The SS increases a sample counter(i), and then an event counter(i) for each incorrect MS reported RXQUAL level, where (i) corresponds to the case determined by the BER of the looped back bursts (table 21.4.3.5). The SS shall take 10 samples.

When $\sum_{i=0..14}(\text{sample counter}(i)) = 550$ the CMI shall be changed to indicate CODEC_MODE_2, and at 1100 CMI = CODEC_MODE_3.

- c) If the previous $\text{RXQUAL}_n \geq 6$ the SS shall set the unwanted signal to a level that ensures SACCH bursts will be successfully received by the MS. The SS shall wait 7 SACCH multiframe periods. The SS shall reapply the unwanted signal, then wait 1 SACCH multiframe period *²
- d) The SS shall increase the level of the unwanted signal in small steps*¹, after each level change repeating steps (b) and (c) until case 14 is reached.
- e) The SS shall decrease the level of the unwanted signal in small steps*¹, after each level change repeating step (b) and (c) until case 0 is reached.
- f) Steps d) and e) should be repeated until the total number of samples, $\sum_{i=0..14}(\text{sample counter}(i))$ is a minimum of 1650.
- g) The SS releases the call.

*¹ NOTE: It is intended that the small steps are ~0.2dB, however the accuracy and linearity of these steps is inconsequential to the outcome of the test. It is intended that the test will be performed over a range of C/I which are representative of the normal operational range of the MS.

*² NOTE: This special case for poor RF conditions is intended to ensure that the RADIO_LINK_TIMEOUT does not expire. The values have been selected to guarantee a net SACCH/T FER less than 62% (effective limit before failure ~67%).

Maximum Duration of Test

14 minutes.

21.4.3.5 Test requirements

The sets of test results for sample counter (i) and event counter (i) should be combined as follows.

$$\sum_{i=0..14} ((\text{event counter } i * 100) / \text{test limit } i)$$

$$\sum_{i=0..14} (\text{sample counter } i)$$

A result of <1 is a pass, >=1 is a fail.

Table 21.4.3.5: Test criteria and limits for RXQUAL_FULL for TCH/AFS

Case (i)	BER estimated by MS/SS (all applicable bursts) (%)	Expected RXQUAL (RXQUAL_)	Test limit DTX Off (%)
0	<0.1	0, 1	18.3
1	>=0.1, <0.26	0, 1, 2	18.3
2	>=0.26, <0.3	0, 1, 2	18.3
3	>=0.3, <0.51	0, 1, 2, 3	18.3
4	>=0.51, <0.64	1, 2, 3	18.3
5	>=0.64, <1.0	1, 2, 3, 4	30.5
6	>=1.0, <1.3	2, 3, 4	30.5
7	>=1.3, <1.9	2, 3, 4, 5	30.5
8	>=1.9, <2.7	3, 4, 5	30.5
9	>=2.7, <3.8	3, 4, 5, 6	30.5
10	>=3.8, <5.4	4, 5, 6	12.2
11	>=5.4, <7.6	4, 5, 6, 7	12.2
12	>=7.6, <11.0	5, 6, 7	12.2
13	>=11.0, <15.0	5, 6, 7	12.2
14	>=15.0	6, 7	12.2

21.4.4 Signal quality under TU High propagation conditions - O-TCH/WFS

21.4.4.1 Definition

The MS shall be capable of measuring the received signal quality, which is specified in terms of bit error ratio (BER) before channel decoding averaged over the reporting period of length of one SACCH multiframe defined in subclause 8.4 of 3GPP TS 05.08. The MS shall map this BER into RXQUAL values using the coding scheme defined in subclause 8.2.4 of 3GPP TS 05.08. For the full rate channel without downlink DTX, the error assessment is based on 104 TDMA frames: RXQUAL_FULL.

21.4.4.2 Conformance requirement

1. The received signal quality shall be measured by the MS and BSS in a manner that can be related to an equivalent average BER before channel decoding (i.e. chip error ratio), assessed over the reporting period of 1 SACCH block; 3GPP TS 05.08 subclauses 8.2.2.

When the quality is assessed over the full-set and sub-set of frames defined in subclause 8.4, eight levels of RXQUAL are defined and shall be mapped to the equivalent BER before channel decoding as follows:

RXQUAL_0		BER < 0,2 %	Assumed value = 0,14 %
RXQUAL_1	0,2 %	< BER < 0,4 %	Assumed value = 0,28 %

RXQUAL_2	0,4 %	< BER	< 0,8 %	Assumed value = 0,57 %
RXQUAL_3	0,8 %	< BER	< 1,6 %	Assumed value = 1,13 %
RXQUAL_4	1,6 %	< BER	< 3,2 %	Assumed value = 2,26 %
RXQUAL_5	3,2 %	< BER	< 6,4 %	Assumed value = 4,53 %
RXQUAL_6	6,4 %	< BER	< 12,8 %	Assumed value = 9,05 %
RXQUAL_7	12,8 %	< BER		Assumed value = 18,10 %

3GPP 05.08, subclause 8.2.4

- For each channel, the measured parameters (RXQUAL) shall be the received signal quality, averaged on that channel over the reporting period of length one SACCH multiframe defined in subclause 8.4. In averaging, measurements made during previous reporting periods shall always be discarded; 3GPP TS 05.08, subclause 8.2.3.

21.4.4.3 Test purpose

- To verify, under TUhigh conditions, that the received signal quality is measured and reported to the eight levels of RXQUAL_FULL by the MS in a manner that can be related to an equivalent average BER before channel decoding (i.e. chip error ratio), assessed over the reporting period of length one SACCH multiframe for the O-TCH/WFS. The probability that the correct RXQUAL band is reported shall meet the values given by the table in 3GPP TS 05.08 subclause 8.2.
- To verify that the reported parameters (RXQUAL) is the received signal quality, averaged over the reporting period of length one SACCH multiframe.

21.4.4.4 Method of test

21.4.4.4.1 Initial conditions

A call is set up according to the generic call set up procedure on a O-TCH/WFS with an ARFCN in the Mid ARFCN range, power control level set to maximum power. The RADIO_LINK_TIMEOUT parameter value is set to maximum.

Specific PICS Statements:

-

PIXIT Statements:

- Loop C delay Full rate

The multirate configuration indicates the use of the following set of codecs modes:

Codec Mode	O-TCH/WFS in kbit/s
CODEC_MODE_4	23,85
CODEC_MODE_3	12,65
CODEC_MODE_2	8,85
CODEC_MODE_1	6,60

The Initial Codec Mode shall be set to the lowest codec mode (CODEC_MODE_1).

The SS sends a CMC and CMI corresponding to the lowest codec mode (CODEC_MODE_1).

The SS produces a wanted signal and an independent uncorrelated interfering (unwanted) signal, both with TUhigh propagation characteristics. The SS transmits the wanted signal (Standard Test Signal C1) on the traffic channel, with TUhigh propagation profile, at the nominal frequency of the receiver at a level of 28 dB \square Vemf (-85 dBm). The unwanted signal is the standard test signal I1, on the same timeslot and on same ARFCN of the wanted signal.

The SS commands the MS to establish the TCH burst-by-burst loop (C), see subclause 36.

21.4.4.4.2 Procedure

- The SS sets the level of the unwanted signal such that the BER of the looped back bursts, averaged over the reporting period as defined in 3GPP TS 05.08, subclause 8.4, is covered by one of the cases 1 to 13 of table 21.4.4.5.

- b) The SS verifies that the MS reports RXQUAL and whether or not the reported level is correct by comparison with the RXQUAL level of the corresponding looped back bursts. The SS increases a sample counter(i), and then an event counter(i) for each incorrect MS reported RXQUAL level, where i corresponds to the case determined by the BER of the looped back bursts (table 21.4.4.5). The SS shall take 10 samples.
- c) When $\sum_{i=0..14}(\text{sample counter}(i)) = 400$ the CMI shall be changed to indicate CODEC_MODE_2, at 800 CMI = CODEC_MODE_3, and at 1200 CMI = CODEC_MODE_4.
- d) If the previous $\text{RXQUAL}_n \geq 6$ the SS shall set the unwanted signal to a level that ensures SACCH bursts will be successfully received by the MS. The SS shall wait 7 SACCH multiframe periods. The SS shall reapply the unwanted signal, then wait 1 SACCH multiframe period *²
- e) The SS shall increase the level of the unwanted signal in small steps*¹, after each level change repeating steps (b) and (c) until case 14 is reached.
- f) The SS shall decrease the level of the unwanted signal in small steps*¹, after each level change repeating step (b) and (c) until case 0 is reached.
- g) Steps d) and e) should be repeated until the total number of samples, $\sum_{i=0..14}(\text{sample counter}(i))$ is a minimum of 1650.
- h) The SS releases the call.

*¹ NOTE: It is intended that the small steps are ~0.2dB, however the accuracy and linearity of these steps is inconsequential to the outcome of the test. It is intended that the test will be performed over a range of C/I which are representative of the normal operational range of the MS.

*² NOTE: This special case for poor RF conditions is intended to ensure that the RADIO_LINK_TIMEOUT does not expire. The values have been selected to guarantee a net SACCH/T FER less than 62% (effective limit before failure ~67%).

Maximum Duration of Test

14 minutes.

21.4.4.5 Test requirements

The sets of test results for sample counter (i) and event counter (i) should be combined as follows.

$$\sum_{i=0..14} ((\text{event counter } i * 100) / \text{test limit } i)$$

$$\sum_{i=0..14} (\text{sample counter } i)$$

A result of <1 is a pass, >=1 is a fail.

Table 21.4.4.5: Test criteria and limits for RXQUAL FULL errors for O-TCH/WFS

Case (i)	BER estimated by MS/SS (all applicable bursts) (%)	Expected RXQUAL (RXQUAL_)	Test limit
0	<0.1	0, 1	18.3
1	>=0.1, <0.26	0, 1, 2	18.3
2	>=0.26, <0.3	0, 1, 2	18.3
3	>=0.3, <0.51	0, 1, 2, 3	18.3
4	>=0.51, <0.64	1, 2, 3	18.3
5	>=0.64, <1.0	1, 2, 3, 4	30.5
6	>=1.0, <1.3	2, 3, 4	30.5
7	>=1.3, <1.9	2, 3, 4, 5	30.5
8	>=1.9, <2.7	3, 4, 5	30.5
9	>=2.7, <3.8	3, 4, 5, 6	30.5
10	>=3.8, <5.4	4, 5, 6	12.2
11	>=5.4, <7.6	4, 5, 6, 7	12.2
12	>=7.6, <11.0	5, 6, 7	12.2
13	>=11.0, <15.0	5, 6, 7	12.2
14	>=15.0	6, 7	12.2

21.8 GMSK_MEAN_BEP Measurement for PDTCH

In order to have a testing performance corresponding to that in clause 14 for high error rates, the multiplication factor of the tested error rate with respect to the specified error rate have been increased. The following figures have been used (static propagation conditions):

Specified error rate	Multiplication factor	Min. error events
≤ 25 %	1,22	200
30 - 40 %	1,15	300
> 40 %	1,1	400

21.8.1 Definition

The MS must be capable of measuring the MEAN_BEP parameters under static channel conditions, which is specified in terms of bit error probability (BEP) before channel decoding averaged over the four bursts in a radio block and then filtered for the measurement report. The MS has to map this filtered BEP into MEAN_BEP values in the table "MEAN_BEP mapping and accuracy for GMSK" in subclause 8.2.5 of 3GPP TS 45.008. The accuracy requirements in this table apply for static channel conditions for sensitivity limited operation for signal levels above the reference sensitivity level for the type of MS.

21.8.2 Conformance requirement

The mapping of the MEAN_BEP to the equivalent BEP and the accuracies to which an MS shall be capable of estimating the quality parameters under static channel conditions are given for EGPRS GMSK in table 21.8-1. The accuracy requirements below apply for sensitivity limited operation for signal levels above the reference sensitivity level for the type of MS, assuming no changes in transmitted downlink power. For EGPRS, filtering according to 3GPP TS 45.008 subclause 10.2.3.2.1 with forgetting factor of 0.03 is assumed.

Table 21.8-1: MEAN_BEP mapping and accuracy for EGPRS GMSK

MEAN_BEP	Range of log ₁₀ (actual BEP)	Expected MEAN_BEP interval	Probability that the expected MEAN_BEP is reported shall not be lower than:
MEAN_BEP_0	> -0.60	MEAN_BEP_0/1	80 %
MEAN_BEP_1	-0.70 -- -0.60	MEAN_BEP_1/0/2	80 %
MEAN_BEP_2	-0.80 -- -0.70	MEAN_BEP_2/1/3	75 %
MEAN_BEP_3	-0.90 -- -0.80	MEAN_BEP_3/2/4	75 %
MEAN_BEP_4	-1.00 -- -0.90	MEAN_BEP_4/3/5	75 %
MEAN_BEP_5	-1.10 -- -1.00	MEAN_BEP_5/4/6	75 %
MEAN_BEP_6	-1.20 -- -1.10	MEAN_BEP_6/5/7	75 %
MEAN_BEP_7	-1.30 -- -1.20	MEAN_BEP_7/6/8	75 %
MEAN_BEP_8	-1.40 -- -1.30	MEAN_BEP_8/7/9	75 %
MEAN_BEP_9	-1.50 -- -1.40	MEAN_BEP_9/8/10	75 %
MEAN_BEP_10	-1.60 -- -1.50	MEAN_BEP_10/9/11	70 %
MEAN_BEP_11	-1.70 -- -1.60	MEAN_BEP_11/10/12	70 %
MEAN_BEP_12	-1.80 -- -1.70	MEAN_BEP_12/11/13	70 %
MEAN_BEP_13	-1.90 -- -1.80	MEAN_BEP_13/12/14	70 %
MEAN_BEP_14	-2.00 -- -1.90	MEAN_BEP_14/13/15	70 %
MEAN_BEP_15	-2.10 -- -2.00	MEAN_BEP_15/13/14/16/17	80 %
MEAN_BEP_16	-2.20 -- -2.10	MEAN_BEP_16/14/15/17/18	80 %
MEAN_BEP_17	-2.30 -- -2.20	MEAN_BEP_17/15/16/18/19	80 %
MEAN_BEP_18	-2.40 -- -2.30	MEAN_BEP_18/16/17/19/20	80 %
MEAN_BEP_19	-2.50 -- -2.40	MEAN_BEP_19/17/18/20/21	80 %
MEAN_BEP_20	-2.60 -- -2.50	MEAN_BEP_20/18/19/21/22	80 %
MEAN_BEP_21	-2.70 -- -2.60	MEAN_BEP_21/19/20/22/23	80 %
MEAN_BEP_22	-2.80 -- -2.70	MEAN_BEP_22/20/21/23/24	80 %
MEAN_BEP_23	-2.90 -- -2.80	MEAN_BEP_23/21/22/24/25	80 %
MEAN_BEP_24	-3.00 -- -2.90	MEAN_BEP_24/22/23/25/26	80 %
MEAN_BEP_25	-3.10 -- -3.00	MEAN_BEP_25/22/23/24/26/27/28	75 %
MEAN_BEP_26	-3.20 -- -3.10	MEAN_BEP_26/23/24/25/27/28/29	75 %
MEAN_BEP_27	-3.30 -- -3.20	MEAN_BEP_27/24/25/26/28/29/30	75 %
MEAN_BEP_28	-3.40 -- -3.30	MEAN_BEP_28/25/26/27/29/30/31	75 %
MEAN_BEP_29	-3.50 -- -3.40	MEAN_BEP_29/26/27/28/30/31	90 %
MEAN_BEP_30	-3.60 -- -3.50	MEAN_BEP_30/27/28/29/31	90 %
MEAN_BEP_31	< -3.60	MEAN_BEP_31/28/29/30	90 %

Reference: 3GPP TS 45.008 subclause 8.2.5.

21.8.3 Test purpose

To verify for EGPRS, under static channel conditions, that the BEP is measured and mapped to the MEAN_BEP values defined in subclause 8.2.5 of 3GPP TS 45.008 by the MS in a manner that can be related to an equivalent average BEP before channel decoding. The probability that the correct MEAN_BEP value is reported shall meet the values in the table “MEAN_BEP mapping and accuracy for GMSK” in subclause 8.2.5 of 3GPP TS 45.008.

21.8.4 Method of test

The SS compares the long-term BER average calculated by counting bit errors determined in EGPRS loop-back mode to a set of related MEAN_BEP values.

The MEAN_BEP values correspond to the same MS-received bits that are looped-back for calculation of the long-term BER average (one-phase approach). For acquiring these MEAN_BEP values, the SS periodically opens the test loop for a short period of time to poll the MS for a measurement report.

The testing of BEP accuracy is performed at 3 sample points inside the ranges given in table 21.8-2.

Table 21.8-2: MEAN_BEP GMSK test intervals

Interval	Range of log ₁₀ (actual BEP)	Range of actual BEP [%]	Range of expected MEAN_BEP
High	< -3.6	< 0.025	31
Mid	-2.7 ... -2.1	0.2 ... 0.79	16 ... 21
Low	-2.0 ... -1.5	1.0 ... 3.16	10 ... 14

NOTE 1: At the beginning of the test procedure, the forgetting factor “e” is set to 0.03. It is not changed any more since the SS does not know if signalling messages are correctly received unless the MS misses the commands to open or close the loop which the SS can easily detect and which requires a retransmission.

NOTE 2: The MS is polled only after 150 radio blocks since only then the BEP contribution of the command to close the loop (which is not looped back) has decayed.

NOTE 3: For acquisition of measurement reports, the test loop has to be opened for a short period of time. During that period, no data shall be received by the MS that is used for calculating MEAN_BEP estimates.

NOTE 4: The above range of expected MEAN_BEP for intervals Mid and Low have been defined in a way that the accuracy requirements are the same for a given range.

21.8.4.1 Initial conditions

The SS produces a wanted signal and a white noise signal as an interferer (random signal) known as unwanted signal, both with static propagation characteristics. The SS transmits the wanted signal (standard test signal C1) on the PDTCH channel using the MCS-4 at the nominal frequency of the receiver and with a level of –82 dBm. The unwanted signal is the standard test signal I3, on the same nominal frequency.

The MS is EGPRS capable and in the state "idle, GMM-registered" with a P-TMSI allocated.

21.8.4.2 Procedure

- a) The unwanted signal is switched off and the forgetting factor “e” is set to 0.03. The SS orders the MS into the EGPRS Switched Radio Block Loopback Mode as specified in 3GPP TS 44.014 Section 5.5.1. The SS commands the MS into Radio Block Loopback Sub-mode: OFF.
- b) The SS commands the MS into Radio Block Loopback Sub-mode: ON. The SS sends 150 radio blocks to the MS. After these 150 radio blocks the SS commands the MS into Radio Block Loopback Sub-mode: OFF and polls the MS to send a measurement report. The SS starts sending data blocks with TFI not assigned to the DUT until it has received the measurement report. The SS stores the MEAN_BEP value reported by the MS and calculates (updates) the average BER of all looped back bits received so far.
- c) The SS repeats the procedure described in step b) for a total of 1640 times.
- d) The SS counts the number of MEAN_BEP values outside the expected MEAN_BEP interval corresponding to MEAN_BEP_31 and stores the result in error counter N_high. The BER calculation is reset.
- e) The SS commands the MS into Radio Block Loopback Sub-mode: ON, switches the noise signal on and raises the level of the unwanted signal until the BER of the looped back data is between 0.25% and 0.63% (calculated based on at least 100 bit errors), corresponding to the inner limits of MEAN_BEP_21 and MEAN_BEP_16, respectively. During the measurements the level of the unwanted signal shall be kept constant.
- f) The SS repeats the procedure described in step b) for a total of 820 times.
- g) The SS determines the expected MEAN_BEP interval corresponding to the average BER of all looped back bits using table 21.8-1. The SS determines the number of MEAN_BEP values outside this interval and stores the result in error counter N_mid. The BER calculation is reset.
- h) The SS commands the MS into Radio Block Loopback Sub-mode: ON and raises the level of the unwanted signal until the BER of the looped back data is between 1.26% and 2.51% (calculated based on at least 100 bit errors), corresponding to the inner limits of MEAN_BEP_14 and MEAN_BEP_10, respectively. During the measurements the level of the unwanted signal shall be kept constant.

- i) The SS repeats the procedure described in step b) for a total of 870 times.
- j) The SS determines the expected MEAN_BEP interval corresponding to the average BER of all looped back bits using table 21.8-1. The SS determines the number of MEAN_BEP values outside this interval and stores the result in error counter N_low.

Expected maximum test time for statistical error limit tests: 3h 30 min.

21.8.5 Test requirements

Testing of the conformance requirement can be done either with fixed minimum number of samples or based on the statistical test method that could lead to an early pass/fail decision with test time significantly reduced for a MS not on the limit.

21.8.5.1 Fixed limit test with minimum number of samples

The fixed testing of the conformance requirement is done using the minimum number of samples and the limit error rate given in table 21.8-3.

The number of error events determined in steps d), g) and j) stored in error counters N_high, N_mid and N_low shall not exceed the error event limit defined in table 21.8-3 for each of the error counters.

Table 21.8-3: Test criteria and error limits for MEAN_BEP_GMSK

Range	Specified error limit	Tested error limit	Number of test samples	Error event limit
High	10 %	12.2 %	1640	200
Mid	20 %	24.4 %	820	200
Low	30 %	34.5 %	870	300

21.8.5.2 Statistical test with early pass / fail decision

Specific details on statistical testing of performance are defined in Annex 7.

The calculation of the error rate for this test shall be done according to the values specified in tables 21.8-4.

Table 21.8-4: Statistical error limits for MEAN_BEP_GMSK

Range	Block per s	Org. error rate requirement	Derived test limit	Target number of samples	Target test time /s Note1	Target test time /hh:mm:ss
High	50	0,122	0,150548	2292	6875	01:54:35
Mid	50	0,244	0,301096	1146	3437	00:57:17
Low	50	0,345	0,42573	810	2431	00:40:31

Note1: Test time is based on the calculation that only every 150th radio block is used for error calculation.

21.9 8PSK_MEAN_BEP Measurement for PDTCH

In order to have a testing performance corresponding to that in clause 14 for high error rates, the multiplication factor of the tested error rate with respect to the specified error rate have been increased. The following figures have been used (static propagation conditions):

Specified error rate	Multiplication factor	Min. error events
≤ 25 %	1,22	200
30 - 40 %	1,15	300
> 40 %	1,1	400

21.9.1 Definition

The MS must be capable of measuring the MEAN_BEP parameters under static channel conditions, which is specified in terms of bit error probability (BEP) before channel decoding averaged over the four bursts in a radio block and then

filtered for the measurement report. The MS has to map this filtered BEP into MEAN_BEP values in the table "MEAN_BEP mapping and accuracy for 8PSK" in subclause 8.2.5 of 3GPP TS 45.008. The accuracy requirements in this table apply for static channel conditions for sensitivity limited operation for signal levels above the reference sensitivity level for the type of MS.

21.9.2 Conformance requirement

The mapping of the MEAN_BEP to the equivalent BEP and the accuracies to which an MS shall be capable of estimating the quality parameters under static channel conditions are given for EGPRS 8PSK in table 21.9-1. The accuracy requirements below apply for sensitivity limited operation for signal levels above the reference sensitivity level for the type of MS, assuming no changes in transmitted downlink power. For EGPRS, filtering according to 3GPP TS 45.008 subclause 10.2.3.2.1 with forgetting factor of 0.03 is assumed.

Table 21.9-1: MEAN_BEP mapping and accuracy for EGPRS 8PSK

MEAN_BEP	Range of log ₁₀ (actual BEP)	Expected MEAN_BEP interval	Probability that the expected MEAN_BEP is reported shall not be lower than:
MEAN_BEP_0	> -0.60	MEAN_BEP_0/1/2	85 %
MEAN_BEP_1	-0.64 -- -0.60	MEAN_BEP_1/0/2/3	85 %
MEAN_BEP_2	-0.68 -- -0.64	MEAN_BEP_2/0/1/3/4	85 %
MEAN_BEP_3	-0.72 -- -0.68	MEAN_BEP_3/1/2/4/5	85 %
MEAN_BEP_4	-0.76 -- -0.72	MEAN_BEP_4/2/3/5/6	85 %
MEAN_BEP_5	-0.80 -- -0.76	MEAN_BEP_5/3/4/6/7	85 %
MEAN_BEP_6	-0.84 -- -0.80	MEAN_BEP_6/4/5/7/8	85 %
MEAN_BEP_7	-0.88 -- -0.84	MEAN_BEP_7/5/6/8/9	85 %
MEAN_BEP_8	-0.92 -- -0.88	MEAN_BEP_8/6/7/9/10	80 %
MEAN_BEP_9	-0.96 -- -0.92	MEAN_BEP_9/7/8/10/11	80 %
MEAN_BEP_10	-1.00 -- -0.96	MEAN_BEP_10/8/9/11/12	80 %
MEAN_BEP_11	-1.04 -- -1.00	MEAN_BEP_11/9/10/12/13	80 %
MEAN_BEP_12	-1.08 -- -1.04	MEAN_BEP_12/10/11/13/14	80 %
MEAN_BEP_13	-1.12 -- -1.08	MEAN_BEP_13/11/12/14/15	80 %
MEAN_BEP_14	-1.16 -- -1.12	MEAN_BEP_14/12/13/15/16	85 %
MEAN_BEP_15	-1.20 -- -1.16	MEAN_BEP_15/13/14/16	85 %
MEAN_BEP_16	-1.36 -- -1.20	MEAN_BEP_16/14/15/17	85 %
MEAN_BEP_17	-1.52 -- -1.36	MEAN_BEP_17/16/18	95 %
MEAN_BEP_18	-1.68 -- -1.52	MEAN_BEP_18/17/19	95 %
MEAN_BEP_19	-1.84 -- -1.68	MEAN_BEP_19/18/20	95 %
MEAN_BEP_20	-2.00 -- -1.84	MEAN_BEP_20/19/21	95 %
MEAN_BEP_21	-2.16 -- -2.00	MEAN_BEP_21/20/22	85 %
MEAN_BEP_22	-2.32 -- -2.16	MEAN_BEP_22/21/23	85 %
MEAN_BEP_23	-2.48 -- -2.32	MEAN_BEP_23/22/24	85 %
MEAN_BEP_24	-2.64 -- -2.48	MEAN_BEP_24/23/25	85 %
MEAN_BEP_25	-2.80 -- -2.64	MEAN_BEP_25/23/24/26/27	85 %
MEAN_BEP_26	-2.96 -- -2.80	MEAN_BEP_26/24/25/27/28	85 %
MEAN_BEP_27	-3.12 -- -2.96	MEAN_BEP_27/25/26/28/29	80 %
MEAN_BEP_28	-3.28 -- -3.12	MEAN_BEP_28/26/27/29/30	80 %
MEAN_BEP_29	-3.44 -- -3.28	MEAN_BEP_29/27/28/30/31	80 %
MEAN_BEP_30	-3.60 -- -3.44	MEAN_BEP_30/28/29/31	90 %
MEAN_BEP_31	< -3.60	MEAN_BEP_31/29/30	90 %

Reference: 3GPP TS 45.008 subclause 8.2.5.

21.9.3 Test purpose

To verify for EGPRS, under static channel conditions, that the BEP is measured and mapped to the MEAN_BEP values defined in subclause 8.2.5 of 3GPP TS 45.008 by the MS in a manner that can be related to an equivalent average BEP before channel decoding. The probability that the correct MEAN_BEP value is reported shall meet the values in the table "MEAN_BEP mapping and accuracy for 8PSK" in subclause 8.2.5 of 3GPP TS 45.008.

21.9.4 Method of test

The SS compares the long-term BER average calculated by counting bit errors determined in EGPRS loop-back mode to a set of related MEAN_BEP values.

The MEAN_BEP values correspond to the same MS-received bits that are looped-back for calculation of the long-term BER average (one-phase approach). For acquiring these MEAN_BEP values, the SS periodically opens the test loop for a short period of time to poll the MS for a measurement report.

The testing of BEP accuracy is performed at 3 sample points inside the ranges given in table 21.9-2.

Table 21.9-2: MEAN_BEP 8PSK test intervals

Interval	Range of log ₁₀ (actual BEP)	Range of actual BEP [%]	Range of expected MEAN_BEP
High	< -3.6	< 0.025	31
Mid	-2.0 ... -1.36	1.0 ... 4.37	17 ... 20
Low	-1.12 ... -0.88	7.59 ... 13.2	8 ... 13

NOTE 1: At the beginning of the test procedure, the forgetting factor “e” is set to 0.03. It is not changed any more since the SS does not know if signalling messages are correctly received unless the MS misses the commands to open or close the loop which the SS can easily detect and which requires a retransmission.

NOTE 2: The MS is polled only after 150 radio blocks since only then the BEP contribution of the command to close the loop (which is not looped back) has decayed.

NOTE 3: For acquisition of measurement reports, the test loop has to be opened for a short period of time. During that period, no data shall be received by the MS that is used for calculating MEAN_BEP estimates.

NOTE 4: The above range of expected MEAN_BEP for intervals Mid and Low have been defined in a way that the accuracy requirements are the same for a given range.

21.9.4.1 Initial conditions

The SS produces a wanted signal and a white noise signal as an interferer (random signal) known as unwanted signal, both with static propagation characteristics. The SS transmits the wanted signal (standard test signal C1) on the PDTCH channel using the MCS-9 at the nominal frequency of the receiver and with a level of –82 dBm. The unwanted signal is the standard test signal I3, on the same nominal frequency.

The MS is EGPRS capable and in the state "idle, GMM-registered" with a P-TMSI allocated.

21.9.4.2 Procedure

- a) The unwanted signal is switched off and the forgetting factor “e” is set to 0.03. The SS orders the MS into the EGPRS Switched Radio Block Loopback Mode as specified in 3GPP TS 44.014 Section 5.5.1. The SS commands the MS into Radio Block Loopback Sub-mode: OFF.
- b) The SS commands the MS into Radio Block Loopback Sub-mode: ON. The SS sends 150 radio blocks to the MS. After these 150 radio blocks the SS commands the MS into Radio Block Loopback Sub-mode: OFF and polls the MS to send a measurement report. The SS starts sending data blocks with TFI not assigned to the DUT until it has received the measurement report. The SS stores the MEAN_BEP value reported by the MS and calculates (updates) the average BER of all looped back bits received so far.
- c) The SS repeats the procedure described in step b) for a total of 1640 times.
- d) The SS counts the number of MEAN_BEP values outside the expected MEAN_BEP interval corresponding to MEAN_BEP_31 and stores the result in error counter N_high. The BER calculation is reset.
- e) The SS commands the MS into Radio Block Loopback Sub-mode: ON, switches the noise signal on and raises the level of the unwanted signal until the BER of the looped back data is between 1.4% and 3% (calculated based on at least 100 bit errors), corresponding to the inner limits of MEAN_BEP_20 and MEAN_BEP_17, respectively. During the measurements the level of the unwanted signal shall be kept constant.

- f) The SS repeats the procedure described in step b) for a total of 3279 times.
- g) The SS determines the expected MEAN_BEP interval corresponding to the average BER of all looped back bits using table 21.9-1. The SS determines the number of MEAN_BEP values outside this interval and stores the result in error counter N_{mid}. The BER calculation is reset.
- h) The SS commands the MS into Radio Block Loopback Sub-mode: ON and raises the level of the unwanted signal until the BER of the looped back data is between 8.3% and 12% (calculated based on at least 100 bit errors), corresponding to the inner limits of MEAN_BEP_13 and MEAN_BEP_8, respectively. During the measurements the level of the unwanted signal shall be kept constant.
- i) The SS repeats the procedure described in step b) for a total of 820 times.
- j) The SS determines the expected MEAN_BEP interval corresponding to the average BER of all looped back bits using table 21.9-1. The SS determines the number of MEAN_BEP values outside this interval and stores the result in error counter N_{low}.

Expected maximum test time for statistical error limit tests: 6h 40 min.

21.9.5 Test requirements

Testing of the conformance requirement can be done either with fixed minimum number of samples or based on the statistical test method that could lead to an early pass/fail decision with test time significantly reduced for a MS not on the limit.

21.9.5.1 Fixed limit test with minimum number of samples

The fixed testing of the conformance requirement is done using the minimum number of samples and the limit error rate given in table 21.9-3.

The number of error events determined in steps d), g) and j) stored in error counters N_{high}, N_{mid} and N_{low} shall not exceed 200 for each of the error counters.

Table 21.9-3: Test criteria and error limits for MEAN_BEP_8PSK

Range	Specified error limit	Tested error limit	Number of test samples	Error event limit
High	10 %	12.2 %	1640	200
Mid	5 %	6.1 %	3279	200
Low	20 %	24.4 %	820	200

21.9.5.2 Statistical test with early pass / fail decision

Specific details on statistical testing of performance are defined in Annex 7.

The calculation of the error rate for this test shall be done according to the values specified in tables 21.8-4.

Table 21.9-4: Statistical error limits for MEAN_BEP_8PSK

Range	Block per s	Org. error rate requirement	Derived test limit	Target number of samples	Target test time /s Note1	Target test time /hh:mm:ss
High	50	0,122	0,150548	2292	6875	01:54:35
Mid	50	0,061	0,075274	4583	13750	03:49:10
Low	50	0,244	0,301096	1146	3437	00:57:17

Note1: Test time is based on the calculation that only every 150th radio block is used for error calculation.

22 Transmit power control timing and confirmation

Unless otherwise specified all tests in clauses 22.1 to 22.10 are applicable for all MSs supporting the bands referred to in clause 1.

22.1 Transmit power control timing and confirmation, single slot

22.1.1 Definition

The RF power level to be employed by the MS is indicated by means of the 5 bit TXPWR field sent in the layer 1 header of each downlink SACCH message block and may be sent in a dedicated signalling block.

When a power change is signalled the MS must change its power control level to the new level at a certain rate of change.

The MS shall confirm the power level that it is currently employing by setting the MS_TXPWR_CONF field in the uplink SACCH L1 header.

22.1.2 Conformance requirement

1. The RF power control level to be employed by the MS is indicated by means of the power control information sent in the layer 1 header of each downlink SACCH message block and may be sent in a dedicated signalling block; 3GPP TS 05.08, subclause 4.2.
2. The MS shall confirm the power level that it is currently employing in the uplink SACCH L1 header. The indicated value shall be the power control level actually used by the MS for the last burst of the previous SACCH period; 3GPP TS 05.08, subclause 4.2.
3. Upon receipt of a command on the SACCH to change its RF power level, the MS shall change to the new level at a rate of one nominal 2 dB power control step every 60 ms; 3GPP TS 05.08, subclause 4.7.
4. The change (in conformance requirement 3) shall commence at the first TDMA frame belonging to the next reporting period; 3GPP TS 05.08, subclause 4.7.
5. In case of channel change the commanded power level shall be applied on the new channel immediately; 3GPP TS 05.08, subclause 4.7.

22.1.3 Test purpose

1. To verify that the MS will set its transmitter output power in accordance with conformance requirement 1.
2. To verify that the MS will confirm the power level it is currently employing according to conformance requirement 2.
3. To verify that the MS, upon receipt of a command from the SACCH to change its RF power level, will change according to conformance requirement 3.
4. To verify that the MS will commence the change of power level at least by the sixth TDMA frame belonging to the next reporting period.
5. To verify that in case of new channel assignment the commanded power level is applied on the new channel according to conformance requirement 5.

22.1.4 Method of test

NOTE: The method of measuring the MS transmitter output power is given in subclause 13.3.

22.1.4.1 Initial conditions

A call is set up by the SS according to the generic call set up procedure on a channel with ARFCN in the Mid ARFCN range (see table 3.3), power control level set to maximum power.

22.1.4.2 Procedure

- a) The SS signals minimum power control level to the MS in the SACCH.

- b) The SS measures the MS transmitter output power on TDMA frames 6, 19, 32 and every subsequent 13th TDMA frame to TDMA frame 214. The SS also monitors the MS_TXPWR_CONF field in the uplink SACCH L1 header for the four SACCH multiframes after the SS signals the power change.
- c) The SS now sets TXPWR in the SACCH to the maximum peak power appropriate to the class of the MS.
- d) The SS measures the MS transmitter output power on TDMA frames 6, 19, 32 and every subsequent 13th TDMA frame to TDMA frame 214. The SS also monitors the MS_TXPWR_CONF field in the uplink SACCH L1 header for the four SACCH multiframes after the SS signals the power change.
- e) The SS now sets the SACCH TXPWR to 8.
- f) After 3 s the SS sets the SACCH TXPWR to 9.
- g) The SS measures the MS transmitter output power on TDMA frame 6.
- h) The SS sets the SACCH TXPWR to 8.
- i) The SS measures the MS transmitter output power on TDMA frame 6.
- j) The channel assignment is changed and the demanded power within the channel assignment is set to the minimum power control level of the MS.
- k) When the MS has changed channel its output power is measured on the first burst on the new channel.

22.1.5 Test requirements

NOTE: Refer to tables 13-2, 13-3 and 13-4 for relationship between the power class, power control level, transmitter output power and the relevant tolerances.

- a) In steps b) and d), the transmitter output power shall change by one power step towards the new level signalled for each measured burst until the MS is operating at the closest supported power control level and from then on, all transmissions shall be at that level.
- b) In steps b) and d), the value of the MS_TXPWR_CONF field in the uplink SACCH L1 header shall correspond to the actual power control level used for the last transmitted burst of the previous SACCH multiframe. The first one shall indicate the initial transmitted power control level, the subsequent ones shall change by 8 each time until the final power control level has been reached in which case that value shall be indicated.
- c) In steps g) and i) the transmitter output power of TDMA frame 6 shall correspond to the new commanded power control level.
- d) In step k) the MS output power, measured on the new channel shall correspond to the power control level in the channel assignment.

22.2 Void

22.3 GPRS Uplink Power Control - Use of α and Γ_{CH} parameters

22.3.1 Definition

Power control is important for spectrum efficiency as well as for power consumption in a cellular system. Power control for a packet oriented connection is more complicated than for a circuit switched connection, since there is no continuous two-way connection.

The RF output power, P_{CH} , to be employed by the MS on each individual uplink PDCH shall be:

$$P_{CH} = \min(\Gamma_0 - \Gamma_{CH} - \alpha \times (C + 48), P_{MAX}),$$

Where:

- Γ_{CH} is an MS and channel specific power control parameter, sent to the MS in an RLC control message (see 3GPP TS 04.60).
- Γ_0 = 36 dBm for DCS 1 800 and PCS 1900
= 39 dBm for all other bands.
- α is a system parameter, broadcast on PBCCH or optionally sent to MS in an RLC control message (see 3GPP TS 04.08 / 3GPP TS 24.008 and 3GPP TS 04.60).
- C is the normalised received signal level at the MS as defined in 3GPP TS 05.08, subclause 10.2.3.1.
- PMAX is the maximum allowed output power in the cell =
GPRS_MS_TXPWR_MAX_CCH if PBCCH exists
MS_TXPWR_MAX_CCH otherwise

All power values are expressed in dBm. (Note that the constants Γ_0 and 48 are included only for optimising the coding of Γ_{CH} and C-value).

This is a flexible tool that can be used for different power control algorithms.

A pure open loop is achieved by setting $\alpha = 1$ and keeping Γ_{CH} constant. With this method the output power is based on the received signal level assuming the same path loss in uplink and downlink. This is useful in the beginning of a packet transmission.

A pure closed loop is achieved by setting $\alpha = 0$. With this method the output power is commanded by the network based on received signal level measurements made in the BTS in a similar way as for a circuit switched connection.

22.3.2 Conformance requirement

The MS shall use the same output power on all four bursts within one radio block. 3GPP TS 05.08, subclause 10.2.1.

If a calculated output power is not supported by the MS, the MS shall use the supported output power which is closest to the calculated output power. 3GPP TS 05.08, subclause 10.2.1.

When the MS receives new Γ_{CH} or α values, the MS shall use the new value to update P_{CH} 2 radio blocks after the end of the frame containing the last timeslot of the message block containing the new value. 3GPP TS 05.08, subclause 10.2.1.

The transmitted power shall be a monotonic function of the calculated output power and any change of 2 dB in the calculated value shall correspond to a change of $2 \pm 1,5$ dB in the transmitted value. The MS may round the calculated output power to the nearest nominal output power value. 3GPP TS 05.08, subclause 10.2.1.

22.3.3 Test purpose

To verify the MS uses that the same output power on all four bursts of a radio block under normal conditions.

To verify that the highest power supported by the MS is used if the calculated power is greater.

To verify that the MS applies new Γ_{CH} or α values 2 radio blocks after the end of the frame containing the last timeslot of the message block containing the new value.

To verify that any change of 2 dB in the calculated power corresponds to a change of $2 \pm 1,5$ dB in the transmitted value under normal conditions.

NOTE: For changes in calculated power which are less than the tolerances specified for absolute power accuracy in a MS, the transmitted power as a function of calculated power cannot be tested for monotonicity. Monotonicity between power control steps is implicitly tested in subclause 13.16.

22.3.4 Method of test

22.3.4.1 Initial conditions

The SS establishes a BCCH, and optionally a PBCCH on the same carrier, in the mid ARFCN range. GPRS_MS_TXPWR_MAX_CCH is set to the maximum level (39 dBm for GSM and 36 dBm for DCS and PCS). The

Γ_{CH} value is set such that $(\Gamma_0 - \Gamma_{CH})$ equals the maximum power control level supported by the Power Class of the MS under test. The α value is set to 0.

The SS establishes a downlink TBF on the same ARFCN as the BCCH and PBCCH, and send data blocks to poll the MS for channel quality reports. The downlink power level is adjusted until a stable RXLEV-value of 58 is reported by the MS in the channel quality report (see 3GPP TS 05.08, subclause 8.1.4 and 10.2.3) – corresponding to a used C value in the range of -52dBm to -53dBm.

MS shall transmit on the uplink. This is achieved using the GPRS test mode by transmitting a GPRS_TEST_MODE_CMD (see 3GPP TS 04.14, subclause 5.4).

22.3.4.2 Procedure

- a) The SS shall trigger a transmitter output power measurement on each of the four bursts of any radio block.

The method of power measurement is described in subclause 13.16.

- b) The SS shall modify the Γ_{CH} value such that $(\Gamma_0 - \Gamma_{CH})$ equals the minimum power control level supported by the MS under test (0dBm for DCS 1 800 and PCS 1 900 and 5dBm for all other bands). If the transmission of the RLC control message containing the new Γ_{CH} value is completed in radio block N, the SS shall trigger a transmitter output power measurement on each of the four bursts of radio block N+3.
- c) The SS shall modify the Γ_{CH} value such that $(\Gamma_0 - \Gamma_{CH})$ equals the maximum power control level supported by the power class of the MS under test. If the transmission of the RLC control message containing the new Γ_{CH} value is completed in radio block N, the SS shall trigger a transmitter output power measurement on each of the four bursts of radio block N+3.
- d) The SS shall modify the Γ_{CH} value such that $(\Gamma_0 - \Gamma_{CH})$ equals the value 5dB below the maximum power control level supported by the power class of the MS under test. The α value is set to 1.
- e) The SS shall decrement the α value with a step size of 0.1 until α equals 0. For each step change in α value, if the transmission of the RLC control message containing the new α value is completed in radio block N, the SS shall trigger a transmitter output power measurement on each of the four bursts of radio block N+3.
- f) For each value of α , the SS shall note the maximum and minimum power values measured from the four bursts of the radio block in step e). The SS shall then calculate the maximum and minimum changes in output power measured for the following two sets of pairs of α values, set1: 1.0 and 0.5; 0.9 and 0.4; 0.8 and 0.3; 0.7 and 0.2; 0.6 and 0.1; 0.5 and 0, set2: 1.0 and 0.6; 0.9 and 0.5; 0.8 and 0.4; 0.7 and 0.3; 0.6 and 0.2; 0.5 and 0.1; 0.4 and 0.0. The maximum change is calculated by subtracting the minimum power measured from the smaller value of α from the maximum power measured for the larger value of α . The minimum step change is calculated by subtracting the maximum power measured from the smaller value of α from the minimum power measured for the larger value of α .

NOTE: If the power values measured for the four bursts of the radio block with α equal to 1.0 are:

$$- P_{m0}, P_{m1}, P_{m2}, P_{m3}.$$

And, the power values measured for the four bursts of the radio block with α equal to 0.5 are:

$$- P_{n0}, P_{n1}, P_{n2}, P_{n3}.$$

Then:

$$- P_{m(\max)} = \text{MAX}(P_{m0}, P_{m1}, P_{m2}, P_{m3});$$

$$- P_{m(\min)} = \text{MIN}(P_{m0}, P_{m1}, P_{m2}, P_{m3});$$

$$- P_{n(\max)} = \text{MAX}(P_{n0}, P_{n1}, P_{n2}, P_{n3});$$

$$- P_{n(\min)} = \text{MIN}(P_{n0}, P_{n1}, P_{n2}, P_{n3}).$$

The maximum and minimum step sizes are:

$$- \text{STEP}(\text{MAX}) = P_{m(\max)} - P_{n(\min)};$$

$$- \text{STEP(MIN)} = P_{m(\min)} - P_{n(\max)}$$

- g) The SS shall modify the Γ_{CH} value such that $(\Gamma_0 - \Gamma_{\text{CH}})$ equals the midrange power control level supported by the MS under test. The α value is set to 0.
- h) The SS shall increment the α value with a step size of 0.1 until α equals 1. For each step change in α value, if the transmission of the RLC control message containing the new α value is completed in radio block N, the SS shall trigger a transmitter output power measurement on each of the four bursts of radio block N+3.
- i) For each value of α , the SS shall note the maximum and minimum power values measured from the four bursts of the radio block in step h). The SS shall then calculate the maximum and minimum changes in output power measured for the following two sets of pairs of α values, set1: 1.0 and 0.5; 0.9 and 0.4; 0.8 and 0.3; 0.7 and 0.2; 0.6 and 0.1; 0.5 and 0, set2: 1.0 and 0.6; 0.9 and 0.5; 0.8 and 0.4; 0.7 and 0.3; 0.6 and 0.2; 0.5 and 0.1; 0.4 and 0.0. The maximum change is calculated by subtracting the minimum power measured from the smaller value of α from the maximum power measured for the larger value of α . The minimum step change is calculated by subtracting the maximum power measured from the smaller value of α from the minimum power measured for the larger value of α .
- j) The SS shall modify the Γ_{CH} value such that $(\Gamma_0 - \Gamma_{\text{CH}})$ equals the minimum power control level supported by the MS under test (0dBm for DCS 1 800 and PCS 1 900 and 5dBm for all other bands). The α value is set to 0.
- k) The SS shall increment the α value with a step size of 0.1 until α equals 1. For each step change in α value, if the transmission of the RLC control message containing the new α value is completed in radio block N, the SS shall trigger a transmitter output power measurement on each of the four bursts of radio block N+3.
- l) For each value of α , the SS shall note the maximum and minimum power values measured from the four bursts of the radio block in step k). The SS shall then calculate the maximum and minimum changes in output power measured for the following two sets of pairs of α values, set1: 1.0 and 0.5; 0.9 and 0.4; 0.8 and 0.3; 0.7 and 0.2; 0.6 and 0.1; 0.5 and 0, set2: 1.0 and 0.6; 0.9 and 0.5; 0.8 and 0.4; 0.7 and 0.3; 0.6 and 0.2; 0.5 and 0.1; 0.4 and 0.0. The maximum change is calculated by subtracting the minimum power measured from the smaller value of α from the maximum power measured for the larger value of α . The minimum step change is calculated by subtracting the maximum power measured from the smaller value of α from the minimum power measured for the larger value of α .

22.3.5 Test requirements

1. The power of all four bursts within the radio block measured in step a) and c) shall be within the accuracies specified for the power class of the mobile under test, as indicated in the following table.

Power class	Bands other than DCS 1 800 and PCS 1 900 Nominal Maximum output power	DCS 1 800 Nominal Maximum output power	PCS 1900 Nominal Maximum output power	Tolerance (dB) for normal conditions
1	-----	1 W (30 dBm)	1 W (30dBm)	± 2
2	8 W (39 dBm)	0,25 W (24 dBm)	0,25 W (24 dBm)	± 2
3	5 W (37 dBm)	4 W (36 dBm)	2 W (33 dBm)	± 2
4	2 W (33 dBm)			± 2
5	0,8 W (29 dBm)			± 2

2. The power of all four bursts within the radio block measured in step b) shall be 0dBm for DCS 1 800 and PCS 1 900 and 5dBm for all other bands with an accuracy of ± 5 dB in both cases.
3. In steps f), i) and l), the maximum change in transmitted power between each identified pair of α values shall be $\leq 4,5$ dB for either set1 or set2.
4. In steps f), i) and l), the minimum change in transmitted power between each identified pair of α values shall be $\geq -0,5$ dB for either set1 or set2.

Note: 1 dB tolerance has to be included in test requirements 3. and 4.
The same alpha value set (either set1 or set2) shall be used in all the steps f), i) and l) and for both test requirements 3. and 4.

22.4 GPRS Uplink Power Control - Independence of TS Power Control

22.4.1 Definition

-

22.4.2 Conformance requirement

For a GPRS multislot MS supporting 2 or more uplink PDCHs, power control shall be employed by the MS on each individual uplink PDCH. 3GPP TS 05.08, subclause 10.2.1.

On a multislot uplink configuration the MS may restrict the interslot output power control range to a 10 dB window, on a TDMA frame basis. On those timeslots where the ordered power level is more than 10 dB lower than the applied power level of the highest power timeslot, the MS shall transmit at a lowest possible power level within 10 dB range from the highest applied power level, if not transmitting at the actual ordered power level. 3GPP TS 45.005, subclause 4.1.1.

22.4.3 Test purpose

To verify that for a GPRS multislot MS supporting 2 or more uplink PDCHs, power control shall be employed by the MS on each individual uplink PDCH.

22.4.4 Method of test

22.4.4.1 Initial conditions

The MS shall transmit on the uplink with the maximum number of TS for the multislot class of the MS.. This is achieved using the GPRS test mode by first establishing a downlink TBF and transmitting a GPRS_TEST_MODE_CMD (see 3GPP TS 04.14, subclause 5.4). Each TS is transmitting on its maximum power. The α -value is set to 0.

Specific PICS Statements:

- MS using reduced interslot dynamic range in multislot configurations (TSPC_Addinfo_Red_IntSlotRange_Mult_Conf)

PIXIT Statements:

-

22.4.4.2 Procedure

- a) The SS shall modify the Γ_{CH} value of one TS such that $(\Gamma_0 - \Gamma_{CH})$ equals the minimum power control level supported by the MS under test (0dBm for DCS 1 800 and PCS 1 900 and 5dBm for all other bands).
- b) The SS shall trigger a transmitter output power measurement on each of the four bursts of any radio block of the TS under test.
- c) The SS shall trigger a transmitter output power measurement on each of the four bursts of any radio block of the other active TS.
- d) The SS shall modify the Γ_{CH} value for the TS under test such that $(\Gamma_0 - \Gamma_{CH})$ equals the maximum power control level supported by the MS under test.
- e) Steps a) to d) shall be repeated for each TS of the multislot configuration.

22.4.5 Test requirements

1. The power of all four bursts within the radio block measured in step b) shall be 0dBm for DCS 1 800 and PCS 1 900 and 5dBm for all other bands with an accuracy of ± 5 dB in both cases. For an MS using reduced interslot dynamic range, the power measured in step b) shall be within $10\text{dB} \pm 3\text{dB}$ of the average power of the timeslots measured in step c).

2. For all TS, the power of all four bursts within the radio block measured in step c) shall be within the accuracies specified for the power class of the mobile under test, as indicated in table 22.4-1 (see also 3GPP TS 45.005).

Table 22.4-1: The MS maximum output power

Power class	Bands other than DCS 1 800 and PCS 1 900 Nominal Maximum output power	DCS 1 800 Nominal Maximum output power	PCS 1900 Nominal Maximum output power	Tolerance (dB) for normal conditions
1	-----	1 W (30 dBm)	1 W (30dBm)	±2
2	8 W (39 dBm)	0,25 W (24 dBm)	0,25 W (24 dBm)	±2
3	5 W (37 dBm)	4 W (36 dBm)	2 W (33 dBm)	±2
4	2 W (33 dBm)			±2
5	0,8 W (29 dBm)			±2

From R99 onwards, in order to manage mobile terminal heat dissipation resulting from transmission on multiple uplink timeslots, the mobile station shall reduce its maximum output power on a per-assignment basis by the values given in table 22.4-2 or 22.4-3:

Table 22.4-2: R99 and Rel-4 MS: Allowed maximum output power reduction in a multislots configuration

Number of timeslots in uplink assignment	Permissible nominal reduction of maximum output power, (dB)
1	0
2	0 to 3,0
3	1,8 to 4,8
4	3,0 to 6,0

Table 22.4-3: From Rel-5 onwards: Allowed maximum output power reduction in a multislots configuration

Number of timeslots in uplink assignment	Permissible nominal reduction of maximum output power, (dB)
1	0
2	3,0
3	4,8
4	6,0
5	7,0
6	7,8
7	8,5
8	9,0

From Rel-5 onwards, the actual supported maximum output power shall be in the range indicated by the parameters GMSK_MULTISLOT_POWER_PROFILE (See 3GPP TS 24.008) for n allocated uplink timeslots:

$$a \leq \text{MS maximum output power} \leq \min(\text{MAX_PWR}, a + b)$$

Where:

$$a = \min(\text{MAX_PWR}, \text{MAX_PWR} + \text{GMSK_MULTISLOT_POWER_PROFILE} - 10\log(n));$$

MAX_PWR equals to the MS maximum output power according to the relevant power class and

- GMSK_MULTISLOT_POWER_PROFILE 0 = 0 dB;
- GMSK_MULTISLOT_POWER_PROFILE 1 = 2 dB;
- GMSK_MULTISLOT_POWER_PROFILE 2 = 4 dB;
- GMSK_MULTISLOT_POWER_PROFILE 3 = 6 dB.

For DCS 1800 and PCS 1900 frequency bands b = 3 dB, for all other bands b = 2 dB.

22.5 Void

22.6 Normal transmit power control timing and confirmation in ECSD

22.6.1 Definition

The RF power level to be employed by the MS is indicated by means of the 5 bit TXPWR field sent in the layer 1 header of each downlink SACCH message block and may be sent in a dedicated signalling block.

When a power change is signalled the MS must change its power control level to the new level at a certain rate of change.

The MS shall confirm the power level that it is currently employing by setting the MS_TXPWR_CONF field in the uplink SACCH L1 header.

22.6.2 Test conformance

1. The RF power control level to be employed by the MS is indicated by means of the power control information sent in the layer 1 header of each downlink SACCH message block and may be sent in a dedicated signalling block; 3GPP TS 05.08, subclause 4.2.
2. The MS shall confirm the power level that it is currently employing in the uplink SACCH L1 header. The indicated value shall be the power control level actually used by the MS for the last burst of the previous SACCH period; 3GPP TS 05.08, subclause 4.2.
3. Upon receipt of a command on the SACCH to change its RF power level, the MS shall change to the new level at a rate of one nominal 2 dB power control step every 60 ms; 3GPP TS 05.08, subclause 4.7.
4. The change (in conformance requirement 3) shall commence at the first TDMA frame belonging to the next reporting period; 3GPP TS 05.08, subclause 4.7.
5. In case of channel change the commanded power level shall be applied on the new channel immediately; 3GPP TS 05.08, subclause 4.7.

22.6.3 Test purpose

1. To verify that the MS will set its transmitter output power in accordance with conformance requirement 1.
2. To verify that the MS will confirm the power level it is currently employing according to conformance requirement 2.
3. To verify that the MS, upon receipt of a command from the SACCH to change its RF power level, will change according to conformance requirement 3.
4. To verify that the MS will commence the change of power level at least by the sixth TDMA frame belonging to the next reporting period.
5. To verify that in case of new channel assignment the commanded power level is applied on the new channel according to conformance requirement 5.

22.6.4 Test method

NOTE: The method of measuring the MS transmitter output power is given in subclause 13.3. For 8PSK modulation, a measurement method for estimating the long term average power from a single burst shall be employed. See subclause 13.17.3.

22.6.4.1 Initial conditions

A call is set up by the SS according to the generic call set up procedure for multislot configuration on a channel with ARFCN in the Mid ARFCN range (see table 3.3), power control level set to maximum power.

The SS commands the MS to operate in multislot configuration where it has highest possible number of Tx slots.

22.6.4.2 Procedure

If the MS supports both GMSK and 8PSK modulation on the uplink, the test is repeated with each modulation format.

- a) The SS signals minimum power control level to the MS in the SACCH for one of the subchannels.
- b) The SS measures the MS transmitter output power on TDMA frames 6, 19, 32 and every subsequent 13th TDMA frame to TDMA frame 214. The SS also monitors the MS_TXPWR_CONF field in the uplink SACCH L1 header for the four SACCH multiframes after the SS signals the power change.
- c) The SS now sets TXPWR in the SACCH to the maximum peak power appropriate to the class of the MS.
- d) The SS measures the MS transmitter output power on TDMA frames 6, 19, 32 and every subsequent 13th TDMA frame to TDMA frame 214. The SS also monitors the MS_TXPWR_CONF field in the uplink SACCH L1 header for the four SACCH multiframes after the SS signals the power change.
- e) The SS now sets the SACCH TXPWR to 8.
- f) After 3 s the SS sets the SACCH TXPWR to 9.
- g) The SS measures the MS transmitter output power on TDMA frame 6.
- h) The SS sets the SACCH TXPWR to 8.
- i) The SS measures the MS transmitter output power on TDMA frame 6.
- j) The channel assignment is changed and the demanded power within the channel assignment is set to the minimum power control level of the MS.
- k) When the MS has changed channel its output power is measured on the first burst on the new channel.
- l) Steps a) to k) are repeated on the next subchannel until each is tested.

22.6.5 Test requirement

NOTE: Refer to tables 13.17.3-1, 13.17.3-2, 13.17.3-3 and 13.17.3-4 for relationship between the power class, power control level, transmitter output power and the relevant tolerances.

- a) In steps b) and d), the transmitter output power shall change by one power step towards the new level signalled for each measured burst until the MS is operating at the closest supported power control level and from then on, all transmissions shall be at that level.
- b) In steps b) and d), the value of the MS_TXPWR_CONF field in the uplink SACCH L1 header shall correspond to the actual power control level used for the last transmitted burst of the previous SACCH multiframe. The first one shall indicate the initial transmitted power control level, the subsequent ones shall change by 8 each time until the final power control level has been reached in which case that value shall be indicated.
- c) In steps g) and i) the transmitter output power of TDMA frame 6 shall correspond to the new commanded power control level.
- d) In step k) the MS output power, measured on the new channel shall correspond to the power control level in the channel assignment.

22.7 ECSD Fast Power Control (FPC) timing and interworking with normal power control

22.7.1 Definition

Using the SACCH L1 header, normal uplink power control modifies the MS transmit power at a maximum rate of one power control level change per SACCH period (480ms). Under Fast Power Control the output power of an MS, in E-TCH mode, is updated each fast power reporting period. There are 24 fast power reporting periods in a 104 frame SACCH period.

22.7.2 Test conformance

1. In the E-TCH mode, the MS shall, if so indicated by the BSS in the SACCH L1 header or Assignment command, use FPC (fast power control); 3GPP TS 05.08, subclause 4.2
2. Switching between the normal power control mechanism and FPC shall be done if FPC is enabled or disabled via signalling in the SACCH L1 header. The respective power control mechanism to be used shall then be active as from the first TDMA frame belonging to the next reporting period; 3GPP TS 05.08, subclause 4.7
3. The initial power control level to be used by the MS immediately after switching between normal and fast power control mechanisms shall, in both cases, be the level last commanded by the normal power control mechanism; 3GPP TS 05.08, subclause 4.7
4. The fast power control mechanism shall use the differential power control mechanism defined in the table of 3GPP TS 05.08, subclause 4.3
5. The MS shall employ the most recently commanded fast power control level on each uplink E-TCH channel; 3GPP TS 05.08, subclause 4.2
6. If a power control command is received but the requested output power is not supported by the MS, the MS shall use the supported output power which is closest to the requested output power; 3GPP TS 05.08, subclause 4.3
7. If FPC is in use, the MS shall report, in the SACCH L1 header, the power control level used at the end of the normal power control reporting period; 3GPP TS 05.08, subclause 4.2
8. In case of a multislot configuration, each bi-directional channel shall be power controlled individually by the corresponding SACCH or fast inband signalling link, whichever is applicable; 3GPP TS 05.08, subclause 4.2

22.7.3 Test purpose

1. To verify that the MS switches between normal power control and fast power control mechanisms in accordance with conformance requirements 1 and 2.
2. To verify that the initial power control level used by the MS after switching between normal and fast power control mechanisms is in accordance with conformance requirement 3.
3. To verify that power level changes using the fast power control are implemented by the MS in accordance with conformance requirements 4 and 5.
4. To verify that power control commands requesting levels not supported by the MS are treated in accordance with conformance requirement 6.
5. To verify that the power reported by the MS at the end of the normal power control reporting period is in accordance with conformance requirement 7.
6. To verify that in a multislot configuration the MS implements fast power control independently on each bi-directional E-TCH in accordance with conformance requirement 8.

22.7.4 Test method

22.7.4.1 Initial conditions

A call is set up by the SS according to the generic call set up procedure for multislot configuration on a channel with ARFCN in the Mid ARFCN range (see table 3.3).

The SS commands the MS to operate in multislot configuration where it has the highest possible number of bi-directional E-TCHs. Using normal power control, the level of each TX slot is set to maximum power.

22.7.4.2 Procedure

For the purpose of this test the SS shall randomly select one bi-directional E-TCH to exercise. All other E-TCHs shall maintain the state defined under the initial conditions. In this procedure these other E-TCHs are referred to as the active but unselected channels.

- a) Using the normal power control mechanism, the SS shall command the MS to transmit at power level 8 in the case of DCS 1 800 and PCS 1 900 or power level 15 in the case of all other bands on the selected E-TCH. After 1s, a power measurement shall be made on each TX slot of the multislot configuration.

NOTE: The method of measuring the MS transmitter output power is given in subclause 13.3. For 8PSK modulation, a measurement method for estimating the long term average power from a single burst shall be employed. See subclause 13.17.3.

- b) The SS shall command the MS to switch between the normal power control and the fast power control mechanism by means of the SACCH L1 header (see 3GPP TS 04.04). Each power control mechanism shall be maintained for a single SACCH period. This cycle shall be repeated until all power measurements specified in steps c) to h) have been completed.

During the SACCH periods when normal power control is active, the SS shall command the MS to maintain the power levels set in step a). During the SACCH period when Fast Power Control is active, the SS shall command the MS to follow the schedule of fast power control detailed in the table below.

FPC Reporting Period Number	Fast Power Control Command	Nominal Output Power during FPC Reporting period Bands other than DCS 1 800 and PCS 1 900	Nominal Output Power during FPC Reporting Period DCS 1 800 & PCS 1 900	Pn
0	1 Step Decrease	13 dBm	14 dBm	P0
1	1 Step Decrease	11 dBm	12 dBm	
2	1 Step Decrease	9 dBm	10 dBm	
3	1 Step Decrease	7 dBm	8 dBm	
4	1 Step Decrease	5 dBm	6 dBm	
5	1 Step Decrease	5 dBm	4 dBm	
6	1 Step Decrease	5 dBm	2 dBm	
7	1 Step Decrease	5 dBm	0 dBm	
8	2 Step Increase	5 dBm	0 dBm	P34
9	2 Step Increase	9 dBm	4 dBm	
10	2 Step Increase	13 dBm	8 dBm	
11	2 Step Increase	17 dBm	12 dBm	
12	2 Step Increase	21 dBm	16 dBm	
13	2 Step Increase	Min (25 dBm, Pmax)	20 dBm	
14	2 Step Increase	Min (29 dBm, Pmax)	Min (24 dBm, Pmax)	
15	2 Step Increase	Min (33 dBm, Pmax)	Min (28 dBm, Pmax)	
16	2 Step Decrease	Pmax	Pmax	P69
17	1 Step Increase	Pmax – 4 dB	Pmax – 4 dB	P73
18	2 Step Decrease	Pmax – 2 dB	Pmax – 2 dB	P78
19	3 Step Increase	Pmax – 6 dB	Pmax – 6 dB	P82
20	2 Step Decrease	Pmax	Pmax	P86
21	2 Step Decrease	Pmax – 4 dB	Pmax – 4 dB	P91
22	4 Step Increase	Pmax – 8 dB	Pmax – 8 dB	P95
23	No Change	Pmax	Pmax	P99

Pmax is the maximum power for the mobile class.

Pn values refer to the power measured in the nth frame of the SACCH period.

- a) The SS shall make power measurements on each active, but unselected timeslot of the multislot configuration during frames 0 and 103 of the SACCH period when normal power control is active.
- b) The SS shall make power measurements on each active, but unselected timeslot of the multislot configuration during frames 0, 34, 69, 73, 78, 82, 86, 91, 95 and 99 of the SACCH period when fast power control is active.
- c) The SS shall make power measurements of the selected timeslots during frames 0 and 103 of the SACCH period when normal power control is active.
- d) The SS shall make power measurements on the selected timeslot during frames 0, 34, 69, 73, 78, 82, 86, 91, 95 and 99 of the SACCH period when fast power control is active. These power measurements shall be referred to as P0, P34, P69, P73, P78, P82, P86, P91, P95 and P99 respectively.

- e) The SS shall note the MS TX power reported by the MS for the selected timeslot in the SACCH reporting period following the change from fast power control to normal power control.
- f) The SS shall note the MS TX power reported by the MS for the selected timeslot in the SACCH reporting period following the change from normal power control to fast power control.

22.7.5 Test requirement

- a) The powers measured for the unselected timeslots in steps a), c) and d) shall conform with the Pmax specification for the MS power class given in the following table.

Power class	Bands other than DCS 1 800 and PCS 1 900 Nominal Maximum output power (MS TX Level)	Bands other than DCS 1 800 and PCS 1 900 Tolerance (dB) for normal conditions	DCS 1 800 Nominal Maximum output power	PCS 1900 Nominal Maximum Output Power (MS TX Level)	DCS 1 800 & PCS 1 900 Tolerance (dB) for normal conditions
E1	33 dBm (5)	±2	30 dBm	30 dBm (0)	±2
E2	27 dBm (8)	±3	26 dBm	26 dBm (2)	-4/+3
E3	23 dBm (10)	±3	22 dBm	22 dBm (4)	±3

- b) The power measured for the selected timeslot in steps a) and e) shall be 14dBm in the case of DCS 1 800 and PCS 1 900 and 13dBm in the case of all other bands. In all cases the tolerance shall be ±3 dB.
- c) The powers measured in step f) shall conform with the power specifications in the following table.

Pn	Bands other than DCS 1 800 and PCS 1 900	DCS 1 800/PCS 1 900	Tolerance
P0	13 dBm	14 dBm	±3 dB
P34	5 dBm	0 dBm	±5 dB
P69	Pmax	Pmax	±2 dB
P73	Pmax – 4 dB	Pmax – 4 dB	±3 dB
P78	Pmax – 2 dB	Pmax – 2 dB	±3 dB
P82	Pmax – 6 dB	Pmax – 6 dB	±3 dB
P86	Pmax	Pmax	±2 dB
P91	Pmax – 4 dB	Pmax – 4 dB	±3 dB
P95	Pmax – 8 dB	Pmax – 8 dB	±3 dB
P99	Pmax	Pmax	±2 dB

See table in test requirement a) for Pmax value for MS power class.

- a) The power level reported by the MS in step g) shall be MS TX level corresponding to Pmax for the MS power class. See the table in test requirement a).
- b) The power level reported by the MS in step h) shall be MS TX Level 8 in the case of DCS1800 and PCS 1 900 and MS TX Level 15 in the case of all other bands.

22.8 EGPRS Uplink Power Control - Use of α and Γ_{CH} parameters

22.8.1 Definition

Power control is important for spectrum efficiency as well as for power consumption in a cellular system. Power control for a packet oriented connection is more complicated than for a circuit switched connection, since there is no continuous two-way connection.

The RF output power, P_{CH} , to be employed by the MS on each individual uplink PDCH shall be:

$$P_{CH} = \min(\Gamma_0 - \Gamma_{CH} - \alpha \times (C + 48), P_{MAX}),$$

Where:

Γ_{CH}	is an MS and channel specific power control parameter, sent to the MS in an RLC control message (see 3GPP TS 04.60).
Γ_0	= 36 dBm for DCS 1 800 and PCS 1 900 = 39 dBm for all other bands.
α	is a system parameter, broadcast on PBCCH or optionally sent to MS in an RLC control message (see 3GPP TS 04.08 / 3GPP TS 24.008 and 3GPP TS 04.60).
C	is the normalised received signal level at the MS as defined in 3GPP TS 05.08, subclause 10.2.3.1.
P _{MAX}	is the maximum allowed output power in the cell = GPRS_MS_TXPWR_MAX_CCH if PBCCH exists MS_TXPWR_MAX_CCH otherwise.

All power values are expressed in dBm. (Note that the constants Γ_0 and 48 are included only for optimising the coding of Γ_{CH} and C-value).

This is a flexible tool that can be used for different power control algorithms.

A pure open loop is achieved by setting $\alpha = 1$ and keeping Γ_{CH} constant. With this method the output power is based on the received signal level assuming the same path loss in uplink and downlink. This is useful in the beginning of a packet transmission.

A pure closed loop is achieved by setting $\alpha = 0$. With this method the output power is commanded by the network based on received signal level measurements made in the BTS in a similar way as for a circuit switched connection.

22.8.2 Conformance requirement

1. The MS shall use the same output power on all four bursts within one radio block. 3GPP TS 3GPP TS 05.08, subclause 10.2.1.
2. If a calculated output power is not supported by the MS, the MS shall use the supported output power which is closest to the calculated output power. 3GPP TS 05.08, subclause 10.2.1.
3. When the MS receives new Γ_{CH} or α values, the MS shall use the new value to update P_{CH} 2 radio blocks after the end of the frame containing the last timeslot of the message block containing the new value. 3GPP TS 05.08, subclause 10.2.1.
4. The transmitted power shall be a monotonic function of the calculated output power and any change of 2 dB in the calculated value shall correspond to a change of $2 \pm 1,5$ dB in the transmitted value. The MS may round the calculated output power to the nearest nominal output power value. 3GPP TS 05.08, subclause 10.2.1.

22.8.3 Test purpose

1. To verify the MS uses that the same output power on all four bursts of a radio block under normal conditions.
2. To verify that the highest power supported by the MS is used if the calculated power is greater.
3. To verify that the MS applies new Γ_{CH} or α values 2 radio blocks after the end of the frame containing the last timeslot of the message block containing the new value.
4. To verify that any change of 2 dB in the calculated power corresponds to a change of $2 \pm 1,5$ dB in the transmitted value under normal conditions.

NOTE: For changes in calculated power which are less than the tolerances specified for absolute power accuracy in a MS, the transmitted power as a function of calculated power cannot be tested for monotonicity. Monotonicity between power control steps is implicitly tested in subclause 13.16.

22.8.4 Test method

22.8.4.1 Initial conditions

The SS establishes a BCCH and optionally a PBCCH on the same carrier in the mid ARFCN range. GPRS_MS_TXPWR_MAX_CCH is set to the maximum level (36dBm for DCS 1 800 and PCS 1 900 and 39dBm for

all other bands). The Γ_{CH} value is set such that $(\Gamma_0 - \Gamma_{CH})$ equals the maximum power control level supported by the Power Class of the MS under test. The α value is set to 0.

The SS establishes a downlink TBF on the same ARFCN as the BCCH and PBCCH, and send data blocks to poll the MS for channel quality reports. The downlink power level is adjusted until a stable RXLEV-value of 58 is reported by the MS in the channel quality report (see 3GPP TS 05.08, subclause 8.1.4 and 10.2.3) – corresponding to a used C value in the range of -52dBm to -53dBm.

The SS orders the MS to transmit on the uplink. This is achieved using the GPRS test mode by transmitting a GPRS_TEST_MODE_CMD (see 3GPP TS 04.14, clause 5.4).

22.8.4.2 Procedure

If the MS supports both GMSK and 8PSK modulation on the uplink, the test is repeated with each modulation format.

- a) The SS shall trigger a transmitter output power measurement on each of the four bursts of any radio block.
- b) The method of power measurement is described in subclause 13.17.3.

NOTE 1: For 8PSK modulation, a measurement method for estimating the long term average power from a single burst shall be employed. See subclause 13.17.3.

- c) Void.
- d) The SS shall modify the Γ_{CH} value such that $(\Gamma_0 - \Gamma_{CH})$ equals the minimum power control level supported by the MS under test (0dBm for DCS 1 800 and PCS 1 900 and 5dBm for all other bands). If the transmission of the RLC control message containing the new Γ_{CH} value is completed in radio block N, the SS shall trigger a transmitter output power measurement on each of the four bursts of radio block N+3.
- e) The SS shall modify the Γ_{CH} value such that $(\Gamma_0 - \Gamma_{CH})$ equals the maximum power control level supported by the power class of the MS under test. If the transmission of the RLC control message containing the new Γ_{CH} value is completed in radio block N, the SS shall trigger a transmitter output power measurement on each of the four bursts of radio block N+3.
- f) The SS shall modify the Γ_{CH} value such that $(\Gamma_0 - \Gamma_{CH})$ equals the value 5dB below the maximum power control level supported by the power class of the MS under test. The α value is set to 1.
- g) The SS shall decrement the α value with a step size of 0.1 until α equals 0. For each step change in α value, if the transmission of the RLC control message containing the new α value is completed in radio block N, the SS shall trigger a transmitter output power measurement on each of the four bursts of radio block N+3.
- h) For each value of α , the SS shall note the maximum and minimum power values measured from the four bursts of the radio block in step e). The SS shall then calculate the maximum and minimum changes in output power measured for the following two sets of pairs of α values, set1: 1.0 and 0.5; 0.9 and 0.4; 0.8 and 0.3; 0.7 and 0.2; 0.6 and 0.1; 0.5 and 0, set2: 1.0 and 0.6; 0.9 and 0.5; 0.8 and 0.4; 0.7 and 0.3; 0.6 and 0.2; 0.5 and 0.1; 0.4 and 0.0. The maximum change is calculated by subtracting the minimum power measured from the smaller value of α from the maximum power measured for the larger value of α . The minimum step change is calculated by subtracting the maximum power measured from the smaller value of α from the minimum power measured for the larger value of α .

NOTE 2: If the power values measured for the four bursts of the radio block with α equal to 1.0 are:

$$- P_{m0}, P_{m1}, P_{m2}, P_{m3}.$$

And, the power values measured for the four bursts of the radio block with α equal to 0.5 are:

$$- P_{n0}, P_{n1}, P_{n2}, P_{n3}.$$

Then:

$$- P_{m(\max)} = \text{MAX}(P_{m0}, P_{m1}, P_{m2}, P_{m3});$$

$$- P_{m(\min)} = \text{MIN}(P_{m0}, P_{m1}, P_{m2}, P_{m3});$$

$$- P_{n(\max)} = \text{MAX}(P_{n0}, P_{n1}, P_{n2}, P_{n3});$$

- $P_{n(\min)} = \text{MIN}(P_{n0}, P_{n1}, P_{n2}, P_{n3})$.

The maximum and minimum step sizes are:

- $\text{STEP}(\text{MAX}) = P_{n(\max)} - P_{n(\min)}$;

- $\text{STEP}(\text{MIN}) = P_{m(\min)} - P_{n(\max)}$.

- g) The SS shall modify the Γ_{CH} value such that $(\Gamma_0 - \Gamma_{\text{CH}})$ equals the midrange power control level supported by the MS under test. The α value is set to 0.
- h) The SS shall increment the α value with a step size of 0.1 until α equals 1. For each step change in α value, if the transmission of the RLC control message containing the new α value is completed in radio block N, the SS shall trigger a transmitter output power measurement on each of the four bursts of radio block N+3.
- i) For each value of α , the SS shall note the maximum and minimum power values measured from the four bursts of the radio block in step h). The SS shall then calculate the maximum and minimum changes in output power measured for the following two sets of pairs of α values, set1: 1.0 and 0.5; 0.9 and 0.4; 0.8 and 0.3; 0.7 and 0.2; 0.6 and 0.1; 0.5 and 0, set2: 1.0 and 0.6; 0.9 and 0.5; 0.8 and 0.4; 0.7 and 0.3; 0.6 and 0.2; 0.5 and 0.1; 0.4 and 0.0. The maximum change is calculated by subtracting the minimum power measured from the smaller value of α from the maximum power measured for the larger value of α . The minimum step change is calculated by subtracting the maximum power measured from the smaller value of α from the minimum power measured for the larger value of α .
- j) The SS shall modify the Γ_{CH} value such that $(\Gamma_0 - \Gamma_{\text{CH}})$ equals the minimum power control level supported by the MS under test (0dBm for DCS 1 800 and PCS 1 900 and 5dBm for all other bands). The α value is set to 0.
- k) The SS shall increment the α value with a step size of 0.1 until α equals 1. For each step change in α value, if the transmission of the RLC control message containing the new α value is completed in radio block N, the SS shall trigger a transmitter output power measurement on each of the four bursts of radio block N+3.
- l) For each value of α , the SS shall note the maximum and minimum power values measured from the four bursts of the radio block in step k). The SS shall then calculate the maximum and minimum changes in output power measured for the following two sets of pairs of α values, set1: 1.0 and 0.5; 0.9 and 0.4; 0.8 and 0.3; 0.7 and 0.2; 0.6 and 0.1; 0.5 and 0, set2: 1.0 and 0.6; 0.9 and 0.5; 0.8 and 0.4; 0.7 and 0.3; 0.6 and 0.2; 0.5 and 0.1; 0.4 and 0.0. The maximum change is calculated by subtracting the minimum power measured from the smaller value of α from the maximum power measured for the larger value of α . The minimum step change is calculated by subtracting the maximum power measured from the smaller value of α from the minimum power measured for the larger value of α .

22.8.5 Test requirement

1. The power of all four bursts within the radio block measured in step a) and c) shall be within the accuracies specified for the power class of the mobile under test, as indicated in the following table.

Power class	Bands except DCS 1 800 and PCS 1 900 Nominal Maximum output power	Bands except DCS 1 800 and PCS 1 900 Tolerance (dB) for normal conditions	DCS 1 800 Nominal Maximum output power	PCS 1900 Nominal Maximum Output power	DCS 1 800 & PCS 1 900 Tolerance (dB) for normal conditions
1	-----		30 dBm	30 dBm	±2
2	39 dBm		24 dBm	24 dBm	±2
3	37 dBm		36 dBm	33 dBm	±2
4	33 dBm				±2
5	29 dBm				±2
E1	33 dBm	±2	30 dBm	30 dBm	±2
E2	27 dBm	±3	26 dBm	26 dBm	-4/+3
E3	23 dBm	±3	22 dBm	22 dBm	±3

2. The power of all four bursts within the radio block measured in step b) shall be 0dBm for a DCS 1 800 or PCS 1 900 MS and 5dBm for all other MS with an accuracy of ±5 dB in all cases.

3. In steps f), i) and l), the maximum change in transmitted power between each identified pair of α values shall be $\leq 4,5$ dB for either set1 or set2.
4. In steps f), i) and l), the minimum change in transmitted power between each identified pair of α values shall be $\geq -0,5$ dB for either set1 or set2.

Note: 1 dB tolerance has to be included in test requirements 3. and 4.
The same alpha value set (either set1 or set2) shall be used in all the steps f), i) and l) and for both test requirements 3. and 4.

22.9 EGPRS Uplink Power Control - Independence of TS Power Control

22.9.1 Definition

-

22.9.2 Test conformance

For an EGPRS multislot MS supporting 2 or more uplink PDCHs, power control shall be employed by the MS on each individual uplink PDCH. 3GPP TS 05.08, subclause 10.2.1.

On a multislot uplink configuration the MS may restrict the interslot output power control range to a 10 dB window, on a TDMA frame basis. On those timeslots where the ordered power level is more than 10 dB lower than the applied power level of the highest power timeslot, the MS shall transmit at a lowest possible power level within 10 dB range from the highest applied power level, if not transmitting at the actual ordered power level. 3GPP TS 45.005, subclause 4.1.1.

22.9.3 Test purpose

To verify that EGPRS power control is applied to each PDCH in a multislot configuration independently.

22.9.4 Test method

22.9.4.1 Initial conditions

The SS establishes a downlink TBF. The SS orders the MS to transmit on the maximum number of timeslots for the multislot class of the MS on the uplink. This is achieved using the GPRS test mode by transmitting a GPRS_TEST_MODE_CMD (see 3GPP TS 04.14, subclause 5.4).

Each timeslot is transmitting on its maximum power. The α -value is set to 0.

Specific PICS Statements:

- MS using reduced interslot dynamic range in multislot configurations

PIXIT Statements:

-

22.9.4.2 Procedure

If the MS supports both GMSK and 8PSK modulation on the uplink, the test is repeated with each modulation format.

- a) The SS shall modify the Γ_{CH} value of one timeslot such that $(\Gamma_0 - \Gamma_{CH})$ equals the minimum power control level supported by the MS under test (0dBm for DCS 1 800 and PCS 1 900 and 5dBm for all other bands).
- b) The SS shall make a transmitter output power measurement on each of the four bursts of any radio block of the timeslot under test.

NOTE: For 8PSK modulation, a measurement method for estimating the long term average power from a single burst shall be employed. See subclause 13.17.3.

- c) The SS shall make a transmitter output power measurement on each of the four bursts of any radio block of the other active timeslots.

- d) The SS shall modify the Γ_{CH} value for the timeslot under test such that $(\Gamma_0 - \Gamma_{CH})$ equals the maximum power control level supported by the MS under test.
- e) Steps a) to d) shall be repeated for each timeslot of the multislot configuration.

22.9.5 Test requirement

1. The power of all four bursts within the radio block measured in step b) shall be 0dBm for a DCS 1 800 or PCS 1 900 MS and 5dBm for all other MS with an accuracy of ± 5 dB in all cases. For an MS using reduced interslot dynamic range, the power measured in step b) shall be within $10\text{dB} \pm 3\text{dB}$ of the average power of the timeslots measured in step c).
2. For all TS, the power of all four bursts within the radio block measured in step c) shall be within the accuracies specified for the power class of the mobile under test, as indicated in table 22.9-1 (see also 3GPP TS 05.05 / 3GPP TS 45.005).

Table 22.9-1: The MS maximum output power

Power class	Bands except DCS 1 800 and PCS 1 900Nominal Maximum output power	Bands except DCS 1 800 and PCS 1 900 Tolerance (dB) for normal conditions	DCS 1 800 Nominal Maximum output power	PCS 1900 Nominal Maximum Output power	DCS 1 800 & PCS 1 900 Tolerance (dB) for normal conditions
1	-----		30 dBm	30 dBm	± 2
2	39 dBm		24 dBm	24 dBm	± 2
3	37 dBm		36 dBm	33 dBm	± 2
4	33 dBm				± 2
5	29 dBm				± 2
E1	33 dBm	± 2	30 dBm	30 dBm	± 2
E2	27dBm	± 3	26 dBm	26 dBm	-4/+3
E3	23dBm	± 3	22 dBm	22 dBm	± 3

From R99 onwards, in order to manage mobile terminal heat dissipation resulting from transmission on multiple uplink timeslots, the mobile station shall reduce its maximum output power on a per-assignment basis by the values given in table 22.9-2 or 22.9-3:

Table 22.9-2: R99 and Rel-4: Allowed maximum output power reduction in a multislot configuration

Number of timeslots in uplink assignment	Permissible nominal reduction of maximum output power (dB)
1	0
2	0 to 3,0
3	1,8 to 4,8
4	3,0 to 6,0

Table 22.9-3: From Rel-5 onwards: Allowed maximum output power reduction in a multislot configuration

Number of timeslots in uplink assignment	Permissible nominal reduction of maximum output power (dB)
1	0
2	3,0
3	4,8
4	6,0
5	7,0
6	7,8
7	8,5
8	9,0

From Rel-5 onwards, the actual supported maximum output power shall be in the range indicated by the parameters XXX_MULTISLOT_POWER_PROFILE (See 3GPP TS 24.008) for n allocated uplink timeslots:

$$a \leq \text{MS maximum output power} \leq \min(\text{MAX_PWR}, a + b)$$

Where:

$$a = \min(\text{MAX_PWR}, \text{MAX_PWR} + \text{XXX_MULTISLOT_POWER_PROFILE} - 10\log(n));$$

MAX_PWR equals to the MS maximum output power according to the relevant power class;

XXX_MULTISLOT_POWER_PROFILE refers either to GMSK_MULTISLOT_POWER PROFILE or 8-PSK_MULTISLOT_POWER_PROFILE depending on the modulation type concerned, and

XXX_MULTISLOT_POWER_PROFILE 0 = 0 dB;
 XXX_MULTISLOT_POWER_PROFILE 1 = 2 dB;
 XXX_MULTISLOT_POWER_PROFILE 2 = 4 dB;
 XXX_MULTISLOT_POWER_PROFILE 3 = 6 dB.

For DCS 1800 and PCS 1900 frequency bands b = 3 dB, for all other bands b = 2 dB.

22.10 Void

22.11 Power control in exclusive allocation mode

22.11.1 Conformance requirements

Sub-clauses 10.2.1 and 10.2.2 do not apply for the PDCH/H in Exclusive MAC mode while in DTM. In this case:

- The MS shall apply the output power ordered by the network on the SACCH to all channels (both for the TCH/H and the PDCH/H).
- The network shall use the same output power on the dedicated connection and on all the blocks on the PDCH/H addressed to the MS. Blocks not addressed to the MS may be transmitted at a lower power level. As an exception, the bursts transmitted on the BCCH carrier shall be transmitted at the BCCH level.

NOTE: Power control is not applicable to point-to-multipoint services.

References

3GPP TS 05.08/45.008, sub-clause 10.2

22.11.2 Test purpose

To verify that MS applies the output power ordered by the network on the SACCH to all channels.

22.11.3 Method of test

Initial Conditions

System Simulator:

1 cell, DTM supported.

Mobile Station:

The MS is in the active state (U10) of a call.

The MS is GPRS idle with a P-TMSI allocated and the PDP context 1 activated.

Test Procedure

The MS is triggered to initiate packet uplink transfer data and sends a DTM REQUEST message to the SS. On receiving the DTM REQUEST message, requesting uplink resources, the SS assigns the MS PS resources in a timeslot adjoining the CS resource. The SS accomplishes the resource assignment by passing a PACKET ASSIGNMENT message to the MS. Once the SS has verified that the MS is correctly sending RLC data blocks to the SS, the SS sets TXPWR in the SACCH to the maximum peak power appropriate to the class of the MS. The SS measures the MS

transmitter output power, on the timeslot(s), which changes by one power step towards the new level signalled for each measured burst until the MS is operating at the closest supported power control level and from then on, all transmissions shall be at that level. The SS then sets the TXPWR to a lower random value and then verifies that the MS lowers the output power of the transmitter for both the PDTCH and the TCH to this level. After the SS has received approximately 9k octets of data from the MS, the SS commands the change of transit power by passing the PACKET POWER / TIMING ADVANCE message to the MS on the PACCH. Whilst the MS continues with the transmission of the 10k octets, the SS verifies that the MS has not followed the order to change power as indicated in the PACKET POWER / TIMING ADVANCE message.

Maximum Duration of Test

5 minutes

Expected Sequence

Step	Direction	Message	Comments
1	MS		MS in the active state (U10) of a call on Timeslot N with set to Channel Type=TCH/H.
2	MS		Trigger the MS to initiate an uplink packet transfer containing 10k octets.
3	MS->SS	DTM REQUEST	
4	SS->MS	PACKET ASSIGNMENT	See specific message contents.
5	MS<->SS	{ Uplink data transfer }	Macro –transmission of ~9k octets.
6	SS->MS	PACKET POWER CONTROL / TIMING ADVANCE	Sent after approximately 9k octets have been correctly passed to the MS. The message only changes the output power of the MS by setting the Γ_{CH} parameter to maximum for each of the timeslots the MS is utilising. Setting the parameter to maximum indicates the MS should turn down the output power in the timeslots indicated.
7	MS<->SS	{ Uplink data transfer }	Macro – Completion on transmission of 10k octets.
8	SS		Verify that no the MS does not change the transmission power after receiving the PACKET POWER CONTROL / TIMING ADVANCE message.

Specific message contents

PACKET ASSIGNMENT (Step 4):

As default message contents except: RR Packet Uplink Assignment IE - TIMESLOT_ALLOCATION RR Packet Downlink Assignment IE	N Not included
--	-------------------

22.12 Downlink power control, PR mode A, GPRS TBF

22.12.1 Conformance requirements

The MS is required to meet the 05.05 specification when the downlink power control is used in PR mode A.

References

3GPP TS 05.08/45.008, sub-clause 10.2.2

22.12.2 Test purpose

To verify that MS still correctly decodes RLC data blocks while the BSS applies power control mode A and PR mode A and makes downlink power variations on an EGPRS TBF which shares the same PDCH.

22.12.3 Method of test

Initial Conditions

System Simulator:

1 cell, GPRS and EGPRS supported.

The test is performed in TU50 radio environment, at the reference point of $c/i = 16\text{dB}$.

Mobile Station:

The MS is in GPRS idle mode with a P-TMSI allocated and the PDP context 2 activated; it is allocated a GPRS TBF.

Test Procedure

The GPRS MS is allocated a downlink TBF (TBF1) and a downlink EGPRS transfer is simulated as if an EGPRS downlink TBF (TBF2) were allocated on the same PDCHs. Downlink RLC data blocks are sent to MS using the same power level while on TBF2 different power levels are used: on the EGPRS TBF, downlink RLC data blocks are sent at the BCCH ($P_0 = 0\text{ dB}$) power level, then RLC data blocks with different attenuations and valid PR fields are sent.

During the transfer, the RLC data blocks shall be correctly received by the GPRS MS (TBF1) under the 05.05 requirements.

Maximum Duration of Test

1 minute

Expected Sequence

Step	Direction	Message	Comments
1.	SS		The SS initiates with MS1 an GPRS Downlink packet transfer containing 20k octets, in BTS_PWR_CTRL_MODE mode A and PR Mode A.
2.	SS -> MS	RLC DATA BLOCK	Send 12 Downlink RLC data blocks in 8PSK (MCS9) to MS2 at the BCCH power-2dB level (PR=00), alternately with MS1 so that one block out of 2 is sent to MS2.
3.	SS -> MS	RLC DATA BLOCK	Send 12 Downlink RLC data blocks (CS3) are sent to the MS at the BCCH power level (PR=00), alternately with MS2 so that one block out of 2 is sent to MS1, and trigger a Packet downlink Ack/Nack on the 12 th RLC data block.
4.	MS -> SS	Packet downlink Ack/Nack	The Packet downlink Ack/Nack acknowledges at least 90% of the RLC data blocks
5.	SS -> MS	RLC DATA BLOCK	Send 12 Downlink RLC data blocks with a 4dB attenuation and a valid PR=01 field in 8PSK (MCS9), alternately with MS1 so that one block out of 2 is sent to MS2.
6.	SS -> MS	RLC DATA BLOCK	Send 12 Downlink RLC data blocks (CS3) are sent to the MS at the BCCH power level (PR=00), alternately with MS2 so that one block out of 2 is sent to MS1, and trigger a Packet downlink Ack/Nack on the 12 th RLC data block.
7.	MS -> SS	Packet downlink Ack/Nack	The Packet downlink Ack/Nack acknowledges at least 90% of the RLC data blocks
8.	SS -> MS	RLC DATA BLOCK	Send 12 Downlink RLC data blocks with a 6dB attenuation and a valid PR=01 field in 8PSK (MCS9), alternately with MS1 so that one block out of 2 is sent to MS2.
9.	SS -> MS	RLC DATA BLOCK	Send 12 Downlink RLC data blocks (CS3) are sent to the MS at the BCCH power level (PR=00), alternately with MS2 so that one block out of 2 is sent to MS1, and trigger a Packet downlink Ack/Nack on the 12 th RLC data block.
10.	MS -> SS	Packet downlink Ack/Nack	The Packet downlink Ack/Nack acknowledges at least 90% of the RLC data blocks
11.	SS -> MS	RLC DATA BLOCK	Send 12 Downlink RLC data blocks to the MS at the BCCH power-2 dB level (PR=00) in GMSK (MCS4) alternately with MS1 so that one block out of 2 is sent to MS2.
12.	SS -> MS	RLC DATA BLOCK	Send 12 Downlink RLC data blocks (CS3) are sent to the MS at the BCCH power level (PR=00), alternately with MS2 so that one block out of 2 is sent to MS1, and trigger a Packet downlink Ack/Nack on the 12 th RLC data block.
13.	MS -> SS	Packet downlink Ack/Nack	The Packet downlink Ack/Nack acknowledges at least 90% of the RLC data blocks
14.	SS -> MS	RLC DATA BLOCK	Send 12 Downlink RLC data blocks with a 10dB attenuation and a valid PR (PR=10) field in GMSK (MCS4) alternately with MS1 so that one block out of 2 is sent to MS2.
15.	SS -> MS	RLC DATA BLOCK	Send 12 Downlink RLC data blocks (CS3) are sent to the MS at the BCCH power level (PR=00), alternately with MS2 so that one block out of 2 is sent to MS1, and trigger a Packet downlink Ack/Nack on the 12 th RLC data block.
16.	MS -> SS	Packet downlink Ack/Nack	The Packet downlink Ack/Nack acknowledges at least 90% of the RLC data blocks
17.	SS -> MS	RLC DATA BLOCK	Send 12 Downlink RLC data blocks with a 8dB attenuation and a valid PR (PR=10) field in GMSK (MCS4) alternately with MS1 so that one block out of 2 is sent to MS2.

18.	SS -> MS	RLC DATA BLOCK	Send 12 Downlink RLC data blocks (CS3) are sent to the MS at the BCCH power level (PR=00), alternately with MS2 so that one block out of 2 is sent to MS1, and trigger a Packet downlink Ack/Nack on the 12 th RLC data block.
19.	MS -> SS	Packet downlink Ack/Nack	The Packet downlink Ack/Nack acknowledges at least 90% of the RLC data blocks
20.	SS<->MS	{ Downlink data transfer }	Macro – Completion on transmission of 20k octets.

Specific message contents

PACKET DOWNLINK ASSIGNMENT (Step 1):

As default message contents except: BTS_PWR_CTRL_MODE PR_MODE P0	0 (mode A) 0 (PR mode A : for one addressed MS) 0000 (0 dB)
---	---

22.13 Enhanced Power Control (EPC) timing and measurement reporting in single slot operation.

22.13.1 Definition

The EPC is Rel-5 feature which is part of GERAN Feature Package 2, see 3GPP TS 24.008. The EPC signalling is mapped onto every SACCH burst, allowing a control interval of 120 ms. It can be used with any speech traffic channel (both GMSK and 8PSK modulated) and does not impact the speech channel coding. The EPC is based on differential control to adjust the employed RF power level, see 3GPP TS 45.008.

22.13.2 Test conformance

1. The MS shall employ the most recently commanded EPC power control level, as indicated by the EPC Uplink Power Control Command sent on the corresponding EPCCH in the downlink. The EPC Uplink Power Control Command is sent once every EPC reporting period, see 3GPP TS 45.008 subclause 8.4.1b. The MS shall ignore the Ordered MS Power Level sent in the SACCH L1 header in the downlink, 3GPP TS 45.008, subclause 4.2.
2. When on a channel in EPC mode, the MS shall use the EPCCH in the uplink for EPC measurement reporting, 3GPP TS 45.008 subclause 4.2.
3. When on a channel in EPC mode, the MS shall confirm, in the SACCH L1 header on the uplink, the RF power control level at the last burst of the previous SACCH period, as specified for normal power control, 3GPP TS 45.008, subclause 4.2
4. If a power control command is received but the requested output power is not supported by the MS, the MS shall use the supported output power which is closest to the requested output power, 3GPP TS 45.008, subclause 4.3
5. The enhanced power control mechanism shall use the differential power control mechanism defined in 3GPP TS 45.008, subclause 4.3
6. When the MS is ordered to obey the Ordered MS Power Level, the timing according to 3GPP TS 45.008 subclause 4.7.1 applies, see 3GPP TS 45.008, subclause 4.7.3
7. When the MS is ordered to obey the EPC Uplink Power Control Command, it shall, upon receipt of an EPC Uplink Power Control Command on an EPCCH in the downlink, change to the new power level on the corresponding uplink channel at the first TDMA frame belonging to the next EPC reporting period (as specified in 3GPP TS 45.008 subclause 8.4.1b), see 3GPP TS 45.008, subclause 4.7.3

22.13.3 Test purpose

1. To verify that power level changes using EPC are implemented by the MS in accordance with conformance requirements 1, 5 and 7.
2. To verify that power control commands requesting levels not supported by the MS are treated in accordance with conformance requirement 4.
3. To verify that the RF power control level confirmed by the MS is in accordance with conformance requirement 3.
4. To verify that the EPC measurement reporting in accordance with conformance requirement 2.
5. To verify that the timing cycle in EPC mode is in accordance with conformance requirements 6 and 7.

22.13.4 Test method

22.13.4.1 Initial conditions

A call is set up by the SS according to the generic call set up procedure for single slot configuration on a channel with ARFCN in the Mid ARFCN range (see table 3.3). The power control level is set to maximum power using normal power control.

Specific PICS statements:

-

PIXIT statements:

-

22.13.4.2 Procedure

If the MS supports both GMSK and 8PSK modulation on the uplink, the test is repeated with each modulation format.

- a) Using the normal power control mechanism, the SS shall command the MS to transmit at power level 8 (14dBm) in the case of DCS 1 800 and PCS 1 900 or power level 15 (13 dBm) in the case of all other bands on the TCH/O-TCH, see 3GPP TS 45.005, clause 4. After 1s, see 3GPP TS45.008, clause 4.71 a power measurement shall be made.

NOTE: The method of measuring the MS transmitter output power is given in subclause 13.3. For 8PSK modulation, a measurement method for estimating the long term average power from a single burst shall be employed. See subclouse 13.17.3.

- b) The SS shall command the MS to switch from normal power control to EPC by means of the SACCH L1 header (see 3GPP TS 44.004). The SS shall note the MS TX power reported by the MS in the EPC reporting period following the change from normal power control to EPC.
- c) The SS shall command the MS to follow the schedule of enhanced power control detailed in table 22.13-1 below. The SS shall make power measurements during frame n of each SACCH period when enhanced power control is active. These power measurements shall be referred to as P_{n,m} respectively.

Table 22.13-1: EPC Timing and Reporting

EPC Reporting Period Number	EPC Uplink Power Control Command	Nominal Output Power during EPC Reporting Period Bands other than DCS 1 800 and PCS 1 900	Nominal Output Power during EPC Reporting Period DCS 1 800 & PCS 1 900	P _{m,n}
0	1 Step Decrease	13 dBm	14 dBm	P1,0
1	1 Step Decrease	11 dBm	12 dBm	P1,12
2	1 Step Decrease	9 dBm	10 dBm	P1,38
3	1 Step Decrease	7 dBm	8 dBm	P1,64
4	1 Step Decrease	5 dBm	6 dBm	P1,90
5	1 Step Decrease	5 dBm	4 dBm	P2,12
6	1 Step Decrease	5 dBm	2 dBm	P2,38
7	1 Step Decrease	5 dBm	0 dBm	P2,64
8	2 Step Increase	5 dBm	0 dBm	P2,90
9	2 Step Increase	9 dBm	4 dBm	P3,12
10	2 Step Increase	13 dBm	8 dBm	P3,38
11	2 Step Increase	17 dBm	12 dBm	P3,64
12	2 Step Increase	21 dBm	16 dBm	P3,90
13	2 Step Increase	Min (25 dBm, P _{max}) for 8PSK 25 dBm for GMSK	20 dBm	P4,12
14	2 Step Increase	Min (29 dBm, P _{max}) for 8PSK 29 dBm for GMSK	Min (24 dBm, P _{max}) for 8PSK 24 dBm for GMSK	P4,38
15	4 Step Increase	Min (33 dBm, P _{max})	Min (28 dBm, P _{max})	P4,64
16	2 Step Decrease	P _{max}	P _{max}	P4,90
17	1 Step Increase	P _{max} – 4 dB	P _{max} – 4 dB	P5,12
18	2 Step Decrease	P _{max} – 2 dB	P _{max} – 2 dB	P5,38
19	3 Step Increase	P _{max} – 6 dB	P _{max} – 6 dB	P5,64
20	2 Step Decrease	P _{max}	P _{max}	P5,90
21	2 Step Decrease	P _{max} – 4 dB	P _{max} – 4 dB	P6,12
22	4 Step Increase	P _{max} – 8 dB	P _{max} – 8 dB	P6,38
23	No Change	P _{max}	P _{max}	P6,64

P_{max} is the maximum power for the mobile class, see table 22.13-3.

P_{m,n} values refer to the power measured in the n-th frame of the m-th SACCH multiframe.

- d) The SS shall command the MS to switch to normal power control. The SS shall note the MS TX power reported by the MS in the SACCH reporting period following the change from EPC to normal power control.

22.13.5 Test requirement

- a) The power measured in steps a) and b) shall be 14dBm in the case of DCS 1 800 and PCS 1 900 and 13dBm in the case of all other bands. In all cases the tolerance shall be ± 3 dB.
- b) The powers measured in step c) shall conform with the power specifications in the following table 22.13-2.

Table 22.13-2: EPC Power Measurements

P _{m,n}	Bands other than DCS 1 800 and PCS 1 900	DCS 1 800/PCS 1 900	Tolerance
P1,0	13 dBm	14 dBm	± 3 dB
P2,90	5 dBm	0 dBm	± 5 dB
P4,90	P _{max}	P _{max}	± 2 dB
P5,12	P _{max} – 4 dB	P _{max} – 4 dB	± 3 dB
P5,38	P _{max} – 2 dB	P _{max} – 2 dB	± 3 dB
P5,64	P _{max} – 6 dB	P _{max} – 6 dB	± 3 dB
P5,90	P _{max}	P _{max}	± 2 dB
P6,12	P _{max} – 4 dB	P _{max} – 4 dB	± 3 dB
P6,38	P _{max} – 8 dB	P _{max} – 8 dB	± 3 dB
P6,64	P _{max}	P _{max}	± 2 dB

- c) The power level reported by the MS in step d) shall be MS TX level corresponding to Pmax for the MS power class, see bellow table 22.13-3.

Table 22.13-3: The MS maximum output power for GMSK and 8PSK modulation

Power class	Bands except DCS 1 800 and PCS 1 900Nominal Maximum output power	Bands except DCS 1 800 and PCS 1 900 Tolerance (dB) for normal conditions	DCS 1 800 Nominal Maximum output power	PCS 1900 Nominal Maximum Output power	DCS 1 800 & PCS 1 900 Tolerance (dB) for normal conditions
1	-----		30 dBm	30 dBm	±2
2	39 dBm		24 dBm	24 dBm	±2
3	37 dBm		36 dBm	33 dBm	±2
4	33 dBm				±2
5	29 dBm				±2
E1	33 dBm	±2	30 dBm	30 dBm	±2
E2	27dBm	±3	26 dBm	26 dBm	-4/+3
E3	23dBm	±3	22 dBm	22 dBm	±3

22.14 Enhanced Power Control (EPC) timing and measurement reporting in multislots operation.

22.14.1 Definition

The EPC is Rel-5 feature which is part of GERAN Feature Package 2, see 3GPP TS 24.008. The EPC is based on differential control to adjust the employed RF power level, see 3GPP TS 45.008.

High Speed Circuit Switched Data (HSCSD) is one possibility for EPC operation in multislots configuration, see 3GPP TS 45.002, clause 6.4.2.1

22.14.2 Test conformance

8. The MS shall employ the most recently commanded EPC power control level, as indicated by the EPC Uplink Power Control Command sent on the corresponding EPCCH in the downlink. The EPC Uplink Power Control Command is sent once every EPC reporting period, see 3GPP TS 45.008 subclause 8.4.1b. The MS shall ignore the Ordered MS Power Level sent in the SACCH L1 header in the downlink, 3GPP TS 45.008, subclause 4.2.
9. In case of a multislots configuration, each bi-directional channel shall be power controlled individually by the corresponding SACCH, E-IACCH or EPCCH, whichever is applicable, 3GPP TS 45.008, subclause 4.2
10. When on a channel in EPC mode, the MS shall use the EPCCH in the uplink for EPC measurement reporting, 3GPP TS 45.008 subclause 4.2.
11. When on a channel in EPC mode, the MS shall confirm, in the SACCH L1 header on the uplink, the RF power control level at the last burst of the previous SACCH period, as specified for normal power control, 3GPP TS 45.008, subclause 4.2
12. If a power control command is received but the requested output power is not supported by the MS, the MS shall use the supported output power which is closest to the requested output power, 3GPP TS 45.008, subclause 4.3
13. The enhanced power control mechanism shall use the differential power control mechanism defined in 3GPP TS 45.008, subclause 4.3
14. When the MS is ordered to obey the Ordered MS Power Level, the timing according to 3GPP TS 45.008 subclause 4.7.1 applies, see 3GPP TS 45.008, subclause 4.7.3
15. When the MS is ordered to obey the EPC Uplink Power Control Command, it shall, upon receipt of an EPC Uplink Power Control Command on an EPCCH in the downlink, change to the new power level on the corresponding uplink channel at the first TDMA frame belonging to the next EPC reporting period (as specified in 3GPP TS 45.008 subclause 8.4.1b), see 3GPP TS 45.008, subclause 4.7.3

22.14.3 Test purpose

1. To verify that power level changes using EPC are implemented by the MS in accordance with conformance requirements 1, 6 and 8.
2. To verify that power control commands requesting levels not supported by the MS are treated in accordance with conformance requirement 5.
3. To verify that the RF power control level confirmed by the MS is in accordance with conformance requirement 4.
4. To verify that in a multislot configuration the MS implements enhanced power control independently on each bi-directional SACCH or EPCCH in accordance with conformance requirement 2.
5. To verify that the EPC measurement reporting in accordance with conformance requirement 3.
6. To verify that the timing cycle in EPC mode is in accordance with conformance requirement 7 and 8.

22.14.4 Test method

22.14.4.1 Initial conditions

A call is set up by the SS according to the generic call set up procedure for multislot configuration on a channel with ARFCN in the Mid ARFCN range (see table 3.3).

The SS commands the MS to operate in multislot configuration where it has the highest possible number of bi-directional TCHs or O-TCHs. Using normal power control, the level of each TX slot is set to maximum power.

Specific PICS statements:

-

PIXIT statements:

-

22.14.4.2 Procedure

If the MS supports both GMSK and 8PSK modulation on the uplink, the test is repeated with each modulation format.

For the purpose of this test the SS shall randomly select one bi-directional TCH (in case of GMSK modulation) or O-TCH (in case of 8PSK) to exercise. All other channels shall maintain the state defined under the initial conditions. In this procedure these other TCHs/O-TCHs are referred to as the active but unselected channels.

- a) Using the normal power control mechanism, the SS shall command the MS to transmit at power level 8 (14dBm) in the case of DCS 1 800 and PCS 1 900 or power level 15 (13 dBm) in the case of all other bands on the selected TCH/O-TCH, see 3GPP TS 45.005, clause 4. After 1s, a power measurement shall be made on each TX slot of the multislot configuration.

NOTE: The method of measuring the MS transmitter output power is given in subclause 13.3. For 8PSK modulation, a measurement method for estimating the long term average power from a single burst shall be employed. See subclause 13.17.3.

- b) The SS shall command the MS to switch between the normal power control and the enhanced power control mechanism on the selected TCH/O-TCH by means of the SACCH L1 header (see 3GPP TS 44.004). Each power control mechanism shall be maintained for 6 SACCH multiframes. This cycle shall be repeated until all power measurements specified in steps iii) to vi) below have been completed.

During the SACCH periods when normal power control is active, the SS shall command the MS to maintain the power levels set in step a). During the SACCH periods when Enhanced Power Control is active, the SS shall command the MS to follow the schedule of enhanced power control detailed in table 22.14-1 below.

Table 22.14-1: EPC Timing and Reporting

EPC Reporting Period Number	EPC Uplink Power Control Command	Nominal Output Power during EPC Reporting Period Bands other than DCS 1 800 and PCS 1 900	Nominal Output Power during EPC Reporting Period DCS 1 800 & PCS 1 900	P _{m,n}
0	1 Step Decrease	13 dBm	14 dBm	P _{1,0}
1	1 Step Decrease	11 dBm	12 dBm	P _{1,12}
2	1 Step Decrease	9 dBm	10 dBm	P _{1,38}
3	1 Step Decrease	7 dBm	8 dBm	P _{1,64}
4	1 Step Decrease	5 dBm	6 dBm	P _{1,90}
5	1 Step Decrease	5 dBm	4 dBm	P _{2,12}
6	1 Step Decrease	5 dBm	2 dBm	P _{2,38}
7	1 Step Decrease	5 dBm	0 dBm	P _{2,64}
8	2 Step Increase	5 dBm	0 dBm	P _{2,90}
9	2 Step Increase	9 dBm	4 dBm	P _{3,12}
10	2 Step Increase	13 dBm	8 dBm	P _{3,38}
11	2 Step Increase	17 dBm	12 dBm	P _{3,64}
12	2 Step Increase	21 dBm	16 dBm	P _{3,90}
13	2 Step Increase	Min (25 dBm, P _{max}) for 8PSK 25 dBm for GMSK	20 dBm	P _{4,12}
14	2 Step Increase	Min (29 dBm, P _{max}) for 8PSK 29 dBm for GMSK	Min (24 dBm, P _{max}) for 8PSK 24 dBm for GMSK	P _{4,38}
15	4 Step Increase	Min (33 dBm, P _{max})	Min (28 dBm, P _{max})	P _{4,64}
16	2 Step Decrease	P _{max}	P _{max}	P _{4,90}
17	1 Step Increase	P _{max} – 4 dB	P _{max} – 4 dB	P _{5,12}
18	2 Step Decrease	P _{max} – 2 dB	P _{max} – 2 dB	P _{5,38}
19	3 Step Increase	P _{max} – 6 dB	P _{max} – 6 dB	P _{5,64}
20	2 Step Decrease	P _{max}	P _{max}	P _{5,90}
21	2 Step Decrease	P _{max} – 4 dB	P _{max} – 4 dB	P _{6,12}
22	4 Step Increase	P _{max} – 8 dB	P _{max} – 8 dB	P _{6,38}
23	No Change	P _{max}	P _{max}	P _{6,64}

P_{max} is the maximum power for the mobile class, see table 22.14-2.

P_{m,n} values refer to the power measured in the n-th frame of the m-th SACCH multiframe.

- i) The SS shall make power measurements on each active, but unselected timeslot of the multislot configuration during frames 0 and 103 of each SACCH period when normal power control is active.
- ii) The SS shall make power measurements on each active, but unselected timeslot of the multislot configuration during frame n of each SACCH period when enhanced power control is active.
- iii) The SS shall make power measurements of the active and selected timeslot during frames 0 and 103 of each SACCH period when normal power control is active.
- iv) The SS shall make power measurements on the active and selected timeslot during frame n of each SACCH period when enhanced power control is active. These power measurements shall be referred to as P_{n,m} respectively.
- v) The SS shall note the MS TX power reported by the MS for the active and selected timeslot in the SACCH reporting period following the change from enhanced power control to normal power control.
- vi) The SS shall note the MS TX power reported by the MS for the active and selected timeslot in the EPC reporting period following the change from normal power control to enhanced power control.

22.14.5 Test requirement

- a) The powers measured for the active but unselected timeslots in steps i), ii) shall conform with the P_{max} specification for the MS power class given in the table 22.14-2 (see 3GPP TS 45.005, clause 4.1.1).

Table 22.14-2: The MS maximum output power for GMSK and 8PSK modulation

Power class	Bands except DCS 1 800 and PCS 1 900 Nominal Maximum output power	Bands except DCS 1 800 and PCS 1 900 Tolerance (dB) for normal conditions	DCS 1 800 Nominal Maximum output power	PCS 1900 Nominal Maximum Output power	DCS 1 800 & PCS 1 900 Tolerance (dB) for normal conditions
1	-----		30 dBm	30 dBm	±2
2	39 dBm		24 dBm	24 dBm	±2
3	37 dBm		36 dBm	33 dBm	±2
4	33 dBm				±2
5	29 dBm				±2
E1	33 dBm	±2	30 dBm	30 dBm	±2
E2	27dBm	±3	26 dBm	26 dBm	-4/+3
E3	23dBm	±3	22 dBm	22 dBm	±3

In order to manage mobile terminal heat dissipation resulting from transmission on multiple uplink timeslots, the mobile station shall reduce its maximum output power on a per-assignment basis, see 3GPP TS 45.005, clause 4.1.1. For Rel-5 onwards these power reductions are shown in the table 22.14-3.

Table 22.14-3: From Rel-5 onwards: Allowed maximum output power reduction in a multislot configuration

Number of timeslots in uplink assignment	Permissible nominal reduction of maximum output power (dB)
1	0
2	3,0
3	4,8
4	6,0
5	7,0
6	7,8
7	8,5
8	9,0

From Rel-5 onwards, the actual supported maximum output power shall be in the range indicated by the parameters XXX_MULTISLOT_POWER_PROFILE (See 3GPP TS 24.008) for n allocated uplink timeslots:

$$a \leq \text{MS maximum output power} \leq \min(\text{MAX_PWR}, a + b)$$

Where:

$$a = \min(\text{MAX_PWR}, \text{MAX_PWR} + \text{XXX_MULTISLOT_POWER_PROFILE} - 10\log(n));$$

MAX_PWR equals to the MS maximum output power according to the relevant power class;

XXX_MULTISLOT_POWER_PROFILE refers either to GMSK_MULTISLOT_POWER PROFILE or 8-PSK_MULTISLOT_POWER_PROFILE depending on the modulation type concerned, and

XXX_MULTISLOT_POWER_PROFILE 0 = 0 dB;
 XXX_MULTISLOT_POWER_PROFILE 1 = 2 dB;
 XXX_MULTISLOT_POWER_PROFILE 2 = 4 dB;
 XXX_MULTISLOT_POWER_PROFILE 3 = 6 dB.

For DCS 1 800 and PCS 1 900 frequency bands b = 3 dB, for all other bands b = 2 dB.

- b) The power measured for the selected timeslot in step iii) shall be 14 dBm in the case of DCS 1 800 and PCS 1 900 and 13 dBm in the case of all other bands. In all cases the tolerance shall be ±3 dB.
- c) The powers measured in step iv) shall conform to the power specifications in the following table 22.14-4.

Table 22.14-4: EPC Power Measurements

P _{m,n}	Bands other than DCS 1 800 and PCS 1 900	DCS 1 800/PCS 1 900	Tolerance
P1,0	13 dBm	14 dBm	±3 dB
P2,90	5 dBm	0 dBm	±5 dB
P4,90	P _{max}	P _{max}	±2 dB
P5,12	P _{max} – 4 dB	P _{max} – 4 dB	±3 dB
P5,38	P _{max} – 2 dB	P _{max} – 2 dB	±3 dB
P5,64	P _{max} – 6 dB	P _{max} – 6 dB	±3 dB
P5,90	P _{max}	P _{max}	±2 dB
P6,12	P _{max} – 4 dB	P _{max} – 4 dB	±3 dB
P6,38	P _{max} – 8 dB	P _{max} – 8 dB	±3 dB
P6,64	P _{max}	P _{max}	±2 dB

- d) The power level reported by the MS in step v) shall be MS TX level corresponding to P_{max} for the MS power class. See the table 22.14-2 in test requirement a).
- e) The power level reported by the MS in step vi) shall be MS TX Level 8 in the case of DCS 1 800 and PCS 1 900 and MS TX Level 15 in the case of all other bands.

23 Single frequency reference

23.1 Definition

The MS is required to use one single frequency reference for both RF generation/reception and baseband signals. A test method to verify this is not available.

23.2 Conformance requirement

The MS shall use the same frequency source for both RF frequency generation and clocking the timebase; 3GPP TS 05.10, subclause 6.1.

23.3 Test purpose

There is no test specified.

24 Tests of the layer 1 signalling functions

Testing of Layer 1 signalling functions is included in the tests in clauses 15, 16, 17, 18, 19, 20, 21, 22, 23. Other Layer 1 functions are tested in clauses 12, 13 and 14. Some testing of Layer 1 functions is integrated with Layer 3 signalling testing (26).

25 Tests of the layer 2 signalling functions

References:

- 1 3GPP TS 04.06 and 3GPP TS 04.08/ 3GPP TS 24.008 / 3GPP TS 44.018, 3GPP TS 04.05.
- 2 ITU-T Recommendation X.290: OSI Conformance Testing Methodology and Framework for CCITT applications, Part 2: Abstract Test Suite Specification.

25.1 Introduction, objective and scope

25.1.1 General

The objective of clause 25 is to provide detail of how Layer 2 of the MS is tested to verify conformance to the testable parameters given in 3GPP TS 04.06. The tests cover SAPI = 0, and they will be carried out on SDCCH and FACCH/F

and on FACCH/H if the MS supports half-rate. Testing of unnumbered information transfer on SACCHs is covered implicitly by the test in subclause 26.6.3.

The testing is performed using the test configuration described in subclause 25.1.1.2. This configuration does not provide for testing of conformance of any maintenance functions.

The MS under test shall conform to the test configuration, and the Remote Single layer (RS) test method (ITU-T Recommendation X.290, subclause 8.1.4) will be used.

25.1.2 Test configurations

The Layer 2 test configuration defines the Layer 2 functional blocks of a MS being tested and the access arrangement between MS and tester.

NOTE: These functional blocks provide the Layer 2 basic capabilities which have to be implemented in accordance with the specification given in 3GPP TS 04.06. However, the definition of Layer 2 in the form of a number of functional blocks places no requirements on the Layer 2 implementation in a MS.

An example of a functional composition of the MS Layer 2 is given in 3GPP TS 04.05. These function blocks provide basic capabilities which have to be implemented in accordance with 3GPP TS 04.05 and 3GPP TS 04.06.

Also there are alternatives or options included in 3GPP TS 04.05 and 3GPP TS 04.06, these are provided as complementary capabilities.

25.1.3 Pre-conditions

Before carrying out any Layer 2 tests the tests specified in clauses 12, 13, 14 and 15 to 23 (Layer 1 tests) shall be performed.

Apart from powering up the MS to be tested and being able to establish a call the only access to the MS needed and used for Layer 2 testing is the radio interface. It therefore is necessary that the MS is able to synchronize to the System Simulator and to decode its BCCH and CCCH. Furthermore, the MS must be able to perform the following elementary Layer 3 procedures:

- Paging;
- Immediate Assignment;
- Dedicated Channel Assignment;
- Handover;
- Channel Release.

It is necessary that the tests are performed in the order specified, except where the starting point is set (subclause 25.1.5).

The data link is maintained by the MS and the SS sending fill frames (see 3GPP TS 04.06, subclause 5.4.2.3) on the SDCCH when no other frames are to be transmitted. Fill frames are also sent on the FACCH while the channel mode is set to signalling. The default mode is signalling. The tests will normally be performed with the MS sending fill frames on the main DCCH (i.e. FACCH or SDCCH). Consequently throughout the tests fill frames will be sent and received even while waiting for other Layer 2 frames. The scheduling of the fill frame sending cannot be specified as this sending is closely linked to the processing times in the MS. Therefore, the instants of transmission of fill frames cannot be tested nor the number of these transmissions however, in certain circumstances, the fact that a fill frame is sent can be used as proof that the MS requirement has been fulfilled.

25.1.4 Layer 2 test frames

The Layer 2 conformance test is accomplished by sequences of those frames which are contained in 3GPP TS 04.06 (Layer 2 frame repertoire etc.).

These frame sequences are under control of the System Simulator and are related to the state that the System Simulator perceives the MS to be in as a result of frames transferred across the MS-BS interface.

These frame sequences shall comply with the following rules:

- 1) The test sequences exchanged between the System Simulator and MS are assumed to be free from transmission errors.
- 2) The tester may introduce errors in the direction tester to MS by inserting wrong parameters in the address, control and length indication field.
- 3) The tester may simulate errors in the direction MS to tester by ignoring the receipt of frames from the MS.
- 4) The tester may violate the protocol rules related to the control of state variables to provoke sequence gaps.
- 5) There is no contention on the Dm channel at Layer 1 (Layer 1 point-to-point).
- 6) With respect to contention on the Dm channel at Layer 2, two distinct situations are defined:
 - i) Test of the protocol procedure supported by a single entity. In this case there is no contention on the Dm channel (one peer-to-peer information transfer invoked at a time). This test applies to all MSs and is performed for SAPI = 0.
 - ii) Test of Layer 2 multiplexing and MS processing capacity in terms of the number of SAPs and links which a MS is able to support simultaneously. In this case there is contention on the Dm channel at Layer 2 and this contention is resolved within Layer 2 based on the SAPI. This test applies to MSs which are designed for supporting SAPI in addition to SAPI = 0.

Examples of special GSM Layer 2 functions to be tested:

- Correct L2 functions on specific GSM control channels;
- Length indication;
- Fill bits;
- Segmentation, more data bit;
- SABM/UA containing information for contention resolution;
- Abnormal release.

25.1.5 Establishment of the dedicated physical resource

The System Simulator shall simulate a BS with BCCH/CCCH on one carrier. The MS shall be listening to this CCCH and able to respond to paging messages. The system simulator sends Paging Request to the MS on the paging channel. The MS shall respond with Channel Request on the random access channel. The system simulator sends Immediate Assign to the MS, thereby ordering the MS either to a SDCCH or to a TCH, that is FACCH. Each test is performed once on SDCCH, once on FACCH/F and once on FACCH/H if the MS supports half-rate. However tests that explicitly check SDCCH and FACCH are performed once if the MS does not support half-rate and twice (once with FACCH/F and once with FACCH/H) if the MS supports half-rate.

25.1.6 Release of the dedicated physical resource

After a test has been performed the System Simulator shall initiate the release of the SDCCH or FACCH, as laid out in 3GPP TS 04.08 / 3GPP TS 23.108, subclause 7.1.6. This shall return the MS to the idle mode, i.e. the MS shall again be listening to the CCCH of the System Simulator.

25.2 Test sequences

Timing requirement:

The MS shall respond to a command within T200 as defined in 3GPP TS 04.06.

The MS shall repeat a command after time-out of T200 if the command has not been acknowledged as defined in 3GPP TS 04.06.

Constant bit values:

In each frame from the MS:

- bits 6 through 8 of the address field shall be set to zero as defined in 3GPP TS 04.06.
- except for test 25.2.7, the address extension bit (EA bit) shall be set to 1 as defined in 3GPP TS 04.06.
- except for test 25.2.7, the length indicator field extension bit (EL bit) shall be set to 1 as defined in 3GPP TS 04.06.

This shall be checked each time a frame from the MS is received.

Fill bits:

The fill bits transmitted with each frame from the MS whose length indicator L is less than N201 as defined in 3GPP TS 04.06 shall be set as defined in 3GPP TS 04.06.

Frame format description

The frames are described by the following parameter sets:

SABM (C, P, M = 0, L = 0) (* SABM without an information field*)

SABM (C, P, M = 0, L > 0) (* SABM with an information field*)

DISC (C, P, M = 0, L = 0)

UA, (F, M = 0, L = 0) (* UA without an information field*)

UA, (F, M = 0, L > 0) (* UA with an information field*)

DM (R, F, M = 0, L = 0)

RR (C, P, M = 0, L = 0, N(R))

RR (R, F, M = 0, L = 0, N(R))

REJ (C, P, M = 0, L = 0, N(R))

REJ (R, F, M = 0, L = 0, N(R))

I (C, P, M = 0, L < N201, N(S), N(R))

I (C, P, M = 1, L = N201, N(S), N(R))

UI (C, P = 0, M = 0, L = 0)

UI (C, P = 0, M = 0, L < N201)

where:

C = command

R = response

P = poll

F = final

M = M bit

L = length indicator

N(S) = send sequence number

N(R) = receive sequence number

25.2.1 Initialization

25.2.1.1 Initialization when contention resolution required

25.2.1.1.1 Normal initialization

25.2.1.1.1.1 Test purpose

To test the normal establishment of multiple frame operation between the SS and the MS when contention resolution is required.

25.2.1.1.1.2 Method of test

The MS is paged as described in the Layer 2 tests general section at 25.1.5.

The MS shall then continue the setup by sending a SABM frame.

The SS responds with a UA frame.

The MS shall send a UI fill frame.

The SS waits for at least T200 after the UA to ensure the SABM frame is not repeated. This confirms that the UA has been received.

The MS is returned to the idle state as described in subclause 25.1.1.6.

Expected sequence

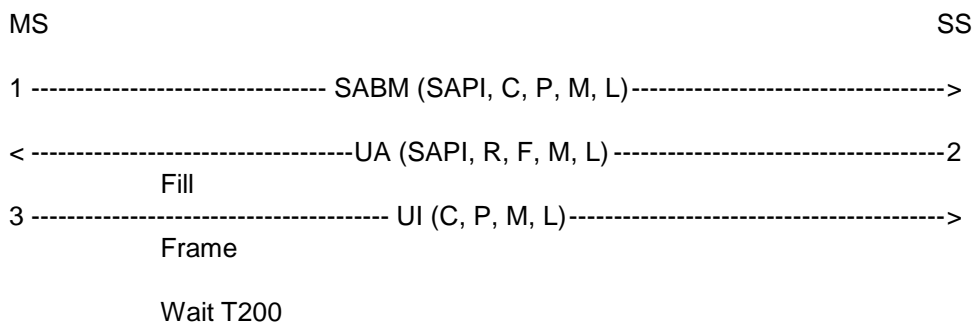

The frames from the SS will be:

2: One UA frame containing:

SAPI = 0, R = 0, F = 1, M = 0, L = L of SABM.

information field = information field of SABM.

25.2.1.1.1.3 Test requirements

The frames from the MS shall be:

1: One SABM frame containing:

SAPI = 0, C = 0, P = 1, M = 0, $0 \leq L \leq N201$.

information field = Page Response.

3: One UI frame containing:

C = 0, P = 0, M = 0, L = 0.

25.2.1.1.2 Initialization failure

25.2.1.1.2.1 Loss of UA frame

25.2.1.1.2.1.1 Test purpose

To test the MS response to the loss of a Layer 2 UA frame during initialization.

25.2.1.1.2.1.2 Method of test

The MS is paged as described in the Layer 2 tests general section at 25.1.5.

The MS shall then continue the setup by sending an SABM frame.

The SS ignores the first SABM frame from the MS.

The MS shall wait for time-out of timer T200 and then send a second SABM frame.

The SS responds with a UA frame.

The MS shall send a UI fill frame.

The SS waits for at least T200 to ensure the SABM frame is not repeated

The MS is returned to the initial condition by clearing of the call (not part of this test).

Expected sequence

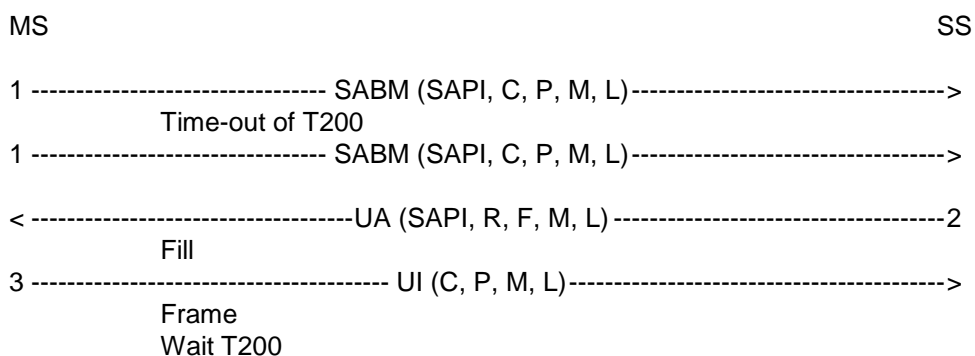

The frames from the SS will be:

2: One UA frame containing:

SAPI = 0, R = 0, F = 1, M = 0, L = L of SABM.

information field = information field of SABM.

25.2.1.1.2.1.3 Test requirements

The frames from the MS shall be:

1: One SABM frame (occurs twice) containing:

SAPI = 0, C = 0, P = 1, M = 0, $0 \leq L \leq N201$.

information field = Page Response.

The second SABM frame shall follow the first SABM frame after.

time-out of timer T200.

3: One UI frame containing:

C = 0, P = 0, M = 0, L = 0.

25.2.1.1.2.2 UA frame with different information field

25.2.1.1.2.2.1 Test purpose

To test that the MS will leave the channel and return to the idle state when multiple frame establishment fails because a UA frame with a different information field is received in response to the SABM frame.

To test that the MS will thereafter repeat the immediate assignment procedure returning to the idle state when multiple frame establishment fails because a UA frame with a different information field is received in response to the SABM frame.

To test that MS will not attempt to perform the immediate assignment procedure after the first repetition.

25.2.1.1.2.2.2 Method of test

The MS is paged as described in the general section for Layer 2 testing in subclause 25.1.5. The MS is now in a condition to test the Layer 2 aspects of multiple frame establishment with contention resolution and a UA frame with an information field different from the one in its SABM frame.

The MS shall send an SABM frame.

The SS shall respond with an UA frame whose information field is different from the one in the SABM frame.

The MS shall send an SABM frame.

The SS shall respond with an UA frame whose information field is different from the one in the SABM frame.

The SS shall wait for $3 \times T200$ to check that the MS does not send any L2 frames other than L2 fill frames on the assigned channel.

After a time equal to $3 \times T200$ the SS checks that there are no more Layer 2 frames on the assigned channel, for a period of 1 s.

NOTE 1: Possible fill frames are allowed in order to take into account processing time inside the MS.

NOTE 2: There are no further attempts of immediate assignment procedure after the repetition.

15 s after sending the UA frame in response to the repetition of the immediate assignment procedure the SS pages the MS according to subclause 25.2.1.1.1, to make sure that the MS has returned to the idle state.

MS	SS
<-----PAGING REQUEST-----	1
2 ----- CHANNEL REQUEST----->	
< ----- IMMEDIATE ASSIGNMENT-----	3
4 ----- SABM (SAPI, C, P, M, L)----->	
< -----UA (SAPI, R, F, M, L)-----	5
6 ----- CHANNEL REQUEST----->	
< ----- IMMEDIATE ASSIGNMENT-----	7
8 ----- SABM (SAPI, C, P, M, L)----->	
< -----UA (SAPI, R, F, M, L)-----	9
Wait for at least $3 \times T200$, fill frames may occur.	
There are no Layer 2 frames on the assigned channel for 1 s.	
The MS is paged 15 s after step 9.	
MS is in idle state.	
<-----PAGING REQUEST-----	10
11 ----- CHANNEL REQUEST----->	

The frames from the SS will be:

5, 9: Two UA frames containing:

SAPI = 0, R = 0, F = 1, M = 0, L = 0.

25.2.1.1.2.2.3 Test requirements

The frames from the MS shall be:

4, 8: Two SABM frames containing:

SAPI = 0, C = 0, P = 1, M = 0, $0 < L \leq N201$.

information field = Page Response.

25.2.1.1.2.3 Information frame and supervisory frames in response to an SABM frame

25.2.1.1.2.3.1 Test purpose

To test that the MS will ignore receipt of frames other than a UA when received in response to the SABM frame.

25.2.1.1.2.3.2 Method of test

As in subclause 25.2.1.1.2.2, but instead of returning a UA frame the SS will respond with an I frame, RR frame, REJ frame. (So this test will actually be performed 3 times.) The MS shall ignore receipt of the frames sent by the SS and therefore resend its SABM frame after time-out of T200.

Expected Sequence

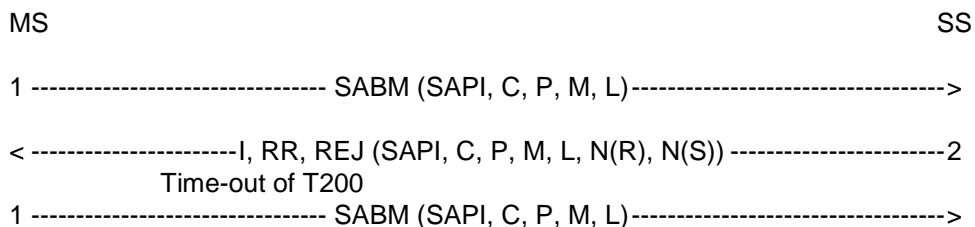

The frames from the SS will be:

2: One I frame containing:

SAPI = 0, C = 1, P = 1, M = 0, $0 \leq L \leq N201$ (arbitrary), N(R), N(S) arbitrary.

information field arbitrary.

or One RR frame containing:

SAPI = 0, C = 1, P = 1, N(R) arbitrary.

or One REJ frame containing:

SAPI = 0, C = 1, P = 1, N(R) arbitrary.

25.2.1.1.2.3.3 Test requirements

The frames from the MS shall be:

1: One SABM frame (occurs twice) containing:

SAPI = 0, C = 0, P = 1, M = 0, $0 \leq L \leq N201$.

information field = Page Response.

The second SABM frame shall follow the first SABM frame after time-out of timer T200.

25.2.1.1.3 Initialization denial

25.2.1.1.3.1 Test purpose

To test that the MS takes appropriate action if the network side indicates that it can not enter the multiple frame established state.

25.2.1.1.3.2 Method of test

The MS is paged as described in the Layer 2 tests general section at 25.1.5.

The MS shall then continue the setup by sending a SABM frame.

The SS responds with a DM frame.

The SS then waits at least T200 for the MS to transmit.

The MS shall not repeat the SABM frame.

Expected Sequence

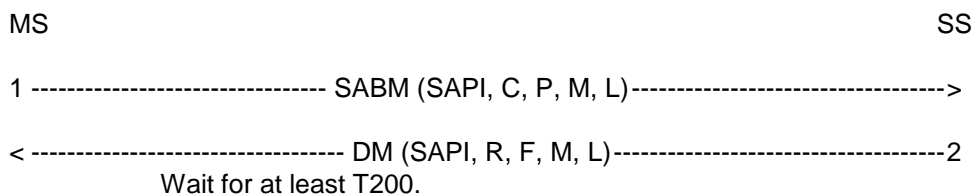

The frames from the SS will be:

2: One DM frame containing:

SAPI = 0, R = 0, F = 1, M = 0, L = 0.

25.2.1.1.3.3 Test requirements

The frames from the MS shall be:

1: One SABM frame containing:

SAPI = 0, C = 0, P = 1, M = 0, $0 \leq L \leq N201$.

information field = Page Response.

25.2.1.1.4 Total initialization failure

25.2.1.1.4.1 Test purpose

To test the MS response to the lack of the system to respond to requests to initialize the data link.

25.2.1.1.4.2 Method of test

The MS is paged as described in the Layer 2 tests general section at 25.1.5.

The MS shall then continue the setup by sending a SABM frame.

The SS ignores the first SABM frame from the MS.

The MS shall wait for time-out of timer T200 and then send a second SABM frame.

This is repeated until the MS has sent the SABM frame six times. The MS shall not send the SABM any more than six times.

The SS continues to send paging messages on the BCCH/CCCH and the test continues as in test 25.2.1.1.1.

Expected Sequence

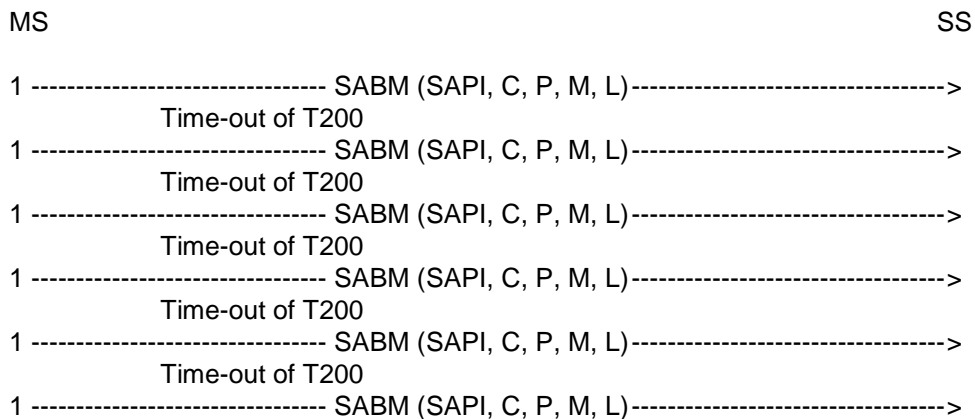

25.2.1.1.4.3 Test requirements

The frames from the MS shall be:

1: One SABM frame (occurs six times) containing:

SAPI = 0, C = 0, P = 1, M = 0, $\leq L \leq N201$.

information field = Page Response.

The subsequent SABM frames shall follow the previous SABM frame after time-out of timer T200.

25.2.1.2 Initialization, contention resolution not required

This procedure is used after a data link has been established with contention resolution and a new data link is established on a new channel e.g. handover, dedicated channel assignment.

25.2.1.2.1 Normal initialization without contention resolution

25.2.1.2.1.1 Test purpose

To test the normal initialization of multiple-frame operation when contention resolution is not required.

25.2.1.2.1.2 Method of test

The data link is setup between the MS and the SS as in test 25.2.1.1.1.

After the MS has sent the UI frame the SS initiates the dedicated channel assignment procedure to assign an SDCCH.

The MS shall then continue the setup by sending a SABM frame without contention resolution.

The SS responds with a UA frame.

The MS shall then send an I frame containing the assignment complete message.

The SS shall acknowledge the I frame with an RR frame.

The SS then waits for the MS to send a UI fill frame.

The SS then initiates the dedicated channel assignment procedure to assign an FACCH.

The expected sequence is then repeated. The SS waits for at least T200 to ensure that the SABM is not repeated.

Expected Sequence

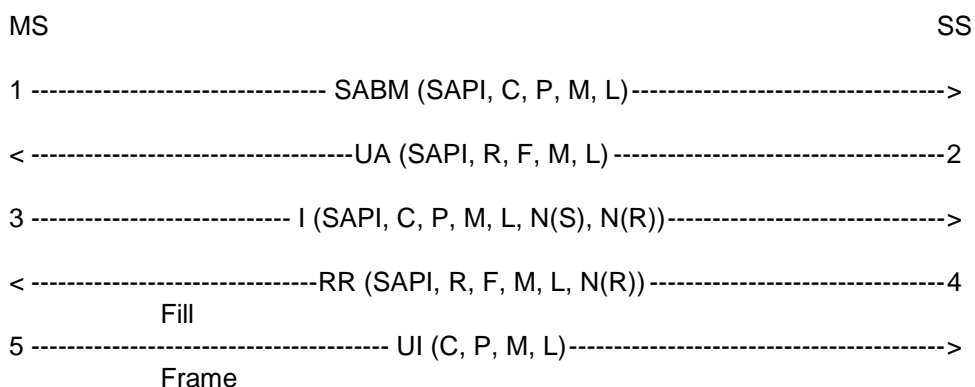

The frames from the SS will be:

2: One UA frame containing:

SAPI = 0, R = 0, F = 1, M = 0, L = 0.

4: One RR frame containing:

SAPI = 0, R = 0, F = 0, M = 0, L = 0, N(R) = 1.

25.2.1.2.1.3 Test requirements

The frames from the MS shall be:

1: One SABM frame containing:

SAPI = 0, C = 0, P = 1, M = 0, L = 0.

3: One I frame containing:

SAPI = 0, C = 0, P = 0, M = 0, $0 \leq L \leq N201$, N(S) = 0, N(R) = 0.

Information field = Assignment Complete.

5: One UI frame containing:

C = 0, P = 0, M = 0, L = 0.

25.2.1.2.2 Initialization failure

25.2.1.2.2.1 Test purpose

To test the MS response to the loss of a Layer 2 UA frame during initialization.

25.2.1.2.2.2 Method of test

The SS initiates the dedicated channel assignment procedure to assign an SDCCH.

The MS shall then continue the setup by sending a SABM frame.

The SS ignores the first SABM frame from the MS.

The MS shall wait for time-out of timer T200 and then send a second SABM frame.

The SS responds with a UA frame.

The MS shall then send an I frame containing the assignment complete message.

The SS shall acknowledge the I frame with an RR frame.

The SS then waits for the MS to send a UI fill frame.

The SS then initiates the dedicated channel assignment procedure to assign a FACCH.

The expected sequence is then repeated. The SS waits for at least T200 to ensure that the SABM is not repeated.

The MS is returned to the idle state as described in subclause 25.1.1.6.

Expected Sequence

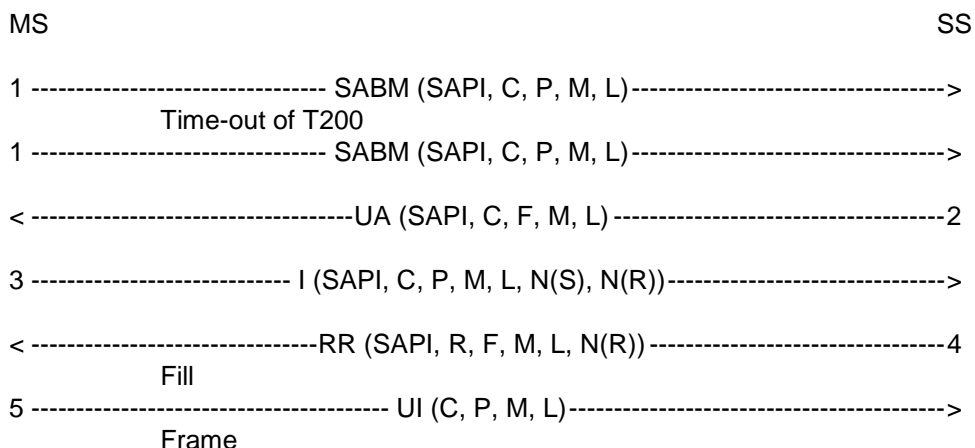

The frames from the SS will be:

2: One UA frame containing:

SAPI = 0, R = 0, F = 1, M = 0, L = 0.

4: One RR frame containing:

SAPI = 0, R = 0, F = 0, M = 0, L = 0, N(R) = 1.

25.2.1.2.2.3 Test requirements

The frames from the MS shall be:

1: One SABM frame (occurs twice) containing:

SAPI = 0, C = 0, P = 1, M = 0, L = 0.

The second SABM frame shall follow the first SABM frame after time-out of timer T200.

3: One I frame containing:

SAPI = 0, C = 0, P = 0, M = 0, $0 \leq L \leq N201$, N(S) = 0, N(R) = 0

Information field = Assignment Complete

5: One UI frame containing:

C = 0, P = 0, M = 0, L = 0.

25.2.1.2.3 Initialization denial

25.2.1.2.3.1 Test purpose

To test that the MS takes appropriate action if the data link can not be initialized if the network side indicates the Layer 3 process is busy.

25.2.1.2.3.2 Method of test

The data link is setup between the MS and the SS as in test 25.2.1.1.1.

After the MS has sent the UI frame the SS initiates the dedicated channel assignment procedure to assign a SDCCH.

The MS shall then continue the setup by sending a SABM frame.

The SS responds with a DM frame.

The SS then waits at least T200.

The MS shall not repeat the SABM frame. However the MS will attempt to re-establish the link on the previous channel.

The test is repeated, but a FACCH is assigned in place of the SDCCH.

Expected Sequence

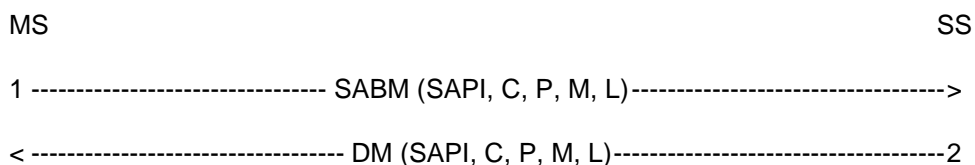

The frames from the SS will be:

2: One DM frame containing:

SAPI = 0, R = 0, F = 1, M = 0, L = 0.

25.2.1.2.3.3 Test requirements

The frames from the MS shall be:

1: One SABM frame containing:

SAPI = 0, C = 0, P = 1, M = 0, L = 0.

25.2.1.2.4 Total initialization failure

25.2.1.2.4.1 Test purpose

To test the MS response to the lack of the system to respond to requests to initialize the data link.

25.2.1.2.4.2 Method of test

The data link is setup between the MS and the SS as in test 25.2.1.1.1.

After the MS has sent the UI frame the SS initiates the dedicated channel assignment procedure to assign a SDCCH.

The MS shall then continue the setup by sending a SABM frame.

The SS ignores the first SABM frame from the MS.

The MS shall wait for time-out of timer T200 and then send a second SABM frame.

This is repeated until the MS has sent the SABM frame six times.

The MS shall not send the SABM any more than six times.

The test is repeated, but a FACCH is assigned in place of the SDCCH.

Expected Sequence

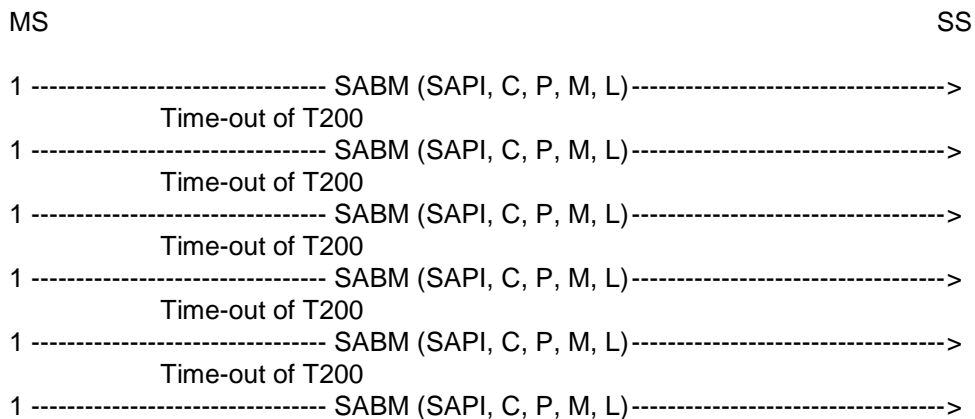

25.2.1.2.4.3 Test requirements

The frames from the MS shall be:

1: One SABM frame (occurs six times) containing:

SAPI = 0, C = 0, P = 1, M = 0, L = 0.

The subsequent SABM frames shall follow the previous SABM frame after time-out of timer T200.

25.2.2 Normal information transfer

25.2.2.1 Sequence counting and I frame acknowledgements

25.2.2.1.1 Test purpose

To test the operation of Layer 2 sequence numbering. Since there are 8 sequence numbers the test cycles through 9 information frame transfers.

25.2.2.1.2 Method of test

The MS is brought into the multiple frame established state as described in test 25.2.1.1.1.

The SS sends an Identity Request message asking for IMEI to the MS.

The MS shall acknowledge this I frame with an Identity Response I frame or a RR frame.

This is repeated a further 8 times as rapidly as possible assuming a window size 1.

The MS Layer 3 response time should be less than $4 \cdot T200$ and therefore the MS responses to at least the 5th, 6th, 7th, 8th and 9th I frames must be an I frame on the SDCCH. On the FACCH it is possible that all MS responses at Layer 2 will be RR frames.

The frames from the SS will be:

1, 3, 5, 7, 9, 11, 13, 15, 17: One I frame (occurs nine times) containing:

SAPI = 0, C = 1, P = 0, M = 0, $0 \leq L \leq N201$.

$N(S) = 0, 1, 2, 3 \dots 7, 0$.

$N(R) = (\text{number of I frames received in the test sequence hitherto}) \bmod 8$.

information field = Identity Request (IMEI).

19, 21, and so on, until the SS has received 9 I frames from the MS: One RR frame containing:

SAPI = 0, R = 0, F = 0, M = 0, L = 0.

$N(R) = (\text{number of I frames received in the test sequence hitherto}) \bmod 8.$

25.2.2.1.3 Test requirements

There shall be an integer $k \geq 0$ such that for $i = 1, 2, \dots, k + 9$ the following conditions (a) and (b) both hold:

(a) The MS sends 9 I frames and k RR frames during the test.

(b) The frames sent by the MS in step $2 \times i$ are:

(b1) If the frame is an RR frame (occurs k times): one RR frame containing:

$SAPI = 0, R = 1, F = 0, M = 0, L = 0.$

$N(R) = ((\text{Value of } N(S) \text{ in the last received I frame from the SS}) + 1) \bmod 8.$

(b2) If the frame is an I frame (occurs 9 times): one I frame containing:

$SAPI = 0, C = 0, P = 0, M = 0, 0 \leq L \leq N201.$

$N(R) = ((\text{Value of } N(S) \text{ in the last received I frame from the SS}) + 1) \bmod 8.$

$N(S) = (\text{number of I frame sent hitherto by the MS to SS excluding the actual I frame}) \bmod 8.$

information field = Identity Response (IMEI).

Example of expected sequence (assuming $3 \times T_{200} < L3 \text{ reaction time} < 4 \times T_{200}$):

MS	SS
<----- I (SAPI, C, P, M, L, N(S), N(R))-----	1
2-----RR (SAPI, R, M, L, N(R), F)----->	
<----- I (SAPI, C, P, M, L, N(S), N(R))-----	3
4-----RR (SAPI, R, M, L, N(R), F)----->	
<----- I (SAPI, C, P, M, L, N(S), N(R))-----	5
6-----RR (SAPI, R, M, L, N(R), F)----->	
<----- I (SAPI, C, P, M, L, N(S), N(R))-----	7
8-----RR (SAPI, R, M, L, N(R), F)----->	
<----- I (SAPI, C, P, M, L, N(S), N(R))-----	9
10----- I (SAPI, C, P, M, L, N(S), N(R))----->	
<----- I (SAPI, C, P, M, L, N(S), N(R))-----	11
12----- I (SAPI, C, P, M, L, N(S), N(R))----->	
<----- I (SAPI, C, P, M, L, N(S), N(R))-----	13
14----- I (SAPI, C, P, M, L, N(S), N(R))----->	
<----- I (SAPI, C, P, M, L, N(S), N(R))-----	15
16----- I (SAPI, C, P, M, L, N(S), N(R))----->	
<----- I (SAPI, C, P, M, L, N(S), N(R))-----	17
18----- I (SAPI, C, P, M, L, N(S), N(R))----->	
<-----RR (SAPI, R, M, L, N(R), F)-----	19
20----- I (SAPI, C, P, M, L, N(S), N(R))----->	
<-----RR (SAPI, R, M, L, N(R), F)-----	21
22----- I (SAPI, C, P, M, L, N(S), N(R))----->	
<-----RR (SAPI, R, M, L, N(R), F)-----	23
24----- I (SAPI, C, P, M, L, N(S), N(R))----->	
<-----RR (SAPI, R, M, L, N(R), F)-----	25
26----- I (SAPI, C, P, M, L, N(S), N(R))----->	
<-----RR (SAPI, R, M, L, N(R), F)-----	27

The frames from the SS will be:

1, 3, 5, 7, 9, 11, 13, 15, 17: One I frame (occurs nine times) containing:

$SAPI = 0, C = 1, P = 0, M = 0, 0 \leq L \leq N201.$

$N(S) = 0, 1, 2, 3, \dots, 7, 0.$

$N(R) = 0, 0, 0, 0, 0, 1, 2, 3, 4.$

information field = Identity Request (IMEI).

19, 21, 23, 25, 27: One RR frame (occurs five times) containing:

$SAPI = 0, R = 0, F = 0, M = 0, L = 0.$

$N(R) = 5, 6, 7, 0, 1.$

The frames from the MS shall be:

2, 4, 6, 8: One RR frame (occurs four times) containing:

$SAPI = 0, R = 1, F = 0, M = 0, L = 0.$

$N(R) = 1, 2, 3, 4.$

10, 12, 14, 16, 18, 20, 22, 24, 26: One I frame (occurs nine times) containing:

$SAPI = 0, C = 0, P = 0, M = 0, 0 \leq L \leq N201.$

$N(R) = 5, 6, 7, 0, 1, 1, 1, 1, 1.$

$N(S) = 0, 1, 2, 3, 4, 5, 6, 7, 0.$

information field = Identity Response (IMEI).

25.2.2.2 Receipt of an I frame in the timer recovery state

25.2.2.2.1 Test purpose

To test that the MS is able to respond to I frames whilst in the timer recovery state.

25.2.2.2.2 Method of test

The MS is brought into the multiple frame established state as described in test 25.2.1.1.1.

The SS sends an Identity Request message asking for IMEI to the MS.

The MS shall respond with a RR frame though this may be incorporated with the Identity Response I frame.

The SS does not respond to the I frame.

The MS shall wait for expiry of timer T200 and then repeat the I frame but with the P bit set to 1.

The SS then sends a valid Identity Request I frame asking for IMEI which does not acknowledge receipt of the I frame from the MS.

On the FACCH the MS may send an RR frame acknowledging the I frame.

The MS shall repeat the I frame, this frame will acknowledge receipt of the second I frame from the SS.

The SS then acknowledges receipt of the MS I frame by sending a RR frame.

The MS shall send the next I frame. The SS acknowledges this I frame.

Expected Sequence

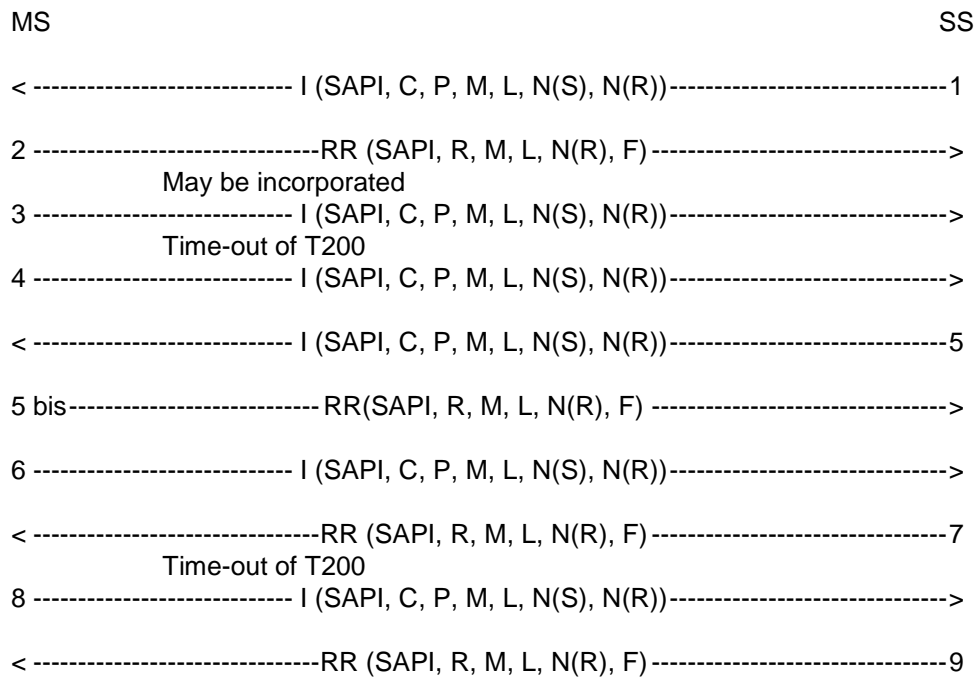

The frames from the SS will be:

1, 5: One I frame (occurs twice) containing:

SAPI = 0, C = 1, P = 0, M = 0, $0 \leq L \leq N201$, N(S) = 0, 1, N(R) = 0.

information field = Identity Request.

7, 9: One RR frame (occurs twice) containing:

SAPI = 0, R = 0, F = 1, 0, M = 0, L = 0, N(R) = 1, 2.

25.2.2.2.3 Test requirements

The frames from the MS shall be:

2: One RR frame containing:

SAPI = 0, R = 1, F = 0, M = 0, L = 0, N(R) = 1.

3, 8: One I frame (occurs twice) containing:

SAPI = 0, C = 0, P = 0, M = 0, $0 \leq L \leq N201$, N(R) = 1, 2, N(S) = 0, 1

information field = Identity Response

4, 6: One I frame (occurs twice) containing:

SAPI = 0, C = 0, P = 1, M = 0, $0 \leq L \leq N201$, N(R) = 1, 2, N(S) = 0.

information field = Identity Response.

5 bis: (possible only on the FACCH) One RR frame containing:

SAPI = 0, R = 1, F = 0, M = 0, L = 0, N(R) = 2.

25.2.2.3 Segmentation and concatenation

25.2.2.3.1 Test purpose

To test the proper use of segmentation and concatenation, suspend and resume.

25.2.2.3.2 Method of test

Specific PICS statements:

- MS supporting USSD (TSPC_Serv_SS_unstruct)
- MS supporting CC protocol for at least one Bearer Capability (TSPC_Addinfo_CCprotocol_oneBC)

If the MS supports the UnStructuredSSData operation, then the MS is made to activate an unknown supplementary service as defined in 3GPP TS 02.30 with the following sequence *NN*si#: NN is chosen to be undefined in 3GPP TS 02.30 annex 2 and is an IA5. Total length of *NN*si# shall be 20 characters.

If the MS does not support the UnStructuredSSData operation, then the MS is made to initiate a call.

The SS responds with the Immediate Assign procedure firstly allocating a SDCCH and on the second repeat of the test a TCH.

The MS is brought into the multiple frame established state by continuing as described in test 25.2.1.1.1. The layer three message element in the SABM will be CM Serv Request.

The SS sends the UA and waits for 10 s. The SS then sends an I frame with CM Serv Accept.

The MS sends either:

- a REGISTER message which is segmented between two I frames; or
- a SETUP message.

The SS shall acknowledge only the I frame with more bit set to 1 (if any) but it shall not acknowledge the I frame with more bit set to 0.

The SS then performs a handover (in the case of SDCCH this shall be finely synchronized) while still on the assigned channel and without acknowledging the last I frame of the MS layer 3 message, making sure to fill the handover command to more than 21 octets (for example by using the cell channel description element).

On the SDCCH the MS will go into timer recovery and resend the last I frame of the layer 3 message with the P bit set to 1 when it acknowledges the two I frames of the handover command. On the FACCH the MS may simply acknowledge both I frames.

The MS does not attempt to resend the last I frame of the REGISTER or SETUP message on the old channel but instead goes to the new channel where it performs a random access using the Handover Access message and then multiple frame establishment without contention resolution as described in test 25.2.1.2.1.

The MS shall then send an I frame with the Handover complete message. Assuming this is a finely synchronized handover.

The SS acknowledges this I frame.

The MS shall then resend the previous REGISTER or SETUP message, that is all frames which are acknowledged in the usual way.

The test has to be repeated on the FACCH.

Expected Sequence

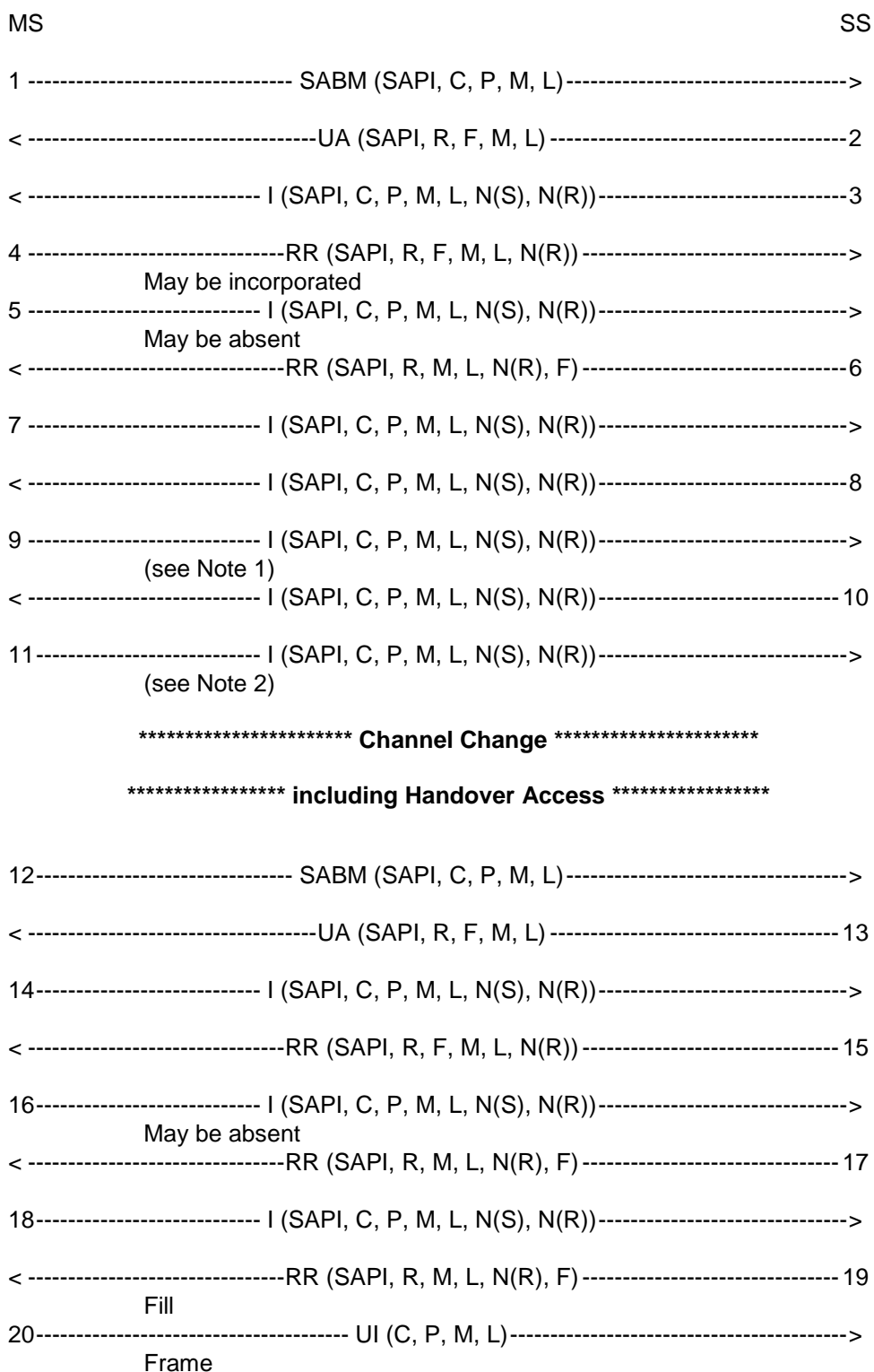

NOTE 1: The MS may send RR frames on the FACCH in addition to the I frames in 9 and 11.

NOTE 2: The I frame in 11 is optional.

The frames from the SS will be:

2: One UA frame containing:

SAPI = 0, R = 0, F = 1, M = 0, L = L of SABM.

information field = information field of SABM.

3: One I frame containing:

SAPI = 0, C = 1, P = 0, M = 0, $0 < L < N201$, N(S) = 0, N(R) = 0.

information field = CM Service Accept.

6: One RR frame containing: (This frame is sent only if frame 5 was received)

SAPI = 0, R = 0, F = 0, M = 0, L = 0, N(R) = 1.

8, 10: Two I frames containing:

SAPI = 0, C = 1, P = 0, M = 1, 0, L = N201, $\leq N201$, N(S) = 1, 2, N(R) = 1 or 0.

information field = Handover.

13: One UA frame containing:

SAPI = 0, R = 0, F = 1, M = 0, L = 0.

15, 17, 19: Two or three RR frames containing:

SAPI = 0, R = 0, F = 0, M = 0, L = 0, N(R) = 1, 2 or 1, 2, 3.

25.2.2.3.3 Test requirements

The frames from the MS shall be:

1: One SABM frame containing:

SAPI = 0, C = 0, P = 1, M = 0, $0 \leq L \leq N201$.

information field = CM Service Request.

4: One RR frame containing:

SAPI = 0, R = 1, F = 0, M = 0, L = 0, N(R) = 1.

5, 7: Two I frames containing: (The first I frame may be missing)

SAPI = 0, C = 0, P = 0, M = 1, 0, L = N201, $\leq N201$, N(S) = 0, 1 or 0, N(R) = 1.

information field = Register or Setup.

9, 11: Two I frames containing:

SAPI = 0, C = 0, P = 1, M = 0, $0 < L \leq N201$, N(S) = 1 or 0, N(R) = 2, 3.

information field = Register or Setup.

NOTE: The I frame in 11 is optional.

12: One SABM frame containing:

SAPI = 0, C = 0, P = 1, M = 0, L = 0.

14: One I frame containing:

SAPI = 0, C = 0, P = 0, M = 0, $0 < L < N201$, N(S) = 0, N(R) = 0.

information field = Handover Complete.

16, 18: Two I frames containing: (The first I frame may be missing)

SAPI = 0, C = 0, P = 0, M = 1, 0, L = N201, $0 < L \leq N201$, N(S) = 1, 2 or 1, N(R) = 0.

information field = Register or Setup.

20: UI frame containing:

C = 0, P = 0, M = 0, L = 0.

25.2.3 Normal layer 2 disconnection

25.2.3.1 Test purpose

To test the normal data link disconnection sequences.

25.2.3.2 Method of test

The data link is setup between the MS and the SS as in test 25.2.1.1.1.

The SS sends a Layer 2 Disconnect message to the MS.

The MS shall respond with a UA frame and return to the idle state; no more Layer 2 (I, S or U) frames, except possibly one or more "Fill" frames, shall be sent. The SS may receive "Fill" frames after the sending of the DISC frame. If this occurs this may only happen for up to T200 after the sending of the DISC frame. The checking for Layer 2 frames, and the recording of any "Fill" frames, is done for a time defined as $4 \times T200$.

The SS confirms that the MS has returned to the idle state by performing test 25.2.1.1.1.

Expected Sequence

MS		SS
	< ----- DISC (SAPI, C, P, M, L) -----	1
	2 ----- UA (SAPI, R, M, L, F) -----	>

The frames from the SS will be:

1: One DISC frame containing:

SAPI = 0, C = 1, P = 1, M = 0, L = 0.

25.2.3.3 Test requirements

The frames from the MS shall be:

2: One UA frame containing:

SAPI = 0, R = 1, F = 1, M = 0, L = 0.

No other Layer 2 (I, S or U) frames shall occur. If "Fill" frames are sent this may only be done for up to T200 after the sending of the DISC frame.

25.2.4 Test of link failure

25.2.4.1 I frame loss (MS to SS)

25.2.4.1.1 Test purpose

To test that the MS repeats an I frame N200 times with T200 between two I frames and that the MS releases the layer 2 link after N200 repetitions of the I frame in the case when no answer to the I frame is received.

25.2.4.1.2 Method of test

The MS is brought into the multiple frame established state as described in test 25.2.1.1.1.

The SS sends an Identity Request message asking for IMEI to the MS.

The MS shall respond with a RR frame though this may be incorporated with the Identity Response I frame.

The SS does not respond to the I frame.

The MS shall wait for expiry of timer T200 and then repeat the I frame but with the P bit set to 1.

This is repeated until the MS has sent the I frame N200+1 times. The MS shall not send any layer 2 frame. This is checked for a time of $4 \times T200$. The MS shall return to the idle state. This is checked by performing test 25.2.1.1.1.

Expected Sequence

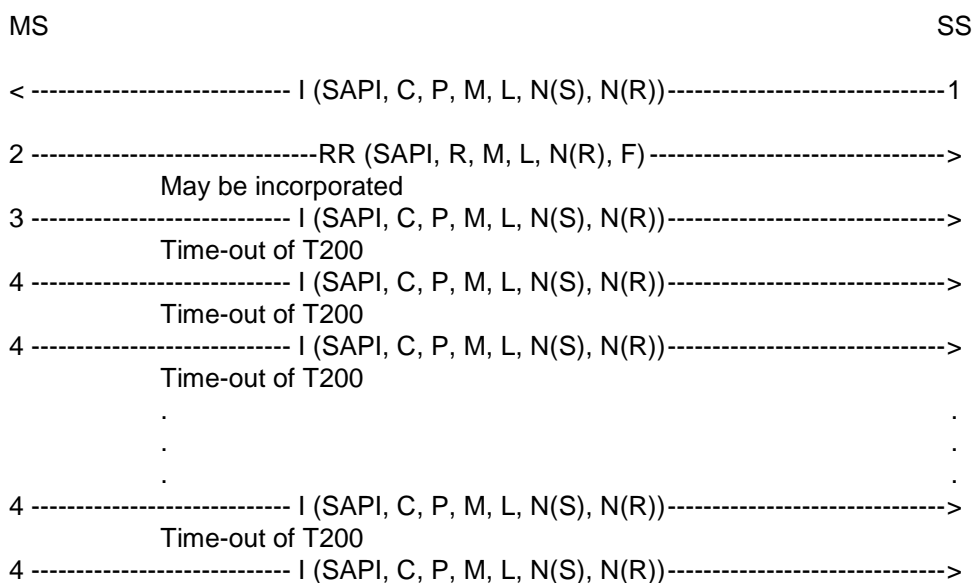

The frames from the SS will be:

1: One I frame containing:

SAPI = 0, C = 1, P = 0, M = 0, $0 \leq L \leq N201$, N(S) = 0, N(R) = 0.

information field = Identity Request.

25.2.4.1.3 Test requirements

The frames from the MS shall be:

2: One RR frame containing:

SAPI = 0, R = 1, F = 0, M = 0, L = 0, N(R) = 1.

3: One I frame containing:

SAPI = 0, C = 0, P = 0, M = 0, $0 \leq L \leq N201$, N(R) = 1, N(S) = 0.

information field = Identity Response.

4: One I frame (occurs N200 times) containing:

SAPI = 0, C = 0, P = 1, M = 0, $0 \leq L \leq N201$, N(R) = 1, N(S) = 0.

information field = Identity Response.

25.2.4.2 RR response frame loss (SS to MS)

Covered in test 25.2.2.2.

25.2.4.3 RR response frame loss (MS to SS)

25.2.4.3.1 Test purpose

To test the Layer 2 recovery mechanism in the event of RR frame loss.

25.2.4.3.2 Method of test

The MS is brought into the multiple frame established state as described in test 25.2.1.1.1.

The SS sends a I frame containing a Layer 3 message using PD = 1111 (e.g. 0FH) to the MS. The L3 message is TEST INTERFACE with tested device equal to 0.

The MS shall respond with a RR frame.

The SS ignores the RR frame from the MS but after T200 from the I frame sent by the SS the SS repeats the I frame but with the P bit set to 1. This simulates loss of the RR from the MS.

The MS shall respond with either an RR or REJ frame.

NOTE: This requirement is less restrictive than 3GPP TS 04.06.

Expected Sequence

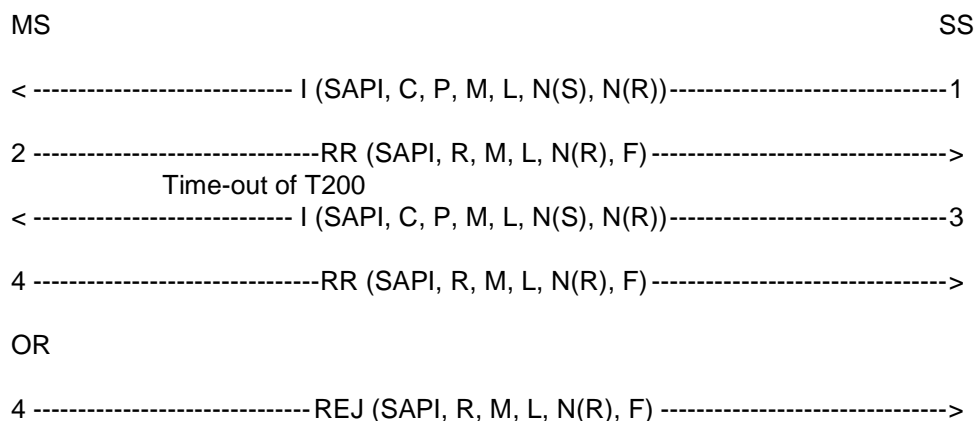

The frames from the SS will be:

1: One I frame containing:

SAPI = 0, C = 1, P = 0, M = 0, L = 3, N(S) = 0, N(R) = 0.

3: One I frame containing:

SAPI = 0, C = 1, P = 1, M = 0, L = 3, N(S) = 0, N(R) = 0.

25.2.4.3.3 Test requirements

The frames from the MS shall be:

2: One RR frame containing:

SAPI = 0, R = 1, F = 0, M = 0, L = 0, N(R) = 1.

4: One RR frame containing:

SAPI = 0, R = 1, F = 1, M = 0, L = 0, N(R) = 1.

OR

4: One REJ frame containing:

SAPI = 0, R = 1, F = 1, M = 0, L = 0, N(R) = 1.

25.2.5 Test of frame transmission with incorrect C/R values

Purpose of tests

To test that the MS will react correctly upon the reception of a frame with incorrect C/R value.

Initial Conditions

Perform the establishment of the dedicated physical resource according to 25.1.5 and initialize the link as in subclause 25.2.1.1.1. Then proceed as stated below.

25.2.5.1 I frame with C bit set to zero

25.2.5.1.1 Test purpose

To test that the MS will take no action when it receives an I frame with the C bit set to zero (R).

25.2.5.1.2 Method of test

The data link is set up between the MS and the SS as in test 25.2.1.1.1.

The SS shall send an I frame with the C bit set to zero to the MS.

The SS shall then wait for at least 4 times T200 to make sure that the MS does not respond to that I frame but that the MS keeps sending fill frames.

The SS shall after 4 times T200 send a RR command, P bit set to 1.

The MS shall respond with a RR response, F bit set to 1.

Expected Sequence

MS	SS
< ----- I (SAPI, C, P, M, L, N(S), N(R))-----	1 ----->
Fill	
2 ----- UI (C, P, M, L)-----	----->
Frame	
< ----- RR (SAPI, C, M, L, N(R), P)-----	3 ----->
4 -----RR (SAPI, R, M, L, N(R), F)-----	----->

The frames from the SS will be:

1: One I frame containing:

SAPI = 0, C = 0, P = 1, M = 0, $0 \leq L \leq N201$, N(R) = 0, N(S) = 0.

Information field = Identity Request.

3: One RR frame containing:

SAPI = 0, C = 1, P = 1, M = 0, L = 0, N(R) = 0.

25.2.5.1.3 Test requirements

The frames from the MS shall be:

2: UI frames containing:

C = 0, P = 0, M = 0, L = 0.

4: One RR frame containing:

SAPI = 0, R = 1, F = 1, M = 0, L = 0, N(R) = 0.

25.2.5.2 SABM frame with C bit set to zero

25.2.5.2.1 Test purpose

To test that the MS will take no action when it receives an SABM frame with the C bit set to zero (R).

25.2.5.2.2 Method of test

The MS is brought into the multiple frame established state as described in test 25.2.1.1.1.

The SS sends an I frame containing a Layer 3 message using PD=1111 (e.g. 0FH) in order to raise V(R) in the MS to 1. The L3 message is TEST INTERFACE with tested device equal to 0.

The MS shall acknowledge this by the appropriate RR frame.

The SS sends SABM with the C bit set to zero.

The SS shall after 4 times T200 send a RR command, P bit set to 1.

The MS shall respond with a RR response, F bit set to 1.

The MS is returned to the idle state as described in subclause 25.2.1.1.6.

Expected Sequence

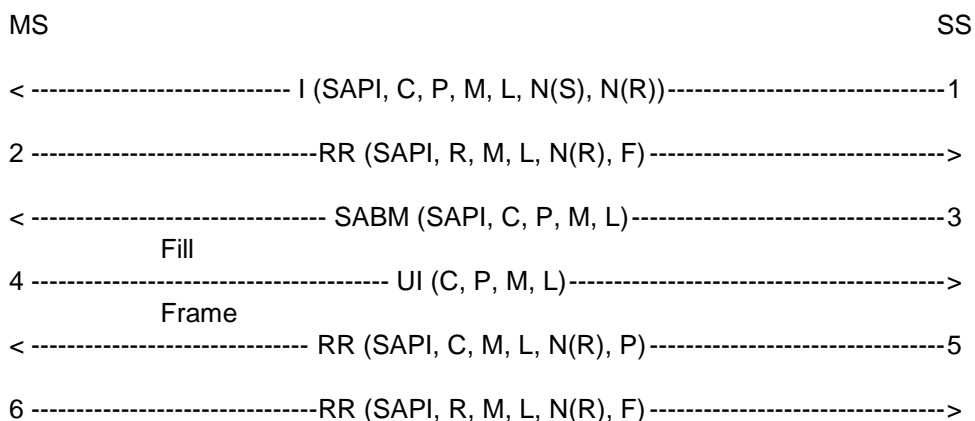

The frames from the SS will be:

1: One I frame containing:

SAPI = 0, C = 1, P = 0, M = 0, L = 3, N(S) = 0, N(R) = 0.

3: One SABM frame containing:

SAPI = 0, C = 0, P = 1, M = 0, L = 0.

5: One RR frame containing:

SAPI = 0, C = 1, P = 1, M = 0, L = 0, N(R) = 0.

25.2.5.2.3 Test requirements

The frames from the MS shall be:

2: One RR frame containing:

SAPI = 0, R = 1, F = 0, M = 0, L = 0, N(R) = 1.

4: One UI frame containing:

C = 0, P = 0, M = 0, L = 0.

6: One RR frame containing:

SAPI = 0, R = 1, F = 1, M = 0, L = 0, N(R) = 1.

25.2.6 Test of errors in the control field

Purpose of tests

To test that the MS will react in the proper way to errors in the Control Field.

25.2.6.1 N(S) sequence error

25.2.6.1.1 Test purpose

To test that the MS will ignore the contents of the I field of an out-of-sequence I frame from the SS.

25.2.6.1.2 Method of test

The MS is brought into the multiple frame established state as described in test 25.2.1.1.1.

The SS shall send a correct I frame containing Identity Request.

The MS shall acknowledge this in a RR frame or piggy back the acknowledgement onto the I frame carrying Identity Response.

The SS shall then send an I frame containing Identity Request with incorrect N(S) but correctly acknowledging the MS's I frame; P bit set to zero.

The MS shall send a REJ frame.

The SS shall, after T200, send another I frame with incorrect N(S), P bit set to 1 this time.

The MS shall respond with a REJ, F bit set to 1.

The MS shall resume the transmission of fill frames.

Expected Sequence

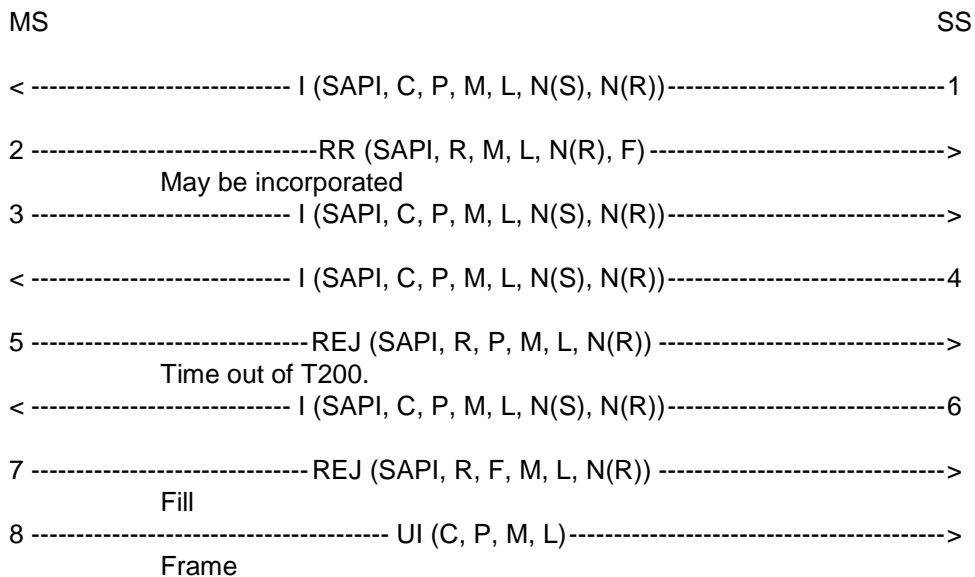

The frames from the SS will be:

1: One I frame containing:

$SAPI = 0, C = 1, P = 0, M = 0, 0 \leq L \leq N201, N(S) = 0, N(R) = 0.$

information field = Identity Request.

4: One I frame containing:

$SAPI = 0, C = 1, P = 0, M = 0, 0 \leq L \leq N201, N(S) = 0, N(R) = 1$

information field = Identity Request

6: One I frame containing:

$SAPI = 0, C = 1, P = 1, M = 0, 0 \leq L \leq N201, N(S) = 0, N(R) = 1$

information field = Identity Request

25.2.6.1.3 Test requirements

The frames from the MS shall be:

2: One RR frame containing:

$SAPI = 0, R = 1, F = 0, M = 0, L = 0, N(R) = 1.$

3: One I frame containing:

$SAPI = 0, C = 0, P = 0, M = 0, 0 \leq L \leq N201, N(R) = 1, N(S) = 0.$

information field = Identity Response.

5: One REJ frame containing:

$SAPI = 0, R = 1, P = 0, M = 0, L = 0, N(R) = 1.$

7: One REJ frame containing:

$SAPI = 0, R = 1, F = 1, M = 0, L = 0, N(R) = 1.$

8: One UI frame containing:

C = 0, P = 0, M = 0, L = 0.

25.2.6.2 N(R) sequence error

25.2.6.2.1 Test purpose

To test that the MS will detect a N(R) sequence error and react in the proper way to it.

25.2.6.2.2 Method of test

The MS is brought into the multiple frame established state as described in test 25.2.1.1.1.

The SS shall send an I frame containing an information field of length N201 and an incorrect receive sequence number.

The MS may:

- a) send a DISC frame within N200×T200; or
- b) perform a "local end release".

In case a) the SS shall respond with a UA frame. In case b) it detects a lower layer failure.

NOTE: The delay N200×T200 is specified for test purpose only. It is assumed that the L3 reaction time within the MS to command a release is less than this delay, which is less than the delay before the SS would detect a L2 failure.

Expected Sequence

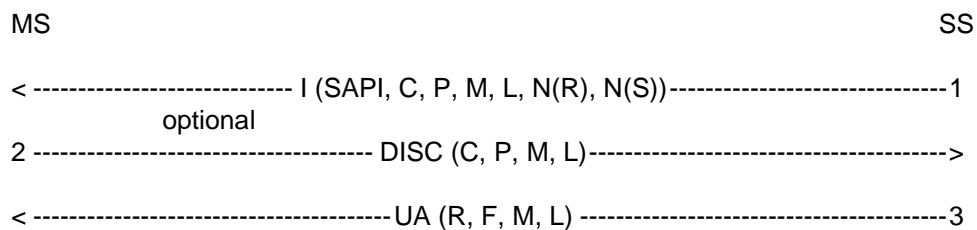

The frames from the SS are:

1: One I frame:

SAPI = 0, C = 1, P = 0, M = 1, L = N201, N(R) = 1, N(S) = 0.

In case a):

3: One UA frame:

SAPI = 0, R = 0, F = 1, M = 0, L = 0.

25.2.6.2.3 Test requirements

The frame from the MS in case a) shall be:

2: One DISC frame:

SAPI = 0, C = 0, P = 1, M = 0, L = 0.

25.2.6.3 Improper F bit

25.2.6.3.1 Test purpose

To test that the MS, being in the timer recovery state, will return to the multiple frame established state only after having received an RR response with the F bit set to 1. This test is covered in test 25.2.2.2.

25.2.7 Test on receipt of invalid frames

25.2.7.1 Test purpose

To test that the MS will ignore all invalid frames.

25.2.7.2 Method of test

The data link is set up between the MS and the SS as in test 25.2.1.1.1.

The SS shall then transmit an:

- RR frame with the Length indicator greater than zero and a faulty N(R);
- REJ frame with the EA bit set to zero and a faulty N(R);
- SABM frame with the EL bit set to zero;
- DM frame with the Length indicator greater than zero;
- DISC frame with the M bit set to 1;
- UA frame with the EA bit set to zero;
- I frame with the Length indicator greater than N201;
- I frame with the M bit set to 1 and the Length indicator less than N201;
- command frames with correct Address and Length indicator field and a non-implemented control field.

After T200 the SS shall in every case transmit an RR command, P bit set to 1.

The MS shall respond with an RR response, F bit set to 1.

Expected Sequence

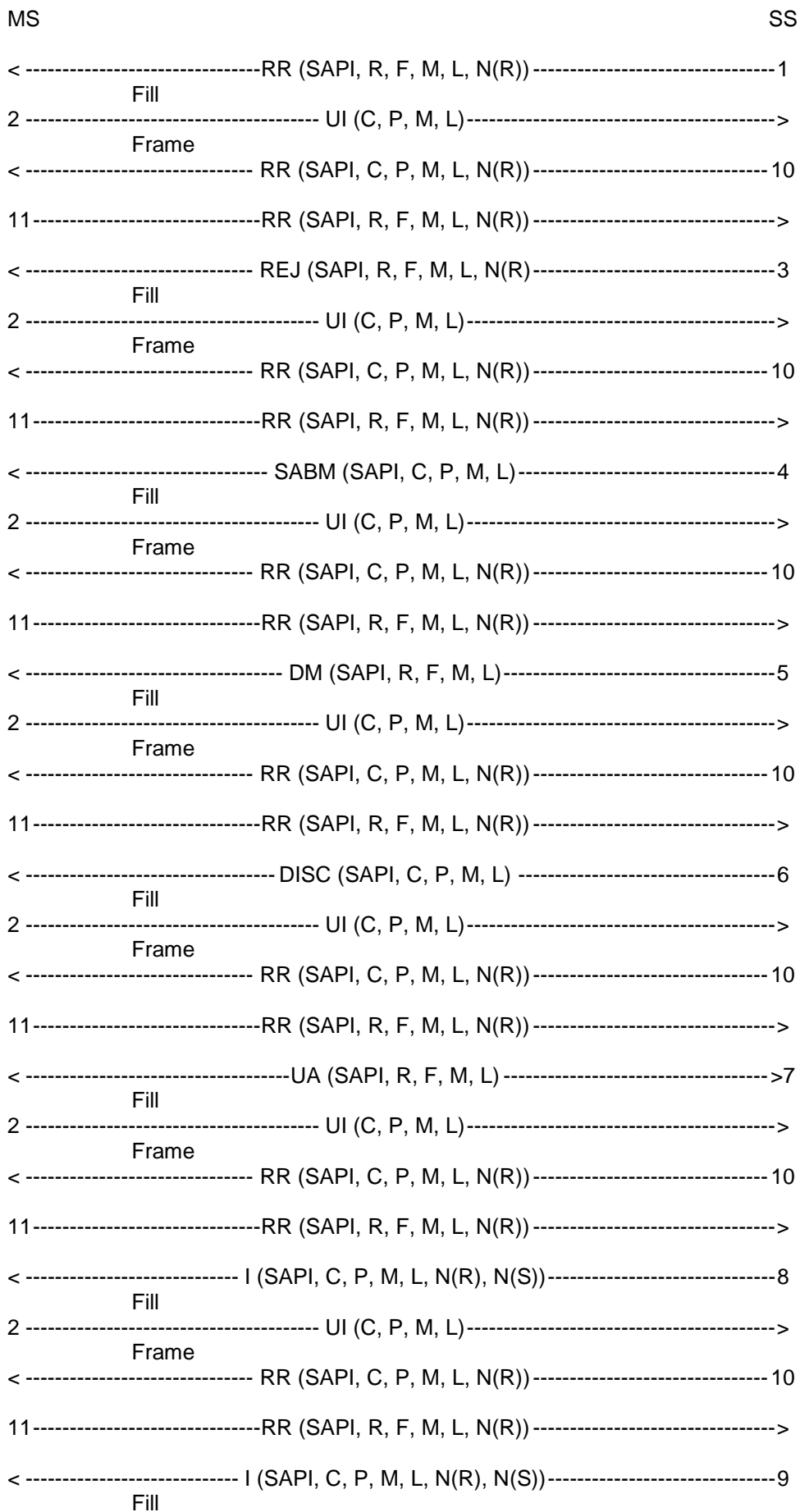

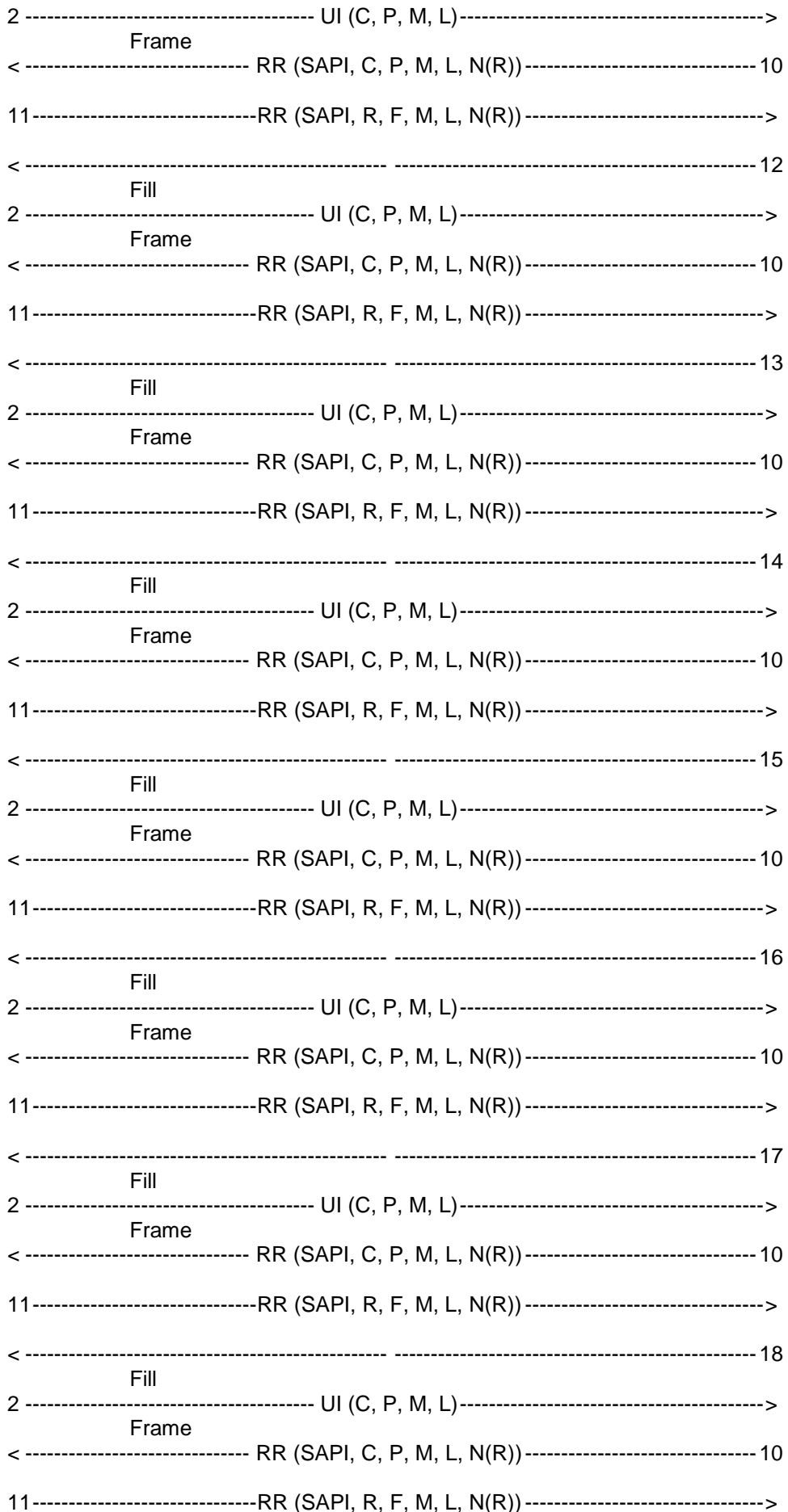

The frames from the SS are:

1: One RR frame:

$SAPI = 0, R = 0, F = 0, M = 0, L > 0, N(R) = 1.$

3: One REJ frame:

$SAPI = 0, R = 0, F = 0, M = 0, L = 0, N(R) = 1, EA = 0.$

4: One SABM frame:

$SAPI = 0, C = 1, P = 1, M = 0, L = 0, EL = 0.$

5: One DM frame:

$SAPI = 0, R = 0, F = 1, M = 0, L > 0.$

6: One DISC frame:

$SAPI = 0, C = 1, P = 1, M = 1, L = 0.$

7: One UA frame:

$SAPI = 0, R = 0, F = 0, M = 0, L = 0, EA = 0.$

8: One I frame:

$SAPI = 0, C = 1, P = 0, M = 0, L > N201, N(R) = 0, N(S) = 6.$

9: One I frame:

$SAPI = 0, C = 1, P = 0, M = 1, L < N201, N(R) = 0, N(S) = 7.$

10: One RR frame:

$SAPI = 0, C = 1, P = 1, M = 0, L = 0, N(R) = 0.$

12: One command frame with

Control Field = xxx1 1101.

13: One command frame with

Control field = xxx1 1011.

14: One command frame with

Control field = xxx1 0111.

15: One command frame with

Control field = 01x1 1111.

16: One command frame with

Control field = 1xx1 1111.

17: One command frame with

Control field = 0011 0011.

18: One command frame with

Control field = 1xx1 0011.

NOTE: An "x" stands for an arbitrary bit value.

25.2.7.3 Test requirements

The frames from the MS shall be:

2: One UI frame (occurs fifteen times):

$C = 0, P = 0, M = 0, L = 0.$

11: One RR frame (occurs fifteen times):

$SAPI = 0, R = 1, F = 1, M = 0, L = 0, N(R) = 0.$

26 Testing of layer 3 functions

Ref.: 3GPP TS 04.08 / 3GPP TS 24.008 / 3GPP TS 44.018

NOTE: The tests on functioning of the elementary procedures in the MS are grouped as the description of those procedures in 3GPP TS 04.08 / 3GPP TS 24.008 / 3GPP TS 44.018. However, the test procedures are carried out in an order which is more logic for the purpose of testing.

26.1 Default conditions and structured sequence of tests

26.1.1 Default test conditions during layer 3 tests

During tests in clause 26 the following default test conditions shall apply if not otherwise stated within the test description. In the table below, decimal values are normally used. Sometimes a hexadecimal value, indicated with a "H", or a binary value, indicated with a "B" is given.

	GSM 900	DCS 1 800
General signalling conditions for all carriers		
Ciphering	yes	yes
General RF-conditions for all carriers		
Frequency hopping mode	Non-hopping	Non-hopping
Propagation profile	Static	Static
Downlink Input Level	63 dB μ Vemf()	63 dB μ Vemf()
Uplink output power	Minimum according to MS power class	Minimum according to MS power class
Serving cell, BCCH/CCCH carrier		
Channel ARFCN	20	590
Alternative channels	40 or 60	690 or 830
Serving cell, Traffic channel, SDCCH		
Channel ARFCN	30	650
Alternative channels	50 or 70	750 or 850
Power Control Indicator	0	0
Neighbouring cells BCCH/CCCH carriers		
Channel ARFCN	10, 80, 90, 100, 110, 120	520, 600, 700, 780, 810, 870
Alternative channels	15, 85, 95, 105, 115, 122	530, 610, 710, 790, 820, 880
Input level	53 dB μ Vemf()	53 dB μ Vemf()
Network dependent parameters		
Cell identity	0001H	0001H
Mobile country code, MCC	001 (decimal)	001 (decimal)
Mobile network code, MNC	01 (decimal)	01 (decimal)
Location area code, LAC	0001H	0001H
Frequency List	Bit Map 0	Range 512
BCCH allocation sequence number(BA_IND)	0	0
Cell Channel Descriptor	Bit Map 0	Range 512
PLMN colour code, NCC	1	1
BS colour code, BCC	5	5
SMS Cell Broadcast	not active	not active
DTX	MS must not use	MS must not use
IMSI Attach-detach	MS shall not apply	MS shall not apply
CCCH_CONF	1 basic physical channel for CCCH combined with SDCCH	1 basic physical channel for CCCH combined with SDCCH
BS_AG_BLKS_RES	0 blocks reserved	0 blocks reserved
BS_PA_MFRMS	5 paging subgroups	5 paging subgroups

	GSM 900	DCS 1 800
CELL_BAR_ACCESS Call-reestablishment (RE) Emergency Call allowed Access Control Class (AC) (0..9, 11..15) Network dependent timers Radio_Link_Time-out T3212 Periodic updating in decihours	(not barred) (allowed) allowed allowed 8 Infinite	(not barred) (allowed) same same 8 Infinite
Access control parameters		
Max retrans Tx-integer, nr. of slots CELL_RESELECT_HYSTERESIS MS_TXPWR_MAX_CCH RXLEV_ACCESS_MIN NECI ACS (ADDITIONAL RESELECTION PARAM IND) C2 parameters POWER OFFSET	1 5 12 dB minimum level minimum New establishment causes are not supported No additional cell parameters are present in SI messages 7 and 8 C2 parameters not present N/A	1 5 12 dB minimum level minimum same same same same POWER OFFSET Parameter not present.

	GSM 450	GSM 480
General signalling conditions for all carriers		
Ciphering	yes	yes
General RF-conditions for all carriers		
Frequency hopping mode Propagation profile Downlink Input Level Uplink output power	Non-hopping Static 63 dB μ Vemf() Minimum according to MS power class	Non-hopping Static 63 dB μ Vemf() Minimum according to MS power class
Serving cell, BCCH/CCCH carrier		
Channel ARFCN Alternative channels	263 274 or 276	310 321 or 323
Serving cell, Traffic channel, SDCCH		
Channel ARFCN Alternative channels Power Control Indicator	267 275 or 279 0	314 322 or 326 0
Neighbouring cells BCCH/CCCH carriers		
Channel ARFCN Alternative channels Input level	260, 281, 284, 287, 290, 293 261, 280, 283, 286, 289, 292 53 dB μ Vemf()	307, 328, 331, 334, 337, 340 308, 327, 330, 333, 336, 339 53 dB μ Vemf()
Network dependent parameters		
Cell identity Mobile country code, MCC Mobile network code, MNC Location area code, LAC Frequency List BCCH allocation sequence number(BA_IND) Cell Channel Descriptor PLMN colour code, NCC BS colour code, BCC SMS Cell Broadcast DTX IMSI Attach-detach CCCH_CONF BS_AG_BLKS_RES BS_PA_MFRMS	0001H 001 (decimal) 01 (decimal) 0001H Range 128 0 Range 128 1 5 not active MS must not use MS shall not apply 1 basic physical channel for CCCH combined with SDCCH 0 blocks reserved 5 paging subgroups	0001H 001 (decimal) 01 (decimal) 0001H Range 128 0 Range 128 1 5 not active MS must not use MS shall not apply 1 basic physical channel for CCCH combined with SDCCH 0 blocks reserved 5 paging subgroups

	GSM 450	GSM 480
CELL_BAR_ACCESS Call-reestablishment (RE) Emergency Call allowed Access Control Class (AC) (0..9, 11..15) Network dependent timers Radio_Link_Time-out T3212 Periodic updating in decihours	(not barred) (allowed) allowed allowed 8 Infinite	(not barred) (allowed) same same 8 Infinite
Access control parameters		
Max retrans Tx-integer, nr. of slots CELL_RESELECT_HYSTERESIS MS_TXPWR_MAX_CCH RXLEV_ACCESS_MIN NECI ACS (ADDITIONAL RESELECTION PARAM IND) C2 parameters POWER OFFSET	1 5 12 dB minimum level minimum New establishment causes are not supported No additional cell parameters are present in SI messages 7 and 8 C2 parameters not present N/A	1 5 12 dB minimum level minimum same same same N/A

	GSM 710 or GSM 750 or T-GSM 810	GSM 850
General signalling conditions for all carriers		
Ciphering	yes	yes
General RF-conditions for all carriers		
Frequency hopping mode Propagation profile Downlink Input Level Uplink output power	Non-hopping Static 63 dB μ Vemf() Minimum according to MS power class	Non-hopping Static 63 dB μ Vemf() Minimum according to MS power class
Serving cell, BCCH/CCCH carrier		
Channel ARFCN Alternative channels	460 480 or 500	150 170 or 190
Serving cell, Traffic channel, SDCCH		
Channel ARFCN Alternative channels Power Control Indicator	470 490 or 510 0	160 180 or 200 0
Neighbouring cells BCCH/CCCH carriers		
Channel ARFCN Alternative channels Input level	440, 445, 450, 455, 475, 495 443, 448, 453, 465, 485, 505 53 dB μ Vemf()	140, 210, 220, 230, 240, 250 145, 215, 225, 235, 245, 251 53 dB μ Vemf()
Network dependent parameters		
Cell identity Mobile country code, MCC Mobile network code, MNC Location area code, LAC Frequency List BCCH allocation sequence number(BA_IND) Cell Channel Descriptor PLMN colour code, NCC BS colour code, BCC SMS Cell Broadcast DTX IMSI Attach-detach CCCH_CONF BS_AG_BLK_RES BS_PA_MFRMS	0001H 001 (decimal) 011(decimal) 0001H Range 128 0 Range 128 1 5 not active MS must not use MS shall not apply 1 basic physical channel for CCCH combined with SDCCH 0 blocks reserved 5 paging subgroups	0001H 001 (decimal) 011(decimal) 0001H Range 128 0 Range 128 1 5 not active MS must not use MS shall not apply 1 basic physical channel for CCCH combined with SDCCH 0 blocks reserved 5 paging subgroups

	GSM 710 or GSM 750 or T-GSM 810	GSM 850
CELL_BAR_ACCESS Call-reestablishment (RE) Emergency Call allowed Access Control Class (AC) (0..9, 11..15) Network dependent timers Radio_Link_Time-out T3212 Periodic updating in decihours	(not barred) (allowed) allowed allowed 8 Infinite	(not barred) (allowed) allowed allowed 8 Infinite
Access control parameters		
Max retrans Tx-integer, nr. of slots CELL_RESELECT_HYSTERESIS MS_TXPWR_MAX_CCH RXLEV_ACCESS_MIN NECI ACS (ADDITIONAL RESELECTION PARAM IND) C2 parameters POWER OFFSET	1 5 12 dB minimum level minimum New establishment causes are not supported No additional cell parameters are present in SI messages 7 and 8 C2 parameters not present N/A	1 5 12 dB minimum level minimum New establishment causes are not supported No additional cell parameters are present in SI messages 7 and 8 C2 parameters not present N/A

	PCS 1 900
General signalling conditions for all carriers	
Ciphering	yes
General RF-conditions for all carriers	
Frequency hopping mode Propagation profile Downlink Input Level Uplink output power	Non-hopping Static 63 dB μ Vemf() Minimum according to MS power class
Serving cell, BCCH/CCCH carrier	
Channel ARFCN Alternative channels	590 690 or 730
Serving cell, Traffic channel, SDCCH	
Channel ARFCN Alternative channels Power Control Indicator	650 750 or 780 0
Neighbouring cells BCCH/CCCH carriers	
Channel ARFCN Alternative channels Input level	520, 600, 700, 720, 760, 780 530, 610, 710, 740, 770, 790 53 dB μ Vemf()
Network dependent parameters	
Cell identity Mobile country code, MCC Mobile network code, MNC Location area code, LAC Frequency List BCCH allocation sequence number(BA_IND) Cell Channel Descriptor PLMN colour code, NCC BS colour code, BCC SMS Cell Broadcast DTX IMSI Attach-detach CCCH_CONF BS_AG_BLKS_RES BS_PA_MFRMS	0001H 001 (decimal) 011 (decimal) 0001H Range 512 0 Range 512 1 5 not active MS must not use MS shall not apply 1 basic physical channel for CCCH combined with SDCCH 0 blocks reserved 5 paging subgroups

	PCS 1 900
CELL_BAR_ACCESS	(not barred)
Call-reestablishment (RE)	(allowed)
Emergency Call allowed	same
Access Control Class (AC) (0..9, 11..15)	same
Network dependent timers	
Radio_Link_Time-out	8
T3212 Periodic updating in decihours	Infinite
Access control parameters	
Max retrans	1
Tx-integer, nr. of slots	5
CELL_RESELECT_HYSTERESIS	12 dB
MS_TXPWR_MAX_CCH	minimum level
RXLEV_ACCESS_MIN	minimum
NECI	same
ACS (ADDITIONAL RESELECTION PARAM IND)	same
C2 parameters	same
POWER OFFSET	N/A

These informations are provided by system information 1, 2, 3 and 4 messages.

The system information elements which are broadcast on the SACCH during the dedicated mode should be consistent with those sent on the BCCH when the MS was in idle mode prior to the channel request.

In addition, all fill paging messages sent on the paging sub-channels will have by default, their page mode set to NORMAL PAGING.

26.1.2 Structured sequence of the tests

The tests shall be performed in the order as indicated in the following table.

The validity of the tests depends upon the results of the tests performed before.

Channel request (basic test)	RR	26.2.1
Immediate assignment	RR	26.6.1
IMSI attach/detach (basic)	RR	26.2.2
Paging	RR	26.6.2
Test of the mobile station functions in idle mode	RR	26.3
Frequency redefinition	RR	26.6.6
Measurement report (incl. system info not idle)	RR	26.6.3
Authentication	MM	26.7.2
Cipher mode setting	RR	26.6.8
Identification	MM	26.7.3
Sequenced MM/CM message transfer	..	26.2.3
Channel release	RR	26.6.12
Location updating	MM	26.7.4
TMSI reallocation	MM	26.7.1
Classmark change	RR	26.6.11
Call control (verification on CC state diagram)	CC	26.8.1.1 and 26.8.1.2
Call rearrangement	CC	26.8.1.4.4
DTMF information transfer	CC	26.8.1.4.1
Handover	RR	26.6.5
Additional assignment	RR	26.6.9
Partial release	RR	26.6.10
Re-establishment	CC	26.8.2
Dedicated channel assignment (during calls)	RR	26.6.4
Transmission mode change	RR	26.6.7
Mobility management connection establishment	MM	26.7.5
Test of Layer 3 error handling		26.5
User to user signalling	CC	26.8.3
Testing of structured procedures		26.9
E-GSM or R-GSM signalling		26.10
Multiband signalling		26.11

26.1.3 General rules for message parameters

The following rules concerning message parameters apply to clause 26:

- 1) Those values of parameters which are a consequence of the context of a test and which are not specific to that test need not be defined.
- 2) If the value of a parameter of an uplink message (MS to Network) is specified in a test, the implicit meaning is that it has to be checked; if the value is not specified, it is not to be checked unless stated otherwise.
- 3) An optional field or optional Information Element of a downlink message (Network to MS), the presence of which is not a consequence of a test description, shall be absent in that test.
- 4) If an optional field or Information Element is not indicated for the uplink (MS to Network) - unless specified otherwise -, it may be included or not.
- 5) The Protocol Discriminator, Transaction Identifier and Message Type of all uplink messages have to be checked.

26.1.4 General rules for layer 3 testing

Unless otherwise specified, before the SS pages the MS, the MS must be given the necessary time to be able to receive paging (see clause 20). In addition and unless otherwise specified, the SS must wait at least 1s after the last time slot of the message block containing a CHANNEL RELEASE, before sending a PAGING to the mobile (see 3GPP TS 04.13).

In the signalling tests, where the following statement is used:

- 'the RF level of cell x is set sufficiently low to ensure that cell x is not suitable as defined in 3GPP TS 05.08 subclause 6.6.2';

this means that for the cell to be "not suitable" by virtue of its RF level, the RF level is to be lowered until C1 is below 0.

26.1.5 Format of layer 3 test descriptions

In subclauses 26.2, 26.5, 26.6, 26.7, 26.9, 26.10 and 26.11 a rigorous description technique is used which is defined here.

For every test, a subclause titled "method of test" and a subclause titled "expected sequence" define the exact test steps and the verifications to be performed in the test. These subclauses are normative and give requirements for the MS behaviour. The information of both subclauses applies.

For the message contents further normative requirements for the MS behaviour are defined in the following parts which apply in the following order (starting with the highest) on basis of the general rules of 26.1.3:

- specifications in the "method of test" and "expected sequence" subclauses;
- specifications in the subclause titled "specific message contents";
- specifications in the subclause "default message contents" at the end of the relevant subclauses 26.5, 26.6, 26.7, 26.9, 26.10 or 26.11;
- specifications of default conditions in subclause 26.1.

The relevant section may contain the definition of abbreviations of L3 message names that are used in that section.

In many cases, a test description contains an introductory subclause explaining the background of the relevant procedures and explaining why the tests of that description are essential.

For every test, test purposes are given. In general conformance testing methodology, the correspondence between test purposes and test cases can be n to m: To one test purpose more than one test case may correspond (e.g. different test cases checking data variations); also a test case may serve more than one test purpose. In some contexts a structure of conformance test descriptions is advisable which specifies in one part (non-duplicated) test purposes with references to corresponding test suites serving the test purposes, in another part test suites realizing the test purposes; this structuring is especially useful for gaining completeness and avoiding duplications. In the present document, however, it is preferred to group descriptions by test cases. The reasons are:

- The structure is more sought to assist the test execution and evaluation than test development. It must be easy to determine why a wrong behaviour leads to a verdict.
- The structure is to be close to GSM 11.10 phase 1.

For every test purpose of a test, a conformance requirement is given.

For each conformance requirement in a test description, references to core specifications are given.

For every test, the related PICS/PIXIT statements that are necessary for performing the test are given.

For every test, initial conditions for both the System Simulator and the Mobile Station are given. Unless otherwise specified, these initial conditions apply together with the default conditions of 26.1, the initial conditions of the test prevailing over the default conditions of 26.1.

For every test, the foreseen final state of the MS after the test and the maximum duration of the test are specified. These parts are non-normative and do not contain a description of verifications to be performed. The contained information might be used for sequencing different tests and for the decision when a test is to be interrupted.

The expected sequence specifies the actions in numbered steps in a tabular form. In the column "direction", "SS -> MS" denotes a message sent from the SS to the MS, "MS -> SS" denotes a message sent from the MS to the SS, "SS" denotes an action at the SS, "MS" denotes an action at the MS (e.g. interaction with the user or higher layers). The column "message" defines the L3 messages to be sent or expected by the SS. In the "comments" column, further normative information is to be found, e.g. message parameters. In some cases, different alternative behaviours are possible in a test. Then test steps in alternative sequences are numbered as:

"A n", "A n + 1", ..., "A n + k";

"B n", "B n + 1", ..., "B n + l";

"C n", "C n + 1", ..., "C n + m";

etc. (n, m, l, k integers > 0).

and step numbering of a re-unified sequence resumes with the lowest of $n + k + 1$, $n + l + 1$, $n + m + 1$.

In some cases the test steps of a test are to be repeated. Then an execution counter is introduced for the test.

26.2 Initial tests

26.2.1 Channel request

The random access procedure is used by the MS to ask for resources to the network. If it is not performed correctly, the MS could prevent other MSs from obtaining resources, or the network could be overloaded if the MS does not respect the duration between 2 CHANNEL REQUEST messages.

26.2.1.1 Channel request / initial time

26.2.1.1.1 Conformance requirement

- 1) The MS shall start the initial access procedure at the latest 0,7 s after reception of the paging message.
- 2) The MS shall spread the initial CHANNEL REQUEST with equal probability on the correct number of time slots.

Reference(s)

3GPP TS 04.08 / 3GPP TS 44.018, subclauses 3.3.1.1.2 and 3.3.2.2.

26.2.1.1.2 Test purpose

- 1) To verify that the MS answers to a PAGING message by sending a CHANNEL REQUEST message within 0,7 s after reception of the PAGING message.
- 2) To verify that the MS does not always use the same delay between reception of paging message and sending of the CHANNEL REQUEST message. If an MS uses a fixed delay, there is a high probability that different MSs of the same product series use the same delay. There would then be a high risk of collision.

26.2.1.1.3 Method of test

Initial Conditions

System Simulator:

1 cell, Tx-Integer = 5. The CCCH is either combined or not with SDCCH. This is arbitrarily chosen.

Mobile Station:

The MS has a valid TMSI. It is "idle updated".

Specific PICS statements:

-

PIXIT Statements:

-

Foreseen Final State of the MS

The MS has a valid TMSI. It is "idle updated".

Test Procedure

Specific test parameters:

K = 200.

The MS is paged. The SS measures and stores the number of CCCH RACH slots between the sending of the PAGING REQUEST message and the reception of the CHANNEL REQUEST from the MS, excluding the slots containing the messages themselves. The SS sends an IMMEDIATE ASSIGNMENT REJECT. The sequence is performed K times.

Maximum Duration of Test

30 min.

Between two consecutive executions (for k and k+1), the SS must wait for an amount of time which is enough to guarantee that the MS is in service (listening to its paging subchannel).

Expected Sequence

The sequence is executed for execution counter $k = 1, \dots, K$.

Step	Direction	Message	Comments
1	SS -> MS	PAGING REQUEST TYPE 1	"Mobile Identity" IE contains the TMSI allocated to the MS.
2	SS		The SS measures the number f of CCCH RACH slots between the sending of PAGING REQUEST message and the reception of a CHANNEL REQUEST message from the MS.
3	SS		The SS stores f. f(k) shall be lower than 700/4,615+8 if the CCCH is not combined or lower than 81+8 if the CCCH is combined with SDCCH.
4	MS -> SS	CHANNEL REQUEST	"Establishment Cause" = Answer to paging.
5	SS -> MS	IMMEDIATE ASSIGNMENT REJECT	the first "request reference" corresponds to the CHANNEL REQUEST sent by the MS.

NOTE: The test limit has been computed to give a confidence of [99,74 %] that a unit which follows the requirements will pass. The number of samples (200) has been chosen to get a good compromise between the test time and the risk of passing a bad unit.

26.2.1.1.4 Test requirements

$S(n) = \text{CARD} \{k \mid f(k) = n\}$

The following requirements shall be met:

$S(n) \leq 41$ for all n.

NOTE: $\text{CARD} \{k \mid f(k) = n\}$ is mathematical notation for the number of times that f(k) equals n.

26.2.1.2 Channel request / repetition time

26.2.1.2.1 Conformance requirement

- 1) The MS shall spread retransmissions of a CHANNEL REQUEST message, with equal probability on Tx-Integer timeslots and with the correct delay after the reception of the PAGING REQUEST.
- 2) The MS shall not retransmit another CHANNEL REQUEST message when Max-retrans is reached.

Reference(s)

3GPP TS 04.08 / 3GPP TS 44.018, subclause 3.3.1.1.2.

26.2.1.2.2 Test purpose

- 1) To verify that the MS spreads retransmission of a CHANNEL REQUEST message with equal probability on Tx-Integer time slots and correctly applies the fixed delay when the following conditions apply:
 - the CCCH is combined or not combined with SDCCHs;
 - the maximum number of retransmissions is equal to one of the following values: 1, 2, 4, 7;
 - Tx-Integer is put to any of the allowed values among those which are greater or equal to 6.

- 2) To verify that the MS retransmits exactly Max_Retrans times a CHANNEL REQUEST message if the network never responds to the CHANNEL REQUEST message.

26.2.1.2.3 Method of test

Initial Conditions

System Simulator:

1 cell.

Tx-Integer is arbitrarily chosen in the set {6, 7, 8, 9, 10, 11, 12, 14, 16, 20, 25, 32, 50}.

Max_Retrans is arbitrarily chosen in the set {1, 2, 4, 7}.

Mobile Station:

The MS has a valid TMSI. It is "idle updated".

Specific PICS statements:

-

PIXIT Statements:

-

Foreseen Final State of the MS

The MS has a valid TMSI. It is "idle updated".

Test Procedure

Specific test parameters

K equals the upper rounded value of $230/\text{Max_Retrans}$.

m equals the upper rounded value of $0,5 \times \text{Tx-Integer}$.

Counter M = 0.

Parameter S: according to table 3.1/3GPP TS 04.08 / 3GPP TS 44.018 (this parameter depend on the value chosen for Tx-Integer).

$N0 = \max(8, \text{Tx-Integer})$.

The MS is paged. The MS sends a CHANNEL REQUEST message. The MS retransmits CHANNEL REQUEST messages Max_Retrans times. The SS measures the number of CCCH RACH slots $f(i,k)$ between the moment where a CHANNEL REQUEST message has been received, and the reception of the following CHANNEL REQUEST message, excluding the slots containing the messages themselves. The SS updates the counter M. The SS does not answer to the CHANNEL REQUEST messages Max_Retrans times. After the last CHANNEL REQUEST message in every sequence where k is lower than K, the SS sends an IMMEDIATE ASSIGNMENT REJECT . In the last sequence ($k = K$), the SS does not respond to the MS. The MS shall not send any other CHANNEL REQUEST message.

Maximum Duration of Test

The execution of one sequence (for one value k): 10 s.

Between two consecutive executions (for k and k+1), the SS must wait for 35 s, which is enough to guarantee that the MS is in service (listening to its paging subchannel).

Expected Sequence

The sequence is executed for execution counter $k = 1, \dots, K$ for each of the 2 test cases.

Step	Direction	Message	Comments
1	SS -> MS	PAGING REQUEST TYPE 1	"Mobile Identity" = TMSI of the MS.
2	MS -> SS	CHANNEL REQUEST	"Establishment Cause" = Answer to paging.
3	MS -> SS	CHANNEL REQUEST	Steps 3, 4, 5 are executed for execution counter $i = 1, \dots, \text{Max_Retrans}$.
4	SS		"Establishment Cause" = Answer to paging. The SS measures the number $f(i,k)$ of CCCH RACH slots between: - the moment where the last CHANNEL REQUEST message has been received, and - the reception of the new CHANNEL REQUEST message from the MS, excluding the slots containing the messages themselves. $f(i,k)$ shall be in the set $\{S, S+1, \dots, S+T-1\}$
5	SS		If $f(i,k) - S \geq m$, $M = M+1$
A6	SS -> MS	IMMEDIATE ASSIGNMENT REJECT	Depending on the value of k , step A6 or B6 is performed: $k < K$ The third "Request Reference" IE corresponds to the last CHANNEL REQUEST message received. The third "Wait Indication" IE specifies 0 s. Other fields do not address the MS under test.
B6	SS		$k = K$ The SS checks that the MS sends no more CHANNEL REQUEST messages. This is verified during 3 s.
7	SS		$M / (K * \text{Max_Retrans})$ shall be inside the following interval: $[0,8 - m/\text{Tx-Integer} ; 1,2 - m/\text{Tx-Integer}]$

NOTE: The confidence interval in step 7, and the number of samples are chosen in such a way that the possibility of not accepting a correct MS is less than [0,26 %].

26.2.1.3 Channel request / random reference

26.2.1.3.1 Conformance requirement

A CHANNEL REQUEST message sent by the MS shall include a random reference randomly drawn from a uniform probability distribution for every new transmission.

Reference(s)

3GPP TS 04.08 / 3GPP TS 44.018, subclause 3.3.1.1.23.3.1.2.

26.2.1.3.2 Test purpose

To verify that an MS produces different random references for a CHANNEL REQUEST. If a MS always produces the same random reference, it makes possible that different MSs of the same product series produce the same random reference.

26.2.1.3.3 Method of test

Initial Conditions

System Simulator:

1 cell, CCCH not combined with SDCCH.

Mobile Station:

The MS has a valid TMSI. It is "idle updated".

Specific PICS statements:

-

PIXIT Statements:

-

Foreseen Final State of the MS

The MS has a valid TMSI. It is in the MM-state "idle, updated" and in the RR idle-mode.

Test Procedure

Specific test parameters:

K = 7.

D = 4.

The SS sends a PAGING REQUEST message. The SS stores the "Random Reference" r(k) contained as a parameter in the CHANNEL REQUEST message sent by the MS. This sequence is performed K times, and it is verified that the MS produces different values r(k).

Maximum Duration of Test

6 min

Between two consecutive executions (for k and k+1), the SS must wait for an amount of time which is enough to guarantee that the MS is in service (listening to its paging subchannel).

Expected Sequence

The sequence is executed for execution counter k = 1, ..., K.

Step	Direction	Message	Comments
1	SS -> MS	PAGING REQUEST TYPE 1	"Establishment Cause" = Answer to paging. The SS stores the "Random Reference" contained in the CHANNEL REQUEST message.
2	MS -> SS	CHANNEL REQUEST	
3	SS		

26.2.1.3.4 Test requirements

At least D values of r(1), ..., r(k) shall be different.

NOTE: D has been computed such that the probability of refusing a correct MS is less than [0,027 %].

26.2.2 IMSI detach and IMSI attach

The IMSI detach/attach procedures are used to indicate to the network that the MS is deactivated/activated. These procedures are allowed or not by the network (ATT flag set to "MSs in the cell shall apply IMSI attach and detach procedure" or "MSs in the cell are not allowed to apply IMSI attach and detach procedure").

If the IMSI attach procedure does not work correctly then the network would in certain situations not try to establish Mobile Terminating call even if the MS is "idle updated".

If an MS performs an unwanted IMSI detach procedure or does not perform IMSI detach when required, network resources are wasted.

26.2.2.1 Conformance requirement

- 1) When the Attach-detach flag in the Control Channel Description of the System Information Type 3 indicates "MSs in the cell are not allowed to apply IMSI attach and detach procedure", the MS shall not perform the IMSI detach procedure upon deactivation.
- 2) When the Attach-detach flag in the Control Channel Description of the System Information Type 3 indicates "MSs in the cell are not allowed to apply IMSI attach and detach procedure", the MS shall not perform the IMSI attach procedure upon activation.

- 3) The MS shall not perform the IMSI detach procedure if the Subscriber Identity Module is removed when the Attach-detach flag in the Control Channel Description of the System Information Type 3 indicates "MSs in the cell are not allowed to apply IMSI attach and detach procedure".
- 4) The MS shall not perform the IMSI attach procedure if the Subscriber Identity Module is inserted, when the Attach-detach flag in the Control Channel Description of the System Information Type 3 indicates "MSs in the cell are not allowed to apply IMSI attach and detach procedure".
- 5) The MS shall correctly perform the IMSI detach procedure, upon switch off, when it is required by the network to do so.
- 6) The MS shall correctly perform the IMSI attach procedure upon switch on when the IMSI attach procedure is required by the network. The MS shall correctly acknowledge the implicit TMSI reallocation procedure, which is part of this IMSI attach procedure, this means that the MS shall send a TMSI REALLOCATION COMPLETE message.
- 7) The MS shall correctly perform the IMSI detach procedure upon SIM removal when it is required by the network to do so.
- 8) The MS shall correctly perform the IMSI attach procedure, following SIM insertion and switch on when the IMSI attach procedure is required by the network. The MS shall correctly acknowledge the implicit TMSI reallocation procedure which is part of this IMSI attach procedure. This means that the MS shall send a TMSI REALLOCATION COMPLETE message.

Reference(s):

3GPP TS 02.07, normative annex B, subclause B1.17.

3GPP TS 04.08 / 3GPP TS 24.008, subclauses 4.4.3 and 4.4.4.

26.2.2.2 Test purpose

- 1) To verify that the MS correctly performs IMSI detach/attach procedures when it is required by the network and upon deactivation/activation or SIM removal/insertion and does not perform these procedures when not required.
- 2) To verify that the mobile station acknowledges a re-allocated TMSI during IMSI attach.

26.2.2.3 Method of test**Initial Conditions****System Simulator:**

1 cell, default parameters.

For procedures 1 and 2 ATT flag is set to "MSs in the cell are not allowed to apply IMSI attach and detach procedure".

For procedures 3 and 4 ATT flag is set to "MSs in the cell should apply IMSI attach and detach procedure".

Mobile Station:

The MS has a valid TMSI. It is "idle updated".

Specific PICS statements:

- a: SIM removal possible without removing power source (TSPC_AddInfo_SIMRmv)
- b: On/off switch (TSPC_Feat_OnOff)
- c: IMSI detach after SIM removal (TSPC_AddInfo_DetachOnSIMRmv)
- d: IMSI detach after removing power source (TSPC_AddInfo_DetachOnPwrDn)

PIXIT Statements:

-

Foreseen Final State of the MS

The MS has a valid TMSI which may be different from the initial one. It is "idle updated".

Test Procedure

The SS indicates that IMSI detach/attach is not allowed. If possible the MS is switched off, then switched on, otherwise it has its power source removed and then restored (see b in PICS). The SS checks that the MS does not perform IMSI detach/attach procedures. If possible (if a = Yes, see PICS), the SIM is removed, then the SIM is inserted. The SS checks that the MS does not perform IMSI detach/attach procedures.

The SS indicates that IMSI detach/attach is allowed. After a delay of 35s the MS should have detected The SS indicates now, that IMSI detach/attach is allowed. If possible (if b = Yes, see PICS) the MS is switched off, otherwise it has its power source removed (if d = Yes, see PICS). The MS initiates an IMSI detach procedure. Then depending on what has been performed before, the MS is switched on or has its power source restored. It initiates an IMSI attach procedure. The location updating procedure contains an implicit TMSI reallocation. The SIM is removed. If (a = yes and c = yes) or (a = no and d = yes) the MS initiates an IMSI detach procedure. Then the SIM is inserted, it initiates an IMSI attach procedure, the location updating procedure contains an implicit TMSI reallocation.

Maximum Duration of Test

4 min

Expected Sequence

Procedure 1

Step	Direction	Message	Comments
1	MS		If possible the MS is switched off (see b in PICS), otherwise the MS has its power source removed.
2	MS		The MS shall not initiate the IMSI detach procedure. This is checked by the SS during 5 s.
3	MS		Depending on what has been performed in step 1, the MS is brought back to operation.
4	MS		The MS shall not initiate an IMSI attach procedure. This is checked by the SS during 30 s.

Procedure 2

1	MS		If possible (a = Yes, see PICS), the SIM is removed from the MS.
2	MS		The MS shall not initiate the IMSI detach procedure. This is checked by the SS during 5 s.
3	MS		The SIM is inserted in the MS.
4	MS		The MS shall not initiate an IMSI attach procedure. This is checked by the SS during 30 s.

Procedure 3

1	MS		The MS is switched off, or has its power source removed , depending on value b in the PICS file. If b = Yes or d = Yes the MS initiates an IMSI detach procedure (steps A2, A3, A4, A5), otherwise the SS goes straight to step 6.
A2 A3 A4 A5	MS -> SS SS -> MS MS -> SS SS -> MS	CHANNEL REQUEST IMMEDIATE ASSIGNMENT IMSI DETACH INDICATION CHANNEL RELEASE	After the sending of this message, the SS waits the disconnection of the main signalling link.
6	MS		Depending on what has been performed in step 1, the MS is brought back to operation.
7	MS -> SS	CHANNEL REQUEST	The MS initiates an IMSI attach procedure.
8	SS -> MS	IMMEDIATE ASSIGNMENT	
9	MS -> SS	LOCATION UPDATING REQUEST	"Location Updating Type" = IMSI attach.
10	SS -> MS	LOCATION UPDATING ACCEPT	The SS allocates a new TMSI
11	MS -> SS	TMSI REALLOCATION COMPLETE	
12	SS -> MS	CHANNEL RELEASE	After the sending of this message, the SS waits the disconnection of the main signalling link.

Specific message contents:

SYSTEM INFORMATION TYPE 3 message:

Information Element	value/remark
Control Channel Description - Attach/Detach allowed	MS shall apply IMSI attach and detach procedures.

Procedure 4

1	MS		The SIM is removed from the MS. If (a = Yes and c= Yes) or (a = no and d = yes) in PICS, the MS initiates an IMSI detach procedure (steps A2, A3, A4, A5), otherwise the SS goes straight to step 6.
A2 A3 A4 A5	MS -> SS SS -> MS MS -> SS SS -> MS	CHANNEL REQUEST IMMEDIATE ASSIGNMENT IMSI DETACH INDICATION CHANNEL RELEASE	After the sending of this message, the SS waits the disconnection of the main signalling link.
6	MS		The SIM is inserted in the MS.
7	MS -> SS	CHANNEL REQUEST	The MS initiates a IMSI attach procedure.
8	SS -> MS	IMMEDIATE ASSIGNMENT	
9	MS -> SS	LOCATION UPDATING REQUEST	"Location Updating Type" = IMSI attach.
10	SS -> MS	LOCATION UPDATING ACCEPT	The SS allocates a new TMSI
11	MS -> SS	TMSI REALLOCATION COMPLETE	
12	SS -> MS	CHANNEL RELEASE	After the sending of this message, the SS waits the disconnection of the main signalling link.

Specific message contents:

SYSTEM INFORMATION TYPE 3 message:

Information Element	value/remark
Control Channel Description - Attach/Detach allowed	MS shall apply IMSI attach and detach procedures.

26.2.3 Sequenced MM / CM message transfer

The RR sublayer of the MS shall have an associated send state variable V(SD) for sending MM and CM messages. This send state variable has been introduced to avoid the duplication of MM and CM messages. It is useful for the network after a handover or a change of channel to identify duplicated messages.

If the MS started V(SD) with 1 instead of 0 the network would incorrectly diagnose loss of message.

If the MS later on does not handle correctly incrementation of V(SD) the network would not be able to continue the dialogue.

26.2.3.1 Conformance requirement

The MS shall implement correctly the "send state variable V(SD)" ("Send duplicated"), included in transmitted MM and CM messages.

Reference(s)

3GPP TS 04.08 / 3GPP TS 44.018, subclause 3.1.4.3.

26.2.3.2 Test purpose

To verify that V(SD) is correctly set to 0 at the beginning of the establishment of the first RR connection and to verify that the MS handles correctly this variable in the special case of IDENTITY REQUEST messages, which are MM messages.

26.2.3.3 Method of test

Initial Conditions

System Simulator:

1 cell, default parameters.

Mobile Station:

The MS has a valid TMSI. It is "idle updated".

Specific PICS statements:

-

PIXIT Statements:

-

Foreseen Final State of the MS

The MS has a valid TMSI. It is "idle updated".

Test Procedure

The MS is paged. After reception of the PAGING RESPONSE message from the MS, the SS sends an IDENTITY REQUEST message. The MS sends an IDENTITY RESPONSE message where N(SD) = 0. The SS repeats its IDENTITY REQUEST message 10 times. The MS transmits IDENTITY RESPONSE message with the value 1 and 0 in the N(SD) field alternately.

Maximum Duration of Test

1 min

Expected Sequence

Step	Direction	Message	Comments
1	SS -> MS	PAGING REQUEST TYPE 1	
2	MS -> SS	CHANNEL REQUEST	
3	SS -> MS	IMMEDIATE ASSIGNMENT	
4	MS -> SS	PAGING RESPONSE	
5	SS -> MS	IDENTITY REQUEST	
6	MS -> SS	IDENTITY RESPONSE	N(SD) = 0
7	SS -> MS	IDENTITY REQUEST	Steps 7, 8, 9 and 10 are repeated 5 times.
8	MS -> SS	IDENTITY RESPONSE	N(SD) = 1.
9	SS -> MS	IDENTITY REQUEST	
10	MS -> SS	IDENTITY RESPONSE	N(SD) = 0.
11	SS -> MS	CHANNEL RELEASE	After the sending of this message, the SS waits the disconnection of the main signalling link.

26.2.4 Establishment cause

The establishment cause set by the MS in the CHANNEL REQUEST message shall be consistent with the requested service or function, with the capabilities of the MS and with the indications given by the network.

If the MS uses a wrong establishment cause, the network might assign an inappropriate or incompatible resource.

In the case of Emergency call a wrong priority might be used.

If a reserved value is used, the network may discard the channel request.

26.2.4.1 Conformance requirements

In the CHANNEL REQUEST message, the MS shall include an establishment cause which correspond to the establishment cause given by the MM sublayer and the broadcasted NECI value, or which correspond to one of the establishment causes "answer to paging" given by the RR entity in response to a PAGING REQUEST message including the Channel Needed information.

Reference(s)

3GPP TS 04.08 / 3GPP TS 44.018, subclause 3.3.1.1.2.

26.2.4.2 Test purpose

To verify that the establishment cause sent by the MS in the Max-Retrans+1 CHANNEL REQUEST messages is consistent with the requested service, with the capabilities of the MS and with the indications of the network in the following cases:

- 1) If the MS supports a service on a traffic channel:
 - 1.1 when the NECI bit is set to 0 and call re-establishment is attempted and the call was established on TCH/H if the MS supports a service on half rate channel or on TCH/F otherwise.
- 2) If the MS supports a service on half rate channel:
 - 2.1 when the NECI bit is set to 1 and call re-establishment is attempted and the call was established on TCH/H.
- 3) If the MS supports speech:
 - 3.1 when the NECI bit is set to 0 and a speech call is attempted.
 - 3.2 when the NECI bit is set to 1 and a speech call is attempted.
- 4) If the MS supports a data service:
 - 4.1 when the NECI bit is set to 0 and a data call is attempted.
 - 4.2 when the NECI bit is set to 1 and a data call is attempted for a service supported on half rate channel (if the MS does not support any data call on half rate channel any data service is used).

- 5)
 - 5.1 when the NECI bit is set to 0 and the MS is paged with the paging indication set to "any channel".
 - 5.2 when the NECI bit is set to 0 and the MS is paged with the paging indication set to "SDCCH".
 - 5.3 when the NECI bit is set to 0 and the MS is paged with the paging indication set to "TCH/F".
 - 5.4 when the NECI bit is set to 0 and the MS is paged with the paging indication set to "TCH/H or TCH/F".
- 6)
 - 6.1 when the NECI bit is set to 0 and IMSI attach is attempted.
 - 6.2 when the NECI bit is set to 0 and normal location updating is attempted.
 - 6.3 when the NECI bit is set to 0 and periodic location updating is attempted.
 - 6.4 when the NECI bit is set to 0 and IMSI detach is attempted.
 - 6.5 when the NECI bit is set to 1 and IMSI attach is attempted.
 - 6.6 when the NECI bit is set to 1 and normal location updating is attempted.
 - 6.7 when the NECI bit is set to 1 and periodic location updating is attempted.
 - 6.8 when the NECI bit is set to 1 and IMSI detach is attempted.
- 7) If the MS supports a non call related supplementary service operation:
 - 7.1 when the NECI bit is set to 0 and a supplementary service operation is attempted at the MS.
 - 7.2 when the NECI bit is set to 1 and a supplementary service operation is attempted at the MS.
- 8) If the MS supports SMS/PP MO:
 - 8.1 when the NECI bit is set to 0 and a mobile originated short message service transaction is attempted.
 - 8.2 when the NECI bit is set to 1 and a mobile originated short message service transaction is attempted.

NOTE: To verify that when the MS supports speech and an emergency call is attempted and the NECI bit is set to 0, then the MS sends a CHANNEL REQUEST message with an establishment cause consistent with the requested service, with the capabilities of the MS and with the indications of the network is done in test 26.9.6.1.1 test purpose 1.

26.2.4.3 Method of test

Initial Conditions

System Simulator:

for all procedures: 1 cell, Max-Retrans = 7 slots. The NECI bit is set to 0.

Mobile Station:

The MS has a valid TMSI. It is "idle updated".

Specific PICS statements:

- a: MS supports speech on TCH/F (TSPC_AddInfo_Full_rate_version_1)
- b: MS supports speech on TCH/H (TSPC_AddInfo_Half_rate_version_1)
- c: MS supports data on TCH/F (TSPC_AddInfo_FullRateData)
- d: MS supports data on TCH/H (TSPC_AddInfo_HalfRateData)
- e: MS only supports SDCCH (TSPC_AddInfo_SDCCHOnly)

- f: MS supports a supplementary service operation (TSPC_AddInfo_SS)
- g: MS supports SMS/PP MO (TSPC_Serv_TS22)
- h: On/Off switch (TSPC_Feat_OnOff)
- i: MS supports AMR (TSPC_AddInfo_Full_rate_version_3)
- j: MS supports Speech for Half Rate Version 3 (TSPC_AddInfo_Half_rate_version_3)

NOTE: In the above PICS, data and speech refer to the Radio Resource Channel Mode.

PIXIT Statements:

-

Foreseen Final State of the MS

The MS has a valid TMSI. It is "idle updated".

Test Procedures

NOTE: If the procedures are chained, the SS shall ensure that at the beginning of each procedure, the initial conditions are reached and that the MS had enough time to decode the broadcasted parameters.

Procedure 1

If the MS supports a service on a traffic channel:

A call is established on TCH/H if the MS supports a service on half rate channel or on TCH/F otherwise. The SS stops transmission on the SACCH. The MS attempts call reestablishment. The SS does not answer to Max-Retrans CHANNEL REQUEST messages and answers to the next CHANNEL REQUEST with an IMMEDIATE ASSIGNMENT REJECT message. The SS checks that all CHANNEL REQUEST messages contain an establishment cause with the value "110".

Procedure 2

If the MS supports a service on half rate channel:

The NECI bit is set to 1. A call is established on TCH/H for a supported service. The SS stops transmission on the SACCH. The MS attempts call reestablishment. The SS does not answer to Max-Retrans CHANNEL REQUEST messages and answers to the next CHANNEL REQUEST with an IMMEDIATE ASSIGNMENT REJECT message. The SS checks that all CHANNEL REQUEST messages contain an establishment cause with the value "011010".

Procedure 3

If the MS supports speech:

A speech call is attempted. The SS does not answer to Max-Retrans CHANNEL REQUEST messages and answers to the next CHANNEL REQUEST with an IMMEDIATE ASSIGNMENT REJECT message. The SS checks that all CHANNEL REQUEST messages contain an establishment cause with the value "111". The NECI bit is set to 1. A speech call is attempted. The SS does not answer to Max-Retrans CHANNEL REQUEST messages and answers to the next CHANNEL REQUEST with an IMMEDIATE ASSIGNMENT REJECT message. The SS checks that all CHANNEL REQUEST messages contain an establishment cause with the value "111" if the MS does not support speech on half rate channel (version 1, GSM, nor version 3, AMR) or "0100" if the MS supports speech on half rate channel (version 1, GSM, or/and version 3, AMR).

Procedure 4

If the MS supports a data service:

A data call is attempted. The SS does not answer to Max-Retrans CHANNEL REQUEST messages and answers to the next CHANNEL REQUEST with an IMMEDIATE ASSIGNMENT REJECT message. The SS checks that all CHANNEL REQUEST messages contain an establishment cause with the value "111". The NECI bit is set to 1. A data call is attempted for a service supported on half rate channel (if the MS does not support any data

call on half rate channel any data service is used). The SS does not answer to Max-Retrans CHANNEL REQUEST messages and answers to the next CHANNEL REQUEST with an IMMEDIATE ASSIGNMENT REJECT message. The SS checks that all CHANNEL REQUEST messages contain an establishment cause with the value "111" if the MS does not support a data service on half rate channel or "0101" if the MS supports a data service on half rate channel.

Procedure 5

The MS is paged with the paging indication set to "any channel". The SS does not answer to Max-Retrans CHANNEL REQUEST messages and answers to the next CHANNEL REQUEST with an IMMEDIATE ASSIGNMENT REJECT message. The SS checks that all CHANNEL REQUEST messages contain an establishment cause with the value "100". The SS waits for a time sufficient for the MS to be "idle updated". The MS is paged with the paging indication set to "SDCCH". The SS does not answer to Max-Retrans CHANNEL REQUEST messages and answers to the next CHANNEL REQUEST with an IMMEDIATE ASSIGNMENT REJECT message. The SS checks that all CHANNEL REQUEST messages contain an establishment cause with the value "0001". The SS waits for a time sufficient for the MS to be "idle updated". The MS is paged with the paging indication set to "TCH/F". The SS does not answer to Max-Retrans CHANNEL REQUEST messages and answers to the next CHANNEL REQUEST with an IMMEDIATE ASSIGNMENT REJECT message. The SS checks that all CHANNEL REQUEST messages contain an establishment cause with the value "100" if the MS capability is full rate only, "0010" if the MS capability is dual rate and "0001" if the MS capability is SDCCH only. The SS waits for a time sufficient for the MS to be "idle updated". The MS is paged with the paging indication set to "TCH/H or TCH/F". The SS does not answer to Max-Retrans CHANNEL REQUEST messages and answers to the next CHANNEL REQUEST with an IMMEDIATE ASSIGNMENT REJECT message. The SS checks that all CHANNEL REQUEST messages contain an establishment cause with the value "100" if the MS capability is full rate only, "0011" if the MS capability is dual rate and "0001" if the MS capability is SDCCH only.

Procedure 6

This procedure is performed twice. Once for NECI = 0 and once for NECI = 1.

The MS is switched off or powered off. Then system information messages are altered so that IMSI attach/detach is allowed in the cell. The MS is switched on or powered on. The MS performs IMSI attach. The SS does not answer to Max-Retrans CHANNEL REQUEST messages and answers to the next CHANNEL REQUEST with an IMMEDIATE ASSIGNMENT message. The SS checks that all CHANNEL REQUEST messages contain an establishment cause with the values "0000" when NECI = 1, or "000" when NECI = 0. The IMSI attach procedure is followed. The location area code of the cell is changed, T3212 is set to 1 deci-hour. The MS performs a location updating. The SS does not answer to Max-Retrans CHANNEL REQUEST messages and answers to the next CHANNEL REQUEST with an IMMEDIATE ASSIGNMENT message. The SS checks that all CHANNEL REQUEST messages contain an establishment cause with the values "0000" when NECI = 1, or "000" when NECI = 0. The location updating procedure is followed. The SS waits for at least 7 minutes. The MS performs a periodic updating. The SS does not answer to Max-Retrans CHANNEL REQUEST messages and answers to the next CHANNEL REQUEST with an IMMEDIATE ASSIGNMENT message. The SS checks that all CHANNEL REQUEST messages contain an establishment cause with the values "0000". The location updating procedure is followed. The MS is switched off or powered off. If the MS has an On/off switch (see PICS), it attempts IMSI detach. The SS does not answer to Max-Retrans CHANNEL REQUEST messages and answers to the next CHANNEL REQUEST with an IMMEDIATE ASSIGNMENT REJECT message. The SS checks that all CHANNEL REQUEST messages contain an establishment cause with the value "0001" when NECI = 1, or "111" when NECI = 0.

Procedure 7

This procedure is performed twice. Once for NECI = 0 and once for NECI = 1.

If the MS supports a non call related supplementary service operation:

A supplementary service operation is attempted at the MS. The SS does not answer to Max-Retrans CHANNEL REQUEST messages and answers to the next CHANNEL REQUEST with an IMMEDIATE ASSIGNMENT REJECT message. The SS checks that all CHANNEL REQUEST messages contain an establishment cause with the value "0001".

Procedure 8

If the MS supports SMS/PP MO:

A mobile originated short message service transaction is attempted. The SS does not answer to Max-Retrans CHANNEL REQUEST messages and answers to the next CHANNEL REQUEST with an IMMEDIATE

ASSIGNMENT REJECT message. The SS checks that all CHANNEL REQUEST messages contain an establishment cause with the value "0001" when NECI = 1, or "111" when NECI = 0.

Maximum Duration of Test

For procedures 1, 2, 3, 4 and 5: 5 minutes, including 1 minute for any necessary operator actions.

For procedure 6: 20 minutes, including 2 minutes for any necessary operator actions.

For procedures 7, 8: 10 minutes, including 2 minutes for any necessary operator actions.

Expected Sequence

Procedure 1

This procedure is performed if the MS supports a service on a traffic channel.

Step	Direction	Message	Comments
1			a call is established on TCH/H if the MS supports a service on half rate channel or on TCH/F otherwise. The generic call setup procedure is used.
2	SS		the SS stops transmission on the SACCH.
3	MS -> SS	8 CHANNEL REQUEST	all messages have establishment cause set to "110"
4	SS -> MS	IMMEDIATE ASSIGNMENT REJECT	

Procedure 2

This procedure is performed if the MS supports a service on half rate channel.

Step	Direction	Message	Comments
1	SS		The NECI bit is set to 1, a call is established on TCH/H for a supported service. The generic call setup procedure is used.
2			the SS stops transmission on the SACCH.
3	SS		all messages have establishment cause set to "011010"
4	MS -> SS	8 CHANNEL REQUEST	
5	SS -> MS	IMMEDIATE ASSIGNMENT REJECT	

Procedure 3

This procedure is performed if the MS supports speech.

Step	Direction	Message	Comments
1	MS		a speech call is attempted
2	MS -> SS	8 CHANNEL REQUEST	all messages have establishment cause set to "111"
3	SS -> MS	IMMEDIATE ASSIGNMENT REJECT	
4	SS		The NECI bit is set to 1
5	SS		The SS waits for 30 s
6	MS		a speech call is attempted
7	MS -> SS	8 CHANNEL REQUEST	all messages have establishment cause set to "0100" if the MS supports speech (GSM and/or AMR) on half rate or set to "111" otherwise
8	SS -> MS	IMMEDIATE ASSIGNMENT REJECT	

Procedure 4

This procedure is performed if the MS supports a data service.

Step	Direction	Message	Comments
1	MS		a data call is attempted
2	MS -> SS	8 CHANNEL REQUEST	all messages have establishment cause set to "111"
3	SS -> MS	IMMEDIATE ASSIGNMENT REJECT	
4	SS		
5	SS		The NECI bit is set to 1
6	MS		The SS waits for 30 s
7	MS -> SS	8 CHANNEL REQUEST	a data call is attempted for a service supported by the MS on half rate (for any data service if the MS does not support any data service on half rate)
8	SS -> MS	IMMEDIATE ASSIGNMENT REJECT	all messages have establishment cause set to "0101" if the MS supports a data service on half rate or set to "111" otherwise

Procedure 5

Step	Direction	Message	Comments
1	SS -> MS	PAGING REQUEST TYPE 1	paging indication = any channel all messages have establishment cause set to "100"
2	MS -> SS	8 CHANNEL REQUEST	
3	SS -> MS	IMMEDIATE ASSIGNMENT REJECT	
4	SS		The SS waits for 5 s paging indication = SDCCH all messages have establishment cause set to "0001"
5	SS -> MS	PAGING REQUEST TYPE 1	
6	MS -> SS	8 CHANNEL REQUEST	
7	SS -> MS	IMMEDIATE ASSIGNMENT REJECT	
8	SS		The SS waits for 5 s paging indication = TCH/F all messages have establishment cause set to "100" if the MS capability is full rate only or "0010" if the MS capability is dual rate or "0001" if the MS capability is SDCCH only
9	SS -> MS	PAGING REQUEST TYPE 1	
10	MS -> SS	8 CHANNEL REQUEST	
11	SS -> MS	IMMEDIATE ASSIGNMENT REJECT	
12	SS		The SS waits for 5 s paging indication = TCH/H or TCH/F all messages have establishment cause set to "100" if the MS capability is full rate only or "0011" if the MS capability is dual rate or "0001" if the MS capability is SDCCH only
13	SS -> MS	PAGING REQUEST TYPE 1	
14	MS -> SS	8 CHANNEL REQUEST	
15	SS -> MS	IMMEDIATE ASSIGNMENT REJECT	

Procedure 6

The sequence is executed for execution counter k = 1, 2.

Step	Direction	Message	Comments
0	SS		When k = 1, NECI set to 0 When k = 2, NECI set to 1
1	MS		The MS is switched off or has its power source removed
2	SS		IMSI attach/detach is set to "MSs in the cell shall apply IMSI attach and detach procedure"
3	MS		The MS is switched on or powered on
4	MS -> SS	8 CHANNEL REQUEST	all messages have establishment cause set to: "000" when k = 1 "0000" when k = 2
5	SS -> MS	IMMEDIATE ASSIGNMENT	
6	MS -> SS	LOCATION UPDATING REQUEST	"location updating type" = IMSI attach
7	SS -> MS	LOCATION UPDATING ACCEPT	with no mobile identity
8	SS -> MS	CHANNEL RELEASE	
9	SS		the LAC of the cell is changed and T3212 is set to 6 minutes
10	MS -> SS	8 CHANNEL REQUEST	all messages have establishment cause set to: "000" when k = 1 "0000" when k = 2. The MS must send its first Channel Request within 33s after the LAC has been changed.
11	SS -> MS	IMMEDIATE ASSIGNMENT	
12	MS -> SS	LOCATION UPDATING REQUEST	"location updating type" = Normal location updating
13	SS -> MS	LOCATION UPDATING ACCEPT	with no mobile identity
14	SS -> MS	CHANNEL RELEASE	
15	MS -> SS	8 CHANNEL REQUEST	all messages have establishment cause set to: "000" when k = 1 "0000" when k = 2. The MS must send its first Channel Request within 7 minutes after the preceding Channel Release
16	SS -> MS	IMMEDIATE ASSIGNMENT	
17	MS -> SS	LOCATION UPDATING REQUEST	"location updating type" = Periodic updating
18	SS -> MS	LOCATION UPDATING ACCEPT	with no mobile identity
19	SS -> MS	CHANNEL RELEASE	
20	MS		If possible (see PICS), the MS is switched off, otherwise it has its power source removed
21	MS		If the MS was switched off it attempts IMSI detach
22	MS -> SS	8 CHANNEL REQUEST	all messages have establishment cause set to: "111" when k = 1 "0001" when k = 2
23	SS -> MS	IMMEDIATE ASSIGNMENT REJECT	

Procedure 7

The sequence is executed for execution counter k = 1, 2.

This procedure is performed if the MS supports a non call related supplementary service operation.

Step	Direction	Message	Comments
0	SS		When k = 1, NECI set to 0 When k = 2, NECI set to 1
1	MS		a non call related supplementary service operation is attempted
2	MS -> SS	8 CHANNEL REQUEST	all messages have establishment cause set to: "111" when k = 1 "0001" when k = 2
3	SS -> MS	IMMEDIATE ASSIGNMENT REJECT	

Procedure 8

This procedure is performed if the MS supports SMS/PP MO.

The sequence is executed for execution counter k = 1, 2.

Step	Direction	Message	Comments
0	SS		When k = 1, NECI set to 0 When k = 2, NECI set to 1 a mobile originated short message service transaction is attempted all messages have establishment cause set to: "111" when k = 1 "0001" when k = 2
1	MS		
2	MS -> SS	8 CHANNEL REQUEST	
3	SS -> MS	IMMEDIATE ASSIGNMENT REJECT	

26.3 Test of MS functions in idle mode

26.3.1 Initial conditions

The SIM shall contain a PLMN-Selector that contains only the HPLMN of the MS, and an empty forbidden PLMN list.

Related PICS/PIXIT statements

During the tests in subclauses 26.3.2 and 26.3.3, the following parameters apply according to the above PICS/PIXIT statement:

RACH control parameters

In cells:

GSM 400:	1 to 7;
GSM 710:	1 to 7;
GSM 750:	1 to 7;
T-GSM 810:	1 to 7; GSM 850: 1 to 7;
GSM 900:	1 to 7;
DCS 1 800:	1 to 6;
PCS 1 900:	1 to 6;
Multiband 900/1 800:	1 to 7;
Multiband 450/900:	1 to 7;
Multiband 480/900:	1 to 7;
Multiband 450/1 800:	1 to 7;
Multiband 480/1 800:	1 to 7;
Multiband 850/1 900:	1 to 7.

Max retrans	= 01	2 retransmissions
Tx-integer	= 0111	(10) slots for spreading
CB, Cell Barred	= 0	access is allowed
RE	= 1	re-establishment not allowed
AC C00 to AC C15	= 0	access is not barred

In cell:

- GSM 400: 8;
- GSM710: 8;
- GSM 750: 8;
- GSM 810: 8;
- GSM 850: 8;
- GSM 900: 8;
- DCS 1 800: 7;
- PCS 1 900: 7;
- Multiband 900/1 800: 8;
- Multiband 450/900: 8;
- Multiband 480/900: 8;
- Multiband 450/1 800: 8;
- Multiband 480/1 800: 8.

- Max retrans = 01 2 retransmissions
- Tx-integer = 0111 (10) slots for spreading
- CB, Cell Barred = 1 access is not allowed
- RE = 1 re-establishment not allowed
- AC C00 to AC C15 = 0 access is not barred

Cell	PLMN perm.	GSM 900								DCS 1 800							
		BA - ARFCN bit = 1								BA - ARFCN bit = 1							
1	00000100	7	39	65	66	85	97	124	520	580	610	702	703	830	885		
2	00000100	8	40	67	68	86	98	123	521	581	612	704	705	831	884		
3	00000100	9	41	69	70	87	99	122	522	582	614	706	707	832	883		
4	00000100	10	42	71	72	88	100	121	523	583	616	708	709	833	882		
5	00000100	11	43	73	74	89	101	120	524	584	618	710	711	844	881		
6	00000100	12	44	75	76	90	102	119	525	585	620	712	713	835	880		
7	00000100	13	45	77	78	91	103	118	526	586	622	714	715	836	879		
8	00000100	124															

Cell	PLMN perm.	GSM 450								GSM 480							
		BA - ARFCN bit = 1								BA - ARFCN bit = 1							
1	00000100	261	267	268	281	288	291	293	308	314	315	328	335	338	340		
2	00000100	260	269	270	282	289	264	275	307	316	317	329	336	311	322		
3	00000100	262	271	272	283	290	265	277	309	318	319	330	337	312	324		
4	00000100	263	273	274	284	292	266	279	310	320	321	331	339	313	326		
5	00000100	264	275	276	285	260	269	270	311	322	323	332	307	316	317		
6	00000100	265	277	278	286	262	271	272	312	324	325	333	309	318	319		
7	00000100	266	279	280	287	263	273	274	313	326	327	334	310	320	321		
8	00000100	293								340							

		GSM 710 OR GSM 750 OR T-GSM 810							GSM 850						
Cell	PLMN perm.	BA - ARFCN bit = 1							BA - ARFCN bit = 1						
1	00000100	444	456	472	473	489	497	511	134	166	192	193	212	224	251
2	00000100	445	457	474	475	490	498	510	135	167	194	195	213	225	250
3	00000100	446	458	476	477	491	499	509	136	168	196	197	214	226	249
4	00000100	447	459	478	479	492	500	508	137	169	198	199	215	227	248
5	00000100	448	460	480	481	493	501	507	138	170	200	201	216	228	247
6	00000100	449	461	482	483	494	502	506	139	171	202	203	217	229	246
7	00000100	450	462	484	485	495	503	505	140	172	204	205	218	230	245
8	00000100	511							251						

		PCS 1 900							Multiband 850/1900						
Cell	PLMN	BA - ARFCN bit = 1							BA - ARFCN bit = 1						
1	00000100	512	520	580	610	702	703	800	134	166	610	193	212	810	251
2	00000100	513	521	581	612	704	705	801	135	167	194	195	213	225	250
3	00000100	514	522	582	614	706	707	802	136	168	196	197	214	226	249
4	00000100	515	523	583	616	708	709	803	523	583	524	585	616	708	709
5	00000100	516	524	584	618	710	711	804	520	170	200	702	216	805	247
6	00000100	517	525	585	620	712	713	805	139	171	202	203	217	229	246
7	00000100	518	526	586	622	714	715	806	526	586	622	714	715	786	808
8	00000100								251						

		Multiband 900/1800						
Cell	PLMN perm.	BA - ARFCN bit = 1						
1	00000100	7	39	702	66	85	885	124
2	00000100	8	40	67	68	86	98	123
3	00000100	9	41	69	70	87	99	122
4	00000100	523	583	616	708	709	833	882
5	00000100	520	7	39	702	85	885	124
6	00000100	12	44	75	76	90	102	119
7	00000100	526	586	622	714	715	836	879
8	00000100	124						

		Multiband 450/900							Multiband 480/900						
Cell	PLMN perm.	BA - ARFCN bit = 1							BA - ARFCN bit = 1						
1	00000100	261	267	65	281	288	124	293	308	314	65	328	335	124	340
2	00000100	260	269	270	282	289	264	275	307	316	317	329	336	311	322
3	00000100	262	271	272	283	290	265	277	309	318	319	330	337	312	324
4	00000100	10	42	71	72	88	100	121	10	42	71	72	88	100	121
5	00000100	7	260	267	65	288	124	293	7	307	314	65	335	124	340
6	00000100	265	277	278	286	262	271	272	312	324	325	333	309	318	319
7	00000100	13	45	77	78	91	103	118	13	45	77	78	91	103	118
8	00000100	293							340						

		Multiband 450/1800							Multiband 480/1800						
Cell	PLMN perm.	BA - ARFCN bit = 1							BA - ARFCN bit = 1						
1	00000100	261	267	702	281	288	885	293	308	314	702	328	335	885	340
2	00000100	260	269	270	282	289	264	275	307	316	317	329	336	311	322
3	00000100	262	271	272	283	290	265	277	309	318	319	330	337	312	324
4	00000100	523	583	616	708	709	833	882	523	583	616	708	709	833	882
5	00000100	520	260	267	702	288	885	293	520	307	314	702	335	885	340
6	00000100	265	277	278	286	262	271	272	312	324	325	333	309	318	319
7	00000100	526	586	622	714	715	836	879	526	586	622	714	715	836	879
8	00000100	293							340						

Location area identification

GSM 400, GSM 710, GSM 750, T-GSM 810, GSM 850 and GSM 900 only - begin

Cell	MCC1	MCC2	MCC3	MNC1	MNC2	LAC	
1	0	0	2	0	F	x	
2	0	0	3	2	F	x	
3	0	0	4	3	F	x	
4	0	0	5	4	F	x	
5	0	0	6	5	F	x	
6	0	0	7	6	F	x	
7	0	0	8	7	F	x	
8	0	0	1	0	1	x	The HPLMN of the MS

GSM 400, GSM 710, GSM 750, T-GSM 810, GSM 850 and GSM 900 only - end

DCS 1 800 only - begin

Cell	MCC1	MCC2	MCC3	MNC1	MNC2	LAC	
1	0	0	2	0	F	x	
2	0	0	3	2	F	x	
3	0	0	4	3	F	x	
4	0	0	5	4	F	x	
5	0	0	6	5	F	x	
6	0	0	7	6	F	x	
7	0	0	1	0	1	x	The HPLMN of the MS

DCS 1 800 only – end

PCS 1 900 only – begin

Cell	MCC1	MCC2	MCC3	MNC1	MNC2	MNC3	LAC	
1	0	0	2	0	F	F	x	
2	0	0	3	2	F	F	x	
3	0	0	4	3	F	F	x	
4	0	0	5	4	F	F	x	
5	0	0	6	5	F	F	x	
6	0	0	7	6	F	F	x	
7	0	0	1	0	1	1	x	The HPLMN of the MS

GSM 1900 only - end

Any Multiband MS - begin

Cell	MCC1	MCC2	MCC3	MNC1	MNC2	LAC	
1	0	0	2	0	F	x	
2	0	0	3	2	F	x	
3	0	0	4	3	F	x	
4	0	0	5	4	F	x	
5	0	0	2	0	F	x	
6	0	0	7	6	F	x	
7	0	0	8	7	F	x	
8	0	0	1	0	1	x	The HPLMN of the MS

Any Multiband MS - end

NOTE 1: 'x' denotes any value.

NOTE 2: The MS representation of the MCC, MNC on the handset can be manufacturer dependant.

NOTE 3: The NCC values of each cell must be different.

Control channel description and BS options

All:

GSM 400: 8 cells;
 GSM 710: 8 cells;
 GSM 750: 8 cells;
 T-GSM 810: 8 cells;
 GSM 850: 8 cells;
 GSM 900: 8 cells;
 DCS 1 800: 7 cells;
 PCS 1 900: 7 cells;
 Any Multiband MS: 8 cells.

CELL_RESELECT_HYSTERESIS = 010 4dB RXLEV hysteresis
 MS_TXPWR_MAX_CCH = value corresponding to the maximum available output power from MS
 RXLEV_ACCESS_MIN = 30
 ATT = 0 no IMSI attach and detach
 DTX = 0 no discontinuous transmission
 BS_AG_BLK_RES = 1 1 block reserved for access grant
 CCCH_CONF = 001 1 SDCCH combined with the CCCH
 RADIO_LINK_TIMEOUT = 5 10 s time-out
 BS_PA_MFRMS = 010 4 multiframe periods for paging
 T3212 time-out value = H'00

Cell	GSM 900		DCS 1 800	
	level dB μ V _m f()	BCCH ARFCN	level dB μ V _m f()	BCCH ARFCN
1	+65	1	+65	520
2	+63	7	+63	580
3	+61	39	+61	610
4	+55	65	+55	702
5	+59	66	+59	703
6	+57	85	+57	830
7	+55	97	+55	885
8	+53	124		

Cell	GSM 450		DCS 480	
	level dB μ Vemf()	BCCH ARFCN	level dB μ Vemf()	BCCH ARFCN
1	+65	259	+65	306
2	+63	261	+63	308
3	+61	267	+61	314
4	+55	268	+55	315
5	+59	281	+59	328
6	+57	288	+57	335
7	+55	291	+55	338
8	+53	293	+53	340

Cell	Multiband 900/1800		PCS 1 900	
	level dB μ Vemf()	BCCH ARFCN	level dB μ Vemf()	BCCH ARFCN
1	+65	520	+65	512
2	+63	7	+63	520
3	+61	39	+61	580
4	+55	702	+55	610
5	+59	66	+59	702
6	+57	85	+57	703
7	+55	885	+55	800
8	+53	124		

Cell	Multiband 450/900		Multiband 480/900	
	level dB μ Vemf()	BCCH ARFCN	level dB μ Vemf()	BCCH ARFCN
1	+65	1	+65	1
2	+63	261	+63	308
3	+61	267	+61	314
4	+55	65	+55	65
5	+59	281	+59	328
6	+57	288	+57	335
7	+55	124	+55	124
8	+53	293	+53	340

Cell	Multiband 450/1800		Multiband 480/1800	
	level dB μ Vemf()	BCCH ARFCN	level dB μ Vemf()	BCCH ARFCN
1	+65	520	+65	520
2	+63	261	+63	308
3	+61	267	+61	314
4	+55	702	+55	702
5	+59	281	+59	328
6	+57	288	+57	335
7	+55	885	+55	885
8	+53	293	+53	340

Cell	GSM 710 or GSM 750 or T-GSM 810		GSM0 850	
	Level dB μ Vemf()	BCCH ARFCN	level dB μ Vemf()	BCCH ARFCN
1	+65	438	+65	128
2	+63	444	+63	134
3	+61	456	+61	166
4	+55	472	+55	192
5	+59	473	+59	193
6	+57	489	+57	212
7	+55	497	+55	224
8	+53	511	+53	251

Cell	GSM 850/1900	
	level dB μ V _{emf} ()	BCCH ARFCN
1	+65	512
2	+63	134
3	+61	166
4	+55	610
5	+59	193
6	+57	212
7	+55	810
8	+53	251

For testing an E-GSM Mobile station (see PICS/PIXIT), the BCCH ARFCN of cell 7 at GSM 900 column shall be 985 (instead of 97). For testing an R-GSM Mobile station (see PICS/PIXIT), the BCCH ARFCN of cell 7 at GSM 900 column shall be 965 (instead of 97).

NOTE 4: The SIM should contain a PLMN-Selector that contains only the HPLMN of the MS, and an empty forbidden PLMN list.

26.3.2 MS indication of available PLMNs

26.3.2.1 Test purpose

To verify that a MS can present the available PLMNs to the user when asked to do so in manual mode according to the requirements of 3GPP TS 05.08 and 3GPP TS 02.11.

26.3.2.2 Method of test

- a) The MS is switched on, equipped with a SIM containing default values except for those values listed under subclause 26.3.1 (initial conditions).
- b) The MS is put into manual network selection mode (see PIXIT).

26.3.2.3 Test requirements

- 1) On entering manual network selection mode, the MS shall present a list of available PLMNs in all its bands of operation (MCC and MNC values, or any other valid indications, see PIXIT), within 2 minutes. Any PLMN shall only be presented once. The list shall include the MCC and MNC of:

GSM 400, GSM 710, GSM 750, T-GSM 810, GSM 850 and GSM 900: cells 1 to 7, but not of cell 8.

DCS 1 800: cells 1 to 6, but not of cell 7.

PCS 1 900: cells 1 to 6, but not of cell 7.

Multiband: cells 2, 3, 4, 6, 7 and 1 or 5 (cell 1 and 5 have the same MCC and MNC), but not of cell 8.

26.3.3 MS will send only if BSS is "on air"

26.3.3.1 Test purpose

To verify that the MS will not produce any RF transmission if no BSS is received.

26.3.3.2 Method of test

- a) The RF-signal for the BCCHs of:

GSM 400, GSM 710, GSM 750, T-GSM 810, GSM 850 and GSM 900: cell 1 to 8 is switched off.

DCS 1 800: cell 1 to 7 is switched off.

PCS 1 900: cell 1 to 7 is switched off.

Any Multiband: cell 1 to 8 is switched off.

- b) The SS shall wait 20 s to allow the MS to detect the loss of cells.
- c) By MMI, an attempt to originate a call is made.
- d) By MMI, an attempt to originate an emergency call is made.

26.3.3.3 Test requirements

26.3.3.3.1 General test requirements

- 1) The MS must not give "service indication".
- 2) In steps c) and d) the MS shall not produce any RF output.

26.3.3.3.2 Test Procedures

26.3.3.3.2.1 Test Procedure 1

For MS not supporting speech (see PICS) perform steps a, b, and c.

26.3.3.3.2.2 Test Procedure 2

For MS supporting speech (see PICS) perform steps a, b, c and d.

26.3.4 Manual mode of PLMN selection

26.3.4.1 Conformance requirements

In manual mode, the MS can try to obtain normal service on any available VPLMN and it shall try to obtain normal service on a VPLMN if and only if the user makes a manual selection of this VPLMN.

Reference

3GPP TS 03.22 subclause 3.1.

26.3.4.2 Test purpose

To check that in manual mode the MS is able to obtain normal service on a PLMN which is neither the better nor a preferred PLMN and that it tries to obtain service on VPLMN if and only if the user selects it manually.

26.3.4.3 Method of test

Initial conditions

System Simulator:

2 cells, defaults parameter unless otherwise specified.

The SS transmits 2 BCCH carriers in the supported band(s) of the mobile station (for a multiband MS carrier A and B shall be in different bands) with the initial following parameters:

		level (dB μ V _{emf})
carrier A	PLMN 1	38
carrier B	PLMN 2	33

Mobile Station:

The MS is "idle updated" on PLMN1 (HPLMN) and is in manual mode.

The preferred PLMN list does not contain PLMN2, it contains PLMN 3.

Specific PICS statements:

- Support of multiband functionality (Type_MB_Simul)

PIXIT Statements:

- Description of the manual PLMN selector.

Foreseen final state of the MS

The MS is "idle updated".

Test procedure

For the different networks and during the whole test, "IMSI attach" flag is set in the BCCH data.

Carrier A is turned off. The MS does not attempt a location updating during 2 minutes.

Carrier A is turned back on with a different MCC-MNC (indicating PLMN 3) and with a higher level (48 dBmVemf) than PLMN 2. The MS does not attempt a location updating during 2 minutes.

PLMN 2 is selected manually. The MS performs a location updating on PLMN 2. Carrier B is turned off. The MS does not attempt a location updating during 2 minutes.

Maximum duration of test

10 minutes.

Expected Sequence

Step	Direction	Message	Comments
1	SS		carrier A is turned off
2			wait 2 min: the MS shall not send any CHANNEL REQUEST messages during this time
3	SS		carrier A is turned on with a different MNC-NCC (PLMN3) and with a high level (48dBmVemf)
4			wait 2 min: the MS shall not send any CHANNEL REQUEST messages during this time
5	MS		PLMN 2 selected manually
6	MS -> SS	CHANNEL REQUEST	
7	SS -> MS	IMMEDIATE ASSIGNMENT	
8	MS -> SS	LOCATION UPDATING REQUEST	on carrier B
9	SS -> MS	LOCATION UPDATING ACCEPT	
10	SS -> MS	CHANNEL RELEASE	
11	SS		carrier B is turned off
12			wait 2 min: the MS shall not send any CHANNEL REQUEST messages during this time

Specific message contents

None.

26.4 Lower layer failures in layer 3 testing

26.4.1 Introduction

The text in this subclause is intended to develop a standardized way of creating lower layer failures whilst testing the performance of Layer 3 signalling.

There are two groups of lower layer failures:

- 1) Detected by analysis of reception at Layer 1 (3GPP TS 05.08, 3GPP TS 04.08 / 3GPP TS 44.018),
- 2) Data link layer failures.

References

3GPP TS 04.08 / 3GPP TS 44.018, 3GPP TS 04.06, 3GPP TS 05.08

26.4.2 Layer 1 reception failures

The absence of reception of correct frames on the SACCH until the S counter reaches value 0 will be interpreted as a Layer 1 failure.

26.4.3 Data link layer failures

Many kinds of error cases can be caused in Layer 2. For example too many "T200 - time-out/retrying" - pairs.

NOTE 1: All types of data link failures are indicated similarly to the RR layer (Release Indication).

NOTE 2: All types of L1 failures are indicated similarly to each layer (Abort Indication, Error Indication).

26.4.4 Lower layer failures, used for the tests in clause 25

For L3 testing different lower layer failures are performed:

- 1) T100 time-out in Layer 1.
- 2) Too many T200 time-outs consecutively in Layer 2.

26.5 Handling of unknown, unforeseen, and erroneous protocol data, and of parallel transactions

26.5.1 Handling of unknown, unforeseen, and erroneous protocol data, and of parallel transactions / unknown protocol discriminator

An MS ignores messages with unknown protocol discriminator. This allows for the introduction of new messages which will be ignored by MS of earlier phases.

26.5.1.1 Conformance requirements

If the mobile station receives a standard L3 message with a protocol discriminator different from those specified in table 9.2/3GPP TS 04.07, the mobile station shall ignore the message.

References

3GPP TS 04.07, subclause 11.2.1.

26.5.1.2 Test purpose

To verify that a MS supporting TCH and the call control protocol ignores a message containing an undefined protocol discriminator in the special case of a message coded otherwise like a CC STATUS ENQUIRY message received by the MS having a mobile terminating call in CC-state U10, "active".

26.5.1.3 Method of test

Initial conditions

System Simulator:

1 cell, default parameters.

Mobile Station:

The MS has been paged and an RR connection has been established.

If the MS supports the call control protocol, the test may alternatively be performed with the MS having a mobile terminating call in the CC-state U10, "active".

Specific PICS statements:

-

PIXIT Statements:

-

Foreseen Final State of the MS

Same as in the initial conditions.

Test Procedure

The SS sends a message to the MS which is coded like a CC STATUS ENQUIRY message relating to the active call except for the fact that the protocol discriminator of the message is undefined.

Maximum duration of test

11 s.

Expected sequence

Step	Direction	Message	Comments
1	SS -> MS	UNKNOWN MESSAGE	The SS waits between 5 s and 10 s verifying during this period that the MS does not send a L3 message on the main signalling link.
2	SS		

Specific message contents

UNKNOWN MESSAGE

Information element	Value/remark
Protocol discriminator	0000
TI flag	transaction originated by SS
TI value	TI value of the active call if the test is performed in state U10 otherwise the value is arbitrary.
Message Type	H'34

26.5.2 Handling of unknown, unforeseen, and erroneous protocol data, and of parallel transactions / TI and skip indicator

26.5.2.1 TI and skip indicator / RR

The MS ignores RR messages with skip indicator different to 0. This allows for the introduction of new RR messages which will be ignored by MS of earlier phases, especially on the downlink CCCH and BCCH.

26.5.2.1.1 TI and skip indicator / RR / Idle Mode

26.5.2.1.1.1 Conformance requirements

A radio resource message received with skip indicator different from 0000 shall be ignored.

Reference(s):

3GPP TS 04.08 / 3GPP TS 24.008, subclause 10.3.1.

26.5.2.1.1.2 Test purpose

To verify that the MS ignores an RR message with skip indicator different from H'0 in the special case of a PAGING REQUEST TYPE 1 message received in the MM-state "idle, updated" and in RR-idle mode.

26.5.2.1.1.3 Method of test

Initial conditions

System Simulator:

1 cell, default parameters.

Mobile Station:

The MS is in the MM-state "idle, updated" and in RR-idle mode. It has a valid TMSI.

Specific PICS statements:

-

PIXIT Statements:

-

Foreseen Final State of the MS

The MS is in the MM-state "idle, updated" and in RR-idle mode. It has a valid TMSI.

Test Procedure

For every binary value x in the range 0001 - 0110 (binary) and for binary value x = 1 000, the following procedure is performed: The SS sends a PAGING REQUEST TYPE 1 message to the MS with skip indicator set to x. It is verified that the MS does not answer to the paging request message.

Maximum duration of test

5 s for each execution.

Expected sequence

The sequence is executed for execution counter k = 1, 2, 3, 4, 5, 6, 8.

Step	Direction	Message	Comments
1	SS -> MS	PAGING REQUEST TYPE 1	The value of the skip indicator IE is the binary encoding of k.
2	SS		During 3 s the SS verifies that the MS does not send any message on the RACH.

Specific message contents

None.

26.5.2.1.2 TI and skip indicator / RR / RR-Connection established

26.5.2.1.2.1 Conformance requirements

A radio resource message received with skip indicator different from H'0 shall be ignored.

Reference(s):

3GPP TS 04.08 / 3GPP TS 24.008, subclause 10.3.1.

26.5.2.1.2.2 Test purpose

To verify that the MS ignores RR messages with skip indicator different from H'0 in the case of a message being received during the RR-connection establishment in the MM-state "idle, updated" / "wait for network command" and in RR-connected mode.

26.5.2.1.2.3 Method of test

Initial conditions

System Simulator:

1 cell, default parameters, max retrans = 2.

Mobile Station:

The MS is in the MM-state "idle, updated" and in RR-idle mode. It has a valid TMSI.

Specific PICS statements:

-

PIXIT Statements:

-

Foreseen Final State of the MS

The MS is in the MM-state "idle, updated" and in RR-idle mode. It has a valid TMSI.

Test Procedure

The SS sends a PAGING REQUEST TYPE 1 message to the MS with skip indicator set to H'0. The first CHANNEL REQUEST message will be answered with an IMMEDIATE ASSIGNMENT addressing the MS but with skip indicator set to H'1. Transmission of the second CHANNEL REQUEST message verifies that the MS has ignored the IMMEDIATE ASSIGNMENT message.

The second CHANNEL REQUEST message is answered by an IMMEDIATE ASSIGNMENT REJECT message addressing the MS but with skip indicator set to H'2 and a reject time set to 255 s. Transmission of the third CHANNEL REQUEST message verifies that the MS has ignored the IMMEDIATE ASSIGNMENT REJECT message.

The third CHANNEL REQUEST message from the MS will be answered with a correct IMMEDIATE ASSIGNMENT addressing the MS and having skip indicator set to H'0.

In the RR-Connected mode messages such as CIPHERING MODE COMMAND, HANDOVER COMMAND, ASSIGNMENT COMMAND and CHANNEL RELEASE are sent with the skip indicator <> H'0 and it is checked that the MS does not take any action on these commands.

Maximum duration of test

40 s.

Expected sequence

Step	Direction	Message	Comments
1	SS -> MS	PAGING REQUEST TYPE 1	The value of the skip indicator IE is H'0
2	MS -> SS	CHANNEL REQUEST	
3	SS -> MS	IMMEDIATE ASSIGNMENT	skip indicator set to H'1
4	MS -> SS	CHANNEL REQUEST	
5	SS -> MS	IMMEDIATE ASSIGNMENT REJECT	skip indicator = H'2, reject time = 255 s
6	MS -> SS	CHANNEL REQUEST	Cause, answer to paging
7	SS -> MS	IMMEDIATE ASSIGNMENT	skip indicator = H'0
8	MS -> SS	PAGING RESPONSE	RR connection established
9	SS -> MS	AUTHENTICATION REQUEST	
10	MS -> SS	AUTHENTICATION RESPONSE	
11	SS -> MS	CIPHERING MODE COMMAND	skip indicator = H'3
12	SS		the SS neither starts ciphering nor deciphering with IMSI requested
13	SS -> MS	IDENTITY REQUEST	to check the MS still uses unciphered mode
14	MS -> SS	IDENTITY RESPONSE	
15	SS -> MS	ASSIGNMENT COMMAND	skip indicator = H'4
16	SS		SS checks no SABM is sent by the MS on the new channel
17	SS -> MS	HANDOVER COMMAND	skip indicator = H'5
18	SS		During 3 s the SS verifies that the MS does not send a handover failure or RR STATUS message on the old channel
19	SS -> MS	CHANNEL RELEASE	skip indicator = H'6
20	SS -> MS	IDENTITY REQUEST	with IMSI requested
21	MS -> SS	IDENTITY RESPONSE	to check the RR connection is still established
22	SS -> MS	CHANNEL RELEASE	skip indicator = H'0
23	SS		The SS checks that the layer 2 connection is released

Specific message contents

None.

26.5.2.2 TI and skip indicator / MM

The MS ignores MM messages with skip indicator different to 0. This allows for the introduction of new MM messages which will be ignored by MS of earlier phases.

26.5.2.2.1 Conformance requirements

A mobility management message received with skip indicator different from 0000 shall be ignored.

References

3GPP TS 04.08 / 3GPP TS 24.008, subclause 10.3.1.

26.5.2.2.2 Test purpose

To verify that the MS ignores an MM message with skip indicator different from H'0 in the special case of an IDENTITY REQUEST message received.

26.5.2.2.3 Method of test

Initial conditions

System Simulator:

1 cell, default parameters.

Mobile Station:

The MS has a mobile terminating call in CC-state U10, "active", or alternatively, the MS has been paged and an RR connection has been established.

Specific PICS statements:

-

PIXIT Statements:

-

Foreseen Final State of the MS

Same as in the initial conditions.

Test Procedure

For every binary value x in the range 0001 - 0110 and for the binary value x = 1 000, the following procedure is performed: The SS sends an IDENTITY REQUEST message to the MS with skip indicator set to x. It is verified during 5 s that the MS does not answer to the IDENTITY REQUEST message.

Maximum duration of test

15 s.

Expected sequence

Step	Direction	Message	Comments
1	SS -> MS	IDENTITY REQUEST	Skip indicator IE has value H'1.
2	SS		The SS starts verifying that the MS does not send any L3 message on the main signalling link. This verification continues until step 16 of this test sequence.
3	SS		The SS waits 1 second.
4	SS -> MS	IDENTITY REQUEST	Skip indicator IE has value H'2.
5	SS		The SS waits 1 second.
6	SS -> MS	IDENTITY REQUEST	Skip indicator IE has value H'3.
7	SS		The SS waits 1 second.
8	SS -> MS	IDENTITY REQUEST	Skip indicator IE has value H'4.
9	SS		The SS waits 1 second.
10	SS -> MS	IDENTITY REQUEST	Skip indicator IE has value H'5.
11	SS		The SS waits 1 second.
12	SS -> MS	IDENTITY REQUEST	Skip indicator IE has value H'6.
13	SS		The SS waits 1 second.
14	SS -> MS	IDENTITY REQUEST	Skip indicator IE has value H'8.
15	SS		The SS waits 5 s.
16	SS		The SS stops verifying that the MS does not send any L3 message on the main signalling link.

Specific message contents

None.

26.5.2.3 TI and skip indicator / CC

26.5.2.3.1 Conformance requirements

- a) Whenever any call control message except SETUP or RELEASE COMPLETE is received specifying a transaction identifier with a value different from 111, which is not recognized as relating to an active call or to a call in progress, the receiving entity shall send a RELEASE COMPLETE message with cause value #81 "invalid transaction identifier value" using the received transaction identifier value and remain in the Null state.
- b1) When a RELEASE COMPLETE message is received specifying a transaction identifier with a value different from 111, which is not recognized as relating to an active call or to a call in progress, the MM-connection associated with that transaction identifier shall be released.
- b2) When a SETUP message is received with a transaction identifier flag set to "1", this message shall be ignored.
- b3) When a SETUP message is received specifying a transaction identifier which is recognized as relating to an active call or to a call in progress, this SETUP message shall be ignored.
- c) When a CC message with a TI value = 111 is received, this message shall be ignored.

References

3GPP TS 04.08 / 3GPP TS 24.008, subclause 8.3.

26.5.2.3.2 Test purpose

- a) To verify that the MS having a mobile terminating call in CC-state U10, "active", on receipt of a DISCONNECT message which includes a transaction identifier with a value different from 111, which is not recognized as relating to an active call or a call in progress, sends a RELEASE COMPLETE message with cause value #81 and referring to the latter TI without changing the state of the active call (this is verified by use of the status enquiry procedure).
- b) To verify that the MS having a mobile terminating call in CC-state U10, "active", on receipt of a:
 - b1) RELEASE COMPLETE message which includes a transaction identifier with a value different from 111, which is not recognized as relating to an active call or a call in progress, or a
 - b2) SETUP message with TI flag referring to a transaction originated by the MS (in the special case where the TI value is equal to the TI value relating to the active call), or a

b3) SETUP message with TI referring to the active call, ignores that message without changing the state of the active call (this is verified by use of the status enquiry procedure).

c) To verify that the MS ignores a CC message with a TI value of 111.

26.5.2.3.3 Method of test

Initial conditions

System Simulator:

1 cell, default parameters.

Mobile Station:

The MS has a mobile terminating call in CC-state U10, "active". No other call is active or in progress.

Specific PICS statements:

-

PIXIT Statements:

-

Foreseen Final State of the MS

The MS has a mobile terminating call in CC-state U10, "active". No other call is active or in progress.

Test Procedure

The SS sends a DISCONNECT message to the MS with a TI not relating to the active call. The MS shall respond with a RELEASE COMPLETE message including cause value #81 and specifying the same transaction. By means of the status enquiry procedure the SS checks that the CC-state of the active call did not change.

Then the SS sends the following call control messages to the MS:

- a RELEASE COMPLETE message, where the TI does not refer to the active call;
- a SETUP message with TI flag set to 1;
- a SETUP message with TI referring to the active call;
- a DISCONNECT message with a TI value of 111.

Each time the SS verifies that the MS does not respond to the message and each time the SS verifies by means of the status enquiry procedure that the CC-state of the active call has not been changed.

Maximum duration of test

40 s.

Expected sequence

Step	Direction	Message	Comments
1	SS -> MS	DISCONNECT	TI flag = 0; TI does not refer to the active call.
2	MS -> SS	RELEASE COMPLETE	TI flag = 1; TI value is equal to TI value received in step 1; Cause IE indicates cause value #81.
3	SS -> MS	STATUS ENQUIRY	TI refers to the active call.
4	MS -> SS	STATUS	TI refers to the active call; Cause IE indicates cause value #30. Call state IE indicates state U10
5	SS -> MS	RELEASE COMPLETE	TI flag = 0; TI does not refer to the active call.
6	SS		The SS verifies during 5 s that the MS does not send any L3 message on the main signalling link.
7	SS -> MS	STATUS ENQUIRY	TI refers to the active call.
8	MS -> SS	STATUS	TI refers to the active call; Cause IE indicates cause value #30. Call state IE indicates state U10
9	SS -> MS	SETUP	TI flag = 1; TI value is equal to TI value of the active call.
10	SS		The SS verifies during 5 s that the MS does not send any L3 message on the main signalling link.
11	SS -> MS	STATUS ENQUIRY	TI refers to the active call.
12	MS -> SS	STATUS	TI refers to the active call; Cause IE indicates cause value #30. Call state IE indicates state U10
13	SS -> MS	SETUP	TI flag = 0; TI refers to the active call.
14	SS		The SS verifies during 5 s that the MS does not send any L3 message on the main signalling link.
15	SS -> MS	STATUS ENQUIRY	TI refers to the active call.
16	MS -> SS	STATUS	TI refers to the active call; Cause IE indicates cause value #30. Call state IE indicates state U10
17	SS -> MS	DISCONNECT	TI flag = 0; TI value is 111.
18	SS		The SS verifies during 5 s that the MS does not send any L3 message on the main signalling link.
19	SS -> MS	STATUS ENQUIRY	TI refers to the active call.
20	MS -> SS	STATUS	TI refers to the active call; Cause IE indicates cause value #30. Call state IE indicates state U10

Specific message contents

None.

26.5.3 Handling of unknown, unforeseen, and erroneous protocol data, and of parallel transactions / undefined or unexpected message type

26.5.3.1 Undefined or unexpected message type / undefined message type / CC

26.5.3.1.1 Conformance requirements

If the Mobile Station receives a message with message type not defined for the PD, it shall ignore the message except for the fact that, if an RR-connection exists, it returns a status message (STATUS, RR STATUS or MM STATUS depending on the protocol discriminator) with cause value #97 "message type non-existent or not implemented".

References

3GPP TS 04.08 / 3GPP TS 24.008, subclause 8.4; 3GPP TS 04.07, subclause 11.2.4.

26.5.3.1.2 Test purpose

To verify that a MS supporting the call control protocol for at least one BC, having a mobile terminating call in CC-state U10, "active", on receipt of a message with CC protocol discriminator and an arbitrary undefined message type, returns a STATUS message with cause value #97 to the peer CC entity without changing the state of the active call (this is verified by use of the status enquiry procedure).

26.5.3.1.3 Method of test

Initial conditions

System Simulator:

1 cell, default parameters.

Mobile Station:

The MS has a mobile terminating call in CC-state U10, "active".

Specific PICS statements:

-

PIXIT Statements:

-

Foreseen Final State of the MS

The MS has a mobile terminating call in CC-state U10, "active".

Test Procedure

The SS sends a message to the MS the PD of which refers to call control, the TI of which refers to the active call, and the message type of which is undefined in the call control protocol (however bit 7 of the message type is "0"). The SS then checks that the MS responds with a STATUS message specifying cause value #97. The SS then sends a STATUS ENQUIRY message to the MS and verifies that the MS responds with a STATUS message specifying cause value #30 and call state U10, "active".

Maximum duration of test

10 s.

Expected sequence

Step	Direction	Message	Comments
1	SS -> MS	see comments	PD = "call control; call related SS messages" TI is that of the active call Message type is undefined for call control, bit 7 of the message type is "0" Cause IE indicates cause value #97.
2	MS -> SS	STATUS	
3	SS -> MS	STATUS ENQUIRY	TI refers to the active call; Cause IE indicates cause value #30. Call state IE indicates state U10
4	MS -> SS	STATUS	

Specific message contents

None.

26.5.3.2 Undefined or unexpected message type / undefined message type / MM

26.5.3.2.1 Conformance requirements

If the Mobile Station receives a message with message type not defined for the PD, it shall ignore the message except for the fact that, if an RR-connection exists, it returns a status message (STATUS, RR STATUS or MM STATUS depending on the protocol discriminator) with cause value #97 "message type non-existent or not implemented".

References

3GPP TS 04.08 / 3GPP TS 24.008, subclause 8.4.

26.5.3.2.2 Test purpose

To verify that a MS supporting the call control protocol for at least one BC, having a mobile terminating call in CC-state U10, "active", on receipt of a message with MM protocol discriminator and message type undefined for the mobility management protocol, returns an MM STATUS message with reject cause value #97 without changing the state of the active call (this is verified by use of the status enquiry procedure.) This is tested in the special case where the CC TI has value 0 (so that it has the same encoding as the skip indicator when sent from the SS) and where the message type has the same encoding as DISCONNECT in CC.

26.5.3.2.3 Method of test

Initial conditions

System Simulator:

1 cell, default parameters.

Mobile Station:

The MS has a mobile terminating call in CC-state U10, "active". The TI of that mobile terminating call has value 0.

Specific PICS statements:

-

PIXIT Statements:

-

Foreseen Final State of the MS

The MS has a mobile terminating call in CC-state U10, "active".

Test Procedure

The SS sends a message to the MS the PD of which refers to mobility management, the skip indicator of which is "0000", and the message type of which is "0000 0000". The SS then checks that the MS responds with an MM STATUS message specifying reject cause value #97. The SS then sends a STATUS ENQUIRY message to the MS and verifies that the MS responds with a STATUS message specifying cause #30 and call state U10, "active".

Maximum duration of test

10 s.

Expected sequence

Step	Direction	Message	Comments
1	SS -> MS	see comments	PD = "mobility management messages" Skip indicator = "0000" Message type = "0000 0000" rest of the message is H'02 H'E0 H'90
2	MS -> SS	MM STATUS	Reject cause IE indicates reject cause value #97.
3	SS -> MS	STATUS ENQUIRY	
4	MS -> SS	STATUS	TI refers to the active call; Cause IE indicates cause value #30. Call state IE indicates state U10

Specific message contents

None.

26.5.3.3 Undefined or unexpected message type / undefined message type / RR

26.5.3.3.1 Conformance requirements

If the Mobile Station receives a message with message type not defined for the PD, it shall ignore the message except for the fact that, if an RR-connection exists, it returns a status message (STATUS, RR STATUS or MM STATUS depending on the protocol discriminator) with cause value #97 "message type non-existent or not implemented".

Reference(s)

3GPP TS 04.08 / 3GPP TS 44.018, subclause 8.4.

26.5.3.3.2 Test purpose

To verify that an MS in RR connected mode on receipt of a message with RR protocol discriminator and message type undefined for the RR protocol, returns an RR STATUS message with reject cause value #97 without changing its state (this is checked by observing that the MS does not send L3 messages).

26.5.3.3.3 Method of test

Initial conditions

System Simulator:

1 cell, default parameters.

Mobile Station:

The MS has been paged and an RR connection has been established.

Specific PICS statements:

-

PIXIT Statements:

-

Foreseen Final State of the MS

The MS is in "idle updated" state.

Test Procedure

The SS sends a message to the MS the PD of which refers to radio resources management, the skip indicator of which is "0000", and the message type of which is "0010 1010". The SS then checks that the MS responds with an RR STATUS message specifying reject cause value #97. The SS then verifies during 5 s that the MS does not send a L3 message on the main signalling link but continues sending L2 fill frames on the main signalling link. Then the SS sends a SETUP message to the MS. This message specifies a BC that is supported by the MS, if there exists any; if the MS does not support any BC, the SETUP message specifies an arbitrary BC. The SS then verifies that the MS responds with a CALL CONFIRMED message if the SETUP had specified a BC supported by the MS, and that the MMS responds with a RELEASE COMPLETE message otherwise. Then the SS sends a CHANNEL RELEASE to the MS and waits for the disconnection of the main signalling link.

Maximum duration of test

15 s.

Expected sequence

Step	Direction	Message	Comments
1	SS->MS	see comments	PD = "radio resources management messages" Skip indicator = "0000" Message type = "0010 0101" rest of the message is H'02 H'E0 H'90
2	MS->SS	RR STATUS	RR cause IE indicates RR cause value #97.
3	SS		During 5 s the SS verifies that the MS does not send a L3 message on the main signalling link but still continues to send L2 fill frames on the main signalling link.
4	SS->MS	SETUP	If the MS supports at least one BC (p = Y), the SETUP specifies a bearer capability supported by the MS. Otherwise (p = N) the SETUP message specifies any bearer capability.
A5	MS->SS	CALL CONFIRMED	This message shall be sent by the MS if p = Y.
B5	MS->SS	RELEASE COMPLETE	This message shall be sent by the MS if p = N.
6	SS->MS	CHANNEL RELEASE	The SS waits for disconnection of the main signalling link.

Specific message contents

None.

26.5.3.4 Undefined or unexpected message type / unexpected message type / CC

26.5.3.4.1 Conformance requirements

If the Mobile Station receives a message not consistent with the protocol state, the Mobile Station shall ignore the message except for the fact that, if an RR-connection exists, it returns a status message (STATUS, RR STATUS or MM STATUS depending on the protocol discriminator) with cause value #98 "Message type not compatible with protocol state".

References

3GPP TS 04.08 / 3GPP TS 24.008, subclause 8.4.

26.5.3.4.2 Test purpose

To verify that a MS supporting the call control protocol for at least one BC, having a call in CC-state U10, "active", on receipt of an inopportune CC message, returns a STATUS message with reject cause value #98 without changing the state of the active call (this is verified by use of the status enquiry procedure.) This is tested in the special case where the inopportune CC message is a CALL PROCEEDING message relating to the active call.

26.5.3.4.3 Method of test

Initial conditions

System Simulator:

1 cell, default parameters.

Mobile Station:

The MS has a call in CC-state U10, "active".

Specific PICS statements:

-

PIXIT Statements:

-

Foreseen Final State of the MS

The MS has a call in CC-state U10, "active".

Test Procedure

The SS sends a CALL PROCEEDING message to the MS. The SS then checks that the MS responds with a STATUS message specifying reject cause value #98. The SS then sends a STATUS ENQUIRY message to the MS and verifies that the MS responds with a STATUS message specifying cause #30 and call state U10, "active".

Maximum duration of test

10 s.

Expected sequence

Step	Direction	Message	Comments
1	SS -> MS	CALL PROCEEDING	
2	MS -> SS	STATUS	Cause IE indicates cause value #98.
3	SS -> MS	STATUS ENQUIRY	
4	MS -> SS	STATUS	TI refers to the active call; Cause IE indicates cause value #30. Call state IE indicates state U10

Specific message contents

None.

26.5.4 Handling of unknown, unforeseen, and erroneous protocol data, and of parallel transactions / unforeseen information elements in the non-imperative message part

26.5.4.1 Unforeseen information elements in the non-imperative message part / duplicated information elements

26.5.4.1.1 Conformance requirements

If an information element with format T, TV, or TLV is repeated in a message in which repetition of the information element is not specified, only the contents of the information element appearing first shall be handled and all subsequent repetitions of the information element shall be ignored.

References

3GPP TS 04.08 / 3GPP TS 24.008 / 3GPP TS 44.018, subclause 8.6.3.

26.5.4.1.2 Test purpose

To verify that the MS ignores an unforeseen second occurrence of an information element with format T, TV, or TLV in the special case of the mobile identity IE which has format TLV in the LOCATION UPDATING ACCEPT message.

26.5.4.1.3 Method of test

Initial conditions

System Simulator:

2 cells A and B belonging to different location areas, default parameters.

Mobile Station:

The MS is in the MM-state "idle, updated" and in RR-idle mode, listening to the BCCH/CCCH of cell A. It has a valid TMSI.

Specific PICS statements:

-

PIXIT Statements:

-

Foreseen Final State of the MS

The MS is in the MM-state "idle, updated" and in RR-idle mode, listening to the BCCH/CCCH of cell B. It does not have a valid TMSI.

Test Procedure

The RF level of cell A is lowered until the MS selects cell B (according to the cell-reselection procedures of 3GPP TS 05.08). The MS shall establish an RR connection and initiate the normal location updating procedure (using TMSI). The SS responds to the location update request with the LOCATION UPDATING ACCEPT message containing the mobile identity IE specifying the IMSI of the MS followed by an additional mobile identity IE specifying the TMSI that was assigned to the MS in the initial conditions (i.e. duplication of information element).

The SS then pages the MS using the PAGING REQUEST TYPE 1 message including the TMSI which was previously used in the LOCATION UPDATE ACCEPT message. The SS then verifies during 5 s that the MS does not answer to paging. The SS then pages the MS with its IMSI. The SS verifies that the MS responds on cell B by initiating the immediate assignment procedure using the CHANNEL REQUEST message.

Maximum duration of test

20 s.

Expected sequence

During 3 s the SS verifies that the MS does not send any message on the RACH.

Step	Direction	Message	Comments
1	SS		The RF level of cell A is lowered until the MS selects cell B.
2	MS -> SS	CHANNEL REQUEST	
3	SS -> MS	IMMEDIATE ASSIGNMENT	
4	MS -> SS	LOCATION UPDATING REQUEST	Mobile identity IE specifies the TMSI of the MS.
5	SS -> MS	LOCATION UPDATING ACCEPT	(see below)
6	SS -> MS	CHANNEL RELEASE	
7	SS		The SS waits at least 5 s to give the MS time to become pageable
8	SS -> MS	PAGING REQUEST TYPE 1	Mobile identity 1 IE specifies the TMSI of the MS. Mobile identity 2 is omitted.
9	SS		The SS waits at least 5 s During that period the SS verifies that the MS does not send any message on the RACH.
10	SS -> MS	PAGING REQUEST TYPE 1	Mobile identity 1 IE specifies the IMSI of the MS. Mobile identity 2 is omitted.
11	MS -> SS	CHANNEL REQUEST	Establishment cause = answer to paging.
12	SS -> MS	IMMEDIATE ASSIGNMENT REJECT	

Specific message contents

LOCATION UPDATING ACCEPT

Information element	value/remark
location area identification	LAI of cell B
Mobile identity	coded TLV, specifies the IMSI of the MS
Type of identity	IMSI
Odd/even indication	corresponding to IMSI
Identity digit 1 etc.	corresponding to IMSI
Mobile identity (duplication)	coded TLV
Type of identity	TMSI of the MS
Odd/even indication	corresponding to TMSI
Identity digit 1 etc.	corresponding to TMSI

26.5.5 Handling of unknown, unforeseen, and erroneous protocol data, and of parallel transactions / non-semantic mandatory IE errors

26.5.5.1 Non-semantic mandatory IE errors / RR

26.5.5.1.1 Non-semantic mandatory IE errors / RR / missing mandatory IE error

26.5.5.1.1.1 Non-semantic mandatory IE errors / RR / missing mandatory IE error / special case

The MS shall accept a CHANNEL RELEASE message whether it contains an RR cause or not. This allows for the shortening of the message in the future.

26.5.5.1.1.1.1 Conformance requirements

When on receipt of a message a "missing mandatory IE" error is diagnosed the MS shall proceed as follows: If the message is a CHANNEL RELEASE message, the actions taken shall be the same as specified for a normal RR-connection release.

References

3GPP TS 04.08 / 3GPP TS 24.008, subclause 8.5.

26.5.5.1.1.1.2 Test purpose

To verify that the MS in RR connected mode releases the connection upon receipt of a CHANNEL RELEASE message with missing RR cause (which is "mandatory" in that message).

26.5.5.1.1.1.3 Method of test

Initial conditions

System Simulator:

1 cell, default parameters.

Mobile Station:

The MS is in the MM-state "idle, updated" and in RR-idle mode. It has a valid TMSI.

Specific PICS statements:

-

PIXIT Statements:

-

Foreseen Final State of the MS

The MS is in the MM-state "idle, updated" and in RR-idle mode. It has a valid TMSI.

Test Procedure

A mobile terminating RR connection is established. Then the SS sends a CHANNEL RELEASE message in which the RR cause IE is missing. It is verified that the MS releases the main signalling link by sending a L2 DISC frame. The main signalling link release is then completed.

Maximum duration of test

10 s.

Expected sequence

Step	Direction	Message	Comments
1	SS -> MS	PAGING REQUEST TYPE 1	
2	MS -> SS	CHANNEL REQUEST	
3	SS -> MS	IMMEDIATE ASSIGNMENT	
4	MS -> SS	PAGING RESPONSE	
5	SS -> MS	CHANNEL RELEASE	The mandatory RR cause IE is missing (the message consists only of protocol discriminator, skip indicator, and message type).
6	MS -> SS		The main signalling link is released (this is observed by a L2 DISC frame sent from the MS to the SS).

Specific message contents

None.

26.5.5.1.1.2 Non-semantical mandatory IE errors / RR / missing mandatory IE error / general case

In the general case, the MS has to report an RR message with missing mandatory IE by the use of an RR STATUS message, but otherwise to ignore it. This is a recovery mechanism for unforeseen states.

26.5.5.1.1.2.1 Conformance requirements

When on receipt of a message a "missing mandatory IE" error is diagnosed the MS shall proceed as follows: If the message is not one of the messages listed in subclauses 8.5.1, 8.5.2, and 8.5.3 of 3GPP TS 04.08 / 3GPP TS 24.008, the Mobile Station shall ignore the message except for the fact that, if an RR-connection exists, it returns a status message (STATUS, RR STATUS or MM STATUS depending on the protocol discriminator) with cause value #96 "invalid mandatory information".

References

3GPP TS 04.08 / 3GPP TS 24.008, subclause 8.5.

26.5.5.1.1.2.2 Test purpose

To verify that the MS in RR connected mode ignores a ciphering mode command message in which the ciphering mode setting IE and cipher response IE are missing except for the fact that it returns a RR STATUS message.

26.5.5.1.1.2.3 Method of test

Initial conditions

System Simulator:

1 cell, default parameters.

Mobile Station:

The MS is in the MM-state "idle, updated" and in RR-idle mode. It has a valid TMSI.

Specific PICS statements:

-

PIXIT Statements:

-

Foreseen Final State of the MS

The MS is in RR-connected mode.

Test Procedure

A mobile terminating RR connection is established. Then the SS sends a ciphering mode command message in which the ciphering mode setting IE and cipher response IE are missing. The SS verifies that the MS does not start ciphering and returns a RR STATUS message.

Maximum duration of test

10 s.

Expected sequence

Step	Direction	Message	Comments
1	SS -> MS	PAGING REQUEST TYPE 1	
2	MS -> SS	CHANNEL REQUEST	
3	SS -> MS	IMMEDIATE ASSIGNMENT	
4	MS -> SS	PAGING RESPONSE	
5	SS -> MS	CIPHERING MODE COMMAND	The mandatory ciphering mode setting IE and cipher response IE are missing.
6	MS -> SS	RR STATUS	RR cause IE specifies RR cause value #96.

Specific message contents

None.

26.5.5.1.2 Non-semantical mandatory IE errors / RR / comprehension required

26.5.5.1.2.1 Conformance requirements

When an RR message containing an IE unknown in the message, but encoded as "comprehension required" (see subclause 10.5 of 3GPP TS 04.08 / 3GPP TS 24.008) is received, the MS shall proceed as follows: When the message is not one of the messages listed in 3GPP TS 04.08 subclauses 8.5.1, 8.5.2 and 8.5.3, the Mobile Station shall ignore the message except for the fact that, if an RR-connection exists, it returns a RR STATUS message with cause value #96 "invalid mandatory information".

References

3GPP TS 04.08 / 3GPP TS 24.008, subclause 8.5.

26.5.5.1.2.2 Test purpose

To verify that the MS having an RR-connection established ignores a HANDOVER COMMAND message containing in the non-imperative part an IE encoded as comprehension required except for the fact that it returns a RR STATUS message with cause # 96 "invalid mandatory information".

26.5.5.1.2.3 Method of test

Initial conditions

System Simulator:

1 cell, default parameters.

Mobile Station:

The MS has an MT call in state U10, "active"; or alternatively, the MS has been paged and an RR-connection has been established.

Specific PICS statements:

-

PIXIT Statements:

-

Foreseen Final State of the MS

As in the initial conditions.

Test Procedure

The SS sends a HANDOVER command message containing in the non-imperative part an IE encoded as comprehension required. The SS verifies that the MS returns a RR STATUS message with cause value #96 without changing the dedicated channel.

Maximum duration of test

10 s.

Expected sequence

Step	Direction	Message	Comments
1	SS -> MS	HANDOVER COMMAND	See below.
2	MS -> SS	RR STATUS	Sent on the old channel. RR cause IE specifies RR cause value #96.

Specific message contents

HANDOVER COMMAND

Information element	value/remark
cell description	as required
channel description	as required
handover reference	as required
power command	as required
comprehension required IEI	0000 0000
length	0000 0001
unrecognized IE contents	xxxx xxxx

26.5.5.2 Non-semantic mandatory IE errors / MM

The MS shall ignore MM messages with syntactically incorrect mandatory IE. This allows to use reserved values in later phases.

26.5.5.2.1 Non-semantic mandatory IE errors / MM / syntactically incorrect mandatory IE

26.5.5.2.1.1 Conformance requirements

When an MM message containing a syntactically incorrect mandatory IE is received, the Mobile Station shall ignore the message except for the fact that, if an RR-connection exists, it returns a MM STATUS message with cause value #96 "invalid mandatory information".

References

3GPP TS 04.08 / 3GPP TS 24.008, subclause 8.5.

26.5.5.2.1.2 Test purpose

To verify that an MS supporting at least one BC, having a CC entity in state U10, "active", ignores an MM message with syntactically incorrect IE except for the fact that it sends an MM STATUS message with reject cause #96. This is tested in the special case of an IDENTITY REQUEST message in which the (mandatory) identity type IE specifies a reserved value for the type of identity; that the MS otherwise ignores the message is checked by means of the status enquiry procedure.

26.5.5.2.1.3 Method of test

Initial conditions

System Simulator:

1 cell, default parameters.

Mobile Station:

The MS has a mobile terminating call in the CC-state U10, "active".

Specific PICS statements:

-

PIXIT Statements:

-

Foreseen Final State of the MS

The MS has a mobile terminating call in the CC-state U10, "active".

Test Procedure

The SS sends an IDENTITY REQUEST message in which the (mandatory) identity type IE specifies a reserved value for the type of identity. The SS verifies that the MS returns an MM STATUS message specifying cause value #96 but does not change its state (this is verified by use of the status enquiry procedure).

Maximum duration of test

10 s.

Expected sequence

Step	Direction	Message	Comments
1	SS -> MS	IDENTITY REQUEST	The identity type IE is encoded as "1111" (so that the type of identity contains the reserved value "111").
2	MS -> SS	MM STATUS	Reject cause IE indicates reject cause value #96.
3	SS -> MS	STATUS ENQUIRY	TI refers to the active call.
4	MS -> SS	STATUS	TI refers to the active call; Cause IE indicates cause value #30. Call state IE indicates state U10.

Specific message contents

None.

26.5.5.2.2 Non-semantic mandatory IE errors / MM / syntactically incorrect mandatory IE

26.5.5.2.2.1 Conformance requirement(s)

When an MM message containing a syntactically incorrect mandatory IE is received, the Mobile Station shall ignore the message except for the fact that, if an RR-connection exists, it returns an MM STATUS message with cause value #96 "invalid mandatory information".

Reference(s)

3GPP TS 04.08 / 3GPP TS 24.008, subclause 8.5.

26.5.5.2.2.2 Test purpose

To verify that an MS having been paged and having an RR connection established ignores an MM message with syntactically incorrect IE except for the fact that it sends an MM STATUS message with reject cause #96. This is tested in the special case of an IDENTITY REQUEST message in which the (mandatory) *identity type* IE specifies a reserved value for the type of identity; the fact that the MS otherwise ignores the message is checked by testing that it answers as usual to an incoming SETUP message.

26.5.5.2.2.3 Method of test

Initial conditions

System Simulator:

1 cell, default parameters.

Mobile Station:

The MS has been paged; an RR connection has been established.

The MS has a valid TMSI.

Specific PICS statements:

-

PIXIT Statements:

-

Foreseen final state of the MS

The MS is in the MM-state "idle updated" listening to the BCCH/CCCH of the cell. It has a valid TMSI.

Test Procedure

The SS sends an IDENTITY REQUEST message in which the (mandatory) identity type IE specifies a reserved value for the type of identity. The SS verifies that the MS returns an MM STATUS message specifying cause value #96 but does not change its state; this is verified as follows:

The SS sends a SETUP message to the MS. This message specifies a BC that is supported by the MS, if there exists any; if the MS does not support any BC, the SETUP message specifies an arbitrary BC. The SS then verifies that the MS responds with a CALL CONFIRMED message if the SETUP had specified a BC supported by the MS, and that the MS responds with a RELEASE COMPLETE message otherwise.

Then the SS sends a CHANNEL RELEASE to the MS and waits for the disconnection of the main signalling link.

Maximum duration of test

10 s.

Expected sequence

Step	Direction	Message	Comments
1	SS -> MS	IDENTITY REQUEST	The identity type IE is encoded as "1111" (so that the type of identity contains the reserved value "1111").
2	MS -> SS	MM STATUS	Reject cause IE indicates reject cause value #96.
3	SS -> MS	SETUP	If the MS supports at least one BC (p = Y), the SETUP specifies a bearer capability supported by the MS. Otherwise (p = N) the SETUP message specifies any bearer capability.
A4	MS -> SS	CALL CONFIRMED	This message shall be sent by the MS if p = Y.
B4	MS -> SS	RELEASE COMPLETE	This message shall be sent by the MS if p = N.
5	SS -> MS	CHANNEL RELEASE	The SS waits for disconnection of the main signalling link.

Specific message contents

None.

26.5.5.2.3 Non-semantical mandatory IE errors / MM / comprehension required

The "comprehension required" mechanism allows for the introduction of essential new information elements into messages, such that a message is ignored and a report is sent if the new information element is not understood.

26.5.5.2.3.1 Conformance requirements

When an MM message containing an IE unknown in the message, but encoded as "comprehension required" (see subclause 10.5 of 3GPP TS 04.08 / 3GPP TS 24.008) is received, the MS shall ignore the message except for the fact that, if an RR-connection exists, it returns an MM STATUS message with cause value #96 "invalid mandatory information".

References

3GPP TS 04.08 / 3GPP TS 24.008, subclause 8.5.

26.5.5.2.3.2 Test purpose

To verify that the MS on receipt of an MM message containing an IE unknown in the message, but encoded as "comprehension required" ignores the message except for the fact that it returns an MM STATUS message with cause value #96 "invalid mandatory information"; this in the special case of the MM message being a LOCATION UPDATING ACCEPT responding to a LOCATION UPDATING REQUEST from the MS.

26.5.5.2.3.3 Method of test

Initial conditions

System Simulator:

The SS simulates two cells, A and B, belonging to different location areas, default parameters.

Mobile Station:

The MS is in the MM-state "idle, updated" listening to the BCCH/CCCH of cell A. It has a valid TMSI.

Specific PICS statements:

-

PIXIT Statements:

-

Foreseen Final State of the MS

The MS is in the MM-state "idle, updated" listening to the BCCH/CCCH of cell B. It has a valid TMSI.

Test Procedure

The Rf level of cell A is lowered until the MS selects cell B. The SS verifies that the MS establishes an RR connection and performs the normal location updating procedure using its TMSI. The SS responds to the location updating request with the LOCATION UPDATING ACCEPT message containing an optional information element coded as "comprehension required". The SS verifies that the MS returns the MM STATUS message with cause #96 in response to the LOCATION UPDATING ACCEPT. The SS then waits for the MS to abort the RR-connection. The SS verifies that the MS establishes a new RR connection and starts a new location updating procedure.

On receipt of the new LOCATION UPDATING REQUEST, the SS sends a correctly coded LOCATION UPDATING ACCEPT allocating a new TMSI.

The SS verifies that the MS sends a TMSI REALLOCATION COMPLETE message. The SS then initiates the RR connection release.

Maximum duration of test

30 s.

Expected sequence

Step	Direction	Message	Comments
1	SS		The RF level of cell A is lowered until the MS selects cell B.
2	MS -> SS	CHANNEL REQUEST	
3	SS -> MS	IMMEDIATE ASSIGNMENT	
4	MS -> SS	LOCATION UPDATING REQUEST	The mobile identity IE specifies the TMSI of the MS.
5	SS -> MS	LOCATION UPDATING ACCEPT	See below.
6	MS -> SS	MM STATUS	Reject cause IE specifies reject cause value #96.
7	MS		The MS aborts the RR connection (it initiates release of L2 on SAPI 0) using the L2 DISC / UA exchange.
8	MS -> SS	CHANNEL REQUEST	
9	SS -> MS	IMMEDIATE ASSIGNMENT	
10	MS -> SS	LOCATION UPDATING REQUEST	The mobile identity IE specifies the IMSI of the MS.
11	SS -> MS	LOCATION UPDATING ACCEPT	see below
12	MS -> SS	TMSI REALLOCATION COMPLETE	
13	SS -> MS	CHANNEL RELEASE	The RR connection is released.

Specific message contents

LOCATION UPDATING ACCEPT - first occurrence

Information element	value/remark
Location area identification	LAI of cell B
Comprehension required IEI	0000 0000
length	1
unrecognized IE contents	xxxx xxxx (arbitrary octet)

LOCATION UPDATING ACCEPT - second occurrence

Information element	value/remark
Location area identification	specifies LAI of cell B
Mobile Identity	specifies a TMSI

26.5.5.3 Non-semantic mandatory IE errors / CC

26.5.5.3.1 Non-semantic mandatory IE errors / CC / missing mandatory IE

26.5.5.3.1.1 Non-semantic mandatory IE errors / CC / missing mandatory IE / disconnect message

26.5.5.3.1.1.1 Conformance requirements

When on receipt of a message a "missing mandatory IE" error is diagnosed, the MS shall proceed as follows: If the message is a DISCONNECT message, a RELEASE message shall be returned with cause value # 96 "invalid mandatory information" and normal call clearing applies.

References

3GPP TS 04.08 / 3GPP TS 24.008, subclause 8.5.

26.5.5.3.1.1.2 Test purpose

To verify that the MS having an MT call in state U10, "active", on receipt of a DISCONNECT message in which the mandatory cause IE is missing shall return a RELEASE message with cause value #96 "invalid mandatory information".

26.5.5.3.1.1.3 Method of test

Initial conditions

System Simulator:

1 cell, default parameters.

Mobile Station:

The MS has an MT call in the CC-state U10, "active".

Specific PICS statements:

-

PIXIT Statements:

-

Foreseen Final State of the MS

The MS is in the MM-state "idle, updated" and in RR-idle mode.

Test Procedure

The SS sends a DISCONNECT message in which the (mandatory) cause IE is missing. The SS verifies that the MS returns a RELEASE message specifying cause value #96. The SS then sends a RELEASE COMPLETE message and performs the RR connection release.

Maximum duration of test

15 s.

Expected sequence

Step	Direction	Message	Comments
1	SS -> MS	DISCONNECT	The mandatory cause IE is missing.
2	MS -> SS	RELEASE	The cause IE indicates cause value #96
3	SS -> MS	RELEASE COMPLETE	
4	SS -> MS	CHANNEL RELEASE	The RR connection is released.

Specific message contents

None.

26.5.5.3.1.2 Non-semantical mandatory IE errors / CC / missing mandatory IE / general case

26.5.5.3.1.2.1 Conformance requirements

When on receipt of a message a "missing mandatory IE" error is diagnosed, the MS shall proceed as follows: If the message is not a SETUP, RELEASE, DISCONNECT, RELEASE COMPLETE, HOLD REJECT or RETRIEVE REJECT message, it shall ignore the message except for the fact that it returns a STATUS message specifying cause value #96.

References

3GPP TS 04.08 / 3GPP TS 24.008, subclause 8.5.

26.5.5.3.1.2.2 Test purpose

To verify that the MS having an MT call in state U10, "active", on receipt of a STATUS message in which the mandatory cause IE and call state IE are missing shall ignore the message except for the fact that it return a STATUS message with cause value #96 "invalid mandatory information" (that the MS does not change state is checked by use of the status enquiry procedure).

26.5.5.3.1.2.3 Method of test

Initial conditions

System Simulator:

1 cell, default parameters.

Mobile Station:

The MS has an MT call in the CC-state U10, "active".

Specific PICS statements:

-

PIXIT Statements:

-

Foreseen Final State of the MS

The MS has an MT call in the CC-state U10, "active".

Test Procedure

The SS sends a STATUS message in which the mandatory cause IE and call state IE are missing. The SS verifies that the MS returns a STATUS message with cause value #96 "invalid mandatory information". Then the SS sends a STATUS ENQUIRY message and checks that the MS returns a STATUS message indicating cause value #30 and call state U10, "active".

Maximum duration of test

15 s.

Expected sequence

Step	Direction	Message	Comments
1	SS -> MS	STATUS	The mandatory cause IE and call state IE are missing.
2	MS -> SS	STATUS	The cause IE indicates cause value #96
3	SS -> MS	STATUS ENQUIRY	TI refers to the active call.
4	MS -> SS	STATUS	TI refers to the active call; Cause IE indicates cause value #30. Call state IE indicates state U10

Specific message contents

None.

26.5.5.3.2 Non-semantic mandatory IE errors / CC / comprehension required

26.5.5.3.2.1 Conformance requirements

When a CC message containing an IE unknown in the message, but encoded as "comprehension required" (see 3GPP TS 04.08 / 3GPP TS 24.008, subclause 10.5) is received, the MS shall proceed as follows: When the message is not one of the messages listed in 3GPP TS 04.08 / 3GPP TS 24.008 subclauses 8.5.1, 8.5.2 and 8.5.3, the Mobile Station shall ignore the message except for the fact that, if an RR-connection exists, it returns a STATUS message with cause value #96 "invalid mandatory information".

References

3GPP TS 04.08 / 3GPP TS 24.008, subclauses 8.5 and 10.5.

26.5.5.3.2.2 Test purpose

To verify that an MS supporting the call control protocol for at least one BC having a call control entity in state U3 ignores a CONNECT message containing in the non-imperative part an IE encoded as comprehension required except for the fact that it returns a STATUS message with cause value #96 "invalid mandatory information".

26.5.5.3.2.3 Method of test

Initial conditions

System Simulator:

1 cell, default parameters.

Mobile Station:

The MS has a call control entity in CC state U3.

Specific PICS statements:

-

PIXIT Statements:

-

Foreseen Final State of the MS

The MS has a call control entity in CC state U3.

Test Procedure

The SS sends a CONNECT message containing an optional information element coded as "comprehension required". The SS verifies that the MS returns a STATUS message specifying cause value #96 "invalid mandatory information". The SS checks by use of the status enquiry procedure that the MS did not change the state.

Maximum duration of test

5 s.

Expected sequence

Step	Direction	Message	Comments
1	SS -> MS	CONNECT	See below.
2	MS -> SS	STATUS	TI refers to the call in progress; cause IE indicates cause value #96.
3	SS -> MS	STATUS ENQUIRY	TI refers to the call in progress.
4	MS -> SS	STATUS	TI refers to the call in progress; Cause IE indicates cause value #30. Call state IE indicates state U3.

Specific message contents

CONNECT

Information element	value/remark
Unknown IE	0000 0000
length	1
unknown IE contents	xxxx xxxx (arbitrary octet)

26.5.6 Handling of unknown, unforeseen, and erroneous protocol data, and of parallel transactions / unknown IE, comprehension not required

26.5.6.1 Unknown information elements in the non-imperative message part / MM

26.5.6.1.1 Unknown IE, comprehension not required / MM / IE unknown in the protocol

26.5.6.1.1.1 Conformance requirements

The MS shall ignore all IEs unknown in a message which are not encoded as "comprehension required".

References

3GPP TS 04.08 / 3GPP TS 24.008, subclauses 8.6.1, 8.6.2 and 10.5.

26.5.6.1.1.2 Test purpose

To verify that the MS on receipt of an MM message containing an IE unknown in the message and unknown in the MM protocol which is not encoded as "comprehension required" ignores that IE; this in the special case of the MM message being a LOCATION UPDATING ACCEPT responding to a LOCATION UPDATING REQUEST from the MS.

26.5.6.1.1.3 Method of test

Initial conditions

System Simulator:

The SS simulates two cells, A and B, belonging to different location areas, default parameters.

Mobile Station:

The MS is in the MM-state "idle, updated" listening to the BCCH/CCCH of cell B. It has a valid TMSI.

Specific PICS statements:

-

PIXIT Statements:

-

Foreseen Final State of the MS

The MS is in the MM-state "idle, updated" listening to the BCCH/CCCH of cell A. It has a valid TMSI.

Test Procedure

The RF level of cell B is lowered until the MS selects cell A. The SS verifies that the MS establishes an RR connection and performs the normal location updating procedure using its TMSI. The SS responds to the location updating request with the LOCATION UPDATING ACCEPT message containing an optional information element not coded as "comprehension required" the IE of which is unknown in the MM protocol. The LOCATION UPDATING ACCEPT message contains a new TMSI in the mobile identity IE which is placed after the unknown IE. The MS shall send the TMSI REALLOCATION COMPLETE message.

Maximum duration of test

20 s.

Expected sequence

Step	Direction	Message	Comments
1	SS		The RF level of cell B is lowered until the MS selects cell A.
2	MS -> SS	CHANNEL REQUEST	
3	SS -> MS	IMMEDIATE ASSIGNMENT	
4	MS -> SS	LOCATION UPDATING REQUEST	The mobile identity IE specifies the TMSI of the MS.
5	SS -> MS	LOCATION UPDATING ACCEPT	See below.
6	MS -> SS	TMSI REALLOCATION COMPLETE	
7	SS -> MS	CHANNEL RELEASE	The main signalling link is released.

Specific message contents

LOCATION UPDATING ACCEPT

Information element	value/remark
Location area identification	LAI of cell A
Unknown IEI	1010 xxx0 (where x is arbitrary)
Mobile Identity IEI	
length	5
Type of identity	TMSI
Identity	4 octets of "new" TMSI

26.5.6.1.2 Unknown IE, comprehension not required / MM / IE unknown in the message

26.5.6.1.2.1 Conformance requirements

The MS shall ignore all IEs unknown in a message which are not encoded as "comprehension required".

References

3GPP TS 04.08 / 3GPP TS 24.008, subclauses 8.6.1, 8.6.2 and 10.5.

26.5.6.1.2.2 Test purpose

To verify that the MS on receipt of an MM message containing an IE unknown in the message, but known in the MM protocol, which is not encoded as "comprehension required" ignores that IE; this in the special case of the MM message being a LOCATION UPDATING ACCEPT responding to a LOCATION UPDATING REQUEST from the MS.

26.5.6.1.2.3 Method of test

Initial conditions

System Simulator:

The SS simulates two cells, A and B, belonging to different location areas, default parameters.

Mobile Station:

The MS is in the MM-state "idle, updated" listening to the BCCH/CCCH of cell B. It has a valid TMSI.

Specific PICS statements:

-

PIXIT Statements:

-

Foreseen Final State of the MS

The MS is in the MM-state "idle, updated" listening to the BCCH/CCCH of cell A. It has a valid TMSI.

Test Procedure

The RF level of cell B is lowered until the MS selects cell A. The SS verifies that the MS establishes an RR connection and performs the normal location updating procedure using its TMSI. The SS responds to the location updating request with the LOCATION UPDATING ACCEPT message containing an optional information element not coded as "comprehension required" the IEI of which is unknown in the message but is used as the location area identification IEI in other messages of the MM protocol. The LOCATION UPDATING ACCEPT message contains a new TMSI in the mobile identity IE which is placed after the unknown IE. The MS shall send the TMSI REALLOCATION COMPLETE message.

Maximum duration of test

20 s.

Expected sequence

Step	Direction	Message	Comments
1	SS		The RF level of cell B is lowered until the MS selects cell A.
2	MS -> SS	CHANNEL REQUEST	
3	SS -> MS	IMMEDIATE ASSIGNMENT	
4	MS -> SS	LOCATION UPDATING REQUEST	The mobile identity IE specifies the TMSI of the MS.
5	SS -> MS	LOCATION UPDATING ACCEPT	See below.
6	MS -> SS	TMSI REALLOCATION COMPLETE	
7	SS -> MS	CHANNEL RELEASE	The main signalling link is released.

Specific message contents

LOCATION UPDATING ACCEPT

Information element	value/remark
Location area identification	LAI of cell A
Unknown IEI	0001 0011
length	2
unknown IE contents	xxxx xxxx xxxx xxxx (2 arbitrary octets)
Mobile Identity IEI	
length	5
Type of identity	TMSI
Identity	4 octets of "new" TMSI

26.5.6.2 Unknown information elements in the non-imperative message part / CC

26.5.6.2.1 Unknown information elements in the non-imperative message part / CC / Call establishment

26.5.6.2.1.1 Conformance requirements

The MS shall ignore all IEs unknown in a message which are not encoded as "comprehension required".

References

3GPP TS 04.08 / 3GPP TS 24.008, subclause 8.6.1.

26.5.6.2.1.2 Test purpose

To verify that an MS supporting the CC protocol for at least one BC receiving a CC message containing an IE unknown in the message which is not encoded as "comprehension required" ignores that IE; this in the special case of the CC message being a CALL PROCEEDING message received by the MS in state U1.

26.5.6.2.1.3 Method of test

Initial conditions

System Simulator:

1 cell, default parameters.

Mobile Station:

The MS has a call control entity in CC state U1.

Specific PICS statements:

-

PIXIT Statements:

-

Foreseen Final State of the MS

The MS has a call control entity in CC state U3.

Test Procedure

The SS sends a CALL PROCEEDING message containing an optional information element not coded as "comprehension required" the IEI of which is unknown in the message, but used for a called party BCD number IE in other messages of the protocol. The SS verifies by use of the status enquiry procedure that the MS did not change the state.

Maximum duration of test

30 s.

Expected sequence

Step	Direction	Message	Comments
1	SS -> MS	CALL PROCEEDING	See below.
2	SS -> MS	STATUS ENQUIRY	TI refers to the call in progress.
3	MS -> SS	STATUS	TI refers to the active call; Cause IE indicates cause value #30. Call state IE indicates state U3.

Specific message contents

CALL PROCEEDING

Information element	value/remark
Unknown IE length	0101 1110
unknown IE contents	1 xxxx xxxx (arbitrary octet)

26.5.6.2.2 Unknown information elements in the non-imperative message part / CC / disconnect

26.5.6.2.2.1 Conformance requirements

The MS shall ignore all IEs unknown in a message which are not encoded as "comprehension required".

References

3GPP TS 04.08 / 3GPP TS 24.008, subclause 8.6.1.

26.5.6.2.2.2 Test purpose

To verify that an MS supporting the CC protocol for at least one BC receiving a CC message containing an IE unknown in the message which is not encoded as "comprehension required" ignores that IE; this in the special case of a DISCONNECT message received by the MS in state U10.

26.5.6.2.2.3 Method of test

Initial conditions

System Simulator:

1 cell, default parameters.

Mobile Station:

The MS has a call control entity in CC state U10.

Specific PICS statements:

-

PIXIT Statements:

-

Foreseen Final State of the MS

The MS has a call control entity in CC state U19.

Test Procedure

The SS sends a DISCONNECT message containing an optional information element not coded as "comprehension required" the IEI of which is unknown in the message, but used for a connected number IE in other messages of the

protocol. The SS verifies that the MS responds with a RELEASE message; the SS verifies by use of the status enquiry procedure that the MS has entered state U19.

Maximum duration of test

5 s.

Expected sequence

Step	Direction	Message	Comments
1	SS -> MS	DISCONNECT	See below. Cause IE indicates cause value #30. Call state IE indicates state U19.
2	MS -> SS	RELEASE	
3	SS -> MS	STATUS ENQUIRY	
4	MS -> SS	STATUS	

Specific message contents

DISCONNECT

Information element	value/remark
Unknown IE length unknown IE contents	0100 1100 1 xxxx xxxx (arbitrary octet)

26.5.6.2.3 Unknown information elements in the non-imperative message part / CC / release

26.5.6.2.3.1 Conformance requirements

The MS shall ignore all IEs unknown in a message which are not encoded as "comprehension required".

References

3GPP TS 04.08 / 3GPP TS 24.008, subclause 8.6.1.

26.5.6.2.3.2 Test purpose

To verify that an MS supporting the CC protocol for at least one BC receiving a CC message containing an IE unknown in the message which is not encoded as "comprehension required" ignores that IE; this in the special case of a RELEASE message received by the MS having sent in state U10 a DISCONNECT message.

26.5.6.2.3.3 Method of test

Initial conditions

System Simulator:

1 cell, default parameters.

Mobile Station:

The MS has a call control entity in CC state U10.

Specific PICS statements:

-

PIXIT Statements:

-

Foreseen Final State of the MS

The MS is in the MM-state "idle, updated" and in RR-idle mode.

Test Procedure

The MS is made to send a DISCONNECT message. The SS responds with a RELEASE message containing an optional information element not coded as "comprehension required" the IEI of which is unknown in the message, but used for a high layer compatibility IE in other messages of the protocol. The SS verifies that the MS responds with a RELEASE COMPLETE message; the SS then releases the RR connection.

Maximum duration of test

10 s.

Expected sequence

Step	Direction	Message	Comments
1	MS		The MS is made to initiate call clearing.
2	MS -> SS	DISCONNECT	
3	SS -> MS	RELEASE	See below.
4	MS -> SS	RELEASE COMPLETE	
5	SS -> MS	CHANNEL RELEASE	The RR connection is released.

Specific message contents

RELEASE

Information element	value/remark
Unknown IEI	0111 1101
length	1
unknown IE contents	1 arbitrary octet

26.5.6.2.4 Unknown information elements in the non-imperative message part / CC / release complete

26.5.6.2.4.1 Conformance requirements

The MS shall ignore all IEs unknown in a message which are not encoded as "comprehension required".

References

3GPP TS 04.08 / 3GPP TS 24.008, subclause 8.6.1.

26.5.6.2.4.2 Test purpose

To verify that an MS supporting the CC protocol for at least one BC receiving a CC message containing an IE unknown in the message which is not encoded as "comprehension required" ignores that IE; this in the special case of a RELEASE COMPLETE message received by the MS in state U19.

26.5.6.2.4.3 Method of test

Initial conditions

System Simulator:

1 cell, default parameters.

Mobile Station:

The MS has a call control entity in CC state U10.

Specific PICS statements:

-

PIXIT Statements:

-

Foreseen Final State of the MS

The MS is in the MM-state "idle, updated" and in RR-idle mode.

Test Procedure

The SS sends a DISCONNECT message. The SS verifies that the MS responds with a RELEASE message. The SS answers with a RELEASE COMPLETE message containing an optional information element not coded as "comprehension required" the IEI of which is unknown in the message, but used for an auxiliary states IE in other messages of the protocol. The SS verifies that the MS releases the link after some time.

Maximum duration of test

20 s.

Expected sequence

Step	Direction	Message	Comments
1	SS -> MS	DISCONNECT	
2	MS -> SS	RELEASE	
3	SS -> MS	RELEASE COMPLETE	See below.
4	MS		The MS aborts the RR connection (it initiates release of L2 on SAPI 0)

Specific message contents

RELEASE COMPLETE

Information element	value/remark
Unknown IE length	0010 0100
unknown IE contents	1 1 arbitrary octet

26.5.6.3 Unknown IE in the non-imperative message part, comprehension not required / RR

26.5.6.3.1 Conformance requirements

The MS shall ignore all IEs unknown in a message which are not encoded as "comprehension required".

References

3GPP TS 04.08 / 3GPP TS 44.018, subclauses 8.6.1, 8.6.2 and 10.5.

26.5.6.3.2 Test purpose

To verify that the MS ignores an IE which is unknown in a message for Radio Resource Management in the special cases of CIPHERING MODE COMMAND, ASSIGNMENT COMMAND and CHANNEL RELEASE.

26.5.6.3.3 Method of test

Initial conditions

System Simulator:

1 cell, default parameters.

Mobile Station:

The MS is in the MM-state "idle, updated" and in the RR-idle mode. It has a valid TMSI.

Specific PICS statements:

-

PIXIT Statements:

-

Foreseen Final State of the MS

The MS is in the MM-state "idle, updated" and in the RR-idle mode. It has a valid TMSI.

Test Procedure

In the normal call establishment the CIPHERING MODE COMMAND and ASSIGNMENT COMMAND contain additional IEs unknown in the message which are not encoded as "comprehension required", and therefore should be ignored by the MS. After sending an ASSIGNMENT COMPLETE, the subsequent CHANNEL RELEASE received by the MS also contains an IE unknown in a message which is not encoded as "comprehension required". The MS should ignore this IE.

Maximum duration of test

10 s.

Expected sequence

Step	Direction	Message	Comments
1	SS -> MS	PAGING REQUEST TYPE 1	
2	MS -> SS	CHANNEL REQUEST	
3	SS -> MS	IMMEDIATE ASSIGNMENT	
4	MS -> SS	PAGING RESPONSE	
5	SS -> MS	CIPHERING MODE COMMAND	See specific message contents
6	MS -> SS	CIPHERING MODE COMPLETE	
7	SS -> MS	ASSIGNMENT COMMAND	See specific message contents
8	MS -> SS	ASSIGNMENT COMPLETE	On the dedicated channel
9	SS -> MS	CHANNEL RELEASE	See specific message contents
10	SS		The SS checks the release of the main signalling link at layer 2 level.

Specific message contents

None.

Step 5: CIPHERING MODE COMMAND

Cipher mode setting - algorithm identifier - SC	cipher with A5/1 start ciphering
Cipher Response Unknown IE (type 2)	IMEI shall not be included 1001 0010

Step 7: ASSIGNMENT COMMAND

Channel Description	
Channel Type	TCH/F + ACCHs
Timeslot number	arbitrarily selected, but not zero
Training sequence code	arbitrarily selected
Hopping	RF hopping channel
MAIO	0
HSN	0
Power Command	arbitrarily selected
First Unknown IE (Type 2)	1101 1010
Cell Channel Description	For GSM 450 mobiles, range 128 encodes ARFCNs 267 and 275. For GSM 480 mobiles, range 128 encodes ARFCNs 315 and 322. For GSM 710 mobiles, range 128 encodes ARFCNs 470 and 490. For GSM 750 mobiles, range 128 encodes ARFCNs 470 and 490. For T-GSM 810 mobiles, range 128 encodes ARFCNs 470 and 490. For GSM 850 mobiles, range 128 encodes ARFCNs 160 and 180. For PGSM and EGSM mobiles, bit map 0 encodes ARFCNs 30 and 50. For DCS 1 800 and PCS 1 900 mobiles, the variable bit map format encodes ARFCNs 650 and 750.
Second Unknown IE (Type 4)	
- IEI	0110 1001
- length	2
- contents	xxxx xxxx xxxx xxxx, where x is arbitrarily coded.
Mobile Allocation	For GSM450 mobiles, indicates ARFCN 275 only. For GSM 480 mobiles, indicates ARFCN 322 only. For GSM 710 mobiles, indicates ARFCN 490 only. For GSM 750 mobiles, indicates ARFCN 490 only. For T-GSM 810 mobiles, indicates ARFCN 490 only. For GSM 850 mobiles, indicates ARFCN 180 only. For PGSM and EGSM mobiles, indicates ARFCN 50, only. For DCS 1 800 and PCS 1 900 mobiles, indicates ARFCN 750, only.

Step 9: CHANNEL RELEASE

RR Cause	normal event
Unknown IE (type 4)	
- IEI	0110 0010
- length	5
- contents	xxxx xxxx xxxx xxxx xxxx xxxx xxxx xxxx xxxx, where x is arbitrarily coded.

26.5.7 Handling of unknown, unforeseen, and erroneous protocol data, and of parallel transactions / spare bits

26.5.7.1 Spare bits / RR

26.5.7.1.1 Spare bits / RR / paging channel

26.5.7.1.1.1 Conformance requirements

The MS shall ignore the value of spare bits.

References

3GPP TS 04.08 / 3GPP TS 44.018, subclause 10.5.

26.5.7.1.1.2 Test purpose

To verify that the MS in the MM-state "idle, updated" and in RR-idle mode ignores the value of spare bits in the special case of the spare bits occurring in the P1 Rest Octets IE of a PAGING REQUEST TYPE 1 message. That the spare bits are ignored is checked by addressing the MS in that PAGING REQUEST message and verifying that the MS responds to that paging.

26.5.7.1.1.3 Method of test

Initial conditions

System Simulator:

1 cell, default parameters.

Mobile Station:

The MS is in the MM-state "idle, updated" and in RR-idle mode.

Specific PICS statements:

-

PIXIT Statements:

-

Foreseen Final State of the MS

The MS is in the MM-state "idle, updated" and in RR-idle mode.

Test Procedure

The SS sends a PAGING REQUEST TYPE 1 message containing at least one octet in the P1 rest octets IE that is different from 0010 1011.

Maximum duration of test

10 s.

Expected sequence

Step	Direction	Message	Comments
1	SS -> MS	PAGING REQUEST TYPE 1	See below.
2	MS -> SS	CHANNEL REQUEST	
3	SS -> MS	IMMEDIATE ASSIGNMENT REJECT	

Specific message contents

PAGING REQUEST TYPE 1

Information element	Value/remark
L2 pseudo length	k+3 where k is the sum of the length of the mobile identity 1 IE
Page Mode	Normal paging
Channels needed for Mobiles 1 and 2	
Channel (first)	Any channel
Channel (second)	(spare)
Mobile identity 1	IMSI or TMSI of MS under test
Mobile identity 2	Omitted
P1 rest octets	not all octets are "0010 1011"

26.5.7.1.2 Spare bits / RR / BCCH

26.5.7.1.2.1 Conformance requirements

The MS shall ignore the value of spare bits.

References

3GPP TS 04.08 / 3GPP TS 44.018, subclause 10.5.

26.5.7.1.2.2 Test purpose

To verify that the MS in the MM-state "idle, updated" and in RR-idle mode ignores the value of spare bits in the special case where these spare bits are contained in the SI3 and SI4 messages. That the MS ignores the value of the spare bits is checked by changing the LAI in those message and observing the MS initiating a location update though the spare bits do not all have the default value.

26.5.7.1.2.3 Method of test

Initial conditions

System Simulator:

1 cell, default parameters.

Mobile Station:

The MS is in the MM-state "idle, updated" and in RR-idle mode.

Specific PICS statements:

-

PIXIT Statements:

-

Foreseen Final State of the MS

The MS is in the MM-state "idle, updated" and in RR-idle mode.

Test Procedure

The SS simulates a BCCH where continuously for at least 30 s at least one octet of the SI3 Rest Octets IE in all SYSTEM INFORMATION TYPE 3 messages and at least one octet of the SI4 Rest Octets IE in all SYSTEM INFORMATION TYPE 4 messages is different from 0010 1011 and the location area identification IE denotes a location area different from the current location area held by the MS. The SS verifies that the MS sends a CHANNEL REQUEST message on the RACH including the establishment cause "location updating". The SS responds with an IMMEDIATE ASSIGNMENT REJECT message.

Maximum duration of test

10 s.

Expected sequence

Step	Direction	Message	Comments
1	SS -> MS		The SS starts sending modified SYSTEM INFORMATION TYPE 3 and SYSTEM INFORMATION TYPE 4 messages (as defined below) continuously for at least 30 s on the BCCH.
2	MS -> SS	CHANNEL REQUEST	Establishment cause = "location updating (SDCCH needed). This message may be received during the 30 s.
3	SS -> MS	IMMEDIATE ASSIGNMENT REJECT	

Specific message contents

SYSTEM INFORMATION TYPE 3

Information element	value/remark
L2 pseudo length	18
cell identity	as required
location area identification	denoting a new location area
control channel description	as required, but with the spare bits arbitrarily selected and at least one spare bit set to 1.
cell options	as required, but with (spare) bit 8 set to 1
cell selection parameters	as required
RACH control parameters	as required
SI3 rest octets	at least one octet is different from "0010 1011"

SYSTEM INFORMATION TYPE 4

Information element	value/remark
L2 pseudo length	12
location area identification	denoting a new location area
cell selection parameters	as required
RACH control parameters	as required
SI4 rest octets	at least one octet is different from "0010 1011"

26.5.7.1.3 Spare bits / RR / AGCH

26.5.7.1.3.1 Conformance requirements

The MS shall ignore the value of spare bits.

References

3GPP TS 04.08 / 3GPP TS 44.018, subclause 10.5.

26.5.7.1.3.2 Test purpose

To verify that the MS in the MM-state "idle, updated" and in RR-idle mode ignores the value of spare bits in the special case of the spare bits occurring in the Page Mode IE, the Spare Half Octet IE, the Channel Description IE, the Timing Advance IE, the IA Rest Octet IE, and in the IAR Rest Octet IE.

26.5.7.1.3.3 Method of test

Initial conditions

System Simulator:

1 cell, default parameters.

Mobile Station:

The MS is in the MM-state "idle, updated" and in RR-idle mode.

Specific PICS statements:

-

PIXIT Statements:

-

Foreseen Final State of the MS

The MS is in the MM-state "idle, updated" and in RR-idle mode.

Test Procedure

The SS sends an IMMEDIATE ASSIGNMENT message containing arbitrary spare bits in the Page Mode IE, in the Spare Half Octet IE, in the Channel Description IE, in the Timing Advance IE, and in the IA Rest Octet IE.

It is checked that the MS answers on the dedicated channel with a PAGING RESPONSE message and releases the main signalling link after a CHANNEL RELEASE message.

After a new paging of the MS an IMMEDIATE ASSIGNMENT REJECT is sent to test the spare bits in the IAR Rest Octet IE.

The MS is then paged again to check the idle state.

Maximum duration of test

20 s.

Expected sequence

Step	Direction	Message	Comments
1	SS -> MS	PAGING REQUEST TYPE 1	Addressing the MS under test
2	MS -> SS	CHANNEL REQUEST	
3	SS -> MS	IMMEDIATE ASSIGNMENT	see below
4	MS -> SS	PAGING RESPONSE	
5	SS -> MS	CHANNEL RELEASE	
6	SS		The SS checks that the MS releases the main signalling link and waits 10 s for a cell reselection of the MS
7	SS -> MS	PAGING REQUEST TYPE 1	Addressing the MS under test
8	MS -> SS	CHANNEL REQUEST	
9	SS -> MS	IMMEDIATE ASSIGNMENT REJECT	normal, waiting time = 0, except the IAR Rest Octet IE (see below)
10	SS		The SS waits six seconds
11	SS -> MS	PAGING REQUEST TYPE 1	Addressing the MS under test
12	MS -> SS	CHANNEL REQUEST	To check that the MS has reached the idle state after the IMMEDIATE ASSIGNMENT REJECT

Specific message contents

IMMEDIATE ASSIGNMENT

Information element	Value/remark
L2 pseudo length	sum of the length of all IE except L2 pseudo length and IA Rest Octets
Protocol Discriminator	RR
Skip Indicator	0000
Message Type	Immediate Assignment
Page mode	xx00 (where "xx" is arbitrary, with at least 1 bit set to 1)
Dedicated mode or TBF	x000 (where "x" is set to 1)
Channel description	normal, no hopping, the two spare bits before ARFCN are chosen arbitrarily with at least one bit set to 1.
Request reference	normal (derived from the CHANNEL REQUEST)
Timing advance	xx00 0000 (where "xx" is arbitrary, with at least 1 bit set to 1)
Mobile allocation	chosen so that, together with the channel description
Length	0
IA rest octets	
first octet	00xx xxxx (where "xx xxxx" is arbitrary but different to 10 1011)
other octets	xxxx xxxx (where "xxxx xxxx" is arbitrary but different to 0010 1011)

IMMEDIATE ASSIGNMENT REJECT

Information element	Value/remark
L2 pseudo length	19
Page mode	normal
Spare half octet	xxxx (where "xxxx" is arbitrary, with at least 1 bit is set to 1)
Request reference 1	addressing the MS under test
Wait indication 1	0 s
...	Other Request References and Wait Indications arbitrary
IAR rest octets	
Octet 1 to 3	xxxx xxxx (where "xxxx xxxx" is arbitrary but different to 0010 1011)

26.5.7.1.4 Spare bits / RR / Connected Mode

26.5.7.1.4.1 Conformance requirements

The MS shall ignore the value of spare bits.

References

3GPP TS 04.08 / 3GPP TS 44.018, subclause 10.5.

26.5.7.1.4.2 Test purpose

To verify that the MS in the MM-state "MM-Connection active" and in RR-Connected mode ignores the value of spare bits in the special case of the spare bits occurring in the Cell Channel Description IE and in the Power Command IE.

26.5.7.1.4.3 Method of test

Initial conditions

System Simulator:

1 cell, default parameters, except:

GSM 450 mobiles are assigned to ARFCN 293 in step 10.

GSM 480 mobiles are assigned to ARFCN 340 in step 10.

GSM 710, GSM 750 and T-GSM 810 mobiles are assigned to ARFCN 511 in step 10.

GSM 850 mobiles are assigned to ARFCN 251 in step 10.

PGSM and EGSM mobiles are assigned to ARFCN 124 in step 10.

DCS 1 800 and PCS 1 900 mobiles are assigned to ARFCN 801 in step 10.

Mobile Station:

The MS is in the MM-state "idle, updated" and in RR-idle mode.

Specific PICS statements:

-

PIXIT Statements:

-

Foreseen Final State of the MS

The MS is in the MM-state "idle, updated" and in RR-idle mode.

Test Procedure

In the procedure of a normal call establishment the ASSIGNMENT COMMAND will be modified to test the spare bits in the Cell Channel Description IE and in the Power Command IE.

Maximum duration of test

10 s.

Expected sequence

Step	Direction	Message	Comments
1	SS -> MS	PAGING REQUEST TYPE 1	Addressing the MS under test
2	MS -> SS	CHANNEL REQUEST	
3	SS -> MS	IMMEDIATE ASSIGNMENT	
4	MS -> SS	PAGING RESPONSE	
5	SS -> MS	CIPHERING MODE COMMAND	
6	MS -> SS	CIPHERING MODE COMPLETE	
7	SS -> MS	SETUP	
8	MS -> SS	CALL CONFIRMED	
A9	MS -> SS	ALERTING	
B9	MS -> SS	CONNECT	
10	SS -> MS	ASSIGNMENT COMMAND	see below on the dedicated channel The SS checks that the MS release the main signalling link
11	MS -> SS	ASSIGNMENT COMPLETE	
12	SS -> MS	CHANNEL RELEASE	
13	SS		

Specific message contents

ASSIGNMENT COMMAND

For GSM 450 mobiles

Information element	Value/remark
Channel Description	normal, hopping HSN=63, MAIO=0
Power Command	
Cell Channel Description octet 2	xxx0 0111 (where "xxx" is arbitrary, with at least 1 bit set to 1)
Mobile Allocation	10xx 110? (where "xx" is arbitrary, with at least 1 bit set to 1) Bit 1 of octet 2 and all of octets 3 to 17 (inclusive) indicate ARFCN 293 only (using the Range 128 format). indicates ARFCN 293 only

For GSM 480 mobiles

Information element	Value/remark
Channel Description	normal, hopping HSN=63, MAIO=0
Power Command	
Cell Channel Description octet 2	xxx0 0111 (where "xxx" is arbitrary, with at least 1 bit set to 1)
Mobile Allocation	10xx 110? (where "xx" is arbitrary, with at least 1 bit set to 1) Bit 1 of octet 2 and all of octets 3 to 17 (inclusive) indicate ARFCN 340 only (using the Range 128 format). indicates ARFCN 340 only

For GSM 710 or GSM 750 or T-GSM 810 mobiles

Information element	Value/remark
Channel Description	normal, hopping HSN=63, MAIO=0
Power Command	xxx0 0111 (where "xxx" is arbitrary, with at least 1 bit set to 1)
Cell Channel Description Octet 2	10xx 110? (where "xx" is arbitrary, with at least 1 bit set to 1) Bit 1 of octet 2 and all of octets 3 to 17 (inclusive)
Mobile Allocation	indicate ARFCN 511 only (using the Range 128 format). indicates ARFCN 511 only

For GSM 850 mobiles

Information element	Value/remark
Channel Description	normal, hopping HSN=63, MAIO=0
Power Command	xxx0 0111 (where "xxx" is arbitrary, with at least 1 bit set to 1)
Cell Channel Description Octet 2	10xx 110? (where "xx" is arbitrary, with at least 1 bit set to 1) Bit 1 of octet 2 and all of octets 3 to 17 (inclusive)
Mobile Allocation	indicate ARFCN 251 only (using the Range 128 format). Indicates ARFCN 251 only

For PGSM and EGSM mobiles

Information element	Value/remark
Channel Description	normal, hopping HSN=63, MAIO=0
Power Command	xxx0 0111 (where "xxx" is arbitrary, with at least 1 bit set to 1)
Cell Channel Description octet 2	00xx 1000 (where "xx" is arbitrary, with at least 1 bit set to 1)
octet 3 to 17 (inclusive)	all bits set to zero
Mobile Allocation	indicates ARFCN 124 only

For DCS 1 800 or PCS 1 900 mobiles

Information element	Value/remark
Channel Description	normal, hopping, HSN=63, MAIO=0
Power Command	xxx0 0111 (where "xxx" is arbitrary, with at least 1 bit set to 1)
Cell Channel Description octet 2	10xx 111? (where "xx" is arbitrary, with at least 1 bit set to 1). Bit 1 of octet 2 and all of octets 3 to 17 (inclusive)
Mobile Allocation	indicate ARFCN 801 only (using the variable bit map format). indicates ARFCN 801 only

26.5.7.2 Spare bits / MM

26.5.7.2.1 Conformance requirements

The MS shall ignore the value of spare bits.

References

3GPP TS 04.08 / 3GPP TS 24.008, subclause 10.5.

26.5.7.2.2 Test purpose

To verify that the MS in the MM-state "wait net cmd" and in RR-Connected mode ignores the value of spare bits in the special case of the spare bits occurring in the Cipher Key Seq. Number IE or in the Identity Type IE.

26.5.7.2.3 Method of test

Initial conditions

System Simulator:

1 cell, default parameters.

Mobile Station:

The MS is in the MM-state "idle, updated" and in RR-idle mode.

Specific PICS statements:

-

PIXIT Statements:

-

Foreseen Final State of the MS

The MS is in the MM-state "idle, updated" and in RR-idle mode.

Test Procedure

After the establishment of the RR-connection, in the AUTHENTICATION REQUEST message the spare bits of the Ciphering Key Sequence Number and of the Spare Half Octet IE will be randomly chosen. The spare bits of the Identity Type IE and the Spare Half Octet IE in the IDENTITY REQUEST message will also be chosen arbitrarily.

Maximum duration of test

10 s.

Expected sequence

Step	Direction	Message	Comments	
1	SS -> MS	PAGING REQUEST TYPE 1	Addressing the MS under test	
2	MS -> SS	CHANNEL REQUEST		
3	SS -> MS	IMMEDIATE ASSIGNMENT		
4	MS -> SS	PAGING RESPONSE		
5	SS -> MS	AUTHENTICATION REQUEST		see below
6	MS -> SS	AUTHENTICATION RESPONSE		
7	SS -> MS	IDENTITY REQUEST		see below
8	MS -> SS	IDENTITY RESPONSE		with the right TMSI
9	SS -> MS	CHANNEL RELEASE		
10	SS			The SS checks that the MS release the main signalling link

Specific message contents

AUTHENTICATION REQUEST

Information element	Value/remark
Ciphering Key Sequence Number	x000 (where "x" is set to 1)
Spare Half Octet	xxxx (where "xxxx" is arbitrary, with at least 1 bit set to 1)
Auth. Parameter RAND	standard value

IDENTITY REQ

Information element	Value/remark
Identity Type	x100 (where "x" is set to 1)
Spare Half Octet	xxxx (where "xxxx" is arbitrary, with at least 1 bit set to 1)

26.5.7.3 Spare bits / CC

26.5.7.3.1 Conformance requirements

The MS shall ignore the value of spare bits.

References

3GPP TS 04.08 / 3GPP TS 24.008, subclause 10.5.

26.5.7.3.2 Test purpose

To verify that the MS in the MM-state "connection established" and in RR-Connected mode ignores the value of spare bits in the special case of the spare bits occurring in the Calling Party BCD Number IE, Calling Party Subaddress IE, Called Party Subaddress IE, Cause IE and Progress Indicator IEs.

26.5.7.3.3 Method of test

Initial conditions

System Simulator:

1 cell, default parameters.

Mobile Station:

The MS is in the MM-state "idle, updated" and in RR-idle mode.

Specific PICS statements:

- Support of speech (TSPC_AddInfo_Full_rate_version_1, TSPC_AddInfo_Half_rate_version_1)

PIXIT Statements:

-

Foreseen Final State of the MS

The MS is in the MM-state "idle, updated" and in RR-idle mode.

Test Procedure

After the establishment of the MM-connection, in the SETUP message the spare bits of the Calling Party BCD Number, Calling Party Subaddress and Called Party Subaddress will be arbitrarily chosen and also in the DISCONNECT message the spare bits of the Progress Indicator IE and of the Cause IE will be arbitrarily chosen.

Maximum duration of test

10 s.

Expected sequence

Step	Direction	Message	Comments
1	SS -> MS	PAGING REQUEST TYPE 1	Addressing the MS under test see below
2	MS -> SS	CHANNEL REQUEST	
3	SS -> MS	IMMEDIATE ASSIGNMENT	
4	MS -> SS	PAGING RESPONSE	
5	SS -> MS	AUTHENTICATION REQUEST	
6	MS -> SS	AUTHENTICATION RESPONSE	
7	SS -> MS	CIPHERING MODE COMMAND	
8	MS -> SS	CIPHERING MODE COMPLETE	
9	SS -> MS	SETUP	
10	MS -> SS	CALL CONFIRMED	
A11	MS -> SS	CONNECT	
B11	MS -> SS	ALERTING	
B12	MS -> SS	CONNECT	
13	SS -> MS	ASSIGNMENT COMMAND	see below If PICS TSPC_AddInfo_Full_rate_version_1 OR TSPC_AddInfo_Half_rate_version_1 is set to TRUE, path 'A' will be followed else path 'B' will be followed. with actual call state U12
14	MS -> SS	ASSIGNMENT COMPLETE	
15	SS -> MS	CONNECT ACKNOWLEDGE	
16	SS -> MS	DISCONNECT	
17A	SS -> MS	STATUS ENQUIRY	
18A	MS -> SS	STATUS	
19A	SS -> MS	RELEASE	
20A	MS -> SS	RELEASE COMPLETE	
17B	MS -> SS	RELEASE	
18B	SS -> MS	RELEASE COMPLETE	
21	SS -> MS	CHANNEL RELEASE	After step 18B test will move to step 21.

Specific message contents

SETUP

Information element	Value/remark
Calling Party BCD Number	
IEI	
length	3
octet 3	0000 0000
octet 3a	100x xx00 (where "x" is chosen arbitrarily, with at least one bit set to 1)
octet 4	0000 0001
Calling Party Subaddress	
IEI	
length	3
octet 3	1000 0xxx (where "x" is chosen arbitrarily, with at least one bit set to 1)
octet 4	0101 0000 (AFI: request IA5 character)
octet 5	0000 0001
Called Party Subaddress	
IEI	
length	3
octet 3	1000 0xxx (where "x" is chosen arbitrarily, with at least one bit set to 1)
octet 4	0101 0000 (AFI: request IA5 character)
octet 5	0000 0001

DISCONNECT

Information element	Value/remark
Cause	
Length	2
octet 3	111x 0000 (where "x" is set to 1)
octet 4	1000 0001
Progress Indicator	
IEI	
Length	2
octet 3	111x 0000 (where "x" is set to 1)
progress description	8 (in band info now available)

26.5.8 Default contents of messages

Default requirements for messages that are not mentioned in this subclause are given in subclause 26.8.4.

CHANNEL RELEASE

Information element	Value/remark
RR cause	Normal event

CHANNEL REQUEST

DISCONNECT (SS -> MS)

Information element	Value/remark
Cause	
Coding standard	Standard defined for the GSM PLMNS
Location	user
Cause value	#16

IDENTITY REQUEST

Information element	Value/remark
Identity type	Depending on test
Spare half octet	0000

IMMEDIATE ASSIGNMENT

Information element	Value/remark
L2 pseudo length	n, where n is the L2 pseudo length of the message
Page mode	arbitrary
Spare half octet	0000
Channel description	a valid description of an SDCCH + SACCH
Request reference	Corresponding to the last CHANNEL REQUEST received from the MS
Timing advance	arbitrary
Mobile allocation	chosen so that, together with the channel description IE, it describes a valid SDCCH + SACCH
Starting time	Omitted
IA rest octets	m octets, each coded as H'2B, where $m = 22 - n$

IMMEDIATE ASSIGNMENT REJECT

Information element	Value/remark
L2 pseudo length	19
Page mode	arbitrary
Spare half octet	0000
Request reference 1	corresponding to the last CHANNEL REQUEST received from the MS
Wait indication 1	0 s
Request reference 2	arbitrary
Wait indication 2	0 s
Request reference 3	arbitrary
Wait indication 3	0 s
Request reference 4	arbitrary
Wait indication 4	0 s
IA rest octets	3 octets, each coded as H'2B

PAGING REQUEST TYPE 1

Information element	Value/remark
L2 pseudo length	n where n is the sum of the mobile identity 1 IE and 3
Page Mode	Normal paging
Channels needed for Mobiles 1 and 2	
Channel (first)	Any channel
Channel (second)	(spare)
Mobile identity 1	IMSI or TMSI of MS under test
Mobile identity 2	Omitted
P1 rest octets	m octets, each coded as H'2B, where $m = 22 - n$

PAGING RESPONSE

RELEASE COMPLETE (MS -> SS)

No default requirements defined for this message.

RELEASE COMPLETE (SS -> MS)

Information element	Value/remark
Cause	
Coding standard	Standard defined for the GSM PLMNS
Location	user
Cause value	#16

STATUS (MS -> SS)

Information element	Value/remark
Cause	
Length	length of cause IE
Coding standard	Standard defined for the GSM PLMNS
Location	user
Cause value	as defined in test
Call state	as defined in test

STATUS ENQUIRY (SS -> MS)

Information element	Value/remark
Transaction identifier	relating to the active call

26.6 Test of the elementary procedures for radio resource management

NOTE: For SS implementor: if tests are concatenated, it is important that unused fields in IMMEDIATE ASSIGNMENT REJECT messages do not use Request References that relate to CHANNEL REQUEST messages recently transmitted by the MS.

26.6.1 Immediate assignment

The immediate assignment procedure is used by the network to establish a dedicated control channel for the MS and network to communicate the detail of the service requested. If the Mobile Station does not implement the procedure correctly, radio resources can be wasted as the Mobile Station might use the wrong channels.

26.6.1.1 Immediate assignment / SDCCH or TCH assignment

26.6.1.1.1 Conformance requirement

1. Following a PAGING REQUEST message, the MS shall correctly set up an RR connection on the SDCCH/8 described in the IMMEDIATE ASSIGNMENT message.
2. Following a PAGING REQUEST message, the MS shall correctly set up an RR connection on the TCH/FACCH described in the IMMEDIATE ASSIGNMENT message.

Reference(s)

3GPP TS 04.08 / 3GPP TS 44.018, subclause 3.3.1.1.2.

26.6.1.1.2 Test purpose

To verify that the MS can correctly set up a dedicated SDCCH control channel and that the MS can correctly set up a dedicated TCH/FACCH control channel.

26.6.1.1.3 Method of test

Initial Conditions

System Simulator:

1 cell, except that CCCH_CONF is set to "1 basic physical channel used for CCCH not combined with SDCCHs".

Mobile Station:

The MS is in the "idle, updated" state, with a TMSI allocated.

Specific PICS statements

- MS supports SDCCH only (TSPC_AddInfo_SDCCHOnly)
- MS supports GSM HR (TSPC_AddInfo_HalfRate)

PIXIT statements

-

Foreseen Final State of the MS

"Idle, updated", with TMSI allocated.

Test Procedure

The System Simulator pages the MS and after the MS has responded with a CHANNEL REQUEST message the SS assigns an SDCCH. The MS shall go to the correct channel and send a PAGING RESPONSE message. Then the SS initiates RR-release by sending a CHANNEL RELEASE message.

If TCH/F is supported by the MS, the test is repeated with the SS assigning a TCH/F (Signalling).

If TCH/H is supported by the MS, the test is repeated with the SS assigning a TCH/H (Signalling).

Maximum Duration of Test

6 s per value of the execution timer.

Expected Sequence

This sequence is performed for execution counter, $K = 1, 2, 3$ (unless the TCH is not supported).

Step	Direction	Message	Comments
1	SS -> MS	PAGING REQUEST TYPE 1	Channel Type: see below Shall be sent on the correct channel
2	MS -> SS	CHANNEL REQUEST	
3	SS -> MS	IMMEDIATE ASSIGNMENT	
4	MS -> SS	PAGING RESPONSE	
5	SS -> MS	CHANNEL RELEASE	

Specific Message Contents

IMMEDIATE ASSIGNMENT

$K=1$, SDCCH test: Channel Type = SDCCH/8.

$K=2$, TCH/F (Signalling) test: Channel Type = Bm + ACCHs.

$K=3$, TCH/H (Signalling) test: Channel Type = Lm + ACCHs, subchannel arbitrarily chosen.

26.6.1.2 Immediate assignment / extended assignment

NOTE 2: In these tests the SS must send the immediate assignment messages in due time to allow for the MS to receive them and send a PAGING RESPONSE rather than another random access. This applies to the whole of clause 26.

26.6.1.2.1 Conformance requirements

1. The MS shall go to the allocated SDCCH/4 and send a PAGING RESPONSE message containing its identity and its classmark.
2. The MS shall go to the allocated SDCCH/8 and send a PAGING RESPONSE message containing its identity and its classmark.
3. The MS shall correctly identify its own assignment in either the Request Reference 1 or the Request Reference 2 information element in an extended assignment message.
4. The MS shall only react to an Immediate Assignment which references one of the last 3 CHANNEL REQUEST messages from the MS.

References

3GPP TS 04.08 / 3GPP TS 44.018, subclause 3.3.

26.6.1.2.2 Test purpose

To verify that the MS goes to the allocated SDCCH/4 and sends a PAGING RESPONSE message containing its identity and its classmark.

To verify that the MS goes to the allocated SDCCH/8 and sends a PAGING RESPONSE message containing its identity and its classmark.

To verify that the MS can correctly identify its own assignment in either the Request Reference 1 or the Request Reference 2 information element in an extended assignment message.

To verify that the MS only reacts to an Immediate Assignment which references one of the last 3 CHANNEL REQUEST messages from the MS.

26.6.1.2.3 Method of test

Initial Conditions

System Simulator:

1 cell, Max-retrans is set to 7.

Mobile Station:

The MS is in the "idle, updated" state. with a TMSI allocated.

Specific PICS statements

-

PIXIT statements

-

Foreseen Final State of the MS

"Idle, updated", with a TMSI allocated.

Test Procedure

In the first part of the test, the SS pages the MS, which shall react by sending CHANNEL REQUEST messages. Immediately after reception of the n-th CHANNEL REQUEST message (n being arbitrarily chosen by the SS from the set {1, 2 ... 8}) the SS sends an IMMEDIATE ASSIGNMENT EXTENDED message, which references one of the last 3 CHANNEL REQUEST messages from the MS. The MS shall then go to the correct channel and send a PAGING RESPONSE message. The SS will then release the channel.

In the second part of the test, the SS again pages the MS, which shall react by sending CHANNEL REQUEST messages. Immediately after reception of the k-th CHANNEL REQUEST message (k being arbitrarily chosen by the SS from the set {4, 5 ... 8}) the SS sends an IMMEDIATE ASSIGNMENT EXTENDED message which, instead of referencing one of the last 3 CHANNEL REQUEST messages from the MS, references an earlier CHANNEL REQUEST message. The MS shall then ignore the IMMEDIATE ASSIGNMENT EXTENDED message and continue to send CHANNEL REQUEST messages until the Max-Retrans value has been reached. Then a period of 7 seconds shall elapse in order to allow the MS to perform cell reselection (this allows for the time between the last CHANNEL REQUEST message and the beginning of cell reselection).

In the third part of the test, the CCCH_CONF of the SS is set to non-combined and the SS pages the MS, which shall react by sending CHANNEL REQUEST messages. Immediately after reception of the r-th CHANNEL REQUEST message (r being arbitrarily chosen by the SS from the set {4, 5 ... 8}) the SS sends an IMMEDIATE ASSIGNMENT EXTENDED message which, in the second request reference, references one of the last 3 CHANNEL REQUEST messages from the MS. The associated Channel Description allocates SDCCH(S) (S being arbitrarily chosen by the SS from the set {0,1 ... 7}). The MS shall then go to the correct channel and send a PAGING RESPONSE message. The SS will then release the channel.

Maximum Duration of Test

90 s.

Expected Sequence

Step	Direction	Message	Comments
1	SS -> MS	PAGING REQUEST TYPE 1	
2	MS -> SS	CHANNEL REQUEST	n CHANNEL REQUESTs (n being arbitrarily chosen from {1... 8}) are sent, all with Establ. Cause = "Answer to paging".
3	MS -> SS	CHANNEL REQUEST	
4	SS -> MS	IMMEDIATE ASSIGNMENT EXTENDED	see note 1.
5	MS -> SS	PAGING RESPONSE	
6	SS -> MS	CHANNEL RELEASE	
7	-----	-----	The SS waits 12 s to allow the MS to perform cell reselection.
8	SS -> MS	PAGING REQUEST TYPE 1	
9	MS -> SS	CHANNEL REQUEST	k CHANNEL REQUESTs (k being arbitrarily chosen from the set {4, 5, 8}) are sent all with Establ. Cause = "Answer to paging".
10	MS -> SS	CHANNEL REQUEST	
11	SS -> MS	IMMEDIATE ASSIGNMENT EXTENDED	see note 2.
12	MS -> SS	CHANNEL REQUEST	8-k CHANNEL REQUESTs are sent, all with Establ. Cause = "Answer to paging".
13	MS -> SS	CHANNEL REQUEST	
14	SS		The SS verifies that the MS does not transmit any Layer 2 frames for at least 3 s.
15	SS		The SS sets CCCH_CONF to non-combined.
16	SS		The SS waits 40 s to allow the MS to perform cell reselection and to read the BCCH information.
17	SS -> MS	PAGING REQUEST TYPE 1	
18	MS -> SS	CHANNEL REQUEST	r CHANNEL REQUESTs (r being arbitrarily chosen from {4, 5... 8}) are sent, all with Establ. Cause = "Answer to paging".
19	MS -> SS	CHANNEL REQUEST	
20	SS -> MS	IMMEDIATE ASSIGNMENT EXTENDED	see note 3.
21	MS -> SS	PAGING RESPONSE	
22	SS -> MS	CHANNEL RELEASE	

Specific Message Contents

NOTE 1: The first Request Reference is the one which pertains to the i-th CHANNEL REQUEST sent by the MS, where i is an integer in the set {max (1,n-2) ... n}, its value being arbitrarily chosen by the SS. The second Request Reference shall be different from any Request Reference the MS has generated in this test.

NOTE 2: The first Request Reference is the one which pertains to the i-th CHANNEL REQUEST sent by the MS, where i is an integer in the set {1 ... k-3}, its value being arbitrarily chosen by the SS. The second Request Reference shall be different from any Request Reference the MS has generated in this test.

NOTE 3: The second Request Reference is the one which pertains to the i-th CHANNEL REQUEST sent by the MS, where i is an integer in the set {r-2, r-1, r}, its value being arbitrarily chosen by the SS. The first Request Reference shall be different from any Request Reference the MS has generated in this test.

26.6.1.3 Immediate assignment / assignment rejection

26.6.1.3.1 Conformance requirements

1. The MS shall respond to the Paging Request message by sending a Channel Request message with establishment cause set to "Answer to Paging". After the reception of IMMEDIATE ASSIGNMENT REJECT, the MS shall not transmit during the time indicated in the "Wait Indication" field of the IMMEDIATE ASSIGNMENT REJECT message, and then it shall answer to the new paging requests.
2. After an assignment rejection, the MS shall perform a cell reselection (idle mode operation) and the MS shall not transmit unless a different cell is selected.

References

3GPP TS 04.08 / 3GPP TS 44.018, subclause 3.3.1.1.3 and 3GPP TS 04.13 subclause 5.2.2.

26.6.1.3.2 Test purpose

To verify that the MS can accept an IMMEDIATE ASSIGNMENT REJECT.

To verify that the MS can respond to paging after an IMMEDIATE ASSIGNMENT REJECT is received on a different cell.

26.6.1.3.3 Method of test

Initial Conditions

System Simulator:

2 cells with the same LAI, Max-Retrans is 7.

Mobile Station:

The MS is camped on cell A and is in the "idle, updated" state, with a TMSI allocated.

Specific PICS statements

-

PIXIT statements

-

Foreseen Final State of the MS

The MS is camped on cell B and is in the "idle, updated" state, with a TMSI allocated.

Test Procedure

The SS pages the MS, which shall react by sending CHANNEL REQUESTs. Immediately after reception of the n-th CHANNEL REQUEST (n being an integer from the set {1, 2 ... 8}, arbitrarily chosen by the SS) the SS sends an IMMEDIATE ASSIGNMENT REJECT message, which references one of the last 3 CHANNEL REQUESTs from the MS, and with the Wait Indication set to x seconds (x being an integer from the set {5, 6 ... 255}, arbitrarily chosen by the SS). The SS continues to send paging messages for that mobile station in every block of the mobile station's paging subgroup for x+2 s. The MS shall not answer to the PAGING REQUEST TYPE 1 messages sent before x seconds have elapsed. The MS may respond to any one of the PAGING REQUEST TYPE 1 messages sent after x seconds have elapsed, but at the latest it shall respond to the first PAGING REQUEST TYPE 1 sent after x+1 seconds have elapsed.

The SS responds to this CHANNEL REQUEST with an IMMEDIATE ASSIGNMENT REJECT message with the Wait Indication set to 255 s.

Immediately afterwards the SS changes the power levels so the MS selects cell B. After 20 s have elapsed the SS pages the MS in cell B and the MS shall answer to this page. In order to avoid another cell reselection the SS then sends another IMMEDIATE ASSIGNMENT REJECT.

Maximum Duration of Test

5 minutes.

Expected Sequence

Step	Direction	Message	Comments
1	SS -> MS	PAGING REQUEST TYPE 1	<p>n CHANNEL REQUESTs (n being arbitrarily chosen from the set {1, 2 ... 8}) are sent, all with Establ. Cause = "Answer to paging"</p> <p>1st, 3rd and 4th Request References are different to all n Request References received from the MS under test. 2nd Request Reference: see note 1. 2nd Wait Indication = x seconds (x being arbitrarily chosen from the set {5, 6 ... 255}).</p> <p>The SS repeatedly pages the MS (on its paging subchannel) until a CHANNEL REQUEST message is received from the MS.</p> <p>(note 2). Establ. Cause = "Answer to paging". The MS may respond to any one of the PAGING REQUEST TYPE 1 messages sent after x seconds expire, but at the latest the MS shall respond to the first PAGING REQUEST TYPE 1 message sent after x+1 seconds expire.</p> <p>1st, 2nd and 4th Request References are different to all n Request References received from the MS. The 3rd Request Reference pertains to the last CHANNEL REQUEST sent by the MS. The 3rd Wait Indication is 255 s.</p> <p>Raise power level of cell B, lower power level of cell A until the MS selects cell B.</p> <p>Sent once, 20 s after the change of levels. Establ. Cause = "Answer to paging".</p>
2	MS -> SS	CHANNEL REQUEST	
.	.	.	
.	.	.	
1+n	MS -> SS	CHANNEL REQUEST	
2+n	SS -> MS	IMMEDIATE ASSIGNMENT REJECT	
3+n	SS -> MS	PAGING REQUEST TYPE 1	
.	.	.	
.	.	.	
k	SS -> MS	PAGING REQUEST TYPE 1	
k+1	MS -> SS	CHANNEL REQUEST	
k+2	SS -> MS	IMMEDIATE ASSIGNMENT REJECT	
k+3	-----	-----	
k+4	SS -> MS	PAGING REQUEST TYPE 1	
k+5	MS -> SS	CHANNEL REQUEST	
k+6	SS -> MS	IMMEDIATE ASSIGNMENT REJECT	
NOTE 1: The Request Reference is the one which pertains to the i-th CHANNEL REQUEST sent by the MS, where i is an integer from the set {max(1,n-2) ... n}, its value being arbitrarily chosen by the SS.			
NOTE 2: the value of k is not important in this test.			

Specific Message Contents

None.

26.6.1.4 Immediate assignment / ignore assignment

26.6.1.4.1 Conformance requirements

1. An MS waiting for a response from the network, following the sending of a CHANNEL REQUEST, shall ignore an IMMEDIATE ASSIGNMENT message with a request reference containing a wrong frame number.
2. An MS is waiting for an assignment of its own, shall ignore an IMMEDIATE ASSIGNMENT message with a request reference containing a wrong random access information.

References

3GPP TS 04.08 / 3GPP TS 44.018, subclause 3.3.1.1.2

26.6.1.4.2 Test purpose

To verify that the MS ignores an assignment for another MS while it is waiting for an assignment of its own.

26.6.1.4.3 Method of test

Initial Conditions

System Simulator:

1 cell.

Mobile Station:

The MS is in the "idle, updated" state, with a TMSI allocated.

Specific PICS statements

-

PIXIT statements

-

Foreseen Final State of the MS

"Idle, updated", with TMSI allocated.

Test Procedure

The SS pages the MS, which reacts with CHANNEL REQUESTs. The SS responds to the first CHANNEL REQUEST with an IMMEDIATE ASSIGNMENT containing a wrong Request Reference (in the first run of the test the frame number is wrong, in the repetition it is the random access info that is wrong). It is verified for 2 s that the MS does not start signalling on the SDCCH. The MS shall ignore the assignment and send another CHANNEL REQUEST message. In order to avoid cell reselection the SS now answers with a correct IMMEDIATE ASSIGNMENT REJECT and repeats the test once.

Maximum Duration of Test

12 s.

Expected Sequence

Step	Direction	Message	Comments
1	SS -> MS	PAGING REQUEST TYPE 1	
2	MS -> SS	CHANNEL REQUEST	Established Cause = "Answer to paging".
3	SS -> MS	IMMEDIATE ASSIGNMENT	Frame number in Request Reference is 2 too high. The MS shall not start signalling on the assigned SDCCH. This is verified for a period of 2 s.
4	MS -> SS	CHANNEL REQUEST	Established Cause = "Answer to paging".
5	SS -> MS	IMMEDIATE ASSIGNMENT REJECT	
6	SS		SS waits for 6 s.
7	SS -> MS	PAGING REQUEST TYPE 1	
8	MS -> SS	CHANNEL REQUEST	Established Cause = "Answer to paging".
9	SS -> MS	IMMEDIATE ASSIGNMENT	Random access info in Request Reference is wrong. The MS shall not start signalling on the assigned SDCCH. This is verified for a period of 2 s.
10	MS -> SS	CHANNEL REQUEST	Established Cause = "Answer to paging".
11	SS -> MS	IMMEDIATE ASSIGNMENT REJECT	

Specific Message Contents

None.

26.6.1.5 Immediate assignment after immediate assignment reject

26.6.1.5.1 Conformance requirement

Following an IMMEDIATE ASSIGNMENT REJECT message, the MS shall listen for IMMEDIATE ASSIGNMENTS until T3126 expires.

Reference

3GPP TS 04.08 / 3GPP TS 44.018, subclause 3.3.1.1.3

26.6.1.5.2 Test purpose

To verify that the MS correctly responds to an IMMEDIATE ASSIGNMENT message sent after an IMMEDIATE ASSIGNMENT REJECT message.

26.6.1.5.3 Method of test

Initial conditions

System Simulator:

1 cell;

CCCH_CONF is set to "1 basic physical channel used for CCCH not combined with SDCCHs";

Max retrans is set to 7;

TX-integer is set to 7;

Mobile Station:

The MS is in "idle, updated" state, with a TMSI allocated.

Specific PICS statements

-

PIXIT statements

-

Foreseen final state of the MS

"idle, updated", with TMSI allocated.

Test Procedure

The SS pages the MS, which shall react by sending CHANNEL REQUESTs. Immediately after reception of the third CHANNEL REQUEST the SS sends an IMMEDIATE ASSIGNMENT REJECT message which references the first CHANNEL REQUEST from the MS and has the Wait Indication IE set to 6 s.

Between 0,75 s and 1,25 s after sending the IMMEDIATE ASSIGNMENT REJECT message the SS sends an IMMEDIATE ASSIGNMENT message referencing the second CHANNEL REQUEST message, and assigning an SDCCH. The MS shall go to the correct channel and send a PAGING RESPONSE message. Then the SS initiates RR-release by sending a CHANNEL RELEASE message.

Maximum duration of test

10 s.

Expected Sequence

Step	Direction	Message	Comments
1	SS -> MS	PAGING REQUEST TYPE 1	
2	MS -> SS	CHANNEL REQUEST	first request.
3	MS -> SS	CHANNEL REQUEST	second request.
4	MS -> SS	CHANNEL REQUEST	third request.
5	SS -> MS	IMMEDIATE ASSIGNMENT REJ	references the first request from MS, Wait Indication IE set to 6 s.
6	SS -> MS	IMMEDIATE ASSIGNMENT	references the second request from the MS Channel type set to SDCCH/8 message sent between 0,75 s and 1,25 s after the completion of step 5.
7	MS -> SS	PAGING RESPONSE	shall be sent on the correct channel.
8	SS -> MS	CHANNEL RELEASE	

Specific message contents

None.

26.6.2 Test of paging

The Paging procedure is used by the network to cause the Mobile Station to establish a radio connection. Normally the Mobile Station listens to its paging subchannel, but this can be modified by the use of different page modes. The correct implementation of the paging procedure in the Mobile Station is essential for the basic establishment of a connection.

26.6.2.1 Normal paging

26.6.2.1.1 Paging / normal / type 1

26.6.2.1.1.1 Conformance requirements

1. The MS shall respond correctly to various PAGING REQUEST TYPE 1 messages, when the page mode is set to normal paging, in the following cases:
 - 1.1 The MS is addressed with its IMSI in the first Mobile Identity field. The optional Mobile Identity field is not present.
 - 1.2. The MS is addressed with its TMSI in the first Mobile Identity field. The optional Mobile Identity field specifies an IMSI different from that of the MS.
 - 1.3. The first Mobile Identity field specifies a TMSI different from that of the MS. The optional Mobile Identity field addresses the MS by its IMSI.
 - 1.4 The first Mobile Identity field specifies a TMSI different from that of the MS. The optional Mobile Identity field contains the correct TMSI of the MS.
2. An MS shall ignore PAGING REQUEST TYPE 1 messages with incorrect information, when the page mode is set to normal paging, in the following case:
 - 2.1 The MS is addressed with its TMSI in the first Mobile Identity field, but the type of identity in this field is set to "No Identity". The optional Mobile Identity field is not present.

References

3GPP TS 04.08 / 3GPP TS 44.018, subclause 3.3.2, 3GPP TS 05.02 subclause 6.5.

26.6.2.1.1.2 Test purpose

To test that the MS is able to determine its CCCH group and paging group correctly and that the MS responds correctly to various PAGING REQUEST TYPE 1 messages when the page mode is set to normal paging. All valid ways of addressing the MS are tested. It is tested that the MS responds with the same type of identity that is used in the PAGING REQUEST TYPE 1 message. It is tested that the MS ignores fill paging.

26.6.2.1.1.3 Method of test

Initial Conditions

System Simulator:

1 cell, Max-Retrans = 2, a legal combination of CCCH_CONF, BS_AG_BLKES_RES and BS_PA_MFRMS is chosen arbitrarily by the SS.

Mobile Station:

The MS is in the "idle, updated" state, with a TMSI allocated.

Specific PICS statements

-

PIXIT statements

-

Foreseen Final State of the MS

"Idle, updated", with TMSI allocated.

Test Procedure

The SS pages the MS 5 times with different PAGING REQUEST TYPE 1 messages on the paging subchannel which corresponds to the MS's IMSI.

In the first 4 cases, where the MS is addressed by its IMSI or its TMSI, the MS shall answer to the paging by sending CHANNEL REQUESTs. The SS responds to the second CHANNEL REQUEST by assigning a channel, and the MS shall then send a correct PAGING RESPONSE. The SS then releases the channel.

In the last case, it is tested that the MS does not answer to paging that does not address it.

Maximum Duration of Test

2 minutes.

Expected Sequence

Step	Direction	Message	Comments
1	SS -> MS	PAGING REQUEST TYPE 1	1st Mobile Ident contains IMSI of MS, 2nd Mobile Ident not present.
2	MS -> SS	CHANNEL REQUEST	Establ. Cause = "Answer to paging".
3	MS -> SS	CHANNEL REQUEST	Establ. Cause = "Answer to paging".
4	SS -> MS	IMMEDIATE ASSIGNMENT	Request Reference = pertaining to the message received in step 3.
5	MS -> SS	PAGING RESPONSE	Mobile Ident: IMSI.
6	SS -> MS	CHANNEL RELEASE	
	-----	-----	The SS waits 12 s to allow the MS to perform cell reselection.
7	SS -> MS	PAGING REQUEST TYPE 1	1st Mobile Ident contains TMSI of MS, 2nd Mobile Ident contains IMSI of another MS.
8	MS -> SS	CHANNEL REQUEST	Establ. Cause = "Answer to paging".
9	MS -> SS	CHANNEL REQUEST	Establ. Cause = "Answer to paging".
10	SS -> MS	IMMEDIATE ASSIGNMENT	Request Reference = pertaining to the message received in step 9.
11	MS -> SS	PAGING RESPONSE	Mobile Ident: TMSI.
12	SS -> MS	CHANNEL RELEASE	
	-----	-----	The SS waits 12 s to allow the MS to perform cell reselection.
13	SS -> MS	PAGING REQUEST TYPE 1	1st Mobile Ident contains TMSI of another MS, 2 nd Mobile Ident contains IMSI of MS.
14	MS -> SS	CHANNEL REQUEST	Establ. Cause = "Answer to paging".
15	MS -> SS	CHANNEL REQUEST	Establ. Cause = "Answer to paging".
16	SS -> MS	IMMEDIATE ASSIGNMENT	Request Reference = pertaining to the message received in step 15.
17	MS -> SS	PAGING RESPONSE	Mobile Ident: IMSI.
18	SS -> MS	CHANNEL RELEASE	
	-----	-----	The SS waits 12 s to allow the MS to perform cell reselection.
19	SS -> MS	PAGING REQUEST TYPE 1	1st Mobile Ident contains TMSI of another MS, 2 nd Mobile Ident contains TMSI of MS.
20	MS -> SS	CHANNEL REQUEST	Establ. Cause = "Answer to paging".
21	MS -> SS	CHANNEL REQUEST	Establ. Cause = "Answer to paging".
22	SS -> MS	IMMEDIATE ASSIGNMENT	Request Reference = pertaining to the message received in step 21.
23	MS -> SS	PAGING RESPONSE	Mobile Ident: TMSI.
24	SS -> MS	CHANNEL RELEASE	
	-----	-----	The SS waits 12 s to allow the MS to perform cell reselection.
25	SS -> MS	PAGING REQUEST TYPE 1	1st Mobile Ident contains TMSI of MS but with type of identity set to "no identity", second Mobile Ident not present.
26	-----	-----	During 1 second, the SS checks that the MS does not produce any Layer 3 messages.

Specific Message Contents

None.

26.6.2.1.2 Paging / normal / type 2

26.6.2.1.2.1 Conformance requirements

1. The MS shall respond correctly (by sending CHANNEL REQUEST messages with an Establishment Cause set to "Answer to Paging") to various PAGING REQUEST TYPE 2 messages, when the page mode is set to normal paging, in the following cases:
 - 1.1 The MS is addressed in the first TMSI field.
 - 1.2 The MS is addressed in the second TMSI field.
 - 1.3 The MS is addressed in the optional Mobile Identity field with its TMSI.
 - 1.4 The MS is addressed in the optional Mobile Identity field with its IMSI.
2. The MS shall ignore PAGING REQUEST TYPE 2 messages with incorrect information, when the page mode is set to normal paging, in the following case:
 - 2.1 The MS is addressed in the optional Mobile Identity field with its TMSI, but the type of identity in this field is set to "No Identity".

References

3GPP TS 04.08 / 3GPP TS 44.018, subclause 3.3.2.

26.6.2.1.2.2 Test purpose

To test that the MS is able to determine its CCCH group and paging group correctly and that the MS responds correctly to various PAGING REQUEST TYPE 2 messages when the page mode is set to normal paging. All valid ways of addressing the MS are tested. It is tested that the MS responds with the same type of identity that is used in the PAGING REQUEST TYPE 2 message. It is tested that the MS ignores a PAGING REQUEST TYPE 2 message that does not address it.

26.6.2.1.2.3 Method of test

Initial Conditions

System Simulator:

1 cell, Max-Retrans = 2, a legal combination of CCCH_CONF, BS_AG_BLKES_RES and BS_PA_MFRMS is chosen arbitrarily by the SS.

Mobile Station:

The MS is in the "idle, updated" state, with a TMSI allocated.

Specific PICS statements

-

PIXIT statements

-

Foreseen Final State of the MS

"Idle, updated", with TMSI allocated.

Test Procedure

The SS pages the MS 5 times with different PAGING REQUEST TYPE 2 messages on the paging subchannel which corresponds to the MS's IMSI.

In the first 4 cases, where the MS is addressed by its IMSI or by its TMSI, the MS shall answer to the paging by sending CHANNEL REQUESTs. The SS responds to the second request by assigning a channel, and the MS shall then send a correct PAGING RESPONSE. The SS then releases the channel.

In the last case, it is tested that the MS does not answer to paging that does not address it.

Maximum Duration of Test

5 minutes, including 1 minute for any necessary operator actions.

Expected Sequence

Step	Direction	Message	Comments
1	SS -> MS	PAGING REQUEST TYPE 2	1st TMSI addresses MS, 2nd TMSI addresses another MS, Mobile Identity IE not present.
2	MS -> SS	CHANNEL REQUEST	Establ. Cause = "Answer to paging".
3	MS -> SS	CHANNEL REQUEST	Establ. Cause = "Answer to paging".
4	SS -> MS	IMMEDIATE ASSIGNMENT	Request Reference = pertaining to the message received in step 3.
5	MS -> SS	PAGING RESPONSE	Mobile Ident: TMSI.
6	SS -> MS	CHANNEL RELEASE	
	-----	-----	The SS waits 12 s to allow the MS to perform cell reselection.
7	SS -> MS	PAGING REQUEST TYPE 2	1st TMSI addresses another MS, 2nd TMSI addresses MS, Mobile Identity IE not present.
8	MS -> SS	CHANNEL REQUEST	Establ. Cause = "Answer to paging".
9	MS -> SS	CHANNEL REQUEST	Establ. Cause = "Answer to paging".
10	SS -> MS	IMMEDIATE ASSIGNMENT	Request Reference = pertaining to the message received in step 9.
11	MS -> SS	PAGING RESPONSE	Mobile Ident: TMSI.
12	SS -> MS	CHANNEL RELEASE	
	-----	-----	The SS waits 12 s to allow the MS to perform cell reselection.
13	SS -> MS	PAGING REQUEST TYPE 2	1st TMSI addresses another MS, 2nd TMSI addresses another MS, Mobile Identity IE contains TMSI of MS.
14	MS -> SS	CHANNEL REQUEST	Establ. Cause = "Answer to paging".
15	MS -> SS	CHANNEL REQUEST	Establ. Cause = "Answer to paging".
16	SS -> MS	IMMEDIATE ASSIGNMENT	Request Reference = pertaining to the message received in step 15
17	MS -> SS	PAGING RESPONSE	Mobile Ident: TMSI.
18	SS -> MS	CHANNEL RELEASE	
	-----	-----	The SS waits 12 s to allow the MS to perform cell reselection
19	SS -> MS	PAGING REQUEST TYPE 2	1st TMSI addresses another MS, 2nd TMSI addresses another MS, Mobile Identity IE contains IMSI of MS.
20	MS -> SS	CHANNEL REQUEST	Establ. Cause = "Answer to paging"
21	MS -> SS	CHANNEL REQUEST	Establ. Cause = "Answer to paging"
22	SS -> MS	IMMEDIATE ASSIGNMENT	Request Reference = pertaining to the message received in step 21
23	MS -> SS	PAGING RESPONSE	Mobile Ident: IMSI.
24	SS -> MS	CHANNEL RELEASE	
	-----	-----	The SS waits 12 s to allow the MS to perform cell reselection
25	SS -> MS	PAGING REQUEST TYPE 2	1st TMSI addresses another MS, 2nd TMSI addresses another MS, Mobile Identity IE contains TMSI of MS but with type of identity set to "no identity".
26	-----	-----	During 1 second, the SS checks that the MS does not produce any Layer 3 messages.

Specific Message Contents

None.

26.6.2.1.3 Paging / normal / type 3

26.6.2.1.3.1 Conformance requirements

An MS shall respond correctly to various PAGING REQUEST TYPE 3 messages, when the page mode is set to normal paging. The MS shall send CHANNEL REQUEST messages, with an Establishment Cause set to "Answer to Paging", until the network answers. The number of CHANNEL REQUEST messages shall be limited by the parameter Max-retrans. After the assignment procedure, the MS shall send a PAGING RESPONSE message on the channel assigned by the network.

References

3GPP TS 04.08 / 3GPP TS 44.018, subclause 3.3.2.

26.6.2.1.3.2 Test purpose

To test that the MS is able to determine its CCCH group and paging group correctly and that the MS responds correctly to various PAGING REQUEST TYPE 3 messages when the page mode is set to normal paging. All valid ways of addressing the MS are tested.

26.6.2.1.3.3 Method of test

Initial Conditions

System Simulator:

1 cell, Max-Retrans = 2, a legal combination of CCCH_CONF, BS_AG_BLKES_RES and BS_PA_MFRMS is chosen arbitrarily by the SS.

Mobile Station:

The MS is in the "idle, updated" state, with a TMSI allocated.

Specific PICS statements

-

PIXIT statements

-

Foreseen Final State of the MS

"Idle, updated", with TMSI allocated.

Test Procedure

The SS pages the MS 4 times with different PAGING REQUEST TYPE 3 messages on the paging subchannel which corresponds to the MS's IMSI.

In all the cases the MS shall answer to the paging by sending CHANNEL REQUESTs. The SS responds to the second request by assigning a channel, and the MS shall then send a correct PAGING RESPONSE. The SS then releases the channel.

Maximum Duration of Test

5 minutes, including 1 minute for any necessary operator actions.

Expected Sequence

Step	Direction	Message	Comments
1	SS -> MS	PAGING REQUEST TYPE 3	1st TMSI addresses MS; 2nd, 3rd and 4th TMSIs address other MSs.
2	MS -> SS	CHANNEL REQUEST	Establ. Cause = "Answer to paging".
3	MS -> SS	CHANNEL REQUEST	Establ. Cause = "Answer to paging".
4	SS -> MS	IMMEDIATE ASSIGNMENT	Request Reference = pertaining to the message received in step 3.
5	MS -> SS	PAGING RESPONSE	Mobile Ident: TMSI.
6	SS -> MS	CHANNEL RELEASE	
	-----	-----	The SS waits 12 s to allow the MS to perform cell reselection.
7	SS -> MS	PAGING REQUEST TYPE 3	2nd TMSI addresses MS; 1st, 3rd and 4th TMSIs address other MSs.
8	MS -> SS	CHANNEL REQUEST	Establ. Cause = "Answer to paging".
9	MS -> SS	CHANNEL REQUEST	Establ. Cause = "Answer to paging".
10	SS -> MS	IMMEDIATE ASSIGNMENT	Request Reference = pertaining to the message received in step 9.
11	MS -> SS	PAGING RESPONSE	Mobile Ident: TMSI.
12	SS -> MS	CHANNEL RELEASE	
	-----	-----	The SS waits 12 s to allow the MS to perform cell reselection.
13	SS -> MS	PAGING REQUEST TYPE 3	3rd TMSI addresses MS; 1st, 2nd and 4th TMSIs address other MSs.
14	MS -> SS	CHANNEL REQUEST	Establ. Cause = "Answer to paging".
15	MS -> SS	CHANNEL REQUEST	Establ. Cause = "Answer to paging".
16	SS -> MS	IMMEDIATE ASSIGNMENT	Request Reference = pertaining to the message received in step 15.
17	MS -> SS	PAGING RESPONSE	Mobile Ident: TMSI.
18	SS -> MS	CHANNEL RELEASE	
	-----	-----	The SS waits 12 s to allow the MS to perform cell reselection.
19	SS -> MS	PAGING REQUEST TYPE 3	4th TMSI addresses MS; 1st, 2nd and 3rd TMSIs address other MSs.
20	MS -> SS	CHANNEL REQUEST	Establ. Cause = "Answer to paging".
21	MS -> SS	CHANNEL REQUEST	Establ. Cause = "Answer to paging".
22	SS -> MS	IMMEDIATE ASSIGNMENT	Request Reference = pertaining to the message received in step 21.
23	MS -> SS	PAGING RESPONSE	Mobile Ident: TMSI.
24	SS -> MS	CHANNEL RELEASE	

Specific Message Contents

None.

26.6.2.2 Paging / extended

26.6.2.2.1 Conformance requirements

1. The MS shall operate in the extended page mode when this is ordered by the network in a PAGING REQUEST TYPE 1 message not addressing the MS but on the paging subchannel which corresponds to the MS's identity.
2. The MS shall operate in the extended page mode when this is ordered by the network in a PAGING REQUEST TYPE 2 message not addressing the MS but on the paging subchannel which corresponds to the MS's identity.
3. The MS shall operate in the extended page mode when this is ordered by the network in a PAGING REQUEST TYPE 3 message not addressing the MS but on the paging subchannel which corresponds to the MS's identity.
4. The MS shall operate in the extended page mode when this is ordered by the network in an IMMEDIATE ASSIGNMENT message on the paging subchannel which corresponds to the MS's identity.
5. The MS shall operate in the extended page mode when this is ordered by the network in an IMMEDIATE ASSIGNMENT EXTENDED message on the paging subchannel which corresponds to the MS's identity.

References

3GPP TS 04.08 / 3GPP TS 44.018, subclause 3.3.2.1; 3GPP TS 05.02, subclause 6.5.

26.6.2.2.2 Test purpose

To test that the MS is operating in the extended page mode when this is ordered by the SS in either a PAGING REQUEST message or an IMMEDIATE ASSIGNMENT message.

26.6.2.2.3 Method of test

Initial Conditions

System Simulator:

1 cell, Max-Retrans = 2, a legal combination of CCCH_CONF, BS_AG_BLKES_RES and BS_PA_MFRMS is chosen arbitrarily by the SS.

Mobile Station:

The MS is in the "idle, updated" state, with a TMSI allocated.

Specific PICS statements

-

PIXIT statements

-

Foreseen Final State of the MS

"Idle, updated", with TMSI allocated.

Test Procedure

The SS sends a PAGING REQUEST TYPE 1 message not addressing the MS under test but on the paging subchannel which corresponds to the MS's identity. The page mode is set to "extended paging". In the next but one paging subblock on the same CCCH the SS sends a PAGING REQUEST TYPE 1 message specifying an arbitrarily chosen page mode and addressing the MS by its TMSI. The MS shall respond to the last page by sending CHANNEL REQUESTs. The SS responds to the second CHANNEL REQUEST with an IMMEDIATE ASSIGNMENT REJECT message.

The SS then sends an IMMEDIATE ASSIGNMENT on the paging subchannel which corresponds to the MS's identity. The random reference is different to those used by the Mobile Station in the last two CHANNEL REQUEST messages. (Phase 2 requires a Mobile Station to react on an IMMEDIATE ASSIGNMENT after a rejection.) The page mode is again set to "extended paging". In the next but one paging subblock on the same CCCH the SS sends a PAGING REQUEST TYPE 2 message specifying an arbitrarily chosen page mode and addressing the MS by its TMSI. The MS shall respond with CHANNEL REQUESTs. The SS responds to the second CHANNEL REQUEST with an IMMEDIATE ASSIGNMENT REJECT message.

The SS then sends an IMMEDIATE ASSIGNMENT EXTENDED on the paging subchannel which corresponds to the MS's identity. The random references are different to those used by the Mobile Station in the last three CHANNEL REQUEST messages. The page mode is again set to "extended paging". In the next but one paging subblock on the same CCCH the SS sends a PAGING REQUEST TYPE 3 message specifying an arbitrarily chosen page mode and addressing the MS by its TMSI. The MS shall respond with CHANNEL REQUESTs. The SS responds to the second CHANNEL REQUEST with an IMMEDIATE ASSIGNMENT REJECT message.

The SS then sends a PAGING REQUEST TYPE 3 message not addressing the MS under test but on the paging subchannel which corresponds to the MS's identity. The page mode is set to "extended paging". In the next but one paging subblock on the same CCCH the SS sends a PAGING REQUEST TYPE 2 message specifying an arbitrarily chosen page mode and addressing the MS by its IMSI. The MS shall respond to the last page by sending CHANNEL REQUESTs. The SS responds to the second CHANNEL REQUEST with an IMMEDIATE ASSIGNMENT REJECT message.

The SS then sends a PAGING REQUEST TYPE 2 message not addressing the MS under test but on the paging subchannel which corresponds to the MS's identity. The page mode is set to "extended paging". In the next but one paging subblock on the same CCCH the SS sends a PAGING REQUEST TYPE 1 message specifying an arbitrarily chosen page mode and addressing the MS by its IMSI. The MS shall respond to the last page by sending CHANNEL REQUESTs. The SS responds to the second CHANNEL REQUEST with an IMMEDIATE ASSIGNMENT REJECT message.

Maximum Duration of Test

10 s.

Expected Sequence

Step	Direction	Message	Comments
1	SS -> MS	PAGING REQUEST TYPE 1	Mobile Ident: IMSI of another MS, page mode = "extended paging".
2	SS -> MS	PAGING REQUEST TYPE 1	Sent in the next but one paging subblock. Page mode is arbitrarily chosen Mobile Ident: TMSI of the MS.
3	MS -> SS	CHANNEL REQUEST	
4	MS -> SS	CHANNEL REQUEST	
5	SS -> MS	IMMEDIATE ASSIGNMENT REJECT	Wait indication = 5 s. page mode = normal.
6	SS		SS waits for 5 s.
	SS -> MS	IMMEDIATE ASSIGNMENT	Sent in the paging subblock of MS under test. Page mode = "extended paging", Request reference chosen arbitrarily by the SS, but different from all references used earlier in this test sequence.
8	SS -> MS	PAGING REQUEST TYPE 1	Sent in the next but one paging subblock. Page mode is arbitrarily chosen. Mobile Ident: TMSI of the MS.
9	MS -> SS	CHANNEL REQUEST	
10	MS -> SS	CHANNEL REQUEST	
11	SS -> MS	IMMEDIATE ASSIGNMENT REJECT	Wait indication = 5 s. page mode = normal.
12	SS	--	SS waits for 5 s.
13	SS -> MS	IMMEDIATE ASSIGNMENT EXT	Sent in the paging subblock of MS under test. Page mode = "extended paging", Request references chosen arbitrarily by the SS, but different from all references used earlier in this test sequence.
14	SS -> MS	PAGING REQUEST TYPE 3	Sent in the next but one paging subblock. Page mode is arbitrarily chosen. Mobile Ident: TMSI of the MS.
15	MS -> SS	CHANNEL REQUEST	
16	MS -> SS	CHANNEL REQUEST	
17	SS -> MS	IMMEDIATE ASSIGNMENT REJECT	Wait indication = 5 s page mode = normal.
18	SS	--	SS waits for 5 s.
19	SS -> MS	PAGING REQUEST TYPE 3	Sent in the paging subblock of MS under test. Page mode = "extended paging".
20	SS -> MS	PAGING REQUEST TYPE 2	Sent in the next but one paging subblock. Page mode is arbitrarily chosen. Mobile Ident: IMSI of the MS.
21	MS -> SS	CHANNEL REQUEST	
22	MS -> SS	CHANNEL REQUEST	
23	SS -> MS	IMMEDIATE ASSIGNMENT REJECT	Wait indication = 5 s page mode = normal.
24	SS	--	SS waits for 5 s
25	SS -> MS	PAGING REQUEST TYPE 2	Sent in the paging subblock of MS under test. Page mode = "extended paging".
26	SS -> MS	PAGING REQUEST TYPE 1	Sent in the next but one paging subblock. Page mode is arbitrarily chosen. Mobile Ident: IMSI of the MS.
27	MS -> SS	CHANNEL REQUEST	
28	MS -> SS	CHANNEL REQUEST	
29	SS -> MS	IMMEDIATE ASSIGNMENT REJECT	Wait indication = 5 s.

Specific Message Contents

None.

26.6.2.3 Paging / reorganization

26.6.2.3.1 Paging / reorganization / procedure 1

26.6.2.3.1.1 Conformance requirements

1. An MS, after reception of a message with page mode set to "paging reorganization", shall answer to paging messages (with page mode set to "normal paging") sent on its old CCCH in paging blocks which do not belong to the MS's paging sub-channel.
2. When the network changes the paging group of the MS by modifying BCCH parameters (to CCCH_CONF set to "1 basic physical channel used for CCCH combined with SDCCH", and BS_AG_BLK_RES set to "2 blocks reserved for access grant"), the MS shall calculate its new paging group and answer to paging messages on its new paging subchannel.
3. When the network changes the paging group of the MS by modifying BCCH parameters (to CCCH_CONF set to "2 basic physical channels used for CCCH, not combined with SDCCHs" and BS_AG_BLK_RES set to "2 blocks reserved for access grant"), the MS shall calculate its new paging group and answer to paging messages on its new paging subchannel.

References

3GPP TS 04.08 / 3GPP TS 44.018, subclause 3.3.2.1; 3GPP TS 05.02, subclause 6.5.

26.6.2.3.1.2 Test purpose

To test that the MS correctly determines its new paging subchannel when the CCCH structure is changed from non-combined to combined and when the number of CCCHs is changed.

26.6.2.3.1.3 Method of test

Initial Conditions

System Simulator:

1 cell, Max-Retrans = 2, CCCH_CONF set to "1 basic physical channel used for CCCH, not combined with SDCCHs", a legal combination of BS_AG_BLK_RES and BS_PA_MFRMS is chosen arbitrarily by the SS, with the exception that BS_PA_MFRMS shall not be set to 9.

Mobile Station:

The MS is in the "idle, updated" state, with a TMSI allocated. The IMSI of the MS is from a defined/default range that ensures its paging channel changes when the broadcast parameters are changed.

Specific PICS statements

-

PIXIT statements

-

Foreseen Final State of the MS

"Idle, updated", with TMSI allocated.

Test Procedure

The SS sends an IMMEDIATE ASSIGNMENT EXTENDED message on the MS's paging subchannel, with the page mode element set to "paging reorganization" and Request References that do not pertain to the MS. Before the MS's original paging subchannel re-occurs, the SS pages it on the CCCH corresponding to the Mobile Station's IMSI with a PAGING REQUEST TYPE 2 message (page mode = normal paging) containing the MS's TMSI in some paging block which does not belong to the Mobile Station's paging subchannel. The MS shall respond by sending CHANNEL REQUESTs. The SS responds to the second CHANNEL REQUEST with an IMMEDIATE ASSIGNMENT REJECT (in order to avoid a cell reselection) on an arbitrarily selected paging subchannel.

Then the SS starts sending messages (PAGING REQUEST TYPE 1 or PAGING REQUEST TYPE 2 or PAGING REQUEST TYPE 3 or IMMEDIATE ASSIGNMENT or IMMEDIATE ASSIGNMENT EXTENDED or IMMEDIATE ASSIGNMENT REJECT) with page mode set to "paging reorganization" on all paging subchannels.

After 5 s (to ensure T3126 expires) the SS pages the MS with its TMSI on an arbitrarily selected paging subchannel (on the CCCH corresponding to the Mobile Station's IMSI). The MS shall respond by sending CHANNEL REQUESTs. The SS responds to the second CHANNEL REQUEST with an IMMEDIATE ASSIGNMENT REJECT (in order to avoid a cell reselection).

The SS changes the paging parameters.

Then the SS sets the page mode to "normal paging".

The SS then waits for the duration of five 51-TDMA multiframes (4 to allow the MS to read all the system information type 1, 2, 3, and 4 messages on the BCCH, and one to calculate the new paging group). Not before 5 s after the last IMMEDIATE ASSIGNMENT REJECT message addressing the MS (to ensure T3126 expires), the MS is paged with a PAGING REQUEST TYPE 1 on its new paging subchannel. The MS shall respond by sending CHANNEL REQUESTs. The SS responds to the second CHANNEL REQUEST with an IMMEDIATE ASSIGNMENT REJECT (in order to avoid a cell reselection) and then waits 5 s (to ensure T3126 expires).

Then the MS is paged with a PAGING REQUEST TYPE 2 on its new paging subchannel. The MS shall respond by sending CHANNEL REQUESTs. The SS responds to the second CHANNEL REQUEST with an IMMEDIATE ASSIGNMENT REJECT (in order to avoid a cell reselection).

Maximum Duration of Test

60 s.

Expected Sequence

This sequence is performed for execution counter, K =1, 2.

Step	Direction	Message	Comments
1	SS -> MS	IMMEDIATE ASSIGNMENT EXTENDED	Sent on the MS's paging channel. Page mode set to "paging reorganization". Request Reference not pertaining to the MS.
2	SS -> MS	PAGING REQUEST TYPE 2	Sent before the MS's original paging subchannel re-occurs, but later than the next paging block of that CCCH.
3	MS -> SS	CHANNEL REQUEST	
4	MS -> SS	CHANNEL REQUEST	
5	SS -> MS	IMMEDIATE ASSIGNMENT REJECT	Wait indication = 0 s.
6	-----	-----	All L3 messages sent on any paging subchannel are paging fill frames specify "paging re organization.
7	SS -> MS	PAGING REQUEST TYPE 2	Sent on an arbitrarily selected paging subchannel Page mode "paging reorganization" Not sent before 5 s after step 5.
8	MS -> SS	CHANNEL REQUEST	
9	MS -> SS	CHANNEL REQUEST	
10	SS -> MS	IMMEDIATE ASSIGNMENT REJECT	Wait indication = 0 s.
11			Change of paging parameters in SYS INFO 3 as described below for K=1, 2.
12			The SS waits until it has sent all system information messages (page mode is still paging reorganization).
13	-----	-----	All L3 messages sent on any paging subchannel specify "normal paging.
14	-----	-----	Wait 3 s.
15	SS -> MS	PAGING REQUEST TYPE 1	Sent on the new paging subchannel of the MS. Not sent before 5 s after step 10.
16	MS -> SS	CHANNEL REQUEST	
17	MS -> SS	CHANNEL REQUEST	
18	SS -> MS	IMMEDIATE ASSIGNMENT REJECT	Wait indication = 0 s.
19	SS -> MS	PAGING REQUEST TYPE 2	Sent on the new paging subchannel of the MS. Not sent before 5 s after step 18.
20	MS -> SS	CHANNEL REQUEST	
21	MS -> SS	CHANNEL REQUEST	
22	SS -> MS	IMMEDIATE ASSIGNMENT REJECT	

Specific Message Contents

For execution counter K:

K=1:

SYSTEM INFORMATION TYPE 3 shall have the Control Channel Description IE changed to:

CCCH_CONF	"1 basic physical channel used for CCCH, combined with SDCCHs"
BS_AG_BLKRES	2
BS_PA_MFRMS	9

K=2:

SYSTEM INFORMATION TYPE 3 shall have the Control Channel Description IE changed to:

CCCH_CONF	"2 basic physical channel used for CCCH, not combined with SDCCHs"
BS_AG_BLKRES	2
BS_PA_MFRMS	9

26.6.2.3.2 Paging / reorganization / procedure 2

26.6.2.3.2.1 Conformance requirement

An MS, after reception of a message with page mode set to "paging reorganization", shall answer to paging messages (with page mode set to "normal paging") sent in a former Access Grant block.

References

3GPP TS 04.08 / 3GPP TS 44.018, subclause 3.3.2.1.

26.6.2.3.2.2 Test purpose

To test that the MS is operating in the "paging reorganization" page mode when this is ordered by the SS and the MS is paged in its former access grant channel.

26.6.2.3.2.3 Method of test

Initial Conditions

System Simulator:

1 cell, Max-Retrans = 1, with the constraint that BS_AG_BLK_RES > 0, a legal combination of CCCH_CONF, BS_AG_BLK_RES and BS_PA_MFRMS is chosen arbitrarily by the SS.

Mobile Station:

The MS is in the "idle, updated" state, with a TMSI allocated. The IMSI of the MS is from a defined/default range that ensures its paging channel changes when the broadcast parameters are changed.

Specific PICS statements

-

PIXIT statements

-

Foreseen Final State of the MS

"Idle, updated", with TMSI allocated.

Test Procedure

The SS sends an IMMEDIATE ASSIGNMENT EXTENDED on the MS's paging subchannel, with the page mode element set to "paging reorganization". The MS is then paged immediately in a former Access Grant block with a PAGING REQUEST TYPE 2 message. The MS shall respond by sending CHANNEL REQUESTs. The SS responds to the second CHANNEL REQUEST with an IMMEDIATE ASSIGNMENT REJECT (in order to avoid a cell reselection).

Maximum Duration of Test

5 s.

Expected Sequence

Step	Direction	Message	Comments
1	SS -> MS	IMMEDIATE ASSIGNMENT EXTENDED	Page mode set to "paging reorganization"
2	SS -> MS	PAGING REQUEST TYPE 2	Sent in a former access grant block.
3	MS -> SS	CHANNEL REQUEST	
4	MS -> SS	CHANNEL REQUEST	
5	SS -> MS	IMMEDIATE ASSIGNMENT REJECT	

Specific Message Contents

None.

26.6.2.4 Paging / same as before

26.6.2.4.1 Conformance requirements

An MS, after first receiving a message on its paging subchannel with page mode set to "extended paging" and then the next message on its paging subchannel with page mode set to "same as before", shall remember the page mode from the previous message and answer to paging messages in the next but one paging sub block.

References

3GPP TS 04.08 / 3GPP TS 44.018, subclause 3.3.2.1; 3GPP TS 05.02, subclause 6.5.

26.6.2.4.2 Test purpose

To test that the MS remembers the page mode from the previous paging request message.

26.6.2.4.3 Method of test

Initial Conditions

System Simulator:

1 cell, Max-Retrans = 2, a legal combination of CCCH_CONF, BS_AG_BLKs_RES and BS_PA_MFRMS is chosen arbitrarily by the SS.

Mobile Station:

The MS is in the "idle, updated" state, with a TMSI allocated.

Specific PICS statements

-

PIXIT statements

-

Foreseen Final State of the MS

"Idle, updated", with TMSI allocated.

Test Procedure

The SS sends an IMMEDIATE ASSIGNMENT REJECT on the MS's paging subchannel, with the page mode element set to "extended paging". In the next but one subblock on the same CCCH, nothing addresses the MS. When the MS's specific paging subchannel reoccurs, a PAGING REQUEST TYPE 3 is sent, not addressing the MS under test and with page mode set to "same as before". In the next but one subblock on the same CCCH the SS sends a PAGING REQUEST TYPE 1 message specifying paging reorganization and addressing the MS. The MS shall respond by sending CHANNEL REQUESTs. The SS responds to the second CHANNEL REQUEST with an IMMEDIATE ASSIGNMENT REJECT (in order to avoid a cell reselection).

Maximum Duration of Test

10 s.

Expected Sequence

Step	Direction	Message	Comments
1	SS -> MS	IMMEDIATE ASSIGNMENT REJECT	Page mode set to "extended paging".
2	SS -> MS	XXXX	In the next but one subblock nothing addresses the MS. This is sent in the next paging subblock on the MS's specific paging subchannel. The page mode is set to "same as before", and the MS under test is not addressed.
3	SS -> MS	PAGING REQUEST TYPE 3	
4	SS -> MS	PAGING REQUEST TYPE 1	
5	MS -> SS	CHANNEL REQUEST	The MS is addressed in this "next but one subblock". Page mode set to "paging reorganization".
6	MS -> SS	CHANNEL REQUEST	
7	SS -> MS	IMMEDIATE ASSIGNMENT REJECT	

Specific Message Contents

None.

26.6.2.5 Paging / multislot CCCH

26.6.2.5.1 Conformance requirements

The MS shall respond correctly to a PAGING REQUEST TYPE 1 message, when the page mode is set to normal paging, when a multislot CCCH is used and the MS is addressed with its IMSI in the first Mobile Identity field, the optional Mobile Identity field being not present.

References

3GPP TS 04.08 / 3GPP TS 44.018, subclause 3.3.2, 3GPP TS 05.02 subclause 6.5.

26.6.2.5.2 Test purpose

- 1) To test that the MS is able to determine its CCCH group and paging group correctly in the case of a CCCH configuration on more than one timeslot when it is paged on a timeslot other than 0. The MS is addressed with a PAGING REQUEST TYPE 1 message when the page mode is set to normal paging. The MS is paged with its IMSI in the 1st Mobile Identity field, the optional Mobile Identity field being not present, is the only way of addressing tested.
- 2) To test that in such conditions the MS answers to the paging message on the timeslot on which the paging message was sent.

26.6.2.5.3 Method of test

Initial Conditions

System Simulator:

1 cell, a legal combination of CCCH_CONF, BS_AG_BLKs_RES and BS_PA_MFRMS is chosen arbitrarily under the following constraint:

CCCH_CONF is in the set:

- 2 basic physical channels used for CCCH, not combined with SDCCHs
- 3 basic physical channels used for CCCH, not combined with SDCCHs
- 4 basic physical channels used for CCCH, not combined with SDCCHs

Mobile Station:

The IMSI last 3 digits are so that the CCCH_GROUP of the MS under test is other than 0. According to subclause 6.5.2 of recommendation 3GPP TS 05.02, this means that:

$(\text{IMSI mod } 1000) \bmod (\text{BS_CC_CHANS} \times N)$ is greater or equal to N , where
 $N = \text{BS_PA_MFRMS} \times (9 - \text{BS_AG_BLKS_RES})$.

The MS is in the "idle, updated" state.

Specific PICS statements

-

PIXIT statements

-

Foreseen Final State of the MS

"Idle updated".

Test Procedure

The SS pages the MS once with a PAGING REQUEST TYPE 1 message on the timeslot and paging subchannel which correspond to the MS's IMSI.

The MS shall send the CHANNEL REQUEST on the same timeslot as the paging message.

The SS sends an IMMEDIATE ASSIGNMENT on the same timeslot as the paging message.

Maximum Duration of Test

10 s.

Expected Sequence

Step	Direction	Message	Comments
1	SS -> MS	PAGING REQUEST TYPE 1	1st Mobile Ident contains IMSI of MS, 2nd Mobile Ident not present.
2	MS -> SS	CHANNEL REQUEST	Establ. Cause = "Answer to paging". on the same timeslot as the paging message.
3	SS -> MS	IMMEDIATE ASSIGNMENT	on the same timeslot as the paging message.
4	MS -> SS	PAGING RESPONSE	Mobile Ident: IMSI.
5	SS -> MS	CHANNEL RELEASE	

Specific Message Contents

None.

26.6.3 Test of measurement report

When an RR-connection exists, the MS shall send measurement reports. These reports contain reception characteristics from serving and neighbouring cells. The measurement report procedure is described in subclause 3.4.1.2 of 3GPP TS 04.08 / 3GPP TS 44.018.

NOTE 8: The capability to calculate RxLev and RxQual is tested in clauses 15 and 16. In this test only the signalling aspect is verified.

26.6.3.1 Measurement / no neighbours

26.6.3.1.1 Conformance requirements

The MS shall continuously send MEASUREMENT REPORT messages on every SACCH block and the measurement valid indication shall be set to valid (0) within the second block at the latest.

References

3GPP TS 04.08 / 3GPP TS 44.018, subclause 3.4.1.2, 3GPP TS 05.08 subclause 8.4.

26.6.3.1.2 Test purpose

To test that, when the SS gives absolutely no information about neighbouring cells, the MS does not report on neighbouring cells.

26.6.3.1.3 Method of test

Initial Conditions

System Simulator:

8 cells with the following settings:

		Transmitter							
		Serving	Neighbour						
		S1	N1	N2	N3	N4	N5	N6	N7
Level		-60	-85	-80	-75	-55	-50	-45	-40
Ncc		1	1	1	1	1	1	1	1
Bcc		3	5	7	1	3	5	7	1
ARFCN	GSM 450	260	264	268	272	276	280	284	288
	GSM 480	307	311	315	319	323	327	331	335
	GSM 710	439	445	451	457	463	469	475	481
	GSM 750	439	445	451	457	463	469	475	481
	T-GSM 810	439	445	451	457	463	469	475	481
	GSM 850	129	135	141	147	153	159	165	171
	GSM 900	002	008	014	020	026	032	038	044
	DCS 1 800	514	530	602	665	762	686	549	810
PCS 1 900	514	530	602	665	762	686	549	810	
Cell Identity		0001H	0002H	0003H	0004H	0005H	0006H	0007H	0008H

With the exception of the Cell Allocation, the rest of the parameters for all eight cells are the same as the default settings and default SYSTEM INFORMATION TYPE 1 to 4 message contents for cell A. The Cell Allocation for the serving cell is the same as the default setting for cell A. The Cell Allocations for the neighbour cells need have only one entry, consisting of the ARFCN of that cell's BCCH.

Mobile Station:

The MS is in the active state of a call (U10).

Specific PICS statements

-

PIXIT statements

-

Foreseen Final State of the MS

Active state of a call (U10).

Test Procedure

This test procedure is performed twice.

With the MS having a call in progress, the SS sends SYSTEM INFORMATION TYPE 5 & 6 (on the second iteration of the test the SS also sends SYSTEM INFORMATION TYPE 5bis) on the SACCH. The BA is indicated as empty. The MS shall send MEASUREMENT REPORTs back to the SS, and it shall be indicated in these that no measurement results have been obtained.

Maximum Duration of Test

5 minutes, including 1 minute for any necessary operator actions.

Expected Sequence

This sequence is performed for execution counter, $k = 1, 2$.

Since when $k = 1$, SYSTEM INFORMATION TYPE 5, SYSTEM INFORMATION TYPE 6 and MEASUREMENT REPORT (and when $k = 2$ an additional SYSTEM INFORMATION TYPE 5bis is included) are sent continuously, a table is not applicable in this test. The interval between 2 successive Layer 2 frames containing MEASUREMENT REPORTs shall not exceed one Layer 2 frame.

Specific Message Contents

DCS 1 800 or PCS 1 900 begin:

SYSTEM INFORMATION TYPE 5:

Information Element	value/remark
Protocol Discriminator	RR management
Message Type	Sys Info 5.
Neighbour Cells Description	
- Format	1 024 range
- BCCH Allocation Sequence number	1
- EXT IND	$k = 1$. Information Element carries the complete BA. $k = 2$. Information Element carries only a part of the BA.
- W(i)	null.

Band	NCD Format
GSM 450	Range 128
GSM 480	Range 128
GSM 710	Range 128
GSM 750	Range 128
T-GSM 810	Range 128
GSM 850	Range 128
GSM 900	Bitmap 0
DCS 1 800	Range 1 024
PCS 1 900	Range 1 024

SYSTEM INFORMATION TYPE 5bis (Sent only when $k = 2$):

Information Element	value/remark
Protocol Discriminator	RR management
Message Type	Sys Info 5bis.
Neighbour Cells Description	
- Format	1 024 range
- BCCH Allocation Sequence number	1
- EXT IND	Information Element carries only a part of the BA.
- W(i)	DCS 1 800 or PCS 1 900: null. Other bands: Only channel 500 belongs to the BCCH allocation

DCS 1 800 or PCS 1 900 begin:

SYSTEM INFORMATION TYPE 6:

Information Element	value/remark
Protocol Discriminator	RR Management
Message Type	sys info 6
Cell Identity	default
LAI	default
Cell Options	
- Power Control Indicator	Power Control Indicator is set
- DTX Indicator	MS shall not use DTX
- Radio_Link_Timeout	default
PLMN permitted	only NCC 1 permitted

DCS 1 800 or PCS 1 900 end:MEASUREMENT REPORT:

Information Element	value/remark
Protocol Discriminator	RR Management
Transaction Identifier	0000
Message Type	MEASUREMENT REPORT
Measurement Results	
BA_used	1
DTX_used	DTX was not used
RXLEV_FULL_SERVING_CELL	See note 1
RXLEV_SUB_SERVING_CELL	See note 1
MEAS_VALID	See note 2
RXQUAL_FULL_SERVING_CELL	See note 1
RXQUAL_SUB_SERVING_CELL	See note 1
NO_NCELL_M	No neighbour cell measurement result, or Neighbour cell information not available for serving cell.
RXLEV_NCELL_1	00 0000
BCCH_FREQ_NCELL_1	0 0000
BSIC_NCELL_1	00 0000
.
.
RXLEV_NCELL_6	00 0000
BCCH_FREQ_NCELL_6	0 0000
BSIC_NCELL_6	00 0000

DSC1800 or PCS 1 900 end:

NOTE 1: The actual values are not checked.

NOTE 2: The Measurement Valid Indication shall be set to valid within the second SACCH block at the latest. When the Indication is set to 'Not Valid', then NOTE 1 applies to ALL fields of the Measurement Results IE.

26.6.3.2 Measurement / all neighbours present

26.6.3.2.1 Conformance requirements

The MS shall continuously send MEASUREMENT REPORT messages on every SACCH blocks and the measurement valid indication shall be set to valid (0) within the second block at the latest. The MEASUREMENT REPORT message shall contain measurement results for the 6 strongest BCCH carriers with known and allowed NCC part of BSIC.

References

3GPP TS 04.08 / 3GPP TS 44.018, subclause 3.4.1.2, 3GPP TS 05.08 subclause 8.4.

26.6.3.2.2 Test purpose

To test that, when the SS gives information about neighbouring cells, the MS reports appropriate results.

26.6.3.2.3 Method of test

Initial Conditions

System Simulator:

8 cells with the following settings:

	Transmitter								
	Serving	Neighbour							
	S1	N1	N2	N3	N4	N5	N6	N7	
Level	-60	-85	-80	-75	-55	-50	-45	-40	
Ncc	1	1	1	1	1	1	1	1	
Bcc	3	5	7	1	3	5	7	1	
ARFCN	GSM 450	260	264	268	272	276	280	284	288
	GSM 480	307	311	315	319	323	327	331	335
	GSM 710	439	445	451	457	463	469	475	481
	GSM 750	439	445	451	457	463	469	475	481
	T-GSM 810	439	445	451	457	463	469	475	481
	GSM 850	129	135	141	147	153	159	165	171
	GSM 900	002	008	014	020	026	032	038	044
	DCS 1 800	514	530	602	665	762	686	549	810
PCS 1 900	514	530	602	665	762	686	549	810	
Cell Identity	0001H	0002H	0003H	0004H	0005H	0006H	0007H	0008H	

With the exception of the Cell Allocation, the rest of the parameters for all eight cells are the same as the default settings and default SYSTEM INFORMATION TYPE 1 to 4 message contents for cell A. The Cell Allocation for the serving cell is the same as the default setting for cell A. The Cell Allocations for the neighbour cells need have only one entry, consisting of the ARFCN of that cell's BCCH.

Mobile Station:

The MS is in the active state of a call (U10).

Specific PICS statements

-

PIXIT statements

-

Foreseen Final State of the MS

Active state of a call (U10).

Test Procedure

This test procedure is performed twice.

With the MS having a call in progress, the SS sends SYSTEM INFORMATION TYPE 5 and 6 (on the second iteration of the test the SS also sends SYSTEM INFORMATION TYPE 5bis) on the SACCH. All 8 of the BCCHs "on air" are indicated in the BA. The MS shall send MEASUREMENT REPORTs back to the SS, and it shall be indicated within 20 s in these that measurement results for the 6 strongest carriers have been obtained.

Maximum Duration of Test

5 minutes, including 1 minute for any necessary operator actions.

Expected Sequence

This sequence is performed for execution counter, k = 1, 2.

Since when k = 1, SYSTEM INFORMATION TYPE 5, SYSTEM INFORMATION TYPE 6 and MEASUREMENT REPORT (and when k = 2 an additional SYSTEM INFORMATION TYPE 5bis is included) are sent continuously, a table is not applicable in this test. The interval between 2 successive Layer 2 frames containing MEASUREMENT REPORTs shall not exceed one Layer 2 frame.

Specific Message Contents

SYSTEM INFORMATION TYPE 5:

Information Element	value/remark
Protocol Discriminator	RR management
Message Type	Sys Info 5.
Neighbour Cells Description	
- Format	See table below
- BCCH Allocation Sequence	1
- EXT IND	k = 1. Information Element carries complete BA. k = 2. Information Element carries only a part of the BA.
- BCCH Allocation ARFCN	See table below

Band	Format Identifier	SYSTEM INFORMATION TYPE 5	
		BCCH Allocation ARFCN k = 1	BCCH Allocation ARFCN k = 2
GSM 450	Variable bitmap	259, 260, 261, 262, 263, 264, 265, 267, 268, 269, 270, 271, 272, 273, 274, 275, 276, 278, 279, 280, 281, 282, 283, 284, 285, 286, 287, 288, 289, 290, 291, 292	
GSM 480	Variable bitmap	306, 307, 308, 309, 310, 311, 312, 314, 315, 316, 317, 318, 319, 320, 321, 322, 323, 325, 326, 327, 328, 329, 330, 331, 332, 333, 334, 335, 336, 337, 338, 339	
GSM 710	Range 128	439, 441, 442, 443, 444, 445, 446, 447, 448, 449, 450, 451, 453, 454, 455, 456, 457, 458, 459, 460, 461, 463, 465, 466, 467, 469, 471, 472, 473, 475, 477, 481	
GSM 750	Range 128	439, 441, 442, 443, 444, 445, 446, 447, 448, 449, 450, 451, 453, 454, 455, 456, 457, 458, 459, 460, 461, 463, 465, 466, 467, 469, 471, 472, 473, 475, 477, 481	
T-GSM 810	Range 128	439, 441, 442, 443, 444, 445, 446, 447, 448, 449, 450, 451, 453, 454, 455, 456, 457, 458, 459, 460, 461, 463, 465, 466, 467, 469, 471, 472, 473, 475, 477, 481	
GSM 850	Range 128		129, 135, 141, 147, 153, 159, 165, 171
GSM 900	Bitmap 0	2, 4, 5, 6, 7, 8, 9, 10, 11, 12, 13, 14, 16, 17, 18, 19, 20, 21, 22, 23, 24, 26, 28, 29, 30, 32, 34, 35, 36, 38, 40, 44	
DCS 1 800	Range 1 024	514, 530, 549, 602, 665, 686, 762, 810	549, 602, 665, 686, 810.
PCS 1 900	Range 1 024	514, 530, 549, 602, 665, 686, 762, 810	549, 602, 665, 686, 810.

SYSTEM INFORMATION TYPE 5bis (Sent only when k = 2):

Information Element	value/remark
Protocol Discriminator	RR management
Message Type	Sys Info 5bis.
Neighbour Cells Description	
- Format	1 024 range
- BCCH Allocation Sequence number	1
- EXT IND	Information Element carries only a part of the BA.
- W(i)	DCS 1 800 or PCS 1 900: Channel 20, 514, 530, 549, 762 belong to the BCCH allocation. Other bands: Channel 0 and 800 belong to the BCCH allocation..

DCS 1 800 or PCS 1 900 begin:

SYSTEM INFORMATION TYPE 6:

Information Element	value/remark
Protocol Discriminator	RR Management
Message Type	sys info 6
Cell Identity	default
LAI	default
Cell Options	
- Power Control Indicator	Power Control Indicator is set
- DTX Indicator	MS shall not use DTX
- Radio_Link_Timeout	default
PLMN permitted	only NCC 1 permitted

DCS 1 800 or PCS 1 900 end:

MEASUREMENT REPORT:

Information Element	value/remark
Protocol Discriminator	RR Management
Transaction Identifier	0000
Message Type	MEASUREMENT REPORT
Measurement Results	
BA_used	1
DTX_used	DTX was not used
RXLEV_FULL_SERVING_CELL	See note 1
RXLEV_SUB_SERVING_CELL	See note 1
MEAS_VALID	See note 2
RXQUAL_FULL_SERVING_CELL	See note 1
RXQUAL_SUB_SERVING_CELL	See note 1
NO_NCELL_M	6 neighbour cell measurement results
RXLEV_NCELL_1	See note 1
BCCH_FREQ_NCELL_1	Shall not correspond to N1 or N2
BSIC_NCELL_1	Corresponds to that of BCCH_FREQ_NCELL_1
RXLEV_NCELL_2	See note 1
BCCH_FREQ_NCELL_2	Shall not correspond to N1 or N2
BSIC_NCELL_2	Corresponds to that of BCCH_FREQ_NCELL_2
RXLEV_NCELL_3	See note 1
BCCH_FREQ_NCELL_3	Shall not correspond to N1 or N2
BSIC_NCELL_3	Corresponds to that of BCCH_FREQ_NCELL_3
RXLEV_NCELL_4	See note 1
BCCH_FREQ_NCELL_4	Shall not correspond to N1 or N2
BSIC_NCELL_4	Corresponds to that of BCCH_FREQ_NCELL_4
RXLEV_NCELL_5	See note 1
BCCH_FREQ_NCELL_5	Shall not correspond to N1 or N2
BSIC_NCELL_5	Corresponds to that of BCCH_FREQ_NCELL_5
RXLEV_NCELL_6	See note 1
BCCH_FREQ_NCELL_6	Shall not correspond to N1 or N2
BSIC_NCELL_6	Corresponds to that of BCCH_FREQ_NCELL_6

NOTE 1: These actual values are not checked.

NOTE 2: The Measurement Valid Indication shall be set to valid within the second SACCH block at the latest. When the Indication is set to 'Not Valid', then NOTE 1 applies to ALL fields of the Measurement Results IE.

26.6.3.3 Measurement / barred cells and non-permitted NCCs

26.6.3.3.1 Conformance requirements

The MS shall continuously send MEASUREMENT REPORTs on every SACCH blocks and the measurement valid indication shall be set to valid (0) within the second block at the latest. After 20 s the messages shall contain measurement results only for the 4 BCCH carriers on which the MS is allowed to report.

References

3GPP TS 04.08 / 3GPP TS 44.018 subclause 3.4.1.2, 3GPP TS 05.08 subclause 8.4.

26.6.3.3.2 Test purpose

To test that, when a combination of normal neighbours, barred cells and non-permitted NCCs is "on air", the MS reports only on normal neighbours.

26.6.3.3.3 Method of test

Initial Conditions

System Simulator:

8 cells with the following settings:

	Serving	Transmitter Neighbour						
		S1	N1	N2	N3	N4	N5	N6
Level dBm	-60	-85	-80	-75	-55	-50	-45	-40
NCC	1	1	1	2	3	4	1	1
BCC	3	5	7	1	3	5	7	1
Cell Identity	0001H	0002H	0003H	0004H	0005H	0006H	0007H	0008H
A GSM 450	260	264	268	272	276	280	284	288
R GSM 480	307	311	315	319	323	327	331	335
F GSM 710	439	445	451	457	463	469	475	481
C GSM 750	439	445	451	457	463	469	475	481
N T-GSM 810	439	445	451	457	463	469	475	481
GSM 850	129	135	141	147	153	159	165	171
GSM 900	002	008	014	020	026	032	038	044
DCS 1 800	514	530	602	665	762	686	549	810
PCS 1 900	514	530	602	665	762	686	549	810

With the exception of the Cell Allocation, the rest of the parameters for all eight cells are the same as the default settings and default SYSTEM INFORMATION TYPE 1 to 4 message contents for cell A. The Cell Allocation for the serving cell is the same as the default setting for cell A. The Cell Allocations for the neighbour cells need have only one entry, consisting of the ARFCN of that cell's BCCH.

NOTE 1: The BA sent in SYSTEM INFORMATION TYPE 5 does not include N1, N4 and N5. N1 may be the case of a barred cell, N3 simulates the case where another operator is transmitting on the same frequency (e.g. in border areas), N4 & N5 simulate the case where other operators are transmitting on other frequencies.

Mobile Station:

The MS is in the active state of a call (U10).

Specific PICS statements

-

PIXIT statements

-

Foreseen Final State of the MS

Active state of a call (U10).

Test Procedure

This test procedure is performed twice.

With the MS having a call in progress, the SS sends SYSTEM INFORMATION TYPE 5 and 6 (on the second iteration of the test the SS also sends SYSTEM INFORMATION TYPE 5bis) on the SACCH. 5 of the 8 BCCHs "on air" are indicated in the BA. The MS shall send MEASUREMENT REPORTs back to the SS, and it shall be indicated in these that measurement results for the 4 strongest permitted carriers have been obtained (one of the carriers in the BA belongs to a non-permitted NCC).

Maximum Duration of Test

5 minutes, including 1 minute for any necessary operator actions.

Expected Sequence

This sequence is performed for execution counter, k = 1, 2.

Since when k = 1 SYSTEM INFORMATION TYPE 5, SYSTEM INFORMATION TYPE 6 and MEASUREMENT REPORT (and when k = 2 an additional SYSTEM INFORMATION TYPE 5bis is included) messages are sent continuously, a table is not applicable in this test. The interval between 2 successive Layer 2 frames containing MEASUREMENT REPORTs shall not exceed one Layer 2 frame.

Specific Message Contents

SYSTEM INFORMATION TYPE 5:

Information Element	value/remark
Protocol Discriminator	RR management
Message Type	Sys Info 5.
Neighbour Cells Description	
- Format	1024 range
- BCCH Allocation Sequence	1
- EXT IND	k = 1. Information Element carries complete BA.
	k = 2. Information Element carries only a part of the BA.
- BCCH Allocation ARFCN	only channel numbers from the table below belong to the BCCH allocation..

	Format	BA ARFCNs K=1	BA ARFCNs K=2
GSM 450	Range 128	260, 268, 272, 284 and 288	260, 268, 272, 284 and 288
GSM 480	Range 128	307, 315, 319, 331 and 335	307, 315, 319, 331 and 335
GSM 710	Range 128	439, 451, 457, 475 and 481	439, 451, 457, 475 and 481
GSM 750	Range 128	439, 451, 457, 475 and 481	439, 451, 457, 475 and 481
T-GSM 810	Range 128	439, 451, 457, 475 and 481	439, 451, 457, 475 and 481
GSM 850	Range 128	129, 141, 147, 165 and 171	129, 141, 147, 165 and 171
GSM 900	Bitmap 0	2, 14, 20, 38, and 44	2, 14, 20, 38, and 44
DCS 1 800	Range 1 024	514, 549, 602, 665, 810	549, 602, 810
PCS 1 900	Range 1 024	514, 549, 602, 665, 810	549, 602, 810

SYSTEM INFORMATION TYPE 5bis (Sent only when k = 2):

Information Element	value/remark
Protocol Discriminator	RR management
Message Type	Sys Info 5bis.
Neighbour Cells Description	
- Format	1024 range
- BCCH Allocation Sequence number	1
- EXT IND	Information Element carries only a part of the BA.
- BCCH Allocation ARFCN	DCS 1 800 or PCS 1 900:514, 665. Other bands: 0, 800

DCS 1 800 or PCS 1 900 begin:

SYSTEM INFORMATION TYPE 6:

Information Element	value/remark
Protocol Discriminator	RR Management
Message Type	sys info 6
Cell Identity	default
LAI	default
Cell Options	
- Power Control Indicator	Power Control Indicator is set
- DTX Indicator	MS shall not use DTX
- Radio-Link-Time-out	default
PLMN permitted	only NCC 1 permitted

DCS 1 800 or PCS 1 900 end:

MEASUREMENT REPORT:

Information Element	value/remark
Protocol Discriminator	RR Management
Transaction Identifier	0000
Message Type	MEASUREMENT REPORT
Measurement Results	
BA_used	1
DTX_used	DTX was not used
RXLEV_FULL_SERVING_CELL	See note 2
RXLEV_SUB_SERVING_CELL	See note 2
MEAS_VALID	See note 3
RXQUAL_FULL_SERVING_CELL	See note 2
RXQUAL_SUB_SERVING_CELL	See note 2
NO_NCELL_M	4 neighbour cell measurement results
RXLEV_NCELL_1	See note 2
BCCH_FREQ_NCELL_1	Corresponds to one of N7, N6, S1 or N2
BSIC_NCELL_1	Corresponds to that of BCCH_FREQ_NCELL_1
RXLEV_NCELL_2	See note 2
BCCH_FREQ_NCELL_2	Corresponds to one of N7, N6, S1 or N2
BSIC_NCELL_2	Corresponds to that of BCCH_FREQ_NCELL_2
RXLEV_NCELL_3	See note 2
BCCH_FREQ_NCELL_3	Corresponds to one of N7, N6, S1 or N2
BSIC_NCELL_3	Corresponds to that of BCCH_FREQ_NCELL_3
RXLEV_NCELL_4	See note 2
BCCH_FREQ_NCELL_4	Corresponds to one of N7, N6, S1 or N2
BSIC_NCELL_4	Corresponds to that of BCCH_FREQ_NCELL_4
RXLEV_NCELL_5	00 0000
BCCH_FREQ_NCELL_5	0 0000
BSIC_NCELL_5	00 0000
RXLEV_NCELL_6	00 0000
BCCH_FREQ_NCELL_6	0 0000
BSIC_NCELL_6	00 0000

NOTE 2: These actual values are not checked.

NOTE 3: The Measurement Valid Indication shall be set to valid within the second SACCH block at the latest. When the Indication is set to 'Not Valid', then NOTE 2 applies to ALL fields of the Measurement Results IE.

26.6.3.4 Measurement / DTX

26.6.3.4.1 Conformance requirements

After the sending of the HANDOVER COMPLETE, the MS shall continuously send measurement reports in every SACCH blocks, the measurement valid indication shall be set to valid (0) within the second block at the latest. After 20 s the order of values in the MEASUREMENT REPORT message shall contain measurement results for the 6 strongest BCCH carriers among those monitored by the MS. Further, in a quiet environment, the DTX_USED field shall be set by the MS to "DTX used".

References

3GPP TS 04.08 / 3GPP TS 44.018 subclause 3.4.1.2, 3GPP TS 05.08 subclause 8.4.

26.6.3.4.2 Test purpose

To test that, in the case of the MS using DTX and the SS indicating that power control is in use, the MS reports appropriate results.

26.6.3.4.3 Method of test

Initial Conditions

System Simulator:

8 cells with the following settings:

	Serving	Transmitter Neighbour						
		S1	N1	N2	N3	N4	N5	N6
Level dBm	-60	-85	-80	-75	-55	-50	-45	-40
NCC	1	1	1	1	1	1	1	1
BCC	3	5	7	1	3	5	7	1
Cell Identity	0001H	0002H	0003H	0004H	0005H	0006H	0007H	0008H
A GSM 450	260	264	268	272	276	280	284	288
R GSM 480	307	311	315	319	323	327	331	335
F GSM 710	439	445	451	457	463	469	475	481
C GSM 750	439	445	451	457	463	469	475	481
N T-GSM 810	439	445	451	457	463	469	475	481
GSM 850	129	135	141	147	153	159	165	171
GSM 900	002	008	014	020	026	032	038	044
DCS 1 800	514	530	602	665	762	686	549	810
PCS 1 900	514	530	602	665	762	686	549	810

In the serving cell, the DTX indicator is set to "MS shall use discontinuous transmission".

With the exception of the Cell Allocation, the rest of the parameters for all eight cells are the same as the default settings and default SYSTEM INFORMATION TYPE 1 to 4 message contents for cell A. The Cell Allocation for the serving cell is the same as the default setting for cell A. The Cell Allocations for the neighbour cells need have only one entry, consisting of the ARFCN of that cell's BCCH.

Mobile Station:

The MS is in the active state of a call (U10).

The MS has just completed a handover into the serving cell, S1.

Specific PICS statements

-

PIXIT statements

-

Foreseen Final State of the MS

Active state of a call (U10).

Test Procedure

This test procedure is performed twice.

With the MS having a call in progress on an arbitrary cell, the MS is handed over to cell S1. On cell S1, the SS sends SYSTEM INFORMATION TYPE 5 and 6 (on the second iteration of the test the SS also sends SYSTEM INFORMATION TYPE 5bis) on the SACCH with all 8 of the BCCHs "on air" indicated in the BA. Cell S1 also indicates that DTX shall be used. The MS shall send MEASUREMENT REPORTs back to the SS, and it shall be indicated in these that measurement results for the 6 strongest carriers have been obtained and that DTX has been used. (The MS is positioned in an environment free from acoustic noise.)

Maximum Duration of Test

5 minutes, including 1 minute for any necessary operator actions.

Expected Sequence

This sequence is performed twice for execution counter, k = 1, 2.

Since when k = 1, SYSTEM INFORMATION TYPE 5, SYSTEM INFORMATION TYPE 6 and MEASUREMENT REPORT (and when k = 2 an additional SYSTEM INFORMATION TYPE 5bis is included) messages are sent continuously, a table is not applicable in this test. The interval between 2 successive Layer 2 frames containing MEASUREMENT REPORTs shall not exceed one Layer 2 frame.

Specific Message Contents

SYSTEM INFORMATION TYPE 5:

Information Element	value/remark
Neighbour Cells Description	See table below 1 only channel numbers from the table below belong to the BCCH allocation. k = 1. Information Element carries the complete BA. k = 2. Information Element carries only a part of the BA.
- Format Identifier	
- BCCH Allocation Sequence	
- BCCH Allocation ARFCN	
- EXT IND	

Band	Format	BCCH Allocation ARFCN k = 1	BCCH Allocation ARFCN k = 2
GSM 450	Range 128	260, 264, 268, 272, 276, 280, 284, 288	260, 264, 268, 272, 276, 280, 284, 288
GSM 480	Range 128	307, 211, 315, 319, 323, 327, 331, 335	307, 211, 315, 319, 323, 327, 331, 335
GSM 710	Range 128	439, 445, 451, 457, 463, 469, 475, 481	439, 445, 451, 457, 463, 469, 475, 481
GSM 750	Range 128	439, 445, 451, 457, 463, 469, 475, 481	439, 445, 451, 457, 463, 469, 475, 481
T-GSM 810	Range 128	439, 445, 451, 457, 463, 469, 475, 481	439, 445, 451, 457, 463, 469, 475, 481
GSM 850	Range 128	129, 135, 141, 147, 153, 159, 165, 171	129, 135, 141, 147, 153, 159, 165, 171
GSM 900	Bitmap 0	2, 8, 14, 20, 26, 32, 38, 44	2, 8, 14, 20, 26, 32, 38, 44
DCS 1 800	Range 1 024	514, 530, 549, 602 665, 686, 762, 810.	549, 602, 665, 686, 810
PCS 1 900	Range 1 024	514, 530, 549, 602, 665, 686, 762, 810.	549, 602, 665, 686, 810

SYSTEM INFORMATION TYPE 5bis (Sent only when k = 2):

Information Element	value/remark
Protocol Discriminator	RR management
Message Type	Sys Info 5bis.
Neighbour Cells Description	
- Format	1024 range
- BCCH Allocation Sequence number	1
- EXT IND	Information Element carries only a part of the BA.
- BCCH Allocation ARFCN	DCS 1 800 or PCS 1 900: Channels 514, 530, 762 belong to the BCCH allocation. Other bands: Only channel 500 belongs to the BCCH allocation.

SYSTEM INFORMATION TYPE 6:

Protocol Discriminator	RR Management
Message Type	sys info 6
Cell Identity	Default
LAI	Default
Cell Options	
- Power Control Indicator	Power Control Indicator is set
- DTX Indicator	MS shall use DTX
- Radio_Link_Timeout	DCS 1 800 or PCS 1 900: default
PLMN permitted (DCS 1 800 and PCS 1 900 only)	Other bands: 8 only NCC 1 permitted

MEASUREMENT REPORT:

Information Element	value/remark
Protocol Discriminator	RR Management
Transaction Identifier	0000
Message Type	MEASUREMENT REPORT
Measurement Results	
- BA_used	1 (note 4)
- DTX_used	DTX was used (note 3)
- RXLEV_FULL_SERVING_CELL	See note 1
- RXLEV_SUB_SERVING_CELL	See note 1
- MEAS_VALID	See note 2
- RXQUAL_FULL_SERVING_CELL	See note 1
- RXQUAL_SUB_SERVING_CELL	See note 1
- NO_NCELL_M	6 neighbour cell measurement results
- RXLEV_NCELL_1	See note 1
- BCCH_FREQ_NCELL_1	Shall not correspond to N1 or N2
- BSIC_NCELL_1	Corresponds to that of BCCH_FREQ_NCELL_1
- RXLEV_NCELL_2	See note 1
- BCCH_FREQ_NCELL_2	Shall not correspond to N1 or N2
- BSIC_NCELL_2	Corresponds to that of BCCH_FREQ_NCELL_2
- RXLEV_NCELL_3	See note 1
- BCCH_FREQ_NCELL_3	Shall not correspond to N1 or N2
- BSIC_NCELL_3	Corresponds to that of BCCH_FREQ_NCELL_3
- RXLEV_NCELL_4	See note 1
- BCCH_FREQ_NCELL_4	Shall not correspond to N1 or N2
- BSIC_NCELL_4	Corresponds to that of BCCH_FREQ_NCELL_4
- RXLEV_NCELL_5	See note 1
- BCCH_FREQ_NCELL_5	Shall not correspond to N1 or N2
- BSIC_NCELL_5	Corresponds to that of BCCH_FREQ_NCELL_5
- RXLEV_NCELL_6	See note 1
- BCCH_FREQ_NCELL_6	Shall not correspond to N1 or N2
- BSIC_NCELL_6	Corresponds to that of BCCH_FREQ_NCELL_6

NOTE 1: These actual values are not checked.

NOTE 2: The Measurement Valid Indication shall be set to valid within the second SACCH block after the HANOVER COMPLETE message at the latest. When the Indication is set to 'Not Valid', then NOTE 1 applies to ALL fields of the Measurement Results IE.

NOTE 3: For an MS that only supports transparent data services, the value of DTX_used shall not be checked. The DTX_used flag must only be checked from the MEASUREMENT REPORT occurring 2 complete SACCH multiframes after the MS has received SYSTEM INFORMATION TYPE 6. This is necessary to give the MS one SACCH multiframe to apply DTX and the second to transmit the updated MEASUREMENT REPORT.

NOTE 4: The BA_used flag must only be checked from the MEASUREMENT REPORT occurring 1 complete SACCH multiframe after the MS has received SYSTEM INFORMATION TYPE 5 (and SYSTEM INFO TYPE 5BIS in the case of k=2). This is necessary to give the MS one SACCH multiframe to transmit the updated MEASUREMENT REPORT.

26.6.3.5 Measurement / Frequency Formats

26.6.3.5.1 Conformance Requirement

The MS shall continuously send MEASUREMENT REPORT messages on every SACCH blocks and the measurement valid indication shall be set to valid (0) within the second block at the latest. After 20 s the values in the MEASUREMENT REPORT message shall contain measurement results for the cells on which the mobile is allowed to report.

References

3GPP TS 04.08 / 3GPP TS 44.018 subclause 3.4.1.2, 3GPP TS 05.08 subclause 8.4.

26.6.3.5.2 Test Purpose

To test that, when the SS gives information about neighbouring cells, the MS reports appropriate results.

26.6.3.5.3 Method of test

Initial Conditions

System Simulator:

2 cells with the following settings:

	Transmitter	
	Serving	Neighbour
	S1	N1
Level	-60	-85
Ncc	1	1
Bcc	3	5
GSM 450	260	264
GSM 480	307	311
GSM 710	439	445
GSM 750	439	445
T-GSM 810	439	445
GSM 850	129	135
GSM 900	002	008
DCS 1 800	715	805
PCS 1 900	715	805
Cell Identity	0001H	0002H

With the exception of the Cell Allocation, the rest of the parameters for both cells are the same as the default settings and default SYSTEM INFORMATION TYPE 1 to 4 message contents for cell A. The Cell Allocation for the serving cell is the same as the default setting for cell A. The Cell Allocations for the neighbour cells need have only one entry, consisting of the ARFCN of that cell's BCCH.

Mobile Station:

The MS is in the active state of a call (U10).

Specific PICS statements

-

PIXIT statements

-

Foreseen Final State of the MS

Active state of a call (U10).

Test Procedure

This test procedure is performed three times.

With the MS having a call in progress, the SS sends SYSTEM INFORMATION TYPE 5, 5bis and 6 on the SACCH. Both of the BCCHs "on air" are indicated in the BA. The MS shall send MEASUREMENT REPORTs back to the SS, and it shall be indicated in these that the appropriate measurement results have been obtained as specified in the Specific Message Contents.

For each iteration of the test the frequency format of the BA list contained in the System Information 5 and 5bis message shall change according to the specific message contents.

Maximum Duration Of Test

5 minutes, including 1 minute for any necessary operator actions.

Expected Sequence

This sequence is performed for execution counter, K = 1, 2, 3.

Since SYSTEM INFORMATION TYPE 5, SYSTEM INFORMATION 5bis, SYSTEM INFORMATION TYPE 6 and MEASUREMENT REPORT are sent continuously, a table is not applicable in this test. The interval between 2 successive Layer 2 frames containing MEASUREMENT REPORTs shall not exceed one Layer 2 frame.

Specific Message Contents

SYSTEM INFORMATION TYPE 5:

Information Element	value/remark
Protocol Discriminator	RR management
Message Type	Sys Info 5.
Neighbour Cells Description	
- Format	See table below
- BCCH Allocation Sequence	1
- EXT IND	Information Element carries only a part of the BA.
- BCCH Allocation ARFCNs	See table below

Band	k	Format	BCCH Allocation ARFCN
GSM 450	1, 2, 3	Range 128	260, 262 and 264
GSM 480	1, 2, 3	Range 128	307, 309 and 311
GSM 710	1, 2, 3	Range 128	439, 443 and 445
T-GSM 810	1, 2, 3	Range 128	439, 443 and 445
GSM 750	1, 2, 3	Range 128	439, 443 and 445
GSM 850	1	Variable Bitmap	129, 133, 135
GSM 850	2	Range 512	530, 595, 965, 1000, 715, 810, 0
GSM 850	3	Range 256	130, 135, 138
GSM 900	1	Bitmap 0	2, 6, 8
GSM 900	2	Range 512	530, 595, 965, 1000, 715, 815, 0
GSM 900	3	Range 128	3, 8, 10
DCS 1 800	1	Range 1 024	500, 530, 595, 715, 815, 965, 1 000, 0
DCS 1 800	2	Variable Bitmap	965, 1 000, 0, 2, 6, 8
DCS 1 800	3	Range 128	695, 715, 800
PCS 1 900	1	Range 1 024	500, 530, 595, 715, 805, 965, 1 000, 0
PCS 1 900	2	Variable Bitmap	965, 1 000, 0, 2, 6, 8
PCS 1 900	3	Range 128	695, 715, 800

SYSTEM INFORMATION TYPE 5bis:

Information Element	value/remark
Protocol Discriminator	RR management
Message Type	Sys Info 5bis.
Neighbour Cells Description	
- Format	K = 1. Bit Map 0. K = 2. Range 512 Format K = 3. Range 256 Format
- BCCH Allocation Sequence number	1
- EXT IND	Information Element carries only a part of the BA.
- W(i) / BCCH Allocation	K = 1. Non null for 2, 6, 8 K = 2. Non null for 500, 530, 595, 715, 815, 965 K = 3. Non Null for 815, 965, 1000, 0, 2, 6

Band	k	Format Identifier	BCCH Allocation ARFCN
GSM 450	1	Range 1 024	500, 530, 595, 965, 1000, 715, 815, 0
GSM 450	2	Range 512	530, 595, 965, 1000, 715, 815, 0
GSM 450	3	Variable Bitmap	965, 1000, 0, 260, 262
GSM 480	1	Range 1 024	500, 530, 595, 965, 1000, 715, 815, 0
GSM 480	2	Range 512	530, 595, 965, 1000, 715, 815, 0
GSM 480	3	Variable Bitmap	965, 1000, 0, 307, 309
GSM 710	1	Range 1 024	500, 530, 595, 965, 1000, 715, 815, 0
GSM 710	2	Range 512	530, 595, 965, 1000, 715, 815, 0
GSM 710	3	Variable Bitmap	965, 1000, 0, 260, 262
GSM 750	1	Range 1 024	500, 530, 595, 965, 1000, 715, 815, 0
GSM 750	2	Range 512	530, 595, 965, 1000, 715, 815, 0
GSM 750	3	Variable Bitmap	965, 1000, 0, 260, 262
T-GSM 810	1	Range 1 024	500, 530, 595, 965, 1000, 715, 815, 0
T-GSM 810	2	Range 512	530, 595, 965, 1000, 715, 815, 0
T-GSM 810	3	Variable Bitmap	965, 1000, 0, 260, 262
GSM 850	1	Range 1 024	500, 530, 595, 965, 1000, 715, 810, 0
GSM 850	2	Range 128	129, 133, 135
GSM 850	3	Range 512	965, 1000, 0, 129, 133
GSM 900	1	Range 1 024	500, 530, 595, 965, 1000, 715, 815, 0
GSM 900	2	Range 512	2, 6, 8
GSM 900	3	Variable Bitmap	965, 1000, 0, 2, 6
DCS 1 800	1	Bitmap 0	2, 6, 8
DCS 1 800	2	Range 512	500, 530, 595, 715, 815, 965
DCS 1 800	3	Range 256	815, 965, 1000, 0, 2, 6
PCS 1 900	1	Bitmap 0	2, 6, 8
PCS 1 900	2	Range 512	500, 530, 595, 715, 805, 965
PCS 1 900	3	Range 256	805, 965, 1000, 0, 2, 6

DCS 1 800 or PCS 1 9 00 begin:

SYSTEM INFORMATION TYPE 6:

Information Element	value/remark
Protocol Discriminator	RR Management
Message Type	sys info 6
Cell Identity	default
LAI	default
Cell Options	
- Power Control Indicator	Power Control Indicator is set
- DTX Indicator	MS shall not use DTX
- Radio_Link_Timeout	default
PLMN permitted	only NCC 1 permitted

DCS 1 800 or PCS 1 9 00 end:

MEASUREMENT REPORT:

Information Element	value/remark
Protocol Discriminator	RR Management
Message Type	MEASUREMENT REPORT
Measurement Results	
BA_used	1
DTX_used	DTX was not used
RXLEV_FULL_SERVING_CELL	See note 1
RXLEV_SUB_SERVING_CELL	See note 1
MEAS_VALID	See note 2
RXQUAL_FULL_SERVING_CELL	See note 1
RXQUAL_SUB_SERVING_CELL	See note 1
NO_NCELL_M	2 neighbour cell measurement results
RXLEV_NCELL_1	See note 1
BCCH_FREQ_NCELL_1	Shall correspond to S1 or N1, i.e., value in table below.
BSIC_NCELL_1	Corresponds to that of BCCH_FREQ_NCELL_1
RXLEV_NCELL_2	See note 1
BCCH_FREQ_NCELL_2	Shall correspond to S1 or N1, i.e., value in table below.
BSIC_NCELL_2	Corresponds to that of BCCH_FREQ_NCELL_2
RXLEV_NCELL_3	00 0000
BCCH_FREQ_NCELL_3	0 0000
BSIC_NCELL_3	00 0000
.
.
RXLEV_NCELL_6	00 0000
BCCH_FREQ_NCELL_6	0 0000
BSIC_NCELL_6	00 0000

MEASUREMENT REPORT				
Band	k	BCCH_FREQ_NCELL_1	BCCH_FREQ_NCELL_2	
GSM 450	1, 2, 3	0 or 2	0 or 2	
GSM 480	1, 2, 3	0 or 2	0 or 2	
GSM 710	1, 2, 3	0 or 2	0 or 2	
GSM 750	1, 2, 3	0 or 2	0 or 2	
T-GSM 810	1, 2, 3	0 or 2	0 or 2	
GSM 850	1, 2	0 or 2	0 or 2	
GSM 850	3	0 or 3	0 or 3	
GSM 900	1, 2	0 or 2	0 or 2	
GSM 900	3	0 or 3	0 or 3	
DCS 1 800	1, 2	6 or 7	6 or 7	
DCS 1 800	3	3 or 5	3 or 5	
PCS 1 900	1, 2	6 or 7	6 or 7	
PCS 1 900	3	3 or 5	3 or 5	

NOTE 1: These actual values are not checked.

NOTE 2: The Measurement Valid Indication shall be set to valid within the second SACCH block at the latest. When the Indication is set to 'Not Valid', then NOTE 1 applies to ALL fields of the Measurement Results IE.

26.6.3.6 Measurement / multiband environment

26.6.3.6.1 Conformance requirements

The MS shall continuously send MEASUREMENT REPORT messages on every SACCH blocks and the measurement valid indication shall be set to valid (0) within the second block at the latest. The MEASUREMENT REPORT message shall contain measurement results for up to the 6 strongest BCCH carriers among those with known and allowed NCC part of BSIC on which the mobile is asked to report.

References

3GPP TS 04.08 / 3GPP TS 44.018 subclause 3.4.1.2, 3GPP TS 05.08 subclause 8.4.

26.6.3.6.2 Test purpose

To test that, when the SS gives information about neighbouring cells using SYSTEM INFORMATION TYPE 2ter/5ter, the MS reports appropriate results.

26.6.3.6.3 Method of test

Initial Conditions

System Simulator:

8 cells with the following settings:

	Serving	Transmitter							
		S1	N1	N2	N3	N4	N5	N6	N7
Level	-60	-85	-80	-75	-55	-50	-45	-40	
Ncc	1	1	1	1	1	1	1	1	
Bcc	3	5	7	1	3	5	7	1	
GSM 450	260	264	268	272	276	280	284	288	
GSM 480	307	311	315	319	323	327	331	335	
GSM 710	439	445	451	457	463	469	475	481	
GSM 750	439	445	451	457	463	469	475	481	
T-GSM 810	439	445	451	457	463	469	475	481	
GSM 850	129	135	141	147	153	159	165	171	
ARFCN	GSM 900	002	008	014	020	026	032	038	044
	DCS 1 800	514	530	602	665	762	686	549	810
	PCS 1 900	514	530	602	665	762	686	549	810
Cell Identity	0001H	0002H	0003H	0004H	0005H	0006H	0007H	0008H	

With the exception of the Cell Allocation, the rest of the parameters for all eight cells are the same as the default settings and default SYSTEM INFORMATION TYPE 1, 2 and 4 message contents for cell A. The Cell Allocation for the serving cell is the same as the default setting for cell A. The Cell Allocations for the neighbour cells need have only one entry, consisting of the ARFCN of that cell's BCCH.

Mobile Station:

The MS is in the active state of a call (U10).

Specific PICS statements

-

PIXIT statements

-

Foreseen Final State of the MS

Active state of a call (U10).

Test Procedure

This test procedure is performed once.

With the MS having a call in progress, the SS sends SYSTEM INFORMATION TYPE 5, 5ter & 6 on the SACCH. All 8 of the BCCHs "on air" are indicated in the BA. The MS shall send MEASUREMENT REPORTs back to the SS, and it shall be indicated within 20 s in these that measurement results for the 6 strongest carriers, on which the mobile is asked to report, have been obtained.

Maximum Duration of Test

5 minutes, including 1 minute for any necessary operator actions.

Expected Sequence

Since SYSTEM INFORMATION TYPE 5, SYSTEM INFORMATION TYPE 5ter, SYSTEM INFORMATION TYPE 6 and MEASUREMENT REPORT are sent continuously, a table is not applicable in this test. The interval between 2 successive Layer 2 frames containing MEASUREMENT REPORTs shall not exceed one Layer 2 frame.

Specific Message Contents

SYSTEM INFORMATION TYPE 2ter:

Information Element	value/remark
Additional Multiband information - Multiband reporting	Minimum 2 cells reported from each band supported excluding the frequency band of the serving cell.
Extension of the BCCH Frequency list - Format identifier - BCCH Allocation Sequence - BCCH Allocation ARFCN	See table below 0 ARFCN 514, 530, 549, 602, 665, 686, 762, 810

Band	Format	BCCH Allocation ARFCN
GSM 450	Range 512	514, 530, 549, 602, 665, 686, 762, 810
GSM 480	Range 512	514, 530, 549, 602, 665, 686, 762, 810
GSM 710	Range 1 024	2, 8, 14, 20, 26, 32, 38, 44
GSM 750	Range 1 024	2, 8, 14, 20, 26, 32, 38, 44
T-GSM 810	Range 1 024	2, 8, 14, 20, 26, 32, 38, 44
GSM 850	Range 512	514, 530, 549, 602, 665, 686, 762, 810
GSM 900	Range 512	514, 530, 549, 602, 665, 686, 762, 810
DCS 1 800	Range 1 024	2, 8, 14, 20, 26, 32, 38, 44
PCS 1 900	Range 128	129, 135, 141, 147, 153, 159, 165, 171

SYSTEM INFORMATION TYPE 3:

as default except:

Information Element	value/remark
SI 3 rest octets - SI 2ter indicator - Early Classmark Sending Control	System Information 2ter is available Early Sending is explicitly accepted

SYSTEM INFORMATION TYPE 5:

Information Element	value/remark
Protocol Discriminator	RR management
Message Type	Sys Info 5.
Neighbour Cells Description	
- Format Identifier	See table below
- BCCH Allocation Sequence	1
- BCCH Allocation ARFCN	See table below
- EXT IND	Information Element carries the complete BA.

Band	Format	BCCH Allocation ARFCN
GSM 450	Range 128	260, 264, 268, 272, 276, 280, 284 , 288
GSM 480	Range 128	307, 311, 315, 319, 323, 327, 331 , 335
GSM 710	Range 128	439, 445, 451, 457, 463, 469, 475, 481
GSM 750	Range 128	439, 445, 451, 457, 463, 469, 475, 481
T-GSM 810	Range 128	439, 445, 451, 457, 463, 469, 475, 481
GSM 850	Range 128	129, 135, 141, 147, 153, 159, 165 , 171
GSM 900	Bitmap 0	2, 8, 14, 20, 26, 32, 38, 44
DCS 1 800	Range 512	514, 530, 549, 602, 665, 686, 762, 810
PCS 1 900	Range 512	514, 530, 549, 602, 665, 686, 762, 810

SYSTEM INFORMATION TYPE 5ter:

Information Element	value/remark
Protocol Discriminator	RR management
Message Type	Sys Info 5ter.
Additional Multiband information	
- Multiband reporting	Minimum 2 cells reported from each band supported excluding the frequency band of the serving cell.
Extension of the BCCH Frequency list	
- Format identifier	See table below
- BCCH Allocation Sequence	1
- BCCH Allocation ARFCN	See table below

Band	Format Identifier	BCCH Allocation ARFCN
GSM 450	Range 512	514, 530, 549, 602, 665, 686, 762, 810
GSM 480	Range 512	514, 530, 549, 602, 665, 686, 762, 810
GSM 710	Range 1 024	2, 8, 14, 20, 26, 32, 38, 44
GSM 750	Range 1 024	2, 8, 14, 20, 26, 32, 38, 44
T-GSM 810	Range 1 024	2, 8, 14, 20, 26, 32, 38, 44
GSM 850	Range 512	514, 530, 549, 602, 665, 686, 762, 810
GSM 900	Range 512	514, 530, 549, 602, 665, 686, 762, 810
DCS 1 800	Range 1 024	2, 8, 14, 20, 26, 32, 38, 44
PCS 1 900	Range 128	129, 135, 141, 147, 153, 159, 165, 171

MEASUREMENT REPORT:

Information Element	value/remark
Protocol Discriminator	RR Management
Transaction Identifier	0000
Message Type	MEASUREMENT REPORT
Measurement Results	
BA_used	1
DTX_used	DTX was not used
RXLEV_FULL_SERVING_CELL	See note 1
RXLEV_SUB_SERVING_CELL	See note 1
MEAS_VALID	See note 3
RXQUAL_FULL_SERVING_CELL	See note 1
RXQUAL_SUB_SERVING_CELL	See note 1
NO_NCELL_M	6 neighbour cell measurement results
RXLEV_NCELL_1	See note 1
BCCH_FREQ_NCELL_1	See note 2
BSIC_NCELL_1	Corresponds to that of BCCH_FREQ_NCELL_1
RXLEV_NCELL_2	See note 1
BCCH_FREQ_NCELL_2	See note 2
BSIC_NCELL_2	Corresponds to that of BCCH_FREQ_NCELL_2
RXLEV_NCELL_3	See note 1
BCCH_FREQ_NCELL_3	See note 2
BSIC_NCELL_3	Corresponds to that of BCCH_FREQ_NCELL_3
RXLEV_NCELL_4	See note 1
BCCH_FREQ_NCELL_4	See note 2
BSIC_NCELL_4	Corresponds to that of BCCH_FREQ_NCELL_4
RXLEV_NCELL_5	See note 1
BCCH_FREQ_NCELL_5	See note 2
BSIC_NCELL_5	Corresponds to that of BCCH_FREQ_NCELL_5
RXLEV_NCELL_6	See note 1
BCCH_FREQ_NCELL_6	See note 2
BSIC_NCELL_6	Corresponds to that of BCCH_FREQ_NCELL_6
NOTE 1: These actual values are not checked.	
NOTE 2: report on ARFCNs See table below.	
NOTE 3: The Measurement Valid Indication shall be set to valid within the second SACCH block at the latest. When the Indication is set to 'Not Valid', then NOTE 1 applies to ALL fields of the Measurement Results IE.	

Band	ARFCNS
GSM 450	260, 272, 276, 280, 284 and 288
GSM 480	307, 319, 323, 327, 331 and 335
GSM 710	439, 445, 451, 457, 463, 469, 475, 481
GSM 750	439, 445, 451, 457, 463, 469, 475, 481
T-GSM 810	439, 445, 451, 457, 463, 469, 475, 481
GSM 850	129, 147, 153, 159, 165 and 171
GSM 900	2, 20, 26, 32, 38 and 44
DCS 1 800	514, 549, 665, 686, 762, 810
PCS 1 900	514, 549, 665, 686, 762, 810

26.6.3.7 Measurement / new cell reporting

26.6.3.7.1 Conformance requirements

The MS shall continuously send MEASUREMENT REPORT messages on every SACCH blocks and the measurement valid indication shall be set to valid (0) within the second block at the latest. The MS shall report a new strongest cell in the measurement report at the latest 5 s after a new strongest cell (which is part of the BA(SACCH)) has been activated under the following network conditions: Initial serving cell at RXLEV= -70 dBm, with 6 neighbours at RXLEV= -75 dBm. Then the new BCCH carrier is switched on at RXLEV= -60 dBm.

NOTE: Because of test equipment limitations it is acceptable to activate the new carrier to replace one of the 6 neighbours.

References

3GPP TS 04.08 / 3GPP TS 44.018 subclause 3.4.1.2, 3GPP TS 05.08 subclause 7.2.

26.6.3.7.2 Test purpose

To test that, when the SS activates a new strongest neighbour cell, the MS reports that cell with a maximum delay of 5 s.

26.6.3.7.3 Method of test

Initial Conditions

System Simulator:

7 cells with the following settings:

	Transmitter							
	Serving	Neighbour						
	S1	N1	N2	N3	N4	N5	N6	
Level	-70	-75	-75	-75	-75	-75	-75	
NCC	1	1	1	1	1	1	1	
BCC	3	5	7	1	3	5	7	
ARFCN	GSM 450	260	264	268	272	276	280	284
	GSM 480	307	311	315	319	323	327	331
	GSM 710	439	445	451	457	463	469	475
	GSM 750	439	445	451	457	463	469	475
	T-GSM 810	439	445	451	457	463	469	475
	GSM 850	129	135	141	147	153	159	165
	GSM 900	002	008	014	020	026	032	038
	DCS 1 800	514	530	602	665	762	686	549
	PCS 1 900	514	530	602	665	762	686	549
	Cell Identity	0001H	0002H	0003H	0004H	0005H	0006H	0007H

With the exception of the Cell Allocation, the rest of the parameters for all seven cells are the same as the default settings and default SYSTEM INFORMATION TYPE 1 to 4 message contents for cell A. The Cell Allocation for the serving cell is the same as the default setting for cell A. The Cell Allocations for the neighbour cells need have only one entry, consisting of the ARFCN of that cell's BCCH.

Mobile Station:

The MS is in the active state of a call (U10).

Specific PICS statements

-

PIXIT statements

-

Foreseen Final State of the MS

Active state of a call (U10).

Test Procedure

The test is performed in two steps a) and b).

Step a)

With the MS having a call in progress, the SS sends SYSTEM INFORMATION TYPE 5 & 6 on the SACCH. All 7 of the BCCHs "on air" are indicated in the BA. The MS shall send MEASUREMENT REPORTs back to the SS, and it shall be indicated within 20 s in these that measurement results for the 6 strongest carriers have been obtained.

Step b)

The SS replaces neighbour cell N1 with neighbour cell N7 with a signal strength of -60 dBm, in order to have the following new settings:

	Transmitter							
	Serving	Neighbour						
	S1	N1	N2	N3	N4	N5	N6	
Level	-70	-60	-75	-75	-75	-75	-75	
Ncc	1	1	1	1	1	1	1	
Bcc	3	1	7	1	3	5	7	
ARFCN	GSM 450	260	288	268	272	276	280	284
	GSM 480	307	335	315	319	323	327	331
	GSM 710	439	481	451	457	463	469	475
	GSM 750	439	481	451	457	463	469	475
	T-GSM 810	439	481	451	457	463	469	475
	GSM 850	129	162	141	147	153	159	165
	GSM 900	002	044	014	020	026	032	038
	DCS 1 800	514	810	602	665	762	686	549
	PCS 1 900	514	810	602	665	762	686	549
	Cell Identity	0001H	0008H	0003H	0004H	0005H	0006H	0007H

With a maximum delay of 5 s, the neighbour cell N7 is included in the measurement report messages.

Maximum Duration of Test

5 minutes, including 1 minute for any necessary operator actions.

Expected Sequence

Since SYSTEM INFORMATION TYPE 5, SYSTEM INFORMATION TYPE 6 and MEASUREMENT REPORT are sent continuously, a table is not applicable in this test. The interval between 2 successive Layer 2 frames containing MEASUREMENT REPORTs shall not exceed one Layer 2 frame.

Specific Message Contents

SYSTEM INFORMATION TYPE 5:

Information Element	value/remark
Protocol Discriminator	RR management
Message Type	Sys Info 5.
Neighbour Cells Description	
- Format	See table below
- BCCH Allocation Sequence	1
- EXT IND	Information Element carries complete BA.
- BCCH Allocation ARFCN	See table below

Band	BCCH Allocation ARFCNs	Format
GSM 450	259, 261, 262, 263, 264, 265, 267, 268, 269, 270, 271, 272, 273, 274, 275, 276, 278, 279, 280, 281, 282, 283, 284, 285, 286, 287, 288, 289, 290, 291, 292	Variable bitmap
GSM 480	306, 308, 309, 310, 311, 312, 314, 315, 316, 317, 318, 319, 320, 321, 322, 323, 325, 326, 327, 328, 329, 330, 331, 332, 333, 334, 335, 336, 337, 338, 339	Variable bitmap
GSM 710	439, 441, 442, 443, 444, 445, 446, 447, 448, 449, 450, 451, 453, 454, 455, 456, 457, 458, 459, 460, 461, 463, 465, 466, 467, 469, 471, 472 and 475	Range 128
GSM 750	439, 441, 442, 443, 444, 445, 446, 447, 448, 449, 450, 451, 453, 454, 455, 456, 457, 458, 459, 460, 461, 463, 465, 466, 467, 469, 471, 472 and 475	Range 128
T-GSM 810	439, 441, 442, 443, 444, 445, 446, 447, 448, 449, 450, 451, 453, 454, 455, 456, 457, 458, 459, 460, 461, 463, 465, 466, 467, 469, 471, 472 and 475	Range 128
GSM 850	129, 131, 132, 133, 134, 135, 136, 137, 138, 139, 140, 141, 143, 144, 145, 146, 147, 148, 149, 150, 151, 153, 155, 156, 157, 159, 161, 162 and 165	Range 128
GSM 900	2, 4, 5, 6, 7, 8, 9, 10, 11, 12, 13, 14, 16, 17, 18, 19, 20, 21, 22, 23, 24, 26, 28, 29, 30, 32, 34, 35, 36, 38, 40, 44	Bitmap 0
DCS 1 800	514, 530, 549, 602, 665, 686, 762, 810.	Range 1 024
PCS 1 900	514, 530, 549, 602, 665, 686, 762, 810.	Range 1 024

DCS 1 800 or PCS 1 900 begin:

SYSTEM INFORMATION TYPE 6:

Information Element	value/remark
Protocol Discriminator	RR Management
Message Type	sys info 6
Cell Identity	default
LAI	default
Cell Options	
- Power Control Indicator	Power Control Indicator is set
- DTX Indicator	MS shall not use DTX
- Radio_Link_Timeout	default
PLMN permitted	only NCC 1 permitted

DCS 1 800 or PCS 1 900 end:

MEASUREMENT REPORT: Step a)

Information Element	value/remark
Protocol Discriminator	RR Management
Transaction Identifier	0000
Message Type	MEASUREMENT REPORT
Measurement Results	
BA_used	1
DTX_used	DTX was not used
RXLEV_FULL_SERVING_CELL	See note 1
RXLEV_SUB_SERVING_CELL	See note 1
MEAS_VALID	See note 2
RXQUAL_FULL_SERVING_CELL	See note 1
RXQUAL_SUB_SERVING_CELL	See note 1
NO_NCELL_M	6 neighbour cell measurement results
RXLEV_NCELL_1	See note 1
BCCH_FREQ_NCELL_1	Shall correspond to S1 or N1 or N2 or N3 or N4 or N5 or N6
BSIC_NCELL_1	Corresponds to that of BCCH_FREQ_NCELL_1
RXLEV_NCELL_2	See note 1
BCCH_FREQ_NCELL_2	Shall correspond to S1 or N1 or N2 or N3 or N4 or N5 or N6
BSIC_NCELL_2	Corresponds to that of BCCH_FREQ_NCELL_2
RXLEV_NCELL_3	See note 1
BCCH_FREQ_NCELL_3	Shall correspond to S1 or N1 or N2 or N3 or N4 or N5 or N6
BSIC_NCELL_3	Corresponds to that of BCCH_FREQ_NCELL_3
RXLEV_NCELL_4	See note 1
BCCH_FREQ_NCELL_4	Shall correspond to S1 or N1 or N2 or N3 or N4 or N5 or N6
BSIC_NCELL_4	Corresponds to that of BCCH_FREQ_NCELL_4
RXLEV_NCELL_5	See note 1
BCCH_FREQ_NCELL_5	Shall correspond to S1 or N1 or N2 or N3 or N4 or N5 or N6
BSIC_NCELL_5	Corresponds to that of BCCH_FREQ_NCELL_5
RXLEV_NCELL_6	See note 1
BCCH_FREQ_NCELL_6	Shall correspond to S1 or N1 or N2 or N3 or N4 or N5 or N6
BSIC_NCELL_6	Corresponds to that of BCCH_FREQ_NCELL_6

MEASUREMENT REPORT: Step b)

Information Element	value/remark
Protocol Discriminator	RR Management
Transaction Identifier	0000
Message Type	MEASUREMENT REPORT
Measurement Results	
BA_used	1
DTX_used	DTX was not used
RXLEV_FULL_SERVING_CELL	See note 1
RXLEV_SUB_SERVING_CELL	See note 1
MEAS_VALID	See note 2
RXQUAL_FULL_SERVING_CELL	See note 1
RXQUAL_SUB_SERVING_CELL	See note 1
NO_NCELL_M	6 neighbour cell measurement results
RXLEV_NCELL_1	See note 1
BCCH_FREQ_NCELL_1	Shall correspond to S1 or N2 or N3 or N4 or N5 or N6 or N7
BSIC_NCELL_1	Corresponds to that of BCCH_FREQ_NCELL_1
RXLEV_NCELL_2	See note 1
BCCH_FREQ_NCELL_2	Shall correspond to S1 or N2 or N3 or N4 or N5 or N6 or N7
BSIC_NCELL_2	Corresponds to that of BCCH_FREQ_NCELL_2
RXLEV_NCELL_3	See note 1
BCCH_FREQ_NCELL_3	Shall correspond to S1 or N2 or N3 or N4 or N5 or N6 or N7
BSIC_NCELL_3	Corresponds to that of BCCH_FREQ_NCELL_3
RXLEV_NCELL_4	See note 1
BCCH_FREQ_NCELL_4	Shall correspond to S1 or N2 or N3 or N4 or N5 or N6 or N7
BSIC_NCELL_4	Corresponds to that of BCCH_FREQ_NCELL_4
RXLEV_NCELL_5	See note 1
BCCH_FREQ_NCELL_5	Shall correspond to S1 or N2 or N3 or N4 or N5 or N6 or N7
BSIC_NCELL_5	Corresponds to that of BCCH_FREQ_NCELL_5
RXLEV_NCELL_6	See note 1
BCCH_FREQ_NCELL_6	Shall correspond to S1 or N2 or N3 or N4 or N5 or N6 or N7
BSIC_NCELL_6	Corresponds to that of BCCH_FREQ_NCELL_6

NOTE 1: These actual values are not checked.

NOTE 2: The Measurement Valid Indication shall be set to valid within the second SACCH block at the latest. When the Indication is set to 'Not Valid', then NOTE 1 applies to ALL fields of the Measurement Results IE.

NOTE 3: Cell S1 shall be included in the Measurement Report sent by the MS.

26.6.3.8 Enhanced Measurement /all neighbours present

26.6.3.8.1 Conformance requirements

When in dedicated mode or group transmit mode, the mobile station regularly sends either MEASUREMENT REPORT or ENHANCED MEASUREMENT REPORT messages to the network.

The Mobile Station shall use ENHANCED MEASUREMENT REPORT messages instead of MEASUREMENT REPORT messages if that is indicated by the parameter REPORT_TYPE and if at least one BSIC is allocated to each BA (list) frequency

For Enhanced Measurement Reporting, cells shall be reported if they are among the at least 6 strongest carriers, and BSIC is successfully decoded and valid (see sub-clause 10.1.1) or, if indicated by the parameter INVALID_BSIC_REPORTING, with known and allowed NCC part. The neighbour cells shall be reported according to the priority defined in sub-clause 8.4.8.1. For other radio access technology/mode, RXLEV is replaced by the relevant measurement quantity (see sub-clause 8.1.5);

For report with the ENHANCED MEASUREMENT REPORT message, the Neighbour Cell list is the concatenation of the GSM Neighbour Cell list and the 3G Neighbour Cell list (if any).

References

3GPP TS 04.08 / 3GPP TS 44.018, sub-clause 3.4.1.2; 3.4.1.2.1.3, 3GPP TS 05.08 sub-clause 10.1.4.1

26.6.3.8.2 Test purpose

To test that, when the SS gives information about neighbouring cells, the MS reports appropriate results.

26.6.3.8.3 Method of test

Initial Conditions

System Simulator:

7 cells with the following settings:

	Transmitter						
	Serving	Neighbour					
	S1	N1	N2	N3	N4	N5	N6
Level	-60	-85	-80	-75	-55	-50	-45
Ncc	1	1	1	1	1	1	1
Bcc	3	5	7	1	3	5	7
GSM 450	260	264	268	272	276	280	284
GSM 480	307	311	315	319	323	327	331
GSM 710	439	445	451	457	463	469	475
GSM 750	439	445	451	457	463	469	475
T-GSM 810	439	445	451	457	463	469	475
GSM 850	129	135	141	147	153	159	165
GSM 900	002	008	014	020	026	032	038
DCS 1 800	514	530	602	665	762	686	549
PCS 1 900	514	530	602	665	762	686	549
Cell Identity	0001H	0002H	0003H	0004H	0005H	0006H	0007H

One UTRAN FDD CELL, N7 with following parameters:

UARFCN=10700 (Downlink UE receive, Node B transmit)

Parameter	Unit	UTRAN FDD Cell
<i>CPICH_{Ec/lor}</i>	dB	-10
<i>PCCPCH_{Ec/lor}</i>	dB	-12
<i>SCH_{Ec/lor}</i>	dB	-12
<i>PICH_{Ec/lor}</i>	dB	-15
<i>DPCH_{Ec/lor}</i>	dB	-∞
OCNS		-0.94
\hat{I}_{or}/I_{oc}	dB	10
<i>I_{oc}</i>	dBm/3.84 MHz	-70
<i>CPICH_{Ec/lo}</i>	dB	-10.4
<i>CPICH_{RSCP}</i>	dBm	-70
FDD_MULTIRAT_ REPORTIN G	integer	1
Qsearch_P	integer	7 (search always)
3G_SEARCH_PRIO	integer	1
Propagation Condition	AWGN	

Reference

TS 45.008 clause 10.1.4.1

Mobile Station

The MS is in the active state of a call (U10).

Specific PICS statements

-

PIXIT statements

-

Foreseen Final State of the MS

Active state of a call (U10).

Test Procedure

With the MS having a call in progress, the SS sends SYSTEM INFORMATION TYPE 5, SYSTEM INFORMATION TYPE 6 and MEASUREMENT INFORMATION message on the SACCH. The Report Type parameter on the SACCH indicated ENHANCED MEASUREMENT REPORT. All 7 of the BCCHs "on air" are indicated in the BA and 3G Neighbour Cell Description is indicated in the MEASUREMENT INFORMATION message. The MS shall send ENHANCED MEASUREMENT REPORT back to the SS, and it shall be indicated within 20 s in these that measurement results for the 6 strongest carriers.

Maximum Duration of Test

5 minutes, including 1 minute for any necessary operator actions.

Expected Sequence

Since SYSTEM INFORMATION TYPE 5, SYSTEM INFORMATION TYPE 6 and MEASUREMENT INFORMATION message are sent continuously on SACCH, a table is not applicable in this test.

Specific Message Contents

GSM 450 begin:

SYSTEM INFORMATION TYPE 5:

Information Element	value/remark
Protocol Discriminator	RR management
Message Type	Sys Info 5.
Neighbour Cells Description	
Format Identifier	See Table below
BCCH Allocation Sequence	1
BCCH Allocation ARFCN	The channel numbers from the table below belong to the BCCH allocation.

Band	BCCH Allocation ARFCNs	Format Identifier
GSM 450	264, 268, 272, 276, 280, 284	Bitmap 0
GSM 480	311, 315, 319, 323, 327, 331	Bitmap 0
GSM 710	445, 451, 457, 463, 469, 475	Bitmap 0
GSM 750	445, 451, 457, 463, 469, 475	Bitmap 0
T-GSM 810	445, 451, 457, 463, 469, 475	Bitmap 0
GSM 850	135, 141, 147, 153, 159, 165	Bitmap 0
GSM 900	8, 14, 20, 26, 32, 38	Bitmap 0
DCS 1 800	530, 549, 602, 665, 686, 762.	Range 1 024
PCS 1 900	530, 549, 602, 665, 686, 762.	Range 1 024

SYSTEM INFORMATION TYPE 6:

Information Element	value/remark
Protocol Discriminator	RR Management
Message Type	sys info 6
Cell Identity	default
LAI	default
Cell Options	
- Power Control Indicator	Power Control Indicator is set
- DTX Indicator	MS shall not use DTX
- Radio_Link_Timeout	Default
PLMN permitted	only NCC 1 permitted

MEASUREMENT INFORMATION

Information Element	value/remark
Protocol Discriminator	RR management
Message Type	Measurement Information (downlink) 00101
BA_IND (BCCH Allocation Sequence)	1
3G_BA_IND	1
Report Type	Enhanced Measurement Report
REPORT_PRIORITY_Description	0
3G UTRAN FDD Neighbour Cells Description	
UARFCN	10700
Absolute_Index_Start_EMR	6
Measurement Parameters	
Multi-band Reporting	0
SERVING_BAND_REPORTING	3
SCALE_ORD	0
900_REPORTING_THRESHOLD	1 (priority reporting if rep. value above threshold for 6)
900_REPORTING_OFFSET	0
3G Measurement Parameters	
Qsearch_C	0
3G_SEARCH_PRIO	1
FDD_REP_QUANT	0 (RSCP)
FDD_MULTIRAT_REPORTING	1 (one sell)
FDD_REPORTING_OFFSET	0
FDD_REPORTING_THRESHOLD	1 (priority reporting if rep. value above threshold for 6)

ENHANCED MEASUREMENT REPORT:

Information Element	Value/remark
Protocol Discriminator	RR Management
Message Type	ENHANCED MEASUREMENT REPORT
Measurement Results	
Serving CELL data	
BA_USED	1
3G_BA_USED	1
SCALE	0
BSIC_Seen	0
DTX_used	DTX was not used
RXLEV_VAL	See note 1
RX_QUAL_FULL	100
MEAN_BEP	See note 1
CV_BEP	See note 1
NBR_RCVD_BLOCKS	See note 1
Neighbour CELL reporting	
RXLEV_NCELL_6	See note 1
Bit in the Bitmap	Corresponds to that of BCCH_FREQ_NCELL_6
RXLEV_NCELL_5	See note 1
Bit in the Bitmap	Corresponds to that of BCCH_FREQ_NCELL_5
RXLEV_NCELL_4	See note 1
Bit in the Bitmap	Corresponds to that of BCCH_FREQ_NCELL_4
RXLEV_NCELL_7	See note 1
Bit in the Bitmap	Corresponds to that of 3G UTRAN FDD_FREQ_NCELL_7

NOTE 1: These actual values are not checked.

26.6.3.9 Enhanced Measurement Report / Measurement Parameters

26.6.3.9.1 Conformance requirements

The BA (list) which is the initial basis for the measurements is derived from information received on the BCCH in System Information 2 and optionally 2bis and/or 2ter and on the SACCH in System Information 5 and optionally 5bis and/or 5ter. MEASUREMENT INFORMATION and SI2quarter messages may add information for the GSM Neighbour Cell List and provide 3G Neighbour Cell list. The Mobile Station shall use ENHANCED MEASUREMENT REPORT messages instead of MEASUREMENT REPORT messages if that is indicated by the parameter REPORT_TYPE and if at least one BSIC is allocated to each BA (list) frequency.

The network may request the MS to report serving cell and neighbour cell measurements with Enhanced Measurement Report message by the parameter REPORT_TYPE, provided that BSIC for all GSM neighbour cells has been sent to the MS (See 3GPP TS 44.018). This reporting is referred as Enhanced Measurement Reporting.

The MS shall use the SCALE value as indicated by the parameter SCALE_ORD in the MEASUREMENT INFORMATION. The MS shall indicate the used SCALE value in each individual ENHANCED MEASUREMENT REPORT or PACKET ENHANCED MEASUREMENT REPORT message.

References

3GPP TS 44.018 subclauses 3.2.2.1 and 3.4.1.2

3GPP TS 45.008 subclauses 8.4.8

26.6.3.9.2 Test purpose

To test that the MS reports appropriate results using Enhanced Measurement Report message when REPORT_TYPE is set to 0 in Measurement Information (System Information 2quarter respectively).

To verify that an MS, in dedicated mode, use the SCALE value as indicated by the parameter SCALE_ORD in the MEASUREMENT INFORMATION.

26.6.3.9.3 Method of test

Initial Conditions

System Simulator:

5 cells with the following settings:

	Transmitter					
	Serving S1	N1	N2	N3	N4	
Level	-60	-85	-80	-75	-55	
Ncc	1	1	1	1	1	
Bcc	3	5	7	1	3	
ARFCN	GSM 450	260	264	268	272	276
	GSM 480	307	311	315	319	323
	GSM 710	439	445	451	457	463
	GSM 750	439	445	451	457	463
	T-GSM 810	439	445	451	457	463
	GSM 850	129	135	141	147	153
	GSM 900	002	008	014	020	026
	DCS 1 800	514	530	602	665	762
	PCS 1 900	514	530	602	665	762
	Cell Identity	0001H	0002H	0003H	0004H	0005H

The parameters for all five cells are the same as the default settings and default SYSTEM INFORMATION TYPE 1 to 4 message contents for cell A with the following exceptions:

- for the serving cell MSCR indicates Release 99 onwards,

- the Cell Allocation for the serving cell is the same as the default setting for cell A. The Cell Allocations for the neighbour cells only have one entry for the ARFCN of that cell's BCCH.

Mobile Station:

The MS is in the active state of a call (U10).

Specific PICS statements:

-

PIXIT statements:

-

Foreseen Final State of the MS

Active state of a call (U10).

Test Procedure

Step a)

With the MS having a call in progress, the SS sends SYSTEM INFORMATION TYPE 5, SYSTEM INFORMATION TYPE 6 and MEASUREMENT INFORMATION messages on the SACCH. The Report Type parameter on the SACCH indicates ENHANCED MEASUREMENT REPORT and SERVING_BAND_REPORTING is set to 3. Serving cell and 4 neighbour cells "on air" are indicated in the BA and no 3G Neighbour Cell Description is indicated in the MEASUREMENT INFORMATION message. The MS shall send ENHANCED MEASUREMENT REPORTs back to the SS, and all carriers present in the BA List shall be indicated within 20 s in these that measurement results.

Step b)

Then the SS sends MEASUREMENT INFORMATION message including the request the use of SCALE_ORD parameter. The MS shall send Enhanced Measurement Report back to the SS and indicate the use of SCALE_ORD parameter. The SS checks that the offset is correctly applied by the MS.

Maximum Duration of Test

5 minutes.

Expected Sequence

Since System Information 5, System Information 6 and Measurement Information are sent on SACCH a table is not applicable in this test.

Specific Message Contents

SYSTEM INFORMATION TYPE 3

Information Element	Value/remark
MSCR 0 1 < SI2Quater Indicator flag > <SI2quater Indicator struct > SI2quater Indicator flag	1 = MSC is Release '99 onwards

MEASUREMENT INFORMATION (Step a)

Information Element	value/remark
Protocol Discriminator	RR management
Message Type	Measurement Information (downlink) 00101
< BA_IND : bit >	Same BA_IND as for SI5
< 3G_BA_IND : bit >	0
< MP_CHANGE_MARK : bit >	0
< MI_INDEX : bit (4) >	'0000'B
< MI_COUNT : bit (4) >	'0000'B
< PWRC : bit >	0
< REPORT_TYPE : bit >	0 = enhanced
< REPORTING_RATE : bit >	0
< INVALID_BSIC_REPORTING : bit >	0
0 1 < Real Time Difference Description >	0
0 1 < BSIC Description >:	1
< BSIC Description struct >	According to the cells table in Initial Conditions of the test case
0 1 < REPORT PRIORITY Description >	0
0 1 < Measurement_Parameters Description >	1
0 1 < MULTIBAND_REPORTING >	0
0 1 < SERVING_BAND_REPORTING:	1
bit(2) >	'11'B
< SCALE_ORD >	'00'B
0 1 < 900_REPORTING_OFFSET >	0
0 1 < 1800_REPORTING_OFFSET >	0
0 1 < 400_REPORTING_OFFSET >	0
0 1 < 1900_REPORTING_OFFSET >	0
0 1 < 850_REPORTING_OFFSET >	0

MEASUREMENT INFORMATION (Step b)

Information Element	value/remark
Protocol Discriminator	RR management
Message Type	Measurement Information (downlink) 00101
< BA_IND : bit >	Same BA_IND as for SI5
< 3G_BA_IND : bit >	0
< MP_CHANGE_MARK : bit >	1
< MI_INDEX : bit (4) >	'0000'B
< MI_COUNT : bit (4) >	'0000'B
< PWRC : bit >	0
< REPORT_TYPE : bit >	0 = enhanced
< REPORTING_RATE : bit >	0
< INVALID_BSIC_REPORTING : bit >	0
0 1 < Real Time Difference Description >	0
0 1 < BSIC Description >:	1
< BSIC Description struct >	According to the cells table in Initial Conditions of the test case
0 1 < REPORT PRIORITY Description >	0
0 1 < Measurement_Parameters Description >	1
0 1 < MULTIBAND_REPORTING >	0
0 1 < SERVING_BAND_REPORTING:	1
bit(2) >	'11'B
< SCALE_ORD >	'01'B
0 1 < 900_REPORTING_OFFSET >	0
0 1 < 1800_REPORTING_OFFSET >	0
0 1 < 400_REPORTING_OFFSET >	0
0 1 < 1900_REPORTING_OFFSET >	0
0 1 < 850_REPORTING_OFFSET >	0

ENHANCED MEASUREMENT REPORT (a):

Information Element	Value/remark
Protocol Discriminator	RR Management
Message Type	ENHANCED MEASUREMENT REPORT
< BA_USED >	0
< BSIC_Seen >	0
< SCALE >	0
0 1 < Serving cell data :	1
< DTX_USED >	0
<i>Serving Data info</i>	<i>Content accuracy not checked (Note 1)</i>
1 <Repeated Invalid_BSIC_Information>	0
0 1 < Bitmap Type Reporting Info flag :	1
Reporting Quantity	<i>Including RXLEV for N1, N2, N3 and N4 present (Note 1)</i>

ENHANCED MEASUREMENT REPORT (b):

Information Element	Value/remark
Protocol Discriminator	RR Management
Message Type	ENHANCED MEASUREMENT REPORT
< 3G_BA_USED >	0
< BA_USED >	0
< BSIC_Seen >	0
< SCALE >	1
0 1 < Serving cell data :	1
< DTX_USED >	0
<i>Serving Data info</i>	<i>Content accuracy not checked (Note 2)</i>
1 <Repeated Invalid_BSIC_Information>	0
0 1 < Bitmap Type Reporting Info flag:	1
Reporting Quantity	<i>Including RXLEV for N1, N2, N3 and N4 present (Note 2)</i>

NOTE 1: The actual values are not checked.

NOTE 2: the RxLev must 10 dB higher than before sending the Measurement Information

26.6.3.10 Enhanced Measurement Report / EMR Reporting after Handover

26.6.3.10.1 Conformance requirements

1. The BA (list) which is the initial basis for the measurements is derived from information received on the BCCH in System Information 2 and optionally 2bis and/or 2ter and on the SACCH in System Information 5 and optionally 5bis and/or 5ter. MEASUREMENT INFORMATION and SI2quarter messages may add information for the GSM Neighbour Cell List and provide 3G Neighbour Cell list. The Mobile Station shall use ENHANCED MEASUREMENT REPORT messages instead of MEASUREMENT REPORT messages if that is indicated by the parameter REPORT_TYPE and if at least one BSIC is allocated to each BA (list) frequency
2. When in dedicated mode or group transmit mode, the mobile station regularly sends either MEASUREMENT REPORT or ENHANCED MEASUREMENT REPORT messages to the network. These messages contain measurement results about reception characteristics from the current cell and from neighbour cells.
3. The Mobile Station shall use ENHANCED MEASUREMENT REPORT messages instead of MEASUREMENT REPORT messages if that is indicated by the parameter REPORT_TYPE and if at least one BSIC is allocated to each BA (list) frequency.

References

3GPP TS 44.018 subclauses 3.2.2.1 and 3.4.1.2

3GPP TS 45.008 subclauses 8.4.8

26.6.3.10.2 Test purpose

1. To verify that an MS, in dedicated mode, on a cell A, after receiving a Measurement Information on SACCH with one BSIC allocated to each BA(list) frequency with REPORT_TYPE set to 0 sends ENHANCED MEASUREMENT REPORT.

2. To verify that the MS after switching to a new cell via handover procedure continues to send ENHANCED MEASUREMENT REPORT only after receiving a new Measurement Information.

26.6.3.10.3 Method of test

Initial Conditions

System Simulator:

2 cells, A and B with same LAI default parameters

Mobile Station:

The MS is in the active state of a call (U10)

Specific PICS statements:

-

PIXIT statements:

-

Test Procedure

With the MS having a call in progress on cell A, the SS sends SYSTEM INFORMATION TYPE 5 & 6 on the SACCH.

The SS sends a Measurement Information with Report Type = 0 to trigger the MS to send Enhanced Measurement Report. Measurement results for cell B shall be indicated there.

The MS is handed over to cell B. The MS sends MEASUREMENT REPORT until it receives the MEASUREMENT INFORMATION. The measurement results for cell A shall be indicated.

Maximum Duration of Test

5 minutes.

Expected Sequence

Step	Direction	Message	Comments
0	MS -> SS		The MS is in the active state of a call on cell A.
1	SS -> MS	MEASUREMENT INFORMATION	
2	MS -> SS	ENHANCED MEASUREMENT REPORT	Measurement results for cell B are present
3	SS -> MS	HANDOVER COMMAND	Contains the parameters for cell B
4	MS -> SS	HANDOVER ACCESS	Repeated on every burst of the uplink main DCCH (and optionally the SACCH) until reception of PHYSICAL INFORMATION.
5	SS -> MS	PHYSICAL INFORMATION	Sent after reception of n HANDOVER ACCESS messages.
6	MS -> SS	SABM	Sent without information field.
7	SS -> MS	UA	
8	MS -> SS	HANDOVER COMPLETE	
9	MS -> SS	MEASUREMENT REPORT	
10	SS -> MS	MEASUREMENT INFORMATION	
11	MS -> SS	ENHANCED MEASUREMENT REPORT	Measurement results for cell A to be reported with in 20 sec of step10.

Specific Message Contents

SYSTEM INFORMATION TYPE 3

Information Element	Value/remark
MSCR 0 1 < SI2Quater Indicator flag >	1 = MSC is Release '99 onwards 0

MEASUREMENT INFORMATION (Step 1)

Information Element	value/remark
Protocol Discriminator	RR management
Message Type	Measurement Information (downlink) 00101
< BA_IND : bit >	Same BA_IND as for SI5
< 3G_BA_IND : bit >	0
< MP_CHANGE_MARK : bit >	0
< MI_INDEX : bit (4) >	'0000'B
< MI_COUNT : bit (4) >	'0000'B
< PWRC : bit >	0
< REPORT_TYPE : bit >	0 = enhanced
< REPORTING_RATE : bit >	0
< INVALID_BSIC_REPORTING : bit >	0
0 1 < Real Time Difference Description >	0
0 1 < BSIC Description >	1
< BSIC Description struct >	According to the neighbour cells list of cell A
0 1 < REPORT PRIORITY Description >	0
0 1 < Measurement_Parameters Description >	1
0 1 < MULTIBAND_REPORTING >	0
0 1 < SERVING_BAND_REPORTING:	1
bit(2) >	'11'B
< SCALE_ORD >	'00'B
0 1 < 900_REPORTING_OFFSET >	0
0 1 < 1800_REPORTING_OFFSET >	0
0 1 < 400_REPORTING_OFFSET >	0
0 1 < 1900_REPORTING_OFFSET >	0
0 1 < 850_REPORTING_OFFSET >	0

MEASUREMENT INFORMATION (Step 10)

Information Element	value/remark
Protocol Discriminator	RR management
Message Type	Measurement Information (downlink) 00101
< BA_IND : bit >	Same BA_IND as for SI5
< 3G_BA_IND : bit >	0
< MP_CHANGE_MARK : bit >	0
< MI_INDEX : bit (4) >	'0000'B
< MI_COUNT : bit (4) >	'0000'B
< PWRC : bit >	0
< REPORT_TYPE : bit >	0 = enhanced
< REPORTING_RATE : bit >	0
< INVALID_BSIC_REPORTING : bit >	0
0 1 < Real Time Difference Description >	0
0 1 < BSIC Description >	1
< BSIC Description struct >	According to the neighbour cells list of cell B
0 1 < REPORT PRIORITY Description >	0
0 1 < Measurement_Parameters Description >	1
0 1 < MULTIBAND_REPORTING >	0
0 1 < SERVING_BAND_REPORTING:	1
bit(2) >	'11'B
< SCALE_ORD >	'00'B
0 1 < 900_REPORTING_OFFSET >	0
0 1 < 1800_REPORTING_OFFSET >	0
0 1 < 400_REPORTING_OFFSET >	0
0 1 < 1900_REPORTING_OFFSET >	0
0 1 < 850_REPORTING_OFFSET >	0

26.6.4 Test of the channel assignment procedure

An intracell change of channel can be requested by upper layers in order to change the channel type, or it may be initiated by the RR-sublayer, e.g. for an intra cell handover. This change is performed using the channel assignment procedure. If the procedure is incorrectly implemented in the MS, the establishment and maintenance of connections is endangered. This applies for the successful case and for the assignment failure: the MS's correct return to the old channel after assignment failure is a necessary part of the GSM system design.

26.6.4.1 Dedicated assignment / successful case

26.6.4.1.1 Conformance requirements

1. Upon receipt of the ASSIGNMENT COMMAND message, the mobile station initiates a local end release of link layer connections, disconnects the physical channels, commands the switching to the assigned channels and initiates the establishment of lower layer connections (this includes the activation of the channels, their connection and the establishment of the main signalling links).
2. MM-messages and CM-messages using SAPI=0 sent from the mobile station to the network can be duplicated by the data link layer in the following case:
 - a channel change of dedicated channels is required (assignment or handover procedure) and the last layer 2 frame has not been acknowledged by the peer data link layer before the mobile station leaves the old channel.

In this case, the mobile station does not know whether the network has received the message correctly. Therefore, the mobile station has to send the message again after the new dedicated channel is established.

3. An ASSIGNMENT COMMAND message may indicate a frequency change in progress, with a starting time and possibly alternative channel descriptions.

In the case of the reception of an ASSIGNMENT COMMAND message which contains only the description of a channel to be used after the starting time, and if the starting time has not already elapsed, the mobile station shall wait up to the starting time before accessing the channel.

4. The MS shall establish the link with the power level specified in the ASSIGNMENT COMMAND message.

The MS shall confirm the power control level that it is currently employing in the uplink SACCH L1 header. The indicated value shall be the power control level actually used by the mobile for the last burst of the previous SACCH period.

5. The MS shall apply the hopping frequencies specified in ASSIGNMENT COMMAND message in the Mobile Allocation IE or the Frequency List IE at the time of accessing the new channel using the last received Cell Allocation.
6. After receipt of the ASSIGNMENT COMMAND the MS shall perform the assignment and return an ASSIGNMENT COMPLETE without undue delay.

References

- | | |
|----------|--|
| 1, 3, 5. | 3GPP TS 04.08 / 3GPP TS 44.018, subclause 3.4.3. |
| 2. | 3GPP TS 04.08 / 3GPP TS 44.018, subclause 3.1.4.3. |
| 4. | 3GPP TS 04.08 / 3GPP TS 44.018, subclause 3.4.3; 3GPP TS 05.08, subclause 4.2. |
| 6. | 3GPP TS 04.13, subclause 5.2.4. |

26.6.4.1.2 Test purpose

1. To verify that upon receipt of an ASSIGNMENT COMMAND, the MS switches to the channel defined in the ASSIGNMENT COMMAND, establishes the link and sends an ASSIGNMENT COMPLETE message. This is tested for an MS supporting TCH in the special cases of a transition.
 - 1.1 from non-hopping SDCCH to hopping TCH/F using a different timeslot;
 - 1.2 from hopping TCH/F to non-hopping TCH/F using a different timeslot;

- 1.3 from non-hopping TCH/F to non-hopping TCH/F using a different timeslot;
- 1.4 from non-hopping TCH/F to hopping TCH/H using a different timeslot; this test purpose is only applicable if the MS supports TCH/H;
- 1.5 from hopping TCH/H to non-hopping TCH/H using a different timeslot; this test purpose is only applicable if the MS supports TCH/H;
- 1.6 from non-hopping TCH/H to hopping TCH/F using a different timeslot; this test purpose is only applicable if the MS supports TCH/H.
2. To verify that an MS supporting TCH, having sent an MM- or CM message which was not acknowledged on L2 before the channel assignment procedure was initiated and before the MS has left the old channel, repeats that message after completion of the assignment procedure without incrementing N(SD). This is tested in the special case of MM message AUTHENTICATION RESPONSE.
 3. To verify that, if an MS supporting TCH has received an ASSIGNMENT COMMAND message which contains only the description of a channel to be used after the starting time, and if the starting time has not already elapsed, the mobile station shall wait up to the starting time before accessing the channel.
 4. To verify that an MS supporting TCH, having received an ASSIGNMENT COMMAND, having sent an SABM frame to establish the main signalling link on the assigned channel, reports the power level specified in the ASSIGNMENT COMMAND message, in the uplink SACCH L1 header of the SACCH message sent in the SACCH period following the transmission of the SABM frame.
 5. To verify that an MS supporting TCH, having received an ASSIGNMENT COMMAND, is able in the case of frequency hopping to decode the Mobile Allocation and Frequency List IEs correctly and applies the specified frequencies using the correct Cell Allocation.
 6. To verify that after receipt of the ASSIGNMENT COMMAND the MS returns an ASSIGNMENT COMPLETE without undue delay.

26.6.4.1.3 Method of test

Initial Conditions

System Simulator:

1 cell, default parameters except:

	BCCH ARFCN	Throughout the test, the CA broadcast in System Information 1 is
GSM 450	263	259, 261, 263, 265, 267, 269, 271, 273, 275, 277
GSM 480	310	306, 308, 310, 312, 314, 316, 318, 320, 322, 324
GSM 710	457	447, 454, 457, 463, 471, 479, 482, 483, 489, 496
GSM 750	457	447, 454, 457, 463, 471, 479, 482, 483, 489, 496
T-GSM 810	457	447, 454, 457, 463, 471, 479, 482, 483, 489, 496
GSM 850	147	137, 144, 147, 153, 161, 169, 172, 173, 179, 186
GSM 900	20	10, 17, 20, 26, 34, 42, 45, 46, 52, 59
DCS 1 800	747	734, 741, 747, 754, 759, 766, 773, 775, 779, 782
PCS 1 900	647	634, 641, 647, 654, 659, 666, 673, 675, 679, 682

Note that the actual CA of the cell contains other frequencies.

Mobile Station:

The MS is in the "idle, updated" state with a TMSI allocated.

Specific PICS statements

- MS supports GSM HR (TSPC_AddInfo_Halfrate)

PIXIT statements

-

Foreseen Final State of the MS

"Idle, updated", with TMSI allocated.

Test Procedure

The SS pages the MS and allocates an SDCCH. Then 2 different channels are assigned with ASSIGNMENT COMMANDs. Each time the MS shall switch to the assigned channel, establish the link and send an ASSIGNMENT COMPLETE message.

Then the SS sends a AUTHENTICATION REQUEST message. The MS shall answer with an AUTHENTICATION RESPONSE message, which is not acknowledged on L2 by the SS. Immediately after the AUTHENTICATION RESPONSE message is received, the SS sends an ASSIGNMENT COMMAND. The MS shall switch to the assigned channel, establish the link with the commanded power level and send as ASSIGNMENT COMPLETE message. Then MS shall repeat the AUTHENTICATION RESPONSE message, with the same N(SD) value.

Then the SS sends an ASSIGNMENT COMMAND, which includes a Starting Time IE. The MS shall react as specified above, but this shall be done at the time specified in Starting Time IE.

For an MS not supporting TCH/H, the SS initiates the channel release procedure and the test ends here. For an MS supporting TCH/H, the channel assignment procedure is performed another three times, with half rate channels involved, and again it is checked that the MS correctly completes the procedures, before the SS initiates the channel release procedure.

Maximum Duration of Test

30 s.

Expected Sequence

NOTE: 3GPP TS 04.08 / 3GPP TS 44.018 appears to be unclear as to whether timer T3240 shall or shall not be started as a result of the AUTHENTICATION REQUEST message sent in step 10. To allow a variety of test equipment implementations, the IDENTITY REQUEST message is included in order to avoid an unexpected expiry of timer T3240 prior to the end of the expected sequence.

Step	Direction	Message	Comments
1	SS -> MS	PAGING REQUEST TYPE 1	See specific message contents.
2	MS -> SS	CHANNEL REQUEST	
3	SS -> MS	IMMEDIATE ASSIGNMENT	
4	MS -> SS	PAGING RESPONSE	
5	SS -> MS	ASSIGNMENT COMMAND	
6	MS -> SS	ASSIGNMENT COMPLETE	
7	SS		See specific message contents. Sent on the correct channel after establishment of the main signalling link. This message shall be ready to be transmitted before 600 ms after the completion of step 5. The SS checks that the MS reports the requested power level in the layer 1 header of the SACCH message that is sent in the first SACCH multiframe following the SABM.
8	SS -> MS	ASSIGNMENT COMMAND	See specific message contents. Sent on the correct channel after establishment of the main signalling link. This message shall be ready to be transmitted before 600 ms after the completion of step 8.
9	MS -> SS	ASSIGNMENT COMPLETE	
10	SS -> MS	AUTHENTICATION REQUEST	This message is not L2 acknowledged by the SS. See specific message contents. Sent on the correct channel after establishment of the main signalling link. This message shall be ready to be transmitted before 600 ms after the completion of step 12. N(SD) shall be the same as in step 10.
11	MS -> SS	AUTHENTICATION RESPONSE	
12	SS -> MS	ASSIGNMENT COMMAND	
13	MS -> SS	ASSIGNMENT COMPLETE	See specific message contents. The SS checks that there is no radio transmission on the new channel before the starting time. Sent on the correct channel after establishment of the main signalling link.
14	MS -> SS	AUTHENTICATION RESPONSE	
15	SS->MS	IDENTITY REQUEST	
16	MS->SS	IDENTITY RESPONSE	
17	SS -> MS	ASSIGNMENT COMMAND	
18	SS		
19	MS -> SS	ASSIGNMENT COMPLETE	
A			This test part is performed if the MS does not support TCH/H (see PICS). The main signalling link is released.
A20	SS -> MS	CHANNEL RELEASE	
B			This test part is performed if the MS supports TCH/H (see PICS). See specific message contents. Sent on the correct channel after establishment of the main signalling link. This message shall be ready to be transmitted before 600 ms after the completion of step B20. See specific message contents. Sent on the correct channel after establishment of the main signalling link. This message shall be ready to be transmitted before 600 ms after the completion of step B24. See specific message contents. Sent on the correct channel after establishment of the main signalling link. This message shall be ready to be transmitted before 600 ms after the completion of step B26. The main signalling link is released.
B20	SS -> MS	ASSIGNMENT COMMAND	
B21	MS -> SS	ASSIGNMENT COMPLETE	
B22	SS -> MS	IDENTITY REQUEST	
B23	MS -> SS	IDENTITY RESPONSE	
B24	SS -> MS	ASSIGNMENT COMMAND	
B25	MS -> SS	ASSIGNMENT COMPLETE	
B26	SS -> MS	ASSIGNMENT COMMAND	
B27	MS -> SS	ASSIGNMENT COMPLETE	
B28	SS -> MS	CHANNEL RELEASE	

Specific Message Contents

Step 3

IMMEDIATE ASSIGNMENT:

As default message contents except Channel Description <ul style="list-style-type: none"> - Channel Type <li style="padding-left: 20px;">TDMA offset - Timeslot Number - Training Sequence Code - Hopping - ARFCN 	SDCCH/8 Chosen arbitrarily N, chosen arbitrarily Chosen arbitrarily Single RF Channel the ARFCN of the BCCH carrier
--	--

Step 5

ASSIGNMENT COMMAND:

Channel Description <ul style="list-style-type: none"> - Channel Type and TDMA offset - Timeslot Number - Training Sequence Code - Hopping - MAIO - HSN Power Command <ul style="list-style-type: none"> - Power level Frequency list IE Channel Mode <ul style="list-style-type: none"> - Mode Mobile Allocation Starting Time	TCH/F (N+1) mod 8 Chosen arbitrarily RF hopping channel Chosen arbitrarily from the set (0, 1 to N-1) where N is the number of frequencies in the Mobile Allocation IE. Chosen arbitrarily from the set (1 to 63) Chosen arbitrarily but with a changed value. Not included Signalling Indicates all of the CA (broadcast on the BCCH) except for the BCCH carrier. Not included
---	--

Step 8

ASSIGNMENT COMMAND:

Channel Description <ul style="list-style-type: none"> - Channel Type and TDMA offset - Timeslot Number - Training Sequence Code - Hopping - ARFCN Power Command <ul style="list-style-type: none"> - Power level Channel Mode Frequency list IE Cell Channel Description Mobile Allocation Starting Time	TCH/F (N+3) mod 8 Chosen arbitrarily Single RF Channel the ARFCN of the BCCH carrier Chosen arbitrarily but with a changed value. A non-signalling mode arbitrarily selected from the full rate capabilities declared for the MS Not Included See table below Not included Not included
---	---

Band	Format	ASSIGNMENT COMMAND	
		Cell Channel Description	ARFCNs
GSM 450	Range 128	271, 273, 275, 277, 278, 279, 281, 282, 284, 287 and 289	
GSM 480	Range 128	318, 320, 322, 324, 325, 326, 328, 329, 331, 334 and 336	
GSM 710	Range 128	482, 483, 489, 496, 498, 500, 501, 502, 503, 506, 508	
GSM 750	Range 128	482, 483, 489, 496, 498, 500, 501, 502, 503, 506, 508	
T-GSM 810	Range 128	482, 483, 489, 496, 498, 500, 501, 502, 503, 506, 508	
GSM 850	Range 128	172, 173, 179, 186, 193, 200, 201, 202, 203, 235, 241	
GSM 900	Bitmap 0	45, 46, 52, 59, 66, 73, 74, 75, 76, 108, 114	
DCS 1 800	Range 128	773, 775, 779, 782, 791, 798, 829, 832, 844	
PCS 1 900	Range 128	673, 675, 679, 682, 691, 698, 729, 732, 744	

Step 12

ASSIGNMENT COMMAND:

Channel Description	TCH/F
- Channel Type and TDMA offset	(N+4) mod 8
- Timeslot Number	Chosen arbitrarily
- Training Sequence Code	RF hopping channel
- Hopping	Chosen arbitrarily from the set (0, 1 to N-1) where N is the number of frequencies in the Mobile Allocation IE.
- MAIO	Chosen arbitrarily from the set (1 to 63)
- HSN	
Power Command	
- Power level	Chosen arbitrarily but with a changed value.
Channel Mode	Not included
Frequency list IE	Not included
Cell Channel Description	Not included (thus the CA from step 8 is used to decode the MA)
Mobile Allocation	Indicates frequencies - See table below
Starting Time	Not included

Band	ASSIGNMENT COMMAND
	Mobile Allocation ARFCNs
GSM 450	271, 273, 279, 281, 282, 284, 287 and 289
GSM 480	318, 320, 326, 328, 329, 331, 334 and 336
GSM 710	482, 483, 500, 501, 502, 503, 506, 508
GSM 750	482, 483, 500, 501, 502, 503, 506, 508
T-GSM 810	482, 483, 500, 501, 502, 503, 506, 508
GSM 850	172, 173, 200, 201, 202, 203, 235, 241
GSM 900	45, 46, 73, 74, 75, 76, 108, 114
DCS 1 800	773, 775, 779, 829, 832, 844
PCS 1 900	673, 675, 679, 729, 732, 744

Step 17

ASSIGNMENT COMMAND:

Channel Description	TCH/F
- Channel Type and TDMA offset	(N+5) mod 8
- Timeslot Number	Chosen arbitrarily
- Training Sequence Code	Single RF Channel
- Hopping	See table below
- ARFCN	
Power Command	
- Power level	Chosen arbitrarily but with a changed value.
Channel Mode	signalling
Frequency list IE	Not included
Cell Channel Description	Not included
Mobile Allocation	Not included
Starting Time	indicates (current frame number + 100 frames) mod 42 432

ASSIGNMENT COMMAND	
Band	Channel Description ARFCN
GSM 450	259
GSM 480	306
GSM 710	447
GSM 750	447
T-GSM 810	447
GSM 850	137
GSM 900	10
DCS 1 800	734
PCS 1 900	634

Step B20

ASSIGNMENT COMMAND:

Channel Description	TCH/H
- Channel Type	Chosen arbitrarily
TDMA offset	(N+6) mod 8
- Timeslot Number	Chosen arbitrarily
- Training Sequence Code	RF hopping channel
- Hopping	Chosen arbitrarily from the set (0, 1 to N-1) where N is the number of frequencies in the Frequency List IE.
- MAIO	0
- HSN	
Power Command	
- Power level	Chosen arbitrarily but with a changed value.
Channel Mode	A non-signalling mode arbitrarily selected from the half rate capabilities declared for the MS
Cell Channel Description	Not included
Frequency list IE	See table below
Mobile Allocation	Not included
Starting Time	Not included

Band	ASSIGNMENT COMMAND	
	Format	Cell Channel Description ARFCNs
GSM 450	Range 128	259, 267, 275, 279, 287 and 289
GSM 480	Range 128	306, 314, 322, 326, 334 and 336
GSM 710	Range 128	447, 471, 489, 500, 506, 508
GSM 750	Range 128	447, 471, 489, 500, 506, 508
T-GSM 810	Range 128	447, 471, 489, 500, 506, 508
GSM 850	Range 128	137, 161, 179, 200, 235, 241
GSM 900	Bitmap 0	10, 34, 52, 73, 108, 114
DCS 1 800	Range 1 024	734, 741, 759, 766, 773, 832, 844
PCS 1 900	Range 1 024	634, 641, 659, 666, 673, 732, 744

Step B24

ASSIGNMENT COMMAND:

Channel Description	TCH/H
- Channel Type	Chosen arbitrarily
- TDMA offset	(N+7) mod 8
- Timeslot Number	Chosen arbitrarily
- Training Sequence Code	Single RF Channel
- Hopping	Chosen arbitrarily, but not the BCCH carrier
- ARFCN	
Power Command	
- Power level	Chosen arbitrarily but with a changed value.
Channel Mode	Not included
Frequency list IE	Not included
Cell Channel Description	Not included
Mobile Allocation	Not included
Starting Time	Not included

Step B26

ASSIGNMENT COMMAND:

Channel Description	TCH/F
- Channel Type and TDMA offset	(N+1) mod 8
- Timeslot Number	Chosen arbitrarily
- Training Sequence Code	RF hopping channel
- Hopping	Chosen arbitrarily from the set (0, 1 to N-1) where N is the number of frequencies in the Mobile Allocation IE.
- MAIO	Chosen arbitrarily from the set (1 to 63)
- HSN	
Power Command	
- Power level	Chosen arbitrarily but with a changed value.
Cell Channel Description	See table below
Frequency list IE	Not included
Mobile Allocation	Indicates ARFCN See table below
Starting Time	Not included

Band	ASSIGNMENT COMMAND		Mobile Allocation ARFCN
	Cell Channel Description Format	ARFCNs	
GSM 450	Range 128	261, 263	261
GSM 480	Range 128	308, 310	308
GSM 710	Range 128	454, 457	454
GSM 750	Range 128	454, 457	454
T-GSM 810	Range 128	454, 457	454
GSM 850	Range 128	144, 147	144
GSM 900	Bitmap 0	17, 20	17
DCS 1 800	Variable bitmap	741, 747	741
PCS 1 900	Variable bitmap	641, 647	641

26.6.4.2 Dedicated assignment / failure

26.6.4.2.1 Dedicated assignment / failure / failure during active state

26.6.4.2.1.1 Conformance requirements

On the mobile station side, if a lower layer failure happens on the new channel before the ASSIGNMENT COMPLETE message has been sent, the mobile station deactivates the new channels, reactivates the old channels, reconnects the TCHs if any and triggers the establishment of the main signalling link. It then sends a ASSIGNMENT FAILURE message, cause "protocol error unspecified" on the main DCCH and resumes the normal operation, as if no assignment attempt had occurred. The operational parameters (e.g. ciphering mode) when returning on the old channel are those applied before the procedure.

References

3GPP TS 04.08 / 3GPP TS 44.018 subclause 3.4.3.3.

3GPP TS 05.08 subclause 4.2.

3GPP TS 05.05 subclause 4.1.1.

26.6.4.2.1.2 Test purpose

To test that, when the MS fails to seize the new channel, the MS reactivates the old channel, reporting use of the last power level used on the old channel.

This is tested in the special cases of a transition:

- from TCH/F to hopping TCH/F in state U10 if the MS supports TCH/F and call control;
- from TCH/H to hopping TCH/H in state U10 if the MS supports TCH/H and call control.

26.6.4.2.1.3 Method of test

Initial Conditions

System Simulator:

1 cell, default parameters. The SS orders the MS to use a power level P, where P is a power level within the range supported by the Type of MS.

Mobile Station:

The MS is in the active state (U10) of a mobile terminated call.

Specific PICS statements

- MS supports GSM HR (TSPC_AddInfo_Halfrate)
- Power class (TSPC_Type_xxx)

PIXIT statements

-

Foreseen Final State of the MS

The active state (U10) of a mobile terminated call.

Test Procedure

The MS is in the active state (U10) of a mobile terminated call. The SS sends an ASSIGNMENT COMMAND allocating a new TCH/F, but does not activate the new channel. It is checked that the MS triggers the establishment of the main signalling link on the old channel and then sends an ASSIGNMENT FAILURE.

Maximum Duration of Test

30 s.

Expected Sequence

The test is repeated for execution counter $k = 1$, and for $k=2$ if the MS supports TCH/H.

Step	Direction	Message	Comments
1	SS -> MS	ASSIGNMENT COMMAND	Channel Type = TCH/F, if $k = 1$, Channel Type = TCH/H, if $k = 2$. Power level specified in power command is different from P, again where P is a power level within the range supported by the Type of MS. The MS attempts (and fails) to establish a signalling link on the new channel.
2			The MS re-establishes the signalling link on the old channel.
3	MS -> SS	ASSIGNMENT FAILURE	RR cause value = "protocol error unspecified".
4	SS		The SS checks that the MS reports power level P in the L1 header of the SACCH message that is sent in the first SACCH multiframe following the SABM.

Specific Message Contents

None.

26.6.4.2.2 Dedicated assignment / failure / general case

26.6.4.2.2.1 Conformance requirements

On the mobile station side, if a lower layer failure happens on the new channel before the ASSIGNMENT COMPLETE message has been sent, the mobile station deactivates the new channels, reactivates the old channels, reconnects the TCHs if any and triggers the establishment of the main signalling link. It then sends a ASSIGNMENT FAILURE message, cause "protocol error unspecified" on the main DCCH and resumes the normal operation, as if no assignment attempt had occurred. The operational parameters (e.g. ciphering mode) when returning on the old channel are those applied before the procedure.

References

3GPP TS 04.08 / 3GPP TS 44.018 subclause 3.4.3.3.

26.6.4.2.2.2 Test purpose

To test that, when the MS fails to seize the new channel, the MS reactivates the old channel.

This is tested in the special cases of a transition:

- from SDCCH to hopping TCH/F; this test part is only applicable if the MS supports TCH/F.
- from non-hopping SDCCH to hopping TCH/H; this test part is only applicable if the MS supports TCH/H.
- from hopping TCH/F to hopping TCH/H; this test part is only applicable if the MS supports TCH/H.

NOTE: Subclause 26.6.8.4 contains the case of an assignment failure SDCCH -> SDCCH.

26.6.4.2.2.3 Method of test

Initial Conditions

System Simulator:

1 cell, default parameters.

Mobile Station:

The MS is "idle updated".

Specific PICS statements

- MS supports GSM HR (TSPC_AddInfo_Halfrate)

PIXIT statements

-

Foreseen Final State of the MS

The MS is "idle updated".

Test Procedure

A mobile terminated RR connection is established on an SDCCH. The SS sends an ASSIGNMENT COMMAND message allocating a hopping TCH/F, but does not activate the assigned channels. The MS shall try to activate the new channel (this is not verified) and shall then reactivate the old channel and trigger the establishment of the main signalling link on the old channel. Then the MS shall send an ASSIGNMENT FAILURE.

For an MS not supporting TCH/H, the SS initiates the channel release procedure and the test ends here. For an MS supporting TCH/H, the test sequence is repeated another two times, with half rate channels involved, and again it is checked that the MS correctly returns to the old channels, before the SS initiates the channel release procedure.

Maximum Duration of Test

30 s.

Expected Sequence

Step	Direction	Message	Comments
1	SS -> MS	PAGING REQUEST TYPE 1	
2	MS -> SS	CHANNEL REQUEST	
3	SS -> MS	IMMEDIATE ASSIGNMENT	Channel Type: SDCCH.
4	MS -> SS	PAGING RESPONSE	
5	SS -> MS	ASSIGNMENT COMMAND	Channel Type = TCH/F, hopping. The MS attempts (and fails) to establish a signalling link on the new channel.
6			The MS re-establishes the signalling link on the old channel.
7	MS -> SS	ASSIGNMENT FAILURE	RR cause value = "protocol error unspecified".
A			This test part is performed if the MS does not support TCH/H.
A8	SS -> MS	CHANNEL RELEASE	The main signalling link is released.
B			This test part is performed if the MS supports TCH/H (see PICS).
B8	SS -> MS	ASSIGNMENT COMMAND	Channel Type = TCH/H, hopping. The MS attempts (and fails) to establish a signalling link on the new channel.
B9			The MS re-establishes the signalling link on the old channel.
B10	MS -> SS	ASSIGNMENT FAILURE	RR cause value = "protocol error unspecified".
B11	SS -> MS	ASSIGNMENT COMMAND	Channel Type = TCH/F, hopping.
B12	MS -> SS	ASSIGNMENT COMPLETE	Sent on the assigned channel after establishment of the main signalling link.
B13	SS -> MS	ASSIGNMENT COMMAND	Channel Type = TCH/H, hopping. The MS attempts (and fails) to establish a signalling link on the new channel.
B14			The MS re-establishes the signalling link on the old channel.
B15	MS -> SS	ASSIGNMENT FAILURE	RR cause value = "protocol error unspecified".
B16	SS -> MS	CHANNEL RELEASE	The main signalling link is released.

Specific Message Contents

None.

26.6.5 Test of handover

With the Handover procedure, it is possible to completely alter the channels allocated to a MS. This makes it possible in particular to switch a call in progress from one cell to another. The procedure is always initiated by the network and with the MS in a dedicated mode.

Subclauses 26.6.5.1 to 26.6.5.4 contain generic test procedures to be used for executing successful Handover tests. Table 26.6-1 contains a summary of the different combinations of parameters which have to be tested, together with a reference to the appropriate generic test procedure. If a test uses a channel rate which the MS under test does not support, the test shall be skipped.

Table 26.6-1

From	To	Timing Adv.	Start Time	Syn ?	State of call	Subclause	Exec Counter
TCH/F, no FH	TCH/F, no FH	20	none	no	U10	26.6.5.1	1
TCH/F, no FH	TCH/F, FH	arbitrary	none	no	U10	26.6.5.1	2
TCH/F, FH	TCH/F, no FH	20	1,1s	no	U10	26.6.5.1	3
TCH/H, FH	TCH/H, no FH	20	none	no	U10	26.6.5.1	6
TCH/H, no FH	TCH/H, FH	arbitrary	none	no	U10	26.6.5.1	7
TCH/H, FH	TCH/H, FH	20	1,1s	no	U10	26.6.5.1	5
TCH/F, no FH	TCH/H, FH	arbitrary	none	no	U10	26.6.5.1	4
TCH/H, FH	TCH/F, no FH	arbitrary	none	no	U10	26.6.5.1	8
SDCCH/4, no FH	TCH/F, FH	20	none	no	estab	26.6.5.2	1
SDCCH/4, no FH	TCH/H, FH	20	none	no	estab	26.6.5.2	2
SDCCH/4, no FH	SDCCH/8, FH	20	none	no	estab	26.6.5.2	3
SDCCH/8, no FH	SDCCH/8, FH	arbitrary	none	no	estab	26.6.5.2	4
TCH/F, no FH	TCH/H, no FH	20	none	no	estab	26.6.5.2	5
TCH/H, FH	TCH/F, FH	20	none	no	estab	26.6.5.2	6
TCH/F, FH	TCH/F, FH	arbitrary	none	no	estab	26.6.5.2	7
SDCCH/8, FH	TCH/F, no FH	20	none	no	estab	26.6.5.2	8
SDCCH/8, no FH	TCH/F, FH	20	none	no	estab	26.6.5.2	9
SDCCH/8, no FH	TCH/H, FH	arbitrary	none	no	estab	26.6.5.2	10
TCH/F, FH	TCH/F, no FH	(2k+y) mod 256	none	yes	U10	26.6.5.3	1
TCH/H, FH	TCH/H, no FH	(2k+y) mod 256	none	yes	U10	26.6.5.3	2
SDCCH/8, FH	SDCCH/8, FH	(2k+y) mod 256	none	yes	estab	26.6.5.4	1
SDCCH/8, FH	SDCCH/4, no FH	(2k+y) mod 256	1,1s	yes	estab	26.6.5.4	2
TCH/F, no FH	TCH/F, FH	(2k+y) mod 256	none	yes	estab	26.6.5.4	3
SDCCH/8, no FH	TCH/F, no FH	(2k+y) mod 256	none	yes	estab	26.6.5.4	4

Table 26.6-2

	TCH/FS	TCH/HS	SDCCH
n	10-20	5-10	2-5

In addition to the successful case of Handover, 2 unsuccessful cases shall be tested. These tests are described in subclauses 26.6.5.8 and 26.6.5.9.

26.6.5.1 Handover / successful / active call / non-synchronized

26.6.5.1.1 Conformance requirements

The MS shall correctly apply the handover procedure in the non-synchronized case when a call is in progress and when handover is performed from a TCH/F without frequency hopping towards a TCH/F without frequency hopping.

The MS shall correctly apply the handover procedure in the non-synchronized case when a call is in progress and when handover is performed from a TCH/H without frequency hopping to a TCH/H with frequency hopping. This does not apply to MSs not supporting TCH/H.

References

3GPP TS 04.08 / 3GPP TS 44.018 subclauses 3.4.4 and 9.1.15.

3GPP TS 04.13 subclause 5.2.6.2.

26.6.5.1.2 Test purpose

To test that when the MS is ordered to make a non-synchronized handover it continuously sends access bursts on the main DCCH (and optionally the SACCH) until it receives a PHYSICAL INFORMATION message from the SS. To test that the MS correctly handles the values of any Starting Time IE in the HANDOVER COMMAND message in the case when none of the information elements referring to before the starting time are present. To test that the MS correctly handles the Timing Advance IE in the PHYSICAL INFORMATION message. To test that the MS activates the new channel correctly and transmits the HANDOVER COMPLETE message without undue delay.

26.6.5.1.3 Method of test

Initial Conditions

System Simulator:

2 cells, A and B with same LAI, default parameters except:

Band	BCCH ARFCN	Cell A Cell Allocation	BCCH ARFCN	Cell B Cell Allocation	Both Cells Format
GSM 450	263	259, 261, 263, 265, 267, 269, 271, 273, 275, 277, 279, 281, 283, 285, 287, 289, 291	274	260, 262, 264, 266, 268, 270, 272, 274, 276, 279, 281, 283, 285, 287, 289, 291	Range 128
GSM 480	310	306, 308, 310, 312, 314, 316, 318, 320, 322, 324, 326, 328, 330, 332, 334, 336, 338	321	307, 309, 311, 313, 315, 317, 319, 321, 323, 326, 328, 330, 332, 334, 336, 338	Range 128
GSM 710	457	447, 454, 457, 463, 471, 479, 482, 483, 489, 496, 498, 500, 501, 502, 503, 506, 508	477	451, 455, 459, 461, 467, 468, 475, 477, 497, 498, 500, 501, 502, 503, 506, 508	Range 128
GSM 750	457	447, 454, 457, 463, 471, 479, 482, 483, 489, 496, 498, 500, 501, 502, 503, 506, 508	477	451, 455, 459, 461, 467, 468, 475, 477, 497, 498, 500, 501, 502, 503, 506, 508	Range 128
T-GSM 810	457	447, 454, 457, 463, 471, 479, 482, 483, 489, 496, 498, 500, 501, 502, 503, 506, 508	477	451, 455, 459, 461, 467, 468, 475, 477, 497, 498, 500, 501, 502, 503, 506, 508	Range 128
GSM 850	147	137, 144, 147, 153, 161, 169, 172, 173, 179, 186, 193, 200, 201, 202, 203, 235, 241	167	141, 145, 149, 151, 157, 158, 165, 167, 187, 193, 200, 201, 202, 203, 235, 241	Range 128
GSM 900	20	10, 17, 20, 26, 34, 42, 45, 46, 52, 59, 66, 73, 74, 75, 76, 108, 114	40	14, 18, 22, 24, 30, 31, 38, 40, 60, 66, 73, 74, 75, 76, 108, 114	Range 128
DCS 1 800	747	734, 741, 747, 754, 759, 762, 766, 767, 773, 775, 779, 782, 791, 798, 829, 832, 844	764	739, 743, 746, 749, 756, 758, 761, 764, 771, 779, 782, 791, 798, 829, 832, 844	Range 256
PCS 1 900	647	634, 641, 647, 654, 659, 662, 666, 667, 673, 675, 679, 682, 691, 698, 729, 732, 744	664	639, 643, 646, 649, 656, 658, 661, 664, 671, 679, 682, 691, 698, 729, 732, 744	Range 256

The frame numbers of cells A and B shall be different by 100.

The timebase of cells A and B shall be such that the edges of their timeslots are not coincident at the antenna connector.

Mobile Station:

The MS is in the active state (U10) of a call on cell A.

Specific PICS statements

- MS supports Speech (TSPC_AddInfo_SDCCHOnly)

PIXIT statements

- supported radio interface rates: 12kbps, 6kbps, 3,6kbps

Foreseen Final State of the MS

The active state (U10) of a call on cell A.

Test Procedure

This procedure is repeated for execution counter $M = 1$ to 8 (see table 26.6-1).

The MS is in the active state (U10) of a call. The SS sends a **HANDOVER COMMAND** on the main DCCH. The MS shall (at the time defined by the Starting Time information element, if included in the message) begin to send access bursts on the new DCCH (and optionally the SACCH) of the target cell. The SS observes the access bursts and after receiving n (n being arbitrarily chosen between values according to table 26.6-2 of subclause 26.6.5) access bursts, the SS sends one **PHYSICAL INFORMATION** message with a Timing Advance as specified in table 26.6-1 of subclause 26.6.5. The MS shall activate the channel in sending and receiving mode. The MS shall establish a signalling link. The MS shall be ready to transmit a **HANDOVER COMPLETE** message, before " x " ms after the end of the **PHYSICAL INFORMATION** message, but not before a UA frame has been sent by the SS.

The term "ready to transmit" is defined in 3GPP TS 04.13. The value of " x " depends upon the target channel and is specified in the specific message contents section.

Maximum Duration of Test

5 minutes, including 1 minute for any necessary operator actions.

Expected Sequence

This sequence is performed for an execution counter $M = 1, 2, 3$ for an MS which only supports TCH/F.

This sequence is performed for an execution counter $M = 1, 2.. 8$ for an MS which supports TCH/F and H

Step	Direction	Message	Comments
0	MS -> SS		The MS and SS are in the active state of a call on the channel described below.
1	SS -> MS	HANDOVER COMMAND	See Specific message contents.
2	MS -> SS	HANDOVER ACCESS	Repeated on every burst of the uplink main DCCH (and optionally the SACCH) until reception of PHYSICAL INFORMATION . Handover Reference as included in the HANDOVER COMMAND . If the HANDOVER COMMAND includes a starting time IE then the first HANDOVER ACCESS message shall be transmitted in the indicated frame (unless the indicated frame is not used by that channel, in which case the next frame used by that channel shall be used).
3	SS -> MS	PHYSICAL INFORMATION	Sent after reception of n HANDOVER ACCESS messages. See specific message contents.
4	MS -> SS	SABM	Sent without information field.
5	SS -> MS	UA	
6	MS -> SS	HANDOVER COMPLETE	The message shall be ready to be transmitted before " x " ms after the completion of step 3.
7	MS -> SS		The MS and SS are in the active state of a call on the channel described below.

Specific Message Contents For Mobiles Supporting Speech

For $M = 1$:

Step 0: The MS and SS are using a full rate TCH in non-hopping mode on cell A.

HANDOVER COMMAND

Information Element	value/remarks
As default message contents, except:	
Cell Description	
- Network Colour Code	1
- Base Station Colour Code	5
- BCCH Carrier Number	See table below
Synchronization Indication	
- Report Observed Time Difference	Shall not be included.
- Synchronization Indication	"Non synchronized".
- Normal Cell Indication	Ignore out of range timing advance.

Band	BCCH Carrier Number
GSM 450	274
GSM 480	321
GSM 710	477
GSM 750	477
T-GSM 810	477
GSM 850	167
GSM 900	40
DCS 1 800	764
PCS 1 900	664

PHYSICAL INFORMATION

Information Element	value/remarks
As default message contents.	

Step 6: x = 500

Step 7: The MS and SS are using a full rate TCH in non hopping mode on cell B.

For M = 2:

Step 0: The MS and SS are using a full rate TCH in non-hopping mode on cell B.

HANDOVER COMMAND

Information Element	value/remarks
As default message contents, except:	
Cell Description	
- Network Colour Code	1
- Base Station Colour Code	5
- BCCH Carrier Number	See table below
Channel Description	
- Channel Type	TCH/F + ACCHs
- Timeslot number	Chosen arbitrarily, but not Zero.
- Training Sequence Code	Chosen arbitrarily
- Hopping	RF hopping channel.
- MAIO	Chosen arbitrarily from the set (0, 1 to N-1), where N is the number of frequencies encoded in the Frequency List IE.
- HSN	Chosen arbitrarily from the set (1,2,...63).
Synchronization Indication IE is not included.	
Channel Mode IE is not included.	
Frequency List after time	
- Frequency List	See table below

Band	HANDOVER COMMAND Frequency List		BCCH Carrier Number ARFCN
	Format	ARFCNs	
GSM 450	Range 128	259, 261, 263, 265, 277, 279, 281, 283, 285, 287, 289, 291	263
GSM 480	Range 128	306, 308, 310, 312, 324, 326, 328, 330, 332, 334, 336, 338	310
GSM 710	Range 256	447, 454, 457, 463, 496, 498, 500, 501, 502, 503, 506, 508	457
GSM 750	Range 256	447, 454, 457, 463, 496, 498, 500, 501, 502, 503, 506, 508	457
T-GSM 810	Range 256	447, 454, 457, 463, 496, 498, 500, 501, 502, 503, 506, 508	457
GSM 850	Variable bitmap	137, 144, 147, 153, 186, 193, 200, 201, 202, 203, 235, 241	147
GSM 900	Variable bitmap	10, 17, 20, 26, 59, 66, 73, 74, 75, 76, 108, 114	20
DCS 1 800	Range 256	747, 775, 779, 782, 791, 798, 829, 832, 844	747
PCS 1 900	Range 256	647, 675, 679, 682, 691, 698, 729, 732, 744	647

PHYSICAL INFORMATION

Information Element	value/remarks
As default message contents, except: Timing advance	Arbitrarily selected but different to default value.

Step 6: $x = 500$.

Step 7: The MS and SS are using a full rate TCH in hopping mode on cell A.

For $M = 3$:

Step 0: The MS and SS are using a full rate TCH in hopping mode on cell A.

HANDOVER COMMAND

Information Element	value/remarks
As default message contents, except: Cell Description	
- Network Colour Code	1
- Base Station Colour Code	5
- BCCH Carrier Number	See table below
Synchronization Indication	
- Report Observed Time Difference	Shall not be included.
- Synchronization Indication	"Non synchronized".
- Normal Cell Indication	Out of range timing advance shall trigger a handover failure procedure.
Starting Time	Indicates the frame number of cell B that will occur approximately 1,1 seconds (238 frames have elapsed) after the HANDOVER COMMAND is sent by cell A.
Mode of first channel	Speech (full rate version 1 or half rate version 1).

Band	BCCH Carrier Number
GSM 450	274
GSM 480	321
GSM 710	477
GSM 750	477
T-GSM 810	477
GSM 850	167
GSM 900	40
DCS 1 800	764
PCS 1 900	664

PHYSICAL INFORMATION

Information Element	value/remarks
As default message contents.	

Step 6: $x = 500$.

Step 7: The MS and SS are using a full rate TCH in non-hopping mode on cell B.

For $M = 4$:

Step 0: The MS and SS are using a full rate TCH in non-hopping mode on cell B.

HANDOVER COMMAND

Information Element	value/remarks
As default message contents, except:	
Cell Description	
- Network Colour Code	1
- Base Station Colour Code	5
- BCCH Carrier Number	See table below
Channel Description	
- Channel Type	TCH/H + ACCHs
- TDMA offset	Chosen arbitrarily.
- Timeslot number	Zero.
- Training Sequence Code	Chosen arbitrarily.
- Hopping	RF hopping channel.
- MAIO	Chosen arbitrarily from the set (0, 1 to N-1), where N is the number of frequencies encoded in the Mobile Allocation.
- HSN	zero (this gives cyclic hopping).
Synchronization Indication IE is not included.	
Cell Channel Description	Use format from table below to encode the complete CA of Cell A.
Mobile Allocation after time	Indicates all of the CA of cell A except for the BCCH frequency.

HANDOVER COMMAND		
Band	Cell Channel Description Format	Cell Description BCCH Carrier Number
GSM 450	Range 128	263
GSM 480	Range 128	310
GSM 710	Range 128	457
GSM 750	Range 128	457
T-GSM 810	Range 128	457
GSM 850	Range 128	147
GSM 900	Bitmap 0	20
DCS 1 800	Range 512	747
PCS 1 900	Range 512	647

PHYSICAL INFORMATION

Information Element	value/remarks
As default message contents, except:	
Timing advance	Arbitrarily selected but different to default value.

Step 6: $x = 750$.

Step 7: The MS and SS are using a half rate TCH in hopping mode on cell A.

For $M = 5$:

Step 0: The MS and SS are using a half rate TCH in hopping mode on cell A.

HANDOVER COMMAND

Information Element	value/remarks
As default message contents, except:	
Cell Description	
- Network Colour Code	1
- Base Station Colour Code	5
- BCCH Carrier Number	See table below
Channel Description	
- Channel Type	TCH/H + ACCHs
- TDMA offset	Chosen arbitrarily.
- Timeslot number	Chosen arbitrarily, but not Zero.
- Training Sequence Code	Chosen arbitrarily.
- Hopping	RF hopping channel.
- MAIO	Chosen arbitrarily from the set (0, 1 to N-1), where N is the number of frequencies encoded in the Frequency List IE.
- HSN	Chosen arbitrarily from the set. (1,2,..63).
Frequency List after time	
- Frequency List	See table below
Synchronization Indication	
- Report Observed Time Difference	Shall not be included.
- Synchronization Indication	"Non synchronized".
- Normal Cell Indication	Ignore out of range timing advance.
Starting Time	Indicates the frame number of cell B. that will occur approximately 1,1 seconds (238 frames have elapsed) after the HANDOVER COMMAND is sent by cell A.

Band	HANDOVER COMMAND		BCCH Carrier Number ARFCN
	Format	Frequency List ARFCNs	
GSM 450	Range 128	260, 262, 264, 266, 276, 279, 281, 283, 285, 287, 289, 291	274
GSM 480	Range 128	307, 309, 311, 313, 323, 326, 328, 330, 332, 334, 336, 338	321
GSM 710	Range 128	451, 455, 459, 461, 497, 498, 500, 501, 502, 503, 506, 508	477
GSM 750	Range 128	451, 455, 459, 461, 497, 498, 500, 501, 502, 503, 506, 508	477
T-GSM 810	Range 128	451, 455, 459, 461, 497, 498, 500, 501, 502, 503, 506, 508	477
GSM 850	Range 128	141, 145, 149, 151, 187, 193, 200, 201, 202, 203,235, 241	167
GSM 900	Bitmap 0	14, 18, 22, 24, 60, 66, 73, 74, 75, 76,108, 114	40
DCS 1 800	Range 1 024	749, 758, 761, 764, 771, 779, 782, 791, 798, 829, 832, 844	764
PCS 1 900	Range 1 024	649, 658, 661, 664, 671, 679, 682, 691, 698, 729, 732, 744	664

For M = 6:

Step 0: The MS and SS are using a half rate TCH in hopping mode on cell B.

HANDOVER COMMAND

Information Element	value/remarks
As default message contents, except:	
Cell Description	
- Network Colour Code	1
- Base Station Colour Code	5
- BCCH Carrier Number	See table below
Channel Description	
- Channel Type	TCH/H + ACCHs
- TDMA offset	Chosen arbitrarily.
- Timeslot number	Chosen arbitrarily but not Zero.
- Training Sequence Code	Chosen arbitrarily.
- Hopping	Single RF channel.
- ARFCN	Chosen arbitrarily from the Cell Allocation of Cell A.
Synchronization Indication IE not included.	

ASSIGNMENT COMMAND

Band	Channel Description ARFCN
GSM 450	263
GSM 480	310
GSM 710	457
GSM 750	457
T-GSM 810	457
GSM 850	147
GSM 900	20
DCS 1 800	747
PCS 1 900	647

PHYSICAL INFORMATION

Information Element	value/remarks
As default message contents.	

Step 6: x = 750.

Step 7: The MS and SS are using a half rate TCH in non-hopping mode on cell A.

For M = 7:

Step 0: The MS and SS are using a half rate TCH in non-hopping mode on cell A.

HANDOVER COMMAND

Information Element	value/remarks
As default message contents, except:	
Cell Description	
- Network Colour Code	1
- Base Station Colour Code	5
- BCCH Carrier Number	See table below
Channel Description	
- Channel Type	TCH/F + ACCHs
- Timeslot number	Chosen arbitrarily but not Zero.
- Training Sequence Code	Chosen arbitrarily.
- Hopping	RF hopping channel.
- MAIO	Chosen arbitrarily from the set (0, 1 to N-1), where N is the number of frequencies encoded in the Frequency List IE.
- HSN	Chosen arbitrarily from the set. (1,2,..63).
Frequency List after time	
- Frequency List	See table below
Synchronization Indication	
- Report Observed Time Difference	Shall not be included.
- Synchronization Indication	"Non synchronized".
- Normal Cell Indication	Ignore out of range timing advance.
Mode of first channel	speech (full rate version 1 or half rate version 1).

Band	HANDOVER COMMAND		BCCH Carrier Number
	Format	Frequency List	
			ARFCN
			ARFCNs
GSM 450	Range 128	274, 279, 281, 283, 285, 287, 289, 291	274
GSM 480	Range 128	321, 326, 328, 330, 332, 334, 336, 338	321
GSM 710	Range 128	477, 498, 500, 501, 502, 503,506, 508	477
GSM 750	Range 128	477, 498, 500, 501, 502, 503,506, 508	477
T-GSM 810	Range 128	477, 498, 500, 501, 502, 503,506, 508	477
GSM 850	Range 128	167, 193, 200, 201, 202, 203 ,235, 241	167
GSM 900	Range 128	40, 66, 73, 74, 75, 76,108, 114	40
DCS 1 800	Variable Bitmap	764, 779, 782, 791, 798, 829, 832, 844	764
PCS 1 900	Variable Bitmap	(664, 679, 682, 691, 698, 729, 732, 744	664

PHYSICAL INFORMATION

Information Element	value/remarks
As default message contents, except:	
Timing advance	Arbitrarily selected but different to default value.

Step 6: x = 750.

Step 7: The MS and SS are using a half rate TCH in hopping mode on cell B.

For M = 8:

Step 0: The MS and SS are using a half rate TCH in hopping mode on cell B.

HANDOVER COMMAND

Information Element	value/remarks
As default message contents, except:	
Cell Description	
- Network Colour Code	1
- Base Station Colour Code	5
- BCCH Carrier Number	See table below
Channel Description	
- Channel Type	TCH/F + ACCHs
- Timeslot number	Chosen arbitrarily but not Zero.
- Training Sequence Code	Chosen arbitrarily.
- Hopping	Single RF channel.
- ARFCN	See table below
Synchronization Indication IE not included.	

Band	Cell Description BCCH Carrier Number and Channel Description ARFCN
GSM 450	263
GSM 480	310
GSM 710	457
GSM 750	457
T-GSM 810	457
GSM 850	147
GSM 900	20
DCS 1 800	747
PCS 1 900	647

PHYSICAL INFORMATION

Information Element	value/remarks
As default message contents, except:	
Timing advance	Arbitrarily selected but different to default value.

Step 6: x = 500.

Step 7: The MS and SS are using a full rate TCH in non-hopping mode on cell A.

Specific Message Contents For Mobiles not Supporting Speech

If the mobile station supports half rate, then the 12 kbps radio interface rate is not used for this test. With this restriction, the radio interface rate is selected arbitrarily from those supported.

The message contents shall be the same for the Mobile Station upporting speech , except for:

M = 3 and 7:

HANDOVER COMMAND

Information Element	value/remarks
Mode of first channel	Data, with the full rate radio interface rate that is in use.

26.6.5.2 Handover / successful / call under establishment / non-synchronized

26.6.5.2.1 Conformance requirements

The MS shall correctly apply the handover procedure from SDCCH/8, TCH/F or TCH/H with or without frequency hopping to SDCCH/8, TCH/F or TCH/H with or without frequency hopping in the non-synchronized case during call establishment. The mobile shall correctly apply the handover procedures from non frequency hopping SDCCH/4 to

SDCCH/8, TCH/F or TCH/H with or without frequency hopping. If during call establishment a Layer 3 MM or CC message just sent by the MS is not Layer 2 acknowledged before the channel change caused by the HANDOVER COMMAND message, the MS shall send the Layer 3 message to the new cell, using the same value in the N(SD) field, after the handover procedure.

References

3GPP TS 04.08 / 3GPP TS 44.018, subclauses 3.1.4.2, 3.4.4 and 9.1.15.

3GPP TS 04.13, subclause 5.2.6.2.

26.6.5.2.2 Test purpose

To test that when the MS is ordered to make a non-synchronized handover, it continuously sends access bursts on the main DCCH (and optionally the SACCH) until it receives a PHYSICAL INFORMATION message from the SS. To test that the MS correctly takes the values of the Timing Advance information element in the PHYSICAL INFORMATION message into account. To test that the MS activates the new channel correctly and transmits the HANDOVER COMPLETE message without undue delay. To test that the MS correctly retransmits Layer 3 MM or CC messages, that were not acknowledged by Layer 2 before the Handover, after completion of the Handover.

26.6.5.2.3 Method of test

Initial Conditions

System Simulator:

2 cells A and B with same LAI, default parameters, except:

Cell A has:

BCCH ARFCN = See table below.

Cell Allocation = See table below

PLMN colour code, NCC = as defaults.

BS colour code, BCC = as defaults.

PLMN_PERM = 00001010.

Cell B has:

BCCH ARFCN = See table below.

Cell Allocation = See table below

PLMN colour code, NCC = 3.

BS colour code, BCC = 0.

Both cells send SYSTEM INFORMATION TYPE 1 messages containing the complete Cell Allocation of the cell, see table below for format.

The timebase of Cells A and B shall be such that the edges of their timeslots are not coincident at the antenna connector.

For execution counter M = 1, 2 and 3 a combined CCH/SDCCH is used.

For execution counter M = 4 to 10 a non combined SDCCH is used.

Band	BCCH ARFCN	Cell A Cell Allocation	BCCH ARFCN	Cell B Cell Allocation	Both Cells Format
GSM 450	263	259, 261, 263, 265, 267, 269, 271, 273, 275, 277, 279, 281, 283, 285, 287, 289, 291	274	260, 262, 264, 266, 268, 270, 272, 274, 276, 279, 281, 283, 285, 287, 289, 291	Range 128
GSM 480	310	306, 308, 310, 312, 314, 316, 318, 320, 322, 324, 326, 328, 330, 332, 334, 336, 338	321	307, 309, 311, 313, 315, 317, 319, 321, 323, 326, 328, 330, 332, 334, 336, 338	Range 128
GSM 710	457	447, 454, 457, 463, 471, 479, 482, 483, 489, 496, 498, 500, 501, 502, 503, 506, 508	477	451, 455, 459, 461, 467, 468, 475, 477, 497, 498, 500, 501, 502, 503, 506, 508	Range 128
GSM 750	457	447, 454, 457, 463, 471, 479, 482, 483, 489, 496, 498, 500, 501, 502, 503, 506, 508	477	451, 455, 459, 461, 467, 468, 475, 477, 497, 498, 500, 501, 502, 503, 506, 508	Range 128
T-GSM 810	457	447, 454, 457, 463, 471, 479, 482, 483, 489, 496, 498, 500, 501, 502, 503, 506, 508	477	451, 455, 459, 461, 467, 468, 475, 477, 497, 498, 500, 501, 502, 503, 506, 508	Range 128
GSM 850	147	137, 144, 147, 153, 161, 169, 172, 173, 179, 186, 193, 200, 201, 202, 203, 235, 241	167	141, 145, 149, 151, 157, 158, 165, 167, 187, 193, 200, 201, 202, 203, 235, 241	Range 128
GSM 900	20	10, 17, 20, 26, 34, 42, 45, 46, 52, 59, 66, 73, 74, 75, 76, 108, 114	40	14, 18, 22, 24, 30, 31, 38, 40, 60, 66, 73, 74, 75, 76, 108, 114	Bitmap 0
DCS 1 800	747	734, 741, 747, 754, 759, 762, 766, 767, 773, 775, 779, 782, 791, 798, 829, 832, 844	764	739, 743, 746, 749, 756, 758, 761, 764, 771, 779, 782, 791, 798, 829, 832, 844	Range 512
PCS 1 900	647	634, 641, 647, 654, 659, 662, 666, 667, 673, 675, 679, 682, 691, 698, 729, 732, 744	664	639, 643, 646, 649, 656, 658, 661, 664, 671, 679, 682, 691, 698, 729, 732, 744	Range 512

Mobile Station:

The MS is in the "idle, updated" state, with a TMSI allocated and camped on cell A.

Specific PICS statements

- MS supports Speech (TSPC_AddInfo_SDCCHOnly)

PIXIT statements

- supported radio interface rates: 12kbps, 6kbps, 3,6kbps

Foreseen Final State of the MS

"Idle, updated" with TMSI allocated and camped on cell B.

Test Procedure

This procedure is repeated for execution counter M = 1, 2 .. 10 (See table 26.6-1.)

A Mobile Originating Call is initiated on Cell A. After the MS has sent the SETUP message (and before the last L2 frame carrying the SETUP message is acknowledged by the SS) the SS sends a HANDOVER COMMAND message, ordering the MS to switch to cell B. The MS shall then begin to send access bursts on the new DCCH (and optionally the SACCH) to cell B. The SS observes the access bursts and after receiving n (n being arbitrarily chosen between values according to table 26.6-2 of subclause 26.6.5) access bursts, the SS sends one PHYSICAL INFORMATION message with a Timing Advance as specified in table 26.6-1 of subclause 26.6.5. The MS shall activate the channel in sending and receiving mode. The MS shall establish a signalling link. The MS shall be ready to transmit a HANDOVER COMPLETE message before x ms after the end of the PHYSICAL INFORMATION message, but not before a UA frame has been sent by the SS. The MS shall then again send the SETUP message to the SS, using the same value in the N(SD) field. Finally the SS sends a CHANNEL RELEASE to end the test.

The term "ready to transmit" is defined in 3GPP TS 04.13. The value of "x" depends upon the target channel and is specified in the specific message contents section.

Maximum Duration of Test

5 minutes, including 1 minute for any necessary operator actions.

Expected Sequence

The sequence is performed for execution counter M = 1, 2..10 (unless a particular TCH is not supported).

Step	Direction	Message	Comments
1	-----	-----	A MO call is initiated on cell A.
2	MS -> SS	CHANNEL REQUEST	Establish. Cause = "Originating call, NECI not set to 1"
3	SS -> MS	IMMEDIATE ASSIGNMENT	See specific message contents.
4	MS -> SS	CM SERVICE REQUEST	CM Service Type = Mobile Originating Call Establishment.
5	SS -> MS	CIPHERING MODE COMMAND	
6	MS -> SS	CIPHERING MODE COMPLETE	
7	MS -> SS	SETUP	Last L2 frame not acknowledged by the SS.
8	SS -> MS	HANDOVER COMMAND	See specific message contents.
9	MS -> SS	HANDOVER ACCESS	Repeated on every burst of the uplink main DCCH (and optionally the SACCH) until reception of PHYSICAL INFORMATION. Handover Reference as included in the HANDOVER COMMAND
10	SS -> MS	PHYSICAL INFORMATION	Sent after reception of n HANDOVER ACCESS message. Timing Advance as specified in table 26.6-1 of subclause 26.6.5.
11	MS -> SS	SABM	Sent without information field.
12	SS -> MS	UA	
13	MS -> SS	HANDOVER COMPLETE	This message shall be ready to be transmitted before "x" ms after the completion of step 10.
14	MS -> SS	SETUP	Same N(SD) as in step 7.
15	SS -> MS	CHANNEL RELEASE	

Specific Message Contents For Mobiles Supporting Speech

M = 1.

IMMEDIATE ASSIGNMENT

Information Element	value/remark
As default message contents.	

HANDOVER COMMAND

Information Element	value/remarks
As default message contents, except:	
Cell Description	
- Network Colour Code	3
- Base Station Colour Code	0
- BCCH Carrier Number	See table below
Channel Description	
- Channel Type	TCH/F + ACCHs
- Timeslot number	zero.
- Training Sequence Code	Chosen arbitrarily.
- Hopping	RF hopping channel.
- MAIO	Chosen arbitrarily from the set (0, 1 to N-1), where N is the number of frequencies encoded in the Frequency Short List IE.
- HSN	Chosen arbitrarily from the set. (1,2,..63).
Synchronization IE is not included.	
Frequency Short List after time	
- Frequency Short List	See table below
Mode of the First Channel	Speech (full rate version 1 or half rate version 1).

Band	HANDOVER COMMAND Frequency Short List		BCCH Carrier Number
	Format	ARFCNs	ARFCN
GSM 450	Range 128	260, 262, 264, 266, 268, 270, 272, 292, 279, 281, 283, 285, 287, 289, 291	274
GSM 480	Range 128	307, 309, 311, 313, 315, 317, 319, 339, 326, 328, 330, 332, 334, 336, 338	321
GSM 710	Range 128	451, 455, 459, 461, 467, 468, 475, 490, 498, 500, 501, 502, 503, 506, 508	477
GSM 750	Range 128	451, 455, 459, 461, 467, 468, 475, 490, 498, 500, 501, 502, 503, 506, 508	477
T-GSM 810	Range 128	451, 455, 459, 461, 467, 468, 475, 490, 498, 500, 501, 502, 503, 506, 508	477
GSM 850	Range 128	141, 145, 149, 151, 157, 158, 165, 180, 193, 200, 201, 202, 203, 235, 241	167
GSM 900	Range 128	14, 18, 22, 24, 30, 31, 38, 53, 66, 73, 74, 75, 76, 108, 114	40
DCS 1 800	Range 128	756, 758, 761, 771, 779, 782, 791, 798, 829, 832, 844	764
PCS 1 900	Range 128	656, 658, 661, 671, 679, 682, 691, 698, 729, 732, 744	664

Step 13: "x" = 500.

M = 2.

IMMEDIATE ASSIGNMENT

Information Element	value/remark
As default message contents.	

HANDOVER COMMAND

Information Element	value/remarks
As default message contents, except:	
Cell Description	
- Network Colour Code	3
- Base Station Colour Code	0
- BCCH Carrier Number	See table below
Channel Description	
- Channel Type	TCH/H + ACCHs
- TDMA offset	Chosen arbitrarily.
- Timeslot number	Chosen arbitrarily but not zero.
- Training Sequence Code	Chosen arbitrarily.
- Hopping	RF hopping channel.
- MAIO	Chosen arbitrarily from the set (0, 1 to N-1), where N is the number of frequencies encoded in the Mobile Allocation.
- HSN	Chosen arbitrarily from the set (1, 2.. 63).
Synchronization Indication	
- Report Observed Time Difference	Shall not be included.
- Synchronization Indication	"Non synchronized".
- Normal Cell Indication	Ignore out of range timing advance.
Cell Channel Description	See table below
Mobile Allocation after time	Indicates (ARFCNs in table below) only.
Mode of First Channel	Speech (full rate version 1 or half rate version 1).

Band	BCCH Carrier Number ARFCN	HANDOVER COMMAND Frequency Short List		Mobile Allocation after time
		Format	ARFCNs	ARFCNs
GSM 450	274	Range 128	274, 279, 281, 283, 285, 287, 289, 291	281, 283, 285
GSM 480	321	Range 128	321, 326, 328, 330, 332, 334, 336, 338	328, 330, 332
GSM 710	477	Range 128	477, 498, 500, 501, 502, 503, 506, 508	500, 501, 502
GSM 750	477	Range 128	477, 498, 500, 501, 502, 503, 506, 508	500, 501, 502
T-GSM 810	477	Range 128	477, 498, 500, 501, 502, 503, 506, 508	500, 501, 502
GSM 850	167	Range 128	167, 193, 200, 201, 202, 203, 235, 241	200, 201, 202
GSM 900	40	Bitmap 0	40, 66, 73, 74, 75, 76, 108, 114	73, 74, 75
DCS 1 800	764	Range 512	761, 764, 771, 779, 782, 791, 798, 829, 832	791, 798, 829
PCS 1 900	664	Range 512	661, 664, 671, 679, 682, 691, 698, 729, 732	691, 698, 729

Step 13: "x" = 750.

M = 3.

IMMEDIATE ASSIGNMENT

Information Element	value/remark
As default message contents.	

DCS 1 800 or PCS 1 900 begin:

HANDOVER COMMAND

Information Element	value/remarks
As default message contents, except:	
Cell Description	
- Network Colour Code	3
- Base Station Colour Code	0
- BCCH Carrier Number	DCS 1 800: 764 PCS 1 900: 664
Channel Description	
- Channel Type	SDCCH/8
- TDMA offset	Chosen arbitrarily.
- Timeslot number	Zero.
- Training Sequence Code	Chosen arbitrarily.
- Hopping	RF hopping channel.
- MAIO	Chosen arbitrarily from the set (0, 1 to N-1), where N is the number of frequencies encoded in the Frequency Short List IE.
- HSN	Zero (this gives cyclic hopping).
Synchronization Indication IE not included.	
Frequency Short List after time	
- Frequency Short List	Use Range 128 to encode the following 2 frequencies: DCS 1 800: 746, 779 PCS 1 900: 646, 679
Mode of First Channel	Signalling Only.

DCS 1 800 or PCS 1 900 end:

Other bands begin:

HANDOVER COMMAND

Information Element	value/remarks
As default message contents, except:	
Cell Description	
- Network Colour Code	3
- Base Station Colour Code	0
- BCCH Carrier Number	See table below
Channel Description	
- Channel Type	SDCCH/8
- TDMA offset	Chosen arbitrarily.
- Timeslot number	Zero.
- Training Sequence Code	Chosen arbitrarily.
- Hopping	RF hopping channel.
- MAIO	Chosen arbitrarily from the set (0, 1 to N-1), where N is the number of frequencies encoded in the Frequency List IE.
- HSN	Chosen arbitrarily from the set {1, 2, ..., 63}.
Synchronization Indication IE is not included	Frequency list after time.
- Frequency List	See table below
Channel Mode IE	signalling only.

Band	Cell Description BCCH Carrier Number	HANDOVER COMMAND	
		Format	Frequency List ARFCNs
GSM 450	274	Range 128	260, 262, 264, 266, 268, 270, 272, 276, 279, 281, 283, 285, 287, 289, 291
GSM 480	321	Range 128	307, 309, 311, 313, 315, 317, 319, 323, 326, 328, 330, 332, 334, 336, 338
GSM 710	477	Range 128	451, 455, 459, 461, 467, 468, 475, 497, 498, 500, 501, 502, 503, 506, 508
GSM 750	477	Range 128	451, 455, 459, 461, 467, 468, 475, 497, 498, 500, 501, 502, 503, 506, 508
T-GSM 810	477	Range 128	451, 455, 459, 461, 467, 468, 475, 497, 498, 500, 501, 502, 503, 506, 508
GSM 850	167	Range 128	141, 145, 149, 151, 157, 158, 165, 187, 193, 200, 201, 202, 203, 235, 241
GSM 900	40	Bitmap 0	14, 18, 22, 24, 30, 31, 38, 60, 66, 73, 74, 75, 76, 108, 114
DCS 1 800	764	Range 128	746, 779
PCS 1 900	664	Range 128	646, 679

Other bands end:

Step 13: "x" = 1 500.

M = 4.

IMMEDIATE ASSIGNMENT

Information Element	value/remark
As default message contents except: - Timeslot number - ARFCN	Arbitrary value, but not zero. See table below

Band	ARFCN
GSM 450	263
GSM 480	310
GSM 710	457
GSM 750	457
T-GSM 810	457
GSM 850	147
GSM 900	20
DCS 1 800	747
PCS 1 900	647

HANDOVER COMMAND

Information Element	value/remarks
As default message contents, except:	
Cell Description	
- Network Colour Code	3
- Base Station Colour Code	0
- BCCH Carrier Number	See table below
Channel Description	
- Channel Type	SDCCH/8
- TDMA offset	Chosen arbitrarily.
- Timeslot number	Arbitrary value but not zero.
- Training Sequence Code	Chosen arbitrarily.
- Hopping	RF hopping channel.
- MAIO	Chosen arbitrarily from the set (0, 1 to N-1), where N is the number of frequencies encoded in the Frequency List IE.
- HSN	zero (this gives cyclic hopping).
Frequency List after time	
- Frequency List	Use format from table below to encode the complete CA of Cell B.
Synchronization Indication	
- Report Observed Time Difference	Shall not be included.
- Synchronization Indication	"Non synchronized".
- Normal Cell Indication	Ignore out of range timing advance.
Channel Mode IE is not included.	

HANDOVER COMMAND

Band	Cell Description BCCH ARFCN	Format	Frequency List
			ARFCNs
GSM 450	274	Range 128	260, 262, 264, 266, 268, 270, 272, 276, 279, 281, 283, 285, 287, 289
GSM 480	321	Range 128	307, 309, 311, 313, 315, 317, 319, 323, 326, 328, 330, 332, 334, 336
GSM 710	477	Range 128	451, 455, 459, 461, 467, 468, 475, 477, 498, 500, 501, 502, 503, 506
GSM 750	477	Range 128	451, 455, 459, 461, 467, 468, 475, 477, 498, 500, 501, 502, 503, 506
T-GSM 810	477	Range 128	451, 455, 459, 461, 467, 468, 475, 477, 498, 500, 501, 502, 503, 506
GSM 850	167	Range 128	141, 145, 149, 151, 157, 158, 165, 167, 193, 200, 201, 202, 203, 235
GSM 900	40	Range 128	14, 18, 22, 24, 30, 31, 38, 40, 66, 73, 74, 75, 76, 108
DCS 1 800	764	Range 1 024	complete CA of Cell B
PCS 1 900	664	Range 1 024	complete CA of Cell B

Step 13: "x" = 1 500.

M = 5.

IMMEDIATE ASSIGNMENT

Information Element	value/remark
As default message contents except:	
Channel Description	
- Channel Type	TCH/F + ACCH's
- Timeslot number	Arbitrary value but not zero.
- Hopping Channel	Single RF Channel.
- ARFCN	Chosen arbitrarily from the Cell Allocation of cell A.

HANDOVER COMMAND

Information Element	value/remarks
As default message contents, except:	
Cell Description	
- Network Colour Code	3
- Base Station Colour Code	0
- BCCH Carrier Number	See table below
Channel Description	
- Channel Type	TCH/H + ACCH's
- TDMA offset	Chosen arbitrarily.
- Timeslot number	Arbitrary value but not zero.
- Training Sequence Code	Chosen arbitrarily.
- Hopping	Single RF Channel.
- ARFCN	Chosen arbitrarily from the Cell Allocation of cell B.
Synchronization Indication	
- Report Observed Time Difference	Shall not be included.
- Synchronization Indication	"Non synchronized".
- Normal Cell Indication	Ignore out of range timing advance.
Mode of First Channel	Signalling only.

HANDOVER COMMAND

Band	ARFCN
GSM 450	274
GSM 480	321
GSM 710	477
GSM 750	477
T-GSM 810	477
GSM 850	167
GSM 900	40
DCS 1 800	764
PCS 1 900	664

Step 13: "x" = 750.

M = 6.

IMMEDIATE ASSIGNMENT

Information Element	value/remark
As default message contents except:	
L2 pseudo length	14 octets (11 + contents of the MA).
Channel Description	Channel Description.
- Channel Type	TCH/H + ACCHs
- TDMA offset	As default message contents.
- Timeslot number	Arbitrary value but not zero.
- Training Sequence Code	Chosen arbitrarily.
- Hopping	RF hopping channel.
- MAIO	Chosen arbitrarily from the set (0, 1 to N-1), where N is the number of frequencies encoded in the Mobile Allocation.
- HSN	Chosen arbitrarily from the set. (1,2,..63).
Mobile Allocation	
- Length	3 octets.
- Contents	Indicates all of the CA of cell A.

DCS 1 800 or PCS 1 900 begin:

HANDOVER COMMAND

Information Element	value/remarks
As default message contents, except:	
Cell Description	
- Network Colour Code	3
- Base Station Colour Code	0
- BCCH Carrier Number	DCS 1 800: 764 DCS 1 900: 664
Channel Description	
- Channel Type	TCH/F + ACCHs
- Timeslot number	Arbitrary value but not zero.
- Training Sequence Code	Chosen arbitrarily.
- Hopping	RF hopping channel.
- MAIO	Chosen arbitrarily from the set (0, 1 to N-1), where N is the number of frequencies encoded in the Frequency List IE.
- HSN	Chosen arbitrarily from the set. (1,2,..63).
Frequency List after time	
- Frequency List	Use Range 256 to encode the following 9 frequencies: DCS 1 800: 746, 749, 756, 761, 764, 798, 829, 832,844 PCS 1 900: 646, 649, 656, 661, 664, 698, 729, 732,744
Synchronization Indication IE not included.	
Channel Mode	Signalling Only.

DCS 1 800 or PCS 1 900 end:Other bands begin:

HANDOVER COMMAND

Information Element	value/remarks
As default message contents, except:	
Cell Description	
- Network Colour Code	3
- Base Station Colour Code	0
- BCCH Carrier Number	See table below
Channel Description	
- Channel Type	TCH/F + ACCHs
- Timeslot number	Arbitrary value but not zero.
- Training Sequence Code	Chosen arbitrarily.
- Hopping	RF hopping channel.
- MAIO	Chosen arbitrarily from the set (0, 1 to N-1), where N is the number of frequencies encoded in the Mobile Allocation IE.
- HSN	Chosen arbitrarily from the set (1,2,..63).
Cell Channel Description	uses Range 128 to encode the complete CA of cell B.
Mobile Allocation after time	Indicates the following 5 frequencies: (260, 262, 264, 270, 274
Synchronization Indication IE not included.	
Channel Mode	Signalling Only.

HANDOVER COMMAND

Band	Cell Description BCCH ARFCN	Cell Channel Description Format	Mobile Allocation ARFCNs
GSM 450	274	Range 128	260, 262, 264, 270, 274
GSM 480	321	Range 128	307, 309, 311, 317, 321
GSM 710	477	Range 128	451, 455, 459, 468, 477
GSM 750	477	Range 128	451, 455, 459, 468, 477
T-GSM 810	477	Range 128	451, 455, 459, 468, 477
GSM 850	167	Range 128	141, 145, 149, 158, 167
GSM 900	40	Bitmap 0	14, 18, 22, 31, 40

Other bands end:

M = 7:

IMMEDIATE ASSIGNMENT

Information Element	value/remark
As default message contents except: L2 pseudo length Channel Description - Channel Type - Timeslot number - Training Sequence Code - Hopping - MAIO - HSN Mobile Allocation - Length - Contents	14 octets (11 + contents of the MA). Channel Description. TCH/F + ACCHs Zero. Chosen arbitrarily. RF hopping channel. Chosen arbitrarily from the set (0, 1 to N-1), where N is the number of frequencies encoded in the Mobile Allocation. Zero. 3 octets. Indicates only one frequency (see table below).

IMMEDIATE ASSIGNMENT

Band	ARFCN
GSM 450	291
GSM 480	338
GSM 710	508
GSM 750	508
T-GSM 810	508
GSM 850	235
GSM 900	114
DCS 1 800	844
PCS 1 900	744

HANDOVER COMMAND

DCS 1 800 or PCS 1 900

Information Element	value/remarks
As default message contents, except: Cell Description - Network Colour Code - Base Station Colour Code - BCCH Carrier Number Channel Description - Channel Type - Timeslot number - Training Sequence Code - Hopping - MAIO - HSN Cell Channel Description Mobile Allocation Mode of First channel	 3 0 DCS 1 800: 764 PCS 1 900: 664 TCH/F + ACCHs Arbitrary value but not zero. Chosen arbitrarily. RF hopping channel. Chosen arbitrarily from the set (0, 1 to N-1), where N is the number of frequencies encoded in the Mobile Allocation. Chosen arbitrarily from the set. (1,2,..63). Use Variable bit map to encode the complete CA of cell B. Indicates all of the CA of cell B except for the following three frequencies: DCS 1 800: 764, 832 and 844 PCS 1 900: 664, 732, 744 Speech (full rate version 1 or half rate version 1).

Other Bands

Information Element	value/remarks
As default message contents, except:	
Cell Description	
- Network Colour Code	3
- Base Station Colour Code	0
- BCCH Carrier Number	See table below
Channel Description	
- Channel Type	TCH/F + ACCHs
- Timeslot number	Arbitrary value but not zero.
- Training Sequence Code	Chosen arbitrarily.
- Hopping	RF hopping channel.
- MAIO	Chosen arbitrarily from the set (0, 1 to N-1), where N is the number of frequencies encoded in the Frequency List IE.
- HSN	Chosen arbitrarily from the set (1,2,..63).
Synchronization Indication IE is not included:	
Frequency list after time.	
- Frequency List IE	See table below
Mode of First channel	Speech (full rate version 1 or half rate version 1).

HANDOVER COMMAND

Band	Cell Description BCCH Carrier Number	Format	Frequency List
			ARFCNs
GSM 450	274	Range 128	260, 262, 264, 266, 268, 270, 272, 274, 276, 279, 281, 283, 285, 287, 289, 291
GSM 480	321	Range 128	307, 309, 311, 313, 315, 317, 319, 321, 323, 326, 328, 330, 332, 334, 336, 338
GSM 710	477	Range 128	451, 455, 459, 461, 467, 468, 475, 477, 497, 498, 500, 501, 502, 503, 506, 508
GSM 750	477	Range 128	451, 455, 459, 461, 467, 468, 475, 477, 497, 498, 500, 501, 502, 503, 506, 508
T-GSM 810	477	Range 128	451, 455, 459, 461, 467, 468, 475, 477, 497, 498, 500, 501, 502, 503, 506, 508
GSM 850	167	Range 128	141, 145, 149, 151, 157, 158, 165, 167, 187, 193, 200, 201, 202, 203, 235, 241
GSM 900	40	Bitmap 0	14, 18, 22, 24, 30, 31, 38, 40, 60, 66, 73, 74, 75, 76, 108, 114

Step 13: "x" = 500.

M = 8:

IMMEDIATE ASSIGNMENT

Information Element	value/remark
As default message contents except:	
L2 pseudo length	14 octets (11 + contents of the MA).
Channel Description	Channel Description.
- Channel Type	SDCCH/8
- TDMA offset	As default message contents.
- Timeslot number	Arbitrary value but not zero.
- Training Sequence Code	Chosen arbitrarily.
- Hopping	RF hopping channel.
- MAIO	Chosen arbitrarily from the set (0, 1 to N-1), where N is the number of frequencies encoded in the Mobile Allocation.
- HSN	Chosen arbitrarily from the set (1,2,..63).
Mobile Allocation	
- Length	3octets.
- Contents	Indicates only three frequencies: (see table below).

IMMEDIATE ASSIGNMENT

Band	ARFCNs
GSM 450	281, 283, 285
GSM 480	328, 330, 332
GSM 710	500, 501, 502
GSM 750	500, 501, 502
T-GSM 810	500, 501, 502
GSM 850	200, 201, 202
GSM 900	73, 74, 75
DCS 1 800	773, 775, 779
PCS 1 900	673, 675, 679

HANDOVER COMMAND

Information Element	value/remarks
As default message contents, except:	
Cell Description	
- Network Colour Code	3
- Base Station Colour Code	0
- BCCH Carrier Number	See table below
Channel Description	
- Channel Type	TCH/F + ACCHs
- Timeslot number	Zero.
- Training Sequence Code	Chosen arbitrarily.
- Hopping	Single RF Channel.
- ARFCN	Chosen arbitrarily from the Cell Allocation of Cell B, but not the BCCH carrier of Cell B.
Synchronization Indication IE not included.	
Mode of First Channel	Speech (full rate version 1 or half rate version 1).

HANDOVER COMMAND

Band	ARFCN
GSM 450	274
GSM 480	321
GSM 710	477
GSM 750	477
T-GSM 810	477
GSM 850	167
GSM 900	40
DCS 1 800	764
PCS 1 900	664

Step 13: "x" = 500.

M = 9:

IMMEDIATE ASSIGNMENT

Information Element	value/remark
As default message contents.	

HANDOVER COMMAND

DCS 1 800 and PCS 1 900 begin:

Information Element	value/remarks
As default message contents, except:	
Cell Description	
- Network Colour Code	3
- Base Station Colour Code	0
- BCCH Carrier Number	DCS 1 800: 764 PCS 1 900: 664
Channel Description	
- Channel Type	TCH/F + ACCHs
- Timeslot number	Arbitrary value, but not zero.
- Training Sequence Code	Chosen arbitrarily.
- Hopping	RF hopping channel.
- MAIO	Chosen arbitrarily from the set (0, 1 to N-1), where N is the number of frequencies encoded in the Frequency Short List IE.
- HSN	Zero (this gives cyclic hopping).
Frequency Short List after time	
- Frequency Short List	Use Range 256 to encode the following 3 frequencies: DCS 1 800: 764, 779, 782 PCS 1 900: 664, 679, 682
Synchronization Indication	
- Report Observed Time Difference	Shall not be included.
- Synchronization Indication	"Non synchronized".
- Normal Cell Indication	Ignore out of range timing advance.
Channel mode	Speech (full rate version 1 or half rate version 1)

DCS 1 800 and PCS 1 900 end:

Other bands begin:

Information Element	value/remarks
As default message contents, except:	
Cell Description	
- Network Colour Code	3
- Base Station Colour Code	0
- BCCH Carrier Number	See table below
Channel Description	
- Channel Type	TCH/F + ACCHs
- Timeslot number	zero.
- Training Sequence Code	Chosen arbitrarily.
- Hopping	RF hopping channel
- MAIO	Chosen arbitrarily from the set {0, 1}.
- HSN	Chosen arbitrarily from the set {1, 2, ..., 63}.
Synchronization Indication IE is not included	
Frequency List, after time.	
- Frequency List	allocates the following two frequencies See table below.
Mode of the first channel	Speech (full rate version 1 or half rate version 1).

Band	HANDOVER COMMAND	
	BCCH Carrier Number	Frequency List ARFCNs
GSM 450	274	260, 291
GSM 480	321	307, 338
GSM 710	447	451, 508
GSM 750	447	451, 508
T-GSM 810	447	451, 508
GSM 850	167	141, 241
GSM 900	40	14, 114

Other bands end:

Step 13: "x" = 500.

M = 10:

IMMEDIATE ASSIGNMENT

Information Element	value/remark
As default message contents.	

HANDOVER COMMAND

DCS 1 800 or PCS 1 9 00 begin:

Information Element	value/remarks
As default message contents, except:	
Cell Description	
- Network Colour Code	3
- Base Station Colour Code	0
- BCCH Carrier Number	DCS 1 800: 764 PCS 1 900: 664
Channel Description	
- Channel Type	TCH/H + ACCHs
- TDMA offset	Chosen arbitrarily.
- Timeslot number	Arbitrary value, but not zero.
- Training Sequence Code	Chosen arbitrarily.
- Hopping	RF hopping channel.
- MAIO	Chosen arbitrarily from the set (0, 1 to N-1), where N is the number of frequencies encoded in the Frequency List IE.
- HSN	Zero (this gives cyclic hopping).
Frequency List after time	
- Frequency List	Use Variable Bit Map to encode the following 15 frequencies: DCS 1 800: 739, 743, 746, 749, 756, 758, 764, 771, 779, 782, 791, 798, 829, 832, 844 PCS 1 900: 639, 643, 646, 649, 656, 658, 664, 671, 679, 682, 691, 698, 729, 732, 744
Synchronization Indication IE is not included.	
Channel mode	Speech (full rate version 1 or half rate version 1).

DCS 1 800 or PCS 1 9 00 end:

Step 13: "x" = 750.

Other bands begin:

Information Element	value/remarks
As default message contents, except:	
Cell Description	
- Network Colour Code	3
- Base Station Colour Code	0
- BCCH Carrier Number	See table below
Channel Description	
- Channel Type	TCH/H + ACCHs
- TDMA offset	Chosen arbitrarily.
- Timeslot number	Chosen arbitrarily but not zero.
- Training Sequence Code	Chosen arbitrarily.
- Hopping	RF hopping channel.
- MAIO	Chosen arbitrarily from the set {0, 1}.
- HSN	Chosen arbitrarily from the set {1, 2, ..., 63}.
Synchronization Indication IE is not included	
Frequency List, after time	
- Frequency List	allocates the following two frequencies { See table below }.
Channel Mode IE	speech (full rate version 1 or half rate version 1).

Band	HANDOVER COMMAND	
	BCCH Carrier Number	Frequency List ARFCNs
GSM 450	274	274, 291
GSM 480	321	321, 338
GSM 710	447	477, 508
GSM 750	447	477, 508
T-GSM 810	447	477, 508
GSM 850	167	167, 241
GSM 900	40	40, 114

Other bands end:

Step 13: "x" = 750.

Specific Message Contents For Mobiles not Supporting Speech

The message contents shall be the same for the Mobile Station supporting speech, except for:

M = 1, 7, 8 and 9:

HANDOVER COMMAND

Information Element	value/remarks
Mode of first channel	Arbitrary from those supported (12, 6, 3,6 kbps).

For M = 2 and 10 :

HANDOVER COMMAND

Information Element	value/remarks
Mode of first channel	Arbitrary from those supported (6, 3,6 kbps).

26.6.5.3 Handover / successful / active call / finely synchronized

26.6.5.3.1 Conformance requirements

The MS shall correctly apply the handover procedure from TCH/F with frequency hopping to TCH/F without frequency hopping in the finely synchronized case when a call is in progress.

The MS shall correctly apply the handover procedure from TCH/H with frequency hopping to TCH/H without frequency hopping in the finely synchronized case when a call is in progress. This requirement does not apply to MSs not supporting TCH/H.

References

3GPP TS 04.08 / 3GPP TS 44.018 subclauses 3.4.4, 9.1.14, 9.1.15 and 9.1.16.

3GPP TS 04.13 subclause 5.2.6.

3GPP TS 05.05 subclause 4.1.1.

3GPP TS 05.10, subclause 6.6.

26.6.5.3.2 Test purpose

To test that when the MS is ordered to make a finely synchronized handover to a synchronized cell, it sends 4 access bursts on the main DCCH (and optionally on the SACCH) and then activates the channel correctly, taking into account the value of any Starting Time information element, power command and correctly calculating the timing advance to use. To test the MS activates the new channel correctly and transmits the HANDOVER COMPLETE message without undue delay.

26.6.5.3.3 Method of test

Initial Conditions

System Simulator:

2 cells, A and B, with same LAI, default parameters, except:

The BCCH of cell A is sent k bit periods before the BCCH of cell B. The timing advance in cell A sent to the MS is y bit periods. k and y are selected such that $0 < (2k+y) \bmod 256 < 60$.

	Cell B BCCH ARFCN
GSM 450	274
GSM 480	321
GSM 710	477
GSM 750	477
T-GSM 810	477
GSM 850	167
GSM 900	40
DCS 1 800	764
PCS 1 900	647

Mobile Station:

The MS is in the active state (U10) of a call (on cell A). The MS is using a power level P . Where P is a power level within the supported range of that type of MS.

Specific PICS statements

- TSPC_Type_xxx (all appropriate power classes)

PIXIT statements

- supported radio interface rates: 12kbps, 6kbps, 3,6kbps

Foreseen Final State of the MS

The active state (U10) of a mobile call (on cell B).

Test Procedure

This procedure is repeated for execution counter $M = 1$ to 2. (See table 26.6-1.)

The MS is in the active state (U10) of a call on cell A. The SS sends a HANOVER COMMAND on the main DCCH. The MS shall (at the time specified in the Starting Time information element, if included) send 4 access bursts, in 4 successive slots on the new DCCH to cell B (Note: Before completion of the 4 access bursts on the DCCH, additional access bursts may also be sent on the SACCH). Then the MS shall establish a signalling link indicating the correct Timing Advance and power level and send a HANOVER COMPLETE message.

The MS shall be "ready to transmit" a HANOVER COMPLETE message before "x" ms after the end of the HANOVER COMMAND message, but not before a UA frame has been sent by the SS.

The term "ready to transmit" is defined in 3GPP TS 04.13. The value of "x" depends upon the target channel and is specified in the specific message contents section.

Maximum Duration of Test

5 minutes, including 1 minute for any necessary operator actions.

Expected Sequence

This sequence is performed for execution counter M = 1 for an MS which only supports TCH/F.

This sequence is performed for execution counter M = 1 to 2 for an MS which supports TCH/F and H.

Step	Direction	Message	Comments
0	MS -> SS		M = 1, The MS and SS are using a full rate TCH in hopping mode on cell A. M = 2, The MS and SS are using a half rate TCH in hopping mode on cell A.
1	SS -> MS	HANOVER COMMAND	See Specific Message Contents.
2	MS -> SS	HANOVER ACCESS	See specific message contents. Four messages.
3	MS -> SS	HANOVER ACCESS	are transmitted to Cell B in 4 successive slots.
4	MS -> SS	HANOVER ACCESS	on the new DCCH.
5	MS -> SS	HANOVER ACCESS	Before completion of the 4 access bursts on the new DCCH, additional access bursts may also be sent on the SACCH
6	MS -> SS	SABM	Sent without information field.
7	SS -> MS	UA	
8	MS -> SS	HANOVER COMPLETE	This message shall be ready to be transmitted before "x" ms after the completion of step 1. See specific message contents.
9	SS		The header of the next uplink SACCH is examined and the Timing Advance and Power Level indications are examined. The correct timing advance shall be indicated. A tolerance of ± 2 bit periods is allowed. The power level indication shall indicate the power level used in the handover command (see note).
10	MS, SS		M = 1, The MS and SS are using a full rate TCH in non-hopping mode on cell B M = 2, The MS and SS are using a half rate TCH in non-hopping mode on cell B.
NOTE:	In case the Handover procedure is completed within 1 SACCH multiframe, the powerlevel indication, of the power level used in the handover command, will be done in the second uplink SACCH sent on the target cell. As the indicated value shall be the power control level actually used by the mobile for the last burst of the previous SACCH period, the first uplink SACCH header will indicate the powerlevel used by the MS on the old cell, if the Handover procedure is completed within 1 SACCH multiframe. In this case the powerlevel examination shall be done in the second uplink SACCH header sent on the target cell. Reference: 05.08/45.008 clause 4.2.		

Specific Message Contents

M = 1:

HANDOVER COMMAND

Information Element	value/remark
As default message contents, except:	
Cell Description	
- Network Colour Code	1
- Base Station Colour Code	5
- BCCH Carrier Number	See table below
Channel Description	
- Channel type	TCH/F + ACCHs
- Timeslot Number	Arbitrary value, but not zero.
- Training Sequence Code	Chosen arbitrarily.
- Hopping	Single RF Channel.
- ARFCN	See table below
Handover Reference	
- Value	Chosen arbitrarily from the range (0, 1..255).
Power command	
- Power Level	Arbitrarily chosen, but different to the one already in use and within the range supported by that type of MS.
Synchronization Indication	
- Report Observed Time Difference	Shall not be included.
- Synchronization Indication	"Synchronized".
- Normal Cell Indication	Ignore out of range timing advance.

HANDOVER COMMAND

Band	BCCH Carrier Number and Channel Description ARFCN
GSM 450	274
GSM 480	321
GSM 710	477
GSM 750	477
T-GSM 810	477
GSM 850	167
GSM 90	40
DCS 1 800	764
PCS 1 900	647

HANDOVER ACCESS

Information Element	value/remark
As default message contents except:	
Handover Reference	
- Value	Same as HANDOVER COMMAND

Step 8: x = 650 ms.

M = 2:

HANDOVER COMMAND

Information Element	value/remark
As default message contents, except:	
Cell Description	
- Network Colour Code	1
- Base Station Colour Code	5
- BCCH Carrier Number	See table below
Channel Description	
- Channel type	TCH/H + ACCHs
- TDMA offset	Chosen arbitrarily.
- Timeslot Number	Arbitrary value, but not zero.
- Training Sequence Code	Chosen arbitrarily.
- Hopping	Single RF Channel.
- ARFCN	See table below
Handover Reference	
- Value	Chosen arbitrarily from the range (0, 1..255).
Power command	
- Power Level	Arbitrarily chosen, but different to the one already in use and within the range supported by that type of MS.
Synchronization Indication	
- Report Observed Time Difference	Shall not be included.
- Synchronization Indication	"Synchronized".
- Normal Cell Indication	Ignore out of range timing advance.
Mode of First Channel	If speech supported: Speech half rate version 1. if speech not supported: Arbitrary from the half rate data rates supported.

HANDOVER COMMAND

Band	BCCH Carrier Number and Channel Description ARFCN
GSM 450	274
GSM 480	321
GSM 710	477
GSM 750	477
T-GSM 810	477
GSM 850	167
GSM 90	40
DCS 1 800	764
PCS 1 900	647

HANDOVER ACCESS

Information Element	value/remark
As default message contents except:	
Handover Reference	
- Value	Same as HANDOVER COMMAND

Step 8: x = 900 ms.

26.6.5.4 Handover / successful / call under establishment / finely synchronized

26.6.5.4.1 Conformance requirements

The MS shall correctly apply the handover procedure from SDCCH/8 or TCH/F with or without frequency hopping to SDCCH4, SDCCH/8 or TCH/F with or without frequency hopping in the finely synchronized case, during call establishment.

If during call establishment a Layer 3 MM or CC message just sent by the MS is not Layer 2 acknowledged before the channel change caused by the HANDOVER COMMAND message, the MS shall send the Layer 3 message to the new cell, using the same value in the N(SD) field, after the handover procedure.

References

3GPP TS 05.10, subclause 6.6.

3GPP TS 04.08 / 3GPP TS 44.018, subclause 3.4.4.

3GPP TS 04.08 / 3GPP TS 44.018, subclause 3.1.4.2.

3GPP TS 04.13, subclause 5.2.6.

26.6.5.4.2 Test purpose

To test that when the MS is ordered to make a finely synchronized handover to a synchronized cell, it sends 4 access bursts on the main DCCH (and optionally the SACCH) and then activates the channel correctly, taking into account the value of any Starting Time information element, power command and correctly calculating the timing advance to use. To test that the MS correctly retransmits Layer 3 MM or CC messages that were not acknowledged by Layer 2 before the Handover, after completion of the Handover. To verify the MS transmits the HANDOVER COMPLETE message without undue delay.

26.6.5.4.3 Method of test

Initial Conditions

System Simulator:

2 cells, A and B, with same LAI, default parameters, except:

The BCCH of cell A is sent k bit periods before the BCCH of cell B. The timing advance in cell A sent to the MS is y bit periods. k and y are selected such that $0 < (2k + y) \bmod 256 < 60$.

The frame numbers of cells A and B shall be different by 100.

Band	BCCH ARFCN	Cell A Cell Allocation	BCCH ARFCN	Cell B Cell Allocation
GSM 450	263	259, 261, 263, 265, 267, 269, 271, 273, 275, 277, 279, 281, 283, 285, 287, 289, 291	274	260, 262, 264, 266, 268, 270, 272, 274, 276, 279, 281, 283, 285, 287, 289, 291
GSM 480	310	306, 308, 310, 312, 314, 316, 318, 320, 322, 324, 326, 328, 330, 332, 334, 336, 338	321	307, 309, 311, 313, 315, 317, 319, 321, 323, 326, 328, 330, 332, 334, 336, 338
GSM 710	457	447, 454, 457, 463, 471, 479, 482, 483, 489, 496, 498, 500, 501, 502, 503, 506, 508	477	451, 455, 459, 461, 467, 468, 475, 477, 497, 498, 500, 501, 502, 503, 506, 508
GSM 750	457	447, 454, 457, 463, 471, 479, 482, 483, 489, 496, 498, 500, 501, 502, 503, 506, 508	477	451, 455, 459, 461, 467, 468, 475, 477, 497, 498, 500, 501, 502, 503, 506, 508
T-GSM 810	457	447, 454, 457, 463, 471, 479, 482, 483, 489, 496, 498, 500, 501, 502, 503, 506, 508	477	451, 455, 459, 461, 467, 468, 475, 477, 497, 498, 500, 501, 502, 503, 506, 508
GSM 850	147	137, 144, 147, 153, 161, 169, 172, 173, 179, 186, 193, 200, 201, 202, 203, 235, 24	167	141, 145, 149, 151, 157, 158, 165, 167, 187, 193, 200, 201, 202, 203, 235, 241
GSM 900	20	10, 17, 20, 26, 34, 42, 45, 46, 52, 59, 66, 73, 74, 75, 76, 108, 114	40	14, 18, 22, 24, 30, 31, 38, 40, 60, 66, 73, 74, 75, 76, 108, 114
DCS 1 800	747	734, 741, 747, 754, 759, 762, 766, 767, 773, 775, 779, 782, 791, 798, 829, 832, 844	764	739, 743, 746, 749, 756, 758, 761, 764, 771, 779, 782, 791, 798, 829, 832, 844
PCS 1 900	647	634, 641, 647, 654, 659, 662, 666, 667, 673, 675, 679, 682, 691, 698, 729, 732, 744	664	639, 643, 646, 649, 656, 658, 661, 664, 671, 679, 682, 691, 698, 729, 732, 744

Mobile Station:

The MS is in the "idle, updated" state, with a TMSI allocated and camped on cell A. The MS is using a power level P , where P is a power level within the supported range of that type of MS.

Specific PICS statements

- MS supports Speech (TSPC_AddInfo_SDCCHOnly)
- TSPC_Type_xxx (all appropriate power classes)

PIXIT statements

- supported radio interface rates: 12kbps, 6kbps, 3,6kbps

Foreseen Final State of the MS

"Idle, updated" with TMSI allocated and camped on cell B.

Test Procedure

This procedure is repeated for execution counter $M = 1, 2, 3, 4$ (see table 26.6-1).

A Mobile Originating Call is initiated on cell A. After the MS has sent the SETUP message (and before the last L2 frame carrying the SETUP message is acknowledged by the SS) the SS sends a HANOVER COMMAND message, ordering the MS to switch to cell B. The MS shall then (at the time specified in the Starting Time information element, if included) send 4 access bursts, in successive slots on the new DCCH to cell B (Note: Before completion of the 4 access bursts on the new DCCH, additional access bursts may also be sent on the SACCH). Then the MS shall establish a signalling link indicating the correct timing advance and power level and send a HANOVER COMPLETE message. The MS shall be "ready to transmit" the HANOVER COMPLETE message before "x" ms after the end of the HANOVER COMMAND message, but not before a UA frame has been sent by the SS. The MS shall then again send the SETUP message to the SS, using the same value in the N(SD) field. Finally the SS sends a CHANNEL RELEASE to end the test.

The term "ready to transmit" is defined in 3GPP TS 04.13. The value "x" depends upon the target channel and is specified in the specific message contents section.

Maximum Duration of Test

5 minutes, including 1 minute for any necessary operator actions.

Expected Sequence

This procedure is repeated for execution counter $M = 1, 2, 3, 4$ (unless a particular TCH is not supported).

Step	Direction	Message	Comments
1	-----	-----	A MO call is initiated.
2	MS -> SS	CHANNEL REQUEST	Establish. Cause = "Originating call, NECI not set to 1"
3	SS -> MS	IMMEDIATE ASSIGNMENT	See Specific Message contents.
4	MS -> SS	CM SERVICE REQUEST	CM Service Type = Mobile Originating Call Establishment.
5	SS -> MS	CIPHERING MODE COMMAND	
6	MS -> SS	CIPHERING MODE COMPLETE	
7	MS -> SS	SETUP	Last L2 frame not acknowledged by the SS.
8	SS -> MS	HANDOVER COMMAND	See Specific Message Contents.
9	MS -> SS	HANDOVER ACCESS	
10	MS -> SS	HANDOVER ACCESS	
11	MS -> SS	HANDOVER ACCESS	See Specific message contents. Four.
12	MS -> SS	HANDOVER ACCESS	Messages are transmitted to cell B in 4 successive slots on the new DCCH. If the HANDOVER COMMAND message includes a starting time IE then the first HANDOVER ACCESS message shall be transmitted in the indicated frame (unless the starting time has elapsed). Before completion of the 4 access bursts on the new DCCH, additional access bursts may also be sent on the SACCH.
13	MS -> SS	SABM	Sent without information field.
14	SS -> MS	UA	
15	MS -> SS	HANDOVER COMPLETE	The message shall be ready to be transmitted before "x" ms after the completion of step 8.
16	SS		The header of the next uplink SACCH is examined and the Timing Advance and Power Level indications are examined. The correct timing advance shall be indicated. A tolerance of ± 2 bit periods is allowed. The power level indication shall indicate the power level used in the handover command (see note).
17	MS -> SS	SETUP	Same N(SD) as in step 7.
18	SS -> MS	CHANNEL RELEASE	
NOTE: In case the Handover procedure is completed within 1 SACCH multiframe, the powerlevel indication, of the power level used in the handover command, will be done in the second uplink SACCH sent on the target cell. As the indicated value shall be the power control level actually used by the mobile for the last burst of the previous SACCH period, the first uplink SACCH header will indicate the powerlevel used by the MS on the old cell, if the Handover procedure is completed within 1 SACCH multiframe. In this case the powerlevel examination shall be done in the second uplink SACCH header sent on the target cell. Reference: 05.08/45.008 clause 4.2.			

Specific Message Contents

M = 1:

IMMEDIATE ASSIGNMENT

Information Element	value/remark
As default message contents except:	
Channel Description	Channel Description.
- Channel Type	SDCCH/8
- TDMA offset	As default message contents.
- Timeslot number	Arbitrary value, but not zero.
- Training Sequence Code	Chosen arbitrarily.
- Hopping	RF hopping channel.
- MAIO	Chosen arbitrarily from the set (0, 1 to N-1), where N is the number of frequencies encoded in the Mobile Allocation.
- HSN	Chosen arbitrarily from the set. (1,2,..63).
Mobile Allocation	Indicates all of the CA of cell A except for the BCCH frequency.

HANDOVER COMMAND

Information Element	value/remark
As default message contents except:	
Cell Description	
- Network Colour Code	1
- Base Station Colour Code	5
- BCCH Carrier Number	See table below
Channel Description	
- Channel Type	SDCCH/8
- TDMA offset	Chosen arbitrarily.
- Timeslot number	Arbitrary value, but not zero.
- Training Sequence Code	Chosen arbitrarily.
- Hopping	RF hopping channel.
- MAIO	Chosen arbitrarily from the set (0, 1 to N-1), where N is the number of frequencies encoded in the Frequency List IE.
- HSN	Zero (this gives cyclic hopping).
Frequency List after time	
- Frequency List	Use format from table below to encode the complete CA of Cell B.
Handover Reference	
- Value	Chosen arbitrarily from the range (0, 1..255).
Power command	
- Power Level	Arbitrarily chosen, but different to the one already in use and within the range supported by the MS.
Synchronization Indication	
- Report Observed Time Difference	Shall not be included.
- Synchronization Indication	"Synchronized".
- Normal Cell Indication	Ignore out of range timing advance.
Mode of First Channel	Signalling only

Band	HANDOVER COMMAND	
	Cell Description BCCH Carrier Number	Frequency List Format
GSM 450	274	Range 128
GSM 480	321	Range 128
GSM 710	477	Range 128
GSM 750	477	Range 128
T-GSM 810	477	Range 128
GSM 850	167	Range 128
GSM 900	40	Bitmap 0
DCS 1 800	764	Range 512
PCS 1 900	664	Range 512

HANDOVER ACCESS

Information Element	value/remark
As default message contents except:	
Handover Reference	
- Value	Same as HANDOVER COMMAND

Step 15: $x = 1\ 500$ ms.

M = 2:

IMMEDIATE ASSIGNMENT

Information Element	value/remark
As default message contents except: Channel Description <ul style="list-style-type: none"> - Channel Type - TDMA offset - Timeslot number - Training Sequence Code - Hopping - MAIO <ul style="list-style-type: none"> - HSN Mobile Allocation	Channel Description. SDCCH/8 As default message contents. zero. Chosen arbitrarily. RF hopping channel. Chosen arbitrarily from the set (0, 1 to N-1), where N is the number of frequencies encoded in the Mobile Allocation. Zero (this gives cyclic hopping). Indicates all of the CA of cell A except for the following 2 frequencies: See table below.

IMMEDIATE ASSIGNMENT

Band	Mobile Allocation ARFCNs
GSM 450	263 and 275
GSM 480	310 and 322
GSM 710	457 and 489
GSM 750	457 and 489
T-GSM 810	457 and 489
GSM 850	147 and 179
GSM 900	20 and 52
DCS 1 800	747 and 767
PCS 1 900	647 and 667

HANDOVER COMMAND

Information Element	value/remark
As default message contents except: Cell Description <ul style="list-style-type: none"> - Network Colour Code - Base Station Colour Code - BCCH Carrier Number Channel Description <ul style="list-style-type: none"> - Channel Type - TDMA offset - Timeslot number - Training Sequence Code - Hopping - ARFCN Handover Reference <ul style="list-style-type: none"> - Value Power command <ul style="list-style-type: none"> - Power Level Synchronization Indication <ul style="list-style-type: none"> - Report Observed Time Difference - Synchronization Indication - Normal Cell Indication Starting Time	1 5 See table below SDCCH/4 Chosen arbitrarily. zero. same as the BCCH. Single RF Channel. See table below Chosen arbitrarily from the range (0, 1..255). Arbitrarily chosen, but different to the one already in use and within the range supported by the MS. Shall not be included. "Synchronized". Ignore out of range timing advance. Indicates the frame number of cell B that will occur approximately 1,1 seconds after the HANDOVER COMMAND message is sent by cell A.

HANDOVER COMMAND
Band **BCCH Carrier Number and**
 Channel Description ARFCN

GSM 450	274
GSM 480	321
GSM 710	477
GSM 750	477
T-GSM 810	477
GSM 850	167
GSM 900	40
DCS 1 800	764
PCS 1 900	664

HANDOVER ACCESS

Information Element	value/remark
As default message contents except: Handover Reference - Value	Same as HANDOVER COMMAND

Step 15: $x = 2\ 600$ ms.

M = 3:

IMMEDIATE ASSIGNMENT

Information Element	value/remark
As default message contents except: Channel Description - Channel Type - Timeslot number - Training Sequence Code - Hopping - ARFCN	Channel Description. TCH/F + ACCHs Arbitrary value, but not zero. Chosen arbitrarily. Single RF Channel. See table below

IMMEDIATE ASSIGNMENT

Band	Channel Description ARFCN
GSM 450	263
GSM 480	310
GSM 710	457
GSM 750	457
T-GSM 810	457
GSM 850	147
GSM 900	20
DCS 1 800	747
PCS 1 900	647

HANDOVER COMMAND

DCS 1 800 or PCS 1 900

Information Element	value/remark
As default message contents except:	
Cell Description	
- Network Colour Code	1
- Base Station Colour Code	5
- BCCH Carrier Number	DCS 1 800: 764 PCS 1 900; 664
Channel Description	
- Channel Type	TCH/F + ACCHs
- Timeslot number	zero
- Training Sequence Code	Chosen arbitrarily.
- Hopping	RF hopping channel.
- MAIO	Chosen arbitrarily from the set (0, 1 to N-1), where N is the number of frequencies encoded in the Frequency Short list IE.
- HSN	Chosen arbitrarily from the set (1,2,..63).
Frequency Short List after time	
- Frequency Short List	Use Range 128 to encode the following 3 frequencies: DCS 1 800: 758, 761, 771 PCS 1 900: 658, 661, 671
Handover Reference	
- Value	Chosen arbitrarily from the range (0, 1..255).
Power command	
- Power Level	Arbitrarily chosen, but different to the one already in use and within the range supported by the MS.
Synchronization Indication	
- Report Observed Time Difference	Shall not be included.
- Synchronization Indication	"Synchronized".
- Normal Cell Indication	Ignore out of range timing advance.

GSM 450, GSM 480, GSM 850:

Information Element	value/remark
As default message contents except:	
Cell Description	
- Network Colour Code	1
- Base Station Colour Code	5
- BCCH Carrier Number	See table below
Channel Description	
- Channel Type	TCH/F + ACCHs
- Timeslot number	zero.
- Training Sequence Code	Chosen arbitrarily.
- Hopping	RF hopping channel.
- MAIO	Chosen arbitrarily from the set (0, 1 to N-1), where N is the number of frequencies encoded in the Frequency List IE.
- HSN	Chosen arbitrarily from the set (1,2,..63).
Frequency List after time	
- Frequency List	See table below
Handover Reference	
- Value	Chosen arbitrarily from the range (0, 1..255).
Power command	
- Power Level	Arbitrarily chosen, but different to the one already in use and within the range supported by the MS.
Synchronization Indication	
- Report Observed Time Difference	Shall not be included.
- Synchronization Indication	"Synchronized".
- Normal Cell Indication	Ignore out of range timing advance.

Band	BCCH ARFCN	Frequency List after Time
GSM 450	274	279, 285, 287, 289
GSM 480	321	326, 332, 334, 336
GSM 850	167	193, 202, 203, 235

GSM 710, GSM 750, T-GSM 810, GSM 900:

Information Element	value/remark
As default message contents except:	
Cell Description	
- Network Colour Code	1
- Base Station Colour Code	5
- BCCH Carrier Number	See table below
Channel Description	
- Channel Type	TCH/F + ACCHs
- Timeslot number	zero.
- Training Sequence Code	Chosen arbitrarily.
- Hopping	RF hopping channel.
- MAIO	Chosen arbitrarily from the set (0, 1 to N-1), where N is the number of frequencies encoded in the Frequency Channel Sequence IE.
- HSN	Chosen arbitrarily from the set (1,2,..63).
Frequency Channel Sequence after time	
- Frequency Channel Sequence	See table below
Handover Reference	
- Value	Chosen arbitrarily from the range (0, 1..255).
Power command	
- Power Level	Arbitrarily chosen, but different to the one already in use and within the range supported by the MS.
Synchronization Indication	
- Report Observed Time Difference	Shall not be included.
- Synchronization Indication	"Synchronized".
- Normal Cell Indication	Ignore out of range timing advance.

Band	BCCH ARFCN	Frequency Channel Sequence
GSM 710	477	498, 502, 503, 506
GSM 750	477	498, 502, 503, 506
T-GSM 810	477	498, 502, 503, 506
GSM 900	40	66, 75, 76, 108

HANDOVER ACCESS

Information Element	value/remark
As default message contents except:	
Handover Reference	
- Value	Same as HANDOVER COMMAND

Step 15: x = 650 ms.

M = 4:

IMMEDIATE ASSIGNMENT

Information Element	value/remark
As default message contents except: Channel Description - Channel Type - TDMA offset - Timeslot number - Training Sequence Code - Hopping - ARFCN	Channel Description. SDCCH/8 As default message contents. As default message contents. Chosen arbitrarily. Single RF Channel. Chosen arbitrarily from the Cell Allocation of Cell A.

HANDOVER COMMAND

Information Element	value/remark
As default message contents except: Cell Description - Network Colour Code - Base Station Colour Code - BCCH Carrier Number Channel Description - Channel Type - Timeslot number - Training Sequence Code - Hopping - ARFCN Handover Reference - Value Power command - Power Level Synchronization Indication - Report Observed Time Difference - Synchronization Indication - Normal Cell Indication Channel Mode	1 5 See table below TCH/F + ACCHs Arbitrary value, but not zero. Chosen arbitrarily. Single RF Channel. Chosen arbitrarily from the Cell Allocation of Cell B. Chosen arbitrarily from the range (0, 1..255). Arbitrarily chosen, but different to the one already in use and within the range supported by the MS. Shall not be included. "Synchronized". Ignore out of range timing advance. If speech is supported: Speech (full rate version 1 or half rate version 1). If speech is not supported: arbitrary from those supported (12, 6, 3,6 kbps).

HANDOVER COMMAND	
Band	BCCH Carrier Number
GSM 450	274
GSM 480	321
GSM 710	477
GSM 750	477
T-GSM 810	477
GSM 850	167
GSM 900	40
DCS 1 800	764
PCS 1 900	664

HANDOVER ACCESS

Information Element	value/remark
As default message contents except: Handover Reference - Value	Same as HANDOVER COMMAND

Step 15: x = 650 ms.

26.6.5.5 Pre-synchronized handovers

26.6.5.5.1 Handover / successful / active call / pre-synchronized / Timing Advance IE not included

If an MS does not implement the pre-synchronized handover procedure correctly then calls may fail.

26.6.5.5.1.1 Conformance requirements

- 1 The MS shall correctly apply the handover procedure from TCH/F without frequency hopping to TCH/F without frequency hopping in the pre-synchronized case when a call is active.
- 2 When the Timing Advance information element is not included in the HANOVER COMMAND, the MS shall access the new cell with the default timing advance of 1 bit period.
- 3 The MS shall be ready to transmit the HANOVER COMPLETE message within 650 ms of the end of the HANOVER COMMAND message.

References

Conformance requirement 1: 3GPP TS 04.08 / 3GPP TS 44.018 subclause 3.4.4.

Conformance requirement 2: 3GPP TS 05.10, subclause 6.6.

Conformance requirement 3: 3GPP TS 04.13, subclause 5.2.6.1.

26.6.5.5.1.2 Test purpose

To verify that when the MS is ordered to make a pre-synchronized handover to another cell, it sends 4 access bursts on the main DCCH (and optionally on the SACCH) and then activates the channel correctly and correctly calculates the time to transmit.

26.6.5.5.1.3 Method of test

Initial Conditions

System Simulator:

2 cells, A and B, with same LAI, default parameters.

The BCCH of cell A is sent k bit periods before the BCCH of cell B. k is arbitrarily selected.

Mobile Station:

The MS is in the active state (U10) of a call (on cell A) using a full rate TCH in non-hopping mode.

Specific PICS statements

-

PIXIT statements

-

Foreseen Final State of the MS

The active state (U10) of a mobile call (on cell B) using a full rate TCH in non-hopping mode.

Test Procedure

The MS is in the active state (U10) of a call on cell A. The SS sends a HANOVER COMMAND for a pre-synchronized handover without the Timing Advance IE on the main DCCH. The MS shall send 4 access bursts, in 4 successive slots of the new DCCH to cell B with a Timing Advance of zero (Note: Before completion of the 4 access bursts on the new DCCH, additional access bursts may also be sent on the SACCH). Then the MS shall establish a signalling link using a Timing Advance of one and send a HANOVER COMPLETE message. The MS shall be ready to transmit the HANOVER COMPLETE message before 650 ms after the end of the HANOVER COMMAND message, but not before a UA frame has been sent by the SS.

The term "ready to transmit" is defined in 3GPP TS 04.13.

Maximum Duration of Test

5 s.

Expected Sequence

Step	Direction	Message	Comments
1	SS -> MS	HANDOVER COMMAND	See specific message contents below.
2	MS -> SS	HANDOVER ACCESS	Handover Reference as included in the
3	MS -> SS	HANDOVER ACCESS	HANDOVER COMMAND.
4	MS -> SS	HANDOVER ACCESS	
5	MS -> SS	HANDOVER ACCESS	Before completion of the 4 access bursts on the new DCCH, additional access bursts may also be sent on the SACCH.
6	MS -> SS	SABM	Sent without information field.
7	SS -> MS	UA	
8	MS -> SS	HANDOVER COMPLETE	This message shall be ready to be transmitted before 650 ms after the completion of step 1.
9	SS	-	The SS checks that the timing advance reported in the layer 1 header of the SACCH message that is sent in the first SACCH multiframe following the SABM is 1 bit period.

Specific Message Contents

HANDOVER COMMAND

As default message contents, except: Synchronization Indication	pre-synchronized; ROT=0; NCI=0.
--	---------------------------------

26.6.5.5.2 Handover / successful / call being established / pre-synchronized / timing advance IE is included / reporting of observed time difference requested

If an MS does not implement the pre-synchronized handover procedure correctly then calls may fail.

If an MS does not report the observed time difference between cells correctly then pseudo synchronized handovers might not be possible for any MS.

26.6.5.5.2.1 Conformance requirements

- 1 The MS shall correctly apply the handover procedure from an SDCCH/4 to a TCH/F without frequency hopping in the pre-synchronized case while a call is being established.
- 2 If during call establishment a Layer 3 MM or CC message just sent by the MS is not Layer 2 acknowledged before the channel change caused by the HANDOVER COMMAND message, the MS shall send the Layer 3 message to the new cell, using the same value in the N(SD) field, after the handover procedure.
- 3 When the Timing Advance information element is included in the HANDOVER COMMAND, the MS shall access the new cell with the timing advance included in the Timing Advance IE.
- 4 The MS shall be ready to transmit the HANDOVER COMPLETE message within 650 ms of the end of the HANDOVER COMMAND message.
- 5 When requested to do so in the HANDOVER COMMAND message, the MS shall return the Mobile Time Difference IE in the HANDOVER COMPLETE message indicating the sum of the observed time difference between the cells and the timing advance used on the old cell.

References

Conformance requirement 1: 3GPP TS 04.08 / 3GPP TS 44.018, subclause 3.4.4.

Conformance requirement 2: 3GPP TS 04.08 / 3GPP TS 44.018, subclause 3.1.4.3.

Conformance requirement 3: 3GPP TS 05.10, subclause 6.6.

Conformance requirement 4: 3GPP TS 04.13, subclause 5.2.6.1.

Conformance requirement 5: 3GPP TS 04.08 / 3GPP TS 44.018, subclause 10.5.2.39.

26.6.5.5.2.2 Test purpose

To test that when the MS is ordered to make a pre-synchronized handover to another cell, it sends 4 access bursts on the main DCCH (and optionally on the SACCH) and then activates the channel correctly and correctly calculates the time to transmit. To test that the MS correctly retransmits Layer 3 MM or CC messages that were not acknowledged by Layer 2 before the Handover, after completion of the Handover. To test that the MS correctly reports on the time difference between the cells.

26.6.5.5.2.3 Method of test

Initial Conditions

System Simulator:

2 cells, A and B, with same LAI, default parameters.

The BCCH of cell A is sent k bit periods before the BCCH of cell B.

Mobile Station:

The MS is in the "idle, updated" state, with a TMSI allocated and camped on cell A.

Specific PICS statements

-

PIXIT statements

-

Foreseen Final State of the MS

"Idle, updated" with TMSI allocated and camped on cell B.

Test Procedure

A Mobile Originating Call is initiated. The SS sends an IMMEDIATE ASSIGNMENT message allocating an SDCCH/4. The MS is commanded to use a timing advance of y bit periods on cell A. After the MS has sent the SETUP message (and before the last L2 frame carrying the SETUP message is acknowledged by the SS) the SS sends a HANDOVER COMMAND, ordering the MS to switch to cell B. The MS shall then send 4 access bursts, in 4 successive slots of the new DCCH to cell B (Note: Before completion of the 4 access bursts on the new DCCH, additional access bursts may also be sent on the SACCH). Then the MS shall establish a signalling link using the correct timing advance and send a HANDOVER COMPLETE message. The MS shall be ready to transmit the HANDOVER COMPLETE message before 650 ms after the end of the HANDOVER COMMAND message, but not before a UA frame has been sent by the SS.

The term "ready to transmit" is defined in 3GPP TS 04.13.

The MS shall then again send the SETUP message to the SS, using the same value in the N(SD) field. Finally the SS sends a CHANNEL RELEASE to end the test.

Maximum Duration of Test

20 s.

Expected Sequence

Step	Direction	Message	Comments
1	-----	-----	A MO call is initiated.
2	MS -> SS	CHANNEL REQUEST	
3	SS -> MS	IMMEDIATE ASSIGNMENT	to an SDCCH/4.
4	MS -> SS	CM SERVICE REQUEST	
5	SS -> MS	CIPHERING MODE COMMAND	
6	MS -> SS	CIPHERING MODE COMPLETE	
7	MS -> SS	SETUP	Last L2 frame not acknowledged by the SS.
8	SS -> MS	HANDOVER COMMAND	See specific message contents below.
9	MS -> SS	HANDOVER ACCESS	Handover Reference as included in the
10	MS -> SS	HANDOVER ACCESS	HANDOVER COMMAND
11	MS -> SS	HANDOVER ACCESS	
12	MS -> SS	HANDOVER ACCESS	Before completion of the 4 access bursts on the new DCCH, additional access bursts may also be sent on the SACCH.
13	MS -> SS	SABM	Sent without information field.
14	SS -> MS	UA	
15	MS -> SS	HANDOVER COMPLETE	This message shall be ready to be transmitted before 650 ms after the completion of step 8. Shall include the Mobile Time Difference IE with value $(2k+y) \bmod 2,097,152$ half bit periods. A tolerance of ± 2 half bit periods is allowed.
16	MS -> SS	SETUP	Same N(SD) as in step 7
17	SS	-	The SS checks that the timing advance reported in the layer 1 header of the SACCH message that is sent in the first SACCH multiframe following the SABM is 9 bit periods. A tolerance of ± 2 bit periods is allowed.
18	SS -> MS	CHANNEL RELEASE	

Specific Message Contents

HANDOVER COMMAND

As default message contents, except: Synchronization Indication Timing Advance	pre-synchronized; ROT=1; NCI=0. 9 bit periods.
--	---

26.6.5.6 Handover / successful / active call / pseudo synchronized

If MSs that claim to support this procedure do not correctly implement it, then calls may fail.

26.6.5.6.1 Conformance requirements

- 1 The MS shall correctly apply the handover procedure from TCH/F without frequency hopping to TCH/F without frequency hopping in the pseudo synchronized case when a call is in progress.
- 2 The MS shall access the new cell with the correct timing advance.
- 3 The MS shall be ready to transmit the HANDOVER COMPLETE message within 650 ms of the end of the HANDOVER COMMAND message.
- 4 When requested to do so in the HANDOVER COMMAND message, the MS shall return the Mobile Time Difference IE in the HANDOVER COMPLETE message indicating the sum of the observed time difference between the cells and the timing advance used on the old cell.

References

Conformance requirement 1: 3GPP TS 04.08 / 3GPP TS 44.018 subclause 3.4.4.

Conformance requirement 2: 3GPP TS 05.10, subclause 6.6.

Conformance requirement 3: 3GPP TS 04.13, subclause 5.2.6.1.

Conformance requirement 4: 3GPP TS 04.08 / 3GPP TS 44.018, subclause 10.5.2.39.

26.6.5.6.2 Test purpose

To test that when the MS is ordered to make a pseudo synchronized handover to another cell, it sends 4 access bursts on the main DCCH (and optionally the SACCH) and then activates the channel correctly and correctly calculates the time to transmit. To test that the MS correctly reports the time difference between the cells.

26.6.5.6.3 Method of test

Initial Conditions

System Simulator:

2 cells, A and B, with same LAI, default parameters.

The BCCH of cell A is sent k bit periods before the BCCH of cell B. k is arbitrarily selected.

The MS is being commanded to use a timing advance of y bit periods on cell A, where y is arbitrarily selected from the set $\{11, 12, \dots, 62\}$.

Mobile Station:

The MS is in the active state (U10) of a call (on cell A) using a full rate TCH in non-hopping mode.

Specific PICS statements

-

PIXIT statements

-

- .

Foreseen Final State of the MS

The active state (U10) of a mobile call (on cell B) using a full rate TCH in non-hopping mode.

Test Procedure

The MS is in the active state (U10) of a call on cell A. The SS sends a HANOVER COMMAND for a pseudo-synchronized handover with the Real Time Difference IE included. The Time Difference value is set to $(2k+10)$ modulo 256. The MS shall send 4 access bursts, , in 4 successive slots of the new DCCH to cell B with a Timing Advance of zero (Note: Before completion of the 4 access bursts on the new DCCH, additional access bursts may also be sent on the SACCH). Then the MS shall establish a signalling link using a Timing Advance of $(y-10)$ bit periods and send a HANOVER COMPLETE message. The MS shall be ready to transmit the HANOVER COMPLETE message before 650 ms after the end of the HANOVER COMMAND message, but not before a UA frame has been sent by the SS.

The term "ready to transmit" is defined in 3GPP TS 04.13.

Maximum Duration of Test

5 s.

Expected Sequence

Step	Direction	Message	Comments
1	SS -> MS	HANDOVER COMMAND	See specific message contents below.
2	MS -> SS	HANDOVER ACCESS	Handover Reference as included in the
3	MS -> SS	HANDOVER ACCESS	HANDOVER COMMAND.
4	MS -> SS	HANDOVER ACCESS	
5	MS -> SS	HANDOVER ACCESS	Before completion of the 4 access bursts on the new DCCH, additional access bursts may also be sent on the SACCH.
6	MS -> SS	SABM	Sent without information field.
7	SS -> MS	UA	
8	MS -> SS	HANDOVER COMPLETE	This message shall be ready to be transmitted before 650 ms after the completion of step 1. Shall include the Mobile Time Difference IE with value $(2k+y) \bmod 2,097,152$ half bit periods. A tolerance of ± 2 half bit periods is allowed.
9	SS	-	The SS checks that the timing advance reported in the layer 1 header of the SACCH message that is sent in the first SACCH multiframe following the SABM is $(y-10)$ bit periods. A tolerance of ± 2 bit periods is allowed.

Specific Message Contents

HANDOVER COMMAND

As default message contents, except: Synchronization Indication Time Difference	pseudo-synchronized; ROT=1; NCI=0. $(2k+10) \bmod 256$.
---	---

26.6.5.7 Handover / successful / active call / non-synchronized / reporting of observed time difference requested

If an MS does not report the observed time difference between cells correctly then pseudo synchronized handovers might not be possible for any MS.

26.6.5.7.1 Conformance requirements

- 1 The MS shall correctly apply the handover procedure from a TCH/F without frequency hopping to a TCH/F without frequency hopping in the non-synchronized case while a call is active.
- 2 When requested to do so in the HANDOVER COMMAND message, the MS shall return the Mobile Time Difference IE in the HANDOVER COMPLETE message indicating the sum of the observed time difference between the cells and the timing advance used on the old cell.

References

Conformance requirement 1: 3GPP TS 04.08 / 3GPP TS 44.018, subclause 3.4.4.

Conformance requirement 2: 3GPP TS 04.08 / 3GPP TS 44.018, subclause 10.5.2.39.

26.6.5.7.2 Test purpose

To verify that when the MS is ordered to make a non-synchronized handover to another cell and is ordered to report on the time difference between the cells, that it does so correctly.

26.6.5.7.3 Method of test

Initial Conditions

System Simulator:

2 cells, A and B with default parameters except the LAI of cell B has MNC = 02 (PCS 1 900: MNC = 021) decimal, MCC = 315 decimal, and LAC = 5344 H.

The BCCH of cell A is sent k bit periods before the BCCH of cell B.

The MS is commanded to use a timing advance of y bit periods on cell A.

Mobile Station:

The MS is in the active state (U10) of a call (on cell A) using a full rate TCH in non-hopping mode.

Specific PICS statements

-

PIXIT statements

-

Foreseen Final State of the MS

The active state (U10) of a mobile call (on cell B) using a full rate TCH in non-hopping mode.

Test Procedure

The MS is in the active state (U10) of a call on cell A. The SS sends a HANOVER COMMAND on the main DCCH. The HANOVER COMMAND includes a Synchronization Indication IE that instructs the MS to supply the observed time difference between the cells. The MS shall begin to send access bursts on the new DCCH (and optionally the SACCH) to cell B and the SS sends one PHYSICAL INFORMATION message. The MS shall activate the channel in sending and receiving mode and establish a signalling link using the correct timing advance. The MS shall transmit a HANOVER COMPLETE message containing the Mobile Time Difference IE with a correct value.

Maximum Duration of Test

5 s.

Expected Sequence

Step	Direction	Message	Comments
1	SS -> MS	HANOVER COMMAND	See specific message contents below.
2	MS -> SS	HANOVER ACCESS	Repeated on every burst of the uplink main DCCH until reception of PHYSICAL INFORMATION. Handover Reference as included in the HANOVER COMMAND.
3	SS -> MS	PHYSICAL INFORMATION	
4	MS -> SS	SABM	Sent without information field.
5	SS -> MS	UA	
6	MS -> SS	HANOVER COMPLETE	Shall include the Mobile Time Difference IE with value $(2k+y) \bmod 2,097,152$ half bit periods. A tolerance of ± 2 half bit periods is allowed.

Specific Message Contents

HANOVER COMMAND

as default message contents, except: Synchronization Indication	"not synchronized"; ROT=1; NCI=0.
--	-----------------------------------

26.6.5.8 Handover / layer 3 failure

26.6.5.8.1 Conformance requirements

The MS shall return to the old channel in the case of an handover failure caused by the non reception of the PHYSICAL INFORMATION message. On the old channel the MS shall use the Power Level that it was previously using on that channel.

References

3GPP TS 04.08 / 3GPP TS 44.018 subclause 3.4.4.

26.6.5.8.2 Test purpose

To verify the function of timer T3124 and the contents in the message HANOVER FAILURE and in the layer 1 header on the SACCH.

26.6.5.8.3 Method of test

Initial Conditions

System Simulator:

2 cells with same LAI, default parameters.

Mobile Station:

The MS is in the active state (U10) of a call (on cell A). Used power level is the maximum supported by the MS.

Specific PICS statements

-

PIXIT statements

-

Foreseen Final State of the MS

The active state (U10) of a mobile call (on cell A). Used power level is the maximum supported by the MS.

Test Procedure

The MS is in the active state (U10) of a call on cell A. The SS sends a HANOVER COMMAND with Power Command set to 8 on the main DCCH. The MS shall begin to send access bursts on the new DCCH (and optionally the SACCH) to cell B. The SS activates the SACCH, but does not send PHYSICAL INFORMATION (thus causing a time-out of T3124). The MS shall re-establish the old link on cell A and send a HANOVER FAILURE within 3 s from the transmission of HANOVER COMMAND, using the old Power Control Level.

Maximum Duration of Test

5 minutes, including 1 minute for any necessary operator actions.

Expected Sequence

Step	Direction	Message	Comments
0	SS	-	The SS records the Power Control Level in the layer 1 header of the last SACCH message sent by the MS before step 1.
1	SS -> MS	HANDOVER COMMAND	Channel description: non-hopping, full rate Power Command: 8. Synchronization Indication: non synchronized.
2	MS -> SS	HANDOVER ACCESS	Several messages are sent, all with correct Handover References.
3	MS -> SS	HANDOVER FAILURE	Sent on old channel, RR cause value = "Abnormal release, unspecified", "Abnormal release, channel unacceptable", "Abnormal release, timer expired", "Abnormal release, no activity on the radio path" or "Protocol error unspecified". Shall be sent within 3 s from the transmission of HANDOVER COMMAND.
4	SS	-	The SS checks that the Power Control Level reported in the layer 1 header of the SACCH message that is sent in the first SACCH multiframe following the SABM is the same as in step 0.

Specific Message Contents

None.

26.6.5.9 Handover / layer 1 failure

26.6.5.9.1 Conformance requirements

The MS shall return to the old channel in the case of an handover failure caused by a layer 1 failure on the target cell. On the old channel the MS shall use the Power Level that it was previously using on that channel.

References

3GPP TS 04.08 / 3GPP TS 44.018 subclause 3.4.4.

26.6.5.9.2 Test purpose

To verify the function of timer T3124 and the contents in the message HANDOVER FAILURE and in the layer 1 header on the SACCH.

26.6.5.9.3 Method of test

Initial Conditions

System Simulator:

2 cells with same LAI, default parameters.

Mobile Station:

The MS is in the active state (U10) of a call (on cell A). Used power level is the maximum supported by the MS.

Specific PICS statements

-

PIXIT statements

-

Foreseen Final State of the MS

The active state (U10) of a mobile call (on cell A). Used power level is the maximum supported by the MS.

Test Procedure

The MS is in the active state (U10) of a call on cell A. The SS sends a HANOVER COMMAND on the main DCCH. The MS shall begin to send access bursts at the commanded Power Control Level on the new DCCH (and optionally the SACCH) to cell B (the commanded Power Control Level must be different than that already used for Cell A). With the exception of normal BCCH signalling, the SS does not transmit anything on cell B (thus causing a time-out of T3124). The MS shall re-establish the old link on cell A and send a HANOVER FAILURE within 3 s from the transmission of HANOVER COMMAND, using the old Power Control Level.

Maximum Duration of Test

5 minutes, including 1 minute for any necessary operator actions.

Expected Sequence

Step	Direction	Message	Comments
0	SS	-	The SS records the Power Control Level in the layer 1 header of the last SACCH message sent by the MS before step 1.
1	SS -> MS	HANOVER COMMAND	Channel description: non-hopping, full rate. Synchronization Indication: non synchronized. Power Level: different than that recorded in step 0.
2	MS -> SS	HANOVER ACCESS	Several messages are sent, all with correct Handover References.
3	MS -> SS	HANOVER FAILURE	Sent on old channel, RR cause value = "Abnormal release, unspecified", "Abnormal release, channel unacceptable", "Abnormal release, timer expired", "Abnormal release, no activity on the radio path" or "Protocol error unspecified". Shall be sent within 3 s from the transmission of HANOVER COMMAND.
4	SS	-	The SS checks that the Power Control Level reported in the layer 1 header of the SACCH message that is sent in the first SACCH multiframe following the SABM is the same as in step 0.

Specific Message Contents

None.

26.6.6 Test of frequency redefinition

The Frequency Redefinition procedure is used by the network to change the frequencies and hopping sequences of the allocated channels.

26.6.6.1 Frequency redefinition

26.6.6.1.1 Conformance requirements

An MS, after receiving a FREQUENCY REDEFINITION message, shall start using the new frequencies and hopping sequence in the correct time slot when the MS is allocated a dedicated channel.

The behaviour described in the test purpose is applied for each combination of the value $T(k)$ ($k = 1,2,3$) and for each supported dedicated channel type.

References

3GPP TS 04.08 / 3GPP TS 44.018 subclauses 3.4.5, 9.1.13 and 10.5.2.13.

26.6.6.1.2 Test purpose

To verify that the MS, after receiving a Frequency Redefinition message, starts using the new frequencies and hopping sequence at the time indicated in the message.

26.6.6.1.3 Method of test

Initial Conditions

System Simulator:

1 cell, CCCH_CONF set to 1 basic physical channel used for CCCH, not combined with SDCCHs. The cell allocation is set to CA (1) , depending on the band of operation of the Mobile Station before each execution of this test.

Mobile Station:

The MS is in the "idle, updated" state, with a TMSI allocated.

Specific PICS statements

- MS supports GSM HR (TSPC_AddInfo_Halfrate)

PIXIT statements

-

Foreseen Final State of the MS

"Idle, updated", with TMSI allocated.

Test Procedure

Test parameters:

ca (1) is set according to the column *ca(1)* of table below.

An arbitrary subset **CA**(1) of the set in the column *CA Range* of the table below containing **ca**(1) elements is drawn. **CA**(1) is then coded using the *coding* scheme from the table below.

An element B of the set **CA**(1) is arbitrarily chosen.

An arbitrary value **ca**(2) in the range indicated in column *ca(2)* of the table below is chosen.

An arbitrary subset **CA**(2) of the set in the column *CA Range* of the table below with **ca**(2) elements and containing B is chosen.

An arbitrary value **ca(3)** in the range indicated in column *ca(3)* of the table below is chosen.

An arbitrary subset **CA(3)** of the set in the column *CA Range* of the table below with **ca(3)** elements and containing B is chosen.

For $j = 1,2,3$, values **ma(j)** in the range $j, \dots, ca(j)-1$ and values **MAIO(j)** in the range $0, \dots, ma(j)-1$ are arbitrarily chosen.

Subsets **MA(j)** of **CA(j)** not containing B and having **ma(j)** elements are arbitrarily chosen.

Band	ca(1)	CA Range	ca(2)	ca(3)	Coding
GSM 450	32	259, ..., 293	17, ..., 31	4, ..., 16	Range 128
GSM 480	32	306, ..., 340	17, ..., 31	4, ..., 16	Range 128
GSM 710	64	438, ..., 511	19, ..., 62	3, ..., 18	Range 128
GSM 750	64	438, ..., 511	19, ..., 62	3, ..., 18	Range 128
T-GSM 810	64	438, ..., 511	19, ..., 62	3, ..., 18	Range 128
GSM 850	64	128, ..., 251	19, ..., 62	3, ..., 18	Variable bitmap
GSM 900	64	1, ..., 124	20, ..., 63	4, ..., 19	Bitmap 0
DCS 1 800	64	700, ..., 812	17, ..., 63	4, ..., 16	Variable bitmap
PCS 1 900	64	700, ..., 810	17, ..., 63	4, ..., 16	Variable bitmap

Let $T(1) = 91$, $T(2) = 42\ 000$.

An arbitrary value **T(3)** in the range $92, \dots, 29999$ is chosen.

The System Simulator pages the MS and after the MS has responded with a CHANNEL REQUEST, the simulator assigns a dedicated channel (TCH/F, TCH/H or SDCCH, as defined by the execution counter R). Then the SS sends a FREQUENCY REDEFINITION message, which modifies the frequencies/hopping sequence to be used by the MS. The MS shall then, at the TDMA frame defined by the contents of the "Starting Time" information element, use the new frequencies/hopping sequence. (The value of T(2) ensures that the MS believes the Starting Time has passed and so the MS shall start transmitting immediately. Immediately being in the scope of this test no later than 73 Frames for SDCCH/8 or TCH/F and 90 Frames for TCH/H after the SS sends the last burst of the first L2 frame containing the beginning of the FREQUENCY REDEFINITION message. The range for T(3) ensures that the MS has to wait until the designated frame before starting transmission on the new frequencies.)

The verification is performed at the RF burst level. The MS transmits the standard test signal C1 (annex 5), and for the TCH case, the SS checks the received pattern with the expected pattern. For the SDCCH case the MS transmits fill frames, and the SS checks for each burst whether the burst is transmitted at the right frequency.

Maximum Duration of Test

$$3 * (\text{number of supported channels} * T(3) + 7)$$

Expected Sequence

This sequence is performed for every combination of execution counters $K = 1,2,3$ and $R = 1,2,3$:

Step	Direction	Message	Comments
1	SS -> MS	PAGING REQUEST TYPE 1	The SS checks that the MS is transmitting on the correct frequencies without delay. See description 1 below. The SS checks that the MS is transmitting on the correct frequencies and that the transmissions started in the correct frame. See description 2 below. The SS checks that the MS is transmitting on the correct frequencies and that the transmissions started in the correct frame.
2	MS -> SS	CHANNEL REQUEST	
3	SS -> MS	IMMEDIATE ASSIGNMENT	
4	MS -> SS	PAGING RESPONSE	
5	-----	-----	
6	SS -> MS	FREQUENCY REDEFINITION	
7	-----	-----	
8	SS -> MS	FREQUENCY REDEFINITION	
9	-----	-----	
10	SS -> MS	CHANNEL RELEASE	

For: K=1, R = 1,2,3 T(K) = T(1);
 K=2, R = 1,2,3 T(K) = T(2);
 K=3, R = 1,2,3 T(K) = T(3).

Specific Message Contents

IMMEDIATE ASSIGNMENT

Information Element	value/remark
L2 pseudo length	value dependent on the length of the Mobile Allocation and thus on the number of channels in CA (1).
Channel Description	
Channel type and TDMA offset	SDCCH/8 arbitrary offset, for R=1 Bm + ACCHs for R=2 Lm + ACCHs arbitrary offset, for R=3
Timeslot number	arbitrarily selected by
TSC	arbitrarily selected
Hopping channel	RF hopping channel
MAIO	MAIO(1)
HSN	0
Request reference	corresponds to the Channel Request
Timing advance	30 bit periods
Mobile Allocation	corresponds to set MA(1)
Starting Time	not present
IA rest octets	all bits are set to spare

FREQUENCY REDEFINITION (Description 1)

Information Element	value/remark
Protocol Discriminator	RR Management
Skip Indicator	0000
Message Type	00101011
Channel Description	
Channel type and TDMA offset	SDCCH/8 offset not changed, for R=1 Bm + ACCHs for R=2 Lm + ACCHs offset not changed, for R=3
Timeslot number	not changed
TSC	not changed
Hopping channel	RF hopping channel
MAIO	MAIO(2)
HSN	0
Mobile Allocation	corresponds to set MA(2)
Starting Time	The last burst of the first L2 frame containing the beginning of this message is transmitted in frame number X. The starting time is set to frame number (X plus T(K) modulo 42 432).
Cell Channel Description	
Information element identifier contents	62H corresponds to set CA(2) encoded according to the table below.

Band	Cell Channel Description – coding format	
	Step 6	Step 8
GSM 450	Range 128	Range 128
GSM 480	Range 128	Range 128
GSM 710	Range 128	Range 128
GSM 750	Range 128	Range 128
T-GSM 810	Range 128	Range 128
GSM 850	Range 128	Range 128
GSM 900	Bitmap 0	Bitmap 0
DCS 1 800	Variable bitmap	K=1: Range 1 024 K=2: Range 256 K=3: Range 512
PCS 1 900	Variable bitmap	K=1: Range 1 024 K=2: Range 256 K=3: Range 512

26.6.7 Test of the channel mode modify procedure

The channel mode modify procedure allows the network to request the MS to change the channel mode for one channel. If the mobile station does not correctly respond to the CHANNEL MODE MODIFY message (with a positive acknowledgement if the new channel mode is supported, with a negative acknowledgement if the new channel mode is not supported), the network may try to repeat the procedure, release the connection, or continue to wait for the acknowledgement (the maximum time resulting from layer two re-transmissions and MS reaction time being around 5 s).

26.6.7.1 Test of the channel mode modify procedure / full rate

26.6.7.1.1 Conformance requirement

When the MS has received the CHANNEL MODE MODIFY message, the mobile station changes the mode for the indicated channel and then replies by a CHANNEL MODE MODIFY ACKNOWLEDGE message indicating the new channel mode.

If the mobile station does not support the indicated mode, it shall retain the old mode and return the associated channel mode information in the CHANNEL MODE MODIFY ACKNOWLEDGE message.

References

3GPP TS 04.08 / 3GPP TS 44.018, subclauses 3.4.6.1.2 and 3.4.6.1.3

26.6.7.1.2 Test purpose

To verify that the MS, in an RR connected state, acknowledges a CHANNEL MODE MODIFY message by sending a CHANNEL MODE MODIFY ACKNOWLEDGEMENT message specifying and switching to the correct mode.

- the new mode if that mode is supported.
- the old mode if the new mode is not supported.

This shall be verified for the channel modes

- signalling only.
- speech full rate version 1.
- data 9,6 Kb/s.
- data 4,8 Kb/s full rate.
- data 2,4 Kb/s full rate.

26.6.7.1.3 Method of test

Initial Conditions

System Simulator:

1 cells, default parameters.

Mobile Station:

The MS is "idle updated", with TMSI allocated.

Specific PICS statements

- GSM FR (TSPC_AddInfo_Full_rate_version_1)
- 9.6 k full rate data mode (TSPC_AddInfo_96Data)
- 4.8 k full rate data mode (TSPC_AddInfo_48DataF)
- 2.4 k full rate data mode (TSPC_AddInfo_24DataF)

PIXIT statements

-

Foreseen Final State of the MS

"Idle, updated", with TMSI allocated.

Test procedure

A Mobile Terminated call is initiated, however following the Channel Request received from the Mobile Station, the SS sends an Immediate Assignment to the MS commanding it to go to a TCH/F. This sets the Channel Mode automatically to "Signalling Only".

The SS then sends a series of CHANNEL MODE MODIFY messages to the MS. Each time it is checked that the MS responds with a CHANNEL MODE MODIFY ACKNOWLEDGE message specifying:

- the channel mode that has been specified in the CHANNEL MODE MODIFY message, if the MS supports that mode (this mode then becomes the "channel mode in use");
- the channel mode that was in use when the CHANNEL MODE MODIFY message has been received, if the MS does not support the channel mode specified in the CHANNEL MODE MODIFY message.

Maximum Duration of Test

30 s.

Expected Sequence

Step	Direction	Message	Comments
1	SS->MS	PAGING REQUEST TYPE 1	Sent on correct paging subchannel.
2	MS->SS	CHANNEL REQUEST	Establishment cause indicates "answer to paging".
3	SS->MS	IMMEDIATE ASSIGNMENT	Assignment to a non hopping TCH/F.
4	MS->SS	PAGING RESPONSE	
5	SS->MS	CHANNEL MODE MODIFY	
6	MS->SS	CHANNEL MODE MODIFY ACKNOWLEDGE	
7	SS->MS	CHANNEL MODE MODIFY	
8	MS->SS	CHANNEL MODE MODIFY ACKNOWLEDGE	
9	SS->MS	CHANNEL MODE MODIFY	
10	MS->SS	CHANNEL MODE MODIFY ACKNOWLEDGE	
11	SS->MS	CHANNEL MODE MODIFY	
12	MS->SS	CHANNEL MODE MODIFY ACKNOWLEDGE	
13	SS->MS	CHANNEL MODE MODIFY	
14	MS->SS	CHANNEL MODE MODIFY ACKNOWLEDGE	
15	SS->MS	CHANNEL RELEASE	

Specific Message Contents

CHANNEL MODE MODIFY

Information Element	value/remark
Channel description	describes the already assigned dedicated channel.
Channel mode	
Mode	in step 5: speech full rate version 1 in step 7: data 9,6 Kb/s in step 9: data 4,8 Kb/s full rate in step 11: data 2,4 Kb/s full rate in step 13 signalling only

CHANNEL MODE MODIFY ACKNOWLEDGE

Information Element	value/remark
Channel mode	
Mode	in step 6: if TSPC_AddInfo_Full_rate_version_1: speech full rate version 1 else: signalling only in step 8: if TSPC_AddInfo_96Data: data 9.6 Kb/s else: same as in step 6 in step 10: if TSPC_AddInfo_48DataF: data 4.8 Kb/s full rate else: same as in step 8 in step 12: if TSPC_AddInfo_24DataF: data 2.4 Kb/s full rate else: same as in step 10 in step 14: signalling only

26.6.7.2 Test of the channel mode modify procedure / half rate

This test is only applicable to an dual rate MS.

26.6.7.2.1 Conformance requirement

When the MS has received the CHANNEL MODE MODIFY message, the mobile station changes the mode for the indicated channel and then replies by a CHANNEL MODE MODIFY ACKNOWLEDGE message indicating the new channel mode.

If the mobile station does not support the indicated mode, it shall retain the old mode and return the associated channel mode information in the CHANNEL MODE MODIFY ACKNOWLEDGE message.

References

3GPP TS 04.08 / 3GPP TS 44.018, subclauses 3.4.6.1.2 and 3.4.6.1.3.

26.6.7.2.2 Test purpose

To verify that the MS, in an RR connected state, acknowledges a CHANNEL MODE MODIFY message by sending a CHANNEL MODE MODIFY ACKNOWLEDGEMENT message specifying and switches to the correct mode:

- the new mode if that mode is supported;
- the old mode if the new mode is not supported.

This shall be verified for the channel modes:

- signalling only;
- speech half rate version 1;
- data 4,8 Kb/s half rate;
- data 2,4 Kb/s half rate;
- speech half rate version 3.

26.6.7.2.3 Method of test

Initial Conditions

System Simulator:

1 cells, default parameters.

Mobile Station:

The MS is "idle updated", with TMSI allocated.

Specific PICS statements

- GSM HR (TSPC_AddInfo_Half_rate_version_1)
- 4.8 k half rate data mode (TSPC_AddInfo_48DataH)
- 2.4 k half rate data mode (TSPC_AddInfo_24DataH)
- HR AMR (TSPC_AddInfo_Half_rate_version_3)

PIXIT statements

-

Foreseen Final State of the MS

"Idle, updated", with TMSI allocated.

Test procedure

A Mobile Terminated call is initiated, however following the Channel Request received from the Mobile Station, the SS sends an Immediate Assignment to the MS commanding it to go to a TCH/H. This sets the Channel Mode automatically to "Signalling Only".

The SS then sends a series of CHANNEL MODE MODIFY messages to the MS. Each time it is checked that the MS responds with a CHANNEL MODE MODIFY ACKNOWLEDGE message specifying:

- the channel mode that has been specified in the CHANNEL MODE MODIFY message, if the MS supports that mode (this mode then becomes the "channel mode in use");
- the channel mode that was in use when the CHANNEL MODE MODIFY message has been received, if the MS does not support the channel mode specified in the CHANNEL MODE MODIFY message.

Maximum Duration of Test

30 s.

Expected Sequence

Step	Direction	Message	Comments
1	SS->MS	PAGING REQUEST TYPE 1	Sent on the correct paging subchannel. Establishment cause indicates "answer to paging". Assignment to a non hopping TCH/H.
2	MS->SS	CHANNEL REQUEST	
3	SS->MS	IMMEDIATE ASSIGNMENT	
4	MS->SS	PAGING RESPONSE	
5	SS->MS	CHANNEL MODE MODIFY	
6	MS->SS	CHANNEL MODE MODIFY ACKNOWLEDGE	
7	SS->MS	CHANNEL MODE MODIFY	
8	MS->SS	CHANNEL MODE MODIFY ACKNOWLEDGE	
9	SS->MS	CHANNEL MODE MODIFY	
10	MS->SS	CHANNEL MODE MODIFY ACKNOWLEDGE	
11	SS->MS	CHANNEL MODE MODIFY	
12	MS->SS	CHANNEL MODE MODIFY ACKNOWLEDGE	
13	SS->MS	CHANNEL MODE MODIFY	
14	MS->SS	CHANNEL MODE MODIFY ACKNOWLEDGE	
15	SS->MS	CHANNEL RELEASE	

Specific Message Contents

CHANNEL MODE MODIFY

Information Element	value/remark
Channel description	describes the already assigned dedicated channel.
Channel mode	
Mode	in step 5: speech half rate version 1 in step 7: data 4,8 Kb/s half rate in step 9: data 2,4 Kb/s half rate in step 11: speech half rate version 3 in step 13: signalling only
Multi-Rate Configuration	Arbitrarily chosen

CHANNEL MODE MODIFY ACKNOWLEDGE

Information Element	value/remark
Channel mode Mode	<p>in step 6: if TSPC_AddInfo_Half_rate_version_1: Speech half rate version 1 else: signalling only</p> <p>in step 8: if TSPC_AddInfo_48DataH: data 4,8 Kb/s half rate else: same as in step 6</p> <p>in step 10: if TSPC_AddInfo_24DataH: data 2,4 Kb/s half rate else: same as in step 8</p> <p>in step 12: if TSPC_AddInfo_Half_rate_version_3: speech half rate version 3 else: same as in step 10.</p> <p>in step 14: signalling only</p>

26.6.8 Test of ciphering mode setting

The Ciphering Mode Setting Procedure can be used by the network to trigger the start and stop of stream ciphering.

The SS shall start and synchronize ciphering and deciphering according to 3GPP TS 03.20. The bitstream shall be generated by algorithm A5 (A5/1 and A5/3 as defined by the test case) using the encryption key Kc.

26.6.8.1 Ciphering mode / start ciphering

26.6.8.1.1 Conformance requirements

- When the MS receives the CIPHERING MODE COMMAND message with Ciphering Mode Setting information element set to "start ciphering", the MS starts ciphering and deciphering with the algorithm indicated by the "algorithm identifier" field:
 - the MS responds with a CIPHERING MODE COMPLETE message in ciphered mode;
 - the ciphering uses the cipher key determined during the authentication procedure.
- The MS responds to the AUTHENTICATION REQUEST message with an AUTHENTICATION RESPONSE message and continues to use the ciphering key obtained from the previous authentication procedure.

References

3GPP TS 04.08 / 3GPP TS 44.018 subclause 3.4.7.

26.6.8.1.2 Test purpose

To verify that the MS starts ciphering when it receives a CIPHERING MODE COMMAND message with Cipher Mode Setting = "Start Ciphering". To verify that it continues to use the old cipher key after it receives an AUTHENTICATION REQUEST whilst in ciphered mode.

26.6.8.1.3 Method of test

Initial Conditions

System Simulator:

1 cells, Radio_Link_Timeout set to 64.

Mobile Station:

The MS is in the "idle, updated" state, with a TMSI allocated.

Specific PICS statements

- Support for A5/3 (TSPC_Feat_A53)

PIXIT statements

-

Foreseen Final State of the MS

"Idle, updated", with TMSI allocated.

Test Procedure

The MS is made to originate a call. It shall send at least one CHANNEL REQUEST message. The SS sends an IMMEDIATE ASSIGNMENT and the MS shall answer with a CM SERVICE REQUEST. The SS sends an AUTHENTICATION REQUEST and the MS shall answer with AUTHENTICATION RESPONSE. Then the SS sends a CIPHERING MODE COMMAND, ordering the MS to start ciphering with an algorithm supported by the MS. After transmission of this command the SS starts deciphering. The MS shall respond with a CIPHERING MODE COMPLETE message in ciphered mode using the cipher key determined during the authentication procedure, and continue to establish the call with a SETUP message. After reception of the CIPHERING MODE COMPLETE the SS starts enciphering.

The SS then sends another AUTHENTICATION REQUEST and the MS shall respond with an AUTHENTICATION RESPONSE. The MS shall continue to use the old cipher key.

Finally the SS sends a CHANNEL RELEASE to end the test.

Maximum Duration of Test

5 minutes, including 1 minute for any necessary operator actions.

Expected Sequence

This sequence is performed for execution counter, K=1 and optionally where the MS supports A5/3 for K=3.

Step	Direction	Message	Comments
1	MS -> SS	CHANNEL REQUEST	Establ. Cause = "Originating Call" NECI not set to 1
2	SS -> MS	IMMEDIATE ASSIGNMENT	
3	MS -> SS	CM SERVICE REQUEST	Cipher Mode Setting = "Start Ciphering; cipher with algorithm A5/K". The SS starts deciphering. Sent in ciphered mode using the cipher key determined in between steps 4&5. The SS start enciphering.
4	SS -> MS	AUTHENTICATION REQUEST	
5	MS -> SS	AUTHENTICATION RESPONSE	
6	SS -> MS	CIPHERING MODE COMMAND	
7	MS -> SS	CIPHERING MODE COMPLETE	
8	MS -> SS	SETUP	
9	SS -> MS	AUTHENTICATION REQUEST	Determines a new cipher key. Sent in ciphered mode using the cipher key determined in between steps 4&5.
10	MS -> SS	AUTHENTICATION RESPONSE	
11	SS -> MS	CHANNEL RELEASE	

Specific Message Contents

CIPHERING MODE COMMAND

For	K = 1, A5/K = A5/1 K = 3, A5/K = A5/3
-----	--

26.6.8.2 Ciphering mode / no ciphering

26.6.8.2.1 Conformance requirements

When the MS receives a CIPHERING MODE COMMAND message with Ciphering Mode Setting information element set to "no ciphering" the MS shall respond in non ciphered mode with a CIPHERING MODE COMPLETE message.

When the CIPHERING MODE COMMAND with Ciphering Mode Setting information element set to "no ciphering" is received as a response to a CM SERVICE REQUEST, the MS shall continue the establishment of the CM service.

References

3GPP TS 04.08 / 3GPP TS 44.018 subclause 3.4.7.

26.6.8.2.2 Test purpose

To verify that the MS does not start ciphering when it receives a CIPHERING MODE COMMAND message with Cipher Mode Setting = "No Ciphering".

26.6.8.2.3 Method of test

Initial Conditions

System Simulator:

1 cells, Radio_Link_Timeout set to 64.

Mobile Station:

The MS is in the "idle, updated" state, with a TMSI allocated.

Specific PICS statements

-

PIXIT statements

-

Foreseen Final State of the MS

"Idle, updated", with TMSI allocated.

Test Procedure

The MS is made to originate a call. It shall send at least one CHANNEL REQUEST message. The SS sends an IMMEDIATE ASSIGNMENT and the MS shall answer with a CM SERVICE REQUEST. The SS sends an AUTHENTICATION REQUEST and the MS shall answer with an AUTHENTICATION RESPONSE. Then the SS sends a CIPHERING MODE COMMAND, ordering the MS not to start ciphering. The MS shall respond with a CIPHERING MODE COMPLETE message in non-ciphered mode and continue to establish the call with a SETUP message.

Finally the SS sends a CHANNEL RELEASE to end the test.

Maximum Duration of Test

5 minutes, including 1 minute for any necessary operator actions.

Expected Sequence

Step	Direction	Message	Comments
1	MS -> SS	CHANNEL REQUEST	Establ. Cause = "Originating call; NECI not equal to 1.
2	SS -> MS	IMMEDIATE ASSIGNMENT	
3	MS -> SS	CM SERVICE REQUEST	Cipher Mode Setting = "No Ciphering". Sent in non-ciphered mode.
4	SS -> MS	AUTHENTICATION REQUEST	
5	MS -> SS	AUTHENTICATION RESPONSE	
6	SS -> MS	CIPHERING MODE COMMAND	
7	MS -> SS	CIPHERING MODE COMPLETE	
8	MS -> SS	SETUP	
11	SS -> MS	CHANNEL RELEASE	

Specific Message Contents

None.

26.6.8.3 Cipherring mode / old cipher key

26.6.8.3.1 Conformance requirements

When the MS receives the CIPHERING MODE COMMAND message with Cipherring Mode Setting information element set to "start cipherring", the MS starts cipherring and deciphering with the algorithm indicated by the "algorithm identifier" field. Also;

- the MS responds with a CIPHERING MODE COMPLETE message in the correct ciphered mode;
- the cipherring shall use the previously stored cipher key;
- in the case of a mobile originating speech call, the MS shall send a SETUP message after the completion of the cipherring procedure.

References

3GPP TS 04.08 / 3GPP TS 44.018 subclause 3.4.7.

26.6.8.3.2 Test purpose

To verify that the MS uses the stored cipher key when it receives a CIPHERING MODE COMMAND without a preceding authentication procedure.

26.6.8.3.3 Method of test

Initial Conditions

System Simulator:

1 cells, Radio_Link_Timeout = 64.

Mobile Station:

The MS is in the "idle, updated" state, with a TMSI allocated and a known cipher key stored.

Specific PICS statements

- Support for A5/3 (TSPC_Feat_A53)

PIXIT statements

-

Foreseen Final State of the MS

"Idle, updated", with TMSI allocated.

Test Procedure

The MS is made to originate a call. It shall send at least one CHANNEL REQUEST message. The SS sends an IMMEDIATE ASSIGNMENT and the MS shall answer with a CM SERVICE REQUEST. The SS sends a CIPHERING MODE COMMAND, ordering the MS to start cipherring with a supported algorithm. After transmission of this command the SS starts deciphering. The MS shall respond with a CIPHERING MODE COMPLETE message in the commanded ciphered mode using the stored cipher key and continue to establish the call with a SETUP message. After reception of the CIPHERING MODE COMPLETE the SS starts enciphering.

Finally the SS sends a CHANNEL RELEASE to end the test.

Maximum Duration of Test

5 minutes, including 1 minute for any necessary operator actions.

Expected Sequence

Step	Direction	Message	Comments
1	MS -> SS	CHANNEL REQUEST	Establ. Cause = "Originating Call: NECI not equal to 1. Cipher Mode Setting = "Start Cipherring", algorithm arbitrarily selected from those supported by the MS. The SS starts deciphering.
2	SS -> MS	IMMEDIATE ASSIGNMENT	
3	MS -> SS	CM SERVICE REQUEST	
4	SS -> MS	CIPHERING MODE COMMAND	
5	MS -> SS	CIPHERING MODE COMPLETE	Sent in commanded ciphered mode with the stored cipher key. The SS starts enciphering.
6	MS -> SS	SETUP	
7	SS -> MS	CHANNEL RELEASE	

Specific Message Contents

None.

26.6.8.4 Cipherring mode / change of mode, algorithm and key

Networks can be implemented that do not have the same cipherring algorithms on all base stations. In such networks changes of algorithms and cipherring mode may occur and calls will fail if MSs incorrectly handle commands or use an incorrect cipher key.

26.6.8.4.1 Conformance requirements

- When the MS in the "not ciphered" mode, receives a CIPHERING MODE COMMAND message with the Ciphering Mode Setting information element set to "start cipherring", the MS shall load the cipher key stored in the SIM into the ME, use this key to start cipherring and deciphering with the algorithm indicated by the "algorithm identifier" field and, respond with a CIPHERING MODE COMPLETE message.
- If the last timeslot of the message block containing a CIPHERING MODE COMMAND message occurs at time T, then the MS shall be ready to transmit the CIPHERING MODE COMPLETE message before T+500 ms.
- When the MS receives an ASSIGNMENT COMMAND message containing a Cipher Mode Setting IE after receipt of a CIPHERING MODE COMMAND message, the MS shall perform the assignment, use the commanded mode and/or algorithm on the new channel, and not change the cipherring key.
- When the MS receives a HANDOVER COMMAND message containing a Cipher Mode Setting IE after receipt of a CIPHERING MODE COMMAND message, the MS shall perform the handover, use the commanded mode and/or algorithm on the new channel, and not change the cipherring key.
- When the MS in the "ciphered" mode receives a CIPHERING MODE COMMAND message with Cipher Mode Setting IE set to "no cipherring", the MS shall load the cipher key stored in the SIM into the ME, load the cipher key stored in the SIM into the ME, stop cipherring and deciphering and, respond with a CIPHERING MODE COMPLETE message.
- When the MS receives an AUTHENTICATION REQUEST message, it shall process the challenge information and send back an AUTHENTICATION RESPONSE message to the network. The new cipherring key calculated from the challenge information shall overwrite the previous one and be stored on the SIM before the AUTHENTICATION RESPONSE message is transmitted. The cipherring key stored in the SIM shall be loaded in to the ME when any valid CIPHERING MODE COMMAND is received.
- When the MS in the not ciphered mode receives a CIPHERING MODE COMMAND message with Cipher Mode Setting IE set to "no cipherring", the MS shall load the cipher key stored in the SIM into the ME, stop cipherring and deciphering and, respond with a CIPHERING MODE COMPLETE message.
- If a handover fails then the operational parameters used when returning to the old channel are those applied before the HANDOVER COMMAND message was received.
- If an assignment fails then the operational parameters used when returning to the old channel are those applied before the ASSIGNMENT COMMAND message was received.

References

- Conformance requirement 1: 3GPP TS 04.08 / 3GPP TS 44.018 subclauses 3.4.7.2 and 4.3.2.2.
- Conformance requirement 2: 3GPP TS 04.13 subclause 5.2.7.
- Conformance requirement 3: 3GPP TS 04.08 / 3GPP TS 44.018 subclause 3.4.3.1.
- Conformance requirement 4: 3GPP TS 04.08 / 3GPP TS 44.018 subclause 3.4.4.1.
- Conformance requirement 5: 3GPP TS 04.08 / 3GPP TS 44.018 subclauses 3.4.7.2 and 4.3.2.2.
- Conformance requirement 6: 3GPP TS 04.08 / 3GPP TS 44.018 subclause 4.3.2.2.
- Conformance requirement 7: 3GPP TS 04.08 / 3GPP TS 44.018 subclause 3.4.7.2.
- Conformance requirement 8: 3GPP TS 04.08 / 3GPP TS 44.018 subclause 3.4.4.4.
- Conformance requirement 9: 3GPP TS 04.08 / 3GPP TS 44.018 subclause 3.4.3.3.

26.6.8.4.2 Test purpose

- 1 To verify that when the MS is in the "not ciphered" mode and receives the CIPHERING MODE COMMAND message with Ciphering Mode Setting information element set to "start ciphering", the MS uses the cipher key stored in the SIM to start ciphering and deciphering with the algorithm indicated by the "algorithm identifier" field and that the MS responds with a CIPHERING MODE COMPLETE message.
- 2 To verify that the MS is ready to transmit the CIPHERING MODE COMPLETE message before 500 ms after the end of the CIPHERING MODE COMMAND message.
- 3 To verify that when the MS receives an ASSIGNMENT COMMAND message containing a Cipher Mode Setting IE after receipt of a CIPHERING MODE COMMAND message, the MS shall perform the assignment, use the commanded mode and/or algorithm on the new channel, and not change the ciphering key.
- 4 To verify that when the MS receives a HANDOVER COMMAND message containing a Cipher Mode Setting IE after receipt of a CIPHERING MODE COMMAND message, the MS shall perform the handover, use the commanded mode and/or algorithm on the new channel, and not change the ciphering key.
- 5 To verify that when the MS is in the "ciphered" mode and receives the CIPHERING MODE COMMAND message with Cipher Mode Setting IE set to "no ciphering", the MS loads the cipher key stored in the SIM into the ME, stops ciphering and deciphering and, responds with a CIPHERING MODE COMPLETE message.
- 6 To verify that the MS responds to an AUTHENTICATION REQUEST message with an AUTHENTICATION RESPONSE message and continues to use the cipher key obtained from the previous authentication procedure.
- 7 To verify that when the MS is in the "not ciphered" mode and receives the CIPHERING MODE COMMAND message with Ciphering Mode Setting information element set to "no ciphering", the MS does not start ciphering or deciphering, but does respond with a CIPHERING MODE COMPLETE message.
- 8 To verify that when the MS receives a HANDOVER COMMAND message and the handover fails, the MS sends a HANDOVER FAILURE message on the old channel using the old ciphering mode and (if ciphered) the old algorithm and old key.
- 9 To verify that when the MS receives an ASSIGNMENT COMMAND message and the assignment fails, the MS sends an ASSIGNMENT FAILURE message on the old channel using the old ciphering mode and (if ciphered) the old algorithm and old key.

26.6.8.4.3 Method of test

Initial Conditions

System Simulator:

- 1 cell, with a legal combination of CCCH_CONF with SDCCH/4s or SDCCH/8s is chosen arbitrarily by the SS.

Mobile Station:

The MS is in the "idle, updated" state, with a TMSI allocated and a known cipher key, K, stored in the SIM.

Specific PICS statements

- Support for A5/3 (TSPC_Feat_A53)
- TSPC_Type_xxx (all appropriate power classes)

PIXIT statements

-

Foreseen Final State of the MS

"Idle, updated", with TMSI allocated.

Test Procedure

The MS is paged. The MS shall send at least one CHANNEL REQUEST message. The SS sends an IMMEDIATE ASSIGNMENT and the MS shall answer with a PAGING RESPONSE message.

The SS sends a CIPHERING MODE COMMAND, ordering the MS to start ciphering with a supported algorithm. After transmission of this command the SS starts deciphering. The MS shall respond with a CIPHERING MODE COMPLETE message in the commanded ciphered mode using the cipher key K. After reception of the CIPHERING MODE COMPLETE the SS starts enciphering. The MS shall be ready to transmit the CIPHERING MODE COMPLETE message before 500 ms after the end of the CIPHERING MODE COMMAND message.

The term "ready to transmit" is defined in 3GPP TS 04.13.

The SS sends an AUTHENTICATION REQUEST message to the MS. Cipher key L is calculated. The MS shall send an AUTHENTICATION RESPONSE message to the SS.

The SS sends a HANDOVER COMMAND (for a finely synchronized intra-BTS handover) with the Cipher Mode Setting IE set to "no ciphering". The MS shall transmit the HANDOVER COMPLETE on the commanded channel in non ciphered mode.

The SS sends an ASSIGNMENT COMMAND message containing a Cipher Mode Setting IE set to "start ciphering". The MS shall start transmitting on the commanded channel using the commanded algorithm and cipher key K. The MS shall transmit the ASSIGNMENT COMPLETE message.

The SS sends a CIPHERING MODE COMMAND, ordering the MS to stop ciphering. After transmission of this command the SS stops deciphering. The MS shall respond with a CIPHERING MODE COMPLETE message in non ciphered mode. After reception of the CIPHERING MODE COMPLETE the SS stops enciphering.

The SS sends a HANDOVER COMMAND (for a finely synchronized intra-BTS handover) with the Cipher Mode Setting IE set to "start ciphering". The MS shall transmit the HANDOVER COMPLETE on the commanded channel in ciphered mode using cipher key L and command algorithm.

The SS sends a HANDOVER COMMAND (for a finely synchronized intra-BTS handover) with the Cipher Mode Setting IE set to "start ciphering" and the algorithm identifier indicating the algorithm currently in use. The MS shall transmit the HANDOVER COMPLETE on the commanded channel in ciphered mode using the same algorithm as before the handover.

The SS sends an ASSIGNMENT COMMAND message containing a Cipher Mode Setting IE set to "no ciphering". The MS shall start transmitting on the commanded channel in non-ciphered mode. The MS shall transmit the ASSIGNMENT COMPLETE message.

The SS sends a CIPHERING MODE COMMAND, containing a Cipher Mode Setting IE set to "no ciphering". The MS shall respond with a CIPHERING MODE COMPLETE message.

The SS sends an AUTHENTICATION REQUEST message to the MS. Cipher key M is calculated. The MS shall send an AUTHENTICATION RESPONSE message to the SS.

The SS sends a HANDOVER COMMAND (for a finely synchronized intra-BTS handover) with the Cipher Mode Setting IE set to "start ciphering". The MS shall transmit the HANDOVER COMPLETE on the commanded channel using the commanded algorithm and cipher key L.

The SS sends a HANOVER COMMAND (for a finely synchronized intra-BTS handover) with the Cipher Mode Setting IE set to "no ciphering". The SS does not activate the commanded channel. The MS's transmissions on the new channel need not be monitored. The MS shall transmit the HANOVER FAILURE message on the "old" channel using the "old" algorithm and cipher key L and commanded algorithm.

The SS sends an ASSIGNMENT COMMAND message containing a Cipher Mode Setting IE set to "start ciphering". The SS does not activate the commanded channel. The MS's transmissions on the new channel need not be monitored. The MS shall transmit the ASSIGNMENT FAILURE message on the "old" channel using the "old" algorithm and cipher key L.

If the MS only supports one ciphering algorithm then the SS sends a CHANNEL RELEASE message.

If the MS supports more than one ciphering algorithm then the following steps are performed:

The SS sends an ASSIGNMENT COMMAND message containing a Cipher Mode Setting IE set to "start ciphering" and the Algorithm Identifier indicating a different supported algorithm to the one in use. The MS shall start transmitting on the commanded channel using the commanded algorithm. The MS shall transmit the ASSIGNMENT COMPLETE message.

The SS sends a HANOVER COMMAND (for a finely synchronized intra-BTS handover) containing a Cipher Mode Setting IE set to "start ciphering" and the Algorithm Identifier indicating a different supported algorithm to the one in use. The MS shall transmit the HANOVER COMPLETE on the commanded channel using the commanded algorithm.

The SS sends a CHANNEL RELEASE to end the test.

Maximum Duration of Test

3 minutes.

Expected Sequence

For MSs that only support one ciphering algorithm, the SS shall use step 61A. For MSs that support more than one ciphering algorithm, the SS shall use step 61B and the subsequent steps.

NOTE: 3GPP TS 04.08 / 3GPP TS 44.018 appears to be unclear as to whether timer T3240 shall or shall not be started as a result of the AUTHENTICATION REQUEST messages sent in steps 8 and 44. To allow a variety of test equipment implementations, the IDENTITY REQUEST messages are included in order to avoid an unexpected expiry of timer T3240 prior to the end of the expected sequence.

Step	Direction	Message	Comments
1	SS -> MS	PAGING REQUEST TYPE 1	
2	MS -> SS	CHANNEL REQUEST	
3	SS -> MS	IMMEDIATE ASSIGNMENT	To either SDCCH4 or SDCCH8 depending upon CCCH_CONF arbitrarily chosen.
4	MS -> SS	PAGING RESPONSE	
5	SS -> MS	CIPHERING MODE COMMAND	Cipher Mode Setting = "Start Ciphering", algorithm arbitrarily selected from those supported by the MS. The SS starts deciphering with the selected algorithm.
6	MS -> SS	CIPHERING MODE COMPLETE	Sent in ciphered mode using key "K", the stored cipher key, and the commanded algorithm. This message shall be ready to be transmitted before 500 ms after the completion of step 5.
7	SS		- The SS starts enciphering using key "K".
8	SS -> MS	AUTHENTICATION REQUEST	Contains a new Ciphering Key Sequence Number which is associated with the new cipher key, "L".
9	MS -> SS	AUTHENTICATION RESPONSE	
10	SS -> MS	HANOVER COMMAND	Includes Cipher Mode Setting IE set to "No Ciphering".
11	SS	-	The SS activates the new channel without ciphering.
12	MS -> SS	HANOVER ACCESS	These four HANOVER ACCESS messages are
13	MS -> SS	HANOVER ACCESS	sent on the new channel in non ciphered
14	MS -> SS	HANOVER ACCESS	mode.
15	MS -> SS	HANOVER ACCESS	Before completion of the 4 access bursts on the new DCCCH, additional access bursts may also be sent on the SACCH
16	MS -> SS	HANOVER COMPLETE	Sent in non ciphered mode on the new channel.

Step	Direction	Message	Comments
17	SS -> MS	ASSIGNMENT COMMAND	Includes Cipher Mode Setting IE set to "Start Ciphering", with algorithm arbitrarily selected from those supported by the MS.
18	SS		The SS activates the new channel with enciphering and deciphering enabled and using cipher key "K".
19	MS -> SS	ASSIGNMENT COMPLETE	Sent on the new channel in ciphered mode using key "K" and the commanded algorithm.
20	SS -> MS	CIPHERING MODE COMMAND	Cipher Mode Setting = "No Ciphering". The SS starts receiving in non ciphered mode.
21	MS -> SS	CIPHERING MODE COMPLETE	Sent in non ciphered mode. This message shall be ready to be transmitted before 500 ms after the completion of step 20.
22	SS	-	The SS starts transmitting in non ciphered mode.
23	SS -> MS	HANDOVER COMMAND	Includes Cipher Mode Setting IE set to "Start Ciphering", with algorithm "X" arbitrarily selected from those supported by the MS.
24	SS		The SS activates the new channel with enciphering and deciphering enabled and using cipher key "L".
25	MS -> SS	HANDOVER ACCESS	These four HANDOVER ACCESS messages are
26	MS -> SS	HANDOVER ACCESS	sent on the new channel in the non ciphered
27	MS -> SS	HANDOVER ACCESS	mode.
28	MS -> SS	HANDOVER ACCESS	Before completion of the 4 access bursts on the new DCCH, additional access bursts may also be sent on the SACCH
29	MS -> SS	HANDOVER COMPLETE	Sent on the new channel in ciphered mode using key "L" and algorithm "X".
30	SS -> MS	IDENTITY REQUEST	
31	MS -> SS	IDENTITY RESPONSE	
32	SS -> MS	HANDOVER COMMAND	Includes Cipher Mode Setting IE set to "Start Ciphering", with algorithm identifier set to "X".
33	SS		The SS activates the new channel with enciphering and deciphering enabled.
34	MS -> SS	HANDOVER ACCESS	These four HANDOVER ACCESS messages are
35	MS -> SS	HANDOVER ACCESS	sent on the new channel in the non ciphered
36	MS -> SS	HANDOVER ACCESS	mode.
37	MS -> SS	HANDOVER ACCESS	Before completion of the 4 access bursts on the new DCCH, additional access bursts may also be sent on the SACCH
38	MS -> SS	HANDOVER COMPLETE	Sent on the new channel in ciphered mode using algorithm "X".
39	SS -> MS	ASSIGNMENT COMMAND	Includes Cipher Mode Setting IE set to "No Ciphering".
40	SS		The SS activates the new channel without ciphering.
41	MS -> SS	ASSIGNMENT COMPLETE	Sent in non-ciphered mode on the new channel.
42	SS -> MS	CIPHERING MODE COMMAND	Cipher Mode Setting = "No Ciphering".
43	MS -> SS	CIPHERING MODE COMPLETE	Sent in non ciphered mode. This message shall be ready to be transmitted before 500 ms after the completion of step 42.
44	SS -> MS	AUTHENTICATION REQUEST	Contains a new Ciphering Key Sequence Number which is associated with the new cipher key, "M".
45	MS -> SS	AUTHENTICATION RESPONSE	
46	SS -> MS	HANDOVER COMMAND	Includes Cipher Mode Setting IE set to "Start Ciphering", with algorithm "Y" arbitrarily selected from those supported by the MS.
47	SS		The SS activates the new channel with enciphering and deciphering enabled and using cipher key "L".
48	MS -> SS	HANDOVER ACCESS	These four HANDOVER ACCESS messages are
49	MS -> SS	HANDOVER ACCESS	sent on the new channel in the non ciphered
50	MS -> SS	HANDOVER ACCESS	mode.
51	MS -> SS	HANDOVER ACCESS	Before completion of the 4 access bursts on the new DCCH, additional access bursts may also be sent on the SACCH
52	MS -> SS	HANDOVER COMPLETE	Sent on the new channel in ciphered mode using key "L"
53	SS -> MS	HANDOVER COMMAND	Includes Cipher Mode Setting IE set to "No Ciphering".

Step	Direction	Message	Comments
54	SS, MS		The SS does not activate the new channel The MS's transmissions on the new channel need not be monitored.
55	MS -> SS	HANDOVER FAILURE	sent on old channel using algorithm "Y" and key "L".
56	SS -> MS	IDENTITY REQUEST	
57	MS -> SS	IDENTITY RESPONSE	
58	SS -> MS	ASSIGNMENT COMMAND	Includes Cipher Mode Setting IE set to "No Cipherng".
59	SS, MS		The SS does not activate the new channel The MS's transmissions on the new channel need not be monitored.
60	MS -> SS	ASSIGNMENT FAILURE	sent on old channel using algorithm "Y" and key "L".
61A	SS -> MS	CHANNEL RELEASE	
61B	SS -> MS	ASSIGNMENT COMMAND	Includes Cipher Mode Setting IE set to "Start Cipherng", with algorithm "Z" arbitrarily selected from those supported by the MS but different to algorithm "Y".
62B	SS		The SS activates the new channel with enciphering and deciphering enabled.
63B	MS -> SS	ASSIGNMENT COMPLETE	Sent on the new channel in ciphered mode using key "L" and algorithm "Z".
64B	SS -> MS	HANDOVER COMMAND	Includes Cipher Mode Setting IE set to "Start Cipherng" and the algorithm identifier set to "Y".
65B	SS		The SS activates the new channel with enciphering and deciphering enabled.
66B	MS -> SS	HANDOVER ACCESS	These four HANDOVER ACCESS messages are
67B	MS -> SS	HANDOVER ACCESS	sent on the new channel in the non ciphered
68B	MS -> SS	HANDOVER ACCESS	mode.
69B	MS -> SS	HANDOVER ACCESS	Before completion of the 4 access bursts on the new DCCH, additional access bursts may also be sent on the SACCH
70B	MS -> SS	HANDOVER COMPLETE	Sent on the new channel in ciphered mode using key "L" and algorithm "Y".
71B	SS -> MS	CHANNEL RELEASE	

Specific Message Contents

ASSIGNMENT COMMAND

Information Element	value/remark
Protocol Discriminator	RR Management.
Skip Indicator	0000
Message Type	00101110
Channel Description	
- Channel Type	SDCCH/8 or SDCCH4 (same type as old channel)
- TDMA offset	Chosen arbitrarily, but different to the one in use (SDCCH4), otherwise arbitrary..
- Timeslot Number	Chosen arbitrarily, but different to the one in use (SDCCH8) or Timeslot zero.(SDCCH4)
- Training Sequence Code	5 (same as the BCC).
- Hopping	Single RF channel.
- ARFCN	See table below.
Power Command	
- Power level	Chosen arbitrarily but within the range supported by the MS.
Cipher Mode Setting	As specified above.
All other information elements:	Not present.

HANDOVER COMMAND

Information Element	value/remark
Protocol Discriminator	RR Management.
Skip Indicator	0000
Message Type	00101011
Cell Description	
- Network Colour Code	1
- Base station Colour Code	5
- BCCH Carrier Number	See table below.
Channel Description	
- Channel Type	SDCCH/8 or SDCCH4(same type as old channel) Chosen arbitrarily, but different to the one in use (SDCCH4), otherwise arbitrary.
- TDMA offset	
- Timeslot Number	Chosen arbitrarily, but different to the one in use (SDCCH8) or Timeslot zero.(SDCCH4
- Training Sequence Code	5 (same as the BCC).
- Hopping	Single RF channel.
- ARFCN	See table below.
Handover Reference	
- Handover Reference Value	Chosen arbitrarily.
Power Command	
- Power level	Chosen arbitrarily, but within the range supported by the MS.
Synchronization Indication	
- Synchronization indication	synchronized.
- Report observed time difference	not included.
- Normal cell indication	out of range ignored.
Cipher Mode setting	As specified above.
All other information elements:	Not present.

Band	ARFCN
GSM 450	265
GSM 480	315
GSM 710	467
GSM 750	467
T-GSM 810	467
GSM 850	157
GSM 900	30
DCS 1 800	650
PCS 1 900	650

CIPHER MODE COMMAND

Information Element	value/remark
As default message contents, except:	
Cipher Mode Setting	
- Algorithm Identifier	As specified above.
- Cipher Mode Set	As specified above.

26.6.8.5 Cipherng mode / IMEISV request

If the MS does not supply the IMEISV when requested, the network will not know whether or not the MS is type approved, i.e. whether or not it has passed any tests.

If the MS supplies its IMEISV when not requested, this may cause calls to systematically fail.

26.6.8.5.1 Conformance requirements

1. When the MS receives the CIPHERING MODE COMMAND message with Cipher Response bit set to "IMEISV shall be included", the MS shall include the IMEISV in the Mobile Identity IE in the CIPHERING MODE COMPLETE message.

2. When the MS receives the CIPHERING MODE COMMAND message with Cipher Response bit set to "IMEISV shall not be included", the MS shall not include the Mobile Identity IE in the CIPHERING MODE COMPLETE message.

References

Conformance requirement 1: 3GPP TS 04.08 / 3GPP TS 44.018 subclauses 3.4.7.2 and 9.1.10.1.

Conformance requirement 2: 3GPP TS 04.08 / 3GPP TS 44.018 subclause 9.1.10.1.

26.6.8.5.2 Test purpose

To verify that the MS supplies its IMEISV in the CIPHERING MODE COMPLETE message when it receives a CIPHERING MODE COMMAND message with a Cipher Response bit set to "IMEISV shall be included".

To verify that the MS does not supply any Mobile Identity IE in the CIPHERING MODE COMPLETE message when it receives a CIPHERING MODE COMMAND message with a Cipher Response bit set to "IMEISV shall not be included".

26.6.8.5.3 Method of test

Initial Conditions

System Simulator:

1 cell.

Mobile Station:

The MS is in the "idle, updated" state, with a TMSI allocated.

Specific PICS statements

-

PIXIT statements

- - IMEISV of the MS.

Foreseen Final State of the MS

"Idle, updated", with TMSI allocated.

Test Procedure

The MS is paged. It shall send at least one CHANNEL REQUEST message. The SS sends an IMMEDIATE ASSIGNMENT and the MS shall answer with a PAGING RESPONSE. Then the SS sends a CIPHERING MODE COMMAND indicating "No ciphering" and with the Cipher Response bit set to "IMEISV shall not be included". The MS shall respond with a CIPHERING MODE COMPLETE message that does not include the Mobile Identity IE.

Then the SS sends a CIPHERING MODE COMMAND indicating "No ciphering" and with the Cipher Response bit set to "IMEISV shall be included". The MS shall respond with a CIPHERING MODE COMPLETE message that carries the IMEISV in the Mobile Identity IE.

Finally the SS sends a CHANNEL RELEASE to end the test.

Maximum Duration of Test

10 s.

Expected Sequence

Step	Direction	Message	Comments
1	SS -> MS	PAGING REQUEST TYPE 1	
2	MS -> SS	CHANNEL REQUEST	
3	SS -> MS	IMMEDIATE ASSIGNMENT	
4	MS -> SS	PAGING RESPONSE	
5	SS -> MS	CIPHERING MODE COMMAND	Cipher Mode Setting = "No Ciphering". Cipher Response = "IMEISV shall not be included".
6	MS -> SS	CIPHERING MODE COMPLETE	Shall not include Mobile Identity IE.
7	SS -> MS	CIPHERING MODE COMMAND	Cipher Mode Setting = "No Ciphering". Cipher Response = "IMEISV shall be included".
8	MS -> SS	CIPHERING MODE COMPLETE	Shall include one Mobile Identity IE carrying the MS's IMEISV.
9	SS -> MS	CHANNEL RELEASE	

Specific Message Contents

None.

26.6.8.6 Ciphering mode / Non support of algorithm A5/2

26.6.8.6.1 Conformance requirements

For the MS it is prohibited to implement algorithm A5/2.

References

3GPP TS 43.020 subclause 4.9

26.6.8.6.2 Test purpose

To verify that the MS does not start ciphering when it receives a CIPHERING MODE COMMAND message with Cipher Mode Setting = "Start Ciphering" and algorithm identifier set to "A5/2".

26.6.8.6.3 Method of test

Initial Conditions

System Simulator:

1 cell. ATT=1.

Mobile Station:

Power off.

Specific PICS statements

-

PIXIT statements

-

Test Procedure

The MS is powered on. The MS sends CHANNEL REQUEST for doing location update procedure. The SS sends an IMMEDIATE ASSIGNMENT and the MS shall answer with a LOCATION UPDATING REQUEST. SS checks that MS does not support A5/2 algorithm by CLASSMARK ENQUIRY Procedure. Then SS sends an AUTHENTICATION REQUEST and the MS shall answer with AUTHENTICATION RESPONSE. Then the SS sends a CIPHERING MODE COMMAND, ordering the MS to start ciphering with algorithm A5/2 which is prohibited for the MS. After transmission of this command the SS starts deciphering. The MS shall not respond with a CIPHERING MODE COMPLETE message in ciphered mode using the cipher key determined during the authentication procedure.

Maximum Duration of Test

3 minutes, including 1 minute for any necessary operator actions.

Expected Sequence

Step	Direction	Message	Comments
1	MS -> SS	CHANNEL REQUEST	MS is switched on or powered on
2	SS -> MS	IMMEDIATE ASSIGNMENT	
3	MS -> SS	LOCATION UPDATING REQUEST	
4	SS->MS	CLASSMARK ENQUIRY	CLASSMARK CHANGE message is requested A5/2 algorithm = "encryption algorithm A5/2 not available" in Mobile Station Classmark 2 IE
5	MS->SS	CLASSMARK CHANGE	
6	SS -> MS	AUTHENTICATION REQUEST	Cipher Mode Setting = "Start Ciphering; cipher with algorithm A5/2". The SS starts deciphering. SS checks that there is no valid L3 message received using algorithm A5/2 (e.g. CIPHERING MODE COMPLETE) within 10s.
7	MS -> SS	AUTHENTICATION RESPONSE	
8	SS -> MS	CIPHERING MODE COMMAND	

Specific Message Contents

None.

26.6.9 Test of additional assignment

The Additional Assignment procedure is used to change an MS's channel configuration from Lm + ACCH to Lm + Lm + ACCH. It is therefore only relevant to those mobiles which perform such an operation.

No tests are specified at the moment.

26.6.10 Test of partial release

The Partial Release procedure is used to change an MS's channel configuration from Lm + Lm + ACCH to Lm + ACCH. It is therefore only relevant to those mobiles which perform such an operation.

No tests are specified at the moment.

26.6.11 Test of classmark

26.6.11.1 Classmark change

This procedure allows the MS to indicate to the network that a change in the classmark (e.g. due to addition of power amplification) has taken place.

26.6.11.1.1 Conformance requirements

If the RF power capability of the MS is changed during a call, this change shall be signalled to the network.

If the RF power capability of the MS is changed in idle mode, the up to date RF power capability shall be signalled to the network during RR connection establishment.

References

3GPP TS 04.08 / 3GPP TS 44.018 subclause 3.4.10.

26.6.11.1.2 Test purpose

To verify that if the RF power capability or any other capability indicated in a Classmark IE of the MS is changed during a call, the change is communicated on the DCCH to the network.

To verify that if the RF power capability or any other capability indicated in a Classmark IE of the MS is changed in idle mode, the out of date capabilities are not communicated to the network during RR connection establishment.

26.6.11.1.3 Method of test

Initial Conditions

System Simulator:

1 cell, default parameters.

Mobile Station:

The MS is in the "idle, updated" state, with a TMSI allocated and with no additional power amplification applied.

Specific PICS statements

- TSPC_Type_xxx (all appropriate power classes)
- TSPC_AddInfo_Full_rate_version_1
- TSPC_AddInfo_Full_rate_version_2
- TSPC_AddInfo_Full_rate_version_3

PIXIT statements

-

Foreseen Final State of the MS

"Idle, updated", with TMSI allocated and with no additional power amplification applied.

Test Procedure

With the MS in idle mode, the RF power capability shall be changed by the addition of power amplification, after which the MS is made to originate a call. The new RF power capability shall be included in the CM SERVICE REQUEST message. After the call has reached the Call Control state U10, the RF power capability of the MS is changed by removal of the additional power amplification. The MS shall send a CLASSMARK CHANGE message indicating the new RF power capability. The RF power capability is then changed by adding the power amplification. The MS shall again send a CLASSMARK CHANGE message indicating the new RF power capability. The call is then released by the SS.

With the MS in idle mode, the power amplification is removed. The SS then pages the MS, which in the PAGING RESPONSE message shall indicate the correct RF power capability.

Finally the SS transmits a CHANNEL RELEASE to end the test.

Maximum Duration of Test

5 minutes, including 1 minute for any necessary operator actions.

Expected Sequence

Step	Direction	Message	Comments
1	-----	-----	Add power amplification.
2	-----	-----	The MS shall be made to originate a call.
3	MS -> SS	CHANNEL REQUEST	Establish. Cause = "Originating call" NECI not equal to one.
4	SS -> MS	IMMEDIATE ASSIGNMENT	
5	MS -> SS	CM SERVICE REQUEST	The "Mobile Station Classmark 2" IE shall indicate the new RF power capability.
6	SS -> MS	CM SERVICE ACCEPT	
7	MS -> SS	SETUP	
8	SS -> MS	CALL PROCEEDING	
9	SS -> MS	ALERTING	
10	SS -> MS	ASSIGNMENT COMMAND	The Channel Mode is a non-signalling mode arbitrarily selected from the full rate capabilities declared for the MS
11	MS -> SS	ASSIGNMENT COMPLETE	
12	SS -> MS	CONNECT	
13	MS -> SS	CONNECT ACKNOWLEDGE	
14	-----	-----	Remove the power amplification.
15	MS -> SS	CLASSMARK CHANGE	The "Mobile Station Classmark 2" IE shall indicate the new power capability.
16	-----	-----	Add power amplification.
17	MS -> SS	CLASSMARK CHANGE	The "Mobile Station Classmark 2" IE shall indicate the new power capability.
18	SS -> MS	CHANNEL RELEASE	
19	-----	-----	Remove the power amplification.
	-----	-----	The SS waits 12 s to allow the MS to perform cell reselection.
20	SS -> MS	PAGING REQUEST TYPE 1	
21	MS -> SS	CHANNEL REQUEST	Establish. Cause = "Answer to paging".
22	SS -> MS	IMMEDIATE ASSIGNMENT	
23	MS -> SS	PAGING RESPONSE	The "Mobile Station Classmark 2" IE shall indicate the new power capability.
24	SS -> MS	CHANNEL RELEASE	

Specific Message Contents

None.

26.6.11.2 Classmark interrogation

This procedure allows the network to request the MS to supply all its classmark information to the network.

Networks may systematically use this procedure (e.g. during location updating) and, if it is incorrectly implemented in the MS, the basic connection establishment procedure may systematically fail.

26.6.11.2.1 Conformance requirements

On receipt of a CLASSMARK ENQUIRY message, the MS sends a CLASSMARK CHANGE message to the network containing the Mobile Station Classmark 2 information element and depending upon the contents of this information element, possibly the Mobile Station Classmark 3 information element.

References

3GPP TS 04.08 / 3GPP TS 44.018 subclauses 3.4.11 and 9.1.11.1.

3GPP TS 04.13 subclause 5.2.9.

26.6.11.2.2 Test purpose

To verify that if the network requests the MS to supply all its classmark information then this information is communicated on the DCCH to the network.

26.6.11.2.3 Method of test

Initial Conditions

System Simulator:

1 cell, default parameters.

Mobile Station:

"Idle, updated", with TMSI allocated.

Specific PICS statements

-

PIXIT statements

- Contents of Mobile Station Classmark 2 information element
- Contents of Mobile Station Classmark 3 information element

Foreseen Final State of the MS

"Idle, updated", with TMSI allocated.

Test Procedure

The MS is switched off (or has its power removed).

The SS then sets the IMSI attach-detach flag in the SYSTEM INFORMATION messages so that the MS shall perform a location update when switched on.

The MS is switched on (or its power is re-applied). The MS then initiates a location update attempt. After the mobile has sent the LOCATION UPDATING REQUEST message, the SS transmits a CLASSMARK ENQUIRY message. The MS shall be ready to transmit the CLASSMARK CHANGE message before 300 ms after the end of the CLASSMARK ENQUIRY message.

The term "ready to transmit" is defined in 3GPP TS 04.13.

Then the SS transmits a LOCATION UPDATING ACCEPT message that does not contain a Mobile Identity IE.

Maximum Duration of Test

2 minutes.

Expected Sequence

Step	Direction	Message	Comments
1	MS		The MS is switched off (or has its power removed). IMSI attach-detach flag changed. The MS is switched on (or its power is re-applied).
2	SS		
3	MS		
4	MS -> SS	CHANNEL REQUEST	Contents as defined for default message. This message shall be ready to be transmitted before 300 ms after the completion of step 7.
5	SS -> MS	IMMEDIATE ASSIGNMENT	
6	MS -> SS	LOCATION UPDATING REQUEST	
7	SS -> MS	CLASSMARK ENQUIRY	
8	MS -> SS	CLASSMARK CHANGE	
9	SS -> MS	LOCATION UPDATING ACCEPT	
10	SS -> MS	CHANNEL RELEASE	

Specific Message Contents

None.

Default Message Contents

Contents of LOCATION UPDATING ACCEPT message:

Protocol Discriminator	MM message
Skip Indicator	0000
Message Type	00000010
Location Area Identification	
- Mobile Country Code	001 decimal
- Mobile Network Code	01 decimal (PCS 1 900: 011 decimal)
- Location Area Code	0001H
Mobile Identity	Not present
Follow on proceed	Not present

26.6.11.3 Classmark interrogation / UTRAN Classmark Change

This procedure allows the network to request the MS to supply all its classmark information to the network. In addition the network may request a MS supporting UTRAN to send the UTRAN classmark information.

Networks may systematically use this procedure (e.g. during location updating) and, if it is incorrectly implemented in the MS, the basic connection establishment procedure may systematically fail.

If the last timeslot of the message block containing a CLASSMARK ENQUIRY message occurs at time T, then the MS shall be ready to transmit the CLASSMARK CHANGE message before T + 300 ms.

26.6.11.3.1 Conformance requirements

On receipt of a CLASSMARK ENQUIRY message, the MS sends a CLASSMARK CHANGE message to the network containing the Mobile Station Classmark 2 information element and depending upon the contents of this information element, possibly the Mobile Station Classmark 3 information element.

References

3GPP TS 04.08 / 3GPP TS 44.018 subclauses 3.4.11 and 9.1.11.1.

3GPP TS 04.13 subclause 5.2.9.

26.6.11.3.2 Test purpose

To verify that if the network requests the MS to supply all its classmark information, including the UTRA Classmark information, then this information is communicated on the DCCH to the network.

26.6.11.3.3 Method of test

Initial Conditions

System Simulator:

1 cell, default parameters. In SI3 is ATT flag is set to 1 and Early Classmark Sending Control flag is set to Low.

Mobile Station:

Powered off.

Specific PICS statements

-

PIXIT statements

- Contents of Mobile Station Classmark 2 information element
- Contents of Mobile Station Classmark 3 information element
- Contents of UTRAN Classmark Change information

Test Procedure

The MS is switched on (or its power is re-applied). The MS then initiates a location update attempt. After the mobile has sent the LOCATION UPDATING REQUEST message, the SS transmits a CLASSMARK ENQUIRY message. The MS shall be ready to transmit the CLASSMARK CHANGE message within 300 ms after the end of the CLASSMARK ENQUIRY message.

The term "ready to transmit" is defined in 3GPP TS 04.13.

Then the SS transmits a LOCATION UPDATING ACCEPT message that does not contain a Mobile Identity IE.

Maximum Duration of Test

2 minutes.

Expected Sequence

Step	Direction	Message	Comments
1	MS		The MS is switched on.
2	MS -> SS	CHANNEL REQUEST	
3	SS -> MS	IMMEDIATE ASSIGNMENT	
4	MS -> SS	LOCATION UPDATING REQUEST	
5	SS -> MS	CLASSMARK ENQUIRY	
6	MS -> SS	CLASSMARK CHANGE	This message shall be ready transmitted within 300 ms after the completion of step 5. If MS support UMTS FDD: UMTS FDD Radio Access Capability = 1 If MS support UMTS TDD: UMTS TDD Radio Access Capability = 1 Contents as declared in PIXIT.
7	MS -> SS	UTRAN Classmark Change	Contents as declared in PIXIT.
8	SS -> MS	LOCATION UPDATING ACCEPT	
9	SS -> MS	CHANNEL RELEASE	

Specific Message Contents

Content of CLASSMARK ENQUIRY message:

Protocol Discriminator	RR management
Skip Indicator	0000
Message Type	00010011
Classmark Enquiry Mask value part	00001000, note
Note	CLASSMARK CHANGE message is requested; UTRAN CLASSMARK CHANGE message is requested; CDMA2000 CLASSMARK CHANGE message not requested; and GERAN IU MODE CLASSMARK CHANGE message not requested.

Contents of LOCATION UPDATING ACCEPT message:

Protocol Discriminator	MM message
Skip Indicator	0000
Message Type	00000010
Location Area Identification	
- Mobile Country Code	001 decimal
- Mobile Network Code	01 decimal (PCS 1 900: 011 decimal)
- Location Area Code	0001H
Mobile Identity	Not present
Follow on proceed	Not present

26.6.11.4 Early UTRAN Classmark Sending

This procedure allows the network to request the MS to supply all its classmark information to the network. In addition the network may request a MS supporting UTRAN to send the UTRAN classmark information.

Networks may systematically use this procedure (e.g. during location updating) and, if it is incorrectly implemented in the MS, the basic connection establishment procedure may systematically fail.

26.6.11.4.1 Conformance requirements

Early classmark sending consists in the mobile station sending as early as possible after access a CLASSMARK CHANGE message to provide the network with additional classmark information. In addition a MS supporting UTRAN sends a UTRAN Classmark Change message; an MS supporting CDMA2000 sends a CDMA2000 Classmark Change. When a CLASSMARK CHANGE message and one or more additional UTRAN Classmark Change or CDMA2000 Classmark Change messages are to be sent, the CLASSMARK CHANGE message shall be sent first.

....

A mobile station which implements the support of one or more 3G Radio Access Technology shall also implement the « Controlled Early Classmark Sending » option; in this case neither UTRAN CLASSMARK CHANGE nor CDMA2000 CLASSMARK CHANGE message shall be sent by the mobile if prohibited by the 3G Early Classmark Sending Restriction parameter in the last reception in the accessed cell of the SYSTEM INFORMATION TYPE 3 message or the PACKET SYSTEM INFORMATION TYPE 2 message (see 3GPP TS 04.60). If the PACKET SYSTEM INFORMATION TYPE 2 messages have been received, but the 3G Early Classmark Sending Restriction flag is not included, the mobile station shall assume neither UTRAN nor cdma2000 classmark change message shall be sent with the Early Classmark Sending.

During a contention resolution procedure, if the last timeslot of the block containing a Layer 2 UA frame, occurs at time T, then the MS shall be ready to transmit the CLASSMARK CHANGE message, if applicable (see GSM 04.06 [3] and GSM 04.08 [4]), before T + 40 ms.

References

3GPP TS 04.08 / 3GPP TS 44.018 subclauses 3.3.1.1.4.1 and 9.1.11.1.

3GPP TS 04.13 subclause 5.2.9.

26.6.11.4.2 Test purpose

To verify that if the network requests the MS to supply all its classmark information, including the UTRAN Classmark information, then this information is communicated on the DCCH to the network. The request of the classmark information is indicated in SYSTEM INFORMATION TYPE 3.

26.6.11.4.3 Method of test

Initial Conditions

System Simulator:

1 cell, default parameters.

The SS shall transmit SI3 with ATT flag is set to 1 and both Early Classmark Sending Restriction and 3G Early Classmark Sending Restriction parameter set to High.

Mobile Station:

Powered off.

Specific PICS statements

-

PIXIT statements

- Contents of Mobile Station Classmark 2 information element
- Contents of Mobile Station Classmark 3 information element
- Contents of UTRAN Classmark Change information

Test Procedure

The MS is switched on (or its power is re-applied). The MS then initiates a location update attempt. After the mobile has sent the LOCATION UPDATING REQUEST message, the MS transmits the CLASSMARK CHANGE and UTRAN CLASSMARK CHANGE messages.

Then the SS transmits a LOCATION UPDATING ACCEPT message that does not contain a Mobile Identity IE.

Maximum Duration of Test

2 minutes.

Expected Sequence

Step	Direction	Message	Comments
1	MS		The MS is switched on.
2	MS -> SS	CHANNEL REQUEST	
3	SS -> MS	IMMEDIATE ASSIGNMENT	
4	MS -> SS	LOCATION UPDATING REQUEST	(SABM)
5	SS -> MS	LOCATION UPDATING REQUEST	(UA)
6	MS -> SS	CLASSMARK CHANGE	This message shall be transmitted within 69 ms after the completion of step 5. If MS support UMTS FDD: UMTS FDD Radio Access Capability = 1 If MS support UMTS TDD: UMTS TDD Radio Access Capability = 1 Contents as declared in PIXIT.
7	MS -> SS	UTRAN CLASSMARK CHANGE	Contents as declared in PIXIT.
8	SS -> MS	LOCATION UPDATING ACCEPT	
9	SS -> MS	CHANNEL RELEASE	

Specific Message Contents

Contents of LOCATION UPDATING ACCEPT message:

Protocol Discriminator	MM message
Skip Indicator	0000
Message Type	00000010
Location Area Identification	
- Mobile Country Code	001 decimal
- Mobile Network Code	01 decimal (PCS 1 900: 011 decimal)
- Location Area Code	0001H
Mobile Identity	Not present
Follow on proceed	Not present

26.6.12 Test of channel release

The purpose of this procedure is to deactivate the dedicated channels in use. When the channels are released, the MS returns to the CCCH configuration, idle mode.

26.6.12.1 Channel release / SDCCH

26.6.12.1.1 Conformance requirements

After the acknowledgement of the Layer 2 disconnection by the network, the MS shall not produce any further RF-transmission.

References

3GPP TS 04.08 / 3GPP TS 44.018 subclause 3.4.13.1

26.6.12.1.2 Test purpose

To verify that the MS is able to correctly release an SDCCH after having received a CHANNEL RELEASE message.

26.6.12.1.3 Method of test

Initial Conditions

System Simulator:

1 cell, default parameters.

Mobile Station:

The MS is in the "idle, updated" state, with a TMSI allocated.

Specific PICS statements

-

PIXIT statements

-

Foreseen Final State of the MS

"Idle, updated", with TMSI allocated.

Test Procedure

The MS is paged and allocated a dedicated channel and the Layer 2 signalling link is established. The SS then sends a CHANNEL RELEASE message, after which the MS shall initiate a Layer 2 disconnection process on the main signalling link. After the acknowledgement of the Layer 2 disconnection by the SS, the MS shall stop transmission of Layer 2 messages. This is verified for 3 s. The MS shall return to the idle state, which is verified through the paging procedure to which the MS shall respond.

Maximum Duration of Test

20 s.

Expected Sequence

Step	Direction	Message	Comments
1	SS -> MS	PAGING REQUEST TYPE 1	
2	MS -> SS	CHANNEL REQUEST	Establ. Cause = "Answer to paging".
3	SS -> MS	IMMEDIATE ASSIGNMENT	Channel Type = SDCCH/8
4	MS -> SS	PAGING RESPONSE	
5	SS -> MS	CHANNEL RELEASE	With a valid RR cause value.
6	MS -> SS	DISC	The MS may send the DISC message without performing a layer 2 acknowledgement of the CHANNEL RELEASE message.
7	SS -> MS	UA	
	-----	-----	The SS verifies for 3 s that the MS does not produce any Layer 2 messages.
	-----	-----	The SS waits 12 s to allow the MS to perform cell reselection.
8	SS -> MS	PAGING REQUEST TYPE 1	
9	MS -> SS	CHANNEL REQUEST	Establ. Cause = "Answer to paging".
10	SS -> MS	IMMEDIATE ASSIGNMENT	
11	MS -> SS	PAGING RESPONSE	
12	SS -> MS	CHANNEL RELEASE	

Specific Message Contents

None.

26.6.12.2 Channel release / SDCCH - no L2 ACK

26.6.12.2.1 Conformance requirements

After the expiry of timer T3110 the MS shall not produce any further RF-transmission.

References

3GPP TS 04.08 / 3GPP TS 44.018 subclause 3.4.13.1.

26.6.12.2.2 Test purpose

To verify that the MS is able to correctly release a SDCCH after having received a CHANNEL RELEASE message, even if the SS does not L2 acknowledge the L2 DISC frame.

26.6.12.2.3 Method of test

Initial Conditions

System Simulator:

1 cell, default parameters.

Mobile Station:

The MS is in the "idle, updated" state, with a TMSI allocated.

Specific PICS statements

-

PIXIT statements

-

Foreseen Final State of the MS

"Idle, updated", with TMSI allocated.

Test Procedure

The MS is paged and allocated a dedicated channel and the Layer 2 signalling link is established. The SS then sends a CHANNEL RELEASE message, after which the MS shall send at least 2 L2 DISC frames. The SS does not acknowledge any of the L2 DISC frames. After 2 s, the SS verifies for 3 s that the MS has stopped transmission of Layer 2 messages. The MS shall return to the idle state, which is verified through the paging procedure to which the MS shall respond.

Maximum Duration of Test

25 s.

Expected Sequence

Step	Direction	Message	Comments
1	SS -> MS	PAGING REQUEST TYPE 1	Establ. Cause = "Answer to paging". Channel Type = SDCCH/8. With a valid RR cause value. The MS may send the DISC message without performing a layer 2 acknowledgement of the CHANNEL RELEASE message. The MS shall send at least 2 L2 DISC frames, to which the SS does not respond. After a period of 2 s, the SS verifies for 3 s that the MS does not produce any further Layer 2 messages. The SS waits 12 s to allow the MS to perform cell reselection.
2	MS -> SS	CHANNEL REQUEST	
3	SS -> MS	IMMEDIATE ASSIGNMENT	
4	MS -> SS	PAGING RESPONSE	
5	SS -> MS	CHANNEL RELEASE	
6	MS -> SS	DISC	
	-----	-----	
7	SS -> MS	PAGING REQUEST TYPE 1	Establ. Cause = "Answer to paging".
8	MS -> SS	CHANNEL REQUEST	
9	SS -> MS	IMMEDIATE ASSIGNMENT	
10	MS -> SS	PAGING RESPONSE	
11	SS -> MS	CHANNEL RELEASE	

Specific Message Contents

None.

26.6.12.3 Channel release / TCH-F

26.6.12.3.1 Conformance requirements

After the acknowledgement of the Layer 2 disconnection by the network the MS shall not produce any further RF-transmission.

References

3GPP TS 04.08 / 3GPP TS 44.018 subclause 3.4.13.1.

26.6.12.3.2 Test purpose

To verify that the MS is able to correctly release a full-rate TCH after having received a CHANNEL RELEASE message.

26.6.12.3.3 Method of test

Initial Conditions

System Simulator:

1 cell, default parameters.

Mobile Station:

The MS is in the "idle, updated" state, with a TMSI allocated.

Specific PICS statements

-

PIXIT statements

-

Foreseen Final State of the MS

"Idle, updated", with TMSI allocated.

Test Procedure

The MS is paged and allocated a dedicated channel and the Layer 2 signalling link is established. The SS then sends a CHANNEL RELEASE message, after which the MS shall initiate a Layer 2 disconnection process on the main signalling link. After the acknowledgement of the Layer 2 disconnection by the SS, the MS shall stop transmission of Layer 2 messages. This is verified for 3 s. The MS shall return to the idle state, which is verified through the paging procedure to which the MS shall respond.

Maximum Duration of Test

20 s.

Expected Sequence

Step	Direction	Message	Comments
1	SS -> MS	PAGING REQUEST TYPE 1	
2	MS -> SS	CHANNEL REQUEST	Establish. Cause = "Answer to paging".
3	SS -> MS	IMMEDIATE ASSIGNMENT	Channel Type = "Bm + ACCHs"
4	MS -> SS	PAGING RESPONSE	
5	SS -> MS	CHANNEL RELEASE	With a valid RR cause value.
6	MS -> SS	DISC	The MS may send the DISC message without performing a layer 2 acknowledgement of the CHANNEL RELEASE message.
7	SS -> MS	UA	
	-----	-----	The SS verifies for 3 s that the MS does not produce any Layer 2 messages.
	-----	-----	The SS waits 12 s to allow the MS to perform cell reselection.
8	SS -> MS	PAGING REQUEST TYPE 1	
9	MS -> SS	CHANNEL REQUEST	Establish. Cause = "Answer to paging".
10	SS -> MS	IMMEDIATE ASSIGNMENT	
11	MS -> SS	PAGING RESPONSE	
12	SS -> MS	CHANNEL RELEASE	

Specific Message Contents

None.

26.6.12.4 Channel release / TCH-F - no L2 ACK

26.6.12.4.1 Conformance requirements

After the expiry of timer T3110 the MS shall not produce any further RF-transmission.

References

3GPP TS 04.08 / 3GPP TS 44.018 subclause 3.4.13.1

26.6.12.4.2 Test purpose

To verify that the MS is able to correctly release a TCH/F after having received a CHANNEL RELEASE message, even if the SS does not L2 acknowledge the L2 DISC frame.

26.6.12.4.3 Method of test

Initial Conditions

System Simulator:

1 cell, default parameters.

Mobile Station:

The MS is in the "idle, updated" state, with a TMSI allocated.

Specific PICS statements

-

PIXIT statements

-

Foreseen Final State of the MS

"Idle, updated", with TMSI allocated.

Test Procedure

The MS is paged and allocated a dedicated channel and the Layer 2 signalling link is established. The SS then sends a CHANNEL RELEASE message (with cause "abnormal release, unspecified"), after which the MS shall send at least 2 L2 DISC frames. The SS does not acknowledge any of the L2 DISC frames. After 2 s, the SS verifies for 3 s that the MS has stopped transmission of Layer 2 messages. The MS shall return to the idle state, which is verified through the paging procedure to which the MS shall respond.

Maximum Duration of Test

25 s.

Expected Sequence

Step	Direction	Message	Comments
1	SS -> MS	PAGING REQUEST TYPE 1	Establ. Cause = "Answer to paging". Channel Type = "Bm + ACCHs". Cause value = "Abnormal release, unspecified". The MS may send the DISC message without performing a layer 2 acknowledgement of the CHANNEL RELEASE message. The MS shall send at least 2 L2 DISC frames, to which the SS does not respond. After a period of 2 s, the SS verifies for 3 s that the MS does not produce any further Layer 2 messages. The SS waits 12 s to allow the MS to perform cell reselection.
2	MS -> SS	CHANNEL REQUEST	
3	SS -> MS	IMMEDIATE ASSIGNMENT	
4	MS -> SS	PAGING RESPONSE	
5	SS -> MS	CHANNEL RELEASE	
6	MS -> SS	DISC	
	-----	-----	
7	SS -> MS	PAGING REQUEST TYPE 1	Establ. Cause = "Answer to paging". Channel Type = SDCCH/8.
8	MS -> SS	CHANNEL REQUEST	
9	SS -> MS	IMMEDIATE ASSIGNMENT	
10	MS -> SS	PAGING RESPONSE	
11	SS -> MS	CHANNEL RELEASE	

Specific Message Contents

None.

26.6.13 Test of starting time

The Assignment, Handover and immediate assignment procedures can include a delayed change of frequency list, MAIO and HSN. This series of tests checks the behaviour of the Mobile Station when receiving channel allocation messages with a starting time and channel description for both before and after the starting time. Tests checking the phase 1 usage of the starting time (that is without a channel description for before the time) are included in the series related to immediate assignment, dedicated assignment and handover.

Throughout subclause 26.6.13 the defaults in the following subclauses

Band Defaults sub-clause

Table 26.6

GSM 450	26.6.16
GSM 480	26.6.17
GSM 710	26.6.21
GSM 750	26.6.19
T-GSM 810	26.6.22
GSM 850	26.6.20
GSM 900	26.6.14
DCS 1 800	26.6.15
PCS 1 900	26.6.18

are used with the following exceptions:

Contents of IMMEDIATE ASSIGNMENT message, unless otherwise defined in the individual test cases:

L2 pseudo length	This is the sum of the lengths of all the information elements present in the message except for the IA rest octets and L2 pseudo length IEs. For the default message the L2 pseudo length is 11.
Protocol Discriminator	RR Management.
Skip Indicator	0000
Message Type	00111111
Page Mode	
- Page Mode	Normal Paging.
Channel Description	
- Channel Type and TDMA offset	Chosen arbitrarily (see initial conditions).
- Timeslot Number	Chosen arbitrarily by the test house;
- Training Sequence Code	Chosen arbitrarily by the test house
- Hopping	Yes.
- Hopping parameters	Chosen arbitrarily.
Request Reference	Pertaining to last Channel Request sent by the MS.
Timing Advance	
- Timing advance value	30 bit periods.
Mobile Allocation	Chosen arbitrarily, at least one frequency. In case of an MA with just one frequency, the frequency should be different from the BCCH carrier.
Starting Time	Not present.
IA rest octets	Not used (all bits set to spare).

Two cells are defined:

Band	BCCH ARFCN	Cell A Cell allocation	BCCH ARFCN	Cell B Cell allocation	CA Coding format – both cells
GSM 450	263	259, 261, 263, 265, 267, 269, 271, 273, 275, 277, 279, 281, 283, 285, 287, 289, 291	274	260, 262, 264, 266, 268, 270, 272, 274, 276, 279, 281, 283, 285, 287, 289, 291	Range 128
GSM 480	310	306, 308, 310, 312, 314, 316, 318, 320, 322, 324, 326, 328, 330, 332, 334, 336, 338	321	307, 309, 311, 313, 315, 317, 319, 321, 323, 326, 328, 330, 332, 334, 336, 338	Range 128
GSM 710	457	447, 454, 457, 463, 471, 479, 482, 483, 489, 496, 498, 500, 501, 502, 503, 506, 508	477	451, 455, 459, 461, 467, 468, 475, 477, 497, 498, 500, 501, 502, 503, 506, 508	Range 128
GSM 750	457	447, 454, 457, 463, 471, 479, 482, 483, 489, 496, 498, 500, 501, 502, 503, 506, 508	477	451, 455, 459, 461, 467, 468, 475, 477, 497, 498, 500, 501, 502, 503, 506, 508	Range 128
T-GSM 810	457	447, 454, 457, 463, 471, 479, 482, 483, 489, 496, 498, 500, 501, 502, 503, 506, 508	477	451, 455, 459, 461, 467, 468, 475, 477, 497, 498, 500, 501, 502, 503, 506, 508	Range 128
GSM 850	147	137, 144, 147, 153, 161, 169, 172, 173, 179, 186, 193, 200, 201, 202, 203, 235, 241	167	141, 145, 149, 151, 157, 158, 165, 167, 187, 193, 200, 201, 202, 203, 235, 241	Range 128
GSM 900	20	10, 17, 20, 26, 34, 42, 45, 46, 52, 59, 66, 73, 74, 75, 76, 108, 114	40	14, 18, 22, 24, 30, 31, 38, 40, 60, 66, 73, 74, 75, 76, 108, 114	Bitmap 0
DCS 1 800	747	737, 741, 747, 754, 759, 762, 766, 767, 773, 775, 779, 782, 791, 798, 829, 832, 844	764	739, 743, 746, 749, 756, 758, 761, 764, 771, 779, 782, 791, 798, 829, 832, 844	Range 256
PCS 1 900	647	637, 641, 647, 654, 659, 662, 666, 667, 673, 675, 679, 682, 691, 698, 729, 732, 744	664	639, 643, 646, 649, 656, 658, 661, 664, 671, 679, 682, 691, 698, 729, 732, 744	Range 256

For DCS 1 800, PCS 1 900 the BCCH ARFCNs shall be added to the default BA-List.

For all other bands the BCCH ARFCNs are already included in the default BA-List.

26.6.13.1 Dedicated assignment with starting time / successful case / time not elapsed

26.6.13.1.1 Conformance requirement

A Mobile Station receiving an ASSIGNMENT COMMAND message with a starting time and channel descriptions for both after and before the starting time, and ready to access before the indicated time has elapsed, shall perform the assignment on the channels as described for before the starting time and shall start using the new frequency parameters (frequencies and hopping sequence, or single frequency) in the correct time slot indicated by the starting time.

The Mobile Station shall accept the ASSIGNMENT COMMAND message for different message formatting, differing by the information elements used to describe frequency lists.

Reference(s)

3GPP TS 04.08 / 3GPP TS 44.018 subclauses 3.4.3.1 and 9.1.2.

26.6.13.1.2 Test purpose

To verify that the MS, after receiving an ASSIGNMENT COMMAND message with a starting time and channel descriptions both for before and after the starting time, and ready to access before the indicated time, performs correctly the assignment using the description for before the time, and eventually starts using the frequency parameters for after the time at the time indicated in the message.

26.6.13.1.3 Method of test

Initial condition(s)

System Simulator:

1 cell, CCCH_CONF set to 1 basic physical channel used for CCCH, not combined with SDCCHs.

Mobile Station:

The MS is in the "idle, updated" state, with a TMSI allocated.

Specific PICS statements

- MS supports Speech (TSPC_AddInfo_SDCCHOnly)
- MS supports GSM HR (TSPC_AddInfo_Halfrate)

PIXIT statements

-

Foreseen final state of the MS

"Idle, updated", with TMSI allocated.

Test procedure

The System Simulator pages the MS and after the MS has responded with a CHANNEL REQUEST, the simulator assigns a hopping SDCCH. Then the SS sends an ASSIGNMENT COMMAND message allocating a channel (TCH/F, TCH/H or SDCCH, arbitrarily chosen among the channels supported), with a starting time and channel descriptions (hopping case) for both before and after the starting time, as detailed in the "specific message contents" clause. The indicated time is such that the Mobile Station is ready to access before that time. The Mobile Station then accesses the channel as described for before the starting time. The MS shall eventually, at the TDMA frame defined by the contents of the "Starting Time" information element of the ASSIGNMENT COMMAND message, use the new frequency parameters. The verification is performed at the RF burst level.

Test parameters:

T1 is set to $T0 + 1000 \pmod{42\,432}$, where T0 is the frame number at which the first burst of the ASSIGNMENT COMMAND message is sent.

Maximum duration of test

45 s.

Expected sequence

Step	Direction	Message	Comments
1	SS -> MS	PAGING REQUEST TYPE 1	
2	MS -> SS	CHANNEL REQUEST	
3	SS -> MS	IMMEDIATE ASSIGNMENT	Hopping channel.
4	MS -> SS	PAGING RESPONSE	
5	SS -> MS	ASSIGNMENT COMMAND	See specific message contents.
6	MS -> SS	ASSIGNMENT COMPLETE	Sent on the correct channel (before time parameters) after establishment of the main signalling link.
7	-----	Time T1	The SS checks that the MS is transmitting now on the correct frequencies (after time parameters) and that the transmission started in the correct frame.
8	SS -> MS	CHANNEL RELEASE	

Specific message contents

ASSIGNMENT COMMAND

Information element	Value/remark
Channel Description, after time	
Channel Type and TDMA offset	Chosen arbitrarily among that supported by the Mobile Station.
Timeslot Number	Chosen arbitrarily.
Training Sequence Code	Chosen arbitrarily.
Hopping	Yes.
Hopping parameters	Chosen arbitrarily.
Power Command	
Power level	Chosen arbitrarily.
Channel Mode	
Mode	Arbitrarily selected from capabilities declared for the MS for the chosen type of channel.
Mobile Allocation, after time	Chosen arbitrarily, at least one frequency. In case of an MA with just one frequency, the frequency should be different from the BCCH carrier.
Starting Time	T1
Channel Description, before time	
Channel Type and TDMA offset	Same as after time.
Timeslot Number	Same as after time.
Training Sequence Code	Same as after time.
Hopping	Yes.
Hopping parameters	Chosen arbitrarily, different from "after time".
Mobile Allocation, before time	Chosen arbitrarily, at least one frequency and different from "Mobile Allocation, after time". In case of an MA with just one frequency, the frequency should be different from the BCCH carrier.

26.6.13.2 Dedicated assignment with starting time / successful case / time elapsed

26.6.13.2.1 Conformance requirement

A Mobile Station receiving an ASSIGNMENT COMMAND message with a starting time and channel descriptions for both after and before the starting time, and ready to access after the indicated time has elapsed, shall perform the assignment on the channels as described for after the starting time.

The Mobile Station shall accept the ASSIGNMENT COMMAND message for different message formatings, differing by the information elements used to describe frequency lists.

Reference(s):

3GPP TS 04.08 / 3GPP TS 44.018 subclauses 3.4.3.1 and 9.1.2.

26.6.13.2.2 Test purpose

To verify that the MS, after receiving an ASSIGNMENT COMMAND message with a starting time and channel descriptions both for before and after the starting time, performs correctly the assignment using the frequency parameters for after the time if the indicated time has already elapsed when the Mobile Station is ready to transmit.

26.6.13.2.3 Method of test

Initial condition(s)

System Simulator:

1 cell, CCCH_CONF set to 1 basic physical channel used for CCCH, not combined with SDCCHs.

Mobile Station:

The MS is in the "idle, updated" state, with a TMSI allocated.

Specific PICS statements

- MS supports Speech (TSPC_AddInfo_SDCCHOnly)
- MS supports GSM HR (TSPC_AddInfo_Halfrate)

PIXIT statements

-

Foreseen final state of the MS

"Idle, updated", with TMSI allocated.

Test procedure

The System Simulator pages the MS and after the MS has responded with a CHANNEL REQUEST, the simulator assigns a hopping SDCCH. Then the SS sends an ASSIGNMENT COMMAND message allocating a channel (TCH/F, TCH/H or SDCCH, arbitrarily chosen among the channels supported), with a starting time and channel descriptions (hopping case) for both before and after the starting time, as detailed in the "specific message contents" clause. The indicated time is such that the Mobile Station is ready to access only after that time. The Mobile Station then accesses the channel as described for after the starting time. The verification is performed at the RF burst level.

Test parameters:

T1 is set to $T0+5 \pmod{42\,432}$, where T0 is the frame number at which the first burst of the ASSIGNMENT COMMAND message is sent.

Maximum duration of test

45 s.

Expected sequence

Step	Direction	Message	Comments
1	SS -> MS	PAGING REQUEST TYPE 1	Hopping channel.
2	MS -> SS	CHANNEL REQUEST	
3	SS -> MS	IMMEDIATE ASSIGNMENT	
4	MS -> SS	PAGING RESPONSE	See specific message contents. Sent on the correct channel (after time parameters) after establishment of the main signalling link.
5	SS -> MS	ASSIGNMENT COMMAND	
6	MS -> SS	ASSIGNMENT COMPLETE	
7	SS -> MS	CHANNEL RELEASE	

Specific message contents

ASSIGNMENT COMMAND

Information element	Value/remark
Channel Description, after time	
Channel Type and TDMA offset	Chosen arbitrarily among that supported by the Mobile Station.
Timeslot Number	Chosen arbitrarily.
Training Sequence Code	Chosen arbitrarily.
Hopping	Yes.
Hopping parameters	Chosen arbitrarily.
Power Command	
Power level	Chosen arbitrarily.
Channel Mode	
Mode	Arbitrarily selected from capabilities declared for the MS for the chosen type of channel.
Mobile Allocation, after time	Chosen arbitrarily, at least one frequency. In case of an MA with just one frequency, the frequency should be different from the BCCH carrier.
Starting Time	T1
Channel Description, before time	
Channel Type and TDMA offset	Same as after time.
Timeslot Number	Same as after time.
Training Sequence Code	Same as after time.
Hopping	Yes.
Hopping parameters	Chosen arbitrarily, different from "after time".
Mobile Allocation, before time	Chosen arbitrarily, at least one frequency and different from "Mobile Allocation, after time". In case of an MA with just one frequency, the frequency should be different from the BCCH carrier.

26.6.13.3 Dedicated assignment with starting time and frequency redefinition / failure case / time not elapsed

26.6.13.3.1 Conformance requirement

An MS, after receiving a FREQUENCY REDEFINITION message, shall keep the provided information until the time is elapsed. The Mobile Station must accept an intervening dedicated assignment, and, in case of failure of this assignment resulting in a return to the old channel before the time indicated in the FREQUENCY REDEFINITION message, shall return on the old channel with the frequency parameters in use at the moment of the reception of the FREQUENCY REDEFINITION message, and shall eventually start using the new frequency parameters in the correct time slot indicated by the starting time of the FREQUENCY REDEFINITION message.

Reference(s):

3GPP TS 04.08 / 3GPP TS 44.018 subclauses 3.4.3 and 3.4.5.

26.6.13.3.2 Test purpose

To verify that the MS, after receiving a FREQUENCY REDEFINITION and then an ASSIGNMENT COMMAND message with a starting time and channel descriptions both for before and after the starting time, failing the assignment and returning on the old channel, and ready to access before the time indicated in the FREQUENCY REDEFINITION, resumes transmission on the channels used at the time of the reception of the FREQUENCY REDEFINITION message and eventually starts using the new frequency parameters at the time indicated in the FREQUENCY REDEFINITION message.

26.6.13.3.3 Method of test

Initial condition(s)

System Simulator:

1 cell, CCCH_CONF set to 1 basic physical channel used for CCCH, not combined with SDCCHs.

Mobile Station:

The MS is in the "idle, updated" state, with a TMSI allocated.

Specific PICS statements

- MS supports Speech (TSPC_AddInfo_SDCCHOnly)
- MS supports GSM HR (TSPC_AddInfo_Halfrate)

PIXIT statements

-

Foreseen final state of the MS

"Idle, updated", with TMSI allocated.

Test procedure

The System Simulator pages the MS and after the MS has responded with a CHANNEL REQUEST, the simulator assigns allocating a hopping channel (TCH/F, TCH/H or SDCCH, arbitrarily chosen among the channels supported). Then the SS sends a FREQUENCY REDEFINITION message (starting time T1), which modifies the frequency parameters to be used by the MS. Then the SS sends an ASSIGNMENT COMMAND message, with a starting time (T2) and channel descriptions for both before and after the starting time. The channels and hopping sequences so allocated are distinct from those used and from those described by the FREQUENCY REDEFINITION message. The System Simulator does not activate the channels defined in the ASSIGNMENT COMMAND. The MS shall try to activate the new channel (this is not verified) and shall then reactivate the old channel and trigger the establishment of the main signalling link on the old channel. Then the MS shall send an ASSIGNMENT FAILURE message. Time T1 is chosen so it is reached only after the sending of the ASSIGNMENT FAILURE message. The MS shall eventually, at the TDMA frame defined by the contents of the "Starting Time" information element of the FREQUENCY REDEFINITION message, use the new frequency parameters. The verification is performed at the RF burst level.

Test parameters:

T1 is set to $T0+5000 \pmod{42\,432}$, where T0 is the frame number at which the first burst of the FREQUENCY REDEFINITION message is sent.

T2 is set to $T0+4000 \pmod{42\,432}$, where T0 is the frame number at which the first burst of the FREQUENCY REDEFINITION message is sent.

Maximum duration of test

180 s.

Expected sequence

Step	Direction	Message	Comments
1	SS -> MS	PAGING REQUEST TYPE 1	
2	MS -> SS	CHANNEL REQUEST	
3	SS -> MS	IMMEDIATE ASSIGNMENT	Hopping channel.
4	MS -> SS	PAGING RESPONSE	
5	SS -> MS	FREQUENCY REDEFINITION	
6	SS -> MS	ASSIGNMENT COMMAND	Hopping channel, type among possible, signalling mode.
7	MS -> SS	ASSIGNMENT FAILURE	Sent on the correct channel (original parameters) after establishment of the main signalling link.
8	-----	Time T1	The SS checks that the MS is transmitting now on the correct frequencies (parameters of the FREQUENCY REDEFINITION message) and that the transmissions started in the correct frame.
9	SS -> MS	CHANNEL RELEASE	

Specific message contents

FREQUENCY REDEFINITION

Information element	Value/remark
Channel Description	
Channel Type and TDMA offset	Same as in IMMEDIATE ASSIGNMENT
Timeslot Number	Same as in IMMEDIATE ASSIGNMENT
Training Sequence Code	Same as in IMMEDIATE ASSIGNMENT
Hopping	Yes
Hopping parameters	Chosen arbitrarily, different than those of the IMMEDIATE ASSIGNMENT message,
Mobile Allocation	HSN same as in IMMEDIATE ASSIGNMENT.
Starting Time	Chosen arbitrarily, at least two frequencies, different than those of the IMMEDIATE ASSIGNMENT message.
	T1

ASSIGNMENT COMMAND:

Information element	Value/remark
Channel Description, after time	
Channel Type and TDMA offset	Chosen arbitrarily among that supported by the Mobile Station.
Timeslot Number	Chosen arbitrarily.
Training Sequence Code	Chosen arbitrarily.
Hopping	Yes.
Hopping parameters	Chosen arbitrarily.
Power Command	
Power level	Chosen arbitrarily.
Channel Mode	
Mode	Arbitrarily selected from capabilities declared for the MS for the chosen type of channel.
Mobile Allocation, after time	Chosen arbitrarily, at least two frequency.
Starting Time	T2
Channel Description, before time	
Channel Type and TDMA offset	Same as after time.
Timeslot Number	Same as after time.
Training Sequence Code	Same as after time.
Hopping	Yes.
Hopping parameters	Chosen arbitrarily, different from "after time".
Mobile Allocation, before time	Chosen arbitrarily, at least two frequencies, different from "Mobile Allocation, after time".

26.6.13.4 Dedicated assignment with starting time and frequency redefinition / failure case / time elapsed

26.6.13.4.1 Conformance requirement

An MS, after receiving a FREQUENCY REDEFINITION message, shall keep the provided information until the time is elapsed. The Mobile Station must accept an intervening dedicated assignment, and, in case of failure of this assignment resulting in a return to the old channel after the time indicated in the FREQUENCY REDEFINITION message, shall return on the old channel with the frequency parameters indicated in the FREQUENCY REDEFINITION message.

Reference(s):

3GPP TS 04.08 / 3GPP TS 44.018 subclauses 3.4.3 and 3.4.5.

26.6.13.4.2 Test purpose

To verify that the MS, after receiving a FREQUENCY REDEFINITION and then an ASSIGNMENT COMMAND message with a starting time and channel descriptions both for before and after the starting time, failing the assignment and returning on the old channel, and ready to access after the time indicated in the FREQUENCY REDEFINITION, resumes transmission using the new frequency parameters indicated in the FREQUENCY REDEFINITION message.

26.6.13.4.3 Method of test

Initial condition(s)

System Simulator:

1 cell, CCCH_CONF set to 1 basic physical channel used for CCCH, not combined with SDCCHs.

Mobile Station:

The MS is in the "idle, updated" state, with a TMSI allocated.

Specific PICS statements

-

PIXIT statements

-

Foreseen final state of the MS

"Idle, updated", with TMSI allocated.

Test procedure

The System Simulator pages the MS and after the MS has responded with a CHANNEL REQUEST, the simulator assigns allocating a hopping channel (SDCCH). Then the SS sends a FREQUENCY REDEFINITION message (starting time T1), which modifies the frequency parameters to be used by the MS. Then the SS sends an ASSIGNMENT COMMAND message, with a starting time (T2) and channel descriptions for both before and after the starting time. Time T1 is chosen so it is reached after the sending of the ASSIGNMENT COMMAND message, but before the return on the old channel. The System Simulator does not activate the channels defined in the ASSIGNMENT COMMAND. The MS shall try to activate the new channel (this is not verified) and shall then reactivate the old channel with the new frequency parameters as indicated by the FREQUENCY REDEFINITION message, and trigger the establishment of the main signalling link on the old channel. Then the MS shall send an ASSIGNMENT FAILURE message. The verification is performed at the RF burst level.

Test parameters:

i.e. for SDCCH

T2 is set to $T0 + 5000 \pmod{42\,432}$, where T0 is the frame number at which the first burst of the FREQUENCY REDEFINITION message is sent.

T1 is set to $T0 + 214 \pmod{42\,432}$, where T0 is the frame number at which the first burst of the FREQUENCY REDEFINITION message is sent.

NOTE: T0 + 214 is calculated for a maximum execution time of:

- FREQUENCY REDEFINITION using 1 L2 frame 51 frames
- ASSIGNMENT COMMAND using 2 L2 frames 102 frames
- + 120 ms maximum time for a channel change 25 frames
- + some frames contention (here 36)

Maximum duration of test

180 s.

Expected sequence

Step	Direction	Message	Comments
1	SS -> MS	PAGING REQUEST TYPE 1	
2	MS -> SS	CHANNEL REQUEST	
3	SS -> MS	IMMEDIATE ASSIGNMENT	Hopping channel.
4	MS -> SS	PAGING RESPONSE	
5	SS -> MS	FREQUENCY REDEFINITION	
6	SS -> MS	ASSIGNMENT COMMAND	Hopping channel, type among possible, signalling mode.
7	MS -> SS	ASSIGNMENT FAILURE	Sent on the correct channel (parameters from the FREQUENCY REDEFINITION message) after establishment of the main signalling link.
8	SS -> MS	CHANNEL RELEASE	

Specific message contents

FREQUENCY REDEFINITION

Information element	Value/remark
Channel Description	
Channel Type and TDMA offset	Same as in IMMEDIATE ASSIGNMENT
Timeslot Number	Same as in IMMEDIATE ASSIGNMENT
Training Sequence Code	Same as in IMMEDIATE ASSIGNMENT
Hopping	Yes
Hopping parameters	Chosen arbitrarily, different than those of the IMMEDIATE ASSIGNMENT message.
Mobile Allocation	Chosen arbitrarily, at least two frequencies, different than those of the IMMEDIATE ASSIGNMENT message, HSN same as in IMMEDIATE ASSIGNMENT.
Starting Time	T1

ASSIGNMENT COMMAND

Information element	Value/remark
Channel Description, after time	
Channel Type and TDMA offset	Chosen arbitrarily among that supported by the Mobile Station.
Timeslot Number	Chosen arbitrarily.
Training Sequence Code	Chosen arbitrarily.
Hopping	Yes.
Hopping parameters	Chosen arbitrarily.
Power Command	
Power level	Chosen arbitrarily.
Channel Mode	
Mode	Arbitrarily selected from capabilities declared for the MS for the chosen type of channel.
Mobile Allocation, after time	Chosen arbitrarily, at least two frequencies.
Starting Time	T2
Channel Description, before time	
Channel Type and TDMA offset	Same as after time.
Timeslot Number	Same as after time.
Training Sequence Code	Same as after time.
Hopping	Yes.
Hopping parameters	Chosen arbitrarily, different from "after time".
Mobile Allocation, before time	Chosen arbitrarily, at least two frequencies, different from "Mobile Allocation, after time".

26.6.13.5 Handover with starting time / successful case / time not elapsed

26.6.13.5.1 Conformance requirement

A Mobile Station receiving an HANOVER COMMAND message with a starting time and channel descriptions for both after and before the starting time, and ready to access before the indicated time has elapsed, shall perform the handover on the channels as described for before the starting time and shall, if specified, use the parameters in the frequency list, MAIO and HSN, in the correct time slot indicated by the starting time.

The Mobile Station shall accept the HANOVER COMMAND message for different message formatting, differing by the information elements used to describe frequency lists.

Reference(s):

3GPP TS 04.08 / 3GPP TS 44.018 subclauses 3.4.4.1 and 9.1.15.

26.6.13.5.2 Test purpose

To verify that the MS, after receiving a HANOVER COMMAND message with a starting time and channel descriptions both for before and after the starting time, and ready to access before the indicated time, performs correctly the handover using the description for before the time, and then starts using the frequency parameters for after the time at the time indicated in the message.

26.6.13.5.3 Method of test

Initial condition(s)

System Simulator:

2 cells, CCCH_CONF set to 1 basic physical channel used for CCCH, not combined with SDCCHs.

Mobile Station:

The MS is in the "idle, updated" state, with a TMSI allocated.

Specific PICS statements

- MS supports Speech (TSPC_AddInfo_SDCCHOnly)
- MS supports GSM HR (TSPC_AddInfo_Halfrate)

PIXIT statements

-

Foreseen final state of the MS

"Idle, updated", with TMSI allocated, and camped on cell B.

Test procedure

The System Simulator pages the MS and after the MS has responded with a CHANNEL REQUEST, the simulator assigns a hopping SDCCH. After the SS has received measurements concerning cell B, the SS sends a HANDOVER COMMAND message allocating a channel (TCH/F, TCH/H or SDCCH, arbitrarily chosen among the channels supported), with a starting time and channel descriptions (hopping case) for both before and after the starting time, as detailed in the "specific message contents" clause. The indicated time is such that the Mobile Station is ready to access before that time. The Mobile Station then accesses the channel as described for before the starting time. The MS shall eventually, at the TDMA frame defined by the contents of the "Starting Time" information element of the HANDOVER COMMAND message, use the new frequency parameters. The verification is performed at the RF burst level.

Test parameters:

T1 is set to $T0+1000 \pmod{42\,432}$, where T0 is the frame number at which the first burst of the HANDOVER COMMAND message is sent.

Maximum duration of test

120 s.

Expected sequence

Step	Direction	Message	Comments
1	SS -> MS	PAGING REQUEST TYPE 1	
2	MS -> SS	CHANNEL REQUEST	
3	SS -> MS	IMMEDIATE ASSIGNMENT	Hopping channel.
4	MS -> SS	PAGING RESPONSE	
5	SS -> MS	HANDOVER COMMAND	See specific message contents.
6	MS -> SS	HANDOVER ACCESS	Repeated on every burst of the uplink main DCCH (and optionally on the SACCH) until reception of PHYSICAL INFORMATION.
7	SS -> MS	PHYSICAL INFORMATION	
8	MS -> SS	HANDOVER COMPLETE	Sent on the correct channel (before time parameters) after establishment of the main signalling link.
9	-----	Time T1	The SS checks that the MS is transmitting now on the correct frequencies (after time parameters) and that the transmissions started in the correct frame.
10	SS -> MS	CHANNEL RELEASE	

Specific message contents

HANDOVER COMMAND:

Information element	Value/remark
Cell Description	As for cell B.
Channel Description, after time	
Channel Type and TDMA offset	Chosen arbitrarily among that supported by the Mobile Station.
Timeslot Number	Chosen arbitrarily.
Training Sequence Code	Chosen arbitrarily.
Hopping	Yes.
Hopping parameters	Chosen arbitrarily.
Power Command	
Power level	Chosen arbitrarily.
Synchronization indication	Non synchronized.
Cell Channel Description	As for cell B.
Channel Mode	
Mode	Arbitrarily selected from capabilities declared for the MS for the chosen type of channel.
Mobile Allocation, after time	Chosen arbitrarily, at least one frequency. In case of an MA with just one frequency, the frequency should be different from the BCCH carrier.
Starting Time	T1
Channel Description, before time	
Channel Type and TDMA offset	Same as after time.
Timeslot Number	Same as after time.
Training Sequence Code	Same as after time.
Hopping	Yes.
Hopping parameters	Chosen arbitrarily, different from "after time".
Mobile Allocation, before time	Chosen arbitrarily, at least one frequency, different from "Mobile Allocation, after time". In case of an MA with just one frequency, the frequency should be different from the BCCH carrier.

26.6.13.6 Handover with starting time / successful case / time elapsed

26.6.13.6.1 Conformance requirement

A Mobile Station receiving a HANDOVER COMMAND message with a starting time and channel descriptions for both after and before the starting time, and ready to access after the indicated time has elapsed, shall perform the handover on the channels as described for after the starting time.

The Mobile Station shall accept the HANDOVER COMMAND message for different message formattings, differing by the information elements used to describe frequency lists.

Reference(s):

3GPP TS 04.08 / 3GPP TS 44.018 sub-clauses 3.4.4.1 and 9.1.15.

26.6.13.6.2 Test purpose:

To verify that the MS, after receiving a HANDOVER COMMAND message with a starting time and channel descriptions both for before and after the starting time, and ready to transmit after the indicated time, performs correctly the handover using the frequency parameters for after the time.

26.6.13.6.3 Method of test

Initial condition(s)

System Simulator:

2 cells, CCCH_CONF set to 1 basic physical channel used for CCCH, not combined with SDCCHs.

Mobile Station:

The MS is in the "idle, updated" state, with a TMSI allocated, and camped on cell A

Specific PICS statements

- MS supports Speech (TSPC_AddInfo_SDCCHOnly)
- MS supports GSM HR (TSPC_AddInfo_Halfrate)

PIXIT statements

-

Foreseen final state of the MS

"Idle, updated", with TMSI allocated, and camped on cell B.

Test procedure

The System Simulator pages the MS and after the MS has responded with a CHANNEL REQUEST, the simulator assigns a hopping SDCCH. After the SS has received measurements concerning cell B, the SS sends a HANDOVER COMMAND message allocating a channel (TCH/F, TCH/H or SDCCH, arbitrarily chosen among the channels supported), with a starting time and channel descriptions (hopping case) for both before and after the starting time., as detailed in the "specific message contents" clause. The indicated time is such that the Mobile Station is ready to access only after that time. The Mobile Station then accesses the channel as described for after the starting time. The verification is performed at the RF burst level.

Test parameters:

T1 is set to $T0+5 \pmod{42\,432}$, where T0 is the frame number at which the first burst of the HANDOVER COMMAND message is sent.

Maximum duration of test

120 s.

Expected sequence

Step	Direction	Message	Comments
1	SS -> MS	PAGING REQUEST TYPE 1	
2	MS -> SS	CHANNEL REQUEST	
3	SS -> MS	IMMEDIATE ASSIGNMENT	Hopping channel.
4	MS -> SS	PAGING RESPONSE	
5	SS -> MS	HANDOVER COMMAND	See specific message contents.
6	MS -> SS	HANDOVER ACCESS	Repeated on every burst of the uplink main DCCH (and optionally on the SACCH) until reception of PHYSICAL INFORMATION.
7	SS -> MS	PHYSICAL INFORMATION	
8	MS -> SS	HANDOVER COMPLETE	Sent on the correct channel (after time parameters) after establishment of the main signalling link.
9	SS -> MS	CHANNEL RELEASE	

Specific message contents

HANDOVER COMMAND:

Information element	Value/remark
Cell Description	As for cell B.
Channel Description, after time	
Channel Type and TDMA offset	Chosen arbitrarily among that supported by the Mobile Station.
Timeslot Number	Chosen arbitrarily.
Training Sequence Code	Chosen arbitrarily.
Hopping	Yes.
Hopping parameters	Chosen arbitrarily.
Power Command	
Power level	Chosen arbitrarily.
Synchronization indication	Non synchronized.
Cell Channel Description	As for cell B.
Channel Mode	
Mode	Arbitrarily selected from capabilities declared for the MS for the chosen type of channel.
Mobile Allocation, after time	Chosen arbitrarily, at least one frequency. In case of an MA with just one frequency, the frequency should be different from the BCCH carrier.
Starting Time	T1
Channel Description, before time	
Channel Type and TDMA offset	Same as after time.
Timeslot Number	Same as after time.
Training Sequence Code	Same as after time.
Hopping	Yes.
Hopping parameters	Chosen arbitrarily, different from "after time".
Mobile Allocation, before time	Chosen arbitrarily, at least one frequency and different from "Mobile Allocation, after time". In case of an MA with just one frequency, the frequency should be different from the BCCH carrier.

26.6.13.7 Handover with starting time and frequency redefinition / failure case / time not elapsed

26.6.13.7.1 Conformance requirement

An MS, after receiving a FREQUENCY REDEFINITION message, shall keep the provided information until the time is elapsed. The Mobile Station must accept an intervening handover, and, in case of failure of this handover resulting in a return to the old channel before the time indicated in the FREQUENCY REDEFINITION message, shall return on the old channel with the frequency parameters in use at the moment of the reception of the FREQUENCY REDEFINITION message, and shall eventually start using the new frequency parameters in the correct time slot indicated by the starting time of the FREQUENCY REDEFINITION message.

Reference(s):

3GPP TS 04.08 / 3GPP TS 44.018 subclauses 3.4.4 and 3.4.5.

26.6.13.7.2 Test purpose:

To verify that the MS, after receiving a FREQUENCY REDEFINITION and then a HANDOVER COMMAND message with a starting time and channel descriptions both for before and after the starting time, failing the handover, and ready to access on the old channel before the time indicated in the FREQUENCY REDEFINITION, resumes transmission on the channels used at the time of the reception of the FREQUENCY REDEFINITION message and eventually starts using the new frequency parameters at the time indicated in the FREQUENCY REDEFINITION message.

26.6.13.7.3 Method of test

Initial condition(s)

System Simulator:

2 cells, CCCH_CONF set to 1 basic physical channel used for CCCH, not combined with SDCCHs.

Mobile Station:

The MS is in the "idle, updated" state, with a TMSI allocated, and camped on cell A.

Specific PICS statements

- MS supports Speech (TSPC_AddInfo_SDCCHOnly)
- MS supports GSM HR (TSPC_AddInfo_Halfrate)

PIXIT statements

-

Foreseen final state of the MS

"Idle, updated", with TMSI allocated, and camped on cell A.

Test procedure

The System Simulator pages the MS and after the MS has responded with a CHANNEL REQUEST, the simulator assigns allocating a hopping channel (TCH/F, TCH/H or SDCCH, arbitrarily chosen among the channels supported). Then the SS sends a FREQUENCY REDEFINITION message (starting time T1), which modifies the frequency parameters to be used by the MS. Then the SS sends a HANOVER COMMAND message, with a starting time (T2) and channel descriptions for both before and after the starting time. The MS shall try to activate the new channel (this is not verified) and shall then reactivate the old channel and trigger the establishment of the main signalling link on the old channel. The System Simulator does not activate the channels defined in the HANOVER COMMAND. Then the MS shall send a HANOVER FAILURE message. Time T1 is chosen so it is reached only after the sending of the HANOVER FAILURE message. The MS shall eventually, at the TDMA frame defined by the contents of the "Starting Time" information element of the FREQUENCY REDEFINITION message, use the new frequency parameters. The verification is performed at the RF burst level.

Test parameters:

T1 is set to $T0+5000 \pmod{42\,432}$, where T0 is the frame number at which the first burst of the FREQUENCY REDEFINITION message is sent.

T2 is set to $T0+4000 \pmod{42\,432}$, where T0 is the frame number at which the first burst of the FREQUENCY REDEFINITION message is sent.

Maximum duration of test

180 s.

Expected sequence

Step	Direction	Message	Comments
1	SS -> MS	PAGING REQUEST TYPE 1	
2	MS -> SS	CHANNEL REQUEST	
3	SS -> MS	IMMEDIATE ASSIGNMENT	Hopping channel.
4	MS -> SS	PAGING RESPONSE	
5	SS -> MS	FREQUENCY REDEFINITION	
6	SS -> MS	HANOVER COMMAND	Hopping channel, type among possible, signalling mode.
7	MS -> SS	HANOVER ACCESS	Not checked.
8	MS -> SS	HANOVER FAILURE	Sent on the correct channel (original parameters) after establishment of the main signalling link.
9	-----	Time T1	The SS checks that the MS is transmitting now on the correct frequencies (parameters of the FREQUENCY REDEFINITION message) and that the transmissions started in the correct frame.
10	SS -> MS	CHANNEL RELEASE	

Specific message contents

FREQUENCY REDEFINITION

Information element	Value/remark
Channel Description	
Channel Type and TDMA offset	Same as in IMMEDIATE ASSIGNMENT
Timeslot Number	Same as in IMMEDIATE ASSIGNMENT
Training Sequence Code	Same as in IMMEDIATE ASSIGNMENT
Hopping	Yes
Hopping parameters	Chosen arbitrarily, different than those of the IMMEDIATE ASSIGNMENT message, HSN same as in IMMEDIATE ASSIGNMENT.
Mobile Allocation	Chosen arbitrarily, at least two frequencies, different than those of the IMMEDIATE ASSIGNMENT message.
Starting Time	T1

HANDOVER COMMAND:

Information element	Value/remark
Cell Description	As for cell B.
Channel Description, after time	
Channel Type and TDMA offset	Chosen arbitrarily among that supported by the Mobile Station.
Timeslot Number	Chosen arbitrarily.
Training Sequence Code	Chosen arbitrarily.
Hopping	Yes.
Hopping parameters	Chosen arbitrarily.
Power Command	
Power level	Chosen arbitrarily.
Synchronization indication	Non synchronized.
Cell Channel Description	As for cell B.
Channel Mode	
Mode	Arbitrarily selected from capabilities declared for the MS for the chosen type of channel.
Mobile Allocation, after time	Chosen arbitrarily, at least one frequency. In case of an MA with just one frequency, the frequency should be different from the BCCH carrier.
Starting Time	T2
Channel Description, before time	
Channel Type and TDMA offset	Same as after time.
Timeslot Number	Same as after time.
Training Sequence Code	Same as after time.
Hopping	Yes.
Hopping parameters	Chosen arbitrarily, different from "after time".
Mobile Allocation, before time	Chosen arbitrarily, at least one frequency and different from "Mobile Allocation, after time". In case of an MA with just one frequency, the frequency should be different from the BCCH carrier.

26.6.13.8 Handover with starting time and frequency redefinition / failure case / time elapsed

26.6.13.8.1 Conformance requirement

An MS, after receiving a FREQUENCY REDEFINITION message, shall keep the provided information until the time is elapsed. The Mobile Station must accept an intervening handover, and, in case of failure of this handover resulting in a return to the old channel after the time indicated in the FREQUENCY REDEFINITION message, shall return on the old channel with the frequency parameters indicated in the FREQUENCY REDEFINITION message.

Reference(s):

3GPP TS 04.08 / 3GPP TS 44.018 subclauses 3.4.4 and 3.4.5.

26.6.13.8.2 Test purpose:

To verify that the MS, after receiving a FREQUENCY REDEFINITION and then a HANDOVER COMMAND message with a starting time and channel descriptions both for before and after the starting time, failing the handover and returning on the old channel, and ready to access after the time indicated in the FREQUENCY REDEFINITION, resumes transmission using the new frequency parameters indicated in the FREQUENCY REDEFINITION message.

26.6.13.8.3 Method of test

Initial condition(s)

System Simulator:

2 cells, CCCH_CONF set to 1 basic physical channel used for CCCH, not combined with SDCCHs.

Mobile Station:

The MS is in the "idle, updated" state, with a TMSI allocated, and camped on cell A.

Specific PICS statements

-

PIXIT statements

-

Foreseen final state of the MS

"Idle, updated", with TMSI allocated, and camped on cell A.

Test procedure

The System Simulator pages the MS and after the MS has responded with a CHANNEL REQUEST, the simulator assigns a hopping channel (SDCCH). Then the SS sends a FREQUENCY REDEFINITION message (starting time T1), which modifies the frequency parameters to be used by the MS. Then the SS sends a HANDOVER COMMAND message, with a starting time (T2) and channel descriptions for both before and after the starting time. Time T1 is chosen so it is reached after the sending of the HANDOVER COMMAND message, but before the return on the old channel. The System Simulator does not activate the channels defined in the HANDOVER COMMAND. The MS shall try to activate the new channel (this is not verified) and shall then reactivate the old channel with the new frequency parameters as indicated by the FREQUENCY REDEFINITION message, and trigger the establishment of the main signalling link on the old channel. Then the MS shall send a HANDOVER FAILURE message. The verification is performed at the RF burst level.

Test parameters:

i.e. for SDCCH

T2 is set to $T0 + 5000 \pmod{42\,432}$, where T0 is the frame number at which the first burst of the FREQUENCY REDEFINITION message is sent.

T1 is set to $T0 + 265 \pmod{42\,432}$, where T0 is the frame number at which the first burst of the FREQUENCY REDEFINITION message is sent.

NOTE: $T0 + 265$ is calculated for a maximum execution time of:

FREQUENCY REDEFINITION	using 1 L2 frame	51 frames
HANDOVER COMMAND	using 3 L2 frames	153 frames
+ 120 ms maximum time for a channel change		25 frames
+ some frames contention (here 36)		

Maximum duration of test

180 s.

Expected sequence

Step	Direction	Message	Comments
1	SS -> MS	PAGING REQUEST TYPE 1	
2	MS -> SS	CHANNEL REQUEST	
3	SS -> MS	IMMEDIATE ASSIGNMENT	Hopping channel.
4	MS -> SS	PAGING RESPONSE	
5	SS -> MS	FREQUENCY REDEFINITION	
6	SS -> MS	HANDOVER COMMAND	Hopping channel, type among possible, signalling mode.
7	MS -> SS	HANDOVER ACCESS	Not checked.
8	MS -> SS	HANDOVER FAILURE	Sent on the correct channel (parameters from the FREQUENCY REDEFINITION message) after establishment of the main signalling link.
9	SS -> MS	CHANNEL RELEASE	

Specific message contents

FREQUENCY REDEFINITION

Information element	Value/remark
Channel Description	
Channel Type and TDMA offset	Same as in IMMEDIATE ASSIGNMENT
Timeslot Number	Same as in IMMEDIATE ASSIGNMENT
Training Sequence Code	Same as in IMMEDIATE ASSIGNMENT
Hopping	Yes.
Hopping parameters	Chosen arbitrarily, different than those of the IMMEDIATE ASSIGNMENT message, HSN same as in IMMEDIATE ASSIGNMENT.
Mobile Allocation	Chosen arbitrarily, at least two frequencies, different than those of the IMMEDIATE ASSIGNMENT message
Starting Time	T1

HANDOVER COMMAND

Information element	Value/remark
Cell Description	As for cell B.
Channel Description, after time	
Channel Type and TDMA offset	Chosen arbitrarily among that supported by the Mobile Station.
Timeslot Number	Chosen arbitrarily.
Training Sequence Code	Chosen arbitrarily.
Hopping	Yes.
Hopping parameters	Chosen arbitrarily.
Power Command	
Power level	Chosen arbitrarily.
Synchronization indication	Non synchronized.
Cell Channel Description	As for cell B.
Channel Mode	
Mode	Arbitrarily selected from capabilities declared for the MS for the chosen type of channel.
Mobile Allocation, after time	Chosen arbitrarily, at least one frequency. In case of an MA with just one frequency, the frequency should be different from the BCCH carrier.
Starting Time	T2
Channel Description, before time	
Channel Type and TDMA offset	Same as after time.
Timeslot Number	Same as after time.
Training Sequence Code	Same as after time.
Hopping	Yes.
Hopping parameters	Chosen arbitrarily, different from "after time".
Mobile Allocation, before time	Chosen arbitrarily, at least one frequency and different from "Mobile Allocation, after time". In case of an MA with just one frequency, the frequency should be different from the BCCH carrier.

26.6.13.9 Immediate assignment with starting time / successful case / time not elapsed

26.6.13.9.1 Conformance requirement

A Mobile Station receiving an IMMEDIATE ASSIGNMENT message with a starting time and channel descriptions for both after and before the starting time, and ready to access before the indicated time has elapsed, shall perform the assignment on the channels as described for before the starting time and shall start using the new frequencies and hopping sequence in the correct time slot when the MS is allocated a dedicated channel.

Reference(s):

3GPP TS 04.08 / 3GPP TS 44.018 subclauses 3.3.1.1.3.1 and 9.1.18.

26.6.13.9.2 Test purpose

To verify that the MS, after receiving an IMMEDIATE ASSIGNMENT message with a starting time and channel descriptions both for before and after the starting time, and ready to access before the indicated time, performs correctly the assignment using the description for before the time, and then starts using the frequency parameters for after the time at the time indicated in the message.

26.6.13.9.3 Method of test

Initial condition(s)

System Simulator:

1 cell, CCCH_CONF set to 1 basic physical channel used for CCCH, not combined with SDCCHs.

Mobile Station:

The MS is in the "idle, updated" state, with a TMSI allocated.

Specific PICS statements

- MS supports Speech (TSPC_AddInfo_SDCCHOnly)
- MS supports GSM HR (TSPC_AddInfo_Halfrate)

PIXIT statements

-

Foreseen final state of the MS

"Idle, updated", with TMSI allocated.

Test procedure

The System Simulator pages the MS and after the MS has responded with a CHANNEL REQUEST, the simulator sends an IMMEDIATE ASSIGNMENT message allocating a hopping channel (TCH/F, TCH/H or SDCCH, arbitrarily chosen among the channels supported), with a starting time and channel descriptions for both before and after the starting time. The indicated time is such that the Mobile Station is ready to access before that time. The Mobile Station then accesses the channel as described for before the starting time. The MS shall eventually, at the TDMA frame defined by the contents of the "Starting Time" information element of the IMMEDIATE ASSIGNMENT message, use the new frequency parameters. The verification is performed at the RF burst level.

Test parameters:

T1 is chosen arbitrarily to be between T0+60 and T0+100 (mod 42 432), where T0 is the frame number at which the first burst of the IMMEDIATE ASSIGNMENT COMMAND message is sent.

Maximum duration of test

45 s.

Expected sequence

Step	Direction	Message	Comments
1	SS -> MS	PAGING REQUEST TYPE 1	See specific message contents.
2	MS -> SS	CHANNEL REQUEST	
3	SS -> MS	IMMEDIATE ASSIGNMENT	
4	MS -> SS	PAGING RESPONSE	
5	-----	Time T1	The SS checks that the MS is transmitting now on the correct frequencies (after time parameters) and that the transmissions started in the correct frame.
6	SS -> MS	CHANNEL RELEASE	

Specific message contents

IMMEDIATE ASSIGNMENT

Information element	Value/remark
Page Mode	Normal.
Channel Description	
Channel Type and TDMA offset	Chosen arbitrarily among that supported by the Mobile Station.
Timeslot Number	Chosen arbitrarily.
Training Sequence Code	Chosen arbitrarily.
Hopping	Yes.
Hopping parameters	Chosen arbitrarily.
Timing Advance	As needed.
Mobile Allocation (after time)	Chosen arbitrarily, at least one frequency. In case of an MA with just one frequency, the frequency should be different from the BCCH carrier.
Starting Time	T1
IA Rest Octet	
MAIO	Chosen arbitrarily, different from "after time".
Mobile Allocation (before time)	Chosen arbitrarily, at least one frequency and different from "Mobile Allocation, after time". In case of an MA with just one frequency, the frequency should be different from the BCCH carrier.

26.6.13.10 Immediate assignment with starting time / successful case / time elapsed

26.6.13.10.1 Conformance requirement

A Mobile Station receiving an IMMEDIATE ASSIGNMENT message with a starting time and channel descriptions for both after and before the starting time, and ready to access after the indicated time has elapsed, shall perform the assignment on the channels as described for after the starting time.

Reference(s):

3GPP TS 04.08 / 3GPP TS 44.018 subclauses 3.3.1.1.3.1 and 9.1.18.

26.6.13.10.2 Test purpose

To verify that the MS, after receiving an IMMEDIATE ASSIGNMENT message with a starting time and channel descriptions both for before and after the starting time, performs correctly the assignment using the frequencies and hopping sequence for after the time if the indicated time has already elapsed when the Mobile Station is ready to transmit.

26.6.13.10.3 Method of test

Initial condition(s)

System Simulator:

1 cell, CCCH_CONF set to 1 basic physical channel used for CCCH, not combined with SDCCHs.

Mobile Station:

The MS is in the "idle, updated" state, with a TMSI allocated.

Specific PICS statements

- MS supports Speech (TSPC_AddInfo_SDCCHOnly)
- MS supports GSM HR (TSPC_AddInfo_Halfrate)

PIXIT statements

-

Foreseen final state of the MS

"Idle, updated", with TMSI allocated.

Test procedure

The System Simulator pages the MS and after the MS has responded with a CHANNEL REQUEST, the simulator sends an IMMEDIATE ASSIGNMENT message allocating a hopping channel (TCH/F, TCH/H or SDCCH, arbitrarily chosen among the channels supported), with a starting time and channel descriptions for both before and after the starting time. The indicated time is such that the Mobile Station is ready to access only after that time. The Mobile Station then accesses the channel as described for after the starting time. The verification is performed at the RF burst level.

Test parameters:

T1 is set to $T0+5 \pmod{42\,432}$, where T0 is the frame number at which the first burst of the IMMEDIATE ASSIGNMENT COMMAND message is sent.

Maximum duration of test

45 s

Expected sequence

Step	Direction	Message	Comments
1	SS -> MS	PAGING REQUEST TYPE 1	See specific message contents. The SS checks that the MS is transmitting now on the correct frequencies (after time parameters).
2	MS -> SS	CHANNEL REQUEST	
3	SS -> MS	IMMEDIATE ASSIGNMENT	
4	MS -> SS	PAGING RESPONSE	
5	SS -> MS	CHANNEL RELEASE	

Specific message contents

IMMEDIATE ASSIGNMENT:

Information element	Value/remark
Page Mode	Normal.
Channel Description	
Channel Type and TDMA offset	Chosen arbitrarily among that supported by the Mobile Station.
Timeslot Number	Chosen arbitrarily.
Training Sequence Code	Chosen arbitrarily.
Hopping	Yes.
Hopping parameters	Chosen arbitrarily.
Timing Advance	As needed.
Mobile Allocation (after time)	Chosen arbitrarily, at least one frequency. In case of an MA with just one frequency, the frequency should be different from the BCCH carrier.
Starting Time	T1
IA Rest Octet	
MAIO	Chosen arbitrarily, different from "after time".
Mobile Allocation (before time)	Chosen arbitrarily, at least one frequency and different from "Mobile Allocation, after time". In case of an MA with just one frequency, the frequency should be different from the BCCH carrier.

26.6.14 Default contents of GSM 900 layer 3 messages for RR tests

This subclause contains the default values of GSM 900 L3 messages, which unless indicated otherwise in subclause 26.6 shall be transmitted by the system simulator and which are required to be received from the GSM 900 MS under test. These values are used in order to be consistent with the phase 2 version of 26.6.

The necessary L3 messages are listed in alphabetic order, with the exception of the SYSTEM INFORMATION messages, where it is the information elements which are listed in alphabetic order (this is because some information elements occur in several SYSTEM INFORMATION types).

In this subclause, decimal values are normally used. However, sometimes a hexadecimal value, indicated by an "H", or a binary value, indicated by a "B" is used.

Default SYSTEM INFORMATION:

NOTE 1: SYSTEM INFORMATION 2 bis, SYSTEM INFORMATION 5 bis, SYSTEM INFORMATION 7, and SYSTEM INFORMATION 8 messages are not used.

Cell A

Contents of information elements in SYSTEM INFORMATION TYPE 1 to 6 messages for cell A.

(CBCH) Channel Description	Not present.
(CBCH) Mobile Allocation	Not present.
Cell Channel Description	
- Format identifier	bit map 0.
- Cell Allocation ARFCN	Channel Numbers 20, 30, 50 and 70.
Cell Identity	
- Cell Identity Value	0001H
Cell Options	
- Power Control Indicator	Power Control Indicator is not set.
- DTX Indicator	MS shall not use DTX.
- Radio_Link_Timeout	8 SACCH blocks.
Cell Selection Parameters	
- Cell_Reselect_Hysteresis	12 dB.
- MX_TXPWR_MAX_CCH	Minimum level.
- ACS	No addition cell parameters are present in SYSTEM INFORMATION messages 7 and 8.
- NECI	New establishment causes not supported.
- RXLEV_ACCESS_MIN	Minimum level.
Control Channel Description	
- Attach-Detach allowed	No Attach/Detach.
- BS_AG_BLKES_RES	0 blocks reserved for access grant.
- CCCH_CONF	1 basic physical channel used for CCCH, combined with SDCCHs.
- BS_PA_MFRMS	5 multiframe periods for transmission of paging messages.
- T3212 Time-out value	Infinite.
L2 pseudo length	
- System information 1	21
- System information 2	22
- System information 3	18
- System information 4	12
Location Area Identification	
- Mobile Country Code	001 decimal
- Mobile Network Code	01 decimal
- Location Area Code	0001H
Message Type	
- System information 1	00011001
- System information 2	00011010
- System information 3	00011011
- System information 4	00011100
- System information 5	00011101
- System information 6	00011110
Neighbour Cells Description	
- Format identifier	bit map 0.
- BCCH Allocation Sequence	0
- BCCH Allocation ARFCN	Channels numbers 10, 20, 40, 80, 90, 100, 110 and 120.
- EXT-IND	This IE carries the complete BA.
NCC Permitted	0000 0010
RACH Control Parameters	
- Max Retrans	Max 1 retrans.
- Tx-integer	5 slots used.
- Cell Barred for Access	Cell is not barred.
- Call Reestablishment Allowed	Not allowed.
- Access Control Class	Access is not barred.
- Emergency Call allowed	Yes.
SI 1 rest octets	Not used (all bits are set to spare).
SI 2 rest octets	Not used (all bits are set to spare).
SI 3 rest octets	Not used (all bits are set to spare).
SI 4 rest octets	Not used (all bits are set to spare).

Default settings for cell A:

Downlink input level	63 dBmicroVolt emf.
Uplink output power	minimum supported by the MS's power class.
Propagation profile	static.
BCCH/CCCH carrier number	20

Cell B

The contents of SYSTEM INFORMATION TYPE 1 to 6 messages for cell B are identical to those of cell A with the following exceptions:

Cell Channel Description - Format Identifier - Cell Allocation ARFCN	Bit map 0. Channel Number 10.
--	----------------------------------

NOTE 2: This IE needs modification when used in handover tests which command the MS to go to a frequency hopping channel in cell B.

Cell Identity

- Cell Identity Value 0002H

Default settings for cell B:

Downlink input level	53 dBmicroVolt emf.
Uplink output power	minimum supported by the MS's power class.
Propagation profile	static.
BCCH/CCCH carrier number	10

Contents of ALERTING message (SS to MS):

Protocol Discriminator	Call Control.
Transaction Identifier	
TI value	As used in the SETUP message.
TI flag	1 (destination side).
Message Type	00000001
All other information elements	Not present.

Contents of ASSIGNMENT COMMAND message:

Protocol Discriminator	RR Management.
Skip Indicator	0000
Message Type	00101110
Channel Description	
- Channel Type and TDMA offset	Bm + ACCHs
- Timeslot Number	Chosen arbitrarily by the test house.
- Training Sequence Code	Chosen arbitrarily by the test house.
- Hopping	Single RF channel.
- ARFCN	Channel number 30.
Power Command	
- EPC mode (for R5 and after MS only)	0 (Channel not in EPC mode)
- FPC (for R99 and R4 MS only)	0 (FPC not in use)
- FPC_EPC mode (for R5 and after MS only)	0 (FPC or EPC not in use)
- Power level	Chosen arbitrarily by the test house.
All other information elements	Not present.

Contents of ASSIGNMENT COMPLETE message:

Protocol Discriminator	RR Management.
Skip Indicator	0000
Message Type	00101001
RR Cause	
- RR Cause Value	Normal event.

Contents of ASSIGNMENT FAILURE message:

Protocol Discriminator	RR Management.
Skip Indicator	0000
Message Type	00101111
RR Cause	
- RR Cause Value	Depending on test.

Contents of AUTHENTICATION REQUEST message:

Protocol Discriminator	MM message.
Skip Indicator	0000
Message Type	00010010
Ciphering Key Sequence Number	
- Key Sequence	Chosen arbitrarily by the test house from the range 0 to 6.
Authentication Parameter RAND	
- RAND value	Chosen arbitrarily by the test house.

Contents of AUTHENTICATION RESPONSE message:

Protocol Discriminator	MM message.
Skip Indicator	0000
Message Type	0X010100
Other information element(s)	Not checked.

Contents of CALL PROCEEDING message:

Protocol Discriminator	Call Control.
Transaction Identifier	
TI value	As used in the SETUP message.
TI flag	1 (destination side).
Message Type	00000010
All other information elements	Not present.

Contents of CHANNEL MODE MODIFY message:

Protocol Discriminator	RR Management.
Skip Indicator	0000
Message Type	00010000
Channel Description	
- Channel Type and TDMA offset	Depending on test.
- Timeslot Number	Chosen arbitrarily by the test house.
- Training Sequence Code	Chosen arbitrarily by the test house.
- Hopping	Single RF channel.
- ARFCN	Channel number 30.
Channel Mode	
- Mode	Depending on test.

Contents of CHANNEL MODE MODIFY ACKNOWLEDGE message:

Protocol Discriminator	RR Management.
Skip Indicator	0000
Message Type	00010111
Channel Description	Depending on test.
- Channel Type and TDMA offset	Same as in the CHANNEL MODE MODIFY message.
- Timeslot Number	Same as in the CHANNEL MODE MODIFY message.
- Training Sequence Code	Single RF channel.
- Hopping	Band number 0.
- Frequency Band	Channel number 30.
- ARFCN	
Channel Mode	
- Mode	Same as in the CHANNEL MODE MODIFY message.

Contents of CHANNEL RELEASE message:

Protocol Discriminator	RR Management.
Skip Indicator	0000
Message Type	00001101
RR Cause	
- RR Cause Value	Normal event.

Contents of CHANNEL REQUEST message

Establishment Cause	Not checked.
Random Reference	Not checked.

Contents of CIPHERING MODE COMMAND message:

Protocol Discriminator	RR Management.
Skip Indicator	0000
Message Type	00110101
Cipher Mode Setting	
- algorithm identifier	cipher with A5/1.
- SC	Start ciphering.
Cipher Response	IMEI shall not be included.

Contents of CIPHERING MODE COMPLETE message:

Protocol Discriminator	RR Management.
Skip Indicator	0000
Message Type	00110010
Mobile Identity	Not present.

Contents of the CLASSMARK CHANGE message:

Protocol Discriminator	RR Management.
Skip Indicator	0000
Message Type	000100110
Mobile Station Classmark 2	See PIXIT.
Mobile Station Classmark 3	For presence and contents see PIXIT.

Contents of CM SERVICE ACCEPT message:

Protocol Discriminator	Mobility Management.
Skip Indicator	0000
Message Type	00100001

Contents of CM SERVICE REQUEST message

Protocol Discriminator	Mobility Management.
Skip Indicator	0000
Message Type	0X100100
Other information elements	Not checked.

Contents of CONNECT message (SS to MS)

Protocol Discriminator	Call Control.
Transaction Identifier	
TI value	As used in the SETUP message.
TI flag	1
Message Type	00000111
All other information elements	Not present.

Contents of CONNECT ACKNOWLEDGE message (MS to SS)

Protocol Discriminator	Call Control.
Transaction Identifier	
TI value	As used in the SETUP message.
TI flag	0
Message Type	0X001111

Contents of HANDOVER ACCESS message:

Handover Reference	Equal to the value included in the Handover Command message.
--------------------	--

Contents of HANDOVER COMMAND message:

Protocol Discriminator	RR Management.
Skip Indicator	0000
Message Type	00101011
Cell Description	
- Network Colour Code	1
- Base station Colour Code	Corresponding to target cell
- BCCH Carrier Number	Set to the BCCH carrier number of cell B. (one of 10, 20, 80, 90, 100, 110 or 120).
Channel Description	
- Channel Type and TDMA offset	Bm + ACCHs.
- Timeslot Number	Chosen arbitrarily by the test house.
- Training Sequence Code	Chosen arbitrarily by the test house.
- Hopping	Single RF channel.
- ARFCN	Chosen arbitrarily by the test house from those supported on the target cell.
Handover Reference	
- Handover Reference Value	Chosen arbitrarily by the test house.
Power Command	
- ATC	0 (Sending of Handover Access is mandatory)
- EPC mode (for R5 and after MS only)	0 (Channel not in EPC mode)
- FPC (for R99 and R4 MS only)	0 (FPC not in use)
- FPC_EPC mode (for R5 and after MS only)	0 (FPC or EPC not in use)
- Power level	Chosen arbitrarily by the test house.
All other information elements	Not present.

Contents of HANDOVER COMPLETE message:

Protocol Discriminator	RR Management.
Skip Indicator	0000
Message Type	00101100
RR cause	Normal event.
Time difference	Not present.

Contents of HANDOVER FAILURE message:

Protocol Discriminator	RR Management.
Skip Indicator	0000
Message Type	00101000
RR cause	Dependent on the test.

IDENTITY REQUEST

Information element	Value/remark
Identity type	IMEI
Spare half octet	0000

IDENTITY RESPONSE

Information element	Value/remark
Mobile identity	not checked

Contents of IMMEDIATE ASSIGNMENT message:

L2 pseudo length	This is the sum of the lengths of all the information elements present in the message except for the IA rest octets and L2 pseudo length IEs. For the default message the L2 pseudo length is 11.
Protocol Discriminator	RR Management.
Skip Indicator	0000
Message Type	00111111
Page Mode	
- Page Mode	Normal Paging.
Channel Description	
- Channel Type and TDMA offset	For non-combined CCCH/SDCCH (see initial conditions), SDCCH/8, with subchannel chosen arbitrarily by the test house For combined CCCH/SDCCH (default SS conditions), SDCCH/4, with subchannel chosen arbitrarily by the test house.
- Timeslot Number	For non-combined CCCH/SDCCH (see initial conditions), chosen arbitrarily by the test house; For combined CCCH/SDCCH (default SS conditions), SDCCH/4, timeslot zero.
- Training Sequence Code	For non-combined CCCH/SDCCH (see initial conditions), chosen arbitrarily by the test house; For combined CCCH/SDCCH (default SS conditions), SDCCH/4, TSC=5 (same as the BCC).
- Hopping	Single RF channel.
- ARFCN	For non-combined CCCH/SDCCH (see initial conditions), Channel number 30; For combined CCCH/SDCCH (default SS conditions), SDCCH/4, Channel number 20.
Request Reference	Pertaining to last Channel Request sent by the MS.
Timing Advance	
- Timing advance value	30 bit periods.
Mobile Allocation	
- Length	0
Starting Time	Not present.
IA rest octets	Not used (all bits set to spare).

Contents of IMMEDIATE ASSIGNMENT EXTENDED message:

L2 pseudo length	This is the sum of the lengths of all the information elements present in the message except for the IAX rest octets and L2 pseudo length IEs. For the default message the L2 pseudo length is 18.
Protocol Discriminator	RR Management.
Skip Indicator	0000
Message Type	00111001
Page Mode	
- Page Mode	Normal Paging.
Channel Description 1	
- Channel Type and TDMA offset	For non-combined CCCH/SDCCH (see test conditions), SDCCH/8, with subchannel chosen arbitrarily by the test house; For combined CCCH/SDCCH (default SS conditions), SDCCH/4, with subchannel chosen arbitrarily by the test house.
- Timeslot Number	For non-combined CCCH/SDCCH (see test conditions), chosen arbitrarily by the test house; For combined CCCH/SDCCH (default SS conditions), SDCCH/4, timeslot zero.
- Training Sequence Code	For non-combined CCCH/SDCCH (see initial conditions), chosen arbitrarily by the test house; For combined CCCH/SDCCH (default SS conditions), SDCCH/4, TSC=5 (same as the BCC). Single RF channel.
- Hopping	For non-combined CCCH/SDCCH (see initial conditions), Channel number 30; For combined CCCH/SDCCH (default SS conditions), SDCCH/4, Channel number 20.
- ARFCN	Pertaining to last Channel Request sent by the MS.
Request Reference 1	
Timing Advance 1	
- Timing advance value	Chosen arbitrarily by the test house.
Channel Description 2	
- Channel Type and TDMA offset	Same channel type as in Channel Description 1, but different TDMA offset to that in Channel Description 1.
- Timeslot Number	equal to the value in Channel Description 1.
- Training Sequence Code	equal to the value in Channel Description 1.
- Hopping	Single RF channel.
- ARFCN	equal to the value in Channel Description 1.
Request Reference 2	Not pertaining to any Channel Requests sent by the MS.
Timing Advance 2	
- Timing advance value	Chosen arbitrarily by the test house.
Mobile Allocation	
- Length	0
Starting Time	Not present.
IAX rest octets	Not used (all bits set to spare).

Contents of IMMEDIATE ASSIGNMENT REJECT message:

L2 pseudo length	19
Protocol Discriminator	RR Management.
Skip Indicator	0000
Message Type	00111010
Page Mode	
- Page Mode	Normal Paging.
Request Reference	Pertaining to last Channel Request sent by the MS.
Wait Indication	0 s.
Request Reference	Not pertaining to the MS under test.
Wait Indication	0 s.
Request Reference	Not pertaining to the MS under test.
Wait Indication	0 s.
Request Reference	Not pertaining to the MS under test.
Wait Indication	0 s.
IAR rest octets	Not used (all bits set to spare).

Contents of LOCATION UPDATING REQUEST message:

Protocol Discriminator	MM message.
Skip Indicator	0000
Message Type	0X001000
Other information elements	Not checked.

Contents of PAGING REQUEST TYPE 1 message:

L2 pseudo length	This is the sum of the lengths of all the information elements present in the message except for the P1 rest octets and L2 pseudo length IEs. For the default message the L2 pseudo length is 9.
Protocol Discriminator	RR Management.
Skip Indicator	0000
Message Type	00100001
Page Mode	
- Page Mode	Normal Paging.
Channels needed	
- first channel	any channel.
- second channel	any channel.
Mobile Identity 1	
- odd/even indication	Even.
- Type of Identity	TMSI.
- Identity Digits	TMSI previously allocated to MS.
Mobile Identity 2	Not present.
P1 rest octets	Not used (all bits set to spare).

Contents of PAGING REQUEST TYPE 2 message:

L2 pseudo length	This is the sum of the lengths of all the information elements present in the message except for the P2 rest octets and L2 pseudo length IEs. For the default message the L2 pseudo length is 11.
Protocol Discriminator	RR Management..
Skip Indicator	0000
Message Type	00100010
Page Mode	
- Page Mode	Normal Paging.
Channels needed	
- first channel	any channel.
- second channel	any channel.
Mobile Identity 1	
- TMSI value	TMSI previously allocated to MS.
Mobile Identity 2	
- TMSI value	TMSI not allocated to MS.
Mobile Identity	Not present.
P2 rest octets	Not used (all bits set to spare).

Contents of PAGING REQUEST TYPE 3 message:

L2 pseudo length	19
Protocol Discriminator	RR Management.
Skip Indicator	0000
Message Type	00100100
Page Mode	
- Page Mode	Normal Paging.
Channels needed	
- first channel	any channel.
- second channel	any channel.
Mobile identity 1	
- TMSI value	TMSI previously allocated to MS.
Mobile identity 2	
- TMSI value	TMSI not allocated to MS.
Mobile identity 3	
- TMSI value	TMSI not allocated to MS.
Mobile identity 4	
- TMSI value	TMSI not allocated to MS.
P3 rest octets	Not used (all bits set to spare).

Contents of PAGING RESPONSE message:

Protocol Discriminator	RR Management.
Skip Indicator	0000
Message Type	00100111
Ciphering Key Sequence Number	
- Key Sequence	Key sequence number previously allocated to MS, or "111" if no key is available.
Mobile Station Classmark 2	
Mobile Identity	
- odd/even indication	Even
- Type of identity	TMSI
- Identity Digits	TMSI previously allocated to MS.

Contents of PHYSICAL INFORMATION message:

Protocol Discriminator	RR Management.
Skip Indicator	0000
Message Type	00101101
Timing advance	20 bit periods.

Contents of SETUP message; (MS to SS):

Protocol Discriminator	Call Control.
Transaction Identifier	
TI value	any value from the set {0, ..., 6}.
TI flag	0
Message Type	0X000101
Other information elements	Not checked.

26.6.15 Default contents of DCS 1 800 layer 3 messages for RR tests

This subclause contains the default values of DCS 1 800 L3 messages, which unless indicated otherwise in subclause 26.6 shall be transmitted by the system simulator and which are required to be received from the DCS 1 800 MS under test. These values are used in order to be consistent with the phase 2 version of 26.6.

The necessary L3 messages are listed in alphabetic order, with the exception of the SYSTEM INFORMATION messages, where it is the information elements which are listed in alphabetic order (this is because some information elements occur in several SYSTEM INFORMATION types).

In this subclause, decimal values are normally used. However, sometimes a hexadecimal value, indicated by an "H", or a binary value, indicated by a "B" is used.

Default SYSTEM INFORMATION:

NOTE 1: SYSTEM INFORMATION 2 bis, SYSTEM INFORMATION 7, and SYSTEM INFORMATION 8 messages are not used.

SYSTEM INFORMATION 5 bis is not sent as a default message. For those tests which require SYSTEM INFORMATION 5 bis see the specific message contents for that test.

Cell A

Contents of information elements in SYSTEM INFORMATION TYPE 1 to 6 messages for cell A.

(CBCH) Channel Description	Not present.
(CBCH) Mobile Allocation	Not present.
Cell Channel Description	
- Format identifier	Range 512.
- Cell Allocation ARFCN	Channel Numbers, 590, 650, 750 and 850.
Cell Identity	
- Cell Identity Value	0001H
Cell Options	
- Power Control Indicator	Power Control Indicator is not set, 0
- DTX Indicator	MS shall not use DTX.
- Radio_Link_Timeout	8 SACCH blocks.
Cell Selection Parameters	
- Cell_Reselect_Hysteresis	12 dB
- MX_TXPWR_MAX_CCH	Minimum level.
- ACS	No addition cell parameters are present in SYSTEM INFORMATION messages 7 and 8.
- NECI	New establishment causes not supported.
- RXLEV_ACCESS_MIN	Minimum level.
Control Channel Description	
- Attach-Detach allowed	MS shall not apply.
- BS_AG_BLK_RES	0 blocks reserved for access grant.
- CCCH_CONF	1 basic physical channel used for CCCH, combined with SDCCHs.
- BS_PA_MFRMS	5 multiframe periods for transmission of paging messages.
- T3212 Time-out value	Infinite.
L2 pseudo length	
- System information 1	21
- System information 2	22
- System information 3	18
- System information 4	12
Location Area Identification	
- Mobile Country Code	001 decimal.
- Mobile Network Code	01 decimal.
- Location Area Code	0001H
Message Type	
- System information 1	00011001
- System information 2	00011010
- System information 3	00011011
- System information 4	00011100
- System information 5	00011101
- System information 6	00011110
Neighbour Cells Description	
- Format identifier	Range 512.
- BCCH Allocation Sequence	0
- BCCH Allocation ARFCN	Channels numbers, 520, 590, 600, 700, 747, 764, 780, 810, 870.
- EXT-IND	This IE carries the complete BA. EXT-IND is 0.
NCC Permitted	0000 0010
RACH Control Parameters	
- Max Retrans	Max 1 retrans.
- Tx-integer	5 slots used.
- Cell Barred for Access	Cell is not barred.
- Call Reestablishment Allowed	Not Allowed.
- Access Control Class	Access is not barred.
- Emergency Call allowed	Yes.
SI 1 rest octets	Not used (all bits are set to spare).
SI 2 rest octets	Not used (all bits are set to spare).
SI 3 rest octets	Not used (all bits are set to spare).
SI 4 rest octets	Not used (all bits are set to spare).

Default settings for cell A:

Downlink input level	63 dBmicroVolt emf().
Uplink output power	minimum supported by the MS's power class
Propagation profile	static.
BCCH/CCCH carrier number	ARFN 590.

Cell B

The contents of SYSTEM INFORMATION TYPE 1 to 6 messages for cell B are identical to those of cell A with the following exceptions:

Cell Channel Description - Format Identifier - Cell Allocation ARFCN	Range 512. Channel Number 520.
--	-----------------------------------

NOTE 2: This IE needs modification when used in handover tests which command the MS to go to a frequency hopping channel in cell B.

Cell Identity - Cell Identity Value	0002H
--	-------

Default settings for cell B:

Downlink input level	53 dBmicroVolt emf().
Uplink output power	minimum supported by the MS's power class
Propagation profile	static.
BCCH/CCCH carrier number	520

Contents of ALERTING message (SS to MS):

Protocol Discriminator	Call Control.
Transaction Identifier TI value TI flag	As used in the SETUP message. 1 (destination side).
Message Type	00000001
All other information elements	Not present.

Contents of ASSIGNMENT COMMAND message:

Protocol Discriminator	RR Management.
Skip Indicator	0000
Message Type	00101110
Channel Description - Channel Type and TDMA offset - Timeslot Number - Training Sequence Code - Hopping - ARFCN	Bm + ACCHs. Chosen arbitrarily by the test house. Chosen arbitrarily by the test house. Single RF channel. Channel number 650.
Power Command - EPC mode (for R5 and after MS only) - FPC (for R99 and R4 MS only) - FPC_EPC mode (for R5 and after MS only) - Power level	0 (Channel not in EPC mode) 0 (FPC not in use) 0 (FPC or EPC not in use) Chosen arbitrarily by the test house.
All other information elements	Not present.

Contents of ASSIGNMENT COMPLETE message:

Protocol Discriminator	RR Management.
Skip Indicator	0000
Message Type	00101001
RR Cause	
- RR Cause Value	Normal event.

Contents of ASSIGNMENT FAILURE message:

Protocol Discriminator	RR Management.
Skip Indicator	0000
Message Type	00101111
RR Cause	
- RR Cause Value	Depending on test.

Contents of AUTHENTICATION REQUEST message:

Protocol Discriminator	MM message.
Skip Indicator	0000
Message Type	00010010
Ciphering Key Sequence Number	
- Key Sequence	Chosen arbitrarily by the test house from the range 0 to 6.
Authentication Parameter RAND	
- RAND value	Chosen arbitrarily by the test house.

Contents of AUTHENTICATION RESPONSE message:

Protocol Discriminator	MM message.
Skip Indicator	0000
Message Type	0X010100
Other information element(s)	Not checked.

Contents of CALL PROCEEDING message:

Protocol Discriminator	Call Control.
Transaction Identifier	
TI value	As used in the SETUP message.
TI flag	1 (destination side).
Message Type	00000010
All other information elements	Not present.

Contents of CHANNEL MODE MODIFY message:

Protocol Discriminator	RR Management.
Skip Indicator	0000
Message Type	00010000
Channel Description	
- Channel Type and TDMA offset	Depending on test.
- Timeslot Number	Chosen arbitrarily by the test house.
- Training Sequence Code	Chosen arbitrarily by the test house.
- Hopping	Single RF channel.
- ARFCN	Channel number 650.
Channel Mode	
- Mode	Depending on test.

Contents of CHANNEL MODE MODIFY ACKNOWLEDGE message:

Protocol Discriminator	RR Management.
Skip Indicator	0000
Message Type	00010111
Channel Description	Depending on test.
- Channel Type and TDMA offset	Same as in the CHANNEL MODE MODIFY message.
- Timeslot Number	Same as in the CHANNEL MODE MODIFY message.
- Training Sequence Code	Single RF channel.
- Hopping	Band number 0.
- Frequency Band	Channel number 650.
- ARFCN	
Channel Mode	
- Mode	Same as in the CHANNEL MODE MODIFY message.

Contents of CHANNEL RELEASE message:

Protocol Discriminator	RR Management.
Skip Indicator	0000
Message Type	00001101
RR Cause	
- RR Cause Value	Normal event.

Contents of CHANNEL REQUEST message:

Establishment Cause	Not checked.
Random Reference	Not checked.

Contents of CIPHERING MODE COMMAND message:

Protocol Discriminator	RR Management.
Skip Indicator	0000
Message Type	00110101
Cipher Mode Setting	
- algorithm identifier	cipher with A5/1.
- SC	Start ciphering.
Cipher Response	IMEI shall not be included.

Contents of CIPHERING MODE COMPLETE message:

Protocol Discriminator	RR Management.
Skip Indicator	0000
Message Type	00110010
Mobile Identity	Not present.

Contents of the CLASSMARK CHANGE message:

Protocol Discriminator	RR Management.
Skip Indicator	0000
Message Type	000100110
Mobile Station Classmark 2	
- RF Power Capability	See PIXIT.
- Frequency Capability	Set to 0.
Mobile Station Classmark 3	For presence and contents see PIXIT.

Contents of CM SERVICE ACCEPT message:

Protocol Discriminator	Mobility Management.
Skip Indicator	0000
Message Type	00100001

Contents of CM SERVICE REQUEST message:

Protocol Discriminator	Mobility Management.
Skip Indicator	0000
Message Type	0X100100
Other information elements	Not checked.

Contents of CONNECT message (SS to MS):

Protocol Discriminator	Call Control.
Transaction Identifier	
TI value	As used in the SETUP message.
TI flag	1
Message Type	00000111
All other information elements	Not present.

Contents of CONNECT ACKNOWLEDGE message (MS to SS):

Protocol Discriminator	Call Control.
Transaction Identifier	
TI value	As used in the SETUP message.
TI flag	0
Message Type	0X001111

Contents of HANDOVER ACCESS message:

Handover Reference	Equal to the value included in the Handover Command message.
--------------------	--

Contents of HANDOVER COMMAND message:

Protocol Discriminator	RR Management.
Skip Indicator	0000
Message Type	00101011
Cell Description	
- Network Colour Code	1
- Base station Colour Code	Corresponding to target cell
- BCCH Carrier Number	Set to the BCCH carrier number of cell B. (one of 520, 590, 600, 700, 780, 810 or 870).
Channel Description	
- Channel Type and TDMA offset	Bm + ACCHs.
- Timeslot Number	Chosen arbitrarily by the test house.
- Training Sequence Code	Chosen arbitrarily by the test house.
- Hopping	Single RF channel.
- ARFCN	Chosen arbitrarily by the test house from those supported on the target cell.
Handover Reference	
- Handover Reference Value	Chosen arbitrarily by the test house.
Power Command	
- ATC	0 (Sending of Handover Access is mandatory)
- EPC mode (for R5 and after MS only)	0 (Channel not in EPC mode)
- FPC (for R99 and R4 MS only)	0 (FPC not in use)
- FPC_EPC mode (for R5 and after MS only)	0 (FPC or EPC not in use)
- Power level	Chosen arbitrarily by the test house.
All other information elements	Not present.

Contents of HANDOVER COMPLETE message:

Protocol Discriminator	RR Management.
Skip Indicator	0000
Message Type	00101100
RR cause	Normal event.
Time difference	Not present.

Contents of HANDOVER FAILURE message:

Protocol Discriminator	RR Management.
Skip Indicator	0000
Message Type	00101000
RR cause	Dependent on the test.

IDENTITY REQUEST

Information element	Value/remark
Identity type	IMEI
Spare half octet	0000

IDENTITY RESPONSE

Information element	Value/remark
Mobile identity	not checked

Contents of IMMEDIATE ASSIGNMENT message:

L2 pseudo length	This is the sum of the lengths of all the information elements present in the message except for the IA rest octets and L2 pseudo length IEs. For the default message the L2 pseudo length is 11.
Protocol Discriminator	RR Management.
Skip Indicator	0000
Message Type	00111111
Page Mode	
- Page Mode	Normal Paging.
Channel Description	
- Channel Type and TDMA offset	For non-combined CCCH/SDCCH (see initial conditions), SDCCH/8, with subchannel chosen arbitrarily by the test house For combined CCCH/SDCCH (default SS conditions), SDCCH/4, with subchannel chosen arbitrarily by the test house.
- Timeslot Number	For non-combined CCCH/SDCCH (see initial conditions), chosen arbitrarily by the test house; For combined CCCH/SDCCH (default SS conditions), SDCCH/4, timeslot zero.
- Training Sequence Code	For non-combined CCCH/SDCCH (see initial conditions), chosen arbitrarily by the test house; For combined CCCH/SDCCH (default SS conditions), SDCCH/4, TSC=5 (same as the BCC).
- Hopping	Single RF channel.
- ARFCN	For non-combined CCCH/SDCCH (see initial conditions), Channel number 650; For combined CCCH/SDCCH (default SS conditions), SDCCH/4, Channel number 590.
Request Reference	Pertaining to last Channel Request sent by the MS.
Timing Advance	
- Timing advance value	30 bit periods.
Mobile Allocation	
- Length	0
Starting Time	Not present.
IA rest octets	Not used (all bits set to spare).

Contents of IMMEDIATE ASSIGNMENT EXTENDED message:

L2 pseudo length	This is the sum of the lengths of all the information elements present in the message except for the IAX rest octets and L2 pseudo length IEs. For the default message the L2 pseudo length is 18.
Protocol Discriminator	RR Management.
Skip Indicator	0000
Message Type	00111001
Page Mode	
- Page Mode	Normal Paging.
Channel Description 1	
- Channel Type and TDMA offset	For non-combined CCCH/SDCCH (see test conditions), SDCCH/8, with subchannel chosen arbitrarily by the test house; For combined CCCH/SDCCH (default SS conditions), SDCCH/4, with subchannel chosen arbitrarily by the test house.
- Timeslot Number	For non-combined CCCH/SDCCH (see test conditions), chosen arbitrarily by the test house; For combined CCCH/SDCCH (default SS conditions), SDCCH/4, timeslot zero.
- Training Sequence Code	For non-combined CCCH/SDCCH (see initial conditions), chosen arbitrarily by the test house; For combined CCCH/SDCCH (default SS conditions), SDCCH/4, TSC=5 (same as the BCC). Single RF channel.
- Hopping	For non-combined CCCH/SDCCH (see initial conditions), Channel number 650; For combined CCCH/SDCCH (default SS conditions), SDCCH/4, Channel number 590.
- ARFCN	Pertaining to last Channel Request sent by the MS.
Request Reference 1	
Timing Advance 1	
- Timing advance value	Chosen arbitrarily by the test house.
Channel Description 2	
- Channel Type and TDMA offset	Same channel type as in Channel Description 1, but different TDMA offset to that in Channel Description 1.
- Timeslot Number	equal to the value in Channel Description 1.
- Training Sequence Code	equal to the value in Channel Description 1.
- Hopping	Single RF channel.
- ARFCN	equal to the value in Channel Description 1.
Request Reference 2	Not pertaining to any Channel Requests sent by the MS.
Timing Advance 2	
- Timing advance value	Chosen arbitrarily by the test house.
Mobile Allocation	
- Length	0
Starting Time	Not present.
IAX rest octets	Not used (all bits set to spare).

Contents of IMMEDIATE ASSIGNMENT REJECT message:

L2 pseudo length	19
Protocol Discriminator	RR Management.
Skip Indicator	0000
Message Type	00111010
Page Mode	
- Page Mode	Normal Paging.
Request Reference	Pertaining to last Channel Request sent by the MS.
Wait Indication	0 s.
Request Reference	Not pertaining to the MS under test.
Wait Indication	0 s.
Request Reference	Not pertaining to the MS under test.
Wait Indication	0 s.
Request Reference	Not pertaining to the MS under test.
Wait Indication	0 s.
IAR rest octets	Not used (all bits set to spare).

Contents of LOCATION UPDATING REQUEST message:

Protocol Discriminator	MM message.
Skip Indicator	0000
Message Type	0X001000
Other information elements	Not checked.

Contents of PAGING REQUEST TYPE 1 message:

L2 pseudo length	This is the sum of the lengths of all the information elements present in the message except for the P1 rest octets and L2 pseudo length IEs. For the default message the L2 pseudo length is 9.
Protocol Discriminator	RR Management.
Skip Indicator	0000
Message Type	00100001
Page Mode	
- Page Mode	Normal Paging.
Channels needed	
- first channel	any channel.
- second channel	any channel.
Mobile Identity 1	
- odd/even indication	Even.
- Type of Identity	TMSI.
- Identity Digits	TMSI previously allocated to MS.
Mobile Identity 2	Not present.
P1 rest octets	Not used (all bits set to spare).

Contents of PAGING REQUEST TYPE 2 message:

L2 pseudo length	This is the sum of the lengths of all the information elements present in the message except for the P2 rest octets and L2 pseudo length IEs. For the default message the L2 pseudo length is 11.
Protocol Discriminator	RR Management.
Skip Indicator	0000
Message Type	00100010
Page Mode	
- Page Mode	Normal Paging.
Channels needed	
- first channel	any channel.
- second channel	any channel.
Mobile Identity 1	
- TMSI value	TMSI previously allocated to MS.
Mobile Identity 2	
- TMSI value	TMSI not allocated to MS.
Mobile Identity	Not present.
P2 rest octets	Not used (all bits set to spare).

Contents of PAGING REQUEST TYPE 3 message:

L2 pseudo length	19
Protocol Discriminator	RR Management.
Skip Indicator	0000
Message Type	00100100
Page Mode	
- Page Mode	Normal Paging.
Channels needed	
- first channel	any channel.
- second channel	any channel.
Mobile identity 1	
- TMSI value	TMSI previously allocated to MS.
Mobile identity 2	
- TMSI value	TMSI not allocated to MS.
Mobile identity 3	
- TMSI value	TMSI not allocated to MS.
Mobile identity 4	
- TMSI value	TMSI not allocated to MS.
P3 rest octets	Not used (all bits set to spare).

Contents of PAGING RESPONSE message:

Protocol Discriminator	RR Management.
Skip Indicator	0000
Message Type	00100111
Ciphering Key Sequence Number	
- Key Sequence	Key sequence number previously allocated to MS, or "111" if no key is available.
Mobile Station Classmark 2	
Mobile Identity	
- odd/even indication	Even.
- Type of identity	TMSI
- Identity Digits	TMSI previously allocated to MS.

Contents of PHYSICAL INFORMATION message:

Protocol Discriminator	RR Management.
Skip Indicator	0000
Message Type	00101101
Timing advance	20 bit periods.

Contents of SETUP message; (MS to SS):

Protocol Discriminator	Call Control.
Transaction Identifier	
TI value	any value from the set {0, ..., 6}.
TI flag	0
Message Type	0X000101
Other information elements	Not checked.

26.6.16 Default contents of GSM 450 layer 3 messages for RR tests

This subclause contains the default values of GSM 450 L3 messages, which unless indicated otherwise in subclause 26.6 shall be transmitted by the system simulator and which are required to be received from the GSM 450 MS under test. These values are used in order to be consistent with the phase 2 version of subclause 26.6.

The necessary L3 messages are listed in alphabetic order, with the exception of the SYSTEM INFORMATION messages, where it is the information elements which are listed in alphabetic order (this is because some information elements occur in several SYSTEM INFORMATION types).

In this subclause, decimal values are normally used. However, sometimes a hexadecimal value, indicated by an "H", or a binary value, indicated by a "B" is used.

Default SYSTEM INFORMATION:

NOTE 1: SYSTEM INFORMATION 2 bis, SYSTEM INFORMATION 5 bis, SYSTEM INFORMATION 7, and SYSTEM INFORMATION 8 messages are not used.

Cell A

Contents of information elements in SYSTEM INFORMATION TYPE 1 to 6 messages for cell A.

(CBCH) Channel Description	Not present.
(CBCH) Mobile Allocation	Not present.
Cell Channel Description	
- Format identifier	Range 128.
- Cell Allocation ARFCN	Channel Numbers 263, 267, 275 and 279.
Cell Identity	
- Cell Identity Value	0001H
Cell Options	
- Power Control Indicator	Power Control Indicator is not set.
- DTX Indicator	MS shall not use DTX.
- Radio_Link_Timeout	8 SACCH blocks.
Cell Selection Parameters	
- Cell_Reselect_Hysteresis	12 dB.
- MX_TXPWR_MAX_CCH	Minimum level.
- ACS	No addition cell parameters are present in SYSTEM INFORMATION messages 7 and 8.
- NECI	New establishment causes not supported.
- RXLEV_ACCESS_MIN	Minimum level.
Control Channel Description	
- Attach-Detach allowed	No Attach/Detach.
- BS_AG_BLK_RES	0 blocks reserved for access grant.
- CCCH_CONF	1 basic physical channel used for CCCH, combined with SDCCHs.
- BS_PA_MFRMS	5 multiframe periods for transmission of paging messages.
- T3212 Time-out value	Infinite.
L2 pseudo length	
- System information 1	21
- System information 2	22
- System information 3	18
- System information 4	12
Location Area Identification	
- Mobile Country Code	001 decimal
- Mobile Network Code	01 decimal
- Location Area Code	0001H
Message Type	
- System information 1	00011001
- System information 2	00011010
- System information 3	00011011
- System information 4	00011100
- System information 5	00011101
- System information 6	00011110
Neighbour Cells Description	
- Format identifier	128 range.
- BCCH Allocation Sequence	0
- BCCH Allocation ARFCN	Channels numbers 262, 263, 274, 282, 284, 287, 290 and 293.
- EXT-IND	This IE carries the complete BA.
NCC Permitted	0000 0010
RACH Control Parameters	
- Max Retrans	Max 1 retrans.
- Tx-integer	5 slots used.
- Cell Barred for Access	Cell is not barred.
- Call Reestablishment Allowed	Not allowed.
- Access Control Class	Access is not barred.
- Emergency Call allowed	Yes.
SI 1 rest octets	Not used (all bits are set to spare).
SI 2 rest octets	Not used (all bits are set to spare).
SI 3 rest octets	Not used (all bits are set to spare).
SI 4 rest octets	Not used (all bits are set to spare).

Default settings for cell A:

Downlink input level	63 dBmicroVolt emf.
Uplink output power	minimum supported by the MS's power class.
Propagation profile	static.
BCCH/CCCH carrier number	263

Cell B

The contents of SYSTEM INFORMATION TYPE 1 to 6 messages for cell B are identical to those of cell A with the following exceptions:

Cell Channel Description - Format Identifier - Cell Allocation ARFCN	128 range. Channel Number 261.
--	-----------------------------------

NOTE 2: This IE needs modification when used in handover tests which command the MS to go to a frequency hopping channel in cell B.

Cell Identity

- Cell Identity Value 0002H

Default settings for cell B:

Downlink input level	53 dBmicroVolt emf.
Uplink output power	minimum supported by the MS's power class.
Propagation profile	static.
BCCH/CCCH carrier number	261

Contents of ALERTING message (SS to MS):

Protocol Discriminator	Call Control.
Transaction Identifier	
TI value	As used in the SETUP message.
TI flag	1 (destination side).
Message Type	00000001
All other information elements	Not present.

Contents of ASSIGNMENT COMMAND message:

Protocol Discriminator	RR Management.
Skip Indicator	0000
Message Type	00101110
Channel Description	
- Channel Type and TDMA offset	Bm + ACCHs
- Timeslot Number	Chosen arbitrarily by the test house.
- Training Sequence Code	Chosen arbitrarily by the test house.
- Hopping	Single RF channel.
- ARFCN	Channel number 267.
Power Command	
Power Command	
- EPC mode (for R5 and after MS only)	0 (Channel not in EPC mode)
- FPC (for R99 and R4 MS only)	0 (FPC not in use)
- FPC_EPC mode (for R5 and after MS only)	0 (FPC or EPC not in use)
- Power level	Chosen arbitrarily by the test house.
All other information elements	Not present.

Contents of ASSIGNMENT COMPLETE message:

Protocol Discriminator	RR Management.
Skip Indicator	0000
Message Type	00101001
RR Cause	
- RR Cause Value	Normal event.

Contents of ASSIGNMENT FAILURE message:

Protocol Discriminator	RR Management.
Skip Indicator	0000
Message Type	00101111
RR Cause	
- RR Cause Value	Depending on test.

Contents of AUTHENTICATION REQUEST message:

Protocol Discriminator	MM message.
Skip Indicator	0000
Message Type	00010010
Ciphering Key Sequence Number	
- Key Sequence	Chosen arbitrarily by the test house from the range 0 to 6.
Authentication Parameter RAND	
- RAND value	Chosen arbitrarily by the test house.

Contents of AUTHENTICATION RESPONSE message:

Protocol Discriminator	MM message.
Skip Indicator	0000
Message Type	0X010100
Other information element(s)	Not checked.

Contents of CALL PROCEEDING message:

Protocol Discriminator	Call Control.
Transaction Identifier	
TI value	As used in the SETUP message.
TI flag	1 (destination side).
Message Type	00000010
All other information elements	Not present.

Contents of CHANNEL MODE MODIFY message:

Protocol Discriminator	RR Management.
Skip Indicator	0000
Message Type	00010000
Channel Description	
- Channel Type and TDMA offset	Depending on test.
- Timeslot Number	Chosen arbitrarily by the test house.
- Training Sequence Code	Chosen arbitrarily by the test house.
- Hopping	Single RF channel.
- ARFCN	Channel number 267.
Channel Mode	
- Mode	Depending on test.

Contents of CHANNEL MODE MODIFY ACKNOWLEDGE message:

Protocol Discriminator	RR Management.
Skip Indicator	0000
Message Type	00010111
Channel Description	Depending on test.
- Channel Type and TDMA offset	Same as in the CHANNEL MODE MODIFY message.
- Timeslot Number	Same as in the CHANNEL MODE MODIFY message.
- Training Sequence Code	Single RF channel.
- Hopping	Band number 0.
- Frequency Band	Channel number 267.
- ARFCN	
Channel Mode	
- Mode	Same as in the CHANNEL MODE MODIFY message.

Contents of CHANNEL RELEASE message:

Protocol Discriminator	RR Management.
Skip Indicator	0000
Message Type	00001101
RR Cause	
- RR Cause Value	Normal event.

Contents of CHANNEL REQUEST message

Establishment Cause	Not checked.
Random Reference	Not checked.

Contents of CIPHERING MODE COMMAND message:

Protocol Discriminator	RR Management.
Skip Indicator	0000
Message Type	00110101
Cipher Mode Setting	
- algorithm identifier	cipher with A5/1.
- SC	Start ciphering.
Cipher Response	IMEI shall not be included.

Contents of CIPHERING MODE COMPLETE message:

Protocol Discriminator	RR Management.
Skip Indicator	0000
Message Type	00110010
Mobile Identity	Not present.

Contents of the CLASSMARK CHANGE message:

Protocol Discriminator	RR Management.
Skip Indicator	0000
Message Type	000100110
Mobile Station Classmark 2	See PIXIT.
Mobile Station Classmark 3	For presence and contents see PIXIT.

Contents of CM SERVICE ACCEPT message:

Protocol Discriminator	Mobility Management.
Skip Indicator	0000
Message Type	00100001

Contents of CM SERVICE REQUEST message

Protocol Discriminator	Mobility Management.
Skip Indicator	0000
Message Type	0X100100
Other information elements	Not checked.

Contents of CONNECT message (SS to MS)

Protocol Discriminator	Call Control.
Transaction Identifier	
TI value	As used in the SETUP message.
TI flag	1
Message Type	00000111
All other information elements	Not present.

Contents of CONNECT ACKNOWLEDGE message (MS to SS)

Protocol Discriminator	Call Control.
Transaction Identifier	
TI value	As used in the SETUP message.
TI flag	0
Message Type	0X001111

Contents of HANDOVER ACCESS message:

Handover Reference	Equal to the value included in the Handover Command message.
--------------------	--

Contents of HANDOVER COMMAND message:

Protocol Discriminator	RR Management.
Skip Indicator	0000
Message Type	00101011
Cell Description	
- Network Colour Code	1
- Base station Colour Code	Corresponding to target cell
- BCCH Carrier Number	Set to the BCCH carrier number of cell B. (one of 261, 263, 282, 284, 287, 290 or 293).
Channel Description	
- Channel Type and TDMA offset	Bm + ACCHs.
- Timeslot Number	Chosen arbitrarily by the test house.
- Training Sequence Code	Chosen arbitrarily by the test house.
- Hopping	Single RF channel.
- ARFCN	Chosen arbitrarily by the test house from those supported on the target cell.
Handover Reference	
- Handover Reference Value	Chosen arbitrarily by the test house.
Power Command	
- ATC	0 (Sending of Handover Access is mandatory)
- EPC mode (for R5 and after MS only)	0 (Channel not in EPC mode)
- FPC (for R99 and R4 MS only)	0 (FPC not in use)
- FPC_EPC mode (for R5 and after MS only)	0 (FPC or EPC not in use)
- Power level	Chosen arbitrarily by the test house.
All other information elements	Not present.

Contents of HANDOVER COMPLETE message:

Protocol Discriminator	RR Management.
Skip Indicator	0000
Message Type	00101100
RR cause	Normal event.
Time difference	Not present.

Contents of HANDOVER FAILURE message:

Protocol Discriminator	RR Management.
Skip Indicator	0000
Message Type	00101000
RR cause	Dependent on the test.

IDENTITY REQUEST

Information element	Value/remark
Identity type	IMEI
Spare half octet	0000

IDENTITY RESPONSE

Information element	Value/remark
Mobile identity	not checked

Contents of IMMEDIATE ASSIGNMENT message:

L2 pseudo length	This is the sum of the lengths of all the information elements present in the message except for the IA rest octets and L2 pseudo length IEs. For the default message the L2 pseudo length is 11.
Protocol Discriminator	RR Management.
Skip Indicator	0000
Message Type	00111111
Page Mode	
- Page Mode	Normal Paging.
Channel Description	
- Channel Type and TDMA offset	For non-combined CCCH/SDCCH (see initial conditions), SDCCH/8, with subchannel chosen arbitrarily by the test house For combined CCCH/SDCCH (default SS conditions), SDCCH/4, with subchannel chosen arbitrarily by the test house.
- Timeslot Number	For non-combined CCCH/SDCCH (see initial conditions), chosen arbitrarily by the test house; For combined CCCH/SDCCH (default SS conditions), SDCCH/4, timeslot zero.
- Training Sequence Code	For non-combined CCCH/SDCCH (see initial conditions), chosen arbitrarily by the test house; For combined CCCH/SDCCH (default SS conditions), SDCCH/4, TSC=5 (same as the BCC).
- Hopping	Single RF channel.
- ARFCN	For non-combined CCCH/SDCCH (see initial conditions), Channel number 30; For combined CCCH/SDCCH (default SS conditions), SDCCH/4, Channel number 263.
Request Reference	Pertaining to last Channel Request sent by the MS.
Timing Advance	
- Timing advance value	30 bit periods.
Mobile Allocation	
- Length	0
Starting Time	Not present.
IA rest octets	Not used (all bits set to spare).

Contents of IMMEDIATE ASSIGNMENT EXTENDED message:

L2 pseudo length	This is the sum of the lengths of all the information elements present in the message except for the IAX rest octets and L2 pseudo length IEs. For the default message the L2 pseudo length is 18.
Protocol Discriminator	RR Management.
Skip Indicator	0000
Message Type	00111001
Page Mode	
- Page Mode	Normal Paging.
Channel Description 1	
- Channel Type and TDMA offset	For non-combined CCCH/SDCCH (see test conditions), SDCCH/8, with subchannel chosen arbitrarily by the test house; For combined CCCH/SDCCH (default SS conditions), SDCCH/4, with subchannel chosen arbitrarily by the test house.
- Timeslot Number	For non-combined CCCH/SDCCH (see test conditions), chosen arbitrarily by the test house; For combined CCCH/SDCCH (default SS conditions), SDCCH/4, timeslot zero.
- Training Sequence Code	For non-combined CCCH/SDCCH (see initial conditions), chosen arbitrarily by the test house; For combined CCCH/SDCCH (default SS conditions), SDCCH/4, TSC=5 (same as the BCC). Single RF channel.
- Hopping	For non-combined CCCH/SDCCH (see initial conditions), Channel number 30; For combined CCCH/SDCCH (default SS conditions), SDCCH/4, Channel number 263.
- ARFCN	Pertaining to last Channel Request sent by the MS.
Request Reference 1	
Timing Advance 1	
- Timing advance value	Chosen arbitrarily by the test house.
Channel Description 2	
- Channel Type and TDMA offset	Same channel type as in Channel Description 1, but different TDMA offset to that in Channel Description 1.
- Timeslot Number	equal to the value in Channel Description 1.
- Training Sequence Code	equal to the value in Channel Description 1.
- Hopping	Single RF channel.
- ARFCN	equal to the value in Channel Description 1.
Request Reference 2	Not pertaining to any Channel Requests sent by the MS.
Timing Advance 2	
- Timing advance value	Chosen arbitrarily by the test house.
Mobile Allocation	
- Length	0
Starting Time	Not present.
IAX rest octets	Not used (all bits set to spare).

Contents of IMMEDIATE ASSIGNMENT REJECT message:

L2 pseudo length	19
Protocol Discriminator	RR Management.
Skip Indicator	0000
Message Type	00111010
Page Mode	
- Page Mode	Normal Paging.
Request Reference	Pertaining to last Channel Request sent by the MS.
Wait Indication	0 s.
Request Reference	Not pertaining to the MS under test.
Wait Indication	0 s.
Request Reference	Not pertaining to the MS under test.
Wait Indication	0 s.
Request Reference	Not pertaining to the MS under test.
Wait Indication	0 s.
IAR rest octets	Not used (all bits set to spare).

Contents of LOCATION UPDATING REQUEST message:

Protocol Discriminator	MM message.
Skip Indicator	0000
Message Type	0X001000
Other information elements	Not checked.

Contents of PAGING REQUEST TYPE 1 message:

L2 pseudo length	This is the sum of the lengths of all the information elements present in the message except for the P1 rest octets and L2 pseudo length IEs. For the default message the L2 pseudo length is 9.
Protocol Discriminator	RR Management.
Skip Indicator	0000
Message Type	00100001
Page Mode	
- Page Mode	Normal Paging.
Channels needed	
- first channel	any channel.
- second channel	any channel.
Mobile Identity 1	
- odd/even indication	Even.
- Type of Identity	TMSI.
- Identity Digits	TMSI previously allocated to MS.
Mobile Identity 2	Not present.
P1 rest octets	Not used (all bits set to spare).

Contents of PAGING REQUEST TYPE 2 message:

L2 pseudo length	This is the sum of the lengths of all the information elements present in the message except for the P2 rest octets and L2 pseudo length IEs. For the default message the L2 pseudo length is 11.
Protocol Discriminator	RR Management..
Skip Indicator	0000
Message Type	00100010
Page Mode	
- Page Mode	Normal Paging.
Channels needed	
- first channel	any channel.
- second channel	any channel.
Mobile Identity 1	
- TMSI value	TMSI previously allocated to MS.
Mobile Identity 2	
- TMSI value	TMSI not allocated to MS.
Mobile Identity	Not present.
P2 rest octets	Not used (all bits set to spare).

Contents of PAGING REQUEST TYPE 3 message:

L2 pseudo length	19
Protocol Discriminator	RR Management.
Skip Indicator	0000
Message Type	00100100
Page Mode	
- Page Mode	Normal Paging.
Channels needed	
- first channel	any channel.
- second channel	any channel.
Mobile identity 1	
- TMSI value	TMSI previously allocated to MS.
Mobile identity 2	
- TMSI value	TMSI not allocated to MS.
Mobile identity 3	
- TMSI value	TMSI not allocated to MS.
Mobile identity 4	
- TMSI value	TMSI not allocated to MS.
P3 rest octets	Not used (all bits set to spare).

Contents of PAGING RESPONSE message:

Protocol Discriminator	RR Management.
Skip Indicator	0000
Message Type	00100111
Ciphering Key Sequence Number	
- Key Sequence	Key sequence number previously allocated to MS, or "111" if no key is available.
Mobile Station Classmark 2	
Mobile Identity	
- odd/even indication	Even
- Type of identity	TMSI
- Identity Digits	TMSI previously allocated to MS.

Contents of PHYSICAL INFORMATION message:

Protocol Discriminator	RR Management.
Skip Indicator	0000
Message Type	00101101
Timing advance	20 bit periods.

Contents of SETUP message; (MS to SS):

Protocol Discriminator	Call Control.
Transaction Identifier	
TI value	any value from the set {0, ..., 6}.
TI flag	0
Message Type	0X000101
Other information elements	Not checked.

26.6.17 Default contents of GSM 480 layer 3 messages for RR tests

This subclause contains the default values of GSM 480 L3 messages, which unless indicated otherwise in subclause 26.6 shall be transmitted by the system simulator and which are required to be received from the GSM 480 MS under test. These values are used in order to be consistent with the phase 2 version of 26.6.

The necessary L3 messages are listed in alphabetic order, with the exception of the SYSTEM INFORMATION messages, where it is the information elements which are listed in alphabetic order (this is because some information elements occur in several SYSTEM INFORMATION types).

In this subclause, decimal values are normally used. However, sometimes a hexadecimal value, indicated by an "H", or a binary value, indicated by a "B" is used.

Default SYSTEM INFORMATION:

NOTE 1: SYSTEM INFORMATION 2 bis, SYSTEM INFORMATION 5 bis, SYSTEM INFORMATION 7, and SYSTEM INFORMATION 8 messages are not used.

Cell A

Contents of information elements in SYSTEM INFORMATION TYPE 1 to 6 messages for cell A.

(CBCH) Channel Description	Not present.
(CBCH) Mobile Allocation	Not present.
Cell Channel Description	
- Format identifier	128 range.
- Cell Allocation ARFCN	Channel Numbers 310, 315, 322 and 326.
Cell Identity	
- Cell Identity Value	0001H
Cell Options	
- Power Control Indicator	Power Control Indicator is not set.
- DTX Indicator	MS shall not use DTX.
- Radio_Link_Timeout	8 SACCH blocks.
Cell Selection Parameters	
- Cell_Reselect_Hysteresis	12 dB.
- MX_TXPWR_MAX_CCH	Minimum level.
- ACS	No addition cell parameters are present in SYSTEM INFORMATION messages 7 and 8.
- NECI	New establishment causes not supported.
- RXLEV_ACCESS_MIN	Minimum level.
Control Channel Description	
- Attach-Detach allowed	No Attach/Detach.
- BS_AG_BLK_RES	0 blocks reserved for access grant.
- CCCH_CONF	1 basic physical channel used for CCCH, combined with SDCCHs.
- BS_PA_MFRMS	5 multiframe periods for transmission of paging messages.
- T3212 Time-out value	Infinite.
L2 pseudo length	
- System information 1	21
- System information 2	22
- System information 3	18
- System information 4	12
Location Area Identification	
- Mobile Country Code	001 decimal
- Mobile Network Code	01 decimal
- Location Area Code	0001H
Message Type	
- System information 1	00011001
- System information 2	00011010
- System information 3	00011011
- System information 4	00011100
- System information 5	00011101
- System information 6	00011110
Neighbour Cells Description	
- Format identifier	128 range.
- BCCH Allocation Sequence	0
- BCCH Allocation ARFCN	Channels numbers 308, 310, 321, 329, 331, 334, 337 and 340.
- EXT-IND	This IE carries the complete BA.
NCC Permitted	0000 0010
RACH Control Parameters	
- Max Retrans	Max 1 retrans.
- Tx-integer	5 slots used.
- Cell Barred for Access	Cell is not barred.
- Call Reestablishment Allowed	Not allowed.
- Access Control Class	Access is not barred.
- Emergency Call allowed	Yes.
SI 1 rest octets	Not used (all bits are set to spare).
SI 2 rest octets	Not used (all bits are set to spare).
SI 3 rest octets	Not used (all bits are set to spare).
SI 4 rest octets	Not used (all bits are set to spare).

Default settings for cell A:

Downlink input level	63 dBmicroVolt emf.
Uplink output power	minimum supported by the MS's power class.
Propagation profile	static.
BCCH/CCCH carrier number	310

Cell B

The contents of SYSTEM INFORMATION TYPE 1 to 6 messages for cell B are identical to those of cell A with the following exceptions:

Cell Channel Description - Format Identifier - Cell Allocation ARFCN	128 range. Channel Number 308.
--	-----------------------------------

NOTE 2: This IE needs modification when used in handover tests which command the MS to go to a frequency hopping channel in cell B.

Cell Identity

- Cell Identity Value 0002H

Default settings for cell B:

Downlink input level	53 dBmicroVolt emf.
Uplink output power	minimum supported by the MS's power class.
Propagation profile	static.
BCCH/CCCH carrier number	308

Contents of ALERTING message (SS to MS):

Protocol Discriminator	Call Control.
Transaction Identifier	
TI value	As used in the SETUP message.
TI flag	1 (destination side).
Message Type	00000001
All other information elements	Not present.

Contents of ASSIGNMENT COMMAND message:

Protocol Discriminator	RR Management.
Skip Indicator	0000
Message Type	00101110
Channel Description	
- Channel Type and TDMA offset	Bm + ACCHs
- Timeslot Number	Chosen arbitrarily by the test house.
- Training Sequence Code	Chosen arbitrarily by the test house.
- Hopping	Single RF channel.
- ARFCN	Channel number 315.
Power Command	
- ATC	0 (Sending of Handover Access is mandatory)
- EPC mode (for R5 and after MS only)	0 (Channel not in EPC mode)
- FPC (for R99 and R4 MS only)	0 (FPC not in use)
- FPC_EPC mode (for R5 and after MS only)	0 (FPC or EPC not in use)
- Power level	Chosen arbitrarily by the test house.
All other information elements	Not present.

Contents of ASSIGNMENT COMPLETE message:

Protocol Discriminator	RR Management.
Skip Indicator	0000
Message Type	00101001
RR Cause	
- RR Cause Value	Normal event.

Contents of ASSIGNMENT FAILURE message:

Protocol Discriminator	RR Management.
Skip Indicator	0000
Message Type	00101111
RR Cause	
- RR Cause Value	Depending on test.

Contents of AUTHENTICATION REQUEST message:

Protocol Discriminator	MM message.
Skip Indicator	0000
Message Type	00010010
Ciphering Key Sequence Number	
- Key Sequence	Chosen arbitrarily by the test house from the range 0 to 6.
Authentication Parameter RAND	
- RAND value	Chosen arbitrarily by the test house.

Contents of AUTHENTICATION RESPONSE message:

Protocol Discriminator	MM message.
Skip Indicator	0000
Message Type	0X010100
Other information element(s)	Not checked.

Contents of CALL PROCEEDING message:

Protocol Discriminator	Call Control.
Transaction Identifier	
TI value	As used in the SETUP message.
TI flag	1 (destination side).
Message Type	00000010
All other information elements	Not present.

Contents of CHANNEL MODE MODIFY message:

Protocol Discriminator	RR Management.
Skip Indicator	0000
Message Type	00010000
Channel Description	
- Channel Type and TDMA offset	Depending on test.
- Timeslot Number	Chosen arbitrarily by the test house.
- Training Sequence Code	Chosen arbitrarily by the test house.
- Hopping	Single RF channel.
- ARFCN	Channel number 315.
Channel Mode	
- Mode	Depending on test.

Contents of CHANNEL MODE MODIFY ACKNOWLEDGE message:

Protocol Discriminator	RR Management.
Skip Indicator	0000
Message Type	00010111
Channel Description	Depending on test.
- Channel Type and TDMA offset	Same as in the CHANNEL MODE MODIFY message.
- Timeslot Number	Same as in the CHANNEL MODE MODIFY message.
- Training Sequence Code	Single RF channel.
- Hopping	Band number 0.
- Frequency Band	Channel number 315.
- ARFCN	
Channel Mode	
- Mode	Same as in the CHANNEL MODE MODIFY message.

Contents of CHANNEL RELEASE message:

Protocol Discriminator	RR Management.
Skip Indicator	0000
Message Type	00001101
RR Cause	
- RR Cause Value	Normal event.

Contents of CHANNEL REQUEST message

Establishment Cause	Not checked.
Random Reference	Not checked.

Contents of CIPHERING MODE COMMAND message:

Protocol Discriminator	RR Management.
Skip Indicator	0000
Message Type	00110101
Cipher Mode Setting	
- algorithm identifier	cipher with A5/1.
- SC	Start ciphering.
Cipher Response	IMEI shall not be included.

Contents of CIPHERING MODE COMPLETE message:

Protocol Discriminator	RR Management.
Skip Indicator	0000
Message Type	00110010
Mobile Identity	Not present.

Contents of the CLASSMARK CHANGE message:

Protocol Discriminator	RR Management.
Skip Indicator	0000
Message Type	000100110
Mobile Station Classmark 2	See PIXIT.
Mobile Station Classmark 3	For presence and contents see PIXIT.

Contents of CM SERVICE ACCEPT message:

Protocol Discriminator	Mobility Management.
Skip Indicator	0000
Message Type	00100001

Contents of CM SERVICE REQUEST message

Protocol Discriminator	Mobility Management.
Skip Indicator	0000
Message Type	0X100100
Other information elements	Not checked.

Contents of CONNECT message (SS to MS)

Protocol Discriminator	Call Control.
Transaction Identifier	
TI value	As used in the SETUP message.
TI flag	1
Message Type	00000111
All other information elements	Not present.

Contents of CONNECT ACKNOWLEDGE message (MS to SS)

Protocol Discriminator	Call Control.
Transaction Identifier	
TI value	As used in the SETUP message.
TI flag	0
Message Type	0X001111

Contents of HANDOVER ACCESS message:

Handover Reference	Equal to the value included in the Handover Command message.
--------------------	--

Contents of HANDOVER COMMAND message:

Protocol Discriminator	RR Management.
Skip Indicator	0000
Message Type	00101011
Cell Description	
- Network Colour Code	1
- Base station Colour Code	Corresponding to target cell
- BCCH Carrier Number	Set to the BCCH carrier number of cell B. (one of 308, 310, 329, 331, 334, 337 or 340).
Channel Description	
- Channel Type and TDMA offset	Bm + ACCHs.
- Timeslot Number	Chosen arbitrarily by the test house.
- Training Sequence Code	Chosen arbitrarily by the test house.
- Hopping	Single RF channel.
- ARFCN	Chosen arbitrarily by the test house from those supported on the target cell.
Handover Reference	
- Handover Reference Value	Chosen arbitrarily by the test house.
Power Command	
- ATC	0 (Sending of Handover Access is mandatory)
- EPC mode (for R5 and after MS only)	0 (Channel not in EPC mode)
- FPC (for R99 and R4 MS only)	0 (FPC not in use)
- FPC_EPC mode (for R5 and after MS only)	0 (FPC or EPC not in use)
- Power level	Chosen arbitrarily by the test house.
All other information elements	Not present.

Contents of HANDOVER COMPLETE message:

Protocol Discriminator	RR Management.
Skip Indicator	0000
Message Type	00101100
RR cause	Normal event.
Time difference	Not present.

Contents of HANDOVER FAILURE message:

Protocol Discriminator	RR Management.
Skip Indicator	0000
Message Type	00101000
RR cause	Dependent on the test.

IDENTITY REQUEST

Information element	Value/remark
Identity type	IMEI
Spare half octet	0000

IDENTITY RESPONSE

Information element	Value/remark
Mobile identity	not checked

Contents of IMMEDIATE ASSIGNMENT message:

L2 pseudo length	This is the sum of the lengths of all the information elements present in the message except for the IA rest octets and L2 pseudo length IEs. For the default message the L2 pseudo length is 11.
Protocol Discriminator	RR Management.
Skip Indicator	0000
Message Type	00111111
Page Mode	
- Page Mode	Normal Paging.
Channel Description	
- Channel Type and TDMA offset	For non-combined CCCH/SDCCH (see initial conditions), SDCCH/8, with subchannel chosen arbitrarily by the test house For combined CCCH/SDCCH (default SS conditions), SDCCH/4, with subchannel chosen arbitrarily by the test house.
- Timeslot Number	For non-combined CCCH/SDCCH (see initial conditions), chosen arbitrarily by the test house; For combined CCCH/SDCCH (default SS conditions), SDCCH/4, timeslot zero.
- Training Sequence Code	For non-combined CCCH/SDCCH (see initial conditions), chosen arbitrarily by the test house; For combined CCCH/SDCCH (default SS conditions), SDCCH/4, TSC=5 (same as the BCC).
- Hopping	Single RF channel.
- ARFCN	For non-combined CCCH/SDCCH (see initial conditions), Channel number 30; For combined CCCH/SDCCH (default SS conditions), SDCCH/4, Channel number 310.
Request Reference	Pertaining to last Channel Request sent by the MS.
Timing Advance	
- Timing advance value	30 bit periods.
Mobile Allocation	
- Length	0
Starting Time	Not present.
IA rest octets	Not used (all bits set to spare).

Contents of IMMEDIATE ASSIGNMENT EXTENDED message:

L2 pseudo length	This is the sum of the lengths of all the information elements present in the message except for the IAX rest octets and L2 pseudo length IEs. For the default message the L2 pseudo length is 18.
Protocol Discriminator	RR Management.
Skip Indicator	0000
Message Type	00111001
Page Mode	
- Page Mode	Normal Paging.
Channel Description 1	
- Channel Type and TDMA offset	For non-combined CCCH/SDCCH (see test conditions), SDCCH/8, with subchannel chosen arbitrarily by the test house; For combined CCCH/SDCCH (default SS conditions), SDCCH/4, with subchannel chosen arbitrarily by the test house.
- Timeslot Number	For non-combined CCCH/SDCCH (see test conditions), chosen arbitrarily by the test house; For combined CCCH/SDCCH (default SS conditions), SDCCH/4, timeslot zero.
- Training Sequence Code	For non-combined CCCH/SDCCH (see initial conditions), chosen arbitrarily by the test house; For combined CCCH/SDCCH (default SS conditions), SDCCH/4, TSC=5 (same as the BCC). Single RF channel.
- Hopping	For non-combined CCCH/SDCCH (see initial conditions), Channel number 30; For combined CCCH/SDCCH (default SS conditions), SDCCH/4, Channel number 310.
- ARFCN	Pertaining to last Channel Request sent by the MS.
Request Reference 1	
Timing Advance 1	
- Timing advance value	Chosen arbitrarily by the test house.
Channel Description 2	
- Channel Type and TDMA offset	Same channel type as in Channel Description 1, but different TDMA offset to that in Channel Description 1.
- Timeslot Number	equal to the value in Channel Description 1.
- Training Sequence Code	equal to the value in Channel Description 1.
- Hopping	Single RF channel.
- ARFCN	equal to the value in Channel Description 1.
Request Reference 2	Not pertaining to any Channel Requests sent by the MS.
Timing Advance 2	
- Timing advance value	Chosen arbitrarily by the test house.
Mobile Allocation	
- Length	0
Starting Time	Not present.
IAX rest octets	Not used (all bits set to spare).

Contents of IMMEDIATE ASSIGNMENT REJECT message:

L2 pseudo length	19
Protocol Discriminator	RR Management.
Skip Indicator	0000
Message Type	00111010
Page Mode	
- Page Mode	Normal Paging.
Request Reference	Pertaining to last Channel Request sent by the MS.
Wait Indication	0 s.
Request Reference	Not pertaining to the MS under test.
Wait Indication	0 s.
Request Reference	Not pertaining to the MS under test.
Wait Indication	0 s.
Request Reference	Not pertaining to the MS under test.
Wait Indication	0 s.
IAR rest octets	Not used (all bits set to spare).

Contents of LOCATION UPDATING REQUEST message:

Protocol Discriminator	MM message.
Skip Indicator	0000
Message Type	0X001000
Other information elements	Not checked.

Contents of PAGING REQUEST TYPE 1 message:

L2 pseudo length	This is the sum of the lengths of all the information elements present in the message except for the P1 rest octets and L2 pseudo length IEs. For the default message the L2 pseudo length is 9.
Protocol Discriminator	RR Management.
Skip Indicator	0000
Message Type	00100001
Page Mode	
- Page Mode	Normal Paging.
Channels needed	
- first channel	any channel.
- second channel	any channel.
Mobile Identity 1	
- odd/even indication	Even.
- Type of Identity	TMSI.
- Identity Digits	TMSI previously allocated to MS.
Mobile Identity 2	Not present.
P1 rest octets	Not used (all bits set to spare).

Contents of PAGING REQUEST TYPE 2 message:

L2 pseudo length	This is the sum of the lengths of all the information elements present in the message except for the P2 rest octets and L2 pseudo length IEs. For the default message the L2 pseudo length is 11.
Protocol Discriminator	RR Management..
Skip Indicator	0000
Message Type	00100010
Page Mode	
- Page Mode	Normal Paging.
Channels needed	
- first channel	any channel.
- second channel	any channel.
Mobile Identity 1	
- TMSI value	TMSI previously allocated to MS.
Mobile Identity 2	
- TMSI value	TMSI not allocated to MS.
Mobile Identity	Not present.
P2 rest octets	Not used (all bits set to spare).

Contents of PAGING REQUEST TYPE 3 message:

L2 pseudo length	19
Protocol Discriminator	RR Management.
Skip Indicator	0000
Message Type	00100100
Page Mode	
- Page Mode	Normal Paging.
Channels needed	
- first channel	any channel.
- second channel	any channel.
Mobile identity 1	
- TMSI value	TMSI previously allocated to MS.
Mobile identity 2	
- TMSI value	TMSI not allocated to MS.
Mobile identity 3	
- TMSI value	TMSI not allocated to MS.
Mobile identity 4	
- TMSI value	TMSI not allocated to MS.
P3 rest octets	Not used (all bits set to spare).

Contents of PAGING RESPONSE message:

Protocol Discriminator	RR Management.
Skip Indicator	0000
Message Type	00100111
Ciphering Key Sequence Number	
- Key Sequence	Key sequence number previously allocated to MS, or "111" if no key is available.
Mobile Station Classmark 2	
Mobile Identity	
- odd/even indication	Even
- Type of identity	TMSI
- Identity Digits	TMSI previously allocated to MS.

Contents of PHYSICAL INFORMATION message:

Protocol Discriminator	RR Management.
Skip Indicator	0000
Message Type	00101101
Timing advance	20 bit periods.

Contents of SETUP message; (MS to SS):

Protocol Discriminator	Call Control.
Transaction Identifier	
TI value	any value from the set {0, ..., 6}.
TI flag	0
Message Type	0X000101
Other information elements	Not checked.

26.6.18 Default contents of PCS 1 900 layer 3 messages for RR tests

This subclause contains the default values of PCS 1 900 L3 messages, which unless indicated otherwise in subclause 26.6 shall be transmitted by the system simulator and which are required to be received from the PCS 1 900 MS under test. These values are used in order to be consistent with the phase 2 version of 26.6.

The necessary L3 messages are listed in alphabetic order, with the exception of the SYSTEM INFORMATION messages, where it is the information elements which are listed in alphabetic order (this is because some information elements occur in several SYSTEM INFORMATION types).

In this subclause, decimal values are normally used. However, sometimes a hexadecimal value, indicated by an "H", or a binary value, indicated by a "B" is used.

Default SYSTEM INFORMATION:

NOTE 1: SYSTEM INFORMATION 2 bis, SYSTEM INFORMATION 7, and SYSTEM INFORMATION 8 messages are not used.

SYSTEM INFORMATION 5 bis is not sent as a default message. For those tests which require SYSTEM INFORMATION 5 bis see the specific message contents for that test.

Cell A

Contents of information elements in SYSTEM INFORMATION TYPE 1 to 6 messages for cell A.

(CBCH) Channel Description	Not present.
(CBCH) Mobile Allocation	Not present.
Cell Channel Description	
- Format identifier	Range 512.
- Cell Allocation ARFCN	Channel Numbers, 590, 650, 750 and 780.
Cell Identity	
- Cell Identity Value	0001H
Cell Options	
- Power Control Indicator	Power Control Indicator is not set, 0
- DTX Indicator	MS shall not use DTX.
- Radio_Link_Timeout	8 SACCH blocks.
Cell Selection Parameters	
- Cell_Reselect_Hysteresis	12 dB
- MX_TXPWR_MAX_CCH	Minimum level.
- ACS	No addition cell parameters are present in SYSTEM INFORMATION messages 7 and 8.
- NECI	New establishment causes not supported.
- RXLEV_ACCESS_MIN	Minimum level.
Control Channel Description	
- Attach-Detach allowed	MS shall not apply.
- BS_AG_BLKES_RES	0 blocks reserved for access grant.
- CCCH_CONF	1 basic physical channel used for CCCH, combined with SDCCHs.
- BS_PA_MFRMS	5 multiframe periods for transmission of paging messages.
- T3212 Time-out value	Infinite.
L2 pseudo length	
- System information 1	21
- System information 2	22
- System information 3	18
- System information 4	12
Location Area Identification	
- Mobile Country Code	001 decimal.
- Mobile Network Code	011 decimal.
- Location Area Code	0001H
Message Type	
- System information 1	00011001
- System information 2	00011010
- System information 3	00011011
- System information 4	00011100
- System information 5	00011101
- System information 6	00011110
Neighbour Cells Description	
- Format identifier	Range 512.
- BCCH Allocation Sequence	0
- BCCH Allocation ARFCN	Channels numbers, 520, 590, 600, 647, 664, 700, 720, 760, 780.
- EXT-IND	This IE carries the complete BA. EXT-IND is 0.
NCC Permitted	0000 0010
RACH Control Parameters	
- Max Retrans	Max 1 retrans.
- Tx-integer	5 slots used.
- Cell Barred for Access	Cell is not barred.
- Call Reestablishment Allowed	Not Allowed.
- Access Control Class	Access is not barred.
- Emergency Call allowed	Yes.
SI 1 rest octets	Not used (all bits are set to spare).
SI 2 rest octets	Not used (all bits are set to spare).
SI 3 rest octets	Not used (all bits are set to spare).
SI 4 rest octets	Not used (all bits are set to spare).

Default settings for cell A:

Downlink input level	63 dBmicroVolt emf().
Uplink output power	minimum supported by the MS's power class.
Propagation profile	static.
BCCH/CCCH carrier number	ARFN 590.

Cell B

The contents of SYSTEM INFORMATION TYPE 1 to 6 messages for cell B are identical to those of cell A with the following exceptions:

Cell Channel Description - Format Identifier - Cell Allocation ARFCN	Range 512. Channel Number 520.
--	-----------------------------------

NOTE 2: This IE needs modification when used in handover tests which command the MS to go to a frequency hopping channel in cell B.

Cell Identity - Cell Identity Value	0002H
--	-------

Default settings for cell B:

Downlink input level	53 dBmicroVolt emf().
Uplink output power	minimum supported by the MS's power class.
Propagation profile	static.
BCCH/CCCH carrier number	520

Contents of ALERTING message (SS to MS):

Protocol Discriminator	Call Control.
Transaction Identifier TI value TI flag	As used in the SETUP message. 1 (destination side).
Message Type	00000001
All other information elements	Not present.

Contents of ASSIGNMENT COMMAND message:

Protocol Discriminator	RR Management.
Skip Indicator	0000
Message Type	00101110
Channel Description - Channel Type and TDMA offset - Timeslot Number - Training Sequence Code - Hopping - ARFCN	Bm + ACCHs. Chosen arbitrarily by the test house. Chosen arbitrarily by the test house. Single RF channel. Channel number 650.
Power Command - EPC mode (for R5 and after MS only) - FPC (for R99 and R4 MS only) - FPC_EPC mode (for R5 and after MS only) - Power level	0 (Channel not in EPC mode) 0 (FPC not in use) 0 (FPC or EPC not in use) Chosen arbitrarily by the test house.
All other information elements	Not present.

Contents of ASSIGNMENT COMPLETE message:

Protocol Discriminator	RR Management.
Skip Indicator	0000
Message Type	00101001
RR Cause	
- RR Cause Value	Normal event.

Contents of ASSIGNMENT FAILURE message:

Protocol Discriminator	RR Management.
Skip Indicator	0000
Message Type	00101111
RR Cause	
- RR Cause Value	Depending on test.

Contents of AUTHENTICATION REQUEST message:

Protocol Discriminator	MM message.
Skip Indicator	0000
Message Type	00010010
Ciphering Key Sequence Number	
- Key Sequence	Chosen arbitrarily by the test house from the range 0 to 6.
Authentication Parameter RAND	
- RAND value	Chosen arbitrarily by the test house.

Contents of AUTHENTICATION RESPONSE message:

Protocol Discriminator	MM message.
Skip Indicator	0000
Message Type	0X010100
Other information element(s)	Not checked.

Contents of CALL PROCEEDING message:

Protocol Discriminator	Call Control.
Transaction Identifier	
TI value	As used in the SETUP message.
TI flag	1 (destination side).
Message Type	00000010
All other information elements	Not present.

Contents of CHANNEL MODE MODIFY message:

Protocol Discriminator	RR Management.
Skip Indicator	0000
Message Type	00010000
Channel Description	
- Channel Type and TDMA offset	Depending on test.
- Timeslot Number	Chosen arbitrarily by the test house.
- Training Sequence Code	Chosen arbitrarily by the test house.
- Hopping	Single RF channel.
- ARFCN	Channel number 650.
Channel Mode	
- Mode	Depending on test.

Contents of CHANNEL MODE MODIFY ACKNOWLEDGE message:

Protocol Discriminator	RR Management.
Skip Indicator	0000
Message Type	00010111
Channel Description	Depending on test.
- Channel Type and TDMA offset	Same as in the CHANNEL MODE MODIFY message.
- Timeslot Number	Same as in the CHANNEL MODE MODIFY message.
- Training Sequence Code	Single RF channel.
- Hopping	Band number 0.
- Frequency Band	Channel number 650.
- ARFCN	
Channel Mode	
- Mode	Same as in the CHANNEL MODE MODIFY message.

Contents of CHANNEL RELEASE message:

Protocol Discriminator	RR Management.
Skip Indicator	0000
Message Type	00001101
RR Cause	
- RR Cause Value	Normal event.

Contents of CHANNEL REQUEST message:

Establishment Cause	Not checked.
Random Reference	Not checked.

Contents of CIPHERING MODE COMMAND message:

Protocol Discriminator	RR Management.
Skip Indicator	0000
Message Type	00110101
Cipher Mode Setting	
- algorithm identifier	cipher with A5/1.
- SC	Start ciphering.
Cipher Response	IMEI shall not be included.

Contents of CIPHERING MODE COMPLETE message:

Protocol Discriminator	RR Management.
Skip Indicator	0000
Message Type	00110010
Mobile Identity	Not present.

Contents of the CLASSMARK CHANGE message:

Protocol Discriminator	RR Management.
Skip Indicator	0000
Message Type	000100110
Mobile Station Classmark 2	
- RF Power Capability	See PIXIT.
- Frequency Capability	Set to 0.
Mobile Station Classmark 3	For presence and contents see PIXIT.

Contents of CM SERVICE ACCEPT message:

Protocol Discriminator	Mobility Management.
Skip Indicator	0000
Message Type	00100001

Contents of CM SERVICE REQUEST message:

Protocol Discriminator	Mobility Management.
Skip Indicator	0000
Message Type	0X100100
Other information elements	Not checked.

Contents of CONNECT message (SS to MS):

Protocol Discriminator	Call Control.
Transaction Identifier	
TI value	As used in the SETUP message.
TI flag	1
Message Type	00000111
All other information elements	Not present.

Contents of CONNECT ACKNOWLEDGE message (MS to SS):

Protocol Discriminator	Call Control.
Transaction Identifier	
TI value	As used in the SETUP message.
TI flag	0
Message Type	0X001111

Contents of HANDOVER ACCESS message:

Handover Reference	Equal to the value included in the Handover Command message.
--------------------	--

Contents of HANDOVER COMMAND message:

Protocol Discriminator	RR Management.
Skip Indicator	0000
Message Type	00101011
Cell Description	
- Network Colour Code	1
- Base station Colour Code	5
- BCCH Carrier Number	Set to the BCCH carrier number of cell B. (one of 520, 590, 600, 700, 720, 760 or 780).
Channel Description	
- Channel Type and TDMA offset	Bm + ACCHs.
- Timeslot Number	Chosen arbitrarily by the test house.
- Training Sequence Code	Chosen arbitrarily by the test house.
- Hopping	Single RF channel.
- ARFCN	Chosen arbitrarily by the test house from those supported on the target cell.
Handover Reference	
- Handover Reference Value	Chosen arbitrarily by the test house.
Power Command	
- ATC	0 (Sending of Handover Access is mandatory)
- EPC mode (for R5 and after MS only)	0 (Channel not in EPC mode)
- FPC (for R99 and R4 MS only)	0 (FPC not in use)
- FPC_EPC mode (for R5 and after MS only)	0 (FPC or EPC not in use)
- Power level	Chosen arbitrarily by the test house.
All other information elements	Not present.

Contents of HANDOVER COMPLETE message:

Protocol Discriminator	RR Management.
Skip Indicator	0000
Message Type	00101100
RR cause	Normal event.
Time difference	Not present.

Contents of HANDOVER FAILURE message:

Protocol Discriminator	RR Management.
Skip Indicator	0000
Message Type	00101000
RR cause	Dependent on the test.

Contents of IMMEDIATE ASSIGNMENT message:

L2 pseudo length	This is the sum of the lengths of all the information elements present in the message except for the IA rest octets and L2 pseudo length IEs. For the default message the L2 pseudo length is 11.
Protocol Discriminator	RR Management.
Skip Indicator	0000
Message Type	00111111
Page Mode	
- Page Mode	Normal Paging.
Channel Description	
- Channel Type and TDMA offset	For non-combined CCCH/SDCCH (see initial conditions), SDCCH/8, with subchannel chosen arbitrarily by the test house For combined CCCH/SDCCH (default SS conditions), SDCCH/4, with subchannel chosen arbitrarily by the test house.
- Timeslot Number	For non-combined CCCH/SDCCH (see initial conditions), chosen arbitrarily by the test house; For combined CCCH/SDCCH (default SS conditions), SDCCH/4, timeslot zero.
- Training Sequence Code	For non-combined CCCH/SDCCH (see initial conditions), chosen arbitrarily by the test house; For combined CCCH/SDCCH (default SS conditions), SDCCH/4, TSC=5 (same as the BCC). Single RF channel.
- Hopping	
- ARFCN	For non-combined CCCH/SDCCH (see initial conditions), Channel number 650; For combined CCCH/SDCCH (default SS conditions), SDCCH/4, Channel number 590.
Request Reference	Pertaining to last Channel Request sent by the MS.
Timing Advance	
- Timing advance value	30 bit periods.
Mobile Allocation	
- Length	0
Starting Time	Not present.
IA rest octets	Not used (all bits set to spare).

Contents of IMMEDIATE ASSIGNMENT EXTENDED message:

L2 pseudo length	This is the sum of the lengths of all the information elements present in the message except for the IAX rest octets and L2 pseudo length IEs. For the default message the L2 pseudo length is 18.
Protocol Discriminator	RR Management.
Skip Indicator	0000
Message Type	00111001
Page Mode	
- Page Mode	Normal Paging.
Channel Description 1	
- Channel Type and TDMA offset	For non-combined CCCH/SDCCH (see test conditions), SDCCH/8, with subchannel chosen arbitrarily by the test house; For combined CCCH/SDCCH (default SS conditions), SDCCH/4, with subchannel chosen arbitrarily by the test house.
- Timeslot Number	For non-combined CCCH/SDCCH (see test conditions), chosen arbitrarily by the test house; For combined CCCH/SDCCH (default SS conditions), SDCCH/4, timeslot zero.
- Training Sequence Code	For non-combined CCCH/SDCCH (see initial conditions), chosen arbitrarily by the test house; For combined CCCH/SDCCH (default SS conditions), SDCCH/4, TSC=5 (same as the BCC). Single RF channel.
- Hopping	For non-combined CCCH/SDCCH (see initial conditions), Channel number 650; For combined CCCH/SDCCH (default SS conditions), SDCCH/4, Channel number 590.
- ARFCN	Pertaining to last Channel Request sent by the MS.
Request Reference 1	
Timing Advance 1	
- Timing advance value	Chosen arbitrarily by the test house.
Channel Description 2	
- Channel Type and TDMA offset	Same channel type as in Channel Description 1, but different TDMA offset to that in Channel Description 1.
- Timeslot Number	equal to the value in Channel Description 1.
- Training Sequence Code	equal to the value in Channel Description 1.
- Hopping	Single RF channel.
- ARFCN	equal to the value in Channel Description 1.
Request Reference 2	Not pertaining to any Channel Requests sent by the MS.
Timing Advance 2	
- Timing advance value	Chosen arbitrarily by the test house.
Mobile Allocation	
- Length	0
Starting Time	Not present.
IAX rest octets	Not used (all bits set to spare).

Contents of IMMEDIATE ASSIGNMENT REJECT message:

L2 pseudo length	19
Protocol Discriminator	RR Management.
Skip Indicator	0000
Message Type	00111010
Page Mode	
- Page Mode	Normal Paging.
Request Reference	Pertaining to last Channel Request sent by the MS.
Wait Indication	0 s.
Request Reference	Not pertaining to the MS under test.
Wait Indication	0 s.
Request Reference	Not pertaining to the MS under test.
Wait Indication	0 s.
Request Reference	Not pertaining to the MS under test.
Wait Indication	0 s.
IAR rest octets	Not used (all bits set to spare).

Contents of LOCATION UPDATING REQUEST message:

Protocol Discriminator	MM message.
Skip Indicator	0000
Message Type	0X001000
Other information elements	Not checked.

Contents of PAGING REQUEST TYPE 1 message:

L2 pseudo length	This is the sum of the lengths of all the information elements present in the message except for the P1 rest octets and L2 pseudo length IEs. For the default message the L2 pseudo length is 9.
Protocol Discriminator	RR Management.
Skip Indicator	0000
Message Type	00100001
Page Mode	
- Page Mode	Normal Paging.
Channels needed	
- first channel	any channel.
- second channel	any channel.
Mobile Identity 1	
- odd/even indication	Even.
- Type of Identity	TMSI.
- Identity Digits	TMSI previously allocated to MS.
Mobile Identity 2	Not present.
P1 rest octets	Not used (all bits set to spare).

Contents of PAGING REQUEST TYPE 2 message:

L2 pseudo length	This is the sum of the lengths of all the information elements present in the message except for the P2 rest octets and L2 pseudo length IEs. For the default message the L2 pseudo length is 11.
Protocol Discriminator	RR Management.
Skip Indicator	0000
Message Type	00100010
Page Mode	
- Page Mode	Normal Paging.
Channels needed	
- first channel	any channel.
- second channel	any channel.
Mobile Identity 1	
- TMSI value	TMSI previously allocated to MS.
Mobile Identity 2	
- TMSI value	TMSI not allocated to MS.
Mobile Identity	Not present.
P2 rest octets	Not used (all bits set to spare).

Contents of PAGING REQUEST TYPE 3 message:

L2 pseudo length	19
Protocol Discriminator	RR Management.
Skip Indicator	0000
Message Type	00100100
Page Mode	
- Page Mode	Normal Paging.
Channels needed	
- first channel	any channel.
- second channel	any channel.
Mobile identity 1	
- TMSI value	TMSI previously allocated to MS.
Mobile identity 2	
- TMSI value	TMSI not allocated to MS.
Mobile identity 3	
- TMSI value	TMSI not allocated to MS.
Mobile identity 4	
- TMSI value	TMSI not allocated to MS.
P3 rest octets	Not used (all bits set to spare).

Contents of PAGING RESPONSE message:

Protocol Discriminator	RR Management.
Skip Indicator	0000
Message Type	00100111
Ciphering Key Sequence Number	
- Key Sequence	Key sequence number previously allocated to MS, or "111" if no key is available.
Mobile Station Classmark 2	
Mobile Identity	
- odd/even indication	Even.
- Type of identity	TMSI
- Identity Digits	TMSI previously allocated to MS.

Contents of PHYSICAL INFORMATION message:

Protocol Discriminator	RR Management.
Skip Indicator	0000
Message Type	00101101
Timing advance	20 bit periods.

Contents of SETUP message; (MS to SS):

Protocol Discriminator	Call Control.
Transaction Identifier	
TI value	any value from the set {0, ..., 6}.
TI flag	0
Message Type	0X000101
Other information elements	Not checked.

26.6.19 Default contents of GSM 750 layer 3 messages for RR tests

This subclause contains the default values of GSM 750 L3 messages, which unless indicated otherwise in subclause 26.6 shall be transmitted by the system simulator and which are required to be received from the GSM 750 MS under test. These values are used in order to be consistent with the phase 2 version of 26.6.

The necessary L3 messages are listed in alphabetic order, with the exception of the SYSTEM INFORMATION messages, where it is the information elements which are listed in alphabetic order (this is because some information elements occur in several SYSTEM INFORMATION types).

In this subclause, decimal values are normally used. However, sometimes a hexadecimal value, indicated by an "H", or a binary value, indicated by a "B" is used.

Default SYSTEM INFORMATION:

NOTE 1: SYSTEM INFORMATION 2 bis, SYSTEM INFORMATION 5 bis, SYSTEM INFORMATION 7, and SYSTEM INFORMATION 8 messages are not used.

Cell A

Contents of information elements in SYSTEM INFORMATION TYPE 1 to 6 messages for cell A.

(CBCH) Channel Description	Not present.
(CBCH) Mobile Allocation	Not present.
Cell Channel Description	
- Format identifier	128 range.
- Cell Allocation ARFCN	Channel Numbers 457, 467, 470 and 475.
Cell Identity	
- Cell Identity Value	0001H
Cell Options	
- Power Control Indicator	Power Control Indicator is not set.
- DTX Indicator	MS shall not use DTX.
- Radio_Link_Timeout	8 SACCH blocks.
Cell Selection Parameters	
- Cell_Reselect_Hysteresis	12 dB.
- MX_TXPWR_MAX_CCH	Minimum level.
- ACS	No addition cell parameters are present in SYSTEM INFORMATION messages 7 and 8.
- NECI	New establishment causes not supported.
- RXLEV_ACCESS_MIN	Minimum level.
Control Channel Description	
- Attach-Detach allowed	No Attach/Detach.
- BS_AG_BLK_RES	0 blocks reserved for access grant.
- CCCH_CONF	1 basic physical channel used for CCCH, combined with SDCCHs.
- BS_PA_MFRMS	5 multiframe periods for transmission of paging messages.
- T3212 Time-out value	Infinite.
L2 pseudo length	
- System information 1	21
- System information 2	22
- System information 3	18
- System information 4	12
Location Area Identification	
- Mobile Country Code	001 decimal
- Mobile Network Code	01 decimal
- Location Area Code	0001H
Message Type	
- System information 1	00011001
- System information 2	00011010
- System information 3	00011011
- System information 4	00011100
- System information 5	00011101
- System information 6	00011110
Neighbour Cells Description	
- Format identifier	Range 128.
- BCCH Allocation Sequence	0
- BCCH Allocation ARFCN	Channels numbers 447, 457, 477, 480, 499, 504, 507 and 510.
- EXT-IND	This IE carries the complete BA.
NCC Permitted	0000 0010
RACH Control Parameters	
- Max Retrans	Max 1 retrans.
- Tx-integer	5 slots used.
- Cell Barred for Access	Cell is not barred.
- Call Reestablishment Allowed	Not allowed.
- Access Control Class	Access is not barred.
- Emergency Call allowed	Yes.
SI 1 rest octets	Not used (all bits are set to spare).
SI 2 rest octets	Not used (all bits are set to spare).
SI 3 rest octets	Not used (all bits are set to spare).
SI 4 rest octets	Not used (all bits are set to spare).

Default settings for cell A:

Downlink input level	63 dBmicroVolt emf.
Uplink output power	Minimum supported by the MS's power class.
Propagation profile	static.
BCCH/CCCH carrier number	457

Cell B

The contents of SYSTEM INFORMATION TYPE 1 to 6 messages for cell B are identical to those of cell A with the following exceptions:

Cell Channel Description - Format Identifier - Cell Allocation ARFCN	128 range. Channel Number 447.
--	-----------------------------------

NOTE 2: This IE needs modification when used in handover tests which command the MS to go to a frequency hopping channel in cell B.

Cell Identity

- Cell Identity Value 0002H

Default settings for cell B:

Downlink input level	53 dBmicroVolt emf.
Uplink output power	minimum supported by the MS's power class.
Propagation profile	static.
BCCH/CCCH carrier number	447

Contents of ALERTING message (SS to MS):

Protocol Discriminator	Call Control.
Transaction Identifier	
TI value	As used in the SETUP message.
TI flag	1 (destination side).
Message Type	00000001
All other information elements	Not present.

Contents of ASSIGNMENT COMMAND message:

Protocol Discriminator	RR Management.
Skip Indicator	0000
Message Type	00101110
Channel Description	
- Channel Type and TDMA offset	Bm + ACCHs
- Timeslot Number	Chosen arbitrarily by the test house.
- Training Sequence Code	Chosen arbitrarily by the test house.
- Hopping	Single RF channel.
- ARFCN	Channel number 467.
Power Command	
- EPC mode (for R5 and after MS only)	0 (Channel not in EPC mode)
- FPC (for R99 and R4 MS only)	0 (FPC not in use)
- FPC_EPC mode (for R5 and after MS only)	0 (FPC or EPC not in use)
- Power level	Chosen arbitrarily by the test house.
All other information elements	Not present.

Contents of ASSIGNMENT COMPLETE message:

Protocol Discriminator	RR Management.
Skip Indicator	0000
Message Type	00101001
RR Cause	
- RR Cause Value	Normal event.

Contents of ASSIGNMENT FAILURE message:

Protocol Discriminator	RR Management.
Skip Indicator	0000
Message Type	00101111
RR Cause	
- RR Cause Value	Depending on test.

Contents of AUTHENTICATION REQUEST message:

Protocol Discriminator	MM message.
Skip Indicator	0000
Message Type	00010010
Ciphering Key Sequence Number	
- Key Sequence	Chosen arbitrarily by the test house from the range 0 to 6.
Authentication Parameter RAND	
- RAND value	Chosen arbitrarily by the test house.

Contents of AUTHENTICATION RESPONSE message:

Protocol Discriminator	MM message.
Skip Indicator	0000
Message Type	0X010100
Other information element(s)	Not checked.

Contents of CALL PROCEEDING message:

Protocol Discriminator	Call Control.
Transaction Identifier	
TI value	As used in the SETUP message.
TI flag	1 (destination side).
Message Type	00000010
All other information elements	Not present.

Contents of CHANNEL MODE MODIFY message:

Protocol Discriminator	RR Management.
Skip Indicator	0000
Message Type	00010000
Channel Description	
- Channel Type and TDMA offset	Depending on test.
- Timeslot Number	Chosen arbitrarily by the test house.
- Training Sequence Code	Chosen arbitrarily by the test house.
- Hopping	Single RF channel.
- ARFCN	Channel number 467.
Channel Mode	
- Mode	Depending on test.

Contents of CHANNEL MODE MODIFY ACKNOWLEDGE message:

Protocol Discriminator	RR Management.
Skip Indicator	0000
Message Type	00010111
Channel Description	Depending on test.
- Channel Type and TDMA offset	Same as in the CHANNEL MODE MODIFY message.
- Timeslot Number	Same as in the CHANNEL MODE MODIFY message.
- Training Sequence Code	Single RF channel.
- Hopping	Band number 0.
- Frequency Band	Channel number 467.
- ARFCN	
Channel Mode	
- Mode	Same as in the CHANNEL MODE MODIFY message.

Contents of CHANNEL RELEASE message:

Protocol Discriminator	RR Management.
Skip Indicator	0000
Message Type	00001101
RR Cause	
- RR Cause Value	Normal event.

Contents of CHANNEL REQUEST message

Establishment Cause	Not checked.
Random Reference	Not checked.

Contents of CIPHERING MODE COMMAND message:

Protocol Discriminator	RR Management.
Skip Indicator	0000
Message Type	00110101
Cipher Mode Setting	
- algorithm identifier	cipher with A5/1.
- SC	Start ciphering.
Cipher Response	IMEI shall not be included.

Contents of CIPHERING MODE COMPLETE message:

Protocol Discriminator	RR Management.
Skip Indicator	0000
Message Type	00110010
Mobile Identity	Not present.

Contents of the CLASSMARK CHANGE message:

Protocol Discriminator	RR Management.
Skip Indicator	0000
Message Type	000100110
Mobile Station Classmark 2	See PIXIT.
Mobile Station Classmark 3	For presence and contents see PIXIT.

Contents of CM SERVICE ACCEPT message:

Protocol Discriminator	Mobility Management.
Skip Indicator	0000
Message Type	00100001

Contents of CM SERVICE REQUEST message

Protocol Discriminator	Mobility Management.
Skip Indicator	0000
Message Type	0X100100
Other information elements	Not checked.

Contents of CONNECT message (SS to MS)

Protocol Discriminator	Call Control.
Transaction Identifier	
TI value	As used in the SETUP message.
TI flag	1
Message Type	00000111
All other information elements	Not present.

Contents of CONNECT ACKNOWLEDGE message (MS to SS)

Protocol Discriminator	Call Control.
Transaction Identifier	
TI value	As used in the SETUP message.
TI flag	0
Message Type	0X001111

Contents of HANDOVER ACCESS message:

Handover Reference	Equal to the value included in the Handover Command message.
--------------------	--

Contents of HANDOVER COMMAND message:

Protocol Discriminator	RR Management.
Skip Indicator	0000
Message Type	00101011
Cell Description	
- Network Colour Code	1
- Base station Colour Code	Corresponding to target cell
- BCCH Carrier Number	Set to the BCCH carrier number of cell B. (one of 447, 457, 480, 499, 504, 507 or 510).
Channel Description	
- Channel Type and TDMA offset	Bm + ACCHs.
- Timeslot Number	Chosen arbitrarily by the test house.
- Training Sequence Code	Chosen arbitrarily by the test house.
- Hopping	Single RF channel.
- ARFCN	Chosen arbitrarily by the test house from those supported on the target cell.
Handover Reference	
- Handover Reference Value	Chosen arbitrarily by the test house.
Power Command	
- ATC	0 (Sending of Handover Access is mandatory)
- EPC mode (for R5 and after MS only)	0 (Channel not in EPC mode)
- FPC (for R99 and R4 MS only)	0 (FPC not in use)
- FPC_EPC mode (for R5 and after MS only)	0 (FPC or EPC not in use)
- Power level	Chosen arbitrarily by the test house.
All other information elements	Not present.

Contents of HANDOVER COMPLETE message:

Protocol Discriminator	RR Management.
Skip Indicator	0000
Message Type	00101100
RR cause	Normal event.
Time difference	Not present.

Contents of HANDOVER FAILURE message:

Protocol Discriminator	RR Management.
Skip Indicator	0000
Message Type	00101000
RR cause	Dependent on the test.

IDENTITY REQUEST

Information element	Value/remark
Identity type	IMEI
Spare half octet	0000

IDENTITY RESPONSE

Information element	Value/remark
Mobile identity	not checked

Contents of IMMEDIATE ASSIGNMENT message:

L2 pseudo length	This is the sum of the lengths of all the information elements present in the message except for the IA rest octets and L2 pseudo length IEs. For the default message the L2 pseudo length is 11.
Protocol Discriminator	RR Management.
Skip Indicator	0000
Message Type	00111111
Page Mode	
- Page Mode	Normal Paging.
Channel Description	
- Channel Type and TDMA offset	For non-combined CCCH/SDCCH (see initial conditions), SDCCH/8, with subchannel chosen arbitrarily by the test house For combined CCCH/SDCCH (default SS conditions), SDCCH/4, with subchannel chosen arbitrarily by the test house.
- Timeslot Number	For non-combined CCCH/SDCCH (see initial conditions), chosen arbitrarily by the test house; For combined CCCH/SDCCH (default SS conditions), SDCCH/4, timeslot zero.
- Training Sequence Code	For non-combined CCCH/SDCCH (see initial conditions), chosen arbitrarily by the test house; For combined CCCH/SDCCH (default SS conditions), SDCCH/4, TSC=5 (same as the BCC).
- Hopping	Single RF channel.
- ARFCN	For non-combined CCCH/SDCCH (see initial conditions), Channel number 467; For combined CCCH/SDCCH (default SS conditions), SDCCH/4, Channel number 457.
Request Reference	Pertaining to last Channel Request sent by the MS.
Timing Advance	
- Timing advance value	30 bit periods.
Mobile Allocation	
- Length	0
Starting Time	Not present.
IA rest octets	Not used (all bits set to spare).

Contents of IMMEDIATE ASSIGNMENT EXTENDED message:

L2 pseudo length	This is the sum of the lengths of all the information elements present in the message except for the IAX rest octets and L2 pseudo length IEs. For the default message the L2 pseudo length is 18.
Protocol Discriminator	RR Management.
Skip Indicator	0000
Message Type	00111001
Page Mode	
- Page Mode	Normal Paging.
Channel Description 1	
- Channel Type and TDMA offset	For non-combined CCCH/SDCCH (see test conditions), SDCCH/8, with subchannel chosen arbitrarily by the test house; For combined CCCH/SDCCH (default SS conditions), SDCCH/4, with subchannel chosen arbitrarily by the test house.
- Timeslot Number	For non-combined CCCH/SDCCH (see test conditions), chosen arbitrarily by the test house; For combined CCCH/SDCCH (default SS conditions), SDCCH/4, timeslot zero.
- Training Sequence Code	For non-combined CCCH/SDCCH (see initial conditions), chosen arbitrarily by the test house; For combined CCCH/SDCCH (default SS conditions), SDCCH/4, TSC=5 (same as the BCC). Single RF channel.
- Hopping	For non-combined CCCH/SDCCH (see initial conditions), Channel number 467; For combined CCCH/SDCCH (default SS conditions), SDCCH/4, Channel number 457.
- ARFCN	Pertaining to last Channel Request sent by the MS.
Request Reference 1	
Timing Advance 1	
- Timing advance value	Chosen arbitrarily by the test house.
Channel Description 2	
- Channel Type and TDMA offset	Same channel type as in Channel Description 1, but different TDMA offset to that in Channel Description 1.
- Timeslot Number	equal to the value in Channel Description 1.
- Training Sequence Code	equal to the value in Channel Description 1.
- Hopping	Single RF channel.
- ARFCN	equal to the value in Channel Description 1.
Request Reference 2	Not pertaining to any Channel Requests sent by the MS.
Timing Advance 2	
- Timing advance value	Chosen arbitrarily by the test house.
Mobile Allocation	
- Length	0
Starting Time	Not present.
IAX rest octets	Not used (all bits set to spare).

Contents of IMMEDIATE ASSIGNMENT REJECT message:

L2 pseudo length	19
Protocol Discriminator	RR Management.
Skip Indicator	0000
Message Type	00111010
Page Mode	
- Page Mode	Normal Paging.
Request Reference	Pertaining to last Channel Request sent by the MS.
Wait Indication	0 s.
Request Reference	Not pertaining to the MS under test.
Wait Indication	0 s.
Request Reference	Not pertaining to the MS under test.
Wait Indication	0 s.
Request Reference	Not pertaining to the MS under test.
Wait Indication	0 s.
IAR rest octets	Not used (all bits set to spare).

Contents of LOCATION UPDATING REQUEST message:

Protocol Discriminator	MM message.
Skip Indicator	0000
Message Type	0X001000
Other information elements	Not checked.

Contents of PAGING REQUEST TYPE 1 message:

L2 pseudo length	This is the sum of the lengths of all the information elements present in the message except for the P1 rest octets and L2 pseudo length IEs. For the default message the L2 pseudo length is 9.
Protocol Discriminator	RR Management.
Skip Indicator	0000
Message Type	00100001
Page Mode	
- Page Mode	Normal Paging.
Channels needed	
- first channel	any channel.
- second channel	any channel.
Mobile Identity 1	
- odd/even indication	Even.
- Type of Identity	TMSI.
- Identity Digits	TMSI previously allocated to MS.
Mobile Identity 2	Not present.
P1 rest octets	Not used (all bits set to spare).

Contents of PAGING REQUEST TYPE 2 message:

L2 pseudo length	This is the sum of the lengths of all the information elements present in the message except for the P2 rest octets and L2 pseudo length IEs. For the default message the L2 pseudo length is 11.
Protocol Discriminator	RR Management..
Skip Indicator	0000
Message Type	00100010
Page Mode	
- Page Mode	Normal Paging.
Channels needed	
- first channel	any channel.
- second channel	any channel.
Mobile Identity 1	
- TMSI value	TMSI previously allocated to MS.
Mobile Identity 2	
- TMSI value	TMSI not allocated to MS.
Mobile Identity	Not present.
P2 rest octets	Not used (all bits set to spare).

Contents of PAGING REQUEST TYPE 3 message:

L2 pseudo length	19
Protocol Discriminator	RR Management.
Skip Indicator	0000
Message Type	00100100
Page Mode	
- Page Mode	Normal Paging.
Channels needed	
- first channel	any channel.
- second channel	any channel.
Mobile identity 1	
- TMSI value	TMSI previously allocated to MS.
Mobile identity 2	
- TMSI value	TMSI not allocated to MS.
Mobile identity 3	
- TMSI value	TMSI not allocated to MS.
Mobile identity 4	
- TMSI value	TMSI not allocated to MS.
P3 rest octets	Not used (all bits set to spare).

Contents of PAGING RESPONSE message:

Protocol Discriminator	RR Management.
Skip Indicator	0000
Message Type	00100111
Ciphering Key Sequence Number	
- Key Sequence	Key sequence number previously allocated to MS, or "111" if no key is available.
Mobile Station Classmark 2	
Mobile Identity	
- odd/even indication	Even
- Type of identity	TMSI
- Identity Digits	TMSI previously allocated to MS.

Contents of PHYSICAL INFORMATION message:

Protocol Discriminator	RR Management.
Skip Indicator	0000
Message Type	00101101
Timing advance	20 bit periods.

Contents of SETUP message; (MS to SS):

Protocol Discriminator	Call Control.
Transaction Identifier	
TI value	any value from the set {0, ..., 6}.
TI flag	0
Message Type	0X000101
Other information elements	Not checked.

26.6.20 Default contents of GSM 850 layer 3 messages for RR tests

This subclause contains the default values of GSM 850 L3 messages, which unless indicated otherwise in subclause 26.6 shall be transmitted by the system simulator and which are required to be received from the GSM 850 MS under test. These values are used in order to be consistent with the phase 2 version of 26.6.

The necessary L3 messages are listed in alphabetic order, with the exception of the SYSTEM INFORMATION messages, where it is the information elements which are listed in alphabetic order (this is because some information elements occur in several SYSTEM INFORMATION types).

In this subclause, decimal values are normally used. However, sometimes a hexadecimal value, indicated by an "H", or a binary value, indicated by a "B" is used.

Default SYSTEM INFORMATION:

NOTE 1: SYSTEM INFORMATION 2 bis, SYSTEM INFORMATION 5 bis, SYSTEM INFORMATION 7, and SYSTEM INFORMATION 8 messages are not used.

Cell A

Contents of information elements in SYSTEM INFORMATION TYPE 1 to 6 messages for cell A.

(CBCH) Channel Description	Not present.
(CBCH) Mobile Allocation	Not present.
Cell Channel Description	
- Format identifier	128 range.
- Cell Allocation ARFCN	Channel Numbers 147, 157, 177 and 197.
Cell Identity	
- Cell Identity Value	0001H
Cell Options	
- Power Control Indicator	Power Control Indicator is not set.
- DTX Indicator	MS shall not use DTX.
- Radio_Link_Timeout	8 SACCH blocks.
Cell Selection Parameters	
- Cell_Reselect_Hysteresis	12 dB.
- MX_TXPWR_MAX_CCH	Minimum level.
- ACS	No addition cell parameters are present in SYSTEM INFORMATION messages 7 and 8.
- NECI	New establishment causes not supported.
- RXLEV_ACCESS_MIN	Minimum level.
Control Channel Description	
- Attach-Detach allowed	No Attach/Detach.
- BS_AG_BLK_RES	0 blocks reserved for access grant.
- CCCH_CONF	1 basic physical channel used for CCCH, combined with SDCCHs.
- BS_PA_MFRMS	5 multiframe periods for transmission of paging messages.
- T3212 Time-out value	Infinite.
L2 pseudo length	
- System information 1	21
- System information 2	22
- System information 3	18
- System information 4	12
Location Area Identification	
- Mobile Country Code	001 decimal
- Mobile Network Code	01 decimal
- Location Area Code	0001H
Message Type	
- System information 1	00011001
- System information 2	00011010
- System information 3	00011011
- System information 4	00011100
- System information 5	00011101
- System information 6	00011110
Neighbour Cells Description	
- Format identifier	128 range.
- BCCH Allocation Sequence	0
- BCCH Allocation ARFCN	Channels numbers 137, 147, 167, 207, 217, 227, 237 and 247.
- EXT-IND	This IE carries the complete BA.
NCC Permitted	0000 0010
RACH Control Parameters	
- Max Retrans	Max 1 retrans.
- Tx-integer	5 slots used.
- Cell Barred for Access	Cell is not barred.
- Call Reestablishment Allowed	Not allowed.
- Access Control Class	Access is not barred.
- Emergency Call allowed	Yes.
SI 1 rest octets	Not used (all bits are set to spare).
SI 2 rest octets	Not used (all bits are set to spare).
SI 3 rest octets	Not used (all bits are set to spare).
SI 4 rest octets	Not used (all bits are set to spare).
SI 6 rest octets	2B2B2B2B2B2B2B

Default settings for cell A:

Downlink input level	63 dBmicroVolt emf.
Uplink output power	minimum supported by the MS's power class.
Propagation profile	static.
BCCH/CCCH carrier number	147

Cell B

The contents of SYSTEM INFORMATION TYPE 1 to 6 messages for cell B are identical to those of cell A with the following exceptions:

Cell Channel Description - Format Identifier - Cell Allocation ARFCN	128 range. Channel Number 137.
--	-----------------------------------

NOTE 2: This IE needs modification when used in handover tests which command the MS to go to a frequency hopping channel in cell B.

Cell Identity

- Cell Identity Value 0002H

Default settings for cell B:

Downlink input level	53 dBmicroVolt emf.
Uplink output power	minimum supported by the MS's power class.
Propagation profile	static.
BCCH/CCCH carrier number	137

Contents of ALERTING message (SS to MS):

Protocol Discriminator	Call Control.
Transaction Identifier	
TI value	As used in the SETUP message.
TI flag	1 (destination side).
Message Type	00000001
All other information elements	Not present.

Contents of ASSIGNMENT COMMAND message:

Protocol Discriminator	RR Management.
Skip Indicator	0000
Message Type	00101110
Channel Description	
- Channel Type and TDMA offset	Bm + ACCHs
- Timeslot Number	Chosen arbitrarily by the test house.
- Training Sequence Code	Chosen arbitrarily by the test house.
- Hopping	Single RF channel.
- ARFCN	Channel number 157.
Power Command	
- EPC mode (for R5 and after MS only)	0 (Channel not in EPC mode)
- FPC (for R99 and R4 MS only)	0 (FPC not in use)
- FPC_EPC mode (for R5 and after MS only)	0 (FPC or EPC not in use)
- Power level	Chosen arbitrarily by the test house.
All other information elements	Not present.

Contents of ASSIGNMENT COMPLETE message:

Protocol Discriminator	RR Management.
Skip Indicator	0000
Message Type	00101001
RR Cause	
- RR Cause Value	Normal event.

Contents of ASSIGNMENT FAILURE message:

Protocol Discriminator	RR Management.
Skip Indicator	0000
Message Type	00101111
RR Cause	
- RR Cause Value	Depending on test.

Contents of AUTHENTICATION REQUEST message:

Protocol Discriminator	MM message.
Skip Indicator	0000
Message Type	00010010
Ciphering Key Sequence Number	
- Key Sequence	Chosen arbitrarily by the test house from the range 0 to 6.
Authentication Parameter RAND	
- RAND value	Chosen arbitrarily by the test house.

Contents of AUTHENTICATION RESPONSE message:

Protocol Discriminator	MM message.
Skip Indicator	0000
Message Type	0X010100
Other information element(s)	Not checked.

Contents of CALL PROCEEDING message:

Protocol Discriminator	Call Control.
Transaction Identifier	
TI value	As used in the SETUP message.
TI flag	1 (destination side).
Message Type	00000010
All other information elements	Not present.

Contents of CHANNEL MODE MODIFY message:

Protocol Discriminator	RR Management.
Skip Indicator	0000
Message Type	00010000
Channel Description	
- Channel Type and TDMA offset	Depending on test.
- Timeslot Number	Chosen arbitrarily by the test house.
- Training Sequence Code	Chosen arbitrarily by the test house.
- Hopping	Single RF channel.
- ARFCN	Channel number 157.
Channel Mode	
- Mode	Depending on test.

Contents of CHANNEL MODE MODIFY ACKNOWLEDGE message:

Protocol Discriminator	RR Management.
Skip Indicator	0000
Message Type	00010111
Channel Description	Depending on test.
- Channel Type and TDMA offset	Same as in the CHANNEL MODE MODIFY message.
- Timeslot Number	Same as in the CHANNEL MODE MODIFY message.
- Training Sequence Code	Single RF channel.
- Hopping	Band number 0.
- Frequency Band	Channel number 157.
- ARFCN	
Channel Mode	
- Mode	Same as in the CHANNEL MODE MODIFY message.

Contents of CHANNEL RELEASE message:

Protocol Discriminator	RR Management.
Skip Indicator	0000
Message Type	00001101
RR Cause	
- RR Cause Value	Normal event.

Contents of CHANNEL REQUEST message

Establishment Cause	Not checked.
Random Reference	Not checked.

Contents of CIPHERING MODE COMMAND message:

Protocol Discriminator	RR Management.
Skip Indicator	0000
Message Type	00110101
Cipher Mode Setting	
- algorithm identifier	cipher with A5/1.
- SC	Start ciphering.
Cipher Response	IMEI shall not be included.

Contents of CIPHERING MODE COMPLETE message:

Protocol Discriminator	RR Management.
Skip Indicator	0000
Message Type	00110010
Mobile Identity	Not present.

Contents of the CLASSMARK CHANGE message:

Protocol Discriminator	RR Management.
Skip Indicator	0000
Message Type	000100110
Mobile Station Classmark 2	See PIXIT.
Mobile Station Classmark 3	For presence and contents see PIXIT.

Contents of CM SERVICE ACCEPT message:

Protocol Discriminator	Mobility Management.
Skip Indicator	0000
Message Type	00100001

Contents of CM SERVICE REQUEST message

Protocol Discriminator	Mobility Management.
Skip Indicator	0000
Message Type	0X100100
Other information elements	Not checked.

Contents of CONNECT message (SS to MS)

Protocol Discriminator	Call Control.
Transaction Identifier	
TI value	As used in the SETUP message.
TI flag	1
Message Type	00000111
All other information elements	Not present.

Contents of CONNECT ACKNOWLEDGE message (MS to SS)

Protocol Discriminator	Call Control.
Transaction Identifier	
TI value	As used in the SETUP message.
TI flag	0
Message Type	0X001111

Contents of HANDOVER ACCESS message:

Handover Reference	Equal to the value included in the Handover Command message.
--------------------	--

Contents of HANDOVER COMMAND message:

Protocol Discriminator	RR Management.
Skip Indicator	0000
Message Type	00101011
Cell Description	
- Network Colour Code	1
- Base station Colour Code	Corresponding to target cell
- BCCH Carrier Number	Set to the BCCH carrier number of cell B. (one of 137, 147, 207, 217, 227, 237 or 247).
Channel Description	
- Channel Type and TDMA offset	Bm + ACCHs.
- Timeslot Number	Chosen arbitrarily by the test house.
- Training Sequence Code	Chosen arbitrarily by the test house.
- Hopping	Single RF channel.
- ARFCN	Chosen arbitrarily by the test house from those supported on the target cell.
Handover Reference	
- Handover Reference Value	Chosen arbitrarily by the test house.
Power Command	
- ATC	0 (Sending of Handover Access is mandatory)
- EPC mode (for R5 and after MS only)	0 (Channel not in EPC mode)
- FPC (for R99 and R4 MS only)	0 (FPC not in use)
- FPC_EPC mode (for R5 and after MS only)	0 (FPC or EPC not in use)
- Power level	Chosen arbitrarily by the test house.
All other information elements	Not present.

Contents of HANDOVER COMPLETE message:

Protocol Discriminator	RR Management.
Skip Indicator	0000
Message Type	00101100
RR cause	Normal event.
Time difference	Not present.

Contents of HANDOVER FAILURE message:

Protocol Discriminator	RR Management.
Skip Indicator	0000
Message Type	00101000
RR cause	Dependent on the test.

IDENTITY REQUEST

Information element	Value/remark
Identity type	IMEI
Spare half octet	0000

IDENTITY RESPONSE

Information element	Value/remark
Mobile identity	not checked

Contents of IMMEDIATE ASSIGNMENT message:

L2 pseudo length	This is the sum of the lengths of all the information elements present in the message except for the IA rest octets and L2 pseudo length IEs. For the default message the L2 pseudo length is 11.
Protocol Discriminator	RR Management.
Skip Indicator	0000
Message Type	00111111
Page Mode	
- Page Mode	Normal Paging.
Channel Description	
- Channel Type and TDMA offset	For non-combined CCCH/SDCCH (see initial conditions), SDCCH/8, with subchannel chosen arbitrarily by the test house For combined CCCH/SDCCH (default SS conditions), SDCCH/4, with subchannel chosen arbitrarily by the test house.
- Timeslot Number	For non-combined CCCH/SDCCH (see initial conditions), chosen arbitrarily by the test house; For combined CCCH/SDCCH (default SS conditions), SDCCH/4, timeslot zero.
- Training Sequence Code	For non-combined CCCH/SDCCH (see initial conditions), chosen arbitrarily by the test house; For combined CCCH/SDCCH (default SS conditions), SDCCH/4, TSC=5 (same as the BCC).
- Hopping	Single RF channel.
- ARFCN	For non-combined CCCH/SDCCH (see initial conditions), Channel number 157; For combined CCCH/SDCCH (default SS conditions), SDCCH/4, Channel number 147.
Request Reference	Pertaining to last Channel Request sent by the MS.
Timing Advance	
- Timing advance value	30 bit periods.
Mobile Allocation	
- Length	0
Starting Time	Not present.
IA rest octets	Not used (all bits set to spare).

Contents of IMMEDIATE ASSIGNMENT EXTENDED message:

L2 pseudo length	This is the sum of the lengths of all the information elements present in the message except for the IAX rest octets and L2 pseudo length IEs. For the default message the L2 pseudo length is 18.
Protocol Discriminator	RR Management.
Skip Indicator	0000
Message Type	00111001
Page Mode	
- Page Mode	Normal Paging.
Channel Description 1	
- Channel Type and TDMA offset	For non-combined CCCH/SDCCH (see test conditions), SDCCH/8, with subchannel chosen arbitrarily by the test house; For combined CCCH/SDCCH (default SS conditions), SDCCH/4, with subchannel chosen arbitrarily by the test house.
- Timeslot Number	For non-combined CCCH/SDCCH (see test conditions), chosen arbitrarily by the test house; For combined CCCH/SDCCH (default SS conditions), SDCCH/4, timeslot zero.
- Training Sequence Code	For non-combined CCCH/SDCCH (see initial conditions), chosen arbitrarily by the test house; For combined CCCH/SDCCH (default SS conditions), SDCCH/4, TSC=5 (same as the BCC). Single RF channel.
- Hopping	For non-combined CCCH/SDCCH (see initial conditions), Channel number 157; For combined CCCH/SDCCH (default SS conditions), SDCCH/4, Channel number 147.
- ARFCN	Pertaining to last Channel Request sent by the MS.
Request Reference 1	
Timing Advance 1	
- Timing advance value	Chosen arbitrarily by the test house.
Channel Description 2	
- Channel Type and TDMA offset	Same channel type as in Channel Description 1, but different TDMA offset to that in Channel Description 1.
- Timeslot Number	equal to the value in Channel Description 1.
- Training Sequence Code	equal to the value in Channel Description 1.
- Hopping	Single RF channel.
- ARFCN	equal to the value in Channel Description 1.
Request Reference 2	Not pertaining to any Channel Requests sent by the MS.
Timing Advance 2	
- Timing advance value	Chosen arbitrarily by the test house.
Mobile Allocation	
- Length	0
Starting Time	Not present.
IAX rest octets	Not used (all bits set to spare).

Contents of IMMEDIATE ASSIGNMENT REJECT message:

L2 pseudo length	19
Protocol Discriminator	RR Management.
Skip Indicator	0000
Message Type	00111010
Page Mode	
- Page Mode	Normal Paging.
Request Reference	Pertaining to last Channel Request sent by the MS.
Wait Indication	0 s.
Request Reference	Not pertaining to the MS under test.
Wait Indication	0 s.
Request Reference	Not pertaining to the MS under test.
Wait Indication	0 s.
Request Reference	Not pertaining to the MS under test.
Wait Indication	0 s.
IAR rest octets	Not used (all bits set to spare).

Contents of LOCATION UPDATING REQUEST message:

Protocol Discriminator	MM message.
Skip Indicator	0000
Message Type	0X001000
Other information elements	Not checked.

Contents of PAGING REQUEST TYPE 1 message:

L2 pseudo length	This is the sum of the lengths of all the information elements present in the message except for the P1 rest octets and L2 pseudo length IEs. For the default message the L2 pseudo length is 9.
Protocol Discriminator	RR Management.
Skip Indicator	0000
Message Type	00100001
Page Mode	
- Page Mode	Normal Paging.
Channels needed	
- first channel	any channel.
- second channel	any channel.
Mobile Identity 1	
- odd/even indication	Even.
- Type of Identity	TMSI.
- Identity Digits	TMSI previously allocated to MS.
Mobile Identity 2	Not present.
P1 rest octets	Not used (all bits set to spare).

Contents of PAGING REQUEST TYPE 2 message:

L2 pseudo length	This is the sum of the lengths of all the information elements present in the message except for the P2 rest octets and L2 pseudo length IEs. For the default message the L2 pseudo length is 11.
Protocol Discriminator	RR Management..
Skip Indicator	0000
Message Type	00100010
Page Mode	
- Page Mode	Normal Paging.
Channels needed	
- first channel	any channel.
- second channel	any channel.
Mobile Identity 1	
- TMSI value	TMSI previously allocated to MS.
Mobile Identity 2	
- TMSI value	TMSI not allocated to MS.
Mobile Identity	Not present.
P2 rest octets	Not used (all bits set to spare).

Contents of PAGING REQUEST TYPE 3 message:

L2 pseudo length	19
Protocol Discriminator	RR Management.
Skip Indicator	0000
Message Type	00100100
Page Mode	
- Page Mode	Normal Paging.
Channels needed	
- first channel	any channel.
- second channel	any channel.
Mobile identity 1	
- TMSI value	TMSI previously allocated to MS.
Mobile identity 2	
- TMSI value	TMSI not allocated to MS.
Mobile identity 3	
- TMSI value	TMSI not allocated to MS.
Mobile identity 4	
- TMSI value	TMSI not allocated to MS.
P3 rest octets	Not used (all bits set to spare).

Contents of PAGING RESPONSE message:

Protocol Discriminator	RR Management.
Skip Indicator	0000
Message Type	00100111
Ciphering Key Sequence Number	
- Key Sequence	Key sequence number previously allocated to MS, or "111" if no key is available.
Mobile Station Classmark 2	
Mobile Identity	
- odd/even indication	Even
- Type of identity	TMSI
- Identity Digits	TMSI previously allocated to MS.

Contents of PHYSICAL INFORMATION message:

Protocol Discriminator	RR Management.
Skip Indicator	0000
Message Type	00101101
Timing advance	20 bit periods.

Contents of SETUP message; (MS to SS):

Protocol Discriminator	Call Control.
Transaction Identifier	
TI value	any value from the set {0, ..., 6}.
TI flag	0
Message Type	0X000101
Other information elements	Not checked.

26.6.21 Default contents of GSM 710 layer 3 messages for RR tests

This subclause contains the default values of GSM 710 L3 messages, which unless indicated otherwise in subclause 26.6 shall be transmitted by the system simulator and which are required to be received from the GSM 710 MS under test. These values are used in order to be consistent with the phase 2 version of 26.6.

The necessary L3 messages are listed in alphabetic order, with the exception of the SYSTEM INFORMATION messages, where it is the information elements which are listed in alphabetic order (this is because some information elements occur in several SYSTEM INFORMATION types).

In this subclause, decimal values are normally used. However, sometimes a hexadecimal value, indicated by an "H", or a binary value, indicated by a "B" is used.

Default SYSTEM INFORMATION:

NOTE 1: SYSTEM INFORMATION 2 bis, SYSTEM INFORMATION 5 bis, SYSTEM INFORMATION 7, and SYSTEM INFORMATION 8 messages are not used.

Cell A

Contents of information elements in SYSTEM INFORMATION TYPE 1 to 6 messages for cell A.

(CBCH) Channel Description	Not present.
(CBCH) Mobile Allocation	Not present.
Cell Channel Description	
- Format identifier	128 range.
- Cell Allocation ARFCN	Channel Numbers 457, 467, 470 and 475.
Cell Identity	
- Cell Identity Value	0001H
Cell Options	
- Power Control Indicator	Power Control Indicator is not set.
- DTX Indicator	MS shall not use DTX.
- Radio_Link_Timeout	8 SACCH blocks.
Cell Selection Parameters	
- Cell_Reselect_Hysteresis	12 dB.
- MX_TXPWR_MAX_CCH	Minimum level.
- ACS	No addition cell parameters are present in SYSTEM INFORMATION messages 7 and 8.
- NECI	New establishment causes not supported.
- RXLEV_ACCESS_MIN	Minimum level.
Control Channel Description	
- Attach-Detach allowed	No Attach/Detach.
- BS_AG_BLK_RES	0 blocks reserved for access grant.
- CCCH_CONF	1 basic physical channel used for CCCH, combined with SDCCHs.
- BS_PA_MFRMS	5 multiframe periods for transmission of paging messages.
- T3212 Time-out value	Infinite.
L2 pseudo length	
- System information 1	21
- System information 2	22
- System information 3	18
- System information 4	12
Location Area Identification	
- Mobile Country Code	001 decimal
- Mobile Network Code	01 decimal
- Location Area Code	0001H
Message Type	
- System information 1	00011001
- System information 2	00011010
- System information 3	00011011
- System information 4	00011100
- System information 5	00011101
- System information 6	00011110
Neighbour Cells Description	
- Format identifier	Range 128.
- BCCH Allocation Sequence	0
- BCCH Allocation ARFCN	Channels numbers 447, 457, 477, 480, 499, 504, 507 and 510.
- EXT-IND	This IE carries the complete BA.
NCC Permitted	0000 0010
RACH Control Parameters	
- Max Retrans	Max 1 retrans.
- Tx-integer	5 slots used.
- Cell Barred for Access	Cell is not barred.
- Call Reestablishment Allowed	Not allowed.
- Access Control Class	Access is not barred.
- Emergency Call allowed	Yes.
SI 1 rest octets	Not used (all bits are set to spare).
SI 2 rest octets	Not used (all bits are set to spare).
SI 3 rest octets	Not used (all bits are set to spare).
SI 4 rest octets	Not used (all bits are set to spare).

Default settings for cell A:

Downlink input level	63 dBmicroVolt emf.
Uplink output power	Minimum supported by the MS's power class.
Propagation profile	static.
BCCH/CCCH carrier number	457

Cell B

The contents of SYSTEM INFORMATION TYPE 1 to 6 messages for cell B are identical to those of cell A with the following exceptions:

Cell Channel Description - Format Identifier - Cell Allocation ARFCN	128 range. Channel Number 447.
--	-----------------------------------

NOTE 2: This IE needs modification when used in handover tests which command the MS to go to a frequency hopping channel in cell B.

Cell Identity

- Cell Identity Value 0002H

Default settings for cell B:

Downlink input level	53 dBmicroVolt emf.
Uplink output power	minimum supported by the MS's power class.
Propagation profile	static.
BCCH/CCCH carrier number	447

Contents of ALERTING message (SS to MS):

Protocol Discriminator	Call Control.
Transaction Identifier	
TI value	As used in the SETUP message.
TI flag	1 (destination side).
Message Type	00000001
All other information elements	Not present.

Contents of ASSIGNMENT COMMAND message:

Protocol Discriminator	RR Management.
Skip Indicator	0000
Message Type	00101110
Channel Description	
- Channel Type and TDMA offset	Bm + ACCHs
- Timeslot Number	Chosen arbitrarily by the test house.
- Training Sequence Code	Chosen arbitrarily by the test house.
- Hopping	Single RF channel.
- ARFCN	Channel number 467.
Power Command	
- EPC mode (for R5 and after MS only)	0 (Channel not in EPC mode)
- FPC (for R99 and R4 MS only)	0 (FPC not in use)
- FPC_EPC mode (for R5 and after MS only)	0 (FPC or EPC not in use)
- Power level	Chosen arbitrarily by the test house.
All other information elements	Not present.

Contents of ASSIGNMENT COMPLETE message:

Protocol Discriminator	RR Management.
Skip Indicator	0000
Message Type	00101001
RR Cause	
- RR Cause Value	Normal event.

Contents of ASSIGNMENT FAILURE message:

Protocol Discriminator	RR Management.
Skip Indicator	0000
Message Type	00101111
RR Cause	
- RR Cause Value	Depending on test.

Contents of AUTHENTICATION REQUEST message:

Protocol Discriminator	MM message.
Skip Indicator	0000
Message Type	00010010
Ciphering Key Sequence Number	
- Key Sequence	Chosen arbitrarily by the test house from the range 0 to 6.
Authentication Parameter RAND	
- RAND value	Chosen arbitrarily by the test house.

Contents of AUTHENTICATION RESPONSE message:

Protocol Discriminator	MM message.
Skip Indicator	0000
Message Type	0X010100
Other information element(s)	Not checked.

Contents of CALL PROCEEDING message:

Protocol Discriminator	Call Control.
Transaction Identifier	
TI value	As used in the SETUP message.
TI flag	1 (destination side).
Message Type	00000010
All other information elements	Not present.

Contents of CHANNEL MODE MODIFY message:

Protocol Discriminator	RR Management.
Skip Indicator	0000
Message Type	00010000
Channel Description	
- Channel Type and TDMA offset	Depending on test.
- Timeslot Number	Chosen arbitrarily by the test house.
- Training Sequence Code	Chosen arbitrarily by the test house.
- Hopping	Single RF channel.
- ARFCN	Channel number 467.
Channel Mode	
- Mode	Depending on test.

Contents of CHANNEL MODE MODIFY ACKNOWLEDGE message:

Protocol Discriminator	RR Management.
Skip Indicator	0000
Message Type	00010111
Channel Description	Depending on test.
- Channel Type and TDMA offset	Same as in the CHANNEL MODE MODIFY message.
- Timeslot Number	Same as in the CHANNEL MODE MODIFY message.
- Training Sequence Code	Single RF channel.
- Hopping	Band number 0.
- Frequency Band	Channel number 467.
- ARFCN	
Channel Mode	
- Mode	Same as in the CHANNEL MODE MODIFY message.

Contents of CHANNEL RELEASE message:

Protocol Discriminator	RR Management.
Skip Indicator	0000
Message Type	00001101
RR Cause	
- RR Cause Value	Normal event.

Contents of CHANNEL REQUEST message

Establishment Cause	Not checked.
Random Reference	Not checked.

Contents of CIPHERING MODE COMMAND message:

Protocol Discriminator	RR Management.
Skip Indicator	0000
Message Type	00110101
Cipher Mode Setting	
- algorithm identifier	cipher with A5/1.
- SC	Start ciphering.
Cipher Response	IMEI shall not be included.

Contents of CIPHERING MODE COMPLETE message:

Protocol Discriminator	RR Management.
Skip Indicator	0000
Message Type	00110010
Mobile Identity	Not present.

Contents of the CLASSMARK CHANGE message:

Protocol Discriminator	RR Management.
Skip Indicator	0000
Message Type	000100110
Mobile Station Classmark 2	See PIXIT.
Mobile Station Classmark 3	For presence and contents see PIXIT.

Contents of CM SERVICE ACCEPT message:

Protocol Discriminator	Mobility Management.
Skip Indicator	0000
Message Type	00100001

Contents of CM SERVICE REQUEST message

Protocol Discriminator	Mobility Management.
Skip Indicator	0000
Message Type	0X100100
Other information elements	Not checked.

Contents of CONNECT message (SS to MS)

Protocol Discriminator	Call Control.
Transaction Identifier	
TI value	As used in the SETUP message.
TI flag	1
Message Type	00000111
All other information elements	Not present.

Contents of CONNECT ACKNOWLEDGE message (MS to SS)

Protocol Discriminator	Call Control.
Transaction Identifier	
TI value	As used in the SETUP message.
TI flag	0
Message Type	0X001111

Contents of HANDOVER ACCESS message:

Handover Reference	Equal to the value included in the Handover Command message.
--------------------	--

Contents of HANDOVER COMMAND message:

Protocol Discriminator	RR Management.
Skip Indicator	0000
Message Type	00101011
Cell Description	
- Network Colour Code	1
- Base station Colour Code	Corresponding to target cell
- BCCH Carrier Number	Set to the BCCH carrier number of cell B. (one of 447, 457, 480, 499, 504, 507 or 510).
Channel Description	
- Channel Type and TDMA offset	Bm + ACCHs.
- Timeslot Number	Chosen arbitrarily by the test house.
- Training Sequence Code	Chosen arbitrarily by the test house.
- Hopping	Single RF channel.
- ARFCN	Chosen arbitrarily by the test house from those supported on the target cell.
Handover Reference	
- Handover Reference Value	Chosen arbitrarily by the test house.
Power Command	
- ATC	0 (Sending of Handover Access is mandatory)
- EPC mode (for R5 and after MS only)	0 (Channel not in EPC mode)
- FPC (for R99 and R4 MS only)	0 (FPC not in use)
- FPC_EPC mode (for R5 and after MS only)	0 (FPC or EPC not in use)
- Power level	Chosen arbitrarily by the test house.
All other information elements	Not present.

Contents of HANDOVER COMPLETE message:

Protocol Discriminator	RR Management.
Skip Indicator	0000
Message Type	00101100
RR cause	Normal event.
Time difference	Not present.

Contents of HANDOVER FAILURE message:

Protocol Discriminator	RR Management.
Skip Indicator	0000
Message Type	00101000
RR cause	Dependent on the test.

IDENTITY REQUEST

Information element	Value/remark
Identity type	IMEI
Spare half octet	0000

IDENTITY RESPONSE

Information element	Value/remark
Mobile identity	not checked

Contents of IMMEDIATE ASSIGNMENT message:

L2 pseudo length	This is the sum of the lengths of all the information elements present in the message except for the IA rest octets and L2 pseudo length IEs. For the default message the L2 pseudo length is 11.
Protocol Discriminator	RR Management.
Skip Indicator	0000
Message Type	00111111
Page Mode	
- Page Mode	Normal Paging.
Channel Description	
- Channel Type and TDMA offset	For non-combined CCCH/SDCCH (see initial conditions), SDCCH/8, with subchannel chosen arbitrarily by the test house For combined CCCH/SDCCH (default SS conditions), SDCCH/4, with subchannel chosen arbitrarily by the test house.
- Timeslot Number	For non-combined CCCH/SDCCH (see initial conditions), chosen arbitrarily by the test house; For combined CCCH/SDCCH (default SS conditions), SDCCH/4, timeslot zero.
- Training Sequence Code	For non-combined CCCH/SDCCH (see initial conditions), chosen arbitrarily by the test house; For combined CCCH/SDCCH (default SS conditions), SDCCH/4, TSC=5 (same as the BCC).
- Hopping	Single RF channel.
- ARFCN	For non-combined CCCH/SDCCH (see initial conditions), Channel number 467; For combined CCCH/SDCCH (default SS conditions), SDCCH/4, Channel number 457.
Request Reference	Pertaining to last Channel Request sent by the MS.
Timing Advance	
- Timing advance value	30 bit periods.
Mobile Allocation	
- Length	0
Starting Time	Not present.
IA rest octets	Not used (all bits set to spare).

Contents of IMMEDIATE ASSIGNMENT EXTENDED message:

L2 pseudo length	This is the sum of the lengths of all the information elements present in the message except for the IAX rest octets and L2 pseudo length IEs. For the default message the L2 pseudo length is 18.
Protocol Discriminator	RR Management.
Skip Indicator	0000
Message Type	00111001
Page Mode	
- Page Mode	Normal Paging.
Channel Description 1	
- Channel Type and TDMA offset	For non-combined CCCH/SDCCH (see test conditions), SDCCH/8, with subchannel chosen arbitrarily by the test house; For combined CCCH/SDCCH (default SS conditions), SDCCH/4, with subchannel chosen arbitrarily by the test house.
- Timeslot Number	For non-combined CCCH/SDCCH (see test conditions), chosen arbitrarily by the test house; For combined CCCH/SDCCH (default SS conditions), SDCCH/4, timeslot zero.
- Training Sequence Code	For non-combined CCCH/SDCCH (see initial conditions), chosen arbitrarily by the test house; For combined CCCH/SDCCH (default SS conditions), SDCCH/4, TSC=5 (same as the BCC). Single RF channel.
- Hopping	For non-combined CCCH/SDCCH (see initial conditions), Channel number 467; For combined CCCH/SDCCH (default SS conditions), SDCCH/4, Channel number 457.
- ARFCN	Pertaining to last Channel Request sent by the MS.
Request Reference 1	
Timing Advance 1	
- Timing advance value	Chosen arbitrarily by the test house.
Channel Description 2	
- Channel Type and TDMA offset	Same channel type as in Channel Description 1, but different TDMA offset to that in Channel Description 1.
- Timeslot Number	equal to the value in Channel Description 1.
- Training Sequence Code	equal to the value in Channel Description 1.
- Hopping	Single RF channel.
- ARFCN	equal to the value in Channel Description 1.
Request Reference 2	Not pertaining to any Channel Requests sent by the MS.
Timing Advance 2	
- Timing advance value	Chosen arbitrarily by the test house.
Mobile Allocation	
- Length	0
Starting Time	Not present.
IAX rest octets	Not used (all bits set to spare).

Contents of IMMEDIATE ASSIGNMENT REJECT message:

L2 pseudo length	19
Protocol Discriminator	RR Management.
Skip Indicator	0000
Message Type	00111010
Page Mode	
- Page Mode	Normal Paging.
Request Reference	Pertaining to last Channel Request sent by the MS.
Wait Indication	0 s.
Request Reference	Not pertaining to the MS under test.
Wait Indication	0 s.
Request Reference	Not pertaining to the MS under test.
Wait Indication	0 s.
Request Reference	Not pertaining to the MS under test.
Wait Indication	0 s.
IAR rest octets	Not used (all bits set to spare).

Contents of LOCATION UPDATING REQUEST message:

Protocol Discriminator	MM message.
Skip Indicator	0000
Message Type	0X001000
Other information elements	Not checked.

Contents of PAGING REQUEST TYPE 1 message:

L2 pseudo length	This is the sum of the lengths of all the information elements present in the message except for the P1 rest octets and L2 pseudo length IEs. For the default message the L2 pseudo length is 9.
Protocol Discriminator	RR Management.
Skip Indicator	0000
Message Type	00100001
Page Mode	
- Page Mode	Normal Paging.
Channels needed	
- first channel	any channel.
- second channel	any channel.
Mobile Identity 1	
- odd/even indication	Even.
- Type of Identity	TMSI.
- Identity Digits	TMSI previously allocated to MS.
Mobile Identity 2	Not present.
P1 rest octets	Not used (all bits set to spare).

Contents of PAGING REQUEST TYPE 2 message:

L2 pseudo length	This is the sum of the lengths of all the information elements present in the message except for the P2 rest octets and L2 pseudo length IEs. For the default message the L2 pseudo length is 11.
Protocol Discriminator	RR Management..
Skip Indicator	0000
Message Type	00100010
Page Mode	
- Page Mode	Normal Paging.
Channels needed	
- first channel	any channel.
- second channel	any channel.
Mobile Identity 1	
- TMSI value	TMSI previously allocated to MS.
Mobile Identity 2	
- TMSI value	TMSI not allocated to MS.
Mobile Identity	Not present.
P2 rest octets	Not used (all bits set to spare).

Contents of PAGING REQUEST TYPE 3 message:

L2 pseudo length	19
Protocol Discriminator	RR Management.
Skip Indicator	0000
Message Type	00100100
Page Mode	
- Page Mode	Normal Paging.
Channels needed	
- first channel	any channel.
- second channel	any channel.
Mobile identity 1	
- TMSI value	TMSI previously allocated to MS.
Mobile identity 2	
- TMSI value	TMSI not allocated to MS.
Mobile identity 3	
- TMSI value	TMSI not allocated to MS.
Mobile identity 4	
- TMSI value	TMSI not allocated to MS.
P3 rest octets	Not used (all bits set to spare).

Contents of PAGING RESPONSE message:

Protocol Discriminator	RR Management.
Skip Indicator	0000
Message Type	00100111
Ciphering Key Sequence Number	
- Key Sequence	Key sequence number previously allocated to MS, or "111" if no key is available.
Mobile Station Classmark 2	
Mobile Identity	
- odd/even indication	Even
- Type of identity	TMSI
- Identity Digits	TMSI previously allocated to MS.

Contents of PHYSICAL INFORMATION message:

Protocol Discriminator	RR Management.
Skip Indicator	0000
Message Type	00101101
Timing advance	20 bit periods.

Contents of SETUP message; (MS to SS):

Protocol Discriminator	Call Control.
Transaction Identifier	
TI value	any value from the set {0, ..., 6}.
TI flag	0
Message Type	0X000101
Other information elements	Not checked.

26.6.22 Default contents of T-GSM 810 layer 3 messages for RR tests

This subclause contains the default values of T-GSM 810 L3 messages, which unless indicated otherwise in subclause 26.6 shall be transmitted by the system simulator and which are required to be received from the T-GSM 810 MS under test. These values are used in order to be consistent with the phase 2 version of 26.6.

The necessary L3 messages are listed in alphabetic order, with the exception of the SYSTEM INFORMATION messages, where it is the information elements which are listed in alphabetic order (this is because some information elements occur in several SYSTEM INFORMATION types).

In this subclause, decimal values are normally used. However, sometimes a hexadecimal value, indicated by an "H", or a binary value, indicated by a "B" is used.

Default SYSTEM INFORMATION:

NOTE 1: SYSTEM INFORMATION 2 bis, SYSTEM INFORMATION 5 bis, SYSTEM INFORMATION 7, and SYSTEM INFORMATION 8 messages are not used.

Cell A

Contents of information elements in SYSTEM INFORMATION TYPE 1 to 6 messages for cell A.

(CBCH) Channel Description	Not present.
(CBCH) Mobile Allocation	Not present.
Cell Channel Description	
- Format identifier	128 range.
- Cell Allocation ARFCN	Channel Numbers 457, 467, 470 and 475.
Cell Identity	
- Cell Identity Value	0001H
Cell Options	
- Power Control Indicator	Power Control Indicator is not set.
- DTX Indicator	MS shall not use DTX.
- Radio_Link_Timeout	8 SACCH blocks.
Cell Selection Parameters	
- Cell_Reselect_Hysteresis	12 dB.
- MX_TXPWR_MAX_CCH	Minimum level.
- ACS	No addition cell parameters are present in SYSTEM INFORMATION messages 7 and 8.
- NECI	New establishment causes not supported.
- RXLEV_ACCESS_MIN	Minimum level.
Control Channel Description	
- Attach-Detach allowed	No Attach/Detach.
- BS_AG_BLK_RES	0 blocks reserved for access grant.
- CCCH_CONF	1 basic physical channel used for CCCH, combined with SDCCHs.
- BS_PA_MFRMS	5 multiframe periods for transmission of paging messages.
- T3212 Time-out value	Infinite.
L2 pseudo length	
- System information 1	21
- System information 2	22
- System information 3	18
- System information 4	12
Location Area Identification	
- Mobile Country Code	001 decimal
- Mobile Network Code	01 decimal
- Location Area Code	0001H
Message Type	
- System information 1	00011001
- System information 2	00011010
- System information 3	00011011
- System information 4	00011100
- System information 5	00011101
- System information 6	00011110
Neighbour Cells Description	
- Format identifier	Range 128.
- BCCH Allocation Sequence	0
- BCCH Allocation ARFCN	Channels numbers 447, 457, 477, 480, 499, 504, 507 and 510.
- EXT-IND	This IE carries the complete BA.
NCC Permitted	0000 0010
RACH Control Parameters	
- Max Retrans	Max 1 retrans.
- Tx-integer	5 slots used.
- Cell Barred for Access	Cell is not barred.
- Call Reestablishment Allowed	Not allowed.
- Access Control Class	Access is not barred.
- Emergency Call allowed	Yes.
SI 1 rest octets	Not used (all bits are set to spare).
SI 2 rest octets	Not used (all bits are set to spare).
SI 3 rest octets	Not used (all bits are set to spare).
SI 4 rest octets	Not used (all bits are set to spare).

Default settings for cell A:

Downlink input level	63 dBmicroVolt emf.
Uplink output power	Minimum supported by the MS's power class.
Propagation profile	static.
BCCH/CCCH carrier number	457

Cell B

The contents of SYSTEM INFORMATION TYPE 1 to 6 messages for cell B are identical to those of cell A with the following exceptions:

Cell Channel Description - Format Identifier - Cell Allocation ARFCN	128 range. Channel Number 447.
--	-----------------------------------

NOTE 2: This IE needs modification when used in handover tests which command the MS to go to a frequency hopping channel in cell B.

Cell Identity

- Cell Identity Value 0002H

Default settings for cell B:

Downlink input level	53 dBmicroVolt emf.
Uplink output power	minimum supported by the MS's power class.
Propagation profile	static.
BCCH/CCCH carrier number	447

Contents of ALERTING message (SS to MS):

Protocol Discriminator	Call Control.
Transaction Identifier	
TI value	As used in the SETUP message.
TI flag	1 (destination side).
Message Type	00000001
All other information elements	Not present.

Contents of ASSIGNMENT COMMAND message:

Protocol Discriminator	RR Management.
Skip Indicator	0000
Message Type	00101110
Channel Description	
- Channel Type and TDMA offset	Bm + ACCHs
- Timeslot Number	Chosen arbitrarily by the test house.
- Training Sequence Code	Chosen arbitrarily by the test house.
- Hopping	Single RF channel.
- ARFCN	Channel number 467.
Power Command	
- EPC mode (for R5 and after MS only)	0 (Channel not in EPC mode)
- FPC (for R99 and R4 MS only)	0 (FPC not in use)
- FPC_EPC mode (for R5 and after MS only)	0 (FPC or EPC not in use)
- Power level	Chosen arbitrarily by the test house.
All other information elements	Not present.

Contents of ASSIGNMENT COMPLETE message:

Protocol Discriminator	RR Management.
Skip Indicator	0000
Message Type	00101001
RR Cause	
- RR Cause Value	Normal event.

Contents of ASSIGNMENT FAILURE message:

Protocol Discriminator	RR Management.
Skip Indicator	0000
Message Type	00101111
RR Cause	
- RR Cause Value	Depending on test.

Contents of AUTHENTICATION REQUEST message:

Protocol Discriminator	MM message.
Skip Indicator	0000
Message Type	00010010
Ciphering Key Sequence Number	
- Key Sequence	Chosen arbitrarily by the test house from the range 0 to 6.
Authentication Parameter RAND	
- RAND value	Chosen arbitrarily by the test house.

Contents of AUTHENTICATION RESPONSE message:

Protocol Discriminator	MM message.
Skip Indicator	0000
Message Type	0X010100
Other information element(s)	Not checked.

Contents of CALL PROCEEDING message:

Protocol Discriminator	Call Control.
Transaction Identifier	
TI value	As used in the SETUP message.
TI flag	1 (destination side).
Message Type	00000010
All other information elements	Not present.

Contents of CHANNEL MODE MODIFY message:

Protocol Discriminator	RR Management.
Skip Indicator	0000
Message Type	00010000
Channel Description	
- Channel Type and TDMA offset	Depending on test.
- Timeslot Number	Chosen arbitrarily by the test house.
- Training Sequence Code	Chosen arbitrarily by the test house.
- Hopping	Single RF channel.
- ARFCN	Channel number 467.
Channel Mode	
- Mode	Depending on test.

Contents of CHANNEL MODE MODIFY ACKNOWLEDGE message:

Protocol Discriminator	RR Management.
Skip Indicator	0000
Message Type	00010111
Channel Description	Depending on test.
- Channel Type and TDMA offset	Same as in the CHANNEL MODE MODIFY message.
- Timeslot Number	Same as in the CHANNEL MODE MODIFY message.
- Training Sequence Code	Single RF channel.
- Hopping	Band number 0.
- Frequency Band	Channel number 467.
- ARFCN	
Channel Mode	
- Mode	Same as in the CHANNEL MODE MODIFY message.

Contents of CHANNEL RELEASE message:

Protocol Discriminator	RR Management.
Skip Indicator	0000
Message Type	00001101
RR Cause	
- RR Cause Value	Normal event.

Contents of CHANNEL REQUEST message

Establishment Cause	Not checked.
Random Reference	Not checked.

Contents of CIPHERING MODE COMMAND message:

Protocol Discriminator	RR Management.
Skip Indicator	0000
Message Type	00110101
Cipher Mode Setting	
- algorithm identifier	cipher with A5/1.
- SC	Start ciphering.
Cipher Response	IMEI shall not be included.

Contents of CIPHERING MODE COMPLETE message:

Protocol Discriminator	RR Management.
Skip Indicator	0000
Message Type	00110010
Mobile Identity	Not present.

Contents of the CLASSMARK CHANGE message:

Protocol Discriminator	RR Management.
Skip Indicator	0000
Message Type	000100110
Mobile Station Classmark 2	See PIXIT.
Mobile Station Classmark 3	For presence and contents see PIXIT.

Contents of CM SERVICE ACCEPT message:

Protocol Discriminator	Mobility Management.
Skip Indicator	0000
Message Type	00100001

Contents of CM SERVICE REQUEST message

Protocol Discriminator	Mobility Management.
Skip Indicator	0000
Message Type	0X100100
Other information elements	Not checked.

Contents of CONNECT message (SS to MS)

Protocol Discriminator	Call Control.
Transaction Identifier	
TI value	As used in the SETUP message.
TI flag	1
Message Type	00000111
All other information elements	Not present.

Contents of CONNECT ACKNOWLEDGE message (MS to SS)

Protocol Discriminator	Call Control.
Transaction Identifier	
TI value	As used in the SETUP message.
TI flag	0
Message Type	0X001111

Contents of HANDOVER ACCESS message:

Handover Reference	Equal to the value included in the Handover Command message.
--------------------	--

Contents of HANDOVER COMMAND message:

Protocol Discriminator	RR Management.
Skip Indicator	0000
Message Type	00101011
Cell Description	
- Network Colour Code	1
- Base station Colour Code	Corresponding to target cell
- BCCH Carrier Number	Set to the BCCH carrier number of cell B. (one of 447, 457, 480, 499, 504, 507 or 510).
Channel Description	
- Channel Type and TDMA offset	Bm + ACCHs.
- Timeslot Number	Chosen arbitrarily by the test house.
- Training Sequence Code	Chosen arbitrarily by the test house.
- Hopping	Single RF channel.
- ARFCN	Chosen arbitrarily by the test house from those supported on the target cell.
Handover Reference	
- Handover Reference Value	Chosen arbitrarily by the test house.
Power Command	
- ATC	0 (Sending of Handover Access is mandatory)
- EPC mode (for R5 and after MS only)	0 (Channel not in EPC mode)
- FPC (for R99 and R4 MS only)	0 (FPC not in use)
- FPC_EPC mode (for R5 and after MS only)	0 (FPC or EPC not in use)
- Power level	Chosen arbitrarily by the test house.
All other information elements	Not present.

Contents of HANDOVER COMPLETE message:

Protocol Discriminator	RR Management.
Skip Indicator	0000
Message Type	00101100
RR cause	Normal event.
Time difference	Not present.

Contents of HANDOVER FAILURE message:

Protocol Discriminator	RR Management.
Skip Indicator	0000
Message Type	00101000
RR cause	Dependent on the test.

IDENTITY REQUEST

Information element	Value/remark
Identity type	IMEI
Spare half octet	0000

IDENTITY RESPONSE

Information element	Value/remark
Mobile identity	not checked

Contents of IMMEDIATE ASSIGNMENT message:

L2 pseudo length	This is the sum of the lengths of all the information elements present in the message except for the IA rest octets and L2 pseudo length IEs. For the default message the L2 pseudo length is 11.
Protocol Discriminator	RR Management.
Skip Indicator	0000
Message Type	00111111
Page Mode	
- Page Mode	Normal Paging.
Channel Description	
- Channel Type and TDMA offset	For non-combined CCCH/SDCCH (see initial conditions), SDCCH/8, with subchannel chosen arbitrarily by the test house For combined CCCH/SDCCH (default SS conditions), SDCCH/4, with subchannel chosen arbitrarily by the test house.
- Timeslot Number	For non-combined CCCH/SDCCH (see initial conditions), chosen arbitrarily by the test house; For combined CCCH/SDCCH (default SS conditions), SDCCH/4, timeslot zero.
- Training Sequence Code	For non-combined CCCH/SDCCH (see initial conditions), chosen arbitrarily by the test house; For combined CCCH/SDCCH (default SS conditions), SDCCH/4, TSC=5 (same as the BCC).
- Hopping	Single RF channel.
- ARFCN	For non-combined CCCH/SDCCH (see initial conditions), Channel number 467; For combined CCCH/SDCCH (default SS conditions), SDCCH/4, Channel number 457.
Request Reference	Pertaining to last Channel Request sent by the MS.
Timing Advance	
- Timing advance value	30 bit periods.
Mobile Allocation	
- Length	0
Starting Time	Not present.
IA rest octets	Not used (all bits set to spare).

Contents of IMMEDIATE ASSIGNMENT EXTENDED message:

L2 pseudo length	This is the sum of the lengths of all the information elements present in the message except for the IAX rest octets and L2 pseudo length IEs. For the default message the L2 pseudo length is 18.
Protocol Discriminator	RR Management.
Skip Indicator	0000
Message Type	00111001
Page Mode	
- Page Mode	Normal Paging.
Channel Description 1	
- Channel Type and TDMA offset	For non-combined CCCH/SDCCH (see test conditions), SDCCH/8, with subchannel chosen arbitrarily by the test house; For combined CCCH/SDCCH (default SS conditions), SDCCH/4, with subchannel chosen arbitrarily by the test house.
- Timeslot Number	For non-combined CCCH/SDCCH (see test conditions), chosen arbitrarily by the test house; For combined CCCH/SDCCH (default SS conditions), SDCCH/4, timeslot zero.
- Training Sequence Code	For non-combined CCCH/SDCCH (see initial conditions), chosen arbitrarily by the test house; For combined CCCH/SDCCH (default SS conditions), SDCCH/4, TSC=5 (same as the BCC). Single RF channel.
- Hopping	For non-combined CCCH/SDCCH (see initial conditions), Channel number 467; For combined CCCH/SDCCH (default SS conditions), SDCCH/4, Channel number 457.
- ARFCN	Pertaining to last Channel Request sent by the MS.
Request Reference 1	
Timing Advance 1	
- Timing advance value	Chosen arbitrarily by the test house.
Channel Description 2	
- Channel Type and TDMA offset	Same channel type as in Channel Description 1, but different TDMA offset to that in Channel Description 1.
- Timeslot Number	equal to the value in Channel Description 1.
- Training Sequence Code	equal to the value in Channel Description 1.
- Hopping	Single RF channel.
- ARFCN	equal to the value in Channel Description 1.
Request Reference 2	Not pertaining to any Channel Requests sent by the MS.
Timing Advance 2	
- Timing advance value	Chosen arbitrarily by the test house.
Mobile Allocation	
- Length	0
Starting Time	Not present.
IAX rest octets	Not used (all bits set to spare).

Contents of IMMEDIATE ASSIGNMENT REJECT message:

L2 pseudo length	19
Protocol Discriminator	RR Management.
Skip Indicator	0000
Message Type	00111010
Page Mode	
- Page Mode	Normal Paging.
Request Reference	Pertaining to last Channel Request sent by the MS.
Wait Indication	0 s.
Request Reference	Not pertaining to the MS under test.
Wait Indication	0 s.
Request Reference	Not pertaining to the MS under test.
Wait Indication	0 s.
Request Reference	Not pertaining to the MS under test.
Wait Indication	0 s.
IAR rest octets	Not used (all bits set to spare).

Contents of LOCATION UPDATING REQUEST message:

Protocol Discriminator	MM message.
Skip Indicator	0000
Message Type	0X001000
Other information elements	Not checked.

Contents of PAGING REQUEST TYPE 1 message:

L2 pseudo length	This is the sum of the lengths of all the information elements present in the message except for the P1 rest octets and L2 pseudo length IEs. For the default message the L2 pseudo length is 9.
Protocol Discriminator	RR Management.
Skip Indicator	0000
Message Type	00100001
Page Mode	
- Page Mode	Normal Paging.
Channels needed	
- first channel	any channel.
- second channel	any channel.
Mobile Identity 1	
- odd/even indication	Even.
- Type of Identity	TMSI.
- Identity Digits	TMSI previously allocated to MS.
Mobile Identity 2	Not present.
P1 rest octets	Not used (all bits set to spare).

Contents of PAGING REQUEST TYPE 2 message:

L2 pseudo length	This is the sum of the lengths of all the information elements present in the message except for the P2 rest octets and L2 pseudo length IEs. For the default message the L2 pseudo length is 11.
Protocol Discriminator	RR Management..
Skip Indicator	0000
Message Type	00100010
Page Mode	
- Page Mode	Normal Paging.
Channels needed	
- first channel	any channel.
- second channel	any channel.
Mobile Identity 1	
- TMSI value	TMSI previously allocated to MS.
Mobile Identity 2	
- TMSI value	TMSI not allocated to MS.
Mobile Identity	Not present.
P2 rest octets	Not used (all bits set to spare).

Contents of PAGING REQUEST TYPE 3 message:

L2 pseudo length	19
Protocol Discriminator	RR Management.
Skip Indicator	0000
Message Type	00100100
Page Mode	
- Page Mode	Normal Paging.
Channels needed	
- first channel	any channel.
- second channel	any channel.
Mobile identity 1	
- TMSI value	TMSI previously allocated to MS.
Mobile identity 2	
- TMSI value	TMSI not allocated to MS.
Mobile identity 3	
- TMSI value	TMSI not allocated to MS.
Mobile identity 4	
- TMSI value	TMSI not allocated to MS.
P3 rest octets	Not used (all bits set to spare).

Contents of PAGING RESPONSE message:

Protocol Discriminator	RR Management.
Skip Indicator	0000
Message Type	00100111
Ciphering Key Sequence Number	
- Key Sequence	Key sequence number previously allocated to MS, or "111" if no key is available.
Mobile Station Classmark 2	
Mobile Identity	
- odd/even indication	Even
- Type of identity	TMSI
- Identity Digits	TMSI previously allocated to MS.

Contents of PHYSICAL INFORMATION message:

Protocol Discriminator	RR Management.
Skip Indicator	0000
Message Type	00101101
Timing advance	20 bit periods.

Contents of SETUP message; (MS to SS):

Protocol Discriminator	Call Control.
Transaction Identifier	
TI value	any value from the set {0, ..., 6}.
TI flag	0
Message Type	0X000101
Other information elements	Not checked.

26.6.23 Test of Repeated SACCH

26.6.23.1 Repeated SACCH / Downlink Repeated SACCH

26.6.23.1.1 Conformance requirement

If a downlink SACCH block is incorrectly decoded (prior to combining with any previously received SACCH block), and the next uplink SACCH block is not a repetition as per the Repeated SACCH procedure (see sub-clause 11.3), then the MS shall set the SACCH Repetition Request in the next uplink SACCH block to "Repeated SACCH required" (see 3GPP TS 44.004).

If a downlink SACCH block is correctly decoded (prior to combining with any previously received SACCH block), and the next uplink SACCH block is not a repetition as per the Repeated SACCH procedure (see sub-clause 11.3), the MS shall set the SACCH Repetition Request in the next uplink SACCH block to "Repeated SACCH not required".

References

3GPP TS 44.006 clause 11.2.

26.6.23.1.2 Test purpose

To verify that when the downlink SACCH block is wrongly decoded, the MS sends an uplink SACCH block containing SACCH Repetition Request set to "Repeated SACCH required" and when the downlink SACCH block is decoded correctly, the MS sends an uplink SACCH block containing SACCH Repetition Request set to "Repeated SACCH not required"

26.6.23.1.3 Method of test

Specific PICS statements:

-

PIXIT statements:

-

Initial conditions

System Simulator:

1 cell, default parameters.

Mobile Station:

The MS is in MM-state "idle, updated" with valid TMSI and CKSN.

Foreseen final state of the MS

U0, null.

26.6.23.1.4 Test procedure

- a) A MS originated call is set up according to the generic call set up procedure.
- b) For 10 secs, the SS sends error free SACCH messages.
- c) SS Sends one SACCH messages with unrecoverable errors.
- d) For 10 secs the SS shall continuously send error free SACCH messages.

26.6.23.1.5 Test requirement

- 1) In step b, check that all the uplink SACCH messages have SACCH Repetition Request set to "Repeated SACCH not required"
- 2) After step c, check that the MS sends a SACCH message having SACCH Repetition Request set to "Repeated SACCH required".
- 3) In step d, check that all the uplink SACCH messages have SACCH Repetition Request set to "Repeated SACCH not required"

Specific Message Contents

SYSTEM INFORMATION TYPE 3

Information Element	Value/remark
MSCR	1 = MSC is Release '99 onwards

26.6.23.2 Repeated SACCH / Uplink Repeated SACCH

26.6.23.2.1 Conformance requirement

At the MS side, if an uplink SACCH block contains a SAPI 0 frame and is not already a repetition, and if the last correctly received SACCH Repetition Order was set to "Repeated SACCH required", then the MS shall repeat this SACCH block at the next SACCH block period.

References

3GPP TS 44.006 clause 11.3.

26.6.23.2.2 Test purpose

To verify that the MS repeats an uplink SACCH block when the downlink SACCH blocks contains SACCH Repetition Order set to "Repeated SACCH required".

26.6.23.2.3 Method of test

Initial conditions

System Simulator:

1 cell, default parameters

Mobile Station:

The MS is in MM-state "idle, updated" with valid TMSI and CKSN.

Specific PICS statements:

-

PIXIT statements:

-

Foreseen final state of the MS

U0, null.

26.6.23.2.4 Test procedure

- a) A MS originated call is set up according to the generic call set up on cell A.
- b) For the duration of test case, power levels of serving cell is changed in a steps from -50dBm to -65dBm to -80dBm and back to -50dBm , by doing one change at every 480 ms. This is made to make sure that every report is different from the previous one.
- c) For 10 sec, the SS sends SACCH messages, setting SACCH Repetition Order to "Repeated SACCH Not Required".
- d) SS Sends one SACCH messages setting SACCH Repetition Order to "Repeated SACCH Required".
- e) For 10 more secs, the SS shall continuously send SACCH messages with SACCH Repetition Order set to "Repeated SACCH Not Required".

26.6.23.2.5 Test requirement

- 1) In step c, check that MS is not retransmitting the SACCH messages on uplink.
- 2) After step d, Check that the MS repeats the last message.
- 3) In step e, check that MS is not retransmitting the SACCH messages on uplink.

Specific Message Contents

SYSTEM INFORMATION TYPE 3

Information Element	Value/remark
MSCR	1 = MSC is Release '99 onwards

26.6.23.3 Repeated SACCH / Uplink Repeated SACCH with SAPI 3 frames

26.6.23.3.1 Conformance requirements

At the MS side, if an uplink SACCH block contains a SAPI 0 frame and is not already a repetition, and if the last correctly received SACCH Repetition Order was set to "Repeated SACCH required", then the MS shall repeat this SACCH block at the next SACCH block period. If a SAPI 3 frame was also scheduled to be sent at this next SACCH period, the MS shall delay the sending of the SAPI 3 frame by one SACCH period in order to make room for the repetition.

Reference

3GPP TS 44.006 clause 11.3.

26.6.23.3.2 Test purpose

To verify that the MS delays sending of a SAPI 3 frame by one SACCH period if a repeated SAPI 0 SACCH frame is to be repeated according to the SACCH Repetition Parameter in the downlink SACCH block.

26.6.23.3.3 Method of test

Initial Conditions

System simulator:

1 cell, default parameters.

Mobile Station:

The MS shall be in "Idle, updated" state.

Specific PICS Statements

-

PIXIT Statements

- Description of the basic procedures to display a mobile originated short message.
- Maximum length (characters) of a mobile originated short message.

Foreseen Final State of MS

U0, null.

Test Procedure

A data or speech call is established on a TCH with the SS and the state U10 of call control is entered. SACCH Repetition Order is set to "Repeated SACCH required" in all the downlink SACCH blocks. The MS is setup to send an SM. During an SMS transfer it is checked that every SAPI0 SACCH block is repeated once and no SAPI3 SACCH block is repeated.

For the duration of test case, power levels of serving cell is changed in a steps from -50dBm to -65dBm to -80dBm and back to -50dBm, by doing one change at every 480 ms. This is made to make sure that every report is different from the previous one.

Expected sequence

Step	Direction	Message	Comments/actions/next state
1	MS< -> SS		MS is brought to U10 state. All the downlink SACCH message has SACCH Repetition Order set to "Repeated SACCH required".
2	MS		The MS is set up to send an SM.
3	MS -> SS	CM SERVICE REQUEST	Sent in a layer 2 frames on the FACCH. CM service type set to "short message transfer"
4	SS -> MS	CM SERVICE ACCEPT	
5	MS -> SS	SABM (SAPI=3)	Receive SAPI=3 uplink SACCH block
6	SS -> MS	UA (SAPI=3)	
7	MS -> SS	CP-DATA	Contains RP-DATA RPDU (SMS SUBMIT TPDU)
8	SS -> MS	CP-ACK	
9	SS -> MS	CP-DATA	
10	MS -> SS	CP-ACK	MO SMS procedure is completed.
11			During steps 7-10, check that the MS is retransmitting every SAPI0 SACCH message once, before sending the new one and no SAPI3 SACCH messages are retransmitted.
12			CS call is released and the MS is brought in idle state.

Specific Message Contents

SYSTEM INFORMATION TYPE 3

Information Element	Value/remark
MSCR	1 = MSC is Release '99 onwards

26.7 Elementary procedures of mobility management

The tests are based on 3GPP TS 04.08 / 3GPP TS 24.008 and 3GPP TS 03.03.

In this subclause, when the expected sequence require that "a mobile originated CM connection is attempted", it shall be for a service other than emergency call.

In this subclause, a initial CM message is either a SETUP message, a REGISTER message or a CP-DATA message (in that case the acknowledged mode of operation on SAPI 3 will have be established and this message will be sent on SAPI 3).

26.7.0 Default contents of messages

Default contents SYSTEM INFORMATION messages and default settings

For cell A and B

For GSM use 26.6.14. For DCS use 26.6.15, for PCS 1 900 use 26.6.18, for GSM 450 use 26.6.16, for GSM 480 use 26.6.17, for GSM 750 use 26.6.19, for GSM 850 use 26.6.20, for GSM 710 use 26.6.21 and for T-GSM 810 use 26.6.22.

Cell C

The contents of SYSTEM INFORMATION TYPE 1 to 6 messages for cell C are identical to those of cell A with the following exceptions:

Cell Channel Description - Format Identifier	Range 128 for GSM 450, GSM 480, GSM 710, GSM 750, T-GSM 810 and GSM 850. Bit map 0 for GSM.
- Cell Allocation ARFCN	Range 512 for DCS and PCS 1 900. Channel number 267 for GSM 450, Channel number 315 for GSM 480, Channel Number 30 for GSM, Channel Number 700 for DCS, PCS 1 900, Channel Number 467 for GSM 710, GSM 750 and T-GSM 810 and Channel Number 157 for GSM 850.
Cell Identity - Cell Identity Value	0003H

Default settings for cell C:

Downlink input level Uplink output power	53 dBmicroVolt emf minimum supported by the MS's power class for GSM and DCS, Power Control Level = 10 for PCS 1 900
Propagation profile BCCH/CCCH carrier number	static. 267 for GSM 450, 315 for GSM 480, 30 for GSM, 700 for DCS and PCS 1 900, 467 for GSM 710, GSM 750 and T-GSM 810 and 157 for GSM 850.

ABORT

Information element	Value/remark
Reject cause	Depending on the test one of either: #6 - Illegal ME #17 - Network Failure.

AUTHENTICATION REQUEST

Information element	Value/remark
Cipher Key Sequence Number Authentication parameter RAND	Arbitrary Arbitrarily chosen by the test house

AUTHENTICATION RESPONSE

Information element	Value/remark
Authentication parameter SRES	As applicable

AUTHENTICATION REJECT

Information element	Value/remark
None but message head	

CHANNEL RELEASE

Information element	Value/remark
RR cause	Normal release

CIPHERING MODE COMMAND

Information element	Value/remark
Cipher mode setting	Start ciphering
Cipher Response	IMEI must not be included

CM RE-ESTABLISHMENT REQUEST

Information element	Value/remark
Cipher Key Sequence Number	According to SIM contents
Mobile station classmark 2	See PICS/PIXIT
Mobile Identity	IMSI of MS under test
Location area identification	As in subclause 26.1.1

CM SERVICE ACCEPT

Information element	Value/remark
None but message head	Omitted

CM SERVICE REQUEST

Information element	Value/remark
CM service type	Mobile originating call establishment unless otherwise specified in test.
Ciphering key sequence number	According to SIM contents
Mobile station classmark 2	See PICS/PIXIT
Mobile identity	TMSI of the MS under test

CM SERVICE REJECT

Information element	Value/remark
Reject cause	Depending on test

IDENTITY REQUEST

Information element	Value/remark
Identity type	Depending on test
Spare half octet	0000

IDENTITY RESPONSE

Information element	Value/remark
Mobile identity	Depending on test

IMMEDIATE ASSIGNMENT

Information element	Value/remark
L2 pseudo length	
Page mode	Normal Paging
Spare half octet	0000
Channel description	
- Channel type and TDMA offset	SDCCH/4 or SDCCH/8
- Time slot number	Arbitrary legal value
- Subsequent fields of the Channel description IE	
depend upon the Type of MS under test, as specified in subclause 26.1.1	
Request reference	
- Random access information	As received from MS
- N51,N32,N26	Corresponding to the frame in which the Channel Request was sent
Timing advance	0
Mobile allocation	Empty (L=0)
Starting time	Omitted
IA rest octets	all bits set to spare

IMSI DETACH INDICATION

Information element	Value/remark
Mobile station classmark 1	See PICS/PIXIT
Mobile identity	TMSI of the MS under test

LOCATION UPDATING ACCEPT

Information element	Value/remark
Location area identification	As in subclause 26.1.1
Mobile identity	Omitted
Follow on proceed	Omitted

LOCATION UPDATING REJECT

Information element	Value/remark
Reject cause	As specified in test

LOCATION UPDATING REQUEST

Information element	Value/remark
Location updating type	Normal location updating
Cipher Key Sequence Number	According to SIM contents
Location area identification	As in subclause 26.1.1
Mobile station classmark	See PICS/PIXIT
Mobile identity	TMSI of the MS

PAGING REQUEST TYPE 1

Information element	Value/remark
L2 pseudo length	
Page Mode	Normal paging
Channels needed	"any channel"
- mobile 1	spare
- mobile 2	TMSI of MS under test
Mobile identity 1	Omitted
Mobile identity 2	All bits set to spare
P1 rest octets	

PAGING RESPONSE

Information element	Value/remark
Ciphering key sequence number	According to SIM contents
Spare half octet	0000
Mobile station classmark 2	See PICS/PIXIT
Mobile identity	TMSI of the MS under test

TMSI REALLOCATION COMMAND

Information element	Value/remark
Location area identification	As in subclause 26.1.1
Mobile identity	TMSI of the MS under test

TMSI REALLOCATION COMPLETE

Information element	Value/remark
None but message head	omitted

26.7.1 TMSI reallocation

The intention of the TMSI Reallocation procedure is to assign a new temporary identity for the MS. If the message is not understood by the MS, the network could not establish a link to the MS. As this is a common MM procedure, it can be initiated at any time.

26.7.1.1 Conformance requirement

- 1) A Mobile Station shall acknowledge a new TMSI when explicitly allocated during a location updating procedure or an incoming call.
- 2) The TMSI shall be updated on the SIM when the Mobile Station is correctly deactivated in accordance with the manufacturer's instructions.
- 3) A Mobile Station shall answer paging with this TMSI and includes it in the Paging Response message.

Reference(s):

3GPP TS 04.08 / 3GPP TS 24.008 subclause 4.3.1, 3GPP TS 03.03 clause 2, 3GPP TS 02.17 subclause 6.1.

26.7.1.2 Test purpose

To verify that the MS is able to receive and acknowledge a new TMSI by means of an explicit TMSI reallocation procedure.

To verify that the MS has stored the TMSI in a non-volatile memory.

The implicit reallocation procedure is tested in subclause 26.7.4.1.

26.7.1.3 Method of test

Initial conditions

System Simulator:

Two cells A and B, belonging to different location areas a and b, default parameters.

Mobile Station:

The MS has valid TMSI (= TMSI1), CKSN, Kc. It is "idle updated" on cell B.

Specific PICS statements:

- On/Off switch (TSPC_Feat_OnOff)

PIXIT statements:

-

Foreseen final state of the MS

The MS has a valid TMSI (= TMSI1), CKSN, Kc. It is "idle updated" on cell A.

Test Procedure

The MS is paged in cell B and the ciphering mode is established. An explicit TMSI reallocation procedure is performed. The channel is released. The MS is switched off and then its power supply is interrupted for 10 s. The power supply is resumed and then the MS is switched on and allowed sufficient time to guarantee that the MS is in service (listening to its paging subchannel). The system simulator then checks, by paging, whether the MS has stored the received TMSI.

The MS is made to select cell A. A normal location updating procedure is performed in cell A. An explicit TMSI reallocation procedure is performed and then the location updating procedure is accepted by the SS. The system simulator checks, by paging, whether the MS has stored the allocated TMSI.

Maximum duration of test

2 minutes.

Expected sequence

Step	Direction	Message	Comments
1	SS -> MS	PAGING REQUEST TYPE 1	The following messages are sent and shall be received on cell B. "Mobile identity" = TMSI1. Establishment Cause: Answer to paging.
2	MS -> SS	CHANNEL REQUEST	
3	SS -> MS	IMMEDIATE ASSIGNMENT	
4	MS -> SS	PAGING RESPONSE	
5	SS -> MS	CIPHERING MODE COMMAND	
6	MS -> SS	CIPHERING MODE COMPLETE	
7	SS -> MS	TMSI REALLOCATION COMMAND	
8	MS -> SS	TMSI REALLOCATION COMPLETE	
9	SS -> MS	CHANNEL RELEASE	
10	MS		After the sending of this message, the SS waits for the disconnection of the main signalling link.
10a	MS		If possible (see PICS), the MS is switched off.
11	MS		The power supply is interrupted for 10 s.
12	SS		The MS is switched on.
13	SS -> MS	PAGING REQUEST TYPE 1	The SS waits an amount of time which is enough to guarantee that the MS is in service (listening to its paging subchannel).
14	MS -> SS	CHANNEL REQUEST	"Mobile identity" = TMSI2. Establishment Cause: Answer to paging.
15	SS -> MS	IMMEDIATE ASSIGNMENT	
16	MS -> SS	PAGING RESPONSE	"Mobile identity" = TMSI2.
17	SS -> MS	CHANNEL RELEASE	After the sending of this message, the SS waits for the disconnection of the main signalling link. The following messages are sent and shall be received on cell A
18	SS		The RF level of cell B is lowered until the MS selects cell A. The RF level of cell B is set sufficiently low to ensure that cell B is not suitable as defined in 3GPP TS 05.08 subclause 6.6.2.
19	MS -> SS	CHANNEL REQUEST	Establishment cause: Location updating.
20	SS -> MS	IMMEDIATE ASSIGNMENT	
21	MS -> SS	LOCATION UPDATING REQUEST	location updating type = normal, "ciphering key sequence number" = CKSN, LAI = b, "mobile identity" = TMSI2.
22	SS -> MS	TMSI REALLOCATION COMMAND	TMSI = TMSI1.
23	MS -> SS	TMSI REALLOCATION COMPLETE	
24	SS -> MS	LOCATION UPDATING ACCEPT	This message does not contain the optional Mobile Identity field.
25	SS -> MS	CHANNEL RELEASE	After the sending of this message, the SS waits for the disconnection of the main signalling link. The SS waits an amount of time which is enough to guarantee that the MS is "idle updated" on cell A.
26	SS -> MS	PAGING REQUEST TYPE 1	"Mobile identity" IE contains the new TMSI (= TMSI1).
27	MS -> SS	CHANNEL REQUEST	"Establishment cause": Answer to paging.
28	SS -> MS	IMMEDIATE ASSIGNMENT	
29	MS -> SS	PAGING RESPONSE	"Mobile identity" IE contains the new TMSI (= TMSI1).
30	SS -> MS	CHANNEL RELEASE	After the sending of this message, the SS waits for the disconnection of the main signalling link.

Specific message contents:

None.

26.7.2 Authentication

The purpose of this procedure is to verify the user identity. A correct response is essential to guarantee the establishment of the connection. If not, the connection will drop.

The SS shall be able to handle vectors of Kc, RAND, and SRES in a similar way as the MSC/BSS entities. The SS shall incorporate a test algorithm for generating SRES and Kc from RAND and Ki which operates as described in annex 4.

26.7.2.1 Authentication accepted

26.7.2.1.1 Conformance requirement

- 1) A Mobile Station shall correctly respond to an Authentication Request message by sending an Authentication Response message with the SRES information field set to the same value as the one produced by the authentication algorithm in the network.
- 2) A Mobile Station shall indicate in a Paging Response message the ciphering key sequence number which was allocated to it through the authentication procedure.

Reference(s)

3GPP TS 04.08 / 3GPP TS 24.008 subclause 4.3.2, 3GPP TS 03.03 clause 2.

26.7.2.1.2 Test purpose

- 1) To check that a Mobile Station correctly responds to an Authentication Request message by sending an Authentication Response message with the SRES information field set to the same value as the one produced by the authentication algorithm in the network.
- 2) To check that a Mobile Station indicates in a Paging Response message the ciphering key sequence number which was allocated to it through the authentication procedure.

26.7.2.1.3 Method of test

Initial conditions

System Simulator:

1 cell, default parameters.

Mobile Station:

The MS has valid TMSI, CKSN (CKSN1), Kc. It is "idle updated" on the cell.

Specific PICS statements:

-

PIXIT statements:

-

Foreseen final state of the MS

The MS has valid TMSI, CKSN and Kc. It is "idle updated" on the cell.

Test Procedure

The MS is paged. After the MS has sent a PAGING RESPONSE message to the SS, the SS initiates an authentication procedure and checks the value SRES sent by the MS in the AUTHENTICATION RESPONSE message. The channel is released. The MS is paged and the SS checks the value of the ciphering key sequence number sent by the MS in the PAGING RESPONSE message.

Maximum duration of test

1 minute.

Expected sequence

Step	Direction	Message	Comments
1	SS -> MS	PAGING REQUEST TYPE 1	<p>Establishment Cause: Answer to paging.</p> <p>CKSN = CKSN1</p> <p>The SS initiates authentication with CKSN2 different from CKSN1.</p> <p>"Auth. parameter SRES" IE shall be bit exact with the value as produced by the authentication algorithm.</p> <p>After the sending of this message, the SS waits for the disconnection of the main signalling link. The SS waits an amount of time which is enough to guarantee that the MS is in service.</p> <p>Establishment Cause: Answer to paging.</p> <p>"Ciphering key sequence number" shall be the same as the value that was sent in the last AUTHENTICATION REQUEST message (= CKSN2).</p> <p>After the sending of this message, the SS waits for the disconnection of the main signalling link.</p>
2	MS -> SS	CHANNEL REQUEST	
3	SS -> MS	IMMEDIATE ASSIGNMENT	
4	MS -> SS	PAGING RESPONSE	
5	SS -> MS	AUTHENTICATION REQUEST	
6	MS -> SS	AUTHENTICATION RESPONSE	
7	SS -> MS	CHANNEL RELEASE	
8	SS -> MS	PAGING REQUEST TYPE 1	
9	MS -> SS	CHANNEL REQUEST	
10	SS -> MS	IMMEDIATE ASSIGNMENT	
11	MS -> SS	PAGING RESPONSE	
12	SS -> MS	CHANNEL RELEASE	

Specific message contents:

None.

26.7.2.2 Authentication rejected

26.7.2.2.1 Conformance requirement

- 1) After reception of an Authentication Reject message the Mobile Station shall:
 - 1.1 not perform normal location updating.
 - 1.2 not perform periodic location updating.
 - 1.3 not respond to paging with TMSI.
 - 1.4 reject any request from CM entity for MM connection except for emergency call.
 - 1.5 not perform IMSI detach if deactivated.
- 2) After reception of an Authentication Reject message the Mobile Station, if it supports speech, shall accept a request for an emergency call by sending a CHANNEL REQUEST message with the establishment cause set to "emergency call" and include an IMEI as mobile identity in the CM SERVICE REQUEST message.
- 3) After reception of an Authentication Reject message the Mobile Station shall delete the stored LAI, CKSN and TMSI.

Reference(s)

3GPP TS 04.08 / 3GPP TS 24.008 subclause 4.3.2.5.

26.7.2.2.2 Test purpose

- 1) To check that ,after reception of an Authentication Reject message, the Mobile Station:
 - 1.1 does not perform normal location updating.
 - 1.2 does not perform periodic location updating.
 - 1.3 does not respond to paging with TMSI.
 - 1.4 rejects any request from CM entity for MM connection except for emergency call.

1.5 does not perform IMSI detach if deactivated.

- 2) To check that, after reception of an Authentication Reject message the Mobile Station, if it supports speech, accepts a request for an emergency call by sending a CHANNEL REQUEST message with the establishment cause set to "emergency call" and includes an IMEI as mobile identity in the CM SERVICE REQUEST message.
- 3) To check that, after reception of an Authentication Reject message and after having been deactivated and reactivated, the MS performs location updating using its IMSI as mobile identity and indicates deleted LAI and CKSN.

26.7.2.2.3 Method of test

Initial conditions

System Simulator:

Two cells: A and B, belonging to different location areas a and b.

IMSI attach/detach is allowed in both cells.

The T3212 time-out value is 1/10 hour in both cells.

Mobile Station:

The MS has valid TMSI, CKSN (CKSN2) and Kc. It is "idle updated" on cell B.

Specific PICS statements:

- On/Off switch (TSPC_Feat_OnOff)
- SIM removable without power down (TSPC_AddInfo_SIMRmv)
- Speech supported for Full rate version 1 (GSM FR) (TSPC_AddInfo_Full_rate_version_1)

PIXIT statements:

-

Foreseen final state of the MS

The MS has valid TMSI, CKSN (CKSN1) and Kc. It is "idle updated" on cell A.

Test procedure

The SS rejects an authentication. The channel is released. The SS checks that the MS has entered the state MM IDLE substate NO IMSI, i.e. does not perform normal location updating, does not perform periodic updating, does not respond to paging, rejects any requests from CM entities except emergency calls and does not perform IMSI detach if SIM detachment is performed, switch off is performed, or the power is removed, depending on the MS (see PICS/PIXIT).

Maximum duration of test

10 minutes.

Expected sequence

Step	Direction	Message	Comments	
The following messages are sent and shall be received on cell B				
1	SS -> MS	PAGING REQUEST TYPE 1	Establishment Cause: Answer to paging. "Ciphering key sequence number" shall be the same as the value that was sent in the last AUTHENTICATION REQUEST message (= CKSN2).	
2	MS -> SS	CHANNEL REQUEST		
3	SS -> MS	IMMEDIATE ASSIGNMENT		
4	MS -> SS	PAGING RESPONSE		
5	SS -> MS	AUTHENTICATION REQUEST	After the sending of this message, the SS waits for the disconnection of the main signalling link. The MS is paged in cell B. "Mobile identity" IE contains TMSI. The MS shall ignore this message. This is verified during 3 s. The SS waits for at least for 15 s. A MO CM connection is attempted. The MS shall not initiate an RR connection establishment on cell A or cell B. This is checked during 3 s. If the MS supports speech (see PICS), an emergency call is attempted. "Establishment cause": Emergency call. "CM service type": Emergency call establishment. "Mobile identity": type of identity is set to IMEI. "Cause" = unassigned number. After the sending of this message, the SS waits for the disconnection of the main signalling link.	
6	MS -> SS	AUTHENTICATION RESPONSE		
7	SS -> MS	AUTHENTICATION REJECT		
8	SS -> MS	CHANNEL RELEASE		
9	SS -> MS	PAGING REQUEST TYPE 1		
10	MS			
11	SS			
12	MS			
13	MS			
14	MS			
15	MS -> SS	CHANNEL REQUEST	"Establishment cause": Emergency call. "CM service type": Emergency call establishment. "Mobile identity": type of identity is set to IMEI. "Cause" = unassigned number. After the sending of this message, the SS waits for the disconnection of the main signalling link.	
16	SS -> MS	IMMEDIATE ASSIGNMENT		
17	MS -> SS	CM SERVICE REQUEST		
18	SS -> MS	CM SERVICE ACCEPT		
19	MS -> SS	EMERGENCY SETUP		
20	SS -> MS	RELEASE COMPLETE		
21	SS -> MS	CHANNEL RELEASE		
The following messages are sent and shall be received on cell A.				
22	SS			The RF levels are changed to make the MS reselect the cell A. The MS performs cell reselection according to procedure as specified in 3GPP TS 05.08 (this however is not checked until step 29). The MS shall not initiate an RR connection establishment on cell A or on cell B. The SS waits at least 7 minutes for a possible periodic updating. The MS shall not initiate an RR connection establishment on cell A or on cell B. If possible (see PICS) SIM detachment is performed. Otherwise if possible (see PICS) switch off is performed. Otherwise the power is removed. The MS shall not initiate an RR connection establishment on cell A or on cell B. This is checked during 3 s. Depending on what has been performed in step 26 the MS is brought back to operation. "Establishment cause": Location updating. "location updating type" = normal, "CKSN" = no key available, "Mobile Identity" = IMSI, "LAI" = deleted LAI (the MCC and MNC hold the previous values, the LAC is coded FFFE). "CKSN" = CKSN1. "Mobile Identity" = TMSI. After the sending of this message, the SS waits for the disconnection of the main signalling link.
23	MS			
24	SS			
25	MS			
26	MS			
27	MS			
28	MS			
29	MS -> SS	CHANNEL REQUEST		
30	SS -> MS	IMMEDIATE ASSIGNMENT		
31	MS -> SS	LOCATION UPDATING REQUEST		
32	SS -> MS	AUTHENTICATION REQUEST		
33	MS -> SS	AUTHENTICATION RESPONSE		
34	SS -> MS	LOCATION UPDATING ACCEPT		
35	MS -> SS	TMSI REALLOCATION COMPLETE		
36	SS -> MS	CHANNEL RELEASE		

Specific message contents

None.

26.7.3 Identification

The purpose of this procedure is to check that the MS gives its identity as requested by the network. If this procedure does not work, it will not be possible for the network to rely on the identity claimed by the MS.

26.7.3.1 General Identification

26.7.3.1.1 Conformance requirement

- 1) When requested by the network the Mobile Station shall send its IMSI.
- 2) When requested by the network the Mobile Station shall send the TMSI which it was previously allocated.
- 3) When requested by the network the Mobile Station shall send its IMEI as stored in the Mobile Equipment.
- 4) When requested by the network the Mobile Station shall send its IMEISV as stored in the Mobile Equipment.

Reference(s)

3GPP TS 04.08 / 3GPP TS 24.008 subclause 4.3.3.

26.7.3.1.2 Test purpose

- 1) To verify that the MS sends identity information as requested by the system in the following cases: IMSI and TMSI are requested in non-ciphered mode, IMEI is requested in ciphered mode.
- 2) To verify that the MS sends its IMEI, when requested to do so, in non-ciphered mode.
- 3) To verify that the MS sends its IMEISV, when requested to do so, in non-ciphered mode.

26.7.3.1.3 Method of test

26.7.3.1.3.1 Identification / test 1

Initial conditions

System Simulator:

1 cell, default values.

Mobile Station:

The MS has a valid TMSI. It is "idle updated" on the cell.

Specific PICS statements:

-

PIXIT statements:

- IMEI of the MS

Foreseen final state of the MS

The MS has a valid TMSI. It is "idle updated" on the cell.

Test Procedure

The SS requests identity information from the MS:

- IMSI in non ciphering mode,
- allocated TMSI in non ciphering mode,

- IMEI in ciphering mode.

Maximum duration of test

30 s.

Expected sequence

Step	Direction	Message	Comments
1	SS -> MS	PAGING REQUEST TYPE 1	Establishment Cause: Answer to paging. "Identity type" IE is IMSI. "Mobile identity" IE specifies the IMSI of the MS. "Identity type" IE is TMSI. "Mobile identity" IE specifies the allocated TMSI of the MS. "Identity type" IE is IMEI. "Mobile identity" IE specifies the IMEI stored in the Mobile Equipment. After the sending of this message, the SS waits for the disconnection of the main signalling link.
2	MS -> SS	CHANNEL REQUEST	
3	SS -> MS	IMMEDIATE ASSIGNMENT	
4	MS -> SS	PAGING RESPONSE	
5	SS -> MS	IDENTITY REQUEST	
6	MS -> SS	IDENTITY RESPONSE	
7	SS -> MS	IDENTITY REQUEST	
8	MS -> SS	IDENTITY RESPONSE	
9	SS -> MS	CIPHERING MODE COMMAND	
10	MS -> SS	CIPHERING MODE COMPLETE	
11	SS -> MS	IDENTITY REQUEST	
12	MS -> SS	IDENTITY RESPONSE	
13	SS -> MS	CHANNEL RELEASE	

Specific message contents:

None.

26.7.3.1.3.2 Identification / test 2

Initial conditions

System Simulator:

1 cell, default values.

Mobile Station:

The MS has a valid TMSI. It is in "idle updated".

Specific PICS statements:

-

PIXIT statements:

- IMEI of the MS
- IMEISV of the MS

Foreseen final state of the MS

The MS has a valid TMSI. It is "idle updated".

Test Procedure

The SS requests identity information from the MS:

- IMEI in non ciphering mode;
- IMEISV in non ciphering mode.

Maximum duration of test

30 s.

Expected sequence

Step	Direction	Message	Comments
1	SS -> MS	PAGING REQUEST TYPE 1	Establishment Cause: Answer to paging. "Identity type" IE is IMEI. "Mobile identity" IE specifies the IMEI of the MS. "Identity type" IE is IMEIS. "Mobile identity" IE specifies the IMEISV of the MS. After the sending of this message, the SS waits for the disconnection of the main signalling link.
2	MS -> SS	CHANNEL REQUEST	
3	SS -> MS	IMMEDIATE ASSIGNMENT	
4	MS -> SS	PAGING RESPONSE	
5	SS -> MS	IDENTITY REQUEST	
6	MS -> SS	IDENTITY RESPONSE	
7	SS -> MS	IDENTITY REQUEST	
8	MS -> SS	IDENTITY RESPONSE	
9	SS -> MS	CHANNEL RELEASE	

Specific message contents:

None.

26.7.3.2 Handling of IMSI shorter than the maximum length

26.7.3.2.1 Conformance requirement

The MS shall be capable of handling an IMSI that is not of the maximum length.

Reference(s)

3GPP TS 04.08 / 3GPP TS 24.008 subclause 10.5.1.4.

26.7.3.2.2 Test purpose

To check that the MS behaves correctly when activated with an IMSI of length less than the maximum length.

In this condition, the MS shall:

- perform location updating;
- answer to paging with IMSI;
- give the correct IMSI when asked by an IDENTITY REQUEST;
- attempt CM connection establishment when requested to;
- attempt call re-establishment when needed;
- attempt IMSI detach when needed;
- erase its TMSI when the IMSI is sent by the network in a LOCATION UPDATING ACCEPT or a TMSI REALLOCATION COMMAND message.

26.7.3.2.3 Method of test

Initial conditions

System Simulator:

1 cell, default values.

IMSI attach/detach bit set to "1".

Mobile Station:

The MS has no valid TMSI.

It is "idle updated".

The IMSI has the value 001011234.

Specific PICS statements:

- On/Off switch (TSPC_Feat_OnOff)

PIXIT statements:

-

Foreseen final state of MS

The MS has no valid TMSI. It is in "idle, updated".

Test Procedure

The MS is paged with its IMSI. The MS shall answer to paging and include the correct IMSI in the PAGING RESPONSE message. During call establishment, the SS asks for the IMSI of the MS. The MS shall answer by an IDENTITY RESPONSE message including the correct IMSI. During the active phase of the call, the SS stops sending valid SACCH frames. The MS performs call re-establishment. The MS shall include the correct IMSI in the CM RE-ESTABLISHMENT message. a TMSI REALLOCATION COMMAND including a TMSI is sent to the MS. The MS acknowledges this message. The call is release.

The MS is paged with its TMSI. The MS shall answer to paging and includes its TMSI in the PAGING RESPONSE message. During call establishment, the SS sends a TMSI REALLOCATION COMMAND including the IMSI to the MS. The MS shall acknowledge this message. The MS shall erase its TMSI. The call is released.

The MS is switched off or has its power source removed. The MS performs IMSI detach. The MS shall include the correct IMSI in the IMSI DETACH INDICATION message.

The MS is switched on or powered on. The MS performs IMSI attach. The MS shall include the correct IMSI in the LOCATION UPDATING REQUEST message. A TMSI is allocated to the MS.

The LAC of the cell is changed. The MS performs location updating. The SS includes the IMSI in the LOCATION UPDATING ACCEPT message.

A mobile originated CM connection is attempted. The MS shall include the correct IMSI in the CM SERVICE REQUEST message.

Maximum duration of test

5 minutes.

Expected sequence

Step	Direction	Message	Comments
1	SS -> MS	PAGING REQUEST TYPE 1	"mobile identity 1" contains IMSI of MS.
2	MS -> SS	CHANNEL REQUEST	Establishment cause: Answer to paging.
3	SS -> MS	IMMEDIATE ASSIGNMENT	
4	MS -> SS	PAGING RESPONSE	"mobile identity" contains the IMSI of the MS.
5	SS -> MS	IDENTITY REQUEST	"identity type" IE is IMSI.
6	MS -> SS	IDENTITY RESPONSE	"mobile identity" IE contains the IMSI of the MS.
7			The call is established using the sequence of the generic terminating call set-up procedure.
8	SS		The SS stops sending valid SACCH frames.
9	MS -> SS	CHANNEL REQUEST	
10	SS -> MS	IMMEDIATE ASSIGNMENT	
11	MS -> SS	CM REESTABLISHMENT REQUEST	"mobile identity" IE contains IMSI of the MS.
12	SS -> MS	TMSI REALLOCATION COMMAND	"mobile identity" contains a TMSI.
13	MS -> SS	TMSI REALLOCATION COMPLETE	
14	SS -> MS	CHANNEL RELEASE	After sending this message, the SS waits for the disconnection of the main signalling link.
15	SS -> MS	PAGING REQUEST TYPE 1	"mobile identity 1" contains TMSI of MS.
16	MS -> SS	CHANNEL REQUEST	Establishment cause: Answer to paging.
17	SS -> MS	IMMEDIATE ASSIGNMENT	
18	MS -> SS	PAGING RESPONSE	"mobile identity" contains the TMSI of the MS.
19	SS -> MS	AUTHENTICATION REQUEST	
20	MS -> SS	AUTHENTICATION RESPONSE	
21	SS -> MS	TMSI REALLOCATION COMMAND	"mobile identity" contains a IMSI of MS.
22	MS -> SS	TMSI REALLOCATION COMPLETE	
23	SS -> MS	CHANNEL RELEASE	
24	MS		If possible (see PICS) the MS is switched off, otherwise the MS has its power source removed.
25	MS -> SS	CHANNEL REQUEST	If the MS was switched off it performs IMSI detach.
26	SS -> MS	IMMEDIATE ASSIGNMENT	
27	MS -> SS	IMSI DETACH INDICATION	"mobile identity" contains IMSI of MS.
28	SS -> MS	CHANNEL RELEASE	
29	MS		The MS is switched on or has power restored.
30	MS -> SS	CHANNEL REQUEST	
31	SS -> MS	IMMEDIATE ASSIGNMENT	
32	MS -> SS	LOCATION UPDATING REQUEST	"mobile identity" contains IMSI of MS.
33	SS -> MS	LOCATION UPDATING ACCEPT	"mobile identity" contains a TMSI.
34	MS -> SS	TMSI REALLOCATION COMPLETE	
35	SS -> MS	CHANNEL RELEASE	
36	SS		The SS changes the LAC of the cell.
37	MS -> SS	CHANNEL REQUEST	Shall be sent within 35s of the LAC being changed.
38	SS -> MS	IMMEDIATE ASSIGNMENT	
39	MS -> SS	LOCATION UPDATING REQUEST	"mobile identity" contains TMSI of the MS.
40	SS -> MS	LOCATION UPDATING ACCEPT	"mobile identity" contains IMSI of the MS.
41	SS -> MS	CHANNEL RELEASE	
42	MS		a mobile originated CM connection is attempted.
43	MS -> SS	CHANNEL REQUEST	
44	SS -> MS	IMMEDIATE ASSIGNMENT	
45	MS -> SS	CM SERVICE REQUEST	"mobile identity" contains IMSI of the MS.
46	SS -> MS	CHANNEL RELEASE	

Specific message contents

None.

26.7.4 Location updating

This procedure is used to register the MS in the network. If it is not performed correctly, no call can be established.

26.7.4.1 Location updating / accepted

26.7.4.1.1 Conformance requirement

1.

1.1 If the network accepts a location updating from the Mobile Station and reallocates a TMSI in the Location Updating Accept message the Mobile Station shall acknowledge the reception of the new TMSI.

1.2 The Mobile Station shall answer to paging with this TMSI and include it in a Paging Response message.

2 If the network accepts a location updating from the Mobile Station and the Location Updating Accept message contains neither TMSI nor IMSI, the Mobile Station shall answer to paging when addressed with the last allocated TMSI and include it in the Paging Response message.

3.

3.1 If the network accepts a location updating from the Mobile Station by use of a Location Updating Accept message containing the IMSI of the Mobile Station, the Mobile Station shall not answer paging with the last allocated TMSI.

3.2 The Mobile Station shall still answer paging with IMSI.

4. A mobile station that supports:

only the GSM 450 band (cf. 3GPP TS 05.05); or

only the GSM 480 band (cf. 3GPP TS 05.05); or

only the GSM 710 band (cf. 3GPP TS 05.05); or

only the GSM 750 band (cf. 3GPP TS 05.05); or

only the T-GSM 810 band (cf. 3GPP TS 05.05); or

only the GSM 850 band (cf. 3GPP TS 05.05); or

only the primary GSM band P-GSM 900 (cf. 3GPP TS 05.05); or

only the DCS 1800 band (cf. 3GPP TS 05.05).

may ignore SYSTEM INFORMATION TYPE 2ter messages ; if it does so it shall assume that the SYSTEM INFORMATION TYPE 2 carries the complete BA, for selection of the cell , where it performs the location updating procedure.

This SYSTEM INFORMATION TYPE 2ter message may be sent by the network with either a L2 pseudo length of 18 or some other value.

See 3GPP TS 04.08 / 3GPP TS 44.018, subclauses 9.1.34 and 3.2.2.1.

Reference(s)

3GPP TS 04.08 / 3GPP TS 24.008 subclause 4.4.4.6.

26.7.4.1.2 Test purpose

1) To test the behaviour of the MS if the network accepts the location updating of the MS.

For the network response three different cases are identified:

1.1) TMSI is allocated;

1.2) Location updating accept contains neither TMSI nor IMSI;

1.3) Location updating accept contains IMSI.

2) To verify that the MS, that supports only the GSM 450 band or only the GSM 480 band or only the GSM 710 or only the GSM 750 or only the T-GSM 810 band or only the GSM 850 band or only the primary GSM900 band or only the DCS1800 band is not disturbed by SYSTEM INFORMATION 2ter messages, with different values of L2pseudolength.

26.7.4.1.3 Method of test

26.7.4.1.3.1 Location Updating/accepted/test1

Initial conditions:

System Simulator:

Two cells, A and B, belonging to different location areas with location area identification a and b of the same PLMN.

IMSI attach/detach is allowed in both cells.

The T3212 time-out value is 1/10 hour in both cells.

Mobile Station:

The MS has a valid TMSI (=TMSI1) and CKSN (=CKSN1). It is "idle updated" on cell A.

Specific PICS statements:

-

PIXIT statements:

-

Foreseen final state of the MS

The MS has no valid TMSI. It has valid CKSN and Kc. It is "idle, updated" on cell B.

Test Procedure

The MS is made to select cell B. A normal location updating with TMSI reallocation is performed in cell B. The channel is released. The SS checks, by paging, that the MS has stored the newly allocated TMSI. The channel is released. The MS is made to select cell A. A normal location updating is performed in cell A. The LOCATION UPDATING ACCEPT message contains neither IMSI nor TMSI. The SS checks, by paging, that the MS has kept the old TMSI. The channel is released. The MS is made to select cell B. A normal location updating is performed in cell B. The LOCATION UPDATING ACCEPT message contains an IMSI. The SS checks, by paging, that the MS has deleted its TMSI and responds to paging with IMSI.

Maximum duration of test

4 minutes.

Expected sequence

Step	Direction	Message	Comments
1	SS		The RF level of cell A is lowered until the MS selects cell B.
2	MS -> SS	CHANNEL REQUEST	"Establishment cause": Location updating.
3	SS -> MS	IMMEDIATE ASSIGNMENT	
4	MS -> SS	LOCATION UPDATING REQUEST	"location updating type" = normal, "CKSN" = CKSN1, "location area identification" = a, "mobile station classmark 1" as given by the PICS and "mobile identity" = TMSI1.
5	SS -> MS	LOCATION UPDATING ACCEPT	"Mobile identity" = new TMSI (=TMSI2), LAI = b.
6	MS -> SS	TMSI REALLOCATION COMPLETE	
7	SS -> MS	CHANNEL RELEASE	After the sending of this message, the SS waits for the disconnection of the main signalling link. The SS waits an amount of time which is enough to guarantee that the MS is in service.
8	SS -> MS	PAGING REQUEST TYPE 1	"Mobile identity" IE contains the new TMSI (= TMSI2).
9	MS -> SS	CHANNEL REQUEST	
10	SS -> MS	IMMEDIATE ASSIGNMENT	
11	MS -> SS	PAGING RESPONSE	"Mobile identity" IE contains the new TMSI (= TMSI2).
12	SS -> MS	CHANNEL RELEASE	After the sending of this message, the SS waits for the disconnection of the main signalling link.
13	SS		The RF level of cell B is lowered until the MS selects cell A.
14	MS -> SS	CHANNEL REQUEST	"Establishment cause": Location updating
15	SS -> MS	IMMEDIATE ASSIGNMENT	
16	MS -> SS	LOCATION UPDATING REQUEST	"location updating type" = normal, "CKSN" = CKSN1, "location area identification" = b, "mobile station classmark 1" as given by the PICS and "mobile identity" = TMSI2.
17	SS -> MS	LOCATION UPDATING ACCEPT	"Mobile identity" IE not included.
18	SS -> MS	CHANNEL RELEASE	After the sending of this message, the SS waits for the disconnection of the main signalling link. The SS waits an amount of time which is enough to guarantee that the MS is in service.
19	SS -> MS	PAGING REQUEST TYPE 1	"Mobile identity" IE contains the TMSI (= TMSI2).
20	MS -> SS	CHANNEL REQUEST	
21	SS -> MS	IMMEDIATE ASSIGNMENT	
22	MS -> SS	PAGING RESPONSE	"Mobile identity" IE contains the TMSI (=TMSI2).
23	SS -> MS	CHANNEL RELEASE	After the sending of this message, the SS waits for the disconnection of the main signalling link.
24	SS		The RF level of cell A is lowered until the MS selects cell B.
25	MS -> SS	CHANNEL REQUEST	"Establishment cause": Location updating.
26	SS -> MS	IMMEDIATE ASSIGNMENT	
27	MS -> SS	LOCATION UPDATING REQUEST	"location updating type" = normal, "CKSN" = CKSN1, "location area identification" = a, "mobile station classmark 1" as given by the PICS and "mobile identity" = TMSI2.
28	SS -> MS	LOCATION UPDATING ACCEPT	"Mobile identity" IE contains IMSI.
29	SS -> MS	CHANNEL RELEASE	After the sending of this message, the SS waits for the disconnection of the main signalling link. The SS waits an amount of time which is enough to guarantee that the MS is in service.
30	SS -> MS	PAGING REQUEST TYPE 1	"Mobile identity" IE contains the old TMSI (= TMSI2).
31	MS		The MS shall ignore this message. This is checked during 5 s.
32	SS -> MS	PAGING REQUEST TYPE 1	"Mobile identity" IE contains the IMSI.
33	MS -> SS	CHANNEL REQUEST	
34	SS -> MS	IMMEDIATE ASSIGNMENT	
35	MS -> SS	PAGING RESPONSE	"Mobile identity" IE contains the IMSI.
36	SS -> MS	CHANNEL RELEASE	After the sending of this message, the SS waits for the disconnection of the main signalling link.

Specific message contents:

None.

26.7.4.1.3.2 Location Updating/accepted/test2

Initial conditions:

System Simulator:

Two cells, A and B, belonging to different location areas with location area identification a and b of the same PLMN.

System information2ter is broadcasted on the two cells (Cell A with L2pseudolength=18, Cell B with L2pseudolength=0) .

IMSI attach/detach is allowed in both cells.

The T3212 time-out value is 1/10 hour in both cells.

Mobile Station:

The MS has a valid TMSI (=TMSI1) and CKSN (=CKSN1). It is "idle updated" on cell A.

Specific PICS statements:

-

PIXIT statements:

-

Foreseen final state of the MS

The MS has no valid TMSI. It has valid CKSN and Kc. It is "idle, updated" on cell B.

Test Procedure

The MS is made to select cell B. A normal location updating with TMSI reallocation is performed in cell B. The channel is released. The SS checks, by paging, that the MS has stored the newly allocated TMSI. The channel is released. The MS is made to select cell A. A normal location updating is performed in cell A. The LOCATION UPDATING ACCEPT message contains neither IMSI nor TMSI. The SS checks, by paging, that the MS has kept the old TMSI. The channel is released. The MS is made to select cell B. A normal location updating is performed in cell B. The LOCATION UPDATING ACCEPT message contains an IMSI. The SS checks, by paging, that the MS has deleted its TMSI and responds to paging with IMSI.

Maximum duration of test

4 minutes.

Expected sequence

Step	Direction	Message	Comments
1	SS		The RF level of cell A is lowered until the MS selects cell B.
2	MS -> SS	CHANNEL REQUEST	"Establishment cause": Location updating.
3	SS -> MS	IMMEDIATE ASSIGNMENT	
4	MS -> SS	LOCATION UPDATING REQUEST	"location updating type" = normal, "CKSN" = CKSN1, "location area identification" = a, "mobile station classmark 1" as given by the PICS and "mobile identity" = TMSI1.
5	SS -> MS	LOCATION UPDATING ACCEPT	"Mobile identity" = new TMSI (=TMSI2), LAI = b.
6	MS -> SS	TMSI REALLOCATION COMPLETE	
7	SS -> MS	CHANNEL RELEASE	After the sending of this message, the SS waits for the disconnection of the main signalling link. The SS waits an amount of time which is enough to guarantee that the MS is in service.
8	SS -> MS	PAGING REQUEST TYPE 1	"Mobile identity" IE contains the new TMSI (= TMSI2).
9	MS -> SS	CHANNEL REQUEST	
10	SS -> MS	IMMEDIATE ASSIGNMENT	
11	MS -> SS	PAGING RESPONSE	"Mobile identity" IE contains the new TMSI (= TMSI2).
12	SS -> MS	CHANNEL RELEASE	After the sending of this message, the SS waits for the disconnection of the main signalling link.
13	SS		The RF level of cell B is lowered until the MS selects cell A.
14	MS -> SS	CHANNEL REQUEST	"Establishment cause": Location updating
15	SS -> MS	IMMEDIATE ASSIGNMENT	
16	MS -> SS	LOCATION UPDATING REQUEST	"location updating type" = normal, "CKSN" = CKSN1, "location area identification" = b, "mobile station classmark 1" as given by the PICS and "mobile identity" = TMSI2.
17	SS -> MS	LOCATION UPDATING ACCEPT	"Mobile identity" IE not included.
18	SS -> MS	CHANNEL RELEASE	After the sending of this message, the SS waits for the disconnection of the main signalling link. The SS waits an amount of time which is enough to guarantee that the MS is in service.
19	SS -> MS	PAGING REQUEST TYPE 1	"Mobile identity" IE contains the TMSI (= TMSI2).
20	MS -> SS	CHANNEL REQUEST	
21	SS -> MS	IMMEDIATE ASSIGNMENT	
22	MS -> SS	PAGING RESPONSE	"Mobile identity" IE contains the TMSI (=TMSI2).
23	SS -> MS	CHANNEL RELEASE	After the sending of this message, the SS waits for the disconnection of the main signalling link.
24	SS		The RF level of cell A is lowered until the MS selects cell B.
25	MS -> SS	CHANNEL REQUEST	"Establishment cause": Location updating.
26	SS -> MS	IMMEDIATE ASSIGNMENT	
27	MS -> SS	LOCATION UPDATING REQUEST	"location updating type" = normal, "CKSN" = CKSN1, "location area identification" = a, "mobile station classmark 1" as given by the PICS and "mobile identity" = TMSI2.
28	SS -> MS	LOCATION UPDATING ACCEPT	"Mobile identity" IE contains IMSI.
29	SS -> MS	CHANNEL RELEASE	After the sending of this message, the SS waits for the disconnection of the main signalling link. The SS waits an amount of time which is enough to guarantee that the MS is in service.
30	SS -> MS	PAGING REQUEST TYPE 1	"Mobile identity" IE contains the old TMSI (= TMSI2).
31	MS		The MS shall ignore this message. This is checked during 5 s.
32	SS -> MS	PAGING REQUEST TYPE 1	"Mobile identity" IE contains the IMSI.
33	MS -> SS	CHANNEL REQUEST	
34	SS -> MS	IMMEDIATE ASSIGNMENT	
35	MS -> SS	PAGING RESPONSE	"Mobile identity" IE contains the IMSI.
36	SS -> MS	CHANNEL RELEASE	After the sending of this message, the SS waits for the disconnection of the main signalling link.

Specific message contents:

SYSTEM INFORMATION TYPE 2ter Cell A :

Information Element	Value/remark
L2 Pseudolength	18
Neighbour Cells Description 2	0
Multiband reporting	
For Cell A	
- Format notation	Range 512
- BA_IND	0
- BCCH Allocation ARFCN	ARFCN 520, 870 (for GSM 400 and GSM 900 tests), ARFCN 43,85 (For GSM 1800 tests) ARFCN 520, 800 (for GSM 710, GSM 750, T-GSM 810 and GSM 850 tests)
SI 2ter rest octets	Not used (All bits set to spare)

SYSTEM INFORMATION TYPE 2ter Cell B :

Information Element	Value/remark
L2 Pseudolength	0
Neighbour Cells Description 2	0
Multiband reporting	
For Cell B	
- Format notation	Range 512
- BA_IND	0
- BCCH Allocation ARFCN	ARFCN 590, 810 (for GSM 400 and GSM 900 tests), ARFCN 44,86 (for GSM 1800 tests), ARFCN 590, 780 (for GSM 710, GSM 750, T-GSM 810 and GSM 850 tests)
SI 2ter rest octets	Not used (All bits set to spare)

SYSTEM INFORMATION TYPE 3 Cell A and cell B:

Same as default content in 26.7.0 except :

Information Element	Value/remark
SI3 rest octets	All bits are set to spare except, System Information 2ter is available
SI 2ter Indicator	

26.7.4.2 Location updating / rejected

26.7.4.2.1 Location updating / rejected / IMSI invalid

26.7.4.2.1.1 Conformance requirement

- 1) If the network rejects a location updating from the Mobile Station with the cause "IMSI unknown in HLR", "Illegal MS" or "Illegal ME" the Mobile Station shall:
 - 1.1 not perform normal location updating;
 - 1.2 not perform periodic location updating;
 - 1.3 not respond to paging with IMSI;
 - 1.4 not respond to paging with TMSI;
 - 1.5 reject any request from CM entity for MM connection other than for emergency call;
 - 1.6 not perform IMSI detach if it is switched off or has its power source removed.

- 2) If the network rejects a location updating from the Mobile Station with the cause "IMSI unknown in HLR", "Illegal MS" or "Illegal ME" the Mobile Station, if it supports speech, shall accept a request for an emergency call by sending a Channel Request message with the establishment cause set to "emergency call" and include an IMEI as mobile identity in the CM SERVICE REQUEST message.
- 3) If the network rejects a location updating from the Mobile Station with the cause "IMSI unknown in HLR", "Illegal MS" or "Illegal ME" the Mobile Station shall delete the stored LAI, CKSN and TMSI.

Reference(s)

3GPP TS 04.08 / 3GPP TS 24.008 subclause 4.4.4.7.

26.7.4.2.1.2 Test purpose

To test the behaviour of the MS if the network rejects the location updating of the MS with the cause "IMSI unknown in HLR", "illegal MS" or "Illegal ME".

26.7.4.2.1.3 Method of test

Initial conditions

System Simulator:

Two cells: A and B, belonging to different location areas of the same PLMN.

IMSI attach/detach is allowed in both cells.

The T3212 time-out value is 1/10 hour in both cells.

Mobile Station:

The MS has valid TMSI, CKSN and Kc. It is "idle updated" on cell A.

Specific PICS statements:

- On/Off switch (TSPC_Feat_OnOff)
- SIM removable without power down (TSPC_AddInfo_SIMRmv)
- Speech supported for Full rate version 1 (GSM FR) (TSPC_AddInfo_Full_rate_version_1)

PIXIT statements:

-

Foreseen final state of the MS

The MS has valid TMSI, CKSN and Kc. It is "idle updated" on cell A.

Test Procedure

The SS rejects a normal location updating with the cause value "IMSI unknown in HLR". The channel is released. The SS checks that the MS has entered the state MM IDLE and the substate NO IMSI, i.e. does not perform normal location updating when a new cell of the same or another PLMN is entered, does not perform periodic updating, does not respond to paging, rejects any requests from CM entities except emergency calls and does not perform IMSI detach if it is switched off or has its power source removed.

The test is repeated with cause value "Illegal MS" and with cause value "Illegal ME".

Maximum duration of test

35 minutes.

Expected sequence

The sequence is executed for execution counter k = 1, 2, 3.

Step	Direction	Message	Comments
1	SS		The following messages are sent and shall be received on cell B.
2	MS -> SS	CHANNEL REQUEST	The RF level of cell A is lowered until the MS selects cell B.
3	SS -> MS	IMMEDIATE ASSIGNMENT	"Establishment cause": Location updating.
4	MS -> SS	LOCATION UPDATING REQUEST	
5	SS -> MS	LOCATION UPDATING REJECT	"Reject cause" IE is "IMSI unknown in HLR" for k = 1, "Illegal MS" for k = 2, "Illegal ME" for k = 3.
6	SS -> MS	CHANNEL RELEASE	After the sending of this message, the SS waits for the disconnection of the main signalling link.
7	SS		The following messages are sent and shall be received on cell A.
8	MS		The RF levels are then changed again to make the MS reselect the cell A.
			The MS performs cell reselection according to procedure as specified in 3GPP TS 05.08 (this however is not checked until step 18). The MS shall not initiate an RR connection establishment on cell A or on cell B.
9	SS		The SS waits at least 7 minutes for a possible periodic updating.
10	MS		The MS shall not initiate an RR connection establishment on cell A or on cell B.
11	SS -> MS	PAGING REQUEST TYPE 1	The MS is paged in cell A. "Mobile identity" IE contains IMSI.
12	MS		The MS shall ignore this message. This is verified during 3 s.
13	SS -> MS	PAGING REQUEST TYPE 1	The MS is paged in cell A. "Mobile identity" IE contains TMSI.
14	MS		The MS shall ignore this message. This is verified during 3 s.
15	MS		A MO CM connection is attempted.
16	MS		The MS shall not initiate an RR connection establishment on cell A or on cell B. This is checked during 3 s.
17	MS		If the MS supports speech (see PICS), it is made to perform an emergency call.
18	MS -> SS	CHANNEL REQUEST	"Establishment cause": Emergency call. This message is sent in cell A.
19	SS -> MS	IMMEDIATE ASSIGNMENT	
20	MS -> SS	CM SERVICE REQUEST	"CM service type": Emergency call establishment. "Mobile identity": type of identity is set to IMEI.
21	SS -> MS	CM SERVICE ACCEPT	
22	MS -> SS	EMERGENCY SETUP	
23	SS -> MS	RELEASE COMPLETE	"Cause" = unassigned number.
24	SS -> MS	CHANNEL RELEASE	After the sending of this message, the SS waits for the disconnection of the main signalling link.
25	MS		If possible (see PICS) SIM detachment is performed.
			Otherwise if possible (see PICS) switch off is performed.
			Otherwise the power is removed.
26	MS		The MS shall not initiate an RR connection establishment on cell A or on cell B. This is checked during 3 s.

Step	Direction	Message	Comments
27	MS		Depending on what has been performed in step 25 the MS is brought back to operation.
28	MS -> SS	CHANNEL REQUEST	"Establishment cause": Location updating.
29	SS -> MS	IMMEDIATE ASSIGNMENT	
30	MS -> SS	LOCATION UPDATING REQUEST	"location updating type" = normal, "CKSN" = no key available, "mobile station classmark 1" as given by the PICS, "Mobile Identity" = IMSI, "LAI" = deleted LAI (the MCC and MNC hold the previous values, the LAC is coded FFFE).
31	SS -> MS	AUTHENTICATION REQUEST	"CKSN" = CKSN1.
32	MS -> SS	AUTHENTICATION RESPONSE	
33	SS -> MS	LOCATION UPDATING ACCEPT	"Mobile Identity" = TMSI.
32	MS -> SS	TMSI REALLOCATION COMPLETE	
33	SS -> MS	CHANNEL RELEASE	After the sending of this message, the SS waits for the disconnection of the main signalling link.

Specific message contents:

None.

26.7.4.2.2 Location updating / rejected / PLMN not allowed

26.7.4.2.2.1 Conformance requirement

- 1) If the network reject a location updating from the Mobile Station with the cause "PLMN not allowed" the Mobile Station shall:
 - 1.1 not perform periodic updating;
 - 1.2 not perform IMSI detach when switched off;
 - 1.3 not perform IMSI attach when switched on in the same location area;
 - 1.4 not perform normal location updating when in the same PLMN and when that PLMN is not selected manually;
 - 1.5 reject any request from CM entity for MM connection other than for emergency call.
- 2) If the network rejects a location updating from the Mobile Station with the cause "PLMN not allowed" the Mobile Station shall:
 - 2.1 perform normal location updating when a new PLMN is entered;
 - 2.2 accept a request for an emergency call, if it supports speech, by sending a Channel Request message with the establishment cause set to "emergency call".
- 3) If the network rejects a location updating from the Mobile Station with the cause "PLMN not allowed" and if after that the PLMN from which this rejection was received, is manually selected, the Mobile Station shall perform a normal location updating procedure.

Reference(s)

3GPP TS 04.08 / 3GPP TS 24.008 subclause 4.4.4.7.

26.7.4.2.2.2 Test purpose

To test the behaviour of the MS if the network rejects the location updating of the MS with the cause "PLMN not allowed".

26.7.4.2.2.3 Method of test

26.7.4.2.2.3.1 Location updating / rejected / PLMN not allowed / test 1

Initial conditions

System Simulator:

One cell: C, belonging to PLMN1.

Two cells: A and B, belonging to different location areas a and b and belonging to PLMN2. PLMN2 is different from HPLMN and from PLMN1.

IMSI attach/detach is allowed in cells A and B but not in cell C.

The T3212 time-out value is 1/10 hour in cells A and B.

Mobile Station:

The MS has a valid TMSI. It is "idle updated" on cell C.

The MS is in manual mode for PLMN selection.

Specific PICS statements:

- On/Off switch (TSPC_Feat_OnOff)
- SIM removable without power down (TSPC_AddInfo_SIMRmv)
- Speech supported for Full rate version 1 (GSM FR) (TSPC_AddInfo_Full_rate_version_1)
- automatically enter automatic selection of PLMN mode (TSPC_AddInfo_AutoAutoMode)

PIXIT statements:

-

Foreseen final state of the MS

The MS has a valid TMSI. It is "idle updated" on cell C. The MS is in automatic mode for PLMN selection.

Test Procedure

The SS rejects a normal location updating with the cause value "PLMN not allowed". The channel is released. The SS checks that the MS does not perform periodic updating, does not perform IMSI detach, does not perform IMSI attach if activated in the same location area, rejects any request for CM connection establishment other than emergency call, accepts a request for an emergency call and performs normal location updating only when a new PLMN is entered.

Maximum duration of test

12 minutes.

Expected sequence

Step	Direction	Message	Comments
1	MS		The following messages are sent and shall be received on cell B.
2	SS		The MS is switched off (or power is removed).
3	MS		The SS activates cells A and B and deactivates cell C. Cell B has a level higher by at least 5 dB than cell A.
4	MS -> SS	CHANNEL REQUEST	The MS is switched on. (or power is reapplied) If necessary the MS is put in manual selection mode. The MS shall offer the new PLMN as available to the user.
5	SS -> MS	IMMEDIATE ASSIGNMENT	The PLMN is manually selected.
6	MS -> SS	LOCATION UPDATING REQUEST	"Establishment cause": Location updating.
7	SS -> MS	LOCATION UPDATING REJECT	"Reject cause" = PLMN not allowed.
8	SS -> MS	CHANNEL RELEASE	After the sending of this message, the SS waits for the disconnection of the main signalling link.
9	SS		The SS waits for a possible periodic updating for 7 minutes.
10	MS		The MS shall not initiate an RR connection establishment on cell A or on cell B.
11	MS		If possible (see PICS) SIM detachment is performed. Otherwise if possible (see PICS) switch off is performed. Otherwise the power is removed.
12	MS		The MS shall not initiate an RR connection establishment on cell A or on cell B. This is checked during 3 s.
13	MS		Depending on what has been performed in step 11 the MS is brought back to operation. The MS is not made to select PLMN 2.
14	MS		The MS shall not initiate an RR connection establishment. This is checked during 3 s.
15	SS		The following message are sent and shall be received on cell A.
16	MS		The RF level of cell B is lowered to make the MS reselect cell A. No access to the network shall be registered by the SS within one minute.
17	MS		If the MS supports speech (see PICS) it is made to perform an emergency.
18	MS -> SS	CHANNEL REQUEST	"Establishment cause": Emergency call.
19	SS -> MS	IMMEDIATE ASSIGNMENT	
20	MS -> SS	CM SERVICE REQUEST	"CM service type" = Emergency call establishment.
21	SS -> MS	CM SERVICE ACCEPT	
22	MS -> SS	EMERGENCY SETUP	
23	SS -> MS	RELEASE COMPLETE	Cause IE: "unassigned number".
24	SS -> MS	CHANNEL RELEASE	After the sending of this message, the SS waits for the disconnection of the main signalling link.
25	MS		A MO CM connection is attempted.
26	MS		The MS shall not initiate an RR connection establishment. This is checked during 3 s.

Step	Direction	Message	Comments
27	MS		The following messages are sent and shall be received on cell C.
28	SS		The MS is switched off.
29	MS		The SS activates cell C and deactivates cells A and B.
30	MS -> SS	CHANNEL REQUEST	The MS is switched on. If necessary the MS is placed into the automatic mode.
31	SS -> MS	IMMEDIATE ASSIGNMENT	"Establishment cause": Location updating.
32	MS -> SS	LOCATION UPDATING REQUEST	"location updating type" = normal, "CKSN" = no key available, "LAI" = deleted LAI (the MCC and MNC hold the values of PLMN1, the LAC is coded FFFE) "mobile identity" = IMSI.
33	SS -> MS	LOCATION UPDATING ACCEPT	"Mobile identity" = TMSI.
34	MS -> SS	TMSI REALLOCATION COMPLETE	
35	SS -> MS	CHANNEL RELEASE	After the sending of this message, the SS waits for the disconnection of the main signalling link.

Specific message contents:

None.

26.7.4.2.2.3.2 Location updating / rejected / PLMN not allowed / test 2

Initial conditions

System Simulator:

One cell C, belonging to PLMN1.

Two cells A and B, belonging to different location areas a and b and belonging to PLMN2. PLMN2 is different from HPLMN.

IMSI attach/detach is allowed in cells A and B but not in cell C.

The T3212 time-out value is 1/10 hour in cells A and B.

Mobile Station:

The MS has a valid TMSI. It is "idle updated" on cell C.

Specific PICS statements:

- On/Off switch (TSPC_Feat_OnOff)
- SIM removable without power down (TSPC_AddInfo_SIMRmv)
- automatically enter automatic selection of PLMN mode (TSPC_AddInfo_AutoAutoMode)

PIXIT statements:

-

Foreseen final state of the MS

The MS has a valid TMSI. It is "idle, updated" on cell C.

The MS is in automatic mode for PLMN selection.

Test Procedure

The SS rejects a normal location updating with the cause value "PLMN not allowed". The channel is released. Then the PLMN from which this rejection was received is manually selected and the SS checks that a normal location updating is performed.

Maximum duration of test

5 minutes.

Expected sequence

Step	Direction	Message	Comments
1	MS		The following messages are sent and shall be received on cell B.
2	SS		The MS is switched off (or power is removed).
3	MS		The SS activates cells A and B and deactivates cell C.
3a	MS		Cell B has a level higher by at least 5 dB than cell A.
4	MS -> SS	CHANNEL REQUEST	The MS is switched on (or power is reapplied).
5	SS -> MS	IMMEDIATE ASSIGNMENT	If the MS is in manual mode, it shall offer the new PLMN as available to the user. In this case the PLMN is manually selected.
6	MS -> SS	LOCATION UPDATING REQUEST	"Establishment cause": Location updating.
7	SS -> MS	LOCATION UPDATING REJECT	"Reject cause" = PLMN not allowed.
8	SS -> MS	CHANNEL RELEASE	After the sending of this message, the SS waits for the disconnection of the main signalling link.
9	MS		The MS is made to search for PLMNs and the PLMN indicated by the SS is manually selected.
10	MS -> SS	CHANNEL REQUEST	"Establishment cause": Location updating.
11	SS -> MS	IMMEDIATE ASSIGNMENT	
12	MS -> SS	LOCATION UPDATING REQUEST	"location updating type" = normal, "CKSN" = no key available, "LAI" = deleted LAI (the MCC and MNC hold the values of PLMN1, the LAC is coded FFFE) "mobile identity" = IMSI.
13	SS -> MS	CHANNEL RELEASE	After the sending of this message, the SS waits for the disconnection of the main signalling link. The following messages are sent and shall be received on cell C.
14	MS		The MS is switched off.
15	SS		The SS activates cell C and deactivates cells A and B.
16	MS		The MS is switched on. If necessary, the MS is put into the automatic mode.
17	MS -> SS	CHANNEL REQUEST	"Establishment cause": Location updating.
18	SS -> MS	IMMEDIATE ASSIGNMENT	
19	MS -> SS	LOCATION UPDATING REQUEST	"location updating type" = normal, "CKSN" = no key available, "LAI" = deleted LAI (the MCC and MNC hold the values of PLMN1, the LAC is coded FFFE) "mobile identity" = IMSI.
20	SS -> MS	LOCATION UPDATING ACCEPT	"Mobile identity" = TMSI.
21	MS -> SS	TMSI REALLOCATION COMPLETE	
22	SS -> MS	CHANNEL RELEASE	After the sending of this message, the SS waits for the disconnection of the main signalling link.

Specific message contents:

None.

26.7.4.2.3 Location updating / rejected / location area not allowed

26.7.4.2.3.1 Conformance requirement

- 1) If the network rejects a location updating from the Mobile Station with the cause "Location Area not allowed" the Mobile Station shall:
 - 1.1 not perform periodic updating;
 - 1.2 not respond to paging with TMSI;
 - 1.3 reject any request from CM entity for MM connection other than for emergency call;

1.4 not perform IMSI detach.

2) If the network rejects a location updating from the Mobile Station with the cause "Location Area not allowed" the Mobile Station shall:

2.1 perform normal location updating when a new location area is entered;

2.2 accept a request for an emergency call, if it supports speech, by sending a Channel Request message with the establishment cause set to "emergency call";

2.3 delete the list of forbidden LAs after switch off (power off).

Reference(s)

3GPP TS 04.08 / 3GPP TS 24.008 subclause 4.4.4.7.

26.7.4.2.3.2 Test purpose

To test the behaviour of the MS if the network rejects the location updating of the MS with the cause "Location Area not allowed".

To test that the MS deletes the list of forbidden LAs after switch off (power off).

26.7.4.2.3.3 Method of test

Initial conditions

System Simulator:

Two cells: A and B, belonging to different location areas a and b.

IMSI attach/detach is allowed in both cells.

The T3212 time-out value is 1/10 hour in both cells.

Mobile Station:

The MS has a valid TMSI. It is "idle updated" on cell A.

Specific PICS statements:

- On/Off switch (TSPC_Feat_OnOff)
- Speech supported for Full rate version 1 (GSM FR) (TSPC_AddInfo_Full_rate_version_1)

PIXIT statements:

- Method to clear the list of forbidden location areas periodically

Foreseen final state of the MS

The MS has a valid TMSI. It is "idle updated" on cell A.

Test Procedure

The SS rejects a normal location updating with the cause value "Location Area not allowed". The channel is released. The SS checks that the MS does not perform periodic updating, does not respond to paging with TMSI, rejects any requests from CM entities for MM-connections except emergency calls, does not perform IMSI detach, performs normal location updating when a new location area is entered and deletes the list of forbidden LAs when switched off.

Different types of MS may use different methods to periodically clear the list of forbidden location areas (e.g. every day at 12am). If the list is cleared while the test is being run, it may be necessary to re-run the test.

Maximum duration of test

12 minutes.

Expected sequence

Step	Direction	Message	Comments
1	SS		The following messages are sent and shall be received on cell B.
2	MS -> SS	CHANNEL REQUEST	The RF level of cell A is lowered so that cell B is selected, while keeping the C1 and C2 of cell A greater than 10.
3	SS -> MS	IMMEDIATE ASSIGNMENT	"Establishment cause": Location updating.
4	MS -> SS	LOCATION UPDATING REQUEST	
5	SS -> MS	LOCATION UPDATING REJECT	"Reject cause" = "Location Area not allowed".
6	SS -> MS	CHANNEL RELEASE	After the sending of this message, the SS waits for the disconnection of the mainsignalling link. The SS waits for a possible location updating for 7 minutes.
7	SS		SS waits for a possible location updating for 7 minutes.
8	MS		The MS shall not initiate an RR-connection establishment either on cell A or cell B.
9	SS -> MS	PAGING REQUEST TYPE 1	The MS is paged in cell B. "Mobile identity" = TMSI.
10	MS		The MS shall ignore this message. This is checked during 3 s.
11	MS		A MO CM connection is attempted.
12	MS		The MS shall not initiate an RR connection establishment on cell A or cell B. This is checked during 3 s.
13	MS		If the MS supports speech (see PICS), it is made to perform an emergency call.
14	MS -> SS	CHANNEL REQUEST	"Establishment cause": Emergency call.
15	SS -> MS	IMMEDIATE ASSIGNMENT	
16	MS -> SS	CM SERVICE REQUEST	"CM service type": Emergency call establishment.
17	SS -> MS	CM SERVICE ACCEPT	
18	MS -> SS	EMERGENCY SETUP	
19	SS -> MS	RELEASE COMPLETE	Cause: "unassigned number".
20	SS -> MS	CHANNEL RELEASE	After the sending of this message, the SS waits for the disconnection of the main signalling link.
21	MS		If possible (see PICS) switch off is performed. Otherwise the power is removed.
22	MS		The MS shall not initiate an RR connection establishment on cell A or on cell B (check for IMSI detach) This is checked during 3 s.
23	MS		Depending on what has been performed in step 21 the MS is brought back to operation.
24	MS -> SS	CHANNEL REQUEST	"Establishment cause": Location updating.
25	SS -> MS	IMMEDIATE ASSIGNMENT	
26	MS -> SS	LOCATION UPDATING REQUEST	"location updating type" = normal, "CKSN" = no key available, "LAI" = deleted LAI, "mobile identity" = IMSI (This checks the deletion of the forbidden lists)
27	SS -> MS	LOCATION UPDATING REJECT	"Reject cause" = "Location Area not allowed".
28	SS -> MS	CHANNEL RELEASE	After the sending of this message, the SS waits for the disconnection of the main signalling link. The following messages are sent and shall be received on cell A.
29	SS		The RF level of cell B is lowered until the MS selects cell A.
30	MS -> SS	CHANNEL REQUEST	"Establishment cause": Location updating.
31	SS -> MS	IMMEDIATE ASSIGNMENT	
32	MS -> SS	LOCATION UPDATING REQUEST	
33	SS -> MS	AUTHENTICATION REQUEST	
34	MS -> SS	AUTHENTICATION RESPONSE	
35	SS -> MS	LOCATION UPDATING ACCEPT	Mobile identity = TMSI.
36	MS -> SS	TMSI REALLOCATION COMPLETE	
37	SS -> MS	CHANNEL RELEASE	After the sending of this message, the SS waits for the disconnection of the main signalling link.

Specific message contents:

None.

26.7.4.2.4 Location updating / rejected / roaming not allowed in this location area

26.7.4.2.4.1 Conformance requirement

- 1) If the network rejects a location updating from the Mobile Station with the cause "Roaming not allowed in this area" the Mobile Station shall:
 - 1.1 not perform periodic updating;
 - 1.2 not respond to paging with TMSI;
 - 1.3 reject any request from CM entity for MM connection other than for emergency call;
 - 1.4 not perform IMSI detach.
- 2) If the network rejects a location updating from the Mobile Station with the cause "Roaming not allowed in this area" the Mobile Station shall:
 - 2.1 perform normal location updating when a new location area is entered;
 - 2.2 accept a request for an emergency call, if it supports speech, by sending a Channel Request message with the establishment cause set to "emergency call";
 - 2.3 periodically search for its HPLMN.
- 3) The mobile station shall reset the list of "Forbidden location areas for roaming" when it is switched off or has its power source removed or when the SIM is removed.
- 4) The MS shall be capable of storing at least 6 entries in the list of "Forbidden location areas for roaming".

Reference(s)

3GPP TS 04.08 / 3GPP TS 24.008 subclause 4.4.4.7.

26.7.4.2.4.2 Test purposes

Test purpose 1

To test that on receipt of a rejection using the Roaming cause code, the MS ceases trying to update on that cell, that this situation continues for at least one periodic location interval period, and that the corresponding list is re-set by switching off the MS or removing its power source.

Test purpose 2

To test that if no cell is available, the MS does not answer to paging with TMSI, rejects a request from CM entity other than for emergency calls.

Test purpose 3

To test that at least 6 entries can be held in the list of "forbidden location areas for roaming" (the requirement in 3GPP TS 04.08 / 3GPP TS 24.008 is to store at least 10 entries. This is not fully tested by the third procedure).

Test purpose 4

To test that if a cell of the Home PLMN is available then the MS returns to it in preference to any other available cell.

Test purpose 5

To test that if the SIM is removed the list of "forbidden location areas for roaming" is cleared.

26.7.4.2.4.3 Method of test

Initial conditions

The initial conditions shall be met before each of the different procedures.

System Simulator:

For procedures 1, 2, 3 and 5: Two cells A and B, belonging to different location areas of the same PLMN with LAI a and b. The MCC of that PLMN is the same as that of the HPLMN. The MNC of that PLMN is different from that of the HPLMN.

For procedure 4: three cells A, B, C of the same PLMN which is not the HPLMN with 3 different location area codes. Cells should differ in signal strength by 10 dB with cell A being the strongest and cell C the weakest. There should be a 20 dB range between A and C. A should be set to a level of - 40 dBm.

IMSI attach/detach is allowed in every cell.

The T3212 time-out value is 1/10 hour in every cell.

Mobile Station:

Procedures 1, 2, 3 and 5: The MS has valid TMSI, CKSN and Kc. It is "idle updated" on cell B.

Procedure 4: The MS has valid TMSI, CKSN and Kc. It is "idle updated" on cell A.

The list of "forbidden location areas for roaming" shall be empty (this may be achieved by either removing the SIM or switching the MS OFF then ON or removing the MS power source depending on PICS).

Specific PICS statements:

- On/Off switch (TSPC_Feat_OnOff)
- automatically enter automatic selection of PLMN mode (TSPC_AddInfo_AutoAutoMode)
- Speech supported for Full rate version 1 (GSM FR) (TSPC_AddInfo_Full_rate_version_1)

PIXIT statements:

- Method to clear the list of location areas for roaming periodically

Foreseen final state of the MS

Procedures 1 and 5: The MS has no valid TMSI and no CKSN. It is "idle updated" on cell A.

Procedure 2 and 3: The MS has no valid TMSI and no CKSN. It is in the "limited service" state on cell A.

Procedure 4: The MS has no valid TMSI and no CKSN. It is "idle updated" on cell C.

Test Procedures

Procedure 1:

The SS rejects a normal location updating with the cause value "Roaming not allowed in this area". The channel is released. The SS checks that the MS does not perform periodic location updating procedure. The MS is turned off and then on. The SS checks that the MS performs location updating on the cell on which its location update request had been rejected (this checks that the LA is not the forbidden list after switch on). This procedure is performed another time but the deletion of the list is checked while removing the SIM (instead of turning off the MS).

Procedure 2:

The SS rejects a normal location updating with the cause value "Roaming not allowed in this area". The channel is released. The SS checks that the MS does not answer to a paging message with TMSI, rejects a request from CM entity but supports an emergency call.

Procedure 3:

The SS rejects a normal location updating with the cause value "Roaming not allowed in this area". This is done for 6 different location areas. Then the SS checks that the MS does not attempt to begin a location updating procedure on the non-allowed location areas.

Procedure 4:

The SS accepts a periodic location updating on a cell not belonging to the HPLMN. Then when the MS attempts to perform a periodic location updating to this cell, the SS rejects this location updating with the cause value "Roaming not allowed in this area". Two cells are then available, one belonging to the HPLMN but with the weakest level. It is checked that the MS returns to its HPLMN.

Procedure 5: If SIM removal is possible while MS is powered:

The SS rejects a normal location updating with the cause value "Roaming not allowed in this area". The channel is released. The SS checks that the MS does not perform periodic location updating procedure. The SIM is removed and inserted in the MS. The SS checks that the MS performs location updating on the cell on which its location update request had been rejected (this checks that the LA is not the forbidden list after switch on).

Different types of MS may use different methods to periodically clear the list of forbidden areas (e.g. every day at 12am) for roaming. If the list is cleared while the test is being run, it may be necessary to re-run the test.

Maximum duration of test

Procedures 1 and 5: 12 minutes each.

Procedure 2: 6 minutes.

Procedure 3: 17 minutes.

Procedure 4: 16 minutes.

Expected sequence

The following procedure is used during the test:

Change_LAI (x):

- The purpose of this procedure is to change the value of Location Area Identifier of cell x.
- The Location Area Identifier of cell x shall be changed. The code shall be chosen arbitrarily but shall be different from any previously used in this procedure. The code shall have the same MCC as the Home PLMN and shall not have the same MNC as the Home PLMN.

Procedure 1

Step	Direction	Message	Comments
1	SS		The following messages are sent and shall be received on cell A. The RF level of cell B is lowered until cell B is no more suitable and the MS selects cell A. "Establishment cause": Location updating.
2	MS -> SS	CHANNEL REQUEST	
3	SS -> MS	IMMEDIATE ASSIGNMENT	
4	MS -> SS	LOCATION UPDATING REQUEST	
5	SS -> MS	LOCATION UPDATING REJECT	"Reject cause" IE is "Roaming not allowed in this location area".
6	SS -> MS	CHANNEL RELEASE	After the sending of this message, the SS waits for the disconnection of the main signalling link.
7	SS		The SS waits at least 7 minutes for a possible location updating.
8	MS		The MS shall not initiate an RR connection establishment on cell A or on cell B.
9	MS		If possible (see PICS) the MS is switched off. Otherwise if possible the power is removed.
10	MS		Depending on what has been performed in step 9 the MS is brought back to operation and placed in a automatic mode.
11	MS -> SS	CHANNEL REQUEST	"Establishment cause": Location updating.
12	SS -> MS	IMMEDIATE ASSIGNMENT	
13	MS -> SS	LOCATION UPDATING REQUEST	Location Updating Type = normal.
14	SS -> MS	LOCATION UPDATING ACCEPT	IE Mobile Identity not present.
15	SS -> MS	CHANNEL RELEASE	After the sending of this message, the SS waits for the disconnection of the main signalling link.

Procedure 2

Step	Direction	Message	Comments
1	SS		The following messages are sent and shall be received on cell A.
2	MS -> SS	CHANNEL REQUEST	The RF level of cell B is lowered until the MS selects cell A. The level of cell B shall be such that cell B is suitable for cell selection.
3	SS -> MS	IMMEDIATE ASSIGNMENT	"Establishment cause": Location updating This message is sent on cell A.
4	MS -> SS	LOCATION UPDATING REQUEST	
5	SS -> MS	LOCATION UPDATING REJECT	"Reject cause" IE is "Roaming not allowed in this location area".
6	SS -> MS	CHANNEL RELEASE	After the sending of this message, the SS waits for the disconnection of the main signalling link.
7	MS -> SS	CHANNEL REQUEST	The following messages are sent and shall be received on cell B.
8	SS -> MS	IMMEDIATE ASSIGNMENT	"Establishment cause": Location updating.
9	MS -> SS	LOCATION UPDATING REQUEST	
10	SS -> MS	LOCATION UPDATING REJECT	"Reject cause" IE is "Roaming not allowed in this location area".
11	SS -> MS	CHANNEL RELEASE	After the sending of this message, the SS waits for the disconnection of the main signalling link.
12	SS		The SS waits for a possible location updating procedure on both cells A and B for 2 minutes.
13	MS		The MS shall not initiate an RR connection establishment on cell A or on cell B within 2 minutes after the end of step 11.
14	SS -> MS	PAGING REQUEST TYPE 1	"Mobile identity" = TMSI. This message is sent on cell A and on cell B.
15	MS		The MS shall not initiate an RR connection on cell A or on cell B. This is checked during 3 s.
16	MS		A MO CM connection is attempted.
17	MS		The MS shall not initiate an RR connection establishment on cell A or on cell B. This is checked during 3 s.
18	MS		The following messages are sent and shall be received on cell A Steps 20 to 27 are performed if the MS supports speech.
19	MS -> SS	CHANNEL REQUEST	An emergency call is attempted.
20	SS -> MS	IMMEDIATE ASSIGNMENT	"Establishment cause":
21	MS -> SS	CM SERVICE REQUEST	"CM service type": Emergency call establishment.
22	SS -> MS	CM SERVICE ACCEPT	
23	MS -> SS	EMERGENCY SETUP	
24	SS -> MS	RELEASE COMPLETE	"Cause" = unassigned number.
25	SS -> MS	CHANNEL RELEASE	After the sending of this message, the SS waits for the disconnection of the main signalling link.

Procedure 3

Step	Direction	Message	Comments
1	SS		The following messages are sent and shall be received on cell A The RF level of cell B is lowered until the MS selects cell A. The level of cell B shall be such that cell B is suitable for cell selection.
2	MS -> SS	CHANNEL REQUEST	"Establishment cause": Location updating.
3	SS -> MS	IMMEDIATE ASSIGNMENT	
4	MS -> SS	LOCATION UPDATING REQUEST	
5	SS -> MS	LOCATION UPDATING REJECT	"Reject cause" IE is "Roaming not allowed in this location area".
6	SS -> MS	CHANNEL RELEASE	After the sending of this message, the SS waits for the disconnection of the main signalling link.
9	MS -> SS	CHANNEL REQUEST	The following messages are sent and shall be received on cell B. "Establishment cause": Location updating.
10	SS -> MS	IMMEDIATE ASSIGNMENT	
11	MS -> SS	LOCATION UPDATING REQUEST	
12	SS -> MS	LOCATION UPDATING REJECT	"Reject cause" IE is "Roaming not allowed in this location area".
13	SS -> MS	CHANNEL RELEASE	After the sending of this message, the SS waits for the disconnection of the main signalling link.
14	SS		Change_LAI (A) within 5 s after step 12.
17	MS -> SS	CHANNEL REQUEST	The following messages are sent and shall be received on cell A. "Establishment cause": Location updating.
18	SS -> MS	IMMEDIATE ASSIGNMENT	
19	MS -> SS	LOCATION UPDATING REQUEST	
20	SS -> MS	LOCATION UPDATING REJECT	"Reject cause" IE is "Roaming not allowed in this location area".
21	SS -> MS	CHANNEL RELEASE	After the sending of this message, the SS waits for the disconnection of the main signalling link.
22	SS		Change_LAI (B) within 5 s after step 20.
25	MS -> SS	CHANNEL REQUEST	The following messages are sent and shall be received on cell B. "Establishment cause": Location updating.
26	SS -> MS	IMMEDIATE ASSIGNMENT	
27	MS -> SS	LOCATION UPDATING REQUEST	
28	SS -> MS	LOCATION UPDATING REJECT	"Reject cause" IE is "Roaming not allowed in this location area".
29	SS -> MS	CHANNEL RELEASE	After the sending of this message, the SS waits for the disconnection of the main signalling link.
30	SS		Change_LAI (A) within 5 s after step 28.
33	MS -> SS	CHANNEL REQUEST	The following messages are sent and shall be received on cell A. "Establishment cause": Location updating.
34	SS -> MS	IMMEDIATE ASSIGNMENT	
35	MS -> SS	LOCATION UPDATING REQUEST	
36	SS -> MS	LOCATION UPDATING REJECT	"Reject cause" IE is "Roaming not allowed in this location area".
37	SS -> MS	CHANNEL RELEASE	After the sending of this message, the SS waits for the disconnection of the main signalling link.
38	SS		Change_LAI (B) within 5 s after step 36.

Step	Direction	Message	Comments
41	MS -> SS	CHANNEL REQUEST	<p>The following messages are sent and shall be received on cell B.</p> <p>"Establishment cause": Location updating.</p> <p>"Reject cause" IE is "Roaming not allowed in this location area".</p> <p>After the sending of this message, the SS waits for the disconnection of the main signalling link.</p> <p>The SS waits for a possible location updating procedure on both cells A and B for 7 minutes.</p> <p>The MS shall not initiate an RR connection establishment on cell A or on cell B within 7 minutes after the end of step 45.</p>
42	SS -> MS	IMMEDIATE ASSIGNMENT	
43	MS -> SS	LOCATION UPDATING REQUEST	
44	SS -> MS	LOCATION UPDATING REJECT	
45	SS -> MS	CHANNEL RELEASE	
46	SS		
47	MS		

Procedure 4

Step	Direction	Message	Comments
1	SS		<p>The following messages are sent and shall be received on cell A.</p> <p>The SS waits for a periodic location updating procedure on cell A for 7 minutes after the initial conditions have been established.</p>
2	MS -> SS	CHANNEL REQUEST	<p>"Establishment cause": Location updating.</p>
3	SS -> MS	IMMEDIATE ASSIGNMENT	
4	MS -> SS	LOCATION UPDATING REQUEST	Location Updating Type = periodic.
5	SS -> MS	LOCATION UPDATING ACCEPT	IE Mobile Identity not present.
6	SS -> MS	CHANNEL RELEASE	<p>After the sending of this message, the SS waits for the disconnection of the main signalling link.</p> <p>The location area identity of cell C shall be changed to that of a location area in the Home PLMN.</p>
7	SS		The SS waits for a periodic location updating procedure on cell A for 7 minutes.
8	SS		
9	MS -> SS	CHANNEL REQUEST	"Establishment cause": Location updating This message is sent on cell A within 7 minutes after the end of step 6.
10	SS -> MS	IMMEDIATE ASSIGNMENT	<p>"Location updating type" = periodic.</p>
11	MS -> SS	LOCATION UPDATING REQUEST	
12	SS -> MS	LOCATION UPDATING REJECT	"Reject cause" IE is "Roaming not allowed in this location area".
13	SS -> MS	CHANNEL RELEASE	<p>After the sending of this message, the SS waits for the disconnection of the main signalling link.</p>
16	MS -> SS	CHANNEL REQUEST	<p>The following messages are sent and shall be received on cell C.</p> <p>"Establishment cause": Location updating.</p> <p>IE Mobile Identity not present.</p> <p>After the sending of this message, the SS waits for the disconnection of the main signalling link.</p>
17	SS -> MS	IMMEDIATE ASSIGNMENT	
18	MS -> SS	LOCATION UPDATING REQUEST	
19	SS -> MS	LOCATION UPDATING ACCEPT	
20	SS -> MS	CHANNEL RELEASE	

Procedure 5

Step	Direction	Message	Comments
1	SS		The following messages are sent and shall be received on cell A. The RF level of cell B is lowered until cell B is no longer suitable and the MS selects cell A. "Establishment cause": Location updating.
2	MS -> SS	CHANNEL REQUEST	
3	SS -> MS	IMMEDIATE ASSIGNMENT	
4	MS -> SS	LOCATION UPDATING REQUEST	
5	SS -> MS	LOCATION UPDATING REJECT	"Reject cause" IE is "Roaming not allowed in this location area".
6	SS -> MS	CHANNEL RELEASE	After the sending of this message, the SS waits for the disconnection of the main signalling link.
7	SS		The SS waits at least 7 minutes for a possible location updating.
8	MS		The MS shall not initiate an RR connection establishment on cell A or on cell B.
9	MS		The SIM is removed.
10	MS		The SIM is inserted into the ME.
11	MS -> SS	CHANNEL REQUEST	"Establishment cause": Location updating.
12	SS -> MS	IMMEDIATE ASSIGNMENT	
13	MS -> SS	LOCATION UPDATING REQUEST	Location Updating Type = normal.
14	SS -> MS	LOCATION UPDATING ACCEPT	IE Mobile Identity not present.
15	SS -> MS	CHANNEL RELEASE	After the sending of this message, the SS waits for the disconnection of the main signalling link.

Specific message contents:

None.

26.7.4.3 Location updating / abnormal cases

26.7.4.3.1 Location updating / abnormal cases / random access fails

26.7.4.3.1.1 Conformance requirement

If during the RR connection establishment phase of a normal location updating procedure, channel requests are not answered by the network, the Mobile Station shall:

1. send (Max-Retrans+1) Channel Request messages;
2. not try to establish a connection during a period of T3213;
3. then perform a normal location updating procedure as it is still necessary;
4. not repeat the complete procedure if the original cause of the location updating procedure has disappeared.

Reference(s):

3GPP TS 04.08 / 3GPP TS 24.008 subclause 4.4.4.9 and 3GPP TS 05.08 subclause 6.6.2.

26.7.4.3.1.2 Test purpose

To verify that when during the RR connection establishment phase of a location updating procedure, channel requests are not answered by the network, after expiry of T3213 (= 4s in Phase 2) and when the cell reselection procedure is finished the complete procedure is repeated if still necessary.

26.7.4.3.1.3 Method of test

Initial conditions

System Simulator:

Two cells: A and B of the same PLMN, belonging to different location areas with LAI a and b.

The RF power level of cell B is higher than the one of cell A.

IMSI attach/detach is not allowed in both cells.

The T3212 time-out value is set to infinite in both cells.

Mobile Station:

The MS has a valid TMSI, CKSN and Kc. It is "Idle updated" on cell B.

Specific PICS statements:

-

PIXIT statements:

-

Foreseen final state of the MS

The MS is "Idle updated" on cell A.

Test Procedure

The SS causes a random access failure in the MS during a normal location updating procedure. After the expiry of T3213 and when the cell reselection procedure is finished the MS will try to restart the normal location updating procedure.

The test is repeated but the original cause of the location updating procedure has disappeared. The SS then checks that the MS will not restart the location updating procedure.

Maximum duration of test

1 minute.

Expected sequence

Step	Direction	Message	Comments
1	MS		The following messages are sent and shall be received on cell A. The RF level of cell B is lowered until the MS selects cell A. The RF level of cell B is set sufficiently low to ensure that cell B is not suitable as defined in 3GPP TS 05.08 subclause 6.6.2..
2	MS -> SS	CHANNEL REQUEST	Establishment cause: Location updating. This message is sent by the MS (Max_Retrans + 1) times.
3	SS		The SS waits for 4 seconds.
4	MS		The MS shall not send any layer 3 message during this time.
5	MS -> SS	CHANNEL REQUEST	Establishment cause: Location updating. The time difference between this message and the last CHANNEL REQUEST sent in step 2 shall be in the range 4 s - 9 s.
6	SS -> MS	IMMEDIATE ASSIGNMENT	
7	MS -> SS	LOCATION UPDATING REQUEST	location updating type = normal, CKSN = initial value, LAI = b, mobile station classmark 1 and mobile identity = TMSI.
8	SS -> MS	LOCATION UPDATING ACCEPT	Optional IE Mobile Identity not included
9	SS -> MS	CHANNEL RELEASE	After the sending of this message, the SS waits for the disconnection of the main signalling link.
10	SS		The RF level of cell B is set to the same value as for cell A.
11	SS		The RF level of cell A is lowered until the MS selects cell B. The RF level of cell A is kept sufficiently high to ensure that cell A is still suitable as defined in 3GPP TS 05.08 subclause 6.6.2.
12	MS -> SS	CHANNEL REQUEST	The following messages are sent and shall be received on cell B. Establishment cause: Location updating. This message is sent by the MS (Max_Retrans + 1) times.
13	SS		Immediately after the end of step 12 the RF level of cell A is set to the same value as for cell B.
14	MS		The MS shall not initiate an RR connection establishment on cell A or on cell B. This is checked during 15 s.

Specific message contents:

None.

26.7.4.3.2 Location updating / abnormal cases / attempt counter less or equal to 4, LAI different

26.7.4.3.2.1 Conformance requirement

- 1) When a failure such as cases d), f) and g) of subclause 4.4.4.9 of 3GPP TS 04.08 / 3GPP TS 24.008 has occurred during a normal location updating procedure, if the attempt counter is smaller than 4 and after expiry of T3211, the Mobile Station shall resend its Location Updating Request message with the Mobile Identity IE set to its IMSI, CKSN IE set to "no key is available" and the Location Updating type set to "normal location updating".
- 2) When a failure such as cases d), f) and g) of subclause 4.4.4.9 of 3GPP TS 04.08 / 3GPP TS 24.008 has occurred during a normal location updating procedure the Mobile Station shall:
 - 2.1 not answer to paging with the previously allocated TMSI;
 - 2.2 not perform the IMSI detach procedure, when switched off.

- 3) When a failure such as case e) of subclause 4.4.4.9 of 3GPP TS 04.08 / 3GPP TS 24.008 has occurred during a normal location updating procedure and when an emergency call establishment is requested by the user the Mobile Station, if it supports speech, shall send a CM Service Request message with CM Service Type IE set to "emergency call establishment", CKSN IE set to "no key available" and Mobile Identity IE set to its IMSI and after acceptance by the network it shall send an Emergency Setup message.
- 4) When a failure such as cases d), f) and g) of subclause 4.4.4.9 of 3GPP TS 04.08 / 3GPP TS 24.008 has occurred during a normal location updating procedure the Mobile Station shall use a request from CM entity other than emergency call as a trigger for a normal location updating procedure and shall send a Location Updating Request message with the Mobile Identity IE set to its IMSI, CKSN IE set to "no key is available" and the Location Updating type IE set to "normal location updating".
- 5) When a failure such as cases d), f) and g) of subclause 4.4.4.9 of 3GPP TS 04.08 / 3GPP TS 24.008 has occurred during a normal location updating procedure the Mobile Station shall answer to paging with IMSI and shall send a Paging Response message with CKSN IE set to "no key available" and Mobile Identity IE set to its IMSI.
- 6) When a failure such as cases d), f) and g) of subclause 4.4.4.9 of 3GPP TS 04.08 / 3GPP TS 24.008 has occurred during a normal location updating procedure the Mobile Station shall perform a normal location updating procedure as soon as it enters a new cell.

References

3GPP TS 04.08 / 3GPP TS 24.008 subclauses 4.4.4.2 and 4.4.4.9 and in 3GPP TS 05.08 subclause 6.6.2.

26.7.4.3.2.2 Test purpose

To verify that the MS performs normal location updating procedures when its attempt counter is smaller than 4.

To check that the MS does not perform the IMSI detach procedure when "idle not updated".

To verify that when "idle not updated" the MS can perform an emergency call.

To verify that when "idle not updated" the MS uses requests from CM layer other than emergency call as triggering of a normal location updating procedure.

To verify that the MS performs a normal location updating procedure if it enters a new cell while being "idle not updated".

26.7.4.3.2.3 Method of test

Initial conditions

System Simulator:

Two cells: A and B of the same PLMN, belonging to different location areas with LAI a and b.

ATT flag shall be set to IMSI attach/detach allowed.

Mobile Station:

The MS is "idle updated" on cell A. A valid CKSN value is stored in the SIM and is noted "initial CKSN". A TMSI is allocated.

Specific PICS statements:

- On/Off switch (TSPC_Feat_OnOff)
- SIM removable without power down (TSPC_AddInfo_SIMRmv)
- Speech supported for Full rate version 1 (GSM FR) (TSPC_AddInfo_Full_rate_version_1)

PIXIT statements:

-

Foreseen final state of the MS

The MS is "Idle updated" on cell A with a valid CKSN and a TMSI.

Test Procedure

The MS is made to perform a normal location updating procedure. Four types of failure cases are triggered:

- sending of a Location Updating Reject with cause #17;
- RR-connection failure (case d);
- sending of a CHANNEL RELEASE message before the normal end of the procedure (case f);
- T3210 time-out (case e).

As there is no stored LAI or the stored LAI is different from the broadcast LAI, and the attempt counter in the MS shall be lower than 4, the MS enters the state MM IDLE and substate ATTEMPTING TO UPDATE and waits for T3211 seconds before trying again a location updating procedure.

Then the behaviour of the MS in the MM IDLE ATTEMPTING TO UPDATE SERVICE state is checked, that is:

- not answer to paging with TMSI;
- not perform an IMSI detach procedure;
- support request for emergency call;
- use requests from CM layer other than emergency call as triggering of a normal location updating procedure;
- perform normal location updating procedure when a new cell is entered.

Maximum duration of test

9 minutes.

Expected sequence

Step	Direction	Message	Comments
The following messages are sent and shall be received on cell B.			
1	MS		The RF level of cell A is lowered until the MS selects cell B. The RF level of cell A is set sufficiently low to ensure that cell A is not suitable as defined in 3GPP TS 05.08 subclause 6.6.2.
2	MS -> SS	CHANNEL REQUEST	Establishment cause: Location updating.
3	SS -> MS	IMMEDIATE ASSIGNMENT	
4	MS -> SS	LOCATION UPDATING REQUEST	location updating type = normal, CKSN = initial value, LAI = a, mobile station classmark 1 as given by the PICS and mobile identity = TMSI.
5	SS -> MS	LOCATION UPDATING REJECT	IE Reject cause is set to a value #17.
6	SS -> MS	CHANNEL RELEASE	After the sending of this message, the SS waits for the disconnection of the main signalling link.
7	MS		The MS shall not initiate an RR connection establishment on cell A or on cell B during T3211 seconds at least after the channel release.
8	MS -> SS	CHANNEL REQUEST	Establishment cause: Location updating.
9	SS -> MS	IMMEDIATE ASSIGNMENT	
10	MS -> SS	LOCATION UPDATING REQUEST	location updating type = normal, CKSN = no key available, LAI = deleted LAI (the MCC and MNC hold the previous values, the LAC is coded FFFE), Mobile Identity = IMSI.
11	SS		The SS deactivates the SACCH on the dedicated channel. The SS waits until there are no more SACCH frames in the uplink direction. This release connection is done within 8 SACCH frames.
12	MS		The MS shall not initiate an RR connection establishment on cell A or on cell B within T3211 + RadioLinkTimeout after the SS deactivates the SACCH.
13	MS -> SS	CHANNEL REQUEST	Establishment cause: Location updating.
14	SS -> MS	IMMEDIATE ASSIGNMENT	
15	MS -> SS	LOCATION UPDATING REQUEST	location updating type = normal, CKSN = no key available, LAI = deleted LAI (the MCC and MNC hold the previous values, the LAC is coded FFFE), Mobile Identity = IMSI.
16	SS -> MS	CHANNEL RELEASE	After the sending of this message, the SS waits for the disconnection of the main signalling link.
17	MS		The MS shall not initiate an RR connection establishment on cell A or on cell B during T3211 seconds at least after the channel release.
18	MS -> SS	CHANNEL REQUEST	Establishment cause: Location updating.
19	SS -> MS	IMMEDIATE ASSIGNMENT	
20	MS -> SS	LOCATION UPDATING REQUEST	location updating type = normal, CKSN = no key available, LAI = deleted LAI (the MCC and MNC hold the previous values, the LAC is coded FFFE), Mobile Identity = IMSI.
21	SS -> MS	AUTHENTICATION REQUEST	CKSN = initial CKSN.
22	MS -> SS	AUTHENTICATION RESPONSE	
23	SS -> MS	LOCATION UPDATING ACCEPT	IE mobile Identity = new TMSI.
24	MS -> SS	TMSI REALLOCATION COMPLETE	
25	SS -> MS	CHANNEL RELEASE	After the sending of this message, the SS waits for the disconnection of the main signalling link. MS is now "idle updated" in cell B.

Step	Direction	Message	Comments
The following messages are sent and shall be received on cell A.			
26	MS		The RF level of cell B is lowered until the MS selects cell A. The RF level of cell B is set sufficiently low to ensure that cell B is not suitable as defined in 3GPP TS 05.08 subclause 6.6.2.
27	MS -> SS	CHANNEL REQUEST	Establishment cause: Location updating.
28	SS -> MS	IMMEDIATE ASSIGNMENT	
29	MS -> SS	LOCATION UPDATING REQUEST	location updating type = normal, CKSN = initial value, LAI = b, mobile station classmark 1 as given by the PICS and mobile identity = TMSI.
30	SS		performs step 5 with reject cause #100 and step 6.
31	SS -> MS	PAGING REQUEST TYPE 1	Mobile identity = old TMSI of the MS. This message is sent continuously to the MS during 8 seconds.
32	SS		The SS checks that there is no answer from the MS during 12 s.
33	SS		If during steps 31 and 32 the MS attempts to perform a location updating procedure the SS will perform step 30 and then continue the procedure.
34	MS		If possible (see PICS) SIM detachment is performed. Otherwise if possible (see PICS) mobile switch off is performed. Otherwise the power is removed.
35	MS		The MS shall not initiate an RR connection establishment on cell A or on cell B. This is checked during 30 s.
36	MS		Depending on what has been performed in step 34 the MS is brought back to operation.
37	MS -> SS	CHANNEL REQUEST	Establishment cause: Location updating.
38	SS -> MS	IMMEDIATE ASSIGNMENT	
39	MS -> SS	LOCATION UPDATING REQUEST	location updating type = normal, CKSN = no key available, LAI = deleted LAI (the MCC and MNC hold the previous values, the LAC is coded FFFE), Mobile Identity = IMSI.
40	SS -> MS	AUTHENTICATION REQUEST	CKSN = initial CKSN.
41	MS -> SS	AUTHENTICATION RESPONSE	
42	SS -> MS	LOCATION UPDATING ACCEPT	IE mobile Identity = new TMSI.
43	MS -> SS	TMSI REALLOCATION COMPLETE	
44	SS -> MS	CHANNEL RELEASE	After the sending of this message, the SS waits for the disconnection of the main signalling link. MS is now "idle updated" in cell A.
45	MS		The RF level of cell A is lowered until the MS selects cell B. The RF level of cell A is set sufficiently low to ensure that cell A is not suitable as defined in 3GPP TS 05.08 subclause 6.6.2.
46	MS -> SS	CHANNEL REQUEST	Establishment cause: Location updating.
47	SS -> MS	IMMEDIATE ASSIGNMENT	
48	MS -> SS	LOCATION UPDATING REQUEST	location updating type = normal, CKSN = initial value, LAI = a, mobile station classmark 1 as given by the PICS and mobile identity = TMSI.
49	SS -> MS	AUTHENTICATION REQUEST	
50	MS->SS	AUTHENTICATION RESPONSE	steps 49 and 50 are performed N times. N shall be chosen in such a way that T3210 expires. Depending on when T3210 expires in the MS, it is possible that on the Nth occurrence of step 50 the MS may send a L2 DISC rather than the AUTHENTICATION RESPONSE message.
51	SS		The SS checks that there is no more activity from the MS on the channel after the DISC/UA exchange has been completed.
52	MS		If the MS supports speech it is made to perform an emergency call.
53	MS -> SS	CHANNEL REQUEST	Establishment cause: Emergency call.
54	SS -> MS	IMMEDIATE ASSIGNMENT	
55	MS -> SS	CM SERVICE REQUEST	CM service type = Emergency call establishment; CKSN = no key available; Mobile Identity = IMSI.
56	SS -> MS	CM SERVICE ACCEPT	
57	MS -> SS	EMERGENCY SETUP	
58	SS -> MS	RELEASE COMPLETE	Cause = unassigned number.

Step	Direction	Message	Comments
59	SS -> MS	CHANNEL RELEASE	Establishment cause: Location updating The SS will wait at most 15 s for this message.
60	MS -> SS	CHANNEL REQUEST	
61	SS -> MS	IMMEDIATE ASSIGNMENT	location updating type = normal, CKSN = no key available, LAI = deleted LAI (the MCC and MNC hold the previous values, the LAC is coded FFFE), Mobile Identity = IMSI. CKSN = initial CKSN.
62	MS -> SS	LOCATION UPDATING REQUEST	
63	SS -> MS	AUTHENTICATION REQUEST	IE mobile Identity = new TMSI.
64	MS -> SS	AUTHENTICATION RESPONSE	
65	SS -> MS	LOCATION UPDATING ACCEPT	After the sending of this message, the SS waits for the disconnection of the main signalling link. MS is now "idle updated" in cell B. The RF level of cell B is lowered until the MS selects cell A. The RF level of cell B is set sufficiently low to ensure that cell B is not suitable as defined in 3GPP TS 05.08 subclause 6.6.2.
66	MS -> SS	TMSI REALLOCATION COMPLETE	
67	SS -> MS	CHANNEL RELEASE	Establishment cause: Location updating.
68	MS		
69	MS -> SS	CHANNEL REQUEST	location updating type = normal, CKSN = initial value, LAI = b, mobile station classmark 1 as given by the PICS and mobile identity = TMSI. performs step 11. A MO CM connection is attempted before T3211 expiry.
70	SS -> MS	IMMEDIATE ASSIGNMENT	
71	MS -> SS	LOCATION UPDATING REQUEST	Establishment cause: Location updating.
72	SS		
73	MS		location updating type = normal, CKSN = no key available, LAI = deleted LAI (the MCC and MNC hold the previous values, the LAC is coded FFFE), Mobile Identity = IMSI. IE mobile Identity = new TMSI.
74	MS -> SS	CHANNEL REQUEST	
75	SS -> MS	IMMEDIATE ASSIGNMENT	location updating type = normal, CKSN = no key available, LAI = deleted LAI (the MCC and MNC hold the previous values, the LAC is coded FFFE), Mobile Identity = IMSI. IE mobile Identity = new TMSI.
76	MS -> SS	LOCATION UPDATING REQUEST	
77	SS -> MS	LOCATION UPDATING ACCEPT	Steps 80 to 83 are optional as the MS may have memorized the request for CM connection attempt Wait 10 s to decide whether to go directly to step 84. Establishment cause: Not checked.
78	MS -> SS	TMSI REALLOCATION COMPLETE	
79	SS -> MS	CHANNEL RELEASE	CKSN = no key available, Mobile identity = TMSI. After the sending of this message, the SS waits for the disconnection of the main signalling link. MS is now "idle updated" in cell A. The RF level of cell A is lowered until the MS selects cell B. The RF level of cell A is set sufficiently low to ensure that cell A is not suitable as defined in 3GPP TS 05.08 subclause 6.6.2.
80	MS -> SS	CHANNEL REQUEST	
81	SS -> MS	IMMEDIATE ASSIGNMENT	Establishment cause: Location updating.
82	MS -> SS	CM SERVICE REQUEST	
83	SS -> MS	CHANNEL RELEASE	location updating type = normal, CKSN = no key available LAI = a, mobile station classmark 1 as given by the PICS and mobile identity = TMSI. performs step 16. The RF level of cell B is lowered until the MS selects cell A. The RF level of cell B is set sufficiently low to ensure that cell B is not suitable as defined in 3GPP TS 05.08 subclause 6.6.2.
84	MS		
85	MS -> SS	CHANNEL REQUEST	Establishment cause: Location updating. The time interval between Cell B being set sufficiently low to ensure that Cell B is not suitable and this message shall be less than 20s.
86	SS -> MS	IMMEDIATE ASSIGNMENT	
87	MS -> SS	LOCATION UPDATING REQUEST	
88	SS		
89	MS		
90	MS -> SS	CHANNEL REQUEST	
91	SS -> MS	IMMEDIATE ASSIGNMENT	

Step	Direction	Message	Comments
92	MS -> SS	LOCATION UPDATING REQUEST	location updating type = normal, CKSN = no key available, LAI = deleted LAI (the MCC and MNC hold the previous values, the LAC is coded FFFE), mobile station classmark 1 as given by the PICS and mobile identity = IMSI.
93	SS -> MS	AUTHENTICATION REQUEST	CKSN = initial CKSN.
94	MS -> SS	AUTHENTICATION RESPONSE	
95	SS -> MS	LOCATION UPDATING ACCEPT	Mobile identity = TMSI.
96	MS -> SS	TMSI REALLOCATION COMPLETE	
97	SS -> MS	CHANNEL RELEASE	After the sending of this message, the SS waits for the disconnection of the main signalling link. MS is now "Idle, updated" in cell A.

Specific message contents

None.

26.7.4.3.3 Location updating / abnormal cases / attempt counter equal to 4

26.7.4.3.3.1 Conformance requirement

- 1) When four failures such as cases d) to g) of subclause 4.4.4.9 of 3GPP TS 04.08 / 3GPP TS 24.008 have occurred during a normal location updating procedure the Mobile Station shall:
 - 1.1 perform location updating after T3212 expiry by sending a Location Updating Request message with the Mobile Identity IE set to its IMSI, CKSN IE set to "no key is available" and the Location Updating type set to "normal updating".
 - 1.2 if the T3212 initiated location updating was unsuccessful, then after T3211 expiry the Mobile Station shall send a Location Updating Request message with the Mobile Identity IE set to its IMSI, CKSN IE set to "no key is available" and the Location Updating type IE set to "normal location updating".
- 2) When four failures such as cases d), f), g) of subclause 4.4.4.9 of 3GPP TS 04.08 / 3GPP TS 24.008 have occurred during a normal location updating procedure the Mobile Station, if it supports speech, shall be able to perform an emergency call i.e. the Mobile Station is able to send a CM Service Request message with the CM Service Type IE set to "emergency call establishment", CKSN IE set to "no key is available" and Mobile Identity IE set to its IMSI and then send an Emergency Setup message.
- 3) When four failures such as cases d), f), g) of subclause 4.4.4.9 of 3GPP TS 04.08 / 3GPP TS 24.008 have occurred during a normal location updating procedure:
 - 3.1 the Mobile Station shall use a request from CM entity for MM connection for a service other than emergency call as a trigger for a normal location updating procedure and shall send a Location Updating Request message with the Mobile Identity IE set to its IMSI, CKSN IE set to "no key is available" and the Location Updating type IE set to "normal location updating".
 - 3.2 after a location updating triggered by a request from the CM layer which was unsuccessful, after T3211 expiry the Mobile Station shall send a Location Updating Request message with the Mobile Identity IE set to its IMSI, CKSN IE set to "no key is available" and the Location Updating type IE set to "normal location updating".
- 4) When four failures such as cases d), f), g) of subclause 4.4.4.9 of 3GPP TS 04.08 / 3GPP TS 24.008 have occurred during a normal location updating procedure:
 - 4.1 the Mobile Station shall perform a normal location updating procedure if it enters a new cell.
 - 4.2 if this location updating is unsuccessful, after T3211 expiry the Mobile Station shall send a Location Updating Request message with the Mobile Identity IE set to its IMSI, CKSN IE set to "no key is available" and the Location Updating type IE set to "normal location updating".

References

3GPP TS 04.08 / 3GPP TS 24.008 subclause 4.4.4.9 and 3GPP TS 05.08 subclause 6.6.2.

26.7.4.3.3.2 Test purpose

To verify that the MS performs normal location updating procedures after T3212 expiry, when its attempt counter has reached value 4 and that the MS reset its attempt counter after a timer T3212 expiry.

To verify that the MS still follows the MM IDLE ATTEMPTING TO UPDATE state requirements after its attempt counter has reached value 4.

To verify that the attempt counter is reset in the cases where it has to be done.

26.7.4.3.3.3 Method of test

Initial conditions

System Simulator:

Two cells: A and B, belonging to different location areas a and b.

IMSI attach/detach is allowed in both cells.

T3212 is set to 6 minutes.

Mobile Station:

The MS is "Idle updated" on cell B with a valid CKSN and a TMSI.

Specific PICS statements:

- On/Off switch (TSPC_Feat_OnOff)
- SIM removable without power down (TSPC_AddInfo_SIMRmv)
- Speech supported for Full rate version 1 (GSM FR) (TSPC_AddInfo_Full_rate_version_1)

PIXIT statements:

-

Foreseen final state of the MS

The MS is "Idle updated" on cell A with a valid CKSN and a TMSI.

Test Procedure

The MS is made to perform a normal location updating. The SS triggers a failure in this procedure. After T3211 expiry the MS will try again the location updating procedure. The SS triggers again a failure. This is done again 2 times. At this point the attempt counter shall be equal to 4. It is then checked that T3212 has been started and that at its expiry the MS will try a normal location updating procedure. It is verified that the MS has reset its attempt counter after timer T3212 expiry.

Then it is checked that, when the attempt counter has reached the value of 4, the MS is in the MM IDLE state and ATTEMPTING TO UPDATE substate, that is:

- not perform an IMSI detach procedure;
- support request for emergency call;
- use requests from CM layer other than emergency call as triggering of a normal location updating procedure;
- perform normal location updating procedure when a new cell is entered.

Maximum duration of test

20 minutes.

Expected sequence

Step	Direction	Message	Comments
1	MS		The following messages are sent and shall be received on cell A. The RF level of cell B is lowered until the MS selects cell A. The RF level of cell B is set sufficiently low to ensure that cell B is not suitable as defined in 3GPP TS 05.08 subclause 6.6.2.
2	MS -> SS	CHANNEL REQUEST	Establishment cause: Location updating.
3	SS -> MS	IMMEDIATE ASSIGNMENT	
4	MS -> SS	LOCATION UPDATING REQUEST	location updating type = normal, CKSN = initial value, LAI = b, mobile station classmark 1 as given by the PICS and mobile identity = TMSI.
5	SS -> MS	LOCATION UPDATING REJECT	IE Reject cause is set to #22.
6	SS -> MS	CHANNEL RELEASE	The SS waits for the disconnection of the main signalling link.
7	MS		The MS shall not initiate an RR connection establishment on cell A or on cell B within T3211.
8	MS -> SS	CHANNEL REQUEST	Establishment cause: Location updating.
9	SS -> MS	IMMEDIATE ASSIGNMENT	
10	MS -> SS	LOCATION UPDATING REQUEST	location updating type = normal, CKSN = no key available, LAI = deleted LAI (the MCC and MNC hold the previous values, the LAC is coded FFFE), Mobile Identity = IMSI.
11	SS		The SS deactivates the SACCH on the dedicated channel and waits until there are no more SACCH frames in the uplink. This is done within 8 SACCH frames.
12	MS		The MS shall not initiate an RR connection establishment on cell A or on cell B with T3211 + RadioLinkTimeout after the SS deactivates the SACCH.
13	MS -> SS	CHANNEL REQUEST	Establishment cause: Location updating.
14	SS -> MS	IMMEDIATE ASSIGNMENT	
15	MS -> SS	LOCATION UPDATING REQUEST	location updating type = normal, CKSN = no key available, LAI = deleted LAI (the MCC and MNC hold the previous values, the LAC is coded FFFE), Mobile Identity = IMSI.
16	SS -> MS	AUTHENTICATION REQUEST	
17	MS -> SS	AUTHENTICATION RESPONSE	these steps (16 and 17) are performed N times. N shall be chosen in such a way that T3210 expires. Depending on when T3210 expires in the MS, it is possible that on the Nth occurrence of step 50 the MS may send a L2 DISC rather than the AUTHENTICATION RESPONSE message.
18	MS		The MS shall cease transmission (after the DISC/UA exchange has been completed) and then shall not initiate an RR connection establishment on cell A or on cell B during T3211 seconds at least after the expiry of T3210.
19	MS -> SS	CHANNEL REQUEST	Establishment cause: Location updating.
20	SS -> MS	IMMEDIATE ASSIGNMENT	
21	MS -> SS	LOCATION UPDATING REQUEST	location updating type = normal, CKSN = no key available, LAI = deleted LAI (the MCC and MNC hold the previous values, the LAC is coded FFFE), Mobile Identity = IMSI.
22	SS -> MS	CHANNEL RELEASE	The SS waits for the disconnection of the main signalling link.
23	MS		The MS shall not initiate an RR connection establishment on cell A or on cell B during T3212 (tolerance -15s; 45s) at least after the channel release.
24	MS -> SS	CHANNEL REQUEST	Establishment cause: Location updating.
25	SS -> MS	IMMEDIATE ASSIGNMENT	
26	MS -> SS	LOCATION UPDATING REQUEST	location updating type: "normal location update" CKSN = no key available, LAI = deleted LAI (the MCC and MNC hold the previous values, the LAC is coded FFFE) mobile station classmark 1 as given by the PICS and mobile identity = IMSI.
27	SS -> MS	LOCATION UPDATING REJECT	IE Reject cause = #17 "network failure".

Step	Direction	Message	Comments
28	SS -> MS	CHANNEL RELEASE	The SS waits for the disconnection of the main signalling link.
29	MS		The MS shall not initiate an RR connection establishment on cell A or on cell B during T3211 seconds at least after the channel release.
30	MS -> SS	CHANNEL REQUEST	Establishment cause: Location updating.
31	SS -> MS	IMMEDIATE ASSIGNMENT	
32	MS -> SS	LOCATION UPDATING REQUEST	location updating type = normal, CKSN = no key available, LAI = deleted LAI (the MCC and MNC hold the previous values, the LAC is coded FFFE) mobile station classmark 1 as given by the PICS and mobile identity = IMSI.
33	SS -> MS	AUTHENTICATION REQUEST	CKSN = initial CKSN.
34	MS -> SS	AUTHENTICATION RESPONSE	
35	SS -> MS	LOCATION UPDATING ACCEPT	IE mobile Identity = new TMSI.
36	MS -> SS	TMSI REALLOCATION COMPLETE	
37	SS -> MS	CHANNEL RELEASE	After the sending of this message, the SS waits for the disconnection of the main signalling link. MS is now "idle, updated" in cell A.
38	MS		The RF level of cell A is lowered until the MS selects cell B. The RF level of cell A is set sufficiently low to ensure that cell A is not suitable as defined in 3GPP TS 05.08 subclause 6.6.2.
39	MS -> SS	CHANNEL REQUEST	Establishment cause: Location updating.
40	SS -> MS	IMMEDIATE ASSIGNMENT	
41	MS -> SS	LOCATION UPDATING REQUEST	location updating type = normal, CKSN = initial value, LAI = a, mobile station classmark 1 as given by the PICS and mobile identity = TMSI.
42	SS -> MS	LOCATION UPDATING REJECT	IE Reject cause is set to #42.
43	SS -> MS	CHANNEL RELEASE	The SS waits for the disconnection of the main signalling link.
44	MS		The MS shall not initiate an RR connection establishment on cell A or on cell B during T3211 seconds at least after the channel release.
45	MS -> SS	CHANNEL REQUEST	Establishment cause: Location updating.
46	SS -> MS	IMMEDIATE ASSIGNMENT	
47	MS -> SS	LOCATION UPDATING REQUEST	location updating type = normal, CKSN = no key available, LAI = deleted LAI (the MCC and MNC hold the previous values, the LAC is coded FFFE), Mobile Identity = IMSI.
48	SS		The SS deactivates the SACCH on the dedicated channel and waits until there is no more SACCH frames in the uplink. This is done within 8 SACCH frames.
48a	MS		The MS shall not initiate an RR connection establishment on cell A or on cell B within T3211 + RadioLinkTimeOut after the SS deactivates the SACCH.
49	MS -> SS	CHANNEL REQUEST	Establishment cause: Location updating.
50	SS -> MS	IMMEDIATE ASSIGNMENT	
51	MS -> SS	LOCATION UPDATING REQUEST	location updating type = normal, CKSN = no key available, LAI = deleted LAI (the MCC and MNC hold the previous values, the LAC is coded FFFE), Mobile Identity = IMSI.
52	SS -> MS	CHANNEL RELEASE	The SS waits for the disconnection of the main signalling link.
53	MS		The MS shall not initiate an RR connection establishment on cell A or on cell B during T3211 seconds at least after the channel release.
54	MS -> SS	CHANNEL REQUEST	Establishment cause: Location updating.
55	SS -> MS	IMMEDIATE ASSIGNMENT	
56	MS -> SS	LOCATION UPDATING REQUEST	location updating type = normal, CKSN = no key available, LAI = deleted LAI (the MCC and MNC hold the previous values, the LAC is coded FFFE) mobile station classmark 1 as given by the PICS and mobile identity = IMSI.
57	SS		performs step 42 with cause #38 and step 43.

Step	Direction	Message	Comments
58	MS		If the MS supports speech, it is made to perform an emergency call.
59	MS -> SS	CHANNEL REQUEST	Establishment cause: Emergency call.
60	SS -> MS	IMMEDIATE ASSIGNMENT	
61	MS -> SS	CM SERVICE REQUEST	CM service type = Emergency call establishment; CKSN = no key available; Mobile Identity = IMSI.
62	SS -> MS	CM SERVICE ACCEPT	
63	MS -> SS	EMERGENCY SETUP	
64	SS -> MS	RELEASE COMPLETE	Cause = unassigned number.
65	SS -> MS	CHANNEL RELEASE	The SS waits for the disconnection of the main signalling link.
66	MS		If possible (see PICS) SIM detachment is performed. Otherwise if possible (see PICS) switch off is performed. Otherwise the power is removed.
67	MS		The MS shall not initiate an RR connection establishment on cell A or on cell B. This is checked during 3 s.
68	MS		Depending on what has been performed in step 66 the MS is brought back to operation.
69	MS -> SS	CHANNEL REQUEST	Establishment cause: Location updating.
70	SS -> MS	IMMEDIATE ASSIGNMENT	
71	MS -> SS	LOCATION UPDATING REQUEST	location updating type = normal, CKSN = no key available, LAI = deleted LAI (the MCC and MNC hold the previous values, the LAC is coded FFFE), Mobile Identity = IMSI.
72	SS -> MS	AUTHENTICATION REQUEST	CKSN = initial CKSN.
73	MS -> SS	AUTHENTICATION RESPONSE	
74	SS -> MS	LOCATION UPDATING ACCEPT	IE mobile Identity = new TMSI.
75	MS -> SS	TMSI REALLOCATION COMPLETE	
76	SS -> MS	CHANNEL RELEASE	After the sending of this message, the SS waits for the disconnection of the main signalling link. MS is now "idle, updated" in cell B.
77	MS		The RF level of cell B is lowered until the MS selects cell A. The RF level of cell B is set sufficiently low to ensure that cell B is not suitable as defined in 3GPP TS 05.08 subclause 6.6.2.
78	MS -> SS	CHANNEL REQUEST	Establishment cause: Location updating.
79	SS -> MS	IMMEDIATE ASSIGNMENT	
80	MS -> SS	LOCATION UPDATING REQUEST	location updating type = normal, CKSN = initial value, LAI = b, mobile station classmark 1 as given by the PICS and mobile identity = TMSI.
81	SS -> MS	LOCATION UPDATING REJECT	IE Reject cause is set to #38.
82	SS -> MS	CHANNEL RELEASE	The SS waits for the disconnection of the main signalling link.
83	MS		The MS shall not initiate an RR connection establishment on cell A or on cell B during T3211 seconds at least after the channel release.
84	MS -> SS	CHANNEL REQUEST	Establishment cause: Location updating.
85	SS -> MS	IMMEDIATE ASSIGNMENT	
86	MS -> SS	LOCATION UPDATING REQUEST	location updating type = normal, CKSN = no key available, LAI = deleted LAI (the MCC and MNC hold the previous values, the LAC is coded FFFE), Mobile Identity = IMSI.
87	SS		The SS deactivates the SACCH on the dedicated channel and waits until there is no more SACCH frames in the uplink. This is done within 8 SACCH frames.
88	MS		The MS shall not initiate an RR connection establishment on cell A or on cell B within T3211 +RadioLinkTimeout seconds after the SS deactivates the SACCH.
89	MS -> SS	CHANNEL REQUEST	Establishment cause: Location updating.
90	SS -> MS	IMMEDIATE ASSIGNMENT	
91	MS -> SS	LOCATION UPDATING REQUEST	location updating type = normal, CKSN = no key available, LAI = deleted LAI (the MCC and MNC hold the previous values, the LAC is coded FFFE), Mobile Identity = IMSI.
92	SS -> MS	CHANNEL RELEASE	The SS waits for the disconnection of the main signalling link.

Step	Direction	Message	Comments
93	MS		The MS shall not initiate an RR connection establishment on cell A or on cell B during T3211 seconds at least after the channel release.
94	MS -> SS	CHANNEL REQUEST	Establishment cause: Location updating.
95	SS -> MS	IMMEDIATE ASSIGNMENT	
96	MS -> SS	LOCATION UPDATING REQUEST	location updating type = normal, CKSN = no key available, LAI = deleted LAI (the MCC and MNC hold the previous values, the LAC is coded FFFE) mobile station classmark 1 as given by the PICS and mobile identity = IMSI.
97	SS		performs step 48.
98	MS		A MO CM connection is attempted.
99	MS -> SS	CHANNEL REQUEST	Establishment cause: Location updating.
100	SS -> MS	IMMEDIATE ASSIGNMENT	
101	MS -> SS	LOCATION UPDATING REQUEST	location updating type = normal, CKSN = no key available, LAI = deleted LAI (the MCC and MNC hold the previous values, the LAC is coded FFFE), Mobile Identity = IMSI.
102	SS		performs step 52.
103	MS		The MS shall not initiate an RR connection establishment on cell A or on cell B during T3211 seconds at least after the channel release.
104	MS -> SS	CHANNEL REQUEST	Establishment cause: Location updating.
105	SS -> MS	IMMEDIATE ASSIGNMENT	
106	MS -> SS	LOCATION UPDATING REQUEST	location updating type = normal, CKSN = no key available, LAI = deleted LAI (the MCC and MNC hold the previous values, the LAC is coded FFFE), Mobile Identity = IMSI.
107	SS -> MS	AUTHENTICATION REQUEST	CKSN = initial CKSN.
108	MS -> SS	AUTHENTICATION RESPONSE	
109	SS -> MS	LOCATION UPDATING ACCEPT	IE mobile Identity = new TMSI.
110	MS -> SS	TMSI REALLOCATION COMPLETE	
111	SS -> MS	CHANNEL RELEASE	MS is now "idle, updated" in cell A The MS may or may not have memorized the request for CM connection. The steps 112 to 116 are therefore optional for the MS. The SS waits 10 s to decide whether to go directly to step 117.
112	MS -> SS	CHANNEL REQUEST	
113	SS -> MS	IMMEDIATE ASSIGNMENT	
114	MS -> SS	CM SERVICE REQUEST	CKSN = initial value, Mobile identity = TMSI.
115	SS -> MS	CM SERVICE REJECT	cause #17 (network failure).
116	SS -> MS	CHANNEL RELEASE	The SS waits for the disconnection of the main signalling link.
117	MS		The RF level of cell A is lowered until the MS selects cell B. The RF level of cell A is set sufficiently low to ensure that cell A is not suitable as defined in 3GPP TS 05.08 subclause 6.6.2.
118	MS -> SS	CHANNEL REQUEST	Establishment cause: Location updating.
119	SS -> MS	IMMEDIATE ASSIGNMENT	
120	MS -> SS	LOCATION UPDATING REQUEST	location updating type = normal, CKSN = initial value, LAI = a, mobile station classmark 1 as given by the PICS and mobile identity = TMSI.
121	SS -> MS	LOCATION UPDATING REJECT	IE Reject cause is set to #38.
122	SS -> MS	CHANNEL RELEASE	The SS waits for the disconnection of the main signalling link
123	MS		The MS shall not initiate an RR connection establishment on cell A or on cell B during T3211 seconds at least after the channel release.
124	MS -> SS	CHANNEL REQUEST	Establishment cause: Location updating.
125	SS -> MS	IMMEDIATE ASSIGNMENT	
126	MS -> SS	LOCATION UPDATING REQUEST	location updating type = normal, CKSN = no key available, LAI = deleted LAI (the MCC and MNC hold the previous values, the LAC is coded FFFE), Mobile Identity = IMSI.

Step	Direction	Message	Comments
127	SS		The SS stops any RF transmission on the dedicated channel and waits until there is no more SACCH in the uplink.
128	MS		The MS shall not initiate an RR connection establishment on cell A or on cell B within T3211 + RadioLinkTimeOut seconds after the SS stops RF transmission.
129	MS -> SS	CHANNEL REQUEST	Establishment cause: Location updating. location updating type = normal, CKSN = no key available, LAI = deleted LAI (the MCC and MNC hold the previous values, the LAC is coded FFFE), Mobile Identity = IMSI.
130	SS -> MS	IMMEDIATE ASSIGNMENT	
131	MS -> SS	LOCATION UPDATING REQUEST	
132	SS -> MS	CHANNEL RELEASE	The SS waits for the disconnection of the main signalling link.
133	MS		The MS shall not initiate an RR connection establishment on cell A or on cell B during T3211 seconds at least after the channel release.
134	MS -> SS	CHANNEL REQUEST	Establishment cause: Location updating. location updating type = normal, CKSN = no key available, LAI = deleted LAI (the MCC and MNC hold the previous values, the LAC is coded FFFE) mobile station classmark 1 as given by the PICS and mobile identity = IMSI.
135	SS -> MS	IMMEDIATE ASSIGNMENT	
136	MS -> SS	LOCATION UPDATING REQUEST	
137	SS		performs steps 42 and 43.
138	MS		The RF level of cell B is lowered until the MS selects cell A. The RF level of cell B is set sufficiently low to ensure that cell B is not suitable as defined in 3GPP TS 05.08 subclause 6.6.2.
139	MS -> SS	CHANNEL REQUEST	Establishment cause: Location updating. location updating type = normal, CKSN = no key available, LAI = deleted LAI (the MCC and MNC hold the previous values, the LAC is coded FFFE) mobile station classmark 1 as given by the PICS and mobile identity = IMSI.
140	SS -> MS	IMMEDIATE ASSIGNMENT	
141	MS -> SS	LOCATION UPDATING REQUEST	
142	SS		performs the step 48.
143	MS		The MS shall not initiate an RR connection establishment on cell A or on cell B until T3211 + RadioLinkTimeout after the SS deactivates the SACCH.
144	MS -> SS	CHANNEL REQUEST	Establishment cause: Location updating. location updating type = normal, CKSN = no key available, LAI = deleted LAI (the MCC and MNC hold the previous values, the LAC is coded FFFE), Mobile Identity = IMSI.
145	SS -> MS	IMMEDIATE ASSIGNMENT	
146	MS -> SS	LOCATION UPDATING REQUEST	
147	SS -> MS	AUTHENTICATION REQUEST	CKSN = initial CKSN.
148	MS -> SS	AUTHENTICATION RESPONSE	
149	SS -> MS	LOCATION UPDATING ACCEPT	IE mobile Identity = new TMSI.
150	MS -> SS	TMSI REALLOCATION COMPLETE	
151	SS -> MS	CHANNEL RELEASE	After the sending of this message, the SS waits for the disconnection of the main signalling link. MS is now "idle, updated" in cell A.

Specific message contents

None.

26.7.4.3.4 Location updating / abnormal cases / attempt counter less or equal to 4, stored LAI equal to broadcast LAI

26.7.4.3.4.1 Conformance requirement

- 1) When a failure such as cases d), f) and g) of subclause 4.4.4.9 of 3GPP TS 04.08 / 3GPP TS 24.008 has occurred during a periodic location updating procedure (the broadcast LAI is equal to the stored LAI):

- 1.1 the Mobile Station shall be able to establish an MM connection i.e. send a Channel Request and then a CM Service Request message, CKSN and LAI set to those which have been allocated to the Mobile Station, Mobile Identity IE set to the TMSI which has been allocated to the Mobile Station;
- 1.2 then the Mobile Station shall not attempt a location updating procedure.
- 2) When a failure such as cases d), f) and g) of subclause 4.4.4.9 of 3GPP TS 04.08 / 3GPP TS 24.008 has occurred during an IMSI attach procedure (the broadcast LAI is equal to the stored LAI):
 - 2.1 the Mobile Station shall be able to establish an MM connection i.e. send a Channel Request and then a CM Service Request message, CKSN and LAI set to those which have been allocated to the Mobile Station, Mobile Identity IE set to the TMSI which has been allocated to the Mobile Station;
 - 2.2 then the Mobile Station shall not attempt a location updating procedure.
- 3) When a failure such as cases d), f) and g) of subclause 4.4.4.9 of 3GPP TS 04.08 / 3GPP TS 24.008 has occurred during a periodic location updating procedure and the attempt counter is smaller than 4 the Mobile Station shall send, after T3211 expiry, a Location Updating Request message with the Mobile Identity IE set to the TMSI which has been allocated to the Mobile Station, CKSN IE and LAI set to those which have been allocated to the Mobile Station and the Location Updating type set to "periodic updating".

When the Mobile Station's attempt counter reaches the value 4 (four failures such as cases d), f) and g) of subclause 4.4.4.9 of 3GPP TS 04.08 / 3GPP TS 24.008 have occurred during a periodic location updating procedure) after T3212 expiry it shall send a Location Updating Request message with the Mobile Identity IE set to its IMSI, CKSN IE set to "no key is available" and the Location Updating type set to "normal".
- 4) When the Mobile Station's attempt counter reaches the value 4 (four failures such as cases d), f) and g) of subclause 4.4.4.9 of 3GPP TS 04.08 / 3GPP TS 24.008 have occurred during a periodic location updating procedure) it shall use a request for a CM connection other than emergency call as a trigger for a location updating procedure.
- 5) When a failure such as cases d), f) and g) of subclause 4.4.4.9 of 3GPP TS 04.08 / 3GPP TS 24.008 has occurred during an IMSI attach procedure and the attempt counter is smaller than 4 the Mobile Station shall send, after T3211 expiry, a Location Updating Request message with the Mobile Identity IE set to the TMSI which has been allocated to the Mobile Station, CKSN IE and LAI set to those which have been allocated to the Mobile Station and the Location Updating type set to "IMSI attach".

When the Mobile Station's attempt counter reaches the value 4 (four failures such as cases d), f) and g) of subclause 4.4.4.9 of 3GPP TS 04.08 / 3GPP TS 24.008 have occurred during an IMSI attach procedure) after T3212 expiry it shall send a Location Updating Request message with the Mobile Identity IE set to its IMSI, CKSN IE set to "no key is available" and the Location Updating type set to "normal".
- 6) When the Mobile Station's attempt counter reaches the value 4 (four failures such as cases d), f) and g) of subclause 4.4.4.9 of 3GPP TS 04.08 / 3GPP TS 24.008 have occurred during an IMSI attach procedure) it shall use a request for a CM connection other than emergency call as a trigger for a location updating procedure.

References

3GPP TS 04.08 / 3GPP TS 24.008 subclause 4.4.4.9.

26.7.4.3.4.2 Test purpose

To verify that in the case when the attempt counter is smaller than 4 and the broadcast LAI is equal to the stored LAI, the MS is in the MM IDLE state and NORMAL SERVICE substate. To verify that timer T3211 is stopped after a MM connection establishment.

To verify that the MS uses the T3211 timer. and that it enters the MM IDLE state and NORMAL SERVICE substate when its attempt counter reaches value 4 even in the case where the stored LAI is equal to the broadcast LAI.

26.7.4.3.4.3 Method of test

Initial conditions

System Simulator:

One cell: B, belonging to location area b.

IMSI attach/detach is allowed.

T3212 is set to 6 minutes.

Mobile Station:

The MS is "Idle updated" on cell B with a valid CKSN and a TMSI.

Specific PICS statements:

- On/Off switch (TSPC_Feat_OnOff)
- SIM removable without power down (TSPC_AddInfo_SIMRmv)

PIXIT statements:

-

Foreseen final state of the MS

The MS is "idle updated" on cell B with a valid CKSN and a TMSI.

Test Procedure

A failure during the periodic location updating is triggered: as the broadcast LAI is equal to the stored LAI, the MS is still in the MM IDLE state and NORMAL SERVICE substate and timer T3211 is started. A CM connection other than for emergency call is attempted. It is checked that this is possible and that T3211 is stopped. Same test is performed with a failure during an IMSI attach procedure.

Then failures are triggered during the periodic location updating to let the attempt counter to reach the value of 4. The MS shall enter the MM IDLE LIMITED SERVICE state and delete any TMSI, stored LAI, ciphering key sequence number and ciphering key. When the attempt counter reaches the value of 4, timer T3212 shall be started. At timer T3212 expiry a location updating procedure is started. A request for CM connection other for than emergency call shall trigger a location updating procedure.

Same tests are performed when the failures are triggered during an IMSI attach procedure.

Maximum duration of test

40 minutes.

Expected sequence

Step	Direction	Message	Comments
1	SS		The SS shall wait at most T3212 + 45 s.
2	MS -> SS	CHANNEL REQUEST	Establishment cause: Location updating.
3	SS -> MS	IMMEDIATE ASSIGNMENT	
4	MS -> SS	LOCATION UPDATING REQUEST	location updating type = periodic, CKSN = initial value, LAI = b, mobile station classmark 1 as given by the PICS and mobile identity = TMSI.
5	SS		performs step 5, of 26.7.4.3.2 with cause #17 and step 6 of 26.7.4.3.2.
6	MS		A MO CM connection is attempted.
7	MS -> SS	CHANNEL REQUEST	
8	SS -> MS	IMMEDIATE ASSIGNMENT	
9	MS -> SS	CM SERVICE REQUEST	CKSN = initial CKSN, Mobile Identity = TMSI.
10	SS -> MS	CM SERVICE ACCEPT	
11	MS -> SS	An initial CM message	
12	SS -> MS	CHANNEL RELEASE	The SS waits for the disconnection of the main signalling link.
13	SS		The MS shall not initiate an RR connection establishment. This is checked during 2*T3211.
14	MS		If possible (see PICS) SIM detachment is performed. Otherwise if possible (see PICS) switch off is performed. Otherwise the power is removed.
15	MS -> SS	CHANNEL REQUEST	Steps 15 to 19 are optional.
16	SS -> MS	IMMEDIATE ASSIGNMENT	
17	MS -> SS	IMSI DETACH INDICATION	
18	SS -> MS	CHANNEL RELEASE	
19	MS		Depending on what has been performed in step 14 the MS is brought back to operation.
20	MS -> SS	CHANNEL REQUEST	Establishment cause: Location updating.
21	SS -> MS	IMMEDIATE ASSIGNMENT	
22	MS -> SS	LOCATION UPDATING REQUEST	location updating type = IMSI attach, CKSN = initial value, LAI = b, mobile station classmark 1 as given by the PICS and mobile identity = TMSI.
23	SS		performs step 11 of 26.7.4.3.2.
24	MS		A MO CM connection is attempted.
25	MS -> SS	CHANNEL REQUEST	
26	SS -> MS	IMMEDIATE ASSIGNMENT	
27	MS -> SS	CM SERVICE REQUEST	CKSN = initial CKSN, Mobile Identity = TMSI.
28	SS -> MS	CIPHERING MODE COMMAND	
29	MS -> SS	CIPHERING MODE COMPLETE	
30	MS -> SS	An initial CM message	
31	SS -> MS	CHANNEL RELEASE	The SS waits for the disconnection of the main signalling link.
32	SS		The MS shall not initiate an RR connection establishment. This is checked during 2*T3211 MS is "idle, updated" in cell B.
32/1	MS		If possible (see PICS) SIM detachment is performed. Otherwise if possible (see PICS) switch off is performed. Otherwise the power is removed.
32/2	MS -> SS	CHANNEL REQUEST	Steps 32/2 to 32/5 are optional.
32/3	SS -> MS	IMMEDIATE ASSIGNMENT	
32/4	MS -> SS	IMSI DETACH INDICATION	
32/5	SS -> MS	CHANNEL RELEASE	
32/6	MS		Depending on what has been performed in step 32/1, the MS is brought back to operation.
32/7	MS -> SS	CHANNEL REQUEST	Establishment cause: Location updating.
32/8	SS -> MS	IMMEDIATE ASSIGNMENT	
32/9	MS -> SS	LOCATION UPDATING REQUEST	location updating type = IMSI attach, CKSN = initial value, LAI = b, mobile station classmark 1 as given by the PICS and mobile identity = TMSI.
32/10	SS -> MS	LOCATION UPDATING ACCEPT	without mobile identity
32/11	SS -> MS	CHANNEL RELEASE	
33	SS		The SS shall wait at most T3212 + 15 s.
34	MS -> SS	CHANNEL REQUEST	Establishment cause: Location updating.

Step	Direction	Message	Comments
35	SS -> MS	IMMEDIATE ASSIGNMENT	location updating type = periodic, CKSN = initial value, LAI = b, mobile station classmark 1 as given by the PICS and mobile identity = TMSI. performs step 16 of 26.7.4.3.2. The MS shall not initiate an RR connection establishment during T3211 at least after the channel release. Establishment cause: Location updating.
36	MS -> SS	LOCATION UPDATING REQUEST	
37	SS		
38	MS		
39	MS -> SS	CHANNEL REQUEST	
40	SS -> MS	IMMEDIATE ASSIGNMENT	
41	MS -> SS	LOCATION UPDATING REQUEST	
42	SS		
43	MS		
44	MS -> SS	CHANNEL REQUEST	
45	SS -> MS	IMMEDIATE ASSIGNMENT	location updating type = periodic, CKSN = initial value, LAI = b, mobile station classmark 1 as given by the PICS and mobile identity = TMSI. performs step 5 of 26.7.4.3.2 with cause #17 and step 6 of 26.7.4.3.2. The MS shall not initiate an RR connection establishment during T3211 at least after the channel release. Establishment cause: Location updating.
46	MS -> SS	LOCATION UPDATING REQUEST	
47	SS		
48	MS		
49	MS -> SS	CHANNEL REQUEST	
50	SS -> MS	IMMEDIATE ASSIGNMENT	
51	MS -> SS	LOCATION UPDATING REQUEST	
52	SS		
53	MS		
54	MS -> SS	CHANNEL REQUEST	
55	SS -> MS	IMMEDIATE ASSIGNMENT	
56	MS -> SS	LOCATION UPDATING REQUEST	
57	SS -> MS	AUTHENTICATION REQUEST	
58	MS -> SS	AUTHENTICATION RESPONSE	
59a	SS -> MS	LOCATION UPDATING ACCEPT TMSI REALLOCATION	
59b	MS -> SS	COMPLETE	
60	SS -> MS	CHANNEL RELEASE	
61	MS		
62	MS -> SS	CHANNEL REQUEST	
63	SS -> MS	IMMEDIATE ASSIGNMENT	location updating type = periodic or normal (see Note 1), CKSN = no key available, LAI = deleted LAI (the MCC and MNC hold the previous values, the LAC is coded FFFE) mobile station classmark 1 as given by the PICS and mobile identity = IMSI. IE mobile Identity = TMSI.
64	MS -> SS	LOCATION UPDATING REQUEST	
65	SS		
66	MS		
67	MS -> SS	CHANNEL REQUEST	
68	SS -> MS	IMMEDIATE ASSIGNMENT	
69	MS -> SS	LOCATION UPDATING REQUEST	
70	SS		

Step	Direction	Message	Comments
71	MS		The MS shall not initiate an RR connection establishment within T3211 + RadioLinkTimeout after the SS deactivates the SACCH.
72	MS -> SS	CHANNEL REQUEST	Establishment cause: Location updating. location updating type = periodic, CKSN = initial value, LAI = b, mobile station classmark 1 as given by the PICS and mobile identity = TMSI. performs step 16 of 26.7.4.3.2. The MS shall not initiate an RR connection establishment during T3211 at least after the channel release. Establishment cause: Location updating. location updating type = periodic, CKSN = initial value, LAI = b, mobile station classmark 1 as given by the PICS and mobile identity = TMSI. performs step 5 of 26.7.4.3.2 with cause #17 and step 6 of 26.7.4.3.2. A MO CM connection is attempted. Establishment cause: Location updating. location updating type = normal, CKSN = no key available, LAI = deleted LAI (the MCC and MNC hold the previous values, the LAC is coded FFFE) mobile station classmark 1 as given by the PICS and mobile identity = IMSI. IE mobile identity = TMSI.
73	SS -> MS	IMMEDIATE ASSIGNMENT	
74	MS -> SS	LOCATION UPDATING REQUEST	
75	SS		
76	MS		
77	MS -> SS	CHANNEL REQUEST	
78	SS -> MS	IMMEDIATE ASSIGNMENT	
79	MS -> SS	LOCATION UPDATING REQUEST	
80	SS		
81	MS		
82	MS -> SS	CHANNEL REQUEST	location updating type = normal, CKSN = no key available, LAI = deleted LAI (the MCC and MNC hold the previous values, the LAC is coded FFFE) mobile station classmark 1 as given by the PICS and mobile identity = IMSI.
83	SS -> MS	IMMEDIATE ASSIGNMENT	
84	MS -> SS	LOCATION UPDATING REQUEST	
85	SS -> MS	LOCATION UPDATING ACCEPT	
86	MS -> SS	TMSI REALLOCATION COMPLETE	IE mobile identity = TMSI.
87	SS -> MS	CHANNEL RELEASE	
88	MS -> SS	CHANNEL REQUEST	Steps 88 to 92 are optional Wait 10 s to decide whether to go directly to step 93. CKSN = no key available, Mobile identity = TMSI cause #17 (network failure).
89	SS -> MS	IMMEDIATE ASSIGNMENT	
90	MS -> SS	CM SERVICE REQUEST	
91	SS -> MS	CM SERVICE REJECT	
92	SS -> MS	CHANNEL RELEASE	
93	MS		If possible (see PICS) SIM detachment is performed. Otherwise if possible (see PICS) switch off is performed. Otherwise the power is removed.
94	MS -> SS	CHANNEL REQUEST	Steps 94 to 97 are optional.
95	SS -> MS	IMMEDIATE ASSIGNMENT	
96	MS -> SS	IMSI DETACH INDICATION	
97	SS -> MS	CHANNEL RELEASE	
98	MS		Depending on what has been performed in step 97 the MS is brought back to operation.
99	MS -> SS	CHANNEL REQUEST	Establishment cause: Location updating. location updating type = IMSI attach, CKSN = no key available, LAI = b, mobile station classmark 1 as given by the PICS and mobile identity = TMSI. performs step 11 of 26.7.4.3.2. The MS shall not initiate an RR connection establishment within T3211 + RadioLinkTimeout after the SS deactivates the SACCH. Establishment cause: Location updating. location updating type = IMSI attach, CKSN = no key available, LAI = b, mobile station classmark 1 as given by the PICS and mobile identity = TMSI. After the sending of the message the SS waits for the disconnection of the main signalling link. The MS shall not initiate an RR connection establishment during T3211 at least after the channel release. Establishment cause: Location updating.
100	SS -> MS	IMMEDIATE ASSIGNMENT	
101	MS -> SS	LOCATION UPDATING REQUEST	
102	SS		
103	MS		
104	MS -> SS	CHANNEL REQUEST	
105	SS -> MS	IMMEDIATE ASSIGNMENT	
106	MS -> SS	LOCATION UPDATING REQUEST	
107	SS -> MS	CHANNEL RELEASE	
108	MS		
109	MS -> SS	CHANNEL REQUEST	Establishment cause: Location updating.
110	SS -> MS	IMMEDIATE ASSIGNMENT	

Step	Direction	Message	Comments
111	MS -> SS	LOCATION UPDATING REQUEST	location updating type = IMSI attach, CKSN = no key available, LAI = b, mobile station classmark 1 as given by the PICS and mobile identity = TMSI.
112a	SS -> MS	LOCATION UPDATING REJECT	IE Reject cause is set to a value #17.
112b	MS -> SS	CHANNEL RELEASE	After the sending of this message, the SS waits for the disconnection of the main signalling link.
113	MS		The MS shall not initiate an RR connection establishment during T3211 at least after the channel release.
114	MS -> SS	CHANNEL REQUEST	Establishment cause: Location updating.
115	SS -> MS	IMMEDIATE ASSIGNMENT	
116	MS -> SS	LOCATION UPDATING REQUEST	location updating type = IMSI attach, CKSN = no key available, LAI = b, mobile station classmark 1 as given by the PICS and mobile identity = TMSI.
117	SS		performs step 11 of 26.7.4.3.2.
118	MS		The MS shall not initiate an RR connection establishment during T3212 - 15 s at least after the channel release.
119	MS -> SS	CHANNEL REQUEST	Establishment cause: Location updating.
120	SS -> MS	IMMEDIATE ASSIGNMENT	
121	MS -> SS	LOCATION UPDATING REQUEST	location updating type = periodic or normal or IMSI attach (see Note 2), CKSN = no key available, LAI = deleted LAI (the MCC and MNC hold the previous values, the LAC is coded FFFE) mobile station classmark 1 as given by the PICS and mobile identity = IMSI.
122	SS -> MS	AUTHENTICATION REQUEST	
123	MS -> SS	AUTHENTICATION RESPONSE	
124	SS -> MS	LOCATION UPDATING ACCEPT	IE mobile Identity = TMSI.
125	MS -> SS	TMSI REALLOCATION COMPLETE	
126	SS -> MS	CHANNEL RELEASE	
127	MS		If possible (see PICS) SIM detachment is performed. Otherwise if possible (see PICS) switch off is performed. Otherwise the power is removed.
128	MS -> SS	CHANNEL REQUEST	Steps 128 to 131 are optional.
129	SS -> MS	IMMEDIATE ASSIGNMENT	
130	MS -> SS	IMSI DETACH INDICATION	
131	SS -> MS	CHANNEL RELEASE	
132	MS		Depending on what has been performed in step 130 the MS is brought back to operation.
133	MS -> SS	CHANNEL REQUEST	Establishment cause: Location updating.
134	SS -> MS	IMMEDIATE ASSIGNMENT	
135	MS -> SS	LOCATION UPDATING REQUEST	location updating type = IMSI attach, CKSN = initial value, LAI = b, mobile station classmark 1 as given by the PICS and mobile identity = TMSI.
136	SS		performs step 16 of 26.7.4.3.2.
137	MS		The MS shall not initiate an RR connection establishment during T3211 at least after the channel release.
138	MS -> SS	CHANNEL REQUEST	Establishment cause: Location updating.
139	SS -> MS	IMMEDIATE ASSIGNMENT	
140	MS -> SS	LOCATION UPDATING REQUEST	location updating type = IMSI attach, CKSN = initial value, LAI = b, mobile station classmark 1 as given by the PICS and mobile identity = TMSI.
141	SS		performs step 5 of 26.7.4.3.2 with cause #17 and step 6 of 26.7.4.3.2.
142	MS		The MS shall not initiate an RR connection establishment during T3211 at least after the channel release.
143	MS -> SS	CHANNEL REQUEST	Establishment cause: Location updating.
144	SS -> MS	IMMEDIATE ASSIGNMENT	

Step	Direction	Message	Comments
145	MS -> SS	LOCATION UPDATING REQUEST	location updating type = IMSI attach, CKSN = initial value, LAI = b, mobile station classmark 1 as given by the PICS and mobile identity = TMSI. performs step 11 of 26.7.4.3.2. The MS shall not initiate an RR connection establishment within T3211 + RadioLinkTimeout after the SS deactivates the SACCH. Establishment cause: Location updating.
146	SS		
147	MS		
148	MS -> SS	CHANNEL REQUEST	location updating type = IMSI attach, CKSN = initial value, LAI = b, mobile station classmark 1 as given by the PICS and mobile identity = TMSI. performs step 16 of 26.7.4.3.2. The MS is made to perform a MO call. Establishment cause: Location updating.
149	SS -> MS	IMMEDIATE ASSIGNMENT	
150	MS -> SS	LOCATION UPDATING REQUEST	
151	SS		location updating type = normal, CKSN = no key available, LAI = deleted LAI (the MCC and MNC hold the previous values, the LAC is coded FFFE) mobile station classmark 1 as given by the PICS and mobile identity = IMSI.
152	MS		
153	MS -> SS	CHANNEL REQUEST	
154	SS -> MS	IMMEDIATE ASSIGNMENT	IE mobile Identity = TMSI.
155	MS -> SS	LOCATION UPDATING REQUEST	
156	SS -> MS	AUTHENTICATION REQUEST	
157	MS -> SS	AUTHENTICATION RESPONSE	Steps 161 to 166 are optional. An MO CM connection is attempted.
158	SS -> MS	LOCATION UPDATING ACCEPT	
159	MS -> SS	TMSI REALLOCATION COMPLETE	
160	SS -> MS	CHANNEL RELEASE	
161	MS		CKSN = initial value, Mobile identity = TMSI. cause #17 (network failure).
162	MS -> SS	CHANNEL REQUEST	
163	SS -> MS	IMMEDIATE ASSIGNMENT	
164	MS -> SS	CM SERVICE REQUEST	
165	SS -> MS	CM SERVICE REJECT	
166	SS -> MS	CHANNEL RELEASE	

NOTE 1: the MS can include both types of Location updating. As T3212 expires it can be a periodic location updating procedure and as there is no stored LAI it can be a normal one.

NOTE 2: same problem as in note 1. Three types of location updating procedures should be allowed.

Specific message contents

None.

26.7.4.4 Location updating / release / expiry of T3240

26.7.4.4.1 Conformance requirement

The mobile station receiving a LOCATION UPDATING REJECT message shall start T3240: it shall abort the RR connection at the expiry of timer T3240.

References

3GPP TS 04.08 / 3GPP TS 24.008 subclauses 4.4.4.8 and 11.2.

26.7.4.4.2 Test purpose

To verify that the MS aborts the RR-connection at the expiry of timer T3240.

26.7.4.4.3 Method of test

Initial conditions

System Simulator:

Two cells: A and B, belonging to different location areas a and b.

Mobile Station:

The MS has a valid TMSI. It is "idle updated" on cell A.

Specific PICS statements:

-

PIXIT statements:

-

Foreseen final state of the MS

The MS is "idle updated" on cell B.

Test Procedure

A normal location updating procedure is performed. The RR-connection is not released by the SS within the timer T3240. It is checked that the MS aborts the RR-connection.

Maximum duration of test

1 minute.

Expected sequence

Step	Direction	Message	Comments
1	SS		The RF level of cell A is lowered until the MS selects cell B.
2	MS -> SS	CHANNEL REQUEST	"Establishment cause": Location updating.
3	SS -> MS	IMMEDIATE ASSIGNMENT	
4	MS -> SS	LOCATION UPDATING REQUEST	
5	SS -> MS	LOCATION UPDATING ACCEPT	
6	SS		The SS waits T3240 expiry.
7	MS		The MS shall abort the RR connection (disconnection of layer 2).

Specific message contents

None.

26.7.4.5 Location updating / periodic

26.7.4.5.1 Location updating / periodic spread

26.7.4.5.1.1 Conformance requirement

- 1) The Mobile Stations shall perform spreading of the time before performing a periodic location updating when the location updating timer value is reduced.
- 2) The Mobile Station shall reset timer T3212 when the Mobile Station is deactivated, and shall start with a value between zero and the broadcasted value when reactivated in the same cell, IMSI attach being forbidden.
- 3) When activated the Mobile Station shall start timer T3212 with a value randomly drawn in the allowed range.

NOTE: This conformance requirement is not covered by a test purpose. It is intended to be covered by a manufacturer declaration.

References

3GPP TS 04.08 / 3GPP TS 24.008 subclause 4.4.2.

26.7.4.5.1.2 Test purpose

- 1) To check that when the location updating timer is reduced, the timer running in the MS is started with a value depending on the current timer value and the new broadcasted T3212 value.
- 2) To verify that when the MS is reactivated in the same cell (as the one in which it was deactivated), IMSI attach being forbidden, the MS starts the timer T3212 with a value between zero and the broadcasted value.

NOTE: It is not tested that the value is random.

26.7.4.5.1.3 Method of test

Initial conditions

System Simulator:

One cell, T3212 is set to 30 minutes.

IMSI attach is allowed in the cell.

Mobile Station:

The MS is deactivated. The stored MCC, MNC and LAC correspond to the broadcasted values. The stored update status is "updated".

Specific PICS statements:

-

PIXIT statements:

-

Foreseen final state of the MS

The MS has a valid TMSI. It is "idle updated".

Test procedure

The MS is activated. It performs IMSI attach. 3 minutes after the end of the IMSI attach procedure, the value of T3212 is set to 6 minutes. The MS shall perform periodic location updating 6 minutes after the end of the IMSI attach procedure.

Then, the IMSI attach/detach is forbidden. T3212 is still set to 6 minutes.

The MS is deactivated. The MS is reactivated. It is checked that the MS performs a periodic location updating during the 6 minutes following activation.

Maximum duration of test

20 minutes.

Expected sequence

Step	Direction	Message	Comments
1	MS		The MS is activated.
2	MS -> SS	CHANNEL REQUEST	"Establishment cause": Location updating.
3	SS -> MS	IMMEDIATE ASSIGNMENT	
4	MS -> SS	LOCATION UPDATING REQUEST	"location updating type": IMSI attach.
5	SS -> MS	LOCATION UPDATING ACCEPT	
6	SS -> MS	CHANNEL RELEASE	After the sending of this message, the SS waits for the disconnection of the main signalling link.
7	SS		3 minutes after step 6 the value of T3212 is set to 6 minutes.
8	MS -> SS	CHANNEL REQUEST	"Establishment cause": Location updating This message shall be sent by the MS between 5minutes 45s and 6minutes 15s after step 6.
9	SS -> MS	IMMEDIATE ASSIGNMENT	
10	MS -> SS	LOCATION UPDATING REQUEST	"location updating type": periodic updating.
11	SS -> MS	LOCATION UPDATING ACCEPT	
12	SS -> MS	CHANNEL RELEASE	After the sending of this message, the SS waits for the disconnection of the main signalling link.
13	SS		IMSI attach/detach is not allowed.
14	MS		The MS is deactivated.
15	MS		The MS is activated.
16	SS		The SS waits until the periodic location updating.
17	MS -> SS	CHANNEL REQUEST	"Establishment cause": Location updating This message shall arrive during the 7 minutes following the MS activation.
18	SS -> MS	IMMEDIATE ASSIGNMENT	
19	MS -> SS	LOCATION UPDATING REQUEST	"Location updating type" = periodic.
20	SS -> MS	LOCATION UPDATING ACCEPT	
21	SS -> MS	CHANNEL RELEASE	After the sending of this message, the SS waits for the disconnection of the main signalling link.

Specific message contents

None.

26.7.4.5.2 Location updating / periodic normal / test 1

26.7.4.5.2.1 Conformance requirement

- 1 The Mobile Station shall stop and reset the timer T3212 of the periodic location updating procedure when the first MM message is received or ciphering mode setting is completed in the case of MM connection establishment.
- 2 The Mobile Station shall stop and reset the timer T3212 of the periodic location updating procedure when the Mobile Station has responded to paging and thereafter has received the first correct L3 message that is not an RR message.

References

3GPP TS 04.08 / 3GPP TS 24.008 subclause 4.4.2.

26.7.4.5.2.2 Test purpose

To verify that the MS stops and resets the timer T3212 of the periodic location updating procedure when:

- the first MM-message is received in the case of MM-connection establishment, ciphering mode being not set;
- the MS has responded to paging and the first correct L3 message that is not an RR message is received.

NOTE: T3212 is stopped when the MM-idle state is left and restarted when the MM sublayer returns to that state, substate NORMAL SERVICE or ATTEMPTING TO UPDATE. As a consequence, the exact time when T3212 is reset between those two events cannot be tested.

26.7.4.5.2.3 Method of test

Initial conditions

System Simulator:

1 cell, default parameters.

IMSI attach/detach is allowed.

The T3212 time-out value is 2/10 hour.

Mobile Station:

The MS has a valid TMSI. It is "idle updated".

Specific PICS statements:

-

PIXIT statements:

-

Foreseen final state of the MS

The MS has a valid TMSI. It is "idle updated".

Test procedure

An MS originated MM connection is established and cleared. The channel is released. It is checked that the MS performs a periodic location updating 12 minutes after the release of the channel.

One minute after the periodic location updating, the MS is paged, it sends a CHANNEL REQUEST message and the SS responds with an IMMEDIATE ASSIGNMENT message, a call is established and then cleared. It is checked that the MS performs a periodic location updating 12 minutes after the release of the link.

Maximum duration of test

30 minutes.

Expected sequence

Step	Direction	Message	Comments
1	MS		A MO CM connection is attempted.
2	MS -> SS	CHANNEL REQUEST	
3	SS -> MS	IMMEDIATE ASSIGNMENT	
4	MS -> SS	CM SERVICE REQUEST	
5	SS -> MS	CM SERVICE REJECT	cause #17 (network failure).
6	SS -> MS	CHANNEL RELEASE	After the sending of this message, the SS waits for the disconnection of the main signalling link.
7	SS		The SS waits until the periodic location updating.
8	MS -> SS	CHANNEL REQUEST	"Establishment cause": Location updating This message shall arrive between 11 minutes 45 s and 12 minutes 15 s after the last release of the RR connection by the SS.
9	SS -> MS	IMMEDIATE ASSIGNMENT	
10	MS -> SS	LOCATION UPDATING REQUEST	"Location updating type" = periodic.
11	SS -> MS	LOCATION UPDATING ACCEPT	
12	SS -> MS	CHANNEL RELEASE	After the sending of this message, the SS waits for the disconnection of the main signalling link.
13	SS		The SS waits 1 minute.
14	SS -> MS	PAGING REQUEST TYPE 1	"Mobile identity" = IMSI.
15	MS -> SS	CHANNEL REQUEST	"Establishment cause": Answer to paging.
16	SS -> MS	IMMEDIATE ASSIGNMENT	
17	MS -> SS	PAGING RESPONSE	
18	SS -> MS	AUTHENTICATION REQUEST	
19	MS -> SS	AUTHENTICATION RESPONSE	
20	SS - MS	CHANNEL RELEASE	After the sending of this message, the SS waits for the disconnection of the main signalling link.
21	SS		The SS waits until the periodic location updating.
22	MS -> SS	CHANNEL REQUEST	"Establishment cause": Location updating This message shall arrive between 11 minutes 45 s and 12 minutes 15 s after the last release of the RR connection by the SS.
23	SS -> MS	IMMEDIATE ASSIGNMENT	
24	MS -> SS	LOCATION UPDATING REQUEST	"Location updating type" = periodic.
25	SS -> MS	LOCATION UPDATING ACCEPT	
26	SS -> MS	CHANNEL RELEASE	After the sending of this message, the SS waits for the disconnection of the main signalling link.

Specific message contents

None.

26.7.4.5.3 Location updating / periodic normal / test 2

26.7.4.5.3.1 Conformance requirement

When a LOCATION UPDATING ACCEPT or a LOCATION UPDATING REJECT message is received, the timer T3212 is stopped and reset and the Mobile Station shall perform a periodic location updating after T3212 expiry.

References

3GPP TS 04.08 / 3GPP TS 24.008 subclause 4.4.2.

26.7.4.5.3.2 Test purpose

To verify that the MS stops and resets the timer T3212 of the periodic location updating procedure when a LOCATION UPDATING ACCEPT message is received.

NOTE: T3212 is stopped when the MM-idle state is left and restarted when the MM sublayer returns to that state, substate NORMAL SERVICE or ATTEMPTING TO UPDATE. As a consequence, the exact time when T3212 is reset between those two events cannot be tested.

26.7.4.5.3.3 Method of test

Initial conditions

System Simulator:

2 cells, IMSI attach/detach is allowed in both cells.

T3212 is set to 6 minutes.

Mobile Station:

The MS has a valid TMSI. It is "idle updated" on cell A.

Specific PICS statements:

- On/Off switch (TSPC_Feat_OnOff)
- SIM removable without power down (TSPC_AddInfo_SIMRmv)

PIXIT statements:

-

Foreseen final state of the MS

The MS has a valid TMSI. It is "idle updated" on cell B.

Test procedure

A normal location updating is performed. The channel is released. One minute later, the MS is deactivated, then reactivated in the same cell. It is checked that the MS performs an IMSI attach and a periodic location updating 6 minutes after the IMSI attach.

Maximum duration of test

20 minutes.

Expected sequence

Step	Direction	Message	Comments
1	SS		The following messages are sent and shall be received on cell B. The RF level of cell A is lowered until the MS selects cell B.
2	MS -> SS	CHANNEL REQUEST	"establishment cause": Location updating.
3	SS -> MS	IMMEDIATE ASSIGNMENT	
4	MS -> SS	LOCATION UPDATING REQUEST	"location updating type" = normal.
5	SS -> MS	LOCATION UPDATING ACCEPT	
6	SS -> MS	CHANNEL RELEASE	After the sending of this message, the SS waits for the disconnection of the main signalling link.
7	SS		The SS waits until the periodic location updating.
8	MS -> SS	CHANNEL REQUEST	"Establishment cause": Location updating This message shall arrive between 5 minutes 45s and 6 minutes 15 s after the last release of the RR connection by the SS.
9	SS -> MS	IMMEDIATE ASSIGNMENT	
10	MS -> SS	LOCATION UPDATING REQUEST	"Location updating type" = periodic.
11	SS -> MS	LOCATION UPDATING ACCEPT	
12	SS -> MS	CHANNEL RELEASE	After the sending of this message, the SS waits for the disconnection of the main signalling link.
13	MS		If possible (see PICS) SIM removal is performed. Otherwise if possible (see PICS) switch off is performed. Otherwise the power is removed. steps 14 to 17 may be performed or not depending on the action made in step 13.
14	MS -> SS	CHANNEL REQUEST	
15	SS -> MS	IMMEDIATE ASSIGNMENT	
16	MS -> SS	IMSI DETACH INDICATION	
17	SS -> MS	CHANNEL RELEASE	After the sending of this message, the SS waits for the disconnection of the main signalling link.
18	MS		Depending on what has been performed in step 13 the MS is brought back to operation.
19	MS -> SS	CHANNEL REQUEST	"Establishment cause": Location updating.
20	SS -> MS	IMMEDIATE ASSIGNMENT	
21	MS -> SS	LOCATION UPDATING REQUEST	"Location updating type" = IMSI attach.
22	SS -> MS	LOCATION UPDATING ACCEPT	
23	SS -> MS	CHANNEL RELEASE	After the sending of this message, the SS waits for the disconnection of the main signalling link.
24	SS		The SS waits until the periodic location updating.
25	MS -> SS	CHANNEL REQUEST	"Establishment cause": Location updating This message shall arrive between 5 minutes 45 s and 6 minutes 15s after the last release of the RR connection by the SS.
26	SS -> MS	IMMEDIATE ASSIGNMENT	
27	MS -> SS	LOCATION UPDATING REQUEST	"Location updating type" = periodic.
28	SS -> MS	LOCATION UPDATING ACCEPT	
29	SS -> MS	CHANNEL RELEASE	After the sending of this message, the SS waits for the disconnection of the main signalling link.

Specific message contents

None.

26.7.4.5.4 Location updating / periodic HPLMN search

26.7.4.5.4.1 Location updating / periodic HPLMN search / MS waits time T

26.7.4.5.4.1.1 Conformance requirement

When in automatic mode and roaming in the home country, the MS shall make an attempt to access the HPLMN, if the MS is on the VPLMN at time T after since the last attempt.

NOTE: This test is not intended to test every value in the range 6 minutes to 8 hours or the default of 30 minutes, but is intended to check that the mobile is capable of using the value stored on the SIM.

References

3GPP TS 02.11 subclause 3.2.2.5.2.

3GPP TS 03.22 subclause 4.4.3.3.

26.7.4.5.4.1.2 Test purpose

To verify that when a cell of the HPLMN becomes available, following the successful location request on the VPLMN of the home country and after the first search the mobile has failed to find its HPLMN, that the MS shall perform a location update request on the HPLMN after time T. Where T is the HPLMN Search Period stored in the SIM.

26.7.4.5.4.1.3 Method of test

Initial conditions

System Simulator:

Two cells A and B, belonging to different location areas with location identification a and b. Cell A shall be a cell of the HPLMN and Cell B shall be a cell of the VPLMN with a Country Code the same as that of Cell A. Initially Cell A shall not be broadcasting. IMSI attach/detach is not allowed on either cell.

Mobile Station:

The MS is switched off. The HPLMN Search Period on the SIM shall be set to 6 minutes. The location area information on the SIM is "deleted".

Specific PICS statements:

- On/Off switch (TSPC_Feat_OnOff)

PIXIT statements:

-

Foreseen final state of the MS

The MS is "idle updated" on Cell A.

Test Procedure

Only Cell B shall be broadcasting. The MS shall be switched on either by using the Power Switch or by applying power. A normal location updating is performed on Cell B. Cell A shall be made available after 8 minutes, thus ensuring the MS fails to find the HPLMN during its first attempt. It is verified that the MS performs a location update request on Cell A, within 6 minutes after broadcasting of Cell A.

Maximum duration of test

17 minutes.

Expected sequence

Step	Direction	Message	Contents
1	MS		The following messages shall be sent and received on Cell B. The MS is switched on by either using the Power Switch or by applying power.
2	MS -> SS	CHANNEL REQUEST	"Establishment cause": Location updating.
3	SS -> MS	IMMEDIATE ASSIGNMENT	
4	MS -> SS	LOCATION UPDATING REQUEST	"Location Update Type": Normal.
5	SS -> MS	LOCATION UPDATING ACCEPT	
6	SS -> MS	CHANNEL RELEASE	After sending this message the SS waits for the disconnection of the main signalling link. The SS waits a period of 8 minutes, this allowing the MS to make its first periodic search.
7			Cell A is made available.
8	SS		Within 8 minutes after step 7 the following messages shall be sent and received on Cell A.
9	MS -> SS	CHANNEL REQUEST	"Establishment cause": Location updating.
10	SS -> MS	IMMEDIATE ASSIGNMENT	
11	MS -> SS	LOCATION UPDATING REQUEST	"Location Update Type": normal.
12	SS -> MS	LOCATION UPDATING ACCEPT	
13	SS -> MS	CHANNEL RELEASE	After sending this message the SS waits for the disconnection of the main signalling link.

Specific message contents

None.

26.7.4.5.4.2 Location updating / periodic HPLMN search / MS in manual mode

26.7.4.5.4.2.1 Conformance requirement

The periodic attempts shall only be performed if in automatic mode when the MS is roaming in its home country.

References

3GPP TS 02.11 subclause 3.2.2.5.2.

3GPP TS 03.22 subclause 4.4.3.3.

26.7.4.5.4.2.2 Test purpose

To verify that no HPLMN Search is performed when the MS is not in automatic mode.

26.7.4.5.4.2.3 Method of test

Initial conditions

System Simulator:

Two cells A and B, belonging to different location areas with location identification a and b. Cell A shall be a cell of the HPLMN and Cell B shall be a cell of the VPLMN with a Country Code the same as that of Cell A. Initially Cell A shall not be broadcasting. IMSI attach/detach is not allowed on either cell.

Mobile Station:

The MS is switched off. The HPLMN Search Period on the SIM shall be set to 6 minutes. The location area information on the SIM is "deleted".

Specific PICS statements:

- On/Off switch (TSPC_Feat_OnOff)

PIXIT statements:

-

Foreseen final state of the MS

The MS is "idle updated" on Cell B.

Test Procedure

Only Cell B shall be broadcasting. The MS shall be switched on either by using the Power Switch or by applying power. A normal location updating is performed on Cell B. The MS is forced into manual selection mode. Cell A is made available. It is verified that the MS does not attempt to perform a location update on Cell A.

Maximum duration of test

7 minutes.

Expected sequence

Step	Direction	Message	Contents
1	MS		The following messages shall be sent and received on Cell B. The MS is switched on by either using the Power Switch or by applying power.
2	MS -> SS	CHANNEL REQUEST	"Establishment cause": Location updating.
3	SS -> MS	IMMEDIATE ASSIGNMENT	
4	MS -> SS	LOCATION UPDATING REQUEST	"Location Update Type": Normal.
5	SS -> MS	LOCATION UPDATING ACCEPT	
6	SS -> MS	CHANNEL RELEASE	After sending this message the SS waits for the disconnection of the main signalling link.
8	MS		The MS is forced into manual selection mode.
9	SS		Cell A is made available.
10	SS		The SS waits a period of 7 minutes. During this time no messages shall be received on Cell A.

Specific message contents

None.

26.7.4.5.4.3 Location updating / periodic HPLMN search / MS waits at least two minutes and at most T minutes

26.7.4.5.4.3.1 Conformance requirement

After switch on, the MS waits at least 2 minutes and at most T minutes before the first HPLMN Search is attempted.

References

3GPP TS 02.11 subclause 3.2.2.5.2.

3GPP TS 03.22 subclause 4.4.3.3.

26.7.4.5.4.3.2 Test purpose

To verify that the MS waits at least 2 minutes and at most T minutes before attempting its first HPLMN Search.

26.7.4.5.4.3.3 Method of test

Initial Conditions

System Simulator:

Two cells A and B, belonging to different location areas with location identification a and b. Cell A shall be a cell of the HPLMN and Cell B shall be a cell of the VPLMN with a Country Code the same as that of Cell A. Initially Cell A shall not be broadcasting. IMSI attach/detach is not allowed on either cell.

Mobile Station:

The MS is switched off. The HPLMN Search Period on the SIM shall be set to 6 minutes. The location area information on the SIM is "deleted".

Specific PICS statements:

- On/Off switch (TSPC_Feat_OnOff)

PIXIT statements:

-

Foreseen final state of the MS

The MS is "idle updated" on Cell A.

Test Procedure

Only Cell B shall be broadcasting. The MS shall be switched on either by using the Power Switch or by applying power. A normal location updating is performed on Cell B. Cell A is made available. It is verified that the MS attempts to perform a location update on Cell A, after at least 2 minutes and at most T minutes have passed following power on.

Maximum duration of test

8 minutes.

Expected sequence

Step	Direction	Message	Contents
			The following messages shall be sent and received on Cell B.
1	MS		The MS is switched on by either using the Power Switch or by applying power.
2	MS -> SS	CHANNEL REQUEST	"Establishment cause": Location updating.
3	SS -> MS	IMMEDIATE ASSIGNMENT	
4	MS -> SS	LOCATION UPDATING REQUEST	"Location Update Type": Normal.
5	SS -> MS	LOCATION UPDATING ACCEPT	
6	SS -> MS	CHANNEL RELEASE	After sending this message the SS waits for the disconnection of the main signalling link.
8	SS		Cell A is made available.
9	SS		The SS waits a period of 2 minutes after MS is switched on. During this time no messages shall be received on Cell A. The following messages shall be sent and received on cell A. Within T minutes after step 5 the following messages shall be sent and received on cell A.
10	MS -> SS	CHANNEL REQUEST	"Establishment cause": Location updating This message shall be sent between 2 and 7 minutes after step 1
11	SS -> MS	IMMEDIATE ASSIGNMENT	
12	MS -> SS	LOCATION UPDATING REQUEST	"Location Update Type": normal.
13	SS -> MS	LOCATION UPDATING ACCEPT	
14	SS -> MS	CHANNEL RELEASE	After sending this message the SS waits for the disconnection of the main signalling link.

Specific message contents

None.

26.7.4.5.4.4 Location updating/periodic search of the higher priority PLMN, when a MS is receiving foreign country's VPLMN/MS is in automatic mode.

26.7.4.5.4.4.1 Conformance requirement

A MS in Automatic Mode shall make periodic attempts to look for a higher priority PLMN of the same country as the currently received PLMN.

References.

3GPP TS 22.011, subclause 3.2.2.5

26.7.4.5.4.4.2 Test purpose

To verify that the MS selects the highest priority network if the HPLMN/higher priority PLMN Search is performed, when a MS is receiving foreign country's VPLMN and MS is in automatic mode.

26.7.4.5.4.4.3 Method of test

Initial conditions

System Simulator:

Three cells A, B and C, belonging to different location areas with location identification a, b and c. Cell A shall be a cell of the HPLMN, Cell B shall be a cell of the VPLMN with a different Mobile Country Codes that of Cell A and Cell C shall be a cell of a higher priority VPLMN but of the same Mobile Country Code as Cell B. Initially Cell A and Cell C shall not be broadcasting. IMSI attach/detach is not allowed on any cell. The downlink input level setting for cells B and C shall be the same as cell A.

Mobile Station:

The MS is switched off. The HPLMN Search Period on the SIM shall be set to 6 minutes. The location area information on the SIM is "deleted".

Specific PICS statements:

- On/Off switch (TSPC_Feat_OnOff)

PIXIT statements:

-

Foreseen final state of the MS

The MS is "idle updated" on Cell C.

Test Procedure

Only Cell B shall be broadcasting. The MS shall be switched on either by using the Power Switch or by applying power. A normal location updating is performed on Cell B. The MS is in automatic selection mode. Cell A and Cell C are made available. It is verified that the MS does not attempt to perform a location update on Cell A. It is verified that the MS does perform a location update on Cell C.

Maximum duration of test

7 minutes.

Expected sequence

Step	Direction	Message	Contents
1	MS		The following messages shall be sent and received on Cell B. The MS is switched on by either using the Power Switch or by applying power.
2	MS -> SS	CHANNEL REQUEST	"Establishment cause": Location updating.
3	SS -> MS	IMMEDIATE ASSIGNMENT	
4	MS -> SS	LOCATION UPDATING REQUEST	"Location Update Type": Normal.
5	SS -> MS	LOCATION UPDATING ACCEPT	
6	SS -> MS	CHANNEL RELEASE	After sending this message the SS waits for the disconnection of the main signalling link.
7	SS		Cell A is made available.
8	SS		Cell C is made available.
9	SS		The SS waits a period of 7 minutes. During this time no messages shall be received on Cell A but the following messages are received on Cell C.
10	MS -> SS	CHANNEL REQUEST	"Establishment cause": Location updating.
11	SS -> MS	IMMEDIATE ASSIGNMENT	
12	MS -> SS	LOCATION UPDATING REQUEST	"Location Update Type": Normal.
13	SS -> MS	LOCATION UPDATING ACCEPT	
14	SS -> MS	CHANNEL RELEASE	After sending this message the SS waits for the disconnection of the main signalling link.

Specific message contents

None.

26.7.4.5.4.5 Location updating/periodic PLMN search in foreign country's border areas/MS is in automatic mode.

26.7.4.5.4.5.1 Conformance requirement

A MS in Automatic Mode shall make periodic attempts to look for a higher priority PLMN of the same country as the currently received PLMN. The MS shall not select a lower priority PLMN of the same country as the currently received PLMN.

References

1. 3GPP TS 22.011, subclause 3.2.2.5

26.7.4.5.4.5.2 Test purpose

To verify that the MS remains on the highest priority network when the HPLMN/higher priority PLMN Search is performed, if the MS is receiving a foreign country's VPLMN and is in automatic mode.

26.7.4.5.4.5.3 Method of test

Initial conditions

System Simulator:

Three cells A, B and C, belonging to different location areas with location identification a, b and c. Cell A shall be a cell of the HPLMN, Cell B shall be a cell of the VPLMN with a different Mobile Country Codes that of Cell A and Cell C shall be a cell of a lower priority VPLMN but of the same Mobile Country Code as Cell B. Initially Cell A and Cell C shall not be broadcasting. IMSI attach/detach is not allowed on any cell. The downlink input level setting for cells B and C shall be the same as cell A.

Mobile Station:

The MS is switched off. The HPLMN Search Period on the SIM shall be set to 6 minutes. The location area information on the SIM is "deleted". The PLMN Selector on the SIM shall contain entries for both PLMNs of Cell B and Cell C, where PLMN B is of a higher priority than PLMN C.

Specific PICS statements:

- On/Off switch (TSPC_Feat_OnOff)

PIXIT statements:

-

Foreseen final state of the MS

The MS is "idle updated" on Cell B.

Test Procedure

Only Cell B shall be broadcasting. The MS shall be switched on either by using the Power Switch or by applying power. A normal location updating is performed on Cell B. The MS is in automatic selection mode. Cell A and Cell C are made available. It is verified that the MS does not attempt to perform a location update on Cell A or Cell C.

Maximum duration of test

7 minutes.

Expected sequence

Step	Direction	Message	Contents
1	MS		The following messages shall be sent and received on Cell B. The MS is switched on by either using the Power Switch or by applying power.
2	MS -> SS	CHANNEL REQUEST	"Establishment cause": Location updating.
3	SS -> MS	IMMEDIATE ASSIGNMENT	
4	MS -> SS	LOCATION UPDATING REQUEST	"Location Update Type": Normal.
5	SS -> MS	LOCATION UPDATING ACCEPT	
6	SS -> MS	CHANNEL RELEASE	After sending this message the SS waits for the disconnection of the main signalling link.
7	SS		Cell A is made available.
8	SS		Cell C is made available.
9	SS		The SS waits a period of 7 minutes. During this time no messages shall be received on Cell A or C.

Specific message contents

None.

26.7.4.5.4.6 Location updating/periodic search for higher priority PLMN when the list of equivalent PLMNs includes the HPLMN, when a MS is registered in a foreign country's VPLMN/MS is in automatic mode.

26.7.4.5.4.6.1 Conformance requirement

A UE in Automatic Mode shall make periodic attempts to look for a higher priority PLMN of the same country as the currently registered PLMN. For the ranking of PLMNs the UE shall use the order used in subclause 3.2.2.2. In the case that the MS has stored a list of equivalent PLMNs, the UE shall only select a PLMN if it has a higher priority than all the PLMNs, in the list of equivalent PLMNs, which are of the same country as the currently registered PLMN

The Mobile Equipment stores a list of "equivalent PLMNs". This list is replaced or deleted at the end of each location update procedure, routing area update procedure and GPRS attach procedure. The stored list consists of a list of equivalent PLMNs as downloaded by the network plus the PLMN code of the network that downloaded the list. All

PLMNs in the stored list are regarded as equivalent to each other for PLMN selection, cell selection/re-selection and handover.

References.

1. 3GPP TS 22.011, subclause 3.2.2.5
2. 3GPP TS 23.122, subclause 4.4.3

26.7.4.5.4.6.2 Test purpose

To verify that, in automatic mode, when registered on a VPLMN of a country different to its HPLMN, the MS only selects the highest priority network available from upon those of the same country as the serving PLMN. It also verifies that the MS does not take into account PLMNs, including the HPLMN, which are included in the Equivalent PLMN list.

26.7.4.5.4.6.3 Method of test

Initial conditions

System Simulator:

Three cells A, B and C, belonging to different location areas with location identification a, b and c. Cell A shall be a cell of the HPLMN, Cell B shall be a cell of the VPLMN with a different Mobile Country Codes that of Cell A and Cell C shall be a cell of a higher priority VPLMN but of the same Mobile Country Code as Cell B. Initially Cell A and Cell C shall not be broadcasting. The downlink input level setting for cells B and C shall be the same as cell A. The BA list of Cell B does not include Cell A or Cell C.

Mobile Station:

The MS is switched off. The HPLMN Search Period on the SIM shall be set to 6 minutes. The location area information on the SIM is "deleted".

Specific PICS statements:

- On/Off switch (TSPC_Feat_OnOff)

PIXIT statements:

-

Foreseen final state of the MS

The MS is "idle updated" on Cell C.

Test Procedure

Only Cell B shall be broadcasting. The MS shall be switched on either by using the Power Switch or by applying power. A normal location updating is performed on Cell B. During the location update procedure Cell B sends an equivalent PLMN list which includes the HPLMN (Cell A). The MS is in automatic selection mode. The MS receives and store the equivalent PLMN list. The Cell A and Cell C are made available. Cell C is of a higher priority VPLMN but of the same Mobile Country Code as Cell B. It is verified that the MS does not attempt to perform a location update on Cell A. It is verified that the MS does perform a location update on Cell C.

Maximum duration of test

8 minutes.

Expected sequence

Step	Direction	Message	Contents
1	MS		The following messages shall be sent and received on Cell B. The MS is switched on by either using the Power Switch or by applying power.
2	MS -> SS	CHANNEL REQUEST	"Establishment cause": Location updating.
3	SS -> MS	IMMEDIATE ASSIGNMENT	
4	MS -> SS	LOCATION UPDATING REQUEST	
5	SS -> MS	LOCATION UPDATING ACCEPT	The MS receives and store an equivalent PLMN list.
6	SS -> MS	CHANNEL RELEASE	After sending this message the SS waits for the disconnection of the main signalling link.
7	SS		Cell A is made available.
8	SS		Cell C is made available.
9	SS		The SS waits a period of 7 minutes. During this time no messages shall be received on Cell A but the following messages are received on Cell C.
10	MS -> SS	CHANNEL REQUEST	"Establishment cause": Location updating.
11	SS -> MS	IMMEDIATE ASSIGNMENT	
12	MS -> SS	LOCATION UPDATING REQUEST	
13	SS -> MS	LOCATION UPDATING ACCEPT	"Location Update Type": Normal.
14	SS -> MS	CHANNEL RELEASE	After sending this message the SS waits for the disconnection of the main signalling link.

Specific message contents

None.

26.7.4.6 Location updating / interworking of attach and periodic

26.7.4.6.1 Conformance requirement

- 1) If the Mobile Station is in service state NO CELL AVAILABLE, LIMITED SERVICE, PLMN SEARCH or PLMN SEARCH-NORMAL SERVICE when the timer expires the location updating procedure is delayed until this service state is left.
- 2) The T3212 time-out value shall not be changed in the NO CELL AVAILABLE, LIMITED SERVICE, PLMN SEARCH and PLMN SEARCH-NORMAL SERVICE states.
- 3) If the selected cell is in the location area where the mobile station is registered and IMSI ATTACH is not required and timer T3212 has not expired, then the state is NORMAL SERVICE.

References

1. 3GPP TS 04.08 / 3GPP TS 24.008 subclause 4.4.2.
2. 3GPP TS 04.08 / 3GPP TS 24.008 subclause 4.4.2.
3. 3GPP TS 04.08 / 3GPP TS 24.008 subclause 4.2.1.1.

26.7.4.6.2 Test purpose

- 1) To check that if the PLU timer expires while the MS is out of coverage, the MS informs the network of its return to coverage.
- 2) To check that the PLU timer is not disturbed by cells of forbidden PLMNs.
- 3) To check that if the PLU timer does not expire while out of coverage and if the mobile returns to the LA where it is updated, the mobile does not inform the network of its return to coverage.

26.7.4.6.3 Method of test

Initial conditions

System Simulator:

Two cells, a and b, of different PLMNs.

T3212 is set to 12 minutes on cell a.

T3212 is set to 6 minutes on cell b.

IMSI attach is allowed in both cells.

Mobile Station:

The MS is deactivated. The PLMN of cell b is entered in the SIM's forbidden PLMN list.

Specific PICS statements:

-

PIXIT statements:

-

Foreseen final state of the MS

The MS is "idle updated". The PLMN of cell b is entered in the SIM's forbidden PLMN list.

Test procedure

The MS is activated and placed in automatic network selection mode. It performs IMSI attach. 1 minute after the end of the IMSI attach procedure, cell a is switched off. The MS shall not location update on cell b. 8 minutes after the end of the IMSI attach procedure, cell a is switched on. The MS shall not location update on cell a before 11,75 minutes after the end of the IMSI attach procedure. The MS shall perform a periodic location update on cell a between 11,75 minutes and 12,25 minutes after the end of the IMSI attach procedure.

3 minutes after the end of the periodic location updating procedure, cell a is switched off. The MS shall not location update on cell b. 14 minutes after the end of the periodic location updating procedure, cell a is switched on and cell b is switched off. The MS shall perform a location update on cell a before 17 minutes after the end of the periodic location updating procedure.

Maximum duration of test

35 minutes.

Expected sequence

Step	Direction	Message	Comments
1	MS		The MS is activated in automatic network selection mode.
2	MS -> SS	CHANNEL REQUEST	
3	SS -> MS	IMMEDIATE ASSIGNMENT	
4	MS -> SS	LOCATION UPDATING REQUEST	"location updating type": IMSI attach.
5	SS -> MS	LOCATION UPDATING ACCEPT	
6	SS -> MS	CHANNEL RELEASE	After the sending of this message, the SS waits for the disconnection of the main signalling link.
7	SS		1 minute after step 6, cell a is switched off.
8	SS		8 minutes after step 6, cell a is switched on.
9	MS -> SS	CHANNEL REQUEST	This message shall be sent by the MS between 11 minutes 45s and 12 minutes 15s after step 6.
10	SS -> MS	IMMEDIATE ASSIGNMENT	
11	MS -> SS	LOCATION UPDATING REQUEST	"location updating type": periodic updating.
12	SS -> MS	LOCATION UPDATING ACCEPT	
13	SS -> MS	CHANNEL RELEASE	After the sending of this message, the SS waits for the disconnection of the main signalling link.
14	SS		3 minutes after step 13, cell a is switched off.
15	SS		14 minutes after step 13, cell a is switched on and cell b is switched off.
16	MS -> SS	CHANNEL REQUEST	This message shall be sent by the MS before 17 minutes after step 13.
17	SS -> MS	IMMEDIATE ASSIGNMENT	
18	MS -> SS	LOCATION UPDATING REQUEST	"Location updating type" = periodic.
19	SS -> MS	LOCATION UPDATING ACCEPT	
22	SS -> MS	CHANNEL RELEASE	After the sending of this message, the SS waits for the disconnection of the main signalling link.

Specific message contents

None.

26.7.5 MM connection

26.7.5.1 Introduction

[tbd]

26.7.5.2 MM connection / establishment with cipher and repeated FACCH

26.7.5.2.1 Conformance requirement

The Mobile Station shall be able to correctly set up an MM connection in a Mobile Originating CM connection attempt and send a CM Service Request message with CKSN information element as stored in the SIM and Mobile Identity information element set to the TMSI.

The Mobile Station shall be able to interpret cipher mode setting as acceptance of its CM service request i.e. send a CM message.

3GPP TS 04.08 / 3GPP TS 24.008 subclause 4.5.1.1;

The BSS may, based on implementation-dependent criteria (e.g. downlink measurements), decide to repeat any downlink LAPDm command frame sent in a FACCH block over the radio interface. If the MS has signalled the Repeated ACCH Capability bit as '1' (see 3GPP TS 24.008), the BSS may also, based on implementation-dependent criteria, decide to repeat any downlink LAPDm response frame sent in a FACCH block over the radio interface. In both cases, the repeated FACCH block shall be sent as specified in sub-clause 10.2.

3GPP TS 44.006 subclause 10.3;

The MS shall, when receiving a downlink FACCH block, always attempt to decode it without combining with any previously received FACCH block.

If the current FACCH block is successfully decoded and an identical FACCH block was previously received (successfully decoded and spaced in time from the current FACCH block as specified in sub-clause 10.2), the MS shall not send the LAPDm frame of the current FACCH block to the LAPDm entity.

3GPP TS 44.006 subclause 10.4;

26.7.5.2.2 Test purpose

To verify that the MS can correctly set up an MM connection in an origination and interpret cipher mode setting as acceptance of its CM service request.

To verify that the MS behaves correctly when Repeated FACCH is used by the SS for LAPDm command frames, and additionally where the MS supported repeated ACCH for LAPDm response frames.

26.7.5.2.3 Method of test

Initial conditions

System Simulator:

1 cell, default parameters.

Mobile Station:

The MS has a valid TMSI. It is "idle updated".

Specific PICS statements:

- at least one half rate service (TSPC_AddInfo_HalfRate)
- Support of Repeated ACCH (TSPC_Repeated_ACCH)

PIXIT statements:

-

Foreseen final state of the MS

The MS has valid TMSI, CKSN. It is "idle updated".

Test Procedure

A mobile originating CM connection is initiated. After the MS has sent the CM SERVICE REQUEST message to the SS, an authentication procedure and a ciphering mode setting procedure are performed. Then, the MS sends a CM message and the SS clears the call and releases the channel.

Throughout this test, the SS shall activate Repeated FACCH for LAPDm command frames on FACCH. Where the MS supports Repeated ACCH, the SS shall additionally activate Repeated FACCH for LAPDm response frames on FACCH for the uplink.

This test is repeated for:

k=1;

k=2;

k=3 where the MS supports at least one half rate service.

Maximum duration of test

3 minute.

Expected sequence

Step	Direction	Message	Comments
1	MS		A MO CM connection is attempted.
2	MS -> SS	CHANNEL REQUEST	
3	SS -> MS	IMMEDIATE ASSIGNMENT	See specific message contents.
4	MS -> SS	CM SERVICE REQUEST	
5	SS -> MS	CLASSMARK ENQUIRY	
6	MS -> SS	CLASSMARK CHANGE	If the Repeated ACCH Capability bit is set the MS should repeat LAPDm response frames also
7	SS -> MS	AUTHENTICATION REQUEST	
8	MS -> SS	AUTHENTICATION RESPONSE	
9	SS -> MS	CIPHERING MODE COMMAND	The SS starts deciphering.
10	MS -> SS	CIPHERING MODE COMPLETE	The SS starts enciphering.
A11	MS -> SS	SETUP	
A112	SS -> MS	RELEASE COMPLETE	"Cause" IE: "unassigned number".
B11	MS -> SS	REGISTER	
B12	SS -> MS	RELEASE COMPLETE	
C11	MS -> SS	CP-DATA	
C12	SS -> MS	CP-ACK	
C13	SS -> MS	CP-DATA	
C14	MS -> SS	CP-ACK	
15	SS -> MS	CHANNEL RELEASE	After the sending of this message, the SS waits for the disconnection of the main signalling link.

Specific message contents

IMMEDIATE ASSIGNMENT

Information Element	value/remarks
Channel description	k=1: SDCCH k=2: TCH/F k=3: TCH/H

SYSTEM INFORMATION TYPE 3

Information Element	Value/remark
MSCR	1 = MSC is Release '99 onwards

26.7.5.3 MM connection / establishment without cipher

26.7.5.3.1 Conformance requirement

Upon reception of the CM SERVICE ACCEPT message, the MS shall send a CM message.

References

3GPP TS 04.08 / 3GPP TS 24.008 subclauses 4.5.1.1.

26.7.5.3.2 Test purpose

To verify that the MS can correctly set up an MM connection in an originating CM connection establishment when ciphering mode setting is not required.

26.7.5.3.3 Method of test

Initial conditions

System Simulator:

1 cell, default parameters.

Mobile Station:

The MS has a valid TMSI. It is "idle updated".

Specific PICS statements:

-

PIXIT statements:

-

Foreseen final state of the MS

The MS has a valid TMSI. It is "idle updated".

Test Procedure

A mobile originating CM connection is attempted. The MM-connection is established without invoking the ciphering mode setting procedure.

Then, the MS sends a CM message and the SS releases the channel.

Maximum duration of test

one minute.

Expected sequence

Step	Direction	Message	Comments
1	MS		A MO CM connection is attempted.
2	MS -> SS	CHANNEL REQUEST	
3	SS -> MS	IMMEDIATE ASSIGNMENT	
4	MS -> SS	CM SERVICE REQUEST	
5	SS -> MS	CM SERVICE ACCEPT	
A6	MS -> SS	SETUP	
B6	MS -> SS	REGISTER	
C6	MS -> SS	CP-DATA	
C7	SS -> MS	CP-ACK	
C8	SS -> MS	CP-DATA	
C9	MS -> SS	CP-ACK	
10	SS -> MS	CHANNEL RELEASE	After the sending of this message, the SS waits for the disconnection of the main signalling link.

Specific message contents

None.

26.7.5.4 MM connection / establishment rejected

26.7.5.4.1 Conformance requirement

Upon reception of a CM SERVICE REJECT message, the MS shall not send any layer 3 message, start timer T3240 and enter the "wait for network command" state.

References

3GPP TS 04.08 / 3GPP TS 24.008 subclause 4.5.1.1.

26.7.5.4.2 Test purpose

To verify that the MS does not send a layer 3 message when the service request is rejected by the SS.

26.7.5.4.3 Method of test

Initial conditions

System Simulator:

1 cell, default parameters.

Mobile Station:

The MS has a valid TMSI. It is "idle updated".

Specific PICS statements:

-

PIXIT statements:

-

Foreseen final state of the MS

The MS has a valid TMSI; It is "idle updated".

Test Procedure

A mobile originating CM connection is attempted. After the MS has sent the CM SERVICE REQUEST message to the SS, the SS responds with a CM SERVICE REJECT message with reject cause "requested service option not subscribed". It is checked that the MS does not send a layer 3 message.

Maximum duration of test

1 minute.

Expected sequence

Step	Direction	Message	Comments
1	MS		A MO CM connection is attempted
2	MS -> SS	CHANNEL REQUEST	
3	SS -> MS	IMMEDIATE ASSIGNMENT	
4	MS -> SS	CM SERVICE REQUEST	
5	SS -> MS	CM SERVICE REJECT	"Reject cause" IE: "requested service option not subscribed".
6	SS		The MS shall not send a layer 3 message. This is checked during 5 s.
7	SS -> MS	CHANNEL RELEASE	After the sending of this message, the SS waits for the disconnection of the main signalling link.

Specific message contents

None.

26.7.5.5 MM connection / establishment rejected cause 4

26.7.5.5.1 Conformance requirement

- 1) The Mobile Station shall be able to correctly set up an MM connection in a Mobile Originating CM connection attempt and send a CM Service Request message with CKSN information element as stored in the SIM and Mobile Identity information element set to the TMSI.
- 2) The Mobile Station, when receiving a CM SERVICE REJECT message with reject cause "IMSI unknown in VLR" shall wait for the network to release the RR connection.
- 3) The Mobile Station shall then be able to perform a location updating procedure.

References

3GPP TS 04.08 / 3GPP TS 24.008 subclause 4.5.1.1.

26.7.5.5.2 Test purpose

To verify that the MS can correctly accept a CM SERVICE REJECT message with reject cause "IMSI unknown in VLR".

26.7.5.5.3 Method of test

Initial conditions

System Simulator:

1 cell, default parameters.

Mobile Station:

The MS has a valid TMSI. It is "idle updated".

Specific PICS statements:

-

PIXIT statements:

-

Foreseen final state of the MS

The MS has valid TMSI, CKSN. It is "idle updated".

Test Procedure

A mobile originating CM connection is attempted. After the MS has sent the CM SERVICE REQUEST message to the SS, the SS responds with a CM SERVICE REJECT message with reject cause "IMSI unknown in VLR". On receipt of this message, the MS shall delete any TMSI, LAI, cipher key and cipher key sequence number. The channel is released. It is checked that the MS performs a normal location updating procedure.

Maximum duration of test

One minute.

Expected sequence

Step	Direction	Message	Comments
1	MS		A MO CM connection is attempted.
2	MS -> SS	CHANNEL REQUEST	
3	SS -> MS	IMMEDIATE ASSIGNMENT	
4	MS -> SS	CM SERVICE REQUEST	
5	SS -> MS	CM SERVICE REJECT	"Reject cause" = "IMSI unknown in VLR".
6	SS -> MS	CHANNEL RELEASE	After the sending of this message, the SS waits for the disconnection of the main signalling link.
7	MS -> SS	CHANNEL REQUEST	"Establishment cause": Location updating.
8	SS -> MS	IMMEDIATE ASSIGNMENT	
9	MS -> SS	LOCATION UPDATING REQUEST	"Ciphering key sequence number" = "No key is available". "Mobile identity" = IMSI. "Location area identification" = deleted LAI (the MCC and MNC hold the previous values, the LAC is coded FFFE).
10	SS -> MS	AUTHENTICATION REQUEST	
11	MS -> SS	AUTHENTICATION RESPONSE	
12	SS -> MS	LOCATION UPDATING ACCEPT	"Mobile identity" = new TMSI.
13	MS -> SS	TMSI REALLOCATION COMPLETE	
14	SS -> MS	CHANNEL RELEASE	After the sending of this message, the SS waits for the disconnection of the main signalling link.

Specific message contents

None.

26.7.5.6 MM connection / expiry T3230

26.7.5.6.1 Conformance requirement

At T3230 expiry (i.e. no response is given but an RR connection is available) the MM connection establishment shall be aborted.

References

3GPP TS 04.08 / 3GPP TS 24.008 subclauses 4.5.1.2 and 11.2.

26.7.5.6.2 Test purpose

To verify that at T3230 expiry, the MS aborts the MM-connection establishment.

26.7.5.6.3 Method of test

Initial conditions

System Simulator:

1 cell, default parameters.

Mobile Station:

The MS has a valid TMSI. It is "idle updated".

Specific PICS statements:

-

PIXIT statements:

-

Foreseen final state of the MS

The MS has a valid TMSI. It is "idle updated".

Test Procedure

A mobile originating CM connection is attempted. After the MS has sent the CM SERVICE REQUEST message to the SS, the SS waits for expiry of timer T3230. It is checked that the MS does not send a layer 3 message but waits for the release of the RR-connection.

Maximum duration of test

1 minute.

Expected sequence

Step	Direction	Message	Comments
1	MS		A MO CM connection is attempted.
2	MS -> SS	CHANNEL REQUEST	
3	SS -> MS	IMMEDIATE ASSIGNMENT	
4	MS -> SS	CM SERVICE REQUEST	
5	SS		The SS waits for expiry of timer T3230.
6	SS -> MS	CM SERVICE ACCEPT	
7	MS -> SS	MM STATUS	"Reject cause " IE is "message not compatible with the call state or not implemented".
8	SS -> MS	CHANNEL RELEASE	After the sending of this message, the SS waits for the disconnection of the main signalling link.

Specific message contents

None.

26.7.5.7 MM connection / abortion by the network

26.7.5.7.1 MM connection / abortion by the network / cause #6

26.7.5.7.1.1 Conformance requirement

- 1) Upon reception of an ABORT message, the MS shall release any ongoing MM connection and enter the "wait for network command" state.
- 2) If the cause in the ABORT message was cause #6, the Mobile Station shall:
 - 2.1 not perform normal location updating;
 - 2.2 not perform periodic location updating;
 - 2.3 not respond to paging with TMSI;
 - 2.4 reject any request for Mobile Originating call establishment except Emergency call;
 - 2.5 not perform IMSI detach if deactivated.
- 3) After reception of an ABORT message with cause #6, the Mobile Station, if it supports speech, shall accept a request for an emergency call by sending a Channel Request message with the establishment cause set to "emergency call".
- 4) After reception of an ABORT message with cause #6, the Mobile Station shall delete the stored LAI, CKSN and TMSI.

Reference(s)

3GPP TS 04.08 / 3GPP TS 24.008 subclause 4.3.5.

26.7.5.7.1.2 Test purpose

To check that upon reception of an ABORT message with cause #6 during call establishment:

- the MS does not send any layer 3 message;
- after reception of an ABORT message and after having been deactivated and reactivated, the MS performs location updating using its IMSI as mobile identity and indicates deleted LAI and CKSN;
- the MS does not perform location updating, does not answer to paging with TMSI, rejects any request for mobile originating call except emergency call, does not perform IMSI detach;
- the MS accepts a request for emergency call.

26.7.5.7.1.3 Method of test

Initial Conditions

System Simulator:

2 cells, default parameters.

Mobile Station:

The MS has a valid TMSI, CKSN and Kc. It is "idle updated" on cell B.

Specific PICS statements:

- On/Off switch (TSPC_Feat_OnOff)
- SIM removable without power down (TSPC_AddInfo_SIMRmv)
- Speech supported for Full rate version 1 (GSM FR) (TSPC_AddInfo_Full_rate_version_1)

PIXIT statements:

-

Foreseen final state of the MS

The MS has a valid TMSI. It is "idle updated" on cell A.

Test procedure

A mobile originating CM connection is attempted. Upon reception of the AUTHENTICATION RESPONSE message, the SS sends an ABORT message with cause #6. The SS waits for 5 s. The MS shall not send any layer 3 message. The SS releases the RR connection.

The SS checks that the MS has entered the state MM IDLE substate NO IMSI, i.e. does not perform normal location updating, does not perform periodic updating, does not respond to paging, rejects any requests from CM entities except emergency calls and does not perform IMSI detach if deactivated.

Maximum Duration Of Test

10 minutes.

Expected Sequence

Step	Direction	Message	Comments
The following messages are sent and shall be received on cell B			
1	MS		A mobile originating CM connection is attempted. "reject cause" = #6. The SS waits for 5 s. The MS shall not send any layer 3 message during that time. After the sending of this message, the SS waits for the disconnection of the main signalling link.
2	MS -> SS	CHANNEL REQUEST	
3	SS -> MS	IMMEDIATE ASSIGNMENT	
4	MS -> SS	CM SERVICE REQUEST	
5	SS -> MS	AUTHENTICATION REQUEST	
6	MS -> SS	AUTHENTICATION RESPONSE	
7	SS -> MS	ABORT	
8	SS		
9	MS		
10	SS -> MS	CHANNEL RELEASE	
The following messages are sent and shall be received on cell A.			
11	SS		The RF levels are changed to make the MS reselect cell A. The MS performs cell reselection according to procedure as specified in 3GPP TS 05.08 (this however is not checked until step 22). The MS shall not initiate an RR connection establishment on cell A or on cell B.
12	MS		
13	SS		The SS waits at least 7 minutes for a possible periodic updating. The MS shall not initiate an RR connection establishment on cell A or on cell B.
14	MS		
15	SS -> MS	PAGING REQUEST TYPE 1	"Mobile identity" IE contains TMSI. The MS shall not initiate an RR connection establishment on cell A or on cell B. This is verified during 3 s.
16	MS		
17	MS		A MO CM connection is attempted. The MS shall not initiate an RR connection establishment on cell A or on cell B. This is checked during 3 s.
18	MS		
19	MS		If the MS supports speech (see PICS), an emergency call is attempted. "Establishment cause": Emergency call. "CM service type": Emergency call establishment. "Cause" = unassigned number. After the sending of this message, the SS waits for the disconnection of the main signalling link.
20	MS -> SS	CHANNEL REQUEST	
21	SS -> MS	IMMEDIATE ASSIGNMENT	
22	MS -> SS	CM SERVICE REQUEST	
23	SS -> MS	CM SERVICE ACCEPT	
24	MS -> SS	EMERGENCY SETUP	
25	SS -> MS	RELEASE COMPLETE	
26	SS -> MS	CHANNEL RELEASE	
27	MS		If possible (see PICS) SIM detachment is performed. Otherwise if possible (see PICS) switch off is performed. Otherwise the power is removed. The MS shall not initiate an RR connection establishment on cell A or on cell B. This is checked during 3 s.
28	MS		
29	MS		Depending on what has been performed in step 29 the MS is brought back to operation. "Establishment cause": Location updating. "location updating type" = normal, "CKSN" = no key available, "Mobile Identity" = IMSI, "LAI" = deleted LAI (the MCC and MNC hold the previous values, the LAC is coded FFFE). "CKSN" = CKSN1. "Mobile Identity" = TMSI. After the sending of this message, the SS waits for the disconnection of the main signalling link.
30	MS -> SS	CHANNEL REQUEST	
31	SS -> MS	IMMEDIATE ASSIGNMENT	
32	MS -> SS	LOCATION UPDATING REQUEST	
33	SS -> MS	AUTHENTICATION REQUEST	
34	MS -> SS	AUTHENTICATION RESPONSE	
35	SS -> MS	LOCATION UPDATING ACCEPT	
36	MS -> SS	TMSI REALLOCATION COMPLETE	
37	SS -> MS	CHANNEL RELEASE	

Specific message contents

None.

26.7.5.7.2 MM connection / abortion by the network / cause not equal to #6

26.7.5.7.2.1 Conformance requirement

Upon reception of an ABORT message, the MS shall release any ongoing MM connection and enter the "wait for network command" state.

Reference(s)

3GPP TS 04.08 / 3GPP TS 24.008 subclause 4.3.5.

26.7.5.7.2.2 Test purpose

1. When multiple MM connections are established, the MS releases all MM connections upon reception of an ABORT message, in the case when the two MM connections are established for a mobile terminating call and a non call related supplementary service operation.
2. The TMSI isn't deleted from MS after reseption of ABORT message with cause another than #6.

26.7.5.7.2.3 Method of test

Initial Conditions

System Simulator:

1 cell, default parameters.

T3212 is set to 6 minutes.

Mobile Station:

The MS is in state U10 of a mobile terminating call.

Specific PICS statements:

-

PIXIT statements:

-

Foreseen final state of the MS

The MS has a valid TMSI. It is "idle updated".

Test procedure

A non call related supplementary service operation is attempted at the MS. Upon reception of the REGISTER message, the SS sends an ABORT message with cause # 17. The SS waits for 5 s. The MS shall not send any layer 3 message. The SS releases the RR connection. The MS shall perform periodic location updating 6 minutes after the CHANNEL RELEASE message. TMSI shall be used as an MS Identity in LOCATION UPDATING REQUEST

Maximum Duration Of Test

15 minutes.

Expected Sequence

This procedure is performed if the MS supports non call related supplementary service operation.

Step	Direction	Message	Comments
1	MS		A non call related supplementary service operation is attempted at the MS.
2	MS -> SS	CM SERVICE REQUEST	
3	SS -> MS	CM SERVICE ACCEPT	
4	MS -> SS	REGISTER	
5	SS -> MS	ABORT	"reject cause" = #17.
6	SS		The SS waits for 5 seconds. The MS shall not send any layer 3 message during that time.
7	SS -> MS	CHANNEL RELEASE	After the sending of this message, the SS waits for the disconnection of the main signalling link.
8	MS -> SS	CHANNEL REQUEST	"Establishment cause": Location updating This message shall be sent by the MS between 5minutes 45s and 6minutes 15s after step 7.
9	SS -> MS	IMMEDIATE ASSIGNMENT	
10	MS -> SS	LOCATION UPDATING REQUEST	"location updating type": periodic updating. Mobile identity IE specifies the TMSI of the MS.
11	SS -> MS	LOCATION UPDATING ACCEPT	
12	SS -> MS	CHANNEL RELEASE	After the sending of this message, the SS waits for the disconnection of the main signalling link.

Specific message contents

None.

26.7.5.8 MM connection / follow-on request pending

26.7.5.8.1 MM connection / follow-on request pending / test 1

26.7.5.8.1.1 Conformance requirement

The MS shall not attempt to establish a new MM connection after location updating on the same RR connection if not allowed by the network.

Reference(s)

3GPP TS 04.08 / 3GPP TS 24.008 subclause 4.4.4.6.

26.7.5.8.1.2 Test purpose

To check that when the network does not include the follow on proceed IE in a LOCATION UPDATING ACCEPT message, a MS that has a CM application request pending does not attempt to establish a new MM connection on that RR connection.

26.7.5.8.1.3 Method of test

Initial Conditions

System Simulator:

1 cell, ATT flag is set to "MSs in the cell shall apply IMSI attach and detach procedure".

Mobile Station:

The MS has a valid TMSI and is deactivated.

Specific PICS statements:

-

PIXIT statements:

-

Foreseen final state of the MS

The MS has a valid TMSI. It is "idle updated".

Test procedure

The MS is activated and a CM connection is attempted during the location updating procedure. The SS does not include the follow on proceed information element in the LOCATION UPDATING ACCEPT message. The SS waits for at least 8 seconds. The MS shall not send any layer 3 message for 8 seconds.

Maximum Duration of Test

60 s.

Expected Sequence

Step	Direction	Message	Comments
1	MS		The MS is activated.
2	MS -> SS	CHANNEL REQUEST	
3	SS -> MS	IMMEDIATE ASSIGNMENT	
4	MS -> SS	LOCATION UPDATING REQUEST	location updating type = IMSI attach. Then the SS waits for 15 s. During this delay a CM connection is attempted.
5	SS -> MS	LOCATION UPDATING ACCEPT	follow on proceed IE not included.
6	SS		The SS wait for at least 8 seconds.
7	MS		The MS shall not send any layer 3 message for 8 seconds after reception of the LOCATION UPDATING ACCEPT message.
8	SS -> MS	CHANNEL RELEASE	After the sending of this message, the SS waits for the disconnection of the main signalling link.

Specific message contents

None.

26.7.5.8.2 MM connection / follow-on request pending / test 2

26.7.5.8.2.1 Conformance requirement

A MS supporting the follow-on request procedure and having a CM connection request pending shall correctly establish an MM connection following a location update when allowed by the network.

Reference(s)

3GPP TS 04.08 / 3GPP TS 24.008 subclause 4.4.4.6.

26.7.5.8.2.2 Test purpose

To check that when the network includes the follow on proceed IE in a LOCATION UPDATING ACCEPT message, a MS that supports the follow on request procedure and that has a CM application request pending establishes successfully a new MM connection on that RR connection.

26.7.5.8.2.3 Method of test

Initial Conditions

System Simulator:

1 cell, ATT flag is set to "MSs in the cell shall apply IMSI attach and detach procedure".

Mobile Station:

The MS has a valid TMSI and is deactivated.

Specific PICS statements:

- follow-on request procedure (TSPC_AddInfo_followOnReq)

PIXIT statements:

-

Foreseen final state of the MS

The MS has a valid TMSI. It is "idle updated".

Test procedure

The MS is activated and a CM connection is attempted during the location updating procedure. The SS includes the follow on proceed information element in the LOCATION UPDATING ACCEPT message. The SS waits for at least 8 seconds.

If the MS supports the follow on request procedure:

The MS shall send a CM SERVICE REQUEST. Upon reception of that message, the SS sends a CM SERVICE ACCEPT message. The MS shall send an initial CM message. Upon reception of that message, the SS releases the RR connection.

If the MS does not support the follow on request procedure:

The MS shall not send any layer 3 message for 8 seconds.

Maximum Duration of Test

60 s.

Expected Sequence

Step	Direction	Message	Comments
1	MS		The MS is activated.
2	MS -> SS	CHANNEL REQUEST	
3	SS -> MS	IMMEDIATE ASSIGNMENT	
4	MS -> SS	LOCATION UPDATING REQUEST	Location updating type = IMSI attach. Then the SS waits for 15 s. During this delay a CM connection is attempted.
5	SS -> MS	LOCATION UPDATING ACCEPT	follow on proceed IE included.
			If the MS supports the follow on request procedure (see PICS) steps A6 to A8 are performed, otherwise steps B6 to B7 are performed.
A6	MS -> SS	CM SERVICE REQUEST	
A7	SS ->MS	CM SERVICE ACCEPT	
A8	MS -> SS	An initial CM message	
B6	SS		The SS wait for at least 8 seconds.
B7	MS		The MS shall not send any layer 3 message for 8 seconds after reception of the LOCATION UPDATING ACCEPT message.
9	SS -> MS	CHANNEL RELEASE	After the sending of this message, the SS waits for the disconnection of the main signalling link.

Specific message contents

None.

26.7.5.8.3 MM connection / follow-on request pending / test 3

26.7.5.8.3.1 Conformance requirement

- 1) The MS shall not set the follow on request bit in a LOCATION UPDATING REQUEST message if no MM connection request is pending.
- 2) When the network includes the follow on proceed IE in a LOCATION UPDATING ACCEPT message, a MS that has no CM application request pending shall not attempt to establish a new MM connection on that RR connection.

- 3) The MS shall correctly handle a CM connection established by the network on the RR connection that was used for the location updating procedure.

Reference(s)

3GPP TS 04.08 / 3GPP TS 24.008 subclause 4.4.4.6.

26.7.5.8.3.2 Test purpose

- 1) To check that a MS that has no CM application request pending sets the Follow-On-Request bit to No follow-on request pending in a LOCATION UPDATING REQUEST message.
- 2) To check that when the network includes the follow on proceed IE in a LOCATION UPDATING ACCEPT message, a MS that has no CM application request pending does not attempt to establish a new MM connection on that RR connection.
- 3) To check that the MS accepts establishment by the network of a new MM connection on the existing RR connection.

26.7.5.8.3.3 Method of test

Initial Conditions

System Simulator:

1 cell, ATT flag is set to "MSs in the cell shall apply IMSI attach and detach procedure".

Mobile Station:

The MS has a valid TMSI and is deactivated.

Specific PICS statements:

- at least one MO circuit switched basic service (TSPC_Addinfo_MOsvc)

PIXIT statements:

-

Foreseen final state of the MS

The MS has a valid TMSI. It is "idle updated".

Test procedure

The MS is activated. The MS performs location updating. The MS shall set the FOR bit to No follow-on request pending in the LOCATION UPDATING REQUEST message. The SS includes the follow on proceed information element in the LOCATION UPDATING ACCEPT message. The SS waits for 5 s. The MS shall not send any layer 3 message for 5 s. The SS sends a SETUP message to the MS requesting a basic service supported by the MS. The MS shall send either a CALL CONFIRMED message if it supports a service on TCH or a RELEASE COMPLETE with cause #88.

Maximum Duration of Test

20 s.

Expected Sequence

Step	Direction	Message	Comments
1	MS		The MS is activated.
2	MS -> SS	CHANNEL REQUEST	
3	SS -> MS	IMMEDIATE ASSIGNMENT	
4	MS -> SS	LOCATION UPDATING REQUEST	"Location updating type" = IMSI attach. The FOR bit is set to No follow-on request pending.
5	SS -> MS	LOCATION UPDATING ACCEPT	follow on proceed IE is included.
6	SS		The SS wait for 5 s.
7	MS		The MS shall not send any layer 3 message for 5 s after reception of the LOCATION UPDATING ACCEPT message.
8	SS -> MS	SETUP	
A9	MS -> SS	CALL CONFIRMED	If the MS supports a basic service on TCH.
B9	MS -> SS	RELEASE COMPLETE	If the MS does not support any basic service on TCH. cause #88.
10	SS -> MS	CHANNEL RELEASE	After the sending of this message, the SS waits for the disconnection of the main signalling link.

Specific message contents

None.

26.7.6 Network Identity and Timezone (NITZ)

26.7.6.1 NITZ and CS location update procedures

26.7.6.1.1 NITZ / CS location update / Timezone, Time and DST Handling

26.7.6.1.1.1 Conformance requirement

The feature Network Identities and Timezone shall make it possible for a serving PLMN to transfer its current identity, universal time, DST and LTZ to MSs, and for the MS to store and use this information. Each one of these elements is optional. The feature significantly enhances roaming as it enables the accurate indication of network identities that are either newer than the ME or have changed their name since the ME was manufactured or sold. Additionally time and timezone information can be utilised by MEs as desired.

The serving PLMN shall make Local Time Zone (LTZ) available to the MS as an offset from Universal Time in units of 15 minutes.

When the LTZ is compensated for DST (summertime), the serving PLMN shall provide a DST parameter to indicate this. The adjustment for DST can be +1h or +2h.

The Time Zone code enables the receiver to calculate the equivalent time in GMT from the other semi-octets in the Service-Centre-Time-Stamp, or indicate the time zone (GMT, GMT+1H etc.), or perform other similar calculations as required by the implementation. The value contained in the Time Zone field must take into account daylight saving time, such that when the sending entity changes from regular (winter) time to daylight saving (summer) time, there is a change to the value in the Time Zone field.

The mobile station should assume that this time zone applies to the Location Area of the cell to which the Channel Request message was sent.

If the local time zone has been adjusted for Daylight Saving Time, the network shall indicate this by including the IE Network Daylight Saving Time.

The network may be able to select particular instants where it can send the MM INFORMATION message without adding delay to, or interrupting, any CM layer transaction, e.g. immediately after the AUTHENTICATION REQUEST message.

Reference(s):

3GPP TS 02.42 / 3GPP TS 22.042 subclause 4

3GPP TS 03.40 / 3GPP TS 23.040 subclause 9.2.3.11

3GPP TS 04.08 / 3GPP TS 24.008 subclause 9.4.19.4, 4.3.6

26.7.6.1.1.2 Test purpose

To verify that a MS supporting any of the NITZ Time related feature (Local Time Zone, Universal Time and DST IE and thus MM Information) is able to handle them properly.

26.7.6.1.1.3 Method of test

Initial conditions

System Simulator:

One cell (cell A)

IMSI attach/detach allowed in the cell

Mobile Station:

The MS has a valid IMSI. MS is powered off.

Specific PICS statements:

- On/Off switch (TSPC_Feat_OnOff)
- Use of NITZ DST (TSPC_NITZ_DST)
- Use of NITZ Universal Time for PLMN (TSPC_NITZ_Universal_Time)
- Use of NITZ Local Time Zone for PLMN (TSPC_NITZ_Time_Zone)

PIXIT statements:

-

Test procedure

During the Location Update procedure on Cell A, SS sends its local time and date (UK, Winter Time) using the MM INFORMATION Message to the MS. The operator verifies then the supported parameters and/or the time and date stored in the MS.

The MS is powered off and then powered on. During the location update the SS sets local time and date (UK, Summer Time). The operator verifies then the supported parameters and/or the time and date stored in the MS.

This is then repeated for the follow scenarios: US East coast summer time (GMT-5+1), US West coast summer time (GMT-8+1), US Mountain time (no summer adjustment) (GMT-7).

Maximum duration of test

10 minutes.

Expected sequence

Step	Direction	Message	Comments
1	MS		The MS is powered up or switched on (see PICS) and initiates a location update.
2	MS -> SS	LOCATION UPDATE REQUEST	
3	SS -> MS	AUTHENTICATION REQUEST	
4	MS -> SS	AUTHENTICATION RESPONSE	
5	SS ->MS	MM INFORMATION	Universal Time IE is included : "< Current Year >/03/15 06:25:00" for UT "0 hour" for Timezone Local Time Zone IE included: "0 hour" for Timezone No DST IE included See specific message content

Step	Direction	Message	Comments
6 7	SS -> MS MS	LOCATION UPDATE ACCEPT	<p>Operator Action : The use of the supported Fields is checked:</p> <p>Universal Time: Year: < Current Year > Month: March Day: 15th Hour: 6 Hours Minute: 25 Minutes Timezone: GMT+0 Local Time Zone: Timezone: GMT+0 DST: Daylight Saving Time not in use (i.e. winter time) cf note</p>
8 9	MS MS -> SS	IMSI DETACH	<p>The MS is switched off or power is removed (see PICS). Message not sent if power is removed. Detach type = IMSI detach</p>
10 11 12 13 14 15 16	MS MS -> SS SS -> MS MS -> SS SS ->MS SS -> MS MS	<p>LOCATION UPDATE REQUEST AUTHENTICATION REQUEST AUTHENTICATION RESPONSE MM INFORMATION</p> <p>LOCATION UPDATE ACCEPT</p>	<p>The MS is powered up or switched on (see PICS) and initiates a location update.</p> <p>Universal Time IE is included : "< Current Year >/03/15 06:25:00" for UT "1 hour" for Timezone (including DST) DST = +1 hour See specific message content</p> <p>Operator Action : The use of the supported Fields is checked:</p> <p>Universal Time: Year: < Current Year > Month: March Day: 15th Hour: 7 Hours Minute: 25 Minutes Timezone: GMT+0 Local Time Zone: Not sent DST: Daylight Saving Time in use (i.e. summer time) cf note</p>
17 18	MS MS -> SS	IMSI DETACH	<p>The MS is switched off or power is removed (see PICS). Message not sent if power is removed. Detach type = IMSI detach</p>
19 20 21 22 23	MS MS -> SS SS -> MS MS -> SS SS ->MS	<p>LOCATION UPDATE REQUEST AUTHENTICATION REQUEST AUTHENTICATION RESPONSE MM INFORMATION</p>	<p>The MS is powered up or switched on (see PICS) and initiates a location update.</p> <p>UniversalTime IE is included : "< Current Year >/03/15 06:25:00" for UT "-4 hours" for Timezone (including DST) DST = +1 hour See specific message content</p>

Step	Direction	Message	Comments
24 25	SS -> MS MS	LOCATION UPDATE ACCEPT	Operator Action : The use of the supported Fields is checked: Universal Time: Year: < Current Year > Month: March Day: 15 th Hour: 2 Hours Minute: 25 Minutes Timezone: GMT-5 Local Time Zone: Not sent DST: Daylight Saving Time in use (i.e. summer time) cf note
26 27	MS MS -> SS	IMSI DETACH	The MS is switched off or power is removed (see PICS). Message not sent if power is removed. Detach type = IMSI detach
28 29 30 31 32 33 34	MS MS -> SS SS -> MS MS -> SS SS ->MS SS -> MS MS	LOCATION UPDATE REQUEST AUTHENTICATION REQUEST AUTHENTICATION RESPONSE MM INFORMATION LOCATION UPDATE ACCEPT	The MS is powered up or switched on (see PICS) and initiates a location update. Universal Time IE is included : "< Current Year >/03/15 06:25:00" for UT "-7 hours" for Timezone (including DST) DST = +1 hour See specific message content Operator Action : The use of the supported Fields is checked: Year: < Current Year > Month: March Day: 14 th Hour: 23 Hours Minute: 25 Minutes Timezone: GMT-8 Local Time Zone: Not sent DST: Daylight Saving Time in use (i.e. summer time) cf note
35 36	MS MS -> SS	IMSI DETACH	The MS is switched off or power is removed (see PICS). Message not sent if power is removed. Detach type = IMSI detach
37 38 39 40 41	MS MS -> SS SS -> MS MS -> SS SS ->MS	LOCATION UPDATE REQUEST AUTHENTICATION REQUEST AUTHENTICATION RESPONSE MM INFORMATION	The MS is powered up or switched on (see PICS) and initiates a location update. Universal Time IE is included : "< Current Year >/03/15 06:25:00" for UT "-7 hour" for Timezone No DST IE included See specific message content

Step	Direction	Message	Comments
42 43	SS -> MS MS	LOCATION UPDATE ACCEPT	Operator Action : The use of the supported Fields is checked: Universal Time: Year: < Current Year > Month: March Day: 14 th Hour: 23 Hours Minute: 25 Minutes Timezone: GMT-7 Local Time Zone: No sent DST: Daylight Saving Time not in use (i.e. winter time) cf note
44 45	MS MS -> SS	IMSI DETACH	The MS is switched off or power is removed (see PICS). Message not sent if power is removed. Detach type = IMSI detach

Note: In steps 7, 16, 25, 34 and 43 the “minute” is not so relevant and can be higher than “25” depending on operator’s action time.

Current Year is derived by the SS.

The check of Timezone and DST is done implicitly by checking the time only in case MS does not support the display of these two fields.

Specific message contents

MM Information on step 5:

Information element	Value/remark
Universal Time IE	47
Year	40 - < Current Year >
Month	30 - March
Day	51 - 15 th
Hour	60 - 6 hours
Minute	52 - 25 Minutes
Second	00 - 0 second
Time Zone	00 - GMT+0 (0*15 minutes + 0*15 minutes DST)
Local Time Zone IE	46
Time Zone	00 - GMT+0 (0*15 minutes + 0*15 minutes DST)

MM Information on step 14:

Information element	Value/remark
UniversalTime IE	47
Year	40 - < Current Year >
Month	30 - March
Day	51 - 15 th
Hour	60 - 6 hours
Minute	52 - 25 Minutes
Second	00 - 0 second
Time Zone	40 - GMT+0+1 (0*15 minutes + (1*4)*15 minutes DST)
Daylight Saving Time IE	49
Length of DST Content	1
Value	1 - + 1 hour (summer time)

MM Information on step 23:

Information element	Value/remark
Universal Time IE	47
Year	40 - < Current Year >
Month	30 - March
Day	51 - 15 th
Hour	60 - 6 hours
Minute	52 - 25 Minutes
Second	00 - 0 second
Time Zone	69 - GMT-5+1 ((-5*4)*15 minutes + (1*4)*15 minutes DST)
Daylight Saving Time IE	49
Length of DST Content	1
Value	1 - + 1 hour (summer time)

MM Information on step 32:

Information element	Value/remark
UniversalTime IE	47
Year	40 - < Current Year >
Month	30 - March
Day	51 - 15 th
Hour	60 - 6 hours
Minute	52 - 25 Minutes
Second	00 - 0 second
Time Zone	8A - GMT-8+1 ((-8*4)*15 minutes + (1*4)*15 minutes DST)
Daylight Saving Time IE	49
Length of DST Content	1
Value	1 - + 1 hour (summer time)

MM Information on step 41:

Information element	Value/remark
Universal Time IE	47
Year	40 - < Current Year >
Month	30 - March
Day	51 - 15 th
Hour	60 - 6 hours
Minute	52 - 25 Minutes
Second	00 - 0 second
Time Zone	8A - GMT-7 ((-7*4)*15 minutes)

26.8 Tests related to circuit switched call control

26.8.1 Circuit switched Call Control (CC) state machine verification

26.8.1.1 General on CC state machine verification

The principle of checking the call control functions consists in the validation of each call control identified state.

State U0 as an initial state is not verified in the tests of 26.8.1.2 (establishment of an outgoing call).

State U0.1 is never verified.

The steps to be followed within each performed test are:

- bring the MS into the required state;
- trigger the tested event;
- check the MS response and new state.

In subclauses 26.8.1.2 and 26.8.1.3 different tables are defined to bring the MS into the required initial state. The exact table to be chosen is specified individually in subclause "Initial conditions" of "Method of test" for each test case.

For each test, unless otherwise specified, a circuit switched basic service among those supported by the MS but excluding the emergency call teleservice shall be chosen arbitrarily, and the test shall be performed according to that basic service. If the only circuit switched basic service supported by the mobile is emergency call, then the incoming call tests shall not be performed and the other call control tests shall be performed with the EMERGENCY SETUP message replacing the SETUP message.

The initial states are to be checked through STATUS ENQUIRY messages sent by the SS, when feasible. This is not explicitly stated in the tables of expected sequences of signalling messages. The checking of final states are explicitly included into the expected sequences of signalling messages.

The following postamble may be used by the SS to bring MS back to idle mode in those test cases, in which it is not already included into expected sequence of signalling messages:

Table 26.8.1.1/1: A postamble to bring the MS back to idle mode.

Step	Direction	Message	Comments
n	SS -> MS	CHANNEL RELEASE	
n+1	MS		the MS shall release the main signalling link (DISC/UA)

The postamble has not been included into the all of the tests in order to leave an option to concatenate the procedures in the future by using a final state of a test case as an initial state to another one.

For the special case of U0, the state is checked by sending STATUS ENQUIRY message with all possible values of transaction identifier (seven values) as U0 is the only state in which for every TI the MS will answer with release complete with cause #81. If U0 is to be verified when no RR connection exists, first a mobile terminating radio connection must be established.

The MS responses are either call management messages received by the SS or lower layers functions activated within the MS or MMI actions (e.g. the buzzing of an alerting tone).

A time-out within the MS is triggered by the SS when it does not answer back an MS expected response.

The test sequences may be split in 3 main groups:

- establishment and release of an outgoing call;
- establishment and release of an incoming call;
- in-call functions.

Remark on verification of transient states:

Some call control states of the mobile station may be transient, depending on implementation, configuration of the MS and previous messages (see annex 3, subclause 3.1.6).

If a test starts in a transient state, then the test is executed without verification of the starting state.

26.8.1.2 Establishment of an outgoing call

Initial conditions

As a minimum requirement the MS is updated and has been given a TMSI, a ciphering key and cipher key sequence number, and the layer 2, RR and MM functionalities have been verified.

There are as many CM initial conditions as states to be checked.

The tables below describe message exchanges which bring the MS in the requested initial states.

A state may be taken as initial only when all the states which lead to this initial states have been validated. The order followed in the test procedure will be U0, U0.1, U1, U3, U4, U10, U12, U19, U11 as seen in the table underneath.

The MS is brought again in the initial state starting with U0 at each new test performed.

Table 26.8.1.2/1: Establishment of an outgoing call, procedure 1 (late assignment)

Step	Direction	Message	Comments/actions/next state
1	MS -> SS	CHANNEL REQUEST	initiate outgoing call
2	SS -> MS	IMMEDIATE ASSIGNMENT	SDCCH, U0
3	MS -> SS	CM SERVICE REQUEST	U0.1
4	SS -> MS	CIPHERING MODE COMMAND	
5	MS -> SS	CIPHERING MODE COMPLETE	
6	MS -> SS	SETUP	U1
7	SS -> MS	CALL PROCEEDING	U3
8	SS -> MS	ALERTING	U4
9	SS -> MS	ASSIGNMENT COMMAND	TCH
10	MS -> SS	ASSIGNMENT COMPLETE	
11	SS -> MS	CONNECT	
12	MS -> SS	CONNECT ACKNOWLEDGE	U10
A13	SS -> MS	DISCONNECT	U12 (note 1)
B13	SS -> MS	DISCONNECT	U12 (note 2)
B14	MS -> SS	RELEASE	U19
C13			MMI action, terminate call
C14	MS -> SS	DISCONNECT	U11
NOTE 1: The Progress Indicator IE with progress description #8 "in band information or appropriate pattern now available" is included.			
NOTE 2: The Progress Indication IE is not included.			

Table 26.8.1.2/2: Establishment of an outgoing call, procedure 2

Step	Direction	Message	Comments/actions/next state
1	MS -> SS	CHANNEL REQUEST	initiate outgoing call
2	SS -> MS	IMMEDIATE ASSIGNMENT	TCH, U0
3	MS -> SS	CM SERVICE REQUEST	U0.1
4	SS -> MS	CHANNEL MODE MODIFY	(note 1)
5	MS -> SS	CHANNEL MODE MODIFY ACKNOWLEDGE	
6	SS -> MS	CIPHERING MODE COMMAND	
7	MS -> SS	CIPHERING MODE COMPLETE	
8	MS -> SS	SETUP	U1
9	SS -> MS	CALL PROCEEDING	U3
10	SS -> SS	ALERTING	U4
11	SS -> MS	CONNECT	
12	MS -> SS	CONNECT ACKNOWLEDGE	U10
A13	SS -> MS	DISCONNECT	U12 (note 2)
B13	SS -> MS	DISCONNECT	U12 (note 3)
B14	MS -> SS	RELEASE	U19
C13			MMI action, terminate call
C14	MS -> SS	DISCONNECT	U11
NOTE 1: Assigned channel is appropriate for the chosen bearer capability (see subclause 26.8.1).			
NOTE 2: The Progress Indicator IE with progress description #8 "in band information or appropriate pattern now available" is included.			
NOTE 3: The Progress Indicator IE is not included.			

Table 26.8.1.2/3: Establishment of an outgoing call, procedure 3

Step	Direction	Message	Comments/actions/next state
1	MS -> SS	CHANNEL REQUEST	initiate outgoing call
2	SS -> MS	IMMEDIATE ASSIGNMENT	SDCCH, U0
3	MS -> SS	CM SERVICE REQUEST	U0.1
4	SS -> MS	CIPHERING MODE COMMAND	
5	MS -> SS	CIPHERING MODE COMPLETE	
6	MS -> SS	SETUP	U1
7	SS -> MS	AUTHENTICATION REQUEST	
8	MS -> SS	AUTHENTICATION RESPONSE	
9	SS -> MS	CALL PROCEEDING	U3
10	SS -> MS	ASSIGNMENT COMMAND	TCH
11	MS -> SS	ASSIGNMENT COMPLETE	
12	SS -> MS	ALERTING	U4
13	SS -> MS	CONNECT	
14	MS -> SS	CONNECT ACKNOWLEDGE	U10
A15	SS -> MS	DISCONNECT	U12 (note 1)
B15	SS -> MS	DISCONNECT	U12 (note 2)
B16	MS -> SS	RELEASE	U19
C15			MMI action, terminate call
C16	MS -> SS	DISCONNECT	U11

NOTE 1: The Progress Indicator IE with progress description #8 "in band information or appropriate pattern now available" is included.

NOTE 2: The Progress indicator IE is not included.

Table 26.8.1.2/4: Establishment of an outgoing call, procedure 4

Step	Direction	Message	Comments
1	MS -> SS	CHANNEL REQUEST	initiate outgoing call
2	SS -> MS	IMMEDIATE ASSIGNMENT	TCH, U0
3	MS -> SS	CM SERVICE REQUEST	U0.1
4	SS -> MS	IDENTITY REQUEST	
5	MS -> SS	IDENTITY RESPONSE	
6	SS -> MS	CIPHERING MODE COMMAND	
7	MS -> SS	CIPHERING MODE COMPLETE	
8	MS -> SS	SETUP	U1
9	SS -> MS	CHANNEL MODE MODIFY	(note 1)
10	MS -> SS	CHANNEL MODE MODIFY ACKNOWLEDGE	
11	SS -> MS	CALL PROCEEDING	U3
12	SS -> MS	ALERTING	U4
13	SS -> MS	CONNECT	
14	MS -> SS	CONNECT ACKNOWLEDGE	U10
A15	SS -> MS	DISCONNECT	U12 (note 2)
B15	SS -> MS	DISCONNECT	U12 (note 3)
B16	MS -> SS	RELEASE	U19
C15			MMI action, terminate call
C16	MS -> SS	DISCONNECT	U11

NOTE 1: Assigned channel is appropriate for the chosen bearer capability (see subclause 26.8.1).

NOTE 2: The Progress Indicator IE with progress description #8 "in band information or appropriate pattern now available" is included.

NOTE 3: The Progress Indicator IE is not included.

26.8.1.2.1 Outgoing call / U0 null state

26.8.1.2.1.1 Outgoing call / U0 null state / MM connection requested

26.8.1.2.1.1.1 Definition

The call control entity of the Mobile Station requests the MM-sublayer to establish a mobile originating MM-connection. This test is applicable for any equipment supporting at least one mobile originated circuit switched basic service.

26.8.1.2.1.1.2 Conformance requirement

- 1) Upon initiation of an outgoing basic call by user the MS shall initiate establishment of an MM connection, using as first MM message a CM SERVICE REQUEST message with CM service type "Mobile originating call establishment or packet mode connection establishment".

References

3GPP TS 04.08 / 3GPP TS 24.008 subclauses 5.2.1.1, 4.5.1.1 and 3.3.1.1.

26.8.1.2.1.1.3 Test purpose

To verify that upon initiation of an outgoing basic call by user the MS initiates establishment of an MM connection, using as first MM message a CM SERVICE REQUEST message with CM service type "Mobile originating call establishment or packet mode connection establishment".

26.8.1.2.1.1.4 Method of test

Specific PICS statements

-

PIXIT statements

-

Initial conditions

System Simulator:

1 cell, default parameters.

Mobile Station:

The MS is in MM-state "idle, updated" with valid TMSI and CKSN.

Foreseen final state of the MS

U0, null.

Test procedure

An MO circuit switched basic service is selected that is supported by the MS; if the MS supports MO telephony, the selected basic service is telephony. If necessary, the MS is configured for that basic service. Then, the MS is made to initiate a call. When the SS receives CM SERVICE REQUEST, the contents of it shall be checked.

Maximum duration of test

30 s.

Expected sequence

Step	Direction	Message	Comments
1	MS -> SS	CHANNEL REQUEST	initiate outgoing call
2	SS -> MS	IMMEDIATE ASSIGNMENT	TCH
3	MS -> SS	CM SERVICE REQUEST	verify the type of call which is asked for "basic" or "emergency by the MS
4	SS -> MS	CHANNEL RELEASE	
5	MS		the MS shall release the main signalling link (DISC/UA)

Specific message contents:

None.

26.8.1.2.2 Outgoing call / U0.1 MM connection pending

26.8.1.2.2.1 Outgoing call / U0.1 MM connection pending / CM service rejected

26.8.1.2.2.1.1 Definition

A request for MM connection is rejected by the SS. This test is applicable for any equipment supporting at least one mobile originated circuit switched basic service.

26.8.1.2.2.1.2 Conformance requirement

Upon receiving indication of an MM-connection establishment being rejected, CC entity should inform upper layer of this rejection.

References

3GPP TS 04.08 / 3GPP TS 24.008, subclause 4.5.1.1, 3GPP TS 04.07 / 3GPP TS 24.007, subclause 6.2.2.

26.8.1.2.2.1.3 Test purpose

To verify that a CC entity of the MS in CC-state U0.1, "MM-connection pending", upon the MS receiving a CM SERVICE REJECT message, returns to CC state U0, "Null".

26.8.1.2.2.1.4 Method of test

Specific PICS statements

-

PIXIT statements

-

Initial conditions

System Simulator:

1 cell, default parameters.

Mobile Station:

The MS is in MM-state "idle, updated" with valid TMSI and CKSN.

The MS is brought into the state U0.1 by using table 26.8.1.2/1.

Foreseen final state of the MS

U0, null.

Maximum duration of test

30 s.

Test procedure

An MO circuit switched basic service is selected that is supported by the MS; if the MS supports MO telephony, the selected basic service is telephony. If necessary, the MS is configured for that basic service. Then, the MS is made to initiate a call. When the SS receives CM SERVICE REQUEST, the contents of it shall be checked. The SS rejects it by CM SERVICE REJECT. Then the SS will check the state of the MS by using STATUS ENQUIRY with all the relevant transaction identifiers.

Expected sequence

Step	Direction	Message	Comments
1	SS -> MS	CM SERVICE REJECT	
2	SS -> MS	STATUS ENQUIRY	
3	MS -> SS	RELEASE COMPLETE	
4	SS		cause shall be 81# (invalid TI value) repeat steps 2-3 to cover all the transaction identifiers from 000 ...110
5	SS -> MS	CHANNEL RELEASE	
6	MS		the MS shall release the main signalling link (DISC/UA)

Specific message contents:

None.

26.8.1.2.2.2 Outgoing call / U0.1 MM connection pending / CM service accepted

26.8.1.2.2.2.1 Definition

A CM request is accepted for the MM-connection by the SS. This test is applicable for any equipment supporting at least one mobile originated circuit switched basic service.

26.8.1.2.2.2.2 Conformance requirement

A CC entity of the MS in CC-state U0.1, "MM-connection pending", upon the MS receiving a CM SERVICE ACCEPT message, shall send a SETUP message specifying the Called party BCD number that was entered into the MS and then enter CC state U1, "Call initiated".

References

3GPP TS 04.08 / 3GPP TS 24.008, subclauses 4.5.1.1 and 5.2.1.1.

26.8.1.2.2.2.3 Test purpose

To verify that a CC entity of the MS in CC-state U0.1, "MM-connection pending", upon the MS receiving a CM SERVICE ACCEPT message, sends a SETUP message specifying the Called party BCD number that was entered into the MS and then enters CC state U1, "Call initiated".

26.8.1.2.2.2.4 Method of test

Specific PICS statements

-

PIXIT statements

-

Initial conditions

System Simulator:

1 cell, default parameters.

Mobile Station:

The MS is in MM-state "idle, updated" with valid TMSI and CKSN.

The MS is brought into the state U0.1 by using table 26.8.1.2/1.

Foreseen final state of the MS

U1, call initiated.

Maximum duration of test

30 s.

Test procedure

An MO circuit switched basic service is selected that is supported by the MS; if the MS supports MO telephony, the selected basic service is telephony. If necessary, the MS is configured for that basic service. Then, the MS is made to initiate a call. When the MS is requesting a MM-connection, the SS will indicate acceptance by sending a CM SERVICE ACCEPT message. The MS shall respond with SETUP. Then the SS will check the state of the call control entity by STATUS ENQUIRY with the relevant transaction identifiers.

Expected sequence

Step	Direction	Message	Comments
1	SS -> MS	CM SERVICE ACCEPT	
2	MS -> SS	SETUP	with called party BCD number.
3	SS -> MS	STATUS ENQUIRY	
4	MS -> SS	STATUS	cause shall be 30# (response to enq.) and state U1 call initiated.

Specific message contents:

None.

26.8.1.2.2.3 Outgoing call / U0.1 MM connection pending / lower layer failure

26.8.1.2.2.3.1 Definition

The call control entity of the MS being in the state, U0.1, a lower layer failure is accomplished at the MS and consequently, communication at layer 3 level with the peer entity is terminated. This test is applicable for any equipment supporting at least one mobile originated circuit switched basic service.

26.8.1.2.2.3.2 Conformance requirement

- 1) Upon a lower layer failure the MS releases the MM connection in progress and returns to idle mode. In that state no call exists, and the CC entities relating to the seven mobile originating transaction identifiers are in state U0, "Null".

References

3GPP TS 04.08 / 3GPP TS 24.008, subclauses 4.5.1.2, 5.2.1.1, 5.5.3.2 and 8.3.

26.8.1.2.2.3.3 Test purpose

To verify that after the MS with a CC entity in state U0.1, "MM-connection pending", has detected a lower layer failure and has returned to idle mode, the CC entities relating to the seven mobile originating transaction identifiers are in state U0, "Null".

26.8.1.2.2.3.4 Method of test

Specific PICS statements

- Support of UTRAN Radio Access Technology (TSPC_Type_UTRAN)

PIXIT statements

-

Initial conditions

System Simulator:

1 cell, default parameters.

Mobile Station:

The MS is in MM-state "idle, updated" with valid TMSI and CKSN.

The MS is brought into the state U0.1 by using table 26.8.1.2/1.

Foreseen final state of the MS

U0, null.

Maximum duration of test

1 min.

Test procedure

An MO circuit switched basic service is selected that is supported by the MS; if the MS supports MO telephony, the selected basic service is telephony. If necessary, the MS is configured for that basic service. Then, the MS is made to initiate a call. When the MS has sent a CM SERVICE REQUEST message, the SS generates a lower layer failure at the MS. The SS waits long enough to enable the MS to return to idle state listening to paging, and then pages MS to create RR-connection. Finally, the SS will check the state of the MS by using STATUS ENQUIRY with the relevant transaction identifiers.

Expected sequence

Step	Direction	Message	Comments
1	SS		SS generates lower layer failure.
2	SS		If PICS statement "Support of UTRAN Radio Access Technology" is 'NO', then the SS waits 20 s for the MS to return to listening to paging. If PICS statement "Support of UTRAN Radio Access Technology" is 'YES', then the SS waits 50 s for the MS to return to listening to paging.
3	SS -> MS	PAGING REQUEST	
4	MS -> SS	CHANNEL REQUEST	
5	SS -> MS	IMMEDIATE ASSIGNMENT	
6	MS -> SS	PAGING RESPONSE	
7	SS -> MS	STATUS ENQUIRY	
8	MS -> SS	RELEASE COMPLETE	cause shall be 81# (invalid TI value).
9	SS		repeat steps 7-8 to cover all the transaction identifiers from 000 ...110.
10	SS -> MS	CHANNEL RELEASE	the main signalling link shall be released by the MS (L2: DISC/UA).

Specific message contents:

None.

26.8.1.2.3 Outgoing call / U1 call initiated

26.8.1.2.3.1 Outgoing call / U1 call initiated / receiving CALL PROCEEDING

26.8.1.2.3.1.1 Definition

The call control entity of the MS being in the state, U1, a CALL PROCEEDING message is sent by the SS. This test is applicable for any equipment supporting at least one mobile originated circuit switched basic service.

26.8.1.2.3.1.2 Conformance requirement

- 1) A CC entity of the MS in CC-state U1, "Call initiated", upon receipt of a CALL PROCEEDING message, shall enter CC state U3, "Mobile originating call proceeding".

References

3GPP TS 04.08 / 3GPP TS 24.008, subclauses 5.2.1.1, 5.2.1.2 and 5.2.1.3.

26.8.1.2.3.1.3 Test purpose

To verify that a CC entity of the MS in CC-state U1, "Call initiated", upon receipt of a CALL PROCEEDING message, enters CC state U3, "Mobile originating call proceeding".

26.8.1.2.3.1.4 Method of test

Specific PICS statements

-

PIXIT statements

-

Initial conditions

System Simulator:

1 cell, default parameters.

Mobile Station:

The MS is in MM-state "idle, updated" with valid TMSI and CKSN.

The MS is brought into the state U1 by using table 26.8.1.2/2.

Foreseen final state of the MS

U3, Mobile originating call proceeding.

Maximum duration of test

30 s.

Test procedure

An MO circuit switched basic service is selected that is supported by the MS; if the MS supports MO telephony, the selected basic service is telephony. If necessary, the MS is configured for that basic service. Then, the MS is made to initiate a call. The CC entity of the MS is brought to the state U1. The SS sends a CALL PROCEEDING message to the MS. The SS checks by using the status enquiry procedure that the CC entity has entered the state U3.

Expected sequence

Step	Direction	Message	Comments
1	SS -> MS	CALL PROCEEDING	tone generation not mandatory
2	SS -> MS	STATUS ENQUIRY	
3	MS -> SS	STATUS	cause 30#, state U3

Specific message contents:

None.

26.8.1.2.3.2 Outgoing call / U1 call initiated / rejecting with RELEASE COMPLETE

26.8.1.2.3.2.1 Definition

The call control entity of the MS being in the state, U1, the call is rejected by a RELEASE COMPLETE message sent by the SS. This test is applicable for any equipment supporting at least one mobile originated circuit switched basic service.

26.8.1.2.3.2.2 Conformance requirement

- 1) A CC entity of the MS in CC-state U1, "Call initiated", upon receipt of a RELEASE COMPLETE message with valid cause value, shall enter CC state U0, "Null".
- 2) On returning to idle mode, the CC entities relating to the seven mobile originating transaction identifiers shall be in state U0, "Null".
- 3) On releasing the MM-connection, the MS shall wait for MM layer release initiated by the network.

References

- Conformance requirement 1: 3GPP TS 04.08 / 3GPP TS 24.008, subclause 5.4.2 and 5.4.4.
- Conformance requirement 2: 3GPP TS 04.08 / 3GPP TS 24.008, subclause 5.5.3.2.
- Conformance requirement 3: 3GPP TS 04.08 / 3GPP TS 24.008, subclauses 5.4.4.3 and 4.5.3,
3GPP TS 04.08 / 3GPP TS 44.018, subclause 3.4.13.1

26.8.1.2.3.2.3 Test purpose

- 1) To verify that a CC entity of the MS in CC-state U1, "Call initiated", upon receipt of a RELEASE COMPLETE message with valid cause value, enters CC state U0, "Null".
- 2) To verify that in returning to idle mode, the CC entities relating to the seven mobile originating transaction identifiers are in state U0, "Null".
- 3) To verify that in releasing the MM-connection, the MS shall wait for MM layer release initiated by SS.

26.8.1.2.3.2.4 Method of test

Specific PICS statements

-

PIXIT statements

-

Initial conditions

System Simulator:

1 cell, default parameters.

Mobile Station:

The MS is in MM-state "idle, updated" with valid TMSI and CKSN.

The MS is brought into the state U1 by using table 26.8.1.2/2.

Foreseen final state of the MS

U0, null.

Maximum duration of test

30 s.

Test procedure

An MO circuit switched basic service is selected that is supported by the MS; if the MS supports MO telephony, the selected basic service is telephony. If necessary, the MS is configured for that basic service. Then, the MS is made to initiate a call. The CC entity of the MS is brought to the state U1. The SS sends a RELEASE COMPLETE message to the MS. The SS checks by using the status enquiry procedure that the CC entity has entered the state U0 with all the relevant transaction identifiers.

Expected sequence

Step	Direction	Message	Comments
1	SS -> MS	RELEASE COMPLETE	See specific message content below. cause 81# (invalid TI value) repeat steps 2-3 to cover all the transaction identifiers from 000...110 the main signalling link shall be released by the MS (L2: DISC/UA).
2	SS -> MS	STATUS ENQUIRY	
3	MS -> SS	RELEASE COMPLETE	
4	SS		
5	SS -> MS	CHANNEL RELEASE	

Specific message contents:

RELEASE COMPLETE

1) With a valid cause value among:

related to numbering,

#1 unallocated number

#3 no route to destination

#22 number changed

#28 invalid number format

related to bearer capabilities,

#8 operator determined barring

#57 bearer capability not authorized

#58 bearer capability not presently available

#63 service or option not available

#65 bearer service not implemented

#34 no circuit/channel available (call queuing).

26.8.1.2.3.3 Outgoing call / U1 call initiated / T303 expiry

26.8.1.2.3.3.1 Definition

The call control entity of the MS being in the state, U1, if no response is then received from the SS, timer T303 expires at the MS side. This test is applicable for any equipment supporting at least one mobile originated circuit switched basic service.

26.8.1.2.3.3.2 Conformance requirement

- 1) A CC entity of the MS in CC-state U1, "Call initiated", upon expiry of T303 shall send a DISCONNECT message to its peer entity and enter state U11, "Disconnect request".

References

3GPP TS 04.08 / 3GPP TS 24.008, subclauses 5.2.1.1 and 5.4.

26.8.1.2.3.3.3 Test purpose

- 1) To verify that a CC entity of the MS in CC-state U1, "Call initiated", upon expiry of T303 (accuracy $\pm 20\%$ between reception of CM SERVICE REQUEST and DISCONNECT by SS) sends a DISCONNECT message to its peer entity and enters state U11, "Disconnect request".

26.8.1.2.3.3.4 Method of test

Specific PICS statements

-

PIXIT statements

-

Initial conditions

System Simulator:

1 cell, default parameters.

Mobile Station:

The MS is in MM-state "idle, updated" with valid TMSI and CKSN.

The MS is brought into the state U1 by using table 26.8.1.2/2.

Foreseen final state of the MS

U11, disconnect request.

Maximum duration of test

1 minute.

Test procedure

An MO circuit switched basic service is selected that is supported by the MS; if the MS supports MO telephony, the selected basic service is telephony. If necessary, the MS is configured for that basic service. Then, the MS is made to initiate a call. The CC entity of the MS is brought to the state U1. When T303 expires at the MS, the MS shall send DISCONNECT. The SS checks by using the status enquiry procedure that the CC entity has entered the state U11, disconnect request.

Expected sequence

Step	Direction	Message	Comments
1	SS		SS waits for T303 expiry.
2	MS -> SS	DISCONNECT	Shall be transmitted between 24 s and 36 s after the CM SERVICE REQUEST.
3	SS -> MS	STATUS ENQUIRY	
4	MS -> SS	STATUS	cause 30#, status U11

Specific message contents:

None.

26.8.1.2.3.4 Outgoing call / U1 call initiated / lower layer failure

26.8.1.2.3.4.1 Definition

The call control entity of the MS being in the state, U1, a lower layer failure is accomplished at the MS and consequently, communication at layer 3 level with the peer entity is terminated. This test is applicable for any equipment supporting at least one mobile originated circuit switched basic service.

26.8.1.2.3.4.2 Conformance requirement

Upon a lower layer failure MM informs the relevant CM entities that the MM connection has been interrupted. As call re-establishment is not allowed, the CC entity must perform a local release. The MS returns to idle mode. In that state no call exists, and the CC entities relating to the seven mobile originating transaction identifiers are in state U0, "Null".

References

3GPP TS 04.08 / 3GPP TS 24.008, subclauses 4.5.2.3, 5.2.1.1 and 5.5.3.2.

26.8.1.2.3.4.3 Test purpose

To verify that after the MS with a CC entity in state U1 "Call initiated", has detected a lower layer failure and has returned to idle mode, the CC entities relating to the seven mobile originating transaction identifiers are in state U0, "Null".

26.8.1.2.3.4.4 Method of test

Specific PICS statements

-

PIXIT statements

-

Initial conditions

System Simulator:

1 cell, default parameters.

Mobile Station:

The MS is in MM-state "idle, updated" with valid TMSI and CKSN.

The MS is brought into the state U1 by using table 26.8.1.2/4.

Foreseen final state of the MS

U0, null.

Maximum duration of test

1 min.

Test procedure

An MO circuit switched basic service is selected that is supported by the MS; if the MS supports MO telephony, the selected basic service is telephony. If necessary, the MS is configured for that basic service. Then, the MS is made to initiate a call. The MS is brought to the state U1. The SS generates a lower layer failure at the MS. The SS waits long enough to enable the MS to return to idle state listening to paging, and then pages MS to create RR-connection. Finally, the SS will check the state of the MS by using STATUS ENQUIRY with the relevant transaction identifiers.

Expected sequence

Step	Direction	Message	Comments
1	SS		SS generates lower layer failure.
2	SS		SS waits 20 s for the MS to return to listening to paging.
3	SS -> MS	PAGING REQUEST	
4	MS -> SS	CHANNEL REQUEST	
5	SS -> MS	IMMEDIATE ASSIGNMENT	
6	MS -> SS	PAGING RESPONSE	
7	SS -> MS	STATUS ENQUIRY	
8	MS -> SS	RELEASE COMPLETE	cause 81# (invalid TI value).
9	SS		repeat steps 7-8 to cover all the transaction identifiers from 000...110.
10	SS -> MS	CHANNEL RELEASE	
11	MS		the MS shall release the main signalling link (DISC/UA).

Specific message contents:

None.

26.8.1.2.3.5 Outgoing call / U1 call initiated / receiving ALERTING

26.8.1.2.3.5.1 Definition

The call control entity of the MS being in the state, U1, an ALERTING message is sent to the MS as a indication that a call is being alerted at a called end. This test is applicable for any equipment supporting at least one mobile originated circuit switched basic service.

26.8.1.2.3.5.2 Conformance requirement

- 1) A CC entity of the MS in CC-state U1, "Call initiated", upon receipt of an ALERTING message, shall enter CC state U4, "Call delivered".

References

3GPP TS 04.08 / 3GPP TS 24.008, subclause 5.2.1.1.

26.8.1.2.3.5.3 Test purpose

To verify that a CC entity of the MS in CC-state U1, "Call initiated", upon receipt of an ALERTING message, enters CC state U4, "Call delivered".

26.8.1.2.3.5.4 Method of test

Specific PICS statements

-

PIXIT statements

-

Initial conditions

System Simulator:

1 cell, default parameters.

Mobile Station:

The MS is in MM-state "idle, updated" with valid TMSI and CKSN.

The MS is brought into the state U1 by using table 26.8.1.2/4.

Foreseen final state of the MS

U4, call delivered.

Maximum duration of test

30 s.

Test procedure

An MO circuit switched basic service is selected that is supported by the MS; if the MS supports MO telephony, the selected basic service is telephony. If necessary, the MS is configured for that basic service. Then, the MS is made to initiate a call. The CC entity of the MS is brought to the state U1. The SS sends an ALERTING message to the MS. The SS checks by using the status enquiry procedure that the CC entity has entered the state U4, call delivered.

Expected sequence

Step	Direction	Message	Comments
1	SS -> MS	ALERTING	
2	SS -> MS	STATUS ENQUIRY	
3	MS -> SS	STATUS	cause 30#, state U4

Specific message contents:

None.

26.8.1.2.3.6 Outgoing call / U1 call initiated / entering state U10

26.8.1.2.3.6.1 Definition

The call control entity of the MS being in the state, U1, a CONNECT message is received by the MS. This test is applicable for any equipment supporting at least one mobile originated circuit switched basic service.

26.8.1.2.3.6.2 Conformance requirement

- 1) A CC entity of the MS in CC-state U1, "Call initiated", upon receipt of a CONNECT message, shall send a CONNECT ACKNOWLEDGE message to its peer entity and enter CC state U10, "Active".

References

3GPP TS 04.08 / 3GPP TS 24.008, subclauses 5.2.1.1 and 5.2.1.6.

26.8.1.2.3.6.3 Test purpose

To verify that a CC entity of the MS in CC-state U1, "Call initiated", upon receipt of a CONNECT message, sends a CONNECT ACKNOWLEDGE message to its peer entity and enters CC state U10, "Active".

26.8.1.2.3.6.4 Method of test

Specific PICS statements

-

PIXIT statements

-

Initial conditions

System Simulator:

1 cell, default parameters.

Mobile Station:

The MS is in MM-state "idle, updated" with valid TMSI and CKSN.

The MS is brought into the state U1 by using table 26.8.1.2/4.

Foreseen final state of the MS

U10, call active.

Maximum duration of test

30 s.

Test procedure

An MO circuit switched basic service is selected that is supported by the MS; if the MS supports MO telephony, the selected basic service is telephony. If necessary, the MS is configured for that basic service. Then, the MS is made to initiate a call. The CC entity of the MS is brought to the state U1. The SS sends a CONNECT message to the MS. The MS shall respond by sending a CONNECT ACKNOWLEDGE message. The SS checks by using the status enquiry procedure that the CC entity has entered the state U10, active.

Expected sequence

Step	Direction	Message	Comments
1	SS -> MS	CONNECT	
2	MS -> SS	CONNECT ACKNOWLEDGE	
3	SS -> MS	STATUS ENQUIRY	
4	MS -> SS	STATUS	cause 30#, state U10

Specific message contents:

None.

26.8.1.2.3.7 Outgoing call / U1 call initiated / unknown message received

26.8.1.2.3.7.1 Definition

The call control entity of the MS being in the state, U1, an unknown message is received by the MS. This test is applicable for any equipment supporting at least one mobile originated circuit switched basic service.

26.8.1.2.3.7.2 Conformance requirement

- 1) A CC entity of the MS in CC-state U1, "Call initiated", upon receipt of a message with message type not defined for the protocol discriminator from its peer entity shall return a STATUS message.

References

3GPP TS 04.08 / 3GPP TS 24.008 subclause 8.4.

26.8.1.2.3.7.3 Test purpose

To verify that a CC entity of the MS in CC-state U1, "Call initiated", upon receipt of a message with message type not defined for the protocol discriminator unknown message from its peer entity returns a STATUS message.

26.8.1.2.3.7.4 Method of test

Specific PICS statements

-

PIXIT statements

-

Initial conditions

System Simulator:

1 cell, default parameters.

Mobile Station:

The MS is in MM-state "idle, updated" with valid TMSI and CKSN.

The MS is brought into the state U1 by using table 26.8.1.2/1.

Foreseen final state of the MS

U1, call initiated.

Maximum duration of test

30 s.

Test procedure

An MO circuit switched basic service is selected that is supported by the MS; if the MS supports MO telephony, the selected basic service is telephony. If necessary, the MS is configured for that basic service. Then, the MS is made to initiate a call. The CC entity of the MS is brought to the state U1. The SS sends a message with message type not defined for the protocol discriminator to the MS. The MS shall respond with a STATUS message, and finally the SS checks by using the status enquiry procedure that the state of the CC entity has remained unchanged.

Expected sequence

Step	Direction	Message	Comments
1	SS -> MS	unknown message	message type not defined for PD
2	MS -> SS	STATUS	cause 97#, state U1
3	SS -> MS	STATUS ENQUIRY	
4	MS -> SS	STATUS	cause 30#, state U1

Specific message contents:

None.

26.8.1.2.4 Outgoing call / U3 MS originating call proceeding

26.8.1.2.4.1 Outgoing call / U3 MS originating call proceeding / ALERTING received

26.8.1.2.4.1.1 Definition

The call control entity of the MS being in the state, U3, an ALERTING message is sent to the MS as a indication that a call is being alerted at a called end. This test is applicable for any equipment supporting at least one mobile originated circuit switched basic service.

26.8.1.2.4.1.2 Conformance requirement

- 1) A CC-entity of the MS in CC-state U3, "Mobile Originating Call Proceeding", upon receipt of a ALERTING message shall enter CC-state U4, "Call Delivered".

References

3GPP TS 04.08 / 3GPP TS 24.008 subclause 5.2.1.5.

26.8.1.2.4.1.3 Test purpose

To verify that a CC-entity of the MS in CC-state U3, "Mobile Originating Call Proceeding", upon receipt of a ALERTING message enters CC-state U4, "Call Delivered".

26.8.1.2.4.1.4 Method of test

Specific PICS statements

-

PIXIT statements

-

Initial conditions

System Simulator:

1 cell, default parameters.

Mobile Station:

The MS is in MM-state "idle, updated" with valid TMSI and CKSN.

The MS is brought into the state U3 by using table 26.8.1.2/2.

Foreseen final state of the MS

U4, call delivered.

Maximum duration of test

30 s.

Test procedure

An MO circuit switched basic service is selected that is supported by the MS; if the MS supports MO telephony, the selected basic service is telephony. If necessary, the MS is configured for that basic service. Then, the MS is made to initiate a call. The CC entity of the MS is brought to the state U3. The SS sends an ALERTING message to the MS. The SS checks by using the status enquiry procedure that the CC entity has entered the state U4, call delivered.

Expected sequence

Step	Direction	Message	Comments
1	SS -> MS	ALERTING	
2	SS -> MS	STATUS ENQUIRY	
3	MS -> SS	STATUS	cause 30#, state U4

Specific message contents:

None.

26.8.1.2.4.2 Outgoing call / U3 MS originating call proceeding / CONNECT received

26.8.1.2.4.2.1 Definition

The call control entity of the MS being in the state, U3, a CONNECT message is received by the MS. This test is applicable for any equipment supporting at least one mobile originated circuit switched basic service.

26.8.1.2.4.2.2 Conformance requirement

- 1) A CC-entity of the MS in CC-state U3, "Mobile Originating Call Proceeding", upon receipt of a CONNECT message shall return a "CONNECT ACKNOWLEDGE" message to its peer entity and enter the CC state U10, "Active".
- 2) The MS shall then stop any locally generated indication.

References

Conformance requirement 1: 3GPP TS 04.08 / 3GPP TS 24.008 subclause 5.2.1.6.

Conformance requirement 2: 3GPP TS 04.08 / 3GPP TS 24.008 subclause 5.2.1.6.

26.8.1.2.4.2.3 Test purpose

- 1) To verify that a CC-entity of the MS in CC-state U3, "Mobile Originating Call Proceeding", upon receipt of a CONNECT message returns a "CONNECT ACKNOWLEDGE" message to its peer entity and enters the CC state U10, "Active".
- 2) To verify that the MS stops locally generated indication, if any.

26.8.1.2.4.2.4 Method of test

Specific PICS statements

-

PIXIT statements

-

Initial conditions

System Simulator:

1 cell, default parameters.

Mobile Station:

The MS is in MM-state "idle, updated" with valid TMSI and CKSN.

The MS is brought into the state U3 by using table 26.8.1.2/2.

Foreseen final state of the MS

U10, active.

Maximum duration of test

30 s.

Test procedure

An MO circuit switched basic service is selected that is supported by the MS; if the MS supports MO telephony, the selected basic service is telephony. If necessary, the MS is configured for that basic service. Then, the MS is made to initiate a call. The CC entity of the MS is brought to the state U3. The SS sends a CONNECT message to the MS. The MS shall respond by sending a CONNECT ACKNOWLEDGE message. The SS checks by using the status enquiry procedure that the CC entity has entered the state U10, active.

Expected sequence

Step	Direction	Message	Comments
1	SS -> MS	CONNECT	the MS shall stop tone generation, if any
2	MS -> SS	CONNECT ACKNOWLEDGE	
3	SS -> MS	STATUS ENQUIRY	cause 30#, state U10
4	MS -> SS	STATUS	

Specific message contents:

None.

26.8.1.2.4.3 Outgoing call / U3 MS originating call proceeding / PROGRESS received without in band information

26.8.1.2.4.3.1 Definition

The call control entity of the MS being in the state, U3, a PROGRESS message is received by the MS. The PROGRESS message does not contain indication of in-band information availability. This test is applicable for any equipment supporting at least one mobile originated circuit switched basic service.

26.8.1.2.4.3.2 Conformance requirement

- 1) A CC-entity of the MS in CC-state U3, "Mobile Originating Call Proceeding", upon receipt of a PROGRESS message with valid cause values shall stay in CC-state U3.
- 2) After receipt of the PROGRESS message timer T310 shall be stopped.

References

Conformance requirement 1: 3GPP TS 04.08 / 3GPP TS 24.008 subclause 5.2.1.4.

Conformance requirement 2: 3GPP TS 04.08 / 3GPP TS 24.008 subclause 11.3.

26.8.1.2.4.3.3 Test purpose

- 1) To verify that a CC-entity of the MS in CC-state U3, "Mobile Originating Call Proceeding", upon receipt of a PROGRESS message with valid cause values stays in CC-state U3.
- 2) To verify that after receipt of the PROGRESS message timer T310 is stopped.

26.8.1.2.4.3.4 Method of test

Specific PICS statements

-

PIXIT statements

-

Initial conditions

System Simulator:

1 cell, default parameters.

Mobile Station:

The MS is in MM-state "idle, updated" with valid TMSI and CKSN.

The MS is brought into the state U3 by using table 26.8.1.2/2.

Foreseen final state of the MS

U3, mobile originating call proceeding.

Maximum duration of test

1 min.

Test procedure

An MO circuit switched basic service is selected that is supported by the MS; if the MS supports MO telephony, the selected basic service is telephony. If necessary, the MS is configured for that basic service. Then, the MS is made to initiate a call. The CC entity of the MS is brought to the state U3. The SS sends a PROGRESS message not containing indication of in-band information availability to the MS. The SS checks that the MS has stopped T310, i.e. at T310 time-out no DISCONNECT message is sent by the MS. Then the SS checks by using the status enquiry procedure that the state of the CC entity has remained unchanged.

Expected sequence

Step	Direction	Message	Comments
1	SS -> MS	PROGRESS	(note)
2	SS -> MS	STATUS ENQUIRY	
3	MS -> SS	STATUS	
4	SS		cause 30#, state U3 SS waits at least 45 s and checks no DISCONNECT is sent by the MS
5	SS -> MS	STATUS ENQUIRY	
6	MS -> SS	STATUS	cause 30#, state U3

NOTE: Tested with a valid cause value among:

#4 call has returned to PLMN/ISDN;

#32 call is end-to-end PLMN/ISDN; or

any value in the set #(21-127).

Specific message contents:

None.

26.8.1.2.4.4 Outgoing call / U3 MS originating call proceeding / PROGRESS with in band information

26.8.1.2.4.4.1 Definition

The call control entity of the MS being in the state, U3, a PROGRESS message indicating availability of in band information is received by the MS. This test is applicable for any equipment supporting at least one mobile originated circuit switched basic service.

26.8.1.2.4.4.2 Conformance requirement

- 1) A CC-entity of the MS in CC-state U3, "Mobile Originating Call Proceeding", upon receipt of a PROGRESS message indicating in-band announcement shall through-connect the traffic channel for speech, if TCH is in a speech mode. If TCH is not in speech mode, the MS shall not through-connect the TCH.
- 2) After receipt of the PROGRESS message, T310 shall be stopped.

References

3GPP TS 04.08 / 3GPP TS 44.018 subclause 3.4.3,

3GPP TS 04.08 / 3GPP TS 24.008 subclauses 5.1.3, 5.2.1.4, 5.2.1.9, 5.5.1 and 11.3.

26.8.1.2.4.4.3 Test purpose

- 1) To verify that a CC-entity of the MS in CC-state U3, "Mobile Originating Call Proceeding", upon receipt of a PROGRESS message indicating in-band announcement through-connects the traffic channel for speech, if TCH is in speech mode. If TCH is not in a speech mode, the MS does not through-connect the TCH.
- 2) To verify that after receipt of the PROGRESS message, T310 is stopped.

26.8.1.2.4.4.4 Method of test

Specific PICS statements

-

PIXIT statements

-

Initial conditions

System Simulator:

1 cell, default parameters.

Mobile Station:

The MS is in MM-state "idle, updated" with valid TMSI and CKSN.

The MS is brought into the state U3 by using table 26.8.1.2/2.

Foreseen final state of the MS

U3, mobile originating call proceeding.

Maximum duration of test

1 minute.

Test procedure

An MO circuit switched basic service is selected that is supported by the MS; if the MS supports MO telephony, the selected basic service is telephony. If necessary, the MS is configured for that basic service. Then, the MS is made to initiate a call. The CC entity of the MS is brought to the state U3. The SS sends a PROGRESS message containing indication of in-band information availability to the MS. The SS checks that if channel mode is speech, the TCH shall be through connected. If channel mode is not speech, the TCH shall not be through connected. Also the SS checks that the MS has stopped T310, i.e. at T310 time-out no DISCONNECT message is sent by the MS. Then the SS checks by using the status enquiry procedure that the state of the CC entity has remained unchanged.

Expected sequence

Step	Direction	Message	Comments
1	SS -> MS	PROGRESS 1)	the MS shall stop all the CC timers (note), if channel mode is speech, the TCH shall be through connected. If channel mode is not speech, the TCH shall not be through connected.
2	SS -> MS	STATUS ENQUIRY	cause 30#, state U3 SS waits at least 45 s and checks no DISCONNECT is sent by the MS.
3	MS -> SS	STATUS	
4	SS		
5	SS -> MS	STATUS ENQUIRY	
6	MS -> SS	STATUS	cause 30#, state U3 If the channel mode is speech the SS will check that the user connection for speech is attached (both downlink and uplink).
7	SS		

Specific message contents:

NOTE: Tested with a valid cause value among:

#1 call is not end to end PLMN/ISDN;

#2 destination address is non PLMN/ISDN;

#3 originating address is non PLMN/ISDN;

#8 in band information or appropriate pattern now available or any value in the set #(6-20).

26.8.1.2.4.5 Outgoing call / U3 MS originating call proceeding / DISCONNECT with in band tones

26.8.1.2.4.5.1 Definition

The call control entity of the MS being in the state, U3, a DISCONNECT message indicating availability of in band information is received by the MS. This test is applicable for any equipment supporting at least one mobile originated circuit switched basic service.

26.8.1.2.4.5.2 Conformance requirement

- 1) A CC-entity of the MS in CC-state U3, "Mobile Originating Call Proceeding", upon receipt of a DISCONNECT with progress indicator #8, shall through-connect the speech channel to make in-band announcements available, if traffic channel is in speech mode. If TCH is not in speech mode, the MS shall send a RELEASE message.

References

3GPP TS 04.08 / 3GPP TS 24.008 subclauses 5.2.1.4 and 5.4.4.

26.8.1.2.4.5.3 Test purpose

To verify that a CC-entity of the MS in CC-state U3, "Mobile Originating Call Proceeding", upon receipt of a DISCONNECT with progress indicator #8 through-connects the speech channel to make in-band announcements available, if traffic channel is in speech mode. If TCH is not in speech mode, the MS sends a RELEASE message.

26.8.1.2.4.5.4 Method of test

Specific PICS statements

-

PIXIT statements

-

Initial conditions

System Simulator:

1 cell, default parameters.

Mobile Station:

The MS is in MM-state "idle, updated" with valid TMSI and CKSN.

The MS is brought into the state U3 by using table 26.8.1.2/2.

Foreseen final state of the MS

U12, disconnect indication.

Maximum duration of test

30 s.

Test procedure

An MO circuit switched basic service is selected that is supported by the MS; if the MS supports MO telephony, the selected basic service is telephony. If necessary, the MS is configured for that basic service. Then, the MS is made to initiate a call. The CC entity of the MS is brought to the state U3. The SS sends a DISCONNECT message containing indication of in-band information availability to the MS. The SS checks that if channel mode is speech, the TCH shall be through connected and the MS enters state U12, disconnect indication. If channel mode is not speech, the TCH shall not be through connected and the MS shall enter state U19, release request.

Expected sequence

Step	Direction	Message	Comments
1	SS -> MS	DISCONNECT	(note)
B2	SS		TCH in speech mode: the SS will check that the audio path for in band tones is attached.
B3	SS -> MS	STATUS ENQUIRY	
B4	MS -> SS	STATUS	cause 30#, state U12
C2	MS -> SS	RELEASE	TCH is not in speech mode:
C3	SS -> MS	STATUS ENQUIRY	
C4	MS -> SS	STATUS	cause 30#, state U19

Specific message contents:

NOTE: the cause value:

#8 in band information or appropriate pattern now available.

26.8.1.2.4.6 Outgoing call / U3 MS originating call proceeding / DISCONNECT without in band tones

26.8.1.2.4.6.1 Definition

The call control entity of the MS being in the state, U3, a DISCONNECT message is received by the MS. The DISCONNECT message does not contain indication of in-band information availability. This test is applicable for any equipment supporting at least one mobile originated circuit switched basic service.

26.8.1.2.4.6.2 Conformance requirement

- 1) A CC-entity of the MS in CC-state U3, "Mobile Originating Call Proceeding", upon receipt of a DISCONNECT without progress indicator shall return a RELEASE message and enter the CC-state U19, "Release Request"

References

3GPP TS 04.08 / 3GPP TS 24.008 subclause 5.4.4.

26.8.1.2.4.6.3 Test purpose

To verify that a CC-entity of the MS in CC-state U3, "Mobile Originating Call Proceeding", upon receipt of a DISCONNECT without progress indicator returns a RELEASE message and enters the CC-state U19, "Release Request".

26.8.1.2.4.6.4 Method of test

Specific PICS statements

-

PIXIT statements

-

Initial conditions

System Simulator:

1 cell, default parameters.

Mobile Station:

The MS is in MM-state "idle, updated" with valid TMSI and CKSN.

The MS is brought into the state U3 by using table 26.8.1.2/2.

Foreseen final state of the MS

U19, release request.

Maximum duration of test

30 s.

Test procedure

An MO circuit switched basic service is selected that is supported by the MS; if the MS supports MO telephony, the selected basic service is telephony. If necessary, the MS is configured for that basic service. Then, the MS is made to initiate a call. The CC entity of the MS is brought to the state U3. The SS sends a DISCONNECT message not containing indication of in-band information availability to the MS. The MS shall respond with a RELEASE message. The SS checks by using the status enquiry procedure that the CC entity of the MS has entered the state U19, release request.

Expected sequence

Step	Direction	Message	Comments
1	SS -> MS	DISCONNECT	
2	MS -> SS	RELEASE	
3	SS -> MS	STATUS ENQUIRY	
4	MS -> SS	STATUS	cause 30#, state U19

Specific message contents:

None.

26.8.1.2.4.7 Outgoing call / U3 MS originating call proceeding / RELEASE received

26.8.1.2.4.7.1 Definition

The call control entity of the MS being in the state, U3, a RELEASE message is received by the MS. This test is applicable for any equipment supporting at least one mobile originated circuit switched basic service.

26.8.1.2.4.7.2 Conformance requirement

- 1) A CC-entity of the MS in CC-state U3, "Mobile Originating Call Proceeding", upon receipt of a RELEASE will return a RELEASE COMPLETE and enter the CC-state U0, "Null".
- 2) The MS on returning to the idle mode shall release the MM-connection and the CC-entities relating to the seven mobile originating transaction identifiers shall be in CC-state U0, "Null".
- 3) On releasing the MM-connection, the MS shall wait for MM layer release initiated by the network.

References

- Conformance requirement 1: 3GPP TS 04.08 / 3GPP TS 24.008 subclauses 5.4.2 and 5.4.4.
- Conformance requirement 2: 3GPP TS 04.08 / 3GPP TS 24.008 subclauses 4.5.3 and 5.5.3.2.
- Conformance requirement 3: 3GPP TS 04.08 / 3GPP TS 24.008, subclauses 5.4.4.3 and 4.5.3,
3GPP TS 04.08 / 3GPP TS 44.018, subclause 3.4.13.1

26.8.1.2.4.7.3 Test purpose

- 1) To verify that a CC-entity of the MS in CC-state U3, "Mobile Originating Call Proceeding", upon receipt of a RELEASE will return a RELEASE COMPLETE and enter the CC-state U0, "Null".
- 2) To verify that the MS on returning to the idle mode releases the MM-connection and that the CC-entities relating to the seven mobile originating transaction identifiers are in CC-state U0, "Null".
- 3) To verify that in releasing the MM-connection, the MS shall wait for MM layer release initiated by SS.

26.8.1.2.4.7.4 Method of test

Specific PICS statements

-

PIXIT statements

-

Initial conditions

System Simulator:

1 cell, default parameters.

Mobile Station:

The MS is in MM-state "idle, updated" with valid TMSI and CKSN.

The MS is brought into the state U3 by using table 26.8.1.2/2.

Foreseen final state of the MS

U0, null.

Maximum duration of test

1 minute 30 s.

Test procedure

An MO circuit switched basic service is selected that is supported by the MS; if the MS supports MO telephony, the selected basic service is telephony. If necessary, the MS is configured for that basic service. Then, the MS is made to initiate a call. The CC entity of the MS is brought to the state U3. The SS sends a RELEASE message to the MS. The MS shall respond with a RELEASE COMPLETE message. The SS checks by using the status enquiry procedure that the CC entity has entered the state U0 with all the relevant transaction identifiers.

Expected sequence

Step	Direction	Message	Comments
1	SS -> MS	RELEASE	with cause "Normal, unspecified" cause 81# (invalid TI value) repeat steps 3-4 to cover all the transaction identifiers from 000...110 the main signalling link shall be released by the MS (L2: DISC/UA).
2	MS -> SS	RELEASE COMPLETE	
3	SS -> MS	STATUS ENQUIRY	
4	MS -> SS	RELEASE COMPLETE	
5	SS		
6	SS -> MS	CHANNEL RELEASE	

Specific message contents:

None.

26.8.1.2.4.8 Outgoing call / U3 MS originating call proceeding / termination requested by the user

26.8.1.2.4.8.1 Definition

The call control entity of the MS being in the state, U3, the user requests to terminate the call. This test is applicable for any equipment supporting at least one mobile originated circuit switched basic service.

26.8.1.2.4.8.2 Conformance requirement

- 1) A CC-entity of the MS in CC-state U3, "Mobile Originating Call Proceeding", upon request by the user to terminate will send a DISCONNECT message and enter the CC-state U11, "Disconnect Request".

References

3GPP TS 04.07 / 3GPP TS 24.007 subclause 6.2.2,

3GPP TS 04.08 / 3GPP TS 24.008 subclause 5.4.3.

26.8.1.2.4.8.3 Test purpose

To verify that a CC-entity of the MS in CC-state U3, "Mobile Originating Call Proceeding", upon request by the user to terminate will send a DISCONNECT message and enter the CC-state U11, "Disconnect Request".

26.8.1.2.4.8.4 Method of test

Specific PICS statements

-

PIXIT statements

-

Initial conditions

System Simulator: 1 cell, default parameters.

Mobile Station: The MS is in MM-state "idle, updated" with valid TMSI and CKSN.

The MS is brought into the state U3 by using table 26.8.1.2/3.

Foreseen final state of the MS

U11, disconnect request.

Maximum duration of test

30 s.

Test procedure

An MO circuit switched basic service is selected that is supported by the MS; if the MS supports MO telephony, the selected basic service is telephony. If necessary, the MS is configured for that basic service. Then, the MS is made to initiate a call. The CC entity of the MS is brought to the state U3. The user requests termination of the call. The MS shall send a DISCONNECT message. The SS checks by using the status enquiry procedure that the CC entity has entered the state U11, disconnect request.

Expected sequence

Step	Direction	Message	Comments
1			MMI action, terminate call
2	MS -> SS	DISCONNECT	
3	SS -> MS	STATUS ENQUIRY	
4	MS -> SS	STATUS	cause 30#, state U11

Specific message contents:

None.

26.8.1.2.4.9 Outgoing call / U3 MS originating call proceeding / traffic channel allocation

26.8.1.2.4.9.1 Definition

The call control entity of the MS being in the state, U3, a traffic channel assignment procedure is performed. This test is applicable for any equipment supporting at least one mobile originated circuit switched basic service.

26.8.1.2.4.9.2 Conformance requirement

- 1) A CC-entity of the MS in CC-state U3, "Mobile Originating Call Proceeding", when allocated a traffic channel by the network performing the assignment procedure, shall perform a layer 2 establishment on the FACCH without changing the state of the call in progress.

References

3GPP TS 04.08 / 3GPP TS 44.018 subclause 3.4.3,

3GPP TS 04.08 / 3GPP TS 24.008 subclause 5.2.1.9.

26.8.1.2.4.9.3 Test purpose

To verify that a CC-entity of the MS in CC-state U3, "Mobile Originating Call Proceeding", when allocated a traffic channel by the network performing the assignment procedure, performs a layer 2 establishment on the FACCH without changing the state of the call in progress.

26.8.1.2.4.9.4 Method of test

Specific PICS statements

-

PIXIT statements

-

Initial conditions

System Simulator:

1 cell, default parameters.

Mobile Station:

The MS is in MM-state "idle, updated" with valid TMSI and CKSN.

The MS is brought into the state U3 by using table 26.8.1.2/3.

Foreseen final state of the MS

U3, mobile originating call proceeding.

Maximum duration of test

30 s.

Test procedure

An MO circuit switched basic service is selected that is supported by the MS; if the MS supports MO telephony, the selected basic service is telephony. If necessary, the MS is configured for that basic service. Then, the MS is made to initiate a call. The CC entity of the MS is brought to the state U3. The SS sends an ASSIGNMENT COMMAND for traffic channel to the MS. The MS shall establish layer 2 link on the newly allocated channel and respond with an ASSIGNMENT COMPLETE message. The SS checks by using the status enquiry procedure that the state of the CC entity has remained unchanged.

Expected sequence

Step	Direction	Message	Comments
1	SS -> MS	ASSIGNMENT COMMAND	(TCH) the MS shall perform L2 establishment on the FACCH
2	MS -> SS	ASSIGNMENT COMPLETE	
3	SS -> MS	STATUS ENQUIRY	
4	MS -> SS	STATUS	cause 30#, state U3

Specific message contents:

None.

26.8.1.2.4.10 Outgoing call / U3 MS originating call proceeding / timer T310 time-out

26.8.1.2.4.10.1 Definition

The call control entity of the MS being in the state, U3, if no response is then received from the SS, timer T310 expires at the MS side. This test is applicable for any equipment supporting at least one mobile originated circuit switched basic service.

26.8.1.2.4.10.2 Conformance requirement

- 1) A CC-entity of the MS in CC-state U3, "Mobile Originating Call Proceeding" shall, upon expiry of timer T310, and not before, initiate call release by sending DISCONNECT and enter the CC-state U11, "Disconnect Request".

References

3GPP TS 04.08 / 3GPP TS 24.008 subclauses 5.2.1.3./Abnormal case, 5.4.3 and 11.3.

26.8.1.2.4.10.3 Test purpose

To verify that a CC-entity of the MS in CC-state U3, "Mobile Originating Call Proceeding" will, upon expiry of timer T310 (accuracy minus 2 %, plus 50 %), initiate call release by sending DISCONNECT and enter the CC-state U11, "Disconnect Request".

26.8.1.2.4.10.4 Method of test

Specific PICS statements

-

PIXIT statements

-

Initial conditions

System Simulator:

1 cell, default parameters.

Mobile Station:

The MS is in MM-state "idle, updated" with valid TMSI and CKSN.

The MS is brought into the state U3 by using table 26.8.1.2/3.

Foreseen final state of the MS

U11, disconnect request.

Maximum duration of test

1 minute.

Test procedure

An MO circuit switched basic service is selected that is supported by the MS; if the MS supports MO telephony, the selected basic service is telephony. If necessary, the MS is configured for that basic service. Then, the MS is made to initiate a call. The CC entity of the MS is brought to the state U3. The T310 expires at the MS and the MS shall send DISCONNECT. The SS checks timer T310 accuracy and that the CC entity has entered the state U11, disconnect request.

Expected sequence

Step	Direction	Message	Comments
1	SS		the SS waits for T310 time-out
2	MS -> SS	DISCONNECT	check the timer T310 accuracy (minus 2 % to plus 50 %)
3	SS -> MS	STATUS ENQUIRY	
4	MS -> SS	STATUS	cause 30#, state U11

Specific message contents:

None.

26.8.1.2.4.11 Outgoing call / U3 MS originating call proceeding / lower layer failure

26.8.1.2.4.11.1 Definition

The call control entity of the MS being in the state, U3, a lower layer failure is accomplished at the MS and consequently, communication at layer 3 level with the peer entity is terminated. This test is applicable for any equipment supporting at least one mobile originated circuit switched basic service.

26.8.1.2.4.11.2 Conformance requirement

- 1) If a CC-entity of the MS in CC-state U3, "Mobile Originating Call Proceeding" has detected a lower layer failure and has returned to idle mode, the CC entities relating to the seven mobile originating transaction identifiers shall be in state U0, "Null".

References

3GPP TS 04.08 / 3GPP TS 24.008 subclause 4.5.2.3, 4.5.3 and 5.5.3.2.

3GPP TS 04.08 / 3GPP TS 44.018 subclause 3.4.13.2.1.

26.8.1.2.4.11.3 Test purpose

To verify that a CC-entity of the MS in CC-state U3, "Mobile Originating Call Proceeding" having detected a lower layer failure and having returned to idle mode, the CC entities relating to the seven mobile originating transaction identifiers are in state U0, "Null".

26.8.1.2.4.11.4 Method of test

Specific PICS statements

-

PIXIT statements

-

Initial conditions

System Simulator:

1 cell, default parameters.

Mobile Station:

The MS is in MM-state "idle, updated" with valid TMSI and CKSN.

The MS is brought into the state U3 by using table 26.8.1.2/4.

Foreseen final state of the MS

U0, null.

Maximum duration of test

1 minute 30 s.

Test procedure

An MO circuit switched basic service is selected that is supported by the MS; if the MS supports MO telephony, the selected basic service is telephony. If necessary, the MS is configured for that basic service. Then, the MS is made to initiate a call. The MS is brought to the state U3. The SS generates a lower layer failure at the MS. The SS waits long enough to enable the MS to return to idle state listening to paging, and then pages MS to create RR-connection. Finally, the SS will check the state of the MS by using STATUS ENQUIRY with the relevant transaction identifiers.

Expected sequence

Step	Direction	Message	Comments
1	SS		SS generates lower layer failure
2	SS		SS waits 20 s for the MS to return to listening to paging
3	SS -> MS	PAGING REQUEST	
4	MS -> SS	CHANNEL REQUEST	
5	SS -> MS	IMMEDIATE ASSIGNMENT	
6	MS -> SS	PAGING RESPONSE	
7	SS -> MS	STATUS ENQUIRY	
8	MS -> SS	RELEASE COMPLETE	cause 81# (invalid TI value)
9	SS		repeat steps 18-19 to cover all the transaction identifiers from 000...110
10	SS -> MS	CHANNEL RELEASE	the main signalling link shall be released by the MS (L2: DISC/UA).

Specific message contents:

None.

26.8.1.2.4.12 Outgoing call / U3 MS originating call proceeding / unknown message received

26.8.1.2.4.12.1 Definition

The call control entity of the MS being in the state, U3, an unknown message is received by the MS. This test is applicable for any equipment supporting at least one mobile originated circuit switched basic service.

26.8.1.2.4.12.2 Conformance requirement

- 1) A CC-entity of the MS in CC-state U3, "Mobile Originating Call Proceeding" having received an unknown message from its peer entity shall return a STATUS message.

References

3GPP TS 04.08 / 3GPP TS 24.008 subclause 8.5.

26.8.1.2.4.12.3 Test purpose

To verify that a CC-entity of the MS in CC-state U3, "Mobile Originating Call Proceeding" having received an unknown message from its peer entity returns a STATUS message.

26.8.1.2.4.12.4 Method of test

Specific PICS statements

-

PIXIT statements

-

Initial conditions

System Simulator:

1 cell, default parameters.

Mobile Station:

The MS is in MM-state "idle, updated" with valid TMSI and CKSN.

The MS is brought into the state U3 by using table 26.8.1.2/1.

Foreseen final state of the MS

U3, mobile originating call proceeding.

Maximum duration of test

30 s.

Test procedure

An MO circuit switched basic service is selected that is supported by the MS; if the MS supports MO telephony, the selected basic service is telephony. If necessary, the MS is configured for that basic service. Then, the MS is made to initiate a call. The CC entity of the MS is brought to the state U3. The SS sends a message with message type not defined for the protocol discriminator to the MS. The MS shall respond with a STATUS message, and finally the SS checks by using the status enquiry procedure that the state of the CC entity has remained unchanged.

Expected sequence

Step	Direction	Message	Comments
1	SS -> MS	unknown message	message type not defined for PD
2	MS -> SS	STATUS	cause 97#, state U3
3	SS -> MS	STATUS ENQUIRY	
4	MS -> SS	STATUS	cause 30#, state U3

Specific message contents:

None.

26.8.1.2.4.13 Outgoing call / U3 MS originating call proceeding / Internal alerting indication

26.8.1.2.4.13.1 Definition

The call control entity of the MS being in the state, U3, an ALERTING message is sent to the MS when the user connection is not attached to the radio path. This test is applicable for any equipment supporting mobile originated circuit switched basic service for telephony.

26.8.1.2.4.13.2 Conformance requirement

- 1) When the call control entity of the MS in the "mobile originating call proceeding" state receives an ALERTING message then it shall enter "call delivered" state and, for speech calls, if the user connection is not attached to the radio path, the MS shall internally generate an alerting indication.

References

3GPP TS 04.08 / 3GPP TS 24.008 subclause 5.2.1.5.

26.8.1.2.4.13.3 Test purpose

When the call control entity of the MS in the "mobile originating call proceeding" state receives an ALERTING message then it enters "call delivered" state and, for speech calls, if the user connection is not attached to the radio path, the MS generates internally an alerting indication.

26.8.1.2.4.13.4 Method of test

Specific PICS statements

-

PIXIT statements

- way to give internally generated alerting indication for outgoing calls

Initial conditions

System Simulator:

1 cell, default parameters.

Mobile Station:

The MS is in MM-state "idle, updated" with valid TMSI and CKSN.

The MS is brought into the state U3 by using table 26.8.1.2/1.

Foreseen final state of the MS

U4, call delivered.

Maximum duration of test

30 s.

Test procedure

The SS sends an ALERTING message to the MS. The SS checks by using the status enquiry procedure that the CC entity has entered the state U4, call delivered. Also it is checked that the MS generates internally alerting indication to the user in the way described in the PIXIT statements.

Expected sequence

Step	Direction	Message	Comments
1	SS -> MS	ALERTING	the MS shall generate an alerting indication to the user in the way described in the PIXIT statements
2	SS -> MS	STATUS ENQUIRY	
3	MS -> SS	STATUS	cause 30#, state U4

Specific message contents:

None.

26.8.1.2.5 Outgoing call / U4 call delivered

26.8.1.2.5.1 Outgoing call / U4 call delivered / CONNECT received

26.8.1.2.5.1.1 Definition

The call control entity of the MS being in the state, U4, a CONNECT message is received by the MS. This test is applicable for any equipment supporting at least one mobile originated circuit switched basic service.

26.8.1.2.5.1.2 Conformance requirement

- 1) A CC-entity of the MS in CC-state U4, "Call Delivered", upon receipt of the CONNECT message shall return a CONNECT ACKNOWLEDGE to its peer entity and enter the CC-state U10, "Active".

References

3GPP TS 04.08 / 3GPP TS 24.008 subclause 5.2.1.6.

26.8.1.2.5.1.3 Test purpose

To verify that a CC-entity of the MS in CC-state U4, "Call Delivered", upon receipt of the CONNECT message returns a CONNECT ACKNOWLEDGE to its peer entity and enters the CC-state U10, "Active".

26.8.1.2.5.1.4 Method of test

Specific PICS statements

-

PIXIT statements

-

Initial conditions

System Simulator:

1 cell, default parameters.

Mobile Station:

The MS is in MM-state "idle, updated" with valid TMSI and CKSN.

The MS is brought into the state U4 by using table 26.8.1.2/3.

Foreseen final state of the MS

U10, active.

Maximum duration of test

30 s.

Test procedure

An MO circuit switched basic service is selected that is supported by the MS; if the MS supports MO telephony, the selected basic service is telephony. If necessary, the MS is configured for that basic service. Then, the MS is made to initiate a call. The CC entity of the MS is brought to the state U4. The SS sends a CONNECT message to the MS. The MS shall respond by sending a CONNECT ACKNOWLEDGE message. The SS checks by using the status enquiry procedure that the CC entity has entered the state U10, active.

Expected sequence

Step	Direction	Message	Comments
1	SS -> MS	CONNECT	
2	MS -> SS	CONNECT ACKNOWLEDGE	MS stops alerting, if applicable
3	SS -> MS	STATUS ENQUIRY	
4	MS -> SS	STATUS	cause 30#, state U10

Specific message contents:

None.

26.8.1.2.5.2 Outgoing call / U4 call delivered / termination requested by the user

26.8.1.2.5.2.1 Definition

The call control entity of the MS being in the state, U4, the user requests to terminate the call. This test is applicable for any equipment supporting at least one mobile originated circuit switched basic service.

26.8.1.2.5.2.2 Conformance requirement

- 1) A CC-entity of the MS in CC-state U4, "Call Delivered", upon request by the user to terminate shall send a DISCONNECT message and enter the CC-state U11, "Disconnect Request".

References

3GPP TS 04.07 / 3GPP TS 24.007 subclause 6.2.2.

3GPP TS 04.08 / 3GPP TS 24.008 subclause 5.4.3.

26.8.1.2.5.2.3 Test purpose

To verify that a CC-entity of the MS in CC-state U4, "Call Delivered", upon request by the user to terminate will send a DISCONNECT message and enter the CC-state U11, "Disconnect Request".

26.8.1.2.5.2.4 Method of test

Specific PICS statements

-

PIXIT statements

-

Initial conditions

System Simulator:

1 cell, default parameters.

Mobile Station:

The MS is in MM-state "idle, updated" with valid TMSI and CKSN.

The MS is brought into the state U4 by using table 26.8.1.2/3.

Foreseen final state of the MS

U11, disconnect request.

Maximum duration of test

30 s.

Test procedure

An MO circuit switched basic service is selected that is supported by the MS; if the MS supports MO telephony, the selected basic service is telephony. If necessary, the MS is configured for that basic service. Then, the MS is made to initiate a call. The CC entity of the MS is brought to the state U4. The user requests termination of the call. The MS shall send a DISCONNECT message. The SS checks by using the status enquiry procedure that the CC entity has entered the state U11, disconnect request.

Expected sequence

Step	Direction	Message	Comments
1			MMI action, terminate call
2	MS -> SS	DISCONNECT	
3	SS -> MS	STATUS ENQUIRY	
4	MS -> SS	STATUS	

Specific message contents:

None.

26.8.1.2.5.3 Outgoing call / U4 call delivered / DISCONNECT with in band tones

26.8.1.2.5.3.1 Definition

The call control entity of the MS being in the state, U4, a DISCONNECT message indicating availability of in band information is received by the MS. This test is applicable for any equipment supporting at least one mobile originated circuit switched basic service.

26.8.1.2.5.3.2 Conformance requirement

- 1) A CC-entity of the MS in CC-state U4, "Call Delivered" shall, upon receipt of a DISCONNECT with a progress indicator indicating in-band information, shall through-connect the speech channel to make in-band announcements available, if traffic channel is in speech mode. If TCH is not in speech mode, the MS shall send a RELEASE message.

References

3GPP TS 04.08 / 3GPP TS 44.018 subclause 3.4.3,

3GPP TS 04.08 / 3GPP TS 24.008 subclauses 5.4.4.1, 5.5.1 and 5.2.1.9.

26.8.1.2.5.3.3 Test purpose

To verify that a CC-entity of the MS in CC-state U4, "Call Delivered", upon receipt of a DISCONNECT with a progress indicator indicating in-band information, through-connects the speech channel to make in-band announcements available, if traffic channel is in speech mode. If TCH is not in speech mode, the MS shall send a RELEASE message.

26.8.1.2.5.3.4 Method of test

Specific PICS statements

-

PIXIT statements

-

Initial conditions

System Simulator:

1 cell, default parameters.

Mobile Station:

The MS is in MM-state "idle, updated" with valid TMSI and CKSN.

The MS is brought into the state U4 by using table 26.8.1.2/2.

Foreseen final state of the MS

U12, disconnect indication.

Maximum duration of test

30 s.

Test procedure

An MO circuit switched basic service is selected that is supported by the MS; if the MS supports MO telephony, the selected basic service is telephony. If necessary, the MS is configured for that basic service. Then, the MS is made to initiate a call. The CC entity of the MS is brought to the state U4. The SS sends a DISCONNECT message containing indication of in-band information availability to the MS. The SS checks that if channel mode is MO telephony, the TCH shall be through connected and the MS enters state U12, disconnect indication. If channel mode is not speech, the TCH shall not be through connected and the MS shall enter state U19, release request.

Expected sequence

Step	Direction	Message	Comments
1	SS -> MS	DISCONNECT	(note)
A2	SS		TCH in speech mode: the SS will check that the audio path for in band tones is attached.
A3	SS -> MS	STATUS ENQUIRY	
A4	MS -> SS	STATUS	cause 30#, state U12
B2	MS -> SS	RELEASE	TCH is not in speech mode:
B3	SS -> MS	STATUS ENQUIRY	
B4	MS -> SS	STATUS	cause 30#, state U19

Specific message contents:

NOTE: the Progress Indicator, Progress Description:

#8 in band information or appropriate pattern now available.

26.8.1.2.5.4 Outgoing call / U4 call delivered / DISCONNECT without in band tones

26.8.1.2.5.4.1 Definition

The call control entity of the MS being in the state, U4, a DISCONNECT message is received by the MS. The DISCONNECT message does not contain indication of in-band information availability. This test is applicable for any equipment supporting at least one mobile originated circuit switched basic service.

26.8.1.2.5.4.2 Conformance requirement

- 1) A CC-entity of the MS in CC-state U4, "Call Delivered", upon receipt of a DISCONNECT without progress indicator, shall return a RELEASE message and enter the CC-state U19, "Release Request".

References

3GPP TS 04.08 / 3GPP TS 24.008 subclause 5.4.4.

26.8.1.2.5.4.3 Test purpose

To verify that a CC-entity of the MS in CC-state U4, "Call Delivered", upon receipt of a DISCONNECT without progress indicator, returns a RELEASE message and enters the CC-state U19, "Release Request".

26.8.1.2.5.4.4 Method of test

Specific PICS statements

-

PIXIT statements

-

Initial conditions

System Simulator:

1 cell, default parameters.

Mobile Station:

The MS is in MM-state "idle, updated" with valid TMSI and CKSN.

The MS is brought into the state U4 by using table 26.8.1.2/2.

Foreseen final state of the MS

U19, release request.

Maximum duration of test

30 s.

Test procedure

An MO circuit switched basic service is selected that is supported by the MS; if the MS supports MO telephony, the selected basic service is telephony. If necessary, the MS is configured for that basic service. Then, the MS is made to initiate a call. The CC entity of the MS is brought to the state U4. The SS sends a DISCONNECT message not containing indication of in-band information availability to the MS. The MS shall respond with a RELEASE message. The SS checks by using the status enquiry procedure that the CC entity of the MS has entered the state U19, release request.

Expected sequence

Step	Direction	Message	Comments
1	SS -> MS	DISCONNECT	
2	MS -> SS	RELEASE	
3	SS -> MS	STATUS ENQUIRY	
4	MS -> SS	STATUS	cause 30#, state U19

Specific message contents:

None.

26.8.1.2.5.5 Outgoing call / U4 call delivered / RELEASE received

26.8.1.2.5.5.1 Definition

The call control entity of the MS being in the state, U4, a RELEASE message is received by the MS. This test is applicable for any equipment supporting at least one mobile originated circuit switched basic service.

26.8.1.2.5.5.2 Conformance requirement

- 1) A CC-entity of the MS in CC-state U4, "Call Delivered", upon receipt of the RELEASE message shall respond with the RELEASE COMPLETE message and enter the CC-state U0, "Null".
- 2) The MS on returning to idle mode shall release the MM-connection and the CC-entities relating to the seven mobile originating transaction identifiers shall be in CC-state U0, "Null".

References

Conformance requirement 1: 3GPP TS 04.08 / 3GPP TS 24.008 subclauses 5.4.2 and 5.4.4.

Conformance requirement 2: 3GPP TS 04.08 / 3GPP TS 24.008 subclauses 4.5.3 and 5.5.3.2.

26.8.1.2.5.5.3 Test purpose

- 1) To verify that a CC-entity of the MS in CC-state U4, "Call Delivered", upon receipt of the RELEASE message will respond with the RELEASE COMPLETE message and enter the CC-state U0, "Null".
- 2) To verify that the MS on returning the idle mode releases the MM-connection and that the CC-entities relating to the seven mobile originating transaction identifiers are in CC-state U0, "Null".

26.8.1.2.5.5.4 Method of test

Specific PICS statements

-

PIXIT statements

-

Initial conditions

System Simulator:

1 cell, default parameters.

Mobile Station:

The MS is in MM-state "idle, updated" with valid TMSI and CKSN.

The MS is brought into the state U4 by using table 26.8.1.2/2.

Foreseen final state of the MS

U0, null.

Maximum duration of test

1 min 30 s.

Test procedure

An MO circuit switched basic service is selected that is supported by the MS; if the MS supports MO telephony, the selected basic service is telephony. If necessary, the MS is configured for that basic service. Then, the MS is made to initiate a call. The CC entity of the MS is brought to the state U4. The SS sends a RELEASE message to the MS. The MS shall respond with a RELEASE COMPLETE message. The SS checks by using the status enquiry procedure that the CC entity has entered the state U0 with all the relevant transaction identifiers.

Expected sequence

Step	Direction	Message	Comments
1	SS -> MS	RELEASE	with cause "Normal, unspecified"
2	MS -> SS	RELEASE COMPLETE	
3	SS -> MS	STATUS ENQUIRY	cause 81# (invalid TI value) repeat steps 19-20 to cover all the transaction identifiers from 000...110
4	MS -> SS	RELEASE COMPLETE	
5	SS		
6	SS -> MS	CHANNEL RELEASE	the main signalling link shall be released by the MS (L2: DISC/UA).

Specific message contents:

None.

26.8.1.2.5.6 Outgoing call / U4 call delivered / lower layer failure

26.8.1.2.5.6.1 Definition

The call control entity of the MS being in the state, U4, a lower layer failure is accomplished at the MS and consequently, communication at layer 3 level with the peer entity is terminated. This test is applicable for any equipment supporting at least one mobile originated circuit switched basic service.

26.8.1.2.5.6.2 Conformance requirement

- 1) When CC-entity of the MS in CC-state U4, "Call Delivered" has detected a lower layer failure and has returned to idle mode, the CC-entities relating to the seven mobile originating transaction identifiers shall be in CC-state U0, "Null".

References

3GPP TS 04.08 / 3GPP TS 24.008 subclauses 4.5.2.3, 4.5.3 and 5.5.3.2,

3GPP TS 04.08 / 3GPP TS 44.018 subclause 3.4.13.2.1.

26.8.1.2.5.6.3 Test purpose

To verify that a CC-entity of the MS in CC-state U4, "Call Delivered" having detected a lower layer failure and has returned to idle mode, the CC-entities relating to the seven mobile originating transaction identifiers are in CC-state U0, "Null".

26.8.1.2.5.6.4 Method of test

Specific PICS statements

-

PIXIT statements

-

Initial conditions

System Simulator:

1 cell, default parameters.

Mobile Station:

The MS is in MM-state "idle, updated" with valid TMSI and CKSN.

The MS is brought into the state U4 by using table 26.8.1.2/2.

Foreseen final state of the MS

U0, null.

Maximum duration of test

1 minute 30 s.

Test procedure

An MO circuit switched basic service is selected that is supported by the MS; if the MS supports MO telephony, the selected basic service is telephony. If necessary, the MS is configured for that basic service. Then, the MS is made to initiate a call. The MS is brought to the state U4. The SS generates a lower layer failure at the MS. The SS waits long enough to enable the MS to return to idle state listening to paging, and then pages MS to create RR-connection. Finally, the SS will check the state of the MS by using STATUS ENQUIRY with the relevant transaction identifiers.

Expected sequence

Step	Direction	Message	Comments
1	SS		SS generates lower layer failure
2	SS		SS waits 20 s for the MS to return to listening to paging
3	SS -> MS	PAGING REQUEST	
4	MS -> SS	CHANNEL REQUEST	
5	SS -> MS	IMMEDIATE ASSIGNMENT	
6	MS -> SS	PAGING RESPONSE	
7	SS -> MS	STATUS ENQUIRY	
8	MS -> SS	RELEASE COMPLETE	cause 81# (invalid TI value)
9	SS		repeat steps 7-8 to cover all the transaction identifiers from 000...110
10	SS -> MS	CHANNEL RELEASE	the main signalling link shall be released by the MS (L2: DISC/UA).

Specific message contents:

None.

26.8.1.2.5.7 Outgoing call / U4 call delivered / traffic channel allocation

26.8.1.2.5.7.1 Definition

The call control entity of the MS being in the state, U4, a traffic channel assignment procedure is performed. This test is applicable for any equipment supporting at least one mobile originated circuit switched basic service.

26.8.1.2.5.7.2 Conformance requirement

- 1) A CC-entity of the MS in CC-state U4, "Call Delivered", when allocated a traffic channel by the network performing the assignment procedure, shall perform a layer 2 establishment on the FACCH without changing the state of the call in progress.

References

3GPP TS 04.08 / 3GPP TS 44.018 subclause 3.4.3,

3GPP TS 04.08 / 3GPP TS 24.008 subclause 5.2.1.9.

26.8.1.2.5.7.3 Test purpose

To verify that a CC-entity of the MS in CC-state U4, "Call Delivered", when allocated a traffic channel by the network performing the assignment procedure, shall perform a layer 2 establishment on the FACCH without changing the state of the call in progress.

26.8.1.2.5.7.4 Method of test

Specific PICS statements

-

PIXIT statements

-

Initial conditions

System Simulator:

1 cell, default parameters.

Mobile Station:

The MS is in MM-state "idle, updated" with valid TMSI and CKSN.

The MS is brought into the state U4 by using table 26.8.1.2/1.

Foreseen final state of the MS

U4, call delivered.

Maximum duration of test

30 s.

Test procedure

An MO circuit switched basic service is selected that is supported by the MS; if the MS supports MO telephony, the selected basic service is telephony. If necessary, the MS is configured for that basic service. Then, the MS is made to initiate a call. The CC entity of the MS is brought to the state U4. The SS sends an ASSIGNMENT COMMAND for traffic channel to the MS. The MS shall establish layer 2 link on the newly allocated channel and respond with an ASSIGNMENT COMPLETE message. The SS checks by using the status enquiry procedure that the state of the CC entity has remained unchanged.

Expected sequence

Step	Direction	Message	Comments
1	SS -> MS	ASSIGNMENT COMMAND	TCH, the MS shall perform L2 establishment on the FACCH cause 30#, state U4
2	MS -> SS	ASSIGNMENT COMPLETE	
3	SS -> MS	STATUS ENQUIRY	
4	MS -> SS	STATUS	

Specific message contents:

None.

26.8.1.2.5.8 Outgoing call / U4 call delivered / unknown message received

26.8.1.2.5.8.1 Definition

The call control entity of the MS being in the state, U4, an unknown message is received by the MS. This test is applicable for any equipment supporting at least one mobile originated circuit switched basic service.

26.8.1.2.5.8.2 Conformance requirement

- 1) A CC-entity of the MS in CC-state U4, "Call Delivered", having received an unknown message from its peer entity shall return a STATUS message.

References

3GPP TS 04.08 / 3GPP TS 24.008 subclause 8.4.

26.8.1.2.5.8.3 Test purpose

To verify that a CC-entity of the MS in CC-state U4, "Call Delivered", having received an unknown message from its peer entity returns a STATUS message.

26.8.1.2.5.8.4 Method of test

Specific PICS statements

-

PIXIT statements

-

Initial conditions

System Simulator:

1 cell, default parameters.

Mobile Station:

The MS is in MM-state "idle, updated" with valid TMSI and CKSN.

The MS is brought into the state U4 by using table 26.8.1.2/4.

Foreseen final state of the MS

U4, call delivered.

Maximum duration of test

30 s.

Test procedure

An MO circuit switched basic service is selected that is supported by the MS; if the MS supports MO telephony, the selected basic service is telephony. If necessary, the MS is configured for that basic service. Then, the MS is made to initiate a call. The CC entity of the MS is brought to the state U4. The SS sends a message with message type not defined for the protocol discriminator to the MS. The MS shall respond with a STATUS message, and finally the SS checks by using the status enquiry procedure that the state of the CC entity has remained unchanged.

Expected sequence

Step	Direction	Message	Comments
1	SS -> MS	unknown message	message type not defined for PD
2	MS -> SS	STATUS	cause 97#, state U4
3	SS -> MS	STATUS ENQUIRY	
4	MS -> SS	STATUS	cause 30#, state U4

Specific message contents:

None.

26.8.1.2.6 U10 call active

26.8.1.2.6.1 U10 call active / termination requested by the user

26.8.1.2.6.1.1 Definition

The call control entity of the MS being in the state, U10, the user requests to terminate the call. This test is applicable for any equipment supporting at least one mobile originated circuit switched basic service.

26.8.1.2.6.1.2 Conformance requirement

- 1) A CC-entity of the MS in CC-state U10, "Call Active", upon request by the user to terminate shall send a DISCONNECT message and enter the CC-state U11, "Disconnect Request".

References

3GPP TS 04.07 / 3GPP TS 24.007 subclause 6.2.2,

3GPP TS 04.08 / 3GPP TS 24.008 subclause 5.4.3.

26.8.1.2.6.1.3 Test purpose

To verify that the a CC-entity of the MS in CC-state U10, "Call Active", upon request by the user to terminate will send a DISCONNECT message and enter the CC-state U11, "Disconnect Request".

26.8.1.2.6.1.4 Method of test

Specific PICS statements

-

PIXIT statements

-

Initial conditions

System Simulator:

1 cell, default parameters.

Mobile Station:

The MS is in MM-state "idle, updated" with valid TMSI and CKSN.

The MS is brought into the state U10 by using table 26.8.1.2/1.

Foreseen final state of the MS

U11, disconnect request.

Maximum duration of test

30 s.

Test procedure

An MO circuit switched basic service is selected that is supported by the MS; if the MS supports MO telephony, the selected basic service is telephony. If necessary, the MS is configured for that basic service. Then, the MS is made to initiate a call. The CC entity of the MS is brought to the state U10. The user requests termination of the call. The MS shall send a DISCONNECT message. The SS checks by using the status enquiry procedure that the CC entity has entered the state U11, disconnect request.

Expected sequence

Step	Direction	Message	Comments
1			MMI action, terminate call
2	MS -> SS	DISCONNECT	U11
3	SS -> MS	STATUS ENQUIRY	
4	MS -> SS	STATUS	cause 30#, state U11

Specific message contents:

None.

26.8.1.2.6.2 U10 call active / RELEASE received

26.8.1.2.6.2.1 Definition

The call control entity of the MS being in the state, U10, a RELEASE message is received by the MS. This test is applicable for any equipment supporting at least one mobile originated circuit switched basic service.

26.8.1.2.6.2.2 Conformance requirement

- 1) A CC-entity of the MS in CC-state U10, "Call Active", upon receipt of the RELEASE shall respond with the RELEASE COMPLETE message and enter the CC-state U0, "Null"
- 2) When the MS returns to the idle mode it shall release the MM-connection and the CC-entities relating to the seven mobile originating transaction identifiers shall be in CC-state U0, "Null"

References

Conformance requirement 1: 3GPP TS 04.08 / 3GPP TS 24.008 subclauses 5.4.2 and 5.4.4.

Conformance requirement 2: 3GPP TS 04.08 / 3GPP TS 24.008 subclauses 4.5.3 and 5.5.3.2.

26.8.1.2.6.2.3 Test purpose

- 1) To verify that the a CC-entity of the MS in CC-state U10, "Call Active", upon receive of the RELEASE will respond with the RELEASE COMPLETE message and enter the CC-state U0, "Null".
- 2) To verify that the MS on returning to the idle mode releases the MM-connection and that the CC-entities relating to the seven mobile originating transaction identifiers are in CC-state U0, "Null".

26.8.1.2.6.2.4 Method of test

Specific PICS statements

-

PIXIT statements

-

Initial conditions

System Simulator:

1 cell, default parameters.

Mobile Station:

The MS is in MM-state "idle, updated" with valid TMSI and CKSN.

The MS is brought into the state U10 by using table 26.8.1.2/1.

Foreseen final state of the MS

U0, null.

Maximum duration of test

1 min 30 s.

Test procedure

An MO circuit switched basic service is selected that is supported by the MS; if the MS supports MO telephony, the selected basic service is telephony. If necessary, the MS is configured for that basic service. Then, the MS is made to initiate a call. The CC entity of the MS is brought to the state U10. The SS sends a RELEASE message to the MS. The MS shall respond with a RELEASE COMPLETE message. The SS checks by using the status enquiry procedure that the CC entity has entered the state U0 with all the relevant transaction identifiers.

Expected sequence

Step	Direction	Message	Comments
1	SS -> MS	RELEASE	with cause "Normal, unspecified"
2	MS -> SS	RELEASE COMPLETE	the MS starts T3240
3	SS -> MS	STATUS ENQUIRY	
4	MS -> SS	RELEASE COMPLETE	cause 81# (invalid TI value)
5	SS		repeat steps 3-4 to cover all the transaction identifiers from 000...110
6	SS -> MS	CHANNEL RELEASE	the main signalling link shall be released by the MS (L2: DISC/UA)

Specific message contents:

None.

26.8.1.2.6.3 U10 call active / DISCONNECT with in band tones

26.8.1.2.6.3.1 Definition

The call control entity of the MS being in the state, U10, a DISCONNECT message indicating availability of in band information is received by the MS. This test is applicable for any equipment supporting at least one mobile originated circuit switched basic service.

26.8.1.2.6.3.2 Conformance requirement

- 1) A CC-entity of the MS in CC-state U10, "Call Active", upon receipt of a DISCONNECT message with a Progress Indicator indicating in-band information, shall through-connect the speech channel to make in-band announcements available, if traffic channel is in speech mode. If TCH is not in speech mode, the MS shall send a RELEASE message.

References

3GPP TS 04.08 / 3GPP TS 24.008 subclauses 5.4.4.1 and 5.5.1.

26.8.1.2.6.3.3 Test purpose

To verify that a CC-entity of the MS in CC-state U10, "Call Active", upon receipt of a DISCONNECT message with a Progress Indicator indicating in-band information, through-connects the speech channel to make in-band announcements available, if traffic channel is in speech mode. If TCH is not in speech mode, the MS sends a RELEASE message.

26.8.1.2.6.3.4 Method of test

Specific PICS statements

-

PIXIT statements

-

Initial conditions

System Simulator:

1 cell, default parameters.

Mobile Station:

The MS is in MM-state "idle, updated" with valid TMSI and CKSN.

The MS is brought into the state U10 by using table 26.8.1.2/2.

Foreseen final state of the MS

U12, disconnect indication.

Maximum duration of test

30 s.

Test procedure

An MO circuit switched basic service is selected that is supported by the MS; if the MS supports MO telephony, the selected basic service is telephony. If necessary, the MS is configured for that basic service. Then, the MS is made to initiate a call. The CC entity of the MS is brought to the state U10. The SS sends a DISCONNECT message containing indication of in-band information availability to the MS. The SS checks that if channel mode is speech, the TCH shall be through connected and the MS enters state U12, disconnect indication. If channel mode is not speech, the TCH shall not be through connected and the MS enters state U19, release request.

Expected sequence

Step	Direction	Message	Comments
1	SS -> MS	DISCONNECT	(note)
A2	SS		TCH in speech mode: the SS will check that the audio path for in band tones is attached.
A3	SS -> MS	STATUS ENQUIRY	
A4	MS -> SS	STATUS	cause 30#, state U12
B2	MS -> SS	RELEASE	TCH is not in speech mode:
B3	SS -> MS	STATUS ENQUIRY	
B4	MS -> SS	STATUS	cause 30#, state U19

Specific message contents:

NOTE: the Progress Indicator, Progress Description:

#8 in band information or appropriate pattern now available.

26.8.1.2.6.4 U10 call active / DISCONNECT without in band tones

26.8.1.2.6.4.1 Definition

The call control entity of the MS being in the state, U10, a DISCONNECT message is received by the MS. The DISCONNECT message does not contain indication of in-band information availability. This test is applicable for any equipment supporting at least one mobile originated circuit switched basic service.

26.8.1.2.6.4.2 Conformance requirement

- 1) A CC-entity of the MS in CC-state U10, "Call Active", upon receipt of a DISCONNECT message without progress indicator, shall return a RELEASE message and enter the CC-state U19, "Release Request".

References

3GPP TS 04.08 / 3GPP TS 24.008 subclause 5.4.4.

26.8.1.2.6.4.3 Test purpose

To verify that the a CC-entity of the MS in CC-state U10, "Call Active", upon receipt of a DISCONNECT message without progress indicator, returns a RELEASE message and enters the CC-state U19, "Release Request".

26.8.1.2.6.4.4 Method of test

Specific PICS statements

-

PIXIT statements

-

Initial conditions

System Simulator:

1 cell, default parameters.

Mobile Station:

The MS is in MM-state "idle, updated" with valid TMSI and CKSN.

The MS is brought into the state U10 by using table 26.8.1.2/2.

Foreseen final state of the MS

U19, release request.

Maximum duration of test

30 s.

Test procedure

An MO circuit switched basic service is selected that is supported by the MS; if the MS supports MO telephony, the selected basic service is telephony. If necessary, the MS is configured for that basic service. Then, the MS is made to initiate a call. The CC entity of the MS is brought to the state U10. The SS sends a DISCONNECT message not containing indication of in-band information availability to the MS. The MS shall respond with a RELEASE message. The SS checks by using the status enquiry procedure that the CC entity of the MS has entered the state U19, release request.

Expected sequence

Step	Direction	Message	Comments
1	SS -> MS	DISCONNECT	
2	MS -> SS	RELEASE	
3	SS -> MS	STATUS ENQUIRY	
4	MS -> SS	STATUS	cause 30#, state U19

Specific message contents:

None.

26.8.1.2.6.5 U10 call active / RELEASE COMPLETE received

26.8.1.2.6.5.1 Definition

The call control entity of the MS being in the state, U10, the call is cleared by a RELEASE COMPLETE message sent by the SS. This test is applicable for any equipment supporting at least one mobile originated circuit switched basic service.

26.8.1.2.6.5.2 Conformance requirement

- 1) A CC entity of the MS in CC-state U10, "active", upon receipt of a RELEASE COMPLETE message with valid cause value, shall enter CC state U0, "Null".
- 2) On returning to idle mode, the CC entities relating to the seven mobile originating transaction identifiers shall be in state U0, "Null".

References

Conformance requirement 1: 3GPP TS 04.08 / 3GPP TS 24.008, subclauses 5.4.2 and 5.4.4.

Conformance requirement 2: 3GPP TS 04.08 / 3GPP TS 24.008, subclause 5.4.4.3.

26.8.1.2.6.5.3 Test purpose

- 1) To verify that a CC entity of the MS in CC-state U10, "Call active" upon receipt of a RELEASE COMPLETE message with valid cause value, enters CC state U0, "Null".
- 2) To verify that in returning to idle mode, the CC entities relating to the seven mobile originating transaction identifiers are in state U0, "Null".

26.8.1.2.6.5.4 Method of test

Specific PICS statements

-

PIXIT statements

-

Initial conditions

System Simulator:

1 cell, default parameters.

Mobile Station:

The MS is in MM-state "idle, updated" with valid TMSI and CKSN.

The MS is brought into the state U10 by using table 26.8.1.2/2.

Foreseen final state of the MS

U0, null.

Maximum duration of test

30 s.

Test procedure

The SS sends a RELEASE COMPLETE message to the MS. The SS checks by using the status enquiry procedure that the CC entity has entered the state U0 with all the relevant transaction identifiers.

Expected sequence

Step	Direction	Message	Comments
1	SS -> MS	RELEASE COMPLETE	note 1
2	SS -> MS	STATUS ENQUIRY	note 2
3	MS -> SS	RELEASE COMPLETE	cause 81# (invalid TI value),
4	SS		repeat steps 2-3 to cover all the transaction identifiers from 000...110
5	SS -> MS	CHANNEL RELEASE	the main signalling link shall be released by the MS (L2: DISC/UA).

Specific message contents:

NOTE 1: With the cause value chosen arbitrarily.

NOTE 2: TI flag has the value indicating the MS as a originator of the call.

26.8.1.2.6.6 U10 call active / SETUP received

26.8.1.2.6.6.1 Definition

If the MS does not react correctly when receiving a SETUP message on a new Transaction Identifier during an active call, the active call may be lost.

This test is applicable for all MS supporting at least one mobile originated circuit switched basic service.

26.8.1.2.6.6.2 Conformance requirement

- 1) A Mobile Station that has a call established when receiving a SETUP message shall respond either with a CALL CONFIRMED message or a RELEASE COMPLETE message, both with cause #17 "user busy".
- 2) The call control state of the existing transaction shall not be affected by the incoming SETUP message.

Reference(s):

Conformance requirement 1: 3GPP TS 04.08 / 3GPP TS 24.008, subclause 5.2.2.3.1.

Conformance requirement 2: 3GPP TS 04.08 / 3GPP TS 24.008, subclause 5.1.1.

26.8.1.2.6.6.3 Test purpose

- 1) To verify that a Mobile Station that has a call established and receives a SETUP message answers either with a CALL CONFIRMED message with cause "user busy" if it supports call waiting, or with a RELEASE COMPLETE message with cause "user busy" otherwise.
- 2) To verify that after having sent this message, the MS is still in state U10 for the established call.

26.8.1.2.6.6.4 Method of test

Initial conditions

System Simulator:

1 cell, default parameters.

Mobile Station:

The MS is idle updated with valid TMSI and CKSN.

The MS is brought into the state U10 by using table 26.8.1.2/14.

Specific PICS statements

- support of call waiting (TSPC_Serv_SS_CW)

PIXIT statements

-

Foreseen final state of the MS

U10, call active.

Maximum duration of test

30 s.

Test Procedure

The MS has a mobile originated call in the U10 state.

The SS sends a SETUP message to the MS (with signal IE indicating "call waiting tone on").

If the MS does not support call waiting it shall answer by a RELEASE COMPLETE message.

If the MS supports call waiting it shall answer by a CALL CONFIRMED message followed by an ALERTING. The second transaction is then released by the SS with a RELEASE COMPLETE message.

In both cases the SS checks by using the status enquiry procedure that the CC entity of the MS is still in state U10, active call for the original call.

Expected sequence

Step	Direction	Message	Comments
1	SS -> MS	SETUP	this message establishes a second transaction The TI value shall be the same as the one that is in use for the MO call. The TI flag shall have the value specified for an MT call.
A2	MS -> SS	RELEASE COMPLETE	if the MS does not support call waiting with cause user busy" with the TI of the second transaction
B2	MS -> SS	CALL CONFIRMED	if the MS supports call waiting with cause user busy" with the TI of the second transaction
B3	MS -> SS	ALERTING	with the TI of the second transaction
B4	SS -> MS	RELEASE COMPLETE	with the TI of the second transaction
5	SS -> MS	STATUS ENQUIRY	with the TI of the original transaction
6	MS -> SS	STATUS	cause 30#, state U10 with the TI of the original transaction

NOTE: The Transaction Identifier of the second transaction shall be different from the one of the already established transaction.

Specific message contents

SETUP message contains a Signal IE with value "call waiting tone on" (H'07).

26.8.1.2.7 U11 disconnect request

26.8.1.2.7.1 U11 disconnect request / clear collision

26.8.1.2.7.1.1 Definition

The call control entity of the MS being in the state, U11, a DISCONNECT message is received by the MS. This test is applicable for any equipment supporting at least one mobile originated circuit switched basic service.

26.8.1.2.7.1.2 Conformance requirement

- 1) A CC-entity of the MS in CC-state U11, "Disconnect Request", upon receipt of a DISCONNECT message, shall return to its peer entity the RELEASE message and enter the CC-state U19, "Release Request".

References

3GPP TS 04.08 / 3GPP TS 24.008 subclause 5.4.5.

26.8.1.2.7.1.3 Test purpose

To verify that the a CC-entity of the MS in CC-state U11, "Disconnect Request", upon receipt of a DISCONNECT message, returns to its peer entity the RELEASE message and enters the CC-state U19, "Release Request".

26.8.1.2.7.1.4 Method of test

Specific PICS statements

-

PIXIT statements

-

Initial conditions

System Simulator:

1 cell, default parameters.

Mobile Station:

The MS is in MM-state "idle, updated" with valid TMSI and CKSN.

The MS is brought into the state U11 by using table 26.8.1.2/3.

Foreseen final state of the MS

U19, release request.

Maximum duration of test

30 s.

Test procedure

An MO circuit switched basic service is selected that is supported by the MS; if the MS supports MO telephony, the selected basic service is telephony. If necessary, the MS is configured for that basic service. Then, the MS is made to initiate a call. The CC entity of the MS is brought to the state U11. The SS sends a DISCONNECT message to the MS. The MS shall respond with a RELEASE message. The SS checks by using the status enquiry procedure that the CC entity of the MS has entered the state U19, release request.

Expected sequence

Step	Direction	Message	Comments
1	SS -> MS	DISCONNECT	
2	MS -> SS	RELEASE	
3	SS -> MS	STATUS ENQUIRY	
4	MS -> SS	STATUS	cause 30#, state U19

Specific message contents:

None.

26.8.1.2.7.2 U11 disconnect request / RELEASE received

26.8.1.2.7.2.1 Definition

The call control entity of the MS being in the state, U11, a RELEASE message is received by the MS. This test is applicable for any equipment supporting at least one mobile originated circuit switched basic service.

26.8.1.2.7.2.2 Conformance requirement

- 1) A CC-entity of the MS in CC-state U11, "Disconnect Request", upon receipt of the RELEASE message shall return RELEASE COMPLETE and enter the CC-state U0, "Null".
- 2) On returning to the idle mode the MS shall release the MM-connection and the CC-entities relating to the seven mobile originating transaction identifiers shall be in CC-state U0, "Null".

References

Conformance requirement 1: 3GPP TS 04.08 / 3GPP TS 24.008 subclause 5.4.3.

Conformance requirement 2: 3GPP TS 04.08 / 3GPP TS 24.008 subclauses 4.5.3, 5.5.3.2 and 8.3.

26.8.1.2.7.2.3 Test purpose

- 1) To verify that the a CC-entity of the MS in CC-state U11, "Disconnect Request", upon receipt of the RELEASE message shall return RELEASE COMPLETE and enter the CC-state U0, "Null".
- 2) To verify that the MS on returning to the idle mode releases the MM-connection and that the CC-entities relating to the seven mobile originating transaction identifiers are in CC-state U0, "Null".

26.8.1.2.7.2.4 Method of test

Specific PICS statements

-

PIXIT statements

-

Initial conditions

System Simulator:

1 cell, default parameters.

Mobile Station:

The MS is in MM-state "idle, updated" with valid TMSI and CKSN.

The MS is brought into the state U11 by using table 26.8.1.2/3.

Foreseen final state of the MS

U0, null.

Maximum duration of test

1 min 30 s.

Test procedure

An MO circuit switched basic service is selected that is supported by the MS; if the MS supports MO telephony, the selected basic service is telephony. If necessary, the MS is configured for that basic service. Then, the MS is made to initiate a call. The CC entity of the MS is brought to the state U11. The SS sends a RELEASE message to the MS. The MS shall respond with a RELEASE COMPLETE message. The SS checks by using the status enquiry procedure that the CC entity has entered the state U0 with all the relevant transaction identifiers.

Expected sequence

Step	Direction	Message	Comments
1	SS -> MS	RELEASE	
2	MS -> SS	RELEASE COMPLETE	
3	SS -> MS	STATUS ENQUIRY	
4	MS -> SS	RELEASE COMPLETE	
5	SS		cause 81# (invalid TI value) repeat steps 3-4 to cover all the transaction identifiers from 000...110
6	SS -> MS	CHANNEL RELEASE	the main signalling link shall be released by the MS (L2: DISC/UA).

Specific message contents:

None.

26.8.1.2.7.3 U11 disconnect request / timer T305 time-out

26.8.1.2.7.3.1 Definition

The call control entity of the MS being in the state, U11, if no response is then received from the SS, timer T305 expires at the MS side. This test is applicable for any equipment supporting at least one mobile originated circuit switched basic service.

26.8.1.2.7.3.2 Conformance requirement

- 1) A CC-entity of the MS in CC-state U11, "Disconnect Request" shall on expiry of T305, proceed with the connection release procedure by sending the RELEASE message to its peer entity and shall enter the CC-state U19, "Release Request".

References

3GPP TS 04.08 / 3GPP TS 24.008 subclauses 5.4.3 and 11.3.

26.8.1.2.7.3.3 Test purpose

To verify that the CC-entity of the MS in CC-state U11, "Disconnect Request" shall on expiry of T305 (accuracy $\pm 10\%$), proceed with the connection release procedure by sending the RELEASE message to its peer entity and enters the CC-state U19, "Release Request".

26.8.1.2.7.3.4 Method of test

Specific PICS statements

-

PIXIT statements

-

Initial conditions

System Simulator:

1 cell, default parameters.

Mobile Station:

The MS is in MM-state "idle, updated" with valid TMSI and CKSN.

The MS is brought into the state U11 by using table 26.8.1.2/3.

Foreseen final state of the MS

U19, release request.

Maximum duration of test

1 minute.

Test procedure

An MO circuit switched basic service is selected that is supported by the MS; if the MS supports MO telephony, the selected basic service is telephony. If necessary, the MS is configured for that basic service. Then, the MS is made to initiate a call. The CC entity of the MS is brought to the state U11. Then T305 expires at the MS and the MS shall send a RELEASE message. The SS checks timer T305 accuracy and that the CC entity has entered the state U19, release request.

Expected sequence

Step	Direction	Message	Comments
1	SS		SS waits until T305 expires at the MS
2	MS -> SS	RELEASE	SS checks the time between DISCONNECT and RELEASE (note), (T305 $\pm 10\%$)
3	SS -> MS	STATUS ENQUIRY	
4	MS -> SS	STATUS	cause 30#, state U19

Specific message contents:

NOTE: With the same cause value as originally contained in the DISCONNECT message. An additional cause information element (#102 recovery on timer expiry) may be included.

26.8.1.2.7.4 U11 disconnect request / lower layer failure

26.8.1.2.7.4.1 Definition

The call control entity of the MS being in the state, U11, a lower layer failure is accomplished at the MS and consequently, communication at layer 3 level with the peer entity is terminated. This test is applicable for any equipment supporting at least one mobile originated circuit switched basic service.

26.8.1.2.7.4.2 Conformance requirement

- 1) A CC-entity of the MS in CC-state U11, "Disconnect Request" having detected a lower layer failure shall return to the idle mode. The CC entities relating to the seven mobile originating transaction identifiers shall be in state U0, "Null".

References

3GPP TS 04.08 / 3GPP TS 24.008 subclauses 4.5.2.3, 4.5.3, 5.5.3.2 and 8.3.

3GPP TS 04.08 / 3GPP TS 44.018 subclause 3.4.13.2.1.

26.8.1.2.7.4.3 Test purpose

To verify that the a CC-entity of the MS in CC-state U11, "Disconnect Request" having detected a lower layer failure returns to the idle mode. The CC entities relating to the seven mobile originating transaction identifiers are thus in state U0, "Null".

26.8.1.2.7.4.4 Method of test

Specific PICS statements

-

PIXIT statements

-

Initial conditions

System Simulator:

1 cell, default parameters.

Mobile Station:

The MS is in MM-state "idle, updated" with valid TMSI and CKSN.

The MS is brought into the state U11 by using table 26.8.1.2/4.

Foreseen final state of the MS

U0, null.

Maximum duration of test

1 minute 30 s.

Test procedure

An MO circuit switched basic service is selected that is supported by the MS; if the MS supports MO telephony, the selected basic service is telephony. If necessary, the MS is configured for that basic service. Then, the MS is made to initiate a call. The MS is brought to the state U11. The SS generates a lower layer failure at the MS. The SS waits long enough to enable the MS to return to idle state listening to paging, and then pages MS to create RR-connection. Finally, the SS will check the state of the MS by using STATUS ENQUIRY with the relevant transaction identifiers.

Expected sequence

Step	Direction	Message	Comments
1	SS		SS generates lower layer failure
2	SS		SS waits 20 s for the MS to return to listening to paging
3	SS -> MS	PAGING REQUEST	
4	MS -> SS	CHANNEL REQUEST	
5	SS -> MS	IMMEDIATE ASSIGNMENT	
6	MS -> SS	PAGING RESPONSE	
7	SS -> MS	STATUS ENQUIRY	
8	MS -> SS	RELEASE COMPLETE	cause 81# (invalid TI value)
9	SS		repeat steps 7-8 to cover all the transaction identifiers from 000...110
10	SS -> MS	CHANNEL RELEASE	the main signalling link shall be released by the MS (L2: DISC/UA).

Specific message contents:

None.

26.8.1.2.7.5 U11 disconnect request / unknown message received

26.8.1.2.7.5.1 Definition

The call control entity of the MS being in the state, U4, an unknown message is received by the MS. This test is applicable for any equipment supporting at least one mobile originated circuit switched basic service.

26.8.1.2.7.5.2 Conformance requirement

- 1) A CC-entity of the MS in CC-state U100, "Call Delivered", having received an unknown message from its peer entity shall return a STATUS message.

References

3GPP TS 04.08 / 3GPP TS 24.008 subclause 8.4.

26.8.1.2.7.5.3 Test purpose

To verify that a CC-entity of the MS in CC-state U11, "Call Delivered", having received an unknown message from its peer entity returns a STATUS message.

26.8.1.2.7.5.4 Method of test

Specific PICS statements

-

PIXIT statements

-

Initial conditions

System Simulator:

1 cell, default parameters.

Mobile Station:

The MS is in MM-state "idle, updated" with valid TMSI and CKSN.

The MS is brought into the state U11 by using table 26.8.1.2/4.

Foreseen final state of the MS

U11, disconnect request.

Maximum duration of test

30 s.

Test procedure

An MO circuit switched basic service is selected that is supported by the MS; if the MS supports MO telephony, the selected basic service is telephony. If necessary, the MS is configured for that basic service. Then, the MS is made to initiate a call. The CC entity of the MS is brought to the state U11. The SS sends a message with message type not defined for the protocol discriminator to the MS. The MS shall respond with a STATUS message, and finally the SS checks by using the status enquiry procedure that the state of the CC entity has remained unchanged.

Expected sequence

Step	Direction	Message	Comments
1	SS -> MS	unknown message	message type not defined for PD
2	MS -> SS	STATUS	cause 97#, state U11
3	SS -> MS	STATUS ENQUIRY	
4	MS -> SS	STATUS	cause 30#, state U11

Specific message contents:

None.

26.8.1.2.8 U12 disconnect indication

26.8.1.2.8.1 U12 disconnect indication / call releasing requested by the user

26.8.1.2.8.1.1 Definition

The call control entity of the MS being in the state, U12, the user requests to terminate the call. This test is applicable only for mobile stations supporting bearer capability for speech.

26.8.1.2.8.1.2 Conformance requirement

- 1) A CC-entity of the MS in CC-state U12, "Disconnect Indication" being in network initiated call release phase, shall, upon receiving a call release request from the user send a RELEASE to its peer entity and enter CC-state U19, "Release Request".

References

3GPP TS 04.07 / 3GPP TS 24.007 subclause 6.2.2,

3GPP TS 04.08 / 3GPP TS 24.008 subclause 5.4.4.

26.8.1.2.8.1.3 Test purpose

To verify that a CC-entity of the MS in CC-state U12, "Disconnect Indication" being in network initiated call release phase, shall, upon receiving a call release request from the user sends a RELEASE to its peer entity and enters CC-state U19, "Release Request"

26.8.1.2.8.1.4 Method of test

Specific PICS statements

-

PIXIT statements

-

Initial conditions

System Simulator:

1 cell, default parameters.

Mobile Station:

The MS is in MM-state "idle, updated" with valid TMSI and CKSN.

The MS is brought into the state U12 by using Option A of table 26.8.1.2/1.

Foreseen final state of the MS

U19, release request.

Maximum duration of test

30 s.

Test procedure

An MO circuit switched basic service is selected that is supported by the MS; if the MS supports MO telephony, the selected basic service is telephony. If necessary, the MS is configured for that basic service. Then, the MS is made to initiate a call. The CC entity of the MS is brought to the state U12. The user requests termination of the call. The MS shall send a RELEASE message. The SS checks by using the status enquiry procedure that the CC entity has entered the state U19, release request.

Expected sequence

Step	Direction	Message	Comments
1			MMI action, "on hook"
2	MS -> SS	RELEASE	
3	SS -> MS	STATUS ENQUIRY	
4	MS -> SS	STATUS	cause 30#, state U19

Specific message contents:

None.

26.8.1.2.8.2 U12 disconnect indication / RELEASE received

26.8.1.2.8.2.1 Definition

The call control entity of the MS being in the state, U12, a RELEASE message is received by the MS. This test is applicable only for mobile stations supporting bearer capability for speech.

26.8.1.2.8.2.2 Conformance requirement

- 1) A CC-entity of the MS in CC-state U12, "Disconnect Indication", upon receipt of a RELEASE message shall return to its peer entity the RELEASE COMPLETE message and enter the CC-state U0, "Null".
- 2) On returning to the idle mode the MS shall release the MM-connection and the CC-entities relating to the seven mobile originating transaction identifiers shall be in CC-state U0, "Null".

References

Conformance requirement 1: 3GPP TS 04.08 / 3GPP TS 24.008 subclause 5.4.2.

Conformance requirement 2: 3GPP TS 04.08 / 3GPP TS 24.008 subclauses 4.5.3, 5.5.3.2 and 8.3.

26.8.1.2.8.2.3 Test purpose

- 1) To verify that a CC-entity of the MS in CC-state U12, "Disconnect Indication", upon receipt of a RELEASE message returns to its peer entity the RELEASE COMPLETE message and enters the CC-state U0, "Null".
- 2) To verify that the MS on returning to the idle mode releases the MM-connection and that the CC-entities relating to the seven mobile originating transaction identifiers are in CC-state U0, "Null".

26.8.1.2.8.2.4 Method of test

Specific PICS statements

-

PIXIT statements

-

Initial conditions

System Simulator:

1 cell, default parameters.

Mobile Station:

The MS is in MM-state "idle, updated" with valid TMSI and CKSN.

The MS is brought into the state U12 by using Option A of table 26.8.1.2/1.

Foreseen final state of the MS

U0, null.

Maximum duration of test

1 min.

Test procedure

An MO circuit switched basic service is selected that is supported by the MS; if the MS supports MO telephony, the selected basic service is telephony. If necessary, the MS is configured for that basic service. Then, the MS is made to initiate a call. The CC entity of the MS is brought to the state U12. The SS sends a RELEASE message to the MS. The MS shall respond with a RELEASE COMPLETE message. The SS checks by using the status enquiry procedure that the CC entity has entered the state U0 with all the relevant transaction identifiers.

Expected sequence

Step	Direction	Message	Comments
1	SS -> MS	RELEASE	
2	MS -> SS	RELEASE COMPLETE	
3	SS -> MS	STATUS ENQUIRY	
4	MS -> SS	RELEASE COMPLETE	
5	SS		cause 81# (invalid TI value) repeat steps 3-4 to cover all the transaction identifiers from 000...110
6	SS -> MS	CHANNEL RELEASE	the main signalling link shall be released by the MS (L2: DISC/UA).

Specific message contents:

None.

26.8.1.2.8.3 U12 disconnect indication / lower layer failure

26.8.1.2.8.3.1 Definition

The call control entity of the MS being in the state, U12, a lower layer failure is accomplished at the MS and consequently, communication at layer 3 level with the peer entity is terminated. This test is applicable only for mobile stations supporting bearer capability for speech.

26.8.1.2.8.3.2 Conformance requirement

- 1) A CC-entity of the MS in CC-state U12, "Disconnect Indication" having detected a lower layer failure shall return to idle mode. The CC-entities relating to the seven mobile originating transaction identifiers shall be in state U0, "Null".

References

3GPP TS 04.08 / 3GPP TS 24.008 subclauses 4.5.3.2, 4.5.3, 5.5.3.2, 3.4.13.2.1 and 8.3.

26.8.1.2.8.3.3 Test purpose

To verify that a CC-entity of the MS in CC-state U12, "Disconnect Indication" having detected a lower layer failure returns to idle mode. The CC-entities relating to the seven mobile originating transaction identifiers are thus in state U0, "Null".

26.8.1.2.8.3.4 Method of test

Specific PICS statements

-

PIXIT statements

-

Initial conditions

System Simulator:

1 cell, default parameters.

Mobile Station:

The MS is in MM-state "idle, updated" with valid TMSI and CKSN.

The MS is brought into the state U12 by using Option A of table 26.8.1.2/2.

Foreseen final state of the MS

U0, null.

Maximum duration of test

1 minute 30 s.

Test procedure

An MO circuit switched basic service is selected that is supported by the MS; if the MS supports MO telephony, the selected basic service is telephony. If necessary, the MS is configured for that basic service. Then, the MS is made to initiate a call. The MS is brought to the state U12. The SS generates a lower layer failure at the MS. The SS waits long enough to enable the MS to return to idle state listening to paging, and then pages MS to create RR-connection. Finally, the SS will check the state of the MS by using STATUS ENQUIRY with the relevant transaction identifiers.

Expected sequence

Step	Direction	Message	Comments
1	SS		SS generates lower layer failure
2	SS		SS waits 20 s for the MS to return to listening to paging
3	SS -> MS	PAGING REQUEST	
4	MS -> SS	CHANNEL REQUEST	
5	SS -> MS	IMMEDIATE ASSIGNMENT	
6	MS -> SS	PAGING RESPONSE	
7	SS -> MS	STATUS ENQUIRY	
8	MS -> SS	RELEASE COMPLETE	cause 81# (invalid TI value)
9	SS		repeat steps 7-8 to cover all the transaction identifiers from 000...110
10	SS -> MS	CHANNEL RELEASE	the main signalling link shall be released by the MS (L2: DISC/UA).

Specific message contents:

None.

26.8.1.2.8.4 U12 disconnect indication / unknown message received

26.8.1.2.8.4.1 Definition

The call control entity of the MS being in the state, U12, an unknown message is received by the MS. This test is applicable only for mobile stations supporting bearer capability for speech.

26.8.1.2.8.4.2 Conformance requirement

A CC-entity of the MS in CC-state U12, "Disconnect Indication" having received an unknown message from its peer entity shall return a STATUS message.

References

3GPP TS 04.08 / 3GPP TS 24.008 subclause 8.4.

26.8.1.2.8.4.3 Test purpose

To verify that a CC-entity of the MS in CC-state U12, "Disconnect Indication" having received an unknown message from its peer entity returns a STATUS message.

26.8.1.2.8.4.4 Method of test

Specific PICS statements

-

PIXIT statements

-

Initial conditions

System Simulator:

1 cell, default parameters.

Mobile Station:

The MS is in MM-state "idle, updated" with valid TMSI and CKSN.

The MS is brought into the state U12 by using Option A of table 26.8.1.2/3.

Foreseen final state of the MS

U12, disconnect indication.

Maximum duration of test

30 s.

Test procedure

An MO circuit switched basic service is selected that is supported by the MS; if the MS supports MO telephony, the selected basic service is telephony. If necessary, the MS is configured for that basic service. Then, the MS is made to initiate a call. The CC entity of the MS is brought to the state U12. The SS sends a message with message type not defined for the protocol discriminator to the MS. The MS shall respond with a STATUS message, and finally the SS checks by using the status enquiry procedure that the state of the CC entity has remained unchanged.

Expected sequence

Step	Direction	Message	Comments
1	SS -> MS	unknown message	message type not defined for PD
2	MS -> SS	STATUS	cause 97#, state U12
3	SS -> MS	STATUS ENQUIRY	
4	MS -> SS	STATUS	cause 30#, state U12

Specific message contents:

None.

26.8.1.2.9 Outgoing call / U19 release request

26.8.1.2.9.1 Outgoing call / U19 release request / timer T308 time-out

26.8.1.2.9.1.1 Definition

The call control entity of the MS being in the state, U19, if no response is then received from the SS, timer T308 expires at the MS side. This test is applicable for any equipment supporting at least one mobile originated circuit switched basic service.

26.8.1.2.9.1.2 Conformance requirement

- 1) A CC-entity of the MS in CC-state U19, "Release Request" will, upon the first expiry of timer T308 send the RELEASE message to its peer entity and remain in the CC-state U19.

References

3GPP TS 04.08 / 3GPP TS 24.008 subclauses 5.4.4.3.1 and 11.3.

26.8.1.2.9.1.3 Test purpose

To verify that a CC-entity of the MS in CC-state U19, "Release Request" will, upon the first expiry of timer T308 (accuracy $\pm 10\%$) send the RELEASE message to its peer entity and remain in the CC-state U19.

26.8.1.2.9.1.4 Method of test

Specific PICS statements

-

PIXIT statements

-

Initial conditions

System Simulator:

1 cell, default parameters.

Mobile Station:

The MS is in MM-state "idle, updated" with valid TMSI and CKSN.

The MS is brought into the state U19 by using table 26.8.1.2/4.

Foreseen final state of the MS

U19, release request.

Maximum duration of test

1 min.

Test procedure

An MO circuit switched basic service is selected that is supported by the MS; if the MS supports MO telephony, the selected basic service is telephony. If necessary, the MS is configured for that basic service. Then, the MS is made to initiate a call. The CC entity of the MS is brought to the state U19. When T308 expires at the MS, the MS shall send a RELEASE message. The SS checks timer T308 accuracy and that the state of the CC entity has remained unchanged.

Expected sequence

Step	Direction	Message	Comments
1	SS		SS waits until T308 at the MS
2	MS -> SS	RELEASE	SS checks the time between the two RELEASE messages (T308 ± 10 %)
3	SS -> MS	STATUS ENQUIRY	
4	MS -> SS	STATUS	cause 30#, state U19

Specific message contents:

None.

26.8.1.2.9.2 Outgoing call / U19 release request / 2nd timer T308 time-out

26.8.1.2.9.2.1 Definition

The call control entity of the MS being in the state, U19, if no response is then received after timer T308 has expired two times in success at the MS. This test is applicable for any equipment supporting at least one mobile originated circuit switched basic service.

26.8.1.2.9.2.2 Conformance requirement

- 1) A CC-entity of the MS in CC-state U19, "Release Request", upon the 2nd expiry of the timer T308, shall enter the CC-state U0, "Null".
- 2) Subsequently the MS shall proceed with releasing the MM-connection and enter the idle mode with the CC entities relating to the seven mobile originating transaction identifiers in state U0, "Null".

References

Conformance requirement 1: 3GPP TS 04.08 / 3GPP TS 24.008 subclauses 5.4.4.3.1 and 11.3.

Conformance requirement 2: 3GPP TS 04.08 / 3GPP TS 24.008 subclauses 4.5.3 and 5.5.3.2.

26.8.1.2.9.2.3 Test purpose

- 1) To verify that a CC-entity of the MS in CC-state U19, "Release Request", upon the 2nd expiry of the timer T308, enters the CC-state U0, "Null".
- 2) To verify that subsequently the MS proceeds with releasing the MM-connection and enters the idle mode with the CC entities relating to the seven mobile originating transaction identifiers in state U0, "Null".

26.8.1.2.9.2.4 Method of test

Specific PICS statements

-

PIXIT statements

-

Initial conditions

System Simulator:

1 cell, default parameters.

Mobile Station:

The MS is in MM-state "idle, updated" with valid TMSI and CKSN.

The MS is brought into the state U19 by using table 26.8.1.2/4.

Foreseen final state of the MS

U0, null.

Maximum duration of test

2 min 30 s.

Test procedure

An MO circuit switched basic service is selected that is supported by the MS; if the MS supports MO telephony, the selected basic service is telephony. If necessary, the MS is configured for that basic service. Then, the MS is made to initiate a call. The CC entity of the MS is brought to the state U19. The SS allows T308 expiry at the MS, and the MS shall repeat sending the RELEASE message and start timer T308 again. The SS allows again T308 expiry at the MS. The MS shall abort the RR-connection (DISC/UA). The SS waits long enough to enable the MS to return to idle state listening to paging, and then pages MS to create RR-connection. Finally, the SS will check the state of the MS by using STATUS ENQUIRY with the relevant transaction identifiers.

Expected sequence

Step	Direction	Message	Comments
1	SS		SS waits until T308 expiry at the MS
2	MS -> SS	RELEASE	
3	SS -> MS	STATUS ENQUIRY	
4	MS -> SS	STATUS	cause 30#, state U19
5	SS		SS waits until the second T308 expiry at the MS
6	SS		SS waits T3240 expiry at the MS
7	MS		the main signalling link shall be released by the MS (L2: DISC/UA).
8	SS		SS waits 10 s for the MS to return to listening to paging
9	SS -> MS	PAGING REQUEST	
10	MS -> SS	CHANNEL REQUEST	
11	SS -> MS	IMMEDIATE ASSIGNMENT	
12	MS -> SS	PAGING RESPONSE	
13	SS -> MS	STATUS ENQUIRY	
14	MS -> SS	RELEASE COMPLETE	cause 81# (invalid TI value)
15	SS		repeat steps 13-14 to cover all the transaction identifiers from 000...110
16	SS -> MS	CHANNEL RELEASE	the main signalling link shall be released by the MS (L2: DISC/UA).

Specific message contents:

None.

26.8.1.2.9.3 Outgoing call / U19 release request / RELEASE received

26.8.1.2.9.3.1 Definition

The call control entity of the MS being in the state, U19, a RELEASE message is received by the MS. This test is applicable for any equipment supporting at least one mobile originated circuit switched basic service.

26.8.1.2.9.3.2 Conformance requirement

- 1) A CC-entity of the MS in CC-state U19, "Release Request", upon receipt of a RELEASE, shall release the MM-connection and enter the CC-state U0, "Null" with the CC entities relating to the seven mobile originating transaction identifiers in state U0, "Null".

References

3GPP TS 04.08 / 3GPP TS 24.008 subclauses 5.4.5, 11.3 and 5.5.3.2.

26.8.1.2.9.3.3 Test purpose

To verify that a CC-entity of the MS in CC-state U19, "Release Request", upon receipt of a RELEASE, shall release the MM-connection and enters the CC-state U0, "Null" with the CC entities relating to the seven mobile originating transaction identifiers in state U0, "Null".

26.8.1.2.9.3.4 Method of test

Specific PICS statements

-

PIXIT statements

-

Initial conditions

System Simulator:

1 cell, default parameters.

Mobile Station:

The MS is in MM-state "idle, updated" with valid TMSI and CKSN.

The MS is brought into the state U19 by using table 26.8.1.2/4.

Foreseen final state of the MS

U0, null.

Maximum duration of test

1 min 30 s.

Test procedure

An MO circuit switched basic service is selected that is supported by the MS; if the MS supports MO telephony, the selected basic service is telephony. If necessary, the MS is configured for that basic service. Then, the MS is made to initiate a call. The CC entity of the MS is brought to the state U19. The SS sends a RELEASE message to the MS. The MS shall release the MM-connection. The SS checks by using the status enquiry procedure that the CC entity has entered the state U0 with all the relevant transaction identifiers.

Expected sequence

Step	Direction	Message	Comments
1	SS -> MS	RELEASE	(note)
2	SS -> MS	STATUS ENQUIRY	
3	MS -> SS	RELEASE COMPLETE	cause 81# (invalid TI value)
4	SS		repeat steps 2-3 to cover all the transaction identifiers from 000...110
5	SS -> MS	CHANNEL RELEASE	the main signalling link shall be released by the MS (L2: DISC/UA).

Specific message contents:

NOTE: With the same cause number as originally contained in DISC and optional cause #102 recovery on timer expiry.

26.8.1.2.9.4 Outgoing call / U19 release request / RELEASE COMPLETE received

26.8.1.2.9.4.1 Definition

The call control entity of the MS being in the state, U19, a RELEASE COMPLETE message is received by the MS. This test is applicable for any equipment supporting at least one mobile originated circuit switched basic service.

26.8.1.2.9.4.2 Conformance requirement

- 1) A CC-entity of the MS in CC-state U19, "Release Request", upon receipt of a RELEASE COMPLETE, shall release the MM-connection and enter the CC-state U0, "Null" with the CC entities relating to the seven mobile originating transaction identifiers in state U0, "Null".

References

3GPP TS 04.08 / 3GPP TS 24.008 subclauses 5.4.4.3, 4.5.3 and 8.3.

26.8.1.2.9.4.3 Test purpose

To verify that a CC-entity of the MS in CC-state U19, "Release Request", upon receipt of a RELEASE COMPLETE, shall release the MM-connection and enters the CC-state U0, "Null" with the CC entities relating to the seven mobile originating transaction identifiers in state U0, "Null".

26.8.1.2.9.4.4 Method of test

Specific PICS statements

-

PIXIT statements

-

Initial conditions

System Simulator:

1 cell, default parameters.

Mobile Station:

The MS is in MM-state "idle, updated" with valid TMSI and CKSN.

The MS is brought into the state U19 by using table 26.8.1.2/1.

Foreseen final state of the MS

U0, null.

Maximum duration of test

1 min 30 s.

Test procedure

An MO circuit switched basic service is selected that is supported by the MS; if the MS supports MO telephony, the selected basic service is telephony. If necessary, the MS is configured for that basic service. Then, the MS is made to initiate a call. The CC entity of the MS is brought to the state U19. The SS sends a RELEASE COMPLETE message to the MS. The MS shall release the MM-connection. The SS checks by using the status enquiry procedure that the CC entity has entered the state U0 with all the relevant transaction identifiers.

Expected sequence

Step	Direction	Message	Comments
1	SS -> MS	RELEASE COMPLETE	
2	SS -> MS	STATUS ENQUIRY	
3	MS -> SS	RELEASE COMPLETE	
4	SS		cause 81# (invalid TI value) repeat steps 2-3 to cover all the transaction identifiers from 000...110
5	SS -> MS	CHANNEL RELEASE	the main signalling link shall be released by the MS (L2: DISC/UA).

Specific message contents:

None.

26.8.1.2.9.5 Outgoing call / U19 release request / lower layer failure

26.8.1.2.9.5.1 Definition

The call control entity of the MS being in the state, U19, a lower layer failure is accomplished at the MS and consequently, communication at layer 3 level with the peer entity is terminated. This test is applicable for any equipment supporting at least one mobile originated circuit switched basic service.

26.8.1.2.9.5.2 Conformance requirement

A CC-entity of the MS in CC-state U19, "Release Request", having detected a lower layer failure, shall return to the idle mode, the CC entities relating to the seven mobile originating transaction identifiers shall be in state U0, "Null".

References

3GPP TS 04.08 / 3GPP TS 24.008 subclauses 4.5.2.3, 4.5.3, 5.5.3.2 and 8.3.

26.8.1.2.9.5.3 Test purpose

To verify that a CC-entity of the MS in CC-state U19, "Release Request", having detected a lower layer failure, returns to the idle mode, the CC entities relating to the seven mobile originating transaction identifiers are in state U0, "Null".

26.8.1.2.9.5.4 Method of test

Specific PICS statements

-

PIXIT statements

-

Initial conditions

System Simulator:

1 cell, default parameters.

Mobile Station:

The MS is in MM-state "idle, updated" with valid TMSI and CKSN.

The MS is brought into the state U19 by using table 26.8.1.2/1.

Foreseen final state of the MS

U0, null.

Maximum duration of test

1 min 30 s.

Test procedure

An MO circuit switched basic service is selected that is supported by the MS; if the MS supports MO telephony, the selected basic service is telephony. If necessary, the MS is configured for that basic service. Then, the MS is made to initiate a call. The MS is brought to the state U19. The SS generates a lower layer failure at the MS. The SS waits long enough to enable the MS to return to idle state listening to paging, and then pages MS to create RR-connection. Finally, the SS will check the state of the MS by using STATUS ENQUIRY with the relevant transaction identifiers.

Expected sequence

Step	Direction	Message	Comments
1	SS		SS generates lower layer failure
2	SS		SS waits 20 s for the MS to return to listening to paging
3	SS -> MS	PAGING REQUEST	
4	MS -> SS	CHANNEL REQUEST	
5	SS -> MS	IMMEDIATE ASSIGNMENT	
6	MS -> SS	PAGING RESPONSE	
7	SS -> MS	STATUS ENQUIRY	
8	MS -> SS	RELEASE COMPLETE	cause 81# (invalid TI value)
9	SS		repeat steps 7-8 to cover all the transaction identifiers from 000...110
10	SS -> MS	CHANNEL RELEASE	the main signalling link shall be released by the MS (L2: DISC/UA).

Specific message contents:

None.

26.8.1.3 Establishment of an incoming call / Initial conditions

The tables below describe message exchanges which bring the MS in the requested initial states in case of an incoming call.

A state may be taken as initial only when all the states which lead to this initial states have been validated. The order will be U0, U6, U9, U7, U8, U10, U26 etc. as in the following tables.

Table 26.8.1.3/1: Establishment of an incoming call, procedure 1

Step	Direction	Message	Comments
1	SS -> MS	PAGING REQUEST	
2	MS -> SS	CHANNEL REQUEST	
3	SS -> MS	IMMEDIATE ASSIGNMENT	U0, SDCCH
4	MS -> SS	PAGING RESPONSE	
5	SS -> MS	AUTHENTICATION REQUEST	
6	MS -> SS	AUTHENTICATION RESPONSE	
7	SS -> MS	CIPHERING MODE COMMAND	
8	MS -> SS	CIPHERING MODE COMPLETE	
9	SS -> MS	SETUP	U6, (note 1)
10	MS -> SS	CALL CONFIRMED	U9
A11	MS -> SS	CONNECT	U8, p = Y, (note 2)
B11	MS -> SS	ALERTING	U7, p = N, (note 2)
B12	MS		(note 3)
B13	MS -> SS	CONNECT	U8
14	SS -> MS	ASSIGNMENT COMMAND	TCH
15	MS -> SS	ASSIGNMENT COMPLETE	
16	SS -> MS	CONNECT ACKNOWLEDGE	U10
NOTE 1: With signal information included in the SETUP message.			
NOTE 2: The MS is supporting immediate connect (p = Y/N). See PICS/PIXIT statement.			
NOTE 3: If necessary (see PICS/PIXIT statement), the MS is made to accept the call in the way described in a PICS/PIXIT statement.			

Table 26.8.1.3/2: Establishment of an incoming call, procedure 2

Step	Direction	Message	Comments
1	SS -> MS	PAGING REQUEST	
2	MS -> SS	CHANNEL REQUEST	
3	SS -> MS	IMMEDIATE ASSIGNMENT	U0, SDCCH
4	MS -> SS	PAGING RESPONSE	
5	SS -> MS	CIPHERING MODE COMMAND	
6	MS -> SS	CIPHERING MODE COMPLETE	
7	SS -> MS	SETUP	U6, (note 1)
8	MS -> SS	CALL CONFIRMED	U9
A9	MS -> SS	CONNECT	U8, p = Y, (note 2)
A10	SS -> MS	ASSIGNMENT COMMAND	TCH
A11	MS -> SS	ASSIGNMENT COMPLETE	
B9	MS -> SS	ALERTING	U7, p = N, (note 2)
B10	SS -> MS	ASSIGNMENT COMMAND	TCH
B11	MS -> SS	ASSIGNMENT COMPLETE	
B12	MS		(note 3)
B13	MS -> SS	CONNECT	U8
14	SS -> MS	AUTHENTICATION REQUEST	
15	MS -> SS	AUTHENTICATION RESPONSE	
16	SS -> MS	CONNECT ACKNOWLEDGE	U10
NOTE 1: With signal information included in the SETUP message.			
NOTE 2: The MS is supporting immediate connect (p = Y/N). See PICS/PIXIT statement.			
NOTE 3: If necessary (see PICS/PIXIT statement), the MS is made to accept the call in the way described in a PICS/PIXIT statement.			

Table 26.8.1.3/3: Establishment of an incoming call, procedure 3

Step	Direction	Message	Comments
1	SS -> MS	PAGING REQUEST	
2	MS -> SS	CHANNEL REQUEST	
3	SS -> MS	IMMEDIATE ASSIGNMENT	U0, TCH
4	MS -> SS	PAGING RESPONSE	
5	SS -> MS	AUTHENTICATION REQUEST	
6	MS -> SS	AUTHENTICATION RESPONSE	
7	SS -> MS	CIPHERING MODE COMMAND	
8	MS -> SS	CIPHERING MODE COMPLETE	
9	SS -> MS	CHANNEL MODE MODIFY	(note 1)
10	MS -> SS	CHANNEL MODE MODIFY ACKNOWLEDGE	
11	SS -> MS	SETUP	U6, (note 2)
12	MS -> SS	CALL CONFIRMED	U9
A13	MS -> SS	CONNECT	U8, p = Y, (note 3)
B13	MS -> SS	ALERTING	U7, p = N, (note 3)
B14	MS		(note 4)
B15	MS -> SS	CONNECT	U8
16	SS -> MS	CONNECT ACKNOWLEDGE	U10
NOTE 1: Assigned channel is appropriate for the chosen mobile originated circuit switched basic service.			
NOTE 2: With signal information included in the SETUP message.			
NOTE 3: The MS is supporting immediate connect (p = Y/N). See PICS/PIXIT statement.			
NOTE 4: If necessary (see PICS/PIXIT statement), the MS is made to accept the call in the way described in a PICS/PIXIT statement.			

Table 26.8.1.3/4: Establishment of an incoming call, procedure 4

Step	Direction	Message	Comments
1	SS -> MS	PAGING REQUEST	
2	MS -> SS	CHANNEL REQUEST	
3	SS -> MS	IMMEDIATE ASSIGNMENT	U0, SDCCH
4	MS -> SS	PAGING RESPONSE	
5	SS -> MS	CIPHERING MODE COMMAND	
6	MS -> SS	CIPHERING MODE COMPLETE	
7	SS -> MS	SETUP	U6, (note 1)
8	MS -> SS	CALL CONFIRMED	U9
9	SS -> MS	ASSIGNMENT COMMAND	TCH
10	MS -> SS	ASSIGNMENT COMPLETE	
A11	MS -> SS	CONNECT	U8, p = Y, (note 2)
B11	MS -> SS	ALERTING	U7, p = N, (note 2)
B12	MS		(note 3)
B13	MS -> SS	CONNECT	U8
14	SS -> MS	AUTHENTICATION REQUEST	
15	MS -> SS	AUTHENTICATION RESPONSE	
16	SS -> MS	CONNECT ACKNOWLEDGE	U10
NOTE 1: The signal information element is not included in the SETUP message.			
NOTE 2: The MS is supporting immediate connect (p = Y/N). See PICS/PIXIT statement.			
NOTE 3: If necessary (see PICS/PIXIT statement), the MS is made to accept the call in the way described in a PICS/PIXIT statement.			

26.8.1.3.1 Incoming call / U0 null state

26.8.1.3.1.1 Incoming call / U0 null state / SETUP received with a non supported bearer capability

26.8.1.3.1.1.1 Definition

The call control entity of the MS being in the state, U0, a SETUP message is received with only one bearer capability and this bearer capability is not supported by the MS. This test is applicable for all equipment.

26.8.1.3.1.1.2 Conformance requirement

- 1) A CC entity of the MS, upon receipt of SETUP containing one bearer capability and this bearer capability is not supported, shall return a RELEASE COMPLETE with correct cause value to its peer entity and return to the idle mode. The CC-entities relating to the seven mobile terminating transaction identifiers shall be in the state U0,"Null".

References

3GPP TS 04.08 / 3GPP TS 24.008 subclause 5.2.2.2 and annex B.

26.8.1.3.1.1.3 Test purpose

To verify that a CC entity of the MS, upon receipt of SETUP containing one bearer capability and this bearer capability is not supported, returns a RELEASE COMPLETE with correct cause value to its peer entity, and returns to the idle mode. To verify that the CC-entities relating to the seven mobile terminating transaction identifiers are then in the state U0,"Null".

26.8.1.3.1.1.4 Method of test

Specific PICS statements

-

PIXIT statements

-

Initial conditions

System Simulator:

1 cell, default parameters.

Mobile Station:

The MS is in MM-state "idle, updated" with valid TMSI and CKSN.

Foreseen final state of the MS

U0, null.

Maximum duration of test

30 s.

Test procedure

A mobile terminated call is initiated. The MS receives a SETUP message that contains a bearer capability not supported by the MS. The MS returns a RELEASE COMPLETE message. The SS checks by using the status enquiry procedure that the CC entity is still in the state U0 with all the relevant transaction identifiers.

Expected sequence

Step	Direction	Message	Comments
1	SS -> MS	PAGING REQUEST	SS sends paging (SDCCH) (note 1) (note 2) Cause #81 (invalid TI value). Repeat steps 11-12 to cover all the transaction identifiers from 000... 110.
2	MS -> SS	CHANNEL REQUEST	
3	SS -> MS	IMMEDIATE ASSIGNMENT	
4	MS -> SS	PAGING RESPONSE	
5	SS -> MS	AUTHENTICATION REQUEST	
6	MS -> SS	AUTHENTICATION RESPONSE	
7	SS -> MS	CIPHERING MODE COMMAND	
8	MS -> SS	CIPHERING MODE COMPLETE	
9	SS -> MS	SETUP	
10	MS -> SS	RELEASE COMPLETE	
11	SS -> MS	STATUS ENQUIRY	
12	MS -> SS	RELEASE COMPLETE	
13	SS		

Specific message contents:

NOTE 1: With one bearer capability and that bearer capability is not supported by the MS.

NOTE 2: With cause #88 incompatible destination.

26.8.1.3.2 Incoming call / U6 call present

26.8.1.3.2.1 Incoming call / U6 call present / automatic call rejection

26.8.1.3.2.1.1 Definition

Although the state U6 is transient, the ability to refuse a call (automatically) in this state is tested, if it is implemented at the MS. The test is applicable for those equipments described above supporting at least one mobile terminating circuit switched basic service.

26.8.1.3.2.1.2 Conformance requirement

- 1) A CC entity of the MS in CC-state U6, "Call Present", upon receipt of a rejection indication of the incoming call from the user, send RELEASE COMPLETE with the appropriate cause value to its peer entity and enter the CC-state U0, "Null". The CC entities relating to the seven mobile terminating transaction identifiers shall be in state U0, "Null".

References

- 3GPP TS 04.07 / 3GPP TS 24.007 subclause 6.2.2,
3GPP TS 04.08 / 3GPP TS 24.008 subclauses 5.2.2.3.1, 5.5.3.2 and 8.3.

26.8.1.3.2.1.3 Test purpose

To verify that a CC entity of the MS in CC-state U6, "Call Present", shall upon receipt of a rejection indication of the incoming call from the user, shall send RELEASE COMPLETE with the appropriate cause value to its peer entity and enter the CC-state U0, "Null". The CC entities relating to the seven mobile terminating transaction identifiers are then in state U0, "Null".

26.8.1.3.2.1.4 Method of test

Specific PICS statements

-

PIXIT statements

-

Initial conditions

System Simulator:

1 cell, default parameters.

Mobile Station:

The MS is in MM-state "idle, updated" with valid TMSI and CKSN.

The MS is brought into the state U6 by using table 26.8.1.3/2.

Foreseen final state of the MS

U0, null.

Maximum duration of test

1 min 30 s.

Test procedure

A teleservice is selected that is supported by the MS; if the MS supports speech, the selected teleservice is speech. If necessary, the MS is configured for that teleservice. Then a mobile terminated call is initiated. The call control entire of the MS is brought to the state U6 (Note: The state U6 is not checked, since it is not stable). The MS is made to refuse the call (the refusal may require some preliminary preparations in order to achieve refusal at this point). The MS shall send a RELEASE COMPLETE message and enter a call control state U0. The SS checks by using the status enquiry procedure that the CC entity has entered the state U0 with all the relevant transaction identifiers.

Expected sequence

Step	Direction	Message	Comments
1			the MS is made to refuse the call
2	MS -> SS	RELEASE COMPLETE	(note)
3	SS -> MS	STATUS ENQUIRY	
4	MS -> SS	RELEASE COMPLETE	cause 81# (invalid TI value)
5	SS		repeat steps 3-4 to cover all the transaction identifiers from 000...110
6	SS -> MS	CHANNEL RELEASE	the main signalling link shall be released by the MS (L2: DISC/UA).

Specific message contents:

NOTE: With cause value #21 call rejected.

26.8.1.3.3 Incoming call / U9 mobile terminating call confirmed

26.8.1.3.3.1 Incoming call / U9 mobile terminating call confirmed / alerting or immediate connecting

26.8.1.3.3.1.1 Definition

The call control entity of the MS having entered the state, U9, with signal information received in the preceding SETUP message, the subsequent behaviour of the MS is tested. This test is applicable for any equipment supporting at least one mobile terminating circuit switched basic service.

26.8.1.3.3.1.2 Conformance requirement

- 1) A CC entity in CC-state U9, "MS Terminating Call Confirmed", (if signalled by the network in previous SETUP message that it may alert) shall either send a ALERTING message to its peer entity and enter state U7, or send a CONNECT message to its peer entity and enter U8.

References

3GPP TS 04.08 / 3GPP TS 24.008 subclause 5.2.2.3.2

26.8.1.3.3.1.3 Test purpose

To verify that a CC entity in CC-state U9, "MS Terminating Call Confirmed", (if signalled by the network in previous SETUP message that it may alert) will either send a ALERTING message to its peer entity and enter state U7, or send a CONNECT message to its peer entity and enter U8.

26.8.1.3.3.1.4 Method of test

Specific PICS statements

- Support of immediate connect (TSPC_AddInfo_ImmConn)

PIXIT statements

-

Initial conditions

System Simulator:

1 cell, default parameters.

Mobile Station:

The MS is in MM-state "idle, updated" with valid TMSI and CKSN.

The MS is brought into the state U9 by using table 26.8.1.3/2.

Foreseen final state of the MS

- U8, connect request, if the MS supports immediate connect for the selected basic service;
- otherwise U7, call received.

Maximum duration of test

30 s.

Test procedure

An MT circuit switched basic service is selected that is supported by the MS; if the MS supports MT telephony, the selected basic service is telephony. If necessary, the MS is configured for that basic service. Then a mobile terminated call is initiated. The CC entity of the MS is brought to the state U9 by using a SETUP message containing signalling information element. (The state U9 is not a stable state in this case, and consequently it is not checked as an initial state.) If the MS supports immediate connect for the selected basic service ($p = Y$), it sends a CONNECT message and enters the state U8, connect request. Otherwise ($p = N$) the MS sends an ALERTING message and enters the state U7, call receiving. The SS checks by using the status enquiry procedure that the CC entity has entered its state as described.

Expected sequence

Step	Direction	Message	Comments
A1	MS -> SS	CONNECT	$p = Y$
A2	SS -> MS	STATUS ENQUIRY	
A3	MS -> SS	STATUS	
B1	MS -> SS	ALERTING	$p = N$
B2	SS -> MS	STATUS ENQUIRY	
B3	MS -> SS	STATUS	

Specific message contents:

None.

26.8.1.3.3.2 Incoming call / U9 mobile terminating call confirmed / TCH assignment

26.8.1.3.3.2.1 Definition

The call control entity of the MS being in the state, U9, an assignment procedure is performed for traffic channel. This test is applicable for any equipment supporting at least one MT circuit switched basic service, for which immediate connect is not used.

26.8.1.3.3.2.2 Conformance requirement

- 1) A CC-entity of the MS in CC-state U9, "MS Terminating Call Confirmed", when allocated a traffic channel by the network performing the assignment procedure, shall perform a layer 2 establishment on the FACCH, send a ALERTING message and enter state U7.

References

3GPP TS 04.08 / 3GPP TS 24.008 subclauses 3.4.3, 5.2.2.7 and 5.2.2.3.2.

26.8.1.3.3.2.3 Test purpose

To verify that a CC-entity of the MS in CC-state U9, "MS Terminating Call Confirmed", when allocated a traffic channel by the network performing the assignment procedure, performs a layer 2 establishment on the FACCH, sends a ALERTING message and enters state U7.

26.8.1.3.3.2.4 Method of test

Specific PICS statements

-

PIXIT statements

-

Initial conditions

System Simulator:

1 cell, default parameters.

Mobile Station:

The MS is in MM-state "idle, updated" with valid TMSI and CKSN.

The MS is brought into the state U9 by using table 26.8.1.3/4.

Foreseen final state of the MS

U9, mobile terminating call confirmed.

Maximum duration of test

30 s.

Test procedure

An MT circuit switched basic service is selected that is supported by the MS and for which the MS does not use immediate connection; if the MS supports MT telephony without immediate connection, the selected basic service is telephony. If necessary, the MS is configured for that basic service. Then a mobile terminated call is initiated. The CC entity of the MS is brought to the state U9 (by using a SETUP message not containing the signal information element). The SS sends an ASSIGNMENT COMMAND for traffic channel to the MS. The MS shall establish layer 2 link on the newly allocated channel and respond with an ASSIGNMENT COMPLETE message. The MS sends an ALERTING message and enters state U7, call received. The SS verifies by using the status enquiry procedure that the MS has entered the correct state.

Expected sequence

Step	Direction	Message	Comments
1	SS -> MS	ASSIGNMENT COMMAND	TCH, an appropriate non-signalling mode the MS shall establish L2 link
2	MS		
3	MS -> SS	ASSIGNMENT COMPLETE	
4	MS -> SS	ALERTING	
5	SS -> MS	STATUS ENQUIRY	
6	MS -> SS	STATUS	cause 30#, state U7

Specific message contents:

None.

26.8.1.3.3.3 Void

26.8.1.3.3.4 Incoming call / U9 mobile terminating call confirmed / DISCONNECT received

26.8.1.3.3.4.1 Definition

The call control entity of the MS being in the state, U9, a DISCONNECT message is received by the MS. This test is applicable for any equipment supporting at least one MT circuit switched basic service, for which immediate connect is not used.

26.8.1.3.3.4.2 Conformance requirement

- 1) A CC-entity of the MS in CC-state U9, "MS Terminating Call Confirmed", upon receipt of a DISCONNECT shall return a RELEASE message and enter the CC-state U19, "Release Request".

References

3GPP TS 04.08 / 3GPP TS 24.008 subclause 5.4.4.

26.8.1.3.3.4.3 Test purpose

To verify that a CC-entity of the MS in CC-state U9, "MS Terminating Call Confirmed", upon receipt of a DISCONNECT returns a RELEASE message and enters the CC-state U19, "Release Request".

26.8.1.3.3.4.4 Method of test

Specific PICS statements

-

PIXIT statements

-

Initial conditions

System Simulator:

1 cell, default parameters.

Mobile Station:

The MS is in MM-state "idle, updated" with valid TMSI and CKSN.

The MS is brought into the state U9 by using table 26.8.1.3/4.

Foreseen final state of the MS

U19, release request.

Maximum duration of test

30 s.

Test procedure

An MT circuit switched basic service is selected that is supported by the MS and for which the MS does not use immediate connection; if the MS supports MT telephony without immediate connection, the selected basic service is telephony. If necessary, the MS is configured for that basic service. Then a mobile terminated call is initiated. The CC entity of the MS is brought to the state U9. The SS sends a DISCONNECT message to the MS. The MS responds by sending a RELEASE message and enters state U19, release request. The SS verifies by using the status enquiry procedure that the MS has entered the correct state.

Expected sequence

Step	Direction	Message	Comments
1	SS -> MS	DISCONNECT	
2	MS -> SS	RELEASE	
3	SS -> MS	STATUS ENQUIRY	
4	MS -> SS	STATUS	cause 30#, state U19

Specific message contents:

None.

26.8.1.3.3.5 Incoming call / U9 mobile terminating call confirmed / RELEASE received

26.8.1.3.3.5.1 Definition

The call control entity of the MS being in the state, U9, a RELEASE message is received by the MS. This test is applicable for any equipment supporting at least one MT circuit switched basic service, for which immediate connect is not used.

26.8.1.3.3.5.2 Conformance requirement

- 1) A CC-entity of the MS in CC-state U9, "MS Terminating Call Confirmed", upon receipt of a RELEASE shall return a RELEASE COMPLETE and enter the CC-state U0, "Null".

3GPP TS 04.08 / 3GPP TS 24.008 subclause 5.4.4.

- 2) On returning to the idle mode the MS shall release the MM-connection and the CC-entities relating to the seven mobile terminating transaction identifiers shall be in CC-state U0, "Null".

References

Conformance requirement 1: 3GPP TS 04.08 / 3GPP TS 24.008 subclause 5.4.4.

Conformance requirement 2: 3GPP TS 04.08 / 3GPP TS 24.008 subclauses 4.5.3, 5.5.3.2 and 8.3.

26.8.1.3.3.5.3 Test purpose

- 1) To verify that a CC-entity of the MS in CC-state U9, "MS Terminating Call Confirmed", upon receipt of a RELEASE will return a RELEASE COMPLETE and enter the CC-state U0, "Null".
- 2) To verify that the MS on returning to the idle mode releases the MM-connection and that the CC-entities relating to the seven mobile terminating transaction identifiers are in CC-state U0, "Null".

26.8.1.3.3.5.4 Method of test

Specific PICS statements

-

PIXIT statements

-

Initial conditions

System Simulator:

1 cell, default parameters.

Mobile Station:

The MS is in MM-state "idle, updated" with valid TMSI and CKSN.

The MS is brought into the state U9 by using table 26.8.1.3/4.

Foreseen final state of the MS

U0, null.

Maximum duration of test

1 min 30 s.

Test procedure

An MT circuit switched basic service is selected that is supported by the MS and for which the MS does not use immediate connection; if the MS supports MT telephony without immediate connection, the selected basic service is telephony. If necessary, the MS is configured for that basic service. Then a mobile terminated call is initiated. The CC entity of the MS is brought to the state U9. The SS sends a RELEASE message to the MS. The MS responds by sending a RELEASE COMPLETE message and enters state U0, null. The SS verifies by using the status enquiry procedure that the MS has entered the correct state with the relevant transaction identifiers.

Expected sequence

Step	Direction	Message	Comments
1	SS -> MS	RELEASE	with cause "Normal, unspecified"
2	MS -> SS	RELEASE COMPLETE	
3	SS -> MS	STATUS ENQUIRY	cause 81# (invalid TI value) repeat steps 3-4 to cover all the transaction identifiers from 000...110
4	MS -> SS	RELEASE COMPLETE	
5	SS		
6	SS -> MS	CHANNEL RELEASE	the main signalling link shall be released by the MS (L2: DISC/UA).

Specific message contents:

None.

26.8.1.3.3.6 Incoming call / U9 mobile terminating call confirmed / lower layer failure

26.8.1.3.3.6.1 Definition

The call control entity of the MS being in the state, U9, a lower layer failure is accomplished at the MS and consequently, communication at layer 3 level with the peer entity is terminated. This test is applicable for any equipment supporting at least one MT circuit switched basic service, for which immediate connect is not used.

26.8.1.3.3.6.2 Conformance requirement

- 1) A CC entity of the MS in CC-state U9, "MS Terminating Call Confirmed", having detected a lower layer failure shall return to idle mode with the CC entities relating to the seven mobile terminating transaction identifiers in CC-state U0, "Null".

References

3GPP TS 04.08 / 3GPP TS 24.008 subclauses 4.5.2.3, 4.5.3, 5.5.3.2 and 8.3.

26.8.1.3.3.6.3 Test purpose

To verify that a CC entity of the MS in CC-state U9, "MS Terminating Call Confirmed", having detected a lower layer failure returns to idle mode with the CC entities relating to the seven mobile terminating transaction identifiers in CC-state U0, "Null".

26.8.1.3.3.6.4 Method of test

Specific PICS statements

- Support of UTRAN Radio Access Technology (TSPC_Type_UTRAN)

PIXIT statements

-

Initial conditions

System Simulator:

1 cell, default parameters.

Mobile Station:

The MS is in MM-state "idle, updated" with valid TMSI and CKSN.

The MS is brought into the state U9 by using table 26.8.1.3/4.

Foreseen final state of the MS

U0, null.

Maximum duration of test

1 min 30 s.

Test procedure

An MT circuit switched basic service is selected that is supported by the MS and for which the MS does not use immediate connection; if the MS supports MT telephony without immediate connection, the selected basic service is telephony. If necessary, the MS is configured for that basic service. Then a mobile terminated call is initiated. The MS is brought to the state U9. The SS generates a lower layer failure at the MS. The SS waits long enough to enable the MS to return to idle state listening to paging, and then pages MS to create RR-connection. Finally, the SS will check the state of the MS by using STATUS ENQUIRY with the relevant transaction identifiers.

Expected sequence

Step	Direction	Message	Comments
1	SS		SS generates lower layer failure
2	SS		If PICS statement "Support of UTRAN Radio Access Technology" is 'NO', then the SS waits 20 s for the MS to return to listening to paging. If PICS statement "Support of UTRAN Radio Access Technology" is 'YES', then the SS waits 50 s for the MS to return to listening to paging.
3	SS -> MS	PAGING REQUEST	
4	MS -> SS	CHANNEL REQUEST	
5	SS -> MS	IMMEDIATE ASSIGNMENT	
6	MS -> SS	PAGING RESPONSE	
7	SS -> MS	STATUS ENQUIRY	
8	MS -> SS	RELEASE COMPLETE	cause 81# (invalid TI value)
9	SS		repeat steps 7-8 to cover all the transaction identifiers from 000...110
10	SS -> MS	CHANNEL RELEASE	the main signalling link shall be released by the MS (L2: DISC/UA).

Specific message contents:

None.

26.8.1.3.3.7 Incoming call / U9 mobile terminating call confirmed / unknown message received

26.8.1.3.3.7.1 Definition

The call control entity of the MS being in the state, U9, an unknown message is received by the MS. This test is applicable for any equipment supporting at least MT circuit switched basic service, for which immediate connect is not used.

26.8.1.3.3.7.2 Conformance requirement

- 1) A CC-entity of the MS in CC-state U9, "MS Terminating Call Confirmed" having received an unknown message from its peer entity shall return a STATUS message.

References

3GPP TS 04.08 / 3GPP TS 24.008 subclause 8.4.

26.8.1.3.3.7.3 Test purpose

To verify that a CC-entity of the MS in CC-state U9, "MS Terminating Call Confirmed" having received an unknown message from its peer entity returns a STATUS message.

26.8.1.3.3.7.4 Method of test

Specific PICS statements

-

PIXIT statements

-

Initial conditions

System Simulator:

1 cell, default parameters.

Mobile Station:

The MS is in MM-state "idle, updated" with valid TMSI and CKSN.

The MS is brought into the state U9 by using table 26.8.1.3/4.

Foreseen final state of the MS

U9, mobile terminating call proceeding.

Maximum duration of test

30 s.

Test procedure

A MT circuit switched basic service is selected that is supported by the MS and for which the MS does not use immediate connection; if the MS supports MT telephony without immediate connection, the selected basic service is telephony. If necessary, the MS is configured for that basic service. Then a mobile terminated call is initiated. The CC entity of the MS is brought to the state U9. The SS sends a message with message type not defined for the protocol discriminator to the MS. The MS shall respond with a STATUS message, and finally the SS checks by using the status enquiry procedure that the state of the CC entity has remained unchanged.

Expected sequence

Step	Direction	Message	Comments
1	SS -> MS	unknown message	message type not defined for PD
2	MS -> SS	STATUS	cause 97#, state U9
3	SS -> MS	STATUS ENQUIRY	
4	MS -> SS	STATUS	cause 30#, state U9

Specific message contents:

None.

26.8.1.3.4 Incoming call / U7 call received

26.8.1.3.4.1 Incoming call / U7 call received / call accepted

26.8.1.3.4.1.1 Definition

The call control entity of the MS being in the state, U7, a user accepts the incoming call. This test is applicable for any equipment supporting at least one mobile terminating circuit switched basic service for which immediate connect is not used.

26.8.1.3.4.1.2 Conformance requirement

- 1) A CC entity of a MS in CC-state U7, "Call Received", upon a user accepting the incoming call, shall send a CONNECT message to its peer entity and enter the CC-state U8, "Connect Request".

References

3GPP TS 04.07 / 3GPP TS 24.007 subclause 6.2.2,
3GPP TS 04.08 / 3GPP TS 24.008 subclause 5.2.2.5.

26.8.1.3.4.1.3 Test purpose

To verify that a CC entity of a MS in CC-state U7, "Call Received", upon a user accepting the incoming call, shall send a CONNECT message to its peer entity and enter the CC-state U8, "Connect Request"

26.8.1.3.4.1.4 Method of test

Specific PICS statements

-

PIXIT statements

-

Initial conditions

System Simulator:

1 cell, default parameters.

Mobile Station:

The MS is in MM-state "idle, updated" with valid TMSI and CKSN.

The MS is brought into the state U7 by using table 26.8.1.3/3.

Foreseen final state of the MS

U8, connect request.

Maximum duration of test

30 s.

Test procedure

An MT circuit switched basic service is selected that is supported by the MS and for which the MS does not use immediate connection; if the MS supports MT telephony without immediate connection, the selected basic service is telephony. If necessary, the MS is configured for that basic service. Then a mobile terminated call is initiated. The CC entity of the MS is brought to the state U7. The user accepts the incoming call. The MS sends a CONNECT message. The SS checks by using the status enquiry procedure that the CC entity has entered state U8, connect request.

Expected sequence

Step	Direction	Message	Comments
1			the MS is made to accept the call by the user
2	MS -> SS	CONNECT	
3	SS -> MS	STATUS ENQUIRY	
4	MS -> SS	STATUS	cause 30#, state U8

Specific message contents:

None.

26.8.1.3.4.2 Incoming call / U7 call received / termination requested by the user

26.8.1.3.4.2.1 Definition

The call control entity of the MS being in the state, U7, a user requests to terminate incoming call. This test is applicable for any equipment supporting at least one mobile terminating circuit switched basic service for which immediate connect is not used.

26.8.1.3.4.2.2 Conformance requirement

- 1) A CC entity of a MS in CC-state U7, "Call Received", upon request by the user to terminate shall send a DISCONNECT message and enter the CC-state U11, "Disconnect Request".

References

3GPP TS 04.07 / 3GPP TS 24.007 subclause 6.2.2,
3GPP TS 04.08 / 3GPP TS 24.008 subclause 5.4.3.

26.8.1.3.4.2.3 Test purpose

To verify that a CC entity of a MS in CC-state U7, "Call Received", upon request by the user to terminate will send a DISCONNECT message and enter the CC-state U11, "Disconnect Request".

26.8.1.3.4.2.4 Method of test

Specific PICS statements

-

PIXIT statements

-

Initial conditions

System Simulator:

1 cell, default parameters.

Mobile Station:

The MS is in MM-state "idle, updated" with valid TMSI and CKSN.

The MS is brought into the state U7 by using table 26.8.1.3/3.

Foreseen final state of the MS

U11, disconnect request.

Maximum duration of test

30 s.

Test procedure

An MT circuit switched basic service is selected that is supported by the MS and for which the MS does not use immediate connection; if the MS supports MT telephony without immediate connection, the selected basic service is telephony. If necessary, the MS is configured for that basic service. Then a mobile terminated call is initiated. The CC entity of the MS is brought to the state U7. The user initiates clearing the incoming call. The MS sends a DISCONNECT message. The SS checks by using the status enquiry procedure that the CC entity has entered state U11, disconnect request.

Expected sequence

Step	Direction	Message	Comments
1			the MS is made to terminate/reject the call
2	MS -> SS	DISCONNECT	
3	SS -> MS	STATUS ENQUIRY	
4	MS -> SS	STATUS	cause 30#, state U11

Specific message contents:

None.

26.8.1.3.4.3 Incoming call / U7 call received / DISCONNECT received

26.8.1.3.4.3.1 Definition

The call control entity of the MS being in the state, U7, a DISCONNECT message is received by the MS. This test is applicable for any equipment supporting at least one mobile terminating circuit switched basic service for which immediate connect is not used.

26.8.1.3.4.3.2 Conformance requirement

- 1) A CC entity of a MS in CC-state U7, "Call Received", upon receipt of a DISCONNECT with a progress indicator indicating in-band information from network, if a TCH was not assigned, shall return a RELEASE message and enter the CC-state U19, "Release Request".

References

3GPP TS 04.08 / 3GPP TS 24.008 subclause 5.4.4.

26.8.1.3.4.3.3 Test purpose

To verify that a CC entity of a MS in CC-state U7, "Call Received", upon receipt of a DISCONNECT with a progress indicator indicating in-band information from network, if a TCH was not assigned, returns a RELEASE message and enters the CC-state U19, "Release Request".

26.8.1.3.4.3.4 Method of test

Specific PICS statements

-

PIXIT statements

-

Initial conditions

System Simulator:

1 cell, default parameters.

Mobile Station:

The MS is in MM-state "idle, updated" with valid TMSI and CKSN.

The MS is brought into the state U7 by using table 26.8.1.3/1.

Foreseen final state of the MS

U19, release request.

Maximum duration of test

30 s.

Test procedure

An MT circuit switched basic service is selected that is supported by the MS and for which the MS does not use immediate connection; if the MS supports MT telephony without immediate connection, the selected basic service is telephony. If necessary, the MS is configured for that basic service. Then a mobile terminated call is initiated. The CC entity of the MS is brought to the state U7. The SS sends a DISCONNECT message. The MS responds with a RELEASE message. The SS checks by using the status enquiry procedure that the CC entity has entered state U19, release request.

Expected sequence

Step	Direction	Message	Comments
1	SS -> MS	DISCONNECT	(note)
2	MS -> SS	RELEASE	
3	SS -> MS	STATUS ENQUIRY	
4	MS -> SS	STATUS	cause 30#, state U19

Specific message contents:

NOTE: With a progress indicator indicating in-band information; Progress Indicator, Progress Description #8.

26.8.1.3.4.4 Incoming call / U7 call received / RELEASE received

26.8.1.3.4.4.1 Definition

The call control entity of the MS being in the state, U7, a RELEASE message is received by the MS. This test is applicable for any equipment supporting at least one mobile terminating circuit switched basic service for which immediate connect is not used.

26.8.1.3.4.4.2 Conformance requirement

- 1) A CC entity of a MS in CC-state U7, "Call Received", upon receipt of a RELEASE shall return a RELEASE COMPLETE and enter the CC-state U0, "Null".
- 2) On returning to the idle mode the MS shall release the MM-connection and the CC-entities relating to the seven mobile terminating transaction identifiers shall be in CC-state U0, "Null".

References

Conformance requirement 1: 3GPP TS 04.08 / 3GPP TS 24.008 subclause 5.4.4.

Conformance requirement 2: 3GPP TS 04.08 / 3GPP TS 24.008 subclauses 4.5.3 and 5.5.3.2.

26.8.1.3.4.4.3 Test purpose

- 1) To verify that a CC entity of a MS in CC-state U7, "Call Received", upon receipt of a RELEASE will return a RELEASE COMPLETE and enter the CC-state U0, "Null".
- 2) To verify that the MS on returning to the idle mode releases the MM-connection and that the CC-entities relating to the seven mobile terminating transaction identifiers are in CC-state U0, "Null".

26.8.1.3.4.4.4 Method of test

Specific PICS statements

-

PIXIT statements

-

Initial conditions

System Simulator:

1 cell, default parameters.

Mobile Station:

The MS is in MM-state "idle, updated" with valid TMSI and CKSN.

The MS is brought into the state U7 by using table 26.8.1.3/1.

Foreseen final state of the MS

U0, null.

Maximum duration of test

1 min.

Test procedure

An MT circuit switched basic service is selected that is supported by the MS and for which the MS does not use immediate connection; if the MS supports MT telephony without immediate connection, the selected basic service is telephony. If necessary, the MS is configured for that basic service. Then a mobile terminated call is initiated. The CC entity of the MS is brought to the state U7. The SS sends a RELEASE message. The MS responds with a RELEASE

COMPLETE message. The SS checks by using the status enquiry procedure that the CC entity has entered state U0, null, with the relevant transaction identifiers.

Expected sequence

Step	Direction	Message	Comments
1	SS -> MS	RELEASE	with cause "Normal, unspecified" cause 81# (invalid TI value) repeat steps 3-4 to cover all the transaction identifiers from 000...110 the main signalling link shall be released by the MS (L2: DISC/UA).
2	MS -> SS	RELEASE COMPLETE	
3	SS -> MS	STATUS ENQUIRY	
4	MS -> SS	RELEASE COMPLETE	
5	SS		
6	SS -> MS	CHANNEL RELEASE	

Specific message contents:

None.

26.8.1.3.4.5 Incoming call / U7 call received / lower layer failure

26.8.1.3.4.5.1 Definition

The call control entity of the MS being in the state, U7, a lower layer failure is accomplished at the MS and consequently, communication at layer 3 level with the peer entity is terminated. This test is applicable for any equipment supporting at least one mobile terminating circuit switched basic service for which immediate connect is not used.

26.8.1.3.4.5.2 Conformance requirement

- 1) A CC entity of a MS in CC-state U7, "Call Received", having detected a lower layer failure shall return to idle mode with the CC entities relating to the seven mobile terminating transaction identifiers in CC-state U0, "Null".

References

3GPP TS 04.08 / 3GPP TS 24.008 subclauses 4.5.2.3, 4.5.3, 5.5.3.2 and 8.3.

26.8.1.3.4.5.3 Test purpose

To verify that a CC entity of a MS in CC-state U7, "Call Received", having detected a lower layer failure returns to idle mode with the CC entities relating to the seven mobile terminating transaction identifiers in CC-state U0, "Null".

26.8.1.3.4.5.4 Method of test

Specific PICS statements

- Support of UTRAN Radio Access Technology

PIXIT statements

-

Initial conditions

System Simulator:

1 cell, default parameters.

Mobile Station:

The MS is in MM-state "idle, updated" with valid TMSI and CKSN.

The MS is brought into the state U7 by using table 26.8.1.3/2.

Foreseen final state of the MS

U0, null.

Maximum duration of test

1 min 30 s.

Test procedure

An MT circuit switched basic service is selected that is supported by the MS and for which the MS does not use immediate connection; if the MS supports MT telephony without immediate connection, the selected basic service is telephony. If necessary, the MS is configured for that basic service. Then a mobile terminated call is initiated. The MS is brought to the state U7. The SS generates a lower layer failure at the MS. The SS waits long enough to enable the MS to return to idle state listening to paging, and then pages MS to create RR-connection. Finally, the SS will check the state of the MS by using STATUS ENQUIRY with the relevant transaction identifiers.

Expected sequence

Step	Direction	Message	Comments
1	SS		SS generates lower layer failure
2	SS		If PICS statement "Support of UTRAN Radio Access Technology" is 'NO', then the SS waits 20 s for the MS to return to listening to paging. If PICS statement "Support of UTRAN Radio Access Technology" is 'YES', then the SS waits 50 s for the MS to return to listening to paging.
3	SS -> MS	PAGING REQUEST	
4	MS -> SS	CHANNEL REQUEST	
5	SS -> MS	IMMEDIATE ASSIGNMENT	
6	MS -> SS	PAGING RESPONSE	
7	SS -> MS	STATUS ENQUIRY	
8	MS -> SS	RELEASE COMPLETE	cause 81# (invalid TI value)
9	SS		repeat steps 7-8 to cover all the transaction identifiers from 000...110
10	SS -> MS	CHANNEL RELEASE	the main signalling link shall be released by the MS (L2: DISC/UA).

Specific message contents:

None.

26.8.1.3.4.6 Incoming call / U7 call received / unknown message received

26.8.1.3.4.6.1 Definition

The call control entity of the MS being in the state, U7, an unknown message is received by the MS. This test is applicable for any equipment supporting at least one mobile terminating circuit switched basic service for which immediate connect is not used.

26.8.1.3.4.6.2 Conformance requirement

- 1) A CC entity of a MS in CC-state U7, "Call Received", having received an unknown message from its peer entity shall return a STATUS message.

References

3GPP TS 04.08 / 3GPP TS 24.008 subclause 8.4.

26.8.1.3.4.6.3 Test purpose

To verify that a CC entity of a MS in CC-state U7, "Call Received", having received an unknown message from its peer entity returns a STATUS message.

26.8.1.3.4.6.4 Method of test

Specific PICS statements

-

PIXIT statements

-

Initial conditions

System Simulator:

1 cell, default parameters.

Mobile Station:

The MS is in MM-state "idle, updated" with valid TMSI and CKSN.

The MS is brought into the state U7 by using table 26.8.1.3/3.

Foreseen final state of the MS

U7, call received.

Maximum duration of test

30 s.

Test procedure

An MT circuit switched basic service is selected that is supported by the MS and for which the MS does not use immediate connection; if the MS supports MT telephony without immediate connection, the selected basic service is telephony. If necessary, the MS is configured for that basic service. Then a mobile terminated call is initiated. The CC entity of the MS is brought to the state U7. The SS sends a message with message type not defined for the protocol discriminator to the MS. The MS shall respond with a STATUS message, and finally the SS checks by using the status enquiry procedure that the state of the CC entity has remained unchanged.

Expected sequence

Step	Direction	Message	Comments
1	SS -> MS	unknown message	message type not defined for PD
2	MS -> SS	STATUS	cause 97#, state U7
3	SS -> MS	STATUS ENQUIRY	
4	MS -> SS	STATUS	cause 30#, state U7

Specific message contents:

None.

26.8.1.3.4.7 Incoming call / U7 call received / TCH assignment

26.8.1.3.4.7.1 Definition

The call control entity of the MS being in the state, U7, an assignment procedure is performed for traffic channel. This test is applicable for any equipment supporting at least one mobile terminating circuit switched basic service for which immediate connect is not used.

26.8.1.3.4.7.2 Conformance requirement

- 1) A CC entity of a MS in CC-state U7, "Call Received", when allocated a traffic channel by the network performing the assignment procedure, shall perform a layer 2 establishment on the FACCH without changing the state of the call in progress.

References

3GPP TS 04.08 / 3GPP TS 44.018 subclause 3.4.3,
3GPP TS 04.08 / 3GPP TS 24.008 subclause 5.2.2.7.

26.8.1.3.4.7.3 Test purpose

To verify that a CC entity of a MS in CC-state U7, "Call Received", when allocated a traffic channel by the network performing the assignment procedure, shall perform a layer 2 establishment on the FACCH without changing the state of the call in progress.

26.8.1.3.4.7.4 Method of test

Specific PICS statements

-

PIXIT statements

-

Initial conditions

System Simulator:

1 cell, default parameters.

Mobile Station:

The MS is in MM-state "idle, updated" with valid TMSI and CKSN.

The MS is brought into the state U7 by using table 26.8.1.3/1.

Foreseen final state of the MS

U7, call received.

Maximum duration of test

30 s.

Test procedure

An MT circuit switched basic service is selected that is supported by the MS and for which the MS does not use immediate connection; if the MS supports MT telephony without immediate connection, the selected basic service is telephony. If necessary, the MS is configured for that basic service. Then a mobile terminated call is initiated. The CC entity of the MS is brought to the state U7. The SS sends an ASSIGNMENT COMMAND for traffic channel to the MS. The MS shall establish layer 2 link on the newly allocated channel and respond with an ASSIGNMENT COMPLETE message. The SS verifies by using the status enquiry procedure that the state of the CC entity has remained unchanged.

Expected sequence

Step	Direction	Message	Comments
1	SS -> MS	ASSIGNMENT COMMAND	TCH the MS shall establish L2 link
2	MS		
3	MS -> SS	ASSIGNMENT COMPLETE	
4	SS -> MS	STATUS ENQUIRY	
5	MS -> SS	STATUS	cause 30#, state U7

Specific message contents:

None.

26.8.1.3.4.8 Incoming call / U7 call received / RELEASE COMPLETE received

26.8.1.3.4.8.1 Definition

The call control entity of the MS being in the state, U7, the call is cleared by a RELEASE COMPLETE message sent by the SS. This test is applicable for any equipment supporting at least one mobile terminating circuit switched basic service, for which immediate connect is not used.

26.8.1.3.4.8.2 Conformance requirement

- 1) A CC entity of the MS in CC-state U7, "call received", upon receipt of a RELEASE COMPLETE message with valid cause value, shall enter CC state U0, "Null".
- 2) On returning to idle mode, the CC entities relating to the seven mobile terminating transaction identifiers shall be in state U0, "Null".

References

Conformance requirement 1: 3GPP TS 04.08 / 3GPP TS 24.008, subclauses 5.4.2 and 5.4.4.

Conformance requirement 2: 3GPP TS 04.08 / 3GPP TS 24.008, subclause 5.4.4.3.

26.8.1.3.4.8.3 Test purpose

- 1) To verify that a CC entity of the MS in CC-state U7, "Call received", upon receipt of a RELEASE COMPLETE message with valid cause value, enters CC state U0, "Null".
- 2) To verify that in returning to idle mode, the CC entities relating to the seven mobile terminating transaction identifiers are in state U0, "Null".

26.8.1.3.4.8.4 Method of test

Specific PICS statements

-

PIXIT statements

-

Initial conditions

System Simulator:

1 cell, default parameters.

Mobile Station:

The MS is in MM-state "idle, updated" with valid TMSI and CKSN.

The MS is brought into the state U7 by using table 26.8.1.3/1.

Foreseen final state of the MS

U0, null.

Maximum duration of test

30 s.

Test procedure

An MT circuit switched basic service is selected that is supported by the MS and for which the MS does not use immediate connection; if the MS supports MT telephony without immediate connection, the selected service is telephony. If necessary, the MS is configured for that basic service. The a mobile terminated call is initiated. the CC entity of the MS is brought to U7. The SS sends a RELEASE COMPLETE message to the MS. The SS checks by using the status enquiry procedure that the CC entity has entered the state U0 with all the relevant transaction identifiers.

Expected sequence

Step	Direction	Message	Comments
1	SS -> MS	RELEASE COMPLETE	note 1
2	SS -> MS	STATUS ENQUIRY	
3	MS -> SS	RELEASE COMPLETE	cause 81# (invalid TI value), note 2
4	SS		repeat steps 2-3 to cover all the transaction identifiers from 000...110
5	SS -> MS	CHANNEL RELEASE	the main signalling link shall be released by the MS (L2: DISC/UA).

Specific message contents:

NOTE 1: With the cause value chosen arbitrarily.

NOTE 2: TI flag has the value indicating the SS as a originator of the call.

26.8.1.3.5 Incoming call / U8 connect request

26.8.1.3.5.1 Incoming call / U8 connect request / CONNECT acknowledged

26.8.1.3.5.1.1 Definition

The call control entity of the MS being in the state, U8, a CONNECT ACKNOWLEDGE message is received by the MS. This test is applicable for any equipment supporting at least one mobile terminating circuit switched basic service.

26.8.1.3.5.1.2 Conformance requirement

A CC entity of a MS in CC-state U8, "Connect Request", upon receipt of CONNECT ACKNOWLEDGE shall enter the CC-state U10, "Call Active".

References

3GPP TS 04.08 / 3GPP TS 24.008 subclause 5.2.2.6.

26.8.1.3.5.1.3 Test purpose

To verify that a CC entity of a MS in CC-state U8, "Connect Request", upon receipt of CONNECT ACKNOWLEDGE shall enter the CC-state U10, "Call Active".

26.8.1.3.5.1.4 Method of test

Specific PICS statements

- Support of immediate connect (TSPC_AddInfo_ImmConn)

PIXIT statements

-

Initial conditions

System Simulator:

1 cell, default parameters.

Mobile Station:

The MS is in MM-state "idle, updated" with valid TMSI and CKSN.

The MS is brought into the state U8 by using table 26.8.1.3/2.

Foreseen final state of the MS

U10, active.

Maximum duration of test

30 s.

Test procedure

An MT circuit switched basic service is selected that is supported by the MS; if the MS supports MT telephony, the selected basic service is telephony. If necessary the MS is configured for that basic service. Then a mobile terminated call is initiated. The CC entity of the MS is brought to the state U8 (if the MS uses immediate connection for the selected basic service then $p = Y$, otherwise $p = N$). The SS sends a CONNECT ACKNOWLEDGE message. The SS checks by using the status enquiry procedure that the CC entity of the MS has entered state U10, active.

Expected sequence

Step	Direction	Message	Comments
A1	SS -> MS	ASSIGNMENT COMMAND	$p = Y$
A2	MS -> SS	ASSIGNMENT COMPLETE	
3	SS -> MS	CONNECT ACKNOWLEDGE	cause 30#, state U10
4	SS -> MS	STATUS ENQUIRY	
5	MS -> SS	STATUS	

Specific message contents:

None.

26.8.1.3.5.2 Incoming call / U8 connect request / timer T313 time-out

26.8.1.3.5.2.1 Definition

The call control entity of the MS being in the state, U8, if no response is then received from the SS, timer T313 expires at the MS side. This test is applicable for any equipment supporting at least one mobile terminating circuit switched basic service.

26.8.1.3.5.2.2 Conformance requirement

A CC entity of a MS in CC-state U8, "Connect Request", having waited for a reasonable length of time (e.g. expiry of timer T313) without receiving the appropriate protocol message to complete the incoming call, shall initiate the clearing of that incoming call by sending the CC message DISCONNECT and enter the CC-state U11, "Disconnect Request".

If an MS disconnects too early then, in the case of very late assignment of a traffic channel, systematic waste of radio resources may occur.

References

3GPP TS 04.08 / 3GPP TS 24.008 subclauses 5.2.2.6 and 5.4.3.

26.8.1.3.5.2.3 Test purpose

To verify that a CC entity of a MS in CC-state U8, "Connect Request", having waited for a reasonable length of time (e.g. expiry of timer T313) without receiving the appropriate protocol message to complete the incoming call, shall initiate the clearing of that incoming call by sending the CC message DISCONNECT and enter the CC-state U11, "Disconnect Request"

26.8.1.3.5.2.4 Method of test

Specific PICS statements

- Support of immediate connect (TSPC_AddInfo_ImmConn)

PIXIT statements

-

Initial conditions

System Simulator:

1 cell, default parameters.

Mobile Station:

The MS is in MM-state "idle, updated" with valid TMSI and CKSN.

The MS is brought into the state U8 by using table 26.8.1.3/2.

Foreseen final state of the MS

U11, disconnect request.

Maximum duration of test

45 s.

Test procedure

An MT circuit switched basic service is selected that is supported by the MS; if the MS supports MT telephony, the selected basic service is telephony. If necessary the MS is configured for that basic service. Then a mobile terminated call is initiated. The CC entity of the MS is brought to the state U8 (if the MS uses immediate connection for the selected basic service then p = Y, otherwise p = N). The T313 expires at the MS and the MS sends a DISCONNECT message and enters state U11, disconnect request. The SS checks by using the status enquiry procedure that the MS has entered the correct state.

Expected sequence

Step	Direction	Message	Comments
A1	SS -> MS	ASSIGNMENT COMMAND	p = Y
A2	MS -> SS	ASSIGNMENT COMPLETE	
3	MS -> SS	DISCONNECT	Shall not be sent before 15 s after entry into state U8. But, shall be sent before 1,1 * T313 after entry into state U8.
4	SS -> MS	STATUS ENQUIRY	cause 30#, state U11
5	MS -> SS	STATUS	

Specific message contents:

None.

26.8.1.3.5.3 Incoming call / U8 connect request / termination requested by the user

26.8.1.3.5.3.1 Definition

The call control entity of the MS being in the state, U8, the user requests for releasing of the call. This test is applicable for any equipment supporting at least one mobile terminating circuit switched basic service.

26.8.1.3.5.3.2 Conformance requirement

- 1) A CC entity of a MS in CC-state U8, "Connect Request", upon request by the user to terminate shall send a DISCONNECT message and enter the CC-state U11, "Disconnect Request".

References

3GPP TS 04.07 / 3GPP TS 24.007 subclause 6.2.2,
3GPP TS 04.08 / 3GPP TS 24.008 subclause 5.4.3

26.8.1.3.5.3.3 Test purpose

To verify that a CC entity of a MS in CC-state U8, "Connect Request", upon request by the user to terminate will send a DISCONNECT message and enter the CC-state U11, "Disconnect Request".

26.8.1.3.5.3.4 Method of test

Specific PICS statements

- MT circuit switched basic services for which immediate connect is not used.

PIXIT statements

-

Initial conditions

System Simulator:

1 cell, default parameters.

Mobile Station:

The MS is in MM-state "idle, updated" with valid TMSI and CKSN.

The MS is brought into the state U8 by using table 26.8.1.3/2.

Foreseen final state of the MS

U11, disconnect request.

Maximum duration of test

30 s.

Test procedure

An MT circuit switched basic service is selected that is supported by the MS; if the MS supports MT telephony, the selected basic service is telephony. If necessary the MS is configured for that basic service. Then a mobile terminated call is initiated. The CC entity of the MS is brought to the state U8 (if the MS uses immediate connection for the selected basic service then p = Y, otherwise p = N). Then the user requests termination of the call. The MS sends a DISCONNECT message and enters state U11, disconnect request. The SS verifies by using the status enquiry procedure that the MS has entered the correct state.

Expected sequence

Step	Direction	Message	Comments
A1	SS -> MS	ASSIGNMENT COMMAND	p = Y
A2	MS -> SS	ASSIGNMENT COMPLETE	
3			the user requests to clear the call
4	MS -> SS	DISCONNECT	
5	SS -> MS	STATUS ENQUIRY	
6	MS -> SS	STATUS	
			cause 30#, state U11

Specific message contents:

None.

26.8.1.3.5.4 Incoming call / U8 connect request / DISCONNECT received with in-band information

26.8.1.3.5.4.1 Definition

The call control entity of the MS being in the state, U8, a DISCONNECT message indicating availability of in band information is received by the MS. This test is applicable for any equipment supporting at least one mobile terminating circuit switched basic service.

26.8.1.3.5.4.2 Conformance requirement

A CC entity of a MS in CC-state U8, "Connect Request", upon receipt of a DISCONNECT with progress indicator #8 shall enter CC-state U12, if the traffic channel is in speech mode. If the TCH is not in speech mode, the MS shall send a RELEASE message and enter CC-state U19.

References

3GPP TS 04.08 / 3GPP TS 24.008 subclauses 5.4.4 and 5.5.1.

26.8.1.3.5.4.3 Test purpose

To verify that a CC entity of a MS in CC-state U8, "Connect Request", upon receipt of a DISCONNECT with progress indicator #8 enters CC-state U12, if the traffic channel is in speech mode, and that the MS sends a RELEASE message and enters CC-state U19 if the TCH is not in speech mode.

26.8.1.3.5.4.4 Method of test

Specific PICS statements

-

PIXIT statements

-

Initial conditions

System Simulator:

1 cell, default parameters.

Mobile Station:

The MS is in MM-state "idle, updated" with valid TMSI and CKSN. The MS is brought into the state U8 by using table 26.8.1.3/3.

Foreseen final state of the MS

U12, disconnect indication or U19 depending on the bearer capabilities.

Maximum duration of test

30 s.

Test procedure

An MT circuit switched basic service is selected that is supported by the MS; if the MS supports MT telephony, the selected basic service is telephony. If necessary the MS is configured for that basic service. Then a mobile terminated call is initiated. The CC entity of the MS is brought to the state U8. The SS sends a DISCONNECT message containing indication of in-band information availability to the MS. If channel mode is speech, the MS enters state U12, disconnect indication. If channel mode is not speech, the MS sends a RELEASE message and enters state U19, release request.

Expected sequence

Step	Direction	Message	Comments
1	SS -> MS	DISCONNECT	(note)
A2 A3	SS -> MS MS -> SS	STATUS ENQUIRY STATUS	TCH in speech mode: cause 30#, state U12
B2 B3 B4	MS -> SS SS -> MS MS -> SS	RELEASE STATUS ENQUIRY STATUS	TCH is not in speech mode: cause 30#, state U19

Specific message contents:

NOTE: With a progress indicator indicating in-band information; Progress Indicator, Progress description #8.

26.8.1.3.5.5 Incoming call / U8 connect request / DISCONNECT received without in-band information

26.8.1.3.5.5.1 Definition

The call control entity of the MS being in the state, U8, a DISCONNECT message is received by the MS. The DISCONNECT message does not contain indication of in-band information availability. This test is applicable for any equipment supporting at least one mobile terminating circuit switched basic service.

26.8.1.3.5.5.2 Conformance requirement

- 1) A CC entity of a MS in CC-state U8, "Connect Request", upon receipt of a DISCONNECT without progress indicator, shall return a RELEASE message and enter the CC-state U19, "Release Request".

References

3GPP TS 04.08 / 3GPP TS 24.008 subclauses 5.4.4 and 5.4.4.2.

26.8.1.3.5.5.3 Test purpose

To verify that a CC entity of a MS in CC-state U8, "Connect Request", upon receipt of a DISCONNECT without progress indicator, returns a RELEASE message and enters the CC-state U19, "Release Request".

26.8.1.3.5.5.4 Method of test

Specific PICS statements

-

PIXIT statements

-

Initial conditions

System Simulator:

1 cell, default parameters.

Mobile Station:

The MS is in MM-state "idle, updated" with valid TMSI and CKSN.

The MS is brought into the state U8 by using table 26.8.1.3/3.

Foreseen final state of the MS

U19, release request.

Maximum duration of test

30 s.

Test procedure

An MT circuit switched basic service is selected that is supported by the MS; if the MS supports MT telephony, the selected basic service is telephony. If necessary the MS is configured for that basic service. Then a mobile terminated call is initiated. The CC entity of the MS is brought to the state U8. The SS sends a DISCONNECT message not containing indication of in-band information availability to the MS. The MS shall respond with a RELEASE message. The SS checks by using the status enquiry procedure that the CC entity of the MS has entered the state U19, release request.

Expected sequence

Step	Direction	Message	Comments
1	SS -> MS	DISCONNECT	(note)
2	MS -> SS	RELEASE	
3	SS -> MS	STATUS ENQUIRY	
4	MS -> SS	STATUS	cause 30#, state U19

Specific message contents:

NOTE: Without a progress indicator indicating in-band information.

26.8.1.3.5.6 Incoming call / U8 connect request / RELEASE received

26.8.1.3.5.6.1 Definition

The call control entity of the MS being in the state, U8, a RELEASE message is received by the MS. This test is applicable for any equipment supporting at least one mobile terminating circuit switched basic service.

26.8.1.3.5.6.2 Conformance requirement

- 1) A CC entity of a MS in CC-state U8, "Connect Request", upon receipt of a RELEASE shall return a RELEASE COMPLETE and enter the CC-state U0, "Null".
- 2) On returning to the idle mode the MS shall release the MM-connection and the CC-entities relating to the seven mobile terminating transaction identifiers shall be in CC-state U0, "Null".

References

Conformance requirement 1: 3GPP TS 04.08 / 3GPP TS 24.008 subclause 5.4.4.

Conformance requirement 2: 3GPP TS 04.08 / 3GPP TS 24.008 subclauses 4.5.3 and 5.5.3.2.

26.8.1.3.5.6.3 Test purpose

- 1) To verify that a CC entity of a MS in CC-state U8, "Connect Request", upon receipt of a RELEASE will return a RELEASE COMPLETE and enter the CC-state U0, "Null".
- 2) To verify that the MS on returning to the idle mode releases the MM-connection and that the CC-entities relating to the seven mobile terminating transaction identifiers are in CC-state U0, "Null".

26.8.1.3.5.6.4 Method of test

Specific PICS statements

-

PIXIT statements

-

Initial conditions

System Simulator:

1 cell, default parameters.

Mobile Station:

The MS is in MM-state "idle, updated" with valid TMSI and CKSN.

The MS is brought into the state U8 by using table 26.8.1.3/3.

Foreseen final state of the MS

U0, null.

Maximum duration of test

1 min.

Test procedure

An MT circuit switched basic service is selected that is supported by the MS; if the MS supports MT telephony, the selected basic service is telephony. If necessary the MS is configured for that basic service. Then a mobile terminated call is initiated. The CC entity of the MS is brought to the state U8. The SS sends a RELEASE message. The MS responds with a RELEASE COMPLETE message. The SS checks by using the status enquiry procedure that the CC entity has entered state U0, null, with the relevant transaction identifiers.

Expected sequence

Step	Direction	Message	Comments
1	SS -> MS	RELEASE	with cause "Normal, unspecified"
2	MS -> SS	RELEASE COMPLETE	
3	SS -> MS	STATUS ENQUIRY	cause 81# (invalid TI value) repeat steps 3-4 to cover all the transaction identifiers from 000...110
4	MS -> SS	RELEASE COMPLETE	
5	SS		
6	SS -> MS	CHANNEL RELEASE	the main signalling link shall be released by the MS (L2: DISC/UA).

Specific message contents:

None.

26.8.1.3.5.7 Incoming call / U8 connect request / lower layer failure

26.8.1.3.5.7.1 Definition

The call control entity of the MS being in the state, U8, a lower layer failure is accomplished at the MS and consequently, communication at layer 3 level with the peer entity is terminated. This test is applicable for any equipment supporting at least one mobile terminating circuit switched basic service.

26.8.1.3.5.7.2 Conformance requirement

- 1) A CC entity of a MS in CC-state U8, "Connect Request", having detected a lower layer failure shall return to idle mode with the CC entities relating to the seven mobile terminating transaction identifiers in CC-state U0, "Null".

References

3GPP TS 04.08 / 3GPP TS 24.008 subclauses 4.5.2.3, 4.5.3 and 5.5.3.2.

26.8.1.3.5.7.3 Test purpose

To verify that a CC entity of a MS in CC-state U8, "Connect Request", having detected a lower layer failure returns to idle mode with the CC entities relating to the seven mobile terminating transaction identifiers in CC-state U0, "Null".

26.8.1.3.5.7.4 Method of test

Specific PICS statements

- Support of UTRAN Radio Access Technology (TSPC_Type_UTRAN)

PIXIT statements

-

Initial conditions

System Simulator:

1 cell, default parameters.

Mobile Station:

The MS is in MM-state "idle, updated" with valid TMSI and CKSN.

The MS is brought into the state U8 by using table 26.8.1.3/1.

Foreseen final state of the MS

U0, null.

Maximum duration of test

1 min 30 s.

Test procedure

An MT circuit switched basic service is selected that is supported by the MS; if the MS supports MT telephony, the selected basic service is telephony. If necessary the MS is configured for that basic service. Then a mobile terminated call is initiated. The MS is brought to the state U8. The SS generates a lower layer failure at the MS. The SS waits long enough to enable the MS to return to idle state listening to paging, and then pages MS to create RR-connection. Finally, the SS will check the state of the MS by using STATUS ENQUIRY with the relevant transaction identifiers.

Expected sequence

Step	Direction	Message	Comments
1	SS		SS generates lower layer failure
2	SS		If PICS statement "Support of UTRAN Radio Access Technology" is 'NO', then the SS waits 20 s for the MS to return to listening to paging. If PICS statement "Support of UTRAN Radio Access Technology" is 'YES', then the SS waits 50 s for the MS to return to listening to paging.
3	SS -> MS	PAGING REQUEST	
4	MS -> SS	CHANNEL REQUEST	
5	SS -> MS	IMMEDIATE ASSIGNMENT	
6	MS -> SS	PAGING RESPONSE	
7	SS -> MS	STATUS ENQUIRY	
8	MS -> SS	RELEASE COMPLETE	cause 81# (invalid TI value)
9	SS		repeat steps 7-8 to cover all the transaction identifiers from 000...110
10	SS -> MS	CHANNEL RELEASE	the main signalling link shall be released by the MS (L2: DISC/UA).

Specific message contents:

None.

26.8.1.3.5.8 Incoming call / U8 connect request / TCH assignment

26.8.1.3.5.8.1 Definition

The call control entity of the MS being in the state, U8, an assignment procedure is performed for traffic channel. This test is applicable for any equipment supporting at least one mobile terminating circuit switched basic service.

26.8.1.3.5.8.2 Conformance requirement

- 1) A CC entity of a MS in CC-state U8, "Connect Request", when allocated a traffic channel by the network performing the assignment procedure, shall perform a layer 2 establishment on the FACCH without changing the state of the call in progress.

References

3GPP TS 04.08 / 3GPP TS 44.018 subclause 3.4.3,
3GPP TS 04.08 / 3GPP TS 24.008 subclause 5.2.2.7.

26.8.1.3.5.8.3 Test purpose

To verify that a CC entity of a MS in CC-state U8, "Connect Request", when allocated a traffic channel by the network performing the assignment procedure, shall perform a layer 2 establishment on the FACCH without changing the state of the call in progress.

26.8.1.3.5.8.4 Method of test

Specific PICS statements

-

PIXIT statements

-

Initial conditions

System Simulator:

1 cell, default parameters.

Mobile Station:

The MS is in MM-state "idle, updated" with valid TMSI and CKSN.

The MS is brought into the state U8 by using table 26.8.1.3/1.

Foreseen final state of the MS

U8, connect request.

Maximum duration of test

30 s.

Test procedure

An MT circuit switched basic service is selected that is supported by the MS; if the MS supports MT telephony, the selected basic service is telephony. If necessary the MS is configured for that basic service. Then a mobile terminated call is initiated. The CC entity of the MS is brought to the state U8. The SS sends an ASSIGNMENT COMMAND for traffic channel to the MS. The MS shall establish layer 2 link on the newly allocated channel and respond with an ASSIGNMENT COMPLETE message. The SS verifies by using the status enquiry procedure that the state of the CC entity has remained unchanged.

Expected sequence

Step	Direction	Message	Comments
1	SS -> MS	ASSIGNMENT COMMAND	TCH cause 30#, state U8
2	MS -> SS	ASSIGNMENT COMPLETE	
3	SS -> MS	STATUS ENQUIRY	
4	MS -> SS	STATUS	

Specific message contents:

None.

26.8.1.3.5.9 Incoming call / U8 connect request / unknown message received

26.8.1.3.5.9.1 Definition

The call control entity of the MS being in the state, U8, an unknown message is received by the MS. This test is applicable for any equipment supporting at least one mobile terminating circuit switched basic service.

26.8.1.3.5.9.2 Conformance requirement

- 1) A CC entity of a MS in CC-state U8, "Connect Request", having received an unknown message from its peer entity shall return a STATUS message.

References

3GPP TS 04.08 / 3GPP TS 24.008 subclause 8.4.

26.8.1.3.5.9.3 Test purpose

To verify that a CC entity of a MS in CC-state U8, "Connect Request", having received an unknown message from its peer entity returns a STATUS message.

26.8.1.3.5.9.4 Method of test

Specific PICS statements

-

PIXIT statements

-

Initial conditions

System Simulator:

1 cell, default parameters.

Mobile Station:

The MS is in MM-state "idle, updated" with valid TMSI and CKSN.

The MS is brought into the state U8 by using table 26.8.1.3/1.

Foreseen final state of the MS

U8, connect request.

Maximum duration of test

30 s.

Test procedure

An MT circuit switched basic service is selected that is supported by the MS; if the MS supports MT telephony, the selected basic service is telephony. If necessary the MS is configured for that basic service. Then a mobile terminated call is initiated. The CC entity of the MS is brought to the state U8. The SS sends a message with message type not defined for the protocol discriminator to the MS. The MS shall respond with a STATUS message, and finally the SS checks by using the status enquiry procedure that the state of the CC entity has remained unchanged.

Expected sequence

Step	Direction	Message	Comments
1	SS -> MS	unknown message	message type not defined for PD
2	MS -> SS	STATUS	cause 97#, state U8
3	SS -> MS	STATUS ENQUIRY	
4	MS -> SS	STATUS	cause 30#, state U8

Specific message contents:

None.

26.8.1.4 In call functions

26.8.1.4.1 In-call functions / DTMF information transfer

26.8.1.4.1.1 In-call functions / DTMF information transfer / basic procedures

26.8.1.4.1.1.1 Definition

Dual Tone Multi Frequency (DTMF) is an inband one out of four plus one out of four signalling system primarily used from terminal instruments in telecommunication networks.

The support of DTMF is only permitted when a bearer capability for speech is in use or during the speech phase of alternate speech/data and alternate speech/facsimile teleservices.

26.8.1.4.1.1.2 Conformance requirement

- 1) An MS supporting the Mobile originating DTMF protocol control procedure, having a CC entity for speech in state U10, "Active": when made to send a DTMF tone, shall send a START DTMF message on the correct DCCH.

References

3GPP TS 04.08 / 3GPP TS 24.008, subclause 5.3.3.

- 2) An MS supporting the Mobile originating DTMF protocol control procedure, having a CC entity for speech in state U10, "Active": when made to send a DTMF tone (the corresponding IA5 character being selected from among the ones supported), shall send a START DTMF message specifying the correct IA5 character in the "keypad information" field of the keypad facility information element.

2.1 3GPP TS 04.08 / 3GPP TS 24.008, subclause 5.3.3.

26.8.1.4.1.1.3 Test purpose

- 1) To verify that an MS supporting the Mobile originating DTMF protocol control procedure, having a CC entity for speech in state U10, "Active": when made to send a DTMF tone, sends a START DTMF message on the correct DCCH.
- 2) To verify that an MS supporting the Mobile originating DTMF protocol control procedure, having a CC entity for speech in state U10, "Active": when made to send a DTMF tone (the corresponding IA5 character being selected from among the ones supported), sends a START DTMF message specifying the correct IA5 character in the "keypad information" field of the keypad facility information element.

26.8.1.4.1.1.4 Method of test

Specific PICS statements

-

PIXIT statements

- supported character set (e.g. 0-9, #, *, A, B, C, D);
- if and how DTMF tone is indicated to the user.

Initial conditions

System Simulator:

1 cell, default parameters.

Mobile Station:

The MS is in CC-state "active".

Foreseen final state of the MS

CC-state "active".

Maximum duration of test

1 min.

Test procedure

The MS being in the call active state, a user causes a DTMF tone to be generated e.g. by depression of a key in the MS. A DTMF digit corresponding to the digit indicated by the user is sent in a START DTMF message by the MS. The SS will return a START DTMF ACKNOWLEDGE message to the MS. This acknowledgement may be used in the MS to generate an indication as a feedback for a successful transmission. Then the user indicates that the DTMF sending should cease e.g. by releasing the key. The MS will send a STOP DTMF message to the network which is acknowledged with STOP DTMF ACKNOWLEDGE by the SS.

The sequence described above is repeated for each of the applicable characters 0-9, #, *, A, B, C, and D.

Then a case of rejecting a DTMF tone is tested and the state of the MS is verified.

Expected sequence

Step	Direction	Message	Comments
1	MS -> SS SS	START DTMF	the user causes DTMF tone to be generated the SS will verify that the transmitted information corresponds to the digit pressed possible indication of a DTMF tone depending the PIXIT statements cause 30#, state U10 the DTMF tone indication shall be stopped the steps 1-6 shall be repeated for each of the applicable characters 0-9, #, *, A, B, C, D. cause 30#, state U10 cause 30#, state U10
2	SS -> MS	START DTMF ACKNOWLEDGE	
3	SS -> MS	STATUS ENQUIRY	
4	MS -> SS	STATUS	
5	MS -> SS	STOP DTMF	
6	SS -> MS	STOP DTMF ACKNOWLEDGE	
7			
8	SS -> MS	STATUS ENQUIRY	
9	MS -> SS	STATUS	
10	MS -> SS	START DTMF	
11	SS -> MS	START DTMF REJECT	
12	SS -> MS	STATUS ENQUIRY	
13	MS -> SS	STATUS	

Specific message contents:

None.

26.8.1.4.2 In-call functions / user notification

User notification procedure allows the network to notify a MS of any call-related event during the "active" state of a call. It also may allow a MS to notify the remote user of any appropriate call-related event during the "active" state of a call by sending a NOTIFY message containing a notification indicator to the network. No state change occurs at any of the interface sides during this procedure.

26.8.1.4.2.1 In-call functions / User notification / MS terminated

26.8.1.4.2.1.1 Definition

This is a case for testing user notification procedure terminated by the mobile station. The test is applicable for those equipments supporting at least one circuit switched basic service.

26.8.1.4.2.1.2 Conformance requirement

- 1) A CC entity of a MS in CC-state U10, "active", upon receiving of a NOTIFY message shall remain in the active state.

References

3GPP TS 04.08 / 3GPP TS 24.008, subclause 5.3.1.

26.8.1.4.2.1.3 Test purpose

To verify that a CC entity of a MS in CC-state U10, "active", upon receiving of a NOTIFY message remains in the active state.

26.8.1.4.2.1.4 Method of test

Specific PICS statements

-

PIXIT statements

-

Initial conditions

System Simulator:

1 cell, default parameters.

Mobile Station:

The MS is in CC-state "active".

Foreseen final state of the MS

CC-state "active".

Maximum duration of test

10 s.

Test procedure

The MS being in the call active state, the SS will send a NOTIFY message to the MS. The state of the MS is checked after that.

Expected sequence

Step	Direction	Message	Comments
1	SS -> MS	NOTIFY	
2	SS -> MS	STATUS ENQUIRY	
3	MS -> SS	STATUS	cause 30#, state U10

Specific message contents:

None.

26.8.1.4.3 In-call functions / channel changes

The two following test cases are for testing some elementary radio resource level procedures during an active state of a call to ensure call maintenance also during physical channel changes.

26.8.1.4.3.1 In-call functions / channel changes / a successful channel change in active state/ Handover and Assignment Command

26.8.1.4.3.1.1 Definition

This is a case to test a change of a physical channel during active state of a call. This test is applicable for any equipment supporting at least one mobile terminating circuit switched basic service.

26.8.1.4.3.1.2 Conformance requirement

- 1) The MS being in the call active state after having successfully completed a channel assignment or a handover command, shall remain in the call active state.

References

3GPP TS 04.08 / 3GPP TS 24.008, subclause 5.3.4.3.2,
3GPP TS 04.08 / 3GPP TS 44.018, subclause 3.4.6.1

26.8.1.4.3.1.3 Test purpose

To verify that the MS being in the call active state after having successfully completed a channel assignment or having completed a handover command remains in the call active state.

26.8.1.4.3.1.4 Method of test

Specific PICS statements

-

PIXIT statements

-

Initial conditions

System Simulator:

1 cell, default parameters.

Mobile Station:

The MS is in CC-state "active".

Foreseen final state of the MS

CC-state "active".

Maximum duration of test

10 s.

Test procedure

The SS initiates a call to the Mobile Station, using an arbitrarily chosen MT circuit switched basic service (see clause 10 for generic call set up procedures).

The MS being in the call active state, the SS initiates channel assignment procedure causing an intracell change of channel by sending ASSIGNMENT COMMAND message to the MS. The MS performs channel assignment procedure and after the main signalling link is successfully established, the MS returns an ASSIGNMENT COMPLETE message. The state of the MS is then checked.

The SS then initiates a Finely Synchronized handover intra cell procedure. On the successful completion of this procedure the state of the MS is checked.

Expected sequence

Step	Direction	Message	Comments
0			Generic call set up procedure defined in subclauses 10.1 and 10.3, depending on choice of Bearer Capability.
1	SS -> MS	ASSIGNMENT COMMAND	
2	MS -> SS	ASSIGNMENT COMPLETE	
3	SS -> MS	STATUS ENQUIRY	
4	MS -> SS	STATUS	cause 30#, state U10
5	SS -> MS	HANDOVER COMMAND	See Specific message contents.
6	MS -> SS	HANDOVER ACCESS	
7	MS -> SS	HANDOVER ACCESS	
8	MS -> SS	HANDOVER ACCESS	
9	MS -> SS	HANDOVER ACCESS	Before completion of the 4 access bursts on the new DCCH, additional access bursts may also be sent on the SACCH
10	MS -> SS	HANDOVER COMPLETE	
11	SS -> MS	STATUS ENQUIRY	
12	MS -> SS	STATUS	cause 30#, state U10

Specific message contents:

ASSIGNMENT COMMAND

Information Element	value/remark
Channel Description As used in Assignment Command when setting up the call, except: - Timeslot Number	Arbitrary value, but different to originally used.

HANDOVER COMMAND

Information Element	value/remark
Cell Description - Network Colour Code - Base Station Colour Code - BCCH Carrier Number	1 5 GSM 450 – ARFCN 263 GSM 480 – ARFCN 310 P-GSM 900 - ARFCN 20 DCS 1 800 - ARFCN 590 PCS 1 900 – ARFCN 650 GSM 710 – ARFCN 457 GSM 750 – ARFCN 457 T-GSM 810 – ARFCN 457 GSM 850 – ARFCN 147
Channel Description As used in Assignment Command when setting up the call, except: - Timeslot Number	Arbitrary value, but different to originally used.
Synchronization Indication - Report Observed Time Difference - Synchronization Indication - Normal Cell Indication	Shall not be included. "Synchronized". Ignore out of range timing advance.

STATUS

Information Element	value/remark
cause	#30, statue U10.

26.8.1.4.3.2 In-call functions / channel changes / an unsuccessful channel change in active mode/
Handover and Assignment Command

26.8.1.4.3.2.1 Definition

This is a case to test an unsuccessful change of a physical channel during active state of a call. This test is applicable for any equipment supporting at least one mobile terminating circuit switched basic service.

26.8.1.4.3.2.2 Conformance requirement

- 1) The MS, when returning to the old channel after handover or Assignment failure and having established the link, shall remain in the call active state.

References

3GPP TS 04.08 / 3GPP TS 24.008, subclause 5.3.4.3.

26.8.1.4.3.2.3 Test purpose

To verify that the MS, when returning to the old channel after handover or Assignment failure and correctly establishing the link, will remain in the call active state.

26.8.1.4.3.2.4 Method of test

Specific PICS statements

-

PIXIT statements

-

Initial conditions

System Simulator:

1 cell, default parameters.

Mobile Station:

The MS is in CC-state "active".

Foreseen final state of the MS

CC-state "active".

Maximum duration of test

30 s.

Test procedure

The SS initiates a call to the Mobile Station, using an arbitrarily chosen circuit switched basic service (see clause 10 for generic call set up procedures).

The MS being in the call active state, the SS initiates non synchronized handover procedure to cell B. The MS begins to send access bursts on the new DCCH (and optionally the SACCH). The SS activates the SACCH, but does not send a PHYSICAL INFORMATION MESSAGE, thus causing timer T3124 to time-out. Then the MS shall return back to the old channel and re-establish the signalling link on cell A and send a HANDOVER FAILURE message. The state of the MS is then checked.

The SS sends an Assignment command message allocating a hopping TCH/F, but does not activate the assigned channel. The MS shall attempt try to activate the new channel (this is not verified) and shall then reactivate the "old" channel and trigger the establishment of the main signalling link on the old channel. The MS shall send an ASSIGNMENT FAILURE message. The state of the MS is then checked.

Expected sequence

Step	Direction	Message	Comments
0			Generic call set up procedure defined in subclauses 10.1 and 10.3, depending on choice of Bearer Capability.
1	SS -> MS	HANDOVER COMMAND	
2	MS -> SS	HANDOVER ACCESS	Several messages are sent, all with the handover reference sent in the HANDOVER COMMAND message.
3	MS -> SS	HANDOVER FAILURE	
4	SS -> MS	STATUS ENQUIRY	
5	MS -> SS	STATUS	cause 30#, state U10
6	SS -> MS	ASSIGNMENT COMMAND	Channel type = TCH/F, hopping. The MS attempts and fails to establish a signalling link on the new channel.
7			The MS re-establishes the signalling link on the "old" channel.
8	MS -> SS	ASSIGNMENT FAILURE	RR cause value = "protocol error unspecified"
9	SS -> MS	STATUS ENQUIRY	
10	MS -> SS	STATUS	cause 30#, state U10

Specific message contents:

ASSIGNMENT FAILURE

Information Element	value/remark
RR cause	"protocol error unspecified"

HANDOVER FAILURE

Information Element	value/remark
RR cause	Not checked, as tested elsewhere.

STATUS

Information Element	value/remark
cause	#30, statue U10.

26.8.1.4.4 In-call functions / MS terminated in-call modification

26.8.1.4.4.1 In-call functions / MS terminated in-call modification / modify when new mode is not supported

26.8.1.4.4.1.1 Definition

This is to test a special case of a in-call modification procedure, in which the new mode is not supported (and consequently not one of those negotiated and agreed during the establishment phase of the call). This test is applicable for any equipment supporting at least one circuit switched basic service.

26.8.1.4.4.1.2 Conformance requirement

- 1) In the case that the MS supports the network originated in-call modification procedure, the MS after having received a MODIFY message with a new mode which is not the actual one and cannot be supported by the MS shall reject it by sending a MODIFY REJECT message or a STATUS message.
- 2) In the case that the MS does not support the network originated in-call modification procedure, the MS shall, when receiving a MODIFY message, treat the message as unknown and respond with a STATUS message.

References

- 1) 3GPP TS 04.08 / 3GPP TS 24.008, subclauses 5.3.4.3.4.2 and 5.3.4.4.
- 2) 3GPP TS 04.08 / 3GPP TS 24.008, subclause 5.3.4.

26.8.1.4.4.1.3 Test purpose

- 1) To verify that an MS supporting the network originated in-call modification procedure, after having received a MODIFY message with a new mode which is not the actual one and cannot be supported by the MS, rejects it by sending a MODIFY REJECT.
- 2) To verify that an MS not supporting the network originated in-call modification procedure, after having received a MODIFY message, responds with a STATUS message.

26.8.1.4.4.1.4 Method of test

Specific PICS statements

- the MS supports the network originated in-call modification procedure (p = Yes/No)
(TSPC_AddInfo_InCallMod)

PIXIT statements

-

Initial conditions

System Simulator:

1 cell, default parameters.

Mobile Station:

The MS is in CC-state "active".

Foreseen final state of the MS

CC-state "active".

Maximum duration of test

10 s.

Test procedure

The MS being in the call active state, the SS initiates in-call modification procedure by sending a MODIFY message with new mode different from actual mode and one of those not supported by the MS. The MS either returns a MODIFY REJECT message with the old bearer capability or a STATUS message with reject cause #97, depending on the PICS statement. The state of the MS is then checked.

Expected sequence

Step	Direction	Message	Comments
1	SS -> MS	MODIFY	with new mode different from actual one
2a	MS -> SS	MODIFY REJECT	with the old call mode included OR, p = Yes
2b	MS -> SS	STATUS	cause #97, state U10, p = No
3	SS -> MS	STATUS ENQUIRY	
4	MS -> SS	STATUS	cause 30#, state U10

Specific message contents:

None.

26.8.1.4.5 In-call functions / MS originated in-call modification

26.8.1.4.5.1 In-call functions / MS originated in-call modification / a successful case of modifying

26.8.1.4.5.1.1 Definition

This test is to test a successful case of in-call modification, which is triggered by the calling tone identification (CNG) received by the MS. This test is applicable for any equipment supporting any dual mode bearer capability service (BS61 - Alternate Speech/Data, BS81 - Speech followed by Data, Teleservice 61 - Alternate Speech/Group 3 fax).

26.8.1.4.5.1.2 Conformance requirement

- 1) The procedure shall be initiated by the MS in the "active" state of the call. It shall send a MODIFY message including the new mode to be changed to; and enter the "mobile originating modify" state. The new mode given in the MODIFY message shall be one of those already negotiated and agreed during the establishment phase of the call. The MS shall stop sending Bm-channel information according to the old mode and enter the state U26 "Mobile Originating Modify".
- 2) Upon receipt of the MODIFY COMPLETE message the MS shall start sending channel information according to the new call mode and enter the "active" state.

References

Conformance requirement 1: 3GPP TS 04.08 / 3GPP TS 24.008, subclause 5.3.4.3.1.

Conformance requirement 2: 3GPP TS 04.08 / 3GPP TS 24.008, subclause 5.3.4.3.2.

26.8.1.4.5.1.3 Test purpose

- 1) To verify that the procedure is initiated by the MS in the "active" state of the call. It sends a MODIFY message including the new mode to be changed to; and enters the "mobile originating modify" state. The new mode given in the MODIFY message is one of those already negotiated and agreed during the establishment phase of the call. The MODIFY originating side stops sending Bm-channel information.
- 2) To verify that upon receipt of the MODIFY COMPLETE message the MS starts sending channel information according to the new call mode and enters the "active" state.

26.8.1.4.5.1.4 Method of test

Specific PICS statements

-

PIXIT statements

- a way to activate a dual mode call

- a way to activate in-call modificationInitial conditions

System Simulator:

1 cell, default parameters.

Mobile Station:

The MS is in MM-state "idle, updated" with valid TMSI and CKSN.

Foreseen final state of the MS

CC-state "active".

Maximum duration of test

10 s.

Test procedure

The MS initiates a call for one of the supported dual mode services. The MS being in the call active state, in-call modification procedure is initiated for the selected service from the MS side. The MS shall send a MODIFY message with the new mode to the SS and the state of the MS is checked. The channel mode is modified with the CHANNEL MODE MODIFY message including the appropriate channel mode for the new service. The SS then returns a MODIFY COMPLETE message. The state of the MS is then checked.

NOTE: ICM can be initiated by manual intervention at the MS.

Expected sequence

Step	Direction	Message	Comments
1	MS		The MS is made to initiate a dual mode call
2	MS -> SS	CHANNEL REQUEST	
3	SS -> MS	IMMEDIATE ASSIGNMENT	SDCCH
4	MS -> SS	CM SERVICE REQUEST	
5	SS -> MS	CIPHERING MODE COMMAND	
6	MS -> SS	CIPHERING MODE COMPLETE	
7	MS -> SS	SETUP	as specified in specific message contents
8	SS -> MS	AUTHENTICATION REQUEST	
9	MS -> SS	AUTHENTICATION RESPONSE	
10	SS -> MS	CALL PROCEEDING	as specified in specific message contents
11	SS -> MS	ASSIGNMENT COMMAND	channel mode: see subclause 10.4
12	MS -> SS	ASSIGNMENT COMPLETE	
13	SS -> MS	ALERTING	
14	SS -> MS	CONNECT	
15	MS -> SS	CONNECT ACKNOWLEDGE	
16	MS -> SS	MODIFY	as specified in specific message contents
17	SS -> MS	STATUS ENQUIRY	
18	MS -> SS	STATUS	cause 30#, state U26
19	SS -> MS	CHANNEL MODE MODIFY	as specified in specific message contents
20	MS -> SS	CHANNEL MODE MODIFY ACKNOWLEDGE	
21	SS -> MS	MODIFY COMPLETE	contains the new mode as bearer capability
22	SS		allow at least 2 s for the MS to adapt for the new mode
23	SS -> MS	STATUS ENQUIRY	
24	MS -> SS	STATUS	cause 30#, state U10
25	SS		verify that the MS starts sending Bm channel information according to the new mode

Specific message contents:

As specified in subclause 26.8.1.4.5.10.

26.8.1.4.5.2 In-call functions / MS originated in-call modification / modify rejected

26.8.1.4.5.2.1 Definition

This is to test a special case of a in-call modification procedure, in which the in-call modification is rejected. This test is applicable for any equipment supporting any dual mode bearer capability service (BS61 - Alternate Speech/Data, BS81 - Speech followed by Data, Teleservice 61 - Alternate Speech/Group 3 fax).

26.8.1.4.5.2.2 Conformance requirement

- 1) Upon receipt of the MODIFY REJECT message with the old bearer capability the MS shall: resume sending Bm-channel information according to the present call mode; resume interpreting received Bm-channel information according to the present call mode; and enter the "active" state.

References

3GPP TS 04.08 / 3GPP TS 24.008, subclause 5.3.4.3.4.1.

26.8.1.4.5.2.3 Test purpose

To verify that upon receipt of the MODIFY REJECT message with the old bearer capability the MS resumes sending Bm-channel information according to the present call mode; resumes interpreting received Bm-channel information according to the present call mode; and enters the "active" state.

26.8.1.4.5.2.4 Method of test

Specific PICS statements

-

PIXIT statements

- a way to activate a dual mode call
- a way to activate in-call modification

Initial conditions

System Simulator:

1 cell, default parameters.

Mobile Station:

The MS is in MM-state "idle, updated" with valid TMSI and CKSN.

Foreseen final state of the MS

CC-state "active".

Maximum duration of test

10 s.

Test procedure

The MS initiates a call for one of the supported dual mode services. The MS being in the call active state, in-call modification procedure is initiated for the selected service from the MS side. The MS shall send a MODIFY message with new mode to the SS. The SS returns a MODIFY REJECT message. The state of the MS is then checked.

Expected sequence

Step	Direction	Message	Comments
1	MS -> SS	CHANNEL REQUEST	MMI action to initiate a dual mode call
2	SS -> MS	IMMEDIATE ASSIGNMENT	SDCCH
3	MS -> SS	CM SERVICE REQUEST	
4	SS -> MS	CIPHERING MODE COMMAND	
5	MS -> SS	CIPHERING MODE COMPLETE	
6	MS -> SS	SETUP	as specified in specific message contents
7	SS -> MS	AUTHENTICATION REQUEST	
8	MS -> SS	AUTHENTICATION RESPONSE	
9	SS -> MS	CALL PROCEEDING	agreeing bearer capabilities for dual mode call
10	SS -> MS	ASSIGNMENT COMMAND	TCH
11	MS -> SS	ASSIGNMENT COMPLETE	
12	SS -> SS	ALERTING	
13	SS -> MS	CONNECT	
14	MS -> SS	CONNECT ACKNOWLEDGE	
15	MS -> SS	MODIFY	MMI action to change the mode
16	SS -> MS	MODIFY REJECT	with cause #58 bearer capability not available and with old bearer capabilities
17	SS -> MS	STATUS ENQUIRY	
18	MS -> SS	STATUS	cause 30#, state U10

Specific message contents:

As specified in subclause 26.8.1.4.5.10.

26.8.1.4.5.3 In-call functions / MS originated in-call modification / an abnormal case of acceptance

26.8.1.4.5.3.1 Definition

This is to test a special case of a in-call modification procedure, in which the in-call modification is accepted incorrectly. This test is applicable for any equipment supporting any dual mode bearer capability service (BS61 - Alternate Speech/Data, BS81 - Speech followed by Data, Teleservice 61 - Alternate Speech/Group 3 fax).

26.8.1.4.5.3.2 Conformance requirement

- 1) Upon receipt of the MODIFY COMPLETE message indicating a call mode which does not correspond to the requested one the MS shall discard it and take no action.

References

3GPP TS 04.08 / 3GPP TS 24.008, subclause 5.3.4.4.

26.8.1.4.5.3.3 Test purpose

To verify that upon receipt of the MODIFY COMPLETE message indicating a call mode which does not correspond to the requested one the MS discards it and takes no action.

26.8.1.4.5.3.4 Method of test

Specific PICS statements

-

PIXIT statements

- a way to activate a dual mode call
- a way to activate in-call modification

Initial conditions

System Simulator:

1 cell, default parameters.

Mobile Station:

The MS is in MM-state "idle, updated" with valid TMSI and CKSN.

Foreseen final state of the MS

CC-state U26 "Mobile Originating Modify".

Maximum duration of test

10 s.

Test procedure

The MS initiates a call for one of the supported dual mode services. The MS being in the call active state, in-call modification procedure is initiated for the selected service from the MS side. The MS shall send a MODIFY message with new mode to the SS. The SS returns a MODIFY COMPLETE message specifying a mode that does not correspond to the requested one. It will be verified then that the MS shall not take any action and the state of the MS will be checked.

Expected sequence

Step	Direction	Message	Comments
1	MS -> SS	CHANNEL REQUEST	MMI action to initiate a dual mode call
2	SS -> MS	IMMEDIATE ASSIGNMENT	SDCCH
3	MS -> SS	CM SERVICE REQUEST	
4	SS -> MS	CIPHERING MODE COMMAND	
5	MS -> SS	CIPHERING MODE COMPLETE	
6	MS -> SS	SETUP	as specified in specific message contents
7	SS -> MS	AUTHENTICATION REQUEST	
8	MS -> SS	AUTHENTICATION RESPONSE	
9	SS -> MS	CALL PROCEEDING	agreeing bearer capabilities for dual mode call
10	SS -> MS	ASSIGNMENT COMMAND	TCH
11	MS -> SS	ASSIGNMENT COMPLETE	
12	SS -> SS	ALERTING	
13	SS -> MS	CONNECT	
14	MS -> SS	CONNECT ACKNOWLEDGE	
15	MS -> SS	MODIFY	MMI action to change the mode
16	SS -> MS	MODIFY COMPLETE	with a mode that does not correspond to the requested one
17	SS -> MS	STATUS ENQUIRY	
18	MS -> SS	STATUS	cause 30#, state U26

Specific message contents:

As specified in subclause 26.8.1.4.5.10.

26.8.1.4.5.4 In-call functions / MS originated in-call modification / an abnormal case of rejection

26.8.1.4.5.4.1 Definition

This is to test a special case of a in-call modification procedure, in which the in-call modification is rejected incorrectly. This test is applicable for any equipment supporting any dual mode bearer capability service (BS61 - Alternate Speech/Data, BS81 - Speech followed by Data, Teleservice 61 - Alternate Speech/Group 3 fax).

26.8.1.4.5.4.2 Conformance requirement

- 1) Upon receipt of the MODIFY REJECT message indicating a call mode which does not correspond to the actual one the MS shall discard it and take no action.

References

3GPP TS 04.08 / 3GPP TS 24.008, subclause 5.3.4.4.

26.8.1.4.5.4.3 Test purpose

To verify that upon receipt of the MODIFY REJECT message indicating a call mode which does not correspond to the actual one the MS discards it and takes no action.

26.8.1.4.5.4.4 Method of test

Specific PICS statements

-

PIXIT statements

- a way to activate a dual mode call
- a way to activate in-call modification

Initial conditions

System Simulator:

1 cell, default parameters.

Mobile Station:

The MS is in MM-state "idle, updated" with valid TMSI and CKSN.

Foreseen final state of the MS

CC-state U26 "Mobile Originating Modify".

Maximum duration of test

10 s.

Test procedure

The MS initiates a call for one of the supported dual mode services. The MS being in the call active state, in-call modification procedure is initiated for the selected service from the MS side. The MS shall send a MODIFY message with new mode to the SS. The SS returns a MODIFY REJECT message specifying a mode that does not correspond to the actual one. The state of the MS is then checked.

Expected sequence

Step	Direction	Message	Comments
1	MS -> SS	CHANNEL REQUEST	MMI action to initiate a dual mode call
2	SS -> MS	IMMEDIATE ASSIGNMENT	SDCCH
3	MS -> SS	CM SERVICE REQUEST	
4	SS -> MS	CIPHERING MODE COMMAND	
5	MS -> SS	CIPHERING MODE COMPLETE	
6	MS -> SS	SETUP	as specified in specific message contents
7	SS -> MS	AUTHENTICATION REQUEST	
8	MS -> SS	AUTHENTICATION RESPONSE	
9	SS -> MS	CALL PROCEEDING	agreeing bearer capabilities for dual mode call
10	SS -> MS	ASSIGNMENT COMMAND	TCH
11	MS -> SS	ASSIGNMENT COMPLETE	
12	SS -> SS	ALERTING	
13	SS -> MS	CONNECT	
14	MS -> SS	CONNECT ACKNOWLEDGE	
15	MS -> SS	MODIFY	MMI action to change the mode
16	SS -> MS	MODIFY REJECT	with a mode that does not correspond to the actual one
17	SS -> MS	STATUS ENQUIRY	
18	MS -> SS	STATUS	cause 30#, state U26

Specific message contents:

As specified in subclause 26.8.1.4.5.10.

26.8.1.4.5.5 In-call functions / MS originated in-call modification / time-out of timer T323

26.8.1.4.5.5.1 Definition

This is to test a special case of a in-call modification procedure, in which timer T323 expires in state U26, mobile originating modify. This test is applicable for any equipment supporting any dual mode bearer capability service (BS61 - Alternate Speech/Data, BS81 - Speech followed by Data, Teleservice 61 - Alternate Speech/Group 3 fax).

26.8.1.4.5.5.2 Conformance requirement

- 1) Upon expiration of T323 the MS shall initiate the procedures for call clearing with cause #102 "recovery on timer expiry".

References

3GPP TS 04.08 / 3GPP TS 24.008, subclause 5.3.4.3.4.3.

26.8.1.4.5.5.3 Test purpose

To verify that upon expiration of T323 (accuracy $\pm 10\%$) the MS shall initiate the procedures for call clearing with cause #102 "recovery on timer expiry".

26.8.1.4.5.5.4 Method of test

Specific PICS statements

-

PIXIT statements

- a way to activate a dual mode call
- a way to activate in-call modification

Initial conditions

System Simulator:

1 cell, default parameters.

Mobile Station:

The MS is in MM-state "idle, updated" with valid TMSI and CKSN.

Foreseen final state of the MS

CC-state U11 "disconnect request".

Maximum duration of test

1 minute.

Test procedure

The MS initiates a call for one of the supported dual mode services. The MS being in the call active state, in-call modification procedure is initiated for the selected service from the MS side. The MS shall send a MODIFY message with new mode to the SS. The SS does not respond until timer T323 expires at the MS. The MS is expected to respond with a DISCONNECT message. The SS checks timer T323 accuracy between emission of MODIFY and reception of DISCONNECT messages, the state of the MS and a cause value from the DISCONNECT message.

Expected sequence

Step	Direction	Message	Comments
1	MS -> SS	CHANNEL REQUEST	MMI action to initiate a dual mode call SDCCH
2	SS -> MS	IMMEDIATE ASSIGNMENT	
3	MS -> SS	CM SERVICE REQUEST	as specified in specific message contents
4	SS -> MS	CIPHERING MODE COMMAND	
5	MS -> SS	CIPHERING MODE COMPLETE	
6	MS -> SS	SETUP	agreeing bearer capabilities for dual mode call
7	SS -> MS	AUTHENTICATION REQUEST	
8	MS -> SS	AUTHENTICATION RESPONSE	TCH
9	SS -> MS	CALL PROCEEDING	
10	SS -> MS	ASSIGNMENT COMMAND	MMI action to change the mode
11	MS -> SS	ASSIGNMENT COMPLETE	
12	SS -> MS	ALERTING	the SS waits for the timer T323 expiry
13	SS -> MS	CONNECT	
14	MS -> SS	CONNECT ACKNOWLEDGE	cause value #102, the SS checks timer T323 accuracy ($\pm 10\%$) between MODIFY and DISCONNECT messages
15	MS -> SS	MODIFY	
16	SS		cause 30#, state U11
17	MS -> SS	DISCONNECT	
18	SS -> MS	STATUS ENQUIRY	
19	MS -> SS	STATUS	

Specific message contents:

As specified in subclause 26.8.1.4.5.10.

26.8.1.4.5.6 In-call functions / MS originated in-call modification / a successful channel change in state mobile originating modify

26.8.1.4.5.6.1 Definition

This is to test a special case of a in-call modification procedure, in which a change of a physical channel occurs in state U26, mobile originating modify. This test is applicable for any equipment supporting any dual mode bearer capability service (BS61 - Alternate Speech/Data, BS81 - Speech followed by Data, Teleservice 61 - Alternate Speech/Group 3 fax).

26.8.1.4.5.6.2 Conformance requirement

- 1) A CC-entity of the MS in CC-state U26, "Mobile Originating Modify", after successful completion of a channel assignment procedure or channel mode modify procedure shall remain in the call state U26.
- 2) Upon receipt of the MODIFY COMPLETE message the MS shall start sending channel information according to the new call mode and enter the "active" state.

References

- 1) 3GPP TS 04.08 / 3GPP TS 24.008, subclause 5.3.4.3.2, 3GPP TS 04.08 / 3GPP TS 44.018, subclause 3.4.6.1.
- 2) 3GPP TS 04.08, subclause 5.3.4.3.2.

26.8.1.4.5.6.3 Test purpose

- 1) To verify that a CC-entity of the MS in CC-state U26, "Mobile Originating Modify", after successful completion of a channel assignment procedure remains in the call state U26.
- 2) To verify that upon receipt of the MODIFY COMPLETE message the MS starts sending channel information according to the new call mode and enters the "active" state.

26.8.1.4.5.6.4 Method of test

Specific PICS statements

-

PIXIT statements

- a way to activate a dual mode call
- a way to activate in-call modification

Initial conditions

System Simulator:

1 cell, default parameters.

Mobile Station:

The MS is in MM-state "idle, updated" with valid TMSI and CKSN.

Foreseen final state of the MS

CC-state U10, active.

Maximum duration of test

10 s.

Test procedure

The MS initiates a call for one of the supported dual mode services. The MS being in the call active state, in-call modification procedure is initiated for the selected service from the MS side. The MS shall send a MODIFY message with a new mode to the SS. The SS does not respond immediately, but performs channel assignment procedure including the appropriate channel mode for the new service. The state of the MS is then checked. The SS then returns a MODIFY COMPLETE message. The state of the MS is checked finally.

Expected sequence

Step	Direction	Message	Comments
1	MS -> SS	CHANNEL REQUEST	MMI action to initiate a dual mode call
2	SS -> MS	IMMEDIATE ASSIGNMENT	SDCCH
3	MS -> SS	CM SERVICE REQUEST	
4	SS -> MS	CIPHERING MODE COMMAND	
5	MS -> SS	CIPHERING MODE COMPLETE	
6	MS -> SS	SETUP	as specified in specific message contents
7	SS -> MS	AUTHENTICATION REQUEST	
8	MS -> SS	AUTHENTICATION RESPONSE	
9	SS -> MS	CALL PROCEEDING	agreeing bearer capabilities for dual mode call
10	SS -> MS	ASSIGNMENT COMMAND	TCH
11	MS -> SS	ASSIGNMENT COMPLETE	
12	SS -> MS	ALERTING	
13	SS -> MS	CONNECT	
14	MS -> SS	CONNECT ACKNOWLEDGE	
15	MS -> SS	MODIFY	MMI action to change the mode
16	SS -> MS	ASSIGNMENT COMMAND	channel mode implied by the MODIFY message
17	MS -> SS	ASSIGNMENT COMPLETE	
18	SS -> MS	STATUS ENQUIRY	
19	MS -> SS	STATUS	cause 30#, state U26
20	SS -> MS	MODIFY COMPLETE	
21	SS -> MS	STATUS ENQUIRY	
22	MS -> SS	STATUS	cause 30#, state U10

Specific message contents:

As specified in subclause 26.8.1.4.5.10.

26.8.1.4.5.7 In-call functions / MS originated in-call modification / an unsuccessful channel change in state mobile originating modify

26.8.1.4.5.7.1 Definition

This is to test a special case of a in-call modification procedure, in which an unsuccessful change of a physical channel occurs in state U26, mobile originating modify. This test is applicable for any equipment supporting any dual mode bearer capability service (BS61 - Alternate Speech/Data, BS81 - Speech followed by Data, Teleservice 61 - Alternate Speech/Group 3 fax).

26.8.1.4.5.7.2 Conformance requirement

- 1) A CC-entity of the MS in CC-state U26, "Mobile Originating Modify", when returning to the old channel after handover failure and having established the link, shall remain in the call state U26.

References

3GPP TS 04.08 / 3GPP TS 24.008, subclause 5.3.4.3.2.

26.8.1.4.5.7.3 Test purpose

To verify that a CC-entity of the MS in CC-state U26, "Mobile Originating Modify", when returning to the old channel after handover failure and having established the link, remains in the call state U26.

26.8.1.4.5.7.4 Method of test

Specific PICS statements

-

PIXIT statements

- a way to activate a dual mode call
- a way to activate in-call modification

Initial conditions

System Simulator:

1 cell, default parameters.

Mobile Station:

The MS is in MM-state "idle, updated" with valid TMSI and CKSN.

Foreseen final state of the MS

CC-state U26, mobile originating modify.

Maximum duration of test

10 s.

Test procedure

The MS initiates a call for one of the supported dual mode services. The MS being in the call active state, in-call modification procedure is initiated for the selected service from the MS side. The MS shall send a MODIFY message with a new mode to the SS. The SS initiates handover procedure. When the MS tries to establish the main signalling link, it is prohibited by the SS. Then the MS shall return back to the old channel and re-establish correctly the link. The state of the MS is then checked.

Expected sequence

Step	Direction	Message	Comments
1	MS -> SS	CHANNEL REQUEST	MMI action to initiate a dual mode call
2	SS -> MS	IMMEDIATE ASSIGNMENT	SDCCH
3	MS -> SS	CM SERVICE REQUEST	
4	SS -> MS	CIPHERING MODE COMMAND	
5	MS -> SS	CIPHERING MODE COMPLETE	
6	MS -> SS	SETUP	as specified in specific message contents
7	SS -> MS	AUTHENTICATION REQUEST	
8	MS -> SS	AUTHENTICATION RESPONSE	
9	SS -> MS	CALL PROCEEDING	agreeing bearer capabilities for dual mode call
10	SS -> MS	ASSIGNMENT COMMAND	TCH
11	MS -> SS	ASSIGNMENT COMPLETE	
12	SS -> SS	ALERTING	
13	SS -> MS	CONNECT	
14	MS -> SS	CONNECT ACKNOWLEDGE	
15	MS -> SS	MODIFY	MMI action to change the mode
16	SS -> MS	HANDOVER COMMAND	
17	MS -> SS	HANDOVER ACCESS	the SS does not respond
18	MS -> SS	HANDOVER FAILURE	after the MS has re-established the main signalling link in the old channel
19	SS -> MS	STATUS ENQUIRY	
20	MS -> SS	STATUS	cause 30#, state U26

Specific message contents:

As specified in subclause 26.8.1.4.5.10.

26.8.1.4.5.8 In-call functions / MS originated in-call modification / unknown message received

26.8.1.4.5.8.1 Definition

This is to test a special case of a in-call modification procedure, in which an unknown message is received in state U26, mobile originating modify. This test is applicable for any equipment supporting any dual mode bearer capability service (BS61 - Alternate Speech/Data, BS81 - Speech followed by Data, Teleservice 61 - Alternate Speech/Group 3 fax).

26.8.1.4.5.8.2 Conformance requirement

A CC entity of a MS in CC-state U26, "Mobile Originating Modify", having received an unknown message from its peer entity shall return a STATUS message.

References

3GPP TS 04.08 / 3GPP TS 24.008, subclause 8.4.

26.8.1.4.5.8.3 Test purpose

To verify that a CC entity of a MS in CC-state U26, "Mobile Originating Modify", having received an unknown message from its peer entity returns a STATUS message.

26.8.1.4.5.8.4 Method of test

Specific PICS statements

-

PIXIT statements

- a way to activate a dual mode call
- a way to activate in-call modification

Initial conditions

System Simulator:

1 cell, default parameters.

Mobile Station:

The MS is in MM-state "idle, updated" with valid TMSI and CKSN.

Foreseen final state of the MS

CC-state U26, mobile originating modify.

Maximum duration of test

10 s.

Test procedure

The MS initiates a call for one of the supported dual mode services. The MS being in the call active state, in-call modification procedure is initiated for the selected service from the MS side. The MS shall send a MODIFY message with a new mode to the SS. The SS sends a message with message type not defined for the protocol discriminator. The state of the MS is then checked.

Expected sequence

Step	Direction	Message	Comments
1	MS -> SS	CHANNEL REQUEST	MMI action to initiate a dual mode call
2	SS -> MS	IMMEDIATE ASSIGNMENT	SDCCH
3	MS -> SS	CM SERVICE REQUEST	
4	SS -> MS	CIPHERING MODE COMMAND	
5	MS -> SS	CIPHERING MODE COMPLETE	
6	MS -> SS	SETUP	as specified in specific message contents
7	SS -> MS	AUTHENTICATION REQUEST	
8	MS -> SS	AUTHENTICATION RESPONSE	
9	SS -> MS	CALL PROCEEDING	agreeing bearer capabilities for dual mode call
10	SS -> MS	ASSIGNMENT COMMAND	TCH
11	MS -> SS	ASSIGNMENT COMPLETE	
12	SS -> SS	ALERTING	
13	SS -> MS	CONNECT	
14	MS -> SS	CONNECT ACKNOWLEDGE	
15	MS -> SS	MODIFY	MMI action to change the mode
16	SS -> MS	unknown message	message type not defined for PD
17	MS -> SS	STATUS	cause 97#, state U26

Specific message contents:

As specified in subclause 26.8.1.4.5.10.

26.8.1.4.5.9 In-call functions / MS originated in-call modification / a release complete received

26.8.1.4.5.9.1 Definition

The call control entity of the MS being in the state, U26, the call is cleared by a RELEASE COMPLETE message sent by the SS. This test is applicable for any equipment supporting any dual mode bearer capability service (BS61 - Alternate Speech / Data, BS81 - Speech followed by Data, Teleservice 61 - Alternate Speech / Group 3 fax).

26.8.1.4.5.9.2 Conformance requirement

- 1) A CC entity of the MS in CC-state U26, "mobile originating modify", upon receipt of a RELEASE COMPLETE message with valid cause value, shall enter CC state U0, "Null".
- 2) On returning to idle mode, the CC entities relating to the seven mobile originating transaction identifiers shall be in state U0, "Null".

Reference(s)

Conformance requirement 1: 3GPP TS 04.08 / 3GPP TS 24.008 subclauses 5.4.2 and 5.4.4.

Conformance requirement 2: 3GPP TS 04.08 / 3GPP TS 24.008 subclause 5.4.4.3.

26.8.1.4.5.9.3 Test purpose

- 1) To verify that a CC entity of the MS in CC-state U26, "mobile originating modify", upon receipt of a RELEASE COMPLETE message with valid cause value, enters CC state U0, "Null".
- 2) To verify that on returning to idle mode, the CC entities relating to the seven mobile originating transaction identifiers are in state U0, "Null".

26.8.1.4.5.9.4 Method of test

Specific PICS statements

-

PIXIT statements

- a way to activate a dual mode call
- a way to activate in-call modification

Initial conditions

System Simulator:

1 cell, default parameters.

Mobile Station:

The MS is in MM-state "idle, updated" with valid TMSI and CKSN.

Foreseen final state of the MS

The MS is in MM-state "idle, updated" with valid TMSI and CKSN.

Maximum duration of test

30 s.

Test Procedure

The MS initiates a call for one of the supported dual mode services. The MS being in the call active state, in-call modification procedure is initiated for the selected service from the MS side. The MS shall send a MODIFY message with the new mode to the SS and the state of the MS is checked. The SS sends a RELEASE COMPLETE message to the MS. The SS checks by using the status enquiry procedure that the CC entity has entered the state U0 with all the relevant transaction identifiers.

NOTE: ICM can be initiated by manual intervention at the MS.

Expected sequence

Step	Direction	Message	Comments
1	MS		The MS is made to initiate a dual mode call
2	MS -> SS	CHANNEL REQUEST	
3	SS -> MS	IMMEDIATE ASSIGNMENT	SDCCH
4	MS -> SS	CM SERVICE REQUEST	
5	SS -> MS	CIPHERING MODE COMMAND	
6	MS -> SS	CIPHERING MODE COMPLETE	
7	MS -> SS	SETUP	as specified in specific message contents
8	SS -> MS	AUTHENTICATION REQUEST	
9	MS -> SS	AUTHENTICATION RESPONSE	
10	SS -> MS	CALL PROCEEDING	as specified in specific message contents
11	SS -> MS	ASSIGNMENT COMMAND	channel mode: see subclause 10.4
12	MS -> SS	ASSIGNMENT COMPLETE	
13	SS -> MS	ALERTING	
14	SS -> MS	CONNECT	
15	MS -> SS	CONNECT ACKNOWLEDGE	
16	MS -> SS	MODIFY	as specified in specific message contents
17	SS -> MS	STATUS ENQUIRY	
18	MS -> SS	STATUS	cause #30, state U26
19	SS -> MS	RELEASE COMPLETE	
20	SS -> MS	STATUS ENQUIRY	
21	MS -> SS	RELEASE COMPLETE	cause #81 (invalid TI value)
22	SS		repeat steps 20 - 21 to cover all the transaction identifiers from 000 ... 110
23	SS -> MS	CHANNEL RELEASE	the main signalling link shall be released by the MS (L2: DISC/UA)

Specific message contents:

As specified in subclause 26.8.1.4.5.10.

26.8.1.4.5.10 In-call functions/MS originated in-call modification/contents of some of the messages

The following messages are used for testing in-call modification procedures, test cases 26.8.1.4.5.*, as default messages for those ones defined below. If any other values are defined in the expected sequence of the actual test cases, those values take precedence over the ones defined hereafter.

SETUP (MS to SS)

Information element	Value/remark
BC Repeat indicator	Sequential, if BS81 is being tested, otherwise circular for successive selection
Repeat indication	
Bearer capability 1	Appropriate for the teleservice/Bearer Service selected as an initial call mode
Bearer capability 2	Appropriate for the teleservice/Bearer Service to be selected as a new call mode
Facility	Omitted
Calling party subaddress	Omitted
Called party BCD number	As entered
Called party subaddress	Omitted
LLC repeat indicator	The same repeat indication as the one for BC. Present if and only if LLC I and LLC II are present
Low layer compatibility I	See note
Low layer compatibility II	See note
HLC repeat indicator	The same repeat indication as the one for BC. Present if and only if HLC i and HLC ii are present.
High layer compatibility i	See note
High layer compatibility ii	See note
User-user	Omitted
SS version	Omitted
CLIR suppression	Omitted
CC Capabilities	present, but contents not checked
NOTE: HLC/LLC may or may not be present. The contents of HLC/LLC are not verified. If LLC I is present then LLC II shall be present. If HLC i is present then HLC ii shall be present.	

CALL PROCEEDING

If the MS offers a choice in a SETUP message with respect to its bearer capabilities (this choice is restricted to the connection element), the bearer capabilities 1 and 2 and BC repeat indicator must all be present in this message. Otherwise, all three IEs are omitted.

Information element	Value/remark
Repeat Indicator	See above
Repeat indication	As received in the SETUP message
Bearer Capability 1	Same as in subclause 10.4
Bearer Capability 2	Same as in subclause 10.4
Facility	Omitted
Progress indicator	Omitted

MODIFY

Information element	Value/remark
Bearer capability	If the bearer capability IEs were present in the CALL PROCEEDING message, then as it was specified in the bearer capability 2 of the CALL PROCEEDING message. Otherwise as in the bearer capability 2 of the SETUP message.
Reverse Call Setup Direction	Presence and value not checked
Low layer compatibility	See note
High layer compatibility	See note
NOTE: HLC (LLC) shall be included if the HLC (LLC) was included in the SETUP message. The contents of LLC/HLC are not verified.	

MODIFY COMPLETE

Information element	Value/remark
Bearer capability	If the bearer capability IEs were present in the CALL PROCEEDING message, then as it was specified in the bearer capability 2 of the CALL PROCEEDING message. Otherwise as in the bearer capability 2 of the SETUP message.
Reverse Call Setup Direction	Same as in MODIFY
Low layer compatibility	See note
High layer compatibility	See note
NOTE: HLC (LLC) shall be included if the HLC (LLC) was included in the SETUP message. The contents of LLC/HLC are not verified.	

MODIFY REJECT

Information element	Value/remark
Bearer capability	If the bearer capability IEs were present in the CALL PROCEEDING message, then as it was specified in the bearer capability 1 of the CALL PROCEEDING message. Otherwise as in the bearer capability 1 of the SETUP message.
Cause	#58 "bearer capability not presently available".
Low layer compatibility	See note
High layer compatibility	See note
NOTE: HLC (LLC) shall be included if the HLC (LLC) was included in the SETUP message. The contents of LLC/HLC are not verified.	

CHANNEL MODE MODIFY

Information element	Value/remark
Channel description	describes non-hopping Bm+ACCHs or Lm+ACCHs as appropriate for the test
Channel Mode	appropriate for the BC in the MODIFY

CHANNEL MODE MODIFY ACKNOWLEDGE

Information element	Value/remark
Channel description	as sent by the SS in the corresponding CHANNEL MODE MODIFY message
Channel mode	as sent by the SS in the corresponding CHANNEL MODE MODIFY message

26.8.2 Call Re-establishment

26.8.2.1 Call Re-establishment/call present, re-establishment allowed

26.8.2.1.1 Definition

This is to test a successful case of a call re-establishment procedure. This test is applicable for any equipment supporting at least one bearer capability. If the MS does not perform call re-establishment procedure correctly, the network will waste resources.

26.8.2.1.2 Conformance requirement

- 1) If the call is in the "active" state or "mobile originating modify" state, the indication from MM that re-establishment is possible shall cause call control to request re-establishment from the MM-connection, suspend any further message to be sent and await the completion of the re-establishment procedure.
- 2) When the call control entity is notified that the MM-connection is re-established, it shall then resume the transmission of possibly suspended messages and resume user data exchange when an appropriate channel is available.

References

- 1) 3GPP TS 04.08 / 3GPP TS 24.008, subclauses 4.5.1.6 and 5.5.4.2.
- 2) 3GPP TS 04.08 / 3GPP TS 24.008, subclauses 4.5.1.6 and 5.5.4.3.

26.8.2.1.3 Test purpose

The purpose of this test is to verify that the MS can correctly perform a call re-establishment procedure.

26.8.2.1.4 Method of test

Specific PICS statements

-

PIXIT statements

-

Initial conditions

System Simulator:

The SS simulates cells A and B. The LAC of cell A is different from the LAC of cell B. The PLMN identities of cell A and B are equal.

The call re-establishment parameter concerning cell A is set to an arbitrary value.

Cell B is not barred, the RACH control parameters information element sent in SYSTEM INFORMATION TYPE 1 to 4 messages of cell A and B specifies "call reestablishment allowed in the cell", the NCC of cell B is indicated as permitted in the PLMN permitted information element of SYSTEM INFORMATION TYPE 2 and 6 messages of cell A. Cell B is indicated as a neighbour cell of cell A in SYSTEM INFORMATION TYPE 2 and 5 messages of cell A. Cell reselect hysteresis parameter of cell A is set to zero.

Mobile Station:

The MS is in MM-state "idle, updated" with valid TMSI and CKSN on cell A.

Foreseen final state of the MS

The MS is in MM-state "idle, updated" with valid TMSI and CKSN.

Maximum duration of test

1 minute.

Test procedure

The MS is brought to active state by using procedure 26.9.2, "structured procedures, MS originated call, early assignment". The RF level of cell A is lowered so that cell B is to be selected (when the MS performs re-establishment after radio link failure), while keeping the C1 and C2 of cell A greater than zero. SS waits for at least 5 s. Then the SS stops transmission on the TCH/SACCH. The MS shall re-establish the call on cell B using a CM RE-ESTABLISHMENT message. The SS performs ciphering mode setting and assignment procedures. The MS shall through-connect the appropriate bearer channel. Then, the call is cleared by the SS.

Expected sequence

Step	Direction	Message	Comments
1			Steps 1-19 of test case 26.9.2 are performed (the appropriate bearer channel is through connected in both directions in TCH)
2	SS		The RF level of cell A is lowered. The SS waits at least 5 s. The SS stops transmission on the TCH/SACCH.
3	MS -> SS	CHANNEL REQUEST	this is sent on cell B. Establ. cause shall be "call re-establishment; TCH/F was in use,..."
4	SS -> MS	IMMEDIATE ASSIGNMENT	
5	MS -> SS	CM REESTABLISHMENT REQUEST	note specific message contents
6	SS -> MS	CIPHERING MODE COMMAND	SS starts deciphering after sending the message.
7	MS -> SS	CIPHERING MODE COMPLETE	Shall be sent enciphered. All following messages shall be sent enciphered.
8	SS		SS starts ciphering.
9	SS -> MS	ASSIGNMENT COMMAND	
10	MS -> SS	ASSIGNMENT COMPLETE	
11	MS		The appropriate bearer channel is through connected in both directions.
12	SS -> MS	DISCONNECT	with cause value "Normal"
13	MS -> SS	RELEASE	
14	SS -> MS	RELEASE COMPLETE	
15	SS -> MS	CHANNEL RELEASE	The main signalling link is released.

Specific message contents:

CM RE-ESTABLISHMENT REQUEST

Information element	Value/remark
Protocol discriminator	Mobility Management
Skip indicator	Encoded as zeroes
Message type	CM RE-ESTABLISHMENT REQUEST
Ciphering key sequence number	The CKSN which the MS was allocated in step 6 of the procedure of subclause 26.9.2.
Spare half octet	zero
Mobile station classmark 2	
- ES_IND	as declared in the PICS/PIXIT
- RF Power capability	as declared in the PICS/PIXIT for band of operation
- Ciphering A5/1	as declared in the PICS/PIXIT
Mobile identity	The TMSI that the MS is having initially
Location area identification	Corresponding the LAI of cell A

26.8.2.2 Call Re-establishment/call present, re-establishment not allowed

26.8.2.2.1 Definition

This is to test a special case of a call re-establishment, in which it is not allowed for a MS to attempt re-establishment of a call. This test is applicable for any equipment supporting at least one mobile originated circuit switched basic service.

26.8.2.2.2 Conformance requirement

When a lower layer failure occurs while an MM-connection is active, if a cell allowing call re-establishment is not available, the MS shall release the MM-connection and shall not attempt call re-establishment.

References

3GPP TS 04.08 / 3GPP TS 24.008, subclauses 4.5.1.6 and 5.5.4.

26.8.2.2.3 Test purpose

The purpose of this test is to verify that the MS does not attempt call re-establishment when it is not allowed to take place because of the unavailability of a cell allowing call re-establishment.

26.8.2.2.4 Method of test

Specific PICS statements

-

PIXIT statements

-

Initial conditions

System Simulator:

The SS simulates cell A.

Cell A is not barred, the NCC of cell A is indicated as permitted in the PLMN permitted information element of SYSTEM INFORMATION TYPE 2 and 6 messages. The RE field of the RACH control parameters information element broadcast in messages SYSTEM INFORMATION TYPE 1, 2, 3 and 4 of cell A are set to "call reestablishment not allowed in the cell".

Mobile Station:

The MS is in MM-state "idle, updated" with valid TMSI and CKSN.

Foreseen final state of the MS

The MS is in MM-state "idle, updated" with valid TMSI and CKSN.

Maximum duration of test

1 minute.

Test procedure

The MS is brought to active state by using procedure 26.9.2, "structured procedures, MS originated call, early assignment". The SS stops transmission on the TCH/SACCH. The MS shall not require re-establishment of the call.

Expected sequence

Step	Direction	Message	Comments
1			Steps 1-19 of test case 26.9.2 are performed (the appropriate bearer channel is through connected in both directions in TCH)
2	SS		the SS stops transmission on the TCH/SACCH
3	MS		the MS shall not attempt re-establishment on cell A. This is checked for 30 s after the radio link failure.

Specific message contents:

None.

26.8.2.3 Call Re-establishment/call under establishment, transmission stopped

26.8.2.3.1 Definition

This is to test a special case of a call re-establishment, in which it is not allowed for a MS to attempt re-establishment of a call, since the call has not been established yet. This test is applicable for any equipment supporting at least one mobile originated circuit switched basic service.

26.8.2.3.2 Conformance requirement

When a lower layer failure occurs while an MM-connection is active, if the state of the call control entity is not "active", the MS shall release the MM-connection and shall not attempt call re-establishment.

References

3GPP TS 04.08 / 3GPP TS 24.008, subclauses 4.5.1.6 and 5.5.4.2.

26.8.2.3.3 Test purpose

The purpose of this test is to verify that the MS does not attempt call re-establishment when it is not allowed to take place because of the call control state.

26.8.2.3.4 Method of test

Specific PICS statements

-

PIXIT statements

-

Initial conditions

System Simulator:

The SS simulates cell A.

Cell A is not barred, the RACH control parameters information element sent in SYSTEM INFORMATION TYPE 1 to 4 messages of cell A specifies "call reestablishment allowed in the cell", the NCC of cell A is indicated as permitted in the PLMN permitted information element of SYSTEM INFORMATION TYPE 2 and 6 messages.

Mobile Station:

The MS is in MM-state "idle, updated" with valid TMSI and CKSN.

Foreseen final state of the MS

The MS is in MM-state "idle, updated" with valid TMSI and CKSN.

Maximum duration of test

1 minute.

Test procedure

The call control entity of the MS is brought to state U4, "call delivered" by using initial part of procedure 26.9.2, "structured procedures, MS originated call, early assignment". The SS stops transmission on the TCH/SACCH. The MS shall not require re-establishment of the call on cell A.

Expected sequence

Step	Direction	Message	Comments
1			the MS is made to initiate a call
2	MS -> SS	CHANNEL REQUEST	
3	SS -> MS	IMMEDIATE ASSIGNMENT	
4	MS -> SS	CM SERVICE REQUEST	
5	SS -> MS	AUTHENTICATION REQUEST	
6	MS -> SS	AUTHENTICATION RESPONSE	
7	SS -> MS	CIPHERING MODE COMMAND	SS starts deciphering after sending the message.
8	MS -> SS	CIPHERING MODE COMPLETE	All following messages shall be sent enciphered.
9	SS		SS starts ciphering.
10	MS -> SS	SETUP	
11	SS -> MS	CALL PROCEEDING	
12	SS -> MS	ASSIGNMENT COMMAND	
13	MS -> SS	ASSIGNMENT COMPLETE	
14	SS -> MS	ALERTING	
15	SS		the SS stops transmission on the TCH/SACCH
16	MS		the MS shall not attempt re-establishment on cell A. This is checked for 30 s after the radio link failure.

Specific message contents:

None.

26.8.3 User to user signalling

26.8.3.1 Definition

The "user to user" information element is used to convey information between the mobile user and a remote ISDN user. This test is therefore applicable for any equipment supporting at least one mobile terminating circuit switched basic service.

NOTE: There is no test for an MS originating call including a "user-user" information element since it is not a mandatory MS feature.

26.8.3.2 Conformance requirement

The inclusion of the "user-user" information element in downlink call control messages shall cause no adverse effects on the operation of the MS.

References

3GPP TS 04.08 / 3GPP TS 24.008 subclauses 5.2.2, 9.3.7, 9.3.23.1 and 10.5.4.25.

26.8.3.3 Purpose of the test

The purpose of this test is to verify that inclusion of the "user-user" information element in either of the down link messages, SETUP or DISCONNECT causes no adverse effects on the operation of the MS.

26.8.3.4 Method of test

Specific PICS statements

-

PIXIT statements

-

Initial conditions.

System Simulator:

The SS simulates 1 cell, with default parameters.

Mobile Station:

The MS is in MM-state "idle updated", with a valid TMSI and CKSN.

Foreseen final state of the MS

The MS is in MM-state "idle updated", with a valid TMSI and CKSN.

Maximum duration of test

2 minutes.

Test procedure

The SS attempts to set up a mobile terminated call, with one of the supported circuit switched basic services which has been arbitrarily chosen, using one of the generic call set up procedures, (either speech or data) as specified in clause 10. The default SETUP message contents are modified to include the user-user Information Element. The MS shall not respond adversely to the inclusion of the user-user information element.

After 30 s the SS sends a DISCONNECT message, again the MS shall not respond adversely to the inclusion of the user-user information element, but shall continue to clear down the call normally.

Expected sequence

Step	Direction	Message	Comments
1			Generic Call Setup procedure defined in clauses 10.1 or 10.3, depending on choice of Bearer Capability. The SETUP message in either case contains the user-user IE, see Specific message contents.
2			The SS waits 30 s.
3	SS -> MS	DISCONNECT	Message contains the user-user IE, see Specific message contents
4	MS -> SS	RELEASE	As defined in subclause 26.8.4
5	SS-> MS	RELEASE COMPLETE	As defined in subclause 26.8.4
6	SS-> MS	CHANNEL RELEASE	As defined in subclause 26.8.4

Specific message contents:

SETUP

As default message contents as defined in the Generic Call setup procedures subclauses 10.1 or 10.3 except:

Information Element	value/remark
Bearer Capability	Bearer capability arbitrarily chosen from those supported by the Mobile Station under test.
user-user	
- length	Length of user-user contents (note)
- PD	IA5 characters (note)
- user-user	The following string coded in IA5 characters: "Call Setup" (note)

DISCONNECT

As default message contents as defined in subclause 26.8.4, except:

Information Element	value/remark
user-user - length - PD - user-user	Length of user-user contents (note) IA5 characters (note) The following string coded in IA5 characters: "Call Disconnect" (note)
NOTE:	The codings above are for example only. For the case of an MS which supports "user-user" signalling it may be necessary to add meaning to the data fields, see PICS/PIXIT statement(s).

26.8.4 Default contents of message

ALERTING (mobile station to network direction)

No default requirements defined for this message.

ALERTING (network to mobile station direction)

Information element	Value/remark
Facility	Omitted
Progress indicator	Omitted
User-user	Omitted

ASSIGNMENT COMMAND

Information element	Value/remark
Description of the first channel	describes non-hopping Bm+ACCHs or Lm+ACCHs as appropriate for the test
Power Command	As in subclause 6.3
Frequency list	Omitted
Cell channel description	Omitted
Mode of the first channel	appropriate for the bearer capability chosen for the test
Description of the second channel	Omitted
Mode of the second channel	Omitted
Mobile allocation	Omitted
Starting time	Omitted
Cipher mode setting	Omitted

ASSIGNMENT COMPLETE

Information element	Value/remark
RR cause	not checked

AUTHENTICATION REQUEST

Information element	Value/remark
Ciphering key sequence number	Arbitrary excluding 111B
Spare half octet	(spare bits)
Authentication parameter RAND	Arbitrary

AUTHENTICATION RESPONSE

Information element	Value/remark
Authentication parameter SRES	not checked

CALL CONFIRMED

No default requirements defined for this message.

CALL PROCEEDING

Information element	Value/remark
Repeat Indicator	Omitted
Bearer Capability 1	Omitted if the SETUP message did not specify in the bearer capability 1 IE a connection element value "both, transparent preferred" or "both, non-transparent preferred". Otherwise included; in that case the connection element specifies the value that is appropriate for the selected basic service (either value "transparent" or value "non transparent (RLP)"), all other parameters are same as in the bearer capability 1 IE of the received SETUP message.
Bearer Capability 2	Omitted
Facility	Omitted
Progress indicator	Omitted

CHANNEL MODE MODIFY

Information element	Value/remark
Channel description	describes non-hopping Bm+ACCHs or Lm+ACCHs as appropriate for the test
Channel mode	appropriate for the bearer capability chosen for the test

CHANNEL MODE MODIFY ACKNOWLEDGE

Information element	Value/remark
Channel description	as sent by the SS in the corresponding CHANNEL MODE MODIFY message
Channel mode	as sent by the SS in the corresponding CHANNEL MODE MODIFY message

CHANNEL RELEASE

Information element	Value/remark
RR cause	Normal event

CHANNEL REQUEST

Information element	Value/remark
Establishment cause	If in response to paging, then "100"; if a mobile originating call, then "111"
Random reference	Arbitrary value of 5 bits length

CIPHERING MODE COMMAND

Information element	Value/remark
Cipher mode setting algorithm identifier SC	indicates a supported algorithm Start ciphering
Cipher response CR	IMEI must not be included

CIPHERING MODE COMPLETE

No default requirements defined for this message.

CM SERVICE ACCEPT

No default values defined for this message.

CM SERVICE REJECT

Information element	Value/remark
Reject cause	Service or option not available, unspecified

CM SERVICE REQUEST

No default requirements defined for this message.

CONNECT (network to mobile station direction)

Information element	Value/remark
Facility	Omitted
Progress indicator	Omitted
Connected number	Omitted
Connected subaddress	Omitted
User-user	Omitted

CONNECT (mobile station to network direction)

No default requirements defined for this message.

CONNECT ACKNOWLEDGE

No default requirements defined for this message.

DISCONNECT (network to mobile station direction)

Information element	Value/remark
Cause	
Coding standard	GSM
Location	User
Cause value	Normal clearing
Facility	Omitted
Progress indicator	Omitted
User-user	Omitted

DISCONNECT (mobile station to network direction)

Information element	Value/remark
Cause	Shall be present, contents not checked
Facility	Omitted
User-user	Omitted
SS version	Omitted

HANDOVER ACCESS

No default requirements defined for this message.

HANDOVER COMMAND

Information element	Value/remark
Cell Description	a BCCH frequency, which is one of the neighbour cells
Description of the first channel	describes non-hopping Bm+ACCHs or Lm+ACCHs as appropriate for the test
Handover Reference	an arbitrary value
Power Command	as in 6.3
Synchronization indication	Omitted
Frequency short list	Omitted
Frequency List	Omitted
Cell Channel Description	Omitted
Channel Mode	Omitted
Channel Description	Omitted
Channel Mode 2	Omitted
Frequency Channel Sequence	Omitted
Mobile Allocation	Omitted
Starting Time	Omitted
Real time difference	Omitted
Timing advance	Omitted
Cipher Mode setting	Omitted

HANDOVER FAILURE

No default requirements defined for this message.

IMMEDIATE ASSIGNMENT

Information element	Value/remark
Page mode	Normal paging
Channel description	describes a valid SDCCH+SACCH in non-hopping mode
Request reference	As received from MS
Random access information	Corresponding to frame number of the CHANNEL
T1', T2, T3	REQUEST
Timing advance	corresponding the timing difference between the MS and the SS
Mobile allocation	Empty (L=0)
Starting time	Omitted

MODIFY

No default values defined for this message.

MODIFY COMPLETE

No default requirements defined for this message.

MODIFY REJECT

No default values defined for this message.

NOTIFY (network to mobile station direction)

Information element	Value/remark
Notification indicator	one of the valid values chosen arbitrarily

PAGING REQUEST TYPE 1

Information element	Value/remark
L2 pseudo length	L2 pseudo length of the message
Page Mode	Normal Paging
Channels needed for Mobiles 1 and 2	
channel (first)	any channel
channel (second)	any channel
Mobile identity 1	TMSI of MS under test
Mobile identity 2	Omitted
P1 rest octets	(spare octets)

PAGING RESPONSE

No default requirements defined for this message.

PROGRESS

No default values defined for this message.

RELEASE (network to mobile station direction)

Information element	Value/remark
Cause	Omitted
Second cause	Omitted
Facility	Omitted
User-user	Omitted

RELEASE (mobile station to network direction)

No default requirements defined for this message.

RELEASE COMPLETE (network to mobile station direction)

Information element	Value/remark
Cause	Omitted
Facility	Omitted
User-user	Omitted

RELEASE COMPLETE (mobile station to network direction)

No default requirements defined for this message.

SETUP (mobile station to network direction)

Information element	Value/remark
BC Repeat indicator	Omitted
Bearer capability 1	Appropriate for the basic service selected for the test
Bearer capability 2	Omitted
Facility	Omitted
Calling party subaddress	Omitted
Called party BCD number	As entered
Called party subaddress	Omitted
LLC repeat indicator	Omitted
Low layer compatibility I	Appropriate for the basic service selected for the test
Low layer compatibility II	Omitted
HLC repeat indicator	Omitted
High layer compatibility i	Appropriate for the basic service selected for the test
High layer compatibility ii	Omitted
User-user	Omitted
SS version	Omitted
CLIR suppression	Omitted
CC Capabilities	present, shall indicate support for DTMF as per subclause 5.5.7 of 3GPP TS 04.08 / 3GPP TS 24.008

SETUP (network to mobile station direction)

Information element	Value/remark
BC repeat indicator	Omitted
Bearer capability 1	Appropriate for the basic service selected for the test
Bearer capability 2	Omitted
Facility	Omitted
Progress indicator	Omitted
Signal	Any defined value as described for Signal IE in 3GPP TS 04.08 / 3GPP TS 24.008
Calling party BCD number	Omitted
Calling party subaddress	Omitted
Called party BCD number	Omitted
Called party subaddress	Omitted
LLC repeat indicator	Omitted
Low layer compatibility I	Appropriate for the basic service selected for the test
Low layer compatibility II	Omitted
HLC repeat indicator	Omitted
High layer compatibility i	Appropriate for the basic service selected for the test
High layer compatibility ii	Omitted
User-user	Omitted

START DTMF

No default requirements defined for this message.

START DTMF ACKNOWLEDGE

Information element	Value/remark
Keypad facility	corresponding to the DTMF digit indicated in the START DTMF message

START DTMF REJECT

Information element	Value/remark
Cause	value "Resources unavailable, unspecified"

STATUS

Information element	Value/remark
Cause	Value "Response to STATUS ENQUIRY"
Call state	Specified separately in each test case
Auxiliary states	Omitted

STATUS ENQUIRY

No default values defined for this message, except that when this message is used to check that "all the transaction identifiers from 000 to 110" are in the null state, the TI flag shall take the value "1" in mobile originating call tests and shall take the value "0" in mobile terminating call tests.

STOP DTMF

No default requirements defined for this message.

STOP DTMF ACKNOWLEDGE

No default values defined for this message.

Unknown Message

Protocol Discriminator	Call Control; Call Related SS
Transaction Identifier	same as in use in the test
Message Type	0000 0100

26.9 Structured procedures

26.9.1 Structured procedures / general

The purpose of these tests is to verify that the MS performs certain elementary procedures of the RR, MM, and CC protocol correctly within a structured procedure. The term "structured procedure" is defined in 3GPP TS 04.08 / 3GPP TS 23.108, clause 7, where also examples of structured procedures are given.

The reason for this test purposes is twofold:

- The behaviour of the MS in an elementary procedure may depend on the preamble which precedes the elementary procedure.
- Structured procedures tested in this subclause are used in other parts of this Technical Specification as preambles to establish the initial conditions for other tests; correct behaviour of an implementation under test in a preamble is essential for the validity of a test.

Mobile originating and terminating calls are tested in cases of both early and late assignment of the traffic channel; in one of the cases call release initiated by the network is tested, in another one, call release initiated by the MS.

The feature Directed Retry is tested in both Mobile Originated and Mobile Terminated Call. The configuration of the assigned channels is described in table 26.9-1:

Table 26.9-1

Directed Retry from	To	Call direction	Start Time	Sync.	Subclause	Exec. Counter
SDCCH/4	TCH/F, cycl. FH	MOC	None	No	26.9.7	1
SDCCH/8, cycl. FH	TCH/H, rand. FH	MOC	None	No	26.9.7	2
SDCCH/4	TCH/F, no FH	MTC	None	No	26.9.8	1
SDCCH/8, rand. FH	TCH/H, cycl. FH	MTC	1.1 sec.	No	26.9.8	2

The tests in this subclause only cover the successful outcome of elementary procedures (i.e. they do not deal with abnormal cases).

In this subclause, the emergency call service is tested for mobile stations that do not support the full rate speech version 2 in the following cases:

- emergency call initiated in the idle, updated state with authentication and ciphering, for speech full rate version 1 and if supported, speech half rate version 1;
- emergency call initiated in the idle, no IMSI state (hence without authentication and without ciphering), the network accepting the call, for either speech full rate version 1 or, provided it is supported, speech half rate version 1;
- emergency call initiated in the idle, no IMSI state (hence without authentication and without ciphering), the network rejecting the call, for either speech full rate version 1 or, provided it is supported, speech half rate version 1.

These tests on emergency calls are only applicable to an MS supporting speech.

For an MS supporting speech the test procedures in 26.9.2, 26.9.3, 26.9.4, 26.9.5, 26.9.7 and 26.9.8 are performed for speech (teleservice 11, telephony), once for speech full rate version 1 and, if supported, once for speech half rate version 1.

For an MS not supporting speech but supporting at least one teleservice, for each of the test procedures in subclauses 26.9.2, 26.9.3, 26.9.4, 26.9.5, 26.9.7 and 26.9.8 and each supported rate (full rate/half rate) a teleservice

supported by the MS (see PICS/PIXIT statement) is chosen, and the test is performed corresponding to that teleservice (note that this teleservice is never a dual service).

In cases where a mobile originated call for the tested teleservice can be initiated both

- via the MMI; and
- via the R or S interface,

procedures 26.9.2 and 26.9.7 (m = 1) shall be performed when initiating the mobile originated call via the MMI and procedures 26.9.3 and 26.9.7 (m = 2) shall be performed when initiating the mobile originated call via an appropriate interface (R or S).

26.9.2 Structured procedures / MS originated call / early assignment

26.9.2.1 Conformance requirements

- 1) An MS in MM state "idle, updated" and in RR idle mode, when made to initiate a call, if it provides a human interface, shall display the dialled number.
- 2) An MS in MM state "idle, updated" and in RR idle mode, when made to initiate a call for a selected teleservice that is supported by the MS, shall start to initiate the immediate assignment procedure by sending a CHANNEL REQUEST message with correct establishment cause.
- 3) Subsequently after establishment of an MM connection, the MS shall send a SETUP message with correct parameters.
- 4) The call control entity of the Mobile Station in the "call initiated" state, in the "mobile originating call proceeding" state or in the "call delivered" state, shall, upon receipt of a CONNECT message:
 - attach the user connection to the radio path;
 - return a CONNECT ACKNOWLEDGE message.
- 5) Subsequently when the network initiates call clearing by sending a DISCONNECT message, the MS shall proceed to release the call by sending a RELEASE message.
- 6) On receipt of a CHANNEL RELEASE message, the MS shall disconnect the main signalling link.

References

- Conformance requirement 1: 3GPP TS 02.07.
- Conformance requirement 2: 3GPP TS 04.08 / 3GPP TS 44.018 subclause 3.3.1.1
- Conformance requirement 3: 3GPP TS 04.08 / 3GPP TS 24.008 subclause 5.2.1.1.
- Conformance requirement 4: 3GPP TS 04.08 / 3GPP TS 24.008 subclause 5.2.1.6.
- Conformance requirement 5: 3GPP TS 04.08 / 3GPP TS 24.008 subclause 5.4.4.
- Conformance requirement 6: 3GPP TS 04.08 / 3GPP TS 44.018, subclause 3.4.13.1

26.9.2.2 Test purpose

- 1) To verify that the MS in MM state "idle, updated" with a TMSI assigned, when made to initiate a call for a selected teleservice that is supported by the MS as declared in a PICS/PIXIT statement, displays the dialled number in the way described in a PICS/PIXIT statement.
- 2) To verify that the MS in MM state "idle, updated" and in RR idle mode, with a TMSI assigned, when made to initiate a call for a selected teleservice that is supported by the MS as declared in a PICS/PIXIT statement, starts to initiate an immediate assignment procedure by sending the CHANNEL REQUEST message with correct establishment cause.
- 3) To verify that subsequently after receipt of an IMMEDIATE ASSIGNMENT message allocating an SDCCH, after completion of establishment of the main signalling link, after having sent a CM SERVICE REQUEST

message, after having successfully performed the authentication and cipher mode setting procedures, the MS sends a SETUP message with correct parameters.

- 4) To verify that subsequently, after receipt of a CALL PROCEEDING message and of an ASSIGNMENT COMMAND message allocating an appropriate TCH, after having completed the traffic channel early assignment procedure by replying with the ASSIGNMENT COMPLETE message, after receipt of an ALERTING message and a CONNECT message, the MS returns a CONNECT ACKNOWLEDGE message.
- 5) To verify that subsequently the MS has attached the user connection to the radio path. (This is checked by verifying that there is a point in time after transmission of the first L2 frame containing the (complete) CONNECT message, where the MS is sending appropriate speech or data frames whenever it does not have to transmit or acknowledge an I frame on layer 2 of the FACCH.)
- 6) To verify that subsequently upon the network initiating call clearing by sending a DISCONNECT message, the MS proceed to release the call with RELEASE.
- 7) To verify that subsequently, on receipt of a RELEASE COMPLETE message followed by a CHANNEL RELEASE message, the MS disconnects the main signalling link.

These test purposes are tested for all rates supported by the MS (full rate/half rate).

26.9.2.3 Method of test

Initial Conditions

System Simulator:

1 cell, default parameters.

Mobile Station:

The MS is in MM-state "idle, updated" with valid TMSI and CKSN.

Specific PICS statements:

- Speech supported for Full rate version 1 (GSM FR) (TSPC_AddInfo_Full_rate_version_1)
- Speech supported for Half rate version 1 (GSM HR) (TSPC_AddInfo_Half_rate_version_1)

PIXIT statements:

- Way to indicate mobile originated alerting
- Way to display the called number

Foreseen Final State of the MS

The MS is in MM-state "idle, updated" with valid TMSI and CKSN.

Test procedure

The following test is performed for all rates (full rate/half rate) supported by the MS:

A teleservice is selected that is supported by the MS; if the MS supports speech version 1, the selected teleservice is speech. If necessary, the MS is configured for that teleservice.

The MS is made to initiate a call. The call is established with early assignment. Having reached the active state, the call is cleared by the SS.

Maximum Duration of Test

1 minute.

Expected Sequence

Step	Direction	Message	Comments
1	MS		The "called number" is entered.
2	MS		If supported, the MS must display the called number in the way defined in PIXIT.
3	MS -> SS	CHANNEL REQUEST	Establishment cause is "originating call and the network does not set the NECI bit to 1".
4	SS -> MS	IMMEDIATE ASSIGNMENT	
5	MS -> SS	CM SERVICE REQUEST	Message is contained in SABM.
6	SS -> MS	AUTHENTICATION REQUEST	
7	MS -> SS	AUTHENTICATION RESPONSE	SRES specifies correct value.
8	SS -> MS	CIPHERING MODE COMMAND	SS starts deciphering after sending the message.
9	MS -> SS	CIPHERING MODE COMPLETE	Shall be sent enciphered. All following messages shall be sent enciphered.
10	SS		SS starts ciphering.
11	MS -> SS	SETUP	
12	SS -> MS	CALL PROCEEDING	
13	SS -> MS	ASSIGNMENT COMMAND	
14	MS -> SS	ASSIGNMENT COMPLETE	
15	SS -> MS	ALERTING	
16	MS		Depending on the PIXIT, an alerting indication is given.
17	SS -> MS	CONNECT	
18	MS -> SS	CONNECT ACKNOWLEDGE	
19	MS		The appropriate bearer channel is through connected in both directions.
20	SS -> MS	DISCONNECT	
21	MS -> SS	RELEASE	
22	SS -> MS	RELEASE COMPLETE	
23	SS -> MS	CHANNEL RELEASE	The main signalling link is released.

Specific Message Contents:

None.

26.9.3 Structured procedures / MS originated call / late assignment

26.9.3.1 Conformance requirement

- 1) An MS in MM state "idle, updated" and in RR idle mode with a TMSI assigned, when made to initiate a call for a selected teleservice that is supported by the MS, shall start to initiate an immediate assignment procedure by sending the CHANNEL REQUEST message with correct establishment cause.
- 2) Upon receipt of the ASSIGNMENT COMMAND message, the Mobile Station initiates a local end release of link layer connections, disconnects the physical channels, commands the switching to the assigned channels and initiates the establishment of lower layer connections (this includes the activation of the channels, their connection and the establishment of the data links). After the main signalling link is successfully established, the MS returns an ASSIGNMENT COMPLETE message, specifying cause "normal event", to the network on the main DCCH.
- 3, 4) The call control entity of the Mobile Station in the "call initiated" state, in the "mobile originating call proceeding" state or in the "call delivered" state, shall, upon receipt of a CONNECT message:
 - attach the user connection to the radio path;
 - return a CONNECT ACKNOWLEDGE message.

References

- Conformance requirement 1: 3GPP TS 04.08 / 3GPP TS 44.018 subclause 3.3.1.1
- Conformance requirement 2: 3GPP TS 04.08 / 3GPP TS 44.018 subclauses 3.4.3.1 and 3.4.3.2.
- Conformance requirement 3: 3GPP TS 04.08 / 3GPP TS 24.008 subclause 5.2.1.6.

26.9.3.2 Test purpose

- 1) To verify that the MS in MM state "idle, updated" and in RR idle mode with a TMSI assigned, when made to initiate a call for a selected teleservice that is supported by the MS as declared in a PICS/PIXIT statement, starts to initiate an immediate assignment procedure by sending the CHANNEL REQUEST message.
- 2) To verify that subsequently after receipt of an IMMEDIATE ASSIGNMENT message allocating an SDCCH, after completion of establishment of the main signalling link, after having sent a CM SERVICE REQUEST message, after having successfully performed authentication and cipher mode setting procedures, after having sent a SETUP message, after having received a CALL PROCEEDING message followed by an ALERTING message and an ASSIGNMENT COMMAND message allocating an appropriate TCH, the MS sends an ASSIGNMENT COMPLETE message.
- 3) To verify that subsequently, after the suite of actions specified in test purposes 1 and 2, the MS after receiving a CONNECT message returns a CONNECT ACKNOWLEDGE message.
- 4) To verify that after the suite of actions specified in test purposes 1 and 2, the MS after receiving a CONNECT message attaches the user connection to the radio path. (This is checked by verifying that there is a point in time after transmission of the first L2 frame containing the (complete) CONNECT message, where the MS is sending appropriate speech or data frames whenever it does not have to transmit or acknowledge an I frame on layer 2 of the FACCH.)

These test purposes are tested for all rates supported by the MS (full rate/half rate).

26.9.3.3 Method of test

Initial Conditions

System Simulator:

1 cell, default parameters.

Mobile Station:

The MS is in MM-state "idle, updated" with valid TMSI and CKSN.

Specific PICS statements:

- Speech supported for Full rate version 1 (GSM FR) (TSPC_AddInfo_Full_rate_version_1)
- Speech supported for Half rate version 1 (GSM HR) (TSPC_AddInfo_Half_rate_version_1)

PIXIT statements:

- Way to indicate mobile originated alerting
- Way to display the called number

Foreseen Final State of the MS

The MS has a MO call in state U10, "active".

Test procedure

The following test is performed for all rates (full rate/half rate) supported by the MS:

A teleservice is selected that is supported by the MS; if the MS supports speech version 1, the selected teleservice is speech. If necessary, the MS is configured for that teleservice.

The MS is made to initiate a call. The call is established with late assignment.

Maximum Duration of Test

30 s.

Expected Sequence

Step	Direction	Message	Comments
1	MS		The "called number" is entered.
2	MS		
3	MS -> SS	CHANNEL REQUEST	Establishment cause is "originating call and the network does not set the NECI bit to 1".
4	SS -> MS	IMMEDIATE ASSIGNMENT	
5	MS -> SS	CM SERVICE REQUEST	Message is contained in SABM.
6	SS -> MS	AUTHENTICATION REQUEST	
7	MS -> SS	AUTHENTICATION RESPONSE	SRES specifies correct value.
8	SS -> MS	CIPHERING MODE COMMAND	SS starts deciphering after sending the message.
9	MS -> SS	CIPHERING MODE COMPLETE	Shall be sent enciphered. All following messages shall be sent enciphered.
10	SS		SS starts ciphering.
11	MS -> SS	SETUP	
12	SS -> MS	CALL PROCEEDING	
13	SS -> MS	ALERTING	
14	MS		Depending on the PIXIT, an alerting indication is given.
15	SS -> MS	ASSIGNMENT COMMAND	
16	MS -> SS	ASSIGNMENT COMPLETE	
17	SS -> MS	CONNECT	
18	MS -> SS	CONNECT ACKNOWLEDGE	
19	MS		The appropriate bearer channel is through connected in both directions.

Specific Message Contents:

None.

26.9.4 Structured procedures / MS terminated call / early assignment

26.9.4.1 Conformance requirements

- 1) The MS shall acknowledge the SETUP message with a CALL CONFIRMED message, if compatibility checking was successful, the MS is not busy, and the user does not refuse the call.
- 2, 3) Upon receipt of the ASSIGNMENT COMMAND message the MS continues a mobile terminating call establishment with early establishment of the traffic channel
 - a) by replying to the ASSIGNMENT COMMAND with an ASSIGNMENT COMPLETE message, and
 - b) if the MS supports immediate connect, by continuing the call establishment by through-connecting the traffic channel in both directions, or if the MS does not support immediate connect, by sending an ALERTING message
- 4) An MS indicates acceptance of a MT call by sending CONNECT.
- 5)

For speech calls:

The mobile station shall attach the user connection at latest when sending the connect message, except if there is no compatible radio resource available at this time. In this case the attachment shall be delayed until such a resource becomes available.

For data calls:

The mobile station shall attach the user connection when receiving the CONNECT ACKNOWLEDGE message from the network.

- 6) The MS initiates call clearing of an active call by sending a DISCONNECT message.
- 7) The MS in this phase of call release, upon receipt of a RELEASE message, shall return a RELEASE COMPLETE message.

- 8) Subsequently the MS, upon receipt of a CHANNEL RELEASE message, shall disconnect the main signalling link.

References

Conformance requirement 1:	3GPP TS 04.08 / 3GPP TS 24.008, subclause 5.2.2.3.1.
Conformance requirements 2, 3:	3GPP TS 04.08 / 3GPP TS 24.008, subclauses 5.2.2.3.2, 3GPP TS 04.08 / 3GPP TS 44.018, subclause 3.4.3.1.
Conformance requirement 4:	3GPP TS 04.08 / 3GPP TS 24.008 subclause 5.2.2.5.
Conformance requirement 5:	3GPP TS 04.08 / 3GPP TS 24.008, subclauses 5.2.2.6 and 5.2.2.9.
Conformance requirements 6, 7, 8:	3GPP TS 04.08 / 3GPP TS 24.008, subclause 5.4.

26.9.4.2 Test purpose

- 1) To verify that the MS in MM state "idle, updated" and in RR idle mode with a TMSI assigned, after being paged by the network on the correct paging subchannel, after initiating the immediate assignment procedure by sending the CHANNEL REQUEST message, after receipt of an IMMEDIATE ASSIGNMENT message allocating an SDCCH, after having sent a PAGING RESPONSE message on the allocated SDCCH, after having performed successful authentication and cipher mode setting procedures, after receipt of a SETUP message not containing a signal information element, returns a CALL CONFIRMED message.
- 2) To verify that subsequently, the SS sending an ASSIGNMENT COMMAND message, the MS successfully continues a mobile terminating call establishment with early assignment of traffic channel:
 - a) by replying to the ASSIGNMENT COMMAND with an ASSIGNMENT COMPLETE message, and
 - b) by continuing the call establishment by either:
 - sending a CONNECT messages and through connecting the TCH in both directions; or
 - sending an ALERTING message.
- 3) To verify that if after sending a CALL PROCEEDING message, the MS sends an ALERTING message during MTC establishment with early assignment, it generates an alerting indication.
- 4) To verify that if an ALERTING had been sent, subsequently, when the user accepts the call (possibly internal action as declared in PIXIT statement), the MS returns a CONNECT message.
- 5) To verify that the MS:
 - if the call is a speech call: after sending the CONNECT message has through connected the TCH in both directions (this is checked by verifying that after transmission of the first L2 frame containing the (complete) CONNECT message, the MS is sending appropriate speech or data frames whenever it does not have to transmit or acknowledge an I frame on layer 2 of the FACCH.)
 - if the call is a data call: after receipt of a subsequent CONNECT ACKNOWLEDGE message through connects the TCH in both directions (this is checked by verifying that there is a point in time after transmission of the first L2 frame containing the (complete) CONNECT ACKNOWLEDGE message, where the MS is sending appropriate speech or data frames whenever it does not have to transmit or acknowledge an I frame on layer 2 of the FACCH.)
- 6) To verify that subsequently, the MS can initiate call clearing by sending a DISCONNECT message.
- 7) To verify that the MS in this phase of call release, upon receipt of a RELEASE message, returns a RELEASE COMPLETE message.
- 8) To verify that subsequently the MS, upon receipt of a CHANNEL RELEASE message, disconnects the main signalling link.

These test purposes are tested for all rates supported by the MS (full rate/half rate).

26.9.4.3 Method of test

Initial Conditions

System Simulator:

1 cell, default parameters.

Mobile Station:

The MS is in MM-state "idle, updated" with valid TMSI and CKSN.

Specific PICS statements:

- Speech supported for Full rate version 1 (GSM FR) (TSPC_AddInfo_Full_rate_version_1).
- Speech supported for Half rate version 1 (GSM HR) (TSPC_AddInfo_Half_rate_version_1)
- Immediate connect supported for all circuit switched basic services. (TSPC_AddInfo_ImmConn)

PIXIT statements:

- Way to indicate alerting.
- Way to make the MS accept an incoming call after alerting.

Foreseen Final State of the MS

The MS is in MM-state "idle, updated" with valid TMSI and CKSN.

Test procedure

The following test is performed for all rates (full rate/half rate) supported by the MS:

A teleservice is selected that is supported by the MS; if the MS supports speech version 1, the selected teleservice is speech. If necessary, the MS is configured for that teleservice.

The MS is paged and the resulting call is established. Having reached the active state, the MS is made to clear the call.

Maximum Duration of Test

1 minute.

Expected Sequence

Step	Direction	Message	Comments
1	SS -> MS	PAGING REQUEST TYPE 1	Sent on the correct paging subchannel.
2	MS -> SS	CHANNEL REQUEST	
3	SS -> MS	IMMEDIATE ASSIGNMENT	
4	MS -> SS	PAGING RESPONSE	Message is contained in SABM.
5	SS -> MS	AUTHENTICATION REQUEST	
6	MS -> SS	AUTHENTICATION RESPONSE	SRES specifies correct value.
7	SS -> MS	CIPHERING MODE COMMAND	SS starts deciphering after sending the message.
8	MS -> SS	CIPHERING MODE COMPLETE	Shall be sent enciphered. All following messages shall be sent enciphered.
9	SS		SS starts ciphering.
10	SS -> MS	SETUP	Message does not contain the signal IE.
11	MS -> SS	CALL CONFIRMED	If the MS supports immediate connect then branch A applies. If the MS does not support immediate connect then branch B applies
A12	MS -> SS	CONNECT	sent on the old channel
A13	SS -> MS	ASSIGNMENT COMMAND	
A14	MS -> SS	ASSIGNMENT COMPLETE	
B12	SS -> MS	ASSIGNMENT COMMAND	
B13	MS -> SS	ASSIGNMENT COMPLETE	sent on the new channel
B14	MS -> SS	ALERTING	
B15	MS		An alerting indication as defined in a PIXIT statement is given by the MS
B16	MS		The MS is made to accept the call in the way described in a PIXIT statement
B17	MS -> SS	CONNECT	
18	MS		If the call is a speech call, the TCH shall be through connected in both directions.
19	SS -> MS	CONNECT ACKNOWLEDGE	
20	MS		If the call is a data call, the TCH shall be through connected in both directions.
21	MS		The MS is made to release the call.
22	MS -> SS	DISCONNECT	
23	SS -> MS	RELEASE	
24	MS -> SS	RELEASE COMPLETE	
25	SS -> MS	CHANNEL RELEASE	The main signalling link is released.

Specific Message Contents:

None.

26.9.5 Structured procedures / MS terminated call / late assignment

26.9.5.1 Conformance requirement

TP1, TP2: The MS shall acknowledge the SETUP message with a CALL CONFIRMED message, if compatibility checking was successful, the MS is not busy, and the user does not refuse the call. The MS on acceptance of the call sends a CONNECT, otherwise user alerting is initiated.

TP3: The MS indicates acceptance of a call by sending a CONNECT message.

TP4: ASSIGNMENT COMMAND is answered by ASSIGNMENT COMPLETE.

TP5: For speech calls:

The mobile station shall attach the user connection at latest when sending the connect message, except if there is no compatible radio resource available at this time. In this case the attachment shall be delayed until such a resource becomes available.

For data calls:

The mobile station shall attach the user connection when receiving the CONNECT ACKNOWLEDGE message from the network.

Requirement reference:

Conformance requirements 1, 2, 3: 3GPP TS 04.08 / 3GPP TS 24.008, subclauses 5.2.2.3.1, 5.2.2.3.2 and 5.2.2.5.

Conformance requirement 4: 3GPP TS 04.08 / 3GPP TS 44.018, subclause 3.4.3.1.

Conformance requirement 5: 3GPP TS 04.08 / 3GPP TS 24.008, subclause 5.2.2.9.

26.9.5.2 Test purpose

- 1) To verify that the MS in "Idle, Updated" state with a TMSI assigned, after being paged by the network on the correct paging subchannel, after initiating the immediate assignment procedure by sending the CHANNEL REQUEST message, after receipt of an IMMEDIATE ASSIGNMENT message allocating an SDCCH, after having established the main signalling link, after having sent a PAGING RESPONSE message, after having performed successful authentication and cipher mode setting procedures, after receipt of a SETUP message containing a signal information element, returns a CALL CONFIRMED message followed by:
 - an ALERTING message;
 - or a CONNECT message.
- 2) To verify that in the situation of test purpose 1, if the MS sends an ALERTING message, the MS generates an alerting indication in the way described in a PIXIT statement.
- 3) To verify that subsequently the MS, if it had not yet sent a CONNECT message, upon acceptance of the call, sends a CONNECT message.
- 4) To verify that subsequently after receipt of an ASSIGNMENT COMMAND, the MS sends an ASSIGNMENT COMPLETE message.
- 5) To verify that subsequently the MS:
 - if the call is a speech call: after sending the ASSIGNMENT COMPLETE message has through connected the TCH in both directions (this is checked by verifying that after transmission of the first L2 frame containing the (complete) ASSIGNMENT COMPLETE message, the MS is sending appropriate speech or data frames whenever it does not have to transmit or acknowledge an I frame on layer 2 of the FACCH.)
 - if the call is a data call: after receipt of a subsequent CONNECT ACKNOWLEDGE message through connects the TCH in both directions (this is checked by verifying that there is a point in time after transmission of the first L2 frame containing the (complete) CONNECT ACKNOWLEDGE message, where the MS is sending appropriate speech or data frames whenever it does not have to transmit or acknowledge an I frame on layer 2 of the FACCH.)

These test purposes are tested for all rates supported by the MS (full rate/half rate).

26.9.5.3 Method of test

Initial Conditions

System Simulator:

1 cell, default parameters.

Mobile Station:

The MS is in MM-state "idle, updated" with valid TMSI and CKSN.

Specific PICS statements:

- Speech supported for Full rate version 1 (GSM FR) (TSPC_AddInfo_Full_rate_version_1).
- Speech supported for Half rate version 1 (GSM HR) (TSPC_AddInfo_Half_rate_version_1)
- Immediate connect supported for all circuit switched basic services. (TSPC_AddInfo_ImmConn)

PIXIT statements:

- Way to indicate alerting.
- Way to make the MS accept an incoming call after alerting.

Foreseen Final State of the MS

CC state U10-call active.

Test procedure

The following test is performed for all rates (full rate/half rate) supported by the MS:

- A teleservice is selected that is supported by the MS; if the MS supports speech version 1, the selected teleservice is speech. If necessary, the MS is configured for that teleservice.
- The MS is paged and a MT call is established with late assignment (after CONNECT).

Maximum Duration of Test

40 s.

Expected Sequence

Step	Direction	Message	Comments
1	SS -> MS	PAGING REQUEST TYPE 1	Sent on the correct paging subchannel.
2	MS -> SS	CHANNEL REQUEST	Establishment cause indicates "answer to paging".
3	SS -> MS	IMMEDIATE ASSIGNMENT	
4	MS -> SS	PAGING RESPONSE	Message is contained in SABM.
5	SS -> MS	AUTHENTICATION REQUEST	
6	MS -> SS	AUTHENTICATION RESPONSE	SRES specifies correct value.
7	SS -> MS	CIPHERING MODE COMMAND	SS starts deciphering after sending the message.
8	MS -> SS	CIPHERING MODE COMPLETE	Shall be sent enciphered. All following messages shall be sent enciphered.
9	SS		SS starts ciphering.
10	SS -> MS	SETUP	Message contains the signal IE.
11	MS -> SS	CALL CONFIRMED	
A12	MS -> SS	CONNECT	
B12	MS -> SS	ALERTING	
B13	MS		An alerting indication as defined in an PIXIT statement is given by the MS.
B14	MS		The MS is made to accept the call in the way described in a PIXIT statement.
B15	MS -> SS	CONNECT	
16	SS -> MS	ASSIGNMENT COMMAND	
17	MS -> SS	ASSIGNMENT COMPLETE	
18	MS		If the call is a speech call, the TCH shall be through connected in both directions.
19	SS -> MS	CONNECT ACKNOWLEDGE	
20	MS		If the call is a data call, the MS shall through connect the TCH in both directions.

Specific Message Contents:

None.

26.9.6 Structured procedures / emergency call

Emergency call establishment can be initiated by an MS whether location updating has been successful or not and whether a SIM is inserted into the MS or not; but only if the MS is equipped for speech.

If the procedures tested in this subclause are not correctly implemented in the MS, establishment, maintenance and clearing of connections might fail in the essential case of emergency calls.

26.9.6.1 Structured procedures / emergency call / idle updated

26.9.6.1.1 Structured procedures / emergency call / idle updated / preferred channel rate

26.9.6.1.1.1 Conformance requirement

- 1) For R97/98 MS: The MS in the "idle, updated" state, as after a successful location update, after the number 112 (for GSM 900 and 1800 MS), or 911 (for GSM 710, GSM 750, T-GSM 810, GSM 850 and PCS 1 900 MS in USA and Canada), or 08 (for GSM 710, GSM 750, T-GSM 810, GSM 850 and PCS 1 900 MS in Mexico) has been entered by user, shall send a CHANNEL REQUEST message with correct establishment cause ("emergency call").

For R99 MS: When a SIM/USIM containing stored emergency numbers is present, those numbers are identified as emergency numbers. As an optional requirement, the ME shall also identify 112 and 911 as emergency numbers irrespective of whether these are stored in the SIM/USIM. Any other emergency numbers stored in the ME shall be ignored.

When no emergency numbers are stored within the SIM the following numbers shall be stored in the ME for use as emergency numbers: 112, and 911.

When no emergency numbers are stored within the USIM the following numbers shall be stored in the ME for use as emergency numbers: 112, and 911.

- 2) After assignment of a dedicated channel the first layer message sent by the MS on the assigned dedicated channel shall be a CM SERVICE REQUEST message specifying the correct CKSN and TMSI , with CM Service Type "emergency call establishment".
- 3) Authentication and cipher mode setting shall be performed successfully.
- 4) After cipher mode setting acceptance by the network, the MS shall send an EMERGENCY SETUP message.
- 5), 6) The emergency call shall be correctly established. The assignment procedure shall be correctly performed.
- 7) After receipt of a CONNECT ACKNOWLEDGE message during correct establishment of the emergency call the TCH shall be through connected in both directions if an appropriate TCH is available.
- 8) The call shall be cleared correctly.

Requirement Reference:

For conformance requirement 1 and 2:

3GPP TS 04.08 / 3GPP TS 44.018 subclause 3.3.1.1,
3GPP TS 04.08 / 3GPP TS 24.008 subclauses 5.2.1 and 4.5.1.5,
3GPP TS 02.30 clause 4,
3GPP TS 22.101 clauses 8.

For conformance requirement 3:

3GPP TS 04.08 / 3GPP TS 44.018, subclause 3.4.7,
3GPP TS 04.08 / 3GPP TS 24.008 subclause 4.3.2.

For conformance requirement 4:

3GPP TS 04.08 / 3GPP TS 24.008, subclause 5.2.1.1.

For conformance requirement 5 and 6:

3GPP TS 04.08 / 3GPP TS 24.008, subclauses 5.2.1.1,
3GPP TS 04.08 / 3GPP TS 44.018 subclause 3.4.3.

For conformance requirement 7:

3GPP TS 04.08 / 3GPP TS 24.008, subclauses 5.2.1.6 and 5.1.3.

For conformance requirement 8:

3GPP TS 04.08 / 3GPP TS 24.008, subclause 5.4.

26.9.6.1.1.2 Test purpose

- 1) To verify that an R97/R98 MS supporting speech in the MM state "idle, updated", when made to call the number 112 (for GSM 900 and 1800 MS), or 911 (for GSM 710, GSM 750, T-GSM 810, GSM 850 and PCS 1 900 MS in USA and Canada), or 08 (for GSM 710, GSM 750, T-GSM 810, GSM 850 and PCS 1 900 MS in Mexico), sends a CHANNEL REQUEST message with establishment cause "emergency call".
To verify that an R99 MS supporting speech (or a R97/98 MS using the R99 Emergency Numbers) in the MM state "idle, updated", when made to call the number 112 or 911, sends a CHANNEL REQUEST message with establishment cause "emergency call".
- 2) To verify that after assignment of a dedicated channel the first layer message sent by the MS on the assigned dedicated channel is a CM SERVICE REQUEST message specifying the correct CKSN and TMSI, with CM Service Type "emergency call establishment".
- 3) To verify that authentication and cipher mode setting are performed successfully.
- 4) To verify that after cipher mode setting acceptance by the SS, the MS sends an EMERGENCY SETUP message.
- 5) To verify that subsequently, the SS having sent a CALL PROCEEDING message and then an ALERT message and having initiated the assignment procedure of an appropriate speech traffic channel, which, if the MS supports both TCH/FS and TCH/HS, is at the preferred rate, the MS performs correctly that assignment procedure.
- 6) To verify subsequent correct performance of a connect procedure.
- 7) To verify that subsequently the MS has through connected the TCH in both directions.
- 8) To verify that the call is cleared correctly.

26.9.6.1.1.3 Method of test

Initial Conditions

System Simulator:

1 cell, default parameters.

Mobile Station:

The MS is in MM-state "idle, updated" with valid TMSI and CKSN.

Specific PICS statements:

- Speech supported for Half rate version 1 (GSM HR) (TSPC_AddInfo_Half_rate_version_1)
- Use of R99 Emergency numbers (TSPC_R99_Emerg)

PIXIT statements:

- .

Foreseen Final State of the MS

The MS is in MM-state "idle, updated" with valid TMSI and CKSN.

Test procedure

The MS is made to initiate an emergency call. The call is established with late assignment. Having reached the active state, the call is cleared by the SS.

Maximum Duration of Test

1 minute.

Expected Sequence

Step	Direction	Message	Comments
1	MS		The appropriate emergency call number is entered.
3	MS -> SS	CHANNEL REQUEST	Establishment cause is emergency call establishment.
4	SS -> MS	IMMEDIATE ASSIGNMENT	
5	MS -> SS	CM SERVICE REQUEST	Message is contained in SABM. The CM service type IE indicates "emergency call establishment".
6	SS -> MS	AUTHENTICATION REQUEST	
7	MS -> SS	AUTHENTICATION RESPONSE	SRES specifies correct value.
8	SS -> MS	CIPHERING MODE COMMAND	SS starts deciphering after sending the message.
9	MS -> SS	CIPHERING MODE COMPLETE	Shall be sent enciphered. All following messages shall be sent enciphered.
10	SS		SS starts ciphering.
11	MS -> SS	EMERGENCY SETUP	If half rate speech version 1 is supported, the message must contain one bearer capability IE indicating in the radio channel requirement field "dual rate/half rate preferred" or "dual rate/full rate preferred". If half rate speech version 1 is not supported, the message must either contain no bearer capability IE or contain one bearer capability IE indicating in the radio channel requirement field "full rate channel".
12	SS -> MS	CALL PROCEEDING	
13	SS -> MS	ALERTING	
14	SS -> MS	ASSIGNMENT COMMAND	The rate of the channel is that one indicated by the EMERGENCY SETUP message, if that message did not offer a choice, and the rate is the preferred one else.
15	MS -> SS	ASSIGNMENT COMPLETE	
16	SS -> MS	CONNECT	
17	MS -> SS	CONNECT ACKNOWLEDGE	
18	MS		The TCH is through connected in both directions.
19	SS -> MS	DISCONNECT	
20	MS -> SS	RELEASE	
21	SS -> MS	RELEASE COMPLETE	
23	SS -> MS	CHANNEL RELEASE	The main signalling link is released.

Note: According to the conformance requirements there is no need to execute the test case by dialling the number 08 for an R99 MS (or a R97/98 MS using the R99 Emergency numbers)

Specific Message Contents:

None.

26.9.6.1.2 Structured procedures / emergency call / idle updated, non-preferred channel rate

This test is identical to the test in subclause 26.9.6.1.1 except that in step 14 the assigned TCH has the non-preferred rate.

26.9.6.2 Structured procedures / emergency call / idle, no IMSI

26.9.6.2.1 Structured procedures / emergency call / idle, no IMSI / accept case

26.9.6.2.1.1 Conformance requirement

- 1) The MS in the "idle, updated" state, as after a successful location update, after the number 112 (for GSM 900 and 1800 MS), or 911 (for GSM 710, GSM 750, T-GSM 810, GSM 850 and PCS 1 900 MS in USA and Canada), or 08 (for GSM 710, GSM 750, T-GSM 810, GSM 850 and PCS 1 900 MS in Mexico) has been entered by user, shall send a CHANNEL REQUEST message with correct establishment cause ("emergency call").
- 2) After assignment of a dedicated channel the first layer message sent by the MS on the assigned dedicated channel shall be a CM SERVICE REQUEST message specifying the correct IMEI and a non-available CKSN, with CM Service Type "emergency call establishment".
- 3) After cipher mode setting acceptance by the network, the MS shall send an EMERGENCY SETUP message.

- 4),5) The emergency call shall be correctly established. The assignment procedure shall be correctly performed.
- 6) After receipt of a CONNECT ACKNOWLEDGE message during correct establishment of the emergency call the TCH shall be through connected in both directions if an appropriate TCH is available.
- 7) The call shall be cleared correctly.

Requirement Reference:

For conformance requirement 1 and 2:

3GPP TS 04.08 / 3GPP TS 44.018 subclause 3.3.1.1,
3GPP TS 04.08 / 3GPP TS 24.008 subclauses 5.2.1 and 4.5.1.5,
3GPP TS 02.30 clause 4.

For conformance requirement 3:

3GPP TS 04.08 / 3GPP TS 24.008, subclause 5.2.1.1.

For conformance requirements 4 and 5:

3GPP TS 04.08 / 3GPP TS 24.008, subclause 5.2.1.1,
3GPP TS 04.08 / 3GPP TS 44.018 subclause 3.4.3.

For conformance requirement 6:

3GPP TS 04.08 / 3GPP TS 24.008, subclauses 5.2.1.6 and 5.1.3.

For conformance requirement 7:

3GPP TS 04.08 / 3GPP TS 24.008, subclause 5.4.

26.9.6.2.1.2 Test purpose

- 1) To verify that the MS in the "idle, no IMSI" state (no SIM inserted) when made to call the number 112 (for GSM 900 and 1800 MS), or 911 (for GSM 710, GSM 750, T-GSM 810, GSM 850 and PCS 1 900 MS in USA and Canada), or 08 (for GSM 710, GSM 750, T-GSM 810, GSM 850 and PCS 1 900 MS in Mexico), sends a CHANNEL REQUEST message with establishment cause "emergency call".
- 2) To verify that after assignment of a dedicated channel the first layer message sent by the MS on the assigned dedicated channel is a CM SERVICE REQUEST message in which the cipher key sequence number IE indicates "no key is available", the CM service type IE indicates "emergency number establishment", and the mobile identity IE specifies the IMEI of the MS.
- 3) To verify that after receipt of a CM SERVICE ACCEPT message from the SS, the MS sends an EMERGENCY SETUP message.
- 4) To verify that subsequently, the SS having sent a CALL PROCEEDING message and then an ALERT message and having initiated the assignment procedure of an appropriate speech traffic channel, which, if the MS supports both TCH/FS and TCH/HS, is at the preferred rate, the MS performs correctly that assignment procedure.
- 5) To verify subsequent correct performance of a connect procedure.
- 6) To verify that subsequently the MS has through connected the TCH in both directions.
- 7) To verify that the call is cleared correctly.

26.9.6.2.1.3 Method of test

Initial Conditions

System Simulator:

1 cell, default parameters.

Mobile Station:

The MS is in MM-state "idle, no IMSI", no SIM inserted.

Specific PICS statements:

- .

PIXIT statements:

- .

Foreseen Final State of the MS

The MS is in MM-state "idle, no IMSI", no SIM inserted.

Test procedure

The MS is made to initiate an emergency call. The call is established without authentication, without ciphering, with late assignment. Having reached the active state, the call is cleared by the SS.

Maximum Duration of Test

1 minute.

Expected Sequence

Step	Direction	Message	Comments
1	MS		The appropriate emergency call number is entered.
3	MS -> SS	CHANNEL REQUEST	Establishment cause is "emergency call".
4	SS -> MS	IMMEDIATE ASSIGNMENT	
5	MS -> SS	CM SERVICE REQUEST	Message is contained in SABM. The CM service type IE indicates "emergency call establishment". The mobile identity IE specifies the IMEI of the MS. The cipher key sequence number IE indicates "no key is available".
4	SS -> MS	CM SERVICE ACCEPT	
11	MS -> SS	EMERGENCY SETUP	
12	SS -> MS	CALL PROCEEDING	
13	SS -> MS	ALERTING	
14	SS -> MS	ASSIGNMENT COMMAND	The rate of the channel is one indicated by the EMERGENCY SETUP message.
15	MS -> SS	ASSIGNMENT COMPLETE	
16	SS -> MS	CONNECT	
17	MS -> SS	CONNECT ACKNOWLEDGE	
18	MS		The TCH is through connected in both directions.
19	SS -> MS	DISCONNECT	
20	MS -> SS	RELEASE	
21	SS -> MS	RELEASE COMPLETE	
23	SS -> MS	CHANNEL RELEASE	The main signalling link is released.

Specific Message Contents:

None.

26.9.6.2.2 Structured procedures / emergency call / idle, no IMSI / reject case

26.9.6.2.2.1 Conformance requirement

- 1) The MS in the "idle, no IMSI" state (no SIM inserted), after the number 112 (for GSM 900 and 1800 MS), or 911 (for GSM 710, GSM 750, T-GSM 810, GSM 850 and PCS 1 900 MS in USA and Canada), or 08 (for GSM 710, GSM 750, T-GSM 810, GSM 850 and PCS 1 900 MS in Mexico) has been entered, shall send a CHANNEL REQUEST message with correct establishment cause ("emergency call").
- 2) After assignment of a dedicated channel the first layer message sent by the MS on the assigned dedicated channel shall be a CM SERVICE REQUEST message specifying the correct IMEI and a non-available CKSN, with CM Service Type "emergency call establishment".

- 3) In the situation at the end of test purpose 2, when the MS receives a CM SERVICE REJECT message, it shall abandon the emergency call.

Requirement Reference:

For conformance requirement 1 and 2:

3GPP TS 04.08 / 3GPP TS 44.018 subclause 3.3.1.1,
3GPP TS 04.08 / 3GPP TS 24.008 subclauses 5.2.1 and 4.5.1.5,
3GPP TS 02.30 clause 4.

For conformance requirement 3:

3GPP TS 04.08 / 3GPP TS 44.018 subclause 3.4.7,
3GPP TS 04.08 / 3GPP TS 24.008 subclause 4.5.1.1.

26.9.6.2.2.2 Test purpose

- 1) To verify that the MS in the "idle, no IMSI" state (no SIM inserted) when made to call the number 112, (for GSM 900 and 1800 MS), or 911 (for GSM 710, GSM 750, T-GSM 810, GSM 850 and PCS 1 900 MS in USA and Canada), or 08 (for GSM 710, GSM 750, T-GSM 810, GSM 850 and PCS 1 900 MS in Mexico) sends a CHANNEL REQUEST message with establishment cause "emergency call".
- 2) To verify that after assignment of a dedicated channel the first layer message sent by the MS on the assigned dedicated channel is a CM SERVICE REQUEST message in which the cipher key sequence number IE indicates "no key is available", the CM service type IE indicates "emergency call establishment", and the mobile identity IE specifies the IMEI of the MS.
- 3) To verify that after receipt of a CM SERVICE REJECT message from the SS, the MS abandons the emergency call establishment.

26.9.6.2.2.3 Method of test

Initial Conditions

System Simulator:

1 cell, default parameters.

Mobile Station:

The MS is in MM-state "idle, no IMSI", no SIM inserted.

Specific PICS statements:

- .

PIXIT statements:

- .

Foreseen Final State of the MS

The MS is in MM-state "idle, no IMSI", no SIM inserted.

Test procedure

The MS is made to initiate an emergency call. The call is established without authentication, without ciphering, with early assignment. The SS responds to the CM SERVICE REQUEST from the MS with a CM SERVICE REJECT message specifying in the reject cause IE the reject cause value "IMEI not accepted". The SS then verifies for during 5 s that the MS does not send a layer 3 message. Then the call is cleared by the SS. The SS verifies during 20 s after disconnection of the main signalling link that the MS does not initiate an RR connection establishment.

Maximum Duration of Test

1 minute.

Expected Sequence

Step	Direction	Message	Comments
1	MS		The appropriate call number is entered.
3	MS -> SS	CHANNEL REQUEST	Establishment cause is "emergency call".
4	SS -> MS	IMMEDIATE ASSIGNMENT	
5	MS -> SS	CM SERVICE REQUEST	
4	SS -> MS	CM SERVICE REJECT	Message is contained in SABM. The CM service type IE indicates "emergency call establishment". The mobile identity IE specifies the IMEI of the MS. The cipher key sequence number IE indicates "no key is available". the reject cause IE specifies reject cause value #5, "IMEI not accepted".
5	SS		During 5 s, the SS verifies that the MS does not send L3 messages.
6	SS -> MS	CHANNEL RELEASE	The main signalling link is released.
7	SS		During 20 s, the SS verifies that the MS does not initiate an RR connection establishment.

Specific Message Contents:

-

26.9.7 Directed Retry / Mobile Originated Call

26.9.7.1 Conformance requirements

The MS shall correctly apply the Directed Retry procedure from SDCCH/8 (with frequency hopping) or SDCCH/4 to TCH/F or TCH/H with or without frequency hopping in the non-synchronized case during call establishment. The call control entity of the Mobile Station in the "mobile originating call proceeding" state shall, upon receipt of a CONNECT message, attach the appropriate user connection to the radio path and return a CONNECT ACKNOWLEDGE message to the SS.

References

3GPP TS 04.08 / 3GPP TS 44.018, subclause 3.4.4,
3GPP TS 04.08 / 3GPP TS 24.008 subclauses 5.2.1.6. and 9.1.15.

3GPP TS 04.13, subclause 5.2.6.2.

26.9.7.2 Test purpose

To test that, when the MS is ordered to perform a non-synchronized handover after the CALL PROCEED message, it continuously sends access bursts on the main DCCH (and optionally on the SACCH) until it receives a PHYSICAL INFORMATION message from the SS. To test that the MS correctly takes the values of the Timing Advance information element in the PHYSICAL INFORMATION message into account. To test that the MS activates the new channel correctly and transmits the HANDOVER COMPLETE message without undue delay. To test that the call control entity of the Mobile Station in the "mobile originating call proceeding" state, upon receipt of a CONNECT message, attaches the appropriate user connection to the radio path and returns a CONNECT ACKNOWLEDGE message to the SS.

26.9.7.3 Method of test

Initial Conditions

System Simulator:

2 cells A and B with same LAI, default parameters, except:

Cell A has:

BCCH ARFCN = See the table below.

Cell Allocation = (See the table below.

PLMN colour code, NCC = as defaults.

BS colour code, BCC = as defaults.

PLMN_PERM = 00001010.

Cell B has:

BCCH ARFCN = See the table below.

Cell Allocation = See the table below.

PLMN colour code, NCC = 3.

BS colour code, BCC = 0.

Band	Cell A		Cell B		Both Cells Format
	BCCH ARFCN	Cell Allocation	BCCH ARFCN	Cell Allocation	
GSM 450	263	259, 261, 263, 265, 267, 269, 271, 273, 275, 277, 279, 281, 283, 285, 287, 289, 291	274	260, 262, 264, 266, 268, 270, 272, 274, 276, 279, 281, 283, 285, 287, 289, 291	Range 128
GSM 480	310	306, 308, 310, 312, 314, 316, 318, 320, 322, 324, 326, 328, 330, 332, 334, 336, 338	321	307, 309, 311, 313, 315, 317, 319, 321, 323, 326, 328, 330, 332, 334, 336, 338	Range 128
GSM 710	457	447, 454, 457, 463, 471, 479, 482, 483, 489, 496, 498, 500, 501, 502, 503, 506, 508	477	451, 455, 459, 461, 467, 468, 475, 477, 497, 498, 500, 501, 502, 503, 506, 508	Range 128
GSM 750	457	447, 454, 457, 463, 471, 479, 482, 483, 489, 496, 498, 500, 501, 502, 503, 506, 508	477	451, 455, 459, 461, 467, 468, 475, 477, 497, 498, 500, 501, 502, 503, 506, 508	Range 128
T-GSM 810	457	447, 454, 457, 463, 471, 479, 482, 483, 489, 496, 498, 500, 501, 502, 503, 506, 508	477	451, 455, 459, 461, 467, 468, 475, 477, 497, 498, 500, 501, 502, 503, 506, 508	Range 128
GSM 850	147	137, 144, 147, 153, 161, 169, 172, 173, 179, 186, 193, 200, 201, 202, 203, 235, 241	167	141, 145, 149, 151, 157, 158, 165, 167, 187, 193, 200, 201, 202, 203, 235, 241	Range 128
GSM 900	20	10, 17, 20, 26, 34, 42, 45, 46, 52, 59, 66, 73, 74, 75, 76, 108, 114	40	14, 18, 22, 24, 30, 31, 38, 40, 60, 66, 73, 74, 75, 76, 108, 114	Bitmap 0
DCS 1 800	747	734, 741, 747, 754, 759, 762, 766, 767, 773, 775, 779, 782, 791, 798, 829, 832, 844	764	739, 743, 746, 749, 756, 758, 761, 764, 771, 779, 782, 791, 798, 829, 832, 844	Range 512
PCS 1 900	647	634, 641, 647, 654, 659, 662, 666, 667, 673, 675, 679, 682, 691, 698, 729, 732, 744	664	639, 643, 646, 649, 656, 658, 661, 664, 671, 679, 682, 691, 698, 729, 732, 744	Range 512

The timebase of Cells A and B shall be such that the edges of their timeslots are not coincident at the antenna connector.

For execution counter M = 1 a combined CCH/SDCCH is used.

For execution counter M = 2 a non-combined SDCCH is used.

Mobile Station:

The MS is in the "idle, updated" state, with a TMSI allocated and camped on cell A.

Specific PICS statements:

- Speech supported for Half rate version 1 (GSM HR) (TSPC_AddInfo_Half_rate_version_1)

PIXIT statements:

- Way to indicate mobile originated alerting.

Foreseen Final State of the MS

"Idle, updated" with TMSI allocated and camped on cell B.

Test Procedure

This procedure is repeated for execution counter $M = 1..2$.

A teleservice is selected that is supported by the MS; if the MS supports speech, the selected teleservice is speech. If necessary, the MS is configured for that teleservice.

The MS is made to initiate a call on Cell A. After the SS has sent the CALL PROCEEDING message the SS sends a HANDOVER COMMAND message, ordering the MS to switch to cell B. The MS shall then begin to send access bursts on the new DCCH (and optionally on the SACCH) to cell B. The SS observes the access bursts and after receiving n (n being arbitrarily chosen between values according to table 26.6-2 of subclause 26.6.5) access bursts, the SS sends one PHYSICAL INFORMATION message with an arbitrarily chosen Timing Advance. The MS shall activate the channel in sending and receiving mode. The MS shall establish a signalling link. The MS shall be ready to transmit a HANDOVER COMPLETE message before x ms after the end of the PHYSICAL INFORMATION message, but not before a UA frame has been sent by the SS. After the successful handover procedure the SS sends the ALERTING message. The correct alerting indication shall be given to the user (only applicable if the MS supports this feature). The SS sends the CONNECT message indicating that the call has been answered. The appropriate bearer channel shall be through connected in both directions. The MS shall send then the CONNECT ACKNOWLEDGE message as the response on the CONNECT message. Having reached the active state, the call is cleared by the SS.

The term "ready to transmit" is defined in 3GPP TS 04.13. The value of " x " depends upon the target channel and is specified in the specific message contents section.

Maximum Duration of Test

2 minutes, including 1 minute for any necessary operator actions.

Expected Sequence

The sequence is performed for execution counter $M = 1..2$ (unless a particular TCH is not supported).

Step	Direction	Message	Comments
1	-----	-----	A MO call is initiated on cell A.
2	MS -> SS	CHANNEL REQUEST	Establishment cause is "originating call and the network does not set the NECI bit to 1".
3	SS -> MS	IMMEDIATE ASSIGNMENT	See specific message contents.
4	MS -> SS	CM SERVICE REQUEST	CM Service Type = Mobile Originating Call Establishment.
5	SS -> MS	AUTHENTICATION REQUEST	
6	MS -> SS	AUTHENTICATION RESPONSE	SRES specifies correct value.
7	SS -> MS	CIPHERING MODE COMMAND	SS starts deciphering after sending the message.
8	MS -> SS	CIPHERING MODE COMPLETE	Shall be sent enciphered. All following messages shall be sent enciphered.
9	SS		SS starts ciphering.
10	MS -> SS	SETUP	
11	SS -> MS	CALL PROCEEDING	
12	SS -> MS	HANDOVER COMMAND	See specific message contents.
13	MS -> SS	HANDOVER ACCESS	Repeated on every burst of the uplink main DCCH (and optionally on the SACCH) until reception of PHYSICAL INFORMATION. Handover Reference as included in the HANDOVER COMMAND.
14	SS -> MS	PHYSICAL INFORMATION	Sent after reception of n HANDOVER ACCESS message. Timing Advance is arbitrarily chosen.
15	MS -> SS	SABM	Sent without information field.
16	SS -> MS	UA	
17	MS -> SS	HANDOVER COMPLETE	This message shall be ready to be transmitted before "x" ms after the completion of step 14.
18	SS -> MS	ALERTING	
19	MS		Depending on the PIXIT, an alerting indication is given.
20	SS -> MS	CONNECT	
21	MS -> SS	CONNECT ACKNOWLEDGE	
22	MS		The appropriate bearer channel is through connected in both directions.
23	SS -> MS	DISCONNECT	
24	MS -> SS	RELEASE	
25	SS -> MS	RELEASE COMPLETE	
26	SS -> MS	CHANNEL RELEASE	The main signalling link is released.

Specific Message Contents For Mobiles Supporting Speech

M = 1:

IMMEDIATE ASSIGNMENT

Information Element	value/remark
As default message contents.	

HANDOVER COMMAND

Information Element	value/remarks
As default message contents, except:	
Cell Description	
- Network Colour Code	3
- Base Station Colour Code	0
- BCCH Carrier Number	See the table below
Channel Description	
- Channel Type	TCH/F + ACCHs
- TDMA offset	Chosen arbitrarily.
- Timeslot number	Chosen arbitrarily but not zero.
- Training Sequence Code	Chosen arbitrarily.
- Hopping	RF hopping channel.
- MAIO	Chosen arbitrarily from the set (0, 1 to N-1), where N is the number of frequencies encoded in the Frequency List IE.
- HSN	Zero (this gives cyclic hopping).
Synchronization Indication IE is not included	
Frequency list after time	
- Frequency List	Encode frequencies as per the table below.
Channel Mode IE	Speech (full rate version 1 or half rate version 1).

Step 17: "x" = 500.

HANDOVER COMMAND			
Band	Frequency Short List		BCCH Carrier Number
	Format	ARFCNs	ARFCN
GSM 450	Range 128	260, 262, 264, 266, 268, 270, 272, 276, 279, 281, 283, 285, 287, 289, 291	274
GSM 480	Range 128	307, 309, 311, 313, 315, 317, 319, 323, 326, 328, 330, 332, 334, 336, 338	321
GSM 710	Range 128	451, 455, 459, 461, 467, 468, 475, 497, 498, 500, 501, 502, 503, 506, 508	477
GSM 750	Range 128	451, 455, 459, 461, 467, 468, 475, 497, 498, 500, 501, 502, 503, 506, 508	477
T-GSM 810	Range 128	451, 455, 459, 461, 467, 468, 475, 497, 498, 500, 501, 502, 503, 506, 508	477
GSM 850	Range 128	141, 145, 149, 151, 157, 158, 165, 187, 193, 200, 201, 202, 203, 235, 241	167
GSM 900	Range 128	14, 18, 22, 24, 30, 31, 38, 60, 66, 73, 74, 75, 76, 108, 114	40
DCS 1 800	Range 128	746, 779	764
PCS 1 900	Range 128	646, 679	664

M = 2:

IMMEDIATE ASSIGNMENT

Information Element	value/remark
As default message contents except:	
L2 pseudo length	See the table below.
Channel Description	
- Channel Type	SDCCH/8
- TDMA offset	As default message contents.
- Timeslot number	Arbitrary value, but not zero.
- Training Sequence Code	Chosen arbitrarily.
- Hopping	RF hopping channel.
- MAIO	Chosen arbitrarily from the set (0, 1 to N-1), where N is the number of frequencies encoded in the Mobile Allocation.
- HSN	Zero (this gives cyclic hopping).
Mobile Allocation	
- Length	3 octets.
- Contents	See the table below.

IMMEDIATE ASSIGNMENT		
Band	Mobile Allocation	L2 pseudo length
GSM 450	281, 283, 285	14 octets (11 + contents of the MA)
GSM 480	328, 330, 332	14 octets (11 + contents of the MA)
GSM 710	500, 501, 502	14 octets (11 + contents of the MA)
GSM 750	500, 501, 502	14 octets (11 + contents of the MA)
T-GSM 810	500, 501, 502	14 octets (11 + contents of the MA)
GSM 850	200, 201, 202	14 octets (11 + contents of the MA)
GSM 900	73, 74, 75	14 octets (11 + contents of the MA)
DCS 1 800	Indicates all of the CA of cell A except ARFCNs 747 and 767.	
PCS 1 900	Indicates all of the CA of cell A except ARFCNs 647 and 667	

HANDOVER COMMAND

As default message contents, except:	
Cell Description	
- Network Colour Code	3
- Base Station Colour Code	0
- BCCH Carrier Number	See the table below
Channel Description	
- Channel Type	TCH/H + ACCHs
- TDMA offset	Chosen arbitrarily.
- Timeslot number	Chosen arbitrarily but not zero.
- Training Sequence Code	Chosen arbitrarily.
- Hopping	RF hopping channel.
- MAIO	Chosen arbitrarily from the set (0, 1 to N-1), where N is the number of frequencies encoded in the Mobile Allocation.
- HSN	Chosen arbitrarily from the set (1, 2.. 63).
Synchronization Indication	
- Report Observed Time Difference	Shall not be included.
- Synchronization Indication	"Non synchronized".
- Normal Cell Indication	Ignore out of range timing advance.
Cell Channel Description	Encode frequencies as per the table below
Mobile Allocation after time	indicates channels as per the table below only
Channel Mode IE	speech (full rate version 1 or half rate version 1).

Step 17: "x" = 750.

HANDOVER COMMAND				
Band	BCCH Carrier Number	Cell Channel Description		Mobile Allocation after time
		ARFCN	Format	
GSM 450	274	Range 128	274, 279, 281, 283, 285, 287, 289, 291	281, 283, 285
GSM 480	321	Range 128	321, 326, 328, 330, 332, 334, 336, 338	328, 330, 332
GSM 710	477	Range 128	477, 498, 500, 501, 502, 503, 506, 508	500, 501, 502
GSM 750	477	Range 128	477, 498, 500, 501, 502, 503, 506, 508	500, 501, 502
T-GSM 810	477	Range 128	477, 498, 500, 501, 502, 503, 506, 508	500, 501, 502
GSM 850	167	Range 128	167, 193, 200, 201, 202, 203, 235, 241	200, 201, 202
GSM 900	40	Bitmap 0	40, 66, 73, 74, 75, 76, 108, 114	73, 74, 75
DCS 1 800	764	Range 512	761, 764, 771, 779, 782, 791, 798, 829, 832	791, 798, 829
PCS 1 900	664	Range 512	661, 664, 671, 679, 682, 691, 698, 629, 632	679, 682, 691

Specific Message Contents For Mobiles not Supporting Speech

The message contents shall be the same as for a Mobile Station supporting speech, except for:

For M = 1 (TCH/F):

HANDOVER COMMAND

Information Element	value/remarks
Mode of first channel	Arbitrary from those supported (12, 6, 3.6 kbps).

For M = 2 (TCH/H):

HANDOVER COMMAND

Information Element	value/remarks
Mode of first channel	Arbitrary from those supported (6, 3.6 kbps).

26.9.8 Directed Retry / Mobile Terminated Call

This test is applicable to all MS which support at least one MT circuit switched basic service.

26.9.8.1 Conformance requirements

The MS shall correctly apply the Directed Retry procedure from SDCCH/8 (with frequency hopping) or SDCCH/4 to TCH/F or TCH/H with or without frequency hopping in the non-synchronized case during call establishment. The call control entity of the Mobile Station in the "call delivered" state shall, if the MS supports immediate connect, continue the call establishment by through-connecting the traffic channel in both directions, or if the MS does not support immediate connect, send an ALERTING message. The MS indicates acceptance of a MT call by sending CONNECT.

For speech calls the mobile station shall attach the user connection at latest when sending the CONNECT message, except if there is no compatible radio resource available at this time. In this case the attachment shall be delayed until such a resource becomes available.

For Data Calls the mobile station shall attach the user connection when receiving the CONNECT ACKNOWLEDGE message from the network.

References

- 3GPP TS 04.08 / 3GPP TS 44.018, subclause 3.4.4,
- 3GPP TS 04.08 / 3GPP TS 24.008, subclauses 5.2.2.5, 5.2.2.6, 5.2.2.9 and 9.1.15.
- 3GPP TS 04.13, subclause 5.2.6.2.

26.9.8.2 Test purpose

To test that when the MS is ordered to perform a non-synchronized handover after the CALL CONFIRM message, it continuously sends access bursts on the main DCCH (and optionally on the SACCH) until it receives a PHYSICAL INFORMATION message from the SS. To test that the MS correctly takes the values of the Timing Advance information element in the PHYSICAL INFORMATION message into account. To test that the MS activates the new channel correctly and transmits the HANDOVER COMPLETE message without undue delay. To test that the call control entity of the Mobile Station in the "call delivered" state, if the MS supports immediate connect, continues the call establishment by through-connecting the traffic channel in both directions, or if the MS does not support immediate connect, sends an ALERTING message. To test that the MS indicates acceptance of a MT call by sending CONNECT.

To test that for speech calls the mobile station attaches the user connection at latest when sending the CONNECT message, except if there is no compatible radio resource available at this time. To test that in this case the attachment is delayed until such a resource becomes available.

To test that for Data Calls the mobile station attaches the user connection when receiving the CONNECT ACKNOWLEDGE message from the network.

26.9.8.3 Method of test

Initial Conditions

System Simulator:

2 cells A and B with same LAI, default parameters, except:

Cell A has:

BCCH ARFCN = See the table below.

Cell Allocation = See the table below.

PLMN colour code, NCC = as defaults.

BS colour code, BCC = as defaults.

PLMN_PERM = 00001010.

Cell B has:

BCCH ARFCN = See the table below.

Cell Allocation = See the table below.

PLMN colour code, NCC = 3.

BS colour code, BCC = 0.

Band	Cell A		Cell B		Both Cells Format
	BCCH ARFCN	Cell Allocation	BCCH ARFCN	Cell Allocation	
GSM 450	263	259, 261, 263, 265, 267, 269, 271, 273, 275, 277, 279, 281, 283, 285, 287, 289, 291	274	260, 262, 264, 266, 268, 270, 272, 274, 276, 279, 281, 283, 285, 287, 289, 291	Range 128
GSM 480	310	306, 308, 310, 312, 314, 316, 318, 320, 322, 324, 326, 328, 330, 332, 334, 336, 338	321	307, 309, 311, 313, 315, 317, 319, 321, 323, 326, 328, 330, 332, 334, 336, 338	Range 128
GSM 710	457	447, 454, 457, 463, 471, 479, 482, 483, 489, 496, 498, 500, 501, 502, 503, 506, 508	477	451, 455, 459, 461, 467, 468, 475, 477, 497, 498, 500, 501, 502, 503, 506, 508	Range 128
GSM 750	457	447, 454, 457, 463, 471, 479, 482, 483, 489, 496, 498, 500, 501, 502, 503, 506, 508	477	451, 455, 459, 461, 467, 468, 475, 477, 497, 498, 500, 501, 502, 503, 506, 508	Range 128
T-GSM 810	457	447, 454, 457, 463, 471, 479, 482, 483, 489, 496, 498, 500, 501, 502, 503, 506, 508	477	451, 455, 459, 461, 467, 468, 475, 477, 497, 498, 500, 501, 502, 503, 506, 508	Range 128
GSM 850	147	137, 144, 147, 153, 161, 169, 172, 173, 179, 186, 193, 200, 201, 202, 203, 235, 241	167	141, 145, 149, 151, 157, 158, 165, 167, 187, 193, 200, 201, 202, 203, 235, 241	Range 128
GSM 900	20	10, 17, 20, 26, 34, 42, 45, 46, 52, 59, 66, 73, 74, 75, 76, 108, 114	40	14, 18, 22, 24, 30, 31, 38, 40, 60, 66, 73, 74, 75, 76, 108, 114	Bitmap 0
DCS 1 800	747	734, 741, 747, 754, 759, 762, 766, 767, 773, 775, 779, 782, 791, 798, 829, 832, 844	764	739, 743, 746, 749, 756, 758, 761, 764, 771, 779, 782, 791, 798, 829, 832, 844	Range 512
PCS 1 900	647	634, 641, 647, 654, 659, 662, 666, 667, 673, 675, 679, 682, 691, 698, 729, 732, 744	664	639, 643, 646, 649, 656, 658, 661, 664, 671, 679, 682, 691, 698, 729, 732, 744	Range 512

The timebase of Cells A and B shall be such that the edges of their timeslots are not coincident at the antenna connector.

For execution counter M = 1 a combined CCH/SDCCH is used.

For execution counter M = 2 a non-combined SDCCH is used.

Mobile Station:

The MS is in the "idle, updated" state, with a TMSI allocated and camped on cell A.

Specific PICS statements:

- Speech supported for Half rate version 1 (GSM HR) (TSPC_AddInfo_Half_rate_version_1)
- Immediate connect supported for all circuit switched basic services. (TSPC_AddInfo_ImmConn)

PIXIT statements:

- Way to indicate alerting.
- Way to make the MS accept an incoming call after alerting.

Foreseen Final State of the MS

"Idle, updated" with TMSI allocated and camped on cell B.

Test Procedure

This procedure is repeated for execution counter M = 1..2.

A teleservice is selected that is supported by the MS; if the MS supports speech, the selected teleservice is speech. If necessary, the MS is configured for that teleservice.

The MS is paged on Cell A. The MS responds to the PAGING REQUEST message and establishes a mobile terminated call on Cell A. If the MS supports immediate connect, it continues the call establishment by through-connecting the traffic channel in both directions, or if the MS does not support immediate connect, it sends an ALERTING message. The MS indicates acceptance of a MT call by sending CONNECT.

After the MS has sent the CALL CONFIRMED message (if the MS supports immediate connect then the MS sends the CONNECT message after the CALL CONFIRMED message on the old channel) the SS sends a HANDOVER COMMAND message, ordering the MS to switch to cell B. The MS shall then begin to send access bursts on the new DCCH (and optionally on the SACCH) to cell B. The SS observes the access bursts and after receiving n (n being arbitrarily chosen between values according to table 26.6-2 of subclause 26.6.5) access bursts, the SS sends one PHYSICAL INFORMATION message with an arbitrarily chosen Timing Advance. The MS shall activate the channel in sending and receiving mode. The MS shall establish a signalling link. The MS shall be ready to transmit a HANDOVER COMPLETE message before x ms after the end of the PHYSICAL INFORMATION message, but not before a UA frame has been sent by the SS. After the successful handover procedure the MS sends the ALERTING message (if the MS runs the immediate connect procedure then the MS does not send an ALERTING message). The correct alerting indication shall be given to the user (only applicable if the MS supports the feature or if the MS is not using the immediate connect procedure). After the MS sent the CONNECT message the appropriate bearer channel shall be through connected in both directions. The SS sends then the CONNECT ACKNOWLEDGE message as the response on the CONNECT message. Having reached the active state, the call is cleared by the SS.

The term "ready to transmit" is defined in 3GPP TS 04.13. The value of "x" depends upon the target channel and is specified in the specific message contents section.

Maximum Duration of Test

2 minutes, including 1 minute for any necessary operator actions.

Expected Sequence

The sequence is performed for execution counter $M = 1..2$ (unless a particular TCH is not supported).

Step	Direction	Message	Comments
1	SS -> MS	PAGING REQUEST TYPE 1	Sent on the correct paging subchannel on cell A.
2	MS -> SS	CHANNEL REQUEST	
3	SS -> MS	IMMEDIATE ASSIGNMENT	See specific message contents.
4	MS -> SS	PAGING RESPONSE	Message is contained in SABM.
5	SS -> MS	AUTHENTICATION REQUEST	
6	MS -> SS	AUTHENTICATION RESPONSE	SRES specifies correct value.
7	SS -> MS	CIPHERING MODE COMMAND	SS starts deciphering after sending the message.
8	MS -> SS	CIPHERING MODE COMPLETE	Shall be sent enciphered. All following messages shall be sent enciphered.
9	SS		SS starts ciphering.
10	SS -> MS	SETUP	
11	MS -> SS	CALL CONFIRMED	
			If the MS supports immediate connect then branch A applies. If the MS does not support immediate connect then branch B applies
A12	MS -> SS	CONNECT	sent on the old channel
A13	SS -> MS	HANDOVER COMMAND	See specific message contents.
A14	MS -> SS	HANDOVER ACCESS	Repeated on every burst of the uplink main DCCH (and optionally on the SACCH) until reception of PHYSICAL INFORMATION. Handover Reference as included in the HANDOVER COMMAND. If the HANDOVER COMMAND includes a starting time IE then the first HANDOVER ACCESS message shall be transmitted in the indicated frame (unless the indicated frame is not used by that channel, in which case the next frame used by that channel shall be used).
A15	SS -> MS	PHYSICAL INFORMATION	Sent after reception of n HANDOVER ACCESS message. Timing Advance is arbitrarily chosen.
A16	MS -> SS	SABM	Sent without information field.
A17	SS -> MS	UA	
A18	MS -> SS	HANDOVER COMPLETE	This message shall be ready to be transmitted before "x" ms after the completion of step A15.
B12	SS -> MS	HANDOVER COMMAND	See specific message contents.
B13	MS -> SS	HANDOVER ACCESS	Repeated on every burst of the uplink main DCCH (and optionally on the SACCH) until reception of PHYSICAL INFORMATION. Handover Reference as included in the HANDOVER COMMAND. If the HANDOVER COMMAND includes a starting time IE then the first HANDOVER ACCESS message shall be transmitted in the indicated frame (unless the indicated frame is not used by that channel, in which case the next frame used by that channel shall be used).
B14	SS -> MS	PHYSICAL INFORMATION	Sent after reception of n HANDOVER ACCESS message. Timing Advance is arbitrarily chosen.
B15	MS -> SS	SABM	Sent without information field.
B16	SS -> MS	UA	
B17	MS -> SS	HANDOVER COMPLETE	This message shall be ready to be transmitted before "x" ms after the completion of step B14.
B18	MS -> SS	ALERTING	
B19	MS		Gives an alerting indication as defined in a PIXIT statement is given by the MS
B20	MS		The MS is made to accept the call in the way described in a PIXIT statement
B21	MS -> SS	CONNECT	
22	MS		If the call is a speech call, the TCH shall be through connected in both directions.
23	SS -> MS	CONNECT ACKNOWLEDGE	
24	MS		If the call is a data call, the TCH shall be through connected in both directions.
25	SS -> MS	DISCONNECT	
26	MS -> SS	RELEASE	
27	SS -> MS	RELEASE COMPLETE	

28	SS -> MS	CHANNEL RELEASE	The main signalling link is released.
----	----------	-----------------	---------------------------------------

Specific Message Contents For Mobiles Supporting Speech

M = 1:

IMMEDIATE ASSIGNMENT

Information Element	value/remark
As default message contents.	

HANDOVER COMMAND

Information Element	value/remarks
As default message contents, except:	
Cell Description	
- Network Colour Code	3
- Base Station Colour Code	0
- BCCH Carrier Number	See the table below
Channel Description	
- Channel Type	TCH/F + ACCHs
- Timeslot number	Zero.
- Training Sequence Code	Chosen arbitrarily.
- Hopping	Single RF Channel.
- ARFCN	Chosen arbitrarily from the Cell Allocation of Cell B, but not the BCCH carrier of Cell B.
Synchronization Indication IE not included.	
Mode of First Channel	Speech (full rate version 1 or half rate version 1).

Band	BCCH Carrier Number
GSM 450	274
GSM 480	321
GSM 710	477
GSM 750	477
T-GSM 810	477
GSM 850	167
GSM 900	40
DCS 1 800	764
PCS 1 900	664

Step A18 / B17: "x" = 500.

M = 2:

IMMEDIATE ASSIGNMENT

Information Element	value/remark
As default message contents except: L2 pseudo length Channel Description <ul style="list-style-type: none"> - Channel Type - TDMA offset - Timeslot number - Training Sequence Code - Hopping - MAIO <ul style="list-style-type: none"> - HSN Mobile Allocation <ul style="list-style-type: none"> - Length - Contents 	See the table below SDCCH/8 As default message contents. Arbitrary value, but not zero. Chosen arbitrarily. RF hopping channel. Chosen arbitrarily from the set (0, 1 to N-1), where N is the number of frequencies encoded in the Mobile Allocation. Chosen arbitrarily from the set (1,2,..63). 3 octets. Indicates only three frequencies, as per the table below

IMMEDIATE ASSIGNMENT		
Band	Mobile Allocation	L2 pseudo length
GSM 450	281, 283, 285	14 octets (11 + contents of the MA)
GSM 480	328, 330, 332	14 octets (11 + contents of the MA)
GSM 710	500, 501, 502	14 octets (11 + contents of the MA)
GSM 750	500, 501, 502	14 octets (11 + contents of the MA)
T-GSM 810	500, 501, 502	14 octets (11 + contents of the MA)
GSM 850	200, 201, 202	14 octets (11 + contents of the MA)
GSM 900	73, 74, 75	14 octets (11 + contents of the MA)
DCS 1 800	773, 775, 779	
PCS 1 900	673, 675, 679	

HANDOVER COMMAND

Information Element	value/remarks
As default message contents, except: Cell Description <ul style="list-style-type: none"> - Network Colour Code - Base Station Colour Code - BCCH Carrier Number Channel Description <ul style="list-style-type: none"> - Channel Type - TDMA offset - Timeslot number - Training Sequence Code - Hopping - MAIO <ul style="list-style-type: none"> - HSN Frequency List after time <ul style="list-style-type: none"> - Frequency List Synchronization Indication <ul style="list-style-type: none"> - Report Observed Time Difference - Synchronization Indication - Normal Cell Indication Mode of First Channel Starting Time	3 0 See the table below TCH/H + ACCHs Chosen arbitrarily. Chosen arbitrarily, but not Zero. Chosen arbitrarily. RF hopping channel. Chosen arbitrarily from the set (0, 1 to N-1), where N is the number of frequencies encoded in the Frequency List IE. Zero (this gives cyclic hopping). Encode the frequencies as per the table below. Shall not be included. "Non synchronized". Ignore out of range timing advance. Speech (full rate version 1 or half rate version 1). Indicates the frame number of cell B. that will occur approximately 1,1 seconds (238 frames have elapsed) after the HANDOVER COMMAND is sent by cell A.

HANDOVER COMMAND			
Band	BCCH Carrier Number	Cell Channel Description	
	ARFCN	Format	ARFCNs
GSM 450	274	Range 128	260, 262, 264, 266, 276, 279, 281, 283, 285, 287, 289, 291
GSM 480	321	Range 128	307, 309, 311, 313, 323, 326, 328, 330, 332, 334, 336, 338
GSM 710	477	Range 128	451, 455, 459, 461, 497, 498, 500, 501, 502, 503, 506, 508
GSM 750	477	Range 128	451, 455, 459, 461, 497, 498, 500, 501, 502, 503, 506, 508
T-GSM 810	477	Range 128	451, 455, 459, 461, 497, 498, 500, 501, 502, 503, 506, 508
GSM 850	167	Range 128	141, 145, 149, 151, 187, 193, 200, 201, 202, 203, 235, 241
GSM 900	40	Bitmap 0	14, 18, 22, 24, 60, 66, 73, 74, 75, 76, 108, 114
DCS 1 800	764	Range 512	749, 758, 761, 764, 771, 779, 782, 791, 798, 829, 832, 844
PCS 1 900	664	Range 512	649, 658, 661, 664, 671, 679, 682, 691, 698, 729, 732, 744

Step A18 / B17: "x" = 750.

Specific Message Contents For Mobiles not Supporting Speech

The message contents shall be the same as for a Mobile Station supporting speech, except for:

For M = 1 (TCH/F):

HANDOVER COMMAND

Information Element	value/remarks
Mode of first channel	Arbitrary from those supported (12, 6, 3.6 kbps).

For M = 2 (TCH/H):

HANDOVER COMMAND

Information Element	value/remarks
Mode of first channel	Arbitrary from those supported (6, 3.6 kbps).

26.9.9 Default contents of messages

ALERTING (mobile station to network direction)

Information element	Value/remark
Facility	Not checked
User-user	Not checked
SS version	Not checked

ALERTING (network to mobile station direction)

Information element	Value/remark
Facility	Omitted
Progress indicator	Omitted
User-user	Omitted

ASSIGNMENT COMMAND

Information element	Value/remark
Description of the first channel	describes non-hopping Bm+ACCHs or Lm+ACCHs as appropriate for the test
Power Command	As in subclause 26.1.1
Frequency list	Omitted
Cell channel description	Omitted
Mode of the first channel	appropriate for one bearer capability chosen for the test
Description of the second channel	Omitted
Mode of the second channel	Omitted
Mobile allocation	Omitted
Starting time	Omitted
Cipher mode setting	Omitted

ASSIGNMENT COMPLETE

Information element	Value/remark
RR cause	normal event

AUTHENTICATION REQUEST

Information element	Value/remark
Ciphering key sequence number	Arbitrary
Spare half octet	(spare bits)
Authentication parameter RAND	Arbitrary

AUTHENTICATION RESPONSE

Information element	Value/remark
Authentication parameter SRES	Correct for given SRES

CALL CONFIRMED

Information element	Value/remark
Repeat indicator	Omitted
Bearer capability 1	The <i>bearer capability 1</i> information element shall be included if and only if at least one of the following cases holds: <ul style="list-style-type: none"> - the mobile station wishes another bearer capability than that given by the <i>bearer capability 1</i> information element of the incoming SETUP message; - the <i>bearer capability 1</i> information element received in the SETUP message is accepted and the "radio channel requirement" of the Mobile Station is other than "full rate support only mobile station". - the <i>bearer capability 1</i> information element received in the SETUP message indicates speech and is accepted and the Mobile Station supports other speech versions than GSM full rate version 1/ half rate version 1.
Bearer capability 2	Omitted
Cause	Omitted
CC Capabilities	may be present

CALL PROCEEDING

Information element	Value/remark
Repeat Indicator	Omitted
Bearer Capability 1	Omitted if the SETUP message did not specify in the bearer capability 1 IE a connection element value "both, transparent preferred" or "both, non-transparent preferred". Otherwise included; in that case the connection element specifies the value that is appropriate for the selected teleservice (either value "transparent" or value "non transparent (RLP)"), all other parameters are same as in the bearer capability 1 IE of the received SETUP message.
Bearer Capability 2	Omitted
Facility	Omitted
Progress indicator	Omitted

CHANNEL RELEASE

Information element	Value/remark
RR cause	Normal event

CHANNEL REQUEST

Information element	Value/remark
Establishment cause	Answer to paging (100)
Random reference	Arbitrary value of 5 bits length

CIPHERING MODE COMMAND

Information element	Value/remark
Cipher mode setting	
algorithm identifier	indicates a supported algorithm
SC	Start ciphering
Cipher response	
CR	IMEI must not be included

CIPHERING MODE COMPLETE

Information element	Value/remark
Mobile equipment identity	Omitted

CM SERVICE ACCEPT

Information element	Value/remark
none but message head	

CM SERVICE REQUEST

Information element	Value/remark
CM service type	Mobile originating call establishment or packet mode connection establishment
Ciphering key sequence number	CKSN of the MS
Mobile station classmark 2	Not checked
Mobile identity	TMSI of MS

CONNECT (network to mobile station direction)

Information element	Value/remark
Facility	Omitted
Progress indicator	Omitted
Connected number	Omitted
Connected subaddress	Omitted
User-user	Omitted

CONNECT (mobile station to network direction)

Information element	Value/remark
Facility	Not checked
Connected subaddress	Not checked
User-user	Not checked
SS version	Not checked

CONNECT ACKNOWLEDGE

Information element	Value/remark
none but message head	

DISCONNECT (network to mobile station direction)

Information element	Value/remark
Cause	
Coding standard	GSM
Location	User
Cause value	Normal clearing
Facility	Omitted
Progress indicator	Omitted
User-user	Omitted

DISCONNECT (mobile station to network direction)

Information element	Value/remark
Cause	
Coding standard	GSM
Location	User
Cause value	Normal clearing
Facility	Not checked
User-user	Not checked
SS version	Not checked

EMERGENCY SETUP

Information element	Value/remark
Bearer Capability	May be present or omitted. If present, it shall indicate speech, the appropriate speech version(s) and have the appropriate value of radio channel requirement field

IMMEDIATE ASSIGNMENT

Information element	Value/remark
Page mode	Normal paging
Channel description	describes a valid SDCCH+SACCH in non-hopping mode
Request reference	
Random access information	As received from MS
N51, N32, N26	Corresponding to frame number of the CHANNEL REQUEST
Timing advance	Arbitrary
Mobile allocation	Empty (L=0)
Starting time	Omitted

PAGING REQUEST TYPE 1

Information element	Value/remark
L2 pseudo length	L2 pseudo length of the message
Page Mode	Normal Paging
Channels needed for Mobiles 1 and 2	
channel (first)	any channel
channel (second)	any channel
Mobile identity 1	TMSI of MS under test
Mobile identity 2	Omitted
P1 rest octets	(spare octets)

PAGING RESPONSE

Information element	Value/remark
Ciphering key sequence number	Value assigned to MS in the initial conditions
Spare half octet	(spare bits)
Mobile station classmark 2	Not checked
Mobile identity	specifies TMSI of MS

RELEASE (network to mobile station direction)

Information element	Value/remark
Cause	Omitted
Second cause	Omitted
Facility	Omitted
User-user	Omitted

RELEASE (mobile station to network direction)

Information element	Value/remark
Cause	Not checked
Second cause	Not checked
Facility	Not checked
User-user	Not checked
SS version	Not checked

RELEASE COMPLETE (network to mobile station direction)

Information element	Value/remark
Cause	Omitted
Facility	Omitted
User-user	Omitted

RELEASE COMPLETE (mobile station to network direction)

Information element	Value/remark
Cause	Not checked
Facility	Not checked
User-user	Not checked
SS version	Not checked

SETUP (MS to SS)

Information element	Value/remark
BC Repeat indicator	Omitted
Bearer capability 1	Appropriate for the teleservice selected for the test
Bearer capability 2	Omitted
Facility	Not checked
Calling party subaddress	Not checked
Called party BCD number	As entered
Called party subaddress	Omitted
LLC repeat indicator	Omitted
Low layer compatibility I	Appropriate for teleservice selected for the test
Low layer compatibility II	Omitted
HLC repeat indicator	Omitted
High layer compatibility i	Appropriate for teleservice selected for the test
High layer compatibility ii	Omitted
User-user	Not checked
SS version	Not checked
CLIR suppression	Not checked
CC Capabilities	may be present

SETUP (SS to MS)

Information element	Value/remark
BC repeat indicator	Omitted
Bearer capability 1	Appropriate for teleservice selected for the test
Bearer capability 2	Omitted
Facility	Omitted
Progress indicator	Omitted
Signal	Omitted
Calling party BCD number	Omitted
Calling party subaddress	Omitted
Called party BCD number	Omitted
Called party subaddress	Omitted
LLC repeat indicator	Omitted
Low layer compatibility I	Appropriate for teleservice selected for the test
Low layer compatibility II	Omitted
HLC repeat indicator	Omitted
High layer compatibility i	Appropriate for the teleservice selected for the test
High layer compatibility ii	Omitted
User-user	Omitted

26.10 E-GSM or R-GSM signalling

26.10.1 E-GSM or R-GSM signalling / general considerations

Subclause 26.10 only applies to E-GSM and R-GSM mobile stations. The details of frequencies used in different test cases are listed below.

Table 26.1: Frequencies used for E-GSM or R-GSM signalling tests

Test Case	Frequencies used in the test case	
	E-GSM testing	R-GSM testing
26.10.2.1	neighbour cell and serving cell: 0, 2, 26, 38, 990, 1003, 1005, 1020,	neighbour cell and serving cell: 0, 2, 26, 38, 960, 970, 990, 1020
26.10.2.2	single RF: 1015, hopping RF's: 0, 80, 1005, 1010	single RF: 972, hopping RF's: 0, 80, 958, 1010
26.10.2.3	k=1 hopping RF's c=1: 1005, 1010, 1015 c=2: 73, 74, 75, 76, 77 c=3: 980, 981, 982, 983 c=4: 30, 40, 1010, 1015 c=5: 980, 991, 992, 993, 994, 1015 c=6: 20, 40, 66 k=2 hopping RF's c=1: 1005, 1010, 1015 c=2: 73, 74, 75, 76, 77 c=3: 980, 981, 982, 983 c=4: 0, 30, 40, 1010, 1015 c=5: 990, 991, 992, 993, 994 c=6: 20, 40, 66	k=1 hopping RF's c=1: 964, 969, 972 c=2: 73, 76, 80, 85, 90 c=3: 956, 959, 976, 980 c=4: 30, 40, 969, 972, 990, 1020 c=5: 956, 960, 963, 966, 969, 972 c=6: 20, 40, 66 k=2 hopping RF's c=1: 964, 969, 972 c=2: 66, 73, 76, 79, 108 c=3: 960, 963, 978, 990 c=4: 0, 30, 40, 969, 972, 990, 1020 c=5: 962, 965, 968, 972 c=6: 20, 40, 66
26.10.2.4.1	Target cell BCCH: 40 k=1 hopping RF's c=1: 1005, 1010, 1015 c=2: 73, 74, 75, 76, 77 c=3: 980, 981, 982, 983 c=4: 30, 40, 1010, 1015 c=5: 980, 991, 992, 993, 994, 1015 k=2 hopping RF's c=1: 1005, 1010, 1015 c=2: 73, 74, 75, 76, 77 c=3: 980, 981, 982, 983 c=4: 30, 40, 1010, 1015 c=5: 980, 991, 992, 993, 994, 1015 c=6: 10, 40, 66 k=3 hopping RF's c=1: 1005, 1010, 1015 c=2: 73, 74, 75, 76, 77 c=3: 980, 981, 982, 983 c=4: 30, 40, 1010, 1015 c=5: 990, 991, 992, 993, 994 c=6: 10, 40, 66	Target cell BCCH: 965 k=1 hopping RF's c=1: 964, 969, 972 c=2: 73, 76, 79, 86, 97 c=3: 956, 960, 963, 970 c=4: 30, 40, 969, 972, 990, 1020 c=5: 956, 960, 964, 967, 970, 973 k=2 hopping RF's c=1: 964, 969, 972 c=2: 73, 76, 79, 86, 97 c=3: 956, 960, 963, 970 c=4: 30, 40, 969, 972, 990, 1020 c=5: 956, 960, 964, 967, 970, 973 c=6: 10, 40, 66 k=3 hopping RF's c=1: 964, 969, 972 c=2: 73, 76, 79, 108, 115 c=3: 960, 964, 969, 972 c=4: 30, 40, 969, 972, 990, 1020 c=5: 960, 963, 966, 969, 972 c=6: 10, 40, 66
26.10.2.4.2	Original cell BCCH: 20 Target cell BCCH: 40 hopping RF's: 1005, 1010, 1015	Original cell BCCH: 990 Target cell BCCH: 965 hopping RF's: 960, 970, 990
26.10.2.5	hopping RF's c=1: 1005, 1010, 1015 c=2: 73, 74, 75, 76, 77 c=3: 980, 981, 982, 983 c=4: 30, 40, 1010, 1015 c=5: 990, 991, 992, 993, 994 c=6: 30, 50, 70	hopping RF's c=1: 964, 969, 972 c=2: 73, 76, 79, 108, 114 c=3: 960, 964, 968, 972 c=4: 30, 40, 969, 972, 990, 1020 c=5: 960, 964, 967, 970, 972 c=6: 30, 50, 70

Test Case	Frequencies used in the test case	
	E-GSM testing	R-GSM testing
26.10.3.1	BCCH: 20 Immediate Assignment: 40 Assignment: 990	BCCH: 20 Immediate Assignment: 40 Assignment: 965
26.10.3.2	BCCH: 20 Immediate Assignment: 40 Assignment: 990	BCCH: 20 Immediate Assignment: 40 Assignment: 965

Conformance requirements of clause 26 fully apply to any mobile station (P-GSM, E-GSM, R-GSM or DCS) in the whole supported band of the mobile station.

Besides, as an E-GSM or R-GSM mobile station shall support the P-GSM band, it shall pass successfully every test of clause 26 under the described GSM 900 conditions.

The purpose of this extra section is to test the different procedures which may be impacted when some channel uses E-GSM or R-GSM frequency(ies).

26.10.2 E-GSM or R-GSM signalling / RR

26.10.2.1 E-GSM or R-GSM signalling / RR / Measurement

26.10.2.1.1 Conformance requirements

The MS shall continuously send MEASUREMENT REPORT messages on every SACCH blocks and the measurement valid indication shall be set to valid (0) within the second block at the latest. After 20 s the values in the MEASUREMENT REPORT message shall contain measurement results for the 6 th strongest cells belonging to the set of cells indicated either in SI5 and SI5bis messages or in SI5 and SI5ter messages.

References

3GPP TS 04.08 / 3GPP TS 44.018 subclauses 3.4.1.2 and 9.1.39,
3GPP TS 05.08 subclause 8.4.

26.10.2.1.2 Test purpose

To test that, when the SS gives information about neighbouring cells indicated either in SI5 and SI5bis messages or in SI5 and SI5ter messages, the MS reports appropriate results.

26.10.2.1.3 Method of test

Initial Conditions

System Simulator:

8 cells with the following settings:

E-GSM:

Transmitter	Level	NCC	BCC	ARFCN	Cell Identity
Serving, S1	-60	1	3	002	0001H
Neighbour, N1	-85	1	5	990	0002H
Neighbour, N2	-80	1	7	1005	0003H
Neighbour, N3	-75	1	1	000	0004H
Neighbour, N4	-55	1	3	026	0005H
Neighbour, N5	-50	1	5	1020	0006H
Neighbour, N6	-45	1	7	038	0007H
Neighbour, N7	-40	1	1	1003	0008H

R-GSM:

Transmitter	Level	NCC	BCC	ARFCN	Cell Identity
Serving, S1	-60	1	3	002	0001H
Neighbour, N1	-85	1	5	990	0002H
Neighbour, N2	-80	1	7	970	0003H
Neighbour, N3	-75	1	1	000	0004H
Neighbour, N4	-55	1	3	026	0005H
Neighbour, N5	-50	1	5	1020	0006H
Neighbour, N6	-45	1	7	038	0007H
Neighbour, N7	-40	1	1	960	0008H

With the exception of the Cell Allocation, the rest of the parameters for all eight cells are the same as the default settings and default SYSTEM INFORMATION TYPE 1 to 4 message contents for cell A. The Cell Allocation for the serving cell is the same as the default setting for cell A. The Cell Allocations for the neighbour cells need have only one entry, consisting of the ARFCN of that cell's BCCH.

Mobile Station:

The MS is in the active state of a call (U10).

Specific PICS statements:

- R-GSM Band (TSPC_Type_GSM_R_Band)

PIXIT statements:

-

Foreseen Final State of the MS

Active state of a call (U10).

Test Procedure

If the MS is R-GSM capable, then this test shall be performed using R-GSM, otherwise this test shall be performed using E-GSM.

The test is performed for execution counter, c=1 to 9.

For c=1 to 6, the following procedure applies:

With the MS having a call in progress, the SS sends SYSTEM INFORMATION TYPE 5, 5bis and 6 on the SACCH. The MS shall send MEASUREMENT REPORTs back to the SS, and it shall be indicated in these that measurement results for the 6 strongest present carriers of the supported band have been obtained.

For c=7 to 9, the following procedure applies:

With the MS having a call in progress, the SS sends SYSTEM INFORMATION TYPE 5, 5ter and 6 on the SACCH. The MS shall send MEASUREMENT REPORTs back to the SS, and it shall be indicated in these that measurement results for the 6 strongest present carriers of the supported band have been obtained.

Maximum Duration of Test

8 minutes, including 1 minute for any necessary operator actions.

Expected Sequence

This sequence is performed for execution counter, c= 1 to 9.

Since SYSTEM INFORMATION TYPE 5, SYSTEM INFORMATION TYPE 6 and MEASUREMENT REPORT are sent continuously, a table is not applicable in this test. The interval between 2 successive Layer 2 frames containing MEASUREMENT REPORTs shall not exceed one Layer 2 frame.

Specific Message Contents

E-GSM:

SYSTEM INFORMATION TYPE 5:

Information Element	value/remark
Protocol Discriminator Message Type Neighbour Cells Description - EXT IND - BA-IND	RR management Sys Info 5. - EXT IND= 1, for c= 1 to 6: Information Element carries only a part of the BA. - EXT IND= 0, for c=7 to 9: Information Element carries the complete BA. 0 for c=1, use range 128 to encode the following frequencies: (26, 38) for c=2, use range 256 to encode the following frequencies (990, 1 003, 1 005) for c=3, use range 512 to encode the following frequencies (520, 990, 1 003, 1 005, 1 020) for c=4, use range 1 024 to encode the following frequencies (0, 26, 38, 990, 1 003, 1 005) for c=5, use variable Bitmap to encode the following frequencies (0, 26, 38) for c=6, use Bitmap 0 to encode the following frequencies (26) for c=7, use range 512 to encode the following frequencies: (520, 990, 1020) for c=8, use range 1024 to encode the following frequencies: (0, 26, 38, 990, 1005, 1020) for c=9, use range 256 to encode the following frequencies: (38)

SYSTEM INFORMATION TYPE 5bis:

Information Element	value/remark
Protocol Discriminator Message Type Neighbour Cells Description - EXT IND - BA-IND	RR management Sys Info 5bis. Information Element carries only a part of the BA. 0 for c=1, use range 512 to encode the following frequencies: (520, 990, 1 003, 1 005, 1 020) for c=2, use range 128 to encode the following frequencies (0, 26, 38) for c=3, use range 256 to encode the following frequencies (0, 26, 38) for c=4, use range 1 024 to encode the following frequencies (520, 1 000) for c=5, use range 128 to encode the following frequencies (884, 990, 1 003, 1 005) for c=6, use range 512 to encode the following frequencies (520, 990, 1 003)

SYSTEM INFORMATION TYPE 5ter:

Information Element	value/remark
Protocol Discriminator Message Type Neighbour Cells Description <ul style="list-style-type: none"> - multiband reporting - BA-IND 	RR management Sys Info 5ter. normal reporting of the six strongest cells, irrespective of the band used. 0 for c=7, use range 1024 to encode the following frequencies (0,26,1003, 1005) for c=8, use variable bitmap to encode the following frequencies (1000,1003) for c=9,, use range 256 to encode the following frequencies (26, 1003, 1020)

SYSTEM INFORMATION TYPE 6:

Information Element	value/ remark
Protocol Discriminator Message Type Cell Identity LAI Cell Options <ul style="list-style-type: none"> - Power Control Indicator - DTX Indicator - Radio-Link-Time-out PLMN permitted	RR Management sys info 6 default default Power Control Indicator is set MS shall not use DTX default only NCC 1 permitted

MEASUREMENT REPORT:

Information Element	value/remark
Protocol Discriminator	RR Management
Transaction Identifier	0000
Message Type	MEASUREMENT REPORT
Measurement Results	
BA-used	0
DTX-used	DTX was not used
RXLEV-FULL-SERVING-CELL	See note 1
RXLEV-SUB-SERVING-CELL	See note 1
MEAS-VALID	See note 3
RXQUAL-FULL-SERVING-CELL	See note 1
RXQUAL-SUB-SERVING-CELL	See note 1
NO-NCELL-M	n (see note 2)
RXLEV-NCELL-1	See note 1
BCCH-FREQ-NCELL-1	See note 2
BSIC-NCELL-1	Corresponds to that of BCCH-FREQ-NCELL-1
RXLEV-NCELL-2	See note 1
BCCH-FREQ-NCELL-2	See note 2
BSIC-NCELL-2	Corresponds to that of BCCH-FREQ-NCELL-2
RXLEV-NCELL-3	See note 1
BCCH-FREQ-NCELL-3	See note 2
BSIC-NCELL-3	Corresponds to that of BCCH-FREQ-NCELL-3
RXLEV-NCELL-4	See note 1
BCCH-FREQ-NCELL-4	See note 2
BSIC-NCELL-4	Corresponds to that of BCCH-FREQ-NCELL-4
RXLEV-NCELL-5	See note 1
BCCH-FREQ-NCELL-5	See note 2
BSIC-NCELL-5	Corresponds to that of BCCH-FREQ-NCELL-5
RXLEV-NCELL-6	See note 1
BCCH-FREQ-NCELL-6	See note 2
BSIC-NCELL-6	Corresponds to that of BCCH-FREQ-NCELL-6
NOTE 1: These actual values are not checked.	
NOTE 2: ARFCN 2 is the serving cell carrier. c=1 report on ARFCNs 26, 38, 990, 1 003, 1 005, 1 020, n=6 c=2 report on ARFCNs 26, 38, 990, 1 003, 1 005, 0, (1 020 stronger than 1 005 but not broadcasted in SYS INFO), n=6 c=3 report on ARFCNs 26, 38, 1 003, 1 005, 1 020, 0 (990 less strong, 520 DCS), n=6 c=4 report on ARFCNs 26, 38, 990, 1 003, 1 005, 0 (1 000 less strong, 520 DCS, 1 020 not broadcasted in SYS INFO), n=6 c=5 report on ARFCNs 26, 38, 990, 1 003, 1 005, 0 (884 DCS), n=6 c=6 report on ARFCNs 26, 990, 1 003, n=3 c=7 report on ARFCNs 26, 990, 1003, 1005, 1020, 0 (520 DCS), n=6 c=8 report on ARFCNs 26, 38, 1003, 1005, 1020, 0 (990 and 1000 less strong), n=6 c=9 report on ARFCNs 26,38, 1003, 1020, n=4.	
NOTE 3: The Measurement Valid Indication shall be set to valid within the second SACCH block at the latest.	

R-GSM:

SYSTEM INFORMATION TYPE 5:

Information Element	value/remark
Protocol Discriminator Message Type Neighbour Cells Description - EXT IND - BA-IND	RR management Sys Info 5. - EXT IND= 1, for c=1 to 6: Information Element carries only a part of the BA. - EXT IND= 0, for c=7 to 9: Information Element carries the BA. 0 for c=1, use range 128 to encode the following frequencies: (26, 38) for c=2, use range 256 to encode the following frequencies (960, 970, 990) for c=3, use range 512 to encode the following frequencies (520, 960, 970, 990, 1020) for c=4, use range 1 024 to encode the following frequencies (0, 26, 38, 960, 970, 990) for c=5, use variable Bitmap to encode the following frequencies (0, 26, 38) for c=6, use Bitmap 0 to encode the following frequencies (26) for c=7, use range 512 to encode the following frequencies: (520, 990, 1020) for c=8, use range 1024 to encode the following frequencies: (0, 26, 38, 970, 990, 1020) for c=9, use range 256 to encode the following frequencies: (38)

SYSTEM INFORMATION TYPE 5bis:

Information Element	value/remark
Protocol Discriminator Message Type Neighbour Cells Description - EXT IND - BA-IND	RR management Sys Info 5bis. Information Element carries only a part of the BA. 0 for c=1, use range 512 to encode the following frequencies: (520, 960, 970, 990, 1020) for c=2, use range 128 to encode the following frequencies (0, 26, 38) for c=3, use range 256 to encode the following frequencies (0, 26, 38) for c=4, use range 1 024 to encode the following frequencies (520, 1 000) for c=5, use variable Bitmap to encode the following frequencies (884, 960, 970, 990) for c=6, use range 512 to encode the following frequencies (520, 960, 990)

SYSTEM INFORMATION TYPE 5ter:

Information Element	value/remark
Protocol Discriminator Message Type Neighbour Cells Description - multiband reporting - BA-IND	RR management Sys Info 5ter. normal reporting of the six strongest cells, irrespective of the band used. 0 for c=7, use range 1024 to encode the following frequencies (0, 26, 960, 970) for c=8, use variable bitmap to encode the following frequencies (960, 1000) for c=9,, use range 256 to encode the following frequencies (26, 960, 1020)

SYSTEM INFORMATION TYPE 6:

Information Element	value/ remark
Protocol Discriminator Message Type Cell Identity LAI Cell Options - Power Control Indicator - DTX Indicator - Radio-Link-Time-out PLMN permitted	RR Management sys info 6 default default Power Control Indicator is set MS shall not use DTX default only NCC 1 permitted

MEASUREMENT REPORT:

Information Element	value/remark
Protocol Discriminator	RR Management
Transaction Identifier	0000
Message Type	MEASUREMENT REPORT
Measurement Results	
BA-used	1
DTX-used	DTX was not used
RXLEV-FULL-SERVING-CELL	See note 1
RXLEV-SUB-SERVING-CELL	See note 1
MEAS-VALID	See note 3
RXQUAL-FULL-SERVING-CELL	See note 1
RXQUAL-SUB-SERVING-CELL	See note 1
NO-NCELL-M	n (see note 2)
RXLEV-NCELL-1	See note 1
BCCH-FREQ-NCELL-1	See note 2
BSIC-NCELL-1	Corresponds to that of BCCH-FREQ-NCELL-1
RXLEV-NCELL-2	See note 1
BCCH-FREQ-NCELL-2	See note 2
BSIC-NCELL-2	Corresponds to that of BCCH-FREQ-NCELL-2
RXLEV-NCELL-3	See note 1
BCCH-FREQ-NCELL-3	See note 2
BSIC-NCELL-3	Corresponds to that of BCCH-FREQ-NCELL-3
RXLEV-NCELL-4	See note 1
BCCH-FREQ-NCELL-4	See note 2
BSIC-NCELL-4	Corresponds to that of BCCH-FREQ-NCELL-4
RXLEV-NCELL-5	See note 1
BCCH-FREQ-NCELL-5	See note 2
BSIC-NCELL-5	Corresponds to that of BCCH-FREQ-NCELL-5
RXLEV-NCELL-6	See note 1
BCCH-FREQ-NCELL-6	See note 2
BSIC-NCELL-6	Corresponds to that of BCCH-FREQ-NCELL-6
NOTE 1: These actual values are not checked.	
NOTE 2: ARFCN 2 is the serving cell carrier. c=1 report on ARFCNs: 26, 38, 960, 970, 990, 1020. n=6 c=2 report on ARFCNs: 26, 38, 960, 970, 990, 0. (1020 stronger than 970 but not broadcasted in SYS INFO). n=6 c=3 report on ARFCNs: 26, 38, 960, 970, 1020, 0. (990 less strong, 520 DCS). n=6 c=4 report on ARFCNs: 26, 38, 960, 970, 990, 0. (1000 less strong, 520 DCS, 1020 not broadcasted in SYS INFO). n=6 c=5 report on ARFCNs: 26, 38, 960, 970, 990, 0. (884 DCS). n=6 c=6 report on ARFCNs: 26, 960, 990. n=3 c=7 report on ARFCNs: 26, 960, 970, 990, 1020, 0 (520 DCS). n=6 c=8 report on ARFCNs: 26, 38, 960, 970, 1020, 0 (990 and 1000 less strong). n=6 c=9 report on ARFCNs: 26, 38, 960, 1020. n=4.	
NOTE 3: The Measurement Valid Indication shall be set to valid within the second SACCH block at the latest.	

26.10.2.2 E-GSM or R-GSM signalling / RR / Immediate assignment

26.10.2.2.1 Conformance requirement

Following a PAGING REQUEST message, the MS shall correctly set up an RR connection on a supported channel described in the IMMEDIATE ASSIGNMENT message, using some E-GSM or R-GSM frequency.

Reference(s)

3GPP TS 04.08 / 3GPP TS 44.018 subclause 3.3.1.1.2.

26.10.2.2.2 Test purpose

To verify that the MS can correctly set up a dedicated control channel when E-GSM or R-GSM frequencies are used.

This tested for a SDCCH/8.

26.10.2.2.3 Method of test

Initial Conditions

System Simulator:

1 cell.

E-GSM:

CCCH-CONF is set to "1 basic physical channel used for CCCH not combined with SDCCHs".

SYSTEM INFORMATION type 1 message contains the following frequencies in the Cell Channel Description IE: 0, 30, 40, 66, 80, 1 005, 1 010, 1 015 (use range 1 024 to encode).

BCCH carrier number 1 015.

R-GSM:

CCCH-CONF is set to "1 basic physical channel used for CCCH not combined with SDCCHs".

SYSTEM INFORMATION type 1 message contains the following frequencies in the Cell Channel Description IE: 0, 30, 40, 66, 80, 958, 1010, 972 (use range 1 024 to encode).

BCCH carrier number 972.

Mobile Station:

The MS is in the "idle, updated" state, with a TMSI allocated.

Specific PICS statements:

- R-GSM Band (TSPC_Type_GSM_R_Band)

PIXIT statements:

-

Foreseen Final State of the MS

"Idle, updated", with TMSI allocated.

Test Procedure

If the MS is R-GSM capable, then this test shall be performed using R-GSM, otherwise this test shall be performed using E-GSM.

This test procedure is performed twice.

The System Simulator pages the MS and after the MS has responded with a CHANNEL REQUEST message the SS assigns an SDCCH channel using some E-GSM or R-GSM frequencies. The MS shall go to the correct channel and send a PAGING RESPONSE message. Then the SS initiates RR-release by sending a CHANNEL RELEASE message.

Maximum Duration of Test

15 seconds.

Expected Sequence

The sequence is performed for execution counter k = 1 to 2.

Step	Direction	Message	Comments
1	SS -> MS	PAGING REQUEST TYPE 1	
2	MS -> SS	CHANNEL REQUEST	cause "answer to paging"
3	SS -> MS	IMMEDIATE ASSIGNMENT	Channel Type: see below
4	MS -> SS	PAGING RESPONSE	Shall be sent on the correct channel
5	SS -> MS	CHANNEL RELEASE	

Specific Message Contents

E-GSM:

IMMEDIATE ASSIGNMENT

As default except:

Information element	remark/value
Channel description	SDCCH/8
- Channel Type	arbitrary but not zero
- Timeslot number	arbitrary
- Training sequence code	k=1 Single RF
- Hopping channel	k=2 RF hopping channel
- Channel Selector	k=1 ARFCN=1 015 k=2 MAIO = arbitrarily chosen HSN arbitrary chosen from the set (1,..63)
Mobile allocation	k=1 empty k=2 indicates the following frequencies (0, 80, 1 005, 1 010)

R-GSM:

IMMEDIATE ASSIGNMENT

As default except:

Information element	remark/value
Channel description	SDCCH/8
- Channel Type	arbitrary but not zero
- Timeslot number	arbitrary
- Training sequence code	k=1 Single RF
- Hopping channel	k=2 RF hopping channel
- Channel Selector	k=1 ARFCN=972 k=2 MAIO = arbitrarily chosen HSN arbitrary chosen from the set (1,..63)
Mobile allocation	k=1 empty k=2 indicates the following frequencies (0, 80, 958, 1010)

26.10.2.3 E-GSM or R-GSM signalling / RR / channel assignment procedure

26.10.2.3.1 Conformance requirements

1. Upon receipt of the ASSIGNMENT COMMAND message, the mobile station initiates a local end release of link layer connections, disconnects the physical channels, commands the switching to the assigned channels and initiates the establishment of lower layer connections (this includes the activation of the channels, their connection and the establishment of the main signalling links).
2. The MS shall apply the hopping frequencies specified in ASSIGNMENT COMMAND message in the mobile allocation or frequency list or frequency short list at the time accessing the new channel.

References

3GPP TS 04.08 / 3GPP TS 44.018, subclauses 3.4.3 and 9.1.2.

26.10.2.3.2 Test purpose

1. To verify that upon receipt of an ASSIGNMENT COMMAND, the MS switches to the channel defined in the ASSIGNMENT COMMAND, establishes the link and sends an ASSIGNMENT COMPLETE message.
2. To verify that an MS, having received an ASSIGNMENT COMMAND, is able in case of frequency hopping to decode the mobile allocation and frequency list correctly and applies the specified frequencies.

26.10.2.3.3 Method of test

Initial Conditions

System Simulator:

1 cell, default parameters.

Mobile Station:

The MS is in the "idle, updated" state with a TMSI allocated.

Specific PICS statements:

- R-GSM Band (TSPC_Type_GSM_R_Band)
- TSPC_AddInfo_Full_rate_version_1

PIXIT statements:

-

Foreseen Final State of the MS

"Idle, updated", with TMSI allocated.

Test Procedure

If the MS is R-GSM capable, then this test shall be performed using R-GSM, otherwise this test shall be performed using E-GSM.

The test procedure is performed 2 times.

The SS pages the MS and allocates an SDCCH. Then a channel is assigned with ASSIGNMENT COMMAND. Each time the MS shall switch to the assigned channel, establish the link and send an ASSIGNMENT COMPLETE message.

The SS initiates the channel release procedure.

Maximum Duration of Test

3 minutes.

Expected Sequence

The test sequence is performed for execution counter k=1 to 2.

Step	Direction	Message	Comments
1	SS -> MS	PAGING REQUEST TYPE 1	Timeslot Number = n.
2	MS -> SS	CHANNEL REQUEST	
3	SS -> MS	IMMEDIATE ASSIGNMENT	
4	MS -> SS	PAGING RESPONSE	
5	SS -> MS	ASSIGNMENT COMMAND	See specific message contents Timeslot Number = (n+1) mod 8 Sent on the correct channel after establishment of the main signalling link. Steps 5 and 6 are repeated cmax times, where cmax is the number of frequency formats allowed for each value of k. Use repetition counter c: See specific message content.
6	MS -> SS	ASSIGNMENT COMPLETE	
7	SS -> MS	CHANNEL RELEASE	The main signalling link is released.

Specific Message Contents

E-GSM:

ASSIGNMENT COMMAND:

Information element	value/remark
Protocol Discriminator	RR
Skip indicator	0000
Message type	ASSIGNMENT COMMAND
Channel Description	
- Channel type	TCH/F + ACCHs if supported by the MS or SDCCH/8 if not
- Timeslot number	arbitrary
- Training sequence code	chosen arbitrarily
- Hopping	RF hopping channel
- MAIO	arbitrary
- HSN	arbitrarily chosen from the set (1,2...63)
Power Command	
- Power level	Arbitrarily chosen
For k=1	
Cell Channel Description IE is not included	
Frequency list	for c=1, use range 128 to encode the following frequencies: (1 005, 1 010, 1 015) for c=2, use range 256 to encode the following frequencies (73, 74, 75, 76, 77) for c=3, use range 512 to encode the following frequencies (980, 981, 982, 983) for c=4, use range 1 024 to encode the following frequencies (30, 40, 1 010, 1 015) for c=5, use variable Bitmap to encode the following frequencies (980, 991, 992, 993, 994, 1 015) with an encoding origin set to 980 for c=6, use Bitmap 0 to encode the following frequencies (20, 40, 66)
For k=2	
Cell Channel Description	for c=1, use range 128 to encode the following 13 frequencies: (980, 981, 982, 983, 990, 991, 992, 993, 994, 1 000, 1 005, 1 010, 1 015) for c=2, use range 256 to encode the following 13 frequencies (20, 40, 66, 73, 74, 75, 76, 77, 78, 79, 108, 114, 115) for c=3, use range 512 to encode the following 13 frequencies (980, 981, 982, 983, 990, 991, 992, 993, 994, 1 000, 1 005, 1 010, 1 015) for c=4, use range 1 024 to encode the following 8 frequencies (0, 30, 40, 66, 80, 1 005, 1 010, 1 015) for c=5, use variable Bitmap to encode the following frequencies (980, 981, 982, 983, 990, 991, 992, 993, 994, 1 000, 1 005, 1 010, 1 015) for c=6, use Bitmap 0 to encode the following 12 frequencies (20, 40, 66, 73, 74, 75, 76, 77, 78, 79, 108, 114)
For k = 2	
Mobile Allocation	indicates the following the frequencies: for c=1 (1 005, 1 010, 1 015) for c=2 (73, 74, 75, 76, 77) for c=3 (980, 981, 982, 983) for c=4 (0, 30, 40, 1 010, 1 015) for c=5 (990, 991, 992, 993, 994) for c=6 (20, 40, 66)
Mode of the First channel	speech full rate version 1 for TCH/F except if speech is not supported: arbitrary from those supported
Starting Time	not included

R-GSM:

ASSIGNMENT COMMAND:

Information element	value/remark
Protocol Discriminator	RR
Skip indicator	0000
Message type	ASSIGNMENT COMMAND
Channel Description	
- Channel type	TCH/F + ACCHs if supported by the MS or SDCCH/8 if not arbitrary
- Timeslot number	chosen arbitrarily
- Training sequence code	RF hopping channel
- Hopping	arbitrary
- MAIO	arbitrarily chosen from the set (1,2...63)
- HSN	
Power Command	
- Power level	Arbitrarily chosen
For k=1	
Cell Channel Description IE is not included	
Frequency list	for c=1, use range 128 to encode the following frequencies: (964, 969, 972) for c=2, use range 256 to encode the following frequencies (73, 76, 80, 85, 90) for c=3, use range 512 to encode the following frequencies (956, 960, 976, 980) for c=4, use range 1 024 to encode the following frequencies (30, 40, 969, 972, 990, 1020) for c=5, use variable Bitmap to encode the following frequencies (956, 960, 963, 966, 969, 972) with an encoding origin set to 956 for c=6, use Bitmap 0 to encode the following frequencies (20, 40, 66)
For k=2	
Cell Channel Description	for c=1, use range 128 to encode the following 13 frequencies: (960, 961, 962, 963, 964, 965, 966, 967, 968, 969, 970, 971, 972) for c=2, use range 256 to encode the following 13 frequencies (20, 40, 66, 73, 74, 75, 76, 77, 78, 79, 108, 114, 115) for c=3, use range 512 to encode the following 13 frequencies (960, 961, 962, 963, 964, 965, 966, 967, 968, 969, 970, 978, 990) for c=4, use range 1 024 to encode the following 10 frequencies (0, 30, 40, 66, 80, 964, 969, 972, 990, 1020) for c=5, use variable Bitmap to encode the following 13 frequencies (960, 961, 962, 963, 964, 965, 966, 967, 968, 969, 970, 971, 972) for c=6, use Bitmap 0 to encode the following 12 frequencies (20, 40, 66, 73, 74, 75, 76, 77, 78, 79, 108, 114)
For k = 2	
Mobile Allocation	indicates the following the frequencies: for c=1 (964, 969, 972) for c=2 (66, 73, 76, 79, 108) for c=3 (960, 964, 978, 990) for c=4 (0, 30, 40, 969, 972, 990, 1020) for c=5 (962, 965, 968, 972) for c=6 (20, 40, 66)
Mode of the First channel	speech full rate version 1 for TCH/F except if speech is not supported: arbitrary from those supported
Starting Time	not included

26.10.2.4 E-GSM or R-GSM signalling / RR / Handover

26.10.2.4.1 E-GSM or R-GSM signalling / RR / Handover / Successful handover

26.10.2.4.1.1 Conformance requirements

The MS shall correctly apply the handover procedure from a channel without frequency hopping in the primary band to a channel with frequency hopping using P-GSM and E-GSM or P-GSM and R-GSM frequencies whatever the coding used for the frequency hopping description.

References

3GPP TS 04.08 / 3GPP TS 44.018, subclauses 3.4.4 and 9.1.15.

26.10.2.4.1.2 Test purpose

To check that the MS correctly performs a non-synchronized handover, from a non hopping primary band SDCCH to a hopping TCH or SDCCH using E-GSM or R-GSM frequencies, whatever the coding used for the hopping sequence description and that it activates the new channel correctly.

This is tested in the following case:

E-GSM or R-GSM signalling / Handover / successful / call under establishment / non-synchronized /:

- from SDCCH/8 to TCH/F if the MS supports a TCH;
- from SDCCH/8 to SDCCH/8 if not.

26.10.2.4.1.3 Method of test

Initial Conditions

System Simulator:

E-GSM:

2 cells A and B with same LAI, default parameters;

except for Cell A: the broadcasted Cell Channel Description in SYSTEM INFORMATION type 1 message contains the following frequencies: 20, 40, 66, 73, 74, 75, 76, 77, 78, 79, 108, 114 (encoded using Bit Map 0 format);

The broadcasted BCCH frequency list for Cell A in SYSTEM INFORMATION type 2 and 5 contains the following frequencies: 10, 20, 40, 80, 90, 100, 110 and 120 (encoded in Bit Map 0 format).

R-GSM:

2 cells A and B with same LAI, default parameters;

except for Cell A: the broadcasted Cell Channel Description in SYSTEM INFORMATION type 1 message contains the following frequencies: 20, 40, 66, 73, 74, 75, 76, 77, 78, 79, 108, 114 (encoded using Bit Map 0 format);

Except for Cell B: the BCCH carrier number is 965.

Mobile Station:

The MS is in the "idle, updated" state, with a TMSI allocated and camped on cell A.

Specific PICS statements:

- R-GSM Band (TSPC_Type_GSM_R_Band)
- TSPC_AddInfo_Full_rate_version_1

PIXIT statements:

-

Foreseen Final State of the MS

"Idle, updated" with TMSI allocated and camped on cell B.

Test Procedure

If the MS is R-GSM capable, then this test shall be performed using R-GSM, otherwise this test shall be performed using E-GSM.

The test procedure is performed 17 times.

A Mobile Originating Call is initiated on cell A. After the MS has sent the SETUP message (and before the last L2 frame carrying the SETUP message is acknowledged by the SS) the SS sends a HANDOVER COMMAND message, ordering the MS to switch to cell B.

The MS shall then begin to send access bursts on the new channel, a TCH/F if supported (see PICS) or an SDCCH if not, to cell B.

The SS observes the access bursts. After receiving n access bursts, n being randomly drawn between 10 and 20 for the TCH case, 2 and 5 for the SDCCH (see table 26.6-2 of subclause 26.6.5), the SS sends one PHYSICAL INFORMATION message with a Timing Advance of 20 (see table 26.6-1 of subclause 26.6.5).

The MS shall activate the channel in sending and receiving mode. Then the MS shall establish a signalling link using the correct timing advance. The MS shall be ready to transmit a HANDOVER COMPLETE message before x ms after the end of the PHYSICAL INFORMATION message but not before a UA frame has been sent by the SS. The MS shall then again send the SETUP message to the SS, using the same value in the N(SD) field. Finally the SS sends a CHANNEL RELEASE to end the test.

The term "ready to transmit" is specified in 3GPP TS 04.13. The value of "x" depends upon the target channel:

- case SDCCH/8 x = 750;
- case TCH/F x=500.

Maximum Duration of Test

10 minutes.

Expected Sequence

The sequence is performed for execution counter k=1 to 3 and c=1 to 6 (excluding k=1 and c=6 as Format Bit Map 0 is not supported in the Frequency Short List IE).

Step	Direction	Message	Comments
1	-----	-----	A MO call is initiated on cell A
2	MS -> SS	CHANNEL REQUEST	Establish. Cause = "Originating call, NECI not set to 1
3	SS -> MS	IMMEDIATE ASSIGNMENT	see specific message contents
4	MS -> SS	CM SERVICE REQUEST	CM Service Type = Mobile Originating Call Establishment.
5	SS -> MS	CIPHERING MODE COMMAND	
6	MS -> SS	CIPHERING MODE COMPLETE	
7	MS -> SS	SETUP	Last L2 frame not acknowledged by the SS.
8	SS -> MS	HANDOVER COMMAND	see specific message contents
9	MS -> SS	HANDOVER ACCESS	Repeated on every burst of the uplink main DCCH (and optionally the SACCH) until reception of PHYSICAL INFORMATION. Handover Reference as included in the HANDOVER COMMAND
10	SS -> MS	PHYSICAL INFORMATION	Sent after reception of n HANDOVER ACCESS. Timing Advance: 20
11	MS -> SS	SABM	Sent without information field
12	SS -> MS	UA	
13	MS -> SS	HANDOVER COMPLETE	This message shall be ready to be transmitted before "x" ms after the completion of step 10
14	MS -> SS	SETUP	Same N(SD) as in step 7.
15	SS -> MS	CHANNEL RELEASE	

Specific Message Contents

E-GSM:

IMMEDIATE ASSIGNMENT

Information Element	Value/remark
As default message contents, except: Channel Description <ul style="list-style-type: none"> - Channel type - Timeslot number - Training sequence code - Hopping - ARFCN 	SDCCH/8 arbitrary but not zero chosen arbitrarily Single RF channel Chosen arbitrarily from the Cell Allocation of Cell A, but not the BCCH carrier of Cell A.

HANDOVER COMMAND

Information Element	Value/remark
As default message contents, except: Cell Description <ul style="list-style-type: none"> - BCCH carrier number Channel Description <ul style="list-style-type: none"> - Channel type - Timeslot number - Training sequence code - Hopping - MAIO - HSN Synchronization Indication IE is not included For k = 1, Cell Channel Description IE is not included Frequency short list	40 TCH/F + ACCHs if supported by the MS or SDCCH/8 if not arbitrary but not zero chosen arbitrarily RF hopping channel arbitrary arbitrarily chosen from the set (1,2...63) for c=1, use range 128 to encode the following frequencies: (1 005, 1 010, 1 015) for c=2, use range 256 to encode the following frequencies (73, 74, 75, 76, 77) for c=3, use range 512 to encode the following frequencies (980, 981, 982, 983) for c=4, use range 1 024 to encode the following frequencies (30, 40, 1 010, 1 015) for c=5, use variable Bitmap to encode the following frequencies (980, 991, 992, 993, 994, 1 015)
For k=2 Cell Channel Description IE is not included Frequency list	for c=1, use range 128 to encode the following frequencies: (1 005, 1 010, 1 015) for c=2, use range 256 to encode the following frequencies (73, 74, 75, 76, 77) for c=3, use range 512 to encode the following frequencies (980, 981, 982, 983) for c=4, use range 1 024 to encode the following frequencies (30, 40, 1 010, 1 015) for c=5, use variable Bitmap to encode the following frequencies (980, 991, 992, 993, 994, 1 015) for c=6, use Bitmap 0 to encode the following frequencies (10, 40, 66)
For k=3 Cell Channel Description	for c=1, use range 128 to encode the following 13 frequencies: (980, 981, 982, 983, 990, 991, 992, 993, 994, 1 000, 1 005, 1 010, 1 015) for c=2, use range 256 to encode the following 13 frequencies (10, 40, 66, 73, 74, 75, 76, 77, 78, 79, 108, 114, 115) for c=3, use range 512 to encode the following 13 frequencies (980, 981, 982, 983, 990, 991, 992, 993, 994,

Information Element	Value/remark
For k = 3 Mobile Allocation	1 000, 1 005, 1 010, 1 015) for c=4, use range 1 024 to encode the following 10 frequencies (0, 30, 40, 66, 80, 520, 975, 1 005, 1 010, 1 015) for c=5, use variable Bitmap to encode the following 13 frequencies (980, 981, 982, 983, 990, 991, 992, 993, 994, 1 000, 1 005, 1 010, 1 015) for c=6, use Bitmap 0 to encode the following 12 frequencies (10, 40, 66, 73, 74, 75, 76, 77, 78, 79, 108, 114)
Mode of the First channel	indicates the following the frequencies: for c=1 (1 005, 1 010, 1 015) for c=2 (73, 74, 75, 76, 77) for c=3 (980, 981, 982, 983) for c=4 (30, 40, 1 010, 1 015) for c=5 (990, 991, 992, 993, 994) for c=6 (10, 40, 66) if SDCCH/8: signalling if TCH/F: speech full rate version 1 if speech is supported, otherwise arbitrary from those supported

R-GSM:

IMMEDIATE ASSIGNMENT

Information Element	Value/remark
As default message contents, except: Channel Description - Channel type - Timeslot number - Training sequence code - Hopping - ARFCN	SDCCH/8 arbitrary but not zero chosen arbitrarily Single RF channel Chosen arbitrarily from the Cell Allocation of Cell A, but not the BCCH carrier of Cell A.

HANDOVER COMMAND

Information Element	Value/remark
As default message contents, except:	
Cell Description	
- BCCH carrier number	965
Channel Description	
- Channel type	TCH/F + ACCHs if supported by the MS or SDCCH/8 if not
- Timeslot number	arbitrary but not zero
- Training sequence code	chosen arbitrarily
- Hopping	RF hopping channel
- MAIO	arbitrary
- HSN	arbitrarily chosen from the set (1,2...63)
Synchronization Indication IE is not included	
For k = 1,	
Cell Channel Description IE is not included	
Frequency short list	for c=1, use range 128 to encode the following frequencies: (964, 969, 972) for c=2, use range 256 to encode the following frequencies (73, 76, 79, 86, 97) for c=3, use range 512 to encode the following frequencies (956, 960, 964, 970) for c=4, use range 1 024 to encode the following frequencies (30, 40, 969, 972, 990, 1020) for c=5, use variable Bitmap to encode the following frequencies (956, 960, 964, 967, 970, 973)
For k=2	
Cell Channel Description IE is not included	
Frequency list	for c=1, use range 128 to encode the following frequencies: (964, 969, 972) for c=2, use range 256 to encode the following frequencies (73, 76, 79, 86, 97) for c=3, use range 512 to encode the following frequencies (956, 960, 963, 970) for c=4, use range 1 024 to encode the following frequencies (30, 40, 969, 972, 990, 1020) for c=5, use variable Bitmap to encode the following frequencies (956, 960, 964, 967, 970, 973) for c=6, use Bitmap 0 to encode the following frequencies (10, 40, 66)
For k=3	
Cell Channel Description	for c=1, use range 128 to encode the following 13 frequencies: (960, 961, 962, 963, 964, 965, 966, 967, 968, 969, 970, 971, 972) for c=2, use range 256 to encode the following 13 frequencies (10, 40, 66, 73, 74, 75, 76, 77, 78, 79, 108, 114, 115) for c=3, use range 512 to encode the following 13 frequencies (960, 961, 962, 963, 964, 965, 966, 967, 968, 969, 970, 971, 972) for c=4, use range 1 024 to encode the following 12 frequencies (0, 30, 40, 66, 80, 520, 955, 964, 969, 972, 990, 1020) for c=5, use variable Bitmap to encode the following frequencies (960, 961, 962, 963, 964, 965, 966, 967, 968, 969, 970, 971, 972) for c=6, use Bitmap 0 to encode the following 12 frequencies (10, 40, 66, 73, 74, 75, 76, 77, 78, 79, 108, 114)

Information Element	Value/remark
For k = 3 Mobile Allocation	indicates the following the frequencies: for c=1 (964, 969, 972) for c=2 (73, 76, 79, 108, 115) for c=3 (960, 964, 969, 972) for c=4 (30, 40, 969, 972, 990, 1020) for c=5 (960, 963, 966, 969, 972) for c=6 (10, 40, 66)
Mode of the First channel	if SDCCH/8: signalling if TCH/F: speech full rate version 1 if speech is supported, otherwise arbitrary from those supported

26.10.2.4.2 E-GSM or R-GSM signalling / RR / Handover / layer 1 failure

26.10.2.4.2.1 Conformance requirements

During a handover from a channel in the E-GSM or R-GSM band to a channel in the P-GSM band, or the contrary, the MS shall correctly return to the old channel in the case of an handover failure caused by a layer 1 failure on the target cell.

References

3GPP TS 04.08 / 3GPP TS 44.018 subclause 3.4.4.

26.10.2.4.2.2 Test purpose

To check that the MS correctly returns to the old channel in the case of a handover failure caused by a layer 1 failure on the target cell, even if the origin is in the P-GSM band and the target in the E-GSM or R-GSM band.

26.10.2.4.2.3 Method of test

Initial Conditions

System Simulator:

E-GSM:

2 cells with same LAI, default parameters.

Cell A: The broadcasted BCCH frequency list for Cell A in SYSTEM INFORMATION type 2 and 5 contains the following frequencies: 10, 20, 40, 80, 90, 100, 110 and 120 (encoded in Bit Map 0 format).

The BCCH carrier number of Cell B is 40. (According to Table 26.1)

R-GSM:

2 cells with same LAI, default parameters, except the BCCH carrier number of Cell A is 990, the BCCH carrier number of Cell B is 965.

Mobile Station:

E-GSM:

The MS is in the active state (U10) of a call on a P-GSM channel of cell A. power level = 10.

R-GSM:

The MS is in the active state (U10) of a call on a E-GSM channel of cell A, power level = 10.

Specific PICS statements:

- R-GSM Band (TSPC_Type_GSM_R_Band)
- TSPC_AddInfo_Full_rate_version_1

PIXIT statements:

-

Foreseen Final State of the MS

The active state (U10) of a mobile call (on cell A), used power level 10.

Test Procedure

If the MS is R-GSM capable, then this test shall be performed using R-GSM, otherwise this test shall be performed using E-GSM.

The MS is in the active state (U10) of a call on a P-GSM channel (on an E-GSM channel for R-GSM testing) of cell A (used power level 10). The SS sends a HANOVER COMMAND on the main DCCH. The MS shall begin to send access bursts at the commanded power level on the new DCCH (and optionally on SACCH) to cell B (power level 12). With the exception of normal BCCH signalling, the SS does not transmit anything on cell B (thus causing a time-out of T3124). The MS shall re-establish the old link on cell A and send a HANOVER FAILURE within 3 seconds from the transmission of HANOVER COMMAND, using the old power level.

Maximum Duration of Test

1 minute.

Expected Sequence

Step	Direction	Message	Comments
1	SS -> MS	HANOVER COMMAND	to an E-GSM or R-GSM channel see specific message contents
2	MS -> SS	HANOVER ACCESS	Several messages are sent, all with correct Handover References.
3	MS -> SS	HANOVER FAILURE	Sent on old channel, RR cause value = "Abnormal release, unspecified", "Abnormal release, channel unacceptable", "Abnormal release, timer expired", "Abnormal release, no activity on the radio path" or "Protocol error unspecified". Layer 1 header has the same power level as the layer 1 header in step 1. Shall be sent within 3 seconds from the transmission of HANOVER COMMAND.

Specific Message Contents

E-GSM:

HANOVER COMMAND

Information Element	Value/remark
As default message contents, except:	
Cell Description	
- BCCH carrier number	40
Channel Description	
- Channel type	TCH/F + ACCHs if supported by the MS
- Timeslot number	arbitrary but not zero
- Training sequence code	chosen arbitrarily
- Hopping	RF hopping channel
- MAIO	arbitrary
- HSN	chosen randomly from the set (1,2...63)
Synchronization Indication IE is not included	
Cell Channel Description IE is not included	
Frequency short list	use range 128 to encode the following frequencies: (1 005, 1 010, 1 015)
Mode of the first channel	Full rate speech version 1 if supported. If not, arbitrary from those supported except signalling.

R-GSM:

HANDOVER COMMAND

Information Element	Value/remark
As default message contents, except:	
Cell Description	
- BCCH carrier number	965
Channel Description	
- Channel type	TCH/F + ACCHs if supported by the MS
- Timeslot number	arbitrary but not zero
- Training sequence code	chosen arbitrarily
- Hopping	RF hopping channel
- MAIO	arbitrary
- HSN	chosen randomly from the set (1,2...63)
Synchronization Indication IE is not included	
Cell Channel Description IE is not included	
Frequency short list	use range 128 to encode the following frequencies: (960, 970, 990)
Mode of the first channel	Full rate speech version 1 if supported. If not, arbitrary from those supported except signalling.

26.10.2.5 E-GSM or R-GSM signalling / RR / Frequency Redefinition

26.10.2.5.1 Conformance requirements

- 1) To verify that the MS, after receiving a FREQUENCY REDEFINITION message, correctly starts using the new frequencies, and hopping sequence when some E-GSM or R-GSM frequencies are used.
- 2) The last received Cell Channel Description information element is used to decode the Mobile Allocation IE received on the FREQUENCY REDEFINITION message.

References

3GPP TS 04.08 / 3GPP TS 44.018, subclauses 3.4.5 and 9.1.13.

26.10.2.5.2 Test purpose

- 1) To verify that the MS, after receiving a FREQUENCY REDEFINITION message, starts using the new frequencies and hopping sequence when some E-GSM or R-GSM frequencies are used.
- 2) To check that the last received Cell Channel Description information element is used to decode the Mobile Allocation IE received in the FREQUENCY REDEFINITION message.

26.10.2.5.3 Method of test

Initial conditions

System Simulator:

1 cell; default parameters.

Mobile Station:

The MS is in "idle, updated" state with TMSI allocated.

Specific PICS statements:

- R-GSM Band (TSPC_Type_GSM_R_Band)
- TSPC_AddInfo_Full_rate_version_1

PIXIT statements:

-

Foreseen final state of the MS

"Idle, updated", with TMSI allocated.

Test procedure

If the MS is R-GSM capable, then this test shall be performed using R-GSM, otherwise this test shall be performed using E-GSM.

The test procedure is performed six times.

The System Simulator pages the MS and after the MS has responded with a CHANNEL REQUEST, the simulator assigns a TCH/F if supported otherwise a SDCCH/8. Then the SS sends to MS a FREQUENCY REDEFINITION. The MS shall then use the new frequencies/hopping sequence.

Maximum duration of test

3 minutes.

Expected sequence

The sequence is performed for execution counter c=1 to 6.

Step	Direction	Message	Comments
1	SS->MS	PAGING REQUEST TYPE 1	
2	MS->SS	CHANNEL REQUEST	
3	SS->MS	IMMEDIATE ASSIGNMENT	Hopping channel, Channel type = TCH/F if a TCH is supported otherwise, Channel type=SDCCH/8.
4	MS->SS	PAGING RESPONSE	Sent on the correct channel after establishment of the main signalling link
5	SS->MS	FREQUENCY REDEFINITION	See specific message contents.
6	-----	-----	The SS checks that the MS is transmitting on the correct frequencies.
7	SS->MS	CHANNEL RELEASE	The main signalling link is released.

Specific Message Contents

E-GSM:

FREQUENCY REDEFINITION

Information Element	Value/remark
As default message contents, except:	
Cell Description	
- BCCH carrier number	40
Channel Description	
- Channel type	Same as in IMMEDIATE ASSIGNMENT
- Timeslot number	Same as in IMMEDIATE ASSIGNMENT
- Training sequence code	Same as in IMMEDIATE ASSIGNMENT
- Hopping	RF hopping channel
- MAIO	arbitrary
- HSN	Same as in IMMEDIATE ASSIGNMENT
Cell Channel Description	for c=1, use range 128 to encode the following 13 frequencies: (980, 981, 982, 983, 990, 991, 992, 993, 994, 1 000, 1 005, 1 010, 1 015) for c=2, use range 256 to encode the following 13 frequencies (20, 40, 66, 73, 74, 75, 76, 77, 78, 79, 108, 114, 115) for c=3, use range 512 to encode the following 13 frequencies (980, 981, 982, 983, 990, 991, 992, 993, 994, 1 000, 1 005, 1 010, 1 015) for c=4, use range 1 024 to encode the following 8 frequencies (0, 30, 40, 66, 80, 1 005, 1 010, 1 015) for c=5, use variable Bitmap to encode the following frequencies (980, 981, 982, 983, 990, 991, 992, 993, 994, 1 000, 1 005, 1 010, 1 015) for c=6, not present (the mobile station will use the last Cell Channel Description IE received, i.e. the one broadcast in the SYSTEM INFORMATION TYPE 1 message).
Mobile Allocation	indicates the following frequencies: for c=1 (1 005, 1 010, 1 015) for c=2 (73, 74, 75, 76, 77) for c=3 (980, 981, 982, 983) for c=4 (30, 40, 1 010, 1 015) for c=5 (990, 991, 992, 993, 994) for c=6 (30, 50, 70)
Starting time	indicates (current frame number + 100 frames) mod 42432

R-GSM:

FREQUENCY REDEFINITION

Information Element	Value/remark
As default message contents, except:	
Cell Description	
- BCCH carrier number	40
Channel Description	
- Channel type	Same as in IMMEDIATE ASSIGNMENT
- Timeslot number	Same as in IMMEDIATE ASSIGNMENT
- Training sequence code	Same as in IMMEDIATE ASSIGNMENT
- Hopping	RF hopping channel
- MAIO	arbitrary
- HSN	Same as in IMMEDIATE ASSIGNMENT
Cell Channel Description	for c=1, use range 128 to encode the following 13 frequencies: (960, 961, 962, 963, 964, 965, 966, 967, 968, 969, 970, 971, 972) for c=2, use range 256 to encode the following 13 frequencies (20, 40, 66, 73, 74, 75, 76, 77, 78, 79, 108, 114, 115) for c=3, use range 512 to encode the following 13 frequencies (960, 961, 962, 963, 964, 965, 966, 967, 968, 969, 970, 971, 972) for c=4, use range 1 024 to encode the following 10 frequencies (0, 30, 40, 66, 80, 964, 969, 972, 990, 1020) for c=5, use variable Bitmap to encode the following 13 frequencies (960, 961, 962, 963, 964, 965, 966, 967, 968, 969, 970, 971, 972) for c=6, not present (the mobile station will use the last Cell Channel Description IE received, i.e. the one broadcast in the SYSTEM INFORMATION TYPE 1 message).
Mobile Allocation	indicates the following frequencies: for c=1 (964, 969, 972) for c=2 (73, 76, 79, 108, 114) for c=3 (960, 964, 968, 972) for c=4 (30, 40, 969, 972, 990, 1020) for c=5 (960, 964, 967, 970, 972) for c=6 (30, 50, 70)
Starting time	indicates (current frame number + 100 frames) mod 42432

26.10.3 E-GSM or R-GSM signalling / Structured procedure

26.10.3.1 E-GSM or R-GSM signalling / Structured procedure / Mobile originated call

26.10.3.1.1 Conformance requirement

- 1) An MS in MM state "idle, updated" and in RR idle mode with a TMSI assigned, when made to initiate a call for a selected teleservice that is supported by the MS, shall start to initiate an immediate assignment procedure by sending the CHANNEL REQUEST message with correct establishment cause.
- 2) Upon receipt of the ASSIGNMENT COMMAND message, the Mobile Station initiates a local end release of link layer connections, disconnects the physical channels, commands the switching to the assigned channels and initiates the establishment of lower layer connections (this includes the activation of the channels, their connection and the establishment of the data links). After the main signalling link is successfully established, the MS returns an ASSIGNMENT COMPLETE message, specifying cause "normal event", to the network on the main DCCH.
- 3, 4) The call control entity of the Mobile Station in the "call initiated" state, in the "mobile originating call proceeding" state or in the "call delivered" state, shall, upon receipt of a CONNECT message:
 - attach the user connection to the radio path;
 - return a CONNECT ACKNOWLEDGE message.

References

- Conformance requirement 1: 3GPP TS 04.08 / 3GPP TS 44.018 subclause 3.3.1.1.
- Conformance requirement 2: 3GPP TS 04.08 / 3GPP TS 44.018 subclauses 3.4.3.1 and 3.4.3.2.
- Conformance requirement 3: 3GPP TS 04.08 / 3GPP TS 44.018 subclause 3.4.3.
- Conformance requirement 4: 3GPP TS 04.08 / 3GPP TS 24.008 subclause 5.2.1.1.6.
- Conformance requirement 5: 3GPP TS 02.07.
- Conformance requirement 6: 3GPP TS 04.08 / 3GPP TS 24.008 subclauses 5.2.1.1.6 and 5.1.3.

26.10.3.1.2 Test purpose

- 1) To verify that the MS in MM state "idle, updated" and in RR idle mode with a TMSI assigned, when made to initiate a call for a selected teleservice that is supported by the MS as declared in a PICS/PIXIT statement, starts to initiate an immediate assignment procedure by sending the CHANNEL REQUEST message.
- 2) To verify that subsequently after receipt of an IMMEDIATE ASSIGNMENT message allocating an SDCCH, after completion of establishment of the main signalling link, after having sent a CM SERVICE REQUEST message, after having successfully performed authentication and cipher mode setting procedures, after having sent a SETUP message, after having received a CALL PROCEEDING message followed by an ALERTING message and an ASSIGNMENT COMMAND message allocating an appropriate TCH, the MS sends an ASSIGNMENT COMPLETE message.
- 3) To verify that subsequently, after the suite of actions specified in test purposes 1 and 2, the MS after receiving a CONNECT message returns a CONNECT ACKNOWLEDGE message.
- 4) To verify that after the suite of actions specified in test purposes 1 and 2, the MS after receiving a CONNECT message attaches the user connection to the radio path. (This is checked by verifying that there is a point in time after transmission of the first L2 frame containing the (complete) CONNECT message, where the MS is sending appropriate speech or data frames whenever it does not have to transmit or acknowledge an I frame on layer 2 of the FACCH.)

26.10.3.1.3 Method of test

Specific PICS statements:

- R-GSM Band (TSPC_Type_GSM_R_Band)
- TSPC_AddInfo_Full_rate_version_1

PIXIT statements:

- Way to indicate mobile originated alerting.
- Way to display the called number

Initial Conditions

System Simulator:

1 cell, default parameters.

Mobile Station:

The MS is in MM-state "idle, updated" with valid TMSI and CKSN.

Foreseen Final State of the MS

The MS is in MM state "idle updated".

Test procedure

If the MS is R-GSM capable, then this test shall be performed using R-GSM, otherwise this test shall be performed using E-GSM.

The following test is performed for one teleservice supported by the MS:

- A teleservice is selected that is supported by the MS; if the MS supports speech, the selected teleservice is speech. If necessary, the MS is configured for that teleservice.
- The MS is made to initiate a call. The call is established with late assignment. The release of the call is initiated by the MS.

Maximum Duration of Test

1 minute.

Expected Sequence

Step	Direction	Message	Comments
1	MS		The "called number" is entered
3	MS		
4	MS -> SS	CHANNEL REQUEST	Establishment cause is "originating call and the network does not set the NECI bit to 1".
5	SS -> MS	IMMEDIATE ASSIGNMENT	
6	MS -> SS	CM SERVICE REQUEST	Message is contained in SABM.
7	SS -> MS	AUTHENTICATION REQUEST	
8	MS -> SS	AUTHENTICATION RESPONSE	SRES specifies correct value.
9	SS -> MS	CIPHERING MODE COMMAND	SS starts deciphering after sending the message.
10	MS -> SS	CIPHERING MODE COMPLETE	Shall be sent enciphered. All following messages shall be sent enciphered.
11	SS		SS starts ciphering.
12	MS -> SS	SETUP	
13	SS -> MS	CALL PROCEEDING	
14	SS -> MS	ALERTING	
15	MS		Depending on the PICS, an alerting indication is given.
16	SS -> MS	ASSIGNMENT COMMAND	
17	MS -> SS	ASSIGNMENT COMPLETE	
18	SS -> MS	CONNECT	
19	MS -> SS	CONNECT ACKNOWLEDGE	
20	MS		The appropriate bearer channel is through connected in both directions.
21	MS		If the call is a data call, the TCH shall be through connected in both directions.
22	MS		The MS is made to release the call.
23	MS -> SS	DISCONNECT	
24	SS -> MS	RELEASE	
25	MS -> SS	RELEASE COMPLETE	
26	SS -> MS	CHANNEL RELEASE	The main signalling link is released.

Specific Message Contents:

None.

26.10.3.2 E-GSM or R-GSM signalling / Structured procedures / emergency call

Emergency call establishment can be initiated by an MS whether location updating has been successful or not and whether a SIM is inserted into the MS or not; but only if the MS is equipped for speech.

This subclause is only applicable to an MS supporting speech.

26.10.3.2.1 Conformance requirement

- 1) The MS in the "idle, updated" state, as after a successful location update, after the number 112 has been entered by user, shall send a CHANNEL REQUEST message with correct establishment cause ("emergency call").

- 2) After assignment of a dedicated channel the first layer message sent by the MS on the assigned dedicated channel shall be a CM SERVICE REQUEST message specifying the correct IMEI and a non-available CKSN, with CM Service Type "emergency call establishment".
- 3) After cipher mode setting acceptance by the network, the MS shall send an EMERGENCY SETUP message.
- 4, 5) The emergency call shall be correctly established. The assignment procedure shall be correctly performed.
- 6) After receipt of a CONNECT ACKNOWLEDGE message during correct establishment of the emergency call the TCH shall be through connected in both directions if an appropriate TCH is available.
- 7) The call shall be cleared correctly.

Requirement Reference:

For conformance requirement 1 and 2:

- 3GPP TS 04.08 / 3GPP TS 44.018 subclause 3.3.1.1;
- 3GPP TS 04.08 / 3GPP TS 24.008 subclauses 5.2.1 and 4.5.1.5;
- 3GPP TS 02.30 clause 4.

For conformance requirement 3:

- 3GPP TS 04.08 / 3GPP TS 24.008, subclause 5.2.1.2.

For conformance requirements 4 and 5:

- 3GPP TS 04.08 / 3GPP TS 24.008, subclause 5.2.1.1; and
- 3GPP TS 04.08 / 3GPP TS 44.018 subclause 3.4.3.

For conformance requirement 6:

- 3GPP TS 04.08 / 3GPP TS 24.008, subclauses 5.2.1.1.6 and 5.1.3.

For conformance requirement 7:

- 3GPP TS 04.08 / 3GPP TS 24.008, subclause 5.4.

26.10.3.2.2 Test purpose

- 1) To verify that the MS in the "idle, no IMSI" state (no SIM inserted) when made to call the number 112, sends a CHANNEL REQUEST message with establishment cause "emergency call".
- 2) To verify that after assignment of a dedicated channel the first layer message sent by the MS on the assigned dedicated channel is a CM SERVICE REQUEST message specifying the correct CKSN and TMSI, with CM Service Type "emergency call establishment".
- 3) To verify that after receipt of a CM SERVICE ACCEPT message from the SS, the MS sends an EMERGENCY SETUP message.
- 4) To verify that subsequently, the SS having sent a CALL PROCEEDING message and then an ALERT message and having initiated the assignment procedure, the MS performs correctly that assignment procedure.
- 5) To verify subsequent correct performance of a connect procedure.
- 6) To verify that subsequently the MS has through connected the TCH in both directions.
- 7) To verify that the call is cleared correctly.

This is tested in the following case:

Structured procedures / emergency call / idle, no IMSI / accept case.

26.10.3.2.3 Method of test

Specific PICS statements:

- R-GSM Band (TSPC_Type_GSM_R_Band)
- TSPC_AddInfo_Full_rate_version_1

PIXIT statements:

-

Initial Conditions

System Simulator:

1 cell, default parameters except:

See Table 26.1

Mobile Station:

The MS is in MM-state "idle, no IMSI", no SIM inserted.

Foreseen Final State of the MS

The MS is in MM-state "idle, no IMSI", no SIM inserted.

Test procedure

If the MS is R-GSM capable, then this test shall be performed using R-GSM, otherwise this test shall be performed using E-GSM.

The MS is made to initiate an emergency call. The call is established without authentication, without ciphering, with early assignment. Having reached the active state, the call is cleared by the SS.

Maximum Duration of Test

1 minute.

Expected Sequence

Step	Direction	Message	Comments
1	MS		The "called number" 112 is entered
2	MS -> SS	CHANNEL REQUEST	Establishment cause is "emergency call".
3	SS -> MS	IMMEDIATE ASSIGNMENT	
4	MS -> SS	CM SERVICE REQUEST	Message is contained in SABM. The CM service type IE indicates "emergency call establishment". The mobile identity IE specifies the IMEI of the MS. The cipher key sequence number IE indicates "no key is available". The mobile station classmark IE is as specified by the manufacturer in a PICS/PIXIT statement.
5	SS -> MS	CM SERVICE ACCEPT	
6	MS -> SS	EMERGENCY SETUP	
7	SS -> MS	CALL PROCEEDING	
8	SS -> MS	ASSIGNMENT COMMAND	The rate of the channel is one indicated by the EMERGENCY SETUP message.
9	MS -> SS	ASSIGNMENT COMPLETE	
10	SS -> MS	ALERTING	
11	SS -> MS	CONNECT	
12	MS -> SS	CONNECT ACKNOWLEDGE	
13	MS		The TCH is through connected in both directions.
14	SS -> MS	DISCONNECT	
15	MS -> SS	RELEASE	
16	SS -> MS	RELEASE COMPLETE	
17	SS -> MS	CHANNEL RELEASE	The main signalling link is released.

Specific Message Contents:

None.

26.10.3.3 Default contents of messages

Same as in subclause 26.9.7 except for the following.

ASSIGNMENT COMMAND

E-GSM:

Information element	Value/remark
Description of the first channel	describes non-hopping Bm+ACCHs or Lm+ACCHs as appropriate for the test ARFCN = 990
Power Command -	Chosen arbitrarily but within the range supported by the MS.
Frequency list	Omitted
Cell channel description	Omitted
Mode of the first channel	appropriate for one bearer capability chosen for the test
Description of the second channel	Omitted
Mode of the second channel	Omitted
Mobile allocation	Omitted
Starting time	Omitted
Cipher mode setting	Omitted

R-GSM:

Information element	Value/remark
Description of the first channel	describes non-hopping Bm+ACCHs or Lm+ACCHs as appropriate for the test ARFCN = 965
Power Command -	Chosen arbitrarily but within the range supported by the MS.
Frequency list	Omitted
Cell channel description	Omitted
Mode of the first channel	appropriate for one bearer capability chosen for the test
Description of the second channel	Omitted
Mode of the second channel	Omitted
Mobile allocation	Omitted
Starting time	Omitted
Cipher mode setting	Omitted

IMMEDIATE ASSIGNMENT

Information element	Value/remark
Page mode	Normal paging
Channel description	describes a valid SDCCH+SACCH in non-hopping mode ARFCN = 40
Request reference Random access information N51, N32, N26	As received from MS Corresponding to frame number of the CHANNEL REQUEST
Timing advance	Arbitrary
Mobile allocation	Empty (L=0)
Starting time	Omitted

26.10.4 E-GSM or R-GSM signalling / Default message contents

Default SYSTEM INFORMATION:

NOTE: SYSTEM INFORMATION 7, and SYSTEM INFORMATION 8 messages are not used.

SYSTEM INFORMATION type 1 message

Information elements	Value/Remark
Cell Channel Description For Cell A - Format identifier - Cell Allocation ARFCN For Cell B - Format identifier - Cell Allocation ARFCN RACH Control parameters SI1 Rest octets	Bit Map 0 Channel Numbers 20, 30, 50 and 70. Bit Map 0 Channel Numbers 10, 12, 40, 60, 62, 63 see below see below

SYSTEM INFORMATION type 2 message

Information elements	Value/Remark
BCCH frequency list For cell A - Format identifier - BCCH Allocation Sequence - BCCH Allocation ARFCN - EXT-IND For cell B - Format identifier - BCCH Allocation Sequence - BCCH Allocation ARFCN - EXT-IND NCC permitted RACH control parameters	bit map 0 0 Channels numbers 10, 20, 80, 90, 100, 110 and 120 This IE does not carry the complete BA bit map 0 0 Channels numbers 10, 36, 40, 114, 118 This IE does not carry the complete BA see below see below

SYSTEM INFORMATION type 2bis message

E-GSM:

Information elements	Value/Remark
Extended BCCH frequency list For cell A - Format identifier - BCCH Allocation Sequence - BCCH Allocation ARFCN - EXT-IND For cell B - Format identifier - BCCH Allocation Sequence - BCCH Allocation ARFCN - EXT-IND RACH control parameters SI 2bis rest octets	range 256 0 988, 990, 1 003 This IE does not carry the complete BA range 128 0 Channels numbers 1 005, 1 010, 1 015 This IE does not carry the complete BA see below see below

R-GSM:

Information elements	Value/Remark
Extended BCCH frequency list	
For cell A	
- Format identifier	range 256
- BCCH Allocation Sequence	0
- BCCH Allocation ARFCN	962, 965, 968, 980, 990
- EXT-IND	This IE does not carry the complete BA
For cell B	
- Format identifier	range 128
- BCCH Allocation Sequence	0
- BCCH Allocation ARFCN	Channels numbers 969, 970, 972, 1005, 1010
- EXT-IND	This IE does not carry the complete BA
RACH control parameters	see below
SI 2bis rest octets	see below

SYSTEM INFORMATION type 3 message

Information elements	Value/Remark
Cell identity	see below
LAI	see below
Control channel description	see below
Cell options	see below
Cell Selection parameters	see below
RACH control parameter	see below
SI3 Rest octets	see below

SYSTEM INFORMATION type 4 message

Information elements	Value/Remark
LAI	see below
Cell selection parameters	see below
RACH control parameters	see below
CBCH Channel Description	see below
CBCH MA	see below
SI4 Rest octets	see below

SYSTEM INFORMATION type 5 message

Information elements	Value/Remark
BCCH frequency list	
For cell A	
- Format identifier	bit map 0
- BCCH Allocation Sequence	0
- BCCH Allocation ARFCN	Channels numbers 10, 20, 80, 90, 100, 110 and 120
- EXT-IND	This IE does not carry the complete BA
For cell B	
- Format identifier	Bit map 0
- BCCH Allocation Sequence	0
- BCCH Allocation ARFCN	Channels numbers 10, 36, 40, 114, 118
- EXT-IND	This IE does not carry the complete BA

SYSTEM INFORMATION type 5bis message

E-GSM:

Information elements	Value/Remark
Extension of BCCH frequency list description For cell A - Format identifier - BCCH Allocation Sequence - BCCH Allocation ARFCN - EXT-IND	Range 256 0 Channels numbers 988, 990, 1 003 This IE does not carry the complete BA
For cell B - Format identifier - BCCH Allocation Sequence - BCCH Allocation ARFCN - EXT-IND	range 128 0 Channels numbers 1 005, 1 010, 1 015 This IE does not carry the complete BA

R-GSM:

Information elements	Value/Remark
Extension of BCCH frequency list description For cell A - Format identifier - BCCH Allocation Sequence - BCCH Allocation ARFCN - EXT-IND	Range 256 0 Channels numbers 962, 965, 968, 980, 990 This IE does not carry the complete BA
For cell B - Format identifier - BCCH Allocation Sequence - BCCH Allocation ARFCN - EXT-IND	range 128 0 Channels numbers 968, 970, 972, 1005, 1010 This IE does not carry the complete BA

SYSTEM INFORMATION type 6 message

Information elements	Value/Remark
Cell identity	see below
LAI	see below
Cell options	see below
NCC permitted	see below

Common contents of information elements in SYSTEM INFORMATION TYPE 1 to 6 messages

(CBCH) Channel Description	Not present
(CBCH) Mobile Allocation	Not present
Cell Identity	
- Cell Identity Value	0001H for cell A, 0002H for cell B
Cell Options	
- Power Control Indicator	Power Control Indicator is not set
- DTX Indicator	MS shall not use DTX
- Radio-Link-Time-out	8 SACCH blocks
Cell Selection Parameters	
- Cell-Reselect-Hysteresis	12 dB
- MX-TXPWR-MAX-CCH	Minimum level
- ACS	No addition cell parameters are present in SYSTEM INFORMATION messages 7 and 8.
- NECI	New establishment causes not supported
- RXLEV-ACCESS-MIN	Minimum level
Control Channel Description	
- Attach-Detach allowed	No Attach/Detach
- BS-AG-BLKS-RES	0 blocks reserved for access grant
- CCCH-CONF	1 basic physical channel used for CCCH, combined with SDCCHs
- BS-PA-MFRMS	5 multiframe periods for transmission of paging messages
- T3212 Time-out value	Infinite
L2 pseudo length	
- System information 1	21
- System information 2	22
- System information 2bis	21
- System information 3	18
- System information 4	12
Location Area Identification	
- Mobile Country Code	001 decimal
- Mobile Network Code	01 decimal
- Location Area Code	0001H
Message Type	
- System information 1	00011001
- System information 2	00011010
- System information 2bis	00000010
- System information 3	00011011
- System information 4	00011100
- System information 5	00011101
- System information 5bis	00000101
- System information 6	00011110
NCC Permitted	0000 0010
RACH Control Parameters	
- Max Retrans	Max 1 retrans
- Tx-integer	5 slots used
- Cell Barred for Access	Cell is not barred
- Call Reestablishment Allowed	Not allowed
- Access Control Class	Access is not barred
- Emergency Call allowed	Yes
SI 1 rest octets	Not used (all bits are set to spare)
SI 2 rest octets	Not used (all bits are set to spare)
SI 3 rest octets	Not used (all bits are set to spare)
SI 4 rest octets	Not used (all bits are set to spare)

Default settings for cell A:

Downlink input level	63 dBmicroVolt emf
Uplink output power	minimum supported by the MS's power class
Propagation profile	static
BCCH/CCCH carrier number	20

Default settings for cell B:

Downlink input level	53 dBmicroVolt emf
Uplink output power	minimum supported by the MS's power class
Propagation profile	static
BCCH/CCCH carrier number	10

Default message contents for other messages

For subclauses 26.10.1 to 26.10.2.5	same as in 26.6.14
For subclause 26.10.3	same as in 26.9.7

26.11 Multiband signalling

26.11.1 General considerations

This subclause applies only to Multiband mobile stations, as defined in 3GPP TS 02.06 subclause 3.2.1.

Conformance requirements of clause 26 fully apply to any Multiband MS in the whole supported band(s) of operation of the mobile station.

A Multiband mobile station has the functionality to perform handover, channel assignment, cell selection and re-selection between all its bands of operation within a PLMN.

A Multiband mobile station shall meet all requirements specified for each individual band. In addition it shall meet the extra functional requirements for multiband mobile stations.

The purpose of this subclause is to test these extra functional requirements for a multiband mobile station.

26.11.2 Multiband signalling / RR

26.11.2.1 Multiband signalling / RR / Immediate assignment procedure

To inform the multiband network of the MSs additional frequency and power capability, the multiband MS has to send a CLASSMARK CHANGE as soon as possible in a connection establishment.

26.11.2.1.1 Conformance requirement

Following a PAGING REQUEST message, the MS shall correctly set up an RR connection on a supported channel described in the IMMEDIATE ASSIGNMENT message. On the MS side, the procedure is terminated when the establishment of the main signalling link is confirmed. When the ES bit is set to 1 in the Classmark 1 or the Classmark 2 information element and the Early Sending Classmark Control bit is set to "high" in SI3 Rest Octets, then the MS shall send, on the first occasion, the CLASSMARK CHANGE message.

During a contention resolution procedure, if the last timeslot of the block containing a L2 UA frame occurs at time T, then the MS shall be ready to transmit the CLASSMARK CHANGE before T + 40 ms.

Reference(s)

3GPP TS 04.08 / 3GPP TS 44.018 subclauses 3.3.1.1.2 and 3.3.1.1.4.

3GPP TS 04.13 subclause 5.2.11.

3GPP TS 05.10 subclause 6.10.

26.11.2.1.2 Test purpose

To verify that the MS can correctly set up a dedicated control channel and that a multi band MS is able to perform early sending of CLASSMARK CHANGE.

To verify the performance requirement on early sending of the CLASSMARK CHANGE message.

26.11.2.1.3 Method of test

Initial Conditions

System Simulator:

For 450/900 MS:

1 cell.

CCCH-CONF is set to "1 basic physical channel used for CCCH not combined with SDCCHs".

BCCH carrier number 263.

For 480/900 MS:

1 cell.

CCCH-CONF is set to "1 basic physical channel used for CCCH not combined with SDCCHs".

BCCH carrier number 310.

For 450/1 800 MS:

1 cell.

CCCH-CONF is set to "1 basic physical channel used for CCCH not combined with SDCCHs".

BCCH carrier number 263.

For 480/1 800 MS:

1 cell.

CCCH-CONF is set to "1 basic physical channel used for CCCH not combined with SDCCHs".

BCCH carrier number 310.

For 900/1 800 MS:

1 cell.

CCCH-CONF is set to "1 basic physical channel used for CCCH not combined with SDCCHs".

BCCH carrier number 20.

For 710/1 900 MS, 750/1 900 MS:

1 cell.

CCCH-CONF is set to "1 basic physical channel used for CCCH not combined with SDCCHs".

BCCH carrier number 457.

For 850/1 900 MS:

1 cell.

CCCH-CONF is set to "1 basic physical channel used for CCCH not combined with SDCCHs".

BCCH carrier number 147.

Mobile Station:

The MS is in the "idle, updated" state, with a TMSI allocated.

Specific PICS statements:

- GSM 450 Band (TSPC_Type_GSM_450_Band)

- Standard GSM Band (P-GSM) (TSPC_Type_GSM_P_Band)
- Extended GSM Band (E-GSM) (TSPC_Type_GSM_E_Band)
- GSM 480 Band (TSPC_Type_GSM_480_Band)
- DCS 1800 band (TSPC_Type_DCS_Band)
- GSM 750 band (TSPC_Type_GSM_750_Band)
- GSM 710 band (TSPC_Type_GSM_710_Band)

PIXIT statements:

-

Foreseen Final State of the MS

"Idle, updated", with TMSI allocated.

Test Procedure

The test is performed twice, first time in the lower band (BCCH carrier number 20, 263, 310, 457 or 147) and second time in the upper band (BCCH carrier number 20 or 590).

The System Simulator pages the MS and after the MS has responded with a CHANNEL REQUEST message the SS assigns an SDCCH. The MS shall go to the correct channel and send a PAGING RESPONSE message followed by a CLASSMARK CHANGE message. Then the SS initiates RR-release by sending a CHANNEL RELEASE message.

Before the procedure is repeated, the SS is reconfigured to transmit BCCH carrier in the upper band of operation (ARFCN 20 or 590).

Maximum Duration of Test

6 seconds per value of the execution timer and 1 min for reconfiguring the SS.

Expected Sequence

This sequence is performed for execution counter k = 1 to 2.

Step	Direction	Message	Comments
1	SS -> MS	PAGING REQUEST TYPE 1	
2	MS -> SS	CHANNEL REQUEST	
3	SS -> MS	IMMEDIATE ASSIGNMENT	Channel Type: SDCCH/8
4	MS -> SS	SABM (PAGING RESPONSE)	Shall be sent on the correct channel
5	SS -> MS	UA (PAGING RESPONSE)	
6	MS -> SS	CLASSMARK CHANGE	Shall be ready to transmit (see 3GPP TS 05.10 subclause 06.10) within 40 ms after the completion of step 4. Shall indicate the MS frequency and power capabilities Note: In this case 'ready to transmit' shall result in the actual transmission of the Classmark Change 51 frames later (51 * 4.62ms = 235.62 ms). Therefore receipt of the Classmark Change within 250ms of step 4 is required.
7	SS -> MS	CHANNEL RELEASE	

Specific Message Contents

For 450/900 MS:

IMMEDIATE ASSIGNMENT

As default except:

Information element	Value/remark
Channel description <ul style="list-style-type: none"> - Channel Type - Timeslot number - Training sequence code - Hopping channel - Channel selector 	SDCCH/8 Arbitrary but not zero Arbitrary Single RF k=1; ARFCN 263 k=2; ARFCN 20
Mobile Allocation	empty

PAGING RESPONSE

Information element	Value/remark
Protocol Discriminator	RR management
Ciphering Key Sequence number <ul style="list-style-type: none"> - Key Sequence 	Key sequence number previously allocated to MS, or "111" if no key is available
Mobile station Classmark 2 <ul style="list-style-type: none"> - ES IND - RF power capability 	Shall indicate early autonomous sending of CLASSMARK CHANGE corresponding to the frequency band in use k=1; GSM 450 power capability k=2; GSM 900 power capability
Mobile Identity <ul style="list-style-type: none"> - odd/even - Type of identity - Identity digits 	Even TMSI TMSI previously allocated to MS

CLASSMARK CHANGE

Information element	Value/remark
Protocol Discriminator	RR management
Mobile station Classmark 2 <ul style="list-style-type: none"> - ES IND - RF power capability 	Shall indicate early autonomous sending of CLASSMARK CHANGE corresponding to the frequency band in use k=1; GSM 450 power capability k=2; GSM 900 power capability
Additional MS Classmark information <ul style="list-style-type: none"> - Band 1 (P-GSM) supported - Band 2 (E-GSM) supported - R-Band (R-GSM) supported - GSM 400 Band (GSM 450) supported - GSM400 Associated radio capability - Associated radio capability 1 - R-Band Associated radio capability 	According to PICS statement According to PICS statement According to PICS statement According to PICS statement Corresponding to GSM 400 band Corresponding to GSM 900 band Corresponding to R-GSM 900 band

For 480/900 MS:

IMMEDIATE ASSIGNMENT

As default except:

Information element	Value/remark
Channel description <ul style="list-style-type: none"> - Channel Type - Timeslot number - Training sequence code - Hopping channel - Channel selector 	SDCCH/8 Arbitrary but not zero Arbitrary Single RF k=1; ARFCN 310 k=2; ARFCN 20
Mobile Allocation	empty

PAGING RESPONSE

Information element	Value/remark
Protocol Discriminator	RR management
Ciphering Key Sequence number <ul style="list-style-type: none"> - Key Sequence 	Key sequence number previously allocated to MS, or "111" if no key is available
Mobile station Classmark 2 <ul style="list-style-type: none"> - ES IND - RF power capability 	Shall indicate early autonomous sending of CLASSMARK CHANGE corresponding to the frequency band in use k=1; GSM 480 power capability k=2; GSM 900 power capability
Mobile Identity <ul style="list-style-type: none"> - odd/even - Type of identity - Identity digits 	Even TMSI TMSI previously allocated to MS

CLASSMARK CHANGE

Information element	Value/remark
Protocol Discriminator	RR management
Mobile station Classmark 2 <ul style="list-style-type: none"> - ES IND - RF power capability 	Shall indicate early autonomous sending of CLASSMARK CHANGE corresponding to the frequency band in use k=1; GSM 480 power capability k=2; GSM 900 power capability
Additional MS Classmark information <ul style="list-style-type: none"> - Band 1 (P-GSM) supported - Band 2 (E-GSM) supported - R-Band (R-GSM) supported - GSM 400 Band (GSM 480) supported - GSM 400 Associated radio capability - Associated radio capability 1 - R-Band Associated radio capability 	According to PICS statement According to PICS statement According to PICS statement According to PICS statement Corresponding to GSM 480 band Corresponding to GSM 900 band Corresponding to R-GSM 900 band

For 450/1 800 MS:

IMMEDIATE ASSIGNMENT

As default except:

Information element	Value/remark
Channel description <ul style="list-style-type: none"> - Channel Type - Timeslot number - Training sequence code - Hopping channel - Channel selector 	SDCCH/8 Arbitrary but not zero Arbitrary Single RF k=1; ARFCN 263 k=2; ARFCN 590
Mobile Allocation	empty

PAGING RESPONSE

Information element	Value/remark
Protocol Discriminator	RR management
Ciphering Key Sequence number <ul style="list-style-type: none"> - Key Sequence 	Key sequence number previously allocated to MS, or "111" if no key is available
Mobile station Classmark 2 <ul style="list-style-type: none"> - ES IND - RF power capability 	Shall indicate early autonomous sending of CLASSMARK CHANGE corresponding to the frequency band in use k=1; GSM 450 power capability k=2; DCS 1 800 power capability
Mobile Identity <ul style="list-style-type: none"> - odd/even - Type of identity - Identity digits 	Even TMSI TMSI previously allocated to MS

CLASSMARK CHANGE

Information element	Value/remark
Protocol Discriminator	RR management
Mobile station Classmark 2 <ul style="list-style-type: none"> - ES IND - RF power capability 	Shall indicate early autonomous sending of CLASSMARK CHANGE corresponding to the frequency band in use k=1; GSM 450 power capability k=2; DCS 1 800 power capability
Additional MS Classmark information <ul style="list-style-type: none"> - Band 3 (DCS 1 800) supported - GSM 400 Band (GSM 450) supported - GSM 400 Associated radio capability - Associated radio capability 2 	According to PICS statement According to PICS statement Corresponding to GSM 450 band Corresponding to DCS 1 800 band

For 480/1 800 MS:

IMMEDIATE ASSIGNMENT

As default except:

Information element	Value/remark
Channel description <ul style="list-style-type: none"> - Channel Type - Timeslot number - Training sequence code - Hopping channel - Channel selector 	SDCCH/8 Arbitrary but not zero Arbitrary Single RF k=1; ARFCN 310 k=2; ARFCN 590
Mobile Allocation	empty

PAGING RESPONSE

Information element	Value/remark
Protocol Discriminator	RR management
Ciphering Key Sequence number <ul style="list-style-type: none"> - Key Sequence 	Key sequence number previously allocated to MS, or "111" if no key is available
Mobile station Classmark 2 <ul style="list-style-type: none"> - ES IND - RF power capability 	Shall indicate early autonomous sending of CLASSMARK CHANGE corresponding to the frequency band in use k=1; GSM 480 power capability k=2; DCS 1 800 power capability
Mobile Identity <ul style="list-style-type: none"> - odd/even - Type of identity - Identity digits 	Even TMSI TMSI previously allocated to MS

CLASSMARK CHANGE

Information element	Value/remark
Protocol Discriminator	RR management
Mobile station Classmark 2 <ul style="list-style-type: none"> - ES IND - RF power capability 	Shall indicate early autonomous sending of CLASSMARK CHANGE corresponding to the frequency band in use k=1; GSM 480 power capability k=2; DCS 1 800 power capability
Additional MS Classmark information <ul style="list-style-type: none"> - Band 3 (DCS 1 800) supported - GSM 400 Band (GSM 480) supported - GSM 400 Associated radio capability - Associated radio capability 2 	According to PICS statement According to PICS statement Corresponding to GSM 480 band Corresponding to DCS 1 800 band

For 900/1 800 MS:

IMMEDIATE ASSIGNMENT

As default except:

Information element	Value/remark
Channel description <ul style="list-style-type: none"> - Channel Type - Timeslot number - Training sequence code - Hopping channel - Channel selector 	SDCCH/8 Arbitrary but not zero Arbitrary Single RF k=1; ARFCN 20 k=2; ARFCN 590
Mobile Allocation	empty

PAGING RESPONSE

Information element	Value/remark
Protocol Discriminator	RR management
Ciphering Key Sequence number <ul style="list-style-type: none"> - Key Sequence 	Key sequence number previously allocated to MS, or "111" if no key is available
Mobile station Classmark 2 <ul style="list-style-type: none"> - ES IND - RF power capability 	Shall indicate early autonomous sending of CLASSMARK CHANGE corresponding to the frequency band in use k=1; GSM 900 power capability k=2; DCS 1 800 power capability
Mobile Identity <ul style="list-style-type: none"> - odd/even - Type of identity - Identity digits 	Even TMSI TMSI previously allocated to MS

CLASSMARK CHANGE

Information element	Value/remark
Protocol Discriminator	RR management
Mobile station Classmark 2 <ul style="list-style-type: none"> - ES IND - RF power capability 	Shall indicate early autonomous sending of CLASSMARK CHANGE corresponding to the frequency band in use k=1; GSM 900 power capability k=2; DCS 1 800 power capability
Additional MS Classmark information <ul style="list-style-type: none"> - Band 1 (P-GSM) supported - Band 2 (E-GSM) supported - Band 3 (DCS 1 800) supported - R-Band (R-GSM) supported - Associated radio capability 1 - Associated radio capability 2 - R-Band Associated radio capability 	According to PICS statement According to PICS statement According to PICS statement According to PICS statement Corresponding to GSM 900 band Corresponding to DCS 1 800 band Corresponding to R-GSM 900 band

For 710/1 900 MS, 750/1 900 MS:

IMMEDIATE ASSIGNMENT

As default except:

Information element	Value/remark
Channel description <ul style="list-style-type: none"> - Channel Type - Timeslot number - Training sequence code - Hopping channel - Channel selector 	SDCCH/8 Arbitrary but not zero Arbitrary Single RF k=1; ARFCN 457 k=2; ARFCN 590
Mobile Allocation	Empty

PAGING RESPONSE

Information element	Value/remark
Protocol Discriminator	RR management
Ciphering Key Sequence number <ul style="list-style-type: none"> - Key Sequence 	Key sequence number previously allocated to MS, or "111" if no key is available
Mobile station Classmark 2 <ul style="list-style-type: none"> - ES IND - RF power capability 	Shall indicate early autonomous sending of CLASSMARK CHANGE corresponding to the frequency band in use k=1; GSM 700 power capability k=2; PCS 1 900 power capability
Mobile Identity <ul style="list-style-type: none"> - odd/even - Type of identity - Identity digits 	Even TMSI TMSI previously allocated to MS

CLASSMARK CHANGE

Information element	Value/remark
Protocol Discriminator	RR management
Mobile station Classmark 2 <ul style="list-style-type: none"> - ES IND - RF power capability 	Shall indicate early autonomous sending of CLASSMARK CHANGE Corresponding to the frequency band in use k=1; GSM 700 power capability k=2; GSM 1900 power capability
Additional MS Classmark information <ul style="list-style-type: none"> - GSM 700 Associated radio capability - PCS 1 900 Associated radio capability 	Corresponding to GSM 700 band Corresponding to PCS 1 900 band

For 850/1 900 MS:

IMMEDIATE ASSIGNMENT

As default except:

Information element	Value/remark
Channel description <ul style="list-style-type: none"> - Channel Type - Timeslot number - Training sequence code - Hopping channel - Channel selector 	SDCCH/8 Arbitrary but not zero Arbitrary Single RF k=1; ARFCN 147 k=2; ARFCN 590
Mobile Allocation	Empty

PAGING RESPONSE

Information element	Value/remark
Protocol Discriminator	RR management
Ciphering Key Sequence number - Key Sequence	Key sequence number previously allocated to MS, or "111" if no key is available
Mobile station Classmark 2 - ES IND - RF power capability	Shall indicate early autonomous sending of CLASSMARK CHANGE corresponding to the frequency band in use k=1; GSM 850 power capability k=2; DCS 1 900 power capability
Mobile Identity - odd/even - Type of identity - Identity digits	Even TMSI TMSI previously allocated to MS

CLASSMARK CHANGE

Information element	Value/remark
Protocol Discriminator	RR management
Mobile station Classmark 2 - ES IND - RF power capability	Shall indicate early autonomous sending of CLASSMARK CHANGE Corresponding to the frequency band in use k=1; GSM 850 power capability k=2; DCS 1 900 power capability
Additional MS Classmark information - GSM 850 Associated radio capability - PCS 1 900 Associated radio capability	Corresponding to GSM 850 band Corresponding to PCS 1 900 band

26.11.2.2 Multiband signalling / RR / Handover

This subclause applies to any multiband mobile stations.

The purpose of this extra section is to test the handover where the target cell uses frequencies outside the frequency band of the serving cell.

26.11.2.2.1 Multiband signalling / RR / Handover / successful / active call / non-synchronized

26.11.2.2.1.1 Conformance requirements

The MS shall correctly apply the handover procedure in the non-synchronized case when a call is in progress and when handover is performed from a TCH/F without frequency hopping in one band towards a TCH/F without frequency hopping in another band.

When the MS releases a TCH or SDCCH and returns to idle mode, it shall, as quickly as possible, camp on the BCCH carrier of the cell whose channel has just been released, ie the BCCH carrier indicated in the HANDOVER COMMAND.

A multi band mobile station shall not consider a HANDOVER COMMAND as invalid because it indicates target channel frequencies that are all in a different frequency band to that of the ARFCN in the Cell Description IE.

References

3GPP TS 04.08 / 3GPP TS 44.018 subclauses 3.4.4 and 9.1.15.

3GPP TS 04.13 subclause 5.2.6.2.

3GPP TS 05.08 subclause 6.7.1.

26.11.2.2.1.2 Test purpose

To test that when the MS is ordered to make a non-synchronized handover it continuously sends access bursts on the main DCCH (and optionally on the SACCH) until it receives a PHYSICAL INFORMATION message from the SS. To test that the MS correctly handles the Timing Advance IE in the PHYSICAL INFORMATION message. To test that the MS activates the new channel correctly and transmits the HANDOVER COMPLETE message without undue delay. To test that upon release of the TCH, the mobile camps on the BCCH carrier of the cell indicated in the HANDOVER COMMAND.

26.11.2.2.1.3 Method of test

Initial Conditions

For execution counter M =1, 2

System Simulator:

For 450/900 MS: 2 cells, A and B with same LAI, default parameters except:

Cell A has:

BCCH ARFCN = 263

Cell Allocation = (259, 261, 263, 265, 267, 269, 271, 273, 275, 277, 279, 281, 283, 285, 287, 289, 291)

Cell B has:

BCCH ARFCN = 20

Cell Allocation = (10, 17, 20, 26, 34, 42, 45, 46, 52, 59, 66, 73, 74, 75, 76, 108, 114)

The frame numbers of cells A and B shall be different by 100.

The timebase of cells A and B shall be such that the edges of their timeslots are not coincident at the antenna connector.

For 480/900 MS: 2 cells, A and B with same LAI, default parameters except:

Cell A has:

BCCH ARFCN = 310

Cell Allocation = (306, 308, 310, 312, 314, 316, 318, 320, 322, 324, 326, 328, 330, 332, 334, 336, 338)

Cell B has:

BCCH ARFCN = 20

Cell Allocation = (10, 17, 20, 26, 34, 42, 45, 46, 52, 59, 66, 73, 74, 75, 76, 108, 114)

The frame numbers of cells A and B shall be different by 100.

The timebase of cells A and B shall be such that the edges of their timeslots are not coincident at the antenna connector.

For 450/1 800 MS: 2 cells, A and B with same LAI, default parameters except:

Cell A has:

BCCH ARFCN = 263

Cell Allocation = (259, 261, 263, 265, 267, 269, 271, 273, 275, 277, 279, 281, 283, 285, 287, 289, 291)

Cell B has:

BCCH ARFCN = 764

Cell Allocation = (739, 743, 746, 749, 756, 758, 761, 764, 771, 779, 782, 791, 798, 829, 832, 844)

The frame numbers of cells A and B shall be different by 100.

The timebase of cells A and B shall be such that the edges of their timeslots are not coincident at the antenna connector.

For 480/1 800 MS: 2 cells, A and B with same LAI, default parameters except:

Cell A has:

BCCH ARFCN = 310

Cell Allocation = (306, 308, 310, 312, 314, 316, 318, 320, 322, 324, 326, 328, 330, 332, 334, 336, 338)

Cell B has:

BCCH ARFCN = 764

Cell Allocation = (739, 743, 746, 749, 756, 758, 761, 764, 771, 779, 782, 791, 798, 829, 832, 844)

The frame numbers of cells A and B shall be different by 100.

The timebase of cells A and B shall be such that the edges of their timeslots are not coincident at the antenna connector.

For 900/1 800 MS: 2 cells, A and B with same LAI, default parameters except:

Cell A has:

BCCH ARFCN = 20

Cell Allocation = (10, 17, 20, 26, 34, 42, 45, 46, 52, 59, 66, 73, 74, 75, 76, 108, 114)

Cell B has:

BCCH ARFCN = 764

Cell Allocation = (739, 743, 746, 749, 756, 758, 761, 764, 771, 779, 782, 791, 798, 829, 832, 844)

The frame numbers of cells A and B shall be different by 100.

The timebase of cells A and B shall be such that the edges of their timeslots are not coincident at the antenna connector.

For 710/1 900 MS, 750/1 900 MS: 2 cells, A and B with same LAI, default parameters except:

Cell A has:

BCCH ARFCN = 457

Cell Allocation = (447, 454, 457, 463, 471, 479, 482, 483, 489, 496, 498, 500, 501, 502, 503, 506, 508)

Cell B has:

BCCH ARFCN = 764

Cell Allocation = (739, 743, 746, 749, 756, 758, 761, 764, 771, 779, 782, 791, 798, 803, 804, 806)

The frame numbers of cells A and B shall be different by 100.

The timebase of cells A and B shall be such that the edges of their timeslots are not coincident at the antenna connector.

For 850/1 900 MS: 2 cells, A and B with same LAI, default parameters except:

Cell A has:

BCCH ARFCN = 147

Cell Allocation = (137, 144, 147, 153, 161, 169, 172, 173, 179, 186, 193, 200, 201, 202, 203, 235, 241)

Cell B has:

BCCH ARFCN = 764

Cell Allocation = (739, 743, 746, 749, 756, 758, 761, 764, 771, 779, 782, 791, 798, 803, 804, 806)

The frame numbers of cells A and B shall be different by 100.

The timebase of cells A and B shall be such that the edges of their timeslots are not coincident at the antenna connector.

Mobile Station:

The MS is in the active state (U10) of a call on cell A. (for execution counter $M = 1$) and on cell B (for execution counter $M=2$).

For execution counter $M = 3$

System Simulator:

For 450/900 MS: 2 cells, A and B with different LAI, default parameters except:

Cell A has:

BCCH ARFCN = 263

Cell Allocation = (259, 261, 263, 265, 267, 269, 271, 273, 275, 277, 279, 281, 283, 285, 287, 289, 291)

Cell B has:

LAI = 0003 H

BCCH ARFCN = 20

Cell Allocation = (10, 17, 20, 26, 34, 42, 45, 46, 52, 59, 66, 73, 74, 75, 76, 108, 114)

The frame numbers of cells A and B shall be the same. The timebase of cells A and B shall be such that the edges of their timeslots are coincident at the antenna connector. ie cells A and B shall be fully synchronised.

For 480/900 MS: 2 cells, A and B with different LAI, default parameters except:

Cell A has:

BCCH ARFCN = 310

Cell Allocation = (306, 308, 310, 312, 314, 316, 318, 320, 322, 324, 326, 328, 330, 332, 334, 336, 338)

Cell B has:

LAI = 0003 H

BCCH ARFCN = 20

Cell Allocation = (10, 17, 20, 26, 34, 42, 45, 46, 52, 59, 66, 73, 74, 75, 76, 108, 114)

The frame numbers of cells A and B shall be the same. The timebase of cells A and B shall be such that the edges of their timeslots are coincident at the antenna connector. ie cells A and B shall be fully synchronised.

For 450/1 800 MS: 2 cells, A and B with different LAI, default parameters except:

Cell A has:

BCCH ARFCN = 263

Cell Allocation = (259, 261, 263, 265, 267, 269, 271, 273, 275, 277, 279, 281, 283, 285, 287, 289, 291)

Cell B has:

LAI = 0003 H

BCCH ARFCN = 764

Cell Allocation = (739, 743, 746, 749, 756, 758, 761, 764, 771, 779, 782, 791, 798, 829, 832, 844)

The frame numbers of cells A and B shall be the same. The timebase of cells A and B shall be such that the edges of their timeslots are coincident at the antenna connector. ie cells A and B shall be fully synchronised.

For 480/1 800 MS: 2 cells, A and B with different LAI, default parameters except:

Cell A has:

BCCH ARFCN = 310

Cell Allocation = (306, 308, 310, 312, 314, 316, 318, 320, 322, 324, 326, 328, 330, 332, 334, 336, 338)

Cell B has:

LAI = 0003 H

BCCH ARFCN = 764

Cell Allocation = (739, 743, 746, 749, 756, 758, 761, 764, 771, 779, 782, 791, 798, 829, 832, 844)

The frame numbers of cells A and B shall be the same. The timebase of cells A and B shall be such that the edges of their timeslots are coincident at the antenna connector. ie cells A and B shall be fully synchronised.

For 900/1 800 MS: 2 cells, A and B with different LAI, default parameters except:

Cell A has:

BCCH ARFCN = 20

Cell Allocation = (10, 17, 20, 26, 34, 42, 45, 46, 52, 59, 66, 73, 74, 75, 76, 108, 114)

Cell B has:

LAI = 0003 H

BCCH ARFCN = 764

Cell Allocation = (739, 743, 746, 749, 756, 758, 761, 764, 771, 779, 782, 791, 798, 829, 832, 844)

The frame numbers of cells A and B shall be the same. The timebase of cells A and B shall be such that the edges of their timeslots are coincident at the antenna connector. ie cells A and B shall be fully synchronised.

For 710/1 900 MS, 750/1 900 MS: 2 cells, A and B with different LAI, default parameters except:

Cell A has:

BCCH ARFCN = 457

Cell Allocation = (447, 454, 457, 463, 471, 479, 482, 483, 489, 496, 498, 500, 501, 502, 503, 506, 508)

Cell B has:

LAI = 0003 H

BCCH ARFCN = 764

Cell Allocation = (739, 743, 746, 749, 756, 758, 761, 764, 771, 779, 782, 791, 798, 803, 804, 806)

The frame numbers of cells A and B shall be the same. The timebase of cells A and B shall be such that the edges of their timeslots are coincident at the antenna connector. ie cells A and B shall be fully synchronised.

For 850/1 900 MS: 2 cells, A and B with different LAI, default parameters except:

Cell A has:

BCCH ARFCN = 147

Cell Allocation = (137, 144, 147, 153, 161, 169, 172, 173, 179, 186, 193, 200, 201, 202, 203, 235, 241)

Cell B has:

LAI = 0003 H

BCCH ARFCN = 764

Cell Allocation = (739, 743, 746, 749, 756, 758, 761, 764, 771, 779, 782, 791, 798, 803, 804, 806)

The frame numbers of cells A and B shall be the same. The timebase of cells A and B shall be such that the edges of their timeslots are coincident at the antenna connector. ie cells A and B shall be fully synchronised.

Mobile Station:

The MS is successfully registered in the LA of cell A and the MS is in the active state (U10) of a call on cell A.

Specific PICS statements:

- GSM 450 Band (TSPC_Type_GSM_450_Band)
- Standard GSM Band (P-GSM) (TSPC_Type_GSM_P_Band)
- Extended GSM Band (E-GSM) (TSPC_Type_GSM_E_Band)
- GSM 480 Band (TSPC_Type_GSM_480_Band)
- DCS 1800 band (TSPC_Type_DCS_Band)
- GSM 750 band (TSPC_Type_GSM_750_Band)
- GSM 710 band (TSPC_Type_GSM_710_Band)

PIXIT statements:

-

Foreseen Final State of the MS

For execution counter M = 1:

The active state (U10) of a call on cell B.

For execution counter M = 2:

The active state (U10) of a call on cell A.

For execution counter M = 3:

The MM idle state on cell A.

Test Procedure

The MS is in the active state (U10) of a call on cell A. The SS sends a HANOVER COMMAND on the main DCCH. The MS shall begin to send access bursts on the new DCCH (and optionally on the SACCH) of the target cell. The SS observes the access bursts and after receiving n (n being randomly drawn between values according to table 26.6-2 of subclause 26.6.5) access bursts, the SS sends one PHYSICAL INFORMATION message with a Timing Advance as specified in table 26.6-1 of subclause 26.6.5. The MS shall activate the channel in sending and receiving mode. The MS shall establish a signalling link. The MS shall be ready to transmit a HANOVER COMPLETE message, before "x" ms after the end of the PHYSICAL INFORMATION message, but not before a UA frame has been sent by the SS.

The term "ready to transmit" is defined in 3GPP TS 04.13. The value of "x" depends upon the target channel and is specified in the specific message contents section.

For execution counter M = 3, the call is then released and then the SS sends a CHANNEL RELEASE message. It is then checked for 2 minutes that the MS does not access Cell B.

Maximum Duration of Test

5 minutes, including 1 minute for any necessary operator actions.

Expected Sequence

This sequence is performed for an execution counter $M = 1, 2, 3$ for an MS which supports TCH/F.

Steps after step 7 are only performed for execution counter $M = 3$.

Step	Direction	Message	Comments
0	MS -> SS		The MS and SS are in the active state of a call on the channel described below.
1	SS -> MS	HANDOVER COMMAND	See Specific message contents
2	MS -> SS	HANDOVER ACCESS	Repeated on every burst of the uplink main DCCH (and optionally on the SACCH) until reception of PHYSICAL INFORMATION. Handover Reference as included in the HANDOVER COMMAND.
3	SS -> MS	PHYSICAL INFORMATION	Sent after reception of n HANDOVER ACCESS messages. See specific message contents.
4	MS -> SS	SABM	Sent without information field
5	SS -> MS	UA	
6	MS -> SS	HANDOVER COMPLETE	The message shall be ready to be transmitted before "x" ms after the completion of step 3.
7	MS -> SS		The MS and SS are in the active state of a call on the channel described below.
8	SS -> MS	RELEASE COMPLETE	steps 8-10 are only performed for execution counter $M = 3$.
9	SS -> MS	CHANNEL RELEASE	
10	SS		The SS checks that for a period of 2 minutes, the MS does not access cell B.

Specific Message Contents **For Mobiles Supporting Speech**

In case of 450/900 MS:

SYSTEM INFORMATION TYPE 5ter

Information Element	Value/remark
Neighbour Cells Description 2	0
Multiband reporting	
For Cell A	
- Format notation	Bit map 0
- BA_IND	0
- BCCH Allocation ARFCN	ARFCN 3, 20, 29, 62, 84, 89, 99 and 119

For $M = 1$:

Step 0: The MS and SS are using a full rate TCH in non-hopping mode on cell A.

HANDOVER COMMAND

Information Element	value/remarks
As default message contents, except:	
Cell Description	
- Network Colour Code	1
- Base Station Colour Code	5
- BCCH Carrier Number	20
Channel description	
- Channel type	TCH/F + ACCHs
- Timeslot number	Chosen arbitrarily, but not zero
- Training Sequence Code	Chosen arbitrarily
- Hopping	Single RF.
- ARFCN	Chosen arbitrarily from Cell Allocation for cell B.
Synchronization Indication	
- Report Observed Time Difference	Shall not be included.
- Synchronization Indication	"Non synchronized".
- Normal Cell Indication	Ignore out of range timing advance.

PHYSICAL INFORMATION

Information Element	value/remarks
As default message contents.	

Step 6: $x = 500$.

Step 7: The MS and SS are using a full rate TCH in non hopping mode on cell B.

For $M = 2$:

Step 0: The MS and SS are using a full rate TCH in non-hopping mode on cell B.

HANDOVER COMMAND

Information Element	value/remarks
As default message contents, except:	
Cell Description	
- Network Colour Code	1
- Base Station Colour Code	5
- BCCH Carrier Number	263
Channel Description	
- Channel Type	TCH/F + ACCHs
- Timeslot number	Chosen arbitrarily, but not Zero
- Training Sequence Code	Chosen arbitrarily
- Hopping	RF hopping channel.
- MAIO	Chosen arbitrarily from the set (0, 1 to N-1), where N is the number of frequencies encoded in the Frequency List IE.
- HSN	Chosen arbitrarily from the set (1,2,..63)
Synchronization Indication IE is not included.	
Channel Mode IE is not included.	
Frequency List after time	
- Frequency List	Allocates the following 12 frequencies (259, 261, 263, 265, 277, 279, 281, 283, 285, 287, 289, 291)

PHYSICAL INFORMATION

Information Element	value/remarks
As default message contents, except:	
Timing advance	Arbitrarily selected but different to default value.

Step 6: $x = 500$.

Step 7: The MS and SS are using a full rate TCH in hopping mode on cell A.

For M = 3:

Step 0: The MS and SS are using a full rate TCH in hopping mode on cell A.

HANDOVER COMMAND

Information Element	value/remarks
As default message contents, except:	
Cell Description	
- Network Colour Code	1
- Base Station Colour Code	5
- BCCH Carrier Number	263
Channel description	
- Channel type	TCH/F + ACCHs
- Timeslot number	Chosen arbitrarily, but not zero
- Training Sequence Code	Chosen arbitrarily
- Hopping	Single RF.
- ARFCN	Chosen arbitrarily from Cell Allocation for cell B.
Synchronisation Indication	
- Report Observed Time Difference	Shall not be included.
- Synchronisation Indication	'Non synchronised'.
- Normal Cell Indication	Ignore out of range timing advance.

PHYSICAL INFORMATION

Information Element	value/remarks
As default message contents.	

Step 6: x = 500

Step 7: The MS and SS are using a full rate TCH in non hopping mode on cell B.

In case of 480/900 MS:

SYSTEM INFORMATION TYPE 5ter

Information Element	Value/remark
Neighbour Cells Description 2 Multiband reporting For Cell A	0
- Format notation	Bit map 0
- BA_IND	0
- BCCH Allocation ARFCN	ARFCN 3, 20, 29, 62, 84, 89, 99 and 119

For M = 1:

Step 0: The MS and SS are using a full rate TCH in non-hopping mode on cell A.

HANDOVER COMMAND

Information Element	value/remarks
As default message contents, except:	
Cell Description	
- Network Colour Code	1
- Base Station Colour Code	5
- BCCH Carrier Number	20
Channel description	
- Channel type	TCH/F + ACCHs
- Timeslot number	Chosen arbitrarily, but not zero
- Training Sequence Code	Chosen arbitrarily
- Hopping	Single RF.
- ARFCN	Chosen arbitrarily from Cell Allocation for cell B.
Synchronization Indication	
- Report Observed Time Difference	Shall not be included.
- Synchronization Indication	"Non synchronized".
- Normal Cell Indication	Ignore out of range timing advance.

PHYSICAL INFORMATION

Information Element	value/remarks
As default message contents.	

Step 6: x = 500.

Step 7: The MS and SS are using a full rate TCH in non hopping mode on cell B.

For M = 2:

Step 0: The MS and SS are using a full rate TCH in non-hopping mode on cell B.

HANDOVER COMMAND

Information Element	value/remarks
As default message contents, except:	
Cell Description	
- Network Colour Code	1
- Base Station Colour Code	5
- BCCH Carrier Number	310
Channel Description	
- Channel Type	TCH/F + ACCHs
- Timeslot number	Chosen arbitrarily, but not Zero
- Training Sequence Code	Chosen arbitrarily
- Hopping	RF hopping channel.
- MAIO	Chosen arbitrarily from the set (0, 1 to N-1), where N is the number of frequencies encoded in the Frequency List IE.
- HSN	Chosen arbitrarily from the set (1,2,..63)
Synchronization Indication IE is not included.	
Channel Mode IE is not included.	
Frequency List after time	
- Frequency List	Allocates the following 12 frequencies (306, 308, 310, 312, 324, 326, 328, 330, 332, 334, 336, 338)

PHYSICAL INFORMATION

Information Element	value/remarks
As default message contents, except:	
Timing advance	Arbitrarily selected but different to default value.

Step 6: x = 500.

Step 7: The MS and SS are using a full rate TCH in hopping mode on cell A.

For M = 3:

Step 0: The MS and SS are using a full rate TCH in hopping mode on cell A.

HANDOVER COMMAND

Information Element	value/remarks
As default message contents, except:	
Cell Description	
- Network Colour Code	1
- Base Station Colour Code	5
- BCCH Carrier Number	310
Channel description	
- Channel type	TCH/F + ACCHs
- Timeslot number	Chosen arbitrarily, but not zero
- Training Sequence Code	Chosen arbitrarily
- Hopping	Single RF.
- ARFCN	Chosen arbitrarily from Cell Allocation for cell B.
Synchronisation Indication	
- Report Observed Time Difference	Shall not be included.
- Synchronisation Indication	'Non synchronised'.
- Normal Cell Indication	Ignore out of range timing advance.

PHYSICAL INFORMATION

Information Element	value/remarks
As default message contents.	

Step 6: $x = 500$

Step 7: The MS and SS are using a full rate TCH in non hopping mode on cell B.

In case of 450/1 800 MS:

SYSTEM INFORMATION TYPE 5ter

Information Element	Value/remark
Neighbour Cells Description 2	0
Multiband reporting	
For Cell A	
- Format notation	Range 512
- BA_IND	0
- BCCH Allocation ARFCN	ARFCN 520, 590, 600, 700, 764, 780, 810 and 870

For $M = 1$:

Step 0: The MS and SS are using a full rate TCH in non-hopping mode on cell A.

HANDOVER COMMAND

Information Element	value/remarks
As default message contents, except:	
Cell Description	
- Network Colour Code	1
- Base Station Colour Code	5
- BCCH Carrier Number	764
Channel description	
- Channel type	TCH/F + ACCHs
- Timeslot number	Chosen arbitrarily, but not zero
- Training Sequence Code	Chosen arbitrarily
- Hopping	Single RF.
- ARFCN	Chosen arbitrarily from Cell Allocation for cell B.
Synchronization Indication	
- Report Observed Time Difference	Shall not be included.
- Synchronization Indication	"Non synchronized".
- Normal Cell Indication	Ignore out of range timing advance.

PHYSICAL INFORMATION

Information Element	value/remarks
As default message contents.	

Step 6: $x = 500$.

Step 7: The MS and SS are using a full rate TCH in non hopping mode on cell B.

For M = 2:

Step 0: The MS and SS are using a full rate TCH in non-hopping mode on cell B.

HANDOVER COMMAND

Information Element	value/remarks
As default message contents, except: Cell Description - Network Colour Code - Base Station Colour Code - BCCH Carrier Number Channel Description - Channel Type - Timeslot number - Training Sequence Code - Hopping - MAIO - HSN Synchronization Indication IE is not included. Channel Mode IE is not included. Frequency List after time - Frequency List	1 5 263 TCH/F + ACCHs Chosen arbitrarily, but not Zero Chosen arbitrarily RF hopping channel. Chosen arbitrarily from the set (0, 1 to N-1), where N is the number of frequencies encoded in the Frequency List IE. Chosen arbitrarily from the set (1,2,..63) Allocates the following 12 frequencies (259, 261, 263, 265, 277, 279, 281, 283, 285, 287, 289, 291)

PHYSICAL INFORMATION

Information Element	value/remarks
As default message contents, except: Timing advance	Arbitrarily selected but different to default value.

Step 6: x = 500.

Step 7: The MS and SS are using a full rate TCH in hopping mode on cell A.

For M = 3:

Step 0: The MS and SS are using a full rate TCH in hopping mode on cell A.

HANDOVER COMMAND

Information Element	value/remarks
As default message contents, except: Cell Description - Network Colour Code - Base Station Colour Code - BCCH Carrier Number Channel description - Channel type - Timeslot number - Training Sequence Code - Hopping - ARFCN Synchronisation Indication - Report Observed Time Difference - Synchronisation Indication - Normal Cell Indication	1 5 263 TCH/F + ACCHs Chosen arbitrarily, but not zero Chosen arbitrarily Single RF. Chosen arbitrarily from Cell Allocation for cell B. Shall not be included. 'Non synchronised'. Ignore out of range timing advance.

PHYSICAL INFORMATION

Information Element	value/remarks
As default message contents.	

Step 6: $x = 500$

Step 7: The MS and SS are using a full rate TCH in non hopping mode on cell B.

In case of 480/1 800 MS:

SYSTEM INFORMATION TYPE 5ter

Information Element	Value/remark
Neighbour Cells Description 2	0
Multiband reporting	
For Cell A	
- Format notation	Range 512
- BA_IND	0
- BCCH Allocation ARFCN	ARFCN 520, 590, 600, 700, 764, 780, 810 and 870

For $M = 1$:

Step 0: The MS and SS are using a full rate TCH in non-hopping mode on cell A.

HANDOVER COMMAND

Information Element	value/remarks
As default message contents, except:	
Cell Description	
- Network Colour Code	1
- Base Station Colour Code	5
- BCCH Carrier Number	764
Channel description	
- Channel type	TCH/F + ACCHs
- Timeslot number	Chosen arbitrarily, but not zero
- Training Sequence Code	Chosen arbitrarily
- Hopping	Single RF.
- ARFCN	Chosen arbitrarily from Cell Allocation for cell B.
Synchronization Indication	
- Report Observed Time Difference	Shall not be included.
- Synchronization Indication	"Non synchronized".
- Normal Cell Indication	Ignore out of range timing advance.

PHYSICAL INFORMATION

Information Element	value/remarks
As default message contents.	

Step 6: $x = 500$.

Step 7: The MS and SS are using a full rate TCH in non hopping mode on cell B.

For M = 2:

Step 0: The MS and SS are using a full rate TCH in non-hopping mode on cell B.

HANDOVER COMMAND

Information Element	value/remarks
As default message contents, except:	
Cell Description	
- Network Colour Code	1
- Base Station Colour Code	5
- BCCH Carrier Number	310
Channel Description	
- Channel Type	TCH/F + ACCHs
- Timeslot number	Chosen arbitrarily, but not Zero
- Training Sequence Code	Chosen arbitrarily
- Hopping	RF hopping channel.
- MAIO	Chosen arbitrarily from the set (0, 1 to N-1), where N is the number of frequencies encoded in the Frequency List IE.
- HSN	Chosen arbitrarily from the set (1,2,..63)
Synchronization Indication IE is not included.	
Channel Mode IE is not included.	
Frequency List after time	
- Frequency List	Allocates the following 12 frequencies (306, 308, 310, 312, 324, 326, 328, 330, 332, 334, 336, 338)

PHYSICAL INFORMATION

Information Element	value/remarks
As default message contents, except:	
Timing advance	Arbitrarily selected but different to default value.

Step 6: x = 500.

Step 7: The MS and SS are using a full rate TCH in hopping mode on cell A.

For M = 3:

Step 0: The MS and SS are using a full rate TCH in hopping mode on cell A.

HANDOVER COMMAND

Information Element	value/remarks
As default message contents, except:	
Cell Description	
- Network Colour Code	1
- Base Station Colour Code	5
- BCCH Carrier Number	310
Channel description	
- Channel type	TCH/F + ACCHs
- Timeslot number	Chosen arbitrarily, but not zero
- Training Sequence Code	Chosen arbitrarily
- Hopping	Single RF.
- ARFCN	Chosen arbitrarily from Cell Allocation for cell B.
Synchronisation Indication	
- Report Observed Time Difference	Shall not be included.
- Synchronisation Indication	'Non synchronised'.
- Normal Cell Indication	Ignore out of range timing advance.

PHYSICAL INFORMATION

Information Element	value/remarks
As default message contents.	

Step 6: $x = 500$

Step 7: The MS and SS are using a full rate TCH in non hopping mode on cell B.

In case of 900/1 800 MS:

SYSTEM INFORMATION TYPE 5ter

Information Element	Value/remark
Neighbour Cells Description 2 Multiband reporting For Cell A	0
- Format notation	Range 512
- BA_IND	0
- BCCH Allocation ARFCN	ARFCN 520, 590, 600, 700, 764, 780, 810 and 870

For $M = 1$:

Step 0: The MS and SS are using a full rate TCH in non-hopping mode on cell A.

HANDOVER COMMAND

Information Element	value/remarks
As default message contents, except:	
Cell Description	
- Network Colour Code	1
- Base Station Colour Code	5
- BCCH Carrier Number	764
Channel description	
- Channel type	TCH/F + ACCHs
- Timeslot number	Chosen arbitrarily, but not zero
- Training Sequence Code	Chosen arbitrarily
- Hopping	Single RF.
- ARFCN	Chosen arbitrarily from Cell Allocation for cell B.
Synchronization Indication	
- Report Observed Time Difference	Shall not be included.
- Synchronization Indication	"Non synchronized".
- Normal Cell Indication	Ignore out of range timing advance.

PHYSICAL INFORMATION

Information Element	value/remarks
As default message contents.	

Step 6: $x = 500$.

Step 7: The MS and SS are using a full rate TCH in non hopping mode on cell B.

For M = 2:

Step 0: The MS and SS are using a full rate TCH in non-hopping mode on cell B.

HANDOVER COMMAND

Information Element	value/remarks
As default message contents, except:	
Cell Description	
- Network Colour Code	1
- Base Station Colour Code	5
- BCCH Carrier Number	20
Channel Description	
- Channel Type	TCH/F + ACCHs
- Timeslot number	Chosen arbitrarily, but not Zero
- Training Sequence Code	Chosen arbitrarily
- Hopping	RF hopping channel.
- MAIO	Chosen arbitrarily from the set (0, 1 to N-1), where N is the number of frequencies encoded in the Frequency Channel Sequence IE.
- HSN	Chosen arbitrarily from the set (1,2,..63)
Synchronization Indication IE is not included.	
Channel Mode IE is not included.	
Frequency Channel Sequence after time	
- Frequency Channel Sequence	Allocates the following 12 frequencies (10, 17, 20, 26, 59, 66, 73, 74, 75, 76,108, 114)

PHYSICAL INFORMATION

Information Element	value/remarks
As default message contents, except:	
Timing advance	Arbitrarily selected but different to default value.

Step 6: x = 500.

Step 7: The MS and SS are using a full rate TCH in hopping mode on cell A.

For M = 3:

Step 0: The MS and SS are using a full rate TCH in hopping mode on cell A.

HANDOVER COMMAND

Information Element	value/remarks
As default message contents, except:	
Cell Description	
- Network Colour Code	1
- Base Station Colour Code	5
- BCCH Carrier Number	20
Channel description	
- Channel type	TCH/F + ACCHs
- Timeslot number	Chosen arbitrarily, but not zero
- Training Sequence Code	Chosen arbitrarily
- Hopping	Single RF.
- ARFCN	Chosen arbitrarily from Cell Allocation for cell B.
Synchronisation Indication	
- Report Observed Time Difference	Shall not be included.
- Synchronisation Indication	'Non synchronised'.
- Normal Cell Indication	Ignore out of range timing advance.

PHYSICAL INFORMATION

Information Element	value/remarks
As default message contents.	

Step 6: x = 500

Step 7: The MS and SS are using a full rate TCH in non hopping mode on cell B.

In case of 710/1 900 MS, 750/1 900 MS:

SYSTEM INFORMATION TYPE 5ter

Information Element	Value/remark
Neighbour Cells Description 2	0
Multiband reporting	
For Cell A	
- Format notation	Range 512
- BA_IND	0
- BCCH Allocation ARFCN	ARFCN 520, 590, 600, 700, 764, 780, 800 and 810

For M = 1:

Step 0: The MS and SS are using a full rate TCH in non-hopping mode on cell A.

HANDOVER COMMAND

Information Element	value/remarks
As default message contents, except:	
Cell Description	
- Network Colour Code	1
- Base Station Colour Code	5
- BCCH Carrier Number	764
Channel description	
- Channel type	TCH/F + ACCHs
- Timeslot number	Chosen arbitrarily, but not zero
- Training Sequence Code	Chosen arbitrarily
- Hopping	Single RF.
- ARFCN	Chosen arbitrarily from Cell Allocation for cell B.
Synchronization Indication	
- Report Observed Time Difference	Shall not be included.
- Synchronization Indication	"Non synchronized".
- Normal Cell Indication	Ignore out of range timing advance.

PHYSICAL INFORMATION

Information Element	value/remarks
As default message contents.	

Step 6: x = 500.

Step 7: The MS and SS are using a full rate TCH in non hopping mode on cell B.

For M = 2:

Step 0: The MS and SS are using a full rate TCH in non-hopping mode on cell B.

HANDOVER COMMAND

Information Element	value/remarks
As default message contents, except: Cell Description - Network Colour Code - Base Station Colour Code - BCCH Carrier Number Channel Description - Channel Type - Timeslot number - Training Sequence Code - Hopping - MAIO - HSN Synchronization Indication IE is not included. Channel Mode IE is not included. Frequency List after time - Frequency List	1 5 457 TCH/F + ACCHs Chosen arbitrarily, but not Zero Chosen arbitrarily RF hopping channel. Chosen arbitrarily from the set (0, 1 to N-1), where N is the number of frequencies encoded in the Frequency Channel Sequence IE. Chosen arbitrarily from the set (1,2,..63) Allocates the following 12 frequencies (447, 454, 457, 463, 496, 498, 500, 501, 502, 503, 506, 508)

PHYSICAL INFORMATION

Information Element	value/remarks
As default message contents, except: Timing advance	Arbitrarily selected but different to default value.

Step 6: x = 500.

Step 7: The MS and SS are using a full rate TCH in hopping mode on cell A.

For M = 3:

Step 0: The MS and SS are using a full rate TCH in hopping mode on cell A.

HANDOVER COMMAND

Information Element	value/remarks
As default message contents, except: Cell Description - Network Colour Code - Base Station Colour Code - BCCH Carrier Number Channel description - Channel type - Timeslot number - Training Sequence Code - Hopping - ARFCN Synchronisation Indication - Report Observed Time Difference - Synchronisation Indication - Normal Cell Indication	1 5 457 TCH/F + ACCHs Chosen arbitrarily, but not zero Chosen arbitrarily Single RF. Chosen arbitrarily from Cell Allocation for cell B. Shall not be included. 'Non synchronised'. Ignore out of range timing advance.

PHYSICAL INFORMATION

Information Element	value/remarks
As default message contents.	

Step 6: $x = 500$

Step 7: The MS and SS are using a full rate TCH in non hopping mode on cell B.

In case of 850/1 900 MS:

SYSTEM INFORMATION TYPE 5ter

Information Element	Value/remark
Neighbour Cells Description 2	0
Multiband reporting	
For Cell A	
- Format notation	Range 512
- BA_IND	0
- BCCH Allocation ARFCN	ARFCN 520, 590, 600, 700, 764, 780, 800 and 810

For $M = 1$:

Step 0: The MS and SS are using a full rate TCH in non-hopping mode on cell A.

HANDOVER COMMAND

Information Element	value/remarks
As default message contents, except:	
Cell Description	
- Network Colour Code	1
- Base Station Colour Code	5
- BCCH Carrier Number	764
Channel description	
- Channel type	TCH/F + ACCHs
- Timeslot number	Chosen arbitrarily, but not zero
- Training Sequence Code	Chosen arbitrarily
- Hopping	Single RF.
- ARFCN	Chosen arbitrarily from Cell Allocation for cell B.
Synchronization Indication	
- Report Observed Time Difference	Shall not be included.
- Synchronization Indication	"Non synchronized".
- Normal Cell Indication	Ignore out of range timing advance.

PHYSICAL INFORMATION

Information Element	value/remarks
As default message contents.	

Step 6: $x = 500$.

Step 7: The MS and SS are using a full rate TCH in non hopping mode on cell B.

For M = 2:

Step 0: The MS and SS are using a full rate TCH in non-hopping mode on cell B.

HANDOVER COMMAND

Information Element	value/remarks
As default message contents, except:	
Cell Description	
- Network Colour Code	1
- Base Station Colour Code	5
- BCCH Carrier Number	147
Channel Description	
- Channel Type	TCH/F + ACCHs
- Timeslot number	Chosen arbitrarily, but not Zero
- Training Sequence Code	Chosen arbitrarily
- Hopping	RF hopping channel.
- MAIO	Chosen arbitrarily from the set (0, 1 to N-1), where N is the number of frequencies encoded in the Frequency Channel Sequence IE.
- HSN	Chosen arbitrarily from the set (1,2,..63)
Synchronization Indication IE is not included.	
Channel Mode IE is not included.	
Frequency List after time	
- Frequency List	Allocates the following 12 frequencies (137, 144, 147, 153, 186, 193, 200, 201, 202, 203, 235, 241)

PHYSICAL INFORMATION

Information Element	value/remarks
As default message contents, except:	
Timing advance	Arbitrarily selected but different to default value.

Step 6: x = 500.

Step 7: The MS and SS are using a full rate TCH in hopping mode on cell A.

For M = 3:

Step 0: The MS and SS are using a full rate TCH in hopping mode on cell A.

HANDOVER COMMAND

Information Element	value/remarks
As default message contents, except:	
Cell Description	
- Network Colour Code	1
- Base Station Colour Code	5
- BCCH Carrier Number	147
Channel description	
- Channel type	TCH/F + ACCHs
- Timeslot number	Chosen arbitrarily, but not zero
- Training Sequence Code	Chosen arbitrarily
- Hopping	Single RF.
- ARFCN	Chosen arbitrarily from Cell Allocation for cell B.
Synchronisation Indication	
- Report Observed Time Difference	Shall not be included.
- Synchronisation Indication	'Non synchronised'.
- Normal Cell Indication	Ignore out of range timing advance.

PHYSICAL INFORMATION

Information Element	value/remarks
As default message contents.	

Step 6: $x = 500$

Step 7: The MS and SS are using a full rate TCH in non hopping mode on cell B.

26.11.2.2.2 Multiband signalling / RR / Handover / layer 1 failure

26.11.2.2.2.1 Conformance requirements

During a handover from a channel in the lower band to a channel in the upper band, or the contrary, the MS shall correctly return to the old channel in the case of an handover failure caused by a layer 1 failure on the target cell.

References

3GPP TS 04.08 / 3GPP TS 44.018 subclause 3.4.4.

26.11.2.2.2.2 Test purpose

To check that the MS correctly returns to the old channel in the case of an handover failure caused by a layer 1 failure on the target cell, if the origin is in the lower band and the target is in the upper band or the contrary.

26.11.2.2.2.3 Method of test

Initial Conditions

System Simulator:

For 450/900 MS: 2 cells, A and B with same LAI, default parameters except:

Cell A has:

BCCH ARFCN = 263.

Cell B has:

BCCH ARFCN = 20.

For 480/900 MS: 2 cells, A and B with same LAI, default parameters except:

Cell A has:

BCCH ARFCN = 310.

Cell B has:

BCCH ARFCN = 20.

For 450/1 800 MS: 2 cells, A and B with same LAI, default parameters except:

Cell A has:

BCCH ARFCN = 263.

Cell B has:

BCCH ARFCN = 764.

For 480/1 800 MS: 2 cells, A and B with same LAI, default parameters except:

Cell A has:

BCCH ARFCN = 310.

Cell B has:

BCCH ARFCN = 764.

For 900/1 800 MS: 2 cells, A and B with same LAI, default parameters except:

Cell A has:

BCCH ARFCN = 20.

Cell B has:

BCCH ARFCN = 764.

For 710/1 900 MS, 750/1 900 MS: 2 cells, A and B with same LAI, default parameters except:

Cell A has:

BCCH ARFCN = 457.

Cell B has:

BCCH ARFCN = 764.

For 850/1 900 MS: 2 cells, A and B with same LAI, default parameters except:

Cell A has:

BCCH ARFCN = 147.

Cell B has:

BCCH ARFCN = 764.

Mobile Station:

The MS is in the active state (U10) of a call on cell A. Used power level is the maximum supported by the MS in the band in use.

Specific PICS statements:

- GSM 450 Band (TSPC_Type_GSM_450_Band)
- Standard GSM Band (P-GSM) (TSPC_Type_GSM_P_Band)
- Extended GSM Band (E-GSM) (TSPC_Type_GSM_E_Band)
- GSM 480 Band (TSPC_Type_GSM_480_Band)
- DCS 1800 band (TSPC_Type_DCS_Band)
- GSM 750 band (TSPC_Type_GSM_750_Band)
- GSM 710 band (TSPC_Type_GSM_710_Band)

PIXIT statements:

-

Foreseen Final State of the MS

The active state (U10) of a mobile call on cell A. Used power level is the maximum supported by the MS in the band in use.

Test Procedure

The MS is in the active state (U10) of a call on cell A. The SS sends a HANOVER COMMAND on the main DCCH. The MS shall begin to send access bursts on the new DCCH (and optionally on the SACCH) to cell B. With the exception of normal BCCH signalling, the SS does not transmit anything on cell B (thus causing a time-out of T3124). The MS shall re-establish the old link on cell A and send a HANOVER FAILURE within 3 seconds from the transmission of HANOVER COMMAND, using the old Power Control Level.

Maximum Duration of Test

5 minutes, including 1 minute for any necessary operator actions.

Expected Sequence

Step	Direction	Message	Comments
0	SS	-	The SS records the old Power Control Level in the layer 1 header of the last SACCH message sent by the MS before step 1.
1	SS -> MS	HANDOVER COMMAND	Channel description: non-hopping, full rate. Synchronisation Indication: non synchronised.
2	MS -> SS	HANDOVER ACCESS	Several messages are sent, all with correct Handover References.
3	MS -> SS	HANDOVER FAILURE	Sent on old channel, RR cause value = "Abnormal release, unspecified", "Abnormal release, channel unacceptable", "Abnormal release, timer expired", "Abnormal release, no activity on the radio path" or "Protocol error unspecified". Shall be sent within 3 seconds from the transmission of HANDOVER COMMAND.
4	SS	-	The SS checks that the PowerControl Level reported in the layer 1 header of the SACCH message that is sent in the first SACCH multiframe following the SABM is the same as in step 0.

Specific Message Contents

For 450/900 MS:

SYSTEM INFORMATION TYPE 5ter

Information Element	Value/remark
Neighbour Cells Description 2	0
Multiband reporting	
For Cell A	
- Format notation	Bit map 0
- BA_IND	0
- BCCH Allocation ARFCN	ARFCN 3, 20, 29, 62, 84, 89, 99 and 119

HANDOVER COMMAND

Information Element	value/remarks
As default message contents, except:	
Cell Description	
- Network Colour Code	1
- Base Station Colour Code	5
- BCCH Carrier Number	20
Channel description	
- Channel type	TCH/F + ACCHs
- Timeslot number	Chosen arbitrarily, but not zero
- Training Sequence Code	Chosen arbitrarily
- Hopping	Single RF.
- ARFCN	Chosen arbitrarily from Cell Allocation for cell B.
Synchronization Indication	
- Report Observed Time Difference	Shall not be included.
- Synchronization Indication	"Non synchronized".
- Normal Cell Indication	Ignore out of range timing advance.

For 480/900 MS:

SYSTEM INFORMATION TYPE 5ter

Information Element	Value/remark
Neighbour Cells Description 2 Multiband reporting For Cell A	0
- Format notation	Bit map 0
- BA_IND	0
- BCCH Allocation ARFCN	ARFCN 3, 20, 29, 62, 84, 89, 99 and 119

HANDOVER COMMAND

Information Element	value/remarks
As default message contents, except:	
Cell Description	
- Network Colour Code	1
- Base Station Colour Code	5
- BCCH Carrier Number	20
Channel description	
- Channel type	TCH/F + ACCHs
- Timeslot number	Chosen arbitrarily, but not zero
- Training Sequence Code	Chosen arbitrarily
- Hopping	Single RF.
- ARFCN	Chosen arbitrarily from Cell Allocation for cell B.
Synchronization Indication	
- Report Observed Time Difference	Shall not be included.
- Synchronization Indication	"Non synchronized".
- Normal Cell Indication	Ignore out of range timing advance.

For 450/1 800 MS:

SYSTEM INFORMATION TYPE 5ter

Information Element	Value/remark
Neighbour Cells Description 2 Multiband reporting For Cell A	0
- Format notation	Range 512
- BA_IND	0
- BCCH Allocation ARFCN	ARFCN 520, 590, 600, 700, 764, 780, 810 and 870

HANDOVER COMMAND

Information Element	value/remarks
As default message contents, except:	
Cell Description	
- Network Colour Code	1
- Base Station Colour Code	5
- BCCH Carrier Number	764
Channel description	
- Channel type	TCH/F + ACCHs
- Timeslot number	Chosen arbitrarily, but not zero
- Training Sequence Code	Chosen arbitrarily
- Hopping	Single RF.
- ARFCN	Chosen arbitrarily from Cell Allocation for cell B.
Synchronization Indication	
- Report Observed Time Difference	Shall not be included.
- Synchronization Indication	"Non synchronized".
- Normal Cell Indication	Ignore out of range timing advance.

For 480/1 800 MS:

SYSTEM INFORMATION TYPE 5ter

Information Element	Value/remark
Neighbour Cells Description 2 Multiband reporting For Cell A	0
- Format notation	Range 512
- BA_IND	0
- BCCH Allocation ARFCN	ARFCN 520, 590, 600, 700, 764, 780, 810 and 870

HANDOVER COMMAND

Information Element	value/remarks
As default message contents, except:	
Cell Description	
- Network Colour Code	1
- Base Station Colour Code	5
- BCCH Carrier Number	764
Channel description	
- Channel type	TCH/F + ACCHs
- Timeslot number	Chosen arbitrarily, but not zero
- Training Sequence Code	Chosen arbitrarily
- Hopping	Single RF.
- ARFCN	Chosen arbitrarily from Cell Allocation for cell B.
Synchronization Indication	
- Report Observed Time Difference	Shall not be included.
- Synchronization Indication	"Non synchronized".
- Normal Cell Indication	Ignore out of range timing advance.

For 900/1 800 MS:

SYSTEM INFORMATION TYPE 5ter

Information Element	Value/remark
Neighbour Cells Description 2 Multiband reporting For Cell A	0
- Format notation	Range 512
- BA_IND	0
- BCCH Allocation ARFCN	ARFCN 520, 590, 600, 700, 764, 780, 810 and 870

HANDOVER COMMAND

Information Element	value/remarks
As default message contents, except:	
Cell Description	
- Network Colour Code	1
- Base Station Colour Code	5
- BCCH Carrier Number	764
Channel description	
- Channel type	TCH/F + ACCHs
- Timeslot number	Chosen arbitrarily, but not zero
- Training Sequence Code	Chosen arbitrarily
- Hopping	Single RF.
- ARFCN	Chosen arbitrarily from Cell Allocation for cell B.
Synchronization Indication	
- Report Observed Time Difference	Shall not be included.
- Synchronization Indication	"Non synchronized".
- Normal Cell Indication	Ignore out of range timing advance.

For 710/1 900 MS, 750/1 900 MS:

SYSTEM INFORMATION TYPE 5ter

Information Element	Value/remark
Neighbour Cells Description 2 Multiband reporting For Cell A	0
- Format notation	Range 512
- BA_IND	0
- BCCH Allocation ARFCN	ARFCN 520, 590, 600, 700, 764, 780, 800 and 810

HANDOVER COMMAND

Information Element	value/remarks
As default message contents, except:	
Cell Description	
- Network Colour Code	1
- Base Station Colour Code	5
- BCCH Carrier Number	764
Channel description	
- Channel type	TCH/F + ACCHs
- Timeslot number	Chosen arbitrarily, but not zero
- Training Sequence Code	Chosen arbitrarily
- Hopping	Single RF.
- ARFCN	Chosen arbitrarily from Cell Allocation for cell B.
Synchronization Indication	
- Report Observed Time Difference	Shall not be included.
- Synchronization Indication	"Non synchronized".
- Normal Cell Indication	Ignore out of range timing advance.

For 850/1 900 MS:

SYSTEM INFORMATION TYPE 5ter

Information Element	Value/remark
Neighbour Cells Description 2 Multiband reporting For Cell A	0
- Format notation	Range 512
- BA_IND	0
- BCCH Allocation ARFCN	ARFCN 520, 590, 600, 700, 764, 780, 800 and 810

HANDOVER COMMAND

Information Element	value/remarks
As default message contents, except:	
Cell Description	
- Network Colour Code	1
- Base Station Colour Code	5
- BCCH Carrier Number	764
Channel description	
- Channel type	TCH/F + ACCHs
- Timeslot number	Chosen arbitrarily, but not zero
- Training Sequence Code	Chosen arbitrarily
- Hopping	Single RF.
- ARFCN	Chosen arbitrarily from Cell Allocation for cell B.
Synchronization Indication	
- Report Observed Time Difference	Shall not be included.
- Synchronization Indication	"Non synchronized".
- Normal Cell Indication	Ignore out of range timing advance.

26.11.2.2.3 Multiband signalling / RR / Handover / Multiband BCCH / successful / active call / non synchronized

26.11.2.2.3.1 Conformance requirements

This test relates to cells supporting frequencies in GSM 400, GSM 710, GSM 750, GSM 850, GSM 900 and DCS 1 800 bands.

The MS shall correctly apply the handover procedure in the non synchronized case when a call is in progress and when handover is performed from a TCH/F without frequency hopping in one band towards a TCH/F either with frequency hopping or not in another band.

References

3GPP TS 04.08 / 3GPP TS 44.018 subclauses 3.4.4 and 9.1.15.

3GPP TS 04.13 subclause 5.2.6.2.

3GPP TS 05.08 subclause 6.7.1.

26.11.2.2.3.2 Test purpose

To test that when the MS is ordered to make a non synchronized handover it sends continuously access bursts on the main DCCH (and optionally on the SACCH) until it receives a PHYSICAL INFORMATION message from the SS. To test that the MS correctly handles the Timing Advance IE in the PHYSICAL INFORMATION. To test that the MS activates the new channel correctly and transmits the HANDOVER COMPLETE message without undue delay.

26.11.2.2.3.3 Method of test

Initial Conditions

For execution counter M =1, 2.

System Simulator:

For 450/900 MS: 2 cells, A and B with same LAI, default parameters except:

Cell A has:

BCCH ARFCN = 263

GSM 450 frequencies: 259, 263, 267, 271, 275, 279, 283, 291.

GSM 900 frequencies: 10, 20, 34, 45, 52, 66, 74, 114.

Cell B has:

BCCH ARFCN = 268

GSM 450 frequencies: 260, 261, 268, 277, 281, 287, 288, 289.

GSM 900 frequencies: 14, 17, 32, 59, 73, 76, 87, 108.

For 480/900 MS: 2 cells, A and B with same LAI, default parameters except:

Cell A has:

BCCH ARFCN = 310

GSM 480 frequencies: 306, 310, 314, 318, 322, 326, 332, 338.

GSM 900 frequencies: 10, 20, 34, 45, 52, 66, 74, 114.

Cell B has:

BCCH ARFCN = 315

GSM 480 frequencies: 307, 308, 315, 324, 328, 334, 335, 336.

GSM 900 frequencies: 14, 17, 32, 59, 73, 76, 87, 108.

For 450/1 800 MS: 2 cells, A and B with same LAI, default parameters except:

Cell A has:

BCCH ARFCN = 263

GSM 450 frequencies: 259, 263, 267, 271, 275, 279, 283, 291.

DCS 1 800 frequencies: 739, 746, 756, 761, 771, 782, 798, 832.

Cell B has:

BCCH ARFCN = 268

GSM 450 frequencies: 260, 261, 268, 277, 281, 287, 288, 289.

DCS 1 800 frequencies: 743, 749, 758, 764, 779, 791, 829, 844.

For 480/1 800 MS: 2 cells, A and B with same LAI, default parameters except:

Cell A has:

BCCH ARFCN = 310

GSM 480 frequencies: 306, 310, 314, 318, 322, 326, 332, 338.

DCS 1 800 frequencies: 739, 746, 756, 761, 771, 782, 798, 832.

Cell B has:

BCCH ARFCN = 315

GSM 480 frequencies: 307, 308, 315, 324, 328, 334, 335, 336.

DCS 1 800 frequencies: 743, 749, 758, 764, 779, 791, 829, 844.

For 900/1 800 MS: 2 cells, A and B with same LAI, default parameters except:

Cell A has:

BCCH ARFCN = 20

GSM 900 frequencies: 10, 20, 34, 45, 52, 66, 74, 114.

DCS 1 800 frequencies: 739, 746, 756, 761, 771, 782, 798, 832.

Cell B has:

BCCH ARFCN = 32

GSM 900 frequencies: 14, 17, 32, 59, 73, 76, 87, 108.

DCS 1 800 frequencies: 743, 749, 758, 764, 779, 791, 829, 844.

For 710/1 900 MS, 750/1 900 MS: 2 cells, A and B with same LAI, default parameters except:

Cell A has:

BCCH ARFCN = 457

GSM 710, GSM 750 frequencies: 447, 457, 471, 482, 489, 498, 501, 508.

PCS 1 900 frequencies: 739, 746, 756, 761, 771, 782, 798, 804.

Cell B has:

BCCH ARFCN = 469

GSM 710, GSM 750 frequencies: 451, 454, 469, 496, 500, 503, 505, 506.

PCS 1 900 frequencies: 743, 749, 758, 764, 779, 791, 803, 806.

For 850/1 900 MS: 2 cells, A and B with same LAI, default parameters except:

Cell A has:

BCCH ARFCN = 147

GSM 850 frequencies: 137, 147, 161, 172, 179, 193, 201, 241.

PCS 1 900 frequencies: 739, 746, 756, 761, 771, 782, 798, 804.

Cell B has:

BCCH ARFCN = 159

GSM 850 frequencies: 141, 144, 159, 186, 200, 203, 214, 235.

PCS 1 900 frequencies: 743, 749, 758, 764, 779, 791, 803, 806.

Mobile Station:

For execution counter M = 1, the MS is in the active state (U10) of a call on cell A, using a TCH in the lower band.

For execution counter M = 2, the MS is in the active state (U10) of a call on cell B, using a TCH in the upper band.

Specific PICS statements:

- GSM 450 Band (TSPC_Type_GSM_450_Band)
- Standard GSM Band (P-GSM) (TSPC_Type_GSM_P_Band)
- Extended GSM Band (E-GSM) (TSPC_Type_GSM_E_Band)
- GSM 480 Band (TSPC_Type_GSM_480_Band)
- DCS 1800 band (TSPC_Type_DCS_Band)
- GSM 750 band (TSPC_Type_GSM_750_Band)
- GSM 710 band (TSPC_Type_GSM_710_Band)

PIXIT statements:

-

Foreseen Final State of the MS

For execution counter M = 1

The active state (U10) of a call with a TCH in the upper band on cell B.

For execution counter M = 2

The active state (U10) of a call in hopping mode in the upper band on cell A.

Test Procedure

The MS is in the active state (U10) of a call. The SS sends a HANDOVER COMMAND on the main DCCH. The MS shall begin to send access bursts on the new DCCH (and optionally on the SACCH) of the target cell. The SS observes the access bursts and after receiving n (n being randomly drawn between values [10-20]) access bursts, the SS sends one PHYSICAL INFORMATION message with an arbitrary Timing Advance. The MS shall activate the channel in sending and receiving mode. The MS shall establish a signalling link. The MS shall be ready to transmit a HANDOVER COMPLETE message, before "x" ms after the end of the PHYSICAL INFORMATION message, but not before a UA frame has been sent by the SS.

The term "ready to transmit" is defined in 3GPP TS 04.13. The value of "x" depends upon the target channel and is specified in the specific message contents section.

Maximum Duration of Test

5 minutes, including 1 minute for any necessary operator actions.

Expected Sequence

This sequence is performed for an execution counter $M = 1$ and 2 for an MS which supports TCH/F.

Step	Direction	Message	Comments
0	MS -> SS		M = 1, The MS and SS are using a full rate TCH in lower band, in non hopping mode on cell A. M=2, the MS and SS are using a full rate TCH in upper band, in non hopping mode on cell B.
1	SS -> MS	HANDOVER COMMAND	See Specific message contents
2	MS -> SS	HANDOVER ACCESS	Repeated on every burst of the uplink main DCCH (and optionally on the SACCH) until reception of PHYSICAL INFORMATION. Handover Reference as included in the HANDOVER COMMAND.
3	SS -> MS	PHYSICAL INFORMATION	Sent after reception of n HANDOVER ACCESS messages. See specific message contents.
4	MS -> SS	SABM	Sent without information field
5	SS -> MS	UA	
6	MS -> SS	HANDOVER COMPLETE	The message shall be ready to be transmitted before "x" ms after the completion of step 3.
7	MS -> SS		The MS and SS are in the active state of a call.

For 450/900 MS:

SYSTEM INFORMATION TYPE 5

Information Element	Value/remark
BCCH Frequency list For Cell A - Format identifier - BCCH Allocation Sequence - BCCH Allocation ARFCN - EXT-IND	Range 128 0 ARFCN 261, 263, 268, 282, 284, 287, 290, 293 "The information element carries the complete BA"

For M = 1:

Step 0: The MS and SS are using a full rate TCH in the GSM 450 band, in non-hopping mode on cell A.

HANDOVER COMMAND

Information Element	value/remarks
As default message contents, except: Cell Description - Network Colour Code - Base Station Colour Code - BCCH Carrier Number Channel description - Channel type - Timeslot number - Training Sequence Code - Hopping - ARFCN Handover Reference - Value Power command - Power Level Synchronization Indication - Report Observed Time Difference - Synchronization Indication - Normal Cell Indication	1 5 268 TCH/F + ACCHs Chosen arbitrarily Chosen arbitrarily Single RF Channel. Chosen arbitrarily from the GSM 900 frequencies allocated to the cell. Chosen arbitrarily from the range (0, 1..255) Arbitrarily chosen, but different to the one already in use and within the range supported by that type of MS. Shall not be included. "Non Synchronized". Ignore out of range timing advance.

PHYSICAL INFORMATION

Information Element	value/remarks
As default message contents, except:	

Step 6: x = 650 ms.

Step 7: The MS and SS are using a full rate TCH in the GSM 900 band, in non hopping mode on cell B.

For M = 2:

Step 0: The MS and SS are using a full rate TCH in the GSM 900 band, in non-hopping mode on cell B.

HANDOVER COMMAND

Information Element	value/remarks
As default message contents, except:	
Cell Description	
- Network Colour Code	1
- Base Station Colour Code	5
- BCCH Carrier Number	263
Channel Description	
- Channel Type	TCH/F + ACCHs
- Timeslot number	Chosen arbitrarily
- Training Sequence Code	Chosen arbitrarily
- Hopping	RF hopping channel.
- MAIO	Chosen arbitrarily from the set (0, 1 to N-1), where N is the number of frequencies in the Mobile Allocation IE.
- HSN	Chosen arbitrarily from the set (1,2,..63)
Handover Reference	
- Value	Chosen arbitrarily from the range (0, 1..255)
Power command	
- Power Level	Arbitrarily chosen, but different to the one already in use and within the range supported by that type of MS.
Synchronization Indication.	
- Report Observed Time Difference	Shall not be included
- Synchronization Indication	"Non Synchronized".
- Normal Cell Indication	Ignore out of range timing advance
Cell Channel Description:	GSM 450 frequencies: 259, 263, 267, 271, 275, 279, 283, 291
	GSM 900 frequencies: 10, 20, 34, 45, 52, 66, 74, 114
Channel Mode IE is not included.	
Mobile Allocation	Indicates GSM 900 frequencies (10, 34, 45, 66, 114).

PHYSICAL INFORMATION

Information Element	value/remarks
As default message contents, except:	
Timing Advance	Arbitrarily selected but different to default value.

Step 6: $x = 650$ ms.

Step 7: The MS and SS are using a full rate TCH in hopping mode in the GSM 900 band on cell A.

For 480/900 MS:

SYSTEM INFORMATION TYPE 5

Information Element	Value/remark
BCCH Frequency list For Cell A	
- Format identifier	Range 128
- BCCH Allocation Sequence	0
- BCCH Allocation ARFCN	ARFCN 308, 310, 315, 329, 331, 334, 337, 340
- EXT-IND	"The information element carries the complete BA"

For M = 1:

Step 0: The MS and SS are using a full rate TCH in the GSM 480 band, in non-hopping mode on cell A.

HANDOVER COMMAND

Information Element	value/remarks
As default message contents, except:	
Cell Description	
- Network Colour Code	1
- Base Station Colour Code	5
- BCCH Carrier Number	315
Channel description	
- Channel type	TCH/F + ACCHs
- Timeslot number	Chosen arbitrarily
- Training Sequence Code	Chosen arbitrarily
- Hopping	Single RF Channel.
- ARFCN	Chosen arbitrarily from the GSM 900 frequencies allocated to the cell.
Handover Reference	
- Value	Chosen arbitrarily from the range (0, 1..255)
Power command	
- Power Level	Arbitrarily chosen, but different to the one already in use and within the range supported by that type of MS.
Synchronization Indication	
- Report Observed Time Difference	Shall not be included.
- Synchronization Indication	"Non Synchronized".
- Normal Cell Indication	Ignore out of range timing advance.

PHYSICAL INFORMATION

Information Element	value/remarks
As default message contents, except:	

Step 6: $x = 650$ ms.

Step 7: The MS and SS are using a full rate TCH in the GSM 900 band, in non hopping mode on cell B.

For M = 2:

Step 0: The MS and SS are using a full rate TCH in the GSM 900 band, in non-hopping mode on cell B.

HANDOVER COMMAND

Information Element	value/remarks
As default message contents, except:	
Cell Description	
- Network Colour Code	1
- Base Station Colour Code	5
- BCCH Carrier Number	310
Channel Description	
- Channel Type	TCH/F + ACCHs
- Timeslot number	Chosen arbitrarily
- Training Sequence Code	Chosen arbitrarily
- Hopping	RF hopping channel.
- MAIO	Chosen arbitrarily from the set (0, 1 to N-1), where N is the number of frequencies in the Mobile Allocation IE.
- HSN	Chosen arbitrarily from the set (1,2,..63)
Handover Reference	
- Value	Chosen arbitrarily from the range (0, 1..255)
Power command	
- Power Level	Arbitrarily chosen, but different to the one already in use and within the range supported by that type of MS.
Synchronization Indication.	
- Report Observed Time Difference	Shall not be included
- Synchronization Indication	"Non Synchronized".
- Normal Cell Indication	Ignore out of range timing advance
Cell Channel Description:	GSM 480 frequencies: 306, 310, 314, 318, 322, 326, 332, 338
	GSM 900 frequencies: 10, 20, 34, 45, 52, 66, 74, 114
Channel Mode IE is not included.	
Mobile Allocation	Indicates GSM 900 frequencies (10, 34, 45, 66, 114).

PHYSICAL INFORMATION

Information Element	value/remarks
As default message contents, except:	
Timing Advance	Arbitrarily selected but different to default value.

Step 6: $x = 650$ ms.

Step 7: The MS and SS are using a full rate TCH in hopping mode in the GSM 900 band on cell A.

For 450/1 800 MS:

SYSTEM INFORMATION TYPE 5

Information Element	Value/remark
BCCH Frequency list For Cell A - Format identifier - BCCH Allocation Sequence - BCCH Allocation ARFCN - EXT-IND	Range 128 0 ARFCN 261, 263, 268, 282, 284, 287, 290, 293 "The information element carries the complete BA"

For $M = 1$:

Step 0: The MS and SS are using a full rate TCH in the GSM 450 band, in non-hopping mode on cell A.

HANDOVER COMMAND

Information Element	value/remarks
As default message contents, except: Cell Description - Network Colour Code - Base Station Colour Code - BCCH Carrier Number Channel description - Channel type - Timeslot number - Training Sequence Code - Hopping - ARFCN Handover Reference - Value Power command - Power Level Synchronization Indication - Report Observed Time Difference - Synchronization Indication - Normal Cell Indication	1 5 268 TCH/F + ACCHs Chosen arbitrarily Chosen arbitrarily Single RF Channel. Chosen arbitrarily from the DCS 1 800 frequencies allocated to the cell. Chosen arbitrarily from the range (0, 1..255) Arbitrarily chosen, but different to the one already in use and within the range supported by that type of MS. Shall not be included. "Non Synchronized". Ignore out of range timing advance.

PHYSICAL INFORMATION

Information Element	value/remarks
As default message contents, except:	

Step 6: $x = 650$ ms.

Step 7: The MS and SS are using a full rate TCH in the DCS 1 800 band, in non hopping mode on cell B.

For M = 2:

Step 0: The MS and SS are using a full rate TCH in the DCS 1 800 band, in non-hopping mode on cell B.

HANDOVER COMMAND

Information Element	value/remarks
As default message contents, except:	
Cell Description	
- Network Colour Code	1
- Base Station Colour Code	5
- BCCH Carrier Number	263
Channel Description	
- Channel Type	TCH/F + ACCHs
- Timeslot number	Chosen arbitrarily
- Training Sequence Code	Chosen arbitrarily
- Hopping	RF hopping channel.
- MAIO	Chosen arbitrarily from the set (0, 1 to N-1), where N is the number of frequencies in the Mobile Allocation IE.
- HSN	Chosen arbitrarily from the set (1,2,..63)
Handover Reference	
- Value	Chosen arbitrarily from the range (0, 1..255)
Power command	
- Power Level	Arbitrarily chosen, but different to the one already in use and within the range supported by that type of MS.
Synchronization Indication.	
- Report Observed Time Difference	Shall not be included
- Synchronization Indication	"Non Synchronized".
- Normal Cell Indication	Ignore out of range timing advance
Cell Channel Description:	GSM 450 frequencies: 259, 263, 267, 271, 275, 279, 283, 291
	GSM 1800 frequencies: 739, 746, 756, 761, 771, 782, 798, 832
Channel Mode IE is not included.	
Mobile Allocation	Indicates DCS 1 800 frequencies (739, 756, 761, 782, 832).

PHYSICAL INFORMATION

Information Element	value/remarks
As default message contents, except:	
Timing Advance	Arbitrarily selected but different to default value.

Step 6: $x = 650$ ms.

Step 7: The MS and SS are using a full rate TCH in hopping mode in the DCS band on cell A.

For 480/1 800 MS:

SYSTEM INFORMATION TYPE 5

Information Element	Value/remark
BCCH Frequency list For Cell A	
- Format identifier	Range 128
- BCCH Allocation Sequence	0
- BCCH Allocation ARFCN	ARFCN 308, 310, 315, 329, 331, 334, 337, 340
- EXT-IND	"The information element carries the complete BA"

For $M = 1$:

Step 0: The MS and SS are using a full rate TCH in the GSM 480 band, in non-hopping mode on cell A.

HANDOVER COMMAND

Information Element	value/remarks
As default message contents, except:	
Cell Description	
- Network Colour Code	1
- Base Station Colour Code	5
- BCCH Carrier Number	315
Channel description	
- Channel type	TCH/F + ACCHs
- Timeslot number	Chosen arbitrarily
- Training Sequence Code	Chosen arbitrarily
- Hopping	Single RF Channel.
- ARFCN	Chosen arbitrarily from the DCS 1 800 frequencies allocated to the cell.
Handover Reference	
- Value	Chosen arbitrarily from the range (0, 1..255)
Power command	
- Power Level	Arbitrarily chosen, but different to the one already in use and within the range supported by that type of MS.
Synchronization Indication	
- Report Observed Time Difference	Shall not be included.
- Synchronization Indication	"Non Synchronized".
- Normal Cell Indication	Ignore out of range timing advance.

PHYSICAL INFORMATION

Information Element	value/remarks
As default message contents, except:	

Step 6: $x = 650$ ms.

Step 7: The MS and SS are using a full rate TCH in the DCS 1 800 band, in non hopping mode on cell B.

For M = 2:

Step 0: The MS and SS are using a full rate TCH in the DCS 1 800 band, in non-hopping mode on cell B.

HANDOVER COMMAND

Information Element	value/remarks
As default message contents, except:	
Cell Description	
- Network Colour Code	1
- Base Station Colour Code	5
- BCCH Carrier Number	310
Channel Description	
- Channel Type	TCH/F + ACCHs
- Timeslot number	Chosen arbitrarily
- Training Sequence Code	Chosen arbitrarily
- Hopping	RF hopping channel.
- MAIO	Chosen arbitrarily from the set (0, 1 to N-1), where N is the number of frequencies in the Mobile Allocation IE.
- HSN	Chosen arbitrarily from the set (1,2,..63)
Handover Reference	
- Value	Chosen arbitrarily from the range (0, 1..255)
Power command	
- Power Level	Arbitrarily chosen, but different to the one already in use and within the range supported by that type of MS.
Synchronization Indication.	
- Report Observed Time Difference	Shall not be included
- Synchronization Indication	"Non Synchronized".
- Normal Cell Indication	Ignore out of range timing advance
Cell Channel Description	GSM 480 frequencies: 306, 310, 314, 318, 322, 326, 332, 338 GSM 1800 frequencies: 739, 746, 756, 761, 771, 782, 798, 832
Channel Mode IE is not included.	
Mobile Allocation	Indicates DCS 1 800 frequencies (739, 756, 761, 782, 832).

PHYSICAL INFORMATION

Information Element	value/remarks
As default message contents, except:	
Timing Advance	Arbitrarily selected but different to default value.

Step 6: $x = 650$ ms.

Step 7: The MS and SS are using a full rate TCH in hopping mode in the DCS band on cell A.

For 900/1 800 MS:

SYSTEM INFORMATION TYPE 5

Information Element	Value/remark
BCCH Frequency list For Cell A - Format identifier - BCCH Allocation Sequence - BCCH Allocation ARFCN - EXT-IND	Bit map 0 0 ARFCN 10, 20, 32, 80, 90, 100, 110 and 120 "The information element carries the complete BA"

For $M = 1$:

Step 0: The MS and SS are using a full rate TCH in the GSM 900 band, in non-hopping mode on cell A.

HANDOVER COMMAND

Information Element	value/remarks
As default message contents, except: Cell Description - Network Colour Code - Base Station Colour Code - BCCH Carrier Number Channel description - Channel type - Timeslot number - Training Sequence Code - Hopping - ARFCN Handover Reference - Value Power command - Power Level Synchronization Indication - Report Observed Time Difference - Synchronization Indication - Normal Cell Indication	1 5 32 TCH/F + ACCHs Chosen arbitrarily Chosen arbitrarily Single RF Channel. Chosen arbitrarily from the DCS 1 800 frequencies allocated to the cell. Chosen arbitrarily from the range (0, 1..255) Arbitrarily chosen, but different to the one already in use and within the range supported by that type of MS. Shall not be included. "Non Synchronized". Ignore out of range timing advance.

PHYSICAL INFORMATION

Information Element	value/remarks
As default message contents, except:	

Step 6: $x = 650$ ms.

Step 7: The MS and SS are using a full rate TCH in the DCS 1 800 band, in non hopping mode on cell B.

For M = 2:

Step 0: The MS and SS are using a full rate TCH in the DCS 1 800 band, in non-hopping mode on cell B.

HANDOVER COMMAND

Information Element	value/remarks
As default message contents, except:	
Cell Description	
- Network Colour Code	1
- Base Station Colour Code	5
- BCCH Carrier Number	20
Channel Description	
- Channel Type	TCH/F + ACCHs
- Timeslot number	Chosen arbitrarily
- Training Sequence Code	Chosen arbitrarily
- Hopping	RF hopping channel.
- MAIO	Chosen arbitrarily from the set (0, 1 to N-1), where N is the number of frequencies in the Mobile Allocation IE.
- HSN	Chosen arbitrarily from the set (1,2,..63)
Handover Reference	
- Value	Chosen arbitrarily from the range (0, 1..255)
Power command	
- Power Level	Arbitrarily chosen, but different to the one already in use and within the range supported by that type of MS.
Synchronization Indication.	
- Report Observed Time Difference	Shall not be included
- Synchronization Indication	"Non Synchronized".
- Normal Cell Indication	Ignore out of range timing advance
Cell channel description:	GSM 900 frequencies: 10, 20, 34, 45, 52, 66, 74, 114 GSM 1800 frequencies: 739, 746, 756, 761, 771, 782, 798, 832
Channel Mode IE is not included.	
Mobile Allocation	Indicates DCS 1 800 frequencies (739, 756, 761, 782, 832).

PHYSICAL INFORMATION

Information Element	value/remarks
As default message contents, except:	
Timing Advance	Arbitrarily selected but different to default value.

Step 6: x = 650 ms.

Step 7: The MS and SS are using a full rate TCH in hopping mode in the DCS band on cell A.

For 710/1 900 MS, 750/1 900 MS:

SYSTEM INFORMATION TYPE 5

Information Element	Value/remark
BCCH Frequency list For Cell A - Format identifier - BCCH Allocation Sequence - BCCH Allocation ARFCN - EXT-IND	128 range 0 ARFCN 447, 457, 469, 480, 499, 504, 507 and 510 "The information element carries the complete BA"

For M = 1:

Step 0: The MS and SS are using a full rate TCH in the GSM 710 or GSM 750 band, in non-hopping mode on cell A.

HANDOVER COMMAND

Information Element	value/remarks
As default message contents, except: Cell Description - Network Colour Code - Base Station Colour Code - BCCH Carrier Number Channel description - Channel type - Timeslot number - Training Sequence Code - Hopping - ARFCN Handover Reference - Value Power command - Power Level Synchronization Indication - Report Observed Time Difference - Synchronization Indication - Normal Cell Indication	1 5 469 TCH/F + ACCHs Chosen arbitrarily Chosen arbitrarily Single RF Channel. Chosen arbitrarily from the PCS 1 900 frequencies allocated to the cell. Chosen arbitrarily from the range (0, 1..255) Arbitrarily chosen, but different to the one already in use and within the range supported by that type of MS. Shall not be included. "Non Synchronized". Ignore out of range timing advance.

PHYSICAL INFORMATION

Information Element	value/remarks
As default message contents, except:	

Step 6: x = 650 ms.

Step 7: The MS and SS are using a full rate TCH in the PCS 1 900 band, in non hopping mode on cell B.

For M = 2:

Step 0: The MS and SS are using a full rate TCH in the PCS 1 900 band, in non-hopping mode on cell B.

HANDOVER COMMAND

Information Element	value/remarks
As default message contents, except:	
Cell Description	
- Network Colour Code	1
- Base Station Colour Code	5
- BCCH Carrier Number	457
Channel Description	
- Channel Type	TCH/F + ACCHs
- Timeslot number	Chosen arbitrarily
- Training Sequence Code	Chosen arbitrarily
- Hopping	RF hopping channel.
- MAIO	Chosen arbitrarily from the set (0, 1 to N-1), where N is the number of frequencies in the Mobile Allocation IE.
- HSN	Chosen arbitrarily from the set (1,2,..63)
Handover Reference	
- Value	Chosen arbitrarily from the range (0, 1..255)
Power command	
- Power Level	Arbitrarily chosen, but different to the one already in use and within the range supported by that type of MS.
Synchronization Indication.	
- Report Observed Time Difference	Shall not be included
- Synchronization Indication	"Non Synchronized".
- Normal Cell Indication	Ignore out of range timing advance
Cell channel description:	GSM 710, GSM 750 frequencies: 447, 457, 471, 482, 489, 498, 501, 508 PCS 1 900 frquencies: 739, 746, 756, 761, 771, 782, 798, 804
Channel Mode IE is not included.	
Mobile Allocation	Indicates PCS 1 900 frequencies (739, 756, 761, 782, 804).

PHYSICAL INFORMATION

Information Element	value/remarks
As default message contents, except:	
Timing Advance	Arbitrarily selected but different to default value.

Step 6: x = 650 ms.

Step 7: The MS and SS are using a full rate TCH in hopping mode in the PCS band on cell A.

For 850/1 900 MS:

SYSTEM INFORMATION TYPE 5

Information Element	Value/remark
BCCH Frequency list For Cell A - Format identifier - BCCH Allocation Sequence - BCCH Allocation ARFCN - EXT-IND	128 range 0 ARFCN 137, 147, 159, 207, 217, 227, 237 and 247 "The information element carries the complete BA"

For M = 1:

Step 0: The MS and SS are using a full rate TCH in the GSM 850 band, in non-hopping mode on cell A.

HANDOVER COMMAND

Information Element	value/remarks
As default message contents, except: Cell Description - Network Colour Code - Base Station Colour Code - BCCH Carrier Number Channel description - Channel type - Timeslot number - Training Sequence Code - Hopping - ARFCN Handover Reference - Value Power command - Power Level Synchronization Indication - Report Observed Time Difference - Synchronization Indication - Normal Cell Indication	1 5 159 TCH/F + ACCHs Chosen arbitrarily Chosen arbitrarily Single RF Channel. Chosen arbitrarily from the PCS 1 900 frequencies allocated to the cell. Chosen arbitrarily from the range (0, 1..255) Arbitrarily chosen, but different to the one already in use and within the range supported by that type of MS. Shall not be included. "Non Synchronized". Ignore out of range timing advance.

PHYSICAL INFORMATION

Information Element	value/remarks
As default message contents, except:	

Step 6: x = 650 ms.

Step 7: The MS and SS are using a full rate TCH in the PCS 1 900 band, in non hopping mode on cell B.

For M = 2:

Step 0: The MS and SS are using a full rate TCH in the PCS 1 900 band, in non-hopping mode on cell B.

HANDOVER COMMAND

Information Element	value/remarks
As default message contents, except:	
Cell Description	
- Network Colour Code	1
- Base Station Colour Code	5
- BCCH Carrier Number	147
Channel Description	
- Channel Type	TCH/F + ACCHs
- Timeslot number	Chosen arbitrarily
- Training Sequence Code	Chosen arbitrarily
- Hopping	RF hopping channel.
- MAIO	Chosen arbitrarily from the set (0, 1 to N-1), where N is the number of frequencies in the Mobile Allocation IE.
- HSN	Chosen arbitrarily from the set (1,2,..63)
Handover Reference	
- Value	Chosen arbitrarily from the range (0, 1..255)
Power command	
- Power Level	Arbitrarily chosen, but different to the one already in use and within the range supported by that type of MS.
Synchronization Indication.	
- Report Observed Time Difference	Shall not be included
- Synchronization Indication	"Non Synchronized".
- Normal Cell Indication	Ignore out of range timing advance
Cell channel description:	GSM 850 frequencies: 137, 147, 161, 172, 179, 193, 201, 241
	PCS 1 900 frequencies: 739, 746, 756, 761, 771, 782, 798, 804
Channel Mode IE is not included.	
Mobile Allocation	Indicates PCS 1 900 frequencies (739, 756, 761, 782, 804).

PHYSICAL INFORMATION

Information Element	value/remarks
As default message contents, except:	
Timing Advance	Arbitrarily selected but different to default value.

Step 6: x = 650 ms.

Step 7: The MS and SS are using a full rate TCH in hopping mode in the DCS band on cell A.

26.11.2.2.4 Multiband signalling / RR / Handover/ Multiband BCCH / Intracell Handover - Interband Assignment

In case of multi-band networks, an intracell change of channel can be requested by upper layers in order to change the channel type (Directed Retry from a channel belonging to one frequency band to a channel belonging to another frequency band), or it may be initiated by the RR-sublayer for an intra cell and inter-band handover for cells supporting GSM 400, GSM 710, GSM750, GSM 850, GSM 900 and DCS 1 800 frequencies. This change is performed using the channel assignment procedure.

26.11.2.2.4.1 Dedicated assignment / successful case

This test is only applicable to an MS supporting a TCH.

26.11.2.2.4.1.1 Conformance requirements

1. Upon receipt of the ASSIGNMENT COMMAND message, the mobile station initiates a local end release of link layer connections, disconnects the physical channels, commands the switching to the assigned channels and

initiates the establishment of lower layer connections (this includes the activation of the channels, their connection and the establishment of the main signalling links).

2. MM-messages and CM-messages using SAPI=0 sent from the mobile station to the network can be duplicated by the data link layer in the following case:
 - a channel change of dedicated channels is required (assignment or handover procedure) and the last layer 2 frame has not been acknowledged by the peer data link layer before the mobile station leaves the old channel;
 - in this case, the mobile station does not know whether the network has received the message correctly. Therefore, the mobile station has to send the message again after the new dedicated channel is established.
3. The MS shall establish the link with the power level specified in the ASSIGNMENT COMMAND message.
 - The MS shall confirm the power control level that it is currently employing in the uplink SACCH L1 header. The indicated value shall be the power control level actually used by the mobile for the last burst of the previous SACCH period.
4. The MS shall apply the hopping frequencies specified in ASSIGNMENT COMMAND message in the Mobile Allocation IE or the Frequency List IE at the time of accessing the new channel using the last received Cell Allocation.
5. After receipt of the ASSIGNMENT COMMAND the MS shall perform the assignment and return an ASSIGNMENT COMPLETE without undue delay.

References

- 1, 3, 5 3GPP TS 04.08 / 3GPP TS 44.018, subclause 3.4.3.
2. 3GPP TS 04.08 / 3GPP TS 44.018, subclause 3.1.4.3.
4. 3GPP TS 04.08 / 3GPP TS 44.018, subclause 3.4.3;
3GPP TS 05.08, subclause 4.2.
6. 3GPP TS 04.13, subclause 5.2.4.

26.11.2.2.4.2 Test purpose

1. To verify that upon receipt of an ASSIGNMENT COMMAND, the MS switches to the channel defined in the ASSIGNMENT COMMAND, establishes the link and sends an ASSIGNMENT COMPLETE message. This is tested for an MS supporting TCH in the special cases of a transition.

NOTE: in all cases the old and the new channel assigned belong to different frequency bands.

- 1.1 from non-hopping SDCCH in the lower band to hopping TCH/F in the upper band using a different timeslot;
- 1.2 from hopping TCH/F in the upper band to non-hopping TCH/F in the lower band using a different timeslot;
- 1.3 from non-hopping TCH/F in the lower band to hopping TCH/F in the upper band using a different timeslot.
- 1.4 from hopping TCH/F in the upper band to hopping TCH/H in the lower band using a different timeslot; this test purpose is only applicable if the MS supports TCH/H;
- 1.5 from hopping TCH/H in the lower band to non-hopping TCH/H in the upper band using a different timeslot; this test purpose is only applicable if the MS supports TCH/H;
- 1.6 from non-hopping TCH/H in the upper band to hopping TCH/F in the lower band using a different timeslot; this test purpose is only applicable if the MS supports TCH/H.
2. To verify that an MS supporting TCH, having received an ASSIGNMENT COMMAND, is able in the case of frequency hopping to decode the Mobile Allocation and Frequency List IEs correctly and applies the specified frequencies using the correct Cell Allocation.
3. To verify that after receipt of the ASSIGNMENT COMMAND the MS returns an ASSIGNMENT COMPLETE without undue delay.

26.11.2.2.4.3 Method of test

Initial Conditions

System Simulator:

For 450/900 MS: 1 cell with GSM 450 and GSM 900 frequencies, using a BCCH in the GSM 450 band, default parameters except:

BCCH ARFCN =263.

System Information 1 Cell Allocation = 259, 263, 267, 271, 275, 279, 283, 291, 10, 20, 34, 45, 52, 66, 76, 114.

For 480/900 MS: 1 cell with GSM 480 and GSM 900 frequencies, using a BCCH in the GSM 480 band, default parameters except:

BCCH ARFCN =310.

System Information 1 Cell Allocation = 306, 310, 314, 318, 322, 326, 332, 338, 10, 20, 34, 45, 52, 66, 76, 114.

For 450/1 800 MS: 1 cell with GSM 450 and DCS 1 800 frequencies, using a BCCH in the GSM 450 band, default parameters except:

BCCH ARFCN =263.

System Information 1 Cell Allocation = 259, 263, 267, 271, 275, 279, 283, 291, 739, 746, 756, 761, 771, 782, 798, 832.

For 480/1 800 MS: 1 cell with GSM 480 and DCS 1 800 frequencies, using a BCCH in the GSM 480 band, default parameters except:

BCCH ARFCN =310.

System Information 1 Cell Allocation = 306, 310, 314, 318, 322, 326, 332, 338, 739, 746, 756, 761, 771, 782, 798, 832.

For 900/1 800 MS: 1 cell with GSM and DCS 1 800 frequencies, using a BCCH in the GSM band, default parameters except:

BCCH ARFCN =20.

System Information 1 Cell Allocation = 10, 20, 34, 45, 52, 66, 76, 114, 739, 746, 756, 761, 771, 782, 798, 832.

For 710/1 900 MS, 750/1 900 MS: 1 cell with GSM and PCS 1 900 frequencies, using a BCCH in the GSM band, default parameters except:

BCCH ARFCN =457.

System Information 1 Cell Allocation = 447, 457, 471, 482, 489, 498, 503, 508, 739, 746, 756, 761, 771, 782, 798, 804.

For 850/1 900 MS: 1 cell with GSM and PCS 1 900 frequencies, using a BCCH in the GSM band, default parameters except:

BCCH ARFCN =147.

System Information 1 Cell Allocation = 137, 147, 161, 172, 179, 193, 203, 241, 739, 746, 756, 761, 771, 782, 798, 804.

NOTE: Cell Allocation IE broadcasted in SYSTEM INFORMATION 1 shall be coded with a format so that frequencies belonging to both lower and upper frequency band can be included. Format Identifier of Cell Channel Description IE will thus be Range 1024.

Mobile Station:

The MS is in the "idle, updated" state with a TMSI allocated.

Specific PICS statements:

- GSM 450 Band (TSPC_Type_GSM_450_Band)
- Standard GSM Band (P-GSM) (TSPC_Type_GSM_P_Band)
- Extended GSM Band (E-GSM) (TSPC_Type_GSM_E_Band)
- GSM 480 Band (TSPC_Type_GSM_480_Band)
- DCS 1800 band (TSPC_Type_DCS_Band)
- GSM 750 band (TSPC_Type_GSM_750_Band)
- GSM 710 band (TSPC_Type_GSM_710_Band)
- at least one half rate service (TSPC_AddInfo_HalfRate)

PIXIT statements:

-

Foreseen Final State of the MS

"Idle, updated", with TMSI allocated.

Test Procedure

The SS pages the MS and allocates an SDCCH. Then three channels are assigned with ASSIGNMENT COMMANDs messages. Each time the MS shall switch to the assigned channel, establish the link and send an ASSIGNMENT COMPLETE message.

For an MS not supporting TCH/H, the SS initiates the channel release procedure and the test ends here. For an MS supporting TCH/H, the channel assignment procedure is performed another three times, with half rate channels involved, and again it is checked that the MS correctly completes the procedures, before the SS initiates the channel release procedure.

Maximum Duration of Test

60 s.

Expected Sequence

Step	Direction	Message	Comments
1	SS -> MS	PAGING REQUEST TYPE 1	
2	MS -> SS	CHANNEL REQUEST	
3	SS -> MS	IMMEDIATE ASSIGNMENT	See specific message contents.
4	MS -> SS	PAGING RESPONSE	
5	SS -> MS	ASSIGNMENT COMMAND	See specific message contents.
6	MS -> SS	ASSIGNMENT COMPLETE	Sent on the correct channel after establishment of the main signalling link. This message shall be ready to be transmitted before 600 ms after the completion of step 5.
7	SS -> MS	ASSIGNMENT COMMAND	See specific message contents.
8	MS -> SS	ASSIGNMENT COMPLETE	Sent on the correct channel after establishment of the main signalling link. This message shall be ready to be transmitted before 600 ms after the completion of step 7.
9	SS -> MS	ASSIGNMENT COMMAND	See specific message contents.
10	MS -> SS	ASSIGNMENT COMPLETE	Sent on the correct channel after establishment of the main signalling link. This message shall be ready to be transmitted before 600 ms after the completion of step 9.
A			This test part is performed if the MS doesn't support TCH/H (see PICS)
A 11	SS -> MS	CHANNEL RELEASE	The main signalling link is released.
B			This test part is performed if the MS supports TCH/H (see PICS).
B11	SS -> MS	ASSIGNMENT COMMAND	See specific message contents.
B12	MS -> SS	ASSIGNMENT COMPLETE	Sent on the correct channel after establishment of the main signalling link. This message shall be ready to be transmitted before 600 ms after the completion of step 11.
B13	SS -> MS	ASSIGNMENT COMMAND	See specific message contents.
B14	MS -> SS	ASSIGNMENT COMPLETE	Sent on the correct channel after establishment of the main signalling link. This message shall be ready to be transmitted before 600 ms after the completion of step 13.
B15	SS -> MS	ASSIGNMENT COMMAND	See specific message contents.
B16	MS -> SS	ASSIGNMENT COMPLETE	Sent on the correct channel after establishment of the main signalling link. This message shall be ready to be transmitted before 600 ms after the completion of step 15.
B17	SS -> MS	CHANNEL RELEASE	The main signalling link is released.

Specific Message Contents

For 450/900 MS:

Step 3

IMMEDIATE ASSIGNMENT:

As default message contents except Channel Description - Channel Type TDMA offset - Timeslot Number - Training Sequence Code - Hopping - ARFCN	SDCCH/8 Chosen arbitrarily N, chosen arbitrarily Chosen arbitrarily Single RF Channel chosen arbitrarily from CA of the common BCCH in the GSM 450 part of the list.
---	---

Step 5

ASSIGNMENT COMMAND:

Channel Description	TCH/F
- Channel Type and TDMA offset	(N+1) mod 8
- Timeslot Number	Chosen arbitrarily
- Training Sequence Code	RF hopping channel
- Hopping	Chosen arbitrarily from the set (0, 1 to N-1) where N is the number of frequencies in the Mobile Allocation IE.
- MAIO	Chosen arbitrarily from the set (1 to 63)
- HSN	
Power Command	Chosen arbitrarily but with a changed value.
- Power level	
Frequency list IE	Not included
Channel Mode	
- Mode	Signalling
Mobile Allocation	Indicates only GSM 900 frequencies of the CA (broadcast on the BCCH). (10, 20, 45, 52, 66, 114)
Starting Time	Not included

Step 7

ASSIGNMENT COMMAND:

Channel Description	TCH/F
- Channel Type and TDMA offset	(N+2) mod 8
- Timeslot Number	Chosen arbitrarily
- Training Sequence Code	Single RF Channel
- Hopping	chosen arbitrarily from CA of the common BCCH in the GSM 450 part of the list.
- ARFCN	
Power Command	Chosen arbitrarily but with a changed value.
- Power level	
Channel Mode	A non-signalling mode arbitrarily selected from the full rate capabilities declared for the MS
Frequency list IE	Not Included
Cell Channel Description	Range 1024 format encodes: (271, 275, 279, 283, 291, 10, 20, 34, 45, 52, 66, 76, 114.).
Mobile Allocation	Not included
Starting Time	Not included

Step 9

ASSIGNMENT COMMAND:

Channel Description	TCH/F
- Channel Type and TDMA offset	(N+3) mod 8
- Timeslot Number	Chosen arbitrarily
- Training Sequence Code	RF Hopping Channel
- Hopping	Chosen arbitrarily from the set (0, 1 to N-1) where N is the number of frequencies in the Mobile Allocation IE.
- MAIO	Chosen arbitrarily from the set (1 to 63).
- HSN	
Power Command	Chosen arbitrarily but with a changed value.
- Power level	
Channel Mode	A non-signalling mode arbitrarily selected from the full rate capabilities declared for the MS
Frequency list IE	Not Included
Mobile Allocation	Indicates GSM 900 frequencies (10, 45, 114).
Starting Time	Not included

Step 11

ASSIGNMENT COMMAND:

Channel Description - Channel Type and TDMA offset - Timeslot Number - Training Sequence Code - Hopping - MAIO - HSN Power Command - Power level Channel Mode Frequency list IE Cell Channel Description Mobile Allocation Starting Time	TCH/H (N+4) mod 8 Chosen arbitrarily RF hopping channel Chosen arbitrarily from the set (0, 1 to N-1) where N is the number of frequencies in the Mobile Allocation IE. Chosen arbitrarily from the set (1 to 63) Chosen arbitrarily but with a changed value. Not included unless the Channel Mode allocated in step 9 is incompatible for a Half Rate Channel Type. Not included Range 1024 format encodes: (259, 263, 267, 271, 275, 279, 283, 291, 10, 20, 34, 45, 52, 66, 76, 114). Indicates frequencies (259, 263, 267, 271, 275, 279, 283, 291). Not included
---	--

Step 13

ASSIGNMENT COMMAND:

Channel Description - Channel Type and TDMA offset - Timeslot Number - Training Sequence Code - Hopping - ARFCN Power Command - Power level Channel Mode Frequency list IE Cell Channel Description Mobile Allocation Starting Time	TCH/H (N+5) mod 8 Chosen arbitrarily Single RF Channel chosen arbitrarily from CA of the BCCH in the GSM 900 part of the list. Chosen arbitrarily but with a changed value. signalling Not included Not included Not included not included
---	--

Step 15

ASSIGNMENT COMMAND:

Channel Description - Channel Type TDMA offset - Timeslot Number - Training Sequence Code - Hopping - MAIO - HSN Power Command - Power level Channel Mode Cell Channel Description Frequency list IE Mobile Allocation Starting Time	TCH/F Chosen arbitrarily (N+6) mod 8 Chosen arbitrarily RF hopping channel Chosen arbitrarily from the set (0, 1 to N-1) where N is the number of GSM 450 frequencies in the Frequency List IE. Chosen arbitrarily from the set (1 to 63) Chosen arbitrarily but with a changed value. A non-signalling mode arbitrarily selected from the full rate capabilities declared for the MS Not included Use Range 128 to encode (259, 263, 267, 271, 275, 279, 283, 291). Not included Not included
--	--

For 480/900 MS:

Step 3

IMMEDIATE ASSIGNMENT:

As default message contents except Channel Description <ul style="list-style-type: none"> - Channel Type <li style="padding-left: 20px;">TDMA offset - Timeslot Number - Training Sequence Code - Hopping - ARFCN 	SDCCH/8 Chosen arbitrarily N, chosen arbitrarily Chosen arbitrarily Single RF Channel chosen arbitrarily from CA of the common BCCH in the GSM 480 part of the list.
--	---

Step 5

ASSIGNMENT COMMAND:

Channel Description <ul style="list-style-type: none"> - Channel Type and TDMA offset - Timeslot Number - Training Sequence Code - Hopping - MAIO - HSN Power Command <ul style="list-style-type: none"> - Power level Frequency list IE Channel Mode <ul style="list-style-type: none"> - Mode Mobile Allocation Starting Time	TCH/F (N+1) mod 8 Chosen arbitrarily RF hopping channel Chosen arbitrarily from the set (0, 1 to N-1) where N is the number of frequencies in the Mobile Allocation IE. Chosen arbitrarily from the set (1 to 63) Chosen arbitrarily but with a changed value. Not included Signalling Indicates only GSM 900 frequencies of the CA (broadcast on the BCCH). (10, 20, 45, 52, 66, 114) Not included
---	--

Step 7

ASSIGNMENT COMMAND:

Channel Description <ul style="list-style-type: none"> - Channel Type and TDMA offset - Timeslot Number - Training Sequence Code - Hopping - ARFCN Power Command <ul style="list-style-type: none"> - Power level Channel Mode Frequency list IE Cell Channel Description Mobile Allocation Starting Time	TCH/F (N+2) mod 8 Chosen arbitrarily Single RF Channel chosen arbitrarily from CA of the common BCCH in the GSM 480 part of the list. Chosen arbitrarily but with a changed value. A non-signalling mode arbitrarily selected from the full rate capabilities declared for the MS Not Included Range 1024 format encodes: (318, 322, 326, 332, 338, 10, 20, 34, 45, 52, 66, 76, 114.). Not included Not included
---	--

Step 9

ASSIGNMENT COMMAND:

Channel Description	TCH/F
- Channel Type and TDMA offset	(N+3) mod 8
- Timeslot Number	Chosen arbitrarily
- Training Sequence Code	RF Hopping Channel
- Hopping	Chosen arbitrarily from the set (0, 1 to N-1) where N is the number of frequencies in the Mobile Allocation IE.
- MAIO	Chosen arbitrarily from the set (1 to 63).
- HSN	
Power Command	Chosen arbitrarily but with a changed value.
- Power level	
Channel Mode	A non-signalling mode arbitrarily selected from the full rate capabilities declared for the MS
Frequency list IE	Not Included
Mobile Allocation	Indicates GSM 900 frequencies (10, 45, 114).
Starting Time	Not included

Step 11

ASSIGNMENT COMMAND:

Channel Description	TCH/H
- Channel Type and TDMA offset	(N+4) mod 8
- Timeslot Number	Chosen arbitrarily
- Training Sequence Code	RF hopping channel
- Hopping	Chosen arbitrarily from the set (0, 1 to N-1) where N is the number of frequencies in the Mobile Allocation IE.
- MAIO	Chosen arbitrarily from the set (1 to 63)
- HSN	
Power Command	Chosen arbitrarily but with a changed value.
- Power level	
Channel Mode	Not included unless the Channel Mode allocated in step 9 is incompatible for a Half Rate Channel Type.
Frequency list IE	Not included
Cell Channel Description	Range 1024 format encodes: (306, 310, 314, 318, 322, 326, 332, 338, 10, 20, 34, 45, 52, 66, 76, 114.).
Mobile Allocation	Indicates frequencies (306, 310, 314, 318, 322, 326, 332, 338).
Starting Time	Not included

Step 13

ASSIGNMENT COMMAND:

Channel Description	TCH/H
- Channel Type and TDMA offset	(N+5) mod 8
- Timeslot Number	Chosen arbitrarily
- Training Sequence Code	Single RF Channel
- Hopping	chosen arbitrarily from CA of the BCCH in the GSM 900 part of the list.
- ARFCN	
Power Command	Chosen arbitrarily but with a changed value.
- Power level	
Channel Mode	signalling
Frequency list IE	Not included
Cell Channel Description	Not included
Mobile Allocation	Not included
Starting Time	not included

Step 15

ASSIGNMENT COMMAND:

Channel Description	TCH/F
- Channel Type	Chosen arbitrarily
TDMA offset	(N+6) mod 8
- Timeslot Number	Chosen arbitrarily
- Training Sequence Code	RF hopping channel
- Hopping	Chosen arbitrarily from the set (0, 1 to N-1) where N is the number of GSM 480 frequencies in the Frequency List IE.
- MAIO	Chosen arbitrarily from the set (1 to 63)
- HSN	
Power Command	Chosen arbitrarily but with a changed value.
- Power level	
Channel Mode	A non-signalling mode arbitrarily selected from the full rate capabilities declared for the MS
Cell Channel Description	Not included
Frequency list IE	Uses Range 128 to encode (306, 310, 314, 318, 322, 326, 332, 338).
Mobile Allocation	Not included
Starting Time	Not included

For 450/1 800 MS:

Step 3

IMMEDIATE ASSIGNMENT:

As default message contents except	
Channel Description	SDCCH/8
- Channel Type	Chosen arbitrarily
TDMA offset	N, chosen arbitrarily
- Timeslot Number	Chosen arbitrarily
- Training Sequence Code	Single RF Channel
- Hopping	chosen arbitrarily from CA of the common BCCH in the GSM 450 part of the list.
- ARFCN	

Step 5

ASSIGNMENT COMMAND:

Channel Description	TCH/F
- Channel Type and TDMA offset	(N+1) mod 8
- Timeslot Number	Chosen arbitrarily
- Training Sequence Code	RF hopping channel
- Hopping	Chosen arbitrarily from the set (0, 1 to N-1) where N is the number of frequencies in the Mobile Allocation IE.
- MAIO	Chosen arbitrarily from the set (1 to 63)
- HSN	
Power Command	Chosen arbitrarily but with a changed value.
- Power level	
Frequency list IE	Not included
Channel Mode	Signalling
- Mode	Indicates only DCS 1 800 frequencies of the CA (broadcast on the BCCH).
Mobile Allocation	(739, 746, 761, 771, 782, 832)
Starting Time	Not included

Step 7

ASSIGNMENT COMMAND:

Channel Description	TCH/F
- Channel Type and TDMA offset	(N+2) mod 8
- Timeslot Number	Chosen arbitrarily
- Training Sequence Code	Single RF Channel
- Hopping	chosen arbitrarily from CA of the common BCCH in the
- ARFCN	GSM 450 part of the list.
Power Command	Chosen arbitrarily but with a changed value.
- Power level	A non-signalling mode arbitrarily selected from the full rate
Channel Mode	capabilities declared for the MS
Frequency list IE	Not Included
Cell Channel Description	Range 1024 format encodes: (271, 275, 279, 283, 291, 739, 746, 756, 761, 771, 782, 798, 832.).
Mobile Allocation	Not included
Starting Time	Not included

Step 9

ASSIGNMENT COMMAND:

Channel Description	TCH/F
- Channel Type and TDMA offset	(N+3) mod 8
- Timeslot Number	Chosen arbitrarily
- Training Sequence Code	RF Hopping Channel
- Hopping	Chosen arbitrarily from the set (O, 1 to N-1) where
- MAIO	N is the number of frequencies in the Mobile Allocation IE.
- HSN	Chosen arbitrarily from the set (1 to 63).
Power Command	Chosen arbitrarily but with a changed value.
- Power level	A non-signalling mode arbitrarily selected from the full rate
Channel Mode	capabilities declared for the MS
Frequency list IE	Not Included
Mobile Allocation	Indicates DCS frequencies (739, 761, 832).
Starting Time	Not included

Step 11

ASSIGNMENT COMMAND:

Channel Description	TCH/H
- Channel Type and TDMA offset	(N+4) mod 8
- Timeslot Number	Chosen arbitrarily
- Training Sequence Code	RF hopping channel
- Hopping	Chosen arbitrarily from the set (0, 1 to N-1) where N is the
- MAIO	number of frequencies in the Mobile Allocation IE.
- HSN	Chosen arbitrarily from the set (1 to 63)
Power Command	Chosen arbitrarily but with a changed value.
- Power level	Not included unless the Channel Mode allocated in step 9
Channel Mode	is incompatible for a Half Rate Channel Type.
Frequency list IE	Not included
Cell Channel Description	Range 1024 format encodes: (259, 263, 267, 271, 275, 279, 283, 291, 739, 746, 756, 761, 771, 782, 798, 832.).
Mobile Allocation	Indicates frequencies (259, 263, 267, 271, 275, 279, 283, 291).
Starting Time	Not included

Step 13

ASSIGNMENT COMMAND:

Channel Description - Channel Type and TDMA offset - Timeslot Number - Training Sequence Code - Hopping - ARFCN Power Command - Power level Channel Mode Frequency list IE Cell Channel Description Mobile Allocation Starting Time	TCH/H (N+5) mod 8 Chosen arbitrarily Single RF Channel chosen arbitrarily from CA of the BCCH in the DCS 1 800 part of the list. Chosen arbitrarily but with a changed value. signalling Not included Not included Not included not included
---	--

Step 15

ASSIGNMENT COMMAND:

Channel Description - Channel Type TDMA offset - Timeslot Number - Training Sequence Code - Hopping - MAIO - HSN Power Command - Power level Channel Mode Cell Channel Description Frequency list IE Mobile Allocation Starting Time	TCH/F Chosen arbitrarily (N+6) mod 8 Chosen arbitrarily RF hopping channel Chosen arbitrarily from the set (0, 1 to N-1) where N is the number of GSM 450 frequencies in the Frequency List IE. Chosen arbitrarily from the set (1 to 63) Chosen arbitrarily but with a changed value. A non-signalling mode arbitrarily selected from the full rate capabilities declared for the MS Not included Use Range 128 to encode (259, 263, 267, 271, 275, 279, 283, 291). Not included Not included
--	--

For 480/1 800 MS:

Step 3

IMMEDIATE ASSIGNMENT:

As default message contents except Channel Description - Channel Type TDMA offset - Timeslot Number - Training Sequence Code - Hopping - ARFCN	SDCCH/8 Chosen arbitrarily N, chosen arbitrarily Chosen arbitrarily Single RF Channel chosen arbitrarily from CA of the common BCCH in the GSM 480 part of the list.
---	---

Step 5

ASSIGNMENT COMMAND:

Channel Description	TCH/F
- Channel Type and TDMA offset	(N+1) mod 8
- Timeslot Number	Chosen arbitrarily
- Training Sequence Code	RF hopping channel
- Hopping	Chosen arbitrarily from the set (0, 1 to N-1) where N is the number of frequencies in the Mobile Allocation IE.
- MAIO	Chosen arbitrarily from the set (1 to 63)
- HSN	
Power Command	Chosen arbitrarily but with a changed value.
- Power level	
Frequency list IE	Not included
Channel Mode	
- Mode	Signalling
Mobile Allocation	Indicates only DCS 1 800 frequencies of the CA (broadcast on the BCCH). (739, 746, 761, 771, 782, 832)
Starting Time	Not included

Step 7

ASSIGNMENT COMMAND:

Channel Description	TCH/F
- Channel Type and TDMA offset	(N+2) mod 8
- Timeslot Number	Chosen arbitrarily
- Training Sequence Code	Single RF Channel
- Hopping	chosen arbitrarily from CA of the common BCCH in the GSM 480 part of the list.
- ARFCN	
Power Command	Chosen arbitrarily but with a changed value.
- Power level	
Channel Mode	A non-signalling mode arbitrarily selected from the full rate capabilities declared for the MS
Frequency list IE	Not Included
Cell Channel Description	Range 1024 format encodes: (318, 322, 326, 332, 338, 739, 746, 756, 761, 771, 782, 798, 832.).
Mobile Allocation	Not included
Starting Time	Not included

Step 9

ASSIGNMENT COMMAND:

Channel Description	TCH/F
- Channel Type and TDMA offset	(N+3) mod 8
- Timeslot Number	Chosen arbitrarily
- Training Sequence Code	RF Hopping Channel
- Hopping	Chosen arbitrarily from the set (0, 1 to N-1) where N is the number of frequencies in the Mobile Allocation IE.
- MAIO	Chosen arbitrarily from the set (1 to 63).
- HSN	
Power Command	Chosen arbitrarily but with a changed value.
- Power level	
Channel Mode	A non-signalling mode arbitrarily selected from the full rate capabilities declared for the MS
Frequency list IE	Not Included
Mobile Allocation	Indicates DCS frequencies (739, 761, 832).
Starting Time	Not included

Step 11

ASSIGNMENT COMMAND:

Channel Description	TCH/H
- Channel Type and TDMA offset	(N+4) mod 8
- Timeslot Number	Chosen arbitrarily
- Training Sequence Code	RF hopping channel
- Hopping	Chosen arbitrarily from the set (0, 1 to N-1) where N is the number of frequencies in the Mobile Allocation IE.
- MAIO	Chosen arbitrarily from the set (1 to 63)
- HSN	
Power Command	Chosen arbitrarily but with a changed value.
- Power level	
Channel Mode	Not included unless the Channel Mode allocated in step 9 is incompatible for a Half Rate Channel Type.
Frequency list IE	Not included
Cell Channel Description	Range 1024 format encodes: (306, 310, 314, 318, 322, 326, 332, 338, 739, 746, 756, 761, 771, 782, 798, 832.).
Mobile Allocation	Indicates frequencies (306, 310, 314, 318, 322, 326, 332, 338).
Starting Time	Not included

Step 13

ASSIGNMENT COMMAND:

Channel Description	TCH/H
- Channel Type and TDMA offset	(N+5) mod 8
- Timeslot Number	Chosen arbitrarily
- Training Sequence Code	Single RF Channel
- Hopping	chosen arbitrarily from CA of the BCCH in the DCS 1 800 part of the list.
- ARFCN	
Power Command	Chosen arbitrarily but with a changed value.
- Power level	
Channel Mode	signalling
Frequency list IE	Not included
Cell Channel Description	Not included
Mobile Allocation	Not included
Starting Time	not included

Step 15

ASSIGNMENT COMMAND:

Channel Description	TCH/F
- Channel Type	Chosen arbitrarily
TDMA offset	(N+6) mod 8
- Timeslot Number	Chosen arbitrarily
- Training Sequence Code	RF hopping channel
- Hopping	Chosen arbitrarily from the set (0, 1 to N-1) where N is the number of GSM 480 frequencies in the Frequency List IE.
- MAIO	Chosen arbitrarily from the set (1 to 63)
- HSN	
Power Command	Chosen arbitrarily but with a changed value.
- Power level	
Channel Mode	A non-signalling mode arbitrarily selected from the full rate capabilities declared for the MS
Cell Channel Description	Not included
Frequency list IE	Use Range 128 to encode (306, 310, 314, 318, 322, 326, 332, 338).
Mobile Allocation	Not included
Starting Time	Not included

For 900/1 800 MS:

Step 3

IMMEDIATE ASSIGNMENT:

As default message contents except Channel Description <ul style="list-style-type: none"> - Channel Type <li style="padding-left: 20px;">TDMA offset - Timeslot Number - Training Sequence Code - Hopping - ARFCN 	SDCCH/8 Chosen arbitrarily N, chosen arbitrarily Chosen arbitrarily Single RF Channel chosen arbitrarily from CA of the common BCCH in the GSM part of the list.
--	---

Step 5

ASSIGNMENT COMMAND:

Channel Description <ul style="list-style-type: none"> - Channel Type and TDMA offset - Timeslot Number - Training Sequence Code - Hopping - MAIO - HSN Power Command <ul style="list-style-type: none"> - Power level Frequency list IE Channel Mode <ul style="list-style-type: none"> - Mode Mobile Allocation Starting Time	TCH/F (N+1) mod 8 Chosen arbitrarily RF hopping channel Chosen arbitrarily from the set (0, 1 to N-1) where N is the number of frequencies in the Mobile Allocation IE. Chosen arbitrarily from the set (1 to 63) Chosen arbitrarily but with a changed value. Not included Signalling Indicates only DCS 1 800 frequencies of the CA (broadcast on the BCCH). (739, 746, 761, 771, 782, 832) Not included
---	---

Step 7

ASSIGNMENT COMMAND:

Channel Description <ul style="list-style-type: none"> - Channel Type and TDMA offset - Timeslot Number - Training Sequence Code - Hopping - ARFCN Power Command <ul style="list-style-type: none"> - Power level Channel Mode Frequency list IE Cell Channel Description Mobile Allocation Starting Time	TCH/F (N+2) mod 8 Chosen arbitrarily Single RF Channel chosen arbitrarily from CA of the common BCCH in the GSM part of the list. Chosen arbitrarily but with a changed value. A non-signalling mode arbitrarily selected from the full rate capabilities declared for the MS Not Included Range 1024 format encodes: (45, 52, 66, 76, 114, 739, 746, 756, 761, 771, 782, 798, 832.). Not included Not included
---	---

Step 9

ASSIGNMENT COMMAND:

Channel Description - Channel Type and TDMA offset - Timeslot Number - Training Sequence Code - Hopping - MAIO - HSN Power Command - Power level Channel Mode Frequency list IE Mobile Allocation Starting Time	TCH/F $(N+3) \text{ mod } 8$ Chosen arbitrarily RF Hopping Channel Chosen arbitrarily from the set (0, 1 to N-1) where N is the number of frequencies in the Mobile Allocation IE. Chosen arbitrarily from the set (1 to 63). Chosen arbitrarily but with a changed value. A non-signalling mode arbitrarily selected from the full rate capabilities declared for the MS Not Included Indicates DCS frequencies (739, 761, 832). Not included
---	--

Step 11

ASSIGNMENT COMMAND:

Channel Description - Channel Type and TDMA offset - Timeslot Number - Training Sequence Code - Hopping - MAIO - HSN Power Command - Power level Channel Mode Frequency list IE Cell Channel Description Mobile Allocation Starting Time	TCH/H $(N+4) \text{ mod } 8$ Chosen arbitrarily RF hopping channel Chosen arbitrarily from the set (0, 1 to N-1) where N is the number of frequencies in the Mobile Allocation IE. Chosen arbitrarily from the set (1 to 63) Chosen arbitrarily but with a changed value. Not included unless the Channel Mode allocated in step 9 is incompatible for a Half Rate Channel Type. Not included Range 1024 format encodes: (10, 20, 34, 45, 52, 66, 76, 114, 739, 746, 756, 761, 771, 782, 798, 832.). Indicates frequencies (10, 20, 34, 45, 52, 66, 76, 114). Not included
---	--

Step 13

ASSIGNMENT COMMAND:

Channel Description - Channel Type and TDMA offset - Timeslot Number - Training Sequence Code - Hopping - ARFCN Power Command - Power level Channel Mode Frequency list IE Cell Channel Description Mobile Allocation Starting Time	TCH/H $(N+5) \text{ mod } 8$ Chosen arbitrarily Single RF Channel chosen arbitrarily from CA of the BCCH in the DCS 1 800 part of the list. Chosen arbitrarily but with a changed value. signalling Not included Not included Not included Not included
---	---

Step 15

ASSIGNMENT COMMAND:

Channel Description	TCH/F
- Channel Type	Chosen arbitrarily
TDMA offset	(N+6) mod 8
- Timeslot Number	Chosen arbitrarily
- Training Sequence Code	RF hopping channel
- Hopping	Chosen arbitrarily from the set (0, 1 to N-1) where N is the number of GSM frequencies in the Frequency List IE.
- MAIO	Chosen arbitrarily from the set (1 to 63)
- HSN	
Power Command	Chosen arbitrarily but with a changed value.
- Power level	
Channel Mode	A non-signalling mode arbitrarily selected from the full rate capabilities declared for the MS
Cell Channel Description	Not included
Frequency list IE	Uses Bitmap 0 to indicate (10, 20, 34, 45, 52, 66, 76, 114).
Mobile Allocation	Not included
Starting Time	Not included

For 710/1 900 MS, 750/1 900 MS:

Step 3

IMMEDIATE ASSIGNMENT:

As default message contents except	
Channel Description	SDCCH/8
- Channel Type	Chosen arbitrarily
TDMA offset	N, chosen arbitrarily
- Timeslot Number	Chosen arbitrarily
- Training Sequence Code	Single RF Channel
- Hopping	chosen arbitrarily from CA of the common BCCH in the GSM part of the list.
- ARFCN	

Step 5

ASSIGNMENT COMMAND:

Channel Description	TCH/F
- Channel Type and TDMA offset	(N+1) mod 8
- Timeslot Number	Chosen arbitrarily
- Training Sequence Code	RF hopping channel
- Hopping	Chosen arbitrarily from the set (0, 1 to N-1) where N is the number of frequencies in the Mobile Allocation IE.
- MAIO	Chosen arbitrarily from the set (1 to 63)
- HSN	
Power Command	Chosen arbitrarily but with a changed value.
- Power level	Not included
Frequency list IE	
Channel Mode	Signalling
- Mode	Indicates only PCS 1 900 frequencies of the CA (broadcast on the BCCH).
Mobile Allocation	(739, 746, 761, 771, 782, 804)
Starting Time	Not included

Step 7

ASSIGNMENT COMMAND:

Channel Description	TCH/F
- Channel Type and TDMA offset	(N+2) mod 8
- Timeslot Number	Chosen arbitrarily
- Training Sequence Code	Single RF Channel
- Hopping	chosen arbitrarily from CA of the common BCCH in the GSM part of the list.
- ARFCN	
Power Command	Chosen arbitrarily but with a changed value.
- Power level	
Channel Mode	A non-signalling mode arbitrarily selected from the full rate capabilities declared for the MS
Frequency list IE	Not Included
Cell Channel Description	Range 1024 format encodes: (482, 489, 498, 503, 508, 739, 746, 756, 761, 771, 782, 798, 804).
Mobile Allocation	Not included
Starting Time	Not included

Step 9

ASSIGNMENT COMMAND:

Channel Description	TCH/F
- Channel Type and TDMA offset	(N+3) mod 8
- Timeslot Number	Chosen arbitrarily
- Training Sequence Code	RF Hopping Channel
- Hopping	Chosen arbitrarily from the set (O, 1 to N-1) where N is the number of frequencies in the Mobile Allocation IE.
- MAIO	Chosen arbitrarily from the set (1 to 63).
- HSN	
Power Command	Chosen arbitrarily but with a changed value.
- Power level	
Channel Mode	A non-signalling mode arbitrarily selected from the full rate capabilities declared for the MS
Frequency list IE	Not Included
Mobile Allocation	Indicates PCS frequencies (739, 761, 804).
Starting Time	Not included

Step 11

ASSIGNMENT COMMAND:

Channel Description	TCH/H
- Channel Type and TDMA offset	(N+4) mod 8
- Timeslot Number	Chosen arbitrarily
- Training Sequence Code	RF hopping channel
- Hopping	Chosen arbitrarily from the set (0, 1 to N-1) where N is the number of frequencies in the Mobile Allocation IE.
- MAIO	Chosen arbitrarily from the set (1 to 63)
- HSN	
Power Command	Chosen arbitrarily but with a changed value.
- Power level	
Channel Mode	Not included unless the Channel Mode allocated in step 9 is incompatible for a Half Rate Channel Type.
Frequency list IE	Not included
Cell Channel Description	Range 1024 format encodes: (447, 457, 471, 482, 489, 498, 503, 508, 739, 746, 756, 761, 771, 782, 798, 804).
Mobile Allocation	Indicates frequencies (447, 457, 471, 482, 489, 498, 503, 508).
Starting Time	Not included

Step 13

ASSIGNMENT COMMAND:

Channel Description - Channel Type and TDMA offset - Timeslot Number - Training Sequence Code - Hopping - ARFCN	TCH/H (N+5) mod 8 Chosen arbitrarily Single RF Channel chosen arbitrarily from CA of the BCCH in the PCS 1 900 part of the list.
Power Command - Power level	Chosen arbitrarily but with a changed value.
Channel Mode	Signalling
Frequency list IE	Not included
Cell Channel Description	Not included
Mobile Allocation	Not included
Starting Time	not included

Step 15

ASSIGNMENT COMMAND:

Channel Description - Channel Type TDMA offset - Timeslot Number - Training Sequence Code - Hopping - MAIO - HSN	TCH/F Chosen arbitrarily (N+6) mod 8 Chosen arbitrarily RF hopping channel Chosen arbitrarily from the set (0, 1 to N-1) where N is the number of GSM frequencies in the Frequency List IE. Chosen arbitrarily from the set (1 to 63)
Power Command - Power level	Chosen arbitrarily but with a changed value.
Channel Mode	A non-signalling mode arbitrarily selected from the full rate capabilities declared for the MS
Cell Channel Description	Not included
Frequency list IE	Uses 128 range to indicate (447, 457, 471, 482, 489, 498, 503, 508).
Mobile Allocation	Not included
Starting Time	Not included

For 850/1 900 MS:

Step 3

IMMEDIATE ASSIGNMENT:

As default message contents except Channel Description - Channel Type TDMA offset - Timeslot Number - Training Sequence Code - Hopping - ARFCN	SDCCH/8 Chosen arbitrarily N, chosen arbitrarily Chosen arbitrarily Single RF Channel chosen arbitrarily from CA of the common BCCH in the GSM part of the list.
---	---

Step 5

ASSIGNMENT COMMAND:

Channel Description	TCH/F
- Channel Type and TDMA offset	(N+1) mod 8
- Timeslot Number	Chosen arbitrarily
- Training Sequence Code	RF hopping channel
- Hopping	Chosen arbitrarily from the set (0, 1 to N-1) where N is the number of frequencies in the Mobile Allocation IE.
- MAIO	Chosen arbitrarily from the set (1 to 63)
- HSN	
Power Command	Chosen arbitrarily but with a changed value.
- Power level	
Frequency list IE	Not included
Channel Mode	
- Mode	Signalling
Mobile Allocation	Indicates only PCS 1 900 frequencies of the CA (broadcast on the BCCH). (739, 746, 761, 771, 782, 804)
Starting Time	Not included

Step 7

ASSIGNMENT COMMAND:

Channel Description	TCH/F
- Channel Type and TDMA offset	(N+2) mod 8
- Timeslot Number	Chosen arbitrarily
- Training Sequence Code	Single RF Channel
- Hopping	chosen arbitrarily from CA of the common BCCH in the GSM part of the list.
- ARFCN	
Power Command	Chosen arbitrarily but with a changed value.
- Power level	
Channel Mode	A non-signalling mode arbitrarily selected from the full rate capabilities declared for the MS
Frequency list IE	Not Included
Cell Channel Description	Range 1024 format encodes: (172, 179, 193, 203, 241, 739, 746, 756, 761, 771, 782, 798, 804).
Mobile Allocation	Not included
Starting Time	Not included

Step 9

ASSIGNMENT COMMAND:

Channel Description	TCH/F
- Channel Type and TDMA offset	(N+3) mod 8
- Timeslot Number	Chosen arbitrarily
- Training Sequence Code	RF Hopping Channel
- Hopping	Chosen arbitrarily from the set (0, 1 to N-1) where N is the number of frequencies in the Mobile Allocation IE.
- MAIO	Chosen arbitrarily from the set (1 to 63).
- HSN	
Power Command	Chosen arbitrarily but with a changed value.
- Power level	
Channel Mode	A non-signalling mode arbitrarily selected from the full rate capabilities declared for the MS
Frequency list IE	Not Included
Mobile Allocation	Indicates PCS frequencies (739, 761, 804).
Starting Time	Not included

Step 11

ASSIGNMENT COMMAND:

Channel Description	TCH/H
- Channel Type and TDMA offset	(N+4) mod 8
- Timeslot Number	Chosen arbitrarily
- Training Sequence Code	RF hopping channel
- Hopping	Chosen arbitrarily from the set (0, 1 to N-1) where N is the number of frequencies in the Mobile Allocation IE.
- MAIO	Chosen arbitrarily from the set (1 to 63)
- HSN	
Power Command	Chosen arbitrarily but with a changed value.
- Power level	
Channel Mode	Not included unless the Channel Mode allocated in step 9 is incompatible for a Half Rate Channel Type.
Frequency list IE	Not included
Cell Channel Description	Range 1024 format encodes: (137, 147, 161, 172, 179, 193, 203, 241, 739, 746, 756, 761, 771, 782, 798, 804).
Mobile Allocation	Indicates frequencies (137, 147, 161, 172, 179, 193, 203, 241).
Starting Time	Not included

Step 13

ASSIGNMENT COMMAND:

Channel Description	TCH/H
- Channel Type and TDMA offset	(N+5) mod 8
- Timeslot Number	Chosen arbitrarily
- Training Sequence Code	Single RF Channel
- Hopping	chosen arbitrarily from CA of the BCCH in the PCS 1 900 part of the list.
- ARFCN	
Power Command	Chosen arbitrarily but with a changed value.
- Power level	
Channel Mode	Signalling
Frequency list IE	Not included
Cell Channel Description	Not included
Mobile Allocation	Not included
Starting Time	not included

Step 15

ASSIGNMENT COMMAND:

Channel Description	TCH/F
- Channel Type	Chosen arbitrarily
TDMA offset	(N+6) mod 8
- Timeslot Number	Chosen arbitrarily
- Training Sequence Code	RF hopping channel
- Hopping	Chosen arbitrarily from the set (0, 1 to N-1) where N is the number of GSM frequencies in the Frequency List IE.
- MAIO	Chosen arbitrarily from the set (1 to 63)
- HSN	
Power Command	Chosen arbitrarily but with a changed value.
- Power level	
Channel Mode	A non-signalling mode arbitrarily selected from the full rate capabilities declared for the MS
Cell Channel Description	Not included
Frequency list IE	Uses 128 range to indicate (137, 147, 161, 172, 179, 193, 203, 241).
Mobile Allocation	Not included
Starting Time	Not included

26.11.2.3 Multiband signalling / RR / Measurement reporting

This test applies to any multiband MSs supporting simultaneous multiband operation.

26.11.2.3.1 Conformance requirements

The MS shall continuously send MEASUREMENT REPORT messages on every SACCH blocks and the measurement valid indication shall be set to valid (0) within the second block at the latest. After 20 s the values in the MEASUREMENT REPORT message shall contain measurement results for up to the 6 strongest BCCH carriers among those with known and allowed NCC part of BSIC on which the mobile is asked to report. For a multi band MS the number of neighbour cells, for each frequency band supported, which shall be included is indicated by the parameter MULTIBAND_REPORTING.

References

3GPP TS 04.08 / 3GPP TS 44.018 subclause 3.4.1.2.

3GPP TS 05.08 subclause 8.4.

26.11.2.3.2 Test purpose

To test that, when the SS gives information about neighbouring cells, the MS reports the appropriate results and correctly orders the BA list made from System Information 5 and System Information 5ter.

26.11.2.3.3 Method of test

Initial Conditions

System Simulator:

For 450/900 MS: 8 cells with the following settings:

Transmitter	Level	NCC	BCC	ARFCN	Cell identity
Serving, S1	-60	1	3	259	0001H
Neighbour, N1	-85	1	5	002	0002H
Neighbour, N2	-79	1	7	261	0003H
Neighbour, N3	-75	1	1	263	0004H
Neighbour, N4	-55	1	3	088	0005H
Neighbour, N5	-50	1	5	274	0006H
Neighbour, N6	-45	1	7	114	0007H
Neighbour, N7	-40	1	1	278	0008H

For 480/900 MS: 8 cells with the following settings:

Transmitter	Level	NCC	BCC	ARFCN	Cell identity
Serving, S1	-60	1	3	306	0001H
Neighbour, N1	-85	1	5	002	0002H
Neighbour, N2	-79	1	7	308	0003H
Neighbour, N3	-75	1	1	310	0004H
Neighbour, N4	-55	1	3	088	0005H
Neighbour, N5	-50	1	5	321	0006H
Neighbour, N6	-45	1	7	114	0007H
Neighbour, N7	-40	1	1	325	0008H

For 450/1 800 MS: 8 cells with the following settings:

Transmitter	Level	NCC	BCC	ARFCN	Cell identity
Serving, S1	-60	1	3	259	0001H
Neighbour, N1	-85	1	5	520	0002H
Neighbour, N2	-79	1	7	261	0003H
Neighbour, N3	-75	1	1	263	0004H
Neighbour, N4	-55	1	3	780	0005H
Neighbour, N5	-50	1	5	274	0006H
Neighbour, N6	-45	1	7	880	0007H
Neighbour, N7	-40	1	1	278	0008H

For 480/1 800 MS: 8 cells with the following settings:

Transmitter	Level	NCC	BCC	ARFCN	Cell identity
Serving, S1	-60	1	3	306	0001H
Neighbour, N1	-85	1	5	520	0002H
Neighbour, N2	-79	1	7	308	0003H
Neighbour, N3	-75	1	1	310	0004H
Neighbour, N4	-55	1	3	780	0005H
Neighbour, N5	-50	1	5	321	0006H
Neighbour, N6	-45	1	7	880	0007H
Neighbour, N7	-40	1	1	325	0008H

For 900/1 800 MS: 8 cells with the following settings:

Transmitter	Level	NCC	BCC	ARFCN	Cell Identity
Serving, S1	-60	1	3	002	0001H
Neighbour, N1	-85	1	5	520	0002H
Neighbour, N2	-79	1	7	014	0003H
Neighbour, N3	-75	1	1	020	0004H
Neighbour, N4	-55	1	3	780	0005H
Neighbour, N5	-50	1	5	032	0006H
Neighbour, N6	-45	1	7	880	0007H
Neighbour, N7	-40	1	1	044	0008H

For 710/1 900 MS, 750/1 900 MS: 8 cells with the following settings:

Transmitter	Level	NCC	BCC	ARFCN	Cell Identity
Serving, S1	-60	1	3	439	0001H
Neighbour, N1	-85	1	5	520	0002H
Neighbour, N2	-79	1	7	451	0003H
Neighbour, N3	-75	1	1	457	0004H
Neighbour, N4	-55	1	3	780	0005H
Neighbour, N5	-50	1	5	469	0006H
Neighbour, N6	-45	1	7	805	0007H
Neighbour, N7	-40	1	1	481	0008H

For 850/1 900 MS: 8 cells with the following settings:

Transmitter	Level	NCC	BCC	ARFCN	Cell Identity
Serving, S1	-60	1	3	129	0001H
Neighbour, N1	-85	1	5	520	0002H
Neighbour, N2	-79	1	7	141	0003H
Neighbour, N3	-75	1	1	147	0004H
Neighbour, N4	-55	1	3	780	0005H
Neighbour, N5	-50	1	5	159	0006H
Neighbour, N6	-45	1	7	805	0007H
Neighbour, N7	-40	1	1	171	0008H

With the exception of the Cell Allocation, the rest of the parameters for all eight cells are the same as the default settings and default SYSTEM INFORMATION TYPE 1, 2 and 4 message contents for cell A. The Cell Allocation for

the serving cell is the same as the default setting for cell A. The Cell Allocations for the neighbour cells need have only one entry, consisting of the ARFCN of that cell's BCCH.

Mobile Station:

The MS is in the active state of a call (U10).

Specific PICS statements:

- GSM 450 Band (TSPC_Type_GSM_450_Band)
- Standard GSM Band (P-GSM) (TSPC_Type_GSM_P_Band)
- Extended GSM Band (E-GSM) (TSPC_Type_GSM_E_Band)
- GSM 480 Band (TSPC_Type_GSM_480_Band)
- DCS 1800 band (TSPC_Type_DCS_Band)
- GSM 750 band (TSPC_Type_GSM_750_Band)
- GSM 710 band (TSPC_Type_GSM_710_Band)

PIXIT statements:

-

Foreseen Final State of the MS

Active state of a call (U10).

Test Procedure

This test procedure is performed three times.

With the MS having a call in progress, the SS sends SYSTEM INFORMATION TYPE 5, 5ter & 6 on the SACCH. All 8 of the BCCHs "on air" are indicated in the BA. The MS shall send MEASUREMENT REPORTs back to the SS, and it shall be indicated in these that measurement results for the 6 strongest carriers, on which the mobile is asked to report (indicated by the parameter MULTIBAND_REPORTING), have been obtained.

Maximum Duration of Test

5 minutes, including 1 minute for any necessary operator actions.

Expected Sequence

This sequence is performed for execution counter, $k = 1, 2, 3$.

Since SYSTEM INFORMATION TYPE 5, SYSTEM INFORMATION TYPE 5ter, SYSTEM INFORMATION TYPE 6 and MEASUREMENT REPORT are sent continuously, a table is not applicable in this test. The interval between 2 successive Layer 2 frames containing MEASUREMENT REPORTs shall not exceed one Layer 2 frame.

Specific Message Contents

For 450/900 MS:

SYSTEM INFORMATION TYPE 2ter:

Information Element	value/remark
As defaults except: Neighbour Cells Description 2 Multiband Reporting	k=1, 3: Minimum 3 cells reported from each band supported excluding the frequency band of the serving cell. k=2: Normal reporting of six strongest cells, irrespective of the band used.

SYSTEM INFORMATION TYPE 3:

Information Element	value/remark
as default except: - SI 2ter indicator - Early Classmark Sending Control	SI 3 rest octets System Information 2ter is available Early Sending is explicitly accepted

SYSTEM INFORMATION TYPE 5:

Information Element	value/remark
Protocol Discriminator Message Type Neighbour Cells Description - Format Identifier - BCCH Allocation Sequence - BCCH Allocation ARFCN - EXT IND	RR management Sys Info 5. k=1, 2: Range 128 k=3: Bit map 0 1 k=1, 2: ARFCN 261, 263, 274, 278 k=3: ARFCN 2, 88, 114 Information Element carries the complete BA.

SYSTEM INFORMATION TYPE 5ter:

Information Element	value/remark
Protocol Discriminator Message Type - Neighbour Cells Description 2 - Multiband reporting - Format notation - BA_IND - BCCH Allocation ARFCN	RR management Sys Info 5ter. k=1, 3: Normal reporting of six strongest cells, irrespective of the band used k=2: Minimum 3 cells reported from each band supported excluding the frequency band of the serving cell. Range 512 1 k=1, 2: ARFCN 2, 88, 114 k=3: ARFCN 261, 263, 274, 278

MEASUREMENT REPORT:

Information Element	value/remark
Protocol Discriminator	RR Management
Transaction Identifier	0000
Message Type	MEASUREMENT REPORT
Measurement Results	
BA-used	1
DTX-used	DTX was not used
RXLEV-FULL-SERVING-CELL	See note 1
RXLEV-SUB-SERVING-CELL	See note 1
MEAS-VALID	See note 3
RXQUAL-FULL-SERVING-CELL	See note 1
RXQUAL-SUB-SERVING-CELL	See note 1
NO-NCELL-M	6 neighbour cell measurement results
RXLEV-NCELL-1	See note 1
BCCH-FREQ-NCELL-1	See note 2
BSIC-NCELL-1	Corresponds to that of BCCH-FREQ-NCELL-1
RXLEV-NCELL-2	See note 1
BCCH-FREQ-NCELL-2	See note 2
BSIC-NCELL-2	Corresponds to that of BCCH-FREQ-NCELL-2
RXLEV-NCELL-3	See note 1
BCCH-FREQ-NCELL-3	See note 2
BSIC-NCELL-3	Corresponds to that of BCCH-FREQ-NCELL-3
RXLEV-NCELL-4	See note 1
BCCH-FREQ-NCELL-4	See note 2
BSIC-NCELL-4	Corresponds to that of BCCH-FREQ-NCELL-4
RXLEV-NCELL-5	See note 1
BCCH-FREQ-NCELL-5	See note 2
BSIC-NCELL-5	Corresponds to that of BCCH-FREQ-NCELL-5
RXLEV-NCELL-6	See note 1
BCCH-FREQ-NCELL-6	See note 2
BSIC-NCELL-6	Corresponds to that of BCCH-FREQ-NCELL-6
NOTE 1: These actual values are not checked.	
NOTE 2: k=1; report on ARFCNs 261, 263, 274, 278, 88, 114 ie: BSIC-NCELL values of 0, 1, 2, 3, 5 and 6 but not 4 k=2; report on ARFCNs 263, 274, 278, 2, 88, 114 ie: BSIC-NCELL values of 1, 2, 3, 4, 5 and 6 but not 0 k=3; report on ARFCNs 88, 114, 261, 263, 274, 278 ie: BSIC-NCELL values of 1, 2, 3, 4, 5 and 6 but not 0	
NOTE 3: The Measurement Valid Indication shall be set to valid within the second SACCH block at the latest.	

For 480/900 MS:

SYSTEM INFORMATION TYPE 2ter:

Information Element	value/remark
As defaults except: Neighbour Cells Description 2 Multiband Reporting	k=1, 3: Minimum 3 cells reported from each band supported excluding the frequency band of the serving cell. k=2: Normal reporting of six strongest cells, irrespective of the band used.

SYSTEM INFORMATION TYPE 3:

Information Element	value/remark
as default except: - SI 2ter indicator - Early Classmark Sending Control	SI 3 rest octets System Information 2ter is available Early Sending is explicitly accepted

SYSTEM INFORMATION TYPE 5:

Information Element	value/remark
Protocol Discriminator	RR management
Message Type	Sys Info 5.
Neighbour Cells Description	
- Format Identifier	k=1, 2: Range 128 k=3: Bit map 0
- BCCH Allocation Sequence	1
- BCCH Allocation ARFCN	k=1, 2: ARFCN 308, 310, 321, 325 k=3: ARFCN 2, 88, 114
- EXT IND	Information Element carries the complete BA.

SYSTEM INFORMATION TYPE 5ter:

Information Element	value/remark
Protocol Discriminator	RR management
Message Type	Sys Info 5ter.
- Neighbour Cells Description 2	
- Multiband reporting	k=1, 3: Normal reporting of six strongest cells, irrespective of the band used k=2: Minimum 3 cells reported from each band supported excluding the frequency band of the serving cell.
- Format notation	Range 512
- BA_IND	1
- BCCH Allocation ARFCN	k=1, 2: ARFCN 2, 88, 114 k=3: ARFCN 308, 310, 321, 325

MEASUREMENT REPORT:

Information Element	value/remark
Protocol Discriminator	RR Management
Transaction Identifier	0000
Message Type	MEASUREMENT REPORT
Measurement Results	
BA-used	1
DTX-used	DTX was not used
RXLEV-FULL-SERVING-CELL	See note 1
RXLEV-SUB-SERVING-CELL	See note 1
MEAS-VALID	See note 3
RXQUAL-FULL-SERVING-CELL	See note 1
RXQUAL-SUB-SERVING-CELL	See note 1
NO-NCELL-M	6 neighbour cell measurement results
RXLEV-NCELL-1	See note 1
BCCH-FREQ-NCELL-1	See note 2
BSIC-NCELL-1	Corresponds to that of BCCH-FREQ-NCELL-1
RXLEV-NCELL-2	See note 1
BCCH-FREQ-NCELL-2	See note 2
BSIC-NCELL-2	Corresponds to that of BCCH-FREQ-NCELL-2
RXLEV-NCELL-3	See note 1
BCCH-FREQ-NCELL-3	See note 2
BSIC-NCELL-3	Corresponds to that of BCCH-FREQ-NCELL-3
RXLEV-NCELL-4	See note 1
BCCH-FREQ-NCELL-4	See note 2
BSIC-NCELL-4	Corresponds to that of BCCH-FREQ-NCELL-4
RXLEV-NCELL-5	See note 1
BCCH-FREQ-NCELL-5	See note 2
BSIC-NCELL-5	Corresponds to that of BCCH-FREQ-NCELL-5
RXLEV-NCELL-6	See note 1
BCCH-FREQ-NCELL-6	See note 2
BSIC-NCELL-6	Corresponds to that of BCCH-FREQ-NCELL-6
NOTE 1: These actual values are not checked.	
NOTE 2: k=1; report on ARFCNs 308, 310, 321, 325, 88, 114 ie: BSIC-NCELL values of 0, 1, 2, 3, 5 and 6 but not 4 k=2; report on ARFCNs 310, 321, 325, 2, 88, 114 ie: BSIC-NCELL values of 1, 2, 3, 4, 5 and 6 but not 0 k=3; report on ARFCNs 88, 114, 308, 310, 321, 325 ie: BSIC-NCELL values of 1, 2, 3, 4, 5 and 6 but not 0	
NOTE 3: The Measurement Valid Indication shall be set to valid within the second SACCH block at the latest.	

For 450/1 800 MS:

SYSTEM INFORMATION TYPE 2ter:

Information Element	value/remark
As defaults except: Neighbour Cells Description 2 Multiband Reporting	k=1, 3: Minimum 3 cells reported from each band supported excluding the frequency band of the serving cell. k=2: Normal reporting of six strongest cells, irrespective of the band used.

SYSTEM INFORMATION TYPE 3:

Information Element	value/remark
as default except: - SI 2ter indicator - Early Classmark Sending Control	SI 3 rest octets System Information 2ter is available Early Sending is explicitly accepted

SYSTEM INFORMATION TYPE 5:

Information Element	value/remark
Protocol Discriminator	RR management
Message Type	Sys Info 5.
Neighbour Cells Description	
- Format Identifier	k=1, 2: Range 128 k=3: Range 512
- BCCH Allocation Sequence	1
- BCCH Allocation ARFCN	k=1, 2: ARFCN 261, 263, 274, 278 k=3: ARFCN 520, 780, 880
- EXT_IND	Information Element carries the complete BA.

SYSTEM INFORMATION TYPE 5ter:

Information Element	value/remark
Protocol Discriminator	RR management
Message Type	Sys Info 5ter.
- Neighbour Cells Description 2	
- Multiband reporting	k=1, 3: Normal reporting of six strongest cells, irrespective of the band used k=2: Minimum 3 cells reported from each band supported excluding the frequency band of the serving cell.
- Format notation	Range 512
- BA_IND	1
- BCCH Allocation ARFCN	k=1, 2: ARFCN 520, 780, 880 k=3: ARFCN 261, 263, 274, 278

MEASUREMENT REPORT:

Information Element	value/remark
Protocol Discriminator	RR Management
Transaction Identifier	0000
Message Type	MEASUREMENT REPORT
Measurement Results	
BA-used	1
DTX-used	DTX was not used
RXLEV-FULL-SERVING-CELL	See note 1
RXLEV-SUB-SERVING-CELL	See note 1
MEAS-VALID	See note 3
RXQUAL-FULL-SERVING-CELL	See note 1
RXQUAL-SUB-SERVING-CELL	See note 1
NO-NCELL-M	6 neighbour cell measurement results
RXLEV-NCELL-1	See note 1
BCCH-FREQ-NCELL-1	See note 2
BSIC-NCELL-1	Corresponds to that of BCCH-FREQ-NCELL-1
RXLEV-NCELL-2	See note 1
BCCH-FREQ-NCELL-2	See note 2
BSIC-NCELL-2	Corresponds to that of BCCH-FREQ-NCELL-2
RXLEV-NCELL-3	See note 1
BCCH-FREQ-NCELL-3	See note 2
BSIC-NCELL-3	Corresponds to that of BCCH-FREQ-NCELL-3
RXLEV-NCELL-4	See note 1
BCCH-FREQ-NCELL-4	See note 2
BSIC-NCELL-4	Corresponds to that of BCCH-FREQ-NCELL-4
RXLEV-NCELL-5	See note 1
BCCH-FREQ-NCELL-5	See note 2
BSIC-NCELL-5	Corresponds to that of BCCH-FREQ-NCELL-5
RXLEV-NCELL-6	See note 1
BCCH-FREQ-NCELL-6	See note 2
BSIC-NCELL-6	Corresponds to that of BCCH-FREQ-NCELL-6
NOTE 1: These actual values are not checked.	
NOTE 2: k=1; report on ARFCNs 261, 263, 274, 278, 780, 880 ie: BSIC-NCELL values of 0, 1, 2, 3, 5 and 6 but not 4 k=2; report on ARFCNs 263, 274, 278, 520, 780, 880 ie: BSIC-NCELL values of 1, 2, 3, 4, 5 and 6 but not 0 k=3; report on ARFCNs 780, 880, 261, 263, 274, 278 ie: BSIC-NCELL values of 1, 2, 3, 4, 5 and 6 but not 0	
NOTE 3: The Measurement Valid Indication shall be set to valid within the second SACCH block at the latest.	

For 480/1 800 MS:

SYSTEM INFORMATION TYPE 2ter:

Information Element	value/remark
As defaults except: Neighbour Cells Description 2 Multiband Reporting	k=1, 3: Minimum 3 cells reported from each band supported excluding the frequency band of the serving cell. k=2: Normal reporting of six strongest cells, irrespective of the band used.

SYSTEM INFORMATION TYPE 3:

Information Element	value/remark
as default except: - SI 2ter indicator - Early Classmark Sending Control	SI 3 rest octets System Information 2ter is available Early Sending is explicitly accepted

SYSTEM INFORMATION TYPE 5:

Information Element	value/remark
Protocol Discriminator	RR management
Message Type	Sys Info 5.
Neighbour Cells Description	
- Format Identifier	k=1, 2: Range 128 k=3: Range 512
- BCCH Allocation Sequence	1
- BCCH Allocation ARFCN	k=1, 2: ARFCN 308, 310, 321, 325 k=3: ARFCN 520, 780, 880
- EXT_IND	Information Element carries the complete BA.

SYSTEM INFORMATION TYPE 5ter:

Information Element	value/remark
Protocol Discriminator	RR management
Message Type	Sys Info 5ter.
- Neighbour Cells Description 2	
- Multiband reporting	k=1, 3: Normal reporting of six strongest cells, irrespective of the band used k=2: Minimum 3 cells reported from each band supported excluding the frequency band of the serving cell. Range 512
- Format notation	1
- BA_IND	
- BCCH Allocation ARFCN	k=1, 2: ARFCN 520, 780, 880 k=3: ARFCN 308, 310, 321, 325

MEASUREMENT REPORT:

Information Element	value/remark
Protocol Discriminator	RR Management
Transaction Identifier	0000
Message Type	MEASUREMENT REPORT
Measurement Results	
BA-used	1
DTX-used	DTX was not used
RXLEV-FULL-SERVING-CELL	See note 1
RXLEV-SUB-SERVING-CELL	See note 1
MEAS-VALID	See note 3
RXQUAL-FULL-SERVING-CELL	See note 1
RXQUAL-SUB-SERVING-CELL	See note 1
NO-NCELL-M	6 neighbour cell measurement results
RXLEV-NCELL-1	See note 1
BCCH-FREQ-NCELL-1	See note 2
BSIC-NCELL-1	Corresponds to that of BCCH-FREQ-NCELL-1
RXLEV-NCELL-2	See note 1
BCCH-FREQ-NCELL-2	See note 2
BSIC-NCELL-2	Corresponds to that of BCCH-FREQ-NCELL-2
RXLEV-NCELL-3	See note 1
BCCH-FREQ-NCELL-3	See note 2
BSIC-NCELL-3	Corresponds to that of BCCH-FREQ-NCELL-3
RXLEV-NCELL-4	See note 1
BCCH-FREQ-NCELL-4	See note 2
BSIC-NCELL-4	Corresponds to that of BCCH-FREQ-NCELL-4
RXLEV-NCELL-5	See note 1
BCCH-FREQ-NCELL-5	See note 2
BSIC-NCELL-5	Corresponds to that of BCCH-FREQ-NCELL-5
RXLEV-NCELL-6	See note 1
BCCH-FREQ-NCELL-6	See note 2
BSIC-NCELL-6	Corresponds to that of BCCH-FREQ-NCELL-6
NOTE 1: These actual values are not checked.	
NOTE 2: k=1; report on ARFCNs 308, 310, 321, 325, 780, 880 ie: BSIC-NCELL values of 0, 1, 2, 3, 5 and 6 but not 4 k=2; report on ARFCNs 310, 321, 325, 520, 780, 880 ie: BSIC-NCELL values of 1, 2, 3, 4, 5 and 6 but not 0 k=3; report on ARFCNs 780, 880, 308, 310, 321, 325 ie: BSIC-NCELL values of 1, 2, 3, 4, 5 and 6 but not 0	
NOTE 3: The Measurement Valid Indication shall be set to valid within the second SACCH block at the latest.	

For 900/1 800 MS:

SYSTEM INFORMATION TYPE 2ter:

Information Element	value/remark
As defaults except: Neighbour Cells Description 2 Multiband Reporting	k=1, 3: Minimum 3 cells reported from each band supported excluding the frequency band of the serving cell. k=2: Normal reporting of six strongest cells, irrespective of the band used.

SYSTEM INFORMATION TYPE 3:

Information Element	value/remark
as default except: - SI 2ter indicator - Early Classmark Sending Control	SI 3 rest octets System Information 2ter is available Early Sending is explicitly accepted

SYSTEM INFORMATION TYPE 5:

Information Element	value/remark
Protocol Discriminator	RR management
Message Type	Sys Info 5.
Neighbour Cells Description	
- Format Identifier	k=1, 2: Bit map 0 k=3: Range 512
- BCCH Allocation Sequence	1
- BCCH Allocation ARFCN	k=1, 2: ARFCN 14, 20, 32, 44 k=3: ARFCN 520, 780, 880
- EXT IND	Information Element carries the complete BA.

SYSTEM INFORMATION TYPE 5ter:

Information Element	value/remark
Protocol Discriminator	RR management
Message Type	Sys Info 5ter.
- Neighbour Cells Description 2	
- Multiband reporting	k=1, 3: Normal reporting of six strongest cells, irrespective of the band used k=2: Minimum 3 cells reported from each band supported excluding the frequency band of the serving cell.
- Format notation	Range 512
- BA_IND	1
- BCCH Allocation ARFCN	k=1, 2: ARFCN 520, 780, 880 k=3: ARFCN 14, 20, 32, 44

MEASUREMENT REPORT:

Information Element	value/remark
Protocol Discriminator	RR Management
Transaction Identifier	0000
Message Type	MEASUREMENT REPORT
Measurement Results	
BA-used	1
DTX-used	DTX was not used
RXLEV-FULL-SERVING-CELL	See note 1
RXLEV-SUB-SERVING-CELL	See note 1
MEAS-VALID	See note 3
RXQUAL-FULL-SERVING-CELL	See note 1
RXQUAL-SUB-SERVING-CELL	See note 1
NO-NCELL-M	6 neighbour cell measurement results
RXLEV-NCELL-1	See note 1
BCCH-FREQ-NCELL-1	See note 2
BSIC-NCELL-1	Corresponds to that of BCCH-FREQ-NCELL-1
RXLEV-NCELL-2	See note 1
BCCH-FREQ-NCELL-2	See note 2
BSIC-NCELL-2	Corresponds to that of BCCH-FREQ-NCELL-2
RXLEV-NCELL-3	See note 1
BCCH-FREQ-NCELL-3	See note 2
BSIC-NCELL-3	Corresponds to that of BCCH-FREQ-NCELL-3
RXLEV-NCELL-4	See note 1
BCCH-FREQ-NCELL-4	See note 2
BSIC-NCELL-4	Corresponds to that of BCCH-FREQ-NCELL-4
RXLEV-NCELL-5	See note 1
BCCH-FREQ-NCELL-5	See note 2
BSIC-NCELL-5	Corresponds to that of BCCH-FREQ-NCELL-5
RXLEV-NCELL-6	See note 1
BCCH-FREQ-NCELL-6	See note 2
BSIC-NCELL-6	Corresponds to that of BCCH-FREQ-NCELL-6
NOTE 1: These actual values are not checked.	
NOTE 2: k=1; report on ARFCNs 14, 20, 32, 44, 780, 880 ie: BSIC-NCELL values of 0, 1, 2, 3, 5 and 6 but not 4 k=2; report on ARFCNs 20, 32, 44, 520, 780, 880 ie: BSIC-NCELL values of 1, 2, 3, 4, 5 and 6 but not 0 k=3; report on ARFCNs 780, 880, 14, 20, 32, 44 ie: BSIC-NCELL values of 1, 2, 3, 4, 5 and 6 but not 0	
NOTE 3: The Measurement Valid Indication shall be set to valid within the second SACCH block at the latest.	

For 710/1 900 MS, 750/1 900 MS:

SYSTEM INFORMATION TYPE 2ter:

Information Element	value/remark
As defaults except: Neighbour Cells Description 2 Multiband Reporting	k=1, 3: Minimum 3 cells reported from each band supported excluding the frequency band of the serving cell. k=2: Normal reporting of six strongest cells, irrespective of the band used.

SYSTEM INFORMATION TYPE 3:

Information Element	value/remark
as default except: - SI 2ter indicator - Early Classmark Sending Control	SI 3 rest octets System Information 2ter is available Early Sending is explicitly accepted

SYSTEM INFORMATION TYPE 5:

Information Element	value/remark
Protocol Discriminator	RR management
Message Type	Sys Info 5.
Neighbour Cells Description	
- Format Identifier	k=1, 2: 128 range k=3: Range 512
- BCCH Allocation Sequence	1
- BCCH Allocation ARFCN	k=1, 2: ARFCN 451, 457, 469, 481 k=3: ARFCN 520, 780, 805
- EXT IND	Information Element carries the complete BA.

SYSTEM INFORMATION TYPE 5ter:

Information Element	Value/remark
Protocol Discriminator	RR management
Message Type	Sys Info 5ter.
- Neighbour Cells Description 2	
- Multiband reporting	k=1, 3: Normal reporting of six strongest cells, irrespective of the band used k=2: Minimum 3 cells reported from each band supported excluding the frequency band of the serving cell.
- Format notation	Range 512
- BA_IND	1
- BCCH Allocation ARFCN	k=1, 2: ARFCN 520, 780, 805 k=3: ARFCN 451, 457, 469, 481

MEASUREMENT REPORT:

Information Element	value/remark
Protocol Discriminator	RR Management
Transaction Identifier	0000
Message Type	MEASUREMENT REPORT
Measurement Results	
BA-used	1
DTX-used	DTX was not used
RXLEV-FULL-SERVING-CELL	See note 1
RXLEV-SUB-SERVING-CELL	See note 1
MEAS-VALID	See note 3
RXQUAL-FULL-SERVING-CELL	See note 1
RXQUAL-SUB-SERVING-CELL	See note 1
NO-NCELL-M	6 neighbour cell measurement results
RXLEV-NCELL-1	See note 1
BCCH-FREQ-NCELL-1	See note 2
BSIC-NCELL-1	Corresponds to that of BCCH-FREQ-NCELL-1
RXLEV-NCELL-2	See note 1
BCCH-FREQ-NCELL-2	See note 2
BSIC-NCELL-2	Corresponds to that of BCCH-FREQ-NCELL-2
RXLEV-NCELL-3	See note 1
BCCH-FREQ-NCELL-3	See note 2
BSIC-NCELL-3	Corresponds to that of BCCH-FREQ-NCELL-3
RXLEV-NCELL-4	See note 1
BCCH-FREQ-NCELL-4	See note 2
BSIC-NCELL-4	Corresponds to that of BCCH-FREQ-NCELL-4
RXLEV-NCELL-5	See note 1
BCCH-FREQ-NCELL-5	See note 2
BSIC-NCELL-5	Corresponds to that of BCCH-FREQ-NCELL-5
RXLEV-NCELL-6	See note 1
BCCH-FREQ-NCELL-6	See note 2
BSIC-NCELL-6	Corresponds to that of BCCH-FREQ-NCELL-6
NOTE 1: These actual values are not checked.	
NOTE 2: k=1; report on ARFCNs 451, 457, 469, 481, 780, 805 ie: BSIC-NCELL values of 0, 1, 2, 3, 5 and 6 but not 4 k=2; report on ARFCNs 457, 469, 481, 520, 780, 805 ie: BSIC-NCELL values of 1, 2, 3, 4, 5 and 6 but not 0 k=3; report on ARFCNs 780, 805, 451, 457, 469, 481 ie: BSIC-NCELL values of 1, 2, 3, 4, 5 and 6 but not 0	
NOTE 3: The Measurement Valid Indication shall be set to valid within the second SACCH block at the latest.	

For 850/1 900 MS:

SYSTEM INFORMATION TYPE 2ter:

Information Element	value/remark
As defaults except: Neighbour Cells Description 2 Multiband Reporting	k=1, 3: Minimum 3 cells reported from each band supported excluding the frequency band of the serving cell. k=2: Normal reporting of six strongest cells, irrespective of the band used.

SYSTEM INFORMATION TYPE 3:

Information Element	value/remark
as default except: - SI 2ter indicator - Early Classmark Sending Control	SI 3 rest octets System Information 2ter is available Early Sending is explicitly accepted

SYSTEM INFORMATION TYPE 5:

Information Element	value/remark
Protocol Discriminator	RR management
Message Type	Sys Info 5.
Neighbour Cells Description	
- Format Identifier	k=1, 2: 128 range k=3: Range 512
- BCCH Allocation Sequence	1
- BCCH Allocation ARFCN	k=1, 2: ARFCN 141, 147, 159, 171 k=3: ARFCN 520, 780, 805
- EXT IND	Information Element carries the complete BA.

SYSTEM INFORMATION TYPE 5ter:

Information Element	Value/remark
Protocol Discriminator	RR management
Message Type	Sys Info 5ter.
- Neighbour Cells Description 2	
- Multiband reporting	k=1, 3: Normal reporting of six strongest cells, irrespective of the band used k=2: Minimum 3 cells reported from each band supported excluding the frequency band of the serving cell. Range 512
- Format notation	1
- BA_IND	
- BCCH Allocation ARFCN	k=1, 2: ARFCN 520, 780, 805 k=3: ARFCN 141, 147, 159, 171

MEASUREMENT REPORT:

Information Element	value/remark
Protocol Discriminator	RR Management
Transaction Identifier	0000
Message Type	MEASUREMENT REPORT
Measurement Results	
BA-used	1
DTX-used	DTX was not used
RXLEV-FULL-SERVING-CELL	See note 1
RXLEV-SUB-SERVING-CELL	See note 1
MEAS-VALID	See note 3
RXQUAL-FULL-SERVING-CELL	See note 1
RXQUAL-SUB-SERVING-CELL	See note 1
NO-NCELL-M	6 neighbour cell measurement results
RXLEV-NCELL-1	See note 1
BCCH-FREQ-NCELL-1	See note 2
BSIC-NCELL-1	Corresponds to that of BCCH-FREQ-NCELL-1
RXLEV-NCELL-2	See note 1
BCCH-FREQ-NCELL-2	See note 2
BSIC-NCELL-2	Corresponds to that of BCCH-FREQ-NCELL-2
RXLEV-NCELL-3	See note 1
BCCH-FREQ-NCELL-3	See note 2
BSIC-NCELL-3	Corresponds to that of BCCH-FREQ-NCELL-3
RXLEV-NCELL-4	See note 1
BCCH-FREQ-NCELL-4	See note 2
BSIC-NCELL-4	Corresponds to that of BCCH-FREQ-NCELL-4
RXLEV-NCELL-5	See note 1
BCCH-FREQ-NCELL-5	See note 2
BSIC-NCELL-5	Corresponds to that of BCCH-FREQ-NCELL-5
RXLEV-NCELL-6	See note 1
BCCH-FREQ-NCELL-6	See note 2
BSIC-NCELL-6	Corresponds to that of BCCH-FREQ-NCELL-6
NOTE 1: These actual values are not checked.	
NOTE 2: k=1; report on ARFCNs 141, 147, 159, 171, 780, 805 ie: BSIC-NCELL values of 0, 1, 2, 3, 5 and 6 but not 4 k=2; report on ARFCNs 147, 159, 171, 520, 780, 805 ie: BSIC-NCELL values of 1, 2, 3, 4, 5 and 6 but not 0 k=3; report on ARFCNs 780, 805, 141, 147, 159, 171 ie: BSIC-NCELL values of 1, 2, 3, 4, 5 and 6 but not 0	
NOTE 3: The Measurement Valid Indication shall be set to valid within the second SACCH block at the latest.	

26.11.3 Multiband signalling / MM

26.11.3.1 Multiband signalling / MM / Location updating

This procedure is used to register the MS in the network. If it is not performed correctly, no call can be established.

26.11.3.1.1 Location updating / accepted

This test is applicable for any Multiband MSs supporting simultaneous multiband operation.

26.11.3.1.1.1 Conformance requirement

If the network accepts a location updating from the Mobile, the Mobile Station shall, after receiving a Location updating Accept message, store the received LAI, stop timer T3210, reset the attempt counter and set the update status in the SIM to updated.

A mobile station that makes use of System information 2ter (to choose correct cell for location updating), shall not ignore this message if it has a L2 pseudolength different from 18.

Reference(s)

3GPP TS 04.08 / 3GPP TS 24.008 subclause 4.4.4.6.

26.11.3.1 1.2 Test purpose

To test the behaviour of the MS if the network accepts the location updating of the MS, irrespective of frequency band used.

To test the behaviour of the MS if it receives a System information 2ter with L2pseudolength different from 18 .

26.11.3.1.1.3 Method of test

Initial conditions:

System Simulator:

Two cells, A and B, belonging to different location areas with location area identification a and b of the same PLMN and using frequencies from different frequency bands.

IMSI attach/detach is allowed in both cells.

The T3212 time-out value is 1/10 hour in both cells.

Mobile Station:

The MS has a valid TMSI, CKSN (CKSN1). It is "idle updated" on cell A.

Specific PICS statements:

- GSM 450 Band (TSPC_Type_GSM_450_Band)
- Standard GSM Band (P-GSM) (TSPC_Type_GSM_P_Band)
- Extended GSM Band (E-GSM) (TSPC_Type_GSM_E_Band)
- GSM 480 Band (TSPC_Type_GSM_480_Band)
- DCS 1800 band (TSPC_Type_DCS_Band)
- GSM 750 band (TSPC_Type_GSM_750_Band)
- GSM 710 band (TSPC_Type_GSM_710_Band)

PIXIT statements:

-

Foreseen final state of the MS

The MS has a valid TMSI and CKSN. It is "idle, updated" on cell A.

Test Procedure

The MS is made to select cell B. A normal location updating is performed in cell B. The channel is released. The MS is made to select cell A. A normal location updating is performed in cell A.

The LOCATION UPDATING ACCEPT message contains neither IMSI nor TMSI.

Maximum duration of test

3 minutes.

Expected sequence

Step	Direction	Message	Comments
1	SS		The RF level of cell A is lowered but kept suitable , and the RF level of cell B is set higher, in order that the MS can choose cell B as a better cell than cell A , if it correctly read the information broadcasted on the BCCH. The following message are received and sent on cell B . "Establishment cause": Location updating.
2	MS -> SS	CHANNEL REQUEST	
3	SS -> MS	IMMEDIATE ASSIGNMENT	
4	MS -> SS	LOCATION UPDATING REQUEST	"location updating type" = normal, "CKSN" = CKSN1, "location area identification" = a and "mobile identity" = TMSI.
5	SS -> MS	UA(LOCATION UPDATING REQUEST)	
6	MS -> SS	CLASSMARK CHANGE	Indicating the frequency and power capability of the MS
7	SS -> MS	LOCATION UPDATING ACC	"Mobile identity" IE not included.
8	SS -> MS	CHANNEL RELEASE	After the sending of this message, the SS waits for the disconnection of the main signalling link.
9	SS		The RF level of cell B is lowered but kept suitable , and the RF level of cell A is set higher, in order that the MS can choose cell A as a better cell than cell B , if it correctly read the information broadcasted on the BCCH. The following message are received and sent on cell A . "Establishment cause": Location updating
10	MS -> SS	CHANNEL REQUEST	
11	SS -> MS	IMMEDIATE ASSIGNMENT	
12	MS -> SS	LOCATION UPDATING REQUEST	"location updating type" = normal, "CKSN" = CKSN1, "location area identification" = b and "mobile identity" = TMSI.
13	SS -> MS	UA(LOCATION UPDATING REQUEST)	
14	MS -> SS	CLASSMARK CHANGE	Indicating the frequency and power capability of the MS
15	SS -> MS	LOCATION UPDATING ACC	"Mobile identity" IE not included
16	SS -> MS	CHANNEL RELEASE	After the sending of this message, the SS waits for the disconnection of the main signalling link.

Specific message contents:

SYSTEM INFORMATION 2TER of CELL B

Information element	Value/remark
as default except: L2 pseudolength	= 0

LOCATION UPDATING REQUEST

Information element	Value/remark
as default except: Mobile station Classmark 1 - ES IND - RF power capability	Controlled Early Classmark Sending option is implemented corresponding to frequency band used

CLASSMARK CHANGE

Information element	Value/remark
as default except: Mobile station Classmark 2 -ES IND -RF power capability	Controlled Early Classmark Sending is implemented. corresponding to the frequency band in use
Additional MS Classmark information -Band 1 (P-GSM) supported -Band 2 (E-GSM) supported - R-Band (R-GSM) supported -Band 3 (DCS) supported -GSM 400 Band supported -Associated radio capability -Associated radio capability -Associated radio capability - R-Band Associated radio capability - GSM 710 Associated radio capability - GSM 750 Associated radio capability - GSM 850 Associated radio capability - PCS 1 900 Associated radio capability	

26.11.3.1.2 Location updating / periodic

This test is applicable for any Multiband MSs supporting simultaneous multiband operation.

26.11.3.1.2.1 Conformance requirement

- 1) If the Mobile Station is in service state NO CELL AVAILABLE, LIMITED SERVICE, PLMN SEARCH or PLMN SEARCH-NORMAL SERVICE when the timer expires the location updating procedure is delayed until this service state is left.
- 2) The T3212 time-out value shall not be changed in the NO CELL AVAILABLE, LIMITED SERVICE, PLMN SEARCH and PLMN SEARCH-NORMAL SERVICE states.
- 3) If the selected cell is in the location area where the mobile station is registered and IMSI ATTACH is not required and timer T3212 has not expired, then the state is NORMAL SERVICE.

References

3GPP TS 04.08 / 3GPP TS 24.008 subclauses 4.4.2 and 4.2.1.1.

26.11.3.1.2.2 Test purpose

- 1) To check that if the PLU timer expires while the MS is out of coverage, the MS informs the network of its return to coverage, irrespective of frequency band used.
- 2) To check that the PLU timer is not disturbed by cells of forbidden PLMNs.
- 3) To check that if the PLU timer does not expire while out of coverage and if the mobile returns to the LA where it is updated, the mobile does not inform the network of its return to coverage.

26.11.3.1.2.3 Method of test

Initial conditions

System Simulator:

Two cells, A and B, belonging to the same location area but using different frequency bands.

Cell A is switched on and cell B is switched off.

T3212 is set to 12 minutes on cell A and cell B.

IMSI attach is allowed in both cells.

Mobile Station:

The MS has a valid TMSI. It is "idle updated" on cell A.

Specific PICS statements:

- GSM 450 Band (TSPC_Type_GSM_450_Band)
- Standard GSM Band (P-GSM) (TSPC_Type_GSM_P_Band)
- Extended GSM Band (E-GSM) (TSPC_Type_GSM_E_Band)
- GSM 480 Band (TSPC_Type_GSM_480_Band)
- DCS 1800 band (TSPC_Type_DCS_Band)
- GSM 750 band (TSPC_Type_GSM_750_Band)
- GSM 710 band (TSPC_Type_GSM_710_Band)

PIXIT statements:

-

Foreseen final state of the MS

The MS is "idle updated" on cell A.

Test procedure

The MS is deactivated. The MS is then activated and placed in automatic network selection mode. It performs IMSI attach. 1 minute after the end of the IMSI attach procedure, cell A is switched off. 8 minutes after the end of the IMSI attach procedure, cell B is switched on. The MS shall not location update on cell B before 11,75 minutes after the end of the IMSI attach procedure. The MS shall perform a periodic location update on cell B between 11,75 minutes and 12,25 minutes after the end of the IMSI attach procedure.

3 minutes after the end of the periodic location updating procedure, cell B is switched off. 14 minutes after the end of the periodic location updating procedure, cell A is switched on. The MS shall perform a location update on cell A before 17 minutes after the end of the periodic location updating procedure.

Maximum duration of test

35 minutes.

Expected sequence

Step	Direction	Message	Comments
1	MS		The MS is activated in automatic network selection mode
2	MS -> SS	CHANNEL REQUEST	
3	SS -> MS	IMMEDIATE ASSIGNMENT	
4	MS -> SS	LOCATION UPDATING REQUEST	"location updating type": IMSI attach
5	SS -> MS	UA(LOCATION UPDATING REQUEST)	
6	MS -> SS	CLASSMARK CHANGE	Indicating the frequency and power capability of the MS
7	SS -> MS	LOCATION UPDATING ACC	
8	SS -> MS	CHANNEL RELEASE	After the sending of this message, the SS waits for the disconnection of the main signalling link.
9	SS		1 minute after step 6, cell A is switched off
10	SS		8 minutes after step 6, cell B is switched on
11	MS -> SS	CHANNEL REQUEST	This message shall be sent on cell B by the MS between 11 minutes 45s and 12 minutes 15s after step 6.
12	SS -> MS	IMMEDIATE ASSIGNMENT	
13	MS -> SS	LOCATION UPDATING REQUEST	"location updating type": periodic updating
14	SS -> MS	UA(LOCATION UPDATING REQUEST)	
15	MS -> SS	CLASSMARK CHANGE	Indicating the frequency and power capability of the MS
16	SS -> MS	LOCATION UPDATING ACC	
17	SS -> MS	CHANNEL RELEASE	After the sending of this message, the SS waits for the disconnection of the main signalling link.
18	SS		3 minutes after step 13, cell B is switched off
19	SS		14 minutes after step 13, cell A is switched on.
20	MS -> SS	CHANNEL REQUEST	This message shall be sent on cell A by the MS before 17 minutes after step 13.
21	SS -> MS	IMMEDIATE ASSIGNMENT	
22	MS -> SS	LOCATION UPDATING REQUEST	"Location updating type" = periodic
23	SS -> MS	UA(LOCATION UPDATING REQUEST)	
24	MS -> SS	CLASSMARK CHANGE	Indicating the frequency and power capability of the MS
25	SS -> MS	LOCATION UPDATING ACC	
26	SS -> MS	CHANNEL RELEASE	After the sending of this message, the SS waits for the disconnection of the main signalling link.

Specific message contents

LOCATION UPDATING REQUEST

Information element	Value/remark
as default except: Mobile station Classmark 1 - ES IND - RF power capability	Controlled Early Classmark Sending option is implemented corresponding to frequency band used

CLASSMARK CHANGE

Information element	Value/remark
as default except: Mobile station Classmark 2 -ES IND -RF power capability	Controlled Early Classmark Sending is implemented. corresponding to the frequency band in use
Additional MS Classmark information -Band 1 (P-GSM) supported -Band 2 (E-GSM) supported -Band 3 (DCS) supported -GSM 400 Band supported - R-Band (R-GSM) supported -Associated radio capability -Associated radio capability -Associated radio capability - R-Band Associated radio capability - GSM 710 Associated radio capability - GSM 750 Associated radio capability - GSM 850 Associated radio capability - PCS 1 900 Associated radio capability	

26.11.4 Multiband signalling / CC

Reserved for future use.

26.11.5 Multiband signalling / Structured procedures

These tests applies only to multiband mobile stations.

26.11.5.1 Multiband signalling / Structured procedures / MS originated call / early assignment

26.11.5.1.1 Conformance requirements

- 1) An MS in MM state "idle, updated" and in RR idle mode, when made to initiate a call, if it provides a human interface, shall display the dialled number.
- 2) An MS in MM state "idle, updated" and in RR idle mode, when made to initiate a call for a selected teleservice that is supported by the MS, shall start to initiate the immediate assignment procedure by sending a CHANNEL REQUEST message with correct establishment cause.
- 3) After the initial message the multiband MS shall send a CLASSMARK CHANGE message in the uplink block followed direct after the Layer 2 UA message sent from the network. The CLASSMARK CHANGE message shall contain information elements Mobile Station Classmark 2 and Mobile Station Classmark 3.
- 4) Subsequently after establishment of an MM connection, the MS shall send a SETUP message with correct parameters.
- 5) The call control entity of the Mobile Station in the "call initiated" state, in the "mobile originating call proceeding" state or in the "call delivered" state, shall, upon receipt of a CONNECT message:
 - attach the user connection to the radio path;
 - return a CONNECT ACKNOWLEDGE message.
- 6) Subsequently when the network initiates call clearing by sending a DISCONNECT message, the MS shall proceed to release the call by sending a RELEASE message.
- 7) On receipt of a CHANNEL RELEASE message, the MS shall disconnect the main signalling link.

References

Conformance requirement 1: 3GPP TS 02.07.

- Conformance requirement 2: 3GPP TS 04.08 / 3GPP TS 44.018 subclause 3.3.1.1.
- Conformance requirement 3: 3GPP TS 04.08 / 3GPP TS 44.018 subclause 3.3.1.1.4.
- Conformance requirement 4: 3GPP TS 04.08 / 3GPP TS 24.008 subclause 5.2.1.1.
- Conformance requirement 5: 3GPP TS 04.08 / 3GPP TS 24.008 subclause 5.2.1.6.
- Conformance requirement 6: 3GPP TS 04.08 / 3GPP TS 24.008 subclause 5.4.4.
- Conformance requirement 7: 3GPP TS 04.08 / 3GPP TS 44.018, subclause 3.4.13.1.

26.11.5.1.2 Test purpose

- 1) To verify that the MS in MM state "idle, updated" with a TMSI assigned, when made to initiate a call for a selected teleservice that is supported by the MS as declared in a PICS/PIXIT statement, displays the dialled number in the way described in a PICS/PIXIT statement.
- 2) To verify that the MS in MM state "idle, updated" and in RR idle mode, with a TMSI assigned, when made to initiate a call for a selected teleservice that is supported by the MS as declared in a PICS/PIXIT statement, starts to initiate an immediate assignment procedure by sending the CHANNEL REQUEST message with correct establishment cause.
- 3) To verify that a multiband MS is able to send an early CLASSMARK CHANGE on the DCCH uplink.
- 4) To verify that subsequently after receipt of an IMMEDIATE ASSIGNMENT message allocating an SDCCH, after completion of establishment of the main signalling link, after having sent a CM SERVICE REQUEST message, after having successfully performed the authentication and cipher mode setting procedures, the MS sends a SETUP message with correct parameters.
- 5) To verify that subsequently, after receipt of a CALL PROCEEDING message and of an HANOVER COMMAND message allocating an appropriate TCH in another band, after having completed the traffic channel early assignment procedure by replying with the HANOVER COMPLETE message, after receipt of an ALERTING message and a CONNECT message, the MS returns a CONNECT ACKNOWLEDGE message.

To verify that subsequently the MS has attached the user connection to the radio path. (This is checked by verifying that there is a point in time after transmission of the first L2 frame containing the (complete) CONNECT message, where the MS is sending appropriate speech or data frames whenever it does not have to transmit or acknowledge an I frame on layer 2 of the FACCH.)

- 6) To verify that subsequently upon the network initiating call clearing by sending a DISCONNECT message, the MS proceed to release the call with RELEASE.
- 7) To verify that subsequently, on receipt of a RELEASE COMPLETE message followed by a CHANNEL RELEASE message, the MS disconnects the main signalling link.

26.11.5.1.3 Method of test

Initial Conditions

System Simulator:

For 450/900 MS:

- 2 cells, A and B, with same LAI.
- Cell A is a GSM 450 cell with default parameters.
- Cell B is a GSM 900 cell with default parameters.

For 480/900 MS:

- 2 cells, A and B, with same LAI.
- Cell A is a GSM 480 cell with default parameters.
- Cell B is a GSM 900 cell with default parameters.

For 450/1800 MS:

2 cells, A and B, with same LAI.

Cell A is a GSM 450 cell with default parameters.

Cell B is a DCS 1 800 cell with default parameters.

For 480/1800 MS:

2 cells, A and B, with same LAI.

Cell A is a GSM 480 cell with default parameters.

Cell B is a DCS 1 800 cell with default parameters.

For 900/1 800 MS:

2 cells, A and B, with same LAI.

Cell A is a GSM 900 cell with default parameters.

Cell B is a DCS 1 800 cell with default parameters.

For 710/1900 MS, 750/1900 MS:

2 cells, A and B, with same LAI.

Cell A is a GSM 710 or GSM 750 cell with default parameters.

Cell B is a PCS 1 900 cell with default parameters.

For 850/1900 MS:

2 cells, A and B, with same LAI.

Cell A is a GSM 850 cell with default parameters.

Cell B is a PCS 1 900 cell with default parameters.

Mobile Station:

The MS is in MM-state idle, updated on cell A with valid TMSI.

Specific PICS statements:

- GSM 450 Band (TSPC_Type_GSM_450_Band)
- Standard GSM Band (P-GSM) (TSPC_Type_GSM_P_Band)
- Extended GSM Band (E-GSM) (TSPC_Type_GSM_E_Band)
- GSM 480 Band (TSPC_Type_GSM_480_Band)
- DCS 1800 band (TSPC_Type_DCS_Band)
- GSM 750 band (TSPC_Type_GSM_750_Band)
- GSM 710 band (TSPC_Type_GSM_710_Band)

PIXIT statements:

- Way to indicate mobile originated alerting.
- Way to display the called number

Foreseen Final State of the MS

The MS is in MM-state idle, updated on cell B with valid TMSI.

Test procedure

The following test is performed for one teleservice supported by the MS:

- A teleservice is selected that is supported by the MS; if the MS supports speech, the selected teleservice is speech. If necessary, the MS is configured for that teleservice.
- The MS is made to initiate a call on any frequency band supported by the MS. The call is established with early assignment. Having reached the active state, the call is cleared by the SS.

Maximum Duration of Test

1 minute.

Expected Sequence

Step	Direction	Message	Comments
1	MS		The "called number" is entered
2	MS -> SS	CHANNEL REQUEST	Establishment cause is "originating call and the network does not set the NECI bit to 1".
3	SS -> MS	IMMEDIATE ASSIGNMENT	
4	MS -> SS	CM SERVICE REQUEST	Message is contained in SABM. Indicating early sending of CLASSMARK CHANGE
5	SS -> MS	UA (CM SERVICE REQUEST)	
6	MS -> SS	CLASSMARK CHANGE	Indicating the frequency and power capability of the MS
7	SS -> MS	AUTHENTICATION REQUEST	
8	MS -> SS	AUTHENTICATION RESP	SRES specifies correct value.
9	SS -> MS	CIPHERING MODE COMMAND	SS starts deciphering after sending the message.
10	MS -> SS	CIPHERING MODE COMPLETE	Shall be sent enciphered. All following messages shall be sent enciphered.
11	SS		SS starts ciphering.
12	MS -> SS	SETUP	
13	SS -> MS	CALL PROCEEDING	
14	SS -> MS	HANDOVER COMMAND	See specific message contents below.
15	MS -> SS	HANDOVER ACCESS	May or may not be sent. The sending of the HANDOVER ACCESS is optional as indicated in HANDOVER COMMAND.
	MS -> SS	HANDOVER ACCESS	
	MS -> SS	HANDOVER ACCESS	
	MS -> SS	HANDOVER ACCESS	Handover Reference is included in the HANDOVER COMMAND.
			Before completion of the 4 access bursts on the new DCCH, additional access bursts may also be sent on the SACCH
16	MS -> SS	SABM	Sent without information field
17	SS -> MS	UA	
18	MS -> SS	HANDOVER COMPLETE	
19	SS -> MS	ALERTING	
20	MS		Depending on the PIXIT, an alerting indication is given
21	SS -> MS	CONNECT	
22	MS -> SS	CONNECT ACKNOWLEDGE	
23	MS		The appropriate bearer channel is through connected in both directions.
24	SS -> MS	DISCONNECT	
25	MS -> SS	RELEASE	
26	SS -> MS	RELEASE COMPLETE	
27	SS -> MS	CHANNEL RELEASE	The main signalling link is released.

Specific Message Contents:

For 450/900 MS:

CM SERVICE REQUEST

as default except:

Information element	Value/remark
Mobile station Classmark 2 - ES IND - RF power capability	Shall indicate early autonomous sending of CLASSMARK CHANGE corresponding to the frequency band in use

CLASSMARK CHANGE

as default except:

Information element	Value/remark
Protocol Discriminator Mobile station Classmark 2 - ES IND - RF power capability Additional MS Classmark information - Band 1 (P-GSM) supported - Band 2 (E-GSM) supported - R-Band (R-GSM) supported - GSM 400 Band supported - GSM 400 Associated radio capability - Associated radio capability 1 - R-Band Associated radio capability	RR management Shall indicate early autonomous sending of CLASSMARK CHANGE corresponding to the frequency band in use According to PICS statement According to PICS statement According to PICS statement According to PICS statement Corresponding to GSM 450 band Corresponding to GSM 900 band Corresponding to R-GSM 900 band

HANDOVER COMMAND

Information element	Value/remark
Protocol Discriminator Cell Description - NCC - BCC - BCCH Carrier Number Channel description - Channel type - Timeslot number - Training sequence code - Hopping - ARFCN Handover Reference Power Command & Access type - Power level - Access type control Synchronization Indication Timing Advance Mode of the First Channel	RR management 1 5 20 TCH/F + ACCH's Arbitrary value Chosen arbitrarily Single RF channel 50 Chosen arbitrarily from the range (0,1...255) Arbitrarily chosen, but different to the one already in use and within the range supported by the MS. Sending of HANDOVER ACCESS is optional pre-synchronized; ROT=0; NCI=0. same as in IMMEDIATE ASSIGNMENT appropriate for the selected bearer service

For 480/900 MS:

CM SERVICE REQUEST

as default except:

Information element	Value/remark
Mobile station Classmark 2 - ES IND - RF power capability	Shall indicate early autonomous sending of CLASSMARK CHANGE corresponding to the frequency band in use

CLASSMARK CHANGE

as default except:

Information element	Value/remark
Protocol Discriminator	RR management
Mobile station Classmark 2 - ES IND - RF power capability	Shall indicate early autonomous sending of CLASSMARK CHANGE corresponding to the frequency band in use
Additional MS Classmark information - Band 1 (P-GSM) supported - Band 2 (E-GSM) supported - GSM 400 Band supported - R-Band (R-GSM) supported - GSM 400 Associated radio capability - Associated radio capability 1 - R-Band Associated radio capability	According to PICS statement According to PICS statement According to PICS statement According to PICS statement Corresponding to GSM 400 band Corresponding to GSM 900 band Corresponding to R-GSM 900 band

HANDOVER COMMAND

Information element	Value/remark
Protocol Discriminator	RR management
Cell Description - NCC - BCC - BCCH Carrier Number	1 5 20
Channel description - Channel type - Timeslot number - Training sequence code - Hopping - ARFCN	TCH/F + ACCH's Arbitrary value Chosen arbitrarily Single RF channel 50
Handover Reference	Chosen arbitrarily from the range (0,1...255)
Power Command & Access type - Power level - Access type control	Arbitrarily chosen, but different to the one already in use and within the range supported by the MS. Sending of HANDOVER ACCESS is optional
Synchronization Indication	pre-synchronized; ROT=0; NCI=0.
Timing Advance	same as in IMMEDIATE ASSIGNMENT
Mode of the First Channel	appropriate for the selected bearer service

For 450/1 800 MS:

CM SERVICE REQUEST

as default except:

Information element	Value/remark
Mobile station Classmark 2 - ES IND - RF power capability	Shall indicate early autonomous sending of CLASSMARK CHANGE corresponding to the frequency band in use

CLASSMARK CHANGE

as default except:

Information element	Value/remark
Protocol Discriminator	RR management
Mobile station Classmark 2 - ES IND - RF power capability	Shall indicate early autonomous sending of CLASSMARK CHANGE corresponding to the frequency band in use
Additional MS Classmark information - Band 3 (DCS 1 800) supported - GSM 400 Band supported - GSM 400 Associated radio capability - Associated radio capability 2	According to PICS statement According to PICS statement Corresponding to GSM 450 band Corresponding to DCS 1 800 band

HANDOVER COMMAND

Information element	Value/remark
Protocol Discriminator	RR management
Cell Description - NCC - BCC - BCCH Carrier Number	1 5 590
Channel description - Channel type - Timeslot number - Training sequence code - Hopping - ARFCN	TCH/F + ACCH's Arbitrary value Chosen arbitrarily Single RF channel 650
Handover Reference	Chosen arbitrarily from the range (0,1...255)
Power Command & Access type - Power level - Access type control	Arbitrarily chosen, but different to the one already in use and within the range supported by the MS. Sending of HANDOVER ACCESS is optional pre-synchronized; ROT=0; NCI=0.
Synchronization Indication	same as in IMMEDIATE ASSIGNMENT
Timing Advance	same as in IMMEDIATE ASSIGNMENT
Mode of the First Channel	appropriate for the selected bearer service

For 480/1 800 MS:

CM SERVICE REQUEST

as default except:

Information element	Value/remark
Mobile station Classmark 2 - ES IND - RF power capability	Shall indicate early autonomous sending of CLASSMARK CHANGE corresponding to the frequency band in use

CLASSMARK CHANGE

as default except:

Information element	Value/remark
Protocol Discriminator	RR management
Mobile station Classmark 2	
- ES IND	Shall indicate early autonomous sending of CLASSMARK CHANGE
- RF power capability	corresponding to the frequency band in use
Additional MS Classmark information	
- Band 3 (DCS 1 800) supported	According to PICS statement
- GSM 400 Band supported	According to PICS statement
- GSM 400 Associated radio capability	Corresponding to GSM 480 band
- Associated radio capability 2	Corresponding to DCS 1 800 band

HANDOVER COMMAND

Information element	Value/remark
Protocol Discriminator	RR management
Cell Description	
- NCC	1
- BCC	5
- BCCH Carrier Number	590
Channel description	
- Channel type	TCH/F + ACCH's
- Timeslot number	Arbitrary value
- Training sequence code	Chosen arbitrarily
- Hopping	Single RF channel
- ARFCN	650
Handover Reference	Chosen arbitrarily from the range (0,1...255)
Power Command & Access type	
- Power level	Arbitrarily chosen, but different to the one already in use and within the range supported by the MS.
- Access type control	Sending of HANDOVER ACCESS is optional
Synchronization Indication	pre-synchronized; ROT=0; NCI=0.
Timing Advance	same as in IMMEDIATE ASSIGNMENT
Mode of the First Channel	appropriate for the selected bearer service

For 900/1 800 MS:

CM SERVICE REQUEST

as default except:

Information element	Value/remark
Mobile station Classmark 2	
- ES IND	Shall indicate early autonomous sending of CLASSMARK CHANGE
- RF power capability	corresponding to the frequency band in use

CLASSMARK CHANGE

as default except:

Information element	Value/remark
Protocol Discriminator	RR management
Mobile station Classmark 2	
- ES IND	Shall indicate early autonomous sending of CLASSMARK CHANGE
- RF power capability	corresponding to the frequency band in use
Additional MS Classmark information	
- Band 1 (P-GSM) supported	According to PICS statement
- Band 2 (E-GSM) supported	According to PICS statement
- Band 3 (DCS 1 800) supported	According to PICS statement
- R-Band (R-GSM) supported	According to PICS statement
- Associated radio capability 1	Corresponding to GSM 900 band
- Associated radio capability 2	Corresponding to DCS 1 800 band
- R-Band Associated radio capability	Corresponding to R-GSM 900 band

HANDOVER COMMAND

Information element	Value/remark
Protocol Discriminator	RR management
Cell Description	
- NCC	1
- BCC	5
- BCCH Carrier Number	590
Channel description	
- Channel type	TCH/F + ACCH's
- Timeslot number	Arbitrary value
- Training sequence code	Chosen arbitrarily
- Hopping	Single RF channel
- ARFCN	650
Handover Reference	Chosen arbitrarily from the range (0,1...255)
Power Command & Access type	
- Power level	Arbitrarily chosen, but different to the one already in use and within the range supported by the MS.
- Access type control	Sending of HANDOVER ACCESS is optional
Synchronization Indication	pre-synchronized; ROT=0; NCI=0.
Timing Advance	same as in IMMEDIATE ASSIGNMENT
Mode of the First Channel	appropriate for the selected bearer service

For 710/1 900 MS, 750/1 900 MS:

CM SERVICE REQUEST

as default except:

Information element	Value/remark
Mobile station Classmark 2	
- ES IND	Shall indicate early autonomous sending of CLASSMARK CHANGE
- RF power capability	corresponding to the frequency band in use

CLASSMARK CHANGE

as default except:

Information element	Value/remark
Protocol Discriminator	RR management
Mobile station Classmark 2	
- ES IND	Shall indicate early autonomous sending of CLASSMARK CHANGE
- RF power capability	corresponding to the frequency band in use
Additional MS Classmark information	
- GSM 710 Associated radio capability	Corresponding to GSM 710 band
- GSM 750 Associated radio capability	Corresponding to GSM 750 band
- PCS 1 900 Associated radio capability	Corresponding to PCS 1 900 band

HANDOVER COMMAND

Information element	Value/remark
Protocol Discriminator	RR management
Cell Description	
- NCC	1
- BCC	5
- BCCH Carrier Number	590
Channel description	
- Channel type	TCH/F + ACCH's
- Timeslot number	Arbitrary value
- Training sequence code	Chosen arbitrarily
- Hopping	Single RF channel
- ARFCN	650
Handover Reference	Chosen arbitrarily from the range (0,1...255)
Power Command & Access type	
- Power level	Arbitrarily chosen, but different to the one already in use and within the range supported by the MS.
- Access type control	Sending of HANDOVER ACCESS is optional
Synchronization Indication	pre-synchronized; ROT=0; NCI=0.
Timing Advance	same as in IMMEDIATE ASSIGNMENT
Mode of the First Channel	appropriate for the selected bearer service

For 850/1 900 MS:

CM SERVICE REQUEST

as default except:

Information element	Value/remark
Mobile station Classmark 2	
- ES IND	Shall indicate early autonomous sending of CLASSMARK CHANGE
- RF power capability	corresponding to the frequency band in use

CLASSMARK CHANGE

as default except:

Information element	Value/remark
Protocol Discriminator	RR management
Mobile station Classmark 2	
- ES IND	Shall indicate early autonomous sending of CLASSMARK CHANGE
- RF power capability	corresponding to the frequency band in use
Additional MS Classmark information	
- GSM 850 Associated radio capability	Corresponding to GSM 850
- PCS 1 900 Associated radio capability	Corresponding to PCS 1 900 band

HANDOVER COMMAND

Information element	Value/remark
Protocol Discriminator	RR management
Cell Description	
- NCC	1
- BCC	5
- BCCH Carrier Number	590
Channel description	
- Channel type	TCH/F + ACCH's
- Timeslot number	Arbitrary value
- Training sequence code	Chosen arbitrarily
- Hopping	Single RF channel
- ARFCN	650
Handover Reference	Chosen arbitrarily from the range (0,1...255)
Power Command & Access type	
- Power level	Arbitrarily chosen, but different to the one already in use and within the range supported by the MS.
- Access type control	Sending of HANDOVER ACCESS is optional
Synchronization Indication	pre-synchronized; ROT=0; NCI=0.
Timing Advance	same as in IMMEDIATE ASSIGNMENT
Mode of the First Channel	appropriate for the selected bearer service

26.11.5.2 Structured procedures / MS terminated call / late assignment

26.11.5.2.1 Conformance requirement

- 1) After the initial message the multiband MS shall send a CLASSMARK CHANGE message in the uplink block followed direct after Layer 2 UA message sent from the network.
- 2) The MS shall acknowledge the SETUP message with a CALL CONFIRMED message, if compatibility checking was successful, the MS is not busy, and the user does not refuse the call.
- 3) The MS on acceptance of the call sends a CONNECT, otherwise user alerting is initiated.
- 4) The MS indicates acceptance of a call by sending a CONNECT message.
- 5) HANDOVER COMMAND is answered by HANDOVER COMPLETE.
- 6) For speech calls:

The mobile station shall attach the user connection at latest when sending the connect message, except if there is no compatible radio resource available at this time. In this case the attachment shall be delayed until such a resource becomes available.

For data calls:

The mobile station shall attach the user connection when receiving the CONNECT ACKNOWLEDGE message from the network.

Requirement reference:

- | | |
|-----------------------------------|--|
| Conformance requirement 1: | 3GPP TS 04.08 / 3GPP TS 44.018, subclause 3.3.1.1.4. |
| Conformance requirements 2, 3, 4: | 3GPP TS 04.08 / 3GPP TS 24.008, subclauses 5.2.2.3.1, 5.2.2.3.2 and 5.2.2.5. |
| Conformance requirement 5: | 3GPP TS 04.08 / 3GPP TS 44.018, subclause 3.4.3.1. |
| Conformance requirement 6: | 3GPP TS 04.08 / 3GPP TS 24.008, subclause 5.2.2.9. |

26.11.5.2.2 Test purpose

- 1) To verify that a multiband MS is able to send an early CLASSMARK CHANGE message on the DCCH uplink.
- 2) To verify that the MS in "Idle, Updated" state with a TMSI assigned, after being paged by the network on the correct paging subchannel, after initiating the immediate assignment procedure by sending the CHANNEL

REQUEST message, after receipt of an IMMEDIATE ASSIGNMENT message allocating an SDCCH, after having established the main signalling link, after having sent a PAGING RESPONSE message, after having performed successful authentication and cipher mode setting procedures, after receipt of a SETUP message containing a signal information element, returns a CALL CONFIRMED message followed by:

- an ALERTING message;
 - or a CONNECT message.
- 3) To verify that in the situation of test purpose 1, if the MS sends an ALERTING message, the MS generates an alerting indication in the way described in a PIXIT statement.
 - 4) To verify that subsequently the MS, if it had not yet sent a CONNECT message, upon acceptance of the call, sends a CONNECT message.
 - 5) To verify that subsequently after receipt of an HANOVER COMMAND ALLOCATING A tch IN another band, the MS sends an HANOVER COMPLETE message.
 - 6) To verify that subsequently the MS:
 - if the call is a speech call: after sending the HANOVER COMPLETE message has through connected the TCH in both directions (this is checked by verifying that after transmission of the first L2 frame containing the (complete) HANOVER COMPLETE message, the MS is sending appropriate speech or data frames whenever it does not have to transmit or acknowledge an I frame on layer 2 of the FACCH).
 - if the call is a data call: after receipt of a subsequent CONNECT ACKNOWLEDGE message through connects the TCH in both directions (this is checked by verifying that there is a point in time after transmission of the first L2 frame containing the (complete) CONNECT ACKNOWLEDGE message, where the MS is sending appropriate speech or data frames whenever it does not have to transmit or acknowledge an I frame on layer 2 of the FACCH).

26.11.5.2.3 Method of test

Initial Conditions

System Simulator:

For 450/900 MS:

2 cells, A and B, with same LAI.

Cell A is a GSM 450 cell with default parameters.

Cell B is a GSM 900 cell with default parameters.

For 480/900 MS:

2 cells, A and B, with same LAI.

Cell A is a GSM 480 cell with default parameters.

Cell B is a GSM 900 cell with default parameters.

For 450/1 800 MS:

2 cells, A and B, with same LAI.

Cell A is a GSM 450 cell with default parameters.

Cell B is a DCS 1 800 cell with default parameters.

For 480/1 800 MS:

2 cells, A and B, with same LAI.

Cell A is a GSM 480 cell with default parameters.

Cell B is a DCS 1 800 cell with default parameters.

For 900/1 800 MS:

2 cells, A and B, with same LAI.

Cell A is a GSM 900 cell with default parameters.

Cell B is a DCS 1 800 cell with default parameters.

For 710/1 900 MS, 750/1 900 MS:

2 cells, A and B, with same LAI.

Cell A is a GSM 710 or GSM 750 cell with default parameters.

Cell B is a PCS 1 900 cell with default parameters.

For 850/1 900 MS:

2 cells, A and B, with same LAI.

Cell A is a GSM 850 cell with default parameters.

Cell B is a PCS 1 900 cell with default parameters.

Mobile Station:

The MS is in MM-state idle, updated on cell A with valid TMSI.

Specific PICS statements:

- GSM 450 Band (TSPC_Type_GSM_450_Band)
- Standard GSM Band (P-GSM) (TSPC_Type_GSM_P_Band)
- Extended GSM Band (E-GSM) (TSPC_Type_GSM_E_Band)
- GSM 480 Band (TSPC_Type_GSM_480_Band)
- DCS 1800 band (TSPC_Type_DCS_Band)
- GSM 750 band (TSPC_Type_GSM_750_Band)
- GSM 710 band (TSPC_Type_GSM_710_Band)

PIXIT statements:

- Way to indicate mobile originated alerting.
- Way to display the called number

Foreseen Final State of the MS

The MS is in MM-state idle, updated on cell B with valid TMSI.

Test procedure

A teleservice is selected that is supported by the MS; if the MS supports speech, the selected teleservice is speech. If necessary, the MS is configured for that teleservice.

The MS is paged on any frequency band supported by the MS and a MT call is established with late assignment (after CONNECT). The release of the call is initiated by the MS.

Maximum Duration of Test

40 s.

Expected Sequence

Step	Direction	Message	Comments
1	SS -> MS	PAGING REQUEST TYPE 1	Sent on the correct paging subchannel Establishment cause indicates "answer to paging". Message is contained in SABM. Indicating the frequency and power capability of the MS SRES specifies correct value. SS starts deciphering after sending the message. Shall be sent enciphered. All following messages shall be sent enciphered. SS starts ciphering. Message contains the signal IE.
2	MS -> SS	CHANNEL REQUEST	
3	SS -> MS	IMMEDIATE ASSIGNMENT	
4	MS -> SS	PAGING RESPONSE	
5	SS -> MS	UA (PAGING RESPONSE)	
6	MS -> SS	CLASSMARK CHANGE	
7	SS -> MS	AUTHENTICATION REQUEST	
8	MS -> SS	AUTHENTICATION RESP	
9	SS -> MS	CIPHERING MODE COMMAND	
10	MS -> SS	CIPHERING MODE COMPLETE	
11	SS		
12	SS -> MS	SETUP	
13	MS -> SS	CALL CONFIRMED	
A14	MS -> SS	CONNECT	
B14	MS -> SS	ALERTING	An alerting indication as defined in an PIXIT statement is given by the MS. The MS is made to accept the call in the way described in a PIXIT statement.
B15	MS		
B16	MS		
B18	MS -> SS	CONNECT	
19	SS -> MS	HANDOVER COMMAND	See specific message contents below. Handover Reference is included in the HANDOVER COMMAND. Before completion of the 4 access bursts on the new DCCH, additional access bursts may also be sent on the SACCH Sent without information field If the call is a speech call, the TCH shall be through connected in both directions. If the call is a data call, the MS shall through connect the TCH in both directions The MS is made to release the call. The main signalling link is released.
20	MS -> SS	HANDOVER ACCESS	
21	MS -> SS	HANDOVER ACCESS	
22	MS -> SS	HANDOVER ACCESS	
23	MS -> SS	HANDOVER ACCESS	
24	MS -> SS	SABM	
25	SS -> MS	UA	
26	MS -> SS	HANDOVER COMPLETE	
27	MS		
28	SS -> MS	CONNECT ACKNOWLEDGE	
29	MS		
30	MS		
31	MS -> SS	DISCONNECT	
32	SS -> MS	RELEASE	
33	MS -> SS	RELEASE COMPLETE	
34	SS -> MS	CHANNEL RELEASE	

Specific Message Contents:

For 450/900 MS:

PAGING RESPONSE

Information element	Value/remark
Mobile station Classmark 2 - ES IND	Shall indicate early autonomous sending of CLASSMARK CHANGE corresponding to the frequency band in use
- RF power capability	

CLASSMARK CHANGE

Information element	Value/remark
Protocol Discriminator	RR management
Mobile station Classmark	Shall indicate early autonomous sending of CLASSMARK CHANGE corresponding to the frequency band in use
- ES IND	
- RF power capability	
Additional MS Classmark information	
- Band 1 (P-GSM) supported	According to PICS statement
- Band 2 (E-GSM) supported	According to PICS statement
- GSM 400 Band supported	According to PICS statement
- R-Band (R-GSM) supported	According to PICS statement
- GSM 400 Associated radio capability	Corresponding to GSM 450 band
- Associated radio capability 1	Corresponding to GSM 900 band
- R-Band Associated radio capability	Corresponding to R-GSM 900 band

HANDOVER COMMAND

Information element	Value/remark
Protocol Discriminator	RR management
Cell Description	
- NCC	1
- BCC	5
- BCCH Carrier Number	20
Channel description	
- Channel type	TCH/F + ACCH's
- Timeslot number	Arbitrary value
- Training sequence code	Chosen arbitrarily
- Hopping	Single RF channel
- ARFCN	50
Handover Reference	Chosen arbitrarily from the range (0,1...255)
Power Command & Access type	
- Power level	Arbitrarily chosen, but different to the one already in use and within the range supported by the MS.
- Access type control	Sending of HANDOVER ACCESS is mandatory.
Synchronization Indication	pre-synchronized; ROT=0; NCI=0.
Timing Advance	same as in IMMEDIATE ASSIGNMENT
Mode of the first channel	appropriate for the selected bearer service

For 480/900 MS:

PAGING RESPONSE

Information element	Value/remark
Mobile station Classmark 2	Shall indicate early autonomous sending of CLASSMARK CHANGE corresponding to the frequency band in use
- ES IND	
- RF power capability	

CLASSMARK CHANGE

Information element	Value/remark
Protocol Discriminator	RR management
Mobile station Classmark	
- ES IND	Shall indicate early autonomous sending of CLASSMARK CHANGE
- RF power capability	corresponding to the frequency band in use
Additional MS Classmark information	
- Band 1 (P-GSM) supported	According to PICS statement
- Band 2 (E-GSM) supported	According to PICS statement
- GSM 400 Band supported	According to PICS statement
- R-Band (R-GSM) supported	According to PICS statement
- GSM 400 Associated radio capability	Corresponding to GSM 480 band
- Associated radio capability 1	Corresponding to GSM 900 band
- R-Band Associated radio capability	Corresponding to R-GSM 900 band

HANDOVER COMMAND

Information element	Value/remark
Protocol Discriminator	RR management
Cell Description	
- NCC	1
- BCC	5
- BCCH Carrier Number	20
Channel description	
- Channel type	TCH/F + ACCH's
- Timeslot number	Arbitrary value
- Training sequence code	Chosen arbitrarily
- Hopping	Single RF channel
- ARFCN	50
Handover Reference	Chosen arbitrarily from the range (0,1...255)
Power Command & Access type	
- Power level	Arbitrarily chosen, but different to the one already in use and within the range supported by the MS.
- Access type control	Sending of HANDOVER ACCESS is mandatory.
Synchronization Indication	pre-synchronized; ROT=0; NCI=0.
Timing Advance	same as in IMMEDIATE ASSIGNMENT
Mode of the first channel	appropriate for the selected bearer service

For 450/1 800 MS:

PAGING RESPONSE

Information element	Value/remark
Mobile station Classmark 2	
- ES IND	Shall indicate early autonomous sending of CLASSMARK CHANGE
- RF power capability	corresponding to the frequency band in use

CLASSMARK CHANGE

Information element	Value/remark
Protocol Discriminator	RR management
Mobile station Classmark	
- ES IND	Shall indicate early autonomous sending of CLASSMARK CHANGE
- RF power capability	corresponding to the frequency band in use
Additional MS Classmark information	
- Band 3 (DCS 1 800) supported	According to PICS statement
- GSM 400 Band supported	According to PICS statement
- GSM 400 Associated radio capability	Corresponding to GSM 450 band
- Associated radio capability 2	Corresponding to DCS 1 800 band

HANDOVER COMMAND

Information element	Value/remark
Protocol Discriminator	RR management
Cell Description	
- NCC	1
- BCC	5
- BCCH Carrier Number	590
Channel description	
- Channel type	TCH/F + ACCH's
- Timeslot number	Arbitrary value
- Training sequence code	Chosen arbitrarily
- Hopping	Single RF channel
- ARFCN	650
Handover Reference	Chosen arbitrarily from the range (0,1...255)
Power Command & Access type	
- Power level	Arbitrarily chosen, but different to the one already in use and within the range supported by the MS.
- Access type control	Sending of HANDOVER ACCESS is mandatory.
Synchronization Indication	pre-synchronized; ROT=0; NCI=0.
Timing Advance	same as in IMMEDIATE ASSIGNMENT
Mode of the first channel	appropriate for the selected bearer service

For 480/1 800 MS:

PAGING RESPONSE

Information element	Value/remark
Mobile station Classmark 2	
- ES IND	Shall indicate early autonomous sending of CLASSMARK CHANGE
- RF power capability	corresponding to the frequency band in use

CLASSMARK CHANGE

Information element	Value/remark
Protocol Discriminator	RR management
Mobile station Classmark	
- ES IND	Shall indicate early autonomous sending of CLASSMARK CHANGE
- RF power capability	corresponding to the frequency band in use
Additional MS Classmark information	
- Band 3 (DCS 1 800) supported	According to PICS statement
- GSM 400 Band supported	According to PICS statement
- GSM 400 Associated radio capability	Corresponding to GSM 480 band
- Associated radio capability 2	Corresponding to DCS 1 800 band

HANDOVER COMMAND

Information element	Value/remark
Protocol Discriminator	RR management
Cell Description	
- NCC	1
- BCC	5
- BCCH Carrier Number	590
Channel description	
- Channel type	TCH/F + ACCH's
- Timeslot number	Arbitrary value
- Training sequence code	Chosen arbitrarily
- Hopping	Single RF channel
- ARFCN	650
Handover Reference	Chosen arbitrarily from the range (0,1...255)
Power Command & Access type	
- Power level	Arbitrarily chosen, but different to the one already in use and within the range supported by the MS.
- Access type control	Sending of HANDOVER ACCESS is mandatory.
Synchronization Indication	pre-synchronized; ROT=0; NCI=0.
Timing Advance	same as in IMMEDIATE ASSIGNMENT
Mode of the first channel	appropriate for the selected bearer service

For 900/1 800 MS:

PAGING RESPONSE

Information element	Value/remark
Mobile station Classmark 2	
- ES IND	Shall indicate early autonomous sending of CLASSMARK CHANGE
- RF power capability	corresponding to the frequency band in use

CLASSMARK CHANGE

Information element	Value/remark
Protocol Discriminator	RR management
Mobile station Classmark	
- ES IND	Shall indicate early autonomous sending of CLASSMARK CHANGE
- RF power capability	corresponding to the frequency band in use
Additional MS Classmark information	
- Band 1 (P-GSM) supported	According to PICS statement
- Band 2 (E-GSM) supported	According to PICS statement
- Band 3 (DCS 1 800) supported	According to PICS statement
- R-Band (R-GSM) supported	According to PICS statement
- Associated radio capability 1	Corresponding to GSM 900 band
- Associated radio capability 2	Corresponding to DCS 1 800 band
- R-Band Associated radio capability	Corresponding to R-GSM 900 band

HANDOVER COMMAND

Information element	Value/remark
Protocol Discriminator	RR management
Cell Description	
- NCC	1
- BCC	5
- BCCH Carrier Number	590
Channel description	
- Channel type	TCH/F + ACCH's
- Timeslot number	Arbitrary value
- Training sequence code	Chosen arbitrarily
- Hopping	Single RF channel
- ARFCN	650
Handover Reference	Chosen arbitrarily from the range (0,1...255)
Power Command & Access type	
- Power level	Arbitrarily chosen, but different to the one already in use and within the range supported by the MS.
- Access type control	Sending of HANDOVER ACCESS is mandatory.
Synchronization Indication	pre-synchronized; ROT=0; NCI=0.
Timing Advance	same as in IMMEDIATE ASSIGNMENT
Mode of the first channel	appropriate for the selected bearer service

For 710/1 900 MS, 750/1 900 MS:

PAGING RESPONSE

Information element	Value/remark
Mobile station Classmark 2	
- ES IND	Shall indicate early autonomous sending of CLASSMARK CHANGE
- RF power capability	corresponding to the frequency band in use

CLASSMARK CHANGE

Information element	Value/remark
Protocol Discriminator	RR management
Mobile station Classmark	
- ES IND	Shall indicate early autonomous sending of CLASSMARK CHANGE
- RF power capability	corresponding to the frequency band in use
Additional MS Classmark information	
- GSM 710 Associated radio capability	Corresponding to GSM 710 band
- GSM 750 Associated radio capability	Corresponding to GSM 750 band
- PCS 1 900 Associated radio capability	Corresponding to PCS 1 900 band

HANDOVER COMMAND

Information element	Value/remark
Protocol Discriminator	RR management
Cell Description	
- NCC	1
- BCC	5
- BCCH Carrier Number	590
Channel description	
- Channel type	TCH/F + ACCH's
- Timeslot number	Arbitrary value
- Training sequence code	Chosen arbitrarily
- Hopping	Single RF channel
- ARFCN	650
Handover Reference	Chosen arbitrarily from the range (0,1...255)
Power Command & Access type	
- Power level	Arbitrarily chosen, but different to the one already in use and within the range supported by the MS.
- Access type control	Sending of HANDOVER ACCESS is mandatory.
Synchronization Indication	pre-synchronized; ROT=0; NCI=0.
Timing Advance	same as in IMMEDIATE ASSIGNMENT
Mode of the first channel	appropriate for the selected bearer service

For 850/1 900 MS:

PAGING RESPONSE

Information element	Value/remark
Mobile station Classmark 2	
- ES IND	Shall indicate early autonomous sending of CLASSMARK CHANGE
- RF power capability	corresponding to the frequency band in use

CLASSMARK CHANGE

Information element	Value/remark
Protocol Discriminator	RR management
Mobile station Classmark	
- ES IND	Shall indicate early autonomous sending of CLASSMARK CHANGE
- RF power capability	corresponding to the frequency band in use
Additional MS Classmark information	
- GSM 850 Associated radio capability	Corresponding to GSM 850 band
- PCS 1 900 Associated radio capability	Corresponding to PCS 1 900 band

HANDOVER COMMAND

Information element	Value/remark
Protocol Discriminator	RR management
Cell Description	
- NCC	1
- BCC	5
- BCCH Carrier Number	590
Channel description	
- Channel type	TCH/F + ACCH's
- Timeslot number	Arbitrary value
- Training sequence code	Chosen arbitrarily
- Hopping	Single RF channel
- ARFCN	650
Handover Reference	Chosen arbitrarily from the range (0,1...255)
Power Command & Access type	
- Power level	Arbitrarily chosen, but different to the one already in use and within the range supported by the MS.
- Access type control	Sending of HANDOVER ACCESS is mandatory.
Synchronization Indication	pre-synchronized; ROT=0; NCI=0.
Timing Advance	same as in IMMEDIATE ASSIGNMENT
Mode of the first channel	appropriate for the selected bearer service

26.11.6 Multiband signalling / Default messages contents

Default SYSTEM INFORMATION

The following parameters shall be coded into the system information messages. Parameters shall be coded according to 3GPP TS 04.08 / 3GPP TS 44.018.

SYSTEM INFORMATION TYPE 2bis, SYSTEM INFORMATION TYPE 5bis, SYSTEM INFORMATION TYPE 7 and SYSTEM INFORMATION TYPE 8 messages are not used.

For 450/900 MS:

SYSTEM INFORMATION TYPE 1

Information Element	Value/remark
Cell channel description	
For Cell A	
- Format identifier	Range 128
- Cell Allocation ARFCN	ARFCN 263, 267, 275 and 279
For Cell B	
- Format identifier	Bit map 0
- Cell Allocation ARFCN	ARFCN 20, 30, 50 and 70
RACH control parameters	see below
SI1 rest octets	see below

SYSTEM INFORMATION TYPE 2

Information Element	Value/remark
BCCH Frequency list	
For Cell A	
- Format identifier	Range 128
- BCCH Allocation Sequence	0
- BCCH Allocation ARFCN	ARFCN 261, 263, 282, 284, 287, 290, 293
- EXT-IND	"The information element carries the complete BA"
For Cell B	
- Format identifier	Bit map 0
- BCCH Allocation Sequence	0
- BCCH Allocation ARFCN	ARFCN 10, 20, 80, 90, 100, 110 and 120
- EXT-IND	"This IE carries the complete BA"
NCC permitted	see below
RACH control parameters	see below

SYSTEM INFORMATION TYPE 2ter

Information Element	Value/remark
Neighbour Cells Description 2	0
Multiband reporting	
For Cell A	
- Format notation	Range 1024
- BA_IND	0
- BCCH Allocation ARFCN	ARFCN 10, 20, 80, 90, 100, 110 and 120
For Cell B	
- Format notation	Range 128
- BA_IND	0
- BCCH Allocation ARFCN	ARFCN 261, 263, 282, 284, 287, 290, 293
SI 2ter rest octets	see below

SYSTEM INFORMATION TYPE 3

Information Element	Value/remark
Cell identity	see below
Location Area Identification	see below
Control Channel Description	see below
Cell options	see below
Cell selection parameters	see below
RACH control parameters	see below
SI3 rest octets	
SI 2ter Indicator	System Information 2ter is available
Early Sending Classmark Control	Early Sending is explicitly accepted

SYSTEM INFORMATION TYPE 4

Information Element	Value/remark
Location Area Identification	see below
Cell selection parameters	see below
RACH control parameters	see below
CBCH Channel Description	see below
CBCH Mobile Allocation	see below
SI4 rest octets	see below

SYSTEM INFORMATION TYPE 5

Information Element	Value/remark
BCCH Frequency list	
For Cell A	
- Format identifier	Range 128
- BCCH Allocation Sequence	0
- BCCH Allocation ARFCN	ARFCN 261, 263, 282, 284, 287, 290, 293
- EXT-IND	"The information element carries the complete BA"
For Cell B	
- Format identifier	Bit map 0
- BCCH Allocation Sequence	0
- BCCH Allocation ARFCN	ARFCN 10, 20, 80, 90, 100, 110 and 120
- EXT-IND	This IE carries the complete BA

SYSTEM INFORMATION TYPE 5ter

Information Element	Value/remark
Neighbour Cells Description 2	0
Multiband reporting	
For Cell A	
- Format notation	Range 1024
- BA_IND	0
- BCCH Allocation ARFCN	ARFCN 10, 20, 80, 90, 100, 110 and 120
For Cell B	
- Format notation	Range 128
- BA_IND	0
- BCCH Allocation ARFCN	ARFCN 261, 263, 282, 284, 287, 290, 293

SYSTEM INFORMATION TYPE 6

Information Element	Value/remark
Cell identity	see below
Location Area Identification	see below
Cell options	see below
NCC permitted	see below

Common contents of information elements in SYSTEM INFORMATION TYPE 1 to 6 messages.

CBCH Channel Description	Not present
CBCH Mobile Allocation	Not present
Cell identity	
CI VALUE	0001H for cell A, 0002H for cell B
Cell options	
Power Control Indicator	power control indicator is not set
DTX Indicator	MS shall not use DTX
RADIO LINK TIME-OUT	8 SACCH blocks
Cell selection parameters	
CELL RESELECT HYSTERESIS	12 dB
MS-TXPWR-MAX-CCH	Minimum level
RXLEV-ACCESS-MIN	Minimum level
ACS	There are no additional cell parameters included in SI7 and SI8
NECI	New establishment cause not supported
Control Channel Description	
ATT	No Attach/Detach
BS-AG-BLKS-RES	0 blocks reserved
CCCH-CONF	Combined CCCH/SDCCH
BS-PA-MFRMS	5 multiframes
T3212	Infinite
L2 pseudo length	
SI 1	21
SI 2	22
SI 2ter	18
SI 3	18
SI 4	12
Location Area Identification	
MCC	001 decimal
MNC	01 decimal
LAC	0001H
Message Type	
SI 1	00011001
SI 2	00011010
SI 2ter	00000011
SI 3	00011011
SI 4	00011100
SI 5	00011101
SI 5ter	00000110
SI 6	00011110
NCC permitted	00000010
RACH control parameters	
MAX RETRANS	Max 1 retrans
TX-INTEGGER	5 slots used
CELL BAR ACCESS	Not barred
CALL RE-ESTABLISHMENT	Not Allowed
EMERGENCY CALL	Allowed
ACCESS CONTROL CLASS (0...9, 11...15)	None Barred
SI 1 rest octets	Not used (all bits are set to spare)
SI 2 rest octets	Not used (all bits are set to spare)
SI 2ter rest octets	Not used (all bits are set to spare)
SI 4 rest octets	Not used (all bits are set to spare)

Default settings for cell A

Downlink input level	63 dBmicroVolt emf
Uplink output power	Minimum supported by the MS
Propagation profile	Static
BCCH/CCCH	ARFCN 263

Default settings for cell B

Downlink input level	53 dBmicroVolt emf
Uplink output power	Minimum supported by the MS
Propagation profile	Static
BCCH/CCCH	ARFCN 20

For 480/900 MS:

SYSTEM INFORMATION TYPE 1

Information Element	Value/remark
Cell channel description	
For Cell A	
- Format identifier	Range 128
- Cell Allocation ARFCN	ARFCN 310, 315, 322, 326
For Cell B	
- Format identifier	Bit map 0
- Cell Allocation ARFCN	ARFCN 20, 30, 50 and 70
RACH control parameters	see below
SI1 rest octets	see below

SYSTEM INFORMATION TYPE 2

Information Element	Value/remark
BCCH Frequency list	
For Cell A	
- Format identifier	Range 128
- BCCH Allocation Sequence	0
- BCCH Allocation ARFCN	ARFCN 308, 310, 329, 331, 334, 337, 340
- EXT-IND	"The information element carries the complete BA"
For Cell B	
- Format identifier	Bit map 0
- BCCH Allocation Sequence	0
- BCCH Allocation ARFCN	ARFCN 10, 20, 80, 90, 100, 110 and 120
- EXT-IND	"This IE carries the complete BA"
NCC permitted	see below
RACH control parameters	see below

SYSTEM INFORMATION TYPE 2ter

Information Element	Value/remark
Neighbour Cells Description 2	0
Multiband reporting	
For Cell A	
- Format notation	Bit map 0
- BA_IND	0
- BCCH Allocation ARFCN	ARFCN 10, 20, 80, 90, 100, 110 and 120
For Cell B	
- Format notation	Range 128
- BA_IND	0
- BCCH Allocation ARFCN	ARFCN 308, 310, 329, 331, 334, 337, 340
SI 2ter rest octets	see below

SYSTEM INFORMATION TYPE 3

Information Element	Value/remark
Cell identity	see below
Location Area Identification	see below
Control Channel Description	see below
Cell options	see below
Cell selection parameters	see below
RACH control parameters	see below
SI3 rest octets	
SI 2ter Indicator	System Information 2ter is available
Early Sending Classmark Control	Early Sending is explicitly accepted

SYSTEM INFORMATION TYPE 4

Information Element	Value/remark
Location Area Identification	see below
Cell selection parameters	see below
RACH control parameters	see below
CBCH Channel Description	see below
CBCH Mobile Allocation	see below
SI4 rest octets	see below

SYSTEM INFORMATION TYPE 5

Information Element	Value/remark
BCCH Frequency list	
For Cell A	
- Format identifier	Range 128
- BCCH Allocation Sequence	0
- BCCH Allocation ARFCN	ARFCN 308, 310, 329, 331, 334, 337, 340
- EXT-IND	"The information element carries the complete BA"
For Cell B	
- Format identifier	Bit map 0
- BCCH Allocation Sequence	0
- BCCH Allocation ARFCN	ARFCN 10, 20, 80, 90, 100, 110 and 120
- EXT-IND	This IE carries the complete BA

SYSTEM INFORMATION TYPE 5ter

Information Element	Value/remark
Neighbour Cells Description 2	0
Multiband reporting	
For Cell A	
- Format notation	Range 1024
- BA_IND	0
- BCCH Allocation ARFCN	ARFCN 10, 20, 80, 90, 100, 110 and 120
For Cell B	
- Format notation	Range 128
- BA_IND	0
- BCCH Allocation ARFCN	ARFCN 308, 310, 329, 331, 334, 337, 340

SYSTEM INFORMATION TYPE 6

Information Element	Value/remark
Cell identity	see below
Location Area Identification	see below
Cell options	see below
NCC permitted	see below

Common contents of information elements in SYSTEM INFORMATION TYPE 1 to 6 messages.

CBCH Channel Description	Not present
CBCH Mobile Allocation	Not present
Cell identity	
CI VALUE	0001H for cell A, 0002H for cell B
Cell options	
Power Control Indicator	power control indicator is not set
DTX Indicator	MS shall not use DTX
RADIO LINK TIME-OUT	8 SACCH blocks
Cell selection parameters	
CELL RESELECT HYSTERESIS	12 dB
MS-TXPWR-MAX-CCH	Minimum level
RXLEV-ACCESS-MIN	Minimum level
ACS	There are no additional cell parameters included in SI7 and SI8
NECI	New establishment cause not supported
Control Channel Description	
ATT	No Attach/Detach
BS-AG-BLKS-RES	0 blocks reserved
CCCH-CONF	Combined CCCH/SDCCH
BS-PA-MFRMS	5 multiframes
T3212	Infinite
L2 pseudo length	
SI 1	21
SI 2	22
SI 2ter	18
SI 3	18
SI 4	12
Location Area Identification	
MCC	001 decimal
MNC	01 decimal
LAC	0001H
Message Type	
SI 1	00011001
SI 2	00011010
SI 2ter	00000011
SI 3	00011011
SI 4	00011100
SI 5	00011101
SI 5ter	00000110
SI 6	00011110
NCC permitted	00000010
RACH control parameters	
MAX RETRANS	Max 1 retrans
TX-INTEGGER	5 slots used
CELL BAR ACCESS	Not barred
CALL RE-ESTABLISHMENT	Not Allowed
EMERGENCY CALL	Allowed
ACCESS CONTROL CLASS (0...9, 11...15)	None Barred
SI 1 rest octets	Not used (all bits are set to spare)
SI 2 rest octets	Not used (all bits are set to spare)
SI 2ter rest octets	Not used (all bits are set to spare)
SI 4 rest octets	Not used (all bits are set to spare)

Default settings for cell A

Downlink input level	63 dBmicroVolt emf
Uplink output power	Minimum supported by the MS
Propagation profile	Static
BCCH/CCCH	ARFCN 310

Default settings for cell B

Downlink input level	53 dBmicroVolt emf
Uplink output power	Minimum supported by the MS
Propagation profile	Static
BCCH/CCCH	ARFCN 20

For 450/1 800 MS:

SYSTEM INFORMATION TYPE 1

Information Element	Value/remark
Cell channel description	
For Cell A	
- Format identifier	Range 128
- Cell Allocation ARFCN	ARFCN 263, 267, 275 and 279
For Cell B	
- Format identifier	Range 512
- Cell Allocation ARFCN	ARFCN 590, 650, 750 and 850
RACH control parameters	see below
SI1 rest octets	see below

SYSTEM INFORMATION TYPE 2

Information Element	Value/remark
BCCH Frequency list	
For Cell A	
- Format identifier	Range 128
- BCCH Allocation Sequence	0
- BCCH Allocation ARFCN	ARFCN 261, 263, 282, 284, 287, 290, 293
- EXT-IND	"The information element carries the complete BA"
For Cell B	
- Format identifier	Range 512
- BCCH Allocation Sequence	0
- BCCH Allocation ARFCN	ARFCN 520, 590, 600, 700, 780, 810 and 870
- EXT-IND	"This IE carries the complete BA"
NCC permitted	see below
RACH control parameters	see below

SYSTEM INFORMATION TYPE 2ter

Information Element	Value/remark
Neighbour Cells Description 2	0
Multiband reporting	
For Cell A	
- Format notation	Range 512
- BA_IND	0
- BCCH Allocation ARFCN	ARFCN 520, 590, 600, 700, 780, 810 and 870
For Cell B	
- Format notation	Range 128
- BA_IND	0
- BCCH Allocation ARFCN	ARFCN 261, 263, 282, 284, 287, 290, 293
SI 2ter rest octets	see below

SYSTEM INFORMATION TYPE 3

Information Element	Value/remark
Cell identity	see below
Location Area Identification	see below
Control Channel Description	see below
Cell options	see below
Cell selection parameters	see below
RACH control parameters	see below
SI3 rest octets	
SI 2ter Indicator	System Information 2ter is available
Early Sending Classmark Control	Early Sending is explicitly accepted

SYSTEM INFORMATION TYPE 4

Information Element	Value/remark
Location Area Identification	see below
Cell selection parameters	see below
RACH control parameters	see below
CBCH Channel Description	see below
CBCH Mobile Allocation	see below
SI4 rest octets	see below

SYSTEM INFORMATION TYPE 5

Information Element	Value/remark
BCCH Frequency list	
For Cell A	
- Format identifier	Range 128
- BCCH Allocation Sequence	0
- BCCH Allocation ARFCN	ARFCN 261, 263, 282, 284, 287, 290, 293
- EXT-IND	"The information element carries the complete BA"
For Cell B	
- Format identifier	Range 512
- BCCH Allocation Sequence	0
- BCCH Allocation ARFCN	ARFCN 520, 590, 600, 700, 780, 810 and 870
- EXT-IND	This IE carries the complete BA

SYSTEM INFORMATION TYPE 5ter

Information Element	Value/remark
Neighbour Cells Description 2	0
Multiband reporting	
For Cell A	
- Format notation	Range 512
- BA_IND	0
- BCCH Allocation ARFCN	ARFCN 520, 590, 600, 700, 780, 810 and 870
For Cell B	
- Format notation	Range 128
- BA_IND	0
- BCCH Allocation ARFCN	ARFCN 261, 263, 282, 284, 287, 290, 293

SYSTEM INFORMATION TYPE 6

Information Element	Value/remark
Cell identity	see below
Location Area Identification	see below
Cell options	see below
NCC permitted	see below

Common contents of information elements in SYSTEM INFORMATION TYPE 1 to 6 messages.

CBCH Channel Description	Not present
CBCH Mobile Allocation	Not present
Cell identity	
CI VALUE	0001H for cell A, 0002H for cell B
Cell options	
Power Control Indicator	power control indicator is not set
DTX Indicator	MS shall not use DTX
RADIO LINK TIME-OUT	8 SACCH blocks
Cell selection parameters	
CELL RESELECT HYSTERESIS	12 dB
MS-TXPWR-MAX-CCH	Minimum level
RXLEV-ACCESS-MIN	Minimum level
ACS	There are no additional cell parameters included in SI7 and SI8
NECI	New establishment cause not supported
Control Channel Description	
ATT	No Attach/Detach
BS-AG-BLKS-RES	0 blocks reserved
CCCH-CONF	Combined CCCH/SDCCH
BS-PA-MFRMS	5 multiframes
T3212	Infinite
L2 pseudo length	
SI 1	21
SI 2	22
SI 2ter	18
SI 3	18
SI 4	12
Location Area Identification	
MCC	001 decimal
MNC	01 decimal
LAC	0001H
Message Type	
SI 1	00011001
SI 2	00011010
SI 2ter	00000011
SI 3	00011011
SI 4	00011100
SI 5	00011101
SI 5ter	00000110
SI 6	00011110
NCC permitted	00000010
RACH control parameters	
MAX RETRANS	Max 1 retrans
TX-INTEGGER	5 slots used
CELL BAR ACCESS	Not barred
CALL RE-ESTABLISHMENT	Not Allowed
EMERGENCY CALL	Allowed
ACCESS CONTROL CLASS (0...9, 11...15)	None Barred
SI 1 rest octets	Not used (all bits are set to spare)
SI 2 rest octets	Not used (all bits are set to spare)
SI 2ter rest octets	Not used (all bits are set to spare)
SI 4 rest octets	Not used (all bits are set to spare)

Default settings for cell A

Downlink input level	63 dBmicroVolt emf
Uplink output power	Minimum supported by the MS
Propagation profile	Static
BCCH/CCCH	ARFCN 263

Default settings for cell B

Downlink input level	53 dBmicroVolt emf
Uplink output power	Minimum supported by the MS
Propagation profile	Static
BCCH/CCCH	ARFCN 590

For 480/1 800 MS:

SYSTEM INFORMATION TYPE 1

Information Element	Value/remark
Cell channel description	
For Cell A	
- Format identifier	Range 128
- Cell Allocation ARFCN	ARFCN 310, 315, 322, 326
For Cell B	
- Format identifier	Range 512
- Cell Allocation ARFCN	ARFCN 590, 650, 750 and 850
RACH control parameters	see below
SI1 rest octets	see below

SYSTEM INFORMATION TYPE 2

Information Element	Value/remark
BCCH Frequency list	
For Cell A	
- Format identifier	Range 128
- BCCH Allocation Sequence	0
- BCCH Allocation ARFCN	ARFCN 308, 310, 329, 331, 334, 337, 340
- EXT-IND	"The information element carries the complete BA"
For Cell B	
- Format identifier	Range 512
- BCCH Allocation Sequence	0
- BCCH Allocation ARFCN	ARFCN 520, 590, 600, 700, 780, 810 and 870
- EXT-IND	"This IE carries the complete BA"
NCC permitted	see below
RACH control parameters	see below

SYSTEM INFORMATION TYPE 2ter

Information Element	Value/remark
Neighbour Cells Description 2	0
Multiband reporting	
For Cell A	
- Format notation	Range 512
- BA_IND	0
- BCCH Allocation ARFCN	ARFCN 520, 590, 600, 700, 780, 810 and 870
For Cell B	
- Format notation	Range 128
- BA_IND	0
- BCCH Allocation ARFCN	ARFCN 308, 310, 329, 331, 334, 337, 340
SI 2ter rest octets	see below

SYSTEM INFORMATION TYPE 3

Information Element	Value/remark
Cell identity	see below
Location Area Identification	see below
Control Channel Description	see below
Cell options	see below
Cell selection parameters	see below
RACH control parameters	see below
SI3 rest octets	
SI 2ter Indicator	System Information 2ter is available
Early Sending Classmark Control	Early Sending is explicitly accepted

SYSTEM INFORMATION TYPE 4

Information Element	Value/remark
Location Area Identification	see below
Cell selection parameters	see below
RACH control parameters	see below
CBCH Channel Description	see below
CBCH Mobile Allocation	see below
SI4 rest octets	see below

SYSTEM INFORMATION TYPE 5

Information Element	Value/remark
BCCH Frequency list	
For Cell A	
- Format identifier	Range 128
- BCCH Allocation Sequence	0
- BCCH Allocation ARFCN	ARFCN 308, 310, 329, 331, 334, 337, 340
- EXT-IND	"The information element carries the complete BA"
For Cell B	
- Format identifier	Range 512
- BCCH Allocation Sequence	0
- BCCH Allocation ARFCN	ARFCN 520, 590, 600, 700, 780, 810 and 870
- EXT-IND	This IE carries the complete BA

SYSTEM INFORMATION TYPE 5ter

Information Element	Value/remark
Neighbour Cells Description 2	0
Multiband reporting	
For Cell A	
- Format notation	Range 512
- BA_IND	0
- BCCH Allocation ARFCN	ARFCN 520, 590, 600, 700, 780, 810 and 870
For Cell B	
- Format notation	Range 128
- BA_IND	0
- BCCH Allocation ARFCN	ARFCN 308, 310, 329, 331, 334, 337, 340

SYSTEM INFORMATION TYPE 6

Information Element	Value/remark
Cell identity	see below
Location Area Identification	see below
Cell options	see below
NCC permitted	see below

Common contents of information elements in SYSTEM INFORMATION TYPE 1 to 6 messages.

CBCH Channel Description	Not present
CBCH Mobile Allocation	Not present
Cell identity	
CI VALUE	0001H for cell A, 0002H for cell B
Cell options	
Power Control Indicator	power control indicator is not set
DTX Indicator	MS shall not use DTX
RADIO LINK TIME-OUT	8 SACCH blocks
Cell selection parameters	
CELL RESELECT HYSTERESIS	12 dB
MS-TXPWR-MAX-CCH	Minimum level
RXLEV-ACCESS-MIN	Minimum level
ACS	There are no additional cell parameters included in SI7 and SI8
NECI	New establishment cause not supported
Control Channel Description	
ATT	No Attach/Detach
BS-AG-BLKS-RES	0 blocks reserved
CCCH-CONF	Combined CCCH/SDCCH
BS-PA-MFRMS	5 multiframes
T3212	Infinite
L2 pseudo length	
SI 1	21
SI 2	22
SI 2ter	18
SI 3	18
SI 4	12
Location Area Identification	
MCC	001 decimal
MNC	01 decimal
LAC	0001H
Message Type	
SI 1	00011001
SI 2	00011010
SI 2ter	00000011
SI 3	00011011
SI 4	00011100
SI 5	00011101
SI 5ter	00000110
SI 6	00011110
NCC permitted	00000010
RACH control parameters	
MAX RETRANS	Max 1 retrans
TX-INTEGGER	5 slots used
CELL BAR ACCESS	Not barred
CALL RE-ESTABLISHMENT	Not Allowed
EMERGENCY CALL	Allowed
ACCESS CONTROL CLASS (0...9, 11...15)	None Barred
SI 1 rest octets	Not used (all bits are set to spare)
SI 2 rest octets	Not used (all bits are set to spare)
SI 2ter rest octets	Not used (all bits are set to spare)
SI 4 rest octets	Not used (all bits are set to spare)

Default settings for cell A

Downlink input level	63 dBmicroVolt emf
Uplink output power	Minimum supported by the MS
Propagation profile	Static
BCCH/CCCH	ARFCN 310

Default settings for cell B

Downlink input level	53 dBmicroVolt emf
Uplink output power	Minimum supported by the MS
Propagation profile	Static
BCCH/CCCH	ARFCN 590

For 900/1 800 MS:

SYSTEM INFORMATION TYPE 1

Information Element	Value/remark
Cell channel description	
For Cell A	
- Format identifier	Bit map 0
- Cell Allocation ARFCN	ARFCN 20, 30, 50 and 70
For Cell B	
- Format identifier	Range 512
- Cell Allocation ARFCN	ARFCN 590, 650, 750 and 850
RACH control parameters	see below
SI1 rest octets	see below

SYSTEM INFORMATION TYPE 2

Information Element	Value/remark
BCCH Frequency list	
For Cell A	
- Format identifier	Bit map 0
- BCCH Allocation Sequence	0
- BCCH Allocation ARFCN	ARFCN 10, 20, 80, 90, 100, 110 and 120
- EXT-IND	"The information element carries the complete BA"
For Cell B	
- Format identifier	Range 512
- BCCH Allocation Sequence	0
- BCCH Allocation ARFCN	ARFCN 520, 590, 600, 700, 780, 810 and 870
- EXT-IND	"This IE carries the complete BA"
NCC permitted	see below
RACH control parameters	see below

SYSTEM INFORMATION TYPE 2ter

Information Element	Value/remark
Neighbour Cells Description 2	0
Multiband reporting	
For Cell A	
- Format notation	Range 512
- BA_IND	0
- BCCH Allocation ARFCN	ARFCN 520, 590, 600, 700, 780, 810 and 870
For Cell B	
- Format notation	Range 1024
- BA_IND	0
- BCCH Allocation ARFCN	ARFCN 10, 20, 80, 90, 100, 110 and 120
SI 2ter rest octets	see below

SYSTEM INFORMATION TYPE 3

Information Element	Value/remark
Cell identity	see below
Location Area Identification	see below
Control Channel Description	see below
Cell options	see below
Cell selection parameters	see below
RACH control parameters	see below
SI3 rest octets	
SI 2ter Indicator	System Information 2ter is available
Early Sending Classmark Control	Early Sending is explicitly accepted

SYSTEM INFORMATION TYPE 4

Information Element	Value/remark
Location Area Identification	see below
Cell selection parameters	see below
RACH control parameters	see below
CBCH Channel Description	see below
CBCH Mobile Allocation	see below
SI4 rest octets	see below

SYSTEM INFORMATION TYPE 5

Information Element	Value/remark
BCCH Frequency list	
For Cell A	
- Format identifier	Bit map 0
- BCCH Allocation Sequence	0
- BCCH Allocation ARFCN	ARFCN 10, 20, 80, 90, 100, 110 and 120
- EXT-IND	"The information element carries the complete BA"
For Cell B	
- Format identifier	Range 512
- BCCH Allocation Sequence	0
- BCCH Allocation ARFCN	ARFCN 520, 590, 600, 700, 780, 810 and 870
- EXT-IND	This IE carries the complete BA

SYSTEM INFORMATION TYPE 5ter

Information Element	Value/remark
Neighbour Cells Description 2	0
Multiband reporting	
For Cell A	
- Format notation	Range 512
- BA_IND	0
- BCCH Allocation ARFCN	ARFCN 520, 590, 600, 700, 780, 810 and 870
For Cell B	
- Format notation	Range 1024
- BA_IND	0
- BCCH Allocation ARFCN	ARFCN 10, 20, 80, 90, 100, 110 and 120

SYSTEM INFORMATION TYPE 6

Information Element	Value/remark
Cell identity	see below
Location Area Identification	see below
Cell options	see below
NCC permitted	see below

Common contents of information elements in SYSTEM INFORMATION TYPE 1 to 6 messages.

CBCH Channel Description	Not present
CBCH Mobile Allocation	Not present
Cell identity	
CI VALUE	0001H for cell A, 0002H for cell B
Cell options	
Power Control Indicator	power control indicator is not set
DTX Indicator	MS shall not use DTX
RADIO LINK TIME-OUT	8 SACCH blocks
Cell selection parameters	
CELL RESELECT HYSTERESIS	12 dB
MS-TXPWR-MAX-CCH	Minimum level
RXLEV-ACCESS-MIN	Minimum level
ACS	There are no additional cell parameters included in SI7 and SI8
NECI	New establishment cause not supported
Control Channel Description	
ATT	No Attach/Detach
BS-AG-BLKS-RES	0 blocks reserved
CCCH-CONF	Combined CCCH/SDCCH
BS-PA-MFRMS	5 multiframes
T3212	Infinite
L2 pseudo length	
SI 1	21
SI 2	22
SI 2ter	18
SI 3	18
SI 4	12
Location Area Identification	
MCC	001 decimal
MNC	01 decimal
LAC	0001H
Message Type	
SI 1	00011001
SI 2	00011010
SI 2ter	00000011
SI 3	00011011
SI 4	00011100
SI 5	00011101
SI 5ter	00000110
SI 6	00011110
NCC permitted	00000010
RACH control parameters	
MAX RETRANS	Max 1 retrans
TX-INTEGGER	5 slots used
CELL BAR ACCESS	Not barred
CALL RE-ESTABLISHMENT	Not Allowed
EMERGENCY CALL	Allowed
ACCESS CONTROL CLASS (0...9, 11...15)	None Barred
SI 1 rest octets	Not used (all bits are set to spare)
SI 2 rest octets	Not used (all bits are set to spare)
SI 2ter rest octets	Not used (all bits are set to spare)
SI 4 rest octets	Not used (all bits are set to spare)

Default settings for cell A

Downlink input level	63 dBmicroVolt emf
Uplink output power	Minimum supported by the MS
Propagation profile	Static
BCCH/CCCH	ARFCN 20

Default settings for cell B

Downlink input level	53 dBmicroVolt emf
Uplink output power	Minimum supported by the MS
Propagation profile	Static
BCCH/CCCH	ARFCN 590

For 710/1 900 MS, 750/1 900 MS:

SYSTEM INFORMATION TYPE 1

Information Element	Value/remark
Cell channel description	
For Cell A	
- Format identifier	128 range
- Cell Allocation ARFCN	ARFCN 457, 467, 475 and 497
For Cell B	
- Format identifier	Range 512
- Cell Allocation ARFCN	ARFCN 590, 650, 750 and 807
RACH control parameters	see below
SI1 rest octets	see below

SYSTEM INFORMATION TYPE 2

Information Element	Value/remark
BCCH Frequency list	
For Cell A	
- Format identifier	128 range
- BCCH Allocation Sequence	0
- BCCH Allocation ARFCN	ARFCN 447, 457, 480, 499, 504, 507 and 510
- EXT-IND	"The information element carries the complete BA"
For Cell B	
- Format identifier	Range 512
- BCCH Allocation Sequence	0
- BCCH Allocation ARFCN	ARFCN 520, 590, 600, 700, 780, 800 and 810
- EXT-IND	"This IE carries the complete BA"
NCC permitted	see below
RACH control parameters	see below

SYSTEM INFORMATION TYPE 2ter

Information Element	Value/remark
Neighbour Cells Description 2	0
Multiband reporting	
For Cell A	
- Format notation	Range 512
- BA_IND	0
- BCCH Allocation ARFCN	ARFCN 520, 590, 600, 700, 780, 800 and 810
For Cell B	
- Format notation	Range 1024
- BA_IND	0
- BCCH Allocation ARFCN	ARFCN 447, 457, 480, 499, 504, 507 and 510
SI 2ter rest octets	see below

SYSTEM INFORMATION TYPE 3

Information Element	Value/remark
Cell identity	see below
Location Area Identification	see below
Control Channel Description	see below
Cell options	see below
Cell selection parameters	see below
RACH control parameters	see below
SI3 rest octets	
SI 2ter Indicator	System Information 2ter is available
Early Sending Classmark Control	Early Sending is explicitly accepted

SYSTEM INFORMATION TYPE 4

Information Element	Value/remark
Location Area Identification	see below
Cell selection parameters	see below
RACH control parameters	see below
CBCH Channel Description	see below
CBCH Mobile Allocation	see below
SI4 rest octets	see below

SYSTEM INFORMATION TYPE 5

Information Element	Value/remark
BCCH Frequency list	
For Cell A	
- Format identifier	128 range
- BCCH Allocation Sequence	0
- BCCH Allocation ARFCN	ARFCN 447, 457, 480, 499, 504, 507 and 510
- EXT-IND	"The information element carries the complete BA"
For Cell B	
- Format identifier	Range 512
- BCCH Allocation Sequence	0
- BCCH Allocation ARFCN	ARFCN 520, 590, 600, 700, 780, 800 and 810
- EXT-IND	This IE carries the complete BA

SYSTEM INFORMATION TYPE 5ter

Information Element	Value/remark
Neighbour Cells Description 2	0
Multiband reporting	
For Cell A	
- Format notation	Range 512
- BA_IND	0
- BCCH Allocation ARFCN	ARFCN 520, 590, 600, 700, 780, 800 and 810
For Cell B	
- Format notation	Range 1024
- BA_IND	0
- BCCH Allocation ARFCN	ARFCN 447, 457, 480, 499, 504, 507 and 510

SYSTEM INFORMATION TYPE 6

Information Element	Value/remark
Cell identity	see below
Location Area Identification	see below
Cell options	see below
NCC permitted	see below

Common contents of information elements in SYSTEM INFORMATION TYPE 1 to 6 messages.

CBCH Channel Description	Not present
CBCH Mobile Allocation	Not present
Cell identity	
CI VALUE	0001H for cell A, 0002H for cell B
Cell options	
Power Control Indicator	power control indicator is not set
DTX Indicator	MS shall not use DTX
RADIO LINK TIME-OUT	8 SACCH blocks
Cell selection parameters	
CELL RESELECT HYSTERESIS	12 dB
MS-TXPWR-MAX-CCH	Minimum level
RXLEV-ACCESS-MIN	Minimum level
ACS	There are no additional cell parameters included in SI7 and SI8
NECI	New establishment cause not supported
Control Channel Description	
ATT	No Attach/Detach
BS-AG-BLKS-RES	0 blocks reserved
CCCH-CONF	Combined CCCH/SDCCH
BS-PA-MFRMS	5 multiframes
T3212	Infinite
L2 pseudo length	
SI 1	21
SI 2	22
SI 2ter	18
SI 3	18
SI 4	12
Location Area Identification	
MCC	001 decimal
MNC	01 decimal
LAC	0001H
Message Type	
SI 1	00011001
SI 2	00011010
SI 2ter	00000011
SI 3	00011011
SI 4	00011100
SI 5	00011101
SI 5ter	00000110
SI 6	00011110
NCC permitted	00000010
RACH control parameters	
MAX RETRANS	Max 1 retrans
TX-INTEGGER	5 slots used
CELL BAR ACCESS	Not barred
CALL RE-ESTABLISHMENT	Not Allowed
EMERGENCY CALL	Allowed
ACCESS CONTROL CLASS (0...9, 11...15)	None Barred
SI 1 rest octets	Not used (all bits are set to spare)
SI 2 rest octets	Not used (all bits are set to spare)
SI 2ter rest octets	Not used (all bits are set to spare)
SI 4 rest octets	Not used (all bits are set to spare)

Default settings for cell A

Downlink input level	63 dBmicroVolt emf
Uplink output power	Minimum supported by the MS
Propagation profile	Static
BCCH/CCCH	ARFCN 457

Default settings for cell B

Downlink input level	53 dBmicroVolt emf
Uplink output power	Minimum supported by the MS
Propagation profile	Static
BCCH/CCCH	ARFCN 590

For 850/1 900 MS:

SYSTEM INFORMATION TYPE 1

Information Element	Value/remark
Cell channel description	
For Cell A	
- Format identifier	128 range
- Cell Allocation ARFCN	ARFCN 147, 157, 177 and 197
For Cell B	
- Format identifier	Range 512
- Cell Allocation ARFCN	ARFCN 590, 650, 750 and 807
RACH control parameters	see below
SI1 rest octets	see below

SYSTEM INFORMATION TYPE 2

Information Element	Value/remark
BCCH Frequency list	
For Cell A	
- Format identifier	128 range
- BCCH Allocation Sequence	0
- BCCH Allocation ARFCN	ARFCN 137, 147, 207, 217, 227, 237 and 247
- EXT-IND	"The information element carries the complete BA"
For Cell B	
- Format identifier	Range 512
- BCCH Allocation Sequence	0
- BCCH Allocation ARFCN	ARFCN 520, 590, 600, 700, 780, 800 and 810
- EXT-IND	"This IE carries the complete BA"
NCC permitted	see below
RACH control parameters	see below

SYSTEM INFORMATION TYPE 2ter

Information Element	Value/remark
Neighbour Cells Description 2	0
Multiband reporting	
For Cell A	
- Format notation	Range 512
- BA_IND	0
- BCCH Allocation ARFCN	ARFCN 520, 590, 600, 700, 780, 800 and 810
For Cell B	
- Format notation	Range 1024
- BA_IND	0
- BCCH Allocation ARFCN	ARFCN 137, 147, 207, 217, 227, 237 and 247
SI 2ter rest octets	see below

SYSTEM INFORMATION TYPE 3

Information Element	Value/remark
Cell identity	see below
Location Area Identification	see below
Control Channel Description	see below
Cell options	see below
Cell selection parameters	see below
RACH control parameters	see below
SI3 rest octets	
SI 2ter Indicator	System Information 2ter is available
Early Sending Classmark Control	Early Sending is explicitly accepted

SYSTEM INFORMATION TYPE 4

Information Element	Value/remark
Location Area Identification	see below
Cell selection parameters	see below
RACH control parameters	see below
CBCH Channel Description	see below
CBCH Mobile Allocation	see below
SI4 rest octets	see below

SYSTEM INFORMATION TYPE 5

Information Element	Value/remark
BCCH Frequency list	
For Cell A	
- Format identifier	128 range
- BCCH Allocation Sequence	0
- BCCH Allocation ARFCN	ARFCN 137, 147, 207, 217, 227, 237 and 247
- EXT-IND	"The information element carries the complete BA"
For Cell B	
- Format identifier	Range 512
- BCCH Allocation Sequence	0
- BCCH Allocation ARFCN	ARFCN 520, 590, 600, 700, 780, 800 and 810
- EXT-IND	This IE carries the complete BA

SYSTEM INFORMATION TYPE 5ter

Information Element	Value/remark
Neighbour Cells Description 2	0
Multiband reporting	
For Cell A	
- Format notation	Range 512
- BA_IND	0
- BCCH Allocation ARFCN	ARFCN 520, 590, 600, 700, 780, 800 and 810
For Cell B	
- Format notation	Range 1024
- BA_IND	0
- BCCH Allocation ARFCN	ARFCN 137, 147, 207, 217, 227, 237 and 247

SYSTEM INFORMATION TYPE 6

Information Element	Value/remark
Cell identity	see below
Location Area Identification	see below
Cell options	see below
NCC permitted	see below

Common contents of information elements in SYSTEM INFORMATION TYPE 1 to 6 messages.

CBCH Channel Description	Not present
CBCH Mobile Allocation	Not present
Cell identity	
CI VALUE	0001H for cell A, 0002H for cell B
Cell options	
Power Control Indicator	power control indicator is not set
DTX Indicator	MS shall not use DTX
RADIO LINK TIME-OUT	8 SACCH blocks
Cell selection parameters	
CELL RESELECT HYSTERESIS	12 dB
MS-TXPWR-MAX-CCH	Minimum level
RXLEV-ACCESS-MIN	Minimum level
ACS	There are no additional cell parameters included in SI7 and SI8
NECI	New establishment cause not supported
Control Channel Description	
ATT	No Attach/Detach
BS-AG-BLKS-RES	0 blocks reserved
CCCH-CONF	Combined CCCH/SDCCH
BS-PA-MFRMS	5 multiframes
T3212	Infinite
L2 pseudo length	
SI 1	21
SI 2	22
SI 2ter	18
SI 3	18
SI 4	12
Location Area Identification	
MCC	001 decimal
MNC	01 decimal
LAC	0001H
Message Type	
SI 1	00011001
SI 2	00011010
SI 2ter	00000011
SI 3	00011011
SI 4	00011100
SI 5	00011101
SI 5ter	00000110
SI 6	00011110
NCC permitted	00000010
RACH control parameters	
MAX RETRANS	Max 1 retrans
TX-INTEGGER	5 slots used
CELL BAR ACCESS	Not barred
CALL RE-ESTABLISHMENT	Not Allowed
EMERGENCY CALL	Allowed
ACCESS CONTROL CLASS (0...9, 11...15)	None Barred
SI 1 rest octets	Not used (all bits are set to spare)
SI 2 rest octets	Not used (all bits are set to spare)
SI 2ter rest octets	Not used (all bits are set to spare)
SI 4 rest octets	Not used (all bits are set to spare)

Default settings for cell A

Downlink input level	63 dBmicroVolt emf
Uplink output power	Minimum supported by the MS
Propagation profile	Static
BCCH/CCCH	ARFCN 147

Default settings for cell B

Downlink input level	53 dBmicroVolt emf
Uplink output power	Minimum supported by the MS
Propagation profile	Static
BCCH/CCCH	ARFCN 590

Default message contents for other messages

- For subclause 26.11.2 Refer to table 26.6
- For subclause 26.11.3 same as in subclause 26.7.
- For subclause 26.11.4 no tests yet defined.
- For subclause 26.11.5 same as in subclause 26.9.7.

26.12 Enhanced Full Rate signalling

This subclause only applies to MS supporting enhanced full rate speech.

As an EFR mobile station necessarily supports the speech full rate version 1 or both speech full rate version 1 and speech half rate version 1, conformance requirements of clause 26 fully apply to this mobile.

The purpose of this extra section is to test the different procedures which may be impacted when Enhanced full rate speech codec is used.

26.12.1 EFR signalling/ test of the channel mode modify procedure

NOTE: This test is derived from the tests in subclauses 26.6.7.1 and 26.6.7.2 respectively entitled "Test of the channel mode modify procedure / full rate" and "Test of the channel mode modify procedure / half rate".

26.12.1.1 Conformance requirement

The MS with a TCH/F allocated acknowledges a CHANNEL MODE MODIFY message by sending a CHANNEL MODE MODIFY ACKNOWLEDGE message specifying the new mode and by switching to this mode when this one is set to:

- speech full rate or half rate version 1.
- speech full rate or half rate version 2.
- any other mode declared supported by the mobile.

If the mobile station does not support the indicated mode, it shall retain the old mode and return the associated channel mode information in the CHANNEL MODE MODIFY ACKNOWLEDGE message.

References

3GPP TS 02.06, subclause 3.2.3.

3GPP TS 04.08 / 3GPP TS 44.018, subclauses 3.4.6.1.1 and 3.4.6.1.2.

26.12.1.2 Test purpose

To verify that the MS with a TCH/F allocated acknowledges a CHANNEL MODE MODIFY message by sending a CHANNEL MODE MODIFY ACKNOWLEDGE message specifying the new mode and by switching to this mode when this one is set to:

- speech full rate or half rate version 1.
- speech full rate or half rate version 2.
- any other mode declared supported by the mobile.

To verify that the MS, in an RR connected state, acknowledges a CHANNEL MODE MODIFY message by sending a CHANNEL MODE MODIFY ACKNOWLEDGE message specifying the old mode when the new mode is not declared as supported by the mobile

26.12.1.3 Method of test

Initial Conditions

System Simulator:

1 cell, default parameters.

Mobile Station:

The MS is "idle updated", with TMSI allocated.

Specific PICS statements:

- Speech supported for Full rate version 3 (TSPC_AddInfo_Full_rate_version_3)
- 2.4 k full rate data mode (TSPC__AddInfo_24DataF)
- 4.8 k full rate data mode. (TSPC__AddInfo_48DataF)
- 9.6 k full rate data mode. (TSPC__AddInfo_96Data)

PIXIT statements:

-

Foreseen Final State of the MS

"Idle, updated", with TMSI allocated.

Test procedure

A Mobile Terminated call is initiated, however following the CHANNEL REQUEST received from the Mobile Station, the SS sends an IMMEDIATE ASSIGNMENT to the MS commanding it to go to a TCH/F. This sets the Channel Mode automatically to "Signalling Only".

The SS then sends a series of CHANNEL MODE MODIFY messages to the MS. Each time it is checked that the MS responds with a CHANNEL MODE MODIFY ACKNOWLEDGE message specifying:

- the channel mode that has been specified in the CHANNEL MODE MODIFY message, if the MS supports that mode (this mode then becomes the "channel mode in use"). If necessary, the MS shall be correctly configured in order to accept this mode.
- the channel mode that was in use when the CHANNEL MODE MODIFY message has been received, if the MS does not support the channel mode specified in the CHANNEL MODE MODIFY message.

Maximum Duration of Test

50 s.

Expected Sequence

Step	Direction	Message	Comments
1	SS->MS	PAGING REQUEST TYPE 1	Sent on correct paging subchannel
2	MS->SS	CHANNEL REQUEST	Establishment cause indicates "answer to paging"
3	SS->MS	IMMEDIATE ASSIGNMENT	Assignment to a non hopping TCH/F
4	SS->MS	CHANNEL MODE MODIFY	
5	MS->SS	CHANNEL MODE MODIDY ACKNOWLEDGE	
6	SS->MS	CHANNEL MODE MODIFY	
7	MS->SS	CHANNEL MODE MODIDY ACKNOWLEDGE	
8	SS->MS	CHANNEL MODE MODIFY	
9	MS->SS	CHANNEL MODE MODIDY ACKNOWLEDGE	
10	SS->MS	CHANNEL MODE MODIFY	
11	MS->SS	CHANNEL MODE MODIDY ACKNOWLEDGE	
12	SS->MS	CHANNEL MODE MODIFY	
13	MS->SS	CHANNEL MODE MODIDY ACKNOWLEDGE	
14	SS->MS	CHANNEL MODE MODIFY	
15	MS->SS	CHANNEL MODE MODIDY ACKNOWLEDGE	
16	SS->MS	CHANNEL MODE MODIFY	
17	MS->SS	CHANNEL MODE MODIDY ACKNOWLEDGE	
18	SS->MS	CHANNEL MODE MODIFY	
19	MS->SS	CHANNEL MODE MODIDY ACKNOWLEDGE	
20	SS->MS	CHANNEL MODE MODIFY	
21	MS->SS	CHANNEL MODE MODIDY ACKNOWLEDGE	
22	SS->MS	CHANNEL MODE MODIFY	
23	MS->SS	CHANNEL MODE MODIDY ACKNOWLEDGE	
24	SS->MS	CHANNEL RELEASE	

Specific Message Contents

In step 4 / step 6 / step 8 / step 10 / step 12 / step 14 / step 16 / step 18 / step 20:

CHANNEL MODE MODIFY

Information Element	value/remark
Channel description	describes the already assigned dedicated channel
Channel mode	
Mode	in step 4: speech full or half rate version 2 in step 6: data 3,6 Kb/s in step 8: speech full or half rate version 2 in step 10: data 6 Kb/s in step 12: speech full or half rate version 2 in step 14: data 12 Kb/s in step 16: speech full or half rate version 2 in step 18: speech full or half rate version 1 in step 20: speech full or half rate version 2

In step 22 :

CHANNEL MODE MODIFY

Information Element	value/remark
Channel description	describes the already assigned dedicated channel
Channel mode	
Mode	speech full or half rate version3
Multi-Rate configuration	adaptive multirate codec mode chosen arbitrarily (see 3GPP TS 04.08 subclause 10.5.2.21aa)

CHANNEL MODE MODIFY ACKNOWLEDGE

Channel mode	
Mode	in steps 5, 9, 13, 17, 21: speech full rate version 2 in step 7: if TSPC__AddInfo_24DataF: data 3,6 Kb/s else same as in step 5 in step 11: if TSPC__AddInfo_48DataF: data 6,0 Kb/s full rate else same as in step 9 in step 15: if TSPC__AddInfo_96Data: data 12 Kb/s full rate else same as in step 13 in step 19: speech full rate version 2 in step 23: if TSPC__AddInfo_Full_rate_version_3speech full rate version 3 else same as in step 21

26.12.2 EFR signalling/ tests of handover

With the Handover procedure, it is possible to completely alter the channels allocated to a MS. This makes it possible in particular to switch a call in progress from one cell to another. The procedure is always initiated by the network and with the MS in a dedicated mode.

Subclause 26.12.2.1 contains generic test procedures to be used for executing successful Handover tests dealing with EFR mode.

It deals with EFR signalling in the Handover/successful/active call/non synchronised case.

Table 1 contains a summary of the different combinations of parameters which have to be tested, together with a reference to the appropriate generic test procedure. If a test uses a channel rate which the MS under test does not support, the test shall be skipped.

sv1 stands for speech full/half rate version 1.

sv2 stands for speech full/half rate version 2 (enhanced full rate).

Table 1

From	To	Timing Adv.	Start Time	Syn ?	State of call	Subclause	Exec Counter
TCH/F, sv2, no FH	TCH/F, sv2, no FH	20	none	no	U10	26.12.2.1	1
TCH/F, sv2, no FH	TCH/F, sv2, FH	arbitrary	none	no	U10	26.12.2.1	2
TCH/F, sv2, FH	TCH/F, sv2, no FH	20	1,1s	no	U10	26.12.2.1	3
TCH/F, sv2, no FH	TCH/F, sv1, no FH	20	none	no	U10	26.12.2.1	4
TCH/F, sv1, no FH	TCH/F, sv2, no FH	arbitrary	none	no	U10	26.12.2.1	5
TCH/F, sv2, no FH	TCH/F, sv1, FH	arbitrary	none	no	U10	26.12.2.1	6
TCH/F, sv1, FH	TCH/F, sv2, FH	20	1,1	no	U10	26.12.2.1	7
TCH/F, sv2, FH	TCH/F, sv1, FH	arbitrary	none	no	U10	26.12.2.1	8
TCH/F, sv1, FH	TCH/F, sv2, no FH	arbitrary	none	no	U10	26.12.2.1	9
TCH/F, sv2, no FH	TCH/H, sv1, FH	arbitrary	none	no	U10	26.12.2.1	10
TCH/H, sv1, FH	TCH/F, sv2, FH	20	1,1	no	U10	26.12.2.1	11
TCH/F, sv2, FH	TCH/H, sv1, FH	arbitrary	none	no	U10	26.12.2.1	12
TCH/H, sv1, FH	TCH/F, sv2, noFH	20	none	no	U10	26.12.2.1	13
TCH/F, sv2, noFH	TCH/H, sv1, noFH	20	none	no	U10	26.12.2.1	14
TCH/H, sv1, noFH	TCH/F, sv2, noFH	20	none	no	U10	26.12.2.1	15

Table 2

	TCH/FS	TCH/HS	SDCCH
n	10-20	5-10	2-5
n: number of access bursts.			

26.12.2.1 EFR signalling / Handover / active call / successful case

NOTE: This test is derived from the one defined in subclause 26.6.5.1 "Handover/successful/active call/non-synchronized".

This test only applies for MS supporting full rate speech version 2 (enhanced full rate speech).

26.12.2.1.1 Conformance requirements

The MS shall correctly apply the handover procedure in the non-synchronized case when:

- a call is in progress; and
- handover is performed from a TCH/F with/without frequency hopping towards a TCH/F with/without frequency hopping; and
- the mode of either the current or the target channel is set to full rate speech version 2 (enhanced full rate speech).

The MS also supporting half rate shall correctly apply the handover procedure in the non-synchronized case when:

- a call is in progress; and
- a handover is performed between a TCH/H with/without frequency hopping and a TCH/F with/without frequency hopping; and
- the mode of the TCH/F is set to full rate speech version 2.

References

3GPP TS 04.08 / 3GPP TS 44.018 subclauses 3.4.4 and 9.1.15.

3GPP TS 04.13 subclause 5.2.6.2.

26.12.2.1.2 Test purpose

To test that the MS shall correctly apply the handover procedure in the non-synchronized case when:

- a call is in progress; and
- handover is performed from a TCH/F with/without frequency hopping towards a TCH/F with/without frequency hopping; and
- the mode of either the current or the target channel is set to full rate speech version 2 (enhanced full rate speech).

To test that the MS also supporting half rate shall correctly apply the handover procedure in the non-synchronized case when:

- a call is in progress; and
- a handover is performed between a TCH/H with/without frequency hopping and a TCH/F with/without frequency hopping; and
- the mode of the TCH/F is set to full rate speech version 2.

26.12.2.1.3 Method of test

Initial Conditions

System Simulator:

2 cells, A and B with same LAI, default parameters except.

Band	BCCH ARFCN	Cell A Cell Allocation	BCCH ARFCN	Cell B Cell Allocation	Both Cells Format
GSM 450	263	259, 261, 263, 265, 267, 269, 271, 273, 275, 277, 279, 281, 283, 285, 287, 289, 291	274	260, 262, 264, 266, 268, 270, 272, 274, 276, 279, 281, 283, 285, 287, 289, 291	Range 128
GSM 480	310	306, 308, 310, 312, 314, 316, 318, 320, 322, 324, 326, 328, 330, 332, 334, 336, 338	321	307, 309, 311, 313, 315, 317, 319, 321, 323, 326, 328, 330, 332, 334, 336, 338	Range 128
GSM 710	457	447, 454, 457, 463, 471, 479, 482, 483, 489, 496, 498, 500, 501, 502, 503, 506, 508	477	451, 455, 459, 461, 467, 468, 475, 477, 497, 498, 500, 501, 502, 503, 506, 508	Range 128
GSM 750	457	447, 454, 457, 463, 471, 479, 482, 483, 489, 496, 498, 500, 501, 502, 503, 506, 508	477	451, 455, 459, 461, 467, 468, 475, 477, 497, 498, 500, 501, 502, 503, 506, 508	Range 128
T-GSM 810	457	447, 454, 457, 463, 471, 479, 482, 483, 489, 496, 498, 500, 501, 502, 503, 506, 508	477	451, 455, 459, 461, 467, 468, 475, 477, 497, 498, 500, 501, 502, 503, 506, 508	Range 128
GSM 850	147	137, 144, 147, 153, 161, 169, 172, 173, 179, 186, 193, 200, 201, 202, 203, 235, 241	167	141, 145, 149, 151, 157, 158, 165, 167, 187, 193, 200, 201, 202, 203, 235, 241	Range 128
GSM 900	20	10, 17, 20, 26, 34, 42, 45, 46, 52, 59, 66, 73, 74, 75, 76, 108, 114	40	14, 18, 22, 24, 30, 31, 38, 40, 60, 66, 73, 74, 75, 76, 108, 114	Range 128
DCS 1 800	747	734, 741, 747, 754, 759, 762, 766, 767, 773, 775, 779, 782, 791, 798, 829, 832, 844	764	739, 743, 746, 749, 756, 758, 761, 764, 771, 779, 782, 791, 798, 829, 832, 844	Range 256
PCS 1 900	647	634, 641, 647, 654, 659, 662, 666, 667, 673, 675, 679, 682, 691, 698, 729, 732, 744	664	639, 643, 646, 649, 656, 658, 661, 664, 671, 679, 682, 691, 698, 729, 732, 744	Range 256

The frame numbers of cells A and B shall be different by 100.

The timebase of cells A and B shall be such that the edges of their timeslots are not coincident at the antenna connector.

Mobile Station:

The MS is in the active state (U10) of a call on cell A.

Specific PICS statements:

- Speech supported for Half rate version 1 (TSPC_AddInfo_Half_rate_version_1)

PIXIT statements:

-

Foreseen Final State of the MS

The active state (U10) of a call on cell A.

Test Procedure

This procedure is repeated for execution counter M = 1 to 15.

The MS is in the active state (U10) of a call. The SS sends a HANDOVER COMMAND on the main DCCH. The MS shall (at the time defined by the Starting Time information element, if included in the message) begin to send access

bursts on the new DCCH (and optionally on the SACCH) of the target cell. The SS observes the access bursts and after receiving n (n being arbitrarily chosen between values according to table 2 of subclause 26.12.2) access bursts, the SS sends one PHYSICAL INFORMATION message with a Timing Advance as specified in table 1 of subclause 26.12.2. The MS shall activate the channel in sending and receiving mode. The MS shall establish a signalling link. The MS shall be ready to transmit a HANDOVER COMPLETE message, before 'x' ms after the end of the PHYSICAL INFORMATION message, but not before a UA frame has been sent by the SS.

The term 'ready to transmit' is defined in 3GPP TS 04.13. The value of 'x' depends upon the target channel and is specified in the specific message contents section.

Maximum Duration of Test

10 minutes, including 1 minute for any necessary operator actions.

Expected Sequence

This sequence is performed for an execution counter $M = 1, 2.. 9$ for an MS which supports enhanced full speech codec and only TCH/F.

This sequence is performed for an execution counter $M = 1, 2.. 15$ for an MS which supports enhanced full speech codec and TCH/F and H.

Step	Direction	Message	Comments
0	MS -> SS		The MS and SS are in the active state of a call on the channel described below.
1	SS -> MS	HANDOVER COMMAND	See Specific message contents
2	MS -> SS	HANDOVER ACCESS	Repeated on every burst of the uplink main DCCH (and optionally on the SACCH) until reception of PHYSICAL INFORMATION. Handover Reference as included in the HANDOVER COMMAND. If the HANDOVER COMMAND includes a starting time IE then the first HANDOVER ACCESS message shall be transmitted in the indicated frame (unless the indicated frame is not used by that channel, in which case the next frame used by that channel shall be used)
3	SS -> MS	PHYSICAL INFORMATION	Sent after reception of n HANDOVER ACCESS messages. See specific message contents.
4	MS -> SS	SABM	Sent without information field
5	SS -> MS	UA	
6	MS -> SS	HANDOVER COMPLETE	The message shall be ready to be transmitted before 'x' ms after the completion of step 3.
7	MS -> SS		The MS and SS are in the active state of a call on the TCH described below. The SS checks that the TCH is through connected in the correct mode.

Specific Message Contents

For $M = 1$:

Step 0: The MS and SS are using a full rate TCH with speech full rate version 2 and in non-hopping mode on cell A.

HANDOVER COMMAND

Information Element	value/remarks
As default message contents, except:	
Cell Description	
- Network Colour Code	1
- Base Station Colour Code	5
- BCCH Carrier Number	See the table below.
Synchronisation Indication	
- Report Observed Time Difference	Shall not be included.
- Synchronisation Indication	'Non synchronised'.
- Normal Cell Indication	Ignore out of range timing advance.

HANDOVER COMMAND	
Band	BCCH ARFCN
GSM 450	274
GSM 480	321
GSM 710	477
GSM 750	477
T-GSM 810	477
GSM 850	167
GSM 900	40
DCS 1 800	764
PCS 1 900	664

PHYSICAL INFORMATION

Information Element	value/remarks
As default message contents.	

Step 6: $x = 500$

Step 7: The MS and SS are using a full rate TCH with speech full rate version 2 and in non hopping mode on cell B.

For $M = 2$:

Step 0: The MS and SS are using a full rate TCH with speech full rate version 2 and in non-hopping mode on cell B.

HANDOVER COMMAND

Information Element	value/remarks
As default message contents, except:	
Cell Description	
- Network Colour Code	1
- Base Station Colour Code	5
- BCCH Carrier Number	See the table below.
Channel Description	
- Channel Type	TCH/F + ACCHs
- Timeslot number	Chosen arbitrarily, but not Zero
- Training Sequence Code	Chosen arbitrarily
- Hopping	RF hopping channel.
- MAIO	Chosen arbitrarily from the set (0, 1 to N-1), where N is the number of frequencies encoded in the Frequency List IE.
- HSN	Chosen arbitrarily from the set (1,2,..63)
Synchronisation Indication IE is not included.	
Channel Mode IE is not included.	
Frequency List after time	
- Frequency List	Allocate frequencies as per the table below

HANDOVER COMMAND			
Band	BCCH ARFCN	Frequency Format	Frequency List
GSM 450	263		259, 261, 263, 265, 277, 279, 281, 283, 285, 287, 289, 291
GSM 480	310		306, 308, 310, 312, 324, 326, 328, 330, 332, 334, 336, 338
GSM 710	457		447, 454, 457, 463, 496, 498, 500, 501, 502, 503, 506, 508
GSM 750	457		447, 454, 457, 463, 496, 498, 500, 501, 502, 503, 506, 508
T-GSM 810	457		447, 454, 457, 463, 496, 498, 500, 501, 502, 503, 506, 508
GSM 850	147		137, 144, 147, 153, 186, 193, 200, 201, 202, 203, 235, 241
GSM 900	20		10, 17, 20, 26, 59, 66, 73, 74, 75, 76,108, 114
DCS 1 800	747	Range 256	747, 775, 779, 782, 791, 798, 829, 832, 844
PCS 1 900	647	Range 256	647, 675, 679, 682, 691, 698, 729, 732, 744

PHYSICAL INFORMATION

Information Element	value/remarks
As default message contents, except: Timing advance	Arbitrarily selected but different to default value.

Step 6: x = 500

Step 7: The MS and SS are using a full rate TCH with speech full rate version 2 and in hopping mode on cell A.

For M = 3:

Step 0: The MS and SS are using a full rate TCH with speech full rate version 2 and in hopping mode on cell A.

HANDOVER COMMAND

Information Element	value/remarks
As default message contents, except: Cell Description	
- Network Colour Code	1
- Base Station Colour Code	5
- BCCH Carrier Number	See the table below.
Synchronisation Indication	
- Report Observed Time Difference	Shall not be included.
- Synchronisation Indication	'Non synchronised'.
- Normal Cell Indication	Out of range timing advance shall trigger a handover failure procedure.
Starting Time	Indicates the frame number of cell B that will occur approximately 1,1 seconds (238 frames have elapsed) after the HANDOVER COMMAND is sent by cell A.

HANDOVER COMMAND	
Band	BCCH ARFCN
GSM 450	274
GSM 480	321
GSM 710	477
GSM 750	477
T-GSM 810	477
GSM 850	167
GSM 900	40
DCS 1 800	764
PCS 1 900	664

PHYSICAL INFORMATION

Information Element	value/remarks
As default message contents.	

Step 6: x = 500

Step 7: The MS and SS are using a full rate TCH with speech full rate version 2 and in non-hopping mode on cell B.

For M = 4:

Step 0: The MS and SS are using a full rate TCH with full rate speech version 2 and in non-hopping mode on cell B.

HANDOVER COMMAND

Information Element	value/remarks
As default message contents, except:	
Cell Description	
- Network Colour Code	1
- Base Station Colour Code	5
- BCCH Carrier Number	263 See the table below.
Synchronisation Indication	
- Report Observed Time Difference	Shall not be included.
- Synchronisation Indication	'Non synchronised'.
- Normal Cell Indication	Ignore out of range timing advance.
Mode of the first channel	
- Mode	speech full rate or half rate version 1

HANDOVER COMMAND	
Band	BCCH ARFCN
GSM 450	263
GSM 480	310
GSM 710	457
GSM 750	457
T-GSM 810	457
GSM 850	147
GSM 900	20
DCS 1 800	747
PCS 1 900	647

PHYSICAL INFORMATION

Information Element	value/remarks
As default message contents.	

Step 6: $x = 500$

Step 7: The MS and SS are using a full rate TCH with speech full rate version 1 and in non hopping mode on cell A.

For $M = 5$:

Step 0: The MS and SS are using a full rate TCH with full rate speech version 1 and in non-hopping mode on cell A.

HANDOVER COMMAND

Information Element	value/remarks
As default message contents, except:	
Cell Description	
- Network Colour Code	1
- Base Station Colour Code	5
- BCCH Carrier Number	See the table below.
Synchronisation Indication	
- Report Observed Time Difference	Shall not be included.
- Synchronisation Indication	'Non synchronised'.
- Normal Cell Indication	Ignore out of range timing advance.
Mode of the first channel	
- Mode	speech full rate version 2

HANDOVER COMMAND	
Band	BCCH ARFCN
GSM 450	274
GSM 480	321
GSM 710	477
GSM 750	477
T-GSM 810	167
GSM 850	477
GSM 900	40
DCS 1 800	764
PCS 1 900	664

PHYSICAL INFORMATION

Information Element	value/remarks
As default message contents, except: Timing advance	Arbitrarily selected but different to default value.

Step 6: $x = 500$

Step 7: The MS and SS are using a full rate TCH with speech full rate version 2 and in non hopping mode on cell B.

For $M = 6$:

Step 0: The MS and SS are using a full rate TCH with speech full rate version 2 and non-hopping mode on cell B.

HANDOVER COMMAND

Information Element	value/remarks
As default message contents, except: Cell Description - Network Colour Code - Base Station Colour Code - BCCH Carrier Number Channel Description - Channel Type - Timeslot number - Training Sequence Code - Hopping - MAIO - HSN Synchronisation Indication IE is not included. Mode of the first channel. - Mode Frequency List after time - Frequency List	1 5 See the table below. TCH/F + ACCHs Chosen arbitrarily, but not Zero Chosen arbitrarily RF hopping channel. Chosen arbitrarily from the set (0, 1 to N-1), where N is the number of frequencies encoded in the Frequency List IE. Chosen arbitrarily from the set (1,2,..63) speech full rate or half rate version 1 Allocates frequencies as per the table below

HANDOVER COMMAND			
Band	BCCH ARFCN	Frequency Format	Frequency List
GSM 450	263		259, 261, 263, 265, 277, 279, 281, 283, 285, 287, 289, 291
GSM 480	310		306, 308, 310, 312, 324, 326, 328, 330, 332, 334, 336, 338
GSM 710	457		447, 454, 457, 463, 496, 498, 500, 501, 502, 503, 506, 508
GSM 750	457		447, 454, 457, 463, 496, 498, 500, 501, 502, 503, 506, 508
T-GSM 810	457		447, 454, 457, 463, 496, 498, 500, 501, 502, 503, 506, 508
GSM 850	147		137, 144, 147, 153, 186, 193, 200, 201, 202, 203, 235, 241
GSM 900	20		10, 17, 20, 26, 59, 66, 73, 74, 75, 76, 108, 114
DCS 1 800	747	Range 256	747, 775, 779, 782, 791, 798, 829, 832, 844
PCS 1 900	647	Range 256	647, 675, 679, 682, 691, 698, 729, 732, 744

PHYSICAL INFORMATION

Information Element	value/remarks
As default message contents, except: Timing advance	Arbitrarily selected but different to default value.

Step 6: $x = 500$

Step 7: The MS and SS are using a full rate TCH with speech full rate version 1 and hopping mode on cell A.

For $M = 7$:

Step 0: The MS and SS are using a full rate TCH with full rate speech version 1 and in hopping mode on cell A.

HANDOVER COMMAND

Information Element	value/remarks
As default message contents, except:	
Cell Description	
- Network Colour Code	1
- Base Station Colour Code	5
- BCCH Carrier Number	See the table below.
Channel Description	
- Channel Type	TCH/F + ACCHs
- TDMA offset	Chosen arbitrarily
- Timeslot number	Chosen arbitrarily, but not Zero
- Training Sequence Code	Chosen arbitrarily
- Hopping	RF hopping channel.
- MAIO	Chosen arbitrarily from the set (0, 1 to N-1), where N is the number of frequencies encoded in the Frequency List IE.
- HSN	Chosen arbitrarily from the set (1,2,..63)
Frequency List after time	
- Frequency List	Allocates frequencies as per the table below
Synchronisation Indication	
- Report Observed Time Difference	Shall not be included.
- Synchronisation Indication	'Non synchronised'.
- Normal Cell Indication	Ignore out of range timing advance.
Starting Time	Indicates the frame number of cell B. that will occur approximately 1,1 seconds (238 frames have elapsed) after the HANDOVER COMMAND is sent by cell A.
Mode of the first channel	
- Mode	speech full rate version 2

HANDOVER COMMAND			
Band	BCCH ARFCN	Frequency Format	Frequency List
GSM 450	274	Range 128	260, 262, 264, 266, 276, 279, 281, 283, 285, 287, 289, 291
GSM 480	321	Range 128	307, 309, 311, 313, 323, 326, 328, 330, 332, 334, 336, 338
GSM 710	477	Range 128	451, 455, 459, 461, 497, 498, 500, 501, 502, 503,506, 508
GSM 750	477	Range 128	451, 455, 459, 461, 497, 498, 500, 501, 502, 503,506, 508
T-GSM 810	477	Range 128	451, 455, 459, 461, 497, 498, 500, 501, 502, 503,506, 508
GSM 850	167	Range 128	141, 145, 149, 151, 187, 193, 200, 201, 202, 203, 235, 241
GSM 900	40	Bit Map 0	14, 18, 22, 24, 60, 66, 73, 74, 75, 76,108, 114
DCS 1 800	764	Range 1024	749, 758, 761, 764, 771, 779, 782, 791, 798, 829, 832, 844
PCS 1 900	664	Range 1024	649, 658, 661, 664, 671, 679, 682, 791, 798, 729, 732, 744

PHYSICAL INFORMATION

Information Element	value/remarks
As default message contents.	

Step 6: $x = 750$

Step 7: The MS and SS are using a full rate TCH with full rate speech version 2 and in hopping mode on cell B.

For $M = 8$:

Step 0: The MS and SS are using a full rate TCH with full rate speech version 2 and in hopping mode on cell B.

HANDOVER COMMAND

same as for $M = 6$

PHYSICAL INFORMATION

same as for $M = 6$

Step 6: $x = 750$

Step 7: The MS and SS are using a full rate TCH with speech full rate version 1 and in hopping mode on cell A.

For $M = 9$:

Step 0: The MS and SS are using a full rate TCH with speech full rate version 1 and in hopping mode on cell A.

HANDOVER COMMAND

same as for $M = 5$.

PHYSICAL INFORMATION

same as For $M = 5$.

Step 6: $x = 750$

Step 7: The MS and SS are using a full rate TCH with speech full rate version 2 and in non hopping mode on cell B.

For $M = 10$:

Step 0: The MS and SS are using a full rate TCH with full rate speech version 2 and in non hopping mode on cell B.

HANDOVER COMMAND

same as for $M = 6$ except:

- Channel Description
- Channel Type: TCH/H + ACCHs

PHYSICAL INFORMATION

same as for $M = 6$

Step 6: $x = 750$

Step 7: The MS and SS are using a half rate TCH with speech half rate version 1 and in hopping mode on cell A.

For $M = 11$:

Step 0: The MS and SS are using a half rate TCH with speech half rate version 1 and in hopping mode on cell A.

HANDOVER COMMAND

same as for $M = 7$

PHYSICAL INFORMATION

same as For $M = 7$.

Step 6: $x = 750$

Step 7: The MS and SS are using a full rate TCH with speech full rate version 2 and in hopping mode on cell B.

For M = 12:

Step 0: The MS and SS are using a full rate TCH with full rate speech version 2 and in hopping mode on cell B.

HANDOVER COMMAND

same as for M = 6 except:

Channel Description - Channel Type	TCH/H + ACCHs
---------------------------------------	---------------

PHYSICAL INFORMATION

same as for M = 6

Step 6: x = 750

Step 7: The MS and SS are using a half rate TCH with speech half rate version 1 and in hopping mode on cell A.

For M = 13:

Step 0: The MS and SS are using a half rate TCH with speech half rate version 1 and in hopping mode on cell A.

HANDOVER COMMAND

same as for M = 1 except:

Mode of the first channel - Mode	speech full rate version 2
-------------------------------------	----------------------------

PHYSICAL INFORMATION

same as For M = 1.

Step 6: x = 750

Step 7: The MS and SS are using a full rate TCH with speech full rate version 2 and in non hopping mode on cell B.

For M = 14:

Step 0: The MS and SS are using a full rate TCH with full rate speech version 2 and in non hopping mode on cell B.

HANDOVER COMMAND

same as for M = 4 except:

Channel Description - Channel Type	TCH/H + ACCHs
---------------------------------------	---------------

PHYSICAL INFORMATION

same as for M = 4

Step 6: x = 750

Step 7: The MS and SS are using a half rate TCH with speech half rate version 1 and in non hopping mode on cell A.

For M = 15:

Step 0: The MS and SS are using a half rate TCH with speech half rate version 1 and in non hopping mode on cell A.

HANDOVER COMMAND

same as for M = 1 except:

Mode of the first channel - Mode	speech full rate version 2
-------------------------------------	----------------------------

PHYSICAL INFORMATION

same as For M = 1.

Step 6: $x = 750$

Step 7: The MS and SS are using a full rate TCH with speech full rate version 2 and in non hopping mode on cell B.

26.12.3 EFR Signalling / Structured procedures / MS originated call / late assignment

NOTE: this test is derived from the one defined in subclause 26.9.3 and entitled "Structured procedures / MS originated call / late assignment".

26.12.3.1 Conformance requirement

- 1) The MS shall indicate and include in the mobile originating SETUP for speech call all the speech versions that it supports.
- 2) Upon receipt of the ASSIGNMENT COMMAND message specifying either speech full rate version 1 or speech full rate version 2 or speech half rate version 1 (for an MS also supporting half rate), the Mobile Station starts a normal channel assignment procedure. It means that the MS initiates a local end release of link layer connections, disconnects the physical channels, commands the switching to the assigned channels and initiates the establishment of lower layer connections (this includes the activation of the channels, their connection and the establishment of the data links). After the main signalling link is successfully established, the MS returns an ASSIGNMENT COMPLETE message, specifying cause 'normal event', to the network on the main DCCH.
- 3, 4) The call control entity of the Mobile Station in the "call initiated" state, in the "mobile originating call proceeding" state or in the "call delivered" state, shall, upon receipt of a CONNECT message:
 - attach the user connection to the radio path;
 - return a CONNECT ACKNOWLEDGE message.

References

Conformance requirement 1: 3GPP TS 04.08 / 3GPP TS 24.008 subclauses 10.5.4.5 and 10.5.4.5.1, and 3GPP TS 02.06 subclause 3.2.3.

Conformance requirement 2: 3GPP TS 04.08 / 3GPP TS 44.018 subclauses 3.4.3.1 and 3.4.3.2.

Conformance requirement 3: 3GPP TS 04.08 / 3GPP TS 24.008 subclause 5.2.1.6.

26.12.3.2 Test purpose

- 1) To verify that the MS indicates and includes in the mobile originating SETUP for speech call all the speech versions that it supports.
- 2) To verify that subsequently after receipt of an IMMEDIATE ASSIGNMENT message allocating an SDCCH, after completion of establishment of the main signalling link, after having sent a CM SERVICE REQUEST message, after having successfully performed authentication and cipher mode setting procedures, after having sent a SETUP message, after having received a CALL PROCEEDING message followed by an ALERTING message and an ASSIGNMENT COMMAND message allocating either speech full rate version 1 TCH or speech full rate version 2 TCH or speech half rate version 1 TCH (for an MS also supporting half rate version 1), the MS sends an ASSIGNMENT COMPLETE message.

- 3) To verify that subsequently, after the suite of actions specified in test purposes 1 and 2, the MS after receiving a CONNECT message returns a CONNECT ACKNOWLEDGE message.
- 4) To verify that after the suite of actions specified in test purposes 1 and 2, the MS after receiving a CONNECT message attaches the user connection to the radio path. (This is checked by verifying that there is a point in time after transmission of the first L2 frame containing the (complete) CONNECT message, where the MS is sending appropriate speech or data frames whenever it doesn't have to transmit or acknowledge an I frame on layer 2 of the FACCH.)

26.12.3.3 Method of test

Specific PICS statements:

- Speech supported for Half rate version 1 (TSPC_AddInfo_Half_rate_version_1)

PIXIT statements:

- Way to indicate mobile originated alerting.
- Way to display the called number

Initial Conditions

System Simulator:

1 cell, default parameters.

Mobile Station:

The MS is in MM-state "idle, updated" with valid TMSI and CKSN.

Foreseen Final State of the MS

The MS has a MO call in state U10, "active".

Test procedure

The following test is performed for all rates (full rate/half rate) supported by the MS:

The MS is made to initiate a speech call. The call is established with late assignment.

Maximum Duration of Test

3 minutes.

Expected Sequence

This test is repeated for execution counter M = 1, 2 for an MS supporting full rate channels only.

This test is repeated for execution counter M = 1, 2, 3 for an MS supporting both half rate speech version 1 and full rate channels.

Step	Direction	Message	Comments
1	MS		The "called number" is entered
2	MS		
3	MS -> SS	CHANNEL REQUEST	Establishment cause is "originating call and the network does not set the NECI bit to 1".
4	SS -> MS	IMMEDIATE ASSIGNMENT	
5	MS -> SS	CM SERVICE REQUEST	Message is contained in SABM.
6	SS -> MS	AUTHENTICATION REQ	
7	MS -> SS	AUTHENTICATION RESP	SRES specifies correct value.
8	SS -> MS	CIPHER MODE COMMAND	SS starts deciphering after sending the message.
9	MS -> SS	CIPHER MODE COMPLETE	Shall be sent enciphered. All following messages shall be sent enciphered.
10	SS		SS starts ciphering.
11	MS -> SS	SETUP	MS shall indicate and include all the speech versions that it supports.
12	SS -> MS	CALL PROCEEDING	
13	SS -> MS	ALERTING	
14	MS		Depending on the PICS, an alerting indication is given.
15	SS -> MS	ASSIGNMENT COMMAND	
16	MS -> SS	ASSIGNMENT COMPLETE	
17	SS -> MS	CONNECT	
18	MS -> SS	CONNECT ACKNOWLEDGE	
19	MS		The appropriate bearer channel is through connected in both directions.

Specific Message Contents:

For M = 1:

ASSIGNMENT COMMAND

See default message contents subclause 26.12.8.

SETUP

Same contents as subclause 26.12.8 but all the speech versions supported by the MS shall be indicated in octet_3a_etc(s).

For M = 2:

ASSIGNMENT COMMAND

same as for default message contents except:

Mode of the first channel - Mode	speech full rate or half rate version 1
-------------------------------------	---

SETUP

Same contents as subclause 26.12.8 but all the speech versions supported by the MS shall be indicated in octet_3a_etc(s).

For M = 3:

ASSIGNMENT COMMAND

same as for default message contents except:

Channel Description - TDMA offset Mode of the first channel - Mode	TCH/H+ACCHs speech full rate or half rate version 1
---	--

SETUP

same contents as subclause 26.12.8 but the supported speech versions and their preferred order indicated in octet_3a_etc(s) shall be as declared by the manufacturer.

26.12.4 Structured procedures / MS terminated call / I early assignment

NOTE: this test is derived from the one described in subclause 26.9.4 and entitled "Structured procedures / MS terminated call / early assignment".

26.12.4.1 Conformance requirement

- 1) In acceptance to a SETUP message indicating speech, the MS shall indicate and include in the CALL CONFIRMED message all the speech versions that it supports.
- 2) Upon receipt of the ASSIGNMENT COMMAND message specifying either speech full rate version 1 or speech full rate version 2 or speech half rate version 1 (for an MS also supporting half rate), the Mobile Station continues a mobile terminating call establishment with early assignment of traffic channel:
 - a) by replying to the ASSIGNMENT command with an ASSIGNMENT COMPLETE message; and
 - b) by continuing the call establishment by through connecting TCH in both directions if it supports immediate connect or by sending an ALERTING message otherwise.
- 3) For speech calls, the mobile station shall attach the user connection at latest when sending the connect message, except if there is no compatible radio resource available at this time. In this case the attachment shall be delayed until such a resource becomes available.

References

- Conformance requirement 1: 3GPP TS 04.08 / 3GPP TS 24.008 subclauses 10.5.4.5 and 10.5.4.5.1
3GPP TS 02.06 subclause 3.2.3.
- Conformance requirement 2: 3GPP TS 04.08 / 3GPP TS 44.018 subclauses 3.4.3.1 and 3.4.3.2.
- Conformance requirement 3: 3GPP TS 04.08 / 3GPP TS 24.008 subclause 5.2.2.9.

26.12.4.2 Test purpose

- 1) To verify that, in acceptance to a SETUP message indicating speech, the MS indicates and includes in the CALL CONFIRMED message all the speech versions that it supports.
- 2) To verify that upon receipt of the ASSIGNMENT COMMAND message specifying either speech full rate version 1 or speech full rate version 2 or speech half rate version 1 (for an MS also supporting half rate speech version 1), the Mobile Station continues a mobile terminating call establishment with early assignment of traffic channel
 - a) by replying to the ASSIGNMENT command with an ASSIGNMENT COMPLETE message; and
 - b) by continuing the call establishment by through connecting TCH in both directions if it supports immediate connect or by sending an ALERTING message otherwise.
- 3) To verify that for speech calls, the mobile station shall attach the user connection at latest when sending the connect message, except if there is no compatible radio resource available at this time. In this case the attachment shall be delayed until such a resource becomes available.

26.12.4.3 Method of test

Specific PICS statements:

- Speech supported for Half rate version 1 (TSPC_AddInfo_Half_rate_version_1)
- Immediate connect supported for all circuit switched basic services. (TSPC_AddInfo_ImmConn)

PIXIT statements:

- Way to indicate alerting.
- Way to make the MS accept an incoming call after alerting.

Initial Conditions

System Simulator:

1 cell, default parameters.

Mobile Station:

The MS is in MM-state "idle, updated" with valid TMSI and CKSN.

Foreseen Final State of the MS

CC state U10-call active.

Test procedure

The following test is performed for all rates (full rate/half rate) supported by the MS:

- A teleservice is selected that is supported by the MS; if the MS supports speech, the selected teleservice is speech. If necessary, the MS is configured for that teleservice.
- The MS is paged and the resulting call is established. Having reached the active state, the MS is made to clear the call.

Maximum Duration of Test

3 minutes.

Expected Sequence

This test is repeated for execution counter $M = 1, 2$ for an MS supporting full rate channels only.

This test is repeated for execution counter $M = 1, 2, 3$ for an MS supporting both half rate speech version 1 and full rate channels.

Step	Direction	Message	Comments
1	SS -> MS	PAGING REQUEST TYPE 1	Sent on the correct paging subchannel Message is contained in SABM. SRES specifies correct value. SS starts deciphering after sending the message. Shall be sent enciphered. All following messages shall be sent enciphered. SS starts ciphering. Message does not contain the signal IE. MS shall indicate and include all the speech versions that it supports.
2	MS -> SS	CHANNEL REQUEST	
3	SS -> MS	IMMEDIATE ASSIGNMENT	
4	MS -> SS	PAGING RESPONSE	
5	SS -> MS	AUTHENTICATION REQUEST	
6	MS -> SS	AUTHENTICATION RESPONSE	
7	SS -> MS	CIPHERING MODE COMMAND	
8	MS -> SS	CIPHERING MODE COMPLETE	
9	SS		
10	SS -> MS	SETUP	
11	MS -> SS	CALL CONFIRMED	
			If the MS supports an Immediate connection then branch A applies. If the MS doesn't support an immediate connection then branch B applies.
A12	MS -> SS	CONNECT	sent on the old channel
A13	SS -> MS	ASSIGNMENT COMMAND	
A14	MS -> SS	ASSIGNMENT COMPLETE	
B12	SS -> MS	ASSIGNMENT COMMAND	Sent on the new channel. An alerting indication as defined in an PIXIT statement is given by the MS. The MS is made to accept the call in the way described in a PIXIT statement.
B13	MS -> SS	ASSIGNMENT COMPLETE	
B14	MS -> SS	ALERTING	
B15	MS		
B16	MS		
B17	MS -> SS	CONNECT	
18	MS		
19	SS -> MS	CONNECT ACKNOWLEDGE	the TCH shall be through connected in both directions. in the indicated mode. The MS is made to release the call. The main signalling link is released.
20	MS		
21	MS -> SS	DISCONNECT	
22	SS -> MS	RELEASE	
23	MS -> SS	RELEASE COMPLETE	
24	SS -> MS	CHANNEL RELEASE	

Specific Message Contents:

For M = 1:

ASSIGNMENT COMMAND

See default message contents subclause 26.12.8.

CALL CONFIRMED

Same contents as subclause 26.12.8 but all the speech versions supported by the MS shall be indicated in octet_3a_etc(s).

For M = 2 :

ASSIGNMENT COMMAND

Same as for default message contents except:

Mode of the first channel - Mode	speech full rate or half rate version 1
-------------------------------------	---

CALL CONFIRMED

Same contents as subclause 26.12.8 but all the speech versions supported by the MS shall be indicated in octet_3a_etc(s).

For M = 3:

ASSIGNMENT COMMAND

Same as for default message contents except:

Channel Description - TDMA offset Mode of the first channel - Mode	TCH/H+ACCHs speech full rate or half rate version 1
---	--

CALL CONFIRMED

Same contents as subclause 26.12.8 but all the speech versions supported by the MS shall be indicated in octet_3a_etc(s).

26.12.5 Structured procedures / emergency call

NOTE: This test is derived from the ones described in subclauses 26.9.6.1.1 and 26.9.6.1.2 and respectively entitled "Structured procedures / emergency call / idle updated, preferred channel rate " and "Structured procedures / emergency call / idle updated, non-preferred channel rate".

This test applies to mobiles supporting Enhanced Full Rate speech.

26.12.5.1 Conformance requirement

- 1) For R97/98 MS: The MS in the "idle, updated" state, as after a successful location update, after the number 112 (for GSM 900 and 1 DCS 800 MS), or 911 (for GSM 710, GSM 750, T_GSM 810, GSM 850, PCS 1 900 MS in USA and Canada), or 08 (for GSM 710, GSM 750, T_GSM 810, GSM 850, PCS 1 900 MS in Mexico) has been entered by user, shall send a CHANNEL REQUEST message with correct establishment cause ("emergency call").

For R99 MS: When a SIM/USIM containing stored emergency numbers is present, those numbers are identified as emergency numbers. As an optional requirement, the ME shall also identify 112 and 911 as emergency numbers irrespective of whether these are stored in the SIM/USIM. Any other emergency numbers stored in the ME shall be ignored.

When no emergency numbers are stored within the SIM the following numbers shall be stored in the ME for use as emergency numbers: 112, and 911.

When no emergency numbers are stored within the USIM the following numbers shall be stored in the ME for use as emergency numbers: 112, and 911.

- 2) After assignment of a dedicated channel the first layer message sent by the MS on the assigned dedicated channel shall be a CM SERVICE REQUEST message specifying the correct CKSN and TMSI , with CM Service Type "emergency call establishment".
- 3) Authentication and cipher mode setting shall be performed successfully.
- 4) After cipher mode setting acceptance by the network, the MS shall send an EMERGENCY SETUP message.
- 5) The EFR mobile station shall accept channel assignment to a TCH full rate speech version 1 or 2 and if it supports half rate, in addition it shall accept channel assignment to a TCH half rate speech version 1.
- 6) After receipt of a CONNECT ACKNOWLEDGE message during correct establishment of the emergency call the TCH shall be through connected in both directions if an appropriate TCH is available.
- 7) The call shall be cleared correctly.

Requirement Reference:

For conformance requirement 1 and 2: 3GPP TS 04.08 / 3GPP TS 44.018 subclause 3.3.1.1,
3GPP TS 04.08 / 3GPP TS 24.008, subclauses 5.2.1 and 4.5.1.5,
3GPP TS 02.30, clause 4,,
3GPP TS 22.101 clause 8.

For conformance requirement 3: 3GPP TS 04.08 / 3GPP TS 44.018, subclause 3.4.7,
3GPP TS 04.08 / 3GPP TS 24.008, subclause 4.3.2.

- For conformance requirement 4: 3GPP TS 04.08 / 3GPP TS 24.008, subclause 5.2.1.1.
- For conformance requirement 5: 3GPP TS 04.08 / 3GPP TS 24.008, subclause 5.2.1.1,
3GPP TS 04.08 / 3GPP TS 44.018, subclause 3.4.3,
3GPP TS 02.06, subclause 3.2.3.
- For conformance requirement 6: 3GPP TS 04.08 / 3GPP TS 24.008, subclause 5.2.1.6.
- For conformance requirement 7: 3GPP TS 04.08 / 3GPP TS 24.008, subclause 5.4.

26.12.5.2 Test purpose

- 1) To verify that an R97/98 MS supporting speech in the MM state "idle, updated", when made to call the number 112, (for GSM 900 and DCS 1800 MS), or 911 (for GSM 710, GSM 750, T_GSM 810, GSM 850 and PCS 1 900 MS in USA and Canada), or 08 (for GSM 710, GSM 750, T_GSM 810, GSM 850 and PCS 1 900 MS in Mexico) sends a CHANNEL REQUEST message with establishment cause "emergency call".

To verify that an R99 MS supporting speech in the MM state "idle, updated", when made to call the number 112 or 911, sends a CHANNEL REQUEST message with establishment cause "emergency call".
- 2) To verify that after assignment of a dedicated channel the first layer message sent by the MS on the assigned dedicated channel is a CM SERVICE REQUEST message specifying the correct CKSN and TMSI, with CM Service Type "emergency call establishment".
- 3) To verify that authentication and cipher mode setting are performed successfully.
- 4) To verify that after cipher mode setting acceptance by the SS, the MS sends an EMERGENCY SETUP message.
- 5) To verify that the EFR mobile station shall both accept channel assignment to a TCH full rate speech versions 1 or 2 and if it supports half rate, in addition it shall accept channel assignment to a TCH half rate speech version 1.
- 6) To verify that subsequently the MS has through connected the TCH in both directions.
- 7) To verify that the call is cleared correctly.

26.12.5.3 Method of test

Specific PICS statements:

- Speech supported for Half rate version 1 (GSM HR) (TSPC_AddInfo_Half_rate_version_1)
- Use of R99 Emergency numbers (TSPC_R99_Emerg)

PIXIT statements:

- .

Initial Conditions

System Simulator:

1 cell, default parameters.

Mobile Station:

The MS is in MM-state "idle, updated" with valid TMSI and CKSN.

Foreseen Final State of the MS

The MS is in MM-state "idle, updated" with valid TMSI and CKSN.

Test procedure

The MS is made to initiate an emergency call. The call is established with late assignment. Having reached the active state, the call is cleared by the SS. This procedure is repeated so that the assignment is made with all the channel rates and speech versions supported by the mobile station.

Maximum Duration of Test

3 minutes

Expected Sequence

The expected sequence is executed for M = 1 and 2, for a full rate only mobile station which includes the bearer capability IE in the emergency setup message.

The expected sequence is executed for M = 1, 2 and 3, for a dual rate mobile station which includes the bearer capability IE in the emergency setup message.

The expected sequence is executed for M = 1, for a mobile which does not include the bearer capability IE in the emergency setup message.

Step	Direction	Message	Comments
1	MS		The appropriate emergency number is entered
3	MS -> SS	CHANNEL REQUEST	Establishment cause is emergency call establishment.
4	SS -> MS	IMMEDIATE ASSIGNMENT	
5	MS -> SS	CM SERVICE REQUEST	Message is contained in SABM. The CM service type IE indicates "emergency call establishment".
6	SS -> MS	AUTHENTICATION REQUEST	
7	MS -> SS	AUTHENTICATION RESPONSE	SRES specifies correct value.
8	SS -> MS	CIPHERING MODE COMMAND	SS starts deciphering after sending the message.
9	MS -> SS	CIPHERING MODE COMPLETE	Shall be sent enciphered. All following messages shall be sent enciphered.
10	SS		SS starts ciphering.
11	MS -> SS	EMERGENCY SETUP	If the bearer capability IE is including, it shall be checked that all the speech versions supported by the MS are present.
12	SS -> MS	CALL PROCEEDING	
13	SS -> MS	ALERTING	
14	SS -> MS	ASSIGNMENT COMMAND	See specific message contents.
15	MS -> SS	ASSIGNMENT COMPLETE	
16	SS -> MS	CONNECT	
17	MS -> SS	CONNECT ACKNOWLEDGE	
18	MS		The TCH is through connected in both directions in the correct mode.
19	SS -> MS	DISCONNECT	
20	MS -> SS	RELEASE	
21	SS -> MS	RELEASE COMPLETE	
23	SS -> MS	CHANNEL RELEASE	The main signalling link is released.

Note: According to the conformance requirements there is no need to execute the test case by dialling the number 08 for an R99 MS.

Specific Message Contents:

For M= 1

ASSIGNMENT COMMAND

same as for default message contents except:

Mode of the first channel - Mode	Speech full rate or half rate version 1
-------------------------------------	---

For M= 2

ASSIGNMENT COMMAND

same as for default message contents.

For M= 3

ASSIGNMENT COMMAND

same as for default message contents except:

Channel Description - TDMA offset Mode of the first channel - Mode	TCH/H+ACCHs Speech full rate or half rate version 1
---	--

26.12.6 EFR Signalling / Directed Retry / Mobile Originated Call

This test is derived from the one defined in subclause 26.9.7 and entitled "Directed Retry / MS originated call".

26.12.6.1 Conformance requirements

The MS shall correctly apply the Directed Retry procedure from SDCCH/8 (no frequency hopping) to TCH/EFR with frequency hopping in the non-synchronized case during call establishment. The call control entity of the Mobile Station in the "mobile originating call proceeding" state shall, upon receipt of a CONNECT message, attach the EFR speech connection to the radio path and return a CONNECT ACKNOWLEDGE message to the SS.

References

3GPP TS 04.08 / 3GPP TS 44.018, subclauses 3.4.4 and 9.1.15.

3GPP TS 04.08 / 3GPP TS 24.008 subclause 5.2.1.6.

3GPP TS 04.13, subclause 5.2.6.2.

26.12.6.2 Test purpose

To test that, when the MS is ordered to perform a non-synchronized handover after the CALL PROCEED message, it continuously sends access bursts on the main DCCH (and optionally on the SACCH) until it receives a PHYSICAL INFORMATION message from the SS. To test that the MS correctly takes the values of the Timing Advance information element in the PHYSICAL INFORMATION message into account. To test that the MS activates the new channel correctly and transmits the HANDOVER COMPLETE message without undue delay. To test that the call control entity of the Mobile Station in the "mobile originating call proceeding" state, upon receipt of a CONNECT message, attaches the EFR speech connection to the radio path and returns a CONNECT ACKNOWLEDGE message to the SS.

26.12.6.3 Method of test

Initial Conditions

System Simulator:

2 cells A and B with same LAI, default parameters, except:

Cell A has:

BCCH ARFCN = See the table below.

Cell Allocation = Allocate as per the table below. PLMN colour code, NCC = as defaults.

BS colour code, BCC = as defaults.

PLMN_PERM = 00001010.

Cell B has:

BCCH ARFCN = See the table below.

Cell Allocation = Allocate as per the table below.

PLMN colour code, NCC = 3.

BS colour code, BCC = 0.

Band	Cell A		Cell B		Both Cells Format
	BCCH ARFCN	Cell Allocation	BCCH ARFCN	Cell Allocation	
GSM 450	263	259, 261, 263, 265, 267, 269, 271, 273, 275, 277, 279, 281, 283, 285, 287, 289, 291	274	260, 262, 264, 266, 268, 270, 272, 274, 276, 279, 281, 283, 285, 287, 289, 291	Range 128
GSM 480	310	306, 308, 310, 312, 314, 316, 318, 320, 322, 324, 326, 328, 330, 332, 334, 336, 338	321	307, 309, 311, 313, 315, 317, 319, 321, 323, 326, 328, 330, 332, 334, 336, 338	Range 128
GSM 710	457	447, 454, 457, 463, 471, 479, 482, 483, 489, 496, 498, 500, 501, 502, 503, 506, 508	477	451, 455, 459, 461, 467, 468, 475, 477, 497, 498, 500, 501, 502, 503, 506, 508	Range 128
GSM 750	457	447, 454, 457, 463, 471, 479, 482, 483, 489, 496, 498, 500, 501, 502, 503, 506, 508	477	451, 455, 459, 461, 467, 468, 475, 477, 497, 498, 500, 501, 502, 503, 506, 508	Range 128
T-GSM 810	457	447, 454, 457, 463, 471, 479, 482, 483, 489, 496, 498, 500, 501, 502, 503, 506, 508	477	451, 455, 459, 461, 467, 468, 475, 477, 497, 498, 500, 501, 502, 503, 506, 508	Range 128
GSM 850	147	137, 144, 147, 153, 161, 169, 172, 173, 179, 186, 193, 200, 201, 202, 203, 235, 241	167	141, 145, 149, 151, 157, 158, 165, 167, 187, 193, 200, 201, 202, 203, 235, 241	Range 128
GSM 900	20	10, 17, 20, 26, 34, 42, 45, 46, 52, 59, 66, 73, 74, 75, 76, 108, 114	40	14, 18, 22, 24, 30, 31, 38, 40, 60, 66, 73, 74, 75, 76, 108, 114	Range 128
DCS 1 800	747	734, 741, 747, 754, 759, 762, 766, 767, 773, 775, 779, 782, 791, 798, 829, 832, 844	764	739, 743, 746, 749, 756, 758, 761, 764, 771, 779, 782, 791, 798, 829, 832, 844	Range 512
PCS 1 900	647	634, 641, 647, 654, 659, 662, 666, 667, 673, 675, 679, 682, 691, 698, 729, 732, 744	664	639, 643, 646, 649, 656, 658, 661, 664, 671, 679, 682, 691, 698, 729, 732, 744	Range 512

The timebase of Cells A and B shall be such that the edges of their timeslots are not coincident at the antenna connector.

A non-combined SDCCH is used.

Mobile Station:

The MS is in the "idle, updated" state, with a TMSI allocated and camped on cell A.

Specific PICS statements:

-

PIXIT statements:

- Way to indicate mobile originated alerting.
- . Way to display the called number

Foreseen Final State of the MS

"Idle, updated" with TMSI allocated and camped on cell B.

Test Procedure

The MS is made to initiate a speech call on Cell A. After the SS has sent the CALL PROCEEDING message the SS sends a HANDOVER COMMAND message, ordering the MS to switch to cell B. The MS shall then begin to send access bursts on the new DCCH (and optionally on the SACCH) to cell B. The SS observes the access bursts and after

receiving n (n being arbitrarily chosen between values according to table 26.6-2 of subclause 26.6.5) access bursts, the SS sends one PHYSICAL INFORMATION message with an arbitrarily chosen Timing Advance. The MS shall activate the channel in sending and receiving mode. The MS shall establish a signalling link. The MS shall be ready to transmit a HANDOVER COMPLETE message before x ms after the end of the PHYSICAL INFORMATION message, but not before a UA frame has been sent by the SS. After the successful handover procedure the SS sends the ALERTING message. The correct alerting indication shall be given to the user (only applicable if the MS supports this feature). The SS sends the CONNECT message indicating that the call has been answered. The EFR speech channel shall be through connected in both directions. The MS shall send then the CONNECT ACKNOWLEDGE message as the response on the CONNECT message. Having reached the active state, the call is cleared by the SS.

The term "ready to transmit" is defined in 3GPP TS 04.13. The value of " x " depends upon the target channel and is specified in the specific message contents section.

Maximum Duration of Test

1 minute, including 30 s for any necessary operator actions.

Expected Sequence

Step	Direction	Message	Comments
1	-----	-----	A MO call is initiated on cell A.
2	MS -> SS	CHANNEL REQUEST	Establishment cause is "originating call and the network does not set the NECI bit to 1".
3	SS -> MS	IMMEDIATE ASSIGNMENT	See specific message contents.
4	MS -> SS	CM SERVICE REQUEST	CM Service Type = Mobile Originating Call Establishment.
5	SS -> MS	AUTHENTICATION REQUEST	
6	MS -> SS	AUTHENTICATION RESPONSE	SRES specifies correct value.
7	SS -> MS	CIPHERING MODE COMMAND	SS starts deciphering after sending the message.
8	MS -> SS	CIPHERING MODE COMPLETE	Shall be sent enciphered. All following messages shall be sent enciphered.
9	SS		SS starts ciphering.
10	MS -> SS	SETUP	EFR speech
11	SS -> MS	CALL PROCEEDING	
12	SS -> MS	HANDOVER COMMAND	See specific message contents.
13	MS -> SS	HANDOVER ACCESS	Repeated on every burst of the uplink main DCCH (and optionally on the SACCH) until reception of PHYSICAL INFORMATION. Handover Reference as included in the HANDOVER COMMAND.
14	SS -> MS	PHYSICAL INFORMATION	Sent after reception of n HANDOVER ACCESS message. Timing Advance is arbitrarily chosen.
15	MS -> SS	SABM	Sent without information field.
16	SS -> MS	UA	
17	MS -> SS	HANDOVER COMPLETE	This message shall be ready to be transmitted before " x " ms after the completion of step 14.
18	SS -> MS	ALERTING	
19	MS		Depending on the PICS, an alerting indication is given.
20	SS -> MS	CONNECT	
21	MS -> SS	CONNECT ACKNOWLEDGE	
22	MS		The EFR speech channel is through connected in both directions.
23	SS -> MS	DISCONNECT	
24	MS -> SS	RELEASE	
25	SS -> MS	RELEASE COMPLETE	
26	SS -> MS	CHANNEL RELEASE	The main signalling link is released.

Specific Message Contents

IMMEDIATE ASSIGNMENT

Information Element	value/remark
As default message contents except: Channel Description - Channel Type - TDMA offset - Timeslot number - Training Sequence Code - Hopping - ARFCN	Channel Description. SDCCH/8 As default message contents. As default message contents. Chosen arbitrarily. Single RF Channel. Chosen arbitrarily from the Cell Allocation of Cell A.

HANDOVER COMMAND

Information Element	value/remarks
As default message contents, except: Cell Description - Network Colour Code - Base Station Colour Code - BCCH Carrier Number Channel Description - Channel Type - TDMA offset - Timeslot number - Training Sequence Code - Hopping - MAIO - HSN Synchronization Indication IE is not included Frequency list after time - Frequency List Channel Mode IE	3 0 See the table below. TCH/F + ACCHs Chosen arbitrarily. Chosen arbitrarily but not zero. Chosen arbitrarily. RF hopping channel. Chosen arbitrarily from the set (0, 1 to N-1), where N is the number of frequencies encoded in the Frequency List IE. Zero (this gives cyclic hopping). Allocate frequencies as per the following table. Speech (full rate version 2 or half rate version 2).

HANDOVER COMMAND			
Band	Frequency List		BCCH Carrier Number
	Format	ARFCNs	ARFCN
GSM 450	Range 128	260, 262, 264, 266, 268, 270, 272, 276, 279, 281, 283, 285, 287, 289, 291	274
GSM 480	Range 128	307, 309, 311, 313, 315, 317, 319, 323, 326, 328, 330, 332, 334, 336, 338	321
GSM 710	Range 128	451, 455, 459, 461, 467, 468, 475, 497, 498, 500, 501, 502, 503, 506, 508	477
GSM 750	Range 128	451, 455, 459, 461, 467, 468, 475, 497, 498, 500, 501, 502, 503, 506, 508	477
T-GSM 810	Range 128	451, 455, 459, 461, 467, 468, 475, 497, 498, 500, 501, 502, 503, 506, 508	477
GSM 850	Range 128	141, 145, 149, 151, 157, 158, 165, 187, 193, 200, 201, 202, 203, 235, 241	167
GSM 900	Bitmap 0	14, 18, 22, 24, 30, 31, 38, 60, 66, 73, 74, 75, 76, 108, 114	40
DCS 1 800	Range 128	746, 779	764
PCS 1 900	Range 128	646, 679	664

Step 17: "x" = 500.

26.12.7 EFR Signalling / Directed Retry / Mobile Terminated Call

This test is applicable to all MS which support EFR speech.

NOTE: This test is derived from the one defined in subclause 26.9.8 and entitled "Directed Retry / MS originated call".

26.12.7.1 Conformance requirements

The MS shall correctly apply the Directed Retry procedure from SDCCH/8 with frequency hopping to TCH/EFR with frequency hopping and starting time in the non-synchronized case during call establishment. The call control entity of the Mobile Station in the "call delivered" state shall, if the MS supports immediate connect, continue the call establishment by through-connecting the EFR traffic channel in both directions, or if the MS does not support immediate connect, send an ALERTING message. The MS indicates acceptance of a MT call by sending CONNECT.

The mobile station shall attach the user connection at latest when sending the CONNECT message, except if there is no compatible radio resource available at this time. In this case the attachment shall be delayed until such a resource becomes available.

References

3GPP TS 04.08 / 3GPP TS 44.018, subclauses 3.4.4 and 9.1.15.

3GPP TS 04.08 / 3GPP TS 24.008, subclauses 5.2.2.5, 5.2.2.6 and 5.2.2.9.

3GPP TS 04.13, subclause 5.2.6.2.

26.12.7.2 Test purpose

To test that when the MS is ordered to perform a non-synchronized handover after the CALL CONFIRM message, it continuously sends access bursts on the main DCCH (and optionally on the SACCH) until it receives a PHYSICAL INFORMATION message from the SS. To test that the MS correctly takes the values of the Timing Advance information element in the PHYSICAL INFORMATION message into account. To test that the MS activates the new channel correctly and transmits the HANDOVER COMPLETE message without undue delay. To test that the call control entity of the Mobile Station in the "call delivered" state, if the MS supports immediate connect, continues the call establishment by through-connecting the EFR traffic channel in both directions, or if the MS does not support immediate connect, sends an ALERTING message. To test that the MS indicates acceptance of a MT call by sending CONNECT.

To test that the mobile station attaches the user connection at latest when sending the CONNECT message, except if there is no compatible radio resource available at this time. To test that in this case the attachment is delayed until such a resource becomes available.

26.12.7.3 Method of test

Initial Conditions

System Simulator:

2 cells A and B with same LAI, default parameters, except:

Cell A has:

BCCH ARFCN = See the table below

Cell Allocation = Allocate as per the table below.

PLMN colour code, NCC = as defaults.

BS colour code, BCC = as defaults.

PLMN_PERM = 00001010.

Cell B has:

BCCH ARFCN = See the table below..

Cell Allocation = Allocate as per the table below.

PLMN colour code, NCC = 3.

BS colour code, BCC = 0.

Band	Cell A		Cell B		Both Cells Format
	BCCH ARFCN	Cell Allocation	BCCH ARFCN	Cell Allocation	
GSM 450	263	259, 261, 263, 265, 267, 269, 271, 273, 275, 277, 279, 281, 283, 285, 287, 289, 291	274	260, 262, 264, 266, 268, 270, 272, 274, 276, 279, 281, 283, 285, 287, 289, 291	Range 128
GSM 480	310	306, 308, 310, 312, 314, 316, 318, 320, 322, 324, 326, 328, 330, 332, 334, 336, 338	321	307, 309, 311, 313, 315, 317, 319, 321, 323, 326, 328, 330, 332, 334, 336, 338	Range 128
GSM 710	457	447, 454, 457, 463, 471, 479, 482, 483, 489, 496, 498, 500, 501, 502, 503, 506, 508	477	451, 455, 459, 461, 467, 468, 475, 477, 497, 498, 500, 501, 502, 503, 506, 508	Range 128
GSM 750	457	447, 454, 457, 463, 471, 479, 482, 483, 489, 496, 498, 500, 501, 502, 503, 506, 508	477	451, 455, 459, 461, 467, 468, 475, 477, 497, 498, 500, 501, 502, 503, 506, 508	Range 128
T-GSM 810	457	447, 454, 457, 463, 471, 479, 482, 483, 489, 496, 498, 500, 501, 502, 503, 506, 508	477	451, 455, 459, 461, 467, 468, 475, 477, 497, 498, 500, 501, 502, 503, 506, 508	Range 128
GSM 850	147	137, 144, 147, 153, 161, 169, 172, 173, 179, 186, 193, 200, 201, 202, 203, 235, 241	167	141, 145, 149, 151, 157, 158, 165, 167, 187, 193, 200, 201, 202, 203, 235, 241	Range 128
GSM 900	20	10, 17, 20, 26, 34, 42, 45, 46, 52, 59, 66, 73, 74, 75, 76, 108, 114	40	14, 18, 22, 24, 30, 31, 38, 40, 60, 66, 73, 74, 75, 76, 108, 114	Range 128
DCS 1 800	747	734, 741, 747, 754, 759, 762, 766, 767, 773, 775, 779, 782, 791, 798, 829, 832, 844	764	739, 743, 746, 749, 756, 758, 761, 764, 771, 779, 782, 791, 798, 829, 832, 844	Range 512
PCS 1 900	647	634, 641, 647, 654, 659, 662, 666, 667, 673, 675, 679, 682, 691, 698, 729, 732, 744	664	639, 643, 646, 649, 656, 658, 661, 664, 671, 679, 682, 691, 698, 729, 732, 744	Range 512

Both cells send SYSTEM INFORMATION TYPE 1 messages containing the complete Cell Allocation of the cell. The timebase of Cells A and B shall be such that the edges of their timeslots are not coincident at the antenna connector.

A non-combined SDCCH is used.

Mobile Station:

The MS is in the "idle, updated" state, with a TMSI allocated and camped on cell A.

Specific PICS statements:

- Immediate connect supported for all circuit switched basic services. (TSPC_AddInfo_ImmConn)

PIXIT statements:

- Way to indicate alerting.
- Way to make the MS accept an incoming call after alerting.

Foreseen Final State of the MS

"Idle, updated" with TMSI allocated and camped on cell B.

Test Procedure

The MS is paged on Cell A. The MS responds to the PAGING REQUEST message and establishes a mobile terminated speech call on Cell A. If the MS supports immediate connect, it continues the call establishment by through-connecting the traffic channel in both directions, or if the MS does not support immediate connect, it sends an ALERTING message. The MS indicates acceptance of a MT call by sending CONNECT.

After the MS has sent the CALL CONFIRMED message (if the MS supports immediate connect then the MS sends the CONNECT message after the CALL CONFIRMED message on the old channel) the SS sends a HANDOVER COMMAND message, ordering the MS to switch to cell B. The MS shall then begin to send access bursts on the new DCCH (and optionally on the SACCH) to cell B. The SS observes the access bursts and after receiving n (n being arbitrarily chosen between values according to table 26.6-2 of subclause 26.6.5) access bursts, the SS sends one PHYSICAL INFORMATION message with an arbitrarily chosen Timing Advance. The MS shall activate the channel in sending and receiving mode. The MS shall establish a signalling link. The MS shall be ready to transmit a HANDOVER COMPLETE message before x ms after the end of the PHYSICAL INFORMATION message, but not before a UA frame has been sent by the SS. After the successful handover procedure the MS sends the ALERTING message (if the MS runs the immediate connect procedure then the MS does not send an ALERTING message). The correct alerting indication shall be given to the user (only applicable if the MS supports the feature or if the MS is not using the immediate connect procedure). After the MS sent the CONNECT message the EFR speech channel shall be through connected in both directions. The SS sends then the CONNECT ACKNOWLEDGE message as the response on the CONNECT message. Having reached the active state, the call is cleared by the SS.

The term "ready to transmit" is defined in 3GPP TS 04.13. The value of " x " depends upon the target channel and is specified in the specific message contents section.

Maximum Duration of Test

1 minute, including 30 s for any necessary operator actions.

Expected Sequence

Step	Direction	Message	Comments
1	SS -> MS	PAGING REQUEST TYPE 1	Sent on the correct paging subchannel on cell A.
2	MS -> SS	CHANNEL REQUEST	
3	SS -> MS	IMMEDIATE ASSIGNMENT	See specific message contents.
4	MS -> SS	PAGING RESPONSE	Message is contained in SABM.
5	SS -> MS	AUTHENTICATION REQUEST	
6	MS -> SS	AUTHENTICATION RESPONSE	SRES specifies correct value.
7	SS -> MS	CIPHERING MODE COMMAND	SS starts deciphering after sending the message.
8	MS -> SS	CIPHERING MODE COMPLETE	Shall be sent enciphered. All following messages shall be sent enciphered.
9	SS		SS starts ciphering.
10	SS -> MS	SETUP	EFR speech.
11	MS -> SS	CALL CONFIRMED	
			If the MS supports immediate connect then branch A applies. If the MS does not support immediate connect then branch B applies
A12	MS -> SS	CONNECT	sent on the old channel
A13	SS -> MS	HANDOVER COMMAND	See specific message contents.
A14	MS -> SS	HANDOVER ACCESS	Repeated on every burst of the uplink main DCCH (and optionally on the SACCH) until reception of PHYSICAL INFORMATION. Handover Reference as included in the HANDOVER COMMAND. The first HANDOVER ACCESS message shall be transmitted in the indicated frame (unless the indicated frame is not used by that channel, in which case the next frame used by that channel shall be used).
A15	SS -> MS	PHYSICAL INFORMATION	Sent after reception of n HANDOVER ACCESS message. Timing Advance is arbitrarily chosen.
A16	MS -> SS	SABM	Sent without information field.
A17	SS -> MS	UA	
A18	MS -> SS	HANDOVER COMPLETE	This message shall be ready to be transmitted before "x" ms after the completion of step A15.
B12	SS -> MS	HANDOVER COMMAND	See specific message contents.
B13	MS -> SS	HANDOVER ACCESS	Repeated on every burst of the uplink main DCCH (and optionally on the SACCH) until reception of PHYSICAL INFORMATION. Handover Reference as included in the HANDOVER COMMAND. The first HANDOVER ACCESS message shall be transmitted in the indicated frame (unless the indicated frame is not used by that channel, in which case the next frame used by that channel shall be used).
B14	SS -> MS	PHYSICAL INFORMATION	Sent after reception of n HANDOVER ACCESS message. Timing Advance is arbitrarily chosen.
B15	MS -> SS	SABM	Sent without information field.
B16	SS -> MS	UA	
B17	MS -> SS	HANDOVER COMPLETE	This message shall be ready to be transmitted before "x" ms after the completion of step B14.
B18	MS -> SS	ALERTING	
B19	MS		Gives an alerting indication as defined in a PICS/PIXIT statement is given by the MS
B20	MS		The MS is made to accept the call in the way described in a PICS/PIXIT statement
B21	MS -> SS	CONNECT	
22	MS		The TCH/EFR channel shall be through connected in both directions.
23	SS -> MS	CONNECT ACKNOWLEDGE	
24	SS -> MS	DISCONNECT	
25	MS -> SS	RELEASE	
26	SS -> MS	RELEASE COMPLETE	
27	SS -> MS	CHANNEL RELEASE	The main signalling link is released.

Specific Message Contents

IMMEDIATE ASSIGNMENT

Information Element	value/remark
As default message contents except: L2 pseudo length Channel Description <ul style="list-style-type: none"> - Channel Type - TDMA offset - Timeslot number - Training Sequence Code - Hopping - MAIO <ul style="list-style-type: none"> - HSN Mobile Allocation	14 octets (11 + contents of the MA). SDCCH/8 As default message contents. Arbitrary value, but not zero. Chosen arbitrarily. RF hopping channel. Chosen arbitrarily from the set (0, 1 to N-1), where N is the number of frequencies encoded in the Mobile Allocation. Chosen arbitrarily from the set (1,2,..63). Contents Indicates only three frequencies. See the table below.

IMMEDIATE ASSIGNMENT		
Band	Mobile Allocation	
	Length	Contents
GSM 450	3 Octets	281, 283, 285
GSM 480	3 Octets	328, 330, 332
GSM 710	3 Octets	500, 501, 502
GSM 750	3 Octets	500, 501, 502
T-GSM 810	3 Octets	500, 501, 502
GSM 850	3 Octets	200, 201, 202
GSM 900	3 Octets	73, 74, 75
DCS 1 800	3 Octets	773, 775, 779
PCS 1 900	3 Octets	673, 675, 679

HANDOVER COMMAND

Information Element	value/remarks
As default message contents, except: Cell Description <ul style="list-style-type: none"> - Network Colour Code - Base Station Colour Code - BCCH Carrier Number Channel Description <ul style="list-style-type: none"> - Channel Type - TDMA offset - Timeslot number - Training Sequence Code - Hopping - MAIO <ul style="list-style-type: none"> - HSN Frequency List after time <ul style="list-style-type: none"> - Frequency List Synchronization Indication <ul style="list-style-type: none"> - Report Observed Time Difference - Synchronization Indication - Normal Cell Indication Mode of First Channel Starting Time	3 0 See below table TCH/F + ACCHs Chosen arbitrarily. Chosen arbitrarily, but not Zero. Chosen arbitrarily. RF hopping channel. Chosen arbitrarily from the set (0, 1 to N-1), where N is the number of frequencies encoded in the Frequency List IE. Chosen arbitrarily from the set (1,2,..63). Allocate frequencies as per the table below Shall not be included. "Non synchronized". Ignore out of range timing advance. Speech (full rate version 2 or half rate version 2). Indicates the frame number of cell B. that will occur approximately 1,1 seconds (238 frames have elapsed) after the HANDOVER COMMAND is sent by cell A.

HANDOVER COMMAND			
Band	Frequency List		BCCH Carrier Number
	Format	ARFCNs	ARFCN
GSM 450	Range 128	260, 262, 264, 266, 276, 279, 281, 283, 285, 287, 289, 291	274
GSM 480	Range 128	307, 309, 311, 313, 323, 326, 328, 330, 332, 334, 336, 338	321
GSM 710	Range 128	451, 455, 459, 461, 497, 498, 500, 501, 502, 503, 506, 508	477
GSM 750	Range 128	451, 455, 459, 461, 497, 498, 500, 501, 502, 503, 506, 508	477
T-GSM 810	Range 128	451, 455, 459, 461, 497, 498, 500, 501, 502, 503, 506, 508	477
GSM 850	Range 128	141, 145, 149, 151, 187, 193, 200, 201, 202, 203, 235, 241	167
GSM 900	Bitmap 0	14, 18, 22, 24, 60, 66, 73, 74, 75, 76, 108, 114	40
DCS 1 800	Range 1 024	749, 758, 761, 764, 771, 779, 782, 791, 798, 829, 832, 844	764
PCS 1 900	Range 1 024	649, 658, 661, 664, 671, 679, 682, 691, 698, 729, 732, 744	664

Step A18 / B17: "x" = 750.

26.12.8 Default contents of layer 3 messages for Enhanced Full rate speech tests

Refer to table 26.6, except for:

Contents of ASSIGNMENT COMMAND message:

Protocol Discriminator	RR Management
Skip Indicator	0000
Message Type	00101110
Channel Description	
- Channel Type and TDMA offset	TCH/F + ACCHs
- Timeslot Number	Chosen arbitrarily by the test house
- Training Sequence Code	Chosen arbitrarily by the test house
- Hopping	Single RF channel
- ARFCN	See the table below
Power Command	
- Power level	Chosen arbitrarily by the test house
Mode of the first channel	
- Mode	speech full rate or half rate version 2
All other information elements	Not present

ASSIGNMENT COMMAND	
Band	Channel Description
	ARFCN
GSM 450	267
GSM 480	315
GSM 710	467
GSM 750	467
T-GSM 810	467
GSM 850	157
GSM 900	30
DCS 1 800	650
PCS 1 900	650

CALL CONFIRMED

Information element	Value/remark
Repeat indicator	Omitted
Bearer capability 1	coding as described in subclause 11.8.2.9
Bearer capability 2	Omitted
Cause	Omitted

Contents of CHANNEL MODE MODIFY message:

Protocol Discriminator	RR Management
Skip Indicator	0000
Message Type	00010000
Channel Description	same as the dedicated channel currently allocated
Channel Mode	
- Mode	speech full rate version 2

Contents of CHANNEL MODE MODIFY ACKNOWLEDGE message:

Protocol Discriminator	RR Management
Skip Indicator	0000
Message Type	00010111
Channel Description	same as the dedicated channel currently allocated
Channel Mode	
- Mode	Speech full rate version 2

Contents of HANDOVER COMMAND message:

Protocol Discriminator	RR Management
Skip Indicator	0000
Message Type	00101011
Cell Description	
- Network Colour Code	1
- Base station Colour Code	5
- BCCH Carrier Number	Set to the BCCH carrier number of cell B. (one of the values from the below table)
Channel Description	
- Channel Type and TDMA offset	TCH/F + ACCHs
- Timeslot Number	Chosen arbitrarily by the test house
- Training Sequence Code	Chosen arbitrarily by the test house
- Hopping	Single RF channel
- ARFCN	Chosen arbitrarily by the test house from those supported on the target cell
Handover Reference	
- Handover Reference Value	Chosen arbitrarily by the test house.
Power Command	
- Power level	Chosen arbitrarily by the test house
Mode of the first channel	
- Mode	speech full/half rate version 2
All other information elements	Not present

HANDOVER COMMAND	
Band	Cell Description
	BCCH ARFCN
GSM 450	261, 263, 282, 284, 287, 290, 293
GSM 480	308, 310, 329, 331, 334, 337, 340
GSM 710	447, 457, 480, 499, 504, 507, 510
GSM 750	447, 457, 480, 499, 504, 507, 510
T-GSM 810	447, 457, 480, 499, 504, 507, 510
GSM 850	137, 147, 207, 217, 227, 237, 247
GSM 900	10, 20, 80, 90, 100, 110, 120
DCS 1 800	of 520, 590, 600, 700, 780, 810, 870
PCS 1 900	520, 590, 650, 600, 680, 710, 770

Contents of SETUP message; (MS to SS);

Protocol Discriminator	Call Control
Transaction Identifier	
TI value	any value from the set {0, ..., 6}
TI flag	0
Message Type	0X000101
Other information elements	Not checked
Protocol Discriminator	Call Control
Transaction Identifier	set {0, ..., 6}
TI flag	0
BC repeat indicator	Not present
Bearer capability 1	coding as described in subclause 11.8.2.9
All other information elements	Not present

Contents of SETUP message; (SS to MS for speech teleservice)

Protocol Discriminator	Call Control
Transaction Identifier	
TI value	any value from the set {0, ..., 6}
TI flag	0
Message Type	0X000101
Other information elements	Not checked
Protocol Discriminator	Call Control
Transaction Identifier	set {0, ..., 6}
TI flag	0
BC repeat indicator	Not present
Bearer capability 1	
octet 2	
length	01 H
octet 3	
extension	1
radio channel requirement	01
coding standard	GSM standardized coding
transfer mode	circuit mode
information transfer capability	speech
All other information elements	Not present

26.13 Multislot signalling

26.13.1 Multislot signalling / RR

26.13.1.1 Multislot signalling / RR / Measurement

26.13.1.1.1 Multislot signalling / RR / Measurement / symmetric

26.13.1.1.1.1 Conformance requirements

The MS shall continuously send MEASUREMENT REPORT messages, on every uplink HSCSD channel used, on every SACCH blocks and the measurement valid indication shall be set to valid (0) within the second block at the latest. After 20 s the values in the MEASUREMENT REPORT message shall contain measurement results for the 4 strongest BCCH carriers with known and allowed NCC part of BSIC.

References

3GPP TS 04.08 / 3GPP TS 44.018, subclauses 3.4.1.2 and 9.1.21.

3GPP TS 05.08, subclause 8.4.

26.13.1.1.1.2 Test purpose

- 1) To test that, when a combination of normal neighbours, and non-permitted NCCs is "on air", the MS reports only on normal neighbours and that in symmetric HSCSD configuration the neighbouring cell measurement reports are copied on every uplink HSCSD channel used.

26.13.1.1.1.3 Method of test

Initial Conditions

System Simulator:

For GSM 450 or GSM 480: 8 cells with the following settings:

Transmitter	Level	NCC	BSCC	ARFCN (GSM 450)	ARFCN (GSM 480)	Cell Identity
Serving, S1	-60	1	3	260	307	0001H
Neighbour, N1	-85	1	5	264	311	0002H
Neighbour, N2	-80	1	7	268	315	0003H
Neighbour, N3	-75	2	1	272	319	0004H
Neighbour, N4	-55	3	3	276	323	0005H
Neighbour, N5	-50	4	5	280	327	0006H
Neighbour, N6	-45	1	7	284	331	0007H
Neighbour, N7	-40	1	1	288	335	0008H

For GSM 900 or DCS 1 800: 8 cells with the following settings:

Transmitter	Level	NCC	BSCC	ARFCN (GSM 900)	ARFCN (DCS 1 800)	Cell Identity
Serving, S1	-60	1	3	002	514	0001H
Neighbour, N1	-85	1	5	008	530	0002H
Neighbour, N2	-80	1	7	014	602	0003H
Neighbour, N3	-75	2	1	020	665	0004H
Neighbour, N4	-55	3	3	026	762	0005H
Neighbour, N5	-50	4	5	032	686	0006H
Neighbour, N6	-45	1	7	038	549	0007H
Neighbour, N7	-40	1	1	044	810	0008H

For GSM 700 or GSM 850: 8 cells with the following settings:

Transmitter	Level	NCC	BSCC	ARFCN (GSM 700)	ARFCN GSM 850)	Cell Identity
Serving, S1	-60	1	3	439	129	0001H
Neighbour, N1	-85	1	5	445	135	0002H
Neighbour, N2	-80	1	7	451	141	0003H
Neighbour, N3	-75	2	1	457	147	0004H
Neighbour, N4	-55	3	3	463	153	0005H
Neighbour, N5	-50	4	5	469	159	0006H
Neighbour, N6	-45	1	7	475	165	0007H
Neighbour, N7	-40	1	1	481	171	0008H

With the exception of the Cell Allocation, the rest of the parameters for all eight cells are the same as the default settings and default SYSTEM INFORMATION TYPE 1 to 4 message contents for cell A. The Cell Allocation for the serving cell is the same as the default setting for cell A. The Cell Allocations for the neighbour cells need have only one entry, consisting of the ARFCN of that cell's BCCH.

Mobile Station:

The MS is in the active state of a service using symmetric multislot connection.

Specific PICS statements:

- Multislot class (TSPC_Type_Multislot_ClassX)

PIXIT statements:

-

Foreseen Final State of the MS

Active state of a service using symmetric multislot connection.

Test Procedure

This test procedure is repeated for all the symmetric multislot configurations MS supports.

With the MS having a multislot connection in progress, the SS sends SYSTEM INFORMATION TYPE 5 & 6 on the SACCH/M. All 7 of the BCCHs "on air" are indicated in the BA (N1 is excluded). The MS shall send MEASUREMENT REPORTs back to the SS on every uplink HSCSD channel, and it shall be indicated in these that measurement results for the 4 strongest carriers have been obtained.

Maximum Duration of Test

5 minutes, including 1 minute for any necessary operator actions.

Expected Sequence

SYSTEM INFORMATION TYPE 5, SYSTEM INFORMATION TYPE 6 and MEASUREMENT REPORT are sent continuously, a table is not applicable in this test. The interval between 2 successive Layer 2 frames containing MEASUREMENT REPORTs shall not exceed one Layer 2 frame.

Specific Message Contents

SYSTEM INFORMATION TYPE 5

DCS 1 800 and PCS 1 900 begin:

Information Element	value/remark
Neighbour Cells Description - Format Identifier - EXT IND - W(i)	1024 range Information Element carries complete BA. Non null for ARFCN 514, 549, 602, 665, 686, 762, 810.

DCS 1 800 and PCS 1 900 end:

Other bands begin:

Information Element	value/remark
Neighbour Cells Description Format Identifier BCCH Allocation Sequence BCCH Allocation ARFCN - EXT IND	See the table below 1 See the table below Information Element carries complete BA.

Band	Neighbour Cells Description	
	Format Identifier	BCCH Allocation ARFCN
GSM 450	Range 128	259, 260, 262, 263, 264, 266, 267, 268, 269, 270, 271, 272, 274, 275, 276, 277, 278, 280, 281, 282, 283, 284, 285, 286, 287, 288, 290, 291, 292, 293
GSM 480	Range 128	306, 307, 308, 310, 311, 312, 313, 315, 316, 317, 318, 319, 321, 322, 323, 324, 325, 326, 327, 329, 330, 331, 332, 333, 334, 335, 337, 338, 339, 340
GSM 710	Range 128	439, 441, 442, 443, 444, 446, 447, 448, 449, 450, 451, 453, 454, 455, 456, 457, 458, 460, 461, 463, 465, 466, 467, 469, 471, 472, 473, 475, 477 and 481
GSM 750	Range 128	439, 441, 442, 443, 444, 446, 447, 448, 449, 450, 451, 453, 454, 455, 456, 457, 458, 460, 461, 463, 465, 466, 467, 469, 471, 472, 473, 475, 477 and 481
T-GSM 810	Range 128	439, 441, 442, 443, 444, 446, 447, 448, 449, 450, 451, 453, 454, 455, 456, 457, 458, 460, 461, 463, 465, 466, 467, 469, 471, 472, 473, 475, 477 and 481
GSM 850	Range 128	129, 131, 132, 133, 134, 136, 137, 138, 139, 140, 141, 143, 144, 145, 146, 147, 148, 150, 151, 153, 155, 156, 157, 159, 161, 162, 163, 165, 167 and 171
GSM 900	Bit map 0	2, 4, 5, 6, 7, 9, 10, 11, 12, 13, 14, 16, 17, 18, 19, 20, 21, 23, 24, 26, 28, 29, 30, 32, 34, 35, 36, 38, 40 and 44

Other bands end:

SYSTEM INFORMATION TYPE 6:

Information Element	value/ remark
Protocol Discriminator	RR Management
Message Type	sys info 6
Cell Identity	Default
LAI	Default
Cell Options	
- Power Control Indicator	Power Control Indicator is set
- DTX Indicator	MS shall not use DTX
- Radio-Link-Time-out	Default
PLMN permitted	only NCC 1 permitted

MEASUREMENT REPORT

Information Element	value/remark
Protocol Discriminator	RR Management
Transaction Identifier	0000
Message Type	MEASUREMENT REPORT
Measurement Results	
BA_used	1
DTX_used	DTX was not used
RXLEV_FULL_SERVING_CELL	See note 1
RXLEV_SUB_SERVING_CELL	See note 1
MEAS_VALID	See note 2
RXQUAL_FULL_SERVING_CELL	See note 1
RXQUAL_SUB_SERVING_CELL	See note 1
NO_NCELL_M	4 neighbour cell measurement results
RXLEV_NCELL_1	See note 1
BCCH_FREQ_NCELL_1	Corresponds to one of N7, N6, S1 or N2
BSIC_NCELL_1	Corresponds to that of BCCH_FREQ_NCELL_1
RXLEV_NCELL_2	See note 1
BCCH_FREQ_NCELL_2	Corresponds to one of N7, N6, S1 or N2
BSIC_NCELL_2	Corresponds to that of BCCH_FREQ_NCELL_2
RXLEV_NCELL_3	See note 1
BCCH_FREQ_NCELL_3	Corresponds to one of N7, N6, S1 or N2
BSIC_NCELL_3	Corresponds to that of BCCH_FREQ_NCELL_3
RXLEV_NCELL_4	See note 1
BCCH_FREQ_NCELL_4	Corresponds to one of N7, N6, S1 or N2
BSIC_NCELL_4	Corresponds to that of BCCH_FREQ_NCELL_4
RXLEV_NCELL_5	00 0000
BCCH_FREQ_NCELL_5	0 0000
BSIC_NCELL_5	00 0000
RXLEV_NCELL_6	00 0000
BCCH_FREQ_NCELL_6	0 0000
BSIC_NCELL_6	00 0000

This message shall contain one report on each of N7, N6, S1 and N2.

NOTE 1: These actual values are not checked.

NOTE 2: The Measurement Valid Indication shall be set to valid within the second SACCH block at the latest.

26.13.1.1.2 Multislot signalling / RR / Measurement / asymmetric

26.13.1.1.2.1 Conformance requirements

The MS shall continuously send MEASUREMENT REPORT messages, on every uplink HSCSD channel used, on every SACCH blocks and the measurement valid indication shall be set to valid (0) within the second block at the latest. After 20 s the values in the MEASUREMENT REPORT message shall contain measurement results for the 4 strongest BCCH carriers with known and allowed NCC part of BSIC.

References

3GPP TS 04.08 / 3GPP TS 44.018 subclauses 3.4.1.2 and 9.1.21.

3GPP TS 05.08 subclause 8.4.

26.13.1.1.2.2 Test purpose

- 1) To test that, when a combination of normal neighbours, barred cells and non-permitted NCCs is "on air", the MS reports only on normal neighbours and that in asymmetric HSCSD configuration the neighbouring cell measurement reports are copied on every uplink HSCSD channel used.

26.13.1.1.2.3 Method of test

Initial Conditions

System Simulator:

For GSM 450 or GSM 480: 8 cells with the following settings:

Transmitter	Level	NCC	BSCC	ARFCN (GSM 450)	ARFCN (GSM 480)	Cell Identity
Serving, S1	-60	1	3	260	307	0001H
Neighbour, N1	-85	1	5	264	311	0002H
Neighbour, N2	-80	1	7	268	315	0003H
Neighbour, N3	-75	2	1	272	319	0004H
Neighbour, N4	-55	3	3	276	323	0005H
Neighbour, N5	-50	4	5	280	327	0006H
Neighbour, N6	-45	1	7	284	331	0007H
Neighbour, N7	-40	1	1	288	335	0008H

For GSM 900 or DCS 1 800: 8 cells with the following settings:

Transmitter	Level	NCC	BSCC	ARFCN (GSM 900)	ARFCN (DCS 1 800)	Cell Identity
Serving, S1	-60	1	3	002	514	0001H
Neighbour, N1	-85	1	5	008	530	0002H
Neighbour, N2	-80	1	7	014	602	0003H
Neighbour, N3	-75	2	1	020	665	0004H
Neighbour, N4	-55	3	3	026	762	0005H
Neighbour, N5	-50	4	5	032	686	0006H
Neighbour, N6	-45	1	7	038	549	0007H
Neighbour, N7	-40	1	1	044	810	0008H

For GSM 700 or GSM 850: 8 cells with the following settings:

Transmitter	Level	NCC	BSCC	ARFCN (GSM 700)	ARFCN (GSM 850)	Cell Identity
Serving, S1	-60	1	3	439	129	0001H
Neighbour, N1	-85	1	5	445	135	0002H
Neighbour, N2	-80	1	7	451	141	0003H
Neighbour, N3	-75	2	1	457	147	0004H
Neighbour, N4	-55	3	3	463	153	0005H
Neighbour, N5	-50	4	5	469	159	0006H
Neighbour, N6	-45	1	7	475	165	0007H
Neighbour, N7	-40	1	1	481	171	0008H

With the exception of the Cell Allocation, the rest of the parameters for all eight cells are the same as the default settings and default SYSTEM INFORMATION TYPE 1 to 4 message contents for cell A. The Cell Allocation for the serving cell is the same as the default setting for cell A. The Cell Allocations for the neighbour cells need have only one entry, consisting of the ARFCN of that cell's BCCH.

Mobile Station:

The MS is in the active state of a service using asymmetric multislot connection.

Specific PICS statements:

- Multislot class (TSPC_Type_Multislot_ClassX)

PIXIT statements:

-

Foreseen Final State of the MS

Active state of a service using asymmetric multislot connection.

Test Procedure

This test procedure is performed twice.

MS having a multislot connection with maximum number of timeslots in the downlink and one slot in uplink direction in progress, the SS sends SYSTEM INFORMATION TYPE 5 & 6 (on the second iteration of the test two timeslots are used in the downlink and one in uplink direction the SS also sends SYSTEM INFORMATION TYPE 5bis) on the SACCH/M. All 7 of the BCCHs "on air" are indicated in the BA (N1 is excluded). The MS shall send MEASUREMENT REPORTs back to the SS on every uplink HSCSD channel, and it shall be indicated in these that measurement results for the 4 strongest carriers have been obtained.

Maximum Duration of Test

5 minutes, including 1 minute for any necessary operator actions.

Expected Sequence

This sequence is performed for execution counter, $k = 1, 2$.

Since when $k = 1$, SYSTEM INFORMATION TYPE 5, SYSTEM INFORMATION TYPE 6 and MEASUREMENT REPORT (and when $k = 2$ an additional SYSTEM INFORMATION TYPE 5bis is included) are sent continuously, a table is not applicable in this test. The interval between 2 successive Layer 2 frames containing MEASUREMENT REPORTs shall not exceed one Layer 2 frame.

Specific Message Contents

SYSTEM INFORMATION TYPE 5

DCS 1 800 and PCS 1 900 begin:

Information Element	value/remark
Neighbour Cells Description - Format Identifier - EXT IND - W(i)	1024 range $k = 1$. Information Element carries complete BA. $k = 2$. Information Element carries only a part of the BA. $k = 1$. Non null for ARFCN 514, 530, 549, 602, 665, 686, 762, 810. $k = 2$. Non null for ARFCN 549, 602, 665, 686, 810.

DCS 1 800 and PCS 1 900 end:

Other bands begin:

Information Element	value/remark
Neighbour Cells Description Format Identifier BCCH Allocation Sequence BCCH Allocation ARFCN - EXT IND	See the table below 1 See the table below $k = 1$. Information Element carries complete BA. $k = 2$. Information Element carries only a part of the BA.

Band	Neighbour Cells Description	
	Format Identifier	BCCH Allocation ARFCN
GSM 450	Range 128	259, 260, 261, 262, 263, 264, 265, 267, 268, 269, 270, 271, 272, 273, 274, 275, 276, 278, 279, 280, 281, 282, 283, 284, 285, 286, 287, 288, 289, 290, 291, 292
GSM 480	Range 128	306, 307, 308, 309, 310, 311, 312, 314, 315, 316, 317, 318, 319, 320, 321, 322, 323, 325, 326, 327, 328, 329, 330, 331, 332, 333, 334, 335, 336, 337, 338, 339
GSM 710	Range 128	439, 441, 442, 443, 444, 445, 446, 447, 448, 449, 450, 451, 453, 454, 455, 457, 457, 458, 459, 460, 461, 463, 465, 466, 467, 469, 471, 472, 473, 475, 477, 481
GSM 750	Range 128	439, 441, 442, 443, 444, 445, 446, 447, 448, 449, 450, 451, 453, 454, 455, 457, 457, 458, 459, 460, 461, 463, 465, 466, 467, 469, 471, 472, 473, 475, 477, 481
T-GSM 810	Range 128	439, 441, 442, 443, 444, 445, 446, 447, 448, 449, 450, 451, 453, 454, 455, 457, 457, 458, 459, 460, 461, 463, 465, 466, 467, 469, 471, 472, 473, 475, 477, 481
GSM 850	Range 128	129, 131, 132, 133, 134, 135, 136, 137, 138, 139, 140, 141, 143, 144, 145, 146, 147, 148, 149, 150, 151, 153, 155, 156, 157, 159, 161, 162, 163, 165, 167, 171
GSM 900	Bit map 0	2, 4, 5, 6, 7, 8, 9, 10, 11, 12, 13, 14, 16, 17, 18, 19, 20, 21, 22, 23, 24, 26, 28, 29, 30, 32, 34, 35, 36, 38, 40, 44

Other bands end:

SYSTEM INFORMATION TYPE 5bis (Sent only when k = 2)

Information Element	value/remark
Protocol Discriminator	RR management
Message Type	Sys Info 5bis.
Neighbour Cells Description	
- Format	256 range
- EXT_IND	k = 2. Information Element carries only a part of the BA.
- W(i)	GSM 450: Channel 0 and 800 belong to the BCCH allocation. GSM 480: Channel 0 and 800 belong to the BCCH allocation. GSM 710: Channel 438 and 800 belong to the BCCH allocation. GSM 750: Channel 438 and 800 belong to the BCCH allocation. T-GSM 810: Channel 438 and 800 belong to the BCCH allocation. GSM 850: Channel 128 and 800 belong to the BCCH allocation. GSM 900: Channel 0 and 800 belong to the BCCH allocation. DCS 1 800: Non null ARFCN 20, 514, 530, 549, 762. PCS 1 900: Non null ARFCN 20, 514, 530, 549, 762.

SYSTEM INFORMATION TYPE 6:

Information Element	value/ remark
Protocol Discriminator	RR Management
Message Type	sys info 6
Cell Identity	default
LAI	default
Cell Options	
- Power Control Indicator	Power Control Indicator is set
- DTX Indicator	MS shall not use DTX
- Radio_Link_Timeout	default
PLMN permitted	only NCC 1 permitted

MEASUREMENT REPORT

Information Element	Value/remark
Protocol Discriminator	RR Management
Transaction Identifier	0000
Message Type	MEASUREMENT REPORT
Measurement Results	
BA_used	1
DTX_used	DTX was not used
RXLEV_FULL_SERVING_CELL	See note 1
RXLEV_SUB_SERVING_CELL	See note 1
MEAS_VALID	See note 2
RXQUAL_FULL_SERVING_CELL	See note 1
RXQUAL_SUB_SERVING_CELL	See note 1
NO_NCELL_M	4 neighbour cell measurement results
RXLEV_NCELL_1	See note 1
BCCH_FREQ_NCELL_1	Corresponds to one of N7, N6, S1 or N2
BSIC_NCELL_1	Corresponds to that of BCCH_FREQ_NCELL_1
RXLEV_NCELL_2	See note 1
BCCH_FREQ_NCELL_2	Corresponds to one of N7, N6, S1 or N2
BSIC_NCELL_2	Corresponds to that of BCCH_FREQ_NCELL_2
RXLEV_NCELL_3	See note 1
BCCH_FREQ_NCELL_3	Corresponds to one of N7, N6, S1 or N2
BSIC_NCELL_3	Corresponds to that of BCCH_FREQ_NCELL_3
RXLEV_NCELL_4	See note 1
BCCH_FREQ_NCELL_4	Corresponds to one of N7, N6, S1 or N2
BSIC_NCELL_4	Corresponds to that of BCCH_FREQ_NCELL_4
RXLEV_NCELL_5	00 0000
BCCH_FREQ_NCELL_5	0 0000
BSIC_NCELL_5	00 0000
RXLEV_NCELL_6	00 0000
BCCH_FREQ_NCELL_6	0 0000
BSIC_NCELL_6	00 0000

This message shall contain one report on each of N7, N6, S1 and N2.

NOTE 1: These actual values are not checked.

NOTE 2: The Measurement Valid Indication shall be set to valid within the second SACCH block at the latest.

26.13.1.1.3 Multislot signaling / RR / Measurement / asymmetric / change of the reported subchannel

26.13.1.1.3.1 Conformance requirements

The MS shall continuously send MEASUREMENT REPORT messages, on the main channel, reporting the worst subchannel. One of the other subchannels is made worse than the one originally reported one and the MEASUREMENT REPORTs sent on the main channel are based on the new worst subchannel.

References

3GPP TS 04.08 / 3GPP TS 44.018 subclauses 3.4.1.2 and 9.1.21.

3GPP TS 05.08 subclause 8.4.

26.13.1.1.3.2 Test purpose

- 1) To test that the MS shall report on the main SACCH: RXLEV_FULL and RXLEV_SUB from the main channel and the worst RXQUAL_FULL values and RXQUAL_SUB values from the main channel and the unidirectional channels.
- 2) To test that, when an another subchannel becomes the worst, MEASUREMENT REPORTs sent on the main channel are based on the new worst subchannel.

26.13.1.1.3.3 Method of test

Initial Conditions

System Simulator:

For GSM 450 or GSM 480: 1 cell with the following settings:

Transmitter	Level	NCC	BCC	ARFCN (GSM 450)	ARFCN (GSM 480)	Cell Identity
Serving, S1	-60	1	3	260	307	0001H

For GSM 900 or DCS 1 800: 1 cell with the following settings:

Transmitter	Level	NCC	BCC	ARFCN (GSM 900)	ARFCN (DCS 1 800)	Cell Identity
Serving, S1	-60	1	3	002	514	0001H

For GSM 700 or GSM 850: 1 cell with the following settings:

Transmitter	Level	NCC	BCC	ARFCN (GSM 700)	ARFCN (GSM 850)	Cell Identity
Serving, S1	-60	1	3	439	129	0001H

Mobile Station:

The MS is in the active state of a service using asymmetric multislot connection.

Specific PICS statements:

- Multislot class (TSPC_Type_Multislot_ClassX)

PIXIT statements:

-

Foreseen Final State of the MS

Active state of a service using asymmetric multislot connection.

Test Procedure

MS having a multislot connection with maximum number of timeslots in the downlink and one slot in uplink direction in progress, the SS sends SYSTEM INFORMATION TYPE 5 & 6 on the SACCH/M. The MS shall send MEASUREMENT REPORTs back to the SS on the main channel based on the worst subchannel. The SS allows 2 seconds for the MS to get used to the RF conditions and then records the reported RXQUAL_FULL_SERVING_CELL and RXQUAL_SUB_SERVING_CELL values.

Then an arbitrarily chosen uni-directional subchannel is made the worst from the RX quality point of view by switching off the ciphering in the SS on this channel. The MS shall send MEASUREMENT REPORTs back to the SS on the main channel based on the new worst channel. The SS allows 2 seconds for the MS to get used to the new RF conditions and then records the reported RXQUAL_FULL_SERVING_CELL and RXQUAL_SUB_SERVING_CELL values.

The difference between the RXQUAL values recorded before and after the change in RX quality shall be greater than 3.

Maximum Duration of Test

5 minutes, including 1 minute for any necessary operator actions.

Expected Sequence

Since SYSTEM INFORMATION TYPE 5, SYSTEM INFORMATION TYPE 6 and MEASUREMENT REPORT are sent continuously, a table is not applicable in this test. The interval between 2 successive Layer 2 frames containing MEASUREMENT REPORTs shall not exceed one Layer 2 frame.

Specific Message Contents

GSM 450 begin:

SYSTEM INFORMATION TYPE 5:

Information Element	value/remark
Neighbour Cells Description	Range 128
Format Identifier	1
BCCH Allocation Sequence	The channel numbers 259, 260, 261, 262, 263, 264, 266, 267, 268, 269, 270, 271, 272, 273, 274, 275, 276, 277, 278, 280, 281, 282, 283, 284, 285, 286, 287, 288, 290, 291, 292 and 293 belong to the BCCH allocation.
BCCH Allocation ARFCN	Information Element carries complete BA.
- EXT IND	

SYSTEM INFORMATION TYPE 6:

Information Element	value/remark
Protocol Discriminator	RR Management
Message Type	sys info 6
Cell Identity	default
LAI	default
Cell Options	
- Power Control Indicator	Power Control Indicator is set
- DTX Indicator	MS shall not use DTX
- Radio_Link_Timeout	default
PLMN permitted	NCC 1 permitted

MEASUREMENT REPORT:

Information Element	value/remark
Protocol Discriminator	RR Management
Transaction Identifier	0000
Message Type	MEASUREMENT REPORT
Measurement Results	
BA_used	1
DTX_used	DTX was not used
RXLEV_FULL_SERVING_CELL	See note 1
RXLEV_SUB_SERVING_CELL	See note 1
MEAS_VALID	See note 2
RXQUAL_FULL_SERVING_CELL	The worst subchannel
RXQUAL_SUB_SERVING_CELL	The worst subchannel

GSM 450 end:

GSM 480 begin:

SYSTEM INFORMATION TYPE 5:

Information Element	value/remark
Neighbour Cells Description	Range 128
Format Identifier	1
BCCH Allocation Sequence	The channel numbers numbers 306, 307, 308, 309, 310, 311, 312, 313, 315, 316, 317, 318, 319, 320, 321, 322, 323, 324, 325, 326, 327, 329, 330, 331, 332, 333, 334, 335, 337, 338, 339 and 340 belong to the BCCH allocation.
BCCH Allocation ARFCN	Information Element carries complete BA.
- EXT IND	

SYSTEM INFORMATION TYPE 6:

Information Element	value/remark
Protocol Discriminator	RR Management
Message Type	sys info 6
Cell Identity	default
LAI	default
Cell Options	
- Power Control Indicator	Power Control Indicator is set
- DTX Indicator	MS shall not use DTX
- Radio_Link_Timeout	default
PLMN permitted	NCC 1 permitted

MEASUREMENT REPORT:

Information Element	value/remark
Protocol Discriminator	RR Management
Transaction Identifier	0000
Message Type	MEASUREMENT REPORT
Measurement Results	
BA_used	1
DTX_used	DTX was not used
RXLEV_FULL_SERVING_CELL	See note 1
RXLEV_SUB_SERVING_CELL	See note 1
MEAS_VALID	See note 2
RXQUAL_FULL_SERVING_CELL	The worst subchannel
RXQUAL_SUB_SERVING_CELL	The worst subchannel

GSM 480 end:

GSM 900 begin:

SYSTEM INFORMATION TYPE 5:

Information Element	value/remark
Neighbour Cells Description	
Format Identifier	bit map 0
BCCH Allocation Sequence	1
BCCH Allocation ARFCN	The channel numbers 2, 4, 5, 6, 7, 8, 9, 10, 11, 12, 13, 14, 16, 17, 18, 19, 20, 21, 22, 23, 24, 26, 28, 29, 30, 32, 34, 35, 36, 38, 40 and 44 belong to the BCCH allocation.
- EXT IND	Information Element carries complete BA.

SYSTEM INFORMATION TYPE 6:

Information Element	value/remark
Protocol Discriminator	RR Management
Message Type	sys info 6
Cell Identity	default
LAI	default
Cell Options	
- Power Control Indicator	Power Control Indicator is set
- DTX Indicator	MS shall not use DTX
- Radio_Link_Timeout	default
PLMN permitted	NCC 1 permitted

MEASUREMENT REPORT:

Information Element	value/remark
Protocol Discriminator	RR Management
Transaction Identifier	0000
Message Type	MEASUREMENT REPORT
Measurement Results	
BA_used	1
DTX_used	DTX was not used
RXLEV_FULL_SERVING_CELL	See note 1
RXLEV_SUB_SERVING_CELL	See note 1
MEAS_VALID	See note 2
RXQUAL_FULL_SERVING_CELL	The worst subchannel
RXQUAL_SUB_SERVING_CELL	The worst subchannel

GSM 900 end:

DCS 1 800 begin:

SYSTEM INFORMATION TYPE 5:

Information Element	value/remark
Protocol Discriminator	RR management
Message Type	Sys Info 5.
Neighbour Cells Description	
- Format	1024 range
- EXT IND	Information Element carries complete BA.
- W(i)	Non null for ARFCN 514, 530, 549, 602, 665, 686, 762, 810.

SYSTEM INFORMATION TYPE 6:

Information Element	value/remark
Protocol Discriminator	RR Management
Message Type	sys info 6
Cell Identity	default
LAI	default
Cell Options	
- Power Control Indicator	Power Control Indicator is set
- DTX Indicator	MS shall not use DTX
- Radio_Link_Timeout	default
PLMN permitted	only NCC 1 permitted

MEASUREMENT REPORT:

Information Element	value/remark
Protocol Discriminator	RR Management
Transaction Identifier	0000
Message Type	MEASUREMENT REPORT
Measurement Results	
BA_used	1
DTX_used	DTX was not used
RXLEV_FULL_SERVING_CELL	See note 1
RXLEV_SUB_SERVING_CELL	See note 1
MEAS_VALID	See note 2
RXQUAL_FULL_SERVING_CELL	The worst subchannel
RXQUAL_SUB_SERVING_CELL	The worst subchannel

DCS 1 800 end:

GSM 700 begin:

SYSTEM INFORMATION TYPE 5:

Information Element	value/remark
Neighbour Cells Description	
Format Identifier	128 range
BCCH Allocation Sequence	1
BCCH Allocation ARFCN	The channel numbers 439, 441, 442, 443, 444, 445, 446, 447, 448, 449, 450, 451, 453, 454, 455, 456, 457, 458, 459, 460, 461, 463, 465, 466, 467, 469, 471, 472, 473, 475, 477 and 481 belong to the BCCH allocation..
- EXT IND	Information Element carries complete BA.

SYSTEM INFORMATION TYPE 6:

Information Element	value/remark
Protocol Discriminator	RR Management
Message Type	sys info 6
Cell Identity	Default
LAI	Default
Cell Options	
- Power Control Indicator	Power Control Indicator is set
- DTX Indicator	MS shall not use DTX
- Radio_Link_Timeout	Default
PLMN permitted	NCC 1 permitted

MEASUREMENT REPORT:

Information Element	value/remark
Protocol Discriminator	RR Management
Transaction Identifier	0000
Message Type	MEASUREMENT REPORT
Measurement Results	
BA_used	1
DTX_used	DTX was not used
RXLEV_FULL_SERVING_CELL	See note 1
RXLEV_SUB_SERVING_CELL	See note 1
MEAS_VALID	See note 2
RXQUAL_FULL_SERVING_CELL	The worst subchannel
RXQUAL_SUB_SERVING_CELL	The worst subchannel

GSM 700 end:

GSM 850 begin:

SYSTEM INFORMATION TYPE 5:

Information Element	value/remark
Neighbour Cells Description	
Format Identifier	128 range
BCCH Allocation Sequence	1
BCCH Allocation ARFCN	The channel numbers 129, 131, 132, 133, 134, 135, 136, 137, 138, 139, 140, 141, 143, 144, 145, 146, 147, 148, 149 150, 151, 153, 155, 156, 157, 159, 161, 162, 163, 165, 167 and 171 belong to the BCCH allocation.
- EXT IND	Information Element carries complete BA.

SYSTEM INFORMATION TYPE 6:

Information Element	value/remark
Protocol Discriminator	RR Management
Message Type	sys info 6
Cell Identity	Default
LAI	Default
Cell Options	
- Power Control Indicator	Power Control Indicator is set
- DTX Indicator	MS shall not use DTX
- Radio_Link_Timeout	Default
PLMN permitted	NCC 1 permitted

MEASUREMENT REPORT:

Information Element	value/remark
Protocol Discriminator	RR Management
Transaction Identifier	0000
Message Type	MEASUREMENT REPORT
Measurement Results	
BA_used	1
DTX_used	DTX was not used
RXLEV_FULL_SERVING_CELL	See note 1
RXLEV_SUB_SERVING_CELL	See note 1
MEAS_VALID	See note 2
RXQUAL_FULL_SERVING_CELL	The worst subchannel
RXQUAL_SUB_SERVING_CELL	The worst subchannel

GSM 850 end:

NOTE 1: These actual values are not checked.

NOTE 2: The Measurement Valid Indication shall be set to valid within the second SACCH block at the latest.

26.13.1.2 Multislot signalling / RR / Dedicated assignment

26.13.1.2.1 Multislot signalling / RR / Dedicated assignment / successful case

26.13.1.2.1.1 Conformance requirements

- 1) Upon receipt of the ASSIGNMENT COMMAND message, the mobile station initiates a local end release of link layer connections, disconnects the physical channels, commands the switching to the assigned channels and initiates the establishment of lower layer connections (this includes the activation of the channels, their connection and the establishment of the main signalling links).
- 2) MM-messages and CM-messages using SAPI=0 sent from the mobile station to the network can be duplicated by the data link layer in the following case:
 - a channel change of dedicated channels is required (assignment or handover procedure) and the last layer 2 frame has not been acknowledged by the peer data link layer before the mobile station leaves the old channel;
 - in this case, the mobile station does not know whether the network has received the message correctly. Therefore, the mobile station has to send the message again after the new dedicated channel is established.
- 3) The MS shall establish the link with the power level specified in the ASSIGNMENT COMMAND message.

The MS shall confirm the power control level that it is currently employing in the uplink SACCH L1 header. The indicated value shall be the power control level actually used by the mobile for the last burst of the previous SACCH period.
- 4) The MS shall apply the hopping frequencies specified in ASSIGNMENT COMMAND message in the Mobile Allocation IE or the Frequency List IE at the time of accessing the new channel using the last received Cell Allocation.

- 5) After receipt of the ASSIGNMENT COMMAND the MS shall perform the assignment and return an ASSIGNMENT COMPLETE without undue delay.

References

- Conformance requirements 1), 4) 3GPP TS 04.08 / 3GPP TS 44.018 subclauses 3.4.3 and 9.1.2.
- Conformance requirements 2) 3GPP TS 04.08 / 3GPP TS 44.018 subclause 3.1.4.3.
- Conformance requirements 3) 3GPP TS 04.08 / 3GPP TS 44.018 subclauses 3.4.3 and 9.1.2;
3GPP TS 05.08, subclause 4.2.
- Conformance requirements 5) 3GPP TS 04.08 / 3GPP TS 44.018 subclauses 3.4.3 and 9.1.3,
3GPP TS 04.13 subclause 5.2.4.

26.13.1.2.1.2 Test purpose

- 1) To verify that upon receipt of an ASSIGNMENT COMMAND, the MS switches to the channel(s) defined in the ASSIGNMENT COMMAND, establishes the link and sends an ASSIGNMENT COMPLETE message. This is tested for an MS supporting TCH and multislot configuration in the special cases of a transition.

- 1.1) from non-hopping SDCCH to hopping multislot configuration;
- 1.2) from hopping multislot configuration to non-hopping multislot configuration;
- 1.3) from non-hopping multislot configuration to hopping multislot configuration;
- 1.4) from hopping symmetric multislot configuration to hopping asymmetric multislot configuration, resource upgrading used;

NOTE: The step 1.5 is applicable to all MS that supports multislot configuration $T_x > 1$ and $Sum > 3$.

- 1.5) from hopping asymmetric multislot configuration to hopping symmetric multislot configuration;
 - 1.6) from hopping multislot configuration to non-hopping multislot configuration, resources downgrading to one TCH/F;
 - 1.7) from non-hopping multislot configuration with one TCH/F to non-hopping multislot configuration, resource upgrading used;
 - 1.8) from non-hopping multislot configuration to hopping multislot configuration, relocating all channels in multislot configuration call without changing the number of TCH/Fs allocated;
 - 1.9) from hopping multislot configuration to non-hopping multislot configuration, partially relocating the channels in multislot configuration call without changing the number of TCH/Fs allocated;
 - 1.10) from non-hopping multislot configuration to hopping multislot configuration, resource downgrading to one TCH/F;
- 2) To verify that an MS supporting TCH and multislot configuration, having sent a MM- or CM message that was not acknowledged on L2 before the channel assignment procedure was initiated and before the MS has left the old channel, repeats that message after completion of the assignment procedure without incrementing N(SD). This is tested in the special case of MM message AUTHENTICATION RESPONSE.
- 3) To verify that an MS supporting TCH and multislot configuration, having received an ASSIGNMENT COMMAND, having sent an SABM frame to establish the main signalling link on the assigned main channel of the multislot configuration, reports the power level(s) specified in the ASSIGNMENT COMMAND message, in the uplink SACCH L1 header of the SACCH message sent in the SACCH period following the transmission of the SABM frame.
- 4) To verify that an MS supporting TCH and multislot configuration, having received an ASSIGNMENT COMMAND, is able in the case of frequency hopping to decode the Mobile Allocation and Frequency List IEs correctly and applies the specified frequencies using the correct Cell Allocation.
- 5) To verify that after receipt of the ASSIGNMENT COMMAND the MS returns an ASSIGNMENT COMPLETE without undue delay.

26.13.1.2.1.3 Method of test

Initial Conditions

System Simulator:

- 1 cell, default parameters except:
 - Early classmark sending enabled in SI3 rest octets.

GSM 450:

- BCCH ARFCN =263.
- Throughout the test, the CA broadcast in System Information 1 is (259, 261, 263, 265, 267, 269, 271, 273, 275, 277).
- Note that the actual CA of the cell contains other frequencies.

GSM 480:

- BCCH ARFCN =310.
- Throughout the test, the CA broadcast in System Information 1 is (306, 308, 310, 312, 314, 316, 318, 320, 322, 324).
- Note that the actual CA of the cell contains other frequencies.

GSM 900:

- BCCH ARFCN =20.
- Throughout the test, the CA broadcast in System Information 1 is (10, 17, 20, 26, 34, 42, 45, 46, 52, 59).
- Note that the actual CA of the cell contains other frequencies.

DCS 1 800:

- BCCH ARFCN =747.
- Throughout the test, the CA broadcast in System Information 1 is (734, 741, 747, 754, 759, 766, 773, 775, 779, 782).
- Note that the actual CA of the cell contains other frequencies.

GSM 700:

- BCCH ARFCN =457.
- Throughout the test, the CA broadcast in System Information 1 is (447, 454, 457, 463, 471, 479, 482, 483, 489, 496).
- Note that the actual CA of the cell contains other frequencies.

GSM 850:

- BCCH ARFCN =147.
- Throughout the test, the CA broadcast in System Information 1 is (137, 144, 147, 153, 161, 169, 172, 173, 179, 186).
- Note that the actual CA of the cell contains other frequencies.

Mobile Station:

- The MS is in the "idle, updated" state with a TMSI allocated.

Specific PICS statements:

- Multislot class (TSPC_Type_Multislot_ClassX)

PIXIT statements:

-

Foreseen Final State of the MS

"Idle, updated", with TMSI allocated.

Test Procedure

The SS pages the MS and allocates an SDCCH. Each time the MS shall switch to the assigned channel, establish the link and send an ASSIGNMENT COMPLETE message.

Then the SS sends an AUTHENTICATION REQUEST message. The MS shall answer with an AUTHENTICATION RESPONSE message, which is not acknowledged on L2 by the SS. Immediately after the AUTHENTICATION RESPONSE message is received, the SS sends an ASSIGNMENT COMMAND. The MS shall switch to the assigned channel, establish the link with the commanded power level and send as ASSIGNMENT COMPLETE message. Then MS shall repeat the AUTHENTICATION RESPONSE message, with the same N(SD) value.

Then the SS sends an ASSIGNMENT COMMAND, which includes a Starting Time IE. The MS shall react as specified above, but this shall be done at the time specified in Starting Time IE.

The SS initiates the channel release procedure and the main signalling link is released.

Maximum Duration of Test

30 s.

Expected Sequence

An MS supporting Multislot Class 1 need only perform steps 1..12, 21..24 and 30.

Step	Direction	Message	Comments
1	SS -> MS	PAGING REQUEST TYPE 1	
2	MS -> SS	CHANNEL REQUEST	
3	SS -> MS	IMMEDIATE ASSIGNMENT	See specific message contents.
4	MS -> SS	PAGING RESPONSE	
5	MS -> SS	CLASSMARK CHANGE	Multislot class
6	SS -> MS	ASSIGNMENT COMMAND	See specific message contents.
7	MS -> SS	ASSIGNMENT COMPLETE	Sent on the correct channel after establishment of the main signalling link. This message shall be ready to be transmitted before 600 ms after the completion of step 6.
8	SS		The SS checks that the MS reports the requested power level in the layer 1 header of the SACCH message that is sent in the first SACCH multiframe following the SABM.
9	SS -> MS	ASSIGNMENT COMMAND	See specific message contents.
10	MS -> SS	ASSIGNMENT COMPLETE	Sent on the correct channel after establishment of the main signalling link. This message shall be ready to be transmitted before 600 ms after the completion of step 9.
11	SS -> MS	ASSIGNMENT COMMAND	See specific message contents.
12	MS -> SS	ASSIGNMENT COMPLETE	Sent on the correct channel after establishment of the main signalling link. This message shall be ready to be transmitted before 600 ms after the completion of step 11.
13	SS -> MS	ASSIGNMENT COMMAND	See specific message contents.
14	MS -> SS	ASSIGNMENT COMPLETE	
15	SS -> MS	ASSIGNMENT COMMAND	See specific message contents.
(note) 16	MS -> SS	ASSIGNMENT COMPLETE	Sent on the correct channel after establishment of the main signalling link. This message shall be ready to be transmitted before 600 ms after the completion of step 15.
(note) 17	SS -> MS	ASSIGNMENT COMMAND	See specific message contents.

Step	Direction	Message	Comments
18	MS -> SS	ASSIGNMENT COMPLETE	Sent on the correct channel after establishment of the main signalling link. This message shall be ready to be transmitted before 600 ms after the completion of step 17.
19	SS -> MS	ASSIGNMENT COMMAND	
20	MS -> SS	ASSIGNMENT COMPLETE	Sent on the correct channel after establishment of the main signalling link. This message shall be ready to be transmitted before 600 ms after the completion of step 19.
21	SS -> MS	ASSIGNMENT COMMAND	
22	MS -> SS	ASSIGNMENT COMPLETE	Sent on the correct channel after establishment of the main signalling link. This message shall be ready to be transmitted before 600 ms after the completion of step 21.
23	SS -> MS	AUTHENTICATION REQUEST	
24	MS -> SS	AUTHENTICATION RESPONSE	This message is not L2 acknowledged by the SS.
25	SS -> MS	ASSIGNMENT COMMAND	
26	MS -> SS	ASSIGNMENT COMPLETE	Sent on the correct channel after establishment of the main signalling link. This message shall be transmitted before 600 ms after the completion of step 25.
27	MS -> SS	AUTHENTICATION RESPONSE	
28	SS -> MS	ASSIGNMENT COMMAND	N(SD) shall be the same as in step 24.
29	MS -> SS	ASSIGNMENT COMPLETE	
30	SS -> MS	CHANNEL RELEASE	The main signalling link is released.
NOTE: This step is applicable to all MS that supports multislots configuration Tx > 1 and Sum > 3. Specific Message Contents.			

GSM 450 begin:

Step 3

IMMEDIATE ASSIGNMENT:

As default message contents except Channel Description	
- Channel Type	SDCCH/8
- TDMA offset	Chosen arbitrarily
- Timeslot Number	N, chosen arbitrarily
- Training Sequence Code	Chosen arbitrarily
- Hopping	Single RF Channel
- ARFCN	the ARFCN of the BCCH carrier

Step 6

ASSIGNMENT COMMAND

Channel Description 2	
- Channel Type and TDMA offset	00000
- Timeslot Number	A suitable value for multislot configuration, chosen arbitrarily
- Training Sequence Code	Chosen arbitrarily
- Hopping	RF hopping channel
- MAIO	Chosen arbitrarily from the set (0, 1 to N-1) where N is the number of frequencies in the Mobile Allocation IE.
- HSN	Chosen arbitrarily from the set (1 to 63)
Power Command	
- Power level	Chosen arbitrarily but with a changed value.
Frequency list IE	Not included
Multislot allocation	
- Downlink assignment	Maximum number of timeslots supported by the MS
- Uplink assignment	Maximum number of timeslots supported by the MS after specifying Downlink timeslots
- Channel set X (1=<X<=8)	Appropriate for the test
Channel Mode	
- Mode	Data, 12.0 kbit/s radio interface rate
Mobile Allocation	Indicates all of the CA (broadcast on the BCCH) except for the BCCH carrier.
Starting Time	Not included

Step 9

ASSIGNMENT COMMAND

Channel Description 2	
- Channel Type and TDMA offset	10XXX (Maximum number of possible additional bidirectional TCH/Fs and SACCH/Ms subtracted by one, minimum being one)
- Timeslot Number	A suitable value for multislot configuration, chosen arbitrarily
- Training Sequence Code	Chosen arbitrarily
- Hopping	Single RF Channel
- ARFCN	the ARFCN of the BCCH carrier
Power Command	
- Power level	Chosen arbitrarily but with a changed value.
Frequency list IE	Not Included
Cell Channel Description	Use Range 128 to encode (271, 273, 275, 277, 279, 281, 283, 285, 287, 289, 291)
Channel Mode	
- Mode	Data, 12.0 kbit/s radio interface rate
Mobile Allocation	Not included
Starting Time	Not included

Step 11

ASSIGNMENT COMMAND

Channel Description 2 - Channel Type and TDMA offset - Timeslot Number	00000 A suitable value for multislot configuration, chosen arbitrarily
- Training Sequence Code	Chosen arbitrarily
- Hopping	RF hopping channel
- MAIO	Chosen arbitrarily from the set (0, 1 to N-1) where N is the number of frequencies in the Mobile Allocation IE.
- HSN	Chosen arbitrarily from the set (1 to 63)
Power Command - Power level	Chosen arbitrarily but with a changed value.
Frequency list IE	Not included
Cell Channel Description	Not included
Multislot allocation - Downlink assignment	Appropriate for the test. Depending on Multislot class, Shall not have maximum number of timeslots.
- Uplink assignment	Appropriate for the test, but as many as in downlink assignment
- Channel set X (1= $X \leq 8$)	Appropriate for the test
Channel Mode - Mode	Data, 12.0 kbit/s radio interface rate
Mobile Allocation	Indicates frequencies (271, 273, 281, 283, 285, 287, 289, 291)
Starting Time	Not included

Step 13

ASSIGNMENT COMMAND

Channel Description 2 - Channel Type and TDMA offset	11XXX (Appropriate number of additional unidirectional TCH/FDs and SACCH/MDs or Additional bidirectional TCH/F and SACCH/M and additional unidirectional TCH/FD and SACCH/MD
- Timeslot Number	Number of downlink timeslots shall be more than in step 11) A suitable value for multislot configuration, chosen arbitrarily
- Training Sequence Code	Chosen arbitrarily
- Hopping	RF hopping channel
- MAIO	Chosen arbitrarily from the set (0, 1 to N-1) where N is the number of frequencies in the Mobile Allocation IE.
- HSN	Chosen arbitrarily from the set (1 to 63)
Power Command - Power level	Chosen arbitrarily but with a changed value.
Frequency list IE	Not included
Cell Channel Description	Not included
Channel Mode - Mode	Data, 12.0 kbit/s radio interface rate
Mobile Allocation	Indicates frequencies (271, 273, 281, 283, 285, 287, 289, 291)
Starting Time	Not included

Step 15

ASSIGNMENT COMMAND

Channel Description 2	
- Channel Type and TDMA offset	00000
- Timeslot Number	A suitable value for multislot configuration, chosen arbitrarily
- Training Sequence Code	Chosen arbitrarily
- Hopping	RF hopping channel
- MAIO	Chosen arbitrarily from the set (0, 1 to N-1) where N is the number of frequencies in the Mobile Allocation IE.
- HSN	Chosen arbitrarily from the set (1 to 63)
Power Command	
- Power level	Chosen arbitrarily but with a changed value.
Frequency list IE	Not included
Cell Channel Description	Not included
Multislot allocation	
- Downlink assignment	Appropriate for the test. Must be more than one.
- Uplink assignment	Appropriate for the test, but as many as in downlink direction.
- Channel set X (1= X ≤8)	Appropriate for the test
Channel Mode	
- Mode	Data, 12.0 kbit/s radio interface rate
Mobile Allocation	Indicates frequencies (271, 273, 281, 283, 285, 287, 289, 291)
Starting Time	Not included

Step 17

ASSIGNMENT COMMAND

Channel Description 2	
- Channel Type and TDMA offset	10000 (no additional timeslots)
- Timeslot Number	A suitable value for multislot configuration, chosen arbitrarily
- Training Sequence Code	Chosen arbitrarily
- Hopping	Single RF Channel
- ARFCN	the ARFCN of the BCCH carrier
Power Command	
- Power level	Chosen arbitrarily but with a changed value.
Frequency list IE	Not Included
Cell Channel Description	Use Range 128 to encode (271, 273, 275, 277, 279, 281, 283, 285, 287, 289, 291)
Channel Mode	
- Mode	Data, 12.0 kbit/s radio interface rate
Mobile Allocation	Not included
Starting Time	Not included

Step 19

ASSIGNMENT COMMAND

Channel Description 2	
- Channel Type and TDMA offset	00000
- Timeslot Number	A suitable value for multislot configuration, chosen arbitrarily
- Training Sequence Code	Chosen arbitrarily
- Hopping	Single RF Channel
- ARFCN	the ARFCN of the BCCH carrier
Power Command	
- Power level	Chosen arbitrarily but with a changed value.
Frequency list IE	Not Included
Cell Channel Description	Use Range 128 to encode 271, 273, 275, 277, 279, 281, 283, 285, 287, 289, 291)
Multislot allocation	
- Downlink assignment	Appropriate for the test, but more than one timeslot allocated and excluding timeslot 0..
- Uplink assignment	Appropriate for the test according to MS Class described in Annex B 05.02.
- Channel set X (1= $X \leq 8$)	Appropriate for the test
Channel Mode	
- Mode	Data, 12.0 kbit/s radio interface rate
Mobile Allocation	Not included
Starting Time	Not included

Step 21

ASSIGNMENT COMMAND

Channel Description 2	
- Channel Type and TDMA offset	10XXX (Same number of TCH/Fs and timeslot mapping as in step 19)
- Timeslot Number	Same as in step 19
- Training Sequence Code	Chosen arbitrarily
- Hopping	Frequency hopping
- MAIO	Chosen arbitrarily from the set (0, 1 to N-1) where N is the number of frequencies in the Mobile Allocation IE.
- HSN	Chosen arbitrarily from the set (1 to 63)
Power Command	
- Power level	Chosen arbitrarily but with a changed value.
Frequency list IE	Not Included
Cell Channel Description	Use Range 128 to encode (271, 273, 275, 277, 279, 281, 283, 285, 287, 289, 291)
Channel Mode	
- Mode	Data, 12.0 kbit/s radio interface rate
Mobile Allocation	Indicate frequencies (273, 281, 283)
Starting Time	Not included

Step 25

ASSIGNMENT COMMAND

Channel Description 2	00000
- Channel Type and TDMA offset	Same as in step 19
- Timeslot Number	Chosen arbitrarily
- Training Sequence Code	Single RF Channel
- Hopping	the ARFCN of the BCCH carrier
- ARFCN	
Power Command	
- Power level	Chosen arbitrarily but with a changed value.
Frequency list IE	Not Included
Cell Channel Description	Use Range 128 to encode (271, 273, 275, 277, 279, 281, 283, 285, 287, 289, 291)
Multislot allocation	
- Downlink assignment	Indicate same timeslots as step 19.
- Uplink assignment	Appropriate for the test according to MS Class described in Annex B 05.02.
- Channel set X (1=<X<=8)	Appropriate for the test
Channel Mode	
- Mode	Data, 12.0 kbit/s radio interface rate
Mobile Allocation	Not included
Starting Time	Not included

Step 28

ASSIGNMENT COMMAND

Channel Description 2	10000 (no additional timeslots)
- Channel Type and TDMA offset	Same as in step 19
- Timeslot Number	Chosen arbitrarily
- Training Sequence Code	Frequency hopping
- Hopping	Chosen arbitrarily from the set (0, 1 to N-1) where N is the number of frequencies in the Mobile Allocation IE.
- MAIO	Chosen arbitrarily from the set (1 to 63)
- HSN	
Power Command	
- Power level	Chosen arbitrarily but with a changed value.
Frequency list IE	Not Included
Cell Channel Description	Not included
Channel Mode	
- Mode	Data, 12.0 kbit/s radio interface rate
Mobile Allocation	Indicate frequencies (273, 281, 283)
Starting Time	Chosen arbitrarily

GSM 450 end:

GSM 480 begin:

Step 3

IMMEDIATE ASSIGNMENT:

As default message contents except	
Channel Description	
- Channel Type	SDCCH/8
TDMA offset	Chosen arbitrarily
- Timeslot Number	N, chosen arbitrarily
- Training Sequence Code	Chosen arbitrarily
- Hopping	Single RF Channel
- ARFCN	the ARFCN of the BCCH carrier

Step 6

ASSIGNMENT COMMAND

Channel Description 2	
- Channel Type and TDMA offset	00000
- Timeslot Number	A suitable value for multislot configuration, chosen arbitrarily
- Training Sequence Code	Chosen arbitrarily
- Hopping	RF hopping channel
- MAIO	Chosen arbitrarily from the set (0, 1 to N-1) where N is the number of frequencies in the Mobile Allocation IE.
- HSN	Chosen arbitrarily from the set (1 to 63)
Power Command	
- Power level	Chosen arbitrarily but with a changed value.
Frequency list IE	Not included
Multislot allocation	
- Downlink assignment	Maximum number of timeslots supported by the MS
- Uplink assignment	Maximum number of timeslots supported by the MS after specifying Downlink timeslots
- Channel set X (1=<X<=8)	Appropriate for the test
Channel Mode	
- Mode	Data, 12.0 kbit/s radio interface rate
Mobile Allocation	Indicates all of the CA (broadcast on the BCCH) except for the BCCH carrier.
Starting Time	Not included

Step 9

ASSIGNMENT COMMAND

Channel Description 2	
- Channel Type and TDMA offset	10XXX (Maximum number of possible additional bidirectional TCH/Fs and SACCH/Ms subtracted by one, minimum being one)
- Timeslot Number	A suitable value for multislot configuration, chosen arbitrarily
- Training Sequence Code	Chosen arbitrarily
- Hopping	Single RF Channel
- ARFCN	the ARFCN of the BCCH carrier
Power Command	
- Power level	Chosen arbitrarily but with a changed value.
Frequency list IE	Not Included
Cell Channel Description	Use Range 128 to encode (318, 320, 322, 324, 326, 328, 330, 332, 334, 336, 338)
Channel Mode	
- Mode	Data, 12.0 kbit/s radio interface rate
Mobile Allocation	Not included
Starting Time	Not included

Step 11

ASSIGNMENT COMMAND

Channel Description 2	
- Channel Type and TDMA offset	00000
- Timeslot Number	A suitable value for multislot configuration, chosen arbitrarily
- Training Sequence Code	Chosen arbitrarily
- Hopping	RF hopping channel
- MAIO	Chosen arbitrarily from the set (0, 1 to N-1) where N is the number of frequencies in the Mobile Allocation IE.
- HSN	Chosen arbitrarily from the set (1 to 63)
Power Command	
- Power level	Chosen arbitrarily but with a changed value.
Frequency list IE	Not included
Cell Channel Description	Not included
Multislot allocation	
- Downlink assignment	Appropriate for the test. Depending on Multislot class, Shall not have maximum number of timeslots.
- Uplink assignment	Appropriate for the test, but as many as in downlink assignment
- Channel set X (1=<X<=8)	Appropriate for the test
Channel Mode	
- Mode	Data, 12.0 kbit/s radio interface rate
Mobile Allocation	Indicates frequencies (318, 320, 328, 330, 332, 334, 336, 338)
Starting Time	Not included

Step 13

ASSIGNMENT COMMAND

Channel Description 2	
- Channel Type and TDMA offset	11XXX (Appropriate number of additional unidirectional TCH/FDs and SACCH/MDs or Additional bidirectional TCH/F and SACCH/M and additional unidirectional TCH/FD and SACCH/MD)
- Timeslot Number	Number of downlink timeslots shall be more than in step 11) A suitable value for multislot configuration, chosen arbitrarily
- Training Sequence Code	Chosen arbitrarily
- Hopping	RF hopping channel
- MAIO	Chosen arbitrarily from the set (0, 1 to N-1) where N is the number of frequencies in the Mobile Allocation IE.
- HSN	Chosen arbitrarily from the set (1 to 63)
Power Command	
- Power level	Chosen arbitrarily but with a changed value.
Frequency list IE	Not included
Cell Channel Description	Not included
Channel Mode	
- Mode	Data, 12.0 kbit/s radio interface rate
Mobile Allocation	Indicates frequencies (318, 320, 328, 330, 332, 334, 336, 338)
Starting Time	Not included

Step 15

ASSIGNMENT COMMAND

Channel Description 2	
- Channel Type and TDMA offset	00000
- Timeslot Number	A suitable value for multislot configuration, chosen arbitrarily
- Training Sequence Code	Chosen arbitrarily
- Hopping	RF hopping channel
- MAIO	Chosen arbitrarily from the set (0, 1 to N-1) where N is the number of frequencies in the Mobile Allocation IE.
- HSN	Chosen arbitrarily from the set (1 to 63)
Power Command	
- Power level	Chosen arbitrarily but with a changed value.
Frequency list IE	Not included
Cell Channel Description	Not included
Multislot allocation	
- Downlink assignment	Appropriate for the test. Must be more than one.
- Uplink assignment	Appropriate for the test, but as many as in downlink direction.
- Channel set X (1= X ≤8)	Appropriate for the test
Channel Mode	
- Mode	Data, 12.0 kbit/s radio interface rate
Mobile Allocation	Indicates frequencies (318, 320, 328, 330, 332, 334, 336, 338)
Starting Time	Not included

Step 17

ASSIGNMENT COMMAND

Channel Description 2	
- Channel Type and TDMA offset	10000 (no additional timeslots)
- Timeslot Number	A suitable value for multislot configuration, chosen arbitrarily
- Training Sequence Code	Chosen arbitrarily
- Hopping	Single RF Channel
- ARFCN	the ARFCN of the BCCH carrier
Power Command	
- Power level	Chosen arbitrarily but with a changed value.
Frequency list IE	Not Included
Cell Channel Description	Use Range 128 to encode (318, 320, 322, 324, 326, 328, 330, 332, 334, 336, 338)
Channel Mode	
- Mode	Data, 12.0 kbit/s radio interface rate
Mobile Allocation	Not included
Starting Time	Not included

Step 19

ASSIGNMENT COMMAND

Channel Description 2	00000
- Channel Type and TDMA offset	A suitable value for multislot configuration, chosen arbitrarily
- Timeslot Number	Chosen arbitrarily
- Training Sequence Code	Single RF Channel
- Hopping	the ARFCN of the BCCH carrier
- ARFCN	
Power Command	Chosen arbitrarily but with a changed value.
- Power level	Not Included
Frequency list IE	Use Range 128 to encode (318, 320, 322, 324, 326, 328, 330, 332, 334, 336, 338)
Cell Channel Description	
Multislot allocation	Appropriate for the test, but more than one timeslot allocated and excluding timeslot 0..
- Downlink assignment	Appropriate for the test according to MS Class described in Annex B 05.02.
- Uplink assignment	Appropriate for the test
- Channel set X (1= $X \leq 8$)	
Channel Mode	Data, 12.0 kbit/s radio interface rate
- Mode	Not included
Mobile Allocation	Not included
Starting Time	Not included

Step 21

ASSIGNMENT COMMAND

Channel Description 2	10XXX (Same number of TCH/Fs and timeslot mapping as in step 19)
- Channel Type and TDMA offset	Same as in step 19
- Timeslot Number	Chosen arbitrarily
- Training Sequence Code	Frequency hopping
- Hopping	Chosen arbitrarily from the set (0, 1 to N-1) where N is the number of frequencies in the Mobile Allocation IE.
- MAIO	Chosen arbitrarily from the set (1 to 63)
- HSN	
Power Command	Chosen arbitrarily but with a changed value.
- Power level	Not Included
Frequency list IE	Use Range 128 to encode (318, 320, 322, 324, 326, 328, 330, 332, 334, 336, 338)
Cell Channel Description	
Channel Mode	Data, 12.0 kbit/s radio interface rate
- Mode	Indicate frequencies (320, 328, 330)
Mobile Allocation	Not included
Starting Time	

Step 25

ASSIGNMENT COMMAND

Channel Description 2	00000
- Channel Type and TDMA offset	Same as in step 19
- Timeslot Number	Chosen arbitrarily
- Training Sequence Code	Single RF Channel
- Hopping	the ARFCN of the BCCH carrier
- ARFCN	
Power Command	
- Power level	Chosen arbitrarily but with a changed value.
Frequency list IE	Not Included
Cell Channel Description	Use Range 128 to encode (318, 320, 322, 324, 326, 328, 330, 332, 334, 336, 338)
Multislot allocation	
- Downlink assignment	Indicate same timeslots as step 19.
- Uplink assignment	Appropriate for the test according to MS Class described in Annex B 05.02.
- Channel set X (1=<X<=8)	Appropriate for the test
Channel Mode	
- Mode	Data, 12.0 kbit/s radio interface rate
Mobile Allocation	Not included
Starting Time	Not included

Step 28

ASSIGNMENT COMMAND

Channel Description 2	10000 (no additional timeslots)
- Channel Type and TDMA offset	Same as in step 19
- Timeslot Number	Chosen arbitrarily
- Training Sequence Code	Frequency hopping
- Hopping	Chosen arbitrarily from the set (0, 1 to N-1) where N is the number of frequencies in the Mobile Allocation IE.
- MAIO	Chosen arbitrarily from the set (1 to 63)
- HSN	
Power Command	
- Power level	Chosen arbitrarily but with a changed value.
Frequency list IE	Not Included
Cell Channel Description	Not included
Channel Mode	
- Mode	Data, 12.0 kbit/s radio interface rate
Mobile Allocation	Indicate frequencies (320, 328, 330)
Starting Time	Chosen arbitrarily

GSM 480 end:

GSM 900 begin:

Step 3

IMMEDIATE ASSIGNMENT:

As default message contents except	
Channel Description	
- Channel Type	SDCCH/8
TDMA offset	Chosen arbitrarily
- Timeslot Number	N, chosen arbitrarily
- Training Sequence Code	Chosen arbitrarily
- Hopping	Single RF Channel
- ARFCN	the ARFCN of the BCCH carrier

Step 6

ASSIGNMENT COMMAND

Channel Description 2	
- Channel Type and TDMA offset	00000
- Timeslot Number	A suitable value for multislot configuration, chosen arbitrarily
- Training Sequence Code	Chosen arbitrarily
- Hopping	RF hopping channel
- MAIO	Chosen arbitrarily from the set (0, 1 to N-1) where N is the number of frequencies in the Mobile Allocation IE.
- HSN	Chosen arbitrarily from the set (1 to 63)
Power Command	
- Power level	Chosen arbitrarily but with a changed value.
Frequency list IE	Not included
Multislot allocation	
- Downlink assignment	Maximum number of timeslots supported by the MS
- Uplink assignment	Maximum number of timeslots supported by the MS after specifying Downlink timeslots
- Channel set X (1=<X<=8)	Appropriate for the test
Channel Mode	
- Mode	Data, 12.0 kbit/s radio interface rate
Mobile Allocation	Indicates all of the CA (broadcast on the BCCH) except for the BCCH carrier.
Starting Time	Not included

Step 9

ASSIGNMENT COMMAND

Channel Description 2	
- Channel Type and TDMA offset	10XXX (Maximum number of possible additional bidirectional TCH/Fs and SACCH/Ms subtracted by one, minimum being one)
- Timeslot Number	A suitable value for multislot configuration, chosen arbitrarily
- Training Sequence Code	Chosen arbitrarily
- Hopping	Single RF Channel
- ARFCN	the ARFCN of the BCCH carrier
Power Command	
- Power level	Chosen arbitrarily but with a changed value.
Frequency list IE	Not Included
Cell Channel Description	Bit map zero encodes (45, 46, 52, 59, 66, 73, 74, 75, 76, 108, 114)
Channel Mode	
- Mode	Data, 12.0 kbit/s radio interface rate
Mobile Allocation	Not included
Starting Time	Not included

Step 11

ASSIGNMENT COMMAND

Channel Description 2	
- Channel Type and TDMA offset	00000
- Timeslot Number	A suitable value for multislot configuration, chosen arbitrarily
- Training Sequence Code	Chosen arbitrarily
- Hopping	RF hopping channel
- MAIO	Chosen arbitrarily from the set (0, 1 to N-1) where N is the number of frequencies in the Mobile Allocation IE.
- HSN	Chosen arbitrarily from the set (1 to 63)
Power Command	
- Power level	Chosen arbitrarily but with a changed value.
Frequency list IE	Not included
Cell Channel Description	Not included
Multislot allocation	
- Downlink assignment	Appropriate for the test. Depending on Multislot class, Shall not have maximum number of timeslots.
- Uplink assignment	Appropriate for the test, but as many as in downlink assignment
- Channel set X (1= X ≤8)	Appropriate for the test
Channel Mode	
- Mode	Data, 12.0 kbit/s radio interface rate
Mobile Allocation	Indicates frequencies (45, 46, 73, 74, 75, 76, 108, 114)
Starting Time	Not included

Step 13

ASSIGNMENT COMMAND

Channel Description 2	
- Channel Type and TDMA offset	11XXX (Appropriate number of additional unidirectional TCH/FDs and SACCH/MDs or Additional bidirectional TCH/F and SACCH/M and additional unidirectional TCH/FD and SACCH/MD)
- Timeslot Number	Number of downlink timeslots shall be more than in step 11) A suitable value for multislot configuration, chosen arbitrarily
- Training Sequence Code	Chosen arbitrarily
- Hopping	RF hopping channel
- MAIO	Chosen arbitrarily from the set (0, 1 to N-1) where N is the number of frequencies in the Mobile Allocation IE.
- HSN	Chosen arbitrarily from the set (1 to 63)
Power Command	
- Power level	Chosen arbitrarily but with a changed value.
Frequency list IE	Not included
Cell Channel Description	Not included
Channel Mode	
- Mode	Data, 12.0 kbit/s radio interface rate
Mobile Allocation	Indicates frequencies (45, 46, 73, 74, 75, 76, 108, 114)
Starting Time	Not included

Step 15

ASSIGNMENT COMMAND

Channel Description 2	
- Channel Type and TDMA offset	00000
- Timeslot Number	A suitable value for multislot configuration, chosen arbitrarily
- Training Sequence Code	Chosen arbitrarily
- Hopping	RF hopping channel
- MAIO	Chosen arbitrarily from the set (0, 1 to N-1) where N is the number of frequencies in the Mobile Allocation IE.
- HSN	Chosen arbitrarily from the set (1 to 63)
Power Command	
- Power level	Chosen arbitrarily but with a changed value.
Frequency list IE	Not included
Cell Channel Description	Not included
Multislot allocation	
- Downlink assignment	Appropriate for the test. Must be more than one.
- Uplink assignment	Appropriate for the test, but as many as in downlink direction.
- Channel set X (1= X ≤8)	Appropriate for the test
Channel Mode	
- Mode	Data, 12.0 kbit/s radio interface rate
Mobile Allocation	Indicates frequencies (45, 46, 73, 74, 75, 76, 108, 114)
Starting Time	Not included

Step 17

ASSIGNMENT COMMAND

Channel Description 2	
- Channel Type and TDMA offset	10000 (no additional timeslots)
- Timeslot Number	A suitable value for multislot configuration, chosen arbitrarily
- Training Sequence Code	Chosen arbitrarily
- Hopping	Single RF Channel
- ARFCN	the ARFCN of the BCCH carrier
Power Command	
- Power level	Chosen arbitrarily but with a changed value.
Frequency list IE	Not Included
Cell Channel Description	Bit map zero encodes (45, 46, 52, 59, 66, 73, 74, 75, 76, 108, 114)
Channel Mode	
- Mode	Data, 12.0 kbit/s radio interface rate
Mobile Allocation	Not included
Starting Time	Not included

Step 19

ASSIGNMENT COMMAND

Channel Description 2	00000
- Channel Type and TDMA offset	A suitable value for multislot configuration, chosen arbitrarily
- Timeslot Number	Chosen arbitrarily
- Training Sequence Code	Single RF Channel
- Hopping	the ARFCN of the BCCH carrier
- ARFCN	
Power Command	Chosen arbitrarily but with a changed value.
- Power level	Not Included
Frequency list IE	Not Included
Cell Channel Description	Bit map zero encodes (45, 46, 52, 59, 66, 73, 74, 75, 76, 108, 114)
Multislot allocation	Appropriate for the test, but more than one timeslot allocated and excluding timeslot 0..
- Downlink assignment	Appropriate for the test according to MS Class described in Annex B 05.02.
- Uplink assignment	Appropriate for the test
- Channel set X (1= $X \leq 8$)	
Channel Mode	Data, 12.0 kbit/s radio interface rate
- Mode	Not included
Mobile Allocation	Not included
Starting Time	Not included

Step 21

ASSIGNMENT COMMAND

Channel Description 2	10XXX (Same number of TCH/Fs and timeslot mapping as in step 19)
- Channel Type and TDMA offset	Same as in step 19
- Timeslot Number	Chosen arbitrarily
- Training Sequence Code	Frequency hopping
- Hopping	Chosen arbitrarily from the set (0, 1 to N-1) where N is the number of frequencies in the Mobile Allocation IE.
- MAIO	Chosen arbitrarily from the set (1 to 63)
- HSN	
Power Command	Chosen arbitrarily but with a changed value.
- Power level	Not Included
Frequency list IE	Not Included
Cell Channel Description	Bit map zero encodes (45, 46, 52, 59, 66, 73, 74, 75, 76, 108, 114)
Channel Mode	Data, 12.0 kbit/s radio interface rate
- Mode	Indicate frequencies (46, 73 74)
Mobile Allocation	Not included
Starting Time	Not included

Step 25

ASSIGNMENT COMMAND

Channel Description 2	00000
- Channel Type and TDMA offset	Same as in step 19
- Timeslot Number	Chosen arbitrarily
- Training Sequence Code	Single RF Channel
- Hopping	the ARFCN of the BCCH carrier
- ARFCN	
Power Command	
- Power level	Chosen arbitrarily but with a changed value.
Frequency list IE	Not Included
Cell Channel Description	Bit map zero encodes (45, 46, 52, 59, 66, 73, 74, 75, 76, 108, 114)
Multislot allocation	
- Downlink assignment	Indicate same timeslots as step 19.
- Uplink assignment	Appropriate for the test according to MS Class described in Annex B 05.02.
- Channel set X (1=<X<=8)	Appropriate for the test
Channel Mode	
- Mode	Data, 12.0 kbit/s radio interface rate
Mobile Allocation	Not included
Starting Time	Not included

Step 28

ASSIGNMENT COMMAND

Channel Description 2	10000 (no additional timeslots)
- Channel Type and TDMA offset	Same as in step 19
- Timeslot Number	Chosen arbitrarily
- Training Sequence Code	Frequency hopping
- Hopping	Chosen arbitrarily from the set (0, 1 to N-1) where N is the number of frequencies in the Mobile Allocation IE.
- MAIO	Chosen arbitrarily from the set (1 to 63)
- HSN	
Power Command	
- Power level	Chosen arbitrarily but with a changed value.
Frequency list IE	Not Included
Cell Channel Description	Not included
Channel Mode	
- Mode	Data, 12.0 kbit/s radio interface rate
Mobile Allocation	Indicate frequencies (46, 73 74)
Starting Time	Chosen arbitrarily

GSM 900 end:

GSM 1800 begin:

Step 3

IMMEDIATE ASSIGNMENT:

As default message contents except	
Channel Description	
- Channel Type	SDCCH/8
TDMA offset	Chosen arbitrarily
- Timeslot Number	N, chosen arbitrarily
- Training Sequence Code	Chosen arbitrarily
- Hopping	Single RF Channel
- ARFCN	the ARFCN of the BCCH carrier

Step 6

ASSIGNMENT COMMAND

Channel Description 2	
- Channel Type and TDMA offset	00000
- Timeslot Number	A suitable value for multislot configuration, chosen arbitrarily
- Training Sequence Code	Chosen arbitrarily
- Hopping	RF hopping channel
- MAIO	Chosen arbitrarily from the set (0, 1 to N-1) where N is the number of frequencies in the Mobile Allocation IE.
- HSN	Chosen arbitrarily from the set (1 to 63)
Power Command	
- Power level	Chosen arbitrarily but with a changed value.
Frequency list IE	Not included
Multislot allocation	
- Downlink assignment	Maximum number of timeslots supported by the MS
- Uplink assignment	Maximum number of timeslots supported by the MS after specifying Downlink timeslots
- Channel set X (1=<X<=8)	Appropriate for the test
Channel Mode	
- Mode	Data, 12.0 kbit/s radio interface rate
Mobile Allocation	Indicates all of the CA (broadcast on the BCCH) except for the BCCH carrier.
Starting Time	Not included

Step 9

ASSIGNMENT COMMAND

Channel Description 2	
- Channel Type and TDMA offset	10XXX (Maximum number of possible additional bidirectional TCH/Fs and SACCH/Ms subtracted by one, minimum being one)
- Timeslot Number	A suitable value for multislot configuration, chosen arbitrarily
- Training Sequence Code	Chosen arbitrarily
- Hopping	Single RF Channel
- ARFCN	the ARFCN of the BCCH carrier
Power Command	
- Power level	Chosen arbitrarily but with a changed value.
Frequency list IE	Not Included
Cell Channel Description	Use Range 128 to encode (773, 775, 779, 782, 791, 798, 829, 832, 844)
Channel Mode	
- Mode	Data, 12.0 kbit/s radio interface rate
Mobile Allocation	Not included
Starting Time	Not included

Step 11

ASSIGNMENT COMMAND

Channel Description 2	
- Channel Type and TDMA offset	00000
- Timeslot Number	A suitable value for multislot configuration, chosen arbitrarily
- Training Sequence Code	Chosen arbitrarily
- Hopping	RF hopping channel
- MAIO	Chosen arbitrarily from the set (0, 1 to N-1) where N is the number of frequencies in the Mobile Allocation IE.
- HSN	Chosen arbitrarily from the set (1 to 63)
Power Command	
- Power level	Chosen arbitrarily but with a changed value.
Frequency list IE	Not included
Cell Channel Description	Not included
Multislot allocation	
- Downlink assignment	Appropriate for the test. Depending on Multislot class, Shall not have maximum number of timeslots.
- Uplink assignment	Appropriate for the test, but as many as in downlink assignment
- Channel set X (1= X ≤8)	Appropriate for the test
Channel Mode	
- Mode	Data, 12.0 kbit/s radio interface rate
Mobile Allocation	Indicates frequencies (773, 775, 779, 829, 832, 844)
Starting Time	Not included

Step 13

ASSIGNMENT COMMAND

Channel Description 2	
- Channel Type and TDMA offset	11XXX (Appropriate number of additional unidirectional TCH/FDs and SACCH/MDs or Additional bidirectional TCH/F and SACCH/M and additional unidirectional TCH/FD and SACCH/MD)
- Timeslot Number	Number of downlink timeslots shall be more than in step 11) A suitable value for multislot configuration, chosen arbitrarily
- Training Sequence Code	Chosen arbitrarily
- Hopping	RF hopping channel
- MAIO	Chosen arbitrarily from the set (0, 1 to N-1) where N is the number of frequencies in the Mobile Allocation IE.
- HSN	Chosen arbitrarily from the set (1 to 63)
Power Command	
- Power level	Chosen arbitrarily but with a changed value.
Frequency list IE	Not included
Cell Channel Description	Not included
Channel Mode	
- Mode	Data, 12.0 kbit/s radio interface rate
Mobile Allocation	Indicates frequencies (773, 775, 779, 829, 832, 844)
Starting Time	Not included

Step 15

ASSIGNMENT COMMAND

Channel Description 2	
- Channel Type and TDMA offset	00000
- Timeslot Number	A suitable value for multislot configuration, chosen arbitrarily
- Training Sequence Code	Chosen arbitrarily
- Hopping	RF hopping channel
- MAIO	Chosen arbitrarily from the set (0, 1 to N-1) where N is the number of frequencies in the Mobile Allocation IE.
- HSN	Chosen arbitrarily from the set (1 to 63)
Power Command	
- Power level	Chosen arbitrarily but with a changed value.
Frequency list IE	Not included
Cell Channel Description	Not included
Multislot allocation	
- Downlink assignment	Appropriate for the test. Must be more than one.
- Uplink assignment	Appropriate for the test, but as many as in downlink direction.
- Channel set X (1= X ≤8)	Appropriate for the test
Channel Mode	
- Mode	Data, 12.0 kbit/s radio interface rate
Mobile Allocation	Indicates frequencies (773, 775, 779, 829, 832, 844)
Starting Time	Not included

Step 17

ASSIGNMENT COMMAND

Channel Description 2	
- Channel Type and TDMA offset	10000 (no additional timeslots)
- Timeslot Number	A suitable value for multislot configuration, chosen arbitrarily
- Training Sequence Code	Chosen arbitrarily
- Hopping	Single RF Channel
- ARFCN	the ARFCN of the BCCH carrier
Power Command	
- Power level	Chosen arbitrarily but with a changed value.
Frequency list IE	Not Included
Cell Channel Description	Use Range 128 to encode (773, 775, 779, 782, 791, 798, 829, 832, 844)
Channel Mode	
- Mode	Data, 12.0 kbit/s radio interface rate
Mobile Allocation	Not included
Starting Time	Not included

Step 19

ASSIGNMENT COMMAND

Channel Description 2	00000
- Channel Type and TDMA offset	A suitable value for multislot configuration, chosen arbitrarily
- Timeslot Number	Chosen arbitrarily
- Training Sequence Code	Single RF Channel
- Hopping	the ARFCN of the BCCH carrier
- ARFCN	
Power Command	Chosen arbitrarily but with a changed value.
- Power level	Not Included
Frequency list IE	Use Range 128 to encode (773, 775, 779, 782, 791, 798, 829, 832, 844)
Cell Channel Description	
Multislot allocation	Appropriate for the test, but more than one timeslot allocated and excluding timeslot 0.
- Downlink assignment	Appropriate for the test according to MS Class described in Annex B 05.02.
- Uplink assignment	Appropriate for the test
- Channel set X (1= $X \leq 8$)	
Channel Mode	Data, 12.0 kbit/s radio interface rate
- Mode	Not included
Mobile Allocation	Not included
Starting Time	Not included

Step 21

ASSIGNMENT COMMAND

Channel Description 2	10XXX (Same number of TCH/Fs and timeslot mapping as in step 19)
- Channel Type and TDMA offset	Same as in step 19
- Timeslot Number	Chosen arbitrarily
- Training Sequence Code	Frequency hopping
- Hopping	Chosen arbitrarily from the set (0, 1 to N-1) where N is the number of frequencies in the Mobile Allocation IE.
- MAIO	Chosen arbitrarily from the set (1 to 63)
- HSN	
Power Command	Chosen arbitrarily but with a changed value.
- Power level	Not Included
Frequency list IE	Use Range 128 to encode (773, 775, 779, 782, 791, 798, 829, 832, 844)
Cell Channel Description	
Channel Mode	Data, 12.0 kbit/s radio interface rate
- Mode	Indicate frequencies (782, 791, 798)
Mobile Allocation	Not included
Starting Time	

Step 25

ASSIGNMENT COMMAND

Channel Description 2	00000
- Channel Type and TDMA offset	Same as in step 19
- Timeslot Number	Chosen arbitrarily
- Training Sequence Code	Single RF Channel
- Hopping	the ARFCN of the BCCH carrier
- ARFCN	
Power Command	
- Power level	Chosen arbitrarily but with a changed value.
Frequency list IE	Not Included
Cell Channel Description	Use Range 128 to encode (773, 775, 779, 782, 791, 798, 829, 832, 844)
Multislot allocation	
- Downlink assignment	Indicate same timeslots as step 19.
- Uplink assignment	Appropriate for the test according to MS Class described in Annex B 05.02.
- Channel set X (1=<X<=8)	Appropriate for the test
Channel Mode	
- Mode	Data, 12.0 kbit/s radio interface rate
Mobile Allocation	Not included
Starting Time	Not included

Step 28

ASSIGNMENT COMMAND

Channel Description 2	10000 (no additional timeslots)
- Channel Type and TDMA offset	Same as in step 19
- Timeslot Number	Chosen arbitrarily
- Training Sequence Code	Frequency hopping
- Hopping	Chosen arbitrarily from the set (0, 1 to N-1) where N is the number of frequencies in the Mobile Allocation IE.
- MAIO	Chosen arbitrarily from the set (1 to 63)
- HSN	
Power Command	
- Power level	Chosen arbitrarily but with a changed value.
Frequency list IE	Not Included
Cell Channel Description	Not Included
Channel Mode	
- Mode	Data, 12.0 kbit/s radio interface rate
Mobile Allocation	Indicate frequencies (782, 791, 798)
Starting Time	Chosen arbitrarily

GSM 1800 end:

GSM 700 begin:

Step 3

IMMEDIATE ASSIGNMENT:

As default message contents except	
Channel Description	
- Channel Type	SDCCH/8
TDMA offset	Chosen arbitrarily
- Timeslot Number	N, chosen arbitrarily
- Training Sequence Code	Chosen arbitrarily
- Hopping	Single RF Channel
- ARFCN	the ARFCN of the BCCH carrier

Step 6

ASSIGNMENT COMMAND

Channel Description 2	
- Channel Type and TDMA offset	00000
- Timeslot Number	A suitable value for multislot configuration, chosen arbitrarily
- Training Sequence Code	Chosen arbitrarily
- Hopping	RF hopping channel
- MAIO	Chosen arbitrarily from the set (0, 1 to N-1) where N is the number of frequencies in the Mobile Allocation IE.
- HSN	Chosen arbitrarily from the set (1 to 63)
Power Command	
- Power level	Chosen arbitrarily but with a changed value.
Frequency list IE	Not included
Multislot allocation	
- Downlink assignment	Maximum number of timeslots supported by the MS
- Uplink assignment	Maximum number of timeslots supported by the MS after specifying Downlink timeslots
- Channel set X (1=<X<=8)	Appropriate for the test
Channel Mode	
- Mode	Data, 12.0 kbit/s radio interface rate
Mobile Allocation	Indicates all of the CA (broadcast on the BCCH) except for the BCCH carrier.
Starting Time	Not included

Step 9

ASSIGNMENT COMMAND

Channel Description 2	
- Channel Type and TDMA offset	10XXX (Maximum number of possible additional bidirectional TCH/Fs and SACCH/Ms subtracted by one, minimum being one)
- Timeslot Number	A suitable value for multislot configuration, chosen arbitrarily
- Training Sequence Code	Chosen arbitrarily
- Hopping	Single RF Channel
- ARFCN	the ARFCN of the BCCH carrier
Power Command	
- Power level	Chosen arbitrarily but with a changed value.
Frequency list IE	Not Included
Cell Channel Description	128 range encodes (482, 483, 489, 496, 498, 500, 501, 502, 503, 506, 508)
Channel Mode	
- Mode	Data, 12.0 kbit/s radio interface rate
Mobile Allocation	Not included
Starting Time	Not included

Step 11

ASSIGNMENT COMMAND

Channel Description 2 - Channel Type and TDMA offset - Timeslot Number	00000 A suitable value for multislot configuration, chosen arbitrarily
- Training Sequence Code	Chosen arbitrarily
- Hopping	RF hopping channel
- MAIO	Chosen arbitrarily from the set (0, 1 to N-1) where N is the number of frequencies in the Mobile Allocation IE.
- HSN	Chosen arbitrarily from the set (1 to 63)
Power Command - Power level	Chosen arbitrarily but with a changed value.
Frequency list IE	Not included
Cell Channel Description	Not included
Multislot allocation - Downlink assignment	Appropriate for the test. Depending on Multislot class, Shall not have maximum number of timeslots.
- Uplink assignment	Appropriate for the test, but as many as in downlink assignment
- Channel set X (1=<X<=8)	Appropriate for the test
Channel Mode - Mode	Data, 12.0 kbit/s radio interface rate
Mobile Allocation	Indicates frequencies (482, 483, 500, 501, 502, 503, 506, 508)
Starting Time	Not included

Step 13

ASSIGNMENT COMMAND

Channel Description 2 - Channel Type and TDMA offset	11XXX (Appropriate number of additional unidirectional TCH/FDs and SACCH/MDs or Additional bidirectional TCH/F and SACCH/M and additional unidirectional TCH/FD and SACCH/MD
- Timeslot Number	Number of downlink timeslots shall be more than in step 11) A suitable value for multislot configuration, chosen arbitrarily
- Training Sequence Code	Chosen arbitrarily
- Hopping	RF hopping channel
- MAIO	Chosen arbitrarily from the set (0, 1 to N-1) where N is the number of frequencies in the Mobile Allocation IE.
- HSN	Chosen arbitrarily from the set (1 to 63)
Power Command - Power level	Chosen arbitrarily but with a changed value.
Frequency list IE	Not included
Cell Channel Description	Not included
Channel Mode - Mode	Data, 12.0 kbit/s radio interface rate
Mobile Allocation	Indicates frequencies (482, 483, 500, 501, 502, 503, 506, 508)
Starting Time	Not included

Step 15

ASSIGNMENT COMMAND

Channel Description 2	
- Channel Type and TDMA offset	00000
- Timeslot Number	A suitable value for multislot configuration, chosen arbitrarily
- Training Sequence Code	Chosen arbitrarily
- Hopping	RF hopping channel
- MAIO	Chosen arbitrarily from the set (0, 1 to N-1) where N is the number of frequencies in the Mobile Allocation IE.
- HSN	Chosen arbitrarily from the set (1 to 63)
Power Command	
- Power level	Chosen arbitrarily but with a changed value.
Frequency list IE	Not included
Cell Channel Description	Not included
Multislot allocation	
- Downlink assignment	Appropriate for the test. Must be more than one.
- Uplink assignment	Appropriate for the test, but as many as in downlink direction.
- Channel set X (1= X ≤8)	Appropriate for the test
Channel Mode	
- Mode	Data, 12.0 kbit/s radio interface rate
Mobile Allocation	Indicates frequencies (482, 483, 500, 501, 502, 503, 506, 508)
Starting Time	Not included

Step 17

ASSIGNMENT COMMAND

Channel Description 2	
- Channel Type and TDMA offset	10000 (no additional timeslots)
- Timeslot Number	A suitable value for multislot configuration, chosen arbitrarily
- Training Sequence Code	Chosen arbitrarily
- Hopping	Single RF Channel
- ARFCN	the ARFCN of the BCCH carrier
Power Command	
- Power level	Chosen arbitrarily but with a changed value.
Frequency list IE	Not Included
Cell Channel Description	128 range encodes (482, 483, 489, 496, 498, 500, 501, 502, 503, 506, 508)
Channel Mode	
- Mode	Data, 12.0 kbit/s radio interface rate
Mobile Allocation	Not included
Starting Time	Not included

Step 19

ASSIGNMENT COMMAND

Channel Description 2	
- Channel Type and TDMA offset	00000
- Timeslot Number	A suitable value for multislot configuration, chosen arbitrarily
- Training Sequence Code	Chosen arbitrarily
- Hopping	Single RF Channel
- ARFCN	the ARFCN of the BCCH carrier
Power Command	
- Power level	Chosen arbitrarily but with a changed value.
Frequency list IE	Not Included
Cell Channel Description	128 range encodes (482, 483, 489, 496, 498, 500, 501, 502, 503, 506, 508)
Multislot allocation	
- Downlink assignment	Appropriate for the test, but more than one timeslot allocated and excluding timeslot 0..
- Uplink assignment	Appropriate for the test according to MS Class described in Annex B 05.02.
- Channel set X (1= $X \leq 8$)	Appropriate for the test
Channel Mode	
- Mode	Data, 12.0 kbit/s radio interface rate
Mobile Allocation	Not included
Starting Time	Not included

Step 21

ASSIGNMENT COMMAND

Channel Description 2	
- Channel Type and TDMA offset	10XXX (Same number of TCH/Fs and timeslot mapping as in step 19)
- Timeslot Number	Same as in step 19
- Training Sequence Code	Chosen arbitrarily
- Hopping	Frequency hopping
- MAIO	Chosen arbitrarily from the set (0, 1 to N-1) where N is the number of frequencies in the Mobile Allocation IE.
- HSN	Chosen arbitrarily from the set (1 to 63)
Power Command	
- Power level	Chosen arbitrarily but with a changed value.
Frequency list IE	Not Included
Cell Channel Description	128 range encodes (482, 483, 489, 496, 498, 500, 501, 502, 503, 506, 508)
Channel Mode	
- Mode	Data, 12.0 kbit/s radio interface rate
Mobile Allocation	Indicate frequencies (483, 500, 501)
Starting Time	Not included

Step 25

ASSIGNMENT COMMAND

Channel Description 2	00000
- Channel Type and TDMA offset	Same as in step 19
- Timeslot Number	Chosen arbitrarily
- Training Sequence Code	Single RF Channel
- Hopping	the ARFCN of the BCCH carrier
- ARFCN	
Power Command	
- Power level	Chosen arbitrarily but with a changed value.
Frequency list IE	Not Included
Cell Channel Description	128 range encodes (482, 483, 489, 496, 498, 500, 501, 502, 503, 506, 508)
Multislot allocation	
- Downlink assignment	Indicate same timeslots as step 19.
- Uplink assignment	Appropriate for the test according to MS Class described in Annex B 05.02.
- Channel set X (1=<X<=8)	Appropriate for the test
Channel Mode	
- Mode	Data, 12.0 kbit/s radio interface rate
Mobile Allocation	Not included
Starting Time	Not included

Step 28

ASSIGNMENT COMMAND

Channel Description 2	10000 (no additional timeslots)
- Channel Type and TDMA offset	Same as in step 19
- Timeslot Number	Chosen arbitrarily
- Training Sequence Code	Frequency hopping
- Hopping	Chosen arbitrarily from the set (0, 1 to N-1) where N is the number of frequencies in the Mobile Allocation IE.
- MAIO	Chosen arbitrarily from the set (1 to 63)
- HSN	
Power Command	
- Power level	Chosen arbitrarily but with a changed value.
Frequency list IE	Not Included
Cell Channel Description	Not included
Channel Mode	
- Mode	Data, 12.0 kbit/s radio interface rate
Mobile Allocation	Indicate frequencies (483, 500, 501)
Starting Time	Chosen arbitrarily

GSM 700 end:

GSM 850 begin:

Step 3

IMMEDIATE ASSIGNMENT:

As default message contents except	
Channel Description	
- Channel Type	SDCCH/8
TDMA offset	Chosen arbitrarily
- Timeslot Number	N, chosen arbitrarily
- Training Sequence Code	Chosen arbitrarily
- Hopping	Single RF Channel
- ARFCN	the ARFCN of the BCCH carrier

Step 6

ASSIGNMENT COMMAND

Channel Description 2	
- Channel Type and TDMA offset	00000
- Timeslot Number	A suitable value for multislot configuration, chosen arbitrarily
- Training Sequence Code	Chosen arbitrarily
- Hopping	RF hopping channel
- MAIO	Chosen arbitrarily from the set (0, 1 to N-1) where N is the number of frequencies in the Mobile Allocation IE.
- HSN	Chosen arbitrarily from the set (1 to 63)
Power Command	
- Power level	Chosen arbitrarily but with a changed value.
Frequency list IE	Not included
Multislot allocation	
- Downlink assignment	Maximum number of timeslots supported by the MS
- Uplink assignment	Maximum number of timeslots supported by the MS after specifying Downlink timeslots
- Channel set X (1=<X<=8)	Appropriate for the test
Channel Mode	
- Mode	Data, 12.0 kbit/s radio interface rate
Mobile Allocation	Indicates all of the CA (broadcast on the BCCH) except for the BCCH carrier.
Starting Time	Not included

Step 9

ASSIGNMENT COMMAND

Channel Description 2	
- Channel Type and TDMA offset	10XXX (Maximum number of possible additional bidirectional TCH/Fs and SACCH/Ms subtracted by one, minimum being one)
- Timeslot Number	A suitable value for multislot configuration, chosen arbitrarily
- Training Sequence Code	Chosen arbitrarily
- Hopping	Single RF Channel
- ARFCN	the ARFCN of the BCCH carrier
Power Command	
- Power level	Chosen arbitrarily but with a changed value.
Frequency list IE	Not Included
Cell Channel Description	128 range encodes (172, 173, 179, 186, 193, 200, 201, 202, 203, 235, 241)
Channel Mode	
- Mode	Data, 12.0 kbit/s radio interface rate
Mobile Allocation	Not included
Starting Time	Not included

Step 11

ASSIGNMENT COMMAND

Channel Description 2 - Channel Type and TDMA offset - Timeslot Number	00000 A suitable value for multislot configuration, chosen arbitrarily
- Training Sequence Code	Chosen arbitrarily
- Hopping	RF hopping channel
- MAIO	Chosen arbitrarily from the set (0, 1 to N-1) where N is the number of frequencies in the Mobile Allocation IE.
- HSN	Chosen arbitrarily from the set (1 to 63)
Power Command - Power level	Chosen arbitrarily but with a changed value.
Frequency list IE	Not included
Cell Channel Description	Not included
Multislot allocation	
- Downlink assignment	Appropriate for the test. Depending on Multislot class, Shall not have maximum number of timeslots.
- Uplink assignment	Appropriate for the test, but as many as in downlink assignment
- Channel set X (1= $X \leq 8$)	Appropriate for the test
Channel Mode - Mode	Data, 12.0 kbit/s radio interface rate
Mobile Allocation	Indicates frequencies (172, 173, 200, 201, 202, 203, 235, 241)
Starting Time	Not included

Step 13

ASSIGNMENT COMMAND

Channel Description 2 - Channel Type and TDMA offset	11XXX (Appropriate number of additional unidirectional TCH/FDs and SACCH/MDs or Additional bidirectional TCH/F and SACCH/M and additional unidirectional TCH/FD and SACCH/MD
- Timeslot Number	Number of downlink timeslots shall be more than in step 11) A suitable value for multislot configuration, chosen arbitrarily
- Training Sequence Code	Chosen arbitrarily
- Hopping	RF hopping channel
- MAIO	Chosen arbitrarily from the set (0, 1 to N-1) where N is the number of frequencies in the Mobile Allocation IE.
- HSN	Chosen arbitrarily from the set (1 to 63)
Power Command - Power level	Chosen arbitrarily but with a changed value.
Frequency list IE	Not included
Cell Channel Description	Not included
Channel Mode - Mode	Data, 12.0 kbit/s radio interface rate
Mobile Allocation	Indicates frequencies (172, 173, 200, 201, 202, 203, 235, 241)
Starting Time	Not included

Step 15

ASSIGNMENT COMMAND

Channel Description 2 - Channel Type and TDMA offset - Timeslot Number - Training Sequence Code - Hopping - MAIO - HSN Power Command - Power level Frequency list IE Cell Channel Description Multislot allocation - Downlink assignment - Uplink assignment - Channel set X (1= $X \leq 8$) Channel Mode - Mode Mobile Allocation Starting Time	00000 A suitable value for multislot configuration, chosen arbitrarily Chosen arbitrarily RF hopping channel Chosen arbitrarily from the set (0, 1 to N-1) where N is the number of frequencies in the Mobile Allocation IE. Chosen arbitrarily from the set (1 to 63) Chosen arbitrarily but with a changed value. Not included Not included Appropriate for the test. Must be more than one. Appropriate for the test, but as many as in downlink direction. Appropriate for the test Data, 12.0 kbit/s radio interface rate Indicates frequencies (172, 173, 200, 201, 202, 203, 235, 241) Not included
---	--

Step 17

ASSIGNMENT COMMAND

Channel Description 2 - Channel Type and TDMA offset - Timeslot Number - Training Sequence Code - Hopping - ARFCN Power Command - Power level Frequency list IE Cell Channel Description Channel Mode - Mode Mobile Allocation Starting Time	10000 (no additional timeslots) A suitable value for multislot configuration, chosen arbitrarily Chosen arbitrarily Single RF Channel the ARFCN of the BCCH carrier Chosen arbitrarily but with a changed value. Not Included 128 range encodes (172, 173, 179, 186, 193, 200, 201, 202, 203, 235, 241) Data, 12.0 kbit/s radio interface rate Not included Not included
---	--

Step 19

ASSIGNMENT COMMAND

Channel Description 2	
- Channel Type and TDMA offset	00000
- Timeslot Number	A suitable value for multislot configuration, chosen arbitrarily
- Training Sequence Code	Chosen arbitrarily
- Hopping	Single RF Channel
- ARFCN	the ARFCN of the BCCH carrier
Power Command	
- Power level	Chosen arbitrarily but with a changed value.
Frequency list IE	Not Included
Cell Channel Description	128 range encodes (172, 173, 179, 186, 193, 200, 201, 202, 203, 235, 241)
Multislot allocation	
- Downlink assignment	Appropriate for the test, but more than one timeslot allocated and excluding timeslot 0..
- Uplink assignment	Appropriate for the test according to MS Class described in Annex B 05.02.
- Channel set X (1= $X \leq 8$)	Appropriate for the test
Channel Mode	
- Mode	Data, 12.0 kbit/s radio interface rate
Mobile Allocation	Not included
Starting Time	Not included

Step 21

ASSIGNMENT COMMAND

Channel Description 2	
- Channel Type and TDMA offset	10XXX (Same number of TCH/Fs and timeslot mapping as in step 19)
- Timeslot Number	Same as in step 19
- Training Sequence Code	Chosen arbitrarily
- Hopping	Frequency hopping
- MAIO	Chosen arbitrarily from the set (0, 1 to N-1) where N is the number of frequencies in the Mobile Allocation IE.
- HSN	Chosen arbitrarily from the set (1 to 63)
Power Command	
- Power level	Chosen arbitrarily but with a changed value.
Frequency list IE	Not Included
Cell Channel Description	128 range encodes (172, 173, 179, 186, 193, 200, 201, 202, 203, 235, 241)
Channel Mode	
- Mode	Data, 12.0 kbit/s radio interface rate
Mobile Allocation	Indicate frequencies (173, 200, 201)
Starting Time	Not included

Step 25

ASSIGNMENT COMMAND

Channel Description 2	00000
- Channel Type and TDMA offset	Same as in step 19
- Timeslot Number	Chosen arbitrarily
- Training Sequence Code	Single RF Channel
- Hopping	the ARFCN of the BCCH carrier
- ARFCN	
Power Command	
- Power level	Chosen arbitrarily but with a changed value.
Frequency list IE	Not Included
Cell Channel Description	128 range encodes (172, 173, 179, 186, 193, 200, 201, 202, 203, 235, 241)
Multislot allocation	
- Downlink assignment	Indicate same timeslots as step 19.
- Uplink assignment	Appropriate for the test according to MS Class described in Annex B 05.02.
- Channel set X (1=<X<=8)	Appropriate for the test
Channel Mode	
- Mode	Data, 12.0 kbit/s radio interface rate
Mobile Allocation	Not included
Starting Time	Not included

Step 28

ASSIGNMENT COMMAND

Channel Description 2	10000 (no additional timeslots)
- Channel Type and TDMA offset	Same as in step 19
- Timeslot Number	Chosen arbitrarily
- Training Sequence Code	Frequency hopping
- Hopping	Chosen arbitrarily from the set (0, 1 to N-1) where N is the number of frequencies in the Mobile Allocation IE.
- MAIO	Chosen arbitrarily from the set (1 to 63)
- HSN	
Power Command	
- Power level	Chosen arbitrarily but with a changed value.
Frequency list IE	Not Included
Cell Channel Description	Not included
Channel Mode	
- Mode	Data, 12.0 kbit/s radio interface rate
Mobile Allocation	Indicate frequencies (173, 200, 201)
Starting Time	Chosen arbitrarily

GSM 850 end:

26.13.1.2.2 Multislot signalling / RR / Dedicated assignment / failure / general case

26.13.1.2.2.1 Conformance requirements

On the mobile station side, if a lower layer failure happens on the new channel before the ASSIGNMENT COMPLETE message has been sent, the mobile station deactivates the new channels, reactivates the old channels, reconnects the TCHs if any and triggers the establishment of the main signalling link. It then sends an ASSIGNMENT FAILURE message, cause "protocol error unspecified" on the main DCCH and resumes the normal operation, as if no assignment attempt had occurred. The operational parameters (e.g. ciphering mode) when returning on the old channel are those applied before the procedure.

References

Conformance requirements: 3GPP TS 04.08 / 3GPP TS 44.018 subclauses 3.4.3, 9.1.3 and 9.1.4.

26.13.1.2.2.2 Test purpose

- 1) To test that, when the MS fails to seize the new channel, the MS reactivates the old channel.
- 2) This is tested in the special cases of transition:
 - 2.1) from non-hopping SDCCH to hopping symmetric multislot configuration;
 - 2.2) from hopping asymmetric multislot configuration to non-hopping symmetric;
 - 2.3) from non hopping symmetric multislot configuration to non-hopping symmetric multislot configuration, resource upgrading used;
 - 2.4) from non-hopping asymmetric multislot configuration to non-hopping asymmetric multislot configuration, resource upgrading used;
 - 2.5) from hopping symmetric multislot configuration to hopping asymmetric multislot configuration, resource upgrading used;
 - 2.6) from hopping asymmetric multislot configuration to non-hopping multislot configuration, resources downgrading to one TCH/F.

26.13.1.2.2.3 Method of test

Initial Conditions

System Simulator:

1 cell, default parameters.

Mobile Station:

The MS is "idle updated".

Specific PICS statements:

- Multislot class (TSPC_Type_Multislot_ClassX)

PIXIT statements:

-

Foreseen Final State of the MS

The MS is "idle updated".

Test Procedure

A mobile terminated RR connection is established on an SDCCH. The following is repeated six times with different parameters:

The SS sends an ASSIGNMENT COMMAND message allocating a hopping/non-hopping symmetric/asymmetric multislot configuration with or without resource upgrading/downgrading, but does not activate the assigned channels. The MS shall try to activate the new channel (this is not verified) and shall then reactivate the old channel and trigger the establishment of the main signalling link on the old channel. Then the MS shall send an ASSIGNMENT FAILURE.

The SS initiates the channel release procedure and the test ends here.

Maximum Duration of Test

30 s.

Expected Sequence

An MS supporting Multislot Class 1 need only perform steps 1..7, 11..13 and 34.

Step	Direction	Message	Comments
1	SS -> MS	PAGING REQUEST TYPE 1	
2	MS -> SS	CHANNEL REQUEST	
3	SS -> MS	IMMEDIATE ASSIGNMENT	Channel Type: SDCCH/4.
4	MS -> SS	PAGING RESPONSE	
5	SS -> MS	ASSIGNMENT COMMAND	See specific message contents below. The MS attempts (and fails) to establish a signalling link on the new channel.
6			The MS re-establishes the signalling link on the old channel.
7	MS -> SS	ASSIGNMENT FAILURE	RR cause value = "protocol error unspecified".
8	SS		The SS checks that the MS reports the old power level (prior to the Assignment command) in the layer 1 header of the SACCH message that is sent in the first SACCH multiframe following the SABM.
9	SS -> MS	ASSIGNMENT COMMAND	See specific message contents below.
10	MS -> SS	ASSIGNMENT COMPLETE	Assignment command is successfully performed.
11	SS -> MS	ASSIGNMENT COMMAND	Channel Type = TCH/F, non-hopping, symmetric multislot configuration. The MS attempts (and fails) to establish a signalling link on the new channel.
12			The MS re-establishes the signalling link on the old channel.
13	MS -> SS	ASSIGNMENT FAILURE	RR cause value = "protocol error unspecified".
14	SS -> MS	ASSIGNMENT COMMAND	Assignment command to non-hopping, symmetric multislot configuration is successfully performed.
15	MS -> SS	ASSIGNMENT COMPLETE	
16	SS -> MS	ASSIGNMENT COMMAND	Channel Type = TCH/F, non-hopping, symmetric multislot configuration, resource upgrading used. The MS attempts (and fails) to establish a signalling link on the new channel.
17			The MS re-establishes the signalling link on the old channel.
18	MS -> SS	ASSIGNMENT FAILURE	RR cause value = "protocol error unspecified".
19	SS -> MS	ASSIGNMENT COMMAND	Assignment command to non-hopping, asymmetric multislot configuration is successfully performed.
20	MS -> SS	ASSIGNMENT COMPLETE	
21	SS -> MS	ASSIGNMENT COMMAND	Channel Type = TCH/F, non-hopping, asymmetric multislot configuration, resource downgrading used. The MS attempts (and fails) to establish a signalling link on the new channel.
22			The MS re-establishes the signalling link on the old channel.
23	MS -> SS	ASSIGNMENT FAILURE	RR cause value = "protocol error unspecified".
24	SS -> MS	ASSIGNMENT COMMAND	Assignment command to hopping, symmetric multislot configuration is successfully performed.
25	MS -> SS	ASSIGNMENT COMPLETE	
26	SS -> MS	ASSIGNMENT COMMAND	Channel Type = TCH/F, hopping, asymmetric multislot configuration, resource upgrading used. The MS attempts (and fails) to establish a signalling link on the new channel.
27			The MS re-establishes the signalling link on the old channel.
28	MS -> SS	ASSIGNMENT FAILURE	RR cause value = "protocol error unspecified".
29	SS -> MS	ASSIGNMENT COMMAND	Assignment command to hopping, asymmetric multislot configuration is successfully performed.
30	MS -> SS	ASSIGNMENT COMPLETE	
31	SS -> MS	ASSIGNMENT COMMAND	Channel Type = TCH/F, non-hopping, multislot configuration, resources downgrading to one TCH/F. The MS attempts (and fails) to establish a signalling link on the new channel.
32			The MS re-establishes the signalling link on the old channel.
33	MS -> SS	ASSIGNMENT FAILURE	RR cause value = "protocol error unspecified".
34	SS -> MS	CHANNEL RELEASE	The main signalling link is released.

Specific Message Contents

GSM 450 begin:

Step 5:

ASSIGNMENT COMMAND

Channel Description 2	00000
- Channel Type and TDMA offset	A suitable value for multislot configuration, chosen arbitrarily
- Timeslot Number	Chosen arbitrarily
- Training Sequence Code	RF hopping channel
- Hopping	
- MAIO	Chosen arbitrarily from the set (0, 1 to N-1) where N is the number of frequencies in the Mobile Allocation IE.
- HSN	Chosen arbitrarily from the set (1 to 63)
Power Command	Chosen arbitrarily but with a changed value.
- Power level	Not Included
Frequency list IE	
Cell Channel Description	Use Range 128 to encode (271, 273, 275, 277, 279, 281, 283, 285, 287, 289, 291)
Multislot allocation	Maximum number of symmetrical timeslots assigned.
- Downlink assignment	As many timeslots as downlink direction.
- Uplink assignment	Appropriate for the test
- Channel set X (1= X ≤8)	
Channel Mode	
- Mode	Data, 12.0 kbit/s radio interface rate
Mobile Allocation	Arbitrarily chosen from Cell channel description
Starting Time	Not included

Step 9:

ASSIGNMENT COMMAND

Channel Description 2	00000
- Channel Type and TDMA offset	A suitable value for multislot configuration, chosen arbitrarily
- Timeslot Number	Chosen arbitrarily
- Training Sequence Code	RF hopping channel
- Hopping	
- MAIO	Chosen arbitrarily from the set (0, 1 to N-1) where N is the number of frequencies in the Mobile Allocation IE.
- HSN	Chosen arbitrarily from the set (1 to 63)
Power Command	Chosen arbitrarily but with a changed value.
- Power level	Not Included
Frequency list IE	
Cell Channel Description	Use Range 128 to encode (271, 273, 275, 277, 279, 281, 283, 285, 287, 289, 291)
Multislot allocation	Maximum number of timeslots that MS supports.
- Downlink assignment	Less timeslots assigned than downlink direction.
- Uplink assignment	Appropriate for the test
- Channel set X (1= X ≤8)	
Channel Mode	
- Mode	Data, 12.0 kbit/s radio interface rate
Mobile Allocation	Arbitrarily chosen from Cell channel description
Starting Time	Not included

Step 11:

ASSIGNMENT COMMAND

Channel Description 2	00000
- Channel Type and TDMA offset	A suitable value for multislot configuration, chosen arbitrarily
- Timeslot Number	Chosen arbitrarily
- Training Sequence Code	Single RF channel
- Hopping	the ARFCN of the BCCH carrier
- ARFCN	
Power Command	Chosen arbitrarily but with a changed value.
- Power level	Not Included
Frequency list IE	Use Range 128 to encode (271, 273, 275, 277, 279, 281, 283, 285, 287, 289, 291)
Cell Channel Description	
Multislot allocation	Maximum number of symmetrical timeslots supported by MS assigned.
- Downlink assignment	As many timeslots as in downlink direction.
- Uplink assignment	Appropriate for the test
- Channel set X (1= X ≤8)	
Channel Mode	Data, 12.0 kbit/s radio interface rate
- Mode	
Mobile Allocation	Not included
Starting Time	Not included

Step 14:

ASSIGNMENT COMMAND

Channel Description 2	00000
- Channel Type and TDMA offset	A suitable value for multislot configuration, chosen arbitrarily
- Timeslot Number	Chosen arbitrarily
- Training Sequence Code	Single RF channel
- Hopping	the ARFCN of the BCCH carrier
- ARFCN	
Power Command	Chosen arbitrarily but with a changed value.
- Power level	Not Included
Frequency list IE	Use Range 128 to encode (271, 273, 275, 277, 279, 281, 283, 285, 287, 289, 291)
Cell Channel Description	
Multislot allocation	Only one timeslot is assigned in downlink direction.
- Downlink assignment	Only one timeslot is assigned in uplink direction.
- Uplink assignment	Appropriate for the test
- Channel set X (1= X ≤8)	
Channel Mode	Data, 12.0 kbit/s radio interface rate
- Mode	
Mobile Allocation	Not included
Starting Time	Not included

Step 16:

ASSIGNMENT COMMAND

Channel Description 2 - Channel Type and TDMA offset - Timeslot Number	00000 A suitable value for multislot configuration, chosen arbitrarily
- Training Sequence Code	Chosen arbitrarily
- Hopping	Single RF channel
- ARFCN	the ARFCN of the BCCH carrier
Power Command - Power level	Chosen arbitrarily but with a changed value.
Frequency list IE	Not Included
Cell Channel Description	Use range 128 to encode (271, 273, 275, 277, 279, 281, 283, 285, 287, 289, 291)
Multislot allocation - Downlink assignment	Maximum number of timeslots that MS supports.
- Uplink assignment	Maximum number of timeslots that MS supports.
- Channel set X (1=<X<=8)	Appropriate for the test
Channel Mode - Mode	Data, 12.0 kbit/s radio interface rate
Mobile Allocation	Not included
Starting Time	Not included

Step 19:

ASSIGNMENT COMMAND

Channel Description 2 - Channel Type and TDMA offset - Timeslot Number	00000 A suitable value for multislot configuration, chosen arbitrarily
- Training Sequence Code	Chosen arbitrarily
- Hopping	Single RF channel
- ARFCN	the ARFCN of the BCCH carrier
Power Command - Power level	Chosen arbitrarily but with a changed value.
Frequency list IE	Not Included
Cell Channel Description	Use Range 128 to encode (271, 273, 275, 277, 279, 281, 283, 285, 287, 289, 291)
Multislot allocation - Downlink assignment	More than one timeslot but less than maximum number of timeslots is assigned in downlink direction.
- Uplink assignment	Only one timeslot is assigned in uplink direction.
- Channel set X (1=<X<=8)	Appropriate for the test
Channel Mode - Mode	Data, 12.0 kbit/s radio interface rate
Mobile Allocation	Not included
Starting Time	Not included

Step 21:

ASSIGNMENT COMMAND

Channel Description 2	00000
- Channel Type and TDMA offset	A suitable value for multislot configuration, chosen arbitrarily
- Timeslot Number	Chosen arbitrarily
- Training Sequence Code	Single RF channel
- Hopping	the ARFCN of the BCCH carrier
- ARFCN	
Power Command	Chosen arbitrarily but with a changed value.
- Power level	Not Included
Frequency list IE	Use Range 128 to encode (271, 273, 275, 277, 279, 281, 283, 285, 287, 289, 291)
Cell Channel Description	
Multislot allocation	Maximum number of timeslots that MS supports.
- Downlink assignment	Less timeslots assigned than downlink direction.
- Uplink assignment	Appropriate for the test
- Channel set X (1= X ≤8)	
Channel Mode	
- Mode	Data, 12.0 kbit/s radio interface rate
Mobile Allocation	Not included
Starting Time	Not included

Step 24:

ASSIGNMENT COMMAND

Channel Description 2	00000
- Channel Type and TDMA offset	A suitable value for multislot configuration, chosen arbitrarily
- Timeslot Number	Chosen arbitrarily
- Training Sequence Code	RF hopping channel
- Hopping	
- MAIO	Chosen arbitrarily from the set (0, 1 to N-1) where N is the number of frequencies in the Mobile Allocation IE.
- HSN	Chosen arbitrarily from the set (1 to 63)
Power Command	Chosen arbitrarily but with a changed value.
- Power level	Not Included
Frequency list IE	Use Range 128 to encode (271, 273, 275, 277, 279, 281, 283, 285, 287, 289, 291)
Cell Channel Description	
Multislot allocation	Only one timeslot is assigned in downlink direction.
- Downlink assignment	Only one timeslot is assigned in uplink direction.
- Uplink assignment	Appropriate for the test
- Channel set X (1= X ≤8)	
Channel Mode	
- Mode	Data, 12.0 kbit/s radio interface rate
Mobile Allocation	Chosen arbitrarily from the Cell channel description
Starting Time	Not included

Step 26:

ASSIGNMENT COMMAND

Channel Description 2	
- Channel Type and TDMA offset	00000
- Timeslot Number	A suitable value for multislot configuration, chosen arbitrarily
- Training Sequence Code	Chosen arbitrarily
- Hopping	RF hopping channel
- MAIO	Chosen arbitrarily from the set (0, 1 to N-1) where N is the number of frequencies in the Mobile Allocation IE.
- HSN	Chosen arbitrarily from the set (1 to 63)
Power Command	
- Power level	Chosen arbitrarily but with a changed value.
Frequency list IE	Not Included
Cell Channel Description	Use Range 128 to encode (271, 273, 275, 277, 279, 281, 283, 285, 287, 289, 291)
Multislot allocation	
- Downlink assignment	Maximum number of timeslots that MS supports.
- Uplink assignment	Less timeslots assigned than in downlink direction.
- Channel set X (1=<X<=8)	Appropriate for the test
Channel Mode	
- Mode	Data, 12.0 kbit/s radio interface rate
Mobile Allocation	Chosen arbitrarily from the Cell channel description
Starting Time	Not included

Step 29:

ASSIGNMENT COMMAND

Channel Description 2	
- Channel Type and TDMA offset	00000
- Timeslot Number	A suitable value for multislot configuration, chosen arbitrarily
- Training Sequence Code	Chosen arbitrarily
- Hopping	RF hopping channel
- MAIO	Chosen arbitrarily from the set (0, 1 to N-1) where N is the number of frequencies in the Mobile Allocation IE.
- HSN	Chosen arbitrarily from the set (1 to 63)
Power Command	
- Power level	Chosen arbitrarily but with a changed value.
Frequency list IE	Not Included
Cell Channel Description	Use Range 128 to encode (271, 273, 275, 277, 279, 281, 283, 285, 287, 289, 291)
Multislot allocation	
- Downlink assignment	Maximum number of timeslots that MS supports.
- Uplink assignment	Less timeslots assigned than in downlink direction.
- Channel set X (1=<X<=8)	Appropriate for the test
Channel Mode	
- Mode	Data, 12.0 kbit/s radio interface rate
Mobile Allocation	Chosen arbitrarily from the Cell channel description
Starting Time	Not included

Step 31:

ASSIGNMENT COMMAND

Channel Description 2	
- Channel Type and TDMA offset	00000
- Timeslot Number	A suitable value for multislot configuration, chosen arbitrarily
- Training Sequence Code	Chosen arbitrarily
- Hopping	Single RF channel
- ARFCN	the ARFCN of the BCCH carrier
Power Command	
- Power level	Chosen arbitrarily but with a changed value.
Frequency list IE	Not Included
Cell Channel Description	Use Range 128 to encode (271, 273, 275, 277, 279, 281, 283, 285, 287, 289, 291)
Multislot allocation	
- Downlink assignment	Only one timeslot is assigned in downlink direction.
- Uplink assignment	Only one timeslot is assigned in uplink direction.
- Channel set X (1= X ≤8)	Appropriate for the test
Channel Mode	
- Mode	Data, 12.0 kbit/s radio interface rate
Mobile Allocation	Not included
Starting Time	Not included

GSM 450 end:

GSM 480 begin:

Step 5:

ASSIGNMENT COMMAND

Channel Description 2	
- Channel Type and TDMA offset	00000
- Timeslot Number	A suitable value for multislot configuration, chosen arbitrarily
- Training Sequence Code	Chosen arbitrarily
- Hopping	RF hopping channel
- MAIO	Chosen arbitrarily from the set (0, 1 to N-1) where N is the number of frequencies in the Mobile Allocation IE.
- HSN	Chosen arbitrarily from the set (1 to 63)
Power Command	
- Power level	Chosen arbitrarily but with a changed value.
Frequency list IE	Not Included
Cell Channel Description	Use Range 128 to encode (318, 320, 322, 324, 326, 328, 330, 332, 334, 336, 338)
Multislot allocation	
- Downlink assignment	Maximum number of symmetrical timeslots assigned.
- Uplink assignment	As many timeslots as downlink direction.
- Channel set X (1= X ≤8)	Appropriate for the test
Channel Mode	
- Mode	Data, 12.0 kbit/s radio interface rate
Mobile Allocation	Arbitrarily chosen from Cell channel description
Starting Time	Not included

Step 9:

ASSIGNMENT COMMAND

Channel Description 2	
- Channel Type and TDMA offset	00000
- Timeslot Number	A suitable value for multislot configuration, chosen arbitrarily
- Training Sequence Code	Chosen arbitrarily
- Hopping	RF hopping channel
- MAIO	Chosen arbitrarily from the set (0, 1 to N-1) where N is the number of frequencies in the Mobile Allocation IE.
- HSN	Chosen arbitrarily from the set (1 to 63)
Power Command	
- Power level	Chosen arbitrarily but with a changed value.
Frequency list IE	Not Included
Cell Channel Description	Use Range 128 to encode (318, 320, 322, 324, 326, 328, 330, 332, 334, 336, 338)
Multislot allocation	
- Downlink assignment	Maximum number of timeslots that MS supports.
- Uplink assignment	Less timeslots assigned than downlink direction.
- Channel set X (1=<X<=8)	Appropriate for the test
Channel Mode	
- Mode	Data, 12.0 kbit/s radio interface rate
Mobile Allocation	Arbitrarily chosen from Cell channel description
Starting Time	Not included

Step 11:

ASSIGNMENT COMMAND

Channel Description 2	
- Channel Type and TDMA offset	00000
- Timeslot Number	A suitable value for multislot configuration, chosen arbitrarily
- Training Sequence Code	Chosen arbitrarily
- Hopping	Single RF channel
- ARFCN	the ARFCN of the BCCH carrier
Power Command	
- Power level	Chosen arbitrarily but with a changed value.
Frequency list IE	Not Included
Cell Channel Description	Use Range 128 to encode (318, 320, 322, 324, 326, 328, 330, 332, 334, 336, 338)
Multislot allocation	
- Downlink assignment	Maximum number of symmetrical timeslots supported by MS assigned.
- Uplink assignment	As many timeslots as in downlink direction.
- Channel set X (1=<X<=8)	Appropriate for the test
Channel Mode	
- Mode	Data, 12.0 kbit/s radio interface rate
Mobile Allocation	Not included
Starting Time	Not included

Step 14:

ASSIGNMENT COMMAND

Channel Description 2 - Channel Type and TDMA offset - Timeslot Number	00000 A suitable value for multislot configuration, chosen arbitrarily
- Training Sequence Code	Chosen arbitrarily
- Hopping	Single RF channel
- ARFCN	the ARFCN of the BCCH carrier
Power Command - Power level	Chosen arbitrarily but with a changed value.
Frequency list IE	Not Included
Cell Channel Description	Use Range 128 to encode (318, 320, 322, 324, 326, 328, 330, 332, 334, 336, 338)
Multislot allocation - Downlink assignment - Uplink assignment - Channel set X (1=<X<=8)	Only one timeslot is assigned in downlink direction. Only one timeslot is assigned in uplink direction. Appropriate for the test
Channel Mode - Mode	Data, 12.0 kbit/s radio interface rate
Mobile Allocation	Not included
Starting Time	Not included

Step 16:

ASSIGNMENT COMMAND

Channel Description 2 - Channel Type and TDMA offset - Timeslot Number	00000 A suitable value for multislot configuration, chosen arbitrarily
- Training Sequence Code	Chosen arbitrarily
- Hopping	Single RF channel
- ARFCN	the ARFCN of the BCCH carrier
Power Command - Power level	Chosen arbitrarily but with a changed value.
Frequency list IE	Not Included
Cell Channel Description	Use Range 128 to encode (318, 320, 322, 324, 326, 328, 330, 332, 334, 336, 338)
Multislot allocation - Downlink assignment - Uplink assignment - Channel set X (1=<X<=8)	Maximum number of timeslots that MS supports. Maximum number of timeslots that MS supports. Appropriate for the test
Channel Mode - Mode	Data, 12.0 kbit/s radio interface rate
Mobile Allocation	Not included
Starting Time	Not included

Step 19:

ASSIGNMENT COMMAND

Channel Description 2 - Channel Type and TDMA offset - Timeslot Number	00000 A suitable value for multislot configuration, chosen arbitrarily
- Training Sequence Code	Chosen arbitrarily
- Hopping	Single RF channel
- ARFCN	the ARFCN of the BCCH carrier
Power Command - Power level	Chosen arbitrarily but with a changed value.
Frequency list IE	Not Included
Cell Channel Description	Use Range 128 to encode (318, 320, 322, 324, 326, 328, 330, 332, 334, 336, 338)
Multislot allocation - Downlink assignment	More than one timeslot but less than maximum number of timeslots is assigned in downlink direction.
- Uplink assignment	Only one timeslot is assigned in uplink direction.
- Channel set X (1= $X \leq 8$)	Appropriate for the test
Channel Mode - Mode	Data, 12.0 kbit/s radio interface rate
Mobile Allocation	Not included
Starting Time	Not included

Step 21:

ASSIGNMENT COMMAND

Channel Description 2 - Channel Type and TDMA offset - Timeslot Number	00000 A suitable value for multislot configuration, chosen arbitrarily
- Training Sequence Code	Chosen arbitrarily
- Hopping	Single RF channel
- ARFCN	the ARFCN of the BCCH carrier
Power Command - Power level	Chosen arbitrarily but with a changed value.
Frequency list IE	Not Included
Cell Channel Description	Use Range 128 to encode (318, 320, 322, 324, 326, 328, 330, 332, 334, 336, 338)
Multislot allocation - Downlink assignment	Maximum number of timeslots that MS supports.
- Uplink assignment	Less timeslots assigned than downlink direction.
- Channel set X (1= $X \leq 8$)	Appropriate for the test
Channel Mode - Mode	Data, 12.0 kbit/s radio interface rate
Mobile Allocation	Not included
Starting Time	Not included

Step 24:

ASSIGNMENT COMMAND

Channel Description 2	
- Channel Type and TDMA offset	00000
- Timeslot Number	A suitable value for multislot configuration, chosen arbitrarily
- Training Sequence Code	Chosen arbitrarily
- Hopping	RF hopping channel
- MAIO	Chosen arbitrarily from the set (0, 1 to N-1) where N is the number of frequencies in the Mobile Allocation IE.
- HSN	Chosen arbitrarily from the set (1 to 63)
Power Command	
- Power level	Chosen arbitrarily but with a changed value.
Frequency list IE	Not Included
Cell Channel Description	Use Range 128 to encode (318, 320, 322, 324, 326, 328, 330, 332, 334, 336, 338)
Multislot allocation	
- Downlink assignment	Only one timeslot is assigned in downlink direction.
- Uplink assignment	Only one timeslot is assigned in uplink direction.
- Channel set X (1= X ≤8)	Appropriate for the test
Channel Mode	
- Mode	Data, 12.0 kbit/s radio interface rate
Mobile Allocation	Chosen arbitrarily from the Cell channel description
Starting Time	Not included

Step 26:

ASSIGNMENT COMMAND

Channel Description 2	
- Channel Type and TDMA offset	00000
- Timeslot Number	A suitable value for multislot configuration, chosen arbitrarily
- Training Sequence Code	Chosen arbitrarily
- Hopping	RF hopping channel
- MAIO	Chosen arbitrarily from the set (0, 1 to N-1) where N is the number of frequencies in the Mobile Allocation IE.
- HSN	Chosen arbitrarily from the set (1 to 63)
Power Command	
- Power level	Chosen arbitrarily but with a changed value.
Frequency list IE	Not Included
Cell Channel Description	Use Range 128 to encode (318, 320, 322, 324, 326, 328, 330, 332, 334, 336, 338)
Multislot allocation	
- Downlink assignment	Maximum number of timeslots that MS supports.
- Uplink assignment	Less timeslots assigned than in downlink direction.
- Channel set X (1= X ≤8)	Appropriate for the test
Channel Mode	
- Mode	Data, 12.0 kbit/s radio interface rate
Mobile Allocation	Chosen arbitrarily from the Cell channel description
Starting Time	Not included

Step 29:

ASSIGNMENT COMMAND

Channel Description 2	
- Channel Type and TDMA offset	00000
- Timeslot Number	A suitable value for multislot configuration, chosen arbitrarily
- Training Sequence Code	Chosen arbitrarily
- Hopping	RF hopping channel
- MAIO	Chosen arbitrarily from the set (0, 1 to N-1) where N is the number of frequencies in the Mobile Allocation IE.
- HSN	Chosen arbitrarily from the set (1 to 63)
Power Command	
- Power level	Chosen arbitrarily but with a changed value.
Frequency list IE	Not Included
Cell Channel Description	Use Range 128 to encode (318, 320, 322, 324, 326, 328, 330, 332, 334, 336, 338)
Multislot allocation	
- Downlink assignment	Maximum number of timeslots that MS supports.
- Uplink assignment	Less timeslots assigned than in downlink direction.
- Channel set X (1= X ≤8)	Appropriate for the test
Channel Mode	
- Mode	Data, 12.0 kbit/s radio interface rate
Mobile Allocation	Chosen arbitrarily from the Cell channel description
Starting Time	Not included

Step 31:

ASSIGNMENT COMMAND

Channel Description 2	
- Channel Type and TDMA offset	00000
- Timeslot Number	A suitable value for multislot configuration, chosen arbitrarily
- Training Sequence Code	Chosen arbitrarily
- Hopping	Single RF channel
- ARFCN	the ARFCN of the BCCH carrier
Power Command	
- Power level	Chosen arbitrarily but with a changed value.
Frequency list IE	Not Included
Cell Channel Description	Use Range 128 to encode (318, 320, 322, 324, 326, 328, 330, 332, 334, 336, 338)
Multislot allocation	
- Downlink assignment	Only one timeslot is assigned in downlink direction.
- Uplink assignment	Only one timeslot is assigned in uplink direction.
- Channel set X (1= X ≤8)	Appropriate for the test
Channel Mode	
- Mode	Data, 12.0 kbit/s radio interface rate
Mobile Allocation	Not included
Starting Time	Not included

GSM 480 end:

GSM 900 begin:

Step 5:

ASSIGNMENT COMMAND

Channel Description 2	00000
- Channel Type and TDMA offset	A suitable value for multislot configuration, chosen arbitrarily
- Timeslot Number	Chosen arbitrarily
- Training Sequence Code	RF hopping channel
- Hopping	
- MAIO	Chosen arbitrarily from the set (0, 1 to N-1) where N is the number of frequencies in the Mobile Allocation IE.
- HSN	Chosen arbitrarily from the set (1 to 63)
Power Command	Chosen arbitrarily but with a changed value.
- Power level	Not Included
Frequency list IE	Not Included
Cell Channel Description	Bit map zero encodes (45, 46, 52, 59, 66, 73, 74, 75, 76, 108, 114)
Multislot allocation	Maximum number of symmetrical timeslots assigned.
- Downlink assignment	As many timeslots as downlink direction.
- Uplink assignment	Appropriate for the test
- Channel set X (1=<X<=8)	
Channel Mode	Data, 12.0 kbit/s radio interface rate
- Mode	Arbitrarily chosen from Cell channel description
Mobile Allocation	Arbitrarily chosen from Cell channel description
Starting Time	Not included

Step 9:

ASSIGNMENT COMMAND

Channel Description 2	00000
- Channel Type and TDMA offset	A suitable value for multislot configuration, chosen arbitrarily
- Timeslot Number	Chosen arbitrarily
- Training Sequence Code	RF hopping channel
- Hopping	
- MAIO	Chosen arbitrarily from the set (0, 1 to N-1) where N is the number of frequencies in the Mobile Allocation IE.
- HSN	Chosen arbitrarily from the set (1 to 63)
Power Command	Chosen arbitrarily but with a changed value.
- Power level	Not Included
Frequency list IE	Not Included
Cell Channel Description	Bit map zero encodes (45, 46, 52, 59, 66, 73, 74, 75, 76, 108, 114)
Multislot allocation	Maximum number of timeslots that MS supports.
- Downlink assignment	Less timeslots assigned than downlink direction.
- Uplink assignment	Appropriate for the test
- Channel set X (1=<X<=8)	
Channel Mode	Data, 12.0 kbit/s radio interface rate
- Mode	Arbitrarily chosen from Cell channel description
Mobile Allocation	Arbitrarily chosen from Cell channel description
Starting Time	Not included

Step 11:

ASSIGNMENT COMMAND

Channel Description 2 - Channel Type and TDMA offset - Timeslot Number	00000 A suitable value for multislot configuration, chosen arbitrarily
- Training Sequence Code	Chosen arbitrarily
- Hopping	Single RF channel
- ARFCN	the ARFCN of the BCCH carrier
Power Command - Power level	Chosen arbitrarily but with a changed value.
Frequency list IE	Not Included
Cell Channel Description	Bit map zero encodes (45, 46, 52, 59, 66, 73, 74, 75, 76, 108, 114)
Multislot allocation - Downlink assignment	Maximum number of symmetrical timeslots supported by MS assigned.
- Uplink assignment	As many timeslots as in downlink direction.
- Channel set X (1=<X<=8)	Appropriate for the test
Channel Mode - Mode	Data, 12.0 kbit/s radio interface rate
Mobile Allocation	Not included
Starting Time	Not included

Step 14:

ASSIGNMENT COMMAND

Channel Description 2 - Channel Type and TDMA offset - Timeslot Number	00000 A suitable value for multislot configuration, chosen arbitrarily
- Training Sequence Code	Chosen arbitrarily
- Hopping	Single RF channel
- ARFCN	the ARFCN of the BCCH carrier
Power Command - Power level	Chosen arbitrarily but with a changed value.
Frequency list IE	Not Included
Cell Channel Description	Bit map zero encodes (45, 46, 52, 59, 66, 73, 74, 75, 76, 108, 114)
Multislot allocation - Downlink assignment	Only one timeslot is assigned in downlink direction.
- Uplink assignment	Only one timeslot is assigned in uplink direction.
- Channel set X (1=<X<=8)	Appropriate for the test
Channel Mode - Mode	Data, 12.0 kbit/s radio interface rate
Mobile Allocation	Not included
Starting Time	Not included

Step 16:

ASSIGNMENT COMMAND

Channel Description 2 - Channel Type and TDMA offset - Timeslot Number	00000 A suitable value for multislot configuration, chosen arbitrarily
- Training Sequence Code	Chosen arbitrarily
- Hopping	Single RF channel
- ARFCN	the ARFCN of the BCCH carrier
Power Command - Power level	Chosen arbitrarily but with a changed value.
Frequency list IE	Not Included
Cell Channel Description	Bit map zero encodes (45, 46, 52, 59, 66, 73, 74, 75, 76, 108, 114)
Multislot allocation - Downlink assignment	Maximum number of timeslots that MS supports.
- Uplink assignment	Maximum number of timeslots that MS supports.
- Channel set X (1= X ≤8)	Appropriate for the test
Channel Mode - Mode	Data, 12.0 kbit/s radio interface rate
Mobile Allocation	Not included
Starting Time	Not included

Step 19:

ASSIGNMENT COMMAND

Channel Description 2 - Channel Type and TDMA offset - Timeslot Number	00000 A suitable value for multislot configuration, chosen arbitrarily
- Training Sequence Code	Chosen arbitrarily
- Hopping	Single RF channel
- ARFCN	the ARFCN of the BCCH carrier
Power Command - Power level	Chosen arbitrarily but with a changed value.
Frequency list IE	Not Included
Cell Channel Description	Bit map zero encodes (45, 46, 52, 59, 66, 73, 74, 75, 76, 108, 114)
Multislot allocation - Downlink assignment	More than one timeslot but less than maximum number of timeslots is assigned in downlink direction.
- Uplink assignment	Only one timeslot is assigned in uplink direction.
- Channel set X (1= X ≤8)	Appropriate for the test
Channel Mode - Mode	Data, 12.0 kbit/s radio interface rate
Mobile Allocation	Not included
Starting Time	Not included

Step 21:

ASSIGNMENT COMMAND

Channel Description 2	00000
- Channel Type and TDMA offset	A suitable value for multislot configuration, chosen arbitrarily
- Timeslot Number	Chosen arbitrarily
- Training Sequence Code	Single RF channel
- Hopping	the ARFCN of the BCCH carrier
- ARFCN	
Power Command	Chosen arbitrarily but with a changed value.
- Power level	Not Included
Frequency list IE	Not Included
Cell Channel Description	Bit map zero encodes (45, 46, 52, 59, 66, 73, 74, 75, 76, 108, 114)
Multislot allocation	Maximum number of timeslots that MS supports.
- Downlink assignment	Less timeslots assigned than downlink direction.
- Uplink assignment	Appropriate for the test
- Channel set X (1=<X<=8)	
Channel Mode	
- Mode	Data, 12.0 kbit/s radio interface rate
Mobile Allocation	Not included
Starting Time	Not included

Step 24:

ASSIGNMENT COMMAND

Channel Description 2	00000
- Channel Type and TDMA offset	A suitable value for multislot configuration, chosen arbitrarily
- Timeslot Number	Chosen arbitrarily
- Training Sequence Code	RF hopping channel
- Hopping	
- MAIO	Chosen arbitrarily from the set (0, 1 to N-1) where N is the number of frequencies in the Mobile Allocation IE.
- HSN	Chosen arbitrarily from the set (1 to 63)
Power Command	Chosen arbitrarily but with a changed value.
- Power level	Not Included
Frequency list IE	Not Included
Cell Channel Description	Bit map zero encodes (45, 46, 52, 59, 66, 73, 74, 75, 76, 108, 114)
Multislot allocation	Only one timeslot is assigned in downlink direction.
- Downlink assignment	Only one timeslot is assigned in uplink direction.
- Uplink assignment	Appropriate for the test
- Channel set X (1=<X<=8)	
Channel Mode	
- Mode	Data, 12.0 kbit/s radio interface rate
Mobile Allocation	Chosen arbitrarily from the Cell channel description
Starting Time	Not included

Step 26:

ASSIGNMENT COMMAND

Channel Description 2	
- Channel Type and TDMA offset	00000
- Timeslot Number	A suitable value for multislot configuration, chosen arbitrarily
- Training Sequence Code	Chosen arbitrarily
- Hopping	RF hopping channel
- MAIO	Chosen arbitrarily from the set (0, 1 to N-1) where N is the number of frequencies in the Mobile Allocation IE.
- HSN	Chosen arbitrarily from the set (1 to 63)
Power Command	
- Power level	Chosen arbitrarily but with a changed value.
Frequency list IE	Not Included
Cell Channel Description	Bit map zero encodes (45, 46, 52, 59, 66, 73, 74, 75, 76, 108, 114)
Multislot allocation	
- Downlink assignment	Maximum number of timeslots that MS supports.
- Uplink assignment	Less timeslots assigned than in downlink direction.
- Channel set X (1=<X<=8)	Appropriate for the test
Channel Mode	
- Mode	Data, 12.0 kbit/s radio interface rate
Mobile Allocation	Chosen arbitrarily from the Cell channel description
Starting Time	Not included

Step 29:

ASSIGNMENT COMMAND

Channel Description 2	
- Channel Type and TDMA offset	00000
- Timeslot Number	A suitable value for multislot configuration, chosen arbitrarily
- Training Sequence Code	Chosen arbitrarily
- Hopping	RF hopping channel
- MAIO	Chosen arbitrarily from the set (0, 1 to N-1) where N is the number of frequencies in the Mobile Allocation IE.
- HSN	Chosen arbitrarily from the set (1 to 63)
Power Command	
- Power level	Chosen arbitrarily but with a changed value.
Frequency list IE	Not Included
Cell Channel Description	Bit map zero encodes (45, 46, 52, 59, 66, 73, 74, 75, 76, 108, 114)
Multislot allocation	
- Downlink assignment	Maximum number of timeslots that MS supports.
- Uplink assignment	Less timeslots assigned than in downlink direction.
- Channel set X (1=<X<=8)	Appropriate for the test
Channel Mode	
- Mode	Data, 12.0 kbit/s radio interface rate
Mobile Allocation	Chosen arbitrarily from the Cell channel description
Starting Time	Not included

Step 31:

ASSIGNMENT COMMAND

Channel Description 2	
- Channel Type and TDMA offset	00000
- Timeslot Number	A suitable value for multislot configuration, chosen arbitrarily
- Training Sequence Code	Chosen arbitrarily
- Hopping	Single RF channel
- ARFCN	the ARFCN of the BCCH carrier
Power Command	
- Power level	Chosen arbitrarily but with a changed value.
Frequency list IE	Not Included
Cell Channel Description	Bit map zero encodes (45, 46, 52, 59, 66, 73, 74, 75, 76, 108, 114)
Multislot allocation	
- Downlink assignment	Only one timeslot is assigned in downlink direction.
- Uplink assignment	Only one timeslot is assigned in uplink direction.
- Channel set X (1=<X<=8)	Appropriate for the test
Channel Mode	
- Mode	Data, 12.0 kbit/s radio interface rate
Mobile Allocation	Not included
Starting Time	Not included

GSM 900 end:

GSM 1800 begin:

Step 5:

ASSIGNMENT COMMAND

Channel Description 2	
- Channel Type and TDMA offset	00000
- Timeslot Number	A suitable value for multislot configuration, chosen arbitrarily
- Training Sequence Code	Chosen arbitrarily
- Hopping	RF hopping channel
- MAIO	Chosen arbitrarily from the set (0, 1 to N-1) where N is the number of frequencies in the Mobile Allocation IE.
- HSN	Chosen arbitrarily from the set (1 to 63)
Power Command	
- Power level	Chosen arbitrarily but with a changed value.
Frequency list IE	Not Included
Cell Channel Description	Use Range 128 to encode (773, 775, 779, 782, 791, 798, 829, 832, 844)
Multislot allocation	
- Downlink assignment	Maximum number of symmetrical timeslots assigned.
- Uplink assignment	As many timeslots as downlink direction.
- Channel set X (1=<X<=8)	Appropriate for the test
Channel Mode	
- Mode	Data, 12.0 kbit/s radio interface rate
Mobile Allocation	Arbitrarily chosen from Cell channel description
Starting Time	Not included

Step 9:

ASSIGNMENT COMMAND

Channel Description 2	00000
- Channel Type and TDMA offset	A suitable value for multislot configuration, chosen arbitrarily
- Timeslot Number	Chosen arbitrarily
- Training Sequence Code	RF hopping channel
- Hopping	
- MAIO	Chosen arbitrarily from the set (0, 1 to N-1) where N is the number of frequencies in the Mobile Allocation IE.
- HSN	Chosen arbitrarily from the set (1 to 63)
Power Command	Chosen arbitrarily but with a changed value.
- Power level	Not Included
Frequency list IE	Use Range 128 to encode (773, 775, 779, 782, 791, 798, 829, 832, 844)
Cell Channel Description	
Multislot allocation	Maximum number of timeslots that MS supports.
- Downlink assignment	Less timeslots assigned than downlink direction.
- Uplink assignment	Appropriate for the test
- Channel set X (1=<X<=8)	
Channel Mode	Data, 12.0 kbit/s radio interface rate
- Mode	Arbitrarily chosen from Cell channel description
Mobile Allocation	Not included
Starting Time	

Step 11:

ASSIGNMENT COMMAND

Channel Description 2	00000
- Channel Type and TDMA offset	A suitable value for multislot configuration, chosen arbitrarily
- Timeslot Number	Chosen arbitrarily
- Training Sequence Code	Single RF channel
- Hopping	the ARFCN of the BCCH carrier
- ARFCN	
Power Command	Chosen arbitrarily but with a changed value.
- Power level	Not Included
Frequency list IE	Use Range 128 to encode (773, 775, 779, 782, 791, 798, 829, 832, 844)
Cell Channel Description	
Multislot allocation	Maximum number symmetrical of timeslots supported by MS assigned.
- Downlink assignment	As many timeslots as in downlink direction.
- Uplink assignment	Appropriate for the test
- Channel set X (1=<X<=8)	
Channel Mode	Data, 12.0 kbit/s radio interface rate
- Mode	Not included
Mobile Allocation	Not included
Starting Time	Not included

Step 14:

ASSIGNMENT COMMAND

Channel Description 2	00000
- Channel Type and TDMA offset	A suitable value for multislot configuration, chosen arbitrarily
- Timeslot Number	Chosen arbitrarily
- Training Sequence Code	Single RF channel
- Hopping	the ARFCN of the BCCH carrier
- ARFCN	
Power Command	Chosen arbitrarily but with a changed value.
- Power level	Not Included
Frequency list IE	Use Range 128 to encode (773, 775, 779, 782, 791, 798, 829, 832, 844)
Cell Channel Description	
Multislot allocation	Only one timeslot is assigned in downlink direction.
- Downlink assignment	Only one timeslot is assigned in uplink direction.
- Uplink assignment	Appropriate for the test
- Channel set X (1=<X<=8)	
Channel Mode	Data, 12.0 kbit/s radio interface rate
- Mode	
Mobile Allocation	Not included
Starting Time	Not included

Step 16:

ASSIGNMENT COMMAND

Channel Description 2	00000
- Channel Type and TDMA offset	A suitable value for multislot configuration, chosen arbitrarily
- Timeslot Number	Chosen arbitrarily
- Training Sequence Code	Single RF channel
- Hopping	the ARFCN of the BCCH carrier
- ARFCN	
Power Command	Chosen arbitrarily but with a changed value.
- Power level	Not Included
Frequency list IE	Use Range 128 to encode (773, 775, 779, 782, 791, 798, 829, 832, 844)
Cell Channel Description	
Multislot allocation	Maximum number of timeslots that MS supports.
- Downlink assignment	Maximum number of timeslots that MS supports.
- Uplink assignment	Appropriate for the test
- Channel set X (1=<X<=8)	
Channel Mode	Data, 12.0 kbit/s radio interface rate
- Mode	
Mobile Allocation	Not included
Starting Time	Not included

Step 19:

ASSIGNMENT COMMAND

Channel Description 2 - Channel Type and TDMA offset - Timeslot Number	00000 A suitable value for multislot configuration, chosen arbitrarily
- Training Sequence Code	Chosen arbitrarily
- Hopping	Single RF channel
- ARFCN	the ARFCN of the BCCH carrier
Power Command	
- Power level	Chosen arbitrarily but with a changed value.
Frequency list IE	Not Included
Cell Channel Description	Use Range 128 to encode (773, 775, 779, 782, 791, 798, 829, 832, 844)
Multislot allocation	
- Downlink assignment	More than one timeslot but less than maximum number of timeslots is assigned in downlink direction.
- Uplink assignment	Only one timeslot is assigned in uplink direction.
- Channel set X (1= $X \leq 8$)	Appropriate for the test
Channel Mode	
- Mode	Data, 12.0 kbit/s radio interface rate
Mobile Allocation	Not included
Starting Time	Not included

Step 21:

ASSIGNMENT COMMAND

Channel Description 2 - Channel Type and TDMA offset - Timeslot Number	00000 A suitable value for multislot configuration, chosen arbitrarily
- Training Sequence Code	Chosen arbitrarily
- Hopping	Single RF channel
- ARFCN	the ARFCN of the BCCH carrier
Power Command	
- Power level	Chosen arbitrarily but with a changed value.
Frequency list IE	Not Included
Cell Channel Description	Use Range 128 to encode (773, 775, 779, 782, 791, 798, 829, 832, 844)
Multislot allocation	
- Downlink assignment	Maximum number of timeslots that MS supports.
- Uplink assignment	Less timeslots assigned than downlink direction.
- Channel set X (1= $X \leq 8$)	Appropriate for the test
Channel Mode	
- Mode	Data, 12.0 kbit/s radio interface rate
Mobile Allocation	Not included
Starting Time	Not included

Step 24:

ASSIGNMENT COMMAND

Channel Description 2 - Channel Type and TDMA offset - Timeslot Number - Training Sequence Code - Hopping - MAIO - HSN Power Command - Power level Frequency list IE Cell Channel Description Multislot allocation - Downlink assignment - Uplink assignment - Channel set X (1=<X<=8) Channel Mode - Mode Mobile Allocation Starting Time	00000 A suitable value for multislot configuration, chosen arbitrarily Chosen arbitrarily RF hopping channel Chosen arbitrarily from the set (0, 1 to N-1) where N is the number of frequencies in the Mobile Allocation IE. Chosen arbitrarily from the set (1 to 63) Chosen arbitrarily but with a changed value. Not Included Use Range 128 to encode (773, 775, 779, 782, 791, 798, 829, 832, 844) Only one timeslot is assigned in downlink direction. Only one timeslot is assigned in uplink direction. Appropriate for the test Data, 12.0 kbit/s radio interface rate Chosen arbitrarily from the Cell channel description Not included
--	--

Step 26:

ASSIGNMENT COMMAND

Channel Description 2 - Channel Type and TDMA offset - Timeslot Number - Training Sequence Code - Hopping - MAIO - HSN Power Command - Power level Frequency list IE Cell Channel Description Multislot allocation - Downlink assignment - Uplink assignment - Channel set X (1=<X<=8) Channel Mode - Mode Mobile Allocation Starting Time	00000 A suitable value for multislot configuration, chosen arbitrarily Chosen arbitrarily RF hopping channel Chosen arbitrarily from the set (0, 1 to N-1) where N is the number of frequencies in the Mobile Allocation IE. Chosen arbitrarily from the set (1 to 63) Chosen arbitrarily but with a changed value. Not Included Use Range 128 to encode (773, 775, 779, 782, 791, 798, 829, 832, 844) Maximum number of timeslots that MS supports. Less timeslots assigned than in downlink direction. Appropriate for the test Data, 12.0 kbit/s radio interface rate Chosen arbitrarily from the Cell channel description Not included
--	--

Step 29:

ASSIGNMENT COMMAND

Channel Description 2	00000
- Channel Type and TDMA offset	A suitable value for multislot configuration, chosen arbitrarily
- Timeslot Number	
- Training Sequence Code	Chosen arbitrarily
- Hopping	RF hopping channel
- MAIO	Chosen arbitrarily from the set (0, 1 to N-1) where N is the number of frequencies in the Mobile Allocation IE.
- HSN	Chosen arbitrarily from the set (1 to 63)
Power Command	Chosen arbitrarily but with a changed value.
- Power level	
Frequency list IE	Not Included
Cell Channel Description	Use Range 128 to encode (773, 775, 779, 782, 791, 798, 829, 832, 844)
Multislot allocation	Maximum number of timeslots that MS supports.
- Downlink assignment	Less timeslots assigned than in downlink direction.
- Uplink assignment	Appropriate for the test
- Channel set X (1=<X<=8)	
Channel Mode	Data, 12.0 kbit/s radio interface rate
- Mode	
Mobile Allocation	Chosen arbitrarily from the Cell channel description
Starting Time	Not included

Step 31:

ASSIGNMENT COMMAND

Channel Description 2	00000
- Channel Type and TDMA offset	A suitable value for multislot configuration, chosen arbitrarily
- Timeslot Number	
- Training Sequence Code	Chosen arbitrarily
- Hopping	Single RF channel
- ARFCN	the ARFCN of the BCCH carrier
Power Command	Chosen arbitrarily but with a changed value.
- Power level	
Frequency list IE	Not Included
Cell Channel Description	Use Range 128 to encode (773, 775, 779, 782, 791, 798, 829, 832, 844)
Multislot allocation	Only one timeslot is assigned in downlink direction.
- Downlink assignment	Only one timeslot is assigned in uplink direction.
- Uplink assignment	Appropriate for the test
- Channel set X (1=<X<=8)	
Channel Mode	Data, 12.0 kbit/s radio interface rate
- Mode	
Mobile Allocation	Not included
Starting Time	Not included

GSM 1800 end:

GSM 700 begin:

Step 5:

ASSIGNMENT COMMAND

Channel Description 2	00000
- Channel Type and TDMA offset	A suitable value for multislot configuration, chosen arbitrarily
- Timeslot Number	Chosen arbitrarily
- Training Sequence Code	RF hopping channel
- Hopping	
- MAIO	Chosen arbitrarily from the set (0, 1 to N-1) where N is the number of frequencies in the Mobile Allocation IE.
- HSN	Chosen arbitrarily from the set (1 to 63)
Power Command	Chosen arbitrarily but with a changed value.
- Power level	Not Included
Frequency list IE	
Cell Channel Description	128 range encodes (482, 483, 489, 496, 498, 500, 501, 502, 503, 506, 508)
Multislot allocation	
- Downlink assignment	Maximum number of symmetrical timeslots assigned.
- Uplink assignment	As many timeslots as downlink direction.
- Channel set X (1=<X<=8)	Appropriate for the test
Channel Mode	
- Mode	Data, 12.0 kbit/s radio interface rate
Mobile Allocation	Arbitrarily chosen from Cell channel description
Starting Time	Not included

Step 9:

ASSIGNMENT COMMAND

Channel Description 2	00000
- Channel Type and TDMA offset	A suitable value for multislot configuration, chosen arbitrarily
- Timeslot Number	Chosen arbitrarily
- Training Sequence Code	RF hopping channel
- Hopping	
- MAIO	Chosen arbitrarily from the set (0, 1 to N-1) where N is the number of frequencies in the Mobile Allocation IE.
- HSN	Chosen arbitrarily from the set (1 to 63)
Power Command	Chosen arbitrarily but with a changed value.
- Power level	Not Included
Frequency list IE	
Cell Channel Description	128 range encodes (482, 483, 489, 496, 498, 500, 501, 502, 503, 506, 508)
Multislot allocation	
- Downlink assignment	Maximum number of timeslots that MS supports.
- Uplink assignment	Less timeslots assigned than downlink direction.
- Channel set X (1=<X<=8)	Appropriate for the test
Channel Mode	
- Mode	Data, 12.0 kbit/s radio interface rate
Mobile Allocation	Arbitrarily chosen from Cell channel description
Starting Time	Not included

Step 11:

ASSIGNMENT COMMAND

Channel Description 2 - Channel Type and TDMA offset - Timeslot Number	00000 A suitable value for multislot configuration, chosen arbitrarily
- Training Sequence Code	Chosen arbitrarily
- Hopping	Single RF channel
- ARFCN	the ARFCN of the BCCH carrier
Power Command - Power level	Chosen arbitrarily but with a changed value.
Frequency list IE	Not Included
Cell Channel Description	128 range encodes (482, 483, 489, 496, 498, 500, 501, 502, 503, 506, 508)
Multislot allocation - Downlink assignment	Maximum number of symmetrical timeslots supported by MS assigned.
- Uplink assignment	As many timeslots as in downlink direction.
- Channel set X (1= $X \leq 8$)	Appropriate for the test
Channel Mode - Mode	Data, 12.0 kbit/s radio interface rate
Mobile Allocation	Not included
Starting Time	Not included

Step 14:

ASSIGNMENT COMMAND

Channel Description 2 - Channel Type and TDMA offset - Timeslot Number	00000 A suitable value for multislot configuration, chosen arbitrarily
- Training Sequence Code	Chosen arbitrarily
- Hopping	Single RF channel
- ARFCN	the ARFCN of the BCCH carrier
Power Command - Power level	Chosen arbitrarily but with a changed value.
Frequency list IE	Not Included
Cell Channel Description	128 range encodes (482, 483, 489, 496, 498, 500, 501, 502, 503, 506, 508)
Multislot allocation - Downlink assignment	Only one timeslot is assigned in downlink direction.
- Uplink assignment	Only one timeslot is assigned in uplink direction.
- Channel set X (1= $X \leq 8$)	Appropriate for the test
Channel Mode - Mode	Data, 12.0 kbit/s radio interface rate
Mobile Allocation	Not included
Starting Time	Not included

Step 16:

ASSIGNMENT COMMAND

Channel Description 2 - Channel Type and TDMA offset - Timeslot Number	00000 A suitable value for multislot configuration, chosen arbitrarily
- Training Sequence Code	Chosen arbitrarily
- Hopping	Single RF channel
- ARFCN	the ARFCN of the BCCH carrier
Power Command - Power level	Chosen arbitrarily but with a changed value.
Frequency list IE	Not Included
Cell Channel Description	128 range encodes (482, 483, 489, 496, 498, 500, 501, 502, 503, 506, 508)
Multislot allocation - Downlink assignment	Maximum number of timeslots that MS supports.
- Uplink assignment	Maximum number of timeslots that MS supports.
- Channel set X (1=<X<=8)	Appropriate for the test
Channel Mode - Mode	Data, 12.0 kbit/s radio interface rate
Mobile Allocation	Not included
Starting Time	Not included

Step 19:

ASSIGNMENT COMMAND

Channel Description 2 - Channel Type and TDMA offset - Timeslot Number	00000 A suitable value for multislot configuration, chosen arbitrarily
- Training Sequence Code	Chosen arbitrarily
- Hopping	Single RF channel
- ARFCN	the ARFCN of the BCCH carrier
Power Command - Power level	Chosen arbitrarily but with a changed value.
Frequency list IE	Not Included
Cell Channel Description	128 range encodes (482, 483, 489, 496, 498, 500, 501, 502, 503, 506, 508)
Multislot allocation - Downlink assignment	More than one timeslot but less than maximum number of timeslots is assigned in downlink direction.
- Uplink assignment	Only one timeslot is assigned in uplink direction.
- Channel set X (1=<X<=8)	Appropriate for the test
Channel Mode - Mode	Data, 12.0 kbit/s radio interface rate
Mobile Allocation	Not included
Starting Time	Not included

Step 21:

ASSIGNMENT COMMAND

Channel Description 2	00000
- Channel Type and TDMA offset	A suitable value for multislot configuration, chosen arbitrarily
- Timeslot Number	Chosen arbitrarily
- Training Sequence Code	Single RF channel
- Hopping	the ARFCN of the BCCH carrier
- ARFCN	
Power Command	Chosen arbitrarily but with a changed value.
- Power level	
Frequency list IE	Not Included
Cell Channel Description	128 range encodes (482, 483, 489, 496, 498, 500, 501, 502, 503, 506, 508)
Multislot allocation	Maximum number of timeslots that MS supports.
- Downlink assignment	Less timeslots assigned than downlink direction.
- Uplink assignment	Appropriate for the test
- Channel set X (1=<X<=8)	
Channel Mode	
- Mode	Data, 12.0 kbit/s radio interface rate
Mobile Allocation	Not included
Starting Time	Not included

Step 24:

ASSIGNMENT COMMAND

Channel Description 2	00000
- Channel Type and TDMA offset	A suitable value for multislot configuration, chosen arbitrarily
- Timeslot Number	Chosen arbitrarily
- Training Sequence Code	RF hopping channel
- Hopping	
- MAIO	Chosen arbitrarily from the set (0, 1 to N-1) where N is the number of frequencies in the Mobile Allocation IE.
- HSN	Chosen arbitrarily from the set (1 to 63)
Power Command	Chosen arbitrarily but with a changed value.
- Power level	
Frequency list IE	Not Included
Cell Channel Description	128 range encodes (482, 483, 489, 496, 498, 500, 501, 502, 503, 506, 508)
Multislot allocation	Only one timeslot is assigned in downlink direction.
- Downlink assignment	Only one timeslot is assigned in uplink direction.
- Uplink assignment	Appropriate for the test
- Channel set X (1=<X<=8)	
Channel Mode	
- Mode	Data, 12.0 kbit/s radio interface rate
Mobile Allocation	Chosen arbitrarily from the Cell channel description
Starting Time	Not included

Step 26:

ASSIGNMENT COMMAND

Channel Description 2	
- Channel Type and TDMA offset	00000
- Timeslot Number	A suitable value for multislot configuration, chosen arbitrarily
- Training Sequence Code	Chosen arbitrarily
- Hopping	RF hopping channel
- MAIO	Chosen arbitrarily from the set (0, 1 to N-1) where N is the number of frequencies in the Mobile Allocation IE.
- HSN	Chosen arbitrarily from the set (1 to 63)
Power Command	
- Power level	Chosen arbitrarily but with a changed value.
Frequency list IE	Not Included
Cell Channel Description	128 range encodes (482, 483, 489, 496, 498, 500, 501, 502, 503, 506, 508)
Multislot allocation	
- Downlink assignment	Maximum number of timeslots that MS supports.
- Uplink assignment	Less timeslots assigned than in downlink direction.
- Channel set X (1=<X<=8)	Appropriate for the test
Channel Mode	
- Mode	Data, 12.0 kbit/s radio interface rate
Mobile Allocation	Chosen arbitrarily from the Cell channel description
Starting Time	Not included

Step 29:

ASSIGNMENT COMMAND

Channel Description 2	
- Channel Type and TDMA offset	00000
- Timeslot Number	A suitable value for multislot configuration, chosen arbitrarily
- Training Sequence Code	Chosen arbitrarily
- Hopping	RF hopping channel
- MAIO	Chosen arbitrarily from the set (0, 1 to N-1) where N is the number of frequencies in the Mobile Allocation IE.
- HSN	Chosen arbitrarily from the set (1 to 63)
Power Command	
- Power level	Chosen arbitrarily but with a changed value.
Frequency list IE	Not Included
Cell Channel Description	128 range encodes (482, 483, 489, 496, 498, 500, 501, 502, 503, 506, 508)
Multislot allocation	
- Downlink assignment	Maximum number of timeslots that MS supports.
- Uplink assignment	Less timeslots assigned than in downlink direction.
- Channel set X (1=<X<=8)	Appropriate for the test
Channel Mode	
- Mode	Data, 12.0 kbit/s radio interface rate
Mobile Allocation	Chosen arbitrarily from the Cell channel description
Starting Time	Not included

Step 31:

ASSIGNMENT COMMAND

Channel Description 2 - Channel Type and TDMA offset - Timeslot Number	00000 A suitable value for multislot configuration, chosen arbitrarily
- Training Sequence Code	Chosen arbitrarily
- Hopping	Single RF channel
- ARFCN	the ARFCN of the BCCH carrier
Power Command - Power level	Chosen arbitrarily but with a changed value.
Frequency list IE	Not Included
Cell Channel Description	128 range encodes (482, 483, 489, 496, 498, 500, 501, 502, 503, 506, 508)
Multislot allocation - Downlink assignment - Uplink assignment - Channel set X (1=<X<=8)	Only one timeslot is assigned in downlink direction. Only one timeslot is assigned in uplink direction. Appropriate for the test
Channel Mode - Mode	Data, 12.0 kbit/s radio interface rate
Mobile Allocation	Not included
Starting Time	Not included

GSM 700 end:

GSM 850 begin:

Step 5:

ASSIGNMENT COMMAND

Channel Description 2 - Channel Type and TDMA offset - Timeslot Number	00000 A suitable value for multislot configuration, chosen arbitrarily
- Training Sequence Code	Chosen arbitrarily
- Hopping	RF hopping channel
- MAIO	Chosen arbitrarily from the set (0, 1 to N-1) where N is the number of frequencies in the Mobile Allocation IE.
- HSN	Chosen arbitrarily from the set (1 to 63)
Power Command - Power level	Chosen arbitrarily but with a changed value.
Frequency list IE	Not Included
Cell Channel Description	128 range encodes (172, 173, 179, 186, 193, 200, 201, 202, 203, 235, 241)
Multislot allocation - Downlink assignment - Uplink assignment - Channel set X (1=<X<=8)	Maximum number of symmetrical timeslots assigned. As many timeslots as downlink direction. Appropriate for the test
Channel Mode - Mode	Data, 12.0 kbit/s radio interface rate
Mobile Allocation	Arbitrarily chosen from Cell channel description
Starting Time	Not included

Step 9:

ASSIGNMENT COMMAND

Channel Description 2	
- Channel Type and TDMA offset	00000
- Timeslot Number	A suitable value for multislot configuration, chosen arbitrarily
- Training Sequence Code	Chosen arbitrarily
- Hopping	RF hopping channel
- MAIO	Chosen arbitrarily from the set (0, 1 to N-1) where N is the number of frequencies in the Mobile Allocation IE.
- HSN	Chosen arbitrarily from the set (1 to 63)
Power Command	
- Power level	Chosen arbitrarily but with a changed value.
Frequency list IE	Not Included
Cell Channel Description	128 range encodes (172, 173, 179, 186, 193, 200, 201, 202, 203, 235, 241)
Multislot allocation	
- Downlink assignment	Maximum number of timeslots that MS supports.
- Uplink assignment	Less timeslots assigned than downlink direction.
- Channel set X (1=<X<=8)	Appropriate for the test
Channel Mode	
- Mode	Data, 12.0 kbit/s radio interface rate
Mobile Allocation	Arbitrarily chosen from Cell channel description
Starting Time	Not included

Step 11:

ASSIGNMENT COMMAND

Channel Description 2	
- Channel Type and TDMA offset	00000
- Timeslot Number	A suitable value for multislot configuration, chosen arbitrarily
- Training Sequence Code	Chosen arbitrarily
- Hopping	Single RF channel
- ARFCN	the ARFCN of the BCCH carrier
Power Command	
- Power level	Chosen arbitrarily but with a changed value.
Frequency list IE	Not Included
Cell Channel Description	128 range encodes (172, 173, 179, 186, 193, 200, 201, 202, 203, 235, 241)
Multislot allocation	
- Downlink assignment	Maximum number of symmetrical timeslots supported by MS assigned.
- Uplink assignment	As many timeslots as in downlink direction.
- Channel set X (1=<X<=8)	Appropriate for the test
Channel Mode	
- Mode	Data, 12.0 kbit/s radio interface rate
Mobile Allocation	Not included
Starting Time	Not included

Step 14:

ASSIGNMENT COMMAND

Channel Description 2 - Channel Type and TDMA offset - Timeslot Number	00000 A suitable value for multislot configuration, chosen arbitrarily
- Training Sequence Code	Chosen arbitrarily
- Hopping	Single RF channel
- ARFCN	the ARFCN of the BCCH carrier
Power Command - Power level	Chosen arbitrarily but with a changed value.
Frequency list IE	Not Included
Cell Channel Description	128 range encodes (172, 173, 179, 186, 193, 200, 201, 202, 203, 235, 241)
Multislot allocation - Downlink assignment - Uplink assignment - Channel set X (1=<X<=8)	Only one timeslot is assigned in downlink direction. Only one timeslot is assigned in uplink direction. Appropriate for the test
Channel Mode - Mode	Data, 12.0 kbit/s radio interface rate
Mobile Allocation	Not included
Starting Time	Not included

Step 16:

ASSIGNMENT COMMAND

Channel Description 2 - Channel Type and TDMA offset - Timeslot Number	00000 A suitable value for multislot configuration, chosen arbitrarily
- Training Sequence Code	Chosen arbitrarily
- Hopping	Single RF channel
- ARFCN	the ARFCN of the BCCH carrier
Power Command - Power level	Chosen arbitrarily but with a changed value.
Frequency list IE	Not Included
Cell Channel Description	128 range encodes (172, 173, 179, 186, 193, 200, 201, 202, 203, 235, 241)
Multislot allocation - Downlink assignment - Uplink assignment - Channel set X (1=<X<=8)	Maximum number of timeslots that MS supports. Maximum number of timeslots that MS supports. Appropriate for the test
Channel Mode - Mode	Data, 12.0 kbit/s radio interface rate
Mobile Allocation	Not included
Starting Time	Not included

Step 19:

ASSIGNMENT COMMAND

Channel Description 2 - Channel Type and TDMA offset - Timeslot Number	00000 A suitable value for multislot configuration, chosen arbitrarily
- Training Sequence Code	Chosen arbitrarily
- Hopping	Single RF channel
- ARFCN	the ARFCN of the BCCH carrier
Power Command - Power level	Chosen arbitrarily but with a changed value.
Frequency list IE	Not Included
Cell Channel Description	128 range encodes (172, 173, 179, 186, 193, 200, 201, 202, 203, 235, 241)
Multislot allocation - Downlink assignment	More than one timeslot but less than maximum number of timeslots is assigned in downlink direction.
- Uplink assignment	Only one timeslot is assigned in uplink direction.
- Channel set X (1= X ≤8)	Appropriate for the test
Channel Mode - Mode	Data, 12.0 kbit/s radio interface rate
Mobile Allocation	Not included
Starting Time	Not included

Step 21:

ASSIGNMENT COMMAND

Channel Description 2 - Channel Type and TDMA offset - Timeslot Number	00000 A suitable value for multislot configuration, chosen arbitrarily
- Training Sequence Code	Chosen arbitrarily
- Hopping	Single RF channel
- ARFCN	the ARFCN of the BCCH carrier
Power Command - Power level	Chosen arbitrarily but with a changed value.
Frequency list IE	Not Included
Cell Channel Description	128 range encodes (172, 173, 179, 186, 193, 200, 201, 202, 203, 235, 241)
Multislot allocation - Downlink assignment	Maximum number of timeslots that MS supports.
- Uplink assignment	Less timeslots assigned than downlink direction.
- Channel set X (1= X ≤8)	Appropriate for the test
Channel Mode - Mode	Data, 12.0 kbit/s radio interface rate
Mobile Allocation	Not included
Starting Time	Not included

Step 24:

ASSIGNMENT COMMAND

Channel Description 2	
- Channel Type and TDMA offset	00000
- Timeslot Number	A suitable value for multislot configuration, chosen arbitrarily
- Training Sequence Code	Chosen arbitrarily
- Hopping	RF hopping channel
- MAIO	Chosen arbitrarily from the set (0, 1 to N-1) where N is the number of frequencies in the Mobile Allocation IE.
- HSN	Chosen arbitrarily from the set (1 to 63)
Power Command	
- Power level	Chosen arbitrarily but with a changed value.
Frequency list IE	Not Included
Cell Channel Description	128 range encodes (172, 173, 179, 186, 193, 200, 201, 202, 203, 235, 241)
Multislot allocation	
- Downlink assignment	Only one timeslot is assigned in downlink direction.
- Uplink assignment	Only one timeslot is assigned in uplink direction.
- Channel set X (1=<X<=8)	Appropriate for the test
Channel Mode	
- Mode	Data, 12.0 kbit/s radio interface rate
Mobile Allocation	Chosen arbitrarily from the Cell channel description
Starting Time	Not included

Step 26:

ASSIGNMENT COMMAND

Channel Description 2	
- Channel Type and TDMA offset	00000
- Timeslot Number	A suitable value for multislot configuration, chosen arbitrarily
- Training Sequence Code	Chosen arbitrarily
- Hopping	RF hopping channel
- MAIO	Chosen arbitrarily from the set (0, 1 to N-1) where N is the number of frequencies in the Mobile Allocation IE.
- HSN	Chosen arbitrarily from the set (1 to 63)
Power Command	
- Power level	Chosen arbitrarily but with a changed value.
Frequency list IE	Not Included
Cell Channel Description	128 range encodes (172, 173, 179, 186, 193, 200, 201, 202, 203, 235, 241)
Multislot allocation	
- Downlink assignment	Maximum number of timeslots that MS supports.
- Uplink assignment	Less timeslots assigned than in downlink direction.
- Channel set X (1=<X<=8)	Appropriate for the test
Channel Mode	
- Mode	Data, 12.0 kbit/s radio interface rate
Mobile Allocation	Chosen arbitrarily from the Cell channel description
Starting Time	Not included

Step 29:

ASSIGNMENT COMMAND

Channel Description 2	
- Channel Type and TDMA offset	00000
- Timeslot Number	A suitable value for multislot configuration, chosen arbitrarily
- Training Sequence Code	Chosen arbitrarily
- Hopping	RF hopping channel
- MAIO	Chosen arbitrarily from the set (0, 1 to N-1) where N is the number of frequencies in the Mobile Allocation IE.
- HSN	Chosen arbitrarily from the set (1 to 63)
Power Command	
- Power level	Chosen arbitrarily but with a changed value.
Frequency list IE	Not Included
Cell Channel Description	128 range encodes (172, 173, 179, 186, 193, 200, 201, 202, 203, 235, 241)
Multislot allocation	
- Downlink assignment	Maximum number of timeslots that MS supports.
- Uplink assignment	Less timeslots assigned than in downlink direction.
- Channel set X (1=<X<=8)	Appropriate for the test
Channel Mode	
- Mode	Data, 12.0 kbit/s radio interface rate
Mobile Allocation	Chosen arbitrarily from the Cell channel description
Starting Time	Not included

Step 31:

ASSIGNMENT COMMAND

Channel Description 2	
- Channel Type and TDMA offset	00000
- Timeslot Number	A suitable value for multislot configuration, chosen arbitrarily
- Training Sequence Code	Chosen arbitrarily
- Hopping	Single RF channel
- ARFCN	the ARFCN of the BCCH carrier
Power Command	
- Power level	Chosen arbitrarily but with a changed value.
Frequency list IE	Not Included
Cell Channel Description	128 range encodes (172, 173, 179, 186, 193, 200, 201, 202, 203, 235, 241)
Multislot allocation	
- Downlink assignment	Only one timeslot is assigned in downlink direction.
- Uplink assignment	Only one timeslot is assigned in uplink direction.
- Channel set X (1=<X<=8)	Appropriate for the test
Channel Mode	
- Mode	Data, 12.0 kbit/s radio interface rate
Mobile Allocation	Not included
Starting Time	Not included

GSM 850 end:

26.13.1.3 Test of handover

With the Handover procedure, it is possible to completely alter the channels allocated to a MS. This makes it possible in particular to switch a call in progress from one cell to another. The procedure is always initiated by the network and with the MS in a dedicated mode.

Subclauses 26.13.1.3.1 to 26.13.1.3.5 contain test procedures to be used for executing successful Handover tests in multislot configuration. Table 26.13.1.3-1 contains a summary of the different combinations of parameters that have to be tested, together with a reference to the appropriate test procedure.

Table 26.13.1.3-1

From	To	Timing Adv.	Start Time	Syn ?	State of call	Subclause	Exec Counter
Multislot configuration, MAX number of timeslots, no FH	Multislot configuration, MAX number of timeslots, FH	arbitrarily	none	no	U10	26.13.1.3.1	1
Multislot configuration, MIN number of timeslots, no FH	Multislot configuration, MAX number of timeslots, no FH	arbitrarily	none	no	estab (note)	26.13.1.3.2	1
Multislot configuration, MAX number of timeslots, FH	Multislot configuration, MIN number of timeslots, no FH	arbitrarily	none	finely	U10	26.13.1.3.3	1
Multislot configuration, FH	Multislot configuration, FH	arbitrarily	none	finely	estab (note)	26.13.1.3.4	1
Multislot configuration, MIN number of timeslots, FH	Multislot configuration, MAX number of timeslots, no FH	arbitrarily	none	pre	estab (note)	26.13.1.3.5	1

NOTE: The MS is in the "idle, updated" state, with a TMSI allocated and camped on cell A.

26.13.1.3.1 Multislot signalling / RR / Handover / successful / active call / non-synchronized

26.13.1.3.1.1 Conformance requirements

- 1) The MS shall correctly apply the handover procedure in the non-synchronized case when a multislot connection is in progress and when handover is performed from a non-hopping multislot configuration towards a hopping multislot configuration.

References

- Conformance requirement 1: 3GPP TS 04.08 / 3GPP TS 44.018 subclauses 3.4.4 and 9.1.15.
3GPP TS 04.13 subclause 5.2.6.2.

26.13.1.3.1.2 Test purpose

- 1) To test that when the MS is ordered to make a non-synchronized handover from non-hopping multislot configuration to hopping multislot configuration, it continuously sends access bursts on the main DCCH (and optionally on the SACCH) until it receives a PHYSICAL INFORMATION message from the SS.
- 2) To test that the MS correctly handles the Timing Advance IE in the PHYSICAL INFORMATION message.
- 3) To test that the MS activates the new channels correctly and transmits the HANDOVER COMPLETE message without undue delay.

26.13.1.3.1.3 Method of test

Initial Conditions

System Simulator:

- 2 cells, A and B with same LAI, default parameters except:
- Early classmark sending enabled in SI3 rest octets

GSM 450:

Cell A has:

- BCCH ARFCN = 263

Cell B has:

- BCCH ARFCN = 274
- Cell Allocation = (260, 262, 264, 266, 268, 270, 272, 274, 276, 279, 281, 283, 285, 287, 289, 291)
- The Cell Allocation of Cell B shall be coded using range 256 format.
- The frame numbers of cells A and B shall be different by 100.
- The timebase of cells A and B shall be such that the edges of their timeslots are not coincident at the antenna connector.

GSM 480:

Cell A has:

- BCCH ARFCN = 310

Cell B has:

- BCCH ARFCN = 321
- Cell Allocation = (307, 309, 311, 313, 315, 317, 319, 321, 323, 326, 328, 330, 332, 334, 336, 338)
- The Cell Allocation of Cell B shall be coded using range 256 format.
- The frame numbers of cells A and B shall be different by 100.
- The timebase of cells A and B shall be such that the edges of their timeslots are not coincident at the antenna connector.

GSM 900:

Cell A has:

- BCCH ARFCN = 20

Cell B has:

- BCCH ARFCN = 40
- Cell Allocation = (14, 18, 22, 24, 30, 31, 38, 40, 60, 66, 73, 74, 75, 76, 108, 114)
- The Cell Allocation of Cell B shall be coded using range 256 format.
- The frame numbers of cells A and B shall be different by 100.
- The timebase of cells A and B shall be such that the edges of their timeslots are not coincident at the antenna connector.

DCS 1 800:

Cell A has:

- BCCH ARFCN = 747

Cell B has:

- BCCH ARFCN = 764
- Cell Allocation = (739, 743, 746, 749, 756, 758, 761, 764, 771, 779, 782, 791, 798, 829, 832, 844)
- The Cell Allocation of Cell B shall be coded using range 256 format.
- The frame numbers of cells A and B shall be different by 100.
- The timebase of cells A and B shall be such that the edges of their timeslots are not coincident at the antenna connector.

GSM 700:

Cell A has:

- BCCH ARFCN = 457

Cell B has:

- BCCH ARFCN = 477
- Cell Allocation = (451, 455, 459, 461, 467, 468, 475, 477, 497, 498, 500, 501, 502, 503, 506, 508)
- The Cell Allocation of Cell B shall be coded using range 256 format.
- The frame numbers of cells A and B shall be different by 100.
- The timebase of cells A and B shall be such that the edges of their timeslots are not coincident at the antenna connector.

GSM 850:

Cell A has:

- BCCH ARFCN = 147

Cell B has:

- BCCH ARFCN = 167
- Cell Allocation = (141, 145, 149, 151, 157, 158, 165, 167, 187, 193, 200, 201, 202, 203, 235, 241)
- The Cell Allocation of Cell B shall be coded using range 256 format.
- The frame numbers of cells A and B shall be different by 100.
- The timebase of cells A and B shall be such that the edges of their timeslots are not coincident at the antenna connector.

Mobile Station:

- The MS is in the active state (U10) of a service using a multislot connection on cell A.

Specific PICS statements:

- Multislot class (TSPC_Type_Multislot_ClassX)

PIXIT statements:

-

Foreseen Final State of the MS

The active state (U10) of a multislot connection on cell B.

Test Procedure

The MS is in the active state (U10) of a multislot connection. The SS sends a HANOVER COMMAND on the main DCCH. The MS shall begin to send access bursts on the new DCCH (and optionally on the SACCH) of the target cell. The SS observes the access bursts and after receiving 10-20 access bursts, the SS sends one PHYSICAL INFORMATION message with a Timing Advance arbitrarily selected. The MS shall activate the new channels that belongs to same multislot configuration. The MS shall establish a signalling link. The MS shall be ready to transmit a HANOVER COMPLETE message, before 500 ms after the end of the PHYSICAL INFORMATION message, but not before a UA frame has been sent by the SS.

The term "ready to transmit" is defined in 3GPP TS 04.13.

Maximum Duration of Test

5 minutes, including 1 minute for any necessary operator actions.

Expected Sequence

Step	Direction	Message	Comments
0	MS, SS		The MS and SS are using a maximum multislot configuration according to the MS multislot class (highest class that MS supports) in non-hopping mode on cell A.
1	SS -> MS	HANDOVER COMMAND	See Specific message contents.
2	MS -> SS	HANDOVER ACCESS	Repeated on every burst of the uplink main DCCH (and optionally on the SACCH) until reception of PHYSICAL INFORMATION. Handover Reference as included in the HANDOVER COMMAND.
3	SS -> MS	PHYSICAL INFORMATION	Sent after reception of n HANDOVER ACCESS messages. See specific message contents.
4	MS -> SS	SABM	Sent without information field.
5	SS -> MS	UA	
6	MS -> SS	HANDOVER COMPLETE	The message shall be ready to be transmitted before 500 ms after the completion of step 3.
7	MS, SS		The MS and SS are using a maximum multislot configuration according to the MS multislot class (highest class that MS supports) in hopping mode on cell B and state U10 is reached.

Specific Message Contents

GSM 450

HANDOVER COMMAND

Information Element	value/remarks
As default message contents, except:	
Cell Description	
- Network Colour Code	1
- Base Station Colour Code	5
- BCCH Carrier Number	274
Channel Description 2	
- Channel Type	00000
- Timeslot number	A suitable value for multislot configuration, chosen arbitrarily.
- Training Sequence Code	Chosen arbitrarily
- Hopping	RF hopping channel.
- MAIO	Chosen arbitrarily from the set (0, 1 to N-1), where N is the number of frequencies encoded in the Frequency List IE.
- HSN	Chosen arbitrarily from the set (1,2,...63).
Synchronization Indication IE is not included.	
Channel Mode IE is not included.	
Description of a multislot configuration:	
- Downlink assignment	As many timeslots assigned as before HANDOVER COMMAND
- Uplink assignment	As many timeslots assigned as before HANDOVER COMMAND
- Channel set X (1=<x<=8)	Same as before HANDOVER COMMAND
Frequency List after time	
- Frequency List	Use Range 128 to encode the following 15 frequencies (260, 262, 264, 266, 268, 270, 272, 276, 279, 281, 283, 285, 287, 289, 291).

PHYSICAL INFORMATION

Information Element	value/remarks
As default message contents, except: Timing advance	Arbitrarily selected but different to default value.

GSM 480

HANDOVER COMMAND

Information Element	value/remarks
As default message contents, except: Cell Description	
- Network Colour Code	1
- Base Station Colour Code	5
- BCCH Carrier Number	321
Channel Description 2	
- Channel Type	00000
- Timeslot number	A suitable value for multislot configuration, chosen arbitrarily.
- Training Sequence Code	Chosen arbitrarily
- Hopping	RF hopping channel.
- MAIO	Chosen arbitrarily from the set (0, 1 to N-1), where N is the number of frequencies encoded in the Frequency List IE.
- HSN	Chosen arbitrarily from the set (1,2,..63).
Synchronization Indication IE is not included.	
Channel Mode IE is not included.	
Description of a multislot configuration:	
- Downlink assignment	As many timeslots assigned as before HANDOVER COMMAND
- Uplink assignment	As many timeslots assigned as before HANDOVER COMMAND
- Channel set X (1=<x<=8)	Same as before HANDOVER COMMAND
Frequency List after time	
- Frequency List	Use Range 128 to encode the following 15 frequencies (307, 309, 311, 313, 315, 317, 319, 323, 326, 328, 330, 332, 334, 336, 338).

PHYSICAL INFORMATION

Information Element	value/remarks
As default message contents, except: Timing advance	Arbitrarily selected but different to default value.

P-GSM 900

HANDOVER COMMAND

Information Element	value/remarks
As default message contents, except:	
Cell Description	
- Network Colour Code	1
- Base Station Colour Code	5
- BCCH Carrier Number	40
Channel Description 2	
- Channel Type	00000
- Timeslot number	A suitable value for multislot configuration, chosen arbitrarily.
- Training Sequence Code	Chosen arbitrarily
- Hopping	RF hopping channel.
- MAIO	Chosen arbitrarily from the set (0, 1 to N-1), where N is the number of frequencies encoded in the Frequency Channel Sequence IE.
- HSN	Chosen arbitrarily from the set (1,2,..63).
Synchronization Indication IE is not included.	
Channel Mode IE is not included.	
Description of a multislot configuration:	
- Downlink assignment	As many timeslots assigned as before HANDOVER COMMAND
- Uplink assignment	As many timeslots assigned as before HANDOVER COMMAND
- Channel set X (1=<x<=8)	Same as before HANDOVER COMMAND
Frequency Channel Sequence after time	
- Frequency Channel Sequence	Allocates the following 15 frequencies (14, 18, 22, 24, 30, 31, 38, 53, 66, 73, 74, 75, 76, 108, 114).

PHYSICAL INFORMATION

Information Element	value/remarks
As default message contents, except:	
Timing advance	Arbitrarily selected but different to default value.

DCS 1 800

HANDOVER COMMAND

Information Element	value/remarks
As default message contents, except:	
Cell Description	
- Network Colour Code	1
- Base Station Colour Code	5
- BCCH Carrier Number	764
Channel Description 2	
- Channel Type	00000
- Timeslot number	A suitable value for multislot configuration, chosen arbitrarily.
- Training Sequence Code	Chosen arbitrarily.
- Hopping	RF hopping channel.
- MAIO	Chosen arbitrarily from the set (0, 1 to N-1), where N is the number of frequencies encoded in the Frequency Short List IE.
- HSN	Chosen arbitrarily from the set (1,2,..63).
Synchronization Indication IE is not included.	
Channel Mode IE is not included.	
Description of a multislot configuration:	
- Downlink assignment	As many timeslots assigned as before HANDOVER COMMAND
- Uplink assignment	As many timeslots assigned as before HANDOVER COMMAND
- Channel set X (1= $X \leq 8$)	Same as before HANDOVER COMMAND
Frequency List after time	
- Frequency List	Use Range 256 to encode the following 15 frequencies: (739, 743, 746, 749, 756, 758, 761, 771, 779, 782, 791, 798, 829, 832, 844).

PHYSICAL INFORMATION

Information Element	value/remarks
As default message contents, except:	
Timing advance	Arbitrarily selected but different to default value.

GSM 700

HANDOVER COMMAND

Information Element	value/remarks
As default message contents, except:	
Cell Description	
- Network Colour Code	1
- Base Station Colour Code	5
- BCCH Carrier Number	477
Channel Description 2	
- Channel Type	00000
- Timeslot number	A suitable value for multislot configuration, chosen arbitrarily.
- Training Sequence Code	Chosen arbitrarily
- Hopping	RF hopping channel.
- MAIO	Chosen arbitrarily from the set (0, 1 to N-1), where N is the number of frequencies encoded in the Frequency Channel Sequence IE.
- HSN	Chosen arbitrarily from the set (1,2,..63).
Synchronization Indication IE is not included.	
Channel Mode IE is not included.	
Description of a multislot configuration:	
- Downlink assignment	As many timeslots assigned as before HANDOVER COMMAND
- Uplink assignment	As many timeslots assigned as before HANDOVER COMMAND
- Channel set X (1=<x<=8)	Same as before HANDOVER COMMAND
Frequency Channel Sequence after time	
- Frequency Channel Sequence	Allocates the following 15 frequencies (451, 455, 459, 461, 467, 468, 475, 490, 498, 500, 501, 502, 503, 506, 508).

PHYSICAL INFORMATION

Information Element	value/remarks
As default message contents, except:	
Timing advance	Arbitrarily selected but different to default value.

P-GSM 850

HANDOVER COMMAND

Information Element	value/remarks
As default message contents, except:	
Cell Description	
- Network Colour Code	1
- Base Station Colour Code	5
- BCCH Carrier Number	167
Channel Description 2	
- Channel Type	00000
- Timeslot number	A suitable value for multislot configuration, chosen arbitrarily.
- Training Sequence Code	Chosen arbitrarily
- Hopping	RF hopping channel.
- MAIO	Chosen arbitrarily from the set (0, 1 to N-1), where N is the number of frequencies encoded in the Frequency Channel Sequence IE.
- HSN	Chosen arbitrarily from the set (1,2,..63).
Synchronization Indication IE is not included.	
Channel Mode IE is not included.	
Description of a multislot configuration:	
- Downlink assignment	As many timeslots assigned as before HANDOVER COMMAND
- Uplink assignment	As many timeslots assigned as before HANDOVER COMMAND
- Channel set X (1=<x<=8)	Same as before HANDOVER COMMAND
Frequency Channel Sequence after time	
- Frequency Channel Sequence	Allocates the following 15 frequencies (141, 145, 149, 151, 157, 158, 165, 180, 193, 200, 201, 202, 203, 235, 241).

PHYSICAL INFORMATION

Information Element	value/remarks
As default message contents, except:	
Timing advance	Arbitrarily selected but different to default value.

26.13.1.3.2 Multislot signalling / RR / Handover / successful / call under establishment / non synchronized / resource upgrading

26.13.1.3.2.1 Conformance requirements

- 1) The MS shall correctly apply the handover procedure from non-hopping multislot configuration to non-hopping multislot configuration in the non-synchronized case during call establishment.
- 2) The MS shall activate the new channels that belongs to same multislot configuration correctly, taking into account upgraded resources.
- 3) If during call establishment a Layer 3 MM or CC message just sent by the MS is not Layer 2 acknowledged before the channel change caused by the HANDOVER COMMAND message, the MS shall send the Layer 3 message to the new cell, using the same value in the N(SD) field, after the handover procedure.

References

Conformance requirements: 3GPP TS 04.08 / 3GPP TS 44.018 subclauses 3.4.4 and 9.1.15.
3GPP TS 04.13 subclause 5.2.6.2

26.13.1.3.2.2 Test purpose

- 1) To test that when the MS is ordered to make a non-synchronized handover from non-hopping multislot configuration to a non-hopping multislot configuration, it continuously sends access bursts on the main DCCH (and optionally on the SACCH) until it receives a PHYSICAL INFORMATION message from the SS.

- 2) To test that the MS correctly takes the values of the Timing Advance information element in the PHYSICAL INFORMATION message into account.
- 3) To test that the MS activates the new channels that belongs to same multislot configuration correctly, taking into account upgraded resources and transmits the HANDOVER COMPLETE message without undue delay.
- 4) To test that MS correctly retransmits Layer 3 MM or CC messages, that were not acknowledged by Layer 2 before the Handover, after completion of the Handover.

26.13.1.3.2.3 Method of test

Initial Conditions

System Simulator:

- 2 cells, A and B with same LAI, default parameters except:
 - Early classmark sending enabled in SI3 rest octets

GSM 450:

Cell A has:

- BCCH ARFCN = 263
- PLMN colour code, NCC = as defaults.
- BS colour code, BCC = as defaults.
- PLMN_PERM = 00001010.

Cell B has:

- BCCH ARFCN = 274
- PLMN colour code, NCC = 3.
- BS colour code, BCC = 0.
- The timebase of cells A and B shall be such that the edges of their timeslots are not coincident at the antenna connector.

GSM 480:

Cell A has:

- BCCH ARFCN = 310
- PLMN colour code, NCC = as defaults.
- BS colour code, BCC = as defaults.
- PLMN_PERM = 00001010.

Cell B has:

- BCCH ARFCN = 321
- PLMN colour code, NCC = 3.
- BS colour code, BCC = 0.
- The timebase of cells A and B shall be such that the edges of their timeslots are not coincident at the antenna connector.

GSM 900:

Cell A has:

- BCCH ARFCN = 20
- PLMN colour code, NCC = as defaults.
- BS colour code, BCC = as defaults.
- PLMN_PERM = 00001010.

Cell B has:

- BCCH ARFCN = 40
- PLMN colour code, NCC = 3.
- BS colour code, BCC = 0.
- The timebase of cells A and B shall be such that the edges of their timeslots are not coincident at the antenna connector.

DCS 1 800:

Cell A has:

- BCCH ARFCN = 747
- PLMN colour code, NCC = as defaults.
- BS colour code, BCC = as defaults.
- PLMN_PERM = 00001010.

Cell B has:

- BCCH ARFCN = 764
- PLMN colour code, NCC = 3.
- BS colour code, BCC = 0.
- The timebase of cells A and B shall be such that the edges of their timeslots are not coincident at the antenna connector.

GSM 700:

Cell A has:

- BCCH ARFCN = 457
- PLMN colour code, NCC = as defaults.
- BS colour code, BCC = as defaults.
- PLMN_PERM = 00001010.

Cell B has:

- BCCH ARFCN = 477
- PLMN colour code, NCC = 3.
- BS colour code, BCC = 0.
- The timebase of cells A and B shall be such that the edges of their timeslots are not coincident at the antenna connector.

GSM 850:

Cell A has:

- BCCH ARFCN = 147
- PLMN colour code, NCC = as defaults.
- BS colour code, BCC = as defaults.
- PLMN_PERM = 00001010.

Cell B has:

- BCCH ARFCN = 167
- PLMN colour code, NCC = 3.
- BS colour code, BCC = 0.
- The timebase of cells A and B shall be such that the edges of their timeslots are not coincident at the antenna connector.

Mobile Station:

- The MS is in the "idle, updated" state, with a TMSI allocated and camped on cell A..

Specific PICS statements:

- Multislot class (TSPC_Type_Multislot_ClassX)

PIXIT statements:

-

Foreseen Final State of the MS

"idle, updated" with a TMSI allocated and camped on cell B.

Test Procedure

A Mobile Originating Call is initiated on Cell A. After the MS has sent the SETUP message (and before the last L2 frame carrying the SETUP message is acknowledged by the SS) the SS sends ASSIGNMENT COMMAND message to MS defining used multislot configuration. Multislot configuration with one TCH/F is allocated. MS responds with ASSIGNMENT COMPLETE message. Then the SS sends a HANDOVER COMMAND message, ordering the MS to switch to cell B. The MS shall then begin to send access bursts on the new DCCH (and optionally on the SACCH) to cell B. The SS observes the access bursts and after receiving 10-20 access bursts, the SS sends one PHYSICAL INFORMATION message with a Timing Advance as specified in table 26.13.1.3-1 of subclause 26.13.1.3.6. The MS shall activate the channels that belongs to same multislot configuration correctly, taking into account upgraded resources. The MS shall establish a signalling link. The MS shall be ready to transmit a HANDOVER COMPLETE message before 650 ms after the end of the PHYSICAL INFORMATION message, but not before a UA frame has been sent by the SS. The MS shall then again send the SETUP message to the SS, using the same value in the N(SD) field. Finally the SS sends a CHANNEL RELEASE to end the test.

The term "ready to transmit" is defined in 3GPP TS 04.13.

Maximum Duration of Test

5 minutes, including 1 minute for any necessary operator actions.

Expected Sequence

Step	Direction	Message	Comments
1	-----	-----	An MO call is initiated on cell A.
2	MS -> SS	CHANNEL REQUEST	Establ. Cause = "Originating call, NECI not set to 1"
3	SS -> MS	IMMEDIATE ASSIGNMENT	
4	MS -> SS	CM SERVICE REQUEST	CM Service Type = Mobile Originating Call Establishment.
5	MS -> SS	CLASSMARK CHANGE	Multislot class
6	SS -> MS	AUTHENTICATION REQUEST	
7	MS -> SS	AUTHENTICATION RESPONSE	
8	SS -> MS	CIPHERING MODE COMMAND	
9	MS -> SS	CIPHERING MODE COMPLETE	
10	MS -> SS	SETUP	Last L2 frame not acknowledged by the SS.
11	SS -> MS	ASSIGNMENT COMMAND	Multislot configuration is sent to MS. Multislot configuration with one TCH/F is allocated. See specific message contents below.
12	MS -> SS	ASSIGNMENT COMPLETE	
13	SS -> MS	HANDOVER COMMAND	See specific message contents. Resource upgrading.
14	MS -> SS	HANDOVER ACCESS	Repeated on every burst of the uplink main DCCH (and optionally on the SACCH) until reception of PHYSICAL INFORMATION. Handover Reference as included in the HANDOVER COMMAND
15	SS -> MS	PHYSICAL INFORMATION	Sent after reception of n HANDOVER ACCESS message. Timing Advance as specified in table 26.13.1.3-1 of subclause 26.13.1.3.6.
16	MS -> SS	SABM	Sent without information field.
17	SS -> MS	UA	
18	MS -> SS	HANDOVER COMPLETE	This message shall be ready to be transmitted before 650 ms after the completion of step 15.
19	MS -> SS	SETUP	Same N(SD) as in step 10.
20	SS -> MS	CHANNEL RELEASE	The main signalling link is released.

Specific Message Contents

GSM 450

ASSIGNMENT COMMAND

Information element	Value/remark
Channel description 2	describes non-hopping Bm+ACCHs or Lm+ACCHs as appropriate for the test
Power Command	As in subclause 26.1.1
Frequency list	Omitted
Cell channel description	Omitted
Description of the multislot configuration	
- Downlink assignment	Only one timeslot is allocated in downlink direction.
- Uplink assignment	Only one timeslot is allocated in uplink direction.
- Channel set X (1= X ≤8)	Appropriate for the test.
Mode of the channel set X (1= X ≤8)	Appropriate for on bearer capability chosen for the test.
Description of the second channel	Omitted
Mode of the second channel	Omitted
Mobile allocation	Omitted
Starting time	Omitted
Cipher mode setting	Omitted

HANDOVER COMMAND

Information Element	value/remarks
As default message contents, except:	
Cell Description	
- Network Colour Code	3
- Base Station Colour Code	0
- BCCH Carrier Number	274
Channel Description 2	
- Channel Type	00000
- Timeslot number	Chosen arbitrarily, but not Zero.
- Training Sequence Code	Chosen arbitrarily
- Hopping	0 (= no hopping)
- ARFCN	The ARFCN of the BCCH carrier
Synchronization Indication IE is not included.	
Channel Mode IE is not included.	
Description of a multislot configuration:	
- Downlink assignment	More timeslots are assigned than before HANDOVER COMMAND
- Uplink assignment	As many timeslots assigned as before HANDOVER COMMAND
- Channel set X (1=<x<=8)	Same as before HANDOVER COMMAND

PHYSICAL INFORMATION

Information Element	value/remarks
As default message contents, except:	
Timing advance	Arbitrarily selected but different to default value.

GSM 480

ASSIGNMENT COMMAND

Information element	Value/remark
Channel description 2	describes non-hopping Bm+ACCHs or Lm+ACCHs as appropriate for the test
Power Command	As in subclause 26.1.1
Frequency list	Omitted
Cell channel description	Omitted
Description of the multislot configuration	
- Downlink assignment	Only one timeslot is allocated in downlink direction.
- Uplink assignment	Only one timeslot is allocated in uplink direction.
- Channel set X (1=<X<=8)	Appropriate for the test.
Mode of the channel set X (1=<X<=8)	Appropriate for on bearer capability chosen for the test.
Description of the second channel	Omitted
Mode of the second channel	Omitted
Mobile allocation	Omitted
Starting time	Omitted
Cipher mode setting	Omitted

HANDOVER COMMAND

Information Element	value/remarks
As default message contents, except:	
Cell Description	
- Network Colour Code	3
- Base Station Colour Code	0
- BCCH Carrier Number	321
Channel Description 2	
- Channel Type	00000
- Timeslot number	Chosen arbitrarily, but not Zero.
- Training Sequence Code	Chosen arbitrarily
- Hopping	0 (= no hopping)
- ARFCN	The ARFCN of the BCCH carrier
Synchronization Indication IE is not included.	
Channel Mode IE is not included.	
Description of a multislot configuration:	
- Downlink assignment	More timeslots are assigned than before HANDOVER COMMAND
- Uplink assignment	As many timeslots assigned as before HANDOVER COMMAND
- Channel set X (1=<x<=8)	Same as before HANDOVER COMMAND

PHYSICAL INFORMATION

Information Element	value/remarks
As default message contents, except:	
Timing advance	Arbitrarily selected but different to default value.

P-GSM 900

ASSIGNMENT COMMAND

Information element	Value/remark
Channel description 2	describes non-hopping Bm+ACCHs or Lm+ACCHs as appropriate for the test
Power Command	As in subclause 26.1.1
Frequency list	Omitted
Cell channel description	Omitted
Description of the multislot configuration	
- Downlink assignment	Only one timeslot is allocated in downlink direction.
- Uplink assignment	Only one timeslot is allocated in uplink direction.
- Channel set X (1=<X<=8)	Appropriate for the test.
Mode of the channel set X (1=<X<=8)	Appropriate for on bearer capability chosen for the test.
Description of the second channel	Omitted
Mode of the second channel	Omitted
Mobile allocation	Omitted
Starting time	Omitted
Cipher mode setting	Omitted

HANDOVER COMMAND

Information Element	value/remarks
As default message contents, except:	
Cell Description	
- Network Colour Code	3
- Base Station Colour Code	0
- BCCH Carrier Number	40
Channel Description 2	
- Channel Type	00000
- Timeslot number	Chosen arbitrarily, but not Zero.
- Training Sequence Code	Chosen arbitrarily
- Hopping	0 (= no hopping)
- ARFCN	The ARFCN of the BCCH carrier
Synchronization Indication IE is not included.	
Channel Mode IE is not included.	
Description of a multislot configuration:	
- Downlink assignment	More timeslots are assigned than before HANDOVER COMMAND
- Uplink assignment	As many timeslots assigned as before HANDOVER COMMAND
- Channel set X (1=<x<=8)	Same as before HANDOVER COMMAND

PHYSICAL INFORMATION

Information Element	value/remarks
As default message contents, except:	
Timing advance	Arbitrarily selected but different to default value.

DCS 1 800

ASSIGNMENT COMMAND

Information element	Value/remark
Channel description 2	describes non-hopping Bm+ACCHs or Lm+ACCHs as appropriate for the test
Power Command	As in subclause 26.1.1
Frequency list	Omitted
Cell channel description	Omitted
Description of the multislot configuration	Appropriate for the teleservice selected for the test
- Downlink assignment	Only one timeslot is allocated in downlink direction.
- Uplink assignment	Only one timeslot is allocated in uplink direction.
- Channel set X (1=<X<=8)	Appropriate for the test.
Mode of the channel set X (1=<X<=8)	Appropriate for on bearer capability chosen for the test
Description of the second channel	Omitted
Mode of the second channel	Omitted
Mobile allocation	Omitted
Starting time	Omitted
Cipher mode setting	Omitted

HANDOVER COMMAND

Information Element	value/remarks
As default message contents, except:	
Cell Description	
- Network Colour Code	3
- Base Station Colour Code	0
- BCCH Carrier Number	764
Channel Description 2	
- Channel Type	00000
- Timeslot number	Chosen arbitrarily, but not Zero.
- Training Sequence Code	Chosen arbitrarily
- Hopping	0 (= no hopping)
- ARFCN	the ARFCN of the BCCH carrier
Synchronization Indication IE is not included.	
Channel Mode IE is not included.	
Description of a multislot configuration:	
- Downlink assignment	More timeslot are assigned than before HANDOVER COMMAND
- Uplink assignment	As many timeslots assigned as before HANDOVER COMMAND
- Channel set X (1=<x<=8)	Same as before HANDOVER COMMAND

PHYSICAL INFORMATION

Information Element	value/remarks
As default message contents, except:	
Timing advance	Arbitrarily selected but different to default value.

GSM 700

ASSIGNMENT COMMAND

Information element	Value/remark
Channel description 2	describes non-hopping Bm+ACCHs or Lm+ACCHs as appropriate for the test
Power Command	As in subclause 26.1.1
Frequency list	Omitted
Cell channel description	Omitted
Description of the multislot configuration	
- Downlink assignment	Only one timeslot is allocated in downlink direction.
- Uplink assignment	Only one timeslot is allocated in uplink direction.
- Channel set X (1=<X<=8)	Appropriate for the test.
Mode of the channel set X (1=<X<=8)	Appropriate for on bearer capability chosen for the test.
Description of the second channel	Omitted
Mode of the second channel	Omitted
Mobile allocation	Omitted
Starting time	Omitted
Cipher mode setting	Omitted

HANDOVER COMMAND

Information Element	value/remarks
As default message contents, except:	
Cell Description	
- Network Colour Code	3
- Base Station Colour Code	0
- BCCH Carrier Number	477
Channel Description 2	
- Channel Type	00000
- Timeslot number	Chosen arbitrarily, but not Zero.
- Training Sequence Code	Chosen arbitrarily
- Hopping	0 (= no hopping)
- ARFCN	The ARFCN of the BCCH carrier
Synchronization Indication IE is not included.	
Channel Mode IE is not included.	
Description of a multislot configuration:	
- Downlink assignment	More timeslots are assigned than before HANDOVER COMMAND
- Uplink assignment	As many timeslots assigned as before HANDOVER COMMAND
- Channel set X (1=<x<=8)	Same as before HANDOVER COMMAND

PHYSICAL INFORMATION

Information Element	value/remarks
As default message contents, except:	
Timing advance	Arbitrarily selected but different to default value.

GSM 850

ASSIGNMENT COMMAND

Information element	Value/remark
Channel description 2	describes non-hopping Bm+ACCHs or Lm+ACCHs as appropriate for the test
Power Command	As in subclause 26.1.1
Frequency list	Omitted
Cell channel description	Omitted
Description of the multislot configuration	
- Downlink assignment	Only one timeslot is allocated in downlink direction.
- Uplink assignment	Only one timeslot is allocated in uplink direction.
- Channel set X (1=<X<=8)	Appropriate for the test.
Mode of the channel set X (1=<X<=8)	Appropriate for on bearer capability chosen for the test.
Description of the second channel	Omitted
Mode of the second channel	Omitted
Mobile allocation	Omitted
Starting time	Omitted
Cipher mode setting	Omitted

HANDOVER COMMAND

Information Element	value/remarks
As default message contents, except:	
Cell Description	
- Network Colour Code	3
- Base Station Colour Code	0
- BCCH Carrier Number	167
Channel Description 2	
- Channel Type	00000
- Timeslot number	Chosen arbitrarily, but not Zero.
- Training Sequence Code	Chosen arbitrarily
- Hopping	0 (= no hopping)
- ARFCN	The ARFCN of the BCCH carrier
Synchronization Indication IE is not included.	
Channel Mode IE is not included.	
Description of a multislot configuration:	
- Downlink assignment	More timeslots are assigned than before HANDOVER COMMAND
- Uplink assignment	As many timeslots assigned as before HANDOVER COMMAND
- Channel set X (1=<x<=8)	Same as before HANDOVER COMMAND

PHYSICAL INFORMATION

Information Element	value/remarks
As default message contents, except:	
Timing advance	Arbitrarily selected but different to default value.

26.13.1.3.3 Multislot signalling / RR / Handover / successful / active call / finely synchronized / resource downgrading

26.13.1.3.3.1 Conformance requirements

- 1) The MS shall correctly apply the handover procedure from multislot configuration with frequency hopping to multislot configuration without frequency hopping in the finely synchronized case when a call is in progress. Resources are downgraded in handover procedure.

References

Conformance requirement 1: 3GPP TS 04.08 / 3GPP TS 44.018 subclauses 3.4.4, 9.1.14, 9.1.15 and 9.1.16.

26.13.1.3.3.2 Test purpose

- 1) To test that when the MS is ordered to make a finely synchronized handover to a synchronized cell from a hopping multislot configuration to a non-hopping multislot configuration, it sends 4 access bursts on the main DCCH (before completion, additional access bursts may also be sent on the SACCH) and then activates the channels correctly, taking into account power command, downgraded resources and correctly calculating the timing advance to use.
- 2) To test the MS activates the new channels that belongs to same multislot configuration correctly, taking into account downgraded resources and transmits the HANDOVER COMPLETE message without undue delay.

26.13.1.3.3.3 Method of test

Initial Conditions

System Simulator:

- 2 cells, A and B, with same LAI, default parameters, except:

- Early classmark sending enabled in SI3 rest octets- The BCCH of cell A is sent k bit periods before the BCCH of cell B. The timing advance in cell A sent to the MS is y bit periods. k and y are selected such that $0 < (2k+y) \bmod 256 < 60$.

GSM 450:

- Cell B has BCCH ARFCN = 274.

GSM 480:

- Cell B has BCCH ARFCN = 321.

P-GSM 900:

- Cell B has BCCH ARFCN = 40.

DCS 1 800:

- Cell B has BCCH ARFCN = 764.

GSM 700:

- Cell B has BCCH ARFCN = 477.

GSM 850:

- Cell B has BCCH ARFCN = 167.

Mobile Station:

- The MS is in the active state (U10) of a service using a multislot connection (on cell A). The MS is using a power level P. Where P is a power level within the supported range of that type of MS.

Specific PICS statements:

- Multislot class (TSPC_Type_Multislot_ClassX)

PIXIT statements:

-

Foreseen Final State of the MS

The active state (U10) of a multislot connection (on cell B).

Test Procedure

The MS is in the active state (U10) of a multislot connection on cell A. Maximum number of channels supported by the MS in a HSCSD configuration, is allocated. The SS sends a HANOVER COMMAND on the main DCCH In the case that the MS supports only 1 timeslot in uplink direction the HANOVER COMMAND'S Uplink assignment shall be one timeslot. The MS shall send 4 access bursts, in 4 successive slots on the new DCCH to cell B. Before completion, additional access bursts may also be sent on the SACCH. Then the MS shall establish a signalling link indicating the correct Timing Advance and power level and send a HANOVER COMPLETE message.

The MS shall be "ready to transmit" a HANOVER COMPLETE message before 650 ms after the end of the HANOVER COMMAND message, but not before a UA frame has been sent by the SS.

The term "ready to transmit" is defined in 3GPP TS 04.13.

Maximum Duration of Test

5 minutes, including 1 minute for any necessary operator actions.

Expected Sequence

Step	Direction	Message	Comments
0	MS, SS		The MS and SS are using a multislot configuration in hopping mode on cell A. Maximum number of channels supported by the MS in a HSCSD configuration, is allocated
1	SS -> MS	HANDOVER COMMAND	See Specific Message Contents.
2	MS -> SS	HANDOVER ACCESS	See specific message contents. Four messages.
3	MS -> SS	HANDOVER ACCESS	are transmitted to Cell B in 4 successive slots.
4	MS -> SS	HANDOVER ACCESS	on the new DCCH.
5	MS -> SS	HANDOVER ACCESS	Before completion of the 4 access bursts on the new DCCH, additional access bursts may also be sent on the SACCH
6	MS -> SS	SABM	Sent without information field.
7	SS -> MS	UA	
8	MS -> SS	HANDOVER COMPLETE	This message shall be ready to be transmitted before 650 ms after the completion of step 1.
9	SS		The header of the next uplink SACCH/M is examined and the Timing Advance and Power Level indications are examined. The correct timing advance shall be indicated. The power level indication shall indicate the power level used in the handover command.
10	MS, SS		The MS and SS are using a multislot configuration in non-hopping mode on cell B

Specific Message Contents

GSM 450

HANDOVER COMMAND

Information Element	value/remark
As default message contents, except:	
Cell Description	
- Network Colour Code	1
- Base Station Colour Code	5
- BCCH Carrier Number	274
Channel Description 2	
- Channel type	00000
- Timeslot Number	A suitable value for multislot configuration, chosen arbitrarily.
- Training Sequence Code	Chosen arbitrarily.
- Hopping	Single RF Channel.
- ARFCN	274
Handover Reference	
- Value	Chosen arbitrarily from the range (0, 1..255).
Power command	
- Power Level	Arbitrarily chosen, but different to the one already in use and within the range supported by that type of MS.
Synchronization Indication	
- Report Observed Time Difference	Shall not be included.
- Synchronization Indication	"Synchronized".
- Normal Cell Indication	Ignore out of range timing advance.
Description of the multislot connection	
- Uplink assignment	If possible fewer timeslots are allocated than before HANDOVER COMMAND
- Downlink assignment	Less timeslots are allocated than before HANDOVER COMMAND
- Channel set X (1=<X<=8)	Appropriate for the test

HANDOVER ACCESS

Information Element	value/remark
As default message contents except: Handover Reference - Value	Same as HANDOVER COMMAND

GSM 480

HANDOVER COMMAND

Information Element	value/remark
As default message contents, except: Cell Description - Network Colour Code - Base Station Colour Code - BCCH Carrier Number Channel Description 2 - Channel type - Timeslot Number - Training Sequence Code - Hopping - ARFCN Handover Reference - Value Power command - Power Level Synchronization Indication - Report Observed Time Difference - Synchronization Indication - Normal Cell Indication Description of the multislot connection - Uplink assignment - Downlink assignment - Channel set X ($1 \leq X \leq 8$)	1 5 321 00000 A suitable value for multislot configuration, chosen arbitrarily. Chosen arbitrarily. Single RF Channel. 321 Chosen arbitrarily from the range (0, 1..255). Arbitrarily chosen, but different to the one already in use and within the range supported by that type of MS. Shall not be included. "Synchronized". Ignore out of range timing advance. If possible fewer timeslots are allocated than before HANDOVER COMMAND Less timeslots are allocated than before HANDOVER COMMAND Appropriate for the test

HANDOVER ACCESS

Information Element	value/remark
As default message contents except: Handover Reference - Value	Same as HANDOVER COMMAND

GSM 900

HANDOVER COMMAND

Information Element	value/remark
As default message contents, except:	
Cell Description	
- Network Colour Code	1
- Base Station Colour Code	5
- BCCH Carrier Number	40
Channel Description 2	
- Channel type	00000
- Timeslot Number	A suitable value for multislot configuration, chosen arbitrarily.
- Training Sequence Code	Chosen arbitrarily.
- Hopping	Single RF Channel.
- ARFCN	40
Handover Reference	
- Value	Chosen arbitrarily from the range (0, 1..255).
Power command	
- Power Level	Arbitrarily chosen, but different to the one already in use and within the range supported by that type of MS.
Synchronization Indication	
- Report Observed Time Difference	Shall not be included.
- Synchronization Indication	"Synchronized".
- Normal Cell Indication	Ignore out of range timing advance.
Description of the multislot connection	
- Uplink assignment	If possible fewer timeslots are allocated than before HANDOVER COMMAND
- Downlink assignment	Less timeslots are allocated than before HANDOVER COMMAND
- Channel set X (1= $X \leq 8$)	Appropriate for the test

HANDOVER ACCESS

Information Element	value/remark
As default message contents except:	
Handover Reference	
- Value	Same as HANDOVER COMMAND

DCS 1 800

HANDOVER COMMAND

Information Element	value/remark
As default message contents, except:	
Cell Description	
- Network Colour Code	1
- Base Station Colour Code	5
- BCCH Carrier Number	764
Channel Description 2	
- Channel type	00000
- Timeslot Number	A suitable value for multislot configuration, chosen arbitrarily.
- Training Sequence Code	Chosen arbitrarily.
- Hopping	Single RF Channel.
- ARFCN	764
Handover Reference	
- Value	Chosen arbitrarily from the range (0, 1..255).
Power command	
- Power Level	Arbitrarily chosen, but different to the one already in use and within the range supported by that type of MS.
Synchronization Indication	
- Report Observed Time Difference	Shall not be included.
- Synchronization Indication	"Synchronized".
- Normal Cell Indication	Ignore out of range timing advance.
Description of the multislot connection	
- Uplink assignment	Same as before HANDOVER COMMAND or less timeslots are allocated than before HANDOVER COMMAND
- Downlink assignment	Less timeslots are allocated than before HANDOVER COMMAND
- Channel set X (1= X ≤8)	Appropriate for the test

HANDOVER ACCESS

Information Element	value/remark
As default message contents except:	
Handover Reference	
- Value	Same as HANDOVER COMMAND

GSM 700

HANDOVER COMMAND

Information Element	value/remark
As default message contents, except:	
Cell Description	
- Network Colour Code	1
- Base Station Colour Code	5
- BCCH Carrier Number	477
Channel Description 2	
- Channel type	00000
- Timeslot Number	A suitable value for multislot configuration, chosen arbitrarily.
- Training Sequence Code	Chosen arbitrarily.
- Hopping	Single RF Channel.
- ARFCN	477
Handover Reference	
- Value	Chosen arbitrarily from the range (0, 1..255).
Power command	
- Power Level	Arbitrarily chosen, but different to the one already in use and within the range supported by that type of MS.
Synchronization Indication	
- Report Observed Time Difference	Shall not be included.
- Synchronization Indication	"Synchronized".
- Normal Cell Indication	Ignore out of range timing advance.
Description of the multislot connection	
- Uplink assignment	If possible fewer timeslots are allocated than before HANDOVER COMMAND
- Downlink assignment	Less timeslots are allocated than before HANDOVER COMMAND
- Channel set X (1= $X \leq 8$)	Appropriate for the test

HANDOVER ACCESS

Information Element	value/remark
As default message contents except:	
Handover Reference	
- Value	Same as HANDOVER COMMAND

GSM 850

HANDOVER COMMAND

Information Element	value/remark
As default message contents, except:	
Cell Description	
- Network Colour Code	1
- Base Station Colour Code	5
- BCCH Carrier Number	167
Channel Description 2	
- Channel type	00000
- Timeslot Number	A suitable value for multislot configuration, chosen arbitrarily.
- Training Sequence Code	Chosen arbitrarily.
- Hopping	Single RF Channel.
- ARFCN	167
Handover Reference	
- Value	Chosen arbitrarily from the range (0, 1..255).
Power command	
- Power Level	Arbitrarily chosen, but different to the one already in use and within the range supported by that type of MS.
Synchronization Indication	
- Report Observed Time Difference	Shall not be included.
- Synchronization Indication	"Synchronized".
- Normal Cell Indication	Ignore out of range timing advance.
Description of the multislot connection	
- Uplink assignment	If possible fewer timeslots are allocated than before HANDOVER COMMAND
- Downlink assignment	Less timeslots are allocated than before HANDOVER COMMAND
- Channel set X (1=<X<=8)	Appropriate for the test

HANDOVER ACCESS

Information Element	value/remark
As default message contents except:	
Handover Reference	
- Value	Same as HANDOVER COMMAND

26.13.1.3.4 Multislot signalling / RR / Handover / successful / call under establishment / finely synchronized / relocation of channels

26.13.1.3.4.1 Conformance requirements

- 1) The MS shall correctly apply the handover procedure from hopping, multislot configuration, finely synchronized case to hopping, multislot configuration, synchronized case during call establishment.
- 2) The MS shall not change number of channels in multislot configuration but the place of each channel is changed.
- 3) If during call establishment a Layer 3 MM or CC message just sent by the MS is not Layer 2 acknowledged before the channel change caused by the HANDOVER COMMAND message, the MS shall send the Layer 3 message to the new cell, using the same value in the N(SD) field, after the handover procedure.

References

Conformance requirements: 3GPP TS 04.08 / 3GPP TS 44.018 subclauses 3.4.4 and 9.1.15.
3GPP TS 04.13 subclause 5.2.6.2.

26.13.1.3.4.2 Test purpose

- 1) To test that when the MS is ordered to make a finely synchronized handover to a synchronized cell, it sends 4 access bursts on the main DCCH (before completion, additional access bursts may also be sent on the SACCH) and then activates the channel correctly, taking into account power command, new order of channels in multislot configuration and correctly calculating the timing advance to use. Handover is done from hopping multislot

configuration to hopping multislot configuration, number of channels in multislot configuration is not changed but the place of each channel is changed.

- 2) To test that MS correctly retransmits Layer 3 MM or CC messages, that were not acknowledged by Layer 2 before the Handover, after completion of the Handover.
- 3) To verify the MS transmits the HANDOVER COMPLETE message without undue delay.

26.13.1.3.4.3 Method of test

Initial Conditions

System Simulator:

- 2 cells, A and B, with same LAI, default parameters, except:
 - Early classmark sending enabled in SI3 rest octets.
- The BCCH of cell A is sent k bit periods before the BCCH of cell B. The timing advance in cell A sent to the MS is y bit periods. k and y are selected such that $0 < (2k + y) \bmod 256 < 60$.
- The frame numbers of cells A and B shall be different by 100.

GSM 450:

Cell A has:

- BCCH ARFCN = 263.
- Cell Allocation = (259, 261, 263, 265, 267, 269, 271, 273, 275, 277, 279, 281, 283, 285, 287, 289, 291).

Cell B has:

- BCCH ARFCN = 274.
- Cell Allocation = (260, 262, 264, 266, 268, 270, 272, 274, 276, 279, 281, 283, 285, 287, 289, 291).

GSM 480:

Cell A has:

- BCCH ARFCN = 310.
- Cell Allocation = (306, 308, 310, 312, 314, 316, 318, 320, 322, 324, 326, 328, 330, 332, 334, 336, 338).

Cell B has:

- BCCH ARFCN = 321.
- Cell Allocation = (307, 309, 311, 313, 315, 317, 319, 321, 323, 326, 328, 330, 332, 334, 336, 338).

GSM 900:

Cell A has:

- BCCH ARFCN = 20.
- Cell Allocation = (10, 17, 20, 26, 34, 42, 45, 46, 52, 59, 66, 73, 74, 75, 76, 108, 114).

Cell B has:

- BCCH ARFCN = 40.
- Cell Allocation = (14, 18, 22, 24, 30, 31, 38, 40, 60, 66, 73, 74, 75, 76, 108, 114).

DCS 1 800:

Cell A has:

- BCCH ARFCN = 747.
- Cell Allocation = (734, 741, 747, 754, 759, 762, 766, 767, 773, 775, 779, 782, 791, 798, 829, 832, 844).

Cell B has:

- BCCH ARFCN = 764.
- Cell Allocation = (739, 743, 746, 749, 756, 758, 761, 764, 771, 779, 782, 791, 798, 829, 832, 844).

GSM 700:

Cell A has:

- BCCH ARFCN = 457.
- Cell Allocation = (447, 454, 457, 463, 471, 479, 482, 483, 489, 496, 498, 500, 501, 502, 503, 506, 508).

Cell B has:

- BCCH ARFCN = 477.
- Cell Allocation = (451, 455, 459, 461, 467, 468, 475, 477, 497, 498, 500, 501, 502, 503, 506, 508).

GSM 850:

Cell A has:

- BCCH ARFCN = 147.
- Cell Allocation = (137, 144, 147, 153, 161, 169, 172, 173, 179, 186, 193, 200, 201, 202, 203, 235, 241).

Cell B has:

- BCCH ARFCN = 167.
- Cell Allocation = (141, 145, 149, 151, 157, 158, 165, 167, 187, 193, 200, 201, 202, 203, 235, 241).

Mobile Station:

- The MS is in the "idle, updated" state, with a TMSI allocated and camped on cell A.

Specific PICS statements:

- Multislot class (TSPC_Type_Multislot_ClassX)

PIXIT statements:

-

Foreseen Final State of the MS

"Idle, updated" with TMSI allocated and camped on cell B.

Test Procedure

A Mobile Originating Call is initiated on cell A. After the MS has sent the SETUP message (and before the last L2 frame carrying the SETUP message is acknowledged by the SS) the SS sends ASSIGNMENT COMMAND message to MS defining used multislot configuration. MS responds with ASSIGNMENT COMPLETE message. Then the SS sends a HANDOVER COMMAND message, ordering the MS to switch to cell B. After the handover timeslots are relocated. Timeslots are also overlapped (this is described in specific message contents). The MS shall then send 4 access bursts, in successive slots on the new DCCH to cell B. Before completion of the 4 access bursts on the new DCCH, additional access bursts may also be sent on the SACCH. Then the MS shall establish a signalling link indicating the correct timing advance and power level (number of channels in multislot configuration is not changed but the place of each channel is changed) and send a HANDOVER COMPLETE message. The MS shall be "ready to transmit" the HANDOVER COMPLETE message before 1500 ms after the end of the HANDOVER COMMAND message, but not

before a UA frame has been sent by the SS. The MS shall then again send the SETUP message to the SS, using the same value in the N(SD) field. Finally the SS sends a CHANNEL RELEASE to end the test.

The term "ready to transmit" is defined in 3GPP TS 04.13.

Maximum Duration of Test

5 minutes, including 1 minute for any necessary operator actions.

Expected Sequence

Step	Direction	Message	Comments
1	-----	-----	An MO call is initiated.
2	MS -> SS	CHANNEL REQUEST	Establish. Cause = "Originating call, NECI not set to 1"
3	SS -> MS	IMMEDIATE ASSIGNMENT	See Specific Message contents.
4	MS -> SS	CM SERVICE REQUEST	CM Service Type = Mobile Originating Call Establishment.
5	MS -> SS	CLASSMARK CHANGE	Multislot class
6	SS -> MS	AUTHENTICATION REQUEST	
7	MS -> SS	AUTHENTICATION RESPONSE	
8	SS -> MS	CIPHERING MODE COMMAND	
9	MS -> SS	CIPHERING MODE COMPLETE	
10	MS -> SS	SETUP	Last L2 frame not acknowledged by the SS.
11	SS -> MS	ASSIGNMENT COMMAND	Multislot configuration is sent to MS. See specific message contents below.
12	MS -> SS	ASSIGNMENT COMPLETE	
13	MS -> SS	SETUP	Last L2 frame not acknowledged by the SS. Same N(SD) as in step 8.
14	SS -> MS	HANDOVER COMMAND	See Specific Message Contents below.
15	MS -> SS	HANDOVER ACCESS	
16	MS -> SS	HANDOVER ACCESS	
17	MS -> SS	HANDOVER ACCESS	See Specific message contents.
18	MS -> SS	HANDOVER ACCESS	Four messages are transmitted to cell B in 4 successive slots on the new DCCH. Before completion of the 4 access bursts on the new DCCH, additional access bursts may also be sent on the SACCH.
19	MS -> SS	SABM	Sent without information field.
20	SS -> MS	UA	
21	MS -> SS	HANDOVER COMPLETE	The message shall be ready to be transmitted before 1500 ms after the completion of step 12.
22	SS		The header of the next uplink SACCH/M is examined and the Timing Advance and Power Level indications are examined. The correct timing advance shall be indicated. The power level indication shall indicate the power level used in the handover command.
23	MS -> SS	SETUP	Same N(SD) as in step 8.
24	SS -> MS	CHANNEL RELEASE	The main signalling link is released.

Specific Message Contents

DCS 1 800:

ASSIGNMENT COMMAND

Information element	Value/remark
Channel description 2	describes hopping Bm+ACCHs or Lm+ACCHs as appropriate for the test
Power Command	As in subclause 26.1.1
Frequency list	Omitted
Cell channel description	Omitted
Description of the multislot configuration	
- Uplink assignment	Appropriate for the test
- Downlink assignment	Appropriate for the test
- Channel set X (1= X ≤8)	Appropriate for the test
Mode of the channel set X (1= X ≤8)	Appropriate for the test
Description of the second channel	Omitted
Mode of the second channel	Omitted
Mobile allocation	Arbitrarily chosen from Cell channel description
Starting time	Omitted
Cipher mode setting	Omitted

IMMEDIATE ASSIGNMENT

Information Element	value/remark
As default message contents except:	
Channel Description	Channel Description.
- Channel Type	SDCCH/8
- TDMA offset	As default message contents.
- Timeslot number	Arbitrary value, but not zero.
- Training Sequence Code	Chosen arbitrarily.
- Hopping	RF hopping channel.
- MAIO	Chosen arbitrarily from the set (0, 1 to N-1), where N is the number of frequencies encoded in the Mobile Allocation.
- HSN	Chosen arbitrarily from the set. (1,2,..63).
Mobile Allocation	Indicates all of the CA of cell A except for the BCCH frequency.

HANDOVER COMMAND

Information Element	value/remark
As default message contents except:	
Cell Description	
- Network Colour Code	1
- Base Station Colour Code	5
- BCCH Carrier Number	764
Channel Description 2	
- Channel Type	00000
- TDMA offset	Chosen arbitrarily.
- Timeslot number	A suitable value for multislot configuration, chosen arbitrarily.
- Training Sequence Code	Chosen arbitrarily.
- Hopping	RF hopping channel.
- MAIO	Chosen arbitrarily from the set (0, 1 to N-1), where N is the number of frequencies encoded in the Frequency List IE.
- HSN	Zero (this gives cyclic hopping).
Handover Reference	
- Value	Chosen arbitrarily from the range (0, 1..255).
Power command	
- Power Level	Arbitrarily chosen, but different to the one already in use and within the range supported by the MS.
Synchronization Indication	
- Report Observed Time Difference	Shall not be included.
- Synchronization Indication	"Synchronized".
- Normal Cell Indication	Ignore out of range timing advance.
Frequency List after time	
- Frequency List	Use Range 512 to encode the complete CA of Cell B.
Description of the multislot configuration	
- Downlink assignment	For Type 1 MS timeslots are shifted one position to right if timeslot 7 is not used. If timeslot 7 is used then timeslots are shifted one position to left. For type 2 MS timeslots are shifted one position to right taking into account rules of multislot capability described in 05.02 Annex B.
- Uplink assignment	For Type 1 MS timeslots are shifted one position to right if timeslot 7 is not used. If timeslot 7 is used then timeslots are shifted one position to left. For type 2 MS timeslots are shifted one position to right taking into account rules of multislot capability described in 05.02 Annex B.
- Channel set X (1=<X<=8)	Appropriate for the test.

HANDOVER ACCESS

Information Element	value/remark
As default message contents except:	
Handover Reference	
- Value	Same as HANDOVER COMMAND

GSM 450:

ASSIGNMENT COMMAND

Information element	Value/remark
Channel description 2	describes hopping Bm+ACCHs or Lm+ACCHs as appropriate for the test
Power Command	As in subclause 26.1.1
Frequency list	Omitted
Cell channel description	Omitted
Description of the multislot configuration	
- Uplink assignment	Appropriate for the test
- Downlink assignment	Appropriate for the test
- Channel set X ($1 \leq X \leq 8$)	Appropriate for the test
Mode of the channel set X ($1 \leq X \leq 8$)	Appropriate for the test
Description of the second channel	Omitted
Mode of the second channel	Omitted
Mobile allocation	Omitted
Starting time	Omitted
Cipher mode setting	Omitted

IMMEDIATE ASSIGNMENT

Information Element	value/remark
As default message contents except:	
Channel Description	Channel Description.
- Channel Type	SDCCH/8
- TDMA offset	As default message contents.
- Timeslot number	Arbitrary value, but not zero.
- Training Sequence Code	Chosen arbitrarily.
- Hopping	RF hopping channel.
- MAIO	Chosen arbitrarily from the set (0, 1 to N-1), where N is the number of frequencies encoded in the Mobile Allocation.
- HSN	Chosen arbitrarily from the set (1,2,..63).
Mobile Allocation	Indicates all of the CA of cell A except for the BCCH frequency.

HANDOVER COMMAND

Information Element	value/remark
As default message contents except:	
Cell Description	
- Network Colour Code	1
- Base Station Colour Code	5
- BCCH Carrier Number	274
Channel Description 2	
- Channel Type	00000
- TDMA offset	Chosen arbitrarily.
- Timeslot number	A suitable value for multislot configuration, chosen arbitrarily.
- Training Sequence Code	Chosen arbitrarily.
- Hopping	RF hopping channel.
- MAIO	Chosen arbitrarily from the set (0, 1 to N-1), where N is the number of frequencies encoded in the Frequency List IE.
- HSN	Zero (this gives cyclic hopping).
Handover Reference	
- Value	Chosen arbitrarily from the range (0, 1..255).
Power command	
- Power Level	Arbitrarily chosen, but different to the one already in use and within the range supported by the MS.
Synchronization Indication	
- Report Observed Time Difference	Shall not be included.
- Synchronization Indication	"Synchronized".
- Normal Cell Indication	Ignore out of range timing advance.
Frequency List after time	
- Frequency List	Use Range 512 to encode the complete CA of Cell B.
Description of the multislot configuration	
- Downlink assignment	For Type 1 MS timeslots are shifted one position to right if timeslot 7 is not used. If timeslot 7 is used then timeslots are shifted one position to left. For type 2 MS timeslots are shifted one position to right taking into account rules of multislot capability described in 05.02 Annex B.
- Uplink assignment	For Type 1 MS timeslots are shifted one position to right if timeslot 7 is not used. If timeslot 7 is used then timeslots are shifted one position to left. For type 2 MS timeslots are shifted one position to right taking into account rules of multislot capability described in 05.02 Annex B.
- Channel set X (1=<X<=8)	Appropriate for the test.

HANDOVER ACCESS

Information Element	value/remark
As default message contents except:	
Handover Reference	
- Value	Same as HANDOVER COMMAND

GSM 480:

ASSIGNMENT COMMAND

Information element	Value/remark
Channel description 2	describes hopping Bm+ACCHs or Lm+ACCHs as appropriate for the test
Power Command	As in subclause 26.1.1
Frequency list	Omitted
Cell channel description	Omitted
Description of the multislot configuration	
- Uplink assignment	Appropriate for the test
- Downlink assignment	Appropriate for the test
- Channel set X ($1 \leq X \leq 8$)	Appropriate for the test
Mode of the channel set X ($1 \leq X \leq 8$)	Appropriate for the test
Description of the second channel	Omitted
Mode of the second channel	Omitted
Mobile allocation	Omitted
Starting time	Omitted
Cipher mode setting	Omitted

IMMEDIATE ASSIGNMENT

Information Element	value/remark
As default message contents except:	
Channel Description	Channel Description.
- Channel Type	SDCCH/8
- TDMA offset	As default message contents.
- Timeslot number	Arbitrary value, but not zero.
- Training Sequence Code	Chosen arbitrarily.
- Hopping	RF hopping channel.
- MAIO	Chosen arbitrarily from the set (0, 1 to N-1), where N is the number of frequencies encoded in the Mobile Allocation.
- HSN	Chosen arbitrarily from the set (1,2,..63).
Mobile Allocation	Indicates all of the CA of cell A except for the BCCH frequency.

HANDOVER COMMAND

Information Element	value/remark
As default message contents except:	
Cell Description	
- Network Colour Code	1
- Base Station Colour Code	5
- BCCH Carrier Number	321
Channel Description 2	
- Channel Type	00000
- TDMA offset	Chosen arbitrarily.
- Timeslot number	A suitable value for multislot configuration, chosen arbitrarily.
- Training Sequence Code	Chosen arbitrarily.
- Hopping	RF hopping channel.
- MAIO	Chosen arbitrarily from the set (0, 1 to N-1), where N is the number of frequencies encoded in the Frequency List IE.
- HSN	Zero (this gives cyclic hopping).
Handover Reference	
- Value	Chosen arbitrarily from the range (0, 1..255).
Power command	
- Power Level	Arbitrarily chosen, but different to the one already in use and within the range supported by the MS.
Synchronization Indication	
- Report Observed Time Difference	Shall not be included.
- Synchronization Indication	"Synchronized".
- Normal Cell Indication	Ignore out of range timing advance.
Frequency List after time	
- Frequency List	Use Range 512 to encode the complete CA of Cell B.
Description of the multislot configuration	
- Downlink assignment	For Type 1 MS timeslots are shifted one position to right if timeslot 7 is not used. If timeslot 7 is used then timeslots are shifted one position to left. For type 2 MS timeslots are shifted one position to right taking into account rules of multislot capability described in 05.02 Annex B.
- Uplink assignment	For Type 1 MS timeslots are shifted one position to right if timeslot 7 is not used. If timeslot 7 is used then timeslots are shifted one position to left. For type 2 MS timeslots are shifted one position to right taking into account rules of multislot capability described in 05.02 Annex B.
- Channel set X (1=<X<=8)	Appropriate for the test.

HANDOVER ACCESS

Information Element	value/remark
As default message contents except:	
Handover Reference	
- Value	Same as HANDOVER COMMAND

GSM 900:

ASSIGNMENT COMMAND

Information element	Value/remark
Channel description 2	describes hopping Bm+ACCHs or Lm+ACCHs as appropriate for the test
Power Command	As in subclause 26.1.1
Frequency list	Omitted
Cell channel description	Omitted
Description of the multislot configuration	
- Uplink assignment	Appropriate for the test
- Downlink assignment	Appropriate for the test
- Channel set X ($1 \leq X \leq 8$)	Appropriate for the test
Mode of the channel set X ($1 \leq X \leq 8$)	Appropriate for the test
Description of the second channel	Omitted
Mode of the second channel	Omitted
Mobile allocation	Arbitrarily chosen from Cell channel description
Starting time	Omitted
Cipher mode setting	Omitted

IMMEDIATE ASSIGNMENT

Information Element	value/remark
As default message contents except:	
Channel Description	Channel Description.
- Channel Type	SDCCH/8
- TDMA offset	As default message contents.
- Timeslot number	Arbitrary value, but not zero.
- Training Sequence Code	Chosen arbitrarily.
- Hopping	RF hopping channel.
- MAIO	Chosen arbitrarily from the set (0, 1 to N-1), where N is the number of frequencies encoded in the Mobile Allocation.
- HSN	Chosen arbitrarily from the set (1,2,..63).
Mobile Allocation	Indicates all of the CA of cell A except for the BCCH frequency.

HANDOVER COMMAND

Information Element	value/remark
As default message contents except:	
Cell Description	
- Network Colour Code	1
- Base Station Colour Code	5
- BCCH Carrier Number	40
Channel Description 2	
- Channel Type	00000
- TDMA offset	Chosen arbitrarily.
- Timeslot number	A suitable value for multislot configuration, chosen arbitrarily.
- Training Sequence Code	Chosen arbitrarily.
- Hopping	RF hopping channel.
- MAIO	Chosen arbitrarily from the set (0, 1 to N-1), where N is the number of frequencies encoded in the Frequency List IE.
- HSN	Zero (this gives cyclic hopping).
Handover Reference	
- Value	Chosen arbitrarily from the range (0, 1..255).
Power command	
- Power Level	Arbitrarily chosen, but different to the one already in use and within the range supported by the MS.
Synchronization Indication	
- Report Observed Time Difference	Shall not be included.
- Synchronization Indication	"Synchronized".
- Normal Cell Indication	Ignore out of range timing advance.
Frequency List after time	
- Frequency List	Use Range 512 to encode the complete CA of Cell B.
Description of the multislot configuration	
- Downlink assignment	For Type 1 MS timeslots are shifted one position to right if timeslot 7 is not used. If timeslot 7 is used then timeslots are shifted one position to left. For type 2 MS timeslots are shifted one position to right taking into account rules of multislot capability described in 05.02 Annex B.
- Uplink assignment	For Type 1 MS timeslots are shifted one position to right if timeslot 7 is not used. If timeslot 7 is used then timeslots are shifted one position to left. For type 2 MS timeslots are shifted one position to right taking into account rules of multislot capability described in 05.02 Annex B.
- Channel set X (1=<X<=8)	Appropriate for the test.

HANDOVER ACCESS

Information Element	value/remark
As default message contents except:	
Handover Reference	
- Value	Same as HANDOVER COMMAND

GSM 700:

ASSIGNMENT COMMAND

Information element	Value/remark
Channel description 2	describes hopping Bm+ACCHs or Lm+ACCHs as appropriate for the test
Power Command	As in subclause 26.1.1
Frequency list	Omitted
Cell channel description	Omitted
Description of the multislots configuration	
- Uplink assignment	Appropriate for the test
- Downlink assignment	Appropriate for the test
- Channel set X ($1 \leq X \leq 8$)	Appropriate for the test
Mode of the channel set X ($1 \leq X \leq 8$)	Appropriate for the test
Description of the second channel	Omitted
Mode of the second channel	Omitted
Mobile allocation	Arbitrarily chosen from Cell channel description
Starting time	Omitted
Cipher mode setting	Omitted

IMMEDIATE ASSIGNMENT

Information Element	value/remark
As default message contents except:	
Channel Description	Channel Description.
- Channel Type	SDCCH/8
- TDMA offset	As default message contents.
- Timeslot number	Arbitrary value, but not zero.
- Training Sequence Code	Chosen arbitrarily.
- Hopping	RF hopping channel.
- MAIO	Chosen arbitrarily from the set (0, 1 to N-1), where N is the number of frequencies encoded in the Mobile Allocation.
- HSN	Chosen arbitrarily from the set (1,2,..63).
Mobile Allocation	Indicates all of the CA of cell A except for the BCCH frequency.

HANDOVER COMMAND

Information Element	value/remark
As default message contents except:	
Cell Description	
- Network Colour Code	1
- Base Station Colour Code	5
- BCCH Carrier Number	477
Channel Description 2	
- Channel Type	00000
- TDMA offset	Chosen arbitrarily.
- Timeslot number	A suitable value for multislot configuration, chosen arbitrarily.
- Training Sequence Code	Chosen arbitrarily.
- Hopping	RF hopping channel.
- MAIO	Chosen arbitrarily from the set (0, 1 to N-1), where N is the number of frequencies encoded in the Frequency List IE.
- HSN	Zero (this gives cyclic hopping).
Handover Reference	
- Value	Chosen arbitrarily from the range (0, 1..255).
Power command	
- Power Level	Arbitrarily chosen, but different to the one already in use and within the range supported by the MS.
Synchronization Indication	
- Report Observed Time Difference	Shall not be included.
- Synchronization Indication	"Synchronized".
- Normal Cell Indication	Ignore out of range timing advance.
Frequency List after time	
- Frequency List	Use Range 512 to encode the complete CA of Cell B.
Description of the multislot configuration	
- Downlink assignment	For Type 1 MS timeslots are shifted one position to right if timeslot 7 is not used. If timeslot 7 is used then timeslots are shifted one position to left. For type 2 MS timeslots are shifted one position to right taking into account rules of multislot capability described in 05.02 Annex B.
- Uplink assignment	For Type 1 MS timeslots are shifted one position to right if timeslot 7 is not used. If timeslot 7 is used then timeslots are shifted one position to left. For type 2 MS timeslots are shifted one position to right taking into account rules of multislot capability described in 05.02 Annex B.
- Channel set X (1=<X<=8)	Appropriate for the test.

HANDOVER ACCESS

Information Element	value/remark
As default message contents except:	
Handover Reference	
- Value	Same as HANDOVER COMMAND

GSM 850:

ASSIGNMENT COMMAND

Information element	Value/remark
Channel description 2	describes hopping Bm+ACCHs or Lm+ACCHs as appropriate for the test
Power Command	As in subclause 26.1.1
Frequency list	Omitted
Cell channel description	Omitted
Description of the multislots configuration	
- Uplink assignment	Appropriate for the test
- Downlink assignment	Appropriate for the test
- Channel set X ($1 \leq X \leq 8$)	Appropriate for the test
Mode of the channel set X ($1 \leq X \leq 8$)	Appropriate for the test
Description of the second channel	Omitted
Mode of the second channel	Omitted
Mobile allocation	Arbitrarily chosen from Cell channel description
Starting time	Omitted
Cipher mode setting	Omitted

IMMEDIATE ASSIGNMENT

Information Element	value/remark
As default message contents except:	
Channel Description	Channel Description.
- Channel Type	SDCCH/8
- TDMA offset	As default message contents.
- Timeslot number	Arbitrary value, but not zero.
- Training Sequence Code	Chosen arbitrarily.
- Hopping	RF hopping channel.
- MAIO	Chosen arbitrarily from the set (0, 1 to N-1), where N is the number of frequencies encoded in the Mobile Allocation.
- HSN	Chosen arbitrarily from the set (1,2,..63).
Mobile Allocation	Indicates all of the CA of cell A except for the BCCH frequency.

HANDOVER COMMAND

Information Element	value/remark
As default message contents except:	
Cell Description	
- Network Colour Code	1
- Base Station Colour Code	5
- BCCH Carrier Number	167
Channel Description 2	
- Channel Type	00000
- TDMA offset	Chosen arbitrarily.
- Timeslot number	A suitable value for multislot configuration, chosen arbitrarily.
- Training Sequence Code	Chosen arbitrarily.
- Hopping	RF hopping channel.
- MAIO	Chosen arbitrarily from the set (0, 1 to N-1), where N is the number of frequencies encoded in the Frequency List IE.
- HSN	Zero (this gives cyclic hopping).
Handover Reference	
- Value	Chosen arbitrarily from the range (0, 1..255).
Power command	
- Power Level	Arbitrarily chosen, but different to the one already in use and within the range supported by the MS.
Synchronization Indication	
- Report Observed Time Difference	Shall not be included.
- Synchronization Indication	"Synchronized".
- Normal Cell Indication	Ignore out of range timing advance.
Frequency List after time	
- Frequency List	Use Range 512 to encode the complete CA of Cell B.
Description of the multislot configuration	
- Downlink assignment	For Type 1 MS timeslots are shifted one position to right if timeslot 7 is not used. If timeslot 7 is used then timeslots are shifted one position to left. For type 2 MS timeslots are shifted one position to right taking into account rules of multislot capability described in 05.02 Annex B.
- Uplink assignment	For Type 1 MS timeslots are shifted one position to right if timeslot 7 is not used. If timeslot 7 is used then timeslots are shifted one position to left. For type 2 MS timeslots are shifted one position to right taking into account rules of multislot capability described in 05.02 Annex B.
- Channel set X (1=<X<=8)	Appropriate for the test.

HANDOVER ACCESS

Information Element	value/remark
As default message contents except:	
Handover Reference	
- Value	Same as HANDOVER COMMAND

26.13.1.3.5 Multislot signalling / RR /Handover / successful / call under establishment / pre-synchronized / resource upgrading

If an MS does not implement the pre-synchronized handover procedure correctly then calls may fail.

If an MS does not report the observed time difference between cells correctly then pseudo synchronized handovers might not be possible for any MS.

26.13.1.3.5.1 Conformance requirements

- 1) If during call establishment a Layer 3 MM or CC message just sent by the MS is not Layer 2 acknowledged before the channel change caused by the HANDOVER COMMAND message, the MS shall send the Layer 3 message to the new cell, using the same value in the N(SD) field, after the handover procedure.

- 2) When the Timing Advance information element is included in the HANOVER COMMAND, the MS shall access the new cell with the timing advance included in the Timing Advance IE.
- 3) The MS shall be ready to transmit the HANOVER COMPLETE message within 650 ms of the end of the HANOVER COMMAND message.
- 4) When requested to do so in the HANOVER COMMAND message, the MS shall return the Mobile Time Difference IE in the HANOVER COMPLETE message indicating the sum of the observed time difference between the cells and the timing advance used on the old cell.

References

Conformance requirement 1: 3GPP TS 04.08 / 3GPP TS 44.018, subclauses 3.1.4.3 and 9.1.5.

Conformance requirement 2: 3GPP TS 05.10, subclause 6.6, 3GPP TS 04.08 subclause 9.1.16.

Conformance requirement 3: 3GPP TS 04.13, subclause 5.2.6.1.

Conformance requirement 4: 3GPP TS 04.08 / 3GPP TS 44.018, subclause 10.5.2.39.

26.13.1.3.5.2 Test purpose

- 1) To verify that when the MS is ordered to make a pre-synchronized handover from hopping multislot configuration to non-hopping multislot configuration, it sends 4 access bursts on the main DCCH (before completion, additional access bursts may also be sent on the SACCH) and then activates the channel correctly and correctly calculates the time to transmit.
- 2) To test that the MS activates the new channels that belong to same multislot configuration correctly, taking into account upgraded resources and transmits the HANOVER COMPLETE message without undue delay.

26.13.1.3.5.3 Method of test

Initial Conditions

System Simulator:

- 2 cells, A and B, with same LAI, default parameters, except:
 - Early classmark sending enabled in SI3 rest octets.
- The BCCH of cell A is sent k bit periods before the BCCH of cell B.

Mobile Station:

- The MS is in the "idle, updated" state, with a TMSI allocated and camped on cell A.

Specific PICS statements:

- Multislot class (TSPC_Type_Multislot_ClassX)

PIXIT statements:

-

Foreseen Final State of the MS

"Idle, updated" with TMSI allocated and camped on cell B.

Test Procedure

A Mobile Originating Call is initiated. The SS sends an IMMEDIATE ASSIGNMENT message allocating an SDCCH/4. The MS is commanded to use a timing advance of y bit periods on cell A. After the MS has sent the SETUP message (and before the last L2 frame carrying the SETUP message is acknowledged by the SS) the SS sends ASSIGNMENT COMMAND message to MS specifying used multislot configuration. MS responds by sending ASSIGNMENT COMPLETE message to SS. Then the SS sends a HANOVER COMMAND, ordering the MS to switch to cell B. The MS shall then send 4 access bursts, at the commanded power level, in 4 successive slots of the new DCCH to cell B. Before completion of the 4 access bursts on the new DCCH, additional access bursts may also be

sent on the SACCH. Then the MS shall establish a signalling link using the correct timing advance and send a HANDOVER COMPLETE message. The MS shall be ready to transmit the HANDOVER COMPLETE message before 650 ms after the end of the HANDOVER COMMAND message, but not before a UA frame has been sent by the SS.

The term "ready to transmit" is defined in 3GPP TS 04.13.

The MS shall then again send the SETUP message to the SS, using the same value in the N(SD) field. Finally the SS sends a CHANNEL RELEASE to end the test.

Maximum Duration of Test

20 s.

Expected Sequence

Step	Direction	Message	Comments
1	-----	-----	An MO call is initiated.
2	MS -> SS	CHANNEL REQUEST	
3	SS -> MS	IMMEDIATE ASSIGNMENT	to an SDCCH/4.
4	MS -> SS	CM SERVICE REQUEST	
5	MS -> SS	CLASSMARK CHANGE	Multislot class
6	SS -> MS	AUTHENTICATION REQUEST	
7	MS -> SS	AUTHENTICATION RESPONSE	
8	SS -> MS	CIPHERING MODE COMMAND	
9	MS -> SS	CIPHERING MODE COMPLETE	
10	MS -> SS	SETUP	Last L2 frame not acknowledged by the SS.
11	SS -> MS	ASSIGNMENT COMMAND	Multislot configuration is sent to MS. Multislot configuration shall not have the maximum number of timeslots allocated. See specific message contents below.
12	MS -> SS	ASSIGNMENT COMPLETE	
13	MS -> SS	SETUP	Last L2 frame not acknowledged by the SS. Same N(SD) as in step 10.
14	SS -> MS	HANDOVER COMMAND	See specific message contents below.
15	MS -> SS	HANDOVER ACCESS	Handover Reference as included in the
16	MS -> SS	HANDOVER ACCESS	HANDOVER COMMAND
17	MS -> SS	HANDOVER ACCESS	
18	MS -> SS	HANDOVER ACCESS	Before completion of the 4 access bursts on the new DCCH, additional access bursts may also be sent on the SACCH.
19	MS -> SS	SABM	Sent without information field.
20	SS -> MS	UA	
21	MS -> SS	HANDOVER COMPLETE	This message shall be ready to be transmitted before 650 ms after the completion of step 14. Shall include the Mobile Time Difference IE with value $(2k+y) \bmod 2,097,152$ half bit periods. A tolerance of ± 2 half bit periods is allowed.
22	MS -> SS	SETUP	Same N(SD) as in step 10
23	SS	-	The SS checks that the timing advance reported in the layer 1 header of the SACCH/M message that is sent in the first SACCH/M multiframe following the SABM is 9 bit periods.
24	SS -> MS	CHANNEL RELEASE	The main signalling link is released.

Specific Message Contents

GSM 450

ASSIGNMENT COMMAND

Information element	Value/remark
Channel description 2	describes hopping Bm+ACCHs or Lm+ACCHs as appropriate for the test
Power Command	As in subclause 26.1.1
Frequency list	Omitted
Cell channel description	Omitted
Description of the multislots configuration	
- Uplink assignment	Appropriate for the test, shall not be the maximum number of timeslots.
- Downlink assignment	Appropriate for the test, but shall not be the maximum number of timeslots.
- Channel set X (1= $X \leq 8$)	Appropriate for the test
Mode of the channel set X (1= $X \leq 8$)	Appropriate for the test
Description of the second channel	Omitted
Mode of the second channel	Omitted
Mobile allocation	Arbitrarily chosen from Cell channel description
Starting time	Omitted
Cipher mode setting	Omitted

HANDOVER COMMAND

Information Element	value/remarks
As default message contents, except:	
Cell Description	
- Network Colour Code	1
- Base Station Colour Code	5
- BCCH Carrier Number	274
Channel Description 2	
- Channel Type	00000
- Timeslot number	A suitable value for multislots configuration, chosen arbitrarily.
- Training Sequence Code	Chosen arbitrarily
- Hopping	0 (= no hopping)
- ARFCN	Chosen arbitrarily
Synchronization Indication.	pre-synchronized; ROT=1; NCI=0.
Channel Mode IE is not included.	
Description of a multislots configuration:	
- Downlink assignment	More timeslots are allocated than before HANDOVER COMMAND
- Uplink assignment	Same as before HANDOVER COMMAND
- Channel set X (1= $x \leq 8$)	Same as before HANDOVER COMMAND
Timing Advance	9 bit periods.

GSM 480

ASSIGNMENT COMMAND

Information element	Value/remark
Channel description 2	describes hopping Bm+ACCHs or Lm+ACCHs as appropriate for the test
Power Command	As in subclause 26.1.1
Frequency list	Omitted
Cell channel description	Omitted
Description of the multislots configuration	
- Uplink assignment	Appropriate for the test, shall not be the maximum number of timeslots.
- Downlink assignment	Appropriate for the test, but shall not be the maximum number of timeslots.
- Channel set X (1= $X \leq 8$)	Appropriate for the test
Mode of the channel set X (1= $X \leq 8$)	Appropriate for the test
Description of the second channel	Omitted
Mode of the second channel	Omitted
Mobile allocation	Arbitrarily chosen from Cell channel description
Starting time	Omitted
Cipher mode setting	Omitted

HANDOVER COMMAND

Information Element	value/remarks
As default message contents, except:	
Cell Description	
- Network Colour Code	1
- Base Station Colour Code	5
- BCCH Carrier Number	321
Channel Description 2	
- Channel Type	00000
- Timeslot number	A suitable value for multislots configuration, chosen arbitrarily.
- Training Sequence Code	Chosen arbitrarily
- Hopping	0 (= no hopping)
- ARFCN	Chosen arbitrarily
Synchronization Indication.	pre-synchronized; ROT=1; NCI=0.
Channel Mode IE is not included.	
Description of a multislots configuration:	
- Downlink assignment	More timeslots are allocated than before HANDOVER COMMAND
- Uplink assignment	Same as before HANDOVER COMMAND
- Channel set X (1= $x \leq 8$)	Same as before HANDOVER COMMAND
Timing Advance	9 bit periods.

P-GSM 900

ASSIGNMENT COMMAND

Information element	Value/remark
Channel description 2	describes hopping Bm+ACCHs or Lm+ACCHs as appropriate for the test
Power Command	As in subclause 26.1.1
Frequency list	Omitted
Cell channel description	Omitted
Description of the multislots configuration	
- Uplink assignment	Appropriate for the test, shall not be the maximum number of timeslots.
- Downlink assignment	Appropriate for the test, but shall not be the maximum number of timeslots.
- Channel set X (1= $X \leq 8$)	Appropriate for the test
Mode of the channel set X (1= $X \leq 8$)	Appropriate for the test
Description of the second channel	Omitted
Mode of the second channel	Omitted
Mobile allocation	Arbitrarily chosen from Cell channel description
Starting time	Omitted
Cipher mode setting	Omitted

HANDOVER COMMAND

Information Element	value/remarks
As default message contents, except:	
Cell Description	
- Network Colour Code	1
- Base Station Colour Code	5
- BCCH Carrier Number	40
Channel Description 2	
- Channel Type	00000
- Timeslot number	A suitable value for multislots configuration, chosen arbitrarily.
- Training Sequence Code	Chosen arbitrarily
- Hopping	0 (= no hopping)
- ARFCN	Chosen arbitrarily
Synchronization Indication.	pre-synchronized; ROT=1; NCI=0.
Channel Mode IE is not included.	
Description of a multislots configuration:	
- Downlink assignment	More timeslots are allocated than before HANDOVER COMMAND
- Uplink assignment	Same as before HANDOVER COMMAND
- Channel set X (1= $x \leq 8$)	Same as before HANDOVER COMMAND
Timing Advance	9 bit periods.

DCS 1 800

ASSIGNMENT COMMAND

Information element	Value/remark
Channel description 2	describes hopping Bm+ACCHs or Lm+ACCHs as appropriate for the test
Power Command	As in subclause 26.1.1
Frequency list	Omitted
Cell channel description	Omitted
Description of the multislots configuration	
- Uplink assignment	Appropriate for the test, but shall not be the maximum number of timeslots.
- Downlink assignment	Appropriate for the test, but shall not be the maximum number of timeslots.
- Channel set X (1= $X \leq 8$)	Appropriate for the test
Mode of the channel set X (1= $X \leq 8$)	Appropriate for the test
Description of the second channel	Omitted
Mode of the second channel	Omitted
Mobile allocation	Arbitrarily chosen from Cell channel description
Starting time	Omitted
Cipher mode setting	Omitted

HANDOVER COMMAND

Information Element	value/remarks
As default message contents, except:	
Cell Description	
- Network Colour Code	1
- Base Station Colour Code	5
- BCCH Carrier Number	764
Channel Description 2	
- Channel Type	00000
- Timeslot number	A suitable value for multislots configuration, chosen arbitrarily.
- Training Sequence Code	Chosen arbitrarily
- Hopping	0 (= no hopping)
- ARFCN	Chosen arbitrarily
Synchronization Indication.	pre-synchronized; ROT=1; NCI=0.
Channel Mode IE is not included.	
Description of a multislots configuration:	
- Downlink assignment	More timeslots are allocated than before HANDOVER COMMAND
- Uplink assignment	Same as before HANDOVER COMMAND
- Channel set X (1= $x \leq 8$)	Same as before HANDOVER COMMAND
Timing Advance	9 bit periods.

GSM 700

ASSIGNMENT COMMAND

Information element	Value/remark
Channel description 2	describes hopping Bm+ACCHs or Lm+ACCHs as appropriate for the test
Power Command	As in subclause 26.1.1
Frequency list	Omitted
Cell channel description	Omitted
Description of the multislots configuration	
- Uplink assignment	Appropriate for the test, shall not be the maximum number of timeslots.
- Downlink assignment	Appropriate for the test, but shall not be the maximum number of timeslots.
- Channel set X (1= $X \leq 8$)	Appropriate for the test
Mode of the channel set X (1= $X \leq 8$)	Appropriate for the test
Description of the second channel	Omitted
Mode of the second channel	Omitted
Mobile allocation	Arbitrarily chosen from Cell channel description
Starting time	Omitted
Cipher mode setting	Omitted

HANDOVER COMMAND

Information Element	value/remarks
As default message contents, except:	
Cell Description	
- Network Colour Code	1
- Base Station Colour Code	5
- BCCH Carrier Number	477
Channel Description 2	
- Channel Type	00000
- Timeslot number	A suitable value for multislots configuration, chosen arbitrarily.
- Training Sequence Code	Chosen arbitrarily
- Hopping	0 (= no hopping)
- ARFCN	Chosen arbitrarily
Synchronization Indication.	pre-synchronized; ROT=1; NCI=0.
Channel Mode IE is not included.	
Description of a multislots configuration:	
- Downlink assignment	More timeslots are allocated than before HANDOVER COMMAND
- Uplink assignment	Same as before HANDOVER COMMAND
- Channel set X (1= $x \leq 8$)	Same as before HANDOVER COMMAND
Timing Advance	9 bit periods.

GSM 850

ASSIGNMENT COMMAND

Information element	Value/remark
Channel description 2	Describes hopping Bm+ACCHs or Lm+ACCHs as appropriate for the test
Power Command	As in subclause 26.1.1
Frequency list	Omitted
Cell channel description	Omitted
Description of the multislot configuration	
- Uplink assignment	Appropriate for the test, shall not be the maximum number of timeslots.
- Downlink assignment	Appropriate for the test, but shall not be the maximum number of timeslots.
- Channel set X (1= $X \leq 8$)	Appropriate for the test
Mode of the channel set X (1= $X \leq 8$)	Appropriate for the test
Description of the second channel	Omitted
Mode of the second channel	Omitted
Mobile allocation	Arbitrarily chosen from Cell channel description
Starting time	Omitted
Cipher mode setting	Omitted

HANDOVER COMMAND

Information Element	value/remarks
As default message contents, except:	
Cell Description	
- Network Colour Code	1
- Base Station Colour Code	5
- BCCH Carrier Number	167
Channel Description 2	
- Channel Type	00000
- Timeslot number	A suitable value for multislot configuration, chosen arbitrarily.
- Training Sequence Code	Chosen arbitrarily
- Hopping	0 (= no hopping)
- ARFCN	Chosen arbitrarily
Synchronization Indication.	pre-synchronized; ROT=1; NCI=0.
Channel Mode IE is not included.	
Description of a multislot configuration:	
- Downlink assignment	More timeslots are allocated than before HANDOVER COMMAND
- Uplink assignment	Same as before HANDOVER COMMAND
- Channel set X (1= $x \leq 8$)	Same as before HANDOVER COMMAND
Timing Advance	9 bit periods.

26.13.1.4 Multislot signalling / RR / Test of the channel mode modify procedure

26.13.1.4.1 Conformance requirements

- 1) When the MS has received the CHANNEL MODE MODIFY message, the mobile station changes the mode for the indicated channel and then replies by a CHANNEL MODE MODIFY ACKNOWLEDGE message indicating the new channel mode.
- 2) If the mobile station does not support the indicated mode, it shall retain the old mode and return the associated channel mode information in the CHANNEL MODE MODIFY ACKNOWLEDGE message.

References

Conformance requirement: 3GPP TS 04.08 / 3GPP TS 44.018, subclauses 3.4.6 and 9.1.5 and 9.1.6.

26.13.1.4.2 Test purpose

- 1) To verify that the MS, in an RR connected state, acknowledges a CHANNEL MODE MODIFY message by sending a CHANNEL MODE MODIFY ACKNOWLEDGEMENT message specifying and switching to the correct mode for the channels in a multislot configuration:
 - the new mode if that mode is supported;
 - the old mode if the new mode is not supported.
- 2) This shall be verified for all existing channel modes:
 - data 9,6 Kb/s:
 - data 4,8 Kb/s full rate:
 - data 14,4 Kb/s.

26.13.1.4.3 Method of test

Initial Conditions

System Simulator:

- 1 cells, default parameters except:
- Early classmark sending enabled in SI3 rest octets

Mobile Station:

- The MS is "idle updated", with TMSI allocated.

Specific PICS statements:

- Multislot class (TSPC_Type_Multislot_ClassX)

PIXIT statements:

supported radio interface rates: 12kbps, 6kbps, 3,6kbps

Foreseen final state of the MS

"Idle, updated " with TMSI allocated.

Test procedure

- 1) A Mobile Terminated multislot connection is initiated, however following the Channel Request received from the Mobile Station, the SS sends an Immediate Assignment to the MS commanding it to go to a TCH/F. This sets the Channel Mode automatically to "Signalling Only".
- 2) The SS then sends a series of CHANNEL MODE MODIFY messages to the MS. Each time it is checked that the MS responds with a CHANNEL MODE MODIFY ACKNOWLEDGE message specifying:
 - 2.1) the channel mode that has been specified in the CHANNEL MODE MODIFY message, if the MS supports that mode (this mode then becomes the "channel mode in use");
 - 2.2) the channel mode that was in use when the CHANNEL MODE MODIFY message has been received, if the MS does not support the channel mode specified in the CHANNEL MODE MODIFY message.

Maximum duration of test

3 minutes.

Expected Sequence

Step	Direction	Message	Comments
1	SS->MS	PAGING REQUEST TYPE 1	Sent on correct paging subchannel.
2	MS->SS	CHANNEL REQUEST	Establishment cause indicates "answer to paging".
3	SS->MS	IMMEDIATE ASSIGNMENT	Assignment to a non hopping TCH/F.
4	MS->SS	PAGING RESPONSE	
5	MS->SS	CLASSMARK CHANGE	Multislot class
6	SS->MS	ASSIGNMENT COMMAND	Multislot configuration, Channel mode = 'signalling only'
7	MS->SS	ASSIGNMENT COMPLETE	
8	SS->MS	CHANNEL MODE MODIFY	See specific message contents
9	MS->SS	CHANNEL MODE MODIFY ACKNOWLEDGE	See specific message contents
10	SS->MS	CHANNEL MODE MODIFY	See specific message contents
11	MS->SS	CHANNEL MODE MODIFY ACKNOWLEDGE	See specific message contents
12	SS->MS	CHANNEL MODE MODIFY	See specific message contents
13	MS->SS	CHANNEL MODE MODIFY ACKNOWLEDGE	See specific message contents
14	SS->MS	CHANNEL RELEASE	The main signalling link is released

Specific Message Contents

CHANNEL MODE MODIFY

Information Element	value/remark
Channel description	describes the already assigned dedicated channel.
Channel mode Mode	in step 8: data 9,6 Kb/s in step 10: data 4,8 Kb/s full rate in step 12: data 14,4 Kb/s

CHANNEL MODE MODIFY ACKNOWLEDGE

Channel mode Mode	In step 9: if 9.6 Kb/s supported: data 9,6 Kb/s; otherwise: signalling only. in step 11: if 4.8 Kb/s supported: data 4,8 Kb/s full rate; otherwise: same as in step 9. in step 13: if 14.4 Kb/s supported: data 14,4 Kb/s full rate; otherwise: same as in step 11.
----------------------	---

26.13.1.5 Multislot signalling / RR / Early classmark sending

26.13.1.5.1 Conformance requirement

- 1) MS uses Controlled Early Classmark Sending procedure when indicated in SYSTEM INFORMATION TYPE 3 (ES ind bit in SI 3 Rest Octets).
 - 1.1) If Controlled Early Classmark Sending is not allowed by network the MS does not send a CLASSMARK CHANGE message.
 - 1.2) If Controlled Early Classmark Sending is allowed by network the MS shall send its multislot class in Mobile Station Classmark 3 in a CLASSMARK CHANGE message.

Reference

Conformance requirement 1: 3GPP TS 04.08 / 3GPP TS 44.018 subclauses 3.3.1.1.4 and 3.4.10.

26.13.1.5.2 Test purpose

- 1) To verify that the MS sends its multislot class in Mobile Station Classmark 3 using Controlled Early Classmark Sending procedure if allowed by network.
- 2) To verify that the MS does not perform Early Classmark Sending if it is not allowed.

26.13.1.5.3 Method of test

Initial conditions

Mobile Station:

- The MS is in MM-state "idle, updated" with valid TMSI and CKSN.

System Simulator:

- 1 cell, default parameters except:
 - Early classmark sending enabled in SI3 rest octets

Specific PICS statements:

-

PIXIT statements:

-

Foreseen final state of the MS

MS is in MM-state "idle, updated" with valid TMSI and CKSN.

Test procedure

The MS is made to initiate a multislot connection. In the first case Controlled Early Classmark Sending procedure is allowed by network, the MS performs Early Classmark sending. In the second case Controlled Early Classmark Sending procedure is not allowed by network, the MS does not send a CLASSMARK CHANGE message.

SS checks Controlled Early Classmark Change procedure from CLASSMARK CHANGE message. If Controlled Early Classmark Sending procedure is allowed by the network ES ind bit in SI 3 Resr Octets is set. If this bit is not set SS sends CHANNEL RELEASE and the main signalling link is released. If ES ind bit was set then the MS's multislot class is sent in Mobile Station Classmark 3 (octet 4) in the CLASSMARK CHANGE message.

Maximum duration of test

2 minutes.

Expected sequence

This test is executed with the following sequences in allowed and not allowed cases respectively.

After the first sequence Early classmark sending is disabled from SI3 rest octets.

Step	Direction	Message	Comments
	SS		Controlled Early Classmark Sending procedure is allowed by the network.
1	SS -> MS	PAGING REQUEST TYPE 1	Sent on the correct paging subchannel.
2	MS -> SS	CHANNEL REQUEST	Establishment cause is: answer to paging
3	SS -> MS	IMMEDIATE ASSIGNMENT	
4	MS -> SS	PAGING RESPONSE	Message is contained in SABM.
5	MS -> SS	CLASSMARK CHANGE	SS checks that MS sent its multislot class in Mobile Station Classmark 3.
7	SS -> MS	CHANNEL RELEASE	The main signalling link is released

Step	Direction	Message	Comments
	SS		Controlled Early Classmark Sending procedure is not allowed by the network.
1	SS -> MS	PAGING REQUEST TYPE 1	Sent on the correct paging subchannel. Establishment cause is: answer to paging Message is contained in SABM SS checks for 2 seconds that no CLASSMARK CHANGE message is sent by the MS.
2	MS -> SS	CHANNEL REQUEST	
3	SS -> MS	IMMEDIATE ASSIGNMENT	
4	MS -> SS	PAGING RESPONSE	
5	SS		
6	SS -> MS	CHANNEL RELEASE	The main signalling link is released.

NOTE: Step 5: 3GPP TS 04.08 / 3GPP TS 44.018 subclause 3.3.1.1.4.1 states that the MS shall send CLASSMARK CHANGE as early as possible. 2 seconds are chosen as a reasonable value to verify that the MS does not send a CLASSMARK CHANGE message.

26.13.1.6 Default contents of layer 3 messages for RR tests

26.13.1.6.1 Default contents of GSM 900 layer 3 messages for RR tests

This subclause contains the default values of GSM 900 L3 messages, which unless indicated otherwise in subclause 26.13 shall be transmitted by the system simulator and which are required to be received from the GSM 900 MS under test.

The necessary L3 messages are listed in alphabetic order, with the exception of the SYSTEM INFORMATION messages, where it is the information elements that are listed in alphabetic order (this is because some information elements occur in several SYSTEM INFORMATION types).

In this subclause, decimal values are normally used. However, sometimes a hexadecimal value, indicated by an "H", or a binary value, indicated by a "B" is used.

Default SYSTEM INFORMATION:

NOTE 1: SYSTEM INFORMATION 2 bis, SYSTEM INFORMATION 5 bis, SYSTEM INFORMATION 7, and SYSTEM INFORMATION 8 messages are not used.

Cell A

Contents of information elements in SYSTEM INFORMATION TYPE 1 to 6 messages for cell A.

(CBCH) Channel Description	Not present.
(CBCH) Mobile Allocation	Not present.
Cell Channel Description	
- Format identifier	bit map 0.
- Cell Allocation ARFCN	Channels 20, 30, 50 and 70.
Cell Identity	
- Cell Identity Value	0001H
Cell Options	
- Power Control Indicator	Power Control Indicator is not set.
- DTX Indicator	MS shall not use DTX.
- Radio_Link_Timeout	8 SACCH blocks.
Cell Selection Parameters	
- Cell_Reselect_Hysteresis	12 dB.
- MX_TXPWR_MAX_CCH	Minimum level.
- ACS	No addition cell parameters are present in SYSTEM INFORMATION messages 7 and 8.
- NECI	New establishment causes not supported.
- RXLEV_ACCESS_MIN	Minimum level.
Control Channel Description	
- Attach-Detach allowed	No Attach/Detach.
- BS_AG_BLK_RES	0 blocks reserved for access grant.
- CCCH_CONF	1 basic physical channel used for CCCH, combined with SDCCHs.
- BS_PA_MFRMS	5 multiframe periods for transmission of paging messages.
- T3212 Time-out value	Infinite.
L2 pseudo length	
- System information 1	21
- System information 2	22
- System information 3	18
- System information 4	12
Location Area Identification	
- Mobile Country Code	001 decimal
- Mobile Network Code	01 decimal
- Location Area Code	0001H
Message Type	
- System information 1	00011001
- System information 2	00011010
- System information 3	00011011
- System information 4	00011100
- System information 5	00011101
- System information 6	00011110
Neighbour Cells Description	
- Format identifier	bit map 0.
- BCCH Allocation Sequence	0
- BCCH Allocation ARFCN	Channels 10, 20, 40, 80, 90, 100, 110 and 120.
- EXT-IND	This IE carries the complete BA.
NCC Permitted	0000 0010
RACH Control Parameters	
- Max Retrans	Max 1 retrans.
- Tx-integer	5 slots used.
- Cell Barred for Access	Cell is not barred.
- Call Reestablishment Allowed	Not allowed.
- Access Control Class	Access is not barred.
- Emergency Call allowed	Yes.
SI 1 rest octets	Not used (all bits are set to spare).
SI 2 rest octets	Not used (all bits are set to spare).
SI 3 rest octets	Not used (all bits are set to spare).
SI 4 rest octets	Not used (all bits are set to spare).

Default settings for cell A:

Downlink input level	63 dBmicroVolt emf.
Uplink output power	minimum supported by the MS's power class.
Propagation profile	static.
BCCH/CCCH carrier number	20

Cell B

The contents of SYSTEM INFORMATION TYPE 1 to 6 messages for cell B are identical to those of cell A with the following exceptions:

Cell Channel Description - Format Identifier - Cell Allocation ARFCN	Bit map 0. Channel Number 10.
--	----------------------------------

NOTE 2: This IE needs modification when used in handover tests that command the MS to go to a frequency hopping channel in cell B.

Cell Identity

- Cell Identity Value: 0002H.

Default settings for cell B:

Downlink input level	53 dBmicroVolt emf.
Uplink output power	minimum supported by the MS's power class.
Propagation profile	static.
BCCH/CCCH carrier number	10

Contents of ALERTING message (SS to MS):

Protocol Discriminator	Call Control.
Transaction Identifier	
TI value	As used in the SETUP message.
TI flag	1 (destination side).
Message Type	00000001
All other information elements	Not present.

Contents of ASSIGNMENT COMMAND message:

Protocol Discriminator	RR Management.
Skip Indicator	0000
Message Type	00101110
Channel Description 2	
- Channel Type and TDMA offset	Bm + ACCHs
- Timeslot Number	Chosen arbitrarily by the test house.
- Training Sequence Code	Chosen arbitrarily by the test house.
- Hopping	Single RF channel.
- ARFCN	Channel number 30.
Power Command	
- Power level	Chosen arbitrarily by the test house.
Multislot allocation	
- Downlink assignment	Appropriate for the test
- Uplink assignment	Appropriate for the test
- Channel set 1=<X<=8	Appropriate for the test
Channel mode	Appropriate for the test

Contents of ASSIGNMENT COMPLETE message:

Protocol Discriminator	RR Management.
Skip Indicator	0000
Message Type	00101001
RR Cause	
- RR Cause Value	Normal event.

Contents of ASSIGNMENT FAILURE message:

Protocol Discriminator	RR Management.
Skip Indicator	0000
Message Type	00101111
RR Cause	
- RR Cause Value	Depending on test.

Contents of AUTHENTICATION REQUEST message:

Protocol Discriminator	MM message.
Skip Indicator	0000
Message Type	00010010
Ciphering Key Sequence Number	
- Key Sequence	Chosen arbitrarily by the test house from the range 0 to 6.
Authentication Parameter RAND	
- RAND value	Chosen arbitrarily by the test house.

Contents of AUTHENTICATION RESPONSE message:

Protocol Discriminator	MM message.
Skip Indicator	0000
Message Type	0X010100
Other information element(s)	Not checked.

Contents of CALL PROCEEDING message:

Protocol Discriminator	Call Control.
Transaction Identifier	
TI value	As used in the SETUP message.
TI flag	1 (destination side).
Message Type	00000010
All other information elements	Not present.

Contents of CHANNEL MODE MODIFY message:

Protocol Discriminator	RR Management.
Skip Indicator	0000
Message Type	00010000
Channel Description 2	
- Channel Type and TDMA offset	Depending on test.
- Timeslot Number	Chosen arbitrarily by the test house.
- Training Sequence Code	Chosen arbitrarily by the test house.
- Hopping	Single RF channel.
- ARFCN	Channel number 30.
Channel Mode	
- Mode	Depending on test.

Contents of CHANNEL MODE MODIFY ACKNOWLEDGE message:

Protocol Discriminator	RR Management.
Skip Indicator	0000
Message Type	00010111
Channel Description 2	Depending on test.
- Channel Type and TDMA offset	Same as in the CHANNEL MODE MODIFY message.
- Timeslot Number	Same as in the CHANNEL MODE MODIFY message.
- Training Sequence Code	Single RF channel.
- Hopping	Band number 0.
- Frequency Band	Channel number 30.
- ARFCN	
Channel Mode	
- Mode	Same as in the CHANNEL MODE MODIFY message.

Contents of CHANNEL RELEASE message:

Protocol Discriminator	RR Management.
Skip Indicator	0000
Message Type	00001101
RR Cause	
- RR Cause Value	Normal event.

Contents of CHANNEL REQUEST message

Establishment Cause	Not checked.
Random Reference	Not checked.

Contents of CIPHERING MODE COMMAND message:

Protocol Discriminator	RR Management.
Skip Indicator	0000
Message Type	00110101
Cipher Mode Setting	
- algorithm identifier	cipher with A5/1.
- SC	Start ciphering.
Cipher Response	IMEI shall not be included.

Contents of CIPHERING MODE COMPLETE message:

Protocol Discriminator	RR Management.
Skip Indicator	0000
Message Type	00110010
Mobile Identity	Not present.

Contents of the CLASSMARK CHANGE message:

Protocol Discriminator	RR Management.
Skip Indicator	0000
Message Type	000100110
Mobile Station Classmark 2	See PICS/PIXIT.
Mobile Station Classmark 3	For presence and contents see PICS/PIXIT.

Contents of CM SERVICE ACCEPT message:

Protocol Discriminator	Mobility Management.
Skip Indicator	0000
Message Type	00100001

Contents of CM SERVICE REQUEST message

Protocol Discriminator	Mobility Management.
Skip Indicator	0000
Message Type	0X100100
Other information elements	Not checked.

Contents of CONFIGURATION CHANGE COMMAND message (SS to MS)

Protocol Discriminator	Radio Resource
Skip Indicator	0000
Message type	00110000
Multislot allocation	Appropriate for the test
- Downlink assignment	Appropriate for the test
- Uplink assignment	Appropriate for the test
- Channel set 1=<X<=8	Appropriate for the test
Channel mode 1=<X<=8	Appropriate for the test

Contents of CONFIGURATION CHANGE ACKNOWLEDGE message (MS to SS)

Protocol Discriminator	Radio Resource
Skip Indicator	0000
Message type	00110001

Contents of CONFIGURATION CHANGE REJECT message (MS to SS)

Protocol Discriminator	Radio Resource
Skip Indicator	0000
Message type	00110011
RR Cause	Protocol Error Unspecified

Contents of CONNECT message (SS to MS)

Protocol Discriminator	Call Control.
Transaction Identifier	
TI value	As used in the SETUP message.
TI flag	1
Message Type	00000111
All other information elements	Not present.

Contents of CONNECT ACKNOWLEDGE message (MS to SS)

Protocol Discriminator	Call Control.
Transaction Identifier	
TI value	As used in the SETUP message.
TI flag	0
Message Type	0X001111

Contents of HANDOVER ACCESS message:

Handover Reference	Equal to the value included in the Handover Command message.
--------------------	--

Contents of HANDOVER COMMAND message:

Protocol Discriminator	RR Management.
Skip Indicator	0000
Message Type	00101011
Cell Description	1
- Network Colour Code	Corresponding to target cell
- Base station Colour Code	Set to the BCCH carrier number of cell B. (one of 10, 20, 80, 90, 100, 110 or 120).
- BCCH Carrier Number	
Channel Description 2	Bm + ACCHs.
- Channel Type and TDMA offset	Chosen arbitrarily by the test house.
- Timeslot Number	Chosen arbitrarily by the test house.
- Training Sequence Code	Single RF channel.
- Hopping	Chosen arbitrarily by the test house from those supported on the target cell.
- ARFCN	
Handover Reference	
- Handover Reference Value	Chosen arbitrarily by the test house.
Power Command	
- Power level	Chosen arbitrarily by the test house.
Multislot allocation	
- Downlink assignment	Appropriate for the test
- Uplink assignment	Appropriate for the test
- Channel set 1= $X \leq 8$	Appropriate for the test
Channel mode	Appropriate for the test

Contents of HANDOVER COMPLETE message:

Protocol Discriminator	RR Management.
Skip Indicator	0000
Message Type	00101100
RR cause	Normal event.
Time difference	Not present.

Contents of HANDOVER FAILURE message:

Protocol Discriminator	RR Management.
Skip Indicator	0000
Message Type	00101000
RR cause	Dependent on the test.

Contents of IMMEDIATE ASSIGNMENT message:

L2 pseudo length	This is the sum of the lengths of all the information elements present in the message except for the IA rest octets and L2 pseudo length IEs. For the default message the L2 pseudo length is 11.
Protocol Discriminator	RR Management.
Skip Indicator	0000
Message Type	00111111
Page Mode	
- Page Mode	Normal Paging.
Channel Description	
- Channel Type and TDMA offset	For non-combined CCCH/SDCCH (see initial conditions), SDCCH/8, with subchannel chosen arbitrarily by the test house For combined CCCH/SDCCH (default SS conditions), SDCCH/4, with subchannel chosen arbitrarily by the test house.
- Timeslot Number	For non-combined CCCH/SDCCH (see initial conditions), chosen arbitrarily by the test house; For combined CCCH/SDCCH (default SS conditions), SDCCH/4, timeslot zero.
- Training Sequence Code	For non-combined CCCH/SDCCH (see initial conditions), chosen arbitrarily by the test house; For combined CCCH/SDCCH (default SS conditions), SDCCH/4, TSC=5 (same as the BCC). Single RF channel.
- Hopping	
- ARFCN	For non-combined CCCH/SDCCH (see initial conditions), Channel number 30; For combined CCCH/SDCCH (default SS conditions), SDCCH/4, Channel number 20.
Request Reference	Pertaining to last Channel Request sent by the MS.
Timing Advance	
- Timing advance value	30 bit periods.
Mobile Allocation	
- Length	0
Starting Time	Not present.
IA rest octets	Not used (all bits set to spare).

Contents of IMMEDIATE ASSIGNMENT EXTENDED message:

L2 pseudo length	This is the sum of the lengths of all the information elements present in the message except for the IAX rest octets and L2 pseudo length IEs. For the default message the L2 pseudo length is 18.
Protocol Discriminator	RR Management.
Skip Indicator	0000
Message Type	00111001
Page Mode	
- Page Mode	Normal Paging.
Channel Description 1	
- Channel Type and TDMA offset	For non-combined CCCH/SDCCH (see test conditions), SDCCH/8, with subchannel chosen arbitrarily by the test house; For combined CCCH/SDCCH (default SS conditions), SDCCH/4, with subchannel chosen arbitrarily by the test house.
- Timeslot Number	For non-combined CCCH/SDCCH (see test conditions), chosen arbitrarily by the test house; For combined CCCH/SDCCH (default SS conditions), SDCCH/4, timeslot zero.
- Training Sequence Code	For non-combined CCCH/SDCCH (see initial conditions), chosen arbitrarily by the test house; For combined CCCH/SDCCH (default SS conditions), SDCCH/4, TSC=5 (same as the BCC). Single RF channel.
- Hopping	For non-combined CCCH/SDCCH (see initial conditions), Channel number 30; For combined CCCH/SDCCH (default SS conditions), SDCCH/4, Channel number 20.
- ARFCN	Pertaining to last Channel Request sent by the MS.
Request Reference 1	
Timing Advance 1	
- Timing advance value	Chosen arbitrarily by the test house.
Channel Description 2	
- Channel Type and TDMA offset	Same channel type as in Channel Description 1, but different TDMA offset to that in Channel Description 1.
- Timeslot Number	equal to the value in Channel Description 1.
- Training Sequence Code	equal to the value in Channel Description 1.
- Hopping	Single RF channel.
- ARFCN	equal to the value in Channel Description 1.
Request Reference 2	Not pertaining to any Channel Requests sent by the MS.
Timing Advance 2	
- Timing advance value	Chosen arbitrarily by the test house.
Mobile Allocation	
- Length	0
Starting Time	Not present.
IAX rest octets	Not used (all bits set to spare).

Contents of IMMEDIATE ASSIGNMENT REJECT message:

L2 pseudo length	19
Protocol Discriminator	RR Management.
Skip Indicator	0000
Message Type	00111010
Page Mode	
- Page Mode	Normal Paging.
Request Reference	Pertaining to last Channel Request sent by the MS.
Wait Indication	0 s.
Request Reference	Not pertaining to the MS under test.
Wait Indication	0 s.
Request Reference	Not pertaining to the MS under test.
Wait Indication	0 s.
Request Reference	Not pertaining to the MS under test.
Wait Indication	0 s.
IAR rest octets	Not used (all bits set to spare).

Contents of LOCATION UPDATING REQUEST message:

Protocol Discriminator	MM message.
Skip Indicator	0000
Message Type	0X001000
Other information elements	Not checked.

Contents of PAGING REQUEST TYPE 1 message:

L2 pseudo length	This is the sum of the lengths of all the information elements present in the message except for the P1 rest octets and L2 pseudo length IEs. For the default message the L2 pseudo length is 9.
Protocol Discriminator	RR Management.
Skip Indicator	0000
Message Type	00100001
Page Mode	
- Page Mode	Normal Paging.
Channels needed	
- first channel	any channel.
- second channel	any channel.
Mobile Identity 1	
- odd/even indication	Even.
- Type of Identity	TMSI.
- Identity Digits	TMSI previously allocated to MS.
Mobile Identity 2	Not present.
P1 rest octets	Not used (all bits set to spare).

Contents of PAGING REQUEST TYPE 2 message:

L2 pseudo length	This is the sum of the lengths of all the information elements present in the message except for the P2 rest octets and L2 pseudo length IEs. For the default message the L2 pseudo length is 11.
Protocol Discriminator	RR Management..
Skip Indicator	0000
Message Type	00100010
Page Mode	
- Page Mode	Normal Paging.
Channels needed	
- first channel	any channel.
- second channel	any channel.
Mobile Identity 1	
- TMSI value	TMSI previously allocated to MS.
Mobile Identity 2	
- TMSI value	TMSI not allocated to MS.
Mobile Identity	Not present.
P2 rest octets	Not used (all bits set to spare).

Contents of PAGING REQUEST TYPE 3 message:

L2 pseudo length	19
Protocol Discriminator	RR Management.
Skip Indicator	0000
Message Type	00100100
Page Mode	
- Page Mode	Normal Paging.
Channels needed	
- first channel	any channel.
- second channel	any channel.
Mobile identity 1	
- TMSI value	TMSI previously allocated to MS.
Mobile identity 2	
- TMSI value	TMSI not allocated to MS.
Mobile identity 3	
- TMSI value	TMSI not allocated to MS.
Mobile identity 4	
- TMSI value	TMSI not allocated to MS.
P3 rest octets	Not used (all bits set to spare).

Contents of PAGING RESPONSE message:

Protocol Discriminator	RR Management.
Skip Indicator	0000
Message Type	00100111
Ciphering Key Sequence Number	
- Key Sequence	Key sequence number previously allocated to MS, or "111" if no key is available.
Mobile Station Classmark 2	
Mobile Identity	
- odd/even indication	Even
- Type of identity	TMSI
- Identity Digits	TMSI previously allocated to MS.

Contents of PHYSICAL INFORMATION message:

Protocol Discriminator	RR Management.
Skip Indicator	0000
Message Type	00101101
Timing advance	20 bit periods.

Contents of SETUP message; (MS to SS):

Protocol Discriminator	Call Control.
Transaction Identifier	
TI value	any value from the set {0, ..., 6}.
TI flag	0
Message Type	0X000101
Other information elements	Not checked.

26.13.1.6.2 Default contents of DCS 1 800 layer 3 messages for RR tests

This subclause contains the default values of DCS 1 800 L3 messages, which unless indicated otherwise in subclause 26.6 shall be transmitted by the system simulator and which are required to be received from the DCS 1 800 MS under test. These values are used in order to be consistent with the phase 2 version of 26.6.

The necessary L3 messages are listed in alphabetic order, with the exception of the SYSTEM INFORMATION messages, where it is the information elements that are listed in alphabetic order (this is because some information elements occur in several SYSTEM INFORMATION types).

In this subclause, decimal values are normally used. However, sometimes a hexadecimal value, indicated by an "H", or a binary value, indicated by a "B" is used.

Default SYSTEM INFORMATION:

NOTE 1: SYSTEM INFORMATION 2 bis, SYSTEM INFORMATION 7, and SYSTEM INFORMATION 8 messages are not used.
SYSTEM INFORMATION 5 bis is not sent as a default message. For those tests that require SYSTEM INFORMATION 5 bis see the specific message contents for that test.

Cell A

Contents of information elements in SYSTEM INFORMATION TYPE 1 to 6 messages for cell A.

(CBCH) Channel Description	Not present.
(CBCH) Mobile Allocation	Not present.
Cell Channel Description	
- Format identifier	Range 512.
- Cell Allocation ARFCN	Channel Numbers, 590, 650, 750 and 850.
Cell Identity	
- Cell Identity Value	0001H
Cell Options	
- Power Control Indicator	Power Control Indicator is not set, 0
- DTX Indicator	MS shall not use DTX.
- Radio_Link_Timeout	8 SACCH blocks.
Cell Selection Parameters	
- Cell_Reselect_Hysteresis	12 dB
- MX_TXPWR_MAX_CCH	Minimum level.
- ACS	No addition cell parameters are present in SYSTEM INFORMATION messages 7 and 8.
- NECI	New establishment causes not supported.
- RXLEV_ACCESS_MIN	Minimum level.
Control Channel Description	
- Attach-Detach allowed	MS shall not apply.
- BS_AG_BLK_RES	0 blocks reserved for access grant.
- CCCH_CONF	1 basic physical channel used for CCCH, combined with SDCCHs.
- BS_PA_MFRMS	5 multiframe periods for transmission of paging messages.
- T3212 Time-out value	Infinite.
L2 pseudo length	
- System information 1	21
- System information 2	22
- System information 3	18
- System information 4	12
Location Area Identification	
- Mobile Country Code	001 decimal.
- Mobile Network Code	01 decimal.
- Location Area Code	0001H
Message Type	
- System information 1	00011001
- System information 2	00011010
- System information 3	00011011
- System information 4	00011100
- System information 5	00011101
- System information 6	00011110
Neighbour Cells Description	
- Format identifier	Range 512.
- BCCH Allocation Sequence	0
- BCCH Allocation ARFCN	Channels numbers, 520, 590, 600, 700, 764, 780, 810, 870.
- EXT-IND	This IE carries the complete BA. EXT-IND is 0.
NCC Permitted	0000 0010
RACH Control Parameters	
- Max Retrans	Max 1 retrans.
- Tx-integer	5 slots used.
- Cell Barred for Access	Cell is not barred.
- Call Reestablishment Allowed	Not Allowed.
- Access Control Class	Access is not barred.
- Emergency Call allowed	Yes.
SI 1 rest octets	Not used (all bits are set to spare).
SI 2 rest octets	Not used (all bits are set to spare).
SI 3 rest octets	Not used (all bits are set to spare).
SI 4 rest octets	Not used (all bits are set to spare).

Default settings for cell A:

Downlink input level	63 dBmicroVolt emf().
Uplink output power	minimum supported by the MS's power class
Propagation profile	static.
BCCH/CCCH carrier number	ARFN 590.

Cell B

The contents of SYSTEM INFORMATION TYPE 1 to 6 messages for cell B are identical to those of cell A with the following exceptions:

Cell Channel Description - Format Identifier - Cell Allocation ARFCN	Range 512. Channel Number 520.
--	-----------------------------------

NOTE 2: This IE needs modification when used in handover tests that command the MS to go to a frequency hopping channel in cell B.

Cell Identity - Cell Identity Value	0002H
--	-------

Default settings for cell B:

Downlink input level	53 dBmicroVolt emf().
Uplink output power	minimum supported by the MS's power class
Propagation profile	static.
BCCH/CCCH carrier number	520

Contents of ALERTING message (SS to MS):

Protocol Discriminator	Call Control.
Transaction Identifier TI value TI flag	As used in the SETUP message. 1 (destination side).
Message Type	00000001
All other information elements	Not present.

Contents of ASSIGNMENT COMMAND message:

Protocol Discriminator	RR Management.
Skip Indicator	0000
Message Type	00101110
Channel Description - Channel Type and TDMA offset - Timeslot Number - Training Sequence Code - Hopping - ARFCN	Bm + ACCHs. Chosen arbitrarily by the test house. Chosen arbitrarily by the test house. Single RF channel. Channel number 650.
Power Command - Power level	Chosen arbitrarily by the test house.
Multislot allocation - Downlink assignment - Uplink assignment - Channel set $1 \leq X \leq 8$	Appropriate for the test Appropriate for the test Appropriate for the test Appropriate for the test
Channel mode $1 \leq X \leq 8$	Appropriate for the test

Contents of ASSIGNMENT COMPLETE message:

Protocol Discriminator	RR Management.
Skip Indicator	0000
Message Type	00101001
RR Cause	
- RR Cause Value	Normal event.

Contents of ASSIGNMENT FAILURE message:

Protocol Discriminator	RR Management.
Skip Indicator	0000
Message Type	00101111
RR Cause	
- RR Cause Value	Depending on test.

Contents of AUTHENTICATION REQUEST message:

Protocol Discriminator	MM message.
Skip Indicator	0000
Message Type	00010010
Ciphering Key Sequence Number	
- Key Sequence	Chosen arbitrarily by the test house from the range 0 to 6.
Authentication Parameter RAND	
- RAND value	Chosen arbitrarily by the test house.

Contents of AUTHENTICATION RESPONSE message:

Protocol Discriminator	MM message.
Skip Indicator	0000
Message Type	0X010100
Other information element(s)	Not checked.

Contents of CALL PROCEEDING message:

Protocol Discriminator	Call Control.
Transaction Identifier	
TI value	As used in the SETUP message.
TI flag	1 (destination side).
Message Type	00000010
All other information elements	Not present.

Contents of CHANNEL MODE MODIFY message:

Protocol Discriminator	RR Management.
Skip Indicator	0000
Message Type	00010000
Channel Description	
- Channel Type and TDMA offset	Depending on test.
- Timeslot Number	Chosen arbitrarily by the test house.
- Training Sequence Code	Chosen arbitrarily by the test house.
- Hopping	Single RF channel.
- ARFCN	Channel number 650.
Channel Mode	
- Mode	Depending on test.

Contents of CHANNEL MODE MODIFY ACKNOWLEDGE message:

Protocol Discriminator	RR Management.
Skip Indicator	0000
Message Type	00010111
Channel Description	Depending on test.
- Channel Type and TDMA offset	Same as in the CHANNEL MODE MODIFY message.
- Timeslot Number	Same as in the CHANNEL MODE MODIFY message.
- Training Sequence Code	Single RF channel.
- Hopping	Band number 0.
- Frequency Band	Channel number 650.
- ARFCN	
Channel Mode	
- Mode	Same as in the CHANNEL MODE MODIFY message.

Contents of CHANNEL RELEASE message:

Protocol Discriminator	RR Management.
Skip Indicator	0000
Message Type	00001101
RR Cause	
- RR Cause Value	Normal event.

Contents of CHANNEL REQUEST message:

Establishment Cause	Not checked.
Random Reference	Not checked.

Contents of CIPHERING MODE COMMAND message:

Protocol Discriminator	RR Management.
Skip Indicator	0000
Message Type	00110101
Cipher Mode Setting	
- algorithm identifier	cipher with A5/1.
- SC	Start ciphering.
Cipher Response	IMEI shall not be included.

Contents of CIPHERING MODE COMPLETE message:

Protocol Discriminator	RR Management.
Skip Indicator	0000
Message Type	00110010
Mobile Identity	Not present.

Contents of the CLASSMARK CHANGE message:

Protocol Discriminator	RR Management.
Skip Indicator	0000
Message Type	000100110
Mobile Station Classmark 2	
- RF Power Capability	See PICS/PIXIT.
- Frequency Capability	Set to 0.
Mobile Station Classmark 3	For presence and contents see PICS/PIXIT.

Contents of CM SERVICE ACCEPT message:

Protocol Discriminator	Mobility Management.
Skip Indicator	0000
Message Type	00100001

Contents of CM SERVICE REQUEST message:

Protocol Discriminator	Mobility Management.
Skip Indicator	0000
Message Type	0X100100
Other information elements	Not checked.

Contents of CONFIGURATION CHANGE COMMAND message (SS to MS)

Protocol Discriminator	Radio Resource
Skip Indicator	0000
Message type	00110000
Multislot allocation	Appropriate for the test
- Downlink assignment	Appropriate for the test
- Uplink assignment	Appropriate for the test
- Channel set 1=<X<=8	Appropriate for the test
Channel mode 1=<X<=8	Appropriate for the test

Contents of CONFIGURATION CHANGE ACKNOWLEDGE message (MS to SS)

Protocol Discriminator	Radio Resource
Skip Indicator	0000
Message type	00110001

Contents of CONFIGURATION CHANGE REJECT message (MS to SS)

Protocol Discriminator	Radio Resource
Skip Indicator	0000
Message type	00110011
RR Cause	Protocol Error Unspecified

Contents of CONNECT message (SS to MS):

Protocol Discriminator	Call Control.
Transaction Identifier	
TI value	As used in the SETUP message.
TI flag	1
Message Type	00000111
All other information elements	Not present.

Contents of CONNECT ACKNOWLEDGE message (MS to SS):

Protocol Discriminator	Call Control.
Transaction Identifier	
TI value	As used in the SETUP message.
TI flag	0
Message Type	0X001111

Contents of HANDOVER ACCESS message:

Handover Reference	Equal to the value included in the Handover Command message.
--------------------	--

Contents of HANDOVER COMMAND message:

Protocol Discriminator	RR Management.
Skip Indicator	0000
Message Type	00101011
Cell Description	
- Network Colour Code	1
- Base station Colour Code	Corresponding to target cell
- BCCH Carrier Number	Set to the BCCH carrier number of cell B. (one of 520, 590, 600, 700, 780, 810 or 870).
Channel Description	
- Channel Type and TDMA offset	Bm + ACCHs.
- Timeslot Number	Chosen arbitrarily by the test house.
- Training Sequence Code	Chosen arbitrarily by the test house.
- Hopping	Single RF channel.
- ARFCN	Chosen arbitrarily by the test house from those supported on the target cell.
Handover Reference	
- Handover Reference Value	Chosen arbitrarily by the test house.
Power Command	
- Power level	Chosen arbitrarily by the test house.
All other information elements	Not present.

Contents of HANDOVER COMPLETE message:

Protocol Discriminator	RR Management.
Skip Indicator	0000
Message Type	00101100
RR cause	Normal event.
Time difference	Not present.

Contents of HANDOVER FAILURE message:

Protocol Discriminator	RR Management.
Skip Indicator	0000
Message Type	00101000
RR cause	Dependent on the test.

Contents of IMMEDIATE ASSIGNMENT message:

L2 pseudo length	This is the sum of the lengths of all the information elements present in the message except for the IA rest octets and L2 pseudo length IEs. For the default message the L2 pseudo length is 11.
Protocol Discriminator	RR Management.
Skip Indicator	0000
Message Type	00111111
Page Mode	
- Page Mode	Normal Paging.
Channel Description	
- Channel Type and TDMA offset	For non-combined CCCH/SDCCH (see initial conditions), SDCCH/8, with subchannel chosen arbitrarily by the test house For combined CCCH/SDCCH (default SS conditions), SDCCH/4, with subchannel chosen arbitrarily by the test house.
- Timeslot Number	For non-combined CCCH/SDCCH (see initial conditions), chosen arbitrarily by the test house; For combined CCCH/SDCCH (default SS conditions), SDCCH/4, timeslot zero.
- Training Sequence Code	For non-combined CCCH/SDCCH (see initial conditions), chosen arbitrarily by the test house; For combined CCCH/SDCCH (default SS conditions), SDCCH/4, TSC=5 (same as the BCC). Single RF channel.
- Hopping	
- ARFCN	For non-combined CCCH/SDCCH (see initial conditions), Channel number 650; For combined CCCH/SDCCH (default SS conditions), SDCCH/4, Channel number 590.
Request Reference	Pertaining to last Channel Request sent by the MS.
Timing Advance	
- Timing advance value	30 bit periods.
Mobile Allocation	
- Length	0
Starting Time	Not present.
IA rest octets	Not used (all bits set to spare).

Contents of IMMEDIATE ASSIGNMENT EXTENDED message:

L2 pseudo length	This is the sum of the lengths of all the information elements present in the message except for the IAX rest octets and L2 pseudo length IEs. For the default message the L2 pseudo length is 18.
Protocol Discriminator	RR Management.
Skip Indicator	0000
Message Type	00111001
Page Mode	
- Page Mode	Normal Paging.
Channel Description 1	
- Channel Type and TDMA offset	For non-combined CCCH/SDCCH (see test conditions), SDCCH/8, with subchannel chosen arbitrarily by the test house; For combined CCCH/SDCCH (default SS conditions), SDCCH/4, with subchannel chosen arbitrarily by the test house.
- Timeslot Number	For non-combined CCCH/SDCCH (see test conditions), chosen arbitrarily by the test house; For combined CCCH/SDCCH (default SS conditions), SDCCH/4, timeslot zero.
- Training Sequence Code	For non-combined CCCH/SDCCH (see initial conditions), chosen arbitrarily by the test house; For combined CCCH/SDCCH (default SS conditions), SDCCH/4, TSC=5 (same as the BCC). Single RF channel.
- Hopping	For non-combined CCCH/SDCCH (see initial conditions), Channel number 650; For combined CCCH/SDCCH (default SS conditions), SDCCH/4, Channel number 590.
- ARFCN	Pertaining to last Channel Request sent by the MS.
Request Reference 1	
Timing Advance 1	
- Timing advance value	Chosen arbitrarily by the test house.
Channel Description 2	
- Channel Type and TDMA offset	Same channel type as in Channel Description 1, but different TDMA offset to that in Channel Description 1.
- Timeslot Number	equal to the value in Channel Description 1.
- Training Sequence Code	equal to the value in Channel Description 1.
- Hopping	Single RF channel.
- ARFCN	equal to the value in Channel Description 1.
Request Reference 2	Not pertaining to any Channel Requests sent by the MS.
Timing Advance 2	
- Timing advance value	Chosen arbitrarily by the test house.
Mobile Allocation	
- Length	0
Starting Time	Not present.
IAX rest octets	Not used (all bits set to spare).

Contents of IMMEDIATE ASSIGNMENT REJECT message:

L2 pseudo length	19
Protocol Discriminator	RR Management.
Skip Indicator	0000
Message Type	00111010
Page Mode	
- Page Mode	Normal Paging.
Request Reference	Pertaining to last Channel Request sent by the MS.
Wait Indication	0 s.
Request Reference	Not pertaining to the MS under test.
Wait Indication	0 s.
Request Reference	Not pertaining to the MS under test.
Wait Indication	0 s.
Request Reference	Not pertaining to the MS under test.
Wait Indication	0 s.
IAR rest octets	Not used (all bits set to spare).

Contents of LOCATION UPDATING REQUEST message:

Protocol Discriminator	MM message.
Skip Indicator	0000
Message Type	0X001000
Other information elements	Not checked.

Contents of PAGING REQUEST TYPE 1 message:

L2 pseudo length	This is the sum of the lengths of all the information elements present in the message except for the P1 rest octets and L2 pseudo length IEs. For the default message the L2 pseudo length is 9.
Protocol Discriminator	RR Management.
Skip Indicator	0000
Message Type	00100001
Page Mode	
- Page Mode	Normal Paging.
Channels needed	
- first channel	any channel.
- second channel	any channel.
Mobile Identity 1	
- odd/even indication	Even.
- Type of Identity	TMSI.
- Identity Digits	TMSI previously allocated to MS.
Mobile Identity 2	Not present.
P1 rest octets	Not used (all bits set to spare).

Contents of PAGING REQUEST TYPE 2 message:

L2 pseudo length	This is the sum of the lengths of all the information elements present in the message except for the P2 rest octets and L2 pseudo length IEs. For the default message the L2 pseudo length is 11.
Protocol Discriminator	RR Management.
Skip Indicator	0000
Message Type	00100010
Page Mode	
- Page Mode	Normal Paging.
Channels needed	
- first channel	any channel.
- second channel	any channel.
Mobile Identity 1	
- TMSI value	TMSI previously allocated to MS.
Mobile Identity 2	
- TMSI value	TMSI not allocated to MS.
Mobile Identity	Not present.
P2 rest octets	Not used (all bits set to spare).

Contents of PAGING REQUEST TYPE 3 message:

L2 pseudo length	19
Protocol Discriminator	RR Management.
Skip Indicator	0000
Message Type	00100100
Page Mode	
- Page Mode	Normal Paging.
Channels needed	
- first channel	any channel.
- second channel	any channel.
Mobile identity 1	
- TMSI value	TMSI previously allocated to MS.
Mobile identity 2	
- TMSI value	TMSI not allocated to MS.
Mobile identity 3	
- TMSI value	TMSI not allocated to MS.
Mobile identity 4	
- TMSI value	TMSI not allocated to MS.
P3 rest octets	Not used (all bits set to spare).

Contents of PAGING RESPONSE message:

Protocol Discriminator	RR Management.
Skip Indicator	0000
Message Type	00100111
Ciphering Key Sequence Number	
- Key Sequence	Key sequence number previously allocated to MS, or "111" if no key is available.
Mobile Station Classmark 2	
Mobile Identity	
- odd/even indication	Even.
- Type of identity	TMSI
- Identity Digits	TMSI previously allocated to MS.

Contents of PHYSICAL INFORMATION message:

Protocol Discriminator	RR Management.
Skip Indicator	0000
Message Type	00101101
Timing advance	20 bit periods.

Contents of SETUP message; (MS to SS):

Protocol Discriminator	Call Control.
Transaction Identifier	
TI value	any value from the set {0, ..., 6}.
TI flag	0
Message Type	0X000101
Other information elements	Not checked.

26.13.1.6.3 Default contents of GSM 450 layer 3 messages for RR tests

This subclause contains the default values of GSM 450 L3 messages, which unless indicated otherwise in subclause 26.13 shall be transmitted by the system simulator and which are required to be received from the GSM 450 MS under test.

The necessary L3 messages are listed in alphabetic order, with the exception of the SYSTEM INFORMATION messages, where it is the information elements that are listed in alphabetic order (this is because some information elements occur in several SYSTEM INFORMATION types).

In this subclause, decimal values are normally used. However, sometimes a hexadecimal value, indicated by an "H", or a binary value, indicated by a "B" is used.

Default SYSTEM INFORMATION:

NOTE 1: SYSTEM INFORMATION 2 bis, SYSTEM INFORMATION 5 bis, SYSTEM INFORMATION 7, and SYSTEM INFORMATION 8 messages are not used.

Cell A

Contents of information elements in SYSTEM INFORMATION TYPE 1 to 6 messages for cell A.

(CBCH) Channel Description	Not present.
(CBCH) Mobile Allocation	Not present.
Cell Channel Description	
- Format identifier	Range 128.
- Cell Allocation ARFCN	Channels 263, 267, 275 and 279.
Cell Identity	
- Cell Identity Value	0001H
Cell Options	
- Power Control Indicator	Power Control Indicator is not set.
- DTX Indicator	MS shall not use DTX.
- Radio_Link_Timeout	8 SACCH blocks.
Cell Selection Parameters	
- Cell_Reselect_Hysteresis	12 dB.
- MX_TXPWR_MAX_CCH	Minimum level.
- ACS	No addition cell parameters are present in SYSTEM INFORMATION messages 7 and 8.
- NECI	New establishment causes not supported.
- RXLEV_ACCESS_MIN	Minimum level.
Control Channel Description	
- Attach-Detach allowed	No Attach/Detach.
- BS_AG_BLKES_RES	0 blocks reserved for access grant.
- CCCH_CONF	1 basic physical channel used for CCCH, combined with SDCCHs.
- BS_PA_MFRMS	5 multiframe periods for transmission of paging messages.
- T3212 Time-out value	Infinite.
L2 pseudo length	
- System information 1	21
- System information 2	22
- System information 3	18
- System information 4	12
Location Area Identification	
- Mobile Country Code	001 decimal
- Mobile Network Code	01 decimal
- Location Area Code	0001H
Message Type	
- System information 1	00011001
- System information 2	00011010
- System information 3	00011011
- System information 4	00011100
- System information 5	00011101
- System information 6	00011110
Neighbour Cells Description	
- Format identifier	Range 128.
- BCCH Allocation Sequence	0
- BCCH Allocation ARFCN	Channels 262, 263, 274, 282, 284, 287, 290 and 293.
- EXT-IND	This IE carries the complete BA.
NCC Permitted	0000 0010
RACH Control Parameters	
- Max Retrans	Max 1 retrans.
- Tx-integer	5 slots used.
- Cell Barred for Access	Cell is not barred.
- Call Reestablishment Allowed	Not allowed.
- Access Control Class	Access is not barred.
- Emergency Call allowed	Yes.
SI 1 rest octets	Not used (all bits are set to spare).
SI 2 rest octets	Not used (all bits are set to spare).
SI 3 rest octets	Not used (all bits are set to spare).
SI 4 rest octets	Not used (all bits are set to spare).

Default settings for cell A:

Downlink input level	63 dBmicroVolt emf.
Uplink output power	minimum supported by the MS's power class.
Propagation profile	static.
BCCH/CCCH carrier number	263

Cell B

The contents of SYSTEM INFORMATION TYPE 1 to 6 messages for cell B are identical to those of cell A with the following exceptions:

Cell Channel Description - Format Identifier - Cell Allocation ARFCN	Range 128. Channel Number 261.
--	-----------------------------------

NOTE 2: This IE needs modification when used in handover tests that command the MS to go to a frequency hopping channel in cell B.

Cell Identity

- Cell Identity Value: 0002H.

Default settings for cell B:

Downlink input level	53 dBmicroVolt emf.
Uplink output power	minimum supported by the MS's power class.
Propagation profile	static.
BCCH/CCCH carrier number	261

Contents of ALERTING message (SS to MS):

Protocol Discriminator	Call Control.
Transaction Identifier	
TI value	As used in the SETUP message.
TI flag	1 (destination side).
Message Type	00000001
All other information elements	Not present.

Contents of ASSIGNMENT COMMAND message:

Protocol Discriminator	RR Management.
Skip Indicator	0000
Message Type	00101110
Channel Description 2	
- Channel Type and TDMA offset	Bm + ACCHs
- Timeslot Number	Chosen arbitrarily by the test house.
- Training Sequence Code	Chosen arbitrarily by the test house.
- Hopping	Single RF channel.
- ARFCN	Channel number 267.
Power Command	
- Power level	Chosen arbitrarily by the test house.
Multislot allocation	
- Downlink assignment	Appropriate for the test
- Uplink assignment	Appropriate for the test
- Channel set 1= $X \leq 8$	Appropriate for the test
Channel mode	Appropriate for the test

Contents of ASSIGNMENT COMPLETE message:

Protocol Discriminator	RR Management.
Skip Indicator	0000
Message Type	00101001
RR Cause	
- RR Cause Value	Normal event.

Contents of ASSIGNMENT FAILURE message:

Protocol Discriminator	RR Management.
Skip Indicator	0000
Message Type	00101111
RR Cause	
- RR Cause Value	Depending on test.

Contents of AUTHENTICATION REQUEST message:

Protocol Discriminator	MM message.
Skip Indicator	0000
Message Type	00010010
Ciphering Key Sequence Number	
- Key Sequence	Chosen arbitrarily by the test house from the range 0 to 6.
Authentication Parameter RAND	
- RAND value	Chosen arbitrarily by the test house.

Contents of AUTHENTICATION RESPONSE message:

Protocol Discriminator	MM message.
Skip Indicator	0000
Message Type	0X010100
Other information element(s)	Not checked.

Contents of CALL PROCEEDING message:

Protocol Discriminator	Call Control.
Transaction Identifier	
TI value	As used in the SETUP message.
TI flag	1 (destination side).
Message Type	00000010
All other information elements	Not present.

Contents of CHANNEL MODE MODIFY message:

Protocol Discriminator	RR Management.
Skip Indicator	0000
Message Type	00010000
Channel Description 2	
- Channel Type and TDMA offset	Depending on test.
- Timeslot Number	Chosen arbitrarily by the test house.
- Training Sequence Code	Chosen arbitrarily by the test house.
- Hopping	Single RF channel.
- ARFCN	Channel number 267.
Channel Mode	
- Mode	Depending on test.

Contents of CHANNEL MODE MODIFY ACKNOWLEDGE message:

Protocol Discriminator	RR Management.
Skip Indicator	0000
Message Type	00010111
Channel Description 2	Depending on test.
- Channel Type and TDMA offset	Same as in the CHANNEL MODE MODIFY message.
- Timeslot Number	Same as in the CHANNEL MODE MODIFY message.
- Training Sequence Code	Single RF channel.
- Hopping	Band number 0.
- Frequency Band	Channel number 267.
- ARFCN	
Channel Mode	
- Mode	Same as in the CHANNEL MODE MODIFY message.

Contents of CHANNEL RELEASE message:

Protocol Discriminator	RR Management.
Skip Indicator	0000
Message Type	00001101
RR Cause	
- RR Cause Value	Normal event.

Contents of CHANNEL REQUEST message

Establishment Cause	Not checked.
Random Reference	Not checked.

Contents of CIPHERING MODE COMMAND message:

Protocol Discriminator	RR Management.
Skip Indicator	0000
Message Type	00110101
Cipher Mode Setting	
- algorithm identifier	cipher with A5/1.
- SC	Start ciphering.
Cipher Response	IMEI shall not be included.

Contents of CIPHERING MODE COMPLETE message:

Protocol Discriminator	RR Management.
Skip Indicator	0000
Message Type	00110010
Mobile Identity	Not present.

Contents of the CLASSMARK CHANGE message:

Protocol Discriminator	RR Management.
Skip Indicator	0000
Message Type	000100110
Mobile Station Classmark 2	See PICS/PIXIT.
Mobile Station Classmark 3	For presence and contents see PICS/PIXIT.

Contents of CM SERVICE ACCEPT message:

Protocol Discriminator	Mobility Management.
Skip Indicator	0000
Message Type	00100001

Contents of CM SERVICE REQUEST message

Protocol Discriminator	Mobility Management.
Skip Indicator	0000
Message Type	0X100100
Other information elements	Not checked.

Contents of CONFIGURATION CHANGE COMMAND message (SS to MS)

Protocol Discriminator	Radio Resource
Skip Indicator	0000
Message type	00110000
Multislot allocation	Appropriate for the test
- Downlink assignment	Appropriate for the test
- Uplink assignment	Appropriate for the test
- Channel set 1=<X<=8	Appropriate for the test
Channel mode 1=<X<=8	Appropriate for the test

Contents of CONFIGURATION CHANGE ACKNOWLEDGE message (MS to SS)

Protocol Discriminator	Radio Resource
Skip Indicator	0000
Message type	00110001

Contents of CONFIGURATION CHANGE REJECT message (MS to SS)

Protocol Discriminator	Radio Resource
Skip Indicator	0000
Message type	00110011
RR Cause	Protocol Error Unspecified

Contents of CONNECT message (SS to MS)

Protocol Discriminator	Call Control.
Transaction Identifier	
TI value	As used in the SETUP message.
TI flag	1
Message Type	00000111
All other information elements	Not present.

Contents of CONNECT ACKNOWLEDGE message (MS to SS)

Protocol Discriminator	Call Control.
Transaction Identifier	
TI value	As used in the SETUP message.
TI flag	0
Message Type	0X001111

Contents of HANDOVER ACCESS message:

Handover Reference	Equal to the value included in the Handover Command message.
--------------------	--

Contents of HANDOVER COMMAND message:

Protocol Discriminator	RR Management.
Skip Indicator	0000
Message Type	00101011
Cell Description	1
- Network Colour Code	Corresponding to target cell
- Base station Colour Code	Set to the BCCH carrier number of cell B. (one of 261, 263, 282, 284, 287, 290 or 293).
- BCCH Carrier Number	
Channel Description 2	Bm + ACCHs.
- Channel Type and TDMA offset	Chosen arbitrarily by the test house.
- Timeslot Number	Chosen arbitrarily by the test house.
- Training Sequence Code	Single RF channel.
- Hopping	Chosen arbitrarily by the test house from those supported on the target cell.
- ARFCN	
Handover Reference	
- Handover Reference Value	Chosen arbitrarily by the test house.
Power Command	
- Power level	Chosen arbitrarily by the test house.
Multislot allocation	
- Downlink assignment	Appropriate for the test
- Uplink assignment	Appropriate for the test
- Channel set 1= $X \leq 8$	Appropriate for the test
Channel mode	Appropriate for the test

Contents of HANDOVER COMPLETE message:

Protocol Discriminator	RR Management.
Skip Indicator	0000
Message Type	00101100
RR cause	Normal event.
Time difference	Not present.

Contents of HANDOVER FAILURE message:

Protocol Discriminator	RR Management.
Skip Indicator	0000
Message Type	00101000
RR cause	Dependent on the test.

Contents of IMMEDIATE ASSIGNMENT message:

L2 pseudo length	This is the sum of the lengths of all the information elements present in the message except for the IA rest octets and L2 pseudo length IEs. For the default message the L2 pseudo length is 11.
Protocol Discriminator	RR Management.
Skip Indicator	0000
Message Type	00111111
Page Mode	
- Page Mode	Normal Paging.
Channel Description	
- Channel Type and TDMA offset	For non-combined CCCH/SDCCH (see initial conditions), SDCCH/8, with subchannel chosen arbitrarily by the test house For combined CCCH/SDCCH (default SS conditions), SDCCH/4, with subchannel chosen arbitrarily by the test house.
- Timeslot Number	For non-combined CCCH/SDCCH (see initial conditions), chosen arbitrarily by the test house; For combined CCCH/SDCCH (default SS conditions), SDCCH/4, timeslot zero.
- Training Sequence Code	For non-combined CCCH/SDCCH (see initial conditions), chosen arbitrarily by the test house; For combined CCCH/SDCCH (default SS conditions), SDCCH/4, TSC=5 (same as the BCC). Single RF channel.
- Hopping	
- ARFCN	For non-combined CCCH/SDCCH (see initial conditions), Channel number 30; For combined CCCH/SDCCH (default SS conditions), SDCCH/4, Channel number 263.
Request Reference	Pertaining to last Channel Request sent by the MS.
Timing Advance	
- Timing advance value	30 bit periods.
Mobile Allocation	
- Length	0
Starting Time	Not present.
IA rest octets	Not used (all bits set to spare).

Contents of IMMEDIATE ASSIGNMENT EXTENDED message:

L2 pseudo length	This is the sum of the lengths of all the information elements present in the message except for the IAX rest octets and L2 pseudo length IEs. For the default message the L2 pseudo length is 18.
Protocol Discriminator	RR Management.
Skip Indicator	0000
Message Type	00111001
Page Mode	
- Page Mode	Normal Paging.
Channel Description 1	
- Channel Type and TDMA offset	For non-combined CCCH/SDCCH (see test conditions), SDCCH/8, with subchannel chosen arbitrarily by the test house; For combined CCCH/SDCCH (default SS conditions), SDCCH/4, with subchannel chosen arbitrarily by the test house.
- Timeslot Number	For non-combined CCCH/SDCCH (see test conditions), chosen arbitrarily by the test house; For combined CCCH/SDCCH (default SS conditions), SDCCH/4, timeslot zero.
- Training Sequence Code	For non-combined CCCH/SDCCH (see initial conditions), chosen arbitrarily by the test house; For combined CCCH/SDCCH (default SS conditions), SDCCH/4, TSC=5 (same as the BCC). Single RF channel.
- Hopping	For non-combined CCCH/SDCCH (see initial conditions), Channel number 30; For combined CCCH/SDCCH (default SS conditions), SDCCH/4, Channel number 263.
- ARFCN	Pertaining to last Channel Request sent by the MS.
Request Reference 1	
Timing Advance 1	
- Timing advance value	Chosen arbitrarily by the test house.
Channel Description 2	
- Channel Type and TDMA offset	Same channel type as in Channel Description 1, but different TDMA offset to that in Channel Description 1.
- Timeslot Number	equal to the value in Channel Description 1.
- Training Sequence Code	equal to the value in Channel Description 1.
- Hopping	Single RF channel.
- ARFCN	equal to the value in Channel Description 1.
Request Reference 2	Not pertaining to any Channel Requests sent by the MS.
Timing Advance 2	
- Timing advance value	Chosen arbitrarily by the test house.
Mobile Allocation	
- Length	0
Starting Time	Not present.
IAX rest octets	Not used (all bits set to spare).

Contents of IMMEDIATE ASSIGNMENT REJECT message:

L2 pseudo length	19
Protocol Discriminator	RR Management.
Skip Indicator	0000
Message Type	00111010
Page Mode	
- Page Mode	Normal Paging.
Request Reference	Pertaining to last Channel Request sent by the MS.
Wait Indication	0 s.
Request Reference	Not pertaining to the MS under test.
Wait Indication	0 s.
Request Reference	Not pertaining to the MS under test.
Wait Indication	0 s.
Request Reference	Not pertaining to the MS under test.
Wait Indication	0 s.
IAR rest octets	Not used (all bits set to spare).

Contents of LOCATION UPDATING REQUEST message:

Protocol Discriminator	MM message.
Skip Indicator	0000
Message Type	0X001000
Other information elements	Not checked.

Contents of PAGING REQUEST TYPE 1 message:

L2 pseudo length	This is the sum of the lengths of all the information elements present in the message except for the P1 rest octets and L2 pseudo length IEs. For the default message the L2 pseudo length is 9.
Protocol Discriminator	RR Management.
Skip Indicator	0000
Message Type	00100001
Page Mode	
- Page Mode	Normal Paging.
Channels needed	
- first channel	any channel.
- second channel	any channel.
Mobile Identity 1	
- odd/even indication	Even.
- Type of Identity	TMSI.
- Identity Digits	TMSI previously allocated to MS.
Mobile Identity 2	Not present.
P1 rest octets	Not used (all bits set to spare).

Contents of PAGING REQUEST TYPE 2 message:

L2 pseudo length	This is the sum of the lengths of all the information elements present in the message except for the P2 rest octets and L2 pseudo length IEs. For the default message the L2 pseudo length is 11.
Protocol Discriminator	RR Management..
Skip Indicator	0000
Message Type	00100010
Page Mode	
- Page Mode	Normal Paging.
Channels needed	
- first channel	any channel.
- second channel	any channel.
Mobile Identity 1	
- TMSI value	TMSI previously allocated to MS.
Mobile Identity 2	
- TMSI value	TMSI not allocated to MS.
Mobile Identity	Not present.
P2 rest octets	Not used (all bits set to spare).

Contents of PAGING REQUEST TYPE 3 message:

L2 pseudo length	19
Protocol Discriminator	RR Management.
Skip Indicator	0000
Message Type	00100100
Page Mode	
- Page Mode	Normal Paging.
Channels needed	
- first channel	any channel.
- second channel	any channel.
Mobile identity 1	
- TMSI value	TMSI previously allocated to MS.
Mobile identity 2	
- TMSI value	TMSI not allocated to MS.
Mobile identity 3	
- TMSI value	TMSI not allocated to MS.
Mobile identity 4	
- TMSI value	TMSI not allocated to MS.
P3 rest octets	Not used (all bits set to spare).

Contents of PAGING RESPONSE message:

Protocol Discriminator	RR Management.
Skip Indicator	0000
Message Type	00100111
Ciphering Key Sequence Number	
- Key Sequence	Key sequence number previously allocated to MS, or "111" if no key is available.
Mobile Station Classmark 2	
Mobile Identity	
- odd/even indication	Even
- Type of identity	TMSI
- Identity Digits	TMSI previously allocated to MS.

Contents of PHYSICAL INFORMATION message:

Protocol Discriminator	RR Management.
Skip Indicator	0000
Message Type	00101101
Timing advance	20 bit periods.

Contents of SETUP message; (MS to SS):

Protocol Discriminator	Call Control.
Transaction Identifier	
TI value	any value from the set {0, ..., 6}.
TI flag	0
Message Type	0X000101
Other information elements	Not checked.

26.13.1.6.4 Default contents of GSM 480 layer 3 messages for RR tests

This subclause contains the default values of GSM 480 L3 messages, which unless indicated otherwise in subclause 26.13 shall be transmitted by the system simulator and which are required to be received from the GSM 480 MS under test.

The necessary L3 messages are listed in alphabetic order, with the exception of the SYSTEM INFORMATION messages, where it is the information elements that are listed in alphabetic order (this is because some information elements occur in several SYSTEM INFORMATION types).

In this subclause, decimal values are normally used. However, sometimes a hexadecimal value, indicated by an "H", or a binary value, indicated by a "B" is used.

Default SYSTEM INFORMATION:

NOTE 1: SYSTEM INFORMATION 2 bis, SYSTEM INFORMATION 5 bis, SYSTEM INFORMATION 7, and SYSTEM INFORMATION 8 messages are not used.

Cell A

Contents of information elements in SYSTEM INFORMATION TYPE 1 to 6 messages for cell A.

(CBCH) Channel Description	Not present.
(CBCH) Mobile Allocation	Not present.
Cell Channel Description	
- Format identifier	Range 128
- Cell Allocation ARFCN	Channels 310, 315, 322 and 326.
Cell Identity	
- Cell Identity Value	0001H
Cell Options	
- Power Control Indicator	Power Control Indicator is not set.
- DTX Indicator	MS shall not use DTX.
- Radio_Link_Timeout	8 SACCH blocks.
Cell Selection Parameters	
- Cell_Reselect_Hysteresis	12 dB.
- MX_TXPWR_MAX_CCH	Minimum level.
- ACS	No addition cell parameters are present in SYSTEM INFORMATION messages 7 and 8.
- NECI	New establishment causes not supported.
- RXLEV_ACCESS_MIN	Minimum level.
Control Channel Description	
- Attach-Detach allowed	No Attach/Detach.
- BS_AG_BLK_RES	0 blocks reserved for access grant.
- CCCH_CONF	1 basic physical channel used for CCCH, combined with SDCCHs.
- BS_PA_MFRMS	5 multiframe periods for transmission of paging messages.
- T3212 Time-out value	Infinite.
L2 pseudo length	
- System information 1	21
- System information 2	22
- System information 3	18
- System information 4	12
Location Area Identification	
- Mobile Country Code	001 decimal
- Mobile Network Code	01 decimal
- Location Area Code	0001H
Message Type	
- System information 1	00011001
- System information 2	00011010
- System information 3	00011011
- System information 4	00011100
- System information 5	00011101
- System information 6	00011110
Neighbour Cells Description	
- Format identifier	Range 128
- BCCH Allocation Sequence	0
- BCCH Allocation ARFCN	Channels 308, 310, 321, 329, 331, 334, 337 and 340.
- EXT-IND	This IE carries the complete BA.
NCC Permitted	0000 0010
RACH Control Parameters	
- Max Retrans	Max 1 retrans.
- Tx-integer	5 slots used.
- Cell Barred for Access	Cell is not barred.
- Call Reestablishment Allowed	Not allowed.
- Access Control Class	Access is not barred.
- Emergency Call allowed	Yes.
SI 1 rest octets	Not used (all bits are set to spare).
SI 2 rest octets	Not used (all bits are set to spare).
SI 3 rest octets	Not used (all bits are set to spare).
SI 4 rest octets	Not used (all bits are set to spare).

Default settings for cell A:

Downlink input level	63 dBmicroVolt emf.
Uplink output power	minimum supported by the MS's power class.
Propagation profile	static.
BCCH/CCCH carrier number	310

Cell B

The contents of SYSTEM INFORMATION TYPE 1 to 6 messages for cell B are identical to those of cell A with the following exceptions:

Cell Channel Description - Format Identifier - Cell Allocation ARFCN	Range 128 Channel Number 308.
--	----------------------------------

NOTE 2: This IE needs modification when used in handover tests that command the MS to go to a frequency hopping channel in cell B.

Cell Identity

- Cell Identity Value: 0002H.

Default settings for cell B:

Downlink input level	53 dBmicroVolt emf.
Uplink output power	minimum supported by the MS's power class.
Propagation profile	static.
BCCH/CCCH carrier number	308

Contents of ALERTING message (SS to MS):

Protocol Discriminator	Call Control.
Transaction Identifier	
TI value	As used in the SETUP message.
TI flag	1 (destination side).
Message Type	00000001
All other information elements	Not present.

Contents of ASSIGNMENT COMMAND message:

Protocol Discriminator	RR Management.
Skip Indicator	0000
Message Type	00101110
Channel Description 2	
- Channel Type and TDMA offset	Bm + ACCHs
- Timeslot Number	Chosen arbitrarily by the test house.
- Training Sequence Code	Chosen arbitrarily by the test house.
- Hopping	Single RF channel.
- ARFCN	Channel number 315.
Power Command	
- Power level	Chosen arbitrarily by the test house.
Multislot allocation	
- Downlink assignment	Appropriate for the test
- Uplink assignment	Appropriate for the test
- Channel set 1= $X \leq 8$	Appropriate for the test
Channel mode	Appropriate for the test

Contents of ASSIGNMENT COMPLETE message:

Protocol Discriminator	RR Management.
Skip Indicator	0000
Message Type	00101001
RR Cause	
- RR Cause Value	Normal event.

Contents of ASSIGNMENT FAILURE message:

Protocol Discriminator	RR Management.
Skip Indicator	0000
Message Type	00101111
RR Cause	
- RR Cause Value	Depending on test.

Contents of AUTHENTICATION REQUEST message:

Protocol Discriminator	MM message.
Skip Indicator	0000
Message Type	00010010
Ciphering Key Sequence Number	
- Key Sequence	Chosen arbitrarily by the test house from the range 0 to 6.
Authentication Parameter RAND	
- RAND value	Chosen arbitrarily by the test house.

Contents of AUTHENTICATION RESPONSE message:

Protocol Discriminator	MM message.
Skip Indicator	0000
Message Type	0X010100
Other information element(s)	Not checked.

Contents of CALL PROCEEDING message:

Protocol Discriminator	Call Control.
Transaction Identifier	
TI value	As used in the SETUP message.
TI flag	1 (destination side).
Message Type	00000010
All other information elements	Not present.

Contents of CHANNEL MODE MODIFY message:

Protocol Discriminator	RR Management.
Skip Indicator	0000
Message Type	00010000
Channel Description 2	
- Channel Type and TDMA offset	Depending on test.
- Timeslot Number	Chosen arbitrarily by the test house.
- Training Sequence Code	Chosen arbitrarily by the test house.
- Hopping	Single RF channel.
- ARFCN	Channel number 315.
Channel Mode	
- Mode	Depending on test.

Contents of CHANNEL MODE MODIFY ACKNOWLEDGE message:

Protocol Discriminator	RR Management.
Skip Indicator	0000
Message Type	00010111
Channel Description 2	Depending on test.
- Channel Type and TDMA offset	Same as in the CHANNEL MODE MODIFY message.
- Timeslot Number	Same as in the CHANNEL MODE MODIFY message.
- Training Sequence Code	Single RF channel.
- Hopping	Band number 0.
- Frequency Band	Channel number 315.
- ARFCN	
Channel Mode	
- Mode	Same as in the CHANNEL MODE MODIFY message.

Contents of CHANNEL RELEASE message:

Protocol Discriminator	RR Management.
Skip Indicator	0000
Message Type	00001101
RR Cause	
- RR Cause Value	Normal event.

Contents of CHANNEL REQUEST message

Establishment Cause	Not checked.
Random Reference	Not checked.

Contents of CIPHERING MODE COMMAND message:

Protocol Discriminator	RR Management.
Skip Indicator	0000
Message Type	00110101
Cipher Mode Setting	
- algorithm identifier	cipher with A5/1.
- SC	Start ciphering.
Cipher Response	IMEI shall not be included.

Contents of CIPHERING MODE COMPLETE message:

Protocol Discriminator	RR Management.
Skip Indicator	0000
Message Type	00110010
Mobile Identity	Not present.

Contents of the CLASSMARK CHANGE message:

Protocol Discriminator	RR Management.
Skip Indicator	0000
Message Type	000100110
Mobile Station Classmark 2	See PICS/PIXIT.
Mobile Station Classmark 3	For presence and contents see PICS/PIXIT.

Contents of CM SERVICE ACCEPT message:

Protocol Discriminator	Mobility Management.
Skip Indicator	0000
Message Type	00100001

Contents of CM SERVICE REQUEST message

Protocol Discriminator	Mobility Management.
Skip Indicator	0000
Message Type	0X100100
Other information elements	Not checked.

Contents of CONFIGURATION CHANGE COMMAND message (SS to MS)

Protocol Discriminator	Radio Resource
Skip Indicator	0000
Message type	00110000
Multislot allocation	Appropriate for the test
- Downlink assignment	Appropriate for the test
- Uplink assignment	Appropriate for the test
- Channel set 1=<X<=8	Appropriate for the test
Channel mode 1=<X<=8	Appropriate for the test

Contents of CONFIGURATION CHANGE ACKNOWLEDGE message (MS to SS)

Protocol Discriminator	Radio Resource
Skip Indicator	0000
Message type	00110001

Contents of CONFIGURATION CHANGE REJECT message (MS to SS)

Protocol Discriminator	Radio Resource
Skip Indicator	0000
Message type	00110011
RR Cause	Protocol Error Unspecified

Contents of CONNECT message (SS to MS)

Protocol Discriminator	Call Control.
Transaction Identifier	
TI value	As used in the SETUP message.
TI flag	1
Message Type	00000111
All other information elements	Not present.

Contents of CONNECT ACKNOWLEDGE message (MS to SS)

Protocol Discriminator	Call Control.
Transaction Identifier	
TI value	As used in the SETUP message.
TI flag	0
Message Type	0X001111

Contents of HANDOVER ACCESS message:

Handover Reference	Equal to the value included in the Handover Command message.
--------------------	--

Contents of HANDOVER COMMAND message:

Protocol Discriminator	RR Management.
Skip Indicator	0000
Message Type	00101011
Cell Description	1
- Network Colour Code	Corresponding to target cell
- Base station Colour Code	Set to the BCCH carrier number of cell B. (one of 308, 310, 329, 331, 334, 337 or 340).
- BCCH Carrier Number	
Channel Description 2	Bm + ACCHs.
- Channel Type and TDMA offset	Chosen arbitrarily by the test house.
- Timeslot Number	Chosen arbitrarily by the test house.
- Training Sequence Code	Single RF channel.
- Hopping	Chosen arbitrarily by the test house from those supported on the target cell.
- ARFCN	
Handover Reference	
- Handover Reference Value	Chosen arbitrarily by the test house.
Power Command	
- Power level	Chosen arbitrarily by the test house.
Multislot allocation	
- Downlink assignment	Appropriate for the test
- Uplink assignment	Appropriate for the test
- Channel set 1= $X \leq 8$	Appropriate for the test
Channel mode	Appropriate for the test

Contents of HANDOVER COMPLETE message:

Protocol Discriminator	RR Management.
Skip Indicator	0000
Message Type	00101100
RR cause	Normal event.
Time difference	Not present.

Contents of HANDOVER FAILURE message:

Protocol Discriminator	RR Management.
Skip Indicator	0000
Message Type	00101000
RR cause	Dependent on the test.

Contents of IMMEDIATE ASSIGNMENT message:

L2 pseudo length	This is the sum of the lengths of all the information elements present in the message except for the IA rest octets and L2 pseudo length IEs. For the default message the L2 pseudo length is 11.
Protocol Discriminator	RR Management.
Skip Indicator	0000
Message Type	00111111
Page Mode	
- Page Mode	Normal Paging.
Channel Description	
- Channel Type and TDMA offset	For non-combined CCCH/SDCCH (see initial conditions), SDCCH/8, with subchannel chosen arbitrarily by the test house For combined CCCH/SDCCH (default SS conditions), SDCCH/4, with subchannel chosen arbitrarily by the test house.
- Timeslot Number	For non-combined CCCH/SDCCH (see initial conditions), chosen arbitrarily by the test house; For combined CCCH/SDCCH (default SS conditions), SDCCH/4, timeslot zero.
- Training Sequence Code	For non-combined CCCH/SDCCH (see initial conditions), chosen arbitrarily by the test house; For combined CCCH/SDCCH (default SS conditions), SDCCH/4, TSC=5 (same as the BCC). Single RF channel.
- Hopping	
- ARFCN	For non-combined CCCH/SDCCH (see initial conditions), Channel number 30; For combined CCCH/SDCCH (default SS conditions), SDCCH/4, Channel number 310.
Request Reference	Pertaining to last Channel Request sent by the MS.
Timing Advance	
- Timing advance value	30 bit periods.
Mobile Allocation	
- Length	0
Starting Time	Not present.
IA rest octets	Not used (all bits set to spare).

Contents of IMMEDIATE ASSIGNMENT EXTENDED message:

L2 pseudo length	This is the sum of the lengths of all the information elements present in the message except for the IAX rest octets and L2 pseudo length IEs. For the default message the L2 pseudo length is 18.
Protocol Discriminator	RR Management.
Skip Indicator	0000
Message Type	00111001
Page Mode	
- Page Mode	Normal Paging.
Channel Description 1	
- Channel Type and TDMA offset	For non-combined CCCH/SDCCH (see test conditions), SDCCH/8, with subchannel chosen arbitrarily by the test house; For combined CCCH/SDCCH (default SS conditions), SDCCH/4, with subchannel chosen arbitrarily by the test house.
- Timeslot Number	For non-combined CCCH/SDCCH (see test conditions), chosen arbitrarily by the test house; For combined CCCH/SDCCH (default SS conditions), SDCCH/4, timeslot zero.
- Training Sequence Code	For non-combined CCCH/SDCCH (see initial conditions), chosen arbitrarily by the test house; For combined CCCH/SDCCH (default SS conditions), SDCCH/4, TSC=5 (same as the BCC). Single RF channel.
- Hopping	For non-combined CCCH/SDCCH (see initial conditions), Channel number 30; For combined CCCH/SDCCH (default SS conditions), SDCCH/4, Channel number 310.
- ARFCN	Pertaining to last Channel Request sent by the MS.
Request Reference 1	
Timing Advance 1	
- Timing advance value	Chosen arbitrarily by the test house.
Channel Description 2	
- Channel Type and TDMA offset	Same channel type as in Channel Description 1, but different TDMA offset to that in Channel Description 1.
- Timeslot Number	equal to the value in Channel Description 1.
- Training Sequence Code	equal to the value in Channel Description 1.
- Hopping	Single RF channel.
- ARFCN	equal to the value in Channel Description 1.
Request Reference 2	Not pertaining to any Channel Requests sent by the MS.
Timing Advance 2	
- Timing advance value	Chosen arbitrarily by the test house.
Mobile Allocation	
- Length	0
Starting Time	Not present.
IAX rest octets	Not used (all bits set to spare).

Contents of IMMEDIATE ASSIGNMENT REJECT message:

L2 pseudo length	19
Protocol Discriminator	RR Management.
Skip Indicator	0000
Message Type	00111010
Page Mode	
- Page Mode	Normal Paging.
Request Reference	Pertaining to last Channel Request sent by the MS.
Wait Indication	0 s.
Request Reference	Not pertaining to the MS under test.
Wait Indication	0 s.
Request Reference	Not pertaining to the MS under test.
Wait Indication	0 s.
Request Reference	Not pertaining to the MS under test.
Wait Indication	0 s.
IAR rest octets	Not used (all bits set to spare).

Contents of LOCATION UPDATING REQUEST message:

Protocol Discriminator	MM message.
Skip Indicator	0000
Message Type	0X001000
Other information elements	Not checked.

Contents of PAGING REQUEST TYPE 1 message:

L2 pseudo length	This is the sum of the lengths of all the information elements present in the message except for the P1 rest octets and L2 pseudo length IEs. For the default message the L2 pseudo length is 9.
Protocol Discriminator	RR Management.
Skip Indicator	0000
Message Type	00100001
Page Mode	
- Page Mode	Normal Paging.
Channels needed	
- first channel	any channel.
- second channel	any channel.
Mobile Identity 1	
- odd/even indication	Even.
- Type of Identity	TMSI.
- Identity Digits	TMSI previously allocated to MS.
Mobile Identity 2	Not present.
P1 rest octets	Not used (all bits set to spare).

Contents of PAGING REQUEST TYPE 2 message:

L2 pseudo length	This is the sum of the lengths of all the information elements present in the message except for the P2 rest octets and L2 pseudo length IEs. For the default message the L2 pseudo length is 11.
Protocol Discriminator	RR Management..
Skip Indicator	0000
Message Type	00100010
Page Mode	
- Page Mode	Normal Paging.
Channels needed	
- first channel	any channel.
- second channel	any channel.
Mobile Identity 1	
- TMSI value	TMSI previously allocated to MS.
Mobile Identity 2	
- TMSI value	TMSI not allocated to MS.
Mobile Identity	Not present.
P2 rest octets	Not used (all bits set to spare).

Contents of PAGING REQUEST TYPE 3 message:

L2 pseudo length	19
Protocol Discriminator	RR Management.
Skip Indicator	0000
Message Type	00100100
Page Mode	
- Page Mode	Normal Paging.
Channels needed	
- first channel	any channel.
- second channel	any channel.
Mobile identity 1	
- TMSI value	TMSI previously allocated to MS.
Mobile identity 2	
- TMSI value	TMSI not allocated to MS.
Mobile identity 3	
- TMSI value	TMSI not allocated to MS.
Mobile identity 4	
- TMSI value	TMSI not allocated to MS.
P3 rest octets	Not used (all bits set to spare).

Contents of PAGING RESPONSE message:

Protocol Discriminator	RR Management.
Skip Indicator	0000
Message Type	00100111
Ciphering Key Sequence Number	
- Key Sequence	Key sequence number previously allocated to MS, or "111" if no key is available.
Mobile Station Classmark 2	
Mobile Identity	
- odd/even indication	Even
- Type of identity	TMSI
- Identity Digits	TMSI previously allocated to MS.

Contents of PHYSICAL INFORMATION message:

Protocol Discriminator	RR Management.
Skip Indicator	0000
Message Type	00101101
Timing advance	20 bit periods.

Contents of SETUP message; (MS to SS):

Protocol Discriminator	Call Control.
Transaction Identifier	
TI value	any value from the set {0, ..., 6}.
TI flag	0
Message Type	0X000101
Other information elements	Not checked.

26.13.1.6.5 Default contents of GSM 700 layer 3 messages for RR tests

This subclause contains the default values of GSM 700 L3 messages, which unless indicated otherwise in subclause 26.13 shall be transmitted by the system simulator and which are required to be received from the GSM 700 MS under test.

The necessary L3 messages are listed in alphabetic order, with the exception of the SYSTEM INFORMATION messages, where it is the information elements that are listed in alphabetic order (this is because some information elements occur in several SYSTEM INFORMATION types).

In this section, decimal values are normally used. However, sometimes a hexadecimal value, indicated by an "H", or a binary value, indicated by a "B" is used.

Default SYSTEM INFORMATION:

NOTE 1: SYSTEM INFORMATION 2 bis, SYSTEM INFORMATION 5 bis, SYSTEM INFORMATION 7, and SYSTEM INFORMATION 8 messages are not used.

Cell A

Contents of information elements in SYSTEM INFORMATION TYPE 1 to 6 messages for cell A.

(CBCH) Channel Description	Not present.
(CBCH) Mobile Allocation	Not present.
Cell Channel Description	
- Format identifier	128 range.
- Cell Allocation ARFCN	Channels 457, 467, 470 and 475.
Cell Identity	
- Cell Identity Value	0001H
Cell Options	
- Power Control Indicator	Power Control Indicator is not set.
- DTX Indicator	MS shall not use DTX.
- Radio_Link_Timeout	8 SACCH blocks.
Cell Selection Parameters	
- Cell_Reselect_Hysteresis	12 dB.
- MX_TXPWR_MAX_CCH	Minimum level.
- ACS	No addition cell parameters are present in SYSTEM INFORMATION messages 7 and 8.
- NECI	New establishment causes not supported.
- RXLEV_ACCESS_MIN	Minimum level.
Control Channel Description	
- Attach-Detach allowed	No Attach/Detach.
- BS_AG_BLKES_RES	0 blocks reserved for access grant.
- CCCH_CONF	1 basic physical channel used for CCCH, combined with SDCCHs.
- BS_PA_MFRMS	5 multiframe periods for transmission of paging messages.
- T3212 Time-out value	Infinite.
L2 pseudo length	
- System information 1	21
- System information 2	22
- System information 3	18
- System information 4	12
Location Area Identification	
- Mobile Country Code	001 decimal
- Mobile Network Code	01 decimal
- Location Area Code	0001H
Message Type	
- System information 1	00011001
- System information 2	00011010
- System information 3	00011011
- System information 4	00011100
- System information 5	00011101
- System information 6	00011110
Neighbour Cells Description	
- Format identifier	128 range
- BCCH Allocation Sequence	0
- BCCH Allocation ARFCN	Channels 447, 457, 477, 480, 499, 504, 507 and 510.
- EXT-IND	This IE carries the complete BA.
NCC Permitted	0000 0010
RACH Control Parameters	
- Max Retrans	Max 1 retrans.
- Tx-integer	5 slots used.
- Cell Barred for Access	Cell is not barred.
- Call Reestablishment Allowed	Not allowed.
- Access Control Class	Access is not barred.
- Emergency Call allowed	Yes.
SI 1 rest octets	Not used (all bits are set to spare).
SI 2 rest octets	Not used (all bits are set to spare).
SI 3 rest octets	Not used (all bits are set to spare).
SI 4 rest octets	Not used (all bits are set to spare).

Default settings for cell A:

Downlink input level	63 dBmicroVolt emf.
Uplink output power	minimum supported by the MS's power class.
Propagation profile	Static.
BCCH/CCCH carrier number	457

Cell B

The contents of SYSTEM INFORMATION TYPE 1 to 6 messages for cell B are identical to those of cell A with the following exceptions:

Cell Channel Description - Format Identifier - Cell Allocation ARFCN	128 range. Channel Number 447.
--	-----------------------------------

NOTE 2: This IE needs modification when used in handover tests that command the MS to go to a frequency hopping channel in cell B.

Cell Identity

- Cell Identity Value: 0002H.

Default settings for cell B:

Downlink input level	53 dBmicroVolt emf.
Uplink output power	minimum supported by the MS's power class.
Propagation profile	static.
BCCH/CCCH carrier number	447

Contents of ALERTING message (SS to MS):

Protocol Discriminator	Call Control.
Transaction Identifier	
TI value	As used in the SETUP message.
TI flag	1 (destination side).
Message Type	00000001
All other information elements	Not present.

Contents of ASSIGNMENT COMMAND message:

Protocol Discriminator	RR Management.
Skip Indicator	0000
Message Type	00101110
Channel Description 2	
- Channel Type and TDMA offset	Bm + ACCHs
- Timeslot Number	Chosen arbitrarily by the test house.
- Training Sequence Code	Chosen arbitrarily by the test house.
- Hopping	Single RF channel.
- ARFCN	Channel number 467.
Power Command	
- Power level	Chosen arbitrarily by the test house.
Multislot allocation	
- Downlink assignment	Appropriate for the test
- Uplink assignment	Appropriate for the test
- Channel set 1= $X \leq 8$	Appropriate for the test
Channel mode	Appropriate for the test

Contents of ASSIGNMENT COMPLETE message:

Protocol Discriminator	RR Management.
Skip Indicator	0000
Message Type	00101001
RR Cause	
- RR Cause Value	Normal event.

Contents of ASSIGNMENT FAILURE message:

Protocol Discriminator	RR Management.
Skip Indicator	0000
Message Type	00101111
RR Cause	
- RR Cause Value	Depending on test.

Contents of AUTHENTICATION REQUEST message:

Protocol Discriminator	MM message.
Skip Indicator	0000
Message Type	00010010
Ciphering Key Sequence Number	
- Key Sequence	Chosen arbitrarily by the test house from the range 0 to 6.
Authentication Parameter RAND	
- RAND value	Chosen arbitrarily by the test house.

Contents of AUTHENTICATION RESPONSE message:

Protocol Discriminator	MM message.
Skip Indicator	0000
Message Type	0X010100
Other information element(s)	Not checked.

Contents of CALL PROCEEDING message:

Protocol Discriminator	Call Control.
Transaction Identifier	
TI value	As used in the SETUP message.
TI flag	1 (destination side).
Message Type	00000010
All other information elements	Not present.

Contents of CHANNEL MODE MODIFY message:

Protocol Discriminator	RR Management.
Skip Indicator	0000
Message Type	00010000
Channel Description 2	
- Channel Type and TDMA offset	Depending on test.
- Timeslot Number	Chosen arbitrarily by the test house.
- Training Sequence Code	Chosen arbitrarily by the test house.
- Hopping	Single RF channel.
- ARFCN	Channel number 467.
Channel Mode	
- Mode	Depending on test.

Contents of CHANNEL MODE MODIFY ACKNOWLEDGE message:

Protocol Discriminator	RR Management.
Skip Indicator	0000
Message Type	00010111
Channel Description 2	Depending on test.
- Channel Type and TDMA offset	Same as in the CHANNEL MODE MODIFY message.
- Timeslot Number	Same as in the CHANNEL MODE MODIFY message.
- Training Sequence Code	Single RF channel.
- Hopping	Band number 0.
- Frequency Band	Channel number 467.
- ARFCN	
Channel Mode	
- Mode	Same as in the CHANNEL MODE MODIFY message.

Contents of CHANNEL RELEASE message:

Protocol Discriminator	RR Management.
Skip Indicator	0000
Message Type	00001101
RR Cause	
- RR Cause Value	Normal event.

Contents of CHANNEL REQUEST message

Establishment Cause	Not checked.
Random Reference	Not checked.

Contents of CIPHERING MODE COMMAND message:

Protocol Discriminator	RR Management.
Skip Indicator	0000
Message Type	00110101
Cipher Mode Setting	
- algorithm identifier	cipher with A5/1.
- SC	Start ciphering.
Cipher Response	IMEI shall not be included.

Contents of CIPHERING MODE COMPLETE message:

Protocol Discriminator	RR Management.
Skip Indicator	0000
Message Type	00110010
Mobile Identity	Not present.

Contents of the CLASSMARK CHANGE message:

Protocol Discriminator	RR Management.
Skip Indicator	0000
Message Type	000100110
Mobile Station Classmark 2	See PICS/PIXIT.
Mobile Station Classmark 3	For presence and contents see PICS/PIXIT.

Contents of CM SERVICE ACCEPT message:

Protocol Discriminator	Mobility Management.
Skip Indicator	0000
Message Type	00100001

Contents of CM SERVICE REQUEST message

Protocol Discriminator	Mobility Management.
Skip Indicator	0000
Message Type	0X100100
Other information elements	Not checked.

Contents of CONFIGURATION CHANGE COMMAND message (SS to MS)

Protocol Discriminator	Radio Resource
Skip Indicator	0000
Message type	00110000
Multislot allocation	Appropriate for the test
- Downlink assignment	Appropriate for the test
- Uplink assignment	Appropriate for the test
- Channel set 1=<X<=8	Appropriate for the test
Channel mode 1=<X<=8	Appropriate for the test

Contents of CONFIGURATION CHANGE ACKNOWLEDGE message (MS to SS)

Protocol Discriminator	Radio Resource
Skip Indicator	0000
Message type	00110001

Contents of CONFIGURATION CHANGE REJECT message (MS to SS)

Protocol Discriminator	Radio Resource
Skip Indicator	0000
Message type	00110011
RR Cause	Protocol Error Unspecified

Contents of CONNECT message (SS to MS)

Protocol Discriminator	Call Control.
Transaction Identifier	
TI value	As used in the SETUP message.
TI flag	1
Message Type	00000111
All other information elements	Not present.

Contents of CONNECT ACKNOWLEDGE message (MS to SS)

Protocol Discriminator	Call Control.
Transaction Identifier	
TI value	As used in the SETUP message.
TI flag	0
Message Type	0X001111

Contents of HANDOVER ACCESS message:

Handover Reference	Equal to the value included in the Handover Command message.
--------------------	--

Contents of HANDOVER COMMAND message:

Protocol Discriminator	RR Management.
Skip Indicator	0000
Message Type	00101011
Cell Description	
- Network Colour Code	1
- Base station Colour Code	Corresponding to target cell
- BCCH Carrier Number	Set to the BCCH carrier number of cell B. (one of 447, 457, 480, 499, 504, 507 or 510).
Channel Description 2	
- Channel Type and TDMA offset	Bm + ACCHs.
- Timeslot Number	Chosen arbitrarily by the test house.
- Training Sequence Code	Chosen arbitrarily by the test house.
- Hopping	Single RF channel.
- ARFCN	Chosen arbitrarily by the test house from those supported on the target cell.
Handover Reference	
- Handover Reference Value	Chosen arbitrarily by the test house.
Power Command	
- Power level	Chosen arbitrarily by the test house.
Multislot allocation	
- Downlink assignment	Appropriate for the test
- Uplink assignment	Appropriate for the test
- Channel set 1= $X \leq 8$	Appropriate for the test
Channel mode	Appropriate for the test

Contents of HANDOVER COMPLETE message:

Protocol Discriminator	RR Management.
Skip Indicator	0000
Message Type	00101100
RR cause	Normal event.
Time difference	Not present.

Contents of HANDOVER FAILURE message:

Protocol Discriminator	RR Management.
Skip Indicator	0000
Message Type	00101000
RR cause	Dependent on the test.

Contents of IMMEDIATE ASSIGNMENT message:

L2 pseudo length	This is the sum of the lengths of all the information elements present in the message except for the IA rest octets and L2 pseudo length IEs. For the default message the L2 pseudo length is 11.
Protocol Discriminator	RR Management.
Skip Indicator	0000
Message Type	00111111
Page Mode	
- Page Mode	Normal Paging.
Channel Description	
- Channel Type and TDMA offset	For non-combined CCCH/SDCCH (see initial conditions), SDCCH/8, with subchannel chosen arbitrarily by the test house For combined CCCH/SDCCH (default SS conditions), SDCCH/4, with subchannel chosen arbitrarily by the test house.
- Timeslot Number	For non-combined CCCH/SDCCH (see initial conditions), chosen arbitrarily by the test house; For combined CCCH/SDCCH (default SS conditions), SDCCH/4, timeslot zero.
- Training Sequence Code	For non-combined CCCH/SDCCH (see initial conditions), chosen arbitrarily by the test house; For combined CCCH/SDCCH (default SS conditions), SDCCH/4, TSC=5 (same as the BCC). Single RF channel.
- Hopping	
- ARFCN	For non-combined CCCH/SDCCH (see initial conditions), Channel number 467; For combined CCCH/SDCCH (default SS conditions), SDCCH/4, Channel number 20.
Request Reference	Pertaining to last Channel Request sent by the MS.
Timing Advance	
- Timing advance value	30 bit periods.
Mobile Allocation	
- Length	0
Starting Time	Not present.
IA rest octets	Not used (all bits set to spare).

Contents of IMMEDIATE ASSIGNMENT EXTENDED message:

L2 pseudo length	This is the sum of the lengths of all the information elements present in the message except for the IAX rest octets and L2 pseudo length IEs. For the default message the L2 pseudo length is 18.
Protocol Discriminator	RR Management.
Skip Indicator	0000
Message Type	00111001
Page Mode	
- Page Mode	Normal Paging.
Channel Description 1	
- Channel Type and TDMA offset	For non-combined CCCH/SDCCH (see test conditions), SDCCH/8, with subchannel chosen arbitrarily by the test house; For combined CCCH/SDCCH (default SS conditions), SDCCH/4, with subchannel chosen arbitrarily by the test house.
- Timeslot Number	For non-combined CCCH/SDCCH (see test conditions), chosen arbitrarily by the test house; For combined CCCH/SDCCH (default SS conditions), SDCCH/4, timeslot zero.
- Training Sequence Code	For non-combined CCCH/SDCCH (see initial conditions), chosen arbitrarily by the test house; For combined CCCH/SDCCH (default SS conditions), SDCCH/4, TSC=5 (same as the BCC). Single RF channel.
- Hopping	For non-combined CCCH/SDCCH (see initial conditions), Channel number 30; For combined CCCH/SDCCH (default SS conditions), SDCCH/4, Channel number 457.
- ARFCN	Pertaining to last Channel Request sent by the MS.
Request Reference 1	
Timing Advance 1	
- Timing advance value	Chosen arbitrarily by the test house.
Channel Description 2	
- Channel Type and TDMA offset	Same channel type as in Channel Description 1, but different TDMA offset to that in Channel Description 1.
- Timeslot Number	equal to the value in Channel Description 1.
- Training Sequence Code	equal to the value in Channel Description 1.
- Hopping	Single RF channel.
- ARFCN	equal to the value in Channel Description 1.
Request Reference 2	Not pertaining to any Channel Requests sent by the MS.
Timing Advance 2	
- Timing advance value	Chosen arbitrarily by the test house.
Mobile Allocation	
- Length	0
Starting Time	Not present.
IAX rest octets	Not used (all bits set to spare).

Contents of IMMEDIATE ASSIGNMENT REJECT message:

L2 pseudo length	19
Protocol Discriminator	RR Management.
Skip Indicator	0000
Message Type	00111010
Page Mode	
- Page Mode	Normal Paging.
Request Reference	Pertaining to last Channel Request sent by the MS.
Wait Indication	0 s.
Request Reference	Not pertaining to the MS under test.
Wait Indication	0 s.
Request Reference	Not pertaining to the MS under test.
Wait Indication	0 s.
Request Reference	Not pertaining to the MS under test.
Wait Indication	0 s.
IAR rest octets	Not used (all bits set to spare).

Contents of LOCATION UPDATING REQUEST message:

Protocol Discriminator	MM message.
Skip Indicator	0000
Message Type	0X001000
Other information elements	Not checked.

Contents of PAGING REQUEST TYPE 1 message:

L2 pseudo length	This is the sum of the lengths of all the information elements present in the message except for the P1 rest octets and L2 pseudo length IEs. For the default message the L2 pseudo length is 9.
Protocol Discriminator	RR Management.
Skip Indicator	0000
Message Type	00100001
Page Mode	
- Page Mode	Normal Paging.
Channels needed	
- first channel	any channel.
- second channel	any channel.
Mobile Identity 1	
- odd/even indication	Even.
- Type of Identity	TMSI.
- Identity Digits	TMSI previously allocated to MS.
Mobile Identity 2	Not present.
P1 rest octets	Not used (all bits set to spare).

Contents of PAGING REQUEST TYPE 2 message:

L2 pseudo length	This is the sum of the lengths of all the information elements present in the message except for the P2 rest octets and L2 pseudo length IEs. For the default message the L2 pseudo length is 11.
Protocol Discriminator	RR Management..
Skip Indicator	0000
Message Type	00100010
Page Mode	
- Page Mode	Normal Paging.
Channels needed	
- first channel	any channel.
- second channel	any channel.
Mobile Identity 1	
- TMSI value	TMSI previously allocated to MS.
Mobile Identity 2	
- TMSI value	TMSI not allocated to MS.
Mobile Identity	Not present.
P2 rest octets	Not used (all bits set to spare).

Contents of PAGING REQUEST TYPE 3 message:

L2 pseudo length	19
Protocol Discriminator	RR Management.
Skip Indicator	0000
Message Type	00100100
Page Mode	
- Page Mode	Normal Paging.
Channels needed	
- first channel	any channel.
- second channel	any channel.
Mobile identity 1	
- TMSI value	TMSI previously allocated to MS.
Mobile identity 2	
- TMSI value	TMSI not allocated to MS.
Mobile identity 3	
- TMSI value	TMSI not allocated to MS.
Mobile identity 4	
- TMSI value	TMSI not allocated to MS.
P3 rest octets	Not used (all bits set to spare).

Contents of PAGING RESPONSE message:

Protocol Discriminator	RR Management.
Skip Indicator	0000
Message Type	00100111
Ciphering Key Sequence Number	
- Key Sequence	Key sequence number previously allocated to MS, or "111" if no key is available.
Mobile Station Classmark 2	
Mobile Identity	
- odd/even indication	Even
- Type of identity	TMSI
- Identity Digits	TMSI previously allocated to MS.

Contents of PHYSICAL INFORMATION message:

Protocol Discriminator	RR Management.
Skip Indicator	0000
Message Type	00101101
Timing advance	20 bit periods.

Contents of SETUP message; (MS to SS):

Protocol Discriminator	Call Control.
Transaction Identifier	
TI value	any value from the set {0, ..., 6}.
TI flag	0
Message Type	0X000101
Other information elements	Not checked.

26.13.1.6.6 Default contents of GSM 850 layer 3 messages for RR tests

This subclause contains the default values of GSM 850 L3 messages, which unless indicated otherwise in subclause 26.13 shall be transmitted by the system simulator and which are required to be received from the GSM 850 MS under test.

The necessary L3 messages are listed in alphabetic order, with the exception of the SYSTEM INFORMATION messages, where it is the information elements that are listed in alphabetic order (this is because some information elements occur in several SYSTEM INFORMATION types).

In this section, decimal values are normally used. However, sometimes a hexadecimal value, indicated by an "H", or a binary value, indicated by a "B" is used.

Default SYSTEM INFORMATION:

NOTE 1: SYSTEM INFORMATION 2 bis, SYSTEM INFORMATION 5 bis, SYSTEM INFORMATION 7, and SYSTEM INFORMATION 8 messages are not used.

Cell A

Contents of information elements in SYSTEM INFORMATION TYPE 1 to 6 messages for cell A.

(CBCH) Channel Description	Not present.
(CBCH) Mobile Allocation	Not present.
Cell Channel Description	
- Format identifier	128 range.
- Cell Allocation ARFCN	Channels 147, 157, 177 and 197.
Cell Identity	
- Cell Identity Value	0001H
Cell Options	
- Power Control Indicator	Power Control Indicator is not set.
- DTX Indicator	MS shall not use DTX.
- Radio_Link_Timeout	8 SACCH blocks.
Cell Selection Parameters	
- Cell_Reselect_Hysteresis	12 dB.
- MX_TXPWR_MAX_CCH	Minimum level.
- ACS	No addition cell parameters are present in SYSTEM INFORMATION messages 7 and 8.
- NECI	New establishment causes not supported.
- RXLEV_ACCESS_MIN	Minimum level.
Control Channel Description	
- Attach-Detach allowed	No Attach/Detach.
- BS_AG_BLKES_RES	0 blocks reserved for access grant.
- CCCH_CONF	1 basic physical channel used for CCCH, combined with SDCCHs.
- BS_PA_MFRMS	5 multiframe periods for transmission of paging messages.
- T3212 Time-out value	Infinite.
L2 pseudo length	
- System information 1	21
- System information 2	22
- System information 3	18
- System information 4	12
Location Area Identification	
- Mobile Country Code	001 decimal
- Mobile Network Code	01 decimal
- Location Area Code	0001H
Message Type	
- System information 1	00011001
- System information 2	00011010
- System information 3	00011011
- System information 4	00011100
- System information 5	00011101
- System information 6	00011110
Neighbour Cells Description	
- Format identifier	128 range.
- BCCH Allocation Sequence	0
- BCCH Allocation ARFCN	Channels 137, 147, 167, 207, 217, 227, 237 and 247.
- EXT-IND	This IE carries the complete BA.
NCC Permitted	0000 0010
RACH Control Parameters	
- Max Retrans	Max 1 retrans.
- Tx-integer	5 slots used.
- Cell Barred for Access	Cell is not barred.
- Call Reestablishment Allowed	Not allowed.
- Access Control Class	Access is not barred.
- Emergency Call allowed	Yes.
SI 1 rest octets	Not used (all bits are set to spare).
SI 2 rest octets	Not used (all bits are set to spare).
SI 3 rest octets	Not used (all bits are set to spare).
SI 4 rest octets	Not used (all bits are set to spare).

Default settings for cell A:

Downlink input level	63 dBmicroVolt emf.
Uplink output power	minimum supported by the MS's power class.
Propagation profile	static.
BCCH/CCCH carrier number	147

Cell B

The contents of SYSTEM INFORMATION TYPE 1 to 6 messages for cell B are identical to those of cell A with the following exceptions:

Cell Channel Description - Format Identifier - Cell Allocation ARFCN	128 range. Channel Number 137.
--	-----------------------------------

NOTE 2: This IE needs modification when used in handover tests that command the MS to go to a frequency hopping channel in cell B.

Cell Identity

- Cell Identity Value: 0002H.

Default settings for cell B:

Downlink input level	53 dBmicroVolt emf.
Uplink output power	minimum supported by the MS's power class.
Propagation profile	static.
BCCH/CCCH carrier number	137

Contents of ALERTING message (SS to MS):

Protocol Discriminator	Call Control.
Transaction Identifier	
TI value	As used in the SETUP message.
TI flag	1 (destination side).
Message Type	00000001
All other information elements	Not present.

Contents of ASSIGNMENT COMMAND message:

Protocol Discriminator	RR Management.
Skip Indicator	0000
Message Type	00101110
Channel Description 2	
- Channel Type and TDMA offset	Bm + ACCHs
- Timeslot Number	Chosen arbitrarily by the test house.
- Training Sequence Code	Chosen arbitrarily by the test house.
- Hopping	Single RF channel.
- ARFCN	Channel number 157.
Power Command	
- Power level	Chosen arbitrarily by the test house.
Multislot allocation	
- Downlink assignment	Appropriate for the test
- Uplink assignment	Appropriate for the test
- Channel set 1=<X<=8	Appropriate for the test
Channel mode	Appropriate for the test

Contents of ASSIGNMENT COMPLETE message:

Protocol Discriminator	RR Management.
Skip Indicator	0000
Message Type	00101001
RR Cause	
- RR Cause Value	Normal event.

Contents of ASSIGNMENT FAILURE message:

Protocol Discriminator	RR Management.
Skip Indicator	0000
Message Type	00101111
RR Cause	
- RR Cause Value	Depending on test.

Contents of AUTHENTICATION REQUEST message:

Protocol Discriminator	MM message.
Skip Indicator	0000
Message Type	00010010
Ciphering Key Sequence Number	
- Key Sequence	Chosen arbitrarily by the test house from the range 0 to 6.
Authentication Parameter RAND	
- RAND value	Chosen arbitrarily by the test house.

Contents of AUTHENTICATION RESPONSE message:

Protocol Discriminator	MM message.
Skip Indicator	0000
Message Type	0X010100
Other information element(s)	Not checked.

Contents of CALL PROCEEDING message:

Protocol Discriminator	Call Control.
Transaction Identifier	
TI value	As used in the SETUP message.
TI flag	1 (destination side).
Message Type	00000010
All other information elements	Not present.

Contents of CHANNEL MODE MODIFY message:

Protocol Discriminator	RR Management.
Skip Indicator	0000
Message Type	00010000
Channel Description 2	
- Channel Type and TDMA offset	Depending on test.
- Timeslot Number	Chosen arbitrarily by the test house.
- Training Sequence Code	Chosen arbitrarily by the test house.
- Hopping	Single RF channel.
- ARFCN	Channel number 157.
Channel Mode	
- Mode	Depending on test.

Contents of CHANNEL MODE MODIFY ACKNOWLEDGE message:

Protocol Discriminator	RR Management.
Skip Indicator	0000
Message Type	00010111
Channel Description 2	Depending on test.
- Channel Type and TDMA offset	Same as in the CHANNEL MODE MODIFY message.
- Timeslot Number	Same as in the CHANNEL MODE MODIFY message.
- Training Sequence Code	Single RF channel.
- Hopping	Band number 0.
- Frequency Band	Channel number 157.
- ARFCN	
Channel Mode	
- Mode	Same as in the CHANNEL MODE MODIFY message.

Contents of CHANNEL RELEASE message:

Protocol Discriminator	RR Management.
Skip Indicator	0000
Message Type	00001101
RR Cause	
- RR Cause Value	Normal event.

Contents of CHANNEL REQUEST message

Establishment Cause	Not checked.
Random Reference	Not checked.

Contents of CIPHERING MODE COMMAND message:

Protocol Discriminator	RR Management.
Skip Indicator	0000
Message Type	00110101
Cipher Mode Setting	
- algorithm identifier	cipher with A5/1.
- SC	Start ciphering.
Cipher Response	IMEI shall not be included.

Contents of CIPHERING MODE COMPLETE message:

Protocol Discriminator	RR Management.
Skip Indicator	0000
Message Type	00110010
Mobile Identity	Not present.

Contents of the CLASSMARK CHANGE message:

Protocol Discriminator	RR Management.
Skip Indicator	0000
Message Type	000100110
Mobile Station Classmark 2	See PICS/PIXIT.
Mobile Station Classmark 3	For presence and contents see PICS/PIXIT.

Contents of CM SERVICE ACCEPT message:

Protocol Discriminator	Mobility Management.
Skip Indicator	0000
Message Type	00100001

Contents of CM SERVICE REQUEST message

Protocol Discriminator	Mobility Management.
Skip Indicator	0000
Message Type	0X100100
Other information elements	Not checked.

Contents of CONFIGURATION CHANGE COMMAND message (SS to MS)

Protocol Discriminator	Radio Resource
Skip Indicator	0000
Message type	00110000
Multislot allocation	Appropriate for the test
- Downlink assignment	Appropriate for the test
- Uplink assignment	Appropriate for the test
- Channel set 1=<X<=8	Appropriate for the test
Channel mode 1=<X<=8	Appropriate for the test

Contents of CONFIGURATION CHANGE ACKNOWLEDGE message (MS to SS)

Protocol Discriminator	Radio Resource
Skip Indicator	0000
Message type	00110001

Contents of CONFIGURATION CHANGE REJECT message (MS to SS)

Protocol Discriminator	Radio Resource
Skip Indicator	0000
Message type	00110011
RR Cause	Protocol Error Unspecified

Contents of CONNECT message (SS to MS)

Protocol Discriminator	Call Control.
Transaction Identifier	
TI value	As used in the SETUP message.
TI flag	1
Message Type	00000111
All other information elements	Not present.

Contents of CONNECT ACKNOWLEDGE message (MS to SS)

Protocol Discriminator	Call Control.
Transaction Identifier	
TI value	As used in the SETUP message.
TI flag	0
Message Type	0X001111

Contents of HANDOVER ACCESS message:

Handover Reference	Equal to the value included in the Handover Command message.
--------------------	--

Contents of HANDOVER COMMAND message:

Protocol Discriminator	RR Management.
Skip Indicator	0000
Message Type	00101011
Cell Description	1
- Network Colour Code	Corresponding to target cell
- Base station Colour Code	Set to the BCCH carrier number of cell B. (one of 137, 147, 207, 217, 227, 237 or 247).
- BCCH Carrier Number	
Channel Description 2	Bm + ACCHs.
- Channel Type and TDMA offset	Chosen arbitrarily by the test house.
- Timeslot Number	Chosen arbitrarily by the test house.
- Training Sequence Code	Single RF channel.
- Hopping	Chosen arbitrarily by the test house from those supported on the target cell.
- ARFCN	
Handover Reference	
- Handover Reference Value	Chosen arbitrarily by the test house.
Power Command	
- Power level	Chosen arbitrarily by the test house.
Multislot allocation	
- Downlink assignment	Appropriate for the test
- Uplink assignment	Appropriate for the test
- Channel set 1= $X \leq 8$	Appropriate for the test
Channel mode	Appropriate for the test

Contents of HANDOVER COMPLETE message:

Protocol Discriminator	RR Management.
Skip Indicator	0000
Message Type	00101100
RR cause	Normal event.
Time difference	Not present.

Contents of HANDOVER FAILURE message:

Protocol Discriminator	RR Management.
Skip Indicator	0000
Message Type	00101000
RR cause	Dependent on the test.

Contents of IMMEDIATE ASSIGNMENT message:

L2 pseudo length	This is the sum of the lengths of all the information elements present in the message except for the IA rest octets and L2 pseudo length IEs. For the default message the L2 pseudo length is 11.
Protocol Discriminator	RR Management.
Skip Indicator	0000
Message Type	00111111
Page Mode	
- Page Mode	Normal Paging.
Channel Description	
- Channel Type and TDMA offset	For non-combined CCCH/SDCCH (see initial conditions), SDCCH/8, with subchannel chosen arbitrarily by the test house For combined CCCH/SDCCH (default SS conditions), SDCCH/4, with subchannel chosen arbitrarily by the test house.
- Timeslot Number	For non-combined CCCH/SDCCH (see initial conditions), chosen arbitrarily by the test house; For combined CCCH/SDCCH (default SS conditions), SDCCH/4, timeslot zero.
- Training Sequence Code	For non-combined CCCH/SDCCH (see initial conditions), chosen arbitrarily by the test house; For combined CCCH/SDCCH (default SS conditions), SDCCH/4, TSC=5 (same as the BCC). Single RF channel.
- Hopping	
- ARFCN	For non-combined CCCH/SDCCH (see initial conditions), Channel number 157; For combined CCCH/SDCCH (default SS conditions), SDCCH/4, Channel number 20.
Request Reference	Pertaining to last Channel Request sent by the MS.
Timing Advance	
- Timing advance value	30 bit periods.
Mobile Allocation	
- Length	0
Starting Time	Not present.
IA rest octets	Not used (all bits set to spare).

Contents of IMMEDIATE ASSIGNMENT EXTENDED message:

L2 pseudo length	This is the sum of the lengths of all the information elements present in the message except for the IAX rest octets and L2 pseudo length IEs. For the default message the L2 pseudo length is 18.
Protocol Discriminator	RR Management.
Skip Indicator	0000
Message Type	00111001
Page Mode	
- Page Mode	Normal Paging.
Channel Description 1	
- Channel Type and TDMA offset	For non-combined CCCH/SDCCH (see test conditions), SDCCH/8, with subchannel chosen arbitrarily by the test house; For combined CCCH/SDCCH (default SS conditions), SDCCH/4, with subchannel chosen arbitrarily by the test house.
- Timeslot Number	For non-combined CCCH/SDCCH (see test conditions), chosen arbitrarily by the test house; For combined CCCH/SDCCH (default SS conditions), SDCCH/4, timeslot zero.
- Training Sequence Code	For non-combined CCCH/SDCCH (see initial conditions), chosen arbitrarily by the test house; For combined CCCH/SDCCH (default SS conditions), SDCCH/4, TSC=5 (same as the BCC). Single RF channel.
- Hopping	For non-combined CCCH/SDCCH (see initial conditions), Channel number 30; For combined CCCH/SDCCH (default SS conditions), SDCCH/4, Channel number 147.
- ARFCN	Pertaining to last Channel Request sent by the MS.
Request Reference 1	
Timing Advance 1	
- Timing advance value	Chosen arbitrarily by the test house.
Channel Description 2	
- Channel Type and TDMA offset	Same channel type as in Channel Description 1, but different TDMA offset to that in Channel Description 1.
- Timeslot Number	equal to the value in Channel Description 1.
- Training Sequence Code	equal to the value in Channel Description 1.
- Hopping	Single RF channel.
- ARFCN	equal to the value in Channel Description 1.
Request Reference 2	Not pertaining to any Channel Requests sent by the MS.
Timing Advance 2	
- Timing advance value	Chosen arbitrarily by the test house.
Mobile Allocation	
- Length	0
Starting Time	Not present.
IAX rest octets	Not used (all bits set to spare).

Contents of IMMEDIATE ASSIGNMENT REJECT message:

L2 pseudo length	19
Protocol Discriminator	RR Management.
Skip Indicator	0000
Message Type	00111010
Page Mode	
- Page Mode	Normal Paging.
Request Reference	Pertaining to last Channel Request sent by the MS.
Wait Indication	0 s.
Request Reference	Not pertaining to the MS under test.
Wait Indication	0 s.
Request Reference	Not pertaining to the MS under test.
Wait Indication	0 s.
Request Reference	Not pertaining to the MS under test.
Wait Indication	0 s.
IAR rest octets	Not used (all bits set to spare).

Contents of LOCATION UPDATING REQUEST message:

Protocol Discriminator	MM message.
Skip Indicator	0000
Message Type	0X001000
Other information elements	Not checked.

Contents of PAGING REQUEST TYPE 1 message:

L2 pseudo length	This is the sum of the lengths of all the information elements present in the message except for the P1 rest octets and L2 pseudo length IEs. For the default message the L2 pseudo length is 9.
Protocol Discriminator	RR Management.
Skip Indicator	0000
Message Type	00100001
Page Mode	
- Page Mode	Normal Paging.
Channels needed	
- first channel	any channel.
- second channel	any channel.
Mobile Identity 1	
- odd/even indication	Even.
- Type of Identity	TMSI.
- Identity Digits	TMSI previously allocated to MS.
Mobile Identity 2	Not present.
P1 rest octets	Not used (all bits set to spare).

Contents of PAGING REQUEST TYPE 2 message:

L2 pseudo length	This is the sum of the lengths of all the information elements present in the message except for the P2 rest octets and L2 pseudo length IEs. For the default message the L2 pseudo length is 11.
Protocol Discriminator	RR Management..
Skip Indicator	0000
Message Type	00100010
Page Mode	
- Page Mode	Normal Paging.
Channels needed	
- first channel	any channel.
- second channel	any channel.
Mobile Identity 1	
- TMSI value	TMSI previously allocated to MS.
Mobile Identity 2	
- TMSI value	TMSI not allocated to MS.
Mobile Identity	Not present.
P2 rest octets	Not used (all bits set to spare).

Contents of PAGING REQUEST TYPE 3 message:

L2 pseudo length	19
Protocol Discriminator	RR Management.
Skip Indicator	0000
Message Type	00100100
Page Mode	
- Page Mode	Normal Paging.
Channels needed	
- first channel	any channel.
- second channel	any channel.
Mobile identity 1	
- TMSI value	TMSI previously allocated to MS.
Mobile identity 2	
- TMSI value	TMSI not allocated to MS.
Mobile identity 3	
- TMSI value	TMSI not allocated to MS.
Mobile identity 4	
- TMSI value	TMSI not allocated to MS.
P3 rest octets	Not used (all bits set to spare).

Contents of PAGING RESPONSE message:

Protocol Discriminator	RR Management.
Skip Indicator	0000
Message Type	00100111
Ciphering Key Sequence Number	
- Key Sequence	Key sequence number previously allocated to MS, or "111" if no key is available.
Mobile Station Classmark 2	
Mobile Identity	
- odd/even indication	Even
- Type of identity	TMSI
- Identity Digits	TMSI previously allocated to MS.

Contents of PHYSICAL INFORMATION message:

Protocol Discriminator	RR Management.
Skip Indicator	0000
Message Type	00101101
Timing advance	20 bit periods.

Contents of SETUP message; (MS to SS):

Protocol Discriminator	Call Control.
Transaction Identifier	
TI value	any value from the set {0, ..., 6}.
TI flag	0
Message Type	0X000101
Other information elements	Not checked.

26.13.2 Multislot signalling / CC

26.13.2.1 Multislot signalling / CC / In-call functions

26.13.2.1.1 Multislot signalling / CC / In-call functions / User initiated service level upgrade / successful

26.13.2.1.1.1 Definition

Multislot connection is established. Multislot configuration with one TCH/F is allocated. User initiated service level upgrade is successfully performed.

26.13.2.1.1.2 Conformance requirements

- 1) MS shall send MODIFY message to SS indicating that User initiated service level upgrade is initiated.
- 2) MS enters CC state 'Mobile originating modify (U26)' after sending MODIFY.
- 3) MS enters CC state 'Active (U10)' when MODIFY COMPLETE is received.

References

- Conformance requirement 1: 3GPP TS 04.08 / 3GPP TS 24.008, subclause 9.3.13.
Conformance requirement 2: 3GPP TS 04.08 / 3GPP TS 24.008, subclause 5.3.5.1.
Conformance requirement 3: 3GPP TS 04.08 / 3GPP TS 24.008, subclause 5.3.5.2.

26.13.2.1.1.3 Test purpose

- 1) To verify that the procedure is initiated by the MS in the "active" state of a multislot connection. It sends a MODIFY message including the wanted value of the "maximum number of traffic channels" and/or the "wanted air interface" parameters; and enters the "mobile originating modify" state. Other parameters of the bearer capability given in MODIFY message and already negotiated and agreed during the establishment phase of the call, may not be changed.
- 2) To verify that upon receipt of the MODIFY COMPLETE message with bearer capability negotiated at call setup in the MS enters the "active" state.

26.13.2.1.1.4 Method of test

Initial conditions

Mobile station:

- MS in the active state of a service using a multislot connection.

System simulator:

- 1 cell, default parameters except:
 - Early classmark sending enabled in SI3 rest octets

Specific PICS statements:

- Multislot class (TSPC_Type_Multislot_ClassX)

PIXIT statements:

-

Foreseen final state of the MS

MS is in the active state of a service using a multislot connection.

Test procedure

MS is in the active state of a multislot connection. Multislot configuration with one TCH/F is allocated. User initiates User initiated service level upgrade by sending MODIFY message including the wanted value of the Maximum number of traffic channels, this being one supported by the MS and channel modes supported by the MS. The MS enters 'mobile originating modify' state. This is verified by a status enquiry procedure.

MS receives MODIFY COMPLETE message from SS and enters the 'active' state. This is verified by a status enquiry procedure.

Maximum duration of test

3 minutes.

Expected sequence

Step	Direction	Message	Comments
1	MS -> SS	MODIFY	User initiated service level upgrade is initiated.
2	MS		MS enters the Mobile originating modify state
3	SS -> MS	STATUS ENQUIRY	
4	MS -> SS	STATUS	Cause shall be 30# (response to enq.) and state U26 Mobile originated modify.
5	SS -> MS	MODIFY COMPLETE	
6	MS		MS enters the active state
7	SS -> MS	STATUS ENQUIRY	
8	MS -> SS	STATUS	Cause shall be 30# (response to enq.) and state U10 Active.

Specific message contents

MODIFY

Information element	Value/remark
Bearer capability	Maximum number of TCH/F's the MS is able to support and channel modes supported by the MS
Low layer comp.	Appropriate for the basic service selected for the test
High layer comp.	Appropriate for the basic service selected for the test
Reverse call setup direction	Presence and value not checked

26.13.2.1.2 Multislot signalling / CC / In-call functions / User initiated service level downgrade / successful

25.13.2.1.2.1 Definition

Multislot connection is established. Multislot configuration has the maximum number of timeslots supported by the MS. User initiated service level downgrade is successfully performed.

26.13.2.1.2.2 Conformance requirements

- 1) MS shall send MODIFY message to SS indicating that User initiated service level downgrade is initiated.
- 2) MS enters CC state 'Mobile originating modify (U26)' after sending MODIFY.
- 3) MS enters CC state 'Active (U10)' when MODIFY COMPLETE is received.

References

- Conformance requirement 1: 3GPP TS 04.08 / 3GPP TS 24.008, subclause 9.3.13.
 Conformance requirement 2: 3GPP TS 04.08 / 3GPP TS 24.008, subclause 5.3.5.1.
 Conformance requirement 3: 3GPP TS 04.08 / 3GPP TS 24.008, subclause 5.3.5.2.

26.13.2.1.2.3 Test purpose

- 1) To verify that the procedure is initiated by the MS in the "active" state of a multislot connection. It sends a MODIFY message including the wanted value of the "maximum number of traffic channels" and/or the "wanted air interface" parameters; and enters the "mobile originating modify" state. Other parameters of the bearer capability given in MODIFY message and already negotiated and agreed during the establishment phase of the call, may not be changed.
- 2) To verify that upon receipt of the MODIFY COMPLETE message with bearer capability negotiated at call setup in the MS enters the "active" state.

26.13.2.1.2.4 Method of test

Initial conditions

Mobile station:

- MS in the active state of a service using a multislot connection. Multislot configuration has maximum number of timeslots supported by the MS.

System simulator:

- 1 cell, default parameters except:
 - Early classmark sending enabled in SI3 rest octets

Specific PICS statements:

- Multislot class (TSPC_Type_Multislot_ClassX)

PIXIT statements:

-

Foreseen final state of the MS

MS is in the active state of a service using a multislot connection.

Test procedure

MS in the active state of a multislot connection. Multislot configuration has maximum number of timeslots supported by the MS. User initiates User initiated service level downgrade by sending MODIFY message including the wanted value of the Maximum number of traffic channels, this being one supported by the MS and channel modes supported by the MS. The MS enters 'mobile originating modify' state. This is verified by a status enquiry procedure. MS receives MODIFY COMPLETE message from SS and enters the active state. This is verified by a status enquiry procedure.

Maximum duration of test

3 minutes.

Expected sequence

Step	Direction	Message	Comments
1	MS -> SS	MODIFY	User initiated service level downgrade is initiated.
2	MS		MS enters the Mobile originating modify state
3	SS -> MS	STATUS ENQUIRY	
4	MS -> SS	STATUS	Cause shall be 30# (response to enq.) and state U26 Mobile originated modify.
5	SS -> MS	MODIFY COMPLETE	
6	MS		MS enters the active state
7	SS -> MS	STATUS ENQUIRY	
8	MS -> SS	STATUS	Cause shall be 30# (response to enq.) and state U10 Active.

Specific message contents

MODIFY

Information element	Value/remark
Bearer capability	One TCH/F is indicated and the channel modes supported by the MS
Low layer comp.	Appropriate for the basic service selected for the test
High layer comp.	Appropriate for the basic service selected for the test
Reverse call setup direction	Presence and value not checked

26.13.2.1.3 Multislot signalling / CC / In-call functions / User initiated service level upgrade / Time-out of timer T323

26.13.2.1.3.1 Definition

Multislot connection is established. Multislot configuration with one TCH/F is allocated. User initiated service level upgrade is requested. Timer T323 expires. Call is cleared.

26.13.2.1.3.2 Conformance requirements

- 1) MS shall send MODIFY message to SS indicating that User initiated service level upgrade is initiated.
- 2) After timer T323 has expired MS starts call clearing by sending DISCONNECT message.
- 3) After receipt of RELEASE message the MS sends RELEASE COMPLETE message and goes to idle updated state.

References

Conformance requirement 1: 3GPP TS 04.08 / 3GPP TS 24.008, subclause 9.3.13.

Conformance requirement 2: 3GPP TS 04.08 / 3GPP TS 24.008, subclause 9.3.7.

Conformance requirement 3: 3GPP TS 04.08 / 3GPP TS 24.008, subclauses 9.3.18 and 5.4.4.2.2, 3GPP TS 04.08 / 3GPP TS 44.018, subclause 9.1.7.

26.13.2.1.3.3 Test purpose

- 1) To verify that upon expiration of T323 (accuracy $\pm 10\%$) the MS shall initiate the procedures for call clearing with cause #102 "recovery on timer expiry".

26.13.2.1.3.4 Method of test

Initial conditions

Mobile station:

- MS in the active state of a service using a multislot connection.

System simulator:

- 1 cell, default parameters

Specific PICS statements:

- Multislot class (TSPC_Type_Multislot_ClassX)

PIXIT statements:

-

Foreseen final state of the MS

"Idle, updated", with TMSI allocated.

Test procedure

MS is in the active state of a multislot connection. Multislot configuration with one TCH/F is allocated. User initiates User initiated service level upgrade by sending MODIFY message including the wanted value of the Maximum number of traffic channels, this being one supported by the MS and channel modes supported by the MS.

Timer T323 expires and MS starts call clearing procedure by sending DISCONNECT message to SS. After MS receives RELEASE message it sends RELEASE COMPLETE message. SS sends CHANNEL RELEASE message to MS and the main signalling link is released.

Maximum duration of test

3 minutes.

Expected sequence

Step	Direction	Message	Comments
1	MS -> SS	MODIFY	User initiated service level upgrade is initiated.
2	MS		Timer T323 expires
3	MS -> SS	DISCONNECT	Cause = #102 "recovery on timer expiry"
4	SS -> MS	RELEASE	
5	MS -> SS	RELEASE COMPLETE	
6	SS -> MS	CHANNEL RELEASE	The main signalling link is released

Specific message contents

MODIFY

Information element	Value/remark
Bearer capability	Maximum number of TCH/F's the MS is able to support and channel modes supported by the MS
Low layer comp.	Appropriate for the basic service selected for the test
High layer comp.	Appropriate for the basic service selected for the test
Reverse call setup direction	Presence and value not checked

26.13.2.1.4 Multislot signalling / CC / In-call functions / User initiated service level upgrade / modify reject

26.13.2.1.4.1 Definition

Multislot connection is established. Multislot configuration with one TCH/F is allocated. User initiated service level upgrade is requested. SS responds to upgrade request by rejecting it. MS enters the active multislot connection state.

26.13.2.1.4.2 Conformance requirements

- 1) MS shall send MODIFY message to SS indicating that User initiated service level upgrade is initiated.
- 2) MS enters CC state 'Mobile originating modify (U26)' after sending MODIFY.
- 3) MS enters CC state 'Active (U10)' when MODIFY REJECT is received.

References

- Conformance requirement 1: 3GPP TS 04.08 / 3GPP TS 24.008, subclause 9.3.13.
 Conformance requirement 2: 3GPP TS 04.08 / 3GPP TS 24.008, subclause 5.3.5.1.
 Conformance requirement 3: 3GPP TS 04.08 / 3GPP TS 24.008, subclause 5.3.5.3.

26.13.2.1.4.3 Test purpose

- 1) To verify that upon receipt of the MODIFY REJECT message with the bearer capability negotiated at the call setup, the MS is continuously sending user information according to current call mode.

26.13.2.1.4.4 Method of test

Initial conditions

Mobile station:

- MS in the active state of a service using a multislot connection.

System simulator:

- 1 cell, default parameters

Specific PICS statements:

- Multislot class (TSPC_Type_Multislot_ClassX)

PIXIT statements:

-

Foreseen final state of the MS

MS is in the active state of a service using a multislot connection.

Test procedure

MS is in the active state of a multislot connection. Multislot configuration with one TCH/F is allocated. Then user initiates User initiated service level upgrade by sending MODIFY message including the wanted value of the Maximum number of traffic channels, this being one supported by the MS and channel modes supported by the MS. The MS enters 'mobile originated modify' state. This is verified by a status enquiry procedure. SS responds to MODIFY message by sending MODIFY REJECT message to MS. MS enters the active state. This is verified by a status enquiry procedure. Maximum duration of test

1 minute.

Expected sequence

Step	Direction	Message	Comments
1	MS -> SS	MODIFY	User initiated service level upgrade is initiated.
2	SS -> MS	STATUS ENQUIRY	Cause shall be 30# (response to enq.) and state U26 Mobile originated modify.
3	MS -> SS	STATUS	
4	SS -> MS	MODIFY REJECT	
5	MS		Cause = #58 "bearer capability not presently available". MS enters in the active state of multislot call
6	SS -> MS	STATUS ENQUIRY	Cause shall be 30# (response to enq.) and state U10 Active.
7	MS -> SS	STATUS	

Specific message contents

MODIFY

Information element	Value/remark
Bearer capability	Maximum number of TCH/F's the MS is able to support and channel modes supported by the MS
Low layer comp.	Appropriate for the basic service selected for the test
High layer comp.	Appropriate for the basic service selected for the test
Reverse call setup direction	Presence and value not checked

26.13.2.1.5 Multislot signalling / CC / In call functions / contents of some of the messages

The following messages are used for testing in-call modification procedures, test cases 26.13.2.1.*, as default messages for those ones defined below. If any other values are defined in the expected sequence of the actual test cases, those values take precedence over the ones defined hereafter.

SETUP (MS to SS)

Information element	Value/remark
BC Repeat indicator	Omitted
Bearer capability 1	Appropriate for the teleservice/Bearer Service selected as an initial call mode
Bearer capability 2	Omitted
Facility	Omitted
Calling party subaddress	Omitted
Called party BCD number	As entered
Called party subaddress	Omitted
LLC repeat indicator	Omitted
Low layer compatibility I	See note
Low layer compatibility II	Omitted
HLC repeat indicator	Omitted
High layer compatibility I	See note
High layer compatibility II	Omitted
User-user	Omitted
SS version	Omitted
CLIR suppression	Omitted
CC Capabilities	present, but contents not checked
NOTE: HLC/LLC may or may not be present. The contents of HLC/LLC are not verified.	

CALL PROCEEDING

Information element	Value/remark
Repeat Indicator	Omitted
Bearer Capability 1	3GPP TS 04.08 / 3GPP TS 24.008 subclause 10.5.4.5
Bearer Capability 2	Omitted
Facility	Omitted
Progress indicator	Omitted

MODIFY

Information element	Value/remark
Bearer capability	Appropriate for the selected test
Low layer comp.	Appropriate for the basic service selected for the test
High layer comp.	Appropriate for the basic service selected for the test
Reverse call setup direction	Presence and value not checked

MODIFY COMPLETE

Information element	Value/remark
Bearer capability	Appropriate for the selected test
Low layer comp.	Appropriate for the basic service selected for the test
High layer comp.	Appropriate for the basic service selected for the test
Reverse call setup direction	Presence and value not checked

MODIFY REJECT

Information element	Value/remark
Bearer capability	Appropriate for the selected test
Cause	#58 "bearer capability not presently available".
Low layer compatibility	Appropriate for the basic service selected for the test
High layer compatibility	Appropriate for the basic service selected for the test

26.13.3 Multislot signalling / Structured procedures

26.13.3.1 Multislot signalling / Structured procedures / MS originated call / early assignment / HSCSD / non-transparent

26.13.3.1.1 Conformance requirements

- 1) An MS in MM state "idle, updated" and in RR idle mode, when made to initiate a call, if it provides a human interface, shall display the dialled number.
- 2) An MS in MM state "idle, updated" and in RR idle mode, when made to initiate a call for a selected teleservice/bearer service for HSCSD that is supported by the MS, starts to initiate the immediate assignment procedure by sending a CHANNEL REQUEST message with correct establishment cause.
- 3) Subsequently after establishment of a MM connection, after MS sends its multislot class in CLASSMARK CHANGE message, the MS shall send a SETUP message with correct parameters.
- 4) The call control entity of the Mobile Station in the "call initiated" state, in the "mobile originating call proceeding" state or in the "call delivered" state, shall, upon receipt of a CONNECT message:
 - 4.1) attach the user connection to the radio path;
 - 4.2) return a CONNECT ACKNOWLEDGE message;
 - 4.3) establish the RLP link.
- 5) User initiated service level upgrade is initiated by sending MODIFY message. After receipt of MODIFY COMPLETE message MS enters the active state.
- 6) After receipt of a CONFIGURATION CHANGE COMMAND message MS sends CONFIGURATION CHANGE ACKNOWLEDGE message.
- 7) Subsequently when the network initiates call clearing by sending a DISCONNECT message, the MS shall proceed to release the call by sending a RELEASE message.
- 8) On receipt of a CHANNEL RELEASE message, the MS shall disconnect the main signalling link.

NOTE: Requirements 5 and 6 are only applicable to Multislot Class 2 and above.

Reference

- Conformance requirement 1: 3GPP TS 02.07.
- Conformance requirement 2: 3GPP TS 04.08 / 3GPP TS 44.018 subclauses 3.3.1.1, 9.1.8 and 9.1.18.
- Conformance requirement 3: 3GPP TS 04.08 / 3GPP TS 44.018 subclauses 3.4.10, 9.1.11 and 9.3.23.
- Conformance requirement 4: 3GPP TS 04.08 / 3GPP TS 24.008 subclauses 9.3.5 and 9.3.6, 3GPP TS 07.01 clause 8.
- Conformance requirement 5: 3GPP TS 04.08 / 3GPP TS 24.008 subclauses 9.3.13 and 9.3.14.
- Conformance requirement 6: 3GPP TS 04.08 / 3GPP TS 44.018 subclauses 9.1.12b and 9.1.12c.
- Conformance requirement 7: 3GPP TS 04.08 / 3GPP TS 24.008 subclauses 5.4.4.2.2, 9.3.7 and 9.3.18.
- Conformance requirement 8: 3GPP TS 04.08 / 3GPP TS 44.018 subclause 9.1.7.

26.13.3.1.2 Test purpose

- 1) To verify that the MS in MM state "idle, updated" with a TMSI assigned, when made to initiate a call for a selected teleservice/bearer service for HSCSD that is supported by the MS as declared in a PICS/PIXIT statement, displays the dialled number in the way described in a PICS/PIXIT statement.
- 2) To verify that the MS in MM state "idle, updated" and in RR idle mode, with a TMSI assigned, when made to initiate a call for a selected teleservice/bearer service for HSCSD that is supported by the MS as declared in a

PICS/PIXIT statement, starts to initiate an immediate assignment procedure by sending the CHANNEL REQUEST message with correct establishment cause.

- 3) To verify that subsequently after receipt of an IMMEDIATE ASSIGNMENT message allocating an SDCCH, after completion of establishment of the main signalling link, after having sent a CM SERVICE REQUEST message, after MS sends it's multislot class in CLASSMARK CHANGE message, after having successfully performed the authentication and cipher mode setting procedures, the MS sends a SETUP message with correct parameters.
- 4) Multislot configuration with one TCH/F is allocated. To verify that subsequently, after receipt of a CALL PROCEEDING message and of an ASSIGNMENT COMMAND message allocating an appropriate TCH, after having completed the early assignment procedure by replying with the ASSIGNMENT COMPLETE message, after receipt of an ALERTING message and a CONNECT message, the MS returns a CONNECT ACKNOWLEDGE message.
- 5) To verify that subsequently the MS has attached the user connection to the radio path. This is verified by checking that the MS establishes the RLP link correctly and sends and receives correct RLP frames in each data block.
- 6) To verify that subsequently upon user requests User initiated service level upgrade, the MS sends MODIFY message and after receipt of MODIFY COMPLETE message the MS enters the active state.
- 7) To verify that subsequently, after receipt of a CONFIGURATION CHANGE COMMAND, after MS sends CONFIGURATION CHANGE ACKNOWLEDGE, MS through connects all bi-directional channel(s) in multislot configuration in both directions and all uni-directional channels in downlink direction. Multislot configuration is upgraded from the simplest case up to the maximum number of channels supported by MS in the HSCSD configuration. This is verified by checking that the MS sends and receives correct RLP frames in each data block.
- 8) To verify that subsequently upon the network initiating call clearing by sending a DISCONNECT message, the MS proceed to release the call with RELEASE.
- 9) To verify that subsequently, on receipt of a RELEASE COMPLETE message followed by a CHANNEL RELEASE message, the MS disconnects the main signalling link.

NOTE: Items 6 and 7 are only applicable to Multislot Class 2 and above.

26.13.3.1.3 Method of test

Initial conditions

Mobile Station:

- The MS is in MM-state "idle, updated" with valid TMSI and CKSN.

System Simulator:

- 1 cell, default parameters except:
 - Early classmark sending enabled in SI3 rest octets.

Specific PICS statements:

- Multislot class (TSPC_Type_Multislot_ClassX)

PIXIT statements:

- Way to display the called number

Foreseen final state of the MS

MS is in MM-state "idle, updated" with valid TMSI and CKSN.

Test procedure

The MS is made to initiate a HSCSD connection. The call is established with early assignment. MS enters the active state. Multislot configuration with one TCH/F is allocated. User initiated service level upgrade is successfully performed. The SS sends CONFIGURATION CHANGE COMMAND message to MS and it reply's with CONFIGURATION CHANGE ACKNOWLEDGE message. This is repeated from simplest case up to the maximum number of channels supported by the MS in the HSCSD configuration (this is performed within highest multislot class that the MS supports).

Maximum duration of test

7 minutes.

Expected Sequence

An MS supporting Multislot Class 1 need only perform steps 1..20 and 25..28.

Step	Direction	Message	Comments
1	MS		The "called number" is entered
2	MS		If supported, the MS must display the called number in the way defined in PICS/PIXIT.
3	MS -> SS	CHANNEL REQUEST	Establishment cause is "Originating call and TCH/F is needed, or originating call and the network does not set NECI bit to 1"
4	SS -> MS	IMMEDIATE ASSIGNMENT	
5	MS -> SS	CM SERVICE REQUEST	Message is contained in SABM
6	MS -> SS	CLASSMARK CHANGE	Multislot class
7	SS -> MS	AUTHENTICATION REQUEST	
8	MS -> SS	AUTHENTICATION RESPONSE	SRES specifies correct value.
9	SS -> MS	CIPHERING MODE COMMAND	SS starts deciphering after sending the message.
10	MS -> SS	CIPHERING MODE COMPLETE	Shall be sent enciphered. All following messages shall be sent enciphered.
11	SS		SS starts ciphering.
12	MS -> SS	SETUP	Non-transparent connection
13	SS -> MS	CALL PROCEEDING	
14	SS -> MS	ASSIGNMENT COMMAND	In multislot allocation only one timeslot is allocated.
15	MS -> SS	ASSIGNMENT COMPLETE	
16	SS -> MS	ALERTING	
17	MS		
18	SS -> MS	CONNECT	
19	MS -> SS	CONNECT ACKNOWLEDGE	
20	MS		The appropriate bearer channel is through connected in both directions. The RLP link establishment is initiated by the MS.
21	MS -> SS	MODIFY	User initiated service level upgrade is initiated
22	SS -> MS	MODIFY COMPLETE	
23	MS		MS enters the active state
24			Next three steps are performed as many times as used multislot class has different channel combinations. Timeslot allocation starts from simplest case and is upgraded up to the maximum that MS multislot class supports, one step at the time (within highest multislot class that the MS supports).
24A	SS -> MS	CONFIGURATION CHANGE COMMAND	Appropriate number of timeslots is selected.
24B	MS -> SS	CONFIGURATION CHANGE ACKNOWLEDGE	
24C	MS		TCH(s) shall be through connected in both directions
25	SS -> MS	DISCONNECT	
26	MS -> SS	RELEASE	
27	SS -> MS	RELEASE COMPLETE	
28	SS -> MS	CHANNEL RELEASE	The main signalling link is released

26.13.3.2 Multislot signalling / Structured procedures / MS originated call / late assignment / HSCSD / non-transparent

26.13.3.2.1 Conformance requirements

- 1) An MS in MM state "idle, updated" and in RR idle mode with a TMSI assigned, when made to initiate a call for a selected teleservice/bearer service for HSCSD that is supported by the MS, shall start to initiate an immediate assignment procedure by sending the CHANNEL REQUEST message with correct establishment cause.
- 2) Subsequently after establishment of a MM connection, after MS sends its multislot class in CLASSMARK CHANGE message, the MS shall send a SETUP message with correct parameters.
- 3) Upon receipt of the ASSIGNMENT COMMAND message, the Mobile Station initiates a local end release of link layer connections, disconnects the physical channels, commands the switching to the assigned channels and initiates the establishment of lower layer connections (this includes the activation of the channels, their connection and the establishment of the data links). After the main signalling link is successfully established, the MS returns an ASSIGNMENT COMPLETE message, specifying cause "normal event", to the network on the main DCCH.
- 4) The call control entity of the Mobile Station in the "call initiated" state, in the "mobile originating call proceeding" state or in the "call delivered" state, shall, upon receipt of a CONNECT message:
 - 4.1) attach the user connection to the radio path;
 - 4.2) return a CONNECT ACKNOWLEDGE message;
 - 4.3) establish the RLP link.
- 5) MS sends User initiated service level upgrade with MODIFY message and after receipt of MODIFY COMPLETE message the MS enters the active state.
- 6) MS receives CONFIGURATION CHANGE COMMAND and answers to it by sending CONFIGURATION CHANGE ACKNOWLEDGE message.
- 7) Subsequently when the network initiates call clearing by sending a DISCONNECT message, the MS shall proceed to release the call by sending a RELEASE message.
- 8) On receipt of a CHANNEL RELEASE message, the MS shall disconnect the main signalling link.

NOTE: Requirements 5 and 6 are only applicable to Multislot Class 2 and above.

Reference

- Conformance requirement 1: 3GPP TS 02.07,
3GPP TS 04.08 / 3GPP TS 44.018 subclauses 3.3.1.1 and 9.1.8.
- Conformance requirement 2: 3GPP TS 04.08 / 3GPP TS 44.018 subclause 9.1.11,
3GPP TS 04.08 / 3GPP TS 24.008 subclause 9.3.23.
- Conformance requirement 3: 3GPP TS 04.08 / 3GPP TS 44.018 subclauses 3.4.3, 9.1.2 and 9.1.3.
- Conformance requirement 4: 3GPP TS 04.08 / 3GPP TS 24.008 subclauses 9.3.5 and 9.3.6,
3GPP TS 07.01 clause 8.
- Conformance requirement 5: 3GPP TS 04.08 / 3GPP TS 24.008 subclauses 9.3.13 and 9.3.14.
- Conformance requirement 6: 3GPP TS 04.08 / 3GPP TS 44.018 subclauses 9.1.12b and 9.1.12c.
- Conformance requirement 7: 3GPP TS 04.08 / 3GPP TS 24.008 subclauses 9.3.7, 9.3.18 and 5.4.4.2.2.
- Conformance requirement 8: 3GPP TS 04.08 / 3GPP TS 44.018 subclause 9.1.7.

26.13.3.2.2 Test purpose

- 1) To verify that the MS in MM state "idle, updated" and in RR idle mode with a TMSI assigned, when made to initiate a call for a selected teleservice/bearer service for HSCSD that is supported by the MS as declared in a

PICS/PIXIT statement, starts to initiate an immediate assignment procedure by sending the CHANNEL REQUEST message.

- 2) Multislot configuration with one TCH/F is allocated. To verify that subsequently after receipt of an IMMEDIATE ASSIGNMENT message allocating an SDCCH, after completion of establishment of the main signalling link, after having sent a CM SERVICE REQUEST message, after MS sends its multislot class in CLASSMARK CHANGE message, after having successfully performed the authentication and cipher mode setting procedures, after having sent a SETUP message, after having received of a CALL PROCEEDING message followed by an ALERTING message and an ASSIGNMENT COMMAND message allocating an appropriate TCH, the MS sends an ASSIGNMENT COMPLETE message.
- 3) To verify that subsequently, after the suite of actions specified in test purposes 1 and 2, the MS after receiving a CONNECT message returns a CONNECT ACKNOWLEDGE message.
- 4) To verify that subsequently the MS has attached the user connection to the radio path. This is verified by checking that the MS establishes the RLP link correctly and sends and receives correct RLP frames in each data block.
- 5) To verify that subsequently upon user requests User initiated service level upgrade, the MS sends MODIFY message and after receipt of MODIFY COMPLETE message the MS enters the active state.
- 6) To verify that subsequently, after receipt of a CONFIGURATION CHANGE COMMAND, after MS sends CONFIGURATION CHANGE ACKNOWLEDGE, MS through connects all bi-directional channel(s) in multislot configuration in both directions and all uni-directional channels in downlink direction. Multislot configuration is upgraded from the simplest case up to the maximum number of channels supported by MS in the HSCSD configuration. This is verified by checking that the MS sends and receives correct RLP frames in each data block.
- 7) To verify that subsequently upon the network initiating call clearing by sending a DISCONNECT message, the MS proceed to release the call with RELEASE.
- 8) To verify that subsequently, on receipt of a RELEASE COMPLETE message followed by a CHANNEL RELEASE message, the MS disconnects the main signalling link.

NOTE: Items 5 and 6 are only applicable to Multislot Class 2 and above.

26.13.3.2.3 Method of test

Initial conditions

Mobile Station:

- The MS is in MM-state "idle, updated" with valid TMSI and CKSN.

System Simulator:

- 1 cell, default parameters except:
 - Early classmark sending enabled in SI3 rest octets.

Specific PICS statements:

- Multislot class (TSPC_Type_Multislot_ClassX)

PIXIT statements:

- Way to display the called number

Foreseen final state of the MS

MS is in MM-state "idle, updated" with valid TMSI and CKSN.

Test procedure

The MS is made to initiate a HSCSD connection. The call is established with late assignment. MS enters the active state. Multislot configuration with one TCH/F is allocated. User initiated service level upgrade is successfully

performed. The SS sends CONFIGURATION CHANGE COMMAND message to MS and it reply's with CONFIGURATION CHANGE ACKNOWLEDGE message. This is done from simplest case up to the maximum number of channels supported by the MS in the HSCSD configuration (this is performed within highest multislot class that MS supports).

Maximum duration of test

7 minutes.

Expected Sequence

An MS supporting Multislot Class 1 need only perform steps 1..20 and 25..28.

Step	Direction	Message	Comments
1	MS		The "called number" is entered
2	MS		If supported, the MS must display the called number in the way defined in PICS/PIXIT.
3	MS -> SS	CHANNEL REQUEST	Establishment cause is "Originating call and TCH/F is needed, or originating call and the network does not set NECI bit to 1"
4	SS -> MS	IMMEDIATE ASSIGNMENT	
5	MS -> SS	CM SERVICE REQUEST	Message is contained in SABM
6	MS -> SS	CLASSMARK CHANGE	Multislot class
7	SS -> MS	AUTHENTICATION REQUEST	
8	MS -> SS	AUTHENTICATION RESPONSE	SRES specifies correct value.
9	SS -> MS	CIPHERING MODE COMMAND	SS starts deciphering after sending the message.
10	MS -> SS	CIPHERING MODE COMPLETE	Shall be sent enciphered. All following messages shall be sent enciphered.
11	SS		SS starts ciphering.
12	MS -> SS	SETUP	Non-transparent connection
13	SS -> MS	CALL PROCEEDING	
14	SS -> MS	ALERTING	
15	MS		
16	SS -> MS	ASSIGNMENT COMMAND	In multislot allocation only one timeslot is allocated.
17	MS -> SS	ASSIGNMENT COMPLETE	
18	SS -> MS	CONNECT	
19	MS -> SS	CONNECT ACKNOWLEDGE	
20	MS		The appropriate bearer channel is through connected in both directions. The RLP link establishment is initiated by the MS.
21	MS -> SS	MODIFY	User initiated service level upgrade is initiated
22	SS -> MS	MODIFY COMPLETE	
23	MS		MS enter the active state
24			Next three steps are performed as many times as used multislot class has different channel combinations. Timeslot allocation starts from simplest case and is upgraded up to the maximum that MS multislot class supports, one step at the time (within highest multislot class that the MS supports).
24A	SS -> MS	CONFIGURATION CHANGE COMMAND	Appropriate number of timeslots is selected.
24B	MS -> SS	CONFIGURATION CHANGE ACKNOWLEDGE	
24C	MS		TCH(s) shall be through connected in both directions
25	SS -> MS	DISCONNECT	
26	MS -> SS	RELEASE	
27	SS -> MS	RELEASE COMPLETE	
28	SS -> MS	CHANNEL RELEASE	The main signalling link is released

26.13.3.3 Multislot signalling / Structured procedures / MS originated call / early assignment / HSCSD / Transparent

26.13.3.3.1 Conformance requirement

- 1) An MS in MM state "idle, updated" and in RR idle mode, when made to initiate a call, if it provides a human interface, shall display the dialled number.
- 2) An MS in MM state "idle, updated" and in RR idle mode, when made to initiate a call for a selected teleservice/bearer service for HSCSD that is supported by the MS, starts to initiate the immediate assignment procedure by sending a CHANNEL REQUEST message with correct establishment cause.
- 3) Subsequently after establishment of a MM connection, after MS sends its multislot class in CLASSMARK CHANGE message, the MS shall send a SETUP message with correct parameters.
- 4) The call control entity of the Mobile Station in the "call initiated" state, in the "mobile originating call proceeding" state or in the "call delivered" state, shall, upon receipt of a CONNECT message:
 - 4.1) attach the user connection to the radio path;
 - 4.2) return a CONNECT ACKNOWLEDGE message.
 - 4.3) establish the TDS link.
- 5) Subsequently when the network initiates call clearing by sending a DISCONNECT message, the MS shall proceed to release the call by sending a RELEASE message.
- 6) On receipt of a CHANNEL RELEASE message, the MS shall disconnect the main signalling link.

Reference

- Conformance requirement 1: 3GPP TS 02.07.
- Conformance requirement 2: 3GPP TS 02.07,
3GPP TS 04.08 / 3GPP TS 44.018 subclauses 3.3.1.1 and 9.1.8.
- Conformance requirement 3: 3GPP TS 04.08 / 3GPP TS 44.018 subclause 9.1.11,
3GPP TS 04.08 / 3GPP TS 24.008 subclause 9.3.23.
- Conformance requirement 4: 3GPP TS 04.08 / 3GPP TS 24.008 subclauses 9.3.5 and 9.3.6,
3GPP TS 07.01 clause 8.
- Conformance requirement 5: 3GPP TS 04.08 / 3GPP TS 24.008 subclauses 9.3.7, 9.3.18 and 5.4.4.2.2.
- Conformance requirement 6: 3GPP TS 04.08 / 3GPP TS 44.018 subclause 9.1.7.

26.13.3.3.2 Test purpose

- 1) To verify that the MS in MM state "idle, updated" with a TMSI assigned, when made to initiate a call for a selected teleservice/bearer service for HSCSD that is supported by the MS as declared in a PICS/PIXIT statement, displays the dialled number in the way described in a PICS/PIXIT statement.
- 2) To verify that the MS in MM state "idle, updated" and in RR idle mode, with a TMSI assigned, when made to initiate a call for a selected teleservice/bearer service for HSCSD that is supported by the MS as declared in a PICS/PIXIT statement, starts to initiate an immediate assignment procedure by sending the CHANNEL REQUEST message with correct establishment cause.
- 3) To verify that subsequently after receipt of an IMMEDIATE ASSIGNMENT message allocating an SDCCH, after completion of establishment of the main signalling link, after having sent a CM SERVICE REQUEST message, after MS sends its multislot class in CLASSMARK CHANGE message, after having successfully performed the authentication and cipher mode setting procedures, the MS sends a SETUP message with correct parameters.
- 4) Multislot configuration with maximum number of channels supported by MS in a HSCSD configuration, is allocated. To verify that subsequently, after receipt of a CALL PROCEEDING message and of an ASSIGNMENT COMMAND message allocating an appropriate TCHs, after having completed the early

assignment procedure for all traffic channel in multislot configuration by replying with the ASSIGNMENT COMPLETE message, after receipt of an ALERTING message and a CONNECT message, the MS returns a CONNECT ACKNOWLEDGE message.

- 5) To verify that subsequently the MS has attached the user connection to the radio path. This is verified by checking that the MS synchronises correctly to the TCHs and sends and receives correct data frames in each data block.
- 6) To verify that subsequently upon the network initiating call clearing by sending a DISCONNECT message, the MS proceed to release the call with RELEASE.
- 7) To verify that subsequently, on receipt of a RELEASE COMPLETE message followed by a CHANNEL RELEASE message, the MS disconnects the main signalling link.

26.13.3.3.3 Method of test

Initial conditions

Mobile Station:

- The MS is in MM-state "idle, updated" with valid TMSI and CKSN.

System Simulator:

- 1 cell, default parameters except:
 - Early classmark sending enabled in SI3 rest octets.

Specific PICS statements:

- Multislot class (TSPC_Type_Multislot_ClassX)

PIXIT statements:

- Way to display the called number

Foreseen final state of the MS

MS is in MM-state "idle, updated" with valid TMSI and CKSN.

Test procedure

The MS is made to initiate a HSCSD connection. Maximum number of channels supported by the MS in a HSCSD configuration, is allocated. The call is established with early assignment. Having reached the active state, the call is cleared by the SS.

Maximum duration of test

7 minutes.

Expected sequence

Step	Direction	Message	Comments
1	MS		The "called number" is entered
2	MS		If supported, the MS must display the called number in the way defined in PICS/PIXIT.
3	MS -> SS	CHANNEL REQUEST	Establishment cause is "Originating call and TCH/F is needed, or originating call and the network does not set NECI bit to 1"
4	SS -> MS	IMMEDIATE ASSIGNMENT	
5	MS -> SS	CM SERVICE REQUEST	Message is contained in SABM
6	MS -> SS	CLASSMARK CHANGE	Multislot class
7	SS -> MS	AUTHENTICATION REQUEST	
8	MS -> SS	AUTHENTICATION RESPONSE	SRES specifies correct value.
9	SS -> MS	CIPHERING MODE COMMAND	SS starts deciphering after sending the message.
10	MS -> SS	CIPHERING MODE COMPLETE	Shall be sent enciphered. All following messages shall be sent enciphered.
11	SS		SS starts ciphering.
12	MS -> SS	SETUP	Transparent connection
13	SS -> MS	CALL PROCEEDING	
14	SS -> MS	ASSIGNMENT COMMAND	In multislot allocation maximum number of timeslots, that MS supports, is allocated.
15	MS -> SS	ASSIGNMENT COMPLETE	
16	SS -> MS	ALERTING	
17	MS		
18	SS -> MS	CONNECT	
19	MS -> SS	CONNECT ACKNOWLEDGE	
20	MS		The appropriate bearer channel is through connected in both directions
21	SS -> MS	DISCONNECT	
22	MS -> SS	RELEASE	
23	SS -> MS	RELEASE COMPLETE	
24	SS -> MS	CHANNEL RELEASE	The main signalling link is released

26.13.3.4 Multislot signalling / Structured procedures / MS Terminated call / early assignment / HSCSD / non-transparent

26.13.3.4.1 Conformance requirement

- 1) The MS is in MM state "idle, updated" and in RR idle mode when being paged by the network.
- 2) The MS sends CHANNEL REQUEST message to the network and after that it receives IMMEDIATE ASSIGNMENT message from the network
- 3) The MS sends PAGING RESPONSE message to network and after that MS sends its multislot class in CLASSMARK CHANGE message to the network.
- 4) The MS performs successfully authentication and cipher mode setting procedures.
- 5) The MS shall acknowledge the SETUP message with a CALL CONFIRMED message, if compatibility checking was successful, the MS is not busy, and the user does not refuse the call.
- 6) Upon receipt of the ASSIGNMENT COMMAND message the MS continues a mobile terminating call establishment with early establishment of the traffic channel(s)
 - 6.1) by replying to the ASSIGNMENT COMMAND with an ASSIGNMENT COMPLETE message; and
 - 6.2) if the MS supports immediate connect, by continuing the call establishment by through-connecting the traffic channel(s) in both directions, or if the MS does not support immediate connect, by sending an ALERTING message.
- 7) An MS indicates acceptance of a MT call by sending CONNECT.
- 8) After receiving the CONNECT ACKNOWLEDGE message from the network the MS shall establish the RLP link.

- 9) User requests User initiated service level upgrade. MS sends MODIFY message and after receipt of MODIFY COMPLETE message the MS enters the active state.
- 10) MS receives CONFIGURATION CHANGE COMMAND message and reply's to SS by sending CONFIGURATION CHANGE ACKNOWLEDGE message.
- 11) The MS initiates call clearing of an active call by sending a DISCONNECT message.
- 12) The MS in this phase of call release, upon receipt of a RELEASE message, shall return a RELEASE COMPLETE message.
- 13) Subsequently the MS, upon receipt of a CHANNEL RELEASE message, shall disconnect the main signalling link.

NOTE: Requirements 9 and 10 are only applicable to Multislot Class 2 and above.

Reference

- Conformance requirement 1: 3GPP TS 02.07.
- Conformance requirement 2: 3GPP TS 04.08 / 3GPP TS 44.018 subclauses 3.3.1.1 and 9.1.8.
- Conformance requirement 3: 3GPP TS 04.08 / 3GPP TS 44.018 subclauses 3.3.2.2, 9.1.25 and 9.1.11.
- Conformance requirement 4: 3GPP TS 04.08 / 3GPP TS 24.008 subclauses 4.3.2, 9.2.2 and 9.2.3, 3GPP TS 04.08 / 3GPP TS 44.018 subclauses 3.4.7, 9.1.9 and 9.1.10.
- Conformance requirement 5: 3GPP TS 04.08 / 3GPP TS 24.008, subclauses 9.3.23 and 9.3.2.
- Conformance requirement 6: 3GPP TS 04.08 / 3GPP TS 44.018 subclauses 9.1.2 and 9.1.3 3GPP TS 04.08 / 3GPP TS 24.008 subclauses 5.2.1.5 and 9.3.1.
- Conformance requirement 7: 3GPP TS 04.08 / 3GPP TS 24.008 subclause 9.3.5.
- Conformance requirement 8: 3GPP TS 04.08 / 3GPP TS 24.008 subclause 9.3.6, 3GPP TS 07.01 clause 8.
- Conformance requirement 9: 3GPP TS 04.08 / 3GPP TS 24.008 subclauses 9.3.13 and 9.3.14.
- Conformance requirement 10: 3GPP TS 04.08 / 3GPP TS 44.018 subclauses 9.1.12b and 9.1.12c.
- Conformance requirement 11: 3GPP TS 04.08 / 3GPP TS 24.008 subclause 9.3.7.
- Conformance requirement 12: 3GPP TS 04.08 / 3GPP TS 24.008 subclauses 9.3.18, 9.3.19 and 5.4.4.2.2.
- Conformance requirement 13: 3GPP TS 04.08 / 3GPP TS 44.018 subclause 9.1.7.

26.13.3.4.2 Test purpose

- 1) To verify that the MS in MM state "idle, updated" and in RR idle mode with a TMSI assigned, after being paged by the network on the correct paging subchannel, after initiating the immediate assignment procedure by sending the CHANNEL REQUEST message, after receipt of an IMMEDIATE ASSIGNMENT message allocating an SDCCH, after having sent a PAGING RESPONSE message on the allocated SDCCH, after having sent multislot class in CLASSMARK CHANGE message, after having performed successful authentication and cipher mode setting procedures, after receipt of a SETUP message not containing a signal information element, returns a CALL CONFIRMED message.
- 2) Multislot configuration with one TCH/F is allocated. To verify that subsequently, the SS sending an ASSIGNMENT COMMAND message, the MS successfully continues a mobile terminating call establishment with early assignment of traffic channel(s):
 - 2.1) by replying to the ASSIGNMENT COMMAND with an ASSIGNMENT COMPLETE message; and
 - 2.2) by continuing the call establishment by either sending a CONNECT message or sending an ALERTING message depending on PICS/PIXIT statement.
- 3) To verify that the MS generates an alerting indication if an ALERTING message had to be sent.

- 4) To verify that if an ALERTING had been sent, subsequently, when the user accepts the call (possibly internal action as declared in PICS/PIXIT statement), the MS returns a CONNECT message.
- 5) To verify that the MS after receipt of a CONNECT ACKNOWLEDGE message subsequently attaches the user connection to the radio path. This is verified by checking that the MS establishes the RLP link correctly and sends and receives correct RLP frames in each data block.
- 6) To verify that subsequently upon user requests User initiated service level upgrade, the MS send MODIFY message and after receipt of MODIFY COMPLETE message the MS enters the active state.
- 7) To verify that subsequently, after receipt of a CONFIGURATION CHANGE COMMAND, after MS sends CONFIGURATION CHANGE ACKNOWLEDGE, MS through connects all bi-directional channel(s) in multislot configuration in both directions and all uni-directional channels in downlink direction. Multislot configuration is upgraded from simplest case up to the maximum number of channels supported by MS in the HSCSD configuration. This is verified by checking that the MS sends and receives correct RLP frames in each data block.
- 8) To verify that subsequently, the MS can initiate call clearing by sending DISCONNECT message.
- 9) To verify that the MS in this phase of call release, upon receipt of a RELEASE message, returns a RELEASE COMPLETE message.
- 10) To verify that subsequently the MS, upon receipt of a CHANNEL RELEASE message, disconnects the main signalling link.

NOTE: Items 6 and 7 are only applicable to Multislot Class 2 and above.

26.13.3.4.3 Method of test

Initial conditions

Mobile Station:

- The MS is in MM-state "idle, updated" with valid TMSI and CKSN.

System Simulator:

- 1 cell, default parameters except:
 - Early classmark sending enabled in SI3 rest octets.

Specific PICS statements:

- Multislot class (TSPC_Type_Multislot_ClassX)
- Immediate connect supported for all circuit switched basic services. (TSPC_AddInfo_ImmConn)

PIXIT statements:

- Way to indicate alerting.
- Way to make the MS accept an incoming call after alerting.

Foreseen final state of the MS

MS is in MM-state "idle, updated" with valid TMSI and CKSN.

Test procedure

The MS is paged and the resulting HSCSD connection is established. Multislot configuration with one TCH/F is allocated. User service level upgrade is performed. MS enters the active state.

For Multislot Class 2 and above, a CONFIGURATION CHANGE COMMAND message is sent to MS and it reply's with CONFIGURATION CHANGE ACKNOWLEDGE message. This is done from simplest case up to the maximum number of channels supported by the MS in the HSCSD configuration (this is performed within highest multislot class that MS supports).

Maximum duration of test

7 minutes.

Expected sequence

An MS supporting Multislot Class 1 need only perform steps 1..20 and 25..29.

Step	Direction	Message	Comments
1	SS -> MS	PAGING REQUEST TYPE 1	Sent on the correct paging subchannel.
2	MS -> SS	CHANNEL REQUEST	Establishment cause indicates "answer to paging".
3	SS -> MS	IMMEDIATE ASSIGNMENT	
4	MS -> SS	PAGING RESPONSE	Message is contained in SABM.
5	MS -> SS	CLASSMARK CHANGE	Multislot class
6	SS -> MS	AUTHENTICATION REQUEST	
7	MS -> SS	AUTHENTICATION RESPONSE	SRES specifies correct value.
8	SS -> MS	CIPHERING MODE COMMAND	SS starts deciphering after sending the message.
9	MS -> SS	CIPHERING MODE COMPLETE	Shall be sent enciphered. All following messages shall be sent enciphered.
10	SS		SS starts ciphering.
11	SS -> MS	SETUP	Message does not contain the signal IE. Setup indicates non-transparent connection.
12	MS -> SS	CALL CONFIRMED	
			If the MS supports immediate connect then branch A applies. If the MS does not support immediate connect then branch B applies
A13	SS -> MS	ASSIGNMENT COMMAND	In multislot allocation only one timeslot is allocated.
A14	MS -> SS	ASSIGNMENT COMPLETE	
A15	MS -> SS	CONNECT	
B13	SS -> MS	ASSIGNMENT COMMAND	In multislot allocation only one timeslot is allocated.
B14	MS -> SS	ASSIGNMENT COMPLETE	
B15	MS -> SS	ALERTING	
B16	MS		An alerting indication as defined in a PICS/PIXIT statement is given by the MS
B17	MS		The MS is made to accept the call in the way described in a PICS/PIXIT statement
B18	MS -> SS	CONNECT	
19	SS -> MS	CONNECT ACKNOWLEDGE	
20	MS		TCH shall be through connected in both directions. The RLP link establishment is initiated by the MS.
21	MS -> SS	MODIFY	User initiated service level upgrade is initiated
22	SS -> MS	MODIFY COMPLETE	
23	MS		MS enters the active state
24			Next three steps are performed as many times as used multislot class has different channel combinations. Timeslot allocation starts from simplest case and is upgraded up to the maximum that MS multislot class supports, one step at the time (within the highest multislot class that MS supports).
24A	SS -> MS	CONFIGURATION CHANGE COMMAND	Appropriate number of timeslots is selected.
24B	MS -> SS	CONFIGURATION CHANGE ACKNOWLEDGE	
24C	MS		MS connects all bi-directional channels in both directions and all uni-directional channels in downlink direction.
25	MS		The MS is made to release the call.
26	MS -> SS	DISCONNECT	
27	SS -> MS	RELEASE	
28	MS -> SS	RELEASE COMPLETE	
29	SS -> MS	CHANNEL RELEASE	The main signalling link is released.

26.13.3.5 Multislot signalling / Structured procedures / MS Terminated call / early assignment / HSCSD / Transparent

26.13.3.5.1 Conformance requirement

- 1) The MS is in MM state "idle, updated" and in RR idle mode when being paged by the network.
- 2) The MS sends CHANNEL REQUEST message to the network and after that it receives IMMEDIATE ASSIGNMENT message from the network.
- 3) The MS sends PAGING RESPONSE message to network and after that MS sends its multislot class in CLASSMARK CHANGE message to the network.
- 4) The MS performs successfully authentication and cipher mode setting procedures.
- 5) The MS shall acknowledge the SETUP message with a CALL CONFIRMED message, if compatibility checking was successful, the MS is not busy, and the user does not refuse the call.
- 6) Upon receipt of the ASSIGNMENT COMMAND message the MS continues a mobile terminating call establishment with early establishment of the traffic channel(s)
 - 6.1) by replying to the ASSIGNMENT COMMAND with an ASSIGNMENT COMPLETE message; and
 - 6.2) if the MS supports immediate connect, by continuing the call establishment by through-connecting the traffic channel(s) in both directions, or if the MS does not support immediate connect, by sending an ALERTING message.
- 7) An MS indicates acceptance of a MT call by sending CONNECT.
- 8) The mobile station shall attach the user connection and establish the TDS link when receiving the CONNECT ACKNOWLEDGE message from the network.
- 9) MS correctly uses different ciphering bit streams on the different timeslots in a multislot configuration.
- 10) The MS initiates call clearing of an active call by sending a DISCONNECT message.
- 11) The MS in this phase of call release, upon receipt of a RELEASE message, shall return a RELEASE COMPLETE message.
- 12) Subsequently the MS, upon receipt of a CHANNEL RELEASE message, shall disconnect the main signalling link.

Reference

- Conformance requirement 1: 3GPP TS 02.07.
- Conformance requirement 2: 3GPP TS 04.08 / 3GPP TS 44.018 subclauses 3.3.1.1 and 9.1.8.
- Conformance requirement 3: 3GPP TS 04.08/ 3GPP TS 44.018 subclauses 3.3.2.2, 9.1.25 and 9.1.11.
- Conformance requirement 4: 3GPP TS 04.08 / 3GPP TS 24.008 subclauses 4.3.2, 9.2.2 and 9.2.3, 3GPP TS 04.08 / 3GPP TS 44.018 subclauses 3.4.7, 9.1.9 and 9.1.10.
- Conformance requirement 5: 3GPP TS 04.08 / 3GPP TS 24.008, subclauses 9.3.23 and 9.3.2.
- Conformance requirement 6: 3GPP TS 04.08/ 3GPP TS 44.018 subclauses 9.1.2 and 9.1.3.
- Conformance requirement 7: 3GPP TS 04.08 / 3GPP TS 24.008 subclause 9.3.5.
- Conformance requirement 8: 3GPP TS 04.08 / 3GPP TS 24.008 subclause 9.3.6, 3GPP TS 07.01 clause 8.
- Conformance requirement 9: 3GPP TS 03.34 subclause 5.2.5, 3GPP TS 04.08/ 3GPP TS 44.018 subclauses 3.4.7 and 9.1.9.
- Conformance requirement 10: 3GPP TS 04.08 / 3GPP TS 24.008 subclause 9.3.7.
- Conformance requirement 11: 3GPP TS 04.08 / 3GPP TS 24.008 subclause 9.3.19.
- Conformance requirement 12: 3GPP TS 04.08/ 3GPP TS 44.018 subclause 9.1.7.

26.13.3.5.2 Test purpose

- 1) To verify that the MS in MM state "idle, updated" and in RR idle mode with a TMSI assigned, after being paged by the network on the correct paging subchannel, after initiating the immediate assignment procedure by sending the CHANNEL REQUEST message, after receipt of an IMMEDIATE ASSIGNMENT message allocating an SDCCH, after having sent a PAGING RESPONSE message on the allocated SDCCH, after having sent multislot class in CLASMARK CHANGE message which has been explicitly accepted by the network, as indicated in the last reception in the accessed cell of the SYSTEM INFORMATION TYPE 3 message, after having performed successful authentication and cipher mode setting procedures, after receipt of a SETUP message not containing a signal information element, returns a CALL CONFIRMED message.
- 2) Multislot configuration with maximum number of channels supported by MS in a HSCSD configuration, is allocated. To verify that subsequently, the SS sending an ASSIGNMENT COMMAND message, the MS successfully continues a mobile terminating call establishment with early assignment of traffic channel(s):
 - 2.1) by replying to the ASSIGNMENT COMMAND with an ASSIGNMENT COMPLETE message; and
 - 2.2) by continuing the call establishment by either sending a CONNECT messages or sending an ALERTING message depending on PICS/PIXIT statement.
- 3) To verify that the MS generates an alerting indication if an ALERTING message had to be sent.
- 4) To verify that if an ALERTING had been sent, subsequently, when the user accepts the call (possibly internal action as declared in PICS/PIXIT statement), the MS returns a CONNECT message.
- 5) To verify that the MS after receipt of a CONNECT ACKNOWLEDGE message subsequently attaches the user connection to the radio path. This is verified by checking that the MS synchronises correctly to the TCHs and sends and receives correct data frames in each data block.
- 6) To verify that the MS correctly uses different ciphering bit streams on the different timeslots in a multislot configuration.
- 7) To verify that subsequently, the MS can initiate call clearing by sending a DISCONNECT message.
- 8) To verify that the MS in this phase of call release, upon receipt of a RELEASE message, returns a RELEASE COMPLETE message.

- 9) To verify that subsequently the MS, upon receipt of a CHANNEL RELEASE message, disconnects the main signalling link.

These test purposes are tested for all rates supported by the MS (full rate).

26.13.3.5.3 Method of test

Initial conditions

Mobile Station:

- The MS is in MM-state "idle, updated" with valid TMSI and CKSN.

System Simulator:

- 1 cell, default parameters except:
 - Early classmark sending enabled in SI3 rest octets.

Specific PICS statements:

- Multislot class (TSPC_Type_Multislot_ClassX)
- Immediate connect supported for all circuit switched basic services. (TSPC_AddInfo_ImmConn)

PIXIT statements:

- Way to indicate alerting.
- Way to make the MS accept an incoming call after alerting.

Foreseen final state of the MS

MS is in MM-state "idle, updated" with valid TMSI and CKSN.

Test procedure

The MS is paged and the resulting HSCSD connection is established. Maximum number of channels supported by the MS in a HSCSD configuration, is allocated. Having reached the active state, the MS is made to clear the call.

Maximum duration of test

7 minutes

Expected sequence

Step	Direction	Message	Comments
1	SS -> MS	PAGING REQUEST TYPE 1	Sent on the correct paging subchannel.
2	MS -> SS	CHANNEL REQUEST	Establishment cause indicates "answer to paging".
3	SS -> MS	IMMEDIATE ASSIGNMENT	
4	MS -> SS	PAGING RESPONSE	Message is contained in SABM.
5	MS -> SS	CLASSMARK CHANGE	Early classmark sending Multislot class indicated
6	SS -> MS	AUTHENTICATION REQUEST	
7	MS -> SS	AUTHENTICATION RESPONSE	SRES specifies correct value.
8	SS -> MS	CIPHERING MODE COMMAND	SS starts deciphering after sending the message.
9	MS -> SS	CIPHERING MODE COMPLETE	Shall be sent enciphered. All following messages shall be sent enciphered.
10	SS		SS starts ciphering.
11	SS -> MS	SETUP	Message does not contain the signal IE.
12	MS -> SS	CALL CONFIRMED	If the MS supports immediate connect then branch A applies. If the MS does not support immediate connect then branch B applies
A13	SS -> MS	ASSIGNMENT COMMAND	In multislot allocation maximum number of timeslots that MS supports, is allocated.
A14	MS -> SS	ASSIGNMENT COMPLETE	
A15	MS -> SS	CONNECT	
B13	SS -> MS	ASSIGNMENT COMMAND	In multislot allocation maximum number of timeslots that MS supports, is allocated.
B14	MS -> SS	ASSIGNMENT COMPLETE	sent on the TCH/Sm channel
B15	MS -> SS	ALERTING	
B16	MS		An alerting indication as defined in a PICS/PIXIT statement is given by the MS
B17	MS		The MS is made to accept the call in the way described in a PICS/PIXIT statement
B18	MS -> SS	CONNECT	
19	SS -> MS	CONNECT ACKNOWLEDGE	
20	MS		The appropriate bearer channel is through connected in both directions and the MS correctly uses different ciphering bit streams on the different timeslots.
21	MS		The MS is made to release the call.
22	MS -> SS	DISCONNECT	
23	SS -> MS	RELEASE	
24	MS -> SS	RELEASE COMPLETE	
25	SS -> MS	CHANNEL RELEASE	The main signalling link is released.

26.13.3.6 Default test conditions during layer 3 tests

During tests in subclause 26.13 the following default test conditions shall apply if not otherwise stated within the test description. In the table below, decimal values are normally used. Sometimes a hexadecimal value, indicated with a "H", or a binary value, indicated with a "B" is given.

	GSM 450	GSM 480
General signalling conditions for all carriers		
Ciphering	yes	yes
General RF-conditions for all carriers		
Frequency hopping mode	Non-hopping	Non-hopping
Propagation profile	Static	Static
Downlink Input Level	63 dB μ Vemf()	63 dB μ Vemf()
Uplink output power	Minimum according to MS power class	Minimum according to MS power class
Serving cell, BCCH/CCCH carrier		
Channel ARFCN	263	310
Alternative channels	274 or 276	321 or 323
Serving cell, Traffic channel, SDCCH		
Channel ARFCN	267	315
Alternative channels	275 or 279	322 or 326
Power Control Indicator	0	0
Neighbouring cells BCCH/CCCH carriers		
Channel ARFCN	261, 282, 284, 287, 290, 293	308, 329, 331, 334, 337, 340
Alternative channels	262, 283, 285, 288, 291, 292	309, 330, 332, 335, 338, 339
Input level	53 dB μ Vemf()	53 dB μ Vemf()
Network dependent parameters		
Cell identity	0001H	0001H
Mobile country code, MCC	001 (decimal)	001 (decimal)
Mobile network code, MNC	01 (decimal)	01 (decimal)
Location area code, LAC	0001H	0001H
Frequency List	Range 128	Range 128
BCCH allocation sequence number(BA_IND)	0	0
Cell Channel Descriptor	Range 128	Range 128
PLMN colour code, NCC	1	1
BS colour code, BCC	5	5
SMS Cell Broadcast DTX	not active	not active
IMSI Attach-detach	MS must not use	MS must not use
CCCH_CONF	MS shall not apply	MS shall not apply
BS_AG_BLK_RES	1 basic physical channel for CCCH combined with SDCCH	1 basic physical channel for CCCH combined with SDCCH
BS_PA_MFRMS	0 blocks reserved	0 blocks reserved
CELL_BAR_ACCESS	5 paging subgroups	5 paging subgroups
Call-re-establishment (RE)	(not barred)	(not barred)
Emergency Call allowed	(allowed)	(allowed)
Access Control Class (AC) (0..9, 11..15)	allowed	same
Network dependent timers		
Radio_Link_Time-out	8	8
T3212 Periodic updating in decihours	Infinite	Infinite
Access control parameters		
Max retrans	1	1
Tx-integer, nr. of slots	5	5
CELL_RESELECT_HYSTERESIS	12 dB	12 dB
MS_TXPWR_MAX_CCH	minimum level	minimum level
RXLEV_ACCESS_MIN	minimum	minimum
NECI	New establishment causes are not supported	same
ACS (ADDITIONAL RESELECTION PARAM IND)	No additional cell parameters are present in SI messages 7 and 8	same
P1 and C2 parameters	C2 parameters not present	same
POI and POWER OFFSET	N/A	N/A

	GSM 900	DCS 1 800
General signalling conditions for all carriers		
Ciphering	yes	yes
General RF-conditions for all carriers		
Frequency hopping mode	Non-hopping	Non-hopping
Propagation profile	Static	Static
Downlink Input Level	63 dB μ Vemf()	63 dB μ Vemf()
Uplink output power	Minimum according to MS power class	Minimum according to MS power class
Serving cell, BCCH/CCCH carrier		
Channel ARFCN	20	590
Alternative channels	40 or 60	690 or 830
Serving cell, Traffic channel, SDCCH		
Channel ARFCN	30	650
Alternative channels	50 or 70	750 or 850
Power Control Indicator	0	0
Neighbouring cells BCCH/CCCH carriers		
Channel ARFCN	10, 80, 90, 100, 110, 120	520, 600, 700, 780, 810, 870
Alternative channels	15, 85, 95, 105, 115, 122	530, 610, 710, 790, 820, 880
Input level	53 dB μ Vemf()	53 dB μ Vemf()
Network dependent parameters		
Cell identity	0001H	0001H
Mobile country code, MCC	001 (decimal)	001 (decimal)
Mobile network code, MNC	01 (decimal)	01 (decimal)
Location area code, LAC	0001H	0001H
Frequency List	Bit Map 0	Range 512
BCCH allocation sequence number(BA_IND)	0	0
Cell Channel Descriptor	Bit Map 0	Range 512
PLMN colour code, NCC	1	1
BS colour code, BCC	5	5
SMS Cell Broadcast DTX	not active	not active
IMSI Attach-detach	MS must not use	MS must not use
CCCH_CONF	MS shall not apply	MS shall not apply
BS_AG_BLK_RES	1 basic physical channel for CCCH combined with SDCCH	1 basic physical channel for CCCH combined with SDCCH
BS_PA_MFRMS	0 blocks reserved	0 blocks reserved
CELL_BAR_ACCESS	5 paging subgroups	5 paging subgroups
Call-re-establishment (RE)	(not barred)	(not barred)
Emergency Call allowed	(allowed)	(allowed)
Access Control Class (AC) (0..9, 11..15)	allowed	same
Network dependent timers		
Radio_Link_Time-out	8	8
T3212 Periodic updating in decihours	Infinite	Infinite
Access control parameters		
Max retrans	1	1
Tx-integer, nr. of slots	5	5
CELL_RESELECT_HYSTERESIS	12 dB	12 dB
MS_TXPWR_MAX_CCH	minimum level	minimum level
RXLEV_ACCESS_MIN	minimum	minimum
NECI	New establishment causes are not supported	same
ACS (ADDITIONAL RESELECTION PARAM IND)	No additional cell parameters are present in SI messages 7 and 8	same
P1 and C2 parameters	C2 parameters not present	same
POI and POWER OFFSET	N/A	POWER OFFSET Parameter not present.

	GSM 700	GSM 850
General signalling conditions for all carriers		
Ciphering	yes	yes
General RF-conditions for all carriers		
Frequency hopping mode	Non-hopping	Non-hopping
Propagation profile	Static	Static
Downlink Input Level	63 dB μ Vemf()	63 dB μ Vemf()
Uplink output power	Minimum according to MS power class	Minimum according to MS power class
Serving cell, BCCH/CCCH carrier		
Channel ARFCN	457	147
Alternative channels	477 or 497	167 or 187
Serving cell, Traffic channel, SDCCH		
Channel ARFCN	467	157
Alternative channels	470 or 475	177 or 207
Power Control Indicator	0	0
Neighbouring cells BCCH/CCCH carriers		
Channel ARFCN	447, 480, 499, 504, 507, 510	137, 207, 217, 227, 237, 247
Alternative channels	452, 465, 485, 495, 505, 509	142, 212, 222, 232, 242, 249
Input level	53 dB μ Vemf()	53 dB μ Vemf()
Network dependent parameters		
Cell identity	0001H	0001H
Mobile country code, MCC	001 (decimal)	001 (decimal)
Mobile network code, MNC	01 (decimal)	01 (decimal)
Location area code, LAC	0001H	0001H
Frequency List	128 Range	128 Range
BCCH allocation sequence number(BA_IND)	0	0
Cell Channel Descriptor	128 Range	128 Range
PLMN colour code, NCC	1	1
BS colour code, BCC	5	5
SMS Cell Broadcast DTX	not active	not active
IMSI Attach-detach	MS must not use	MS must not use
CCCH_CONF	MS shall not apply	MS shall not apply
BS_AG_BLK_RES	1 basic physical channel for CCCH combined with SDCCH	1 basic physical channel for CCCH combined with SDCCH
BS_PA_MFRMS	0 blocks reserved	0 blocks reserved
CELL_BAR_ACCESS	5 paging subgroups	5 paging subgroups
Call-re-establishment (RE)	(not barred)	(not barred)
Emergency Call allowed	(allowed)	(allowed)
Access Control Class (AC) (0..9, 11..15)	allowed	allowed
Network dependent timers		
Radio_Link_Time-out	8	8
T3212 Periodic updating in decihours	Infinite	Infinite
Access control parameters		
Max retrans	1	1
Tx-integer, nr. of slots	5	5
CELL_RESELECT_HYSTERESIS	12 dB	12 dB
MS_TXPWR_MAX_CCH	minimum level	minimum level
RXLEV_ACCESS_MIN	minimum	Minimum
NECI	New establishment causes are not supported	New establishment causes are not supported
ACS (ADDITIONAL RESELECTION PARAM IND)	No additional cell parameters are present in SI messages 7 and 8	No additional cell parameters are present in SI messages 7 and 8
C2 parameters	C2 parameters not present	C2 parameters not present
POWER OFFSET	N/A	N/A

These information's are provided by system information 1, 2, 3 and 4 messages.

The system information elements that are broadcast on the SACCH/M during the dedicated mode should be consistent with those sent on the BCCH when the MS was in idle mode prior to the channel request.

In addition, all fill paging messages sent on the paging sub-channels will have by default, their page mode set to NORMAL PAGING.

26.13.3.7 Default contents of messages

ALERTING (mobile station to network direction)

Information element	Value/remark
Facility	Not checked
User-user	Not checked
SS version	Not checked

ALERTING (network to mobile station direction)

Information element	Value/remark
Facility	Omitted
Progress indicator	Omitted
User-user	Omitted

ASSIGNMENT COMMAND

Information element	Value/remark
Description of the first channel	describes non-hopping Bm+ACCHs or Lm+ACCHs as appropriate for the test
Power Command	As in subclause 26.1.1
Frequency list	Omitted
Cell channel description	Omitted
Description of the multislot configuration	Appropriate for the teleservice selected for the test
Mode of the channel set X (1= X ≤8)	Appropriate for on bearer capability chosen for the test
Description of the second channel	Omitted
Mode of the second channel	Omitted
Mobile allocation	Omitted
Starting time	Omitted
Cipher mode setting	Omitted

ASSIGNMENT COMPLETE

Information element	Value/remark
RR cause	normal event

AUTHENTICATION REQUEST

Information element	Value/remark
Ciphering key sequence number	Arbitrary
Spare half octet	(spare bits)
Authentication parameter RAND	Arbitrary

AUTHENTICATION RESPONSE

Information element	Value/remark
Authentication parameter SRES	Correct for given SRES

CALL CONFIRMED

Information element	Value/remark
Repeat indicator	Omitted
Bearer capability 1	3GPP TS 04.08 / 3GPP TS 24.008 subclause 10.5.4.5
Bearer capability 2	Omitted
Cause	Omitted

CALL PROCEEDING

Information element	Value/remark
Repeat Indicator	Omitted
Bearer Capability 1	3GPP TS 04.08 / 3GPP TS 24.008 subclause 10.5.4.5
Bearer Capability 2	Omitted
Facility	Omitted
Progress indicator	Omitted

CHANNEL RELEASE

Information element	Value/remark
RR cause	Normal event

CHANNEL REQUEST

Information element	Value/remark
Establishment cause	Answer to paging (100)
Random reference	Arbitrary value of 5 bits length

CIPHERING MODE COMMAND

Information element	Value/remark
Cipher mode setting algorithm identifier	indicates a supported algorithm
SC	Start ciphering
Cipher response CR	IMEI must not be included

CIPHERING MODE COMPLETE

Information element	Value/remark
Mobile equipment identity	Omitted

CLASSMARK CHANGE

Information element	Value/remark
MS classmark	Multislot classmark value appropriate for the test
Additional mobile station classmark information	Omitted

CM SERVICE ACCEPT

Information element	Value/remark
none but message head	

CM SERVICE REQUEST

Information element	Value/remark
CM service type	Mobile originating call establishment or packet mode connection establishment
Ciphering key sequence number	CKSN of the MS
Mobile station classmark 2	as given by PICS.
Mobile identity	TMSI of MS

CONFIGURATION CHANGE COMMAND

Information element	Value/remark
Description of the multislot configuration Mode of channel set X (1=<X<=8)	Appropriate for the teleservice selected for the test Appropriate channel mode is selected

CONFIGURATION CHANGE REJECT

Information element	Value/remark
RR Cause	Cause = "Channel mode unacceptable"

CONNECT (network to mobile station direction)

Information element	Value/remark
Facility	Omitted
Progress indicator	Omitted
Connected number	Omitted
Connected subaddress	Omitted
User-user	Omitted

CONNECT (mobile station to network direction)

Information element	Value/remark
Facility	Not checked
Connected subaddress	Not checked
User-user	Not checked
SS version	Not checked

CONNECT ACKNOWLEDGE

Information element	Value/remark
none but message head	

DISCONNECT (network to mobile station direction)

Information element	Value/remark
Cause	
Coding standard	GSM
Location	User
Cause value	Normal clearing
Facility	Omitted
Progress indicator	Omitted
User-user	Omitted

DISCONNECT (mobile station to network direction)

Information element	Value/remark
Cause	
Coding standard	GSM
Location	User
Cause value	Normal clearing
Facility	Not checked
User-user	Not checked
SS version	Not checked

IMMEDIATE ASSIGNMENT

Information element	Value/remark
Page mode	Normal paging
Channel description	describes a valid SDCCH+SACCH in non-hopping mode
Request reference Random access information N51, N32, N26	As received from MS Corresponding to frame number of the CHANNEL REQUEST
Timing advance	Arbitrary
Mobile allocation	Empty (L=0)
Starting time	Omitted

MODIFY

Information element	Value/remark
Bearer capability Connection element (octet 6c)	Transparent for cases: 26.13.3.3, 26.13.3.5 Non-transparent for cases: 26.13.3.1, 26.13.3.2, 26.13.3.4
Low layer comp.	Appropriate for the basic service selected for the test
High layer comp.	Appropriate for the basic service selected for the test
Reverse call setup direction	Presence and value not checked

MODIFY COMPLETE

Information element	Value/remark
Bearer capability Connection element (octet 6c)	Transparent for cases: 26.13.3.3, 26.13.3.5 Non-transparent for cases: 26.13.3.1, 26.13.3.2, 26.13.3.4
Low layer comp.	Appropriate for the basic service selected for the test
High layer comp.	Appropriate for the basic service selected for the test
Reverse call setup direction	Presence and value not checked

MODIFY REJECT

Information element	Value/remark
Bearer capability Connection element (octet 6c)	Transparent for cases: 26.13.3.3, 26.13.3.5 Non-transparent for cases: 26.13.3.1, 26.13.3.2, 26.13.3.4
Cause	Cause = Channel Unacceptable
Low layer comp.	Appropriate for the basic service selected for the test
High layer comp.	Appropriate for the basic service selected for the test

PAGING REQUEST TYPE 1

Information element	Value/remark
L2 pseudo length	L2 pseudo length of the message
Page Mode	Normal Paging
Channels needed for Mobiles 1 and 2 channel (first)	any channel
channel (second)	any channel
Mobile identity 1	TMSI of MS under test
Mobile identity 2	Omitted
P1 rest octets	(spare octets)

PAGING RESPONSE

Information element	Value/remark
Ciphering key sequence number	Value assigned to MS in the initial conditions (spare bits) as given by PICS specifies TMSI of MS
Spare half octet	
Mobile station classmark 2	
Mobile identity	

RELEASE (network to mobile station direction)

Information element	Value/remark
Cause	Omitted
Second cause	Omitted
Facility	Omitted
User-user	Omitted

RELEASE (mobile station to network direction)

Information element	Value/remark
Cause	Not checked
Second cause	Not checked
Facility	Not checked
User-user	Not checked
SS version	Not checked

RELEASE COMPLETE (network to mobile station direction)

Information element	Value/remark
Cause	Omitted
Facility	Omitted
User-user	Omitted

RELEASE COMPLETE (mobile station to network direction)

Information element	Value/remark
Cause	Not checked
Facility	Not checked
User-user	Not checked
SS version	Not checked

SETUP (MS to SS)

Information element	Value/remark
BC Repeat indicator	Omitted
Bearer capability 1	Appropriate for the teleservice selected for the test
Bearer capability 2	Omitted
Facility	Not checked
Calling party subaddress	Not checked
Called party BCD number	As entered
Called party subaddress	Omitted
LLC repeat indicator	Omitted
Low layer compatibility I	Appropriate for teleservice selected for the test
Low layer compatibility II	Omitted
HLC repeat indicator	Omitted
High layer compatibility i	Appropriate for teleservice selected for the test
High layer compatibility ii	Omitted
User-user	Not checked
SS version	Not checked
CLIR suppression	Not checked
CC Capabilities	Not checked

SETUP (SS to MS)

Information element	Value/remark
BC repeat indicator	Omitted
Bearer capability 1	Appropriate for teleservice selected for the test
Bearer capability 2	Omitted
Facility	Omitted
Progress indicator	Omitted
Signal	Omitted
Calling party BCD number	Omitted
Calling party subaddress	Omitted
Called party BCD number	Omitted
Called party subaddress	Omitted
LLC repeat indicator	Omitted
Low layer compatibility I	Appropriate for the teleservice selected for the test
Low layer compatibility II	Omitted
HLC repeat indicator	Omitted
High layer compatibility i	Appropriate for the teleservice selected for the test
High layer compatibility ii	Omitted
User-user	Omitted

26.14 VGCS and VBS Tests

This clause applies to mobile station supporting Voice Group Call Service (TS 91) and/or Voice Broadcast Service (TS 92). The objective of this clause is to test VGCS/VBS concerned procedures. A specific VGCS/VBS SIM card is needed for testing. If a mobile supports both VGCS and VBS, the VGCS is selected for tests except when otherwise stated.

For VGCS and VBS, the following possible mobile station implementations exist:

- support of VBS listening;
- support of VBS originating;
- support of VGCS listening;
- support of VGCS talking. This always includes the implementation for VGCS listening;
- support of VGCS originating. This always includes the implementation for VGCS talking.

Apart from the explicitly mentioned combinations, all possible combinations are optional.

In this clause some L3 messages are sent in UI format to which no L2 acknowledgement/re-transmission mechanism is applied. It is important for overall tests in this clause to ensure that the radio conditions are ideal.

Tables 26.14.1 to 26.14.3 define generic procedures to bring the MS into an initial state. For establishment of group transmit mode table 26.14.1 is used if the MS supports VGCS talking. If an MS supporting VBS originating rather than VGCS, table 26.14.2 is used for establishment of a VBS call and to bring the MS into group transmit mode. For establishment of group receive mode table 26.14.3 is applied.

Unless indicated in individual sub-clauses, the default message contents in subclause 26.14.10 are applied.

Table 26.14.1: Establishment of group transmit mode for VGCS

Step	Direction	Message	Comments
0	MS		the MS is in idle mode
1	SS -> MS	NOTIFICATION/NCH	with a description of VGCS channel and a VGCS call reference active in the MS
2	MS		After the indication of the notification, MMI action to join the VGCS call
3	SS -> MS	UPLINK FREE	
4	MS		MMI action to request uplink access
5	MS -> SS	UPLINK ACCESS	
6	MS -> SS	UPLINK ACCESS	
7	SS -> MS	UPLINK BUSY	
8	SS -> MS	VGCS UPLINK GRANT	
9	MS -> SS	TALKER INDICATION	L2: SABM / UA

Table 26.14.2: Establishment of a VBS call

Step	Direction	Message	Comments
0	MS		the MS is in idle mode
1	MS		MMI action to initiate a VBS call with setup procedure.
2	MS -> SS	CHANNEL REQUEST	
3	SS -> MS	IMMEDIATE ASSIGNMENT	TCH/F, single RF channel GSM 450: 275, GSM 480: 322 GSM 900: 50, DCS 1 800: 750 PCS 1 900: 650 GSM710: 470 GSM 750: 470 T-GSM 810: 470 GSM 850: 177
4	MS -> SS	CM SERVICE REQUEST	VBS establishment, L2: SABM / UA
5	SS -> MS	CM SERVICE ACCEPT	
6	MS -> SS	SETUP	
7	SS -> MS	CHANNEL MODE MODIFY	
8	MS -> SS	CHANNEL MODE MODIFY ACKNOWLEDGE	
9	SS -> MS	CONNECT	

Table 26.14.3: Establishment of group receive mode for VGCS or VBS

Step	Direction	Message	Comments
0	MS		the MS is in idle mode
1	SS -> MS	NOTIFICATION/NCH	with a description of VGCS/VBS channel and a VGCS/VBS call reference active in the MS, for VGCS call the SF set to '1', for VBS call the SF set to '0'
2	MS		After the indication of the notification, MMI action to join the VGCS/VBS call

26.14.1 VGCS-VBS / Notification

26.14.1.1 VGCS-VBS / Notification / notification indication

26.14.1.1.1 Conformance requirement

1. Having received a NOTIFICATION/NCH or NOTIFICATION/FACCH which contains group call reference(s) that are active in the MS, the MS shall correctly indicate the notified group/broadcast call reference(s).
2. On request to respond to the call notification, the MS shall join the VGCS/VBS call on the correct channel if a description for the VGCS/VBS channel is included.
3. On request to respond to the call notification, the MS shall establish an RR connection to respond the notification if no description for the VGCS/VBS channel is included.
4. The MS shall ignore any NOTIFICATION/NCH or NOTIFICATION/FACCH which contains group call reference(s) that are not active in the MS.

Reference(s)

3GPP TS 04.08 / 3GPP TS 44.018 subclauses 3.3.3.1 and 3.3.3.2.

3GPP TS 03.68 subclauses 4.1, 11.3.1.3a and 11.3.1.3b.

3GPP TS 03.69 subclauses 4.1, 11.3.1.3a and 11.3.1.3b.

26.14.1.1.2 Test purpose

1. To verify that the MS indicates correctly the notified group/broadcast call reference(s) after receiving a NOTIFICATION/NCH or NOTIFICATION/FACCH message which contains group call reference(s) that are active in the MS.
2. To verify that the MS, on request to respond to a call notification, joins the VGCS/VBS call on the correct channel if a description for the VGCS/VBS channel is included in the NOTIFICATION message.
3. To verify that the MS, on request to respond to a call notification, establishes an RR connection to respond to the notification if no description for the VGCS/VBS channel is included in the NOTIFICATION message.
4. To verify that the MS ignores any NOTIFICATION/NCH or NOTIFICATION/FACCH which contains group call reference(s) that are not active in the MS.
5. To verify that there is no uplink transmission from the MS on TCH after the MS join the call.

26.14.1.1.3 Method of test

Initial Conditions

System Simulator:

1 cell default parameters for ASCII testing

Mobile Station:

The MS is in MM-state "idle, updated". No automatic answering is configured.

Specific PICS statements:

- Support VGCS talking (TSPC_Addinfo_VGCS_Talking)
- Support VBS originating (TSPC_Addinfo_VBS_Originating)

PIXIT Statements:

- Way to configure VGCS or VBS.
- Way to indicate a call notification.
- Way to accept a VGCS or VBS.
- Way to verify the downlink speech path.

Foreseen Final State of the MS

"Idle, updated".

Test Procedure

The MS is in idle mode, the SS sends NOTIFICATION/NCH containing VGCS/VBS channel description and VGCS/VBS call reference not active in the MS. It is checked that the MS ignores the message. The SS sends NOTIFICATION/NCH containing VGCS/VBS channel description and VGCS/VBS call reference active in the MS ("good reference"). It is checked whether the MS indicates correctly the notified group call reference(s) and joins VGCS/VBS call on request of responding to the notification. The group call is terminated. The SS sends NOTIFICATION/NCH which contains the "good reference" but no VGCS/VBS channel description. It is checked that the MS indicates correctly the notified group call reference(s) and establishes a RR connection to respond to the notification on request of responding to the call, then joins the call. The group call is terminated.

The MS is brought to group receive mode or CC state U10 or dedicated mode with signalling connection or group transmit mode (for k=1, 2, 3, 4 respectively), the SS sends NOTIFICATION/FACCH containing the "good reference" but no VGCS/VBS channel description. It is checked that the MS gives correct notified group call reference(s) and on request of responding to the call, establishes a RR connection to respond to the notification and joins the call. The call is terminated.

Finally, the MS is brought to group receive mode or CC state U10 or dedicated mode with signalling connection or group transmit mode (for k=1, 2, 3, 4 respectively), the SS sends NOTIFICATION/FACCH containing the "good reference" and VGCS/VBS channel description. It is checked the MS indicates correctly the notified group call reference(s) and joins VGCS/VBS call on request of responding to the notification. The group call is terminated.

Maximum Duration of Test

10 minutes excluding operator operations.

Expected Sequence

Test steps 20 to 50 are executed for k=1, 2, 3, 4 conditionally. If the MS does not support CC state U10, test steps 20 to 50 are not executed for k=2. If the MS does not support VGCS talking or VBS originating, test steps 20 to 50 are not executed for k=4.

Step	Direction	Message	Comments
0	MS		the MS is in idle mode
1	SS -> MS	NOTIFICATION/NCH	with a description of VGCS/VBS channel and a VGCS/VBS call reference not active in the MS
2	MS		check that the MS ignores the notification and there is no uplink transmission on that channel for 10 s.
3	SS -> MS	NOTIFICATION/NCH	with a description of VGCS/VBS channel and a VGCS/VBS call reference active in the MS
4	MS		check that the MS gives an indication containing the notified group call reference
5	MS		MMI action to join the VGCS/VBS call
6	MS		check that the TCH in downlink is through connected and there is no uplink transmission on that channel for 10 s.
7	SS		stop sending NOTIFICATION/NCH
8	SS -> MS	CHANNEL RELEASE	UI format, return to the idle updated state
9	SS		wait for the MS returning to idle updated mode and listening to NCH again
10	SS -> MS	NOTIFICATION/NCH	with a VGCS/VBS call reference active in the MS but different from step 3 and no VGCS/VBS channel description
11	MS		MMI action to join the VGCS/VBS call
12	MS -> SS	CHANNEL REQUEST	
13	SS -> MS	IMMEDIATE ASSIGNMENT	
14	MS -> SS	NOTIFICATION RESPONSE	L2: SABM / UA
15	SS -> MS	CHANNEL RELEASE	release the dedicated channel with a group channel description. The MS releases L2 multiple frame link L2:DISC/UA.
16	MS		check that the TCH in downlink is through connected and there is no uplink transmission on that channel for 10 s.
17	SS		stop sending NOTIFICATION/NCH
18	SS -> MS	CHANNEL RELEASE	UI format, to return to idle updated state
19			wait 5s.
A20 B20 C20 D20	MS		for k=1, the MS is brought into group receive mode for k=2, the MS is brought into CC state U10 for k=3, the MS is brought into dedicated mode with a signalling connection for k=4, the MS is brought into group transmit mode
21	SS -> MS	NOTIFICATION/FACCH	with a VGCS/VBS call reference not active in the MS, but no VGCS/VBS channel description
22	MS		check that the MS ignores the notification and there is no uplink transmission on that channel for 10 s.
23	SS -> MS	NOTIFICATION/FACCH	with a VGCS/VBS call reference active in the MS, but no VGCS/VBS channel description
24	MS		check the MS's indication of the notified VGCS/VBS call reference
25	MS		MMI action to join the VGCS/VBS call

Step	Direction	Message	Comments
A26			for k=1, no signalling needed
B26	MS -> SS	DISCONNECT	for k=2, release the old call and the channel The MS releases L2 multiple frame link L2:DISC/UA.
B27	SS -> MS	RELEASE	
B28	MS -> SS	RELEASE COMPLETE	
B29	SS -> MS	CHANNEL RELEASE	
C26	MS -> SS	DISC/UA	for k=3, release the original dedicated. The MS releases L2 multiple frame link L2:DISC/UA.
D26	MS -> SS	UPLINK RELEASE	for k=4, release original uplink - for VGCS only UI format, to return to idle updated state - for VGCS only for VBS call only for VBS call only The MS releases L2 multiple frame link L2:DISC/UA -for VBS call only
D27	SS -> MS	CHANNEL RELEASE	
D28	MS -> SS	TERMINATION REQUEST	
D29	SS -> MS	TERMINATION	
D30	SS -> MS	CHANNEL RELEASE	
31	MS -> SS	CHANNEL REQUEST	L2: SABM / UA with group channel description. The MS releases L2 multiple frame link L2:DISC/UA. check that the TCH in downlink is through connected and there is no uplink transmission on that channel for 10 s. if the MS supports VGCS talking stop sending NOTIFICATION/NCH UI format, return to the idle updated state wait for the MS returning to idle updated mode
32	SS -> MS	IMMEDIATE ASSIGNMENT	
33	MS -> SS	NOTIFICATION RESPONSE	
34	SS -> MS	CHANNEL RELEASE	
35	MS		
36	SS		
37	SS -> MS	CHANNEL RELEASE	
38			
A	MS		for k=1, the MS is brought into group receive mode for k=2, the MS is brought into CC state U10 for k=3, the MS is brought into dedicated mode with a signalling connection for k=4, the MS is brought into group transmit mode with VGCS/VBS channel description and VGCS/VBS call reference active in the MS check the indication of the notified VGCS/VBS call reference MMI action to join the VGCS/VBS call
B40			
C40			
D40			
41	SS -> MS	NOTIFICATION/FACCH	
42	MS		
43	MS		
A44			for k=1, no signalling needed
B44	MS -> SS	DISCONNECT	for k=2, release the old call and the channel The MS releases L2 multiple frame link L2:DISC/UA.
B45	SS -> MS	RELEASE	
B46	MS -> SS	RELEASE COMPLETE	
B47	SS -> MS	CHANNEL RELEASE	
C44	MS -> SS	DISC/UA	for k=3, release the original dedicated channel. The MS releases L2 multiple frame link L2:DISC/UA.
D44	MS -> SS	UPLINK RELEASE	for k=4, release original uplink - for VGCS call only UI format, to return to idle updated state - for VGCS only for VBS call only for VBS call only The MS releases L2 multiple frame link L2:DISC/UA -for VBS call only
D45	SS -> MS	CHANNEL RELEASE	
D46	MS -> SS	TERMINATION REQUEST	
D47	SS -> MS	TERMINATION	
D48	SS -> MS	CHANNEL RELEASE	
49	MS		check that the TCH in downlink is through connected and there is no uplink transmission on that channel for 10 s. stop sending NOTIFICATION/NCH UI format, to return to the idle updated state
50	SS		
51	SS -> MS	CHANNEL RELEASE	

26.14.1.2 VGCS-VBS / Notification / NCH position

26.14.1.2.1 Conformance requirement

The MS shall recognise correctly different NCH positions and blocks if supporting VGCS or VBS.

In the case the CCCH configuration is not compatible with the NCH position, the MS shall behave as if the NCH position field was not present.

Reference(s)

3GPP TS 05.02, subclauses 6.5.1 and 6.5.5, clause 7 and table 3.

3GPP TS 04.08 / 3GPP TS 44.018, subclause 10.5.2.32.

26.14.1.2.2 Test purpose

To verify that the MS recognises correctly different NCH positions of first block and number of blocks.

To verify that the MS behaves as if the NCH position field was not present when the CCCH configuration is not compatible with the NCH position.

26.14.1.2.3 Method of test

Initial Conditions

System Simulator:

1 cell, BS_AG_BLK_RES = 5, CCCH non-combined.

Mobile Station:

The MS is in MM-state "idle, updated". No automatic answering is configured.

Specific PICS statements:

-

PIXIT Statements:

- Way to configure VGCS or VBS.
- Way to indicate a call notification.

Foreseen Final State of the MS

"Idle, updated".

Test Procedure

The MS is in idle mode, the SS sends SI 1 containing the 1st NCH block number = 3 (B3) and No. of blocks = 1. After the MS decodes the SI 1, the SS sends on the block B1 NOTIFICATION/NCH containing VGCS/VBS channel description and VGCS/VBS call reference active in the MS. It is checked that the MS ignores the notification. The SS stops sending NOTIFICATION/NCH on block B1, but sends on block B3 containing VGCS/VBS channel description and VGCS/VBS call reference active in the MS. It is checked that the MS indicates correctly the notified group call reference(s).

The SS stops sending NOTIFICATION/NCH on block B3 and changes SI 1 containing The 1st NCH block number = 1 and No. of blocks = 2. After the MS decodes the SI the SS sends NOTIFICATION/NCH on the block B2 containing VGCS/VBS channel description and VGCS/VBS call reference active in the MS. It is checked that the MS indicates correctly the notified group call reference(s).

The SS stops sending NOTIFICATION/NCH on block B2 and changes the CCCH configuration with combined SDCCH, BS_AG_BLK_RES = 1. Wait 30 s. and then sends NOTIFICATION/NCH on the block B2 containing VGCS/VBS channel description and VGCS/VBS call reference active in the MS. It is checked that the MS ignores the notification.

Maximum Duration of Test

5 minutes.

Expected Sequence

Step	Direction	Message	Comments
0	MS		the MS is in idle mode
1	SS -> MS	SYSTEM INFORMATION TYPE1	containing The 1st NCH block number = 3 and No. of blocks = 1
2	SS		wait for 5 s.
3	SS -> MS	NOTIFICATION/NCH	sent on block B1, containing a VGCS/VBS channel description and a VGCS/VBS call reference active in the MS
4	MS		check that the MS ignores the notification
5	SS		stop sending NOTIFICATION/NCH on block 1
6	SS -> MS	NOTIFICATION/NCH	sent on block B3, containing a VGCS/VBS channel description and a VGCS/VBS call reference active in the MS
7	MS		check that the MS indicates the notification to user
8	MS		user action to reject the group/broadcast call
10	SS		stop sending NOTIFICATION/NCH on block 3
11	SS -> MS	SYSTEM INFORMATION TYPE 1	containing The 1st NCH block number = 1 and No. of blocks = 2
12	SS		wait for 30 s.
13	SS -> MS	NOTIFICATION/NCH	sent on block B2, containing a VGCS/VBS channel description and a VGCS/VBS call reference active in the MS
14	MS		check that the MS indicates the notification to user
15	MS		user action to reject the group/broadcast call
20	SS		change CCCH with combined SDCCH, BS_AG_BLK_RES = 1 and stop sending NOTIFICATION/NCH on block B2
21	SS -> MS	SYSTEM INFORMATION TYPE 1	containing The 1st NCH block number = 0 and No. of block = 1
22	SS		wait for 30 s.
23	SS -> MS	NOTIFICATION/NCH	sent on block B2, containing a VGCS/VBS channel description and a VGCS/VBS call reference active in the MS
24	MS		check that the MS ignores the notification

26.14.1.3 VGCS-VBS / Notification / Reduced NCH monitoring

26.14.1.3.1 Conformance requirement

1. When the mobile station in idle mode enters a cell and deduces from the BCCH that an NCH is present, it shall read the NCH until it has received at least two messages on the NCH indicating NLN, with the two last received NLN being identical. Then it may stop reading the NCH until it receives on the PCH an NLN(PCH) different from the last previously received NLN.
2. If the reduced NCH monitoring mechanism is used on the NCH, when the MS in group receive mode or group transmit mode enters a cell, it should read the NCH until it has received at least two messages on the NCH indicating NLN, with the two last received NLN being identical. Then it should stop reading the NCH until it receives on the SACCH an NLN(SACCH) different from the last previously received NLN.

3. A change of the NLN status field indicates a change of information on the NCH which is not related to new calls.

Reference(s)

3GPP TS 04.08 / 3GPP TS 44.018 subclause 3.3.3.3.

3GPP TS 04.08 / 3GPP TS 44.018 subclause 3.4.15.1.2.4.1.

26.14.1.3.2 Test purpose

To verify that:

1. when the MS in idle mode on a cell where a reduced monitoring is activated, it reads the NCH until it has received at least two NLN (NCH) being identical. Then it stops reading the NCH until it receives a PAGING REQUEST message of any TYPE containing an NLN (PCH) different from the last previously received NLN.
2. after the MS entered in group receive mode or group transmit mode it continues the reduced monitoring until it receives SI6 containing an NLN (SACCH) different from the last previously received NLN (SACCH).
3. when the MS in group receive mode or group transmit mode enters a new cell, it reads the NCH until it has received at least two messages on the NCH indicating NLN, with the two last received NLN being identical. Then it stops reading the NCH until it receives SI6 on the SACCH an NLN(SACCH) different from the last previously received NLN.
4. the MS understands the change of the NLN status field.

26.14.1.3.3 Method of test

Initial Conditions

System Simulator:

2 cells with default parameters for ASCII testing, same LAI.

The values specified in Table 26.14.1.3 override the values in default contents of SI messages in subclauses 26.6.14. and 26.6.15.

Table 26.14.1.3: Default values of the system information fields

Parameter	3GPP TS 04.08 / 3GPP TS 44.018 reference	Abbr.	Normal Setting
CELL_BAR_QUALIFY	10.5.2.35	CBQ	0
CELL_RESELECT_OFFSET	10.5.2.35	CRO	0
TEMPORARY_OFFSET	10.5.2.35	TO	0
PENALTY_TIME	10.5.2.35	PT	31
Power Offset	10.5.2.35	PO	0

Mobile Station:

The MS is in MM-state "idle, updated" with a TMSI allocated on cell A. No automatic answering configured.

Specific PICS statements:

- Support VGCS talking (TSPC_Addinfo_VGCS_Talking)
- Support VBS originating. (TSPC_Addinfo_VBS_Originating)

PIXIT Statements:

- Way to configure VGCS or VBS.
- Way to indicate uplink granted/rejected.
- Way to accept a VGCS or VBS.

- Way to request uplink.

Foreseen Final State of the MS

"Idle, updated" on cell B.

Test Procedure

The MS is in idle mode on cell A. The SS sends NOTIFICATION/NCH with NLN (value is '00'B) but not addressing the MS on cell A. After at least 2 such messages have been received by the MS, the SS sends another NLN value ('01'B) in the NOTIFICATION/NCH message which contains call reference active in the MS and VGCS/VBS channel description. It is checked that the MS does not indicate the notification. The SS sends PAGING REQUEST TYPE1 message on the MS's paging sub-channel on cell A with NLN(PCH) containing value '01'B. It is checked that the MS indicates the notification to the user. The MS rejects the VGCS/VBS call on request from MMI. The same procedure is repeated once except SS sends PAGING REQUEST TYPE2 message instead of PAGING REQUEST TYPE1. The NLN value is set to '10'B.

Change the RF levels of cell A and cell B so that the MS re-selects cell B. The same test procedure as described above is repeated once except the SS sends PAGING REQUEST TYPE 3 message on the MS's paging sub-channel on cell B. The NLN value is set to '11'B. The MS joins the VGCS/VBS call on request from MMI and is in group receive mode on cell B.

On cell A the SS sends NOTIFICATION/NCH containing VGCS/VBS channel description, the same call reference and NLN value as those of cell B. Adjust the RF levels of cell A and cell B so that cell B keeps suitable but the MS re-selects cell A. The MS is still in group receive mode. After the MS has consecutively received at least two identical NLN (NCH) the SS sends NOTIFICATION/NCH containing an NLN valued '01'B, VGCS/VBS channel description and call reference active in the MS. It is checked that the MS does not indicate the notification. The SS changes NLN value to '01'B in SI 6 message. It is checked that the MS indicates the notification to the user. The call is rejected. The SS changes NLN status value to '1'B in SI 6 message. It is checked that the MS does not indicate any new notification to the user.

The MS is brought into group transmit mode and handed over to cell B. After at least two NOTIFICATION/NCH messages received on cell B, the SS sends an another NOTIFICATION/NCH message with NLN value ('00'B) and addressing the MS on cell B. It is checked that the MS does not indicate the notification. The SS changes NLN value to '00'B in SI 6 message. It is checked that the MS indicates the notification to the user.

Maximum Duration of Test

10 minutes

Expected Sequence

Test steps 0 to 8 are executed for k=1, 2, 3. When finished the test then goes to step 9. If the MS does not support VGCS talking, test step 18 to 44 are not executed.

Step	Direction	Message	Comments
A0, B0	MS		for k=1, 2 the MS is in idle mode on cell A. The following messages are received and sent on cell A.
C0			for k=3, adjust the power level of cell A to 32 dB μ V emf() so that the MS re-selects cell B. The following messages are sent and received on cell B.
1	SS -> MS	NOTIFICATION/NCH	with an initial NLN, a channel description and a call reference not addressing MS.
2	SS		wait 1 second, ensuring that the MS has consecutively received at least two identical NLN (NCH).
3	SS -> MS	NOTIFICATION/NCH	with an NLN different to step 1, a call reference active in the MS. For k= 1, 2, 3, each NLN is different.
A5 B5 C5	SS -> MS SS -> MS SS -> MS	PAGING REQUEST TYPE 1 PAGING REQUEST TYPE 2 PAGING REQUEST TYPE 3	for k=1, with the NLN (PCH) same as step 3 for k=2, with the NLN (PCH) same as step 3. for k=3, with the NLN (PCH) same as step 3.

Step	Direction	Message	Comments
6 7	SS MS		wait 1 s. check that the MS indicates the notification sent in step 5.
A8, B8 C8			MMI action to reject the VGCS/VBS call. The MS remains in idle mode on cell A. MMI action to join the VGCS/VBS call. The MS is in group receive mode on cell B.
9 10	SS -> MS SS	NOTIFICATION/NCH	sent on cell A with a channel description, the same NLN and the call reference in step C5. adjust the power levels of cell A to 63 dB μ V emf() and cell B to 45 dB μ V emf() so that the MS re-selects cell A. Wait 30 s. The following messages are sent and received on cell A.
12 14 15	SS -> MS SS -> MS MS	NOTIFICATION/NCH SYSTEM INFORMATION TYPE 6	with a different NLN from step C5, a valid channel description, a call reference active in the MS . with the NLN(SACCH) same as step 12. wait 5 s. and check that the MS indicates the notification, MMI action to reject the new call.
18 19 20 21 22 23 24 25 26 27 28 29	SS -> MS MS MS -> SS MS -> SS SS -> MS SS -> MS MS -> SS MS SS -> MS MS	UPLINK FREE UPLINK ACCESS UPLINK ACCESS UPLINK BUSY VGCS UPLINK GRANT TALKER INDICATION NOTIFICATION/NCH SYSTEM INFORMATION TYPE 6	MMI action to request uplink access of the call. Reference to step 21. L2: SABM / UA check that the TCH is through connected and the MS gives indication to the user. with a different NLN from step 12, a valid channel description, a call reference active in the MS. check that the MS does not indicate the notification. with the NLN (SACCH) same as step 26. wait 5 s. and check that the MS indicates the notification, MMI action to reject the new call.
30 31 32 33 34 35 36 37 38 39 41	SS -> MS MS -> SS MS -> SS MS -> SS MS -> SS MS -> MS SS -> MS SS -> MS MS SS -> MS SS -> MS	HANDOVER COMMAND HANDOVER ACCESS HANDOVER ACCESS HANDOVER ACCESS HANDOVER ACCESS SABM UA HANDOVER COMPLETE NOTIFICATION/NCH SYSTEM INFORMATION TYPE 6	handover to cell B. The following messages are sent and received on cell B. Before completion of the 4 access bursts on the new DCCH, additional access bursts may also be sent on the SACCH Sent without information field. wait 1 second, for the MS receiving consecutively at least two identical NLN (NCH). with an NLN different from those in step 12 and 26, a valid channel description, a call reference active in the MS. with the NLN(SACCH) same as step 39.

Step	Direction	Message	Comments
42	MS		check that the MS indicates the notification. MMI action to reject the new call.
43	SS -> MS	UPLINK RELEASE	
44	SS -> MS	CHANNEL RELEASE	The MS returns to idle mode. L2:DISC/UA.

Specific Message Contents

NOTIFICATION/NCH

Information Element	value/remark
NT/N Rest Octets Reduced monitoring indication NLN (NCH)	'1'B, reduced monitoring as specified in the test step

PAGING REQUEST TYPE 1

Information Element	value/remark
Mobile Identity 1 P1 Rest Octets - NLN (PCH) indication - NLN (PCH) - NLN status - Priority 1 indication - Priority 2 indication - Group call information indication - Spare padding	TMSI not allocated to MS H as specified in the test step '0'B L L L logic L

PAGING REQUEST TYPE 2

Information Element	value/remark
Mobile Identity 1 P2 Rest Octets - CN3 indication - NLN (PCH) indication - NLN (PCH) - NLN status - Priority 1 indication - Priority 2 indication - Priority 3 indication - Spare padding	TMSI not allocated to MS L H as specified in the test step '0'B L L L logic L

PAGING REQUEST TYPE 3

Information Element	value/remark
Mobile Identity 1 P3 Rest Octets - CN3 indication - NLN (PCH) indication - NLN (PCH) - Priority 1 indication - Priority 2 indication - Priority 3 indication - Priority 4 indication - NLN status indication - NLN status - Spare padding	TMSI not allocated to MS L H as specified in the test step L L L L L H '0'B logic L

SYSTEM INFORMATION TYPE 6

Information Element	value/remark
S6 Rest Octets	7 octets length
- PCH/NCH info indication	H
- PCH/NCH info	
- paging channel restructuring	0 (not restructured)
- NLN (SACCH)	as specified in the test step
- Call priority indication	'0'B, priority not included
- NLN status	'0'B
- VGCS/VBS options	
- in-band notifications	H
- in-band paging	H
- Spare padding	logic L

HANDOVER COMMAND

Information Element	Value/remark
As default message contents, except:	
Channel Description	
- Channel type	TCH/F + ACCHs
- Timeslot number	arbitrary but not zero
- Training sequence code	chosen arbitrarily
- Hopping	Single RF channel
- ARFCN	GSM 900: 60 DCS 1 800: 830 PCS 1 900:730 GSM 450: 276 GSM 480: 323 GSM 710: 497 GSM 750: 497 T-GSM 810: 497 GSM 850: 187
Synchronisation Indication	Synchronised
VGCS target mode indication	Group transmit mode

26.14.1.4 VGCS-VBS / Notification / Limited Service state

26.14.1.4.1 Conformance requirement

In state MM IDLE and service state LIMITED SERVICE:

1. The MS shall indicate notifications to the GCC or BCC sub-layer for which a channel description has been received in the notification by the RR sub-layer.
2. The MS shall reject requests of the GCC or BCC sub-layer to respond to notifications for which no channel description has been received in the notification by the RR sub-layer.
3. The MS shall request the RR sub-layer to receive a voice group or broadcast call if the GCC or BCC sublayer requests the reception of a voice group or broadcast call for which a channel description has been received in the notification by the RR sublayer and then go to the service state RECEIVING GROUP CALL (LIMITED SERVICE).
4. The MS shall reject any request of establishing a group call.

Reference(s)

3GPP TS 04.08 / 3GPP TS 24.008 subclause 4.2.2.3.

26.14.1.4.2 Test purpose

To verify that while in state MM IDLE and service state LIMITED SERVICE:

1. The MS rejects requests from user to respond to notifications for which no channel description has been received in the notification by the RR sub-layer.
2. The MS indicates notifications for which a channel description has been received in the notification.
3. The MS accepts user requests to respond to notifications for which channel description has been received in the notification and goes to the service state RECEIVING GROUP CALL (LIMITED SERVICE).
4. The MS rejects any request of establishing a group call.

26.14.1.4.3 Method of test

Initial Conditions

System Simulator:

1 cell with default parameters for ASCII testing.

Mobile Station:

The MS, with SIM, is in MM-state "idle, limited service" because LA not allowed.

Specific PICS statements:

- Support VGCS originating (TSPC_Addinfo_VGCS_Originating)
- Support VBS originating (TSPC_Addinfo_VBS_Originating)

PIXIT Statements:

- Way to configure VGCS or VBS.
- Way to indicate a call notification.
- Way to accept VGCS or VBS call.
- Way to initiate a normal VGCS/VBS call.

Foreseen Final State of the MS

"limited service" mode.

Test Procedure

The MS, with SIM, is in MM idle limited service state because LA is not allowed. The SS sends NOTIFICATION/NCH message containing call reference active in the MS but no VGCS/VBS channel description. It is checked that the MS indicates the notification and rejects the request of joining the notified call. The SS sends NOTIFICATION/NCH message containing call reference active in the MS and VGCS/VBS channel description. It is checked that the MS indicates the notification, and joins the notified call on request. If the MS supports VGCS/VBS originating, the MS is requested to initiate VGCS/VBS call. It is checked that the MS rejects the request.

Maximum Duration of Test

5 minutes.

Expected Sequence

Step	Direction	Message	Comments
0	MS		the MS is in MM idle mode limited service state
1	SS -> MS	NOTIFICATION/NCH	without VGCS/VBS channel description
2	MS		MMI action to request responding to the notification
3	MS		check that the MS rejects the request and that no RR connection establishment is attempted for 10s.
5	SS -> MS	NOTIFICATION/NCH	with VGCS/VBS channel description
6	MS		check that the MS indicates the notification
7	MS		MMI action to request to join the notification
8	MS		check that the TCH in downlink is through connected and there is no uplink transmission on that channel for 10 s.
9	SS -> MS	CHANNEL RELEASE	UI format
10	MS		If the MS supports VGCS/VBS originating MMI action to initiate a normal VGCS/VBS call
11	SS		check that the MS rejects the request and that no RR connection establishment is attempt.

26.14.2 VGCS-VBS / Paging

26.14.2.1 VGCS-VBS / Paging / Paging indication

26.14.2.1.1 Conformance requirement

1. Paging into on-going voice group calls shall be provided as an implementation option.
2. In group receive mode the MS shall be ready to receive paging information on the FACCH containing the mobile subscriber identity and the priority level if eMLPP applies.
3. In group transmit mode if the MS has received a paging message with the own mobile station identity on the PCH or on the voice group call channel downlink, the RR entity shall provide an indication to the upper layers, together with the related priority, if applicable.
4. In group transmit mode if the MS receives information on the voice group call channel of the existence of a paging message in its paging subgroup of the PCH, the RR entity shall pass this information to the upper layers together with the related priority.

Reference(s)

3GPP TS 04.08 / 3GPP TS 44.018 subclauses 3.4.12, 9.1.21a, 3.4.15.1.2.4, 10.5.2.23, 10.5.2.24 and 10.5.2.25.

3GPP TS 03.68 subclause 11.3.1.3c.

3GPP TS 03.69 subclause 11.3.1.3c.

26.14.2.1.2 Test purpose

It is checked that:

1. When the MS in group receive mode if a NOTIFICATION/FACCH message on the voice group call channel containing in-band paging information is received, the MS provides an indication with the correct priority if applicable.
2. When the MS in group receive mode if a paging message with the own mobile station identity on PCH is received, it provides an indication with the correct priority.
3. When the MS in group transmit mode if a NOTIFICATION/FACCH message on the voice group call channel containing in-band paging information is received, the MS provides an indication with the correct priority.

4. If the MS in group transmit mode if a paging message with the own mobile station identity on PCH is received, it provides an indication with the correct priority.

26.14.2.1.3 Method of test

Initial Conditions

System Simulator:

1 cell with default parameters for ASCE testing.

Mobile Station:

No automatic answering configured.

Specific PICS statements:

- Support VGCS talking (TSPC_Addinfo_VGCS_Talking)
- Support VBS originating (TSPC_Addinfo_VBS_Originating)
- Support eMLPP (TSPC_Serv_eMLPP)
- Support monitoring on PCH in group transmit mode (TSPC_AddInfo_MonitorPCH_GroupTransmitMode)

PIXIT Statements:

- Way to configure VGCS or VBS.
- Way to request uplink.

Foreseen Final State of the MS

"Idle, updated".

Test Procedure

The MS is in group receive mode. The SS sends NOTIFICATION/FACCH message containing Paging Information IE which addresses the MS. It is checked that the MS indicates the paging information.

The SS changes SI 6 indicating no support of in-band paging. After waiting 5 s. the SS sends a PAGING REQUEST TYPE 1 message addressing the MS on the paging sub-channel of the MS. It is checked that the MS indicates the paging information, together with the priority level if it supports eMLPP. The test procedure is repeated for sending PAGING REQUEST TYPE 2 and PAGING REQUEST TYPE 3 messages.

The same test procedure is repeated for the MS in group transmit mode if supporting VGCS talking or VBS originating.

Maximum Duration of Test

5 minutes.

Expected Sequence

If the MS mode supports VGCS talking or VBS originating the test sequence is repeated once for $k=2$. If the MS supports monitoring PCH in group transmit mode steps 5 - 17 for $k=2$ are executed.

Step	Direction	Message	Comments
0	SS		broadcast the default SIs.
A1	MS		for k=1, the MS is brought in group receive mode.
B1			for k=2, the MS is in brought group transmit mode.
2 3 4	SS -> MS MS MS	NOTIFICATION/FACCH	In-band paging Information addresses the MS. check that the MS indicates correctly the paging information of a new MT call with priority 4 if the MS supports eMLPP. user action to reject the point-to-point MT call.
5 6	SS -> MS SS	SYSTEM INFORMATION TYPE 6	indicating no in-band paging on FACCH wait 5s.
7 8 9 10	SS -> MS MS MS SS	PAGING REQUEST TYPE 1	with priority 2 check that the MS indicates correctly the paging information of a new MT call with the priority if the MS supports eMLPP. user action to reject the incoming call. wait 5 s.
11 12 13 14	SS -> MS MS MS SS	PAGING REQUEST TYPE 2	with priority 3 check that the MS indicates correctly the paging information of a new MT call with the priority if the MS supports eMLPP. user action to reject the incoming call. wait 5s.
15 16 17	SS -> MS MS MS	PAGING REQUEST TYPE 3	no priority check that the MS indicates correctly the paging information of a new MT call which no priority is provided to. user action to reject the incoming call.
A18			for k=1, no signalling
B18	SS -> MS	UPLINK RELEASE	for k=2, return to group receive mode. Only for a VGCS call.
19 20	SS -> MS SS -> MS	CHANNEL RELEASE CHANNEL RELEASE	UI format, the MS returns to idle updated state. For (k=1) and (k=2 in case of VGCS call). For k=2, for a VBS call, the MS returns to idle mode. L2:DISC/UA.

Specific Message Contents

NOTIFICATION/FACCH - in step 2

Information Element	value/remark
Group call / Paging information indication	'1', paging information
Paging Information	
- mobility identity	TMSI previously allocated to MS
- channel first	'10'B, TCH/F
eMLPP priority indication	'1'B
- priority	'001'B, call priority level 4
spare padding	logic L

SYSTEM INFORMATION TYPE 6 - in step 5

Information Element	value/remark
S6 Rest Octets	7 octets length
- PCH/NCH info indication	L
- VGCS/VBS options	
- in-band notifications	H
- in-band paging	L
- Spare padding	logic L

PAGING REQUEST TYPE 1 - in step 7

Information Element	value/remark
P1 Rest Octets - NLN (PCH) indication - Priority 1 indication - Priority - Spare padding	L H '011'B, level 2 logic L

PAGING REQUEST TYPE 2 - in step 11

Information Element	value/remark
P2 Rest Octets - CN3 indication - NLN (PCH) indication - Priority 1 indication - Priority - Spare padding	L L H '010'B, level 3 logic L

PAGING REQUEST TYPE 3 - in step 15

Information Element	value/remark
Mobile Identity 1 P3 Rest Octets - CN3 indication - NLN (PCH) indication - Priority 1 indication - Priority - Spare padding	TMSI not allocated to MS L L H '000'B, no level applied logic L

26.14.2.2 VGCS-VBS / Paging / Notification

26.14.2.2.1 Conformance requirement

A PAGING REQUEST TYPE 1 message may have an additional notification coded in the P1 rest octets information element. It allows to notify the mobile an emergency group or broadcast call even when the MS at the moment does not monitor the NCH channel.

Reference(s)

3GPP TS 04.08 / 3GPP TS 44.018 subclauses 3.3.2.1, 3.3.3.1 and 10.5.2.23.

26.14.2.2.2 Test purposes

To verify that:

1. the MS in idle mode indicates correctly an incoming broadcast or group call when having received a PAGING REQUEST TYPE 1 message whose P1 rest octets information element contains group call information addressing the MS.
2. the MS in group receive mode indicates correctly an incoming broadcast or group call when having received a PAGING REQUEST TYPE 1 message whose P1 rest octets information element contains group call information addressing the MS.

26.14.2.2.3 Method of test

Initial Conditions

System Simulator:

1 cell with default parameters for ASCI testing.

Mobile Station:

The MS is in MM-state "idle, updated" with a TMSI allocated.

Specific PICS statements:

- Support VGCS talking (TSPC_Addinfo_VGCS_Talking)
- Support VBS originating (TSPC_Addinfo_VBS_Originating)

PIXIT Statements:

- Way to configure VGCS or VBS.
- Way to indicate a call notification.
- Way to accept a VGCS or VBS.
- Way to verify the downlink speech path.

Foreseen Final State of the MS

"Idle, updated", with TMSI allocated.

Test Procedure

The MS is in idle mode. The SS sends in the NCH block only access grant messages. The SS sends a PAGING REQUEST TYPE 1 message on the paging sub-channel of the MS. The Mobile Identity in the message does not address the MS. The P1 rest octets in the message contains VGCS/VBS channel description and VGCS/VBS call reference not active in the MS. It is checked that the MS ignores the paging message. Similarly, the SS sends again the PAGING REQUEST TYPE 1 message on the paging sub-channel of the MS, not addressing the MS. The message contains VGCS/VBS channel description and VGCS/VBS call reference active in the MS. It is checked that the MS indicates correctly the notified group call reference(s) and joins VGCS/VBS call on request of responding to the notification. The group call is terminated. The SS sends PAGING REQUEST TYPE 1 message on the paging sub-channel of the MS which contains the "good reference" but no VGCS/VBS channel description. The Mobile Identity in the message does not address the MS. It is checked that the MS indicates correctly the notified group call reference(s) and establishes a RR connection to respond to the notification on request of responding to the call, then joins the call. The group call is terminated.

The initial conditions for SS are set to the same as ASCII default. The MS is brought to group receive mode the test procedure is repeated once.

Maximum Duration of Test

5 minutes.

Expected Sequence

Test steps 0 to 19 are executed for k=1, 2.

Step	Direction	Message	Comments
A0	SS		For k = 1, the initial conditions for SS are same as ASCII default, except the NCH block containing only access grant messages.
A1	MS		the MS is in idle mode.
B0	SS		For k = 2, the initial conditions for SS are same as ASCII default, except the NCH block containing only access grant messages.
B1	MS		the MS is brought in group receive mode
2	SS -> MS	PAGING REQUEST TYPE 1	with a description of VGCS/VBS channel and a VGCS/VBS call reference not active in the MS check that the MS ignores the notification and there is no uplink transmission on that channel for 10 s.
3	MS		
4	SS -> MS	PAGING REQUEST TYPE 1	with a description of VGCS/VBS channel and a VGCS/VBS call reference active in the MS check that the MS gives an indication containing the notified group call reference MMI action to join the VGCS/VBS call check that the TCH in downlink is through connected and there is no uplink transmission on that channel for 10 s. UI format, return to the idle updated state wait 5s.
5	MS		
6	MS		
7	MS		
8	SS -> MS	CHANNEL RELEASE	with a VGCS/VBS call reference active in the MS but no VGCS/VBS channel description check that the MS gives an indication containing the notified group call reference
9	SS		
10	SS -> MS	PAGING REQUEST TYPE 1	
11	MS		
A12	MS		For k = 1, MMI action to join the VGCS/VBS call L2: SABM / UA release the dedicated channel. The MS releases L2 multiple frame link L2:DISC/UA. check that the TCH in downlink is through connected and there is no uplink transmission on that channel for 10 s.
A13	MS -> SS	CHANNEL REQUEST	
A14	SS -> MS	IMMEDIATE ASSIGNMENT	
A15	MS -> SS	NOTIFICATION RESPONSE	
A16	SS -> MS	CHANNEL RELEASE	
A17	MS		
B12	SS		For k = 2, MMI action to reject the new VGCS/VBS call
18	SS -> MS	CHANNEL RELEASE	UI format, to return to idle updated state wait 5s.
19			

Specific Message Contents

PAGING REQUEST TYPE 1 - in steps 2

Information Element	value/remark
Mobile Identity 1	TMSI not allocated to MS
P1 Rest Octets	
- NLN (PCH) indication	L
- Priority 1 indication	L
- Priority 2 indication	L
- NLN status indication	L
- Group call information indication	H
- Group or broadcast call reference	not active in the SIM
- SF	VBS if only VBS supported, otherwise VGCS
- AF	'0'B, acknowledgement not required
- priority	4
- Ciphering information	No ciphering
Group Channel Description indication	'1', group channel description
Channel Description	24 bits
- Channel type and TDMA offset	TCH/FS
- Timeslot number	arbitrarily chosen, but not 0
- TSC	arbitrarily chosen
- Hopping	Single RF, non hopping channel
- ARFCN	GSM 450: 279 GSM 480: 326 GSM 900: 70 DCS 1 800: 850 PCS 1 900: 750 GSM: 475 GSM 750: 475 T-GSM 810: 475 GSM 850: 197
MA or FSL	'0'B, non hopping
Spare padding	logic L

PAGING REQUEST TYPE 1 - in steps 4

Information Element	value/remark
Mobile Identity 1	TMSI not allocated to MS
P1 Rest Octets	
- NLN (PCH) indication	L
- Priority 1 indication	L
- Priority 2 indication	L
- NLN status indication	L
- Group call information indication	H
- Group or broadcast call reference	PICS/PIXIT (27 bits), active in the SIM
- SF	VBS if only VBS supported, otherwise VGCS
- AF	'0'B, acknowledgement not required
- priority	4
- Ciphering information	No ciphering
Group Channel Description indication	'1', group channel description
Channel Description	24 bits
- Channel type and TDMA offset	TCH/FS
- Timeslot number	arbitrarily chosen, but not 0
- TSC	arbitrarily chosen
- Hopping	Single RF, non hopping channel
- ARFCN	GSM 450: 279 GSM 480: 326 GSM 900: 70 DCS 1 800: 850 PCS 1 900: 750 GSM: 475 GSM 750: 475 T-GSM 810: 475 GSM 850: 197
MA or FSL	'0'B, non hopping
Spare padding	logic L

PAGING REQUEST TYPE 1 - in steps 10

Information Element	value/remark
Mobile Identity 1	TMSI not allocated to MS
P1 Rest Octets	
- NLN (PCH) indication	L
- Priority 1 indication	L
- Priority 2 indication	L
- NLN status indication	L
- Group call information indication	H
- Group or broadcast call reference	PICS/PIXIT (27 bits), active in the SIM
- SF	VBS if only VBS supported, otherwise VGCS
- AF	'0'B, acknowledgement not required
- priority	4
- Ciphering information	No ciphering
Group Channel Description indication	'0', no group channel description
Spare padding	logic L

26.14.3 VGCS-VBS / RR Procedures

26.14.3.1 VGCS-VBS / RR Procedures / frequency redefinition

26.14.3.1.1 Conformance requirements

The MS, after receiving a FREQUENCY REDEFINITION message in group transmit mode, shall start using the new frequencies and hopping sequence in the correct time slot.

References

3GPP TS 04.08 / 3GPP TS 44.018 subclause 3.4.5.

26.14.3.1.2 Test purpose

To verify that after receiving a FREQUENCY REDEFINITION message in group transmit mode, the MS starts using the new frequencies and hopping sequence at the time indicated in the message.

26.14.3.1.3 Method of test

Initial Conditions

System Simulator:

1 cell, CCCH_CONF set to 1 basic physical channel used for CCCH, not combined with SDCCHs. The cell allocation is set to CA₄₅₀(1), CA₄₈₀(1), CA_{PGSM}(1), CA_{DCS}(1), CA_{PCS}(1), CA₇₁₀(1), CA₇₅₀(1), CA₈₁₀(1) or CA₈₅₀(1), depending on the band of operation of the Mobile Station (See PICS/PIXIT), before each execution of this test.

Mobile Station:

The MS is in group transmit mode.

Specific PICS statements:

-

PIXIT Statements:

- Way to configure VGCS or VBS.
- Way to accept a VGCS or VBS.

Foreseen Final State of the MS

"Idle, updated", with TMSI allocated.

Test Procedure

Test parameters:

An arbitrary value T in the range 92,....,29999 is chosen.

GSM 450:

Ca₄₅₀(1) is set to 32.

An arbitrary subset CA₄₅₀(1) of the set {259,....,293} containing ca₄₅₀(1) elements is drawn.

An element B of the set CA₄₅₀(1) is arbitrarily chosen.

An arbitrary value ca₄₅₀(2) in the range 17,....,31 is chosen.

An arbitrary subset CA₄₅₀(2) of the set {259,....,293} with ca₄₅₀(2) elements and containing B is chosen.

For j = 1,2, values ma₄₅₀(j) in the range j,....,ca₄₅₀(j)-1 and values MAIO₄₅₀(j) in the range 0,....,ma₄₅₀(j)-1 are arbitrarily chosen.

Subsets MA₄₅₀(j) of CA₄₅₀(j) not containing B and having ma(j) elements are arbitrarily chosen.

GSM 480:

Ca₄₈₀(1) is set to 32.

An arbitrary subset CA₄₈₀(1) of the set {306,....,340} containing ca₄₈₀(1) elements is drawn.

An element B of the set CA₄₈₀(1) is arbitrarily chosen.

An arbitrary value ca₄₈₀(2) in the range 17,....,31 is chosen.

An arbitrary subset CA₄₈₀(2) of the set {306,....,340} with ca₄₈₀(2) elements and containing B is chosen.

For $j = 1, 2$, values $ma_{480}(j)$ in the range $j, \dots, ca_{480}(j)-1$ and values $MAIO_{480}(j)$ in the range $0, \dots, ma_{480}(j)-1$ are arbitrarily chosen.

Subsets $MA_{480}(j)$ of $CA_{480}(j)$ not containing B and having $ma(j)$ elements are arbitrarily chosen.

GSM 900:

$ca_{PGSM}(1)$ is set to 64.

An arbitrary subset $CA_{PGSM}(1)$ of the set $\{1, \dots, 124\}$ containing $ca_{PGSM}(1)$ elements is drawn.

An element B of the set $CA_{PGSM}(1)$ is arbitrarily chosen.

An arbitrary value $ca_{PGSM}(2)$ in the range $20, \dots, 63$ is chosen.

An arbitrary subset $CA_{PGSM}(2)$ of the set $\{1, \dots, 124\}$ with $ca_{PGSM}(2)$ elements and containing B is chosen.

For $j = 1, 2$, values $ma_{PGSM}(j)$ in the range $j, \dots, ca_{PGSM}(j)-1$ and values $MAIO_{PGSM}(j)$ in the range $0, \dots, ma_{PGSM}(j)-1$ are arbitrarily chosen.

Subsets $MA_{PGSM}(j)$ of $CA_{PGSM}(j)$ not containing B and having $ma(j)$ elements are arbitrarily chosen.

DCS 1 800:

$ca_{DCS}(1)$ is set to 64.

An arbitrary subset $CA_{DCS}(1)$ of the set $\{700, \dots, 812\}$ containing $ca_{DCS}(1)$ elements is chosen.

An element B of the set $CA_{DCS}(1)$ is arbitrarily chosen. $CA_{DCS}(1)$ is then coded using the Variable Bit Map coding scheme.

An arbitrary value $ca_{DCS}(2)$ in the range $17, \dots, 63$ is chosen.

An arbitrary subset $CA_{DCS}(2)$ of the set $\{700, \dots, 812\}$ with $ca_{DCS}(2)$ elements and containing B is chosen. $CA_{DCS}(2)$ is then coded using the Variable Bit Map coding scheme.

For $j = 1, 2$, values $ma_{DCS}(j)$ in the range $j, \dots, ca_{DCS}(j)-1$ and values $MAIO_{DCS}(j)$ in the range $0, \dots, ma_{DCS}(j)-1$ are arbitrarily chosen.

Subsets $MA_{DCS}(j)$ of $CA_{DCS}(j)$ not containing B and having $ma_{DCS}(j)$ elements are arbitrarily chosen.

PCS 1 900:

$ca_{PCS}(1)$ is set to 64.

An arbitrary subset $CA_{PCS}(1)$ of the set $\{700, \dots, 812\}$ containing $ca_{PCS}(1)$ elements is chosen.

An element B of the set $CA_{PCS}(1)$ is arbitrarily chosen. $CA_{PCS}(1)$ is then coded using the Variable Bit Map coding scheme.

An arbitrary value $ca_{PCS}(2)$ in the range $17, \dots, 63$ is chosen.

An arbitrary subset $CA_{PCS}(2)$ of the set $\{700, \dots, 812\}$ with $ca_{PCS}(2)$ elements and containing B is chosen. $CA_{PCS}(2)$ is then coded using the Variable Bit Map coding scheme.

For $j = 1, 2$, values $ma_{PCS}(j)$ in the range $j, \dots, ca_{PCS}(j)-1$ and values $MAIO_{PCS}(j)$ in the range $0, \dots, ma_{PCS}(j)-1$ are arbitrarily chosen.

Subsets $MA_{PCS}(j)$ of $CA_{PCS}(j)$ not containing B and having $ma_{PCS}(j)$ elements are arbitrarily chosen.

GSM 710:

$ca_{710}(1)$ is set to 64.

An arbitrary subset $CA_{710}(1)$ of the set $\{438, \dots, 511\}$ containing $ca_{710}(1)$ elements is drawn.

An element B of the set $CA_{710}(1)$ is arbitrarily chosen.

An arbitrary value $ca_{710}(2)$ in the range 457,...,500 is chosen.

An arbitrary subset $CA_{710}(2)$ of the set {438,...,511} with $ca_{710}(2)$ elements and containing B is chosen.

For $j = 1, 2$, values $ma_{710}(j)$ in the range $j, \dots, ca_{710}(j)-1$ and values $MAIO_{710}(j)$ in the range $0, \dots, ma_{710}(j)-1$ are arbitrarily chosen.

Subsets $MA_{710}(j)$ of $CA_{710}(j)$ not containing B and having $ma(j)$ elements are arbitrarily chosen.

GSM 750:

$ca_{750}(1)$ is set to 64.

An arbitrary subset $CA_{750}(1)$ of the set {438,...,511} containing $ca_{750}(1)$ elements is drawn.

An element B of the set $CA_{750}(1)$ is arbitrarily chosen.

An arbitrary value $ca_{750}(2)$ in the range 457,...,500 is chosen.

An arbitrary subset $CA_{750}(2)$ of the set {438,...,511} with $ca_{750}(2)$ elements and containing B is chosen.

For $j = 1, 2$, values $ma_{750}(j)$ in the range $j, \dots, ca_{750}(j)-1$ and values $MAIO_{750}(j)$ in the range $0, \dots, ma_{750}(j)-1$ are arbitrarily chosen.

Subsets $MA_{750}(j)$ of $CA_{750}(j)$ not containing B and having $ma(j)$ elements are arbitrarily chosen.

T-GSM 810:

$ca_{810}(1)$ is set to 64.

An arbitrary subset $CA_{810}(1)$ of the set {438,...,511} containing $ca_{810}(1)$ elements is drawn.

An element B of the set $CA_{810}(1)$ is arbitrarily chosen.

An arbitrary value $ca_{810}(2)$ in the range 457,...,500 is chosen.

An arbitrary subset $CA_{810}(2)$ of the set {438,...,511} with $ca_{810}(2)$ elements and containing B is chosen.

For $j = 1, 2$, values $ma_{810}(j)$ in the range $j, \dots, ca_{810}(j)-1$ and values $MAIO_{810}(j)$ in the range $0, \dots, ma_{810}(j)-1$ are arbitrarily chosen.

Subsets $MA_{810}(j)$ of $CA_{810}(j)$ not containing B and having $ma(j)$ elements are arbitrarily chosen.

GSM 850:

$ca_{850}(1)$ is set to 64.

An arbitrary subset $CA_{850}(1)$ of the set {128,...,251} containing $ca_{850}(1)$ elements is drawn.

An element B of the set $CA_{850}(1)$ is arbitrarily chosen.

An arbitrary value $ca_{850}(2)$ in the range 147,...,200 is chosen.

An arbitrary subset $CA_{850}(2)$ of the set {128,...,251} with $ca_{850}(2)$ elements and containing B is chosen.

For $j = 1, 2$, values $ma_{850}(j)$ in the range $j, \dots, ca_{850}(j)-1$ and values $MAIO_{850}(j)$ in the range $0, \dots, ma_{850}(j)-1$ are arbitrarily chosen.

Subsets $MA_{850}(j)$ of $CA_{850}(j)$ not containing B and having $ma(j)$ elements are arbitrarily chosen.

The MS is brought into group transmit mode. The SS sends a FREQUENCY REDEFINITION message. It is checked that the MS uses the new frequencies/hopping sequence at the TDMA frame defined by the contents of the "Starting Time" information element. (The range for T ensures that the MS does not start transmission on the new frequencies until the designated frame.)

The check is performed at the RF burst level. The SS checks the received pattern with the expected pattern, and the SS checks for each burst whether the burst is transmitted at the right frequency.

Maximum Duration of Test

T + 7

Expected Sequence

Step	Direction	Message	Comments
1	MS		the MS is in group transmit mode using full rate on an RF hopping channel
9	SS -> MS	FREQUENCY REDEFINITION	see description 1 below.
10	MS		check that the MS uses the new frequencies in the correct frame.
11	SS -> MS	FREQUENCY REDEFINITION	see description 2 below.
12	MS		check that the MS uses the new frequencies in the correct frame.
13	SS -> MS	CHANNEL RELEASE	The MS releases L2 multiple frame link L2:DISC/UA.

Specific Message Contents

FREQUENCY REDEFINITION (Description 1)

Information Element	value/remark
as default except:	
Channel Description	
- Channel type and TDMA offset	TCH/FS
- Timeslot number	not changed
- TSC	not changed
- Hopping channel	RF hopping channel
- MAIO	GSM 450: MAIO450(1) GSM 480: MAIO480(1) GSM 710: MAIO710(1) GSM 750: MAIO750(1) T-GSM 810: MAIO810(1) GSM 850: MAIO850(1) GSM 900: MAIOPGSM(1) DCS 1 800: MAIODCS(1) PCS 1 900: MAIOPCS(1)
- HSN	0
Mobile Allocation	GSM 450: corresponds to set MA450(1) GSM 480: corresponds to set MAIO480(1) GSM 710: corresponds to set MAIO710(1) GSM 750: corresponds to set MAIO750(1) T-GSM 810: corresponds to set MAIO810(1) GSM 850: corresponds to set MAIO850(1) GSM 900: corresponds to set MAIOPGSM(1) DCS 1 800: corresponds to set MAIODCS(1) PCS 1 900: corresponds to set MAIOPCS(1)
Starting Time	The last burst of the first L2 frame containing the beginning of this message is transmitted in frame number X. The starting time is set to frame number (X plus T modulo 42 432).
Cell Channel Description	
- Information element identifier	62H
- contents	GSM 450: corresponds to set CA450(1) with "Format ID" set to "Range 128". GSM 480: corresponds to set CA480(1) with "Format ID" set to "Range 128". GSM 710: corresponds to set CA710(1) with "Format ID" set to "bit map 0". GSM 750: corresponds to set CA750(1) with "Format ID" set to "bit map 0". T-GSM 810: corresponds to set CA810(1) with "Format ID" set to "bit map 0". GSM 850: corresponds to set CA850(1) with "Format ID" set to "128 range". GSM 900: corresponds to set CAPGSM(1) with "Format ID" set to "bit map 0". DCS 1 800: corresponds to set CADCS(1) with "Format ID" set to " Variable Bit Map" PCS 1 900: corresponds to set CAPCS(1) with "Format ID" set to " Variable Bit Map"

FREQUENCY REDEFINITION (Description 2)

Information Element	value/remark
as default except:	
Channel Description	
- Channel type and TDMA offset	TCH/FS
- Timeslot number	not changed
- TSC	not changed
- Hopping channel	RF hopping channel
- MAIO	GSM 450: MAIO450(2) GSM 480: MAIO480(2) GSM 710: MAIO710(2) GSM 750: MAIO750(2) T-GSM 810: MAIO810(2) GSM 850: MAIO850(2) GSM 900: MAIOPGSM(2) DCS 1 800: MAIODCS(2) PCS 1 900: MAIOPCS(2)
- HSN	0
Mobile Allocation	GSM 450: corresponds to set MA450(2) GSM 480: corresponds to set MAIO480(2) GSM 710: corresponds to set MAIO710(2) GSM 750: corresponds to set MAIO750(2) T-GSM 810: corresponds to set MAIO810(2) GSM 850: corresponds to set MAIO850(2) GSM 900: corresponds to set MAIOPGSM(2) DCS 1 800: corresponds to set MAIODCS(2) PCS 1 900: corresponds to set MAIOPCS(2)
Starting Time	The last burst of the first L2 frame containing the beginning of this message is transmitted in frame number X. The starting time is set to frame number (X plus T modulo 42 432).
Cell Channel Description	
- Information element identifier	62H
- contents	GSM 450: corresponds to set CA450(2) with "Format ID" set to "Range 128". GSM 480: corresponds to set CA480(2) with "Format ID" set to "Range 128". GSM 710: corresponds to set CA710(2) with "Format ID" set to "bit map 0". GSM 750: corresponds to set CA750(2) with "Format ID" set to "bit map 0". T-GSM 810: corresponds to set CA810(2) with "Format ID" set to "bit map 0". GSM 850: Corresponds to set CA850(2) with "Format ID" set to "128 range". GSM 900: corresponds to set CAPGSM(2) with "Format ID" set to "bit map 0". DCS 1 800: corresponds to set CADCS(2) with "Format ID" set to " Variable Bit Map" PCS 1 900: corresponds to set CAPCS(2) with "Format ID" set to " Variable Bit Map"

26.14.3.2 VGCS-VBS / RR Procedures / assignment

26.14.3.2.1 Conformance requirements

1. Upon receipt of the ASSIGNMENT COMMAND message in group transmit mode, the mobile station shall initiate a local end release of link layer connections, disconnect the physical channels, command the switching to the assigned channels and initiate the establishment of lower layer connections (this includes the activation of the channels, their connection and the establishment of the main signalling links).
2. MM-messages and CM-messages using SAPI=0 sent from the mobile station to the network shall be duplicated by the data link layer in the following case:

A channel change of dedicated channels is required (assignment or handover procedure) and the last layer 2 frame has not been acknowledged by the peer data link layer before the mobile station leaves the old channel.

In this case, the mobile station does not know whether the network has received the message correctly. Therefore, the mobile station shall send the message again after the new dedicated channel is established.

3. An ASSIGNMENT COMMAND message may indicate a frequency change in progress, with a starting time and possibly alternative channel descriptions.

In the case of the reception of an ASSIGNMENT COMMAND message which contains only the description of a channel to be used after the starting time, and if the starting time has not already elapsed, the mobile station shall wait up to the starting time before accessing the channel.

4. The MS shall apply the hopping frequencies specified in ASSIGNMENT COMMAND message in the Mobile Allocation IE or the Frequency List IE at the time of accessing the new channel using the last received Cell Allocation.
5. After receipt of the ASSIGNMENT COMMAND the MS shall perform the assignment and return an ASSIGNMENT COMPLETE without undue delay.
6. On the mobile station side, if a lower layer failure happens on the new channel before the ASSIGNMENT COMPLETE message has been sent, the mobile station deactivates the new channels, reactivates the old channels, reconnects the TCHs if any and triggers the establishment of the main signalling link. It then sends a ASSIGNMENT FAILURE message, cause "protocol error unspecified" on the main DCCH and resumes the normal operation, as if no assignment attempt had occurred. The operational parameters (e.g. ciphering mode) when returning on the old channel are those applied before the procedure.

References

3GPP TS 04.08 / 3GPP TS 44.018 subclauses 3.1.4.3, 3.4.3 and 3.4.3.3.

3GPP TS 04.13 subclause 5.2.4.

26.14.3.2.2 Test purpose

1. To verify that upon receipt of an ASSIGNMENT COMMAND in group transmit mode, the MS switches to the channel defined in the ASSIGNMENT COMMAND, establishes the link and sends an ASSIGNMENT COMPLETE message.
 - 1.1 from non-hopping TCH/F to hopping TCH/F using a different timeslot;
 - 1.2 from hopping TCH/F to non-hopping TCH/F using a different timeslot.
2. To verify that the MS, supporting TCH, having sent an MM- or CM message which was not acknowledged on L2 before the channel assignment procedure was initiated and before the MS has left the old channel, repeats that message after completion of the assignment procedure without incrementing N(SD). This is tested in the special case of MM message AUTHENTICATION RESPONSE.
3. To verify that, if the MS has received an ASSIGNMENT COMMAND message which contains only the description of a channel to be used after the starting time, and if the starting time has not already elapsed, the mobile station waits up to the starting time before accessing the channel.
4. To verify that the MS having received an ASSIGNMENT COMMAND, correctly decodes the Mobile Allocation and Frequency List IEs for frequency hopping and applies the specified frequencies using the correct Cell Allocation.
5. To verify that after receipt of the ASSIGNMENT COMMAND the MS returns an ASSIGNMENT COMPLETE without undue delay.
6. To test that, when the MS fails to seize the new channel, the MS reactivates the old channel.

26.14.3.2.3 Method of test

Initial Conditions

System Simulator:

1 cell, default parameters except:

Band	BCCH ARFCN	Throughout the test, the CA broadcast in System Information 1 is
GSM 450	263	259, 261, 263, 265, 267, 269, 271, 273, 275, 277
GSM 480	310	306, 308, 310, 312, 314, 316, 318, 320, 322, 324
GSM 710	457	447, 454, 457, 463, 471, 479, 482, 483, 489, 496
GSM 750	457	447, 454, 457, 463, 471, 479, 482, 483, 489, 496
T-GSM 810	457	447, 454, 457, 463, 471, 479, 482, 483, 489, 496
GSM 850	147	137, 144, 147, 153, 161, 169, 172, 173, 179, 186
GSM 900	20	10, 17, 20, 26, 34, 42, 45, 46, 52, 59
DCS 1 800	747	734, 741, 747, 754, 759, 766, 773, 775, 779, 782
PCS 1 900	647	634, 641, 647, 654, 659, 666, 673, 675, 679, 682
		Note that the actual CA of the cell contains other frequencies.

Mobile Station:

The MS is in group transmit mode.

Specific PICS statements:

-

PIXIT Statements:

- Way to configure VGCS or VBS.
- Way to initiate a VBS call.

Foreseen Final State of the MS

"Idle, updated", with TMSI allocated.

Test Procedure

The MS is brought into group transmit mode. A hopping channel is assigned with ASSIGNMENT COMMAND, which includes a Starting Time IE. It is checked that the MS switches to the assigned channel at the time specified in Starting Time IE, establishes the link and sends an ASSIGNMENT COMPLETE message.

Then the SS sends a AUTHENTICATION REQUEST message. The MS shall answer with an AUTHENTICATION RESPONSE message, which is not acknowledged on L2 by the SS. Immediately after the AUTHENTICATION RESPONSE message is received, the SS sends an ASSIGNMENT COMMAND. It is checked that the MS switches to the assigned channel, establishes the link with the commanded power level, sends as ASSIGNMENT COMPLETE message and then MS repeats the AUTHENTICATION RESPONSE message, with the same N(SD) value.

Then the SS sends an ASSIGNMENT COMMAND, but the SS does not activate the specified new channel. It is checked that the MS re-establishes the old channel and sends ASSIGNMENT FALIURE message on the old channel.

Maximum Duration of Test

30 s.

Expected Sequence

Step	Direction	Message	Comments
1	MS		the MS is in group transmit mode.
2	SS -> MS	ASSIGNMENT COMMAND	See specific message contents.
3	MS -> SS	ASSIGNMENT COMPLETE	Sent on the correct channel after establishment of the main signalling link. This message shall be ready to be transmitted before 600 ms after the completion of step 2.
4	SS		The SS checks that the MS reports the requested power level in the layer 1 header of the SACCH message that is sent in the first SACCH multiframe following the SABM.
5	SS -> MS	AUTHENTICATION REQUEST	
6	MS -> SS	AUTHENTICATION RESPONSE	This message is not L2 acknowledged by the SS.
7	SS -> MS	ASSIGNMENT COMMAND	See specific message contents.
8	MS -> SS	ASSIGNMENT COMPLETE	Sent on the correct channel after establishment of the main signalling link. This message shall be ready to be transmitted before 600 ms after the completion of step 7.
9	MS -> SS	AUTHENTICATION RESPONSE	N(SD) shall be the same as in step 6.
10	SS -> MS	ASSIGNMENT COMMAND	See specific message contents, the SS does not activate the new channel. The MS attempts (and fails) to establish a signalling link on the new channel.
11	MS		The MS re-establishes the signalling link on the old channel.
12	MS -> SS	ASSIGNMENT FAILURE	RR cause value = "protocol error unspecified".
13	SS -> MS	UPLINK RELEASE	
14	SS -> MS	CHANNEL RELEASE	UI format, the main signalling link is released.

Specific Message Contents

ASSIGNMENT COMMAND - step 2

Channel Description	
- Channel Type and TDMA offset	TCH/F
- Timeslot Number	(N+1) mod 8
- Training Sequence Code	Chosen arbitrarily
- Hopping	RF hopping channel
- MAIO	Chosen arbitrarily from the set (0, 1 to N-1) where N is the number of frequencies in the Mobile Allocation IE.
- HSN	Chosen arbitrarily from the set (1 to 63)
Power Command	
- Power level	Chosen arbitrarily but with a changed value.
Frequency list IE	Not included
Channel Mode	
- Mode	A speech mode arbitrarily chosen from the full rate capabilities declared for the MS
Mobile Allocation	Indicates all of the CA (broadcast on the BCCH) except for the BCCH carrier.
Starting Time	indicates (current frame number + 100 frames) mod 42432
VGCS target mode Indication	
- Target mode	group transmit mode
- Group cipher key number	no ciphering

ASSIGNMENT COMMAND - step 7

Channel Description	TCH/F
- Channel Type and TDMA offset	(N+3) mod 8
- Timeslot Number	Chosen arbitrarily
- Training Sequence Code	Single RF Channel
- Hopping	the ARFCN of the BCCH carrier
- ARFCN	
Power Command	Chosen arbitrarily but with a changed value.
- Power level	A speech mode arbitrarily chosen from the full rate capabilities declared for the MS
Channel Mode	Not included
Frequency list IE	GSM 450: range 128 encoding (271, 273, 275, 277, 279, 281, 283, 285, 287, 289, 291)
Cell Channel Description	GSM 480: range 128 encoding (318, 320, 322, 324, 326, 328, 330, 332, 334, 336, 338)
	GSM 900: bit map zero encoding (45, 46, 52, 59, 66, 73, 74, 75, 76, 108, 114)
	DCS 1 800: range 128 encoding (773, 775, 779, 782, 791, 798, 829, 832, 844)
	PCS 1 900: range 128 encoding (673, 675, 679, 682, 691, 698, 729, 732, 744)
	GSM 710: 128 range encoding (482, 483, 489, 496, 498, 500, 501, 502, 503, 506, 508)
	GSM 750: 128 range encoding (482, 483, 489, 496, 498, 500, 501, 502, 503, 506, 508)
	T-GSM 810: 128 range encoding (482, 483, 489, 496, 498, 500, 501, 502, 503, 506, 508)
	GSM 850: 128 range encoding (172, 173, 179, 186, 193, 200, 201, 202, 203, 235, 241)
Mobile Allocation	Not included
Starting Time	Not included
VGCS target mode Indication	Not included

ASSIGNMENT COMMAND - step 10

Channel Description	TCH/F
- Channel Type and TDMA offset	(N+2) mod 8
- Timeslot Number	Chosen arbitrarily
- Training Sequence Code	Single RF Channel
- Hopping	The ARFCN of the BCCH carrier
- ARFCN	
Power Command	Chosen arbitrarily but with a changed value.
- Power level	A speech mode arbitrarily chosen from the full rate capabilities declared for the MS
Channel Mode	Not included
Frequency list IE	Not included
Cell Channel Description	Not included
Mobile Allocation	Not included
Starting Time	Not included
VGCS target mode Indication	
- Target mode	group transmit mode
- Group cipher key number	no ciphering

26.14.3.3 VGCS-VBS / RR Procedures / handover / successful in group transmit mode

This clause deals with signalling tests in non-synchronised handover in successful case.

Table 26.14.3.3.1 contains a summary of the different combinations of parameters which have to be tested. For execution counter=3, the target channel is dedicated mode.

Table 26.14.3.3.1

From	To	Timing Adv.	Start Time	Sync ?	State of call	Exec Counter
TCH/F, no FH	TCH/F, no FH	20	1,1s	no	group trans. mode	1
TCH/F, no FH	TCH/F, FH	arbitrary	none	no	group trans. mode	2
TCH/F, FH	TCH/F, no FH	20	none	no	group trans. mode	3

26.14.3.3.1 Conformance requirements

The MS shall correctly apply the handover procedure in the non-synchronised case when in group call transmit mode and when handover is performed from a traffic channel with/without frequency hopping towards a traffic channel with/without frequency hopping.

References

3GPP TS 04.08 / 3GPP TS 44.018 subclause 3.4.4.

26.14.3.3.2 Test purpose

To verify that:

1. When the MS is ordered to make a non-synchronised handover it continuously sends access bursts on the main DCCH (and optionally on the SACCH) until it receives a PHYSICAL INFORMATION message from the SS.
2. The MS correctly handles the values of any Starting Time IE in the HANDOVER COMMAND message in the case when none of the information elements referring to before the starting time are present.
3. The MS correctly handles the Timing Advance IE in the PHYSICAL INFORMATION message.
4. The MS activates the new channel correctly and transmits the HANDOVER COMPLETE message without undue delay.

26.14.3.3.3 Method of test

Initial Conditions

System Simulator:

2 cells, A and B with same LAI, default parameters except:

Band	Cell A		Cell B	
	BCCH ARFCN	Cell Allocation	BCCH ARFCN	Cell Allocation
GSM 450	263	259, 261, 263, 265, 267, 269, 271, 273, 275, 277, 279, 281, 283, 285, 287, 289, 291	274	260, 262, 264, 266, 268, 270, 272, 274, 276, 279, 281, 283, 285, 287, 289, 291
GSM 480	310	306, 308, 310, 312, 314, 316, 318, 320, 322, 324, 326, 328, 330, 332, 334, 336, 338	321	307, 309, 311, 313, 315, 317, 319, 321, 323, 326, 328, 330, 332, 334, 336, 338
GSM 710	457	447, 454, 457, 463, 471, 479, 482, 483, 489, 496, 498, 500, 501, 502, 503, 506, 508	477	451, 455, 459, 461, 467, 468, 475, 477, 497, 498, 500, 501, 502, 503, 506, 508
GSM 750	457	447, 454, 457, 463, 471, 479, 482, 483, 489, 496, 498, 500, 501, 502, 503, 506, 508	477	451, 455, 459, 461, 467, 468, 475, 477, 497, 498, 500, 501, 502, 503, 506, 508
T-GSM 810	457	447, 454, 457, 463, 471, 479, 482, 483, 489, 496, 498, 500, 501, 502, 503, 506, 508	477	451, 455, 459, 461, 467, 468, 475, 477, 497, 498, 500, 501, 502, 503, 506, 508
GSM 850	147	137, 144, 147, 153, 161, 169, 172, 173, 179, 186, 193, 200, 201, 202, 203, 235, 241	167	141, 145, 149, 151, 157, 158, 165, 167, 187, 193, 200, 201, 202, 203, 235, 241
GSM 900	20	10, 17, 20, 26, 34, 42, 45, 46, 52, 59, 66, 73, 74, 75, 76, 108, 114	40	14, 18, 22, 24, 30, 31, 38, 40, 60, 66, 73, 74, 75, 76, 108, 114
DCS 1 800	747	734, 741, 747, 754, 759, 762, 766, 767, 773, 775, 779, 782, 791, 798, 829, 832, 844	764	739, 743, 746, 749, 756, 758, 761, 764, 771, 779, 782, 791, 798, 829, 832, 844
PCS 1 900	664	639, 643, 646, 649, 656, 658, 661, 664, 671, 679, 682, 691, 698, 729, 732, 744	664	639, 643, 646, 649, 656, 658, 661, 664, 671, 679, 682, 691, 698, 729, 732, 744

The frame numbers of cells A and B shall be different by 100.

The timebase of cells A and B shall be such that the edges of their timeslots are not coincident at the antenna connector.

Mobile Station:

The MS is in group transmit mode on cell A.

Specific PICS statements:

-

PIXIT Statements:

- Way to configure VGCS or VBS.
- Way to request uplink.
- Way to initiate VBS call.

Foreseen Final State of the MS

idle mode on cell B.

Test Procedure

This procedure is repeated for execution counter M = 1 to 3.

The MS is in group transmit mode. The SS sends a HANDOVER COMMAND. The MS (at the time defined by the Starting Time information element, if included in the message) begins to send access bursts on the new DCCH (and optionally on the SACCH) of the target cell. The SS observes the access bursts and after receiving n (n being arbitrarily chosen between 10 - 20) access bursts, the SS sends one PHYSICAL INFORMATION message with an arbitrary Timing Advance. It is checked that the MS activates the new channel in sending and receiving mode, and it is checked that the MS is ready to transmit a HANDOVER COMPLETE message, before "x" MS after the end of the PHYSICAL INFORMATION message, but not before a UA frame has been sent by the SS.

The term "ready to transmit" is defined in 3GPP TS 04.13. The value of "x" depends upon the target channel and is specified in the specific message contents clause.

Maximum Duration of Test

5 minutes, including 1 minute for any necessary operator actions.

Expected Sequence

This sequence is performed for execution counter M = 1, 2, 3.

Step	Direction	Message	Comments
0	MS		The MS is in group transmit mode.
1	SS -> MS	HANDOVER COMMAND	See Specific message contents.
2	MS -> SS	HANDOVER ACCESS	Repeated on every burst of the uplink main DCCH (and optionally on the SACCH) until reception of PHYSICAL INFORMATION. Handover Reference as included in the HANDOVER COMMAND. If the HANDOVER COMMAND includes a starting time IE then the first HANDOVER ACCESS message shall be transmitted in the indicated frame (unless the indicated frame is not used by that channel, in which case the next frame used by that channel shall be used).
3	SS -> MS	PHYSICAL INFORMATION	Sent after reception of n HANDOVER ACCESS messages. See specific message contents.
4	MS -> SS	SABM	Sent without information field.
5	SS -> MS	UA	
6	MS -> SS	HANDOVER COMPLETE	The message shall be ready to be transmitted before "x" ms after the completion of step 3.
A7	MS		for M = 1, 2, check that the TCH specified is through connected.
B7			for M=3, check that the TCH specified is through connected.
B8	SS -> MS	CHANNEL RELEASE	The MS releases L2 multiple frame link L2:DISC/UA.

Specific Message Contents

For M = 1:

HANDOVER COMMAND

Information Element	value/remarks
As default message contents, except:	
Cell Description	
- Network Colour Code	1
- Base Station Colour Code	5
- BCCH Carrier Number	See the table below
Synchronisation Indication	
- Report Observed Time Difference	Shall not be included.
- Synchronisation Indication	'Non synchronised'.
- Normal Cell Indication	Ignore out of range timing advance.
Starting Time	Indicates the frame number of cell B that will occur approximately 1,1 s (238 frames have elapsed) after the HANDOVER COMMAND is sent by cell A.
VGCS target mode Indication	
- Target mode	group transmit mode
- Group cipher key number	no ciphering

HANDOVER COMMAND	
Band	Channel Description
	ARFCN
GSM 450	274
GSM 480	321
GSM 710	477
GSM 750	477
T-GSM 810	477
GSM 850	167
GSM 900	40
DCS 1 800	764
PCS 1 900	664

PHYSICAL INFORMATION

Information Element	value/remarks
As default message contents.	

Step 6: $x = 500$

Step 7: The MS and SS are using a full rate TCH in non hopping mode on cell B.

For $M = 2$:

Step 0: The MS and SS are using a full rate TCH in non-hopping mode on cell B.

HANDOVER COMMAND

Information Element	value/remarks
As default message contents, except:	
Cell Description	
- Network Colour Code	1
- Base Station Colour Code	5
- BCCH Carrier Number	See the table below
Channel Description	
- Channel Type	TCH/F + ACCHs
- Timeslot number	Chosen arbitrarily, but not Zero
- Training Sequence Code	Chosen arbitrarily
- Hopping	RF hopping channel.
- MAIO	Chosen arbitrarily from the set (0, 1 to N-1), where N is the number of frequencies encoded in the Frequency List IE.
- HSN	Chosen arbitrarily from the set (1,2,..63)
Synchronisation Indication IE is not included.	
Channel Mode IE is not included.	
Frequency List after time	
- Frequency List	Encode frequencies as per the table below
VGCS target mode Indication	
- Target mode	group transmit mode
- Group cipher key number	no ciphering

HANDOVER COMMAND			
Band	BCCH ARFCN	Frequency Format	Frequency List
GSM 450	263	Range 128	259, 261, 263, 265, 277, 279, 281, 283, 285, 287, 289, 291
GSM 480	310	Range 128	306, 308, 310, 312, 324, 326, 328, 330, 332, 334, 336, 338
GSM 710	457	Range 128	447, 454, 457, 463, 496, 498, 500, 501, 502, 503, 506, 508
GSM 750	457	Range 128	447, 454, 457, 463, 496, 498, 500, 501, 502, 503, 506, 508
T-GSM 810	457	Range 128	447, 454, 457, 463, 496, 498, 500, 501, 502, 503, 506, 508
GSM 850	147	Range 128	137, 144, 147, 153, 186, 193, 200, 201, 202, 203, 235, 241
GSM 900	20	Range 128	10, 17, 20, 26, 59, 66, 73, 74, 75, 76, 108, 114
DCS 1 800	747	Range 256	747, 775, 779, 782, 791, 798, 829, 832, 844
PCS 1 900	647	Range 256	647, 675, 679, 682, 691, 698, 729, 732, 744

PHYSICAL INFORMATION

Information Element	value/remarks
As default message contents, except: Timing advance	Arbitrarily chosen but different to default value.

Step 6: $x = 500$

Step 7: The MS and SS are using a full rate TCH in hopping mode on cell A.

For $M = 3$:

Step 0: The MS and SS are using a full rate TCH in hopping mode on cell A.

HANDOVER COMMAND

Information Element	value/remarks
As default message contents, except: Cell Description - Network Colour Code - Base Station Colour Code - BCCH Carrier Number	1 5 See the table below
Synchronisation Indication - Report Observed Time Difference - Synchronisation Indication - Normal Cell Indication	Shall not be included. 'Non synchronised'. Out of range timing advance shall trigger a handover failure procedure.
VGCS target mode Indication - Target mode - Group cipher key number	dedicated mode no ciphering

HANDOVER COMMAND	
Band	Channel Description
	ARFCN
GSM 450	274
GSM 480	321
GSM 710	477
GSM 750	477
T-GSM 810	477
GSM 850	167
GSM 900	40
DCS 1 800	764
PCS 1 900	664

PHYSICAL INFORMATION

Information Element	value/remarks
As default message contents.	

Step 6: x = 500

Step 7: The MS and SS are using a full rate TCH in non-hopping mode on cell B.

26.14.3.4 VGCS-VBS / RR Procedures / handover / successful at group call establishment

This clause deals with signalling in the Handover/successful/group call establishment/non synchronised case. This subclause is aligned with subclause 26.6.5.2 (M = 1 and M = 8).

Table 26.14.3.4.1 contains a summary of the different combinations of parameters which have to be tested. If a test uses a channel rate which the MS under test does not support, the test shall be skipped.

Table 26.14.3.4.1

From	To	Timing Adv.	Start Time	Sync	State of call	Exec Counter
SDCCH/4, no FH	TCH/F, FH	20	none	no	group or broadcast call establishment	1
SDCCH/8, FH	TCH/F, no FH	20	1,1s	no	group or broadcast call establishment	2

Table 26.14.3.4.2

	TCH/FS	SDCCH
n	10-20	2-5
n: number of access bursts.		

26.14.3.4.1 Conformance requirements

In dedicated mode or group transmit mode, an intercell or intracell change of channel(s) can be requested by the network RR sublayer. This changed may be performed through the handover procedure.

The purpose of the handover procedure is to completely modify the channels allocated to the mobile station e.g. when the cell is changed. A change in the channel configuration nature is possible. This procedure is used only while in dedicated mode or group transmit mode.

References

3GPP TS 04.08 / 3GPP TS 44.018, subclauses 3.4.4 and 9.1.15.

3GPP TS 04.13, subclause 5.2.6.2.

26.14.3.4.2 Test purpose

To verify that:

1. The MS correctly applies the handover procedure from non frequency hopping SDCCH/4 to TCH/F with frequency hopping in the non-synchronized case during group or broadcast call establishment.
2. The mobile correctly applies the handover procedures from SDCCH/8with frequency hopping to TCH/F without frequency hopping in the non-synchronized case during group or broadcast call establishment.
3. If during call establishment a Layer 3 MM or CC message just sent by the MS is not Layer 2 acknowledged before the channel change caused by the HANDOVER COMMAND message, the MS sends the Layer 3 message to the new cell, using the same value in the N(SD) field, after the handover procedure.

26.14.3.4.3 Method of test

Initial Conditions

System Simulator:

2 cells A and B with same LAI, default parameters, except:

Cell A has:

BCCH ARFCN = See the table below

Cell Allocation = See the table below

PLMN colour code, NCC = as defaults.

BS colour code, BCC = as defaults.

Cell B has:

BCCH ARFCN = See the table below

Cell Allocation = See the table below

PLMN colour code, NCC = 3.

BS colour code, BCC = 0.

Band	Cell A		Cell B		Both Cells Format
	BCCH ARFCN	Cell Allocation	BCCH ARFCN	Cell Allocation	
GSM 450	263	259, 261, 263, 265, 267, 269, 271, 273, 275, 277, 279, 281, 283, 285, 287, 289, 291	274	260, 262, 264, 266, 268, 270, 272, 274, 276, 279, 281, 283, 285, 287, 289, 291	Range 128
GSM 480	310	306, 308, 310, 312, 314, 316, 318, 320, 322, 324, 326, 328, 330, 332, 334, 336, 338	321	307, 309, 311, 313, 315, 317, 319, 321, 323, 326, 328, 330, 332, 334, 336, 338	Range 128
GSM 710	457	447, 454, 457, 463, 471, 479, 482, 483, 489, 496, 498, 500, 501, 502, 503, 506, 508	477	451, 455, 459, 461, 467, 468, 475, 477, 497, 498, 500, 501, 502, 503, 506, 508	Range 128
GSM 750	457	447, 454, 457, 463, 471, 479, 482, 483, 489, 496, 498, 500, 501, 502, 503, 506, 508	477	451, 455, 459, 461, 467, 468, 475, 477, 497, 498, 500, 501, 502, 503, 506, 508	Range 128
T-GSM 810	457	447, 454, 457, 463, 471, 479, 482, 483, 489, 496, 498, 500, 501, 502, 503, 506, 508	477	451, 455, 459, 461, 467, 468, 475, 477, 497, 498, 500, 501, 502, 503, 506, 508	Range 128
GSM 850	147	137, 144, 147, 153, 161, 169, 172, 173, 179, 186, 193, 200, 201, 202, 203, 235, 241	167	141, 145, 149, 151, 157, 158, 165, 167, 187, 193, 200, 201, 202, 203, 235, 241	Range 128
GSM 900	20	10, 17, 20, 26, 34, 42, 45, 46, 52, 59, 66, 73, 74, 75, 76, 108, 114	40	14, 18, 22, 24, 30, 31, 38, 40, 60, 66, 73, 74, 75, 76, 108, 114	Bit map 0
DCS 1 800	747	734, 741, 747, 754, 759, 762, 766, 767, 773, 775, 779, 782, 791, 798, 829, 832, 844	764	739, 743, 746, 749, 756, 758, 761, 764, 771, 779, 782, 791, 798, 829, 832, 844	Range 512
PCS 1 900	647	634, 641, 647, 654, 659, 662, 666, 667, 673, 675, 679, 682, 691, 698, 729, 732, 744	664	639, 643, 646, 649, 656, 658, 661, 664, 671, 679, 682, 691, 698, 729, 732, 744	Range 512

Both cells send SI 1 messages containing the complete Cell Allocation of the cell, using Range 128 format.

The timebase of Cells A and B shall be such that the edges of their timeslots are not coincident at the antenna connector.

For execution counter $M = 1$ a combined CCH/SDCCH is used.

For execution counter $M = 2$ a non combined SDCCH is used.

Mobile Station:

The MS is in MM-state "idle, updated" with a TMSI allocated and camped on cell A.

Specific PICS statements:

-

PIXIT Statements:

- Way to initiate VGCS call.
- Way to initiate VBS call.

Foreseen Final State of the MS

"Idle, updated" with TMSI allocated and camped on cell B.

Test Procedure

This procedure is repeated for execution counter $M = 1$ and 2 (see table 26.14.3.4.1).

A VBS call is initiated on cell A by setup procedure if the MS supports VBS only, otherwise a VGCS call is initiated by setup procedure on cell A. After the MS has sent the SETUP message (and before the last L2 frame carrying the SETUP message is acknowledged by the SS) the SS sends a HANDOVER COMMAND message, ordering the MS to switch to cell B. The MS shall then begin to send access bursts on the new DCCH (and optionally on the SACCH) to cell B. The SS observes the access bursts and after receiving n (n being arbitrarily chosen between values according to table 26.14.3.4.2) access bursts, the SS sends one PHYSICAL INFORMATION message with a Timing Advance as specified in table 26.14.3.4.1. It is checked that the MS activates the new channel and the MS is ready to transmit a HANDOVER COMPLETE message before x ms after the end of the PHYSICAL INFORMATION message, but not before a UA frame has been sent by the SS. It is also checked that the MS sends again the SETUP message with the same value in the $N(SD)$ field.

The term 'ready to transmit' is defined in 3GPP TS 04.13. The value of ' x ' depends upon the target channel and is specified in the specific message contents clause.

Maximum Duration of Test

5 minutes, including 1 minute for any necessary operator actions.

Expected Sequence

The sequence is performed for execution counter $M = 1$ and 2 .

Step	Direction	Message	Comments
1	MS		MMI action, a VBS or a VGCS call is initiated on cell A.
2	MS -> SS	CHANNEL REQUEST	
3	SS -> MS	IMMEDIATE ASSIGNMENT	See specific message contents.
4	MS -> SS	CM SERVICE REQUEST	L2: SABM / UA
5	MS -> SS	SETUP	Last L2 frame not acknowledged by the SS.
6	SS -> MS	HANDOVER COMMAND	See specific message contents.
7	MS -> SS	HANDOVER ACCESS	Repeated on every burst of the uplink main DCCH (and optionally on the SACCH) until reception of PHYSICAL INFORMATION. Handover Reference as included in the HANDOVER COMMAND
8	SS -> MS	PHYSICAL INFO	Sent after reception of n HANDOVER ACCESS message. Timing Advance as specified in table 26.14.3.4.1.
9	MS -> SS	SABM	Sent without information field
10	SS -> MS	UA	
11	MS -> SS	HANDOVER COMPLETE	This message shall be ready to be transmitted before ' x ' ms after the completion of step 8.
12	MS -> SS	SETUP	Same $N(SD)$ as in step 5.
13	SS -> MS	CHANNEL RELEASE	The MS releases L2 multiple frame link L2:DISC/UA.

Specific Message Contents

M = 1

IMMEDIATE ASSIGNMENT

Information Element	value/remark
As default message contents.	

HANDOVER COMMAND

Information Element	value/remarks
As default message contents, except:	
Cell Description	
- Network Colour Code	3
- Base Station Colour Code	0
- BCCH Carrier Number	See the table below
Channel Description	
- Channel Type	TCH/F + ACCHs
- Timeslot number	zero.
- Training Sequence Code	Chosen arbitrarily
- Hopping	RF hopping channel.
- MAIO	Chosen arbitrarily from the set (0, 1 to N-1), where N is the number of frequencies encoded in the Frequency Short List IE.
- HSN	Chosen arbitrarily from the set (1,2,..63).
Synchronization IE is not included.	
Channel Mode IE	speech full rate
Frequency Short List after time	
- Frequency Short List	Encode frequencies as per the table below

HANDOVER COMMAND			
Band	Frequency List		BCCH Carrier Number
	Format	ARFCNs	ARFCN
GSM 450	Range 128	260, 262, 264, 266, 268, 270, 272, 276, 279, 281, 283, 285, 287, 289, 291	274
GSM 480	Range 128	307, 309, 311, 313, 315, 317, 319, 323, 326, 328, 330, 332, 334, 336, 338	321
GSM 710	Range 128	451, 455, 459, 461, 467, 468, 475, 497, 498, 500, 501, 502, 503, 506, 508	477
GSM 750	Range 128	451, 455, 459, 461, 467, 468, 475, 497, 498, 500, 501, 502, 503, 506, 508	477
T-GSM 810	Range 128	451, 455, 459, 461, 467, 468, 475, 497, 498, 500, 501, 502, 503, 506, 508	477
GSM 850	Range 128	141, 145, 149, 151, 157, 158, 165, 187, 193, 200, 201, 202, 203, 235, 241	167
GSM 900	Bitmap 0	14, 18, 22, 24, 30, 31, 38, 60, 66, 73, 74, 75, 76, 108, 114	40
DCS 1 800	Range 128	756, 758, 761, 771, 779, 782, 791, 798, 829, 832, 844	764
PCS 1 900	Range 1 024	656, 658, 661, 671, 679, 682, 691, 698, 729, 732, 744	664

Step 13: 'x' = 500

M = 2

IMMEDIATE ASSIGNMENT

Information Element	value/remark
As default message contents except: L2 pseudo length	14 octets (11 + contents of the MA)
Channel Description	SDCCH/8
- Channel Type	As default message contents
- TDMA offset	Arbitrary value but not zero.
- Timeslot number	Chosen arbitrarily
- Training Sequence Code	RF hopping channel.
- Hopping	Chosen arbitrarily from the set (0, 1 to N-1), where N is the number of frequencies encoded in the Mobile Allocation.
- MAIO	Chosen arbitrarily from the set (1,2,..63)
- HSN	
Mobile Allocation	3 octets.
- Length	Indicates only three frequencies:
- Contents	GSM 450: 281, 283, 285 GSM 480: 328, 330, 332 GSM 710: 500, 501, 502 GSM 750: 500, 501, 502 T-GSM 810: 500, 501, 502 GSM 850: 200, 201, 202 GSM 900: 73, 74, 75 DCS 1 800: 773, 775, 779 PCS 1 900: 673, 675, 679

HANDOVER COMMAND

Information Element	value/remarks
As default message contents, except:	
Cell Description	
- Network Colour Code	3
- Base Station Colour Code	0
- BCCH Carrier Number	See the table below
Channel Description	
- Channel Type	TCH/F + ACCHs
- Timeslot number	Zero
- Training Sequence Code	Chosen arbitrarily
- Hopping	Single RF Channel
- ARFCN	Chosen arbitrarily from the Cell Allocation of Cell B, but not the BCCH carrier of Cell B.
Synchronization Indication IE not included.	

HANDOVER COMMAND	
Band	Channel Description
	ARFCN
GSM 450	274
GSM 480	321
GSM 710	477
GSM 750	477
T-GSM 810	477
GSM 850	167
GSM 900	40
DCS 1 800	764
PCS 1 900	664

Step 13: 'x' = 500

26.14.3.5 VGCS-VBS / RR Procedures / handover / failure

26.14.3.5.1 Conformance requirements

After a HANOVER COMMAND message and subsequent handover failure in group transmit mode, the MS shall return to the old channel.

References

3GPP TS 04.08 / 3GPP TS 44.018 subclause 3.4.4.4.

26.14.3.5.2 Test purpose

To verify that after a HANOVER COMMAND message and subsequent handover failure in group transmit mode, the MS returns to the old channel.

26.14.3.5.3 Method of test

Initial Conditions

System Simulator:

2 cells with same LAI, default parameters.

Mobile Station:

The MS is in group transmit mode on cell A.

Specific PICS statements:

-

PIXIT Statements:

- Way to configure VGCS or VBS.
- Way to request uplink.
- Way to initiate VBS call.

Foreseen Final State of the MS

"Idle, updated", with TMSI allocated.

Test Procedure

The MS is brought to group transmit mode, then the SS sends a HANOVER COMMAND message with Power Command set to 8. The MS begins to send access bursts at the commanded power level on the new DCCH (and optionally on the SACCH). The SS activates the SACCH, but does not send PHYSICAL INFORMATION (thus causing a time-out of T3124). It is checked that the MS re-establishes the old link and sends a HANOVER FAILURE within 3 s from the transmission of HANOVER COMMAND, using the old power level.

Maximum Duration of Test

5 minutes, including 1 minute for any necessary operator actions.

Expected Sequence

Step	Direction	Message	Comments
1	MS		the MS is in group transmit mode
2	SS -> MS	HANDOVER COMMAND	Channel description: non-hopping, full rate Power Command: 8. Synchronisation Indication: non synchronised.
3	MS -> SS	HANDOVER ACCESS	Several messages are sent, all with correct Handover References.
4	MS -> SS	HANDOVER FAILURE	Sent on old channel, RR cause value = "Abnormal release, unspecified", "Abnormal release, channel unacceptable", "Abnormal release, timer expired", "Abnormal release, no activity on the radio path" or "Protocol error unspecified". Shall be sent within 3 s from the transmission of HANDOVER COMMAND.
5	SS -> MS	CHANNEL RELEASE	The MS releases L2 multiple frame link L2:DISC/UA.

26.14.3.6 VGCS-VBS / RR / Measurement Report

This subclause tests measurement report of the MS in group transmit mode.

26.14.3.6.1 Measurement / all neighbours present

26.14.3.6.1.1 Conformance requirements

In group transmit mode the MS shall continuously send MEASUREMENT REPORT messages on every SACCH blocks and the measurement valid indication shall be set to valid (0) within the second block at the latest.

After 20 s the values in the MEASUREMENT REPORT message shall contain measurement results for the 6 strongest BCCH carriers with known and allowed NCC part of BSIC when the SS gives information of more than 6 neighbouring cells .

References

3GPP TS 04.08 / 3GPP TS 44.018 subclause 3.4.1.2.

3GPP TS 05.08 subclause 8.4.

26.14.3.6.1.2 Test purpose

To verify that, when the SS gives information of more than 6 neighbouring cells, the MS in group transmit mode reports measurement results for the 6 strongest BCCH carriers with known and allowed NCC part of BSIC.

26.14.3.6.1.3 Method of test

Initial Conditions

System Simulator:

For GSM 450 or GSM 480: 8 cells with the following settings:

Transmitter	Level	NCC	BSCC	ARFCN (GSM 450)	ARFCN (GSM 480)	Cell Identity
Serving, S1	-60	1	3	260	307	0001H
Neighbour, N1	-85	1	5	264	311	0002H
Neighbour, N2	-80	1	7	268	315	0003H
Neighbour, N3	-75	1	1	272	319	0004H
Neighbour, N4	-55	1	3	276	323	0005H
Neighbour, N5	-50	1	5	280	327	0006H
Neighbour, N6	-45	1	7	284	331	0007H
Neighbour, N7	-40	1	1	288	335	0008H

For GSM 900 or DCS 1 800: 8 cells with the following settings:

Transmitter	Level	NCC	BSCC	ARFCN (GSM 900)	ARFCN (DCS 1 800)	ARFCN (PCS 1 900)	Cell Identity
Serving, S1	-60	1	3	002	514	514	0001H
Neighbour, N1	-85	1	5	008	530	530	0002H
Neighbour, N2	-80	1	7	014	602	602	0003H
Neighbour, N3	-75	1	1	020	665	665	0004H
Neighbour, N4	-55	1	3	026	762	762	0005H
Neighbour, N5	-50	1	5	032	686	686	0006H
Neighbour, N6	-45	1	7	038	549	549	0007H
Neighbour, N7	-40	1	1	044	810	810	0008H

For GSM 710 or GSM 750 or T-GSM 810 or GSM 850: 8 cells with the following settings:

Transmitter	Level	NCC	BSCC	ARFCN (GSM 710)	ARFCN (T-GSM 810)	ARFCN (GSM 750)	ARFCN (GSM 850)	Cell Identity
Serving, S1	-60	1	3	439	439	439	129	0001H
Neighbour, N1	-85	1	5	445	445	445	135	0002H
Neighbour, N2	-80	1	7	451	451	451	141	0003H
Neighbour, N3	-75	1	1	457	457	457	147	0004H
Neighbour, N4	-55	1	3	463	463	463	153	0005H
Neighbour, N5	-50	1	5	469	469	469	159	0006H
Neighbour, N6	-45	1	7	475	475	475	165	0007H
Neighbour, N7	-40	1	1	481	481	481	171	0008H

With the exception of the Cell Allocation, the rest of the parameters for all eight cells are the same as the default settings and default SI 1 to 4 message contents for cell A. The Cell Allocation for the serving cell is the same as the default setting for cell A. The Cell Allocations for the neighbour cells need have only one entry, consisting of the ARFCN of that cell's BCCH.

Mobile Station:

The MS is in group transmit mode.

Specific PICS statements:

-

PIXIT Statements:

- Way to initiate VBS call.

Foreseen Final State of the MS

group transmit mode.

Test Procedure

This test procedure is performed twice.

The MS is in group transmit mode. The SS sends SI 5 and 6 (on the second iteration of the test the SS also sends SI 5bis) on the SACCH. All 8 of the BCCHs are indicated in the BA. It is checked that the MS sends MEASUREMENT REPORTs containing measurement results for the 6 strongest carriers.

Maximum Duration of Test

5 minutes, including 1 minute for any necessary operator actions.

Expected Sequence

This sequence is performed for execution counter, $k = 1, 2$.

Since when $k = 1$, SI 5, SI 6 and MEASUREMENT REPORT (and when $k = 2$ an additional SI 5bis is included) are sent continuously, a table is not applicable in this test. The interval between 2 successive Layer 2 frames containing MEASUREMENT REPORTs shall not exceed one Layer 2 frame.

Specific Message Contents

SYSTEM INFORMATION TYPE 5:

DCS 1 800 and PCS 1 900 begin:

Information Element	value/remark
Neighbour Cells Description - Format Identifier - EXT IND - W(i)	1024 range k = 1. Information Element carries complete BA. k = 2. Information Element carries only a part of the BA. k = 1. Non null for ARFCN 514, 530, 549, 602, 665, 686, 762, 810. k = 2. Non null for ARFCN 549, 602, 665, 686, 810.

DCS 1 800 and PCS 1 900 end:

Other bands begin:

Information Element	value/remark
Neighbour Cells Description Format Identifier BCCH Allocation Sequence BCCH Allocation ARFCN - EXT IND	See the table below 1 See the table below. k = 1. Information Element carries complete BA. k = 2. Information Element carries only a part of the BA.

Band	Neighbour Cells Description	
	Format Identifier	BCCH Allocation ARFCN
GSM 450	Range 128	259, 260, 261, 262, 263, 264, 265, 267, 268, 269, 270, 271, 272, 273, 274, 275, 276, 278, 279, 280, 281, 282, 283, 284, 285, 286, 287, 288, 289, 290, 291, 292
GSM 480	Range 128	306, 307, 308, 309, 310, 311, 312, 314, 315, 316, 317, 318, 319, 320, 321, 322, 323, 325, 326, 327, 328, 329, 330, 331, 332, 333, 334, 335, 336, 337, 338, 339
GSM 710	Range 128	439, 441, 442, 443, 444, 445, 446, 447, 448, 449, 450, 451, 453, 454, 455, 457, 457, 458, 459, 460, 461, 463, 465, 466, 467, 469, 471, 472, 473, 475, 477, 481
GSM 750	Range 128	439, 441, 442, 443, 444, 445, 446, 447, 448, 449, 450, 451, 453, 454, 455, 457, 457, 458, 459, 460, 461, 463, 465, 466, 467, 469, 471, 472, 473, 475, 477, 481
T-GSM 810	Range 128	439, 441, 442, 443, 444, 445, 446, 447, 448, 449, 450, 451, 453, 454, 455, 457, 457, 458, 459, 460, 461, 463, 465, 466, 467, 469, 471, 472, 473, 475, 477, 481
GSM 850	Range 128	129, 131, 132, 133, 134, 135, 136, 137, 138, 139, 140, 141, 143, 144, 145, 146, 147, 148, 149, 150, 151, 153, 155, 156, 157, 159, 161, 162, 163, 165, 167, 171
GSM 900	Bit map 0	2, 4, 5, 6, 7, 8, 9, 10, 11, 12, 13, 14, 16, 17, 18, 19, 20, 21, 22, 23, 24, 26, 28, 29, 30, 32, 34, 35, 36, 38, 40, 44

Other bands end:

SYSTEM INFORMATION TYPE 5bis (Sent only when k = 2):

Information Element	value/remark
Protocol Discriminator	RR Management
Message Type	Sys Info 5bis.
Neighbour Cells Description	
- Format	1024 range
- EXT IND	k = 2. Information Element carries only a part of the BA.
- W(i)	GSM 450: Channel 0 and 800 belong to the BCCH allocation.
	GSM 480: Channel 0 and 800 belong to the BCCH allocation.
	GSM 710: Channel 438 and 800 belong to the BCCH allocation.
	GSM 750: Channel 438 and 800 belong to the BCCH allocation.
	T-GSM 810: Channel 438 and 800 belong to the BCCH allocation.
	GSM 850: Channel 128 and 800 belong to the BCCH allocation.
	GSM 900: Channel 0 and 800 belong to the BCCH allocation.
	DCS 1 800: Non null ARFCN 20, 514, 530, 549, 762.
	PCS 1 900: Non null ARFCN 20, 514, 530, 549, 762.

SYSTEM INFORMATION TYPE 6:

DCS 1 800 and PCS 1 900 begin:

Information Element	value/ remark
Protocol Discriminator	RR Management
Message Type	sys info 6
Cell Identity	default
LAI	default
Cell Options	
- Power Control Indicator	Power Control Indicator is set
- DTX Indicator	MS shall not use DTX
- Radio_Link_Timeout	default
PLMN permitted	only NCC 1 permitted

DCS 1 800 and PCS 1 900 end:

MEASUREMENT REPORT:

Information Element	value/remark
Protocol Discriminator	RR Management
Transaction Identifier	0000
Message Type	MEASUREMENT REPORT
Measurement Results	
BA_used	1
DTX_used	DTX was not used
RXLEV_FULL_SERVING_CELL	See note 1
RXLEV_SUB_SERVING_CELL	See note 1
MEAS_VALID	See note 2
RXQUAL_FULL_SERVING_CELL	See note 1
RXQUAL_SUB_SERVING_CELL	See note 1
NO_NCELL_M	6 neighbour cell measurement results
RXLEV_NCELL_1	See note 1
BCCH_FREQ_NCELL_1	Shall not correspond to N1 or N2
BSIC_NCELL_1	Corresponds to that of BCCH_FREQ_NCELL_1
RXLEV_NCELL_2	See note 1
BCCH_FREQ_NCELL_2	Shall not correspond to N1 or N2
BSIC_NCELL_2	Corresponds to that of BCCH_FREQ_NCELL_2
RXLEV_NCELL_3	See note 1
BCCH_FREQ_NCELL_3	Shall not correspond to N1 or N2
BSIC_NCELL_3	Corresponds to that of BCCH_FREQ_NCELL_3
RXLEV_NCELL_4	See note 1
BCCH_FREQ_NCELL_4	Shall not correspond to N1 or N2
BSIC_NCELL_4	Corresponds to that of BCCH_FREQ_NCELL_4
RXLEV_NCELL_5	See note 1
BCCH_FREQ_NCELL_5	Shall not correspond to N1 or N2
BSIC_NCELL_5	Corresponds to that of BCCH_FREQ_NCELL_5
RXLEV_NCELL_6	See note 1
BCCH_FREQ_NCELL_6	Shall not correspond to N1 or N2
BSIC_NCELL_6	Corresponds to that of BCCH_FREQ_NCELL_6

NOTE 1: These actual values are not checked.

NOTE 2: The Measurement Valid Indication shall be set to valid within the second SACCH block at the latest.

26.14.4 VGCS-VBS / Uplink Access and Uplink Reply Procedures

26.14.4.1 VGCS-VBS / Uplink Access / uplink investigation

26.14.4.1.1 Conformance requirement

1. On receipt of a request from the upper layer to access the uplink and the uplink is free the MS shall start the uplink access procedure.
2. The uplink is not free when receipt of request from the upper layer to access the uplink, and before the Timer T3128 expiring the uplink is still not free, the MS shall remain in group receive mode and indicate a reject of the uplink request to the upper layer.

Reference(s)

3GPP TS 04.08 / 3GPP TS 44.018 subclause 3.3.1.2.1.1.

26.14.4.1.2 Test purpose

To verify that:

1. The MS starts the uplink access procedure on receipt of a request from the user to access the uplink and the uplink is free.
2. The MS remains in group receive mode and indicates a reject of the uplink request to the user till Timer T3128 expiring.

26.14.4.1.3 Method of test

Initial Conditions

System Simulator:

1 cell with default parameters for ASCII testing.

Mobile Station:

The MS is in group receive mode.

Specific PICS statements:

-

PIXIT Statements:

- Way to configure VGCS.
- Way to indicate uplink granted/rejected.
- Way to accept a VGCS.
- Way to request uplink.

Foreseen Final State of the MS

"Idle, updated", with TMSI allocated.

Test Procedure

The MS is brought into group receive mode. The SS indicates uplink free to the MS. The MS is requested to access uplink by MMI action. It is checked that the MS initiates the uplink access procedure. The request is not granted (a VGCS UPLINK GRANT to irrelevant request reference and an UPLINK BUSY message). It is checked that the MS remains in group receive mode. The MS is requested to access uplink by MMI action. It is checked that the MS does not send UPLINK ACCESS message and indicates uplink access rejected.

Maximum Duration of Test

5 minutes.

Expected Sequence

Step	Direction	Message	Comments
0	MS		the MS is in group receive mode.
1	SS -> MS	UPLINK FREE	Uplink access request set to 'L'. MMI action to request uplink access. request reference different from those in step 3 and 4. check that the MS indicates rejection of uplink request and check that the TCH in downlink is still through connected and there is no uplink transmission on that channel for 10 s.
2	MS		
3	MS -> SS	UPLINK ACCESS	
4	MS -> SS	UPLINK ACCESS	
5	SS -> MS	UPLINK BUSY	
6	SS -> MS	VGCS UPLINK GRANT	
7	MS		
10	MS		MMI action to request uplink access. check that there is no UPLINK ACCESS messages for 2 s. check that the MS indicates the access rejection to the user. UI format
11	SS		
12	MS		
13	SS -> MS	CHANNEL RELEASE	

26.14.4.2 Uplink Access / uplink access procedure

26.14.4.2.1 Conformance requirement

1. The mobile station shall send UPLINK ACCESS messages on the voice group call channel with the appropriate establishment cause. The first UPLINK ACCESS message shall be transmitted by the mobile station with a random delay between 0 and 20ms. The UPLINK ACCESS messages shall be repeated after a further period of 100ms plus a random delay between 0 and 20ms.
2. At expiration of timer T3130, the mobile station shall repeat the uplink access procedure if the uplink is free. A maximum of three attempts is allowed and after that a rejection of the uplink request is indicated to the upper layers.
3. When receiving a UPLINK BUSY or a VGCS UPLINK GRANT message aimed to another mobile station (i.e. not corresponding to one of its UPLINK ACCESS messages), the mobile station shall stop sending UPLINK ACCESS message and remain in group receive mode and shall indicate a rejection of the uplink request to the upper layers.
4. On receipt of an VGCS UPLINK GRANT message corresponding to one of its UPLINK ACCESS messages, the mobile station stops T3130, stops sending UPLINK ACCESS messages, and establishes the main signalling link with an SABM containing the TALKER INDICATION message in the information field. Controlled early classmark sending shall be performed. If a UA is received containing the message sent, the mobile station enters group transmit mode and indicates the successful seizure of the uplink to the upper layer.
5. If an uplink identity code (UIC) of the current cell has been provided by the network in the UPLINK FREE message, the mobile station shall use this UIC IE for the coding of the UPLINK ACCESS messages . If no UIC is provided, the mobile station shall use the BSIC received from the current cell, for instance from the initial synchronisation.

Reference(s)

3GPP TS 04.08 / 3GPP TS 44.018 subclause 3.3.1.2.1.2.

3GPP TS 03.68 subclause 11.3.7.

3GPP TS 05.03 subclause 4.6.

26.14.4.2.2 Test purpose

To verify that:

1. When a request to talk is made by the user and the uplink has been free the MS in group receive mode sends UPLINK ACCESS messages on the voice group call channel with the appropriate establishment cause.
2. The first UPLINK ACCESS message is transmitted by the MS with a random delay between 0 and 20 ms. The UPLINK ACCESS messages is repeated after a further period of 100ms plus a random delay between 0 and 20 ms.
3. At expiration of timer T3130, the MS repeats the uplink access procedure if the uplink is free and maximum of attempts is three. After three failed attempts a rejection of the uplink request is indicated.
4. The MS stops sending UPLINK ACCESS message and remains in group receive mode and indicates a rejection of the uplink request when receiving a UPLINK BUSY or a VGCS UPLINK GRANT message aimed to another mobile station (i.e., not corresponding to one of its UPLINK ACCESS messages).
5. On receipt of an VGCS UPLINK GRANT message corresponding to one of its UPLINK ACCESS messages, the MS stops T3130, stops sending UPLINK ACCESS messages, and establishes the main signalling link with an SABM containing the TALKER INDICATION message in the information field. Controlled early classmark sending is performed. If a UA is received containing the message sent, the MS enters group transmit mode and indicates the successful uplink seizure.
6. If an uplink identity code (UIC) of the current cell has been provided by the network in the UPLINK FREE message, the mobile station shall use this UIC IE for the coding of the UPLINK ACCESS messages . If no UIC is provided, the mobile station shall use the BSIC received from the current cell, for instance from the initial synchronisation.

26.14.4.2.3 Method of test

Initial Conditions

System Simulator:

1 cell with default parameters for ASCII testing.

Mobile Station:

The MS is in group receive mode.

Specific PICS statements:

-

PIXIT Statements:

- Way to configure VGCS.
- Way to indicate uplink granted/rejected.
- Way to accept a VGCS.

Way to request uplink.

Foreseen Final State of the MS

"Idle, updated", with TMSI allocated.

Test Procedure

The MS is brought into group receive mode. The SS sends UPLINK FREE without UIC. The MS is made to access uplink. It is checked that the MS initiates uplink access procedure with correct establishment cause and with random delay for transmissions and retransmissions and that the access bursts are coded with BSIC. The SS does not respond to the access request. It is checked that the MS repeats the same procedure three times, after three attempts it indicates access rejection and remains in group receive mode.

The SS sends UPLINK FREE with UIC. The MS is made to access uplink. It is checked that the access bursts are coded with UIC. After the second UPLINK ACCESS message, the SS responds with VGCS UPLINK GRANT aimed to another MS and UPLINK BUSY messages. It is checked that the MS stops sending UPLINK ACCESS, remains in group receive mode and indicates uplink access rejection. The SS sends UPLINK FREE. The MS is made to access uplink. The SS sends a message on the downlink SACCH. It is checked that the MS stops sending UPLINK ACCESS for 10 s, then the SS sends another SACCH message. It is checked that the MS is back to group receive mode and indicates access rejection. The MS is made to access uplink. The SS accepts the request. It is checked that the MS establishes the main signalling link correctly, enters group transmit mode and indicates the successful seizure of uplink.

Maximum Duration of Test

5 minutes.

Expected Sequence

Step	Direction	Message	Comments
0	MS		The MS is in group receive mode.
1	SS -> MS	UPLINK FREE	Uplink access request set to 'L'. UIC indication set to 'L'.
2	MS		MMI action to request uplink access.
3	MS -> SS	UPLINK ACCESS	check that establishment cause is "Subsequent talker uplink request" and this access burst is coded with BSIC.
4	MS -> SS	UPLINK ACCESS	check that the interval between this burst and the one in step 3 is 100ms plus a value between 0 and 20ms.
5	MS -> SS	UPLINK ACCESS	check that the interval between this burst and the one in step 3 is 5s plus a value between 0 and 20ms.
6	MS -> SS	UPLINK ACCESS	check that the interval between this burst and the one in step 5 is 100ms plus a value between 0 and 20ms, and the interval is different from the interval in step 4.

Step	Direction	Message	Comments
7	MS -> SS	UPLINK ACCESS	check that the interval between this burst and the one in step 5 is 5s plus a value between 0 and 20ms, and the interval is different from the interval in step 5. check that the interval between this burst and the one in step 7 is 100ms plus a value between 0 and 20ms, and the interval is different from the intervals in step 4 and step 6.
8	MS -> SS	UPLINK ACCESS	
9	MS		check that there is no more UPLINK ACCESS, and that the TCH in downlink is through connected and there is no uplink transmission on that channel for 10 s. The MS indicates also a rejection of the uplink request. containing UIC.
10	SS -> MS	UPLINK FREE	
11	MS		MMI action to request uplink access. request reference different from step 12 and 13 check that within 1 second the MS does not send further UPLINK ACCESS. this message sent 0.9 s. after step 14. check that the MS indicates a rejection of the uplink request and that the TCH in downlink is through connected and there is no uplink transmission on that channel for 10 s..
12	MS -> SS	UPLINK ACCESS	
13	MS -> SS	UPLINK ACCESS	
14	SS -> MS	VGCS UPLINK GRANT	
15	SS		
16	SS -> MS	UPLINK BUSY	
17	MS		
18	SS -> MS	UPLINK FREE	MMI action to request uplink access. check that there is no more UPLINK ACCESS, and that the TCH in downlink is through connected and there is no uplink transmission on that channel for 10 s. The MS indicates also a rejection of the uplink request.
19	MS		
20	MS -> SS	UPLINK ACCESS	
21	MS -> SS	UPLINK ACCESS	
22	SS -> MS	UPLINK BUSY	
23	SS		
24	SS -> MS	UPLINK FREE	
26	MS		MMI action to request uplink access. Reference to step 27 L2: SABM / UA no ciphering Check that the TCH is through connected and the MS gives indication to the user. The MS may send a DISC (step 38) without performing a layer 2 acknowledgement of the CHANNEL RELEASE message. The MS shall send at least 2 L2 DISC frames, to which the SS does not respond. After a period of 2 seconds, the SS verifies for 3 seconds that the MS does not produce any further Layer 2 messages.
27	MS -> SS	UPLINK ACCESS	
28	MS -> SS	UPLINK ACCESS	
29	SS -> MS	UPLINK BUSY	
30	SS -> MS	VGCS UPLINK GRANT	
31	MS -> SS	TALKER INDICATION	
32	SS -> MS	AUTHENTICATION REQUEST	
33	MS -> SS	AUTHENTICATION RESPONSE	
34	SS -> MS	CIPHERING MODE COMMAND	
35	MS -> SS	CIPHERING MODE COMPLETE	
36	MS		
37	SS -> MS	CHANNEL RELEASE	
38	MS -> SS	DISC	

26.14.4.3 VGCS-VBS / Uplink Reply in VGCS receive mode

26.14.4.3.1 Conformance requirement

1. On receipt of an UPLINK FREE message with an uplink access request indication from the network on the voice group call channel downlink, the mobile station shall send two UPLINK ACCESS messages on the voice group call channel with the appropriate establishment cause and then stop immediately transmitting on the uplink.
2. The first UPLINK ACCESS message shall be transmitted by the mobile station with a random delay between 0 and 20 ms. The second UPLINK ACCESS messages shall be repeated after a further period of 100 ms plus a random delay between 0 and 20 ms.

3. If an uplink identity code (UIC) of the current cell has been provided by the network in the UPLINK FREE message, the mobile station shall use this UIC for the coding of the UPLINK ACCESS messages. If no UIC is provided, the mobile station shall use the BSIC received of the serving cell, for instance as received from the initial synchronisation.

Reference(s)

3GPP TS 04.08 / 3GPP TS 44.018 subclause 3.4.15.1.3.

26.14.4.3.2 Test purpose

To verify that when the MS is in group receive mode:

1. On receipt of an UPLINK FREE message with an uplink access request indication from the network on the voice group call channel downlink, the MS sends two UPLINK ACCESS messages on the voice group call channel with the appropriate establishment cause and then stops immediately transmitting on the uplink.
2. The first UPLINK ACCESS message is transmitted by the MS with a random delay between 0 and 20 ms. The second UPLINK ACCESS messages is repeated after a further period of 100 ms plus a random delay between 0 and 20 ms.
3. If an uplink identity code (UIC) of the current cell has been provided by the network in the UPLINK FREE message, the MS uses this UIC for the coding of the UPLINK ACCESS messages. If no UIC is provided, the MS uses the BSIC received of the serving cell, for instance as received from the initial synchronisation.

26.14.4.3.3 Method of test

Initial Conditions

System Simulator:

- 1 cell with default parameters for ASCI testing.

Mobile Station:

- The MS is in group receive mode.

Specific PICS statements:

-

PIXIT Statements:

- Way to configure VGCS.
- Way to indicate uplink granted/rejected.
- Way to accept a VGCS call.
- Way to request uplink.

Foreseen Final State of the MS

"Idle, updated", with TMSI allocated.

Test Procedure

The MS is in (VGCS) group receive mode. The SS sends UPLINK FREE message with Uplink Access Request Indication Information Element but without UIC Information Element. It is checked that the MS sends two UPLINK ACCESS messages in correct scheduling and the L1 coding of the messages is with BSIC. The SS sends UPLINK FREE containing Uplink Access Request Indication Information Element and UIC Information Element. It is checked that the MS sends two UPLINK ACCESS messages in correct scheduling and the L1 coding of the messages is with UIC.

Maximum Duration of Test

Expected Sequence

Step	Direction	Message	Comments
0	MS		The MS is in group receive mode.
1	SS -> MS	UPLINK FREE	Uplink access request set to 'H'. UIC indication set to 'L'.
2	MS -> SS	UPLINK ACCESS	check that the establishment cause is "Reply on uplink access request" and the L1 coding is with BSIC
3	MS -> SS	UPLINK ACCESS	check that the burst and the one in step 2 is 100ms plus a value between 0 and 20ms, and check that the L1 coding is with BSIC.
4	SS -> MS	UPLINK FREE	with "uplink access request indication" and UIC.
5	MS -> SS	UPLINK ACCESS	check that the establishment cause is "Reply on uplink access request" and the L1 coding is with UIC
6	MS -> SS	UPLINK ACCESS	check that the burst and the one in step 5 is 100ms plus a value between 0 and 20ms; the interval is different from the intervals in step 2 and step 3, and check that the L1 coding is with UIC.
7	SS -> MS	CHANNEL RELEASE	UI format.

26.14.5 VGCS-VBS / Leaving Group Receive or Group Transmit Mode

26.14.5.1 VGCS-VBS / Leaving group receive mode

26.14.5.1.1 Conformance requirement

In group receive mode:

1. The MS shall return to idle mode and give an indication to the upper layer when it received a CHANNEL RELEASE message of UI format.
2. In sub-state NO CHANNEL for VGCS or RECEIVE MODE ACTIVE for VBS, when $T_{no_channel}$ expires, the GCC/BCC entity in the MS shall inform higher layers, ask lower sub-layers to abort resources and enter the idle state.
3. If the upper layer requests to abort group receive mode, the mobile station shall return to idle mode.

Reference(s)

3GPP TS 04.08 / 3GPP TS 44.018 subclauses 3.4.15.1.2.6 and 3.4.15.1.4.1.

3GPP TS 04.68 subclauses 6.1.2.1.10 and 6.3.1.1.

3GPP TS 04.69 subclauses 6.1.2.1.10 and 6.3.3.

26.14.5.1.2 Test purpose

To verify that in group receive mode:

1. The MS enters idle mode when it received a CHANNEL RELEASE message of UI format.
2. On user's request to abort group receive mode, the MS returns to idle mode.
3. In sub-state NO CHANNEL for VGCS or RECEIVE MODE ACTIVE for VBS, when $T_{no_channel}$ expires the MS aborts resources and enters the idle mode.

26.14.5.1.3 Method of test

Initial Conditions

System Simulator:

1 cell with default parameters for ASCII testing

Mobile Station:

The MS is in group receive mode.

Specific PICS statements:

-

PIXIT Statements:

- Way to configure VGCS or VBS.
- Way to indicate a call notification.
- Way to accept a VGCS or VBS.
- Way to verify the downlink speech path.

Foreseen Final State of the MS

"Idle, updated", with TMSI allocated.

Test Procedure

The MS is in group receive mode. The SS sends CHANNEL RELEASE. It is checked that the MS returns to idle mode by sending PAGING REQUEST. The MS is brought into group receive mode. The MS is requested to stop VGCS/VBS listening by MMI action. It is checked that the MS returns to idle mode. The MS is brought into group receive mode again. The SS stops downlink transmissions on VGCS/VBS downlink channel. It is checked that the MS returns to idle mode after $T_{no\ channel}$ times out (3 s after the SS stops downlink transmission).

Maximum Duration of Test

5 minutes.

Expected Sequence

Step	Direction	Message	Comments
0	MS		the MS is in group receive mode.
1	SS -> MS	CHANNEL RELEASE	UI format.
2	SS		wait 5s.
3	SS -> MS	PAGING REQUEST TYPE 1	"Mobile Identity" IE contains the TMSI allocated to the MS.
4	MS -> SS	CHANNEL REQUEST	"Establishment Cause" = Answer to paging.
5	SS -> MS	IMMEDIATE ASSIGNMENT REJECT	the first "request reference" corresponds to the CHANNEL REQUEST sent by the MS.
6	SS		wait 5s.
7	SS -> MS	NOTIFICATION/NCH	with group call channel description and the call reference active in the MS. The call reference is different from that used in step 0.
8	MS		MMI action to join the VGCS/VBS call.
9	MS		MMI action to stop the VGCS/VBS listening.
10	SS		wait 5s..
11	SS -> MS	PAGING REQUEST TYPE 1	"Mobile Identity" IE contains the TMSI allocated to the MS.
12	MS -> SS	CHANNEL REQUEST	"Establishment Cause" = Answer to paging.
13	SS -> MS	IMMEDIATE ASSIGNMENT REJECT	the first "request reference" corresponds to the CHANNEL REQUEST sent by the MS.
14	SS		wait 5s.
15	SS -> MS	NOTIFICATION/NCH	with group call channel description and the call reference active in the MS. The call reference is different from that used in step 0 and 3.
16	MS		MMI action to join the VGCS/VBS call.
17	SS		stop the VGCS/VBS downlink transmissions and wait 4 s.
18	SS -> MS	PAGING REQUEST TYPE 1	"Mobile Identity" IE contains the TMSI allocated to the MS.
19	MS -> SS	CHANNEL REQUEST	"Establishment Cause" = Answer to paging.
20	SS -> MS	IMMEDIATE ASSIGNMENT REJECT	the first "request reference" corresponds to the CHANNEL REQUEST sent by the MS.

26.14.5.2 VGCS-VBS / Leaving group transmit mode

26.14.5.2.1 Conformance requirement

In group transmit mode (VGCS):

1. If the uplink release is requested by the upper layer the mobile station shall send an UPLINK RELEASE message on the voice group call channel uplink, perform a release of the main signalling link and go back to group receive mode.
2. If the UPLINK RELEASE message is received from the network on the voice group call channel downlink, the MS shall perform a release of the main signalling link and go back to group receive mode.
3. The talking subscriber's mobile station which has lost the contact with the network shall return immediately to group receive mode.

Reference(s)

3GPP TS 04.08 / 3GPP TS 44.018 subclause 3.4.13.4 and 3.4.13.5.1.

3GPP TS 03.68 subclause 4.2.2.2.

26.14.5.2.2 Test purpose

To verify that in group transmit mode (VGCS):

1. When uplink release is requested by the user the mobile station sends an UPLINK RELEASE message on the voice group call channel uplink, performs a release of the main signalling link and goes back to group receive mode.
2. When the UPLINK RELEASE message is received from the network on the voice group call channel downlink, the MS performs a release of the main signalling link and goes back to group receive mode.
3. When a radio link failure is detected by the MS the MS shall return to idle mode and, when possible, to group receive mode.

26.14.5.2.3 Method of test

Initial Conditions

System Simulator:

1 cell with default parameters for ASCI testing.

Mobile Station:

The MS is in group transmit mode.

Specific PICS statements:

-

PIXIT Statements:

- Way to configure VGCS.
- Way to initiate VGCS talking.
- Way to verify the downlink speech path.

Foreseen Final State of the MS

"Idle, updated", with TMSI allocated.

Test Procedure

The MS is in VGCS group transmit mode. The MS is requested to quit group transmit mode by MMI action. It is checked that the MS sends an UPLINK RELEASE message and goes to group receive mode. The MS is brought into group transmit mode. The SS sends UPLINK RELEASE message. It is checked that the MS returns to group receive mode. The MS is brought into group transmit mode again. The SS stops radio transmitting on SACCH. It is checked that the MS returns to group receive mode.

Maximum Duration of Test

5 minutes.

Expected Sequence

Step	Direction	Message	Comments
0	MS		The MS is in group transmit mode.
1	MS		MMI action to quit the VGCS transmit mode.
2	MS -> SS	UPLINK RELEASE	
3	MS		check that the TCH in downlink is through connected and there is no uplink transmission on that channel for 10 s.
8	SS -> MS	UPLINK FREE	
9	MS		MMI action to request access uplink.
10	MS -> SS	UPLINK ACCESS	
11	MS -> SS	UPLINK ACCESS	
12	SS -> MS	UPLINK BUSY	
13	SS -> MS	VGCS UPLINK GRANT	Reference to step 10
14	MS -> SS	TALKER INDICATION	L2: SABM / UA
15	MS		the MS is in group transmit mode for 5 s.
16	SS -> MS	UPLINK RELEASE	
17	MS		check that the TCH in downlink is through connected and there is no uplink transmission on that channel for 10 s.
20	SS -> MS	UPLINK FREE	
21	MS		MMI action to request access uplink.
22	MS -> SS	UPLINK ACCESS	
23	MS -> SS	UPLINK ACCESS	
24	SS -> MS	UPLINK BUSY	
25	SS -> MS	VGCS UPLINK GRANT	Reference to step 23
26	MS -> SS	TALKER INDICATION	L2: SABM / UA
27	MS		the MS is in group transmit mode for 5 s.
28	SS		deactivate downlink SACCH transmissions, but keep TCH active, wait until there is no more uplink SACCH frames received
29	MS		check that the TCH in downlink is through connected and there is no uplink transmission on that channel for 10 s.
30	SS -> MS	CHANNEL RELEASE	UI format

26.14.6 VGCS-VBS / GCC-BCC Procedures

26.14.6.1 VGCS-VBS / GCC-BCC Procedures / MO call establishment

26.14.6.1.1 Conformance requirement

1. The MS in idle updated mode shall initiate a VGCS/VBS call correctly using IMMEDIATE SETUP procedure if a priority level is requested by the user for which the user has the subscription and the fast call setup is enabled.
2. The MS in idle updated mode shall initiate a VGCS/VBS call correctly using SETUP procedure on request.
3. For VGCS call after establishment, the MS shall indicate to the user that an indication of the desire to speak should be made if he wants to speak. If this is not done within a certain time, the MS shall send an UPLINK RELEASE.

Reference(s)

3GPP TS 04.68 subclause 6.2.2.

3GPP TS 04.69 subclause 6.2.2.

3GPP TS 03.68 subclause 11.3.1.1.3.

26.14.6.1.2 Test purpose

To verify that in idle updated mode:

1. The MS initiates a VGCS/VBS call correctly using IMMEDIATE SETUP procedure if a priority level is requested by the user for which the user has the subscription and the fast call setup is enabled.
2. The MS initiates a VGCS/VBS call correctly using SETUP procedure on request.
3. After establishment of VGCS call, the MS indicates that an user action is required if he wants to speak. If such user action is not made within a certain time, the MS sends an UPLINK RELEASE.

26.14.6.1.3 Method of test

Initial Conditions

System Simulator:

1 cell with default parameters for ASCII testing.

Mobile Station:

The MS is in MM-state "idle, updated" with a TMSI allocated.

Specific PICS statements:

- Support eMLPP (TSPC_Serv_eMLPP)

PIXIT Statements:

- Way to configure VGCS or VBS.
- Way to initiate a VGCS/VBS call.
- Way to select the immediate set-up or the normal set-up.
- Way to verify the downlink speech path.
- Way to indicate the desire of speaking.

The allowed duration between an indication of a required user action for speaking and an action performed by user.

Foreseen Final State of the MS

"Idle, updated", with TMSI allocated.

Test Procedure

The MS is in MM-state "idle, updated". The MS is requested to initiate a VGCS or VBS call using immediate setup procedure by selecting the subscribed priority '0' with the appropriate MMI action. The field EF_{eMLPP} associates to the subscribed priority '0' the fast-call setup subscription. It is checked that the MS performs correctly the immediate setup procedure. The call is terminated. The MS is requested to initiate a VGCS or VBS call using setup procedure by selecting the priority '4' with the appropriate MMI action. It is checked that the MS performs correctly the setup procedure. The call is cleared.

Maximum Duration of Test

5 minutes.

Expected Sequence

Steps 0 to 18 are executed if MS supports eMLPP.

Step	Direction	Message	Comments
0	MS		The MS is in idle updated state. MMI action to select a priority level 0 and MMI action to initiate VGCS/VBS call with immediate setup.
1	MS		
2	MS -> SS	CHANNEL REQUEST	

Step	Direction	Message	Comments
3	SS -> MS	IMMEDIATE ASSIGNMENT	TCH/F, single RF channel GSM 450: 275, GSM 480: 322, GSM 900: 50, DCS 1 800: 750 PCS 1 900: 650 GSM710: 470 GSM 750: 470 T-GSM 810: 470 GSM 850: 177 L2: SABM / UA
4	MS -> SS	IMMEDIATE SETUP	
5	SS -> MS	AUTHENTICATION REQUEST	
6	MS -> SS	AUTHENTICATION RESPONSE	
7	SS -> MS	CIPHERING MODE COMMAND	no ciphering
8	MS -> SS	CIPHERING MODE COMPLETE	
9	SS -> MS	CHANNEL MODE MODIFY	very early assignment
10	MS -> SS	CHANNEL MODE MODIFY ACKNOWLEDGE	
11	SS -> MS	CONNECT	verify that the TCH is through connected
12	SS -> MS	GET STATUS	
13	MS -> SS	STATUS	check that the MS is in state U2sr (for VGCS) or U2 (for VBS).
A14	MS		for VGCS call check that the MS indicates a user action needed for a desire of speaking. user does not answer the indication.
A15	MS		
A16	MS -> SS	UPLINK RELEASE	
A17	SS -> MS	UPLINK FREE	
A18	SS -> MS	CHANNEL RELEASE	UI format
B14	SS -> MS	TERMINATION	for VBS call terminate the call.
B15	SS -> MS	CHANNEL RELEASE	The MS releases L2 multiple frame link L2:DISC/UA.
20	MS		MMI action to initiate VGCS/VBS call with setup by selecting the priority '4'.
21	MS -> SS	CHANNEL REQUEST	
22	SS -> MS	IMMEDIATE ASSIGNMENT	TCH/F, single RF channel GSM 450: 275, GSM 480: 322, GSM 900: 50, DCS 1 800: 750 PCS 1 900: 650 GSM710: 470 GSM 750: 470 T-GSM 810: 470 GSM 850: 177 L2: SABM / UA
23	MS -> SS	CM SERVICE REQUEST	
24	SS -> MS	AUTHENTICATION REQUEST	
25	MS -> SS	AUTHENTICATION RESPONSE	
26	SS -> MS	CIPHERING MODE COMMAND	no ciphering
27	MS -> SS	CIPHERING MODE COMPLETE	
28	MS -> SS	SETUP	
29	SS -> MS	CHANNEL MODE MODIFY	very early assignment
30	MS -> SS	CHANNEL MODE MODIFY ACKNOWLEDGE	
31	SS -> MS	CONNECT	verify that the TCH is through connected
A32	MS		only for VGCS call check that the MS indicates a user action needed for a desire of speaking. An user action for speaking.
35	SS -> MS	GET STATUS	
36	MS -> SS	STATUS	check that the MS is in state U2sr (for VGCS) or U2 (for VBS).
37	SS -> MS	TERMINATION	terminate the call.
38	SS -> MS	CHANNEL RELEASE	The MS releases L2 multiple frame link L2:DISC/UA.

26.14.6.2 VGCS-VBS / GCC-BCC Procedures / Transaction Identifier

26.14.6.2.1 Conformance requirement

1. The originator of the GCC or BCC transaction shall choose the Transaction Identifier (TI).
2. When the MS (not originator) goes to group transmit mode, it may only send GCC or BCC messages when it has received a GCC or BCC message from network, it shall use the TI value which has been used in the messages from network.

Reference(s)

3GPP TS 04.07 subclause 11.2.3.1.3.

3GPP TS 04.68 clause 5.

3GPP TS 04.69 clause 5.

26.14.6.2.2 Test purpose

1. To verify that The originator of the GCC or BCC transaction chooses the Transaction Identifier (TI).
2. To verify that when the MS (not originator) goes to group transmit mode, if the MS sends GCC or BCC message to network to respond to messages from network, it uses the TI value which is used in the messages received from network.

26.14.6.2.3 Method of test

Initial Conditions

System Simulator:

1 cell with default parameters for ASCII testing.

Mobile Station:

The MS is in MM-state "idle, updated" with a TMSI allocated.

Specific PICS statements:

-

PIXIT Statements:

- Support VBS originating.
- Way to configure VGCS or VBS.
- Way to accept a group call.
- Way to request uplink access.
- Way to select the immediate set-up or the normal set-up.
- Way to initiate VBS call.

Foreseen Final State of the MS

MM idle updated state.

Test Procedure

If the MS supports only VBS, the MS is requested to initiate a VBS call using setup procedure by MMI action. In the BROADCAST CALL ACTIVE (U2) state, it is checked that the MS uses correct TI in the STATUS message to respond to the GET STATUS message.

If the MS supports VGCS, the MS is brought into group transmit mode. In the SEND and RECEIVE state (U2sr), it is checked that the MS uses correct TI in the STATUS message to respond to the GET STATUS message.

Maximum Duration of Test

5 minutes.

Expected Sequence

Step	Direction	Message	Comments
0	MS		If the MS supports VBS originating, step 0 to step 13 are executed.
1	MS		the MS is in idle mode
2	MS -> SS	CHANNEL REQUEST	MMI action to initiate VBS call with setup procedure.
3	SS -> MS	IMMEDIATE ASSIGNMENT	TCH/F, single RF channel GSM 450: 275, GSM 480: 322, GSM 900: 50, DCS 1 800: 750 PCS 1 900: 650 GSM 710: 470 GSM 750: 470 T-GSM 810: 470 GSM 850: 177 L2: SABM / UA
4	MS -> SS	CM SERVICE REQUEST	
5	SS -> MS	CM SERVICE ACCEPT	
6	MS -> SS	SETUP	check that the flag of the TI is set to '0'B, and the value of the TI is within '000'B to '110'B.
7	SS -> MS	AUTHENTICATION REQUEST	
8	MS -> SS	AUTHENTICATION RESPONSE	
9	SS -> MS	CHANNEL MODE MODIFY	
10	MS -> SS	CHANNEL MODE MODIFY ACKNOWLEDGE	
11	SS -> MS	CONNECT	
10	SS -> MS	GET STATUS	TI= the TI in step 6 with the flag='1'B.
11	MS -> SS	STATUS	TI value is the same as that in step 10 with flag='0'B.
12	SS -> MS	TERMINATION	
13	SS -> MS	CHANNEL RELEASE	The MS releases L2 multiple frame link L2:DISC/UA.
15	MS		If the MS supports VGCS talking, the following steps are performed.
16	SS -> MS	GET STATUS	the MS is in group transmit mode (VGCS), but is not the originator of the call.
17	MS -> SS	STATUS	TI="0001".
18	SS -> MS	UPLINK RELEASE	TI is set to "1001".
19	SS -> MS	CHANNEL RELEASE	UI format.

26.14.6.3 VGCS-VBS / GCC-BCC Procedures / Call Termination / originator / group transmit mode

26.14.6.3.1 Conformance requirement

When in group transmit mode, on request of upper layer, the MS which is the originator of the VGCS/VBS call shall initiate the termination procedure by sending a TERMINATION REQUEST message to its peer entity in the network and setting timer T_{term} , entering state U5. The network accepts the termination or on T_{term} expiration, the MS returns to idle state.

Reference(s)

3GPP TS 04.68 subclause 6.4.1.

3GPP TS 04.69 subclause 6.4.1.

26.14.6.3.2 Test purpose

To verify that when in group transmit mode, on request of the user, the MS which is the originator of the VGCS/VBS call initiates the termination procedure by sending a TERMINATION REQUEST message to its peer entity in the

network and setting timer T_{term} , entering state U5. If the termination is accepted or on T_{term} is expired, the MS returns to idle mode.

26.14.6.3.3 Method of test

Initial Conditions

System Simulator:

1 cell with default parameters for ASCI testing.

Mobile Station:

The MS is in MM-state "idle, updated" with a TMSI allocated.

Specific PICS statements:

-

PIXIT Statements:

- Way to configure VGCS or VBS.
- Way to initiate VBS call.
- Way to initiate VGCS call.
- Way to select the immediate set-up or the normal set-up.
- Way to terminate VGCS/VBS call.

Foreseen Final State of the MS

MM idle, updated state.

Test Procedure

A VGCS/VBS call is established and the MS, as the originator, is brought into group transmit mode. The MS is requested to terminate the VGCS/VBS call by MMI action. It is checked that the MS sends TERMINATION REQUEST message and enters state U5.

For execution counter $k=1$, before T_{term} times out, the SS accepts the termination request, the call is terminated. For $k=2$, the SS does not respond to the termination request. It is checked that after T_{term} times out, the MS clears the context related to the group call and returns to idle mode.

Maximum Duration of Test

5 minutes.

Expected Sequence

The test sequence is executed for $k = 1, 2$.

Step	Direction	Message	Comments
0	MS		the MS is in idle updated mode.
1	MS		MMI action to initiate VGCS/VBS call using setup procedure.
2	MS -> SS	CHANNEL REQUEST	
3	SS -> MS	IMMEDIATE ASSIGNMENT	TCH/F, single RF channel GSM 450: 275, GSM 480: 322, GSM 900: 50, DCS 1 800: 750 PCS 1 900: 650 GSM710: 470 GSM 750: 470 T-GSM 810: 470 GSM 850: 177 L2: SABM / UA
4	MS -> SS	CM SERVICE REQUEST	
5	SS -> MS	IDENTITY REQUEST	
6	MS -> SS	IDENTITY RESPONSE	
7	SS -> MS	CIPHERING MODE COMMAND	no ciphering
8	MS -> SS	CIPHERING MODE COMPLETE	
9	MS -> SS	SETUP	
10	SS -> MS	CHANNEL MODE MODIFY	
11	MS -> SS	CHANNEL MODE MODIFY ACKNOWLEDGE	
12	SS -> MS	CONNECT	verify that the TCH is through connected
13	MS		MMI action to terminate the call.
14	MS -> SS	TERMINATION REQUEST	
A15	SS -> MS	TERMINATION	for k = 1 sent 8 s. from step 14, cause = protocol error, unspecified
A16	SS -> MS	CHANNEL RELEASE	The MS releases L2 multiple frame link L2:DISC/UA.
B15	SS		for k = 2 wait for T_{term} timeout (round 10s)
B16	MS -> SS	UPLINK RELEASE	received between 9 - 11 s. from step 14 - for VGCS only.
B17	SS -> MS	CHANNEL RELEASE	UI format
18	SS -> MS	NOTIFICATION/NCH	with a description of VGCS/VBS channel and a VGCS/VBS call reference active in the MS.
19	MS		check that the MS gives an indication containing the notified group call reference
20	MS		MMI action to join the VGCS/VBS call
21	MS		check that the TCH in downlink is through connected and there is no uplink transmission on that channel for 10 s.
22	SS -> MS	CHANNEL RELEASE	UI format

26.14.6.4 VGCS-VBS / GCC-BCC Procedures / Call Termination / originator in group receive mode

26.14.6.4.1 Conformance requirement

When in group receive mode, on request of upper layer, the MS which is the originator of the VGCS call shall enter sub-state U2ws and ask RR to enter group transmit mode. As soon as $COMM = T$, it shall send a TERMINATION REQUEST message to its peer entity in the network, set timer T_{term} , and enter state U5. The network accepts the termination or on T_{term} expiration, the MS returns to idle mode.

Reference(s)

3GPP TS 04.68 subclause 6.4.1.

26.14.6.4.2 Test purpose

To verify that when in group receive mode, on request of the user, the MS which is the originator of the VGCS call enters sub-state U2ws and asks RR to enter group transmit mode. As soon as $COMM = T$, it sends a TERMINATION REQUEST message to its peer entity in the network, set timer T_{term} , and enters state U5. The network accepts the termination or on T_{term} expiration, the MS returns to idle mode.

26.14.6.4.3 Method of test

Initial Conditions

System Simulator:

1 cell with default parameters for ASCII testing.

Mobile Station:

The MS is in MM-state "idle, updated" with a TMSI allocated.

Specific PICS statements:

- Support of Half Rate Speech (TSPC_AddInfo_Half_rate_version_1)

PIXIT Statements:

- Way to configure VGCS.
- Way to initiate a VGCS call.
- Way to select the immediate set-up or the normal set-up.
- Way to terminate a VGCS call.

Foreseen Final State of the MS

MM idle, updated state.

Test Procedure

The MS originates a VGCS call and is brought into group receive mode. The MS is requested to terminate the VGCS call by MMI action. It is checked that the MS firstly enters group transmit mode and then sends TERMINATION REQUEST message, enters state U5.

For $k = 1$, the SS accepts the request, the call is terminated. For $k = 2$, the SS does not respond to the request. It is checked that after T_{term} timeout the MS aborts the call.

Maximum Duration of Test

5 minutes.

Expected Sequence

The test sequence is executed for k = 1, 2.

Step	Direction	Message	Comments
0	MS		the MS is in idle updated mode.
1	MS		MMI action to initiate VGCS call using setup procedure.
2	MS -> SS	CHANNEL REQUEST	
3	SS -> MS	IMMEDIATE ASSIGNMENT	
4	MS -> SS	CM SERVICE REQUEST	VGCS establishment, L2: SABM / UA
5	SS -> MS	CIPHERING MODE COMMAND	no ciphering
6	MS -> SS	CIPHERING MODE COMPLETE	
7	MS -> SS	SETUP	
8	SS -> MS	AUTHENTICATION REQUEST	
9	MS -> SS	AUTHENTICATION RESPONSE	
10	SS -> MS	ASSIGNMENT COMMAND	TCH/F, for k = 2 TCH/H if possible
11	MS -> SS	ASSIGNMENT COMPLETE	
12	SS -> MS	CONNECT	verify that the TCH is through connected
13	MS		MMI action to quit the VGCS transmit mode
14	MS -> SS	UPLINK RELEASE	check that the TCH in downlink is through connected and there is no uplink transmission on that channel for 10 s.
15	SS -> MS	UPLINK FREE	
17	MS		MMI action to terminate the call, a pending request
18	MS -> SS	UPLINK ACCESS	RR attempts to enter group transmit mode
19	MS -> SS	UPLINK ACCESS	
20	SS -> MS	UPLINK BUSY	
21	SS -> MS	VGCS UPLINK GRANT	Reference to step 19
22	MS -> SS	TALKER INDICATION	L2: SABM / UA
23	MS -> SS	TERMINATION REQUEST	
A25	SS -> MS	TERMINATION	for k = 1
A26	SS -> MS	CHANNEL RELEASE	sent 8 s. from step 23, cause = protocol error, unspecified The MS releases L2 multiple frame link L2:DISC/UA.
B25	SS		for k = 2
B26	MS -> SS	UPLINK RELEASE	wait for T_{term} timeout (round 10s)
B27	SS -> MS	CHANNEL RELEASE	received 9 - 11 s. from step 23. UI format
28	SS -> MS	NOTIFICATION/NCH	with a description of VGCS/VBS channel and a VGCS/VBS call reference active in the MS.
29	MS		check that the MS gives an indication containing the notified group call reference
30	MS		MMI action to join the VGCS/VBS call
31	MS		check that the TCH in downlink is through connected and there is no uplink transmission on that channel for 10 s.
32	SS -> MS	CHANNEL RELEASE	UI format

26.14.6.5 VGCS-VBS / GCC-BCC Procedures / Call Termination / not originator

26.14.6.5.1 Conformance requirement

1. If the MS is not the originator of the VGCS/VBS call, on request of upper layer, the MS shall not attempt to terminate the call.

Reference(s)

3GPP TS 04.68, subclause 6.4.1 (implicitly).

3GPP TS 04.69, subclause 6.4.1 (implicitly).

26.14.6.5.2 Test purpose

To verify that when the MS is not the originator of the VGCS/VBS call, on request of the user, the MS does not attempt to terminate the call.

26.14.6.5.3 Method of test

Initial Conditions

System Simulator:

1 cell with default parameters for ASCI testing.

Mobile Station:

The MS is in group receive mode (not originator).

Specific PICS statements:

-

PIXIT Statements:

- Way to configure VGCS or VBS.
- Way to join a VGCS/VBS call.
- Way to terminate a call.

Foreseen Final State of the MS

MM-state idle, updated.

Test Procedure

The MS is brought into group receive mode (not originator). The MS is requested to terminate the call by MMI action. It is checked that the MS does not attempt the termination.

Maximum Duration of Test

2 minutes.

Expected Sequence

Step	Direction	Message	Comments
0	MS		the MS is in group receive mode (not the originator).
1	MS		MMI action to terminate the call.
2	SS		check that there is no transmission from the MS for 10 s.
3	SS -> MS	CHANNEL RELEASE	UI format

26.14.6.6 VGCS-VBS / GCC-BCC Procedures / GCC states

26.14.6.6.1 Conformance requirement

1. The GCC entity of the MS performs transitions between (main) states. In main state GROUP CALL ACTIVE (U2) it performs transitions between sub-states. It has certain parameters and attributes, which it sets and changes based on interaction with higher layer and lower layers and on message exchanges with its peer entity. These states and parameters shall be consistent as defined.
2. The mobile station in group transmit mode shall mute the downlink speech if SET STATUS message is received with DA bit set to 1. The mobile station shall no longer mute the downlink after receipt of a downlink SET STATUS message with a reset DA bit.

Reference(s)

3GPP TS 04.68, subclauses 6.1.2.1, 6.1.2.1.1 to 6.1.2.1.11, 6.5.1.1, 8.4 and 9.5.7.

26.14.6.6.2 Test purpose

1. To verify that the GCC states and parameters of the MS are consistent as defined.
2. To verify that the MS in group transmit mode mutes the downlink speech if downlink SET STATUS message is received setting DA bit. The mobile station no longer mutes the downlink speech after a SET STATUS message is received.

26.14.6.6.3 Method of test

Initial Conditions

System Simulator:

1 cell with default parameters for ASCI testing.

Mobile Station:

The MS is in MM-state "idle, updated" with a TMSI allocated.

Specific PICS statements:

- Support VGCS originating (TSPC_Addinfo_VGCS_Originating)
- Support VGCS listening (TSPC_Addinfo_VGCS_Listening)

PIXIT Statements:

- Way to configure VGCS.
- Way to check downlink is muted or not.
- Way to accept VGCS call.
- Way to initiate VGCS call.

Foreseen Final State of the MS

MM-state Idle, updated.

Test Procedure

If the MS supports VGCS originating, it is requested to initiate a VGCS call. It is checked by getting status that the MS goes through different GCC states with correct parameters. If the MS supports VGCS talking but not VGCS originating, it is brought to group receive mode and then group transmit mode.

When MS is in group transmit mode the SS sends SET PARAMETER message The DA bit in state attributes is set to 0. It is checked that the downlink of the MS is muted. The SS sends SET PARAMETER message with DA bit set to 1. It is checked that the downlink of the MS is unmuted.

Similarly, it is checked that the MS goes through different GCC states with correct parameters.

Maximum Duration of Test

5 minutes.

Expected Sequence

If the MS supports VGCS originating, the step 1 to step 40 are performed.

Step	Direction	Message	Comments
0	MS		The MS is in idle mode.
1	MS		MMI action to initiate VGCS call
2	MS -> SS	CHANNEL REQUEST	

Step	Direction	Message	Comments
3	SS -> MS	IMMEDIATE ASSIGNMENT	TCH/F, single RF channel GSM 450: 275, GSM 480: 322, GSM 900: 50, DCS 1 800: 750 PCS 1 900: 650 GSM: 470 GSM 750: 470 T-GSM 810: 470 GSM 850: 177 VGC establishment, L2: SABM / UA
4	MS -> SS	CM SERVICE REQUEST	
5	SS -> MS	CM SERVICE ACCEPT	
6	MS -> SS	SETUP	
7	SS -> MS	GET STATUS	
8	MS -> SS	STATUS	state U1, ORIG=T COMM=T D-ATT=F U-ATT=F
9	SS -> MS	CONNECT	
10	SS -> MS	GET STATUS	
11	MS -> SS	STATUS	state U2sl, ORIG=T COMM=T D-ATT=T U-ATT=T
12	SS -> MS	CHANNEL MODE MODIFY	
13	MS -> SS	CHANNEL MODE MODIFY ACKNOWLEDGE	
14	SS -> MS	GET STATUS	
15	MS -> SS	STATUS	state U2sr, ORIG=T COMM=T D-ATT=T U-ATT=T
16	MS		the MS asks to indicate the desire of speaking. MMI action to indicate desire of talking.
17	MS		the MS in group talking mode for 5 s.
18	SS -> MS	SET PARAMETER	DA = '0'B
19	MS		check that the downlink is muted
20	SS -> MS	SET PARAMETER	DA = '1'B
21	MS		check that the downlink is not muted
22	MS		MMI action to quit group talking
23	MS -> SS	UPLINK RELEASE	
24	SS -> MS	UPLINK FREE	
25	MS		MMI action to request uplink access
26	MS -> SS	UPLINK ACCESS	
27	MS -> SS	UPLINK ACCESS	
28	SS -> MS	UPLINK BUSY	
29	SS -> MS	VGCS UPLINK GRANT	Reference to step 28
30	MS -> SS	TALKER INDICATION	L2: SABM / UA
31	SS -> MS	GET STATUS	
32	MS -> SS	STATUS	state U2sr, ORIG=T COMM=T D-ATT=T U-ATT=T
33	MS		MMI action to terminate the VGCS call
34	MS -> SS	TERMINATION REQUEST	
35	SS -> MS	GET STATUS	
36	MS -> SS	STATUS	state U5, ORIG=T COMM=T D-ATT=T U-ATT=T
37	SS -> MS	TERMINATION	
38	SS -> MS	CHANNEL RELEASE	The MS releases L2 multiple frame link L2:DISC/UA. The MS is in idle mode.
39	SS -> MS	NOTIFICATON/NCH	with VGCS call reference active in the MS, but without VGCS channel description
40	MS		MMI action to join the VGCS call
41	MS -> SS	CHANNEL REQUEST	
42	SS -> MS	IMMEDIATE ASSIGNMENT	a signalling channel
43	MS -> SS	NOTIFICATION RESPONSE	L2: SABM / UA
44	SS -> MS	GET STATUS	
45	MS -> SS	STATUS	state U2wr, ORIG=F COMM=T D-ATT=F U-ATT=F
46	SS -> MS	CHANNEL RELEASE	I format, with group channel description. The MS releases L2 multiple frame link L2:DISC/UA.
47	SS -> MS	UPLINK FREE	
48	MS		MMI action to request uplink access
49	MS -> SS	UPLINK ACCESS	
50	MS -> SS	UPLINK ACCESS	
51	SS -> MS	UPLINK BUSY	
52	SS -> MS	VGCS UPLINK GRANT	Reference to step 54
53	MS -> SS	TALKER INDICATION	L2: SABM / UA
54	SS -> MS	GET STATUS	
55	MS -> SS	STATUS	state U2sr, ORIG=F COMM=T D-ATT=T U-ATT=T

Step	Direction	Message	Comments
56	SS -> MS	UPLINK RELEASE	UI format, the MS returns to idle updated. The MS releases L2 multiple frame link L2:DISC/UA.
57	SS -> MS	CHANNEL RELEASE	

26.14.6.7 VGCS-VBS / GCC-BCC Procedures / BCC states

26.14.6.7.1 Conformance requirement

The BCC entity of the MS performs transitions between states. It has certain parameters and attributes, which it sets and changes based on interaction with higher layer and lower layers and on message exchanges with its peer entity. These states and parameters shall be consistent as defined.

Reference(s)

3GPP TS 04.69 subclauses 6.1.2.1 to 6.1.2.11 and 6.5.1.1.

26.14.6.7.2 Test purpose

To verify that the BCC states and parameters of the MS are consistent as defined.

26.14.6.7.3 Method of test

Initial Conditions

System Simulator:

1 cell with default parameters for ASCII testing.

Mobile Station:

The MS is in MM-state "idle, updated" with a TMSI allocated.

Specific PICS statements:

-

PIXIT Statements:

- Way to configure VBS.
- Way to select the immediate set-up or the normal set-up.
- Way to initiate VBS call.

Foreseen Final State of the MS

MM-state Idle, updated.

Test Procedure

The MS is requested to initiate VBS call. Then it is checked by getting status procedure that the MS goes through different GCC states with correct parameters.

Maximum Duration of Test

5 minutes.

Expected Sequence

Step	Direction	Message	Comments
0	MS		The MS is in idle mode.
1	MS		MMI action to initiate VBS call
2	MS -> SS	CHANNEL REQUEST	
3	SS -> MS	IMMEDIATE ASSIGNMENT	TCH/F, single RF channel GSM 450: 275, GSM 480: 322, GSM 900: 50, DCS 1 800: 750 PCS 1 900: 650 GSM710: 470 GSM 750: 470 T-GSM 810: 470 GSM 850: 177
4	MS -> SS	CM SERVICE REQUEST	VBC establishment, L2: SABM / UA
5	SS -> MS	GET STATUS	
6	MS -> SS	STATUS	state U0.p, ORIG=T COMM=F D-ATT=F U-ATT=F
7	SS -> MS	CM SERVICE ACCEPT	
8	MS -> SS	SETUP	
9	SS -> MS	GET STATUS	
10	MS -> SS	STATUS	state U1, ORIG=T COMM=T D-ATT=F U-ATT=F
11	SS -> MS	CONNECT	
12	SS -> MS	GET STATUS	
13	MS -> SS	STATUS	state U2, ORIG=T COMM=T D-ATT=T U-ATT=T
14	SS -> MS	CHANNEL MODE MODIFY	
15	MS -> SS	CHANNEL MODE MODIFY ACKNOWLEDGE	
16	MS		MMI action to terminate VBS call
17	MS -> SS	TERMINATION REQUEST	
18	SS -> MS	GET STATUS	
19	MS -> SS	STATUS	state U5, ORIG=T COMM=T D-ATT=T U-ATT=T
20	SS -> MS	TERMINATION	
21	SS -> MS	CHANNEL RELEASE	The MS releases L2 multiple frame link L2:DISC/UA.

26.14.7 VGCS-VBS / Error Handling

26.14.7.1 VGCS-VBS / Error Handling / short message length, unknown message type and TI

26.14.7.1.1 Conformance requirement

1. Whenever a message is received specifying a transaction identifier which is not recognised as relating to an active transaction, if COMM = T, the MS shall send a STATUS message with cause #81 "invalid transaction identifier value" using the received transaction identifier value and including, if possible, as diagnostics the complete message received (this may not be possible, e.g. due to length restrictions). and remain idle.
2. If COMM = T, the MS shall answer to a message received with TI value "111" by sending a STATUS message with same TI value, cause "invalid transaction identifier value", and including, if possible, as diagnostics the complete message received (this may not be possible, e.g. due to length restrictions).
3. When a message is received that is too short to contain a complete message type information element, that message shall be ignored.
4. If the GCC or BCC in the MS receives a message with message type not defined for the PD or not implemented by the receiver, the MS shall ignore the message except for the fact that, if COMM = T, it shall return a STATUS message with cause "message type non-existent or not implemented" and including as diagnostics the message type of the message received.
5. If the GCC or BCC in the MS receives a message not compatible with the protocol state, the MS shall ignore the message except for the fact that, if COMM = T, it shall return a STATUS message with cause " message type not compatible with protocol state" and including as diagnostic the message type of the message received.

6. When a message with semantically incorrect contents is received, the foreseen reaction of the procedural part are performed. If however no such reactions are specified, the MS shall ignore the message except for the fact that, if COMM = T, it returns a STATUS message with cause value "semantically incorrect message" and including, if possible, as diagnostics the complete message received (this may not be possible).

Reference(s)

3GPP TS 04.68 subclauses 7.2, 7.3, 7.4 and 7.8.

3GPP TS 04.69 subclauses 7.2, 7.3, 7.4 and 7.8.

26.14.7.1.2 Test purpose

To verify that:

1. Whenever a message is received specifying a transaction identifier which is not recognised as relating to an active transaction, if COMM = T, the MS sends a STATUS message with cause #81 "invalid transaction identifier value" using the received transaction identifier value and including, if possible, as diagnostics the complete message received (this may not be possible, e.g., due to length restrictions).
2. If COMM = T, the MS answers to a message received with TI value "111" by sending a STATUS message with same TI value, cause "invalid transaction identifier value", and including, if possible, as diagnostics the complete message received (this may not be possible, e.g., due to length restrictions).
3. When a message is received that is too short to contain a complete message type information element, that message is ignored.
4. If the GCC or BCC in the MS receives a message with message type not defined for the PD or not implemented by the receiver, the MS ignores the message. In addition, if COMM = T, it returns a STATUS message with cause "message type non-existent or not implemented" and including as diagnostics the message type of the message received.
5. If the GCC or BCC in the MS receives a message not compatible with the protocol state, the MS ignores the message. In addition, if COMM = T, it returns a STATUS message with cause " message type not compatible with protocol state" and including as diagnostic the message type of the message received.
6. When a message containing semantically incorrect contents is received and no reactions are specified in the procedural part, the MS ignores the message. In addition, if COMM = T, the MS returns a STATUS message with cause value "semantically incorrect message" and as diagnostics, including the complete message received, if possible (this may not be possible).

26.14.7.1.3 Method of test

Initial Conditions

System Simulator

1 cell with default parameters for ASCII testing.

Mobile Station:

The MS is in MM-state "idle, updated" with a TMSI allocated.

Specific PICS statements:

- Support VGCS originating (TSPC_Addinfo_VGCS_Originating)
- Support VGCS talking (TSPC_Addinfo_VGCS_Talking)
- Support VBS originating (TSPC_Addinfo_VBS_Originating)

PIXIT Statements:

-

Foreseen Final State of the MS

MM-state "Idle, updated".

Test Procedure

If the MS supports VGCS/VBS originating, the test starts from step 1, otherwise if the MS supports VGCS talking the test starts from step 30. If the MS supports VBS originating but no VGCS originating nor VGCS talking, the test stops on step 24.

The MS is requested to initiate a VGCS/VBS call with setup procedure. After the MS sends SETUP message, the SS sends incorrect CONNECT messages which contains incorrect TI flag or incorrect TI value or TI value set to '111'B. It is checked that the MS ignores these messages and responds with STATUS messages containing cause #81. The SS sends a message which is too short to contain a complete message. It is checked that the MS ignores this short message. Finally the SS sends a undefined message, a message not compatible with current protocol state and a message semantically incorrect. It is checked that the MS ignores these messages and returns STATUS messages containing cause #97, #98, #95 respectively. The following steps is applicable to the MS supporting VGCS talking. The MS is brought into group transmit mode. The SS sends GET STATUS message with TI='1001'B, the MS responds with STATUS message containing state U2sr, then the SS sends GET STATUS messages containing TI= '1111'B or '1010'B. It is checked that the MS ignores these messages and responds with STATUS messages containing cause #81.

Maximum Duration of Test

5 minutes.

Expected Sequence

The step 30 -46 are performed if the MS supports VGCS.

Step	Direction	Message	Comments
0	MS		The MS is in idle mode.
1	MS		MMI action to initiate VGCS/VBS call using setup procedure.
2	MS -> SS	CHANNEL REQUEST	
3	SS -> MS	IMMEDIATE ASSIGNMENT	a TCH/FS
4	MS -> SS	CM SERVICE REQUEST	L2: SABM / UA
5	SS -> MS	CM SERVICE ACCEPT	
6	MS -> SS	SETUP	
7	SS -> MS	CONNECT	flag of TI set to '0'B, value of TI is the same as that of SETUP message in step 6.
8	MS -> SS	STATUS	cause #81, "invalid transaction id value".
9	SS -> MS	CONNECT	flag of TI set to '1'B, value of TI is different from that of SETUP message in step 6.
10	MS -> SS	STATUS	cause #81, value of TI is that of step 9.
11	SS -> MS	CONNECT	value of TI set to '111'B.
12	MS -> SS	STATUS	cause #81, value of TI is '111'B
13	SS -> MS	CONNECT	too short message without Call Reference and Originator Indication.
14	SS -> MS	GET STATUS	
15	MS -> SS	STATUS	state U1 ORIG=T COMM=T D-ATT=F U-ATT=F.
16	SS -> MS	UNDEF MESSAGE TYPE	see specific message contents
17	MS -> SS	STATUS	cause #97, "message type non-existent or not implemented".
18	SS -> MS	TERMINATION REJECT	
19	MS -> SS	STATUS	cause #98, "message type not compatible with the protocol state".
20	SS -> MS	CONNECT	value of Originator Indication set to not originator
21	MS -> SS	STATUS	cause #95, "Semantically incorrect message".
22	SS -> MS	TERMINATION	
23	SS -> MS	CHANNEL RELEASE	The MS releases L2 multiple frame link L2:DISC/UA.
30	SS -> MS	NOTIFICATION/NCH	with a description of VGCS channel and a VGCS call reference active in the MS
31	MS		MMI action to join the call
32	SS -> MS	UPLINK FREE	
33	MS		MMI action to request to access uplink
34	MS -> SS	UPLINK ACCESS	
35	MS -> SS	UPLINK ACCESS	
36	SS -> MS	UPLINK BUSY	
37	SS -> MS	VGCS UPLINK GRANT	Reference to step 34
38	MS -> SS	TALKER INDICATION	L2: SABM / UA
39	SS -> MS	GET STATUS	TI = '1001'B, GCC of the MS will take this value as the TI of the group call
40	MS -> SS	STATUS	state U2sr
41	SS -> MS	GET STATUS	TI='1111'B
42	MS -> SS	STATUS	cause #81, value of TI is '111'B
43	SS -> MS	GET STATUS	TI='1010'B
44	MS -> SS	STATUS	cause #81, value of TI is '010'B
45	SS -> MS	UPLINK RELEASE	
46	SS -> MS	CHANNEL RELEASE	UI format

Specific message contents:

UNDEF MESSAGE TYPE

Information Element	value/remark
Protocol Discriminator	'0000'B if the test is for VGCS; '0001'B if the test is for VBS.
Message Type	'0x110111'B
Group call reference	PICS/PIXIT
Originator indication	Originator
Spare half octet	

26.14.7.2 VGCS-VBS / Error Handling / incorrect information elements

26.14.7.2.1 Conformance requirement

1. When on receipt of a message containing "imperative message part" error or "missing mandatory IE" error or syntactically incorrect mandatory IE's or unknown IE's encoded as "comprehension required" or out of sequence IE's encoded as "comprehension required", the MS shall ignore the message except for the fact that, if COMM = T, it shall return a STATUS message with cause "invalid mandatory information" and including, if possible, as diagnostics the complete message received.
2. The GCC or BCC in the MS shall ignore all unknown information elements not encoded as "comprehension required" in the non-imperative part.
3. The GCC or BCC in the MS shall ignore all out of sequence information elements not encoded as "comprehension required" in the non-imperative part.
4. The GCC or BCC in the MS shall ignore all syntactically incorrect optional information elements in the non-imperative part.
5. If an information element with format T, TV, or TLV is repeated in a message in which repetition of the information element is not specified, only the contents of the information element appearing first shall be handled and all subsequent repetitions of the information element shall be ignored. When repetition of information elements is specified, only the contents of specified repeated information elements shall be handled. If the limit on repetition of information elements is exceeded, the contents of information elements appearing first up to the limit of repetitions shall be handled and all subsequent repetitions of the information element shall be ignored.

Reference(s)

3GPP TS 04.68 subclauses 7.5, 7.6 and 7.7.

3GPP TS 04.69 subclauses 7.5, 7.6 and 7.7.

26.14.7.2.2 Test purpose

To verify that:

1. On receipt of a message containing "imperative message part" error or "missing mandatory IE" error or syntactically incorrect mandatory IE's or unknown IE's encoded as "comprehension required" or out of sequence IE's encoded as "comprehension required", the MS ignores the message. In addition, if COMM = T, the MS returns a STATUS message with cause "invalid mandatory information" and including, if possible, as diagnostics the complete message received.
2. The MS ignores unknown information elements not encoded as "comprehension required" in the non-imperative part.
3. The MS ignores out of sequence information elements not encoded as "comprehension required" in the non-imperative part.
4. The MS ignores syntactically incorrect optional information elements in the non-imperative part.
5. The MS ignores subsequent repetition of the information element for which repetition is not specified, only the contents of the information element appearing first are handled. For specified repeated information element, the

MS ignores all subsequent repetitions of the information element beyond the limit on repetition, only the contents of information element appearing first up to the limit of repetitions are handled.

26.14.7.2.3 Method of test

Initial Conditions

System Simulator:

1 cell with default parameters for ASCII testing.

Mobile Station:

The MS is in MM-state "idle, updated" with a TMSI allocated.

Specific PICS statements:

- Support VGCS originating (TSPC_Addinfo_VGCS_Originating)
- Support VGCS talking (TSPC_Addinfo_VGCS_Talking)
- Support VGCS listening (TSPC_Addinfo_VGCS_Listening)
- Support VBS originating (TSPC_Addinfo_VBS_Originating)
- Support VBS listening (TSPC_Addinfo_VBS_Listening)

PIXIT Statements:

-

Foreseen Final State of the MS

MM-state "Idle, updated".

Test Procedure

The MS is in idle updated mode. The SS sends NOTIFICATION/NCH messages with incorrect mandatory IE (skip='0001'B) or with comprehension required IE. It is checked that the MS ignores these NOTIFICATION/NCH messages. The SS sends NOTIFICATION/NCH containing unknown IE not encoded as comprehension required in non-imperative part. It is checked that the MS ignores the unknown IE and accepts the NOTIFICATION/NCH message. If the MS supports VGCS/VBS listening only, the test stops here.

If the MS supports VGCS talking the test continues on step 7. The MS joins the call. The SS sends correct UPLINK BUSY message then sends UPLINK FREE message containing incorrect mandatory IE. It is checked that the UPLINK FREE message is ignored by the MS. The SS sends correct UPLINK FREE message and the MS is requested to access the uplink. During the uplink access procedure it is checked that the MS ignores the VGCS UPLINK GRANT message in which mandatory IE is missing. After the MS enters group transmit mode, it is brought back to idle updated mode. The test stops here if the MS supports VGCS talking but not VGCS originating.

If the MS supports VGCS/VBS originating the test proceeds on step 30. The MS is requested to originate a VGCS call. During the call establishment it is checked that the MS ignores the CONNECT messages that missing mandatory IE or containing unknown IE encoded as comprehension required, and that the MS ignores unknown IE which is in non-imperative part and is not encoded as comprehension required, it is also checked that the MS ignores subsequent repetition of the information element for which repetition is not specified.

Maximum Duration of Test

5 minutes.

Expected Sequence

The test steps 7 to 29 are performed if the MS supports VGCS talking. The test steps 30 to 56 are performed if the MS supports VGCS/VBS originating.

Step	Direction	Message	Comments
0	MS		The MS is in Idle updated mode.
1	SS -> MS	NOTIFICATION/NCH	skip = '0001'B, with VGCS/VBS channel description and call reference active in the MS
2	MS		check that the MS ignores the NOTIFICATION/NCH message in step 1. This is checked for 10 s.
3	SS -> MS	NOTIFICATION/NCH	containing comprehension required IE, see specific message contents
4	MS		check that the MS ignores the NOTIFICATION/NCH message in step 3. This is checked for 10 s
5	SS -> MS	NOTIFICATION/NCH	unknown IE not encoded as comprehension required, see specific message contents
6	MS		check that the MS indicates the notified call
7	MS		MMI action to join the notified VGCS call
8	SS -> MS	UPLINK BUSY	
9	SS -> MS	UPLINK FREE	message type = '11010'B, the MS shall ignore this message
10	MS		MMI action to request the uplink access
11	SS		check that there is no UPLINK ACCESS for 6 s.
12	SS -> MS	UPLINK FREE	as default
13	MS		MMI action to request the uplink access
14	MS -> SS	UPLINK ACCESS	
15	MS -> SS	UPLINK ACCESS	
16	SS -> MS	VGCS UPLINK GRANT	missing mandatory IE Timing Advance, request reference refers to step 14.
17	MS -> SS	UPLINK ACCESS	The MS ignores VGCS UPLINK GRANT.
18	MS -> SS	UPLINK ACCESS	
19	SS -> MS	VGCS UPLINK GRANT	request reference does not refer to steps 14, 15, 17, 18.
20	SS -> MS	UPLINK BUSY	
21	SS		check that there is no UPLINK ACCESS for 6 s
22	SS -> MS	UPLINK FREE	
23	MS		MMI action to request uplink access
24	MS -> SS	UPLINK ACCESS	
25	MS -> SS	UPLINK ACCESS	
26	SS -> MS	UPLINK BUSY	
27	SS -> MS	VGCS UPLINK GRANT	refer to the reference in step 25
28	MS -> SS	TALKER INDICATION	L2: SABM / UA
29	SS -> MS	CHANNEL RELEASE	The MS releases L2 multiple frame link L2:DISC/UA.
30	MS		MMI action to originate a VGCS/VBS call with setup
31	MS -> SS	CHANNEL REQUEST	
32	SS -> MS	IMMEDIATE ASSIGNMENT	TCH/F, single RF channel GSM 450: 275, GSM 480: 322, GSM 900: 50, DCS 1 800: 750 PCS 1 900: 650 GSM710: 470 GSM 750: 470 T-GSM 810: 470 GSM 850: 177 L2: SABM / UA
33	MS -> SS	CM SERVICE REQUEST	
34	SS -> MS	CM SERVICE ACCEPT	
36	MS -> SS	SETUP	
37	SS -> MS	CHANNEL MODE MODIFY	
38	MS -> SS	CHANNEL MODE MODIFY ACKNOWLEDGE	
39	SS -> MS	CONNECT	missing mandatory IE: Group call reference
40	MS -> SS	STATUS	cause #96

Step	Direction	Message	Comments
41	SS -> MS	CONNECT	unknown IE encoded as comprehension required, see specific message contents cause #96 unknown IE in non-imperative part, see specific message contents state U1
42	MS -> SS	STATUS	
43	SS -> MS	GET STATUS	
44	MS -> SS	STATUS	
45	SS -> MS	CONNECT	
46	SS -> MS	GET STATUS	
A47	MS -> SS	STATUS	for VGCS test state U2sr check the MS asks to indicate the desire of speaking wait for time-out. duplicated IE, see specific message contents check that the MS does not respond
A48	MS		
A49	MS		
A50	MS -> SS	UPLINK RELEASE	
A51	SS -> MS	GET STATUS	
A52	SS		
A53	SS -> MS	GET STATUS	
A54	MS -> SS	STATUS	
B47	MS -> SS	STATUS	for VBS test state U2
55	SS -> MS	TERMINATOIN	
56	SS -> MS	CHANNEL RELEASE	
			The MS releases L2 multiple frame link L2:DISC/UA.

Specific message contents:

NOTIFICATION/NCH - in step 3

Information Element	value/remark
L2 Pseudo Length	'15'B
RR Protocol Discriminator	'0110'B
Skip Indicator	'0000'B
Message Type	'00100000'B
Comprehension required IEI	'00000000'B
- Length	1
- unrecognised IE contents	'xxxxxxx'B (arbitrary octet)
NT/N Rest Octets	As default

NOTIFICATION/NCH - in step 6

Information Element	value/remark
L2 Pseudo Length	'15'B
RR Protocol Discriminator	'0110'B
Skip Indicator	'0000'B
Message Type	'00100000'B
Unknown IEI	'11101001'B
- Length	1
- unrecognised IE contents	'xxxxxxx'B (arbitrary octet)
NT/N Rest Octets	As default

CONNECT - in step 41

Information Element	value/remark
Protocol Discriminator	'0000'B for GCC, '0001'B for BCC
Transaction identifier	depending on the context of the test
Message Type	'0x110011'B
Group call reference	PICS/PIXIT
Comprehension required IEI	'00000000'B
- Length	1
- unrecognised IE contents	'xxxxxxx'B (arbitrary octet)
Originator indication	Originator
Spare half octet	'0000'B

GET STATUS - in step 43

Information Element	value/remark
Protocol Discriminator	'0000'B for GCC, '0001'B for BCC
Transaction identifier	depending on the context of the test
Message Type	'0x111001'B
Mobile identity	PICS/PIXIT
Unknown IEI	'11101001'B
- Length	1
- unrecognised IE contents	'xxxxxxx'B (arbitrary octet)

GET STATUS - in step A51

Information Element	value/remark
GCC Protocol Discriminator	'0000'B
Transaction identifier	depending on the context of the test
Message Type	'0x111001'B
Mobile identity	not address the MS
Mobile identity	PICS/PIXIT

26.14.7.3 VGCS-VBS / Messages not addressing VGCS receive mode**26.14.7.3.1 Conformance requirement**

In group receive mode the MS shall ignore messages which are allowed in group receive mode but not sent in UI format on the VGCS or VBS channel downlink.

Mobile stations in group receive mode shall ignore all messages which are not sent in UI format or which are not related to the following procedures: channel mode modify, notification and paging information, uplink status messages, channel release message, information on channel restructuring.

Reference(s)

3GPP TS 04.08 / 3GPP TS 44.018 subclause 3.4.15.1.2.

26.14.7.3.2 Test purpose

To verify that the MS in group receive mode ignores:

1. Messages which are applicable to group receive mode but not sent in UI format.
2. ASSIGNMENT COMMAND and HANDOVER COMMAND messages in which the target mode information element indicates "dedicated mode".
3. Messages which are not applicable to group receive mode.

26.14.7.3.3 Method of test**Initial Conditions**

System Simulator:

1 cell with default parameters for ASCI testing.

Mobile Station:

The MS is in MM-state "idle, updated" with a TMSI allocated.

Specific PICS statements:

-

PIXIT Statements:

- Way to configure VGCS or VBS.
- Way to indicate a call notification.
- Way to accept a VGCS or VBS.
- Way to verify the downlink speech path.

Foreseen Final State of the MS

"Idle, updated", with TMSI allocated.

Test Procedure

The MS is brought into group receive mode. The SS sends, in UI format, the messages which are not applicable to group receive mode. It is checked that the MS ignores these messages. The SS sends, in L2 I format, messages which are applicable to group receive mode. It is checked that the MS ignores these messages.

Maximum Duration of Test

5 minutes.

Expected Sequence

Step	Direction	Message	Comments
0	MS		The MS is in Idle updated mode.
1	SS -> MS	NOTIFICATION/NCH	
2	MS		MMI action to join VGCS/VBS call.
3	SS -> MS	IMMEDIATE ASSIGNMENT	UI format.
4	MS		check that the MS ignores the above message.
5	SS -> MS	IMMEDIATE ASSIGNMENT EXTENDED	UI format.
6	MS		check that the MS ignores the above message.
7	SS -> MS	CIPHERING MODE COMMAND	UI format.
8	MS		check that the MS ignores the above message.
9	SS -> MS	ASSIGNMENT COMMAND	sent in the L2 I format.
10	MS		check that the MS ignores the above message.
11	SS -> MS	HANDOVER COMMAND	sent in the L2 I format.
12	MS		check that the MS ignores the above message.
13	SS -> MS	FREQUENCY REDEFINITION	sent in the L2 I format.
14	MS		check that the MS ignores the above message.
15	SS -> MS	CHANNEL MODE MODIFY	sent in the L2 I format.
16	MS		check that the MS ignores the above message.
17	SS -> MS	CHANNEL RELEASE	I format
18	MS		check that the MS ignores the above message.
19	SS -> MS	CHANNEL RELEASE	UI format.

26.14.8 VGCS-VBS / Structured Procedures

The objective of this test group is to verify that the MS in the ASCII context performs certain elementary procedures of the RR, MM, and GCC/BCC protocol correctly within a structured procedure, especially when some channels use R-GSM frequencies with ARFCNs between 955 and 974.

26.14.8.1 VGCS-VBS / Structured Procedures / Very early and early assignment

26.14.8.1.1 Conformance requirement

1. The mobile station initiates immediate assignment, service request, and contention resolution.

2. After sending the CIPHERING MODE COMPLETE message, the mobile station initiates call establishment by sending the SETUP message to the network.
3. The network allocates a traffic channel to the mobile station before it initiates call establishment in the fixed network.
4. The network assigns the traffic channel at the earliest possible moment, i.e. in the immediate assignment procedure. The mode of the traffic channel is changed from signalling only to the mode necessary for the call by means of the channel mode change procedure.

Reference(s)

3GPP TS 04.08 / 3GPP TS 23.108 subclause 7.3.2.

26.14.8.1.2 Test purposes

1. To verify that the MS initiates immediate assignment, service request using the IMMEDIATE ASSIGNMENT or CM SERVICE REQUEST message, and contention resolution.
2. To verify that the MS after sending the CIPHERING MODE COMPLETE message, initiates call establishment by sending the SETUP message to the network.
3. To check that the MS performs correctly the early assignment procedure.
4. To check that the MS performs correctly the very early assignment procedure.

26.14.8.1.3 Method of test

Initial Conditions

System Simulator:

1 cell with default parameters for ASCII testing.

Mobile Station:

The MS is in MM-state "idle, updated" with a TMSI allocated.

Specific PICS statements:

- Support eMLPP (TSPC_Serv_eMLPP)
- Support of Half Rate Speech (TSPC_AddInfo_Half_rate_version_1)
- Support of Enhanced Full Rate Speech (Full Rate Version 2) (TSPC_AddInfo_Full_rate_version_2)
- Support of R-GSM Band (TSPC_Type_GSM_R_Band)

PIXIT Statements:

- Way to configure a necessary radio channel rate.
- Way to configure VGCS or VBS.
- Way to select the immediate set-up or the normal set-up.
- Way to verify the downlink speech path.

Foreseen Final State of the MS

"Idle, updated", with TMSI allocated.

Test Procedure

The MS is requested to initiate a VGCS/VBS call using immediate setup procedure. The authentication and ciphering mode setting (to no ciphering) procedures are applied. The call is established by using early assignment procedure. For an R-band MS a carrier with ARFCN in the range of 955 - 974 is assigned for the traffic channel. The MS needs to be configured to use EFR codec for the test, if it supports EFR. The MS is requested to terminate the call.

The MS is requested to initiate a VGCS/VBS call using setup procedure. The authentication and ciphering mode setting (to no ciphering) procedures are applied. The call is established by using assignment procedure. For an R-band MS a carrier with ARFCN in the range of 955 - 974 is assigned for the traffic channel. The MS needs to be configured to use half rate codec for the test, if it supports dual rate. The call is terminated.

Maximum Duration of Test

5 minutes.

Expected Sequence

Steps 0 to 20 are executed if MS supports eMLPP.

Step	Direction	Message	Comments
0	MS		The MS is in idle updated mode.
1	MS		MMI action to select a priority level 0 and MMI action to initiate VGCS /VBS call using immediate setup procedure.
2	MS -> SS	CHANNEL REQUEST	
3	SS -> MS	IMMEDIATE ASSIGNMENT	
4	MS -> SS	IMMEDIATE SETUP	L2: SABM / UA
5	SS -> MS	AUTHENTICATION REQUEST	
6	MS -> SS	AUTHENTICATION RESPONSE	
7	SS -> MS	CIPHERING MODE COMMAND	no ciphering
8	MS -> SS	CIPHERING MODE COMPLETE	
9	SS -> MS	ASSIGNMENT COMMAND	see specific message contents
10	MS -> SS	ASSIGNMENT COMPLETE	
11	SS -> MS	CONNECT	verify that the TCH is through connected
12	MS		MMI action to terminate the call
13	MS -> SS	TERMINATION REQUEST	
14	SS -> MS	TERMINATION	cause = protocol error, unspecified
15	SS -> MS	CHANNEL RELEASE	The MS releases L2 multiple frame link L2:DISC/UA.
21	MS		MMI action to initiate VGCS/VBS call with setup procedure. TCH/F needed
22	MS -> SS	CHANNEL REQUEST	
23	SS -> MS	IMMEDIATE ASSIGNMENT	
24	MS -> SS	CM SERVICE REQUEST	L2: SABM / UA
25	SS -> MS	AUTHENTICATION REQUEST	
26	MS -> SS	AUTHENTICATION RESPONSE	
27	SS -> MS	CIPHERING MODE COMMAND	no ciphering
28	MS -> SS	CIPHERING MODE COMPLETE	
29	MS -> SS	SETUP	
30	SS -> MS	CHANNEL MODE MODIFY	
31	MS -> SS	CHANNEL MODE MODIFY ACKNOWLEDGE	
32	SS -> MS	CONNECT	verify that the TCH is through connected
33	SS -> MS	TERMINATION	
34	SS -> MS	CHANNEL RELEASE	The MS releases L2 multiple frame link L2:DISC/UA.

Specific message contents:

Step 9

ASSIGNMENT COMMAND:

Channel Description - Channel Type and TDMA offset - Timeslot Number - Training Sequence Code - Hopping - ARFCN	TCH/F 7 3 Single RF Channel 957 if the MS supports R-GSM, otherwise chosen arbitrarily, but not BCCH
Power Command - Power level	Chosen arbitrarily but with a changed value.
Channel Mode	speech full rate or half rate version 2 if the MS supports EFR otherwise speech full rate or half rate version 1
Other IEs	Not present

Step 23

IMMEDIATE ASSIGNMENT:

Channel Description - Channel Type and TDMA offset - Timeslot Number - Training Sequence Code - Hopping - ARFCN	TCH/H if the MS supports dual rate, otherwise TCH/F 3 3 Single RF Channel 970, if the MS supporting R-band otherwise: GSM 450: 275, GSM 480: 322, GSM 900: 50 DCS 1 800: 750 PCS 1 900: 650 GSM710: 470 GSM 750: 470 T-GSM 810: 470 GSM 850: 177
--	---

26.14.9 VGCS-VBS / Cell change

26.14.9.1 VGCS-VBS / Cell Change / Same LA

26.14.9.1.1 Conformance requirement

After cell change within the same LA:

1. if no NCH is present on the new cell the MS shall leave group receive mode and go to idle mode;
2. if NCH is present on the new cell but the MS does not receive any notification message for the current group or broadcast call the MS shall leave group receive mode and go to idle mode;
3. if the MS receives a notification message for the current group or broadcast call with the related channel position and if the channel is found, the MS shall change to it and stay in group receive mode;
4. if the MS receives a notification message for the current group or broadcast call without information on the related channel position, the MS shall leave group receive mode, go to idle mode in order to establish a dedicated connection with the network to become informed on the related channel position.

Reference(s)

3GPP TS 03.22 subclause 5.2.3.

26.14.9.1.2 Test purpose

The MS was in group receive mode. After cell change within a same LA it is verified that:

1. if no NCH is present on the new cell the MS leaves group receive mode and enters idle mode;

2. if NCH is present on the new cell but there is no NOTIFICATION / NCH for the current group or broadcast call the MS leaves group receive mode and enters idle mode;
3. if the MS receives NOTIFICATION / NCH for the current group or broadcast call with the related channel position the MS changes onto the group channel and stays in group receive mode;
4. if the MS receives NOTIFICATION / NCH for the current group or broadcast call without information on the related channel position, the MS leaves group receive mode, enters idle mode and establishes a dedicated connection with the network to get the related channel position.

26.14.9.1.3 Method of test

26.14.9.1.3.1 Initial Conditions

Initial Conditions

System Simulator:

2 cells within a same LA: cell A and cell B, with default parameters for this clause except:

- for k=1, no NCH on cell B;
- for k=2, 3, 4, NCH present on cell B.

Mobile Station:

The MS is in MM-state "idle, updated" with a TMSI allocated. No automatic answering is configured.

Specific PICS statements:

-

PIXIT Statements:

- Way to configure VGCS or VBS.
- Way to verify the downlink speech path.

Foreseen Final State of the MS

"Idle, updated".

Test Procedure

The following test procedure is repeated for k=1, 2, 3, 4 and c=1, 2.

For c=1, the MS is brought into group receive mode on cell A. Start cell B without NCH (k=1), or with NCH but NOTIFICATION/NCH containing irrelevant group call references (k=2), or with NCH whilst NOTIFICATION/NCH containing the relevant group call reference and VGCS/VBS channel description (k=3), or with NCH whilst NOTIFICATION/NCH containing the relevant group call reference but no VGCS/VBS channel description (k=4). Lower the transmission levels of cell A so that C1 of cell A becomes less than zero. After the MS re-selects to the cell B it is checked that the MS returns to idle mode on cell B (for k=1, 2), or that the MS remains in group receive mode on cell B (for k=3, 4).

The same test procedure is repeated for c=2. Instead of lowering the power level of cell A, the SACCH transmission of cell A is stopped.

Maximum Duration of Test

10 minutes.

Expected Sequence

The test sequence is repeated for test counter k= 1, 2, 3, 4 and c=1, 2.

Step	Direction	Message	Comments
0	MS		the MS is brought into group receive mode on cell A.
1	SS		k=1, S11 on cell B not indicating NCH position; k=2, 3, 4, S11 on cell B indicating NCH position
A2 B2	SS -> MS	NOTIFICATION/NCH	k=1
C2	SS -> MS	NOTIFICATION/NCH	k=2, sent on cell B, containing an irrelevant group call reference.
D2	SS -> MS	NOTIFICATION/NCH	k=3, sent on cell B, containing the relevant group call reference and VGCS/VBS channel description. k=4, sent on cell B, with the relevant group call reference but no VGCS/VBS channel description.
3	SS		for c=1, the RF level of cell A is lowered until the MS re-selects cell B. for c=2, to stop downlink SACCH transmission of cell A. The following messages are sent and received on cell B.
A4, B4 A5, B5 A9, B9	SS -> MS MS -> SS SS -> MS	PAGING REQUEST TYPE 1 CHANNEL REQUEST IMMEDIATE ASSIGNMENT REJECT	k=1 or k=2, Wait 5s. until the MS is in idle mode on cell B. "Mobile Identity" IE contains the TMSI allocated to the MS. "Establishment Cause" = Answer to paging. the first "request reference" corresponds to the CHANNEL REQUEST sent by the MS.
C4 C9	MS SS -> MS	CHANNEL RELEASE	k=3, Wait 5s. to ensure that the MS has enough time entering group receive mode on cell B. Check that the TCH in downlink is through connected and there is no uplink transmission on that channel for 10 s. UI format, the MS returns to idle mode.
D4 D5 D6 D7 D8 D9	MS -> SS SS -> MS MS -> SS SS -> MS MS SS -> MS	CHANNEL REQUEST IMMEDIATE ASSIGNMENT NOTIFICATION REPOSENSE CHANNEL RELEASE CHANNEL RELEASE	k=4, a TCH Respond to notification. I format, MS leaves the dedicated mode and changes onto VGCS/VBS channel. Check that the TCH in downlink is through connected and there is no uplink transmission on that channel for 10 s. UI format, the MS returns to idle state.
10	SS		For c=1, the RF level of cell A is increased to 63 dB μ V emf(), the RF level of cell B is lowered until the MS re-select cell A. For c=2, downlink SACCH on cell A is recovered. Wait 5s.
11 12	MS SS		Check that the TCH in downlink on cell A is through connected and there is no uplink transmission on that channel for 10 s. The RF level of cell B is increased to 53 dB μ V emf().

26.14.9.2 VGCS-VBS / Cell Change / Different LA

26.14.9.2.1 Conformance requirement

1. After a cell change the MS shall leave group receive mode and go to idle mode in order to establish a dedicated connection with the network to perform a location update if the cell belongs to a new LA.
2. If NCH is present on the new cell but the MS does not receive any notification message for the current group or broadcast call the MS shall leave group receive mode and go to idle mode.
3. If the MS receives a notification message for the current group or broadcast call with the related channel position and if the channel is found, the MS shall change to it and stay in group receive mode.
4. If the MS receives a notification message for the current group or broadcast call without information on the related channel position, the MS shall leave group receive mode, go to idle mode and in order to establish a dedicated connection with the network to become informed on the related channel position.
5. If a CHANNEL RELEASE is send to a mobile station which is in dedicated mode and which is involved in a voice group call or voice broadcast call, a group channel description may be included, describing the voice group call channel or voice broadcast channel to which the mobile station shall go after the channel release procedure.

Reference(s)

3GPP TS 03.22 subclause 5.2.3.

3GPP TS 04.08 / 3GPP TS 44.018 subclause 9.1.7.1.

26.14.9.2.2 Test purpose

In group receive mode it is verified that:

1. after a cell change to a different LA, the MS leaves group receive mode, enters idle mode and establishes a dedicated connection with the network to perform location updating;
2. after location updating, if NCH is present on the new cell but there is no NOTIFICATION / NCH for the current group or broadcast call the MS stays in idle mode;
3. after location updating, if the MS receives NOTIFICATION / NCH for the current group or broadcast call with the related channel position the MS changes to the group channel and stays in group receive mode;
4. after location updating, if the MS receives NOTIFICATION / NCH for the current group or broadcast call without information on the related channel position, the MS establishes a dedicated connection with the network to get the related channel position and then enters to group receive mode;
5. it is also tested, when a mobile, in dedicated mode and involved in a voice group or broadcast call, receives CHANNEL RELEASE including a group channel description channel the mobile station goes onto the channel after the channel release procedure.

26.14.9.2.3 Method of test

Initial Conditions

System Simulator:

2 cells with different LA within a same PLMN: cell A and cell B, with default parameters.

Mobile Station:

The MS is in MM-state "idle, updated" with a TMSI allocated on cell A. No automatic answering is configured.

Specific PICS statements:

-

PIXIT Statements:

- Way to configure VGCS or VBS.
- Way to verify the downlink speech path.

Foreseen Final State of the MS

"Idle, updated".

Test Procedure

The following test procedure is repeated for k = 1, 2, 3.

The MS is brought into group receive mode on cell A. Start cell B with NCH but NOTIFICATON/NCH containing irrelevant group call references (k=1), or with NOTIFICATON/NCH containing the relevant group call reference but no VGCS/VBS channel description (k=2), or with NOTIFICATON/NCH containing the relevant group call reference and VGCS/VBS channel description (k=3). Lower the transmission levels of cell A so that C1 of cell A becomes less than zero. The MS re-selects to the cell B. It is checked that the MS does location update on cell B. If it is succeeded the MS either remains in the idle mode (for k=1), or enters to group receive mode on cell B (for k=2, 3) without manual intervention.

Increase the power level of cell A to the default value and decrease the power level of cell B so that the MS re-selects the cell A. The MS attempts a location updating. The SS rejects it with cause #17 (network failure) to force the MS re-initiate location updating. The SS checks that the TCH in downlink is not connected before a location updated. The MS initiates again a new attempt for location updating, the SS accepts it, then the MS initiates a new group call and enters the group transmit mode, SS sends an UPLINK RELEASE message to bring MS to group receive mode. Then SS assigns a new group channel for it in the CHANNEL RELEASE message. It is checked that the MS enters group receive mode and the new TCH assigned in downlink is through connected.

Maximum Duration of Test

10 minutes.

Expected Sequence

Repeat the test sequence for test counter k= 1, 2, 3.

Step	Direction	Message	Comments
0	MS		the MS is brought into group receive mode on cell A.
A1	SS -> MS	NOTIFICATION/NCH	k=1, sent on cell B, containing an irrelevant group call reference.
B1	SS -> MS	NOTIFICATION/NCH	k=2, sent on cell B, containing the relevant group call reference but without VGCS/VBS channel description.
C1	SS -> MS	NOTIFICATION/NCH	k=3, sent on cell B, with the relevant group call reference and the VGCS/VBS channel description.
2	SS		The RF level of cell A is lowered until the MS re-selects cell B. The following messages are sent and received on cell B.
3	MS -> SS	CHANNEL REQUEST	location updating
4	SS -> MS	IMMEDIATE ASSIGNMENT	
5	MS -> SS	LOCATION UPDATING REQUEST	"location updating type" = normal, "CKSN" = CKSN1, "location area identification" = a, "mobile station classmark 1" as given by the PICS and "mobile identity" = TMSI1, L2: SABM / UA.
6	SS -> MS	LOCATION UPDATING ACCEPT	MI omitted, follow-on proceed IE included
A7	MS -> SS	CHANNEL RELEASE	k=1, the MS in idle mode on cell B, wait 5s.
A8	SS -> MS	PAGING REQUEST TYPE 1	"Mobile Identity" IE contains the TMSI allocated to the MS.
A9	MS -> SS	CHANNEL REQUEST	"Establishment Cause" = Answer to paging.

Step	Direction	Message	Comments
A10	SS -> MS	IMMEDIATE ASSIGNMENT REJECT	the first "request reference" corresponds to the CHANNEL REQUEST sent by the MS.
B7	MS -> SS	NOTIFICATION REPOSE	k=2, Respond to notification.
B8	SS -> MS	CHANNEL RELEASE	I format, change from the dedicated channel onto VGCS channel.
B9	MS		Check that the TCH in downlink is through connected and there is no uplink transmission on that channel for 10 s.
B10	SS -> MS	CHANNEL RELEASE	UI format, the MS returns to idle mode.
C7	MS -> SS	CHANNEL RELEASE	k=3, MS in group receive mode on cell B
C8	MS		Check that the TCH in downlink is through connected and there is no uplink transmission on that channel for 10 s.
C10	SS -> MS	CHANNEL RELEASE	UI format, the MS returns to idle mode.
11	SS		The RF level of cell A is increased to 63 dB μ V emf(), the RF level of cell B is lowered until the MS re-select cell A. The following messages are sent and received on cell A
12	MS -> SS	CHANNEL REQUEST	location updating.
13	SS -> MS	IMMEDIATE ASSIGNMENT	
14	MS -> SS	LOCATION UPDATING REQUEST	"location updating type" = normal, "CKSN" = CKSN1, "location area identification" = b, "mobile station classmark 1" as given by the PICS and "mobile identity" = TMSI1, L2: SABM / UA.
15	SS -> MS	LOCATION UPDATING REJECT	cause #17
16	SS -> MS	CHANNEL RELEASE	
17	SS		Check that the TCH used in the test step 0 is not through connected for 10 s.
18	MS -> SS	CHANNEL REQUEST	"Establishment cause": Location updating. This message is sent by the MS 15s after step 16 (no check for that).
19	SS -> MS	IMMEDIATE ASSIGNMENT	
20	MS -> SS	LOCATION UPDATING REQUEST	"location updating type" = normal, "CKSN" = CKSN1, "location area identification" = b, "mobile station classmark 1" as given by the PICS and "mobile identity" = TMSI1, L2: SABM / UA.
21	SS -> MS	LOCATION UPDATING ACCEPT	both MI and follow-on proceed IE omitted
22	MS		MMI action, a VGCS call is initiated on cell A
23	MS -> SS	CHANNEL REQUEST	
24	SS -> MS	IMMEDIATE ASSIGNMENT	
25	MS -> SS	CM SERVICE REQUEST	L2: SABM / UA
26	SS -> MS	CM SERVICE ACCEPT	
27	MS -> SS	SETUP	
28	SS -> MS	AUTHENTICATION REQUEST	
29	MS -> SS	AUTHENTICATION RESPONSE	
30	SS -> MS	CHANNEL MODE MODIFY	
31	MS -> SS	CHANNEL MODE MODIFY ACKNOWLEDGE	
32	SS -> MS	CONNECT	The MS is in transmit mode and is involved in a voice group call or in a broadcast call
33	MS		Check the MS is involved in group call
34	SS -> MS	CHANNEL RELEASE	Including a new group channel description different from the one in step 0. The MS releases L2 multiple frame link (L2:DISC/UA) and enters group receive mode.
35	MS		Check that the TCH assigned in step 22 is in downlink through connected and there is no uplink transmission on that channel for 10 s.
36	SS -> MS	CHANNEL RELEASE	UI format, the MS returns to idle state.

Specific message contents:

CHANNEL RELEASE

Information Element	value/remark
Group channel description	
- IEI	74
- Length	
- Channel type and TDMA offset	TCH/F
- Timeslot number	arbitrarily chosen, but not 0
- TSC	arbitrarily chosen
- Hopping	Single RF, non hopping channel
- ARFCN	GSM 450: 279 GSM 480: 326 GSM 900: 70 DCS 1 800: 850 PCS 1 900: 750 GSM710: 475 GSM 750: 475 T-GSM 810: 475 GSM 850: 197
Group cipher key number	Not included

26.14.9.3 VGCS-VBS / Cell Change / Different PLMN

26.14.9.3.1 Conformance requirement

1. After a cell change to a different LA, if the selected cell belongs to an another PLMN the MS shall leave group receive mode and go to idle mode.

Reference(s)

3GPP 03.22 subclause 5.2.3.

26.14.9.3.2 Test purpose

In group receive mode it is verified that after a cell change to a different LA of an another PLMN, the MS leaves group receive mode, enters idle mode.

26.14.9.3.3 Method of test

Initial Conditions

System Simulator:

2 cells with different LA belonging to the different PLMN: cell A /PLMN1 and cell B / PLMN2, with default parameters.

Mobile Station:

The MS is in MM-state "idle, updated" with a TMSI allocated on cell A. No automatic answering is configured.

Specific PICS statements:

-

PIXIT Statements:

- Way to configure VGCS or VBS.
- Way to verify the downlink speech path.

Foreseen Final State of the MS

"Idle, updated".

Test Procedure

The following test procedure is repeated for $k=1, 2$.

The MS is brought into group receive mode on cell A. Start cell B with NOTIFICATON/NCH containing an another group call references ($k=1$), or with NOTIFICATON/NCH containing the same group call reference ($k=2$). Lower the transmission levels of cell A so that C1 of cell A becomes less than zero. The MS re-selects the cell B and enters idle mode. It is checked that the MS does location update on cell B. If it is succeeded the MS indicates a group/broadcast call with the reference and joins the VGCS/VBS call on MMI request.

Increase the power level of cell A to the default value and decrease the power level of cell B so that the MS re-selects the cell A. The MS does a new location updating and indicates a group/broadcast call.

Maximum Duration of Test

5 minutes.

Expected Sequence

Repeat the test sequence for test counter k= 1, 2.

Step	Direction	Message	Comments
0	MS		the MS is brought into group receive mode on cell A.
A1	SS -> MS	NOTIFICATION/NCH	k=1, sent on cell B, with an another group call reference but with the same VGCS/VBS channel description as in test step 0.
B1	SS -> MS	NOTIFICATION/NCH	k=2, sent on cell B, with the same group call reference and an another VGCS/VBS channel description as in step 0.
2	SS		The RF level of cell A is lowered until the MS re-selects cell B. The following messages are sent and received on cell B.
3	MS -> SS	CHANNEL REQUEST	location updating
4	SS -> MS	IMMEDIATE ASSIGNMENT	
5	MS -> SS	LOCATION UPDATING REQUEST	"location updating type" = normal, "CKSN" = CKSN1, "location area identification" = a, "mobile station classmark 1" as given by the PICS and "mobile identity" = TMSI1, L2: SABM / UA.
6	SS -> MS	LOCATION UPDATING ACCEPT	New TMSI2
7	MS -> SS	TMSI REALLOCATION COMPLETE	
8	SS -> MS	CHANNEL RELEASE	I format , MS returns to idle mode
9	MS		check that the MS gives an indication containing the notified group call reference
10	MS		MMI action to join the VGCS/VBS call
11	MS		check that the downlink voice is received and there is no uplink transmission on that channel for 5 s.
12	SS -> MS	CHANNEL RELEASE	UI format, the MS returns to idle state.
13	SS		The RF level of cell A is increased to 63 dBμV emf(), the RF level of cell B is lowered until the MS re-select cell A. The following messages are sent and received on cell A.
14	MS -> SS	CHANNEL REQUEST	location updating
15	SS -> MS	IMMEDIATE ASSIGNMENT	
16	MS -> SS	LOCATION UPDATING REQUEST	"location updating type" = normal, "CKSN" = CKSN2, "location area identification" = b, "mobile station classmark 1" as given by the PICS and "mobile identity" = TMSI2, L2: SABM / UA.
17	SS -> MS	LOCATION UPDATING ACCEPT	TMSI1
18	MS -> SS	TMSI REALLOCATION COMPLETE	
19	SS -> MS	CHANNEL RELEASE	I format
20	MS		check that the MS gives an indication containing the notified group call reference
21	SS->MS	CHANNEL RELEASE	UI format.
22	SS		The RF level of cell B is increased to 53 dBμV emf()).

26.14.10 VGCS-VBS / Default Message Contents

The default message contents listed in subclauses 26.6.14, 26.6.15, 26.6.16, 26.6.17 and 26.6.18 are applicable to the subclause 26.14, except BS_AG_BLK_RES = 1. Additional default message contents are specified below.

SYSTEM INFORMATION TYPE 1

Information Element	value/remark
S1 Rest Octets - NCH position indication - NCH position - Spare padding	2 octets length H The 1st NCH block number = 1, No. of blocks = 1

SYSTEM INFORMATION TYPE 6

Information Element	value/remark
S6 Rest Octets - PCH/NCH info indication - VGCS/VBS options - in-band notifications - in-band paging - Spare padding	7 octets length L H 1 1 logical L

NOTIFICATION/NCH

Information Element	value/remark
L2 Pseudo Length	This is the sum of the lengths of all the information elements present in the message except for the NT/N rest octets and L2 pseudo length IEs. For the default message the L2 pseudo length is '09'B.
RR Protocol Discriminator	'0110'B
Skip Indicator	'0000'B
Message Type	'00100000'B
NT/N Rest Octets	
Reduced monitoring indication	'0'B, no reduced monitoring
List of group call NCH information	
Group call reference 1 indication	'1'B
Group or broadcast call reference	
- Group or broadcast call reference	PICS/PIXIT, active in the SIM (27 bits)
- SF	VBS if only VBS supported, otherwise VGCS
- AF	acknowledgement not required
- Ciphering information	No ciphering
Group Channel Description indication	'1'
Channel Description	
- Channel type and TDMA offset	TCH/F
- Timeslot number	arbitrarily chosen but not 0
- TSC	arbitrarily chosen
- Hopping	Single RF Channel
- ARFCN	GSM 450: 275 GSM 480: 322 GSM 900: 50 DCS 1 800: 750 PCS 1 900: 650 GSM710: 470 GSM 750: 470 T-GSM 810: 470 GSM 850: 177
- MA or FSL	'0'B, non hopping
Another Group call references	'0'B, no
Spare padding	logic L

NOTIFICATION/FACCH

Information Element	value/remark
RR short PD	'0'B
message type	'00001'B
short layer 2 header	'00' for UI frame
Group call / Paging information indication	'0', group call information
Group or broadcast call reference	PICS/PIXIT (27 bits), active in the SIM
- Group or broadcast call reference	VBS if only VBS supported, otherwise VGCS
- SF	'0'B, acknowledgement not required
- AF	4
- priority	No ciphering
- Ciphering information	'1', group channel description
Group Channel Description indication	24 bits
Channel Description	TCH/F
- Channel type and TDMA offset	arbitrarily chosen, but not 0
- Timeslot number	arbitrarily chosen
- TSC	Single RF, non hopping channel
- Hopping	GSM 450: 279
- ARFCN	GSM 480: 326
	GSM 900: 70
	DCS 1 800: 850
	PCS 1 900: 750
	GSM710: 475
	GSM 750: 475
	T-GSM 810: 475
	GSM 850: 197
MA or FSL	'0'B, non hopping
Spare padding	logic L

NOTIFICATION RESPONSE

Information Element	value/remark
RR Protocol Discriminator	'0110'B
Skip Indicator	'0000'B
Message Type	'0x100110'B
Mobile station classmark	PICS/PIXIT
Mobile identity	PICS/PIXIT
Group or broadcast call reference 1	
- Group or broadcast call reference	Not checked
- SF	Not checked
- AF	Not checked
- Ciphering information	No ciphering

UPLINK ACCESS

Information field	value/remark
Establishment Cause	'110'B for subsequent talker uplink access; '00100101'B for reply on uplink access request
Random Reference	Not checked for subsequent talker uplink request

UPLINK BUSY

Information Element	value/remark
RR Protocol Discriminator	'0110'B
Skip Indicator	'0000'B
Message Type	'00101010'B

UPLINK FREE

Information Element	value/remark
RR short PD	'0'B
Message Type	'00010'B
short L2 header	'00'B, type 1
Uplink access request bit	L
UIC indication	H
UIC	PICS/PIXIT, bit(6)
Spare padding	logic L

UPLINK RELEASE

Information Element	value/remark
RR Protocol Discriminator	'0110'B
Skip Indicator	'0000'B
Message Type	'00001110'B
RR Cause	Normal event

VGCS UPLINK GRANT

Information Element	value/remark
RR Protocol Discriminator	'0110'B
Skip Indicator	'0000'B
Message Type	'00001001'B
Request Reference	Same as that in UPLINK ACCESS
Timing Advance	30

TALKER INDICATION

Information Element	value/remark
RR Protocol Discriminator	'0110'B
Skip Indicator	'0000'B
Message Type	'00010001'B
Mobile station classmark	PICS/PIXIT
Mobile identity	PICS/PIXIT

Default Message contents for GCC/BCC

CHANNEL MODE MODIFY:

Channel Description	Same as in IMMEDIATE ASSIGNMENT in test
Channel Mode	
- Mode	speech full rate or half rate version 1
VGCS target mode indication	
- iei	
- target mode	group transmit mode
- group cipher key number	no ciphering
- spare bit	'11'B

CHANNEL MODE MODIFY ACKNOWLEDGE:

Channel Description	Same as in CHANNEL MODE in test
Channel Mode	Same as in CHANNEL MODE in test

CM SERVICE REQUEST

Information Element	value/remark
CM service type	VGC or VBC establishment, depending on the service
Priority	any or omit

CONNECT

Information Element	value/remark
GCC/BCC Protocol Discriminator	'0000'B for GCC, '0001'B for BCC
Transaction identifier	depending on the context of the test
Message Type	'0x110011'B
Broadcast call reference	PICS/PIXIT
Originator indication	Originator
Spare half octet	'0000'B

GET STATUS

Information Element	value/remark
GCC/BCC Protocol Discriminator	'0000'B for GCC, '0001'B for BCC
Transaction identifier	depending on the context of the test
Message Type	'0x111001'B
Mobile identity	PICS/PIXIT
Parameters	call state & state attribute requested

IMMEDIATE SETUP

Information Element	value/remark
GCC/BCC Protocol Discriminator	'0000'B for GCC, '0001'B for BCC
Transaction identifier	'0001'B
Message Type	'0x110001'B
Spare half octet	'0000'B
Ciphering key sequence number	PICS/PIXIT
Mobile station classmark	PICS/PIXIT
Mobile identity	PICS/PIXIT
Group identity	PICS/PIXIT

SET PARAMETER

Information Element	value/remark
GCC/BCC Protocol Discriminator	'0000'B for GCC, '0001'B for BCC
Transaction identifier	depending on the context of the test
Message Type	'0x111010'B
All other information elements	Not present

SETUP

Information Element	value/remark
GCC/BCC Protocol Discriminator	'0000'B for GCC, '0001'B for BCC
Transaction identifier	'0001'B
Message Type	'0x110010'B
Broadcast identity	PICS/PIXIT

STATUS

Information Element	value/remark
GCC/BCC Protocol Discriminator	'0000'B for GCC, '0001'B for BCC
Transaction identifier	depending on the context of the test
Message Type	'0x111000'B
Cause	Not checked
Call state	depending on the context of the test
State attributes	depending on the context of the test

TERMINATION

Information Element	value/remark
GCC/BCC Protocol Discriminator	'0000'B for GCC, '0001'B for BCC
Transaction identifier	depending on the context of the test
Message Type	'0x110100'B
Cause	any

TERMINATION REJECT

Information Element	value/remark
GCC/BCC Protocol Discriminator	'0000'B for GCC, '0001'B for BCC
Transaction identifier	depending on the context of the test
Message Type	'0x110110'B
Reject cause	any

TERMINATION REQUEST

Information Element	value/remark
GCC/BCC Protocol Discriminator	'0000'B for GCC, '0001'B for BCC
Transaction identifier	depending on the context of the test
Message Type	'0x110101'B
Broadcast identity	PICS/PIXIT

26.14.11 VGCS-VBS / User-to-Dispatcher Information

26.14.11.1 VGCS-VBS / User-to-Dispatcher Information / BCC MO call

26.14.11.1.1 Conformance requirement

The request of the calling subscriber to set up a voice group call may specify information to be sent as user-to-dispatcher information to the network; in this case the user-to-dispatcher information is included in the signalling for call setup from the mobile station to the network. It is the responsibility of the input function to ensure that the user-to-dispatcher information has a correct format (in particular, an allowed length).

The initial signalling from the originating service subscriber informs the network that a voice group call is required and details the group ID; it may specify user-to-dispatcher information.

The User-to-dispatcher information element is included in the SETUP message.

References

3GPP TS 03.69 subclauses 4.2.1.1 and 11.3.1.1.1.

3GPP TS 04.69 subclause 8.5.

26.14.11.1.2 Test purpose

1. To verify that upon initiation of an outgoing broadcast call with User-to-Dispatcher information by the user, the MS includes a User-to-dispatcher information element in the SETUP message.
2. To verify correct establishment and clearing of the broadcast call.

26.14.11.1.3 Method of test

Initial Conditions

System Simulator:

- 1 cell with default parameters for ASCII testing.

Mobile Station:

- The MS is in MM-state "idle, updated" with a TMSI allocated.

Specific PICS statements:

-

PIXIT Statements:

- Way to activate User-to-Dispatcher Information
- Way to configure VBS.
- Way to initiate VBS calls.

Foreseen Final State of the MS

"Idle, updated", with TMSI allocated.

Test Procedure

By means of appropriate MMI function, the user enters a string, which shall be included in the User-to-Dispatcher Information.

Then MS is made to initiate a broadcast call. In the SETUP message, the User-to-dispatcher information element shall be present and shall include the requested string. Then, SS releases immediately the call with a TERMINATION message.

Then MS is made to initiate a second broadcast call with User-to-Dispatcher Information including a long string. In the SETUP message, the User-to-dispatcher information element shall be present with the requested string. Then it is checked that the call can be successfully established and cleared.

Maximum Duration of Test

2 minutes

Expected Sequence

Step	Direction	Message	Comments
0	MS		The MS is in idle mode.
1	MS		MMI actions to initiate a VBS call with User-to-Dispatcher Information including the string 'abcdef9'
2	MS -> SS	CHANNEL REQUEST	
3	SS -> MS	IMMEDIATE ASSIGNMENT	TCH/FS
4	MS -> SS	CM SERVICE REQUEST	L2: SABM / UA
5	SS -> MS	CM SERVICE ACCEPT	
6	MS -> SS	SETUP	User-to-dispatcher IE included. See specific message contents.
7	SS -> MS	TERMINATION	
8	SS -> MS	CHANNEL RELEASE	The MS releases L2 multiple frame link. L2: DISC/UA.
9	MS		MMI actions to initiate a VBS call with User-to-Dispatcher Information with the string 'abcdefghijklmnpqrstuvwxyz012345'
10	MS -> SS	CHANNEL REQUEST	
11	SS -> MS	IMMEDIATE ASSIGNMENT	TCH/F, single RF channel GSM 450: 275 GSM 480: 322 GSM 900: 50, DCS 1 800: 750 PCS 1 900: 650 GSM710: 470 GSM 750: 470 T-GSM 810: 470 GSM 850: 177 L2: SABM / UA
12	MS -> SS	CM SERVICE REQUEST	
13	SS -> MS	CM SERVICE ACCEPT	
14	MS -> SS	SETUP	User-to-dispatcher IE included. See specific message contents.
15	SS -> MS	CHANNEL MODE MODIFY	
16	MS -> SS	CHANNEL MODE MODIFY ACKNOWLEDGE	
17	SS -> MS	CONNECT	
18	SS -> MS	TERMINATION	
19	SS -> MS	CHANNEL RELEASE	The MS releases L2 multiple frame link L2: DISC/UA.

Specific message contents:

SETUP

As default message contents as defined in subclause 26.14.10 except:

Information Element	Value/remark
User-to-dispatcher	
- IEI	'7E'O
- length	1+the entered string length
- PD	User specific protocol
- user-user	The string as entered coded in IA5 characters

26.14.11.2 VGCS-VBS / User-to-Dispatcher information / GCC MO call

26.14.11.2.1 Conformance requirement

The request of the calling subscriber to set up a voice group call may specify information to be sent as user-to-dispatcher information to the network; in this case the user-to-dispatcher information is included in the signalling for call setup from the mobile station to the network. It is the responsibility of the input function to ensure that the user-to-dispatcher information has a correct format (in particular, an allowed length).

The initial signalling from the originating service subscriber informs the network that a voice group call is required and details the group ID; it may specify user-to-dispatcher information.

The User-to-dispatcher information element is included in the SETUP message.

References

3GPP TS 03.68 subclauses 4.2.1.1 and 11.3.1.1.1

3GPP TS 04.68 subclause 8.5.

26.14.11.2.2 Test purpose

1. To verify that upon initiation of an outgoing group call with User-to-Dispatcher Information by the user, the MS includes a User-to-dispatcher information element in the SETUP message.
2. To verify that the group call can be successfully established and cleared.

26.14.11.2.3 Method of test

Initial Conditions

System Simulator:

1 cell with default parameters for ASCII testing.

Mobile Station:

The MS is in MM-state "idle, updated" with a TMSI allocated.

Specific PICS statements:

-

PIXIT Statements:

- Way to activate User-to-Dispatcher Information.
- Way to configure VGCS.
- Way to initiate VGCS calls.

Foreseen Final State of the MS

"Idle, updated", with TMSI allocated.

Test Procedure

By means of appropriate MMI function, the user enters a string, which shall be included in the User-to-Dispatcher Information.

Then MS is made to initiate a VGCS call. In the SETUP message, the User-to-dispatcher information element shall be present and shall include the requested string. Then, SS releases immediately the call with a TERMINATION message.

Then MS is made to initiate a second VGCS call with User-to-Dispatcher Information including a long string. In the SETUP message, the User-to-dispatcher information element shall be present with the requested string. Then it is checked that the call can be successfully established and cleared.

Maximum Duration of Test

2 minutes.

Expected Sequence

Step	Direction	Message	Comments
0	MS		MMI actions to initiate a VGCS call with User-to-Dispatcher Information with the string 'abcdef9'.
1	MS -> SS	CHANNEL REQUEST	
2	SS -> MS	IMMEDIATE ASSIGNMENT	TCH/FS
3	MS -> SS	CM SERVICE REQUEST	L2: SABM / UA
4	SS -> MS	CM SERVICE ACCEPT	
5	MS -> SS	SETUP	User-to dispatcher IE included. See specific message contents
6	SS -> MS	TERMINATION	
7	SS -> MS	CHANNEL RELEASE	The MS releases L2 multiple frame link L2: DISC/UA.
10	MS		MMI actions to initiate a VGCS call with User-to-Dispatcher Information with the string 'abcdefghijklmnopqrstuvwxy012345'.
11	MS -> SS	CHANNEL REQUEST	
12	SS -> MS	IMMEDIATE ASSIGNMENT	TCH/F, single RF channel GSM 450: 275 GSM 480: 322 GSM 900: 50 DCS 1 800: 750 PCS 1 900: 650 GSM710: 470 GSM 750: 470 T-GSM 810: 470 GSM 850: 177 L2: SABM / UA
13	MS -> SS	CM SERVICE REQUEST	
14	SS -> MS	CM SERVICE ACCEPT	
15	MS -> SS	SETUP	User-to-dispatcher IE included
16	SS -> MS	CHANNEL MODE MODIFY	
17	MS -> SS	CHANNEL MODE MODIFY ACKNOWLEDGE	
18	SS -> MS	CONNECT	
19	SS -> MS	TERMINATION	
20	SS -> MS	CHANNEL RELEASE	The MS releases L2 multiple frame link L2: DISC/UA.

Specific message contents:

SETUP

As default message contents as defined in subclause 26.14.10 except:

Information Element	Value/remark
User-user	
- IEI	'7E'O
- length	1 + the entered string length
- PD	User specific protocol
- user-user	The string as entered coded in IA5 characters

26.14.11.3 VGCS-VBS / User-to-Dispatcher information / Compressed user information in VBS fast call set-up

26.14.11.3.1 Conformance requirement

The request of the calling subscriber to set up a voice group call may specify information to be sent as user-to-dispatcher information to the network; in this case the user-to-dispatcher information is included in the signalling for call setup from the mobile station to the network. It is the responsibility of the input function to ensure that the user-to-dispatcher information has a correct format (in particular, an allowed length).

User-to-dispatcher information can be compressed or uncompressed.

The message IMMEDIATE SETUP 2 is sent by the MS to the network in order to set-up a group call immediately, i.e. without previous establishment of an MM connection, and to include compressed user-to-dispatcher information. The message shall be used if the MS has a valid TMSI.

References

3GPP TS 04.69 subclauses 4.2.1.1, 4.2.7, 11.3.1.1.1 and 11.3.1.1.3.

3GPP TS 04.69 subclause 6.2.2 and clause 8.

26.14.11.3.2 Test purpose

To verify that upon initiation of an outgoing VBS fast call with User-to-Dispatcher Information by the user, the MS includes a Compressed User-to-Dispatcher Information information element in the IMMEDIATE SETUP 2 message;

To verify that the VBS fast call can be successfully established and cleared.

26.14.11.3.3 Method of test

Initial Conditions

System Simulator:

1 cell with default parameters for ASCII testing.

Mobile Station:

The MS is in MM-state "idle, updated" with a TMSI allocated.

Specific PICS statements:

-

PIXIT Statements:

- Way to activate User-to-Dispatcher Information.
- Way to configure VBS.
- Way to initiate VBS fast calls set-up.

Foreseen Final State of the MS

"Idle, updated", with TMSI allocated.

Test Procedure

By means of appropriate MMI function, the user enters a string, which shall be included in the User-to-Dispatcher Information. Then MS is made to initiate a VBS fast call. Check that the MS sends an IMMEDIATE SETUP 2 message, and check that the Compressed User-to-Dispatcher Information element is present. Then, it is checked that the call can be successfully established and released.

Maximum Duration of Test

2 minutes.

Expected Sequence

Step	Direction	Message	Comments
0	MS		The MS is in idle mode.
1	MS		MMI actions to initiate a VBS fast call with the User-to-Dispatcher Information "1234567890"
2	MS -> SS	CHANNEL REQUEST	
3	SS -> MS	IMMEDIATE ASSIGNMENT	TCH/F, single RF channel GSM 450: 275 GSM 480: 322 GSM 900: 50 DCS 1 800: 750 PCS 1 900: 650 GSM710: 470 GSM 750: 470 T-GSM 810: 470 GSM 850: 177
4	MS -> SS	IMMEDIATE SETUP	L2: SABM / UA, BCC message including the Compressed User-to-Dispatcher Information information element shall be present, see Specific message contents Very early assignment
5	SS -> MS	CHANNEL MODE MODIFY	
6	MS -> SS	CHANNEL MODE MODIFY ACK	
7	SS -> MS	CONNECT	
8	SS -> MS	TERMINATION	
9	SS -> MS	CHANNEL RELEASE	

Specific message contents:

IMMEDIATE SETUP 2

Information element	Value/remark
Protocol discriminator	'0001'B for BCC
Transaction identifier	'0001'B
Message type	'0x111011'B
Spare half octet	'0000'B
Ciphering key sequence number	PICS/PIXIT
Mobile station classmark	PICS/PIXIT
TMSI	PICS/PIXIT
Group identity	PICS/PIXIT
Compressed utdi	'00075BCD16'O

26.14.11.4 VGCS-VBS / User-to-Dispatcher information / Compressed User-to-Dispatcher information in VGCS fast call set-up

26.14.11.4.1 Conformance requirement

The request of the calling subscriber to set up a voice group call may specify information to be sent as user-to-dispatcher information to the network; in this case the user-to-dispatcher information is included in the signalling for call setup from the mobile station to the network. It is the responsibility of the input function to ensure that the user-to-dispatcher information has a correct format (in particular, an allowed length).

User-to-dispatcher information can be compressed or uncompressed.

The message IMMEDIATE SETUP 2 is sent by the MS to the network in order to set-up a group call immediately, i.e. without previous establishment of an MM connection, and to include compressed user-to-dispatcher information. The message shall be used if the MS has a valid TMSI.

References

3GPP TS 03.68 subclauses 4.2.1.1, 4.2.7, 11.3.1.1.1 and 11.3.1.1.3.

3GPP TS 04.68 subclause 6.2.2 and clause 8.

26.14.11.4.2 Test purpose

1. To verify that upon initiation of an outgoing VGCS fast call with Compressed User-to-Dispatcher Information by the user, the MS includes a Compressed User-to-Dispatcher Information information element in the IMMEDIATE SETUP 2 message.
2. To verify that the VGCS fast call can be successfully established and cleared.

26.14.11.4.3 Method of test

Initial Conditions

System Simulator:

1 cell with default parameters for ASCII testing.

Mobile Station:

The MS is in MM-state "idle, updated" with a TMSI allocated.

Specific PICS statements:

-

PIXIT Statements:

- Way to activate User-to-Dispatcher Information.
- Way to configure VGCS.
- Way to initiate VGCS fast calls set-up.

Foreseen Final State of the MS

"Idle, updated", with TMSI allocated.

Test Procedure

By means of appropriate MMI function, the user enters a string, which shall be included in the User-to-Dispatcher Information. Then MS is made to initiate a VGCS fast call. Check that the MS sends an IMMEDIATE SETUP 2 message, and check that the Compressed User-to-Dispatcher Information information element is present. Then, it is checked that the VGCS fast call can be successfully established and released.

Maximum Duration of Test

2 minutes.

Expected Sequence

Step	Direction	Message	Comments
0	MS		The MS is in idle mode.
1	MS		MMI actions to initiate a VGCS fast call with the User-to-Dispatcher Information "1234567890"
2	MS -> SS	CHANNEL REQUEST	
3	SS -> MS	IMMEDIATE ASSIGNMENT	TCH/F, single RF channel GSM 450: 275 GSM 480: 322 GSM 900: 50 DCS 1 800: 750 PCS 1 900: 650 GSM710: 470 GSM 750: 470 T-GSM 810: 470 GSM 850: 177
4	MS -> SS	IMMEDIATE SETUP	L2: SABM / UA, GCC message including the Compressed utdi information element shall be present, see Specific message contents Very early assignment
5	SS -> MS	CHANNEL MODE MODIFY	
6	MS -> SS	CHANNEL MODE MODIFY ACK	
7	SS -> MS	CONNECT	
8	SS -> MS	TERMINATION	
9	SS -> MS	CHANNEL RELEASE	

Specific message contents:

IMMEDIATE SETUP 2

Information element	value/remark
Protocol discriminator	'0000'B for GCC
Transaction identifier	'0001'B
Message type	'0x111011'B
Spare half octet	'0000'B
Ciphering key sequence number	PICS/PIXIT
Mobile station classmark	PICS/PIXIT
TMSI	PICS/PIXIT
Group identity	PICS/PIXIT
Compressed utdi	'00075BCD16'O

26.15 SoLSA signalling

26.15.1 General considerations

This subclause applies only to mobile stations supporting SoLSA, as defined in 3GPP TS 02.43 and 3GPP TS 03.73.

Conformance requirements of clause 26 fully apply to any SoLSA MS.

The purpose of this subclause is to test these extra functional requirements for a SoLSA mobile station.

Additional to the abbreviations and definitions in TR 21.905 the definitions in subclause 20.24 are used within this subclause.

26.15.1.1 Default message content

Default contents SYSTEM INFORMATION messages and default settings

For cell A and B refer to table 26.6

The following parameters shall be coded into the system information messages. Parameters shall be coded according to 3GPP TS 04.18.

SYSTEM INFORMATION TYPE 2bis, SYSTEM INFORMATION TYPE 5bis messages are not used.

SYSTEM INFORMATION TYPE 3

Default except:

Information Element	Value/remark
SI3 rest octets Early Classmark Sending Control	Early Sending is explicitly accepted

Default message contents for other messages:

For subclause 26.15.2	same as in subclause 26.7.0
For subclause 26.15.3	same as in subclause 26.7.0
For subclause 26.15.4	same as in subclause 26.7.0
For subclause 26.15.5	same as in subclause 26.9.0

26.15.1.2 General initial conditions for SIM card

- Following LSA values shall be defined in the fields of the EF_{SLL} (GSM 11.11, subclause 10.4.1.2) and in the LSA descriptor files (GSM 11.11, subclause 10.4.1.3) on the SIM card used for testing:

	LSA ID	CI	LAC	LAC + CI	PLMN code	LSA Priority	Idle mode support	LSA indication for idle mode
LSA1	54 66.001	-			HPLMN	0	On	Off
LSA3	9.000.000			2 + [250..254]	HPLMN	8	On	On

- List of values, that shall not be found in the SIM card, in order to be sure that the SoLSA MS is not subscribed to the LSA defined by the current carrier:

	LSA ID	CI	LAC	LAC + CI
LSA value	[250..255]	[5000..5005]	5	5 + [5000..5005]

26.15.2 SoLSA signalling / RR

26.15.2.1 SoLSA signalling / RR / classmark interrogation

This procedure allows the network to request the MS to supply all its classmark information to the network.

Networks may systematically use this procedure (e.g. during location updating) and, if it is incorrectly implemented in the MS, the basic connection establishment procedure may systematically fail.

26.15.2.1.1 Conformance requirements

On receipt of a CLASSMARK ENQUIRY message, the MS sends a CLASSMARK CHANGE message to the network containing the Mobile Station Classmark 2 information element and depending upon the contents of this information element, possibly the Mobile Station Classmark 3 information element.

References

3GPP TS 04.18 subclauses 3.3.1.1.4.1, 3.4.11 and 9.1.11.

3GPP TS 04.13 subclause 5.2.9.

26.15.2.1.2 Test purpose

To verify that if the network requests the SoLSA MS to supply all its classmark information then this information is communicated on the DCCH to the network.

26.15.2.1.3 Method of test

Initial Conditions

System Simulator:

1 cell, default parameters.

Mobile Station:

"Idle, updated", with TMSI allocated.

Specific PICS statements:

-

PIXIT statements:

-

Foreseen Final State of the MS

"Idle, updated", with TMSI allocated.

Test Procedure

The MS is switched off (or has its power removed).

The SS then sets the IMSI attach-detach flag in the SYSTEM INFORMATION messages so that the MS shall perform a location update when switched on.

The MS is switched on (or its power is re-applied). The MS then initiates a location update attempt. After the successful completion of the location update procedure (with TMSI reallocation) the SS transmits a CLASSMARK ENQUIRY message. The MS shall be ready to transmit the CLASSMARK CHANGE message before 300 ms after the end of the CLASSMARK ENQUIRY message.

The term "ready to transmit" is defined in 3GPP TS 04.13.

Then the channel is released.

Maximum Duration of Test

2 minutes.

Expected Sequence

Step	Direction	Message	Comments
1	MS		The MS is switched off (or has its power removed). IMSI attach-detach flag changed. The MS is switched on (or its power is re-applied). "Establishment cause": Location updating. "location updating type" = normal, "CKSN" = CKSN1, "location area identification" = a, "mobile station classmark 1" and "mobile station classmark 2" including settings for ES IND and SoLSA and "mobile identity" = TMSI1. Shall be ready to transmit (see 3GPP TS 05.10 subclause 06.10) within 40 ms after the completion of step 4. Shall indicate the MS frequency and power capabilities Note: In this case 'ready to transmit' shall result in the actual transmission of the Classmark Change 51 frames later (51 * 4.62ms = 235.62 ms). Therefore receipt of the Classmark Change within 250ms of step 4 is required. "mobile station classmark 2" includes settings for ES IND and SoLSA "Mobile identity" = new TMSI (=TMSI2). Contents as defined in step 6. This message shall be ready to be transmitted before 300 ms after the completion of step 9.
2	SS		
3	MS		
2	MS -> SS	CHANNEL REQUEST	
3	SS -> MS	IMMEDIATE ASSIGNMENT	
4	MS -> SS	LOCATION UPDATING REQUEST	
5	SS -> MS	UA(LOCATION UPDATING REQUEST)	
6	MS -> SS	CLASSMARK CHANGE	
7	SS -> MS	LOCATION UPDATING ACCEPT	
8	MS -> SS	TMSI REALLOCATION COMPLETE	
9	SS -> MS	CLASSMARK ENQUIRY	
10	MS -> SS	CLASSMARK CHANGE	
11	SS -> MS	CHANNEL RELEASE	

Specific message contents:

LOCATION UPDATING REQUEST

Information element	Value/remark
as default except:	
Mobile station Classmark 1 - ES IND	Controlled Early Classmark Sending option is implemented
Mobile station Classmark 2 - ES IND	Controlled Early Classmark Sending option is implemented
- SoLSA	SoLSA supported

CLASSMARK CHANGE

Information element	Value/remark
as default except:	
Mobile station Classmark 2 -ES IND -SoLSA	Controlled Early Classmark Sending is implemented. SoLSA supported

26.15.3 SoLSA signalling / MM

26.15.3.1 SoLSA signalling / MM / location updating

This procedure is used to register the MS in the network. If it is not performed correctly, no call can be established.

26.15.3.1.1 Location updating / accepted

To inform the network of the MSs additional SoLSA capability, the SoLSA MS has to send a CLASSMARK CHANGE as soon as possible during a normal location update procedure.

26.15.3.1.1.1 Conformance requirement

If the network accepts a location updating from the Mobile where the ES IND bit is set to 1 in the Classmark 1 and the Classmark 2 information element, the SoLSA bit is set to 1 in the classmark 2 information element and the Early Classmark Sending Control bit is set to high in SI3 Rest Octets, then the MS shall send, on the first occasion, the CLASSMARK CHANGE message.

During a contention resolution procedure, if the last timeslot of the block containing a L2 UA frame occurs at time T, then the MS shall be ready to transmit the CLASSMARK CHANGE before T + 40 ms.

The Mobile Station shall, after receiving a Location updating Accept message, store the relevant received informations and answer correctly to a paging request from the network.

This test is applicable for any SoLSA MSs with an LSA SIM supporting the SoLSA operations.

Reference(s)

3GPP TS 24.008 subclauses 4.4.4.6, 9.2.15, 10.5.1.5 and 10.5.1.6.

3GPP TS 04.18 subclauses 3.3.1.1.4.1, 9.1.11 and 10.5.2.34.

26.15.3.1.1.2 Test purpose

To verify that the SoLSA MS supports "early classmark sending procedure", e.g. sending information to the network about SoLSA support during location update procedure.

26.15.3.1.1.3 Method of test

Initial conditions:

System Simulator:

Two cells, A and B, belonging to different location areas with location area identification a and b of the same PLMN.

IMSI attach/detach is allowed in both cells.

The T3212 time-out value is 1/10 hour in both cells.

Mobile Station:

The MS has a valid TMSI (=TMSI1) and CKSN (=CKSN1). It is "idle updated" on cell A.

Specific PICS statements:

-

PIXIT statements:

-

Foreseen final state of the MS

The MS has no valid TMSI. It has valid CKSN and Kc. It is "idle, updated" on cell B.

Test Procedure

The MS is made to select cell B. A normal location updating with TMSI reallocation is performed in cell B. The channel is released. The SS checks, by paging, that the MS has stored the newly allocated TMSI. The channel is released. The MS is made to select cell A. A normal location updating is performed in cell A. The LOCATION UPDATING ACCEPT message contains neither IMSI nor TMSI. The SS checks, by paging, that the MS has kept the old TMSI. The channel is released. The MS is made to select cell B. A normal location updating is performed in cell B. The LOCATION UPDATING ACCEPT message contains an IMSI. The SS checks, by paging, that the MS has deleted its TMSI and responds to paging with IMSI.

Maximum duration of test

4 minutes.

Expected sequence

Step	Direction	Message	Comments
1	SS		The RF level of cell A is lowered until the MS selects cell B.
2	MS -> SS	CHANNEL REQUEST	"Establishment cause": Location updating.
3	SS -> MS	IMMEDIATE ASSIGNMENT	
4	MS -> SS	LOCATION UPDATING REQUEST	"location updating type" = normal, "CKSN" = CKSN1, "location area identification" = a, "mobile station classmark 1" and "mobile station classmark 2" including settings for ES IND and SoLSA and "mobile identity" = TMSI1.
5	SS -> MS	UA(LOCATION UPDATING REQUEST)	
6	MS -> SS	CLASSMARK CHANGE	Shall be ready to transmit (see 3GPP TS 05.10 subclause 06.10) within 40 ms after the completion of step 4. Shall indicate the MS frequency and power capabilities Note: In this case 'ready to transmit' shall result in the actual transmission of the Classmark Change 51 frames later (51 * 4.62ms = 235.62 ms). Therefore receipt of the Classmark Change within 250ms of step 4 is required. "mobile station classmark 2" includes settings for ES IND and SoLSA
7	SS -> MS	LOCATION UPDATING ACCEPT	"Mobile identity" = new TMSI (=TMSI2), LAI = b.
8	MS -> SS	TMSI REALLOCATION COMPLETE	
9	SS -> MS	CHANNEL RELEASE	After the sending of this message, the SS waits for the disconnection of the main signalling link. The SS waits an amount of time which is enough to guarantee that the MS is in service.
10	SS -> MS	PAGING REQUEST TYPE 1	"Mobile identity" IE contains the new TMSI (= TMSI2).
11	MS -> SS	CHANNEL REQUEST	
12	SS -> MS	IMMEDIATE ASSIGNMENT	
13	MS -> SS	SABM (PAGING RESPONSE)	"Mobile identity" IE contains the new TMSI (= TMSI2). "mobile station classmark 2" including settings for ES IND and SoLSA
14	SS -> MS	UA (PAGING RESPONSE)	
15	MS -> SS	CLASSMARK CHANGE	Shall be ready to transmit (see 3GPP TS 05.10 subclause 06.10) within 40 ms after the completion of step 13. Shall indicate the MS frequency and power capabilities Note: In this case 'ready to transmit' shall result in the actual transmission of the Classmark Change 51 frames later (51 * 4.62ms = 235.62 ms). Therefore receipt of the Classmark Change within 250ms of step 13 is required. "mobile station classmark 2" includes settings for ES IND and SoLSA
16	SS -> MS	CHANNEL RELEASE	After the sending of this message, the SS waits for the disconnection of the main signalling link.
17	SS		The RF level of cell B is lowered until the MS selects cell A.
18	MS -> SS	CHANNEL REQUEST	"Establishment cause": Location updating

Step	Direction	Message	Comments
19	SS -> MS	IMMEDIATE ASSIGNMENT	
20	MS -> SS	LOCATION UPDATING REQUEST	"location updating type" = normal, "CKSN" = CKSN1, "location area identification" = b, "mobile station classmark 1" and "mobile station classmark 2" including settings for ES IND and SoLSA and "mobile identity" = TMSI2.
21	SS -> MS	UA(LOCATION UPDATING REQUEST)	
22	MS -> SS	CLASSMARK CHANGE	Shall be ready to transmit (see 3GPP TS 05.10 subclause 06.10) within 40 ms after the completion of step 20. Shall indicate the MS frequency and power capabilities Note: In this case 'ready to transmit' shall result in the actual transmission of the Classmark Change 51 frames later (51 * 4.62ms = 235.62 ms). Therefore receipt of the Classmark Change within 250ms of step 20 is required. "mobile station classmark 2" includes settings for ES IND and SoLSA
23	SS -> MS	LOCATION UPDATING ACCEPT	"Mobile identity" IE not included.
24	SS -> MS	CHANNEL RELEASE	After the sending of this message, the SS waits for the disconnection of the main signalling link. The SS waits an amount of time which is enough to guarantee that the MS is in service.
25	SS -> MS	PAGING REQUEST TYPE 1	"Mobile identity" IE contains the TMSI (= TMSI2).
26	MS -> SS	CHANNEL REQUEST	
27	SS -> MS	IMMEDIATE ASSIGNMENT	
28	MS -> SS	SABM (PAGING RESPONSE)	"Mobile identity" IE contains the TMSI (= TMSI2). "mobile station classmark 2" including settings for ES IND and SoLSA
29	SS -> MS	UA (PAGING RESPONSE)	
30	MS -> SS	CLASSMARK CHANGE	Shall be ready to transmit (see 3GPP TS 05.10 subclause 06.10) within 40 ms after the completion of step 28. Shall indicate the MS frequency and power capabilities Note: In this case 'ready to transmit' shall result in the actual transmission of the Classmark Change 51 frames later (51 * 4.62ms = 235.62 ms). Therefore receipt of the Classmark Change within 250ms of step 28 is required. "mobile station classmark 2" includes settings for ES IND and SoLSA
31	SS -> MS	CHANNEL RELEASE	After the sending of this message, the SS waits for the disconnection of the main signalling link.
32	SS		The RF level of cell A is lowered until the MS selects cell B.
33	MS -> SS	CHANNEL REQUEST	"Establishment cause": Location updating.
34	SS -> MS	IMMEDIATE ASSIGNMENT	
35	MS -> SS	LOCATION UPDATING REQUEST	"location updating type" = normal, "CKSN" = CKSN1, "location area identification" = a, "mobile station classmark 1" and "mobile station classmark 2" including settings for ES IND and SoLSA and "mobile identity" = TMSI2.
36	SS -> MS	UA(LOCATION UPDATING REQUEST)	"Mobile identity" IE contains IMSI.
37	MS -> SS	CLASSMARK CHANGE	Shall be ready to transmit (see 3GPP TS 05.10 subclause 06.10) within 40 ms after the completion of step 35. Shall indicate the MS frequency and power capabilities Note: In this case 'ready to transmit' shall result in the actual transmission of the Classmark Change 51 frames later (51 * 4.62ms = 235.62 ms). Therefore receipt of the Classmark Change within 250ms of step 35 is required. "mobile station classmark 2" includes settings for ES IND and SoLSA
38	SS -> MS	LOCATION UPDATING ACCEPT	"Mobile identity" IE contains IMSI.

Step	Direction	Message	Comments
39	SS -> MS	CHANNEL RELEASE	After the sending of this message, the SS waits for the disconnection of the main signalling link. The SS waits an amount of time which is enough to guarantee that the MS is in service.
40 41	SS -> MS MS	PAGING REQUEST TYPE 1	"Mobile identity" IE contains the old TMSI (= TMSI2). The MS shall ignore this message. This is checked during 5 seconds.
42 43	SS -> MS MS -> SS	PAGING REQUEST TYPE 1 CHANNEL REQUEST	"Mobile identity" IE contains the IMSI.
44 45	SS -> MS MS -> SS	IMMEDIATE ASSIGNMENT SABM (PAGING RESPONSE)	"Mobile identity" IE contains the IMSI. "mobile station classmark 2" including settings for ES IND and SoLSA
46 47	SS -> MS MS -> SS	UA (PAGING RESPONSE) CLASSMARK CHANGE	Shall be ready to transmit (see 3GPP TS 05.10 subclause 06.10) within 40 ms after the completion of step 45. Shall indicate the MS frequency and power capabilities Note: In this case 'ready to transmit' shall result in the actual transmission of the Classmark Change 51 frames later (51 * 4.62ms = 235.62 ms). Therefore receipt of the Classmark Change within 250ms of step 45 is required. "mobile station classmark 2" includes settings for ES IND and SoLSA
48	SS -> MS	CHANNEL RELEASE	After the sending of this message, the SS waits for the disconnection of the main signalling link.

Specific message contents:

LOCATION UPDATING REQUEST

Information element	Value/remark
as default except: Mobile station Classmark 1 - ES IND	Controlled Early Classmark Sending option is implemented
Mobile station Classmark 2 - ES IND - SoLSA	Controlled Early Classmark Sending option is implemented SoLSA supported

CLASSMARK CHANGE

Information element	Value/remark
as default except: Mobile station Classmark 2 -ES IND -SoLSA	Controlled Early Classmark Sending is implemented. SoLSA supported

PAGING RESPONSE

Information element	Value/remark
Protocol Discriminator	RR management
Ciphering Key Sequence number - Key Sequence	Key sequence number previously allocated to MS, or "111" if no key is available
Mobile station Classmark 2 - ES IND	Shall indicate early autonomous sending of CLASSMARK CHANGE
- SoLSA	SoLSA supported
Mobile Identity - odd/even	Even
- Type of identity	TMSI
- Identity digits	TMSI previously allocated to MS

26.15.3.2 SoLSA signalling / MM / MM information

26.15.3.2.1 General remark

1. The network has total control of the LSA indication in active mode.
2. Whatever the System Informations are, the LSA ID transmitted in the MM Information message has higher priority.
3. The indication of the current LSA in active mode is independent from the setting of the configurations parameters "LSA indication in idle mode" and "idle mode support" stored in the SIM in EF_{SLL} (see 3GPP TS 11.11, subclause 10.4.1.2).

26.15.3.2.2 Definition

The SoLSA MS in active mode may inform the user whether or not the serving cell is an LSA cell. The information about a serving cell is indicated in the display of the SoLSA MS.

The change out of an LSA or into an LSA may be indicated by the SoLSA MS, e.g. using a beep.

26.15.3.2.3 Conformance requirement

1. It shall be possible to assign a subscriber defined identifier by the operator to each LSA (alphanumeric text up to 10 characters), which can be provided to the user in idle and active mode. As an MS manufacturer option the user may assign an icon or another form of indication to each LSA.

It shall be possible to indicate a change of localised service area during idle and active mode.

The indication is a network option (activated/deactivated by the network).

2. The network decides when to send a notification to the MS about a change of current LSA. The information will be sent from the MSC to the MS and will contain the LSA ID. This is done by adding the LSA ID of the current cell to the MM INFORMATION message. If no LSA ID is included in the MM Information message the MS shall assume that the current cell does not belong to any of the allowed LSAs for the subscriber.

The indication towards the user is optional and can be heard as e.g. a beep in the receiver or by displaying the stored LSA name that corresponds to the received LSA ID.

3. The MM INFORMATION message support is optional in the network. The MM information procedure may be invoked by the network at any time during an RR connection.

The MM information procedure consists only of the MM INFORMATION message sent from the network to the mobile station. During an RR connection, the network shall send none, one, or more MM INFORMATION messages to the mobile station. If more than one MM INFORMATION message is sent, the messages need not have the same content.

NOTE: The network may be able to select particular instants where it can send the MM INFORMATION message without adding delay to, or interrupting, any CM layer transaction, e.g. immediately after the AUTHENTICATION REQUEST message.

When the mobile station (supporting the MM INFORMATION message) receives an MM INFORMATION message, it shall accept the message and optionally use the contents to update appropriate information stored within the mobile station.

If the mobile station does not support the MM INFORMATION message the mobile station shall ignore the contents of the message and return an MM STATUS message with cause #97.

4. This IE (LSA Identity IE) may be sent by the network. The contents of this IE indicate the LSA identity of the serving cell.
5. The form of display and indication are left to manufacturer's choice.
6. If the Length of the LSA Identifier content is equal to 0, then no LSA ID is included. This is used to indicate that the MS has moved to an area where there is no LSA available for that MS.

References

- Conformance requirement 1: 3GPP TS 02.43, subclause 4.2.1.
 Conformance requirement 2: 3GPP TS 03.73, subclause 11.8.2.
 Conformance requirement 3: 3GPP TS 24.008, subclause 4.3.6.
 Conformance requirement 4: 3GPP TS 24.008, subclause 9.2.15a.5.
 Conformance requirement 5: 3GPP TS 03.73, subclause 4.3.2.
 Conformance requirement 6: 3GPP TS 24.008, subclause 10.5.3.11.

26.15.3.2.4 Test Purpose

To verify that the SoLSA MS correctly handles the LSA information received in MM INFORMATION and performs indication accordingly.

26.15.3.2.5 Method of test

26.15.3.2.5.1 Initial Conditions

- a) The SoLSA MS is in the active state of a call (U10).
- b) The serving cell is cell 1 (carrier 1).
- c) Parameters: same default values defined in table 20.24.1, except for the following values:

Parameter/condition	Carrier 1
LSA ID	54, 9.000.000, 250
LAC	5
CI	5000
Matching LSA on SIM	LSA1, LSA3
Escape PLMN	No

Run the following test procedure twice by using two different sets of initial conditions:

- with an LSA only SIM (see Definitions in subclause 20.24);
- with a normal LSA SIM (see Definitions in subclause 20.24).

Specific PICS statements:

-

PIXIT statements:

- Way to indicate the identity of the current LSA
- Way to indicate the change of the current LSA

26.15.3.2.5.2 Test Procedure

- a) A MM INFORMATION message including the LSA Identity IE is sent by the SS. The LSA Identity IE contains the LSA ID = 54 (LSA stored in the SIM).
- b) A MM INFORMATION message including the LSA Identity IE is sent by the SS. The LSA Identity IE contains the LSA ID = 250 (LSA not stored in the SIM).
- c) A MM INFORMATION message including the LSA Identity IE is sent by the SS. The LSA Identity IE contains the LSA ID = 54 (LSA stored in the SIM).
- d) The SS sends an MM INFORMATION message without an LSA Identity IE.
- e) A MM INFORMATION message including the LSA Identity IE is sent by the SS. The LSA Identity IE contains the LSA ID = 54 (LSA stored in the SIM).
- f) The SS sends an MM INFORMATION message which contains an LSA Identity IE. The value of the Length of LSA Identifier (octet 2) is set to zero (i.e. there are no LSA IDs included).
- g) A MM INFORMATION message including the LSA Identity IE is sent by the SS. The LSA Identity IE contains the LSA ID = 54 (LSA stored in the SIM).
- h) A MM INFORMATION message including the LSA Identity IE is sent by the SS. The LSA Identity IE contains the LSA ID = 9.000.000 (LSA stored in the SIM).

26.15.3.2.5.3 Void

26.15.3.2.5.4 Test Requirements

- 1) After step a) the SoLSA MS indicates a change of LSA (a subscribed LSA is entered).
- 2) After step b) the SoLSA MS indicates a change of LSA (a not subscribed LSA is entered).
- 3) After step c) the SoLSA MS indicates a change of LSA (a subscribed LSA is entered).
- 4) After step d) the SoLSA MS indicates a change of LSA (a not subscribed LSA is entered).
- 5) After step e) the SoLSA MS indicates a change of LSA (a subscribed LSA is entered).
- 6) After step f) the SoLSA MS indicates a change of LSA (a not subscribed LSA is entered).
- 7) After step g) the SoLSA MS indicates a change of LSA (a subscribed LSA is entered).
- 8) After step h) the SoLSA MS indicates a change of LSA (another subscribed LSA is entered).

26.15.4 SoLSA signalling / CC

26.15.4.1 SoLSA signalling / CC / call re-establishment / call present

26.15.4.1.1 Conformance requirement

- 1) If the call is in the "active" state or "mobile originating modify" state, the indication from MM that re-establishment is possible shall cause call control to request re-establishment from the MM-connection, suspend any further message to be sent and await the completion of the re-establishment procedure.
- 2) After the initial message the SoLSA MS shall send a CLASSMARK CHANGE message in the uplink block followed direct after the Layer 2 UA message sent from the network. The CLASSMARK CHANGE message shall contain information elements Mobile Station Classmark 2.
- 3) When the call control entity is notified that the MM-connection is re-established, it shall then resume the transmission of possibly suspended messages and resume user data exchange when an appropriate channel is available.

References

3GPP TS 24.008, subclauses 4.5.1.6 and 5.5.4.2.

3GPP TS 04.18 subclause 3.3.1.1.4.1 and 9.1.11,
3GPP TS 03.73 subclause 11.4.1,
3GPP TS 24.008 subclauses 9.2.9, 9.2.15, 10.5.1.5 and 10.5.1.6.

3GPP TS 24.008, subclauses 4.5.1.6 and 5.5.4.3.

26.15.4.1.2 Test purpose

To verify that the SoLSA MS supports "early classmark sending procedure", e.g. sending information to the network about SoLSA support during the re-establishment of an ongoing call.

26.15.4.1.3 Method of test

Initial conditions

System Simulator:

The SS simulates cells A and B. The LAC of cell A is different from the LAC of cell B. The PLMN identities of cell A and B are equal.

The call re-establishment parameter concerning cell A is set to an arbitrary value.

Cell B is not barred, the RACH control parameters information element sent in SYSTEM INFORMATION TYPE 1 to 4 messages of cell A and B specifies "call reestablishment allowed in the cell", the NCC of cell B is indicated as permitted in the PLMN permitted information element of SYSTEM INFORMATION TYPE 2 and 6 messages of cell A. Cell B is indicated as a neighbour cell of cell A in SYSTEM INFORMATION TYPE 2 and 5 messages of cell A. Cell reselect hysteresis parameter of cell A is set to zero.

Mobile Station:

The MS is in MM-state "idle, updated" with valid TMSI and CKSN on cell A.

Specific PICS statements:

-

PIXIT statements:

-

Foreseen final state of the MS

The MS is in MM-state "idle, updated" with valid TMSI and CKSN.

Maximum duration of test

1 minute.

Test procedure

The MS is brought to active state by using procedure 26.9.2, "structured procedures, MS originated call, early assignment". The RF level of cell A is lowered so that cell B is to be selected (when the MS performs re-establishment after radio link failure), while keeping the C1 and C2 of cell A greater than zero. SS waits for at least 5 seconds. Then the SS stops transmission on the TCH/SACCH. The MS shall re-establish the call on cell B using a CM RE-ESTABLISHMENT message. The SS performs ciphering mode setting and assignment procedures. The MS shall through-connect the appropriate bearer channel. Then, the call is cleared by the SS.

Expected sequence

Step	Direction	Message	Comments
1			Steps 1-21 of test case 26.15.3.1 are performed (the appropriate bearer channel is through connected in both directions in TCH)
2	SS		The RF level of cell A is lowered. The SS waits at least 5 seconds. The SS stops transmission on the TCH/SACCH. this is sent on cell B. Establ. Cause shall be "call re-establishment; TCH/F was in use,..."
3	MS -> SS	CHANNEL REQUEST	
4	SS -> MS	IMMEDIATE ASSIGNMENT	
5	MS -> SS	CM REESTABLISHMENT REQUEST	note specific message contents
6	SS -> MS	UA (CM REESTABLISHMENT REQUEST)	
7	MS -> SS	CLASSMARK CHANGE	Shall be ready to transmit (see 3GPP TS 05.10 subclause 06.10) within 40 ms after the completion of step 5. "mobile station classmark 2" includes settings for ES IND and SoLSA Note: In this case 'ready to transmit' shall result in the actual transmission of the Classmark Change 51 frames later (51 * 4.62ms = 235.62 ms). Therefore receipt of the Classmark Change within 250ms of step 5 is required.
7	SS -> MS	CIPHERING MODE COMMAND	SS starts deciphering after sending the message.
8	MS -> SS	CIPHERING MODE COMPLETE	Shall be sent enciphered. All following messages shall be sent enciphered.
9	SS		SS starts ciphering.
10	SS -> MS	ASSIGNMENT COMMAND	
11	MS -> SS	ASSIGNMENT COMPLETE	
12	MS		The appropriate bearer channel is through connected in both directions.
13	SS -> MS	DISCONNECT	with cause value "Normal"
14	MS -> SS	RELEASE	
15	SS -> MS	RELEASE COMPLETE	
16	SS -> MS	CHANNEL RELEASE	The main signalling link is released.

Specific message contents:

CM RE-ESTABLISHMENT REQUEST

Information element	Value/remark
Protocol discriminator	Mobility Management
Skip indicator	Encoded as zeroes
Message type	CM RE-ESTABLISHMENT REQUEST
Ciphering key sequence number	The CKSN which the MS was allocated in step 6 of the procedure of subclause 26.15.3.1
Spare half octet	zero
Mobile station Classmark 2	
- ES IND	Shall indicate early autonomous sending of CLASSMARK CHANGE
- SoLSA	SoLSA supported
Mobile identity	The TMSI that the MS is having initially
Location area identification	Corresponding the LAI of cell A

CLASSMARK CHANGE

Information element	Value/remark
as default except: Mobile station Classmark 2 -ES IND -SoLSA	Controlled Early Classmark Sending is implemented. SoLSA supported

26.15.5 SoLSA signalling / structured procedures

26.15.5.1 SoLSA signalling / structured procedures / MS originated call / early assignment

26.15.5.1.1 Conformance requirements

- 1) An MS in MM state "idle, updated" and in RR idle mode, when made to initiate a call, if it provides a human interface, shall display the dialled number.
- 2) An MS in MM state "idle, updated" and in RR idle mode, when made to initiate a call for a selected teleservice that is supported by the MS, shall start to initiate the immediate assignment procedure by sending a CHANNEL REQUEST message with correct establishment cause.
- 3) After the initial message the SoLSA MS shall send a CLASSMARK CHANGE message in the uplink block followed direct after the Layer 2 UA message sent from the network. The CLASSMARK CHANGE message shall contain information elements Mobile Station Classmark 2.
- 4) Subsequently after establishment of an MM connection, the MS shall send a SETUP message with correct parameters.
- 5) The call control entity of the Mobile Station in the "call initiated" state, in the "mobile originating call proceeding" state or in the "call delivered" state, shall, upon receipt of a CONNECT message:
 - attach the user connection to the radio path;
 - return a CONNECT ACKNOWLEDGE message.
- 6) Subsequently when the network initiates call clearing by sending a DISCONNECT message, the MS shall proceed to release the call by sending a RELEASE message.
- 7) On receipt of a CHANNEL RELEASE message, the MS shall disconnect the main signalling link.

References

- Conformance requirement 1: 3GPP TS 02.07 subclause B.1.1.
- Conformance requirement 2: 3GPP TS 04.18 subclause 3.3.1.1.
- Conformance requirement 3: 3GPP TS 04.18 subclauses 3.3.1.1.4.1 and 9.1.11,
3GPP TS 03.73 subclause 11.4.1,
3GPP TS 24.008 subclauses 9.2.9, 9.2.15, 10.5.1.5 and 10.5.1.6.
- Conformance requirement 4: 3GPP TS 24.008 subclause 5.2.1.
- Conformance requirement 5: 3GPP TS 24.008 subclause 5.2.1.6.
- Conformance requirement 6: 3GPP TS 24.008 subclause 5.4.4.
- Conformance requirement 7: 3GPP TS 04.18 subclause 3.4.13.1.

26.15.5.1.2 Test purpose

To verify that the SoLSA MS supports "early classmark sending procedure", e.g. sending information to the network about SoLSA support during a mobile originating call (MOC) with early assignment procedure.

26.15.5.1.3 Method of test

Initial Conditions

System Simulator:

1 cell, default parameters.

Mobile Station:

The MS is in MM-state "idle, updated" with valid TMSI and CKSN.

Specific PICS statements:

- Speech supported for Full rate version 1 (GSM FR) (TSPC_AddInfo_Full_rate_version_1).
- Speech supported for Half rate version 1 (GSM HR) (TSPC_AddInfo_Half_rate_version_1)
- Speech supported for Half rate version 3 (GSM HR) (TSPC_AddInfo_Half_rate_version_3)

PIXIT statements:

- Way to indicate mobile originated alerting.
- Way to display the called number

Foreseen Final State of the MS

The MS is in MM-state "idle, updated" with valid TMSI and CKSN.

Test procedure

The following test is performed for all rates (full rate/half rate) supported by the MS:

- A teleservice is selected that is supported by the MS; if the MS supports speech, the selected teleservice is speech. If necessary, the MS is configured for that teleservice.
- The MS is made to initiate a call on any frequency band supported by the MS. The call is established with early assignment. Having reached the active state, the call is cleared by the SS.

Maximum Duration of Test

1 minute.

Expected Sequence

Step	Direction	Message	Comments
1	MS		The "called number" is entered
2	MS		If supported, the MS must display the called number in the way defined in PIXIT.
3	MS -> SS	CHANNEL REQUEST	Establishment cause is "originating call and the network does not set the NECI bit to 1".
4	SS -> MS	IMMEDIATE ASSIGNMENT	
5	MS -> SS	CM SERVICE REQUEST	Message is contained in SABM. Indicating early sending of CLASSMARK CHANGE and SoLSA support
6	SS -> MS	UA (CM SERVICE REQUEST)	
7	MS -> SS	CLASSMARK CHANGE	Shall be ready to transmit (see 3GPP TS 05.10 subclause 06.10) within 40 ms after the completion of step 5. "mobile station classmark 2" includes settings for ES IND and SoLSA Note: In this case 'ready to transmit' shall result in the actual transmission of the Classmark Change 51 frames later (51 * 4.62ms = 235.62 ms). Therefore receipt of the Classmark Change within 250ms of step 5 is required.
8	SS -> MS	AUTHENTICATION REQUEST	
9	MS -> SS	AUTHENTICATION RESP	SRES specifies correct value.
10	SS -> MS	CIPHERING MODE COMMAND	SS starts deciphering after sending the message.
11	MS -> SS	CIPHERING MODE COMPLETE	Shall be sent enciphered. All following messages shall be sent enciphered.
12	SS		SS starts ciphering.
13	MS -> SS	SETUP	
14	SS -> MS	CALL PROCEEDING	
15	SS -> MS	ASSIGNMENT COMMAND	
16	MS -> SS	ASSIGNMENT COMPLETE	
17	SS -> MS	ALERTING	
18	MS		Depending on the PIXIT, an alerting indication is given
19	SS -> MS	CONNECT	
20	MS -> SS	CONNECT ACKNOWLEDGE	
21	MS		The appropriate bearer channel is through connected in both directions.
22	SS -> MS	DISCONNECT	
23	MS -> SS	RELEASE	
24	SS -> MS	RELEASE COMPLETE	
25	SS -> MS	CHANNEL RELEASE	The main signalling link is released.

Specific Message Contents:

CM SERVICE REQUEST

Information element	Value/remark
as default except: Mobile station Classmark 2	
- ES IND	Shall indicate early autonomous sending of CLASSMARK CHANGE
- SoLSA	SoLSA supported

CLASSMARK CHANGE

Information element	Value/remark
as default except: Mobile station Classmark 2	
-ES IND	Controlled Early Classmark Sending is implemented.
-SoLSA	SoLSA supported

26.15.5.2 SoLSA signalling / structured procedures / MS originated call / late assignment

26.15.5.2.1 Conformance requirements

- 1) An MS in MM state "idle, updated" and in RR idle mode, when made to initiate a call, if it provides a human interface, shall display the dialled number.
- 2) An MS in MM state "idle, updated" and in RR idle mode, when made to initiate a call for a selected teleservice that is supported by the MS, shall start to initiate the immediate assignment procedure by sending a CHANNEL REQUEST message with correct establishment cause.
- 3) After the initial message the SoLSA MS shall send a CLASSMARK CHANGE message in the uplink block followed direct after the Layer 2 UA message sent from the network. The CLASSMARK CHANGE message shall contain information element Mobile Station Classmark 2.
- 4) Upon receipt of the ASSIGNMENT COMMAND message, the Mobile Station initiates a local end release of link layer connections, disconnects the physical channels, commands the switching to the assigned channels and initiates the establishment of lower layer connections (this includes the activation of the channels, their connection and the establishment of the data links). After the main signalling link is successfully established, the MS returns an ASSIGNMENT COMPLETE message, specifying cause "normal event", to the network on the main DCCH.
- 5, 6) The call control entity of the Mobile Station in the "call initiated" state, in the "mobile originating call proceeding" state or in the "call delivered" state, shall, upon receipt of a CONNECT message:
 - attach the user connection to the radio path;
 - return a CONNECT ACKNOWLEDGE message.
- 7) Subsequently when the network initiates call clearing by sending a DISCONNECT message, the MS shall proceed to release the call by sending a RELEASE message.
- 8) On receipt of a CHANNEL RELEASE message, the MS shall disconnect the main signalling link.

References

- Conformance requirement 1: 3GPP TS 02.07 subclause B.1.1.
- Conformance requirement 2: 3GPP TS 04.18 subclause 3.3.1.1.
- Conformance requirement 3: 3GPP TS 04.18 subclause 3.3.1.1.4.1 and 9.1.11,
3GPP TS 03.73 subclause 11.4.1,
3GPP TS 24.008 subclauses 9.2.9, 9.2.15, 10.5.1.5 and 10.5.1.6.
- Conformance requirement 4: 3GPP TS 04.18 subclauses 3.4.3.1 and 3.4.3.2.
- Conformance requirement 5: 3GPP TS 24.008 subclause 5.2.1.6.
- Conformance requirement 6: 3GPP TS 24.008 subclause 5.2.1.6.
- Conformance requirement 7: 3GPP TS 24.008 subclause 5.4.4.
- Conformance requirement 8: 3GPP TS 04.18 subclause 3.4.13.1.

26.15.5.2.2 Test purpose

To verify that the SoLSA MS supports "early classmark sending procedure", e.g. sending information to the network about SoLSA support during a mobile originating call (MOC) with late assignment procedure.

26.15.5.2.3 Method of test

Initial Conditions

System Simulator:

1 cell, default parameters

Mobile Station:

The MS is in MM-state "idle, updated" with valid TMSI and CKSN.

Specific PICS statements:

- Speech supported for Full rate version 1 (GSM FR) (TSPC_AddInfo_Full_rate_version_1).
- Speech supported for Half rate version 1 (GSM HR) (TSPC_AddInfo_Half_rate_version_1)
- Speech supported for Half rate version 3 (GSM HR) (TSPC_AddInfo_Half_rate_version_3)

PIXIT statements:

- Way to indicate mobile originated alerting.
- Way to display the called number

Foreseen Final State of the MS

The MS is in MM-state "idle, updated" with valid TMSI and CKSN.

Test procedure

The following test is performed for all rates (full rate/half rate) supported by the MS:

- A teleservice is selected that is supported by the MS; if the MS supports speech, the selected teleservice is speech. If necessary, the MS is configured for that teleservice.
- The MS is made to initiate a call on any frequency band supported by the MS. The call is established with late assignment. Having reached the active state, the call is cleared by the SS.

Maximum Duration of Test

1 minute.

Expected Sequence

Step	Direction	Message	Comments
1	MS		The "called number" is entered
2	MS		If supported, the MS must display the called number in the way defined in PIXIT.
3	MS -> SS	CHANNEL REQUEST	Establishment cause is "originating call and the network does not set the NECI bit to 1".
4	SS -> MS	IMMEDIATE ASSIGNMENT	
5	MS -> SS	CM SERVICE REQUEST	Message is contained in SABM. Indicating early sending of CLASSMARK CHANGE and SoLSA support
6	SS -> MS	UA (CM SERVICE REQUEST)	
7	MS -> SS	CLASSMARK CHANGE	Shall be ready to transmit (see 3GPP TS 05.10 subclause 06.10) within 40 ms after the completion of step 5. "mobile station classmark 2" includes settings for ES IND and SoLSA Note: In this case 'ready to transmit' shall result in the actual transmission of the Classmark Change 51 frames later (51 * 4.62ms = 235.62 ms). Therefore receipt of the Classmark Change within 250ms of step 5 is required.
8	SS -> MS	AUTHENTICATION REQUEST	
9	MS -> SS	AUTHENTICATION RESP	SRES specifies correct value.
10	SS -> MS	CIPHERING MODE COMMAND	SS starts deciphering after sending the message.
11	MS -> SS	CIPHERING MODE COMPLETE	Shall be sent enciphered. All following messages shall be sent enciphered.
12	SS		SS starts ciphering.
13	MS -> SS	SETUP	
14	SS -> MS	CALL PROCEEDING	
15	SS -> MS	ALERTING	
16	MS		Depending on thePIXIT, an alerting indication is given
17	SS -> MS	ASSIGNMENT COMMAND	
18	MS -> SS	ASSIGNMENT COMPLETE	
19	SS -> MS	CONNECT	
20	MS -> SS	CONNECT ACKNOWLEDGE	
21	MS		The appropriate bearer channel is through connected in both directions.
22	SS -> MS	DISCONNECT	
23	MS -> SS	RELEASE	
24	SS -> MS	RELEASE COMPLETE	
25	SS -> MS	CHANNEL RELEASE	The main signalling link is released.

Specific Message Contents:

CM SERVICE REQUEST

Information element	Value/remark
as default except: Mobile station Classmark 2	
- ES IND	Shall indicate early autonomous sending of CLASSMARK CHANGE
- SoLSA	SoLSA supported

CLASSMARK CHANGE

Information element	Value/remark
as default except: Mobile station Classmark 2	
-ES IND	Controlled Early Classmark Sending is implemented.
-SoLSA	SoLSA supported

26.15.5.3 SoLSA signalling / structured procedures / MS terminated call / early assignment

26.15.5.3.1 Conformance requirement

- 1) After the initial message the SoLSA MS shall send a CLASSMARK CHANGE message in the uplink block followed direct after Layer 2 UA message sent from the network.
- 2) The MS shall acknowledge the SETUP message with a CALL CONFIRMED message, if compatibility checking was successful, the MS is not busy, and the user does not refuse the call.
- 3, 4) Upon receipt of the ASSIGNMENT COMMAND message the MS continues a mobile terminating call establishment with early establishment of the traffic channel
 - a) by replying to the ASSIGNMENT COMMAND with an ASSIGNMENT COMPLETE message; and
 - b) if the MS supports immediate connect, by continuing the call establishment by through-connecting the traffic channel in both directions, or if the MS does not support immediate connect, by sending an ALERTING message.
- 5) An MS indicates acceptance of a MT call by sending CONNECT.
- 6) For speech calls:

The mobile station shall attach the user connection at latest when sending the connect message, except if there is no compatible radio resource available at this time. In this case the attachment shall be delayed until such a resource becomes available.

For data calls:

The mobile station shall attach the user connection when receiving the CONNECT ACKNOWLEDGE message from the network.
- 7) The MS initiates call clearing of an active call by sending a DISCONNECT message.
- 8) The MS in this phase of call release, upon receipt of a RELEASE message, shall return a RELEASE COMPLETE message.
- 9) Subsequently the MS, upon receipt of a CHANNEL RELEASE message, shall disconnect the main signalling link.

Requirement reference:

- Conformance requirement 1: 3GPP TS 04.18 subclauses 3.3.1.1.4.1 and 9.1.11,
3GPP TS 03.73 subclause 11.4.1,
3GPP TS 24.008 subclauses 9.2.9, 9.2.15, 10.5.1.5 and 10.5.1.6.
- Conformance requirements 2: 3GPP TS 24.008 subclauses 5.2.2.3.1.
- Conformance requirement 3, 4: 3GPP TS 04.18 subclauses 3.4.3.1 and 3.4.3.2.
- Conformance requirement 5: 3GPP TS 24.008 subclause 5.2.2.5.
- Conformance requirement 6: 3GPP TS 24.008 subclause 5.2.2.9.
- Conformance requirement 7: 3GPP TS 24.008 subclause 5.4.3.1.
- Conformance requirement 8: 3GPP TS 24.008 subclause 5.4.3.3.
- Conformance requirement 9: 3GPP TS 04.18 subclause 3.4.13.1.

26.15.5.3.2 Test Purpose

To verify that the SoLSA MS supports "early classmark sending procedure", e.g. sending information to the network about SoLSA support during a mobile terminated call (MTC) with early assignment procedure.

26.15.5.3.3 Method of test

Initial Conditions

System Simulator:

1 cell, default parameters.

Mobile Station:

The MS is in MM-state "idle, updated" with valid TMSI and CKSN.

Specific PICS statements:

- Speech supported for Full rate version 1 (GSM FR) (TSPC_AddInfo_Full_rate_version_1).
- Speech supported for Half rate version 1 (GSM HR) (TSPC_AddInfo_Half_rate_version_1)
- Speech supported for Half rate version 3 (GSM HR) (TSPC_AddInfo_Half_rate_version_3)
- Immediate connect supported for all circuit switched basic services. (TSPC_AddInfo_ImmConn)

PIXIT statements:

- Way to indicate alerting.
- Way to make the MS accept an incoming call after alerting.

Test procedure

The following test is performed for all rates (full rate/half rate) supported by the MS:

- A teleservice is selected that is supported by the MS; if the MS supports speech, the selected teleservice is speech. If necessary, the MS is configured for that teleservice.
- The MS is paged and the resulting call is established. Having reached the active state, the MS is made to clear the call.

Maximum Duration of Test

1 minute.

Expected Sequence

Step	Direction	Message	Comments
1	SS -> MS	PAGING REQUEST TYPE 1	Sent on the correct paging subchannel
2	MS -> SS	CHANNEL REQUEST	Establishment cause indicates "answer to paging".
3	SS -> MS	IMMEDIATE ASSIGNMENT	
4	MS -> SS	PAGING RESPONSE	Message is contained in SABM "Mobile identity" IE contains the IMSI. "mobile station classmark 2" including settings for ES IND and SoLSA.
5	SS -> MS	UA (PAGING RESPONSE)	
6	MS -> SS	CLASSMARK CHANGE	Shall be ready to transmit (see 3GPP TS 05.10 subclause 06.10) within 40 ms after the completion of step 4. "mobile station classmark 2" includes settings for ES IND and SoLSA Note: In this case 'ready to transmit' shall result in the actual transmission of the Classmark Change 51 frames later (51 * 4.62ms = 235.62 ms). Therefore receipt of the Classmark Change within 250ms of step 4 is required.
7	SS -> MS	AUTHENTICATION REQUEST	
8	MS -> SS	AUTHENTICATION RESP	SRES specifies correct value.
9	SS -> MS	CIPHERING MODE COMMAND	SS starts deciphering after sending the message.
10	MS -> SS	CIPHERING MODE COMPLETE	Shall be sent enciphered. All following messages shall be sent enciphered.
11	SS		SS starts ciphering.
12	SS -> MS	SETUP	Message contains the signal IE.
13	MS -> SS	CALL CONFIRMED	If the MS supports immediate connect then branch A applies. If the MS does not support immediate connect then branch B applies
A12	MS -> SS	CONNECT	sent on the old channel
A13	SS -> MS	ASSIGNMENT COMMAND	
A14	MS -> SS	ASSIGNMENT COMPLETE	
B12	SS -> MS	ASSIGNMENT COMMAND	sent on the new channel
B13	MS -> SS	ASSIGNMENT COMPLETE	
B14	MS -> SS	ALERTING	
B15	MS		An alerting indication as defined in a PIXIT statement is given by the MS
B16	MS		The MS is made to accept the call in the way described in a PIXIT statement
B17	MS -> SS	CONNECT	
18	MS		If the call is a speech call, the TCH shall be through connected in both directions.
19	SS -> MS	CONNECT ACKNOWLEDGE	
20	MS		If the call is a data call, the TCH shall be through connected in both directions.
21	MS		The MS is made to release the call.
22	MS -> SS	DISCONNECT	
23	SS -> MS	RELEASE	
24	MS -> SS	RELEASE COMPLETE	
25	SS -> MS	CHANNEL RELEASE	The main signalling link is released.

Specific Message Contents:

CLASSMARK CHANGE

Information element	Value/remark
as default except: Mobile station Classmark 2 -ES IND -SoLSA	Controlled Early Classmark Sending is implemented. SoLSA supported

PAGING RESPONSE

Information element	Value/remark
Protocol Discriminator	RR management
Ciphering Key Sequence number - Key Sequence	Key sequence number previously allocated to MS, or "111" if no key is available
Mobile station Classmark 2 - ES IND	Shall indicate early autonomous sending of CLASSMARK CHANGE
- SoLSA	SoLSA supported
Mobile Identity	Even
- odd/even	TMSI
- Type of identity	TMSI previously allocated to MS
- Identity digits	

26.15.5.4 SoLSA signalling / structured procedures / MS terminated call / late assignment

26.15.5.4.1 Conformance requirement

- 1) After the initial message the SoLSA MS shall send a CLASSMARK CHANGE message in the uplink block followed direct after Layer 2 UA message sent from the network.
- 2) The MS shall acknowledge the SETUP message with a CALL CONFIRMED message, if compatibility checking was successful, the MS is not busy, and the user does not refuse the call.
- 3) An MS indicates acceptance of a MT call by sending CONNECT. If the MS does not support immediate connect, it sends an ALERTING message
- 4, 5) Upon receipt of the ASSIGNMENT COMMAND message the MS continues a mobile terminating call establishment with late establishment of the traffic channel:
 - a) by replying to the ASSIGNMENT COMMAND with an ASSIGNMENT COMPLETE message.
- 6) For speech calls:

The mobile station shall attach the user connection at latest when sending the connect message, except if there is no compatible radio resource available at this time. In this case the attachment shall be delayed until such a resource becomes available.

For data calls:

The mobile station shall attach the user connection when receiving the CONNECT ACKNOWLEDGE message from the network.
- 7) The MS initiates call clearing of an active call by sending a DISCONNECT message.
- 8) The MS in this phase of call release, upon receipt of a RELEASE message, shall return a RELEASE COMPLETE message.
- 9) Subsequently the MS, upon receipt of a CHANNEL RELEASE message, shall disconnect the main signalling link.

Requirement reference:

- Conformance requirement 1: 3GPP TS 04.18 subclauses 3.3.1.1.4.1 and 9.1.11,
3GPP TS 03.73 subclause 11.4.1,
3GPP TS 24.008 subclauses 9.2.9, 9.2.15, 10.5.1.5 and 10.5.1.6.
- Conformance requirements 2: 3GPP TS 24.008 section 5.2.2.3.1.
- Conformance requirement 3, 4: 3GPP TS 04.18 subclauses 3.4.3.1 and 3.4.3.2.
- Conformance requirement 5: 3GPP TS 24.008 subclause 5.2.2.5.

Conformance requirement 6: 3GPP TS 24.008 subclause 5.2.2.9.

Conformance requirement 7: 3GPP TS 24.008 subclause 5.4.3.1.

Conformance requirement 8: 3GPP TS 24.008 subclause 5.4.3.3.

Conformance requirement 9: 3GPP TS 04.18 subclause 3.4.13.1.

26.15.5.4.2 Test Purpose

To verify that the SoLSA MS supports "early classmark sending procedure", e.g. sending information to the network about SoLSA support during a mobile terminated call (MTC) with late assignment procedure.

26.15.5.4.3 Method of test

Initial Conditions

System Simulator:

1 cell, default parameters.

Mobile Station:

The MS is in MM-state "idle, updated" with valid TMSI and CKSN.

Specific PICS statements:

- Speech supported for Full rate version 1 (GSM FR) (TSPC_AddInfo_Full_rate_version_1).
- Speech supported for Half rate version 1 (GSM HR) (TSPC_AddInfo_Half_rate_version_1)
- Speech supported for Half rate version 3 (GSM HR) (TSPC_AddInfo_Half_rate_version_3)
- Immediate connect supported for all circuit switched basic services. (TSPC_AddInfo_ImmConn)

PIXIT statements:

- Way to indicate alerting.
- Way to make the MS accept an incoming call after alerting.

Test procedure

The following test is performed for all rates (full rate/half rate) supported by the MS:

- A teleservice is selected that is supported by the MS; if the MS supports speech, the selected teleservice is speech. If necessary, the MS is configured for that teleservice.
- The MS is paged and a MT call is established with late assignment (after CONNECT). Having reached the active state, the MS is made to clear the call.

Maximum Duration of Test

1 minute.

Expected Sequence

Step	Direction	Message	Comments
1	SS -> MS	PAGING REQUEST TYPE 1	Sent on the correct paging subchannel Establishment cause indicates "answer to paging". Message is contained in SABM "Mobile identity" IE contains the IMSI. "mobile station classmark 2" including settings for ES IND and SoLSA.
2	MS -> SS	CHANNEL REQUEST	
3	SS -> MS	IMMEDIATE ASSIGNMENT	
4	MS -> SS	PAGING RESPONSE	
5	SS -> MS	UA (PAGING RESPONSE)	Shall be ready to transmit (see 3GPP TS 05.10 subclause 06.10) within 40 ms after the completion of step 4. "mobile station classmark 2" includes settings for ES IND and SoLSA Note: In this case 'ready to transmit' shall result in the actual transmission of the Classmark Change 51 frames later ($51 * 4.62\text{ms} = 235.62\text{ms}$). Therefore receipt of the Classmark Change within 250ms of step 4 is required.
6	MS -> SS	CLASSMARK CHANGE	
7	SS -> MS	AUTHENTICATION REQUEST	
8	MS -> SS	AUTHENTICATION RESP	
9	SS -> MS	CIPHERING MODE COMMAND	
10	MS -> SS	CIPHERING MODE COMPLETE	
11	SS		SS starts ciphering.
12	SS -> MS	SETUP	Message contains the signal IE.
13	MS -> SS	CALL CONFIRMED	
A14	MS -> SS	CONNECT	An alerting indication as defined in a PIXIT statement is given by the MS The MS is made to accept the call in the way described in a PIXIT statement
B14	MS -> SS	ALERTING	
B15	MS		
B16	MS		
B17	MS -> SS	CONNECT	
18	SS -> MS	ASSIGNMENT COMMAND	
19	MS -> SS	ASSIGNMENT COMPLETE	
20	MS		If the call is a speech call, the TCH shall be through connected in both directions.
21	SS -> MS	CONNECT ACKNOWLEDGE	If the call is a data call, the TCH shall be through connected in both directions. The MS is made to release the call.
22	MS		
23	MS		
24	MS -> SS	DISCONNECT	
25	SS -> MS	RELEASE	
26	MS -> SS	RELEASE COMPLETE	
27	SS -> MS	CHANNEL RELEASE	
			The main signalling link is released.

Specific Message Contents:

CLASSMARK CHANGE

Information element	Value/remark
as default except: Mobile station Classmark 2 -ES IND -SoLSA	Controlled Early Classmark Sending is implemented. SoLSA supported

PAGING RESPONSE

Information element	Value/remark
Protocol Discriminator	RR management
Ciphering Key Sequence number - Key Sequence	Key sequence number previously allocated to MS, or "111" if no key is available
Mobile station Classmark 2 - ES IND	Shall indicate early autonomous sending of CLASSMARK CHANGE
- SoLSA	SoLSA supported
Mobile Identity - odd/even	Even
- Type of identity	TMSI
- Identity digits	TMSI previously allocated to MS

26.15.5.5 SoLSA signalling / structured procedures / emergency call / idle updated

26.15.5.5.1 Conformance requirements

- 1) The MS in the "idle, updated" state, as after a successful location update, after the number 112 (for GSM 900 and 1800 MS), or 911 (for GSM 710, GSM 750, T-GSM 810, GSM 850 and PCS 1 900 MS in USA and Canada), or 08 (for GSM 710, GSM 750, T-GSM 810, GSM 850 and PCS 1 900 MS in Mexico) has been entered by user, shall send a CHANNEL REQUEST message with correct establishment cause ("emergency call").
- 2) After assignment of a dedicated channel the first layer message sent by the MS on the assigned dedicated channel shall be a CM SERVICE REQUEST message specifying the correct CKSN and TMSI, with CM Service Type "emergency call establishment" and indicating early sending of classmark change and SoLSA support.
- 3) After the initial message the SoLSA MS shall send a CLASSMARK CHANGE message in the uplink block followed direct after the Layer 2 UA message sent from the network. The CLASSMARK CHANGE message shall contain information elements Mobile Station Classmark 2.
- 4) Authentication and cipher mode setting shall be performed successfully.
- 5) After cipher mode setting acceptance by the network, the MS shall send an EMERGENCY SETUP message.
- 6), 7) The emergency call shall be correctly established. The assignment procedure shall be correctly performed.
- 8) After receipt of a CONNECT ACKNOWLEDGE message during correct establishment of the emergency call the TCH shall be through connected in both directions if an appropriate TCH is available.
- 9) The call shall be cleared correctly.

Requirement Reference:

- Conformance requirement 1 and 2: 3GPP TS 04.18 subclause 3.3.1.1,
3GPP TS 24.008 subclauses 5.2.1 and 4.5.1.5,
3GPP TS 02.30 subclause 4.2.2.
- Conformance requirement 3: 3GPP TS 04.18 subclauses 3.3.1.1.4.1 and 9.1.11,
3GPP TS 03.73 subclause 11.4.1,
3GPP TS 24.008 subclauses 9.2.9, 9.2.15, 10.5.1.5 and 10.5.1.6.
- Conformance requirement 4: 3GPP TS 04.18, subclause 3.4.7,
3GPP TS 24.008 subclause 4.3.2.
- Conformance requirement 5: 3GPP TS 24.008, subclause 5.2.1.
- Conformance requirement 6 and 7: 3GPP TS 04.18, subclause 3.4.3.
- Conformance requirement 8: 3GPP TS 24.008, section 5.2.1.6.

Conformance requirement 9: 3GPP TS 24.008, subclause 5.4.

26.15.5.2 Test purpose

To verify that the SoLSA MS supports "early classmark sending procedure", e.g. sending information to the network about SoLSA support during an Emergency Call.

26.15.5.3 Method of test

Initial Conditions

System Simulator:

1 cell, default parameters.

Mobile Station:

The MS is in MM-state "idle, updated" with valid TMSI and CKSN.

Specific PICS statements:

- Speech supported for Half rate version 1 (GSM HR) (TSPC_AddInfo_Half_rate_version_1)
- Speech supported for Half rate version 3 (GSM HR) (TSPC_AddInfo_Half_rate_version_3)
- Use of R99 Emergency numbers (TSPC_R99_Emerg)

PIXIT statements:

- .

Foreseen Final State of the MS

The MS is in MM-state "idle, updated" with valid TMSI and CKSN.

Test procedure

The MS is made to initiate an emergency call. The call is established with late assignment. Having reached the active state, the call is cleared by the SS.

Maximum Duration of Test

1 minute.

Expected Sequence

Step	Direction	Message	Comments
1	MS		The appropriate emergency call number is entered.
2	MS -> SS	CHANNEL REQUEST	Establishment cause is emergency call establishment.
3	SS -> MS	IMMEDIATE ASSIGNMENT	
4	MS -> SS	CM SERVICE REQUEST	Message is contained in SABM. The CM service type IE indicates "emergency call establishment". The classmark 2 IE indicates early sending of CLASSMARK CHANGE and SoLSA support
5	SS -> MS	UA (CM SERVICE REQUEST)	
6	MS -> SS	CLASSMARK CHANGE	Shall be ready to transmit (see 3GPP TS 05.10 subclause 06.10) within 40 ms after the completion of step 4. "mobile station classmark 2" includes settings for ES IND and SoLSA Note: In this case 'ready to transmit' shall result in the actual transmission of the Classmark Change 51 frames later (51 * 4.62ms = 235.62 ms). Therefore receipt of the Classmark Change within 250ms of step 4 is required.
7	SS -> MS	AUTHENTICATION REQUEST	
8	MS -> SS	AUTHENTICATION RESPONSE	SRES specifies correct value.
9	SS -> MS	CIPHERING MODE COMMAND	SS starts deciphering after sending the message.
10	MS -> SS	CIPHERING MODE COMPLETE	Shall be sent enciphered. All following messages shall be sent enciphered.
11	SS		SS starts ciphering.
12	MS -> SS	EMERGENCY SETUP	If a half rate speech service is supported, the message must contain one bearer capability IE indicating in the radio channel requirement field "dual rate/half rate preferred" or "dual rate/full rate preferred". If no half rate speech service is supported, the message must either contain no bearer capability IE or contain one bearer capability IE indicating in the radio channel requirement field "full rate channel".
13	SS -> MS	CALL PROCEEDING	
14	SS -> MS	ALERTING	
15	SS -> MS	ASSIGNMENT COMMAND	The rate of the channel is that one indicated by the EMERGENCY SETUP message, if that message did not offer a choice, and the rate is the preferred one else.
16	MS -> SS	ASSIGNMENT COMPLETE	
17	SS -> MS	CONNECT	
18	MS -> SS	CONNECT ACKNOWLEDGE	
19	MS		The TCH is through connected in both directions.
20	SS -> MS	DISCONNECT	
21	MS -> SS	RELEASE	
22	SS -> MS	RELEASE COMPLETE	
23	SS -> MS	CHANNEL RELEASE	The main signalling link is released.

Specific Message Contents:

CM SERVICE REQUEST

Information element	Value/remark
as default except:	
CM Service type	Emergency call establishment
Mobile station Classmark 2	
- ES IND	Shall indicate early autonomous sending of CLASSMARK CHANGE
- SoLSA	SoLSA supported

CLASSMARK CHANGE

Information element	Value/remark
as default except: Mobile station Classmark 2 -ES IND -SoLSA	Controlled Early Classmark Sending is implemented. SoLSA supported

26.15.5.6 SoLSA signalling / structured procedures / emergency call / idle, no IMSI

26.15.5.6.1 Conformance requirements

- 1) The MS in the "idle, updated" state, as after a successful location update, after the number 112 (for GSM 900 and 1800 MS), or 911 (for GSM710, GSM 750, T-GSM 810, GSM 850 and PCS 1 900 MS in USA and Canada), or 08 (for GSM 710, GSM 750, T-GSM 810, GSM 850 and PCS 1 900 MS in Mexico) has been entered by user, shall send a CHANNEL REQUEST message with correct establishment cause ("emergency call").
- 2) After assignment of a dedicated channel the first layer message sent by the MS on the assigned dedicated channel shall be a CM SERVICE REQUEST message specifying the correct IMEI and a non-available CKSN, with CM Service Type "emergency call establishment" and indicating early sending of classmark change and SoLSA support.
- 3) After the initial message the SoLSA MS shall send a CLASSMARK CHANGE message in the uplink block followed direct after the Layer 2 UA message sent from the network. The CLASSMARK CHANGE message shall contain information elements Mobile Station Classmark 2.
- 4) After cipher mode setting acceptance by the network, the MS shall send an EMERGENCY SETUP message.
- 5), 6) The emergency call shall be correctly established. The assignment procedure shall be correctly performed.
- 7) After receipt of a CONNECT ACKNOWLEDGE message during correct establishment of the emergency call the TCH shall be through connected in both directions if an appropriate TCH is available.
- 8) The call shall be cleared correctly.

Requirement Reference:

- Conformance requirement 1 and 2: 3GPP TS 04.18 subclause 3.3.1.1,
3GPP TS 24.008 subclauses 5.2.1 and 4.5.1.5,
3GPP TS 02.30 subclause 4.2.2.
- Conformance requirement 3: 3GPP TS 04.18 subclauses 3.3.1.1.4.1 and 9.1.11,
3GPP TS 03.73 subclause 11.4.1,
3GPP TS 24.008 subclauses 9.2.9, 9.2.15, 10.5.1.5 and 10.5.1.6.
- Conformance requirement 4: 3GPP TS 24.008, subclause 5.2.1.
- Conformance requirement 5 and 6: 3GPP TS 04.18, subclause 3.4.3.
- Conformance requirement 7: 3GPP TS 24.008, subclause 5.2.1.6.
- Conformance requirement 8: 3GPP TS 24.008, subclause 5.4.

26.15.5.6.2 Test purpose

To verify that the SoLSA MS in the "idle, no IMSI" state (no SIM inserted), supports "early classmark sending procedure", e.g. sending information to the network about SoLSA support during an Emergency Call.

26.15.5.6.3 Method of test

Initial Conditions

System Simulator:

1 cell, default parameters.

Mobile Station:

The MS is in MM-state "idle, no IMSI" no SIM inserted.

Specific PICS statements:

- Speech supported for Half rate version 1 (GSM HR) (TSPC_AddInfo_Half_rate_version_1)
- Speech supported for Half rate version 3 (GSM HR) (TSPC_AddInfo_Half_rate_version_3)
- Use of R99 Emergency numbers (TSPC_R99_Emerg)

PIXIT statements:

- .

Foreseen Final State of the MS

The MS is in MM-state "idle, no IMSI" no SIM inserted.

Test procedure

The MS is made to initiate an emergency call. The call is established without authentication, without ciphering, with late assignment. Having reached the active state, the call is cleared by the SS.

Maximum Duration of Test

1 minute.

Expected Sequence

Step	Direction	Message	Comments
1	MS		The appropriate emergency call number is entered.
2	MS -> SS	CHANNEL REQUEST	Establishment cause is emergency call establishment.
3	SS -> MS	IMMEDIATE ASSIGNMENT	
4	MS ->	CM SERVICE REQUEST	Message is contained in SABM. The CM service type IE indicates "emergency call establishment". The mobile identity IE specifies the IMEI of the MS. The cipher key sequence number IE indicates "no key is available". The classmark 2 IE indicates early sending of CLASSMARK CHANGE and SoLSA support
5	SS -> MS	UA (CM SERVICE REQUEST)	
6	MS -> SS	CLASSMARK CHANGE	Shall be ready to transmit (see 3GPP TS 05.10 subclause 06.10) within 40 ms after the completion of step 4. "mobile station classmark 2" includes settings for ES IND and SoLSA Note: In this case 'ready to transmit' shall result in the actual transmission of the Classmark Change 51 frames later (51 * 4.62ms = 235.62 ms). Therefore receipt of the Classmark Change within 250ms of step 4 is required.
7	SS -> MS	CM SERVICE ACCEPT	
8	MS -> SS	EMERGENCY SETUP	If a half rate speech service is supported, the message must contain one bearer capability IE indicating in the radio channel requirement field "dual rate/half rate preferred" or "dual rate/full rate preferred". If no half rate speech service is supported, the message must either contain no bearer capability IE or contain one bearer capability IE indicating in the radio channel requirement field "full rate channel".
9	SS -> MS	CALL PROCEEDING	
10	SS -> MS	ALERTING	
11	SS -> MS	ASSIGNMENT COMMAND	The rate of the channel is that one indicated by the EMERGENCY SETUP message, if that message did not offer a choice, and the rate is the preferred one else.
12	MS -> SS	ASSIGNMENT COMPLETE	
13	SS -> MS	CONNECT	
14	MS -> SS	CONNECT ACKNOWLEDGE	
15	MS		The TCH is through connected in both directions.
16	SS -> MS	DISCONNECT	
17	MS -> SS	RELEASE	
18	SS -> MS	RELEASE COMPLETE	
19	SS -> MS	CHANNEL RELEASE	The main signalling link is released.

Specific Message Contents:

CM SERVICE REQUEST

Information element	Value/remark
as default except: CM Service type	Emergency call establishment
Mobile station Classmark 2 - ES IND	Shall indicate early autonomous sending of CLASSMARK CHANGE
- SoLSA	SoLSA supported

CLASSMARK CHANGE

Information element	Value/remark
as default except: Mobile station Classmark 2 -ES IND	Controlled Early Classmark Sending is implemented.
-SoLSA	SoLSA supported

26.16 Adaptive Multi Rate Signalling

The purpose of this subclause is to test the different procedures, which may be impacted by the multi rate codec.

26.16.0 Default contents of layer 3 messages for AMR signalling tests

Refer to table 26.6.

26.16.1 Void

26.16.2 Inband Signalling, Uplink Codec Adaptation

26.16.2.1 Conformance Requirement

The MS shall after reception of a Codec Mode Command apply the corresponding codec mode in the uplink direction for the next possible speech frame and no more than three speech frames later. This test is not intended to verify these conformance requirements, but to verify the correctness of the involved layer 1 and layer 3 signalling.

References:

3GPP TS 05.09 subclauses 3.3 and 3.4.

26.16.2.2 Test Purpose

This test is concerned with the link adaptation for AMR uplink and the related inband signalling. The test shall verify that the MS in the uplink direction applies the codec mode indicated by the network transmitted Codec Mode Commands, and that the MS correctly signals the used codec as Codec Mode Indication in the uplink inband signalling.

NOTE: The inband signals are L1 signalling transmitted every speech frame, as defined in 3GPP TS 05.09: In uplink directions Codec Mode Requests and Codec Mode Indications are transmitted alternately, whereas downlink signalling contains of alternately Codec Mode Commands and Codec Mode Indications.

26.16.2.3 Method of Test

Initial Conditions

The MS is "idle updated", with TMSI allocated.

Specific PICS statements:

- Speech supported for Half rate version 3 (HR AMR).

PIXIT statements:

-

Foreseen Final State of MS

"Idle, updated", with TMSI allocated.

Test Procedure

- a) A mobile originated call is initiated, following the CHANNEL REQUEST received from the MS the SS sends an IMMEDIATE ASSIGNMENT to the MS commanding it to go to a SDCCH. The MS indicates to the SS that it supports the multi-rate speech codec. The SS allocates the MS a TCH/AFS and signals the allowed codec subset and adaptation thresholds as part of the ASSIGNMENT COMMAND. DTX shall not be activated. Hopping is activated. The hopping band is centred around an ARFCN in the Mid ARFCN range. The hopping frequencies are chosen from those defined in clause 6.

The following active codec mode subset shall apply:

Codec Mode	TCH/AFS in kbit/s
CODEC_MODE_1	4,75
CODEC_MODE_2	5,9
CODEC_MODE_3	7,95
CODEC_MODE_4	12,2

The following decision threshold and hysteresis values in terms of normalized carrier to interference ratio (C/I_{norm}), shall apply for Codec Mode Command / Request (MC', MR'):

MC'/MR'	THR_MC_Dn(MC')/ THR_MR_Dn(MR')	THR_MC_Up(MC')/ THR_MR_Up(MR')
CODEC_MODE_4	16,5 dB	+ ∞
CODEC_MODE_3	11,5 dB	18,5 dB
CODEC_MODE_2	6,5 dB	13,5 dB
CODEC_MODE_1	- ∞	8,5 dB

- b) The SS signals that a new codec is wanted in uplink direction by changing the value of the Codec Mode Command. The MS shall apply the commanded mode in uplink by changing the mode and correspondingly the value of the Codec Mode Indication to match the used codec. This is repeated for all neighbouring mode transitions in the Active Codec Set.
- c) If the MS supports TCH/AHS the SS sends an ASSIGNMENT COMMAND allocating the MS a TCH/AHS and signals the allowed codec subset and adaptation thresholds as part of the ASSIGNMENT COMMAND. DTX shall not be activated. Hopping is activated. The hopping band is centred around an ARFCN in the Mid ARFCN range. The hopping frequencies are chosen from those defined in clause 6.

The following active codec mode subset shall apply:

Codec Mode	TCH/AHS in kbit/s
CODEC_MODE_1	5,15
CODEC_MODE_2	6,7
CODEC_MODE_3	7,95

The following decision threshold and hysteresis values in terms of normalized carrier to interference ratio (C/I_{norm}), shall apply for Codec Mode Command / Request (MC', MR'):

MC'/MR'	THR_MC_Dn(MC')/ THR_MR_Dn(MR')	THR_MC_Up(MC')/ THR_MR_Up(MR')
CODEC_MODE_3	12,5 dB	+ ∞
CODEC_MODE_2	11,0 dB	15,0 dB
CODEC_MODE_1	- ∞	13,0 dB

- d) Step b) is repeated for the settings given in step c).

Maximum Duration of Test

2 minutes

Expected Sequence in step b)

Step	Direction	Message	Comments
A1	SS->MS	Codec Mode Command change	Codec Mode 3 is commanded by inband signalling
A2	MS->SS	Codec Mode Indication change	Codec Mode Indication shows current active mode in uplink, thus changed when mode changes
3	SS->MS	Codec Mode Command change	Codec Mode 2 is commanded by inband signalling
4	MS->SS	Codec Mode Indication change	Codec Mode 2 is indicated in inband signalling with first frame using Codec Mode 2
5	SS->MS	Codec Mode Command change	Codec Mode 1 is commanded by changing inband signal
6	MS->SS	Codec Mode Indication change	Codec Mode 1 is indicated in inband signalling with first frame using Codec Mode 1.
7	SS->MS	Codec Mode Command change	Codec Mode 2 is commanded by changing inband signal
8	MS->SS	Codec Mode Indication change	Codec Mode 2 is indicated in inband signalling with first frame using Codec Mode 2.
9	SS->MS	Codec Mode Command change	Codec Mode 3 is commanded by changing inband signal
10	MS->SS	Codec Mode Indication change	Codec Mode 3 is indicated in inband signalling with first frame using Codec Mode 3.
A11	SS->MS	Codec Mode Command change	Codec Mode 4 is commanded by changing inband signal
A12	MS->SS	Codec Mode Indication change	Codec Mode 4 is indicated in inband signalling with first frame using Codec Mode 4

In TCH/AHS the Active Codec Set contains only three of four possible codecs, thus steps prefixing A are not implemented in this case.

Specific Message Contents

ASSIGNMENT COMMAND

Information Element	Value/remark
Assignment Command	In step a) of Test Procedure: codec mode 4 selected (codec mode 3 for TCH/AHS) (ref: 3GPP TS 04.08 / 3GPP TS 44.018 subclause 9.1.2)

Codec mode commands, downlink inband signalling

Information Element	Value/remark
Channel Mode to be used for uplink	In step a) of Test Procedure: Codec Mode 4 commanded in AFS and Codec Mode 3 in AHS In step 1-2: Codec Mode 3 commanded In step 3-4: Codec Mode 2 commanded In step 5-6: Codec Mode 1 commanded In step 7-8: Codec Mode 2 commanded In step 9-10: Codec Mode 3 commanded In step 11-12: Codec Mode 4 commanded

Codec mode indications, uplink inband signalling

Information Element	Value/remark
Indicating Codec Mode currently used uplink	In step a) of Test Procedure: Codec Mode 4 indicated in AFS and Codec Mode 3 in AHS In step 1: Codec Mode 4 indicated in AFS (step ignored in AHS) In step 2-3: Codec Mode 3 indicated In step 4-5: Codec Mode 2 indicated In step 6-7: Codec Mode 1 indicated In step 8-9: Codec Mode 2 indicated In step 10-11: Codec Mode 3 indicated In step 12: Codec Mode 4 indicated

26.16.3 Structured procedures / MS terminated call / early assignment / no initial codec mode

NOTE: This test is derived from the one described in subclause 26.12 and entitled: "Structured procedures / MS terminated call / early assignment"

26.16.3.1 Conformance requirement

- 1) In acceptance to a SETUP message indicating speech, the MS shall indicate and include in the CALL CONFIRMED message all the speech versions that it supports.
- 2) Upon receipt of the ASSIGNMENT COMMAND message specifying using CHx-FR or CHx/HR the Mobile Station continues a mobile terminating call establishment with early assignment of traffic channel:
 - a) by replying to the ASSIGNMENT command with an ASSIGNMENT COMPLETE message; and
 - b) by continuing the call establishment by through connecting TCH in both directions if it supports immediate connect or by sending an ALERTING message otherwise.
- 3) The ASSIGNMENT command will not specify which of the codec modes the MS should use, but allow the handset to select the default codec mode.
- 4) For speech calls, the mobile station shall attach the user connection at latest when sending the connect message, except if there is no compatible radio resource available at this time. In this case the attachment shall be delayed until such a resource becomes available.

CHx: identifies any of the Channel Codec mode.

FR: full rate channel.

HR: half rate channel.

References:

3GPP TS 04.08 / 3GPP TS 44.018 subclauses 9.1.2 and 9.1.5.

3GPP TS 05.09 subclause 3.4.

26.16.3.2 Test purpose

- 1) To verify that, in acceptance to a SETUP message indicating speech, the MS indicates and includes in the CALL CONFIRMED message all the speech versions that it supports.
- 2) To verify that upon receipt of the ASSIGNMENT COMMAND message specifying using CHx-FR or CHx/HR the Mobile Station continues a mobile terminating call establishment with early assignment of traffic channel:
 - a) by replying to the ASSIGNMENT COMMAND with an ASSIGNMENT COMPLETE message; and
 - b) by continuing the call establishment by through connecting TCH in both directions if it supports immediate connect or by sending an ALERTING message otherwise.
- 3) To verify that upon receipt of an ASSIGNMENT COMMAND with no codec mode specified, the MS shall use the default codec mode.
- 4) To verify that for speech calls, the mobile station shall attach the user connection at latest when sending the connect message, except if there is no compatible radio resource available at this time. In this case the attachment shall be delayed until such a resource becomes available.

26.16.3.3 Method of Test

Initial Conditions

SS 1 cell, default parameters.

MS in MM-state "idle, updated" with valid TMSI and CKSN.

Specific PICS statements:

- Speech supported for Half rate version 3 (HR AMR).
- Immediate connect supported for all circuit switched basic services.

PIXIT statements:

- Way to indicate alerting.
- Way to make the MS accept an incoming call after alerting.

Foreseen Final State of MS

"Idle, updated", with TMSI allocated.

Test Procedure

The following test is performed for both channel modes of the multi-rate codec, i.e. full rate and half rate:

- A teleservice is selected that is supported by the MS; if the MS supports speech, the selected teleservice is speech. If necessary, the MS is configured for that teleservice.
- The MS is paged and the resulting call is established. Having reached the active state, the MS is made to clear the call.

Maximum Duration of Test

3 minutes

Expected Sequence

This test is repeated for $M = 1, 2, 3, 4$.

This test is repeated for $K=1$, and where the MS supports half rate version 3 $K=2$.

Step	Direction	Message	Comments
1	SS->MS	PAGING REQUEST TYPE 1	Sent on the correct paging sub-channel Message is contained in the SABM SRES specifies correct value SS starts deciphering after sending the message Shall be sent enciphered. All following messages shall be sent enciphered. SS starts ciphering
2	MS->SS	CHANNEL REQUEST	
3	SS->MS	IMMEDIATE ASSIGNMENT	
4	MS->SS	PAGING RESPONSE	
5	SS->MS	AUTHENTICATION REQUEST	
6	MS->SS	AUTHENTICATION RESPONSE	
7	SS->MS	CIPHERING MODE COMMAND	
8	MS->SS	CIPHERING MODE COMPLETE	
9	SS		
10	SS->MS	SETUP	
11	MS->SS	CALL CONFIRMED	
			If the MS supports an Immediate connection then branch A applies. If the MS doesn't support an immediate connection then branch B applies.
A12	MS->SS	CONNECT	sent on the old channel SS allocates allowed subset codec modes, but does not identify a mode for immediate operation.
A13	SS->MS	ASSIGNMENT COMMAND	
A14	MS->SS	ASSIGNMENT COMPLETE	
B12	SS->MS	ASSIGNMENT COMMAND	Sent on the new channel. SS allocates allowed subset codec modes, but does not identify a mode for immediate operation. An alerting indication as defined in the PIXIT statement is given by the MS. The MS is made to accept the call.
B13	MS->SS	ASSIGNMENT COMPLETE	
B14	MS->SS	ALERTING	
B15	MS		
B16	MS		
B17	MS->SS	CONNECT	
18	MS		
19	SS->MS	CONNECT ACK	The TCH shall be through connected by both directions in the dedicated mode, using the default codec mode specified. The MS is made to release the call. The main signalling link is released.
20	MS		
21	MS->SS	DISCONNECT	
22	SS->MS	RELEASE	
23	MS->SS	RELEASE COMPLETE	
24	SS->MS	CHANNEL RELEASE	

Specific Message Content

M = 1

Assignment Command

Information Element	value/remark
Channel mode Mode Multi-Rate configuration	Speech full or half rate version 3 ICMI = 0 1 codec mode specified

M=2

Assignment Command

Information Element	value/remark
Channel mode Mode Multi-Rate configuration	Speech full or half rate version 3 ICMI = 0 2 codec modes and threshold values specified

M=3

Assignment Command

Information Element	value/remark
Channel mode Mode Multi-Rate configuration	Speech full or half rate version 3 ICMI = 0 3 codec modes and threshold values specified

M = 4

Assignment Command

Information Element	value/remark
Channel mode Mode Multi-Rate configuration	Speech full or half rate version 3 ICMI = 0 4 codec modes and threshold values specified

K = 1

Assignment Command

Information Element	value/remark
Channel description Channel mode Mode	TCH/F Speech full or half rate version 3

K = 2

This step is applicable only if the MS supports half rate version 3.

Assignment Command

Information Element	value/remark
Channel description Channel mode Mode	TCH/H Speech full or half rate version 3

26.16.3a Structured procedures / MS terminated call / early assignment / specified initial codec mode

NOTE: this test is derived from the one described in subclause 26.12 and entitled: "Structured procedures / MS terminated call / early assignment"

26.16.3a.1 Conformance requirement

- 1) In acceptance to a SETUP message indicating speech, the MS shall indicate and include in the CALL CONFIRMED message all the speech versions that it supports.
- 2) Upon receipt of the ASSIGNMENT COMMAND message specifying using CHx-FR or CHx/HR the Mobile Station continues a mobile terminating call establishment with early assignment of traffic channel:
 - a) by replying to the ASSIGNMENT command with an ASSIGNMENT COMPLETE message; and
 - b) by continuing the call establishment by through connecting TCH in both directions if it supports immediate connect or by sending an ALERTING message otherwise.
- 3) The ASSIGNMENT COMMAND will specify the subset of codec modes that the MS is allowed to use for the call, the thresholds and the initial codec mode for immediate use by the MS.

- 4) For speech calls, the mobile station shall attach the user connection at latest when sending the connect message, except if there is no compatible radio resource available at this time. In this case the attachment shall be delayed until such a resource becomes available.

CHx: identifies any of the Channel Codec mode.

FR: full rate channel.

HR: half rate channel.

References:

3GPP TS 04.08 / 3GPP TS 44.018 subclauses 9.12 and 9.1.5.

3GPP TS 05.09 subclause 3.4.

26.16.3a.2 Test purpose

- 1) To verify that, in acceptance to a SETUP message indicating speech, the MS indicates and includes in the CALL CONFIRMED message all the speech versions that it supports.
- 2) To verify that upon receipt of the ASSIGNMENT COMMAND message specifying using CHx-FR or CHx/HR the Mobile Station continues a mobile terminating call establishment with early assignment of traffic channel:
 - a) by replying to the ASSIGNMENT command with an ASSIGNMENT COMPLETE message; and
 - b) by continuing the call establishment by through connecting TCH in both directions if it supports immediate connect or by sending an ALERTING message otherwise.
- 3) To verify that upon receipt of an ASSIGNMENT COMMAND with codec mode specified, the MS shall use that specified codec mode.
- 4) To verify that for speech calls, the mobile station shall attach the user connection at latest when sending the connect message, except if there is no compatible radio resource available at this time. In this case the attachment shall be delayed until such a resource becomes available.

26.16.3a.3 Method of Test

Initial Conditions

SS 1 cell, default parameters

MS in MM-state "idle, updated" with valid TMSI and CKSN

Specific PICS statements:

- Speech supported for Half rate version 3 (HR AMR).
- Immediate connect supported for all circuit switched basic services.

PIXIT statements:

- Way to indicate alerting.
- Way to make the MS accept an incoming call after alerting.

Foreseen Final State of MS

"Idle, updated", with TMSI allocated.

Test Procedure

The following test is performed for both channel modes of the multi-rate codec, ie full rate and half rate:

A teleservice is selected that is supported by the MS; if the MS supports speech, the selected teleservice is speech. If necessary, the MS is configured for that teleservice.

The MS is paged and the resulting call is established. Having reached the active state, the MS is made to clear the call.

Maximum Duration of Test

3 minutes

Expected Sequence

This test is repeated for M=1,2,3,4.

This test is repeated for K=1, and where the MS supports half rate version 3 K=2.

Step	Direction	Message	Comments
1	SS->MS	PAGING REQUEST TYPE 1	Sent on the correct paging sub-channel
2	MS->SS	CHANNEL REQUEST	
3	SS->MS	IMMEDIATE ASSIGNMENT	
4	MS->SS	PAGING RESPONSE	Message is contained in the SABM
5	SS->MS	AUTHENTICATION REQUEST	
6	MS->SS	AUTHENTICATION RESPONSE	SRES specifies correct value
7	SS->MS	CIPHERING MODE COMMAND	SS starts deciphering after sending the message
8	MS->SS	CIPHERING MODE COMPLETE	Shall be sent enciphered. All following messages shall be sent enciphered.
9	SS		SS starts ciphering
10	SS->MS	SETUP	
11	MS->SS	CALL CONFIRMED	
			If the MS supports an Immediate connection then branch A applies. If the MS doesn't support an immediate connection then branch B applies.
A12	MS->SS	CONNECT	sent on the old channel
A13	SS->MS	ASSIGNMENT COMMAND	SS allocates allowed subset codec modes and identifies a mode for immediate operation.
A14	MS->SS	ASSIGNMENT COMPLETE	
B12	SS->MS	ASSIGNMENT COMMAND	SS allocates allowed subset codec modes and identifies a mode for immediate operation.
B13	MS->SS	ASSIGNMENT COMPLETE	
B14	MS->SS	ALERTING	An alerting indication as defined in the PIXIT statement is given by the MS.
B15	MS		The MS is made to accept the call.
B16	MS		
B17	MS->SS	CONNECT	
18	MS		The TCH shall be through connected by both directions in the dedicated mode, using the codec mode specified.
19	SS->MS	CONNECT ACK	
20	MS		The MS is made to release the call.
21	MS->SS	DISCONNECT	
22	SS->MS	RELEASE	
23	MS->SS	RELEASE COMPLETE	
24	SS->MS	CHANNEL RELEASE	The main signalling link is released.

Specific Message Content

M=1

Assignment Command

Information Element	value/remark
Channel mode Mode Multi-Rate configuration	Speech full or half rate version 3 ICMI = 1 Start Mode specified 1 codec mode specified

M=2

Assignment Command

Information Element	value/remark
Channel mode Mode Multi-Rate configuration	Speech full or half rate version 3 ICMI = 1 Start Mode specified 2 codec modes and threshold vales specified

M=3

Assignment Command

Information Element	value/remark
Channel mode Mode Multi-Rate configuration	Speech full or half rate version 3 ICMI = 1 Start Mode specified 3 codec modes and threshold vales specified

M=4

Assignment Command

Information Element	value/remark
Channel mode Mode Multi-Rate configuration	Speech full or half rate version 3 ICMI = 1 Start Mode specified 4 codec modes and threshold vales specified

K = 1

Assignment Command

Information Element	value/remark
Channel description Channel mode Mode	TCH/H Speech full or half rate version 3

K = 2

This step is applicable only if the MS supports half rate version 3.

Assignment Command

Information Element	value/remark
Channel description Channel mode Mode	TCH/H Speech full or half rate version 3

26.16.4 Structured procedures / MS originated call / late assignment / specified initial codec mode

NOTE: This test is derived from the one described in subclause 26.12 and entitled: "Structured procedures / MS terminated call / early assignment".

26.16.4.1 Conformance requirement

- 1) The MS shall indicate and include in the mobile originating SETUP for speech call all the speech versions that it supports.
- 2) Upon receipt of the ASSIGNMENT COMMAND message using full rate version 3 or half rate version 3, the Mobile Station starts a normal channel assignment procedure. It means that the MS initiates a local end release of link layer connections, disconnects the physical channels, commands the switching to the assigned channels and initiates the establishment of lower layer connections (this includes the activation of the channels, their connection and the establishment of the data links). After the main signalling link is successfully established, the MS returns an ASSIGNMENT COMPLETE message, specifying cause 'normal event', to the network on the main DCCH.

References:

3GPP TS 04.08 / 3GPP TS 44.018 subclauses 9.12 and 9.1.5.

3GPP TS 05.09 subclause 3.4.

26.16.4.2 Test purpose

- 1) To verify that the MS indicates and includes in the mobile originating SETUP for speech call all the speech versions that it supports.
- 2) To verify that subsequently after receipt of an IMMEDIATE ASSIGNMENT message allocating an SDCCH, after completion of establishment of the main signalling link, after having sent a CM SERVICE REQUEST message, after having successfully performed authentication and cipher mode setting procedures, after having sent a SETUP message, after having received a CALL PROCEEDING message followed by an ALERTING message and an ASSIGNMENT COMMAND message allocating using full rate version 3 or half rate version 3, the MS sends an ASSIGNMENT COMPLETE message. The ASSIGNMENT COMMAND message will also identify which codec mode the MS is allowed to use for the call, the threshold values and the initial codec mode for immediate use.

26.16.4.3 Method of Test

Initial Conditions

SS 1 cell, default parameters.

MS in MM-state "idle, updated" with valid TMSI and CKSN.

Specific PICS statements:

- Speech supported for Half rate version 3 (HR AMR).

PIXIT statements:

- Way to indicate mobile originated alerting.

Foreseen Final State of MS

The MS has a MO call in state U10, "active".

Test Procedure

The following test is performed for both channel modes of the multi-rate codec, ie full rate and half rate.

The MS is made to initiate a speech call. The call is established with a late assignment.

Maximum Duration of Test

3 minutes.

Expected Sequence

This test is repeated for M = 1, 2, 3, 4.

For each M, this test is repeated for K=1, and where the MS supports half rate version 3 K=2.

Step	Direction	Message	Comments
1	MS		The "called number" is entered
2	MS->SS	CHANNEL REQUEST	
3	SS->MS	IMMEDIATE ASSIGNMENT	
4	MS->SS	CM SERVICE REQUEST	Message is contained in SABM
5	SS->MS	AUTHENTICATION REQUEST	
6	MS->SS	AUTHENTICATION RESPONSE	SRES specifies correct value
7	SS->MS	CIPHERING MODE COMMAND	SS starts deciphering after sending the message
8	MS->SS	CIPHERING MODE COMPLETE	Shall be sent enciphered. All following messages shall be sent enciphered.
9	SS		SS starts ciphering
10	MS->SS	SETUP	The MS indicates it supports the FR version 3 speech and if supported, HR version 3 speech also.
11	SS->MS	CALL PROCEEDING	
12	SS->MS	ALERTING	
13	MS		An alerting indication as defined in the PIXIT statement is given by the MS.
14	SS->MS	ASSIGNMENT COMMAND	SS allocates allowed subset codec modes, but does identifies a mode for immediate operation.
15	MS->SS	ASSIGNMENT COMPLETE	
16	SS->MS	CONNECT	
17	MS		The TCH shall be through connected by both directions in the dedicated mode, using the codec mode specified.
18	MS->SS	CONNECT ACK	

Specific Message Content

M = 1

Assignment Command

Information Element	value/remark
Channel mode Mode	If K=1 Speech full rate version 3 If K=2 Speech half rate version 3
Multi-Rate configuration	ICMI = 1 Start mode specified 1 codec mode specified

M=2

Assignment Command

Information Element	value/remark
Channel mode Mode	If K=1 Speech full rate version 3 If K=2 Speech half rate version 3
Multi-Rate configuration	ICMI = 1 Start mode specified 2 codec modes and threshold vales specified

M=3

Assignment Command

Information Element	value/remark
Channel mode Mode	If K=1 Speech full rate version 3 If K=2 Speech half rate version 3
Multi-Rate configuration	ICMI = 1 Start mode specified 3 codec modes and threshold vales specified

M = 4

Assignment Command

Information Element	value/remark
Channel mode Mode	If K=1 Speech full rate version 3 If K=2 Speech half rate version 3
Multi-Rate configuration	ICMI = 1 Start mode specified 4 codec modes and threshold vales specified

26.16.4a Structured procedures / MS originated call / late assignment / no initial codec mode

NOTE: This test is derived from the one described in subclause 26.16.4 and entitled: "Structured procedures / MS originated call / late assignment / specified initial codec mode".

26.16.4a.1 Conformance requirement

- 1) The MS shall indicate and include in the mobile originating SETUP for speech call all the speech versions that it supports.
- 2) Upon receipt of the ASSIGNMENT COMMAND message using full rate version 3 or half rate version 3, the Mobile Station starts a normal channel assignment procedure. It means that the MS initiates a local end release of link layer connections, disconnects the physical channels, commands the switching to the assigned channels and initiates the establishment of lower layer connections (this includes the activation of the channels, their connection and the establishment of the data links). After the main signalling link is successfully established, the MS returns an ASSIGNMENT COMPLETE message, specifying cause 'normal event', to the network on the main DCCH. The ASSIGNMENT COMMAND message will also specify the subset of codec modes that the MS is allowed to use for the call and the threshold values. The ASSIGNMENT COMMAND will not specify the initial codec mode but will, rather, allow the MS to select the default codec mode.

If the Initial Codec Mode is not signalled, then the default Initial Codec Mode is given by the following implicit rule. If the Active Codec Set contains:

- 1 mode, then this shall be the Initial Codec Mode.
- 2 or 3 modes, then the Initial Codec mode shall be the most robust mode of the set (with lowest bit rate).
- 4 modes, then the Initial Codec Mode shall be the second most robust mode of the set (with second lowest bit rate. If the Active Codec Set is changed during the call, then this default Initial Codec Mode shall used until an other ICM is explicitly signalled.

References

- 3GPP TS 04.08 / 3GPP TS 44.018 subclauses 9.12 and 9.1.5.
- 3GPP TS 05.09 subclause 3.4.

26.16.4a.2 Test purpose

- 1) To verify that the MS indicates and includes in the mobile originating SETUP for speech call all the speech versions that it supports.
- 2) To verify that subsequently after receipt of an IMMEDIATE ASSIGNMENT message allocating an SDCCH, after completion of establishment of the main signalling link, after having sent a CM SERVICE REQUEST message, after having successfully performed authentication and cipher mode setting procedures, after having sent a SETUP message, after having received a CALL PROCEEDING message followed by an ALERTING message and an ASSIGNMENT COMMAND message allocating using speech full rate version 3 or speech half rate version 3, the MS sends an ASSIGNMENT COMPLETE message. The ASSIGNMENT COMMAND message will also specify the subset of codec modes that the MS is allowed to use for the call and the threshold values. The ASSIGNMENT COMMAND will not specify the initial codec mode but will, rather, allow the MS to select the default codec mode.

26.16.4a.3 Method of Test

Initial Conditions

SS 1 cell, default parameters

MS in MM-state "idle, updated" with valid TMSI and CKSN

Specific PICS statements:

- Speech supported for Half rate version 3 (HR AMR).

PIXIT statements:

- Way to indicate mobile originated alerting.

Foreseen Final State of MS

The MS has a MO call in state U10, "active".

Test Procedure

The following test is performed for both channel modes of the multi-rate codec, ie full rate and half rate.

The MS is made to initiate a speech call. The call is established with a late assignment.

Maximum Duration of Test

3 minutes

Expected Sequence

This test is repeated for M=1,2,3,4.

For each M, this test is repeated for K=1, and where the MS supports half rate version 3 K=2.

Step	Direction	Message	Comments
1	MS		The "called number" is entered
2	MS->SS	CHANNEL REQUEST	
3	SS->MS	IMMEDIATE ASSIGNMENT	
4	MS->SS	CM SERVICE REQUEST	Message is contained in SABM
5	SS->MS	AUTHENTICATION REQUEST	
6	MS->SS	AUTHENTICATION RESPONSE	SRES specifies correct value
7	SS->MS	CIPHERING MODE COMMAND	SS starts deciphering after sending the message
8	MS->SS	CIPHERING MODE COMPLETE	Shall be sent enciphered. All following messages shall be sent enciphered.
9	SS		SS starts ciphering
10	MS->SS	SETUP	The MS indicates it supports the FR version 3 speech and if supported, HR version 3 speech also.
12	SS->MS	CALL PROCEEDING	
13	SS->MS	ALERTING	
14	MS		An alerting indication as defined in the PIXIT statement is given by the MS.
15	SS->MS	ASSIGNMENT COMMAND	SS allocates allowed subset of codec modes and thresholds, but does not identify a mode for immediate operation.
16	MS->SS	ASSIGNMENT COMPLETE	
17	SS->MS	CONNECT	
18	MS		The TCH shall be through connected by both directions in the dedicated mode, using the codec mode specified (M=1 CMI=0, M=2 CMI=0, M=3 CMI=0, M=4 CMI=1).
19	MS->SS	CONNECT ACK	

Specific Message Content

M=1

Assignment Command

Information Element	value/remark
Channel mode Mode	If K=1 Speech full rate version 3 If K=2 Speech half rate version 3
Multi-Rate configuration	ICMI = 0 1 codec mode specified

M=2

Assignment Command

Information Element	value/remark
Channel mode Mode	If K=1 Speech full rate version 3 If K=2 Speech half rate version 3
Multi-Rate configuration	ICMI = 0 2 codec modes and threshold vales specified

M=3

Assignment Command

Information Element	value/remark
Channel mode Mode	If K=1 Speech full rate version 3 If K=2 Speech half rate version 3
Multi-Rate configuration	ICMI = 0 3 codec modes and threshold vales specified

M=4

Assignment Command

Information Element	value/remark
Channel mode Mode	If K=1 Speech full rate version 3 If K=2 Speech half rate version 3
Multi-Rate configuration	ICMI = 0 4 codec modes and threshold vales specified

26.16.5 AMR signalling / Handover / active call / successful case

NOTE: This test is derived from 26.12.2 – EFR Signalling/Handover/active call/successful case.

26.16.5.1 Conformance requirements

The MS shall correctly apply the handover procedure in the non-synchronised case when:

- a call is in progress; and
- handover is performed from a TCH/F with/without frequency hopping towards a TCH/F with/without frequency hopping;
- the mode of either the current or the target channel is set to full rate speech version 3.

The MS also supporting half rate speech version 3 shall correctly apply the handover procedure in the non-synchronized case when:

- a call is in progress; and
- a handover is performed between a TCH/H with/without frequency hopping and a TCH/F or TCH/H with/without frequency hopping; and
- the mode of either the current or the target channel is set to half rate speech version 3.

References

3GPP TS 04.08 / 3GPP TS 44.018 subclauses 3.4.4 and 9.1.15.

3GPP TS 04.13 subclause 5.2.6.2.

26.16.5.2 Test Purpose

To test that the MS shall correctly apply the handover procedure in the non-synchronized case when:

- a call is in progress; and
- handover is performed from a TCH/F with/without frequency hopping towards a TCH/F with/without frequency hopping; and
- the mode of either the current or the target channel is set to full rate speech version 3 (AMR full rate speech).

To test that the MS also supporting half rate shall correctly apply the handover procedure in the non-synchronized case when:

- a call is in progress; and
- a handover is performed between a TCH/H with/without frequency hopping and a TCH/F with/without frequency hopping; and
- the mode of either the current or the target channel is set to half rate speech version 3.

26.16.5.3 Method of Test

Initial Conditions

MS in call active state U10 on cell A.

SS 2 cells, A and B with same LAI, default parameters except:

Band	Cell A		Cell B		Both Cells Format
	BCCH ARFCN	Cell Allocation	BCCH ARFCN	Cell Allocation	
GSM 450	263	259, 261, 263, 265, 267, 269, 271, 273, 275, 277, 279, 281, 283, 285, 287, 289, 291	274	260, 262, 264, 266, 268, 270, 272, 274, 276, 279, 281, 283, 285, 287, 289, 291	Range 128
GSM 480	310	306, 308, 310, 312, 314, 316, 318, 320, 322, 324, 326, 328, 330, 332, 334, 336, 338	321	307, 309, 311, 313, 315, 317, 319, 321, 323, 326, 328, 330, 332, 334, 336, 338	Range 128
GSM 710	457	447, 454, 457, 463, 471, 479, 482, 483, 489, 496, 498, 500, 501, 502, 503, 506, 508	477	451, 455, 459, 461, 467, 468, 475, 477, 497, 498, 500, 501, 502, 503, 506, 508	Range 128
GSM 750	457	447, 454, 457, 463, 471, 479, 482, 483, 489, 496, 498, 500, 501, 502, 503, 506, 508	477	451, 455, 459, 461, 467, 468, 475, 477, 497, 498, 500, 501, 502, 503, 506, 508	Range 128
T-GSM 810	457	447, 454, 457, 463, 471, 479, 482, 483, 489, 496, 498, 500, 501, 502, 503, 506, 508	477	451, 455, 459, 461, 467, 468, 475, 477, 497, 498, 500, 501, 502, 503, 506, 508	Range 128
GSM 850	147	137, 144, 147, 153, 161, 169, 172, 173, 179, 186, 193, 200, 201, 202, 203, 235, 241	167	141, 145, 149, 151, 157, 158, 165, 167, 187, 193, 200, 201, 202, 203, 235, 241	Range 128
GSM 900	20	10, 17, 20, 26, 34, 42, 45, 46, 52, 59, 66, 73, 74, 75, 76, 108, 114	40	14, 18, 22, 24, 30, 31, 38, 40, 60, 66, 73, 74, 75, 76, 108, 114	Bitmap 0
DCS 1 800	747	734, 741, 747, 754, 759, 762, 766, 767, 773, 775, 779, 782, 791, 798, 829, 832, 844	764	739, 743, 746, 749, 756, 758, 761, 764, 771, 779, 782, 791, 798, 829, 832, 844	Range 256
PCS 1 900	647	634, 641, 647, 654, 659, 662, 666, 667, 673, 675, 679, 682, 691, 698, 729, 732, 744	664	639, 643, 646, 649, 656, 658, 661, 664, 671, 679, 682, 691, 698, 729, 732, 744	Range 256

The frame numbers of cells A and B shall be different by 100.

The timebase of cells A and B shall be such that the edges of their timeslots are not coincident at the antenna connector.

Specific PICS statements:

- Speech supported for Half rate version 3 (HR AMR) (TSPC_AddInfo_Half_rate_version_3)
- Speech supported for Full rate version 2 (GSM EFR) (TSPC_AddInfo_Full_rate_version_2)
- Speech supported for Half rate version 1 (GSM HR) (TSPC_AddInfo_Half_rate_version_1)

PIXIT statements:

-.

Foreseen Final State of MS

The MS has a MO call in state U10, "active".

Test Procedure

Table 1

Exec Counter	From	To	Timing Adv.	Start Time
1	TCH/F, sv3, no FH	TCH/F, sv3, no FH	20	none
2	TCH/F, sv3, no FH	TCH/F, sv3, FH	arbitrary	none
3	TCH/F, sv3, FH	TCH/F, sv3, FH	20	1,1s
4	TCH/F, sv3, FH	TCH/F, sv3, no FH	20	none
5	TCH/F, sv3, no FH	TCH/F, sv1, no FH	20	none
6	TCH/F, sv1, no FH	TCH/F, sv3, no FH	arbitrary	none
7	TCH/F, sv3, no FH	TCH/F, sv2, FH	arbitrary	none
8	TCH/F, sv2, FH	TCH/F, sv3, FH	20	1,1
9	TCH/F, sv3, FH	TCH/H, sv1, FH	arbitrary	none
10	TCH/H, sv1, FH	TCH/F, sv3, noFH	20	none
11	TCH/F, sv3, noFH	TCH/H, sv3, FH	arbitrary	1.1
12	TCH/H, sv3, FH	TCH/H, sv3, no FH	20	none
13	TCH/H, sv3, no FH	TCH/F, sv1, no FH	20	none
14	TCH/F, sv1, no FH	TCH/H, sv3, no FH	arbitrary	none
15	TCH/H, sv3, no FH	TCH/F, sv2, FH	arbitrary	none
16	TCH/F, sv2, FH	TCH/H, sv3, FH	20	1,1
17	TCH/H, sv3, FH	TCH/H, sv1, FH	arbitrary	none
18	TCH/H, sv1, FH	TCH/H, sv3, noFH	20	none
19	TCH/H, sv3, noFH	TCH/F, sv3, no FH	20	none

Note: for all execution counters: State of call is U10 and the handover procedure is non-synchronized
sv1 stands for speech full/half rate version 1.
sv2 stands for speech full rate version 2 (enhanced full rate).
sv3 stands for speech full/half rate version 3 (AMR).

Table 2

	TCH/FS	TCH/HS	SDCCH
n	10-20	5-10	2-5
n:	number of access bursts.		

The MS is in the active state (U10) of a call. The SS sends a HANOVER COMMAND on the main DCCH. The MS shall (at the time defined by the Starting Time information element, if included in the message) begin to send access bursts on the new DCCH (and optionally on the SACCH) of the target cell. The SS observes the access bursts and after receiving n (n being arbitrarily chosen between values according to table 2) access bursts, the SS sends one PHYSICAL INFORMATION message with a Timing Advance as specified in table 1. The MS shall activate the channel in sending and receiving mode. The MS shall establish a signalling link. The MS shall be ready to transmit a HANOVER COMPLETE message, before 'x' ms after the end of the PHYSICAL INFORMATION message, but not before a UA frame has been sent by the SS.

The term 'ready to transmit' is defined in 3GPP TS 04.13. The value of 'x' depends upon the target channel and is specified in the specific message contents section.

Maximum Duration of Test

10 minutes.

Expected Sequence

This sequence is performed for an execution counter M = 1, 2..10 for an MS that supports TCH/F and speech version 3, version 2 and version 1. Steps M=7 and M=8 are performed only if an MS supports full rate speech version 2. Steps M=9 and M=10 are performed only if an MS supports half rate speech version 1.

This sequence is performed for an execution counter M = 1, 2..19 for an MS that supports TCH/F and TCH/H and speech version 3, version 2 and version 1. Steps M=7, M=8, M=15 and M=16 are performed only if an MS supports speech version 2. Steps M=9, M=10, M=17 and M=18 are performed only if an MS supports half rate speech version 1.

Step	Direction	Message	Comments
0	MS -> SS		The MS and SS are in the active state of a call on the channel described below.
1	SS -> MS	HANDOVER COMMAND	See Specific message contents
2	MS -> SS	HANDOVER ACCESS	Repeated on every burst of the uplink main DCCH (and optionally on the SACCH) until reception of PHYSICAL INFORMATION. Handover Reference as included in the HANDOVER COMMAND. If the HANDOVER COMMAND includes a starting time IE then the first HANDOVER ACCESS message shall be transmitted in the indicated frame (unless the indicated frame is not used by that channel, in which case the next frame used by that channel shall be used)
3	SS -> MS	PHYSICAL INFORMATION	Sent after reception of n HANDOVER ACCESS messages. See specific message contents.
4	MS -> SS	SABM	Sent without information field
5	SS -> MS	UA	
6	MS -> SS	HANDOVER COMPLETE	The message shall be ready to be transmitted before 'x' ms after the completion of step 3.
7	MS -> SS		The MS and SS are in the active state of a call on the TCH described below. The SS checks that the TCH is through connected in the correct mode.

Specific Message Contents

For M = 1:

Step 0: The MS and SS are using a full rate TCH with speech full rate version 3 and in non-hopping mode on cell A.

HANDOVER COMMAND

Information Element	value/remarks
As default message contents, except:	
Cell Description	
- Network Colour Code	1
- Base Station Colour Code	5
- BCCH Carrier Number	GSM450: 274 GSM480: 321 GSM900: 40 GSM1800: 764 PCS1900: 664 GSM710: 477 GSM750: 477 T-GSM810: 477 GSM850: 167
Channel Description	
- Channel Type	TCH/F + ACCHs
- TDMA offset	Chosen arbitrarily
- Timeslot number	0
- Training Sequence Code	Chosen arbitrarily
- ARFCN	Chosen arbitrarily from the CA
Synchronisation Indication	
- Report Observed Time Difference	Shall not be included.
- Synchronisation Indication	'Non synchronised'.
- Normal Cell Indication	Ignore out of range timing advance.
Mode of the first channel.	
- Mode	speech full rate rate version 3
Multi-Rate configuration	ICMI = 0 Arbitrary set of codec modes, thresholds and hysteresis specified according to 3GPP TS 05.09 / 45.009

PHYSICAL INFORMATION

Information Element	value/remarks
As default message contents.	

Step 6: $x = 500$

Step 7: The MS and SS are using a full rate TCH with speech full rate version 3 and in non-hopping mode on cell B.

For $M = 2$:

Step 0: The MS and SS are using a full rate TCH with speech full rate version 3 and in non-hopping mode on cell B.

HANDOVER COMMAND

Information Element	value/remarks
As default message contents, except:	
Cell Description	
- Network Colour Code	1
- Base Station Colour Code	5
- BCCH Carrier Number	GSM450: 263 GSM480: 310 GSM900: 20 GSM1800: 747 PCS1900: 647 GSM710: 457 GSM750: 457 T-GSM 810: 457 GSM850: 147
Channel Description	
- Channel Type	TCH/F + ACCHs
- Timeslot number	Chosen arbitrarily, but not Zero
- Training Sequence Code	Chosen arbitrarily
- Hopping	RF hopping channel.
- MAIO	Chosen arbitrarily from the set (0, 1 to N-1), where N is the number of frequencies encoded in the Frequency List IE or Frequency Channel Sequence IE.
- HSN	Chosen arbitrarily from the set (1,2,..63)
Synchronisation Indication IE is not included.	
Channel Mode IE is not included.	
Frequency List after time	
- Frequency List	IE Present only for GSM450 and GSM480 GSM450: Allocates the following 12 frequencies (259, 261, 263, 265, 277, 279, 281, 283, 285, 287, 289, 291) GSM480: Allocates the following 12 frequencies (306, 308, 310, 312, 324, 326, 328, 330, 332, 334, 336, 338)
Frequency Channel Sequence after time	
- Frequency Channel Sequence	IE Present only for GSM900, GSM 710, GSM750 and T-GSM 810 GSM900: Allocates the following 12 frequencies (10, 17, 20, 26, 59, 66, 73, 74, 75, 76,108, 114) GSM710, GSM 750 and T-GSM 810: Allocates the following 12 frequencies (447, 454, 457, 463, 496, 498, 500, 501, 502, 503, 506, 508)
Frequency Short List after time	
- Frequency List	IE Present only for GSM1800, PCS1900 and GSM850 GSM1800: Use Range 256 to encode the following 9 frequencies: (747, 775, 779, 782, 791, 798, 829, 832, 844) PCS1900: Use Range 256 to encode the following 9 frequencies: (647, 675, 679, 682, 691, 698, 729, 732, 744) GSM850: Allocates the following 12 frequencies (137, 144, 147, 153, 186, 193, 200, 201, 202, 203, 235, 241)
Multi-Rate configuration IE is not included	

PHYSICAL INFORMATION

Information Element	value/remarks
As default message contents, except: Timing advance	Arbitrarily selected but different to default value.

Step 6: $x = 500$

Step 7: The MS and SS are using a full rate TCH with speech full rate version 3 and in hopping mode on cell A.

For $M = 3$:

Step 0: The MS and SS are using a full rate TCH with speech full rate version 3 and in hopping mode on cell A.

HANDOVER COMMAND

Information Element	value/remarks
As default message contents, except:	
Cell Description	
- Network Colour Code	1
- Base Station Colour Code	5
- BCCH Carrier Number	GSM450: 274 GSM480: 321 GSM900: 40 GSM1800: 764 PCS1900: 664 GSM710: 477 GSM750: 477 T-GSM810: 477 GSM850: 167
Channel Description	
- Channel Type	TCH/F + ACCHs
- Timeslot number	Chosen arbitrarily, but not Zero
- Training Sequence Code	Chosen arbitrarily
- Hopping	RF hopping channel.
- MAIO	1
- HSN	zero for cyclic
Synchronisation Indication	
- Report Observed Time Difference	Shall not be included.
- Synchronisation Indication	'Non synchronised'.
- Normal Cell Indication	Out of range timing advance shall trigger a handover failure procedure.
Frequency List after time	
- Frequency List	Use Range 128 to encode the following 2 frequencies: GSM450: (260, 291) GSM480: (307, 338) GSM900: (14, 114) GSM1800: (749, 844) PCS1900: (649, 744) GSM710: (451, 508) GSM750: (451, 508) T-GSM810: (451, 508) GSM850: (141, 241)
Mode of the first channel.	
- Mode	speech full rate rate version 3
Starting Time	Indicates the frame number of cell B that will occur approximately 1,1 seconds (238 frames have elapsed) after the HANDOVER COMMAND is sent by cell A.
Multi-Rate configuration	ICMI = 1 Arbitrary set of codec modes, thresholds and hysteresis specified according to 3GPP TS 05.09 / 45.009

PHYSICAL INFORMATION

Information Element	value/remarks
As default message contents.	

Step 6: $x = 500$

Step 7: The MS and SS are using a full rate TCH with speech full rate version 3 and in hopping mode on cell B.

For $M = 4$:

Step 0: The MS and SS are using a full rate TCH with full rate speech version 3 and in hopping mode on cell B.

HANDOVER COMMAND

Information Element	value/remarks
As default message contents, except:	
Cell Description	
- Network Colour Code	1
- Base Station Colour Code	5
- BCCH Carrier Number	GSM450: 263 GSM480: 310 GSM900: 20 GSM1800: 747 PCS1900: 647 GSM710: 457 GSM750: 457 T-GSM810: 457 GSM850: 147
Channel Description	
- Channel Type	TCH/F + ACCHs
- TDMA offset	Chosen arbitrarily
- Timeslot number	Chosen arbitrarily, but not Zero
- Training Sequence Code	Chosen arbitrarily
- ARFCN	The ARFCN of the BCCH Carrier
Synchronisation Indication	
- Report Observed Time Difference	Shall not be included.
- Synchronisation Indication	'Non synchronised'.
- Normal Cell Indication	Ignore out of range timing advance.
Mode of the first channel IE is not included	
Multi-Rate configuration IE is not included	

PHYSICAL INFORMATION

Information Element	value/remarks
As default message contents.	

Step 6: $x = 500$

Step 7: The MS and SS are using a full rate TCH with speech full rate version 3 and in non-hopping mode on cell A.

For $M = 5$:

Step 0: The MS and SS are using a full rate TCH with full rate speech version 3 and in non-hopping mode on cell A.

HANDOVER COMMAND

Information Element	value/remarks
As default message contents, except:	
Cell Description	
- Network Colour Code	1
- Base Station Colour Code	5
- BCCH Carrier Number	GSM450: 274 GSM480: 321 GSM900: 40 GSM1800: 764 PCS1900: 664 GSM710: 477 GSM750: 477 T-GSM810: 477 GSM850: 167
Channel Description	
- Channel Type	TCH/F + ACCHs
- TDMA offset	Chosen arbitrarily
- Timeslot number	Chosen arbitrarily, but not Zero
- Training Sequence Code	Chosen arbitrarily
- ARFCN	Chosen arbitrarily from the CA
Synchronisation Indication	
- Report Observed Time Difference	Shall not be included.
- Synchronisation Indication	'Non synchronised'.
- Normal Cell Indication	Ignore out of range timing advance.
Mode of the first channel.	
- Mode	speech full rate or half rate version 1

PHYSICAL INFORMATION

Information Element	value/remarks
As default message contents.	

Step 6: $x = 500$

Step 7: The MS and SS are using a full rate TCH with speech full rate version 1 and in non-hopping mode on cell B.

For $M = 6$:

Step 0: The MS and SS are using a full rate TCH with full rate speech version 1 and in non-hopping mode on cell B.

HANDOVER COMMAND

Information Element	value/remarks
As default message contents, except:	
Cell Description	
- Network Colour Code	1
- Base Station Colour Code	5
- BCCH Carrier Number	GSM450: 263 GSM480: 310 GSM900: 20 GSM1800: 747 PCS1900: 647 GSM710: 457 GSM750: 457 T-GSM810: 457 GSM850: 147
Channel Description	
- Channel Type	TCH/F + ACCHs
- TDMA offset	Chosen arbitrarily
- Timeslot number	Chosen arbitrarily, but not Zero
- Training Sequence Code	Chosen arbitrarily
- ARFCN	Chosen arbitrarily from the CA
Synchronisation Indication	
- Report Observed Time Difference	Shall not be included.
- Synchronisation Indication	'Non synchronised'.
- Normal Cell Indication	Ignore out of range timing advance.
Mode of the first channel	
- Mode	speech full rate rate version 3
Multi-Rate configuration	ICMI = 1 Arbitrary set of codec modes, thresholds and hysteresis specified according to 3GPP TS 05.09 / 45.009

PHYSICAL INFORMATION

Information Element	value/remarks
As default message contents, except:	
Timing advance	Arbitrarily selected but different to default value.

Step 6: $x = 500$

Step 7: The MS and SS are using a full rate TCH with speech full rate version 3 and in non-hopping mode on cell A.

For $M = 7$:

Step 0: The MS and SS are using a full rate TCH with full rate speech version 3 and in non-hopping mode on cell A.

HANDOVER COMMAND

Information Element	value/remarks
As default message contents, except:	
Cell Description	
- Network Colour Code	1
- Base Station Colour Code	5
- BCCH Carrier Number	GSM450: 274 GSM480: 321 GSM900: 40 GSM1800: 764 PCS1900: 664 GSM710: 477 GSM750: 477 T-GSM810: 477 GSM850: 167
Channel Description	
- Channel Type	TCH/F + ACCHs
- TDMA offset	Chosen arbitrarily
- Timeslot number	Chosen arbitrarily, but not Zero
- Training Sequence Code	Chosen arbitrarily
- Hopping	RF hopping channel.
- MAIO	Chosen arbitrarily from the set (0, 1 to N-1), where N is the number of frequencies encoded in the Frequency List IE.
- HSN	Chosen arbitrarily from the set (1,2,..63)
Frequency List after time	
- Frequency List	GSM450: use Range 128 to encode the following 12 frequencies: (260, 262, 264, 266, 276, 279, 281, 283, 285, 287, 289, 291) GSM480: use Range 128 to encode the following 12 frequencies: (307, 309, 311, 313, 323, 326, 328, 330, 332, 334, 336, 338) GSM900: use bit map 0 to allocates the following 12 frequencies: (14, 18, 22, 24, 60, 66, 73, 74, 75, 76,108, 114) GSM1800: Use Range 1024 to allocate the following 12 frequencies: (749, 758, 761, 764, 771, 779, 782, 791, 798, 829, 832, 844) PCS1900: Use Range 1024 to allocate the following 12 frequencies: (649, 658, 661, 664, 671, 679, 682, 791, 798, 729, 732, 744) GSM710, GSM 750 and T-GSM 810: Use 128 range to allocates the following 12 frequencies: (451, 455, 459, 461, 497, 498, 500, 501, 502, 503,506, 508) GSM850: Use 128 range to allocates the following 12 frequencies: (141, 145, 149, 151, 187, 193, 200, 201, 202, 203, 235, 241)
Synchronisation Indication	
- Report Observed Time Difference	Shall not be included.
- Synchronisation Indication	'Non synchronised'.
- Normal Cell Indication	Ignore out of range timing advance.
Mode of the first channel	
- Mode	speech full rate version 2

PHYSICAL INFORMATION

Information Element	value/remarks
As default message contents, except:	
Timing advance	Arbitrarily selected but different to default value.

Step 6: $x = 500$

Step 7: The MS and SS are using a full rate TCH with full rate speech version 2 and in hopping mode on cell B.

For M = 8:

Step 0: The MS and SS are using a full rate TCH with speech full rate version 2 and hopping mode on cell B.

HANDOVER COMMAND

Information Element	value/remarks
As default message contents, except:	
Cell Description	
- Network Colour Code	1
- Base Station Colour Code	5
- BCCH Carrier Number	GSM450: 263 GSM480: 310 GSM900: 20 GSM1800: 747 PCS1900: 647 GSM710: 457 GSM750: 457 T-GSM810: 457 GSM850: 147
Channel Description	
- Channel Type	TCH/F + ACCHs
- Timeslot number	Chosen arbitrarily, but not Zero
- Training Sequence Code	Chosen arbitrarily
- Hopping	RF hopping channel.
- MAIO	Chosen arbitrarily from the set (0, 1 to N-1), where N is the number of frequencies encoded in the Frequency List IE.
- HSN	Chosen arbitrarily from the set (1,2,..63)
Synchronisation Indication IE is not included.	
Mode of the first channel.	
- Mode	speech full rate version 3
Frequency List after time	IE Present only for GSM450, GSM480 and GSM850
- Frequency List	GSM450: Allocates the following 12 frequencies (259, 261, 263, 265, 277, 279, 281, 283, 285, 287, 289, 291) GSM480: Allocates the following 12 frequencies (306, 308, 310, 312, 324, 326, 328, 330, 332, 334, 336, 338) GSM850: Allocates the following 12 frequencies (137, 144, 147, 153, 186, 193, 200, 201, 202, 203, 235, 241)
Frequency Channel Sequence after time	IE Present only for GSM900, GSM 710, GSM750 and T-GSM 810
- Frequency Channel Sequence	GSM900: Allocates the following 12 frequencies (10, 17, 20, 26, 59, 66, 73, 74, 75, 76,108, 114) GSM710, GSM 750 and T-GSM 810: Allocates the following 12 frequencies (447, 454, 457, 463, 496, 498, 500, 501, 502, 503, 506, 508)
Frequency Short List after time	IE Present only for GSM1800 and PCS1900
- Frequency List	GSM1800: Use Range 256 to encode the following 9 frequencies: (747, 775, 779, 782, 791, 798, 829, 832, 844) PCS1900: Use Range 256 to encode the following 9 frequencies: (647, 675, 679, 682, 691, 698, 629, 632, 644)
Starting Time	Indicates the frame number of cell B. that will occur approximately 1,1 seconds (238 frames have elapsed) after the HANDOVER COMMAND is sent by cell A.
Multi-Rate configuration	ICMI = 0 Arbitrary set of codec modes, thresholds and hysteresis specified according to 3GPP TS 05.09 / 45.009

PHYSICAL INFORMATION

Information Element	value/remarks
As default message contents	

Step 6: x = 500

Step 7: The MS and SS are using a full rate TCH with speech full rate version 3 and hopping mode on cell A.

For M = 9:

Step 0: The MS and SS are using a full rate TCH with full rate speech version 3 and in hopping mode on cell A.

HANDOVER COMMAND

Information Element	value/remarks
As default message contents, except:	
Cell Description	
- Network Colour Code	1
- Base Station Colour Code	5
- BCCH Carrier Number	GSM450: 274 GSM480: 321 GSM900: 40 GSM1800: 764 PCS1900: 664 GSM710: 477 GSM750: 477 T-GSM810: 477 GSM850: 167
Channel Description	
- Channel Type	TCH/H + ACCHs
- TDMA offset	Chosen arbitrarily
- Timeslot number	Chosen arbitrarily, but not Zero
- Training Sequence Code	Chosen arbitrarily
- Hopping	RF hopping channel. Chosen arbitrarily from the set (0, 1 to N-1), where N is the number of frequencies encoded in the Frequency List IE.
- MAIO	Chosen arbitrarily from the set (1,2,..63)
- HSN	
Frequency List after time	
- Frequency List	GSM450: use Range 128 to encode the following 12 frequencies: (260, 262, 264, 266, 276, 279, 281, 283, 285, 287, 289, 291) GSM480: use Range 128 to encode the following 12 frequencies: (307, 309, 311, 313, 323, 326, 328, 330, 332, 334, 336, 338) GSM900: use bit map 0 to allocates the following 12 frequencies: (14, 18, 22, 24, 60, 66, 73, 74, 75, 76,108, 114) GSM1800: Use Range 1024 to allocate the following 12 frequencies: (749, 758, 761, 764, 771, 779, 782, 791, 798, 829, 832, 844) PCS1900: Use Range 1024 to allocate the following 12 frequencies: (649, 658, 661, 664, 671, 679, 682, 791, 798, 729, 732, 744) GSM710, GSM 750 and T-GSM 810: Use 128 range to allocates the following 12 frequencies: (451, 455, 459, 461, 497, 498, 500, 501, 502, 503,506, 508) GSM850: Use 128 range to allocates the following 12 frequencies: (141, 145, 149, 151, 187, 193, 200, 201, 202, 203, 235, 241)
Synchronisation Indication	
- Report Observed Time Difference	Shall not be included.
- Synchronisation Indication	'Non synchronised'.
- Normal Cell Indication	Ignore out of range timing advance.
Mode of the first channel	
- Mode	speech half rate version 1

PHYSICAL INFORMATION

Information Element	value/remarks
As default message contents, except: Timing advance	Arbitrarily selected but different to default value.

Step 6: $x = 750$

Step 7: The MS and SS are using a half rate TCH with half rate speech version 1 and in hopping mode on cell B.

For $M = 10$:

Step 0: The MS and SS are using a half rate TCH with speech half rate version 1 and hopping mode on cell B.

HANDOVER COMMAND

Information Element	value/remarks
As default message contents, except: Cell Description	
- Network Colour Code	1
- Base Station Colour Code	5
- BCCH Carrier Number	GSM450: 263 GSM480: 310 GSM900: 20 GSM1800: 747 PCS1900: 647 GSM710: 457 GSM750: 457 T-GSM810: 457 GSM850: 147
Channel Description	
- Channel Type	TCH/F + ACCHs
- TDMA offset	Chosen arbitrarily
- Timeslot number	Chosen arbitrarily, but not Zero
- Training Sequence Code	Chosen arbitrarily
- ARFCN	Chosen arbitrarily from the CA
Synchronisation Indication IE is not included.	
Mode of the first channel.	
- Mode	speech full rate version 3
Multi-Rate configuration	ICMI = 0 Arbitrary set of codec modes, thresholds and hysteresis specified according to 3GPP TS 05.09 / 45.009

PHYSICAL INFORMATION

Information Element	value/remarks
As default message contents	

Step 6: $x = 500$

Step 7: The MS and SS are using a full rate TCH with speech full rate version 3 and non-hopping mode on cell A.

For $M = 11$:

Step 0: The MS and SS are using a full rate TCH with speech full rate version 3 and in non-hopping mode on cell A.

HANDOVER COMMAND

Information Element	value/remarks
As default message contents, except:	
Cell Description	
- Network Colour Code	1
- Base Station Colour Code	5
- BCCH Carrier Number	GSM450: 274 GSM480: 321 GSM900: 40 GSM1800: 764 PCS1900: 664 GSM710: 477 GSM750: 477 T-GSM810: 477 GSM850: 167
Channel Description	
- Channel Type	TCH/H + ACCHs
- TDMA offset	Chosen arbitrarily
- Timeslot number	Chosen arbitrarily, but not Zero
- Training Sequence Code	Chosen arbitrarily
- Hopping	RF hopping channel.
- MAIO	Chosen arbitrarily from the set (0, 1 to N-1), where N is the number of frequencies encoded in the Frequency List IE.
- HSN	Chosen arbitrarily from the set (1,2,..63)
Frequency List after time	
- Frequency List	GSM450: use Range 128 to encode the following 12 frequencies: (260, 262, 264, 266, 276, 279, 281, 283, 285, 287, 289, 291) GSM480: use Range 128 to encode the following 12 frequencies: (307, 309, 311, 313, 323, 326, 328, 330, 332, 334, 336, 338) GSM900: use bit map 0 to allocates the following 12 frequencies: (14, 18, 22, 24, 60, 66, 73, 74, 75, 76,108, 114) GSM1800: Use Range 1024 to allocate the following 12 frequencies: (749, 758, 761, 764, 771, 779, 782, 791, 798, 829, 832, 844) PCS1900: Use Range 1024 to allocate the following 12 frequencies: (649, 658, 661, 664, 671, 679, 682, 791, 798, 729, 732, 744) GSM710, GSM 750 and T-GSM 810: Use 128 range to allocates the following 12 frequencies: (451, 455, 459, 461, 497, 498, 500, 501, 502, 503,506, 508) GSM850: Use 128 range to allocates the following 12 frequencies: (141, 145, 149, 151, 187, 193, 200, 201, 202, 203, 235, 241)
Synchronisation Indication	
- Report Observed Time Difference	Shall not be included.
- Synchronisation Indication	'Non synchronised'.
- Normal Cell Indication	Ignore out of range timing advance.
Mode of the first channel	
- Mode	speech half rate version 3
Starting Time	Indicates the frame number of cell B. that will occur approximately 1,1 seconds (238 frames have elapsed) after the HANDOVER COMMAND is sent by cell A.
Multi-Rate configuration	ICMI = 0 Arbitrary set of codec modes, thresholds and hysteresis specified according to 3GPP TS 05.09 / 45.009

PHYSICAL INFORMATION

Information Element	value/remarks
As default message contents, except: Timing advance	Arbitrarily selected but different to default value.

Step 6: $x = 750$

Step 7: The MS and SS are using a half rate TCH with half rate speech version 3 and in hopping mode on cell B.

For $M = 12$:

Step 0: The MS and SS are using a half rate TCH with half rate speech version 3 and in hopping mode on cell B.

HANDOVER COMMAND

same as for $M = 4$ except:

Channel Description - Channel Type	TCH/H + ACCHs
---------------------------------------	---------------

PHYSICAL INFORMATION

same as for $M = 4$

Step 6: $x = 750$

Step 7: The MS and SS are using a half rate TCH with half rate speech version 3 and in non-hopping mode on cell A.

For $M = 13$:

Step 0: The MS and SS are using a half rate TCH with speech half rate version 3 and in non-hopping mode on cell A.

HANDOVER COMMAND

same as for $M = 5$

PHYSICAL INFORMATION

same as for $M = 5$

Step 6: $x = 500$

Step 7: The MS and SS are using a full rate TCH with speech full rate version 1 and in non-hopping mode on cell B.

For $M = 14$:

Step 0: The MS and SS are using a full rate TCH with speech full rate version 1 and in non-hopping mode on cell B.

HANDOVER COMMAND

same as for $M = 6$ except:

Channel Description - Channel Type	TCH/H + ACCHs
---------------------------------------	---------------

PHYSICAL INFORMATION

same as for $M = 6$

Step 6: $x = 750$

Step 7: The MS and SS are using a half rate TCH with speech half rate version 3 and in non-hopping mode on cell A.

For M = 15:

Step 0: The MS and SS are using a half rate TCH with speech half rate version 3 and in non-hopping mode on cell A.

HANDOVER COMMAND

same as for M = 7

PHYSICAL INFORMATION

same as for M = 7

Step 6: x = 500

Step 7: The MS and SS are using a full rate TCH with full rate speech version 2 and in hopping mode on cell B.

For M = 16:

Step 0: The MS and SS are using a full rate TCH with full rate speech version 2 and in hopping mode on cell B.

HANDOVER COMMAND

same as for M = 8 except:

Channel Description - Channel Type	TCH/H + ACCHs
---------------------------------------	---------------

PHYSICAL INFORMATION

same as for M = 8

Step 6: x = 750

Step 7: The MS and SS are using a half rate TCH with speech half rate version 3 and in hopping mode on cell A.

For M = 17:

Step 0: The MS and SS are using a half rate TCH with speech half rate version 3 and in hopping mode on cell A.

HANDOVER COMMAND

same as for M = 9

PHYSICAL INFORMATION

same as for M = 9

Step 6: x = 750

Step 7: The MS and SS are using a half rate TCH with speech half rate version 1 and in hopping mode on cell B.

For M = 18:

Step 0: The MS and SS are using a half rate TCH with speech half rate version 1 and in hopping mode on cell B.

HANDOVER COMMAND

same as for M = 10 except:

Channel Description - Channel Type	TCH/H + ACCHs
---------------------------------------	---------------

PHYSICAL INFORMATION

same as for M = 10

Step 6: x = 750

Step 7: The MS and SS are using a half rate TCH with speech half rate version 3 and in non-hopping mode on cell A.

For M = 19:

Step 0: The MS and SS are using a half rate TCH with speech half rate version 3 and in non-hopping mode on cell A.

HANDOVER COMMAND

same as for M = 1

PHYSICAL INFORMATION

same as for M = 1

Step 6: x = 500

Step 7: The MS and SS are using a full rate TCH with speech full rate version 3 and in non-hopping mode on cell B.

26.16.6 Structured procedures / emergency call

NOTE: this test is derived from subclause 26.15.5 - Structured procedures / emergency call.

26.16.6.1 Conformance requirement

- 1) The MS in the "idle, updated" state, after a successful location update, the number 112 (for GSM 900 and DCS 1800 MS), or 911 (for GSM 710, GSM 750, T_GSM 810, GSM 850 and PCS 1 900 MS in USA and Canada), or 08 (for GSM 710, GSM 750, T_GSM 810, GSM 850 and PCS 1 900 MS in Mexico) has been entered by user, shall send a CHANNEL REQUEST message with correct establishment cause ("emergency call").
- 2) After assignment of a dedicated channel the first layer message sent by the MS on the assigned dedicated channel shall be a CM SERVICE REQUEST message specifying the correct CKSN and TMSI, with CM Service Type "emergency call establishment".
- 3) Authentication and cipher mode setting shall be performed successfully.
- 4) After cipher mode setting acceptance by the network, the MS shall send an EMERGENCY SETUP message.
- 5) The AMR mobile station shall accept channel assignment to an AMR full-rate channel and if supported an AMR half rate channel depending what the network signals to the mobile and also select the correct codec mode. The call shall be set up using the AMR codec.
- 6) After receipt of a CONNECT ACKNOWLEDGE message during correct establishment of the emergency call the TCH/AF or TCH/AH shall be through connected in both directions if an appropriate channel is available.
- 7) The call shall be cleared correctly.

References:

3GPP TS 04.08 / 3GPP TS 44.018 subclauses 3.4.3.1, 3.4.6, 9.1.2 and 9.1.5.

26.16.6.2 Test purpose

- 1) To verify that an MS supporting speech in the MM state "idle, updated", when made to call the number 112 (for GSM 900 and DCS 1800 MS), or 911 (for GSM 710, GSM 750, T_GSM 810, GSM 850 and PCS 1 900 MS in USA and Canada), or 08 (for GSM 710, GSM 750, T_GSM 810, GSM 850 and PCS 1 900 MS in Mexico), sends a CHANNEL REQUEST message with establishment cause "emergency call".

- 2) To verify that after assignment of a dedicated channel the first layer message sent by the MS on the assigned dedicated channel is a CM SERVICE REQUEST message specifying the correct CKSN and TMSI, with CM Service Type "emergency call establishment".
- 3) To verify that authentication and cipher mode setting are performed successfully.
- 4) To verify that after cipher mode setting acceptance by the SS, the MS sends an EMERGENCY SETUP message.
- 5) To verify that the AMR mobile station shall accept channel assignment to a TCH/AF and if it supports half rate, also to a TCH/A depending what the network signals to the mobile and also select the correct codec mode. The call shall be set up using the AMR codec.
- 6) To verify that subsequently the MS has through connected the TCH in both directions.
- 7) To verify the call is cleared correctly.

26.16.6.3 Method of Test

Initial Conditions

SS: 1 cell default parameters.

MS: The MS is in the MM-state "idle, updated" with valid TMSI and CKSN.

Foreseen Final State of the MS

The MS is in the MM-state "idle, updated" with valid TMSI and CKSN.

Specific PICS statements:

- Speech supported for Half rate version 3 (HR AMR).

PIXIT statements:

-.

Test Procedure

The MS is made to initiate an emergency call. The call is established with late assignment. Having reached the active state, the call is cleared by the SS. This procedure is repeated so that the assignment is made with full rate and half rate speech versions as supported by the MS.

Maximum Duration of Test

3 minutes.

Expected Sequence

This test is repeated for $K=1$, and where the MS supports half rate version 3 $K=2$.

Step	Direction	Message	Comments
1	MS		The appropriate emergency call number is entered
2	MS->SS	CHANNEL REQUEST	Establishment cause is emergency call establishment.
3	SS->MS	IMMEDIATE ASSIGNMENT	
4	MS->SS	CM SERVICE REQUEST	Message is contained in SABM. The CM service type IE indicates "emergency call establishment".
5	SS->MS	AUTHENTICATION REQUEST	
6	MS->SS	AUTHENTICATION RESPONSE	SRES specifies correct value
7	SS->MS	CIPHERING MODE COMMAND	SS starts deciphering after sending the message
8	MS->SS	CIPHERING MODE COMPLETE	Shall be sent enciphered. All following messages shall be sent enciphered.
9	SS		SS starts ciphering
10	MS->SS	EMERGENCY SETUP	The MS indicates it which speech it supports.
11	SS->MS	CALL PROCEEDING	
12	SS->MS	ALERTING	
13	SS->MS	ASSIGNMENT COMMAND	See specific message contents.
14	MS->SS	ASSIGNMENT COMPLETE	
15	SS->MS	CONNECT	
16	MS->SS	CONNECT ACK	
17	MS		The TCH shall be through connected by both directions in the dedicated mode, using the codec mode specified.
18	SS->MS	DISCONNECT	
19	MS->SS	RELEASE	
20	SS->MS	RELEASE COMPLETE	
21	SS->MS	CHANNEL RELEASE	

Specific Message Contents:

K = 1

Assignment Command

Information Element	value/remark
Channel description	TCH/AF
Channel mode - Mode	Speech full rate version 3

K = 2

This step is applicable only if the MS supports half rate version 3.

Assignment Command

Information Element	value/remark
Channel description	TCH/AH
Channel mode - Mode	Speech half rate version 3

26.16.7 AMR Signalling / Directed Retry / Mobile Originated Call

NOTE: This test is derived from the one defined in subclause 26.12.6 and entitled "EFR Signalling / Directed Retry / Mobile Originated Call".

26.16.7.1 Conformance requirements

The MS shall correctly apply the Directed Retry procedure from SDCCH/8 (no frequency hopping) to TCH/AMR with frequency hopping in the non-synchronized case during call establishment. The call control entity of the Mobile Station in the "mobile originating call proceeding" state shall, upon receipt of a CONNECT message, attach the AMR speech connection to the radio path and return a CONNECT ACKNOWLEDGE message to the SS.

References

3GPP TS 04.08 / 3GPP TS 44.018, subclauses 3.4.4 and 9.1.15,
3GPP TS 04.08 / 3GPP TS 24.008, subclause 5.2.1.6.

3GPP TS 04.13, subclause 5.2.6.2.

26.16.7.2 Test purpose

To test that, when the MS is ordered to perform a non-synchronized handover after the CALL PROCEED message, it continuously sends access bursts on the main DCCH (and optionally on the SACCH) until it receives a PHYSICAL INFORMATION message from the SS. To test that the MS correctly takes the values of the Timing Advance information element in the PHYSICAL INFORMATION message into account. To test that the MS activates the new channel correctly and transmits the HANDOVER COMPLETE message without undue delay. To test that the call control entity of the Mobile Station in the "mobile originating call proceeding" state, upon receipt of a CONNECT message, attaches the AMR speech connection to the radio path and returns a CONNECT ACKNOWLEDGE message to the SS.

26.16.7.3 Method of test

Initial Conditions

System Simulator:

2 cells A and B with same LAI, default parameters, except:

Cell A has:

BCCH ARFCN = See the table below.

Cell Allocation = See the table below.

PLMN colour code, NCC = as defaults.

BS colour code, BCC = as defaults.

NCC_PERM = 00001010.

Cell B has:

BCCH ARFCN = See the table below.

Cell Allocation = See the table below.

PLMN colour code, NCC = 3.

BS colour code, BCC = 0.

Band	Cell A		Cell B		Both Cells Format
	BCCH ARFCN	Cell Allocation	BCCH ARFCN	Cell Allocation	
GSM 450	263	259, 261, 263, 265, 267, 269, 271, 273, 275, 277, 279, 281, 283, 285, 287, 289, 291	274	260, 262, 264, 266, 268, 270, 272, 274, 276, 279, 281, 283, 285, 287, 289, 291	Range 128
GSM 480	310	306, 308, 310, 312, 314, 316, 318, 320, 322, 324, 326, 328, 330, 332, 334, 336, 338	321	307, 309, 311, 313, 315, 317, 319, 321, 323, 326, 328, 330, 332, 334, 336, 338	Range 128
GSM 710	457	447, 454, 457, 463, 471, 479, 482, 483, 489, 496, 498, 500, 501, 502, 503, 506, 508	477	451, 455, 459, 461, 467, 468, 475, 477, 497, 498, 500, 501, 502, 503, 506, 508	Range 128
GSM 750	457	447, 454, 457, 463, 471, 479, 482, 483, 489, 496, 498, 500, 501, 502, 503, 506, 508	477	451, 455, 459, 461, 467, 468, 475, 477, 497, 498, 500, 501, 502, 503, 506, 508	Range 128
T-GSM 810	457	447, 454, 457, 463, 471, 479, 482, 483, 489, 496, 498, 500, 501, 502, 503, 506, 508	477	451, 455, 459, 461, 467, 468, 475, 477, 497, 498, 500, 501, 502, 503, 506, 508	Range 128
GSM 850	147	137, 144, 147, 153, 161, 169, 172, 173, 179, 186, 193, 200, 201, 202, 203, 235, 241	167	141, 145, 149, 151, 157, 158, 165, 167, 187, 193, 200, 201, 202, 203, 235, 241	Range 128
GSM 900	20	10, 17, 20, 26, 34, 42, 45, 46, 52, 59, 66, 73, 74, 75, 76, 108, 114	40	14, 18, 22, 24, 30, 31, 38, 40, 60, 66, 73, 74, 75, 76, 108, 114	Bitmap 0
DCS 1 800	747	734, 741, 747, 754, 759, 762, 766, 767, 773, 775, 779, 782, 791, 798, 829, 832, 844	764	739, 743, 746, 749, 756, 758, 761, 764, 771, 779, 782, 791, 798, 829, 832, 844	Range 512
PCS 1 900	647	634, 641, 647, 654, 659, 662, 666, 667, 673, 675, 679, 682, 691, 698, 729, 732, 744	664	639, 643, 646, 649, 656, 658, 661, 664, 671, 679, 682, 691, 698, 729, 732, 744	Range 512

The timebase of Cells A and B shall be such that the edges of their timeslots are not coincident at the antenna connector.

A non-combined SDCCH is used.

Mobile Station:

The MS is in the "idle, updated" state, with a TMSI allocated and camped on cell A.

Specific PICS statements:

- Speech supported for Half rate version 3 (HR AMR).

PIXIT statements:

- Way to indicate mobile originated alerting.

Foreseen Final State of the MS

"Idle, updated" with TMSI allocated and camped on cell B.

Test Procedure

The MS is made to initiate a speech call on Cell A. After the SS has sent the CALL PROCEEDING message the SS sends a HANOVER COMMAND message, ordering the MS to switch to cell B. The MS shall then begin to send access bursts on the new DCCH (and optionally on the SACCH) to cell B. The SS observes the access bursts and after receiving n (n being arbitrarily chosen between values according to table 26.6-2 of subclause 26.6.5) access bursts, the SS sends one PHYSICAL INFORMATION message with an arbitrarily chosen Timing Advance. The MS shall activate the channel in sending and receiving mode. The MS shall establish a signalling link. The MS shall be ready to transmit a HANOVER COMPLETE message before x ms after the end of the PHYSICAL INFORMATION message, but not before a UA frame has been sent by the SS. After the successful handover procedure the SS sends the ALERTING message. The correct alerting indication shall be given to the user (only applicable if the MS supports this feature). The SS sends the CONNECT message indicating that the call has been answered. The AMR speech channel shall be through connected in both directions. The MS shall send then the CONNECT ACKNOWLEDGE message as the response on the CONNECT message. Having reached the active state, the call is cleared by the SS.

The term "ready to transmit" is defined in 3GPP TS 04.13. The value of "x" depends upon the target channel and is specified in the specific message contents section.

Maximum Duration of Test

1 minute, including 30 s for any necessary operator actions.

Expected Sequence

Step	Direction	Message	Comments
1	-----	-----	A MO call is initiated on cell A.
2	MS -> SS	CHANNEL REQUEST	Establishment cause is "originating call and the network does not set the NECI bit to 1".
3	SS -> MS	IMMEDIATE ASSIGNMENT	See specific message contents.
4	MS -> SS	CM SERVICE REQUEST	CM Service Type = Mobile Originating Call Establishment.
5	SS -> MS	AUTHENTICATION REQUEST	
6	MS -> SS	AUTHENTICATION RESPONSE	SRES specifies correct value.
7	SS -> MS	CIPHERING MODE COMMAND	SS starts deciphering after sending the message.
8	MS -> SS	CIPHERING MODE COMPLETE	Shall be sent enciphered. All following messages shall be sent enciphered.
9	SS		SS starts ciphering.
10	MS -> SS	SETUP	AMR speech
11	SS -> MS	CALL PROCEEDING	
12	SS -> MS	HANOVER COMMAND	See specific message contents.
13	MS -> SS	HANOVER ACCESS	Repeated on every burst of the uplink main DCCH (and optionally on the SACCH) until reception of PHYSICAL INFORMATION. Handover Reference as included in the HANOVER COMMAND.
14	SS -> MS	PHYSICAL INFORMATION	Sent after reception of n HANOVER ACCESS message. Timing Advance is arbitrarily chosen.
15	MS -> SS	SABM	Sent without information field.
16	SS -> MS	UA	
17	MS -> SS	HANOVER COMPLETE	This message shall be ready to be transmitted before "x" ms after the completion of step 14.
18	SS -> MS	ALERTING	
19	MS		An alerting indication is given as described in the PIXIT.
20	SS -> MS	CONNECT	
21	MS -> SS	CONNECT ACKNOWLEDGE	
22	MS		The AMR speech channel is through connected in both directions.
23	SS -> MS	DISCONNECT	
24	MS -> SS	RELEASE	
25	SS -> MS	RELEASE COMPLETE	
26	SS -> MS	CHANNEL RELEASE	The main signalling link is released.

Specific Message Contents

IMMEDIATE ASSIGNMENT

Information Element	value/remark
As default message contents except: Channel Description - Channel Type - TDMA offset - Timeslot number - Training Sequence Code - Hopping - ARFCN	Channel Description. SDCCH/8 As default message contents. As default message contents. Chosen arbitrarily. Single RF Channel. Chosen arbitrarily from the Cell Allocation of Cell A.

HANDOVER COMMAND

Information Element	value/remarks
As default message contents, except: Cell Description - Network Colour Code - Base Station Colour Code - BCCH Carrier Number Channel Description - Channel Type - TDMA offset - Timeslot number - Training Sequence Code - Hopping - MAIO - HSN Synchronization Indication IE is not included Frequency list after time - Frequency List Channel Mode IE Multi-Rate configuration	3 0 See the table below TCH/F + ACCHs Chosen arbitrarily. Chosen arbitrarily but not zero. Chosen arbitrarily. RF hopping channel. Chosen arbitrarily from the set (0, 1 to N-1), where N is the number of frequencies encoded in the Frequency List IE. Zero (this gives cyclic hopping). Allocate frequencies as per the table below Speech (multi rate version 1). ICMI = 1 Arbitrary set of codec modes, thresholds and hysteresis specified according to 3GPP TS 05.09 / 45.009

HANDOVER COMMAND			
Band	Frequency Short List		BCCH Carrier Number
	Format	ARFCNs	ARFCN
GSM 450	Range 128	260, 262, 264, 266, 268, 270, 272, 276, 279, 281, 283, 285, 287, 289, 291	274
GSM 480	Range 128	307, 309, 311, 313, 315, 317, 319, 323, 326, 328, 330, 332, 334, 336, 338	321
GSM 710	Range 128	451, 455, 459, 461, 467, 468, 475, 497, 498, 500, 501, 502, 503, 506, 508	477
GSM 750	Range 128	451, 455, 459, 461, 467, 468, 475, 497, 498, 500, 501, 502, 503, 506, 508	477
T-GSM 810	Range 128	451, 455, 459, 461, 467, 468, 475, 497, 498, 500, 501, 502, 503, 506, 508	477
GSM 850	Range 128	141, 145, 149, 151, 157, 158, 165, 187, 193, 200, 201, 202, 203, 235, 241	167
GSM 900	Range 128	14, 18, 22, 24, 30, 31, 38, 60, 66, 73, 74, 75, 76, 108, 114	40
DCS 1 800	Range 128	746, 779	764
PCS 1 900	Range 128	646, 679	664

Step 17: "x" = 500.

26.16.8 AMR Signalling / Directed Retry / Mobile Terminated Call

NOTE: This test is derived from the one defined in subclause 26.12.7 and entitled "EFR Signalling / Directed Retry / Mobile Terminated Call".

26.16.8.1 Conformance requirements

The MS shall correctly apply the Directed Retry procedure from SDCCH/8 with frequency hopping to TCH/AMR with frequency hopping and starting time in the non-synchronized case during call establishment. The call control entity of the Mobile Station in the "call delivered" state shall, if the MS supports immediate connect, continue the call establishment by through-connecting the AMR traffic channel in both directions, or if the MS does not support immediate connect, send an ALERTING message. The MS indicates acceptance of a MT call by sending CONNECT.

The mobile station shall attach the user connection at latest when sending the CONNECT message, except if there is no compatible radio resource available at this time. In this case the attachment shall be delayed until such a resource becomes available.

References

- 3GPP TS 04.08 / 3GPP TS 44.018, subclauses 3.4.4 and 9.1.15,
- 3GPP TS 04.08 / 3GPP TS 24.008, subclauses 5.2.2.5, 5.2.2.6 and 5.2.2.9.
- 3GPP TS 04.13, subclause 5.2.6.2.

26.16.8.2 Test purpose

To test that when the MS is ordered to perform a non-synchronized handover after the CALL CONFIRM message, it continuously sends access bursts on the main DCCH (and optionally on the SACCH) until it receives a PHYSICAL INFORMATION message from the SS. To test that the MS correctly takes the values of the Timing Advance information element in the PHYSICAL INFORMATION message into account. To test that the MS activates the new channel correctly and transmits the HANDOVER COMPLETE message without undue delay. To test that the call control entity of the Mobile Station in the "call delivered" state, if the MS supports immediate connect, continues the call establishment by through-connecting the AMR traffic channel in both directions, or if the MS does not support immediate connect, sends an ALERTING message. To test that the MS indicates acceptance of a MT call by sending CONNECT.

To test that the mobile station attaches the user connection at latest when sending the CONNECT message, except if there is no compatible radio resource available at this time. To test that in this case the attachment is delayed until such a resource becomes available.

26.16.8.3 Method of test

Initial Conditions

System Simulator:

2 cells A and B with same LAI, default parameters, except:

Cell A has:

BCCH ARFCN = See the table below.

Cell Allocation = See the table below. PLMN colour code, NCC = as defaults.

BS colour code, BCC = as defaults.

NCC_PERM = 00001010.

Cell B has:

BCCH ARFCN = See the table below.

Cell Allocation = See the table below.

PLMN colour code, NCC = 3.

BS colour code, BCC = 0.

Band	Cell A		Cell B		Both Cells Format
	BCCH ARFCN	Cell Allocation	BCCH ARFCN	Cell Allocation	
GSM 450	263	259, 261, 263, 265, 267, 269, 271, 273, 275, 277, 279, 281, 283, 285, 287, 289, 291	274	260, 262, 264, 266, 268, 270, 272, 274, 276, 279, 281, 283, 285, 287, 289, 291	Range 128
GSM 480	310	306, 308, 310, 312, 314, 316, 318, 320, 322, 324, 326, 328, 330, 332, 334, 336, 338	321	307, 309, 311, 313, 315, 317, 319, 321, 323, 326, 328, 330, 332, 334, 336, 338	Range 128
GSM 710	457	447, 454, 457, 463, 471, 479, 482, 483, 489, 496, 498, 500, 501, 502, 503, 506, 508	477	451, 455, 459, 461, 467, 468, 475, 477, 497, 498, 500, 501, 502, 503, 506, 508	Range 128
GSM 750	457	447, 454, 457, 463, 471, 479, 482, 483, 489, 496, 498, 500, 501, 502, 503, 506, 508	477	451, 455, 459, 461, 467, 468, 475, 477, 497, 498, 500, 501, 502, 503, 506, 508	Range 128
T-GSM 810	457	447, 454, 457, 463, 471, 479, 482, 483, 489, 496, 498, 500, 501, 502, 503, 506, 508	477	451, 455, 459, 461, 467, 468, 475, 477, 497, 498, 500, 501, 502, 503, 506, 508	Range 128
GSM 850	147	137, 144, 147, 153, 161, 169, 172, 173, 179, 186, 193, 200, 201, 202, 203, 235, 241	167	141, 145, 149, 151, 157, 158, 165, 167, 187, 193, 200, 201, 202, 203, 235, 241	Range 128
GSM 900	20	10, 17, 20, 26, 34, 42, 45, 46, 52, 59, 66, 73, 74, 75, 76, 108, 114	40	14, 18, 22, 24, 30, 31, 38, 40, 60, 66, 73, 74, 75, 76, 108, 114	Bitmap 0
DCS 1 800	747	734, 741, 747, 754, 759, 762, 766, 767, 773, 775, 779, 782, 791, 798, 829, 832, 844	764	739, 743, 746, 749, 756, 758, 761, 764, 771, 779, 782, 791, 798, 829, 832, 844	Range 512
PCS 1 900	647	634, 641, 647, 654, 659, 662, 666, 667, 673, 675, 679, 682, 691, 698, 729, 732, 744	664	639, 643, 646, 649, 656, 658, 661, 664, 671, 679, 682, 691, 698, 729, 732, 744	Range 512

The timebase of Cells A and B shall be such that the edges of their timeslots are not coincident at the antenna connector.

A non-combined SDCCH is used.

Mobile Station:

The MS is in the "idle, updated" state, with a TMSI allocated and camped on cell A.

Specific PICS statements:

- Speech supported for Half rate version 3 (HR AMR).
- Immediate connect supported for all circuit switched basic services.

PIXIT statements:

- Way to indicate alerting.
- Way to make the MS accept an incoming call after alerting.

Foreseen Final State of the MS

"Idle, updated" with TMSI allocated and camped on cell B.

Test Procedure

The MS is paged on Cell A. The MS responds to the PAGING REQUEST message and establishes a mobile terminated speech call on Cell A. If the MS supports immediate connect, it continues the call establishment by through-connecting the traffic channel in both directions, or if the MS does not support immediate connect, it sends an ALERTING message. The MS indicates acceptance of a MT call by sending CONNECT.

After the MS has sent the CALL CONFIRMED message (if the MS supports immediate connect then the MS sends the CONNECT message after the CALL CONFIRMED message on the old channel) the SS sends a HANDOVER COMMAND message, ordering the MS to switch to cell B. The MS shall then begin to send access bursts on the new DCCH (and optionally on the SACCH) to cell B. The SS observes the access bursts and after receiving n (n being

arbitrarily chosen between values according to table 26.6-2 of subclause 26.6.5) access bursts, the SS sends one PHYSICAL INFORMATION message with an arbitrarily chosen Timing Advance. The MS shall activate the channel in sending and receiving mode. The MS shall establish a signalling link. The MS shall be ready to transmit a HANDOVER COMPLETE message before x ms after the end of the PHYSICAL INFORMATION message, but not before a UA frame has been sent by the SS. After the successful handover procedure the MS sends the ALERTING message (if the MS runs the immediate connect procedure then the MS does not send an ALERTING message). The correct alerting indication shall be given to the user (only applicable if the MS supports the feature or if the MS is not using the immediate connect procedure). After the MS sent the CONNECT message the AMR speech channel shall be through connected in both directions. The SS sends then the CONNECT ACKNOWLEDGE message as the response on the CONNECT message. Having reached the active state, the call is cleared by the SS.

The term "ready to transmit" is defined in 3GPP TS 04.13. The value of " x " depends upon the target channel and is specified in the specific message contents section.

Maximum Duration of Test

1 minute, including 30 s for any necessary operator actions.

Expected Sequence

Step	Direction	Message	Comments
1	SS -> MS	PAGING REQUEST TYPE 1	Sent on the correct paging subchannel on cell A.
2	MS -> SS	CHANNEL REQUEST	
3	SS -> MS	IMMEDIATE ASSIGNMENT	See specific message contents.
4	MS -> SS	PAGING RESPONSE	Message is contained in SABM.
5	SS -> MS	AUTHENTICATION REQUEST	
6	MS -> SS	AUTHENTICATION RESPONSE	SRES specifies correct value.
7	SS -> MS	CIPHERING MODE COMMAND	SS starts deciphering after sending the message.
8	MS -> SS	CIPHERING MODE COMPLETE	Shall be sent enciphered. All following messages shall be sent enciphered.
9	SS		SS starts ciphering.
10	SS -> MS	SETUP	AMR speech.
11	MS -> SS	CALL CONFIRMED	
			If the MS supports immediate connect then branch A applies. If the MS does not support immediate connect then branch B applies
A12	MS -> SS	CONNECT	sent on the old channel
A13	SS -> MS	HANDOVER COMMAND	See specific message contents.
A14	MS -> SS	HANDOVER ACCESS	Repeated on every burst of the uplink main DCCH (and optionally on the SACCH) until reception of PHYSICAL INFORMATION. Handover Reference as included in the HANDOVER COMMAND. The first HANDOVER ACCESS message shall be transmitted in the indicated frame (unless the indicated frame is not used by that channel, in which case the next frame used by that channel shall be used).
A15	SS -> MS	PHYSICAL INFORMATION	Sent after reception of n HANDOVER ACCESS message. Timing Advance is arbitrarily chosen.
A16	MS -> SS	SABM	Sent without information field.
A17	SS -> MS	UA	
A18	MS -> SS	HANDOVER COMPLETE	This message shall be ready to be transmitted before "x" ms after the completion of step A15.
B12	SS -> MS	HANDOVER COMMAND	See specific message contents.
B13	MS -> SS	HANDOVER ACCESS	Repeated on every burst of the uplink main DCCH (and optionally on the SACCH) until reception of PHYSICAL INFORMATION. Handover Reference as included in the HANDOVER COMMAND. The first HANDOVER ACCESS message shall be transmitted in the indicated frame (unless the indicated frame is not used by that channel, in which case the next frame used by that channel shall be used).
B14	SS -> MS	PHYSICAL INFORMATION	Sent after reception of n HANDOVER ACCESS message. Timing Advance is arbitrarily chosen.
B15	MS -> SS	SABM	Sent without information field.
B16	SS -> MS	UA	
B17	MS -> SS	HANDOVER COMPLETE	This message shall be ready to be transmitted before "x" ms after the completion of step B14.
B18	MS -> SS	ALERTING	
B19	MS		Gives an alerting indication as defined in a PIXIT statement is given by the MS
B20	MS		The MS is made to accept the call in the way described in a PIXIT statement
B21	MS -> SS	CONNECT	
22	MS		The TCH/AMR channel shall be through connected in both directions.
23	SS -> MS	CONNECT ACKNOWLEDGE	
24	SS -> MS	DISCONNECT	
25	MS -> SS	RELEASE	
26	SS -> MS	RELEASE COMPLETE	
27	SS -> MS	CHANNEL RELEASE	The main signalling link is released.

Specific Message Contents

IMMEDIATE ASSIGNMENT

Information Element	value/remark
As default message contents except: L2 pseudo length Channel Description - Channel Type - TDMA offset - Timeslot number - Training Sequence Code - Hopping - MAIO - HSN Mobile Allocation - Length - Contents	14 octets (11 + contents of the MA). SDCCH/8 As default message contents. Arbitrary value, but not zero. Chosen arbitrarily. RF hopping channel. Chosen arbitrarily from the set (0, 1 to N-1), where N is the number of frequencies encoded in the Mobile Allocation. Chosen arbitrarily from the set (1,2,..63). 3 octets. Indicates only three frequencies, as per the table below.

IMMEDIATE ASSIGNMENT	
Band	Mobile Allocation
GSM 450	281, 283, 285
GSM 480	328, 330, 332
GSM 710	500, 501, 502
GSM 750	500, 501, 502
T-GSM 810	500, 501, 502
GSM 850	200, 201, 202
GSM 900	73, 74, 75
DCS 1 800	773, 775, 779
PCS 1 900	673, 675, 679

HANDOVER COMMAND

Information Element	value/remarks
As default message contents, except: Cell Description - Network Colour Code - Base Station Colour Code - BCCH Carrier Number Channel Description - Channel Type - TDMA offset - Timeslot number - Training Sequence Code - Hopping - MAIO - HSN Frequency List after time - Frequency List Synchronization Indication - Report Observed Time Difference - Synchronization Indication - Normal Cell Indication Mode of First Channel Starting Time Multi-Rate configuration	3 0 See the table below TCH/F + ACCHs Chosen arbitrarily. Chosen arbitrarily, but not Zero. Chosen arbitrarily. RF hopping channel. Chosen arbitrarily from the set (0, 1 to N-1), where N is the number of frequencies encoded in the Frequency List IE. Chosen arbitrarily from the set (1,2,..63). Allocate frequencies as per the table below. Shall not be included. "Non synchronized". Ignore out of range timing advance. Speech (multi rate version 1). Indicates the frame number of cell B that will occur approximately 1,1 seconds (238 frames have elapsed) after the HANDOVER COMMAND is sent by cell A. ICMI = 1 Arbitrary set of codec modes, thresholds and hysteresis specified according to 3GPP TS 05.09 / 45.009

HANDOVER COMMAND			
Band	BCCH Carrier Number	Cell Channel Description	
	ARFCN	Format	ARFCNs
GSM 450	274	Range 128	260, 262, 264, 266, 276, 279, 281, 283, 285, 287, 289, 291
GSM 480	321	Range 128	307, 309, 311, 313, 323, 326, 328, 330, 332, 334, 336, 338
GSM 710	477	Range 128	451, 455, 459, 461, 497, 498, 500, 501, 502, 503, 506, 508
GSM 750	477	Range 128	451, 455, 459, 461, 497, 498, 500, 501, 502, 503, 506, 508
T-GSM 810	477	Range 128	451, 455, 459, 461, 497, 498, 500, 501, 502, 503, 506, 508
GSM 850	167	Range 128	141, 145, 149, 151, 187, 193, 200, 201, 202, 203, 235, 241
GSM 900	40	Bitmap 0	14, 18, 22, 24, 60, 66, 73, 74, 75, 76, 108, 114
DCS 1 800	764	Range 1024	749, 758, 761, 764, 771, 779, 782, 791, 798, 829, 832, 844
PCS 1 900	664	Range 1024	649, 658, 661, 664, 671, 679, 682, 691, 698, 729, 732, 744

Step A18 / B17: "x" =500.

26.16.9 AMR RATSCCH Protocol

26.16.9.1 AMR Configuration Change (normal)

26.16.9.1.1 Conformance requirements

The AMR_CONFIG_REQ message may be sent by the BTS during a call to change the AMR configuration on the radio interface without interruption of the speech transmission.

The ACK_OK message serves as an acknowledgement that a RATSCCH REQ message has been detected, correctly decoded (no CRC error) and that it is defined for the Addressee. It defines the exact activation time in direction from Addressee to Initiator.

Reference

3GPP TS 05.09 sub-clauses: 3.2.2.3.1, 3.2.2.3.5

26.16.9.1.2 Test purpose

This test will verify that the MS is able to handle a properly formatted AMR_CONFIG_REQ message.

26.16.9.1.3 Method of test

Initial Conditions

System Simulator:

1 cell with default parameters

Mobile Station:

The MS is in the "idle, updated" state, with a TMSI allocated and camped on cell A.

Specific PICS statements:

- Speech supported for Half rate version 3 (HR AMR).

PIXIT statements:

-.

Foreseen Final State of the MS

Idle Updated, TMSI allocated and camped on cell A.

Test Procedure

This sequence is performed for execution counter, $k = 1, 2$.

When $k = 1$, DTX is not used:

- 1) User initiates a Mobile Originated call.
- 2) The network and the MS indicate Bearer capabilities IE with the AMR speech Full Rate and Half Rate (Version 3).
- 3) The network performs an assignment on a TCH channel with MultiRate configuration to the MS.
- 4) The call is maintained during a programmable time without variation of RxLev /RxQual.
- 5) The SS shall send a properly formatted AMR_CONFIG_REQ message during the call at a programmable time.
- 6) The MS answers with a ACK_OK message within 3 speech frames
- 7) The network initiates the call release.

When $k = 2$, DTX is used:

- 1) In the serving cell, the DTX indicator is set to "MS shall use discontinuous transmission".
- 2) User initiates a Mobile Originated call.
- 3) The network and the MS indicate Bearer capabilities IE with the AMR speech Full Rate and Half Rate (Version 3).
- 4) The network performs an assignment on a TCH channel with MultiRate configuration to the MS.
- 5) The call is maintained during a programmable time without variation of RxLev /RxQual.
- 6) The SS shall send a properly formatted AMR_CONFIG_REQ message during the call at a programmable time.
- 7) The MS answers with a ACK_OK message within 3 speech frames.
- 8) The network initiates the call release.

This test is repeated for $M=1$, and where the MS supports half rate version 3 $M=2$.

Maximum Duration of Test

5 minutes

Expected Sequence

When $k=1$:

Step	Direction	Message	Comments
1	MS		MS is in idle mode
2	MS		MS initiates Mobile Originated call
3	MS->SS	Channel Request	Establishment cause is "originating call and the network does not set the NECI bit to 1".
4	SS->MS	Immediate Assignment	See Default Messages for AMR
5	MS->SS	CM Service Request	CM Service Type = Mobile Originating Call Establishment.
6	SS->MS	AUTHENTICATION REQUEST	
7	MS->SS	AUTHENTICATION RESPONSE	SRES specifies correct value
8	SS->MS	CIPHERING MODE COMMAND	SS starts deciphering after sending the message
9	MS->SS	CIPHERING MODE COMPLETE	Shall be sent enciphered. All following messages shall be sent enciphered.
10	MS->SS	Setup	MS indicates supported speech versions
11	SS->MS	Call Proceeding	
12	SS->MS	Alerting	
13	SS->MS	Assignment Command	See specific message contents.
14	MS->SS	Assignment Complete	
15	SS->MS	Connect	
16	MS->SS	Connect Acknowledge	
17	MS		The TCH shall be through connected by both directions in the dedicated mode, using the codec mode specified.
18	SS->MS	AMR_CONFIG_REQ	See specific message contents.
19	MS->SS	ACK_OK	Message must be received within 3 speech frames
20	SS->MS	Disconnect	
21	MS->SS	Release	
22	SS->MS	Release Complete	
23	SS->MS	Channel Release	

When k=2:

Step	Direction	Message	Comments
1	MS		MS is in idle mode
2	MS		MS initiates Mobile Originated call
3	MS->SS	Channel Request	Establishment cause is "originating call and the network does not set the NECI bit to 1".
4	SS->MS	Immediate Assignment	See Default Messages for AMR
5	MS->SS	CM Service Request	CM Service Type = Mobile Originating Call Establishment.
6	SS->MS	AUTHENTICATION REQUEST	
7	MS->SS	AUTHENTICATION RESPONSE	SRES specifies correct value
8	SS->MS	CIPHERING MODE COMMAND	SS starts deciphering after sending the message
9	MS->SS	CIPHERING MODE COMPLETE	Shall be sent enciphered. All following messages shall be sent enciphered.
10	MS->SS	Setup	MS indicates supported speech versions
11	SS->MS	Call Proceeding	
12	SS->MS	Alerting	
13	SS->MS	Assignment Command	See specific message contents.
14	MS->SS	Assignment Complete	
15	SS->MS	Connect	
16	MS->SS	Connect Acknowledge	
17	MS		The TCH shall be through connected by both directions in the dedicated mode, using the codec mode specified.
18	SS->MS	AMR_CONFIG_REQ	Using DTX mode
19	MS->SS	ACK_OK	Message must be received within 3 speech frames
20	SS->MS	Disconnect	
21	MS->SS	Release	
22	SS->MS	Release Complete	
23	SS->MS	Channel Release	

Specific Message Contents

ASSIGNMENT COMMAND

Information Element	value/remarks
Channel description	M=1: TCH/F M=2: TCH/H
Mode of the first channel - Mode	Full rate of half rate version 3

AMR_CONFIG_REQ

Information Element	value/remarks
ICM	CODEC_MODE_1
ACS	2 codec modes
HYST2	Not defined (set to all 1s)
THRESH2	Not defined (set to all 1s)
HYST1	2 dB
THRESH1	12.5 dB

26.16.9.2 AMR Configuration Change (abnormal)

26.16.9.2.1 Conformance requirements

The AMR_CONFIG_REQ message may be sent by the BTS during a call to change the AMR configuration on the radio interface without interruption of the speech transmission.

The ACK_ERR message serves as a negative acknowledgement that a RATSCCH REQ message has been detected, i.e. the RATSCCH pattern was detected, but could not be decoded correctly (CRC error), or its content is not understandable by the addressee.

Reference:

3GPP TS 05.09 sub-clauses: 3.2.2.3.2, 3.2.2.3.5

26.16.9.2.2 Test purpose

This test will verify that the MS is able to handle an improperly formatted AMR_CONFIG_REQ message.

26.16.9.2.3 Method of test

Initial Conditions

System Simulator:

1 cell with default parameters

Mobile Station:

The MS is in the "idle, updated" state, with a TMSI allocated and camped on cell A.

Specific PICS statements:

- Speech supported for Half rate version 3 (HR AMR).

PIXIT statements:

..

Foreseen Final State of the MS

Idle Updated, TMSI allocated and camped on cell A.

Test Procedure

- 1) User initiates a Mobile Originated call.
- 2) The network and the MS indicate Bearer capabilities IE with the AMR speech Full Rate and Half Rate (Version 3).
- 3) The network performs an assignment on a TCH channel with MultiRate configuration to the MS.
- 4) The call is maintained during a programmable time without variation of RxLev /RxQual.
- 5) The SS shall send an AMR_CONFIG_REQ message, with an incorrect CRC, during the call at a programmable time.
- 6) The MS answers with a ACK_ERR message within 3 speech frames
- 7) The network initiates the call release.

This test is repeated for M=1, and where the MS supports half rate version 3 M=2.

Maximum Duration of Test

5 minutes

Expected Sequence

Step	Direction	Message	Comments
1	MS		MS is in idle mode
2	MS		MS initiates Mobile Originated call
3	MS->SS	Channel Request	Establishment cause is "originating call and the network does not set the NECI bit to 1".
4	SS->MS	Immediate Assignment	See Default Messages for AMR
5	MS->SS	CM Service Request	CM Service Type = Mobile Originating Call Establishment.
6	SS->MS	AUTHENTICATION REQUEST	
7	MS->SS	AUTHENTICATION RESPONSE	SRES specifies correct value
8	SS->MS	CIPHERING MODE COMMAND	SS starts deciphering after sending the message
9	MS->SS	CIPHERING MODE COMPLETE	Shall be sent enciphered. All following messages shall be sent enciphered.
10	MS->SS	Setup	MS indicates supported speech versions
11	SS->MS	Call Proceeding	
12	SS->MS	Alerting	
13	SS->MS	Assignment Command	See specific message contents.
14	MS->SS	Assignment Complete	
15	SS->MS	Connect	
16	MS->SS	Connect Acknowledge	
17	MS		The TCH shall be through connected by both directions in the dedicated mode, using the codec mode specified.
18	SS->MS	AMR_CONFIG_REQ	Message contains an incorrect CRC
19	MS->SS	ACK_ERR	Message must be received within 3 speech frames
20	SS->MS	Disconnect	
21	MS->22	Release	
22	SS->MS	Release Complete	
23	SS->MS	Channel Release	

Specific Message Contents

ASSIGNMENT COMMAND

Information Element	value/remarks
Channel description	M=1: TCH/F M=2: TCH/H
Mode of the first channel - Mode	Full rate or half rate version 3

AMR_CONFIG_REQ

Information Element	value/remarks
ICM	CODEC_MODE_1
ACS	2 codec modes
HYST2	Not defined (set to all 1s)
THRESH2	Not defined (set to all 1s)
HYST1	2 dB
THRESH1	12.5 dB

26.16.9.3 Codec Mode Phase Change (normal)

26.16.9.3.1 Conformance requirements

The CMI_PHASE_REQ message may be sent by the BTS to change the phase of the Codec Mode Indication in downlink.

The ACK_OK message serves as an acknowledgement that a RATSCCH_REQ message has been detected, correctly decoded (no CRC error) and that it is defined for the Addressee. It defines the exact activation time in direction from Addressee to Initiator.

Reference:

3GPP TS 05.09 sub-clauses: 3.2.2.3.1, 3.2.2.3.4

26.16.9.3.2 Test purpose

This test will verify that the MS can correctly handle a properly formatted CMI_PHASE_REQ message.

26.16.9.3.3 Method of test

Initial Conditions

System Simulator:

1 cell with default parameters

Mobile Station:

The MS is in the "idle, updated" state, with a TMSI allocated and camped on cell A.

Specific PICS statements:

- Speech supported for Half rate version 3 (HR AMR).

PIXIT statements:

-.

Foreseen Final State of the MS

Idle Updated, TMSI allocated and camped on cell A.

Test Procedure

- 1) User initiates a Mobile Originated call.
- 2) The network and the MS indicate Bearer capabilities IE with the AMR speech Full Rate and Half Rate (Version 3).
- 3) The network performs an assignment on a TCH channel with MultiRate configuration to the MS.
- 4) The call is maintained during a programmable time without variation of RxLev /RxQual.

- 5) The SS shall send the CMI_PHASE_REQ message during the call at a programmable time. The CMI_PHASE_REQ shall be sent either in place of a "CMI" speech frame, or in place of a "CMC" speech frame, to cover both kinds of changes.
- 6) The MS answers with a ACK_OK message within 3 speech frames.
- 7) The downlink CMI phase is changed (or not) according to the CMI_PHASE_REQ message starting with speech frame N+12.
- 8) The network initiates the call release.

This test is repeated for M=1, and where the MS supports half rate version 3 M=2.

Maximum Duration of Test

5 minutes

Expected Sequence

Step	Direction	Message	Comments
1	MS		MS is in idle mode
2	MS		MS initiates Mobile Originated call
3	MS->SS	Channel Request	Establishment cause is "originating call and the network does not set the NECI bit to 1".
4	SS->MS	Immediate Assignment	See Default Messages for AMR
5	MS->SS	CM Service Request	CM Service Type = Mobile Originating Call Establishment.
6	SS->MS	AUTHENTICATION REQUEST	
7	MS->SS	AUTHENTICATION RESPONSE	SRES specifies correct value
8	SS->MS	CIPHERING MODE COMMAND	SS starts deciphering after sending the message
9	MS->SS	CIPHERING MODE COMPLETE	Shall be sent enciphered. All following messages shall be sent enciphered.
10	MS->SS	Setup	MS indicates supported speech versions
11	SS->MS	Call Proceeding	
12	SS->MS	Alerting	
13	SS->MS	Assignment Command	See specific message contents.
14	MS->SS	Assignment Complete	
15	SS->MS	Connect	
16	MS->SS	Connect Acknowledge	
17	MS		The TCH shall be through connected by both directions in the dedicated mode, using the codec mode specified.
18	SS->MS	CMI_PHASE_REQ	See specific message contents.
19	MS->SS	ACK_OK	Message must be received within 3 speech frames
20	SS->MS	Disconnect	
21	MS->SS	Release	
22	SS->MS	Release Complete	
23	SS->MS	Channel Release	

Specific Message Contents

ASSIGNMENT COMMAND

Information Element	value/remarks
Channel description	M=1: TCH/F M=2: TCH/H
Mode of the first channel - Mode	Full rate or half rate version 3

CMI_PHASE_REQ

Information Element	value/remarks
CMIP	1 (default)

26.16.9.4 Codec Mode Phase Change (abnormal)

26.16.9.4.1 Conformance requirements

The CMI_PHASE_REQ message may be sent by the BTS to change the phase of the Codec Mode Indication in downlink.

The ACK_ERR message serves as a negative acknowledgement that a RATSCCH REQ message has been detected, i.e. the RATSCCH pattern was detected, but could not be decoded correctly (CRC error), or its content is not understandable by the addressee.

Reference

3GPP TS 05.09 sub-clauses: 3.2.2.3.2, 3.2.2.3.4

26.16.9.4.2 Test purpose

This test will verify that the MS can correctly handle an improperly formatted CMI_PHASE_REQ message.

26.16.9.4.3 Method of test

Initial Conditions

System Simulator:

1 cell with default parameters

Mobile Station:

The MS is in the "idle, updated" state, with a TMSI allocated and camped on cell A.

Specific PICS statements:

- Speech supported for Half rate version 3 (HR AMR).

PIXIT statements:

-.

Foreseen Final State of the MS

Idle Updated, TMSI allocated and camped on cell A.

Test Procedure

- 1) User initiates a Mobile Originated call.
- 2) The network and the MS indicate Bearer capabilities IE with the AMR speech Full Rate and Half Rate (Version 3).
- 3) The network performs an assignment on a TCH channel with MultiRate configuration to the MS.
- 4) The call is maintained during a programmable time without variation of RxLev /RxQual.
- 5) The SS shall send the CMI_PHASE_REQ message, with an incorrect CRC, during the call at a programmable time. The CMI_PHASE_REQ shall be sent either in place of a "CMI" speech frame, or in place of a "CMC" speech frame, to cover both kinds of changes.
- 6) The MS answers with a ACK_ERR message within 3 speech frames.
- 7) The network initiates the call release.

This test is repeated for M=1, and where the MS supports half rate version 3 M=2.

Maximum Duration of Test

5 minutes

Expected Sequence

Step	Direction	Message	Comments
1	MS		MS is in idle mode
2	MS		MS initiates Mobile Originated call
3	MS->SS	Channel Request	Establishment cause is "originating call and the network does not set the NECI bit to 1".
4	SS->MS	Immediate Assignment	See Default Messages for AMR
5	MS->SS	CM Service Request	CM Service Type = Mobile Originating Call Establishment.
6	SS->MS	AUTHENTICATION REQUEST	
7	MS->SS	AUTHENTICATION RESPONSE	SRES specifies correct value
8	SS->MS	CIPHERING MODE COMMAND	SS starts deciphering after sending the message
9	MS->SS	CIPHERING MODE COMPLETE	Shall be sent enciphered. All following messages shall be sent enciphered.
10	MS->SS	Setup	MS indicates supported speech versions
11	SS->MS	Call Proceeding	
12	SS->MS	Alerting	
13	SS->MS	Assignment Command	See specific message contents.
14	MS->SS	Assignment Complete	
15	SS->MS	Connect	
16	MS->SS	Connect Acknowledge	
17	MS		The TCH shall be through connected by both directions in the dedicated mode, using the codec mode specified.
18	SS->MS	CMI_PHASE_REQ	Message contains an incorrect CRC
19	MS->SS	ACK_ERR	Message must be received within 3 speech frames
20	SS->MS	Disconnect	
21	MS->SS	Release	
22	SS->MS	Release Complete	
23	SS->MS	Channel Release	

Specific Message Contents

ASSIGNMENT COMMAND

Information Element	value/remarks
Channel description	M=1: TCH/F M=2: TCH/H
Mode of the first channel - Mode	Full rate or half rate version 3

CMI_PHASE_REQ

Information Element	value/remarks
CMIP	1 (default)

26.16.9.5 Threshold Change (normal)

26.16.9.5.1 Conformance requirements

The THRESH_REQ message may be sent by the BTS to change the thresholds in the DL Mode Request Generator.

The ACK_OK message serves as an acknowledgement that a RATSCCH REQ message has been detected, correctly decoded (no CRC error) and that it is defined for the Addressee. It defines the exact activation time in direction from Addressee to Initiator.

Reference:

3GPP TS 05.09 sub-clauses: 3.2.2.3.1, 3.2.2.3.6

26.16.9.5.2 Test purpose

This test will verify that an RATSCCH capable MS is able to handle a properly formatted THRESH_REQ message

26.16.9.5.3 Method of test

Initial Conditions

System Simulator:

1 cell with default parameters

Mobile Station:

The MS is in the "idle, updated" state, with a TMSI allocated and camped on cell A.

Specific PICS statements:

- Speech supported for Half rate version 3 (HR AMR).

PIXIT statements:

-.

Foreseen Final State of the MS

Idle Updated, TMSI allocated and camped on cell A.

Test Procedure

- 1) User initiates a Mobile Originated call.
- 2) The network and the MS indicate Bearer capabilities IE with the AMR speech Full Rate and Half Rate (Version 3).
- 3) The network performs an assignment on a TCH channel with MultiRate configuration to the MS.
- 4) The call is maintained during a programmable time without variation of RxLev /RxQual.
- 5) The SS shall send a properly formatted THRESH_REQ message during the call at a programmable time.
- 6) The MS answers with a ACK_OK message within 3 speech frames
- 7) The network initiates the call release.

This test is repeated for M=1, and where the MS supports half rate version 3 M=2.

Maximum Duration of Test

5 minutes

Expected Sequence

Step	Direction	Message	Comments
1	MS		MS is in idle mode
2	MS		MS initiates Mobile Originated call
3	MS->SS	Channel Request	Establishment cause is "originating call and the network does not set the NECI bit to 1".
4	SS->MS	Immediate Assignment	See Default Messages for AMR
5	MS->SS	CM Service Request	CM Service Type = Mobile Originating Call Establishment.
6	SS->MS	AUTHENTICATION REQUEST	
7	MS->SS	AUTHENTICATION RESPONSE	SRES specifies correct value
8	SS->MS	CIPHERING MODE COMMAND	SS starts deciphering after sending the message
9	MS->SS	CIPHERING MODE COMPLETE	Shall be sent enciphered. All following messages shall be sent enciphered.
10	MS->SS	Setup	MS indicates supported speech versions
11	SS->MS	Call Proceeding	
12	SS->MS	Alerting	
13	SS->MS	Assignment Command	See specific message contents.
14	MS->SS	Assignment Complete	
15	SS->MS	Connect	
16	MS->SS	Connect Acknowledge	
17	MS		The TCH shall be through connected by both directions in the dedicated mode, using the codec mode specified.
18	SS->MS	THRESH_REQ	See specific message contents.
19	MS->SS	ACK_OK	Message must be received within 3 speech frames
20	SS->MS	Disconnect	
21	MS->SS	Release	
22	SS->MS	Release Complete	
23	SS->MS	Channel Release	

Specific Message Contents

ASSIGNMENT COMMAND

Information Element	value/remarks
Channel description	M=1: TCH/F M=2: TCH/H
Mode of the first channel - Mode	Full rate or half rate version 3
Multi-Rate configuration	2 codec modes specified

THRESH_REQ

Information Element	value/remarks
HYST3	Not defined (set to all 1s)
THRESH3	Not defined (set to all 1s)
HYST2	Not defined (set to all 1s)
THRESH2	Not defined (set to all 1s)
HYST1	2 dB
THRESH1	12.5 dB

26.16.9.6 Threshold Change (abnormal)

26.16.9.6.1 Conformance requirements

The THRESH_REQ message may be sent by the BTS to change the thresholds in the DL Mode Request Generator.

The ACK_ERR message serves as a negative acknowledgement that a RATSCCH REQ message has been detected, i.e. the RATSCCH pattern was detected, but could not be decoded correctly (CRC error), or its content is not understandable by the addressee.

Reference:

3GPP TS 05.09 sub-clauses: 3.2.2.3.2, 3.2.2.3.6

26.16.9.6.2 Test purpose

This test will verify that an RATSCCH capable MS is able to handle an improperly formatted THRESH_REQ message.

26.16.9.6.3 Method of test**Initial Conditions****System Simulator:**

1 cell with default parameters

Mobile Station:

The MS is in the "idle, updated" state, with a TMSI allocated and camped on cell A.

Specific PICS statements:

- Speech supported for Half rate version 3 (HR AMR).

PIXIT statements:

-.

Foreseen Final State of the MS

Idle Updated, TMSI allocated and camped on cell A.

Test Procedure

- 1) User initiates a Mobile Originated call.
- 2) The network and the MS indicate Bearer capabilities IE with the AMR speech Full Rate and Half Rate (Version 3).
- 3) The network performs an assignment on a TCH channel with MultiRate configuration to the MS.
- 4) The call is maintained during a programmable time without variation of RxLev /RxQual.
- 5) The SS shall send an improperly formatted THRESH_REQ message, with an incorrect CRC, during the call at a programmable time.
- 6) The MS answers with a ACK_ERR message within 3 speech frames
- 7) The network initiates the call release.

This test is repeated for M=1, and where the MS supports half rate version 3 M=2.

Maximum Duration of Test

5 minutes

Expected Sequence

Step	Direction	Message	Comments
1	MS		MS is in idle mode
2	MS		MS initiates Mobile Originated call
3	MS->SS	Channel Request	Establishment cause is "originating call and the network does not set the NECI bit to 1".
4	SS->MS	Immediate Assignment	See Default Messages for AMR
5	MS->SS	CM Service Request	CM Service Type = Mobile Originating Call Establishment.
6	SS->MS	AUTHENTICATION REQUEST	
7	MS->SS	AUTHENTICATION RESPONSE	SRES specifies correct value
8	SS->MS	CIPHERING MODE COMMAND	SS starts deciphering after sending the message
9	MS->SS	CIPHERING MODE COMPLETE	Shall be sent enciphered. All following messages shall be sent enciphered.
10	MS->SS	Setup	MS indicates supported speech versions
11	SS->MS	Call Proceeding	
12	SS->MS	Alerting	
13	SS->MS	Assignment Command	See specific message contents.
14	MS->SS	Assignment Complete	
15	SS->MS	Connect	
16	MS->SS	Connect Acknowledge	
17	MS		The TCH shall be through connected by both directions in the dedicated mode, using the codec mode specified.
18	SS->MS	THRESH_REQ	Message contains an incorrect CRC
19	MS->SS	ACK_ERR	Message must be received within 3 speech frames
20	SS->MS	Disconnect	
21	MS->SS	Release	
22	SS->MS	Release Complete	
23	SS->MS	Channel Release	

Specific Message Contents

ASSIGNMENT COMMAND

Information Element	value/remarks
Channel description	M=1: TCH/F M=2: TCH/H
Mode of the first channel - Mode	Full rate or half rate version 3

THRESH_REQ

Information Element	value/remarks
HYST3	Not defined (set to all 1s)
THRESH3	Not defined (set to all 1s)
HYST2	Not defined (set to all 1s)
THRESH2	Not defined (set to all 1s)
HYST1	2 dB
THRESH1	12.5 dB

26.16.9.7 Unknown RATSCCH REQ Message

26.16.9.7.1 Conformance requirements

The ACK_UNKNOWN message serves as an acknowledgement that a RATSCCH REQ message has been detected and correctly decoded, but was unknown to the Addressee.

Reference:

3GPP TS 05.09 sub-clause: 3.2.2.3.3

26.16.9.7.2 Test purpose

This test will verify that the MS can correctly handle an unknown RATSCCH REQ message.

26.16.9.7.3 Method of test

Initial Conditions

System Simulator:

1 cell with default parameters

Mobile Station:

The MS is in the "idle, updated" state, with a TMSI allocated and camped on cell A.

Specific PICS statements:

- Speech supported for Half rate version 3 (HR AMR).

PIXIT statements:

-.

Foreseen Final State of the MS

Idle Updated, TMSI allocated and camped on cell A.

Test Procedure

- 1) User initiates a Mobile Originated call.
- 2) The network and the MS indicate Bearer capabilities IE with the AMR speech Full Rate and Half Rate (Version 3).
- 3) The network performs an assignment on a TCH channel with MultiRate configuration to the MS.
- 4) The call is maintained during a programmable time without variation of RxLev /RxQual.
- 5) The SS shall send an unknown RATSCCH_REQ message, with message content as all zeros, during the call at a programmable time.
- 6) The MS answers with a ACK_UNKNOWN message within 3 speech frames
- 7) The network initiates the call release.

This test is repeated for M=1, and where the MS supports half rate version 3 M=2.

Maximum Duration of Test

5 minutes

Expected Sequence

Step	Direction	Message	Comments
1	MS		MS is in idle mode
2	MS		MS initiates Mobile Originated call
3	MS->SS	Channel Request	Establishment cause is "originating call and the network does not set the NECI bit to 1".
4	SS->MS	Immediate Assignment	See Default Messages for AMR
5	MS->SS	CM Service Request	CM Service Type = Mobile Originating Call Establishment.
6	SS->MS	AUTHENTICATION REQUEST	
7	MS->SS	AUTHENTICATION RESPONSE	SRES specifies correct value
8	SS->MS	CIPHERING MODE COMMAND	SS starts deciphering after sending the message
9	MS->SS	CIPHERING MODE COMPLETE	Shall be sent enciphered. All following messages shall be sent enciphered.
10	MS->SS	Setup	MS indicates supported speech versions
11	SS->MS	Call Proceeding	
12	SS->MS	Alerting	
13	SS->MS	Assignment Command	See specific message contents.
14	MS->SS	Assignment Complete	
15	SS->MS	Connect	
16	MS->SS	Connect Acknowledge	
17	MS		The TCH shall be through connected by both directions in the dedicated mode, using the codec mode specified.
18	SS->MS	Unknown RATSCCH message	Message contents all 0's
19	MS->SS	ACK_UNKNOWN	Message must be received within 3 speech frames
20	SS->MS	Disconnect	
21	MS->SS	Release	
22	SS->MS	Release Complete	
23	SS->MS	Channel Release	

Specific Message Contents

ASSIGNMENT COMMAND

Information Element	value/remarks
Channel description	M=1: TCH/F M=2: TCH/H
Mode of the first channel - Mode	Full rate or half rate version 3

RATSCCH_REQ

Information Element	value/remarks
all bits	0

26.16.9.8 Ignore subsequent REQ prior to expiry of REQ_Activation counter

26.16.9.8.1 Conformance requirements

If another REQ message is received by the MS before the REQ_Activation counter has elapsed, the MS shall ignore the message.

Reference:

3GPP TS 45.009 sub-clause: 3.2.2.2

26.16.9.8.2 Test purpose

This test will verify that the MS ignores a REQ message which is received before the REQ_Activation counter has elapsed. The test will verify that both the following conditions are satisfied:

- the MS ignores a subsequent REQ message received after it has sent the ACK_OK but before the REQ_Activation counter has elapsed.

26.16.9.8.3 Method of test

Initial Conditions

System Simulator:

1 cell with default parameters

Mobile Station:

The MS is in the "idle, updated" state, with a TMSI allocated and camped on cell A.

Specific PICS statements:

- Speech supported for Half rate version 3 (HR AMR).

PIXIT statements:

-.

Foreseen Final State of the MS

Idle Updated, TMSI allocated and camped on cell A.

Test Procedure

- 1) User initiates a Mobile Originated call.
- 2) The network and the MS indicate Bearer capabilities IE with the AMR speech Full Rate and Half Rate (Version 3).
- 3) The network performs an assignment on a TCH channel with MultiRate configuration to the MS.
- 4) The call is maintained during a programmable time without variation of RxLev /RxQual.
- 5) The SS shall send an AMR_CONFIG_REQ message during the call at a programmable time.
- 6) The MS answers the AMR_CONFIG_REQ with an ACK_OK message within 3 speech frames of the AMR_CONFIG_REQ.
- 7) The SS shall send a second AMR_CONFIG_REQ message within 11 speech frames of sending the first AMR_CONFIG_REQ message .
- 8) The SS shall verify that the codec mode used by the MS after the REQ_Activation counter has elapsed is consistent with the first AMR_CONFIG_REQ message, and not the second AMR_CONFIG_REQ message.
- 9) The SS initiates the call release.

This test is repeated for M=1, and where the MS supports half rate version 3 M=2.

Maximum Duration of Test

5 minutes

Expected Sequence

Step	Direction	Message	Comments
1	MS		MS is in idle mode
2	MS		MS initiates Mobile Originated call
3	MS->SS	Channel Request	Establishment cause is "originating call and the network does not set the NECI bit to 1".
4	SS->MS	Immediate Assignment	See Default Messages for AMR
5	MS->SS	CM Service Request	CM Service Type = Mobile Originating Call Establishment.
6	SS->MS	AUTHENTICATION REQUEST	
7	MS->SS	AUTHENTICATION RESPONSE	SRES specifies correct value
8	SS->MS	CIPHERING MODE COMMAND	SS starts deciphering after sending the message
9	MS->SS	CIPHERING MODE COMPLETE	Shall be sent enciphered. All following messages shall be sent enciphered.
10	MS->SS	Setup	MS indicates supported speech versions
11	SS->MS	Call Proceeding	
12	SS->MS	Alerting	
13	SS->MS	Assignment Command	See specific message contents.
14	MS->SS	Assignment Complete	
15	SS->MS	Connect	
16	MS->SS	Connect Acknowledge	
17	MS		The TCH shall be through connected by both directions in the dedicated mode, using the codec mode specified.
18	SS->MS	AMR_CONFIG_REQ	See specific message contents.
19	MS->SS	ACK_OK	Message must be received within 3 speech frames
20	SS->MS	AMR_CONFIG_REQ	See specific message contents. To be sent to MS within 11 speech frames of having sent the first message in step 18.
21	MS		Verify that the codec mode used by the MS is that specified in step 18.
22	SS->MS	Disconnect	
23	MS->SS	Release	
24	SS->MS	Release Complete	
25	SS->MS	Channel Release	

Specific Message Contents

ASSIGNMENT COMMAND

Information Element	value/remarks
Channel description	M=1: TCH/F M=2: TCH/H
Mode of the first channel - Mode	Full rate or half rate version 3.

AMR_CONFIG_REQ

In step 18:

Information Element	value/remarks
ICM	CODEC_MODE_1
ACS	2 codec modes
HYST2	Not defined (set to all 1s)
THRESH2	Not defined (set to all 1s)
HYST1	2 dB
THRESH1	12.5 dB

In step 20:

Information Element	value/remarks
ICM	CODEC_MODE_1
ACS	1 codec mode – different to any codec mode specified in the ACS in step 15.
HYST2	Not defined (set to all 1s)
THRESH2	Not defined (set to all 1s)
HYST1	Not defined (set to all 1s)
THRESH1	Not defined (set to all 1s)

26.16.9.9 Initiation of Transaction with ACK_ERR or ACK_UNKNOWN

26.16.9.9.1 Conformance requirements

If at either side an ACK_ERR or ACK_UNKNOWN is received although no corresponding REQ has been sent before, the ACK message shall be ignored.

Reference:

3GPP TS 45.009 sub-clause: 3.2.2.2

26.16.9.9.2 Test purpose

This test will verify that the MS ignores any ACK_ERR or ACK_UNKNOWN which is received without a corresponding REQ having been sent.

26.16.9.9.3 Method of test

Initial Conditions

System Simulator:

1 cell with default parameters

Mobile Station:

The MS is in the "idle, updated" state, with a TMSI allocated and camped on cell A.

Specific PICS statements:

- Speech supported for Half rate version 3 (HR AMR).

PIXIT statements:

-.

Foreseen Final State of the MS

Idle Updated, TMSI allocated and camped on cell A.

Test Procedure

- 1) User initiates a Mobile Originated call.
- 2) The network and the MS indicate Bearer capabilities IE with the AMR speech Full Rate and Half Rate (Version 3).
- 3) The network performs an assignment on a TCH channel with MultiRate configuration to the MS.
- 4) The call is maintained during a programmable time without variation of RxLev /RxQual.
- 5) The SS shall send an ACK_ERR message during the call at a programmable time.
- 6) The SS verifies that no message is received from the MS on the RATSCCH within 12 speech frames.
- 7) The SS shall send an ACK_UNKNOWN message during the call at a programmable time.

- 8) The SS verifies that no message is received from the MS on the RATSCCH within 12 speech frames.
 9) The network initiates the call release.

This test is repeated for M=1, and where the MS supports half rate version 3 M=2.

Maximum Duration of Test

5 minutes

Expected Sequence

Step	Direction	Message	Comments
1	MS		MS is in idle mode
2	MS		MS initiates Mobile Originated call
3	MS->SS	Channel Request	Establishment cause is "originating call and the network does not set the NECI bit to 1".
4	SS->MS	Immediate Assignment	See Default Messages for AMR
5	MS->SS	CM Service Request	CM Service Type = Mobile Originating Call Establishment.
6	SS->MS	AUTHENTICATION REQUEST	
7	MS->SS	AUTHENTICATION RESPONSE	SRES specifies correct value
8	SS->MS	CIPHERING MODE COMMAND	SS starts deciphering after sending the message
9	MS->SS	CIPHERING MODE COMPLETE	Shall be sent enciphered. All following messages shall be sent enciphered.
10	MS->SS	Setup	MS indicates supported speech versions
11	SS->MS	Call Proceeding	
12	SS->MS	Alerting	
13	SS->MS	Assignment Command	See specific message contents for codec modes.
14	MS->SS	Assignment Complete	
15	SS->MS	Connect	
16	MS->SS	Connect Acknowledge	
17	MS		The TCH shall be through connected by both directions in the dedicated mode, using the codec mode specified.
18	SS->MS	ACK_ERR	
19	MS		Wait at least 12 speech frames to ensure that no message is received from the MS.
20	SS->MS	ACK_UNKNOWN	
21	MS		Wait at least 12 speech frames to ensure that no message is received from the MS.
22	SS->MS	Disconnect	
23	MS->SS	Release	
24	SS->MS	Release Complete	
25	SS->MS	Channel Release	

Specific Message Contents

ASSIGNMENT COMMAND

Information Element	value/remarks
Channel description	M=1: TCH/F M=2: TCH/H
Mode of the first channel - Mode	Full rate or half rate version 3

26.16.9.10 Inversion of the Phase of the CMR/CMI

26.16.9.10.1 Conformance requirements

The phase of the Codec Mode Indication in the downlink can be changed during a call by using a CMI_PHASE_REQ message sent on the RATSCCH.

The CMI_PHASE_REQ message may be sent by the BTS during a call to change the phase of the Codec Mode Indication in the downlink without interruption of the speech transmission.

The ACK_OK message serves as an acknowledgement that a RATSCCH REQ message has been detected, correctly decoded (no CRC error) and that it is defined for the Addressee.

References:

3GPP TS 05.09 clauses 3.2.1.3 and 3.2.2.3.4.

26.16.9.10.2 Test purpose

This test shall verify that the MS is able to change the phase of the Codec Mode Indication in the downlink using the RATSCCH protocol.

26.16.9.10.3 Method of test

Initial Conditions

System Simulator:

1 cell with default parameters

Mobile Station:

The MS is in the "idle, updated" state, with a TMSI allocated and camped on cell A.

Specific PICS statements:

- Speech supported for Half rate version 3 (HR AMR).

PIXIT statements:

-.

Foreseen Final State of the MS

Idle Updated, TMSI allocated and camped on cell A.

Test Procedure

- 1) User initiates a Mobile Originated call.
- 2) The network and the MS indicate Bearer capabilities IE with the AMR speech Full Rate and Half Rate (Version 3).
- 3) The network performs an assignment on a TCH channel with MultiRate configuration to the MS.
- 4) The network shall indicate Codec Mode Command = 0 and Codec Mode Indication = 1.
- 5) The SS sends a series of CMI_PHASE_REQ messages during the call to change the phase of the Codec Mode Indication in the downlink.
- 6) The MS responds to each CMI_PHASE_REQ message with an ACK_OK message on the RATSCCH.
- 7) The SS shall ensure that the phase request has been handled correctly by checking the Uplink CMI = 0 for 20 speech frames following the receipt of the ACK_OK.
- 8) The network initiates the call release.

This test is repeated for M=1, and where the MS supports half rate version 3 M=2.

Maximum Duration of Test

5 minutes

Expected Sequence

Step	Direction	Message	Comments
1	MS		MS is in idle mode
2	MS		MS initiates Mobile Originated call
3	MS->SS	Channel Request	Establishment cause is "originating call and the network does not set the NECI bit to 1".
4	SS->MS	Immediate Assignment	See Default Messages for AMR
5	MS->SS	CM Service Request	CM Service Type = Mobile Originating Call Establishment.
6	SS->MS	AUTHENTICATION REQUEST	
7	MS->SS	AUTHENTICATION RESPONSE	SRES specifies correct value
8	SS->MS	CIPHERING MODE COMMAND	SS starts deciphering after sending the message
9	MS->SS	CIPHERING MODE COMPLETE	Shall be sent enciphered. All following messages shall be sent enciphered.
10	SS->MS	Setup	AMR speech
11	MS->SS	Call Proceeding	
12	MS->SS	Alerting	
13	SS->MS	Assignment Command	Multirate Configuration for 2 codec modes
14	MS->SS	Assignment Complete	
15	SS->MS	Connect	
16	MS->SS	Connect Acknowledge	
17	MS		The TCH shall be through connected by both directions in the dedicated mode, using the codec mode specified.
18	SS->MS	CMI_PHASE_REQ	See specific message contents
19	MS->SS	ACK_OK	
20	MS		Wait 20 speech frames, then check that UL CMI = 0
21	SS->MS	CMI_PHASE_REQ	See specific message contents
22	MS->SS	ACK_OK	
23	MS		Wait 20 speech frames, then check that UL CMI = 0
24	SS->MS	CMI_PHASE_REQ	See specific message contents
25	MS->SS	ACK_OK	
26	MS		Wait 20 speech frames, then check that UL CMI = 0
27	SS->MS	CMI_PHASE_REQ	See specific message contents
28	MS->SS	ACK_OK	
29	MS		Wait 20 speech frames, then check that UL CMI = 0
30	SS->MS	Disconnect	
31	MS->SS	Release	
32	SS->MS	Release Complete	
33	SS->MS	Channel Release	

Specific Message Contents

ASSIGNMENT COMMAND

Information Element	value/remarks
Channel description	M=1: TCH/F M=2: TCH/H
Mode of the first channel - Mode	Full rate or half rate version 3.

In step 18:

CMI_PHASE_REQ

Information Element	value/remark
CMIP	0: CMI transmitted in even speech frames

This message should be sent in a RATSCCH frame where the RATSCCH frame (or RATSCCH_DATA part for AHS) replaces a speech frame which would have carried a Codec Mode Command.

In step 21:

CMI_PHASE_REQ

Information Element	value/remark
CMIP	1: CMI transmitted in odd speech frames (back to default)

This message should be sent in a RATSCCH frame where the RATSCCH frame (or RATSCCH_DATA part for AHS) replaces a speech frame which would have carried a Codec Mode Command.

In step 24:

CMI_PHASE_REQ

Information Element	value/remark
CMIP	0: CMI transmitted in even speech frames

This message should be sent in a RATSCCH frame where the RATSCCH frame (or RATSCCH_DATA part for AHS) replaces a speech frame which would have carried a Codec Mode Indication.

In step 27:

CMI_PHASE_REQ

Information Element	value/remark
CMIP	1: CMI transmitted in odd speech frames (back to default)

This message should be sent in a RATSCCH frame where the RATSCCH frame (or RATSCCH_DATA part for AHS) replaces a speech frame which would have carried a Codec Mode Indication.

26.16.9.11 Change of Active Codec Set

26.16.9.11.1 Conformance requirements

AMR codec mode adaptation is done within a set of 4 codec modes. The codec mode set (Active Codec Set) to be used by the BSS and the MS is defined during call setup and/or handover by layer 3 signalling. The ACS can be changed during a call using an AMR_CONFIG_REQ message sent on the RATSCCH.

The AMR_CONFIG_REQ message may be sent by the BTS during a call to change the AMR configuration on the radio interface without interruption of the speech transmission.

The ACK_OK message serves as an acknowledgement that a RATSCCH REQ message has been detected, correctly decoded (no CRC error) and that it is defined for the Addressee.

If the ACS consists of four modes, then the complete set of thresholds/hysteresis can not be sent with this message. In that case, all THRESH_j and HYST_j fields are reserved for future use and shall be set to "1". Similar, if the BTS has no threshold and hysteresis parameters for the given configuration, then all THRESH_j and HYST_j field bits shall be set to "1" to indicate that they are undefined. The THRESH_REQ message shall be used to transmit these parameters at a later point in time. As long as the MS has no defined threshold and hysteresis parameters it shall use the Initial Codec Mode for the Codec Mode Request.

References:

3GPP TS 05.09 clauses 3.2.2.3.5 and 3.4.

26.16.9.11.2 Test purpose

This test shall verify that the MS is able to change its Active Codec Set using the RATSCCH protocol, with change of thresholds, and with non-specification of thresholds.

26.16.9.11.3 Method of test

Initial Conditions

System Simulator:

1 cell with default parameters

Mobile Station:

The MS is in the "idle, updated" state, with a TMSI allocated and camped on cell A.

Specific PICS statements:

- Speech supported for Half rate version 3 (HR AMR).

PIXIT statements:

-.

Foreseen Final State of the MS

Idle Updated, TMSI allocated and camped on cell A.

Test Procedure

- 1) User initiates a Mobile Originated call.
- 2) The network and the MS indicate Bearer capabilities IE with the AMR speech Full Rate and Half Rate (Version 3).
- 3) The network performs an assignment on a TCH channel with MultiRate configuration to the MS.
- 4) The SS uses the codec with the highest bit-rate in the current ACS for the Codec Mode Indication, and that with the lowest bit-rate for the Codec Mode Command.
- 5) The SS sends an AMR_CONFIG_REQ message during the call to reconfigure the Multirate settings.
- 6) The MS responds to each AMR_CONFIG_REQ message with an ACK_OK message on the RATSCCH.
- 7) The SS shall ensure that the change occurs correctly for downlink (12 speech frames after AMR_CONFIG_REQ message was sent), and for uplink (12 speech frames after ACK_OK was received) by checking parity of received speech frames, and correct implementation of Uplink Codec mode Request.
- 8) The SS shall ensure that each of the codecs in the ACS have been implemented correctly by setting the CMC to each of the applicable modes, and ensuring that the UL frames with each CMI are received without parity error. The SS shall then set the CMI and CMC to the codec with highest and lowest bit rates respectively.
- 9) Steps 4 to 8 shall be repeated for differing AMR_CONFIG_REQ parameters and sending conditions.
- 10) The network initiates the call release.

This test is repeated for M=1, and where the MS supports half rate version 3 M=2.

Maximum Duration of Test

5 minutes

Expected Sequence

Step	Direction	Message	Comments
1	MS		MS is in idle mode
2	MS		MS initiates Mobile Originated call
3	MS->SS	Channel Request	Establishment cause is "originating call and the network does not set the NECI bit to 1".
4	SS->MS	Immediate Assignment	See Default Messages for AMR
5	MS->SS	CM Service Request	CM Service Type = Mobile Originating Call Establishment.
6	SS->MS	AUTHENTICATION REQUEST	
7	MS->SS	AUTHENTICATION RESPONSE	SRES specifies correct value
8	SS->MS	CIPHERING MODE COMMAND	SS starts deciphering after sending the message
9	MS->SS	CIPHERING MODE COMPLETE	Shall be sent enciphered. All following messages shall be sent enciphered.
10	MS->SS	Setup	AMR speech
11	SS->MS	Call Proceeding	
12	SS->MS	Alerting	
13	SS->MS	Assignment Command	Multirate Configuration for 2 codec modes
14	MS->SS	Assignment Complete	
15	SS->MS	Connect	
16	MS->SS	Connect Acknowledge	
17	MS		The TCH shall be through connected by both directions in the dedicated mode, using the codec mode specified.
18	SS->MS	AMR_CONFIG_REQ	See specific message contents.
19	MS->SS	ACK_OK	
20	MS		Check that ACS changes have been implemented correctly. Expected CMR = 0.
21	SS->MS	AMR_CONFIG_REQ	See specific message contents.
22	MS->SS	ACK_OK	
23	MS		Check that ACS changes have been implemented correctly. Expected CMR = 0 or 1.
24	SS->MS	AMR_CONFIG_REQ	See specific message contents.
25	MS->SS	ACK_OK	
26	MS		Check that ACS changes have been implemented correctly. Expected CMR = 0, 1 or 2.
27	SS->MS	AMR_CONFIG_REQ	See specific message contents.
28	MS->SS	ACK_OK	
29	MS		Check that ACS changes have been implemented correctly. Expected CMR = 0, 1, 2 or 3.
30	SS->MS	AMR_CONFIG_REQ	See specific message contents.
31	MS->SS	ACK_OK	
32	MS		Check that ACS changes have been implemented correctly. Expected CMR = 2 (special case where CMR = ICM).
33	SS->MS	Disconnect	
34	MS->SS	Release	
35	SS->MS	Release Complete	
36	SS->MS	Channel Release	

Specific Message Contents

In all cases, the Active Codec Set field of the AMR_CONFIG_REQ messages should be programmed to ensure that the codec rate changes when the new configuration takes effect.

ASSIGNMENT COMMAND

Information Element	value/remarks
Channel description	M=1: TCH/F M=2: TCH/H
Mode of the first channel - Mode Multi-Rate configuration	Full rate or half rate version 3. Arbitrary set of codec modes, thresholds and hysteresis specified according to 3GPP TS 05.09 / 45.009

In step 18:

AMR_CONFIG_REQ

Information Element	value/remark
ICM	CODEC_MODE_1
ACS	1 codec mode (different from that in Assignment Command)
HYST2	n/a – set to all 1's
THRESH2	n/a – set to all 1's
HYST1	n/a – set to all 1's
THRESH1	n/a – set to all 1's

This message should be sent in a RATSCCH frame where the RATSCCH frame (or RATSCCH_DATA part for AHS) replaces a speech frame which would have carried a Codec Mode Command.

In step 21:

AMR_CONFIG_REQ

Information Element	value/remark
ICM	CODEC_MODE_1
ACS	2 codec modes
HYST2	n/a – set to all 1's
THRESH2	n/a – set to all 1's
HYST1	2 dB
THRESH1	12.5 dB

This message should be sent in a RATSCCH frame where the RATSCCH frame (or RATSCCH_DATA part for AHS) replaces a speech frame which would have carried a Codec Mode Command.

In step 24:

AMR_CONFIG_REQ

Information Element	value/remark
ICM	CODEC_MODE_2
ACS	3 codec modes
HYST2	2 dB
THRESH2	13 dB
HYST1	2 dB
THRESH1	7 dB

This message should be sent in a RATSCCH frame where the RATSCCH frame (or RATSCCH_DATA part for AHS) replaces a speech frame which would have carried a Codec Mode Indication.

In step 27:

AMR_CONFIG_REQ

Information Element	value/remark
ICM	CODEC_MODE_3
ACS	4 codec modes
HYSTc	2 dB
THRESH3	18 dB
THRESH2	12 dB
THRESH1	6.5 dB

This message should be sent in a RATSCCH frame where the RATSCCH frame (or RATSCCH_DATA part for AHS) replaces a speech frame which would have carried a Codec Mode Indication.

In step 30:

AMR_CONFIG_REQ

Information Element	value/remark
ICM	CODEC_MODE_3
ACS	4 codec modes
HYST2	Undefined – set to all 1's
THRESH2	Undefined – set to all 1's
HYST1	Undefined – set to all 1's
THRESH1	Undefined – set to all 1's

This message should be sent in a RATSCCH frame where the RATSCCH frame (or RATSCCH_DATA part for AHS) replaces a speech frame which would have carried a Codec Mode Command.

26.16.9.12 Void

26.16.10 AMR signalling/ test of the channel mode modify procedure

NOTE: This test is derived from the test in sub-clause 26.12.1 entitled "EFR signalling / Test of the channel mode modify procedure".

26.16.10.1 AMR signalling/ test of the channel mode modify procedure/ full rate

26.16.10.1.1 Conformance requirement

The MS with a TCH/F allocated acknowledges a CHANNEL MODE MODIFY message by sending a CHANNEL MODE MODIFY ACKNOWLEDGE message specifying the new mode and by switching to this mode.

References

3GPP TS 04.08 / 3GPP TS 44.018, subclauses 3.4.6.1.1 and 3.4.6.1.2

26.16.10.1.2 Test purpose

To verify that the MS with a TCH/F allocated acknowledges a CHANNEL MODE MODIFY message by sending a CHANNEL MODE MODIFY ACKNOWLEDGE message specifying the new mode and by switching to this mode.

26.16.10.1.3 Method of test

Initial Conditions

System Simulator: 1 cell, default parameters.

Mobile Station: The MS is "idle updated", with TMSI allocated.

Specific PICS statements:

-.

PIXIT statements:

-.

Foreseen Final State of the MS

"Idle, updated", with TMSI allocated.

Test procedure

A Mobile Terminated call is initiated, however following the CHANNEL REQUEST received from the Mobile Station, the SS sends an IMMEDIATE ASSIGNMENT to the MS commanding it to go to a TCH/F. This sets the Channel Mode automatically to "Signalling Only".

The SS then sends a series of CHANNEL MODE MODIFY messages to the MS. Each time it is checked that the MS responds with a CHANNEL MODE MODIFY ACKNOWLEDGE message specifying the channel mode that has been specified in the CHANNEL MODE MODIFY message

Maximum Duration of Test

30 seconds.

Expected Sequence

Step	Direction	Message	Comments
1	SS->MS	PAGING REQUEST TYPE 1	Sent on correct paging subchannel
2	MS->SS	CHANNEL REQUEST	Establishment cause indicates "answer to paging"
3	SS->MS	IMMEDIATE ASSIGNMENT	Assignment to a non hopping TCH/F signalling only
4	MS->SS	PAGING RESPONSE	Message is contained in the SABM
5	SS->MS	AUTHENTICATION REQUEST	
6	MS->SS	AUTHENTICATION RESPONSE	SRES specifies correct value
7	SS->MS	CIPHERING MODE COMMAND	SS starts deciphering after sending the message
8	MS->SS	CIPHERING MODE COMPLETE	Shall be sent enciphered. All following messages shall be sent enciphered.
9	SS		SS starts ciphering
10	SS->MS	CHANNEL MODE MODIFY	
11	MS->SS	CHANNEL MODE MODIFY ACKNOWLEDGE	Verify that Channel description = TCH/F, Channel mode = speech full or half rate version 3
12	SS->MS	CHANNEL MODE MODIFY	
13	MS->SS	CHANNEL MODE MODIFY ACKNOWLEDGE	Verify that Channel description = TCH/F, Channel mode = speech full or half rate version 3
14	SS->MS	CHANNEL MODE MODIFY	
15	MS->SS	CHANNEL MODE MODIFY ACKNOWLEDGE	Verify that Channel description = TCH/F, Channel mode = speech full or half rate version 3
16	SS->MS	CHANNEL MODE MODIFY	
17	MS->SS	CHANNEL MODE MODIFY ACKNOWLEDGE	Verify that Channel description = TCH/F, Channel mode = speech full or half rate version 3
18	SS->MS	CHANNEL RELEASE	

Specific Message Contents

In steps 10 – 16:

CHANNEL MODE MODIFY

Information Element	value/remark
Channel description	in steps 10, 12, 14, 16: same as for step 3
Channel mode	speech full or half rate version 3
Mode	
Multi-Rate configuration	in steps 10: change of MR configuration, no initial codec mode in steps 12: change of MR configuration, initial codec mode specified in steps 14: change of MR thresholds, no initial codec mode in steps 16: initial codec mode specified

26.16.10.2 AMR signalling/ test of the channel mode modify procedure/ half rate

26.16.10.2.1 Conformance requirement

The MS with a TCH/H allocated acknowledges a CHANNEL MODE MODIFY message by sending a CHANNEL MODE MODIFY ACKNOWLEDGE message specifying the new mode and by switching to this mode.

References

3GPP TS 04.08 / 3GPP TS 44.018, subclauses 3.4.6.1.1 and 3.4.6.1.2

26.16.10.2.2 Test purpose

To verify that the MS with a TCH/H allocated acknowledges a CHANNEL MODE MODIFY message by sending a CHANNEL MODE MODIFY ACKNOWLEDGE message specifying the new mode and by switching to this mode.

26.16.10.2.3 Method of test

Initial Conditions

System Simulator: 1 cell, default parameters.

Mobile Station: The MS is "idle updated", with TMSI allocated.

Specific PICS statements:

-.

PIXIT statements:

-.

Foreseen Final State of the MS

"Idle, updated", with TMSI allocated.

Test procedure

A Mobile Terminated call is initiated, however following the CHANNEL REQUEST received from the Mobile Station, the SS sends an IMMEDIATE ASSIGNMENT to the MS commanding it to go to a TCH/H. This sets the Channel Mode automatically to "Signalling Only".

The SS then sends a series of CHANNEL MODE MODIFY messages to the MS. Each time it is checked that the MS responds with a CHANNEL MODE MODIFY ACKNOWLEDGE message specifying the channel mode that has been specified in the CHANNEL MODE MODIFY message

Maximum Duration of Test

30 seconds.

Expected Sequence

Step	Direction	Message	Comments
1	SS->MS	PAGING REQUEST TYPE 1	Sent on correct paging subchannel
2	MS->SS	CHANNEL REQUEST	Establishment cause indicates "answer to paging"
3	SS->MS	IMMEDIATE ASSIGNMENT	Assignment to a non hopping TCH/H signalling only
4	MS->SS	PAGING RESPONSE	Message is contained in the SABM
5	SS->MS	AUTHENTICATION REQUEST	
6	MS->SS	AUTHENTICATION RESPONSE	SRES specifies correct value
7	SS->MS	CIPHERING MODE COMMAND	SS starts deciphering after sending the message
8	MS->SS	CIPHERING MODE COMPLETE	Shall be sent enciphered. All following messages shall be sent enciphered.
9	SS		SS starts ciphering
10	SS->MS	CHANNEL MODE MODIFY	
11	MS->SS	CHANNEL MODE MODIFY ACKNOWLEDGE	Verify that Channel description = TCH/H, Channel mode = speech full or half rate version 3
12	SS->MS	CHANNEL MODE MODIFY	
13	MS->SS	CHANNEL MODE MODIFY ACKNOWLEDGE	Verify that Channel description = TCH/H, Channel mode = speech full or half rate version 3
14	SS->MS	CHANNEL MODE MODIFY	
15	MS->SS	CHANNEL MODE MODIFY ACKNOWLEDGE	Verify that Channel description = TCH/H, Channel mode = speech full or half rate version 3
16	SS->MS	CHANNEL MODE MODIFY	
17	MS->SS	CHANNEL MODE MODIFY ACKNOWLEDGE	Verify that Channel description = TCH/H, Channel mode = speech full or half rate version 3
18	SS->MS	CHANNEL RELEASE	

Specific Message Contents

In steps 10 – 16:

CHANNEL MODE MODIFY

Information Element	value/remark
Channel description	in steps 10, 12, 14, 16: same as for step 3
Channel mode	
Mode	speech full or half rate version 3
Multi-Rate configuration	in steps 10: change of MR configuration, no initial codec mode
	in steps 12: change of MR configuration, initial codec mode specified
	in steps 14: change of MR thresholds, no initial codec mode
	in steps 16: initial codec mode specified

26.16.11 Handover / layer 1 failure

Note: This test is derived from 26.6.5.9 Handover / layer 1 failure.

26.16.11.1 Conformance requirements

The MS shall return to the old channel in the case of a handover failure caused by a layer 1 failure on the target cell. On the old channel the MS shall use the AMR Parameters that it was previously using on that channel.

References

3GPP TS 04.08 / 3GPP TS 44.018 section 3.4.4.

26.16.11.2 Test purpose

To verify the contents in the message HANDOVER FAILURE .

To verify the mobile returns to the correct channel configuration prior to handover following the handover failure.

26.16.11.3 Method of test

Initial Conditions

System Simulator:

2 cells with same LAI, default parameters.

Mobile Station:

The MS is in the active state (U10) of a call (on cell A). Used power level is the maximum supported by the MS.

Specific PICS statements:

- Speech supported for Half rate version 3 (HR AMR).
- Speech supported for Full rate version 2 (GSM EFR)
- Speech supported for Half rate version 1 (GSM HR)

PIXIT statements:

..

Foreseen Final State of the MS

The active state (U10) of a mobile call (on cell A). Used power level is the maximum supported by the MS.

Test Procedure

The MS is in the active state (U10) of a call on cell A. The SS sends a HANDOVER COMMAND on the main DCCH. The MS shall begin to send access bursts at the commanded power level on the new DCCH (and optionally on the SACCH) to cell B. With the exception of normal BCCH signalling, the SS does not transmit anything on cell B (thus causing a time-out of T3124). The MS shall re-establish the old link on cell A and send a HANDOVER FAILURE within 3 seconds from the transmission of HANDOVER COMMAND.

Maximum Duration of Test

10 minutes

Expected Sequence

This test is repeated for M=1, M=2 (only if MS supports half rate version 3), M=3, M=4, M=5 (only if MS supports half rate version 3), M=6 (only if MS supports half rate version 3), M=7 (only if MS supports full rate version 2), M=8 (only if MS supports half rate version 1).

This test is repeated for K=1, K=2 (only if MS supports half rate version 3).

Step	Direction	Message	Comments
1	SS	-	The MS and SS are in the active state of a call on a Multirate channel (full rate version 3 where K=1 or half rate version 3 where K=2).
2	SS -> MS	HANDOVER COMMAND	Channel description: non-hopping. Synchronization Indication: non synchronized.
3	MS -> SS	HANDOVER ACCESS	Several messages are sent, all with correct Handover References.
4	MS -> SS	HANDOVER FAILURE	Sent on old channel, RR cause value = "Abnormal release, unspecified", "Abnormal release, channel unacceptable", "Abnormal release, timer expired", "Abnormal release, no activity on the radio path" or "Protocol error unspecified". Shall be sent within 3 seconds from the transmission of HANDOVER COMMAND.
5	MS	-	The SS checks that the codec mode used by the MS is the same as in step 1.

Specific Message Contents

M=1

HANDOVER COMMAND

Information Element	value/remark
Channel description	TCH/F
Channel mode	
Mode	Speech full or half rate version 3
Multi-Rate configuration	Not specified

M=2

This sequence shall not be performed when $K = 1$. This step is applicable only if the MS supports half rate version 3.

HANDOVER COMMAND

Information Element	value/remark
Channel description	TCH/H
Channel mode	
Mode	Speech full or half rate version 3
Multi-Rate configuration	Not specified

M=3

HANDOVER COMMAND

Information Element	value/remark
Channel description	TCH/F
Channel mode	
Mode	Speech full or half rate version 3
Multi-Rate configuration	ICMI = 0 Arbitrary set of codec modes, thresholds and hysteresis specified according to 3GPP TS 05.09 / 45.009

M=4

HANDOVER COMMAND

Information Element	value/remark
Channel description	TCH/F
Channel mode	
Mode	Speech full or half rate version 3
Multi-Rate configuration	ICMI = 1 Arbitrary set of codec modes, thresholds and hysteresis specified according to 3GPP TS 05.09 / 45.009

M=5

This step is applicable only if the MS supports half rate version 3.

HANDOVER COMMAND

Information Element	value/remark
Channel description	TCH/H
Channel mode	
Mode	Speech full or half rate version 3
Multi-Rate configuration	ICMI = 0 Arbitrary set of codec modes, thresholds and hysteresis specified according to 3GPP TS 05.09 / 45.009

M=6

This step is applicable only if the MS supports half rate version 3.

HANDOVER COMMAND

Information Element	value/remark
Channel description Channel mode Mode Multi-Rate configuration	TCH/H Speech full or half rate version 3 ICMI = 1 Arbitrary set of codec modes, thresholds and hysteresis specified according to 3GPP TS 05.09 / 45.009

M=7

This step is applicable only if the MS supports full rate version 2.

HANDOVER COMMAND

Information Element	value/remark
Channel description Channel mode Mode	TCH/F Speech full or half rate version 2

M=8

This step is applicable only if the MS supports half rate version 1.

HANDOVER COMMAND

Information Element	value/remark
Channel description Channel mode Mode	TCH/H Speech full or half rate version 1

K=1

ASSIGNMENT COMMAND

Information Element	value/remark
Channel description Channel mode Mode Multi-Rate configuration	TCH/F Speech full or half rate version 3 Arbitrary set of codec modes, thresholds and hysteresis specified according to 3GPP TS 05.09 / 45.009

K=2

This step is applicable only if the MS supports half rate version 3.

ASSIGNMENT COMMAND

Information Element	value/remark
Channel description Channel mode Mode Multi-Rate configuration	TCH/H Speech full or half rate version 3 Arbitrary set of codec modes, thresholds and hysteresis specified according to 3GPP TS 05.09 / 45.009

26.17 Adaptive Multi Rate Signalling – 8PSK

26.17.1 Void

26.17.2 Inband Signalling, Uplink Codec Adaptation

26.17.2.1 Conformance Requirement

The MS shall after reception of a Codec Mode Command apply the corresponding codec mode in the uplink direction for the next possible speech frame and no more than three speech frames later.

NOTE: This test is not intended to verify these conformance requirements, but to verify the correctness of the involved layer 1 and layer 3 signalling.

References:

3GPP TS 45.009 subclauses 3.3 and 3.4.

26.17.2.2 Test Purpose

This test is concerned with the link adaptation for AMR uplink and the related inband signalling. The test shall verify that the MS in the uplink direction applies the codec mode indicated by the network transmitted Codec Mode Commands, and that the MS correctly signals the used codec as Codec Mode Indication in the uplink inband signalling.

NOTE: The inband signals are L1 signalling transmitted every speech frame, as defined in 3GPP TS 45.009: In uplink directions Codec Mode Requests and Codec Mode Indications are transmitted alternately, whereas downlink signalling contains of alternately Codec Mode Commands and Codec Mode Indications.

26.17.2.3 Method of Test

Initial Conditions

The MS is "idle updated", with TMSI allocated.

Specific PICS statements:

-

PIXIT statements:

-

Foreseen Final State of MS

"Idle, updated", with TMSI allocated.

Test Procedure

- a) A mobile originated call is initiated, following the CHANNEL REQUEST received from the MS the SS sends an IMMEDIATE ASSIGNMENT to the MS commanding it to go to a SDCCH. The MS indicates to the SS that it supports the multi-rate speech codec. The SS allocates the MS a O-TCH/AHS and signals the allowed codec subset and adaptation thresholds as part of the ASSIGNMENT COMMAND. DTX shall not be activated. Hopping is activated. The hopping band is centred around an ARFCN in the Mid ARFCN range. The hopping frequencies are chosen from those defined in clause 6.

The following active codec mode subset shall apply:

Codec Mode	O-TCH/AHS in kbit/s
CODEC_MODE_1	4,75
CODEC_MODE_2	5,9
CODEC_MODE_3	7,95
CODEC_MODE_4	12,2

The following decision threshold and hysteresis values in terms of normalized carrier to interference ratio (C/I_{norm}), shall apply for Codec Mode Command / Request (MC', MR'):

MC'/MR'	THR_MC_Dn(MC')/ THR_MR_Dn(MR')	THR_MC_Up(MC')/ THR_MR_Up(MR')
CODEC_MODE_4	16,5 dB	+ ∞
CODEC_MODE_3	11,5 dB	18,5 dB
CODEC_MODE_2	6,5 dB	13,5 dB
CODEC_MODE_1	- ∞	8,5 dB

- b) The SS signals that a new codec is wanted in uplink direction by changing the value of the Codec Mode Command. The MS shall apply the commanded mode in uplink by changing the mode and correspondingly the value of the Codec Mode Indication to match the used codec. This is repeated for all neighbouring mode transitions in the Active Codec Set.

Maximum Duration of Test

2 minutes

Expected Sequence in step b)

Step	Direction	Message	Comments
1	SS->MS	Codec Mode Command change	Codec Mode 3 is commanded by inband signalling
2	MS->SS	Codec Mode Indication change	Codec Mode Indication shows current active mode in uplink, thus changed when mode changes
3	SS->MS	Codec Mode Command change	Codec Mode 2 is commanded by inband signalling
4	MS->SS	Codec Mode Indication change	Codec Mode 2 is indicated in inband signalling with first frame using Codec Mode 2
5	SS->MS	Codec Mode Command change	Codec Mode 1 is commanded by changing inband signal
6	MS->SS	Codec Mode Indication change	Codec Mode 1 is indicated in inband signalling with first frame using Codec Mode 1.
7	SS->MS	Codec Mode Command change	Codec Mode 2 is commanded by changing inband signal
8	MS->SS	Codec Mode Indication change	Codec Mode 2 is indicated in inband signalling with first frame using Codec Mode 2.
9	SS->MS	Codec Mode Command change	Codec Mode 3 is commanded by changing inband signal
10	MS->SS	Codec Mode Indication change	Codec Mode 3 is indicated in inband signalling with first frame using Codec Mode 3.
11	SS->MS	Codec Mode Command change	Codec Mode 4 is commanded by changing inband signal
12	MS->SS	Codec Mode Indication change	Codec Mode 4 is indicated in inband signalling with first frame using Codec Mode 4

Specific Message Contents

ASSIGNMENT COMMAND

Information Element	Value/remark
Assignment Command	In step a) of Test Procedure: codec mode 4 selected (ref: 3GPP TS 44.018 subclause 9.1.2)

Codec mode commands, downlink inband signalling

Information Element	Value/remark
Channel Mode to be used for uplink	In step a) of Test Procedure: Codec Mode 4 commanded In step 1-2: Codec Mode 3 commanded In step 3-4: Codec Mode 2 commanded In step 5-6: Codec Mode 1 commanded In step 7-8: Codec Mode 2 commanded In step 9-10: Codec Mode 3 commanded In step 11-12: Codec Mode 4 commanded

Codec mode indications, uplink inband signalling

Information Element	Value/remark
Indicating Codec Mode currently used uplink	In step a) of Test Procedure: Codec Mode 4 indicated In step 1: Codec Mode 4 indicated In step 2-3: Codec Mode 3 indicated In step 4-5: Codec Mode 2 indicated In step 6-7: Codec Mode 1 indicated In step 8-9: Codec Mode 2 indicated In step 10-11: Codec Mode 3 indicated In step 12: Codec Mode 4 indicated

26.17.3 8-PSK AMR HR / Structured procedures / MS terminated call / early assignment / no initial codec mode

NOTE: this test is derived from the one described in subclause 26.16 and entitled: "Structured procedures / MS terminated call / early assignment / no initial codec mode"

26.17.3.1 Conformance requirement

- 1) In acceptance to a SETUP message indicating speech, the MS shall indicate and include in the CALL CONFIRMED message all the speech versions that it supports.
- 2) Upon receipt of the ASSIGNMENT COMMAND message specifying using CHx/HR the Mobile Station continues a mobile terminating call establishment with early assignment of traffic channel:
 - a) by replying to the ASSIGNMENT command with an ASSIGNMENT COMPLETE message; and
 - b) by continuing the call establishment by through connecting TCH in both directions if it supports immediate connect or by sending an ALERTING message otherwise.
- 3) The ASSIGNMENT command will not specify which of the codec modes the MS should use, but allow the handset to select the default codec mode.
- 4) For speech calls, the mobile station shall attach the user connection at latest when sending the connect message, except if there is no compatible radio resource available at this time. In this case the attachment shall be delayed until such a resource becomes available.

CHx: identifies any of the Channel Codec mode.

HR: half rate channel.

References:

3GPP TS 44.018 subclauses 9.1.2 and 9.1.5.

3GPP TS 45.009 subclause 3.4.

26.17.3.2 Test purpose

- 1) To verify that, in acceptance to a SETUP message indicating speech, the MS indicates and includes in the CALL CONFIRMED message all the speech versions that it supports.
- 2) To verify that upon receipt of the ASSIGNMENT COMMAND message specifying using CHx/HR the Mobile Station continues a mobile terminating call establishment with early assignment of traffic channel:
 - a) by replying to the ASSIGNMENT COMMAND with an ASSIGNMENT COMPLETE message; and
 - b) by continuing the call establishment by through connecting TCH in both directions if it supports immediate connect or by sending an ALERTING message otherwise.
- 3) To verify that upon receipt of an ASSIGNMENT COMMAND with no codec mode specified, the MS shall use the default codec mode.

- 4) To verify that for speech calls, the mobile station shall attach the user connection at latest when sending the connect message, except if there is no compatible radio resource available at this time. In this case the attachment shall be delayed until such a resource becomes available.

26.17.3.3 Method of Test

Initial Conditions

SS 1 cell, default parameters.

MS in MM-state "idle, updated" with valid TMSI and CKSN.

Specific PICS statements:

- Immediate connect supported for all circuit switched basic services.

PIXIT statements:

- Way to indicate alerting.
- Way to make the MS accept an incoming call after alerting.

Foreseen Final State of MS

"Idle, updated", with TMSI allocated.

Test Procedure

The following test is performed for the half rate channel mode of the multi-rate codec:

- A teleservice is selected that is supported by the MS; if the MS supports speech, the selected teleservice is speech. If necessary, the MS is configured for that teleservice.
- The MS is paged and the resulting call is established. Having reached the active state, the MS is made to clear the call.

Maximum Duration of Test

3 minutes

Expected Sequence

This test is repeated for $M = 1, 2, 3, 4$.

Step	Direction	Message	Comments
1	SS->MS	PAGING REQUEST TYPE 1	Sent on the correct paging sub-channel Message is contained in the SABM SRES specifies correct value SS starts deciphering after sending the message Shall be sent enciphered. All following messages shall be sent enciphered. SS starts ciphering
2	MS->SS	CHANNEL REQUEST	
3	SS->MS	IMMEDIATE ASSIGNMENT	
4	MS->SS	PAGING RESPONSE	
5	SS->MS	AUTHENTICATION REQUEST	
6	MS->SS	AUTHENTICATION RESPONSE	
7	SS->MS	CIPHERING MODE COMMAND	
8	MS->SS	CIPHERING MODE COMPLETE	
9	SS		
10	SS->MS	SETUP	
11	MS->SS	CALL CONFIRMED	
			If the MS supports an Immediate connection then branch A applies. If the MS doesn't support an immediate connection then branch B applies.
A12	MS->SS	CONNECT	sent on the old channel SS allocates allowed subset codec modes, but does not identify a mode for immediate operation.
A13	SS->MS	ASSIGNMENT COMMAND	
A14	MS->SS	ASSIGNMENT COMPLETE	
B12	SS->MS	ASSIGNMENT COMMAND	Sent on the new channel. SS allocates allowed subset codec modes, but does not identify a mode for immediate operation. An alerting indication as defined in the PIXIT statement is given by the MS. The MS is made to accept the call.
B13	MS->SS	ASSIGNMENT COMPLETE	
B14	MS->SS	ALERTING	
B15	MS		
B16	MS		
B17	MS->SS	CONNECT	
18	MS		
19	SS->MS	CONNECT ACK	The TCH shall be through connected by both directions in the dedicated mode, using the default codec mode specified. The MS is made to release the call. The main signalling link is released.
20	MS		
21	MS->SS	DISCONNECT	
22	SS->MS	RELEASE	
23	MS->SS	RELEASE COMPLETE	
24	SS->MS	CHANNEL RELEASE	

Specific Message Content

M = 1

Assignment Command

Information Element	value/remark
Channel mode Mode Multi-Rate configuration	Half rate speech version 6 ICMI = 0 1 codec mode specified

M = 2

Assignment Command

Information Element	value/remark
Channel mode Mode Multi-Rate configuration	Half rate speech version 6 ICMI = 0 2 codec modes and threshold values specified

M = 3

Assignment Command

Information Element	value/remark
Channel mode Mode Multi-Rate configuration	Half rate speech version 6 ICMI = 0 3 codec modes and threshold values specified

M = 4

Assignment Command

Information Element	value/remark
Channel mode Mode Multi-Rate configuration	Half rate speech version 6 ICMI = 0 4 codec modes and threshold values specified

26.17.3a 8-PSK AMR HR / Structured procedures / MS terminated call / early assignment / specified initial codec mode

NOTE: this test is derived from the one described in subclause 26.16.3a and entitled: "Structured procedures / MS terminated call / early assignment / specified initial codec mode"

26.17.3a.1 Conformance requirement

- 1) In acceptance to a SETUP message indicating speech, the MS shall indicate and include in the CALL CONFIRMED message all the speech versions that it supports.
- 2) Upon receipt of the ASSIGNMENT COMMAND message specifying using CH_x/HR the Mobile Station continues a mobile terminating call establishment with early assignment of traffic channel:
 - a) by replying to the ASSIGNMENT command with an ASSIGNMENT COMPLETE message; and
 - b) by continuing the call establishment by through connecting TCH in both directions if it supports immediate connect or by sending an ALERTING message otherwise.
- 3) The ASSIGNMENT COMMAND will specify the subset of codec modes that the MS is allowed to use for the call, the thresholds and the initial codec mode for immediate use by the MS.
- 4) For speech calls, the mobile station shall attach the user connection at latest when sending the connect message, except if there is no compatible radio resource available at this time. In this case the attachment shall be delayed until such a resource becomes available.

CH_x: identifies any of the Channel Codec mode.

HR: half rate channel.

References:

3GPP TS 44.018 subclauses 9.12 and 9.1.5.

3GPP TS 45.009 subclause 3.4.

26.17.3a.2 Test purpose

- 1) To verify that, in acceptance to a SETUP message indicating speech, the MS indicates and includes in the CALL CONFIRMED message all the speech versions that it supports.
- 2) To verify that upon receipt of the ASSIGNMENT COMMAND message specifying using CH_x/HR the Mobile Station continues a mobile terminating call establishment with early assignment of traffic channel:

- a) by replying to the ASSIGNMENT command with an ASSIGNMENT COMPLETE message; and
 - b) by continuing the call establishment by through connecting TCH in both directions if it supports immediate connect or by sending an ALERTING message otherwise.
- 3) To verify that upon receipt of an ASSIGNMENT COMMAND with codec mode specified, the MS shall use that specified codec mode.
 - 4) To verify that for speech calls, the mobile station shall attach the user connection at latest when sending the connect message, except if there is no compatible radio resource available at this time. In this case the attachment shall be delayed until such a resource becomes available.

26.17.3a.3 Method of Test

Initial Conditions

SS 1 cell, default parameters

MS in MM-state "idle, updated" with valid TMSI and CKSN

Specific PICS statements:

- Immediate connect supported for all circuit switched basic services.

PIXIT statements:

- Way to indicate alerting.
- Way to make the MS accept an incoming call after alerting.

Foreseen Final State of MS

"Idle, updated", with TMSI allocated.

Test Procedure

The following test is performed for the half rate channel mode of the multi-rate codec:

A teleservice is selected that is supported by the MS; if the MS supports speech, the selected teleservice is speech. If necessary, the MS is configured for that teleservice.

The MS is paged and the resulting call is established. Having reached the active state, the MS is made to clear the call.

Maximum Duration of Test

3 minutes

Expected Sequence

This test is repeated for M=1,2,3,4.

Step	Direction	Message	Comments
1	SS->MS	PAGING REQUEST TYPE 1	Sent on the correct paging sub-channel Message is contained in the SABM SRES specifies correct value SS starts deciphering after sending the message Shall be sent enciphered. All following messages shall be sent enciphered. SS starts ciphering
2	MS->SS	CHANNEL REQUEST	
3	SS->MS	IMMEDIATE ASSIGNMENT	
4	MS->SS	PAGING RESPONSE	
5	SS->MS	AUTHENTICATION REQUEST	
6	MS->SS	AUTHENTICATION RESPONSE	
7	SS->MS	CIPHERING MODE COMMAND	
8	MS->SS	CIPHERING MODE COMPLETE	
9	SS		
10	SS->MS	SETUP	
11	MS->SS	CALL CONFIRMED	
			If the MS supports an Immediate connection then branch A applies. If the MS doesn't support an immediate connection then branch B applies.
A12	MS->SS	CONNECT	sent on the old channel SS allocates allowed subset codec modes and identifies a mode for immediate operation.
A13	SS->MS	ASSIGNMENT COMMAND	
A14	MS->SS	ASSIGNMENT COMPLETE	
B12	SS->MS	ASSIGNMENT COMMAND	SS allocates allowed subset codec modes and identifies a mode for immediate operation. An alerting indication as defined in the PIXIT statement is given by the MS. The MS is made to accept the call.
B13	MS->SS	ASSIGNMENT COMPLETE	
B14	MS->SS	ALERTING	
B15	MS		
B16	MS		
B17	MS->SS	CONNECT	
18	MS		
19	SS->MS	CONNECT ACK	The TCH shall be through connected by both directions in the dedicated mode, using the codec mode specified. The MS is made to release the call. The main signalling link is released.
20	MS		
21	MS->SS	DISCONNECT	
22	SS->MS	RELEASE	
23	MS->SS	RELEASE COMPLETE	
24	SS->MS	CHANNEL RELEASE	

Specific Message Content

M = 1

Assignment Command

Information Element	value/remark
Channel mode Mode Multi-Rate configuration	Half rate speech version 6 ICMI = 1 Start Mode specified 1 codec mode specified

M = 2

Assignment Command

Information Element	value/remark
Channel mode Mode Multi-Rate configuration	Half rate speech version 6 ICMI = 1 Start Mode specified 2 codec modes and threshold vales specified

M = 3

Assignment Command

Information Element	value/remark
Channel mode Mode Multi-Rate configuration	Half rate speech version 6 ICMI = 1 Start Mode specified 3 codec modes and threshold vales specified

M = 4

Assignment Command

Information Element	value/remark
Channel mode Mode Multi-Rate configuration	Half rate speech version 6 ICMI = 1 Start Mode specified 4 codec modes and threshold vales specified

26.17.4 8-PSK AMR HR / Structured procedures / MS originated call / late assignment / specified initial codec mode

NOTE: This test is derived from the one described in subclause 26.16.4 and entitled: "Structured procedures / MS originated call / late assignment / specified initial codec mode".

26.17.4.1 Conformance requirement

- 1) The MS shall indicate and include in the mobile originating SETUP for speech call all the speech versions that it supports.
- 2) Upon receipt of the ASSIGNMENT COMMAND message using half rate speech version 6, the Mobile Station starts a normal channel assignment procedure. It means that the MS initiates a local end release of link layer connections, disconnects the physical channels, commands the switching to the assigned channels and initiates the establishment of lower layer connections (this includes the activation of the channels, their connection and the establishment of the data links). After the main signalling link is successfully established, the MS returns an ASSIGNMENT COMPLETE message, specifying cause 'normal event', to the network on the main DCCH.

References:

3GPP TS 44.018 subclauses 9.12 and 9.1.5.

3GPP TS 45.009 subclause 3.4.

26.17.4.2 Test purpose

- 1) To verify that the MS indicates and includes in the mobile originating SETUP for speech call all the speech versions that it supports.

- 2) To verify that subsequently after receipt of an IMMEDIATE ASSIGNMENT message allocating an SDCCH, after completion of establishment of the main signalling link, after having sent a CM SERVICE REQUEST message, after having successfully performed authentication and cipher mode setting procedures, after having sent a SETUP message, after having received a CALL PROCEEDING message followed by an ALERTING message and an ASSIGNMENT COMMAND message allocating using half rate speech version 6, the MS sends an ASSIGNMENT COMPLETE message. The ASSIGNMENT COMMAND message will also identify which codec mode the MS is allowed to use for the call, the threshold values and the initial codec mode for immediate use.

26.17.4.3 Method of Test

Initial Conditions

SS 1 cell, default parameters.

MS in MM-state "idle, updated" with valid TMSI and CKSN.

Specific PICS statements:

-

PIXIT statements:

- Way to indicate alerting.
- Way to make the MS accept an incoming call after alerting.

Foreseen Final State of MS

The MS has a MO call in state U10, "active".

Test Procedure

The following test is performed for the half rate channel mode of the multi-rate codec.

The MS is made to initiate a speech call. The call is established with a late assignment.

Maximum Duration of Test

3 minutes.

Expected Sequence

This test is repeated for $M = 1, 2, 3, 4$.

Step	Direction	Message	Comments
1	MS		The "called number" is entered
2	MS->SS	CHANNEL REQUEST	
3	SS->MS	IMMEDIATE ASSIGNMENT	
4	MS->SS	CM SERVICE REQUEST	Message is contained in SABM
5	SS->MS	AUTHENTICATION REQUEST	
6	MS->SS	AUTHENTICATION RESPONSE	SRES specifies correct value
7	SS->MS	CIPHERING MODE COMMAND	SS starts deciphering after sending the message
8	MS->SS	CIPHERING MODE COMPLETE	Shall be sent enciphered. All following messages shall be sent enciphered.
9	SS		SS starts ciphering
10	MS->SS	SETUP	The MS indicates it supports the HR speech version 6.
11	SS->MS	CALL PROCEEDING	
12	SS->MS	ALERTING	
13	MS		An alerting indication as defined in the PIXIT statement is given by the MS.
14	SS->MS	ASSIGNMENT COMMAND	SS allocates allowed subset codec modes, but does identifies a mode for immediate operation.
15	MS->SS	ASSIGNMENT COMPLETE	
16	SS->MS	CONNECT	
17	MS		The TCH shall be through connected by both directions in the dedicated mode, using the codec mode specified.
18	MS->SS	CONNECT ACK	

Specific Message Content

M = 1

Assignment Command

Information Element	value/remark
Channel mode Mode Multi-Rate configuration	Half rate speech version 6 ICMI = 1 Start mode specified 1 codec mode specified

M = 2

Assignment Command

Information Element	value/remark
Channel mode Mode Multi-Rate configuration	Half rate speech version 6 ICMI = 1 Start mode specified 2 codec modes and threshold vales specified

M = 3

Assignment Command

Information Element	value/remark
Channel mode Mode Multi-Rate configuration	Half rate speech version 6 ICMI = 1 Start mode specified 3 codec modes and threshold vales specified

M = 4

Assignment Command

Information Element	value/remark
Channel mode Mode Multi-Rate configuration	Half rate speech version 6 ICMI = 1 Start mode specified 4 codec modes and threshold vales specified

26.17.4a 8-PSK AMR HR / Structured procedures / MS originated call / late assignment / no initial codec mode

NOTE: This test is derived from the one described in subclause 26.16.4a and entitled: "Structured procedures / MS originated call / late assignment / no initial codec mode".

26.17.4a.1 Conformance requirement

- 1) The MS shall indicate and include in the mobile originating SETUP for speech call all the speech versions that it supports.
 - 2) Upon receipt of the ASSIGNMENT COMMAND message using half rate speech version 6, the Mobile Station starts a normal channel assignment procedure. It means that the MS initiates a local end release of link layer connections, disconnects the physical channels, commands the switching to the assigned channels and initiates the establishment of lower layer connections (this includes the activation of the channels, their connection and the establishment of the data links). After the main signalling link is successfully established, the MS returns an ASSIGNMENT COMPLETE message, specifying cause 'normal event', to the network on the main DCCH. The ASSIGNMENT COMMAND message will also specify the subset of codec modes that the MS is allowed to use for the call and the threshold values. The ASSIGNMENT COMMAND will not specify the initial codec mode but will, rather, allow the MS to select the default codec mode.
- If the Initial Codec Mode is not signalled, then the default Initial Codec Mode is given by the following implicit rule. If the Active Codec Set contains:
- 1 mode then this shall be the Initial Codec Mode.
 - 2 or 3 modes then the Initial Codec mode shall be the most robust mode of the set (with lowest bit rate).
 - 4 modes then the Initial Codec Mode shall be the second most robust mode of the set (with second lowest bit rate. If the Active Codec Set is changed during the call, then this default Initial Codec Mode shall used until an other ICM is explicitly signalled.

References

3GPP TS 44.018 subclauses 9.12 and 9.1.5.

3GPP TS 45.009 subclause 3.4.

26.17.4a.2 Test purpose

- 1) To verify that the MS indicates and includes in the mobile originating SETUP for speech call all the speech versions that it supports.
- 2) To verify that subsequently after receipt of an IMMEDIATE ASSIGNMENT message allocating an SDCCH, after completion of establishment of the main signalling link, after having sent a CM SERVICE REQUEST message, after having successfully performed authentication and cipher mode setting procedures, after having sent a SETUP message, after having received a CALL PROCEEDING message followed by an ALERTING message and an ASSIGNMENT COMMAND message allocating using speech half rate speech version 6, the MS sends an ASSIGNMENT COMPLETE message. The ASSIGNMENT COMMAND message will also specify the subset of codec modes that the MS is allowed to use for the call and the threshold values. The ASSIGNMENT COMMAND will not specify the initial codec mode but will, rather, allow the MS to select the default codec mode.

26.17.4a.3 Method of Test

Initial Conditions

SS 1 cell, default parameters

MS in MM-state "idle, updated" with valid TMSI and CKSN

Specific PICS statements:

-

PIXIT statements:

- Way to indicate alerting.
- Way to make the MS accept an incoming call after alerting.

Foreseen Final State of MS

The MS has a MO call in state U10, "active".

Test Procedure

The following test is performed for the half rate channel mode of the multi-rate codec.

The MS is made to initiate a speech call. The call is established with a late assignment.

Maximum Duration of Test

3 minutes

Expected Sequence

This test is repeated for M=1,2,3,4.

Step	Direction	Message	Comments
1	MS		The "called number" is entered
2	MS->SS	CHANNEL REQUEST	
3	SS->MS	IMMEDIATE ASSIGNMENT	
4	MS->SS	CM SERVICE REQUEST	Message is contained in SABM
5	SS->MS	AUTHENTICATION REQUEST	
6	MS->SS	AUTHENTICATION RESPONSE	SRES specifies correct value
7	SS->MS	CIPHERING MODE COMMAND	SS starts deciphering after sending the message
8	MS->SS	CIPHERING MODE COMPLETE	Shall be sent enciphered. All following messages shall be sent enciphered.
9	SS		SS starts ciphering
10	MS->SS	SETUP	The MS indicates support of the HR speech version 6.
12	SS->MS	CALL PROCEEDING	
13	SS->MS	ALERTING	
14	MS		An alerting indication as defined in the PIXIT statement is given by the MS.
15	SS->MS	ASSIGNMENT COMMAND	SS allocates allowed subset of codec modes and thresholds, but does not identify a mode for immediate operation.
16	MS->SS	ASSIGNMENT COMPLETE	
17	SS->MS	CONNECT	
18	MS		The TCH shall be through connected by both directions in the dedicated mode, using the codec mode specified (M=1 CMI=0, M=2 CMI=0, M=3 CMI=0, M=4 CMI=1).
19	MS->SS	CONNECT ACK	

Specific Message Content

M = 1

Assignment Command

Information Element	value/remark
Channel mode Mode Multi-Rate configuration	Half rate speech version 6 ICMI = 0 1 codec mode specified

M = 2

Assignment Command

Information Element	value/remark
Channel mode Mode Multi-Rate configuration	Half rate speech version 6 ICMI = 0 2 codec modes and threshold vales specified

M = 3

Assignment Command

Information Element	value/remark
Channel mode Mode Multi-Rate configuration	Half rate speech version 6 ICMI = 0 3 codec modes and threshold vales specified

M =4

Assignment Command

Information Element	value/remark
Channel mode Mode Multi-Rate configuration	Half rate speech version 6 ICMI = 0 4 codec modes and threshold vales specified

26.17.6 8-PSK AMR HR / Structured procedures / emergency call

NOTE: this test is derived from subclause 26.16.6 - Structured procedures / emergency call.

26.17.6.1 Conformance requirement

- 1) For R97/R98 MS: The MS in the "idle, updated" state, after a successful location update, the number 112 (for GSM 900 and DCS 1800 MS), or 911 (for GSM 710, GSM 750, T_GSM 810, GSM 850 and PCS 1 900 MS in USA and Canada), or 08 (for GSM 710, GSM 750, T_GSM 810, GSM 850 and PCS 1 900 MS in Mexico) has been entered by user, shall send a CHANNEL REQUEST message with correct establishment cause ("emergency call").

For R99 and later MS: When a SIM/USIM containing stored emergency numbers is present, those numbers are identified as emergency numbers. As an optional requirement, the ME shall also identify 112 and 911 as emergency numbers irrespective of whether these are stored in the SIM/USIM. Any other emergency numbers stored in the ME shall be ignored.

When no emergency numbers are stored within the SIM the following numbers shall be stored in the ME for use as emergency numbers: 112, and 911.

When no emergency numbers are stored within the USIM the following numbers shall be stored in the ME for use as emergency numbers: 112, and 911.

- 2) After assignment of a dedicated channel the first layer message sent by the MS on the assigned dedicated channel shall be a CM SERVICE REQUEST message specifying the correct CKSN and TMSI , with CM Service Type "emergency call establishment".
- 3) Authentication and cipher mode setting shall be performed successfully.
- 4) After cipher mode setting acceptance by the network, the MS shall send an EMERGENCY SETUP message.
- 5) The AMR mobile station shall accept channel assignment to an 8-PSK AMR half rate channel and also select the correct codec mode. The call shall be set up using the 8-PSK AMR HR codec.
- 6) After receipt of a CONNECT ACKNOWLEDGE message during correct establishment of the emergency call the O-TCH/AHS shall be through connected in both directions if an appropriate channel is available.
- 7) The call shall be cleared correctly.

References:

3GPP TS 44.018 subclauses 3.4.3.1, 3.4.6, 9.1.2 and 9.1.5.

3GPP TS 02.30, clause 4.

3GPP TS 22.101, clause 8.

26.17.6.2 Test purpose

- 1) To verify that a R97/R98 MS supporting speech in the MM state "idle, updated", when made to call the number 112 (for GSM 900 and DCS 1800 MS), or 911 (for GSM 710, GSM 750, T_GSM 810, GSM 850 and PCS 1 900 MS in USA and Canada), or 08 (for GSM 710, GSM 750, T_GSM 810, GSM 850 and PCS 1 900 MS in Mexico), sends a CHANNEL REQUEST message with establishment cause "emergency call".

To verify that a R99 and later MS supporting speech in the MM state "idle, updated", when made to call the number 112 or 911, sends a CHANNEL REQUEST message with establishment cause "emergency call".

- 2) To verify that after assignment of a dedicated channel the first layer message sent by the MS on the assigned dedicated channel is a CM SERVICE REQUEST message specifying the correct CKSN and TMSI, with CM Service Type "emergency call establishment".
- 3) To verify that authentication and cipher mode setting are performed successfully.
- 4) To verify that after cipher mode setting acceptance by the SS, the MS sends an EMERGENCY SETUP message.
- 5) To verify that the AMR mobile station shall accept channel assignment to a O-TCH/AHS and also select the correct codec mode. The call shall be set up using the 8-PSK AMR HR codec.
- 6) To verify that subsequently the MS has through connected the TCH in both directions.
- 7) To verify the call is cleared correctly.

26.17.6.3 Method of Test

Initial Conditions

SS: 1 cell default parameters.

MS: The MS is in the MM-state "idle, updated" with valid TMSI and CKSN.

Foreseen Final State of the MS

The MS is in the MM-state "idle, updated" with valid TMSI and CKSN.

Specific PICS statements:

-

PIXIT statements:

-

Test Procedure

The MS is made to initiate an emergency call. The call is established with late assignment. Having reached the active state, the call is cleared by the SS.

Maximum Duration of Test

3 minutes.

Expected Sequence

Step	Direction	Message	Comments
1	MS		The appropriate emergency call number is entered
2	MS->SS	CHANNEL REQUEST	Establishment cause is emergency call establishment.
3	SS->MS	IMMEDIATE ASSIGNMENT	
4	MS->SS	CM SERVICE REQUEST	Message is contained in SABM. The CM service type IE indicates "emergency call establishment".
5	SS->MS	AUTHENTICATION REQUEST	
6	MS->SS	AUTHENTICATION RESPONSE	SRES specifies correct value
7	SS->MS	CIPHERING MODE COMMAND	SS starts deciphering after sending the message
8	MS->SS	CIPHERING MODE COMPLETE	Shall be sent enciphered. All following messages shall be sent enciphered.
9	SS		SS starts ciphering
10	MS->SS	EMERGENCY SETUP	The MS indicates which speech it supports.
11	SS->MS	CALL PROCEEDING	
12	SS->MS	ALERTING	
13	SS->MS	ASSIGNMENT COMMAND	See specific message contents.
14	MS->SS	ASSIGNMENT COMPLETE	
15	SS->MS	CONNECT	
16	MS->SS	CONNECT ACK	
17	MS		The TCH shall be through connected by both directions in the dedicated mode, using the codec mode specified.
18	SS->MS	DISCONNECT	
19	MS->SS	RELEASE	
20	SS->MS	RELEASE COMPLETE	
21	SS->MS	CHANNEL RELEASE	

Specific Message Contents:

Assignment Command

Information Element	value/remark
Channel description	O-TCH/AHS
Channel mode - Mode	Half rate speech version 6

26.17.9 8-PSK AMR HR / RATSCCH Protocol

26.17.9.1 AMR Configuration Change (normal)

26.17.9.1.1 Conformance requirements

The AMR_CONFIG_REQ message may be sent by the BTS during a call to change the AMR configuration on the radio interface without interruption of the speech transmission.

The ACK_OK message serves as an acknowledgement that a RATSCCH REQ message has been detected, correctly decoded (no CRC error) and that it is defined for the Addressee. It defines the exact activation time in direction from Addressee to Initiator.

Reference

3GPP TS 45.009 sub-clauses: 3.2.2.3.1, 3.2.2.3.5

26.17.9.1.2 Test purpose

This test will verify that the MS is able to handle a properly formatted AMR_CONFIG_REQ message.

26.17.9.1.3 Method of test

Initial Conditions

System Simulator:

1 cell with default parameters

Mobile Station:

The MS is in the "idle, updated" state, with a TMSI allocated and camped on cell A.

Specific PICS statements:

-

PIXIT statements:

-

Foreseen Final State of the MS

Idle Updated, TMSI allocated and camped on cell A.

Test Procedure

This sequence is performed for execution counter, $k = 1, 2$.

When $k = 1$, DTX is not used:

- 1) User initiates a Mobile Originated call.
- 2) The network and the MS indicate Bearer capabilities IE with the AMR speech Half Rate (Version 6).
- 3) The network performs an assignment on a TCH channel with MultiRate configuration to the MS.
- 4) The call is maintained during a programmable time without variation of RxLev /RxQual.
- 5) The SS shall send a properly formatted AMR_CONFIG_REQ message during the call at a programmable time.
- 6) The MS answers with a ACK_OK message within 3 speech frames
- 7) The network initiates the call release.

When $k = 2$, DTX is used:

- 1) In the serving cell, the DTX indicator is set to "MS shall use discontinuous transmission".
- 2) User initiates a Mobile Originated call.
- 3) The network and the MS indicate Bearer capabilities IE with the AMR speech Half Rate (Version 6).
- 4) The network performs an assignment on a TCH channel with MultiRate configuration to the MS.
- 5) The call is maintained during a programmable time without variation of RxLev /RxQual.
- 6) The SS shall send a properly formatted AMR_CONFIG_REQ message during the call at a programmable time.

7) The MS answers with a ACK_OK message within 3 speech frames.

8) The network initiates the call release.

Maximum Duration of Test

5 minutes

Expected Sequence

When k=1:

Step	Direction	Message	Comments
1	MS		MS is in idle mode
2	MS		MS initiates Mobile Originated call
3	MS->SS	Channel Request	Establishment cause is "originating call and the network does not set the NECI bit to 1".
4	SS->MS	Immediate Assignment	See Default Messages for AMR
5	MS->SS	CM Service Request	CM Service Type = Mobile Originating Call Establishment.
6	SS->MS	AUTHENTICATION REQUEST	
7	MS->SS	AUTHENTICATION RESPONSE	SRES specifies correct value
8	SS->MS	CIPHERING MODE COMMAND	SS starts deciphering after sending the message
9	MS->SS	CIPHERING MODE COMPLETE	Shall be sent enciphered. All following messages shall be sent enciphered.
10	MS->SS	Setup	MS indicates supported speech versions
11	SS->MS	Call Proceeding	
12	SS->MS	Alerting	
13	SS->MS	Assignment Command	See specific message contents.
14	MS->SS	Assignment Complete	
15	SS->MS	Connect	
16	MS->SS	Connect Acknowledge	
17	MS		The TCH shall be through connected by both directions in the dedicated mode, using the codec mode specified.
18	SS->MS	AMR_CONFIG_REQ	See specific message contents.
19	MS->SS	ACK_OK	Message must be received within 3 speech frames
20	SS->MS	Disconnect	
21	MS->SS	Release	
22	SS->MS	Release Complete	
23	SS->MS	Channel Release	

When k=2:

Step	Direction	Message	Comments
1	MS		MS is in idle mode
2	MS		MS initiates Mobile Originated call
3	MS->SS	Channel Request	Establishment cause is "originating call and the network does not set the NECI bit to 1".
4	SS->MS	Immediate Assignment	See Default Messages for AMR
5	MS->SS	CM Service Request	CM Service Type = Mobile Originating Call Establishment.
6	SS->MS	AUTHENTICATION REQUEST	
7	MS->SS	AUTHENTICATION RESPONSE	SRES specifies correct value
8	SS->MS	CIPHERING MODE COMMAND	SS starts deciphering after sending the message
9	MS->SS	CIPHERING MODE COMPLETE	Shall be sent enciphered. All following messages shall be sent enciphered.
10	MS->SS	Setup	MS indicates supported speech versions
11	SS->MS	Call Proceeding	
12	SS->MS	Alerting	
13	SS->MS	Assignment Command	See specific message contents.
14	MS->SS	Assignment Complete	
15	SS->MS	Connect	
16	MS->SS	Connect Acknowledge	
17	MS		The TCH shall be through connected by both directions in the dedicated mode, using the codec mode specified.
18	SS->MS	AMR_CONFIG_REQ	Using DTX mode
19	MS->SS	ACK_OK	Message must be received within 3 speech frames
20	SS->MS	Disconnect	
21	MS->SS	Release	
22	SS->MS	Release Complete	
23	SS->MS	Channel Release	

Specific Message Contents

ASSIGNMENT COMMAND

Information Element	value/remarks
Channel description	O-TCH/AHS
Mode of the first channel	
- Mode	Half rate version 6

AMR_CONFIG_REQ

Information Element	value/remarks
ICM	CODEC_MODE_1
ACS	2 codec modes
HYST2	Not defined (set to all 1s)
THRESH2	Not defined (set to all 1s)
HYST1	2 dB
THRESH1	12.5 dB

26.17.9.2 AMR Configuration Change (abnormal)

26.17.9.2.1 Conformance requirements

The AMR_CONFIG_REQ message may be sent by the BTS during a call to change the AMR configuration on the radio interface without interruption of the speech transmission.

The ACK_ERR message serves as a negative acknowledgement that a RATSCCH REQ message has been detected, i.e. the RATSCCH pattern was detected, but could not be decoded correctly (CRC error), or its content is not understandable by the addressee.

Reference:

3GPP TS 45.009 sub-clauses: 3.2.2.3.2, 3.2.2.3.5

26.17.9.2.2 Test purpose

This test will verify that the MS is able to handle an improperly formatted AMR_CONFIG_REQ message.

26.17.9.2.3 Method of test

Initial Conditions

System Simulator:

1 cell with default parameters

Mobile Station:

The MS is in the "idle, updated" state, with a TMSI allocated and camped on cell A.

Specific PICS statements:

-

PIXIT statements:

-

Foreseen Final State of the MS

Idle Updated, TMSI allocated and camped on cell A.

Test Procedure

- 1) User initiates a Mobile Originated call.
- 2) The network and the MS indicate Bearer capabilities IE with the AMR speech Half Rate (Version 6).
- 3) The network performs an assignment on a TCH channel with MultiRate configuration to the MS.
- 4) The call is maintained during a programmable time without variation of RxLev /RxQual.
- 5) The SS shall send an AMR_CONFIG_REQ message, with an incorrect CRC, during the call at a programmable time.
- 6) The MS answers with a ACK_ERR message within 3 speech frames
- 7) The network initiates the call release.

Maximum Duration of Test

5 minutes

Expected Sequence

Step	Direction	Message	Comments
1	MS		MS is in idle mode
2	MS		MS initiates Mobile Originated call
3	MS->SS	Channel Request	Establishment cause is "originating call and the network does not set the NECI bit to 1".
4	SS->MS	Immediate Assignment	See Default Messages for AMR
5	MS->SS	CM Service Request	CM Service Type = Mobile Originating Call Establishment.
6	SS->MS	AUTHENTICATION REQUEST	
7	MS->SS	AUTHENTICATION RESPONSE	SRES specifies correct value
8	SS->MS	CIPHERING MODE COMMAND	SS starts deciphering after sending the message
9	MS->SS	CIPHERING MODE COMPLETE	Shall be sent enciphered. All following messages shall be sent enciphered.
10	MS->SS	Setup	MS indicates supported speech versions
11	SS->MS	Call Proceeding	
12	SS->MS	Alerting	
13	SS->MS	Assignment Command	See specific message contents.
14	MS->SS	Assignment Complete	
15	SS->MS	Connect	
16	MS->SS	Connect Acknowledge	
17	MS		The TCH shall be through connected by both directions in the dedicated mode, using the codec mode specified.
18	SS->MS	AMR_CONFIG_REQ	Message contains an incorrect CRC
19	MS->SS	ACK_ERR	Message must be received within 3 speech frames
20	SS->MS	Disconnect	
21	MS->22	Release	
22	SS->MS	Release Complete	
23	SS->MS	Channel Release	

Specific Message Contents

ASSIGNMENT COMMAND

Information Element	value/remarks
Channel description	O-TCH/AHS
Mode of the first channel - Mode	Half rate version 6

AMR_CONFIG_REQ

Information Element	value/remarks
ICM	CODEC_MODE_1
ACS	2 codec modes
HYST2	Not defined (set to all 1s)
THRESH2	Not defined (set to all 1s)
HYST1	2 dB
THRESH1	12.5 dB

26.17.9.3 Codec Mode Phase Change (normal)

26.17.9.3.1 Conformance requirements

The CMI_PHASE_REQ message may be sent by the BTS to change the phase of the Codec Mode Indication in downlink.

The ACK_OK message serves as an acknowledgement that a RATSCCH REQ message has been detected, correctly decoded (no CRC error) and that it is defined for the Addressee. It defines the exact activation time in direction from Addressee to Initiator.

Reference:

3GPP TS 45.009 sub-clauses: 3.2.2.3.1, 3.2.2.3.4

26.17.9.3.2 Test purpose

This test will verify that the MS can correctly handle a properly formatted CMI_PHASE_REQ message.

26.17.9.3.3 Method of test**Initial Conditions****System Simulator:**

1 cell with default parameters

Mobile Station:

The MS is in the "idle, updated" state, with a TMSI allocated and camped on cell A.

Specific PICS statements:

-

PIXIT statements:

-

Foreseen Final State of the MS

Idle Updated, TMSI allocated and camped on cell A.

Test Procedure

- 1) User initiates a Mobile Originated call.
- 2) The network and the MS indicate Bearer capabilities IE with the AMR speech Half Rate (Version 6).
- 3) The network performs an assignment on a TCH channel with MultiRate configuration to the MS.
- 4) The call is maintained during a programmable time without variation of RxLev /RxQual.
- 5) The SS shall send the CMI_PHASE_REQ message during the call at a programmable time. The CMI_PHASE_REQ shall be sent either in place of a "CMI" speech frame, or in place of a "CMC" speech frame, to cover both kinds of changes.
- 6) The MS answers with a ACK_OK message within 3 speech frames.
- 7) The downlink CMI phase is changed (or not) according to the CMI_PHASE_REQ message starting with speech frame N+12.
- 8) The network initiates the call release.

Maximum Duration of Test

5 minutes

Expected Sequence

Step	Direction	Message	Comments
1	MS		MS is in idle mode
2	MS		MS initiates Mobile Originated call
3	MS->SS	Channel Request	Establishment cause is "originating call and the network does not set the NECI bit to 1".
4	SS->MS	Immediate Assignment	See Default Messages for AMR
5	MS->SS	CM Service Request	CM Service Type = Mobile Originating Call Establishment.
6	SS->MS	AUTHENTICATION REQUEST	
7	MS->SS	AUTHENTICATION RESPONSE	SRES specifies correct value
8	SS->MS	CIPHERING MODE COMMAND	SS starts deciphering after sending the message
9	MS->SS	CIPHERING MODE COMPLETE	Shall be sent enciphered. All following messages shall be sent enciphered.
10	MS->SS	Setup	MS indicates supported speech versions
11	SS->MS	Call Proceeding	
12	SS->MS	Alerting	
13	SS->MS	Assignment Command	See specific message contents.
14	MS->SS	Assignment Complete	
15	SS->MS	Connect	
16	MS->SS	Connect Acknowledge	
17	MS		The TCH shall be through connected by both directions in the dedicated mode, using the codec mode specified.
18	SS->MS	CMI_PHASE_REQ	See specific message contents.
19	MS->SS	ACK_OK	Message must be received within 3 speech frames
20	SS->MS	Disconnect	
21	MS->SS	Release	
22	SS->MS	Release Complete	
23	SS->MS	Channel Release	

Specific Message Contents

ASSIGNMENT COMMAND

Information Element	value/remarks
Channel description	O-TCH/AHS
Mode of the first channel - Mode	Half rate version 6

CMI_PHASE_REQ

Information Element	value/remarks
CMIP	1 (default)

26.17.9.4 Codec Mode Phase Change (abnormal)

26.17.9.4.1 Conformance requirements

The CMI_PHASE_REQ message may be sent by the BTS to change the phase of the Codec Mode Indication in downlink.

The ACK_ERR message serves as a negative acknowledgement that a RATSCCH REQ message has been detected, i.e. the RATSCCH pattern was detected, but could not be decoded correctly (CRC error), or its content is not understandable by the addressee.

Reference

3GPP TS 45.009 sub-clauses: 3.2.2.3.2, 3.2.2.3.4

26.17.9.4.2 Test purpose

This test will verify that the MS can correctly handle an improperly formatted CMI_PHASE_REQ message.

26.17.9.4.3 Method of test

Initial Conditions

System Simulator:

1 cell with default parameters

Mobile Station:

The MS is in the "idle, updated" state, with a TMSI allocated and camped on cell A.

Specific PICS statements:

-

PIXIT statements:

-

Foreseen Final State of the MS

Idle Updated, TMSI allocated and camped on cell A.

Test Procedure

- 1) User initiates a Mobile Originated call.
- 2) The network and the MS indicate Bearer capabilities IE with the AMR speech Half Rate (Version 6).
- 3) The network performs an assignment on a TCH channel with MultiRate configuration to the MS.
- 4) The call is maintained during a programmable time without variation of RxLev /RxQual.
- 5) The SS shall send the CMI_PHASE_REQ message, with an incorrect CRC, during the call at a programmable time. The CMI_PHASE_REQ shall be sent either in place of a "CMI" speech frame, or in place of a "CMC" speech frame, to cover both kinds of changes.
- 6) The MS answers with a ACK_ERR message within 3 speech frames.
- 7) The network initiates the call release.

Maximum Duration of Test

5 minutes

Expected Sequence

Step	Direction	Message	Comments
1	MS		MS is in idle mode
2	MS		MS initiates Mobile Originated call
3	MS->SS	Channel Request	Establishment cause is "originating call and the network does not set the NECI bit to 1".
4	SS->MS	Immediate Assignment	See Default Messages for AMR
5	MS->SS	CM Service Request	CM Service Type = Mobile Originating Call Establishment.
6	SS->MS	AUTHENTICATION REQUEST	
7	MS->SS	AUTHENTICATION RESPONSE	SRES specifies correct value
8	SS->MS	CIPHERING MODE COMMAND	SS starts deciphering after sending the message
9	MS->SS	CIPHERING MODE COMPLETE	Shall be sent enciphered. All following messages shall be sent enciphered.
10	MS->SS	Setup	MS indicates supported speech versions
11	SS->MS	Call Proceeding	
12	SS->MS	Alerting	
13	SS->MS	Assignment Command	See specific message contents.
14	MS->SS	Assignment Complete	
15	SS->MS	Connect	
16	MS->SS	Connect Acknowledge	
17	MS		The TCH shall be through connected by both directions in the dedicated mode, using the codec mode specified.
18	SS->MS	CMI_PHASE_REQ	Message contains an incorrect CRC
19	MS->SS	ACK_ERR	Message must be received within 3 speech frames
20	SS->MS	Disconnect	
21	MS->SS	Release	
22	SS->MS	Release Complete	
23	SS->MS	Channel Release	

Specific Message Contents

ASSIGNMENT COMMAND

Information Element	value/remarks
Channel description	O-TCH/AHS
Mode of the first channel - Mode	Half rate version 6

CMI_PHASE_REQ

Information Element	value/remarks
CMIP	1 (default)

26.17.9.5 Threshold Change (normal)

26.17.9.5.1 Conformance requirements

The THRESH_REQ message may be sent by the BTS to change the thresholds in the DL Mode Request Generator.

The ACK_OK message serves as an acknowledgement that a RATSCCH REQ message has been detected, correctly decoded (no CRC error) and that it is defined for the Addressee. It defines the exact activation time in direction from Addressee to Initiator.

Reference:

3GPP TS 45.009 sub-clauses: 3.2.2.3.1, 3.2.2.3.6

26.17.9.5.2 Test purpose

This test will verify that an RATSCCH capable MS is able to handle a properly formatted THRESH_REQ message

26.17.9.5.3 Method of test

Initial Conditions

System Simulator:

1 cell with default parameters

Mobile Station:

The MS is in the "idle, updated" state, with a TMSI allocated and camped on cell A.

Specific PICS statements:

-

PIXIT statements:

-

Foreseen Final State of the MS

Idle Updated, TMSI allocated and camped on cell A.

Test Procedure

- 1) User initiates a Mobile Originated call.
- 2) The network and the MS indicate Bearer capabilities IE with the AMR speech Half Rate (Version 6).
- 3) The network performs an assignment on a TCH channel with MultiRate configuration to the MS.
- 4) The call is maintained during a programmable time without variation of RxLev /RxQual.
- 5) The SS shall send a properly formatted THRESH_REQ message during the call at a programmable time.
- 6) The MS answers with a ACK_OK message within 3 speech frames
- 7) The network initiates the call release.

Maximum Duration of Test

5 minutes

Expected Sequence

Step	Direction	Message	Comments
1	MS		MS is in idle mode
2	MS		MS initiates Mobile Originated call
3	MS->SS	Channel Request	Establishment cause is "originating call and the network does not set the NECI bit to 1".
4	SS->MS	Immediate Assignment	See Default Messages for AMR
5	MS->SS	CM Service Request	CM Service Type = Mobile Originating Call Establishment.
6	SS->MS	AUTHENTICATION REQUEST	
7	MS->SS	AUTHENTICATION RESPONSE	SRES specifies correct value
8	SS->MS	CIPHERING MODE COMMAND	SS starts deciphering after sending the message
9	MS->SS	CIPHERING MODE COMPLETE	Shall be sent enciphered. All following messages shall be sent enciphered.
10	MS->SS	Setup	MS indicates supported speech versions
11	SS->MS	Call Proceeding	
12	SS->MS	Alerting	
13	SS->MS	Assignment Command	See specific message contents.
14	MS->SS	Assignment Complete	
15	SS->MS	Connect	
16	MS->SS	Connect Acknowledge	
17	MS		The TCH shall be through connected by both directions in the dedicated mode, using the codec mode specified.
18	SS->MS	THRESH_REQ	See specific message contents.
19	MS->SS	ACK_OK	Message must be received within 3 speech frames
20	SS->MS	Disconnect	
21	MS->SS	Release	
22	SS->MS	Release Complete	
23	SS->MS	Channel Release	

Specific Message Contents

ASSIGNMENT COMMAND

Information Element	value/remarks
Channel description	O-TCH/AHS
Mode of the first channel - Mode	Half rate version 6
Multi-Rate configuration	2 codec modes specified

THRESH_REQ

Information Element	value/remarks
HYST3	Not defined (set to all 1s)
THRESH3	Not defined (set to all 1s)
HYST2	Not defined (set to all 1s)
THRESH2	Not defined (set to all 1s)
HYST1	2 dB
THRESH1	12.5 dB

26.17.9.6 Threshold Change (abnormal)

26.17.9.6.1 Conformance requirements

The THRESH_REQ message may be sent by the BTS to change the thresholds in the DL Mode Request Generator.

The ACK_ERR message serves as a negative acknowledgement that a RATSCCH REQ message has been detected, i.e. the RATSCCH pattern was detected, but could not be decoded correctly (CRC error), or its content is not understandable by the addressee.

Reference:

3GPP TS 45.009 sub-clauses: 3.2.2.3.2, 3.2.2.3.6

26.17.9.6.2 Test purpose

This test will verify that an RATSCCH capable MS is able to handle an improperly formatted THRESH_REQ message.

26.17.9.6.3 Method of test**Initial Conditions****System Simulator:**

1 cell with default parameters

Mobile Station:

The MS is in the "idle, updated" state, with a TMSI allocated and camped on cell A.

Specific PICS statements:

-

PIXIT statements:

-

Foreseen Final State of the MS

Idle Updated, TMSI allocated and camped on cell A.

Test Procedure

- 1) User initiates a Mobile Originated call.
- 2) The network and the MS indicate Bearer capabilities IE with the AMR speech Half Rate (Version 6).
- 3) The network performs an assignment on a TCH channel with MultiRate configuration to the MS.
- 4) The call is maintained during a programmable time without variation of RxLev /RxQual.
- 5) The SS shall send an improperly formatted THRESH_REQ message, with an incorrect CRC, during the call at a programmable time.
- 6) The MS answers with a ACK_ERR message within 3 speech frames
- 7) The network initiates the call release.

Maximum Duration of Test

5 minutes

Expected Sequence

Step	Direction	Message	Comments
1	MS		MS is in idle mode
2	MS		MS initiates Mobile Originated call
3	MS->SS	Channel Request	Establishment cause is "originating call and the network does not set the NECI bit to 1".
4	SS->MS	Immediate Assignment	See Default Messages for AMR
5	MS->SS	CM Service Request	CM Service Type = Mobile Originating Call Establishment.
6	SS->MS	AUTHENTICATION REQUEST	
7	MS->SS	AUTHENTICATION RESPONSE	SRES specifies correct value
8	SS->MS	CIPHERING MODE COMMAND	SS starts deciphering after sending the message
9	MS->SS	CIPHERING MODE COMPLETE	Shall be sent enciphered. All following messages shall be sent enciphered.
10	MS->SS	Setup	MS indicates supported speech versions
11	SS->MS	Call Proceeding	
12	SS->MS	Alerting	
13	SS->MS	Assignment Command	See specific message contents.
14	MS->SS	Assignment Complete	
15	SS->MS	Connect	
16	MS->SS	Connect Acknowledge	
17	MS		The TCH shall be through connected by both directions in the dedicated mode, using the codec mode specified.
18	SS->MS	THRESH_REQ	Message contains an incorrect CRC
19	MS->SS	ACK_ERR	Message must be received within 3 speech frames
20	SS->MS	Disconnect	
21	MS->SS	Release	
22	SS->MS	Release Complete	
23	SS->MS	Channel Release	

Specific Message Contents

ASSIGNMENT COMMAND

Information Element	value/remarks
Channel description	O-TCH/AHS
Mode of the first channel - Mode	Half rate version 6

THRESH_REQ

Information Element	value/remarks
HYST3	Not defined (set to all 1s)
THRESH3	Not defined (set to all 1s)
HYST2	Not defined (set to all 1s)
THRESH2	Not defined (set to all 1s)
HYST1	2 dB
THRESH1	12.5 dB

26.17.9.7 Unknown RATSCCH REQ Message

26.17.9.7.1 Conformance requirements

The ACK_UNKNOWN message serves as an acknowledgement that a RATSCCH REQ message has been detected and correctly decoded, but was unknown to the Addressee.

Reference:

3GPP TS 45.009 sub-clause: 3.2.2.3.3

26.17.9.7.2 Test purpose

This test will verify that the MS can correctly handle an unknown RATSCCH REQ message.

26.17.9.7.3 Method of test

Initial Conditions

System Simulator:

1 cell with default parameters

Mobile Station:

The MS is in the "idle, updated" state, with a TMSI allocated and camped on cell A.

Specific PICS statements:

-

PIXIT statements:

-

Foreseen Final State of the MS

Idle Updated, TMSI allocated and camped on cell A.

Test Procedure

- 1) User initiates a Mobile Originated call.
- 2) The network and the MS indicate Bearer capabilities IE with the AMR speech Half Rate (Version 6).
- 3) The network performs an assignment on a TCH channel with MultiRate configuration to the MS.
- 4) The call is maintained during a programmable time without variation of RxLev /RxQual.
- 5) The SS shall send an unknown RATSCCH_REQ message, with message content as all zeros, during the call at a programmable time.
- 6) The MS answers with a ACK_UNKNOWN message within 3 speech frames
- 7) The network initiates the call release.

Maximum Duration of Test

5 minutes

Expected Sequence

Step	Direction	Message	Comments
1	MS		MS is in idle mode
2	MS		MS initiates Mobile Originated call
3	MS->SS	Channel Request	Establishment cause is "originating call and the network does not set the NECI bit to 1".
4	SS->MS	Immediate Assignment	See Default Messages for AMR
5	MS->SS	CM Service Request	CM Service Type = Mobile Originating Call Establishment.
6	SS->MS	AUTHENTICATION REQUEST	
7	MS->SS	AUTHENTICATION RESPONSE	SRES specifies correct value
8	SS->MS	CIPHERING MODE COMMAND	SS starts deciphering after sending the message
9	MS->SS	CIPHERING MODE COMPLETE	Shall be sent enciphered. All following messages shall be sent enciphered.
10	MS->SS	Setup	MS indicates supported speech versions
11	SS->MS	Call Proceeding	
12	SS->MS	Alerting	
13	SS->MS	Assignment Command	See specific message contents.
14	MS->SS	Assignment Complete	
15	SS->MS	Connect	
16	MS->SS	Connect Acknowledge	
17	MS		The TCH shall be through connected by both directions in the dedicated mode, using the codec mode specified.
18	SS->MS	Unknown RATSCCH message	Message contents all 0's
19	MS->SS	ACK_UNKNOWN	Message must be received within 3 speech frames
20	SS->MS	Disconnect	
21	MS->SS	Release	
22	SS->MS	Release Complete	
23	SS->MS	Channel Release	

Specific Message Contents

ASSIGNMENT COMMAND

Information Element	value/remarks
Channel description	O-TCH/AHS
Mode of the first channel - Mode	Half rate version 6

RATSCCH_REQ

Information Element	value/remarks
all bits	0

26.17.9.8 Ignore subsequent REQ prior to expiry of REQ_Activation counter

26.17.9.8.1 Conformance requirements

If another REQ message is received by the MS before the REQ_Activation counter has elapsed, the MS shall ignore the message.

Reference:

3GPP TS 45.009 sub-clause: 3.2.2.2

26.17.9.8.2 Test purpose

This test will verify that the MS ignores a REQ message which is received before the REQ_Activation counter has elapsed. The test will verify that both the following conditions are satisfied:

- the MS ignores a subsequent REQ message received after it has sent the ACK_OK but before the REQ_Activation counter has elapsed.

26.17.9.8.3 Method of test

Initial Conditions

System Simulator:

1 cell with default parameters

Mobile Station:

The MS is in the "idle, updated" state, with a TMSI allocated and camped on cell A.

Specific PICS statements:

-

PIXIT statements:

-

Foreseen Final State of the MS

Idle Updated, TMSI allocated and camped on cell A.

Test Procedure

- 1) User initiates a Mobile Originated call.
- 2) The network and the MS indicate Bearer capabilities IE with the AMR speech Half Rate (Version 6).
- 3) The network performs an assignment on a TCH channel with MultiRate configuration to the MS.
- 4) The call is maintained during a programmable time without variation of RxLev /RxQual.
- 5) The SS shall send an AMR_CONFIG_REQ message during the call at a programmable time.
- 6) The MS answers the AMR_CONFIG_REQ with an ACK_OK message within 3 speech frames of the AMR_CONFIG_REQ.
- 7) The SS shall send a second AMR_CONFIG_REQ message within 11 speech frames of sending the first AMR_CONFIG_REQ message .
- 8) The SS shall verify that the codec mode used by the MS after the REQ_Activation counter has elapsed is consistent with the first AMR_CONFIG_REQ message, and not the second AMR_CONFIG_REQ message.
- 9) The SS initiates the call release.

Maximum Duration of Test

5 minutes

Expected Sequence

Step	Direction	Message	Comments
1	MS		MS is in idle mode
2	MS		MS initiates Mobile Originated call
3	MS->SS	Channel Request	Establishment cause is "originating call and the network does not set the NECI bit to 1".
4	SS->MS	Immediate Assignment	See Default Messages for AMR
5	MS->SS	CM Service Request	CM Service Type = Mobile Originating Call Establishment.
6	SS->MS	AUTHENTICATION REQUEST	
7	MS->SS	AUTHENTICATION RESPONSE	SRES specifies correct value
8	SS->MS	CIPHERING MODE COMMAND	SS starts deciphering after sending the message
9	MS->SS	CIPHERING MODE COMPLETE	Shall be sent enciphered. All following messages shall be sent enciphered.
10	MS->SS	Setup	MS indicates supported speech versions
11	SS->MS	Call Proceeding	
12	SS->MS	Alerting	
13	SS->MS	Assignment Command	See specific message contents.
14	MS->SS	Assignment Complete	
15	SS->MS	Connect	
16	MS->SS	Connect Acknowledge	
17	MS		The TCH shall be through connected by both directions in the dedicated mode, using the codec mode specified.
18	SS->MS	AMR_CONFIG_REQ	See specific message contents.
19	MS->SS	ACK_OK	Message must be received within 3 speech frames
20	SS->MS	AMR_CONFIG_REQ	See specific message contents. To be sent to MS within 11 speech frames of having sent the first message in step 18.
21	MS		Verify that the codec mode used by the MS is that specified in step 18.
22	SS->MS	Disconnect	
23	MS->SS	Release	
24	SS->MS	Release Complete	
25	SS->MS	Channel Release	

Specific Message Contents

ASSIGNMENT COMMAND

Information Element	value/remarks
Channel description	O-TCH/AHS
Mode of the first channel	
- Mode	Half rate version 6.

AMR_CONFIG_REQ

In step 18:

Information Element	value/remarks
ICM	CODEC_MODE_1
ACS	2 codec modes
HYST2	Not defined (set to all 1s)
THRESH2	Not defined (set to all 1s)
HYST1	2 dB
THRESH1	12.5 dB

In step 20:

Information Element	value/remarks
ICM	CODEC_MODE_1
ACS	1 codec mode – different to any codec mode specified in the ACS in step 15.
HYST2	Not defined (set to all 1s)
THRESH2	Not defined (set to all 1s)
HYST1	Not defined (set to all 1s)
THRESH1	Not defined (set to all 1s)

26.17.9.9 Initiation of Transaction with ACK_ERR or ACK_UNKNOWN

26.17.9.9.1 Conformance requirements

If at either side an ACK_ERR or ACK_UNKNOWN is received although no corresponding REQ has been sent before, the ACK message shall be ignored.

Reference:

3GPP TS 45.009 sub-clause: 3.2.2.2

26.17.9.9.2 Test purpose

This test will verify that the MS ignores any ACK_ERR or ACK_UNKNOWN which is received without a corresponding REQ having been sent.

26.17.9.9.3 Method of test

Initial Conditions

System Simulator:

1 cell with default parameters

Mobile Station:

The MS is in the "idle, updated" state, with a TMSI allocated and camped on cell A.

Specific PICS statements:

-

PIXIT statements:

-

Foreseen Final State of the MS

Idle Updated, TMSI allocated and camped on cell A.

Test Procedure

- 1) User initiates a Mobile Originated call.
- 2) The network and the MS indicate Bearer capabilities IE with the AMR speech Half Rate (Version 6).
- 3) The network performs an assignment on a TCH channel with MultiRate configuration to the MS.
- 4) The call is maintained during a programmable time without variation of RxLev /RxQual.
- 5) The SS shall send an ACK_ERR message during the call at a programmable time.
- 6) The SS verifies that no message is received from the MS on the RATSCCH within 12 speech frames.
- 7) The SS shall send an ACK_UNKNOWN message during the call at a programmable time.
- 8) The SS verifies that no message is received from the MS on the RATSCCH within 12 speech frames.

9) The network initiates the call release.

Maximum Duration of Test

5 minutes

Expected Sequence

Step	Direction	Message	Comments
1	MS		MS is in idle mode
2	MS		MS initiates Mobile Originated call
3	MS->SS	Channel Request	Establishment cause is "originating call and the network does not set the NECI bit to 1".
4	SS->MS	Immediate Assignment	See Default Messages for AMR
5	MS->SS	CM Service Request	CM Service Type = Mobile Originating Call Establishment.
6	SS->MS	AUTHENTICATION REQUEST	
7	MS->SS	AUTHENTICATION RESPONSE	SRES specifies correct value
8	SS->MS	CIPHERING MODE COMMAND	SS starts deciphering after sending the message
9	MS->SS	CIPHERING MODE COMPLETE	Shall be sent enciphered. All following messages shall be sent enciphered.
10	MS->SS	Setup	MS indicates supported speech versions
11	SS->MS	Call Proceeding	
12	SS->MS	Alerting	
13	SS->MS	Assignment Command	See specific message contents for codec modes.
14	MS->SS	Assignment Complete	
15	SS->MS	Connect	
16	MS->SS	Connect Acknowledge	
17	MS		The TCH shall be through connected by both directions in the dedicated mode, using the codec mode specified.
18	SS->MS	ACK_ERR	
19	MS		Wait at least 12 speech frames to ensure that no message is received from the MS.
20	SS->MS	ACK_UNKNOWN	
21	MS		Wait at least 12 speech frames to ensure that no message is received from the MS.
22	SS->MS	Disconnect	
23	MS->SS	Release	
24	SS->MS	Release Complete	
25	SS->MS	Channel Release	

Specific Message Contents

ASSIGNMENT COMMAND

Information Element	value/remarks
Channel description	O-TCH/AHS
Mode of the first channel - Mode	Half rate version 6

26.17.9.10 Inversion of the Phase of the CMR/CMI

26.17.9.10.1 Conformance requirements

The phase of the Codec Mode Indication in the downlink can be changed during a call by using a CMI_PHASE_REQ message sent on the RATSCCH.

The CMI_PHASE_REQ message may be sent by the BTS during a call to change the phase of the Codec Mode Indication in the downlink without interruption of the speech transmission.

The ACK_OK message serves as an acknowledgement that a RATSCCH REQ message has been detected, correctly decoded (no CRC error) and that it is defined for the Addressee.

References:

3GPP TS 45.009 clauses 3.2.1.3 and 3.2.2.3.4.

26.17.9.10.2 Test purpose

This test shall verify that the MS is able to change the phase of the Codec Mode Indication in the downlink using the RATSCCH protocol.

26.17.9.10.3 Method of test**Initial Conditions****System Simulator:**

1 cell with default parameters

Mobile Station:

The MS is in the "idle, updated" state, with a TMSI allocated and camped on cell A.

Specific PICS statements:

-

PIXIT statements:

-

Foreseen Final State of the MS

Idle Updated, TMSI allocated and camped on cell A.

Test Procedure

- 1) User initiates a Mobile Originated call.
- 2) The network and the MS indicate Bearer capabilities IE with the AMR speech Half Rate (Version 6).
- 3) The network performs an assignment on a TCH channel with MultiRate configuration to the MS.
- 4) The network shall indicate Codec Mode Command = 0 and Codec Mode Indication = 1.
- 5) The SS sends a series of CMI_PHASE_REQ messages during the call to change the phase of the Codec Mode Indication in the downlink.
- 6) The MS responds to each CMI_PHASE_REQ message with an ACK_OK message on the RATSCCH.
- 7) The SS shall ensure that the phase request has been handled correctly by checking the Uplink CMI = 0 for 20 speech frames following the receipt of the ACK_OK.
- 8) The network initiates the call release.

Maximum Duration of Test

5 minutes

Expected Sequence

Step	Direction	Message	Comments
1	MS		MS is in idle mode
2	MS		MS initiates Mobile Originated call
3	MS->SS	Channel Request	Establishment cause is "originating call and the network does not set the NECI bit to 1".
4	SS->MS	Immediate Assignment	See Default Messages for AMR
5	MS->SS	CM Service Request	CM Service Type = Mobile Originating Call Establishment.
6	SS->MS	AUTHENTICATION REQUEST	
7	MS->SS	AUTHENTICATION RESPONSE	SRES specifies correct value
8	SS->MS	CIPHERING MODE COMMAND	SS starts deciphering after sending the message
9	MS->SS	CIPHERING MODE COMPLETE	Shall be sent enciphered. All following messages shall be sent enciphered.
10	SS->MS	Setup	AMR speech
11	MS->SS	Call Proceeding	
12	MS->SS	Alerting	
13	SS->MS	Assignment Command	Multirate Configuration for 2 codec modes
14	MS->SS	Assignment Complete	
15	SS->MS	Connect	
16	MS->SS	Connect Acknowledge	
17	MS		The TCH shall be through connected by both directions in the dedicated mode, using the codec mode specified.
18	SS->MS	CMI_PHASE_REQ	See specific message contents
19	MS->SS	ACK_OK	
20	MS		Wait 20 speech frames, then check that UL CMI = 0
21	SS->MS	CMI_PHASE_REQ	See specific message contents
22	MS->SS	ACK_OK	
23	MS		Wait 20 speech frames, then check that UL CMI = 0
24	SS->MS	CMI_PHASE_REQ	See specific message contents
25	MS->SS	ACK_OK	
26	MS		Wait 20 speech frames, then check that UL CMI = 0
27	SS->MS	CMI_PHASE_REQ	See specific message contents
28	MS->SS	ACK_OK	
29	MS		Wait 20 speech frames, then check that UL CMI = 0
30	SS->MS	Disconnect	
31	MS->SS	Release	
32	SS->MS	Release Complete	
33	SS->MS	Channel Release	

Specific Message Contents

ASSIGNMENT COMMAND

Information Element	value/remarks
Channel description	O-TCH/AHS
Mode of the first channel	
- Mode	Half rate version 6.

In step 15:

CMI_PHASE_REQ

Information Element	value/remark
CMIP	0: CMI transmitted in even speech frames

This message should be sent in a RATSCCH frame where the RATSCCH_DATA part for AHS replaces a speech frame which would have carried a Codec Mode Command.

In step 18:

CMI_PHASE_REQ

Information Element	value/remark
CMIP	1: CMI transmitted in odd speech frames (back to default)

This message should be sent in a RATSCCH frame where the RATSCCH_DATA part for AHS replaces a speech frame which would have carried a Codec Mode Command.

In step 21:

CMI_PHASE_REQ

Information Element	value/remark
CMIP	0: CMI transmitted in even speech frames

This message should be sent in a RATSCCH frame where the RATSCCH_DATA part for AHS replaces a speech frame which would have carried a Codec Mode Indication.

In step 24:

CMI_PHASE_REQ

Information Element	value/remark
CMIP	1: CMI transmitted in odd speech frames (back to default)

This message should be sent in a RATSCCH frame where the RATSCCH_DATA part for AHS replaces a speech frame which would have carried a Codec Mode Indication.

26.17.9.11 Change of Active Codec Set

26.17.9.11.1 Conformance requirements

AMR codec mode adaptation is done within a set of 4 codec modes. The codec mode set (Active Codec Set) to be used by the BSS and the MS is defined during call setup and/or handover by layer 3 signalling. The ACS can be changed during a call using an AMR_CONFIG_REQ message sent on the RATSCCH.

The AMR_CONFIG_REQ message may be sent by the BTS during a call to change the AMR configuration on the radio interface without interruption of the speech transmission.

The ACK_OK message serves as an acknowledgement that a RATSCCH REQ message has been detected, correctly decoded (no CRC error) and that it is defined for the Addressee.

If the ACS consists of four modes, then the complete set of thresholds/hysteresis can not be sent with this message. In that case, all THRESH_j and HYST_j fields are reserved for future use and shall be set to "1". Similar, if the BTS has no threshold and hysteresis parameters for the given configuration, then all THRESH_j and HYST_j field bits shall be set to "1" to indicate that they are undefined. The THRESH_REQ message shall be used to transmit these parameters at a later point in time. As long as the MS has no defined threshold and hysteresis parameters it shall use the Initial Codec Mode for the Codec Mode Request.

References:

3GPP TS 45.009 clauses 3.2.2.3.5 and 3.4.

26.17.9.11.2 Test purpose

This test shall verify that the MS is able to change its Active Codec Set using the RATSCCH protocol, with change of thresholds, and with non-specification of thresholds.

26.17.9.11.3 Method of test

Initial Conditions

System Simulator:

1 cell with default parameters

Mobile Station:

The MS is in the "idle, updated" state, with a TMSI allocated and camped on cell A.

Specific PICS statements:

-

PIXIT statements:

-

Foreseen Final State of the MS

Idle Updated, TMSI allocated and camped on cell A.

Test Procedure

- 1) User initiates a Mobile Originated call.
- 2) The network and the MS indicate Bearer capabilities IE with the AMR speech Half Rate (Version 6).
- 3) The network performs an assignment on a TCH channel with MultiRate configuration to the MS.
- 4) The SS uses the codec with the highest bit-rate in the current ACS for the Codec Mode Indication, and that with the lowest bit-rate for the Codec Mode Command.
- 5) The SS sends an AMR_CONFIG_REQ message during the call to reconfigure the Multirate settings.
- 6) The MS responds to each AMR_CONFIG_REQ message with an ACK_OK message on the RATSCCH.
- 7) The SS shall ensure that the change occurs correctly for downlink (12 speech frames after AMR_CONFIG_REQ message was sent), and for uplink (12 speech frames after ACK_OK was received) by checking parity of received speech frames, and correct implementation of Uplink Codec mode Request.
- 8) The SS shall ensure that each of the codecs in the ACS have been implemented correctly by setting the CMC to each of the applicable modes, and ensuring that the UL frames with each CMI are received without parity error. The SS shall then set the CMI and CMC to the codec with highest and lowest bit rates respectively.
- 9) Steps 4 to 8 shall be repeated for differing AMR_CONFIG_REQ parameters and sending conditions.
- 10) The network initiates the call release.

Maximum Duration of Test

5 minutes

Expected Sequence

Step	Direction	Message	Comments
1	MS		MS is in idle mode
2	MS		MS initiates Mobile Originated call
3	MS->SS	Channel Request	Establishment cause is "originating call and the network does not set the NECI bit to 1".
4	SS->MS	Immediate Assignment	See Default Messages for AMR
5	MS->SS	CM Service Request	CM Service Type = Mobile Originating Call Establishment.
6	SS->MS	AUTHENTICATION REQUEST	
7	MS->SS	AUTHENTICATION RESPONSE	SRES specifies correct value
8	SS->MS	CIPHERING MODE COMMAND	SS starts deciphering after sending the message
9	MS->SS	CIPHERING MODE COMPLETE	Shall be sent enciphered. All following messages shall be sent enciphered.
10	MS->SS	Setup	AMR speech
11	SS->MS	Call Proceeding	
12	SS->MS	Alerting	
13	SS->MS	Assignment Command	Multirate Configuration for 2 codec modes
14	MS->SS	Assignment Complete	
15	SS->MS	Connect	
16	MS->SS	Connect Acknowledge	
17	MS		The TCH shall be through connected by both directions in the dedicated mode, using the codec mode specified.
18	SS->MS	AMR_CONFIG_REQ	See specific message contents.
19	MS->SS	ACK_OK	
20	MS		Check that ACS changes have been implemented correctly. Expected CMR = 0.
21	SS->MS	AMR_CONFIG_REQ	See specific message contents.
22	MS->SS	ACK_OK	
23	MS		Check that ACS changes have been implemented correctly. Expected CMR = 0 or 1.
24	SS->MS	AMR_CONFIG_REQ	See specific message contents.
25	MS->SS	ACK_OK	
26	MS		Check that ACS changes have been implemented correctly. Expected CMR = 0, 1 or 2.
27	SS->MS	AMR_CONFIG_REQ	See specific message contents.
28	MS->SS	ACK_OK	
29	MS		Check that ACS changes have been implemented correctly. Expected CMR = 0, 1, 2 or 3.
30	SS->MS	AMR_CONFIG_REQ	See specific message contents.
31	MS->SS	ACK_OK	
32	MS		Check that ACS changes have been implemented correctly. Expected CMR = 2 (special case where CMR = ICM).
33	SS->MS	Disconnect	
34	MS->SS	Release	
35	SS->MS	Release Complete	
36	SS->MS	Channel Release	

Specific Message Contents

In all cases, the Active Codec Set field of the AMR_CONFIG_REQ messages should be programmed to ensure that the codec rate changes when the new configuration takes effect.

ASSIGNMENT COMMAND

Information Element	value/remarks
Channel description Mode of the first channel - Mode Multi-Rate configuration	O-TCH/AHS Half rate version 6. Arbitrary set of codec modes, thresholds and hysteresis specified according to 3GPP TS 45.009

In step 18:

AMR_CONFIG_REQ

Information Element	value/remark
ICM ACS	CODEC_MODE_1 1 codec mode (different from that in Assignment Command)
HYST2 THRESH2	n/a – set to all 1's n/a – set to all 1's
HYST1 THRESH1	n/a – set to all 1's n/a – set to all 1's

This message should be sent in a RATSCCH frame where the RATSCCH_DATA part for AHS replaces a speech frame which would have carried a Codec Mode Command.

In step 21:

AMR_CONFIG_REQ

Information Element	value/remark
ICM ACS	CODEC_MODE_1 2 codec modes
HYST2 THRESH2	n/a – set to all 1's n/a – set to all 1's
HYST1 THRESH1	2 dB 12.5 dB

This message should be sent in a RATSCCH frame where the RATSCCH_DATA part for AHS replaces a speech frame which would have carried a Codec Mode Command.

In step 24:

AMR_CONFIG_REQ

Information Element	value/remark
ICM ACS	CODEC_MODE_2 3 codec modes
HYST2 THRESH2	2 dB 13 dB
HYST1 THRESH1	2 dB 7 dB

This message should be sent in a RATSCCH frame where the RATSCCH_DATA part for AHS replaces a speech frame which would have carried a Codec Mode Indication.

In step 27:

AMR_CONFIG_REQ

Information Element	value/remark
ICM	CODEC_MODE_3
ACS	4 codec modes
HYSTc	2 dB
THRESH3	18 dB
THRESH2	12 dB
THRESH1	6.5 dB

This message should be sent in a RATSCCH frame where the RATSCCH_DATA part for AHS replaces a speech frame which would have carried a Codec Mode Indication.

In step 30:

AMR_CONFIG_REQ

Information Element	value/remark
ICM	CODEC_MODE_3
ACS	4 codec modes
HYST2	Undefined – set to all 1's
THRESH2	Undefined – set to all 1's
HYST1	Undefined – set to all 1's
THRESH1	Undefined – set to all 1's

This message should be sent in a RATSCCH frame where the RATSCCH_DATA part for AHS replaces a speech frame which would have carried a Codec Mode Command.

26.17.108-PSK AMR HR signalling/ test of the channel mode modify procedure

NOTE: This test is derived from the test in sub-clause 26.16.10 entitled "AMR signalling/ test of the channel mode modify procedure".

26.17.10.1 Void

26.17.10.2 8-PSK AMR HR signalling/ test of the channel mode modify procedure/ half rate

26.17.10.2.1 Conformance requirement

The MS with a TCH/H allocated acknowledges a CHANNEL MODE MODIFY message by sending a CHANNEL MODE MODIFY ACKNOWLEDGE message specifying the new mode and by switching to this mode.

References

3GPP TS 04.08 / 3GPP TS 44.018, subclauses 3.4.6.1.1 and 3.4.6.1.2

26.17.10.2.2 Test purpose

To verify that the MS with a TCH/H allocated acknowledges a CHANNEL MODE MODIFY message by sending a CHANNEL MODE MODIFY ACKNOWLEDGE message specifying the new mode and by switching to this mode.

26.17.10.2.3 Method of test

Initial Conditions

System Simulator: 1 cell, default parameters.

Mobile Station: The MS is "idle updated", with TMSI allocated.

Specific PICS statements:

-

PIXIT statements:

-

Foreseen Final State of the MS

"Idle, updated", with TMSI allocated.

Test procedure

A Mobile Terminated call is initiated, however following the CHANNEL REQUEST received from the Mobile Station, the SS sends an IMMEDIATE ASSIGNMENT to the MS commanding it to go to a TCH/H. This sets the Channel Mode automatically to "Signalling Only".

The SS then sends a series of CHANNEL MODE MODIFY messages to the MS. Each time it is checked that the MS responds with a CHANNEL MODE MODIFY ACKNOWLEDGE message specifying the channel mode that has been specified in the CHANNEL MODE MODIFY message (ie Half Rate version 6)

Maximum Duration of Test

30 seconds.

Expected Sequence

Step	Direction	Message	Comments
1	SS->MS	PAGING REQUEST TYPE 1	Sent on correct paging sub channel
2	MS->SS	CHANNEL REQUEST	Establishment cause indicates "answer to paging"
3	SS->MS	IMMEDIATE ASSIGNMENT	Assignment to a non hopping TCH/H signalling only
4	MS->SS	PAGING RESPONSE	Message is contained in the SABM
5	SS->MS	AUTHENTICATION REQUEST	
6	MS->SS	AUTHENTICATION RESPONSE	SRES specifies correct value
7	SS->MS	CIPHERING MODE COMMAND	SS starts deciphering after sending the message
8	MS->SS	CIPHERING MODE COMPLETE	Shall be sent enciphered. All following messages shall be sent enciphered.
9	SS		SS starts ciphering
10	SS->MS	CHANNEL MODE MODIFY	
11	MS->SS	CHANNEL MODE MODIFY ACKNOWLEDGE	Verify that Channel description = TCH/H, Channel mode = Half rate version 6
12	SS->MS	CHANNEL MODE MODIFY	
13	MS->SS	CHANNEL MODE MODIFY ACKNOWLEDGE	Verify that Channel description = TCH/H, Channel mode = Half rate version 6
14	SS->MS	CHANNEL MODE MODIFY	
15	MS->SS	CHANNEL MODE MODIFY ACKNOWLEDGE	Verify that Channel description = TCH/H, Channel mode = Half rate version 6
16	SS->MS	CHANNEL MODE MODIFY	
17	MS->SS	CHANNEL MODE MODIFY ACKNOWLEDGE	Verify that Channel description = TCH/H, Channel mode = Half rate version 6
18	SS->MS	CHANNEL RELEASE	

Specific Message Contents

In steps 10 – 16:

CHANNEL MODE MODIFY

Information Element	value/remark
Channel description	in steps 10, 12, 14, 16: same as for step 3
Channel mode	
Mode	Speech Full or Half rate version 6
Multi-Rate configuration	in steps 10: change of MR configuration, no initial codec mode
	in steps 12: change of MR configuration, initial codec mode specified
	in steps 14: change of MR thresholds, no initial codec mode
	in steps 16: initial codec mode specified

26.18 Dynamic ARFCN mapping tests

26.18.1 Control of dynamic ARFCN mapping with SI14 and SI15

26.18.1.1 Conformance Requirement

The dynamic mapping of ARFCN to carrier frequencies is specified as follow in 3GPP TS 45.005:

“The carrier frequency is designated by the absolute radio frequency channel number (ARFCN). If we call $F_l(n)$ the frequency value of the carrier ARFCN n in the lower band, and $F_u(n)$ the corresponding frequency value in the upper band, we have for the dynamically mapped ARFCNs:

T-GSM 380	$F_l(n) = 380.2 + 0.2*(n-x+y)$	$x \leq n \leq x+z$	$F_u(n)=F_l(n) + 10$
T-GSM 410	$F_l(n) = 410.2 + 0.2*(n-x+y)$	$x \leq n \leq x+z$	$F_u(n)=F_l(n) + 10$
T-GSM 810	$F_l(n) = 806.2 + 0.2*(n-x+y)$	$x \leq n \leq x+z$	$F_u(n)=F_l(n) + 45$
T-GSM 900	$F_l(n) = 870.4 + 0.2*(n-x+y)$	$x \leq n \leq x+z$	$F_u(n)=F_l(n) + 45$
GSM 710	$F_l(n) = 698.2 + 0.2*(n-x+y)$	$x \leq n \leq x+z$	$F_u(n) = F_l(n) + 30$
GSM 750	$F_l(n) = 747.2 + 0.2*(n-x+y)$	$x \leq n \leq x+z$	$F_u(n) = F_l(n) + 30$
DCS 1 800	$F_l(n) = 1710.2 + 0.2*(n-x+y)$	$x \leq n \leq x+z$	$F_u(n) = F_l(n) + 95$
PCS 1 900	$F_l(n) = 1850.2 + 0.2*(n-x+y)$	$x \leq n \leq x+z$	$F_u(n) = F_l(n) + 80$

where the applicable band is indicated by the GSM_Band parameter, $x = \text{ARFCN_FIRST}$, $y = \text{BAND_OFFSET}$ and $z = \text{ARFCN_RANGE}$ (See 3GPP TS 44.018). Parameters defining carrier frequencies not belonging to the indicated band shall not be considered erroneous.

Information about dynamic mapping is provided by System Information type 15 or Packet System Information type 8 if PBCCH exists, and optionally by System Information type 14. Dynamic ARFCN mapping shall be valid for the whole PLMN. Dynamic mapping has priority over the fixed designation of carrier frequencies. The support of dynamic ARFCN mapping is optional for all other mobile stations except those supporting GSM 700 and T-GSM.”

The frequency band for T-GSM and GSM 700 (dynamic ARFCN mapping is mandatory for these frequencies bands as there is no physical mapping specified) are defined as follow in 3GPP TS 45.005:

- i) T-GSM 380 band:
 - for T-GSM 380, the system is required to operate in the following band:
 - 380,2 MHz to 389,8 MHz: mobile transmit, base receive;
 - 390,2 MHz to 399,8 MHz base transmit, mobile receive.
- ii) T-GSM 410 band:
 - for T-GSM 410, the system is required to operate in the following band:
 - 410,2 MHz to 419,8 MHz: mobile transmit, base receive;
 - 420,2 MHz to 429,8 MHz base transmit, mobile receive.

...

v) GSM 710 Band:

- for GSM 710, the system is required to operate in the following band:
 - 698 MHz to 716 MHz: base transmit, mobile receive;
 - 728 MHz to 746 MHz: mobile transmit, base receive.

vi) GSM 750 Band:

- for GSM 750, the system is required to operate in the following band:
 - 747 MHz to 762 MHz: base transmit, mobile receive;
 - 777 MHz to 792 MHz: mobile transmit, base receive.

vii) T-GSM 810 Band:

- for T-GSM 810, the system is required to operate in the following band:
 - 806 MHz to 821 MHz: mobile transmit, base receive;
 - 851 MHz to 866 MHz: base transmit, mobile receive.

...

xii) T-GSM 900 Band:

- for T-GSM 900 band, the system is required to operate in the following frequency band:
 - 870.4 MHz to 876 MHz: mobile transmit, base receive;
 - 915.4 MHz to 921 MHz: base transmit, mobile receive.

...

The way to change dynamic ARFCN mapping is specified as follow in 3GPP TS 44.018:

“SYSTEM INFORMATION TYPE 15 message is broadcast if dynamic ARFCN mapping is used in the PLMN. In this case ARFCN values are allocated and dynamically mapped to physical frequencies, see 3GPP TS 45.005. The presence of dynamic ARFCN mapping shall be indicated in Cell Options (BCCH) IE. When the value of the parameter DM_CHANGE_MARK is changed in the SYSTEM INFORMATION TYPE 15 message, the mobile station shall re-read information on dynamic mapping in a full set of SYSTEM INFORMATION 15 messages.

After the release of a dedicated connection, when returning to idle mode or packet idle mode, the mobile station may keep the dynamic ARFCN mapping information for the PLMN of the chosen cell under the following conditions:

- there has not been any handover during the connection; or
- the mobile station chooses the last cell (identified by the BCCH carrier and BSIC) that was used during the connection and there has not been any handover including dynamic ARFCN mapping information after reception of the dynamic ARFCN mapping information.

Otherwise, the mobile station shall acquire new dynamic ARFCN mapping information.”

References:

3GPP TS 45.005, subclause 2.

3GPP TS 44.018, subclauses 3.2.2.1, 9.1.43i, 9.1.43j, 10.5.2.3, 10.5.2.11b, 10.5.2.37j, 10.5.2.37k.

26.18.1.2 Test Purpose

To verify that for the frequencies bands for which Dynamic ARFCN mapping is mandatory, the MS:

- 1) detects that dynamic ARFCN mapping is supported in the cell (signalled via the DN-IND field of the Cell Options (BCCH) IE in the SI3)
- 2) decodes and interprets correctly the parameters $x = \text{ARFCN_FIRST}$, $y = \text{BAND_OFFSET}$ and $z = \text{ARFCN_RANGE}$ transmitted in the SI15 message broadcast on the BCCH.
- 3) decodes and interprets correctly the parameters $x = \text{ARFCN_FIRST}$, $y = \text{BAND_OFFSET}$ and $z = \text{ARFCN_RANGE}$ transmitted in the SI14 message broadcast on the SACCH.
- 4) detects a change of dynamic ARFCN mapping in the SI15 message broadcast on the BCCH (signalled via the DM_CHANGE_MARK field in SI15)

26.18.1.3 Method of Test

Initial Conditions

MS:

Switched off

MS operating in a band for which support of Dynamic ARFCN mapping is mandatory.

System Simulator:

1 cell, default setting for the frequency band to be tested.

Cell Options (BCCH) IE shall indicate that Dynamic ARFCN is supported

Specific PICS statements:

-

PIXIT statements:

-

Test Procedure

Two dynamic ARFCN mapping of the carrier frequencies of the band to be tested are defined (the two mappings shall not overlap):

- a) the first mapping referred as DM1 maps the N carrier frequencies of the band to be tested to the ARFCNs 438 to $438 + N$.
- b) the second mapping referred as DM2 maps $N - 1$ carrier frequencies (the first frequency is excluded) of the band to be tested to the ARFCNs $438 + N + 1$ to $438 + N + N$

The parameters of the SI14/SI15 rest octets corresponding to these mapping are defined in the following table:

SI14/SI15 rest octets parameters	DM1 mapping	DM2 mapping
GSM_Band	GSM T 380 or GSM T 410 or GSM T 810 or GSM 710 or GSM T 900	GSM T 380 or GSM T 410 or GSM T 810 or GSM 710 or GSM T 900
ARFCN_FIRST	438	$438 + N$
ARFCN_OFFSET	0	1
ARFCN_RANGE	N	$N - 1$

With:

$N = 47$ for T-GSM 380,

$N = 47$ for T-GSM 410,

$N = 89$ for GSM 710,

$N = 74$ for GSM 750,

N = 74 for T-GSM 810,

N = 27 for T-GSM 900.

The default layer 3 messages of the section 26.6.19 shall be used but when the DM2 mapping is used, the ARFCN numbers shall be modified by adding N.

The test is done in 3 steps:

- 1) Checking that the MS takes into account the ARFCN mapping defined in SI15

The SS broadcasts on the BCCH the default SIs and the SI15 containing the DM1 parameters. The MS is switched on. The MS shall trigger a IMSI Attach procedure. The SS assigns a SDCCH channel according to the dynamic ARFCN mapping defined in DM1. It is checked that the MS uses the frequency assigned in the IMMEDIATE ASSIGNMENT message. Before releasing the SDCCH channel, the SS sends to the MS on the SACCH the SI14 containing the DM2 parameters.

- 2) Checking that the MS takes into account the ARFCN mapping defined in SI14

When the channel has been released and before the MS receives on the BCCH the SI14 containing the DM2 parameters, the SS establishes a SDCCH by assigning a channel according to the dynamic ARFCN mapping defined in DM2. It is checked that the MS uses the frequency assigned in the IMMEDIATE ASSIGNMENT message.

- 3) Checking that the MS takes into account a change of dynamic ARFCN mapping in SI15

When the channel has been released by the MS the SS broadcasts on the BCCH the SI15 containing the the DM2 parameters and then the DM1 parameters. The SS establishes a SDCCH by assigning a channel according to the dynamic ARFCN mapping defined in DM1. It is checked that the MS uses the frequency assigned in the IMMEDIATE ASSIGNMENT message.

Maximum Duration of Test

1 minutes

Expected Sequence

Step	Direction	Message	Comments
1	SS -> MS		The SS broadcasts the SI15 containing the DM1 parameters.
2	MS		The MS is switched on.
3	MS -> SS	CHANNEL REQUEST	The MS initiates an IMSI attach procedure.
4	SS -> MS	IMMEDIATE ASSIGNMENT	The assigned carrier frequency is set using the dynamic ARFCN mapping defined with the DM1 parameters.
5	MS -> SS	LOCATION UPDATING REQUEST	It is checked that the LOCATION UPDATING REQUEST message is received on the carrier frequency assigned with the IMMEDIATE ASSIGNMENT message sent in step 4.
6	SS -> MS	LOCATION UPDATING ACCEPT	The SS allocates a new TMSI.
7	MS -> SS	TMSI REALLOCATION COMPLETE	
8	SS -> MS		The SS sends to the MS on the SACCH the SI14 containing the DM2 parameters.
9	SS -> MS	CHANNEL RELEASE	After the sending of this message, the SS waits the disconnection of the main signalling link.
10	MS		The MS shall stay in "idle" state for a short time and shall not receive the SI15 with the DM2 parameters during this time.
11	SS -> MS	PAGING REQUEST TYPE 1	
12	MS -> SS	CHANNEL REQUEST	"Establishment cause ": answer to paging.
13	SS -> MS	IMMEDIATE ASSIGNMENT	The assigned carrier frequency is set using the dynamic ARFCN mapping defined with the DM2 parameters.
14	MS -> SS	PAGING RESPONSE	It is checked that the PAGING RESPONSE message is received on the carrier frequency assigned with the IMMEDIATE ASSIGNMENT message sent in step 13.
15	SS -> MS	CHANNEL RELEASE	After the sending of this message, the SS waits the disconnection of the main signalling link.
16	SS -> MS		The SS broadcasts the SI15 containing the DM2 parameters during 5 seconds and then the SI15 containing the DM1 parameters.
17	SS -> MS	PAGING REQUEST TYPE 1	
18	MS -> SS	CHANNEL REQUEST	"Establishment cause ": answer to paging.
19	SS -> MS	IMMEDIATE ASSIGNMENT	The assigned carrier frequency is set using the dynamic ARFCN mapping defined with the DM1 parameters.
20	MS -> SS	PAGING RESPONSE	It is checked that the PAGING RESPONSE message is received on the carrier frequency assigned with the IMMEDIATE ASSIGNMENT message sent in step 19.
21	SS -> MS	CHANNEL RELEASE	

26.19 AMR WB - signalling

26.19.1 Reserved for future use

26.19.2 Reserved for future use

26.19.3 Reserved for future use

26.19.3a WB AMR / Structured procedures / MS terminated call / early assignment / specified initial codec mode

NOTE: this test is derived from the one described in subclause 26.16.3a and entitled: "Structured procedures / MS terminated call / early assignment/ specified initial codec mode"

26.19.3a.1 Conformance requirement

- 1) In acceptance to a SETUP message indicating speech, the MS shall indicate and include in the CALL CONFIRMED message all the speech versions that it supports.

- 2) Upon receipt of the ASSIGNMENT COMMAND message specifying using CHx-FR or CHx/HR the Mobile Station continues a mobile terminating call establishment with early assignment of traffic channel:
 - a) by replying to the ASSIGNMENT command with an ASSIGNMENT COMPLETE message; and
 - b) by continuing the call establishment by through connecting TCH in both directions if it supports immediate connect or by sending an ALERTING message otherwise.
- 3) The ASSIGNMENT COMMAND will specify the subset of codec modes that the MS is allowed to use for the call, the thresholds and the initial codec mode for immediate use by the MS.
- 4) For speech calls, the mobile station shall attach the user connection at latest when sending the connect message, except if there is no compatible radio resource available at this time. In this case the attachment shall be delayed until such a resource becomes available.

CHx: identifies any of the Channel Codec modes.

FR: full rate channel.

HR: half rate channel.

References:

3GPP TS 04.08 / 3GPP TS 44.018 subclauses 9.12 and 9.1.5.

3GPP TS 05.09 subclause 3.4.

26.19.3a.2 Test purpose

- 1) To verify that, in acceptance to a SETUP message indicating speech, the MS indicates and includes in the CALL CONFIRMED message all the speech versions that it supports.
- 2) To verify that upon receipt of the ASSIGNMENT COMMAND message specifying using CHx-FR or CHx/HR the Mobile Station continues a mobile terminating call establishment with early assignment of traffic channel:
 - a) by replying to the ASSIGNMENT command with an ASSIGNMENT COMPLETE message; and
 - b) by continuing the call establishment by through connecting TCH in both directions if it supports immediate connect or by sending an ALERTING message otherwise.
- 3) To verify that upon receipt of an ASSIGNMENT COMMAND with codec mode specified, the MS shall use that specified codec mode.
- 4) To verify that for speech calls, the mobile station shall attach the user connection at latest when sending the connect message, except if there is no compatible radio resource available at this time. In this case the attachment shall be delayed until such a resource becomes available.

26.19.3a.3 Method of Test

Initial Conditions

SS 1 cell, default parameters

MS in MM-state "idle, updated" with valid TMSI and CKSN

Specific PICS statements:

- Support of GSM speech full rate version 4 (O-TCH/WFS).
- Support of GSM speech Half rate version 4 (O-TCH/WHS).
- Support of GSM Speech Full Rate version 5 (TCH/WFS).
- Immediate connect supported for all circuit switched basic services.

PIXIT statements:

- Way to indicate alerting.
- Way to make the MS accept an incoming call after alerting.

Foreseen Final State of MS

"Idle, updated", with TMSI allocated.

Test Procedure

The following test is performed for both channel modes of the multi-rate codec, ie full rate and half rate:

A teleservice is selected that is supported by the MS; if the MS supports speech, the selected teleservice is speech. If necessary, the MS is configured for that teleservice.

The MS is paged and the resulting call is established. Having reached the active state, the MS is made to clear the call.

Maximum Duration of Test

3 minutes

Expected Sequence

This test is repeated for M=1, 2, 3, 4 (M=4 only when k=2 and 3).

This test is repeated for

- k =1 if full rate speech version 5 is supported, and
- k = 2 if full rate speech version 4 is supported, and
- k = 3 if half rate speech version 4 is supported.

Step	Direction	Message	Comments
1	SS->MS	PAGING REQUEST TYPE 1	Sent on the correct paging sub-channel Message is contained in the SABM SRES specifies correct value SS starts deciphering after sending the message Shall be sent enciphered. All following messages shall be sent enciphered. SS starts ciphering
2	MS->SS	CHANNEL REQUEST	
3	SS->MS	IMMEDIATE ASSIGNMENT	
4	MS->SS	PAGING RESPONSE	
5	SS->MS	AUTHENTICATION REQUEST	
6	MS->SS	AUTHENTICATION RESPONSE	
7	SS->MS	CIPHERING MODE COMMAND	
8	MS->SS	CIPHERING MODE COMPLETE	
9	SS		
10	SS->MS	SETUP	
11	MS->SS	CALL CONFIRMED	
			If the MS supports an Immediate connection then branch A applies. If the MS doesn't support an immediate connection then branch B applies.
A12	MS->SS	CONNECT	sent on the old channel SS allocates allowed subset codec modes and identifies a mode for immediate operation.
A13	SS->MS	ASSIGNMENT COMMAND	
A14	MS->SS	ASSIGNMENT COMPLETE	
B12	SS->MS	ASSIGNMENT COMMAND	SS allocates allowed subset codec modes and identifies a mode for immediate operation. An alerting indication as defined in the PIXIT statement is given by the MS. The MS is made to accept the call.
B13	MS->SS	ASSIGNMENT COMPLETE	
B14	MS->SS	ALERTING	
B15	MS		
B16	MS		
B17	MS->SS	CONNECT	
18	MS		
19	SS->MS	CONNECT ACK	The TCH shall be through connected by both directions in the dedicated mode, using the codec mode specified. The MS is made to release the call. The main signalling link is released.
20	MS		
21	MS->SS	DISCONNECT	
22	SS->MS	RELEASE	
23	MS->SS	RELEASE COMPLETE	
24	SS->MS	CHANNEL RELEASE	

Specific Message Content

M=1

Assignment Command

Information Element	value/remark
Channel mode Mode	Speech full or half rate version 4, or speech full rate version 5
Multi-Rate configuration	ICMI = 1 Start Mode specified 1 codec mode specified

M=2

Assignment Command

Information Element	value/remark
Channel mode Mode	Speech full or half rate version 4, or speech full rate version 5
Multi-Rate configuration	ICMI = 1 Start Mode specified 2 codec modes and threshold vales specified

M=3

Assignment Command

Information Element	value/remark
Channel mode Mode	Speech full or half rate version 4, or speech full rate version 5
Multi-Rate configuration	ICMI = 1 Start Mode specified 3 codec modes and threshold vales specified

M=4

This step is applicable only if the MS supports full or half rate version 4.

Assignment Command

Information Element	value/remark
Channel mode Mode	Speech full or half rate version 4
Multi-Rate configuration	ICMI = 1 Start Mode specified 4 codec modes and threshold vales specified

K = 1

This step is applicable only if the MS supports full rate version 5.

Assignment Command

Information Element	value/remark
Channel description	TCH/F
Channel mode Mode	Speech full rate version 5

K = 2

This step is applicable only if the MS supports full rate version 4.

Assignment Command

Information Element	value/remark
Channel description	TCH/F
Channel mode Mode	Speech full rate version 4

K = 3

This step is applicable only if the MS supports half rate version 4.

Assignment Command

Information Element	value/remark
Channel description	TCH/H
Channel mode Mode	Speech half rate version 4

26.19.4 Reserved for future use

26.19.5 WB AMR / Adaptive Multi Rate Signalling / AMR signalling / Handover / active call / successful case

NOTE: This test is derived from 26.16.5 – AMR signalling / Handover / active call / successful case.

26.19.5.1 Conformance requirements

The MS shall correctly apply the handover procedure in the non-synchronised case when:

- a call is in progress; and
- handover is performed from a TCH/F with/without frequency hopping towards a TCH/F with/without frequency hopping;
- the mode of either the current or the target channel is set to full rate speech version 4 or 5.

The MS also supporting half rate speech version 3 shall correctly apply the handover procedure in the non-synchronized case when:

- a call is in progress; and
- a handover is performed between a TCH/H with/without frequency hopping and a TCH/F or TCH/H with/without frequency hopping; and
- the mode of either the current or the target channel is set to half rate speech version 4.

References

3GPP TS 04.08 / 3GPP TS 44.018 subclauses 3.4.4 and 9.1.15.

3GPP TS 04.13 subclause 5.2.6.2.

26.19.5.2 Test Purpose

To test that the MS shall correctly apply the handover procedure in the non-synchronized case when:

- a call is in progress; and
- handover is performed from a TCH/F with/without frequency hopping towards a TCH/F with/without frequency hopping; and
- the mode of either the current or the target channel is set to full rate speech version 4 or 5 (AMR WB full rate speech).

To test that the MS also supporting half rate shall correctly apply the handover procedure in the non-synchronized case when:

- a call is in progress; and
- a handover is performed between a TCH/H with/without frequency hopping and a TCH/F with/without frequency hopping; and

- the mode of either the current or the target channel is set to half rate speech version 4.

26.19.5.3 Method of Test

Initial Conditions

MS in call active state U10 on cell A.

SS 2 cells, A and B with same LAI, default parameters except:

Band	BCCH ARFCN	Cell A Cell Allocation	BCCH ARFCN	Cell B Cell Allocation	Both Cells Format
GSM 450	263	259, 261, 263, 265, 267, 269, 271, 273, 275, 277, 279, 281, 283, 285, 287, 289, 291	274	260, 262, 264, 266, 268, 270, 272, 274, 276, 279, 281, 283, 285, 287, 289, 291	Range 128
GSM 480	310	306, 308, 310, 312, 314, 316, 318, 320, 322, 324, 326, 328, 330, 332, 334, 336, 338	321	307, 309, 311, 313, 315, 317, 319, 321, 323, 326, 328, 330, 332, 334, 336, 338	Range 128
GSM 710	457	447, 454, 457, 463, 471, 479, 482, 483, 489, 496, 498, 500, 501, 502, 503, 506, 508	477	451, 455, 459, 461, 467, 468, 475, 477, 497, 498, 500, 501, 502, 503, 506, 508	Range 128
GSM 750	457	447, 454, 457, 463, 471, 479, 482, 483, 489, 496, 498, 500, 501, 502, 503, 506, 508	477	451, 455, 459, 461, 467, 468, 475, 477, 497, 498, 500, 501, 502, 503, 506, 508	Range 128
T-GSM 810	457	447, 454, 457, 463, 471, 479, 482, 483, 489, 496, 498, 500, 501, 502, 503, 506, 508	477	451, 455, 459, 461, 467, 468, 475, 477, 497, 498, 500, 501, 502, 503, 506, 508	Range 128
GSM 850	147	137, 144, 147, 153, 161, 169, 172, 173, 179, 186, 193, 200, 201, 202, 203, 235, 241	167	141, 145, 149, 151, 157, 158, 165, 167, 187, 193, 200, 201, 202, 203, 235, 241	Range 128
GSM 900	20	10, 17, 20, 26, 34, 42, 45, 46, 52, 59, 66, 73, 74, 75, 76, 108, 114	40	14, 18, 22, 24, 30, 31, 38, 40, 60, 66, 73, 74, 75, 76, 108, 114	Bit Map 0
DCS 1 800	747	734, 741, 747, 754, 759, 762, 766, 767, 773, 775, 779, 782, 791, 798, 829, 832, 844	764	739, 743, 746, 749, 756, 758, 761, 764, 771, 779, 782, 791, 798, 829, 832, 844	Range 256
PCS 1 900	647	634, 641, 647, 654, 659, 662, 666, 667, 673, 675, 679, 682, 691, 698, 729, 732, 744	664	639, 643, 646, 649, 656, 658, 661, 664, 671, 679, 682, 691, 698, 729, 732, 744	Range 256

The frame numbers of cells A and B shall be different by 100.

The timebase of cells A and B shall be such that the edges of their timeslots are not coincident at the antenna connector.

Specific PICS statements:

- Support of GSM speech full rate version 4 (O-TCH/WFS).
- Support of GSM speech Half rate version 4 (O-TCH/WHF).
- Support of GSM Speech Full Rate version 5 (TCH/WFS).
- Speech supported for Full rate version 2 (GSM EFR)
- Speech supported for Half rate version 1 (GSM HR)

PIXIT statements:

-

Foreseen Final State of MS

The MS has a MO call in state U10, "active".

Test Procedure

Table 1

Exec Counter	From	To	Timing Adv.	Start Time
1	TCH/F, sv4, no FH	TCH/F, sv4, no FH	20	none
2	TCH/F, sv4, no FH	TCH/F, sv4, FH	arbitrary	none
3	TCH/F, sv4, FH	TCH/F, sv4, FH	20	1,1s
4	TCH/F, sv4, FH	TCH/F, sv4, no FH	20	none
5	TCH/F, sv4, no FH	TCH/F, sv1, no FH	20	none
6	TCH/F, sv1, no FH	TCH/F, sv4, no FH	arbitrary	none
7	TCH/F, sv4, no FH	TCH/F, sv2, FH	arbitrary	none
8	TCH/F, sv2, FH	TCH/F, sv4, FH	20	1,1s
9	TCH/F, sv4, FH	TCH/H, sv1, FH	arbitrary	none
10	TCH/H, sv1, FH	TCH/F, sv4, noFH	20	none
11	TCH/F, sv4, noFH	TCH/H, sv4, FH	arbitrary	1.1s
12	TCH/H, sv4, FH	TCH/H, sv4, no FH	20	none
13	TCH/H, sv4, no FH	TCH/F, sv1, no FH	20	none
14	TCH/F, sv1, no FH	TCH/H, sv4, no FH	arbitrary	none
15	TCH/H, sv4, no FH	TCH/F, sv2, FH	Arbitrary	none
16	TCH/F, sv2, FH	TCH/H, sv4, FH	20	1,1s
17	TCH/H, sv4, FH	TCH/H, sv1, FH	Arbitrary	none
18	TCH/H, sv1, FH	TCH/H, sv4, noFH	20	none
19	TCH/H, sv4, noFH	TCH/F, sv4, no FH	20	None
20	TCH/F, sv4, no FH	TCH/F, sv5, no FH	20	None
21	TCH/F, sv5, no FH	TCH/F, sv5, no FH	20	None
22	TCH/F, sv5, no FH	TCH/F, sv5, FH	Arbitrary	None
23	TCH/F, sv5, FH	TCH/F, sv5, FH	20	1.1s
24	TCH/F, sv5, FH	TCH/F, sv5, no FH	20	None
25	TCH/F, sv5, no FH	TCH/F, sv1, no FH	20	None
26	TCH/F, sv1, no FH	TCH/F, sv5, no FH	Arbitrary	None
27	TCH/F, sv5, no FH	TCH/F, sv2, FH	Arbitrary	None
28	TCH/F, sv2, FH	TCH/H, sv5, FH	20	1.1s
29	TCH/F, sv5, FH	TCH/H, sv1, FH	Arbitrary	None
30	TCH/H, sv1, FH	TCH/F, sv5, noFH	20	None

Note: for all execution counters: State of call is U10 and the handover procedure is non-synchronized
sv1 stands for speech full/half rate version 1.
sv2 stands for speech full rate version 2 (enhanced full rate).
sv4 stands for speech full/half rate version 4 (AMR WB 8PSK).
sv5 stands for speech full rate version 5 (AMR WB GMSK)

Table 2

	TCH/FS	TCH/HS	SDCCH
n	10-20	5-10	2-5
n:	number of access bursts.		

The MS is in the active state (U10) of a call. The SS sends a HANDOVER COMMAND on the main DCCH. The MS shall (at the time defined by the Starting Time information element, if included in the message) begin to send access bursts on the new DCCH (and optionally on the SACCH) of the target cell. The SS observes the access bursts and after receiving n (n being arbitrarily chosen between values according to table 2) access bursts, the SS sends one PHYSICAL INFORMATION message with a Timing Advance as specified in table 1. The MS shall activate the channel in sending and receiving mode. The MS shall establish a signalling link. The MS shall be ready to transmit a HANDOVER COMPLETE message, before 'x' ms after the end of the PHYSICAL INFORMATION message, but not before a UA frame has been sent by the SS.

The term 'ready to transmit' is defined in 3GPP TS 04.13. The value of 'x' depends upon the target channel and is specified in the specific message contents section.

Maximum Duration of Test

10 minutes.

Expected Sequence

This sequence is performed for an execution counter $M = 1, 2 \dots 10$ for an MS that supports TCH/F and speech version 4, version 2 and version 1. Steps $M=7$ and $M=8$ are performed only if an MS supports full rate speech version 2. Steps $M=9$ and $M=10$ are performed only if an MS supports half rate speech version 1.

This sequence is performed for an execution counter $M = 1, 2 \dots 19$ for an MS that supports TCH/F and TCH/H and speech version 4, version 2 and version 1. Steps $M=7, M=8, M=15$ and $M=16$ are performed only if an MS supports speech version 2. Steps $M=9, M=10, M=17$ and $M=18$ are performed only if an MS supports half rate speech version 1.

This sequence is performed for an execution counter $M = 20, 21 \dots 30$ for an MS that supports TCH/F and speech version 5, version 2 and version 1. Steps $M=27$ and $M=28$ are performed only if an MS supports full rate speech version 2. Steps $M=29$ and $M=30$ are performed only if an MS supports half rate speech version 1.

Step	Direction	Message	Comments
0	MS -> SS		The MS and SS are in the active state of a call on the channel described below.
1	SS -> MS	HANDOVER COMMAND	See Specific message contents
2	MS -> SS	HANDOVER ACCESS	Repeated on every burst of the uplink main DCCH (and optionally the SACCH) until reception of PHYSICAL INFORMATION. Handover Reference as included in the HANDOVER COMMAND. If the HANDOVER COMMAND includes a starting time IE then the first HANDOVER ACCESS message shall be transmitted in the indicated frame (unless the indicated frame is not used by that channel, in which case the next frame used by that channel shall be used)
3	SS -> MS	PHYSICAL INFORMATION	Sent after reception of n HANDOVER ACCESS messages. See specific message contents.
4	MS -> SS	SABM	Sent without information field
5	SS -> MS	UA	
6	MS -> SS	HANDOVER COMPLETE	The message shall be ready to be transmitted before 'x' ms after the completion of step 3.
7	MS -> SS		The MS and SS are in the active state of a call on the TCH described below. The SS checks that the TCH is through connected in the correct mode.

Specific Message Contents

For $M = 1$:

Step 0: The MS and SS are using a full rate TCH with speech full rate version 4 and in non-hopping mode on cell A.

HANDOVER COMMAND

Information Element	value/remarks
As default message contents, except:	
Cell Description	
- Network Colour Code	1
- Base Station Colour Code	5
- BCCH Carrier Number	See table below
Channel Description	
- Channel Type	TCH/F + ACCHs
- TDMA offset	Chosen arbitrarily
- Timeslot number	0
- Training Sequence Code	Chosen arbitrarily
- ARFCN	Chosen arbitrarily from the CA
Synchronisation Indication	
- Report Observed Time Difference	Shall not be included.
- Synchronisation Indication	'Non synchronised'.
- Normal Cell Indication	Ignore out of range timing advance.
Mode of the first channel.	
- Mode	speech full rate rate version 4
Multi-Rate configuration	ICMI = 0 Arbitrary set of codec modes, thresholds and hysteresis specified according to 3GPP TS 05.09 / 45.009

Band	BCCH Carrier Number
GSM 450	274
GSM 480	321
GSM 710	477
GSM 750	477
T-GSM 810	477
GSM 850	167
GSM 900	40
DCS 1 800	764
PCS 1 900	664

PHYSICAL INFORMATION

Information Element	value/remarks
As default message contents.	

Step 6: $x = 500$

Step 7: The MS and SS are using a full rate TCH with speech full rate version 4 and in non-hopping mode on cell B.

For $M = 2$:

Step 0: The MS and SS are using a full rate TCH with speech full rate version 4 and in non-hopping mode on cell B.

HANDOVER COMMAND

Information Element	value/remarks
As default message contents, except:	
Cell Description	
- Network Colour Code	1
- Base Station Colour Code	5
- BCCH Carrier Number	See table below
Channel Description	
- Channel Type	TCH/F + ACCHs
- Timeslot number	Chosen arbitrarily, but not Zero
- Training Sequence Code	Chosen arbitrarily
- Hopping	RF hopping channel.
- MAIO	Chosen arbitrarily from the set (0, 1 to N-1), where N is the number of frequencies encoded in the Frequency List IE or Frequency Channel Sequence IE.
- HSN	Chosen arbitrarily from the set (1,2,..63)
Synchronisation Indication IE is not included.	
Channel Mode IE is not included.	
Frequency List after time	IE Present only for GSM450 and GSM480
- Frequency List	See table below
Frequency Channel Sequence after time	IE Present only for GSM900, GSM 710, GSM750 and T-GSM810
- Frequency Channel Sequence	See table below
Frequency Short List after time	IE Present only for GSM1800, PCS1900 and GSM850
- Frequency List	See table below
Multi-Rate configuration IE is not included	

Band	HANDOVER COMMAND Frequency List		BCCH Carrier Number ARFCN
	Format	ARFCNs	
GSM 450	Range 128	259, 261, 263, 265, 277, 279, 281, 283, 285, 287, 289, 291	263
GSM 480	Range 128	306, 308, 310, 312, 324, 326, 328, 330, 332, 334, 336, 338	310
GSM 710	Range 256	447, 454, 457, 463, 496, 498, 500, 501, 502, 503, 506, 508	457
GSM 750	Range 256	447, 454, 457, 463, 496, 498, 500, 501, 502, 503, 506, 508	457
T-GSM 810	Range 256	447, 454, 457, 463, 496, 498, 500, 501, 502, 503, 506, 508	457
GSM 850	Variable bitmap	137, 144, 147, 153, 186, 193, 200, 201, 202, 203, 235, 241	147
GSM 900	Variable bitmap	10, 17, 20, 26, 59, 66, 73, 74, 75, 76, 108, 114	20
DCS 1 800	Range 256	747, 775, 779, 782, 791, 798, 829, 832, 844	747
PCS 1 900	Range 256	647, 675, 679, 682, 691, 698, 729, 732, 744	647

PHYSICAL INFORMATION

Information Element	value/remarks
As default message contents, except:	
Timing advance	Arbitrarily selected but different to default value.

Step 6: $x = 500$

Step 7: The MS and SS are using a full rate TCH with speech full rate version 4 and in hopping mode on cell A.

For $M = 3$:

Step 0: The MS and SS are using a full rate TCH with speech full rate version 4 and in hopping mode on cell A.

HANDOVER COMMAND

Information Element	value/remarks
As default message contents, except:	
Cell Description	
- Network Colour Code	1
- Base Station Colour Code	5
- BCCH Carrier Number	See table below
Channel Description	
- Channel Type	TCH/F + ACCHs
- Timeslot number	Chosen arbitrarily, but not Zero
- Training Sequence Code	Chosen arbitrarily
- Hopping	RF hopping channel.
- MAIO	1
- HSN	zero for cyclic
Synchronisation Indication	
- Report Observed Time Difference	Shall not be included.
- Synchronisation Indication	'Non synchronised'.
- Normal Cell Indication	Out of range timing advance shall trigger a handover failure procedure.
Frequency List after time	
- Frequency List	See table below
Mode of the first channel.	
- Mode	speech full rate rate version 4
Starting Time	Indicates the frame number of cell B that will occur approximately 1,1 seconds (238 frames have elapsed) after the HANDOVER COMMAND is sent by cell A.
Multi-Rate configuration	ICMI = 1 Arbitrary set of codec modes, thresholds and hysteresis specified according to 3GPP TS 05.09 / 45.009

HANDOVER COMMAND			
Band	Frequency List		BCCH Carrier Number
	Format	ARFCNs	ARFCN
GSM 450	Range 128	260, 291	274
GSM 480	Range 128	307, 338	321
GSM 710	Range 128	451, 508	477
GSM 750	Range 128	451, 508	477
T-GSM 810	Range 128	451, 508	477
GSM 850	Range 128	141, 241	167
GSM 900	Range 128	14, 114	40
DCS 1 800	Range 128	749, 844	764
PCS 1 900	Range 128	649, 744	664

PHYSICAL INFORMATION

Information Element	value/remarks
As default message contents.	

Step 6: $x = 500$

Step 7: The MS and SS are using a full rate TCH with speech full rate version 4 and in hopping mode on cell B.

For $M = 4$:

Step 0: The MS and SS are using a full rate TCH with full rate speech version 4 and in hopping mode on cell B.

HANDOVER COMMAND

Information Element	value/remarks
As default message contents, except:	
Cell Description	
- Network Colour Code	1
- Base Station Colour Code	5
- BCCH Carrier Number	See table below
Channel Description	
- Channel Type	TCH/F + ACCHs
- TDMA offset	Chosen arbitrarily
- Timeslot number	Chosen arbitrarily, but not Zero
- Training Sequence Code	Chosen arbitrarily
- ARFCN	The ARFCN of the BCCH Carrier
Synchronisation Indication	
- Report Observed Time Difference	Shall not be included.
- Synchronisation Indication	'Non synchronised'.
- Normal Cell Indication	Ignore out of range timing advance.
Mode of the first channel IE is not included	
Multi-Rate configuration IE is not included	

Band	BCCH Carrier Number
GSM 450	263
GSM 480	310
GSM 710	457
GSM 750	457
T-GSM 810	457
GSM 850	147
GSM 900	20
DCS 1 800	747
PCS 1 900	647

PHYSICAL INFORMATION

Information Element	value/remarks
As default message contents.	

Step 6: $x = 500$

Step 7: The MS and SS are using a full rate TCH with speech full rate version 4 and in non-hopping mode on cell A.

For $M = 5$:

Step 0: The MS and SS are using a full rate TCH with full rate speech version 4 and in non-hopping mode on cell A.

HANDOVER COMMAND

Information Element	value/remarks
As default message contents, except:	
Cell Description	
- Network Colour Code	1
- Base Station Colour Code	5
- BCCH Carrier Number	See table below
Channel Description	
- Channel Type	TCH/F + ACCHs
- TDMA offset	Chosen arbitrarily
- Timeslot number	Chosen arbitrarily, but not Zero
- Training Sequence Code	Chosen arbitrarily
- ARFCN	Chosen arbitrarily from the CA
Synchronisation Indication	
- Report Observed Time Difference	Shall not be included.
- Synchronisation Indication	'Non synchronised'.
- Normal Cell Indication	Ignore out of range timing advance.
Mode of the first channel.	
- Mode	speech full rate or half rate version 1

Band	BCCH Carrier Number
GSM 450	274
GSM 480	321
GSM 710	477
GSM 750	477
T-GSM 810	477
GSM 850	167
GSM 900	40
DCS 1 800	764
PCS 1 900	664

PHYSICAL INFORMATION

Information Element	value/remarks
As default message contents.	

Step 6: $x = 500$

Step 7: The MS and SS are using a full rate TCH with speech full rate version 1 and in non-hopping mode on cell B.

For $M = 6$:

Step 0: The MS and SS are using a full rate TCH with full rate speech version 1 and in non-hopping mode on cell B.

HANDOVER COMMAND

Information Element	value/remarks
As default message contents, except:	
Cell Description	
- Network Colour Code	1
- Base Station Colour Code	5
- BCCH Carrier Number	See table below
Channel Description	
- Channel Type	TCH/F + ACCHs
- TDMA offset	Chosen arbitrarily
- Timeslot number	Chosen arbitrarily, but not Zero
- Training Sequence Code	Chosen arbitrarily
- ARFCN	Chosen arbitrarily from the CA
Synchronisation Indication	
- Report Observed Time Difference	Shall not be included.
- Synchronisation Indication	'Non synchronised'.
- Normal Cell Indication	Ignore out of range timing advance.
Mode of the first channel	
- Mode	speech full rate rate version 4
Multi-Rate configuration	ICMI = 1 Arbitrary set of codec modes, thresholds and hysteresis specified according to 3GPP TS 05.09 / 45.009

Band	BCCH Carrier Number
GSM 450	263
GSM 480	310
GSM 710	457
GSM 750	457
T-GSM 810	457
GSM 850	147
GSM 900	20
DCS 1 800	747
PCS 1 900	647

PHYSICAL INFORMATION

Information Element	value/remarks
As default message contents, except:	
Timing advance	Arbitrarily selected but different to default value.

Step 6: $x = 500$

Step 7: The MS and SS are using a full rate TCH with speech full rate version 4 and in non-hopping mode on cell A.

For $M = 7$:

Step 0: The MS and SS are using a full rate TCH with full rate speech version 4 and in non-hopping mode on cell A.

HANDOVER COMMAND

Information Element	value/remarks
As default message contents, except:	
Cell Description	
- Network Colour Code	1
- Base Station Colour Code	5
- BCCH Carrier Number	See table below
Channel Description	
- Channel Type	TCH/F + ACCHs
- TDMA offset	Chosen arbitrarily
- Timeslot number	Chosen arbitrarily, but not Zero
- Training Sequence Code	Chosen arbitrarily
- Hopping	RF hopping channel.
- MAIO	Chosen arbitrarily from the set (0, 1 to N-1), where N is the number of frequencies encoded in the Frequency List IE.
- HSN	Chosen arbitrarily from the set (1,2,..63)
Frequency List after time	
- Frequency List	See table below
Synchronisation Indication	
- Report Observed Time Difference	Shall not be included.
- Synchronisation Indication	'Non synchronised'.
- Normal Cell Indication	Ignore out of range timing advance.
Mode of the first channel	
- Mode	speech full rate version 2

Band	HANDOVER COMMAND Frequency Short List			BCCH Carrier Number ARFCN
	Format	ARFCNs		
GSM 450	Range 128	260, 262, 264, 266, 276, 279, 281, 283, 285, 287, 289, 291		274
GSM 480	Range 128	307, 309, 311, 313, 323, 326, 328, 330, 332, 334, 336, 338		321
GSM 710	Range 128	451, 455, 459, 461, 497, 498, 500, 501, 502, 503,506, 508		477
GSM 750	Range 128	451, 455, 459, 461, 497, 498, 500, 501, 502, 503,506, 508		477
T-GSM 810	Range 128	451, 455, 459, 461, 497, 498, 500, 501, 502, 503,506, 508		477
GSM 850	Range 128	141, 145, 149, 151, 187, 193, 200, 201, 202, 203, 235, 241		167
GSM 900	Bit map 0	14, 18, 22, 24, 60, 66, 73, 74, 75, 76,108, 114		40
DCS 1 800	Range 1024	749, 758, 761, 764, 771, 779, 782, 791, 798, 829, 832, 844		764
PCS 1 900	Range 1024	649, 658, 661, 664, 671, 679, 682, 791, 798, 729, 732, 744		664

PHYSICAL INFORMATION

Information Element	value/remarks
As default message contents, except:	
Timing advance	Arbitrarily selected but different to default value.

Step 6: x = 500

Step 7: The MS and SS are using a full rate TCH with full rate speech version 2 and in hopping mode on cell B.

For M = 8:

Step 0: The MS and SS are using a full rate TCH with speech full rate version 2 and hopping mode on cell B.

HANDOVER COMMAND

Information Element	value/remarks
As default message contents, except:	
Cell Description	
- Network Colour Code	1
- Base Station Colour Code	5
- BCCH Carrier Number	See table below
Channel Description	
- Channel Type	TCH/F + ACCHs
- Timeslot number	Chosen arbitrarily, but not Zero
- Training Sequence Code	Chosen arbitrarily
- Hopping	RF hopping channel.
- MAIO	Chosen arbitrarily from the set (0, 1 to N-1), where N is the number of frequencies encoded in the Frequency List IE.
- HSN	Chosen arbitrarily from the set (1,2,..63)
Synchronisation Indication IE is not included.	
Mode of the first channel.	
- Mode	speech full rate version 4
Frequency List after time	IE Present only for GSM450, GSM480 and GSM850
- Frequency List	See table below
Frequency Channel Sequence after time	IE Present only for GSM900, GSM 710, GSM750 and T-GSM 810
- Frequency Channel Sequence	See table below
Frequency Short List after time	IE Present only for GSM1800 and PCS1900
- Frequency List	See table below
Starting Time	Indicates the frame number of cell B. that will occur approximately 1,1 seconds (238 frames have elapsed) after the HANDOVER COMMAND is sent by cell A.
Multi-Rate configuration	ICMI = 0 Arbitrary set of codec modes, thresholds and hysteresis specified according to 3GPP TS 05.09 / 45.009

Band	HANDOVER COMMAND Frequency Short List		BCCH Carrier Number ARFCN
	Format	ARFCNs	
GSM 450		259, 261, 263, 265, 277, 279, 281, 283, 285, 287, 289, 291	274
GSM 480		306, 308, 310, 312, 324, 326, 328, 330, 332, 334, 336, 338	321
GSM 710		447, 454, 457, 463, 496, 498, 500, 501, 502, 503, 506, 508	477
GSM 750		447, 454, 457, 463, 496, 498, 500, 501, 502, 503, 506, 508	477
T-GSM 810		447, 454, 457, 463, 496, 498, 500, 501, 502, 503, 506, 508	477
GSM 850		137, 144, 147, 153, 186, 193, 200, 201, 202, 203, 235, 241	167
GSM 900		10, 17, 20, 26, 59, 66, 73, 74, 75, 76, 108, 114	40
DCS 1 800	Range 256	747, 775, 779, 782, 791, 798, 829, 832, 844	764
PCS 1 900	Range 256	647, 675, 679, 682, 691, 698, 629, 632, 644	664

PHYSICAL INFORMATION

Information Element	value/remarks
As default message contents	

Step 6: x = 500

Step 7: The MS and SS are using a full rate TCH with speech full rate version 4 and hopping mode on cell A.

For M = 9:

Step 0: The MS and SS are using a full rate TCH with full rate speech version 4 and in hopping mode on cell A.

HANDOVER COMMAND

Information Element	value/remarks
As default message contents, except:	
Cell Description	
- Network Colour Code	1
- Base Station Colour Code	5
- BCCH Carrier Number	See table below
Channel Description	
- Channel Type	TCH/H + ACCHs
- TDMA offset	Chosen arbitrarily
- Timeslot number	Chosen arbitrarily, but not Zero
- Training Sequence Code	Chosen arbitrarily
- Hopping	RF hopping channel.
- MAIO	Chosen arbitrarily from the set (0, 1 to N-1), where N is the number of frequencies encoded in the Frequency List IE.
- HSN	Chosen arbitrarily from the set (1,2,..63)
Frequency List after time	
- Frequency List	See table below
Synchronisation Indication	
- Report Observed Time Difference	Shall not be included.
- Synchronisation Indication	'Non synchronised'.
- Normal Cell Indication	Ignore out of range timing advance.
Mode of the first channel	
- Mode	speech half rate version 1

Band	HANDOVER COMMAND Frequency Short List			BCCH Carrier Number ARFCN
	Format	ARFCNs		
GSM 450	Range 128	260, 262, 264, 266, 276, 279, 281, 283, 285, 287, 289, 291		274
GSM 480	Range 128	307, 309, 311, 313, 323, 326, 328, 330, 332, 334, 336, 338		321
GSM 710	Range 128	451, 455, 459, 461, 497, 498, 500, 501, 502, 503,506, 508		477
GSM 750	Range 128	451, 455, 459, 461, 497, 498, 500, 501, 502, 503,506, 508		477
T-GSM 810	Range 128	451, 455, 459, 461, 497, 498, 500, 501, 502, 503,506, 508		477
GSM 850	Range 128	141, 145, 149, 151, 187, 193, 200, 201, 202, 203, 235, 241		167
GSM 900	Bit map 0	14, 18, 22, 24, 60, 66, 73, 74, 75, 76,108, 114		40
DCS 1 800	Range 1024	749, 758, 761, 764, 771, 779, 782, 791, 798, 829, 832, 844		764
PCS 1 900	Range 1024	649, 658, 661, 664, 671, 679, 682, 791, 798, 729, 732, 744		664

PHYSICAL INFORMATION

Information Element	value/remarks
As default message contents, except:	
Timing advance	Arbitrarily selected but different to default value.

Step 6: $x = 750$

Step 7: The MS and SS are using a half rate TCH with half rate speech version 1 and in hopping mode on cell B.

For $M = 10$:

Step 0: The MS and SS are using a half rate TCH with speech half rate version 1 and hopping mode on cell B.

HANDOVER COMMAND

Information Element	value/remarks
As default message contents, except:	
Cell Description	
- Network Colour Code	1
- Base Station Colour Code	5
- BCCH Carrier Number	See table below
Channel Description	
- Channel Type	TCH/F + ACCHs
- TDMA offset	Chosen arbitrarily
- Timeslot number	Chosen arbitrarily, but not Zero
- Training Sequence Code	Chosen arbitrarily
- ARFCN	Chosen arbitrarily from the CA
Synchronisation Indication IE is not included.	
Mode of the first channel.	
- Mode	speech full rate version 4
Multi-Rate configuration	ICMI = 0
	Arbitrary set of codec modes, thresholds and hysteresis specified according to 3GPP TS 05.09 / 45.009

Band	BCCH Carrier Number
GSM 450	263
GSM 480	310
GSM 710	457
GSM 750	457
T-GSM 810	457
GSM 850	147
GSM 900	20
DCS 1 800	747
PCS 1 900	647

PHYSICAL INFORMATION

Information Element	value/remarks
As default message contents	

Step 6: $x = 500$

Step 7: The MS and SS are using a full rate TCH with speech full rate version 4 and non-hopping mode on cell A.

For $M = 11$:

Step 0: The MS and SS are using a full rate TCH with speech full rate version 4 and in non-hopping mode on cell A.

HANDOVER COMMAND

Information Element	value/remarks
As default message contents, except:	
Cell Description	
- Network Colour Code	1
- Base Station Colour Code	5
- BCCH Carrier Number	See table below
Channel Description	
- Channel Type	TCH/H + ACCHs
- TDMA offset	Chosen arbitrarily
- Timeslot number	Chosen arbitrarily, but not Zero
- Training Sequence Code	Chosen arbitrarily
- Hopping	RF hopping channel.
- MAIO	Chosen arbitrarily from the set (0, 1 to N-1), where N is the number of frequencies encoded in the Frequency List IE.
- HSN	Chosen arbitrarily from the set (1,2,..63)
Frequency List after time	
- Frequency List	See table below
Synchronisation Indication	
- Report Observed Time Difference	Shall not be included.
- Synchronisation Indication	'Non synchronised'.
- Normal Cell Indication	Ignore out of range timing advance.
Mode of the first channel	
- Mode	speech half rate version 4
Starting Time	Indicates the frame number of cell B. that will occur approximately 1,1 seconds (238 frames have elapsed) after the HANDOVER COMMAND is sent by cell A.
Multi-Rate configuration	ICMI = 0 Arbitrary set of codec modes, thresholds and hysteresis specified according to 3GPP TS 05.09 / 45.009

Band	HANDOVER COMMAND Frequency Short List		BCCH Carrier Number
	Format	ARFCNs	ARFCN
GSM 450	Range 128	260, 262, 264, 266, 276, 279, 281, 283, 285, 287, 289, 291	274
GSM 480	Range 128	307, 309, 311, 313, 323, 326, 328, 330, 332, 334, 336, 338	321
GSM 710	Range 128	451, 455, 459, 461, 497, 498, 500, 501, 502, 503,506, 508	477
GSM 750	Range 128	451, 455, 459, 461, 497, 498, 500, 501, 502, 503,506, 508	477
T-GSM 810	Range 128	451, 455, 459, 461, 497, 498, 500, 501, 502, 503,506, 508	477
GSM 850	Range 128	141, 145, 149, 151, 187, 193, 200, 201, 202, 203, 235, 241	167
GSM 900	Bit map 0	14, 18, 22, 24, 60, 66, 73, 74, 75, 76,108, 114	40
DCS 1 800	Range 1024	749, 758, 761, 764, 771, 779, 782, 791, 798, 829, 832, 844	764
PCS 1 900	Range 1024	649, 658, 661, 664, 671, 679, 682, 791, 798, 729, 732, 744	664

PHYSICAL INFORMATION

Information Element	value/remarks
As default message contents, except:	
Timing advance	Arbitrarily selected but different to default value.

Step 6: $x = 750$

Step 7: The MS and SS are using a half rate TCH with half rate speech version 4 and in hopping mode on cell B.

For $M = 12$:

Step 0: The MS and SS are using a half rate TCH with half rate speech version 4 and in hopping mode on cell B.

HANDOVER COMMAND

same as for M = 4 except:

Channel Description - Channel Type	TCH/H + ACCHs
---------------------------------------	---------------

PHYSICAL INFORMATION

same as for M = 4

Step 6: $x = 750$

Step 7: The MS and SS are using a half rate TCH with half rate speech version 4 and in non-hopping mode on cell A.

For M = 13:

Step 0: The MS and SS are using a half rate TCH with speech half rate version 4 and in non-hopping mode on cell A.

HANDOVER COMMAND

same as for M = 5

PHYSICAL INFORMATION

same as for M = 5

Step 6: $x = 500$

Step 7: The MS and SS are using a full rate TCH with speech full rate version 1 and in non-hopping mode on cell B.

For M = 14:

Step 0: The MS and SS are using a full rate TCH with speech full rate version 1 and in non-hopping mode on cell B.

HANDOVER COMMAND

same as for M = 6 except:

Channel Description - Channel Type	TCH/H + ACCHs
---------------------------------------	---------------

PHYSICAL INFORMATION

same as for M = 6

Step 6: $x = 750$

Step 7: The MS and SS are using a half rate TCH with speech half rate version 4 and in non-hopping mode on cell A.

For M = 15:

Step 0: The MS and SS are using a half rate TCH with speech half rate version 4 and in non-hopping mode on cell A.

HANDOVER COMMAND

same as for M = 7

PHYSICAL INFORMATION

same as for $M = 7$

Step 6: $x = 500$

Step 7: The MS and SS are using a full rate TCH with full rate speech version 2 and in hopping mode on cell B.

For $M = 16$:

Step 0: The MS and SS are using a full rate TCH with full rate speech version 2 and in hopping mode on cell B.

HANDOVER COMMAND

same as for $M = 8$ except:

Channel Description - Channel Type	TCH/H + ACCHs
---------------------------------------	---------------

PHYSICAL INFORMATION

same as for $M = 8$

Step 6: $x = 750$

Step 7: The MS and SS are using a half rate TCH with speech half rate version 4 and in hopping mode on cell A.

For $M = 17$:

Step 0: The MS and SS are using a half rate TCH with speech half rate version 4 and in hopping mode on cell A.

HANDOVER COMMAND

same as for $M = 9$

PHYSICAL INFORMATION

same as for $M = 9$

Step 6: $x = 750$

Step 7: The MS and SS are using a half rate TCH with speech half rate version 1 and in hopping mode on cell B.

For $M = 18$:

Step 0: The MS and SS are using a half rate TCH with speech half rate version 1 and in hopping mode on cell B.

HANDOVER COMMAND

same as for $M = 10$ except:

Channel Description - Channel Type	TCH/H + ACCHs
---------------------------------------	---------------

PHYSICAL INFORMATION

same as for $M = 10$

Step 6: $x = 750$

Step 7: The MS and SS are using a half rate TCH with speech half rate version 4 and in non-hopping mode on cell A.

For M = 19:

Step 0: The MS and SS are using a half rate TCH with speech half rate version 4 and in non-hopping mode on cell A.

HANDOVER COMMAND

same as for M = 1

PHYSICAL INFORMATION

same as for M = 1

Step 6: x = 500

Step 7: The MS and SS are using a full rate TCH with speech full rate version 4 and in non-hopping mode on cell B.

For M = 20:

Step 0: The MS and SS are using a full rate TCH with speech half rate version 4 and in non-hopping mode on cell B.

HANDOVER COMMAND

same as for M = 1 except:

Mode of the first channel. - Mode	speech full rate rate version 5
--------------------------------------	---------------------------------

PHYSICAL INFORMATION

same as for M = 1

Step 6: x = 500

Step 7: The MS and SS are using a full rate TCH with speech full rate version 5 and in non-hopping mode on cell A.

For M = 21:

Step 0: The MS and SS are using a full rate TCH with speech full rate version 5 and in non-hopping mode on cell A.

HANDOVER COMMAND

same as for M = 1 except:

Mode of the first channel. - Mode	speech full rate rate version 5
--------------------------------------	---------------------------------

PHYSICAL INFORMATION

same as for M = 1

Step 6: x = 500

Step 7: The MS and SS are using a full rate TCH with speech full rate version 5 and in non-hopping mode on cell B.

For M = 22:

Step 0: The MS and SS are using a full rate TCH with speech full rate version 5 and in non-hopping mode on cell B.

HANDOVER COMMAND

same as for M = 2 except:

Mode of the first channel. - Mode	Speech full rate rate version 5
--------------------------------------	---------------------------------

PHYSICAL INFORMATION

same as for M = 2

Step 6: x = 500

Step 7: The MS and SS are using a full rate TCH with speech full rate version 5 and in hopping mode on cell A.

For M = 23:

Step 0: The MS and SS are using a full rate TCH with speech full rate version 5 and in hopping mode on cell A.

HANDOVER COMMAND

same as for M = 3 except:

Mode of the first channel. - Mode	Speech full rate rate version 5
--------------------------------------	---------------------------------

PHYSICAL INFORMATION

same as for M = 3

Step 6: x = 500

Step 7: The MS and SS are using a full rate TCH with speech full rate version 5 and in hopping mode on cell B.

For M = 24:

Step 0: The MS and SS are using a full rate TCH with speech full rate version 5 and in hopping mode on cell B.

HANDOVER COMMAND

same as for M = 4 except:

Mode of the first channel. - Mode	Speech full rate rate version 5
--------------------------------------	---------------------------------

PHYSICAL INFORMATION

same as for M = 4

Step 6: x = 500

Step 7: The MS and SS are using a full rate TCH with speech full rate version 5 and in non-hopping mode on cell A.

For M = 25:

Step 0: The MS and SS are using a full rate TCH with speech full rate version 5 and in non-hopping mode on cell A.

HANDOVER COMMAND

same as for M = 5 except:

Mode of the first channel. - Mode	Speech full rate rate version 1
--------------------------------------	---------------------------------

PHYSICAL INFORMATION

same as for M = 5

Step 6: x = 500

Step 7: The MS and SS are using a full rate TCH with speech full rate version 1 and in non-hopping mode on cell B.

For M = 26:

Step 0: The MS and SS are using a full rate TCH with speech full rate version 5 and in non-hopping mode on cell B.

HANDOVER COMMAND

same as for M = 6 except:

Mode of the first channel. - Mode	Speech full rate rate version 5
--------------------------------------	---------------------------------

PHYSICAL INFORMATION

same as for M = 6

Step 6: x = 500

Step 7: The MS and SS are using a full rate TCH with speech full rate version 5 and in non-hopping mode on cell A.

For M = 27:

Step 0: The MS and SS are using a full rate TCH with speech full rate version 5 and in non-hopping mode on cell A.

HANDOVER COMMAND

same as for M = 7 except:

Mode of the first channel. - Mode	Speech full rate rate version 2
--------------------------------------	---------------------------------

PHYSICAL INFORMATION

same as for M = 7

Step 6: x = 500

Step 7: The MS and SS are using a full rate TCH with speech full rate version 2 and in hopping mode on cell B.

For M = 28:

Step 0: The MS and SS are using a full rate TCH with speech full rate version 2 and in hopping mode on cell B.

HANDOVER COMMAND

same as for M = 8 except:

Mode of the first channel. - Mode	Speech full rate rate version 5
--------------------------------------	---------------------------------

PHYSICAL INFORMATION

same as for M = 8

Step 6: x = 500

Step 7: The MS and SS are using a full rate TCH with speech full rate version 5 and in hopping mode on cell A.

For M = 29:

Step 0: The MS and SS are using a full rate TCH with speech full rate version 5 and in hopping mode on cell A.

HANDOVER COMMAND

same as for M = 9 except:

Mode of the first channel. - Mode	speech half rate rate version 1
--------------------------------------	---------------------------------

PHYSICAL INFORMATION

same as for M = 9

Step 6: x = 500

Step 7: The MS and SS are using a half rate TCH with speech half rate version 1 and in hopping mode on cell B.

For M = 30:

Step 0: The MS and SS are using a half rate TCH with speech half rate version 1 and in hopping mode on cell B.

HANDOVER COMMAND

same as for M = 10 except:

Mode of the first channel. - Mode	speech full rate rate version 5
--------------------------------------	---------------------------------

PHYSICAL INFORMATION

same as for M = 10

Step 6: x = 500

Step 7: The MS and SS are using a full rate TCH with speech full rate version 5 and in non-hopping mode on cell A.

26.19.6 Reserved for future use

26.19.7 Reserved for future use

26.19.8 Reserved for future use

26.19.9 WB AMR RATSCCH Protocol

26.19.9.1 WB AMR Configuration Change (normal)

NOTE: this test is derived from the one described in subclause 26.16.9.1 and entitled: "AMR Configuration Change (normal)"

26.19.9.1.1 Conformance requirements

The AMR_CONFIG_REQ message may be sent by the BTS during a call to change the AMR WB configuration on the radio interface without interruption of the speech transmission.

The ACK_OK message serves as an acknowledgement that a RATSCCH REQ message has been detected, correctly decoded (no CRC error) and that it is defined for the Addressee. It defines the exact activation time in direction from Addressee to Initiator.

Reference

3GPP TS 05.09 sub-clauses: 3.2.2.3.1, 3.2.2.3.5

26.19.9.1.2 Test purpose

This test will verify that the MS is able to handle a properly formatted AMR_CONFIG_REQ message.

26.19.9.1.3 Method of test

Initial Conditions

System Simulator:

1 cell with default parameters

Mobile Station:

The MS is in the "idle, updated" state, with a TMSI allocated and camped on cell A.

Specific PICS statements:

- Support of GSM speech full rate version 4 (O-TCH/WFS).
- Support of GSM speech Half rate version 4 (O-TCH/WHS).
- Support of GSM Speech Full Rate version 5 (TCH/WFS).

PIXIT statements:

-

Foreseen Final State of the MS

Idle Updated, TMSI allocated and camped on cell A.

Test Procedure

This sequence is performed for execution counter, $k = 1, 2$.

When $k = 1$, DTX is not used:

- 1) User initiates a Mobile Originated call.
- 2) The network and the MS indicate Bearer capabilities IE with the AMR speech Full Rate (Version 4 or 5) and Half Rate (Version 4).
- 3) The network performs an assignment on a TCH channel with MultiRate configuration to the MS.
- 4) The call is maintained during a programmable time without variation of RxLev /RxQual.
- 5) The SS shall send a properly formatted AMR_CONFIG_REQ message during the call at a programmable time.
- 6) The MS answers with an ACK_OK message within 3 speech frames
- 7) The network initiates the call release.

When $k = 2$, DTX is used:

- 1) In the serving cell, the DTX indicator is set to "MS shall use discontinuous transmission".
- 2) User initiates a Mobile Originated call.

- 3) The network and the MS indicate Bearer capabilities IE with the AMR speech Full Rate (Version 4 or 5) and Half Rate (Version 4).
- 4) The network performs an assignment on a TCH channel with MultiRate configuration to the MS.
- 5) The call is maintained during a programmable time without variation of RxLev /RxQual.
- 6) The SS shall send a properly formatted AMR_CONFIG_REQ message during the call at a programmable time.
- 7) The MS answers with an ACK_OK message within 3 speech frames.
- 8) The network initiates the call release.

This test is repeated for

- M = 1 if full rate speech version 5 is supported, and
- M = 2 if full rate speech version 4 is supported, and
- M = 3 if half rate speech version 4 is supported.

Maximum Duration of Test

5 minutes

Expected Sequence

When k=1:

Step	Direction	Message	Comments
1	MS		MS is in idle mode
2	MS		MS initiates Mobile Originated call
3	MS->SS	Channel Request	Establishment cause is "originating call and the network does not set the NECI bit to 1".
4	SS->MS	Immediate Assignment	See Default Messages for AMR
5	MS->SS	CM Service Request	CM Service Type = Mobile Originating Call Establishment.
6	SS->MS	AUTHENTICATION REQUEST	SRES specifies correct value
7	MS->SS	AUTHENTICATION RESPONSE	SS starts deciphering after sending the message
8	SS->MS	CIPHERING MODE COMMAND	Shall be sent enciphered. All following messages shall be sent enciphered.
9	MS->SS	CIPHERING MODE COMPLETE	MS indicates supported speech versions
10	MS->SS	Setup	
11	SS->MS	Call Proceeding	
12	SS->MS	Alerting	
13	SS->MS	Assignment Command	See specific message contents.
14	MS->SS	Assignment Complete	
15	SS->MS	Connect	
16	MS->SS	Connect Acknowledge	
17	MS		The TCH shall be through connected by both directions in the dedicated mode, using the codec mode specified.
18	SS->MS	AMR_CONFIG_REQ	See specific message contents.
19	MS->SS	ACK_OK	Message must be received within 3 speech frames
20	SS->MS	Disconnect	
21	MS->SS	Release	
22	SS->MS	Release Complete	
23	SS->MS	Channel Release	

When k=2:

Step	Direction	Message	Comments
1	MS		MS is in idle mode
2	MS		MS initiates Mobile Originated call
3	MS->SS	Channel Request	Establishment cause is "originating call and the network does not set the NECI bit to 1".
4	SS->MS	Immediate Assignment	See Default Messages for AMR
5	MS->SS	CM Service Request	CM Service Type = Mobile Originating Call Establishment.
6	SS->MS	AUTHENTICATION REQUEST	
7	MS->SS	AUTHENTICATION RESPONSE	SRES specifies correct value
8	SS->MS	CIPHERING MODE COMMAND	SS starts deciphering after sending the message
9	MS->SS	CIPHERING MODE COMPLETE	Shall be sent enciphered. All following messages shall be sent enciphered.
10	MS->SS	Setup	MS indicates supported speech versions
11	SS->MS	Call Proceeding	
12	SS->MS	Alerting	
13	SS->MS	Assignment Command	See specific message contents.
14	MS->SS	Assignment Complete	
15	SS->MS	Connect	
16	MS->SS	Connect Acknowledge	
17	MS		The TCH shall be through connected by both directions in the dedicated mode, using the codec mode specified.
18	SS->MS	AMR_CONFIG_REQ	Using DTX mode
19	MS->SS	ACK_OK	Message must be received within 3 speech frames
20	SS->MS	Disconnect	
21	MS->SS	Release	
22	SS->MS	Release Complete	
23	SS->MS	Channel Release	

Specific Message Contents

ASSIGNMENT COMMAND

Information Element	value/remarks
Channel description	M=1: TCH/F M=2: TCH/F M=3: TCH/H
Mode of the first channel - Mode	M = 1: Full rate version 5 M = 2: Full rate version 4 M = 3: Half rate version 4

AMR_CONFIG_REQ

Information Element	value/remarks
ICM	CODEC_MODE_1
ACS	2 codec modes
HYST2	Not defined (set to all 1s)
THRESH2	Not defined (set to all 1s)
HYST1	2 dB
THRESH1	10 dB

26.19.9.2 AMR WB Configuration Change (abnormal)

NOTE: this test is derived from the one described in subclause 26.16.9.2 and entitled: "AMR Configuration Change (abnormal)"

26.19.9.2.1 Conformance requirements

The AMR_CONFIG_REQ message may be sent by the BTS during a call to change the AMR WB configuration on the radio interface without interruption of the speech transmission.

The ACK_ERR message serves as a negative acknowledgement that a RATSCCH REQ message has been detected, i.e. the RATSCCH pattern was detected, but could not be decoded correctly (CRC error), or its content is not understandable by the addressee.

Reference:

3GPP TS 05.09 sub-clauses: 3.2.2.3.2, 3.2.2.3.5

26.19.9.2.2 Test purpose

This test will verify that the MS is able to handle an improperly formatted AMR_CONFIG_REQ message.

26.19.9.2.3 Method of test

Initial Conditions

System Simulator:

1 cell with default parameters

Mobile Station:

The MS is in the "idle, updated" state, with a TMSI allocated and camped on cell A.

Specific PICS statements:

- Support of GSM speech full rate version 4 (O-TCH/WFS).
- Support of GSM speech Half rate version 4 (O-TCH/WHS).
- Support of GSM Speech Full Rate version 5 (TCH/WFS).

PIXIT statements:

-

Foreseen Final State of the MS

Idle Updated, TMSI allocated and camped on cell A.

Test Procedure

- 1) User initiates a Mobile Originated call.
- 2) The network and the MS indicate Bearer capabilities IE with the AMR speech Full Rate (Version 4 or 5) and Half Rate (Version 4).
- 3) The network performs an assignment on a TCH channel with MultiRate configuration to the MS.
- 4) The call is maintained during a programmable time without variation of RxLev /RxQual.
- 5) The SS shall send an AMR_CONFIG_REQ message, with an incorrect CRC, during the call at a programmable time.
- 6) The MS answers with a ACK_ERR message within 3 speech frames
- 7) The network initiates the call release.

This test is repeated for

- M = 1 if full rate speech version 5 is supported, and
- M = 2 if full rate speech version 4 is supported, and
- M = 3 if half rate speech version 4 is supported..

Maximum Duration of Test

5 minutes

Expected Sequence

Step	Direction	Message	Comments
1	MS		MS is in idle mode
2	MS		MS initiates Mobile Originated call
3	MS->SS	Channel Request	Establishment cause is "originating call and the network does not set the NECI bit to 1".
4	SS->MS	Immediate Assignment	See Default Messages for AMR
5	MS->SS	CM Service Request	CM Service Type = Mobile Originating Call Establishment.
6	SS->MS	AUTHENTICATION REQUEST	
7	MS->SS	AUTHENTICATION RESPONSE	SRES specifies correct value
8	SS->MS	CIPHERING MODE COMMAND	SS starts deciphering after sending the message
9	MS->SS	CIPHERING MODE COMPLETE	Shall be sent enciphered. All following messages shall be sent enciphered.
10	MS->SS	Setup	MS indicates supported speech versions
11	SS->MS	Call Proceeding	
12	SS->MS	Alerting	
13	SS->MS	Assignment Command	See specific message contents.
14	MS->SS	Assignment Complete	
15	SS->MS	Connect	
16	MS->SS	Connect Acknowledge	
17	MS		The TCH shall be through connected by both directions in the dedicated mode, using the codec mode specified.
18	SS->MS	AMR_CONFIG_REQ	Message contains an incorrect CRC
19	MS->SS	ACK_ERR	Message must be received within 3 speech frames
20	SS->MS	Disconnect	
21	MS->22	Release	
22	SS->MS	Release Complete	
23	SS->MS	Channel Release	

Specific Message Contents

ASSIGNMENT COMMAND

Information Element	value/remarks
Channel description	M=1: TCH/F M=2: TCH/F M=3: TCH/H
Mode of the first channel - Mode	M = 1: Full rate version 5 M = 2: Full rate version 4 M = 3: Half rate version 4

AMR_CONFIG_REQ

Information Element	value/remarks
ICM	CODEC_MODE_1
ACS	2 codec modes
HYST2	Not defined (set to all 1s)
THRESH2	Not defined (set to all 1s)
HYST1	2 dB
THRESH1	10 dB

26.19.9.3 Codec Mode Phase Change (normal)

NOTE: this test is derived from the one described in subclause 26.16.9.3 and entitled: "Codec Mode Phase Change (normal)"

26.19.9.3.1 Conformance requirements

The CMI_PHASE_REQ message may be sent by the BTS to change the phase of the Codec Mode Indication in downlink.

The ACK_OK message serves as an acknowledgement that a RATSCCH REQ message has been detected, correctly decoded (no CRC error) and that it is defined for the Addressee. It defines the exact activation time in direction from Addressee to Initiator.

Reference:

3GPP TS 05.09 sub-clauses: 3.2.2.3.1, 3.2.2.3.4

26.19.9.3.2 Test purpose

This test will verify that the MS can correctly handle a properly formatted CMI_PHASE_REQ message.

26.19.9.3.3 Method of test

Initial Conditions

System Simulator:

1 cell with default parameters

Mobile Station:

The MS is in the "idle, updated" state, with a TMSI allocated and camped on cell A.

Specific PICS statements:

- Support of GSM speech full rate version 4 (O-TCH/WFS).
- Support of GSM speech Half rate version 4 (O-TCH/WHS).
- Support of GSM Speech Full Rate version 5 (TCH/WFS).

PIXIT statements:

-

Foreseen Final State of the MS

Idle Updated, TMSI allocated and camped on cell A.

Test Procedure

- 1) User initiates a Mobile Originated call.
- 2) The network and the MS indicate Bearer capabilities IE with the AMR speech Full Rate (Version 4 or 5) and Half Rate (Version 4).
- 3) The network performs an assignment on a TCH channel with MultiRate configuration to the MS.
- 4) The call is maintained during a programmable time without variation of RxLev /RxQual.
- 5) The SS shall send the CMI_PHASE_REQ message during the call at a programmable time. The CMI_PHASE_REQ shall be sent either in place of a "CMI" speech frame, or in place of a "CMC" speech frame, to cover both kinds of changes.
- 6) The MS answers with an ACK_OK message within 3 speech frames.
- 7) The downlink CMI phase is changed (or not) according to the CMI_PHASE_REQ message starting with speech frame N+12.
- 8) The network initiates the call release.

This test is repeated for

- M = 1 if full rate speech version 5 is supported, and
- M = 2 if full rate speech version 4 is supported, and
- M = 3 if half rate speech version 4 is supported.

Maximum Duration of Test

5 minutes

Expected Sequence

Step	Direction	Message	Comments
1	MS		MS is in idle mode
2	MS		MS initiates Mobile Originated call
3	MS->SS	Channel Request	Establishment cause is "originating call and the network does not set the NECI bit to 1".
4	SS->MS	Immediate Assignment	See Default Messages for AMR
5	MS->SS	CM Service Request	CM Service Type = Mobile Originating Call Establishment.
6	SS->MS	AUTHENTICATION REQUEST	
7	MS->SS	AUTHENTICATION RESPONSE	SRES specifies correct value
8	SS->MS	CIPHERING MODE COMMAND	SS starts deciphering after sending the message
9	MS->SS	CIPHERING MODE COMPLETE	Shall be sent enciphered. All following messages shall be sent enciphered.
10	MS->SS	Setup	MS indicates supported speech versions
11	SS->MS	Call Proceeding	
12	SS->MS	Alerting	
13	SS->MS	Assignment Command	See specific message contents.
14	MS->SS	Assignment Complete	
15	SS->MS	Connect	
16	MS->SS	Connect Acknowledge	
17	MS		The TCH shall be through connected by both directions in the dedicated mode, using the codec mode specified.
18	SS->MS	CMI_PHASE_REQ	See specific message contents.
19	MS->SS	ACK_OK	Message must be received within 3 speech frames
20	SS->MS	Disconnect	
21	MS->SS	Release	
22	SS->MS	Release Complete	
23	SS->MS	Channel Release	

Specific Message Contents

ASSIGNMENT COMMAND

Information Element	value/remarks
Channel description	M=1: TCH/F M=2: TCH/F M=3: TCH/H
Mode of the first channel - Mode	M = 1: Full rate version 5 M = 2: Full rate version 4 M = 3: Half rate version 4

CMI_PHASE_REQ

Information Element	value/remarks
CMIP	1 (default)

26.19.9.4 Reserved for future use

26.19.9.5 Threshold Change (normal)

NOTE: this test is derived from the one described in subclause 26.16.9.5 and entitled: "Threshold Change (normal)"

26.19.9.5.1 Conformance requirements

The THRESH_REQ message may be sent by the BTS to change the thresholds in the DL Mode Request Generator.

The ACK_OK message serves as an acknowledgement that a RATSCCH REQ message has been detected, correctly decoded (no CRC error) and that it is defined for the Addressee. It defines the exact activation time in direction from Addressee to Initiator.

Reference:

3GPP TS 05.09 sub-clauses: 3.2.2.3.1, 3.2.2.3.6

26.19.9.5.2 Test purpose

This test will verify that an RATSCCH capable MS is able to handle a properly formatted THRESH_REQ message

26.19.9.5.3 Method of test

Initial Conditions

System Simulator:

1 cell with default parameters

Mobile Station:

The MS is in the "idle, updated" state, with a TMSI allocated and camped on cell A.

Specific PICS statements:

- Support of GSM speech full rate version 4 (O-TCH/WFS).
- Support of GSM speech Half rate version 4 (O-TCH/WHS).
- Support of GSM Speech Full Rate version 5 (TCH/WFS).

PIXIT statements:

-

Foreseen Final State of the MS

Idle Updated, TMSI allocated and camped on cell A.

Test Procedure

- 1) User initiates a Mobile Originated call.
- 2) The network and the MS indicate Bearer capabilities IE with the AMR speech Full Rate (Version 4 or 5) and Half Rate (Version 4).
- 3) The network performs an assignment on a TCH channel with MultiRate configuration to the MS.
- 4) The call is maintained during a programmable time without variation of RxLev /RxQual.
- 5) The SS shall send a properly formatted THRESH_REQ message during the call at a programmable time.
- 6) The MS answers with a ACK_OK message within 3 speech frames
- 7) The network initiates the call release.

This test is repeated for

- M = 1 if full rate speech version 5 is supported, and
- M = 2 if full rate speech version 4 is supported, and
- M = 3 if half rate speech version 4 is supported.

Maximum Duration of Test

5 minutes

Expected Sequence

Step	Direction	Message	Comments
1	MS		MS is in idle mode
2	MS		MS initiates Mobile Originated call
3	MS->SS	Channel Request	Establishment cause is "originating call and the network does not set the NECI bit to 1".
4	SS->MS	Immediate Assignment	See Default Messages for AMR
5	MS->SS	CM Service Request	CM Service Type = Mobile Originating Call Establishment.
6	SS->MS	AUTHENTICATION REQUEST	
7	MS->SS	AUTHENTICATION RESPONSE	SRES specifies correct value
8	SS->MS	CIPHERING MODE COMMAND	SS starts deciphering after sending the message
9	MS->SS	CIPHERING MODE COMPLETE	Shall be sent enciphered. All following messages shall be sent enciphered.
10	MS->SS	Setup	MS indicates supported speech versions
11	SS->MS	Call Proceeding	
12	SS->MS	Alerting	
13	SS->MS	Assignment Command	See specific message contents.
14	MS->SS	Assignment Complete	
15	SS->MS	Connect	
16	MS->SS	Connect Acknowledge	
17	MS		The TCH shall be through connected by both directions in the dedicated mode, using the codec mode specified.
18	SS->MS	THRESH_REQ	See specific message contents.
19	MS->SS	ACK_OK	Message must be received within 3 speech frames
20	SS->MS	Disconnect	
21	MS->SS	Release	
22	SS->MS	Release Complete	
23	SS->MS	Channel Release	

Specific Message Contents

ASSIGNMENT COMMAND

Information Element	value/remarks
Channel description	M=1: TCH/F M=2: TCH/F M=3: TCH/H
Mode of the first channel - Mode	M = 1: Full rate version 5 M = 2: Full rate version 4 M = 3: Half rate version 4
Multi-Rate configuration	2 codec modes specified

THRESH_REQ

Information Element	value/remarks
HYST3	Not defined (set to all 1s)
THRESH3	Not defined (set to all 1s)
HYST2	Not defined (set to all 1s)
THRESH2	Not defined (set to all 1s)
HYST1	2 dB
THRESH1	10 dB

26.19.9.6 Reserved for future use

26.19.9.7 Reserved for future use

26.19.9.8 Reserved for future use

26.19.9.9 Reserved for future use

26.19.9.10 Inversion of the Phase of the CMR/CMI

NOTE: this test is derived from the one described in subclause 26.16.9.10 and entitled: "Inversion of the Phase of the CMR/CMI"

26.19.9.10.1 Conformance requirements

The phase of the Codec Mode Indication in the downlink can be changed during a call by using a CMI_PHASE_REQ message sent on the RATSCCH.

The CMI_PHASE_REQ message may be sent by the BTS during a call to change the phase of the Codec Mode Indication in the downlink without interruption of the speech transmission.

The ACK_OK message serves as an acknowledgement that a RATSCCH REQ message has been detected, correctly decoded (no CRC error) and that it is defined for the Addressee.

References:

3GPP TS 05.09 clauses 3.2.1.3 and 3.2.2.3.4.

26.19.9.10.2 Test purpose

This test shall verify that the MS is able to change the phase of the Codec Mode Indication in the downlink using the RATSCCH protocol.

26.19.9.10.3 Method of test

Initial Conditions

System Simulator:

1 cell with default parameters

Mobile Station:

The MS is in the "idle, updated" state, with a TMSI allocated and camped on cell A.

Specific PICS statements:

- Support of GSM speech full rate version 4 (O-TCH/WFS).
- Support of GSM speech Half rate version 4 (O-TCH/WHF).
- Support of GSM Speech Full Rate version 5 (TCH/WFS).

PIXIT statements:

-

Foreseen Final State of the MS

Idle Updated, TMSI allocated and camped on cell A.

Test Procedure

- 1) User initiates a Mobile Originated call.
- 2) The network and the MS indicate Bearer capabilities IE with the AMR speech Full Rate (Version 4 or 5) and Half Rate (Version 4).
- 3) The network performs an assignment on a TCH channel with MultiRate configuration to the MS.
- 4) The network shall indicate Codec Mode Command = 0 and Codec Mode Indication = 1.
- 5) The SS sends a series of CMI_PHASE_REQ messages during the call to change the phase of the Codec Mode Indication in the downlink.
- 6) The MS responds to each CMI_PHASE_REQ message with an ACK_OK message on the RATSCCH.
- 7) The SS shall ensure that the phase request has been handled correctly by checking the Uplink CMI = 0 for 20 speech frames following the receipt of the ACK_OK.
- 8) The network initiates the call release.

This test is repeated for

- M = 1 if full rate speech version 5 is supported, and
- M = 2 if full rate speech version 4 is supported, and
- M = 3 if half rate speech version 4 is supported.

Maximum Duration of Test

5 minutes

Expected Sequence

Step	Direction	Message	Comments
1	MS		MS is in idle mode
2	MS		MS initiates Mobile Originated call
3	MS->SS	Channel Request	Establishment cause is "originating call and the network does not set the NECI bit to 1".
4	SS->MS	Immediate Assignment	See Default Messages for AMR
5	MS->SS	CM Service Request	CM Service Type = Mobile Originating Call Establishment.
6	SS->MS	AUTHENTICATION REQUEST	
7	MS->SS	AUTHENTICATION RESPONSE	SRES specifies correct value
8	SS->MS	CIPHERING MODE COMMAND	SS starts deciphering after sending the message
9	MS->SS	CIPHERING MODE COMPLETE	Shall be sent enciphered. All following messages shall be sent enciphered.
10	SS->MS	Setup	AMR speech
11	MS->SS	Call Proceeding	
12	MS->SS	Alerting	
13	SS->MS	Assignment Command	Multirate Configuration for 2 codec modes
14	MS->SS	Assignment Complete	
15	SS->MS	Connect	
16	MS->SS	Connect Acknowledge	
17	MS		The TCH shall be through connected by both directions in the dedicated mode, using the codec mode specified.
18	SS->MS	CMI_PHASE_REQ	See specific message contents
19	MS->SS	ACK_OK	
20	MS		Wait 20 speech frames, then check that UL CMI = 0
21	SS->MS	CMI_PHASE_REQ	See specific message contents
22	MS->SS	ACK_OK	
23	MS		Wait 20 speech frames, then check that UL CMI = 0
24	SS->MS	CMI_PHASE_REQ	See specific message contents
25	MS->SS	ACK_OK	
26	MS		Wait 20 speech frames, then check that UL CMI = 0
27	SS->MS	CMI_PHASE_REQ	See specific message contents
28	MS->SS	ACK_OK	
29	MS		Wait 20 speech frames, then check that UL CMI = 0
30	SS->MS	Disconnect	
31	MS->SS	Release	
32	SS->MS	Release Complete	
33	SS->MS	Channel Release	

Specific Message Contents

ASSIGNMENT COMMAND

Information Element	value/remarks
Channel description	M=1: TCH/F M=2: TCH/F M=3: TCH/H
Mode of the first channel - Mode	M = 1: Full rate version 5 M = 2: Full rate version 4 M = 3: Half rate version 4

In step 18:

CMI_PHASE_REQ

Information Element	value/remark
CMIP	0: CMI transmitted in even speech frames

This message should be sent in a RATSCCH frame where the RATSCCH frame (or RATSCCH_DATA part for O-TCH/AHS) replaces a speech frame which would have carried a Codec Mode Command.

In step 21:

CMI_PHASE_REQ

Information Element	value/remark
CMIP	1: CMI transmitted in odd speech frames (back to default)

This message should be sent in a RATSCCH frame where the RATSCCH frame (or RATSCCH_DATA part for O-TCH/AHS) replaces a speech frame which would have carried a Codec Mode Command.

In step 24:

CMI_PHASE_REQ

Information Element	value/remark
CMIP	0: CMI transmitted in even speech frames

This message should be sent in a RATSCCH frame where the RATSCCH frame (or RATSCCH_DATA part for O-TCH/AHS) replaces a speech frame which would have carried a Codec Mode Indication.

In step 27:

CMI_PHASE_REQ

Information Element	value/remark
CMIP	1: CMI transmitted in odd speech frames (back to default)

This message should be sent in a RATSCCH frame where the RATSCCH frame (or RATSCCH_DATA part for O-TCH/AHS) replaces a speech frame which would have carried a Codec Mode Indication.

26.19.9.11 Change of Active Codec Set

NOTE: this test is derived from the one described in subclause 26.16.9.11 and entitled: "Change of Active Codec Set"

26.19.9.11.1 Conformance requirements

AMR codec mode adaptation is done within a set of 4 codec modes. The codec mode set (Active Codec Set) to be used by the BSS and the MS is defined during call setup and/or handover by layer 3 signalling. The ACS can be changed during a call using an AMR_CONFIG_REQ message sent on the RATSCCH.

The AMR_CONFIG_REQ message may be sent by the BTS during a call to change the AMR WB configuration on the radio interface without interruption of the speech transmission.

The ACK_OK message serves as an acknowledgement that a RATSCCH REQ message has been detected, correctly decoded (no CRC error) and that it is defined for the Addressee.

If the ACS consists of four modes, then the complete set of thresholds/hysteresis can not be sent with this message. In that case, all THRESH_j and HYST_j fields are reserved for future use and shall be set to "1". Similar, if the BTS has no threshold and hysteresis parameters for the given configuration, then all THRESH_j and HYST_j field bits shall be set to

"1" to indicate that they are undefined. The THRESH_REQ message shall be used to transmit these parameters at a later point in time. As long as the MS has no defined threshold and hysteresis parameters it shall use the Initial Codec Mode for the Codec Mode Request.

References:

3GPP TS 05.09 clauses 3.2.2.3.5 and 3.4.

26.19.9.11.2 Test purpose

This test shall verify that the MS is able to change its Active Codec Set using the RATSCCH protocol, with change of thresholds, and with non-specification of thresholds.

26.19.9.11.3 Method of test

Initial Conditions

System Simulator:

1 cell with default parameters

Mobile Station:

The MS is in the "idle, updated" state, with a TMSI allocated and camped on cell A.

Specific PICS statements:

- Support of GSM speech full rate version 4 (O-TCH/WFS).
- Support of GSM speech Half rate version 4 (O-TCH/WHS).
- Support of GSM Speech Full Rate version 5 (TCH/WFS).

PIXIT statements:

-

Foreseen Final State of the MS

Idle Updated, TMSI allocated and camped on cell A.

Test Procedure

- 1) User initiates a Mobile Originated call.
- 2) The network and the MS indicate Bearer capabilities IE with the AMR speech Full Rate (Version 4 or 5) and Half Rate (Version 4).
- 3) The network performs an assignment on a TCH channel with MultiRate configuration to the MS.
- 4) The SS uses the codec with the highest bit-rate in the current ACS for the Codec Mode Indication, and that with the lowest bit-rate for the Codec Mode Command.
- 5) The SS sends an AMR_CONFIG_REQ message during the call to reconfigure the Multirate settings.
- 6) The MS responds to each AMR_CONFIG_REQ message with an ACK_OK message on the RATSCCH.
- 7) The SS shall ensure that the change occurs correctly for downlink (12 speech frames after AMR_CONFIG_REQ message was sent), and for uplink (12 speech frames after ACK_OK was received) by checking parity of received speech frames, and correct implementation of Uplink Codec mode Request.
- 8) The SS shall ensure that each of the codecs in the ACS have been implemented correctly by setting the CMC to each of the applicable modes, and ensuring that the UL frames with each CMI are received without parity error. The SS shall then set the CMI and CMC to the codec with highest and lowest bit rates respectively.
- 9) Steps 4 to 8 shall be repeated for differing AMR_CONFIG_REQ parameters and sending conditions.
- 10) The network initiates the call release.

This test is repeated for

- M = 1 if full rate speech version 5 is supported, and
- M = 2 if full rate speech version 4 is supported, and
- M = 3 if half rate speech version 4 is supported.

In case of full rate speech version 5, the maximum number of codec is 3 then the step 27 to 29 are skipped.

Maximum Duration of Test

5 minutes

Expected Sequence

Step	Direction	Message	Comments
1	MS		MS is in idle mode
2	MS		MS initiates Mobile Originated call
3	MS->SS	Channel Request	Establishment cause is "originating call and the network does not set the NECI bit to 1".
4	SS->MS	Immediate Assignment	See Default Messages for AMR
5	MS->SS	CM Service Request	CM Service Type = Mobile Originating Call Establishment.
6	SS->MS	AUTHENTICATION REQUEST	
7	MS->SS	AUTHENTICATION RESPONSE	SRES specifies correct value
8	SS->MS	CIPHERING MODE COMMAND	SS starts deciphering after sending the message
9	MS->SS	CIPHERING MODE COMPLETE	Shall be sent enciphered. All following messages shall be sent enciphered.
10	MS->SS	Setup	AMR speech
11	SS->MS	Call Proceeding	
12	SS->MS	Alerting	
13	SS->MS	Assignment Command	Multirate Configuration for 2 codec modes
14	MS->SS	Assignment Complete	
15	SS->MS	Connect	
16	MS->SS	Connect Acknowledge	
17	MS		The TCH shall be through connected by both directions in the dedicated mode, using the codec mode specified.
18	SS->MS	AMR_CONFIG_REQ	See specific message contents.
19	MS->SS	ACK_OK	
20	MS		Check that ACS changes have been implemented correctly. Expected CMR = 0.
21	SS->MS	AMR_CONFIG_REQ	See specific message contents.
22	MS->SS	ACK_OK	
23	MS		Check that ACS changes have been implemented correctly. Expected CMR = 0 or 1.
24	SS->MS	AMR_CONFIG_REQ	See specific message contents.
25	MS->SS	ACK_OK	
26	MS		Check that ACS changes have been implemented correctly. Expected CMR = 0, 1 or 2.
27(for M=2 or 3)	SS->MS	AMR_CONFIG_REQ	See specific message contents.
28(for M=2 or 3)	MS->SS	ACK_OK	
29(for M=2 or 3)	MS		Check that ACS changes have been implemented correctly. Expected CMR = 0, 1, 2 or 3.
30	SS->MS	AMR_CONFIG_REQ	See specific message contents.
31	MS->SS	ACK_OK	
32	MS		Check that ACS changes have been implemented correctly. Expected CMR = 2 (special case where CMR = ICM).
33	SS->MS	Disconnect	
34	MS->SS	Release	
35	SS->MS	Release Complete	
36	SS->MS	Channel Release	

Specific Message Contents

In all cases, the Active Codec Set field of the AMR_CONFIG_REQ messages should be programmed to ensure that the codec rate changes when the new configuration takes effect.

ASSIGNMENT COMMAND

Information Element	value/remarks
Channel description	M=1: TCH/F M=2: TCH/F M=3: TCH/H
Mode of the first channel - Mode	M = 1: Full rate version 5 M = 2: Full rate version 4 M = 3: Half rate version 4.
Multi-Rate configuration	Arbitrary set of codec modes, thresholds and hysteresis specified according to 3GPP TS 05.09 / 45.009

In step 18:

AMR_CONFIG_REQ

Information Element	value/remark
ICM	CODEC_MODE_1
ACS	1 codec mode (different from that in Assignment Command)
HYST2	n/a – set to all 1's
THRESH2	n/a – set to all 1's
HYST1	n/a – set to all 1's
THRESH1	n/a – set to all 1's

This message should be sent in a RATSCCH frame where the RATSCCH frame (or RATSCCH_DATA part for O-TCH/AHS) replaces a speech frame which would have carried a Codec Mode Command.

In step 21:

AMR_CONFIG_REQ

Information Element	value/remark
ICM	CODEC_MODE_1
ACS	2 codec modes
HYST2	n/a – set to all 1's
THRESH2	n/a – set to all 1's
HYST1	2 dB
THRESH1	10 dB

This message should be sent in a RATSCCH frame where the RATSCCH frame (or RATSCCH_DATA part for O-TCH/AHS) replaces a speech frame which would have carried a Codec Mode Command.

In step 24:

AMR_CONFIG_REQ

Information Element	value/remark
ICM	CODEC_MODE_2
ACS	3 codec modes
HYST2	2 dB
THRESH2	10 dB
HYST1	2 dB
THRESH1	7 dB

This message should be sent in a RATSCCH frame where the RATSCCH frame (or RATSCCH_DATA part for O-TCH/AHS) replaces a speech frame which would have carried a Codec Mode Indication.

In step 27:

This step is applicable only if the MS supports full or half rate version 4

AMR_CONFIG_REQ

Information Element	value/remark
ICM	CODEC_MODE_3
ACS	4 codec modes
HYSTc	2 dB
THRESH3	12 dB
THRESH2	10 dB
THRESH1	6.5 dB

This message should be sent in a RATSCCH frame where the RATSCCH frame (or RATSCCH_DATA part for O-TCH/AHS) replaces a speech frame which would have carried a Codec Mode Indication.

In step 30:

AMR_CONFIG_REQ for M = 1 (MS supports full rate version 5)

Information Element	value/remark
ICM	CODEC_MODE_3
ACS	3 codec modes
HYST2	Undefined – set to all 1's
THRESH2	Undefined – set to all 1's
HYST1	Undefined – set to all 1's
THRESH1	Undefined – set to all 1's

AMR_CONFIG_REQ for M = 2 and 3 (MS supports full or half rate version 4)

Information Element	value/remark
ICM	CODEC_MODE_3
ACS	4 codec modes
HYST2	Undefined – set to all 1's
THRESH2	Undefined – set to all 1's
HYST1	Undefined – set to all 1's
THRESH1	Undefined – set to all 1's

This message should be sent in a RATSCCH frame where the RATSCCH frame (or RATSCCH_DATA part for O-TCH/AHS) replaces a speech frame which would have carried a Codec Mode Command.

26.19.10 AMR signalling/ test of the channel mode modify procedure

26.19.10.1 WB AMR signalling test of the channel mode modify procedure / full rate

NOTE: this test is derived from the one described in subclause 26.16.10.1 and entitled: "AMR signalling/ test of the channel mode modify procedure/full rate"

26.19.10.1.1 Conformance requirement

The MS with a TCH/F allocated acknowledges a CHANNEL MODE MODIFY message by sending a CHANNEL MODE MODIFY ACKNOWLEDGE message specifying the new mode and by switching to this mode.

References

3GPP TS 04.08 / 3GPP TS 44.018, subclauses 3.4.6.1.1 and 3.4.6.1.2

26.19.10.1.2 Test purpose

To verify that the MS with a TCH/F allocated acknowledges a CHANNEL MODE MODIFY message by sending a CHANNEL MODE MODIFY ACKNOWLEDGE message specifying the new mode and by switching to this mode.

26.19.10.1.3 Method of test

Initial Conditions

System Simulator:

1 cell, default parameters.

Mobile Station:

The MS is "idle updated", with TMSI allocated.

Specific PICS statements:

- Support of GSM speech full rate version 4 (O-TCH/WFS).
- Support of GSM speech Half rate version 4 (O-TCH/WHS).
- Support of GSM Speech Full Rate version 5 (TCH/WFS).

PIXIT statements:

-

Foreseen Final State of the MS

"Idle, updated", with TMSI allocated.

Test procedure

A Mobile Terminated call is initiated, however following the CHANNEL REQUEST received from the Mobile Station, the SS sends an IMMEDIATE ASSIGNMENT to the MS commanding it to go to a TCH/F. This sets the Channel Mode automatically to "Signalling Only".

The SS then sends a series of CHANNEL MODE MODIFY messages to the MS. Each time it is checked that the MS responds with a CHANNEL MODE MODIFY ACKNOWLEDGE message specifying the channel mode that has been specified in the CHANNEL MODE MODIFY message

This test is repeated for

- M = 1 if full rate speech version 5 is supported, and
- M = 2 if full rate speech version 4 is supported

Maximum Duration of Test

30 seconds.

Expected Sequence

Step	Direction	Message	Comments
1	SS->MS	PAGING REQUEST TYPE 1	Sent on correct paging subchannel
2	MS->SS	CHANNEL REQUEST	Establishment cause indicates "answer to paging"
3	SS->MS	IMMEDIATE ASSIGNMENT	Assignment to a non hopping TCH/F signalling only
4	MS->SS	PAGING RESPONSE	Message is contained in the SABM
5	SS->MS	AUTHENTICATION REQUEST	
6	MS->SS	AUTHENTICATION RESPONSE	SRES specifies correct value
7	SS->MS	CIPHERING MODE COMMAND	SS starts deciphering after sending the message
8	MS->SS	CIPHERING MODE COMPLETE	Shall be sent enciphered. All following messages shall be sent enciphered.
9	SS		SS starts ciphering
10	SS->MS	CHANNEL MODE MODIFY	
11	MS->SS	CHANNEL MODE MODIFY ACKNOWLEDGE	Verify that Channel description = TCH/F, Channel mode = speech full or half rate version 5 for M = 1 or speech full or half rate version 4 for M = 2.
12	SS->MS	CHANNEL MODE MODIFY	
13	MS->SS	CHANNEL MODE MODIFY ACKNOWLEDGE	Verify that Channel description = TCH/F, Channel mode = speech full or half rate version 5 or speech full or half rate version 4 for M = 2.
14	SS->MS	CHANNEL MODE MODIFY	
15	MS->SS	CHANNEL MODE MODIFY ACKNOWLEDGE	Verify that Channel description = TCH/F, Channel mode = speech full or half rate version 5 or speech full or half rate version 4 for M = 2.
16	SS->MS	CHANNEL MODE MODIFY	
17	MS->SS	CHANNEL MODE MODIFY ACKNOWLEDGE	Verify that Channel description = TCH/F, Channel mode = speech full or half rate version 5 or speech full or half rate version 4 for M = 2.
18	SS->MS	CHANNEL RELEASE	

Specific Message Contents

In steps 12 – 19:

CHANNEL MODE MODIFY

Information Element	value/remark
Channel description	in steps 12, 14, 16, 18: same as for step 3
Channel mode Mode	speech full or half rate version 4 or 5
Multi-Rate configuration	in steps 12: change of MR configuration, no initial codec mode in steps 14: change of MR configuration, initial codec mode specified in steps 16: change of MR thresholds, no initial codec mode in steps 18: initial codec mode specified

26.20 Enhanced Power Control

26.20.1 Enhanced Power Control / MS Supports EPC

26.20.1.1 Conformance requirements

The purpose of the *Mobile Station Classmark 3* information element is to provide the network with information concerning aspects of the mobile station. The contents might affect the manner in which the network handles the operation of the mobile station. The Mobile Station Classmark information indicates general mobile station characteristics and it shall therefore, except for fields explicitly indicated, be independent of the frequency band of the channel it is sent on.

<Classmark 3 Value part> ::=

{ 0 | 1 < High Multislot Capability : bit(2) > }

---Release 5 starts here.

{ 0 | 1 < GERAN Iu Mode Capabilities > } -- '1' also means support of GERAN Iu mode
< GERAN Feature Package 2 : bit >

GERAN Feature Package 2 (1 bit field)

This field indicates the MS support of the GERAN Feature Package 2. The GERAN Feature Package 2 includes **Enhanced Power Control (EPC)** (see 3GPP TS 45.008).

- 0 GERAN feature package 2 not supported.
- 1 GERAN feature package 2 supported.

In *A/Gb mode*, when assigned a TCH or O-TCH, the MS shall configure the channel in enhanced power control (EPC) mode if so commanded by BSS in the channel assignment (see 3GPP TS 44.018). On such a channel, EPC may be used for uplink power control and/or downlink power control.

When on a channel in EPC mode,

- the MS shall use the EPCCH in the uplink for EPC measurement reporting (see subclause 8.4.1b).
- the MS shall, depending on what is signalled in the L1 header of the downlink SACCH (see 3GPP TS 44.004) and during channel assignment (see 3GPP TS 44.018), obey either the EPC Uplink Power Control Command (sent on the EPCCH in the downlink) or the Ordered MS Power Level (sent in the L1 header of the downlink SACCH).
 - If the signalling indicates that EPC shall be used in the uplink, the MS shall employ the most recently commanded EPC power control level, as indicated by the EPC Uplink Power Control Command sent on the corresponding EPCCH in the downlink. The EPC Uplink Power Control Command is sent once every EPC reporting period (see subclause 8.4.1b). The MS shall ignore the Ordered MS Power Level sent in the SACCH L1 header in the downlink.
 - If the signalling indicates that normal power control shall be used in the uplink, the MS shall ignore the EPC Uplink Power Control Command and use normal power control.

When in enhanced power control (EPC) mode, the MS shall for uplink power control obey either the EPC Uplink Power Control Commands or the Ordered MS Power Level. This is controlled by signalling via the SACCH L1 header in the downlink (see 3GPP TS 44.004) and during channel assignment (see 3GPP TS 44.018 and 3GPP TS 44.118). The type of power control commands to be obeyed by the MS during one SACCH period is determined by what is signalled in the L1 header during the previous SACCH period and, before any SACCH block has been correctly decoded, by what is signalled during channel assignment.

NOTE: This signalling via the SACCH L1 header and during channel assignment only controls the uplink power control mechanism. In *A/Gb mode*, EPC measurement procedures shall always be followed by the MS when on a TCH or O-TCH in EPC mode. Similarly in *Iu mode*, EPC measurement procedures shall always be followed by the MS when on a DBPSCH in EPC mode.

When the MS is ordered to obey the Ordered MS Power Level, the timing according to subclause 4.7.1 applies.

When the MS is ordered to obey the EPC Uplink Power Control Command, it shall, upon receipt of an EPC Uplink Power Control Command on an EPCCH in the downlink, change to the new power level on the corresponding uplink channel at the first TDMA frame belonging to the next EPC reporting period (as specified in subclause 8.4.1b).

References

3GPP TS 24.008, subclause 10.5.1.7

3GPP TS 45.008, subclause 4.2, subclause 4.7.3

26.20.1.2 Test purpose

To verify that a MS that supports EPC indicates to the network that it supports GERAN feature package 2.

To verify that when commanded to do so the MS shall configure the assigned TCH or O-TCH channel in EPC mode.

To verify that when on a channel in EPC mode the MS ignores the EPC Uplink Power Control command if the signalling indicates that normal power control shall be used in the uplink.

To verify that when in EPC mode, the MS shall for uplink power control obey either the EPC Uplink Power Control Commands or the Ordered MS Power Level.

26.20.1.3 Method of test

Initial Conditions

System Simulator:

1 cell, default parameters except IMSI Attach-detach shall be applied.

Mobile Station:

MS is switched off.

Specific PICS Statements:

-

PIXIT Statements:

-

Test Procedure

The MS is switched on (or its power is re-applied). After the start of the LOCATION UPDATING procedure the SS initiates a CLASSMARK ENQUIRY procedure. The MS shall report in the CLASSMARK CHANGE that it supports "GERAN FEATURES PACKAGE 2". The SS then completes the LOCATION UPDATING procedure assignment a mobile identity.

The MS is paged and a MT speech call (TCH) is established with an early assignment (before CONNECT). The MS is made to initiate a call. The call is established with an early assignment. The MS is assigned a channel that supports "Enhanced Power Control" with the power level set to the maximum allowed. The MS shall send a MEASUREMENT REPORT on the EPCCH that reports the power level used is that of the one set in the ASSIGNMENT COMMAND.

The SS then checks that the MS is using the enhanced power control mechanism by commanding it to lower its power level. This is then checked on the subsequent MEASUREMENT REPORT sent by the MS on the EPCCH.

"Enhanced Power Control" is disabled and the SS checks that the MS goes back to using the normal power control mechanism.

Maximum Duration of Test

Expected Sequence

Step	Direction	Message	Comments
1	MS		The MS is switched on (or its power is re-applied).
2	MS -> SS	CHANNEL REQUEST	
3	SS -> MS	IMMEDIATE ASSIGNMENT	
4	MS -> SS	LOCATION UPDATING REQUEST	
5	SS -> MS	CLASSMARK ENQUIRY	
6	MS -> SS	CLASSMARK CHANGE	Classmark 3 should be present indicating that the MS supports GERAN Feature Package 2.
7	SS -> MS	LOCATION UPDATING ACCEPT	Assign a TMSI
8	MS -> SS	LOCATION UPDATE COMPLETE	
9	SS -> MS	CHANNEL RELEASE	
10	SS -> MS	PAGING REQUEST TYPE 1	Sent on the correct paging subchannel. "Mobile Identity" IE contains the TMSI allocated to the MS
11	MS -> SS	CHANNEL REQUEST	
12	SS -> MS	IMMEDIATE ASSIGNMENT	
13	MS -> SS	PAGING RESPONSE	
14	SS -> MS	SETUP	Message does not contain the signal IE.
15	MS -> SS	CALL CONFIRMED	
16	SS -> MS	ASSIGNMENT COMMAND	Set the power level to the maximum allowed for the class of MS being tested and enable EPC.
17	MS -> SS	ASSIGNMENT COMPLETE	Sent on the new channel.
18	SS		Change the SACCH L1 header to indicate "EPC in use for MS power control".
19	SS -> MS	ALERTING	
20	MS		An alert indication is given by the MS.
21	MS		The MS is made to accept the call.
22	MS -> SS	CONNECT	
23	MS		The TCH shall be through connected by both directions in the dedicated mode.
24	SS -> MS	CONNECT ACKNOWLEDGE	
25	MS -> SS	MEASUREMENT REPORT	Message is sent on EPCCH. Determine the RF power control level being used from the SACCH L1 header.
26	SS		Command the MS to lower its power level by 2 dB (setting Ordered MS power level in the SACCH header) using the EPC UPLINK POWER CONTROL COMMAND. Sent on the EPCCH.
27	MS -> SS	MEASUREMENT REPORT	Message is sent on EPCCH. Confirm that the reported power level used by the MS is 2dB lower.
28	SS -> MS	ASSIGNMENT COMMAND	Disable EPC, using normal power control. Set power level to value seen in step 27.
29	MS -> SS	ASSIGNMENT COMPLETE	
30	SS		Change the SACCH L1 header to indicate "EPC not in use for MS power control".
31	SS		Command the MS to lower its power level by 2 dB using the EPC UPLINK POWER CONTROL COMMAND. Sent on the EPCCH.
32	MS -> SS	MEASUREMENT REPORT	Message is sent on SACCH. Report power level used by MS should not have changed from that used in step 27.
33	SS		Change the SACCH L1 header to indicate the MS to lower its power by 4 dB.
34	MS -> SS	MEASUREMENT REPORT	Message is sent on SACCH. Confirm that the reported power level used by the MS is 4 dB lower than that reported at step 27.

27 Testing of the SIM/ME interface

The following sequence of tests confirms:

- a) the correct interpretation of data read from the SIM (Subscriber Identification Module) by the ME;
- b) the correct writing of data to the SIM by the ME;
- c) the initiation of appropriate procedures by the ME;
- d) low level protocols;
- e) electrical characteristics;
- f) physical characteristics.

NOTE 0: Throughout clause 27:

the term PCS 1 900 indicates GSM 710, GSM 750, T-GSM 810, GSM 850 and PCS 1 900 bands, which use 3-digit MNC

the term GSM indicates all other bands, which use 2-digit MNC.

A SIM simulator will be required as part of the SS. Alternatively, to perform the logical tests, SIMs programmed with specific data may be used. The SIM data is not defined within the initial conditions of the tests unless it differs from the default values defined below.

Definition of default values for SIM/ME interface testing

A SIM containing the following default values is used for all tests of this subclause unless otherwise stated.

For each data item, the logical default values and the coding within the elementary files (EF) of the SIM follow.

NOTE 1: Bx represents Byte x of the coding.

NOTE 2: Unless otherwise defined, the coding values are hexadecimal.

EF_{IMSI} (IMSI)

Logically: 246813579

Coding:

B1	B2	B3	B4	B5	B6	B7	B8	B9
05	29	64	18	53	97	FF	FF	FF

EF_{LOCi} (Location Information)

Logically: LAI-MCC: 246

LAI-MNC: 81 or 813 (see Note 0)

LAI-LAC: 0001

TMSI: "FF .. FF"

Coding:

Coding:	B1	B2	B3	B4	B5	B6	B7	B8	B9	B10	B11
2-digit MNC	FF	FF	FF	FF	42	F6	18	00	01	FF	00
3-digit MNC	FF	FF	FF	FF	42	36	18	00	01	FF	00

EF_{Kc} (Ciphery Key Kc)

Logically: Key Kc: xx

Sequence No: 1

Coding:	B1	B2	B3	B4	B5	B6	B7	B8	B9
	xx	xx	xx	xx	xx	xx	xx	xx	01

EF_{ACC} (Access Control Class)

Logically: One and only one access class from 0 - 9, e.g. class 7 for which the coding is "00 80".

EF_{FPLMN} (Forbidden PLMNs)

Logically:

	MCC	PLMN1	PLMN2	PLMN3	PLMN4
	234	234	234	234	234
MNC 2-digit	02	03	04	05	05
3-digit	023	034	045	056	

Coding:

	B1	B2	B3	B4	B5	B6	B7	B8	B9	B10	B11	B12
2-digit MNC	32	F4	20	32	F4	30	32	F4	40	32	F4	50
3-digit MNC	32	34	20	32	44	30	32	54	40	32	64	50

EF_{SST} (SIM Service Table)

Logically: CHV1 disable function allocated and activated.

Abbreviated dialling numbers allocated and activated.

PLMN selector allocated and activated.

Fixed dialling numbers not activated.

Coding:

	B1	B2	B3	B4
Value (binary)	xx0x1111	0011xxxx	xxxxxxxx	0000xxxx

The coding of EF_{SST} shall conform with the capabilities of the SIM used.

EF_{ADN} (Abbreviated Dialling Number)

Logically:

At least 10 records, each non-empty record unique.

Record 1:	Length of alpha identifier:	32 characters
	Alpha identifier:	"ABCDEFGHJKLMNOPQRSTUVWXYZABCDEF"
	Length of BCD number:	"03"
	TON and NPI:	Telephony and Unknown

Dialled number: 123

CCI: None

Ext1: None

Coding:	B1	B2	B3	...	B32	B33	B34	B35	B36	B37	B38	B39	...	B46
Record 1:	41	42	43	...	46	03	81	21	F3	FF	FF	FF	...	FF

EF_{Phase}

Logically: Phase 2

Coding: "02"

EF_{PLMNsel} (PLMN Selector)

Logically:

		PLMN1	PLMN2	PLMN3	PLMN4	PLMN5	PLMN6	PLMN7	PLMN8
	MCC	234	234	234	234	234	234	246	246
MNC	2-digit	01	02	03	04	05	06	81	82
	3-digit	012	023	034	045	056	067	813	824

Coding:

	B1	B2	B3	B4	B5	B6	B7	B8	B0	B10	B11	B12
2-digit MNC	32	F4	10	32	F4	20	32	F4	30	32	F4	40
3-digit MNC	32	24	10	32	34	20	32	44	30	32	54	40
	B13	B14	B15	B16	B17	B18	B19	B20	B21	B22	B23	B24
2-digit MNC	32	F4	50	32	F4	60	42	F6	18	42	F6	28
3-digit MNC	32	64	50	32	74	60	42	36	18	42	46	28

CHV1 (PIN)

Logically: 2468

Coding:

B1	B2	B3	B4	B5	B6	B7	B8
32	34	36	38	FF	FF	FF	FF

CHV2 (PIN2)

Logically: 3579

Coding:

B1	B2	B3	B4	B5	B6	B7	B8
33	35	37	39	FF	FF	FF	FF

Unblock CHV1 (PUK)

Logically: 13243546

Coding:

B1	B2	B3	B4	B5	B6	B7	B8
31	33	32	34	33	35	34	36

Unblock CHV2 (PUK2)

Logically: 08978675

Coding:

B1	B2	B3	B4	B5	B6	B7	B8
30	38	39	37	38	36	37	35

Definition of FDN SIM

Some test cases require a different configuration than the one described above. For that purpose a default FDN SIM is defined. In general the values of the FDN SIM are identical to the default SIM, with the following exceptions.

EF_{SST} (SIM Service Table)

- Logically:
- CHV1 disable function allocated and activated.
 - Abbreviated dialling numbers allocated and activated.
 - PLMN selector allocated and activated.
 - Fixed dialling numbers allocated and activated.
 - Advice of Charge allocated and activated.

Coding:

	B1	B2	B3	B4
Value (binary)	xx111111	0011xx11	xxxxxxxx	0000xxxx

The coding of EF_{SST} shall conform with the capabilities of the SIM used.

EF_{FDN} (Fixed Dialling Numbers)

Logically:

- Record 1:
- Length of alpha identifier: 6 characters
 - Alpha identifier: "FDN111"
 - Length of BCD number: "06"
 - TON and NPI: Telephony and International
 - Dialled number: +1357924680
 - CCI: None
 - Ext1: None

Coding:

	B1	B2	B3	B4	B5	B6	B7	B8	B9	B10
For record 1:	46	44	4E	31	31	31	06	91	31	75
	B11	B12	B13	B14	B15	B16	B17	B18	B19	B20
For record 1:	29	64	08	FF	FF	FF	FF	FF	FF	FF

Logically:

- Record 2:
- Length of alpha identifier: 6 characters
 - Alpha identifier: "FDN222"
 - Length of BCD number: "04"
 - TON and NPI: Telephony and Unknown
 - Dialled number: 24680

CCI: None

Ext1: None

Coding:

	B1	B2	B3	B4	B5	B6	B7	B8	B9	B10
For record 2	46	44	4E	32	32	32	04	81	42	86
	B11	B12	B13	B14	B15	B16	B17	B18	B19	B20
For record 2	F0	FF	FF	FF	FF	FF	FF	FF	FF	FF

Logically:

Record 3: Length of alpha identifier: 6 characters
 Alpha identifier: "FDN333"
 Length of BCD number: "0B"
 TON and NPI: Telephony and International
 Dialed number: +12345678901234567890
 CCI: None
 Ext1: None

Coding:

For record 3	B1	B2	B3	B4	B5	B6	B7	B8	B9	B10
	46	44	4E	33	33	33	0B	91	21	43
For record 3	B11	B12	B13	B14	B15	B16	B17	B18	B19	B20
	65	87	09	21	43	65	87	09	FF	FF

27.1 MS identification by short IMSI

27.1.1 MS identification by short IMSI - Normal case

27.1.1.1 Definition

The IMSI is used for unique identification of the MS by a GSM network. The IMSI is stored in the SIM and read during the SIM/ME initialization procedure.

27.1.1.2 Conformance requirement

On the receipt of an IMMEDIATE ASSIGNMENT message the MS shall send PAGING RESPONSE containing the IMSI of the SIM.

3GPP TS 11.11, subclauses 11.2.1 and 11.4.2, 3GPP TS 04.08 / 3GPP TS 24.008, subclause 10.5.1.4.

27.1.1.3 Test purpose

- 1) To verify that the ME uses the IMSI of the SIM.
- 2) To verify that the ME can handle an IMSI of less than the maximum length.

27.1.1.4 Method of test

27.1.1.4.1 Initial conditions

The SS transmits on the BCCH, with the following network parameters:

Attach/detach: disabled.

LAI-MCC: 246

LAI-MNC 81 or 813 (see Note 0)

LAI-LAC: 0001

Access control: unrestricted.

The default SIM is installed into the ME and the MS is powered on.

27.1.1.4.2 Procedure

- a) The SS sends PAGING REQUEST to the MS using the IMSI stored in the SIM.
- b) After receipt of a CHANNEL REQUEST from the MS, the SS sends IMMEDIATE ASSIGNMENT to the MS.
- c) After receipt of a PAGING RESPONSE from the MS, the SS sends CHANNEL RELEASE to the MS.

27.1.1.5 Test requirement

After step b) the MS shall send PAGING RESPONSE to the SS containing the IMSI stored in the SIM.

27.1.2 MS identification by short IMSI, Phase 1 DCS SIM

27.1.2.1 Definition

Different from Phase 2, the IMSI in a Phase 1 DCS SIM is stored in a directory $DF_{DCS1800}$ with the specific identifier "7F 21". To ensure backwards compatibility, if selection of the phase 2 identifier "7F 20" fails, the MS shall select "7F 21". Otherwise access to the IMSI and other data is impossible with a Phase 1 DCS SIM

-27.1.2.2 Conformance requirement

If selection of DF_{GSM} by the identifier "7F 20" fails, the ME shall select $DF_{DCS1800}$ with "7F 21".

3GPP TS 11.11, subclause 10.4.

27.1.2.3 Test purpose

To verify that the ME uses the identifier "7F 21" to select $DF_{DCS1800}$ in a Phase 1 DCS SIM.

27.1.2.4 Method of test

27.1.2.4.1 Initial conditions

The SS transmits on the BCCH, with the following network parameters:

Attach/detach: disabled.

LAI (MCC/MNC/LAC): 246/81/0001.

Access control: unrestricted.

A phase 1 DCS SIM (identifier of $DF_{DCS1800}$ is "7F 21", DF_{GSM} not existing) with default values is installed into the ME and the MS is powered on.

27.1.2.4.2 Procedure

- a) The SS sends PAGING REQUEST to the MS using the IMSI stored in the SIM.
- b) After receipt of a CHANNEL REQUEST from the MS, the SS sends IMMEDIATE ASSIGNMENT to the MS.
- c) After receipt of a PAGING RESPONSE from the MS, the SS sends CHANNEL RELEASE to the MS.

27.1.2.5 Test requirement

After step b) the MS shall send PAGING RESPONSE to the SS containing the IMSI stored in the SIM.

27.2 MS identification by short TMSI

27.2.1 Definition

The TMSI is temporarily used for identification of the MS by a GSM network. It will have been previously assigned by the network. The TMSI is stored in the SIM by the ME and read during the SIM/ME initialization procedure.

27.2.2 Conformance requirement

On the receipt of an IMMEDIATE ASSIGNMENT message the MS shall send PAGING RESPONSE containing the TMSI stored in the SIM.

3GPP TS 11.11, subclauses 11.2.1 and 11.4.5, 3GPP TS 04.08 / 3GPP TS 24.008, subclause 10.5.1.4.

27.2.3 Test purpose

- 1) To verify that the ME uses the TMSI stored in the SIM.
- 2) To verify that the ME can handle a TMSI of less than maximum length.

27.2.4 Method of test

27.2.4.1 Initial conditions

The SS transmits on the BCCH, with the following network parameters:

Attach/detach: disabled.
 LAI-MCC: 246
 LAI-MNC 81 or 813 (see Note 0)
 LAI-LAC: 0001
 Access control: unrestricted.

The default SIM is used with the following exception.

EF_{LOCI} (Location Information)

Logically: LAI-MCC: 246
 LAI-MNC: 81 or 813 (See Note 0)
 LAI-LAC: 0001
 TMSI: "2143"

Coding:

	B1	B2	B3	B4	B5	B6	B7	B8	B9	B10	B11
2-digit MNC	00	00	21	43	42	F6	18	00	01	FF	00
3-digit MNC	00	00	21	43	42	36	18	00	01	FF	00

The SIM is installed into the ME and the MS is powered on.

27.2.4.2 Procedure

- a) The SS sends PAGING REQUEST to the MS using the TMSI stored in the SIM.
- b) After receipt of a CHANNEL REQUEST from the MS, the SS sends IMMEDIATE ASSIGNMENT to the MS.
- c) After receipt of a PAGING RESPONSE from the MS, the SS sends CHANNEL RELEASE to the MS.

27.2.5 Test requirement

After step b) the MS shall send PAGING RESPONSE to the SS containing the TMSI stored in the SIM.

27.3 MS identification by long TMSI

27.3.1 Definition

The TMSI is temporarily used for identification of the MS by a GSM network. It will have been previously assigned by the network. The TMSI is stored in the SIM by the ME and read during the SIM/ME initialization procedure.

27.3.2 Conformance requirement

On the receipt of an IMMEDIATE ASSIGNMENT message the MS shall send PAGING RESPONSE containing the correct TMSI stored in the SIM.

3GPP TS 11.11, subclauses 11.2.1 and 11.4.5, 3GPP TS 04.08 / 3GPP TS 24.008, subclause 10.5.1.4.

27.3.3 Test purpose

- 1) To verify that the ME uses the TMSI stored in the SIM.
- 2) To verify that the ME can handle a TMSI of maximum length.
- 3) To verify that the ME does not respond to page requests containing a previous TMSI.

27.3.4 Method of test

27.3.4.1 Initial conditions

Prior to this test, the ME shall have been operated with a SIM containing TMSI "2143". This will be achieved by executing the previous test (27.2) prior to this test. Only under this condition will test be verified.

The SS transmits on the BCCH, with the following network parameters:

Attach/detach: disabled.
 LAI-MCC: 246
 LAI-MNC 81 or 813 (see Note 0)
 LAI-LAC: 0001
 Access control: unrestricted.

The default SIM is used with the following exception:

EF_{LOCI} (Location Information)

Logically: LAI-MCC: 246
 LAI-MNC: 81 or 813 (See Note 0)
 LAI-LAC: 0001
 TMSI: "21430000"

Coding:

	B1	B2	B3	B4	B5	B6	B7	B8	B9	B10	B11
2-digit MNC	21	43	00	00	42	F6	18	00	01	FF	00
3-digit MNC	21	43	00	00	42	36	18	00	01	FF	00

Bands using 2-digit MNC end

The SIM is installed into the ME and the MS is powered on.

27.3.4.2 Procedure

- a) The SS sends PAGING REQUEST to the MS using the TMSI "2143".

- b) The SS sends PAGING REQUEST to the MS using the TMSI stored in the SIM.
- c) After receipt of a CHANNEL REQUEST from the MS, the SS sends IMMEDIATE ASSIGNMENT to the MS.
- d) After receipt of a PAGING RESPONSE from the MS, the SS sends CHANNEL RELEASE to the MS.

27.3.5 Test requirement

- 1) After step a) the MS shall not respond to the PAGING REQUEST.
- 2) After step c) the MS shall send PAGING RESPONSE to the SS containing the TMSI stored in the SIM.

27.4 MS identification by long IMSI, TMSI updating and cipher key sequence number assignment

27.4.1 Definition

The IMSI and TMSI are used for identification of the MS by a GSM network. They are read from the SIM during the SIM/ME initialization procedure. Within the authentication procedure the network sends a cipher key sequence number to the MS. In addition the network may allocate a new TMSI to the MS. Cipher key sequence number and TMSI are stored in the SIM after call termination and/or at GSM session termination.

Test purpose 2) will only be verified if this test sequentially follows the previous test (27.3).

27.4.2 Conformance requirement

- 1. On the receipt of an IMMEDIATE ASSIGNMENT message the MS shall send PAGING RESPONSE containing the correct IMSI stored in the SIM.

3GPP TS 11.11, subclauses 11.2.1 and 11.4.2, 3GPP TS 04.08 / 3GPP TS 24.008, subclause 10.5.1.4.

- 2. After call termination the SIM shall contain the cipher key sequence number and TMSI received by the MS during the authentication and TMSI reallocation procedures.

3GPP TS 11.11, subclauses 11.2.2, 11.4.5 and 11.4.6, 3GPP TS 02.17, subclause 6.1.

27.4.3 Test purpose

- 1) To verify that the ME uses the IMSI stored in the SIM.
- 2) To verify that the ME does not respond to page requests containing a previous IMSI.
- 3) To verify that the ME can handle an IMSI of maximum length.
- 4) To verify that the ME correctly updates the cipher key sequence number at call termination.
- 5) To verify that the ME correctly updates the TMSI at call termination.

27.4.4 Method of test

27.4.4.1 Initial conditions

Prior to this test, the ME shall have been operated with a SIM containing IMSI "246813579". This will be achieved by executing the previous test (27.3) prior to this test. Only under this condition will this test be verified.

The SS transmits on the BCCH, with the following network parameters:

Attach/detach:	disabled.
LAI-MCC:	246
LAI-MNC	81 or 813 (see Note 0)
LAI-LAC:	0001
Access control:	unrestricted.

The default SIM is used with the following exception:

EF_{IMSI} (IMSI)

Logically: 2468111111111111 (2-digit MNC) or 2468131111111111 (3-digit MNC) (see Note 0)

Coding:

	B1	B2	B3	B4	B5	B6	B7	B8	B9
2-digit MNC	08	29	64	18	11	11	11	11	11
3-digit MNC	08	29	64	18	13	11	11	11	11

The SIM is installed into the ME and the MS is powered on.

27.4.4.2 Procedure

- The SS sends PAGING REQUEST to the MS using the IMSI "246813579".
- The SS sends PAGING REQUEST to the MS using the IMSI stored in the SIM.
- After receipt of a CHANNEL REQUEST from the MS, the SS sends IMMEDIATE ASSIGNMENT to the MS.
- After receipt of a PAGING RESPONSE from the MS, the SS sends AUTHENTICATION REQUEST to the MS containing cipher key sequence number set to binary 010.
- After receipt of AUTHENTICATION RESPONSE from the MS, the SS sends TMSI REALLOCATION to the MS containing TMSI "32547698".
- Within 5 s after receipt of TMSI REALLOCATION COMPLETE from the MS, the SS sends CHANNEL RELEASE to the MS.
- To allow examination of the values in the SIM after call termination the MS shall not be soft powered down. If the test is performed with a SIM simulator, the simulation is stopped. If the test is performed with a SIM, the SIM is removed without soft powering down the MS. If this is not possible, the power supply of the ME is removed and then the SIM removed.

27.4.5 Test requirement

- After step a) the MS shall not respond to the PAGING REQUEST.
- After step c) the MS shall send PAGING RESPONSE to the SS containing the IMSI stored in the SIM.
- After step e) the MS shall send TMSI REALLOCATION COMPLETE to the SS.
- After step g) the SIM shall contain the following values.

EF_{LOCI} (Location Information)

Logically: LAI-MCC: 246
 LAI-MNC: 81 or 813 (See Note 0)
 TMSI: "32547698"

Coding:

	B1	B2	B3	B4	B5	B6	B7	B8	B9	B10	B11
2-digit MNC	32	54	76	98	42	F6	18	xx	xx	xx	xx
3-digit MNC	32	54	76	98	42	36	18	xx	xx	xx	xx

EF_{Kc} (Ciphering Key Kc)

Logically: Key Kc: xx (result of the authentication algorithm)
 Sequence No: 2

Coding:

B1	B2	B3	B4	B5	B6	B7	B8	B9
xx	xx	xx	xx	xx	xx	xx	xx	02

27.5 Forbidden PLMNs, location updating and undefined cipher key

27.5.1 Definition

A list of forbidden PLMNs stored in the SIM and providing storage for up to 4 entries is managed by the MS. In automatic PLMN selection mode the MS controls location updating attempts to appropriate networks with respect to this list of forbidden PLMNs. As a result of a location update reject with the cause "PLMN not allowed" the MS stores the PLMN which rejected the update request in the SIM.

After a location update, which is not followed by an authentication procedure, the cipher key sequence number indicates that the cipher key is undefined.

27.5.2 Conformance requirement

1. In automatic PLMN selection mode the MS shall only attempt a LOCATION UPDATE if it receives a BCCH containing a LAI that is not indicated in the EF_{FPLMN} in the SIM.

3GPP TS 02.11, subclause 2.3, 3GPP TS 11.11, subclauses 11.2.1 and 11.4.8.

2. After receipt of a LOCATION UPDATE REJECT message with the cause "PLMN not allowed" the ME shall update the EF_{FPLMN} in the SIM.

3GPP TS 02.11, subclause 2.3, 3GPP TS 11.11, subclauses 11.2.1 and 11.4.8.

3. After call termination the SIM shall contain the correct cipher key sequence number.

3GPP TS 11.11, subclauses 11.2.2, 11.4.5 and 11.4.6, 3GPP TS 02.17, subclause 6.1.

4. After call termination the SIM shall contain the correct TMSI and location information received by the MS.

3GPP TS 11.11, subclauses 11.2.2, 11.4.5 and 11.4.6, 3GPP TS 02.17, subclause 6.1.

27.5.3 Test purpose

- 1) To verify that in automatic PLMN selection mode the MS does not attempt to access PLMNs stored in EF_{FPLMN} on the SIM.
- 2) To verify that the EF_{FPLMN} is correctly updated by the ME after receipt of a LOCATION UPDATE REJECT message with cause "PLMN not allowed".
- 3) To verify that the EF_{Kc} has been correctly updated by the ME.
- 4) To verify that the EF_{LOCI} has been correctly updated by the ME.

27.5.4 Method of test

27.5.4.1 Initial conditions

The SS transmits on the BCCH, with the following network parameters:

Attach/detach:	disabled.
LAI-MCC:	234
LAI-MNC	02 or 023 (see Note 0)
LAI-LAC:	0001
Access control:	unrestricted.

The default SIM is used with the following exception:

EF_{IMSI} (IMSI)

Logically: 2468111111111111 (2-digit MNC) or 2468131111111111 (3-digit MNC)

Coding:

	B1	B2	B3	B4	B5	B6	B7	B8	B9
2-digit MNC	08	29	64	18	11	11	11	11	11
3-digit MNC	08	29	64	18	13	11	11	11	11

EF_{LOCI} (Location Information)

Logically: LAI-MCC: 234

LAI-MNC: 01 or 012 (See Note 0)

LAI-LAC: 0000

TMSI: "32547698"

Coding:

B1	B2	B3	B4	B5	B6	B7	B8	B9	B10	B11
32	54	76	98	32	F4	10	00	00	FF	00

The SIM is installed into the ME and the MS is set to automatic PLMN selection mode.

EF_{Kc} (Ciphering Key Kc)

Logically: Key Kc: undefined

Sequence No: 2

Coding:

B1	B2	B3	B4	B5	B6	B7	B8	B9
xx	xx	xx	xx	xx	xx	xx	xx	02

27.5.4.2 Procedure

- a) The MS is powered on.
- b) The SS stops all RF output on the BCCH for a long enough period of time to cause a cell reselection procedure in the MS. The BCCH is changed to contain:

LAI (MCC/MNC): 234/03 or 234/034 (see Note 0).

The SS then resumes RF output on the BCCH.
- c) The SS stops all RF output on the BCCH for a long enough period of time to cause a cell reselection procedure in the MS. The BCCH is changed to contain:

LAI (MCC/MNC): 234/04 or 234/045 (see Note 0).

The SS then resumes RF output on the BCCH.
- d) The SS stops all RF output on the BCCH for a long enough period of time to cause a cell reselection procedure in the MS. The BCCH is changed to contain:

LAI (MCC/MNC): 234/05 or 234/056 (see Note 0).

The SS then resumes RF output on the BCCH.

- e) The SS stops all RF output on the BCCH for a long enough period of time to cause a cell reselection procedure in the MS. The BCCH is changed to contain:

LAI (MCC/MNC): 234/01 or 234/012 (see Note 0).

The SS then resumes RF output on the BCCH.

- f) After receipt of a CHANNEL REQUEST from the MS, the SS sends IMMEDIATE ASSIGNMENT to the MS.

- g) After receipt of a LOCATION UPDATE REQUEST from the MS, the SS sends LOCATION UPDATE REJECT to the MS with cause "PLMN Not Allowed", followed by CHANNEL RELEASE.

The SS stops all RF output on the BCCH for a long enough period of time to cause a cell reselection procedure in the MS. The BCCH is changed to contain:

LAI (MCC/MNC): 234/06 or 234/067 (see Note 0).

The SS then resumes RF output on the BCCH.

- h) After receipt of a CHANNEL REQUEST from the MS, the SS sends IMMEDIATE ASSIGNMENT to the MS.

- i) After receipt of a LOCATION UPDATE REQUEST from the MS, the SS sends LOCATION UPDATE ACCEPT with:

LAI-MCC: 234

LAI-MNC 06 or 067 (see Note 0)

TMSI: "43658709".

to the MS.

- j) After receipt of a TMSI REALLOCATION COMPLETE from the MS, the SS sends CHANNEL RELEASE to the MS.

- k) The MS is soft powered down.

27.5.5 Test requirement

- 1) After each of the steps a) to d) the MS shall not attempt a LOCATION UPDATE.
- 2) After step f) the MS shall send LOCATION UPDATE REQUEST to the SS.
- 3) After step h) the MS shall send LOCATION UPDATE REQUEST to the SS.
- 4) After step i) the MS shall respond with TMSI REALLOCATION COMPLETE.
- 5) After step k) the SIM shall contain the following values:

EF_{LOCi} (Location Information)

Logically: LAI-MCC: 234
 LAI-MNC: 06 or 067 (See Note 0)
 TMSI: "43658709"

Coding:

	B1	B2	B3	B4	B5	B6	B7	B8	B9	B10	B11
2-digit MNC	43	65	87	09	32	F4	60	xx	xx	xx	00
3-digit MNC	43	65	87	09	32	74	60	xx	xx	xx	00

EF_{Kc} (Ciphering Key Kc)

Logically: Key Kc: xx

Sequence No: 7

Coding:

B1	B2	B3	B4	B5	B6	B7	B8	B9
XX	XX	XX	XX	XX	XX	XX	XX	07

EF_{FPLMN} (Forbidden PLMNs)

Logically:

		PLMN1	PLMN2	PLMN3	PLMN4
MCC		234	234	234	234
MNC	2-digit	03	04	05	01
	3-digit	034	045	056	012

Coding:

	B1	B2	B3	B4	B5	B6	B7	B8	B9	B10	B11	B12
2-digit MNC	32	F4	30	32	F4	40	32	F4	50	32	F4	10
3-digit MNC	32	44	30	32	54	40	32	64	50	32	24	10

27.6 MS updating forbidden PLMNs

27.6.1 Definition

A list of forbidden PLMNs stored in the SIM provides storage for up to 4 entries, and is managed by the MS. In automatic PLMN selection mode the MS controls location updating attempts to appropriate networks with respect to this list of forbidden PLMNs. As a result of a location update reject with the cause "PLMN not allowed" the MS stores the PLMN which rejected the update request in the SIM.

27.6.2 Conformance requirement

After the receipt of a LOCATION UPDATE REJECT message with the cause "PLMN not allowed" the MS shall update the EF_{FPLMN} in the SIM.

3GPP TS 02.11, subclause 3.2.2.4.

27.6.3 Test purpose

To verify that the MS correctly updates the EF_{FPLMN}, i.e. fill up existing gaps in the elementary file before overwriting any existing entries.

27.6.4 Method of test

27.6.4.1 Initial conditions

The SS transmits on the BCCH, with the following network parameters:

Attach/detach:	disabled.
LAI-MCC:	234
LAI-MNC	03 or 034 (see Note 0)
LAI-LAC:	0001
Access control:	unrestricted.

The default SIM is used with the following exception:

Bands using 2-digit MNC (see Note 0) begin

EF_{FPLMN} (Forbidden PLMNs)

Logically:

	MCC	PLMN1	PLMN2	PLMN3	PLMN4
MNC	2-digit	234	EMPTY	234	234
	3-digit	02		04	05
		023		045	056

Coding:

	B1	B2	B3	B4	B5	B6	B7	B8	B9	B10	B11	B12
2-digit MNC	32	F4	20	FF	FF	FF	32	F4	40	32	F4	50
3-digit MNC	32	34	20	FF	FF	FF	32	54	40	32	64	50

The SIM is installed into the ME and the MS is set to automatic PLMN selection mode.

27.6.4.2 Procedure

- The MS is powered on.
- After receipt of a CHANNEL REQUEST from the MS, the SS sends IMMEDIATE ASSIGNMENT to the MS.
- After receipt of a LOCATION UPDATE REQUEST from the MS, the SS sends LOCATION UPDATE REJECT to the MS with the cause "PLMN not allowed", followed by CHANNEL RELEASE.
- The MS is soft powered down.

27.6.5 Test requirement

- After step b) the MS shall send LOCATION UPDATE REQUEST to the SS.
- After step d) the SIM shall contain:

EF_{FPLMN} (Forbidden PLMNs)

Logically:

	MCC		PLMN1	PLMN2	PLMN3	PLMN4
MNC	2-digit	Either	234	234	234	234
(See		Or	02	03	04	05
Note			02	04	05	03
0)	3-digit	Either	023	034	045	056
		Or	023	045	056	023

Coding:

		B1	B2	B3	B4	B5	B6	B7	B8	B9	B10	B11	B12
2-digit MNC	Either	32	F4	20	32	F4	30	32	F4	40	32	F4	50
	Or	32	F4	20	32	F4	40	32	F4	50	32	F4	30
3-digit MNC	Either	32	34	20	32	44	30	32	54	40	32	64	50
	Or	32	34	20	32	54	40	32	64	50	32	44	30

27.7 MS deleting forbidden PLMNs

27.7.1 Definition

In manual PLMN selection mode the MS allows location update attempts to all available PLMNs, including forbidden PLMNs (as indicated by the forbidden PLMN list on the SIM). As a result of a successful location update procedure onto a PLMN which is in the forbidden PLMN list, the forbidden PLMN list is automatically updated by the MS.

27.7.2 Conformance requirement

1. In manual PLMN selection mode the MS shall be able to perform a LOCATION UPDATE attempt to a PLMN which is in the forbidden PLMN list.

3GPP TS 02.11, subclause 3.2.2.2.

2. After receipt of LOCATION UPDATE ACCEPT the MS shall delete the forbidden PLMN from the forbidden PLMN list.

3GPP TS 02.11, subclause 3.2.2.4.

27.7.3 Test purpose

- 1) To verify that in automatic PLMN selection mode the MS does not attempt to access PLMNs stored in EF_{FPLMN} on the SIM.
- 2) To verify that the MS is able to perform a LOCATION UPDATE on a forbidden PLMN in manual PLMN selection mode.
- 3) To verify that the MS after a successful LOCATION UPDATE deletes the PLMN in the EF_{FPLMN} on the SIM.

27.7.4 Method of test

27.7.4.1 Initial conditions

The SS transmits on the BCCH, with the following network parameters:

Attach/detach: disabled.
 LAI-MCC: 234
 LAI-MNC 01 or 012 (see Note 0)
 LAI-LAC: 0001
 Access control: unrestricted.

The default SIM is used with the following exception:

EF_{FPLMN} (Forbidden PLMNs)

Logically: PLMN1: empty
 PLMN2: empty
 PLMN3: MCC: 234
 MNC: 01 or 012 (See Note 0)
 PLMN4: empty

Coding:

	B1	B2	B3	B4	B5	B6	B7	B8	B9	B10	B11	B12
2-digit MNC	FF	FF	FF	FF	FF	FF	32	F4	10	FF	FF	FF
3-digit MNC	FF	FF	FF	FF	FF	FF	32	24	10	FF	FF	FF

The SIM is installed into the ME and the MS is set to automatic PLMN selection mode.

27.7.4.2 Procedure

- a) The MS is powered on.
- b) PLMN with MCC/MNC of 234/01 or 234/012 (see Note 0) is manually selected.
- c) After receipt of a CHANNEL REQUEST from the MS, the SS sends IMMEDIATE ASSIGNMENT to the MS.

- d) After receipt of a LOCATION UPDATE REQUEST from the MS, the SS sends LOCATION UPDATE ACCEPT with:

LAI-MCC: 234
 LAI-MNC 01 or 012 (see Note 0)
 TMSI: "12345678".

to the MS.

- e) After receipt of TMSI REALLOCATION COMPLETE from the MS, the SS sends CHANNEL RELEASE.
 f) The MS is soft powered down.

27.7.5 Test requirement

- 1) After step a) the MS shall not attempt a LOCATION UPDATE.
- 2) After step c) the MS shall send LOCATION UPDATE REQUEST to the SS.
- 3) After step d) the MS shall respond with TMSI REALLOCATION COMPLETE.
- 4) After step f) the SIM shall contain the following values:

EF_{LOCi} (Location Information)

Logically: LAI-MCC: 234
 LAI-MNC: 01 or 012 (See Note 0)
 TMSI: "12345678"

Coding:

	B1	B2	B3	B4	B5	B6	B7	B8	B9	B10	B11
2-digit MNC	12	34	56	78	32	F4	10	xx	xx	xx	00
3-digit MNC	12	34	56	78	32	24	10	xx	xx	xx	00

EF_{FPLMN} (Forbidden PLMNs)

Logically: PLMN1: empty
 PLMN2: empty
 PLMN3: empty
 PLMN4: empty

Coding:

B1	B2	B3	B4	B5	B6	B7	B8	B9	B10	B11	B12
FF	FF	FF	FF	FF	FF	FF	FF	FF	FF	FF	FF

27.8 MS updating the PLMN selector list

27.8.1 Definition

The PLMN selector list gives in priority order the preferred PLMNs on which the MS shall register. The list is stored on the SIM in the EF_{PLMNsel}. Update and deletion of PLMNs may be performed by the subscriber.

27.8.2 Conformance requirement

The MS shall correctly replace the selected PLMN in the PLMN selector list.

3GPP TS 11.11, subclause 11.5.5.

27.8.3 Test purpose

To verify that the MS correctly updates the $EF_{PLMNsel}$.

27.8.4 Method of test

27.8.4.1 Initial conditions

No SS is required for this test.

The default SIM is used.

The SIM is installed into the ME and the MS is powered on.

27.8.4.2 Procedure

- a) The user shall initiate an MMI dependent procedure to change the second PLMN in the PLMN selector list to MCC/MNC of 567/01 or 567/018 (see Note 0).
- b) The MS is soft powered down.

27.8.5 Test requirement

After step b) the SIM shall contain the following values:

$EF_{PLMNsel}$ (PLMN Selector)

Logically:

PLMN	1st	2nd	3rd	4th	5th	6th	7th	8th
MCC	234	567	234	234	234	234	246	246
2-digit MNC	01	01	03	04	05	06	81	82
3-digit MNC	012	018	034	045	056	067	813	824

Coding:

	B1	B2	B3	B4	B5	B6	B7	B8	B9	B10	B11	B12
2-digit MNC	32	F4	10	65	F7	10	32	F4	30	32	F4	40
3-digit MNC	32	24	10	65	87	10	32	44	30	32	54	40
	B13	B14	B15	B16	B17	B18	B19	B20	B21	B22	B23	B24
2-digit MNC	32	F4	50	32	F4	60	42	F6	18	42	F6	28
3-digit MNC	32	64	50	32	74	60	42	36	18	42	46	28

27.9 MS recognizing the priority order of the PLMN selector list

27.9.1 Definition

The PLMN selector list gives in priority order the preferred PLMNs on which the MS shall register. The list is stored on the SIM in the $EF_{PLMNsel}$. Update and deletion of PLMNs may be performed by the subscriber by the use of the PIN.

27.9.2 Conformance requirement

When registering onto a VPLMN the MS shall take into account the priority order of the PLMNs in the preferred list on the SIM.

3GPP TS 02.11, subclause 3.2.2.2.

27.9.3 Test purpose

To verify that the PLMN with the higher priority (defined by its position in $EF_{PLMNsel}$) takes precedence over the PLMN with the lower priority when the MS performs a network selection.

27.9.4 Method of test

27.9.4.1 Initial conditions

The SS transmits on two BCCHs, with the following network parameters:

BCCH	Attach / Detach	MCC	LAI			LAC	Access Control
			MNC (2-digit)	MNC (3-digit)	MNC (3-digit)		
BCCH 1	disabled	234	33	334	0001	unrestricted	
BCCH 2	disabled	234	34	345	0001	unrestricted	

The default SIM is used with the following exception:

EF_{PLMNsel} (PLMN Selector)

Logically: MCC: 234

MNC:

PLMN	1st	2nd	32nd	33rd	34 th
2-digit MNC	01	02	32	34	33
3-digit MNC	012	023	323	345	334

Coding:

	B1	B2	B3	B4	B5	B6
2-digit MNC	32	F4	10	32	F4	20
3-digit MNC	32	24	10	32	34	20
	B94	B95	B96	B97	B98	B99	B100	B101	B102
2-digit MNC	32	F4	23	32	F4	43	32	F4	33
3-digit MNC	32	34	23	32	54	43	32	44	33

The SIM is installed into the ME and the MS is set to automatic PLMN selection mode.

27.9.4.2 Procedure

- The MS is powered on.
- After receipt of a CHANNEL REQUEST from the MS, the SS sends IMMEDIATE ASSIGNMENT to the MS.
- After receipt of a LOCATION UPDATE REQUEST from the MS, the SS sends LOCATION UPDATE ACCEPT with:

LAI-MCC: 234

LAI-MNC 34 or 345 (see Note 0)

TMSI: "34567890".

to the MS

- After receipt of a TMSI REALLOCATION COMPLETE from the MS, the SS sends CHANNEL RELEASE to the MS.

- The MS is soft powered down.

27.9.5 Test requirement

- After step b) the MS shall send LOCATION UPDATE REQUEST containing an MCC/MNC of 234/34 or 234/345 (see Note 0) to the SS.
- After step c) the MS shall respond with TMSI REALLOCATION COMPLETE.
- After step e) the SIM shall contain the following values:

EF_{LOCI} (Location Information)

Logically: LAI-MCC: 234
 LAI-MNC: 34 or 345 (See Note 0)
 TMSI: "34567890"

Coding:	B1	B2	B3	B4	B5	B6	B7	B8	B9	B10	B11
2-digit MNC	34	56	78	90	32	F4	43	xx	xx	xx	00
3-digit MNC	34	56	78	90	32	54	43	xx	xx	xx	00

27.10 MS access control management

27.10.1 Definition

Access Control allows restriction of call access attempts. All mobile stations are assigned to a "low order class", and optionally (for priority uses) also to one or more "high order classes".

A "high order class" is only valid in the HPLMN or HPLMN country. Otherwise, the "low order class" is used.

The classes are programmed on the SIM. The network controls which classes at any time may be barred.

In addition, there is a separate mechanism for control of network access for emergency call attempts.

27.10.2 Conformance requirement

1. The ME shall read the access control value as part of the SIM/ME initialization procedure, and subsequently adopt this value.

3GPP TS 11.11, subclause 11.2.1.

2. If the MS is a member of at least one access class which corresponds to the permitted classes as signalled over the air interface, and the access class is applicable in the serving network, the MS may make call attempts. Otherwise call access attempts are not allowed.

If access class 10 is barred, MS of classes 0 - 9 and ME without SIMs shall not make emergency call attempts.

MS of classes 11 - 15 are not allowed to make emergency call attempts if access class 10 and the relevant access class(es) between 11 and 15 are barred. Otherwise, emergency call attempts are allowed irrespective of the conditions of access class 10.

All options are shown in figure 27-1 and are referenced to the tests.

3GPP TS 02.11, subclauses 4.3 and 4.4.

3. For PCS 1 900: The test requirements 1 and 2 above are also tested for emergency call number 911.

27.10.3 Test purpose

- 1) To verify that the ME reads the access control value as part of the SIM/ME initialization procedure, and subsequently adopts this value.
- 2) To verify that the MS controls its network access in accordance with its access control class and the conditions imposed by the serving network.
- 3) For PCS 1 900: To verify the requirements in 1 and 2 above by using the emergency call number 911.

The tests verify ME performance for the following:

Tests (a) and (b) No SIM in ME.

Tests (c) to (e) MS with access class 0 to 9.

Test (f) MS with access class 11 and 15 not in HPLMN; and

MS with access class 12,13 and 14 not in HPLMN country.

Test (g) and (h) MS with access class 11 and 15 in HPLMN; and

MS with access class 12,13 and 14 in HPLMN country.

Each of the above are tested against all relevant combinations of access control and emergency call bits signalled by the network, as shown in table 27-1.

27.10.4 Method of test

27.10.4.1 Initial conditions

The SS transmits on the BCCH, with the following network parameters:

Attach/detach: disabled.
 LAI (MCC/MNC/LAC): see table 27-1.
 Access control: see table 27-1.
 RACH: see table 27-1.

A SIM is installed in the ME containing IMSI and access control values as given in table 27-1 and the MS is powered on.

NOTE: Depending on the initial value of the EF_{LOC1}, the MS may perform a location update. This will be accepted by the SS.

Coding details

SIM IMSI: Data Field 6F 07

	Value 246813579	Value 2468135x9
byte 1	05H	05H
byte 2	29H	29H
byte 3	64H	64H
byte 4	18H	18H
byte 5	53H	53H
byte 6	97H	9xH
byte 7	FFH	FFH
byte 8	FFH	FFH
byte 9	FFH	FFH

Access class: Data field 6F 78

See 3GPP TS 11.11.

NETWORK (SS)

RACH: As defined in 3GPP TS 04.08 / 3GPP TS 44.018 subclause 10.5.2.29.

octet 1 01111000
 octet 2 00001000
 octet 3 }
 octet 4 } as table 27-1

27.10.4.2 Procedure

- Using the MMI or EMMI a normal call set-up is attempted.
- Using the MMI or EMMI an emergency call set-up is attempted.
- The test is repeated for each set of values in table 27-1.

27.10.5 Test requirement

After steps a) and b) the MS shall access the network, or shall make no access attempt, in accordance with table 27-1.

NOTE: For type approval, to limit testing, in tests (c), (d) and (e) it is only necessary that one of the access classes is tested.

Table 27-1

	IMSI	Access class	RACH	BCCH/LAI	Normal calls	Emergency calls
			octet 3	MCC		
			octet 4	MNC (see Note 0)		
TEST (a)	No SIM in ME		00000100 00000000	234 01 or 012	No	No
TEST (b)	No SIM in ME		00000000 00000000	234 01 or 012	No	Yes
TEST (c)	246813579	0	00000100 00000001	246 81 or 813	No	No
	246813579	1	00000100 00000010	246 81 or 813	No	No
	246813579	2	00000100 00000100	246 81 or 813	No	No
	246813579	3	00000100 00001000	246 81 or 813	No	No
	246813579	4	00000100 00010000	246 81 or 813	No	No
	246813579	5	00000100 00100000	246 81 or 813	No	No
	246813579	6	00000100 01000000	246 81 or 813	No	No
	246813579	7	00000100 10000000	246 81 or 813	No	No
	246813579	8	00000101 00000000	246 81 or 813	No	No
	246813579	9	00000110 00000000	246 81 or 813	No	No
	TEST (d)	246813579	0	00000000 00000001	246 81 or 813	No
246813579		1	00000000 00000010	246 81 or 813	No	Yes
246813579		2	00000000 00000100	246 81 or 813	No	Yes
246813579		3	00000000 00001000	246 81 or 813	No	Yes
246813579		4	00000000 00010000	246 81 or 813	No	Yes
246813579		5	00000000 00100000	246 81 or 813	No	Yes
246813579		6	00000000 01000000	246 81 or 813	No	Yes
246813579		7	00000000 10000000	246 81 or 813	No	Yes
246813579		8	00000001 00000000	246 81 or 813	No	Yes
246813579		9	00000010 00000000	246 81 or 813	No	Yes
TEST (e)		246813579	0	11111011 11111110	246 81 or 813	Yes
	246813579	1	11111011 11111101	246 81 or 813	Yes	Yes
	246813579	2	11111011 11111011	246 81 or 813	Yes	Yes

	IMSI	Access class	RACH	BCCH/LAI	Normal calls	Emergency calls
			octet 3	MCC		
			octet 4	MNC (see Note 0)		
	246813579	3	11111011 11110111	246 81 or 813	Yes	Yes
	246813579	4	11111011 11101111	246 81 or 813	Yes	Yes
	246813579	5	11111011 11011111	246 81 or 813	Yes	Yes
	246813579	6	11111011 10111111	246 81 or 813	Yes	Yes
	246813579	7	11111011 01111111	246 81 or 813	Yes	Yes
	246813579	8	11111010 11111111	246 81 or 813	Yes	Yes
	246813579	9	11111001 11111111	246 81 or 813	Yes	Yes
TEST (f)	2468135 x 9	11 & x	00000111 11111111	246 82 or 824	No	No
	2468135 x 9	11 & x	00000011 11111111	246 82 or 824	No	Yes
	2468135 x 9	11 & x	00000000 00000000	246 82 or 824	Yes	Yes
	Set "x" to an arbitrary value in the range 0 to 9 2468135 x 9	12 & x	00000111 11111111	234 01 or 012	No	No
	2468135 x 9	12 & x	00000011 11111111	234 01 or 012	No	Yes
	2468135 x 9	12 & x	00000000 00000000	234 01 or 012	Yes	Yes
	Set "x" to an arbitrary value in the range 0 to 9 2468135 x 9	13 & x	00000111 11111111	234 01 or 012	No	No
	2468135 x 9	13 & x	00000011 11111111	234 01 or 012	No	Yes
	2468135 x 9	13 & x	00000000 00000000	234 01 or 012	Yes	Yes
	Set "x" to an arbitrary value in the range 0 to 9 2468135 x 9	14 & x	00000111 11111111	234 01 or 012	No	No
	2468135 x 9	14 & x	00000011 11111111	234 01 or 012	No	Yes
	2468135 x 9	14 & x	00000000 00000000	234 01 or 012	Yes	Yes
	Set "x" to an arbitrary value in the range 0 to 9 2468135 x 9	15 & x	00000111 11111111	246 82 or 824	No	No
	2468135 x 9	15 & x	00000011 11111111	246 82 or 824	No	Yes
	2468135 x 9	15 & x	00000000 00000000	246 82 or 824	Yes	Yes
	Set "x" to an arbitrary value in the range 0 to 9					

	IMSI	Access class	RACH	BCCH/LAI	Normal calls	Emergency calls	
			octet 3	MCC			
			octet 4	MNC (see Note 0)			
TEST (g)	246813579	11 & x	00001111 11111111	246 81 or 813	No	No	
	246813579	11 & x	00001011 11111111	246 81 or 813	No	Yes	
	246813579	12 & x	00010111 11111111	246 82 or 824	No	No	
	246813579	12 & x	00010011 11111111	246 82 or 824	No	Yes	
	246813579	13 & x	00100111 11111111	246 82 or 824	No	No	
	246813579	13 & x	00100011 11111111	246 82 or 824	No	Yes	
	246813579	14 & x	01000111 11111111	246 82 or 824	No	No	
	246813579	14 & x	01000011 11111111	246 82 or 824	No	Yes	
	246813579	15 & x	10000111 11111111	246 81 or 813	No	No	
	246813579	15 & x	10000011 11111111	246 81 or 813	No	Yes	
	Set "x" to an arbitrary value in the range 0 to 9						
	TEST (h)	246813579	11 & x	11110011 11111111	246 81 or 813	Yes	Yes
246813579		12 & x	11101011 11111111	246 82 or 824	Yes	Yes	
246813579		13 & x	11011011 11111111	246 82 or 824	Yes	Yes	
246813579		14 & x	10111011 11111111	246 82 or 824	Yes	Yes	
246813579		15 & x	01111011 11111111	246 81 or 813	Yes	Yes	
246813579		11 & x	11110111 11111111	246 81 or 813	Yes	Yes	
246813579		12 & x	11101111 11111111	246 82 or 824	Yes	Yes	
246813579		13 & x	11011111 11111111	246 82 or 824	Yes	Yes	
246813579		14 & x	10111111 11111111	246 82 or 824	Yes	Yes	
246813579		15 & x	01111111 11111111	246 81 or 813	Yes	Yes	
Set "x" to an arbitrary value in the range 0 to 9							

ACCESS CONTROL

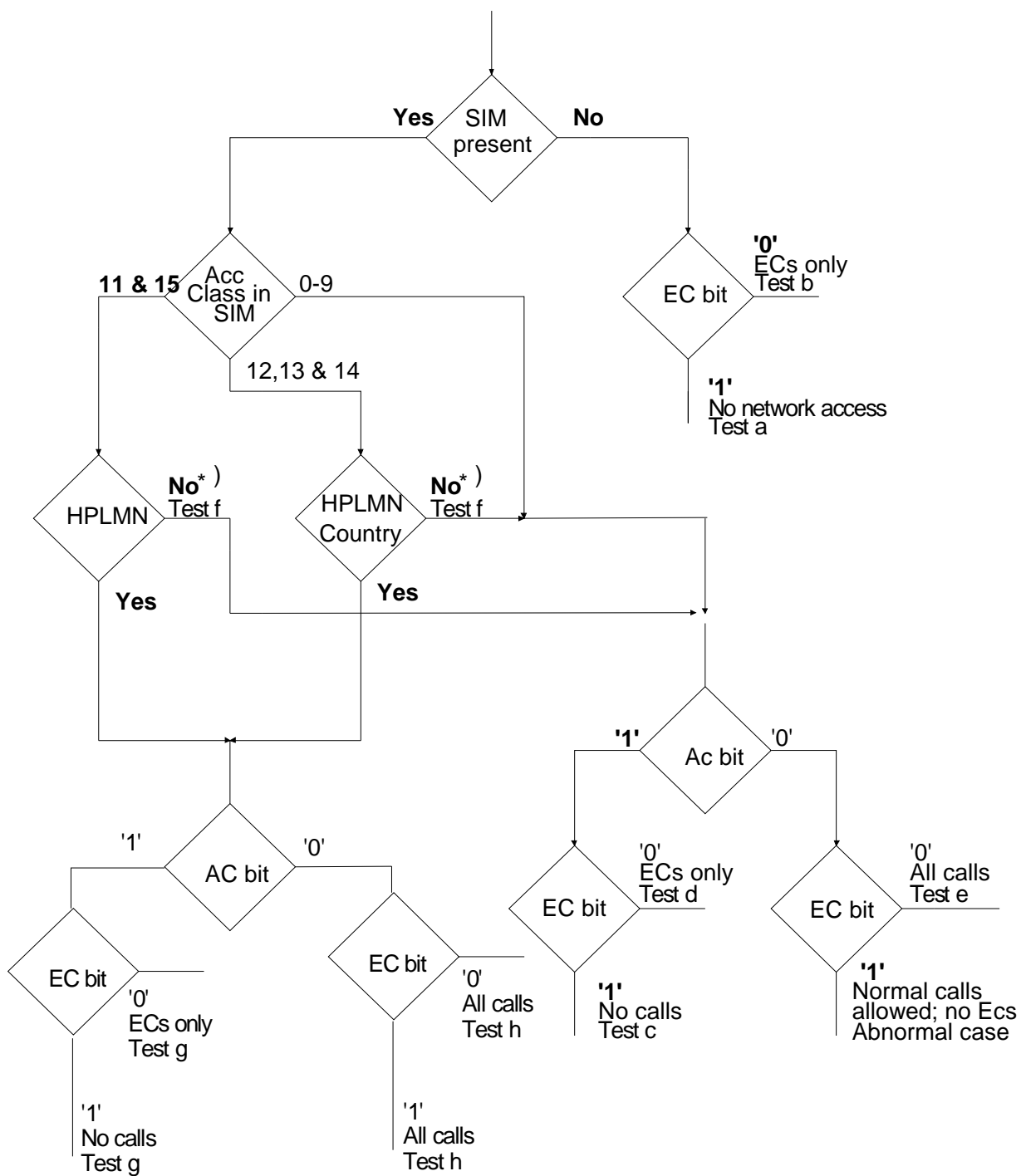

ECs = Emergency Calls

Access Class in SIM - See GSM 11.11 Data Field 6F 78

EC bit = bit3 of octet 3 of RACH Control Parameters - See GSM 04.08 Para 10.5.2.29

AC bit = See bytes 3 & 4 of RACHControl Parameters

*) Mobile adopts Access Class 0-9, based on IMSI. See GSM 02.11

27.11 Exchange protocol tests

27.11.1 Character transmission

27.11.1.1 Bit/character duration during the transmission from the ME to the SIM

27.11.1.1.1 Definition

Data is transmitted serially across the SIM/ME interface. A character comprises:

- the start bit;
- eight data bits;
- the parity bit.

27.11.1.1.2 Conformance requirement

The bit/character duration and the delay between two consecutive characters (between start leading edges) sent by the ME shall be in the range specified.

3GPP TS 11.11, subclause 5.9.

27.11.1.1.3 Test purpose

To verify the timing during the transmission from the ME to the SIM.

27.11.1.1.4 Method of test

27.11.1.1.4.1 Initial conditions

The ME is connected to the SIM simulator, and powered on.

27.11.1.1.4.2 Procedure

A number of characters are transmitted from the ME to the SIM simulator. The SIM simulator shall measure the bit/character duration and the delay between two consecutive characters for all characters transmitted by the ME.

27.11.1.1.5 Test requirement

The timing shall be in the range specified.

27.11.1.2 Bit/character duration during the transmission from the SIM simulator to the ME

27.11.1.2.1 Definition

Data is transmitted serially across the SIM/ME interface. A character comprises:

- the start bit;
- eight data bits;
- the parity bit.

27.11.1.2.2 Conformance requirement

Responses with maximum and minimum bit/character duration times shall be accepted by the ME.

3GPP TS 11.11, subclause 5.9.

27.11.1.2.3 Test purpose

To verify the acceptance of maximum and minimum bit/character duration during the transmission from the SIM to the ME.

27.11.1.2.4 Method of test

27.11.1.2.4.1 Initial conditions

The ME is connected to the SIM simulator, and powered on.

27.11.1.2.4.2 Procedure

The SIM simulator shall send responses with the maximum and minimum bit/character durations specified in 3GPP TS 11.11.

27.11.1.2.5 Test requirement

The ME shall accept the response and act accordingly.

27.11.1.3 Inter-character delay

27.11.1.3.1 Definition

The inter-character delay is defined as the time between the start edge of a character and the start edge of the previous character. It is given by:

- the length of a character plus an extra guard time of N etu during transmission from the ME to the SIM. N is indicated in ATR character TC1;
- the work waiting time during transmission from the SIM to the ME.

27.11.1.3.2 Conformance requirement

- 1) If TC1 is 0 or 255 the ME shall work with the SIM.
- 2) If TC1 is not 0 or 255 the ME shall repeat the reset at least 2 times before it rejects the SIM.
- 3) The ME shall accept characters sent by the SIM with the work waiting time within the specified range.

3GPP TS 11.11, clause 5.9.

27.11.1.3.3 Test purpose

- 1) To verify the correct evaluation of the character TC1 indicated in the ATR.
- 2) To verify that the ME accepts the minimum and maximum work waiting time during the transmission from the SIM to the ME.

27.11.1.3.4 Method of test

27.11.1.3.4.1 Initial conditions

The ME is connected to the SIM simulator, and powered on.

27.11.1.3.4.2 Procedure

a) Upon reception of a reset the SIM simulator transmits the ATR as follows:

a.1) $N = 0$.

character name	content	meaning
TS	3B	direct convention
T0	40	TA1, TB1, TD1 not transmitted, TC1 transmitted, no historical characters
TC1	00	$N = 0$

a.2) $N = 255$.

character name	content	meaning
TS	3B	direct convention
T0	40	TA1, TB1, TD1 not transmitted, TC1 transmitted, no historical characters
TC1	FF	N = 255

a.3) N = Value other than 0 and 255.

character name	content	meaning
TS	3B	direct convention
T0	40	TA1, TB1, TD1 not transmitted, TC1 transmitted, no historical characters
TC1	00 < XX < FF	0 < N < 255

b) The SIM simulator transmits with a work-waiting-time of 12 etu.

c) The SIM simulator transmits with a work-waiting-time of 9 600 etu.

27.11.1.3.5 Test requirement

In steps a.1) and a.2) the ME shall work with the SIM simulator.

In step a.3) the ME shall repeat the reset at least 2 times and then reject the SIM simulator.

In steps b) and c) the ME shall work with the SIM simulator.

27.11.1.4 Error handling during the transmission from the ME to the SIM

27.11.1.4.1 Definition

Error checking is done for each character transmitted by making use of the parity bit. If the SIM detects a parity error, an error signal is sent to the ME, and the ME retransmits that character.

27.11.1.4.2 Conformance requirement

Subsequent to Answer to Reset and the protocol type selection, the error detection and character repetition procedure specified in GSM 11.11 is mandatory for transmission on the basis of T = 0. On receipt of an error signal, the ME shall repeat the previously transmitted character.

3GPP TS 11.11, subclause 5.10.

27.11.1.4.3 Test purpose

To verify the error handling during the transmission from the ME to the SIM.

27.11.1.4.4 Method of test

27.11.1.4.4.1 Initial conditions

The ME is connected to the SIM simulator, and powered on.

27.11.1.4.4.2 Procedure

The SIM simulator shall transmit an error signal in response to a received character in accordance with ISO 7816-3, subclause 6.3.3.

27.11.1.4.5 Test requirement

The ME shall repeat the character in accordance with ISO 7816-3, subclause 6.3.3.

27.11.1.5 Error handling during transmission from the SIM to the ME

27.11.1.5.1 Definition

Error checking is done for each character transmitted by making use of the parity bit. If the ME detects a parity error, an error signal is sent to the SIM, and the SIM retransmits that character.

27.11.1.5.2 Conformance requirement

Subsequent to Answer to Reset and the protocol type selection, the error detection and character repetition procedure specified in GSM 11.11 is mandatory for transmission on the basis of $T = 0$. On receipt of a response with a parity error, the ME shall send an error signal and expect the previously transmitted character to be repeated.

3GPP TS 11.11, subclause 5.10.

27.11.1.5.3 Test purpose

To verify the error handling during the transmission from the SIM to the ME.

27.11.1.5.4 Method of test

27.11.1.5.4.1 Initial conditions

The ME is connected to the SIM simulator, and powered on.

27.11.1.5.4.2 Procedure

The SIM simulator shall send a response with a parity error and check that the ME performs error handling in accordance with ISO/IEC 7816-3, subclause 6.3.3.

27.11.1.5.5 Test requirement

The ME shall send an error signal in accordance with ISO/IEC 7816-3, subclause 6.3.3, and expect a repetition of the character. The ME shall correctly evaluate the character when repeated by the SIM simulator.

27.11.2 Answer to reset (RST)

27.11.2.1 Void

27.11.2.2 Acceptance of SIMs with active low RST

27.11.2.2.1 Definition

Active low RST is one possible implementation of reset, and MEs must be able to accept SIMs with active low reset.

27.11.2.2.2 Conformance requirement

The ME shall accept a SIM with active low reset by putting the RST contact to state H. The signal timing shall be in accordance with the specification.

3GPP TS 11.11, clause 5.

ISO/IEC 7816-3, subclause 5.3.2.

27.11.2.2.3 Test purpose

To verify that the ME accepts a SIM with active low reset. The timing of the RST signal shall be in accordance with the specification.

27.11.2.2.4 Method of test

27.11.2.2.4.1 Initial conditions

The SIM simulator is configured for active low reset. The ME is connected to the SIM simulator and powered on.

27.11.2.2.4.2 Procedure

The SIM simulator measures the timing of the RST signal.

27.11.2.2.5 Test requirement

The ME shall accept the SIM simulator with active low reset. The RST signal shall be put to state H after a minimum of (400/f_i)s.

27.11.2.3 Characters of the answer to reset

27.11.2.3.1 Definition

When the SIM is reset, it sends up to 33 characters to the ME, containing information which must be interpreted by the ME to ascertain the transmission protocol to be used.

27.11.2.3.2 Conformance requirement

1. The ME shall adopt the data encoding convention and initial etu time defined in the initial character TS of the ATR.

3GPP TS 11.11, subclause 5.8.

2. The ME shall be able to receive interface characters for other transmission protocols than T = 0, historical characters and a check byte, even if only T = 0 is used by the ME.

3GPP TS 11.11, subclause 5.8.1.

27.11.2.3.3 Test purpose

1. To verify that the ME adopts the appropriate data encoding convention and initial elementary time unit (etu) defined in the initial character TS of the Answer to Reset.
2. To verify that the ME accepts interface characters for transmission protocols other than T=0, historical characters and the check byte.

27.11.2.3.4 Method of test

27.11.2.3.4.1 Initial conditions

The ME is connected to the SIM (or SIM simulator).

27.11.2.3.4.2 Procedure

- a) The ME is powered on
- b) The SIM (or SIM simulator) sends an ATR as follows:

character name	content	meaning
TS	3B	direct convention
T0	9F	TB1, TC1 not transmitted, TA1, TD1 transmitted, 15 historical characters
TA1	11	default values F = 372, D = 1
TD1	80	TA2, TB2, TC2 not transmitted, TD2 transmitted, protocol T=0 offered
TD2	01	TA2, TB2, TC2, TD2 not transmitted, protocol T=1 offered
Ti	53 49 4D 20 53 55 42 47 52 4F 55 50 20 39 35	historical characters
TCK	4F	check byte

- c) The ME is made to send further commands to the SIM (or SIM simulator) (e.g. by entering the PIN).
- d) The ME is switched off and on. This time the SIM (or SIM simulator) sends an ATR as follows:

character name	content	meaning
TS	3F	inverse convention
T0	9F	TB1, TC1 not transmitted, TA1, TD1 transmitted, 15 historical characters
TA1	11	default values F = 372, D = 1
TD1	80	TA2, TB2, TC2 not transmitted, TD2 transmitted, protocol T=0 offered
TD2	01	TA2, TB2, TC2, TD2 not transmitted, protocol T=1 offered
Ti	53 49 4D 20 53 55 42 47 52 4F 55 50 20 39 35	historical characters
TCK	4F	check byte

e) The ME is made to send further commands to the SIM (e.g. by entering the PIN).

27.11.2.3.5 Test requirement

1. After step b), the ME shall work with the SIM (or SIM simulator).
2. After step d), the ME shall work with the SIM (or SIM simulator).

27.11.2.4 PPS procedure

27.11.2.4.1 Definition

The PPS procedure is required to select the standard transmission protocol if the SIM does not use this as a default.

27.11.2.4.2 Conformance requirement

If the ME receives an Answer to Reset where TA1 is not equal to "11", it shall initiate the PPS procedure as defined in 3GPP TS 11.11.

3GPP TS 11.11, subclause 5.8.2.

27.11.2.4.3 Test purpose

To verify that ME uses the PPS procedure as specified in 3GPP TS 11.11.

27.11.2.4.4 Method of test

27.11.2.4.4.1 Initial conditions

The ME is connected to the SIM (or SIM simulator).

27.11.2.4.4.2 Procedure

- a) The ME is powered on.
- b) The SIM (or the SIM simulator) sends an ATR as follows:

character name	content	meaning
TS	3B	direct convention
T0	10	TB1, TC1, TD1 not transmitted, TA1 transmitted, no historical characters
TA1	77	invalid values for F and D

27.11.2.4.5 Test requirement

After step b), the ME shall send to the SIM (or the SIM simulator) "FF00FF".

27.11.2.5 Reset repetition

27.11.2.5.1 Definition

If transmission errors result in the ATR being unintelligible to the ME, the ME performs the reset again. The minimum number of reset attempts is three.

27.11.2.5.2 Conformance requirement

Following receipt of a wrong ATR, the ME shall perform a reset. The ME shall not reject the SIM until at least three consecutive wrong ATRs are received.

3GPP TS 11.11, subclause 5.10.

27.11.2.5.3 Test purpose

To verify that the ME repeats the reset procedure on receipt of a wrong ATR, and does not reject the SIM unless at least three consecutive wrong ATRs are received.

27.11.2.5.4 Method of test

27.11.2.5.4.1 Initial conditions

The ME is connected to the SIM simulator.

27.11.2.5.4.2 Procedure

- a) The ME is powered on.
- b) The SIM simulator sends a non understandable answer to reset to the ME. (e.g. a wrong TS byte), at each reset initiated by the ME.

27.11.2.5.5 Test requirement

After step b), the ME shall repeat the reset at least two times.

27.11.2.6 Speed Enhancement

27.11.2.6.1 Definition

MEs that support speed enhancement use a specific PPS sequence to indicate the use of different transmission parameters F and D. If this PPS fails, the ME retries with standard parameters.

27.11.2.6.2 Conformance requirement

1. If speed enhancement is implemented in the ME, it is mandatory to support F=512 and D=8 (in addition to the default values F=372 and D=1).
2. If the SIM does not answer the PPS request within the initial waiting time the ME shall reset the SIM. After two failed PPS attempts using F=512 and D=8 or values indicated in TA1, (no PPS response from the SIM) the ME shall initiate PPS procedure using default values.
3. If this also fails (no PPS response from the SIM) the ME may proceed using default values without requesting PPS.

3GPP TS 11.11, subclause 5.8.3.

27.11.2.6.3 Test purpose

1. To verify that the ME supports the transmission parameters F=512 and D=8.
2. To verify that the ME resets the SIM if the SIM does not answer the PPS request within the initial waiting time and initiates a PPS procedure using default values F=372 and D=1 after the second failed PPS attempt.

3. To verify that if the ME proceeds it uses the default values without requesting PPS.

27.11.2.6.4 Method of test

27.11.2.6.4.1 Initial conditions

The ME is connected to the SIM simulator.

27.11.2.6.4.2 Procedure

Part 1:

- a) The ME is powered on.
- b) The SIM simulator sends an ATR as follows:

character name	content	meaning
TS	3B	direct convention
T0	10	TB1, TC1, TD1 not transmitted, TA1 transmitted, no historical characters
TA1	94	F=512, D=8

- c) After receipt of the PTS Request, the SIM simulator answers with the PTS Response "FF 10 94 7B" using a work waiting time of 9600 etu (initial waiting time).
- d) The ME and SIM simulator transmits with enhanced speed (F=512, D=8).

Part 2:

- e) The ME is switched off and on. The SIM simulator sends an ATR as in step b).
- f) After receipt of the PPS Request, the SIM simulator does not answer within the initial waiting time.
- g) After being reset by the ME the SIM simulator sends an ATR as in step b)
- h) After receipt of the PPS Request, the SIM simulator does not answer within the initial waiting time
- i) After being reset by the ME the SIM simulator sends an ATR as in step b)
- j) After receipt of the PPS Request using default values "FF 00 FF", the SIM simulator answers with the PPS Response "FF 00 FF" using a work waiting time of 9600 etu (initial waiting time).
- k) The SIM simulator sends with normal speed (F=372, D=1),

Part 3:

- l) The ME is switched off and on. The SIM simulator sends an ATR as in step b).
- m) After receipt of the PPS Request, the SIM simulator does not answer within the initial waiting time.
- n) After being reset by the ME the SIM simulator sends an ATR as in step b)
- o) After receipt of the PPS Request, the SIM simulator does not answer within the initial waiting time
- p) After being reset by the ME the SIM simulator sends an ATR as in step b)
- q) After receipt of the PPS Request using default values "FF 00 FF", the SIM simulator does not answer within the initial waiting time
- r) The ME may reset the SIM
- s) After being reset by the ME the SIM simulator sends an ATR as in step b)
- t) If the ME reset the SIM in step p) it shall not send a PPS request

u) The SIM simulator sends with normal speed (F=372, D=1),

Note: Part 3 is optional for ME27.11.2.6.5 Test requirement

After step b) the ME shall send to the SIM simulator the PPS Request "FF 10 94 7B".

After step c) the ME shall work with the SIM simulator.

After step e) the ME shall send to the SIM simulator the PPS Request "FF 10 94 7B".

After step f) the ME shall reset the SIM after the initial waiting time has expired.

After step g) the ME shall send to the SIM simulator the PPS Request "FF 10 94 7B".

After step h) the ME shall reset the SIM after the initial waiting time has expired.

After step i) the ME shall send to the SIM simulator the PPS Request "FF 00 FF".

After step m) the ME may reset the SIM after the initial waiting time has expired.

After step t) the ME shall not send a PPS request to the SIM simulator but continue to work with the SIM using default values (F=372, D=1).

27.11.3 Command processing, procedure bytes

27.11.3.1 Definition

The procedure bytes ACK, NULL, and SW1 are sent from the SIM to the ME, and give the ME an acknowledgement for the previous instruction, information concerning transfer of data and the card status at the end of the command.

27.11.3.2 Conformance requirement

On the basis of protocol T = 0, the ME shall correctly use the different modes of data transmission defined in ISO/IEC 7816-3, subclause 8.2.2.

3GPP TS 11.11, clause 5

ISO/IEC 7816: 1990, subclause 8.2.2.

27.11.3.3 Test purpose

To verify that the ME uses correctly the different modes of data transmission.

27.11.3.4 Method of test

27.11.3.4.1 Initial conditions

The ME is connected to the SIM simulator and powered on.

27.11.3.4.2 Procedure

- a) The ME is made to initiate a VERIFY CHV command.
- b) The SIM simulator answers the first 3 bytes with ACK=INS complemented.
- c) The SIM simulator answers the next data byte with NULL (NULL="60").
- d) The SIM simulator then sends ACK=INS. This byte is sent when the elapsed time since step b) is greater than the work waiting time.
- e) The SIM simulator answers the transmission of the rest of the data with NULL.
- f) The SIM simulator then sends SW1 and SW2, indicating correct execution of the command ("90" and "00" for SW1 and SW2 respectively). These bytes are sent when the elapsed time since step d) is greater than the work waiting time.

27.11.3.5 Test requirement

The command shall be executed correctly.

27.12 Evaluation of directory characteristics

27.12.1 Operating speed in authentication procedure

27.12.1.1 Definition

Authentication is performed by a GSM network on the SIM, by sending a random number to the SIM. The SIM then performs a calculation on the random number, and sends the result to the network for verification.

27.12.1.2 Conformance requirement

If bit b2 of the file characteristics is set to 1, then the ME shall provide a clock frequency of at least 13/4 MHz to enable the SIM to run the authentication process in the required time.

3GPP TS 11.11, subclause 5.4.

27.12.1.3 Test purpose

To verify that the authentication procedure is done with a frequency of at least 13/4 MHz if the bit b2 of the file characteristics (byte 1 of the directory characteristics) is set to 1.

27.12.1.4 Method of test

27.12.1.4.1 Initial conditions

System simulator:

1 cell, default parameters.

Mobile Equipment:

Connected to a SIM-simulator with bit b2 of the file characteristics set to 1.

ME is powered on.

27.12.1.4.2 Procedure

An authentication is made in the same way as in test [26.7.2. Authentication]. The MS is paged. After the MS has responded with a PAGING RESPONSE message to the SS, the SS initiates an authentication procedure, sending the MS the value RAND. During authentication, the SIM simulator checks the frequency of the clock supplied by the ME. Following the AUTHENTICATION RESPONSE from the MS, the SS sends CHANNEL RELEASE.

27.12.1.5 Test requirement

The frequency of the clock shall be at least 13/4 MHz during the authentication procedure.

27.12.2 Clock stop

27.12.2.1 Definition

The ME may switch off the clock signal to the SIM, but only if the SIM indicates that it supports this feature.

27.12.2.2 Conformance requirement

1. The ME shall not stop the clock, unless the requirements indicated in byte 1 of the file characteristics are met.

3GPP TS 11.11, subclauses 5.6 and 9.2.1.

2. The ME shall wait at least 1 860 clock cycles after having received the last character including the minimum guard time (2 etu) of the response before switching off the clock. The ME shall wait at least 744 clock cycles before it sends the first command after having restarted the clock.

3GPP TS 11.11, subclause 5.6.

27.12.2.3 Test purpose

1. To verify that the clock is only switched off if requirements are met as indicated in the file characteristics (byte 1 of the directory characteristics).
2. To verify that the timing of the clock switching is as specified.

27.12.2.4 Method of test

27.12.2.4 Method of test

Specific PICS statements:

- 5V only SIM/ME interface (TSPC_AddInfo_5V)

PIXIT statements:

-

27.12.2.4.1 Initial conditions

The ME is connected to a SIM simulator. CHV 1 is enabled.

27.12.2.4.2 Procedure

- a) A SIM simulator is used with bits set as follows:

Bit b1	Bit b3	Bit b4
0	0	0

- b) The ME is powered on. When the ME is in mode PIN check, 10 s shall elapse before the PIN is entered.

- c) The ME is powered off, and a SIM simulator is used with bits set as follows:

Bit b1	Bit b3	Bit b4
0	1	0

- d) The ME is powered on. When the ME is in mode PIN check, 10 s shall elapse before the PIN is entered.

- e) The ME is powered off, and a SIM simulator is used with bits set as follows:

Bit b1	Bit b3	Bit b4
0	0	1

- f) The ME is powered on. When the ME is in mode PIN check, 10 s shall elapse before the PIN is entered.

- g) The ME is powered off, and a SIM simulator is used with bits set as follows:

Bit b1	Bit b3	Bit b4
1	0	0

- h) The ME is powered on. When the ME is in mode PIN check, 10 s shall elapse before the PIN is entered.

27.12.2.5 Test requirement

1. During step b), the ME shall not switch off the clock. This applies only to MEs supporting 5V SIM interface (see PICS).
2. During step d), the ME shall not switch off the clock, unless at high level.
3. During step f), the ME shall not switch off the clock, unless at low level.
4. During steps d), f) and h), the ME shall not switch off the clock until at least 1 860 clock cycles after having received the last character of the response including the minimum guard time (2 etu).
5. During steps d), f) and h), the ME shall wait at least 744 clock cycles before it sends the first command after having restarted the clock.

27.13 Mechanical tests

27.13.1 Contact pressure

27.13.1.1 Definition

The contacts of the card reader must exert a force to maintain a good electrical contact, but the force must not be excessive and damage the SIM.

27.13.1.2 Conformance requirement

A contact force may not be greater than 0,5 N per contact.

3GPP TS 11.11, subclause 4.3.4.

27.13.1.3 Test purpose

To verify that the contact pressure of each contacting element is not greater than 0,5 N when each of the following types of card is used:

- i) Unembossed.
- ii) Embossed on the contact side.
- iii) Embossed on the opposite side to the contacts.

NOTE: Only type i) applies to the plug-in SIM.

27.13.1.4 Method of test

27.13.1.4.1 Initial conditions

The ME manufacturers shall provide a separate card reader (mechanical components) to make the measurement possible.

27.13.1.4.2 Procedure

The pressure of each contacting element is measured.

27.13.1.5 Test requirement

The contact pressure of each contacting element shall be not greater than 0,5 N.

27.13.2 Shape of contacts for IC card SIM card reader

27.13.2.1 Definition

The shape of the contacts is important to maintain a good electrical contact, but must not damage the SIM.

27.13.2.2 Conformance requirement

The radius of curvature of the contacting elements shall be greater than or equal to 0,8 mm in the contact area of both axes.

3GPP TS 11.11, subclause 4.3.4.

27.13.2.3 Test purpose

To verify that the radius of curvature of the contacting elements is greater than or equal to 0,8 mm in the contact area on both axes.

27.13.2.4 Method of test

27.13.2.4.1 Initial conditions

The ME manufacturers shall provide a separate card reader (mechanical components) to make the measurement possible.

27.13.2.4.2 Procedure

The radius of curvature of the contacting elements is measured on both axes.

27.13.2.5 Test requirement

The radius of curvature of the contacting elements shall be greater than or equal to 0,8 mm in the contact area on both axes.

27.14 Secret code usage

27.14.1 Entry of PIN

27.14.1.1 Definition

The PIN is a number used to authenticate the user to the SIM for security. Entry of the correct PIN allows PIN-protected data to be accessed over the SIM-ME interface.

27.14.1.2 Conformance requirement

Following insertion of the SIM and switching on the MS, the ME shall check the state of the PIN. If the PIN is enabled, the ME asks the user for PIN verification.

The VERIFY CHV function verifies the PIN presented by the ME to the SIM.

Reference:

3GPP TS 02.30, subclause 4.6.1; 3GPP TS 11.11, subclauses 8.9, 9.2.9 and 11.3.1.

27.14.1.3 Test purpose

1. To verify that the PIN verification procedure is performed by the ME correctly.
2. To verify that the GSM basic public MMI string is supported.

27.14.1.4 Method of test

27.14.1.4.1 Initial conditions

The ME is connected to a SIM or SIM-simulator with the PIN enabled, and powered off.

The default SIM is used.

27.14.1.4.2 Procedure

- a) The ME is powered on.
- b) When the MS is in mode "PIN check" enter "2468#".

27.14.1.5 Test requirement

- 1) The ME shall send a VERIFY CHV command to the SIM, with CHV number = "01".
- 2) The MS shall give an indication "OK", following a successful execution of the command.

27.14.2 Change of PIN

27.14.2.1 Definition

The PIN may be changed by the user, by entering the old and new PINs. The length of the PIN is between 4 and 8 digits.

27.14.2.2 Conformance requirement

The ME shall support the change of PIN procedure as defined in 3GPP TS 02.30 and 3GPP TS 11.11.

Reference:

3GPP TS 02.30, subclause 4.6.2; 3GPP TS 11.11, subclauses 8.10, 9.2.10 and 11.3.2.

27.14.2.3 Test purpose

1. To verify that the PIN substitution procedure is performed correctly by the ME.
2. To verify that the GSM basic public MMI string is supported.

27.14.2.4 Method of test

27.14.2.4.1 Initial conditions

The ME is connected to a SIM or SIM-simulator with the PIN enabled.

The default SIM is used.

The ME is powered-on, with the correct PIN entered.

27.14.2.4.2 Procedure

- a) Enter "***04*2468*01234567*01234567#".
- b) The MS is switched off and on.
- c) When the MS is in mode "PIN-check", the sequence "01234567#" is entered.
- d) The MS is switched off and on.
- e) When the MS is in mode "PIN check" enter "2468#".

27.14.2.5 Test requirement

- 1) After step a), the ME shall send a CHANGE CHV command to the SIM, with CHV number set to "01".
- 2) Following the successful execution of the command, the MS shall give an indication that the new PIN is accepted.
- 3) After step c), the MS shall give an indication "OK".
- 4) After step e), the MS shall give an indication that the entered PIN is not accepted.

27.14.3 Disabling the PIN

27.14.3.1 Definition

Entry of the PIN may be disabled by the user, depending on the service table of the SIM. It is the responsibility of the ME to check the SIM service table.

27.14.3.2 Conformance requirement

Disabling PIN is achieved through the DISABLE CHV command. If the PIN disable function in the SIM service table is not allocated or activated, then the ME shall not attempt to disable the PIN.

Reference:

3GPP TS 11.11, subclauses 8.11, 9.2.11, 10.2.7, 11 and 11.3.3.

27.14.3.3 Test purpose

To verify that the ME does not attempt to disable the PIN.

27.14.3.4 Method of test

27.14.3.4.1 Initial conditions

The ME is connected to the SIM simulator.

Elementary files in the SIM simulator shall be default, with the exception of:

EF_{SST} (SIM Service Table)

Logically: CHV1 disable function not activated.
 Abbreviated dialling numbers allocated and activated.
 PLMN selector allocated and activated.
 Fixed dialling numbers not activated.

Coding:

	B1	B2	B3	B4
Value (binary)	xx0x110x	0011xxxx	xxxxxxxx	0000xxxx

The coding of EF_{SST} shall conform with the capabilities of the SIM simulator.

The ME is powered on and a correct PIN entered.

27.14.3.4.2 Procedure

Using the ME's MMI procedure, an attempt is made to disable the PIN.

27.14.3.5 Test requirement

The ME shall not send a DISABLE CHV command across the SIM/ME interface.

27.14.4 PUK entry

27.14.4.1 Definition

After three consecutive wrong entries of the PIN, the PIN becomes blocked. The PUK is used to unblock the PIN. This function may be performed whether or not the PIN is blocked.

27.14.4.2 Conformance requirement

The ME shall support the procedure to unblock PIN using PUK, as defined in 3GPP TS 02.30 and 3GPP TS 11.11.

Reference:

3GPP TS 02.30, subclause 4.6.3; 3GPP TS 11.11, subclauses 8.13, 9.2.13 and 11.3.5.

27.14.4.3 Test purpose

1. To verify that the CHV unblocking procedure is performed correctly.

2. To verify that the GSM basic public MMI string is supported.

27.14.4.4 Method of test

27.14.4.4.1 Initial conditions

The ME is connected to the SIM simulator.

The default SIM is used.

27.14.4.4.2 Procedure

- a) The ME is powered on.
- b) Enter "***05*13243546*1234*1234#"
- c) The ME is powered off and on.
- d) Enter the new PIN: "1234".
- e) The ME is powered off and on.
- f) Enter a wrong PIN three times.
- g) Enter "***05*13243546*2468*2468#".
- h) The ME is powered off and on.
- i) Enter the new PIN: "2468".

27.14.4.5 Test requirements

1. After step b), the ME shall send an UNBLOCK CHV command to the SIM, with CHV number = "00".
2. After step d), the ME shall indicate that the PIN has been accepted.
3. After step f), the ME shall indicate that the PIN has been blocked.
4. After step g), the ME shall send an UNBLOCK CHV command to the SIM, with CHV number = "00".
5. After step j), the ME shall indicate that the PIN has been accepted.

27.14.5 Entry of PIN2

27.14.5.1 Definition

PIN2 is a number used to authenticate the user to the SIM for security. Entry of the correct PIN2 allows PIN2-protected data to be accessed over the SIM-ME interface.

27.14.5.2 Conformance requirement

Where entry of PIN2 is necessary for security access, the ME shall indicate that PIN2 is to be entered.

The VERIFY CHV function verifies the PIN presented by the ME to the SIM.

Reference:

3GPP TS 02.30, subclause 4.6.1; 3GPP TS 11.11, subclauses 8.9, 9.2.9 and 11.3.1.

27.14.5.3 Test purpose

To verify that entry of PIN2 is processed by the ME correctly.

27.14.5.4 Method of test

27.14.5.4.1 Initial conditions

The ME is connected to a SIM or SIM-simulator and powered on, with the correct PIN entered.

A default FDN SIM is used.

27.14.5.4.2 Procedure

- a) A feature is accessed which requires the entry of PIN2, e.g. resetting ACM for Advice of Charge, or changing a Fixed Dialling Number.
- b) The MMI is used to enter PIN2: "3579".

27.14.5.5 Test requirement

- 1) After step b), the ME shall send a VERIFY CHV command to the SIM, with CHV number = "02".
- 2) Following the successful execution of the command, the MS shall give an indication that PIN2 was accepted.

27.14.6 Change of PIN2

27.14.6.1 Definition

The PIN2 may be changed by the user, by entering the old and new PIN2s. The length of the PIN is between 4 and 8 digits.

27.14.6.2 Conformance requirement

The ME shall support the change of PIN2 procedure as defined in 3GPP TS 02.30 and 3GPP TS 11.11.

Reference:

3GPP TS 02.30, subclause 4.6.2; 3GPP TS 11.11, subclauses 8.10, 9.2.10 and 11.3.2.

27.14.6.3 Test purpose

1. To verify that PIN2 substitution procedure is performed correctly by the ME.
2. To verify that the GSM basic public MMI string is supported.

27.14.6.4 Method of test

27.14.6.4.1 Initial conditions

The ME is connected to a SIM or SIM-simulator.

The default FDN SIM is used, with PIN enabled.

The ME is powered on, with the correct PIN entered.

27.14.6.4.2 Procedure

- a) Enter "***042*3579*12345678*12345678#".
- b) The MS is switched off and on, and PIN entered: "2468".
- c) Enter "***042*3579*12345678*12345678#".
- d) Enter "***042*12345678*3579*3579#".

27.14.6.5 Test requirement

- 1) After step a), the ME shall send a CHANGE CHV command to the SIM, with CHV number set to "02".
- 2) Following the successful execution of the command, the MS shall give an indication that the new PIN2 is accepted.
- 3) After step c), the MS shall give an indication that the new PIN2 is not accepted.
- 4) After step d), the MS shall give an indication that the new PIN2 is accepted.

27.14.7 PUK2 entry

27.14.7.1 Definition

After three consecutive wrong entries of PIN2, it becomes blocked. PUK2 is used to unblock PIN2. This function may be performed whether or not PIN2 is blocked.

27.14.7.2 Conformance requirement

The ME shall support the procedure to unblock PIN2 using PUK2, as defined in 3GPP TS 02.30 and 3GPP TS 11.11.

Reference:

3GPP TS 02.30, subclause 4.6.3; 3GPP TS 11.11, subclauses 8.13, 9.2.13 and 11.3.5.

27.14.7.3 Test purpose

1. To verify that the PUK2 unblock procedure is performed correctly by the ME.
2. To verify that the GSM basic public MMI string is supported.

27.14.7.4 Method of test

27.14.7.4.1 Initial conditions

The ME is connected to the SIM simulator.

The default FDN SIM is used, with PIN enabled.

27.14.7.4.2 Procedure

- a) The ME is powered on and a correct PIN entered.
- b) Enter "***052*08978675*1234*1234#".
- c) The MS is powered off and on, and PIN entered: "2468".
- d) A feature is selected requiring the entry of PIN2, and the new PIN2 "1234" is entered.
- e) A wrong PIN2 is entered three times.
- f) Enter "***052*08978675*3579*3579#".
- g) A feature is selected requiring the entry of PIN2, and the new PIN2 "3579" is entered.

27.14.7.5 Test requirements

1. After step b), the ME shall send an UNBLOCK CHV command to the SIM, with CHV number = "02".
2. After step d), the ME shall send a VERIFY CHV command, with CHV number = "02". Following the successful execution of the command, the ME shall indicate that the PIN2 has been accepted.
3. After step e), the ME shall indicate that PIN2 has been blocked.
4. After step f), the ME shall send an UNBLOCK CHV command to the SIM, with CHV number = "02".
5. After step g), the ME shall indicate that PIN2 has been accepted.

27.15 Abbreviated Dialling Numbers (ADN)

27.15.1 Definition

Abbreviated Dialling Numbers contain subscriber number and supplementary service control strings. They may also contain alpha identifiers.

27.15.2 Conformance requirement

The ME shall be able to manage the storage and retrieval of ADNs from the SIM, and set up calls to these numbers.

Reference:

3GPP TS 02.07, subclause B.3.1; 3GPP TS 02.30 subclause 4.6.4; 3GPP TS 11.11, subclause 11.5.1.

27.15.3 Test purpose

To verify that the ME manages the storage and retrieval of ADNs from the SIM.

27.15.4 Method of Test

27.15.4.1 Initial conditions

Coding of elementary files in the SIM shall be as default, with the addition of:

EF_{ADN} (Abbreviated Dialling Number)

Logically:

At least 101 records, each record unique. Example of record 1 below

Record 1:	Length of alpha identifier:	32 characters
Alpha identifier:	"ABCDEFGHJKLMNOPQRSTUVWXYZABCDEF"	
Length of BCD number:	"03"	
TON and NPI:	Telephony and Unknown	
Dialled number:	123	
CCI:	None	
Ext1:	None	

Coding:

For record 1:	B1	B2	B3	...	B32	B33	B34	B35	B36	B37	B38	B39	...	B46
	41	42	43	...	46	03	81	21	F3	FF	FF	FF	...	FF

The ME is installed with the default SIM or SIM simulator, and switched on.

The code "+123456789012345" is stored as abbreviated dialling entry number 7 on the SIM.

The code "00112233" is stored as abbreviated dialling entry number 6 on the SIM.

The code "***21*44556677#" is stored as abbreviated dialling entry number 101 on the SIM.

27.15.4.2 Procedure

- Retrieve data from SIM entry number 7 using the procedure N(N)(N)#.
- Retrieve data from SIM entry number 6 using the procedure N(N)(N)#.
- Retrieve data from SIM entry number 101 using the procedure N(N)(N)#.
- Retrieve data from SIM entry number 1 using the procedure N(N)(N)#, and display the alpha identifier.

27.15.5 Test requirements

- After step a), the number "+123456789012345" shall be displayed.
- After step b), the number "00112233" shall be displayed.
- After step c), the number "***21*44556677#" (or an equivalent representation) shall be displayed.

4) After step d), the ME shall display at least part of the alpha identifier, and shall sustain normal operation.

27.16 MMI reaction to SIM status encoding

27.16.1 Definition

The SIM gives status information in response to instructions, as two-byte codes. Some of these codes give valuable information to the user, and appropriate indication by the ME is mandatory.

27.16.2 Conformance requirement

It is mandatory to give the user an appropriate indication when any of the codes given below appear.

Reference:

3GPP TS 02.30, subclause 4.6.5.

27.16.3 Test purpose

To verify that the ME gives an appropriate indication to the user in response to status information return codes from the SIM.

27.16.4 Method of test

27.16.4.1 Initial conditions

The ME is connected to the SIM simulator. All elementary files are coded as default.

The ME is powered on.

27.16.4.2 Procedure.

The SIM simulator is used to send the following error codes as reaction on an instruction from the ME:

- 9240 Memory Problem;
- 9804 Access security policy not fulfilled or secret code rejected;
- 9840 Secret code locked;
- 6FXX Technical problem with no diagnostic given as reaction on an instruction from the ME.

27.16.5 Test requirement

For each error code, the ME shall give an appropriate MMI indication.

27.17 Electrical tests

General test purpose

Testing of electrical characteristics of the SIM/ME interface.

Whilst non-conformance in this area would be unlikely to cause difficulties to other users or the network (type approval criteria), significant deviations from the specifications (3GPP TS 11.11 and ISO 7816) may damage the SIM. If an attempt is then made to use the SIM in a different ME, then its failure may reflect badly on both that ME and the network.

This subclause lists the electrical tests to be performed.

They include:

- i) tests during activation and deactivation phases; and
- ii) tests to be performed on each contact in both static and dynamic states: e.g. voltages, currents and signal characteristics.

However, due to the likely difficulty of accessing the terminals of the SIM/ME interface for the purposes of measurements, the ME manufacturer shall provide a test interface in accordance with subclause 36.5 for the purpose of conformance testing.

General measurement conventions

For the 5V interface operation mode, the measurement conventions are specified in ISO/IEC 7816-3 subclause 4.2.1.

For the 3V and 1,8V interface operation mode these conditions apply in an analogous way.

27.17.1 Test of the power transition phases

27.17.1.1 Phase preceding ME power on

27.17.1.1.1 Definition

When the mobile equipment is switched off, the contacts of the SIM/ME interface remain in an inactive state in order to prevent any damage to the SIM.

27.17.1.1.2 Conformance requirement

The residual voltage across the contacts of the SIM/ME interface (C1, C2, C3, C6, C7) shall not exceed $\pm 0,4$ Volts referenced to GND.

Reference:

3GPP TS 11.11, subclause 4.3.3.

27.17.1.1.3 Test purpose

To verify that the residual voltage across the contacts of the SIM/ME interface (C1, C2, C3, C6, C7) is not greater than $\pm 0,4$ Volts referenced to GND.

27.17.1.1.4 Method of test

27.17.1.1.4.1 Initial condition

The ME is connected to a SIM Simulator.

The contact C1 (Vcc) of the SIM/ME interface is loaded with an impedance of 10 kOhm.

The other contacts (C2, C3, C6, C7) are loaded with an impedance of 50 kOhm.

27.17.1.1.4.2 Procedure

The residual voltage on each contact is measured.

27.17.1.1.5 Test requirement

The residual voltage on each contact shall not exceed $\pm 0,4$ Volts referenced to GND.

27.17.1.2 Phase during SIM power on

27.17.1.2.1 Definition

When the mobile station is switched on or when the SIM/ME interface is being activated after 3V/5V or 1,8V/3V switching, the contacts shall be activated in a defined sequence in order to prevent any damage to the SIM.

The timing of this sequence is not defined, a measurement resolution better than or equivalent to 100 ns is assumed.

An ME supporting both 5V and 3V interface operation mode may switch from 3V to 5V after it has read the SIM type identification in the SIM status information by deactivating the SIM and activating it at the new supply voltage.

An ME supporting both 3V and 1,8V interface operation mode may switch from 1,8V to 3V after it has read the SIM type identification in the SIM status information by deactivating the SIM and activating it at the new supply voltage.

27.17.1.2.2 Conformance requirement

- a) When the MS is soft powered on, the contacts of the SIM/ME interface shall be activated in the following order:
1. VCC at state H and stable;
 2. CLK stable;
 3. RST at state L for at least 400 clock cycles after the clock signal is applied to CLK;
 4. I/O at state Z within 200 clock cycles after the clock signal is applied to CLK.

When Vpp is connected to Vcc, as allowed by 3GPP TS 11.11 (subclauses 4.3.2 and 5.3), then Vpp is activated together with Vcc, at the time of Vcc (step 1 in the sequence above).

- b) When the MS is soft powered on, the contacts of the SIM/ME interface shall be activated in the following order:
1. VCC at state H and stable;
 2. CLK stable;
 3. RST at state L for at least 400 clock cycles after the clock signal is applied to CLK;
 4. I/O at state Z within 200 clock cycles after the clock signal is applied to CLK.
- c.1) When the MS is soft powered on, the contacts of the SIM/ME interface shall be activated to 3V mode in the following order:
1. VCC at state H and stable;
 2. CLK stable;
 3. RST at state L for at least 400 clock cycles after the clock signal is applied to CLK;
 4. I/O at state Z within 200 clock cycles after the clock signal is applied to CLK.
- c.2) When the SIM/ME interface is being activated after the 3V/5V switching the contacts shall be activated to 5V mode in the order given in c.1).
- d) When the MS is soft powered on, the contacts of the SIM/ME interface shall be activated in the following order:
1. VCC at state H and stable;
 2. CLK stable;
 3. RST at state L for at least 400 clock cycles after the clock signal is applied to CLK;
 4. I/O at state Z within 200 clock cycles after the clock signal is applied to CLK.
- e.1) When the MS is soft powered on, the contacts of the SIM/ME interface shall be activated to 1.81,8V mode in the following order:
1. VCC at state H and stable;
 2. CLK stable;
 3. RST at state L for at least 400 clock cycles after the clock signal is applied to CLK;
 4. I/O at state Z within 200 clock cycles after the clock signal is applied to CLK.
- e.2) When the SIM/ME interface is being activated after the 1.81,8V/3V switching the contacts shall be activated to 3V mode in the order given in ce.1).

Reference:

- a): 3GPP TS 11.11, subclause 4.3.2.

b), c.1), c.2): 3GPP TS 11.12, subclause 4.4 and subclause 4.5.

d), e.1), e.2): 3GPP TS 11.18, subclause 4.4 and subclause 4.5.

27.17.1.2.3 Test purpose

To verify that the contacts of the SIM/ME interface are activated in the correct order, as described in the conformance requirement.

27.17.1.2.4 Method of test

27.17.1.2.4.1 Initial condition

The ME is connected to a SIM Simulator.

27.17.1.2.4.2 Procedure

To test the requirements a), b), c.1), d) and e.1) the MS is soft powered on.

To test the requirement c.2) and e.2), the ME is caused to switch the voltage on the SIM/ME interface.

The verification of each activation procedure starts with the first contact leaving the inactive state. The SIM/ME interface is monitored until it is fully activated.

27.17.1.2.5 Test requirement

The contacts of the SIM/ME interface shall be activated in the correct order, as described in the conformance requirement.

27.17.1.3 Phase during ME power off with clock stop forbidden

27.17.1.3.1 Definition

When the mobile station is soft powered off, the contacts shall be deactivated in a defined sequence in order to prevent any damage to the SIM.

The timing of this sequence is not defined, a measurement resolution better than or equivalent to 100 ns is assumed.

NOTE 1: If during MS operation the SIM is physically removed it is impractical to ensure correct sequencing of deactivation and the possible damage to the SIM cannot be safeguarded by a type approval test. Furthermore, in this situation the integrity of SIM data is not guaranteed (see 3GPP TS 02.17).

NOTE 2: Since 3V technology SIMs and 1,8V technology SIMs shall not indicate that clock stop is forbidden, this test applies only to MEs with a 5V interface and MEs with a 3V/5V interface when powered down from 5V mode.

27.17.1.3.2 Conformance requirement

- a) When the ME is soft powered down, the contacts of the SIM/ME interface shall be deactivated in the following order:
 1. RST at low state;
 2. Clock stopped at low state;
 3. Vpp inactive (only if Vpp is provided independent of Vcc, see 3GPP TS 11.11 subclause 5.3);
 4. I/O at state A;
 5. Vcc inactive.
- b) When Vpp is connected to Vcc, as allowed by 3GPP TS 11.11 (subclause 5.3), then Vpp is deactivated together with Vcc, at the time of Vcc (step 5 in the sequence above).
- c) When the ME is soft powered down from 5V mode, the contacts of the SIM/ME interface shall be deactivated in the following order:

1. RST at low state;
2. Clock stopped at low state;
3. I/O at status A;
4. Vcc inactive.

Reference:

- a) 3GPP TS 11.11, subclause 4.3.2.
- c) 3GPP TS 11.12, subclause 4.5.

27.17.1.3.3 Test purpose

To verify that the contacts of the SIM/ME interface become deactivated in the correct order, as given in the conformance requirement.

27.17.1.3.4 Method of test

27.17.1.3.4.1 Initial condition

The ME is connected to a SIM Simulator.

The file characteristics of the directories (byte 14 of STATUS information) shall indicate a 5V SIM with clock stop forbidden.

27.17.1.3.4.2 Procedure

The MS is soft powered off.

The SIM/ME interface is monitored until it is fully deactivated.

27.17.1.3.5 Test requirement

The contacts of the SIM/ME interface shall be deactivated in the correct order, as given in the conformance requirement.

27.17.1.4 Phase during ME power off with clock stop allowed

27.17.1.4.1 Definition

When the mobile station is soft powered off or when the SIM/ME interface is being deactivated for 3V/5V or 1,8V/3V switching, the contacts shall be deactivated in a defined sequence in order to prevent any damage to the SIM.

The timing of this sequence is not defined, a measurement resolution better than or equivalent to 100 ns is assumed.

NOTE: If during MS operation the SIM is physically removed it is impractical to ensure correct sequencing of deactivation and the possible damage to the SIM cannot be safeguarded by a type approval test. Furthermore, in this situation the integrity of the SIM data is not guaranteed (see 3GPP TS 02.17).

27.17.1.4.2 Conformance requirement

- a) Depending on the state of the clock at the time of deactivation, the contacts of the SIM/ME shall be deactivated in one of two ways.

If the clock is running, the contacts of the SIM/ME interface shall be deactivated in the following order:

1. RST at low level;
2. Clock stopped at low level;
3. Vpp inactive (only if Vpp is provided independent of Vcc, see 3GPP TS 11.11 subclause 5.3);
4. I/O at status A;
5. Vcc inactive.

When V_{pp} is connected to V_{cc} , as allowed by 3GPP TS 11.11 (subclause 5.3), then V_{pp} is deactivated together with V_{cc} , at the time of V_{cc} (step 5 in the sequence above).

If the clock is stopped and is not restarted, the ME is allowed to deactivate all the contacts in any order, provided that all signals reach low level before V_{cc} leaves high level.

- b) Depending on the state of the clock at the time of deactivation, the contacts of the SIM/ME shall be deactivated in one of two ways.

If the clock is running, the contacts of the SIM/ME interface shall be deactivated in the following order:

1. RST at low level;
2. Clock stopped at low level;
3. I/O at status A;
4. V_{cc} inactive.

If the clock is stopped and is not restarted, the ME is allowed to deactivate all the contacts in any order, provided that all signals reach low level before V_{cc} leaves high level.

- c.1) Depending on the state of the clock at the time of deactivation, the contacts of the SIM/ME interface shall be deactivated in one of two ways.

If the clock is running, the contacts of the SIM/ME interface shall be deactivated in the following order:

1. RST at low level;
2. Clock stopped at low level;
3. I/O at status A;
4. V_{cc} inactive.

If the clock is stopped and is not restarted, the ME is allowed to deactivate all the contacts in any order, provided that all signals reach low level before V_{cc} leaves high level.

- c.2) When the SIM/ME interface is deactivated for 3V/5V switching, the contacts shall be deactivated as given in c.1).

- d) Depending on the state of the clock at the time of deactivation, the contacts of the SIM/ME shall be deactivated in one of two ways.

If the clock is running, the contacts of the SIM/ME interface shall be deactivated in the following order:

1. RST at low level;
2. Clock stopped at low level;
3. I/O at status A;
4. V_{cc} inactive.

If the clock is stopped and is not restarted, the ME is allowed to deactivate all the contacts in any order, provided that all signals reach low level before V_{cc} leaves high level.

- e.1) Depending on the state of the clock at the time of deactivation, the contacts of the SIM/ME interface shall be deactivated in one of two ways.

If the clock is running, the contacts of the SIM/ME interface shall be deactivated in the following order:

1. RST at low level;
2. Clock stopped at low level;
3. I/O at status A;

4. Vcc inactive.

If the clock is stopped and is not restarted, the ME is allowed to deactivate all the contacts in any order, provided that all signals reach low level before Vcc leaves high level.

- e.2) When the SIM/ME interface is deactivated for 1,8V/3V switching, the contacts shall be deactivated as given in e.1).

Reference:

- a): 3GPP TS 11.11, subclause 4.3.2.
b), c.1), c.2): 3GPP TS 11.12, subclause 4.5.
d), e.1), e.2): 3GPP TS 11.18, subclause 4.5.

27.17.1.4.3 Test purpose

To verify that, depending on the state of the clock (running or stopped), the contacts of the SIM/ME interface become deactivated in the correct order, as given in the conformance requirement.

27.17.1.4.4 Method of test

27.17.1.4.4.1 Initial condition

The ME is connected to a SIM Simulator.

The file characteristics of the directories (byte 14 of STATUS information) shall indicate that clock stop is allowed.

27.17.1.4.4.2 Procedure

To test the requirements a), b), c.1), d) and e.1), the MS is soft powered off.

To test the requirement c.2) and e.2), the ME is caused to switch the voltage on the SIM/ME interface.

The SIM/ME interface is monitored until it is fully deactivated.

27.17.1.4.5 Test requirement

The contacts of the SIM/ME interface shall be deactivated in the correct order, as given in the conformance requirements.

27.17.1.5 SIM Type Recognition and Voltage Switching

27.17.1.5.1 Reaction of 3V only MEs on SIM type recognition failure

27.17.1.5.1.1 Definition

When a 3V only ME detects a failure during the SIM type recognition procedure, the ME shall reject the SIM in order to prevent any damage to the SIM.

27.17.1.5.1.2 Conformance requirement

- 1) The procedure for deriving the identification bit (SIM type recognition procedure) shall be performed by the ME immediately after the ATR and before issuing any other command. The procedure shall consist of the two commands "SELECT GSM" and "STATUS/GET RESPONSE".
- 2) If a 3V only ME cannot complete the SIM type recognition procedure the ME shall deactivate the SIM/ME interface and reject the SIM immediately without issuing any further command.

This procedure shall be finished within 5 s after the "STATUS/GET RESPONSE" command.

Reference:

3GPP TS 11.12 subclauses 4.3 and 4.5.

27.17.1.5.1.3 Test purpose

- 1) To verify that a 3V only ME correctly performs the SIM type recognition procedure.
- 2) To verify that a 3V only ME deactivates the SIM/ME interface and rejects the SIM in case that the SIM does not respond to the "STATUS/GET RESPONSE" command.

27.17.1.5.1.4 Method of test

27.17.1.5.1.4.1 Initial condition

The ME is connected to a SIM Simulator simulating a 3V technology SIM with nominal test conditions according to table 27.2-2. All elementary files are coded as default.

The ME is powered on.

27.17.1.5.1.4.2 Procedure

After sending the ATR the SIM simulator checks the presence of the commands "SELECT GSM" and "STATUS/GET RESPONSE" as the first and only commands of the GSM card session.

The SIM simulator does not respond to the "STATUS/GET RESPONSE" command.

The SIM/ME interface is monitored for at least 1 minute until the MS is switched off.

27.17.1.5.1.5 Test requirement

- 1) Immediately after the ATR only the two commands "SELECT GSM" and "STATUS/GET RESPONSE" shall be sent by the ME.
- 2) The 3V only ME shall deactivate the SIM/ME interface within 5 s and reject the SIM (i.e. not activate the SIM/ME interface within the test procedure).

27.17.1.5.2 Reaction of 3V only MEs on type recognition of 5V only SIMs

27.17.1.5.2.1 Definition

When a 3V only ME detects a 5V only SIM during the SIM type recognition procedure, the ME shall reject the SIM in order to prevent any damage to the SIM.

27.17.1.5.2.2 Conformance requirement

- 1) The procedure for deriving the identification bit (SIM type recognition procedure) shall be performed by the ME immediately after the ATR and before issuing any other command. The procedure shall consist of the two commands "SELECT GSM" and "STATUS/GET RESPONSE"
- 2) If a 3V only ME identifies a 5V only SIM during the SIM type recognition procedure the ME shall deactivate the SIM/ME interface and reject the SIM immediately without issuing any further command.

Reference:

3GPP TS 11.12 subclauses 4.3 and 4.5.

27.17.1.5.2.3 Test purpose

- 1) To verify that a 3V only ME correctly performs the SIM type recognition procedure.
- 2) To verify that a 3V only ME deactivates the SIM/ME interface and rejects the SIM if a 5V only SIM is applied.

27.17.1.5.2.4 Method of test

27.17.1.5.2.4.1 Initial condition

The ME is connected to a SIM Simulator simulating a 3V technology SIM (to ensure that the ME can perform the SIM type recognition procedure) with nominal test conditions according to table 27.2-2. All elementary files are coded as default. Bit 5 in byte 14 of the status information is set to "0" (i.e. 5V only SIM).

The ME is powered on.

27.17.1.5.2.4.2 Procedure

After sending the ATR the SIM simulator checks the presence of the commands "SELECT GSM" and "STATUS/GET RESPONSE" as the first and only commands of the GSM card session.

The SIM simulator responds to the "STATUS/GET RESPONSE" command with a status information indicating a 5V only SIM.

The SIM/ME interface is monitored for at least 1 minute until the MS is switched off.

27.17.1.5.2.5 Test requirement

- 1) Immediately after the ATR only the two command "SELECT GSM" and "STATUS/GET RESPONSE" shall be sent by the ME.
- 2) The 3V only ME shall deactivate the SIM/ME interface immediately after receipt of the status information from the SIM (but not later than 5 s after the "STATUS/GET RESPONSE" command) and reject the SIM (i.e. not activate the SIM/ME interface again within the test procedure).

27.17.1.5.3 Reaction of 3V technology MEs on type recognition of 5V only SIMs

27.17.1.5.3.1 Definition

When a 3V technology ME detects a 5V only SIM during the SIM type recognition procedure, the ME shall switch to 5V operation.

27.17.1.5.3.2 Conformance requirement

- 1) A 3V technology ME shall initially activate the SIM at 3V (i.e. the first activation of a GSM card session).
- 2) The procedure for deriving the identification bit (SIM type recognition procedure) shall be performed by the ME immediately after the ATR procedure and before issuing any other command. The procedure shall consist of the two commands "SELECT GSM" and "STATUS/GET RESPONSE".
- 3) If a 3V technology ME identifies a 5V only SIM during the SIM type recognition procedure, the ME shall switch to 5V operation mode. Switching from 3V to 5V shall only be performed by deactivating the SIM and activating it with 5V supply voltage immediately after the SIM type recognition procedure without issuing any further command.

Reference:

3GPP TS 11.12 subclauses 4.3 and 4.4.

27.17.1.5.3.3 Test purpose

- 1) To verify that a 3V technology ME initially activates the SIM with 3V.
- 2) To verify that a 3V technology ME correctly performs the SIM type recognition procedure.
- 3) To verify that a 3V technology ME deactivates the SIM/ME interface immediately after the SIM type recognition procedure (in order to switch the supply voltage) without issuing any further command.

27.17.1.5.3.4 Method of test

27.17.1.5.3.4.1 Initial condition

The ME is connected to a SIM Simulator simulating a 5V only SIM with nominal test conditions according to table 27.2-1. All elementary files are coded as default. Bit 5 in byte 14 of the status information is set to "0" (i.e. 5V only SIM).

The ME is powered on.

27.17.1.5.3.4.2 Procedure

After sending the ATR the SIM simulator checks the presence of the commands "SELECT GSM" and "STATUS/GET RESPONSE" as the first and only commands of the GSM card session.

The SIM simulator responds to the "STATUS/GET RESPONSE" command with a status information indicating a 5V only SIM.

The SIM/ME interface is monitored for at least 1 minute until the MS is switched off.

27.17.1.5.3.5 Test requirement

- 1) The initial activation of the SIM/ME interface shall be performed with 3V supply voltage.
- 2) Immediately after the ATR the two commands "SELECT GSM" and "STATUS/GET RESPONSE" shall be sent by the ME before issuing further commands.
- 3) The 3V technology ME shall deactivate the SIM/ME interface immediately after receipt of the status information from the SIM.

27.17.1.5.4 Reaction of 3V technology MEs on type recognition of 3V technology SIMs

27.17.1.5.4.1 Definition

When a 3V technology ME detects a 3V technology SIM during the SIM type recognition procedure the ME may either switch to 5V operation or stay in 3V operation.

27.17.1.5.4.2 Conformance requirement

- 1) A 3V technology ME shall initially activate the SIM with a 3V (i.e. the first activation of a GSM card session).
- 2) The procedure for deriving the identification bit (SIM type recognition procedure) shall be performed by the ME immediately after the ATR and before issuing any other command. the procedure shall consist of the two commands "SELECT GSM" and "STATUS/GET RESPONSE".
- 3) If a 3V technology ME identifies a 3V technology SIM during the SIM type recognition the ME may switch to 5V operation. Switching from 3V to 5V shall only be performed by deactivating the SIM and activating it with 5V supply voltage immediately after the SIM type recognition procedure without issuing any further commands.

Reference:

3GPP TS 11.12, subclauses 4.3, 4.4 and 4.7.

27.17.1.5.4.3 Test purpose

- 1) To verify that a 3V technology ME initially activates the SIM with 3V.
- 2) To verify that a 3V technology ME correctly performs the SIM type recognition procedure.
- 3) To verify that a 3V technology ME deactivates the SIM/ME interface immediately after the recognition of a 3V technology SIM (in order to switch the supply voltage) or proceeds with the 3V operation during the whole GSM card session without switching to 5V supply voltage.

27.17.1.5.4.4 Method of test

27.17.1.5.4.4.1 Initial condition

The ME is connected to a SIM Simulator simulating a 3V technology SIM with nominal test conditions according to table 27.2-2. All elementary files are coded as default. Bit 5 in byte 14 of the status information is set to "1" (i.e. 3V technology SIM.)

The ME is powered on.

27.17.1.5.4.4.2 Procedure

After sending the ATR the SIM simulator checks the presence of commands "SELECT GSM" and "STATUS/GET RESPONSE" as the first and only commands of the GSM card session.

The SIM simulator responds to the "STATUS/GET RESPONSE" command with a status information indicating a 3V technology SIM.

The SIM/ME interface is monitored for at least 1 minute until the MS is switched off.

27.17.1.5.4.5 Test requirement

- 1) The initial activation of the SIM/ME interface shall be performed with 3V supply voltage.
- 2) Immediately after the ATR the two commands "SELECT GSM" and "STATUS/GET RESPONSE" shall be sent by the ME.
- 3) The ME shall react in one of the following ways:
 - a) The ME deactivates the SIM/ME interface immediately after the receipt of the status information from the SIM.
 - b) the ME proceeds with the GSM card session without switching to another supply voltage.

27.17.1.5.5 Reaction of 1,8V only MEs on SIM type recognition failure

27.17.1.5.5.1 Definition

When a 1,8V only ME detects a failure during the SIM type recognition procedure, the ME shall reject the SIM in order to prevent any damage to the SIM.

27.17.1.5.5.2 Conformance requirement

- 1) The procedure for deriving the identification bit (SIM type recognition procedure) shall be performed by the ME immediately after the ATR and before issuing any other command. The procedure shall consist of the two commands "SELECT GSM" and "STATUS/GET RESPONSE".
- 2) If a 1,8V only ME cannot complete the SIM type recognition procedure the ME shall deactivate the SIM/ME interface and reject the SIM immediately without issuing any further command.

This procedure shall be finished within 5 s after the "STATUS/GET RESPONSE" command.

Reference:

3GPP TS 11.18 subclauses 4.3 and 4.5.

27.17.1.5.5.3 Test purpose

- 1) To verify that a 1,8V only ME correctly performs the SIM type recognition procedure.
- 2) To verify that a 1,8V only ME deactivates the SIM/ME interface and rejects the SIM in case that the SIM does not respond to the "STATUS/GET RESPONSE" command.

27.17.1.5.5.4 Method of test

27.17.1.5.5.4.1 Initial condition

The ME is connected to a SIM Simulator simulating a 1,8V technology SIM with nominal test conditions according to table 27.2-3. All elementary files are coded as default.

The ME is powered on.

27.17.1.5.5.4.2 Procedure

After sending the ATR the SIM simulator checks the presence of the commands "SELECT GSM" and "STATUS/GET RESPONSE" as the first and only commands of the GSM card session.

The SIM simulator does not respond to the "STATUS/GET RESPONSE" command.

The SIM/ME interface is monitored for at least 1 minute until the MS is switched off.

27.17.1.5.5.5 Test requirement

- 1) Immediately after the ATR only the two commands "SELECT GSM" and "STATUS/GET RESPONSE" shall be sent by the ME.
- 2) The 1,8V only ME shall deactivate the SIM/ME interface within 5 s and reject the SIM (i.e. not activate the SIM/ME interface within the test procedure).

27.17.1.5.6 Reaction of 1,8V only MEs on type recognition of 3V SIMs

27.17.1.5.6.1 Definition

When a 1,8V only ME detects a 3V technology SIM during the SIM type recognition procedure, the ME shall reject the SIM in order to prevent any damage to the SIM.

27.17.1.5.6.2 Conformance requirement

- 1) The procedure for deriving the identification bit (SIM type recognition procedure) shall be performed by the ME immediately after the ATR and before issuing any other command. The procedure shall consist of the two commands "SELECT GSM" and "STATUS/GET RESPONSE"
- 2) If a 1,8V only ME identifies a 3V technology SIM during the SIM type recognition procedure the ME shall deactivate the SIM/ME interface and reject the SIM immediately without issuing any further command.

Reference:

3GPP TS 11.18 subclauses 4.3 and 4.5.

27.17.1.5.6.3 Test purpose

- 1) To verify that a 1,8V only ME correctly performs the SIM type recognition procedure.
- 2) To verify that a 1,8V only ME deactivates the SIM/ME interface and rejects the SIM if a 3V technology SIM is applied.

27.17.1.5.6.4 Method of test

27.17.1.5.6.4.1 Initial condition

The ME is connected to a SIM Simulator simulating a 1,8V technology SIM (to ensure that the ME can perform the SIM type recognition procedure) with nominal test conditions according to table 27.2-3. All elementary files are coded as default. Bits 6 and 5 in byte 14 of the status information are set to "01" (i.e. 3V technology SIM).

The ME is powered on.

27.17.1.5.6.4.2 Procedure

After sending the ATR the SIM simulator checks the presence of the commands "SELECT GSM" and "STATUS/GET RESPONSE" as the first and only commands of the GSM card session.

The SIM simulator responds to the "STATUS/GET RESPONSE" command with a status information indicating a 3V technology SIM.

The SIM/ME interface is monitored for at least 1 minute until the MS is switched off.

27.17.1.5.6.5 Test requirement

- 1) Immediately after the ATR only the two command "SELECT GSM" and "STATUS/GET RESPONSE" shall be sent by the ME.
- 2) The 1,8V only ME shall deactivate the SIM/ME interface immediately after receipt of the status information from the SIM (but not later than 5 s after the "STATUS/GET RESPONSE" command) and reject the SIM (i.e. not activate the SIM/ME interface again within the test procedure).

27.17.1.5.7 Reaction of 1,8V technology MEs on type recognition of 3V technology SIMs

27.17.1.5.7.1 Definition

When a 1,8V technology ME detects a 3V technology SIM during the SIM type recognition procedure, the ME shall switch to 3V operation.

27.17.1.5.7.2 Conformance requirement

- 1) A 1,8V technology ME shall initially activate the SIM at 1,8V (i.e. the first activation of a GSM card session).
- 2) The procedure for deriving the identification bit (SIM type recognition procedure) shall be performed by the ME immediately after the ATR procedure and before issuing any other command. The procedure shall consist of the two commands "SELECT GSM" and "STATUS/GET RESPONSE".
- 3) If a 1,8V technology ME identifies a 3V technology SIM during the SIM type recognition procedure, the ME shall switch to 3V operation mode. Switching from 1,8V to 3V shall only be performed by deactivating the SIM and activating it with 3V supply voltage immediately after the SIM type recognition procedure without issuing any further command.

Reference:

3GPP TS 11.18 subclauses 4.3 and 4.4.

27.17.1.5.7.3 Test purpose

- 1) To verify that a 1,8V technology ME initially activates the SIM with 1,8V.
- 2) To verify that a 1,8V technology ME correctly performs the SIM type recognition procedure.
- 3) To verify that a 1,8V technology ME deactivates the SIM/ME interface immediately after the SIM type recognition procedure (in order to switch the supply voltage) without issuing any further command.

27.17.1.5.7.4 Method of test

27.17.1.5.7.4.1 Initial condition

The ME is connected to a SIM Simulator simulating a 3V technology SIM with nominal test conditions according to table 27.2-2. All elementary files are coded as default. Bits 6 and 5 in byte 14 of the status information are set to "01" (i.e. 3V technology SIM).

The ME is powered on.

27.17.1.5.7.4.2 Procedure

After sending the ATR the SIM simulator checks the presence of the commands "SELECT GSM" and "STATUS/GET RESPONSE" as the first and only commands of the GSM card session.

The SIM simulator responds to the "STATUS/GET RESPONSE" command with a status information indicating a 3V technology SIM.

The SIM/ME interface is monitored for at least 1 minute until the MS is switched off.

27.17.1.5.7.5 Test requirement

- 1) The initial activation of the SIM/ME interface shall be performed with 1,8V supply voltage.

- 2) Immediately after the ATR the two commands "SELECT GSM" and "STATUS/GET RESPONSE" shall be sent by the ME before issuing further commands.
- 3) The 1,8V technology ME shall deactivate the SIM/ME interface immediately after receipt of the status information from the SIM.

27.17.1.5.8 Reaction of 1,8V technology MEs on type recognition of 1,8V technology SIMs

27.17.1.5.8.1 Definition

When a 1,8V technology ME detects a 1,8V technology SIM during the SIM type recognition procedure the ME may either switch to 3V operation or stay in 1,8V operation.

27.17.1.5.8.2 Conformance requirement

- 1) A 1,8V technology ME shall initially activate the SIM with a 1,8V (i.e. the first activation of a GSM card session).
- 2) The procedure for deriving the identification bit (SIM type recognition procedure) shall be performed by the ME immediately after the ATR and before issuing any other command. the procedure shall consist of the two commands "SELECT GSM" and "STATUS/GET RESPONSE".
- 3) If a 1,8V technology ME identifies a 1,8V technology SIM during the SIM type recognition the ME may switch to 3V operation. Switching from 1,8V to 3V shall only be performed by deactivating the SIM and activating it with 3V supply voltage immediately after the SIM type recognition procedure without issuing any further commands.

Reference:

3GPP TS 11.18, subclauses 4.3, 4.4 and 4.7.

27.17.1.5.8.3 Test purpose

- 1) To verify that a 1,8V technology ME initially activates the SIM with 1,8V.
- 2) To verify that a 1,8V technology ME correctly performs the SIM type recognition procedure.
- 3) To verify that a 1,8V technology ME deactivates the SIM/ME interface immediately after the recognition of a 1,8V technology SIM (in order to switch the supply voltage) or proceeds with the 1,8V operation during the whole GSM card session without switching to 3V supply voltage.

27.17.1.5.8.4 Method of test

27.17.1.5.8.4.1 Initial condition

The ME is connected to a SIM Simulator simulating a 1,8V technology SIM with nominal test conditions according to table 27.2-3. All elementary files are coded as default. Bits 6 and 5 in byte 14 of the status information are set to "11" (i.e. 1,8V technology SIM.)

The ME is powered on.

27.17.1.5.8.4.2 Procedure

After sending the ATR the SIM simulator checks the presence of commands "SELECT GSM" and "STATUS/GET RESPONSE" as the first and only commands of the GSM card session.

The SIM simulator responds to the "STATUS/GET RESPONSE" command with a status information indicating a 1,8V technology SIM.

The SIM/ME interface is monitored for at least 1 minute until the MS is switched off.

27.17.1.5.8.5 Test requirement

- 1) The initial activation of the SIM/ME interface shall be performed with 1,8V supply voltage.
- 2) Immediately after the ATR the two commands "SELECT GSM" and "STATUS/GET RESPONSE: shall be sent by the ME.

3) The ME shall react in one of the following ways:

a) The ME deactivates the SIM/ME interface immediately after the receipt of the status information from the SIM.

b) the ME proceeds with the GSM card session without switching to another supply voltage.

27.17.2 Electrical tests on each ME contact

The following tables give the electrical conditions that must be applied by the SIM simulator to all contacts during a test if not stated otherwise.

Table 27.2-1: Nominal test conditions on 5V SIM/ME interface

Contacts	Low level	High level	Max. capacitive load
C1 (Vcc)	---	I = 10 mA	
C2 (RST)	I = -200 μ A	I = +20 μ A	30 pF
C3 (CLK)	I = -200 μ A	I = +20 μ A	30 pF
C5 (GND)	---	---	
C6 ((Vpp)	---	I = 0 mA	
C7 (I/O)			30 pF
ME input	V = 0 V	I = +20 μ A	
ME output	I = -1 mA	I = +20 μ A	

Table 27.2-2: Nominal test conditions on 3V SIM/ME interface

Contacts	Low level	High level	Max. capacitive load
C1 (Vcc)	---	I = 6 mA	
C2 (RST)	I = -200 μ A	I = +200 μ A	30 pF
C3 (CLK)	I = -20 μ A	I = +20 μ A	30 pF
C5 (GND)	---	---	
C6 ((Vpp)	---	---	
C7 (I/O)			30 pF
ME input	V = 0 V	I = +20 μ A	
ME output	I = -1 mA	I = +20 μ A	

Table 27.2-3: Nominal test conditions on 1,8V SIM/ME interface

Contacts	Low level	High level	Max. capacitive load
C1 (Vcc)	---	I = 4 mA	
C2 (RST)	I = -200 μ A	I = +200 μ A	30 pF
C3 (CLK)	I = -20 μ A	I = +20 μ A	30 pF
C5 (GND)	---	---	
C6 ((Vpp)	---	---	
C7 (I/O)			30 pF
ME input	V = 0 V	I = +20 μ A	
ME output	I = -1 mA	I = +20 μ A	

NOTE 1: Measurements of contacts voltage levels can be done at any time since the beginning of activation of the SIM and the end of deactivation of the SIM (ISO/IEC 7816-3 subclause 5.1).

NOTE 2: The reference point of all measurements is the contact C5 (Ground).

NOTE 3: Currents flowing into the SIM are considered positive.

27.17.2.1 Electrical tests on contact C1

C1 = Card power supply (Vcc).

27.17.2.1.1 Test 1

27.17.2.1.1.1 Definition

When the mobile station is activated, the supply voltage on the SIM/ME interface shall remain in the specified range in order to ensure correct operation and to prevent any damage to the SIM.

27.17.2.1.1.2 Conformance requirement

- a) The voltage on contact C1 of the SIM/ME interface shall be $5V \pm 10\%$ for I_{cc} up to 10 mA.
- b) The voltage on contact C1 of the SIM/ME interface shall be $3V \pm 10\%$ for I_{cc} up to 6 mA.
- c.1) The voltage on contact C1 of the SIM/ME interface shall be $5V \pm 10\%$ for I_{cc} up to 10 mA when the interface is in 5V operation mode.
- c.2) The voltage on contact C1 of the SIM/ME interface shall be $3V \pm 10\%$ for I_{cc} up to 6 mA when the interface is in 3V operation mode.
- d) The voltage on contact C1 of the SIM/ME interface shall be $1,8V \pm 10\%$ for I_{cc} up to 4 mA.
- e.1) The voltage on contact C1 of the SIM/ME interface shall be $3V \pm 10\%$ for I_{cc} up to 6 mA when the interface is in 3V operation mode.
- e.2) The voltage on contact C1 of the SIM/ME interface shall be $1,8V \pm 10\%$ for I_{cc} up to 4 mA when the interface is in 1,8V operation mode.

Reference:

- a), c.1): 3GPP TS 11.11, subclause 5.1.
- b), c.2), e.1): 3GPP TS 11.12, clause 5.
- d), e.2): 3GPP TS 11.18, clause 5.

27.17.2.1.1.3 Test purpose

To verify that the ME keeps the voltage on contact C1 of the SIM/ME interface within the ranges specified in the conformance requirements.

27.17.2.1.1.4 Method of test

Initial condition

The ME is connected to a SIM Simulator.

The MS is activated.

The remaining contacts of the SIM/ME interface are in nominal test conditions (see 3GPP TS 11.10 subclause 27.17.2).

Test Procedure

The voltage of contact C1 (V_{cc}) of the SIM/ME interface is measured.

27.17.2.1.1.5 Test requirement

The voltage on contact C1 of the SIM/ME interface shall be within the ranges specified in the conformance requirements.

27.17.2.1.2 Test 2

27.17.2.1.2.1 Definition

When the mobile station is activated, the supply voltage on the SIM/ME interface shall be able to counteract spikes in the current consumption of the SIM up to the limits given in the conformance requirement, ensuring that the supply voltage stays in the specified range.

27.17.2.1.2.2 Conformance requirement

- a) The voltage on contact C1 of the SIM/ME interface shall be $5V \pm 10\%$ for spikes in the current consumption with a maximum charge of 40 nAs with no more than 400 ns duration and an amplitude of at most 200 mA.
- b) The voltage on contact C1 of the SIM/ME interface shall be $3V \pm 10\%$ for spikes in the current consumption with a maximum charge of 12 nAs with no more than 400 ns duration and an amplitude of at most 60 mA.
- c.1) The voltage on contact C1 of the SIM/ME interface shall be $5V \pm 10\%$ for spikes in the current consumption with a maximum charge of 40 nAs with no more than 400 ns duration and an amplitude of at most 200 mA when the interface is in 5V operation mode.
- c.2) The voltage on contact C1 of the SIM/ME interface shall be $3V \pm 10\%$ for spikes in the current consumption with a maximum charge of 12 nAs with no more than 400 ns duration and an amplitude of at most 60 mA when the interface is in 3V operation mode.
- d) The voltage on contact C1 of the SIM/ME interface shall be $1,8V \pm 10\%$ for spikes in the current consumption with a maximum charge of 12 nAs with no more than 400 ns duration and an amplitude of at most 60 mA.
- e.1) The voltage on contact C1 of the SIM/ME interface shall be $3V \pm 10\%$ for spikes in the current consumption with a maximum charge of 12 nAs with no more than 400 ns duration and an amplitude of at most 60 mA when the interface is in 3V operation mode.
- e.2) The voltage on contact C1 of the SIM/ME interface shall be $1,8V \pm 10\%$ for spikes in the current consumption with a maximum charge of 12 nAs with no more than 400 ns duration and an amplitude of at most 60 mA when the interface is in 1,8V operation mode.

Reference:

- a), c.1): 3GPP TS 11.11, subclause 5.2.
- b), c.2), e.1): 3GPP TS 11.12, clause 5.
- d), e.2): 3GPP TS 11.18, clause 5.

27.17.2.1.2.3 Test purpose

To verify that the ME keeps the voltage on contact C1 of the SIM/ME interface within the specified range for the conditions given in the conformance requirement.

27.17.2.1.2.4 Method of test

Initial condition

The ME is connected to a SIM Simulator.

The MS is activated.

The remaining contacts of the SIM/ME interface are held in nominal test condition (see 3GPP TS 11.10 subclause 27.17.2).

Procedure

To test the requirements a) and c-1), the voltage on contact C1 of the SIM/ME interface is monitored and the following current spikes are applied:

- 1) continuous spikes:
 - current amplitude 20 mA
 - current offset 0 mA
 - Duration 100 ns
 - Pause 100 ns
- 2) continuous spikes:

current 20 mA

current offset 0 mA

Duration 400 ns

Pause 400 ns

3) continuous spikes:

current amplitude 15 mA

current offset 5 mA

(i.e. maximum amplitude = 5 mA + 15 mA = 20 mA)

Duration 150 ns

Pause 300 ns

4) random spikes:

current amplitude 200 mA

current offset 0 mA

Duration 200 ns

Pause between 0,1 ms and 500 ms, randomly varied

5) random spikes:

current amplitude 100 mA

current offset 0 mA

Duration 400 ns

Pause between 0,1 ms and 500 ms, randomly varied

6) random spikes

current amplitude 195 mA

current offset 5mA

(i.e. maximum amplitude = 5 mA + 195 mA = 200 mA)

Duration 200 ns

Pause between 0,1 ms and 500 ms, randomly varied

To test the requirements b), c.2), d), e.1) and e.2) the voltage on contact C1 of the SIM/ME interface is monitored and the following current spikes are applied:

1) continuous spikes:

current amplitude 12 mA

current offset 0 mA

Duration 100 ns

Pause 100 ns

2) continuous spikes:

current 12 mA

current offset 0 mA

Duration 400 ns

Pause 400 ns

3) continuous spikes:

current amplitude 9 mA

current offset 3 mA

(i.e. maximum amplitude = 3 mA + 9 mA = 12 mA)

Duration 150 ns

Pause 300 ns

4) random spikes:

current amplitude 60 mA

current offset 0 mA

Duration 200 ns

Pause between 0,1 ms and 500 ms, randomly varied

5) random spikes:

current amplitude 30 mA

current offset 0 mA

Duration 400 ns

Pause between 0,1 ms and 500 ms, randomly varied

6) random spikes

current amplitude 57 mA

current offset 3 mA

(i.e. maximum amplitude = 3 mA + 57 mA = 60 mA)

Duration 200 ns

Pause between 0,1 ms and 500 ms, randomly varied

NOTE: The specified spike durations are measured at 50 % of the spike amplitude.

27.17.2.1.2.5 Test requirement

The voltage on contact C1 of the SIM/ME interface shall be within the ranges specified in the conformance requirements.

27.17.2.2 Electrical tests on contact C2

C2 = Reset (RST).

27.17.2.2.1 Definition

When the mobile station is activated, the voltage on contact C2 of the SIM/ME interface shall remain in the specified range in order to ensure correct operation and to prevent any damage to the SIM.

27.17.2.2.2 Conformance requirement

- a) The voltage on contact C2 (RST) of the SIM/ME interface shall be between -0,3V and +0,6V for a current of -200 μ A in low state and between 3,8V and $V_{cc} + 0,3V$ for a current of +20 μ A in high state.
- b) The voltage on contact C2 (RST) of the SIM/ME interface shall be between -0,3V and +0,7V for a current of -200 μ A in low state and between 2,15 V and $V_{cc} + 0,3V$ for a current of +200 μ A in high state.
- c.1) The voltage on contact C2 (RST) of the SIM/ME interface shall be between -0,3V and +0,6V for a current of -200 μ A in low state and between 3,8V and $V_{cc} + 0,3V$ for a current of +20 μ A in high state when the interface is in 5V operation mode.
- c.2) The voltage on contact C2 (RST) of the SIM/ME interface shall be between -0,3V and +0,7V for a current of -200 μ A in low state and between 2,15 V and $V_{cc} + 0,3V$ for a current of +200 μ A in high state when the interface is in 3V operation mode.
- d) The voltage on contact C2 (RST) of the SIM/ME interface shall be between -0,3V and +0,47V for a current of -200 μ A in low state and between 1,3 V and $V_{cc} + 0,3V$ for a current of +200 μ A in high state.
- e.1) The voltage on contact C2 (RST) of the SIM/ME interface shall be between -0,3V and +0,7V for a current of -200 μ A in low state and between 2,15 V and $V_{cc} + 0,3V$ for a current of +200 μ A in high state when the interface is in 3V operation mode.
- e.2) The voltage on contact C2 (RST) of the SIM/ME interface shall be between -0,3V and +0,47V for a current of -200 μ A in low state and between 1,3 V and $V_{cc} + 0,3V$ for a current of +200 μ A in high state when the interface is in 1,8V operation mode.

Reference:

- a), c.1): 3GPP TS 11.11, clause 5.
- b), c.2), e.1): 3GPP TS 11.12, clause 5.
- d), e.2): 3GPP TS 11.18, clause 5.

27.17.2.2.3 Test purpose

To verify that the ME keeps the voltage on contact C2 (RST) of the SIM/ME interface within the specified range, as given in the conformance requirement.

27.17.2.2.4 Method of test

27.17.2.2.4.1 Initial condition

The ME is connected to a SIM Simulator.

The MS is activated.

The remaining contacts of the SIM/ME interface are held in nominal test conditions (see 3GPP TS 11.10 subclause 27.17.2).

27.17.2.2.4.2 Procedure

The voltage on contact C2 (RST) of the SIM/ME interface is measured.

27.17.2.2.5 Test requirement

The voltage on contact C2 (RST) of the SIM/ME interface shall be within the range specified in the conformance requirement.

27.17.2.3 Electrical tests on contact C3

C3 = Clock (CLK).

27.17.2.3.1 Definition

When the mobile station is activated, the voltage, the rise/fall time of the signal, the clock cycle ratio and the frequency on contact C3 of the SIM/ME interface shall remain in the specified range in order to ensure correct operation and to prevent any damage to the SIM.

27.17.2.3.2 Conformance requirement

- a.1) The voltage on contact C3 (CLK) of the SIM/ME interface shall be between -0,3V and +0,5V for a current of -200 μ A in low state and between 3,15V and V_{cc} +0,3V for a current of +20 μ A in high state.
- a.2) The rise and the fall time of the clock signal shall not exceed 9 % of the clock period .
- a.3) The cycle ratio of the clock signal shall be between 40 % and 60 % of the period, in steady state.
- a.4) The frequency of the clock signal shall be between 1 MHz and 5 MHz.
- b.1) The voltage on contact C3 (CLK) of the SIM/ME interface shall be between -0,3V and +0,6V for a current of -20 μ A in low state and between 1,9V and V_{cc} +0,3V for a current of +20 μ A in high state.
- b.2) The rise and the fall time of the clock signal shall not exceed 50 ns.
- b.3) The cycle ratio of the clock signal shall be between 40 % and 60 % of the period, in steady state.
- b.4) The frequency of the clock signal shall be between 1 MHz and 4 MHz.
- c.1) The voltage on contact C3 (CLK) of the SIM/ME interface shall be between -0,3V and +0,5V for a current of -200 μ A in low state and between 3,15V and V_{cc} +0,3V for a current of +20 μ A in high state when the interface is in 5V operation mode.
- c.2) The rise and the fall time of the clock signal shall not exceed 9 % of the clock period when the interface is in 5V operation mode.
- c.3) The cycle ratio of the clock signal shall be between 40 % and 60 % of the period, in steady state when the interface is in 5V operation mode.
- c.4) The frequency of the clock signal shall be between 1 MHz and 5 MHz when the interface is in 5V operation mode.
- c.5) The voltage on contact C3 (CLK) of the SIM/ME interface shall be between -0,3V and +0,6V for a current of -20 μ A in low state and between 1,9V and V_{cc} +0,3V for a current of +20 μ A in high state when the interface is in 3V operation mode.
- c.6) The rise and the fall time of the clock signal shall not exceed 50 ns when the interface is in 3V operation mode.
- c.7) The cycle ratio of the clock signal shall be between 40 % and 60 % of the period, in steady state when the interface is in 3V operation mode.
- c.8) The frequency of the clock signal shall be between 1 MHz and 4 MHz when the interface is in 3V operation mode.
- d.1) The voltage on contact C3 (CLK) of the SIM/ME interface shall be between -0,3V and +0,47V for a current of -20 μ A in low state and between 1,21V and V_{cc} +0,3V for a current of +20 μ A in high state.
- d.2) The rise and the fall time of the clock signal shall not exceed 50 ns.
- d.3) The cycle ratio of the clock signal shall be between 40 % and 60 % of the period, in steady state.
- d.4) The frequency of the clock signal shall be between 1 MHz and 4 MHz.

- e.1) The voltage on contact C3 (CLK) of the SIM/ME interface shall be between -0,3V and +0,47V for a current of -20 μ A in low state and between 1,21V and $V_{cc} + 0,3V$ for a current of +20 μ A in high state when the interface is in 1,8V operation mode.
- e.2) The rise and the fall time of the clock signal shall not exceed 50 ns when the interface is in 1,8V operation mode.
- e.3) The cycle ratio of the clock signal shall be between 40 % and 60 % of the period, in steady state when the interface is in 1,8V operation mode.
- e.4) The frequency of the clock signal shall be between 1 MHz and 4 MHz when the interface is in 1,8V operation mode.
- e.5) The voltage on contact C3 (CLK) of the SIM/ME interface shall be between -0,3V and +0,6V for a current of -20 μ A in low state and between 1,9V and $V_{cc} + 0,3V$ for a current of +20 μ A in high state when the interface is in 3V operation mode.
- e.6) The rise and the fall time of the clock signal shall not exceed 50 ns when the interface is in 3V operation mode.
- e.7) The cycle ratio of the clock signal shall be between 40 % and 60 % of the period, in steady state when the interface is in 3V operation mode.
- e.8) The frequency of the clock signal shall be between 1 MHz and 4 MHz when the interface is in 3V operation mode.

Reference:

- a), c.1,2,3,4) 3GPP TS 11.11, clause 5 and subclause 5.4.
- b), c.5,6,7,8), e.1,2,3,4) 3GPP TS 11.12, subclause 4.2 and clause 5.
- d), e.5,6,7,8) 3GPP TS 11.18, subclause 4.2 and clause 5.

27.17.2.3.3 Test purpose

To verify that the ME keeps the voltage, the rise and fall time, the cycle ratio and the frequency on contact C3 (CLK) of the SIM/ME interface within the ranges specified in the conformance requirements.

27.17.2.3.4 Method of test

27.17.2.3.4.1 Initial condition

The ME is connected to a SIM Simulator.

The MS is activated.

The remaining contacts of the SIM/ME interface are held in nominal test conditions (see 3GPP TS 11.10 subclause 27.17.2).

27.17.2.3.4.2 Procedure

The voltage, the rise/fall time, the clock cycle ratio and the frequency on contact C3 (CLK) of the SIM/ME interface are measured.

27.17.2.3.5 Test requirement

The voltage, the rise and fall time, the cycle ratio and the frequency on contact C3 (CLK) of the SIM/ME interface shall be within the ranges specified in the conformance requirements.

27.17.2.4 [Not used]

27.17.2.5 Electrical tests on contact C7

C7 = Input - output (I/O).

27.17.2.5.1 Definition

When the mobile station is activated, the ME shall keep the voltage, the current and the rise/fall time of the signal on contact C7 of the SIM/ME interface within the specified range in order to ensure correct operation and to prevent any damage to the SIM..

27.17.2.5.2 Conformance requirement

a.1) ME receiving state A (low state):

With an imposed voltage of 0V the current flowing out of the ME shall not exceed 1 mA.

a.2) ME transmitting state A (low state):

The voltage shall be between -0,3V and 0,4V when a current of 1 mA flowing into the ME is applied.

a.3) ME transmitting or receiving state Z (high state):

The voltage shall be between +3,8V and $V_{cc} + 0,3V$ when a current of 20 μA flowing out of the ME is applied.

a.4) The rise time and the fall time of the I/O signal shall not exceed 1 μs .

b.1) ME receiving state A (low state):

With an imposed voltage of 0V the current flowing out of the ME shall not exceed 1 mA.

b.2) ME transmitting state A (low state):

The voltage shall be between -0,3V and 0,4V when a current of 1 mA flowing into the ME is applied.

b.3) ME transmitting or receiving state Z (high state):

The voltage shall be between $0,7 * V_{cc}$ and $V_{cc} + 0,3V$ when a current of 20 μA flowing out of the ME is applied.

b.4) The rise time and the fall time of the I/O signal shall not exceed 1 μs .

c.1) ME receiving state A (low state):

With an imposed voltage of 0V the current flowing out of the ME shall not exceed 1 mA when the ME is in 5V operation mode.

c.2) ME transmitting state A (low state):

The voltage shall be between -0,3V and 0,4V when a current of 1 mA flowing into the ME is applied when the ME is in 5V operation mode.

c.3) ME transmitting or receiving state Z (high state):

The voltage shall be between +3,8V and $V_{cc} + 0,3V$ when a current of 20 μA flowing out of the ME is applied when the ME is in 5V operation mode.

c.4) The rise time and the fall time of the I/O signal shall not exceed 1 μs when the ME is in 5V operation mode.

c.5) ME receiving state A (low state):

With an imposed voltage of 0V the current flowing out of the ME shall not exceed 1 mA when the ME is in 3V operation mode.

c.6) ME transmitting state A (low state):

The voltage shall be between -0,3V and 0,4V when a current of 1 mA flowing into the ME is applied when the ME is in 3V operation mode.

c.7) ME transmitting or receiving state Z (high state):

The voltage shall be between $0,7 \cdot V_{cc}$ and $V_{cc} + 0,3V$ when a current of $20 \mu A$ flowing out of the ME is applied when the ME is in 3V operation mode.

c.8) The rise time and the fall time of the I/O signal shall not exceed $1 \mu s$ when the ME is in 3V operation mode.

d.1) ME receiving state A (low state):

With an imposed voltage of 0V the current flowing out of the ME shall not exceed 1 mA.

d.2) ME transmitting state A (low state):

The voltage shall be between $-0,3V$ and $0,3V$ when a current of 1 mA flowing into the ME is applied.

d.3) ME transmitting or receiving state Z (high state):

The voltage shall be between $0,7 \cdot V_{cc}$ and $V_{cc} + 0,3V$ when a current of $20 \mu A$ flowing out of the ME is applied.

d.4) The rise time and the fall time of the I/O signal shall not exceed $1 \mu s$.

e.1) ME receiving state A (low state):

With an imposed voltage of 0V the current flowing out of the ME shall not exceed 1 mA when the ME is in 3V operation mode.

e.2) ME transmitting state A (low state):

The voltage shall be between $-0,3V$ and $0,4V$ when a current of 1 mA flowing into the ME is applied when the ME is in 3V operation mode.

e.3) ME transmitting or receiving state Z (high state):

The voltage shall be between $0,7 \cdot V_{cc}$ and $V_{cc} + 0,3V$ when a current of $20 \mu A$ flowing out of the ME is applied when the ME is in 3V operation mode.

e.4) The rise time and the fall time of the I/O signal shall not exceed $1 \mu s$ when the ME is in 3V operation mode.

e.5) ME receiving state A (low state):

With an imposed voltage of 0V the current flowing out of the ME shall not exceed 1 mA when the ME is in 1,8V operation mode.

e.6) ME transmitting state A (low state):

The voltage shall be between $-0,3V$ and $0,3V$ when a current of 1 mA flowing into the ME is applied when the ME is in 1,8V operation mode.

e.7) ME transmitting or receiving state Z (high state):

The voltage shall be between $0,7 \cdot V_{cc}$ and $V_{cc} + 0,3V$ when a current of $20 \mu A$ flowing out of the ME is applied when the ME is in 1,8V operation mode.

e.8) The rise time and the fall time of the I/O signal shall not exceed $1 \mu s$ when the ME is in 3V operation mode.

Reference:

- a), c.1,2,3,4) 3GPP TS 11.11, clause 5.
- b), c-5,6,7,8), e.1,2,3,4) 3GPP TS 11.12, clause 5.
- d), e-5,6,7,8) 3GPP TS 11.18, clause 5.

27.17.2.5.3 Test purpose

To verify that the ME keeps the voltage, the current and the rise and fall times of the signal on contact C7 (I/O) of the SIM/ME interface within the ranges specified in the conformance requirements.

27.17.2.5.4 Method of test

27.17.2.5.4.1 Initial condition

The ME is connected to a SIM Simulator.

The MS is activated.

The remaining contacts of the SIM/ME interface are held in nominal test conditions (see 3GPP TS 11.10 subclause 27.17.2).

27.17.2.5.4.2 Procedure

The voltage, the current and the rise/fall time on contact C7 (I/O) of the SIM/ME interface are measured.

27.17.2.5.5 Test requirement

The voltage, the current and the rise and fall times of the signal on contact C7 (I/O) of the SIM/ME interface shall be within the ranges specified in the conformance requirements.

27.18 Fixed Number Dialling (FND)

27.18.1 ME and SIM with FND activated

27.18.1.1 EF_{ADN} invalidated and not readable or updatable

27.18.1.1.1 Definition

Fixed Number Dialling (FND) is a service defined for the SIM. An activated FND service results in call restrictions for the MS. The call restrictions are controlled by the ME. To ascertain the type of SIM and state of FND the MS runs the FND capability request procedure during SIM/ME initialization.

27.18.1.1.2 Conformance requirement

1. Recognizing the state of the SIM (FND enabled) the MS shall perform the SIM initialization procedure as specified.
2. The MS allows call set-up to a directory number as stored in EF_{FND}.
3. The MS allows call set-up to a directory number as stored in EF_{FND} and extended by digits in the end.
4. The MS does not allow call set-up to a directory number stored in EF_{FND} but with missing digits at the end.
5. The MS does not allow call set-up to a directory number having no reference in EF_{FND}.
6. The MS allows call set-up of an emergency call.
7. For PCS 1 900: To verify the requirement 6 above by using the emergency call number 911.

Reference:

3GPP TS 11.11, subclauses 9.3, 10.2.7, 10.3.2, 11.2.1 and 11.5.1, 3GPP TS 02.07, subclause 3.2.

27.18.1.1.3 Test purpose

1. To verify that the ME as a result of the state of the SIM rehabilitates EF_{IMSI} and EF_{LOCI} during SIM/ME initialization procedure.
2. To verify that the ME allows call set-up to a FND number.
3. To verify that the ME allows call set-up to a FND number extended by some digits in the end.
4. To verify that the ME rejects call set-up to a FND number not completely corresponding to an entry in EF_{FND}.
5. To verify that the ME rejects call set-up to number having no reference in EF_{FND}.
6. To verify that the ME allows emergency call set-up.

7. For PCS 1 900: To verify the requirement 6 above by using the emergency call number 911.

27.18.1.1.4 Method of test

27.18.1.1.4.1 Initial conditions

The SS transmits on the BCCH, with the following network parameters

Attach/detach:	disabled.
LAI-MCC:	246
LAI-MNC	81 or 813 (see Note 0)
LAI-LAC:	0001
LAI (MCC/MNC/LAC):	246/81/0001 or 246/813/0001 (see Note 0).
Access control:	unrestricted.

The default FDN-SIM with FDN service enabled and EF_{ADN} invalidated and neither readable nor updatable is installed into the ME.

27.18.1.1.4.2 Procedure

- The MS is powered on and PIN1 is entered.
- Using the MMI a call set-up to the fixed dialling number 1 is attempted.
- Using the MMI a call set-up to the fixed dialling number 2 extended by "123" in the end is attempted.
- Using the MMI a call set-up to a number which is equal to the fixed dialling number 3 without the last digit is attempted, e.g. by recalling the fixed dialling number 3 and deleting the last digit (only in display).
- Using the MMI a call set-up to the number "1234567" is attempted.
- Using the MMI an emergency call set-up is attempted.

27.18.1.1.5 Test requirement

- After step a) the MS is registered and in idle state.
- After steps b) and c) the MS shall allow call set-up and send the requested number across the air interface.
- After steps d) and e) the MS shall prevent call set-up.
- After step f) the MS shall allow emergency call set-up and send the requested number across the air interface.

27.18.1.2 EF_{ADN} invalidated but readable and updatable

27.18.1.2.1 Definition

Fixed Number Dialling (FDN) is a service defined for the SIM. An activated FDN service results in call restrictions for the MS. The call restrictions are controlled by the ME.

27.18.1.2.2 Conformance requirement

The MS allows call set-up to a directory number as stored in EF_{FDN} and extended by digits added from an EF_{ADN} .

Reference:

3GPP TS 11.11, subclauses 9.3, 10.2.7, 10.3.2, 11.2.1 and 11.5.1, 3GPP TS 02.07, subclause 3.2.

27.18.1.2.3 Test purpose

To verify that the ME allows call set-up to a FDN number extended by digits from an EF_{ADN} .

27.18.1.2.4 Method of test

27.18.1.2.4.1 Initial conditions

The SS transmits on the BCCH, with the following network parameters

Attach/detach:	disabled.
LAI-MCC:	246
LAI-MNC	81 or 813 (see Note 0)
LAI-LAC:	0001
LAI (MCC/MNC/LAC):	246/81/0001 or 246/813/0001 (see Note 0).
Access control:	unrestricted.

The default FDN-SIM with FDN service enabled and EF_{ADN} invalidated but readable and updatable is installed into the ME.

27.18.1.2.4.2 Procedure

- a) The MS is powered on and PIN1 is entered.
- b) Using the MMI a call set-up to the fixed dialling number 1 extended by the abbreviated dialling number 1 in the end is attempted.

27.18.1.2.5 Test requirement

- 1) After step a) the MS is registered and in idle state.
- 2) After steps b) the MS shall allow call set-up and send the requested number across the air interface.

27.18.2 ME and SIM with FND deactivated

27.18.2.1 Definition

Fixed Number Dialling (FND) is a service defined for the SIM. An activated FND service results in call restrictions for the MS. Only directory numbers which are stored in the EF_{FND} may be dialled by the MS. The call restrictions are controlled by the ME. To ascertain the type of SIM and state of FND the MS runs the FND capability request procedure during SIM/ME initialization. Deactivation of the service by the subscriber is possible under the control of PIN2 and switches the SIM into a "normal", non restrictive SIM.

27.18.2.2 Conformance requirement

1. Recognizing the state of the SIM (FND disabled) the MS correctly performs the SIM initialization procedure.
2. The MS allows call set-up to a directory number as stored in EF_{FND} .
3. The MS allows call set-up to a directory number as stored in EF_{ADN} .
4. The MS allows call set-up to a directory number given in manually.

Reference:

3GPP TS 11.11, subclauses 10.2.7, 10.3.2, 11.2.1 and 11.5.1, 3GPP TS 02.07, subclause 3.2.

27.18.2.3 Test purpose

1. To verify that the ME as a result of the state of the SIM correctly performs the SIM/ME initialization procedure.
2. To verify that the ME allows call set-up to a FDN number.
3. To verify that the ME allows call set-up to a ADN number.
4. To verify that the ME allows call set-up to manually given number.

27.18.2.4 Method of test

27.18.2.4.1 Initial conditions

The SS transmits on the BCCH, with the following network parameters

Attach/detach:	disabled.
LAI-MCC:	246
LAI-MNC	81 or 813 (see Note 0)
LAI-LAC:	0001
LAI (MCC/MNC/LAC):	246/81/0001 or 246/813/0001 (see Note 0).
Access control:	unrestricted.

The default FDN SIM with FDN service disabled is installed into the ME and the MS is powered on.

27.18.2.4.2 Procedure

- Using the MMI a call set-up to the fixed dialling number 1 is attempted.
- Using the MMI a call set-up to the abbreviated dialling number 1 is attempted.
- Using the MMI a call set-up to the number "1234567" is attempted.

27.18.2.5 Test requirement

After steps a), b) and c) the MS shall allow call set-up and send the requested number across the air interface.

27.18.3 Enabling, disabling and updating of FND

27.18.3.1 Definition

FND may be enabled and disabled by the subscriber under control of PIN2. Fixed dialling numbers are read with PIN and updated under control of PIN2.

27.18.3.2 Conformance requirement

- Recognizing the state of the SIM (FND enabled) the MS shall perform the SIM initialization procedure as specified.
- The MS shall allow updating of EF_{FND} by the use of PIN2.
- The MS provides means to disable the FND service by the use of PIN2.
- The MS shall allow the use of EF_{ADN} after disabling of FND.

Reference:

3GPP TS 11.11, subclauses 10.2.7, 10.3.2, 11.2.1 and 11.5.1, 3GPP TS 02.07, subclause 3.2.

27.18.3.3 Test purpose

- To verify that the ME as a result of the state of the SIM rehabilitates EF_{IMSI} and EF_{LOCI} during SIM/ME initialization procedure.
- To verify that the ME correctly performs the update of a number in EF_{FND}.
- To verify that the ME correctly disables FND service.
- To verify that the ME recognizes disabling of FND and allows access to EF_{ADN}.

27.18.3.4 Method of test

27.18.3.4.1 Initial conditions

The SS transmits on the BCCH, with the following network parameters

Attach/detach:	disabled.
LAI-MCC:	246
LAI-MNC	81 or 813 (see Note 0)
LAI-LAC:	0001
LAI (MCC/MNC/LAC):	246/81/0001 or 246/813/0001 (see Note 0).
Access control:	unrestricted.

The default FDN SIM with FDN service enabled is installed into the ME and the MS is powered on.

27.18.3.4.2 Procedure

- The MS is powered on and PIN 1 is entered.
- Using the MMI the directory number "+876543210" is stored in EF_{FDN} as fixed dialling number 1 (The alpha identifier is not changed).
- Using the MMI the FDN disabling procedure is performed. On request of the MS PIN2 is entered.
- Using the MMI a call set-up to the abbreviated dialling number 1 is attempted.
- The MS is soft-powered down.

27.18.3.5 Test requirement

- After step a) the MS is registered and in idle state.
- After step c) the MS shall indicate that the FDN disabling procedure has been successful.
- After step d) the MS shall allow call set-up and send the requested number across the air interface.
- After step e) the value of bit 1 of byte 12 in the response data of EF_{ADN} in the SIM shall be "1" and record 1 in EF_{FDN}, shall contain the following values:

B1	B2	B3	B4	B5	B6	B7	B8	B9	B10
46	44	4E	31	31	31	06	91	78	56
B11	B12	B13	B14	B15	B16	B17	B18	B19	B20
34	12	F0	FF	FF	FF	FF	FF	FF	FF

27.19 Phase identification

27.19.1 Definition

The phase of the SIM is indicated in the Elementary File EF_{PHASE}. This allows the ME to identify the phase of the SIM and adapt its functionality accordingly.

27.19.2 Conformance requirement

The phase of the card shall be determined as part of the initialization procedure.

Reference:

3GPP TS 11.11, subclauses 10.2.16 and 11.2.1.

27.19.3 Test purpose

To verify that the ME requests the SIM phase as part of the initialization procedure.

27.19.4 Method of test

27.19.4.1 Initial conditions

The ME is connected to the SIM simulator, and powered off.

The default values are used.

27.19.4.2 Procedure

- a) The mobile is powered on.
- b) The SIM simulator monitors the SIM initialization procedure.

27.19.5 Test requirement

The ME shall request the phase of the SIM as part of the initialization procedure.

27.20 SIM presence detection

27.20.1 Definition

The presence of the SIM is an essential requirement for setting up and maintaining a call. The ME detects the presence of the SIM electronically.

27.20.2 Conformance requirement

To ensure that the SIM has not been removed during a card session, the ME shall send STATUS commands within all 30 second periods of inactivity on the SIM-ME interface during a call. Inactivity in this case is defined as starting at the end of the last communication or the last issued STATUS command. If the ME detects that the SIM has been removed, a possibly ongoing call shall be terminated by the ME within 5 s at the latest after having detected the SIM removal.

Reference:

3GPP TS 11.11, subclause 11.2.8 and TS 102.221, subclause 14.5.2.

27.20.3 Test purpose

1. To verify that there are no periods of inactivity on the SIM-ME interface greater than 30 seconds during a call.
2. To verify that the ME terminates a call within 5 s at the latest after having received a wrong response to the STATUS command.

27.20.4 Method of test

27.20.4.1 Initial conditions

The ME is connected to the SIM-simulator.

All elementary files are coded as default.

27.20.4.2 Procedure

- a) A call is set up using the generic call setup.
- b) The SIM simulator monitors the periods of inactivity on the SIM-ME interface.
- c) After 3 minutes, the call is cleared.
- d) A call is set up using the generic call setup.
- e) After one minute after the call was successfully set up, the SIM simulator responds to a STATUS command with the response data of the MF.

27.20.5 Test requirements

1. During step b), the time periods of inactivity shall not be longer than 30 s.

2. After step e), the ME shall terminate the call within 5 s at the latest after having received the wrong response to the STATUS command.

27.21 Advice of Charge (AoC)

27.21.1 AoC not supported by SIM

27.21.1.1 Definition

If the ME under test supports Advice of Charge Charging, it shall still look at the capability of the SIM, before responding to any AoCC information from the network.

27.21.1.2 Conformance requirement

1. An MS not supporting AoCC and in the outgoing call / U4 call delivered state, on receipt of a CONNECT message containing AoCC information shall acknowledge the CONNECT message but ignore and not acknowledge the AoCC information sent within the CONNECT.
2. An MS not supporting AoCC and in the outgoing call / U4 call delivered state, on receipt of a FACILITY message containing AoCC information shall ignore and not acknowledge the AoCC information sent within the FACILITY.
3. An MS not supporting AoCC and in the incoming call / U9 call confirmed state, on receipt of a FACILITY message containing AoCC information shall ignore and not acknowledge the AoCC information sent within the FACILITY.
4. An MS not supporting AoCC and in the U10 call active state, on receipt of a FACILITY message containing AoCC information, shall ignore and not acknowledge the AoCC information sent within the FACILITY.

References:

3GPP TS 03.86, subclauses 1.2, 1.3, 2.2, 2.3; 3GPP TS 04.86, clause 2.

27.21.1.3 Test purpose

1. To verify that an MS not supporting AoCC (where the ME does support AoCC but the SIM does not) and in the outgoing call / U4 call delivered state, on receipt of a CONNECT message containing AoCC information shall acknowledge the CONNECT message but ignore and not acknowledge the AoCC information sent within the CONNECT.
2. To verify that an MS not supporting AoCC (where the ME does support AoCC but the SIM does not) and in the outgoing call / U4 call delivered state, on receipt of a FACILITY message containing AoCC information shall ignore and not acknowledge the AoCC information sent within the FACILITY.
3. To verify that an MS not supporting AoCC (where the ME does support AoCC but the SIM does not) and in the incoming call / U9 call confirmed state, on receipt of a FACILITY message containing AoCC information shall ignore and not acknowledge the AoCC information sent within the FACILITY.
4. To verify that an MS not supporting AoCC (where the ME does support AoCC but the SIM does not) and in the U10 call active state, on receipt of a FACILITY message containing AoCC information, shall ignore and not acknowledge the AoCC information sent within the FACILITY.

27.21.1.4 Method of test

27.21.1.4.1 Initial conditions

The ME shall be installed with a SIM or SIM simulator, with all elementary files coded as for the default SIM, with the exception of:

EF_{SST} (SIM Service Table)

- Logically:
- CHV1 disable function allocated and activated.
 - Abbreviated dialling numbers allocated and activated.

PLMN selector allocated and activated.

Fixed dialling numbers not activated.

AoC not activated.

Coding:

	B1	B2	B3	B4
Value (binary)	xx0x1111	0011xx0x	xxxxxxxx	0000xxxx

The coding of EF_{SST} shall conform with the capabilities of the SIM used.

The generic call set up procedures are followed up to and including the reception, or transmission of the ALERTING message by the MS.

27.21.1.4.2 Procedure

- For an MO call in the U4 state the SS transmits CONNECT containing AoCC information.
- For an MO call in the U4 state the SS transmits FACILITY containing AoCC information.
- For an MTcall in the U9 state the SS transmits FACILITY containing AoCC information.
- For an MO call in the U10 state the SS transmits FACILITY containing AoCC information.

27.21.1.5 Test requirement

In all cases, the MS shall ignore the AoCC information sent to it in the Facility information elements as part of the CONNECT/FACILITY messages and not send any AoCC information acknowledgement. It shall be checked for 15 s that the MS does not transmit any AoCC information acknowledgement after the receipt of AoCC information.

27.21.2 Maximum frequency of ACM updating

27.21.2.1 Definition

During a call, the ACM shall be updated at the end of every interval. The interval length is the greater of either 5 s or the value given by parameter e2.

27.21.2.2 Conformance requirement

The ACM shall be incremented when the CCM is incremented or once every 5 s, whichever is the longer period.

Reference:

3GPP TS 02.24, subclause 4.3, part h.

27.21.2.3 Test purpose

To verify that the terminal, during a call, increments the ACM every 5 s when e2 is less or equal to 5 s.

27.21.2.4 Method of test

27.21.2.4.1 Initial conditions

The ME shall be connected to the SIM simulator, with all elementary files coded as default with the exception of:

EF_{SST} (SIM Service Table)

- Logically:
- CHV1 disable function allocated and activated.
 - Abbreviated dialling numbers allocated and activated.
 - PLMN selector allocated and activated.
 - Fixed dialling numbers not activated.

AoC allocated and activated.

Coding:

	B1	B2	B3	B4
Value (binary)	xx0x1111	0011xx11	xxxxxxxx	0000xxxx

The coding of EF_{SST} shall conform with the capabilities of the SIM used.

EF_{ACM} (Accumulated call meter)

Logically: 50 units

EF_{ACMmax} (Accumulated call meter maximum)

Logically: 150 units

System Simulator:

1 cell, default parameters, IMSI attach/detach disabled.

Mobile Station:

The MS is in MM-state "idle, updated".

27.21.2.4.2 Procedure

- a) The MS is made to initiate a call. The call is established with AoCC e-parameters sent in a Facility IE in the CONNECT message, as given below. The MS returns the AoCC acknowledgement within 1 second of the CONNECT message. It is an implementation option whether the AoCC acknowledge is sent by the MS before or after the CONNECT ACKNOWLEDGE.
- b) The call is maintained for 90 s, then terminated by the SS. During the call, the SIM-simulator monitors the time intervals between successive INCREMENT commands. As the final INCREMENT command will have occurred as a result of call termination, the time interval calculated since the prior INCREMENT command shall be ignored.

Maximum Duration of Test:

2 minutes.

Expected Sequence:

Step	Direction	Message	Comments
1	MS		The MS is made to initiate a call to a supported channel type As default message except contains Facility IE with contents as indicated in i below
2	MS -> SS	CHANNEL REQUEST	
3	SS -> MS	IMMEDIATE ASSIGNMENT	
4	MS -> SS	CM SERVICE REQUEST	
5	SS -> MS	CM SERVICE ACCEPT	
6	MS -> SS	SETUP	
7	SS -> MS	CALL PROCEEDING	
8	SS -> MS	ASSIGNMENT COMMAND	
9	MS -> SS	ASSIGNMENT COMPLETE	
10	SS -> MS	ALERTING	
11	SS -> MS	CONNECT	
			Either A or B branch is taken
A12	MS -> SS	CONNECT ACKNOWLEDGE	As default message except contains Facility IE with contents as indicated in ii below
A13	MS -> SS	FACILITY	
B12	MS -> SS	FACILITY	As default message except contains Facility IE with contents as indicated in ii below
B13	MS -> SS	CONNECT ACKNOWLEDGE	
14			call duration 90 s after CAI information sent by SS,
15	SS -> MS	DISCONNECT	The main signalling link is released.
16	MS -> SS	RELEASE	
17	SS -> MS	RELEASE COMPLETE	
18	SS -> MS	CHANNEL RELEASE	

Specific Message Contents:

i) FACILITY Information Element with Invoke = ForwardChargeInformation component type as defined in 3GPP TS 04.80 subclause 3.6.1 table 3.3.

For ASN.1 description see default message contents in subclause 31.6.1.3.

The values of the e-parameters within the parameter part of the Facility Information Element shall be set as below:

parameter	e-parameters						
	1	2	3	4	5	6	7
value	1	1	1	0	0	0	0

Values shown in table are in the format and have units as in 3GPP TS 02.24 subclause 3.

ii) FACILITY Information Element with Return Result component type as defined in 3GPP TS 04.80 subclause 3.6.1 table 3.4.

For ASN.1 description see default message contents in subclause 31.6.1.3.

27.21.2.5 Test requirement

The MS shall, during a call, send INCREMENT commands to the SIM every 5 s.

27.21.3 Call terminated when ACM greater than ACMmax

27.21.3.1 Definition

ACMmax gives the maximum value of ACM, at which the current calls shall be terminated and no further outgoing calls and charged incoming calls may be made (except emergency calls).

27.21.3.2 Conformance requirement

ACM shall be incremented by the value of CCM.

If the ACMmax is valid, and the ACM becomes equal to or exceeds the value of the ACMmax, then all calls in progress, chargeable to the user, shall be terminated by the MS with cause value #68, once the chargeable interval determined by the CAI has elapsed, (except emergency calls).

Reference:

3GPP TS 02.24, subclause 4.3 part h and subclause 4.2.2.

3GPP TS 04.86, subclause 2.3.

27.21.3.3 Test purpose

1. To verify that the ME increments the ACM by the correct number of units, even though this may take ACM above ACMmax.
2. To verify that the ME terminates the call with cause value #68.

27.21.3.4 Method of test

27.21.3.4.1 Initial conditions

The ME shall be connected to a SIM or the SIM simulator, with all elementary files coded as default with the exception of:

EF_{SST} (SIM Service Table)

Logically:

- CHV1 disable function allocated and activated.
- Abbreviated dialling numbers allocated and activated.
- PLMN selector allocated and activated.
- Fixed dialling numbers not activated.
- AoC allocated and activated.

Coding:

	B1	B2	B3	B4
Value (Binary)	xx0x1111	0011xx11	xxxxxxxx	0000xxxx

The coding of EF_{SST} shall conform with the capabilities of the SIM used.

EF_{ACM} (Accumulated call meter)

Logically: 80 units

EF_{ACMmax} (Accumulated call meter maximum)

Logically: 94 units

System Simulator:

1 cell, default parameters, IMSI attach/detach disabled.

Mobile Station:

The MS is in MM-state "idle, updated".

27.21.3.4.2 Procedure

- a) The MS is made to initiate a call. The call is established with AoCC e-parameters sent in a Facility IE in the CONNECT message, as given below. The MS returns the AoCC acknowledgement within 1 second of the CONNECT message. It is an implementation option whether the AoCC acknowledge is sent by the MS before or after the CONNECT ACKNOWLEDGE.
- b) The call is maintained until cleared by the MS (after 30 s) with cause value #68.

c) The contents of ACM are checked.

Maximum Duration of Test:

2 minutes.

Expected Sequence:

Step	Direction	Message	Comments
1	MS		The MS is made to initiate a call
2	MS -> SS	CHANNEL REQUEST	
3	SS -> MS	IMMEDIATE ASSIGNMENT	
4	MS -> SS	CM SERVICE REQUEST	
5	SS -> MS	CM SERVICE ACCEPT	
6	MS -> SS	SETUP	
7	SS -> MS	CALL PROCEEDING	
8	SS -> MS	ASSIGNMENT COMMAND to a supported channel type	
9	MS -> SS	ASSIGNMENT COMPLETE	
10	SS -> MS	ALERTING	
11	SS -> MS	CONNECT	As default message except contains Facility IE with contents as indicated in i below
			Either A or B branch is taken
A12	MS -> SS	CONNECT ACKNOWLEDGE	
A13	MS -> SS	FACILITY	As default message except contains Facility IE with contents as indicated in ii below
B12	MS -> SS	FACILITY	As default message except contains Facility IE with contents as indicated in ii below
B13	MS -> SS	CONNECT ACKNOWLEDGE	
14			call duration 30 s after CAI information sent by SS
15	MS -> SS	DISCONNECT	Cause value #68
16	SS -> MS	RELEASE	
17	MS -> SS	RELEASE COMPLETE	
18	MS -> SS	CHANNEL RELEASE	The main signalling link is released.

Specific Message Contents:

i) **FACILITY Information Element** with **Invoke = ForwardChargeInformation** component type as defined in 3GPP TS 04.80 subclause 3.6.1 table 3.3.

For ASN.1 description see default message contents in subclause 31.6.1.3.

The values of the e-parameters within the parameter part of the Facility Information Element shall be set as below:

parameter	e-parameters						
	1	2	3	4	5	6	7
value	10	10	1	0	0	0	0

Values shown in table are in the format and have units as in 3GPP TS 02.24 clause 3.

ii) **FACILITY Information Element** with **Return Result** component type as defined in 3GPP TS 04.80 subclause 3.6.1 table 3.4.

For ASN.1 description see default message contents in subclause 31.6.1.3.

27.21.3.5 Test requirement

- 1) The MS shall terminate the call correctly 30 s after CAI was sent.
- 2) The value of ACM shall be 100 units.

27.21.4 Response codes of increase command

27.21.4.1 Definition

ACM has a maximum value in terms of coding, and an attempt by the ME to exceed that value by sending an INCREASE command shall result in an error message from the SIM.

27.21.4.2 Conformance requirement

The ME shall perform the increasing procedure, sending the amount to be increased.

The running accumulated charge shall be stored in the ACM of the SIM.

Where this charge cannot be stored in the MS, use of the telecommunications service shall be prevented.

References:

3GPP TS 11.11, subclause 11.5.3; 3GPP TS 02.86, subclauses 2.2.1 and 2.1.

27.21.4.3 Test purpose

To verify that the ME clears a charged call if the SIM indicates that the ACM cannot be increased.

27.21.4.4 Method of test

27.21.4.4.1 Initial conditions

The ME shall be connected to the SIM simulator, with all elementary files coded as default with the exception of:

EF_{SST} (SIM Service Table)

Logically:

- CHV1 disable function allocated and activated.
- Abbreviated dialling numbers allocated and activated.
- PLMN selector allocated and activated.
- Fixed dialling numbers not activated.
- AoC allocated and activated.

Coding:

	B1	B2	B3	B4
Value (binary)	xx0x1111	0011xx11	xxxxxxxx	0000xxxx

The coding of EF_{SST} shall conform with the capabilities of the SIM used.

EF_{ACM} (Accumulated call meter)

Logically: (Maximum-10) units

EF_{ACMmax} (Accumulated call meter maximum)

Logically: (Maximum-2) units

System Simulator:

1 cell, default parameters, IMSI attach/detach disabled.

Mobile Station:

The MS is in MM-state "idle, updated".

27.21.4.4.2 Procedure

- a) The MS is made to initiate a call. The call is established with AoCC e-parameters sent in a Facility IE in the CONNECT message, as given below. The MS returns the AoCC acknowledgement within 1 second of the CONNECT message. It is an implementation option whether the AoCC acknowledge is sent by the MS before or after the CONNECT ACKNOWLEDGE.
- b) After an interval has elapsed, the ME increments the ACM. When an INCREASE command is received, the SIM-sim sends back the error "98 50".
- c) Conditions are reset to those described in the initial conditions. Steps a) and b) of the test are repeated, except that the error code sent by the SIM simulator at step b) is now "6F xx".
- d) Conditions are reset to those described in the initial conditions. Steps a) and b) of the test are repeated, except that the error code sent by the SIM simulator at step b) is now "92 40".

Maximum Duration of Test:

3 minutes.

Expected Sequence:

Step	Direction	Message	Comments
1	MS		The MS is made to initiate a call
2	MS -> SS	CHANNEL REQUEST	
3	SS -> MS	IMMEDIATE ASSIGNMENT	
4	MS -> SS	CM SERVICE REQUEST	
5	SS -> MS	CM SERVICE ACCEPT	
6	MS -> SS	SETUP	
7	SS -> MS	CALL PROCEEDING	
8	SS -> MS	ASSIGNMENT COMMAND to a supported channel type	
9	MS -> SS	ASSIGNMENT COMPLETE	
10	SS -> MS	ALERTING	
11	SS -> MS	CONNECT	
			As default message except contains Facility IE with contents as indicated in i below
			Either A or B branch is taken
A12	MS -> SS	CONNECT ACKNOWLEDGE	As default message except contains Facility IE with contents as indicated in ii below
A13	MS -> SS	FACILITY	
B12	MS -> SS	FACILITY	As default message except contains Facility IE with contents as indicated in ii below
B13	MS -> SS	CONNECT ACKNOWLEDGE	
14			call duration approx 10s after CAI information sent by SS
15	MS -> SS	DISCONNECT	
16	SS -> MS	RELEASE	
17	MS -> SS	RELEASE COMPLETE	
18	MS -> SS	CHANNEL RELEASE	
			The main signalling link is released.

Specific Message Contents:

i) FACILITY Information Element with **Invoke = ForwardChargeInformation** component type as defined in 3GPP TS 04.80 subclause 3.6.1 table 3.3.

The values of the e-parameters within the parameter part of the Facility Information Element shall be set as below:

parameter	e-parameters						
	1	2	3	4	5	6	7
value	20	10	1	0	0	0	0

Values shown in table are in the format and have units as in 3GPP TS 02.24 subclause 3.

ii) FACILITY Information Element with **Return Result** component type as defined in 3GPP TS 04.80 subclause 3.6.1 table 3.4.

27.21.4.5 Test requirement

In each of the three cases, as described in steps b), c) and d) of the procedure, the MS shall terminate the call correctly when it receives an indication from the SIM that the ACM cannot be incremented.

28 Test of autocalling restrictions

28.1 General

It is essential that all autocalling apparatus is prevented from continuously dialling a given number, to avoid machines repeatedly disturbing PSTN subscribers in error, or numerous repeat attempts to unobtainable numbers which cause waste of valuable network resources. Therefore autocalling restrictions are defined by 3GPP TS 02.07.

The tests shall be performed using all of the call methods specified by the supplier in the PIXIT statement (annex 3). The supplier shall state any autocalling procedures implemented and how many times they can be repeated to a single number and the minimum re-attempt interval(s), i.e. the complete re-try schedule or algorithm with parameter values. The supplier shall further describe any automatic methods for making repeated calls to a single number. The supplier shall also state in the PIXIT statement (annex 3) the number of B-party numbers that can be stored on the list of blacklisted numbers as described in 3GPP TS 02.07, annex A.

For an external R-interface the supplier shall state in the PIXIT statement (annex 3) the procedure for autocalling restrictions for that interface and the possible parameter settings for the number of times the LTE can make a re-attempt and the minimum accepted time between re-attempts accepted by the MS. The conditions for clearing the autocalling constraints shall be stated in the PIXIT statement (annex 3).

For external interfaces the LTE must be programmed so that it clearly attempts to violate the autocalling constraints.

28.2 Constraining the access to a single number (3GPP TS 02.07 category 3)

During this test the SETUP messages shall contain the same B-party number.

No manual intervention shall be performed except to initiate and end the test.

28.2.1 Conformance requirement

A repeat call attempt may be made when a call attempt is unsuccessful for the reasons listed below (as defined in 3GPP TS 04.08 / 3GPP TS 24.008).

These reasons are classified in three major categories:

1. "Busy destination".
2. "Unobtainable destination - temporary".
3. "Unobtainable destination - permanent/long term".

NOTE: Cause values for each category are defined in 3GPP TS 02.07, annex A.

The table below describes a repeat call restriction pattern to any B number. This pattern defines a maximum number (n) of call repeat attempts; when this number n is reached, the associated B number shall be blacklisted by the MT until a manual re-set at the MT is performed in respect of that B number. When a repeat attempt to anyone B number fails, or is blacklisted, this does not prevent calls being made to other B numbers.

For the categories 1 and 2 above, n shall be 10; for category 3, n shall be 1.

Call attempt	Minimum duration between call attempts
Initial call attempt	-
1st repeat attempt	5 s
2nd repeat attempt	1 min
3rd repeat attempt	1 min
4th repeat attempt	1 min
5th repeat attempt	3 min
.	
.	
nth repeat attempt	3 min

Reference:

3GPP TS 02.07, annex A.

Purpose of the test

28.2.2 Test purpose

To ensure the correct behaviour of the MS to 3GPP TS 02.07 Category 3.

28.2.3 Method of test

Initial condition.

There shall be no numbers in the list of blacklisted numbers in the MS. The time set between the first re-attempt and the next re-attempt is set to the minimum value possible. The number of re-attempts is set to the lowest possible number, greater than 1, that is supported by the MS. The autocalling function is invoked for the B-party number to be used during the test.

Specific PICS statements:

- Implementation of cause number 27 of busy autocalling in category 2 (TSPC_AddInfo_Impl_CNr27_Cat2)
- Implementation of cause number 27 of busy autocalling in category 3 (TSPC_AddInfo_Impl_CNr27_Cat3)

PIXIT statements:

- Description of auto calling management:
- selection of the auto calling;
- indication that the call failed and a re-try is attempted;
- indication that a call finally failed;
- number of B-party numbers that can be stored in the list of blacklisted numbers
- Non standard keystroke sequences to be used on the EMMI (in line with 3GPP TS 11.10, clause 36).

Foreseen Final State of the MS

The MS has a valid TMSI. It is "idle updated".

Test Procedure

A MS initiated generic call setup is performed upto and including CIPERING MODE COMPLETE. The SS then releases the establishment with a cause value from Category 3 3GPP TS 02.07 annex A.

The MS will make one futher generic call setup attempt invoked by the auto calling function after a channel release is sent out by the SS.

Step	Direction	Message	Comments
1	MS		"called number" entered
2	MS -> SS	CHANNEL REQUEST	Establishment cause indicates "originating call".
3	SS -> MS	IMMEDIATE ASSIGNMENT	
4	MS -> SS	CM SERVICE REQUEST	Message is contained in SABM.
5	SS -> MS	AUTHENTICATION REQUEST	
6	MS -> SS	AUTHENTICATION RESPONSE	
7	SS -> MS	CIPHERING MODE COMMAND	
8	MS -> SS	CIPHERING MODE COMPLETE	
9	SS		SS starts ciphering.
10	MS -> SS	SETUP	
11	SS -> MS	CIPHERING MODE COMMAND	
12	MS -> SS	CIPHERING MODE COMPLETE	
13	SS		SS stops ciphering
14	SS -> MS	RELEASE COMPLETE	Cause value from category 3 of 3GPP TS 02.07, annex A.
15	SS -> MS	CHANNEL RELEASE	The main signalling link is released
16			The MS is invoking the auto calling function. The time between step 15 and 17 must be minimum 5 sec.
17	MS -> SS	CHANNEL REQUEST	Establishment cause indicates "originating call".
18	SS -> MS	IMMEDIATE ASSIGNMENT	
19	MS -> SS	CM SERVICE REQUEST	Message is contained in SABM.
20	SS -> MS	AUTHENTICATION REQUEST	
21	MS -> SS	AUTHENTICATION RESPONSE	
22	SS -> MS	CIPHERING MODE COMMAND	
23	MS -> SS	CIPHERING MODE COMPLETE	
24	SS		SS starts ciphering.
25	MS -> SS	SETUP	
26	SS -> MS	CIPHERING MODE COMMAND	
27	MS -> SS	CIPHERING MODE COMPLETE	
28	SS		SS stops ciphering
29	SS -> MS	RELEASE COMPLETE	Cause value from category 3 of 3GPP TS 02.07, annex A.
30	SS -> MS	CHANNEL RELEASE	The main signalling link is released
31	MS		Clear the auto calling constraint by manual intervention after a minimum of 2 minutes from step 30.

28.3 Constraining the access to a single number (3GPP TS 02.07 categories 1 and 2)

During this test the SETUP messages shall contain the same B-party number.

No manual intervention shall be performed except to initiate and end the test.

28.3.1 Conformance requirement

The MS must fulfil the requirements for category 1 and 2, see subclause 28.2.1

Reference:

3GPP TS 02.07, annex A.

28.3.2 Test purpose

To ensure the correct behaviour of the MS to 3GPP TS 02.07 Categories 1 and 2.

28.3.3 Method of test

Initial condition.

There shall be no numbers in the list of blacklisted numbers in the MS. The re-try scheme is set to give the shortest possible intervals between re-tries. The number of re-attempts is set to the maximum possible number (N), that is supported by the MS. The autocalling function is invoked for the B-party number to be used during the test.

Specific PICS statements:

- Implementation of cause number 27 of busy autocalling in category 2 (TSPC_AddInfo_Impl_CNr27_Cat2)
- Implementation of cause number 27 of busy autocalling in category 3 (TSPC_AddInfo_Impl_CNr27_Cat3)

PIXIT statements:

- Description of auto calling management:
- selection of the auto calling;
- indication that the call failed and a re-try is attempted;
- indication that a call finally failed;
- number of B-party numbers that can be stored in the list of blacklisted numbers
- Non standard keystroke sequences to be used on the EMMI (in line with 3GPP TS 11.10, clause 36).

Foreseen Final State of the MS

The MS has a valid TMSI. It is "idle updated".

Test Procedure

A, MS initiated, generic call setup is performed up to and including CIPHERING MODE COMPLETE. The SS then releases the establishment with a cause value from category 1 or 2 (3GPP TS 02.07, annex A).

The MS is continuously making new generic call setup attempts invoked by the auto calling function after each CHANNEL RELEASE from the SS.

Step	Direction	Message	Comments
1	MS		"called number" entered
2	MS -> SS	CHANNEL REQUEST	Establishment cause indicates "originating call".
3	SS -> MS	IMMEDIATE ASSIGNMENT	
4	MS -> SS	CM SERVICE REQUEST	Message is contained in SABM.
5	SS -> MS	AUTHENTICATION REQUEST	
6	MS -> SS	AUTHENTICATION RESPONSE	
7	SS -> MS	CIPHERING MODE COMMAND	SS starts deciphering after sending the message.
8	MS -> SS	CIPHERING MODE COMPLETE	
9	SS		SS starts ciphering.
10	MS -> SS	SETUP	
11	SS -> MS	CIPHERING MODE COMMAND	
12	MS -> SS	CIPHERING MODE COMPLETE	
13	SS		SS stops ciphering
14	SS -> MS	RELEASE COMPLETE	Cause value from category 1 or 2 of 3GPP TS 02.07, annex A. This shall be chosen randomly, from both categories. Cause no. 27 shall be excluded if the MS has implemented in category 3 of 3GPP TS 02.07, as declared in PIXIT statement
15	SS -> MS	CHANNEL RELEASE	The main signalling link is released
16			The MS is invoking the auto calling function. 1: At the first re-attempt the time between step 15 and 17 must be minimum 5 sec. 2: At the 2nd, 3rd and 4th re-attempt the time between step 15 and 17 must be minimum 1 min. 3: At the 5th to 10th re-attempt the time between step 15 and 17 must be minimum 3 min.
17	MS -> SS	CHANNEL REQUEST	Establishment cause indicates "originating call".
18	SS -> MS	IMMEDIATE ASSIGNMENT	
19	MS -> SS	CM SERVICE REQUEST	Message is contained in SABM.
20	SS -> MS	AUTHENTICATION REQUEST	
21	MS -> SS	AUTHENTICATION RESPONSE	
22	SS -> MS	CIPHERING MODE COMMAND	SS starts deciphering after sending the message.
23	MS -> SS	CIPHERING MODE COMPLETE	
24	SS		SS starts ciphering.
25	MS -> SS	SETUP	
26	SS -> MS	CIPHERING MODE COMMAND	
27	MS -> SS	CIPHERING MODE COMPLETE	
28	SS		SS stops ciphering
29	SS -> MS	RELEASE COMPLETE	Cause value from category 1 or 2 of 3GPP TS 02.07, annex A. This shall be chosen randomly, from both categories. Cause no. 27 shall be excluded if the MS has implemented in category 3 of 3GPP TS 02.07, as declared in PIXIT statement
30	SS -> MS	CHANNEL RELEASE	The main signalling link is released.
31			The auto calling function shall repeat step 16 to 30 (N-1) times. The MS shall not make more than maximum 10 re-attempts.
32	MS		Clear the auto calling constraint by manual intervention after a minimum of 4 minutes from step 31. Following the final completion of step 31 the MS initiate a call prior to manual intervention.

28.4 Behaviour of the MS when its list of blacklisted numbers is full

The number of B-party numbers that can be stored in the list of blacklisted numbers, as stated in the PIXIT statement (annex 3), is M.

28.4.1 Conformance requirement

The number of B numbers that can be held in the blacklist is at the manufacturers discretion but there shall be at least 8. However, when the blacklist is full the MT shall prohibit further automatic call attempts to any one number until the blacklist is manually cleared at the MT in respect of one or more B numbers.

Reference:

3GPP TS 02.07, annex A.

28.4.2 Test purpose

To ensure the correct behaviour of the MS when its list of blacklisted numbers is full.

28.4.3 Method of test**Initial condition.**

The list of blacklisted numbers, in the MS, shall be full. This may be achieved as described in the procedure in subclause 28.2, applied to M B-party numbers.

Specific PICS statements:

- Implementation of cause number 27 of busy autocalling in category 2 (TSPC_AddInfo_Impl_CNr27_Cat2)
- Implementation of cause number 27 of busy autocalling in category 3 (TSPC_AddInfo_Impl_CNr27_Cat3)

PIXIT statements:

- Description of auto calling management:
- selection of the auto calling;
- indication that the call failed and a re-try is attempted;
- indication that a call finally failed;
- number of B-party numbers that can be stored in the list of blacklisted numbers.
- Non standard keystroke sequences to be used on the EMMI (in line with 3GPP TS 11.10, clause 36).

Foreseen Final State of the MS

The MS has a valid TMSI. It is "idle updated".

Test Procedure

The autocalling function is invoked for a B-party number that is not in the list of blacklisted numbers.

Clear the autocalling constraint by manual intervention after a minimum of 2 minutes.

28.4.4 Test requirements

The MS must not initiate a call.

Step	Direction	Message	Comments
1	MS		"called number" entered
2	MS -> SS	CHANNEL REQUEST	Establishment cause indicates "originating call".
3	SS -> MS	IMMEDIATE ASSIGNMENT	
4	MS -> SS	CM SERVICE REQUEST	Message is contained in SABM.
5	SS -> MS	AUTHENTICATION REQUEST	
6	MS -> SS	AUTHENTICATION RESPONSE	
7	SS -> MS	CIPHERING MODE COMMAND	SS starts deciphering after sending the message.
8	MS -> SS	CIPHERING MODE COMPLETE	
9	SS		SS starts ciphering.
10	MS -> SS	SETUP	
11	SS -> MS	CIPHERING MODE COMMAND	SS stops deciphering after sending the message.
12	MS -> SS	CIPHERING MODE COMPLETE	
13	SS		SS stops ciphering.
14	SS -> MS	RELEASE COMPLETE	Cause value from category 3 of 3GPP TS 02.07, annex A. This shall be chosen randomly. Cause no. 27 shall be excluded if the MS has implemented in category 2 of 3GPP TS 02.07, as declared in PIXIT statement
15	SS -> MS	CHANNEL RELEASE	The main signalling link is released
16			The MS is invoking the auto calling function. The time between step 15 and 17 must be minimum 5 sec.
17	MS -> SS	CHANNEL REQUEST	Establishment cause indicates "originating call".
18	SS -> MS	IMMEDIATE ASSIGNMENT	
19	MS -> SS	CM SERVICE REQUEST	Message is contained in SABM.
20	SS -> MS	AUTHENTICATION REQUEST	
21	MS -> SS	AUTHENTICATION RESPONSE	
22	SS -> MS	CIPHERING MODE COMMAND	SS starts deciphering after sending the message.
23	MS -> SS	CIPHERING MODE COMPLETE	
24	SS		SS starts ciphering.
25	MS -> SS	SETUP	
26	SS -> MS	CIPHERING MODE COMMAND	SS stops deciphering after sending the message.
27	MS -> SS	CIPHERING MODE COMPLETE	
28	SS		SS stops ciphering.
29	SS -> MS	RELEASE COMPLETE	Cause value from category 3 of 3GPP TS 02.07, annex A. This shall be chosen randomly. Cause no. 27 shall be excluded if the MS has implemented in category 2 of 3GPP TS 02.07, as declared in PIXIT statement
30	SS -> MS	CHANNEL RELEASE	The main signalling link is released.
31			The test shall be repeated from steps 1 to 30 using a different B party number each time until the blacklist is full as declared in PIXIT statement. The MS shall not make more than a maximum of 1 re-attempt on each number.
32			The test shall be repeated from steps 1 to 15 using a non-blacklisted B party number
33	SS		The SS verifies that the MS does not initiate an automatic re-attempt for a minimum of 2 minutes from step 32.
34	MS		Clear the auto calling constraint by manual intervention.

29 Testing of bearer services

29.1 General

In 3GPP TS 07.01, subclause 2 the reference configurations for access to the data services of a GSM PLMN are described. For testing purposes only the following classifications are used:

- MT2 configuration (Um- and R-interface available for testing).
- Configurations (only Um-interface available for testing) where it is possible to enable the MS to issue or accept a data call and send data over the Um-interface. An MT1 connected to an ISDN TE belongs to this type.

- For efficient testing it is essential that such configurations have some means to specifically activate every function towards the Um-interface the MS will perform during operation.
- The correctness of the data bits transferred to the Um-interface will not be tested in these configurations. However the correctness of the 3GPP TS 04.21 frames sent by the MS will be tested.

Testing the S-interface for the MT1 configuration is for further study.

For some tests it is of no importance whether the call is MO or MT. However, there might be configurations allowing the call to be established only from one side. In this case the appropriate actions shall be taken to establish the call.

In all other cases the data call shall be set up by the SS (i.e. MT) with an appropriate BC-IE which is supported by the MS.

At the beginning of all tests the MS shall be in the idle updated state.

29.2 Testing of transparent data services

During all the tests the 3GPP TS 04.21 frames received as output of the channel coder in the SS shall be checked for correctness against 3GPP TS 04.21; this means checking that:

- S bits are coded as zeroes unless otherwise specified;
- the E bits have the correct value (for the synchronous services);
- the data bits correctly include the start and stop bits (for the asynchronous services).

29.2.1 Verification of synchronization

29.2.1.1 Definition

-29.2.1.2 Conformance requirement

A Mobile Stations in MT2 configuration has to comply with all requirements whilst for other configurations some of the requirements are not relevant. These restrictions are explicitly indicated in subclause 29.2.1.5.

29.2.1.3 Test purpose

This test verifies the correct synchronization procedure of user data and status information which are mapped on modified ITU-T Recommendation V.110 frames (as per 3GPP TS 04.21).

As V-series interfaces are supported in full duplex mode, it will test the capability to synchronize these frames in the direction from the TAF to the IWF and vice versa.

29.2.1.4 Method of test

The test shall be carried out under ideal radio conditions for all bearer services and user rates in transparent mode that are supported by the MS in case of mobile originated and terminated calls and in-call modification. The setting of Bearer Capability Information Elements in signalling messages sent to the MS by the SS must be supported by the MS for the bearer service(s) to be tested.

NOTE 1: Since "steady state" is implementation dependent, there is no means to define a test "steady state detected". However, the whole testing procedure is limited to 1s. This includes an implicit upper time limit for the MS to detect a steady state. A MS failing this test is highly estimated to never detect a steady state under real radio conditions.

NOTE 2: t_i , as used in the description of the test procedures, are points of time, not timers.

29.2.1.4.1 Procedure for Mobile Originated Calls

- a) The MS is connected to the System Simulator at the Um interface and to the LTE using the appropriate R interface in case of MT2 only.
- b) The MS is configured for data transmission. In the case of MT2 configurations, the LTE shall set the signalling lines of the R interface Ct 105, Ct 108.2 for V-series interface to ON.

- c) A mobile originated call shall be set up.
- d) At the reception of the SETUP message sent by the MS the SS shall send a CONNECT message and starts sending "1/OFF". t1 is at the completion of the CONNECT message.
- e) The reception of "1/OFF" at the SS side (see table 29-1) defines t2. t2 will be reset at the reception of again "1/OFF" after an interruption of continuous "1/OFF" pattern.
- f) The SS checks bits S1, S3, S6 and S8 of the modified ITU-T Recommendation V.110 frames (as described in 3GPP TS 04.21). Let t3 be the time when all four bits change from OFF to ON (i.e. if $t < t3$, (S1,S3,S6,S8) \langle (0,0,0,0) and $t \geq t3$, (S1,S3,S6,S8) = (0,0,0,0)).

29.2.1.4.2 Procedure for Mobile Terminated Calls

- a) The MS is connected to the System Simulator at the Um interface and to the LTE using the appropriate R interface in case of MT2 only.
- b) The MS is configured for data transmission. In the case of MT2 configurations, The LTE shall set the signalling lines of the R interface Ct. 105, Ct 108.2 for V-series interface to ON.
- c) A mobile terminated call shall be set up.
- d) At the reception of CONNECT the SS sends CONNECT ACKNOWLEDGE. t1 is at the completion of the CONNECT ACKNOWLEDGE message.
- e) The reception of "1/OFF" at the SS side (see table 29-1) defines t2. t2 will be reset at the reception of again "1/OFF" after an interruption of continuous "1/OFF" pattern.
- f) The SS checks bits S1, S3, S6 and S8 of the modified ITU-T Recommendation V.110 frames (as described in 3GPP TS 04.21). Let t3 be the time when all four bits change from OFF to ON (i.e. if $t < t3$, (S1,S3,S6,S8) \langle (0,0,0,0) and $t \geq t3$, (S1,S3,S6,S8) = (0,0,0,0)).

29.2.1.4.3 Procedure for In Call Modification

- a) The MS is connected to the System Simulator at the Um interface and to the LTE using the appropriate R interface in case of MT2 only.
- b) The MS is configured for data transmission. In the case of MT2 configurations, the LTE shall set the signalling lines of the R interface Ct. 105, Ct 108.2 for V-series interface to ON.
- c) A speech call shall be established with a SETUP message containing two bearer capabilities for speech and the bearer service to be tested.
- d) The MS shall start the ICM procedure with a bearer capability information element supporting the bearer service to be tested.
- e) At the reception of the MODIFY message sent by the MS the SS shall send a CHANNEL MODE MODIFY message.
- f) At the reception of the CHANNEL MODE MODIFY ACKNOWLEDGE message the SS shall send a MODIFY COMPLETE message. t1 is at the completion of the MODIFY COMPLETE message.
- g) The reception of "1/OFF" (see table 29-1) defines t2. t2 will be reset at the reception of again "1/OFF" after an interruption of continuous "1/OFF" pattern.
- h) The SS checks bits S1, S3, S6 and S8 of the modified ITU-T Recommendation V.110 frames (as described in 3GPP TS 04.21). Let t3 be the time when all four bits change from OFF to ON (i.e. if $t < t3$, (S1,S3,S6,S8) \langle (0,0,0,0) and $t \geq t3$, (S1,S3,S6,S8) = (0,0,0,0)).

29.2.1.5 Test requirements

29.2.1.5.1 Test requirements for Mobile Originated Calls

- 1) After step b) Cts 106, 107, 109 must be in the "OFF" condition, dataline 104 shall be set to "1".
- 2) At t1 + 500 ms Ct 107 must still be in the "OFF" condition.

- 3) Between $t_1 + 500$ ms and $t_1 + 1\ 000$ ms Ct 107 must switch to the "ON" condition. This indicates successful synchronization of TAF towards IFE.
- 4) Between t_2 and t_3 the SS must receive continuous "1/OFF" frames.
- 5) The time between t_2 and t_3 must be more than 450 ms.
- 6) At $t_1 + 1000$ ms the SS must check 3GPP TS 04.21 frames sent by the MS with SA and SB bits (i.e. bits S1, S3, S4, S6, S8 and S9) set to "ON". This indicates successful synchronization of IFE towards TAF. At this point of time the whole synchronization procedure has been completed successfully.

NOTE: If the MS is not MT2, only requirements 4 to 6 apply.

29.2.1.5.2 Test requirements for Mobile Terminated Calls

- 1) After step b) Cts 106, 107, 109 must be in the "OFF" condition, dataline 104 shall be set to "1".
- 2) At $t_1 + 500$ ms Ct 107 must still be in the "OFF" condition.
- 3) Between $t_1 + 500$ ms and $t_1 + 1\ 000$ ms Ct 107 must switch to the "ON" condition. This indicates successful synchronization of TAF towards IFE.
- 4) Between t_2 and t_3 the SS must receive continuous "1/OFF" frames.
- 5) The time between t_2 and t_3 must be more than 450 ms.
- 6) At $t_1 + 1000$ ms the SS must check 3GPP TS 04.21 frames sent by the MS with SA and SB bits (i.e. bits S1, S3, S4, S6, S8 and S9) set to "ON". This indicates successful synchronization of IFE towards TAF. At this point of time the whole synchronization procedure has been completed successfully.

NOTE: If the MS is not MT2, only requirements 4 to 6 apply.

29.2.1.5.3 Test requirements for In Call Modification

- 1) After step b) Cts 106, 107, 109 must be in the "OFF" condition, dataline 104 shall be set to "1".
- 2) At $t_1 + 500$ ms Ct 107 must still be in the "OFF" condition.
- 3) Between $t_1 + 500$ ms and $t_1 + 1\ 000$ ms Ct 107 must switch to the "ON" condition. This indicates successful synchronization of TAF towards IFE.
- 4) Between t_2 and t_3 the SS must receive continuous "1/OFF" frames.
- 5) The time between t_2 and t_3 must be more than 450 ms.
- 6) At $t_1 + 1\ 000$ ms the SS must check 3GPP TS 04.21 frames sent by the MS with SA and SB bits (i.e. bits S1, S3, S4, S6, S8 and S9) set to "ON". This indicates successful synchronization of IFE towards TAF. At this point of time the whole synchronization procedure has been completed successfully.

NOTE: If the MS is not MT2, only requirements 4 to 6 apply.

**Table 29-1: Definition of synchronization pattern "1/OFF"
3GPP TS 04.21 60 bits frame**

Synch-Frame							Data-Frame						
1	1	1	1	1	1	1	D1	D2	D3	D4	D5	D6	S1
1	1	1	1	1	1	1	D7	D8	D9	D10	D11	D12	X
1	1	1	1	1	1	1	D13	D14	D15	D16	D17	D18	S3
1	1	1	1	1	1	1	D19	D20	D21	D22	D23	D24	S4
1	1	1	1	1	1	1	E4	E5	E6	E7	D25	D26	S27
1	1	1	1	1	1	1	D28	D29	D30	S6	D31	D32	S33
1	1	1	1	1	1	1	D34	D35	D36	X	D37	D38	S39
1	1	1	1	1	1	1	D40	D41	D42	S8	D43	D44	S45
1	1	1	1				D46	D47	D48	S9			

**Table 29-1: Definition of synchronization pattern "1/OFF"
3GPP TS 04.21 36 bits frame**

Synch-Frame								Data-Frame							
1	1	1	1	1	1	1	1	D1	D2	D3	S1	D4	D5	D6	X
1	1	1	1	1	1	1	1	D7	D8	D9	S3	D10	D11	D12	S4
1	1	1	1	1	1	1	1	E4	E5	E6	E7	D13	D14	D15	S6
1	1	1	1	1	1	1	1	D16	D17	D18	X	D19	D20	D21	S8
1	1	1	1	1				D22	D23	D24	S9				

29.2.2 Filtering of channel control information for transparent BCs

29.2.2.1 Definition

-29.2.2.2 Conformance requirement

An MS supporting data services shall decode and filter channel control information received over the Um-interface.

1. 3GPP TS 04.21, clause 7;
2. 3GPP TS 07.01, subclause 8.2.2;
3. 3GPP TS 07.02, subclause 3.2.1 (for asynchronous bearer services only);
4. 3GPP TS 07.03, subclauses 4.2.1 and 4.2.2 (for synchronous bearer services only).

29.2.2.3 Test purpose

The purpose of this test is to verify the correct decoding and filtering of channel control information from the 3GPP TS 04.21 frames to the V.24/X.21 interface circuits. The tests apply after synchronization has been completed.

29.2.2.4 Method of test

The Test shall be carried out for all user data rates supported by the MS (see below) and the circuits CT106 (V.24) (interface circuit bit X) and CT109 (V.24) (interface circuit bit SB) and I (X.21) (S-bits). The test shall be carried out only for those frame formats and circuits which are supported by the MS. The test is to be repeated for all circuits.

Let T(ON-OFF) and T(OFF-ON) be the timers to integrate the ON-OFF and the OFF-ON transition respectively for the circuit to be tested as stated in 3GPP TS 07.01, subclause 8.2.2.

Procedure:

- a) A data call shall be set up between the SS and the MS with a combination of BCIEs (see below) supported by the MS. The interface circuit bit(s) in the 3GPP TS 04.21 frame shall be set to OFF. The next step shall be entered 6 s after CT107 has been set to ON by the MS.
- b) The SS shall set the interface circuit bit(s) to continuously ON, wait half of T(OFF-ON) and then set the interface circuit bit(s) again to continuously OFF. The SS shall wait 6 s before entering the next step.
- c) The SS shall set the interface circuit bit(s) to continuously ON, wait twice T(OFF-ON) and then set the interface circuit bit(s) again to continuously OFF. The SS shall wait 6 s before entering the next step.
- d) The SS shall set interface circuit bit(s) to continuously ON and wait 6 s before entering the next step
- e) The SS shall set the interface circuit bit(s) to continuously OFF, wait half of T(ON-OFF) and then set the interface circuit bit(s) again to continuously ON. The SS shall wait 6 s before entering the next step.
- f) The SS shall set the interface circuit bit(s) to continuously OFF, wait twice T(ON-OFF) and then set the interface circuit bit(s) again to continuously ON. The SS shall wait 6 s before entering the next step.

29.2.2.5 Test requirements

- 1) After step a) the interface circuit at the R-interface shall be OFF.
- 2) During step b) the interface circuit at the R-interface shall not change.

- 3) During step c) the interface circuit at the R-interface shall change to ON and then again to OFF.
- 4) After step d) the interface circuit at the R-interface shall be ON.
- 5) During step e) the interface circuit at the R-interface shall not change.
- 6) During step f) the interface circuit at the R-interface shall change to OFF and then again to ON.

29.2.2.6 BCIE

The following combinations shall be considered (ref. 3GPP TS 07.01, annex 2):

- a) User Rate = 9,6 kbit/s;
- b) User Rate = 4,8 kbit/s;
- c) User Rate = 2,4 kbit/s;
- d) User Rate = 1,2 kbit/s;
- e) User Rate = 1 200/75 bit/s (only with asynchronous Bearer Services);
- f) User Rate = 300 bit/s (only with asynchronous Bearer Services).

The remaining parameters of the BCIE and the channel type (FR/HR) shall be set to a value supported by the MS.

29.2.3 Correct Terminal Compatibility Decision

29.2.3.1 Negotiation of Radio Channel Requirement (RCR)

29.2.3.1.1 Test purpose

To verify that the MS ignores the RCR field in a mobile terminating setup and negotiates according to its capabilities and to the service requested. A Dual Rate support MS shall accept the channel rate chosen by the network in the ASSIGNMENT COMMAND message.

29.2.3.1.2 Initial conditions

For an MS with an external interface, the interface shall be setup in such a way that the MS is able to successfully receive the call for the service in question.

Specific PICS statements:

-

PIXIT statements:

- Way to receive the call
- Features which must be activated by MMI before an incoming call can be accepted.

29.2.3.1.3 Test method

- a) The SS transmits a SETUP message containing a BC-IE among those declared as supported by the MS and with the RCR field set to "01".
- b) The SS sends a ASSIGNMENT COMMAND message with a channel type set to "Full Rate" unless the CALL CONFIRM message indicates "dual rate mobile station/full rate preferred". In that case, the channel type is set to "Half Rate".
- c) The call is released and steps a) and b) are repeated with RCR field set to "00".
- d) The call is released and steps a) and b) are repeated with RCR field set to "10".
- e) The call is released and steps a) and b) are repeated with RCR field set to "11".

29.2.3.1.4 Test requirements

- 1) After step a), the MS shall send a CALL CONFIRM message. If present, the BC-IE shall be coded according to 3GPP TS 07.01. If any other parameters than those listed below have different values than those of the BC-IE included in the SETUP, then the test shall be failed:
 - Number of stop bits, number of data bits, parity;
 - Connection Element, Structure, Intermediate rate, User Information Layer 2 Protocol, Modem Type, NIRR;
 - Radio Channel Requirement.
- 2) After step b), the MS shall answer to the ASSIGNMENT COMMAND message with an ASSIGNMENT COMPLETE message.

29.2.3.2 Negotiation of Connection Element (CE)

29.2.3.2.1 Test purpose

To verify that the MS accepts a CE equal to "Both, Transparent Preferred" or "Both Non Transparent Preferred" and indicates its choice in the CALL CONFIRM message.

29.2.3.2.2 Initial condition

For an MS with an external interface, the interface shall be setup in such a way that the MS is able to successfully receive the call for the service in question.

Specific PICS statements:

-

PIXIT statements:

- Way to receive the call
- Features which must be activated by MMI before an incoming call can be accepted.

29.2.3.2.3 Test method

- a) The SS transmits a SETUP message containing a BC-IE among those declared as supported by the MS and with the CE field set to "Both Transparent Preferred". The RCR parameter shall be set to "Full Rate". The UIL2P is not included (i.e. octet 7 is absent). The NIRR is set to "no meaning" (i.e. 0). The IR is set to "16 kbit/s". The modem type is any according to declared capabilities. The user rate is any according to declared capabilities and modem type.
- b) The call is released and step a) is repeated with CE field set to "Both Non Transparent Preferred".

29.2.3.2.4 Test requirements

After step a), the MS shall send a CALL CONFIRM message. The BC-IE shall be present and shall be coded according to 3GPP TS 07.01 and shall correspond to a Bearer Service or Teleservice supported by the MS. The CE shall be set to either "Transparent" or "Non Transparent" If any other parameters than those listed bellow have different values than those of the BC-IE included in the SETUP, then the test shall be failed:

- number of stop bits, number of data bits, parity;
- Connection Element, Structure, Intermediate rate, User Information Layer 2 Protocol, Modem Type, NIRR;
- Radio Channel Requirement.

29.2.3.3 Negotiation of Number of Stop Bits, Number of Data bits, and Parity

29.2.3.3.1 Test purpose

To verify that the MS accepts any value for the parameters Number of Stop Bits, Number of Data bits, and Parity in a mobile terminating Setup and negotiates according to its capabilities and to the service requested.

29.2.3.3.2 Initial condition

For an MS with an external interface, the interface shall be setup in such a way that the MS is able to successfully receive the call for the service in question.

Specific PICS statements:

-

PIXIT statements:

- Way to receive the call
- Features which must be activated by MMI before an incoming call can be accepted.

29.2.3.3.3 Test method

- a) The SS transmits a SETUP message containing a BC-IE among those declared as supported by the MS and corresponding to an asynchronous Bearer Service, and with the Number of Stop Bits (NSB) field set to "1 bit", the Number of Data Bits (NDB) field set to "8 bits", and the Parity field set to "none".
- b) The call is released and step a) is repeated with the Number of Stop Bits (NSB) field set to "2 bit", the Number of Data Bits (NDB) field set to "7 bits", and the Parity field set to "odd".

29.2.3.3.4 Test requirements

After steps a) and b), the MS shall send a CALL CONFIRMED message. If present, the BC-IE shall be coded according to 3GPP TS 07.01 and shall correspond to a Bearer Service supported by the MS. If any other parameters than those listed below have different values than those of the BC-IE included in the SETUP, then the test shall be failed:

- Number of stop bits, number of data bits, parity;
- Connection Element, Structure, Intermediate rate, User Information Layer 2 Protocol, Modem Type, NIRR;
- Radio Channel Requirement.

29.2.3.4 Negotiation of Modem Type

29.2.3.4.1 Test purpose

To verify that the MS accepts the value "autobauding type 1" for the parameter Modem Type in a mobile terminating Setup and negotiates according to its capabilities and to the service requested.

NOTE: It is not clear if the MS should also accept any possible value for the Modem Type field.

29.2.3.4.2 Initial condition

For an MS with an external interface, the interface shall be setup in such a way that the MS is able to successfully receive the call for the service in question.

Specific PICS statements:

-

PIXIT statements:

- Way to receive the call
- Features which must be activated by MMI before an incoming call can be accepted.

29.2.3.4.3 Test method

- a) The SS transmits a SETUP message containing a BC-IE among those declared as supported by the MS and corresponding to a non transparent Bearer Service (the Connection Element field is coded "Non transparent"), and with the Modem Type field set to "autobauding type 1".

- b) The call is released and step a) is repeated with the same BC in the SETUP message, but with the Connection Element set to "both, non-transparent preferred".

29.2.3.4.4 Test requirements

After steps a) and b), the MS shall send a CALL CONFIRMED message. If present, the BC-IE shall be coded according to 3GPP TS 07.01 and shall correspond to a Bearer Service or Teleservice supported by the MS. If any other parameters than those listed below have different values than those of the BC-IE included in the SETUP, then the test shall be failed:

- Number of stop bits, number of data bits, parity;
- Connection Element, Structure, Intermediate rate, User Information Layer 2 Protocol, Modem Type, NIRR;
- Radio Channel Requirement.

29.2.3.5 Negotiation of Intermediate Rate

29.2.3.5.1 Test purpose

To verify that the MS responds correctly to a request for a negotiation of the Intermediate Rate parameter in a mobile terminating Setup and negotiates according to its capabilities and to the service requested.

NOTE: The MS may support these services with a 6 Kbit/s or (non exclusive) 12 Kbit/s radio interface rate.

29.2.3.5.2 Initial condition

For an MS with an external interface, the interface shall be setup in such a way that the MS is able to successfully receive the call for the service in question.

Specific PICS statements:

-

PIXIT statements:

- Way to receive the call
- Features which must be activated by MMI before an incoming call can be accepted.

29.2.3.5.3 Test method

- a) The SS transmits a SETUP message containing a BC-IE among those declared as supported by the MS and corresponding to a non transparent Bearer Service (the Connection Element field is coded "Non transparent") with the user rate lower to or equal 4,8 kbit/s, and with the NIRR field set to "No meaning". The RCR field is set to "full rate", and the Intermediate Rate field is set to "16 kbit/s".
- b) The call is released and step a) is repeated with the same BC in the SETUP message, but with the Connection Element set to "both, non-transparent preferred".
- c) The call is released and steps a) and b) are repeated with the NIRR field of the SETUP message set to "6 kbit/s".

29.2.3.5.4 Test requirements

- 1) After steps a), b) and c), the MS shall send a CALL CONFIRMED message. If present, the BC-IE shall be coded according to 3GPP TS 07.01 and shall correspond to a Bearer Service or Teleservice supported by the MS. If any other parameters than those listed below have different values than those of the BC-IE included in the SETUP, then the test shall be failed:
 - Number of stop bits, number of data bits, parity;
 - Connection Element, Structure, Intermediate rate, User Information Layer 2 Protocol, Modem Type, NIRR;
 - Radio Channel Requirement.
- 2) If the BC-IE is present in the CALL CONFIRMED message after step c) and if the Connection Element field contains the value "non transparent", the Intermediate Rate field shall indicate:

- 8 kbit/s if the NIRR field is set to "6 kbit/s";
- 16 kbit/s if the NIRR field is set to "no meaning".

29.2.3.6 Negotiation of User Information Layer 2 Protocol

29.2.3.6.1 Test purpose

To verify that the MS accepts any value (including the absence of) the UIL2P parameter in a mobile terminating Setup and negotiates according to its capabilities and to the service requested.

29.2.3.6.2 Initial condition

For an MS with an external interface, the interface shall be setup in such a way that the MS is able to successfully receive the call for the service in question.

Specific PICS statements:

-

PIXIT statements:

- Way to receive the call
- Features which must be activated by MMI before an incoming call can be accepted.

29.2.3.6.3 Test method

- a) The SS transmits a SETUP message containing a BC-IE among those declared as supported by the MS and corresponding to a non transparent Bearer Service (the Connection Element field is coded "Non transparent") and with no UIL2P parameter (i.e. octet 7 of the BC IE is absent).
- b) The call is released and step a) is repeated with the same BC in the SETUP message, but with the value "ISO6429, codeset 0 (DC1/DC3)" in the UIL2P parameter.
- c) The call is released and step b) is repeated with the same BC in the SETUP message, but with the value "COPnoFLCt" in the UIL2P parameter.
- d) The call is released and steps a), b) and c) are repeated with the same BC in the SETUP message, but with the Connection Element set to "both, non-transparent preferred".

29.2.3.6.4 Test requirements

- 1) After steps a), b) and c), the MS shall send a CALL CONFIRMED message. If present, the BC-IE shall be coded according to 3GPP TS 07.01 and shall correspond to a Bearer Service or Teleservice supported by the MS. If any other parameters than those listed below have different values than those of the BC-IE included in the SETUP, then the test shall be failed:
 - Number of stop bits, number of data bits, parity;
 - Connection Element, Structure, Intermediate rate, User Information Layer 2 Protocol, Modem Type, NIRR;
 - Radio Channel Requirement.
- 2) If the BC-IE is present in the CALL CONFIRMED message, and if the Connection Element is set to "transparent", octet 7 (containing the UIL2P parameter) shall be absent.

29.2.3.7 Negotiation between TS 61 and TS 62: Mobile Originated call

29.2.3.7.1 Test purpose

To verify that the MS accepts a negotiation from TS 61 to TS 62.

29.2.3.7.2 Initial condition

For an MS with an external interface, the interface shall be setup in such a way that the MS is able to successfully set up a call for TS 61.

Specific PICS statements:

-

PIXIT statements:

- Way to set up the call
- Features which must be activated by MMI before an outgoing call can be set up.

29.2.3.7.3 Test method

- a) The MS is made to set up a call for TS 61. If the MS supports it, the first phase of the call is speech.
- b) The SS responds to the SETUP message with a CALL PROCEEDING message containing a BC-IE coded according to 3GPP TS 07.01 and corresponding to TS 62.
- c) The SS sends an ALERTING message followed by a CONNECT message.
- d) If the MS supports it, steps a), b) and c) are repeated with a call setup for TS 61 with the first phase of the call being fax.

29.2.3.7.4 Test requirements

- 1) After step b), the MS shall accept the call (i.e. it shall not reject the call with a DISCONNECT message).
- 2) After step c), the MS shall answer with a CONNECT ACKNOWLEDGE message.

29.2.3.8 Negotiation between TS 61 and TS 62: Mobile Terminated call

29.2.3.8.1 Test purpose

To verify that an MS that does not support TS 61 accepts a Mobile Terminated call setup request for TS 61 and negotiates the demand to TS 62.

29.2.3.8.2 Initial condition

For an MS with an external interface, the interface shall be setup in such a way that the MS is able to successfully receive the call for the service in question.

Specific PICS statements:

-

PIXIT statements:

- Way to receive the call
- Features which must be activated by MMI before an incoming call can be accepted.

29.2.3.8.3 Test method

- a) The SS transmits a SETUP message containing two BC-IEs: the first BC shall indicate speech, the second BC shall indicate fax group 3.
- b) The call is released, and the SS transmits a SETUP message containing two BC-IEs: the first BC shall indicate fax group 3, the second BC shall indicate speech.

29.2.3.8.4 Test requirements

After steps a) and b), the MS shall send a CALL CONFIRMED message with one and only one BC-IE. The BC-IE shall be coded according to 3GPP TS 07.01 and shall correspond to TS 62.

29.2.4 Data Rate Adaptation for Synchronous Transparent Bearer Capabilities

29.2.4.1 Definition

-29.2.4.2 Conformance requirement

An MS supporting synchronous transparent bearer capabilities shall perform data rate adaptation and support the frames at the Um-interface according to the following specifications:

1. 3GPP TS 04.21, clauses 5 and 7.

29.2.4.3 Test purpose

The purpose of these tests is to verify:

- that the format and the data bits of the 3GPP TS 04.21 frames sent by the MS are consistent with the data input and data rate at the R-interface; and
- that the data bits output by the MS at the R-interface are consistent with the received 3GPP TS 04.21 frames.

29.2.4.4 Method of test

The Test shall be carried out for all possible user data rates which are supported by the MS (see below). In case of an MT2 configuration, the interface circuits CT105 and CT108 shall be set to the ON condition from the start.

Procedure:

- a) A data call shall be set up between the SS and the MS with a BCIE (see below) supported by the MS. The next step shall be entered immediately after TCH synchronization has been completed at the SS side.
- b) The interface circuit bit(s) in the 3GPP TS 04.21 frame shall be set to ON and the SS shall start to transmit pseudo random data bits in the 3GPP TS 04.21 frames over the Um-interface to the MS.
- c) MT2 configuration: The SS shall input pseudo random data over the R-interface of the MS.
MT0 configuration: the transmission of data from the MS over the Um-interface shall be stimulated (if it does not start automatically).
- d) Approximately 5 s after the data have been received by the SS over the Um-interface the test shall be stopped.

29.2.4.5 Test requirements

- 1) During the test no 3GPP TS 04.21 frame with incorrect format (i.e. format not compliant to 3GPP TS 04.21 (see conformance requirement) or not corresponding to the user data rate currently under test) shall have been received by the SS.
- 2) Only MT2 configuration: the user data stream input to the R-interface shall match bit-exactly the user data stream sent to the SS over the Um-interface and the user data stream output from the R-interface shall match bit-exactly the user data stream sent by the SS over the Um-interface.

29.2.4.6 BCIE

The following combinations shall be considered (ref. 3GPP TS 07.01, annex 2):

- a) User Rate = 9,6 kbit/s;
- b) User Rate = 4,8 kbit/s;
- c) User Rate = 2,4 kbit/s;
- d) User Rate = 1,2 kbit/s.

The remaining parameters of the BCIE and the channel type (FR/HR) shall be set to a value supported by the MS.

29.2.5 Network Independent Clocking

For further study.

29.2.6 Asynchronous Transparent Bearer Capabilities

29.2.6.1 Data Rate Adaptation

29.2.6.1.1 Definition

-29.2.6.1.2 Conformance requirement

An MS supporting asynchronous transparent bearer capabilities shall perform data rate adaptation and support the frames at the Um-interface according to the following specifications:

1. 3GPP TS 04.21, subclauses 4.1 and 4.4, clauses 5 and 7.

29.2.6.1.3 Test purpose

The purpose of these tests is to verify the conversion between an asynchronous data stream at the R-interface and the 3GPP TS 04.21 frames at the Um-interface.

29.2.6.1.4 Method of test

The Test shall be carried out for all possible user data rates which are supported by the MS in asynchronous mode (see below).

Procedure:

- a) A data call shall be set up between the SS and the MS with a BCIE (see below) supported by the MS. The next step shall be entered immediately after TCH synchronization has been completed at the SS side.
- b) The interface circuit bit(s) in the 3GPP TS 04.21 frame shall be set to ON and the SS shall start to transmit pseudo random characters as described below to the MS.
- c) MT2 configuration: The SS shall input pseudo random characters as described below over the R-interface to the MS.

MT0 configuration: the transmission of data from the MS over the Um-interface shall be stimulated (if it does not start automatically).

- d) Approximately 5 s after the data have been received by the SS over the Um-interface the test shall be stopped.

29.2.6.1.5 Test requirements

- 1) During the test no 3GPP TS 04.21 frame with incorrect format (i.e. format not compliant to 3GPP TS 04.21 (see conformance requirement) or not corresponding to the user data rate currently under test) shall have been received by the SS.
- 2) MT2 configuration only: the user data stream input to the R-interface shall match character by character the user data stream sent to the SS over the Um-interface and the user data streams output from the R-interface shall match character by character the user data stream sent by the SS over the Um-interface.

29.2.6.1.6 Generation of the asynchronous pseudo random characters

Downlink direction:

The 3GPP TS 04.21 frames shall contain a bit stream which consists of repeating:

- a character which is generated pseudo randomly every time;
- n stop bits, where n is drawn pseudo randomly from the interval 1..15 every time.

Uplink direction:

The data stream at the R-interface consists of repeating:

- a character which is generated pseudo randomly every time;
- 1 stop bit;
- $1,13 \pm 1$ % bit frames (i.e. 1/nominal data rate) of stop polarity.

29.2.6.1.7 BCIE

Same as subclause 29.2.3.

The Number of Data Bits per character (excl. parity) shall be 8. No parity bit shall be used. The Number of Stop Bits shall be 1. If the MS does not support these values different ones shall be chosen.

The remaining parameters of the BCIE shall and the channel type (FR/HR) be set to a value supported by the MS.

29.2.6.2 Passage of the Break Signal

29.2.6.2.1 Definition

-29.2.6.2.2 Conformance requirement

An MS supporting asynchronous transparent bearer capabilities shall perform passage of the break signal in uplink and downlink direction according to:

1. 3GPP TS 04.21, subclauses 4.1, 4.2 and 4.4, clauses 5 and 7.

29.2.6.2.3 Test purpose

The purpose of these tests is to verify the ability of the MS to transfer a Break Signal to the R-interface and vice versa.

29.2.6.2.4 Method of test

The Test shall be carried out for all possible user data rates which are supported by the MS in asynchronous mode (see below).

Procedure:

- a) A data call shall be set up between the SS and the MS with a BCIE (see below) supported by the MS. The next step shall be entered immediately after TCH synchronization has been completed at the SS side.
- b) The interface circuit bit(s) in the 3GPP TS 04.21 frame shall be set to ON.
- c) The SS shall send pseudo random characters with start and stop bit(s) (as selected by the BCIE) in the 3GPP TS 04.21 frames to the MS for approximately 5 s. Then it shall send the following bit sequence in the 3GPP TS 04.21 frames:
 - $2M+3$ bits of start polarity;
 - $2M$ bits of stop polarity.
- d) The SS shall send pseudo random characters with start and stop bit(s) (as selected by the BCIE) in the 3GPP TS 04.21 frames to the MS for approximately 2 s. Then it shall send the following bit sequence in the 3GPP TS 04.21 frames:
 - for 1 s bits of start polarity;
 - $2M$ bits of stop polarity,

where M is as defined in 3GPP TS 04.21, subclause 4.2, and then again pseudo random characters as above.

- e) The SS shall input pseudo random characters with start and stop bit(s) (as selected by the BCIE) over the R-interface to the MS for approximately 2 s. Then it shall input the following bit sequence to the R-interface:
 - M bits of start polarity;
 - $2M$ bits of stop polarity.

f) The SS shall input pseudo random characters with start and stop bit(s) (as selected by the BCIE) over the R-interface to the MS for approximately 2 s. Then it shall input the following bit sequence to the R-interface:

- for 1 s bits of start polarity;
- 2M bits of stop polarity,

where M is as defined in 3GPP TS 04.21, subclause 4.2, and then again pseudo random characters as above.

g) the test shall be stopped 2 s later.

29.2.6.2.5 Test requirements

- 1) During the test no 3GPP TS 04.21 frame with incorrect format (i.e. format not compliant to 3GPP TS 04.21 (see conformance requirement) or not corresponding to the user data rate currently under test) shall have been received by the SS.
- 2) The user data stream sent over the Um-interface by the SS shall match character by character the user data stream output at the R-interface.
- 3) The two Break Signals shall be detectable at the R-interface between the same characters as having been sent.
- 4) The user data stream received over the Um-interface by the SS shall match character by character the user data stream input at the R-interface.
- 5) The two Break Signals shall be detectable at the Um-interface between the same characters as having been input.

29.2.6.2.6 BCIE

Same as subclause 29.2.2.6.

29.2.6.3 Overspeed/Underspeed Handling (Local Terminal)

29.2.6.3.1 Definition

-29.2.6.3.2 Conformance requirement

An MS supporting asynchronous transparent bearer capabilities shall handle overspeed and underspeed of the local terminal according to:

1. 3GPP TS 04.21, subclauses 4.1, 4.3 and 4.4, clauses 5 and 7.

29.2.6.3.3 Test purpose

The purpose of these tests is to verify the ability of the MS to deal with plesiosynchronous bit clocks in the MS and the TE in case of asynchronous Bearer Capabilities.

29.2.6.3.4 Method of test

The Test shall be carried out for all possible user data rates supported by the MS in asynchronous mode (see below).

Procedure:

- a) A data call shall be set up between the SS and the MS with a BCIE (see below) supported by the MS. The next step shall be entered immediately after CT107 has been set to ON by the MS.
- b) The interface circuit bit(s) in the 3GPP TS 04.21 frame shall be set to ON.
- c) The SS shall input continuously pseudo random characters with a bit clock of:
 - nominal user data rate +2,5 % bit/s in case of less than 600 bit/s user data rate;
 - nominal user data rate +1 % in the other cases.

(ref. 3GPP TS 04.21, subclause 4.3) to the R-interface of the MS for approximately 5 s.

- d) The SS shall input continuously pseudo random characters with a bit clock of nominal user rate -2,5 % (ref. ITU-T Recommendation V.14, clause 3) to the R-interface of the MS for approximately 5 s.
- e) The test shall be stopped.

29.2.6.3.5 Test requirements

- 1) During the test no 3GPP TS 04.21 frame with incorrect format (i.e. format not compliant to 3GPP TS 04.21 (see conformance requirement) or not corresponding to the user data rate currently under test) shall have been received by the SS.
- 2) The user data stream input to the R-interface shall match character by character the user data stream sent to the SS over the Um-interface.

29.2.6.3.6 BCIE

Same as subclause 29.2.2.6.

The Number of Data Bits per character (excl. parity) shall be 8. No parity bit shall be used. The Number of Stop Bits shall be 1. If the MS does not support these values different ones shall be chosen.

The remaining parameters of the BCIE and the channel type (FR/HR) shall be set to a value supported by the MS.

29.2.6.4 Overspeed/Underspeed Handling (Remote Terminal)

29.2.6.4.1 Definition

-29.2.6.4.2 Conformance requirement

An MS supporting asynchronous transparent bearer capabilities shall handle overspeed and underspeed of the remote terminal (which shows in the structure of the 3GPP TS 04.21 frames received over the Um-interface) according to:

- 1. 3GPP TS 04.21, subclauses 4.1, 4.3 and 4.4, clauses 5 and 7.

29.2.6.4.3 Test purpose

The purpose of these tests is to verify the ability of the MS to deal with plesiosynchronous bit clocks in the MS and the remote Terminal in case of asynchronous Bearer Capabilities.

The case of underspeed is covered by subclause 29.6.1. The case of overspeed shall be tested as follows.

29.2.6.4.4 Method of test

The Test shall be carried out for all possible user data rates supported by the MS in asynchronous mode (see below).

Procedure:

- a) A data call shall be set up between the SS and the MS with a BCIE (see below) supported by the MS. The next step shall be entered immediately after CT107 has been set to on by the MS.
- b) The interface circuit bit(s) in the 3GPP TS 04.21 frame shall be set to ON.
- c) The SS shall start sending pseudo random characters in the 3GPP TS 04.21 frames over the Um-interface with minimal number of stop bits between the characters and where one stop bit is omitted every 8th character.
- e) The test shall be stopped 5 s later.

29.2.6.4.5 Test requirements

- 1) During the test no 3GPP TS 04.21 frame with incorrect format (i.e. format not compliant to 3GPP TS 04.21 (see conformance requirement) or not corresponding to the user data rate currently under test) shall have been received by the SS.
- 2) The user data stream sent by the SS over the Um-interface shall match character by character the user data stream sent by the MS over the R-interface.

29.2.6.4.6 BCIE

Same as subclause 29.2.6.3.6.

29.2.7 Interchange circuit mapping for transparent bearer capabilities

29.2.7.1 Definition

This test cannot be applied fully to MSs which support e.g.:

- CT108/2 for releasing the call (e.g. support of ITU-T Recommendation V.25bis) and/or
- similar use of the circuit C for ITU-T Recommendation X.21.

Therefore the test shall be applied only for those interchange circuits which do not influence Layer 3 signalling.

In case of circuit C the X.21-byte timing circuit B shall not be used.

29.2.7.2 Conformance requirement

- 1) An MS supporting transparent bearer capabilities with a V-series R-interface shall map the interchange circuits CT105 and CT108/2 to the 3GPP TS 04.21 frames sent over the Um-interface according to:

1.1 3GPP TS 04.21, subclauses 4.1 and 4.4, clauses 5 and 7.

1.2 3GPP TS 07.02, subclause 3.2.1.

- 2) An MS supporting transparent bearer capabilities with an X-series R-interface shall map the interchange circuit C to the 3GPP TS 04.21 frames sent over the Um-interface according to:

2.1 3GPP TS 04.21, subclauses 4.1 and 4.4, clauses 5 and 7.

2.2 3GPP TS 07.03, subclauses 4.2.1 and 4.2.2.

29.2.7.3 Test purpose

The purpose of these tests is to verify the ability of the MS to correctly convey changes of the interface circuits at the R-interface to the 3GPP TS 04.21 frame sent over the Um-interface in case of Transparent Bearer Capabilities.

29.2.7.4 Method of test

Specific PICS statements:

-

PIXIT statements:

- Interchange Circuits which influence Layer 3 signalling

The Test shall be carried out for all user data rates supported by the MS (see below) and the circuits CT105 and CT108/2 (ITU-T Recommendation V.24) and C (ITU-T Recommendation X.21). The test shall be carried out only for those frame formats and circuits which are supported by the MS (exceptions see above).

Procedure:

- a) A data call shall be set up between the SS and the MS with a BCIE (see below) supported by the MS. The next step shall be entered immediately after CT107 has been set to ON by the MS.
- b) The interface circuit bit(s) in the 3GPP TS 04.21 frame shall be set to ON and the SS shall input continuously pseudo random data to the R-interface during the following steps. The SS shall wait for approximately 1 s before entering the next step.
- c) The SS shall set the interchange circuit at the R-interface to OFF and wait for 2 s.
- d) The SS shall again set the interchange circuit at the R-interface to ON.
- e) After further 2 s the test shall be stopped.

29.2.7.5 Test requirements

- 1) During the test no 3GPP TS 04.21 frame with incorrect format (i.e. format not compliant to 3GPP TS 04.21 (see conformance requirement) or not corresponding to the user data rate currently under test) shall have been received by the SS.
- 2) The change of the interchange circuit signal level shall be indicated in the 3GPP TS 04.21 frames as required by 3GPP TS 04.21 and ITU-T Recommendation V.110 (i.e. OFF state shall start and end in the correct 3GPP TS 04.21 frame).

29.2.7.6 BCIE

Same as subclause 29.2.2.5.

29.3 Testing of non transparent data services (RLP tests)

SS sends NULL (C/R=0, P/F=0) frames when it has nothing else to send in ADM mode.

SS does not use DTX if not explicitly indicated in the test and sends supervisory RR (C/R=0, P/F=0) frames when it has nothing else to send in ABM mode. N(R) is equal to N(R) of the previous frame. For the first frame N(R)=0.

The information field of the Supervisory frames sent by the SS is fully coded with "1".

The tolerance on timers or delays is $\pm 10\%$.

The SS will check FSI (Frame Start Identifier) alignment in all received RLP frames. The information field of the Supervisory frames sent by the MS is never verified.

The SABM-UA exchange for RLP link establishment is initiated by the MS.

Immediately upon RLP link connection, the MS may send an I+S frame containing updated status bits SA, SB and X and the SS must send it.

29.3.1 Initialization

29.3.1.1 Normal initialization done by the MS

29.3.1.1.1 Test purpose

To test the normal establishment of multiple frame operation between the SS and the MS.

This test is performed twice for testing MO and MT data calls:

29.3.1.1.2 Method of test

Initial Conditions

System Simulator:

The SS is configured to use default RLP parameters.

Mobile Station:

The MS is configured to use default RLP parameters.

MO data call:

The MS is made to establish a MO non transparent data call, so that the initial conditions are that the MS is in call state U10 ("Call Active") after having sent a CONNECT ACKNOWLEDGE message.

MT data call:

The SS establishes a MT non transparent data call, so that the initial conditions are that the MS is in call state U10 ("Call Active") after having received a CONNECT ACKNOWLEDGE message from the SS.

Case a: No negotiation will be initiated by the MS.

Case b: The MS initiates negotiation of RLP default parameters.

NOTE: The MS is allowed to initiate the negotiation of the RLP default parameters, within allowed ranges, defined in 3GPP TS 04.22. The MS shall do this in the ADM, after having sent a CONNECT ACKNOWLEDGE message (MO-case) or after having received a CONNECT ACKNOWLEDGE message from the SS (MT-case). The SS shall accept and use the new RLP parameters till the end of the test.

Procedure

The MS shall send a SABM frame.

The SS responds with a correct UA frame (within T1).

The SS waits for 2*T1 after the UA to ensure the SABM frame is not repeated. This confirms that the UA has been received.

The MS shall be in ABM mode. After optional status bits exchange between the MS and the SS, this is verified by sending an I + S frame and waiting for the acknowledgement from the MS.

The MS is returned to the idle state by clearing the call.

Expected sequence

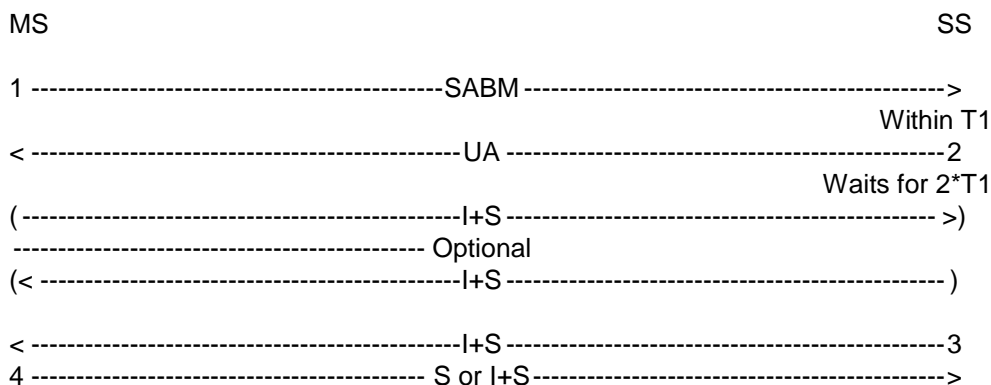

The frames from the SS will be:

2: One UA frame containing:

R=0, F=1.

3: One correct I+S frame in a RR frame with N(S)=0.

29.3.1.1.3 Test requirements

The frames from the MS shall be:

1: One SABM frame containing:

C=1, P=1.

The SABM shall not be repeated.

4: One S or I+S frame with N(R)=1 acknowledging the I+S frame.

29.3.1.2 Initialization failure

29.3.1.2.1 Loss of UA frame

29.3.1.2.1.1 Test purpose

To test the MS response to the loss of an UA frame during initialization.

29.3.1.2.1.2 Method of test

Initial Conditions

System Simulator:

The SS is configured to use default RLP parameters.

Mobile Station:

The MS is configured to use default RLP parameters. The MS is made to establish a MO non transparent data call so that the initial conditions are that the MS is in call state U10 ("Call Active") after having sent a CONNECT ACKNOWLEDGE message.

Case a: No negotiation will be initiated by the MS.

Case b: The MS initiates negotiation of RLP default parameters.

NOTE: The MS is allowed to initiate the negotiation of the RLP default parameters, within allowed ranges, defined in 3GPP TS 04.22. The MS shall do this in the ADM, after having sent a CONNECT ACKNOWLEDGE message (MO-case) or after having received a CONNECT ACKNOWLEDGE message from the SS (MT-case). The SS shall accept and use the new RLP parameters till the end of the test.

Procedure

The MS shall send an SABM frame.

The SS ignores the first SABM frame from the MS.

The MS shall wait for time-out of timer T1 and then send a second SABM frame.

The SS responds to the second SABM frame with an UA frame (within T1).

The MS enters in ABM mode. After optional status bits exchange between the MS and the SS, this is verified by sending an I+S frame and waiting for the acknowledgement from the MS.

The MS is returned to the idle state by clearing the call.

Expected sequence

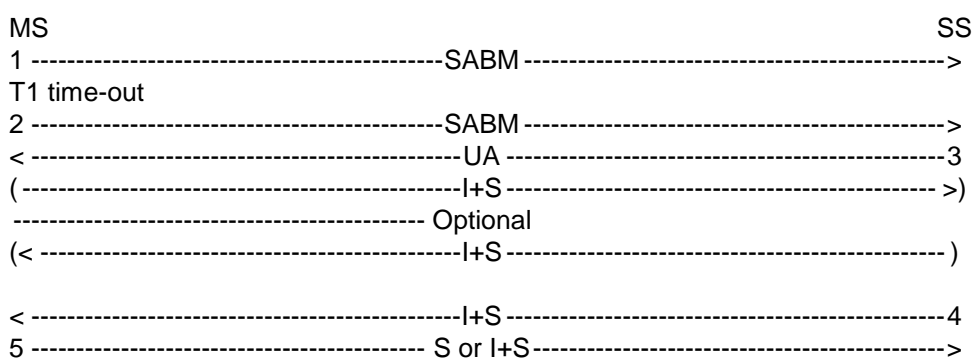

The frames from the SS will be:

3: One UA frame containing:

R=0, F=1.

within T1 after the second SABM.

4: One correct I+S frame in a RR frame with N(S)=0.

29.3.1.2.1.3 Test requirements

The frames from the MS shall be:

1, 2: One SABM frame containing:

C=1, P=1.

The second SABM frame shall follow the first SABM frame after time-out of timer T1.

5: One S or I+S frame with N(R)=1 acknowledging the I+S frame.

29.3.1.2.2 Total loss of UA frame

29.3.1.2.2.1 Test purpose

To test the MS response to a total loss of UA frame during initialization.

29.3.1.2.2.2 Method of test

Initial Conditions

System Simulator:

The SS is configured to use default RLP parameters.

Mobile Station:

The MS is configured to use default RLP parameters.

The MS is made to establish a MO non transparent data call so that the initial conditions are that the MS is in call state U10 ("Call Active") after having sent a CONNECT ACKNOWLEDGE message.

Case a: No negotiation will be initiated by the MS.

Case b: The MS initiates negotiation of RLP default parameters.

NOTE: The MS is allowed to initiate the negotiation of the RLP default parameters, within allowed ranges, defined in 3GPP TS 04.22. The MS shall do this in the ADM, after having sent a CONNECT ACKNOWLEDGE message (MO-case) or after having received a CONNECT ACKNOWLEDGE message from the SS (MT-case). The SS shall accept and use the new RLP parameters till the end of the test.

Procedure

The MS shall send an SABM frame.

The SS ignores the SABM frame from the MS.

The MS shall wait for time-out of timer T1 and then send a new SABM frame.

The SS ignores the SABM frame sent by the MS. These 2 last steps are repeated N2 times.

The SS waits for $2 * T1$ to ensure the SABM frame is not repeated.

The MS shall not enter in ABM mode. This is verified by sending an I+S frame. The MS shall ignore this frame.

The MS is returned to the idle state by clearing the call.

Expected sequence:

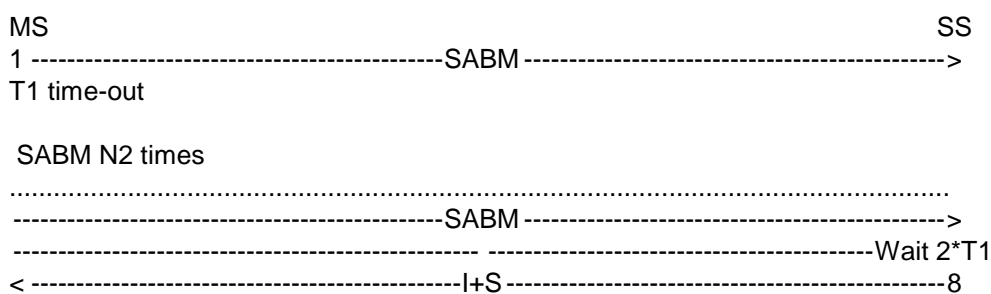

The frames from the SS will be:

8: One correct I+S frame in a RR frame containing with $N(S)=0$.

29.3.1.2.2.3 Test requirements:

The frames from the MS shall be:

1, ..., N2: One SABM frame containing:

$C=1, P=1$.

An SABM frame follows the previous one after time-out of timer T1.

29.3.2 Data transfer

29.3.2.1 Default conditions

The initial conditions are that the MS is in call state U10 ("Call Active") and in RLP ABM mode.

During the synchronization of the traffic channel, the MS and the SS have transmitted I+S frames. Unless, other indication in the test, each test of this subclause will begin in the following conditions:

- the MS has previously sent I+S frames numbered $N(S)=0, \dots, NMS-1 \text{ mod}(62)$ and has previously sent a frame containing $N(R) = NSS \text{ mod}(62)$;
- the SS has previously sent I+S frames numbered $N(S)=0, \dots, NSS-1 \text{ mod}(62)$ and has previously sent a frame containing $N(R) = NMS \text{ mod}(62)$.

The first I+S frame that an MS will send in a test will be numbered $N(S)= NMS$ and the first I+S frame that the SS will send will be numbered NSS.

29.3.2.2 MS sends I+S frames

29.3.2.2.1 N(S) sequence number

29.3.2.2.1.1 Test purpose

To test the correct handling of the N(S) sequence number.

29.3.2.2.1.2 Method of test

Initial Conditions

System Simulator:

The SS is configured to use default RLP parameters.

Mobile Station:

The MS is configured to use RLP default parameters except the window size from MS to IWF (SS), called KMI.

A non transparent data call will be established, so that the MS is in call state U10 ("Call Active").

Since some RLP parameters are different from the default parameters, a negotiation procedure will be initiated by the MS after the CONNECKT ACKNOWLEDGE message. The MS may negotiate the RLP default parameters within allowed ranges, defined in 3GPP TS 04.22, except the window size from MS to IWF (SS), called KMI, which has to be a non default value.

The SS shall accept and use the new RLP parameters till the end of the test.

After the negotiation procedure the ABM will be entered. This test is performed twice with 2 different values of KMI, randomly chosen.

Procedure

After optional status bits exchange between the MS and the SS, the MS is made to send continuously I+S frames (more than 2*64 frames). The MS shall send I+S frames with N(S) incremented by 1 mod(62) in each frame.

The SS acknowledges the I+S frames in RR frame in sequence.

The MS is returned to the idle state by clearing the call.

Expected sequence

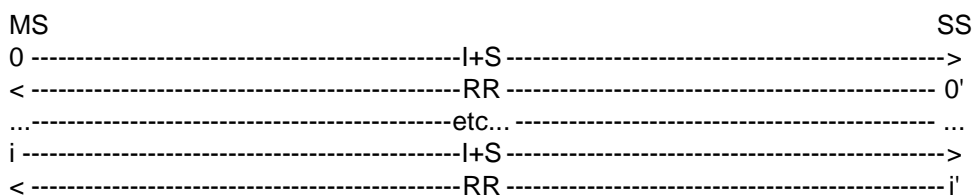

The frames from the SS will be:

0',...,i': One supervisory RR frame containing:

$$N(R) = NMS+1, \dots, NMS+i+1 \text{ mod}(62).$$

29.3.2.2.1.3 Test requirements

The frames from the MS shall be:

0',...,i: One I+S frame containing:

$$N(S) = NMS, \dots, NMS+i \text{ mod}(62)$$

29.3.2.2.2 Transmission window

29.3.2.2.2.1 Test purpose

To test the correct handling of the transmission window.

29.3.2.2.2.2 Method of test

Initial Conditions

System Simulator:

The SS is configured to use default RLP parameters.

Mobile Station:

The MS is configured to use RLP default parameters except the window size from MS to IWF (SS), called KMI.

A non transparent data call will be established, so that the MS is in call state U10 ("Call Active").

Since some RLP parameters are different from the default parameters, a negotiation procedure will be initiated by the MS after the CONNECKT ACKNOWLEDGE message. The MS may negotiate the RLP default parameters within allowed ranges, defined in 3GPP TS 04.22, except the window size from MS to IWF (SS), called KMI, which has to be a non default value.

The SS shall accept and use the new RLP parameters till the end of the test.

After the negotiation procedure the ABM will be entered.

This test is performed twice with 2 different values of KMI, randomly chosen.

Procedure

The MS is made to send continuously I+S frames with a delay inferior to T1 between each frame.

The SS does not acknowledge the first KMI frames.

The MS stops sending I+S frames after having sent KMI frames, due to the window size.

The SS waits for $0,5 * T1$ after the last frame of the sequence ($N(S)=NMS+KMI-1$) to acknowledge the first j frames, with $j < KMI$.

The MS shall transmit j new I+S frames and stop sending I+S frames after having sent them, due to the window size.

The SS waits for $0,5 * T1$ after the last frame of the sequence ($N(S)=NMS+KMI-1+j \text{ mod } (62)$) to acknowledge all frames transmitted by the MS.

The MS shall transmit all the following I+S frames.

The SS acknowledges the I+S frames sequentially (i.e. 1 after 1).

The MS is returned to the idle state by clearing the call.

Expected sequence

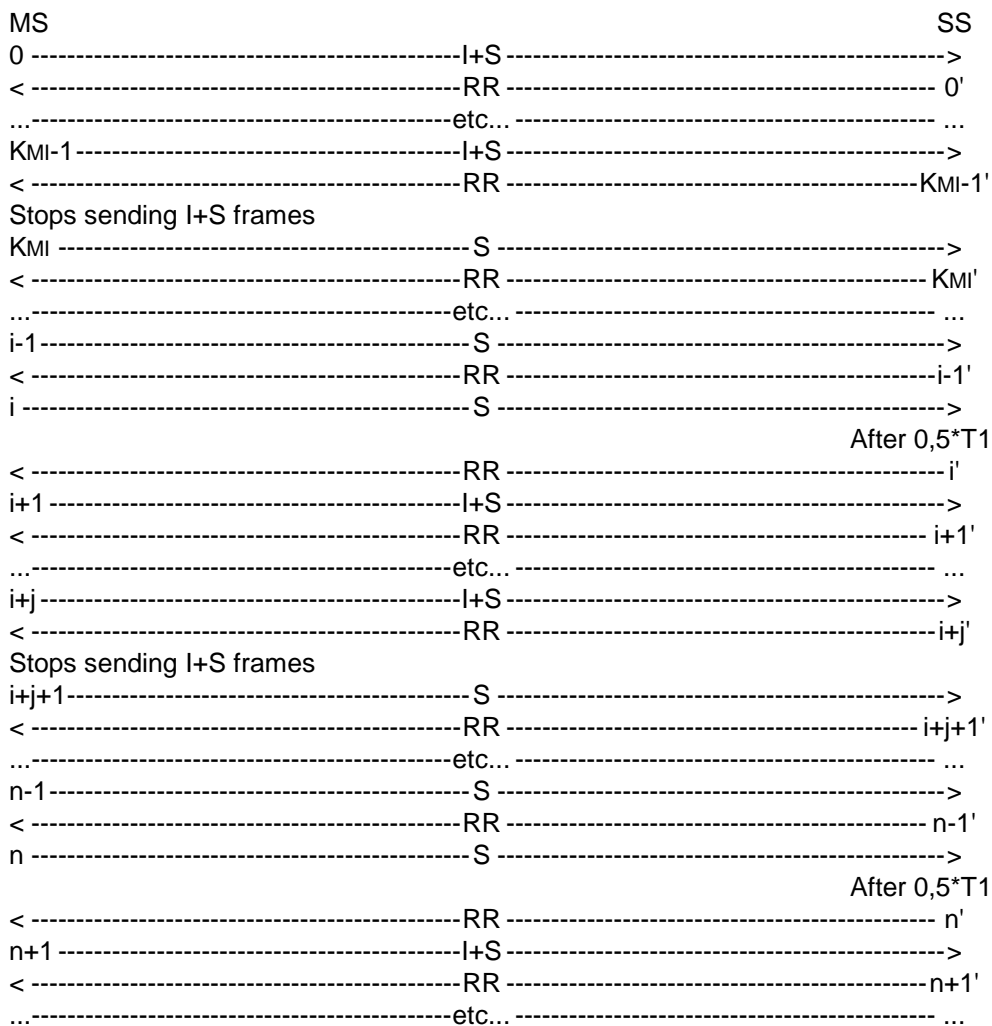

The frames from the SS will be:

0',...,i-1': One RR frame containing:

$$N(R)=NMS \bmod(62).$$

i': One RR frame containing:

$$N(R)=NMS+j \bmod(62) \text{ with } j < KMI,$$

after a delay of $0,5 * T1$ after the last received I+S frame.

i+1',...,n-1': One RR frame containing:

$$N(R)=NMS+j \bmod(62).$$

n': One RR frame containing:

$$N(R)=NMS+KMI+j \bmod(62),$$

after a delay of $0,5 * T1$ after the last received I+S frame.

n+1', n+2',...: One RR frame containing:

$$N(R) = NMS + KMI + j + 1 , NMS + KMI + j + 2 , \dots \bmod(62).$$

29.3.2.2.2.3 Test requirements

The frames from the MS shall be:

0',...,KMI-1': One I+S frame containing:

$$N(S) = NMS, \dots, NMS + KMI - 1 \bmod(62).$$

MS stops sending I+S frames until reception of an acknowledgement of at least one I+S frame.

KMI',...,i': One S frame.

i+1',...,i+j': One I+S frame containing:

$$N(S)=NMS+KMI', \dots, NMS+KMI'+j-1 \bmod(62).$$

MS stops sending I+S frames until reception of an acknowledgement of at least one I+S frame.

i+j+1',...,n': One S frame.

n+1',n+2',...: One I+S frame containing:

$$N(S)=NMS+KMI'+j, NMS+KMI'+j+1, \dots \bmod(62).$$

29.3.2.2.3 Busy condition

29.3.2.2.3.1 Test purpose

To test the correct handling of a RNR frame received.

29.3.2.2.3.2 Method of test

Initial Conditions

System Simulator:

The SS is configured to use default RLP parameters.

Mobile Station:

The MS is configured to use default RLP parameters.

A non transparent data call will be established, so that the MS is in call state U10 ("Call Active").

Case a: No negotiation will be initiated by the MS.

Case b: The MS initiates negotiation of RLP default parameters.

NOTE: The MS is allowed to initiate the negotiation of the RLP default parameters, within allowed ranges, defined in 3GPP TS 04.22. The MS shall do this in the ADM, after having sent a CONNECT ACKNOWLEDGE message (MO-case) or after having received a CONNECT ACKNOWLEDGE message from the SS (MT-case). The SS shall accept and use the new RLP parameters till the end of the test.

The ABM will be entered.

Procedure

The MS is made to send continuously I+S frames.

The SS acknowledges the received I+S frames in supervisory RR frames. After 1 second it acknowledged the received I+S frames in supervisory RNR frames.

After the first RNR frame, the MS shall stop sending I+S frames and shall start sending supervisory frames within T2.

After 1 second receiving supervisory frames, the SS sends RR frames instead of RNR.

After the first RR frame, the MS will restart the transmission of I+S frames within T2.

The MS is returned to the idle state by clearing the call.

Expected sequence

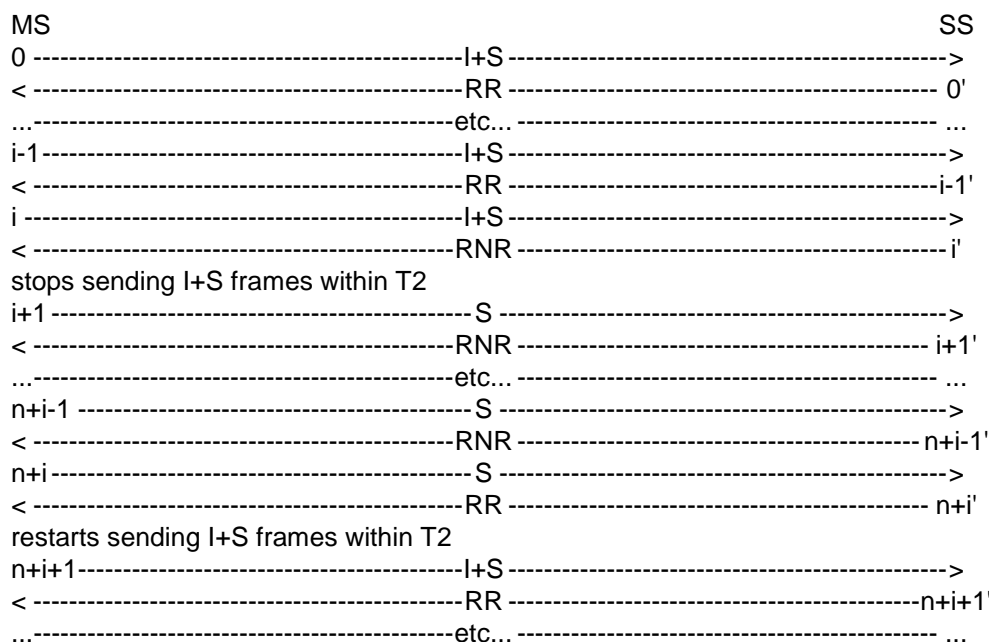

The frames from the SS will be:

0',...,i-1': One RR frame containing:

$$N(R)=NMS+1,\dots,NMS+i \text{ mod}(62).$$

i',...,n+i-1': One RNR frame containing:

$$N(R)=NMS+i+1 \text{ mod}(62).$$

n+i': One RR frame containing:

$$N(R)=NMS+i+1 \text{ mod}(62).$$

n+i+1',n+i+2',...: One RR frame containing:

$$N(R)=NMS+i+2,NMS+i+3,\dots \text{ mod}(62).$$

29.3.2.2.3.3 Test requirements

The frames from the MS shall be:

0,...,i: One I+S frame containing:

$$N(S)=NMS,\dots,NMS+i \text{ mod}(62).$$

MS stops sending I+S frames within T2 after the reception of the first RNR frame from the SS.

i+1,...,n+i: One S frame.

MS restarts sending I+S frames within T2 after the reception of the first RR frame from the SS.

n+i+1,n+i+2,...: One I+S frame containing:

$$N(S)=NMS+i+1,NMS+i+2,\dots \text{ mod}(62).$$

29.3.2.3 SS sends I+S frames

29.3.2.3.1 N(R) sequence number

29.3.2.3.1.1 Test purpose

To test the correct handling of the N(R) sequence number.

29.3.2.3.1.2 Method of test

Initial Conditions

System Simulator:

The SS is configured to use default RLP parameters.

Mobile Station:

The MS is configured to use RLP default parameters except the window size from IWF (SS) to MS, called KIM.

A non transparent data call will be established, so that the MS is in call state U10 ("Call Active").

Since some RLP parameters are different from the default parameters, a negotiation procedure will be initiated by the MS after the CONNECKT ACKNOWLEDGE message. The MS may negotiate the RLP default parameters within allowed ranges, defined in 3GPP TS 04.22, except the window size from IWF (SS) to MS, called KIM, which has to be a non default value.

The SS shall accept and use the new RLP parameters till the end of the test.

After the negotiation procedure the ABM will be entered. This test is performed twice with 2 different values of KIM, randomly chosen.

Procedure

The SS is made to send continuously I+S frames (more than 2*64 frames). The delay between two I+S frames shall be superior to T2 and inferior to T1.

The MS is made to send no data i.e. no I+S frame.

NOTE: The MS may have previously sent I+S frames.

The SS sends I+S frames in I+S RR frames.

The MS shall acknowledge the I+S frames in RR frame sequentially within T2.

The MS is returned to the idle state by clearing the call.

Expected sequence

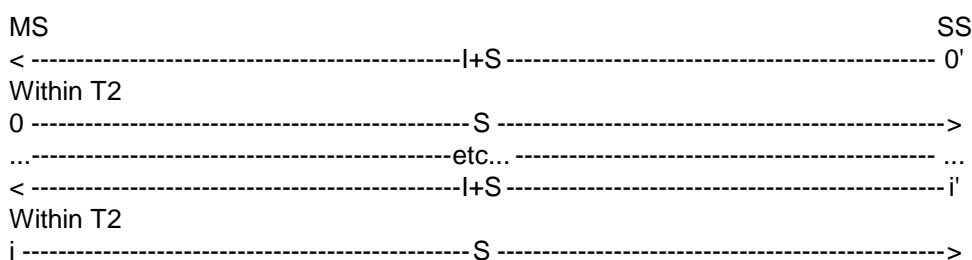

The frames from the SS will be:

0,...,i': One I+S frame containing

$$N(S)=N_{ss}, \dots, N_{ss}+i \bmod(62).$$

29.3.2.3.1.3 Test requirements

The frames from the MS shall be:

0,...,i: One S frame containing:

$$N(R)=N_{ss}+1, \dots, N_{ss}+i+1 \bmod(62).$$

The MS shall acknowledge the I+S frames sent by the SS within T2.

NOTE: If T2 parameter is equal to default T2 (<80 ms), the SS has to checked that the MS acknowledges an I+S frame within 80 ms.

29.3.2.3.2 Busy condition

29.3.2.3.2.1 Test purpose

To test the correct handling of a RNR frame with information received.

29.3.2.3.2.2 Method of test

Initial Conditions

System Simulator:

The SS is configured to use default RLP parameters.

Mobile Station:

The MS is configured to use default RLP parameters.

A non transparent data call will be established, so that the MS is in call state U10 ("Call Active").

Case a: No negotiation will be initiated by the MS.

Case b: The MS initiates negotiation of RLP default parameters.

NOTE: The MS is allowed to initiate the negotiation of the RLP default parameters, within allowed ranges, defined in 3GPP TS 04.22. The MS shall do this in the ADM, after having sent a CONNECT ACKNOWLEDGE message (MO-case) or after having received a CONNECT ACKNOWLEDGE message from the SS (MT-case). The SS shall accept and use the new RLP parameters till the end of the test.

The ABM will be entered.

Procedure

The SS is made to send continuously I+S frames. The delay between two consecutive I+S frames shall be inferior to T1.

The MS is made to send continuously I+S frames with a delay inferior to T1 between each frame.

The SS acknowledges the received I+S frames in I+S RR frames. After 1 second, it acknowledged the received I+S frames in supervisory RNR frames. The MS shall acknowledge the I+S frames in I+S RR frame sequentially.

After the first RNR frame, the MS shall stop sending I+S frames and shall acknowledge the I+S received frame in supervisory frames within T2.

After 1 second receiving supervisory frames, the SS sends I+S RR frames instead of RNR.

After the first RR frame, the MS will restart the transmission of I+S frames, it shall acknowledge the I+S received frame in I+S frame within T2.

The MS is returned to the idle state by clearing the call.

Expected sequence

MS	SS
0 -----I+S----->	
< ----- RR(I+S)-----	0'
...-----etc...-----	...
i-1-----I+S----->	
< ----- RR(I+S)-----	i-1'
i -----I+S----->	
< ----- RNR(I+S)-----	i'
stops sending I+S frames within T2	
i+1 ----- S ----->	
< ----- RNR(I+S)-----	i+1'
...-----etc...-----	...
n+i-1 ----- S ----->	
< ----- RNR(I+S)-----	n+i-1'
n+i ----- S ----->	
< ----- RR(I+S)-----	n+i'
restarts sending I+S frames within T2	
n+i+1-----I+S----->	
< ----- RR(I+S)-----	n+i+1'
...-----etc...-----	...

The frames from the SS will be:

0',...,i-1': One I+S RR frame containing:

$$N(S)=N_{SS},\dots,N_{SS+i-1} \bmod(62),$$

$$N(R)=N_{MS}+1,\dots,N_{MS}+i \bmod(62).$$

i',...,n+i-1': One I+S RNR frame containing:

$$N(S)=N_{SS}+i,\dots,N_{SS}+n+i-1 \bmod(62),$$

$$N(R)=N_{MS}+i+1 \bmod(62).$$

n+i',n+i+1',...: One I+S RR frame containing:

$$N(S)=N_{SS}+n+i,N_{SS}+n+i+1,\dots \bmod(62),$$

$$N(R)=N_{MS}+i+1,N_{MS}+i+2,\dots \bmod(62).$$

29.3.2.3.2.3 Test requirements

The frames from the MS shall be:

0',...,i: One I+S frame containing:

$$N(S)=N_{MS},\dots,N_{MS}+i \bmod(62),$$

$$N(R)=N_{SS},\dots,N_{SS}+i \bmod(62).$$

MS stops sending I+S frames within T2 after the reception of the first RNR frame from the SS.

$i+1, \dots, n+i$: One S frame containing:

$$N(R) = N_{SS+i+1}, \dots, N_{SS+n+i} \text{ mod}(62).$$

MS restarts sending I+S frames within T2 after the reception of the first RR frame from the SS.

$n+i+1, n+i+2, \dots$: One I+S frame containing:

$$N(S) = N_{MS+i+1}, N_{MS+i+2}, \dots \text{ mod}(62),$$

$$N(R) = N_{SS+n+i+1}, N_{SS+n+i+1} \dots \text{ mod}(62).$$

29.3.2.4 SS rejects I+S frames

29.3.2.4.1 REJ frame

29.3.2.4.1.1 Test purpose

To test the correct handling of a REJ frame received.

29.3.2.4.1.2 Method of test

Initial Conditions

The window size from MS to IWF (SS) is called KMI.

System Simulator:

The SS is configured to use default RLP parameters.

Mobile Station:

The MS is configured to use default RLP parameters.

A non transparent data call will be established, so that the MS is in call state U10 ("Call Active").

Case a: No negotiation will be initiated by the MS.

Case b: The MS initiates negotiation of RLP default parameters.

NOTE: The MS is allowed to initiate the negotiation of the RLP default parameters, within allowed ranges, defined in 3GPP TS 04.22. The MS shall do this in the ADM, after having sent a CONNECT ACKNOWLEDGE message (MO-case) or after having received a CONNECT ACKNOWLEDGE message from the SS (MT-case). The SS shall accept and use the new RLP parameters till the end of the test.

The ABM will be entered.

Procedure

The MS is made to send continuously I+S frames with a delay inferior to T1 between each frame.

The SS acknowledges the i first I+S frames in supervisory RR frames.

The SS does not acknowledge the following I+S frames.

The SS rejects the 2 last I+S frames with a REJ and then send UI frames.

The MS shall retransmit the rejected I+S frames and the continue to send I+S frames.

The MS shall stop sending I+S frame when the transmission window is full.

The SS acknowledges all the received I+S frames with a RR frame after a delay of $0,5 * T1$ after the last received I+S frame.

The MS restarts sending I+S frame.

The SS acknowledges the received I+S frames.

The MS is returned to the idle state by clearing of the call.

Expected sequence

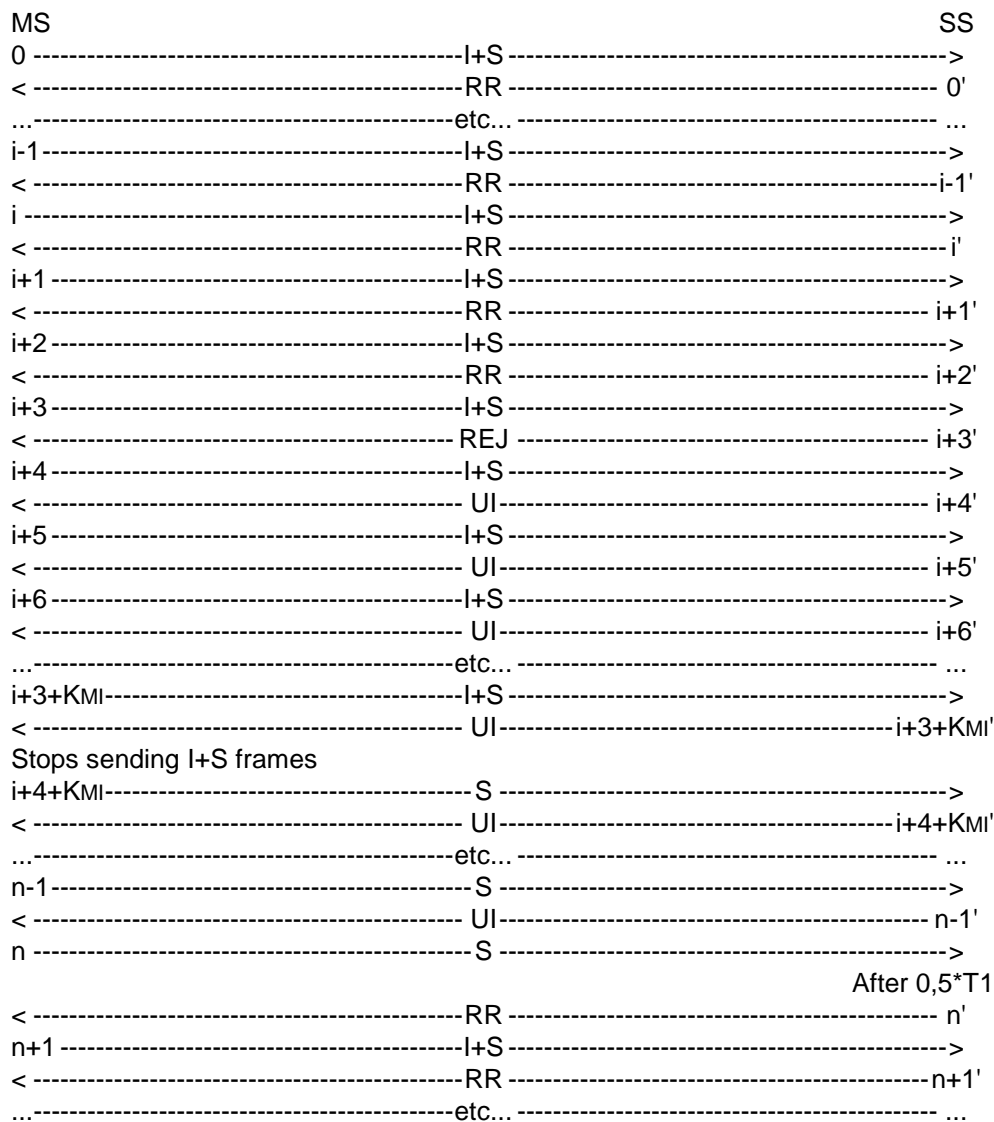

The frames from the SS will be:

0',...,i-1': One RR frame containing:

$$N(R)=NMS+1, \dots, NMS+i \text{ mod}(62).$$

i',...,i+2': One RR frame containing:

$$N(R)=NMS+i \text{ mod}(62).$$

i+3': One REJ frame containing:

$$N(R)=NMS+i+2 \text{ mod}(62).$$

i+4',...,n-1': One UI frame.

n': One RR frame containing:

$$N(R)=NMS+i+2+KMI \text{ mod}(62),$$

after a delay of $0,5 \cdot T1$ after the last received I+S frame.

$n+1, \dots$: One RR frame containing

$$N(R) = NMS + i + 3 + KMI, \dots \text{ mod}(62).$$

29.3.2.4.1.3 Test requirements

The frames from the MS shall be:

$0, \dots, i+3$: One I+S frame containing

$$N(S) = NMS, \dots, NMS + i + 3 \text{ mod}(62).$$

$i+4, i+5$: One I+S frame containing

$$N(S) = NMS + i + 2, NMS + i + 3 \text{ mod}(62).$$

$i+6, \dots, i+3+KMI$: One I+S frame containing:

$$N(S) = NMS + i + 4, \dots, NMS + i + KMI + 1 \text{ mod}(62).$$

$i+4+KMI, \dots, n$: One S frame.

MS stops sending I+S frames until reception of an acknowledging of at least 1 I+S frame of the window (received $N(R)$ from $NMS + i + 3$ to $NMS + i + 2 + KMI \text{ mod}(62)$).

$n+1, \dots$: One I+S frame containing:

$$N(S) = NMS + i + KMI, \dots \text{ mod}(62).$$

29.3.2.4.2 SREJ frame

29.3.2.4.2.1 Test purpose

To test the correct handling of a SREJ frame received.

29.3.2.4.2.2 Method of test

Initial Conditions

The window size from MS to IWF (SS) is called KMI.

System Simulator:

The SS is configured to use default RLP parameters.

Mobile Station:

The MS is configured to use default RLP parameters.

A non transparent data call will be established, so that the MS is in call state U10 ("Call Active").

Case a: No negotiation will be initiated by the MS.

Case b: The MS initiates negotiation of RLP default parameters.

NOTE: The MS is allowed to initiate the negotiation of the RLP default parameters, within allowed ranges, defined in 3GPP TS 04.22. The MS shall do this in the ADM, after having sent a CONNECT ACKNOWLEDGE message (MO-case) or after having received a CONNECT ACKNOWLEDGE message from the SS (MT-case). The SS shall accept and use the new RLP parameters till the end of the test.

The ABM will be entered.

Procedure

The MS is made to send continuously I+S frames with a delay inferior to $T1$ between each frame.

The SS acknowledges the i first I+S frames in supervisory RR frames.

The SS does not acknowledge the following I+S frames.

The SS rejects one I+S frame with a SREJ and then send UI frames.

The MS shall retransmit the rejected I+S frame and the continue to send I+S frames.

The MS shall stop sending I+S frame when the transmission window is full.

The SS acknowledges all the received I+S frames with a RR frame after a delay of $0,5 * T1$ after the last received I+S frame.

The MS restarts sending I+S frame.

The SS acknowledges the received I+S frames.

The MS is returned to the idle state by clearing of the call.

Expected sequence

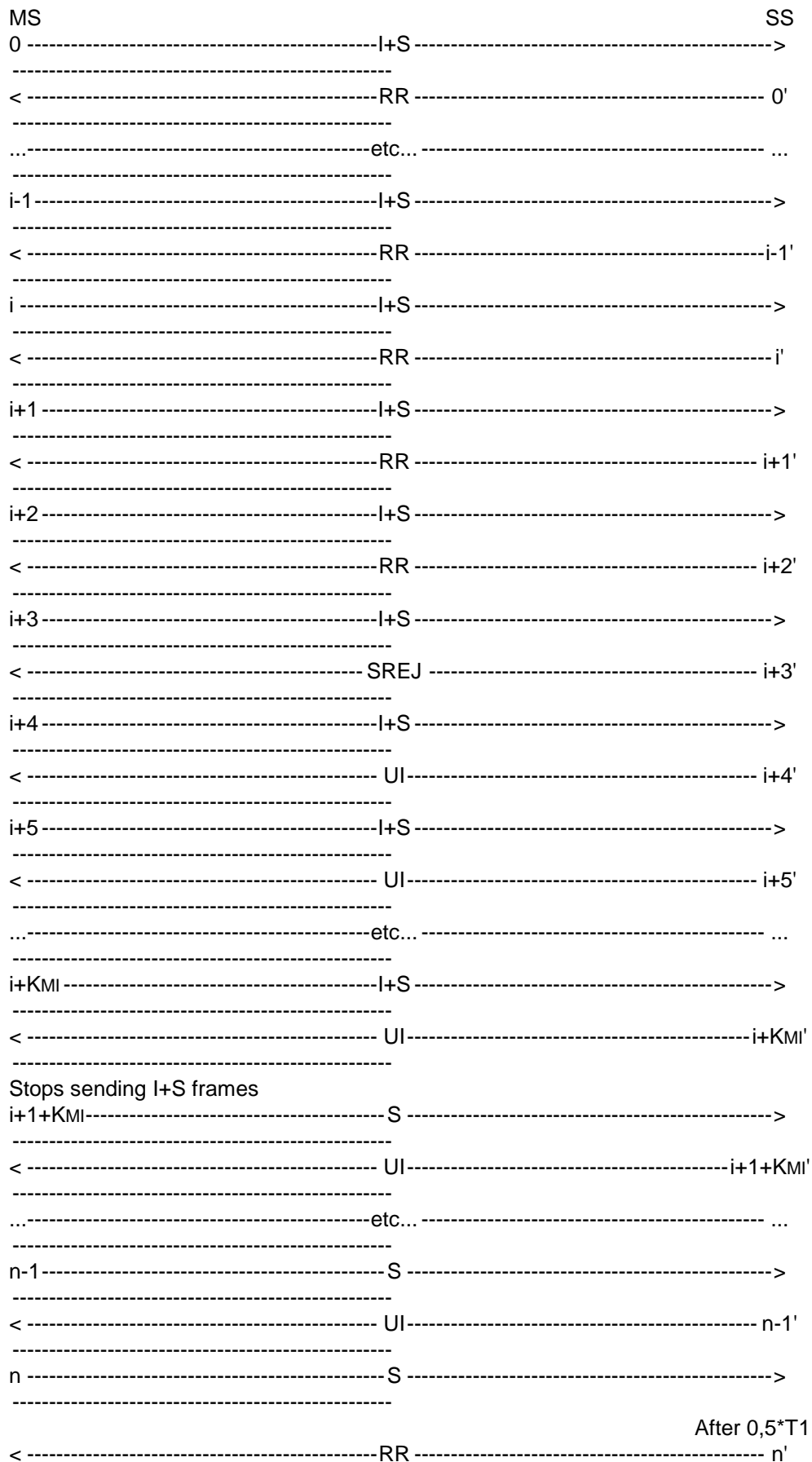

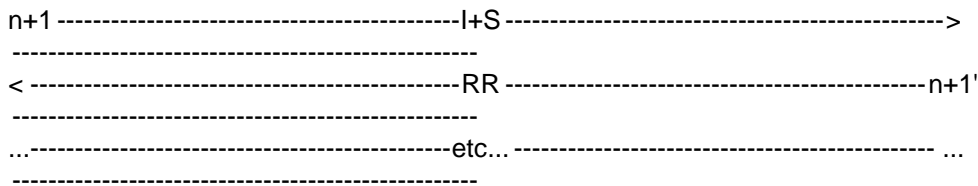

The frames from the SS will be:

0',...,i-1': One RR frame containing:

$$N(R)=NMS+1,\dots,NMS+i \bmod(62).$$

i',...,i+2': One RR frame containing:

$$N(R)=NMS+i \bmod(62).$$

i+3': One SREJ frame containing:

$$N(R)=NMS+i+2 \bmod(62).$$

i+4',...,n-1': One UI frame.

n': One RR frame containing:

$$N(R)=NMS+i+KMI \bmod(62),$$

after a delay of $0,5 * T1$ after the last received I+S frame.

n+1',...: One RR frame containing:

$$N(R)=NMS+i+1+KMI \bmod(62).$$

29.3.2.4.2.3 Test requirements

The frames from the MS shall be:

0',...,i+3: One I+S frame containing:

$$N(S)=NMS,\dots,NMS+i+3 \bmod(62).$$

i+4: One I+S frame containing:

$$N(S)=NMS+i+2 \bmod(62).$$

i+5',...,i+KMI: One I+S frame containing:

$$N(S)=NMS+i+4,\dots,NMS+i+KMI-1 \bmod(62).$$

i+1+KMI',...,n: One S frame.

MS stops sending I+S frames until reception of an acknowledging of at least 1 I+S frame of the window (received $N(R)$ from $NMS+i+1$ to $NMS+i+KMI \bmod(62)$).

n+1',...: One I+S frame containing:

$$N(S)=NMS+i+KMI,\dots \bmod(62).$$

29.3.2.4.3 I+S reject frame

29.3.2.4.3.1 Test purpose

To test the correct handling of a I+S reject frame received.

29.3.2.4.3.2 Method of test

Initial Conditions

The window size from MS to IWF (SS) is called KMI.

System Simulator:

The SS is configured to use default RLP parameters.

Mobile Station:

The MS is configured to use default RLP parameters.

A non transparent data call will be established, so that the MS is in call state U10 ("Call Active").

Case a: No negotiation will be initiated by the MS.

Case b: The MS initiates negotiation of RLP default parameters.

NOTE: The MS is allowed to initiate the negotiation of the RLP default parameters, within allowed ranges, defined in 3GPP TS 04.22. The MS shall do this in the ADM, after having sent a CONNECT ACKNOWLEDGE message (MO-case) or after having received a CONNECT ACKNOWLEDGE message from the SS (MT-case). The SS shall accept and use the new RLP parameters till the end of the test.

The ABM will be entered.

Procedure

The MS is made to send continuously I+S frames with a delay inferior to T1 between each frame.

The SS acknowledges the i first I+S frames in supervisory RR frames.

The SS does not acknowledge the following I+S frames.

The SS rejects the 2 last I+S frames with a REJ.

The MS shall retransmit the 2 rejected I+S frames.

The SS acknowledges these 2 frames.

The MS shall continue sending I+S frames.

The SS does not acknowledge these frames.

The SS rejects one I+S frame with a SREJ.

The MS shall retransmit the rejected I+S frame and continue sending I+S frames.

The SS acknowledges the received I+S frames.

The MS is returned to the idle state by clearing of the call.

Expected sequence

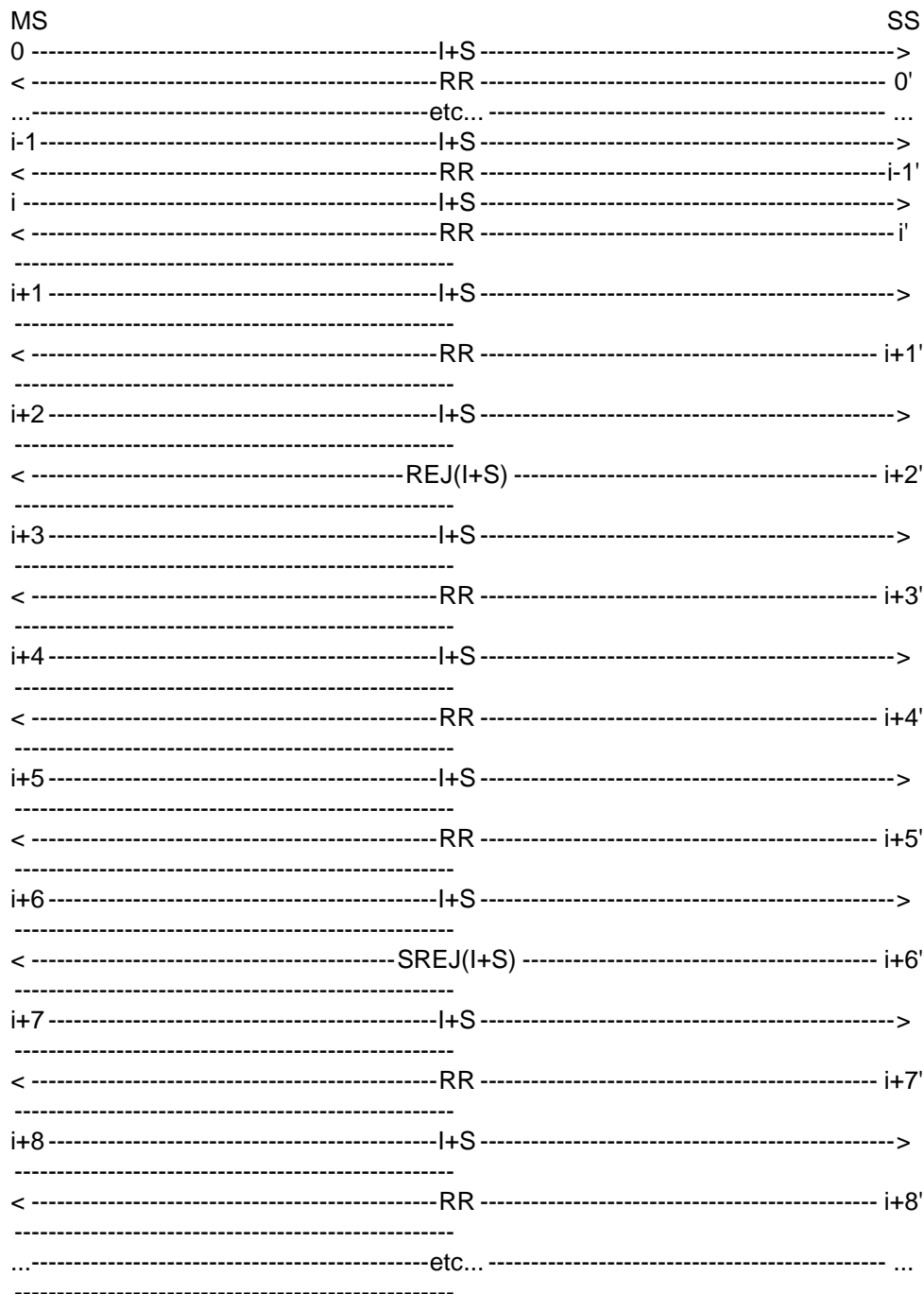

The frames from the SS will be:

0',...,i-1': One RR frame containing:

$$N(R)=NMS+1,\dots,NMS+i \text{ mod}(62).$$

i',i+1': One RR frame containing:

$$N(R)=NMS+i \text{ mod}(62).$$

i+2': One I+S REJ frame containing:

$$N(R)=NMS+i+1 \text{ mod}(62),$$

$$N(S)=Nss \text{ mod}(62).$$

$i+3, i+4$: One RR frame containing:

$$N(R) = NMS + i + 2, NMS + i + 3 \pmod{62}.$$

$i+5$: One RR frame containing:

$$N(R) = NMS + i + 3 \pmod{62}.$$

$i+6$: One I+S REJ frame containing:

$$N(R) = NMS + i + 3 \pmod{62},$$

$$N(S) = NSS + 1 \pmod{62}.$$

$i+7$: One RR frame containing:

$$N(R) = NMS + i + 3 \pmod{62}.$$

$i+8$: One RR frame containing:

$$N(R) = NMS + i + 6, \dots \pmod{62}.$$

29.3.2.4.3.3 Test requirements

The frames from the MS shall be:

$0, \dots, i+2$: One I+S frame containing:

$$N(S) = NMS, \dots, NMS + i + 2 \pmod{62}.$$

$i+3, i+4$: One I+S frame containing:

$$N(S) = NMS + i + 1, NMS + i + 2 \pmod{62}.$$

$i+5, i+6$: One I+S frame containing:

$$N(S) = NMS + i + 3, NMS + i + 4 \pmod{62}.$$

$i+7$: One I+S frame containing:

$$N(S) = NMS + i + 3 \pmod{62}.$$

$i+8, \dots$: One I+S frame containing:

$$N(S) = NMS + i + 5, \dots \pmod{62}.$$

The MS shall acknowledge the I+S frames sent by the SS within T_2 .

29.3.2.5 MS rejects I+S frames

29.3.2.5.1 Rejection with REJ or SREJ supervisory frames

29.3.2.5.1.1 Conformance requirements

The MS shall be able to detect that an I+S frame is out of sequence, and to indicate to the network that some information needs to be retransmitted. This shall be done by using either a REJ or a SREJ RLP frame. The MS has the freedom to choose either one of these frames, but it shall correctly indicate which frames need to be retransmitted.

References

3GPP TS 04.22 subclauses 5.2.3.4, 5.2.3.6 and 5.3.2.

29.3.2.5.1.2 Test purpose

To test that the MS is able to send correct REJ or SREJ supervisory frames to ask for the transmission of a sequence when an out of sequence information frame has been received.

29.3.2.5.1.3 Test method

Initial Conditions

The window size from IWF (SS) to MS is called K_{IM} .

System Simulator:

The SS is configured to use default RLP parameters.

Mobile Station:

The MS is configured to use default RLP parameters.

A non transparent data call will be established, so that the MS is in call state U10 ("Call Active").

Case a: No negotiation will be initiated by the MS.

Case b: The MS initiates negotiation of RLP default parameters.

NOTE: The MS is allowed to initiate the negotiation of the RLP default parameters, within allowed ranges, defined in 3GPP TS 04.22. The MS shall do this in the ADM, after having sent a CONNECT ACKNOWLEDGE message (MO-case) or after having received a CONNECT ACKNOWLEDGE message from the SS (MT-case). The SS shall accept and use the new RLP parameters till the end of the test.

The ABM will be entered.

Specific PICS statements:

-

PIXIT statements:

- Bearer services supported
- Characteristics of non-transparent services.

Foreseen final state of the MS

Idle.

Test procedure

The SS is made to send continuously I+S frames. The delay between two consecutive I+S frames shall be inferior to T1.

The MS is made to send no user data. It sends only supervisory frames.

The SS sends a I+S frame numbered Nss. The MS shall acknowledge this frame. Then the SS sends a I+S frame numbered Nss+2.

The MS shall ask for the retransmission of the missing frame numbered Nss+1. The MS may send a SREJ frame (see case a). If it cannot send SREJ, it shall send a REJ frame (see case b).

Case a: If the MS chooses to send a SREJ, it shall send a SREJ frame containing $N(R)=Nss+1$.

The SS sends a I+S frame numbered Nss+4.

The MS shall ask for the retransmission of the missing frame numbered Nss+3. The MS may send a SREJ frame (see case a/a). If it cannot send SREJ, it shall send a REJ frame (see case a/b).

Case a/a: If the MS chooses to send a SREJ, it shall send a SREJ frame containing $N(R)=Nss+3$.

The SS sends a I+S frame numbered Nss+1 and the MS shall acknowledge this frame ($N(R)=Nss+3$).

The SS sends a I+S frame numbered Nss+3 and the MS shall acknowledge this frame ($N(R)=Nss+5$).

Case a/b: If the MS chooses to send a REJ, it shall send a REJ frame containing $N(R)=N_{ss}+1$.

The SS sends I+S frames numbered $N_{ss}+1, \dots, N_{ss}+4$ and the MS shall acknowledge these frames ($N(R)=N_{ss}+2, \dots, N_{ss}+5$).

Case b: If the MS chooses to send a REJ, it shall send a REJ frame containing $N(R)=N_{ss}+1$.

The SS sends I+S frames numbered $N_{ss}+1, N_{ss}+2$ and the MS shall acknowledge this frame ($N(R)=N_{ss}+2, N_{ss}+3$).

The SS sends a I+S frame numbered $N_{ss}+4$.

The MS shall ask for the retransmission of the missing frame numbered $N_{ss}+3$. The MS may send a SREJ frame (see case b/a). If it cannot send SREJ, it shall send a REJ frame (see case b/b).

Case b/a: If the MS chooses to send a SREJ, it shall send a SREJ frame containing $N(R)=N_{ss}+3$.

The SS sends a I+S frame numbered $N_{ss}+3$ and the MS shall acknowledge this frame ($N(R)=N_{ss}+5$).

Case b/b: If the MS chooses to send a REJ, it shall send a REJ frame containing $N(R)=N_{ss}+3$.

The SS sends I+S frames numbered $N_{ss}+3, N_{ss}+4$ and the MS shall acknowledge these frames ($N(R)=N_{ss}+4, N_{ss}+5$).

The SS sends a I+S frame numbered $N_{ss}+5$. The MS shall acknowledge this frame. Then the SS sends a I+S frame numbered $N_{ss}+5+K_{IM}$.

The MS shall ask for the retransmission of the missing frame numbered $N_{ss}+6$ to $N_{ss}+4+K_{IM}$. The MS may send a SREJ frame (see sequence c with $k=1$). If it cannot send SREJ, it shall send a REJ frame (see sequence d with $k=1$).

Sequence c: If the MS chooses to send a SREJ, it shall send a SREJ frame containing $N(R)=N_{ss}+5+k$.

The SS sends a I+S frame numbered $N_{ss}+5+k$.

When using SREJ frames, the MS shall send RR frames to acknowledge the received I+S frames. The time when these RR frames are sent is not tested.

If $k < K_{IM}-1$, the MS shall ask for the retransmission of the missing frames numbered $N_{ss}+5+k+1$ to $N_{ss}+4+K_{IM}$. The MS may send a SREJ frame (see sequence c with $k=k+1$). If it cannot send SREJ, it shall send a REJ frame (see sequence d with $k=k+1$).

If $k = K_{IM}-1$, the MS has no more frame to reject. It shall acknowledge the frame numbered $N_{ss}+5+K_{IM}$. with a frame containing $N(R)=N_{ss}+6+K_{IM}$. The SS sends I+S frames numbered $N_{ss}+6+K_{IM}$, etc... and the MS shall acknowledge these frames ($N(R)=N_{ss}+7+K_{IM}$, etc).

Sequence d: If the MS chooses to send a REJ, it shall send a REJ frame containing $N(R)=N_{ss}+5+k$.

The SS sends a I+S frame numbered $N_{ss}+5+k$ and the MS shall acknowledge this frame ($N(R)=N_{ss}+5+k+1$).

The SS sends a I+S frame numbered $N_{ss}+5+K_{IM}$.

If $k < K_{IM}-1$, the MS shall ask for the retransmission of the missing frames numbered $N_{ss}+5+k+1$ to $N_{ss}+4+K_{IM}$. The MS may send a SREJ frame (see sequence c with $k=k+1$). If it cannot send SREJ, it shall send a REJ frame (see sequence d with $k=k+1$).

If $k = K_{IM}-1$, the MS has no more frame to reject. It shall acknowledge the frame numbered $N_{ss}+5+K_{IM}$. with a frame containing $N(R)=N_{ss}+6+K_{IM}$. The SS sends I+S frames numbered $N_{ss}+6+K_{IM}$, etc... and the MS shall acknowledge these frames ($N(R)=N_{ss}+7+K_{IM}$, etc).

The MS is returned to the idle state by clearing of the call.

Maximum duration of test

1 minute.

Expected sequence

	MS			SS	
		<-----	I+S	-----	0'
	0	-----	RR	----->	
		<-----	I+S	-----	1'
	1		SREJ(a) or REJ(b) ?		
Case a					
	a - 1	-----	SREJ	----->	
		<-----	I+S	-----	a - 2'
	a - 2		SREJ(a/a) or REJ(a/b) ?		
Case a/a					
	a/a - 1	-----	SREJ	----->	
		<-----	I+S	-----	a/a - 2'
	a/a - 2	-----	RR	----->	
		<-----	I+S	-----	a/a - 3'
	a/a - 3	-----	RR	----->	
Case a/b					
	a/b - 1	-----	REJ	----->	
		<-----	I+S	-----	a/b - 2'
	a/b - 2	-----	RR	----->	
		<-----	I+S	-----	a/b - 3'
	a/b - 3	-----	RR	----->	
		<-----	I+S	-----	a/b - 4'
	a/b - 4	-----	RR	----->	
		<-----	I+S	-----	a/b - 5'
	a/b - 5	-----	RR	----->	
Case b					
	b - 1	-----	REJ	----->	
		<-----	I+S	-----	b - 2'
	b - 2	-----	RR	----->	
		<-----	I+S	-----	b - 3'
	b - 3	-----	RR	----->	
		<-----	I+S	-----	b - 4'
	b - 4		SREJ(b/a) or REJ(b/b) ?		
Case b/a					
	b/a - 1	-----	SREJ	----->	
		<-----	I+S	-----	b/a - 2'
	b/a - 2	-----	RR	----->	
Case b/b					
	b/b - 1	-----	REJ	----->	

	<-----	I+S	-----	b/b - 2'
b/b - 2	-----	RR	----->	
	<-----	I+S	-----	b/b - 3'
b/b - 3	-----	RR	----->	
	<-----	I+S	-----	i'
i	-----	RR	----->	
	<-----	I+S	-----	i+1'
i+1		SREJ(c) or REJ(d) ?		
Sequence c (SREJ used)				
c/k - 0	-----	SREJ	----->	
	<-----	I+S	-----	c/k - 0'
c/k - 1		SREJ(c) or REJ(d) ?		
Sequence d (REJ used)				
d/k - 0	-----	REJ	----->	
	<-----	I+S	-----	d/k - 0'
d/k - 1	-----	RR	----->	
	<-----	I+S	-----	d/k - 1'
d/k - 2		SREJ(c) or REJ(d) ?		
j	-----	RR	----->	
	<-----	I+S	-----	j'
...		etc...		...

The frames from the SS will be:

0': One I+S frame containing $N(S)=N_{ss} \bmod(62)$, $N(R)=N_{ms}+1 \bmod(62)$.

1': One I+S frame containing $N(S)=N_{ss}+2 \bmod(62)$, $N(R)=N_{ms}+1 \bmod(62)$.

Case a:

a - 2': One I+S frame containing $N(S)=N_{ss}+4 \bmod(62)$, $N(R)=N_{ms}+1 \bmod(62)$.

Case a/a:

a/a - 2': One I+S frame containing $N(S)=N_{ss}+1 \bmod(62)$, $N(R)=N_{ms}+1 \bmod(62)$.

a/a - 3': One I+S frame containing $N(S)=N_{ss}+3 \bmod(62)$, $N(R)=N_{ms}+1 \bmod(62)$.

Case a/b:

a/b - 2': One I+S frame containing $N(S)=N_{ss}+1 \bmod(62)$, $N(R)=N_{ms}+1 \bmod(62)$.

a/b - 3': One I+S frame containing $N(S)=N_{ss}+2 \bmod(62)$, $N(R)=N_{ms}+1 \bmod(62)$.

a/b - 4': One I+S frame containing $N(S)=N_{ss}+3 \bmod(62)$, $N(R)=N_{ms}+1 \bmod(62)$.

a/b - 5': One I+S frame containing $N(S)=N_{ss}+4 \bmod(62)$, $N(R)=N_{ms}+1 \bmod(62)$.

Case b:

b - 2': One I+S frame containing $N(S)=N_{ss}+1 \bmod(62)$, $N(R)=N_{ms}+1 \bmod(62)$.

b - 3': One I+S frame containing $N(S)=N_{ss}+2 \bmod(62)$, $N(R)=N_{ms}+1 \bmod(62)$.

b - 4': One I+S frame containing $N(S)=N_{SS}+4 \bmod(62)$, $N(R)=N_{MS}+1 \bmod(62)$.

Case b/a:

b/a - 2': One I+S frame containing $N(S)=N_{SS}+3 \bmod(62)$, $N(R)=N_{MS}+1 \bmod(62)$.

Case b/b:

b/b - 2': One I+S frame containing $N(S)=N_{SS}+3 \bmod(62)$, $N(R)=N_{MS}+1 \bmod(62)$.

b/b - 3': One I+S frame containing $N(S)=N_{SS}+4 \bmod(62)$, $N(R)=N_{MS}+1 \bmod(62)$.

i': One I+S frame containing $N(S)=N_{SS}+5 \bmod(62)$, $N(R)=N_{MS}+1 \bmod(62)$.

i+1': One I+S frame containing $N(S)=N_{SS}+5+K_{IM} \bmod(62)$, $N(R)=N_{MS}+1 \bmod(62)$.

Sequence c (with $k=1$ to $K_{IM}-1$):

c/k - 0': One I+S frame containing $N(S)=N_{SS}+5+k \bmod(62)$, $N(R)=N_{MS}+1 \bmod(62)$.

Sequence d (with $k=1$ to $K_{IM}-1$):

d/k - 0': One I+S frame containing $N(S)=N_{SS}+5+k \bmod(62)$, $N(R)=N_{MS}+1 \bmod(62)$.

d/k - 1': One I+S frame containing $N(S)=N_{SS}+5+K_{IM} \bmod(62)$, $N(R)=N_{MS}+1 \bmod(62)$.

j',...: One I+S frame containing $N(S)=N_{SS}+K_{IM}+6,... \bmod(62)$, $N(R)=N_{MS}+1 \bmod(62)$.

Specific message content

The frames from the MS shall be:

0: One RR frame containing $N(R)=N_{SS}+1 \bmod(62)$.

1: The MS shall reject the missing I+S frame numbered $N_{SS}+1$. It may send a SREJ frame (see case a). If it cannot send SREJ, it shall send a REJ frame (see case b).

Case a

a - 1: One supervisory SREJ frame containing $N(R)=N_{SS}+1 \bmod(62)$.

a - 2: The MS shall reject the missing I+S frame numbered $N_{SS}+3$. It may send a SREJ frame (see case a). If it cannot send SREJ, it shall send a REJ frame (see case b).

Case a/a

a/a - 1: One supervisory SREJ frame containing $N(R)=N_{SS}+3 \bmod(62)$.

a/a - 2: One RR frame containing $N(R)=N_{SS}+3 \bmod(62)$.

a/a - 3: One RR frame containing $N(R)=N_{SS}+5 \bmod(62)$.

Case a/b

a/b - 1: One supervisory REJ frame containing $N(R)=N_{SS}+1 \bmod(62)$.

a/b - 2: One RR frame containing $N(R)=N_{SS}+2 \bmod(62)$.

a/b - 3: One RR frame containing $N(R)=N_{SS}+3 \bmod(62)$.

a/b - 4: One RR frame containing $N(R)=N_{SS}+4 \bmod(62)$.

a/b - 5: One RR frame containing $N(R)=N_{SS}+5 \bmod(62)$.

Case b

b - 1: One supervisory REJ frame containing $N(R)=N_{SS}+1 \bmod(62)$.

b - 2: One RR frame containing $N(R)=N_{SS}+2 \bmod(62)$.

b - 3: One RR frame containing $N(R)=N_{ss}+3 \text{ mod}(62)$.

b - 4: The MS shall reject the missing I+S frame numbered $N_{ss}+2$. It may send a SREJ frame (see case a). If it cannot send SREJ, it shall send a REJ frame (see case b).

Case b/a

b/a - 1: One supervisory SREJ frame containing $N(R)=N_{ss}+2 \text{ mod}(62)$.

b/a - 2: One RR frame containing $N(R)=N_{ss}+5 \text{ mod}(62)$.

Case b/b

b/b - 1: One supervisory REJ frame containing $N(R)=N_{ss}+2 \text{ mod}(62)$.

b/b - 2: One RR frame containing $N(R)=N_{ss}+4 \text{ mod}(62)$.

b/b - 3: One RR frame containing $N(R)=N_{ss}+5 \text{ mod}(62)$.

i: One RR frame containing $N(R)=N_{ss}+6 \text{ mod}(62)$.

i+1: The MS shall reject all missing I+S frames (i.e. KIM-1 frames). It may send a SREJ frame (see sequence c with $k=1$). If it cannot send SREJ, it shall send a REJ frame (see sequence d with $k=1$).

Sequence c (with $k=1$ to $K_{IM}-1$):

c/k - 0: One SREJ frame containing $N(R)=N_{ss}+5+k \text{ mod}(62)$.

c/k - 1: If $k < K_{IM}-1$, the MS shall reject all missing I+S frames (i.e. KIM-1 frames). It may send a SREJ frame (see sequence c with $k=k+1$). If it cannot send SREJ, it shall send a REJ frame (see sequence d with $k=k+1$). If $k=K_{IM}-1$, the MS has no more frame to reject (see frame numbered j).

Sequence d (with $k=1$ to $K_{IM}-1$):

d/k - 0: One REJ frame containing $N(R)=N_{ss}+5+k \text{ mod}(62)$.

d/k - 1: One RR frame containing $N(R)=N_{ss}+5+k+1 \text{ mod}(62)$.

d/k - 2: If $k < K_{IM}-1$, the MS shall reject all missing I+S frames (i.e. KIM-1 frames). It may send a SREJ frame (see sequence c with $k=k+1$). If it cannot send SREJ, it shall send a REJ frame (see sequence d with $k=k+1$). If $k=K_{IM}-1$, the MS has no more frame to reject (see frame numbered j).

j,...: One RR frame containing $N(R)=N_{ss}+K_{IM}+6,... \text{ mod}(62)$.

29.3.2.5.2 Retransmission of REJ or SREJ frames

29.3.2.5.2.1 Conformance requirements

The MS shall not retransmit a REJ frame upon time-out. It may repeat SREJ frames.

References

3GPP TS 04.22 subclauses 5.2.3.4 and 5.2.3.6.

29.3.2.5.2.2 Test purpose

To test that the MS is able to retransmit a SREJ supervisory frames, and does not retransmit a REJ frame.

29.3.2.5.2.3 Test method

Initial Conditions

The window size from IWF (SS) to MS is called K_{IM} .

System Simulator:

The SS is configured to use default RLP parameters.

Mobile Station:

The MS is configured to use default RLP parameters.

A non transparent data call will be established, so that the MS is in call state U10 ("Call Active").

Case a: No negotiation will be initiated by the MS.

Case b: The MS initiates negotiation of RLP default parameters.

NOTE: The MS is allowed to initiate the negotiation of the RLP default parameters, within allowed ranges, defined in 3GPP TS 04.22. The MS shall do this in the ADM, after having sent a CONNECT ACKNOWLEDGE message (MO-case) or after having received a CONNECT ACKNOWLEDGE message from the SS (MT-case). The SS shall accept and use the new RLP parameters till the end of the test.

The ABM will be entered.

Specific PICS statements:

-

PIXIT statements:

- Bearer services supported
- Characteristics of non-transparent services.

Foreseen final state of the MS

Idle.

Test procedure

After optional status bits exchange between the MS and the SS, the SS is made to send continuously I+S frames. The delay between two consecutive I+S frames shall be inferior to T1.

The MS is made to send no user data. It sends only supervisory frames.

The SS sends a I+S frame numbered Nss. The MS shall acknowledge this frame. Then the SS sends a I+S frame numbered Nss+2.

The MS shall ask for the retransmission of the missing frame numbered Nss+1. The MS may send a SREJ frame (see case a). If it cannot send SREJ, it shall send a REJ frame (see case b).

Case a: If the MS chooses to send a SREJ, it shall send a SREJ frame containing $N(R)=Nss+1$.

The SS does not retransmit the rejected frame.

The MS may repeat (see case a1) or not (see case a2) the reject SREJ frame.

Case a1: If the MS chooses to retransmit the SREJ, it shall send a SREJ frame containing $N(R)=Nss+1$, at the expiry of T1.

The SS sends a I+S frame numbered Nss+1 and the MS shall acknowledge this frame ($N(R)=Nss+3$).

The SS sends a I+S frame numbered Nss+4.

The MS shall ask for the retransmission of the missing frame numbered Nss+3. The MS shall send a SREJ frame containing $N(R)=Nss+3$.

At expiry of T1, the MS shall send a new SREJ frame containing $N(R)=Nss+3$. This step is repeated N2 times.

The SS checks for $2*T1$ that the SREJ frame is not repeated by the MS.

Case a2: If the MS chooses not to repeat the SREJ frame, The SS checks for $2 \cdot T1$ that the SREJ frame is not repeated by the MS.

Case b: If the MS chooses to send a REJ, it shall send a REJ frame containing $N(R)=N_{ss}+1$.

The SS does not retransmit the rejected frame.

The MS shall not repeat the reject REJ frame.

The SS checks for $2 \cdot T1$ that the SREJ frame is not repeated by the MS.

The MS is returned to the idle state by clearing of the call.

Maximum duration of test

1 minute.

Expected sequence

	MS			SS
		<-----	I+S	----->
	0	-----	RR	----->
		<-----	I+S	----->
	1		SREJ(a) or REJ(b) ?	1'

Case a

	a - 1	-----	SREJ	----->
	a - 2		SREJ repeated (a1) or not (a2) ?	

Case a1

T1 Time-out	a1 - 1	-----	SREJ	----->	
		<-----	I+S	----->	a1 - 1'
	a1 - 2	-----	RR	----->	
		<-----	I+S	----->	a1 - 2'
	a1 - 3	-----	SREJ	----->	
T1 Time-out	a1 - 4	-----	SREJ	----->	
	...		etc...		...
T1 Time-out	a1 - 3+N2	-----	SREJ	----->	
T1 Time-out	SREJ not repeated				

Case a2

T1 Time-out SREJ not repeated

Case b

	b - 1	-----	REJ	----->
--	-------	-------	-----	--------

T1 Time-out SREJ not repeated

The frames from the SS will be:

0': One I+S frame containing $N(S)=N_{ss} \bmod(62)$, $N(R)=N_{ms}+1 \bmod(62)$.

1': One I+S frame containing $N(S)=N_{ss}+2 \bmod(62)$, $N(R)=N_{ms}+1 \bmod(62)$.

Case a:

Case a1:

a1 - 1': One I+S frame containing $N(S)=N_{ss}+1 \bmod(62)$, $N(R)=N_{ms}+1 \bmod(62)$.

a1 - 2': One I+S frame containing $N(S)=N_{ss}+4 \bmod(62)$, $N(R)=N_{ms}+1 \bmod(62)$.

Specific message content

The frames from the MS shall be:

0: One RR frame containing $N(R)=N_{ss}+1 \text{ mod}(62)$.

1: The MS shall reject the missing I+S frame numbered $N_{ss}+1$. It may send a SREJ frame (see case a). If it cannot send SREJ, it shall send a REJ frame (see case b).

Case a

a - 1: One supervisory SREJ frame containing $N(R)=N_{ss}+1 \text{ mod}(62)$.

a - 2: SREJ frame may be repeated, (see case a1) or not (see case a2).

Case a1

a1 - 1: On T1 Time-out, one supervisory SREJ frame containing $N(R)=N_{ss}+1 \text{ mod}(62)$.

a1 - 2: One RR frame containing $N(R)=N_{ss}+3 \text{ mod}(62)$.

a1 - 3,...,b2 - 3+N2: On T1 Time-out, one supervisory SREJ frame containing $N(R)=N_{ss}+3 \text{ mod}(62)$.

Case b

b - 1: One supervisory REJ frame containing $N(R)=N_{ss}+1 \text{ mod}(62)$.

29.3.2.5.3 I+S reject frame

29.3.2.5.3.1 Conformance requirements

The MS shall be able to use I+S frames to carry a REJ or SREJ frame when it detects that one or more numbered information frame is received out of sequence.

References

3GPP TS 04.22 subclauses 5.2.3.4 and 5.2.3.6.

29.3.2.5.3.2 Test purpose

To test the MS is able to send SREJ or REJ frames in I+S frames when an out of sequence information frame has been received.

29.3.2.5.3.3 Test method

Initial Conditions

The window size from IWF (SS) to MS is called K_{IM} .

System Simulator:

The SS is configured to use default RLP parameters.

Mobile Station:

The MS is configured to use default RLP parameters.

A non transparent data call will be established, so that the MS is in call state U10 ("Call Active").

Case a: No negotiation will be initiated by the MS.

Case b: The MS initiates negotiation of RLP default parameters.

NOTE: The MS is allowed to initiate the negotiation of the RLP default parameters, within allowed ranges, defined in 3GPP TS 04.22. The MS shall do this in the ADM, after having sent a CONNECT ACKNOWLEDGE message (MO-case) or after having received a CONNECT ACKNOWLEDGE message from the SS (MT-case). The SS shall accept and use the new RLP parameters till the end of the test.

The ABM will be entered.

Specific PICS statements:

-

PIXIT statements:

- Bearer services supported
- Characteristics of non-transparent services.

Foreseen final state of the MS

Idle.

Test procedure

The SS is made to send continuously I+S frames. The delay between two consecutive I+S frames shall be inferior to T1.

The SS acknowledges all the received I+S frames.

The MS is made to send continuously I+S frames.

The SS sends a I+S frame numbered Nss. The MS shall acknowledge this frame. Then the SS sends a I+S frame numbered Nss+2.

The MS shall ask for the retransmission of the missing frame numbered Nss+1. The MS may send a SREJ frame (see case a). If it cannot send SREJ, it shall send a REJ frame (see case b). The MS has user data to transmit, it shall use an I+S frame (instead of supervisory frame) to reject the missing frame.

Case a: If the MS chooses to send a SREJ, it shall send a I+S SREJ frame containing $N(R)=Nss+1$.

The SS sends a I+S frame numbered Nss+1 and the MS acknowledges this frame ($N(R)=Nss+3$).

The SS sends a I+S frame numbered Nss+3, etc... and the MS acknowledges these frames ($N(R)=Nss+4$, etc...).

Case b: If the MS chooses to send a REJ, it shall send a I+S REJ frame containing $N(R)=Nss+1$.

The SS sends I+S frames numbered Nss+1, Nss+2, etc... and the MS shall acknowledge this frame ($N(R)=Nss+2$, Nss+3, etc...).

The MS is returned to the idle state by clearing of the call.

Maximum duration of test

1 minute.

Expected sequence

	MS		SS
		<----- I+S ----->	0'
	0	----- I+S ----->	
		<----- I+S ----->	1'
	1	SREJ(a) or REJ(b) ?	
Case a			
	a - 1	----- SREJ(I+S) ----->	
		<----- I+S ----->	a - 2'
	a - 2	----- I+S ----->	
		<----- I+S ----->	a - 3'
	a - 3	----- I+S ----->	
Case b			
	b - 1	----- REJ (I+S) ----->	
		<----- I+S ----->	b - 2'
	b - 2	----- I+S ----->	
		<----- I+S ----->	b - 3'
	b - 3	----- I+S ----->	
	...	etc...	...

The frames from the SS will be:

0': One I+S frame containing $N(S)=N_{ss} \bmod(62)$, $N(R)=N_{ms}+1 \bmod(62)$.

1': One I+S frame containing $N(S)=N_{ss}+2 \bmod(62)$, $N(R)=N_{ms}+2 \bmod(62)$.

Case a:

a - 2': One I+S frame containing $N(S)=N_{ss}+1 \bmod(62)$, $N(R)=N_{ms}+3 \bmod(62)$.

a - 3': One I+S frame containing $N(S)=N_{ss}+3 \bmod(62)$, $N(R)=N_{ms}+4 \bmod(62)$.

Case b:

b - 2': One I+S frame containing $N(S)=N_{ss}+1 \bmod(62)$, $N(R)=N_{ms}+3 \bmod(62)$.

b - 3': One I+S frame containing $N(S)=N_{ss}+2 \bmod(62)$, $N(R)=N_{ms}+4 \bmod(62)$.

Specific message content

The frames from the MS shall be:

0: One I+S RR frame containing $N(S)=N_{ms}+1$, $N(R)=N_{ss}+1 \bmod(62)$.

1: The MS shall reject the missing I+S frame numbered $N_{ss}+1$. It may send a I+S SREJ frame (see case a). If it cannot send SREJ, it shall send a I+S REJ frame (see case b).

Case a

a - 1: One I+S SREJ frame containing $N(S)=N_{MS}+2$, $N(R)=N_{SS}+1 \text{ mod}(62)$.

a - 2: One I+S RR frame containing $N(S)=N_{MS}+3$, $N(R)=N_{SS}+3 \text{ mod}(62)$.

a - 3: One I+S RR frame containing $N(S)=N_{MS}+4$, $N(R)=N_{SS}+4 \text{ mod}(62)$.

Case b

b - 1: One I+S REJ frame containing $N(S)=N_{MS}+2$, $N(R)=N_{SS}+1 \text{ mod}(62)$.

b - 2: One I+S RR frame containing $N(S)=N_{MS}+3$, $N(R)=N_{SS}+2 \text{ mod}(62)$.

b - 3: One I+S RR frame containing $N(S)=N_{MS}+4$, $N(R)=N_{SS}+3 \text{ mod}(62)$.

29.3.2.6 Checkpoint recovery

29.3.2.6.1 SS in checkpoint recovery mode

29.3.2.6.1.1 Test purpose

To test the correct handling of received frame with $P=1$.

29.3.2.6.1.2 Method of test

Initial Conditions

System Simulator:

The SS is configured to use default RLP parameters.

Mobile Station:

The MS is configured to use default RLP parameters.

A non transparent data call will be established, so that the MS is in call state U10 ("Call Active").

Case a: No negotiation will be initiated by the MS.

Case b: The MS initiates negotiation of RLP default parameters.

NOTE: The MS is allowed to initiate the negotiation of the RLP default parameters, within allowed ranges, defined in 3GPP TS 04.22. The MS shall do this in the ADM, after having sent a CONNECT ACKNOWLEDGE message (MO-case) or after having received a CONNECT ACKNOWLEDGE message from the SS (MT-case). The SS shall accept and use the new RLP parameters till the end of the test.

The ABM will be entered.

Procedure

The MS is made to send continuously I+S frames with a delay inferior to $T1$ between each frame.

The SS is made to send continuously I+S frames with a delay superior to $T2$ and inferior to $T1$ between each frame.

The SS acknowledges the received I+S frames in its sending I+S frames.

The MS shall acknowledge the received I+S frames in its sending I+S frames.

After having sent i I+S frames, the SS sends a I+S frame with P bit set to 1.

The MS shall answer with a supervisory RR or RNR frame with F bit set to 1 and $N(R)$ coded to the next frame waited by the MS.

The SS continue sending I+S frames and acknowledging the I+S frames received from the MS.

The MS shall continue sending I+S frames and acknowledging the I+S frames received from the SS.

The SS rejects 1 I+S frame in a supervisory SREJ frame with P bit set to 1.

The MS shall answer with a supervisory RR or RNR frame with F bit set to 1 and N(R) coded to the next frame waited by the MS.

Then the MS shall retransmit the rejected I+S frame.

The SS continue sending I+S frames and acknowledging the I+S frames received from the MS.

The MS shall continue sending I+S frames and acknowledging the I+S frames received from the SS.

After having sent j I+S frames, the SS sends a supervisory RR frame with P bit set to 1.

The MS shall answer with a supervisory RR or RNR frame with F bit set to 1 and N(R) coded to the next frame waited by the MS.

The SS continue sending I+S frames and acknowledging the I+S frames received from the MS.

The MS shall continue sending I+S frames and acknowledging the I+S frames received from the SS.

The MS is returned to the idle state by clearing of the call.

Expected sequence

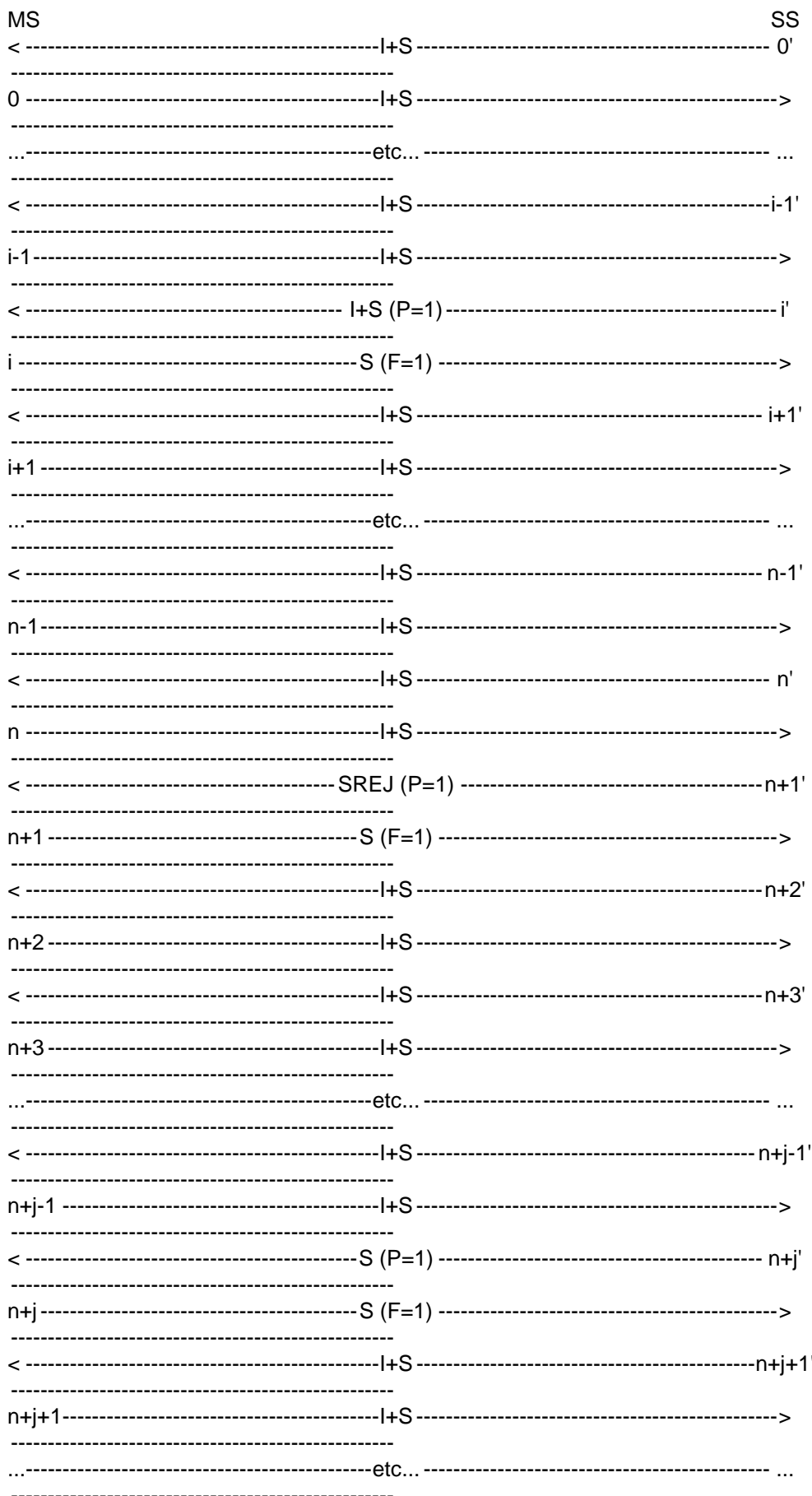

The frames from the SS will be:

0',...,i-1': One I+S RR frame containing:

$$N(S)=N_{SS},\dots,N_{SS}+i-1 \pmod{62},$$

$$N(R)=N_{MS},\dots,N_{MS}+i-1 \pmod{62}.$$

i': One I+S RR frame containing:

$$C/R=1,$$

$$P/F=1,$$

$$N(S)=N_{SS}+i \pmod{62},$$

$$N(R)=N_{MS}+i \pmod{62}.$$

i+1',...,n-1': One I+S RR frame containing:

$$N(S)=N_{SS}+i+1,\dots,N_{SS}+n-1 \pmod{62},$$

$$N(R)=N_{MS}+i-1,\dots,N_{MS}+n-3 \pmod{62}.$$

n: One I+S RR frame containing:

$$N(S)=N_{SS}+n \pmod{62},$$

$$N(R)=N_{MS}+n-3 \pmod{62}.$$

n+1: One supervisory SREJ frame containing:

$$C/R=1,$$

$$P/F=1,$$

$$N(R)=N_{MS}+n-2 \pmod{62}.$$

n+2': One I+S RR frame containing:

$$N(S)=N_{SS}+n+1 \pmod{62},$$

$$N(R)=N_{MS}+n-2 \pmod{62}.$$

n+3',...,n+j-1': One I+S RR frame containing:

$$N(S)=N_{SS}+n+2,\dots,N_{SS}+n+j \pmod{62},$$

$$N(R)=N_{MS}+n,\dots,N_{MS}+n+j-3 \pmod{62}.$$

n+j: One supervisory SREJ frame containing:

$$C/R=1,$$

$$P/F=1,$$

$$N(R)=N_{MS}+n-2 \pmod{62}.$$

n+j+1',...: One I+S RR frame containing:

$$N(S)=N_{SS}+n+j+1,\dots \pmod{62},$$

$$N(R)=N_{MS}+n+j-2,\dots \pmod{62}.$$

29.3.2.6.1.3 Test requirements

The frames from the MS shall be:

0,...,i-1: One I+S frame containing:

$$N(S)=NMS,\dots,NMS+i-1 \text{ mod}(62),$$

$$N(R)=Nss+1,\dots,Nss+i \text{ mod}(62).$$

i': One supervisory RR frame containing:

$$C/R=0,$$

$$P/F=1,$$

$$N(R)=Nss+i+1 \text{ mod}(62).$$

i+1,...,n: One I+S frame containing:

$$N(S)=NMS+i,\dots,NMS+n-1 \text{ mod}(62),$$

$$N(R)=Nss+i+2,\dots,Nss+n+1 \text{ mod}(62).$$

n+1: One supervisory RR frame containing:

$$C/R=0,$$

$$P/F=1,$$

$$N(R)=Nss+n+1 \text{ mod}(62).$$

n+2: One I+S frame containing:

$$N(S)=NMS+n-2 \text{ mod}(62),$$

$$N(R)=Nss+n+2 \text{ mod}(62).$$

n+3,...,n+j-1: One I+S frame containing:

$$N(S)=NMS+n,\dots,NMS+n+j-3 \text{ mod}(62),$$

$$N(R)=Nss+n+3,\dots,Nss+n+j+1 \text{ mod}(62).$$

n+j: One supervisory RR frame containing:

$$C/R=0,$$

$$P/F=1,$$

$$N(R)=Nss+n+j+1 \text{ mod}(62).$$

n+j+1,...: One I+S frame containing:

$$N(S)=NMS+n+j-2 \text{ mod}(62),$$

$$N(R)=Nss+n+j+2,\dots \text{ mod}(62).$$

29.3.2.6.2 End of the window

29.3.2.6.2.1 Test purpose

To test the correct handling of checkpoint recovery at the end of the window.

29.3.2.6.2.2 Method of test

Initial Conditions

System Simulator:

The SS is configured to use default RLP parameters.

Mobile Station:

The MS is configured to use RLP default parameters except the window size from MS to IWF (SS), called KMI.

A non transparent data call will be established, so that the MS is in call state U10 ("Call Active").

Since some RLP parameters are different from the default parameters, a negotiation procedure will be initiated by the MS after the CONNECKT ACKNOWLEDGE message. The MS may negotiate the RLP default parameters within allowed ranges, defined in 3GPP TS 04.22, except the window size from MS to IWF (SS), called KMI, which has to be a non default value.

The SS shall accept and use the new RLP parameters till the end of the test.

After the negotiation procedure the ABM will be entered. This test is repeated twice with 2 different values of KMI, randomly chosen.

Procedure

The MS is made to send continuously I+S frames with a delay inferior to T1 between each frame.

The SS does not acknowledge the received I+S frames in RR frames.

The MS stops sending I+S frames after having sent KMI frames without acknowledgement, due to the window size.

At the expiry of T1 after the last sending I+S frame, the MS shall send a supervisory command RR frame with P bit set to 1.

The SS answer in a RR response frame with F bit set to 1 and acknowledging $j < KMI$ frames (j is randomly chosen).

The MS shall retransmit the $KMI - j$ lost I+S frames and then shall continue to send I+S frames.

The SS acknowledges the received I+S frames in RR frames.

The MS is returned to the idle state by clearing of the call.

Expected sequence

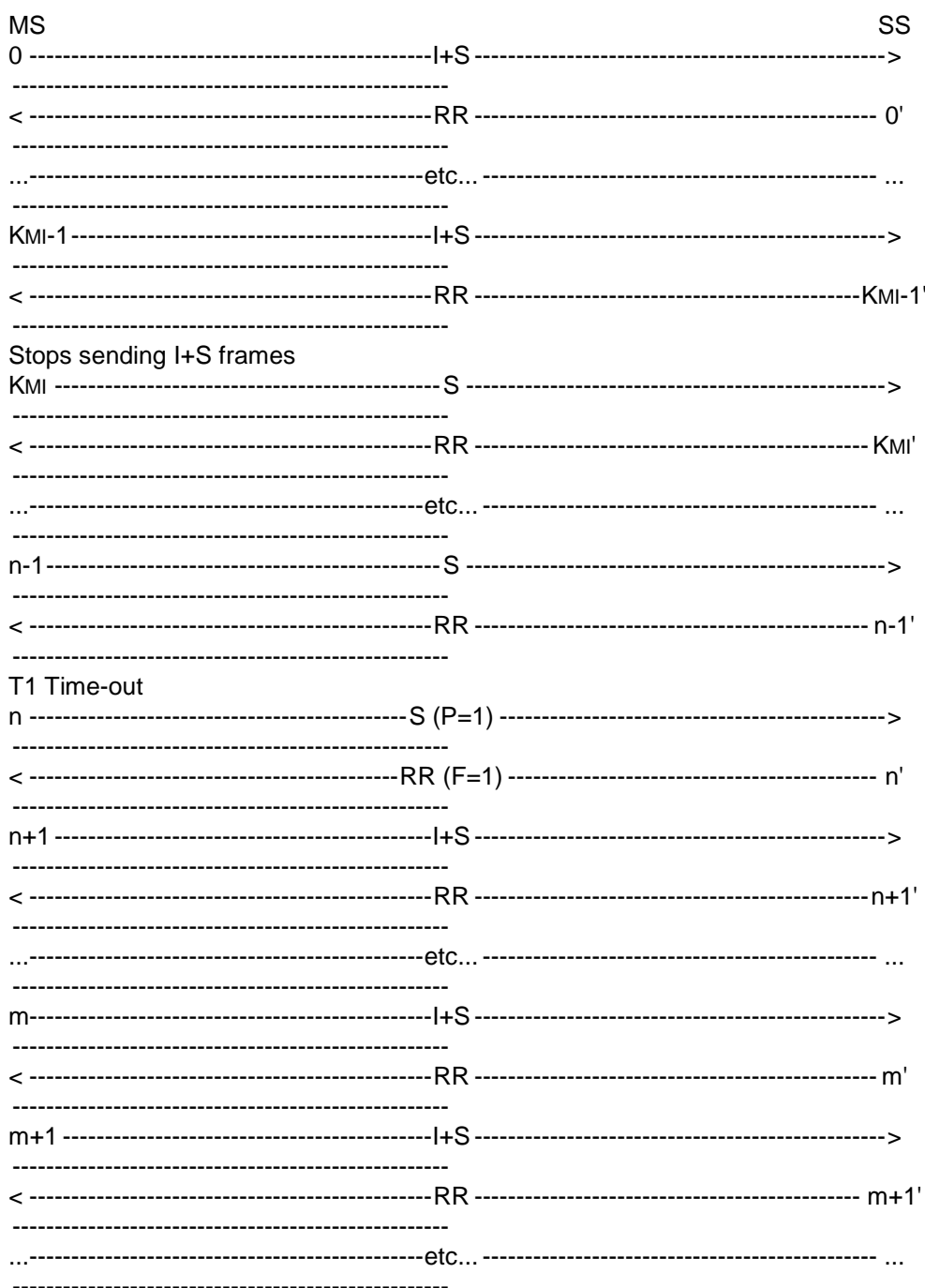

The frames from the SS will be:

0',...,n-1': One RR frame containing:

$$N(R)=NMS \text{ mod}(62).$$

n': One supervisory RR frame containing:

$$C/R=0,$$

$$P/F=1,$$

$$N(R)=NMS+i-1+j \text{ mod}(62).$$

$n+1, \dots$: One supervisory RR frame containing:

$$N(R) = NMS + i + j \text{ mod}(62).$$

29.3.2.6.2.3 Test requirements

The frames from the MS shall be:

$0, \dots, KMI-1$: One I+S frame containing:

$$N(S) = NMS, \dots, NMS + KMI - 1 \text{ mod}(62).$$

$KMI, \dots, n-1$: The MS stops sending I+S frames. It sends S frames.

n : On T1 Time-out after the last sent I+S frame, the MS sends a S frame containing C/R=1 and P/F=1.

$n+1, \dots, m$: The MS retransmits the lost I+S frames, it send I+S frames containing $N(S) = NMS - 1 + j, \dots, NMS + KMI - 1 \text{ mod}(62)$.

$m+1, \dots$: One I+S frames containing:

$$N(S) = NMS + KMI, \dots \text{ mod}(62)$$

29.3.2.6.3 End of a sequence

29.3.2.6.3.1 Test purpose

To test the correct handling of checkpoint recovery at the end of a sequence of frames

29.3.2.6.3.2 Method of test

Initial Conditions

System Simulator:

The SS is configured to use default RLP parameters.

Mobile Station:

The MS is configured to use RLP default parameters except the window size from MS to IWF (SS), called KMI.

A non transparent data call will be established, so that the MS is in call state U10 ("Call Active").

Since some RLP parameters are different from the default parameters, a negotiation procedure will be initiated by the MS after the CONNECKT ACKNOWLEDGE message. The MS may negotiate the RLP default parameters within allowed ranges, defined in 3GPP TS 04.22, except the window size from MS to IWF (SS), called KMI, which has to be a non default value.

The SS shall accept and use the new RLP parameters till the end of the test.

After the negotiation procedure the ABM will be entered.

This test is repeated twice with 2 different values of KMI, randomly chosen.

Procedure

The MS is made to send a sequence of i I+S frames ($1 < i < KIM$) with a delay inferior to T1 between each frame.

The SS does not acknowledge the received I+S frames.

The MS sends S frames.

At the expiry of T1 after the last sending I+S frame, the MS shall send a supervisory command RR frame with P bit set to 1.

The SS answer in a RR response frame with F bit set to 1 and acknowledging $j < i$ frames (j is randomly chosen).

The MS shall retransmit the $i-j$ lost I+S frames.

The SS acknowledges the received I+S frames in RR frames.

The MS is returned to the idle state by clearing of the call.

Expected sequence

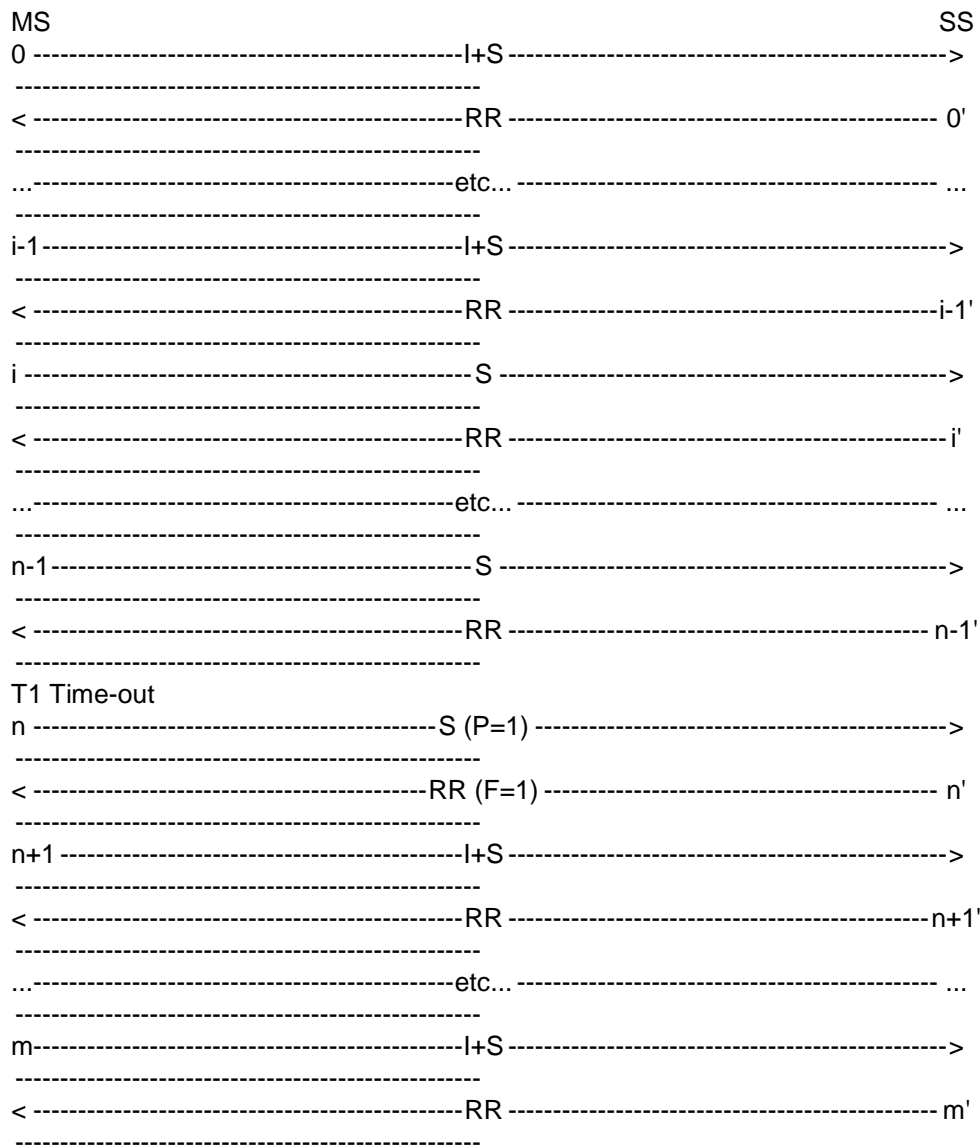

The frames from the SS will be:

0',...,n-1': One RR frame containing:

$$N(R)=NMS \text{ mod}(62).$$

n': One supervisory RR frame containing:

$$C/R=0,$$

$$P/F=1,$$

$$N(R)=NMS+j \text{ mod}(62).$$

$n+1, \dots$: One supervisory RR frame containing:

$$N(R) = N_{MS} + j \bmod(62).$$

29.3.2.6.3.3 Test requirements

The frames from the MS shall be:

$0, \dots, i-1$: One I+S frame containing:

$$N(S) = N_{MS}, \dots, N_{MS} + i - 1 \bmod(62).$$

$i-1, \dots, n-1$: The MS sends S frames.

n : On T1 Time-out after the last sent I+S frame, the MS sends a S frame containing C/R=1 and P/F=1.

$n+1, \dots, m$: The MS retransmits the lost I+S frames, it send I+S frames containing $N(S) = N_{MS} + j, \dots, N_{MS} + i - 1 \bmod(62)$.

29.3.2.6.4 Time-out of one frame

29.3.2.6.4.1 Test purpose

To test the correct handling of checkpoint recovery when a frame is not acknowledge.

29.3.2.6.4.2 Method of test

Initial Conditions

System Simulator:

The SS is configured to use default RLP parameters.

Mobile Station:

The MS is configured to use default RLP parameters.

A non transparent data call will be established, so that the MS is in call state U10 ("Call Active").

Case a: No negotiation will be initiated by the MS.

Case b: The MS initiates negotiation of RLP default parameters.

NOTE: The MS is allowed to initiate the negotiation of the RLP default parameters, within allowed ranges, defined in 3GPP TS 04.22. The MS shall do this in the ADM, after having sent a CONNECT ACKNOWLEDGE message (MO-case) or after having received a CONNECT ACKNOWLEDGE message from the SS (MT-case). The SS shall accept and use the new RLP parameters till the end of the test.

The ABM will be entered.

Procedure

The MS is made to send only one I+S frames.

The SS does not acknowledge the received I+S frame.

At the expiry of T1 after the sending of the I+S frame, the MS shall send a supervisory command RR frame with P bit set to 1.

The SS answer in a RR response frame with F bit set to 1 and N(R) corresponding to the I+S frame sent by the MS.

The MS shall retransmit the I+S frame.

The SS acknowledges the received I+S frame in RR frame.

The MS is returned to the idle state by clearing of the call.

Expected sequence

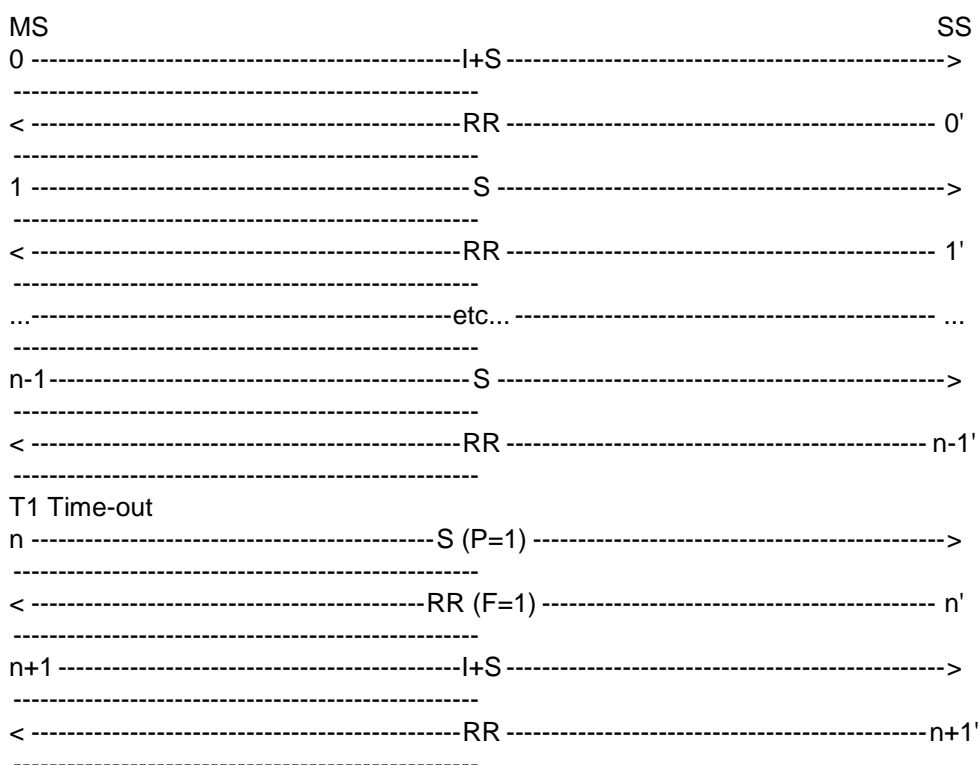

The frames from the SS will be:

0',...,n-1': One RR frame containing:

$$N(R)=NMS \text{ mod}(62).$$

n': One supervisory RR frame containing:

$$C/R=0,$$

$$P/F=1,$$

$$N(R)=NMS \text{ mod}(62).$$

n+1': One supervisory RR frame containing:

$$N(R)=NMS+1 \text{ mod}(62).$$

29.3.2.6.4.3 Test requirements

The frames from the MS shall be:

0,: One I+S frame containing:

$$N(S)=NMS \text{ mod}(62).$$

1,...,n-1: The MS sends S frames.

n: On T1 Time-out after the I+S frame, the MS sends a S frame containing C/R=1 and P/F=1.

n+1: The MS retransmits the I+S frame containing N(S)=NMS mod(62).

29.3.2.6.5 No response to checkpointing

29.3.2.6.5.1 Test purpose

To test the correct repetition of a frame with P=1 if SS does not answer to checkpointing.

29.3.2.6.5.2 Method of test

Initial Conditions

System Simulator:

The SS is configured to use default RLP parameters.

Mobile Station:

The MS is configured to use default RLP parameters.

A non transparent data call will be established, so that the MS is in call state U10 ("Call Active").

Case a: No negotiation will be initiated by the MS.

Case b: The MS initiates negotiation of RLP default parameters.

NOTE: The MS is allowed to initiate the negotiation of the RLP default parameters, within allowed ranges, defined in 3GPP TS 04.22. The MS shall do this in the ADM, after having sent a CONNECT ACKNOWLEDGE message (MO-case) or after having received a CONNECT ACKNOWLEDGE message from the SS (MT-case). The SS shall accept and use the new RLP parameters till the end of the test.

The ABM will be entered.

Procedure

The MS is made to send only one I+S frames.

The SS does not acknowledge the received I+S frame.

At the expiry of T1 after the sending of the I+S frame, the MS shall send a supervisory command RR frame with P bit set to 1.

The SS answer in a RR response frame with F bit set to 0 and N(R) acknowledging the I+S frame sent by the MS.

At the expiry of T1 after the sending of the frame with P=1, the MS shall send a new supervisory command RR frame with P bit set to 1.

The SS answer in a RR response frame with F bit set to 1 and N(R) corresponding to the I+S frame sent by the MS.

The MS shall retransmit the I+S frame.

The SS acknowledges the received I+S frame in RR frame.

The MS is returned to the idle state by clearing of the call.

Expected sequence

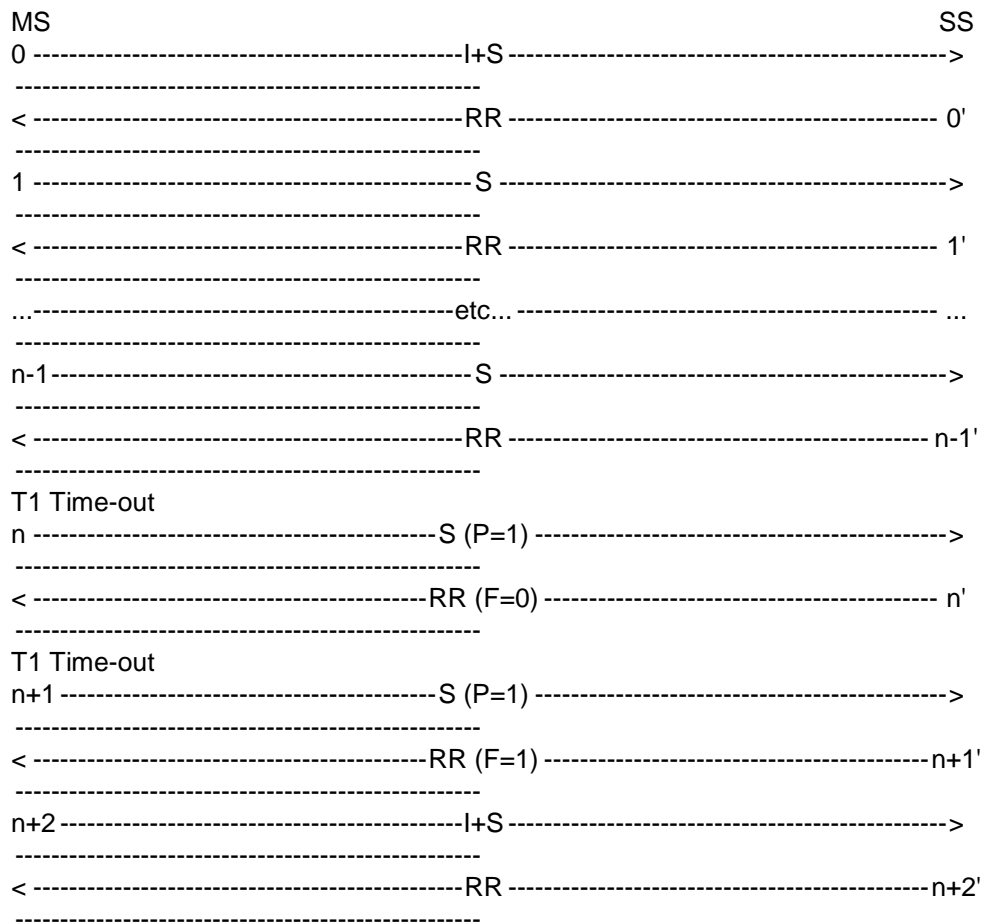

The frames from the SS will be:

0',...,n-1': One RR frame containing:

$$N(R) = NMS \text{ mod}(62).$$

n': One supervisory RR frame containing:

$$C/R = 0,$$

$$P/F = 0,$$

$$N(R) = NMS + 1 \text{ mod}(62).$$

n+1': One supervisory RR frame containing:

$$C/R = 0,$$

$$P/F = 1,$$

$$N(R) = NMS \text{ mod}(62).$$

n+2': One supervisory RR frame containing:

$$N(R) = NMS + 1 \text{ mod}(62).$$

29.3.2.6.5.3 Test requirements

The frames from the MS shall be:

0,: One I+S frame containing:

$$N(S)=NMS \bmod(62).$$

1,...,n-1: The MS sends S frames.

n: On T1 Time-out after the I+S frame, the MS sends a S frame containing C/R=1 and P/F=1.

n+1: On T1 Time-out after the sending of the first frame with P=1, the MS sends a S frame containing C/R=1 and P/F=1.

n+2: The MS retransmits the I+S frame containing $N(S)=NMS \bmod(62)$.

29.3.2.6.6 Incorrect response to checkpointing

29.3.2.6.6.1 Test purpose

To test the correct repetition of a frame with P=1 if the answer to checkpointing is incorrect.

29.3.2.6.6.2 Method of test

Initial Conditions

System Simulator:

The SS is configured to use default RLP parameters.

Mobile Station:

The MS is configured to use default RLP parameters.

A non transparent data call will be established, so that the MS is in call state U10 ("Call Active").

Case a: No negotiation will be initiated by the MS.

Case b: The MS initiates negotiation of RLP default parameters.

NOTE: The MS is allowed to initiate the negotiation of the RLP default parameters, within allowed ranges, defined in 3GPP TS 04.22. The MS shall do this in the ADM, after having sent a CONNECT ACKNOWLEDGE message (MO-case) or after having received a CONNECT ACKNOWLEDGE message from the SS (MT-case). The SS shall accept and use the new RLP parameters till the end of the test.

The ABM will be entered.

Procedure

The MS is made to send only one I+S frames.

The SS does not acknowledge the received I+S frame.

The MS sends supervisory frame with P set to 0 when it has nothing else to send.

At the expiry of T1 after the sending of the I+S frame, the MS shall send a supervisory command RR frame with P bit set to 1.

The SS answer in a supervisory SREJ response frame with F bit set to 1 and N(R) rejecting the I+S frame sent by the MS.

At the expiry of T1 after the sending of the frame with P=1, the MS shall send a new supervisory command RR frame with P bit set to 1.

The SS answer in a supervisory REJ response frame with F bit set to 1 and N(R) rejecting the I+S frame sent by the MS.

At the expiry of T1 after the sending of the frame with P=1, the MS shall send a new supervisory command RR frame with P bit set to 1.

The SS answer in a RR response frame with F bit set to 1 and N(R) corresponding to the I+S frame sent by the MS.

The MS shall retransmit the I+S frame.

The SS acknowledges the received I+S frame in RR frame.

The MS is returned to the idle state by clearing of the call.

Expected sequence

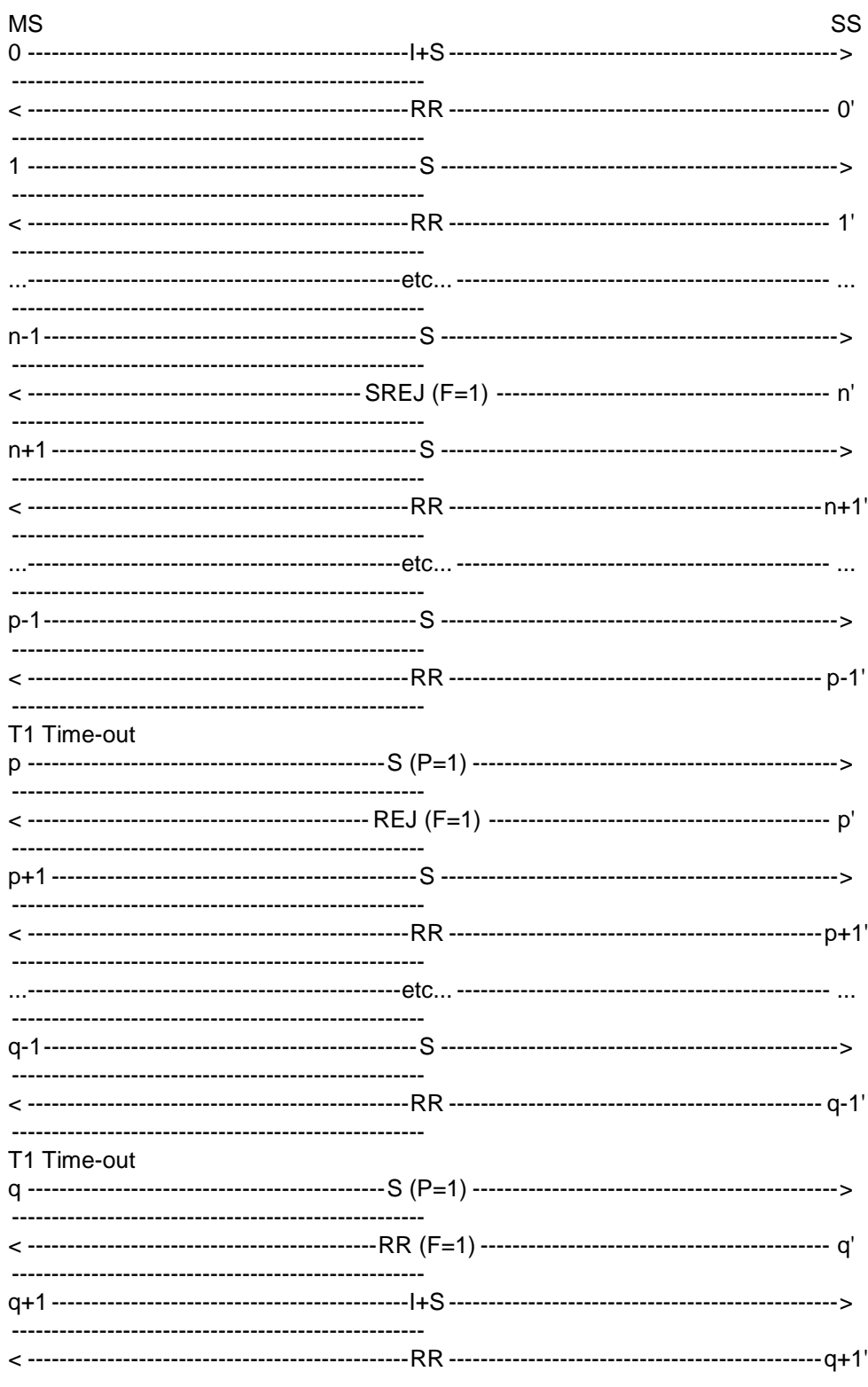

The frames from the SS will be:

0',...,n-1': One RR frame containing:

$$N(R)=NMS \text{ mod}(62).$$

n': One supervisory SREJ frame containing:

C/R=0,
P/F=1,
N(R)=NMSmod(62).

m+1',...,p-1': One RR frame containing:

N(R)=NMS mod(62).

p': One supervisory REJ frame containing:

C/R=0,
P/F=1,
N(R)=NMSmod(62).

p+1',...,q-1': One RR frame containing:

N(R)=NMS mod(62).

q': One supervisory RR frame containing:

C/R=0,
P/F=1,
N(R)=NMSmod(62).

q+1': One RR frame containing:

N(R)=NMS+1 mod(62).

29.3.2.6.6.3 Test requirements

The frames from the MS shall be:

0,: One I+S frame containing:

N(S)=NMS mod(62).

1,...,n-1: The MS sends S frames.

n: On T1 Time-out after the I+S frame, the MS sends a S frame containing:

C/R=1,
P/F=1.

n+1,...,p-1: The MS sends S frames.

p: On T1 Time-out after the I+S frame, the MS sends a S frame containing:

C/R=1,
P/F=1.

p+1,...,q-1: The MS sends S frames.

q: On T1 Time-out after the I+S frame, the MS sends a S frame containing:

C/R=1,
P/F=1.

q+1: The MS retransmits the I+S frame containing:

$N(S)=NMS \bmod(62)$.

29.3.2.6.7 Total loss of response to checkpointing

29.3.2.6.7.1 Definition

The last frame of a sequence of numbered information frames is guarded by timer T1. Failure to receive an acknowledgement, or a reject, within a time T1, shall result in the RLP entity starting a checkpoint recovery procedure. If the RLP peer entity fails to respond to a checkpoint command, which is also guarded by timer T1, the checkpoint recovery procedure shall be repeated, up to N2 times.

29.3.2.6.7.2 Conformance requirements

The MS shall start the checkpoint procedure after failure to receive acknowledgement of a numbered information frame within a time T1. 3GPP TS 04.22, subclauses 5.3.3 and 5.3.3.2.

The MS shall repeat the checkpoint procedure, up to N2 times, if the peer RLP entity fails to respond to a checkpoint command within a time T1. 3GPP TS 04.22, subclause 5.3.3.2.

The MS shall disconnect or reset the RLP link after the checkpoint procedure has been performed N2+1 times, 3GPP TS 04.22, subclause 5.3.3.2.

References

3GPP TS 04.22 subclauses 5.3.3 and 5.3.3.2.

29.3.2.6.7.3 Test purpose

To test the correct handling of a total loss of response to checkpointing.

29.3.2.6.7.4 Method of test

Initial Conditions

System Simulator:

The SS is configured to use default RLP parameters.

Mobile Station:

If possible, the MS is configured to use RLP default parameters except the number of retransmission N2. If a MS cannot be configured to use a non default N2 value, the SS shall use XID negotiation to modify the value of N2 to be used during the test.

A non transparent data call will be established, so that the MS is in call state U10 ("Call Active").

Since some RLP parameters are different from the default parameters, a negotiation procedure will be initiated by the MS after the CONNECKT ACKNOWLEDGE message. The MS may negotiate the RLP default parameters within allowed ranges, defined in 3GPP TS 04.22, except the number of retransmission N2, which has to be a non default value.

The SS shall accept and use the new RLP parameters till the end of the test.

After the negotiation procedure the ABM will be entered.

Once in ABM, the SS shall initiate the transmission of an I+S frame, which will transfer L2RCOP status information between peer L2RCOP entities (SS to MS). The MS may respond with an I+S frame containing L2RCOP status information. The SS shall be capable of initiating this sequence, or responding to an I+S L2RCOP status frame from the MS.

This test is repeated twice with 2 different values of N2, randomly chosen.

Test Procedure

The MS is made to send only one I+S frames.

The SS does not acknowledge the received I+S frame.

At the expiry of T1 after the sending of the I+S frame, the MS shall send a supervisory command RR frame with P bit set to 1.

The SS answer in a RR response frame with F bit set to 0 and N(R) acknowledging the I+S frame sent by the MS.

At the expiry of T1 after the sending of the frame with P=1, the MS shall send a new supervisory command RR frame with P bit set to 1.

The SS answer in a RR response frame with F bit set to 0 and N(R) corresponding to the I+S frame sent by the MS.

These 2 last steps are repeated N2 times.

At the expiry of T1 after the sending of the frame with P=1, the MS shall reset (SABM) or disconnect (DISC) the link.

The SS answer with an UA frame.

The MS is returned to the idle state by clearing of the call.

Expected sequence

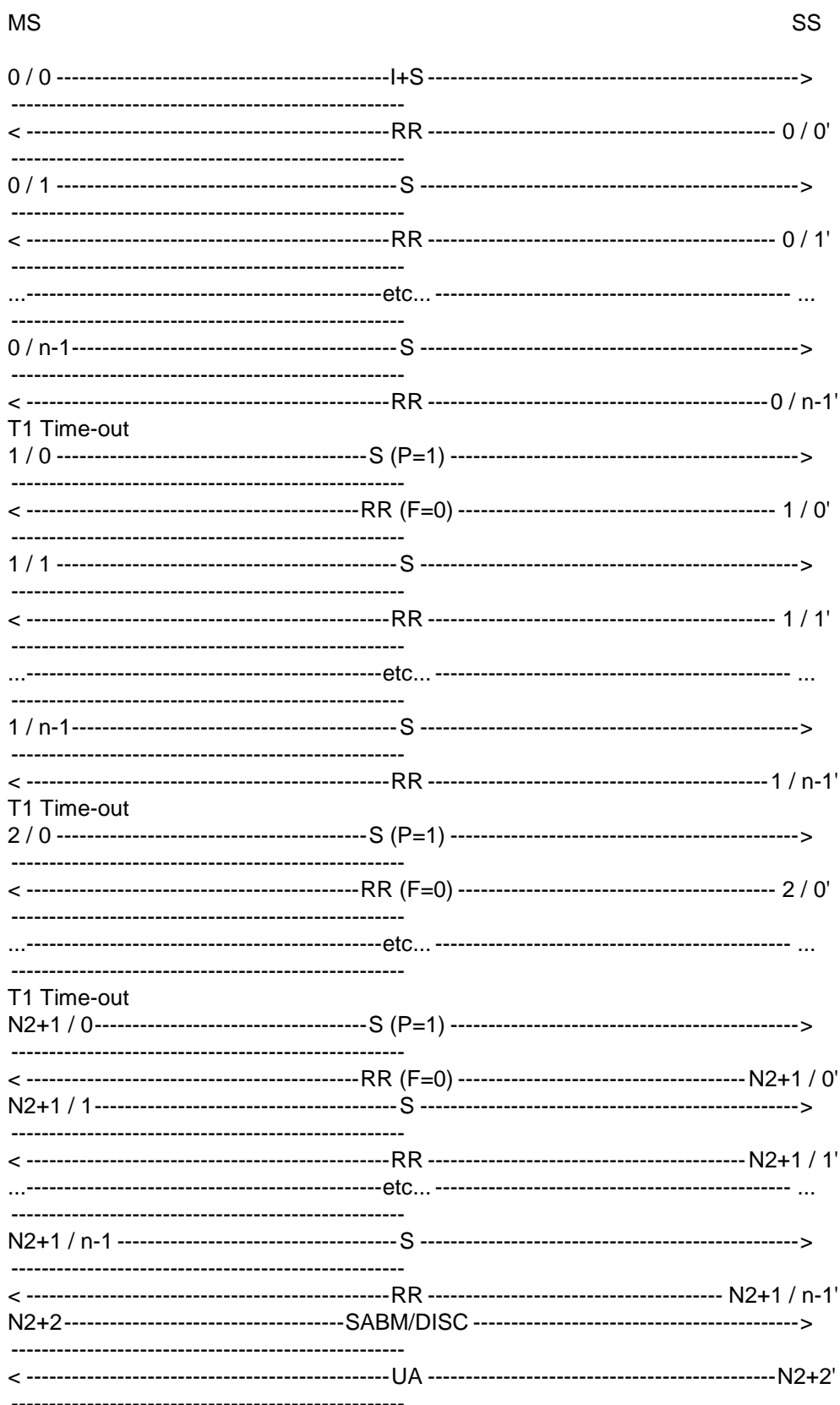

The frames from the SS will be:

0 / i',...,0 / i': One RR frame containing:

P/F=0,

$N(R) = NMS \bmod(62)$.

$i = 0, \dots, n-1$.

$k / i', \dots, k / i'$: One RR frame containing:

$P/F=0$,

$N(R) = NMS \bmod(62)$.

$k = 1, \dots, N2+1, i = 0, \dots, n-1$.

$N2+2'$: One UA frame containing:

$C/R=0$,

$P/F = P/F$ received in the DISC or SABM.

29.3.2.6.7.5 Test requirements

The frames from the MS shall be:

$0 / 0$: One I+S frame containing:

$N(S) = NMS \bmod(62)$.

$0 / 1, \dots, 0 / n-1$: The MS sends S frames.

$k / 0$: On T1 Time-out after the I+S frame, the MS sends a S frame containing:

$C/R=1$,

$P/F=1$.

$k = 1, \dots, N2+1$.

$k / 1, \dots, k / n-1$: The MS sends S frames.

$N2+2$: The MS sends a SABM ($C/R=1, P/F=1$) or a DISC($C/R=1$) frame.

29.3.2.6.8 Retransmission of a sequence

29.3.2.6.8.1 Test purpose

To test the correct repetition of a sequence of frame.

29.3.2.6.8.2 Method of test

Initial Conditions

System Simulator:

The SS is configured to use default RLP parameters.

Mobile Station:

The MS is configured to use RLP default parameters except the number of retransmission $N2$.

A non transparent data call will be established, so that the MS is in call state U10 ("Call Active").

Since some RLP parameters are different from the default parameters, a negotiation procedure will be initiated by the MS after the CONNECT ACKNOWLEDGE message. The MS may negotiate the RLP default parameters within allowed ranges, defined in 3GPP TS 04.22, except the number of retransmission $N2$, which has to be a non default value.

The SS shall accept and use the new RLP parameters till the end of the test.

After the negotiation procedure the ABM will be entered.

This test is repeated twice with 2 different values of N_2 , randomly chosen. The window size from MS to IWF (SS) is called KMI.

Procedure

The MS is made to send a sequence of i I+S frames ($1 < i < KIM$) with a delay inferior to T_1 between each frame.

The SS does not acknowledge the received I+S frames.

The MS starts sending supervisory frames after having sent i frames.

At the expiry of T_1 after the last sending I+S frame, the MS shall send a supervisory command RR frame with P bit set to 1.

The SS answers in a RR response frame with F bit set to 1 and acknowledging no frames.

The MS shall retransmit the all I+S frames. Then the MS shall sends supervisory frames.

At the expiry of T_1 after the last sending I+S frame, the MS shall send a supervisory command RR frame with P bit set to 1.

The SS answers in a RR response frame with F bit set to 1 and acknowledging $j < i$ frames. (j randomly chosen).

The MS shall retransmit the $i-j$ lost I+S frames.

$0,25 * T_1$ after the last I+S frame of the sequence, the SS acknowledges all the received I+S frames in RR frame.

The MS is returned to the idle state by clearing of the call.

Expected sequence

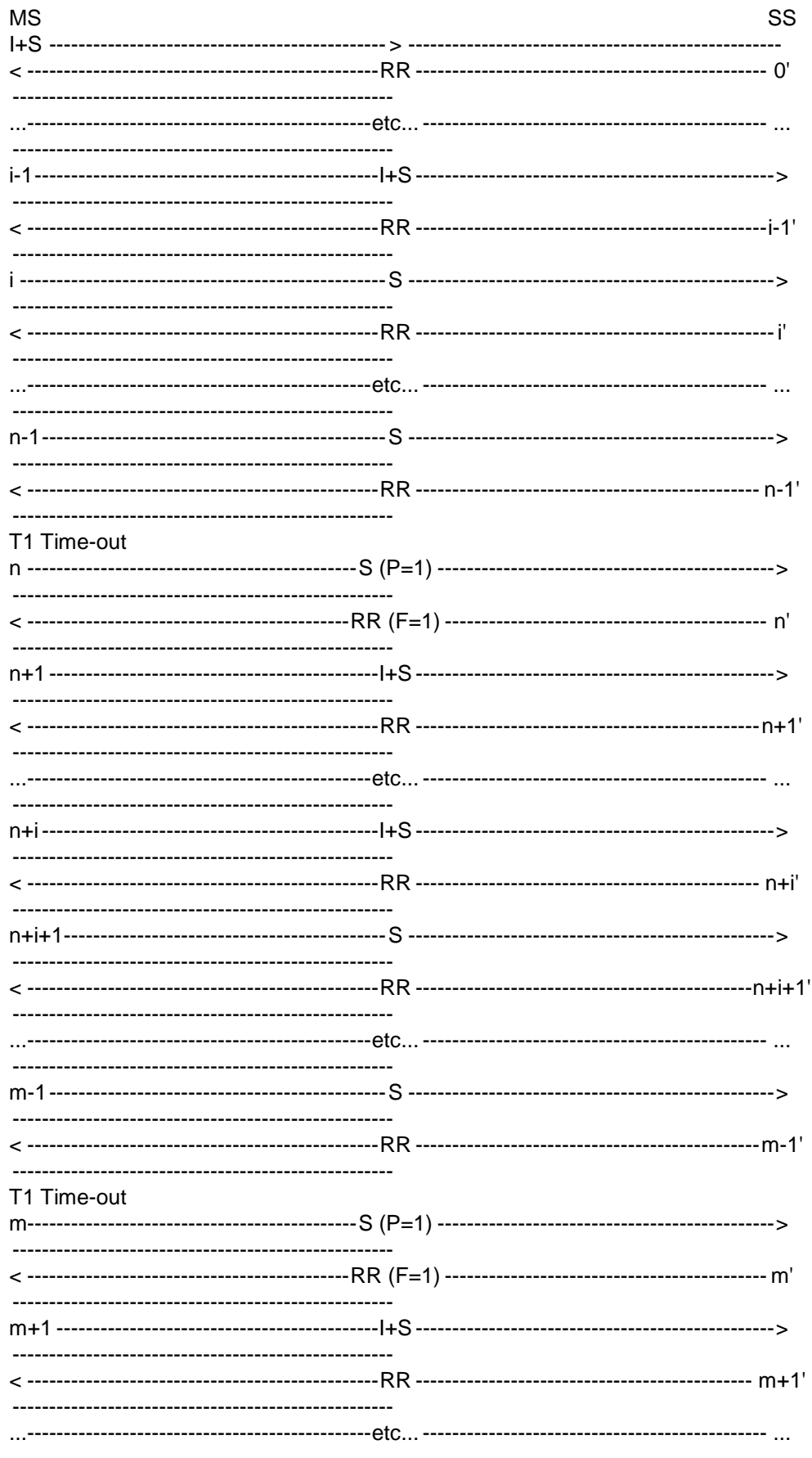

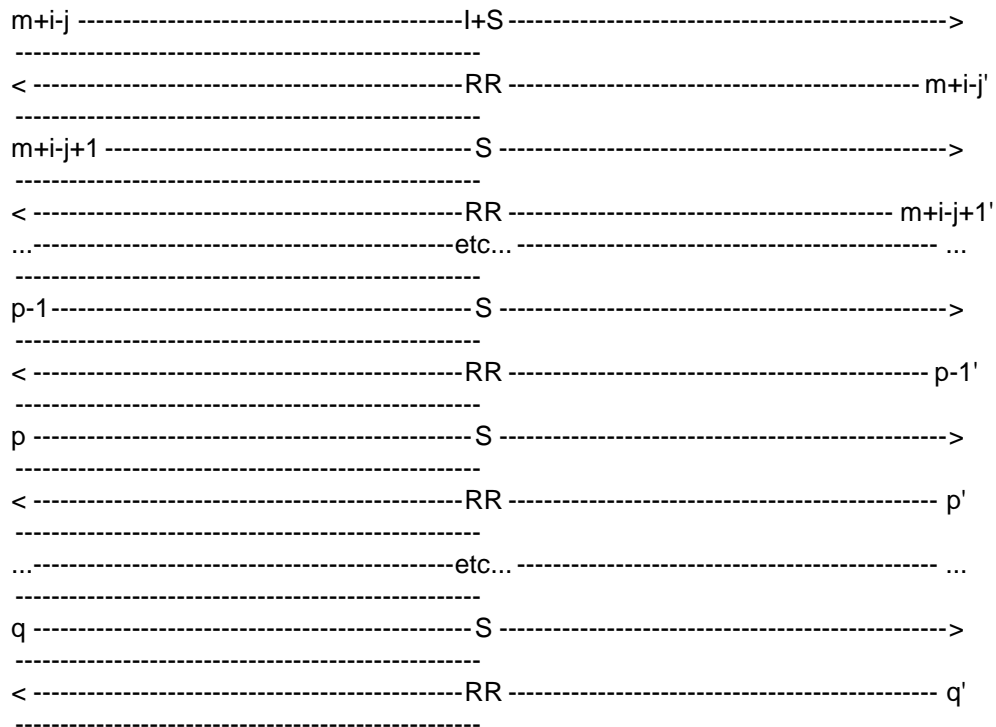

The frames from the SS will be:

0',...,n-1': One RR frame containing:

$$N(R)=NMS \text{ mod}(62).$$

n': One supervisory RR frame containing:

$$C/R=0,$$

$$P/F=1,$$

$$N(R)=NMS \text{ mod}(62).$$

n+1',...,m-1': One supervisory RR frame containing:

$$N(R)=NMS \text{ mod}(62).$$

m': One supervisory RR frame containing:

$$C/R=0,$$

$$P/F=1,$$

$$N(R)=NMS+j \text{ mod}(62).$$

m+1',...,p-2': One supervisory RR frame containing:

$$N(R)=NMS+j \text{ mod}(62).$$

p-1': 0,25*T1 after the last received I+S frame, the SS sends a supervisory RR frame containing:

$$N(R)=NMS+i \text{ mod}(62).$$

p',...,q': during at least T1, the SS sends supervisory frames.

29.3.2.6.8.3 Test requirements

The frames from the MS shall be:

0',...,i-1: One I+S frame containing:

$N(S)=N_{MS},\dots,N_{MS+i-1} \bmod(62)$.

$i,\dots,n-1$: The MS sends S frames with P bit set to 0.

n : On $T1$ Time-out after the $I+S$ frame, the MS sends a S frame containing:

$C/R=1$,

$P/F=1$.

$n+1,\dots,n+i$: The MS retransmits the $I+S$ frames containing:

$N(S)=N_{MS},\dots,N_{MS+i-1} \bmod(62)$.

$n+i+1,\dots,m-1$: The MS sends S frames with P bit set to 0.

m : On $T1$ Time-out after the $I+S$ frame, the MS sends a S frame containing:

$C/R=1$,

$P/F=1$.

$m+1,\dots,m+i-j$: The MS retransmits the $I+S$ frames containing:

$N(S)=N_{MS+j},\dots,N_{MS+i-1} \bmod(62)$.

$m+i-j+1,\dots,q$: The MS sends S frames with P bit set to 0.

29.3.2.6.9 N2 retransmission of a sequence

29.3.2.6.9.1 Definition

The last frame of a sequence of numbered information frames is guarded by timer $T1$. Failure to receive an acknowledgement, or a reject, within a time $T1$, shall result in the RLP entity starting a checkpoint recovery procedure. If the peer RLP entity responds with a Supervisory frame with the F -bit set to "1", the MS shall retransmit the numbered frames, if appropriate.

29.3.2.6.9.2 Conformance requirements

The MS shall start the checkpoint procedure after failure to receive acknowledgement of a numbered information frame within a time $T1$. 3GPP TS 04.22, subclauses 5.3.3 and 5.3.3.2.

The MS shall retransmit the $I+S$ frame sequence starting at $N(R)$, upon reception of a Supervisory frame with the F -bit set to "1" from the peer RLP entity. This shall constitute a retransmission of the original $I+S$ sequence only if $N(R)$ remains constant, 3GPP TS 04.22, subclause 5.3.3.

The MS shall disconnect or reset the RLP link after the $I+S$ sequence and checkpoint procedure has been performed $N2+1$ times, 3GPP TS 04.22, subclause 5.3.3.2.

References

3GPP TS 04.22 subclauses 5.3.3 and 5.3.3.2.

29.3.2.6.9.3 Test purpose

To test the correct repetition of a sequence of frame.

29.3.2.6.9.4 Method of test

Initial Conditions

System Simulator:

The SS is configured to use default RLP parameters.

Mobile Station:

If possible, the MS is configured to use RLP default parameters except the number of retransmission N2. If a MS cannot be configured to use a non default N2 value, the SS shall use XID negotiation to modify the value of N2 to be used during the test.

A non transparent data call will be established, so that the MS is in call state U10 ("Call Active").

Since some RLP parameters are different from the default parameters, a negotiation procedure will be initiated by the MS after the CONNECKT ACKNOWLEDGE message. The MS may negotiate the RLP default parameters within allowed ranges, defined in 3GPP TS 04.22, except the number of retransmission N2, which has to be a non default value.

The SS shall accept and use the new RLP parameters till the end of the test.

After the negotiation procedure the ABM will be entered.

Once in ABM, the SS shall initiate the transmission of an I+S frame, which will transfer L2RCOP status information between peer L2RCOP entities (SS to MS). The MS may respond with an I+S frame containing L2RCOP status information. The SS shall be capable of initiating this sequence, or responding to an I+S L2RCOP status frame from the MS.

This test is repeated twice with 2 different values of N2, randomly chosen.

The window size from MS to IWF (SS) is called KMI.

Test Procedure

The MS is made to send a sequence of i I+S frames ($1 < i < KMI$, and $i > N2$) with a delay inferior to T1 between each frame.

The SS does not acknowledge the received I+S frames.

The MS shall send S frames after having sent the i I+S frames.

At the expiry of T1 after the last sending I+S frame, the MS shall send a supervisory command RR frame with P bit set to 1.

The SS answer in a RR response frame with F bit set to 1 and acknowledging 1 frame.

The MS shall retransmit the $i-1$ lost I+S frames.

The SS does not acknowledge the received I+S frames.

The MS shall send S frames after having sent the i I+S frames.

The 5 last steps are repeated N2 times.

At the expiry of T1 after sending the last I+S frame, the MS shall reset or disconnect the RLP link by sending an SABM (C/R=1, P/F=1) or a DISC (C/R=1) frame.

The SS answer with an UA frame.

The MS is returned to the idle state by clearing of the call.

Expected sequence

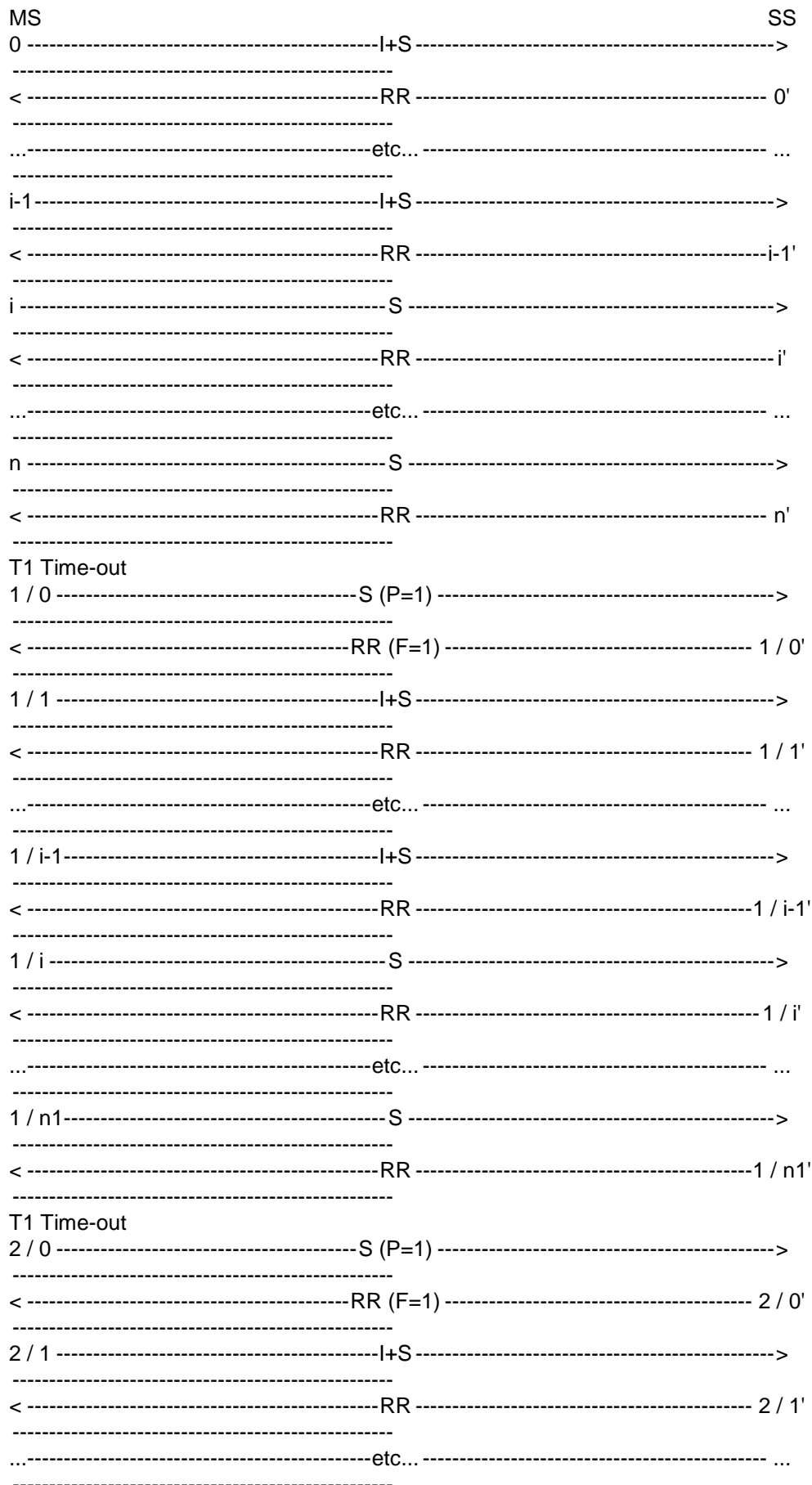

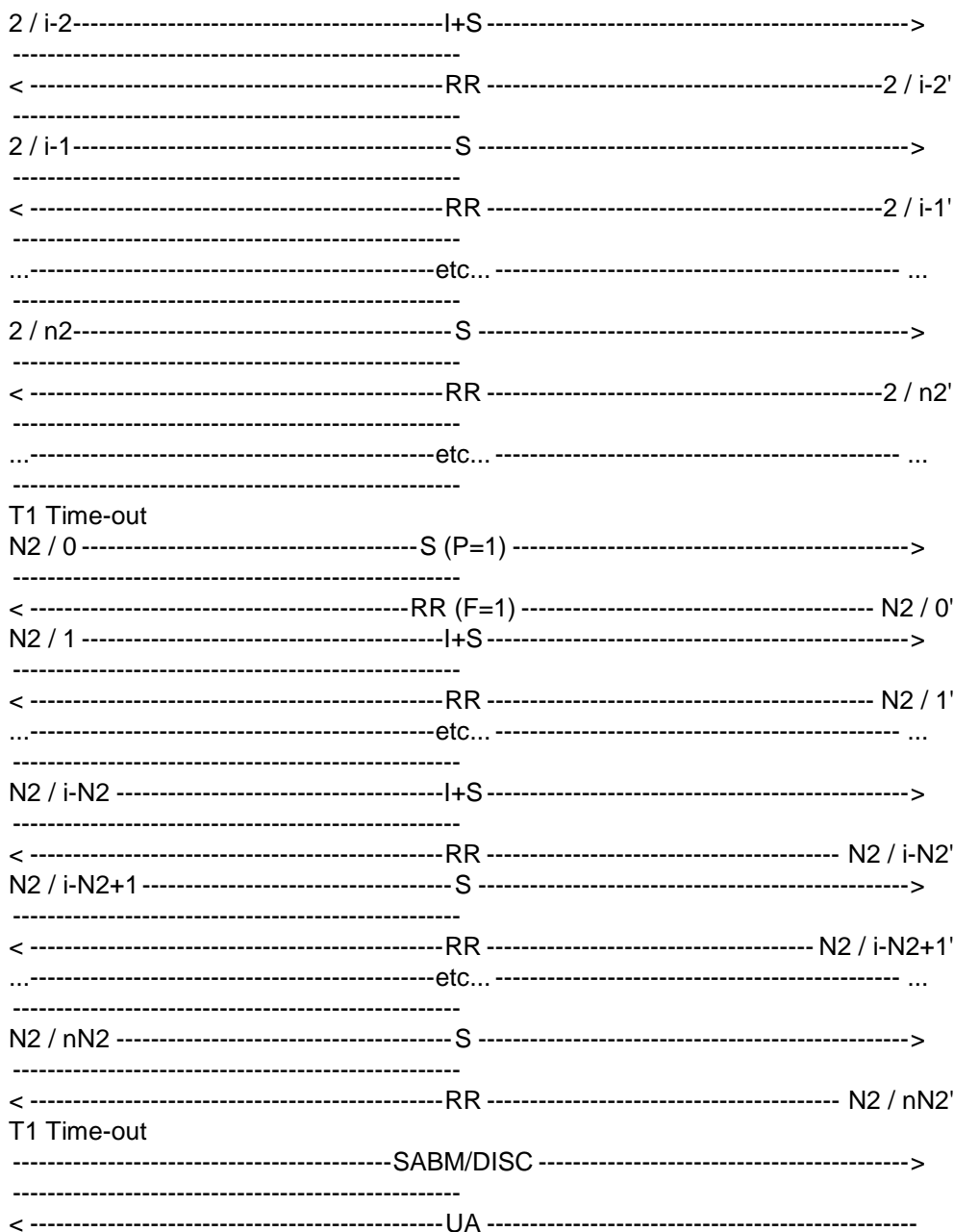

The frames from the SS will be:

0',...,n': One RR frame containing:

$$N(R)=NMS \text{ mod}(62).$$

k / 0': One supervisory RR frame containing:

$$C/R=0,$$

$$P/F=1,$$

$$N(R)=NMS+k \text{ mod}(62).$$

$$k = 1, \dots, N2+1.$$

k / 1',...,k / nk': One RR frame containing:

$$N(R)=NMS+k \text{ mod}(62).$$

$$k = 1, \dots, N2.$$

One UA frame with P/F bit equal to the P/F received.

29.3.2.6.9.5 Test requirements

The frames from the MS shall be:

0,...,i-1: One I+S frame containing:

$$N(S)=NMS,\dots,NMS+i-1 \bmod(62).$$

i,..., n: The MS sends S frames.

k / 0: The MS stops sending I+S frames. It sends S frames. On T1 Time-out after the last sent I+S frame, the MS sends a S frame containing:

$$C/R=1,$$

$$P/F=1.$$

$$k = 1, \dots, N2+1.$$

k / 1,..., k / i-k: The MS retransmits the I+S frames containing:

$$N(S)=NMS+k,\dots,NMS+i-1 \bmod(62).$$

$$k = 1, \dots, N2.$$

k / i-k+1,..., k / nk: The MS sends S frames. k= 1, ..., N2.

The MS shall reset to disconnect the RLP link. It shall send an SABM (C/R=1, P/F=1) or a DISC (C/R=1).

29.3.3 Negotiation of the RLP parameters

29.3.3.1 Negotiation initiated by the SS

29.3.3.1.1 Conformance requirements

The MS shall be able to respond to a negotiation request from the network and to configure its RLP parameters accordingly. It shall do so in ABM mode as well as in ADM mode.

References

3GPP TS 04.22 subclause 5.2.2.6.

29.3.3.1.2 Test purpose

To test the correct handling of the MS to a received XID frame in ADM or ABM mode.

29.3.3.1.3 Test method

Initial Conditions

System Simulator:

The SS is configured to use default RLP parameters.

Mobile Station:

The MS is configured to use RLP default parameters. The window size from IWF (SS) to MS is called K_M .

The MS is made to establish a MO non transparent data call. In initial conditions MS is in call state U10 ("Call Active") after having sent a CONN_ACK message.

Case a: No negotiation will be initiated by the MS.

Case b: The MS initiates negotiation of RLP default parameters.

NOTE: The MS is allowed to initiate the negotiation of the RLP default parameters, within allowed ranges, defined in 3GPP TS 04.22. The MS shall do this in the ADM, after having sent a CONNECT ACKNOWLEDGE message (MO-case) or after having received a CONNECT ACKNOWLEDGE message from the SS (MT-case.)

Specific PICS statements:

-

PIXIT statements:

- Bearer services supported
- Characteristics of non-transparent services.

Foreseen final state of the MS

Idle.

Test procedure

Case 1: Testing of the correct handling of the MS to a received XID frame in ADM

Immediately after having received the "CONN_ACK", the SS sends a correct XID frame containing randomly chosen parameters different from the default parameters and supported by the MS.

If the MS initiates a negotiation procedure, before the SS is able to transmit the XID frame (timing conflict), the SS should accept this - XID frame from the MS and start his own negotiation afterwards.

The MS shall respond with a XID frame. If parameters sent in this frame are different from those chosen by the SS, the correct sense of negotiation is checked. The final parameters are noted (T1, T2, N2, K_{IM} (window IWF (SS) -> MS), K_{MI} (window MS -> IWF (SS))).

The MS sends a SABM and the SS answers with an UA. Note: the SABM frame may be sent by the MS before the XID response frame. In such a case, the SS waits for the XID response before sending the UA.

Case 2: Testing of the correct handling of the MS to a received XID frame in ABM

The MS sends a SABM and the SS answer with an UA.

The SS sends a correct XID frame containing parameters different from the default parameters and supported by the MS.

The MS shall respond with a XID frame. If parameters sent in this frame are different from those chosen by the SS, the correct sense of negotiation is checked. The final parameters are noted (T1, T2, N2, K_{IM} (window IWF (SS) -> MS), K_{MI} (window MS -> IWF (SS))).

The SS checks that the MS uses the new parameters determined during the negotiation procedure.

Verification of T2

After optional status bits exchange between the MS and the SS, the SS is configured to send I+S frames with a delay inferior to T1 between each frame. The MS is made to send no user data, it sends only supervisory frame.

The SS sends an I+S frame numbered $N(S)=N_{ss} \bmod(62)$, the MS shall acknowledge this frame within T2.

Verification of K_{IM}

The SS sends an I+S frame numbered $N_{ss}+K_{IM}+1 \bmod(62)$. The MS shall ignore this frame (out of the window), it shall not acknowledge or reject it. This is checked during at least T2.

The SS sends an I+S frame numbered $N(S)=N_{ss}+1 \bmod(62)$, the MS shall acknowledge this frame.

The SS sends an I+S frame numbered $N_{ss}+K_{IM}+1 \bmod(62)$. The MS shall reject all the lost frames numbered $N_{ss}+2 \bmod(62)$ to $N_{ss}+K_{IM} \bmod(62)$. It shall send a REJ or SREJ frame with $N(R)=N_{ss}+2 \bmod(62)$.

If REJ frame is used by the MS, the SS restarts the transmission of I+S frames from frame numbered $N_{ss}+2 \bmod(62)$. The MS shall acknowledge these frames. After having sent at least the frame numbered $N_{ss}+K_{IM}+2 \bmod(62)$, the SS stops sending I+S frames.

If SREJ frame is used by the MS, the SS restarts the transmission of I+S frames from frame numbered $N_{ss}+2 \bmod(62)$. It does send the frame numbered $N_{ss}+K_{IM}+1 \bmod(62)$ a second time. The MS shall acknowledge these frames. After having sent at least the frame numbered $N_{ss}+K_{IM}+2 \bmod(62)$, the SS stops sending I+S frames.

Verification of K_{MI}

The MS is now configured to send continuously I+S frames with a delay inferior to T_1 between each frame.

The MS sends I+S frames, the SS does not acknowledge these frames.

After having sent K_{MI} I+S frames, the MS shall stop sending I+S frames (end of the window).

Verification of T_1

At the expiry of T_1 after the last I+S frame, the MS shall enter in "checkpoint recovery" mode, it shall send a supervisory RR frame with $C=1$ and $P=1$.

The SS does not answer to checkpointing.

Verification of N_2

At the expiry of T_1 after the last RR ($C=1, P=1$) frame, the MS shall resend a supervisory RR frame with $C=1$ and $P=1$. The SS does not answer to checkpointing. This is repeated N_2 times.

After N_2 retransmissions of the same RR frame ($C=1, P=1$), The MS shall reset or disconnect the RLP link by sending a SABM ($C=1, P=1$) or a DISC ($C=1$) frame. The SS answers with an UA ($R=0$) frame with F bit set to P bit received in SABM or DISC frame.

The MS is returned to the idle state by clearing of the call.

The test is performed for case 1 and 2.

Maximum duration of test

1 minute.

Expected sequence

MS

SS

Case 1

optionally:

	-----	XID	----->	
	<-----	XID	-----	
			
	<-----	XID	-----	0'
0	-----	XID	----->	
1	-----	SABM	----->	
	<-----	UA	-----	1'

Case 2

optionally:

	-----	XID	----->	
	<-----	XID	-----	
			
0	-----	SABM	----->	
	<-----	UA	-----	0'
	(-----	I+S	----->)	Optional
	(<-----	S	----->)	
	<-----	XID	-----	1'
1	-----	XID	----->	
	<-----	I+S	-----	2'
2	-----	RR	----->	
	<-----	I+S	-----	3'
3	-----	RR	----->	
	<-----	I+S	-----	4'
4	-----	RR	----->	
	<-----	I+S	-----	5'
5	-----	REJ or SREJ	----->	
	<-----	I+S	-----	6'
6	-----	RR	----->	
...		etc...		...
	<-----	I+S	-----	i-1'
i-1	-----	RR	----->	
	<-----	RR	-----	i'
i	-----	RR	----->	
...		etc...		...
	<-----	RR	-----	j-1'

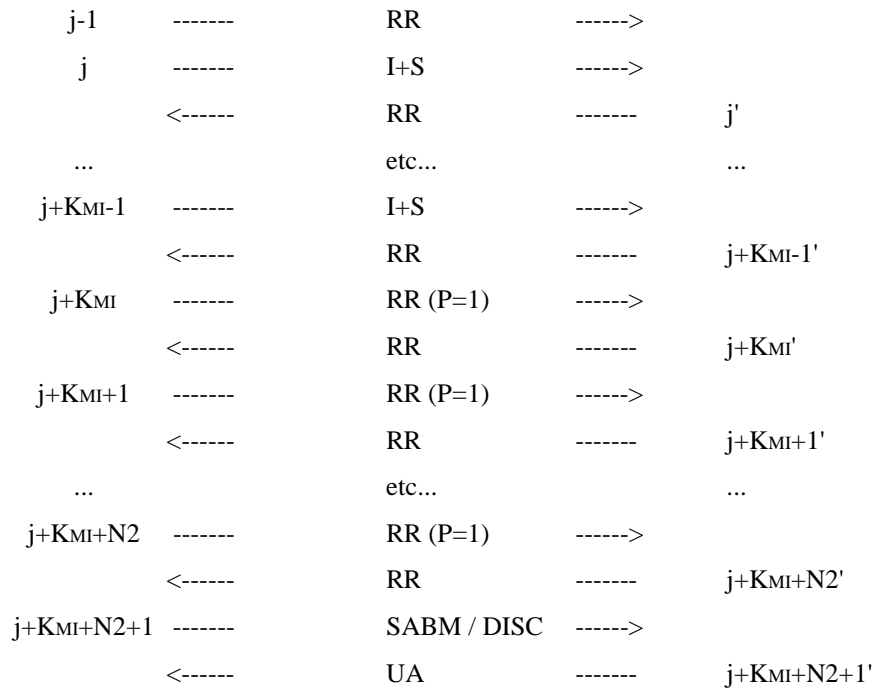

The frame from the SS will be:

Case 1:

0': One XID frame containing: C=1, P=1.

1': One UA frame containing: R=0, F=1. Note: If SABM is received before the reception of the XID response frame, the SS will wait for the XID before sending the UA frame.

Case 2:

0': One UA frame containing: R=0, F=1.

1': One XID frame containing: C=1, P=1.

2': One I+S frame containing $N(S)=N_{ss} \bmod(62)$, $N(R)=N_{ms} \bmod(62)$.

3': One I+S frame containing $N(S)=N_{ss}+K_{IM}+1 \bmod(62)$, $N(R)=N_{ms} \bmod(62)$.

4': A delay D ($T_2 < D < T_1$) after step 3', one I+S frame containing $N(S)=N_{ss}+1 \bmod(62)$, $N(R)=N_{ms} \bmod(62)$.

5': One I+S frame containing $N(S)=N_{ss}+K_{IM}+1 \bmod(62)$, $N(R)=N_{ms} \bmod(62)$.

If REJ frame is used by the MS:

6',..., $K_{IM}+5'$: One I+S frame containing $N(S)=N_{ss}+2, \dots, N_{ss}+K_{IM}+1 \bmod(62)$, $N(R)=N_{ms} \bmod(62)$.

$K_{IM}+6', \dots, i-1'$: One I+S frame containing $N(S)=N_{ss}+K_{IM}+2, \dots, k-1 \bmod(62)$, $N(R)=N_{ms} \bmod(62)$.

If SREJ frame is used by the MS:

6',..., $K_{IM}+4'$: One I+S frame containing $N(S)=N_{ss}+2, \dots, N_{ss}+K_{IM} \bmod(62)$, $N(R)=N_{ms} \bmod(62)$.

$K_{IM}+5', \dots, i-1'$: One I+S frame containing $N(S)=N_{ss}+K_{IM}+2, \dots, k-1 \bmod(62)$, $N(R)=N_{ms} \bmod(62)$.

The SS stops sending I+S frames.

$i', \dots, j-1'$: One RR frame containing, $N(R)=N_{ms} \bmod(62)$.

$j', \dots, j+K_{MI}-1'$: One RR frame containing $N(R)=N_{ms} \bmod(62)$.

$j+K_{MI}', \dots, j+K_{MI}+N2'$: One RR (R=0, F=0) frame containing $N(R)=N_{ms} \bmod(62)$.

$j+K_{MI}+N2+1$: One UA (R=0) frame with F bit set to P bit received in SABM or DISC frame.

Specific message content

The frame from the MS shall be:

Case 1:

0: One XID frame containing: R=0, F=1. The MS may changed the RLP parameters. In this case the SS verifies the correct sense of negotiation. The final parameters are noted (T1, T2, N2, K_{IM} , K_{MI}).

1: One SABM frame containing: C=1,P=1.

NOTE: The MS may send an SABM frame before the XID.

Case 2:

0: One SABM frame containing: C=1,P=1.

1: One XID frame containing: R=0, F=1. The MS may changed the RLP parameters. In this case the SS verifies the correct sense of negotiation. The final parameters are noted (T1, T2, N2, K_{IM} , K_{MI}).

2: One RR frame containing $N(R)=N_{ss}+1 \bmod (62)$ within T2.

3: One RR frame containing $N(R)=N_{ss}+1 \bmod (62)$.

4: One RR frame containing $N(R)=N_{ss}+2 \bmod (62)$.

5: One REJ or SREJ frame containing $N(R)=N_{ss}+2 \bmod (62)$.

If REJ frame is used by the MS:

$6, \dots, K_{IM}+5$: One RR frame containing $N(R)=N_{ss}+3, \dots, N_{ss}+K_{IM}+2 \bmod (62)$.

$K_{IM}+6, \dots, i-1$: One RR frame containing $N(R)=N_{ss}+K_{IM}+3, \dots, k \bmod (62)$.

If SREJ frame is used by the MS:

$6, \dots, K_{IM}+3$: One RR frame containing $N(R)=N_{ss}+3, \dots, N_{ss}+K_{IM} \bmod (62)$.

$K_{IM}+4$: One RR frame containing $N(R)=N_{ss}+K_{IM}+2 \bmod (62)$.

$K_{IM}+5, \dots, i-1$: One RR frame containing $N(R)=N_{ss}+K_{IM}+3, \dots, k \bmod (62)$.

$i, \dots, j-1$: One RR frame containing, $N(R)=k \bmod (62)$.

The MS starts sending data.

$j, \dots, j+K_{MI}-1$: One I+S frame containing $N(S)=N_{MS}, \dots, N_{MS}+K_{MI}-1 \bmod (62)$, $N(R)=k \bmod (62)$.

$j+K_{MI}$: T1 after the last I+S frame sent, one supervisory RR (C=1, P=1) frame containing $N(R)=k \bmod (62)$.

$j+K_{MI}+1, \dots, j+K_{MI}+N2$: At T1 expiry, one supervisory RR (C=1, P=1) frame containing $N(R)=k \bmod (62)$.

$j+K_{MI}+N2+1$: One SABM (C=1, P=1) or DISC (C=1) frame.

29.3.3.2 Negotiation initiated by the MS

29.3.3.2.1 Definition

The XID negotiation procedure allows RLP parameters to be negotiated between peer RLP entities.

29.3.3.2.2 Conformance requirements

The MS shall be able to initiate a negotiation with the network when its RLP parameters are set to non default values. It shall then configure its RLP parameters accordingly. It shall do so in ABM mode as well as in ADM mode. 3GPP TS 04.22, subclause 5.2.2.6.

References

3GPP TS 04.22 subclause 5.2.2.6.

29.3.3.2.3 Test purpose

To test that the MS initiate the negotiation if RLP parameters are different from default parameters.

29.3.3.2.4 Method of test

Initial Conditions

System Simulator:

The SS is configured to use default RLP parameters.

Mobile Station:

The MS is configured to use RLP arbitrary chosen parameters different from the default parameters.

1. The MS is made to establish a MO non transparent data call. In initial conditions MS is in call state U10 ("Call Active") after having sent a CONN_ACK message.
2. The MS is made to establish a MT non transparent data call. In initial conditions MS is in call state U10 ("Call Active") after having received a CONN_ACK message.

This test is performed for initial conditions 1 and 2.

Once in ABM, the SS shall initiate the transmission of an I+S frame, which will transfer L2RCOP status information between peer L2RCOP entities (SS to MS). The MS may respond with an I+S frame containing L2RCOP status information. The SS shall be capable of initiating this sequence, or responding to an I+S L2RCOP status frame from the MS.

Specific PICS statements:

-

PIXIT statements:

- Bearer services supported
- Characteristics of non-transparent services.

Foreseen final state of the MS

Idle.

Test procedure

The MS shall send an XID (C=1, P=1) frame containing a set of RLP parameters different from the default set. The SS answers with XID (R=0, F=1) containing new parameters randomly chosen, the sense of negotiation is correct. Optionally, a renegotiation initiated by the MS should be possible, if the parameters, randomly chosen by the SS are not supported by the MS. In this case, the SS should accept the parameters renegotiated by the MS, if they are within the allowed range defined in 3GPP TS 04.22. The final parameters are noted (T1, T2, N2, K_{IM} (window IWF (SS) -> MS), K_{MI} (window MS -> IWF (SS))).

The MS established the ABM mode by sending a SABM (C=1, P=1) frame. The SS answers with a UA (R=0, F=1) frame. The SABM frame may be sent by the MS before the XID. In such a case, the SS answers to the XID after having established the ABM mode (i.e. after having sent the UA).

The SS checks that the MS uses the new parameters determined during the negotiation procedure.

Verification of T2:

The SS is configured to send I+S frames with a delay inferior to T1 between each frame. The MS is made to send no user data, it sends only supervisory frame.

The SS sends an I+S frame numbered $N(S)=N_{ss} \bmod(62)$, the MS shall acknowledge this frame within T2.

Verification of K_{IM} :

The SS sends an I+S frame numbered $N_{ss}+K_{IM}+1 \bmod(62)$. The MS shall ignore this frame (out of the window), it shall not acknowledge or reject it. This is checked during at least T2.

The SS sends an I+S frame numbered $N(S)=N_{ss}+1 \bmod(62)$, the MS shall acknowledge this frame.

The SS sends an I+S frame numbered $N_{ss}+K_{IM}+1 \bmod(62)$. The MS shall reject all the lost frames numbered $N_{ss}+2 \bmod(62)$ to $N_{ss}+K_{IM} \bmod(62)$. It shall send a REJ or SREJ frame with $N(R)=N_{ss}+2 \bmod(62)$

If REJ frame is used by the MS, the SS restarts the transmission of I+S frames from frame numbered $N_{ss}+2 \bmod(62)$. The MS shall acknowledge these frames. After having sent at least the frame numbered $N_{ss}+K_{IM}+2 \bmod(62)$, the SS stops sending I+S frames.

If SREJ frame is used by the MS, the SS restarts the transmission of I+S frames from frame numbered $N_{ss}+2 \bmod(62)$. It does send the frame numbered $N_{ss}+K_{IM}+1 \bmod(62)$ a second time. The MS shall acknowledge these frames. After having sent at least the frame numbered $N_{ss}+K_{IM}+2 \bmod(62)$, the SS stops sending I+S frames.

Verification of K_{MI} :

The MS is now configured to send continuously I+S frames with a delay inferior to T1 between each frame.

The MS sends I+S frames, the SS does not acknowledge these frames.

After having sent K_{MI} I+S frames, the MS shall stop sending I+S frames (end of the window).

Verification of T1:

At the expiry of T1 after the last I+S frame, the MS shall enter in "checkpoint recovery" mode, it shall send a supervisory RR frame with C=1 and P=1.

The SS does not answer to checkpointing.

Verification of N2:

At the expiry of T1 after the last RR (C=1, P=1) frame, the MS shall resend a supervisory RR frame with C=1 and P=1. The SS does not answer to checkpointing. This is repeated N2 times.

After N2 retransmissions of the same RR frame (C=1, P=1), The MS shall reset or disconnect the RLP link by sending a SABM (C=1,P=1) or a DISC (C=1) frame. The SS answers with an UA (R=0) frame with F bit set to P bit received in SABM or DISC frame.

The MS is returned to the idle state by clearing of the call.

Expected sequence

MS				SS
0	----->	XID	----->	
	<-----	XID	-----	0
optional renegotiation:				
	----->	XID	----->	
	<-----	XID	-----	
1	----->	SABM	----->	
	<-----	UA	-----	1'
	<-----	I+S	-----	2'
2	----->	RR	----->	
	<-----	I+S	-----	3'
3	----->	RR	----->	
	<-----	I+S	-----	4'
4	----->	RR	----->	
	<-----	I+S	-----	5'
5	----->	REJ or SREJ	----->	
	<-----	I+S	-----	6'
6	----->	RR	----->	
...		etc...		...
	<-----	I+S	-----	i-1'
i-1	----->	RR	----->	
	<-----	RR	-----	i'
i	----->	RR	----->	
...		etc...		...
	<-----	RR	-----	j-1'
j-1	----->	RR	----->	
j	----->	I+S	----->	
	<-----	RR	-----	j'
...		etc...		...
j+K _{MI} -1	----->	I+S	----->	
	<-----	RR	-----	j+K _{MI} -1'
j+K _{MI}	----->	RR	----->	
	<-----	RR	-----	j+K _{MI} '

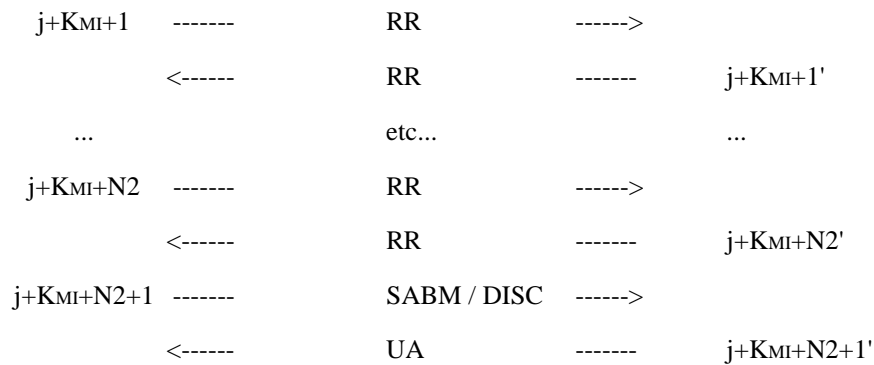

The frame from the SS will be:

- 0': One XID frame containing: $R=0, F=1$. The RLP parameters are changed by the SS, the sense of negotiation is correct. The final parameters are noted ($T1, T2, N2, K_{IM}, K_{MI}$).
- 1': One UA frame containing: $R=0, F=1$. Note: If SABM is received before the XID, the SS answers to the XID after having established the ABM mode (i.e. after having sent the UA).
- 2': One I+S frame containing $N(S)=N_{ss} \bmod(62), N(R)=N_{ms} \bmod(62)$.
- 3': One I+S frame containing $N(S)=N_{ss}+K_{IM}+1 \bmod(62), N(R)=N_{ms} \bmod(62)$.
- 4': A delay D ($T2 < D < T1$) after step 3', one I+S frame containing $N(S)=N_{ss}+1 \bmod(62), N(R)=N_{ms} \bmod(62)$.
- 5': One I+S frame containing $N(S)=N_{ss}+K_{IM}+1 \bmod(62), N(R)=N_{ms} \bmod(62)$.

If REJ frame is used by the MS:

- $6', \dots, K_{IM}+5'$: One I+S frame containing $N(S)=N_{ss}+2, \dots, N_{ss}+K_{IM}+1 \bmod(62), N(R)=N_{ms} \bmod(62)$.
- $K_{IM}+6', \dots, i-1'$: One I+S frame containing $N(S)=N_{ss}+K_{IM}+2, \dots, k-1 \bmod(62), N(R)=N_{ms} \bmod(62)$.

If SREJ frame is used by the MS:

- $6', \dots, K_{IM}+4'$: One I+S frame containing $N(S)=N_{ss}+2, \dots, N_{ss}+K_{IM} \bmod(62), N(R)=N_{ms} \bmod(62)$.
- $K_{IM}+5', \dots, i-1'$: One I+S frame containing $N(S)=N_{ss}+K_{IM}+2, \dots, k-1 \bmod(62), N(R)=N_{ms} \bmod(62)$.

The SS stops sending I+S frames.

- $i', \dots, j-1'$: One RR frame containing, $N(R)=N_{ms} \bmod(62)$.
- $j', \dots, j+K_{MI}-1'$: One RR frame containing $N(R)=N_{ms} \bmod(62)$.
- $j+K_{MI}', \dots, j+K_{MI}+N2'$: One RR ($R=0, F=0$) frame containing $N(R)=N_{ms} \bmod(62)$.
- $j+K_{MI}+N2+1'$: One UA ($R=0$) frame with F bit set to P bit received in SABM or DISC frame.

29.3.3.2.5 Test requirements

Specific message content

The frame from the MS shall be:

- 0: One XID frame containing: $C=1, P=1$.
 - 1: One SABM frame containing: $C=1, P=1$.
- NOTE: The MS may send the SABM frame before the XID.
- 2: One RR frame containing $N(R)=N_{ss}+1 \bmod(62)$ within $T2$.
 - 3: One RR frame containing $N(R)=N_{ss}+1 \bmod(62)$.

4: One RR frame containing $N(R)=N_{ss}+2 \bmod (62)$.

5: One REJ or SREJ frame containing $N(R)=N_{ss}+2 \bmod (62)$.

If REJ frame is used by the MS:

6,..., $K_{IM}+5$: One RR frame containing $N(R)=N_{ss}+3, \dots, N_{ss}+K_{IM}+2 \bmod(62)$.

$K_{IM}+6, \dots, i-1$: One RR frame containing $N(R)=N_{ss}+K_{IM}+3, \dots, k \bmod(62)$.

If SREJ frame is used by the MS:

6,..., $K_{IM}+3$: One RR frame containing $N(R)=N_{ss}+3, \dots, N_{ss}+K_{IM} \bmod(62)$.

$K_{IM}+4$: One RR frame containing $N(R)=N_{ss}+K_{IM}+2 \bmod(62)$.

$K_{IM}+5, \dots, i-1$: One RR frame containing $N(R)=N_{ss}+K_{IM}+3, \dots, k \bmod(62)$.

$i, \dots, j-1$: One RR frame containing, $N(R)=k \bmod (62)$.

The MS starts sending data.

$j, \dots, j+K_{MI}-1$: One I+S frame containing $N(S)=N_{MS}, \dots, N_{MS}+K_{MI}-1 \bmod(62)$, $N(R)=k \bmod (62)$.

$j+K_{MI}$: T1 after the last I+S frame sent, one supervisory RR (C=1, P=1) frame containing $N(R)=k \bmod (62)$.

$j+K_{MI}+1, \dots, j+K_{MI}+N_2$: At T1 expiry, one supervisory RR (C=1, P=1) frame containing $N(R)=k \bmod (62)$.

$j+K_{MI}+N_2+1$: One SABM (C=1, P=1) or DISC (C=1) frame.

29.3.3.3 Collision of XID frames

29.3.3.3.1 Definition

The XID negotiation procedure allows RLP parameters to be negotiated between peer RLP entities. If a collision of XID frames occurs, the MS shall ignore all XID frames and restart the parameter negotiation on expiry of timer T1.

29.3.3.3.2 Conformance requirements

The MS shall be able to ignore an XID frame from the network in the case where it has sent a XID frame asking for a negotiation to the network, and to restart the negotiation procedure after expiry of timer T1. 3GPP TS 04.22, 5.2.2.6.

References

3GPP TS 04.22 subclause 5.2.2.6.

29.3.3.3.3 Test purpose

To test that the correct reaction of the MS to a collision of XID frames.

29.3.3.3.4 Method of test

Initial Conditions

System Simulator:

The SS is configured to use default RLP parameters.

Mobile Station:

The MS is configured to use RLP parameters different from the default parameters and arbitrary chosen.

The MS is made to establish a MO non transparent data call. In initial conditions MS is in call state U10 ("Call Active") after having sent a CONN_ACK message.

Once in ABM, the SS shall initiate the transmission of an I+S frame, which will transfer L2RCOP status information between peer L2RCOP entities (SS to MS). The MS may respond with an I+S frame containing L2RCOP status

information. The SS shall be capable of initiating this sequence, or responding to an I+S L2RCOP status frame from the MS.

Specific PICS statements:

-

PIXIT statements:

- Bearer services supported
- Characteristics of non-transparent services.

Foreseen final state of the MS

Idle.

Test procedure

The MS shall send an XID (C=1, P=1) frame containing a set of RLP parameters different from the default set. The SS sends a XID (C=1, P=1) command frame containing new parameters. After a delay the MS shall resend the same XID that it has previously sent. The SS answers with XID (R=0, F=1) accepting the parameters chosen by the MS. These parameters are noted (T1, T2, N2, K_{IM} (window IWF (SS) -> MS), K_{MI} (window MS -> IWF (SS))).

The MS established the ABM mode by sending a SABM (C=1, P=1) frame. The SS answers with a UA (R=0, F=1) frame. The SABM frame may be sent by the MS at any instant (i.e. just after having received an XID, before having sent the response). In such a case, the SS answers to the XID after having established the ABM mode (i.e. after having sent the UA).

The SS checks that the MS uses the new parameters determined during the negotiation procedure.

Verification of T2:

The SS is configured to send I+S frames with a delay inferior to T1 between each frame. The MS is made to send no user data, it sends only supervisory frame.

The SS sends an I+S frame numbered $N(S)=N_{ss} \bmod(62)$, the MS shall acknowledge this frame within T2.

Verification of K_{IM}:

The SS sends an I+S frame numbered $N_{ss}+K_{IM}+1 \bmod(62)$. The MS shall ignore this frame (out of the window), it shall not acknowledge or reject it. This is checked during at least T2.

The SS sends an I+S frame numbered $N(S)=N_{ss}+1 \bmod(62)$, the MS shall acknowledge this frame.

The SS sends an I+S frame numbered $N_{ss}+K_{IM}+1 \bmod(62)$. The MS shall reject all the lost frames numbered $N_{ss}+2 \bmod(62)$ to $N_{ss}+K_{IM} \bmod(62)$. It shall send a REJ or SREJ frame with $N(R)=N_{ss}+2 \bmod(62)$.

If REJ frame is used by the MS, the SS restarts the transmission of I+S frames from frame numbered $N_{ss}+2 \bmod(62)$. The MS shall acknowledge these frames. After having sent at least the frame numbered $N_{ss}+K_{IM}+2 \bmod(62)$, the SS stops sending I+S frames.

If SREJ frame is used by the MS, the SS restarts the transmission of I+S frames from frame numbered $N_{ss}+2 \bmod(62)$. It does send the frame numbered $N_{ss}+K_{IM}+1 \bmod(62)$ a second time. The MS shall acknowledge these frames. After having sent at least the frame numbered $N_{ss}+K_{IM}+2 \bmod(62)$, the SS stops sending I+S frames.

Verification of K_{MI}:

The MS is now configured to send continuously I+S frames with a delay inferior to T1 between each frame.

The MS sends I+S frames, the SS does not acknowledge these frames.

After having sent K_{MI} I+S frames, the MS shall stop sending I+S frames (end of the window).

Verification of T1:

At the expiry of T1 after the last I+S frame, the MS shall enter in "checkpoint recovery" mode, it shall send a supervisory RR frame with C=1 and P=1.

The SS does not answer to checkpointing.

Verification of N2:

At the expiry of T1 after the last RR (C=1, P=1) frame, the MS shall resend a supervisory RR frame with C=1 and P=1. The SS does not answer to checkpointing. This is repeated N2 times.

After N2 retransmissions of the same RR frame (C=1, P=1), The MS shall reset or disconnect the RLP link by sending a SABM (C=1,P=1) or a DISC (C=1) frame. The SS answers with an UA (R=0) frame with F bit set to P bit received in SABM or DISC frame.

The MS is returned to the idle state by clearing of the call.

Maximum duration of test

1 minute.

Expected sequence

MS				SS
0	-----	XID	----->	
	<-----	XID	-----	0'
1	-----	XID	----->	
	<-----	XID	-----	1'
2	-----	SABM	----->	
	<-----	UA	-----	2'
	<-----	I+S	-----	3'
3	-----	RR	----->	
	<-----	I+S	-----	4'
4	-----	RR	----->	
	<-----	I+S	-----	5'
5	-----	RR	----->	
	<-----	I+S	-----	6'
6	-----	REJ or SREJ	----->	
	<-----	I+S	-----	7'
7	-----	RR	----->	
...		etc...		...
	<-----	I+S	-----	i-1'
i-1	-----	RR	----->	
	<-----	RR	-----	i'
i	-----	RR	----->	
...		etc...		...
	<-----	RR	-----	j-1'
j-1	-----	RR	----->	
j	-----	I+S	----->	
	<-----	RR	-----	j'
...		etc...		...
j+K _{Mi} -1	-----	I+S	----->	
	<-----	RR	-----	j+K _{Mi} -1'
j+K _{Mi}	-----	RR	----->	
	<-----	RR	-----	j+K _{Mi} '
j+K _{Mi} +1	-----	RR	----->	
	<-----	RR	-----	j+K _{Mi} +1'
...		etc...		...
j+K _{Mi} +N2	-----	RR	----->	
	<-----	RR	-----	j+K _{Mi} +N2'
j+K _{Mi} +N2+1	-----	SABM / DISC	----->	
	<-----	UA	-----	j+K _{Mi} +N2+1'

The frame from the SS will be:

- 0': One XID frame containing: C=1, P=1.
- 1': One XID frame containing: R=0, F=1. The RLP parameters are changed by the SS, the sense of negotiation is correct. The final parameters are noted (T1, T2, N2, K_{IM}, K_{MI}).
- 2': One UA frame containing: R=0, F=1. Note: If SABM is received before one of the XID frames, the SS will answer to the XID after having established the ABM mode (i.e. after having sent the UA).
- 3': One I+S frame containing $N(S)=N_{ss} \bmod(62)$, $N(R)=N_{ms} \bmod(62)$.
- 4': One I+S frame containing $N(S)=N_{ss}+K_{IM}+1 \bmod(62)$, $N(R)=N_{ms} \bmod(62)$.
- 5': A delay D ($T2 < D < T1$) after step 3', one I+S frame containing $N(S)=N_{ss}+1 \bmod(62)$, $N(R)=N_{ms} \bmod(62)$.
- 6': One I+S frame containing $N(S)=N_{ss}+K_{IM}+1 \bmod(62)$, $N(R)=N_{ms} \bmod(62)$.

If REJ frame is used by the MS:

- 7',..., K_{IM}+6': One I+S frame containing $N(S)=N_{ss}+2, \dots, N_{ss}+K_{IM}+1 \bmod(62)$, $N(R)=N_{ms} \bmod(62)$.
- K_{IM}+7',...,i-1': One I+S frame containing $N(S)=N_{ss}+K_{IM}+2, \dots, k-1 \bmod(62)$, $N(R)=N_{ms} \bmod(62)$.

If SREJ frame is used by the MS:

- 7',..., K_{IM}+5': One I+S frame containing $N(S)=N_{ss}+2, \dots, N_{ss}+K_{IM} \bmod(62)$, $N(R)=N_{ms} \bmod(62)$.
- K_{IM}+6',...,i-1': One I+S frame containing $N(S)=N_{ss}+K_{IM}+2, \dots, k-1 \bmod(62)$, $N(R)=N_{ms} \bmod(62)$.

The SS stops sending I+S frames.

- i',...,j-1': One RR frame containing, $N(R)=N_{ms} \bmod(62)$.
- j',...,j+K_{MI}-1': One RR frame containing $N(R)=N_{ms} \bmod(62)$.
- j+K_{MI}',...,j+K_{MI}+N2': One RR (R=0, F=0) frame containing $N(R)=N_{ms} \bmod(62)$.
- j+K_{MI}+N2+1': One UA (R=0) frame with F bit set to P bit received in SABM or DISC frame.

29.3.3.3.5 Test requirements

Specific message content

The frame from the MS shall be:

- 0: One XID frame containing: C=1, P=1.
 - 1: After T1(def) expiry, one XID frame containing: C=1, P=1.
- NOTE: The MS may send an SABM frame before the 1st or the 2nd XID frame.
- 2: One SABM frame containing: C=1,P=1.
 - 3: One RR frame containing $N(R)=N_{ss}+1 \bmod(62)$ within T2.
 - 4: One RR frame containing $N(R)=N_{ss}+1 \bmod(62)$.
 - 5: One RR frame containing $N(R)=N_{ss}+2 \bmod(62)$.
 - 6: One REJ or SREJ frame containing $N(R)=N_{ss}+2 \bmod(62)$.

If REJ frame is used by the MS:

- 7',..., K_{IM}+6: One RR frame containing $N(R)=N_{ss}+3, \dots, N_{ss}+K_{IM}+2 \bmod(62)$.
- K_{IM}+7',...,i-1: One RR frame containing $N(R)=N_{ss}+K_{IM}+3, \dots, k \bmod(62)$.

If SREJ frame is used by the MS:

7,..., $K_{IM}+4$: One RR frame containing $N(R)=N_{SS}+3, \dots, N_{SS}+K_{IM} \bmod(62)$.

$K_{IM}+5$: One RR frame containing $N(R)=N_{SS}+K_{IM}+2 \bmod(62)$.

$K_{IM}+6, \dots, i-1$: One RR frame containing $N(R)=N_{SS}+K_{IM}+3, \dots, k \bmod(62)$.

$i, \dots, j-1$: One RR frame containing, $N(R)=k \bmod(62)$.

The MS starts sending data.

$j, \dots, j+K_{MI}-1$: One I+S frame containing $N(S)=N_{MS}, \dots, N_{MS}+K_{MI}-1 \bmod(62)$, $N(R)=k \bmod(62)$.

$j+K_{MI}$: T1 after the last I+S frame sent, one supervisory RR (C=1, P=1) frame containing $N(R)=k \bmod(62)$.

$j+K_{MI}+1, \dots, j+K_{MI}+N_2$: At T1 expiry, one supervisory RR (C=1, P=1) frame containing $N(R)=k \bmod(62)$.

$j+K_{MI}+N_2+1$: One SABM (C=1, P=1) or DISC (C=1) frame.

29.3.3.4 Loss of XID frames

29.3.3.4.1 Conformance requirements

The MS shall repeat an XID frame upon expiry of RLP timer T1 if the network has not acknowledged it by a correct XID frame.

References

3GPP TS 04.22 subclause 5.2.2.6.

29.3.3.4.2 Test purpose

To test that the MS repeats the XID frame if the SS does not answer correctly.

29.3.3.4.3 Test method

Initial Conditions

System Simulator:

The SS is configured to use default RLP parameters.

Mobile Station:

The MS is configured to use RLP parameters different from the default parameters (T1 different from T1(def)).

The MS is made to establish a MO non transparent data call. In initial conditions MS is in call state U10 ("Call Active") after having sent a CONN_ACK message.

Specific PICS statements:

-

PIXIT statements:

- Bearer services supported
- Characteristics of non-transparent services.

Foreseen final state of the MS

Idle.

Test procedure

The MS shall send an XID (C=1, P=1) frame containing a set of RLP parameters different from the default set. The SS sends a XID (R=0, F=0) command frame. The MS shall ignore this frame.

After a delay the MS shall resend the same XID that it has previously sent. The SS does not answer.

After a delay the MS shall resend the same XID that it has previously sent. The SS answers with XID (R=0, F=1) accepting the parameters chosen by the MS.

The MS established the ABM mode by sending a SABM (C=1, P=1) frame. The answer with a UA (R=0, F=1) frame. The SABM frame may be sent by the MS at any instant (i.e. just after having received an XID). In such a case, the SS answers to the XID after having established the ABM mode (i.e. after having sent the UA).

The MS is returned to the idle state by clearing of the call.

Maximum duration of test

1 minute.

Expected sequence

MS			SS
0	-----	XID	----->
	<-----	XID	----- 0'
1	-----	XID	----->
2	-----	XID	----->
	<-----	XID	----- 2'
3	-----	SABM	----->
	<-----	UA	----- 3'

The frame from the SS will be:

0': One XID frame containing: R=0, F=0.

2': One XID frame containing: R=0, F=1. The RLP parameters are accepted by the SS.

3': One UA frame containing: R=0, F=1. Note: If SABM is received before the XID, the SS will answer to the XID after having established the ABM mode (i.e. after having sent the UA).

Specific message content

The frame from the MS shall be:

0: One XID frame containing: C=1, P=1.

1: After T1(def) expiry, one XID frame containing: C=1, P=1.

2: After T1(def) expiry, one XID frame containing: C=1, P=1.

3: One SABM frame containing: C=1,P=1.

NOTE: The MS may send the SABM frame before XID(s), at any moment.

29.3.3.5 Total loss of XID frames

29.3.3.5.1 Definition

The XID negotiation procedure allows RLP parameters to be negotiated between peer RLP entities. An unsuccessful XID exchange shall be repeated on expiry of T1. After N2 times of unsuccessful repetition, the RLP link shall be disconnected.

29.3.3.5.2 Conformance requirements

The MS shall not repeat an unacknowledged XID frame more than N2 times. After N2 repetition it shall disconnect the RLP link if it had been connected earlier. 3GPP TS 04.22, subclause 5.2.2.6.

References

3GPP TS 04.22 subclause 5.2.2.6.

29.3.3.5.3 Test purpose

To test that the MS repeats the XID frame no more than N2 times, if the SS does not answer correctly.

29.3.3.5.4 Method of test

Initial Conditions

System Simulator:

The SS is configured to use default RLP parameters.

Mobile Station:

The MS is configured to use RLP parameters different from the default parameters.

The MS is made to establish a MO non transparent data call. In initial conditions MS is in call state U10 ("Call Active") after having sent a CONN_ACK message.

Specific PICS statements:

-

PIXIT statements:

- Bearer services supported
- Characteristics of non-transparent services.

Foreseen final state of the MS

Idle.

Test procedure

Case a: The MS sends an XID (C=1, P=1) frame in ADM mode

Case b: The MS enters the ABM mode and sends an XID (C=1, P=1) frame after optional status bits exchange between the MS and the SS.

The SS does not answer.

After a delay T1 (def), the MS shall resend the same XID that it has previously sent. The SS does not answer. This step is repeated N2 (def) times.

Case a: After N2 (def) retransmissions the SS waits for $2 * T1$ to ensure that the XID frame is not repeated any more.

Case b: After N2 (def) retransmissions the link shall be disconnected. The MS shall send a DISC (C=1) frame, and the SS answers with a UA (R=0, F equal to the P bit received in the DISC).

The MS is returned to the idle state by clearing of the call.

Maximum duration of test

1 minute.

Expected sequence

MS

SS

Case a:

1	----->	XID	----->	
2	----->	XID	----->	
...		etc...		...
N2(def)+1	----->	XID	----->	
				Wait for 2*T1

Case b:

0	----->	SABM	----->	
	<-----	UA	-----	0'
	(-----	I+S	----->)	Optional
	(<-----	S	-----)	
1	----->	XID	----->	
2	----->	XID	----->	
...		etc...		...
N2(def)+1	----->	XID	----->	
N2(def)+2	----->	DISC	----->	
	<-----	UA	----->	N2+2'

The frame from the SS will be:

0': One UA frame containing: R=0, F=1, if the MS sends a SABM.

N2+2': One UA frame containing: R=0, F equal to P bit received in DISC frame.

29.3.3.5.5 Test requirements

Specific message content

The frame from the MS shall be:

0: The MS may send a SABM frame containing: C=1, P=1. This frame may be sent at any instant. This is not verified.

1: One XID frame containing: C=1, P=1.

2,...,N2(def)+1: After T1 (def) expiry, one XID frame containing: C=1, P=1.

N2(def)+2: If the MS has previously established the ABM mode (SABM/UA exchange), it shall disconnect the link by sending a DISC (C=1) frame.

29.4 Facsimile tests for the transparent network support

29.4.1 General

According to ITU-T Recommendation T.30 a facsimile call can be divided into the following phases:

- Phase A - call establishment procedure;
- Phase B - pre-message procedure (identification and selection of required facilities);

- Phase C - message transmission according to ITU-T Recommendation T.4;
- Phase D - post-message procedure;
- Phase E - call release procedure.

For each phase a single test sequence was drafted, i.e. the verification of the basic procedures of a fax call will at least consist of 5 tests, in order to verify the above described phases.

In the IDLE state the fax adapter, originating or terminating, will send continuously SYNC frames containing the pattern specified in 3GPP TS 03.45 (CT105 (see note 2) and 109 (see note 2) are in OFF condition).

For the test of the facsimile data transmission, i.e. the phase C, test chart #2 according to ITU-T Recommendation T.21 should be used.

The T.4/30 messages marked with the '*' sign indicate that for the transmission across the radio interface in case of the BCS phase STATUS frames are used, and in case of the message phase the usage of DATA frames is implied.

Manufacturer-declared fax equipment should be connected to the MS, i.e. where possible a fax adapter and a fax machine Group 3. Measuring devices to monitor the T.4/T.30 protocol, the circuits and the SYNC, STATUS and DATA frames should be provided. Configurations, where no access to the interfaces to monitor the protocol and circuits is possible, might exist.

Abbreviations used:

BC-IE	Bearer Capability Information Element
BCS	Binary Coded Signalling
BCS-REC	BCS Reception State of the FA
BCS-TRA	BCS Transmission State of the FA
CED	Called Station Identification
CFR	Confirmation To Receive
CMM	Channel Mode Modify
CMM ACK	Channel Mode Modify Acknowledge
CNG	Calling Tone
DCD	Data Call Direction
DCS	Digital Command Signal
DIS	Digital Identification Signal
EOM	End Of Message
EOP	End Of Procedure
FA	Fax Adapter
Fax	Facsimile App. or PC-Fax (e.g. fax softw. running on a notebook)
ICM	In-Call Modification
IDLE	Idle State of the FA
MCF	Message Confirmation
MO	Mobile Originating
MPS	Multi Page Signal
MSG-REC	Message Reception State of the FA

MT	Mobile Terminating
RCSD-IE	Reverse Call Setup Direction Information Element
TCF	Training Check Frame
TCH	Traffic Channel
TS 61	Teleservice 61 (alternate speech/fax)
TS 62	Teleservice 62 (automatic fax)

29.4.2 Mobile originated call

29.4.2.1 Call establishment procedure

29.4.2.1.1 Alternate speech / facsimile

29.4.2.1.1.1 Definition

-29.4.2.1.1.2 Conformance requirement

An MS supporting transparent facsimile group 3 shall perform the ICM and shall support the frames and circuits at the Um-, R- and 2w-interface according to the specifications referred to in the subclause "Reference".

Reference

3GPP TS 03.45, 3GPP TS 07.01, ITU-T Recommendation T.30.

29.4.2.1.1.3 Test purpose

To verify the transition from speech to fax in case of an MS supporting TS 61 and that the circuit and tone handling of the MT and FA is correct.

29.4.2.1.1.4 Method of test

Initial conditions

A TS 61 s/f call is set up. The speech phase is active.

Test procedure

The transition from speech to fax is initiated by manual intervention at both ends of the connection. The data call direction DCD is mobile originated. Upon connection to line the FA turns on CT108.2 (see note 2) as a basic requirement for the transition from speech to fax. Now, within the next 3 seconds the FA has to detect the DCD, which is in this case is mobile originated, i.e. CT105 is set to ON (see note 2) condition. The following ICM procedure via the MODIFY message is carried out by the MT 3 seconds after circuit CT108.2 was set to ON (see note 2) condition. On completion of the ICM procedure the synchronization of the TCH begins and after its completion the MT has to set CT107 to ON (see note 2) condition and the FA has to send the CED tone (see note 2) towards the connected fax. When CT106/109 are set to ON (see note 2) phase A is completed. Then the call is cleared by manual intervention at the MT or the activity progress of the call proceeds to the next phase.

Expected sequence

MS:		SS:	
Step	Direction		

1	MS-->SS	Fax: Connect to line (see note 1) FA: CT108.2 ON (see note 2) Detect DCD CT105 ON (see note 2)	Connect to line (see note 1)
		MT: Send MODIFY message 3 seconds after CT108.2 ON (see note 2)	Receive MODIFY message
2	SS-->MS		Send MODIFY COMPLETE
3	MS<->SS	TCH Synchronization	TCH Synchronization
		MT: CT107 ON (see note 2), when synchronized FA: Generate CED (see note 2) Fax: Detect CED (see note 2)	
4	SS-->MS		Set X and SB bit in V.110 frame
		MT: CT106/109 ON (see note 2) FA: Enter BCS-TRA state	Enter BCS-REC state

29.4.2.1.1.5 Test requirements

1. The condition of CT108.2 and CT105 is verified (see note 2); CT106, 107, 109 have to be in OFF (see note 2) condition. The MODIFY message has to be sent 3 seconds after circuit CT108.2 has gone to ON condition (see note 2).
2. To be verified that the MT begins the synchronization phase by sending the pattern 1/OFF after the reception of the MODIFY COMPLETE message, that CT107 is turned on (see note 2) by the MT after successful synchronization and that the CED tone (see note 2) is transmitted by the FA after CT107 has gone to ON condition (see note 2).
3. To be verified that CT106 and CT109 are turned on (see note 2), when in the modified V.110 frames received from the SS the X and SB bits are set. The state of the FA shall be verified (-> BCS-TRA).

29.4.2.1.2 Automatic facsimile

29.4.2.1.2.1 Definition

-29.4.2.1.2.2 Conformance requirement

The MS supporting transparent facsimile group 3 shall perform the call setup procedure and shall support the frames and the circuits at the Um-,R- and 2w-interface according the specifications referred to in the subclause "Reference".

Reference

3GPP TS 03.45, 3GPP TS 07.01, ITU-T Recommendation T.30.

29.4.2.1.2.3 Test purpose

To verify that the circuit and tone handling of the MT and FA is correct.

29.4.2.1.2.4 Method of test

Initial conditions

The MS, configured for the TS 62 fax call, is updated. Then the call establishment phase A begins.

Test procedure

The FA sets CT108.2 to ON (see note 2) condition and passes the dialling information to the MT. A SETUP message is then sent by the MT towards the SS. When the TCH is available (indicated by the CONNECT message) the synchronization phase begins, i.e. both entities start sending the synchronization pattern 1/OFF. CT106, 107, 109 have to be in OFF condition (see note 2). Upon completion of the synchronization phase the MT sets CT107 to ON condition

(see note 2) causing the FA to connect the fax to line. The SS sets CT106 and CT109 to ON at the MT by means of the V.110 X and SB bits. The FA then generates the CED tone (see note 2), which completes phase A. Then the call is cleared by manual intervention at the MT or the activity progress of the call proceeds to the next phase.

Expected sequence

MS:	SS:
Step	Direction
1	MS-->SS
	Fax: Dial
	FA: Pass dialling info, CT108.2 ON (see note 2)
	MT: Send SETUP message
2	SS-->MS
	Receive SETUP message
3	MS<->SS
	TCH Synchronization
	MT: CT107 ON (see note 2), when synchronized
4	SS-->MS
	Send CONNECT message
	TCH Synchronization
	Set X and SB bit in V.110 frame
	MT: CT106/109 ON (see note 2)
	FA: Generate CED (see note 2)
	Fax: Detect CED (see note 2)
5	FA: Enter BCS-TRA state (see note 3)
	Enter BCS-REC state

29.4.2.1.2.5 Test requirements

1. The condition of CT108.2 (see note 2) is verified and the SETUP message should contain the BC-IE for TS 62.
2. To be verified that at the MT CT106, 107, 109 are in OFF (see note 2) condition, that the MT begins the synchronization phase by sending the pattern 1/OFF and that CT107 (see note 2) is turned on by the MT after successful synchronization.
3. To be verified that CT106 and CT109 are turned on (see note 2), when in the V.110 frames received from the SS the X and SB bits are set and that the FA sends the CED (see note 2) tone towards the fax machine.
4. The state of the FA shall be verified (-> BCS-TRA).

29.4.2.2 Pre-message procedure

29.4.2.2.1 Definition

-29.4.2.2.2 Conformance requirement

The MS supporting transparent facsimile group 3 shall perform the pre-message procedure and shall support the frames and the circuits at the Um-,R- and 2w-interface according the specifications referred to in the subclause "Reference".

Reference

3GPP TS 03.45, ITU-T Recommendation T.30.

29.4.2.2.3 Test purpose

To verify the correct handling of the T.30 DIS/DCS/TCF frames.

29.4.2.2.4 Method of test

Initial conditions

The activity progress of the fax call is brought to the beginning of Phase B.

Test procedure

After phase A the FA is in BCS-TRA state and sends SYNC frames. The SS being in BCS-REC state sends the T.30 DIS embedded in STATUS frames indicating its capabilities. The received DIS is checked, if necessary edited by the FA and sent to the fax. Then the FA returns to the idle state. The fax checks whether the indicated capabilities are in line with its own or not, and chooses the capabilities which are supported end-to-end by the connected fax machines by answering with the DCS frame preceded by the preamble. The FA enters the BCS-REC state and the BCS information is transmitted using the STATUS frames. Afterwards the FA returns to the idle state. Upon reception of the training

sequence the FA enters the MSG-REC state without waiting for an acknowledge from the SS, i.e. the TCF is conveyed by means of the DATA frames. The FA enters the idle state and sends at least 5 SYNC frames to indicate that the message phase is over. Then the CFR frame is received, i.e. the FA enters the BCS-TRA state and receives the CFR in STATUS frames. Now, phase B is completed and the data transfer phase C begins. Then the call is cleared by manual intervention at the MT or the activity progress of the call proceeds to the next phase.

Expected sequence

MS:	SS:
Step	Direction
1	SS-->MS
	FA: BCS-TRA Monitor DIS Generate preamble,DIS CT105 OFF (see note 2) IDLE
	Fax: Receive preamble,DIS
2	MS-->SS
	Fax: Send preamble,DCS FA: CT109 ON (see note 2) BCS-REC Monitor DCS Send preamble*,DCS* CT109 OFF (see note 2) IDLE
	-----> Receive preamble*,DCS*
3	MS-->SS
	Fax: Send training,TCF FA: CT109 ON (see note 2) MSG-REC Send TCF* CT109 OFF (see note 2)
	-----> Receive TCF*
4	SS<--MS
	FA: CT105 ON (see note 2) BCS-TRA Generate preamble, CFR CT105 OFF (see note 2) IDLE
	Fax: Receive preamble, CFR
	<----- Send preamble*,CFR*

29.4.2.2.5 Test requirements

1. To be verified that SYNC frames are transmitted across the radio interface in BCS-TRA and in the IDLE state and that CT105 is set to OFF (see note 2). The correct generation of the T.30 BCS shall be verified (down-conversion to the BCS speed according to 3GPP TS 03.45).
2. The condition of CT109 shall be verified (see note 2); that the DCS is correctly inserted into the STATUS frames and that the IDENT octet contains the BCS-REC identifier. At CT109=OFF (see note 2), the FA returns to the idle state and sends SYNC frames (pattern according to 3GPP TS 03.45).
3. To be verified that the FA turns on CT109 (see note 2), enters the MSG-REC state and sends the TCF embedded in DATA frames without waiting for the confirmation that the SS has entered the MSG-TRA state. The ident octet has to be checked (-> MSG-REC). CT109 shall be in OFF condition (see note 2).
4. The condition of CT105 (see note 2) is to be verified. The correct generation of the T.30 BCS shall be checked. In IDLE state SYNC frames have to be sent.

29.4.2.3 Message procedure

29.4.2.3.1 Definition

-29.4.2.3.2 Conformance requirement

The MS supporting transparent facsimile group 3 shall perform the message procedure and shall support the frames and the circuits at the Um,-R- and 2w-interface according the specifications referred to in the subclause "Reference".

Reference

3GPP TS 03.45, ITU-T Recommendation T.30, ITU-T Recommendation T.4, ITU-T Recommendation T.21.

29.4.2.3.3 Test purpose

To verify the facsimile data transmission phase.

29.4.2.3.4 Method of test

Initial conditions

The activity progress of the fax call is brought to the beginning of Phase C. The ECM shall not be used.

Test procedure

The FA is in IDLE state. The connected fax starts transmitting the fax message. Upon reception of the training sequence the FA enters the MSG-REC state and sends STATUS frames, which contain the ident octet set to MSG-REC, interleaved with SYNC frames to the SS. When the SS has entered the MSG-TRA state, which is indicated to the FA by means of the ident octet set to MSG-TRA, the FA starts sending the fax coded data (received from the connected fax) embedded in DATA frames. When the transmission is finished the FA is again in the idle state for at least 5 SYNC frames to indicate that the message phase is over and Phase D begins. Then the call is cleared by manual intervention at the MT or the activity progress of the call proceeds to the next phase.

Expected sequence

MS:	SS:
Step	Direction
1	MS-->SS
	Fax: Send training, fax message
	FA: CT109 ON (see note 2)
	MSG-REC
	Send STATUS frames (MSG-REC)
	interleaved with SYNC
	frames
	Wait for MSG-TRA indication
	from SS
2	SS-->MS
	<----- Send STATUS frames with
	MSG-TRA identifier
3	MS-->SS
	Send fax message*
	"
	"
	"
	CT109 OFF (see note 2)
	IDLE
4	MS-->SS
	FA: Send at least
	5 SYNC frames
	-----> Receive SYNC frames

29.4.2.3.5 Test requirements

1. To be verified that the FA enters the MSG-REC state and inserts the correct ident octet in the STATUS frames interleaved with SYNC frames.
2. To be verified that the FA sends the fax message after the SS has sent the STATUS frames containing the MSG-TRA identifier.
3. At the end of the document transmission the condition of CT109 (see note 2) shall be checked.
4. It shall be verified that at least 5 SYNC frames are sent in order to indicate the end of phase C.

29.4.2.4 Post-message procedure

29.4.2.4.1 Definition

-29.4.2.4.2 Conformance requirement

The MS supporting transparent facsimile group 3 shall perform the post-message procedure and shall support the frames and the circuits at the Um-,R- and 2w-interface according the specifications referred to in the subclause "Reference".

Reference

3GPP TS 03.45, ITU-T Recommendation T.30.

29.4.2.4.3 Test purpose

To verify phase D of the facsimile transmission.

29.4.2.4.4 Method of test

Initial conditions

The activity progress of the fax call is brought to the beginning of Phase D. The ECM shall not be used.

Test procedure

The fax sends the preamble followed by the EOP frame. The FA then enters the BCS-REC state after having transmitted at least 5 SYNC frames since the last transition to the idle state and sends the EOP frame embedded in STATUS frames to the SS. The FA enters the idle state again. Upon detection of the BCS-REC identifier octet the BCS-TRA state is entered in order to receive the MCF frame issued by the SS. Then the preamble and the MCF frame are conveyed to the connected fax by the FA. The FA enters the idle state. Phase D of the fax transmission is completed. Then the call is cleared by manual intervention at the MT or the activity progress of the call proceeds to the next phase.

Expected sequence

MS:		SS:	
Step	Direction		

1	MS-->SS	Fax: Send preamble, EOP FA: CT109 ON (see note 2) BCS-REC Send preamble*, EOP* CT109 OFF (see note 2) IDLE	-----> Receive preamble*, EOP*
2	SS-->MS	FA: CT105 ON (see note 2) BCS-TRA Transmit preamble, MCF CT105 OFF (see note 2) IDLE Fax: Receive preamble, MCF	<----- Send preamble*, MCF*

29.4.2.4.5 Test requirements

- To be verified that the FA enters the BCS-REC state and inserts the correct ident octet in the STATUS frames. The up-conversion to the message speed has to be checked.. The condition of CT109 has to be verified (see note 2). The contents of the SYNC frames shall be checked.
- To be verified that the FA enters the BCS-TRA state upon detection of the BCS-REC identifier and that the correct T.30 message is conveyed to the connected fax machine (down-conversion to the BCS speed). The condition of CT105 should be checked (see note 2).

29.4.2.5 Call release procedure

29.4.2.5.1 Definition

-29.4.2.5.2 Conformance requirement

The MS supporting transparent facsimile group 3 shall perform the call release procedure and shall support the frames and the circuits at the Um-,R- and 2w-interface according the specifications referred to in the subclause "Reference".

Reference

3GPP TS 03.45, ITU-T Recommendation T.30.

29.4.2.5.3 Test purpose

To verify phase E of the facsimile transmission.

29.4.2.5.4 Method of test

Initial conditions

The activity progress of the fax call is brought to the beginning of Phase E.

Test procedure

The fax sends the preamble followed by the DCN frame. The FA then enters the BCS-REC state and sends the DCN frame embedded in STATUS frames to the SS. The FA enters the IDLE state again. CT108.2 will go OFF condition (see note 2) and after 200ms CT109 will go to OFF condition (see note 2) too. The MT then sends the DISC message and the call is cleared.

Expected sequence

MS:		SS:
Step	Direction	
1	MS-->SS	
	Fax: Send preamble, DCN	
	FA: CT109 ON (see note 2)	
	BCS-REC	
	CT108.2 OFF (see note 2)	
	Transmit preamble*, DCN*	
	CT109 OFF (see note 2)	-----> Receive preamble*, DCN*
	after 200 ms	
	IDLE	
	MT: Send DISC message	-----> Receive DISC message

29.4.2.5.5 Test requirements

To be verified that CT108.2 is turned off (see note 2) and that CT109 is set to OFF (see note 2) 200ms after the DCN frame has been sent. The contents of the STATUS frames including the ident octet has to be checked (up-conversion to the message speed according to 3GPP TS 03.45). The MT shall send the DISC message.

29.4.2.6 CTC processing - 4th PPR for the same block

29.4.2.6.1 Definition

-29.4.2.6.2 Conformance requirement

The MS supporting transparent facsimile group 3 shall perform the CTC processing procedure and shall support the frames and the circuits at the Um-,R- and 2w-interface according the specifications referred to in the subclause "Reference".

Reference

3GPP TS 03.45, ITU-T Recommendation T.30.

29.4.2.6.3 Test purpose

To verify phase D of the facsimile transmission in case of a 4th PPR for the same block.

29.4.2.6.4 Method of test

Initial conditions

The activity progress of the fax call is brought to the beginning of Phase C. The ECM shall be used. The fax transmission shall start a speed of 9,6 kBit/s.

Test procedure

The fax sends the preamble followed by the PPS-NULL(0,0) frame. The FA then enters the BCS-REC state and sends the PPS* frame embedded in STATUS frames to the SS. The SS responds with the PPR* frame requesting corrupted frames to be retransmitted. This test sequence is repeated 4 times causing the fax machine to send the CTC frame which indicates the fallback bit rate of 7 200 kBit/s. The FA sends the CTC* after recognizing the new message speed to the SS. The SS responds with the CTR* frame and the fax machine retransmits the corrupted frames which are inserted into DATA frames by the FA. After every third DATA frame the FA has to insert a SYNC frame. After the retransmission, the fax machine sends the PPS-NULL(0,0) which is answered by the SS with the MCF* frame. Phase D of the fax transmission is completed. Then the call is cleared by manual intervention at the MT or the activity progress of the call proceeds to the next phase.

Expected sequence

MS:	SS:
Step	Direction
1	MS-->SS
	Fax: Send training, fax message
	FA: CT109 ON (see note 2)
	MSG-REC
	Send fax message*
	-----> Receive fax message*
	"
	"
	"
	CT109 OFF (see note 2)
	IDLE
2	MS-->SS
	FA: Send at least
	5 SYNC frames
	-----> Receive SYNC frames
3	MS-->SS
	Fax: Send preamble, PPS-NULL
	FA: CT109 ON (see note 2)
	BCS-REC
	Send preamble*, PPS-NULL*
	CT109 OFF (see note 2)
	-----> Receive preamble*, PPS-NULL*
	IDLE
4	SS-->MS
	<----- Send preamble*, PPR*
	FA: CT105 ON (see note 2)
	BCS-TRA
	Transmit preamble, PPR
	CT105 OFF (see note 2)
	IDLE
	Fax: Receive preamble, PPR
5	Repeat steps 1 to 4 four times
6	MS-->SS
	Fax: Send preamble, CTC
	FA: CT109 ON (see note 2)
	BCS-REC
	Monitor CTC
	Send preamble*, CTC*
	-----> Receive preamble*, CTC*
	CT109 OFF (see note 2)
	IDLE

7	SS-->MS	FA: CT105 ON (see note 2) BCS-TRA Transmit preamble, CTR CT105 OFF (see note 2) IDLE	<----- Send preamble*, CTR*
8	MS-->SS	Fax: Receive preamble, CTR Fax: Send training, fax message FA: CT109 ON (see note 2) MSG-REC Send fax message* " " " CT109 OFF (see note 2) IDLE	-----> Receive fax message* " " "
9	MS-->SS	FA: Send at least 5 SYNC frames	-----> Receive SYNC frames
10	MS-->SS	Fax: Send preamble, PPS-NULL FA: CT109 ON (see note 2) BCS-REC Send preamble*, PPS-NULL* CT109 OFF (see note 2) IDLE	-----> Receive preamble*, PPS-NULL*
11	SS-->MS	FA: CT105 ON (see note 2) BCS-TRA Transmit preamble, MCF CT105 OFF (see note 2) IDLE Fax: Receive preamble, MCF	<----- Send preamble*, MCF*

29.4.2.6.5 Test requirement

It shall be verified that the FA transmits 1 SYNC frame every 3 DATA frames.

29.4.2.7 Transition from Facsimile to Speech - Procedure interrupt generated by receiving station

29.4.2.7.1 Definition

-29.4.2.7.2 Conformance requirement

The MS supporting transparent facsimile group 3 shall perform the ICM procedure and shall support the frames and the circuits at the Um-,R- and 2w-interface according the specifications referred to in the subclause "Reference".

Reference

3GPP TS 03.45, ITU-T Recommendation T.30.

29.4.2.7.3 Test purpose

To verify the transition from fax to speech in case of an MS supporting TS 61.

29.4.2.7.4 Method of test

Initial conditions

The activity progress of the fax call is brought to phase C (message phase). The ECM shall not be used.

Test procedure

During the message phase a procedure interrupt is generated by the SS, which is executed as soon as phase D is entered. The SS then sends the PIP frame causing an alert at the mobile side. When the operator at the mobile side goes on line the PRI-Q frame is generated and results in an alarm at the SS side. The operator at this side going on line completes the PRI handshaking by causing the PIP frame to be sent. Upon completion of the PRI handshaking the MT executes the MODIFY procedure, which leads to the speech phase. Then the call is cleared by manual intervention at the MT or the facsimile phase maybe reselected.

Expected sequence

MS:	Direction	SS:

1	Message Procedure (as described above)	Operator intervention requested
2	MS-->SS Fax: Send preamble, EOP FA: CT109 ON (see note 2) BCS-REC Send preamble*, EOP* CT109 OFF (see note 2) IDLE	-----> Receive preamble*, EOP*
3	SS-->MS FA: CT105 ON (see note 2) BCS-TRA Transmit preamble, PIP CT105 OFF (see note 2) IDLE Fax: Receive preamble, PIP Alert operator	<----- Send preamble*, PIP*
4	MS-->SS Operator goes on line Fax: Send preamble, PRI-EOP FA: CT109 ON (see note 2) BCS-REC Send preamble*, PRI-EOP* CT109 OFF (see note 2) IDLE MT: CT106/109 OFF (see note 2)	-----> Receive preamble*, PRI-EOP* Alert operator
5	SS-->MS FA: CT105 ON (see note 2) BCS-TRA Transmit preamble, PIP CT105 OFF (see note 2) IDLE Fax: Receive preamble, PIP	<----- Operator goes on line Send preamble*, PIP*
6	MS-->SS FA: CT108.2 OFF (see note 2) MT: Send MODIFY message CT107 OFF (see note 2)	-----> Receive MODIFY m. <----- Send MODIFY COMPLETE

SPEECH PHASE

29.4.2.7.5 Test requirements

1. To be verified that CT106/109 are in OFF (see note 2) condition.
2. To be verified that CT108.2 goes to OFF (see note 2) upon completion of the PRI handshaking, that this transition to OFF triggers the MODIFY message to be sent and that the reception of the MODIFY COMPLETE message causes CT107 to be set to OFF (see note 2) condition by the MT. In addition the availability of the speech channel shall be checked.

29.4.2.8 Transition from Facsimile to Speech - Procedure interrupt generated by transmitting station

29.4.2.8.1 Definition

-29.4.2.8.2 Conformance requirement

The MS supporting transparent facsimile group 3 shall perform the ICM procedure and shall support the frames and the circuits at the Um-,R- and 2w-interface according the specifications referred to in the subclause "Reference".

Reference

3GPP TS 03.45, ITU-T Recommendation T.30.

29.4.2.8.3 Test purpose

To verify the transition from fax to speech in case of an MS supporting TS 61.

29.4.2.8.4 Method of test

Initial conditions

The activity progress of the fax call is brought to phase C (message phase). The ECM shall not be used.

Test procedure

During the message phase a procedure interrupt is generated at the MS side, which is executed as soon as phase D is entered. The fax then sends the PRI-EOP frame causing an alert at the SS side. When the operator at the SS side goes on line the PIP frame is generated and results in an alarm at the MS side. The operator at this side going on line completes the PRI handshaking by causing the PRI-EOP frame to be sent. Upon completion of the PRI handshaking the MT executes the MODIFY procedure, which leads to the speech phase. Then the call is cleared by manual intervention at the MT or the facsimile phase maybe reselected.

Expected sequence

MS:

SS:

Step Direction

1	Message Procedure (as described above) Operator intervention requested			
2	MS-->SS	Fax: Send preamble, PRI-EOP FA: CT109 ON (see note 2) BCS-REC Send preamble*, PRI-EOP* CT109 OFF (see note 2) IDLE	----->	Receive preamble*, PRI-EOP*
3	SS-->MS	FA: CT105 ON (see note 2) BCS-TRA Transmit preamble, PIP CT105 OFF (see note 2) IDLE Fax: Receive preamble, PIP Alert operator	<-----	Send preamble*, PIP*
4	MS-->SS	Operator goes on line MT: CT106/109 OFF (see note 2) Fax: Send preamble, PRI-EOP FA: CT109 ON (see note 2) BCS-REC Send preamble*, PRI-EOP* CT109 OFF (see note 2) IDLE	----->	Receive preamble*, PRI-EOP*
5	MS-->SS	FA: CT108.2 OFF (see note 2) MT: Send MODIFY message CT107 OFF (see note 2)	-----> <-----	Receive MODIFY m. Send MODIFY COMPLETE

SPEECH PHASE

29.4.2.8.5 Test requirements

1. To be verified that CT106/109 are in OFF (see note 2) condition.
2. To be verified that CT108.2 goes to OFF (see note 2) upon completion of the PRI handshaking, that this transition to OFF triggers the MODIFY message to be sent and that the reception of the MODIFY COMPLETE message causes CT107 to be set to OFF (see note 2) condition by the MT. In addition the availability of the speech channel shall be checked.

29.4.2.9 Quality check

29.4.2.9.1

Definition

-29.4.2.9.2

Conformance requirement

The configuration supporting transparent facsimile group 3 shall decode the T.4 coding and shall generate a document.

Reference

3GPP TS 03.45, ITU-T Recommendation T.21, ITU-T Recommendation T.4.

29.4.2.9.3

Test purpose

To verify the quality of the received document.

29.4.2.9.4 Method of test

Initial conditions

The document has been received at the called side.

Test procedure

The quality of the received document at the SS side shall be checked.

29.4.2.9.5 Test requirement

The contents of the transmitted and the received document shall be the same.

29.4.3 Mobile terminated call

29.4.3.1 Call Establishment Procedure

29.4.3.1.1 Alternate Speech/Facsimile

29.4.3.1.1.1 DCD Mobile Terminated

29.4.3.1.1.1.1 Definition

-29.4.3.1.1.1.2 Conformance requirement

The MS supporting transparent facsimile group 3 shall perform the ICM procedure and shall support the frames and the circuits at the Um-,R- and 2w-interface according the specifications referred to in the subclause "Reference".

Reference

3GPP TS 03.45, ITU-T Recommendation T.30.

29.4.3.1.1.1.3 Test purpose

To verify the transition from speech to fax in case of an MS supporting TS 61 and that the circuit and tone handling of the MT and FA is correct in case of an MT DCD.

29.4.3.1.1.1.4 Method of test

Initial conditions

A TS 61 s/f call is set up. The speech phase is active.

Test procedure

The transition from speech to fax is initiated by manual intervention at both ends of the connection, i.e. the data call direction DCD is mobile terminated. Upon connection to line the FA turns on CT108.2 (see note 2) as a basic requirement for the transition from speech to fax. Now, within the next 3 seconds the FA has to detect the DCD, which is in this case mobile terminated, i.e. CT105 is set to OFF condition (see note 2). The following ICM procedure via the MODIFY message is carried out by the MT 3 seconds after circuit CT108.2 (see note 2) was set to ON condition. On completion of the ICM the synchronization of the TCH begins and after its completion the MT has to set CT107 to ON condition (see note 2). When CT106/109 are set to ON (see note 2) phase A is completed. Then the call is cleared by manual intervention at the MT or the activity progress of the call proceeds to the next phase.

Expected sequence

Step	Direction	MS:	SS:
1	MS-->SS	Fax: Connect to line (see note 1) FA: CT108.2 ON (see note 2) Detect DCD CT105 OFF (see note 2) MT: Send MODIFY message 3 seconds after CT108.2 ON (see note 2)	Connect to line (see note 1) -----> Receive MODIFY message
2	SS-->MS		<----- Send MODIFY COMPLETE
3	MS<->SS	TCH Synchronization MT: CT107 ON (see note 2), when synchronized	<-----> TCH Synchronization
4	SS-->MS	MT: CT106/109 ON (see note 2) FA: Enter BCS-REC state	<----- Set X and SB bit in V.110 frame Enter BCS-TRA state

29.4.3.1.1.1.5 Test requirements

1. The condition of CT108.2 and CT105 is verified (see note 2); CT106, 107, 109 have to be in OFF (see note 2) condition. The MODIFY message has to be sent 3 seconds \pm 10% after circuit CT108.2 has gone to ON (see note 2) condition.
2. The RCSD-IE shall not be included in the MODIFY message.
3. To be verified that the MT begins the synchronization phase by sending the pattern 1/OFF after the reception of the MODIFY COMPLETE message, that CT107 is turned on (see note 2) by the MT after successful synchronization.
4. To be verified that CT106 and CT109 are turned on (see note 2), when in the V.110 frames received from the SS the X and SB bits are set. The state of the FA shall be verified (->BCS-REC).

29.4.3.1.1.2 DCD mobile originated

29.4.3.1.1.2.1 Definition

-29.4.3.1.1.2.2 Conformance requirement

The MS supporting transparent facsimile group 3 shall perform the ICM procedure and shall support the frames and the circuits at the Um-,R- and 2w-interface according the specifications referred to in the subclause "Reference".

Reference

3GPP TS 03.45, ITU-T Recommendation T.30.

29.4.3.1.1.2.3 Test purpose

To verify the transition from speech to fax in case of an MS supporting TS 61 and that the circuit and tone handling of the MT and FA is correct in case of an MO DCD.

29.4.3.1.1.2.4 Method of test

Initial conditions

A TS 61 s/f call is set up. The speech phase is active.

Test procedure

The transition from speech to fax is initiated by manual intervention at both ends of the connection, i.e. the data call direction DCD is mobile originated. Upon connection to line the FA turns on CT108.2 (see note 2) as a basic requirement for the transition from speech to fax. Now, within the next 3 seconds the FA has to detect the DCD, which is in this case mobile originated, i.e. CT105 is set to ON condition (see note 2), indicating that the MT has to include the RCSD-IE in the MODIFY message. The following ICM procedure via the MODIFY message is carried out by the MT 3 seconds after circuit CT108.2 (see note 2) was set to ON condition. On completion of the ICM the synchronization of

the TCH begins and after its completion the MT has to set CT107 to ON condition (see note 2). When CT106/109 are set to ON (see note 2), phase A is completed. Then the call is cleared by manual intervention at the MT or the activity progress of the call proceeds to the next phase.

Expected sequence

MS:		SS:	
Step	Direction		
1	MS-->SS	Fax: Connect to line (see note 1) FA: CT108.2 ON (see note 2) Detect DCD CT105 ON (see note 2) MT: Send MODIFY message with RCSD-IE 3 seconds after CT108.2 ON (see note 2)	Connect to line (see note 1) -----> Receive MODIFY message
2	SS-->MS		<----- Send MODIFY COMPLETE with RCSD-IE
3	MS<->SS	TCH Synchronization MT: CT107 ON (see note 2), when synchronized FA: Generate CED (see note 2) Fax: Detect CED (see note 2)	<-----> TCH Synchronization
4	SS-->MS	MT: CT106/109 ON (see note 2) FA: Enter BCS-TRA state	<----- Set X and SB bit in modified V.110 frame Enter BCS-REC state

29.4.3.1.1.2.5 Test requirements

1. The condition of CT108.2 and CT105 is verified (see note 2); CT106, 107, 109 have to be in OFF (see note 2) condition.
2. The MODIFY message containing the RCSD-IE has to be sent 3 seconds \pm 10% after circuit CT108.2 has gone to ON (see note 2) condition.
3. To be verified that the MT begins the synchronization phase by sending the pattern 1/OFF after the reception of the MODIFY COMPLETE message, that CT107 is turned on (see note 2) by the MT after successful synchronization. The CED (see note 2) tone has to be transmitted by the FA.
4. To be verified that CT106 and CT109 are turned on (see note 2), when in the modified V.110 frames received from the SS the X and SB bits are set. The state of the FA shall be verified (-> BCS-TRA).

29.4.3.1.2 Automatic facsimile

29.4.3.1.2.1 Definition

-29.4.3.1.2.2 Conformance requirement

The MS supporting transparent facsimile group 3 shall perform the call setup procedure and shall support the frames and the circuits at the Um-,R- and 2w-interface according the specifications referred to in the subclause "Reference".

Reference

3GPP TS 03.45, 3GPP TS 07.01, ITU-T Recommendation T.30.

29.4.3.1.2.3 Test purpose

To verify that the circuit and tone handling of the MT and FA is correct.

29.4.3.1.2.4 Method of test

Initial conditions

The MS, configured for the fax call, is updated. Then the call establishment phase begins.

Test procedure

The SS will send the SETUP message causing CT125 (see note 2) going to ON condition at the MT. The FA then sends ring current (see note 2) to the fax machine, which will connect to line. The FA sets CT108.2 (see note 2) to ON condition which causes the MT to send the CONNECT message towards the SS. When the TCH is available (indicated by the CONNECT ACK message) the synchronization phase begins, i.e. both entities start sending the synchronization pattern 1/OFF. CT106, 107, 109 have to be in OFF (see note 2) condition. Upon completion of the synchronization phase the MT sets CT107 (see note 2) to ON condition causing the FA to send the CNG tone (see note 2) while the SS turns on CT108.2 causing the CED tone to be sent. Then the SS sets CT106 and 109 to ON (see note 2) at the MT by means of the modified V.110 X and SB bits, which completes Phase A. Then the call is cleared by manual intervention at the MT or the activity progress of the call proceeds to the next phase.

Expected sequence

MS:	Direction	SS:
1	SS-->MS	<----- Send SETUP message
	MT: CT125 ON (see note 2)	
	FA: Cause ring current to flow (see note 2)	
2	MS-->SS	-----> Receive CONNECT message
	Fax: Connect to line (see note 1)	
	FA: CT108.2 ON (see note 2)	
	MT: Send CONNECT message	Send CONN ACK message
3	SS-->MS	<-----> TCH Synchronization
4	MS<->SS	<-----> TCH Synchronization
	MT: CT107 ON (see note 2), when completed	
	FA: Generate CNG (see note 2)	
	Fax: Receive CNG (see note 2)	
5	SS-->MS	<----- Set X and SB bit in modified V.110 frame
	MT: CT106/109 ON (see note 2)	
6	FA: Enter BCS-REC state	Enter BCS-TRA state

29.4.3.1.2.5 Test requirements

1. The condition of CT125 (see note 2) shall be verified.
2. CT108.2 to be verified (see note 2) and the CONNECT message has to be sent by the MT.
3. To be verified that at the MT CT106, 107, 109 are in OFF (see note 2) condition, that the MT begins the synchronization phase by sending the pattern 1/OFF, that CT107 is turned on (see note 2) by the MT after successful synchronization and that the CNG tone (see note 2) is sent.
4. It shall be verified that CT106 and CT109 are turned on (see note 2), when in the modified V.110 frames received from the SS the X and SB bits are set.
5. The state of the FA shall be verified (-> BCS-REC).

29.4.3.2 Pre-message procedure

29.4.3.2.1 Definition

-29.4.3.2.2 Conformance requirement

The MS supporting transparent facsimile group 3 shall perform the pre-message procedure and shall support the frames and the circuits at the Um-,R- and 2w-interface according the specifications referred to in the subclause "Reference".

Reference

3GPP TS 03.45, ITU-T Recommendation T.30.

29.4.3.2.3 Test purpose

To verify the correct handling of the T.30 DIS/DCS/TCF frames.

29.4.3.2.4 Method of test

Initial conditions

The activity progress of the fax call is brought to the beginning of Phase B. The fax transmission shall start using a speed of 9,6 kBit/s.

Test procedure

After phase A the FA being in BCS-REC state, sends the DIS* frame in order to indicate the capabilities of the connected fax and the FA and returns to the idle state. The SS's answer to the DIS is the DCS*. Upon detection of the BCS-REC identifier the FA enters the BCS-TRA state, receives the DCS* and transmits the DCS to the fax. After being for 75 ± 20 ms in IDLE state the FA autonomously enters the MSG-TRA state and begins transmitting the training sequence towards the fax without being triggered by the remote FA/SS. Meanwhile the SS sends the TCF*, which is buffered by the FA. When the training is done the FA transmits the buffered TCF towards the fax. Then the CFR* frame is transmitted to the SS. Now, phase B is completed and the data transfer phase C begins. Then the call is cleared by manual intervention at the MT or the call activity progress proceeds to the next phase.

Expected sequence

MS:	SS:
Step	Direction
1	MS-->SS
	Fax: Send preamble,DIS
	FA: BCS-REC
	Filter DIS
	Send preamble*,DIS* -----> Receive preamble*,DIS*
	CT109 OFF (see note 2)
	IDLE
2	SS-->MS
	FA: CT105 ON (see note 2)
	BCS-TRA
	Monitor DCS
	Transmit preamble,DCS
	CT105 OFF (see note 2)
	IDLE
	Fax: Receive preamble,DCS <----- Send TCF*
3	SS-->MS
	FA: CT105 ON (see note 2)
	MSG-TRA
	Initiate training after 75 ms +-20 ms in IDLE
	Transmit TCF
	CT105 OFF (see note 2)
	IDLE
	Fax: Receive training,TCF
4	MS-->SS
	Fax: Send preamble, CFR
	FA: CT109 ON (see note 2)
	BCS-REC
	Send preamble*,CFR* -----> Receive preamble*,CFR*
	CT109 OFF (see note 2)
	IDLE

29.4.3.2.5 Test requirements

1. To be verified that the DIS is filtered and that the correct up-conversion to the message speed is applied. CT109 should go to OFF (see note 2).
2. The DCS shall indicate a message speed of 7 200 bit/s and the down-conversion to the BCS speed shall be verified.
3. The FA, after the reception of the DCS, sends SYNC frames for 75 ± 20 ms and changes to the MSG-TRA state without being triggered by the SS. When the training is over the TCF is transmitted to the fax.

4.The condition of CT109 (see note 2), the ident octet of the STATUS frames and the up-conversion to the message speed shall be verified.

29.4.3.3 Message procedure

29.4.3.3.1 Definition

-29.4.3.3.2 Conformance requirement

The MS supporting transparent facsimile group 3 shall perform the message procedure and shall support the frames and the circuits at the Um-,R- and 2w-interface according the specifications referred to in the subclause "Reference".

Reference

3GPP TS 03.45, ITU-T Recommendation T.30, ITU-T Recommendation T.4, ITU-T Recommendation T.21.

29.4.3.3.3 Test purpose

To verify the facsimile data transmission phase.

29.4.3.3.4 Method of test

Initial conditions

The activity progress of the fax call is brought to the beginning of Phase C. The ECM shall not be used.

Test procedure

The FA is in idle state. Upon reception of the MSG-REC identifier the FA enters the MSG-TRA state, sends the MSG-TRA identifier and initiates the training. While the training is in progress data being received is buffered and conveyed to the connected fax upon end of training. When the transmission is finished the FA is again in the IDLE state and Phase D begins. Then the call is cleared by manual intervention at the MT or the activity progress of the call will proceed to the next phase.

Expected sequence

MS:			SS:
Step	Direction		

1	SS-->MS		<----- Transmit STATUS interleaved with SYNC frames
2	MS-->SS	FA: CT105 ON (see note 2) MSG-TRA Initiate training Send STATUS interleaved with SYNC frames	----->
3	SS-->MS	FA: Buffer received data during training Receive fax message* " " "	<----- Send fax message* " " "
		CT105 OFF (see note 2) IDLE Fax: Receive training, fax message	

29.4.3.3.5 Test requirements

1. To be verified that the FA enters the MSG-TRA state and inserts the correct ident octet in the STATUS frames. Training has to be initiated (see note 2). STATUS frames have to be sent interleaved with SYNC frames.
2. The condition of CT105 (see note 2) shall be checked.

29.4.3.4 Post-message procedure

29.4.3.4.1 Definition

-29.4.3.4.2 Conformance requirement

The MS supporting transparent facsimile group 3 shall perform the post-message procedure and shall support the frames and the circuits at the Um-,R- and 2w-interface according the specifications referred to in the subclause "Reference".

Reference

3GPP TS 03.45, ITU-T Recommendation T.30

29.4.3.4.3 Test purpose

To verify phase D of the facsimile transmission.

29.4.3.4.4 Method of test

Initial conditions

The activity progress of the fax call is brought to the beginning of Phase D. The ECM shall not be used.

Test procedure

The SS sends the EOP* frame. The FA then enters the BCS-TRA state and conveys the EOP frame to the fax machine. The fax answers the EOP with the MCF frame. The FA will enter the BCS-REC state, transmit the BCS-REC identifier and will convey the MCF* frame to the SS. Afterwards the FA enters the IDLE state. Phase D of the fax transmission is completed. Then the call is cleared by manual intervention at the MT or the activity progress of the call will proceed to the next phase.

Expected sequence

MS:	Direction	SS:
1	SS-->MS	<----- Send preamble*, EOP*
	FA: CT105 ON (see note 2)	
	BCS-TRA	
	Transmit preamble, EOP	
	CT105 OFF (see note 2)	
	IDLE	
2	MS-->SS	-----> Receive preamble*, MCF*
	Fax: Receive preamble, EOP	
	Fax: Send preamble, MCF	
	FA: CT109 ON (see note 2)	
	BCS-REC	
	Send preamble*, MCF*	
	CT109 OFF (see note 2)	
	IDLE	

29.4.3.4.5 Test requirements

1. To be verified that the FA enters the BCS-TRA state upon detection of the BCS-REC identifier and that the correct T.30 message (down conversion to the message speed) is conveyed to the connected fax.
2. To be verified that the FA enters the BCS-REC state and that the correct STATUS frames are sent (up-conversion to the message speed).

29.4.3.5 Call release procedure

29.4.3.5.1 Definition

-

29.4.3.5.2 Conformance requirement

The MS supporting transparent facsimile group 3 shall perform the call release procedure and shall support the frames and the circuits at the Um-,R- and 2w-interface according the specifications referred to in the subclause "Reference".

Reference

3GPP TS 03.45, ITU-T Recommendation T.30.

29.4.3.5.3 Test purpose

To verify phase E of the facsimile transmission.

29.4.3.5.4 Method of test

Initial conditions

The activity progress of the fax call is brought to the beginning of Phase E.

Test procedure

The SS sends the preamble followed by the DCN frame. The FA then enters the BCS-TRA state and sends the DCN frame to the fax terminal. The FA enters the idle state again. CT108.2 (see note 2) will go OFF condition. The MT then sends the DISC message and the call is cleared.

Expected sequence

MS:	Direction	SS:

1	SS-->MS	<----- Send preamble*, DCN*
	FA: CT105 ON (see note 2) BCS-TRA CT108.2 OFF (see note 2) Generate preamble, DCN CT105 OFF (see note 2) IDLE	
	Fax: Receive preamble, DCN	
	MT: Send DISC message	-----> Receive DISC message

29.4.3.5.5 Test requirements

To be verified that CT108.2 is turned off (see note 2) and that the correct down-conversion to the BCS speed is applied. The MT shall send the DISC message.

29.4.3.6 Speed conversion factor

29.4.3.6.1 Definition

-

29.4.3.6.2 Conformance requirement

The MS supporting transparent facsimile group 3 shall perform the up- and down-conversion procedure and shall support the frames and the circuits at the Um-,R- and 2w-interface according the specifications referred to in the subclause "Reference".

Reference

3GPP TS 03.45, ITU-T Recommendation T.30.

29.4.3.6.3 Test purpose

To verify the correct speed conversion for the BCS phases.

29.4.3.6.4 Method of test

Initial conditions

The activity progress of the fax call is brought to the beginning of Phase B. The ECM shall not be used.

Test procedure

The following test sequence is repeated 5 times with 5 different DCS frames indicating a message speed of 9,6/7,2/4,8/2,4 and 9,6 kBit/s. This test is done to verify that the FA detects a change of the TCH access rate and due to this updates the speed conversion factor, which is used for the up-conversion of the BCS signalling to the message speed and vice versa. Then the call is cleared by manual intervention at the MT or the activity progress of the call proceeds to the next phase.

Expected sequence

MS:	Direction	SS:
1	MS-->SS	
	Fax: Send preamble,DIS	
	FA: BCS-REC	
	Monitor DIS	
	Send preamble*,DIS*	-----> Receive preamble*,DIS*
	CT109 OFF (see note 2)	
	IDLE	
2	SS-->MS	<----- Send preamble*,DCS*
	FA: CT105 ON (see note 2)	
	BCS-TRA	
	Monitor DCS	
	Transmit preamble,DCS	
	CT105 OFF (see note 2)	
	IDLE	
3	SS<->MS	
	Fax: Receive preamble,DCS	
	Execution of the CMM procedure **): The SS sends the CMM message	
	150 ms after the DCS has been sent and the MT completes the procedure	
	by sending the CMM ACK message	
4	SS-->MS	<----- Send TCF*
	FA: CT105 ON (see note 2)	
	MSG-TRA	
	Initiate training after 75 ms ± 20 ms in idle	
	Generate TCF	
	CT105 OFF (see note 2)	
	IDLE	
5	MS-->SS	
	Fax: Receive training,TCF	
	Fax: Send preamble, CFR	
	FA: CT109 ON (see note 2)	
	BCS-REC	
	Send preamble*,CFR*	
	CT109 OFF (see note 2)	-----> Receive preamble*,CFR*
	IDLE	
6	SS-->MS	<----- Send fax message*
	FA: CT105 ON (see note 2)	
	MSG-TRA	
	Initiate training	
	Buffer received data during training	
	Receive fax message*	
	"	"
	"	"
	"	"
	CT105 OFF (see note 2)	
	IDLE	
7	SS-->MS	<----- Send preamble*, EOM*
	Fax: Receive training, fax message	
	FA: CT105 ON (see note 2)	
	BCS-TRA	
	Transmit preamble, EOM	
	CT105 OFF (see note 2)	
	IDLE	
8	MS-->SS	
	Fax: Receive preamble, EOM	
	Fax: Send preamble, MCF	
	FA: CT109 ON (see note 2)	
	BCS-REC	
	Send preamble*, MCF*	
	CT109 OFF (see note 2)	-----> Receive preamble*, MCF*
	IDLE	
9	Repeat steps 2 to 8 four times	

- ***) only if the requested rate in the DCS differs from the existing radio channel rate (when the radio channel rate equals 9 600 kbit/s and the DCS requests 7 200 kbit/s no CMM will be executed)

29.4.3.6.5 Test requirements

1. The MT shall send the CMM ACK message.
2. For 7,2/9,6 kBit/s:

The correct up- and down-conversion shall be verified (4 STATUS frames for 1 BCS octet)

For 4,8 kBit/s:

The correct up- and down-conversion shall be verified (2 STATUS frames for 1 BCS octet)

For 2,4 kBit/s:

The correct up- and down-conversion shall be verified (1 STATUS frame for 1 BCS octet)

The IDENT octet shall be set to BCS-REC in case of the up-conversion.

29.4.3.7 Quality Check

29.4.3.7.1 Definition

-

29.4.3.7.2 Conformance requirement

The configuration supporting transparent facsimile group 3 shall decode the T.4 coding and shall generate a document.

Reference

3GPP TS 03.45, ITU-T Recommendation T.21, ITU-T Recommendation T.4.

29.4.3.7.3 Test purpose

To verify the quality of the received document.

29.4.3.7.4 Method of test

Initial conditions

The document has been received at the called side.

Test procedure

The quality of the document at the receiving side shall be checked.

29.4.3.7.5 Test requirements

The contents of the transmitted and the received document shall be the same.

29.4.4 Notes

The following notes apply throughout the subclause 29.4.

NOTE 1: By pressing the START button on the facsimile apparatus or in case of PC fax by selecting the appropriate software menu point or automatically.

NOTE 2: Or equivalent function/means having the same result.

NOTE 3: Tested by monitoring the contents of the STATUS frame ident octet identifier.

NOTE 4: If no access is available to the 2w interface, this requirement cannot always be verified.

30 Speech teleservices

When an artificial ear is required, the ITU-T Recommendation P.57 [108] Type 1 artificial ear may be used for up to release 4 handsets. See below for details.

If requested by the terminal supplier, the ITU-T Recommendation P.57 [108] Type 3.2 artificial ear shall be used. In this case the following shall apply:

- either the low leakage option or the high leakage option of Type 3.2 artificial ear may be adopted;
- the force against the ear shall be as specified in ITU-T Recommendation P.57 [108];
- sound pressure measurements shall be referred to the ERP as specified in ITU-T Recommendation P.57 [108] or DRP according to the Terminal Supplier's request;
- no leakage correction shall be made in the calculation of RLR (i.e. $L_E=0$).

If requested by the terminal supplier, the ITU-T Recommendation P.57 [108] Type 3.4 artificial ear may be used for Release 96 MS or later. The positioning is defined in ITU-T Recommendation P.64.

If requested by the terminal supplier, the ITU-T Recommendation P.57 [108] Type 3.3 artificial ear may be used for Release 96 MS or later. The positioning is defined in ITU-T Recommendation P.64.

Note that for measurement of STMR in release 4 or later MS as specified in 3GPP TS 26.132, the 3.2 ear with the low leakage option shall be used. For release 4 it is also possible to use the type 1 ear.

The manufacturer declares in the IXIT statement which type of artificial ear will be used for teleservices speech testings.

NOTE 1: An MS may be either a handset MS, a handsfree MS or a combined handset and handsfree MS. The test description for handsfree operation, however, at the moment only covers the stability margin as no test method could be defined for the other parameter.

NOTE 2: Frequency settings in the following tests are taken from ISO 3, R10 series or R40 series or from table 2 of ITU-T Recommendation P.79. A departure from the nominal frequencies of +5 % below 240 Hz and +2 % at 240 Hz and above is accepted. Any sub-multiple of the sampling frequency of 8 kHz shall be avoided. In the case of 4 kHz the departure is restricted to -2 %.

NOTE 3: The measurement accuracy for signal level is $\pm 0,2$ dB and for sound pressure $\pm 0,6$ dB.

NOTE 4: The digital test signals shall be generated as 8 bit A-law companded PCM signals, which internally in the SS are expanded according to ITU-T Recommendation G.721 ($L_{aw}=1$) to 13 bit linear before being applied to the MS via the DAI.

NOTE 5: When measuring signal levels on the DAI, a digital measuring instrument is connected to the 64 kbit/s output of the A-law compression equipment in the SS, which is in turn connected to the DAI in the MS.

NOTE 6: Measurements shall be possible with and without psophometric weighting according to ITU-T Recommendation G.223, table 4.

30.1 Sending sensitivity/frequency response

30.1.1 Definition

The sending sensitivity frequency response is, as a function of the input test signal frequency, the ratio expressed in dB between the output level at the Digital Audio Interface (DAI) or at the audio output of the reference speech decoder of the SS and the input sound pressure in the artificial mouth required to obtain this.

30.1.2 Conformance requirement

The sending sensitivity frequency response shall be within the mask given in 3GPP TS 03.50.

3GPP TS 03.50; subclause 3.8.1.1, table 1.

30.1.3 Test purpose

To verify that the sending sensitivity frequency response is within the mask given in 3GPP TS 03.50, subclause 3.8.1.1, table 1.

30.1.4 Method of test

30.1.4.1 Initial conditions

When measured at the DAI:

- a) The handset is mounted in the LRGP (see annex A of ITU-T Recommendation P.76). The earpiece is sealed to the knife-edge of the artificial ear.
- b) A pure tone with a sound pressure of -4,7 dBPa (in accordance with ITU-T Recommendation P.64) is applied at the mouth reference point (MRP) as described in ITU-T Recommendation P.64 using an artificial mouth conforming to ITU-T Recommendation P.51.
- c) A digital measuring instrument, or high quality digital decoder followed by an analogue level measuring set, is connected to the Digital Audio Interface (DAI). The DAI is set to the operating mode "Test of acoustic devices and A/D & D/A".

When measured at the output of the reference speech decoder of the SS:

- a) The handset is mounted in the LRGP and the earpiece is sealed to the knife-edge of an artificial ear.
- b) A full rate speech call is set up between the MS and the SS.
- c) Artificial speech conforming to ITU-T Recommendation P.50, shall be applied to the MRP, at a wideband sound pressure level of -4,7 dBPa. This implementation could be a real time algorithm producing the artificial speech or a pre-recorded tape of the artificial speech.
- d) The artificial speech shall comprise of a concatenation of three 10 s intervals of "male" and "female" voice. The first 10 s interval is not used for measurement purposes but allows any noise/echo cancelling devices in the MS to adapt. The second and third 10 s intervals consist of separately "male" and "female" artificial voice.

30.1.4.2 Procedure

When measured at the DAI:

The SS measures the output level represented by the PCM bit stream at the DAI (pin 23) at one-twelfth-octave intervals as given by the R40 series of preferred numbers in ISO 3 for frequencies from 100 Hz to 4 000 Hz inclusive.

When measured at the output of the reference speech decoder of the SS:

The 1/3 octave filtered long-term average spectrum of the signal is measured at the analogue or digital output of the reference speech decoder of the SS and an average for the "male" and "female" voices is obtained. The sending sensitivity/frequency response is calculated as the difference between the 1/3 octave input power and the 1/3 octave output power.

30.1.5 Test requirement

The sending sensitivity/frequency response shall be within a mask given in table 30.1. The mask can be drawn with straight lines between the breaking points in the table on a logarithmic (frequency) vs linear (dB sensitivity) scale.

All sensitivity levels are dB on an arbitrary scale.

Table 30.1

Frequency (Hz)	Upper Limit (dB)	Lower Limit (dB)
100	-12	
200	0	
300	0	-12
1 000	0	-6
2 000	4	-6
3 000	4	-6
3 400	4	-9
4 000	0	

30.2 Sending loudness rating

30.2.1 Definition

The Sending Loudness Rating (SLR) is a means of expressing the sending frequency response based on objective measurements in a way which relates to how a speech signal would be perceived by a listener.

30.2.2 Conformance requirement

The Sending Loudness Rating (SLR) shall be 8 ± 3 dB.

3GPP TS 03.50; subclause 3.1.1.

30.2.3 Test Purpose

To verify that the Sending Loudness Rating (SLR) is 8 ± 3 dB.

30.2.4 Method of test

30.2.4.1 Initial conditions

When measured at the DAI:

- The DAI of the MS is connected to the SS and is set to the operating mode "Test of acoustic devices and A/D & D/A".

When measured at the output of the reference speech decoder of the SS:

- A full rate speech call is set up between the MS and the SS.

30.2.4.2 Procedure

When measured at the DAI:

- a) The sending sensitivity is measured at each of the 14 frequencies given in table 2 of ITU-T P.79, bands 4 to 17.
- b) The sensitivity is expressed in terms of dBV/Pa and the SLR is calculated according to ITU-T Recommendation P.79 formula 4.19 b of ITU-T Recommendation P.79, over bands 4 to 17, using the sending weighting factors from ITU-T Recommendation P.79 table 2, adjusted according to table 3 of ITU-T Recommendation P.79.

When measured at the output of the reference speech decoder of the SS:

- a) The sending sensitivity from the MRP to the analogue or digital output of the reference speech decoder of the SS is determined according to subclauses 30.1.4.1 and 30.1.4.2.
- b) The sensitivity is expressed in terms of dBV/Pa and the SLR shall be calculated according to ITU-T Recommendation P.79 formula 2.1, over bands 4 to 17, and using $m = 0,175$ and the sending weighting factors from ITU-T Recommendation P.79 table 1.

30.2.5 Test requirement

The SLR shall be 8 ± 3 dB.

30.3 Receiving sensitivity/frequency response

30.3.1 Definition

The receiving sensitivity frequency response is, as a function of the input test signal frequency, the ratio expressed in dB between the output sound pressure in the artificial ear and the input level, represented by the PCM bit stream at the Digital Audio Interface (DAI) or the level at the SS audio input, required to obtain this.

30.3.2 Conformance requirement

The receiving sensitivity frequency response shall be within the mask given in 3GPP TS 03.50.

3GPP TS 03.50; subclause 3.8.1.2, table 2.

30.3.3 Test purpose

To verify that the receiving sensitivity frequency response is within the mask given in 3GPP TS 03.50; subclause 3.8.1.2, table 2.

30.3.4 Method of test

30.3.4.1 Initial conditions

When measured from the DAI:

- a) The handset is mounted in the LRGP and the earpiece is sealed to the knife-edge of the artificial ear.
- b) A digital signal generator is connected at the digital interface delivering a signal equivalent to a pure tone level of -16 dBm₀, see ITU-T Recommendation P.64.
- c) The DAI of the MS is connected to the SS and is set to the operating mode "Test of acoustic devices and A/D & D/A".

When measured from the input of the reference speech encoder of the SS:

- a) The handset is mounted in the LRGP and the earpiece is sealed to the knife-edge of the artificial ear.
- b) A full rate speech call is set up between the MS and the SS.
- c) Artificial speech conforming to ITU-T Recommendation P.50, shall be applied to the analogue or digital input of the reference speech encoder of the SS, at a wideband level of -16 dBm₀. This implementation could be a real time algorithm producing the artificial speech or a pre-recorded tape of the artificial speech.
- d) The artificial speech shall comprise of a concatenation of three 10 s intervals of "male" and "female" voice. The first 10 s interval is not used for measurement purposes but allows any echo cancellation devices in the MS to adapt. The second and third 10 s intervals consist of separately "male" and "female" artificial voice.

30.3.4.2 Procedure

When measured from the DAI:

- Measurements are made at one twelfth-octave intervals as given in the R.40 series of preferred numbers in ISO 3 for frequencies from 100 Hz to 4 kHz inclusive. At each frequency, the sound pressure in the artificial ear is measured by connecting a suitable measuring set to the artificial ear.

When measured from the input of the reference speech encoder of the SS:

- The 1/3 octave filtered long-term average spectrum of the signal is measured and an average for the "male" and "female" voices is obtained. The receiving sensitivity/frequency response is calculated as the difference between the 1/3 octave input power and the 1/3 octave output power.

30.3.5 Test requirement

The receiving sensitivity/frequency response shall be within the mask given by table 30.2. The mask can be drawn with straight lines between the breaking points in the following table on a logarithmic (frequency) vs linear (dB sensitivity) scale.

All sensitivity levels are dB on an arbitrary scale.

Table 30.2

Frequency (Hz)	Upper Limit (dB)	Lower Limit (dB)
100	-12	
200	0	
300	2	-7
500	see note	-5
1 000	0	-5
3 000	2	-5
3 400	2	-10
4 000	2	

NOTE: The limit at intermediate frequencies lies on a straight line drawn between the given values on a log (frequency) vs linear (dB) scale.

30.4 Receiving loudness rating

30.4.1 Definition

The Receiving Loudness Rating (RLR) is a means of expressing the receiving frequency response based on objective measurements in a way which relates to how a speech signal would be perceived by a listener.

30.4.2 Conformance requirement

- 1) The nominal Receiving Loudness Rating (RLR) shall be 2 ± 3 dB.

If a user controlled receive volume control is provided the equipment shall meet this nominal value for at least one setting of the control.

3GPP TS 03.50; subclause 3.1.1.

- 2) If a user controlled receive volume control is provided the Receive Loudness Rating (RLR) shall not be less than -13 dB when the control is set to maximum.

3GPP TS 03.50; subclause 3.1.1.

30.4.3 Test purpose

- 1) To verify that the nominal Receiving Loudness Rating (RLR) is 2 ± 3 dB.
- 2) To verify that if a user controlled receive volume control is provided the Receive Loudness Rating (RLR) is not less than -13 dB when the control is set to maximum.

30.4.4 Method of test

30.4.4.1 Initial conditions

When measured at the DAI:

- The DAI of the MS is connected to the SS and is set to the operating mode "Test of acoustic devices and A/D & D/A".

When measured at the output of the reference speech decoder of the SS:

- A full rate speech call is set up between the MS and the SS.

30.4.4.2 Procedure

When measured at the DAI:

- a) The receiving sensitivity is measured at each of the 14 frequencies listed in table 2 of ITU-T Recommendation P.79, bands 4 to 17.

- b) The sensitivity is expressed in terms of dBPa/V and the RLR is calculated according to ITU-T Recommendation P.79 formula 4.19 c, over bands 4 to 17, using the receiving weighting factors from table 2 of ITU-T Recommendation P.79, adjusted according to table 3 of ITU-T Recommendation P.79.
- c) The artificial ear sensitivity must be corrected according to the real ear correction of table 4 of ITU-T Recommendation P.79.

NOTE: The values of real ear correction in ITU-T Recommendation P.79 table 4 were derived for one type of handset conforming to the shape defined in ITU-T Recommendation P.35.

These values are used in the present document because there is no measurement method agreed for the real ear correction. If a method of measurement is agreed, it is intended to change the present document to use the values appropriate to each handset.

When measured from the input of the reference speech encoder of the SS:

- a) The receiving sensitivity from the analogue or digital input of the reference speech encoder of the SS to the output of the artificial ear is determined according to subclauses 30.3.4.1 and 30.3.4.2.
- b) The sensitivity is expressed in terms of dBPa/V and the RLR shall be calculated according to ITU-T Recommendation P.79 formula 2.1, over bands 4 to 17, using $m = 0,175$ and the receiving weighting factors from table 1 of ITU-T Recommendation P.79.

30.4.5 Test requirement

If no user controlled receive volume control is provided, the RLR shall be 2 ± 3 dB.

If a user controlled receive volume control is provided, the RLR shall meet this nominal value for (at least) one setting of the receive volume control.

When the receive volume control is set to maximum the RLR shall not be less than (i.e. louder than) -13 dB.

30.5 Side tones

30.5.1 Side Tone Masking Rating (STMR)

30.5.1.1 Definition

The sidetone loudness ratings are a means of expressing the path loss from the artificial mouth to the artificial ear based on objective single tone measurements in a way that relates to how a speaker will perceive his own voice when speaking (talker sidetone, expressed by the sidetone masking rating - STMR), or how a listener will perceive the background noise picked up by the microphone (listener sidetone rating - LSTR).

30.5.1.2 Conformance requirement

The nominal value of the Side Tone Masking Rating (STMR) shall be 13 ± 5 dB. Where a user controlled receiving volume control is provided the STMR shall meet the requirement at the setting where the RLR is equal to the nominal value.

3GPP TS 03.50; subclause 3.10.1.

30.5.1.3 Test purpose

- 1) To verify that the Side Tone Masking Rating (STMR) is 13 ± 5 dB.
- 2) To verify that is a user controlled receiving volume control is provided, the STMR is 13 ± 5 dB at the setting where the RLR is equal to the nominal value.

30.5.1.4 Method of test

30.5.1.4.1 Initial conditions

- a) The DAI of the MS is connected to the SS and is set to the operating mode "Test of acoustic devices and A/D & D/A".

- b) The handset is mounted in the LRGP (see annex 1 of ITU-T Recommendation P.76) and the earpiece is sealed to the knife-edge of the artificial ear conforming to ITU-T Recommendation P.51.

30.5.1.4.2 Procedure

- a) The SS sends a PCM bit stream coded with the value No 1 over the DAI (pin 25). Or alternatively the activation of the A/D and D/A converters is performed via a call setup, in which case the DAI connection between the MS and SS, and the PCM bit stream are optional.

NOTE: The idle channel noise in the receiving direction is the acoustic sound pressure in the artificial ear when the digital input signal at the DAI is the PCM coded value No. 1.

- b) The SS applies a pure tone with a sound pressure of -4,7 dBPa at the mouth reference point as described in ITU-T P.64 using an artificial mouth conforming to ITU-T Recommendation P 51.
- c) For each frequency given in table 2 of ITU-T Recommendation P.79, bands 4 to 17, the sound pressure in the artificial ear is measured.
- d) The sidetone path loss (LmeST) is expressed in dB and the STMR (in dB) is calculated from the formula 8.4 of ITU-T Recommendation P.79, using the weighting factors of column (3) in table 6 of ITU-T Recommendation P.79 (unsealed), and values of LE in accordance with table 4 of ITU-T Recommendation P.79.

30.5.1.5 Test requirement

The STMR shall be 13 ± 5 dB.

Where a user controlled receive volume control is provided, the STMR shall meet the requirement given above at the setting where the RLR is equal to the nominal value.

30.5.2 Listener Side Tone Rating (LSTR)

30.5.2.1 Definition

The Listener Sidetone Rating (LSTR) is considered a major parameter affecting the user perception of the system.

30.5.2.2 Conformance requirement

The value of the Listener Sidetone Rating (LSTR) shall not be less than 15 dB.

3GPP TS 03.50, subclause 3.10.1.

30.5.2.3 Test purpose

To verify that the value of LSTR is not less than 15 dB.

30.5.2.4 Method of test

30.5.2.4.1 Initial conditions

The DAI of the MS is connected to the SS and is set to the operating mode "Test of acoustic devices and A/D & D/A".

The SS sends a PCM bit stream coded with the value No. 1 over the DAI (pin 25) to the MS.

30.5.2.4.2 Procedure

- a) The sound field is calibrated in the absence of any local obstacles. The averaged field shall be uniform to within +4 dB/-2 dB within a radius of 0,15 m of the MRP, when measured in one-third octave bands from 100 Hz to 8 kHz (bands 1 to 20).
- b) A calibrated half-inch microphone is mounted at MRP. The sound field is measured in one-third octave bands. The spectrum shall be "Pink noise" as described in ITU-T recommendation P.64 annex B to within ± 1 dB and the level shall be adjusted to 70 dBA (-24 dBPa(A)). The tolerance on this level is ± 1 dB.
- c) The artificial mouth and ear are placed in the correct position relative to MRP, the handset is mounted at LRGP and the earpiece is sealed to the knife-edge of the artificial ear.

- d) Measurements are made in one-third octave bands for the 14 bands centred at 200 Hz to 4 kHz (bands 4 to 17). For each band the sound pressure in the artificial ear shall be measured by connecting a suitable measuring set to the artificial ear.
- e) The listener sidetone path loss is expressed in dB and the LSTR shall be calculated from the ITU-T Recommendation P.79 formula 8-4, using the weighting factors in column (3) in table 6 of the Recommendation, and the values of LE; in accordance with table 4 of the Recommendation.

30.5.2.5 Test requirement

The LSTR shall not be less than 15 dB.

30.6 Telephone Acoustic coupling Loss (TAL)

30.6.1 Echo Loss (EL)

30.6.1.1 Definition

The echo loss is the path loss from the input of the reference speech encoder of the SS to the output of the reference speech decoder of the SS.

30.6.1.2 Conformance requirement

The echo loss from the input to the output of the reference speech codec in the SS shall be at least 46 dB.

3GPP TS 03.50; subclause 3.4.3.2.

30.6.1.3 Test purpose

To verify that the echo loss from the input to the output of the reference speech codec in the SS is at least 46 dB.

30.6.1.4 Method of test

30.6.1.4.1 Initial conditions

The DAI of the MS is connected to the SS and is set to the operating mode "Normal operation".

The SS sets up a speech call according to the generic call set up procedure.

The handset is mounted in the LRGP (see annex 1 of ITU-T Recommendation P.76) and the earpiece is sealed to the knife-edge of the artificial ear conforming to ITU-T Recommendation P.51.

Where a user controlled volume control is provided it is set to maximum.

30.6.1.4.2 Procedure

An implementation of the ITU-T P.50 artificial speech is connected to the analogue or digital input of the reference speech encoder of the SS. This implementation is either a real time algorithm producing the artificial speech or a pre-recorded tape of artificial speech. Both "male" and "female" artificial speech is required.

A ten second segment of the "male" artificial speech is applied to the analogue or digital input of the reference speech encoder of the SS. The third octave power of the input signal is measured. The echo loss signal is not measured at this stage as the first ten second segment is used to allow any acoustic echo cancellation devices within the MS to adapt to the echo path.

Immediately after a second ten second segment of the "male" artificial speech is applied to the analogue or digital input of the reference speech encoder of the SS. The third octave power of the echo signal is measured at the analogue or digital output of the reference speech decoder of the SS.

The difference between the third octave input power and the third octave output power is entered into the ITU-T G.122 TCL algorithm and the acoustic echo loss calculated.

The test is repeated with the "female" artificial speech and the results of both "male" and "female" averaged to give the final result.

30.6.1.5 Test requirement

The echo loss from the input to the output of the reference speech codec in the SS shall be at least 46 dB.

30.6.2 Stability margin

30.6.2.1 Definition

The receive-transmit stability margin is a measure of the gain that would have to be inserted between the go and return paths of the reference speech coder in the SS for oscillation to occur.

30.6.2.2 Conformance requirement

The stability margin shall be at least 6 dB.

3GPP TS 03.50; subclause 3.2.

30.6.2.3 Test purpose

To verify that the stability margin is at least 6 dB.

30.6.2.4 Method of test

30.6.2.4.1 Initial conditions

For handset operation the handset is placed on a hard plane surface with the transducers facing the surface.

For handsfree operation the test setup is shown in ITU-T Recommendation P.34 (figure 3), but omitting the test table.

Where a user controlled volume control is provided it is set to maximum.

30.6.2.4.2 Procedure

- a) A gain equivalent to the minimum stability margin is inserted in the loop between the go and return paths of the reference speech coder in the SS and any acoustic echo control is enabled.
- b) A test signal according to ITU-T Recommendation O.131 is injected into the loop at the analogue or digital input of the reference speech codec of the SS and the stability is measured. The test signal has a level of -10 dBm0 and a duration of 1 s.

30.6.2.5 Test requirement

The minimum stability margin shall be 6 dB and no audible oscillation shall be detected.

30.7 Distortion

30.7.1 Sending

30.7.1.1 Definition

The transmit signal to total distortion ratio is a measure of the linearity of the transmitter equipment.

30.7.1.2 Conformance requirement

The ratio of signal to total distortion power in the sending direction measured with a psophometric filter at the DAI of the MS or at the output of the reference speech decoder of the SS shall be above the limits given in 3GPP TS 03.50; subclause 3.9.1, table 3, unless the sound pressure at MRP exceeds +10 dBPa.

3GPP TS 03.50; subclause 3.9.1.

30.7.1.3 Test purpose

To verify that the ratio of signal to total distortion power in the sending direction measured with psophometric filter is above the limits given in 3GPP TS 03.50; subclause 3.9.1, table 3.

30.7.1.4 Method of test

30.7.1.4.1 Initial conditions

The handset is mounted in the LRGP (see annex 1 of ITU-T Recommendation P.76) and the earpiece is sealed to the knife-edge of the artificial ear conforming to ITU-T Recommendation P.51.

When measured at the DAI:

The DAI of the MS is connected to the SS and is set to the operating mode "Test of acoustic devices and A/D & D/A".

When measured at the output of the reference speech decoder of the SS:

A full rate speech call is set up between the MS and the SS.

30.7.1.4.2 Procedure

- a) A sine-wave signal with a frequency in the range 1 004 Hz to 1 025 Hz is applied to the MRP. The level of this signal is adjusted until the level at the DAI output (pin 23) of the MS or at the analogue or digital output of the reference speech decoder of the SS corresponds to -10 dBm₀. The level of the signal at the MRP is then the acoustic reference level (ARL).
- b) The test signal is applied at the following levels: -35 dB, -30 dB, -25 dB, -20 dB, -15 dB, -10 dB, -5 dB, 0 dB, 5 dB, 10 dB relative to the ARL.
- c) The ratio of signal to total distortion power is measured at the DAI of the MS or at the analogue or digital output of the reference speech decoder of the SS with the psophometric noise weighting (see ITU-T Recommendations G.714 and O.132) at each signal level.

NOTE: The measurement is not to be carried out at sound pressures exceeding +10 dBPa.

30.7.1.5 Test requirement

The ratio of signal to total distortion power measured with the psophometric noise weighting (see table 4/ ITU-T G.223) shall be above the limits given in table 30.3.

Table 30.3

dB relative to ARL	Level ratio
-35 dB	17,5 dB
-30 dB	22,5 dB
-20 dB	30,7 dB
-10 dB	33,3 dB
0 dB	33,7 dB
7 dB	31,7 dB
10 dB	25,5 dB

Limits for the signal to total distortion ratio (sending) when using the sine wave method.

Limits for intermediate levels are found by drawing a straight line between breaking points in a linear (dB signal level) vs linear (dB ratio) scale.

30.7.2 Receiving

30.7.2.1 Definition

The receive signal to total distortion ratio is a measure of the linearity in the receive equipment (excluding the speech decoder).

30.7.2.2 Conformance requirement

The ratio of signal to total distortion power in the receiving direction measured at the ERP or DRP according to the Terminal Supplier's request with psophometric filter shall be above the limits given in 3GPP TS 03.50; subclause 3.9.2, table 5.

3GPP TS 03.50; subclause 3.9.2.

30.7.2.3 Test purpose

To verify that the ratio of signal to total distortion power in the receiving direction measured at the ERP or DRP according to the Terminal Supplier's request with psophometric filter is above the limits given in 3GPP TS 03.50; subclause 3.9.2, table 5.

30.7.2.4 Method of test

30.7.2.4.1 Initial conditions

The handset is mounted in the LRGP (see annex 1 of ITU-T Recommendation P.76) and the earpiece is sealed to the knife-edge of the artificial ear conforming to ITU-T Recommendation P.51.

The DAI of the MS is connected to the SS and is set to the operating mode "Test of acoustic devices and A/D & D/A".

30.7.2.4.2 Procedure

- a) The SS sends, via the DAI (Pin 25), a PCM bit stream simulating a sine-wave signal with a frequency in the range 1 004 Hz to 1 025 Hz corresponding to ITU-T O.132 at the following levels: -45 dBm0, -40 dBm0, -35 dBm0, -30 dBm0, -25 dBm0, -20 dBm0, -15 dBm0, -10 dBm0, -5 dBm0, 0 dBm0.
- b) The ratio of signal to total distortion power is measured with the psophometric noise weighting in the artificial ear (see ITU-T Recommendations G.714 and O.132) at each signal level.
- c) The measurement is only carried out at sound pressures between -50 dBPa and +10 dBPa.

30.7.2.5 Test requirement

The ratio of signal to total distortion power measured at the artificial ear with the psophometric noise weighting (see table 4/ ITU-T Recommendation G.223) shall be above the limits given in table 30.4.

Table 30.4

Level at the digital audio interface	Level ratio
-45 dBm0	17,5 dB
-40 dBm0	22,5 dB
-30 dBm0	30,5 dB
-20 dBm0	33,0 dB
-10 dBm0	33,5 dB
-3 dBm0	31,2 dB
0 dBm0	25,5 dB

Limits for the signal to total distortion ratio (receiving) when using the sine wave method.

Limits for intermediate levels are found by drawing a straight line between breaking points in a linear (dB signal level) vs linear (dB ratio) scale.

30.8 Sidetone distortion

30.8.1 Definition

The sidetone distortion expresses the linearity of the sidetone path in the handset.

30.8.2 Conformance requirement

The third harmonic distortion of the sidetone shall not be greater than 10 %.

3GPP TS 03.50; subclause 3.10.2.

30.8.3 Test purpose

To verify that the third harmonic distortion of the sidetone is not greater than 10 %.

30.8.4 Method of test

30.8.4.1 Initial conditions

The DAI of the MS is connected to the SS and is set to the operating mode "Test of acoustic devices and A/D & D/A".

The handset is mounted in the LRGP (see annex 1 of ITU-T Recommendation P.76) and the earpiece is sealed to the knife-edge of the artificial ear conforming to ITU-T Recommendation P.51.

30.8.4.2 Procedure

- a) The SS sends the PCM bit stream coded with the value No 1 over the DAI (pin 25) to the MS.
- b) An instrument capable of measuring the third harmonic distortion of signals with fundamental frequencies in the range 315 Hz to 1 000 Hz is connected to the artificial ear.
- c) A pure-tone signal of -4,7 dBPa is applied at the mouth reference point at frequencies of 315 Hz, 500 Hz, and 1 000 Hz. For each frequency the third harmonic distortion is measured in the artificial ear.

30.8.5 Test requirement

The third harmonic distortion generated shall not be greater than 10 %.

30.9 Out-of-band signals

30.9.1 Sending

30.9.1.1 Definition

The discrimination against out-of-band input signals in the sending direction is a requirement on the in-band image frequencies created by any out-of-band input signals.

30.9.1.2 Conformance requirement

With any sine wave signal above 4,6 kHz and up to 8 kHz applied at the MRP at a level of -4,7 dBPa, the level of any image frequency produced at the digital interface shall be below a reference level obtained at 1 kHz (-4,7 dBPa at MRP) by at least the amount (in dB) specified in 3GPP TS 03.50; subclause 3.11.1, table 7.

3GPP TS 03.50; subclause 3.11.1.

30.9.1.3 Test purpose

To verify that the conformance requirement is met for input signals with frequencies of 4,65 kHz, 5 kHz, 6 kHz, 6,5 kHz, 7 kHz and 7,5 kHz.

30.9.1.4 Method of test

30.9.1.4.1 Initial conditions

The handset is mounted in the LRGP (see annex 1 of ITU-T Recommendation P.76) and the earpiece is sealed to the knife-edge of the artificial ear conforming to ITU-T Recommendation P.51.

The DAI of the MS is connected to the SS and is set to the operating mode "Test of acoustic devices and A/D & D/A".

30.9.1.4.2 Procedure

- a) A pure tone with a sound pressure of -4,7 dBPa is applied at the mouth reference point as described in ITU-T Recommendation P.64 using an artificial mouth conforming to ITU-T Recommendation P 51.
- b) For input signals at frequencies of 4,65 kHz, 5 kHz, 6 kHz, 6,5 kHz, 7 kHz, and 7,5 kHz, the level represented by the PCM bit stream at the DAI (Pin 23) of any image frequency is measured.

30.9.1.5 Test requirement

The level of any image frequency shall be below a reference obtained at 1 kHz by at least the amount as specified in table 30.5.

Table 30.5

Applied sine-wave frequency	Limit (minimum)
4,6 kHz	30 dB
8 kHz	40 dB

Limits for the image frequency discrimination.

The limit at intermediate frequencies lies on a straight line drawn between the given values on a log(frequency) vs linear(dB) scale.

30.9.2 Receiving

30.9.2.1 Definition

The discrimination against out-of-band signals in the receiving direction is a requirement on the out-of-band signals generated in the artificial ear from in-band input signals.

30.9.2.2 Conformance requirement

With a digitally simulated sine wave signal in the frequency range of 300 Hz to 3,4 kHz and at a level of 0 dBm applied at the digital interface, the level of spurious out-of-band image signals in the frequency range of 4,6 to 8 kHz measured selectively in the artificial ear shall be lower than the in-band acoustic level produced by a digital signal at 1 kHz set at the level specified in 3GPP TS 03.50; subclause 3.11.2, table 8.

3GPP TS 03.50; subclause 3.11.2.

30.9.2.3 Test purpose

To verify that the conformance requirement is met for input signals at the nominal frequencies 500 Hz, 1 000 Hz, 2 000 Hz and 3 350 Hz.

30.9.2.4 Method of test

30.9.2.4.1 Initial conditions

The handset is mounted in the LRGP (see annex 1 of ITU-T Recommendation P.76) and the earpiece is sealed to the knife-edge of the artificial ear conforming to ITU-T Recommendation P.51.

The DAI of the MS is connected to the SS and is set to the operating mode "Test of acoustic devices and A/D & D/A".

30.9.2.4.2 Procedure

- a) The SS sends over the DAI (pin 25) a PCM bit stream simulating a sine-wave signal with a level of 0 dBm0.
- b) For input signals at the nominal frequencies 500 Hz, 1 000 Hz, 2 000 Hz and 3 350 Hz (bearing in mind the restriction on sub-multiples of the sampling frequency) the level of any out-of-band signals at frequencies up to 8 kHz is measured in the artificial ear.

30.9.2.5 Test requirement

The level of out-of-band signals shall be lower than the in-band acoustic level obtained by a digital signal at 1 kHz set at the level specified in table 30.6.

Table 30.6

Image signal frequency	Equivalent input signal level
4,6 kHz	-35 dBm0
8 kHz	-45 dBm0

Limits for the image frequency discrimination.

The limit at intermediate frequencies lies on a straight line drawn between the given values on a log(frequency) vs linear(dB) scale.

30.10 Idle channel noise

30.10.1 Sending

30.10.1.1 Definition

The idle channel noise in the sending direction is the equivalent noise level produced at the DAI, when the mouth reference point is in a quiet environment.

30.10.1.2 Conformance requirement

The idle noise in the sending direction shall not exceed -64 dBm_{0p} at the UPCMI under silent conditions.

3GPP TS 03.50; subclause 3.6.1.

30.10.1.3 Test purpose

To verify that the idle noise in the sending direction does not exceed -64 dBm_{0p} at the UPCMI under silent conditions.

30.10.1.4 Method of test

30.10.1.4.1 Initial conditions

The handset is mounted in the LRGP (see annex 1 of ITU-T Recommendation P.76) and the earpiece is sealed to the knife-edge of the artificial ear conforming to ITU-T Recommendation P.51 in a quiet environment (ambient noise less than 30 dBA).

The DAI of the MS is connected to the SS and is set to the operating mode "Test of acoustic devices and A/D & D/A".

30.10.1.4.2 Procedure

The noise level represented by the PCM bit stream output at the DAI (pin 23) is measured with psophometric weighting according to ITU-T Recommendation G.223, table 4.

NOTE: The ambient noise criterion should be met if the ambient noise does not exceed NR20.

30.10.1.5 Test requirement

The noise produced by the MS in the sending direction shall not exceed -64 dBm_{0p}.

30.10.2 Receiving

30.10.2.1 Definition

The idle channel noise in the receiving direction is the acoustic sound pressure in the artificial ear when the digital input signal at the DAI, is the PCM coded value No 1.

30.10.2.2 Conformance requirement

1. If no user controlled receiving volume control is provided, or if it is provided, at the setting of the user controlled receiving volume at which the RLR is equal to the nominal value, the noise measured in the artificial ear contributed by the receiving equipment alone shall not exceed -57 dBPa (A) when driven by a PCM signal corresponding to the decoder output value No. 1.

3GPP TS 03.50; subclause 3.6.2.

2. Where a volume control is provided, the measured noise shall not exceed -54 dBPa(A) at the maximum setting of the volume control.

3GPP TS 03.50; subclause 3.6.2.

30.10.2.3 Test purpose

1. To verify that the idle noise in the receiving direction does not exceed -57 dBPa (A). If a user controlled receive volume control is provided it shall be set to the position where RLR is equal to the nominal value.

2. To verify that if a user controlled receive volume control is provided, the idle noise in the receiving direction does not exceed -54 dBPa(A) when the control is set to maximum.

30.10.2.4 Method of test

30.10.2.4.1 Initial conditions

The handset is mounted in the LRGP (see annex 1 of ITU-T Recommendation P.76) and the earpiece is sealed to the knife-edge of the artificial ear conforming to ITU-T Recommendation P.51.

The DAI of the MS is connected to the SS and is set to the operating mode "Test of acoustic devices and A/D & D/A".

30.10.2.4.2 Procedure

- The SS sends a PCM bit stream coded with the value No 1 over the DAI (Pin 25) to the MS.
- The level of the noise is measured in the artificial ear with any volume control set at the position at which the RLR is equal to the nominal value.
- Where a volume control is provided, the level of the noise is measured in the artificial ear with the volume control set to maximum.

30.10.2.5 Test requirement

In step b) the measured noise generated by the MS shall not exceed -57 dBPa (A).

In step c) the measured noise shall not exceed -54 dBPa (A).

30.11 Ambient Noise Rejection

30.11.1 Definition

An MS that supports speech will typically be operated within an area of high ambient acoustic noise. A level of noise rejection will therefore be required.

30.11.2 Conformance Requirement

Compliance shall be checked by calculating the single figure DELSM (SFDELSM) according to the following formula, the SFDELSM shall be ≥ 0 dB.

$$SFDELSM = -\frac{4}{5} \times \sum_{n=1}^{14} Del_n \times 10^{(-0.0175 \times W_m)}$$

where:

n = the third octave band centre frequencies from 160 Hz to 3 150 Hz inclusive.

Del_n = is the 1/3 octave band pressure level centered on the nth frequency.

W_m = is the SLR weighting for the nth 1/3 octave band centre frequency.

3GPP TS 03.50; subclause 3.14.1.

30.11.3 Test Purpose

To verify that ambient noise calculated as SFDELSM shall be rejected, by verifying that SFDELSM ≥ 0 dB.

30.11.4 Method of Test

30.11.4.1 Initial Conditions

A 1/2 inch pressure microphone is calibrated using a known sound source and mounted at the MRP, without the LRGP head present. A frequency analyser is calibrated to enable the sound pressure levels at the microphone to be determined in 1/3rd octave bands.

Flood the room in which the measurement is to be made with the selected noise file, and adjust the level such that the noise level at the MRP is 70 dBA. A single noise file of real noise, covering the various noise environments that the MS could be subjected to, is used. This file is three minutes long and also commences with a three minute signal. Once this tone has been adjusted to a level of 70 dBA, the average level of the noise will be 70 dBA. The resulting sound spectrum is P_{rn} dBPa, measured in $1/3^{rd}$ octave bands.

To ensure that the sound field is diffuse enough, the following apply:

- The diffuse sound field is calibrated in the absence of any local obstacles. The averaged field shall be uniform to within ± 3 dB within a radius of 0,15 m of the MRP, when measured in one-third octave bands from 100 Hz to 3,15 KHz.
- Where more than one loudspeaker is used to produce the desired sound field, the loudspeakers may require to be fed with non-coherent signals to eliminate standing waves and other interference effects.
- Position an LRGP in the correct relative position to the MRP and mount the MS under test. Recalibrate the $1/3^{rd}$ octave frequency analyser using a known voltage source to facilitate the analysis of the Voltage V_{rn} , where V_{rn} is the voltage at the audio output of the System Simulator (SS) due to the noise spectrum input.

30.11.4.2 Procedure

Set up a full rate speech path between the MS and the SS.

The SS determines, as a function of frequency, using the frequency analyser, in $1/3^{rd}$ octave bands, the electrical output V_{rn} , (expressed as dB rel 1V) at the audio output of the SS for the applied acoustic pressure P_{rn} (expressed as dB rel 1Pa) at the MRP. Since, the MS sending sensitivity is not defined above 3,4 kHz and below 300 Hz the measurement shall be cut off at 3,4 kHz and for the bands below 300 Hz. The noise level shall be referenced to the speech level at 300 Hz to yield the DELSM.

The room noise sensitivity is defined as:

- $S_{mj_m} = V_{rn} \text{ (dBV)} - P_{rn} \text{ (dBPa)}$.

The ambient noise send sensitivity has now been determined.

The MS speech send sensitivity is now required. The required sensitivity is defined as the electrical output from the MS, measured at the audio output of the SS, as a function of the free field sound pressure at the MRP of the artificial mouth.

The measurement is made using an artificial speech source at the MRP of the artificial mouth. The 1/2 inch pressure microphone is calibrated using a known sound source. The frequency analyser is calibrated to measure in $1/3^{rd}$ octave bands. The artificial mouth output shall be in accordance with the ITU-T Recommendation P.50 male artificial voice. Whilst maintaining the ITU-T Recommendation P.50 'male' spectrum, the total signal level is adjusted to -4,7 dBPa. The resulting sound spectrum is P_0 dBPa, measured in $1/3^{rd}$ octave bands. The $1/3^{rd}$ octave frequency analyser shall be re-calibrated, using a known voltage source, to facilitate the analysis of the voltage V_j . Where V_j is the voltage at the audio output of the SS due to the speech spectrum input. A speech path is setup between the MS and the SS. The function of the frequency is determined using the frequency analyser, and in $1/3^{rd}$ octave bands, the electrical output V_j , (expressed as dB rel. 1V), at the audio output of the SS for the applied acoustic pressure, P_0 , (expressed as dB rel. 1Pa/V), at the MRP.

The sending sensitivity is expressed as:

$$S_{mjs} \text{ (dB)} = V_j \text{ (dBV)} - P_0 \text{ (dBPa)} \text{ dB rel 1V / Pa}$$

The D_{SM} for the MS is determined as:

$$D_{SM} = S_{mj_m} - S_{mjs} \text{ (dB)}.$$

30.11.5 Test Requirement

The MS ambient noise rejection, calculated as a single figure DELSM (SFDELSM) shall be greater than or equal to 0 dB.

30.12 Sending sensitivity/frequency response

30.12.1 Definition

The sending sensitivity frequency response is, as a function of the input test signal frequency, the ratio expressed in dB between the output level at the Digital Audio Interface (DAI) or at the audio output of the reference speech decoder of the SS and the input sound pressure in the artificial mouth required to obtain this.

30.12.2 Conformance requirement

The sending sensitivity frequency response shall be within the mask given in 3GPP TS 26.131.

3GPP TS 26.131, subclause 5.4.1, table 1

30.12.3 Test purpose

To verify that the sending sensitivity frequency response is within the mask given in 3GPP TS 26.131, subclause 5.4.1, table 1.

30.12.4 Method of test

30.12.4.1 Initial conditions

When measured at the DAI:

- a) The handset is mounted in the LRGP (see annex A of ITU-T Recommendation P.76). The earpiece is sealed to the knife-edge of the artificial ear.
- b) A pure tone with a sound pressure of $-4,7$ dBPa (in accordance with ITU-T Recommendation P.64) is applied at the mouth reference point (MRP) as described in ITU-T Recommendation P.64 using an artificial mouth conforming to ITU-T Recommendation P.51.
- c) A digital measuring instrument, or high quality digital decoder followed by an analogue level measuring set, is connected to the Digital Audio Interface (DAI). The DAI is set to the operating mode "Test of acoustic devices and A/D & D/A".

When measured at the output of the reference speech decoder of the SS:

- a) The handset is mounted in the LRGP and the earpiece is sealed to the knife-edge of an artificial ear.
- b) A full rate speech call is set up between the MS and the SS.

30.12.4.2 Procedure

When measured at the DAI:

- The SS measures the output level represented by the PCM bit stream at the DAI (pin 23) at one-twelfth-octave intervals as given by the R40 series of preferred numbers in ISO 3 for frequencies from 100 Hz to 4 000 Hz inclusive.

When measured at the output of the reference speech decoder of the SS:

- The test shall be performed according to the test specification as described in 3GPP TS 26.132.

30.12.5 Test requirement

The sending sensitivity/frequency response shall be within a mask given in table 30.1. The mask can be drawn with straight lines between the breaking points in the table on a logarithmic (frequency) vs linear (dB sensitivity) scale.

All sensitivity levels are dB on an arbitrary scale.

Table 30.1

Frequency (Hz)	Upper Limit (dB)	Lower Limit (dB)
100	-12	
200	0	
300	0	-12
1000	0	-6
2000	4	-6
3000	4	-6
3400	4	-9
4000	0	

30.13 Sending loudness rating

30.13.1 Definition

The Sending Loudness Rating (SLR) is a means of expressing the sending frequency response based on objective measurements in a way which relates to how a speech signal would be perceived by a listener.

30.13.2 Conformance requirement

The Sending Loudness Rating (SLR) shall be 8 ± 3 dB.

3GPP TS 26.131; subclause 5.2.2.

30.13.3 Test Purpose

To verify that the Sending Loudness Rating (SLR) is 8 ± 3 dB.

30.13.4 Method of test

30.13.4.1 Initial conditions

When measured at the DAI:

- The DAI of the MS is connected to the SS and is set to the operating mode "Test of acoustic devices and A/D & D/A".

When measured at the output of the reference speech decoder of the SS:

- A full rate speech call is set up between the MS and the SS.

30.13.4.2 Procedure

When measured at the DAI:

- a) The sending sensitivity is measured at each of the 14 frequencies given in table 2 of ITU-T Recommendation P.79, bands 4 to 17.
- b) The sensitivity is expressed in terms of dBV/Pa and the SLR is calculated according to ITU-T Recommendation P.79 formula 4.19 b of ITU-T Recommendation P.79, over bands 4 to 17, using the sending weighting factors from ITU-T Recommendation P.79 table 2, adjusted according to table 3 of ITU-T Recommendation P.79.

When measured at the output of the reference speech decoder of the SS:

- The test shall be performed according to the test specification as described in 3GPP TS 26.132.

30.13.5 Test requirement

The SLR shall be 8 ± 3 dB.

30.14 Receiving sensitivity/frequency response

30.14.1 Definition

The receiving sensitivity frequency response is, as a function of the input test signal frequency, the ratio expressed in dB between the output sound pressure in the artificial ear and the input level, represented by the PCM bit stream at the Digital Audio Interface (DAI) or the level at the SS audio input, required to obtain this.

30.14.2 Conformance requirement

When measured with the type 1 artificial ear (only release 4 handsets) the receiving sensitivity frequency response shall be within the mask given in 3GPP TS 43.050.

3GPP TS 43.050; subclause 3.8.1.2, table 2.

When measured with 3.x artificial ear (release 4 and later handsets) the receiving sensitivity frequency response shall be within the mask given in 3GPP TS 26.131.

3GPP TS 26.131; subclause 5.4.2, table 2

30.14.3 Test purpose

To verify that the receiving sensitivity frequency response is within the mask given in 3GPP TS 43.050; subclause 3.8.1.2, table 2 when measured with the type 1 artificial ear (release 4 handsets only) or within the mask given in 3GPP TS 26.131; subclause 5.4.2, table 2 when measured with a type 3.x artificial ear.

30.14.4 Method of test

30.14.4.1 Initial conditions

When measured from the DAI:

- a) The handset is mounted in the LRGP and the earpiece is sealed to the knife-edge of the artificial ear.
- b) A digital signal generator is connected at the digital interface delivering a signal equivalent to a pure tone level of -16 dBm0, see ITU-T Recommendation P.64.
- c) The DAI of the MS is connected to the SS and is set to the operating mode "Test of acoustic devices and A/D & D/A".

When measured from the input of the reference speech encoder of the SS:

- a) The handset is mounted in the LRGP and the earpiece is sealed to the knife-edge of the artificial ear.
- b) A full rate speech call is set up between the MS and the SS.

30.14.4.2 Procedure

When measured from the DAI:

- Measurements are made at one twelfth-octave intervals as given in the R.40 series of preferred numbers in ISO 3 for frequencies from 100 Hz to 4 kHz inclusive. At each frequency, the sound pressure in the artificial ear is measured by connecting a suitable measuring set to the artificial ear.

When measured from the input of the reference speech encoder of the SS:

- The test shall be performed according to the test specification as described in 3GPP TS 26.132.

30.14.5 Test requirement

when measured in the type 1 artificial ear (allowed for release 4 handsets only) the receiving sensitivity/frequency response shall be within the mask given by table 30.2. The mask can be drawn with straight lines between the breaking points in the following table on a logarithmic (frequency) vs linear (dB sensitivity) scale.

All sensitivity levels are dB on an arbitrary scale.

Table 30.2

Frequency (Hz)	Upper Limit (dB)	Lower Limit (dB)
100	-12	
200	0	
300	2	-7
500	see note	-5
1 000	0	-5
3 000	2	-5
3 400	2	-10
4 000	2	

NOTE: The limit at intermediate frequencies lies on a straight line drawn between the given values on a log (frequency) vs linear (dB) scale.

When measured in a type 3.x artificial ear, the receiving sensitivity/frequency response shall be within the mask given in 3GPP TS 26.131; subclause 5.4.2, table 2.

30.15 Receiving loudness rating

30.15.1 Definition

The Receiving Loudness Rating (RLR) is a means of expressing the receiving frequency response based on objective measurements in a way which relates to how a speech signal would be perceived by a listener.

30.15.2 Conformance requirement

- 1) The nominal Receiving Loudness Rating (RLR) shall be 2 ± 3 dB.

If a user controlled receive volume control is provided the equipment shall meet this nominal value for at least one setting of the control.

3GPP TS 26.131; subclause 5.2.2.

- 2) If a user controlled receive volume control is provided the Receive Loudness Rating (RLR) shall not be less than -13 dB when the control is set to maximum.

3GPP TS 26.131; subclause 5.2.2.

30.15.3 Test purpose

- 1) To verify that the nominal Receiving Loudness Rating (RLR) is 2 ± 3 dB.
- 2) To verify that if a user controlled receive volume control is provided the Receive Loudness Rating (RLR) is not less than -13 dB when the control is set to maximum.

30.15.4 Method of test

30.15.4.1 Initial conditions

When measured at the DAI:

- The DAI of the MS is connected to the SS and is set to the operating mode "Test of acoustic devices and A/D & D/A".

When measured at the output of the reference speech decoder of the SS:

- A full rate speech call is set up between the MS and the SS.

30.15.4.2 Procedure

When measured at the DAI:

- a) The receiving sensitivity is measured at each of the 14 frequencies listed in table 2 of ITU-T Recommendation P.79, bands 4 to 17.

- b) The sensitivity is expressed in terms of dBPa/V and the RLR is calculated according to ITU-T Recommendation P.79 formula 4.19 c, over bands 4 to 17, using the receiving weighting factors from table 2 of ITU-T Recommendation P.79, adjusted according to table 3 of ITU-T Recommendation P.79.
- c) The artificial ear sensitivity must be corrected according to the real ear correction of table 4 of ITU-T Recommendation P.79.

NOTE: The values of real ear correction in ITU-T Recommendation P.79 table 4 were derived for one type of handset conforming to the shape defined in ITU-T Recommendation P.35.

These values are used in the present document because there is no measurement method agreed for the real ear correction. If a method of measurement is agreed, it is intended to change the present document to use the values appropriate to each handset.

When measured from the input of the reference speech encoder of the SS:

- The test shall be performed according to the test specification as described in 3GPP TS 26.132.

30.15.5 Test requirement

If no user controlled receive volume control is provided, the RLR shall be 2 ± 3 dB.

If a user controlled receive volume control is provided, the RLR shall meet this nominal value for (at least) one setting of the receive volume control.

When the receive volume control is set to maximum the RLR shall not be less than (i.e. louder than) -13 dB.

30.16 Side Tone Masking Rating (STMR)

30.16.1 Definition

The sidetone loudness ratings are a means of expressing the path loss from the artificial mouth to the artificial ear based on objective single tone measurements in a way that relates to how a speaker will perceive his own voice when speaking (talker sidetone, expressed by the sidetone masking rating - STMR), or how a listener will perceive the background noise picked up by the microphone (listener sidetone rating - LSTR).

30.16.2 Conformance requirement

The conformance requirement is specified in 3GPP TS 26.131.

30.16.3 Test purpose

To verify that the requirement for STMR stated in TS 26.131 is met.

30.16.4 Method of test

The method of test shall be as specified in 3GPP TS 26.132.

30.16.5 Test requirement

The STMR shall be within the limits specified in 3GPP TS 26.131.

30.17 Telephone Acoustic coupling Loss (TAL)

30.17.1 Echo Loss (EL)

30.17.1.1 Definition

The echo loss is the path loss from the input of the reference speech encoder of the SS to the output of the reference speech decoder of the SS.

30.17.1.2 Conformance requirement

The echo loss from the input to the output of the reference speech codec in the SS shall be as specified in 3GPP TS 26.131.

30.17.1.3 Test purpose

To verify that the echo loss from the input to the output of the reference speech codec in the SS is as specified in 3GPP TS 26.131.

30.17.1.4 Method of test

The method of test shall be as specified in 3GPP TS 26.132.

30.17.1.5 Test requirement

The echo loss from the input to the output of the reference speech codec in the SS shall be as specified in 3GPP TS 26.131.

30.17.2 Stability margin

30.17.2.1 Definition

The receive-transmit stability margin is a measure of the gain that would have to be inserted between the go and return paths of the reference speech coder in the SS for oscillation to occur.

30.17.2.2 Conformance requirement

The stability margin shall be as specified in 3GPP TS 26.131.

30.17.2.3 Test purpose

To verify that the stability margin is as specified in 3GPP TS 26.131.

30.17.2.4 Method of test

The method of test shall be as specified in 3GPP TS 26.132.

30.17.2.5 Test requirement

The minimum stability margin shall be as specified in 3GPP TS 26.131.

30.18 Sending Distortion

30.18.1 Definition

The transmit signal to total distortion ratio is a measure of the linearity of the transmitter equipment.

30.18.2 Conformance requirement

The ratio of signal to total distortion power in the sending direction measured with a psophometric filter at the DAI of the MS or at the output of the reference speech decoder of the SS shall be above the limits given in 3GPP TS 03.50; subclause 3.9.1, table 3, unless the sound pressure at MRP exceeds +10 dBPa.

3GPP TS 03.50; subclause 3.9.1.

30.18.3 Test purpose

To verify that the ratio of signal to total distortion power in the sending direction measured with psophometric filter is above the limits given in 3GPP TS 03.50; subclause 3.9.1, table 3.

30.18.4 Method of test

30.18.4.1 Initial conditions

The handset is mounted in the LRGP (see annex 1 of ITU-T Recommendation P.76) and the earpiece is sealed to the knife-edge of the artificial ear conforming to ITU-T Recommendation P.51.

When measured at the DAI:

- The DAI of the MS is connected to the SS and is set to the operating mode "Test of acoustic devices and A/D & D/A".

When measured at the output of the reference speech decoder of the SS:

- A full rate speech call is set up between the MS and the SS.

30.18.4.2 Procedure

When measured at the DAI:

- a) A sine-wave signal with a frequency in the range 1 004 Hz to 1 025 Hz is applied to the MRP. The level of this signal is adjusted until the level at the DAI output (pin 23) of the MS or at the analogue or digital output of the reference speech decoder of the SS corresponds to -10 dBm₀. The level of the signal at the MRP is then the acoustic reference level (ARL).
- b) The test signal is applied at the following levels: -35 dB, -30 dB, -25 dB, -20 dB, -15 dB, -10 dB, -5 dB, 0 dB, 5 dB and 10 dB relative to the ARL.
- c) The ratio of signal to total distortion power is measured at the DAI of the MS with the psophometric noise weighting (see ITU-T Recommendations G.714 and O.132) at each signal level.

When measured at the output of the reference speech decoder of the SS:

- The test shall be performed according to the test specification as described in 3GPP TS 26.132.

NOTE: The measurement is not to be carried out at sound pressures exceeding +10 dBPa.

30.18.5 Test requirement

The ratio of signal to total distortion power measured with the psophometric noise weighting (see table 4/ITU-T G.223) shall be above the limits given in table 30.3.

Table 30.3

dB relative to ARL	Level ratio
-35 dB	17,5 dB
-30 dB	22,5 dB
-20 dB	30,7 dB
-10 dB	33,3 dB
0 dB	33,7 dB
7 dB	31,7 dB
10 dB	25,5 dB

Limits for the signal to total distortion ratio (sending) when using the sine wave method.

Limits for intermediate levels are found by drawing a straight line between breaking points in a linear (dB signal level) vs linear (dB ratio) scale.

30.19 Ambient Noise Rejection

30.19.1 Definition

An MS that supports speech will typically be operated within an area of high ambient acoustic noise. A level of noise rejection will therefore be required.

30.19.2 Conformance Requirement

The conformance requirement shall be as specified in 3GPP TS 26.131.

30.19.3 Test Purpose

To verify that ambient noise rejection is conforming to the specification in 3GPP TS 26.131.

30.19.4 Method of Test

The test method shall be as specified in 3GPP TS 26.132.

30.19.5 Test Requirement

The MS ambient noise rejection shall be as specified in 3GPP TS 26.132.

31 Test of supplementary services

The general aspects of the specification of supplementary services at the layer 3 radio interface are given in 3GPP TS 04.10.

The formats and coding are given in 3GPP TS 04.80. If the value of a parameter of an uplink message (MS to network) is specified in a test, the implicit meaning is that it has to be checked; if the value is not specified, it is not to be checked unless otherwise stated.

Unless otherwise stated, the MS shall be in the idle updated state at the beginning of each test (including repetition of a test).

In each test, before the MS sends the first REGISTER message, a MM connection is established.

3GPP TS 04.81 to 3GPP TS 04.88 give the procedures used at the radio interface for normal operation, registration, erasure, activation, deactivation, invocation and interrogation of supplementary services.

The supplementary services are described in 3GPP TS 02.04 and 3GPP TS 02.81 to 3GPP TS 02.88.

Whenever activation via the standard MMI is mentioned, if the MS does not support it but supports a different procedure, this different procedure is used. In the supplementary services tests, only the applicable (see 3GPP TS 02.8x series) MMI service code groups (3GPP TS 02.30 annex 4), of the basic service code in 3GPP TS 09.02, which are supported by the MAP, will be used.

31.1 Number identification supplementary services

31.1.1 CLIP

31.1.1.1 Normal operation

Conformance requirement:

3GPP TS 04.81 subclause 1.1.

Purpose:

To test that the MS presents to the user the calling number presented to it in an incoming SETUP message.

Specific PICS Statements

- Supported MT circuit switched basic services (TSPC_AddInfo_MTsvc)

PIXIT Statements

- Description of display for CLIP.
- Support of displaying the calling party subaddress.

Initial conditions

System Simulator:

1 cell, default parameters.

Mobile Station:

The MS is in MM-state "idle, updated" with valid TMSI and CKSN.

The SIM in the MS under test has CLIP enabled.

Foreseen final state of the MS

State U7

Maximum duration of test

30 s.

Procedure:

Set up an MT call to the MS under test. The SETUP message shall include a calling party BCD number information element and a calling party subaddress information element.

Expected sequence

Step	Direction	Message	Comments
1	SS -> MS	PAGING REQUEST	SS sends paging (SDCCH)
2	MS -> SS	CHANNEL REQUEST	
3	SS -> MS	IMMEDIATE ASSIGNMENT	
4	MS -> SS	PAGING RESPONSE	
5	SS -> MS	AUTHENTICATION REQUEST	
6	MS -> SS	AUTHENTICATION RESPONSE	
7	SS -> MS	CIPHERING MODE COMMAND	
8	MS -> SS	CIPHERING MODE COMPLETE	
9	SS -> MS	SETUP	
10	MS -> SS	CALL CONFIRMED	Depending on the PICS, the MS shall display the calling party BCD number and calling party subaddress
11	MS -> SS	ALERTING	
12	MS		

31.1.1.2 Interrogation

31.1.1.2.1 Interrogation accepted

Conformance requirement:

3GPP TS 04.81 subclause 1.2.

Test purpose

To test the correct operation of the interrogation procedure, and correct display of the response from the SS in the case of successful interrogation.

Initial conditions

System Simulator:

1 cell, default parameters.

Mobile Station:

The MS is "idle updated".

Specific PICS Statements

-

PIXIT Statements

- Description of the user's commands and of display of the answers from the network for interrogation of CLIP.

Foreseen final state of the MS

The MS is "idle updated".

Test procedure

By means of appropriate MMI functions (using either 3GPP TS 02.30 or manufacturer defined MMI), the user requests interrogation of CLIP for all basic service groups.

Upon receipt of the operation (in a REGISTER message), the system simulator answers with a RELEASE COMPLETE message with the Facility information element containing the return result of the InterrogateSS operation.

The SS transaction is released and the dedicated channel is released.

Maximum duration of test

3 minutes.

Expected sequence

Step	Direction	Message	Comments
1	MS		
2	MS -> SS	CHANNEL REQUEST	The MS is made to initiate an interrogation of CLIP (all) with establishment cause "Other procedures which can be completed with an SDCCH" cause: "supplementary service activation"
3	SS -> MS	IMMEDIATE ASSIGNMENT	
4	MS -> SS	CM SERVICE REQUEST	
5	SS -> MS	CM SERVICE ACCEPT	
6	MS -> SS	REGISTER	
7	SS -> MS	RELEASE COMPLETE	InterrogateSS operation Return_result provide user MMI indication
8	MS		
9	SS -> MS	CHANNEL RELEASE	

Specific message content

step 6 - CLIP

- protocol discriminator: non call related SS message.
- message type: REGISTER.
- facility:

invoke = Interrogation

Supplementary service code = CLIP.

Basic service code: no Bearer Service present, no teleservice present.

31.1.1.2.2 Interrogation rejected

Conformance requirement

3GPP TS 04.81 subclause 1.2.

Test purpose

To test the correct operation of the interrogation procedure, and correct display of the response from the SS in the case of an error response and an invoke problem.

Initial conditions

System Simulator:

1 cell, default parameters.

Mobile Station:

The MS is in CC state U10.

Specific PICS Statements

-

PIXIT Statements

- Description of the user's commands and of display of the answers from the network for interrogation of CLIP.

Foreseen final state of the MS

The MS is in CC state U10.

Test procedure

By means of appropriate MMI functions (using either 3GPP TS 02.30 or manufacturer defined MMI), the user requests interrogation of CLIP for all basic service groups.

Upon receipt of the operation (in a REGISTER message), the system simulator answers with a RELEASE COMPLETE message with the Facility information element containing a Return_error(error: SS not available) of the InterrogateSS operation.

The system simulator sends STATUS ENQUIRY, the MS responds with STATUS message indicating CC state U10.

Then again, by means of appropriate MMI functions as defined by the basic public MMI described in 3GPP TS 02.30, the user requests interrogation of CLIP for all basic service groups.

Upon receipt of the REGISTER message, the system simulator answers with the RELEASE COMPLETE message (same PD and TI that in the REGISTER message) with the Facility information element containing a reject(invoke_problem: resource limitation) of the InterrogateSS operation.

The system simulator sends STATUS ENQUIRY, the MS responds with STATUS message indicating CC state U10.

Maximum duration of test

3 minutes.

Expected sequence

Step	Direction	Message	Comments
1	MS		
2	MS -> SS	CM SERVICE REQUEST	The MS is made to initiate an interrogation for CLIP (all) cause: "supplementary service activation"
3	SS -> MS	CM SERVICE ACCEPT	
4	MS -> SS	REGISTER	
5	SS -> MS	RELEASE COMPLETE	InterrogateSS operation Return_error
6	SS -> MS	STATUS ENQUIRY	CC state U10
7	MS -> SS	STATUS	
8	MS		The MS is made to initiate an interrogation of CLIP (all) cause: "supplementary service activation"
9	MS -> SS	CM SERVICE REQUEST	
10	SS -> MS	CM SERVICE ACCEPT	
11	MS -> SS	REGISTER	
12	SS -> MS	RELEASE COMPLETE	InterrogateSS operation Reject
13	MS		provide correct MMI user indication
14	SS -> MS	STATUS ENQUIRY	CC state U10
15	MS -> SS	STATUS	

Specific message content

step 4, 11 - CLIP

- protocol discriminator: non call related SS message.
- message type: REGISTER.
- facility:

invoke = Interrogation

Supplementary service code = CLIP.

Basic service code: no Bearer Service present, no teleservice present.

step 5 - CLIP

- protocol discriminator: non call related SS message.
- transaction identifier: same TI as previous REGISTER message.
- message type: RELEASE COMPLETE.
- facility:
 - return error code: SS not available.

For the return error the invoke ID must be the same as in the invoke of the InterrogateSS operation.

step 12 -

- protocol discriminator: non call related SS message.
- transaction identifier: same TI as previous REGISTER message.
- message type: RELEASE COMPLETE.
- facility:
 - reject code: resource limitation.

For the reject the invoke ID must be the same as in the invoke of the InterrogateSS operation.

31.1.2 CLIR

31.1.2.1 Normal operation - requesting presentation of CLI

Conformance requirement:

3GPP TS 04.81 subclause 2.2.

Test Purpose

To test that when the CLIR presentation mode is temporary (presentation restricted), it is possible for the subscriber to present his CLI on a per call basis.

Method of test

Specific PICS Statements

- Supported MO circuit switched basic services (TSPC_AddInfo_MOsvc)

PIXIT Statements

-

Initial conditions

System Simulator:

1 cell, default parameters.

Mobile Station:

The SIM in the MS under test has CLIR enabled with CLIR presentation mode "temporary (presentation restricted)".

The MS is in MM-state "idle, updated" with valid TMSI and CKSN.

The MS is brought into the state U0.1 by using table 26.8.1.2/1.

Foreseen final state of the MS

U1, call initiated.

Maximum duration of test

30 s.

Test procedure

An MO circuit switched basic service is selected that is supported by the MS; if the MS supports MO telephony, the selected basic service is telephony. If necessary, the MS is configured for that basic service. Using MMI commands, the MS is made to initiate an outgoing call with CLI presented. When the MS is requesting a MM-connection, the SS will indicate acceptance by sending a CM SERVICE ACCEPT message. The MS shall respond with SETUP. The SETUP message shall contain the CLIR suppression information element.

Expected sequence

Step	Direction	Message	Comments
1	SS -> MS	CM SERVICE ACCEPT	
2	MS -> SS	SETUP	with CLIR suppression information element

31.1.2.2 Normal operation - requesting restriction of CLI presentation

Conformance requirement:

3GPP TS 04.81 subclause 2.3.

Test Purpose

To test that when the CLIR presentation mode is temporary (presentation allowed), it is possible for the subscriber to present his CLI on a per call basis.

Procedure

Using MMI commands, the MS is made to initiate an outgoing call with CLI restricted.

Requirements:

The SETUP message sent by the MS shall include the CLIR invocation information element.

Method of test

Specific PICS Statements

- Supported MO circuit switched basic services (TSPC_AddInfo_MOsvc)

PIXIT Statements

-

Initial conditions

System Simulator:

1 cell, default parameters.

Mobile Station:

The SIM in the MS under test has CLIR enabled with CLIR presentation mode "temporary (presentation allowed)".

The MS is in MM-state "idle, updated" with valid TMSI and CKSN.

The MS is brought into the state U0.1 by using table 26.8.1.2/1.

Foreseen final state of the MS

U1, call initiated.

Maximum duration of test

30 s.

Test procedure

An MO circuit switched basic service is selected that is supported by the MS; if the MS supports MO telephony, the selected basic service is telephony. If necessary, the MS is configured for that basic service. Using MMI commands, the MS is made to initiate an outgoing call with CLI restricted. When the MS is requesting a MM-connection, the SS will indicate acceptance by sending a CM SERVICE ACCEPT message. The MS shall respond with SETUP. The SETUP message sent by the MS shall include the CLIR invocation information element.

Expected sequence

Step	Direction	Message	Comments
1	SS -> MS	CM SERVICE ACCEPT	
2	MS -> SS	SETUP	with CLIR invocation information element

31.1.2.3 Interrogation

31.1.2.3.1 Interrogation accepted

Conformance requirement:

3GPP TS 04.81 subclause 2.4.

Applicability

MS supporting the CLIR supplementary service.

Test purpose

To test the correct operation of the interrogation procedure, and correct display of the response from the SS in the case of successful interrogation.

Initial conditions

System Simulator:

1 cell, default parameters.

Mobile Station:

The MS is "idle updated".

Specific PICS Statements

-

PIXIT Statements

- Description of the user's commands and of display of the answers from the network for interrogation of CLIR.

Foreseen final state of the MS

The MS is "idle updated".

Test procedure

By means of appropriate MMI functions (using either 3GPP TS 02.30 or manufacturer defined MMI), the user requests interrogation of CLIR for all basic service groups.

Upon receipt of the operation (in a REGISTER message), the system simulator answers with a RELEASE COMPLETE message with the Facility information element containing the return result of the InterrogateSS operation.

The SS transaction is released and the dedicated channel is released.

Maximum duration of test

3 minutes.

Expected sequence

Step	Direction	Message	Comments
1	MS		The MS is made to initiate an interrogation of CLIR (all) with establishment cause "Other procedures which can be completed with an SDCCH" cause: "supplementary service activation"
2	MS -> SS	CHANNEL REQUEST	
3	SS -> MS	IMMEDIATE ASSIGNMENT	
4	MS -> SS	CM SERVICE REQUEST	
5	SS -> MS	CM SERVICE ACCEPT	
6	MS -> SS	REGISTER	
7	SS -> MS	RELEASE COMPLETE	InterrogateSS operation Return_result provide user MMI indication
8	MS		
9	SS -> MS	CHANNEL RELEASE	

Specific message content

step 6 - CLIR

- protocol discriminator: non call related SS message.
- message type: REGISTER.
- facility:

invoke = Interrogation:

Supplementary service code = CLIR.

Basic service code: no Bearer Service present, no teleservice present.

31.1.2.3.2 Interrogation rejected

Conformance requirement

3GPP TS 04.81 subclause 2.4.

Test purpose

To test the correct operation of the interrogation procedure, and correct display of the response from the SS in the case of an error response and an invoke problem.

Initial conditions

System Simulator:

1 cell, default parameters.

Mobile Station:

The MS is in CC state U10.

Specific PICS Statements

-

PIXIT Statements

- Description of the user's commands and of display of the answers from the network for interrogation of CLIR.

Foreseen final state of the MS

The MS is in CC state U10.

Test procedure

By means of appropriate MMI functions (using either 3GPP TS 02.30 or manufacturer defined MMI), the user requests interrogation of CLIR for all basic service groups.

Upon receipt of the operation (in a REGISTER message), the system simulator answers with a RELEASE COMPLETE message with the Facility information element containing a Return_error(error: SS not available) of the InterrogateSS operation.

The system simulator sends STATUS ENQUIRY, the MS responds with STATUS message indicating CC state U10.

Then again, by means of appropriate MMI functions as defined by the basic public MMI described in 3GPP TS 02.30, the user requests interrogation of CLIR for all basic service groups.

Upon receipt of the REGISTER message, the system simulator answers with the RELEASE COMPLETE message (same PD and TI that in the REGISTER message) with the Facility information element containing a reject(invoke_problem: resource limitation) of the InterrogateSS operation.

The system simulator sends STATUS ENQUIRY, the MS responds with STATUS message indicating CC state U10.

Maximum duration of test

3 minutes.

Expected sequence

Step	Direction	Message	Comments
1	MS		The MS is made to initiate an interrogation for CLIR (all) cause: "supplementary service activation"
2	MS -> SS	CM SERVICE REQUEST	
3	SS -> MS	CM SERVICE ACCEPT	
4	MS -> SS	REGISTER	
5	SS -> MS	RELEASE COMPLETE	InterrogateSS operation Return_error
6	SS -> MS	STATUS ENQUIRY	
7	MS -> SS	STATUS	CC state U10
8	MS		
9	MS -> SS	CM SERVICE REQUEST	The MS is made to initiate an interrogation of CLIR (all) cause: "supplementary service activation"
10	SS -> MS	CM SERVICE ACCEPT	
11	MS -> SS	REGISTER	
12	SS -> MS	RELEASE COMPLETE	InterrogateSS operation Reject provide correct MMI user indication
13	MS		
14	SS -> MS	STATUS ENQUIRY	CC state U10
15	MS -> SS	STATUS	

Specific message content

step 4, 11 - CLIR

- protocol discriminator: non call related SS message.
- message type: REGISTER.
- facility:

invoke = Interrogation:

Supplementary service code = CLIR.

Basic service code: no Bearer Service present, no teleservice present.

step 5 - CLIR

- protocol discriminator: non call related SS message.
- transaction identifier: same TI as previous REGISTER message.
- message type: RELEASE COMPLETE.
- facility:
 - return error code: SS not available.

For the return error the invoke ID must be the same as in the invoke of the InterrogateSS operation.

step 12 -

- protocol discriminator: non call related SS message.
- transaction identifier: same TI as previous REGISTER message.
- message type: RELEASE COMPLETE.
- facility:
 - reject code: resource limitation.

For the reject the invoke ID must be the same as in the invoke of the InterrogateSS operation.

31.1.3 COLP

31.1.3.1 Normal operation

Conformance requirement:

3GPP TS 04.81 subclause 3.1.

Purpose:

To test that the MS displays the connected number presented to it in an incoming CONNECT message.

Method of test

Specific PICS Statements

- Supported MO circuit switched basic services (TSPC_AddInfo_MOsvc)

PIXIT Statements

- Description of display for COLP.

Initial conditions

System Simulator:

- 1 cell, default parameters.

Mobile Station:

The SIM in the MS under test has COLP enabled.

The MS is in MM-state "idle, updated" with valid TMSI and CKSN.

The MS is brought into the state U1 by using table 26.8.1.2/4.

Foreseen final state of the MS

U10, call active.

Maximum duration of test

30 s.

Test procedure

1. An MO circuit switched basic service is selected that is supported by the MS; if the MS supports MO telephony, the selected basic service is telephony. If necessary, the MS is configured for that basic service. Then, the MS is made to initiate a call. The CC entity of the MS is brought to the state U4. The SS sends a CONNECT message to the MS containing a connected number information element and a connected party subaddress information element. The MS shall respond by sending a CONNECT ACKNOWLEDGE message. The MS shall correctly display the connected line information.

Expected sequence, procedure 1

Step	Direction	Message	Comments
1	SS -> MS	CONNECT	See specific message contents
2	MS -> SS	CONNECT ACKNOWLEDGE	
3	MS		The MS shall correctly display the connected line information

Specific message contents

CONNECT

Connected number information element	
Presentation indicator	Presentation allowed
Screening indicator	User provided, not screened
Connected subaddress	Any valid subaddress

31.1.3.2 Interrogation

31.1.3.2.1 Interrogation accepted

Conformance requirement:

3GPP TS 04.81 subclause 3.2.

Test purpose

To test the correct operation of the interrogation procedure, and correct display of the response from the SS in the case of successful interrogation.

Initial conditions

System Simulator:

1 cell, default parameters.

Mobile Station:

The MS is "idle updated".

Specific PICS Statements

-

PIXIT Statements

- Description of the user's commands and of display of the answers from the network for interrogation of COLP.

Foreseen final state of the MS

The MS is "idle updated".

Test procedure

By means of appropriate MMI functions (using either 3GPP TS 02.30 or manufacturer defined MMI), the user requests interrogation of COLP for all basic service groups.

Upon receipt of the operation (in a REGISTER message), the system simulator answers with a RELEASE COMPLETE message with the Facility information element containing the return result of the InterrogateSS operation.

The SS transaction is released and the dedicated channel is released.

Maximum duration of test

3 minutes.

Expected sequence

Step	Direction	Message	Comments
1	MS		The MS is made to initiate an interrogation of COLP (all) with establishment cause "Other procedures which can be completed with an SDCCH" cause: "supplementary service activation"
2	MS -> SS	CHANNEL REQUEST	
3	SS -> MS	IMMEDIATE ASSIGNMENT	
4	MS -> SS	CM SERVICE REQUEST	
5	SS -> MS	CM SERVICE ACCEPT	
6	MS -> SS	REGISTER	
7	SS -> MS	RELEASE COMPLETE	InterrogateSS operation Return_result provide user MMI indication
8	MS		
9	SS -> MS	CHANNEL RELEASE	

Specific message content

step 6 - COLP

- protocol discriminator: non call related SS message.
- message type: REGISTER.
- facility:

invoke = Interrogation:

Supplementary service code = COLP.

Basic service code: no Bearer Service present, no teleservice present.

31.1.3.2.2 Interrogation rejected

Conformance requirement

3GPP TS 04.81 subclause 3.2.

Test purpose

To test the correct operation of the interrogation procedure, and correct display of the response from the SS in the case of an error response and an invoke problem.

Initial conditions

System Simulator:

1 cell, default parameters.

Mobile Station:

The MS is in CC state U10.

Specific PICS Statements

-

PIXIT Statements

- Description of the user's commands and of display of the answers from the network for interrogation of COLP.

Foreseen final state of the MS

The MS is in CC state U10.

Test procedure

By means of appropriate MMI functions (using either 3GPP TS 02.30 or manufacturer defined MMI), the user requests interrogation of COLP for all basic service groups.

Upon receipt of the operation (in a REGISTER message), the system simulator answers with a RELEASE COMPLETE message with the Facility information element containing a Return_error(error: SS not available) of the InterrogateSS operation.

The system simulator sends STATUS ENQUIRY, the MS responds with STATUS message indicating CC state U10.

Then again, by means of appropriate MMI functions as defined by the basic public MMI described in 3GPP TS 02.30, the user requests interrogation of COLP for all basic service groups.

Upon receipt of the REGISTER message, the system simulator answers with the RELEASE COMPLETE message (same PD and TI that in the REGISTER message) with the Facility information element containing a reject(involve_problem: resource limitation) of the InterrogateSS operation.

The system simulator sends STATUS ENQUIRY, the MS responds with STATUS message indicating CC state U10.

Maximum duration of test

3 minutes.

Expected sequence

Step	Direction	Message	Comments
1	MS		
2	MS -> SS	CM SERVICE REQUEST	The MS is made to initiate an interrogation for COLP (all) cause: "supplementary service activation"
3	SS -> MS	CM SERVICE ACCEPT	
4	MS -> SS	REGISTER	
5	SS -> MS	RELEASE COMPLETE	InterrogateSS operation Return_error
6	SS -> MS	STATUS ENQUIRY	
7	MS -> SS	STATUS	CC state U10
8	MS		
9	MS -> SS	CM SERVICE REQUEST	The MS is made to initiate an interrogation of COLP (all) cause: "supplementary service activation"
10	SS -> MS	CM SERVICE ACCEPT	
11	MS -> SS	REGISTER	
12	SS -> MS	RELEASE COMPLETE	InterrogateSS operation Reject
13	MS		
14	SS -> MS	STATUS ENQUIRY	provide correct MMI user indication
15	MS -> SS	STATUS	
			CC state U10

Specific message content

step 4, 11 - COLP

- protocol discriminator: non call related SS message.
- message type: REGISTER.
- facility:

invoke = Interrogation:

Supplementary service code = COLP.

Basic service code: no Bearer Service present, no teleservice present.

step 5 - COLP

- protocol discriminator: non call related SS message.
- transaction identifier: same TI as previous REGISTER message.
- message type: RELEASE COMPLETE.
- facility:

return error code: SS not available.

For the return error the invoke ID must be the same as in the invoke of the InterrogateSS operation.

step 12 -

- protocol discriminator: non call related SS message.
- transaction identifier: same TI as previous REGISTER message.
- message type: RELEASE COMPLETE.
- facility:

reject code: resource limitation.

For the reject the invoke ID must be the same as in the invoke of the InterrogateSS operation.

31.1.4 COLR

31.1.4.1 Interrogation

31.1.4.1.1 Interrogation accepted

Conformance requirement:

3GPP TS 04.81 subclause 4.2.

Test purpose

To test the correct operation of the interrogation procedure, and correct display of the response from the SS in the case of successful interrogation.

Initial conditions

System Simulator:

1 cell, default parameters.

Mobile Station:

The MS is "idle updated".

Specific PICS Statements

-

PIXIT Statements

- Description of the user's commands and of display of the answers from the network for interrogation of COLR.

Foreseen final state of the MS

The MS is "idle updated".

Test procedure

By means of appropriate MMI functions (using either 3GPP TS 02.30 or manufacturer defined MMI), the user requests interrogation of COLR for all basic service groups.

Upon receipt of the operation (in a REGISTER message), the system simulator answers with a RELEASE COMPLETE message with the Facility information element containing the return result of the InterrogateSS operation.

The SS transaction is released and the dedicated channel is released.

Maximum duration of test

3 minutes.

Expected sequence

Step	Direction	Message	Comments
1	MS		The MS is made to initiate an interrogation of COLR (all) with establishment cause "Other procedures which can be completed with an SDCCH" cause: "supplementary service activation"
2	MS -> SS	CHANNEL REQUEST	
3	SS -> MS	IMMEDIATE ASSIGNMENT	
4	MS -> SS	CM SERVICE REQUEST	
5	SS -> MS	CM SERVICE ACCEPT	
6	MS -> SS	REGISTER	
7	SS -> MS	RELEASE COMPLETE	InterrogateSS operation Return_result provide user MMI indication
8	MS		
9	SS -> MS	CHANNEL RELEASE	

Specific message content

step 6 - COLR

- protocol discriminator: non call related SS message.
- message type: REGISTER.
- facility:

invoke = Interrogation:

Supplementary service code = COLR.

Basic service code: no Bearer Service present, no teleservice present.

31.1.4.1.2 Interrogation rejected

Conformance requirement

3GPP TS 04.81 subclause 4.2.

Test purpose

To test the correct operation of the interrogation procedure, and correct display of the response from the SS in the case of an error response and an invoke problem.

Initial conditions

System Simulator:

1 cell, default parameters.

Mobile Station:

The MS is in CC state U10.

Specific PICS Statements

-

PIXIT Statements

- Description of the user's commands and of display of the answers from the network for interrogation of COLR.

Foreseen final state of the MS

The MS is in CC state U10.

Test procedure

By means of appropriate MMI functions (using either 3GPP TS 02.30 or manufacturer defined MMI), the user requests interrogation of COLR for all basic service groups.

Upon receipt of the operation (in a REGISTER message), the system simulator answers with a RELEASE COMPLETE message with the Facility information element containing a Return_error(error: SS not available) of the InterrogateSS operation.

The system simulator sends STATUS ENQUIRY, the MS responds with STATUS message indicating CC state U10.

Then again, by means of appropriate MMI functions as defined by the basic public MMI described in 3GPP TS 02.30, the user requests interrogation of COLR for all basic service groups.

Upon receipt of the REGISTER message, the system simulator answers with the RELEASE COMPLETE message (same PD and TI that in the REGISTER message) with the Facility information element containing a reject(invoke_problem: resource limitation) of the InterrogateSS operation.

The system simulator sends STATUS ENQUIRY, the MS responds with STATUS message indicating CC state U10.

Maximum duration of test

3 minutes.

Expected sequence

Step	Direction	Message	Comments
1	MS		
2	MS -> SS	CM SERVICE REQUEST	The MS is made to initiate an interrogation for COLR (all) cause: "supplementary service activation"
3	SS -> MS	CM SERVICE ACCEPT	
4	MS -> SS	REGISTER	
5	SS -> MS	RELEASE COMPLETE	InterrogateSS operation Return_error
6	SS -> MS	STATUS ENQUIRY	CC state U10
7	MS -> SS	STATUS	
8	MS		The MS is made to initiate a interrogation of COLR (all) cause: "supplementary service activation"
9	MS -> SS	CM SERVICE REQUEST	
10	SS -> MS	CM SERVICE ACCEPT	
11	MS -> SS	REGISTER	
12	SS -> MS	RELEASE COMPLETE	InterrogateSS operation Reject
13	MS		provide correct MMI user indication
14	SS -> MS	STATUS ENQUIRY	CC state U10
15	MS -> SS	STATUS	

Specific message content

step 4, 11 - COLR

- protocol discriminator: non call related SS message.
- message type: REGISTER.
- facility:

invoke = Interrogation:

Supplementary service code = COLR.

Basic service code: no Bearer Service present, no teleservice present.

step 5 - COLR

- protocol discriminator: non call related SS message.
- transaction identifier: same TI as previous REGISTER message.
- message type: RELEASE COMPLETE.
- facility:

return error code: SS not available.

For the return error the invoke ID must be the same as in the invoke of the InterrogateSS operation.

step 12 -

- protocol discriminator: non call related SS message.
- transaction identifier: same TI as previous REGISTER message.
- message type: RELEASE COMPLETE.
- facility:

reject code: resource limitation.

For the reject the invoke ID must be the same as in the invoke of the InterrogateSS operation.

31.1.4.2 Void

31.1.5 CNAP

31.1.5.1.1 Normal Operation – Name indication contained in Setup message

Conformance requirements

3GPP TS 24.096 subclause 4.1

Purpose

To test that the MS presents to the user the name information of the calling party to the called party at call setup time for all incoming calls.

Specific PICS Statements

- Supported MT circuit switched basic services (TSPC_AddInfo_MTsvc)

PIXIT Statements

- Description of display for CNAP.

Initial Conditions

System Simulator:

1 cell, default parameters

Mobile Station:

The MS is in MM-state "idle, updated" with valid TMSI and CKSN

Foreseen final state of the MS

State U7

Maximum Duration of Test

3 minutes.

Procedure

Set up an MT Call to the MS under test. The SS sends the Name Indication in the Facility IE of the CC Setup

Expected Sequence

Step	Direction	Message	Comments
1	SS -> MS	PAGING REQUEST	SS sends paging (SDCCH)
2	MS -> SS	CHANNEL REQUEST	
3	SS -> MS	IMMEDIATE ASSIGNMENT	
4	MS -> SS	PAGING RESPONSE	
5	SS -> MS	AUTHENTICATION REQUEST	
6	MS -> SS	AUTHENTICATION RESPONSE	
7	SS -> MS	CIPHERING MODE COMMAND	
8	MS -> SS	CIPHERING MODE COMPLETE	
9	SS -> MS	SETUP	
10	MS -> SS	CALL CONFIRMED	Shall include Facility (Invoke = NotifySS (CNAP, nameIndicator)) Signal IE included
11	MS -> SS	ALERTING	
12	MS		
			Depending on the PICS, the MS shall display the calling nameIndicator

Specific message content

step 9 – CNAP nameIndicator settings:

- namePresentationAllowed
- NameSet: "TESTNAME"

31.1.5.1.2 Normal Operation – Name indication contained in Facility message

Conformance requirements

3GPP TS 24.096 subclause 4.1

Purpose

To test that the MS presents to the user the name information of the calling party to the called party at call setup time for all incoming calls.

Specific PICS Statements

- Supported MT circuit switched basic services (TSPC_AddInfo_MTsvc)

PIXIT Statements

- Description of display for CNAP.

Initial Conditions

System Simulator:

1 cell, default parameters

Mobile Station:

The MS is in MM-state "idle, updated" with valid TMSI and CKSN

Foreseen final state of the MS

State U7

Maximum Duration of Test

3 minutes.

Procedure

Set up an MT Call to the MS under test. The SS sends the Name Indication in a Facility message

Expected Sequence

Step	Direction	Message	Comments
1	SS -> MS	PAGING REQUEST	SS sends paging
2	MS -> SS	CHANNEL REQUEST	
3	SS -> MS	IMMEDIATE ASSIGNMENT	(SDCCH)
4	MS -> SS	PAGING RESPONSE	
5	SS -> MS	AUTHENTICATION REQUEST	
6	MS -> SS	AUTHENTICATION RESPONSE	
7	SS -> MS	CIPHERING MODE COMMAND	
8	MS -> SS	CIPHERING MODE COMPLETE	
9	SS -> MS	SETUP	Signal IE included
10	MS -> SS	CALL CONFIRMED	
11	MS -> SS	ALERTING	
12	SS -> MS	FACILITY	Facility (Invoke=NotifiSS (CNAP, nameIndicator))
13	MS		Depending on the PICS, the MS shall display the calling nameIndicator

Specific message content

step 10 – CNAP nameIndicator settings:

- namePresentationAllowed
- NameSet: "TESTNAME"

31.1.5.2.1 Interrogation accepted

Conformance requirements

3GPP TS 24.096 subclause 4.2

Purpose

To test the correct operation of the interrogation procedure, and correct display of the response from the SS in the case of successful interrogation

Initial Conditions

System Simulator:

1 cell, default parameters

Mobile Station:

The MS is "Idle Updated"

Specific PICS Statements

-

PIXIT Statements

- Description of the user's commands and of display of the answers from the network for interrogation of CNAP.

Forseen final state of the MS

The MS is Idle Updated

Maximum Duration of Test

3 minutes.

Procedure

By means of appropriate MMI functions (using either 3GPP TS 02.30 or manufacturer defined MMI), the users requests interrogation of CNAP for all basic service groups.

Upon receipt of the operation (in a register message), the system simulator answers with a RELEASE COMPLETE message with the Facility information element containing the return result of the InterrogateSS operation .

The SS transaction is released and the dedicated channel is released

Expected Sequence

Step	Direction	Message	Comments
1	MS		
2	MS -> SS	CHANNEL REQUEST	The MS is made to initiate an interrogation of CNAP (all) with establishment cause "Other procedures which can be completed with an SDCCH"
3	SS -> MS	IMMEDIATE ASSIGNMENT	
4	MS -> SS	CM SERVICE REQUEST	
5	SS -> MS	CM SERVICE ACCEPT	cause: "supplementary service activation"
6	MS -> SS	REGISTER	Facility (Invoke = InterrogateSS (CNAP))
7	SS -> MS	RELEASE COMPLETE	Facility (Return Result = InterrogateSS (ss-status)) provide user MMI indication
8	MS		
9	SS -> MS	CHANNEL RELEASE	

Specific message content

step 6 - CNAP

- protocol discriminator: non call related SS message.
- message type: REGISTER.
- facility:

invoke = Interrogation

Supplementary service code = CNAP.

Basic service code: no Bearer Service present, no teleservice present.

31.1.5.2.2 Interrogation rejected

Conformance requirements

3GPP TS 24.096 subclause 4.2

Purpose

To test the correct operation of the interrogation procedure, and correct display of the response from the SS in the case of an error response and an invoke problem.

Specific PICS Statements

-

PIXIT Statements

- Description of the user's commands and of display of the answers from the network for interrogation of CNAP.

Initial Conditions

System Simulator:

1 cell, default parameters

Mobile Station:

The MS is in CC state U10

Maximum Duration of Test

3 minutes.

Procedure

By means of appropriate MMI functions (using either 3GPP TS 02.30 or manufacturer defined MMI), the user requests interrogation of CNAP for all basic service groups.

Upon receipt of the operation (in a REGISTER message), the system simulator answers with a RELEASE COMPLETE message with the Facility information element containing a Return_error (error: SS not available) of the InterrogateSS operation.

The system simulator sends STATUS ENQUIRY, the MS responds with STATUS message indicating CC state U10.

Then again, by means of appropriate MMI functions as defined by the basic public MMI described in 3GPP TS 02.30, the user requests interrogation of CNAP for all basic service groups.

Upon receipt of the REGISTER message, the system simulator answers with the RELEASE COMPLETE message (same PD and TI that in the REGISTER message) with the Facility information element containing a reject (invoke_problem: resource limitation) of the InterrogateSS operation.

The system simulator sends STATUS ENQUIRY, the MS responds with STATUS message indicating CC state U10.

Expected Sequence

Step	Direction	Message	Comments
1	MS		
2	MS -> SS	CM SERVICE REQUEST	The MS is made to initiate an interrogation for CNAP (all) cause: "supplementary service activation"
3	SS -> MS	CM SERVICE ACCEPT	
4	MS -> SS	REGISTER	
5	SS -> MS	RELEASE COMPLETE	InterrogateSS operation Return_error
6	SS -> MS	STATUS ENQUIRY	
7	MS -> SS	STATUS	CC state U10
8	MS		
9	MS -> SS	CM SERVICE REQUEST	The MS is made to initiate an interrogation of CNAP (all) cause: "supplementary service activation"
10	SS -> MS	CM SERVICE ACCEPT	
11	MS -> SS	REGISTER	
12	SS -> MS	RELEASE COMPLETE	InterrogateSS operation Reject provide correct MMI user indication
13	MS		
14	SS -> MS	STATUS ENQUIRY	CC state U10
15	MS -> SS	STATUS	

Specific message content

step 4, 11 - CNAP

- protocol discriminator: non call related SS message.
- message type: REGISTER.
- facility:

invoke = Interrogation

Supplementary service code = CNAP.

Basic service code: no Bearer Service present, no teleservice present.

step 5 - CNAP

- protocol discriminator: non call related SS message.
- transaction identifier: same TI as previous REGISTER message.
- message type: RELEASE COMPLETE.
- facility:

return error code: SS not available.

For the return error the invoke ID must be the same as in the invoke of the InterrogateSS operation.

step 12 -

- protocol discriminator: non call related SS message.
- transaction identifier: same TI as previous REGISTER message.
- message type: RELEASE COMPLETE.
- facility:

reject code: resource limitation.

For the reject the invoke ID must be the same as in the invoke of the InterrogateSS operation.

31.2 Call offering supplementary services

The following abbreviations are used:

CF:	Call Forwarding (common name for CFU, CFB, CFNRy and CFNRc).
CFB:	Call Forwarding on mobile subscriber Busy
CFC:	Call Forwarding Conditional (common name for CFB, CFNRy and CFNRc)
CFNRc:	Call Forwarding on mobile subscriber Not Reachable
CFNRy:	Call Forwarding on No Reply
CFU:	Call Forwarding Unconditional

NOTE: These abbreviations are also used to represent the corresponding SS-Code; e.g. CFC is the SS-Code for all conditional forwarding services.

31.2.1 Call forwarding supplementary services

31.2.1.1 Registration

31.2.1.1.1 Registration accepted

31.2.1.1.1.1 Conformance requirements

For registration of any type of call forwarding with any parameters, the MS shall transmit successively:

- 1) a CHANNEL REQUEST with establishment cause set to "other services requested by the mobile user";
- 2) a CM SERVICE REQUEST with CM service type indicating "supplementary service activation";
- 3) and then the REGISTER message containing a facility IE that includes an invoke of the RegisterSS operation with parameter values according to the user's request (MMI action);
- 4) Upon receipt of the RELEASE COMPLETE message, the MS shall provide the appropriate user indication (which is to be described by the manufacturer).

References

- 1) 3GPP TS 04.08 / 3GPP TS 44.018 subclauses 3.3.1.1.2 and 9.1.9.
- 2) 3GPP TS 04.08 / 3GPP TS 24.008 subclauses 4.5.1.1, 9.2.9 and 10.5.33.
- 3) 3GPP TS 04.82, 3GPP TS 04.80 subclauses 2.3 and 3.6.
- 4) 3GPP TS 02.30 subclause 4.5.

31.2.1.1.1.2 Test purpose

- 1) To check that the MS correctly requests a supplementary service transaction for registration of call forwarding in CHANNEL REQUEST message.
- 2) To check that the MS correctly requests a supplementary service transaction for registration of call forwarding in the subsequent CM SERVICE REQUEST.
- 3) To check that the MS sends a REGISTER message containing the invoke of the RegisterSS operation with the expected parameter values for registration of call forwarding.
- 4) To check that upon receipt of the result of the operation (in a RELEASE COMPLETE message), the MS provides the appropriate user indication (as described by the manufacturer).

These checks are done for:

- a) CFNRy, for basic service group speech.
- b) CFU, for basic service group all facsimile.

31.2.1.1.1.3 Method of test

Initial conditions

System Simulator:

1 cell, default parameters.

Mobile Station:

The MS is "idle updated".

Specific PICS Statements

-

PIXIT Statements

- Description of the user's commands and of display of the answers from the network for call forwarding.

Foreseen final state of the MS

The MS is "idle updated".

Test procedure

By means of appropriate MMI functions (using either 3GPP TS 02.30 or manufacturer defined MMI), the user requests registration of CFNRy for Speech, to a number arbitrarily selected and with a no reply time value arbitrarily selected.

Upon receipt of the operation (in a REGISTER message), the system simulator answers with a RELEASE COMPLETE message with the Facility information element containing the return result of the RegisterSS operation.

The SS transaction is released and the dedicated channel is released.

Then again, by means of appropriate MMI functions as defined by the basic public MMI described in 3GPP TS 02.30, the user requests registration of CFU for all facsimile, to a number arbitrarily selected.

Upon receipt of the REGISTER message, the system simulator answers with the RELEASE COMPLETE message with the Facility information element containing the return result of the RegisterSS operation.

Maximum duration of test

3 minutes.

Expected sequence

Step	Direction	Message	Comments
1	MS		The MS is made to initiate a registration of call forwarding service for CFNRy (Speech) with establishment cause "Other procedures which can be completed with an SDCCH"
2	MS -> SS	CHANNEL REQUEST	
3	SS -> MS	IMMEDIATE ASSIGNMENT	
4	MS -> SS	CM SERVICE REQUEST	
5	SS -> MS	CM SERVICE ACCEPT	
6	MS -> SS	REGISTER	
7	SS -> MS	RELEASE COMPLETE	CNFRySS operation Return_result provide correct MMI user indication
8	MS		
9	SS -> MS	CHANNEL RELEASE	
10	MS		The MS is made to initiate a registration of call forwarding service for CFU (all facsimile) with establishment cause "Other procedures which can be completed with an SDCCH"
11	MS -> SS	CHANNEL REQUEST	
12	SS -> MS	IMMEDIATE ASSIGNMENT	
13	MS -> SS	CM SERVICE REQUEST	
14	SS -> MS	CM SERVICE ACCEPT	
15	MS -> SS	REGISTER	
16	SS -> MS	RELEASE COMPLETE	RegisterSS operation Return result provide correct MMI user indication
17	MS		
18	SS -> MS	CHANNEL RELEASE	

Specific message content

step 6 - CFNRy

- protocol discriminator: non call related SS message.
- message type: REGISTER.
- facility:

invoke = Registration:

Supplementary service code = CFNRy.

Forwarded to number: as selected.

No reply condition time: as selected.

Basic service code: TeleService AllSpeechTransmissionServices (TS10) or Telephony (TS 11), no Bearerservice present.

step 7 - CFU

- protocol discriminator: non call related SS message.
- transaction identifier: same as at step 6.
- message type: RELEASE COMPLETE.
- facility:

Return Result = Registration:

Supplementary service code = CFNRy.

Forwarded to number.

No Reply condition time.

Basic service code: TeleService AllSpeechTransmissionServices (TS10) or Telephony (TS 11), no Bearerservice present.

step 15 - CFU

- protocol discriminator: non call related SS message.
- message type: REGISTER.
- facility:

invoke = Registration:

Supplementary service code = CFU.

Forwarded to number: as selected.

Basic service code: no bearer service present, teleservice (all facsimile).

step 16 - CFU

- protocol discriminator: non call related SS message.
- transaction identifier: same as at step 15.
- message type: RELEASE COMPLETE.
- facility:

Return Result = Registration:

Supplementary service code = CFU.

Forwarded to number.

Basic service code: TeleService (all facsimile), no Bearerservice present.

31.2.1.1.2 Registration rejected

31.2.1.1.2.1 Conformance requirements

- 1) A transaction of any kind being already established, for registration of any type of call forwarding with any parameters, the MS shall establish a parallel MM transaction, sending a CM SERVICE REQUEST with CM service type indicating "supplementary service activation".
- 2) Then the MS shall send a REGISTER message related to the present SS transaction containing a facility IE that includes an invoke of the RegisterSS operation with parameter values according to the user's request (MMI action).

- 3) Upon receipt of the RELEASE COMPLETE message related to the present SS transaction, the SS transaction shall be released but the first transaction shall remain unaffected.
- 4) Upon receipt of the RELEASE COMPLETE message, the MS shall provide the appropriate user indication (which is to be described by the Manufacturer).

References

- 1) 3GPP TS 04.08 / 3GPP TS 44.018 subclauses 3.3.1.1.2 and 9.1.9.
- 2) 3GPP TS 04.08 / 3GPP TS 24.008 subclauses 4.5.1.1, 9.2.9 and 10.5.33.
- 3) 3GPP TS 04.82, 3GPP TS 04.80 subclauses 2.3 and 3.6.
- 4) 3GPP TS 02.30 subclause 4.5.

31.2.1.1.2.2 Test purpose

- 1) To check that the MS correctly requests the establishment of a parallel MM transaction for supplementary service transaction of registration of call forwarding, sending a CM SERVICE REQUEST.
- 2) To check that the MS sends a REGISTER message containing the invoke of the RegisterSS operation with the expected parameter values for registration of call forwarding.
- 3) To check that upon receipt of the RELEASE COMPLETE message related to the present SS transaction, the first transaction remains unaffected.
- 4) To check that upon receipt of the RELEASE COMPLETE message, the MS provides the appropriate user indication (as described by the Manufacturer).

These checks are performed with a call transaction already established for:

- a) CFB, for all asynchronous services, the RELEASE COMPLETE message being sent with a facility IE containing a return_error(error) where error is "Bearer Service not provisioned".
- b) CF, for all facsimile, the RELEASE COMPLETE message being sent with a facility IE containing a reject(involve_problem) where involve_problem is "resource limitation".

31.2.1.1.2.3 Method of test

Initial conditions

System Simulator:

1 cell, default parameters.

Mobile Station:

The MS is in CC state U10.

Specific PICS Statements

-

PIXIT Statements

- Description of the user's commands and of display of the answers from the network for call forwarding.

Foreseen final state of the MS

The MS is in CC state U10.

Test procedure

By means of appropriate MMI functions (using either 3GPP TS 02.30 or manufacturer defined MMI), the user requests registration of CFB for all asynchronous services, to a number arbitrarily selected.

Upon receipt of the operation (in a REGISTER message), the system simulator answers with a RELEASE COMPLETE message with the Facility information element containing a Return_error(error: BearerService not provisioned) of the RegisterSS operation.

The system simulator sends STATUS ENQUIRY, the MS responds with STATUS message indicating CC state U10.

Then again, by means of appropriate MMI functions as defined by the basic public MMI described in 3GPP TS 02.30, the user requests registration of CF for all facsimile, to a number arbitrarily selected.

Upon receipt of the REGISTER message, the system simulator answers with the RELEASE COMPLETE message with the Facility information element containing a reject(involve_problem: resource limitation) of the RegisterSS operation.

The system simulator sends STATUS ENQUIRY, the MS responds with STATUS message indicating CC state U10.

Maximum duration of test

3 minutes.

Expected sequence

Step	Direction	Message	Comments
1	MS		The MS is made to initiate a registration of call forwarding service for CFB (all asynchronous services) cause: "supplementary service activation"
2	MS -> SS	CM SERVICE REQUEST	
3	SS -> MS	CM SERVICE ACCEPT	
4	MS -> SS	REGISTER	
5	SS -> MS	RELEASE COMPLETE	RegisterSS operation Return_error
6	SS -> MS	STATUS ENQUIRY	
7	MS -> SS	STATUS	CC state U10
8	MS		The MS is made to initiate a registration of call forwarding service for CF (all facsimile) cause: "supplementary service activation"
9	MS -> SS	CM SERVICE REQUEST	
10	SS -> MS	CM SERVICE ACCEPT	
11	MS -> SS	REGISTER	
12	SS -> MS	RELEASE COMPLETE	RegisterSS operation Reject
13	MS		provide correct MMI user indication
14	SS -> MS	STATUS ENQUIRY	
15	MS -> SS	STATUS	CC state U10

Specific message content

step 4 - CFB

- protocol discriminator: non call related SS message.
- message type: REGISTER.
- facility:

invoke = Registration:

Supplementary service code = CFB.

Forwarded to number: as selected.

Basic service code: Bearer Service (all asynchronous services), no teleservice present.

step 5 -

- protocol discriminator: non call related SS message.
- transaction identifier: same TI as previous REGISTER message.
- message type: RELEASE COMPLETE.
- facility:
 - return error code: BearerService not provisioned.

For the return error the invoke ID must be the same as in the invoke of the RegisterSS operation.

step 11 - CF

- protocol discriminator: non call related SS message.
- message type: REGISTER.
- facility:
 - invoke = Registration:
 - Supplementary service code = CF.
 - Forwarded to number: as selected.
 - Basic service code: no bearer service present, teleservice (all facsimile)).

step 12 -

- protocol discriminator: non call related SS message.
- transaction identifier: same TI as previous REGISTER message.
- message type: RELEASE COMPLETE.
- facility:
 - reject code: resource limitation.

For the reject the invoke ID must be the same as in the invoke of the Register SS operation.

31.2.1.2 Erasure by the subscriber

31.2.1.2.1 Erasure accepted

31.2.1.2.1.1 Conformance requirements

For erasure of any type of call forwarding, the MS shall transmit successively:

- 1) a CHANNEL REQUEST with establishment cause set to "other services requested by the mobile user";
- 2) a CM SERVICE REQUEST with CM service type indicating "supplementary service activation";
- 3) and then the REGISTER message containing a facility that includes an invoke of the EraseSS operation with the expected parameter values according to the user request (MMI action);
- 4) Upon receipt of the RELEASE COMPLETE message, the MS shall provide the appropriate user indication (which is to be described by the manufacturer).

References

- 1) 3GPP TS 04.08 / 3GPP TS 44.018 subclauses 3.3.1.1.2 and 9.1.9.
- 2) 3GPP TS 04.08 / 3GPP TS 24.008 subclauses 4.5.1.1, 9.2.9 and 10.5.33.
- 3) 3GPP TS 04.82, 3GPP TS 04.80 subclauses 2.3 and 3.6.
- 4) 3GPP TS 02.30 subclause 4.5.

31.2.1.2.1.2 Test purpose

- 1) To check that the MS correctly requests supplementary service transaction for erasure of call forwarding in CHANNEL REQUEST message.
- 2) To check that the MS correctly requests supplementary service transaction for erasure of call forwarding in the subsequent CM SERVICE REQUEST.
- 3) To check that the MS sends a REGISTER message containing the invoke of the EraseSS operation with the expected parameter values for erasure of call forwarding.
- 4) To check that upon receipt of the result of the operation (in a RELEASE COMPLETE message), the MS provides the appropriate user indication (as described by the manufacturer).

These checks are done for:

- a) CFC, for basic service group all facsimile.
- b) CFNRc, for all basic service groups.

31.2.1.2.1.3 Method of test

Initial conditions

System Simulator:

1 cell, default parameters.

Mobile Station:

The MS is "idle updated".

Specific PICS Statements

-

PIXIT Statements

- Description of the user's commands and of display of the answers from the network for call forwarding.

Foreseen final state of the MS

The MS is "idle updated".

Test procedure

By means of appropriate MMI functions (using either 3GPP TS 02.30 or manufacturer defined MMI), the user requests erasure of CFC for all facsimile.

Upon receipt of the operation (in a REGISTER message), the system simulator answers with a RELEASE COMPLETE message with the facility information element containing a return result of the EraseSS operation.

The SS transaction is released and the dedicated channel is released.

Then again, by means of appropriate MMI functions as defined by the basic public MMI described in 3GPP TS 02.30, the user requests erasure of CFNRc for all basic service groups.

Upon receipt of the REGISTER message, the system simulator answers with the RELEASE COMPLETE message with the Facility information element containing the return result of the EraseSS operation.

The dedicated channel is released.

Maximum duration of test

3 minutes.

Expected sequence

Step	Direction	Message	Comments
1	MS		The MS is made to initiate erasure of call forwarding for CFC (all facsimile)
2	MS -> SS	CHANNEL REQUEST	with establishment cause "Other procedures which can be completed with an SDCCH"
3	SS -> MS	IMMEDIATE ASSIGNMENT	
4	MS -> SS	CM SERVICE REQUEST	cause: "supplementary service activation"
5	SS -> MS	CM SERVICE ACCEPT	
6	MS -> SS	REGISTER	
7	SS -> MS	RELEASE COMPLETE	EraseSS operation Return_result
8	MS		provide user MMI indication
9	SS -> MS	CHANNEL RELEASE	
10	MS		The MS is made to initiate a erasure of call forwarding service for CFNRc (all basic services)
11	MS -> SS	CHANNEL REQUEST	with establishment cause "Other procedures which can be completed with an SDCCH"
12	SS -> MS	IMMEDIATE ASSIGNMENT	
13	MS -> SS	CM SERVICE REQUEST	cause: "supplementary service activation"
14	SS -> MS	CM SERVICE ACCEPT	
15	MS -> SS	REGISTER	
16	SS -> MS	RELEASE COMPLETE	EraseSS operation Return result
17	MS		provide correct MMI user indication
18	SS -> MS	CHANNEL RELEASE	

Specific message content

step 6 - CFC

- protocol discriminator: non call related SS message.
- message type: REGISTER.
- facility:

invoke = Erasure:

Supplementary service code = CFC.

Basic service code: no Bearer Service, teleservice (all facsimile).

step 15 - CFNRc

- protocol discriminator: non call related SS message.
- message type: REGISTER.
- facility:

invoke = Erasure:

Supplementary service code = CFNRc.

Basic service code: no bearer service present, no teleservice present.

31.2.1.2.2 Erasure rejected

31.2.1.2.2.1 Conformance requirements

- 1) A transaction of any kind being already established, for erasure of any type of call forwarding with any parameters, the MS shall establish a parallel MM transaction, sending a CM SERVICE REQUEST with CM service type indicating "supplementary service activation".
- 2) Then the MS shall send a REGISTER message related to the present SS transaction containing a facility IE that includes an invoke of the EraseSS operation with parameter values according to the user's request (MMI action).
- 3) Upon receipt of the RELEASE COMPLETE message related to the present SS transaction, the SS transaction shall be released but the first transaction shall remain unaffected.
- 4) Upon receipt of the RELEASE COMPLETE message, the MS shall provide the appropriate user indication (which is to be described by the Manufacturer).

References

- 1) 3GPP TS 04.08 / 3GPP TS 44.018 subclauses 3.3.1.1.2 and 9.1.9.
- 2) 3GPP TS 04.08 / 3GPP TS 24.008 subclauses 4.5.1.1, 9.2.9 and 10.5.33.
- 3) 3GPP TS 04.82,
3GPP TS 04.80 subclauses 2.3 and 3.6.
- 4) 3GPP TS 02.30 subclause 4.5.

31.2.1.2.2.2 Test purpose

- 1) To check that the MS correctly requests the establishment of a parallel MM transaction for supplementary service transaction of erasure of call forwarding, sending a CM SERVICE REQUEST.
- 2) To check that the MS sends a REGISTER message containing the invoke of the EraseSS operation with the expected parameter values for erasure of call forwarding.
- 3) To check that upon receipt of the RELEASE COMPLETE message related to the present SS transaction, the first transaction remains unaffected.
- 4) To check that upon receipt of the RELEASE COMPLETE message, the MS provides the appropriate user indication (as described by the Manufacturer).

These checks are performed with a call transaction already established for:

- a) CFU, for Speech, the RELEASE COMPLETE message being sent with a facility IE containing a return_error(error) where error is "Teleservice not provisioned".
- b) CFNRy, for all facsimile, the RELEASE COMPLETE message being sent with a facility IE containing a reject(invoked_problem) where invoked_problem is "resource limitation".

31.2.1.2.2.3 Method of test

Initial conditions

System Simulator:

1 cell, default parameters.

Mobile Station:

The MS is in CC state U10.

Specific PICS Statements

-

PIXIT Statements

- Description of the user's commands and of display of the answers from the network for call forwarding.

Foreseen final state of the MS

The MS is in CC state U10.

Test procedure

By means of appropriate MMI functions (using either 3GPP TS 02.30 or manufacturer defined MMI), the user requests erasure of CFU for Speech.

Upon receipt of the operation (in a REGISTER message), the system simulator answers with a RELEASE COMPLETE message with the Facility information element containing a Return_error(error: TeleService not provisioned) of the EraseSS operation.

The system simulator sends STATUS ENQUIRY, the MS responds with STATUS message indicating CC state U10.

Then again, by means of appropriate MMI functions as defined by the basic public MMI described in 3GPP TS 02.30, the user requests erasure of CFNRy for all facsimile.

Upon receipt of the REGISTER message, the system simulator answers with the RELEASE COMPLETE message with the Facility information element containing a reject(involve_problem: resource limitation) of the EraseSS operation.

The system simulator sends STATUS ENQUIRY, the MS responds with STATUS message indicating CC state U10.

Maximum duration of test

3 minutes.

Expected sequence

Step	Direction	Message	Comments
1	MS		The MS is made to initiate a erasure of call forwarding service for CFU (speech) cause: "supplementary service activation"
2	MS -> SS	CM SERVICE REQUEST	
3	SS -> MS	CM SERVICE ACCEPT	
4	MS -> SS	REGISTER	
5	SS -> MS	RELEASE COMPLETE	EraseSS operation Return_error
6	SS -> MS	STATUS ENQUIRY	CC state U10
7	MS -> SS	STATUS	
8	MS		The MS is made to initiate a erasure of call forwarding service for CFNRy (all facsimile) cause: "supplementary service activation"
9	MS -> SS	CM SERVICE REQUEST	
10	SS -> MS	CM SERVICE ACCEPT	
11	MS -> SS	REGISTER	
12	SS -> MS	RELEASE COMPLETE	EraseSS operation Reject
13	MS		provide correct MMI user indication
14	SS -> MS	STATUS ENQUIRY	CC state U10
15	MS -> SS	STATUS	

Specific message content

step 4 - CFU

- protocol discriminator: non call related SS message.
- message type: REGISTER.
- facility:

invoke = Erasure:

Supplementary service code = CFU.

Basic service code: Tele Service AllSpeechTransmissionServices (TS10) or Telephony (TS 11), no Bearer service present.

step 5 -

- protocol discriminator: non call related SS message.
- transaction identifier: same TI as previous REGISTER message.
- message type: RELEASE COMPLETE.
- facility:

return error code: TeleService not provisioned.

For the return error the invoke ID must be the same as in the invoke of the EraseSS operation.

step 11 - CFNRy

- protocol discriminator: non call related SS message.
- message type: REGISTER.
- facility:

invoke = Erasure:

Supplementary service code = CFNRy.

Basic service code: no bearer service present, teleservice (all facsimile).

step 12 -

- protocol discriminator: non call related SS message.
- transaction identifier: same TI as previous REGISTER message.
- message type: RELEASE COMPLETE.
- facility:

reject code: resource limitation.

For the reject the invoke ID must be the same as in the invoke of the EraseSS operation.

31.2.1.3 Activation

31.2.1.3.1 Conformance requirements

For activation of any type of call forwarding with any parameters, the MS shall transmit successively

- 1) a CHANNEL REQUEST with establishment cause set to "other services requested by the mobile user";
- 2) a CM SERVICE REQUEST with CM service type indicating "supplementary service activation";

- 3) and then the REGISTER message containing a facility IE that includes an invoke of the ActivateSS operation with parameter values according to the user's request (MMI action);
- 4) upon receipt of the RELEASE COMPLETE message, the MS shall provide the appropriate user indication (which is to be described by the manufacturer).

References

- 1) 3GPP TS 04.08 / 3GPP TS 44.018 subclauses 3.3.1.1.2 and 9.1.9.
- 2) 3GPP TS 04.08 / 3GPP TS 24.008 subclauses 4.5.1.1, 9.2.9 and 10.5.33.
- 3) 3GPP TS 04.82,
3GPP TS 04.80 subclauses 2.3 and 3.6.
- 4) 3GPP TS 02.30 subclause 4.5.

31.2.1.3.2 Test purpose

- 1) To check that the MS correctly requests a supplementary service transaction for activation of call forwarding in CHANNEL REQUEST message.
- 2) To check that the MS correctly requests a supplementary service transaction for activation of call forwarding in the subsequent CM SERVICE REQUEST.
- 3) To check that the MS sends a REGISTER message containing the invoke of the ActivateSS operation with the expected parameter values for activation of call forwarding.
- 4) To check that upon receipt of the result of the operation (in a RELEASE COMPLETE message), the MS provides the appropriate user indication (as described by the manufacturer).

These checks are done for:

- a) CF, for basic service group "all synchronous services".
- b) CFU, for all basic service groups.

31.2.1.3.3 Method of test

Initial conditions

System Simulator:

1 cell, default parameters.

Mobile Station:

The MS is "idle updated".

Specific PICS Statements

-

PIXIT Statements

- Description of the user's commands and of display of the answers from the network for call forwarding.

Foreseen final state of the MS

The MS is "idle updated".

Test procedure

By means of appropriate MMI functions (using either 3GPP TS 02.30 or manufacturer defined MMI), the user requests activation of CF for all synchronous services.

Upon receipt of the operation (in a REGISTER message), the system simulator answers with the FACILITY message with the Facility information element containing the return result of the ActivateSS operation.

The SS transaction is released and the dedicated channel is released.

Then again, by means of appropriate MMI functions as defined by the basic public MMI described in 3GPP TS 02.30, the user requests activation of CFU for all basic service groups.

Upon receipt of the REGISTER message, the system simulator answers with the RELEASE COMPLETE message with the Facility information element containing the return result of the ActivateSS operation.

Maximum duration of test

3 minutes.

Expected sequence

Step	Direction	Message	Comments
1	MS		The MS is made to initiate a activation of call forwarding service for CF (all synchronous services)
2	MS -> SS	CHANNEL REQUEST	with establishment cause "Other procedures which can be completed with an SDCCH"
3	SS -> MS	IMMEDIATE ASSIGNMENT	
4	MS -> SS	CM SERVICE REQUEST	cause: "supplementary service activation"
5	SS -> MS	CM SERVICE ACCEPT	
6	MS -> SS	REGISTER	
7	SS -> MS	RELEASE COMPLETE	ActivateSS operation Return_result
8	MS		provide user MMI indication
9	SS -> MS	CHANNEL RELEASE	
10	MS		The MS is made to initiate a activation of call forwarding service for CFU (all basic service groups)
11	MS -> SS	CHANNEL REQUEST	with establishment cause "Other procedures which can be completed with an SDCCH"
12	SS -> MS	IMMEDIATE ASSIGNMENT	
13	MS -> SS	CM SERVICE REQUEST	cause: "supplementary service activation"
14	SS -> MS	CM SERVICE ACCEPT	
15	MS -> SS	REGISTER	
16	SS -> MS	RELEASE COMPLETE	ActivateSS operation Return result
17	MS		provide correct MMI user indication
18	SS -> MS	CHANNEL RELEASE	

Specific message contents:

step 6 - CF

- protocol discriminator: non call related SS message.
- message type: REGISTER.
- facility:

invoke = Activation:

Supplementary service code = CF.

Basic service code: Bearer Service (all synchronous services), no teleservice present.

step 15 - CFU

- protocol discriminator: non call related SS message.
- message type: REGISTER.
- facility:

invoke = Activation:

Supplementary service code = CFU.

Basic service code: no bearer service present, no teleservice present.

31.2.1.4 Deactivation

31.2.1.4.1 Conformance requirements

For deactivation of any type of call forwarding with any parameters, the MS shall transmit successively:

- 1) a CHANNEL REQUEST with establishment cause set to "other services requested by the mobile user";
- 2) a CM SERVICE REQUEST with CM service type indicating "supplementary service activation";
- 3) and then the REGISTER message containing a facility IE that includes an invoke of the DeactivateSS operation with parameter values according to the user's request (MMI action);
- 4) upon receipt of the RELEASE COMPLETE message, the MS shall provide the appropriate user indication (which is to be described by the manufacturer).

References

- 1) 3GPP TS 04.08 / 3GPP TS 44.018 subclauses 3.3.1.1.2 and 9.1.9.
- 2) 3GPP TS 04.08 / 3GPP TS 24.008 subclauses 4.5.1.1, 9.2.9 and 10.5.33.
- 3) 3GPP TS 04.82,
3GPP TS 04.80 subclauses 2.3 and 3.6.
- 4) 3GPP TS 02.30 subclause 4.5.

31.2.1.4.2 Test purpose

- 1) To check that the MS correctly requests a supplementary service transaction for deactivation of call forwarding in CHANNEL REQUEST message.
- 2) To check that the MS correctly requests a supplementary service transaction for deactivation of call forwarding in the subsequent CM SERVICE REQUEST.
- 3) To check that the MS sends a REGISTER message containing the invoke of the DeactivateSS operation with the expected parameter values for deactivation of call forwarding.
- 4) To check that upon receipt of the result of the operation (in a RELEASE COMPLETE message), the MS provides the appropriate user indication (as described by the manufacturer).

These checks are done for:

- a) CFC, for basic service group speech.
- b) CFNRc, for basic service group all facsimile.

31.2.1.4.3 Method of test

Initial conditions

System Simulator:

- 1 cell, default parameters.

Mobile Station:

The MS is "idle updated".

Specific PICS Statements

-

PIXIT Statements

- Description of the user's commands and of display of the answers from the network for call forwarding.

Foreseen final state of the MS

The MS is "idle updated".

Test procedure

By means of appropriate MMI functions (using either 3GPP TS 02.30 or manufacturer defined MMI), the user requests deactivation of CFC for speech.

Upon receipt of the operation (in a REGISTER message), the system simulator answers with a RELEASE COMPLETE message with the Facility information element containing the return result of the DeactivateSS operation.

The SS transaction is released and the dedicated channel is released.

Then again, by means of appropriate MMI functions as defined by the basic public MMI described in 3GPP TS 02.30, the user requests deactivation of CFNRc for all facsimile.

Upon receipt of the REGISTER message, the system simulator answers with the RELEASE COMPLETE message with the Facility information element containing the return result of the DeactivateSS operation.

The dedicated channel is released.

Maximum duration of test

3 minutes.

Expected sequence

Step	Direction	Message	Comments
1	MS		The MS is made to initiate a deactivation of call forwarding service for CFC (speech)
2	MS -> SS	CHANNEL REQUEST	with establishment cause "Other procedures which can be completed with an SDCCH"
3	SS -> MS	IMMEDIATE ASSIGNMENT	
4	MS -> SS	CM SERVICE REQUEST	cause: "supplementary service activation"
5	SS -> MS	CM SERVICE ACCEPT	
6	MS -> SS	REGISTER	
7	SS -> MS	RELEASE COMPLETE	DeactivateSS operation Return_result
8	MS		provide user MMI indication
9	SS -> MS	CHANNEL RELEASE	
10	MS		The MS is made to initiate a deactivation of call forwarding service for CFNRc (all facsimile)
11	MS -> SS	CHANNEL REQUEST	with establishment cause "Other procedures which can be completed with an SDCCH"
12	SS -> MS	IMMEDIATE ASSIGNMENT	
13	MS -> SS	CM SERVICE REQUEST	cause: "supplementary service activation"
14	SS -> MS	CM SERVICE ACCEPT	
15	MS -> SS	REGISTER	
16	SS -> MS	RELEASE COMPLETE	DeactivateSS operation Return result
17	MS		provide correct MMI user indication
18	SS -> MS	CHANNEL RELEASE	

Specific message content

step 6 - CFC

- protocol discriminator: non call related SS message.
- message type: REGISTER.
- facility:

invoke = Deactivation:

Supplementary service code = CFC.

Basic service code: no bearer service , teleservice (All Speech Transmission Services).

step 15 - CFNRc

- protocol discriminator: non call related SS message.
- message type: REGISTER.
- facility:

invoke = Deactivation:

Supplementary service code = CFNRc.

Basic service code: no bearer service present, teleservice (all facsimile).

31.2.1.5 Invocation

Invocation is not applicable to the MS and causes no signalling on the radio path.

31.2.1.6 Interrogation

31.2.1.6.1 Interrogation accepted

31.2.1.6.1.1 Conformance requirements

For interrogation of any specific call forwarding service (not applicable to a group of services) with any parameters, the MS shall transmit successively:

- 1) a CHANNEL REQUEST with establishment cause set to "other services requested by the mobile user";
- 2) a CM SERVICE REQUEST with CM service type indicating "supplementary service activation";
- 3) and then the REGISTER message containing a facility IE that includes an invoke of the InterrogateSS operation with parameter values according to the user's request (MMI action);
- 4) upon receipt of the RELEASE COMPLETE message, the MS shall provide the appropriate user indication (which is to be described by the manufacturer).

References

- 1) 3GPP TS 04.08 / 3GPP TS 44.018 subclauses 3.3.1.1.2 and 9.1.9.
- 2) 3GPP TS 04.08 / 3GPP TS 24.008 subclauses 4.5.1.1, 9.2.9 and 10.5.33.
- 3) 3GPP TS 04.82,
3GPP TS 04.80 subclauses 2.3 and 3.6.
- 4) 3GPP TS 02.30 subclause 4.5.

31.2.1.6.1.2 Test purpose

- 1) To check that the MS correctly requests a supplementary service transaction for interrogation of a specific call forwarding in CHANNEL REQUEST message.

- 2) To check that the MS correctly requests a supplementary service transaction for interrogation of call forwarding in the subsequent CM SERVICE REQUEST.
- 3) To check that the MS sends a REGISTER message containing the invoke of the InterrogateSS operation with the expected parameter values for interrogation of call forwarding.
- 4) To check that upon receipt of the result of the operation (in a RELEASE COMPLETE message), the MS provides the appropriate user indication (as described by the manufacturer).

These checks are done for:

- a) CFB, for all basic service groups.
- b) CFNRy, for basic service group speech.

31.2.1.6.1.3 Method of test

Initial conditions

System Simulator:

1 cell, default parameters.

Mobile Station:

The MS is "idle updated".

Specific PICS Statements

-

PIXIT Statements

- Description of the user's commands and of display of the answers from the network for call forwarding.

Foreseen final state of the MS

The MS is "idle updated".

Test procedure

By means of appropriate MMI functions (using either 3GPP TS 02.30 or manufacturer defined MMI), the user requests interrogation of CFB for all basic service groups.

Upon receipt of the operation (in a REGISTER message), the system simulator answers with a RELEASE COMPLETE message with the Facility information element containing the return result of the InterrogateSS operation.

The SS transaction is released and the dedicated channel is released.

Then again, by means of appropriate MMI functions as defined by the basic public MMI described in 3GPP TS 02.30, the user requests interrogation of CFNRy for speech.

Upon receipt of the REGISTER message, the system simulator answers with the RELEASE COMPLETE message with the Facility information element containing the return result of the InterrogateSS operation.

The dedicated channel is released.

Maximum duration of test

3 minutes.

Expected sequence

Step	Direction	Message	Comments
1	MS		The MS is made to initiate a registration of call forwarding service for CFB (all) with establishment cause "Other procedures which can be completed with an SDCCH"
2	MS -> SS	CHANNEL REQUEST	
3	SS -> MS	IMMEDIATE ASSIGNMENT	
4	MS -> SS	CM SERVICE REQUEST	
5	SS -> MS	CM SERVICE ACCEPT	
6	MS -> SS	REGISTER	
7	SS -> MS	RELEASE COMPLETE	InterrogateSS operation Return_result provide user MMI indication
8	MS		
9	SS -> MS	CHANNEL RELEASE	
10	MS		The MS is made to initiate a registration of call forwarding service for CFNRy(speech) with establishment cause "Other procedures which can be completed with an SDCCH"
11	MS -> SS	CHANNEL REQUEST	
12	SS -> MS	IMMEDIATE ASSIGNMENT	
13	MS -> SS	CM SERVICE REQUEST	
14	SS -> MS	CM SERVICE ACCEPT	
16	MS -> SS	REGISTER	
17	SS -> MS	RELEASE COMPLETE	InterrogateSS operation Return result provide correct MMI user indication
18	MS		
19	SS -> MS	CHANNEL RELEASE	

Specific message content

step 6 - CFB

- protocol discriminator: non call related SS message.
- message type: REGISTER.
- facility:

invoke = Interrogation:

Supplementary service code = CFB.

Basic service code: no Bearer Service present, no teleservice present.

step 15 - CFNRy

- protocol discriminator: non call related SS message.
- message type: REGISTER.
- facility:

invoke = Interrogation:

Supplementary service code = CFNRy.

Basic service code: no bearer service present, teleservice (speech).

31.2.1.6.2 Interrogation rejected

31.2.1.6.2.1 Conformance requirements

- 1) A transaction of any kind being already established, for interrogation of any specific call forwarding service with any parameters, the MS shall establish a parallel MM transaction, sending a CM SERVICE REQUEST with CM service type indicating "supplementary service activation".
- 2) Then the MS shall send a REGISTER message related to the present SS transaction containing a facility IE that includes an invoke of the InterrogateSS operation with parameter values according to the user's request (MMI action).
- 3) Upon receipt of the RELEASE COMPLETE message related to the present SS transaction, the SS transaction shall be released but the first transaction shall remain unaffected.
- 4) Upon receipt of the RELEASE COMPLETE message, the MS shall provide the appropriate user indication (which is to be described by the Manufacturer).

References

- 1) 3GPP TS 04.08 / 3GPP TS 44.018 subclauses 3.3.1.1.2 and 9.1.9.
- 2) 3GPP TS 04.08 / 3GPP TS 24.008 subclauses 4.5.1.1, 9.2.9 and 10.5.33.
- 3) 3GPP TS 04.82,
3GPP TS 04.80 subclauses 2.3 and 3.6.
- 4) 3GPP TS 02.30 subclause 4.5.

31.2.1.6.2.2 Test purpose

- 1) To check that the MS correctly requests the establishment of a parallel MM transaction for supplementary service transaction of interrogation of a specific call forwarding service, sending a CM SERVICE REQUEST.
- 2) To check that the MS sends a REGISTER message containing the invoke of the InterrogateSS operation with the expected parameter values for interrogation of call forwarding.
- 3) To check that upon receipt of the RELEASE COMPLETE message related to the present SS transaction, the first transaction remains unaffected.
- 4) To check that upon receipt of the RELEASE COMPLETE message, the MS provides the appropriate user indication (as described by the Manufacturer).

These checks are performed with a call transaction already established for:

- a) CFNRc, for all basic service group, the RELEASE COMPLETE message being sent with a facility IE containing a return_error(error) where error is "SS not available".
- b) CFB, for all facsimile, the RELEASE COMPLETE message being sent with a facility IE containing a reject(involve_problem) where involve_problem is "resource limitation".

31.2.1.6.2.3 Method of test

Initial conditions

System Simulator:

1 cell, default parameters.

Mobile Station:

The MS is in CC state U10.

Specific PICS Statements

-

PIXIT Statements

- Description of the user's commands and of display of the answers from the network for call forwarding.

Foreseen final state of the MS

The MS is in CC state U10.

Test procedure

By means of appropriate MMI functions (using either 3GPP TS 02.30 or manufacturer defined MMI), the user requests interrogation of CFNRc for all basic service groups.

Upon receipt of the operation (in a REGISTER message), the system simulator answers with a RELEASE COMPLETE message with the Facility information element containing a Return_error(error: SS not available) of the InterrogateSS operation.

The system simulator sends STATUS ENQUIRY, the MS responds with STATUS message indicating CC state U10.

Then again, by means of appropriate MMI functions as defined by the basic public MMI described in 3GPP TS 02.30, the user requests interrogation of CFB for all facsimile.

Upon receipt of the REGISTER message, the system simulator answers with the RELEASE COMPLETE message (same PD and TI that in the REGISTER message) with the Facility information element containing a reject(invoke_problem: resource limitation) of the InterrogateSS operation.

The system simulator sends STATUS ENQUIRY, the MS responds with STATUS message indicating CC state U10.

Maximum duration of test

3 minutes.

Expected sequence

Step	Direction	Message	Comments
1	MS		The MS is made to initiate a registration of call forwarding service for CFNRc (all) cause: "supplementary service activation"
2	MS -> SS	CM SERVICE REQUEST	
3	SS -> MS	CM SERVICE ACCEPT	
4	MS -> SS	REGISTER	
5	SS -> MS	RELEASE COMPLETE	InterrogateSS operation Return_error
6	SS -> MS	STATUS ENQUIRY	
7	MS -> SS	STATUS	CC state U10
8	MS		
9	MS -> SS	CM SERVICE REQUEST	The MS is made to initiate a interrogation of call forwarding service for CFB (all facsimile) cause: "supplementary service activation"
10	SS -> MS	CM SERVICE ACCEPT	
11	MS -> SS	REGISTER	
12	SS -> MS	RELEASE COMPLETE	InterrogateSS operation Reject provide correct MMI user indication
13	MS		
14	SS -> MS	STATUS ENQUIRY	CC state U10
15	MS -> SS	STATUS	

Specific message content

step 4 - CFNRc

- protocol discriminator: non call related SS message.
- message type: REGISTER.
- facility:

invoke = Interrogation:

Supplementary service code = CFNRc.

Basic service code: no Bearer Service present, no teleservice present.

step 5 -

- protocol discriminator: non call related SS message.
- transaction identifier: same TI as previous REGISTER message.
- message type: RELEASE COMPLETE.
- facility:

return error code: SS not available.

For the return error the invoke ID must be the same as in the invoke of the InterrogateSS operation.

step 11 - CFB

- protocol discriminator: non call related SS message.
- message type: REGISTER.
- facility:

invoke = Interrogation:

Supplementary service code = CFB.

Basic service code: no bearer service present, teleservice (all facsimile)).

step 12 -

- protocol discriminator: non call related SS message.
- transaction identifier: same TI as previous REGISTER message.
- message type: RELEASE COMPLETE.
- facility:

reject code: resource limitation.

For the reject the invoke ID must be the same as in the invoke of the InterrogateSS operation.

31.2.1.7 Normal operation

31.2.1.7.1 Served mobile subscriber side

31.2.1.7.1.1 Notification during an incoming call

This subscription option is only applicable to CFB and CFNRy.

31.2.1.7.1.1.1 Conformance requirements

- 1) During a call transaction, call establishment or not, upon receipt of a FACILITY message notifying an incoming call, the MS shall provide the appropriate user indication (which is to be described by the manufacturer).
- 2) If a call transaction is being established or is already established when the notification of incoming call is received, the receipt of the notification has no effect on its state.

References

- 1) 3GPP TS 02.30 subclause 4.5.
- 2) 3GPP TS 04.82 clause 1.

31.2.1.7.1.1.2 Test purpose

- 1) To check that, in state U7 or U10, upon receipt of a FACILITY message notifying an incoming call, the MS shall provide the appropriate user indication (which is to be described by the manufacturer).
- 2) To check that when the notification of incoming call is received while the MS is in CC state U7 and U10 of another incoming call, it has no effect on its state.

These checks are performed in the case of CFB.

31.2.1.7.1.1.3 Method of test

Initial conditions

System Simulator:

1 cell, default parameters.

Mobile Station:

The MS is "idle updated".

Specific PICS Statements

-

PIXIT Statements

- Description of the user's commands and of display of the answers from the network for call forwarding.

Foreseen final state of the MS

The MS is "idle updated".

Test procedure

The MS is brought to the call state U7 of an incoming call.

The system simulator transmits a FACILITY message with the facility information element containing an invoke of the NotifySS operation for CFB.

The system simulator sends STATUS ENQUIRY, the MS responds with STATUS message indicating CC state U7.

The MS is brought into the call state U10 of an incoming call.

The system simulator transmits a FACILITY message with the facility information element containing an invoke of the NotifySS operation for CFB.

The system simulator sends STATUS ENQUIRY, the MS responds with STATUS message indicating CC state U10.

The transaction and the channel are released by the SS.

Maximum duration of test

1 minute.

Expected sequence

Step	Direction	Message	Comments
1	SS -> MS	PAGING	
2	MS -> SS	CHANNEL REQUEST	with establishment cause "answer to paging"
3	SS -> MS	IMMEDIATE ASSIGNMENT	
4	MS -> SS	PAGING RESPONSE	
5	SS -> MS	SETUP	
6	MS -> SS	CALL CONFIRMED	
7	SS -> MS	ASSIGNMENT COMMAND	
8	MS -> SS	ASSIGNMENT COMPLETE	
9	MS -> SS	ALERTING	
10	SS -> MS	FACILITY	(invoke NotifySS)
11	SS -> MS	STATUS ENQUIRY	
12	MS -> SS	STATUS	(U7)
13	MS -> SS	CONNECT	MS off hook
14	SS -> MS	CONNECT ACKNOWLEDGE	
15	SS -> MS	FACILITY	(invoke NotifySS)
16	SS -> MS	STATUS ENQUIRY	
17	MS -> SS	STATUS	(U10)
18	SS -> MS	RELEASE COMPLETE	
19	SS -> MS	CHANNEL RELEASE	

Specific message contents

Steps 10 and 15

- protocol discriminator: CC.
- transaction identifier: same as for the call transaction already established.
- message type: FACILITY.
- facility:

invoke = notification:

Supplementary service code = CFB.

SS notification = incoming call is forwarded.

(call is forwarded indication to B subscriber).

31.2.1.7.1.2 Notification during an outgoing call

31.2.1.7.1.2.1 Conformance requirements

- 1) As an outgoing call is being established, if the ALERTING message is received with the facility information element containing an SS notification (for CFU or CFC), the MS shall correctly reach CC state U4.
- 2) As an outgoing call is being established, if the ALERTING message is received with the facility information element containing an SS notification (for CFU or CFC), the MS shall provide the appropriate user indication (which is to be described by the manufacturer).
- 3) As an outgoing call is being established, if the CONNECT message is received with the facility information element containing an SS notification (for CFU or CFC), the MS shall normally send a CONNECT ACKNOWLEDGE message and enter CC state U10.
- 4) As an outgoing call is being established, if the CONNECT message is received with the facility information element containing an SS notification (for CFU or CFC), the MS shall provide the appropriate user indication (which is to be described by the manufacturer).

References

- 1) 3GPP TS 04.82,
3GPP TS 04.80 subclause 3.6.
- 2) 3GPP TS 04.82 TBS,
3GPP TS 04.80 subclause 3.6.

31.2.1.7.1.2.2 Test purpose

- 1) To check that when an outgoing call is being established, if the ALERTING message is received with the facility information element containing an SS notification, the MS correctly reaches CC state U4. This is tested for CFU.
- 2) As an outgoing call is being established, if the ALERTING message is received with the facility information element containing an SS notification, the MS provides the appropriate user indication (which is to be described by the manufacturer). This is tested for CFU.
- 3) As an outgoing call is being established, if the CONNECT message is received with the facility information element containing an SS notification, the MS normally sends a CONNECT ACKNOWLEDGE message and enter CC state U10. This is tested for CFC.
- 4) As an outgoing call is being established, if the CONNECT message is received with the facility information element containing an SS notification (for CFU or CFC), the MS provides the appropriate user indication (which is to be described by the manufacturer). This is tested for CFC.

31.2.1.7.1.2.3 Method of test

Initial conditions

System Simulator:

1 cell, default parameters.

Mobile Station:

The MS is "idle updated".

Specific PICS Statements

-

PIXIT Statements

- Description of the user's commands and of display of the answers from the network for call forwarding.

Foreseen final state of the MS

The MS is "idle updated".

Test procedure

The MS is made to place an outgoing call.

After having received a SETUP message and sent a CALL PROCEEDING message and after a TCH has been allocated the system simulator transmits an ALERTING message with the facility information element containing a notification.

The system simulator send then a STATUS ENQUIRY message. On receipt of the STATUS ENQUIRY message the MS shall send a STATUS message with CC-state U4.

After that, the system simulator transmits a CONNECT with the facility information element containing a notification.

After reception of a CONNECT ACKNOWLEDGE message the system simulator sends a STATUS ENQUIRY message.

The MS shall respond with a STATUS message indicating CC-state U10.

The transaction and the channel are released by the SS.

Maximum duration of test

1 minute.

Expected sequence

Step	Direction	Message	Comments
1	MS -> SS	CHANNEL REQUEST	
2	SS -> MS	IMMEDIATE ASSIGNMENT	
3	MS -> SS	CM SERVICE REQUEST	"mobile originating call establishment"
4	SS -> MS	CM SERVICE ACCEPT	
5	MS -> SS	SETUP	
6	SS -> MS	CALL PROCEEDING	
7	SS -> MS	ASSIGNMENT COMMAND	
8	MS -> SS	ASSIGNMENT COMPLETE	
9	SS -> MS	ALERTING	containing facility IE
10	SS -> MS	STATUS ENQUIRY	
11	MS -> SS	STATUS	(U4)
12	SS -> MS	CONNECT	containing facility IE
13	MS -> SS	CONNECT ACKNOWLEDGE	
14	SS -> MS	STATUS ENQUIRY	
15	MS -> SS	STATUS	(U10)
16	SS -> MS	RELEASE COMPLETE	
17	SS -> MS	CHANNEL RELEASE	

Specific message contents

At step 9 -

Facility invoke = notification:

- SS-Code (CFU).
- SS-Status (indicating:
Provisioned, registered and active).

At step 12 -

Facility invoke = notification:

- SS-Code (CFC).
- SS-Status (indicating:
Provisioned, registered and active).

31.2.1.7.2 Forwarded-to mobile subscriber side

31.2.1.7.2.1 Conformance requirements

- 1) Upon receipt of the SETUP message containing a notification indication that the call is a forwarded one (with any SS code except CFC), the MS shall correctly continue call establishment and enter CC state U6.
- 2) Upon receipt of the SETUP message containing a notification indication that the call is a forwarded one, or after sending CALL CONFIRMED, or after sending ALERTING, the MS shall provide the appropriate user indication (which is to be described by the manufacturer).

References

- 1) 3GPP TS 04.82.
- 2) 3GPP TS 02.30 subclause 4.5.

31.2.1.7.2.2 Test purpose

- 1) To check that, upon receipt of the SETUP message containing a notification indication that the call is a forwarded one, the MS correctly continues call establishment and enters CC state U6.
- 2) To check that upon receipt of the SETUP message containing a notification indication that the call is a forwarded one, or after sending CALL CONFIRMED, or after sending ALERTING, the MS provides the appropriate user indication (which is to be described by the manufacturer).

31.2.1.7.2.3 Method of test

Initial conditions

System Simulator:

1 cell, default parameters.

Mobile Station:

The MS is "idle updated".

Specific PICS Statements

-

PIXIT Statements

- Description of the user's commands and of display of the answers from the network for call forwarding.

Foreseen final state of the MS

The MS is "idle updated".

Test procedure

An incoming call is given to the MS with the SETUP message with the facility information element containing an invoke of the NotifySS operation with the indication that the call is forwarded.

After the MS was brought to CC state U7, the SS sends a STATUS ENQUIRY message. The MS responds indicating CC state U7 (implying that it has travelled through CC state U6).

The transaction and the channel are released by the SS.

Maximum duration of test

1 minute.

Expected sequence

Step	Direction	Message	Comments
1	SS -> MS	PAGING	with establishment cause "answer to paging"
2	MS -> SS	CHANNEL REQUEST	
3	SS -> MS	IMMEDIATE ASSIGNMENT	
4	MS -> SS	PAGING RESPONSE	containing the notification that the call is a forwarded one
5	SS -> MS	SETUP	
6	MS -> SS	CALL CONFIRMED	
7	SS -> MS	ASSIGNMENT COMMAND	
8	MS -> SS	ASSIGNMENT COMPLETE	
9	MS -> SS	ALERTING	Ringling and user indication that the incoming call is forwarded
10	SS -> MS	STATUS ENQUIRY	(U7)
11	MS -> SS	STATUS	
12	SS -> MS	RELEASE COMPLETE	
13	SS -> MS	CHANNEL RELEASE	

Specific message contents

at step 5 -

- protocol discriminator: CC.
- transaction identifier.
- message type: SETUP.
- facility.

invoke = notification:

- SS-Code (CFU, CFB, CFNRy, CFNRc or CF).
- SS-Notification (indicating: call is forwarded i.e.:

Call is forwarded indication to C-subscriber.

31.2.2 Call transfer and mobile access hunting supplementary services

(Reserved).

31.3 Call completion supplementary services

NOTE: In this subclause, Subscriber B is the MS under test, and subscribers A, C and D are distant parties to the calls made during the tests.

31.3.1 Call Waiting

31.3.1.1 Waiting call indication and confirmation

Conformance requirement

3GPP TS 04.83 subclause 1.1.

Test purpose

With an active call, an MS receiving an MT call shall include Cause #17 "user busy" in the CALL CONFIRMED message sent to the SS, and indicate the waiting call to the subscriber.

Method of test

Specific PICS Statements

- Supported MT circuit switched basic services (TSPC_AddInfo_MTsvc)

PIXIT Statements

- Method of indicating a waiting call to the user.

Initial conditions

System Simulator:

1 cell, default parameters.

Mobile Station:

The MS has a call ("Call A-B") of a basic service supported by the MS and applicable to Call Waiting as described in 3GPP TS 02.04 table A.1 in the active state. The SIM in the MS under test has Call Waiting enabled.

Foreseen final state of the MS

Call A-B, state U10. Call C-B, state U7.

Maximum duration of test

30 s.

Procedure

The SS shall initiate Call C-B by sending a SETUP message to the MS. The MS shall respond with a CALL CONFIRMED message including cause #17 "user busy", followed by an ALERTING message.

The MS shall remain in state U10 in respect of the Call A-B, and enter state U7 "Call received" in respect of Call C-B. The MS shall indicate the existence of the waiting call to the user by a method defined by the manufacturer. The call states shall be verified by the SS sending a STATUS ENQUIRY message in respect of the transaction identifier of each call, and receiving a STATUS message indicating the appropriate call state.

Expected sequence

Step	Direction	Message	Comments
1	SS -> MS	SETUP	Transaction identifier different from that of Call A-B cause #17 "user busy".
2	MS -> SS	CALL CONFIRMED	
3	MS -> SS	ALERTING	
4	MS		A waiting call indication as defined in a PICS/PIXIT statement is given by the MS.
5	SS -> MS	STATUS ENQUIRY	Transaction identifier of Call A-B
6	MS -> SS	STATUS	Transaction identifier of Call A-B, state U10
7	SS -> MS	STATUS ENQUIRY	Transaction identifier of Call C-B
8	MS -> SS	STATUS	Transaction identifier of Call C-B, state U7

31.3.1.2 Normal operation with successful outcome

31.3.1.2.1 Waiting call accepted; existing call released

Conformance requirement

3GPP TS 04.83 subclause 1.2.1.

Test purpose

The MS shall release the active call using the call clearing procedures of 3GPP TS 04.08 / 3GPP TS 24.008, and then accept the waiting call.

Method of test

Specific PICS Statements

- Supported MT circuit switched basic services (TSPC_AddInfo_MTsvc)

PIXIT Statements

- Method of clearing an active call and answering a waiting call.

Initial conditions

System Simulator:

1 cell, default parameters.

Mobile Station:

The MS has Call A-B of a basic service supported by the MS and applicable to Call Waiting as described in 3GPP TS 02.04 table A.1 in the state U10 "Active" and Call C-B in the state U7 "Call Received".

Foreseen final state of the MS

Call A-B, state U0. Call C-B, state U10.

Maximum duration of test

30 s.

Procedure

Using suitable MMI commands, the MS shall clear Call A-B, and then answer Call C-B.

The MS shall send a DISCONNECT message with the transaction identifier Call A-B, and then respond to a RELEASE message from the SS with a RELEASE COMPLETE message, and then enter state U0 "Null" in respect of this call.

The MS shall then send a CONNECT in respect of Call C-B, and enter state U10 "Active" on receipt of a CONNECT ACKNOWLEDGE message. The call states shall be verified by the SS sending a STATUS ENQUIRY message in respect of the transaction identifier of each call, and receiving a RELEASE COMPLETE message with cause #81 "invalid transaction identifier value" for Call A-B and a STATUS message indicating the appropriate call state for Call C-B.

Expected sequence

Step	Direction	Message	Comments
1	MS		Call A-B is cleared using MMI commands
2	MS -> SS	DISCONNECT	Transaction identifier of Call A-B
3	SS -> MS	RELEASE	Transaction identifier of Call A-B
4	MS -> SS	RELEASE COMPLETE	Transaction identifier of Call A-B
5	MS		Call C-B is answered using MMI commands
6	MS -> SS	CONNECT	Transaction identifier of Call C-B
7	SS -> MS	CONNECT ACKNOWLEDGE	Transaction identifier of Call C-B
8	SS -> MS	STATUS ENQUIRY	Transaction identifier of Call A-B
9	MS -> SS	RELEASE COMPLETE	Transaction identifier of Call A-B, with cause #81 "invalid transaction identifier value"
10	SS -> MS	STATUS ENQUIRY	Transaction identifier of Call C-B
11	MS -> SS	STATUS	Transaction identifier of Call C-B, state U10

31.3.1.2.2 Waiting call accepted; existing call on hold

31.3.1.2.2.1 Waiting call accepted; existing call on hold, no additional calls

Conformance requirement

3GPP TS 04.83 subclause 1.2.2.

Test purpose

With one active call and one waiting call, the MS shall place the active call on hold, and then accept the waiting call.

Method of test

Specific PICS Statements

-

PIXIT Statements

- Method of placing an active call on hold and answering a waiting call.

Initial conditions

System Simulator:

1 cell, default parameters.

Mobile Station:

- The MS has Call A-B of a basic service supported by the MS and applicable to Call Waiting as described in 3GPP TS 02.04 table A.1 in the state U10 "Active" and Call C-B in the state U7 "Call Received".

Foreseen final state of the MS

Call A-B, state U10, auxiliary state "Call held". Call C-B, state U10.

Maximum duration of test

30 s.

Procedure

Using suitable MMI commands, the MS shall place Call A-B on hold, and then answer Call C-B.

The MS shall send a HOLD message to the SS using the transaction identifier of Call A-B and enter state U10 "Active" with auxiliary state "Call held". On receipt of a HOLD ACKNOWLEDGE from the SS the MS shall enter state U10 "Active" with auxiliary state "Call held".

The MS shall then send a CONNECT message to the SS, using the transaction identifier of Call C-B, and on receipt of a CONNECT ACKNOWLEDGE message, shall enter state U10 "Active". The call states shall be verified by the SS sending a STATUS ENQUIRY message in respect of the transaction identifier of each call, and receiving a STATUS message indicating the appropriate call state.

Expected sequence

Step	Direction	Message	Comments
1	MS		Call A-B is placed on hold using MMI commands
2	MS -> SS	HOLD	Transaction identifier of Call A-B
3	SS -> MS	HOLD ACKNOWLEDGE	Transaction identifier of Call A-B
4	MS		Call C-B is answered using MMI commands
5	MS -> SS	CONNECT	Transaction identifier of Call C-B
6	SS -> MS	CONNECT ACKNOWLEDGE	Transaction identifier of Call C-B
7	SS -> MS	STATUS ENQUIRY	Transaction identifier of Call A-B
8	MS -> SS	STATUS	Transaction identifier of Call A-B, state U10, auxiliary state "Call Held"
9	SS -> MS	STATUS ENQUIRY	Transaction identifier of Call C-B
10	MS -> SS	STATUS	Transaction identifier of Call C-B, state U10

31.3.1.2.3 Existing call released by user A; waiting call accepted

Conformance requirement

3GPP TS 04.83 subclause 1.2.3.

Test purpose

The MS, on receipt of a DISCONNECT message from the active call, shall complete the clearance of the active call, and accept the waiting call.

Method of test

Specific PICS Statements

- Supported MT circuit switched basic services (TSPC_AddInfo_MTsvc)

PIXIT Statements

- Method of clearing an active call and answering a waiting call.

Initial conditions

System Simulator:

- 1 cell, default parameters.

Mobile Station:

- The MS has Call A-B of a basic service supported by the MS and applicable to Call Waiting as described in 3GPP TS 02.04 table A.1 in the state U10 "Active" and Call C-B in the state U7 "Call Received".

Foreseen final state of the MS

Call A-B, state U0. Call C-B, state U10.

Maximum duration of test

30 s.

Procedure

On receipt of a DISCONNECT message using the transaction identifier of Call A-B, the MS shall respond with a RELEASE message. On receipt of a RELEASE COMPLETE message, the MS shall enter state U0 "Null". The call states shall be verified by the SS sending a STATUS ENQUIRY message in respect of the transaction identifier of each call, and receiving a STATUS message indicating the appropriate call state.

If necessary, MMI commands shall be entered to accept call C-B. The MS shall then send a CONNECT message using the transaction identifier of Call C-B, and on receipt of a CONNECT ACKNOWLEDGE message, shall enter state U10 "Active". The call states shall be verified by the SS sending a STATUS ENQUIRY message in respect of the transaction identifier of each call, and receiving a RELEASE COMPLETE message with cause #81 "invalid transaction identifier value" for Call A-B and a STATUS message indicating the appropriate call state for Call C-B.

Expected sequence

Step	Direction	Message	Comments
1	SS -> MS	DISCONNECT	Transaction identifier of Call A-B
2	MS -> SS	RELEASE	Transaction identifier of Call A-B
3	SS -> MS	RELEASE COMPLETE	Transaction identifier of Call A-B
4	MS		If necessary, call C-B is answered using MMI commands
5	MS -> SS	CONNECT	Transaction identifier of Call C-B
6	SS -> MS	CONNECT ACKNOWLEDGE	Transaction identifier of Call C-B
7	SS -> MS	STATUS ENQUIRY	Transaction identifier of Call A-B
8	MS -> SS	RELEASE COMPLETE	Transaction identifier of Call A-B, with cause #81 "invalid transaction identifier value"
9	SS -> MS	STATUS ENQUIRY	Transaction identifier of Call C-B
10	MS -> SS	STATUS	Transaction identifier of Call C-B, state U10

31.3.1.3 Normal operation with unsuccessful outcome

31.3.1.3.1 Waiting call released by subscriber B

Conformance requirement

3GPP TS 04.83 subclause 1.3.1.

Test purpose

To test that, using MMI commands, the MS shall clear the waiting call.

Method of test

Specific PICS Statements

- Supported MT circuit switched basic services (TSPC_AddInfo_MTsvc)

PIXIT Statements

- Method of clearing a waiting call.

Initial conditions

System Simulator:

1 cell, default parameters.

Mobile Station:

The MS has Call A-B of a basic service supported by the MS and applicable to Call Waiting as described in 3GPP TS 02.04 table A.1 in the state U10 "Active" and Call C-B in the state U7 "Call Received".

Foreseen final state of the MS

Call A-B, state U10. Call C-B, state U0.

Maximum duration of test

30 s.

Procedure

Using appropriate MMI commands, the MS shall clear Call C-B.

The MS shall send a DISCONNECT message with the transaction identifier of Call B, and on receipt of a RELEASE message from the network, shall send a RELEASE COMPLETE and enter state U0 "Null". The call states shall be verified by the SS sending a a RELEASE COMPLETE message with cause #81 "invalid transaction identifier value" for Call C-B and STATUS ENQUIRY message in respect of the transaction identifier of each call, and receiving a RELEASE COMPLETE message with cause #81 "invalid transaction identifier value" for Call C-B and a STATUS message indicating the appropriate call state for Call A-B.

Expected sequence

Step	Direction	Message	Comments
1	MS		Call C-B is cleared using MMI commands
2	MS -> SS	DISCONNECT	Transaction identifier of Call C-B
3	SS -> MS	RELEASE	Transaction identifier of Call C-B
4	MS -> SS	RELEASE COMPLETE	Transaction identifier of Call C-B
5	SS -> MS	STATUS ENQUIRY	Transaction identifier of Call A-B
6	MS -> SS	STATUS	Transaction identifier of Call A-B, state U10
7	SS -> MS	STATUS ENQUIRY	Transaction identifier of Call C-B
8	MS -> SS	RELEASE COMPLETE	Transaction identifier of Call C-B, with cause #81 "invalid transaction identifier value"

31.3.1.3.2 Waiting call released by calling user C

Conformance requirement

3GPP TS 04.83 subclause 1.3.2.

Test purpose

To test that the MS responds correctly to the receipt of a clearing message from the waiting call.

Method of test

Specific PICS Statements

- Supported MT circuit switched basic services (TSPC_AddInfo_MTsvc)

PIXIT Statements

-

Initial conditions

System Simulator:

1 cell, default parameters.

Mobile Station:

The MS has Call A-B of a basic service supported by the MS and applicable to Call Waiting as described in 3GPP TS 02.04 table A.1 in the state U10 "Active" and Call C-B in the state U7 "Call Received".

Foreseen final state of the MS

Call A-B, state U10. Call C-B, state U0.

Maximum duration of test

30 s.

Procedure

On receipt of a DISCONNECT message using the transaction identifier of Call C-B, the MS shall respond with a RELEASE message. On receipt of a RELEASE COMPLETE message, the MS shall enter state U0 "Null". Call A-B shall remain in state U10. The call states shall be verified by the SS sending a STATUS ENQUIRY message in respect of the transaction identifier of each call, and receiving a a RELEASE COMPLETE message with cause #81 "invalid transaction identifier value" for Call C-B and STATUS message indicating the appropriate call state for Call A-B.

Expected sequence

Step	Direction	Message	Comments
1	SS -> MS	DISCONNECT	Transaction identifier of Call C-B
2	MS -> SS	RELEASE	Transaction identifier of Call C-B
3	SS -> MS	RELEASE COMPLETE	Transaction identifier of Call C-B
4	SS -> MS	STATUS ENQUIRY	Transaction identifier of Call A-B
5	MS -> SS	STATUS	Transaction identifier of Call A-B, state U10
6	SS -> MS	STATUS ENQUIRY	Transaction identifier of Call C-B
7	MS -> SS	RELEASE COMPLETE	Transaction identifier of Call C-B, with cause #81 "invalid transaction identifier value"

31.3.1.4 Activation

Conformance requirement

3GPP TS 04.83 subclause 1.4.

Test purpose

To test the correct operation of the activation procedure, and correctly display of the response from the SS in the following cases.

- 1) Successful activation.
- 2) Error response (reject).
- 3) Activation reject (Invoke problem).

Initial conditions

System Simulator:

1 cell, default parameters.

Mobile Station:

The MS is "idle updated".

Specific PICS Statements

-

PIXIT Statements

- Description of the user's commands and of display of the answers from the network for activation of call waiting.

Foreseen final state of the MS

The MS is "idle updated".

Test procedure

By means of appropriate MMI functions (using either 3GPP TS 02.30 or manufacturer defined MMI), the user requests activation of CW for a basic service group supported by the MS.

Upon receipt of the operation (in a REGISTER message), the system simulator answers with the RELEASE COMPLETE message with the Facility information element containing the return result of the ActivateSS operation.

The SS transaction is released and the dedicated channel is released.

Then again, by means of appropriate MMI functions as defined by the basic public MMI described in 3GPP TS 02.30, the user requests activation of CW for all basic service groups.

Upon receipt of the REGISTER message, the system simulator answers with the RELEASE COMPLETE message with the Facility information element containing the return result of the ActivateSS operation.

The SS transaction is released and the dedicated channel is released.

By means of appropriate MMI functions (using either 3GPP TS 02.30 or manufacturer defined MMI), the user requests activation of CW for a basic service group supported by the MS.

Upon receipt of the operation (in a REGISTER message), the system simulator answers with the RELEASE COMPLETE message with the Facility information element containing a Return Error component with Error code:SS not available.

The SS transaction is released and the dedicated channel is released.

Then again, by means of appropriate MMI functions as defined by the basic public MMI described in 3GPP TS 02.30, the user requests activation of CW for all basic service groups.

Upon receipt of the operation (in a REGISTER message), the system simulator answers with the RELEASE COMPLETE message with the Facility information element containing a Return Error component with Error code:SS not available.

The SS transaction is released and the dedicated channel is released.

By means of appropriate MMI functions (using either 3GPP TS 02.30 or manufacturer defined MMI), the user requests activation of CW for a basic service group supported by the MS.

Upon receipt of the REGISTER message, the system simulator answers with the RELEASE COMPLETE message with the Facility information element containing a Reject component with Invoke problem (Resource limitation).

The SS transaction is released and the dedicated channel is released.

Then again, by means of appropriate MMI functions as defined by the basic public MMI described in 3GPP TS 02.30, the user requests activation of CW for all basic service groups.

Upon receipt of the REGISTER message, the system simulator answers with the RELEASE COMPLETE message with the Facility information element containing A Reject component with Invoke problem (Resource limitation).

Maximum duration of test

9 minutes

Expected sequence

Step	Direction	Message	Comments
1	MS		The MS is made to initiate a activation of call forwarding service for CW for the selected basic service group with establishment cause "Other procedures which can be completed with an SDCCH" cause: "supplementary service activation"
2	MS -> SS	CHANNEL REQUEST	
3	SS -> MS	IMMEDIATE ASSIGNMENT	
4	MS -> SS	CM SERVICE REQUEST	

Step	Direction	Message	Comments
5	SS -> MS	CM SERVICE ACCEPT	
6	MS -> SS	REGISTER	
7	SS -> MS	RELEASE COMPLETE	ActivateSS operation Return_result
8	MS		provide user MMI indication
9	SS -> MS	CHANNEL RELEASE	
10	MS		The MS is made to initiate a activation of CW (all basic service groups)
11	MS -> SS	CHANNEL REQUEST	with establishment cause "Other procedures which can be completed with an SDCCH"
12	SS -> MS	IMMEDIATE ASSIGNMENT	
13	MS -> SS	CM SERVICE REQUEST	cause: "supplementary service activation"
14	SS -> MS	CM SERVICE ACCEPT	
15	MS -> SS	REGISTER	
16	SS -> MS	RELEASE COMPLETE	ActivateSS operation Return result
17	MS		provide correct MMI user indication
18	SS -> MS	CHANNEL RELEASE	
19	MS		The MS is made to initiate a activation of call forwarding service for CW for the selected basic service group
20	MS -> SS	CHANNEL REQUEST	with establishment cause "Other procedures which can be completed with an SDCCH"
21	SS -> MS	IMMEDIATE ASSIGNMENT	
22	MS -> SS	CM SERVICE REQUEST	cause: "supplementary service activation"
23	SS -> MS	CM SERVICE ACCEPT	
24	MS -> SS	REGISTER	
25	SS -> MS	RELEASE COMPLETE	ActivateSS operation Return Error
26	MS		provide user MMI indication
27	SS -> MS	CHANNEL RELEASE	
28	MS		The MS is made to initiate a activation of CW (all basic service groups)
29	MS -> SS	CHANNEL REQUEST	with establishment cause "Other procedures which can be completed with an SDCCH"
30	SS -> MS	IMMEDIATE ASSIGNMENT	
31	MS -> SS	CM SERVICE REQUEST	cause: "supplementary service activation"
32	SS -> MS	CM SERVICE ACCEPT	
33	MS -> SS	REGISTER	
34	SS -> MS	RELEASE COMPLETE	ActivateSS operation Return Error
35	MS		provide correct MMI user indication
36	SS -> MS	CHANNEL RELEASE	
37	MS		The MS is made to initiate a activation of call forwarding service for CW for the selected basic service group
38	MS -> SS	CHANNEL REQUEST	with establishment cause "Other procedures which can be completed with an SDCCH"
39	SS -> MS	IMMEDIATE ASSIGNMENT	
40	MS -> SS	CM SERVICE REQUEST	cause: "supplementary service activation"
41	SS -> MS	CM SERVICE ACCEPT	
42	MS -> SS	REGISTER	
43	SS -> MS	RELEASE COMPLETE	ActivateSS operation Reject
44	MS		provide user MMI indication
45	SS -> MS	CHANNEL RELEASE	
46	MS		The MS is made to initiate a activation of CW (all basic service groups)
47	MS -> SS	CHANNEL REQUEST	with establishment cause "Other procedures which can be completed with an SDCCH"
48	SS -> MS	IMMEDIATE ASSIGNMENT	
49	MS -> SS	CM SERVICE REQUEST	cause: "supplementary service activation"
50	SS -> MS	CM SERVICE ACCEPT	
51	MS -> SS	REGISTER	
52	SS -> MS	RELEASE COMPLETE	ActivateSS operation Reject
53	MS		provide correct MMI user indication
54	SS -> MS	CHANNEL RELEASE	

Specific message contents:

step 6, 24, 42 - CW

- protocol discriminator: non call related SS message.
- message type: REGISTER.
- facility:

invoke = Activation:

Supplementary service code = CW.

Basic service code: the selected basic service group.

step 15, 33, 51 - CW

- protocol discriminator: non call related SS message.
- message type: REGISTER.
- facility:

invoke = Activation:

Supplementary service code = CW.

Basic service code: no bearer service present, no teleservice present.

31.3.1.5 Deactivation

Conformance requirement

3GPP TS 04.83 subclause 1.5.

Test purpose

To test the correct operation of the deactivation procedure, and correct display of the response from the SS in the following cases.

- 1) Successful deactivation.
- 2) Error response (reject).
- 3) Activation reject (Invoke problem).

Initial conditions

System Simulator:

1 cell, default parameters.

Mobile Station:

The MS is "idle updated".

Specific PICS Statements

-

PIXIT Statements

- Description of the user's commands and of display of the answers from the network for deactivation of call waiting.

Foreseen final state of the MS

The MS is "idle updated".

Test procedure

By means of appropriate MMI functions (using either 3GPP TS 02.30 or manufacturer defined MMI), the user requests deactivation of CW for a basic service group supported by the MS.

Upon receipt of the operation (in a REGISTER message), the system simulator answers with a RELEASE COMPLETE message with the Facility information element containing the return result of the DeactivateSS operation.

The SS transaction is released and the dedicated channel is released.

Then again, by means of appropriate MMI functions as defined by the basic public MMI described in 3GPP TS 02.30, the user requests deactivation of CW for all basic service groups.

Upon receipt of the REGISTER message, the system simulator answers with the RELEASE COMPLETE message with the Facility information element containing the return result of the DeactivateSS operation.

The SS transaction is released and the dedicated channel is released.

By means of appropriate MMI functions (using either 3GPP TS 02.30 or manufacturer defined MMI), the user requests deactivation of CW for a basic service group supported by the MS.

Upon receipt of the operation (in a REGISTER message), the system simulator answers with the RELEASE COMPLETE message with the Facility information element containing a Return Error component with Error code:SS not available.

The SS transaction is released and the dedicated channel is released.

Then again, by means of appropriate MMI functions as defined by the basic public MMI described in 3GPP TS 02.30, the user requests deactivation of CW for all basic service groups.

Upon receipt of the operation (in a REGISTER message), the system simulator answers with the RELEASE COMPLETE message with the Facility information element containing a Return Error component with Error code:SS not available.

The SS transaction is released and the dedicated channel is released.

By means of appropriate MMI functions (using either 3GPP TS 02.30 or manufacturer defined MMI), the user requests deactivation of CW for a basic service group supported by the MS.

Upon receipt of the REGISTER message, the system simulator answers with the RELEASE COMPLETE message with the Facility information element containing A Reject component with Invoke problem (Resource limitation).

The SS transaction is released and the dedicated channel is released.

Then again, by means of appropriate MMI functions as defined by the basic public MMI described in 3GPP TS 02.30, the user requests deactivation of CW for all basic service groups.

Upon receipt of the REGISTER message, the system simulator answers with the RELEASE COMPLETE message with the Facility information element containing A Reject component with Invoke problem (Resource limitation).

Maximum duration of test

9 minutes.

Expected sequence

Step	Direction	Message	Comments
1	MS		The MS is made to initiate a deactivation of CW for a basic service group supported by the MS
2	MS -> SS	CHANNEL REQUEST	with establishment cause "Other procedures which can be completed with an SDCCH"
3	SS -> MS	IMMEDIATE ASSIGNMENT	
4	MS -> SS	CM SERVICE REQUEST	cause: "supplementary service activation"

Step	Direction	Message	Comments
5	SS -> MS	CM SERVICE ACCEPT	
6	MS -> SS	REGISTER	
7	SS -> MS	RELEASE COMPLETE	DeactivateSS operation Return_result
8	MS		provide user MMI indication
9	SS -> MS	CHANNEL RELEASE	
10	MS		The MS is made to initiate a deactivation of CW (all basic services)
11	MS -> SS	CHANNEL REQUEST	with establishment cause "Other procedures which can be completed with an SDCCH"
12	SS -> MS	IMMEDIATE ASSIGNMENT	
13	MS -> SS	CM SERVICE REQUEST	cause: "supplementary service activation"
14	SS -> MS	CM SERVICE ACCEPT	
15	MS -> SS	REGISTER	
16	SS -> MS	RELEASE COMPLETE	DeactivateSS operation Return result
17	MS		provide correct MMI user indication
18	SS -> MS	CHANNEL RELEASE	
19	MS		The MS is made to initiate a deactivation of call forwarding service for CW for the selected basic service group
20	MS -> SS	CHANNEL REQUEST	with establishment cause "Other procedures which can be completed with an SDCCH"
21	SS -> MS	IMMEDIATE ASSIGNMENT	
22	MS -> SS	CM SERVICE REQUEST	cause: "supplementary service activation"
23	SS -> MS	CM SERVICE ACCEPT	
24	MS -> SS	REGISTER	
25	SS -> MS	RELEASE COMPLETE	DeactivateSS operation Return Error
26	MS		provide user MMI indication
27	SS -> MS	CHANNEL RELEASE	
28	MS		The MS is made to initiate a deactivation of CW (all basic service groups)
29	MS -> SS	CHANNEL REQUEST	with establishment cause "Other procedures which can be completed with an SDCCH"
30	SS -> MS	IMMEDIATE ASSIGNMENT	
31	MS -> SS	CM SERVICE REQUEST	cause: "supplementary service activation"
32	SS -> MS	CM SERVICE ACCEPT	
33	MS -> SS	REGISTER	
34	SS -> MS	RELEASE COMPLETE	DeactivateSS operation Return Error
35	MS		provide correct MMI user indication
36	SS -> MS	CHANNEL RELEASE	
37	MS		The MS is made to initiate a deactivation of call forwarding service for CW for the selected basic service group
38	MS -> SS	CHANNEL REQUEST	with establishment cause "Other procedures which can be completed with an SDCCH"
39	SS -> MS	IMMEDIATE ASSIGNMENT	
40	MS -> SS	CM SERVICE REQUEST	cause: "supplementary service activation"
41	SS -> MS	CM SERVICE ACCEPT	
42	MS -> SS	REGISTER	
43	SS -> MS	RELEASE COMPLETE	DeactivateSS operation Reject
44	MS		provide user MMI indication
45	SS -> MS	CHANNEL RELEASE	
46	MS		The MS is made to initiate a deactivation of CW (all basic service groups)
47	MS -> SS	CHANNEL REQUEST	with establishment cause "Other procedures which can be completed with an SDCCH"
48	SS -> MS	IMMEDIATE ASSIGNMENT	
49	MS -> SS	CM SERVICE REQUEST	cause: "supplementary service activation"
50	SS -> MS	CM SERVICE ACCEPT	
51	MS -> SS	REGISTER	
52	SS -> MS	RELEASE COMPLETE	DeactivateSS operation Reject
53	MS		provide correct MMI user indication
54	SS -> MS	CHANNEL RELEASE	

Specific message content

step 6, 24, 42 - CW

- protocol discriminator: non call related SS message.
- message type: REGISTER.
- facility:

invoke = Deactivation:

Supplementary service code = CW.

Basic service code: the selected basic service group.

step 15, 33, 51 - CW

- protocol discriminator: non call related SS message.
- message type: REGISTER.
- facility:

invoke = Deactivation:

Supplementary service code = CW.

Basic service code: no bearer service present

31.3.1.6 Interrogation

31.3.1.6.1 Interrogation accepted

Conformance requirement

3GPP TS 04.83 subclause 1.6.

Test purpose

To test the correct operation of the interrogation procedure, and correct display of the response from the SS in the case of successful interrogation.

Initial conditions

System Simulator:

1 cell, default parameters.

Mobile Station:

The MS is "idle updated".

Specific PICS Statements

-

PIXIT Statements

- Description of the user's commands and of display of the answers from the network for interrogation of call waiting.

Foreseen final state of the MS

The MS is "idle updated".

Test procedure

By means of appropriate MMI functions (using either 3GPP TS 02.30 or manufacturer defined MMI), the user requests interrogation of CW for all basic service groups.

Upon receipt of the operation (in a REGISTER message), the system simulator answers with a RELEASE COMPLETE message with the Facility information element containing the return result of the InterrogateSS (BasicServiceCode(s)) operation.

The SS transaction is released and the dedicated channel is released.

Then again, by means of appropriate MMI functions as defined by the basic public MMI described in 3GPP TS 02.30, the user requests interrogation of CW for all basic service groups.

Upon receipt of the REGISTER message, the system simulator answers with the RELEASE COMPLETE message with the Facility information element containing the return result of the InterrogateSS (SS-Status) operation.

The dedicated channel is released.

Maximum duration of test

3 minutes.

Expected sequence

Step	Direction	Message	Comments
1	MS		The MS is made to initiate an interrogation of CW (all) with establishment cause "Other procedures which can be completed with an SDCCH"
2	MS -> SS	CHANNEL REQUEST	
3	SS -> MS	IMMEDIATE ASSIGNMENT	
4	MS -> SS	CM SERVICE REQUEST	
5	SS -> MS	CM SERVICE ACCEPT	
6	MS -> SS	REGISTER	
7	SS -> MS	RELEASE COMPLETE	InterrogateSS (BasicServiceCode(s)) operation Return_result provide user MMI indication
8	MS		
9	SS -> MS	CHANNEL RELEASE	
10	MS		The MS is made to initiate an interrogation of CW (all) with establishment cause "Other procedures which can be completed with an SDCCH"
11	MS -> SS	CHANNEL REQUEST	
12	SS -> MS	IMMEDIATE ASSIGNMENT	
13	MS -> SS	CM SERVICE REQUEST	
14	SS -> MS	CM SERVICE ACCEPT	
15	MS -> SS	REGISTER	
16	SS -> MS	RELEASE COMPLETE	InterrogateSS (SS-Status) operation Return result provide correct MMI user indication
17	MS		
18	SS -> MS	CHANNEL RELEASE	

Specific message content

step 6, 15 - CW

- protocol discriminator: non call related SS message.
- message type: REGISTER.
- facility:

invoke = Interrogation:

Supplementary service code = CW.

Basic service code: no Bearer Service present, no teleservice present.

31.3.1.6.2 Interrogation rejected

Conformance requirement

3GPP TS 04.83 subclause 1.6.

Test purpose

To test the correct operation of the interrogation procedure, and correct display of the response from the SS in the case of an error response and an invoke problem

Initial conditions

System Simulator:

1 cell, default parameters.

Mobile Station:

The MS is in CC state U10.

Specific PICS Statements

-

PIXIT Statements

- Description of the user's commands and of display of the answers from the network for call waiting.

Foreseen final state of the MS

The MS is in CC state U10.

Test procedure

By means of appropriate MMI functions (using either 3GPP TS 02.30 or manufacturer defined MMI), the user requests interrogation of CW for all basic service groups.

Upon receipt of the operation (in a REGISTER message), the system simulator answers with a RELEASE COMPLETE message with the Facility information element containing a Return_error(error: SS not available) of the InterrogateSS operation.

The system simulator sends STATUS ENQUIRY, the MS responds with STATUS message indicating CC state U10.

Then again, by means of appropriate MMI functions as defined by the basic public MMI described in 3GPP TS 02.30, the user requests interrogation of CW for all basic service groups.

Upon receipt of the REGISTER message, the system simulator answers with the RELEASE COMPLETE message (same PD and TI that in the REGISTER message) with the Facility information element containing a reject(invoke_problem: resource limitation) of the InterrogateSS operation.

The system simulator sends STATUS ENQUIRY, the MS responds with STATUS message indicating CC state U10.

Maximum duration of test

3 minutes.

Expected sequence

Step	Direction	Message	Comments
1	MS		The MS is made to initiate an interrogation of CW (all) cause: "supplementary service activation"
2	MS -> SS	CM SERVICE REQUEST	
3	SS -> MS	CM SERVICE ACCEPT	
4	MS -> SS	REGISTER	
5	SS -> MS	RELEASE COMPLETE	InterrogateSS operation Return_error
6	SS -> MS	STATUS ENQUIRY	
7	MS -> SS	STATUS	CC state U10
8	MS		
9	MS -> SS	CM SERVICE REQUEST	The MS is made to initiate an interrogation of CW for (all) cause: "supplementary service activation"
10	SS -> MS	CM SERVICE ACCEPT	
11	MS -> SS	REGISTER	
12	SS -> MS	RELEASE COMPLETE	InterrogateSS operation Reject provide correct MMI user indication
13	MS		
14	SS -> MS	STATUS ENQUIRY	CC state U10
15	MS -> SS	STATUS	

Specific message content

step 4, 11 - CW

- protocol discriminator: non call related SS message.
- message type: REGISTER.
- facility:

invoke = Interrogation:

Supplementary service code = CW.

Basic service code: no Bearer Service present, no teleservice present.

step 5 -

- protocol discriminator: non call related SS message.
- transaction identifier: same TI as previous REGISTER message.
- message type: RELEASE COMPLETE.
- facility:

return error code: SS not available.

For the return error the invoke ID must be the same as in the invoke of the InterrogateSS operation.

step 12 -

- protocol discriminator: non call related SS message.
- transaction identifier: same TI as previous REGISTER message.
- message type: RELEASE COMPLETE.
- facility:

reject code: resource limitation.

For the reject the invoke ID must be the same as in the invoke of the InterrogateSS operation.

31.3.2 Call Hold

31.3.2.1 Hold invocation

Conformance requirement

3GPP TS 04.83 subclause 2.1.2.

Test purpose

To test the correct operation of the Hold procedure, and the MS reaction to the following messages sent in response to the HOLD message.

1. HOLD REJECT.
2. HOLD ACKNOWLEDGE.

Method of test

Specific PICS Statements

-

PIXIT Statements

- Method of placing a call on hold.

Initial conditions

System Simulator:

- 1 cell, default parameters.

Mobile Station:

The MS shall have a call of a basic service supported by the MS and applicable to Call Hold as described in 3GPP TS 02.04 table A.1 in state U10 "Active"

Foreseen final state of the MS

State U10, Auxiliary state "Call Held".

Maximum duration of test

30 s.

Procedure

Using suitable MMI commands, the MS shall request that the call is placed on hold. The MS shall send a HOLD message and enter auxiliary state "hold request". On receipt of a HOLD REJECT message from the SS shall return to state U10 "Active". The call state shall be verified by the SS sending a STATUS ENQUIRY message in respect of the transaction identifier of the call, and receiving a STATUS message indicating the appropriate call state and auxiliary state.

Using suitable MMI commands, the MS shall again request that the call is placed on hold. The MS shall send a HOLD message and enter auxiliary state "hold request". On receipt of a HOLD ACKNOWLEDGE message from the SS shall enter to state U10 "Active " with auxiliary state "Call held". The call state shall be verified by the SS sending a STATUS ENQUIRY message in respect of the transaction identifier of call, and receiving a STATUS message indicating the appropriate call state and auxiliary state.

Expected sequence

Step	Direction	Message	Comments
1	MS		Using MMI commands, the MS places the call on hold
2	MS -> SS	HOLD	
3	SS -> MS	STATUS ENQUIRY	
4	MS -> SS	STATUS	State U10, auxiliary state "Hold request"
5	SS -> MS	HOLD REJECT	
6	SS -> MS	STATUS ENQUIRY	
7	MS -> SS	STATUS	State U10, no auxiliary state
8	SS		Check that the TCH is through-connected
9	MS		Using MMI commands, the MS places the call on hold
10	MS -> SS	HOLD	
11	SS -> MS	STATUS ENQUIRY	
12	MS -> SS	STATUS	State U10, auxiliary state "Hold request"
13	SS -> MS	HOLD ACKNOWLEDGE	
14	SS -> MS	STATUS ENQUIRY	
15	MS -> SS	STATUS	State U10, auxiliary state "Call held"

31.3.2.2 Retrieve procedure

Conformance requirement

3GPP TS 04.83 subclause 2.1.3.

Applicability

MS supporting the Call Hold supplementary service.

Test purpose

To test the correct operation of the retrieve procedure, and the MS reaction to the following messages sent in response to the RETRIEVE message.

- 1) RETRIEVE REJECT.
- 2) RETRIEVE ACKNOWLEDGE.

Initial conditions

The MS shall have a call of a basic service supported by the MS and applicable to Call Hold as described in 3GPP TS 02.04 table A.1 in state U10 "Active" with auxiliary state "Call held".

Method of test

Specific PICS Statements

-

PIXIT Statements

- Method of retrieving a held call.

Initial conditions

System Simulator:

- 1 cell, default parameters.

Mobile Station:

- The MS shall have a call of a basic service supported by the MS and applicable to Call Hold as described in 3GPP TS 02.04 table A.1 in state U10 "Active" with auxiliary state "Call held".

Foreseen final state of the MS

State U10, no auxiliary state.

Maximum duration of test

30 s.

Procedure

Using suitable MMI commands, the MS shall request that the call is placed on RETRIEVE. The MS shall send a RETRIEVE message and enter auxiliary state "retrieve request". On receipt of a RETRIEVE REJECT message from the SS, the MS shall return to state U10 "Active" with auxiliary state "Call held". The call state shall be verified by the SS sending a STATUS ENQUIRY message in respect of the transaction identifier of call, and receiving a STATUS message indicating the appropriate call state and auxiliary state.

Using suitable MMI commands, the MS shall again request that the call is placed on RETRIEVE. The MS shall send a RETRIEVE message and enter auxiliary state "retrieve request". On receipt of a RETRIEVE ACKNOWLEDGE message from the SS, the MS shall enter state U10 "Active". The call state shall be verified by the SS sending a STATUS ENQUIRY message in respect of the transaction identifier of call, and receiving a STATUS message indicating the appropriate call state and auxiliary state.

Expected sequence

Step	Direction	Message	Comments
1	MS		Using MMI commands, the MS retrieves the held call
2	MS -> SS	RETRIEVE	
3	SS -> MS	STATUS ENQUIRY	
4	MS -> SS	STATUS	State U10, auxiliary state "Retrieve request"
5	SS -> MS	RETRIEVE REJECT	
6	SS -> MS	STATUS ENQUIRY	
7	MS -> SS	STATUS	State U10, auxiliary state "Call held"
8	MS		Using MMI commands, the MS retrieves the held call
9	MS -> SS	RETRIEVE	
10	SS -> MS	STATUS ENQUIRY	
11	MS -> SS	STATUS	State U10, auxiliary state "Retrieve request"
12	SS -> MS	RETRIEVE ACKNOWLEDGE	
13	SS -> MS	STATUS ENQUIRY	
14	MS -> SS	STATUS	State U10, no auxiliary state
15	SS		Check that the TCH is through-connected

31.3.2.3 Alternate from one call to the other

Conformance requirement

3GPP TS 04.83 subclause 2.1.4.

Test purpose

To test that the MS correctly alternates between one call and the other, by placing the active call on hold, and retrieving the previously held call.

To test that the MS correctly returns to the original call states in the event of receipt of a HOLD REJECT or RETRIEVE REJECT.

Method of test

Specific PICS Statements

-

PIXIT Statements

- Method of alternating between an active call and a held call.

Initial conditions

System Simulator:

- 1 cell, default parameters.

Mobile Station:

The MS shall have Call A-B in state U10 "Active", and Call C-B in state U10 "Active" with auxiliary state "Call held". Both calls shall be of a basic service supported by the MS and applicable to Call Hold as described in 3GPP TS 02.04 table A.1.

Foreseen final state of the MS

Call A-B: State U10, Auxiliary State "Call Held".

Call C-B: State U10, No Auxiliary State.

Maximum duration of test

30 s.

Procedure

Using suitable MMI commands, the MS shall alternate between Call A-B and Call C-B. The MS shall send a HOLD message with the transaction identifier for Call A-B and enter auxiliary state "hold request", and send a RETRIEVE message with the transaction identifier for Call C-B and enter auxiliary state "retrieve request". On receipt of a HOLD ACKNOWLEDGE and RETRIEVE ACKNOWLEDGE message, the MS shall have Call A-B in state U10 "Active" with auxiliary state "Call held", and Call C-B in state U10 "Active". The call states shall be verified by the SS sending a STATUS ENQUIRY message in respect of the transaction identifier of each call, and receiving a STATUS message indicating the appropriate call state and auxiliary state.

Using suitable MMI commands, the MS shall alternate between Call A-B and Call C-B. The MS shall send a HOLD message with the transaction identifier for Call C-B and enter auxiliary state "hold request", and send a RETRIEVE message with the transaction identifier for Call A-B and enter auxiliary state "retrieve request". On receipt of a HOLD REJECT and RETRIEVE REJECT message, the MS shall have Call A-B remain in state U10 "Active" with auxiliary state "Call held", and Call C-B in state U10 "Active". The call states shall be verified by the SS sending a STATUS ENQUIRY message in respect of the transaction identifier of each call, and receiving a STATUS message indicating the appropriate call state and auxiliary state.

Expected sequence

Step	Direction	Message	Comments
1	MS		Using MMI commands, the MS changes from call A-B to call C-B
2	MS -> SS	HOLD	Transaction identifier for call A-B
3	MS -> SS	RETRIEVE	Transaction identifier for call C-B
4	SS -> MS	STATUS ENQUIRY	Transaction identifier for call A-B
5	MS -> SS	STATUS	Transaction identifier for call A-B, State U10, auxiliary state "Hold request"
6	SS -> MS	STATUS ENQUIRY	Transaction identifier for call C-B
7	MS -> SS	STATUS	Transaction identifier for call C-B, State U10, auxiliary state "Retrieve request"
8	SS -> MS	HOLD ACKNOWLEDGE	Transaction identifier for call A-B
9	SS -> MS	RETRIEVE ACKNOWLEDGE	Transaction identifier for call C-B
10	SS -> MS	STATUS ENQUIRY	Transaction identifier for call A-B
11	MS -> SS	STATUS	Transaction identifier for call A-B, state U10, auxiliary state "Call Held"
12	SS -> MS	STATUS ENQUIRY	Transaction identifier for call C-B
13	MS -> SS	STATUS	Transaction identifier for call C-B, state U10, no auxiliary state
14	SS		Check that the TCH is through-connected
15	MS		Using MMI commands, the MS changes from call C-B to call A-B
16	MS -> SS	HOLD	Transaction identifier for call C-B
17	MS -> SS	RETRIEVE	Transaction identifier for call A-B
18	SS -> MS	STATUS ENQUIRY	Transaction identifier for call C-B
19	MS -> SS	STATUS	Transaction identifier for call C-B, State U10, auxiliary state "Hold request"
20	SS -> MS	STATUS ENQUIRY	Transaction identifier for call A-B
21	MS -> SS	STATUS	Transaction identifier for call A-B, State U10, auxiliary state "Retrieve request"
22	SS -> MS	HOLD REJECT	Transaction identifier for call C-B
23	SS -> MS	RETRIEVE REJECT	Transaction identifier for call A-B
24	SS -> MS	STATUS ENQUIRY	Transaction identifier for call C-B
25	MS -> SS	STATUS	Transaction identifier for call C-B, state U10, no auxiliary state
26	SS -> MS	STATUS ENQUIRY	Transaction identifier for call A-B
27	MS -> SS	STATUS	Transaction identifier for call A-B, state U10, auxiliary state "Call Held"
28	SS		Check that the TCH is through-connected

31.4 Multi-party supplementary services

NOTE: In this subclause, subscriber A is the MS under test, and subscribers B to G are distant parties in the calls used in the tests.

31.4.1 Beginning the MultiParty service

31.4.1.1 Beginning the MultiParty service, successful case

Conformance requirement

3GPP TS 04.84 subclause 1.1.

Test purpose

To test that the MS correctly starts the MultiParty service when it has an active call and a held call, and reacts correctly to a response from the SS indicating success.

Method of test

Specific PICS Statements

-

PIXIT Statements

- Method of joining two calls into a MultiParty call.

Initial conditions

System Simulator:

1 cell, default parameters.

Mobile Station:

The MS shall have Call A-B in state U10 "Active" and Call A-C in state U10 "Active" with Auxiliary state "Call held". Both calls shall be of a basic service supported by the MS and relevant to the MultiParty supplementary service as stated in 3GPP TS 02.04 table A.1.

Foreseen final state of the MS

Call A-B, state U10, auxiliary state "Call in MPTY". Call A-C, state U10, auxiliary state "Call in MPTY".

Maximum duration of test

30 s.

Procedure

Using suitable MMI commands, the MS shall join the two calls in a MultiParty call. The MS shall send a FACILITY message containing an invoke component set to BuildMPTY, and with the transaction identifier for either Call A-B or Call A-C. Both calls shall enter auxiliary state "MPTY request". The call states shall be verified by the SS sending a STATUS ENQUIRY message in respect of the transaction identifier of each call, and receiving a STATUS message indicating the appropriate call state.

On receipt of a FACILITY message including a Return Result component, the MS shall enter the state U10 "Active" with auxiliary state "Call in MPTY". The call states shall be verified by the SS sending a STATUS ENQUIRY message in respect of the transaction identifier of each call, and receiving a STATUS message indicating the appropriate call state.

Expected sequence

Step	Direction	Message	Comments
1	MS		Using MMI commands, join the two calls
2	MS -> SS	FACILITY	TI for Call A-B or Call A-C, BuildMPTY Invoke component
3	SS -> MS	STATUS ENQUIRY	Transaction identifier of Call A-B
4	MS -> SS	STATUS	Transaction identifier of Call A-B, state U10, auxiliary state "MPTY request"
5	SS -> MS	STATUS ENQUIRY	Transaction identifier of Call A-C
6	MS -> SS	STATUS	Transaction identifier of Call A-C, state U10, auxiliary state "MPTY request, call held"
7	SS -> MS	FACILITY	Same TI as step 2, Return Result component
8	SS -> MS	STATUS ENQUIRY	Transaction identifier of Call A-B
9	MS -> SS	STATUS	Transaction identifier of Call A-B, state U10, auxiliary state "Call in MPTY"
10	SS -> MS	STATUS ENQUIRY	Transaction identifier of Call A-C
11	MS -> SS	STATUS	Transaction identifier of Call A-C, state U10, auxiliary state "Call in MPTY"
12	SS		Check that the TCH is through-connected

31.4.1.2 Beginning the MultiParty service, unsuccessful case

Conformance requirement

3GPP TS 04.84 subclause 1.1.

Test purpose

To test that the MS correctly starts the MultiParty service when it has an active call and a held call, and reacts correctly to the following responses from the SS.

- 1) Return error.
- 2) Reject.

Method of test

Specific PICS Statements

-

PIXIT Statements

- Method of joining two calls into a MultiParty call.

Initial conditions

System Simulator:

- 1 cell, default parameters.

Mobile Station:

- The MS shall have Call A-B in state U10 "Active" and Call A-C in state U10 "Active" with Auxiliary state "Call held". Both calls shall be of a basic service supported by the MS and relevant to the MultiParty supplementary service as stated in 3GPP TS 02.04 table A.1.

Foreseen final state of the MS

Call A-B, state U10, no auxiliary state. Call A-C, state U10, auxiliary state "Call Held".

Maximum duration of test

45 s.

Procedure

Using suitable MMI commands, the MS shall initiate a MultiParty call. The MS shall send a FACILITY message containing an invoke component set to BuildMPTY, and with the transaction identifier for either Call A-B or Call A-C. Both calls shall enter auxiliary state "MPTY request". The call states shall be verified by the SS sending a STATUS ENQUIRY message in respect of the transaction identifier of each call, and receiving a STATUS message indicating the appropriate call state.

On receipt of a FACILITY message including a Return Error component, the MS shall return both calls to their original call states. The call states shall be verified by the SS sending a STATUS ENQUIRY message in respect of the transaction identifier of each call, and receiving a STATUS message indicating the appropriate call state.

Using suitable MMI commands, the MS shall initiate a MultiParty call. The MS shall send a FACILITY message containing an invoke component set to BuildMPTY, and with the transaction identifier for boeither Call A-B or Call A-C. Both calls shall enter auxiliary state "MPTY request". The call states shall be verified by the SS sending a STATUS ENQUIRY message in respect of the transaction identifier of each call, and receiving a STATUS message indicating the appropriate call state.

On receipt of a FACILITY message including a Reject component, the MS shall return both calls to their original call states. The call states shall be verified by the SS sending a STATUS ENQUIRY message in respect of the transaction identifier of each call, and receiving a STATUS message indicating the appropriate call state.

Expected sequence

Step	Direction	Message	Comments
1	MS		Using MMI commands, set up a MultiParty call
2	MS -> SS	FACILITY	TI for Call A-B or Call A-C, BuildMPTY Invoke component
3	SS -> MS	STATUS ENQUIRY	Transaction identifier of Call A-B
4	MS -> SS	STATUS	Transaction identifier of Call A-B, state U10, auxiliary state "MPTY request"
5	SS -> MS	STATUS ENQUIRY	Transaction identifier of Call A-C
6	MS -> SS	STATUS	Transaction identifier of Call A-C, state U10, auxiliary state "MPTY request, call held"
7	SS -> MS	FACILITY	Same TI as step 2, Return Error component
8	SS -> MS	STATUS ENQUIRY	Transaction identifier of Call A-B
9	MS -> SS	STATUS	Transaction identifier of Call A-B, state U10, no auxiliary state
10	SS -> MS	STATUS ENQUIRY	Transaction identifier of Call A-C
11	MS -> SS	STATUS	Transaction identifier of Call A-C, state U10, auxiliary state "Call Held"
12	MS		Using MMI commands, set up a MultiParty call
13	MS -> SS	FACILITY	TI for Call A-B or Call A-C, BuildMPTY Invoke component
14	SS -> MS	STATUS ENQUIRY	Transaction identifier of Call A-B
15	MS -> SS	STATUS	Transaction identifier of Call A-B, state U10, auxiliary state "MPTY request"
16	SS -> MS	STATUS ENQUIRY	Transaction identifier of Call A-C
17	MS -> SS	STATUS	Transaction identifier of Call A-C, state U10, auxiliary state "MPTY request, call held"
18	SS -> MS	FACILITY	Same TI as step 13, Reject component
19	SS -> MS	STATUS ENQUIRY	Transaction identifier of Call A-B
20	MS -> SS	STATUS	Transaction identifier of Call A-B, state U10, no auxiliary state
21	SS -> MS	STATUS ENQUIRY	Transaction identifier of Call A-C
22	MS -> SS	STATUS	Transaction identifier of Call A-C, state U10, auxiliary state "Call Held"

31.4.1.3 Beginning the MultiParty service, expiry of timer T(BuildMPTY)

Conformance requirement

3GPP TS 04.84 subclause 1.1.

Test purpose

To test that the MS correctly starts the MultiParty service when it has an active call and a held call, and on expiry of timer T(BuildMPTY) returns both calls to their original states.

Method of test

Specific PICS Statements

-

PIXIT Statements

- Method of joining two calls into a MultiParty call.

Initial conditions

System Simulator:

- 1 cell, default parameters.

Mobile Station:

The MS shall have Call A-B in state U10 "Active" and Call A-C in state U10 "Active" with Auxiliary state "Call held". Both calls shall be of a basic service supported by the MS and relevant to the MultiParty supplementary service as stated in 3GPP TS 02.04 table A.1.

Foreseen final state of the MS

Branch A - Call A-B, state U10, no auxiliary state. Call A-C, state U10, auxiliary state "Call Held".

Branch B - Call A-B, state U10, auxiliary state "MPTY Request". Call A-C, state U10, auxiliary state "MPTY Request".

Maximum duration of test

45 s.

Procedure

Using suitable MMI commands, the MS shall initiate a MultiParty call. The MS shall send a FACILITY message containing an invoke component set to BuildMPTY, and with the transaction identifier for either Call A-B or Call A-C. Both calls shall enter auxiliary state "MPTY request". The call states shall be verified by the SS sending a STATUS ENQUIRY message in respect of the transaction identifier of each call, and receiving a STATUS message indicating the appropriate call state.

Not less than 5s and not more than 30s after sending the FACILITY message, one of the following shall have occurred:

- both calls shall be in their original call states and the MS shall have indicated the failure to the user; or
- the MS shall have sent another FACILITY message with the same contents.

The call states shall be verified by the SS sending a STATUS ENQUIRY message in respect of the transaction identifier of each call, and receiving a STATUS message indicating the appropriate call state.

Expected sequence

Step	Direction	Message	Comments
1	MS		Using MMI commands, set up a MultiParty call
2	MS -> SS	FACILITY	TI for Call A-B or Call A-C, BuildMPTY Invoke component
3	SS -> MS	STATUS ENQUIRY	Transaction identifier of Call A-B
4	MS -> SS	STATUS	Transaction identifier of Call A-B, state U10, auxiliary state "MPTY request"
5	SS -> MS	STATUS ENQUIRY	Transaction identifier of Call A-C
6	MS -> SS	STATUS	Transaction identifier of Call A-C, state U10, auxiliary state "MPTY request, call held"
7	SS		Wait 30 s from receiving FACILITY message
A8	SS -> MS	STATUS ENQUIRY	Take this branch if no message is received within 30 s
A9	MS -> SS	STATUS	Transaction identifier of Call A-B
A10	SS -> MS	STATUS ENQUIRY	Transaction identifier of Call A-C
A11	MS -> SS	STATUS	Transaction identifier of Call A-C, state U10, auxiliary state "Call Held"
B8	MS -> SS	FACILITY	Take this branch if a message is received within 30 s
B9	SS -> MS	STATUS ENQUIRY	Same as Step 2. Message shall not be received less than 5 s after the first FACILITY message
B10	MS -> SS	STATUS	Transaction identifier of Call A-B
B11	SS -> MS	STATUS ENQUIRY	Transaction identifier of Call A-C
B12	MS -> SS	STATUS	Transaction identifier of Call A-C, state U10, auxiliary state "MPTY request, call held"

31.4.2 Managing an active MultiParty call

31.4.2.1 Served mobile subscriber

31.4.2.1.1 Put the MultiParty call on hold

31.4.2.1.1.1 Put the MultiParty call on hold, successful case

Conformance requirement

3GPP TS 04.84 subclause 1.2.1.1.

Test purpose

To test that the MS correctly places an active MultiParty call on hold, and reacts correctly to a response from the SS indicating success.

Method of test

Specific PICS Statements

-

PIXIT Statements

- Method of placing a MultiParty call on hold.

Initial conditions

System Simulator:

1 cell, default parameters.

Mobile Station:

The MS shall have a MultiParty call to two destinations (Call A-B and Call A-C) active. Both call states shall be U10 "Active" with auxiliary state "Call in MPTY". The call shall be of a basic service supported by the MS and relevant to the MultiParty supplementary service as stated in 3GPP TS 02.04 table A.1.

NOTE: The MultiParty call may be set up using the procedures of subclause 31.4.1.1.

Foreseen final state of the MS

Call A-B, state U10, auxiliary state "Call in MPTY, call held". Call A-C, state U10, auxiliary state "Call in MPTY, call held".

Maximum duration of test

30 s.

Procedure

Using suitable MMI commands, the MS shall place the MultiParty call on hold. The MS shall send a FACILITY message containing one of the transaction identifiers of the call, and containing an invoke component HoldMPTY. Both calls shall enter the auxiliary state "Call in MPTY, hold request". The call states shall be verified by the SS sending a STATUS ENQUIRY message in respect of the transaction identifier of each call, and receiving a STATUS message indicating the appropriate call state.

On receipt of a FACILITY message with the same transaction identifier and containing a return result component, the MS shall enter the state U10 "Active" with auxiliary state "Call in MPTY, call held" for both transaction identifiers. The call states shall be verified by the SS sending a STATUS ENQUIRY message in respect of the transaction identifier of each call, and receiving a STATUS message indicating the appropriate call state.

Expected sequence

Step	Direction	Message	Comments
1	MS		Using MMI commands, put the MultiParty call on hold
2	MS -> SS	FACILITY	TI for Call A-B or Call A-C, HoldMPTY Invoke component
3	SS -> MS	STATUS ENQUIRY	Transaction identifier of Call A-B
4	MS -> SS	STATUS	Transaction identifier of Call A-B, state U10, auxiliary state "Call in MPTY, hold request"
5	SS -> MS	STATUS ENQUIRY	Transaction identifier of Call A-C
6	MS -> SS	STATUS	Transaction identifier of Call A-C, state U10, auxiliary state "Call in MPTY, hold request"
7	SS -> MS	FACILITY	Same TI as step 2, Return Result component
8	SS -> MS	STATUS ENQUIRY	Transaction identifier of Call A-B
9	MS -> SS	STATUS	Transaction identifier of Call A-B, state U10, auxiliary state "Call in MPTY, call held"
10	SS -> MS	STATUS ENQUIRY	Transaction identifier of Call A-C
11	MS -> SS	STATUS	Transaction identifier of Call A-C, state U10, auxiliary state "Call in MPTY, call held"

31.4.2.1.1.2 Put the MultiParty call on hold, unsuccessful case

Conformance requirement

3GPP TS 04.84 subclause 1.2.1.1.

Test purpose

To test that the MS correctly places an active MultiParty call on hold, and reacts correctly to a response from the SS indicating an error or a reject condition.

Method of test

Specific PICS Statements

-

PIXIT Statements

- Method of placing a MultiParty call on hold.

Initial conditions

System Simulator:

1 cell, default parameters.

Mobile Station:

The MS shall have a MultiParty call to two destinations (Call A-B and Call A-C) active. Both call states shall be U10 "Active" with auxiliary state "Call in MPTY". The call shall be of a basic service supported by the MS and relevant to the MultiParty supplementary service as stated in 3GPP TS 02.04 table A.1.

NOTE: The MultiParty call may be set up using the procedures of subclause 31.4.1.1.

Foreseen final state of the MS

Call A-B, state U10, auxiliary state "Call in MPTY". Call A-C, state U10, auxiliary state "Call in MPTY".

Maximum duration of test

45 s.

Procedure

Using suitable MMI commands, the MS shall place the MultiParty call on hold. The MS shall send a FACILITY message containing one of the transaction identifiers of the call, and containing an invoke component HoldMPTY. Both calls shall enter the auxiliary state "Call in MPTY, hold request". The call states shall be verified by the SS sending a

STATUS ENQUIRY message in respect of the transaction identifier of each call, and receiving a STATUS message indicating the appropriate call state.

On receipt of a FACILITY message with the same transaction identifier and containing a return error component, the MS shall return to the original states for both transaction identifiers. The call states shall be verified by the SS sending a STATUS ENQUIRY message in respect of the transaction identifier of each call, and receiving a STATUS message indicating the appropriate call state.

Using suitable MMI commands, the MS shall place the MultiParty call on hold. The MS shall send a FACILITY message containing one of the transaction identifiers of the call, and containing an invoke component HoldMPTY. Both calls shall enter the auxiliary state "Call in MPTY, hold request". The call states shall be verified by the SS sending a STATUS ENQUIRY message in respect of the transaction identifier of each call, and receiving a STATUS message indicating the appropriate call state.

On receipt of a FACILITY message with the same transaction identifier and containing a Reject component, the MS shall return to the original states for both transaction identifiers. The call states shall be verified by the SS sending a STATUS ENQUIRY message in respect of the transaction identifier of each call, and receiving a STATUS message indicating the appropriate call state.

Expected sequence

Step	Direction	Message	Comments
1	MS		Using MMI commands, put the MultiParty call on hold
2	MS -> SS	FACILITY	TI for Call A-B or Call A-C, HoldMPTY Invoke component
3	SS -> MS	STATUS ENQUIRY	Transaction identifier of Call A-B
4	MS -> SS	STATUS	Transaction identifier of Call A-B, state U10, auxiliary state "Call in MPTY, hold request"
5	SS -> MS	STATUS ENQUIRY	Transaction identifier of Call A-C
6	MS -> SS	STATUS	Transaction identifier of Call A-C, state U10, auxiliary state "Call in MPTY, hold request"
7	SS -> MS	FACILITY	Same TI as step 2, Return Error component
8	SS -> MS	STATUS ENQUIRY	Transaction identifier of Call A-B
9	MS -> SS	STATUS	Transaction identifier of Call A-B, state U10, auxiliary state "Call in MPTY"
10	SS -> MS	STATUS ENQUIRY	Transaction identifier of Call A-C
11	MS -> SS	STATUS	Transaction identifier of Call A-C, state U10, auxiliary state "Call in MPTY"
12	MS		Using MMI commands, place the MultiParty call on hold
13	MS -> SS	FACILITY	TI for Call A-B or Call A-C, HoldMPTY Invoke component
14	SS -> MS	STATUS ENQUIRY	Transaction identifier of Call A-B
15	MS -> SS	STATUS	Transaction identifier of Call A-B, state U10, auxiliary state "Call in MPTY, hold request"
16	SS -> MS	STATUS ENQUIRY	Transaction identifier of Call A-C
17	MS -> SS	STATUS	Transaction identifier of Call A-C, state U10, auxiliary state "Call in MPTY, hold request"
18	SS -> MS	FACILITY	Same TI as step 13, Reject component
19	SS -> MS	STATUS ENQUIRY	Transaction identifier of Call A-B
20	MS -> SS	STATUS	Transaction identifier of Call A-B, state U10, auxiliary state "Call in MPTY"
21	SS -> MS	STATUS ENQUIRY	Transaction identifier of Call A-C
22	MS -> SS	STATUS	Transaction identifier of Call A-C, state U10, auxiliary state "Call in MPTY"

31.4.2.1.1.3 Put the MultiParty call on hold, expiry of timer T(HoldMPTY)

Conformance requirement

3GPP TS 04.84 subclause 1.2.1.1.

Test purpose

To test that the MS correctly places an active MultiParty call on hold, and on expiry of T(HoldMPTY) returns the MultiParty call to the auxiliary state "Call in MPTY".

Method of test

Specific PICS Statements

-

PIXIT Statements

- Method of placing a MultiParty call on hold.

Initial conditions

System Simulator:

1 cell, default parameters.

Mobile Station:

The MS shall have a MultiParty call to two destinations (Call A-B and Call A-C) active. Both call states shall be U10 "Active" with auxiliary state "Call in MPTY". The call shall be of a basic service supported by the MS and relevant to the MultiParty supplementary service as stated in 3GPP TS 02.04 table A.1.

NOTE: The MultiParty call may be set up using the procedures of subclause 31.4.1.1.

Foreseen final state of the MS

Branch A, Call A-B, state U10, auxiliary state "Call in MPTY". Call A-C, state U10, auxiliary state "Call in MPTY".

Branch B, Call A-B, state U10, auxiliary state "Call in MPTY, hold request". Call A-C, state U10, auxiliary state "Call in MPTY, hold request".

Maximum duration of test

45 s.

Procedure

Using suitable MMI commands, the MS shall place the MultiParty call on hold. The MS shall send a FACILITY message containing one of the transaction identifiers of the call, and containing an invoke component HoldMPTY. Both calls shall enter the auxiliary state "Call in MPTY, hold request". The call states shall be verified by the SS sending a STATUS ENQUIRY message in respect of the transaction identifier of each call, and receiving a STATUS message indicating the appropriate call state.

Not less than 5s and not more than 30s after sending the FACILITY message, one of the following shall have occurred:

- both calls shall be in their original call states and the MS shall have indicated the failure to the user; or
- the MS shall have sent another FACILITY message with the same contents.

The call states shall be verified by the SS sending a STATUS ENQUIRY message in respect of the transaction identifier of each call, and receiving a STATUS message indicating the appropriate call state.

Expected sequence

Step	Direction	Message	Comments
1	MS		Using MMI commands, put the MultiParty call on hold
2	MS -> SS	FACILITY	TI for Call A-B or Call A-C, HoldMPTY Invoke component
3	SS -> MS	STATUS ENQUIRY	Transaction identifier of Call A-B
4	MS -> SS	STATUS	Transaction identifier of Call A-B, state U10, auxiliary state "Call in MPTY, hold request"
5	SS -> MS	STATUS ENQUIRY	Transaction identifier of Call A-C
6	MS -> SS	STATUS	Transaction identifier of Call A-C, state U10, auxiliary state "Call in MPTY, hold request"
7	SS		Wait 30 s from receiving FACILITY message
A8	SS -> MS	STATUS ENQUIRY	Take this branch if no message is received within 30 s
A9	MS -> SS	STATUS	Transaction identifier of Call A-B
A10	SS -> MS	STATUS ENQUIRY	Transaction identifier of Call A-B, state U10, auxiliary state "Call in MPTY"
A11	MS -> SS	STATUS	Transaction identifier of Call A-C
			Transaction identifier of Call A-C, state U10, auxiliary state "Call in MPTY"
B8	MS -> SS	FACILITY	Take this branch if a message is received within 30 s
B9	SS -> MS	STATUS ENQUIRY	Same as Step 2. Message shall not be received less than 5 s after the first FACILITY message
B10	MS -> SS	STATUS	Transaction identifier of Call A-B
B11	SS -> MS	STATUS ENQUIRY	Transaction identifier of Call A-B, state U10, auxiliary state "Call in MPTY, hold request"
B12	MS -> SS	STATUS	Transaction identifier of Call A-C
			Transaction identifier of Call A-C, state U10, auxiliary state "Call in MPTY, hold request"

31.4.2.1.2 Create a private communication with one of the remote parties

31.4.2.1.2.1 Create a private communication with one of the remote parties, successful case

Conformance requirement

3GPP TS 04.84 subclause 1.2.1.2.

Test purpose

To test that the MS correctly splits an active MultiParty call, and reacts correctly to a response from the SS indicating success.

Method of test

Specific PICS Statements

-

PIXIT Statements

- Method of creating a private communication with one party of a MultiParty call.

Initial conditions

System Simulator:

1 cell, default parameters.

Mobile Station:

The MS shall have a MultiParty call to two destinations (Call A-B and Call A-C) active. Both call states shall be U10 "Active" with auxiliary state "Call in MPTY". The call shall be of a basic service supported by the MS and relevant to the MultiParty supplementary service as stated in 3GPP TS 02.04 table A.1.

NOTE: The MultiParty call may be set up using the procedures of subclause 31.4.1.1.

Foreseen final state of the MS

Call A-B, state U10, no auxiliary state. Call A-C, state U10, auxiliary state "Call Held".

Maximum duration of test

30 s.

Procedure

Using suitable MMI commands, the MS shall request a private communication with Call A-B. The MS shall send a FACILITY message containing the transaction identifier for Call A-B and an invoke component SplitMPTY. Call A-B shall enter the auxiliary state "split request" and call A-C shall remain in state "Call in MPTY". The call states shall be verified by the SS sending a STATUS ENQUIRY message in respect of the transaction identifier of each call, and receiving a STATUS message indicating the appropriate call state.

On receipt of a FACILITY message containing the same transaction identifier and a return result component, Call A-B shall enter the state U10 "Active", and Call A-C shall enter the state U10 "Active" with auxiliary state "Call held". The call states shall be verified by the SS sending a STATUS ENQUIRY message in respect of the transaction identifier of each call, and receiving a STATUS message indicating the appropriate call state.

Expected sequence

Step	Direction	Message	Comments
1	MS		Using MMI commands, request a private communication with Call A-B
2	MS -> SS	FACILITY	TI for Call A-B, SplitMPTY Invoke component
3	SS -> MS	STATUS ENQUIRY	Transaction identifier of Call A-B
4	MS -> SS	STATUS	Transaction identifier of Call A-B, state U10, auxiliary state "Split request"
5	SS -> MS	STATUS ENQUIRY	Transaction identifier of Call A-C
6	MS -> SS	STATUS	Transaction identifier of Call A-C, state U10, auxiliary state "Call in MPTY"
7	SS -> MS	FACILITY	Return Result component
8	SS -> MS	STATUS ENQUIRY	Transaction identifier of Call A-B
9	MS -> SS	STATUS	Transaction identifier of Call A-B, state U10, no auxiliary state
10	SS -> MS	STATUS ENQUIRY	Transaction identifier of Call A-C
11	MS -> SS	STATUS	Transaction identifier of Call A-C, state U10, auxiliary state "Call held"
12	SS		Check that the TCH is through-connected

31.4.2.1.2.2 Create a private communication with one of the remote parties, unsuccessful case

Conformance requirement

3GPP TS 04.84 subclause 1.2.1.2.

Test purpose

To test that the MS correctly splits an active MultiParty call, and reacts correctly to a response from the SS indicating an error or reject condition.

Method of test

Specific PICS Statements

-

PIXIT Statements

- Method of creating a private communication with one party of a MultiParty call.

Initial conditions

System Simulator:

1 cell, default parameters.

Mobile Station:

The MS shall have a MultiParty call to two destinations (Call A-B and Call A-C) active. Both call states shall be U10 "Active" with auxiliary state "Call in MPTY". The call shall be of a basic service supported by the MS and relevant to the MultiParty supplementary service as stated in 3GPP TS 02.04 table A.1.

NOTE: The MultiParty call may be set up using the procedures of subclause 31.4.1.1.

Foreseen final state of the MS

Call A-B, state U10, auxiliary state "Call in MPTY". Call A-C, state U10, auxiliary state "Call in MPTY".

Maximum duration of test

30 s.

Procedure

Using suitable MMI commands, the MS shall request a private communication with Call A-B. The MS shall send a FACILITY message containing the transaction identifier for Call A-B and an invoke component SplitMPTY. Call A-B shall enter the auxiliary state "Split request" and call A-C shall remain in state "Call in MPTY". The call states shall be verified by the SS sending a STATUS ENQUIRY message in respect of the transaction identifier of each call, and receiving a STATUS message indicating the appropriate call state.

On receipt of a FACILITY message containing the same transaction identifier and a return error component, both calls shall return to their initial states. The call states shall be verified by the SS sending a STATUS ENQUIRY message in respect of the transaction identifier of each call, and receiving a STATUS message indicating the appropriate call state.

Using suitable MMI commands, the MS shall request a private communication with Call A-B. The MS shall send a FACILITY message containing the transaction identifier for Call A-B and an invoke component SplitMPTY. Call A-B shall enter the auxiliary state "Split request" and call A-C shall remain in state "Call in MPTY". The call states shall be verified by the SS sending a STATUS ENQUIRY message in respect of the transaction identifier of each call, and receiving a STATUS message indicating the appropriate call state.

On receipt of a FACILITY message containing the same transaction identifier and a Reject component, both calls shall return to their initial states. The call states shall be verified by the SS sending a STATUS ENQUIRY message in respect of the transaction identifier of each call, and receiving a STATUS message indicating the appropriate call state.

Expected sequence

Step	Direction	Message	Comments
1	MS		Using MMI commands, create a private communication for Call A-B
2	MS -> SS	FACILITY	TI for Call A-B, SplitMPTY Invoke component
3	SS -> MS	STATUS ENQUIRY	Transaction identifier of Call A-B
4	MS -> SS	STATUS	Transaction identifier of Call A-B, state U10, auxiliary state "Split request"
5	SS -> MS	STATUS ENQUIRY	Transaction identifier of Call A-C
6	MS -> SS	STATUS	Transaction identifier of Call A-C, state U10, auxiliary state "Call in MPTY"
7	SS -> MS	FACILITY	Return Error component
8	SS -> MS	STATUS ENQUIRY	Transaction identifier of Call A-B
9	MS -> SS	STATUS	Transaction identifier of Call A-B, state U10, auxiliary state "Call in MPTY"
10	SS -> MS	STATUS ENQUIRY	Transaction identifier of Call A-C
11	MS -> SS	STATUS	Transaction identifier of Call A-C, state U10, auxiliary state "Call in MPTY"
12	MS		Using MMI commands, create a private communication for Call A-B
13	MS -> SS	FACILITY	TI for Call A-B, SplitMPTY Invoke component
14	SS -> MS	STATUS ENQUIRY	Transaction identifier of Call A-B
15	MS -> SS	STATUS	Transaction identifier of Call A-B, state U10, auxiliary state "Split request"
16	SS -> MS	STATUS ENQUIRY	Transaction identifier of Call A-C
17	MS -> SS	STATUS	Transaction identifier of Call A-C, state U10, auxiliary state "Call in MPTY"
18	SS -> MS	FACILITY	Reject component
19	SS -> MS	STATUS ENQUIRY	Transaction identifier of Call A-B
20	MS -> SS	STATUS	Transaction identifier of Call A-B, state U10, auxiliary state "Call in MPTY"
21	SS -> MS	STATUS ENQUIRY	Transaction identifier of Call A-C
22	MS -> SS	STATUS	Transaction identifier of Call A-C, state U10, auxiliary state "Call in MPTY"

31.4.2.1.2.3 Create a private communication with one of the remote parties, expiry of timer T(SplitMPTY)

Conformance requirement

3GPP TS 04.84 subclause 1.2.1.2.

Test purpose

To test that the MS correctly splits an active MultiParty call, and on expiry of T(SplitMPTY) returns the call to the auxiliary state "Call in MPTY".

Method of test

Specific PICS Statements

-

PIXIT Statements

- Method of creating a private communication with one party of a MultiParty call.

Initial conditions

System Simulator:

1 cell, default parameters.

Mobile Station:

The MS shall have a MultiParty call to two destinations (Call A-B and Call A-C) active. Both call states shall be U10 "Active" with auxiliary state "Call in MPTY". The call shall be of a basic service supported by the MS and relevant to the MultiParty supplementary service as stated in 3GPP TS 02.04 table A.1.

NOTE: The MultiParty call may be set up using the procedures of subclause 31.4.1.1.

Foreseen final state of the MS

Branch A, Call A-B, state U10, auxiliary state "Call in MPTY". Call A-C, state U10, auxiliary state "Call in MPTY".

Branch B, Call A-B, state U10, auxiliary state "Call in MPTY". Call A-C, state U10, auxiliary state "Call in MPTY".

Maximum duration of test

30 s.

Procedure

Using suitable MMI commands, the MS shall request a private communication with Call A-B. The MS shall send a FACILITY message containing the transaction identifier for Call A-B and an invoke component SplitMPTY. Call A-B shall enter the auxiliary state "Split request" and call A-C shall remain in state "Call in MPTY". The call states shall be verified by the SS sending a STATUS ENQUIRY message in respect of the transaction identifier of each call, and receiving a STATUS message indicating the appropriate call state.

After not less than 5s and not more than 30s, the MS shall either:

- return both calls to their original states; or
- send another FACILITY message with the same contents.

The call states shall be verified by the SS sending a STATUS ENQUIRY message in respect of the transaction identifier of each call, and receiving a STATUS message indicating the appropriate call state.

Expected sequence

Step	Direction	Message	Comments
1	MS		Using MMI commands, request a private communication with Call A-B
2	MS -> SS	FACILITY	TI for Call A-B, SplitMPTY Invoke component
3	SS -> MS	STATUS ENQUIRY	Transaction identifier of Call A-B
4	MS -> SS	STATUS	Transaction identifier of Call A-B, state U10, auxiliary state "Split request"
5	SS -> MS	STATUS ENQUIRY	Transaction identifier of Call A-C
6	MS -> SS	STATUS	Transaction identifier of Call A-C, state U10, auxiliary state "Call in MPTY"
7	SS		Wait 30 s from receiving FACILITY message
A8	SS -> MS	STATUS ENQUIRY	Take this branch if no message is received within 30 s
A9	MS -> SS	STATUS	Transaction identifier of Call A-B
A10	SS -> MS	STATUS ENQUIRY	Transaction identifier of Call A-B, state U10, auxiliary state "Call in MPTY"
A11	MS -> SS	STATUS	Transaction identifier of Call A-C
			Transaction identifier of Call A-C, state U10, auxiliary state "Call in MPTY"
B8	MS -> SS	FACILITY	Take this branch if a message is received within 30 s
B9	SS -> MS	STATUS ENQUIRY	Same as Step 2. Message shall not be received less than 5 s after the first FACILITY message
B10	MS -> SS	STATUS	Transaction identifier of Call A-B
			Transaction identifier of Call A-B, state U10, auxiliary state "Split request"
B11	SS -> MS	STATUS ENQUIRY	Transaction identifier of Call A-C
B12	MS -> SS	STATUS	Transaction identifier of Call A-C, state U10, auxiliary state "Call in MPTY"

31.4.2.1.3 Terminate the entire MultiParty call

Conformance requirement

3GPP TS 04.84 subclause 1.2.1.3.

Test purpose

To test that the MS correctly terminates an entire MultiParty call by implementing the call clearance procedure for each call in turn.

Method of test

Specific PICS Statements

-

PIXIT Statements

- Method of terminating a MultiParty call.

Initial conditions

System Simulator:

1 cell, default parameters.

Mobile Station:

The MS shall have a MultiParty call to two destinations (Call A-B and Call A-C) active. Both call states shall be U10 "Active" with auxiliary state "Call in MPTY". The call shall be of a basic service supported by the MS and relevant to the MultiParty supplementary service as stated in 3GPP TS 02.04 table A.1.

NOTE: The MultiParty call may be set up using the procedures of subclause 31.4.1.1.

Foreseen final state of the MS

Call A-B, state U0. Call A-C, state U0.

Maximum duration of test

30 s.

Procedure

Using suitable MMI commands, the MS shall initiate a clearance of the entire MultiParty call. The MS shall send a DISCONNECT message in respect of each of the transaction identifiers of the call. On receipt of a RELEASE message in respect of each transaction identifier, the MS shall respond with a RELEASE COMPLETE message, and enter state U0 "Null". The call states shall be verified by the SS sending a STATUS ENQUIRY message in respect of the transaction identifier of each call, and receiving a RELEASE COMPLETE message with cause #81 "invalid transaction identifier value".

Expected sequence

Step	Direction	Message	Comments
1	MS		Using MMI commands, terminate the entire MultiParty call
2	MS -> SS	DISCONNECT	Steps 2 and 3 may occur in any order
3	MS -> SS	DISCONNECT	Transaction identifier of Call A-B
4	SS -> MS	RELEASE	Transaction identifier of Call A-C
5	MS -> SS	RELEASE COMPLETE	Transaction identifier of Call A-B
6	SS -> MS	RELEASE	Transaction identifier of Call A-C
7	MS -> SS	RELEASE COMPLETE	Transaction identifier of Call A-B
8	SS -> MS	STATUS ENQUIRY	Transaction identifier of Call A-C
9	MS -> SS	RELEASE COMPLETE	Transaction identifier of Call A-B, with cause #81 "invalid transaction identifier value"
10	SS -> MS	STATUS ENQUIRY	Transaction identifier of Call A-C
11	MS -> SS	RELEASE COMPLETE	Transaction identifier of Call A-C, with cause #81 "invalid transaction identifier value"

31.4.2.1.4 Explicitly disconnect a remote party

Conformance requirement

3GPP TS 04.84 subclause 1.2.1.4.

Test purpose

To test that the MS correctly disconnects a single remote party by implementing the call clearance procedure for that party.

Method of test

Specific PICS Statements

-

PIXIT Statements

- Method of disconnecting one party of a MultiParty call.

Initial conditions

System Simulator:

1 cell, default parameters.

Mobile Station:

The MS shall have a MultiParty call to two destinations (Call A-B and Call A-C) active. Both call states shall be U10 "Active" with auxiliary state "Call in MPTY". The call shall be of a basic service supported by the MS and relevant to the MultiParty supplementary service as stated in 3GPP TS 02.04 table A.1.

NOTE: The MultiParty call may be set up using the procedures of subclause 31.4.1.1.

Foreseen final state of the MS

Call A-B, state U0. Call A-C, state U10, with auxiliary state "Call in MPTY".

Maximum duration of test

30 s.

Procedure

Using suitable MMI commands, the MS shall initiate a clearance of the Call A-B. The MS shall send a DISCONNECT message containing the transaction identifier of Call A-B. On receipt of a RELEASE message the MS shall respond with a RELEASE COMPLETE message, and enter state U0 "Null" for Call A-B. Call A-C shall enter state U10

"Active" with, auxiliary state "Call in MPTY". The call states shall be verified by the SS sending a STATUS ENQUIRY message in respect of the transaction identifier of each call, and receiving a STATUS message indicating state U10, with auxiliary state "Call in MPTY" for Call A-C, and receiving a RELEASE COMPLETE message with cause #81 "invalid transaction identifier value" for Call A-B.

Expected sequence

Step	Direction	Message	Comments
1	MS		Using MMI commands, clear call A-B
2	MS -> SS	DISCONNECT	Transaction identifier of Call A-B
3	SS -> MS	RELEASE	Transaction identifier of Call A-B
4	MS -> SS	RELEASE COMPLETE	Transaction identifier of Call A-B
5	SS -> MS	STATUS ENQUIRY	Transaction identifier of Call A-B
6	MS -> SS	RELEASE COMPLETE	Transaction identifier of Call A-B, with cause #81 "invalid transaction identifier value"
7	SS -> MS	STATUS ENQUIRY	Transaction identifier of Call A-C
8	MS -> SS	STATUS	Transaction identifier of Call A-C, state U10, with auxiliary state "Call in MPTY"

31.4.2.2 Remote parties

31.4.2.2.1 Release from the MultiParty call

Conformance requirement

3GPP TS 04.84 subclause 1.2.1.4.

Test purpose

To test that the MS responds correctly to a call clearance from one of the remote parties.

Method of test

Specific PICS Statements

-

PIXIT Statements

-

Initial conditions

System Simulator:

1 cell, default parameters.

Mobile Station:

The MS shall have a MultiParty call to two destinations (Call A-B and Call A-C) active. Both call states shall be U10 "Active" with auxiliary state "Call in MPTY". The call shall be of a basic service supported by the MS and relevant to the MultiParty supplementary service as stated in 3GPP TS 02.04 table A.1.

NOTE: The MultiParty call may be set up using the procedures of subclause 31.4.1.1.

Foreseen final state of the MS

Call A-B, state U0. Call A-C, state U10, with auxiliary state "Call in MPTY".

Maximum duration of test

30 s.

Procedure

On receipt of a DISCONNECT message containing the transaction identifier of Call A-B, the MS shall send a RELEASE message. On receipt of a RELEASE COMPLETE message the MS shall enter state U0 "Null" for Call A-B. Call A-C shall enter state U10 "Active", with auxiliary state "Call in MPTY". The call states shall be verified by the SS sending a STATUS ENQUIRY message in respect of the transaction identifier of each call, and receiving a STATUS message indicating state U10, with auxiliary state "Call in MPTY" for Call A-C, and receiving a RELEASE COMPLETE message with cause #81 "invalid transaction identifier value" for Call A-B.

Expected sequence

Step	Direction	Message	Comments
1	SS -> MS	DISCONNECT	Transaction identifier of Call A-B
2	MS -> SS	RELEASE	Transaction identifier of Call A-B
3	SS -> MS	RELEASE COMPLETE	Transaction identifier of Call A-B
4	SS -> MS	STATUS ENQUIRY	Transaction identifier of Call A-B
5	MS -> SS	RELEASE COMPLETE	Transaction identifier of Call A-B, with cause #81 "invalid transaction identifier value"
6	SS -> MS	STATUS ENQUIRY	Transaction identifier of Call A-C
7	MS -> SS	STATUS	Transaction identifier of Call A-C, state U10, with auxiliary state "Call in MPTY"

31.4.3 Managing a held MultiParty call

31.4.3.1 Retrieve the held MultiParty call

31.4.3.1.1 Retrieve the held MultiParty call, successful case

Conformance requirement

3GPP TS 04.84 subclause 1.3.1.1.

Test purpose

To test that the MS correctly retrieves a held MultiParty call, and reacts correctly to a response from the SS indicating success.

Method of test

Specific PICS Statements

-

PIXIT Statements

- Method of retrieving a held MultiParty call.

Initial conditions

System Simulator:

1 cell, default parameters.

Mobile Station:

The MS shall have a held MultiParty call to two destinations (Call A-B and Call A-C). Both call states shall be U10 "Active" with auxiliary state "Call in MPTY, call held". The call shall be of a basic service supported by the MS and relevant to the MultiParty supplementary service as stated in 3GPP TS 02.04 table A.1.

NOTE: The MultiParty call may be set up using the procedures of subclause 31.4.2.1.1.1.

Foreseen final state of the MS

Call A-B, state U10, auxiliary state "Call in MPTY". Call A-C, state U10, auxiliary state "Call in MPTY".

Maximum duration of test

30 s.

Procedure

Using suitable MMI commands, the MS shall retrieve the MultiParty call. The MS shall send a FACILITY message containing one of the transaction identifiers of the call, and containing an invoke component RetrieveMPTY. Both calls shall enter the auxiliary state "Call in MPTY, retrieve request". The call states shall be verified by the SS sending a STATUS ENQUIRY message in respect of the transaction identifier of each call, and receiving a STATUS message indicating the appropriate call state.

On receipt of a FACILITY message with the same transaction identifier and containing a return result component, the MS shall enter the state U10 "Active" with auxiliary state "Call in MPTY" for both transaction identifiers. The call states shall be verified by the SS sending a STATUS ENQUIRY message in respect of the transaction identifier of each call, and receiving a STATUS message indicating the appropriate call state.

Expected sequence

Step	Direction	Message	Comments
1	MS		Using MMI commands, retrieve the MultiParty call
2	MS -> SS	FACILITY	TI for Call A-B or Call A-C, RetrieveMPTY Invoke component
3	SS -> MS	STATUS ENQUIRY	Transaction identifier of Call A-B
4	MS -> SS	STATUS	Transaction identifier of Call A-B, state U10, auxiliary state "Call in MPTY, Retrieve request"
5	SS -> MS	STATUS ENQUIRY	Transaction identifier of Call A-C
6	MS -> SS	STATUS	Transaction identifier of Call A-C, state U10, auxiliary state "Call in MPTY, Retrieve request"
7	SS -> MS	FACILITY	Same TI as step 2, Return Result component
8	SS -> MS	STATUS ENQUIRY	Transaction identifier of Call A-B
9	MS -> SS	STATUS	Transaction identifier of Call A-B, state U10, auxiliary state "Call in MPTY"
10	SS -> MS	STATUS ENQUIRY	Transaction identifier of Call A-C
11	MS -> SS	STATUS	Transaction identifier of Call A-C, state U10, auxiliary state "Call in MPTY"
12	SS		Check that the TCH is through-connected

31.4.3.1.2 Retrieve the held MultiParty call, unsuccessful case

Conformance requirement

3GPP TS 04.84 subclause 1.3.1.1.

Test purpose

To test that the MS correctly retrieves a held MultiParty call, and reacts correctly to a response from the SS indicating an error or a reject condition.

Method of test

Specific PICS Statements

-

PIXIT Statements

- Method of retrieving a held MultiParty call.

Initial conditions

System Simulator:

1 cell, default parameters.

Mobile Station:

The MS shall have a held MultiParty call to two destinations (Call A-B and Call A-C). Both call states shall be U10 "Active" with auxiliary state "Call in MPTY, call held". The call shall be of a basic service supported by the MS and relevant to the MultiParty supplementary service as stated in 3GPP TS 02.04 table A.1.

NOTE: The MultiParty call may be set up using the procedures of subclause 31.4.2.1.1.1.

Foreseen final state of the MS

Call A-B, state U10, auxiliary state "Call in MPTY, call held". Call A-C, state U10, auxiliary state "Call in MPTY, call held".

Maximum duration of test

30 s.

Procedure

Using suitable MMI commands, the MS shall retrieve the MultiParty call. The MS shall send a FACILITY message containing one of the transaction identifiers of the call, and containing an invoke component RetrieveMPTY. Both calls shall enter the auxiliary state "Call in MPTY, retrieve request". The call states shall be verified by the SS sending a STATUS ENQUIRY message in respect of the transaction identifier of each call, and receiving a STATUS message indicating the appropriate call state.

On receipt of a FACILITY message with the same transaction identifier and containing a return error component, the MS shall return to the original states for both transaction identifiers. The call states shall be verified by the SS sending a STATUS ENQUIRY message in respect of the transaction identifier of each call, and receiving a STATUS message indicating the appropriate call state.

Using suitable MMI commands, the MS shall retrieve the MultiParty call. The MS shall send a FACILITY message containing one of the transaction identifiers of the call, and containing an invoke component RetrieveMPTY. Both calls shall enter the auxiliary state "Call in MPTY, retrieve request". The call states shall be verified by the SS sending a STATUS ENQUIRY message in respect of the transaction identifier of each call, and receiving a STATUS message indicating the appropriate call state.

On receipt of a FACILITY message with the same transaction identifier and containing a reject component, the MS shall return to the original states for both transaction identifiers. The call states shall be verified by the SS sending a STATUS ENQUIRY message in respect of the transaction identifier of each call, and receiving a STATUS message indicating the appropriate call state.

Expected sequence

Step	Direction	Message	Comments
1	MS		Using MMI commands, retrieve the held MultiParty call
2	MS -> SS	FACILITY	TI for Call A-B or Call A-C, RetrieveMPTY Invoke component
3	SS -> MS	STATUS ENQUIRY	Transaction identifier of Call A-B
4	MS -> SS	STATUS	Transaction identifier of Call A-B, state U10, auxiliary state "Call in MPTY, retrieve request"
5	SS -> MS	STATUS ENQUIRY	Transaction identifier of Call A-C
6	MS -> SS	STATUS	Transaction identifier of Call A-C, state U10, auxiliary state "Call in MPTY, retrieve request"
7	SS -> MS	FACILITY	Same TI as step 2, Return Error component
8	SS -> MS	STATUS ENQUIRY	Transaction identifier of Call A-B
9	MS -> SS	STATUS	Transaction identifier of Call A-B, state U10, auxiliary state "Call in MPTY, call held"
10	SS -> MS	STATUS ENQUIRY	Transaction identifier of Call A-C
11	MS -> SS	STATUS	Transaction identifier of Call A-C, state U10, auxiliary state "Call in MPTY, call held"
12	MS		Using MMI commands, retrieve the held MultiParty call
13	MS -> SS	FACILITY	TI for Call A-B or Call A-C, RetrieveMPTY Invoke component
14	SS -> MS	STATUS ENQUIRY	Transaction identifier of Call A-B
15	MS -> SS	STATUS	Transaction identifier of Call A-B, state U10, auxiliary state "Call in MPTY, retrieve request"
16	SS -> MS	STATUS ENQUIRY	Transaction identifier of Call A-C
17	MS -> SS	STATUS	Transaction identifier of Call A-C, state U10, auxiliary state "Call in MPTY, retrieve request"
18	SS -> MS	FACILITY	Same TI as step 13, Reject component
19	SS -> MS	STATUS ENQUIRY	Transaction identifier of Call A-B
20	MS -> SS	STATUS	Transaction identifier of Call A-B, state U10, auxiliary state "Call in MPTY, call held"
21	SS -> MS	STATUS ENQUIRY	Transaction identifier of Call A-C
22	MS -> SS	STATUS	Transaction identifier of Call A-C, state U10, auxiliary state "Call in MPTY, call held"

31.4.3.1.3 Retrieve the held MultiParty call, expiry of timer T(RetrieveMPTY)

Conformance requirement

3GPP TS 04.84 subclause 1.3.1.1.

Test purpose

To test that the MS correctly retrieves a MultiParty call on hold, and on expiry of T(RetrieveMPTY) returns the MultiParty call to the auxiliary state "Call in MPTY, call held".

Method of test

Specific PICS Statements

-

PIXIT Statements

- Method of retrieving a held MultiParty call.

Initial conditions

System Simulator:

1 cell, default parameters.

Mobile Station:

The MS shall have a held MultiParty call to two destinations (Call A-B and Call A-C). Both call states shall be U10 "Active" with auxiliary state "Call in MPTY, call held". The call shall be of a basic service supported by the MS and relevant to the MultiParty supplementary service as stated in 3GPP TS 02.04 table A.1.

NOTE: The MultiParty call may be set up using the procedures of subclause 31.4.2.1.1.1.

Foreseen final state of the MS

Branch A, Call A-B, state U10, auxiliary state "Call in MPTY, call held". Call A-C, state U10, auxiliary state "Call in MPTY, call held".

Branch B, Call A-B, state U10, auxiliary state "Call in MPTY, retrieve request". Call A-C, state U10, auxiliary state "Call in MPTY, retrieve request".

Maximum duration of test

45 s.

Procedure

Using suitable MMI commands, the MS shall retrieve the MultiParty call. The MS shall send a FACILITY message containing one of the transaction identifiers of the call, and containing an invoke component RetrieveMPTY. Both calls shall enter the auxiliary state "Call in MPTY, retrieve request". The call states shall be verified by the SS sending a STATUS ENQUIRY message in respect of the transaction identifier of each call, and receiving a STATUS message indicating the appropriate call state.

Not less than 5s and not more than 30s after sending the FACILITY message, one of the following shall have occurred:

- both calls shall be in their original call states and the MS shall have indicated the failure to the user; or
- the MS shall have sent another FACILITY message with the same contents.

The call states shall be verified by the SS sending a STATUS ENQUIRY message in respect of the transaction identifier of each call, and receiving a STATUS message indicating the appropriate call state.

Expected sequence

Step	Direction	Message	Comments
1	MS		Using MMI commands, retrieve the held MultiParty call
2	MS -> SS	FACILITY	TI for Call A-B or Call A-C, RetrieveMPTY Invoke component
3	SS -> MS	STATUS ENQUIRY	Transaction identifier of Call A-B
4	MS -> SS	STATUS	Transaction identifier of Call A-B, state U10, auxiliary state "Call in MPTY, retrieve request"
5	SS -> MS	STATUS ENQUIRY	Transaction identifier of Call A-C
6	MS -> SS	STATUS	Transaction identifier of Call A-C, state U10, auxiliary state "Call in MPTY, retrieve request"
7	SS		Wait 30 s from receiving FACILITY message
A8	SS -> MS	STATUS ENQUIRY	Take this branch if no message is received within 30 s
A9	MS -> SS	STATUS	Transaction identifier of Call A-B
A10	SS -> MS	STATUS ENQUIRY	Transaction identifier of Call A-B, state U10, auxiliary state "Call in MPTY, call held"
A11	MS -> SS	STATUS	Transaction identifier of Call A-C
			Transaction identifier of Call A-C, state U10, auxiliary state "Call in MPTY, call held"
B8	MS -> SS	FACILITY	Take this branch if a message is received within 30 s
B9	SS -> MS	STATUS ENQUIRY	Same as Step 2. Message shall not be received less than 5 s after the first FACILITY message
B10	MS -> SS	STATUS	Transaction identifier of Call A-B
B11	SS -> MS	STATUS ENQUIRY	Transaction identifier of Call A-B, state U10, auxiliary state "Call in MPTY, retrieve request"
B12	MS -> SS	STATUS	Transaction identifier of Call A-C
			Transaction identifier of Call A-C, state U10, auxiliary state "Call in MPTY, retrieve request"

31.4.3.2 Initiate a new call

Conformance requirement

3GPP TS 04.84 subclause 1.3.1.2.

Test purpose

To test that the MS can set up a new outgoing call with a held MultiParty call.

Method of test

Specific PICS Statements

-

PIXIT Statements

- Method of making a new outgoing call.

Initial conditions

System Simulator:

1 cell, default parameters.

Mobile Station:

The MS shall have a held MultiParty call to two destinations (Call A-B and Call A-C). Both call states shall be U10 "Active" with auxiliary state "Call in MPTY, call held". The call shall be of a basic service supported by the MS and relevant to the MultiParty supplementary service as stated in 3GPP TS 02.04 table A.1.

NOTE: The MultiParty call may be set up using the procedures of subclause 31.4.2.1.1.1.

Foreseen final state of the MS

Call A-B, state U10, auxiliary state "Call in MPTY, call held". Call A-C, state U10, auxiliary state "Call in MPTY, call held". Call A-D State U10.

Maximum duration of test

30 s.

Procedure

Using suitable MMI commands, the MS shall initiate a new outgoing call A-D. The MS shall send a SETUP message with a new transaction identifier and enter state U1 "Call initiated". On receipt of an ALERTING message followed by a CONNECT message, the MS shall send a CONNECT ACKNOWLEDGE message and enter state U10 "Active". The call state of the MultiParty call shall not be affected. The call states shall be verified by the SS sending a STATUS ENQUIRY message in respect of the transaction identifier of each call, and receiving a STATUS message indicating the appropriate call state.

Expected sequence

Step	Direction	Message	Comments
1	MS		Using MMI commands, make a new call
2	MS -> SS	CM SERVICE REQUEST	
3	SS -> MS	CM SERVICE ACCEPT	
4	MS -> SS	SETUP	TI different from Call A-B or Call A-C (new Call A-D)
5	SS -> MS	ALERTING	Transaction identifier of Call A-D
6	SS -> MS	CONNECT	Transaction identifier of Call A-D
7	MS -> SS	CONNECT ACKNOWLEDGE	Transaction identifier of Call A-D
8	SS -> MS	STATUS ENQUIRY	Transaction identifier of Call A-B
9	MS -> SS	STATUS	Transaction identifier of Call A-B, state U10, auxiliary state "Call in MPTY, call held"
10	SS -> MS	STATUS ENQUIRY	Transaction identifier of Call A-C
11	MS -> SS	STATUS	Transaction identifier of Call A-C, state U10, auxiliary state "Call in MPTY, call held"
12	SS -> MS	STATUS ENQUIRY	Transaction identifier of Call A-D
13	MS -> SS	STATUS	Transaction identifier of Call A-D, state U10, no auxiliary state.

31.4.3.3 Process a call waiting request

Conformance requirement

3GPP TS 04.84 subclause 1.3.1.3.

Test purpose

To test that the MS can correctly process a Call Waiting request with a held MultiParty call.

Method of test

Specific PICS Statements

-

PIXIT Statements

- Method of answering a waiting call.

Initial conditions

System Simulator:

1 cell, default parameters.

Mobile Station:

The MS shall have a MultiParty call to two destinations (Call A-B and Call A-C) active. Both calls states shall be U10 "Active" with auxiliary state "Call in MPTY". The MS shall also have a Call A-D in state U7 "Call received". The Multiparty call shall be of a basic service supported by the MS and relevant to the MultiParty supplementary service as stated in 3GPP TS 02.04 table A.1.

NOTE: The MultiParty call may be set up using the procedures of subclause 31.4.1.1.

Foreseen final state of the MS

Call A-B, state U10, auxiliary state "Call in MPTY, call held". Call A-C, state U10, auxiliary state "Call in MPTY, call held". Call A-D State U10.

Maximum duration of test

30 s.

Procedure

Using suitable MMI commands, the MS shall place the MultiParty on hold, and answer Call A-D.

The MS shall send a FACILITY message to the SS using any one of the transaction identifiers of the MultiParty call and containing an invoke component HoldMPTY, and shall enter state U10 "Active", with auxiliary state "call in MPTY, hold request" in respect of each of the transaction identifiers.

On receipt of a FACILITY message using the same transaction identifier and containing a return result component, the MS shall enter state U10 "Active" with auxiliary state "Call in MPTY, call held" for each of the transaction identifiers.

The MS shall then send a CONNECT message to the SS, using the transaction identifier of Call A-D, and on receipt of a CONNECT ACKNOWLEDGE message, shall enter state U10 "Active". The call states shall be verified by the SS sending a STATUS ENQUIRY message in respect of the transaction identifier of each call, and receiving a STATUS message indicating the appropriate call state.

Expected sequence

Step	Direction	Message	Comments
1	MS		Using MMI commands, place the multiparty call on hold and answer the waiting call
2	MS -> SS	FACILITY	Transaction identifier of Call A-B or A-C, HoldMPTY invoke component
3	SS -> MS	FACILITY	Same transaction identifier as step 2
4	MS -> SS	CONNECT	Transaction identifier of Call A-D
5	SS -> MS	CONNECT ACKNOWLEDGE	Transaction identifier of Call A-D
6	SS -> MS	STATUS ENQUIRY	Transaction identifier of Call A-B
7	MS -> SS	STATUS	Transaction identifier of Call A-B, state U10, auxiliary state "Call in MPTY, call held"
8	SS -> MS	STATUS ENQUIRY	Transaction identifier of Call A-C
9	MS -> SS	STATUS	Transaction identifier of Call A-C, state U10, auxiliary state "Call in MPTY, call held"
10	SS -> MS	STATUS ENQUIRY	Transaction identifier of Call A-D
11	MS -> SS	STATUS	Transaction identifier of Call A-D, state U10, no auxiliary state.

31.4.3.4 Terminate the held MultiParty call

Conformance requirement

3GPP TS 04.84 subclause 1.3.1.4.

Test purpose

To test that the MS correctly terminates a held MultiParty call by initiating call clearance for each party in turn.

Method of test

Specific PICS Statements

-

PIXIT Statements

- Method of terminating a held MultiParty call.

Initial conditions

System Simulator:

1 cell, default parameters.

Mobile Station:

The MS shall have a held MultiParty call to two destinations (Call A-B and Call A-C). Both call states shall be U10 "Active" with auxiliary state "Call in MPTY, call held". The call shall be of a basic service supported by the MS and relevant to the MultiParty supplementary service as stated in 3GPP TS 02.04 table A.1.

NOTE: The MultiParty call may be set up using the procedures of subclause 31.4.2.1.1.1.

Foreseen final state of the MS

Call A-B, state U0. Call A-C, state U0.

Maximum duration of test

30 s.

Procedure

Using suitable MMI commands, the MS shall initiate a clearance of the entire held MultiParty call. The MS shall send a DISCONNECT message in respect of each of the transaction identifiers of the call. On receipt of a RELEASE message in respect of each transaction identifier, the MS shall respond with a RELEASE COMPLETE message, and enter state U0 "Null". The call states shall be verified by the SS sending a STATUS ENQUIRY message in respect of the transaction identifier of each call and receiving a RELEASE COMPLETE message with cause #81 "invalid transaction identifier value" for each call.

Expected sequence

Step	Direction	Message	Comments
1	MS		Using MMI commands, terminate the entire MultiParty call
2	MS -> SS	DISCONNECT	Steps 2 and 3 may occur in any order
3	MS -> SS	DISCONNECT	Transaction identifier of Call A-B
4	SS -> MS	RELEASE	Transaction identifier of Call A-C
5	MS -> SS	RELEASE COMPLETE	Transaction identifier of Call A-B
6	SS -> MS	RELEASE	Transaction identifier of Call A-C
7	MS -> SS	RELEASE COMPLETE	Transaction identifier of Call A-C
8	SS -> MS	STATUS ENQUIRY	Transaction identifier of Call A-B
9	MS -> SS	RELEASE COMPLETE	Transaction identifier of Call A-B, with cause #81 "invalid transaction identifier value"
10	SS -> MS	STATUS ENQUIRY	Transaction identifier of Call A-C
11	MS -> SS	RELEASE COMPLETE	Transaction identifier of Call A-C, with cause #81 "invalid transaction identifier value"

31.4.4 Managing a single call and a MultiParty call

31.4.4.1 Served mobile subscriber

31.4.4.1.1 Disconnect the single call

31.4.4.1.1.1 Disconnect active single call

Conformance requirement

3GPP TS 04.84 subclause 1.4.1.1.

Test purpose

To test that the MS correctly clears the single call when the single call is active and the MultiParty call is held.

Initial conditions

The MS shall have a MultiParty call to two destinations (A-B and A-C) both in state U10 "Active" with auxiliary state "Call in MPTY, call held". The MS shall have in addition a single call (A-D) in state U10 "Active" with no auxiliary state. Both calls shall be of a basic service supported by the MS and relevant to the MultiParty supplementary service as stated in 3GPP TS 02.04 table A.1.

NOTE: The MultiParty call may be set up using the procedures of subclause 31.4.2.1.1.2.

Method of test

Specific PICS Statements

-

PIXIT Statements

- Method of clearing the single call.

Initial conditions

System Simulator:

1 cell, default parameters.

Mobile Station:

The MS shall have a MultiParty call to two destinations (A-B and A-C) both in state U10 "Active" with auxiliary state "Call in MPTY, call held". The MS shall have in addition a single call (A-D) in state U10 "Active" with no auxiliary state. Both calls shall be of a basic service supported by the MS and relevant to the MultiParty supplementary service as stated in 3GPP TS 02.04 table A.1.

NOTE: The MultiParty call may be set up using the procedures of subclause 31.4.2.1.1.2.

Foreseen final state of the MS

Call A-B, state U10, auxiliary state "Call in MPTY, call held". Call A-C, state U10, auxiliary state "Call in MPTY, call held". Call A-D State U0.

Maximum duration of test

30 s.

Procedure

Using suitable MMI commands, the MS shall clear Call A-D. The MS shall send a DISCONNECT message with the transaction identifier for Call A-D. On receipt of a RELEASE message the SM shall send a RELEASE COMPLETE message and enter state U0 "Null" for Call A-D.

Within 5 s of sending the RELEASE COMPLETE message, the MS may send a FACILITY message to retrieve the Held Call. The SS must reject this request. The call state and auxiliary state for Call A-B and Call A-C shall not change. The call states shall be verified by the SS sending a STATUS ENQUIRY message in respect of the transaction identifier of each call, and receiving a STATUS message indicating the appropriate call state for Calls A-B and A-C, and receiving a RELEASE COMPLETE message with cause #81 "invalid transaction identifier value" for Call A-D.

Expected sequence

Step	Direction	Message	Comments
1	MS		Using MMI commands, clear call A-D
2	MS -> SS	DISCONNECT	Transaction identifier of Call A-D
3	SS -> MS	RELEASE	Transaction identifier of Call A-D
4	MS -> SS	RELEASE COMPLETE	Transaction identifier of Call A-D
5	SS		Wait 5 s from receiving a RELEASE COMPLETE
A1	SS -> MS	STATUS ENQUIRY	Take this branch if no message is received within 5s
A2	MS -> SS	STATUS	Transaction identifier of Call A-B
A3	SS -> MS	STATUS ENQUIRY	Transaction identifier of Call A-B, state U10, auxiliary state "Call in MPTY, call held"
A4	MS -> SS	STATUS	Transaction identifier of Call A-C
A5	SS -> MS	STATUS ENQUIRY	Transaction identifier of Call A-C, state U10, auxiliary state "Call in MPTY, call held"
A6	MS -> SS	RELEASE COMPLETE	Transaction identifier of Call A-D
			Transaction identifier of Call A-D, with cause #81 "invalid transaction identifier value"
B1	MS -> SS	FACILITY	Take this branch if a message is received within 5s
B2	SS -> MS	FACILITY	TI for Call A-B, RetrieveMPTY Invoke component
B3	SS -> MS	STATUS ENQUIRY	TI for Call A-B, Reject component
B4	MS -> SS	STATUS	Transaction identifier of Call A-B
B5	SS -> MS	STATUS ENQUIRY	Transaction identifier of Call A-B, state U10, auxiliary state "Call in MPTY, call held"
B6	MS -> SS	STATUS	Transaction identifier of Call A-C
B7	SS -> MS	STATUS ENQUIRY	Transaction identifier of Call A-C, state U10, auxiliary state "Call in MPTY, call held"
B8	MS -> SS	RELEASE COMPLETE	Transaction identifier of Call A-D
			Transaction identifier of Call A-D, with cause #81 "invalid transaction identifier value"

31.4.4.1.1.2 Disconnect held single call

Conformance requirement

3GPP TS 04.84 subclause 1.4.1.1.

Test purpose

To test that the MS correctly clears the single call when the single call is held and the MultiParty call is active.

Method of test

Specific PICS Statements

-

PIXIT Statements

- Method of clearing the held single call.

Initial conditions

System Simulator:

1 cell, default parameters.

Mobile Station:

The MS shall have a MultiParty call to two destinations (A-B and A-C) both in state U10 "Active" with auxiliary state "Call in MPTY". The MS shall have in addition a single call (A-D) in state U10 "Active" with auxiliary state "Call held". Both calls shall be of a basic service supported by the MS and relevant to the MultiParty supplementary service as stated in 3GPP TS 02.04 table A.1.

NOTE: The MultiParty call may be set up using the procedures of subclause 31.4.1.1.

Foreseen final state of the MS

Call A-B, state U10, auxiliary state "Call in MPTY". Call A-C, state U10, auxiliary state "Call in MPTY". Call A-D State U0.

Maximum duration of test

30 s.

Procedure

Using suitable MMI commands, the MS shall clear Call A-D. The MS shall send a DISCONNECT message with the transaction identifier for Call A-D. On receipt of a RELEASE message the MS shall send a RELEASE COMPLETE message and enter state U0 "Null" for Call A-D. The call state and auxiliary state for Call A-B and Call A-C shall not change. The call states shall be verified by the SS sending a STATUS ENQUIRY message in respect of the transaction identifier of each call, and receiving a STATUS message indicating the appropriate call state for Calls A-B and A-C, and receiving a RELEASE COMPLETE message with cause #81 "invalid transaction identifier value" for Call A-D.

Expected sequence

Step	Direction	Message	Comments
1	MS		Using MMI commands, clear call A-D
2	MS -> SS	DISCONNECT	Transaction identifier of Call A-D
3	SS -> MS	RELEASE	Transaction identifier of Call A-D
4	MS -> SS	RELEASE COMPLETE	Transaction identifier of Call A-D
5	SS -> MS	STATUS ENQUIRY	Transaction identifier of Call A-B
6	MS -> SS	STATUS	Transaction identifier of Call A-B, state U10, auxiliary state "Call in MPTY"
7	SS -> MS	STATUS ENQUIRY	Transaction identifier of Call A-C
8	MS -> SS	STATUS	Transaction identifier of Call A-C, state U10, auxiliary state "Call in MPTY"
9	SS -> MS	STATUS ENQUIRY	Transaction identifier of Call A-D
10	MS -> SS	RELEASE COMPLETE	Transaction identifier of Call A-D, with cause #81 "invalid transaction identifier value"

31.4.4.1.2 Disconnect the MultiParty call

31.4.4.1.2.1 Void

31.4.4.1.2.2 Void

31.4.4.1.2.3 Clear all parties of held MultiParty call

Conformance requirement

3GPP TS 04.84 subclause 1.4.1.2.

Test purpose

To test that the MS correctly clears the MultiParty call by clearing all remote parties to a held MultiParty call.

Initial conditions

The MS shall have a MultiParty call to two destinations (A-B and A-C) both in state U10 "Active" with auxiliary state "Call in MPTY, Call held". The MS shall have in addition a single call (A-D) in state U10 "Active" with no auxiliary state. Both calls shall be of a basic service supported by the MS and relevant to the MultiParty supplementary service as stated in 3GPP TS 02.04 table A.1.

NOTE: The MultiParty call may be set up using the procedures of subclause 31.4.2.1.1.2.

Method of test

Specific PICS Statements

-

PIXIT Statements

- Method of clearing a held MultiParty call.

Initial conditions

System Simulator:

1 cell, default parameters.

Mobile Station:

The MS shall have a MultiParty call to two destinations (A-B and A-C) both in state U10 "Active" with auxiliary state "Call in MPTY, Call held". The MS shall have in addition a single call (A-D) in state U10 "Active" with no auxiliary state. Both calls shall be of a basic service supported by the MS and relevant to the MultiParty supplementary service as stated in 3GPP TS 02.04 table A.1.

Foreseen final state of the MS

Call A-B, state U0. Call A-C, state U0. Call A-D State U10, no auxiliary state.

Maximum duration of test

30 s.

Procedure

Using suitable MMI commands, the MS shall clear the MultiParty call. The MS shall send DISCONNECT messages with the transaction identifier for Call A-B and A-C. On receipt of a RELEASE message to each DISCONNECT the MS shall send a RELEASE COMPLETE message and enter state U0 "Null. Call A-B and Call A-C shall enter state U0 "Null". The call state and auxiliary state for Call A-D shall not change. The call states shall be verified by the SS sending a STATUS ENQUIRY message in respect of the transaction identifier of each call, and receiving a STATUS message indicating the appropriate call state for Call A-D, and receiving a RELEASE COMPLETE message with cause #81 "invalid transaction identifier value" for Calls A-B and A-C.

Expected sequence

Step	Direction	Message	Comments
1	MS		Using MMI commands, terminate the entire MultiParty call
2	MS -> SS	DISCONNECT	Steps 2 and and 3 may occur in any order
3	MS -> SS	DISCONNECT	Transaction identifier of Call A-C
4	SS -> MS	RELEASE	Transaction identifier of Call A-B
5	MS -> SS	RELEASE COMPLETE	Transaction identifier of Call A-B
6	SS -> MS	RELEASE	Transaction identifier of Call A-C
7	MS -> SS	RELEASE COMPLETE	Transaction identifier of Call A-C
8	SS -> MS	STATUS ENQUIRY	Transaction identifier of Call A-B
9	MS -> SS	RELEASE COMPLETE	Transaction identifier of Call A-B, with cause #81 "invalid transaction identifier value"
10	SS -> MS	STATUS ENQUIRY	Transaction identifier of Call A-C
11	MS -> SS	RELEASE COMPLETE	Transaction identifier of Call A-C, with cause #81 "invalid transaction identifier value"
12	SS -> MS	STATUS ENQUIRY	Transaction identifier of Call A-D
13	MS -> SS	STATUS	Transaction identifier of Call A-D, state U10

31.4.4.1.2.4 Clear all parties of active MultiParty call

Conformance requirement

3GPP TS 04.84 subclause 1.4.1.2.

Test purpose

To test that the MS correctly clears the MultiParty call by clearing all remote parties to an active MultiParty call.

Method of test

Specific PICS Statements

-

PIXIT Statements

- Method of clearing an active MultiParty call.

Initial conditions

System Simulator:

1 cell, default parameters.

Mobile Station:

The MS shall have a MultiParty call to two destinations (A-B and A-C) both in state U10 "Active" with auxiliary state "Call in MPTY". The MS shall have in addition a single call (A-D) in state U10 "Active" with auxiliary state "Call held". Both calls shall be of a basic service supported by the MS and relevant to the MultiParty supplementary service as stated in 3GPP TS 02.04 table A.1.

Foreseen final state of the MS

Call A-B, state U0. Call A-C, state U0. Call A-D State U10, auxiliary state "Call Held".

Maximum duration of test

30 s.

Procedure

Using suitable MMI commands, the MS shall clear the MultiParty call. The MS shall send DISCONNECT messages with the transaction identifier for Call A-B and A-C. On receipt of a RELEASE message to each DISCONNECT the MS shall send a RELEASE COMPLETE message and enter state U0 "Null". Call A-B and Call A-C shall enter state U0 "Null". Within 5 s of sending the RELEASE COMPLETE message, the MS may send a RETRIEVE message to retrieve the Held Call. The SS shall reject this request. The call state and auxiliary state for Call A-D shall not change. The call states shall be verified by the SS sending a STATUS ENQUIRY message in respect of the transaction identifier of each call, and receiving a STATUS message indicating the appropriate call state. for Call A-D, and receiving a RELEASE COMPLETE message with cause #81 "invalid transaction identifier value" for Calls A-B and A-C.

Expected sequence

Step	Direction	Message	Comments
1	MS		Using MMI commands, terminate the entire MultiParty call
2	MS -> SS	DISCONNECT	Steps 2 and 3 may occur in any order
3	MS -> SS	DISCONNECT	Transaction identifier of Call A-B
4	SS -> MS	RELEASE	Transaction identifier of Call A-C
5	MS -> SS	RELEASE COMPLETE	Transaction identifier of Call A-B
6	SS -> MS	RELEASE	Transaction identifier of Call A-C
7	MS -> SS	RELEASE COMPLETE	Transaction identifier of Call A-C
8	SS		Wait 5 s from receiving a RELEASE COMPLETE
A9	SS -> MS	STATUS ENQUIRY	Take this branch if no message is received within 5s
A10	MS -> SS	RELEASE COMPLETE	Transaction identifier of Call A-B
A11	SS -> MS	STATUS ENQUIRY	Transaction identifier of Call A-B, with cause #81 "invalid transaction identifier value"
A12	MS -> SS	RELEASE COMPLETE	Transaction identifier of Call A-C
A13	SS -> MS	STATUS ENQUIRY	Transaction identifier of Call A-C, with cause #81 "invalid transaction identifier value"
A14	MS -> SS	STATUS	Transaction identifier of Call A-D
			Transaction identifier of Call A-D, state U10, auxiliary state "Call Held"
B9	MS -> SS	RETRIEVE	Take this branch if a message is received within 5s
B10	SS -> MS	RETRIEVE REJECT	Transaction identifier of Call A-D
B11	SS -> MS	STATUS ENQUIRY	
B12	MS -> SS	RELEASE COMPLETE	Transaction identifier of Call A-B
B13	SS -> MS	STATUS ENQUIRY	Transaction identifier of Call A-B, with cause #81 "invalid transaction identifier value"
B14	MS -> SS	RELEASE COMPLETE	Transaction identifier of Call A-C
B15	SS -> MS	STATUS ENQUIRY	Transaction identifier of Call A-C, with cause #81 "invalid transaction identifier value"
B16	MS -> SS	STATUS	Transaction identifier of Call A-D
			Transaction identifier of Call A-D, state U10, auxiliary state "Call Held"

31.4.4.2 Disconnect all calls

Conformance requirement

3GPP TS 04.84 subclause 1.4.1.3.

Test purpose

To test the MS correctly clears all active calls, by clearing in turn each connected party.

Method of test

Specific PICS Statements

-

PIXIT Statements

- Method of clearing all active calls.

Initial conditions

System Simulator:

1 cell, default parameters.

Mobile Station:

The MS shall have a MultiParty call to two destinations (A-B and A-C) both in state U10 "Active" with auxiliary state "Call in MPTY". The MS shall have in addition a single call (A-D) in state U10 "Active" with auxiliary

state "Call held". Both calls shall be of a basic service supported by the MS and relevant to the MultiParty supplementary service as stated in 3GPP TS 02.04 table A.1.

Foreseen final state of the MS

Call A-B, state U0. Call A-C, state U0. Call A-D state U0.

Maximum duration of test

30 s.

Procedure

Using suitable MMI commands, the MS shall clear all calls. The MS shall send DISCONNECT messages with the transaction identifier for Call A-B, Call A-C and Call A-D. On receipt of a RELEASE message to each DISCONNECT the MS shall send a RELEASE COMPLETE message and enter state U0 "Null". Call A-B, Call A-C Call A-D shall enter state U0 "Null". The call states shall be verified by the SS sending a STATUS ENQUIRY message in respect of the transaction identifier of each call, and receiving a RELEASE COMPLETE message with cause #81 "invalid transaction identifier value" for each call.

Expected sequence

Step	Direction	Message	Comments
1	MS		Using MMI commands, terminate the entire MultiParty call
2	MS -> SS	DISCONNECT	Steps 2, 3 and 4 may occur in any order. Transaction identifier of Call A-B
3	MS -> SS	DISCONNECT	Transaction identifier of Call A-C
4	MS -> SS	DISCONNECT	Transaction identifier of Call A-D
5	SS -> MS	RELEASE	Transaction identifier of Call A-B
6	MS -> SS	RELEASE COMPLETE	Transaction identifier of Call A-B
7	SS -> MS	RELEASE	Transaction identifier of Call A-C
8	MS -> SS	RELEASE COMPLETE	Transaction identifier of Call A-C
9	SS -> MS	RELEASE	Transaction identifier of Call A-D
10	MS -> SS	RELEASE COMPLETE	Transaction identifier of Call A-D
11	SS -> MS	STATUS ENQUIRY	Transaction identifier of Call A-B
12	MS -> SS	RELEASE COMPLETE	Transaction identifier of Call A-B, with cause #81 "invalid transaction identifier value"
13	SS -> MS	STATUS ENQUIRY	Transaction identifier of Call A-C
14	MS -> SS	RELEASE COMPLETE	Transaction identifier of Call A-C, with cause #81 "invalid transaction identifier value"
15	SS -> MS	STATUS ENQUIRY	Transaction identifier of Call A-D
16	MS -> SS	RELEASE COMPLETE	Transaction identifier of Call A-D, with cause #81 "invalid transaction identifier value"

31.4.4.3 Add the single call to the MPTY

31.4.4.3.1 Add the single call to the MPTY, successful case

Conformance requirement

3GPP TS 04.84 subclause 1.4.1.4.

Test purpose

To test that the MS correctly adds a single held call to an active MultiParty call, and reacts correctly to a response from the SS indicating success.

Method of test

Specific PICS Statements

-

PIXIT Statements

- Method of adding the single call to the MultiParty call.

Initial conditions

System Simulator:

1 cell, default parameters.

Mobile Station:

The MS shall have a MultiParty call to two destinations (A-B and A-C) both in state U10 "Active" with auxiliary state "Call in MPTY". The MS shall have in addition a single call (A-D) in state U10 "Active" with auxiliary state "Call held". Both calls shall be of a basic service supported by the MS and relevant to the MultiParty supplementary service as stated in 3GPP TS 02.04 table A.1.

NOTE: The MultiParty call may be set up using the procedures of subclause 31.4.1.1.

Foreseen final state of the MS

Call A-B, state U10, auxiliary state "Call in MPTY". Call A-C, state U10, auxiliary state "Call in MPTY". Call A-D state U10, auxiliary state "Call in MPTY".

Maximum duration of test

30 s.

Procedure

Using suitable MMI commands, the MS shall add the single call to the MultiParty call. The MS shall send a FACILITY message containing one of the transaction identifiers A-B, A-C or A-D and containing a BuildMPTY invoke component. Calls A-B and A-C shall remain in state U10 "Active" with auxiliary state "Call in MPTY". Call A-D shall enter state U10 "Active" with auxiliary state "MPTY request, call held". The call states shall be verified by the SS sending a STATUS ENQUIRY message in respect of the transaction identifier of each call, and receiving a STATUS message indicating the appropriate call state.

On receipt of a FACILITY message containing a return result component, all calls shall enter state U10 "Active" with auxiliary state "Call in MPTY". The call states shall be verified by the SS sending a STATUS ENQUIRY message in respect of the transaction identifier of each call, and receiving a STATUS message indicating the appropriate call state.

Expected sequence

Step	Direction	Message	Comments
1	MS		Using MMI commands, join the single call to the MultiParty call
2	MS -> SS	FACILITY	TI for Call A-B, Call A-C or call A-D, BuildMPTY Invoke component
3	SS -> MS	STATUS ENQUIRY	Transaction identifier of Call A-B
4	MS -> SS	STATUS	Transaction identifier of Call A-B, state U10, auxiliary state "Call in MPTY"
5	SS -> MS	STATUS ENQUIRY	Transaction identifier of Call A-C
6	MS -> SS	STATUS	Transaction identifier of Call A-C, state U10, auxiliary state "Call in MPTY"
7	SS -> MS	STATUS ENQUIRY	Transaction identifier of Call A-D
8	MS -> SS	STATUS	Transaction identifier of Call A-D, state U10, auxiliary state "MPTY request, Call held"
9	SS -> MS	FACILITY	TI same as step 2, Return Result component
10	SS -> MS	STATUS ENQUIRY	Transaction identifier of Call A-B
11	MS -> SS	STATUS	Transaction identifier of Call A-B, state U10, auxiliary state "Call in MPTY"
12	SS -> MS	STATUS ENQUIRY	Transaction identifier of Call A-C
13	MS -> SS	STATUS	Transaction identifier of Call A-C, state U10, auxiliary state "Call in MPTY"
14	SS -> MS	STATUS ENQUIRY	Transaction identifier of Call A-D
15	MS -> SS	STATUS	Transaction identifier of Call A-D, state U10, auxiliary state "Call in MPTY"
16	SS		Check that the TCH is through-connected

31.4.4.3.2 Add the single call to the MPTY, maximum number of participants exceeded

Conformance requirement

3GPP TS 04.84 subclause 1.4.1.4.

Test purpose

To test that the MS correctly adds a single held call to an active MultiParty call, and reacts correctly to a response from the SS indicating maximum number of participants exceeded.

Method of test

Specific PICS Statements

-

PIXIT Statements

- Method of adding the single call to the MultiParty call.

Initial conditions

System Simulator:

1 cell, default parameters.

Mobile Station:

The MS shall have a MultiParty call to five destinations (A-B, A-C and A-D) all in state U10 "Active" with auxiliary state "Call in MPTY". The MS shall have in addition a single call (A-E) in state U10 "Active" with auxiliary state "Call held". Both calls shall be of a basic service supported by the MS and relevant to the MultiParty supplementary service as stated in 3GPP TS 02.04 table A.1.

Foreseen final state of the MS

Call A-B, state U10, auxiliary state "Call in MPTY". Call A-C, state U10, auxiliary state "Call in MPTY". Call A-D state U10, auxiliary state "Call in MPTY", Call A-E state U10, auxiliary state "Call Held".

Maximum duration of test

30 s.

Procedure

Using suitable MMI commands, the MS shall add the single call to the MultiParty call. The MS shall send a FACILITY message containing any one of the transaction identifiers and containing a BuildMPTY invoke component. Calls A-B to A-D shall remain in state U10 "Active" with auxiliary state "Call in MPTY". Call A-E shall enter state U10 "Active" with auxiliary state "MPTY request, call held". The call states shall be verified by the SS sending a STATUS ENQUIRY message in respect of the transaction identifier of each call, and receiving a STATUS message indicating the appropriate call state.

On receipt of a FACILITY message containing a return error component "MaxNumberOfMPTY-ParticipantsExceeded", then all calls shall return to their original states. The call states shall be verified by the SS sending a STATUS ENQUIRY message in respect of the transaction identifier of each call, and receiving a STATUS message indicating the appropriate call state.

Expected sequence

Step	Direction	Message	Comments
1	MS		Using MMI commands, join the single call to the MultiParty call
2	MS -> SS	FACILITY	TI for Call A-B, Call A-C, Call A-D or Call A-E, BuildMPTY Invoke component
3	SS -> MS	STATUS ENQUIRY	Transaction identifier of Call A-B
4	MS -> SS	STATUS	Transaction identifier of Call A-B, state U10, auxiliary state "Call in MPTY"
5	SS -> MS	STATUS ENQUIRY	Transaction identifier of Call A-C
6	MS -> SS	STATUS	Transaction identifier of Call A-C, state U10, auxiliary state "Call in MPTY"
7	SS -> MS	STATUS ENQUIRY	Transaction identifier of Call A-D
8	MS -> SS	STATUS	Transaction identifier of Call A-D, state U10, auxiliary state "Call in MPTY"
9	SS -> MS	STATUS ENQUIRY	Transaction identifier of Call A-E
10	MS -> SS	STATUS	Transaction identifier of Call A-E, state U10, auxiliary state "MPTY request, Call held"
11	SS -> MS	FACILITY	Same TI as step 2, Return error component "MaxNumberOfMPTY-ParticipantsExceeded"
12	SS -> MS	STATUS ENQUIRY	Transaction identifier of Call A-B
13	MS -> SS	STATUS	Transaction identifier of Call A-B, state U10, auxiliary state "Call in MPTY"
14	SS -> MS	STATUS ENQUIRY	Transaction identifier of Call A-C
15	MS -> SS	STATUS	Transaction identifier of Call A-C, state U10, auxiliary state "Call in MPTY"
16	SS -> MS	STATUS ENQUIRY	Transaction identifier of Call A-D
17	MS -> SS	STATUS	Transaction identifier of Call A-D, state U10, auxiliary state "Call in MPTY"
18	SS -> MS	STATUS ENQUIRY	Transaction identifier of Call A-E
19	MS -> SS	STATUS	Transaction identifier of Call A-E, state U10, auxiliary state "Call Held"

31.4.4.4 Alternate between the MPTY call and the single call

Conformance requirement

3GPP TS 04.84 subclause 1.4.1.5.

Test purpose

To test that the MS correctly alternates between the single call and the MultiParty call, by proper use of the hold and retrieve procedures.

Method of test

Specific PICS Statements

-

PIXIT Statements

- Method of alternating between the single call to the MultiParty call.

Initial conditions

System Simulator:

- 1 cell, default parameters.

Mobile Station:

The MS shall have a MultiParty call to two destinations (A-B and A-C) both in state U10 "Active" with auxiliary state "Call in MPTY". The MS shall have in addition a single call (A-D) in state U10 "Active" with auxiliary state "Call held". Both calls shall be of a basic service supported by the MS and relevant to the MultiParty supplementary service as stated in 3GPP TS 02.04 table A.1.

Foreseen final state of the MS

Call A-B, state U10, auxiliary state "Call in MPTY". Call A-C, state U10, auxiliary state "Call in MPTY". Call A-D state U10, auxiliary state "Call Held",

Maximum duration of test

30 s.

Procedure

Using suitable MMI commands, the MS shall alternate between the single call and the MultiParty call. The MS shall send a FACILITY message containing one of the transaction identifiers of the MultiParty call, and containing an invoke component HoldMPTY. The MS shall then send a RETRIEVE message with the transaction identifier for Call A-D. Call A-B and Call A-C shall enter the auxiliary state "Call in MPTY, hold request". Call A-D shall enter auxiliary state "retrieve request". The call states shall be verified by the SS sending a STATUS ENQUIRY message in respect of the transaction identifier of each call, and receiving a STATUS message indicating the appropriate call state.

The SS shall send a FACILITY message with a return result component and then send a RETRIEVE ACKNOWLEDGE message. On receipt of these messages, Calls A-B and A-C shall enter auxiliary state "Call in MPTY, call held", and Call A-D shall enter state U10 "Active" with no auxiliary state. The call states shall be verified by the SS sending a STATUS ENQUIRY message in respect of the transaction identifier of each call, and receiving a STATUS message indicating the appropriate call state.

Using suitable MMI commands, the MS shall again alternate between the single call and the MultiParty call. The MS shall send a FACILITY message containing one of the transaction identifiers of the MultiParty call, and containing an invoke component RetrieveMPTY. The MS shall also send a HOLD message with the transaction identifier for Call A-D. Call A-B and Call A-C shall enter the auxiliary state "Call in MPTY, retrieve request". Call A-D shall enter auxiliary state "hold request". The call states shall be verified by the SS sending a STATUS ENQUIRY message in respect of the transaction identifier of each call, and receiving a STATUS message indicating the appropriate call state.

The SS shall send a FACILITY message with a return result component and shall also send a HOLD ACKNOWLEDGE message. On receipt of these messages, Call A-B and A-C shall enter auxiliary state "Call in MPTY", and Call A-D shall enter state U10 "Active" with auxiliary state "Call held". The call states shall be verified by the SS sending a STATUS ENQUIRY message in respect of the transaction identifier of each call, and receiving a STATUS message indicating the appropriate call state.

Expected sequence

Step	Direction	Message	Comments
1	MS		Using MMI commands, alternate between the active and held calls
2	MS -> SS	FACILITY	TI for Call A-B or call A-C, HoldMPTY Invoke component
3	MS -> SS	RETRIEVE	Transaction identifier of Call A-D
4	SS -> MS	STATUS ENQUIRY	Transaction identifier of Call A-B
5	MS -> SS	STATUS	Transaction identifier of Call A-B, state U10, auxiliary state "Call in MPTY, Hold request"
6	SS -> MS	STATUS ENQUIRY	Transaction identifier of Call A-C
7	MS -> SS	STATUS	Transaction identifier of Call A-C, state U10, auxiliary state "Call in MPTY, Hold request"
8	SS -> MS	STATUS ENQUIRY	Transaction identifier of Call A-D
9	MS -> SS	STATUS	Transaction identifier of Call A-D, state U10, auxiliary state "Retrieve request"
10	SS -> MS	FACILITY	Same TI as step 2, Return result component
11	SS -> MS	RETRIEVE ACKNOWLEDGE	Transaction identifier of Call A-D
12	SS -> MS	STATUS ENQUIRY	Transaction identifier of Call A-B
13	MS -> SS	STATUS	Transaction identifier of Call A-B, state U10, auxiliary state "Call in MPTY, Call held"
14	SS -> MS	STATUS ENQUIRY	Transaction identifier of Call A-C
15	MS -> SS	STATUS	Transaction identifier of Call A-C, state U10, auxiliary state "Call in MPTY, Call held"
16	SS -> MS	STATUS ENQUIRY	Transaction identifier of Call A-D
17	MS -> SS	STATUS	Transaction identifier of Call A-D, state U10, no auxiliary state
21	SS		Check that the TCH is through-connected
18	MS		Using MMI commands, alternate between the active and held calls
19	MS -> SS	HOLD	Transaction identifier of Call A-D
20	MS -> SS	FACILITY	TI for Call A-B or call A-C, RetrieveMPTY Invoke component
21	SS -> MS	STATUS ENQUIRY	Transaction identifier of Call A-B
22	MS -> SS	STATUS	Transaction identifier of Call A-B, state U10, auxiliary state "Call in MPTY, Retrieve request"
23	SS -> MS	STATUS ENQUIRY	Transaction identifier of Call A-C
24	MS -> SS	STATUS	Transaction identifier of Call A-C, state U10, auxiliary state "Call in MPTY, Retrieve request"
25	SS -> MS	STATUS ENQUIRY	Transaction identifier of Call A-D
26	MS -> SS	STATUS	Transaction identifier of Call A-D, state U10, auxiliary state "Holdrequest"
27	SS -> MS	HOLD ACKNOWLEDGE	Transaction identifier of Call A-D
28	SS -> MS	FACILITY	Same TI as step 20, Return result component
29	SS -> MS	STATUS ENQUIRY	Transaction identifier of Call A-B
30	MS -> SS	STATUS	Transaction identifier of Call A-B, state U10, auxiliary state "Call in MPTY"
31	SS -> MS	STATUS ENQUIRY	Transaction identifier of Call A-C
32	MS -> SS	STATUS	Transaction identifier of Call A-C, state U10, auxiliary state "Call in MPTY"
33	SS -> MS	STATUS ENQUIRY	Transaction identifier of Call A-D
34	MS -> SS	STATUS	Transaction identifier of Call A-D, state U10, auxiliary state "Call Held"
35	SS		Check that the TCH is through-connected

31.4.5 Adding extra remote parties

Conformance requirement

3GPP TS 04.84 subclause 1.5.

Test purpose

To test that the MS adds extra remote parties to the MultiParty call.

Method of test**Specific PICS Statements**

-

PIXIT Statements

- Method of alternating between the single call to the MultiParty call.

Initial conditions**System Simulator:**

1 cell, default parameters.

Mobile Station:

The MS shall have a MultiParty call to two destinations (Call A-B and Call A-C) active. Both call states shall be U10 "Active" with auxiliary state "Call in MPTY". The call shall be of a basic service supported by the MS and relevant to the MultiParty supplementary service as stated in 3GPP TS 02.04 table A.1.

Foreseen final state of the MS

Call A-B, state U10, auxiliary state "Call in MPTY". Call A-C, state U10, auxiliary state "Call in MPTY". Call A-D state U10, auxiliary state "Call in MPTY".

Maximum duration of test

30 s.

Procedure

The procedure of test 34.4.2.1.1.1 "Put the MultiParty call on hold, successful case" shall be performed followed by the procedure of 34.4.3.2 "Initiate a new call", followed by the procedure of 31.4.4.3.1 " Add the single call to the MPTY, successful case".

Expected sequence

Step	Direction	Message	Comments
1	MS		Using MMI commands, put the MultiParty call on Hold
2	MS -> SS	FACILITY	TI for Call A-B or call A-C, HoldMPTY Invoke component
3	SS -> MS	FACILITY	Same TI as step 2, Return Result component
4	MS -> SS	SETUP	TI different from Call A-B or Call A-C (new Call A-D)
5	SS -> MS	ALERTING	Transaction identifier of Call A-D
6	SS -> MS	CONNECT	Transaction identifier of Call A-D
7	MS -> SS	CONNECT ACKNOWLEDGE	Transaction identifier of Call A-D
8	MS -> SS	FACILITY	TI for Call A-B, Call A-C or call A-D, BuildMPTY Invoke component
9	SS -> MS	FACILITY	TI same as step 8, Return Result component
10	SS -> MS	STATUS ENQUIRY	Transaction identifier of Call A-B
11	MS -> SS	STATUS	Transaction identifier of Call A-B, state U10, auxiliary state "Call in MPTY"
12	SS -> MS	STATUS ENQUIRY	Transaction identifier of Call A-C
13	MS -> SS	STATUS	Transaction identifier of Call A-C, state U10, auxiliary state "Call in MPTY"
14	SS -> MS	STATUS ENQUIRY	Transaction identifier of Call A-D
15	MS -> SS	STATUS	Transaction identifier of Call A-D, state U10, auxiliary state "Call in MPTY"
16	SS		Check that the TCH is through-connected

31.5 Community of interest supplementary services

(Reserved).

31.6 Charging supplementary services

The following Advice of Charge abbreviations are used in this subclause:

AoC	Advice of Charge
AoCC	Advice of Charge Charging
AoCI	Advice of Charge Information
ACM	Accumulated Charge Meter
ACMmax	Accumulated Charge Meter Maximum
CCM	Current Call Meter
CAI	Charge Advice Information
CDUR	Chargeable Duration

The following other abbreviations are used:

IE	Information Element
FIE	Facility Information Element
TCH	Traffic CHannel

General on Advice of Charge.

The purpose of these tests is to verify that the MS under test correctly performs procedures related to the AoC supplementary service.

The reasons for these test purposes are:

- One example of a possible use for AoCC is in applications where the subscriber hires out a GSM ME and SIM to a user and bills the user according to the charge stored on the SIM at the end of the hire period. If a mobile station claims to support AoCC but does so incorrectly or not at all, this may cause the subscriber to mischarge the user of the hire phone. Hence an MS claiming to support AoCC must be shown to be reliable in that context.
- Since AoCC offers the use of telecommunication services according to the charge stored independently in the MS, the AoCC service must not be susceptible to fraud at the MS end.
- To ensure that a mobile station **not** claiming to support AoCC does not respond with a signal to the network indicating that it does. This could cause the network to allow the call to be placed without any charge being inserted on to the SIM.

Mobile originating and terminating speech AoC calls are tested and if supported, Call Hold and Multi-party calls. The type testing of data calls (i.e. those calls with a volume related charging component) will not be specified at the phase 2 stage but will be deferred to phase 2+ since the interaction of AoC with packet services is not yet defined in 3GPP TS 09.06 and 3GPP TS 09.07.

Tests are made on the ME-SIM interface to ensure that call charges are being correctly stored in the ACM field of the SIM in several situations. The AoC ACMmax function is also tested for incoming and outgoing calls.

Basic service verification tests for the AoCC, Call Hold, and Multi-party supplementary services which have direct relevance to the testing of AoC have been added to 3GPP TS 11.10, subclauses 11.3, 11.4 and 11.5 respectively.

31.6.1 Advice of Charge Charging

31.6.1.1 AoCC time related charging / MS originated call

Purpose:

- 1) To verify that when the MS receives the AoCC parameters in a Facility IE which is contained in the CONNECT message and when a TCH has already been assigned, the MS returns a FACILITY message containing the acknowledgement within 1 s.

- 2) To verify that when the MS receives the AoCC parameters in a Facility IE which is contained in a CONNECT message and when a TCH has already been assigned, the MS stores the correct value in the ACM field of the SIM.
- 3) To verify that when the call has no volume related component the MS ignores non-zero AoCC e5, e6 parameters sent to it.

Conformance Requirement(s):

- 1) When the MS receives the AoCC parameters in a Facility IE which is contained in a CONNECT message and when a TCH has already been assigned, the MS shall return a FACILITY message containing the acknowledgement within 1 s.
- 2) When the MS receives the AoCC parameters in a Facility IE which is contained in a CONNECT or FACILITY message and when a TCH has already been assigned, the MS shall store the correct value in the ACM field of the SIM.
- 3) When the call has no volume related component the MS shall ignore non-zero AoC e5 and e6 parameters sent to it.

Reference(s):

- Conformance requirement 1: 3GPP TS 03.86, 3GPP TS 04.13, 3GPP TS 04.86.
- Conformance requirement 2: 3GPP TS 02.24.
- Conformance requirement 3: 3GPP TS 02.24.

Specific PICS Statements

- Supported teleservices (TSPC_AddInfo_TeleSvc).

PIXIT Statements

- Method of reading ACM from the SIM via the ME.
- Support for active state of the call control protocol (U10).

Initial Conditions:

System Simulator:

1 cell, default parameters, IMSI attach/detach disabled.

Mobile Station:

The MS is in MM-state "idle, updated".

Foreseen Final State of the MS:

The MS is in MM-state "idle, updated".

Method of Test:

The MS is made to initiate a call. The call is established with certain AoCC e-parameters sent in a Facility IE in the CONNECT message. The MS shall return the AoCC acknowledgement within 1 s of the CONNECT message. It is an implementation option whether the AoCC acknowledgement is sent by the MS before or after the CONNECT ACKNOWLEDGE.

The SS sends the DISCONNECT y seconds after sending the CONNECT message containing the CAI. The MS shall have stored the correct amount on the SIM according to the e-parameters sent. The test is repeated for several different sets of e-parameters as defined below.

Maximum Duration of Test:

30 minutes.

Expected Sequence:

The sequence step 1-20 is executed for execution counter k = 1,...,5.

Step	Direction	Message	Comments
0			At start of test only, read and note value of ACM on SIM The MS is made to initiate a call
1	MS		
2	MS -> SS	CHANNEL REQUEST	
3	SS -> MS	IMMEDIATE ASSIGNMENT	
4	MS -> SS	CM SERVICE REQUEST	
5	SS -> MS	CM SERVICE ACCEPT	
6	MS -> SS	SETUP	
7	SS -> MS	CALL PROCEEDING	
8	SS -> MS	ASSIGNMENT COMMAND	
9	MS -> SS	ASSIGNMENT COMPLETE	
10	SS -> MS	ALERTING	
11	SS -> MS	CONNECT	As default message except contains Facility IE with contents as indicated in i below
			Either A or B branch is taken
A12	MS -> SS	CONNECT ACKNOWLEDGE	As default message except contains Facility IE with contents as indicated in ii below
A13	MS -> SS	FACILITY	
B12	MS -> SS	FACILITY	As default message except contains Facility IE with contents as indicated in ii below
B13	MS -> SS	CONNECT ACKNOWLEDGE	
14			call duration y seconds after CAI information sent by SS
15	SS -> MS	DISCONNECT	
16	MS -> SS	RELEASE	
17	SS -> MS	RELEASE COMPLETE	
18	SS -> MS	CHANNEL RELEASE	
19	MS		
			The main signalling link is released. SIM contents checked (either via MMI or by removing the SIM and using SIM reader). ACM shall have been incremented correctly.

NOTE: The value of y is given below.

The correct value of the ACM is found from the general AoC formula given in 3GPP TS 02.24 clause 4 with CDUR = y seconds and e parameters as defined below.

Specific Message Contents:

i) FACILITY Information Element with Invoke = ForwardChargeAdvice component type as defined in 3GPP TS 04.80 subclause 3.6.1 table 3.3.

For ASN.1 description see default message contents in subclause 31.6.4.

y is set to a constant value of 90 s.

The values of the e-parameters within the parameter part of the Facility Information Element shall be set as below:

k-value	e-parameter							CCM Total at call end increased by	Step 0 ACM value
	1	2	3	4	5	6	7		
1	6	14	1	25	0	0	60	43	43
2	0	0	1	100	0	0	0	100	143
3	250	16	2	500	0	0	60	2 000	2 143
4	1	1	1	0	10	10	1	89 or 90	2 232 or 2 233
5	12,5	30	1	25	10	10	30	50 or 62,5	2 295, 2 296, 2 282 or 2 283

Values shown in table are in the format and have units as in 3GPP TS 02.24 clause 3.

The ASN.1 description for each e-parameter allows integers in the range 0 to 8191 to be transmitted but some e-parameters have different actual ranges (e.g. e1 can take any value 0..819,1 with 0,1 resolution). The MS knows how to

interpret the received parameter (e.g. received e1 refers to 10 times actual e1, see 3GPP TS 04.80 subclause 4.4.3). Therefore e1=12,5 would be sent to the MS as 125. The MS knows the value sent is 10 times the "real" e1 and hence interprets the value as 12,5.

The non-zero e5 and e6 values for the k=4 and k=5 execution of the test are to check that the MS ignores the volume related parameters when carrying out time only related charging.

- ii) FACILITY Information Element with Return Result component type as defined in 3GPP TS 04.80 subclause 3.6.1 table 3.4.

For ASN.1 description see default message contents in subclause 31.6.4.

31.6.1.2 AoCC time related charging / MS terminated call

Purpose:

- 1) To verify that when the MS receives certain AoCC e-parameters in a Facility IE which is contained in a FACILITY message sent after the CONNECT message and when a TCH has already been assigned, the MS returns a FACILITY message containing the acknowledgement within 1 s.
- 2) To verify that when the MS receives the AoCC parameters in a Facility IE which is contained in a FACILITY message and when a TCH has already been assigned, the MS stores the correct value in the ACM field of the SIM.

Conformance Requirement(s):

- 1) When the MS receives the AoCC parameters in a Facility IE which is contained in a FACILITY message sent after the CONNECT message and when a TCH has already been assigned, the MS shall return a Facility message containing the acknowledgement within 1 s.
- 2) When the MS receives the AoCC parameters in a Facility IE which is contained in a FACILITY message and when a TCH has already been assigned, the MS shall store the correct value in the ACM field of the SIM.

Reference(s):

Conformance requirement 1: 3GPP TS 03.86, 3GPP TS 04.13, 3GPP TS 04.86.

Conformance requirement 2: 3GPP TS 02.24.

Specific PICS Statements

- Supported teleservices (TSPC_AddInfo_TeleSvc).

PIXIT Statements

- Method of reading ACM from the SIM via the ME.
- Support for active state of the call control protocol (U10).

Initial Conditions:

System Simulator:

1 cell, default parameters, IMSI attach/detach disabled.

Mobile Station:

The MS is in MM-state "idle, updated".

Foreseen Final State of the MS:

The MS is in MM-state "idle, updated".

Method of Test:

The SS is made to initiate a call. The call is established and certain AoCC e-parameters are sent to the MS in a Facility IE contained within a FACILITY message. The MS shall return the AoCC acknowledgement within 1 s of the

FACILITY message. It is an implementation option whether the AoCC e-parameters and the AoCC acknowledge are sent before or after the CONNECT ACKNOWLEDGE.

The SS sends the DISCONNECT y seconds after sending the FACILITY message. The MS shall have stored the correct amount on the SIM according to the e-parameters sent. The test is repeated for several different sets of e-parameters as defined below.

Maximum Duration of Test:

30 minutes.

Expected Sequence:

The sequence step 1-20 is executed for execution counter $k = 1, \dots, 5$.

Step	Direction	Message	Comments
0			At start of test only, read and note value of ACM on SIM
1	SS		The SS is made to initiate a call
2	SS -> MS	PAGING REQUEST	
3	MS -> SS	CHANNEL REQUEST	
4	SS -> MS	IMMEDIATE ASSIGNMENT	
5	MS -> SS	PAGING RESPONSE	
6	SS -> MS	SETUP	
7	MS -> SS	CALL CONFIRMED	
8	SS -> MS	ASSIGNMENT COMMAND	to a supported channel type
9	MS -> SS	ASSIGNMENT COMPLETE	
10	MS -> SS	ALERTING	
11	MS -> SS	CONNECT	
12	SS -> MS	FACILITY	As default message except contains Facility IE with contents as indicated in i below
			Either A or B branch is taken
A13	SS -> MS	CONNECT ACKNOWLEDGE	
A14	MS -> SS	FACILITY	As default message except contains Facility IE with contents as indicated in ii below
B13	MS -> SS	FACILITY	As default message except contains Facility IE with contents as indicated in ii below
B14	SS -> MS	CONNECT ACKNOWLEDGE	
15			call duration y seconds after CAI information sent by SS
16	SS -> MS	DISCONNECT	
17	MS -> SS	RELEASE	
18	SS -> MS	RELEASE COMPLETE	
19	SS -> MS	CHANNEL RELEASE	The main signalling link is released.
20	MS		SIM contents checked (either via MMI or by removing the SIM and using SIM reader) ACM shall have been incremented correctly.

NOTE: The value of y is given below.

The correct value of the ACM is found from the general AoC formula given in 3GPP TS 02.24 clause 4 with $CDUR = y$ seconds and e parameters as defined below.

Specific Message Contents:

i) FACILITY Information Element with Invoke = ForwardChargeAdvice component type as defined in 3GPP TS 04.80 subclause 3.6.1 table 3.3.

For ASN.1 description see default message contents in subclause 31.6.4.

y is set to a constant value of 90 s.

The values of the e-parameters within the parameter part of the Facility Information Element shall be set as below:

k-value	e-parameter							CCM total at call end increased by	Step 0 ACM value
	1	2	3	4	5	6	7		
1	0	0	0	0	0	0	0	0	0
2	0	0	1	100	0	0	0	100	100
3	6	14	1	25	0	0	60	43	143
4	1	1	1	0	0	0	1	89 or 90	233 or 232
5	12,5	30	1	25	0	0	30	50 or 62,5	296, 295, 282 or 283

Values shown in table are in the format and have units as in 3GPP TS 02.24 clause 3.

ii) FACILITY Information Element with Return Result component type as defined in 3GPP TS 04.80 subclause 3.6.1 table 3.4.

For ASN.1 description see default message contents in subclause 31.6.4.

31.6.1.3 AoCC volume related charging / MS originated call

Future addition at GSM Phase 2+ stage.

31.6.1.4 AoCC volume related charging / MS terminated call

Future addition at GSM Phase 2+ stage.

31.6.1.5 Change in charging information during a call

Purpose:

- 1) To verify that when the MS receives new AoCC parameters mid-way through a call in a Facility IE which is contained within a FACILITY message the MS returns a FACILITY message containing the acknowledgement within 1 s.
- 2) To verify that when the MS receives new charging information mid-way through a call in the form of a Facility IE contained within a FACILITY message the MS correctly indicates the total charge considering both sets of charging information.

Conformance Requirement(s):

- 1) When the MS receives new AoCC parameters mid-way through a call in a Facility IE which is contained within a FACILITY message the MS shall return a FACILITY message containing the acknowledgement within 1 s.
- 2) When the MS receives new charging information mid-way through a call in the form of a Facility IE contained within a FACILITY message the MS correctly indicates the total charge considering both sets of charging information.

Reference(s):

Conformance requirement 1: 3GPP TS 03.86, 3GPP TS 04.13, 3GPP TS 04.86.

Conformance requirement 2: 3GPP TS 02.24.

Specific PICS Statements

- Supported teleservices (TSPC_AddInfo_TeleSvc)

PIXIT Statements

- Method of reading ACM from the SIM via the ME.
- Support for active state of the call control protocol (U10).

Initial Conditions:

System Simulator:

1 cell, default parameters, IMSI attach/detach disabled.

Mobile Station:

The MS is in MM-state "idle, updated".

Foreseen Final State of the MS:

The MS is in MM-state "idle, updated".

Method of Test:

The MS is made to initiate a call. The call is established with certain AoCC e-parameters sent in a Facility IE in a FACILITY message sent after the CONNECT message. The MS shall return the AoCC acknowledgement within 1 s of the FACILITY message. x seconds after sending the original CAI, new (and different) e-parameters are sent to the MS in a Facility IE contained within a FACILITY message. The MS shall return the AoCC acknowledge within 1 s of the FACILITY message.

The SS sends the DISCONNECT y seconds after sending the first CAI in the FACILITY message. The MS shall have stored the correct amount on the SIM according to the two sets of e-parameters sent and the times for the two parts of the call.

Maximum Duration of Test:

10 minutes.

Expected Sequence:

Step	Direction	Message	Comments
0			At start of test only, read and note value of ACM on SIM
1	MS		The MS is made to initiate a call
2	MS -> SS	CHANNEL REQUEST	
3	SS -> MS	IMMEDIATE ASSIGNMENT	
4	MS -> SS	CM SERVICE REQUEST	
5	SS -> MS	CM SERVICE ACCEPT	
6	MS -> SS	SETUP	
7	SS -> MS	CALL PROCEEDING	
8	SS -> MS	ASSIGNMENT COMMAND	to a supported channel type
9	MS -> SS	ASSIGNMENT COMPLETE	
10	SS -> MS	ALERTING	
11	SS -> MS	CONNECT	
			Either A, B or C branch is taken
A12	SS -> MS	FACILITY	As default message except contains Facility IE with contents as indicated in i below
A13	MS -> SS	CONNECT ACKNOWLEDGE	
A14	MS -> SS	FACILITY	As default message except contains Facility IE with contents as indicated in ii below
B12	MS -> SS	CONNECT ACKNOWLEDGE	
B13	SS -> MS	FACILITY	As default message except contains Facility IE with contents as indicated in i below
B14	MS -> SS	FACILITY	As default message except contains Facility IE with contents as indicated in ii below
C12	SS -> MS	FACILITY	As default message except contains Facility IE with contents as indicated in i below
C13	MS -> SS	FACILITY	As default message except contains Facility IE with contents as indicated in ii below
C14	MS-> SS	CONNECT ACKNOWLEDGE	
15	SS -> MS	FACILITY	Second CAI sent x sec after first CAI As default message except contains Facility IE with contents as indicated in iii below
16	MS -> SS	FACILITY	As default message except contains Facility IE with contents as indicated in ii below New CAI held in abeyance until CDUR has timed out present e2 value
17			Call duration y seconds after first CAI information sent by SS
18	SS -> MS	DISCONNECT	
19	MS -> SS	RELEASE	
20	SS -> MS	RELEASE COMPLETE	
21	SS -> MS	CHANNEL RELEASE	The main signalling link is released.
22	MS		SIM contents checked (either via MMI or by removing the SIM and using SIM reader) ACM shall have been incremented correctly

NOTE The values of x and y are given below.

The correct value of the ACM is found from the general AoC formula given in 3GPP TS 02.24 clause 4 with CDUR = x, y seconds and e parameters as defined below.

Specific Message Contents:

- i) FACILITY Information Element with Invoke = ForwardChargeAdvice component type as defined in 3GPP TS 04.80 subclause 3.6.1 table 3.3.

For ASN.1 description see default message contents in subclause 31.6.4.

The values of the e-parameters within the parameter part of the Facility Information Element shall be set as defined below:

e-parameter							CCM total at call end increased by	Step 0 ACM value
1	2	3	4	5	6	7		
10	28	1	10	0	0	60	(30)	(30)

Values shown in table are in the format and have units as in 3GPP TS 02.24 clause 3.

- ii) FACILITY Information Element with Return Result component type as defined in 3GPP TS 04.80 subclause 3.6.1 table 3.4.

For ASN.1 description see default message contents in subclause 31.6.4.

- iii) FACILITY Information Element with Invoke = ForwardChargeAdvice component type as defined in 3GPP TS 04.80 subclause 3.6.1 table 3.3.

For ASN.1 description see default message contents in subclause 31.6.4.

x is set to a constant value of 80 s.

y is set to a constant value of 180 s.

The values of the e-parameters within the parameter part of the Facility Information Element shall be set to:

e-parameter							CCM total at call end increased by	Step 0 ACM value
1	2	3	4	5	6	7		
10	14	1	5	0	0	60	65	65

Values shown in table are in the format and have units as in 3GPP TS 02.24 clause 3.

31.6.1.6 Different formats of charging information

Purpose:

- 1) To verify that when the MS receives a Facility IE in which certain e-parameters are set to zero the total charge accumulated is the same as that when the same e-parameters are completely omitted from the Facility IE.
- 2) To verify the operation of a shortened channel release procedure where the SS does not send DISCONNECT but only the RELEASE COMPLETE and CHANNEL RELEASE messages or just the CHANNEL RELEASE message.

Conformance Requirement(s):

- 1) When the MS receives a Facility IE in which certain e-parameters are set to zero the total charge accumulated shall be the same as that when the same e-parameters are completely omitted from the Facility IE.
- 2) The channel shall be correctly released when a shortened channel release procedure is used - the SS does not send DISCONNECT but only the RELEASE COMPLETE and CHANNEL RELEASE messages or just the CHANNEL RELEASE message.

Reference(s):

Conformance requirement 1: 3GPP TS 02.24.

Conformance requirement 2: 3GPP TS 04.08 / 3GPP TS 44.018.

Specific PICS Statements

- Supported teleservices (TSPC_AddInfo_TeleSvc).

PIXIT Statements

- Method of reading ACM from the SIM via the ME.
- Support for active state of the call control protocol (U10).

Initial Conditions:

System Simulator:

1 cell, default parameters, IMSI attach/detach disabled.

Mobile Station:

The MS is in MM-state "idle, updated".

Foreseen Final State of the MS:

The MS is in MM-state "idle, updated".

Method of Test:

Part 1:

The MS is made to initiate a call. The call is established with certain AoCC e-parameters sent in a Facility IE in a FACILITY message sent before the CONNECT message.

The SS sends the DISCONNECT y seconds after sending the FACILITY message containing the e-parameters. The MS shall have stored the correct amount on the SIM according to the e-parameters sent.

Part 2:

Part 1 is repeated twice with the e-parameters that were set to zero above now omitted completely from the Facility IE. The shortened release procedures are used. The MS shall have stored the correct amount on the SIM.

The results of parts 1 and 2 are compared. The value for the charge calculated by the MS shall be identical for parts 1 and 2.

Maximum Duration of Test:

20 minutes.

Expected Sequence:

The sequence step 1-20 is executed for execution counter $k = 1, \dots, 3$.

Step	Direction	Message	Comments
0			At start of test only, read and note value of ACM on SIM
1	MS		The MS is made to initiate a call
2	MS -> SS	CHANNEL REQUEST	
3	SS -> MS	IMMEDIATE ASSIGNMENT	
4	MS -> SS	CM SERVICE REQUEST	
5	SS -> MS	CM SERVICE ACCEPT	
6	MS -> SS	SETUP	
7	SS -> MS	CALL PROCEEDING	
8	SS -> MS	ASSIGNMENT COMMAND	to a supported channel type
9	MS -> SS	ASSIGNMENT COMPLETE	
10	SS -> MS	ALERTING	
11	SS -> MS	FACILITY	As default message except contains Facility IE with contents as indicated in i below
			Either A, B or C branch is taken
A12	SS -> MS	CONNECT	
A13	MS -> SS	CONNECT ACKNOWLEDGE	
A14	MS -> SS	FACILITY	As default message except contains Facility IE with contents as indicated in ii below
B12	SS -> MS	CONNECT	
B13	MS -> SS	FACILITY	As default message except contains Facility IE with contents as indicated in ii below
B14	MS -> SS	CONNECT ACKNOWLEDGE	
C12	MS -> SS	FACILITY	As default message except contains Facility IE with contents as indicated in ii below
C13	SS -> MS	CONNECT	
C14	MS -> SS	CONNECT ACKNOWLEDGE	
15			call duration y seconds after CAI information sent by SS
			Branch D, E and F shall be taken for $k = 1, 2$ and 3 respectively
D16	SS -> MS	DISCONNECT	
D17	MS -> SS	RELEASE	
D18	SS -> MS	RELEASE COMPLETE	
D19	SS -> MS	CHANNEL RELEASE	The main signalling link is released.
E16	SS -> MS	RELEASE COMPLETE	Shortened channel release procedure
E17	SS -> MS	CHANNEL RELEASE	The main signalling link is released.
F16	SS -> MS	CHANNEL RELEASE	
20	MS		SIM contents checked (either via MMI or by removing the SIM and using SIM reader) ACM shall have been incremented correctly.

NOTE The value of y is given below.

The correct value of the ACM is found from the general AoC formula given in 3GPP TS 02.24 clause 4 with $CDUR = y$ seconds and e parameters as defined below.

Specific Message Contents:

- i) FACILITY Information Element with Invoke = ForwardChargeAdvice component type as defined in 3GPP TS 04.80 subclause 3.6.1 table 3.3.

For ASN.1 description see default message contents in subclause 31.6.4.

y is set to a constant value of 90 s.

The values of the e -parameters within the parameter part of the Facility Information Element shall be set to:

k-value	e-parameter							CCM total at call end increased by	Step 0 ACM value
	1	2	3	4	5	6	7		
1	10	40	1	0	0	0	0	20	20
2	10	40	1	-----omitted-----				20	40
3	10	40	1	-----omitted-----				20	60

Values shown in table are in the format and have units as in 3GPP TS 02.24 clause 3.

ii) FACILITY Information Element with Return Result component type as defined in 3GPP TS 04.80 subclause 3.6.1 table 3.4.

For ASN.1 description see default message contents in subclause 31.6.4.

31.6.1.7 AoCC on a Call Hold call

Purpose:

- 1) To verify that when the MS invokes a Call Hold call and hence receives Facility IEs containing AoCC e-parameters for each chargeable call the MS returns a FACILITY message containing the AoCC acknowledgement within 1 s of transmission of each set of e-parameters.
- 2) To verify that when the MS invokes a Call Hold call and hence receives Facility IEs containing CAI elements for each chargeable call the CCM records the sum of all the charges for the services currently being used and hence that the ME inserts the correct charge in the ACM field of the SIM.

Conformance Requirement(s)

- 1) When the MS invokes a Call Hold call and hence receives Facility IEs containing AoCC e-parameters for each chargeable call the MS shall return a FACILITY message containing the AoCC acknowledgement within 1 s of receiving each set of e-parameters.
- 2) When the MS invokes a Call Hold call and hence receives Facility IEs containing CAI elements for each chargeable call the CCM shall record the sum of all the charges for the services currently being used and hence the ME shall insert the correct charge in the ACM field of the SIM.

Reference(s):

Conformance requirement 1: 3GPP TS 04.13.

Conformance requirement 2: 3GPP TS 02.24, 3GPP TS 04.83, 3GPP TS 04.84, 3GPP TS 04.86.

Specific PICS Statements

- Supported teleservices (TSPC_AddInfo_TeleSvc).

PIXIT Statements

- Method of reading ACM from the SIM via the ME.
- Support for active state of the call control protocol (U10).

Initial Conditions:

System Simulator:

1 cell, default parameters, IMSI attach/detach disabled.

Mobile Station:

The MS is in MM-state "idle, updated".

Foreseen Final State of the MS:

The MS is in MM-state "idle, updated".

Method of Test:

The MS is made to initiate a call. The call is established with certain AoCC e-parameters sent in a Facility IE in the CONNECT message. The MS shall return the AoCC acknowledgement within 1 s of transmission of the CONNECT message.

The call (call B) is then put on hold by sending a HOLD message from the MS to the SS. The SS shall reply with a HOLD ACKNOWLEDGE. The traffic channel is now available to originate another call.

The MS is made to initiate a second call (call C). The call is established with certain AoCC e-parameters sent in a Facility IE in the CONNECT message. The MS shall return the AoCC acknowledgement in a FACILITY message within 1 s of transmission of the CONNECT message.

The SS sends the DISCONNECT to the MS for call B x seconds after sending the call B CAI in the CONNECT/FACILITY message and the DISCONNECT for call C y seconds after sending the call C CAI in the CONNECT/FACILITY message. The MS shall have stored the correct amount on the SIM according to the two sets of e-parameters sent and call times x and y.

Maximum Duration of Test:

10 minutes.

Expected Sequence:

Step	Direction	Message	Comments
0			At start of test only, read and note value of ACM on SIM
1	MS		The MS is made to initiate a call
2	MS -> SS	CHANNEL REQUEST	
3	SS -> MS	IMMEDIATE ASSIGNMENT	
4	MS -> SS	CM SERVICE REQUEST	
5	SS -> MS	CM SERVICE ACCEPT	
6	MS -> SS	SETUP	
7	SS -> MS	CALL PROCEEDING	
8	SS -> MS	ASSIGNMENT COMMAND	to a supported channel type
9	MS -> SS	ASSIGNMENT COMPLETE	
10	SS -> MS	ALERTING	
11	SS -> MS	CONNECT	As default message except contains Facility IE with contents as indicated in i below
			Either D or E branch is taken
D12	MS -> SS	CONNECT ACKNOWLEDGE	
D13	MS -> SS	FACILITY	As default message except contains Facility IE with contents as indicated in ii below
E12	MS -> SS	FACILITY	As default message except contains Facility IE with contents as indicated in ii below
E13	MS -> SS	CONNECT ACKNOWLEDGE	
14	MS		The MS is made to initiate a second call, and the first call is placed on hold. DTMF signalling may occur, when MMI keys are depressed
15	MS -> SS	HOLD	
16	SS -> MS	HOLD ACKNOWLEDGE	
17	MS -> SS	CM SERVICE REQUEST	
18	SS -> MS	CM SERVICE ACCEPT	
19	MS -> SS	SETUP	TI arbitrary but different from existing TI
20	SS -> MS	CALL PROCEEDING	
21	SS -> MS	ALERTING	
22	SS -> MS	CONNECT	As default message except contains Facility IE with contents as indicated in i below
			Either F or G branch is taken
F23	MS -> SS	CONNECT ACKNOWLEDGE	
F24	MS -> SS	FACILITY	As default message except contains Facility IE with contents as indicated in ii below
G23	MS -> SS	FACILITY	As default message except contains Facility IE with contents as indicated in ii below
G24	MS -> SS	CONNECT ACKNOWLEDGE	
25			Call durations x and y seconds after respective CAI information sent by SS
			Branch H and I branch are taken, the sequence depending on the durations x and y
H26	SS -> MS	DISCONNECT	For call C
H27	MS -> SS	RELEASE	y seconds after call C CAI sent
H28	SS -> MS	RELEASE COMPLETE	
I26	SS -> MS	DISCONNECT	For call B
I27	MS -> SS	RELEASE	x seconds after call B CAI sent
I28	SS -> MS	RELEASE COMPLETE	
29	SS -> MS	CHANNEL RELEASE	The main signalling link is released
30	MS		SIM contents checked (either via MMI or by removing the SIM and using SIM reader) ACM shall have been incremented correctly.

NOTE The value of x and y are given below.

The correct value of the ACM is found from the general AoC formula given in 3GPP TS 02.24 clause 4 with CDUR = x,y seconds and e parameters as defined below.

Specific Message Contents:

- i) FACILITY Information Element with Invoke = ForwardChargeAdvice component type as defined in 3GPP TS 04.80 subclause 3.6.1 table 3.3.

For ASN.1 description see default message contents in subclause 31.6.4.

x set to 180 s, y is set to 90 s.

The values of the e-parameters within the parameter part of the Facility Information Element shall be set to:

Call	e-parameter							CCM total at call end increased by	Step 0 ACM value
	1	2	3	4	5	6	7		
B(time x)	7	40	1	0	0	0	0		
C(time y)	13	40	1	0	0	0	0	54	54

Values shown in table are in the format and have units as in 3GPP TS 02.24 clause 3.

- ii) FACILITY Information Element with Return Result component type as defined in 3GPP TS 04.80 subclause 3.6.1 table 3.4.

For ASN.1 description see default message contents in subclause 31.6.4.

31.6.1.8 AoCC on a Multi-party call

Purpose:

- 1) To verify that when the MS invokes a Multi-party call and hence receives Facility IEs containing AoCC e-parameters for each chargeable call the MS returns a FACILITY message containing the AoCC acknowledgement within 1 s of transmission of each set of e-parameters.
- 2) To verify that when the MS originates a Multi-party call and hence receives Facility IEs containing CAI elements for each chargeable call the CCM records the sum of all the charges for the services currently being used and hence the ME inserts the correct charge in the ACM field of the SIM.

Conformance Requirement(s):

- 1) When the MS invokes a Multi-party call and hence receives Facility IEs containing AoCC e-parameters for each chargeable call the MS shall return a FACILITY message containing the AoCC acknowledgement within 1 s of receiving each set of e-parameters.
- 2) When the MS originates a Multi-party call and hence receives Facility IEs containing CAI elements for each chargeable call the CCM shall record the sum of all the charges for the services currently being used and hence the ME shall insert the correct charge in the ACM field of the SIM.

Reference(s):

Conformance requirement 1: 3GPP TS 04.13.

Conformance requirement 2: 3GPP TS 02.24, 3GPP TS 04.83, 3GPP TS 04.84, 3GPP TS 04.86.

Specific PICS Statements

- Supported teleservices (TSPC_AddInfo_TeleSvc).

PIXIT Statements

- Method of reading ACM from the SIM via the ME.
- Support for active state of the call control protocol (U10).

Initial Conditions:

System Simulator:

1 cell, default parameters, IMSI attach/detach disabled.

Mobile Station:

The MS is in MM-state "idle, updated".

Foreseen Final State of the MS:

The MS is in MM-state "idle, updated".

Method of Test:

The MS is made to initiate a call. The call is established with certain AoCC e-parameters sent in a Facility IE in the CONNECT message. The MS shall return the AoCC acknowledgement within 1 s of transmission of the CONNECT message.

The call (call B) is then put on hold by sending a HOLD message from the MS to the SS. The SS shall reply with a HOLD ACKNOWLEDGE. The traffic channel is now available to originate another call.

The MS is made to initiate a second call (call C). The call is established with certain AoCC e-parameters sent in a Facility IE in the CONNECT message. The MS shall return the AoCC acknowledgement within 1 s of transmission of the CONNECT message.

The MS invokes the multi-party service by sending a FACILITY message to the SS containing the BuildMPTY request.

The SS accepts the request and connects the MS with the other existing connections (active call C and held call B) and confirms with a FACILITY message.

The SS sends the DISCONNECT to the MS for call B x seconds after sending the call B CAI in the CONNECT message and the DISCONNECT for call C y seconds after sending the call C CAI in the CONNECT message. The MS shall have stored the correct amount on the SIM according to the two sets of e-parameters sent and call times x and y.

Maximum Duration of Test:

10 minutes.

Expected Sequence:

Step	Direction	Message	Comments
0			At start of test only, read and note value of ACM on SIM
1	MS		The MS is made to initiate a call
2	MS -> SS	CHANNEL REQUEST	
3	SS -> MS	IMMEDIATE ASSIGNMENT	
4	MS -> SS	CM SERVICE REQUEST	
5	SS -> MS	CM SERVICE ACCEPT	
6	MS -> SS	SETUP	
7	SS -> MS	CALL PROCEEDING	
8	SS -> MS	ASSIGNMENT COMMAND	to a supported channel type
9	MS -> SS	ASSIGNMENT COMPLETE	
10	SS -> MS	ALERTING	
11	SS -> MS	CONNECT	As default message except contains Facility IE with contents as indicated in i below
			Either D or E branch is taken
D12	MS -> SS	CONNECT ACKNOWLEDGE	
D13	MS -> SS	FACILITY	As default message except contains Facility IE with contents as indicated in ii below
E12	MS -> SS	FACILITY	As default message except contains Facility IE with contents as indicated in ii below
E13	MS -> SS	CONNECT ACKNOWLEDGE	
14	MS -> SS	HOLD	The MS is made to initiate a second call and the first call (call B) is placed on hold. DTMF signalling may occur, when MMI keys are depressed
15	MS->SS	HOLD	
16	SS -> MS	HOLD ACKNOWLEDGE	
17	MS -> SS	CM SERVICE REQUEST	
18	SS -> MS	CM SERVICE ACCEPT	

Step	Direction	Message	Comments
19	MS -> SS	SETUP	TI arbitrary but different from existing TI As default message except contains Facility IE with contents as indicated in i below Either F or G branch is taken
20	SS -> MS	CALL PROCEEDING	
21	SS -> MS	ALERTING	
22	SS -> MS	CONNECT	
F23	MS -> SS	CONNECT ACKNOWLEDGE	As default message except contains Facility IE with contents as indicated in ii below
F24	MS -> SS	FACILITY	
G23	MS -> SS	FACILITY	As default message except contains Facility IE with contents as indicated in ii below
G24	MS -> SS	CONNECT ACKNOWLEDGE	
25	MS -> SS	FACILITY (TI A-B/A-C)	The MS is made to build a multi-party call. DTMF signalling may occur, when MMI keys are depressed As default message except contains Facility IE with contents as indicated in iii below As default message except contains Facility IE with contents as indicated in iv, below Call durations x and y seconds after respective CAI information sent by SS Branch H and branch I are taken, the sequence depending on the durations x and y
26	SS -> MS	FACILITY (TI A-B/A-C)	
27			
H28	SS -> MS	DISCONNECT	For call C y seconds after call C CAI sent
H29	MS -> SS	RELEASE	
H30	SS -> MS	RELEASE COMPLETE	
I28	SS -> MS	DISCONNECT	For call B x seconds after call B CAI sent
I29	MS -> SS	RELEASE	
I30	SS -> MS	RELEASE COMPLETE	
31	SS -> MS	CHANNEL RELEASE	The main signalling link is released. SIM contents checked (either via MMI or by removing the SIM and using SIM reader) ACM shall have been incremented correctly.
32	MS		

NOTE: A-B/A-C indicates a choice. the transaction identifier (TI) used must be that of the active call or the held call (ref. 3GPP TS 04.84).

The values of x and y are given below.

The correct value of the ACM is found from the general AoC formula given in 3GPP TS 02.24 clause 4 with CDUR = x,y seconds and e parameters as defined below.

Specific Message Contents:

i) FACILITY Information Element with Invoke = ForwardChargeAdvice component type as defined in 3GPP TS 04.80 subclause 3.6.1 table 3.3.

For ASN.1 description see default message contents in subclause 31.6.4.

x set to 180 s, y set to 90 s.

The values of the e-parameters within the parameter part of the Facility Information Element shall be set to:

Call	e-parameter							CCM total at call end increased by	Step 0 ACM value
	1	2	3	4	5	6	7		
B(time x)	19	40	1	0	0	0	0		
C(time y)	29	40	1	0	0	0	0	134	134

Values shown in table are in the format and have units as in 3GPP TS 02.24 clause 3.

- ii) FACILITY Information Element with Return Result component type as defined in 3GPP TS 04.80 subclause 3.6.1 table 3.4.

For ASN.1 description see default message contents in subclause 31.6.4.

- iii) FACILITY Information Element with Invoke = BuildMPTY component type as defined in 3GPP TS 04.80 subclause 3.6.1 table 3.4.

The following abbreviations are used in the descriptions below:

- U Universal tag class.
 CS Context Specific tag class.
 P Primitive tag form.
 C Constructed tag form.
 FIE Facility Information Element.

Contents Facility IE Identifier	Value/remark As 3GPP TS 04.80	Coding 00011100
Length of FIE contents	8	00001000
Component type tag	CS/C/tag=1	10100001
Component length	6	00000110
Invoke ID tag	U/P/tag=2	00000010
Invoke ID length	1	00000001
Invoke ID	Arbitrary (1 octet)	(00000000)
Op-Code tag	From 3GPP TS 04.80	00000010
Op-Code length	1	00000001
Op-Code	Build Multi-party operation (local value 124)	00000001

- ii) FACILITY Information Element with Return Result component type as defined in 3GPP TS 04.80 subclause 3.6.1 table 3.4.

Contents Facility IE Identifier	Value/remark As 3GPP TS 04.80	Coding 00111100
Length of FIE contents	5	00001001
Component type tag	CS/C/tag=2	10100010
Component length	3	00000011
Invoke ID tag	U/P/Integer	00000010
Invoke ID length	1	00000001
Invoke ID	Same as used as Invoke ID in Invoke FIE	(00000000)

31.6.2 Charge Storage

31.6.2.1 Removal of SIM during an active call

Purpose:

- 1) To verify that when the SIM is removed from the ME during an active AoCC call the ME immediately terminates the call.
- 2) To verify that when the SIM is removed during an active AoCC call the ME has written the total charge up to that point in the call to the ACM field of the SIM.

Conformance Requirement(s):

- 1) When the SIM is removed from the ME during an active AoCC call the ME shall immediately terminate the call.

- 2) When the SIM is removed during an active AoCC call midway through an AoC charging time interval (e7 or e2) the ME shall have written the total charge up to the point in the call where the charging time interval last expired to the ACM field of the SIM.

Reference(s):

Conformance requirement 1: 3GPP TS 02.17.

Conformance requirement 1: 3GPP TS 02.24.

Specific PICS Statements

- Supported teleservices (TSPC_AddInfo_TeleSvc).

PIXIT Statements

- Support for active state of the call control protocol (U10).

Initial Conditions:**System Simulator:**

1 cell, default parameters, IMSI attach/detach disabled.

Mobile Station:

The MS is in MM-state "idle, updated".

Foreseen Final State of the MS:

The MS is in MM-state "idle, updated".

Method of Test:

This test is only performed if it is possible to remove SIM without disconnecting the power supply. If the battery pack must be removed to get at the SIM see subclause 31.6.2.2.

The MS is made to initiate a call. The call is established with certain AoCC e-parameters sent in a Facility IE in the CONNECT message. It is an implementation option whether the AoCC acknowledge is sent before or after the CONNECT ACKNOWLEDGE.

If possible, without removing the power supply, the SIM is removed from the ME y seconds after the SS sends the CAI in the CONNECT/FACILITY message. The call shall be terminated immediately by the MS and the MS shall have stored the correct amount on the SIM according to the e-parameters sent.

Maximum Duration of Test:

5 minutes.

Expected Sequence:

Step	Direction	Message	Comments
0			At start of test only, read and note value of ACM on SIM
1	MS		The MS is made to initiate a call
2	MS -> SS	CHANNEL REQUEST	
3	SS -> MS	IMMEDIATE ASSIGNMENT	
4	MS -> SS	CM SERVICE REQUEST	
5	SS -> MS	CM SERVICE ACCEPT	
6	MS -> SS	SETUP	
7	SS -> MS	CALL PROCEEDING	
8	SS -> MS	ASSIGNMENT COMMAND	to a supported channel type
9	MS -> SS	ASSIGNMENT COMPLETE	
10	SS -> MS	ALERTING	
11	SS -> MS	CONNECT	As default message except contains Facility IE with contents as indicated in i below
			Either A or B branch is taken
A12	MS -> SS	CONNECT ACKNOWLEDGE	
A13	MS -> SS	FACILITY	As default message except contains Facility IE with contents as indicated in ii below
B12	MS -> SS	FACILITY	As default message except contains Facility IE with contents as indicated in ii below
B13	MS -> SS	CONNECT ACKNOWLEDGE	
14			SIM removed y seconds after CAI information sent by SS.
			Either C, D, E or F branch is taken
C15	MS -> SS	DISCONNECT	
C16	SS -> MS	RELEASE	
C17	MS -> SS	RELEASE COMPLETE	
C18	SS -> MS	CHANNEL RELEASE	The main signalling link is released.
D15	MS -> SS	RELEASE COMPLETE	
D16	SS -> MS	CHANNEL RELEASE	The main signalling link is released.
E15	MS -> SS	Layer 2 DISC	
E16	SS -> MS	UA	
F15			No further messages are sent
19			SIM contents checked (by removing the SIM and using SIM reader). ACM shall have been incremented correctly.

NOTE: The value of y is given below.

The correct value of the ACM is found from the general AoC formula given in 3GPP TS 02.24 clause 4 with CDUR = y seconds and e parameters as defined below.

Specific Message Contents:

i) FACILITY Information Element with Invoke = ForwardChargeAdvice component type as defined in 3GPP TS 04.80 subclause 3.6.1 table 3.3.

For ASN.1 description see default message contents in subclause 31.6.4.

The SIM is removed after approximately y=90 s.

The values of the e-parameters within the parameter part of the Facility Information Element shall be set to:

k-value	e-parameter							CCM total at call end increased by	Step 0 ACM value
	1	2	3	4	5	6	7		
	10	55	1	10	0	0	10	30	30

Values shown in table are in the format and have units as in 3GPP TS 02.24 clause 3.

ii) FACILITY Information Element with Return Result component type as defined in 3GPP TS 04.80 subclause 3.6.1 table 3.4.

For ASN.1 description see default message contents in subclause 31.6.4.

31.6.2.2 Interruption of power supply during an active call

Purpose:

To verify that when the power supply of the MS is removed during an active AoCC call the ME has written the total charge up to that point in the call to the ACM field of the SIM.

Conformance Requirement(s):

When the power supply of the MS is removed during an active AoCC call midway through an AoC charging time interval (e7 or e2) the ME shall have written the total charge up to the point in the call where the charging time interval last expired to the ACM field of the SIM.

Reference(s):

Conformance requirement 1: 3GPP TS 02.24.

Specific PICS Statements

- Supported teleservices (TSPC_AddInfo_TeleSvc).

PIXIT Statements

- Method of removing power supply.
- Support for active state of the call control protocol (U10).

Initial Conditions:

System Simulator:

1 cell, default parameters, IMSI attach/detach disabled.

Mobile Station:

The MS is in MM-state "idle, updated".

Foreseen Final State of the MS:

The MS is switched off.

Method of Test:

The MS is made to initiate a call. The call is established with certain AoCC e-parameters sent in a Facility IE in the CONNECT message. It is an implementation option whether the AoCC acknowledge is sent before or after the CONNECT ACKNOWLEDGE.

The ME power is switched off by pressing power button on MMI during the active call. The call shall be terminated immediately and the MS shall have stored the correct amount on the SIM according to the e-parameters sent.

The test is repeated for ME power being lost by removal of battery pack. The call shall be terminated immediately and the MS shall have stored the correct amount on the SIM according to the e-parameters sent.

Maximum Duration of Test:

10 minutes.

Expected Sequence:

The sequence step 1-20 is executed for execution counter k = 1,2.

Step	Direction	Message	Comments
0			At start of test only, read and note value of ACM on SIM
1	MS		The MS is made to initiate a call
2	MS -> SS	CHANNEL REQUEST	
3	SS -> MS	IMMEDIATE ASSIGNMENT	
4	MS -> SS	CM SERVICE REQUEST	
5	SS -> MS	CM SERVICE ACCEPT	
6	MS -> SS	SETUP	
7	SS -> MS	CALL PROCEEDING	
8	SS -> MS	ASSIGNMENT COMMAND	to a supported channel type
9	MS -> SS	ASSIGNMENT COMPLETE	
10	SS -> MS	ALERTING	
11	SS -> MS	CONNECT	As default message except contains Facility IE with contents as indicated in i below
			Either A or B branch is taken
A12	MS -> SS	CONNECT ACKNOWLEDGE	
A13	MS -> SS	FACILITY	As default message except contains Facility IE with contents as indicated in ii below
B12	MS -> SS	FACILITY	As default message except contains Facility IE with contents as indicated in ii below
B13	MS -> SS	CONNECT ACKNOWLEDGE	
14			ME power interrupted y seconds after CAI information sent by SS by: MMI power switch (for k=1) Removing battery pack (for k=2) Depending on the value of k C or D branch is taken
15			SIM contents checked (by removing the SIM and using SIM reader). ACM shall have been incremented correctly.

NOTE: The value of y is given below.

The correct value of the ACM is found from the general AoC formula given in 3GPP TS 02.24 clause 4 with CDUR = y seconds and e parameters as defined below.

Specific Message Contents:

i) FACILITY Information Element with Invoke = ForwardChargeAdvice component type as defined in 3GPP TS 04.80 subclause 3.6.1 table 3.3.

For ASN.1 description see default message contents in subclause 31.6.4.

The ME power is removed after approximately $y=90$ s.

The values of the e-parameters within the parameter part of the Facility Information Element shall be set to:

k-value	e-parameter							CCM total at call end increased by	Step 0 ACM value
	1	2	3	4	5	6	7		
	10	55	1	10	0	0	10	30	30

Values shown in table are in the format and have units as in 3GPP TS 02.24 clause 3.

ii) FACILITY Information Element with Return Result component type as defined in 3GPP TS 04.80 subclause 3.6.1 table 3.4.

For ASN.1 description see default message contents in subclause 31.6.4.

31.6.2.3 MS going out of coverage during an active AoCC call

NOTE: At present the core recommendations for AoCC in the case where the radio link is lost during an active call are vague. Does the mobile go on charging for a fixed period after radio link loss and continue as usual if radio link reestablishment occurs, or does charging stop? Input from people involved in charging for GSM is required.

Hence this test will be enhanced in the future when the requirements become clearer.

Purpose:

To verify that when the MS goes out of radio coverage area and an active call is dropped the ME has written the total charge up to that point in the call to the ACM field of the SIM.

Conformance Requirement(s):

When the MS goes out of radio coverage area during an active AoCC call midway through an AoC charging time interval (e7 or e2) and the call is dropped the ME shall have written the total charge up to the point in the call where the charging time interval last expired to the ACM field of the SIM.

Reference(s):

Conformance requirement 1: 3GPP TS 02.24.

Specific PICS Statements

- Supported teleservices (TSPC_AddInfo_TeleSvc).

PIXIT Statements

- Method of reading ACM from the SIM via the ME.
- Support for active state of the call control protocol (U10).

Initial Conditions:**System Simulator:**

1 cell, default parameters, IMSI attach/detach disabled.

Mobile Station:

The MS is in MM-state "idle, updated".

Foreseen Final State of the MS:

The MS is in MM-state "idle, updated".

Method of Test:

The MS is made to initiate a call. The call is established with certain AoCC e-parameters sent in a Facility IE in the CONNECT message. It is an implementation option whether the AoCC acknowledge is sent before or after the CONNECT ACKNOWLEDGE.

The cell simulated by the system simulator is then switched off to model the MS losing radio coverage. The MS shall have stored the correct amount on the SIM according to the e-parameters sent. [What happens on call reestablishment?]

Maximum Duration of Test:

5 minutes.

Expected Sequence:

Step	Direction	Message	Comments
0			At start of test only, read and note value of ACM on SIM
1	MS		The MS is made to initiate a call
2	MS -> SS	CHANNEL REQUEST	
3	SS -> MS	IMMEDIATE ASSIGNMENT	
4	MS -> SS	CM SERVICE REQUEST	
5	SS -> MS	CM SERVICE ACCEPT	
6	MS -> SS	SETUP	
7	SS -> MS	CALL PROCEEDING	
8	SS -> MS	ASSIGNMENT COMMAND	to a supported channel type
9	MS -> SS	ASSIGNMENT COMPLETE	
10	SS -> MS	ALERTING	
11	SS -> MS	CONNECT	As default message except contains Facility IE with contents as indicated in i below
			Either A or B branch is taken
A12	MS -> SS	CONNECT ACKNOWLEDGE	
A13	MS -> SS	FACILITY	As default message except contains Facility IE with contents as indicated in ii below
B12	MS -> SS	FACILITY	As default message except contains Facility IE with contents as indicated in ii below
B13	MS -> SS	CONNECT ACKNOWLEDGE	
14			SS cell switched off y seconds after CAI information sent by SS Failure of radio path, end of call (CEND) occurs and MS stops charging (ref. 3GPP TS 02.24 sec 2)
15			SIM contents checked (either via MMI or by removing the SIM and using SIM reader). ACM shall have been incremented correctly.

NOTE: The value of y is given below.

The correct value of the ACM is found from the general AoC formula given in 3GPP TS 02.24 clause 4 with CDUR = y seconds and e parameters as defined below.

Specific Message Contents:

i) FACILITY Information Element with Invoke = ForwardChargeAdvice component type as defined in 3GPP TS 04.80 subclause 3.6.1 table 3.3.

For ASN.1 description see default message contents in subclause 31.6.4.

The cell being simulated by the SS is switched off after approximately y=90 s.

The values of the e-parameters within the parameter part of the Facility Information Element shall be set to:

k-value	e-parameter							CCM total at call end increased by	Step 0 ACM value
	1	2	3	4	5	6	7		
	10	55	1	10	0	0	10	30	30

Values shown in table are in the format and have units as in 3GPP TS 02.24 clause 3.

ii) FACILITY Information Element with Return Result component type as defined in 3GPP TS 04.80 subclause 3.6.1 table 3.4.

For ASN.1 description see default message contents in subclause 31.6.4.

31.6.2.4 ACMmax operation / Mobile Originating

Purpose:

- 1) To verify that when the value stored in the ACM becomes equal to or exceeds its maximum value, the ACMmax, any outgoing calls in progress for which a non-zero CAI exists are terminated by the ME, with cause value #68 once the chargeable interval determined by the CAI has elapsed, with an appropriate indication given to the user.
- 2) To verify that when the value stored in the ACM becomes equal to or exceeds its maximum limit, the ACMmax, the making of non-emergency calls is inhibited.
- 3) To verify that when the value stored in the ACM becomes equal to or exceeds its maximum limit, the ACMmax, the making of emergency calls is uninhibited.

Conformance Requirement(s):

- 1) When the value stored in the ACM becomes equal to or exceeds its maximum value, the ACMmax, any outgoing calls in progress for which a non-zero CAI exists shall be terminated by the ME with cause value #68, once the chargeable interval determined by the CAI has elapsed, with an appropriate indication given to the user.
- 2) When the value stored in the ACM becomes equal to or exceeds its maximum limit, the ACMmax, the making of further non-emergency calls shall be inhibited.
- 3) When the value stored in the ACM becomes equal to or exceeds its maximum limit, the ACMmax, the making of emergency calls shall be uninhibited.

Reference(s):

Conformance requirement 1: 3GPP TS 02.24,
3GPP TS 04.86 subclause 2.3.

Conformance requirement 2: 3GPP TS 02.24.

Conformance requirement 3: 3GPP TS 02.24.

Specific PICS Statements

- Supported teleservices (TSPC_AddInfo_TeleSvc).

PIXIT Statements

- Method of reading ACM from the SIM via the ME.
- Type of user indication when ACMmax exceeded.
- Support for active state of the call control protocol (U10).

Initial Conditions:

System Simulator:

1 cell, default parameters, IMSI attach/detach disabled.

Mobile Station:

The MS is in MM-state "idle, updated".

PIN 2 is entered into the MS allowing modification of both the ACM and ACMmax fields on the SIM. The ACM is reset to zero and the ACMmax is set to 2 units.

Foreseen Final State of the MS:

The MS is in MM-state "idle, updated".

Method of Test:

The MS is made to initiate a call. The call is established with certain AoCC non-zero e-parameters sent in a Facility IE in the CONNECT message. It is an implementation option whether the AoCC acknowledge is sent before or after the CONNECT ACKNOWLEDGE.

After the ACM has been incremented to 2 units (60 s) the call shall be terminated by the MS once an additional chargeable interval of 30 s has elapsed, and an indication given to the user. The call duration is recorded and the ACM is checked to ensure it has been incremented to 2 units.

The MS is then made to attempt to originate an ordinary call to the MS for which a non-zero CAI exists for the calling party and shall be unsuccessful. The MS shall not send a CHANNEL REQUEST for that call.

The MS is then made to attempt to originate an emergency call and shall be successful.

Maximum Duration of Test:

10 minutes.

Expected Sequence:

Step	Direction	Message	Comments
0			At start of test only, read and note value of ACM on SIM (it shall be zero)
A1	MS		For k= 1 The MS is made to initiate an ordinary call
A2	MS -> SS	CHANNEL REQUEST	
A3	SS -> MS	IMMEDIATE ASSIGNMENT	
A4	MS -> SS	CM SERVICE REQUEST	
A5	SS -> MS	CM SERVICE ACCEPT	
A6	MS -> SS	SETUP	
A7	SS -> MS	CALL PROCEEDING	
A8	SS -> MS	ASSIGNMENT COMMAND	to a supported channel type
A9	MS -> SS	ASSIGNMENT COMPLETE	
A10	SS -> MS	ALERTING	
A11	SS -> MS	CONNECT	As default message except contains Facility IE with contents as indicated in I below
B1	MS		For k = 3 The MS is made to initiate an emergency call
B2	MS -> SS	CHANNEL REQUEST	Establishment cause is emergency call establishment
B3	SS -> MS	IMMEDIATE ASSIGNMENT	
B4	MS -> SS	CM SERVICE REQUEST	CM service type IE indicates "emergency call establishment"
B5	SS -> MS	CM SERVICE ACCEPT	
B6	MS -> SS	EMERGENCY SETUP	
B7	SS -> MS	CALL PROCEEDING	
B8	SS -> MS	ASSIGNMENT COMMAND	to a supported channel type
B9	MS -> SS	ASSIGNMENT COMPLETE	
B10	SS -> MS	ALERTING	
B11	SS -> MS	CONNECT	As default message except contains Facility IE with contents as indicated in i below For k=1 or 3 either branch C or D is taken
C12	MS -> SS	CONNECT ACKNOWLEDGE	
C13	MS -> SS	FACILITY	As default message except contains Facility IE with contents as indicated in ii below
D12	MS -> SS	FACILITY	As default message except contains Facility IE with contents as indicated in ii below
D13	MS -> SS	CONNECT ACKNOWLEDGE	
L14			For k=1 Record call duration, x seconds, after CAI information sent by SS until call is terminated by the ME Cause value #68
L15	MS -> SS	DISCONNECT	
L16	SS -> MS	RELEASE	
L17	MS -> SS	RELEASE COMPLETE	
L18	SS -> MS	CHANNEL RELEASE	The main signalling link is released. ACM checked (shall be 2 units)
L19			
M14			For k=3 Call duration y seconds after CAI information sent by SS
M15	MS -> SS	DISCONNECT	
M16	SS -> MS	RELEASE	
M17	MS -> SS	RELEASE COMPLETE	
M18	SS -> MS	CHANNEL RELEASE	The main signalling link is released. ACM checked (shall be 2 units)
M19			

k=1 - Non zero CAI call attempted by MS and should succeed.

k=2 - Non zero CAI call attempted by MS and should fail.

k=3 - Emergency call attempted by MS and should succeed.

NOTE: The values of x and y are given below.

The correct value of the ACM is found from the general AoC formula given in 3GPP TS 02.24 clause 4 with CDUR = x,y seconds and e parameters as defined below.

Specific Message Contents:

- i) FACILITY Information Element with Invoke = ForwardChargeAdvice component type as defined in 3GPP TS 04.80 subclause 3.6.1 table 3.3.

For ASN.1 description see default message contents in subclause 31.6.4.

x shall be 90 ± 2 s.

y shall be set to 120 s.

The values of the e-parameters within the parameter part of the Facility Information Element shall be set to:

k-value	e-parameter							CCM total at call end increased by	Step 0 ACM value
	1	2	3	4	5	6	7		
1	1	30	1	0	0	0	0	2	2
2	1	30	1	0	0	0	0	0	2
3	0	0	0	0	0	0	0	0	2

Values shown in table are in the format and have units as in 3GPP TS 02.24 clause 3.

- ii) FACILITY Information Element with Return Result component type as defined in 3GPP TS 04.80 subclause 3.6.1 table 3.4.

For ASN.1 description see default message contents in subclause 31.6.4.

31.6.2.5 ACMmax operation / Mobile Terminating

Purpose:

- 1) To verify that when the value stored in the ACM becomes equal to or exceeds its maximum value, the ACMmax, any mobile terminating calls in progress for which a non-zero CAI exists are terminated by the ME with cause value #68, once the chargeable interval determined by the CAI has elapsed, with an appropriate indication given to the user.
- 2) To verify that when the value stored in the ACM becomes equal to or exceeds its maximum value, the ACMmax, and an incoming call is received for which subsequently a non-zero CAI is received, then the call is terminated by the ME using cause value #68 with an appropriate indication given to the user.
- 3) To verify that when the value stored in the ACM becomes equal to or exceeds its maximum limit, the ACMmax, the receiving of calls for which the CAI is zero is uninhibited.

Conformance Requirement(s):

- 1) When the value stored in the ACM becomes equal to or exceeds its maximum value, the ACMmax, any mobile terminating calls in progress for which a non-zero CAI exists shall be terminated by the ME with cause value #68, once the chargeable interval determined by the CAI has elapsed, with an appropriate indication given to the user.
- 2) When the value stored in the ACM becomes equal to or exceeds its maximum value, the ACMmax, and an incoming call is received for which subsequently a non-zero CAI is received, the call shall be terminated by the ME using cause value #68 with an appropriate indication given to the user.
- 3) When the value stored in the ACM becomes equal to or exceeds its maximum limit, the ACMmax, the receiving of calls for which the CAI is zero shall be uninhibited.

Reference(s):

Conformance requirement 1: 3GPP TS 02.24,
3GPP TS 04.86 subclause 2.3.

Conformance requirement 2: 3GPP TS 02.24,
3GPP TS 04.86 subclause 2.3.

Conformance requirement 2: 3GPP TS 02.24.

Specific PICS Statements

- Supported teleservices (TSPC_AddInfo_TeleSvc).

PIXIT Statements

- Method of reading ACM from the SIM via the ME.
- Type of user indication when ACMmax exceeded.
- Support for active state of the call control protocol (U10).

Initial Conditions:

System Simulator:

1 cell, default parameters, IMSI attach/detach disabled.

Mobile Station:

The MS is in MM-state "idle, updated".

PIN 2 is entered into the MS allowing modification of both the ACM and ACMmax fields on the SIM. The ACM is reset to zero and the ACMmax is set to 2 units.

Foreseen Final State of the MS:

The MS is in MM-state "idle, updated".

Method of Test:

The SS is made to initiate a call. The call is established with certain non-zero AoCC e-parameters sent in a Facility IE contained in a FACILITY message sent before the CONNECT message. It is an implementation option whether the AoCC e-parameters and AoCC acknowledge are sent before or after the CONNECT ACKNOWLEDGE.

After the ACM has been incremented to 2 units (60s) the call shall be terminated by the MS once an additional chargeable interval of 30s has elapsed and an indication given to the user. The ACM shall be checked to ensure that it has been incremented to 2 units.

The SS is then made to attempt to make an ordinary call to the MS for which a non-zero CAI exists for the called party and shall be unsuccessful. The MS shall terminate the call with a DISCONNECT message.

The SS is then made to attempt to make an ordinary call to the MS for which a zero CAI exists for the called party and shall be successful.

Maximum Duration of Test:

10 minutes.

Expected Sequence:

The sequence step 1-20 is executed for execution counter $k = 1, \dots, 3..$

Step	Direction	Message	Comments
0			At start of test only, read and note value of ACM on SIM
1	SS		The SS is made to initiate a call
2	SS -> MS	PAGING REQUEST	
3	MS -> SS	CHANNEL REQUEST	
4	SS -> MS	IMMEDIATE ASSIGNMENT	
5	MS -> SS	PAGING RESPONSE	
6	SS -> MS	SETUP	
7	MS -> SS	CALL CONFIRMED	
8	SS -> MS	ASSIGNMENT COMMAND	to a supported channel type
9	MS -> SS	ASSIGNMENT COMPLETE	
10	MS -> SS	ALERTING	
11	MS -> SS	CONNECT	
12	SS -> MS	CONNECT ACKNOWLEDGE	
			For $k=1$ or 3 branch A is taken
A13	SS -> MS	FACILITY	As default message except contains Facility IE with contents as indicated in i below
A14	MS -> SS	FACILITY	As default message except contains Facility IE with contents as indicated in ii below
			For $k=2$ branch B, and then either branch C, D or E is taken
B13	SS -> MS	FACILITY	As default message except contains Facility IE with contents as indicated in i below
C13	MS -> SS	FACILITY	As default message except contains Facility IE with contents as indicated in ii below
C14	MS -> SS	DISCONNECT	MS terminates call with cause value #68
D13	MS -> SS	DISCONNECT	MS terminates call with cause value #68
D14	MS -> SS	FACILITY	As default message except contains Facility IE with contents as indicated in ii below
E13	MS -> SS	DISCONNECT	MS terminates call with cause value #68. DISCONNECT may or may not contain Facility IE with contents as indicated in ii below
			For $k= 1, 2$ and 3, F, G and branch shall be taken respectively
F15			For $k=1$ Record call duration, x seconds, after CAI information sent by SS until call is terminated by the ME
F16	MS -> SS	DISCONNECT	MS terminates call with cause value #68
F17	SS -> MS	RELEASE	
F18	MS -> SS	RELEASE COMPLETE	
F19	SS -> MS	CHANNEL RELEASE	The main signalling link is released.
			For $k=2$
G15	SS -> MS	RELEASE	
G16	MS -> SS	RELEASE COMPLETE	RELEASE COMPLETE may or may not contain Facility IE with contents as indicated in ii below
G17	SS -> MS	CHANNEL RELEASE	The main signalling link is released.
			For $k=3$
H15			Call duration y seconds after CAI information sent by SS
H16	MS -> SS	DISCONNECT	MS terminates call
H17	SS -> MS	RELEASE	
H18	MS -> SS	RELEASE COMPLETE	
H19	SS -> MS	CHANNEL RELEASE	The main signalling link is released.
20			ACM checked (should be 2 units)

$k=1$ - Non zero CAI call attempted to MS and should succeed.

$k=2$ - Non zero CAI call attempted to MS and should fail.

$k=3$ - Zero CAI call attempted to MS and should succeed.

NOTE: The values of x and y are given below.

The correct value of the ACM is found from the general AoC formula given in 3GPP TS 02.24 clause 4 with CDUR = x,y seconds and e parameters as defined below.

Specific Message Contents:

- i) FACILITY Information Element with Invoke = ForwardChargeAdvice component type as defined in 3GPP TS 04.80 subclause 3.6.1 table 3.3.

For ASN.1 description see default message contents in subclause 31.6.4.

x shall be 90 ± 2 s.

y shall be set to 120 s.

The values of the e-parameters within the parameter part of the Facility Information Element shall be set to:

k-value	e-parameter							CCM total at call end increased by	Step 0 ACM value
	1	2	3	4	5	6	7		
1	1	30	1	0	0	0	0	2	2
2	1	30	1	0	0	0	0	0	2
3	0	0	0	0	0	0	0	0	2

Values shown in table are in the format and have units as in 3GPP TS 02.24 clause 3.

- ii) FACILITY Information Element with Return Result component type as defined in 3GPP TS 04.80 subclause 3.6.1 table 3.4.

For ASN.1 description see default message contents in subclause 31.6.4.

31.6.3 Advice of Charge Information

31.6.3.1 AoCI time related charging / MS originated call

Purpose:

- 1) To verify that when the MS receives the AoCI parameters in a Facility IE which is contained in the CONNECT message and when a TCH has already been assigned, the MS returns a FACILITY message containing the acknowledgement within 1 s.
- 2) To verify that when the call has no volume related component the MS ignores non-zero AoCI e5, e6 parameters sent to it.

Conformance Requirement(s):

- 1) When the MS receives the AoCI parameters in a Facility IE which is contained in a CONNECT message and when a TCH has already been assigned, the MS shall return a FACILITY message containing the acknowledgement within 1 s.
- 2) When the call has no volume related component the MS shall ignore non-zero AoC e5 and e6 parameters sent to it.

Reference(s):

Conformance requirement 1: 3GPP TS 03.86,
3GPP TS 04.13,
3GPP TS 04.86.

Conformance requirement 2: 3GPP TS 02.24.

Specific PICS Statements

- Supported teleservices (TSPC_AddInfo_TeleSvc).

PIXIT Statements

- Support for active state of the call control protocol (U10).
- MMI method of reading the AoCI information.

Initial Conditions:

System Simulator:

1 cell, default parameters, IMSI attach/detach disabled.

Mobile Station:

The MS is in MM-state "idle, updated".

Foreseen Final State of the MS:

The MS is in MM-state "idle, updated".

Method of Test:

The MS is made to initiate a call. The call is established with certain AoCI e-parameters sent in a Facility IE in the CONNECT message. The MS shall return the AoCI acknowledgement within 1 s of the CONNECT message. It is an implementation option whether the AoCI acknowledge is sent by the MS before or after the CONNECT ACKNOWLEDGE.

The SS sends the DISCONNECT y seconds after sending the CONNECT message containing the CAI. The test is repeated for several different sets of e-parameters as defined below.

Maximum Duration of Test:

30 minutes.

Expected Sequence:

The sequence step 1-20 is executed for execution counter k = 1,....,5.

Step	Direction	Message	Comments
1	MS		The MS is made to initiate a call
2	MS -> SS	CHANNEL REQUEST	
3	SS -> MS	IMMEDIATE ASSIGNMENT	
4	MS -> SS	CM SERVICE REQUEST	
5	SS -> MS	CM SERVICE ACCEPT	
6	MS -> SS	SETUP	
7	SS -> MS	CALL PROCEEDING	
8	SS -> MS	ASSIGNMENT COMMAND	to a supported channel type
9	MS -> SS	ASSIGNMENT COMPLETE	
10	SS -> MS	ALERTING	
11	SS -> MS	CONNECT	As default message except contains Facility IE with contents as indicated in i below
			Either A or B branch is taken
A12	MS -> SS	CONNECT ACKNOWLEDGE	
A13	MS -> SS	FACILITY	As default message except contains Facility IE with contents as indicated in ii below
B12	MS -> SS	FACILITY	As default message except contains Facility IE with contents as indicated in ii below
B13	MS -> SS	CONNECT ACKNOWLEDGE	
14			call duration y seconds after CAI information sent by SS
15	SS -> MS	DISCONNECT	
16	MS -> SS	RELEASE	
17	SS -> MS	RELEASE COMPLETE	
18	SS -> MS	CHANNEL RELEASE	The main signalling link is released.
19	MS		MS display is checked to determine whether the correct call charge has been indicated

NOTE: The value of y is given below.

The correct value of the ACM is found from the general AoC formula given in 3GPP TS 02.24 clause 4 with CDUR = y seconds and e parameters as defined below.

Specific Message Contents:

- i) FACILITY Information Element with Invoke = ForwardChargeAdvice component type as defined in 3GPP TS 04.80 subclause 3.6.1 table 3.3.

For ASN.1 description see default message contents in subclause 31.6.4.

y is set to a constant value of 90 s.

The values of the e-parameters within the parameter part of the Facility Information Element shall be set as below:

k-value	e-parameter							CCM total at call end increased by	Step 0 ACM value
	1	2	3	4	5	6	7		
1	6	14	1	25	0	0	60	43	43
2	0	0	1	100	0	0	0	100	143
3	250	16	2	500	0	0	60	2 000	2 143
4	1	1	1	0	10	10	1	89 or 90	2 232 or 2 233
5	12,5	30	1	25	10	10	30	50 or 62,5	2 295, 2 296, 2 282 or 2 283

Values shown in table are in the format and have units as in 3GPP TS 02.24 clause 3.

The ASN.1 description for each e-parameter allows integers in the range 0 to 8 191 to be transmitted but some e-parameters have different actual ranges (e.g. e1 can take any value 0..819,1 with 0,1 resolution). The MS knows how to interpret the received parameter (e.g. received e1 refers to 10 times actual e1, see 3GPP TS 04.80 subclause 4.4.3). Therefore e1=12,5 would be sent to the MS as 125. The MS knows the value sent is 10 times the "real" e1 and hence interprets the value as 12,5.

The non-zero e5 and e6 values for the k=4 and k=5 execution of the test are to check that the MS ignores the volume related parameters when carrying out time only related charging.

- ii) FACILITY Information Element with Return Result component type as defined in 3GPP TS 04.80 subclause 3.6.1 table 3.4.

For ASN.1 description see default message contents in subclause 31.6.4.

31.6.3.2 AoCI time related charging / MS terminated call

Purpose:

- To verify that when the MS receives certain AoCI e-parameters in a Facility IE which is contained in a FACILITY message sent after the CONNECT message and when a TCH has already been assigned, the MS returns a FACILITY message containing the acknowledgement within 1 s.

Conformance Requirement(s):

- When the MS receives the AoCI parameters in a Facility IE which is contained in a FACILITY message sent after the CONNECT message and when a TCH has already been assigned, the MS shall return a Facility message containing the acknowledgement within 1 s.

Reference(s):

Conformance requirement 1: 3GPP TS 03.86,
3GPP TS 04.13,
3GPP TS 04.86.

Conformance requirement 2: 3GPP TS 02.24.

Specific PICS Statements

- Supported teleservices (TSPC_AddInfo_TeleSvc).

PIXIT Statements

- Support for active state of the call control protocol (U10).
- MMI method of reading the AoCI information.

Initial Conditions:

System Simulator:

1 cell, default parameters, IMSI attach/detach disabled.

Mobile Station:

The MS is in MM-state "idle, updated".

Foreseen Final State of the MS:

The MS is in MM-state "idle, updated".

Method of Test:

The SS is made to initiate a call. The call is established and certain AoCI e-parameters are sent to the MS in a Facility IE contained within a FACILITY message. The MS shall return the AoCI acknowledgement within 1 s of the FACILITY message. It is an implementation option whether the AoCI e-parameters and the AoCI acknowledge are sent before or after the CONNECT ACKNOWLEDGE.

The SS sends the DISCONNECT y seconds after sending the FACILITY message. The test is repeated for several different sets of e-parameters as defined below.

Maximum Duration of Test:

30 minutes.

Expected Sequence:

The sequence step 1-20 is executed for execution counter $k = 1, \dots, 5$.

Step	Direction	Message	Comments
0			At start of test only, read and note value of ACM on SIM
1	SS		The SS is made to initiate a call
2	SS -> MS	PAGING REQUEST	
3	MS -> SS	CHANNEL REQUEST	
4	SS -> MS	IMMEDIATE ASSIGNMENT	
5	MS -> SS	PAGING RESPONSE	
6	SS -> MS	SETUP	
7	MS -> SS	CALL CONFIRMED	
8	SS -> MS	ASSIGNMENT COMMAND	to a supported channel type
9	MS -> SS	ASSIGNMENT COMPLETE	
10	MS -> SS	ALERTING	
11	MS -> SS	CONNECT	
12	SS -> MS	FACILITY	As default message except contains Facility IE with contents as indicated in i below
			Either A or B branch is taken
A13	SS -> MS	CONNECT ACKNOWLEDGE	
A14	MS -> SS	FACILITY	As default message except contains Facility IE with contents as indicated in ii below
B13	MS -> SS	FACILITY	As default message except contains Facility IE with contents as indicated in ii below
B14	SS -> MS	CONNECT ACKNOWLEDGE	
15			call duration y seconds after CAI information sent by SS
16	SS -> MS	DISCONNECT	
17	MS -> SS	RELEASE	
18	SS -> MS	RELEASE COMPLETE	
19	SS -> MS	CHANNEL RELEASE	The main signalling link is released.
20	MS		MS display is checked to determine whether the correct call charge has been indicated

NOTE: The value of y is given below.

The correct value of the ACM is found from the general AoC formula given in 3GPP TS 02.24 clause 4 with CDUR = y seconds and e parameters as defined below.

Specific Message Contents:

- i) FACILITY Information Element with Invoke = ForwardChargeAdvice component type as defined in 3GPP TS 04.80 subclause 3.6.1 table 3.3.

For ASN.1 description see default message contents in subclause 31.6.4.

y is set to a constant value of 90 s.

The values of the e-parameters within the parameter part of the Facility Information Element shall be set as below:

k-value	e-parameter							CCM total at call end increased by	Step 0 ACM value
	1	2	3	4	5	6	7		
1	0	0	0	0	0	0	0	0	0
2	0	0	1	100	0	0	0	100	100
3	6	14	1	25	0	0	60	43	143
4	1	1	1	0	0	0	1	89 or 90	233 or 232
5	12,5	30	1	25	0	0	30	50 or 62,5	296, 295, 282 or 283

Values shown in table are in the format and have units as in 3GPP TS 02.24 clause 3.

- ii) FACILITY Information Element with Return Result component type as defined in 3GPP TS 04.80 subclause 3.6.1 table 3.4.

For ASN.1 description see default message contents in subclause 31.6.4.

31.6.3.3 AoCI volume related charging / MS originated call

Future addition at GSM Phase 2+ stage.

31.6.3.4 AoCI volume related charging / MS terminated call

Future addition at GSM Phase 2+ stage.

31.6.3.5 Change in charging information during a call

Purpose:

- 1) To verify that when the MS receives new AoCI parameters mid-way through a call in a Facility IE which is contained within a FACILITY message the MS returns a FACILITY message containing the acknowledgement within 1 s.
- 2) To verify that when the MS receives new charging information mid-way through a call in the form of a Facility IE contained within a FACILITY message the MS correctly indicates the total charge considering both sets of charging information.

Conformance Requirement(s):

- 1) When the MS receives new AoCI parameters mid-way through a call in a Facility IE which is contained within a FACILITY message the MS shall return a FACILITY message containing the acknowledgement within 1 s.
- 2) When the MS receives new charging information mid-way through a call in the form of a Facility IE contained within a FACILITY message the MS correctly indicates the total charge considering both sets of charging information.

Reference(s):

Conformance requirement 1: 3GPP TS 03.86, 3GPP TS 04.13, 3GPP TS 04.86.

Conformance requirement 2: 3GPP TS 02.24.

Specific PICS Statements

- Supported teleservices (TSPC_AddInfo_TeleSvc).

PIXIT Statements

- Support for active state of the call control protocol (U10).
- MMI method of reading the AoCI information.

Initial Conditions:

System Simulator:

1 cell, default parameters, IMSI attach/detach disabled.

Mobile Station:

The MS is in MM-state "idle, updated".

Foreseen Final State of the MS:

The MS is in MM-state "idle, updated".

Method of Test:

The MS is made to initiate a call. The call is established with certain AoCI e-parameters sent in a Facility IE in a FACILITY message sent after the CONNECT message. The MS shall return the AoCI acknowledgement within 1 s of the FACILITY message. x seconds after sending the original CAI, new (and different) e-parameters are sent to the MS in a Facility IE contained within a FACILITY message. The MS shall return the AoCI acknowledge within 1 s of the FACILITY message.

The SS sends the DISCONNECT y seconds after sending the first CAI in the FACILITY message.

Maximum Duration of Test:

10 minutes.

Expected Sequence:

Step	Direction	Message	Comments
0			At start of test only, read and note value of ACM on SIM
1	MS		The MS is made to initiate a call
2	MS -> SS	CHANNEL REQUEST	
3	SS -> MS	IMMEDIATE ASSIGNMENT	
4	MS -> SS	CM SERVICE REQUEST	
5	SS -> MS	CM SERVICE ACCEPT	
6	MS -> SS	SETUP	
7	SS -> MS	CALL PROCEEDING	
8	SS -> MS	ASSIGNMENT COMMAND	to a supported channel type
9	MS -> SS	ASSIGNMENT COMPLETE	
10	SS -> MS	ALERTING	
11	SS -> MS	CONNECT	
			Either A, B or C branch is taken
A12	SS -> MS	FACILITY	As default message except contains Facility IE with contents as indicated in i below
A13	MS -> SS	CONNECT ACKNOWLEDGE	
A14	MS -> SS	FACILITY	As default message except contains Facility IE with contents as indicated in ii below
B12	MS -> SS	CONNECT ACKNOWLEDGE	
B13	SS -> MS	FACILITY	As default message except contains Facility IE with contents as indicated in i below
B14	MS -> SS	FACILITY	As default message except contains Facility IE with contents as indicated in ii below
C12	SS -> MS	FACILITY	As default message except contains Facility IE with contents as indicated in i below
C13	MS -> SS	FACILITY	As default message except contains Facility IE with contents as indicated in ii below
C14	MS-> SS	CONNECT ACKNOWLEDGE	
15	SS -> MS	FACILITY	Second CAI sent x sec after first CAI As default message except contains Facility IE with contents as indicated in iii below
16	MS -> SS	FACILITY	As default message except contains Facility IE with contents as indicated in ii below New CAI held in abeyance until CDUR has timed out present e2 value
17			Call duration y seconds after first CAI information sent by SS
18	SS -> MS	DISCONNECT	
19	MS -> SS	RELEASE	
20	SS -> MS	RELEASE COMPLETE	
21	SS -> MS	CHANNEL RELEASE	The main signalling link is released.
22	MS		MS display is checked to determine whether the correct call charge has been indicated

NOTE The values of x and y are given below.

The correct value of the ACM is found from the general AoC formula given in 3GPP TS 02.24 clause 4 with CDUR = x, y seconds and e parameters as defined below.

Specific Message Contents:

- i) FACILITY Information Element with Invoke = ForwardChargeAdvice component type as defined in 3GPP TS 04.80 subclause 3.6.1 table 3.3.

For ASN.1 description see default message contents in subclause 31.6.4.

The values of the e-parameters within the parameter part of the Facility Information Element shall be set as defined below:

k-value	e-parameter							CCM total at call end increased by	Step 0 ACM value
	1	2	3	4	5	6	7		
	10	28	1	10	0	0	60	(30)	(30)

Values shown in table are in the format and have units as in 3GPP TS 02.24 clause 3.

- ii) FACILITY Information Element with Return Result component type as defined in 3GPP TS 04.80 subclause 3.6.1 table 3.4.

For ASN.1 description see default message contents in subclause 31.6.4.

- iii) FACILITY Information Element with Invoke = ForwardChargeAdvice component type as defined in 3GPP TS 04.80 subclause 3.6.1 table 3.3.

For ASN.1 description see default message contents in subclause 31.6.4.

x is set to a constant value of 80 s.

y is set to a constant value of 180 s.

The values of the e-parameters within the parameter part of the Facility Information Element shall be set to:

	e-parameter							CCM total at call end increased by	Step 0 ACM value
	1	2	3	4	5	6	7		
	10	14	1	5	0	0	60	65	65

Values shown in table are in the format and have units as in 3GPP TS 02.24 clause 3.

31.6.3.6 Different formats of charging information

Purpose:

- 1) To verify that when the MS receives a Facility IE in which certain e-parameters are set to zero the total charge accumulated is the same as that when the same e-parameters are completely omitted from the Facility IE.
- 2) To verify the operation of a shortened channel release procedure where the SS does not send DISCONNECT but only the RELEASE COMPLETE and CHANNEL RELEASE messages or just the CHANNEL RELEASE message.

Conformance Requirement(s):

- 1) When the MS receives a Facility IE in which certain e-parameters are set to zero the total charge accumulated shall be the same as that when the same e-parameters are completely omitted from the Facility IE.
- 2) The channel shall be correctly released when a shortened channel release procedure is used - the SS does not send DISCONNECT but only the RELEASE COMPLETE and CHANNEL RELEASE messages or just the CHANNEL RELEASE message.

Reference(s):

- Conformance requirement 1: 3GPP TS 02.24.

Conformance requirement 2: 3GPP TS 04.08 / 3GPP TS 44.018.

Specific PICS Statements

- Supported teleservices (TSPC_AddInfo_TeleSvc).

PIXIT Statements

- Support for active state of the call control protocol (U10).
- MMI method of reading the AoCI information.

Initial Conditions:

System Simulator:

1 cell, default parameters, IMSI attach/detach disabled.

Mobile Station:

The MS is in MM-state "idle, updated".

Foreseen Final State of the MS:

The MS is in MM-state "idle, updated".

Method of Test:

Part 1:

The MS is made to initiate a call. The call is established with certain AoCI e-parameters sent in a Facility IE in a FACILITY message sent before the CONNECT message.

The SS sends the DISCONNECT y seconds after sending the FACILITY message containing the e-parameters. The MS shall have stored the correct amount on the SIM according to the e-parameters sent.

Part 2:

Part 1 is repeated twice with the e-parameters that were set to zero above now omitted completely from the Facility IE. The shortened release procedures are used. The MS shall have stored the correct amount on the SIM.

The results of parts 1 and 2 are compared. The value for the charge calculated by the MS shall be identical for parts 1 and 2.

Maximum Duration of Test:

20 minutes.

Expected Sequence:

The sequence step 1-20 is executed for execution counter k = 1,..3.

Step	Direction	Message	Comments
0			At start of test only, read and note value of ACM on SIM
1	MS		The MS is made to initiate a call
2	MS -> SS	CHANNEL REQUEST	
3	SS -> MS	IMMEDIATE ASSIGNMENT	
4	MS -> SS	CM SERVICE REQUEST	
5	SS -> MS	CM SERVICE ACCEPT	
6	MS -> SS	SETUP	
7	SS -> MS	CALL PROCEEDING	
8	SS -> MS	ASSIGNMENT COMMAND	to a supported channel type
9	MS -> SS	ASSIGNMENT COMPLETE	
10	SS -> MS	ALERTING	
11	SS -> MS	FACILITY	As default message except contains Facility IE with contents as indicated in i below
			Either A, B or C branch is taken
A12	SS -> MS	CONNECT	
A13	MS -> SS	CONNECT ACKNOWLEDGE	
A14	MS -> SS	FACILITY	As default message except contains Facility IE with contents as indicated in ii below
B12	SS -> MS	CONNECT	
B13	MS -> SS	FACILITY	As default message except contains Facility IE with contents as indicated in ii below
B14	MS -> SS	CONNECT ACKNOWLEDGE	
C12	MS -> SS	FACILITY	As default message except contains Facility IE with contents as indicated in ii below
C13	SS -> MS	CONNECT	
C14	MS -> SS	CONNECT ACKNOWLEDGE	
15			call duration y seconds after CAI information sent by SS
			Branch D, E and F shall be taken for k= 1,2 and 3 respectively
D16	SS -> MS	DISCONNECT	
D17	MS -> SS	RELEASE	
D18	SS -> MS	RELEASE COMPLETE	
D19	SS -> MS	CHANNEL RELEASE	The main signalling link is released.
E16	SS -> MS	RELEASE COMPLETE	Shortened channel release procedure
E17	SS -> MS	CHANNEL RELEASE	The main signalling link is released.
F16	SS -> MS	CHANNEL RELEASE	
20	MS		MS display is checked to determine whether the correct call charge has been indicated

NOTE The value of y is given below.

The correct value of the ACM is found from the general AoC formula given in 3GPP TS 02.24 clause 4 with CDUR = y seconds and e parameters as defined below.

Specific Message Contents:

- i) FACILITY Information Element with Invoke = ForwardChargeAdvice component type as defined in 3GPP TS 04.80 subclause 3.6.1 table 3.3.

For ASN.1 description see default message contents in subclause 31.6.4.

y is set to a constant value of 90 s.

The values of the e-parameters within the parameter part of the Facility Information Element shall be set to:

k-value	e-parameter							CCM total at call end increased by	Step 0 ACM value
	1	2	3	4	5	6	7		
1	10	40	1	0	0	0	0	20	20
2	10	40	1	-----omitted-----				20	40
3	10	40	1	-----omitted-----				20	60

Values shown in table are in the format and have units as in 3GPP TS 02.24 clause 3.

ii) FACILITY Information Element with Return Result component type as defined in 3GPP TS 04.80 subclause 3.6.1 table 3.4.

For ASN.1 description see default message contents in subclause 31.6.4.

31.6.3.7 AoCI on a Call Hold call

Purpose:

- 1) To verify that when the MS invokes a Call Hold call and hence receives Facility IEs containing AoCI e-parameters for each chargeable call the MS returns a FACILITY message containing the AoCI acknowledgement within 1 s of transmission of each set of e-parameters.

Conformance Requirement(s):

- 1) When the MS invokes a Call Hold call and hence receives Facility IEs containing AoCI e-parameters for each chargeable call the MS shall return a FACILITY message containing the AoCI acknowledgement within 1 s of receiving each set of e-parameters.

Reference(s):

Conformance requirement 1: 3GPP TS 04.13.

Conformance requirement 2: 3GPP TS 02.24, 3GPP TS 04.83, 3GPP TS 04.84, 3GPP TS 04.86.

Specific PICS Statements

- Supported teleservices (TSPC_AddInfo_TeleSvc).

PIXIT Statements

- Support for active state of the call control protocol (U10).
- MMI method of reading the AoCI information.

Initial Conditions:

System Simulator:

1 cell, default parameters, IMSI attach/detach disabled.

Mobile Station:

The MS is in MM-state "idle, updated".

Foreseen Final State of the MS:

The MS is in MM-state "idle, updated".

Method of Test:

The MS is made to initiate a call. The call is established with certain AoCI e-parameters sent in a Facility IE in the CONNECT message. The MS shall return the AoCI acknowledgement within 1 s of transmission of the CONNECT message.

The call (call B) is then put on hold by sending a HOLD message from the MS to the SS. The SS shall reply with a HOLD ACKNOWLEDGE. The traffic channel is now available to originate another call.

The MS is made to initiate a second call (call C). The call is established with certain AoCI e-parameters sent in a Facility IE in the CONNECT message. The MS shall return the AoCI acknowledgement in a FACILITY message within 1 s of transmission of the CONNECT message.

The SS sends the DISCONNECT to the MS for call B x seconds after sending the call B CAI in the CONNECT/FACILITY message and the DISCONNECT for call C y seconds after sending the call C CAI in the CONNECT/FACILITY message.

Maximum Duration of Test:

10 minutes.

Expected Sequence:

Step	Direction	Message	Comments
1	MS		The MS is made to initiate a call
2	MS -> SS	CHANNEL REQUEST	
3	SS -> MS	IMMEDIATE ASSIGNMENT	
4	MS -> SS	CM SERVICE REQUEST	
5	SS -> MS	CM SERVICE ACCEPT	
6	MS -> SS	SETUP	
7	SS -> MS	CALL PROCEEDING	
8	SS -> MS	ASSIGNMENT COMMAND	to a supported channel type
9	MS -> SS	ASSIGNMENT COMPLETE	
10	SS -> MS	ALERTING	
11	SS -> MS	CONNECT	As default message except contains Facility IE with contents as indicated in i below
			Either D or E branch is taken
D12	MS -> SS	CONNECT ACKNOWLEDGE	
D13	MS -> SS	FACILITY	As default message except contains Facility IE with contents as indicated in ii below
E12	MS -> SS	FACILITY	As default message except contains Facility IE with contents as indicated in ii below
E13	MS -> SS	CONNECT ACKNOWLEDGE	
14	MS		The MS is made to initiate a second call, and the first call is placed on hold. DTMF signalling may occur, when MMI keys are depressed
15	MS -> SS	HOLD	
16	SS -> MS	HOLD ACKNOWLEDGE	
17	MS -> SS	CM SERVICE REQUEST	
18	SS -> MS	CM SERVICE ACCEPT	
19	MS -> SS	SETUP	TI arbitrary but different from existing TI
20	SS -> MS	CALL PROCEEDING	
21	SS -> MS	ALERTING	
22	SS -> MS	CONNECT	As default message except contains Facility IE with contents as indicated in i below
			Either F or G branch is taken
F23	MS -> SS	CONNECT ACKNOWLEDGE	
F24	MS -> SS	FACILITY	As default message except contains Facility IE with contents as indicated in ii below
G23	MS -> SS	FACILITY	As default message except contains Facility IE with contents as indicated in ii below
G24	MS -> SS	CONNECT ACKNOWLEDGE	
25			Call durations x and y seconds after respective CAI information sent by SS
			Branch H and I branch are taken, the sequence depending on the durations x and y
H26	SS -> MS	DISCONNECT	For call C
H27	MS -> SS	RELEASE	y seconds after call C CAI sent
H28	SS -> MS	RELEASE COMPLETE	
I26	SS -> MS	DISCONNECT	For call B
I27	MS -> SS	RELEASE	x seconds after call B CAI sent
I28	SS -> MS	RELEASE COMPLETE	
29	SS -> MS	CHANNEL RELEASE	The main signalling link is released
30	MS		MS display is checked to determine whether the correct call charge has been indicated

NOTE The value of x and y are given below.

The correct value of the ACM is found from the general AoC formula given in 3GPP TS 02.24 clause 4 with CDUR = x,y seconds and e parameters as defined below.

Specific Message Contents:

- i) FACILITY Information Element with Invoke = ForwardChargeAdvice component type as defined in 3GPP TS 04.80 subclause 3.6.1 table 3.3.

For ASN.1 description see default message contents in subclause 31.6.4.

x set to 180 s, y is set to 90 s.

The values of the e-parameters within the parameter part of the Facility Information Element shall be set to:

Call	e-parameter							CCM total at call end increased by	Step 0 ACM value
	1	2	3	4	5	6	7		
B(time x)	7	40	1	0	0	0	0		
C(time y)	13	40	1	0	0	0	0	54	54

Values shown in table are in the format and have units as in 3GPP TS 02.24 clause 3.

- ii) FACILITY Information Element with Return Result component type as defined in 3GPP TS 04.80 subclause 3.6.1 table 3.4.

For ASN.1 description see default message contents in subclause 31.6.4.

31.6.3.8 AoCI on a Multi-party call

Purpose:

- 1) To verify that when the MS invokes a Multi-party call and hence receives Facility IEs containing AoCI e-parameters for each chargeable call the MS returns a FACILITY message containing the AoCI acknowledgement within 1 s of transmission of each set of e-parameters.
- 2) To verify that when the MS originates a Multi-party call and hence receives Facility IEs containing CAI elements for each chargeable call the CCM records the sum of all the charges for the services currently being used and hence the ME inserts the correct charge in the ACM field of the SIM.

Conformance Requirement(s):

- 1) When the MS invokes a Multi-party call and hence receives Facility IEs containing AoCI e-parameters for each chargeable call the MS shall return a FACILITY message containing the AoCI acknowledgement within 1 s of receiving each set of e-parameters.
- 2) When the MS originates a Multi-party call and hence receives Facility IEs containing CAI elements for each chargeable call the CCM shall record the sum of all the charges for the services currently being used and hence the ME shall insert the correct charge in the ACM field of the SIM.

Reference(s):

Conformance requirement 1: 3GPP TS 04.13.

Conformance requirement 2: 3GPP TS 02.24, 3GPP TS 04.83, 3GPP TS 04.84, 3GPP TS 04.86.

Specific PICS Statements

- Supported teleservices (TSPC_AddInfo_TeleSvc).

PIXIT Statements

- Support for active state of the call control protocol (U10).
- MMI method of reading the AoCI information.

Initial Conditions:

System Simulator:

1 cell, default parameters, IMSI attach/detach disabled.

Mobile Station:

The MS is in MM-state "idle, updated".

Foreseen Final State of the MS:

The MS is in MM-state "idle, updated".

Method of Test:

The MS is made to initiate a call. The call is established with certain AoCI e-parameters sent in a Facility IE in the CONNECT message. The MS shall return the AoCI acknowledgement within 1 s of transmission of the CONNECT message.

The call (call B) is then put on hold by sending a HOLD message from the MS to the SS. The SS shall reply with a HOLD ACKNOWLEDGE. The traffic channel is now available to originate another call.

The MS is made to initiate a second call (call C). The call is established with certain AoCI e-parameters sent in a Facility IE in the CONNECT message. The MS shall return the AoCI acknowledgement within 1 s of transmission of the CONNECT message.

The MS invokes the multi-party service by sending a FACILITY message to the SS containing the BuildMPTY request.

The SS accepts the request and connects the MS with the other existing connections (active call C and held call B) and confirms with a FACILITY message.

The SS sends the DISCONNECT to the MS for call B x seconds after sending the call B CAI in the CONNECT message and the DISCONNECT for call C y seconds after sending the call C CAI in the CONNECT message. The MS shall have stored the correct amount on the SIM according to the two sets of e-parameters sent and call times x and y.

Maximum Duration of Test:

10 minutes.

Expected Sequence:

Step	Direction	Message	Comments
0			At start of test only, read and note value of ACM on SIM
1	MS		The MS is made to initiate a call
2	MS -> SS	CHANNEL REQUEST	
3	SS -> MS	IMMEDIATE ASSIGNMENT	
4	MS -> SS	CM SERVICE REQUEST	
5	SS -> MS	CM SERVICE ACCEPT	
6	MS -> SS	SETUP	
7	SS -> MS	CALL PROCEEDING	
8	SS -> MS	ASSIGNMENT COMMAND	to a supported channel type
9	MS -> SS	ASSIGNMENT COMPLETE	
10	SS -> MS	ALERTING	
11	SS -> MS	CONNECT	As default message except contains Facility IE with contents as indicated in i below
			Either D or E branch is taken
D12	MS -> SS	CONNECT ACKNOWLEDGE	
D13	MS -> SS	FACILITY	As default message except contains Facility IE with contents as indicated in ii below
E12	MS -> SS	FACILITY	As default message except contains Facility IE with contents as indicated in ii below
E13	MS -> SS	CONNECT ACKNOWLEDGE	
14	MS -> SS	HOLD	The MS is made to initiate a second call and the first call (call B) is placed on hold. DTMF signalling may occur, when MMI keys are depressed
15	MS->SS	HOLD	
16	SS -> MS	HOLD ACKNOWLEDGE	
17	MS -> SS	CM SERVICE REQUEST	
18	SS -> MS	CM SERVICE ACCEPT	

Step	Direction	Message	Comments
19	MS -> SS	SETUP	TI arbitrary but different from existing TI As default message except contains Facility IE with contents as indicated in i below Either F or G branch is taken
20	SS -> MS	CALL PROCEEDING	
21	SS -> MS	ALERTING	
22	SS -> MS	CONNECT	
F23	MS -> SS	CONNECT ACKNOWLEDGE	As default message except contains Facility IE with contents as indicated in ii below
F24	MS -> SS	FACILITY	
G23	MS -> SS	FACILITY	As default message except contains Facility IE with contents as indicated in ii below
G24	MS -> SS	CONNECT ACKNOWLEDGE	
25	MS -> SS	FACILITY (TI A-B/A-C)	The MS is made to build a multi-party call. DTMF signalling may occur, when MMI keys are depressed As default message except contains Facility IE with contents as indicated in iii below As default message except contains Facility IE with contents as indicated in iv, below Call durations x and y seconds after respective CAI information sent by SS
26	SS -> MS	FACILITY (TI A-B/A-C)	
27			
			Branch H and branch I are taken, the sequence depending on the durations x and y
H28	SS -> MS	DISCONNECT	For call C y seconds after call C CAI sent
H29	MS -> SS	RELEASE	
H30	SS -> MS	RELEASE COMPLETE	
I28	SS -> MS	DISCONNECT	For call B x seconds after call B CAI sent
I29	MS -> SS	RELEASE	
I30	SS -> MS	RELEASE COMPLETE	
31	SS -> MS	CHANNEL RELEASE	The main signalling link is released. MS display is checked to determine whether the correct call charge has been indicated
32	MS		

NOTE: A-B/A-C indicates a choice. the transaction identifier (TI) used must be that of the active call or the held call (ref. 3GPP TS 04.84).

The values of x and y are given below.

The correct value of the ACM is found from the general AoC formula given in 3GPP TS 02.24 clause 4 with CDUR = x,y seconds and e parameters as defined below.

Specific Message Contents:

i) FACILITY Information Element with Invoke = ForwardChargeAdvice component type as defined in 3GPP TS 04.80 subclause 3.6.1 table 3.3.

For ASN.1 description see default message contents in subclause 31.6.4.

x set to 180 s, y set to 90 s.

The values of the e-parameters within the parameter part of the Facility Information Element shall be set to:

Call	e-parameter							CCM total at call end increased by	Step 0 ACM value
	1	2	3	4	5	6	7		
B(time x)	19	40	1	0	0	0	0		
C(time y)	29	40	1	0	0	0	0	134	134

Values shown in table are in the format and have units as in 3GPP TS 02.24 clause 3.

- ii) FACILITY Information Element with Return Result component type as defined in 3GPP TS 04.80 subclause 3.6.1 table 3.4.

For ASN.1 description see default message contents in subclause 31.6.4.

- iii) FACILITY Information Element with Invoke = BuildMPTY component type as defined in 3GPP TS 04.80 subclause 3.6.1 table 3.4.

The following abbreviations are used in the descriptions below:

- U Universal tag class.
- CS Context Specific tag class.
- P Primitive tag form.
- C Constructed tag form.
- FIE Facility Information Element.

Contents Facility IE Identifier	Value/remark As 3GPP TS 04.80	Coding 00011000
Length of FIE contents	8	00001000
Component type tag	CS/C/tag=1	10100001
Component length	6	00000110
Invoke ID tag	U/P/tag=2	00000010
Invoke ID length	1	00000001
Invoke ID	Arbitrary (1 octet)	(00000000)
Op-Code tag	From 3GPP TS 04.80	00000010
Op-Code length	1	00000001
Op-Code	Build Multi-party operation (local value 124)	00000001

- ii) FACILITY Information Element with Return Result component type as defined in 3GPP TS 04.80 subclause 3.6.1 table 3.4.

Contents Facility IE Identifier	Value/remark As 3GPP TS 04.80	Coding 00111100
Length of FIE contents	5	00001001
Component type tag	CS/C/tag=2	10100010
Component length	3	00000011
Invoke ID tag	U/P/Integer	00000010
Invoke ID length	1	00000001
Invoke ID	Same as used as Invoke ID in Invoke FIE	(00000000)

31.6.4 Default contents of messages

As default message contents in 3GPP TS 11.10 subclause 26.8. These messages shall not contain SS version IEs.

Where indicated in specific tests CONNECT and FACILITY messages have Facility Information Elements as defined below.

Default contents of ForwardChargeAdvice Facility Information Elements

The following abbreviations are used in the descriptions below:

- U Universal tag class.
- CS Context Specific tag class.
- P Primitive tag form.
- C Constructed tag form.

FIE Facility Information Element.

- i) FACILITY Information Element with Invoke = ForwardChargeAdvice component type as defined in 3GPP TS 04.80 subclause 3.6.1 table 3.3.

Contents	Value/remark	Coding
Facility IE Identifier	As 3GPP TS 04.80	00011100
Length of FIE contents	43	00101011
Component type tag	CS/C/tag=1	10100001
Component length	41	00101001
Invoke ID tag	U/P/tag=2	00000010
Invoke ID length	1	00000001
Invoke ID	Arbitrary	(00000000) (1 octet)
Op-Code tag	From 3GPP TS 04.80	00000010
Op-Code length	1	00000001
Op-Code	Forward Charge Advice operation	01111101 (local value 125)
Sequence Identifier	U/C/tag=16	00110000 from CCITT X.208
Length Indicator	33	00100001
SS-Code Identifier	CS/P/tag=0	10000000
Length Indicator	1	00000001
SS-Code	AoCC SS-Code (for AoCC tests) AoCI SS-Code (for AoCI tests)	01110010 01110001
Charging Info. identifier	CS/C/tag=1	10100001
Length Indicator	28	00011100
e1 Identifier	CS/P/tag=1	10000001
Length Indicator	2	00000010
e1	(2 Octets)	See e-parameter table in relevant test
e2 Identifier	CS/P/tag=2	10000010
Length Indicator	2	00000010
e2	(2 Octets)	See e-parameter table in relevant test
.	.	.
.	.	.
.	.	.
e7 Identifier	CS/P/tag=7	10000111
Length Indicator	2	00000010
e7	(2 Octets)	See e-parameter table in relevant test

- ii) FACILITY Information Element with Return Result component type as defined in 3GPP TS 04.80 subclause 3.6.1 table 3.4.

Contents	Value/remark	Coding
Facility IE Identifier	As 3GPP TS 04.80	00111100
Length of FIE contents	5	00001001
Component type tag	CS/C/tag=2	10100010
Component length	3	00000011
Invoke ID tag	U/P/Integer	00000010
Invoke ID length	1	00000001
Invoke ID	Same as used as	(00000000)
Invoke ID in Invoke FIE		

31.7 Additional information transfer supplementary services

(Reserved).

31.8 Call restriction supplementary services

The following abbreviations are used:

BO:	Barring of Outgoing calls.
BAOC:	Barring of All Outgoing Calls.
BOIC:	Barring of Outgoing International Calls.
BOICExHC:	Barring of Outgoing International Call EXcept those directed to the Home PLMN country.
BI:	Barring of Incoming calls.
BAIC:	Barring of All Incoming calls.
BICRoam:	Barring of Incoming when Roaming outside the home PLMN country.
B:	Barring (common name for BAOB, BOIC, BOICExHC, BAIC and BICRoam).

These abbreviations are also used to represent the corresponding SS-Code; e.g. B is the SS-Code for all barring services.

NOTE: The password(s) to be used during tests of this subclause 31.8 may be randomly chosen - unless otherwise stated - in accordance with 3GPP TS 02.04 subclause 5.2.

31.8.1 Registration of a password

31.8.1.1 Registration accepted

31.8.1.1.1 Conformance requirements

- 1) For registration of a password for all barring services, the MS shall transmit successively:
 - 1.1) a CHANNEL REQUEST with establishment cause set to "other services requested by the mobile user";
 - 1.2) a CM SERVICE REQUEST with CM service type indicating "supplementary service activation";
 - 1.3) and then the REGISTER message containing a facility IE that includes an invoke of the RegisterPassword operation with parameter values according to the user's request (MMI action).
- 2) When the mobile subscriber wants to register a new password, the old password, the new password and the repeat of the new password shall be entered into the MS. Then the MS sends to the network an invoke component of the operation "register password".
- 3) The MS shall be able to send a password by sending a FACILITY message in accordance to the user request (MMI actions).
- 4) Upon receipt of the result of the procedure, contained in RELEASE COMPLETE or FACILITY message, the MS shall provide the appropriate user indication (which is to be described by the manufacturer).

References

- 1.1) 3GPP TS 04.08 / 3GPP TS 44.018 subclauses 3.3.1.1.2 and 9.1.9.
- 1.2) 3GPP TS 04.08 / 3GPP TS 24.008 subclauses 4.5.1.1, 9.2.9 and 10.5.33.
- 1.3) 3GPP TS 04.88, 3GPP TS 04.80 subclauses 2.3 and 3.6.
- 2) 3GPP TS 04.10 subclause 4.2.
- 3) 3GPP TS 04.80.
- 4) 3GPP TS 02.30.

31.8.1.1.2 Test purpose

- 1) To check that the MS correctly requests a supplementary service transaction for registration of a password for all barring services in CHANNEL REQUEST message.
- 2) To check that the MS correctly requests a supplementary service transaction for registration of a password for all barring services in the subsequent CM SERVICE REQUEST.

- 3) To check that the MS sends a REGISTER message containing the invoke of the RegisterPassword operation with the expected parameter values for registration of a password for all barring services.
- 4) To check that when the mobile subscriber wants to register a new password, the old password, the new password and the repeat of the new password shall be entered into the MS before the MS sends to the network a CHANNEL REQUEST.
- 5) To check that the MS is able to send a password by sending a FACILITY message in accordance to the user request (MMI actions).
- 6) To check that upon receipt of the result of the procedure, contained in RELEASE COMPLETE or FACILITY message, the MS provides the appropriate user indication (as described by the manufacturer).

These checks are done for:

- All barring services, the result of the operation being sent in a RELEASE COMPLETE message.

31.8.1.1.3 Method of test

Initial conditions

System Simulator:

1 cell, default parameters.

Mobile Station:

The MS is "idle updated".

Specific PICS Statements

-

PIXIT Statements

- Description of the user's commands and of display of the answers from the network for call barring.

Foreseen final state of the MS

The MS is "idle updated".

Test procedure

By means of appropriate MMI functions (using either 3GPP TS 02.30 or manufacturer defined MMI), the user requests registration of a new password for all barring services by entering the old password, new password and a repeat of the old password.

Upon receipt of the operation (in a REGISTER message), the system simulator answers with the FACILITY message with the Facility information element containing an invoke of the GetPassword operation requiring the old password.

Upon receipt of the FACILITY message, the system simulator answers with the FACILITY message with the Facility information element containing an invoke of the GetPassword operation requiring a new password.

Upon receipt of the FACILITY message, the system simulator answers with the FACILITY message with the Facility information element containing an invoke of the GetPassword operation requiring again the new password.

Upon receipt of the FACILITY message, the system simulator answers with the RELEASE COMPLETE message with the Facility information element containing the return result of the RegisterPassword operation.

Maximum duration of test

3 minutes.

Expected sequence

Step	Direction	Message	Comments
1	MS		The MS is made to initiate a registration of a password for all call barring services. The old password, the new password and a repeat of the new password are entered. with establishment cause "Other procedures which can be completed with an SDCCH"
2	MS -> SS	CHANNEL REQUEST	
3	SS -> MS	IMMEDIATE ASSIGNMENT	
4	MS -> SS	CM SERVICE REQUEST	
5	SS -> MS	CM SERVICE ACCEPT	
6	MS -> SS	REGISTER	
7	SS -> MS	FACILITY	Invoke = GetPassword (password) GetPassword operation ReturnResult Invoke = GetPassword (new password) Invoke = GetPassword (new password again) GetPassword operation ReturnResult RegisterPassword operation ReturnResult
8	MS -> SS	FACILITY	
9	SS -> MS	FACILITY	
10	MS -> SS	FACILITY	
11	SS -> MS	FACILITY	
12	MS -> SS	FACILITY	
13	SS -> MS	RELEASE COMPLETE	
14	SS -> MS	CHANNEL RELEASE	

Specific message content

step 6 -

- protocol discriminator: non call related SS message.
- message type: REGISTER.
- facility:

invoke = RegisterPassword:

Supplementary service code = B.

steps 7, 9, and 11 -

- protocol discriminator: non call related SS message.
- message type: FACILITY.
- facility:

invoke = GetPassword:

Guidance info: Password (step 7), new password (step 9), new password again (step 11).

The linked ID must be the same as the invoke ID in the invoke of the RegisterPassword operation.

31.8.1.2 Registration rejected

31.8.1.2.1 Rejection after invoke of the RegisterPassword operation

31.8.1.2.1.1 Conformance requirements

- 1) A transaction of any kind being already established, for registration of a password for all call restriction services, the MS shall establish a parallel MM transaction, sending a CM SERVICE REQUEST with CM service type indicating "supplementary service activation",
- 2) Then the MS shall send a REGISTER message related to the present SS transaction containing a facility IE that includes an invoke of the RegisterPassword operation with parameter values according to the user's request (MMI action).
- 3) Upon receipt of the RELEASE COMPLETE message related to the present SS transaction, the SS transaction shall be released but the first transaction shall remain unaffected.

- 4) Upon receipt of the RELEASE COMPLETE message, the MS shall provide the appropriate user indication (which is to be described by the Manufacturer).

References

- 1) 3GPP TS 04.08 / 3GPP TS 44.018 subclauses 3.3.1.1.2 and 9.1.9.
- 2) 3GPP TS 04.08 / 3GPP TS 24.008 subclauses 4.5.1.1, 9.2.9 and 10.5.33.
- 3) 3GPP TS 04.88,
3GPP TS 04.80 subclauses 2.3 and 3.6.
- 4) 3GPP TS 02.30 subclause 4.5.

31.8.1.2.1.2 Test purpose

- 1) To check that, when a call transaction is already established, the MS correctly requests the establishment of a parallel MM transaction for supplementary service transaction of registration of a password for all call restriction services, sending a CM SERVICE REQUEST.
- 2) To check that the MS sends a REGISTER message containing the invoke of the RegisterPassword operation with the expected parameter values for registration of a password for all call restriction services.
- 3) To check that upon receipt of the RELEASE COMPLETE message related to the present SS transaction, the first transaction remains unaffected.
- 4) To check that upon receipt of the RELEASE COMPLETE message, the MS provides the appropriate user indication (as described by the Manufacturer).

Those checks are performed with a call transaction already established for:

- all call restriction services, the RELEASE COMPLETE message being sent at the beginning of the procedure with a facility IE containing a return_error(error) where error is "SS subscription violation".

31.8.1.2.1.3 Method of test

Initial conditions

System Simulator:

1 cell, default parameters.

Mobile Station:

The MS is in CC state U10.

Specific PICS Statements

-

PIXIT Statements

- Description of the user's commands and of display of the answers from the network for call barring.

Foreseen final state of the MS

The MS is in CC state U10.

Test procedure

By means of appropriate MMI functions (using either 3GPP TS 02.30 or manufacturer defined MMI), the user requests registration of a new password for all call restriction services by entering the old password, the new password and a repeat of the new password.

Upon receipt of the operation (in a REGISTER message), the system simulator answers with the RELEASE COMPLETE (PD and TI of the SS transaction) message with the Facility information element containing a Return_error(error: SS subscription violation) of the RegisterPassword operation.

Upon receipt of the FACILITY message, the system simulator sends STATUS ENQUIRY, the MS responds with STATUS message indicating CC state U10.

Maximum duration of test

2 minutes.

Expected sequence

Step	Direction	Message	Comments
1	MS		The MS is made to initiate a registration of a new password for all call restriction services. The old password, the new password and a repeat of the new password are entered. cause: "supplementary service activation"
2	MS -> SS	CM SERVICE REQUEST	
3	SS -> MS	CM SERVICE ACCEPT	
4	MS -> SS	REGISTER	
5	SS -> MS	RELEASE COMPLETE	RegisterPassword operation Return_error provide correct MMI user indication
6	MS		
7	SS -> MS	STATUS ENQUIRY	CC staTE U10
8	MS -> SS	STATUS	

Specific message content

step 4 -

- protocol discriminator: non call related SS message.
- message type: REGISTER.
- facility:

invoke = RegisterPassword:

Supplementary service code = all call restrictions.

step 5 -

- protocol discriminator: non call related SS message.
- transaction identifier: same TI as previous REGISTER message.
- message type: RELEASE COMPLETE.
- facility:

return error code: SS subscription violation.

For the return error the invoke ID must be the same as in the invoke of the RegisterPassword operation.

31.8.1.2.2 Rejection after password check with negative result

31.8.1.2.2.1 Conformance requirements

- 1) A transaction of any kind being already established, for registration of a password for all call restriction services, the MS shall establish a parallel MM transaction, sending a CM SERVICE REQUEST with CM service type indicating "supplementary service activation".
- 2) Then the MS shall send a REGISTER message related to the present SS transaction containing a facility IE that includes an invoke of the RegisterPassword operation with parameter values according to the user's request (MMI action).
- 3) Upon receipt of the RELEASE COMPLETE message related to the present SS transaction, the SS transaction shall be released but the first transaction shall remain unaffected.

- 4) Upon receipt of the RELEASE COMPLETE message, the MS shall provide the appropriate user indication (which is to be described by the Manufacturer).

References

- 1) 3GPP TS 04.08 / 3GPP TS 44.018 subclauses 3.3.1.1.2 and 9.1.9.
- 2) 3GPP TS 04.08 / 3GPP TS 24.008 subclauses 4.5.1.1, 9.2.9 and 10.5.33.
- 3) 3GPP TS 04.88,
3GPP TS 04.80 subclauses 2.3 and 3.6,
3GPP TS 04.10 subclause 4.2.2,
3GPP TS 03.11 clause 3.
- 4) 3GPP TS 02.30 subclause 4.5.

31.8.1.2.2.2 Test purpose

- 1) To check that, when a call transaction is already established, the MS correctly requests the establishment of a parallel MM transaction for supplementary service transaction of registration of a password for all call restriction services, sending a CM SERVICE REQUEST.
- 2) To check that the MS sends a REGISTER message containing the invoke of the RegisterPassword operation with the expected parameter values for registration of a password for all call restriction services.
- 3) To check that upon receipt of the RELEASE COMPLETE message related to the present SS transaction, the first transaction remains unaffected.
- 4) To check that upon receipt of the RELEASE COMPLETE message, the MS provides the appropriate user indication (as described by the Manufacturer).

Those checks are performed with a call transaction already established for:

- all call restriction services, the RELEASE COMPLETE message being sent at the end of the procedure with a facility IE containing a return_error(error) where error is "NegativePasswordCheck".

31.8.1.2.2.3 Method of test

Initial conditions

System Simulator:

1 cell, default parameters.

WPA > 3.

Mobile Station:

The MS is in CC state U10.

Specific PICS Statements

-

PIXIT Statements

- Description of the user's commands and of display of the answers from the network for call barring.

Foreseen final state of the MS

The MS is in CC state U10.

Test procedure

By means of appropriate MMI functions (using either 3GPP TS 02.30 or manufacturer defined MMI), the user requests registration of a new password for all call restriction services. By means of appropriate MMI functions the user enters the old and new passwords.

Upon receipt of the REGISTER message, the system simulator answers with the FACILITY message with the Facility information element containing an invoke of the GetPassword operation requiring the old password.

Upon receipt of the FACILITY message, the system simulator answers with the RELEASE COMPLETE message (PD and TI of the SS transaction) with the Facility information element containing a Return_error(error: NegativePasswordCheck) of the RegisterPassword operation.

The system simulator sends STATUS ENQUIRY, the MS responds with STATUS message indicating CC state U10.

Maximum duration of test

5 minutes.

Expected sequence

Step	Direction	Message	Comments
1	MS		The MS is made to initiate a registration of a new password for all call restriction services. The old and new passwords are entered.
2	MS -> SS	CM SERVICE REQUEST	cause: "supplementary service activation"
3	SS -> MS	CM SERVICE ACCEPT	
4	MS -> SS	REGISTER	
5	SS -> MS	FACILITY	Invoke = GetPassword (password)
6	SS -> MS	RELEASE COMPLETE	Register Password operation ReturnError
7	MS		provide correct MMI user indication
8	SS -> MS	STATUS ENQUIRY	
9	MS -> SS	STATUS	CC staTE U10

Specific message content

step 4 -

- protocol discriminator: non call related SS message.
- message type: REGISTER.
- facility:
invoke = RegisterPassword:

Supplementary service code = B.

step 6 -

- protocol discriminator: non call related SS message.
- transaction identifier: same TI as previous REGISTER message.
- message type: RELEASE COMPLETE.
- facility:
error code: NegativePasswordCheck.

For the reject the invoke ID must be the same as in the invoke of the Registerpassword operation.

step 5 -

- protocol discriminator: non call related SS message.
- transaction identifier: in FACILITY same as previous REGISTER message.
- message type: FACILITY.
- facility:
invoke = GetPassword:

Guidance info: Password (step 1).

31.8.1.2.3 Rejection after new password mismatch

31.8.1.2.3.1 Conformance requirements

- 1) A transaction of any kind being already established, for registration of a password for all call restriction services, the MS shall establish a parallel MM transaction, sending a CM SERVICE REQUEST with CM service type indicating "supplementary service activation".
- 2) Then the MS shall send a REGISTER message related to the present SS transaction containing a facility IE that includes an invoke of the RegisterPassword operation with parameter values according to the user's request (MMI action).
- 3) Upon receipt of the RELEASE COMPLETE message related to the present SS transaction, the SS transaction shall be released but the first transaction shall remain unaffected.
- 4) Upon receipt of the RELEASE COMPLETE message, the MS shall provide the appropriate user indication (which is to be described by the Manufacturer).

References

- 1) 3GPP TS 04.08 / 3GPP TS 44.018 subclauses 3.3.1.1.2 and 9.1.9.
- 2) 3GPP TS 04.08 / 3GPP TS 24.008 subclauses 4.5.1.1, 9.2.9 and 10.5.33.
- 3) 3GPP TS 04.88,
3GPP TS 04.80 subclauses 2.3 and 3.6.
- 4) 3GPP TS 02.30 subclause 4.5.
- 5) 3GPP TS 04.10 subclause 4.2.

31.8.1.2.3.2 Test purpose

- 1) To check that, when a call transaction is already established, the MS correctly requests the establishment of a parallel MM transaction for supplementary service transaction of registration of a password for all call restriction services, sending a CM SERVICE REQUEST.
- 2) To check that the MS sends a REGISTER message containing the invoke of the RegisterPassword operation with the expected parameter values for registration of a password for all call restriction services.
- 3) To check that upon receipt of the RELEASE COMPLETE message related to the present SS transaction, the first transaction remains unaffected.
- 4) To check that upon receipt of the RELEASE COMPLETE message, the MS provides the appropriate user indication (as described by the Manufacturer).

Those checks are performed with a call transaction already established for:

- all call restriction services, the RELEASE COMPLETE message being sent at the end of the procedure with a facility IE containing a return_error(error) where error is "PasswordRegistrationFailure" with diagnostic "new password mismatch".

31.8.1.2.3.3 Method of test

Initial conditions

System Simulator:

1 cell, default parameters.

Mobile Station:

The MS is in CC state U10.

Specific PICS Statements

-

PIXIT Statements

- Description of the user's commands and of display of the answers from the network for call barring.

Foreseen final state of the MS

The MS is in CC state U10.

Test procedure

By means of appropriate MMI functions (using either 3GPP TS 02.30 or manufacturer defined MMI), the user requests registration of a new password for all call restriction services by entering the old password, the new password and a repeat of the new password.

Upon receipt of the REGISTER message, the system simulator answers with the FACILITY message with the Facility information element containing an invoke of the GetPassword operation requiring the old password.

Upon receipt of the FACILITY message, the system simulator answers with the FACILITY message with the Facility information element containing an invoke of the GetPassword operation requiring the new password.

Upon receipt of the FACILITY message, the system simulator answers with the FACILITY message with the Facility information element containing an invoke of the GetPassword operation requiring again the new password.

Upon receipt of the FACILITY message, the system simulator answers with the RELEASE COMPLETE message (PD and TI of the SS transaction) with the Facility information element containing a Return_error(error: PasswordRegistrationFailure, parameter: NewPasswordMismatch) of the RegisterPassword operation.

The system simulator sends STATUS ENQUIRY, the MS responds with STATUS message indicating CC state U10.

Maximum duration of test

3 minutes.

Expected sequence

Step	Direction	Message	Comments
1	MS		The MS is made to initiate a registration of a new password for all call restriction services. The old password, new password and a repeat of the new password are entered. cause: "supplementary service activation"
2	MS -> SS	CM SERVICE REQUEST	
3	SS -> MS	CM SERVICE ACCEPT	
4	MS -> SS	REGISTER	
5	SS -> MS	FACILITY	Invoke = GetPassword (password)
6	MS -> SS	FACILITY	GetPassword operation ReturnResult
7	SS -> MS	FACILITY	Invoke = GetPassword (new password)
8	MS -> SS	FACILITY	GetPassword operation ReturnResult
9	SS -> MS	FACILITY	Invoke = GetPassword (new password again)
10	MS -> SS	FACILITY	GetPassword operation ReturnResult
11	SS -> MS	RELEASE COMPLETE	Register Password operation ReturnError
12	MS		provide correct MMI user indication
13	SS -> MS	STATUS ENQUIRY	
14	MS -> SS	STATUS	CC staTE U10

Specific message content

step 4 -

- protocol discriminator: non call related SS message.
- message type: REGISTER.
- facility:
invoke = RegisterPassword:
Supplementary service code = B.

step 11 -

- protocol discriminator: non call related SS message.
- transaction identifier: same TI as previous REGISTER message.
- message type: RELEASE COMPLETE.
- facility:
error code: PasswordRegistrationFailure.
parameter: NewPasswordMismatch.

For the reject the invoke ID must be the same as in the invoke of the Registerpassword operation.

steps 5, 7, and 8 -

- protocol discriminator: non call related SS message.
- transaction identifier: in FACILITY same as previous REGISTER message.
- message type: FACILITY.
- facility:
invoke = GetPassword:
Supplementary service code = B.
Guidance info: Password (step 5), new password (step 7), new password again (step 8).

31.8.2 Erasure

Not applicable.

31.8.3 Activation

31.8.3.1 Activation accepted

31.8.3.1.1 Conformance requirements

- 1) For activation of any specific call restriction service with any parameters, the MS shall transmit successively
 - 1.1) a CHANNEL REQUEST with establishment cause set to "other services requested by the mobile user";
 - 1.2) a CM SERVICE REQUEST with CM service type indicating "supplementary service activation";
 - 1.3) and then the REGISTER message containing a facility IE that includes an invoke of the ActivateSS operation with parameter values according to the user's request (MMI action).
- 2) Upon receipt of FACILITY message requiring the password, the MS shall be able to send a password by sending a FACILITY message.
- 3) Upon receipt of the RELEASE COMPLETE message, the MS shall provide the appropriate user indication (which is to be described by the manufacturer).

References

- 1) 3GPP TS 04.08 / 3GPP TS 44.018 subclauses 3.3.1.1.2 and 9.2.9.
- 2) 3GPP TS 04.88,
3GPP TS 04.80 subclauses 2.3 and 3.6.
- 3) 3GPP TS 02.30 subclause 4.5.

31.8.3.1.2 Test purpose

- 1) To check that the MS correctly requests a supplementary service transaction for activation of a specific call restriction service in CHANNEL REQUEST message.
- 2) To check that the MS correctly requests a supplementary service transaction for activation of call restriction service in the subsequent CM SERVICE REQUEST.
- 3) To check that the MS sends a REGISTER message containing the invoke of the ActivateSS operation with the expected parameter values for activation of a specific call restriction service.
- 4) To check that upon receipt of FACILITY message requiring the password, the MS is able to send a password by sending a FACILITY.
- 5) To check that upon receipt of the RELEASE COMPLETE message, the MS provides the appropriate user indication (which is to be described by the manufacturer).

These checks are done for:

- a) BAOC, for basic service group "all synchronous services".
- b) BICRoam, for all basic service groups.

31.8.3.1.3 Method of test

Initial conditions

System Simulator:

1 cell, default parameters.

Mobile Station:

The MS is "idle updated".

Specific PICS Statements

-

PIXIT Statements

- Description of the user's commands and of display of the answers from the network for call barring.

Foreseen final state of the MS

The MS is "idle updated".

Test procedure

By means of appropriate MMI functions (using either 3GPP TS 02.30 or manufacturer defined MMI), the user requests activation of BAOC, for basic service group "all synchronous services".

Upon receipt of the operation (in a REGISTER message), the system simulator answers with the FACILITY message with the Facility information element containing an invoke of the GetPassword operation requiring the current password.

If the manufacturer defined MMI has been used to request the activation of BAOC, then the MS may, by means of appropriate manufacturer defined MMI functions, prompt the user to give a password, depending on the implementation of the manufacturer defined MMI functions.

Upon receipt of the FACILITY message, the system simulator answers with a RELEASE COMPLETE message with the Facility information element containing the Return_result of the ActivateSS operation.

The SS transaction and the dedicated channel are released.

Then again, by means of appropriate MMI functions, the user requests activation of BICRoam, for all basic service groups.

Upon receipt of the operation (in a REGISTER message), the system simulator answers with the FACILITY message with the Facility information element containing an invoke of the GetPassword operation requiring the current password.

If the manufacturer defined MMI has been used to request the activation of BICRoam, then the MS may, by means of appropriate manufacturer defined MMI functions, prompt the user to give a password, depending on the implementation of the manufacturer defined MMI functions.

Upon receipt of the FACILITY message, the system simulator answers with a RELEASE COMPLETE message with the Facility information element containing the Return_result of the ActivateSS operation.

The dedicated channel is released.

Maximum duration of test

3 minutes.

Expected sequence

Step	Direction	Message	Comments
1	MS		The MS is made to initiate a activation of BAOC(all synchronous services)
2	MS -> SS	CHANNEL REQUEST	with establishment cause "Other procedures which can be completed with an SDCCH"
3	SS -> MS	IMMEDIATE ASSIGNMENT	
4	MS -> SS	CM SERVICE REQUEST	cause: "supplementary service activation"
5	SS -> MS	CM SERVICE ACCEPT	
6	MS -> SS	REGISTER	
7	SS -> MS	FACILITY	GetPassword
8	MS -> SS	FACILITY	Getpassword operation Return Result
9	SS -> MS	RELEASE COMPLETE	ActivateSS operation Return_result
10	MS		provide user MMI indication
11	SS -> MS	CHANNEL RELEASE	
12	MS		The MS is made to initiate an activation of BICRoam(all basic service groups),
13	MS -> SS	CHANNEL REQUEST	with establishment cause "Other procedures which can be completed with an SDCCH"
14	SS -> MS	IMMEDIATE ASSIGNMENT	
15	MS -> SS	CM SERVICE REQUEST	cause: "supplementary service activation"
16	SS -> MS	CM SERVICE ACCEPT	
17	MS -> SS	REGISTER	
18	SS -> MS	FACILITY	GetPassword
19	MS -> SS	FACILITY	Getpassword operation Return Result
20	SS -> MS	RELEASE COMPLETE	ActivateSS operation Return result
21	MS		provide correct MMI user indication
22	SS -> MS	CHANNEL RELEASE	

Specific message contents

step 6 - BAOC

- protocol discriminator: non call related SS message.
- message type: REGISTER.
- facility:

invoke = Activation:

Supplementary service code = BAOC.

Basic service code: Bearer Service (all synchronous services), no teleservice present.

step 17 - BICRoam

- protocol discriminator: non call related SS message.
- message type: REGISTER.
- facility:

invoke = Activation:

Supplementary service code = BICRoam.

Basic service code: no bearer service present, no teleservice present.

steps 7, 18 -

- protocol discriminator: non call related SS message.
- transaction identifier: in FACILITY same as previous REGISTER message.
- message type: FACILITY.
- facility:

invoke = GetPassword:

Guidance info: Password.

31.8.3.2 Activation rejected

31.8.3.2.1 Rejection after invoke of ActivateSS operation

31.8.3.2.1.1 Conformance requirements

- 1) A transaction of any kind being already established, for activation of one specific barring services, the MS shall establish a parallel MM transaction, sending a CM SERVICE REQUEST with CM service type indicating "supplementary service activation".
- 2) Then the MS shall send a REGISTER message related to the present SS transaction containing a facility IE that includes an invoke of the ActivateSS operation with parameter values according to the user's request (MMI action).
- 3) Upon receipt of the RELEASE COMPLETE message related to the present SS transaction, the SS transaction shall be released but the first transaction shall remain unaffected.
- 4) Upon receipt of the RELEASE COMPLETE message, the MS shall provide the appropriate user indication (which is to be described by the Manufacturer).

References

- 1) 3GPP TS 04.08 / 3GPP TS 44.018 subclauses 3.3.1.1.2 and 9.1.9.
- 2) 3GPP TS 04.08 / 3GPP TS 24.008 subclauses 4.5.1.1, 9.2.9 and 10.5.33.
- 3) 3GPP TS 04.88,
3GPP TS 04.80 subclauses 2.3 and 3.6.

4) 3GPP TS 02.30 subclause 4.5.

31.8.3.2.1.2 Test purpose

- 1) To check that, when a call transaction is already established, the MS correctly requests the establishment of a parallel MM transaction for supplementary service transaction of specific call barring service, sending a CM SERVICE REQUEST.
- 2) To check that the MS sends a REGISTER message containing the invoke of the ActivateSS operation with the expected parameter values for specific call barring service.
- 3) To check that upon receipt of the RELEASE COMPLETE message related to the present SS transaction, the first transaction remains unaffected.
- 4) To check that upon receipt of the RELEASE COMPLETE message, the MS provides the appropriate user indication (as described by the Manufacturer).

Those checks are performed with a call transaction already established for:

- BOIC, the RELEASE COMPLETE message being sent at the beginning of the procedure with a facility IE containing a return_error(error) where error is "SS subscription violation".

31.8.3.2.1.3 Method of test

Initial conditions

System Simulator:

1 cell, default parameters.

Mobile Station:

The MS is in CC state U10.

Specific PICS Statements

-

PIXIT Statements

- Description of the user's commands and of display of the answers from the network for call barring.

Foreseen final state of the MS

The MS is in CC state U10.

Test procedure

By means of appropriate MMI functions (using either 3GPP TS 02.30 or manufacturer defined MMI), the user requests activation of BOIC.

Upon receipt of the operation (in a REGISTER message), the system simulator answers with the RELEASE COMPLETE (PD and TI of the SS transaction) message with the Facility information element containing a Return_error(error: SS subscription violation) of the ActivateSS operation.

The system simulator then sends STATUS ENQUIRY, and the MS responds with STATUS message indicating CC state U10.

Maximum duration of test

2 minutes.

Expected sequence

Step	Direction	Message	Comments
1	MS		The MS is made to initiate a registration of a new password for BOIC cause: "supplementary service activation"
2	MS -> SS	CM SERVICE REQUEST	
3	SS -> MS	CM SERVICE ACCEPT	
4	MS -> SS	REGISTER	
5	SS -> MS	RELEASE COMPLETE	RegisterPassword operation Return_error provide correct MMI user indication
6	MS		
7	SS -> MS	STATUS ENQUIRY	
8	MS -> SS	STATUS	
			CC state U10

Specific message content

step 4 -

- protocol discriminator: non call related SS message.
- message type: REGISTER.
- facility:
- invoke = ActivateSS:

Supplementary service code = BOIC.

step 5 -

- protocol discriminator: non call related SS message.
- transaction identifier: same TI as previous REGISTER message.
- message type: RELEASE COMPLETE.
- facility:

return error code: SS subscription violation.

For the return error the invoke ID must be the same as in the invoke of the ActivateSS operation.

31.8.3.2.2 Rejection after use of password procedure

31.8.3.2.2.1 Conformance requirements

- 1) A transaction of any kind being already established, for activation of any specific call restriction services, the MS shall establish a parallel MM transaction, sending a CM SERVICE REQUEST with CM service type indicating "supplementary service activation".
- 2) Then the MS shall send a REGISTER message related to the present SS transaction containing a facility IE that includes an invoke of the ActivateSS operation with parameter values according to the user's request (MMI action).
- 3) Upon receipt of the RELEASE COMPLETE message related to the present SS transaction, the SS transaction shall be released but the first transaction shall remain unaffected.
- 4) Upon receipt of the RELEASE COMPLETE message, the MS shall provide the appropriate user indication (which is to be described by the Manufacturer).

References

- 1) 3GPP TS 04.08 / 3GPP TS 44.018 subclauses 3.3.1.1.2 and 9.1.9.
- 2) 3GPP TS 04.08 / 3GPP TS 24.008 subclauses 4.5.1.1, 9.2.9 and 10.5.33.

- 3) 3GPP TS 04.88,
3GPP TS 04.80 subclauses 2.3 and 3.6.
- 4) 3GPP TS 02.30 subclause 4.5.

31.8.3.2.2.2 Test purpose

- 1) To check that, when a call transaction is already established, the MS correctly requests the establishment of a parallel MM transaction for supplementary service transaction of activation of one specific call restriction service, sending a CM SERVICE REQUEST.
- 2) To check that the MS sends a REGISTER message containing the invoke of the ActivateSS operation with the expected parameter values for activation of one specific call restriction service.
- 3) To check that upon receipt of the RELEASE COMPLETE message related to the present SS transaction, the first transaction remains unaffected.
- 4) To check that upon receipt of the RELEASE COMPLETE message, the MS provides the appropriate user indication (as described by the Manufacturer).

Those checks are performed with a call transaction already established for:

- BAIC, the RELEASE COMPLETE message being sent at the end of the procedure with a facility IE containing a return_error(error) where error is "NegativePasswordCheck".

31.8.3.2.2.3 Method of test

Initial conditions

System Simulator:

1 cell, default parameters.

Mobile Station:

The MS is in CC state U10.

Specific PICS Statements

-

PIXIT Statements

- Description of the user's commands and of display of the answers from the network for call barring.

Foreseen final state of the MS

The MS is in CC state U10.

Test procedure

By means of appropriate MMI functions (using either 3GPP TS 02.30 or manufacturer defined MMI), the user requests activation of BAIC.

Upon receipt of the REGISTER message, the system simulator answers with the FACILITY message with the Facility information element containing an invoke of the GetPassword operation requiring the current password.

If the manufacturer defined MMI has been used to request the activation of BAIC, then the MS may, by means of appropriate manufacturer defined MMI functions, prompt the user to give a password, depending on the implementation of the manufacturer defined MMI functions.

Upon receipt of the FACILITY message, the system simulator sends RELEASE COMPLETE message (PD and TI of the SS transaction) with the Facility information element containing a Return_error(error: NegativePasswordCheck) of the GetPassword operation.

The system simulator sends STATUS ENQUIRY, the MS responds with STATUS message indicating CC state U10.

Maximum duration of test

3 minutes.

Expected sequence

Step	Direction	Message	Comments
1	MS		The MS is made to initiate a registration of BAIC cause: "supplementary service activation"
2	MS -> SS	CM SERVICE REQUEST	
3	SS -> MS	CM SERVICE ACCEPT	
4	MS -> SS	REGISTER	
5	SS -> MS	FACILITY	Invoke = GetPassword (password) GetPassword operation Return Result Register Password operation ReturnError provide correct MMI user indication
6	MS -> SS	FACILITY	
7	SS -> MS	RELEASE COMPLETE	
8	MS		
9	SS -> MS	STATUS ENQUIRY	CC state U10
10	MS -> SS	STATUS	

Specific message content

step 4 - BAIC

- protocol discriminator: non call related SS message.
- message type: REGISTER.
- facility:

invoke = Activation:

Supplementary service code = BAIC.

step 5 - All Barring services

- protocol discriminator: non call related SS message.
- transaction identifier: in FACILITY same as previous REGISTER message.
- message type: FACILITY.
- facility:

invoke = GetPassword:

Guidance info: Password (step 5).

step 8 -

- protocol discriminator: non call related SS message.
- transaction identifier: same TI as previous REGISTER message.
- message type: RELEASE COMPLETE.
- facility:

reject code: NegativePasswordCheck.

For the reject the invoke ID must be the same as in the invoke of the GetPassword operation.

31.8.4 Deactivation

31.8.4.1 Deactivation accepted

31.8.4.1.1 Conformance requirements

- 1) For deactivation of any group of call restriction services with any parameters, the MS shall transmit successively
 - 1.1) a CHANNEL REQUEST with establishment cause set to "other services requested by the mobile user";
 - 1.2) a CM SERVICE REQUEST with CM service type indicating "supplementary service activation";
 - 1.3) and then the REGISTER message containing a facility IE that includes an invoke of the DeactivateSS operation with parameter values according to the user's request (MMI action).
- 2) Upon receipt of FACILITY message requiring the password, the MS shall be able to send a password by sending a FACILITY message.
- 3) Upon receipt of the RELEASE COMPLETE message, the MS shall provide the appropriate user indication (which is to be described by the manufacturer).

References

- 1) 3GPP TS 04.08 / 3GPP TS 44.018 subclauses 3.3.1.1.2 and 9.2.9.
- 2) 3GPP TS 04.88,
3GPP TS 04.80 subclauses 2.3 and 3.6.
- 3) 3GPP TS 02.30 subclause 4.5.

31.8.4.1.2 Test purpose

- 1) To check that the MS correctly requests a supplementary service transaction for deactivation of a group of call barring services in CHANNEL REQUEST message.
- 2) To check that the MS correctly requests a supplementary service transaction for deactivation of a group of call barring services in the subsequent CM SERVICE REQUEST.
- 3) To check that the MS sends a REGISTER message containing the invoke of the DeactivateSS operation with the expected parameter values for deactivation of a group of call restriction services.
- 4) To check that upon receipt of FACILITY message requiring the password, the MS is able to send a password by sending a FACILITY message.
- 5) To check that upon receipt of the RELEASE COMPLETE message, the MS provides the appropriate user indication (which is to be described by the manufacturer).

These checks are done for:

- a) all restrictions, for basic service group "speech".
- b) barring of outgoing calls, for all facsimile.

31.8.4.1.3 Method of test

Initial conditions

System Simulator:

1 cell, default parameters.

Mobile Station:

The MS is "idle updated".

Specific PICS Statements

-

PIXIT Statements

- Description of the user's commands and of display of the answers from the network for call barring.

Foreseen final state of the MS

The MS is "idle updated".

Test procedure

By means of appropriate MMI functions (using either 3GPP TS 02.30 or manufacturer defined MMI), the user requests deactivation of all restrictions, for speech.

Upon receipt of the operation (in a REGISTER message), the system simulator answers with the FACILITY message with the Facility information element containing an invoke of the GetPassword operation requiring the current password.

If the manufacturer defined MMI has been used to request the deactivation of all restrictions for speech, then the MS may, by means of appropriate manufacturer defined MMI functions, prompt the user to give a password, depending on the implementation of the manufacturer defined MMI functions.

Upon receipt of the FACILITY message, the system simulator answers with the FACILITY message with the Facility information element containing the Return_result of the DeactivateSS operation.

The SS transaction and the dedicated channel are released.

Then again, by means of appropriate MMI functions, the user requests deactivation of barring of outgoing calls, for all facsimile.

Upon receipt of the operation (in a REGISTER message), the system simulator answers with the FACILITY message with the Facility information element containing an invoke of the GetPassword operation requiring the current password.

If the manufacturer defined MMI has been used to request the deactivation of barring of outgoing calls for all facsimile, then the MS may, by means of appropriate manufacturer defined MMI functions, prompt the user to give a password, depending on the implementation of the manufacturer defined MMI functions.

Upon receipt of the FACILITY message, the system simulator answers with a RELEASE COMPLETE message with the Facility information element containing the Return_result of the DeactivateSS operation.

The dedicated channel is released.

Maximum duration of test

5 minutes.

Expected sequence

Step	Direction	Message	Comments
1	MS		The MS is made to initiate a deactivation of all call restrictions(speech)
2	MS -> SS	CHANNEL REQUEST	with establishment cause "Other procedures which can be completed with an SDCCH"
3	SS -> MS	IMMEDIATE ASSIGNMENT	
4	MS -> SS	CM SERVICE REQUEST	cause: "supplementary service activation"
5	SS -> MS	CM SERVICE ACCEPT	
6	MS -> SS	REGISTER	
7	SS -> MS	FACILITY	GetPassword
8	MS -> SS	FACILITY	Getpassword operation Return Result
9	SS -> MS	RELEASE COMPLETE	DeactivateSS operation Return_result
10	SS -> MS	CHANNEL RELEASE	
11	MS		The MS is made to initiate a deactivation of barring of outgoing calls(all facsimile),
12	MS -> SS	CHANNEL REQUEST	with establishment cause "Other procedures which can be completed with an SDCCH"
13	SS -> MS	IMMEDIATE ASSIGNMENT	
14	MS -> SS	CM SERVICE REQUEST	cause: "supplementary service activation"
15	SS -> MS	CM SERVICE ACCEPT	
16	MS -> SS	REGISTER	
17	SS -> MS	FACILITY	GetPassword
18	MS -> SS	FACILITY	Getpassword operation Return Result
19	SS -> MS	RELEASE COMPLETE	DeactivateSS operation Return result
20	MS		provide correct MMI user indication
21	SS -> MS	CHANNEL RELEASE	

Specific message contents

step 6 - all call restrictions:

- protocol discriminator: non call related SS message.
- message type: REGISTER.
- facility:

invoke = Deactivation:

Supplementary service code = B.

Basic service code: no Bearer Service present, Tele Service AllSpeechTransmissionServices (TS10) or Telephony (TS 11).

step 16 - barring of outgoing calls,

- protocol discriminator: non call related SS message.
- message type: REGISTER.
- facility:

invoke = Deactivation:

Basic service code: no bearer service present, teleservice: all facsimile.

steps 7, 17 -

- protocol discriminator: non call related SS message.
- transaction identifier: in FACILITY same as previous REGISTER message.
- message type: FACILITY.
- facility:

invoke = GetPassword:

Guidance info: Password.

31.8.4.2 Deactivation rejected

31.8.4.2.1 Rejection after invoke of DeactivateSS operation

31.8.4.2.1.1 Conformance requirements

- 1) A transaction of any kind being already established, for deactivation of a group of call restriction services, the MS shall establish a parallel MM transaction, sending a CM SERVICE REQUEST with CM service type indicating "supplementary service activation".
- 2) Then the MS shall send a REGISTER message related to the present SS transaction containing a facility IE that includes an invoke of the DeactivateSS operation with parameter values according to the user's request (MMI action).
- 3) Upon receipt of the RELEASE COMPLETE message related to the present SS transaction, the SS transaction shall be released but the first transaction shall remain unaffected.
- 4) Upon receipt of the RELEASE COMPLETE message, the MS shall provide the appropriate user indication (which is to be described by the Manufacturer).

References

- 1) 3GPP TS 04.08 / 3GPP TS 44.018 subclauses 3.3.1.1.2 and 9.1.9.
- 2) 3GPP TS 04.08 / 3GPP TS 24.008 subclauses 4.5.1.1, 9.2.9 and 10.5.33.
- 3) 3GPP TS 04.88,
3GPP TS 04.80 subclauses 2.3 and 3.6.
- 4) 3GPP TS 02.30 subclause 4.5.

31.8.4.2.1.2 Test purpose

- 1) To check that, when a call transaction is already established, the MS correctly requests the establishment of a parallel MM transaction for supplementary service transaction of a group of call barring services, sending a CM SERVICE REQUEST.
- 2) To check that the MS sends a REGISTER message containing the invoke of the DeactivateSS operation with the expected parameter values for a group of call barring services.
- 3) To check that upon receipt of the RELEASE COMPLETE message related to the present SS transaction, the first transaction remains unaffected.
- 4) To check that upon receipt of the RELEASE COMPLETE message, the MS provides the appropriate user indication (as described by the Manufacturer).

These checks are performed with a call transaction already established for:

BOIC, the RELEASE COMPLETE message being sent at the beginning of the procedure with a facility IE containing a return_error(error) where error is "SS subscription violation".

31.8.4.2.1.3 Method of test

Initial conditions

System Simulator:

1 cell, default parameters.

Mobile Station:

The MS is in CC state U10.

Specific PICS Statements

-

PIXIT Statements

- Description of the user's commands and of display of the answers from the network for call barring.

Foreseen final state of the MS

The MS is in CC state U10.

Test procedure

By means of appropriate MMI functions (using either 3GPP TS 02.30 or manufacturer defined MMI), the user requests deactivation of incoming calls.

Upon receipt of the operation (in a REGISTER message), the system simulator answers with the RELEASE COMPLETE (PD and TI of the SS transaction) message with the Facility information element containing a Return_error(error: SS subscription violation) of the DeactivateSS operation.

The system simulator then sends STATUS ENQUIRY, and the MS responds with STATUS message indicating CC state U10.

Maximum duration of test

30 s.

Expected sequence

Step	Direction	Message	Comments
1	MS		The MS is made to initiate a deactivation for bi cause: "supplementary service activation"
2	MS -> SS	CM SERVICE REQUEST	
3	SS -> MS	CM SERVICE ACCEPT	
4	MS -> SS	REGISTER	
5	SS -> MS	RELEASE COMPLETE	DeactivateSS operation Return_error provide correct MMI user indication
6	MS		
7	SS -> MS	STATUS ENQUIRY	CC state U10
8	MS -> SS	STATUS	

Specific message content

step 4 -

- protocol discriminator: non call related SS message.
- message type: REGISTER.
- facility:

invoke = DeactivateSS:

Supplementary service code = bi.

step 5 -

- protocol discriminator: non call related SS message.
- transaction identifier: same TI as previous REGISTER message.
- message type: RELEASE COMPLETE.
- facility:

return error code: SS subscription violation.

For the return error the invoke ID must be the same as in the invoke of the DeactivateSS operation.

31.8.4.2.2 Rejection after use of password procedure

31.8.4.2.2.1 Conformance requirements

- 1) A transaction of any kind being already established, for deactivation of a group of call restriction services, the MS shall establish a parallel MM transaction, sending a CM SERVICE REQUEST with CM service type indicating "supplementary service activation".
- 2) Then the MS shall send a REGISTER message related to the present SS transaction containing a facility IE that includes an invoke of the DeactivateSS operation with parameter values according to the user's request (MMI action).
- 3) Upon receipt of the RELEASE COMPLETE message related to the present SS transaction, the SS transaction shall be released but the first transaction shall remain unaffected.
- 4) Upon receipt of the RELEASE COMPLETE message, the MS shall provide the appropriate user indication (which is to be described by the Manufacturer).

References

- 1) 3GPP TS 04.08 / 3GPP TS 44.018 subclauses 3.3.1.1.2 and 9.1.9.
- 2) 3GPP TS 04.08 / 3GPP TS 24.008 subclauses 4.5.1.1, 9.2.9 and 10.5.33.
- 3) 3GPP TS 04.88,
3GPP TS 04.80 subclauses 2.3 and 3.6.
- 4) 3GPP TS 02.30 subclause 4.5.

31.8.4.2.2.2 Test purpose

- 1) To check that, when a call transaction is already established, the MS correctly requests the establishment of a parallel MM transaction for supplementary service transaction of deactivation of a group of call restriction services, sending a CM SERVICE REQUEST.
- 2) To check that the MS sends a REGISTER message containing the invoke of the DeactivateSS operation with the expected parameter values for deactivation of a group of call restriction service.
- 3) To check that upon receipt of the RELEASE COMPLETE message related to the present SS transaction, the first transaction remains unaffected.
- 4) To check that upon receipt of the RELEASE COMPLETE message, the MS provides the appropriate user indication (as described by the Manufacturer).

Those checks are performed with a call transaction already established for:

BOICExHC, the RELEASE COMPLETE message being sent at the end of the procedure with a facility IE containing a return_error(error) where error is "NegativePasswordCheck".

31.8.4.2.2.3 Method of test

Initial conditions

System Simulator:

1 cell, default parameters.

Mobile Station:

The MS is in CC state U10.

Specific PICS Statements

-

PIXIT Statements

- Description of the user's commands and of display of the answers from the network for call barring.

Foreseen final state of the MS

The MS is in CC state U10.

Test procedure

By means of appropriate MMI functions (using either 3GPP TS 02.30 or manufacturer defined MMI), the user requests deactivation of a group of call restriction services.

Upon receipt of the REGISTER message, the system simulator answers with the FACILITY message with the Facility information element containing an invoke of the DeactivateSS operation requiring the current password.

If the manufacturer defined MMI has been used to request the deactivation of a group of call restriction services, then the MS may, by means of appropriate manufacturer defined MMI functions, prompt the user to give a password, depending on the implementation of the manufacturer defined MMI functions.

Upon receipt of the FACILITY message, the system simulator sends RELEASE COMPLETE message (PD and TI of the SS transaction) with the Facility information element containing a Return_error(error: NegativePasswordCheck) of the GetPassword operation.

The system simulator sends STATUS ENQUIRY, the MS responds with STATUS message indicating CC state U10.

Maximum duration of test

3 minutes.

Expected sequence

Step	Direction	Message	Comments
1	MS		The MS is made to initiate a deactivation of BoicExHC cause: "supplementary service activation"
2	MS -> SS	CM SERVICE REQUEST	
3	SS -> MS	CM SERVICE ACCEPT	
4	MS -> SS	REGISTER	
5	SS -> MS	FACILITY	Invoke = GetPassword (password)
6	MS -> SS	FACILITY	GetPassword operation Return Result
7	SS -> MS	RELEASE COMPLETE	Register Password operation ReturnError
8	MS		provide correct MMI user indication
9	SS -> MS	STATUS ENQUIRY	
10	MS -> SS	STATUS	CC state U10

Specific message content

step 4 -

- protocol discriminator: non call related SS message.
- message type: REGISTER.
- facility:

invoke = DeactivateSS:

Supplementary service code = BOICExHC.

step 7 -

- protocol discriminator: non call related SS message.
- transaction identifier: same TI as previous REGISTER message.
- message type: RELEASE COMPLETE.
- facility:

reject code: NegativePasswordCheck.

For the reject the invoke ID must be the same as in the invoke of the DeactivateSS operation.

step 5 -

- protocol discriminator: non call related SS message.
- transaction identifier: in FACILITY same as previous REGISTER message.
- message type:FACILITY.
- facility:

invoke = GetPassword:

Guidance info: Password (step 5).

31.8.5 Invocation

Invocation is not applicable.

31.8.6 Interrogation

31.8.6.1 Interrogation accepted

31.8.6.1.1 Conformance requirements

- 1) For interrogation of any specific call restriction service with any parameters, the MS shall transmit successively:
 - 1.1) a CHANNEL REQUEST with establishment cause set to "other services requested by the mobile user";
 - 1.2) a CM SERVICE REQUEST with CM service type indicating "supplementary service activation";
 - 1.3) and then the REGISTER message containing a facility IE that includes an invoke of the InterrogateSS operation with parameter values according to the user's request (MMI action).
- 2) Upon receipt of the RELEASE COMPLETE message, the MS shall provide the appropriate user indication (which is to be described by the manufacturer).

References

- 1) 3GPP TS 04.08 / 3GPP TS 44.018 subclauses 3.3.1.1.2 and 9.1.9.
- 2) 3GPP TS 04.08 / 3GPP TS 24.008 subclauses 4.5.1.1, 9.2.9 and 10.5.33.
- 3) 3GPP TS 04.88,
3GPP TS 04.80 subclauses 2.3 and 3.6.
- 4) 3GPP TS 02.30 subclause 4.5.

31.8.6.1.2 Test purpose

- 1) To check that the MS correctly requests a supplementary service transaction for interrogation of a specific call barring service in CHANNEL REQUEST message.
- 2) To check that the MS correctly requests a supplementary service transaction for interrogation of a call barring service in the subsequent CM SERVICE REQUEST.
- 3) To check that the MS sends a REGISTER message containing the invoke of the InterrogateSS operation with the expected parameter values for interrogation of one call restriction service.
- 4) To check that upon receipt of the RELEASE COMPLETE message, the MS provides the appropriate user indication (which is to be described by the manufacturer).

These checks are done for:

- a) BAIC, the result of the operation being a Basic Service code.
- b) BOICExHC, the result of the operation being a SS-status.

31.8.6.1.3 Method of test

Initial conditions

System Simulator:

1 cell, default parameters.

Mobile Station:

The MS is "idle updated".

Specific PICS Statements

-

PIXIT Statements

- Description of the user's commands and of display of the answers from the network for call barring.

Foreseen final state of the MS

The MS is "idle updated".

Test procedure

By means of appropriate MMI functions (using either 3GPP TS 02.30 or manufacturer defined MMI), the user requests interrogation of BAIC.

Upon receipt of the operation (in a REGISTER message), the system simulator answers with a RELEASE COMPLETE message with the Facility information element containing the Return_result (basic service) of the InterrogateSS operation.

The SS transaction and the dedicated channel are released.

Then again, by means of appropriate MMI functions, the user requests interrogation of BOICExHC.

Upon receipt of the operation (in a REGISTER message), the system simulator answers with a RELEASE COMPLETE message with the Facility information element containing the Return_result(SS-status) of the InterrogateSS operation.

The dedicated channel is released.

Maximum duration of test

3 minutes.

Expected sequence

Step	Direction	Message	Comments
1	MS		
2	MS -> SS	CHANNEL REQUEST	The MS is made to initiate a interrogation of BAIC with establishment cause "Other procedures which can be completed with an SDCCH" cause: "supplementary service activation"
3	SS -> MS	IMMEDIATE ASSIGNMENT	
4	MS -> SS	CM SERVICE REQUEST	
5	SS -> MS	CM SERVICE ACCEPT	
6	MS -> SS	REGISTER	
7	SS -> MS	RELEASE COMPLETE	InterrogateSS operation Return_result
8	SS -> MS	CHANNEL RELEASE	
9	MS		
10	MS -> SS	CHANNEL REQUEST	The MS is made to initiate a interrogation of call forwarding service for BOICExHC, with establishment cause "Other procedures which can be completed with an SDCCH" cause: "supplementary service activation"
11	SS -> MS	IMMEDIATE ASSIGNMENT	
12	MS -> SS	CM SERVICE REQUEST	
13	SS -> MS	CM SERVICE ACCEPT	
14	MS -> SS	REGISTER	InterrogateSS operation Return result provide correct MMI user indication
15	SS -> MS	RELEASE COMPLETE	
16	MS		
17	SS -> MS	CHANNEL RELEASE	

Specific message contents

step 6 - BOIC

- protocol discriminator: non call related SS message.
- message type: REGISTER.
- facility:

invoke = Interrogation:

Supplementary service code = BAIC.

step 14 - BOICExHC

- protocol discriminator: non call related SS message.
- message type: REGISTER.
- facility:

invoke = Interrogation:

Supplementary service code = BOICExHC.

31.8.6.2 Interrogation rejected

31.8.6.2.1 Conformance requirements

- 1) A transaction of any kind being already established, for interrogation of any specific call barring with any parameters, the MS shall establish a parallel MM transaction, sending a CM SERVICE REQUEST with CM service type indicating "supplementary service activation".

- 2) Then the MS shall send a REGISTER message related to the present SS transaction containing a facility IE that includes an invoke of the InterrogateSS operation with parameter values according to the user's request (MMI action).
- 3) Upon receipt of the RELEASE COMPLETE message related to the present SS transaction, the SS transaction shall be released but the first transaction shall remain unaffected.
- 4) Upon receipt of the RELEASE COMPLETE message, the MS shall provide the appropriate user indication (which is to be described by the Manufacturer).

References

- 1) 3GPP TS 04.08 / 3GPP TS 44.018 subclauses 3.3.1.1.2 and 9.1.9.
- 2) 3GPP TS 04.08 / 3GPP TS 24.008 subclauses 4.5.1.1, 9.2.9 and 10.5.33.
- 3) 3GPP TS 04.88,
3GPP TS 04.80 subclauses 2.3 and 3.6.
- 4) 3GPP TS 02.30 subclause 4.5.

31.8.6.2.2 Test purpose

- 1) To check that the MS correctly requests the establishment of a parallel MM transaction for supplementary service transaction of interrogation of a specific call barring service message, sending a CM SERVICE REQUEST.
- 2) To check that the MS sends a REGISTER message containing the invoke of the InterrogateSS operation with the expected parameter values for interrogation of call barring.
- 3) To check that upon receipt of the RELEASE COMPLETE message related to the present SS transaction, the first transaction remains unaffected.
- 4) To check that upon receipt of the RELEASE COMPLETE message, the MS provides the appropriate user indication (as described by the Manufacturer).

These checks are performed with a call transaction already established for:

- a) BICRoam, the RELEASE COMPLETE message being sent with a facility IE containing a return_error(error) where error is "SS not available".
- b) BOIC, the RELEASE COMPLETE message being sent with a facility IE containing a reject(invoke_problem) where invoke_problem is "resource limitation".

31.8.6.2.3 Method of test

Initial conditions

System Simulator:

1 cell, default parameters.

Mobile Station:

The MS is in CC state U10.

Specific PICS Statements

-

PIXIT Statements

- Description of the user's commands and of display of the answers from the network for call barring.

Foreseen final state of the MS

The MS is in CC state U10.

Test procedure

By means of appropriate MMI functions (using either 3GPP TS 02.30 or manufacturer defined MMI), the user requests interrogation of BICRoam.

Upon receipt of the operation (in a REGISTER message), the system simulator answers with a RELEASE COMPLETE message with the Facility information element containing a Return_error(error: SS not available) of the InterrogateSS operation.

The system simulator sends STATUS ENQUIRY, the MS responds with STATUS message indicating CC state U10.

Then again, by means of appropriate MMI functions, the user requests interrogation of BOIC.

Upon receipt of the REGISTER message, the system simulator answers with the RELEASE COMPLETE message (same PD and TI that in the REGISTER message) with the Facility information element containing a reject(invoke_problem: resource limitation) of the InterrogateSS operation.

The system simulator sends STATUS ENQUIRY, the MS responds with STATUS message indicating CC state U10.

Maximum duration of test

3 minutes.

Expected sequence

Step	Direction	Message	Comments
1	MS		The MS is made to initiate a interrogation of call barring service for BICRoam
2	MS -> SS	CM SERVICE REQUEST	cause: "supplementary service activation"
3	SS -> MS	CM SERVICE ACCEPT	
4	MS -> SS	REGISTER	
5	SS -> MS	RELEASE COMPLETE	InterrogateSS operation Return_error
6	SS -> MS	STATUS ENQUIRY	
7	MS -> SS	STATUS	CC state U10
8	MS		The MS is made to initiate a interrogation of call barring service for BOIC
9	MS -> SS	CM SERVICE REQUEST	cause: "supplementary service activation"
10	SS -> MS	CM SERVICE ACCEPT	
11	MS -> SS	REGISTER	
12	SS -> MS	RELEASE COMPLETE	(SS)
13	MS		provide correct MMI user indication
14	SS -> MS	STATUS ENQUIRY	
15	MS -> SS	STATUS	CC state U10

Specific message content

step 4 - BICRoam

- protocol discriminator: non call related SS message.
- message type: REGISTER.
- facility:

invoke = Interrogation:

Supplementary service code = BICRoam.

step 5 -

- protocol discriminator: non call related SS message.
- transaction identifier: same TI as previous REGISTER message.
- message type: RELEASE COMPLETE.
- facility:
 - return error code: SS not available.

For the return error the invoke ID must be the same as in the invoke of the InterrogateSS operation.

step 11 - BOIC

- protocol discriminator: non call related SS message.
- message type: REGISTER.
- facility:
 - invoke = Interrogation:
 - Supplementary service code = BOIC.

step 12 -

- protocol discriminator: non call related SS message.
- transaction identifier: same TI as previous REGISTER message.
- message type: RELEASE COMPLETE.
- facility:
 - reject code: resource limitation.

For the reject the invoke ID must be the same as in the invoke of the InterrogateSS operation.

31.8.7 Normal operation

In case of barring of outgoing call the calling mobile receives information about the activation of supplementary services subscribed.

In case of barring of incoming call the calling mobile receives information about the activation of supplementary services subscribed by the other party (the mobile called).

31.8.7.1 Conformance requirements

Upon receipt of the RELEASE COMPLETE message the MS shall provide the appropriate user indication (which is to be described by the manufacturer).

References

31.8.7.2 Test purpose

To check that upon receipt of the RELEASE COMPLETE message the MS provides the appropriate user indication (as described by the manufacturer).

This is tested in the case of an MS making a call to a mobile with incoming calls barred.

31.8.7.3 Method of test

Initial conditions

System Simulator:

- 1 cell, default parameters.

Mobile Station:

The MS is "idle updated".

Specific PICS Statements

-

PIXIT Statements

- Description of the user's commands and of display of the answers from the network for call barring.

Foreseen final state of the MS

The MS is "idle updated".

Test procedure

The MS is made to initiate a call.

Upon receipt of the SETUP message, the system simulator answers with the negative acknowledgement RELEASE COMPLETE (to simulate a case where call barring is activated).

Maximum duration of test

1 minute.

Expected sequence

Step	Direction	Message	Comments
1	MS -> SS	CHANNEL REQUEST	
2	SS -> MS	IMMEDIATE ASSIGNMENT	
3	MS -> SS	CM SERVICE REQUEST	
4	SS -> MS	CM SERVICE ACCEPT	
5	MS -> SS	SETUP	
6	SS -> MS	RELEASE COMPLETE	provide correct MMI user indication
7	SS -> MS	CHANNEL RELEASE	

Specific message content

RELEASE COMPLETE

- protocol discriminator.
- transaction identifier.
- message type.
- cause: cause value #8.
- facility:

invoke = notification:

SS code = BI.

SS status = activation indicator (indicating: Provisioned, registered and active).

31.9 Handling of undefined (future) GSM supplementary services

31.9.1 Mobile station initiated Unstructured supplementary service data operation

31.9.1.1 ProcessUnstructuredSS-request/accepted

Conformance requirements

- 1) The mobile station shall invoke an USSD request by sending a REGISTER message to the network containing a ProcessUnstructuredSS-Request invoke component. This message will contain the alphabet indicator set to "SMS default alphabet" and the language indicator set to "language unspecified". The ussd-string parameter shall contain the following digits and symbols depending on the operation initiated:

Activation: *NN(N)# (no supplementary information included)
 *NN(N)*SI# (one field of supplementary infor. included)
 *NN(N)*SIA*SIB# (two fields of supplementary infor. included)

Deactivation: #NN(N)#
 #NN(N)*SI#
 #NN(N)*SIA*SIB#

Interrogation: ##NN(N)#
 ##NN(N)*SI#
 ##NN(N)*SIA*SIB#

Registration **NN(N)#
 **NN(N)*SI#
 **NN(N)*SIA*SIB#

Erasure ###NN(N)#
 ###NN(N)*SI#
 ###NN(N)*SIA*SIB#

Operations not yet: see conformance requirement 2).

defined in 3GPP TS 02.30.

NN(N) features a set of service codes which have not yet been allocated for GSM supplementary services (see 3GPP TS 02.30 for service codes already specified).

N is a digit within 1..9 and SI, SIA, SIB strings of characters.

- 2) Concerning operations which are not yet specified in 3GPP TS 02.30, the MS shall proceed as follows:

The entry of 1 or 2 characters defined in the 3GPP TS 03.38 default alphabet followed by "SEND" shall be interpreted by the MS as an USSD request unless the MS is not engaged in a call and the first of the two character entry followed by "SEND" is a "1". Except if the 1 or 2 characters are MS manufacturer defined procedure in idle mode.

- 3) For supplementary service procedures independent of any call, the initiating side shall establish a MM-connection between the network and the mobile station according to the rules given in 3GPP TS 04.08 / 3GPP TS 24.008.
- 4) Within a call, the MS shall transmit a USSD request from the user if any. See 3GPP TS 04.07 and 3GPP TS 04.08 / 3GPP TS 24.008 for the handling of multiple MM connections.
- 5) Upon receipt of the RELEASE COMPLETE message, the MS shall display the information contained to the user in a way described by the manufacturer.

References

- Conformance requirement 1: 3GPP TS 04.90 subclause 6.1,
3GPP TS 02.30 subclause 4.5.2, and
3GPP TS 02.90 subclause 4.1.1.
- Conformance requirement 2: 3GPP TS 02.30 subclause 4.5.3.2.
- Conformance requirement 3: 3GPP TS 04.10 subclause 3.2.1.
- Conformance requirement 4: 3GPP TS 04.08 / 3GPP TS 24.008 subclause 4.5.1.1.
- Conformance requirement 5: 3GPP TS 03.90 subclause 6.2.1.

Test Purpose

- 1) To verify that the mobile station invokes an USSD request by sending a REGISTER message to the network containing a ProcessUnstructuredSS-Request invoke component. This message will contain the alphabet indicator set to "SMS default alphabet" and the language indicator set to "language unspecified". The ussd-string parameter shall contain the following digits and symbols depending on the operation initiated:

Activation *NN(N)# (no supplementary information included)
 *NN(N)*SI# (one field of supplementary infor. included)
 *NN(N)*SIA*SIB# (two fields of supplementary infor. included)

Deactivation ##NN(N)#
 #NN(N)*SI#
 #NN(N)*SIA*SIB#

Interrogation *##NN(N)#
 *##NN(N)*SI#
 *##NN(N)*SIA*SIB#

Registration **NN(N)#
 **NN(N)*SI#
 **NN(N)*SIA*SIB#

Erasure ###NN(N)#
 ##NN(N)*SI#
 ##NN(N)*SIA*SIB#

Operations not yet: see 2).

defined in 3GPP TS 02.30

NN(N) features a set of service codes which have not yet been allocated for GSM supplementary services (see 3GPP TS 02.30 for service codes already specified).

N is a digit within 1..9 and SI, SIA, SIB strings of characters.

- 2) To check that the entry of 1 or 2 characters defined in the 3GPP TS 03.38 default alphabet followed by "SEND" shall be interpreted by the MS as an USSD request unless the MS is not engaged in a call and the first of the two character entry followed by "SEND" is a "1". Except if the 1 or 2 characters are MS manufacturer defined procedure in idle mode.
- 3) To verify that, for supplementary service procedures independent of any call, the initiating side must establish a MM-connection between the network and the mobile station according to the rules given in 3GPP TS 04.07 and 3GPP TS 04.08 / 3GPP TS 24.008.
- 4) To verify that, within a call the MS shall transmit a USSD request if any. See 3GPP TS 04.07 and 3GPP TS 04.08 / 3GPP TS 24.008 for the handling of multiple MM connections.
- 5) To check that upon receipt of the RELEASE COMPLETE message, the MS shall display the information contained to the user in a way described by the manufacturer.

Specific PICS Statements

- Full rate supported (TSPC_AddInfo_Full_rate_version_1)
- Supported teleservices (TSPC_AddInfo_TeleSvc)

PIXIT Statements

- Description of the user's commands and of display of USSD.
- Support of active state of the call control protocol (U10).
- Identification of the short strings defining MS manufacturer defined procedure in idle mode (1 or 2 characters defined in the 3GPP TS 03.38 default alphabet followed by "SEND").

Initial Conditions

System Simulator:

1 cell, default parameters.

Mobile Station:

The MS is in the MM-state "idle updated".

Foreseen final state of the MS

MM-state "idle updated".

Test Procedure

By means of appropriate MMI functions (using either 3GPP TS 02.30 or manufacturer defined MMI) the mobile is made to initiate an Unstructured SS data operation. The mobile first establishes a MM-connection with the SS. Then, a REGISTER message is sent to the SS. Upon receipt of this message, the system simulator answers with the RELEASE COMPLETE message. Then a CHANNEL RELEASE message is sent to the MS to release the main signalling link.

The mobile station is forced to originate a call. After the MS has received a CONNECT ACKNOWLEDGE, MMI keys are depressed on the mobile in order to initiate an Unstructured SS data operation. Then a REGISTER message is sent to the SS. Upon receipt of this message, the system simulator answers with the RELEASE COMPLETE message. Finally, the main signalling link is released by transferring a CHANNEL RELEASE message to the MS.

Expected Sequence

The sequence is executed for execution counters $c=1, \dots, 16$.

The second part of the sequence, namely from step 9 to step 18, is executed for execution counter $c=17$.

Counter c determines the ussd-string selected by the user and sent by the MS (see specific message contents concerning the REGISTER message).

Step	Direction	Message	Comments
1	MS		The user presses appropriate MMI keys to initiate the desired unstructured SS data operation.
2	MS -> SS	CHANNEL REQUEST	with establishment cause set to "Other procedures which can be completed with an SDCCH". "Supplementary service activation". The SS checks that the content of this message matches specific message content i).
3	SS -> MS	IMMEDIATE ASSIGNMENT	
4	MS -> SS	CM SERVICE REQUEST	
5	SS -> MS	CM SERVICE ACCEPT	
6	MS -> SS	REGISTER	
7	SS -> MS	RELEASE COMPLETE	
8	SS -> MS	CHANNEL RELEASE	The main signalling link is released.
9	MS		The MS is brought to state U10 by initiating a Mobile originating call
10			Specific MMI keys are depressed to initiate the desired undefined SS service operation. DTMF signalling may occur.
11	MS -> SS	CM SERVICE REQUEST	"Supplementary service activation". The MS starts the transaction on the radio interface. The SS checks that REGISTER matches i).
12	SS -> MS	CM SERVICE ACCEPT	
13	MS -> SS	REGISTER	
14	SS -> MS	RELEASE COMPLETE	It terminates the transaction used to activate the desired undefined SS data operation. See specific message contents ii).
15	SS -> MS	DISCONNECT	See message contents iii). The main signalling link is released.
16	MS -> SS	RELEASE	
17	SS -> MS	RELEASE COMPLETE	
18	SS -> MS	CHANNEL RELEASE	

Specific message contents.

i) REGISTER message.

Contents	Value/remark
Protocol Discriminator	set to "Supplementary service (call independent)"
Transaction identifier	
Register message type	As 3GPP TS 04.80
Facility Information Element	See below
SS version indicator	As specified in 3GPP TS 04.80

Facility Information Element with Invoke = ProcessUnstructuredSS-Request component type as defined in 3GPP TS 04.80 subclause 3.6.1 table 3.3.

Contents	Value/remark
Facility IE identifier	As 3GPP TS 04.08 / 3GPP TS 24.008
Length of FIE contents	
Component type tag	Invoke from 3GPP TS 04.80
Component length	depending on the length of ussd-string
InvokeID tag	From 3GPP TS 04.80
Invoke ID length	1
Invoke ID	Arbitrary (1 octet)
Operation Code tag	From 3GPP TS 04.80
Operation Code length	1
Operation Code	ProcessUnstructuredSS-Request
ussd-dataCodingScheme	1 octet long. Alphabet indicator set to "default alphabet". Language indicator set to "undefined"
ussd-string	c=1, *60# (Activation with no supplementary information included) c=2, *201*35# (Activation with one field of supplementary information included) c=3, *70*635*562# (Activation with two fields of supplementary information included) c=4, #60# (Deactivation with no supplementary information included) c=5, #201*35# (Deactivation with one field of supplementary information included) c=6, #70*635*562# (Deactivation with two fields of supplementary information included) c=7, ##60# (Interrogation with no supplementary information included) c=8, ##201*35# (Interrogation with one field of supplementary information included) c=9, ##70*635*562# (Interrogation with two fields of supplementary information included) c=10, **60# (Registration with no supplementary information included) c=11, **201*35# (Registration with one field of supplementary information included) c=12, **70*635*562# (Registration with two fields of supplementary information included) c=13, ###60# (Erasure with no supplementary information included) c=14, ###201*35# (Erasure with one field of supplementary information included) c=15, ###70*635*562# (Erasure with two fields of supplementary information included) in idle mode : c=16, 1 or 2 characters defined in the 3GPP TS 03.38 default alphabet followed by "SEND" (related to conformance requirement 2). This short string shall not be a MS manufacturer defined procedure as identified in PIXIT statements and shall not be in the format 1x in active call : c=16, 36 (related to conformance requirement 2) in active call : c=17, 7 (related to conformance requirement 2)

ii) RELEASE COMPLETE message.

Contents	Value/remark
Protocol Discriminator	set to "Supplementary service (call independent)"
Transaction identifier	the transaction value is the same as REGISTER transaction value but the transaction flag is different
Release Complete message type	As 3GPP TS 04.80
Cause	omitted.
Facility Information Element	See below

Facility information element with Return Result = ProcessUnstructuredSS-Request component type as defined in 3GPP TS 04.80 subclause 3.6.1 table 3.4.

Contents	Value/remark
Facility IE identifier	As 3GPP TS 04.08 / 3GPP TS 24.008
Length of IE contents	
Component type tag	Return Result from 3GPP TS 04.80
Component length	depending on the length of the ussd-string
Invoke ID tag	
From 3GPP TS 04.80	
Invoke ID length	1
Invoke ID	The same as the invoke of the ProcessUnstructuredSS-Request
Sequence Identifier	From 3GPP TS 04.80
Operation Code tag	From 3GPP TS 04.80
Operation Code length	1
Operation Code	ProcessUnstructuredSS-Request
ussd-dataCodingScheme	1 octet long. Alphabet indicator set to "default alphabet" Language indicator set to "undefined"
ussd-string	chosen at random

iii) RELEASE COMPLETE message.

Contents	Value/remark
Protocol Discriminator	set to "Supplementary service (call control)"
Transaction identifier	same as current call.
Release Complete message type	As 3GPP TS 04.08 / 3GPP TS 24.008

31.9.1.2 ProcessUnstructuredSS-request/cross phase compatibility and error handling

Conformance requirements

- 1) If a mobile initiated USSD request using protocol version 2 is rejected by the network, and the reason for the rejection is indicated either by the problem code "unrecognized operation" or a cause "facility rejected", the mobile station shall assume that the network only supports protocol version 1 of USSD operations. The mobile station shall re-attempt the request by using the appropriate protocol version 1 USSD operation without a SS version indicator if the unstructured data entered by the user can be coded as an IA5 string.
- 2) Upon receipt of the RELEASE COMPLETE message, the MS shall provide the appropriate user indication (which is to be described by the manufacturer). If ussd-String information is included this shall be given to the user (in a way described by the manufacturer).

References

Conformance requirement1: 3GPP TS 04.90 subclause 6.2.1.

Conformance requirement2: 3GPP TS 03.90.

Test Purpose

- 1) To verify that If a mobile initiated USSD request using protocol version 2 is rejected by the network, and the reason for the rejection is indicated either by the problem code "unrecognized operation" or a cause "facility rejected", the mobile station shall assume that the network only supports protocol version 1 of USSD operations. The mobile station shall re-attempt the request by using the appropriate protocol version 1 USSD operation without a SS version indicator if the unstructured data entered by the user can be coded as an IA5 string.
- 2) To check that, upon receipt of the RELEASE COMPLETE message, the MS shall provide the appropriate user indication (which is to be described by the manufacturer). If ussd-String information is included this shall be given to the user (in a way described by the manufacturer).

Specific PICS Statements

- Full rate supported (TSPC_AddInfo_Full_rate_version_1)
- Supported teleservices (TSPC_AddInfo_TeleSvc)

PIXIT Statements

- Support of active state of the call control protocol (U10).

Initial Conditions

System Simulator:

1 cell, default parameters.

Mobile Station:

The MS is in the MM-state "idle updated".

Foreseen final state of the MS

MM-state "idle updated".

Test Procedure

Appropriate MMI keys are pressed on the mobile in order to activate an USSD service. The mobile first establishes a MM-connection with the SS. Then, a REGISTER message is sent to the SS. Upon receipt of this message, the system simulator answers with the RELEASE COMPLETE message with the problem code set to "unrecognized operation", the main signalling link is released. Then the SS checks that the MS re-establishes a MM-connection and re-attempts the request by using a REGISTER message containing an invoke of the ProcessUnstructuredData operation. The SS answers with a normal RELEASE COMPLETE to terminate the transaction. Finally the main signalling link is released by transferring to the MS a CHANNEL RELEASE.

Appropriate MMI keys are pressed on the mobile in order to activate an USSD service. The mobile first establishes a MM-connection with the SS. Then, a REGISTER message is sent to the SS. Upon receipt of this message, the system simulator answers with the RELEASE COMPLETE message with the cause element set to "Facility rejected", the main signalling link is released. Then the SS checks that the MS re-establishes a MM-connection and re-attempts the request by using a REGISTER message containing an invoke of the ProcessUnstructuredData operation. Then the SS answers with a normal RELEASE COMPLETE to terminate the transaction. Finally the main signalling link is released by transferring to the MS a CHANNEL RELEASE.

The mobile station is forced to originate a call. After the SS has sent a CONNECT ACKNOWLEDGE, MMI keys are pressed on the mobile in order to activate an USSD service. A REGISTER message is sent to the SS. Upon receipt of this message, the system simulator answers with the RELEASE COMPLETE message containing a return error with an error or a reject with a problem. Then the radio link is release by transferring to the MS a CHANNEL RELEASE message. This substest is repeated with different errors and problems in the RELEASE COMPLETE message.

Expected Sequence

Step	Direction	Message	Comments
1	MS		The user presses appropriate MMI keys to initiate the desired undefined supplementary service operation.
2	MS -> SS	CHANNEL REQUEST	with establishment cause set to "Other procedures which can be completed with an SDCCH".
3	SS -> MS	IMMEDIATE ASSIGNMENT	"Supplementary service activation".
4	MS -> SS	CM SERVICE REQUEST	
5	SS -> MS	CM SERVICE ACCEPT	
6	MS -> SS	REGISTER	See specific message contents i). Operation code set to "ProcessUnstructuredSS-Request"
7	SS -> MS	RELEASE COMPLETE	See specific message contents ii).
8	SS -> MS	CHANNEL RELEASE	The main signalling link is released.
9	MS -> SS	CHANNEL REQUEST	with establishment cause set to "Other procedures which can be completed with an SDCCH".
10	SS -> MS	IMMEDIATE ASSIGNMENT	"Supplementary service activation".
11	MS -> SS	CM SERVICE REQUEST	
12	SS -> MS	CM SERVICE ACCEPT	
13	MS -> SS	REGISTER	Operation code is set to "ProcessUnstructuredSS-Data". See specific message content i).
14	SS -> MS	RELEASE COMPLETE	normal release of the transaction. See iii).
15	SS -> MS	CHANNEL RELEASE	The main signalling link is released.

Step	Direction	Message	Comments
16	MS		The user presses appropriate MMI keys to initiate the desired undefined supplementary service.
17	MS -> SS	CHANNEL REQUEST	with establishment cause set to "Other procedures which can be completed with an SDCCH".
18	SS -> MS	IMMEDIATE ASSIGNMENT	"Supplementary service activation".
19	MS -> SS	CM SERVICE REQUEST	
20	SS -> MS	CM SERVICE ACCEPT	
21	MS -> SS	REGISTER	
22	SS -> MS	RELEASE COMPLETE	
23	SS -> MS	CHANNEL RELEASE	see iii).cause is set to "facility rejected"
24	MS -> SS	CHANNEL REQUEST	The main signalling link is released. with establishment cause set to "Other procedures which can be completed with an SDCCH".
25	SS -> MS	IMMEDIATE ASSIGNMENT	"Supplementary service activation".
26	MS -> SS	CM SERVICE REQUEST	
27	SS -> MS	CM SERVICE ACCEPT	
28	MS -> SS	REGISTER	
29	SS -> MS	RELEASE COMPLETE	Operation code is "ProcessUnstructuredSSdata". See specific message contents i).
30	SS -> MS	CHANNEL RELEASE	normal release of the transaction. See iiiia). The main signalling link is released.
			For k=1 to 10, go through steps 31 to 40. Counter k deals with different kinds of general and invoke problems in step 36.
31	MS		The MS is brought to state U10 by initiating a Mobile originating call
32			Specific MMI keys are pressed to initiate the desired undefined supplementary service. DTMF signalling may occur.
33	MS -> SS	CM SERVICE REQUEST	"supplementary service activation"
34	SS -> MS	CM SERVICE ACCEPT	
35	MS -> SS	REGISTER	
36	SS -> MS	RELEASE COMPLETE	The MS starts the transaction on the radio interface. See specific message contents i). The operation code is set to "ProcessUnstructuredSS-Request".
37	SS -> MS	DISCONNECT	different errors and problems are sent. See specific message contents iiib) and iiic).
38	MS -> SS	RELEASE	See message contents iv). The main signalling link is released.
39	SS -> MS	RELEASE COMPLETE	
40	SS -> MS	CHANNEL RELEASE	

Specific message contents.

i) **REGISTER** message.

Contents	Value/remark
Protocol Discriminator	set to "Supplementary service (call independent)"
Transaction identifier	
Register message type	As 3GPP TS 04.80
Facility Information Element	See below
SS version indicator	As specified in 3GPP TS 04.80 for version 2 protocol Always omitted for version 1 protocol

For steps 6, 21 and 35, Facility Information Element with Invoke = ProcessUnstructuredSS-Request (for version 2 protocol) component type as defined in 3GPP TS 04.80 subclause 3.6.1 table 3.3.

For steps 13 and 28, Facility Information Element with Invoke = ProcessUnstructuredSS-Data (for version 1 protocol) as defined in 3GPP TS 04.80 subclause 3.6.1 table 3.3.

Contents	Value/remark
Facility IE identifier	As 3GPP TS 04.08 / 3GPP TS 24.008
Length of FIE contents	
Component type tag	Invoke from 3GPP TS 04.80
Component length	Depending on the length of ussd-string
InvokeID tag	From 3GPP TS 04.80
Invoke ID length	1
Invoke ID	Arbitrary (1 octet)
Operation Code tag	From 3GPP TS 04.80
Operation Code length	1
Operation Code	ProcessUnstructuredSS-Request (for version 2 protocol) ProcessUnstructuredSS-Data (for version 1 protocol)
ussd-dataCodingScheme	1 octet long. Alphabet indicator set to "default alphabet". Language indicator set to "undefined"
ussd-string	*70*635*562#

ii) RELEASE COMPLETE message.

Contents	Value/remark
Protocol Discriminator	Set to "Supplementary service (call independent)"
Transaction identifier	The transaction value is the same as the REGISTER transaction value but the transaction flag is different
Facility message type	As 3GPP TS 04.80
Facility Information Element	See below

Facility Information Element with Reject = ProcessUnstructuredSS-Request component type as defined in 3GPP TS 04.80 subclause 3.6.1 table 3.6.

Contents	Value/remark
Facility IE identifier	As 3GPP TS 04.08 / 3GPP TS 24.008
Length of FIE contents	
Component type tag	Reject from 3GPP TS 04.80
Component length	Depending on the length of ussd-string
InvokeID tag	From 3GPP TS 04.80
Invoke ID length	1
Invoke ID	The same as the invoke of the ProcessUnstructuredSS-Request
Problem Code tag	As 3GPP TS 04.80
Problem Code length	
General Problem code	Unrecognized operation

iii) RELEASE COMPLETE message.

Contents	Value/remark
Protocol Discriminator	Set to "Supplementary service (call independent)"
Transaction identifier	The transaction value is the same as the REGISTER transaction value but the transaction flag is different
Release complete message type	As 3GPP TS 04.80
Cause	For step 22, cause is set to "facility rejected" and FIE is omitted. For steps 14, 29 and 36 this field is omitted.
Facility Information Element	For step 14 and 29 see iiii). For step 36 see iiib) and iiic). For step 22 this field is omitted.

iiii) For steps 14 and 29, Facility Information Element with Return Result = ProcessUnstructuredSS-Data component type as defined in 3GPP TS 04.80 subclause 3.6.1 table 3.4.

Contents	Value/remark
Facility IE identifier	As 3GPP TS 04.08 / 3GPP TS 24.008
Length of FIE contents	
Component type tag	ReturnResult from 3GPP TS 04.80
Component length	Depending on the length of ussd-string
InvokeID tag	From 3GPP TS 04.80
Invoke ID length	1
Invoke ID	The same as the invoke of the ProcessUnstructuredSS-Data

iiib) Facility Information Element with Return Error = ProcessUnstructuredSS-Request component type as defined in 3GPP TS 04.80 subclause 3.6.1 table 3.5.

Contents	Value/remark
Facility IE identifier	As 3GPP TS 04.08 / 3GPP TS 24.008
Length of FIE contents	
Component type tag	Return Error from 3GPP TS 04.80
Component length	Depending on the length of ussd-string
InvokeID tag	From 3GPP TS 04.80
Invoke ID length	1
Invoke ID	The same as the invoke of the ProcessUnstructuredSS-Request
Error Code tag	As 3GPP TS 04.80
Error Code length	
Error Code	k=1, system failure k=2, data missing k=3, unknown alphabet k=4, unexpected data value

iiic) Facility Information Element with Reject = ProcessUnstructuredSS-Request component type as defined in 3GPP TS 04.80 subclause 3.6.1 table 3.6.

Contents	Value/remark
Facility IE identifier	As 3GPP TS 04.08 / 3GPP TS 24.008
Length of FIE contents	
Component type tag	Reject from 3GPP TS 04.80
Component length	Depending on the length of ussd-string
InvokeID tag	From 3GPP TS 04.80
Invoke ID length	1
Invoke ID	The same as the invoke of the ProcessUnstructuredSS-Request
Problem Code tag	As 3GPP TS 04.80
Problem Code length	
General Problem code	k=5, Unrecognized component k=6, Mistyped component k=7, Badly structured component
Invoke Problem code	k=8, Mistyped parameter k=9, Resource limitation k=10, Initiating release

iv) **RELEASE COMPLETE** message.

Contents	Value/remark
Protocol Discriminator	Set to "Supplementary service (call control)"
Transaction identifier	Same as current call.
Release Complete message type	As 3GPP TS 04.08 / 3GPP TS 24.008

31.9.2 Network initiated unstructured supplementary service operations

31.9.2.1 UnstructuredSS-Notify/accepted

Conformance requirements

- 1) For a USSD notification, the MS shall display the text provided and await user input. The MS shall acknowledge the operation by sending a FACILITY message containing an empty result component to the network.
- 2) The MS shall include alphabet and language indicators in the response to the network. The alphabet indicator shall indicate "SMS default alphabet". The language indicator shall indicate "language unspecified".
- 3) At any stage while the MS is registered with a network, the network may send an unstructured string to the MS. So, the MS shall be able to process the operation during a call or out of a call.

References

- Conformance requirement 1: 3GPP TS 04.90 subclause 5.2.1.
- Conformance requirement 2: 3GPP TS 02.90 subclause 4.2.2.
- Conformance requirement 3: 3GPP TS 02.90 subclause 4.2.1.

Test Purpose

- 1) To verify that for a USSD notification, the MS shall display the text provided and await user input. If the user enters a response, the MS shall acknowledge the operation by sending a FACILITY message containing an empty result component to the network.
- 2) To verify that the MS shall include alphabet and language indicators in the response to the network. The alphabet indicator shall indicate "SMS default alphabet". The language indicator shall indicate "language unspecified".
- 3) To check that the MS shall be able to process the operation during a call or out of a call.

Specific PICS Statements

- Full rate supported (TSPC_AddInfo_Full_rate_version_1)
- Supported teleservices (TSPC_AddInfo_TeleSvc)

PIXIT Statements

- Support of active state of the call control protocol (U10).

Initial Conditions

System Simulator:

1 cell, default parameters.

Mobile Station:

The MS is in the MM-state "idle updated".

Foreseen final state of the MS

MM-state "idle updated".

Test Procedure

- The MS is paged and a RR-connection is established. Then, the SS sends a REGISTER message containing a facility information element with operation code set to ProcessUnstructuredSS-Notify. The user checks that the ussd string sent by the SS is correctly displayed by the MS. The MS has to send a FACILITY message with an empty return result component.
- Then the SS originates a call to the MS. When the MS is in the U10 state, the SS releases the transaction identifier concerning USSD transaction by sending a RELEASE COMPLETE. The SS initiates a new ussd

transaction by sending a REGISTER message containing a facility information element with operation code set to UnstructuredSS-Notify. The user checks that the ussd string sent by the SS is correctly displayed by the MS. The MS has to send a FACILITY message with an empty return result component. Finally the SS releases both MM connections and the radio link.

Step	Direction	Message	Comments
1	SS -> MS	PAGING REQUEST TYPE 1	
2	MS -> SS	CHANNEL REQUEST	
3	SS -> MS	IMMEDIATE ASSIGNMENT	a SDCCH is allocated to the MS.
4	MS -> SS	PAGING RESPONSE	
5	SS -> MS	REGISTER	initiation of the transaction concerning the USSD notification operation. See i).
6			The MS has to display the USSD string sent from the network.
7	MS -> SS	FACILITY	signalling message sent by the MS as the response. The SS checks that it matches ii).
8	SS -> MS	SETUP	incoming call.
9	MS -> SS	CALL CONFIRMED	
10	MS -> SS	ALERTING	
11	MS -> SS	CONNECT	
12	SS -> MS	ASSIGNMENT COMMAND	a TCH is allocated to the MS.
13	MS -> SS	ASSIGNMENT COMPLETE	
14	SS -> MS	CONNECT ACKNOWLEDGE	
15	SS -> MS	RELEASE COMPLETE	this message releases the transaction concerning the USSD operation. See iii).
16	SS -> MS	REGISTER	initiation of a USS request operation during a call. See specific message contents i).
17			The MS has to display the USSD string received from the SS.
18	MS -> SS	FACILITY	The SS checks that this message matches ii).
19	SS -> MS	RELEASE COMPLETE	It releases the transaction identifier concerning the ussd operation.
20	SS -> MS	DISCONNECT	call release initiation. see iv).
21	MS -> SS	RELEASE	
22	SS -> MS	RELEASE COMPLETE	
23	SS -> MS	CHANNEL RELEASE	

Specific message contents.

i) REGISTER message.

Contents	Value/remark
Protocol Discriminator	set to "Supplementary service (call independent)"
Transaction identifier	
Register message type	As 3GPP TS 04.80
Facility Information Element	See below

Facility Information Element with Invoke = UnstructuredSS-Notify component type as defined in 3GPP TS 04.90, subclause 5.2.1.

Contents	Value/remark
Facility IE identifier	As 3GPP TS 04.08 / 3GPP TS 24.008
Length of FIE contents	
Component type tag	Invoke from 3GPP TS 04.80
Component length	depending on the length of ussd-string
InvokeID tag	From 3GPP TS 04.80
Invoke ID length	1
Invoke ID	Arbitrary (1 octet)
Operation Code tag	From 3GPP TS 04.80
Operation Code length	1
Operation Code	UnstructuredSS-Notify
ussd-dataCodingScheme	1 octet long. Alphabet indicator set to "default alphabet". Language indicator set to "undefined"
ussd-string	arbitrary chosen by the SS

ii) Facility message.

Contents	Value/remark
Protocol Discriminator	set to "Supplementary service (call independent)"
Transaction identifier	the transaction value is the same as REGISTER transaction value but the transaction flag is different
Facility message type	As 3GPP TS 04.80
Facility Information Element	See below

Facility Information Element with Return Result = empty result component according to 3GPP TS 04.90, subclause 5.2.1, figure 5.3.

Contents	Value/remark
Facility IE identifier	As 3GPP TS 04.08 / 3GPP TS 24.008
Length of FIE contents	
Component type tag	Return Result from 3GPP TS 04.80
Component length	
InvokeID tag	From 3GPP TS 04.80
Invoke ID length	1
Invoke ID	The same as the invoke of the UnstructuredSS-Notify

iii) RELEASE COMPLETE message.

Contents	Value/remark
Protocol Discriminator	set to "Supplementary service (call independent)"
Transaction identifier	the transaction value is the same as REGISTER transaction flag is different
Release Complete message type	As 3GPP TS 04.80
Facility Information Element	omitted

iv) RELEASE COMPLETE message.

Contents	Value/remark
Protocol Discriminator	set to "Supplementary service (call control)"
Transaction identifier	same as current call.
Release Complete message type	As 3GPP TS 04.08 / 3GPP TS 24.008

31.9.2.2 UnstructuredSS-Notify/rejected on user busy

Conformance requirements

- 1) When the mobile station receives an USSD operation in parallel to any call independent supplementary transaction, it shall respond with a return error component in a RELEASE COMPLETE message, containing the "USSD-Busy" error.

References

Conformance requirement 1: 3GPP TS 04.90 subclause 5.1.1.

Test Purpose

- 1) To verify that when the mobile station receives an USSD operation in parallel to any call independent supplementary transaction, it responds with a return error component in a RELEASE COMPLETE message, containing the "USSD-Busy" error.

Specific PICS Statements

- Full rate supported (TSPC_AddInfo_Full_rate_version_1)
- Supported teleservices (TSPC_AddInfo_TeleSvc)

PIXIT Statements

- Support of active state of the call control protocol (U10).

Initial Conditions

System Simulator:

1 cell, default parameters.

Mobile Station:

The MS is in the MM-state "idle updated".

Foreseen final state of the MS

MM-state "idle updated".

Test Procedure

- The MS is paged and a RR-connection is established. Then, the SS sends a REGISTER message containing a facility information element with operation code set to UnstructuredSS-Notify. The SS initiates an other USSD transaction by sending a REGISTER message with transaction identifier different from the previous one. The SS checks that the MS answers with a RELEASE COMPLETE message with an error component set to "USSD busy". Then the SS releases the radio link.

Test Procedure

Step	Direction	Message	Comments
1	SS -> MS	PAGING REQUEST TYPE 1	<p>a SDCCH is allocated to the MS.</p> <p>initiation of the transaction concerning the USSD notification operation. See i).</p> <p>The MS has to display the USSD string sent from the SS. See ii).</p> <p>initiation of an other USSD notification. The transaction identifier is different from that in step 5. See i).</p> <p>error set to "USSD busy". Transaction initiated in step 6 by the network is rejected by the MS. See iii).</p> <p>normal release of transaction initiated in step 5. See iii).</p> <p>release of the main signalling link.</p>
2	MS -> SS	CHANNEL REQUEST	
3	SS -> MS	IMMEDIATE ASSIGNMENT	
4	MS -> SS	PAGING RESPONSE	
5	SS -> MS	REGISTER	
6			
7	MS -> SS	FACILITY	
8	SS -> MS	REGISTER	
9	MS -> SS	RELEASE COMPLETE	
10	SS -> MS	RELEASE COMPLETE	
11	SS -> MS	CHANNEL RELEASE	

Specific message contents.

i) REGISTER message.

See subclause 31.9.2.1.

ii) FACILITY message.

See subclause 31.9.2.1.

iii) RELEASE COMPLETE message.

Contents	Value/remark
Protocol Discriminator	set to "Supplementary service (call independent)"
Transaction identifier	for step 10, same as REGISTER transaction identifier for step 9, the transaction value is the same as REGISTER transaction value but the transaction flag is different.
Release complete message type	As 3GPP TS 04.80
Facility Information Element	for step 9 see iiib). for step 10, see iiia).

iiia) Facility Information Element with Return Result = UnstructuredSS-Notify component type as defined in 3GPP TS 04.80 subclause 3.6.1 table 3.4.

Contents	Value/remark
Facility IE identifier	As 3GPP TS 04.08 / 3GPP TS 24.008
Length of FIE contents	
Component type tag	Return Result from 3GPP TS 04.80
Component length	
InvokeID tag	From 3GPP TS 04.80
Invoke ID length	1
Invoke ID	The same as the invoke of the UnstructuredSS-Notify in step 5

iiib) Facility Information Element with Return Error = UnstructuredSS-Notify component type as defined in 3GPP TS 04.80 subclause 3.6.1 table 3.5.

Contents	Value/remark
Facility IE identifier	As 3GPP TS 04.08
Length of FIE contents	
Component type tag	Return Result from 3GPP TS 04.80
Component length	
InvokeID tag	From 3GPP TS 04.80
Invoke ID length	1
Invoke ID	The same as the invoke of the UnstructuredSS-Notify in step 8
Error Code tag	As 3GPP TS 04.80
Error Code length	
Error Code	USSD Busy

31.9.2.3 UnstructuredSS-Request/accepted

Conformance requirements

- 1) For a USSD request, the MS shall display the text provided and await user input. if the user enters a response, the MS shall return the response to the network, maintaining the transaction.
- 2) The MS shall include alphabet and language indicators in the response to the network. The alphabet indicator shall indicate "SMS default alphabet". The language indicator shall indicate "language unspecified".
- 3) At any stage while the MS is registered with a network, the network may send an unstructured string to the MS. So, the MS shall be able to process the operation during a call or out of a call.

References

- Conformance requirement 1: 3GPP TS 03.90 subclause 5.2.5.
 Conformance requirement 2: 3GPP TS 02.90 subclause 4.2.2.
 Conformance requirement 3: 3GPP TS 02.90 subclause 4.2.1.

Test Purpose

- 1) To test that, for a USSD request, the MS shall display the text provided and await user input. if the user enters a response, the MS shall return the response to the network, maintaining the transaction.
- 2) To verify that the MS shall include alphabet and language indicators in the response to the network. The alphabet indicator shall indicate "SMS default alphabet". The language indicator shall indicate "language unspecified".
- 3) To check that the MS shall be able to process the operation during a call or out of a call.

Specific PICS Statements

- Full rate supported (TSPC_AddInfo_Full_rate_version_1)
- Supported teleservices (TSPC_AddInfo_TeleSvc)

PIXIT Statements

- Support of active state of the call control protocol (U10).

Initial Conditions

System Simulator:

1 cell, default parameters.

Mobile Station:

The MS is in the MM-state "idle updated".

Foreseen final state of the MS

MM-state "idle updated".

Test Procedure

- The MS is paged and a RR-connection is established. Then, the SS sends a REGISTER message containing a facility information element with operation code set to ProcessUnstructuredSS-Request. The user checks that the ussd string sent by the SS is correctly displayed by the MS and answers the request by depressing MMI keys. Then the MS has to send a FACILITY message with ussd string exactly containing the digits and symbols expressed on the mobile equipment keypad.
- Then the SS originates a call to the MS. When the MS is in the U10 state, the SS releases the transaction identifier concerning USSD transaction by sending a RELEASE COMPLETE. The SS initiates a new ussd transaction by sending a REGISTER message containing a facility information element with operation code set to UnstructuredSS-Request. The user checks that the ussd string sent by the SS is correctly displayed by the MS and answers the request by depressing MMI keys. Then the MS has to send a FACILITY message with ussd string exactly containing the digits and symbols expressed on the mobile equipment keypad. Finally the SS releases both MM connections and the radio link.

Step	Direction	Message	Comments
1	SS -> MS	PAGING REQUEST TYPE 1	
2	MS -> SS	CHANNEL REQUEST	
3	SS -> MS	IMMEDIATE ASSIGNMENT	a SDCCH is allocated to the MS.
4	MS -> SS	PAGING RESPONSE	
5	SS -> MS	REGISTER	initiation of the transaction concerning the USSD Request operation. See i).
6			The MS has to display the USSD string sent from the network and waits for the user response. By depressing MMI keys followed by SEND the user answers signalling message sent by the MS as the response. See ii).
7	MS -> SS	FACILITY	incoming call.
8	SS -> MS	SETUP	
9	MS -> SS	CALL CONFIRMED	
10	MS -> SS	ALERTING	
11	MS -> SS	CONNECT	
12	SS -> MS	ASSIGNMENT COMMAND	a TCH is allocated to the MS.
13	MS -> SS	ASSIGNMENT COMPLETE	
14	SS -> MS	CONNECT ACKNOWLEDGE	
15	SS -> MS	RELEASE COMPLETE	this message releases the transaction concerning the USSD operation. See iii).
16	SS -> MS	REGISTER	initiation of a USS request operation during a call. See specific message contents i).
17			The MS has to display the USSD string received from the SS. By depressing MMI keys followed by SEND, the user answers. DTMF signalling may occur.
18	MS -> SS	FACILITY	See ii).
19	SS -> MS	RELEASE COMPLETE	It releases the transaction identifier concerning the ussd operation.
20	SS -> MS	DISCONNECT	
21	MS -> SS	RELEASE	
22	SS -> MS	RELEASE COMPLETE	call release initiation. see iv).
23	SS -> MS	CHANNEL RELEASE	

Specific message contents

i) REGISTER message.

Contents	Value/remark
Protocol Discriminator	set to "Supplementary service (call independent)"
Transaction identifier	
Register message type	As 3GPP TS 04.80
Facility Information Element	See below

Facility Information Element with Invoke = UnstructuredSS-Request component type as defined in 3GPP TS 04.80 subclause 3.6.1 table 3.3.

Contents	Value/remark
Facility IE identifier	As 3GPP TS 04.08 / 3GPP TS 24.008
Length of FIE contents	
Component type tag	Invoke from 3GPP TS 04.80
Component length	depending on the length of ussd-string
InvokeID tag	From 3GPP TS 04.80
Invoke ID length	1
Invoke ID	Arbitrary (1 octet)
Operation Code tag	From 3GPP TS 04.80
Operation Code length	1
Operation Code	UnstructuredSS-Request
ussd-dataCodingScheme	1 octet long. Alphabet indicator set to "default alphabet". Language indicator set to "undefined"
ussd-string	arbitrary chosen by the SS

ii) Facility message.

Contents	Value/remark
Protocol Discriminator	set to "Supplementary service (call independent)"
Transaction identifier	the transaction identifier value is the same as REGISTER transaction value but the transaction flag is different.
Facility message type	As 3GPP TS 04.80
Facility Information Element	See below

Facility Information Element with Return Result = UnstructuredSS-Request component type as defined in 3GPP TS 04.80 subclause 3.6.1 table 3.4.

Contents	Value/remark
Facility IE identifier	As 3GPP TS 04.08 / 3GPP TS 24.008
Length of FIE contents	
Component type tag	Return Result from 3GPP TS 04.80
Component length	depending on the length of ussd-string
InvokeID tag	From 3GPP TS 04.80
Invoke ID length	1
Invoke ID	The same as the invoke of the UnstructuredSS-Request
Sequence Identifier	
Sequence length	
Operation Code tag	1
Operation Code length	1
Operation Code	UnstructuredSS-Request
ussd-dataCodingScheme	1 octet long. Alphabet indicator set to "default alphabet". Language indicator set to "undefined"
ussd-string	contains exactly the digits and symbols expressed on the mobile equipment keypad.

iii) RELEASE COMPLETE message.

Contents	Value/remark
Protocol Discriminator	set to "Supplementary service (call independent)"
Transaction identifier	same as REGISTER transaction identifier
Release Complete message type	As 3GPP TS 04.80
Facility Information Element	omitted

iv) RELEASE COMPLETE message.

Contents	Value/remark
Protocol Discriminator	set to "Supplementary service (call control)"
Transaction identifier	same as current call.
Release Complete message type	As 3GPP TS 04.08 / 3GPP TS 24.008

31.9.2.4 UnstructuredSS-Request/rejected on user busy

Conformance requirements

- 1) When the mobile station receives an USSD operation in parallel to any call independent supplementary transaction, it shall respond with a return error component in a RELEASE COMPLETE message, containing the "USSD-Busy" error.

References

Conformance requirement 1: 3GPP TS 04.90 subclause 5.1.1.

Test Purpose

- 1) To verify that when the mobile station receives an USSD operation in parallel to any call independent supplementary transaction, it responds with a return error component in a RELEASE COMPLETE message, containing the "USSD-Busy" error.

Specific PICS Statements

- Full rate supported (TSPC_AddInfo_Full_rate_version_1)
- Supported teleservices (TSPC_AddInfo_TeleSvc)

PIXIT Statements

- Support of active state of the call control protocol (U10).

Initial Conditions

System Simulator:

1 cell, default parameters.

Mobile Station:

The MS is in the MM-state "idle updated".

Foreseen final state of the MS

MM-state "idle updated".

Test Procedure

- The MS is paged and a RR-connection is established. Then, the SS sends a REGISTER message containing a facility information element with operation code set to UnstructuredSS-Request. The SS initiates an other USSD transaction by sending a REGISTER message with transaction identifier different from the previous one. The SS checks that the MS answers with a RELEASE COMPLETE message with an error component set to "USSD busy". Then the SS releases the radio link.

Test Procedure

Step	Direction	Message	Comments
1	SS -> MS	PAGING REQUEST TYPE 1	
2	MS -> SS	CHANNEL REQUEST	
3	SS -> MS	IMMEDIATE ASSIGNMENT	a SDCCH is allocated to the MS.
4	MS -> SS	PAGING RESPONSE	
5	SS -> MS	REGISTER	initiation of the transaction concerning the USSD Request operation. See i).
6			The MS has to display the USSD string sent from the network and waits for the user response. By depressing MMI keys followed by SEND the user answers.
7	MS -> SS	FACILITY	signalling message sent by the MS as the response to the request. See ii).
8	SS -> MS	REGISTER	initiation of an other USSD request. The transaction identifier is different from that in step 5. See i).
9	MS -> SS	RELEASE COMPLETE	error set to "USSD busy". Transaction initiated in step 6 by the network is rejected by the MS. See iii).
10	SS -> MS	RELEASE COMPLETE	normal release of transaction initiated in step 5. See iii).
11	SS -> MS	CHANNEL RELEASE	release of the main signalling link.

Specific message contents

i) REGISTER message.

See subclause 31.9.2.3.

ii) FACILITY message.

See subclause 31.9.2.3.

iii) RELEASE COMPLETE message.

Contents	Value/remark
Protocol Discriminator Transaction identifier	set to "Supplementary service (call independent)" the transaction identifier value is the same as REGISTER transaction value but the transaction flag is different.
Release complete message type Facility Information Element	As 3GPP TS 04.80 for step 9 see iiib). for step10 see iiiia).

iiiia) Facility Information Element with Return Result = UnstructuredSS-Request component type as defined in 3GPP TS 04.80 subclause 3.6.1 table 3.4.

Contents	Value/remark
Facility IE identifier Length of FIE contents Component type tag Component length InvokeID tag Invoke ID length Invoke ID	As 3GPP TS 04.08 / 3GPP TS 24.008 Return Result from 3GPP TS 04.80 depending on the length of ussd-string From 3GPP TS 04.80 1 The same as the invoke of the UnstructuredSS-Request

iiib) Facility Information Element with Return Error = UnstructuredSS-Request component type as defined in 3GPP TS 04.80 subclause 3.6.1 table 3.5.

Contents	Value/remark
Facility IE identifier Length of FIE contents Component type tag Component length InvokeID tag Invoke ID length Invoke ID Error Code tag Error Code length Error Code	As 3GPP TS 04.08 / 3GPP TS 24.008 Return Error from 3GPP TS 04.80 depending on the length of ussd-string From 3GPP TS 04.80 1 The same as the invoke of the UnstructuredSS-Request As 3GPP TS 04.80 USSD Busy

31.10 MMI input for USSD

31.10.1 Conformance requirements

If the MS cannot interpret the MMI input as a defined GSM Supplementary Services, SIM control procedure or MS manufacturer-defined procedure, and if the MMI input is in the form:

- "entry of any characters defined in the 3GPP TS 03.38 Default Alphabet (up to the maximum defined in 3GPP TS 04.80) followed by #SEND"; or
- "entry of 1 or 2 characters defined in the 3GPP TS 03.38 Default Alphabet followed by SEND";

then it shall be interpreted by the MS as Unstructured SS Data and sent transparently towards the network, unless the MS is not engaged in a call and the first digit of the 2 character entry, followed by SEND, is a "1". In this case the MS shall transmit this as a call-setup request.

References

3GPP TS 02.30 subclause 4.5.3.

31.10.2 Test purpose

To check that the entry of 2 digits in the form 1X (X in the set 0,...9) followed by SEND is accepted by the mobile station in idle mode as a normal call establishment for the 1X number. It is checked that the MS sends a CHANNEL REQUEST, sends CM SERVICE REQUEST message for mobile originated call (after having received an IMMEDIATE ASSIGNMENT), and then sends the SETUP message containing the 1X phone number as called number (after having received the CM SERVICE ACCEPT message).

31.10.3 Method of test

Initial conditions

System Simulator:

1 cell, default parameters.

Mobile Station

The MS is "idle updated";

Specific PICS Statements

-

PIXIT Statements

-

Foreseen final state of the MS:

The MS is "idle updated.

Test procedure

The user requests call establishment successively for every 2 digit phone number of the 1X form (X in the set 0,...9) allowing ten seconds between each attempts.

Maximum duration of test

3 minutes.

Expected Sequence

The following sequence is executed for execution counter $k = 1$ to 10.

Step	Direction	Message	Comments
1	MS		The MS is made to initiate call establishment for phone number 1X (where $X = k-1$) with establishment cause related to mobile originating call
2	MS -> SS	CHANNEL REQUEST	
3	SS -> MS	IMMEDIATE ASSIGNMENT	
4	MS -> SS	CM SERVICE REQUEST	"mobile originating call"
5	SS -> MS	CM SERVICE ACCEPT	
6	MS -> SS	SETUP	called BCD number is 1X
7	SS -> MS	RELEASE COMPLETE	
8			Wait for 10 seconds

Specific message contents.

None.

31.11 Specific message contents and ASN.1 codings

Introduction

In this subclause a mixed form of ASN.1 coding has been used in ASN.1 components within the messages.

Some components use the indefinite form of coding, and some use the short definite form.

An example of a FACILITY message using indefinite form of coding is described below.

The same message using short definite form of coding is described in Test 31.2.1.1.1 Step 7 of this subclause.

Contents	Value/remark	Coding
Length of FIE contents	43	2B
Component type tag	Return Result	A2
Component length	indefinite	80
Invoke ID tag		02
Invoke ID length	1	01
Invoke ID	As received	--
Sequence tag		30
Sequence length	indefinite	80
Operation Code tag		02
Operation Code length	1	01
Operation Code	RegisterSS	0A
SS-Information		
Forwarding Info tag	Tag=A0	A0
Forwarding Info length	indefinite	80
SS-Code tag	Tag=4	04
SS-Code length	1	01
SS-Code	CFNRy	2A
Forwarding Feature List	Seq.	30
Length Indicator	indefinite	80
Forwarding Feature	Seq.	30
Forwarding Feature length	indefinite	80
Basic Service Code identifier	TeleserviceCode	83
Teleservice length	1	01
Teleservice code	AllSpeechTransmissionServices	10
SS-Status	Tag=84	84
SS-Status length	1	01
SS-Status code	Prov., Registered, Active	07
Forwarded To Number identifier	Tag=85	85
ISDN-AddressString length	5	05
AddressString type	Unknown	81
AddressString	TBCD-String: 00431234	00 34 21 43
NoReplyConditionTime	Tag=87	87
Length Indicator	1	01
NoReplyConditionTime	5	05
End-Of-Content Tag	0	00
Length Indicator	0	00
End-Of-Content Tag	0	00
Length Indicator	0	00
End-Of-Content Tag	0	00
Length Indicator	0	00
End-Of-Content Tag	0	00
Length Indicator	0	00
End-Of-Content Tag	0	00
Length Indicator	0	00

Test 31.2.1.1.1. Registration accepted

MMI sequence: **61*00431234*11*5#

Step 6: MS -> SS REGISTER

Contents	Value/remark	Coding
Length of FIE contents	26	1A
Component type tag	Invoke	A1 (note 1)
Component length	24	18
Invoke ID tag		02
Invoke ID length	1	01
Invoke ID	Arbitrary	--
Operation Code tag		02
Operation Code length	1	01
Operation Code	RegisterSS	0A
RegisterSS-Arg	Seq.	30 (note 1)
RegisterSS-Arg length	16	10
SS-Code tag	Tag=4	04
SS-Code length	1	01
SS-Code	CFNRy	2A
Basic Service Code identifier	TeleserviceCode	83
Teleservice length	1	01
Teleservice code	AllSpeechTransmissionServices	10
Forwarded To Number identifier	Tag=84	84
AddressString length	5	05
AddressString type	Unknown	81
AddressString	TBCD-String: 00431234	00 34 21 43
NoReplyConditionTime tag	Tag=85	85
NoReplyConditionTime length	1	01
NoReplyConditionTime	5	05

NOTE 1: This component may use the indefinite form.

Step 7: SS -> MS RELEASE COMPLETE

Contents	Value/remark	Coding
Length of FIE contents	35	23
Component type tag	Return Result	A2 (note 1)
Component length	33	21
Invoke ID tag		02
Invoke ID length	1	01
Invoke ID	As received	--
Sequence tag		30 (note 1)
Sequence length	28	1C
Operation Code tag		02
Operation Code length	1	01
Operation Code	RegisterSS	0A
SS-Information		
Forwarding Info tag	Tag=A0	A0 (note 1)
Forwarding Info length	23	17
SS-Code tag	Tag=4	04
SS-Code length	1	01
SS-Code	CFNRy	2A
Forwarding Feature List	Seq.	30 (note 1)
Length Indicator	18	12
Forwarding Feature	Seq.	30 (note 1)
Forwarding Feature length	16	10
Basic Service Code identifier	TeleserviceCode	83
Teleservice length	1	01
Teleservice code	AllSpeechTransmissionServices	10
SS-Status	Tag=84	84
SS-Status length	1	01
SS-Status code	Prov., Registered, Active	07
Forwarded To Number identifier	Tag=85	85
ISDN-AddressString length	5	05
AddressString type	Unknown	81
AddressString	TBCD-String: 00431234	00 34 21 43
NoReplyConditionTime	Tag=87	87
Length Indicator	1	01
NoReplyConditionTime	5	05

MMI sequence: **21*00431234*13#

Step 15: MS -> SS REGISTER

Contents	Value/remark	Coding
Length of FIE contents	23	17
Component type tag	Invoke	A1 (note 1)
Component length	21	15
Invoke ID tag		02
Invoke ID length	1	01
Invoke ID	Arbitrary	--
Operation Code tag		02
Operation Code length	1	01
Operation Code	RegisterSS	0A
RegisterSS-Arg	Seq.	30 (note 1)
RegisterSS-Arg length	13	0D
SS-Code tag	Tag=4	04
SS-Code length	1	01
SS-Code	CFU	21
Basic Service Code identifier	TeleserviceCode	83
Teleservice length	1	01
Teleservice code	All Facsimile Services	60
Forwarded To Number identifier	Tag=84	84
AddressString length	5	05
AddressString type	Unknown	81
AddressString	TBCD-String: 00431234	00 34 21 43

Step 16: SS -> MS RELEASE COMPLETE

Contents	Value/remark	Coding
Length of FIE contents	42	2A
Component type tag	Return Result	A2 (note 1)
Component length	indefinite	80
Invoke ID tag		02
Invoke ID length	1	01
Invoke ID	As received	--
Sequence tag		30 (note 1)
Sequence length	indefinite	80
Operation Code tag		02
Operation Code length	1	01
Operation Code	RegisterSS	0A
SS-Information		
Forwarding Info tag	Tag=A0	A0 (note 1)
Forwarding Info length	indefinite	80
SS-Code tag	Tag=4	04
SS-Code length	1	01
SS-Code	CFU	21
Forwarding Feature List	Seq.	30 (note 1)
Length indicator	indefinite	80
Forwarding Feature	Seq.	30 (note 1)
Forwarding Feature length	indefinite	80
Basic Service Code identifier	TeleserviceCode	83
Teleservice length	1	01
Teleservice code	All Facsimile Services	60
SS-Status	Tag=84	84
SS-Status length	1	01
SS-Status code	Prov., Registered, Active	07
Forwarded To Number identifier	Tag=85	85
ISDN-AddressString length	5	05
AddressString type	Unknown	81
AddressString	TBCD-String: 00431234	00 34 21 43
End-Of-Content Tag	0	00
Length Indicator	0	00
End-Of-Content Tag	0	00
Length Indicator	0	00
End-Of-Content Tag	0	00
Length Indicator	0	00
End-Of-Content Tag	0	00
Length Indicator	0	00
End-Of-Content Tag	0	00
Length Indicator	0	00

Test 31.2.1.1.2. Registration rejected

MMI sequence: **67*00431234*21#

Step 4: MS -> SS REGISTER

Contents	Value/remark	Coding
Length of FIE contents	23	17
Component type tag	Invoke	A1 (note 1)
Component length	21	15
Invoke ID tag		02
Invoke ID length	1	01
Invoke ID	Arbitrary	--
Operation Code tag		02
Operation Code length	1	01
Operation Code	RegisterSS	0A
RegisterSS-Arg	Seq.	30 (note 1)
RegisterSS-Arg length	13	0D
SS-Code tag	Tag=4	04
SS-Code length	1	01
SS-Code	CFB	29
Basic Service Code identifier	BearerserviceCode	82
Bearerservice length	1	01
Bearerservice code	AllAsynchronousServices	60
Forwarded To Number identifier	Tag=84	84
AddressString length	5	05
AddressString type	Unknown	81
AddressString	TBCD-String: 00431234	00 34 21 43

Step 5: SS -> MS RELEASE COMPLETE

Contents	Value/remark	Coding
Length of FIE contents	8	08
Component type tag	Return Error	A3 (note 1)
Component length	6	06
Invoke ID tag		02
Invoke ID length	1	01
Invoke ID	As received	--
Error Code tag		02
Error Code length	1	01
Error Code	BearerServiceNot Provisioned	0A

MMI sequence: **002*00431234*13#

Step 11: MS -> SS REGISTER

Contents	Value/remark	Coding
Length of FIE contents	23	1715
Component type tag	Invoke	A1 (note 1)
Component length	21	15
Invoke ID tag		02
Invoke ID length	1	01
Invoke ID	Arbitrary	--
Operation Code tag		02
Operation Code length	1	01
Operation Code	RegisterSS	0A
RegisterSS-Arg		30 (note 1)
RegisterSS-Arg length	13	0D
SS-Code tag	Tag=4	04
SS-Code length	1	01
SS-Code	CF	20
Basic Service Code identifier	TeleserviceCode	83
Teleservice length	1	01
Teleservice code	All Facsimile Services	60
Forwarded To Number identifier	Tag=84	84
AddressString length	5	05
AddressString type	Unknown	81
AddressString	TBCD-String: 00431234	00 34 21 43

Step 12: SS -> MS RELEASE COMPLETE

Contents	Value/remark	Coding
Length of FIE contents	8	08
Component type tag	Reject	A4 (note 1)
Component length	6	06
Invoke ID tag		02
Invoke ID length	1	01
Invoke ID	As received	--
Invoke Problem tag	Tag=81	81
Invoke Problem length	1	01
Invoke Problem code	Resource limitation	03

Test 31.2.1.2.1. Erasure accepted

MMI sequence: ##004**13#

Step 6: MS -> SS REGISTER

Contents	Value/remark	Coding
Length of FIE contents	16	10
Component type tag	Invoke	A1 (note 1)
Component length	14	0E
Invoke ID tag		02
Invoke ID length	1	01
Invoke ID	Arbitrary	--
Operation Code tag		02
Operation Code length	1	01
Operation Code	EraseSS	0B
SS-ForBS	Seq.	30 (note 1)
SS-ForBS length	6	06
SS-Code tag	Tag=4	04
SS-Code length	1	01
SS-Code	CFC	28
Basic Service Code identifier	TeleserviceCode	83
Teleservice length	1	01
Teleservice code	All Facsimile Services	60

Step 7: SS -> MS RELEASE COMPLETE

Contents	Value/remark	Coding
Length of FIE contents	31	1F
Component type tag	Return Result	A2 (note 1)
Component length	29	1D
Invoke ID tag		02
Invoke ID length	1	01
Invoke ID	As received	--
Sequence tag		30 (note 1)
Sequence length	24	18
Operation Code tag		02
Operation Code length	1	01
Operation Code	EraseSS	0B
SS-Information		
Forwarding Info tag	Tag=A0	A0 (note 1)
Forwarding Info length	indefinite	80
SS-Code tag	Tag=4	04
SS-Code length	1	01
SS-Code	CFC	28
Forwarding Feature List	Seq.	30 (note 1)
Length Indicator	indefinite	80
Forwarding Feature	Seq.	30 (note 1)
Forwarding Feature length	indefinite	80
Basic Service Code identifier	TeleserviceCode	83
Teleservice length	1	01
Teleservice code	All Facsimile Services	60
SS-Status	Tag=84	84
SS-Status length	1	01
SS-Status code	Provisioned	04
End-Of-Content Tag	0	00
Length Indicator	0	00
End-Of-Content Tag	0	00
Length Indicator	0	00
End-Of-Content Tag	0	00
Length Indicator	0	00

MMI sequence: ##62#

Step 15: MS -> SS REGISTER

Contents	Value/remark	Coding
Length of FIE contents	13	0D
Component type tag	Invoke	A1 (note 1)
Component length	11	0B
Invoke ID tag		02
Invoke ID length	1	01
Invoke ID	Arbitrary	--
Operation Code tag		02
Operation Code length	1	01
Operation Code	EraseSS	0B
SS-ForBS	Seq.	30 (note 1)
SS-ForBS length	3	03
SS-Code tag	Tag=4	04
SS-Code length	1	01
SS-Code	CFNRc	2B

Step 16: SS -> MS RELEASE COMPLETE

Contents	Value/remark	Coding
Length of FIE contents	22	16
Component type tag	Return Result	A2 (note 1)
Component length	20	14
Invoke ID tag		02
Invoke ID length	1	01
Invoke ID	As received	--
Sequence tag		30 (note 1)
Sequence length	15	0F
Operation Code tag		02
Operation Code length	1	01
Operation Code	EraseSS	0B
SS-Information		
Forwarding Info tag	Tag=A0	A0 (note 1)
Forwarding Info length	10	0A
SS-Code tag	Tag=4	04
SS-Code length	1	01
SS-Code	CFNRc	2B
Forwarding Feature List	Seq.	30 (note 1)
Length Indicator	5	05
Forwarding Feature	Seq.	30 (note 1)
Forwarding Feature length	3	03
SS-Status	Tag=84	84
SS-Status length	1	01
SS-Status code	Provisioned	04

Test 31.2.1.2.2. Erasure rejected

MMI sequence: ##21**11#

Step 4: MS -> SS REGISTER

Contents	Value/remark	Coding
Length of FIE contents	16	10
Component type tag	Invoke	A1 (note 1)
Component length	14	0E
Invoke ID tag		02
Invoke ID length	1	01
Invoke ID	Arbitrary	--
Operation Code tag		02
Operation Code length	1	01
Operation Code	EraseSS	0B
SS-ForBS		30 (note 1)
SS-ForBS length	6	06
SS-Code tag	Tag=4	04
SS-Code length	1	01
SS-Code	CFU	21
Basic Service Code identifier	TeleserviceCode	83
Teleservice length	1	01
Teleservice code	AllSpeechTransmissionServices	10

Step 5: SS -> MS RELEASE COMPLETE

Contents	Value/remark	Coding
Length of FIE contents	8	08
Component type tag	Return Error	A3 (note 1)
Component length	6	06
Invoke ID tag		02
Invoke ID length	1	01
Invoke ID	As received	--
Error Code tag	Tag=2	02
Error Code length	1	01
Error Code	TeleserviceNotProvisioned	0B

MMI sequence: ##61**13#

Step 11: MS -> SS REGISTER

Contents	Value/remark	Coding
Length of FIE contents	16	10
Component type tag	Invoke	A1 (note 1)
Component length	14	0E
Invoke ID tag		02
Invoke ID length	1	01
Invoke ID	Arbitrary	--
Operation Code tag		02
Operation Code length	1	01
Operation Code	EraseSS	0B
SS-ForBS		30 (note 1)
SS-ForBS length	6	06
SS-Code tag	Tag=4	04
SS-Code length	1	01
SS-Code	CFNRy	2A
Basic Service Code identifier	TeleserviceCode	83
Teleservice length	1	01
Teleservice code	All Facsimile Services	60

Step 12: SS -> MS RELEASE COMPLETE

Contents	Value/remark	Coding
Length of FIE contents	10	0A
Component type tag	Reject	A4 (note 1)
Component length	indefinite	80
Invoke ID tag		02
Invoke ID length	1	01
Invoke ID	As received	--
Invoke Problem tag		81
Invoke Problem length	1	01
Invoke Problem	Resource limitation	03
End-Of-Content Tag	0	00
Length Indicator	0	00

Test 31.2.1.3. Activation

MMI sequence: *002**22#

Step 6: MS -> SS REGISTER

Contents	Value/remark	Coding
Length of FIE contents	16	10
Component type tag	Invoke	A1 (note 1)
Component length	14	0E
Invoke ID tag		02
Invoke ID length	1	01
Invoke ID	Arbitrary	--
Operation Code tag		02
Operation Code length	1	01
Operation Code	ActivateSS	0C
SS-ForBS		30 (note 1)
SS-ForBS length	6	06
SS-Code tag	Tag=4	04
SS-Code length	1	01
SS-Code	CF	20
Basic Service Code identifier	BearerserviceCode	82
Bearerservice length	1	01
Bearerservice code	AllSynchronousServices	68

Step 7:SS -> MS RELEASE COMPLETE

Contents	Value/remark	Coding
Length of FIE contents	29	1D
Component type tag	Return Result	A2 (note 1)
Component length	indefinite	80
Invoke ID tag		02
Invoke ID length	1	01
Invoke ID	As received	--
Sequence tag		30 (note 1)
Sequence length	20	14
Operation Code tag		02
Operation Code length	1	01
Operation Code	ActivateSS	0C
SS-Information		
Forwarding Info tag	Tag=A0	A0 (note 1)
Forwarding Info length	indefinite	80
SS-Code tag	Tag=4	04
SS-Code length	1	01
SS-Code	CF	20
Forwarding Feature List	Seq.	30 (note 1)
Length Indicator	8	08
Forwarding Feature	Seq.	30 (note 1)
Forwarding Feature length	6	06
Basic Service Code identifier	BearerserviceCode	82
Bearerservice length	1	01
Bearerservice code	AllSynchronousServices	68
SS-Status	Tag=4	84
SS-Status length	1	01
SS-Status code	Prov., Registered, Active	07
End-Of-Content Tag	0	00
Length Indicator	0	00
End-Of-Content Tag	0	00
Length Indicator	0	00

MMI sequence: *21#

Step 15: MS -> SS REGISTER

Contents	Value/remark	Coding
Length of FIE contents	13	0D
Component type tag	Invoke	A1 (note 1)
Component length	11	0B
Invoke ID tag		02
Invoke ID length	1	01
Invoke ID	Arbitrary	--
Operation Code tag		02
Operation Code length	1	01
Operation Code	ActivateSS	0C
SS-ForBS	Seq.	30 (note 1)
SS-ForBS length	3	06
SS-Code tag	Tag=4	04
SS-Code length	1	01
SS-Code	CFU	21

Step 16: SS -> MS RELEASE COMPLETE

Contents	Value/remark	Coding
Length of FIE contents	26	1A
Component type tag	Return Result	A2 (note 1)
Component length	24	18
Invoke ID tag		02
Invoke ID length	1	01
Invoke ID	As received	--
Sequence tag		30 (note 1)
Sequence length	indefinite	80
Operation Code tag		02
Operation Code length	1	01
Operation Code	ActivateSS	0C
SS-Information		
Forwarding Info tag	Tag=A0	A0 (note 1)
Forwarding Info length	indefinite	80
SS-Code tag	Tag=4	04
SS-Code length	1	01
SS-Code	CFU	21
Forwarding Feature List	Seq.	30 (note 1)
Length Indicator	5	05
Forwarding Feature	Seq.	30 (note 1)
Forwarding Feature length	3	03
SS-Status	Tag=84	84
SS-Status length	1	01
SS-Status code	Prov. Registered, Active	07
End-Of-Content Tag	0	00
Length Indicator	0	00
End-Of-Content Tag	0	00
Length Indicator	0	00

Test 31.2.1.4. Deactivation

MMI sequence: #004**11#

Step 6: MS -> SS REGISTER

Contents	Value/remark	Coding
Length of FIE contents	16	10
Component type tag	Invoke	A1 (note 1)
Component length	14	0E
Invoke ID tag		02
Invoke ID length	1	01
Invoke ID	Arbitrary	--
Operation Code tag		02
Operation Code length	1	01
Operation Code	DeactivateSS	0D
SS-ForBS	Seq.	30 (note 1)
SS-ForBS length	6	06
SS-Code tag	Tag=4	04
SS-Code length	1	01
SS-Code	CFC	28
Basic Service Code identifier	TeleserviceCode	83
Teleservice length	1	01
Teleservice code	AllSpeechTransmissionServices	10

Step 7: SS -> MS RELEASE COMPLETE

Contents	Value/remark	Coding
Length of FIE contents	29	1D
Component type tag	Return Result	A2 (note 1)
Component length	27	1B
Invoke ID tag		02
Invoke ID length	1	01
Invoke ID	As received	--
Sequence tag		30 (note 1)
Sequence length	22	16
Operation Code tag		02
Operation Code length	1	01
Operation Code	DeactivateSS	0D
SS-Information		
Forwarding Info tag	Tag=A0	A0 (note 1)
Forwarding Info length	indefinite	80
SS-Code tag	Tag=4	04
SS-Code length	1	01
SS-Code	CFC	28
Forwarding Feature List	Seq.	30 (note 1)
Length Indicator	indefinite	80
Forwarding Feature	Seq.	30 (note 1)
Forwarding Feature length	6	06
Basic Service Code identifier	TeleserviceCode	83
Teleservice length	1	01
Teleservice code	AllSpeechTransmissionServices	10
SS-Status	Tag=84	84
SS-Status length	1	01
SS-Status code	Provisioned, Registered	06
End-Of-Content Tag	0	00
Length Indicator	0	00
End-Of-Content Tag	0	00
Length Indicator	0	00

MMI sequence: #62**13#

Step 15: MS -> SS REGISTER

Contents	Value/remark	Coding
Same header as Step 6		
SS-Code tag	Tag=4	04
SS-Code length	1	01
SS-Code	CFNRc	2B
Basic Service Code identifier	TeleserviceCode	83
Teleservice length	1	01
Teleservice code	All Facsimile Services	60

Step 16: SS -> MS RELEASE COMPLETE

Contents	Value/remark	Coding
Length of FIE contents	27	1B
Component type tag	Return Result	A2 (note 1)
Component length	25	19
Invoke ID tag		02
Invoke ID length	1	01
Invoke ID	As received	--
Sequence tag		30 (note 1)
Sequence length	20	14
Operation Code tag		02
Operation Code length	1	01
Operation Code	DeactivateSS	0D
SS-Information		
Forwarding Info tag	Tag=A0	A0 (note 1)
Forwarding Info length	15	0F
SS-Code tag	Tag=4	04
SS-Code length	1	01
SS-Code	CFNRc	2B
Forwarding Feature List	Seq.	30 (note 1)
Length Indicator	10	0A
Forwarding Feature	Seq.	30 (note 1)
Forwarding Feature length	indefinite	80
Basic Service Code identifier	TeleserviceCode	83
Teleservice length	1	01
Teleservice code	All Facsimile Services	60
SS-Status	Tag=4	84
SS-Status length	1	01
SS-Status code	Provisioned, Registered	06
End-Of-Content Tag	0	00
Length Indicator	0	00

Test 31.2.1.6.1. Interrogation accepted

MMI sequence: *#67#

Step 6: MS -> SS REGISTER

Contents	Value/remark	Coding
Length of FIE contents	13	0D
Component type tag	Invoke	A1 (note 1)
Component length	11	0B
Invoke ID tag		02
Invoke ID length	1	01
Invoke ID	Arbitrary	--
Operation Code tag		02
Operation Code length	1	01
Operation Code	InterrogateSS	0E
SS-ForBS		30 (note 1)
SS-ForBS length	3	03
SS-Code tag	Tag=4	04
SS-Code length	1	01
SS-Code	CFB	29

Step 7: SS -> MS RELEASE COMPLETE

Contents	Value/Remark	Coding
Length of FIE contents	13	0D
Component type tag	Return Result	A2 (note 1)
Component length	11	0B
Invoke ID tag	Tag=02	02
Invoke ID length	1	01
Invoke ID	As received	03
Sequence tag		30 (note 1)
Sequence length	6	06
Operation code tag	Tag=02	02
Operation code length	1	01
Operation code	InterrogateSS	0E
InterrogateSS-Res	Choice	
SS-Status	Tag=80	80
SS-Status length	1	01
SS-Status	Provisioned	04

MMI sequence: *#61**11#

Step 15: MS -> SS REGISTER

Contents	Value/Remark	Coding
Length of FIE contents	16	10
Component type tag	Invoke	A1 (note 1)
Component length	14	0E
Invoke ID tag		02
Invoke ID length	1	01
Invoke ID	Arbitrary	--
Operation code tag		02
Operation code length	1	01
Operation code	InterrogateSS	0E
SS-ForBS	Seq	30 (note 1)
SS-ForBS length	6	06
SS code tag	Tag=4	04
SS code length	1	01
SS code	CFNRy	2A
Basic Service Code identifier	TeleserviceCode	83
Teleservice length	1	01
Teleservice code	AllSpeechTransmissionServices	10

Step 16: SS -> MS RELEASE COMPLETE

Contents	Value/Remark	Coding
Length of FIE contents	26	1A
Component type tag	Return Result	A2 (note 1)
Component length	24	18
Invoke ID tag		02
Invoke ID length	1	01
Invoke ID	As received	03
Sequence tag		30 (note 1)
Sequence length	19	13
Operation code tag		02
Operation code length	1	01
Operation code	InterrogateSS	0E
InterrogateSS-Res	Choice	
Forwarding Feature List	Seq.	A3 (note 1)
length indicator	14	0E
Forwarding Feature tag	Seq.	30 (note 1)
Forwarding Feature length	12	0C
Basic Service Code identifier	TeleserviceCode	83
Teleservice length	1	01
Teleservice code	AllSpeechTransmissionServices	10
SS-Status	Tag=84	84
SS-Status length	1	01
SS-Status code	Prov. Registered Active	07
Forwarded To Number Identifier	Tag=85	85
ISDN-AddressString length	4	04
AddressString type	International Number	91
AddressString	TBCD-String: 431234	34 21 43

Test 31.2.1.6.2. Interrogation rejected

MMI sequence: *#62#

Step 4: MS -> SS REGISTER

Contents	Value/remark	Coding
Length of FIE contents	13	0D
Component type tag	Invoke	A1 (note 1)
Component length	11	0B
Invoke ID tag		02
Invoke ID length	1	01
Invoke ID	Arbitrary	--
Operation Code tag		02
Operation Code length	1	01
Operation Code	InterrogateSS	0E
SS-ForBS		30 (note 1)
SS-ForBS length	3	03
SS-Code tag	Tag=4	04
SS-Code length	1	01
SS-Code	CFNRc	2B

Step 5: SS -> MS RELEASE COMPLETE

Contents	Value/remark	Coding
Length of FIE contents	8	08
Component type tag	Return Error	A3 (note 1)
Component length	6	06
Invoke ID tag		02
Invoke ID length	1	01
Invoke ID	As received	--
Error Code tag		02
Error Code length	1	01
Error Code	SS-NotAvailable	12

MMI sequence: *#67**13#

Step 11: MS -> SS REGISTER

Contents	Value/remark	Coding
Length of FIE contents	16	10
Component type tag	Invoke	A1 (note 1)
Component length	14	0E
Invoke ID tag		02
Invoke ID length	1	01
Invoke ID	Arbitrary	--
Operation code tag		02
Operation code length	1	01
Operation code	InterrogateSS	0E
SS-ForBS	Seq	30 (note 1)
SS-ForBS length	6	06
SS code tag	Tag=04	04
SS code length	1	01
SS code	CFB: CF on MS Busy	29
Basic Service Code identifier	TeleserviceCode	83
Teleservice length	1	01
Teleservice code	AllFacsimileServices	60

Step 12: SS -> MS RELEASE COMPLETE

Contents	Value/remark	Coding
Length of FIE contents	8	08
Component type tag	Reject	A4 (note 1)
Component length	indefinite	80
Invoke ID tag		02
Invoke ID length	1	01
Invoke ID	As received	--
Problem code tag	Tag=81	81
Problem code length	1	01
Invoke problem	Resource limitation	03
End-Of-Content Tag	0	00
Length Indicator	0	00

Test 31.2.1.7.1.1. Notification during an incoming call

Step 10 and 15: SS -> MS FACILITY

Contents	Value/remark	Coding
Length of FIE contents	18	12
Component type tag	Invoke	A1 (note 1)
Component length	16	10
Invoke ID tag		02
Invoke ID length	1	01
Invoke ID	Arbitrary	--
Operation Code tag		02
Operation Code length	1	01
Operation Code	NotifySS	10
SS-ForBS		30 (note 1)
SS-ForBS length	indefinite	80
SS-Code tag	Tag=81	81
SS-Code length	1	01
SS-Code	CFB	29
SS-Notification tag	Tag=85	85
SS-Notification length	1	01
SS-Notification	Incoming call forwarded	02
End-Of-Content Tag	0	00
Length Indicator	0	00

Test 31.2.1.7.1.2. Notification during an outgoing call

Step 9 : SS -> MS ALERTING

Contents	Value/remark	Coding
Length of FIE contents	18	12
Component type tag	Invoke	A1 (note 1)
Component length	indefinite	80
Invoke ID tag		02
Invoke ID length	1	01
Invoke ID	Arbitrary	00
Operation code tag		02
Operation code length	1	01
Operation code	NotifySS	10
NotifySS-Arg tag	Seq.	30 (note 1)
NotifyBS-Arg length	6	06
SS code tag	Tag=81	81
SS code length	1	01
SS code	CFU: Forw Unconditional	21
SS-Status	Tag=84	84
SS-Status length	1	01
SS-Status code	Prov. Registered Active	07
End-Of-Content Tag	0	00
Length Indicator	0	00

Step 10 : SS -> MS CONNECT

Contents	Value/remark	Coding
Length of FIE contents	18	12
Component type tag	Invoke	A1 (note 1)
Component length	16	10
Invoke ID tag		02
Invoke ID length	1	01
Invoke ID	Arbitrary	01
Operation code tag		02
Operation code length	1	01
Operation code	NotifySS	10
NotifySS-Arg tag	Seq.	30 (note 1)
NotifyBS-Arg length	indefinite	80
SS code tag	Tag=81	81
SS code length	1	01
SS code	CFC: Conditional Forw.	28
SS-Status	Tag=84	84
SS-Status length	1	01
SS-Status code	Prov. Registered Active	07
End-Of-Content Tag	0	00
Length Indicator	0	00

Test 31.2.1.7.2. Forwarded-to mobile subscriber side

Step 5 : SS -> MS SETUP

Contents	Value/remark	Coding
Length of FIE contents	18	12
Component type tag	Invoke	A1 (note 1)
Component length	indefinite	80
Invoke ID tag		02
Invoke ID length	1	01
Invoke ID	Arbitrary	00
Operation code tag		02
Operation code length	1	01
Operation code	NotifySS	10
NotifySS-Arg tag	Seq.	30 (note 1)
NotifyBS-Arg length	6	06
SS code tag	Tag=81	81
SS code length	1	01
SS code	CFNRc MS not reachable	2B
SS-Notification tag	Tag=85	85
SS-Notification length	1	01
SS-Notification	Forwarded call	01
End-Of-Content Tag	0	00
Length Indicator	0	00

Test 31.6.1.1. AOC time related charging/MS originated call

k=1 Step 11: SS -> MS CONNECT

Contents	Value/remark	Coding
Length of FIE contents	41	29
Component type tag	Invoke	A1 (note 1)
Component length	39	27
Invoke ID tag		02
Invoke ID length	1	01
Invoke ID	Arbitrary	--
Operation code tag		02
Operation code length	1	01
Operation code	ForwardChargeAdvice	7D
ForwardChargeAdviceArg	Seq.	30 (note 1)
ForwardChargeAdviceArg length	indefinite	80
SS code tag	Tag=80	80
SS code length	1	01
SS code	AoC-Charging	72
Charging Information	Tag=a1	A1 (note 1)
Charging Information length	24	18
e1 tag	Tag=81	81
e1 length	1	01
e1	Value = 6,0	3C
e2 tag	Tag=82	82
e2 length	2	02
e2	Value = 14,0	00 8C
e3 tag	Tag=83	83
e3 length	1	01
e3	Value = 1,0	64
e4 tag	Tag=84	84
e4 length	2	02
e4	Value = 25,0	00 FA
e5 tag	Tag=85	85
e5 length	1	01
e5	Value = 0,0	00
e6 tag	Tag=86	86
e6 length	1	01
e6	Value = 0,0	00
e7 tag	Tag=87	87
e7 length	2	02
e7	Value = 60,0	02 58
End-Of-Content Tag	0	00
Length Indicator	0	00

Step A13/B12: MS -> SS FACILITY

Contents	Value/remark	Coding
Length of FIE contents	5	05
Component type tag	Return Result	A2 (note 1)
Component length	3	03
Invoke ID tag		02
Invoke ID length	1	01
Invoke ID	As received	--

k=1...5: e-parameters

k-value	e-parameter values						
	e1	e2	e3	e4	e5	e6	e7
1	6	14	1	25	0	0	60
2	0	0	1	100	0	0	0
3	250	16	2	500	0	0	60
4	1	1	1	0	10	10	1
5	12,5	30	1	25	10	10	30

k-value	e-parameter coding						
	e1	e2	e3	e4	e5	e6	e7
1	3C	00 8C	64	00 FA	00	00	02 58
2	00	00	64	03 E8	00	00	00
3	09 C4	00 A0	00 C8	13 88	00	00	02 58
4	00 0A	00 0A	00 64	00 00	00 64	00 0A	00 0A
5	7D	01 2C	64	00 FA	64	0A	01 2C

Test 31.6.1.2. AOC time related charging/MS terminated call

k=1...5 Step 12: SS -> MS FACILITY e-parameters

k-value	e-parameter values						
	e1	e2	e3	e4	e5	e6	e7
1	0	0	0	0	0	0	0
2	0	0	1	100	0	0	0
3	6	14	1	25	0	0	60
4	1	1	1	0	0	0	1
5	12,5	30	1	25	0	0	30

k-value	e-parameter coding						
	e1	e2	e3	e4	e5	e6	e7
1	00	00	00	00	00	00	00
2	00	00	64	03 E8	00	00	00
3	3C	00 8C	64	00 FA	00	00	02 58
4	0A	0A	64	00	00	00	0A
5	7D	01 2C	00 64	FA	00	00	01 2C

Test 31.6.1.5. Change in charging information during a call

Step A12: SS -> MS FACILITY (initial CAI message)

Contents	Value/remark	Coding
CAI header element		
e1 tag	Tag=81	81
e1 length	1	01
e1	Value = 10,0	64
e2 tag	Tag=82	82
e2 length	2	02
e2	Value = 28,0	01 18
e3 tag	Tag=83	83
e3 length	1	01
e3	Value = 1,0	64
e4 tag	Tag=84	84
e4 length	1	01
e4	Value = 10,0	64
e5 tag	Tag=85	85
e5 length	1	01
e5	Value = 0,0	00
e6 tag	Tag=86	86
e6 length	1	01
e6	Value = 0,0	00
e7 tag	Tag=87	87
e7 length	2	02
e7	Value = 60,0	02 58

Step A12: SS -> MS FACILITY (subsequent CAI message)

Contents	Value/remark	Coding
CAI header element		
e1	Value = 10,0	64
e2	Value = 14,0	00 8C
e3	Value = 1,0	64
e4	Value = 5,0	32
e5	Value = 0,0	00
e6	Value = 0,0	00
e7	Value = 60,0	02 58

Test 31.6.1.6. Different formats of charging information

k=1 SS -> MS FACILITY

Contents	Value/remark	Coding
CAI header element		
e1	Value = 10,0	64
e2	Value = 40,0	01 90
e3	Value = 1,0	64
e4	Value = 0,0	00
e5	Value = 0,0	00
e6	Value = 0,0	00
e7	Value = 0,0	00 00

k=2 SS -> MS FACILITY

Contents	Value/remark	Coding
Length of FIE contents	27	1B
Component type tag	Invoke	A1 (note 1)
Component length	25	19
Invoke ID tag		02
Invoke ID length	1	01
Invoke ID	Arbitrary	--
Operation code tag		02
Operation code length	1	01
Operation code	forwardChargeAdvice	7D
ForwardChargeAdviceArg	Seq.	30 (note 1)
ForwardChargeAdviceArg length	17	11
SS code tag	Tag=80	80
SS code length	1	01
SS code	AoC-Charging	72
Charging Information	Tag=a1	A1 (note 1)
Charging Information length	indefinite	80
e1 tag	Tag=81	81
e1 length	1	01
e1	Value = 10,0	64
e2 tag	Tag=82	82
e2 length	2	02
e2	Value = 40,0	01 90
e3 tag	Tag=83	83
e3 length	1	01
e3	Value = 1,0	64
End-Of-Content Tag	0	00
Length Indicator	0	00

Test 31.6.1.7. AOC on a Call Hold call

Step 11: SS -> MS CONNECT

Contents	Value/remark	Coding
CAI header element		
e1	Value = 7,0	46
e2	Value = 40,0	01 90
e3	Value = 1,0	64
e4	Value = 0,0	00
e5	Value = 0,0	00
e6	Value = 0,0	00
e7	Value = 0,0	00

Step 20: SS -> MS CONNECT

Contents	Value/remark	Coding
CAI header element		
e1	Value = 13,0	00 82
e2	Value = 40,0	01 90
e3	Value = 1,0	64
e4	Value = 0,0	00
e5	Value = 0,0	00
e6	Value = 0,0	00
e7	Value = 0,0	00

Test 31.6.1.8. AOC on a Multi-party call

Step 11 & 20: SS -> MS CONNECT

k-value	e-parameter values						
	e1	e2	e3	e4	e5	e6	e7
1	19	40	1	0	0	0	0
2	29	40	1	0	0	0	0

k-value	e-parameter coding						
	e1	e2	e3	e4	e5	e6	e7
1	00 BE	01 90	64	00	00	00	00
2	01 22	01 90	64	00	00	00	00

Step 23: MS -> SS FACILITY

Contents	Value/remark	Coding
Length of FIE contents	8	08
Component type tag	Invoke	A1 (note 1)
Component length	6	06
Invoke ID tag		02
Invoke ID length	1	01
Invoke ID	Arbitrary	--
Operation code tag		02
Operation code length	1	01
Operation code	BuildMPTY	7C

Step 24: SS -> MS FACILITY

Contents	Value/remark	Coding
Length of FIE contents	7	07
Component type tag	Return Result	A2 (note 1)
Component length	indefinite	80
Invoke ID tag		02
Invoke ID length	1	01
Invoke ID	As received	--
End-Of-Content Tag	0	00
Length Indicator	0	00

Test 31.6.2. Charge Storage

31.6.2.1 Removal of SIM during an active call

and 31.6.2.2 Interruption of power supply during an active call

and 31.6.2.3 MS going out of coverage during an active AoCC call

Step A11: SS -> MS CONNECT

Contents	Value/remark	Coding
Length of FIE contents	39	27
Component type tag	Invoke	A1 (note 1)
Component length	indefinite	80
Invoke ID tag		02
Invoke ID length	1	01
Invoke ID	Arbitrary	--
Operation code tag		02
Operation code length	1	01
Operation code	forwardChargeAdvice	7D
ForwardChargeAdviceArg	Seq.	30 (note 1)
ForwardChargeAdviceArg length	27	1B
SS code tag	Tag=80	80
SS code length	1	01
SS code	AoC-Charging	72
Charging Information	Tag=a1	A1 (note 1)
Charging Information length	22	16
e1 tag	Tag=81	81
e1 length	1	01
e1	Value = 10,0	64
e2 tag	Tag=82	82
e2 length	2	02
e2	Value = 55,0	02 26
e3 tag	Tag=83	83
e3 length	1	01
e3	Value = 1,0	64
e4 tag	Tag=84	84
e4 length	1	01
e4	Value = 10,0	64
e5 tag	Tag=85	85
e5 length	1	01
e5	Value = 0,0	00
e6 tag	Tag=86	86
e6 length	1	01
e6	Value = 0,0	00
e7 tag	Tag=87	87
e7 length	1	01
e7	Value = 10,0	64
End-Of-Content Tag	0	00
Length Indicator	0	00

Test 31.6.2.4. ACMmax operation/Mobile Originating

k=1 Step A11: SS -> MS FACILITY

Contents	Value/remark	Coding
Length of FIE contents	41	29
Component type tag	Invoke	A1 (note 1)
Component length	indefinite	80
Invoke ID tag		02
Invoke ID length	1	01
Invoke ID	Arbitrary	--
Operation code tag		02
Operation code length	1	01
Operation code	ForwardChargeAdvice	7D
ForwardChargeAdviceArg	Seq.	30 (note 1)
ForwardChargeAdviceArg length	27	1B
SS code tag	Tag=80	80
SS code length	1	01
SS code	AoC-Charging	72
Charging Information	Tag=a1	A1 (note 1)
Charging Information length	22	16
e1 tag	Tag=81	81
e1 length	1	01
e1	Value = 1,0	0A
e2 tag	Tag=82	82
e2 length	2	02
e2	Value = 30,0	01 2C
e3 tag	Tag=83	83
e3 length	1	01
e3	Value = 1,0	64
e4 tag	Tag=84	84
e4 length	1	01
e4	Value = 0,0	00
e5 tag	Tag=85	85
e5 length	1	01
e5	Value = 0,0	00
e6 tag	Tag=86	86
e6 length	1	01
e6	Value = 0,0	00
e7 tag	Tag=87	87
e7 length	1	01
e7	Value = 0,0	00
End-Of-Content Tag	0	00
Length Indicator	0	00

k=2 Step A11: SS -> MS FACILITY

Contents	Value/remark	Coding
Length of FIE contents	40	28
Component type tag	Invoke	A1 (note 1)
Component length	indefinite	80
Invoke ID tag		02
Invoke ID length	1	01
Invoke ID	Arbitrary	--
Operation code tag		02
Operation code length	1	01
Operation code	ForwardChargeAdvice	7D
ForwardChargeAdviceArg	Seq.	30 (note 1)
ForwardChargeAdviceArg length	26	1A
SS code tag	Tag=80	80
SS code length	1	01
SS code	AoC-Charging	72
Charging Information	Tag=a1	A1 (note 1)
Charging Information length	21	15
e1		
e1 tag	Tag=81	81
e1 length	1	01
e1	Value = 0,0	00
e2		
e2 tag	Tag=82	82
e2 length	1	01
e2	Value = 0,0	00
e3		
e3 tag	Tag=83	83
e3 length	1	01
e3	Value = 0,0	00
e4		
e4 tag	Tag=84	84
e4 length	1	01
e4	Value = 0,0	00
e5		
e5 tag	Tag=85	85
e5 length	1	01
e5	Value = 0,0	00
e6		
e6 tag	Tag=86	86
e6 length	1	01
e6	Value = 0,0	00
e7		
e7 tag	Tag=87	87
e7 length	1	01
e7	Value = 0,0	00
End-Of-Content Tag	0	00
Length Indicator	0	00

Test 31.6.2.5 ACMmax operation/Mobile Terminating

k=1 Step A13: SS -> MS FACILITY, k=2 Step B13: SS -> MS FACILITY

Contents	Value/remark	Coding
Length of FIE contents	41	29
Component type tag	Invoke	A1 (note 1)
Component length	indefinite	80
Invoke ID tag		02
Invoke ID length	1	01
Invoke ID	Arbitrary	--
Operation code tag		02
Operation code length	1	01
Operation code	ForwardChargeAdvice	7D
ForwardChargeAdviceArg	Seq.	30 (note 1)
ForwardChargeAdviceArg length	27	1B
SS code tag	Tag=80	80
SS code length	1	01
SS code	AoC-Charging	72
Charging Information	Tag=a1	A1 (note 1)
Charging Information length	28	1C
e1 tag	Tag=81	81
e1 length	1	01
e1	Value = 1,0	00 0A
e2 tag	Tag=82	82
e2 length	2	02
e2	Value = 30,0	01 2C
e3 tag	Tag=83	83
e3 length	1	01
e3	Value = 1,0	64
e4 tag	Tag=84	84
e4 length	1	01
e4	Value = 0,0	00
e5 tag	Tag=85	85
e5 length	1	01
e5	Value = 0,0	00
e6 tag	Tag=86	86
e6 length	1	01
e6	Value = 0,0	00
e7 tag	Tag=87	87
e7 length	1	01
e7	Value = 0,0	00
End-Of-Content Tag	0	00
Length Indicator	0	00

k=3 Step A13: SS -> MS FACILITY

Contents	Value/remark	Coding
Length of FIE contents	40	28
Component type tag	Invoke	A1 (note 1)
Component length	indefinite	80
Invoke ID tag		02
Invoke ID length	1	01
Invoke ID	Arbitrary	--
Operation code tag		02
Operation code length	1	01
Operation code	ForwardChargeAdvice	7D
ForwardChargeAdviceArg	Seq.	30 (note 1)
ForwardChargeAdviceArg length	26	1A
SS code tag	Tag=80	80
SS code length	1	01
SS code	AoC-Charging	72
Charging Information	Tag=a1	A1 (note 1)
Charging Information length	21	15
e1		
e1 tag	Tag=81	81
e1 length	1	01
e1	Value = 0,0	00
e2		
e2 tag	Tag=82	82
e2 length	1	01
e2	Value = 0,0	00
e3		
e3 tag	Tag=83	83
e3 length	1	01
e3	Value = 0,0	00
e4		
e4 tag	Tag=84	84
e4 length	1	01
e4	Value = 0,0	00
e5		
e5 tag	Tag=85	85
e5 length	1	01
e5	Value = 0,0	00
e6		
e6 tag	Tag=86	86
e6 length	1	01
e6	Value = 0,0	00
e7		
e7 tag	Tag=87	87
e7 length	1	01
e7	Value = 0,0	00
End-Of-Content Tag	0	00
Length Indicator	0	00

Test 31.8.1.1. Registration of a password accepted

MMI sequence:**03*330*1234*9876*9876#

Step 6: MS -> SS REGISTER

Contents	Value/remark	Coding
Length of FIE contents	11	0B
Component type tag	Invoke	A1 (note 1)
Component length	9	09
Invoke ID tag		02
Invoke ID length	1	01
Invoke ID	Arbitrary	--
Operation Code tag		02
Operation Code length	1	01
Operation Code	RegisterPasswordSS	11
SS-Code tag	Tag=4	04
SS-Code length	1	01
SS-Code	B: All barring services	90

Step 7: SS -> MS FACILITY

Contents	Value/remark	Coding
Length of FIE contents	14	0E
Component type tag	Invoke	A1 (note 1)
Component length	12	0C
Invoke ID tag		02
Invoke ID length	1	01
Invoke ID	Arbitrary	--
Linked ID tag		80
Linked ID length	1	01
Linked ID	As received	--
Operation Code tag		02
Operation Code length	1	01
Operation Code	GetPasswordSS	12
Guidance information	Enumerated	0A
Guidance length	1	01
Guidance	enter password	00

Step 9: MS -> SS FACILITY

Contents	Value/remark	Coding
Length of FIE contents	16	10
Component type tag	Return Result	A2 (note 1)
Component length	14	0E
Invoke ID tag		02
Invoke ID length	1	01
Invoke ID	As received	--

Contents	Value/remark	Coding
Sequence tag		30 (note 1)
Sequence length	9	09
Operation Code tag		02
Operation Code length	1	01
Operation Code	GetPasswordSS	12
Password tag	Numeric String	12
Password length	4	04
Password	Password = 1234	31 32 33 34

Step 10 & 12: FACILITY

Contents	Value/remark	Coding
Guidance	Enter New Password	01

Contents	Value/remark	Coding
Password	Password = 9876	39 38 37 36

Step 13 & 15: FACILITY

Contents	Value/remark	Coding
Guidance	EnterNewPasswordAgain	02

Contents	Value/remark	Coding
Password	Password = 9876	39 38 37 36

Step 16: SS -> MS RELEASE COMPLETE

Contents	Value/remark	Coding
Length of FIE contents	20	14
Component type tag	Return Result	A2 (note 1)
Component length	indefinite	80
Invoke ID tag		02
Invoke ID length	1	01
Invoke ID	As received	--
Sequence tag		30 (note 1)
Sequence length	indefinite	80
Operation Code tag		02
Operation Code length	1	01
Operation Code	RegisterPasswordSS	11
Password tag	Numeric String	12
Password length	4	04
Password	Password = 1234	31 32 33 34
End-Of-Content Tag	0	00
Length Indicator	0	00
End-Of-Content Tag	0	00
Length Indicator	0	00

Test 31.8.1.2. Registration of a password rejected

MMI sequence:**03*330*1234*9876*987X#

Test 31.8.1.2.1. Rejection after invoke of the RegisterPassword operation

Step 4: MS -> SS REGISTER

Contents	Value/remark	Coding
Length of FIE contents	11	0B
Component type tag	Invoke	A1 (note 1)
Component length	9	09
Invoke ID tag		02
Invoke ID length	1	01
Invoke ID	Arbitrary	--
Operation Code tag		02
Operation Code length	1	01
Operation Code	RegisterPasswordSS	11
SS-Code tag	Tag=4	04
SS-Code length	1	01
SS-Code	B: All barring services	90

Step 5: SS -> MS RELEASE COMPLETE

Contents	Value/remark	Coding
Length of FIE contents	8	08
Component type tag	Return Error	A3 (note 1)
Component length	6	06
Invoke ID tag		02
Invoke ID length	1	01
Invoke ID	As received	--
Error Code tag	Tag=2	02
Error Code length	1	01
Error Code	SS subscription violation	13

Test 31.8.1.2.2. Rejection after password check with negative result

Step 6: SS -> MS RELEASE COMPLETE

Contents	Value/remark	Coding
Length of FIE contents	10	0A
Component type tag	Return Error	A3 (note 1)
Component length	indefinite	80
Invoke ID tag		02
Invoke ID length	1	01
Invoke ID	As received	--
Error Code tag	Tag=2	02
Error Code length	1	01
Error Code	Negative Password Check	26
End-Of-Content Tag	0	00
Length Indicator	0	00

Test 31.8.1.2.3. Rejection after new password mismatch

Step 14: SS -> MS RELEASE COMPLETE

Contents	Value/remark	Coding
Length of FIE contents	11	0B
Component type tag	Return Error	A3 (note 1)
Component length	9	09
Invoke ID tag		02
Invoke ID length	1	01
Invoke ID	As received	--
Error Code tag	Tag=2	02
Error Code length	1	01
Error Code	PW-Registration Failure	25
pw-Registration Failure cause	Tag=04	04 (note 2)
pw-Registration Failure length	1	01
pw-Registration Failure	New Password Mismatch	02

NOTE 2: This element is described in Rec. 3GPP TS 04.80 subclause 4.3.2.12, but there is no ASN.1 description in subclause 4.5. Description given in the informative annex A should be put at the end of subclause 4.5.

Test 31.8.3.1. Activation accepted

MMI sequence: *33*1234*22#

Step 6: MS -> SS REGISTER

Contents	Value/remark	Coding
Length of FIE contents	16	10
Component type tag	Invoke	A1 (note 1)
Component length	14	0E
Invoke ID tag		02
Invoke ID length	1	01
Invoke ID	Arbitrary (01)	--
Operation code tag		02
Operation code length	1	01
Operation code	ActivateSS	0C
SS-ForBS	Seq.	30 (note 1)
SS-ForBS length	6	06
SS code tag	Tag=04	04
SS code length	1	01
SS code	BAOC	92
Basic Service Code identifier	BearerserviceCode	82
BearerService length	1	01
BearerService code	AllSynchronousServices	68

Step 7: SS -> MS FACILITY

Contents	Value/remark	Coding
Length of FIE contents	14	0E
Component type tag	Invoke	A1 (note 1)
Component length	12	0C
Invoke ID tag		02
Invoke ID length	1	01
Invoke ID	Arbitrary (02)	--
Linked ID tag		80
Linked ID length	1	01
Linked ID	As received (01)	--
Operation code tag		02
Operation code length	1	01
Operation code	Getpassword	12
Guidance tag	Enumerated	0a
Guidance length	1	01
Guidance	Enter Password	00

Step 8: MS -> SS FACILITY

Contents	Value/remark	Coding
Length of FIE contents	16	10
Component type tag	Return Result	A2 (note 1)
Component length	14	0E
Invoke ID tag		02
Invoke ID length	1	01
Invoke ID	As received (02)	--
Sequence tag		30 (note 1)
Sequence length	9	09
Operation code tag		02
Operation code length	1	01
Operation code	Getpassword	12
Password tag	NumericString	12
Password length	4	04
Password	Password = 1234	31 32 33 34

Step 9: SS -> MS RELEASE COMPLETE

This message is coded to give a complete answer to the MS request. Shorter message can also be used (see last paragraph).

Contents	Value/remark	Coding
Length of FIE contents	29	1D
Component type tag	Return Result	A2 (note 1)
Component length	27	1B
Invoke ID tag		02
Invoke ID length	1	01
Invoke ID	As received (01)	--
Sequence tag		30 (note 1)
Sequence length	indefinite	80
Operation code tag		02
Operation code length	1	01
Operation code	ActivateSS	0C
SS information		
CallBarringInfo	Tag=a1	A1 (note 1)
CallBarringInfo length	indefinite	80
SS code tag	Tag=04	04
SS code length	1	01
SS code	BAOC	92
CallBarringFeature List	Seq.	30 (note 1)
Length indicator	8	08
CallBarring Feature tag	Seq.	30 (note 1)
CallBarring Feature length	6	06
Basic Service Code identifier	BearerserviceCode	82
BearerService length	1	01
BearerService code	AllSynchronousServices	68
SS-Status	Tag=84	84
SS-Status length	1	01
SS-Status code	Prov. Registered Active	07
End-Of-Content Tag	0	00
Length Indicator	0	00
End-Of-Content Tag	0	00
Length Indicator	0	00

MMI sequence: *351*1234#

Step 17: MS -> SS REGISTER

Contents	Value/remark	Coding
Length of FIE contents	13	0D
Component type tag	Invoke	A1 (note 1)
Component length	11	0B
Invoke ID tag		02
Invoke ID length	1	01
Invoke ID	Arbitrary	--
Operation code tag		02
Operation code length	1	01
Operation code	ActivateSS	0C
SS-ForBS	Seq	30 (note 1)
SS-ForBS length	3	03
SS code tag	Tag=04	04
SS code length	1	01
SS code	BICRoam	9B

Step 20: SS -> MS RELEASE COMPLETE

Contents	Value/remark	Coding
Length of FIE contents	26	1A
Component type tag	Return Result	A2 (note 1)
Component length	24	18
Invoke ID tag		02
Invoke ID length	1	01
Invoke ID	As received	--
Sequence identifier		30 (note 1)
Sequence length	19	13
Operation code tag		02
Operation code length	1	01
Operation code	ActivateSS	0C
SS-Information		
CallBarringInfo	Tag=a1	A1 (note 1)
CallBarringInfo length	14	0E
SS code tag	Tag=04	04
SS code length	1	01
SS code	BICRoam	9B
CallBarringFeature List	Seq.	30 (note 1)
Length indicator	indefinite	80
CallBarring Feature tag	Seq.	30 (note 1)
CallBarring Feature length	indefinite	80
SS-Status	Tag=84	84
SS-Status length	1	01
SS-Status code	Prov. Registered Active	07
End-Of-Content Tag	0	00
Length Indicator	0	00
End-Of-Content Tag	0	00
Length Indicator	0	00

Step 9 & 20: short messages

Step 10 and 22 messages can be coded using this shorter form:

Message containing only the "Return result"

Contents	Value/remark	Coding
Length of FIE contents	5	05
Component type tag	Return Result	A2 (note 1)
Component length	3	03
Invoke ID tag		02
Invoke ID length	1	01
Invoke ID	As received	--

Message containing the "Return result" and the "Operation Code"

Contents	Value/remark	Coding
Length of FIE contents	12	0C
Component type tag	Return Result	A2 (note 1)
Component length	indefinite	80
Invoke ID tag		02
Invoke ID length	1	01
Invoke ID	As received	--
Sequence identifier		30 (note 1)
Sequence length	3	03
Operation code tag		02
Operation code length	1	01
Operation code	ActivateSS	0C
End-Of-Content Tag	0	00
Length Indicator	0	00

Test 31.8.3.2.1. Rejection after invoke of ActivateSS operation

MMI sequence: *331*1234#

Step 4: MS -> SS REGISTER

Contents	Value/remark	Coding
Length of FIE contents	13	0D
Component type tag	Invoke	A1 (note 1)
Component length	11	0B
Invoke ID tag		02
Invoke ID length	1	01
Invoke ID	Arbitrary	--
Operation code tag		02
Operation code length	1	01
Operation code	ActivateSS	0C
SS-ForBS	Seq	30 (note 1)
SS-ForBS length	3	03
SS code tag	Tag=04	04
SS code length	1	01
SS code	BOIC	93

Step 5: SS -> MS RELEASE COMPLETE

Contents	Value/remark	Coding
Length of FIE contents	8	08
Component type tag	Return Error	A3 (note 1)
Component length	6	06
Invoke ID tag		02
Invoke ID length	1	01
Invoke ID	As received	--
Error code tag		02
Error code length	1	01
Error code	SS Subscription Violation	13

Test 31.8.3.2.2. Rejection after use of password procedure

MMI sequence: *35*1234#

Step 4: MS -> SS REGISTER

Contents	Value/remark	Coding
Length of FIE contents	13	0D
Component type tag	Invoke	A1 (note 1)
Component length	11	0B
Invoke ID tag		02
Invoke ID length	1	01
Invoke ID	Arbitrary	--
Operation code tag		02
Operation code length	1	01
Operation code	ActivateSS	0C
SS-ForBS	Seq	30 (note 1)
SS-ForBS length	3	03
SS code tag	Tag=04	04
SS code length	1	01
SS code	BAIC	9A

Step 7: SS -> MS RELEASE COMPLETE

Contents	Value/remark	Coding
Length of FIE contents	10	0A
Component type tag	Return Error	A3 (note 1)
Component length	indefinite	80
Invoke ID tag		02
Invoke ID length	1	01
Invoke ID	As received	--
Error code tag		02
Error code length	1	01
Error code	NegativePasswordCheck	26
End-Of-Content Tag	0	00
Length Indicator	0	00

Test 31.8.4.1. Deactivation accepted

MMI sequence: #330*1234*11#

Step 6: MS -> SS REGISTER

Contents	Value/remark	Coding
Length of FIE contents	16	10
Component type tag	Invoke	A1 (note 1)
Component length	14	0D
Invoke ID tag		02
Invoke ID length	1	01
Invoke ID	Arbitrary	--
Operation code tag		02
Operation code length	1	01
Operation code	DeactivateSS	0D
SS-ForBS	Seq	30 (note 1)
SS-ForBS length	3	03
SS code tag	Tag=04	04
SS code length	1	01
SS code	B: All barring services	90
Basic Service Code identifier	TeleserviceCode	83
Teleservice length	1	01
Teleservice code	AllSpeechTransmission	10

Step 10: SS -> MS RELEASE COMPLETE

Contents	Value/remark	Coding
Length of FIE contents	21	15
Component type tag	Return Result	A2 (note 1)
Component length	indefinite	80
Invoke ID tag		02
Invoke ID length	1	01
Invoke ID	As received	--
Sequence identifier		30 (note 1)
Sequence length	12	0C
Operation code tag		02
Operation code length	1	01
Operation code	DeactivateSS	0D
SS-Information		
CallBarringInfo	Tag=a1	A1 (note 1)
CallBarringInfo length	7	07
CallBarringFeature List	Seq.	30 (note 1)
Length indicator	5	05
CallBarring Feature tag	Seq.	30 (note 1)
CallBarring Feature length	3	03
Basic Service Code Identifier	TeleserviceCode	83
Teleservice Length	1	01
Teleservice code	AllSpeechTransmission	10
End-Of-Content Tag	0	00
Length Indicator	0	00

MMI sequence: #333*1234*13#

Step 17: MS -> SS REGISTER

Contents	Value/remark	Coding
Length of FIE contents	16	10
Component type tag	Invoke	A1 (note 1)
Component length	14	0E
Invoke ID tag		02
Invoke ID length	1	01
Invoke ID	Arbitrary	--
Operation code tag		02
Operation code length	1	01
Operation code	DeactivateSS	0D
SS-ForBS		
SS-ForBS length	Seq	30 (note 1)
SS code tag	Tag=04	04
SS code length	1	01
SS code	BO	91
Basic Service Code identifier	TeleserviceCode	83
Teleservice length	1	01
Teleservice code	AllFacsimileServices	60

Step 21: MS -> SS RELEASE COMPLETE

Contents	Value/remark	Coding
Length of FIE contents	21	15
Component type tag	Return Result	A2 (note 1)
Component length	indefinite	80
Invoke ID tag		02
Invoke ID length	1	01
Invoke ID	As received	--
Sequence identifier		30 (note 1)
Sequence length	12	0C
Operation code tag		02
Operation code length	1	01
Operation code	DeactivateSS	0D
SS-Information		
CallBarringInfo	Tag=a1	A1 (note 1)
CallBarringInfo length	7	07
CallBarringFeature List	Seq.	30 (note 1)
Length indicator	5	05
CallBarring Feature tag	Seq.	30 (note 1)
CallBarring Feature length	3	03
Basic Service Code Identifier	TeleserviceCode	83
Teleservice Length	1	01
Teleservice code	AllFacsimileServices	60
End-Of-Content Tag	0	00
Length Indicator	0	00

Test 31.8.4.2.1. Deactivation rejected after invoke operation

MMI sequence: *#353*1234#

Step 4: MS -> SS REGISTER

Contents	Value/remark	Coding
Length of FIE contents	13	0D
Component type tag	Invoke	A1 (note 1)
Component length	11	0B
Invoke ID tag		02
Invoke ID length	1	01
Invoke ID	Arbitrary	--
Operation code tag		02
Operation code length	1	01
Operation code	DeactivateSS	0D
SS-ForBS	Seq	30 (note 1)
SS-ForBS length	3	03
SS code tag	Tag=04	04
SS code length	1	01
SS code	BI	99

Step 5: SS -> MS RELEASE COMPLETE

Contents	Value/remark	Coding
Length of FIE contents	10	0A
Component type tag	Return Error	A3 (note 1)
Component length	indefinite	80
Invoke ID tag		02
Invoke ID length	1	01
Invoke ID	As received	--
Error code tag		02
Error code length	1	01
Error code	SS Subscription Violation	13
End-Of-Content Tag	0	00
Length Indicator	0	00

Test 31.8.4.2.2. Deactivation rejection after password operation

MMI sequence: *#332*1234#

Step 4: MS -> SS REGISTER

Contents	Value/remark	Coding
Length of FIE contents	13	0D
Component type tag	Invoke	A1 (note 1)
Component length	11	0B
Invoke ID tag		02
Invoke ID length	1	01
Invoke ID	Arbitrary	--
Operation code tag		02
Operation code length	1	01
Operation code	DeactivateSS	0D
SS-ForBS	Seq	30 (note 1)
SS-ForBS length	3	03
SS code tag	Tag=04	04
SS code length	1	01
SS code	BOICExHome	94

Step 7: SS -> MS RELEASE COMPLETE

Contents	Value/remark	Coding
Length of FIE contents	8	08
Component type tag	Return Error	A3 (note 1)
Component length	6	06
Invoke ID tag		02
Invoke ID length	1	01
Invoke ID	As received	--
Error code tag		02
Error code length	1	01
Error code	NegativePasswordCheck	26

Test 31.8.6.1. Interrogation accepted

MMI sequence: *#35#

Step 6: MS -> SS REGISTER

Contents	Value/remark	Coding
Length of FIE contents	13	0D
Component type tag	Invoke	A1 (note 1)
Component length	11	0B
Invoke ID tag		02
Invoke ID length	1	01
Invoke ID	Arbitrary	--
Operation code tag		02
Operation code length	1	01
Operation code	InterrogateSS	0E
SS-ForBS	Seq	30 (note 1)
SS-ForBS length	3	03
SS code tag	Tag=04	04
SS code length	1	01
SS code	BAIC	9A

Step 10: SS -> MS RELEASE COMPLETE

Contents	Value/remark	Coding
Length of FIE Contents	15	0F
Component type tag	Return Result	A2
Component length	13	0D
Invoke ID tag		02
Invoke ID length	1	01
Invoke ID	As received	--
Sequence tag		30
Sequence length	8	08
Operation Code tag		02
Operation Code length	1	01
Operation Code	InterrogateSS	0E
InterrogateSS-Res	Choice	
BasicServiceGroupList tag	Seq.	A2
BasicServiceGroupList length	3	03
BasicService Code identifier	TeleserviceCode	83
Teleservice length	1	01
Teleservice code	Telephony	11

MMI sequence: *#332#

Step 17: MS -> SS REGISTER

Contents	Value/remark	Coding
Length of FIE Contents	13	0D
Component type tag	Invoke	A1
Component length	11	0B
Invoke ID tag		02
Invoke ID length	1	01
Invoke ID	Arbitrary	--
Operation Code tag		02
Operation Code length	1	01
Operation Code	InterrogateSS	0E
SS-ForBS	Seq	30
SS-ForBS length	3	03
SS-Code tag	Tag=4	04
SS-Code length	1	01
SS-Code	BOICExHome	94

Step 21: SS -> MS RELEASE COMPLETE

Contents	Value/remark	Coding
Length of FIE Contents	13	0D
Component type tag	Return Result	A2
Component length	11	0B
Invoke ID tag		02
Invoke ID length	1	01
Invoke ID	As received	--
Sequence tag		30
Sequence length	6	06
Operation Code tag		02
Operation Code length	1	01
Operation Code	InterrogateSS	0E
InterrogateSS-Res	Choice	
SS-Status	Tag=80	80
SS-Status length	1	01
SS-Status	Prov., Registered, Deactive	06

Test 31.8.6.2. Interrogation rejected

MMI sequence: *#351#

Step 4: MS -> SS REGISTER

Contents	Value/remark	Coding
Length of FIE Contents	13	0D
Component type tag	Invoke	A1
Component length	11	0B
Invoke ID tag		02
Invoke ID length	1	01
Invoke ID	Arbitrary	--
Operation Code tag		02
Operation Code length	1	01
Operation Code	InterrogateSS	0E
SS-ForBS	Seq	30
SS-ForBS length	3	03
SS-Code tag	Tag=4	04
SS-Code length	1	01
SS-Code	BICRoam	9B

Step 5: SS -> MS RELEASE COMPLETE

Contents	Value/remark	Coding
Length of FIE Contents	10	0A
Component type tag	Return Error	A3
Component length	indefinite	80
Invoke ID tag		02
Invoke ID length	1	01
Invoke ID	As received	--
Error code tag		02
Error code length	1	01
Error code	SS_NotAvailable	12
End-Of-Content Tag	0	00
Length Indicator	0	00

MMI sequence: *#331#

Step 11: MS -> SS REGISTER

Contents	Value/remark	Coding
Length of FIE Contents	13	0D
Component type tag	Invoke	A1
Component length	11	0B
Invoke ID tag		02
Invoke ID length	1	01
Invoke ID	Arbitrary	--
Operation Code tag		02
Operation Code length	1	01
Operation Code	InterrogateSS	0E
SS-ForBS	Seq	30
SS-ForBS length	3	03
SS-Code tag	Tag=4	04
SS-Code length	1	01
SS-Code	BOIC	93

Step 12: SS -> MS RELEASE COMPLETE

Contents	Value/remark	Coding
Length of FIE Contents	8	08
Component type tag	Reject	A4
Component length	6	06
Invoke ID tag		02
Invoke ID length	1	01
Invoke ID	As received	--
Problem code tag	Tag=81	81
Problem code length	1	01
Invoke problem code	Resource limitation	03

Test 31.8.7. Normal operation

Incoming call

Step 6: MS -> SS RELEASE COMPLETE

Contents	Value/remark	Coding
Length of FIE contents	16	10
Component type tag	Invoke	A1 (note 1)
Component length	14	0E
Invoke ID tag		02
Invoke ID length	1	01
Invoke ID	Arbitrary	--
Operation code tag		02
Operation code length	1	01
Operation code	NotifySS	10
NotifySS-Arg tag	Seq.	30 (note 1)
NotifySS-Arg length	6	06
SS code tag	Tag=81	81
SS code length	1	01
SS code	BI	99
SS-Status	Tag=84	84
SS-Status length	1	01
SS-Status code	Prov. Registered Active	07

Test 31.9. Registration accepted of a USSD

MMI sequence: **00#

Contents	Value/remark	Coding
Length of FIE contents	15	0F
Component type tag	Invoke	A1 (note 1)
Component length	13	0D
Invoke ID tag		02
Invoke ID length	1	01
Invoke ID	Arbitrary	--
Operation Code tag		02
Operation Code length	1	01
Operation Code	ProcessUSSDSS	0A
IA5 String tag	Tag=16	16
IA5 String length	5	05
Content	**00#	2A 2A 30 30 23

31.12 eMLPP Service

This subclause is applicable to the mobile stations supporting eMLPP service. The eMLPP is applicable to teleservices 1x, 6x, 9x and bearer services 2x, 3x, 4x, 5x.

For an MS supporting speech the test procedures in subclauses 31.12.1 and 31.12.2 are performed for full rate speech (teleservice 11, telephony). For an MS not supporting speech but supporting at least one of telecommunication services (TS6x, BS2x, BS3x, BS4x, BS5x), for each of the test procedures 31.12.1 and 31.12.2 a full rate service supported by the MS (see PICS/PIXIT statement) is chosen, and the test is performed corresponding to that service.

31.12.1 eMLPP Service / priority level of MO call

31.12.1.1 Conformance requirement

For the MS supporting MO calls:

1. Mobile stations indicate the priority of their call in the signalling that takes place during the call establishment process.
2. The MS shall verify the selected priority level against the priority levels stored in the SIM. If the selected priority is not allowed, then the priority of the call shall be modified to that of the nearest allowed priority level below the requested level.
3. In case of no priority selection or use of a non-compatible Mobile Station the Mobile Station shall send a standard service request message.
4. Signalling information required for the prioritisation at mobile originating call establishment. (see figure 1 of 3GPP TS 04.67 subclause 4.1.1) and Signalling information between the network and the calling mobile station required for the prioritisation in case of a VGCS or VBS call (figure 4 of 3GPP TS 04.67 subclause 4.1.4).
5. The user or the network may wish to omit or postpone authentication and ciphering in order to provide for a faster call set-up.

Reference(s)

3GPP TS 03.67 subclauses 11.3.1.1, 11.3.1.2, 11.6 and 11.3.1.3.

3GPP TS 02.67 clause 4.

3GPP TS 04.67 subclauses 4.1.1 and 4.1.4.

31.12.1.2 Test purpose

For the MS supporting MO, to verify that:

1. When user selects priority level for normal MO call, the priority level is indicated in the signalling message.

2. The MS verifies the selected priority level against the priority levels stored in the SIM. If the selected priority is not allowed, then the priority of the call shall be modified to that of the nearest allowed priority level below the requested level.
3. If the user does not select a priority level, the priority level is not indicated in the signalling message.
4. If a priority selection is performed by the user the MS provides the priority level information element in L3-MM CM SERVICE REQUEST message when a group call is initiated.
5. The mobile is able to establish a normal MO call with a priority level or a group call with a priority level according to the procedure specified in 3GPP TS 04.67 subclause 4.1.1 and the procedure in 3GPP TS 04.67 subclause 4.1.4.
6. The mobile is able to initiate a fast call set-up without authentication and ciphering.

31.12.1.3 Method of test

Initial Conditions

System Simulator:

1 cell with default parameters.

Mobile Station:

The MS is in idle mode with SIM in which the available priority levels are level 2, level 3, and level 4

Specific PICS Statements

- Support mobile originating call (TSPC_AddInfo_MOsvc)
- Support mobile emergency call (TSPC_Serv_TS12)
- Support VGCS originating (TSPC_AddInfo_VGCS_Originating)
- Support VBS originating (TSPC_AddInfo_VBS_Originating)

PIXIT Statements

- Way to select a priority level.

Foreseen Final State of the MS

"Idle, updated".

Test Procedure

The test steps 1 to 26 are repeated for k=1, 2, 3. After the repetition is finished the steps 27 to 71 are performed.

The test steps 1 to 7 are performed if the mobile station supports normal MO call. The steps 8 to 13 are executed if the MS supports TS12. The test steps 20 to step 26 are executed for k= 1, 2, 3, if the mobile station supports VGCS/VBS originating.

An allowed priority level (level 3) or a priority level (level 1) higher than allowed level or no priority level is selected by MMI action (for k=1, 2, 3 respectively). An MO call is attempted. It is checked that the MS indicates the selected priority level (for k=1) or the nearest allowed priority level below the selected level (for k=2) or no priority level (for k=3) in the signalling message.

A normal MO call is attempted with an allowed priority level (level 3). It is checked that the MS establishes completely this call.

If the mobile station supports VGCS/VBS originating a VGCS/VBS call is initiated via the MMI by using the SETUP procedure.

A MO VGCS/VBS call is attempted with the allowed priority level 0. It is checked that the MS establishes completely this call using the immediate setup procedure without authentication and ciphering.

Maximum Duration of Test

5 minutes.

Expected Sequence

Step	Direction	Message	Comments
1	MS		for k=1, MMI action to select a priority level 3 for k=2, MMI action to select a priority level 0 for k=3, no MMI action to select priority level to initiate a normal MO call
2	MS		
3	MS -> SS	CHANNEL REQUEST	
4	SS -> MS	IMMEDIATE ASSIGNMENT	
5	MS -> SS	CM SERVICE REQUEST	for k=1, containing priority IE with the selected priority for k=2, containing priority IE with a priority level nearest allowed priority level below the requested one (level 2) for k=3, containing no priority IE
6	SS -> MS	CM SERVICE REJECT	
7	SS -> MS	CHANNEL RELEASE	
8	MS		to initiate a normal MO emergency call
9	MS -> SS	CHANNEL REQUEST	
10	SS -> MS	IMMEDIATE ASSIGNMENT	
11	MS -> SS	CM SERVICE REQUEST	for k=1, containing priority IE with the selected priority for k=2, containing priority IE with a priority level nearest allowed priority level below the requested one (level 2) for k=3, containing no priority IE
12	SS -> MS	CM SERVICE REJECT	
13	SS -> MS	CHANNEL RELEASE	
20	MS		for k=1, MMI action to select a priority level 3 for k=2, MMI action to select a priority level 0 for k=3, no MMI action to select priority level to initiate a VGCS call by setup procedure, if supporting VGCS originating. to initiate a VBS call by setup procedure, if supporting only VBS originating.
21	MS		
22	MS -> SS	CHANNEL REQUEST	
23	SS -> MS	IMMEDIATE ASSIGNMENT	
24	MS -> SS	CM SERVICE REQUEST	for k=1, containing priority IE with the selected priority for k=2, containing priority IE with a priority level nearest allowed priority level below the requested one (level 2) for k=3, containing no priority IE
25	SS -> MS	CM SERVICE REJECT	
26	SS -> MS	CHANNEL RELEASE	
27	MS		MMI action to select a priority level 3
28	MS		initiate a normal MO call
29	MS -> SS	CHANNEL REQUEST	
30	SS -> MS	IMMEDIATE ASSIGNMENT	
31	MS -> SS	CM SERVICE REQUEST	containing priority IE with a priority level nearest allowed priority level below the requested one (level 3)
32	SS -> MS	AUTHENTICATION REQUEST	
33	MS -> SS	AUTHENTICATION RESPONSE	
34	SS -> MS	CIPHERING MODE COMMAND	no ciphering
35	MS -> SS	CIPHERING MODE COMPLETE	
36	MS -> SS	SETUP	
37	SS -> MS	CALL PROCEEDING	
38	SS -> MS	ASSIGNMENT COMMAND	
39	MS -> SS	ASSIGNMENT COMPLETE	

Step	Direction	Message	Comments
40	SS -> MS	ALERTING	
41	SS -> MS	CONNECT	
42	MS -> MS	CONNECT ACKNOWLEDGE	
43	SS -> MS	DISCONNECT	
44	MS -> SS	RELEASE	
45	SS -> MS	RELEASE COMPLETE	
46	SS -> MS	CHANNEL RELEASE	
			Steps 47 – 71 are performed if the MS supports VGCS/VBS originating
47	MS		MMI action to select a priority level 3 and initiate a VGCS/VBS call by setup procedure
49	MS -> SS	CHANNEL REQUEST	
50	SS -> MS	IMMEDIATE ASSIGNMENT	
51	MS -> SS	CM SERVICE REQUEST	containing priority IE with a priority level nearest allowed priority level below the requested one (level 3)
52	SS -> MS	AUTHENTICATION REQUEST	
53	MS -> SS	AUTHENTICATION RESPONSE	
54	SS -> MS	CIPHERING MODE COMMAND	no ciphering
55	MS -> SS	CIPHERING MODE COMPLETE	
56	MS -> SS	SETUP	
57	SS -> MS	CHANNEL MODE MODIFY	
58	MS -> SS	CHANNEL MODE MODIFY ACKNOWLEDGE	
59	SS -> MS	CONNECT	
60	SS		Verify that TCH is through connected
61	SS -> MS	TERMINATION	
62	SS -> MS	CHANNEL RELEASE	
63	MS		MMI action to select a priority level 0, MMI action to initiate VGCS/VBS call.
64	MS -> SS	CHANNEL REQUEST	
65	SS -> MS	IMMEDIATE ASSIGNMENT	TCH/F, single RF channel GSM 450: 275 GSM 480: 322 GSM 900: 50 DCS 1800: 750 PCS 1 900: 650 GSM 710, GSM 750, T-GSM 810: 470 GSM 850: 177
66	MS -> SS	IMMEDIATE SETUP	L2: SABM / UA
67	SS -> MS	CHANNEL MODE MODIFY	very early assignment
68	MS -> SS	CHANNEL MODE MODIFY ACKNOWLEDGE	
69	SS -> MS	CONNECT	verify that the TCH is through connected
70	SS		Verify that TCH is through connected
70	SS -> MS	TERMINATION	
71	SS -> MS	CHANNEL RELEASE	

Special Message Contents

CM SERVICE REQUEST in step 5 and step 24

for k=1, 2

Information Element	value/remark
as default except:	
CM Service Type	not checked
Ciphering key sequence number	not checked
Mobile station classmark	not checked
Priority	
Information element identifier	0001
Spare	0
Call priority	010 for k=1 011 for k=2

for k=3

Information Element	value/remark
as default except:	
CM Service Type	not checked
Ciphering key sequence number	not checked
Mobile station classmark	not checked
Priority	not present

CM SERVICE REQUEST in step 11

for k=1, 2

Information Element	value/remark
as default except:	
CM Service Type	"emergency call establishment"
Ciphering key sequence number	not checked
Mobile station classmark	not checked
Priority	
Information element identifier	0001
Spare	0
Call priority	010 for k=1

for k=3

Information Element	value/remark
as default except:	
CM Service Type	"emergency call establishment"
Ciphering key sequence number	not checked
Mobile station classmark	not checked
Priority	not present

31.12.2 eMLPP Service / automatic answering point-to-point MT call

31.12.2.1 Conformance requirement

For the MS supporting MT call:

1. Automatic answering or, if necessary, called-party pre-emption has to be performed by the Mobile Station as defined in the following:

- point-to-point calls:

If the user is in idle mode, the Mobile Station shall automatically connect to an incoming call of a sufficient priority level. If the user is in dedicated mode and has a subscription to Call Waiting, a Call

Waiting indication including the priority level of the call shall be given to the Mobile Station which automatically accepts the waiting call.

2. In dedicated mode, in the case where the called subscriber has a subscription for eMLPP and for Call Waiting and is using a compatible Mobile Station, the Mobile Station shall be informed of the priority of the new call together with the call waiting indication. The Mobile Station will then consult the internal service configuration list stored on the SIM to establish whether it should automatically accept the waiting call without consulting the user, or whether the call waiting facility will be used as normal.
3. In the case where the called subscriber has a subscription for eMLPP and for CW, the mobile station shall be informed of the priority of the new call together with the CW indication. On reception of the set-up message the compatible mobile station decides on called party pre-emption. If called party pre-emption applies, the mobile station shall automatically accept the waiting call and send a hold message to the network. If a hold acknowledge is received, the waiting call is accepted. If a hold reject is received for any reason, e.g. there is no subscription for hold, the other call shall be released and the waiting call accepted. If the ongoing call is not a TS11 call, the mobile station should not send a hold message to the network but release the call and accept the waiting call.

Reference(s)

3GPP TS 02.67 subclause 4, 5.9.

3GPP TS 03.67 clause 4, subclauses 11.3.2.4, 11.3.2.5 and 11.6.

3GPP TS 04.67 subclause 4.1.3.

3GPP TS 04.83 subclauses 1.1 and 1.2.

31.12.2.2 Test purpose

For the MS supporting MT call, to verify that:

1. In idle mode the MS automatically accepts an incoming point-to-point call of priority level for which automatic answering is enabled.
2. In idle mode the MS alerts an incoming point-to-point call of a priority level for which automatic answering is disabled.
3. In dedicated mode and supporting Call Waiting, when a Call Waiting indication includes a level for which automatic answering is enabled and the priority level is higher than the ongoing point-to-point call, the MS automatically confirms the waiting call and sends a hold message to the network. If a hold reject is received the other call is released and the waiting call is accepted.
4. In dedicated mode and supporting Call Waiting, when a Call Waiting indication includes a priority level for which automatic answering is enabled and the priority level is equal or lower than the priority level of the ongoing call, the MS indicates the waiting call.
5. In group receive mode the MS automatically responds to the paging message containing a priority level for which automatic answering is enabled and the priority level is higher than the priority level of the ongoing call.
6. In group receive mode the MS indicates an incoming point-to-point call of a priority level for which automatic answering is enabled and the priority level is equal or lower than the priority level of the ongoing call.

31.12.2.3 Method of test

Initial Conditions

System Simulator:

1 cell with default parameters.

Mobile Station:

The MS is in idle mode.

The auto answering priority level is set to higher than priority level 2.

Specific PICS Statements

- Support VGCS listening (TSPC_AddInfo_VGCS_Listening)
- Support VBS listening (TSPC_AddInfo_VBS_Listening)

PIXIT Statements

- Way to configure automatic answering.
- Way to indicate a call has been automatically answered.

Foreseen Final State of the MS

"Idle, updated".

Test Procedure

The call waiting is activated. The MS is in idle mode and automatic answering for priority level 2 is disabled. A PAGING REQUEST message containing priority level 2 is sent. It is checked that the MS indicates the incoming call to the user. The automatic answering for level 1 is enabled. A PAGING REQUEST message with priority level 2 is sent. It is checked that the MS automatically accepts the incoming normal call. The call is released. A PAGING REQUEST message without priority level is sent, and during the call set-up the SETUP message contains priority level 1. It is checked that the MS automatically accepts the incoming normal call.

The MS is in dedicated mode (If the MS supports TS11, TS11 service shall be selected for the dedicated mode testing). a SETUP message with priority level higher enough for auto answering is sent by the SS. It is checked that the MS automatically accepts the incoming normal call. A SETUP message containing low priority level without auto answering is sent. It is checked that the MS indicates the incoming call to the user.

The MS is in group receive mode, a NOTIFICATION/FACCH message containing paging information and a PAGING REQUEST message with priority level 0 are sent. It is checked that the MS automatically accepts the incoming normal call. The MS is brought into group receive mode. A NOTIFICATION/FACCH message containing paging information and a PAGING REQUEST message containing low priority level are sent. It is checked that the MS indicates the incoming call to the user.

Maximum Duration of Test

5 minutes.

Expected Sequence

Step	Direction	Message	Comments
0	MS		the MS is in idle mode and auto answering for priority level 2 is disabled with priority level 2
1	SS -> MS	PAGING REQUEST TYPE 1	
2	MS -> SS	CHANNEL REQUEST	
3	SS -> MS	IMMEDIATE ASSIGNMENT	SDCCH
4	MS -> SS	PAGING RESPONSE	
5	SS -> MS	SETUP	containing priority level 2, but no signal IE
6	MS -> SS	CALL CONFIRMED	
7	SS -> MS	ASSIGNMENT COMMAND	TCH
8	MS -> SS	ASSIGNMENT COMPLETE	
9	MS -> SS	ALERTING	
10	MS		An alerting indication as defined in a PICS/PIXIT statement is given by the MS
11	MS		The MS is made to accept the call in the way described in a PICS/PIXIT statement
12	MS -> SS	CONNECT	
13	SS -> MS	CONNECT ACKNOWLEDGE	
14	SS -> MS	DISCONNECT	
15	MS -> SS	RELEASE	
16	SS -> MS	RELEASE COMPLETE	
17	SS -> MS	CHANNEL RELEASE	return to idle mode
21	SS -> MS	PAGING REQUEST TYPE 1	containing priority level 1
22	MS -> SS	CHANNEL REQUEST	

Step	Direction	Message	Comments
23	SS -> MS	IMMEDIATE ASSIGNMENT	SDCCH
24	MS -> SS	PAGING RESPONSE	
25	SS -> MS	SETUP	containing priority level 1, but no signal IE
26	MS -> SS	CALL CONFIRMED	
27	MS -> SS	CONNECT	automatic connection
28	SS -> MS	ASSIGNMENT COMMAND	TCH
29	MS -> SS	ASSIGNMENT COMPLETE	
30	SS -> MS	CONNECT ACKNOWLEDGE	
31	MS		to check that the MS gives an indication as defined in a PICS/PIXIT statement for call automatically answered
32	SS -> MS	DISCONNECT	
33	MS -> SS	RELEASE	
34	SS -> MS	RELEASE COMPLETE	
35	SS -> MS	CHANNEL RELEASE	return to idle mode
36	SS -> MS	PAGING REQUEST TYPE 1	containing no priority level
37	MS -> SS	CHANNEL REQUEST	
38	SS -> MS	IMMEDIATE ASSIGNMENT	SDCCH
39	MS -> SS	PAGING RESPONSE	
40	SS -> MS	SETUP	containing priority level 3, but no signal IE
41	MS -> SS	CALL CONFIRMED	
42	MS -> SS	CONNECT	automatic connection
43	SS -> MS	ASSIGNMENT COMMAND	TCH
44	MS -> SS	ASSIGNMENT COMPLETE	
45	SS -> MS	CONNECT ACKNOWLEDGE	
51	SS -> MS	SETUP	new transaction, containing priority level 1 and Signal Information Element with value #7
52	MS -> SS	CALL CONFIRMED	on new transaction with cause #17
53a	MS -> SS	HOLD	on old transaction for service TS11
53b			no signalling for services other than TS11
54a	SS -> MS	HOLD REJECT	on old transaction for service TS11 with cause #69
54b			no signalling for services other than TS11
55	MS -> SS	DISCONNECT	on old transaction, cause = 'Normal call clearing'
56	SS -> MS	RELEASE	on old transaction
57	MS -> SS	RELEASE COMPLETE	on old transaction
58	MS -> SS	CONNECT	on new transaction
59	SS -> MS	CONNECT ACKNOWLEDGE	on new transaction
60	SS -> MS	SETUP	another new transaction different from step 51, containing priority level 1 and Signal Information Element with value #7
61	MS -> SS	CALL CONFIRMED	on the same transaction as step 60, with cause #17
62	MS -> SS	ALERTING	on the same transaction as step 60
63	MS		to check that the MS gives incoming call indication
64	SS -> MS	DISCONNECT	on the same transaction as step 51
65	MS -> SS	RELEASE	on the same transaction as step 51
66	SS -> MS	RELEASE COMPLETE	on the same transaction as step 51
67	SS -> MS	CHANNEL RELEASE	
70	MS		the MS is in group receive mode, the priority level of current call is level 3
72	SS -> MS	PAGING REQUEST TYPE 1	containing priority level 0
73	MS -> SS	CHANNEL REQUEST	
74	SS -> MS	IMMEDIATE ASSIGNMENT	SDCCH
75	MS -> SS	PAGING RESPONSE	
76	SS -> MS	SETUP	without priority level and signal IE
77	MS -> SS	CALL CONFIRMED	
78	MS -> SS	CONNECT	automatic connection
79	SS -> MS	ASSIGNMENT COMMAND	TCH
80	MS -> SS	ASSIGNMENT COMPLETE	
81	SS -> MS	CONNECT ACKNOWLEDGE	
82	SS -> MS	DISCONNECT	
83	MS -> SS	RELEASE	
84	SS -> MS	RELEASE COMPLETE	
85	SS -> MS	CHANNEL RELEASE	

Step	Direction	Message	Comments
86	MS		the MS is brought into group receive mode with the priority level 3
88	SS -> MS	PAGING REQUEST TYPE 1	containing priority level 3
89	MS		to check that the MS gives incoming call indication
90	SS -> MS	CHANNEL RELEASE	UI format

31.12.3 eMLP Service / automatic answering MT VGCS or VBS call

31.12.3.1 Conformance requirement

For the MS supporting VGCS/VBS listening:

1. Automatic answering or, if necessary, called-party pre-emption has to be performed by the Mobile Station as defined in the following:

- voice group calls and voice broadcast calls:

Notifications for other voice group calls, voice broadcast calls or information on paging for point-to-point calls shall be given to the Mobile Stations involved in on-going voice group calls or voice broadcast calls as defined in 3GPP TS 03.68 and 3GPP TS 03.69, respectively. The notifications include the related priority level of the call. In case of a notified call with higher priority where called-party pre-emption applies, the Mobile Station shall automatically leave the on-going voice group call or voice broadcast call and react according to the type of the notified call type.

2. In dedicated mode, in the case where the called subscriber has a subscription for eMLPP and for Call Waiting and is using a compatible Mobile Station, the Mobile Station shall be informed of the priority of the new call together with the call waiting indication. The Mobile Station will then consult the internal service configuration list stored on the SIM to establish whether it should automatically accept the waiting call without consulting the user, or whether the call waiting facility will be used as normal.
3. In the case where the called subscriber has a subscription for eMLPP and for CW, the mobile station shall be informed of the priority of the new call together with the CW indication. On reception of the notification message the compatible mobile station decides on called party pre-emption. If called party pre-emption applies, the mobile station shall automatically release the call and join the new call.

Reference(s)

3GPP TS 02.67 clause 4.

3GPP TS 03.68 clause 4, subclauses 11.3.1.3 and 11.3.1.4.

3GPP TS 03.67 clause 4.

3GPP TS 04.67 subclause 4.1.5.

31.12.3.2 Test purpose

For the MS supporting VGCS/VBS listening, to verify that:

1. In idle mode the MS automatically accepts an incoming VGCS or VBS call of sufficient priority level.
2. In idle mode the MS indicates an incoming VGCS or VBS call of priority level not high enough for automatic answering.
3. In dedicated mode, the MS automatically accepts an incoming VGCS or VBS call of sufficient priority level.
4. In dedicated mode, the MS indicates an incoming VGCS or VBS call of priority level not high enough for automatic answering.
5. In group receive mode the MS automatically accepts an incoming VGCS or VBS call of sufficient priority level.
6. In group receive mode the MS indicates an incoming VGCS or VBS call of priority level not high enough for automatic answering.

31.12.3.3 Method of test

Initial Conditions

System Simulator:

1 cell with default parameters.

Mobile Station:

The MS is in idle mode.

The auto answering priority level is set to higher than priority level 2.

Specific PICS Statements

-

PIXIT Statements

- Way to configure automatic answering.
- Way to indicate that a VGCS/VBS call has been automatically accepted.

Foreseen Final State of the MS

"Idle, updated".

Test Procedure

The MS is in idle mode. a NOTIFICATION/NCH message with priority level higher enough for auto answering is sent. It is checked that the MS automatically accepts the incoming VGCS/VBS call. The call is released. A NOTIFICATION/NCH message containing low priority level without auto answering is sent. It is checked that the MS indicates the incoming VGCS/VBS call to the user.

The MS is in dedicated mode. a NOTIFICATION/FACCH message with priority level higher enough for auto answering is sent. It is checked that the MS automatically accepts the incoming VGCS/VBS call. A NOTIFICATION/FACCH message containing low priority level without auto answering is sent. It is checked that the MS indicates the incoming VGCS/VBS call to the user.

The MS is in group receive mode. a NOTIFICATION/FACCH message with priority level higher enough for auto answering and containing VGCS/VBS channel description is sent. It is checked that the MS automatically accepts the incoming VGCS/VBS call. A NOTIFICATION/FACCH message containing priority level not higher enough for auto answering and containing VGCS/VBS channel description is sent. It is checked that the MS indicates the incoming VGCS/VBS call to the user.

Maximum Duration of Test

5 minutes.

Expected Sequence

Step	Direction	Message	Comments
1	MS		the MS is in idle mode
2	SS -> MS	NOTIFICATION/NCH	containing priority level 1
3	MS		to check that the MS automatically accepts the VGCS/VBS call
4	SS		stop sending NOTIFICATION/NCH
5	SS -> MS	CHANNEL RELEASE	UI format, release VGCS/VBS channel
6	SS -> MS	NOTIFICATION/NCH	containing priority level 3
7	MS		to check that the MS indicates the VGCS/VBS call to the user
8	SS		stop sending NOTIFICATION/NCH
15	MS		the MS is in dedicated mode, the priority level of current call is level 3
16	SS -> MS	NOTIFICATION/FACCH	containing priority level 2
17	MS -> SS	DISCONNECT	
18	SS -> MS	RELEASE	
19	MS -> SS	RELEASE COMPLETE	
20	SS -> MS	CHANNEL RELEASE	
21	MS		to check that the MS automatically accepts the VGCS/VBS call
22	SS -> MS	CHANNEL RELEASE	UI format, release VGCS/VBS channel
23	MS		the MS is brought into dedicated mode, the priority level of current call is level 3
24	SS -> MS	NOTIFICATION/FACCH	containing priority level 4
25	MS		to check that the MS indicates the VGCS/VBS call to the user
26	SS		stop sending NOTIFICATION/FACCH
27	SS -> MS	DISCONNECT	
28	MS -> SS	RELEASE	
29	SS -> MS	RELEASE COMPLETE	
30	SS -> MS	CHANNEL RELEASE	UI format, release dedicated channel
31	MS		the MS is in group receive mode, the priority level of current call is level 3
32	SS -> MS	NOTIFICATION/FACCH	containing priority level 1 and with VGCS/VBS channel description
33	MS		to check the MS automatically accepts the incoming VGCS/VBS call
34	SS -> MS	NOTIFICATION/FACCH	containing priority level 4 and with VGCS/VBS channel description
35	MS		to check the MS indicates the incoming VGCS/VBS call to the user
36	SS -> MS	CHANNEL RELEASE	UI format, release VGCS/VBS channel

31.12.4 eMLPP Service / registration

31.12.4.1 Conformance requirement

For registration of eMLPP default priority level, the MS shall transmit successively:

1. A CHANNEL REQUEST with establishment cause set to "other services requested by the mobile user".
2. A CM SERVICE REQUEST with CM service type indicating "supplementary service activation".
3. An eMLPP registration request from a mobile user shall include the SS-Code of the eMLPP service and the default priority level.

Reference(s)

3GPP TS 04.67 subclause 4.2 (figure 6).

3GPP TS 04.08 / 3GPP TS 44.018 subclauses 3.3.1.2 and 9.1.8.

3GPP TS 04.08 / 3GPP TS 24.008 subclauses 4.5.1.1 and 9.2.9.

31.12.4.2 Test purpose

To check that the MS:

1. Correctly requests a supplementary service transaction for registration of eMLPP in CHANNEL REQUEST message.
2. Correctly requests a supplementary service transaction for registration of eMLPP in the subsequent CM SERVICE REQUEST.
3. Then sends a REGISTER message containing the invoke of the RegisterSS operation with the expected parameter values for registration of eMLPP default priority level.
4. Provides the appropriate user indication (as described by the manufacturer) upon receipt of the result of the operation (in a RELEASE COMPLETE message).

31.12.4.3 Method of test

Initial Conditions

System Simulator:

1 cell with default parameters.

Mobile Station:

the MS is in idle mode

Specific PICS Statements

-

PIXIT Statements

- Way to select a priority level.
- Way to initiate eMLPP registration.
- Way to indicate the result of the eMLPP registration.

Foreseen Final State of the MS

"Idle, updated".

Test Procedure

By means of appropriate MMI functions (using either 3GPP TS 02.30 or manufacturer defined MMI), the user requests registration of eMLPP for a default priority level DefaultPriorityLevel arbitrarily selected.

Upon receipt of the operation (in a REGISTER message), the system simulator answers with a RELEASE COMPLETE message with the Facility information element containing the return result of the RegisterSS operation.

The SS transaction is released and the dedicated channel is released.

Then check the MS provides a correct user indication.

Maximum Duration of Test

3 minutes.

Expected Sequence

Step	Direction	Message	Comments
1	MS		The MS is made to initiate a registration of eMLPP default priority level
2	MS -> SS	CHANNEL REQUEST	with establishment cause "Other procedures which can be completed with an SDCCH"
3	SS -> MS	IMMEDIATE ASSIGNMENT	
4	MS -> SS	CM SERVICE REQUEST	cause: "supplementary service activation"
5	SS -> MS	CM SERVICE ACCEPT	
6	MS -> SS	REGISTER	RegisterSS(eMLPP, DefaultPriorityLevel)
7	SS -> MS	RELEASE COMPLETE	RegisterSS operation Return_result
8	MS		provide correct MMI user indication
9	SS -> MS	CHANNEL RELEASE	

Special Message Contents

REGISTER:

Information Element	value/remark
as default except: Facility invoke Supplementary service code Default Priority	RegisterSS eMLPP arbitrary

31.12.5 eMLPP Service / interrogation

31.12.5.1 Conformance requirement

For interrogation of eMLPP default priority level, the MS shall transmit successively:

1. A CHANNEL REQUEST with establishment cause set to "other services requested by the mobile user".
2. A CM SERVICE REQUEST with CM service type indicating "supplementary service activation".
3. And then the REGISTER message containing a facility IE that includes an invoke of the InterrogateSS operation with parameter values eMLPP (MMI action) (see figure 7 of 3GPP TS 04.67 subclause 4.5).

Reference(s)

3GPP TS 04.67 subclause 4.5 (figure 7).

3GPP TS 04.08 / 3GPP TS 44.018 subclauses 3.3.1.2 and 9.1.9.

3GPP TS 04.08 / 3GPP TS 24.008 subclauses 4.5.1.1 and 9.2.9.

31.12.5.2 Test purpose

To check that the MS:

1. Correctly requests a supplementary service transaction for interrogation of eMLPP in CHANNEL REQUEST message.
2. Correctly requests a supplementary service transaction for interrogation of eMLPP in the subsequent CM SERVICE REQUEST.
3. Then sends a REGISTER message containing the invoke of the InterrogateSS operation with the expected parameter values for interrogation of eMLPP default priority level.

4. Provides the appropriate user indication (as described by PIXIT) upon receipt of the result of the operation (in a RELEASE COMPLETE message).

31.12.5.3 Method of test

Initial Conditions

System Simulator:

1 cell with default parameters.

Mobile Station:

the MS is in idle mode

Specific PICS Statements

-

PIXIT Statements

- Way to select a priority level.
- Way to initiate eMLPP interrogation.
- Way to indicate the result of the eMLPP interrogation.

Foreseen Final State of the MS

"Idle, updated".

Test Procedure

1. By means of appropriate MMI functions (using either 3GPP TS 02.30 or manufacturer defined MMI), the user requests interrogation of eMLPP.
2. Upon receipt of the operation (in a REGISTER message), the system simulator answers with a RELEASE COMPLETE message with the Facility information element containing the return result of the InterrogateSS operation.
3. The SS transaction is released and the dedicated channel is released.
4. Then check the MS provides a correct user indication.

Maximum Duration of Test

3 minutes.

Expected Sequence

Step	Direction	Message	Comments
1	MS		The MS is made to initiate a interrogation of eMLPP default priority level
2	MS -> SS	CHANNEL REQUEST	with establishment cause "Other procedures which can be completed with an SDCCH"
3	SS -> MS	IMMEDIATE ASSIGNMENT	
4	MS -> SS	CM SERVICE REQUEST	cause: "supplementary service activation"
5	SS -> MS	CM SERVICE ACCEPT	
6	MS -> SS	REGISTER	InterrogateSS(eMLPP)
7	SS -> MS	RELEASE COMPLETE	InterrogateSS operation Return_result containing SS-Status, MaximumPriorityLevel, DefaultPriorityLevel
8	MS		provide correct MMI user indication
9	SS -> MS	CHANNEL RELEASE	

Special Message Contents

REGISTER:

Information Element	value/remark
as default except: Facility invoke Supplementary service code	InterrogateSS eMLPP

31.13 Explicit Call Transfer (ECT)

NOTE: In this subclause, Subscriber A is the MS under test, and subscribers B and C are distant parties to the calls made during the tests.

31.13.1 Explicit Call Transfer invocation

31.13.1.1 Explicit Call Transfer invocation, successful case, both calls active, clearing using DISCONNECT

Conformance requirement

3GPP TS 04.91 subclauses 4.1 and 4.2.

Applicability

MS supporting the Explicit Call Transfer supplementary service.

Test purpose

To test that the MS invokes explicit call transfer between two active calls by sending a FACILITY message with the correct invoke component, and reacts correctly on receipt of a DISCONNECT response from the network.

Method of test

Specific PICS Statements

-

PIXIT Statements

- Method of performing Explicit Call transfer on two active calls.

Initial conditions

System Simulator:

1 cell, default parameters.

Mobile Station:

The MS shall have Call A-B in state U10 "Active" with auxiliary state "Call held" and Call A-C in state U10 "Active" with no auxiliary state. Both calls shall be of a basic service supported by the MS and applicable to the ECT supplementary service as described in 3GPP TS 02.04 table A.1.

Foreseen final state of the MS

Call A-B, state U0. Call A-C, state U0.

Maximum duration of test

30 s.

Procedure

Using suitable MMI commands, the MS shall invoke an explicit call transfer between the two calls. The MS shall send a FACILITY message with a transaction identifier for either call A-B or call A-C and containing an ExplicitCT invoke component. The call state of both calls shall be unchanged. The call states shall be verified by the SS sending a STATUS ENQUIRY message in respect of the transaction identifier of each call, and receiving a STATUS message indicating the appropriate call state.

On receipt of a DISCONNECT message with respect to one of the calls containing a return result component, followed by a DISCONNECT message for the other call, the MS shall respond with a RELEASE message for each call. On receipt of a RELEASE COMPLETE message for each call, the MS shall enter state U0 "Null". The call states shall be verified by the SS sending a STATUS ENQUIRY message in respect of the transaction identifier of each call, and receiving a RELEASE COMPLETE message with cause #81 "invalid transaction identifier value".

Expected sequence

Step	Direction	Message	Comments
1	MS		Using MMI commands, perform and explicit call transfer
2	MS -> SS	FACILITY	TI for Call A-B or Call A-C, ExplicitCT Invoke component
3	SS -> MS	STATUS ENQUIRY	Transaction identifier of Call A-B
4	MS -> SS	STATUS	Transaction identifier of Call A-B, state U10, auxiliary state "Call held"
5	SS -> MS	STATUS ENQUIRY	Transaction identifier of Call A-C
6	MS -> SS	STATUS	Transaction identifier of Call A-C, state U10, no auxiliary state
7	SS -> MS	DISCONNECT	Transaction identifier of Call A-B
8	MS -> SS	RELEASE	Transaction identifier of Call A-B
9	SS -> MS	DISCONNECT	Transaction identifier of Call A-C
10	MS -> SS	RELEASE	Transaction identifier of Call A-C
11	SS -> MS	RELEASE COMPLETE	Transaction identifier of Call A-B
12	SS -> MS	RELEASE COMPLETE	Transaction identifier of Call A-C
13	SS -> MS	STATUS ENQUIRY	Transaction identifier of Call A-B
14	MS -> SS	RELEASE COMPLETE	Transaction identifier of Call A-B, with cause #81 "invalid transaction identifier value"
15	SS -> MS	STATUS ENQUIRY	Transaction identifier of Call A-C
16	MS -> SS	RELEASE COMPLETE	Transaction identifier of Call A-C, with cause #81 "invalid transaction identifier value"

31.13.1.2 Explicit Call Transfer invocation, successful case, both calls active, clearing using RELEASE

Conformance requirement

3GPP TS 04.91 subclauses 4.1 and 4.2.

Applicability

MS supporting the Explicit Call Transfer supplementary service.

Test purpose

1. To test that the MS invokes explicit call transfer between two active calls by sending a FACILITY message with the correct invoke component, and reacts correctly on receipt of a RELEASE response from the network.

Method of test

Specific PICS Statements

-

PIXIT Statements

- Method of performing Explicit Call transfer on two active calls.

Initial conditions

System Simulator:

1 cell, default parameters.

Mobile Station:

The MS shall have Call A-B in state U10 "Active" with auxiliary state "Call held" and Call A-C in state U10 "Active" with no auxiliary state. Both calls shall be of a basic service supported by the MS and applicable to the ECT supplementary service as described in 3GPP TS 02.04 table A.1.

Foreseen final state of the MS

Call A-B, state U0. Call A-C, state U0.

Maximum duration of test

30 s.

Procedure

Using suitable MMI commands, the MS shall invoke an explicit call transfer between the two calls. The MS shall send a FACILITY message with a transaction identifier for either call A-B or call A-C and containing an ExplicitCT invoke component. The call state of both calls shall be unchanged. The call states shall be verified by the SS sending a STATUS ENQUIRY message in respect of the transaction identifier of each call, and receiving a STATUS message indicating the appropriate call state.

On receipt of a RELEASE message with respect to one of the calls containing a return result component, followed by a RELEASE message for the other call, the MS shall respond with a RELEASE COMPLETE message for each call and shall enter state U0 "Null". The call states shall be verified by the SS sending a STATUS ENQUIRY message in respect of the transaction identifier of each call, and receiving a RELEASE COMPLETE message with cause #81 "invalid transaction identifier value".

Expected sequence

Step	Direction	Message	Comments
1	MS		Using MMI commands, perform and explicit call transfer
2	MS -> SS	FACILITY	TI for Call A-B or Call A-C, ExplicitCT Invoke component
3	SS -> MS	STATUS ENQUIRY	Transaction identifier of Call A-B
4	MS -> SS	STATUS	Transaction identifier of Call A-B, state U10, auxiliary state "Call held"
5	SS -> MS	STATUS ENQUIRY	Transaction identifier of Call A-C
6	MS -> SS	STATUS	Transaction identifier of Call A-C, state U10, no auxiliary state
7	SS -> MS	RELEASE	Transaction identifier of Call A-B
8	MS -> SS	RELEASE COMPLETE	Transaction identifier of Call A-B
9	SS -> MS	RELEASE	Transaction identifier of Call A-C
10	MS -> SS	RELEASE COMPLETE	Transaction identifier of Call A-C
11	SS -> MS	STATUS ENQUIRY	Transaction identifier of Call A-B
12	MS -> SS	RELEASE COMPLETE	Transaction identifier of Call A-B, with cause #81 "invalid transaction identifier value"
13	SS -> MS	STATUS ENQUIRY	Transaction identifier of Call A-C
14	MS -> SS	RELEASE COMPLETE	Transaction identifier of Call A-C, with cause #81 "invalid transaction identifier value"

31.13.1.3 Explicit Call Transfer invocation, successful case, both calls active, clearing using RELEASE COMPLETE

Conformance requirement

3GPP TS 04.91 subclauses 4.1 and 4.2.

Applicability

MS supporting the Explicit Call Transfer supplementary service.

Test purpose

1. To test that the MS invokes explicit call transfer between two active calls by sending a FACILITY message with the correct invoke component, and reacts correctly on receipt of a RELEASE COMPLETE response from the network.

Method of test

Specific PICS Statements

-

PIXIT Statements

- Method of performing Explicit Call transfer on two active calls.

Initial conditions

System Simulator:

1 cell, default parameters.

Mobile Station:

The MS shall have Call A-B in state U10 "Active" with auxiliary state "Call held" and Call A-C in state U10 "Active" with no auxiliary state. Both calls shall be of a basic service supported by the MS and applicable to the ECT supplementary service as described in 3GPP TS 02.04 table A.1.

Foreseen final state of the MS

Call A-B, state U0. Call A-C, state U0.

Maximum duration of test

30 s.

Procedure

Using suitable MMI commands, the MS shall invoke an explicit call transfer between the two calls. The MS shall send a FACILITY message with a transaction identifier for either call A-B or call A-C and containing an ExplicitCT invoke component. The call state of both calls shall be unchanged. The call states shall be verified by the SS sending a STATUS ENQUIRY message in respect of the transaction identifier of each call, and receiving a STATUS message indicating the appropriate call state.

On receipt of a RELEASE COMPLETE message with respect to one of the calls containing a return result component, followed by a RELEASE COMPLETE message for the other call, the MS shall enter state U0 "Null". The call states shall be verified by the SS sending a STATUS ENQUIRY message in respect of the transaction identifier of each call, and receiving a RELEASE COMPLETE message with cause #81 "invalid transaction identifier value".

Expected sequence

Step	Direction	Message	Comments
1	MS		Using MMI commands, perform and explicit call transfer
2	MS -> SS	FACILITY	TI for Call A-B or Call A-C, ExplicitCT Invoke component
3	SS -> MS	STATUS ENQUIRY	Transaction identifier of Call A-B
4	MS -> SS	STATUS	Transaction identifier of Call A-B, state U10, auxiliary state "Call held"
5	SS -> MS	STATUS ENQUIRY	Transaction identifier of Call A-C
6	MS -> SS	STATUS	Transaction identifier of Call A-C, state U10, no auxiliary state
7	SS -> MS	RELEASE COMPLETE	Transaction identifier of Call A-B
8	SS -> MS	RELEASE COMPLETE	Transaction identifier of Call A-C
9	SS -> MS	STATUS ENQUIRY	Transaction identifier of Call A-B
10	MS -> SS	RELEASE COMPLETE	Transaction identifier of Call A-B, with cause #81 "invalid transaction identifier value"
11	SS -> MS	STATUS ENQUIRY	Transaction identifier of Call A-C
12	MS -> SS	RELEASE COMPLETE	Transaction identifier of Call A-C, with cause #81 "invalid transaction identifier value"

31.13.1.4 Explicit Call Transfer invocation, successful case, second call alerting

Conformance requirement

3GPP TS 04.91 subclauses 4.1 and 4.2.

Applicability

MS supporting the Explicit Call Transfer supplementary service.

Test purpose

1. To test that the MS invokes explicit call transfer between an active held call and an alerting call by sending a FACILITY message with the correct invoke component, and reacts correctly on receipt of clearing messages from the network.

Method of test

Specific PICS Statements

-

PIXIT Statements

- Method of performing Explicit Call transfer on an active call and an alerting call.

Initial conditions

System Simulator:

1 cell, default parameters.

Mobile Station:

The MS shall have Call A-B in state U10 "Active" with auxiliary state "Call held" and Call A-C in state U4 "Call Delivered" with no auxiliary state. Both calls shall be of a basic service supported by the MS and applicable to the ECT supplementary service as described in 3GPP TS 02.04 table A.1.

Foreseen final state of the MS

Call A-B, state U0. Call A-C, state U0.

Maximum duration of test

30 s.

Procedure

Using suitable MMI commands, the MS shall invoke an explicit call transfer between the two calls. The MS shall send a FACILITY message with a transaction identifier for either call A-B or call A-C and containing an ExplicitCT invoke component. The call state of both calls shall be unchanged. The call states shall be verified by the SS sending a STATUS ENQUIRY message in respect of the transaction identifier of each call, and receiving a STATUS message indicating the appropriate call state.

On receipt of a DISCONNECT message with respect to one of the calls containing a return result component, followed by a DISCONNECT message for the other call, the MS shall respond with a RELEASE message for each call. On receipt of a RELEASE COMPLETE message for each call, the MS shall enter state U0 "Null". The call states shall be verified by the SS sending a STATUS ENQUIRY message in respect of the transaction identifier of each call, and receiving a RELEASE COMPLETE message with cause #81 "invalid transaction identifier value".

Expected sequence

Step	Direction	Message	Comments
1	MS		Using MMI commands, perform and explicit call transfer
2	MS -> SS	FACILITY	TI for Call A-B or Call A-C, ExplicitCT Invoke component
3	SS -> MS	STATUS ENQUIRY	Transaction identifier of Call A-B
4	MS -> SS	STATUS	Transaction identifier of Call A-B, state U10, auxiliary state "Call held"
5	SS -> MS	STATUS ENQUIRY	Transaction identifier of Call A-C
6	MS -> SS	STATUS	Transaction identifier of Call A-C, state U4
7	SS -> MS	DISCONNECT	Transaction identifier of Call A-B
8	MS -> SS	RELEASE	Transaction identifier of Call A-B
9	SS -> MS	DISCONNECT	Transaction identifier of Call A-C
10	MS -> SS	RELEASE	Transaction identifier of Call A-C
11	SS -> MS	RELEASE COMPLETE	Transaction identifier of Call A-B
12	SS -> MS	RELEASE COMPLETE	Transaction identifier of Call A-C
13	SS -> MS	STATUS ENQUIRY	Transaction identifier of Call A-B
14	MS -> SS	RELEASE COMPLETE	Transaction identifier of Call A-B, with cause #81 "invalid transaction identifier value"
15	SS -> MS	STATUS ENQUIRY	Transaction identifier of Call A-C
16	MS -> SS	RELEASE COMPLETE	Transaction identifier of Call A-C, with cause #81 "invalid transaction identifier value"

31.13.1.5 Explicit Call Transfer invocation, unsuccessful case

Conformance requirement

3GPP TS 04.91 subclauses 4.1 and 4.2

Applicability

MS supporting the Explicit Call Transfer supplementary service.

Test purpose

1. To test that the MS invokes explicit call transfer between an active held call and an alerting call by sending a FACILITY message with the correct invoke component, and returns both calls to their original states on receipt of an error or reject response.

Initial conditions

The MS shall have Call A-B in state U10 "Active" with auxiliary state "Call held" and Call A-C in state U10 "Active" with no auxiliary state. Both calls shall be of a basic service supported by the MS and applicable to the ECT supplementary service as described in 3GPP TS 02.04 Table A.1.

Method of test

Specific PICS Statements

-

PIXIT Statements

- Method of performing Explicit Call transfer on two active calls.

Initial conditions

System Simulator:

1 cell, default parameters.

Mobile Station:

The MS shall have Call A-B in state U10 "Active" with auxiliary state "Call held" and Call A-C in state U10 "Active" with no auxiliary state. Both calls shall be of a basic service supported by the MS and applicable to the ECT supplementary service as described in 3GPP TS 02.04 table A.1.

Foreseen final state of the MS

Call A-B, state U10, auxiliary state "Call held". Call A-C, state U10, no auxiliary state.

Maximum duration of test

30 s.

Procedure

Using suitable MMI commands, the MS shall invoke an explicit call transfer between the two calls. The MS shall send a FACILITY message with a transaction identifier for either call A-B or call A-C and containing an ExplicitCT invoke component. The call state of both calls shall be unchanged. The call states shall be verified by the SS sending a STATUS ENQUIRY message in respect of the transaction identifier of each call, and receiving a STATUS message indicating the appropriate call state.

On receipt of a FACILITY message using the same transaction identifier and including a return error component, the MS shall not send any further messages in respect of the transfer attempt, and shall remain in the same call state for both calls. The call states shall be verified by the SS sending a STATUS ENQUIRY message in respect of the transaction identifier of each call, and receiving a STATUS message indicating the appropriate call state.

Using suitable MMI commands, the MS shall again invoke an explicit call transfer between the two calls. The MS shall send a FACILITY message with a transaction identifier for either call A-B or call A-C and containing an ExplicitCT invoke component. The call state of both calls shall be unchanged. The call states shall be verified by the SS sending a STATUS ENQUIRY message in respect of the transaction identifier of each call, and receiving a STATUS message indicating the appropriate call state.

On receipt of a FACILITY message using the same transaction identifier and including a reject component, the MS shall not send any further messages in respect of the transfer attempt, and shall remain in the same call state for both calls. The call states shall be verified by the SS sending a STATUS ENQUIRY message in respect of the transaction identifier of each call, and receiving a STATUS message indicating the appropriate call state.

Expected sequence

Step	Direction	Message	Comments
1	MS		Using MMI commands, perform an explicit call transfer
2	MS -> SS	FACILITY	TI for Call A-B or Call A-C, ExplicitCT Invoke component
3	SS -> MS	STATUS ENQUIRY	Transaction identifier of Call A-B
4	MS -> SS	STATUS	Transaction identifier of Call A-B, state U10, auxiliary state "Call held"
5	SS -> MS	STATUS ENQUIRY	Transaction identifier of Call A-C
6	MS -> SS	STATUS	Transaction identifier of Call A-C, state U10, no auxiliary state
7	SS -> MS	FACILITY	TI same as step 2, Return Error component
8	SS -> MS	STATUS ENQUIRY	Transaction identifier of Call A-B
9	MS -> SS	STATUS	Transaction identifier of Call A-B, state U10, auxiliary state "Call held"
10	SS -> MS	STATUS ENQUIRY	Transaction identifier of Call A-C
11	MS -> SS	STATUS	Transaction identifier of Call A-C, state U10, no auxiliary state
12	MS		Using MMI commands, perform an explicit call transfer
13	MS -> SS	FACILITY	TI for Call A-B or Call A-C, ExplicitCT Invoke component
14	SS -> MS	STATUS ENQUIRY	Transaction identifier of Call A-B
15	MS -> SS	STATUS	Transaction identifier of Call A-B, state U10, auxiliary state "Call held"
16	SS -> MS	STATUS ENQUIRY	Transaction identifier of Call A-C
17	MS -> SS	STATUS	Transaction identifier of Call A-C, state U10, no auxiliary state
18	SS -> MS	FACILITY	TI same as step 2, Reject component
19	SS -> MS	STATUS ENQUIRY	Transaction identifier of Call A-B
20	MS -> SS	STATUS	Transaction identifier of Call A-B, state U10, auxiliary state "Call held"
21	SS -> MS	STATUS ENQUIRY	Transaction identifier of Call A-C
22	MS -> SS	STATUS	Transaction identifier of Call A-C, state U10, no auxiliary state

31.13.1.6 Explicit Call Transfer invocation, expiry of T(ECT)

Conformance requirement

3GPP TS 04.91 subclauses 4.1 and 4.2.

3GPP TS 04.80 subclause 4.2.

Applicability

MS supporting the Explicit Call Transfer supplementary service.

Test purpose

To test that the MS invokes explicit call transfer between an active held call and an alerting call by sending a FACILITY message with the correct invoke component, and returns both calls to their original states on expiry of T(ECT).

Method of test

Specific PICS Statements

-

PIXIT Statements

- Method of performing Explicit Call transfer on two active calls.

Initial conditions

System Simulator:

1 cell, default parameters.

Mobile Station:

The MS shall have Call A-B in state U10 "Active" with auxiliary state "Call held" and Call A-C in state U10 "Active" with no auxiliary state. Both calls shall be of a basic service supported by the MS and applicable to the ECT supplementary service as described in 3GPP TS 02.04 table A.1.

Foreseen final state of the MS

Call A-B, state U10, auxiliary state "Call held". Call A-C, Call A-C, state U10, no auxiliary state.

Maximum duration of test

45 s.

Procedure

Using suitable MMI commands, the MS shall invoke an explicit call transfer between the two calls. The MS shall send a FACILITY message with a transaction identifier for either call A-B or call A-C and containing an ExplicitCT invoke component. The call state of both calls shall be unchanged. The call states shall be verified by the SS sending a STATUS ENQUIRY message in respect of the transaction identifier of each call, and receiving a STATUS message indicating the appropriate call state.

Between 5s and 15s after sending the FACILITY message, the MS shall either:

- remain in the same call states and indicate failure to the user; or
- send another FACILITY message with the same contents.

The call states shall be verified by the SS sending a STATUS ENQUIRY message in respect of the transaction identifier of each call, and receiving a STATUS message indicating the appropriate call state.

Expected sequence

Step	Direction	Message	Comments
1	MS		Using MMI commands, perform an explicit call transfer
2	MS -> SS	FACILITY	TI for Call A-B or Call A-C, ExplicitCT Invoke component
3	SS -> MS	STATUS ENQUIRY	Transaction identifier of Call A-B
4	MS -> SS	STATUS	Transaction identifier of Call A-B, state U10, auxiliary state "Call held"
5	SS -> MS	STATUS ENQUIRY	Transaction identifier of Call A-C
6	MS -> SS	STATUS	Transaction identifier of Call A-C, state U10, no auxiliary state
7	SS		Wait 15 s from receiving FACILITY message
A8	SS -> MS	STATUS ENQUIRY	Take this branch if no message is received within 15 s
A9	MS -> SS	STATUS	Transaction identifier of Call A-B
A10	SS -> MS	STATUS ENQUIRY	Transaction identifier of Call A-B, state U10, auxiliary state "Call held"
A11	MS -> SS	STATUS	Transaction identifier of Call A-C
			Transaction identifier of Call A-C, state U10, no auxiliary state
B8	MS -> SS	FACILITY	Take this branch if a message is received within 15 s
B9	SS -> MS	STATUS ENQUIRY	Same as Step 2. Message shall not be received less than 5 s after the first FACILITY message
B10	MS -> SS	STATUS	Transaction identifier of Call A-B
B11	SS -> MS	STATUS ENQUIRY	Transaction identifier of Call A-B, state U10, auxiliary state "Call held"
B12	MS -> SS	STATUS	Transaction identifier of Call A-C
			Transaction identifier of Call A-C, state U10, no auxiliary state

31.14 User-to-User Signalling (UUS)

This subclause applies to mobile station supporting User-to-User Signalling (UUS). The objective of this clause is to test UUS concerned procedures.

Unless indicated in individual sub-clauses, the default message contents in subclause 26.8.4 are applied for CC calls and default message contents in subclause 26.14.10 are applied for VGCS/VBS calls.

31.14.1 UUS / Implicit UUS1

31.14.1.1 UUS / Implicit UUS1 / CC MO call

31.14.1.1.1 Conformance requirement

The UUI service is activated implicitly by the presence of UUI in the set-up request from the mobile station.

To activate UUS1 implicitly, the MS shall include a User-user information element in the SETUP message as part of a normal call request.

The MS shall accept the presence of User-user information element in the ALERTING, CONNECT, DISCONNECT, RELEASE or RELEASE COMPLETE messages (as indicated in 3GPP TS 24.087, figure 1 in subclause 4.1.1).

References

3GPP TS 23.087 subclauses 4.1.1 and 5.2.1.2.1.

3GPP TS 24.087 subclause 4.1.1.

31.14.1.1.2 Test purpose

1. To verify that upon initiation of an outgoing basic call with implicit UUS1 by the user, the MS includes a User-user information element in the SETUP message.
2. To verify that inclusion of the User-user information element with different data length in either of the downlink messages ALERTING, CONNECT, DISCONNECT or RELEASE COMPLETE, causes no adverse effects on the operation of the MS.

31.14.1.1.3 Method of test

Initial conditions

System Simulator:

1 cell, default parameters.

Mobile Station:

The MS is in MM-state "idle, updated" with valid TMSI and CKSN.

Specific PICS Statements

- Support MO telephony (TSPC_AddInfo_MOsvc)
- Support UUS (TSPC_Serv_SS_UUS)

PIXIT Statements

- Way to activate implicit UUS1.
- Description of display of the User-user data received from the network.

Foreseen final state of the MS

The MS is in MM-state "idle, updated" with valid TMSI.

Test procedure

By means of appropriate MMI function, the user requests implicit UUS1 and enters a string, which shall be included in the UUS1. Then MS is made to initiate a call. In the SETUP message, the User-user information element shall be present and shall include the requested string. Then, SS releases the call.

The MS is made to initiate a second call with implicit UUS1. In the SETUP message, the User-user information element shall be present with the requested string. SS releases the call, by sending a RELEASE COMPLETE message including a User-user information element with a long data value. It is checked that the MS is not disturbed by the optional User-user information element.

The MS is made to initiate a third call with implicit UUS1. In the SETUP message, the User-user information element shall be present with the requested string. Then SS shall include User-user information element in the ALERTING and in the CONNECT message with respectively short and long data value, it is checked that MS does not respond adversely to the inclusion of the optional User-user information element. After 10 seconds, SS initiates call clearing. SS sends DISCONNECT and RELEASE COMPLETE messages with User-user information element respectively without data and with a short data value, again the MS shall not respond adversely to the inclusion of the User-user information element, but shall continue to clear down the call normally.

Maximum Duration of Test

2 minutes.

Expected Sequence

Step	Direction	Message	Comments/actions/next state
0	MS		The MS is in idle mode. MMI actions to initiate a CC call with implicit UUS1 including the string 'abc0123456'.
1	MS -> SS	CHANNEL REQUEST	SDCCH4
2	SS -> MS	IMMEDIATE ASSIGNMENT	
3	MS -> SS	CM SERVICE REQUEST	
4	MS -> SS	SETUP	Check User-user IE is included. See specific message contents
5	SS -> MS	RELEASE COMPLETE	The main signalling link shall be released by the MS (L2: DISC/UA).
6	SS -> MS	CHANNEL RELEASE	
10	MS		MMI actions to initiate a CC call with implicit UUS1 including the string 'abc'
11	MS -> SS	CHANNEL REQUEST	SDCCH4
12	SS -> MS	IMMEDIATE ASSIGNMENT	
13	MS -> SS	CM SERVICE REQUEST	
14	MS -> SS	SETUP	Check User-user IE is included. See specific message contents
15	SS -> MS	RELEASE COMPLETE	Message contains the User-user IE with a long data value, see Specific message contents
16	MS		It is checked that the MS, in a way described by the manufacturer, displays user-user data.
17	SS -> MS	CHANNEL RELEASE	The main signalling link shall be released by the MS (L2: DISC/UA).
20	MS		MMI actions to initiate a CC call with implicit UUS1 including the string '123497'.
21	MS -> SS	CHANNEL REQUEST	SDCCH4
22	SS -> MS	IMMEDIATE ASSIGNMENT	
23	MS -> SS	CM SERVICE REQUEST	
24	MS -> SS	SETUP	Check User-user IE is included. See specific message contents
25	SS -> MS	AUTHENTICATION REQUEST	TCH
26	MS -> SS	AUTHENTICATION RESPONSE	
27	SS -> MS	CALL PROCEEDING	
28	SS -> MS	ASSIGNMENT COMMAND	
29	MS -> SS	ASSIGNMENT COMPLETE	
30	SS -> MS	ALERTING	
			Message contains the User-user IE with a short data value, see Specific message contents

Step	Direction	Message	Comments/actions/next state
31	MS		It is checked that the MS, in a way described by the manufacturer, displays user-user data.
32	SS -> MS	CONNECT	Message contains the User-user IE with a long data value, see Specific message contents
33	MS		It is checked that the MS, in a way described by the manufacturer, displays user-user data.
34	MS -> SS	CONNECT ACKNOWLEDGE	
35	SS -> MS	DISCONNECT	Without Progress Indication IE Including the User-user IE without data, see Specific message contents
36	MS		It is checked that the MS, in a way described by the manufacturer, displays no user-user data.
37	MS -> SS	RELEASE	
38	SS-> MS	RELEASE COMPLETE	Message contains the User-user IE with a short data value, see Specific message contents
39	SS		It is checked that the MS, in a way described by the manufacturer, displays user-user data.
40	SS -> MS	CHANNEL RELEASE	The main signalling link shall be released by the MS (L2: DISC/UA).

Specific message contents:

SETUP

As default message contents as defined in subclause 26.8.4 (mobile station to network direction), except:

Information Element	value/remark
User-user	
- IEI	'7E'O
- length	1 + the entered string length
- PD	User specific protocol
- user-user	The string as entered coded in IA5 characters

ALERTING

As default message contents as defined in subclause 26.8.4 (network to mobile station direction), except:

Information Element	value/remark
User-user	
- IEI	'7E'O
- length	2
- PD	User specific protocol
- user-user	The following string coded in IA5 characters: "A"

CONNECT

As default message contents as defined in subclause 26.8.4 (network to mobile station direction), except:

Information Element	value/remark
User-user	
- IEI	'7E'O
- length	101
- PD	User specific protocol
- user-user	The following string with a length of 100 octets coded in IA5 characters: "abcdefghijklmnopqrstuvwxy0123456789abc....."

DISCONNECT

As default message contents as defined in subclause 26.8.4 (network to mobile station direction), except:

Information Element	value/remark
User-user	
- IEI	'7E'O
- length	1
- PD	User specific protocol
- user-user	-

RELEASE COMPLETE – step 15

As default message contents as defined in subclause 26.8.4 (network to mobile station direction), except:

Information Element	value/remark
User-user	
- IEI	'7E'O
- length	37
- PD	User specific protocol
- user-user	The following string coded in IA5 characters: "0123456789abcdefghijklmnopqrstuvwxyz"

RELEASE COMPLETE – step 38

As default message contents as defined in subclause 26.8.4 (network to mobile station direction), except:

Information Element	value/remark
User-user	
- IEI	'7E'O
- length	17
- PD	User specific protocol
- user-user	The following string coded in IA5 characters: "RELEASE COMPLETE"

31.14.1.2 UUS / Implicit UUS1 / CC MT call

31.14.1.2.1 Conformance requirement

The MS shall accept the presence of User-user information element in the SETUP and DISCONNECT messages (as indicated in 3GPP TS 23.087, figure 5.2.1.2.1.1).

The MS may include User-user information element in the ALERTING or CONNECT messages (as indicated in 3GPP TS 23.087, figure 5.2.1.2.1.1).

References

3GPP TS 23.087 subclause 5.2.1.2.1.

3GPP TS 24.087.

31.14.1.2.2 Test purpose

1. To verify that, the receipt of SETUP message including user-user information element with a short or large data value causes no adverse effects on the call establishment operation of the MS.
2. To verify that MS could include User-user information element in either of the uplink messages ALERTING or CONNECT.
3. To verify that inclusion of the User-user information element with different data length in either of the downlink message DISCONNECT or RELEASE COMPLETE, causes no adverse effects on the operation of the MS.

31.14.1.2.3 Method of test

Initial conditions

System Simulator:

1 cell, default parameters.

Mobile Station:

The MS is in MM-state "idle, updated" with valid TMSI and CKSN.

Specific PICS Statements

- Support MT telephony (TSPC_AddInfo_MTsvc)
- Support UUS (TSPC_Serv_SS_UUS)

PIXIT Statements

- Support the sending of UUS1 information element in ALERTING message
- Support the sending of UUS1 information element in CONNECT message
- Way to activate implicit UUS1.
- Description of display of the User-user data received from the network.

Foreseen final state of the MS

The MS is in MM-state "idle, updated" with valid TMSI.

Test procedure

SS initiates a call. In the SETUP message, the User-user information element shall be present. It is checked that the MS, in a way described by the manufacturer, displays the user-user data. Then, SS releases the call immediately after the MS call confirmation.

The SS initiates a second call and in the SETUP message, the User-user information element shall contain a larger data value. It is checked that the MS, in a way described by the manufacturer, displays the user-user data. Then the SS releases the call immediately after the MS call confirmation. In the RELEASE COMPLETE message, the User-user information element shall also contain a large data value. It is checked that the MS is not disturbed by the User-user optional information element.

By means of appropriate MMI function and if MS supports User-user information element in ALERTING or CONNECT messages, the user enters a string, which shall be included in the UUS1. The SS initiates a third call and in the SETUP message, the User-user information element shall be included without data. After the MS call confirmation and depending on the MS capability, it is checked that the MS sends in the User-user information element of the ALERTING message the string as requested. When the TCH is allocated and depending on the MS capability, it is checked that the MS sends in the User-user information element of the CONNECT message the string as requested. When the call is established, the SS releases the call and shall include in the DISCONNECT message the optional User-user information element. It is checked that the MS is not disturbed by the User-user information element. The SS shall also include in the RELEASE COMPLETE message the optional User-user information element. It is checked that the MS is not disturbed by the User-user information element.

Maximum Duration of Test

2 minutes.

Expected Sequence

Step	Direction	Message	Comments/actions/next state
0	MS		The MS is in idle mode.
1	SS -> MS	PAGING REQUEST	
2	MS -> SS	CHANNEL REQUEST	
3	SS -> MS	IMMEDIATE ASSIGNMENT	U0, SDCCH4
4	MS -> SS	PAGING RESPONSE	
7	SS -> MS	SETUP	User-user IE included with a short data value, see Specific message contents
8	MS		Check that the MS, in a way described by the manufacturer, displays the User-user data value.
9	MS -> SS	CALL CONFIRMED	
10	SS -> MS	RELEASE COMPLETE	
11	SS -> MS	CHANNEL RELEASE	The main signalling link shall be released by the MS (L2: DISC/UA).
15	SS -> MS	PAGING REQUEST	
16	MS -> SS	CHANNEL REQUEST	
17	SS -> MS	IMMEDIATE ASSIGNMENT	U0, SDCCH4
18	MS -> SS	PAGING RESPONSE	
21	SS -> MS	SETUP	User-user IE included with a large data value, see Specific message contents
22	MS		Check that the MS, in a way described by the manufacturer, displays the User-user data value.
23	MS -> SS	CALL CONFIRMED	
24	SS -> MS	RELEASE COMPLETE	Message contains the User-user IE with a long data value, see Specific message contents.
25	MS		Check that the MS, in a way described by the manufacturer, displays the User-user data value.
26	SS -> MS	CHANNEL RELEASE	The main signalling link shall be released by the MS (L2: DISC/UA).
30	SS -> MS	PAGING REQUEST	If supported, MMI actions to initiate implicit UUS1 with the string '12346aA'
31	MS -> SS	CHANNEL REQUEST	
32	SS -> MS	IMMEDIATE ASSIGNMENT	U0, SDCCH4
33	MS -> SS	PAGING RESPONSE	
34	SS -> MS	AUTHENTICATION REQUEST	
35	MS -> SS	AUTHENTICATION RESPONSE	
36	SS -> MS	SETUP	User-user IE included without data. See Specific message contents.
37	MS		Check that the MS, in a way described by the manufacturer, displays no User-user data value.
38	MS -> SS	CALL CONFIRMED	
39	MS -> SS	ALERTING	If MS support User-user IE in ALERTING message, then check the presence of this IE. See specific message contents.
40	MS -> SS	CONNECT	If MS support User-user IE in CONNECT message, then check the presence of this IE. See specific message contents.
41	SS -> MS	ASSIGNMENT COMMAND	TCH
42	MS -> SS	ASSIGNMENT COMPLETE	
43	SS -> MS	CONNECT ACKNOWLEDGE	

Step	Direction	Message	Comments/actions/next state
44	SS -> MS	DISCONNECT	With the User-user IE with a long data value, see Specific message contents Check that the MS, in a way described by the manufacturer, displays the User-user data value.
45	MS		
46	MS -> SS	RELEASE	Message contains the User-user IE with a short data value, see Specific message contents. Check that the MS, in a way described by the manufacturer, displays the User-user data value.
47	SS-> MS	RELEASE COMPLETE	
48	MS		The main signalling link shall be released by the MS (L2: DISC/UA).
49	SS -> MS	CHANNEL RELEASE	

Specific message contents:

SETUP – step 7

As default message contents as defined in subclause 26.8.4 (network to mobile station direction), except:

Information Element	value/remark
User-user	
- IEI	'7E'O
- length	4
- PD	User specific protocol
- user-user	The following string coded in IA5 characters : "012"

SETUP – step 21

As default message contents as defined in subclause 26.8.4 (network to mobile station direction), except:

Information Element	value/remark
User-user	
- IEI	'7E'O
- length	33
- PD	User specific protocol
- user-user	The following string coded in IA5 characters : "abcdefghijklmnopqrstuvwxy012345"

SETUP – step 36

As default message contents as defined in subclause 26.8.4 (network to mobile station direction), except:

Information Element	value/remark
User-user	
- IEI	'7E'O
- length	1
- PD	User specific protocol
- user-user	-

RELEASE COMPLETE – step 24

As default message contents as defined in subclause 26.8.4 (network to mobile station direction), except:

Information Element	value/remark
User-user	
- IEI	'7E'O
- length	37
- PD	User specific protocol
- user-user	The following string coded in IA5 characters : "abcdefghijklmnopqrstuvwxy0123456789"

RELEASE COMPLETE – step 47

As default message contents as defined in subclause 26.8.4 (network to mobile station direction), except:

Information Element	value/remark
User-user - IEI - length - PD - user-user	'7E'O 2 User specific protocol The following string coded in IA5 characters: "A"

ALERTING

As default message contents as defined in subclause 26.8.4 (mobile station to network direction), except:

Information Element	value/remark
User-user - IEI - length - PD - user-user	'7E'O 8 User specific protocol The string '12346aA' coded in IA5 characters

CONNECT

As default message contents as defined in subclause 26.8.4 (mobile station to network direction), except:

Information Element	Value/remark
User-user - IEI - length - PD - user-user	'7E'O 8 User specific protocol The string '12346aA ' coded in IA5 characters

DISCONNECT

As default message contents as defined in subclause 26.8.4 (network to mobile station direction), except:

Information Element	Value/remark
User-user - IEI - length - PD - user-user	'7E'O 37 User specific protocol The following string coded in IA5 characters : "abcdefghijklmnopqrstuvwxy0123456789"

31.14.1.3 UUS / Implicit UUS1 / Interactions with Call Waiting and call HOLD supplementary services

31.14.1.3.1 Conformance requirement

There are no interactions between UUS and the Call hold (HOLD) and Call waiting (CW) supplementary services.

To activate UUS1 implicitly, the MS shall include a User-user information element in the SETUP message as part of a normal call request.

The MS shall accept the presence of User-user information element in the SETUP and DISCONNECT messages (as indicated in 3GPP TS 23.087, figure 5.2.1.2.1.1).

References

3GPP TS 23.087 subclauses 4.1.1, 5.2.1.2.1.1 and 5.2.1.2.1.

3GPP TS 24.087 subclauses 4.1.1, 6.4 and 6.5.

31.14.1.3.2 Test purpose

1. To verify that when in active Call State and supporting Call Hold, to initiate a second call with implicit UUS1, the MS places the first call on hold and sends a SETUP message with the User-user information element. Verify that the second call is successfully established.
2. In call active state and supporting Call Waiting, when a Call Waiting indication includes a User-user information element, the MS accepts the waiting call and places the first call on hold and successfully establishes the second call.

31.14.1.3.3 Method of test

Initial conditions

System Simulator:

1 cell, default parameters.

Mobile Station:

The MS has a call ("Call A-B") in the active state. The SIM in the MS under test has Call Waiting enabled.

Specific PICS Statements

- Support MO telephony (TSPC_AddInfo_MOsvc)
- Support MT telephony (TSPC_AddInfo_MTsvc)
- Support UUS (TSPC_Serv_SS_UUS)
- Support hold (TSPC_Serv_SS_HOLD)

PIXIT Statements

- Way to activate implicit UUS1.
- Description of display of the User-user data received from the network.

Foreseen final state of the MS

The MS is in MM-state "idle, updated" with valid TMSI.

Test procedure

A call is established between the MS and SS. This call is the active call named Call A-B.

Using suitable MMI commands, the MS shall request that the call A-B be placed on hold. The MS shall send a HOLD message and enter auxiliary state "hold request". On receipt of a HOLD ACKNOWLEDGE message from the SS, the MS is made to initiate a second call with implicit UUS1. It is checked that the MS includes the User-user information element in the SETUP message. Then the SS sends an ALERTING message including the optional User-user information. It is checked that the MS, in a way described by the manufacturer, displays the User-user data value. Then the SS sends a CONNECT message including the optional User-user information element. It is checked that the MS, in a way described by the manufacturer, displays the User-user data value. On receipt of a CONNECT ACKNOWLEDGE message, MS shall enter state U10 "Active". The SS releases the second call A-C and shall include in the DISCONNECT message the optional User-user information element. It is checked that the MS is not disturbed by the User-user information element. The SS shall also include in the RELEASE COMPLETE message the optional User-user information element. It is checked that the MS is not disturbed by the User-user information element.

The Call A-B is still alive. By means of appropriate MMI function, the user enters a string, which shall be included in the UUS1 sent by the MS. The SS sends a SETUP message including a User-user information element and indicating the request of a new call, named Call C-A. It is checked with the appropriate MMI function, that the MS displays the contents of the User-user information element. Then the MS shall place Call A-B on hold, and answer Call C-A. The MS shall send a HOLD message to the SS using the transaction identifier of Call A-B. On receipt of a HOLD ACKNOWLEDGE from the SS, the MS shall send a CALL CONFIRMED message and an ALERTING message to the SS, using the transaction identifier of Call C-A, and depending on the MS capability including the optional User-user information element as requested by the user. Then the MS shall send a CONNECT message to the SS, using the

transaction identifier of Call C-A, and depending on the MS capability including the optional User-user information element as entered by the user. On receipt of a CONNECT ACKNOWLEDGE message, MS shall enter state U10 "Active". The SS releases the call C-A and shall include in the DISCONNECT message the optional User-user information element. It is checked that the MS is not disturbed by the User-user information element. The SS shall also include in the RELEASE COMPLETE message the optional User-user information element. It is checked that the MS is not disturbed by the User-user information element.

Then SS releases the first call A-B.

Maximum Duration of Test

2 minutes.

Expected Sequence

Step	Direction	Message	Comments/actions/next state
0	MS		Active call state with call A-B.
1	MS		If supported, MMI actions to initiate implicit UUS1 with the string '12345'.
2	MS		Call A-C is requested using MMI commands and Call A-B is placed on hold using MMI commands
3	MS -> SS	CM SERVICE REQUEST	Transaction identifier of Call A-C
4	SS -> MS	CM SERVICE ACCEPT	Transaction identifier of Call A-C
5	MS -> SS	SETUP	Check User-user IE is included, transaction identifier of Call A-C, see Specific message contents.
6	SS -> MS	ALERTING	Message contains the User-user IE with a short data value, transaction identifier of Call A-C, see Specific message contents
7	MS		Check that the MS, in a way described by the manufacturer, displays the User-user data value.
8	MS -> SS	HOLD	Transaction identifier of Call A-B
9	SS -> MS	HOLD ACKNOWLEDGE	Transaction identifier of Call A-B
10	SS -> MS	CONNECT	Message contains the User-user IE with a long data value, transaction identifier of Call A-C, see Specific message contents
11	MS		Check that the MS, in a way described by the manufacturer, displays the User-user data value.
12	MS -> SS	CONNECT ACKNOWLEDGE	Transaction identifier of Call A-C
13	SS -> MS	DISCONNECT	Without Progress Indication IE, transaction identifier of Call A-C. With the User-user IE without data, see Specific message contents
14	MS		Check that the MS, in a way described by the manufacturer, displays the User-user data value.
15	MS -> SS	RELEASE	
16	SS-> MS	RELEASE COMPLETE	Message contains the User-user IE with a short data value, transaction identifier of Call A-C, see Specific message contents
17	MS		Check that the MS, in a way described by the manufacturer, displays the User-user data value.
18	SS		Call A-B is released
19	SS -> MS	CHANNEL RELEASE	The main signalling link shall be released by the MS (L2: DISC/UA).
20			Active call state with call A-B.
21	MS		MMI actions to initiate implicit UUS1 with the string '201'.
22	SS -> MS	PAGING REQUEST	
23	MS -> SS	PAGING RESPONSE	
31	SS->MS	SETUP	User-user IE is included, see Specific message contents. Transaction identifier of Call C-A
32	MS		Check that the MS, in a way described by the manufacturer, displays the User-user data value. Call A-B is placed on hold using MMI commands.
34	MS -> SS	HOLD	Transaction identifier of Call A-B
35	SS -> MS	HOLD ACKNOWLEDGE	Transaction identifier of Call A-B
36	MS		Call C-A is answered using MMI commands
37	MS -> SS	CALL CONFIRMED	Transaction identifier of Call C-A
38	MS -> SS	ALERTING	If MS support User-user IE in ALERTING message, then check the presence of this IE. Transaction identifier of Call C-A
39	MS -> SS	CONNECT	If MS supports User-user IE in CONNECT message, then check the presence of this IE. Transaction identifier of Call C-A

Step	Direction	Message	Comments/actions/next state
40	SS -> MS	CONNECT ACKNOWLEDGE	Transaction identifier of Call C-A
41	SS -> MS	DISCONNECT	With the User-user IE without data, transaction identifier of Call C-A, see Specific message contents. Check that the MS, in a way described by the manufacturer, displays the User-user data value.
42	MS		
43	MS -> SS	RELEASE	Message contains the User-user IE with a short data value, see Specific message contents. Transaction identifier of Call C-A
44	SS-> MS	RELEASE COMPLETE	
45	MS		Check that the MS, in a way described by the manufacturer, displays the User-user data value.

Specific message contents:

SETUP – step 5

As default message contents as defined in subclause 26.8.4 (mobile station to network direction), except:

Information Element	value/remark
User-user	'7E'O
- IEI	1 + the entered string length
- length	User specific protocol
- PD	The string as entered, coded in IA5 characters
- user-user	

SETUP – step 31

As default message contents as defined in subclause 26.8.4 (network direction to mobile station), except:

Information Element	value/remark
User-user	'7E'O
- IEI	4
- length	User specific protocol
- PD	The following string coded in IA5 characters : "012"
- user-user	

ALERTING– step 6

As default message contents as defined in subclause 26.8.4 (network to mobile station direction), except:

Information Element	value/remark
User-user	'7E'O
- IEI	4
- length	User specific protocol
- PD	The following string coded in IA5 characters : "012"
- user-user	

ALERTING– step 38

As default message contents as defined in subclause 26.8.4 (mobile station to network direction), except:

Information Element	value/remark
User-user	'7E'O
- IEI	1 + the entered string length
- length	User specific protocol
- PD	The string as entered, coded in IA5 characters
- user-user	

CONNECT– step 10

As default message contents as defined in subclause 26.8.4 (network to mobile station direction), except:

Information Element	value/remark
User-user - IEI - length - PD - user-user	'7E'O 37 User specific protocol The following string coded in IA5 characters : "abcdefghijklmnopqrstuvwxy0123456789"

CONNECT– step 39

As default message contents as defined in subclause 26.8.4 (mobile station to network direction), except:

Information Element	value/remark
User-user - IEI - length - PD - user-user	'7E'O 1 + the entered string length User specific protocol The string as entered in IA5 characters

DISCONNECT

As default message contents as defined in subclause 26.8.4 (network to mobile station direction), except:

Information Element	value/remark
User-user - IEI - length - PD - user-user	'7E'O 1 User specific protocol -

RELEASE COMPLETE

As default message contents as defined in subclause 26.8.4 (network to mobile station direction), except:

Information Element	value/remark
User-user - IEI - length - PD - user-user	'7E'O 2 User specific protocol The following string coded in IA5 characters: "A"

31.15 Follow Me (FM)

This subclause applies to mobile station supporting Follow Me (FM). The objective of this clause is to test FM concerned procedures.

Unless indicated in individual sub-clauses, the default message contents in subclause 31.11 are applied.

31.15.1 Follow Me (FM) / Registration**31.15.1.1 Conformance requirement**

1. The initiating subscriber registers the Follow Me feature with respect to a particular remote party. The initiating subscriber shall provide the following information to the network: the number of the remote party. The initiating subscriber shall receive an indication if the FM registration request was accepted or rejected by the network.
2. MS shall behave as indicated in the Information flow as indicated in 3GPP TS 23.094, figure 4.1.

3. As an operator's option additional information (such as passwords) for registration may be required from the initiating subscriber. This information shall be coded as a USSD string with a length not exceeding 30 characters.
4. All the messages between MS and the mobile network and internal to the mobile network, which are used for control of Follow Me, are USSD Phase 2 messages.
5. If a mobile initiated USSD request using protocol version 2 is rejected by the network, and the reason for the rejection is indicated either by the problem code "unrecognized operation" or a cause "Facility rejected", the MS shall assume that the network only supports protocol version 1 of USSD operations. The MS shall re-attempt the request by using the appropriate protocol version 1 USSD operation without an SS version indicator if the unstructured data entered by the user can be coded as an IA5 string.

References

3GPP TS 22.094 subclause 6.3.

3GPP TS 23.094 subclauses 4.1, 4.2 and 4.4.

3GPP TS 24.090 subclause 6.1.

31.15.1.2 Test purpose

1. To check that the MS correctly requests a supplementary service transaction for registration of FM in CHANNEL REQUEST message and in the subsequent CM SERVICE REQUEST.
2. To check that the MS sends a REGISTER message using USSD phase 2 and containing the FM-request control message for registration.
3. To check that upon receipt of the result or the error of the operation (in a RELEASE COMPLETE message), the MS provides the appropriate user indication (as described by the manufacturer).
4. To check that upon receipt of a rejection from the network with the problem code "unrecognized operation" or a cause "Facility rejected", the MS re-attempt the request by using USSD version 1.

31.15.1.3 Method of test

Initial conditions

System Simulator:

1 cell, default parameters.

Mobile Station:

The MS is in MM-state "idle, updated" with valid TMSI and CKSN.

Specific PICS Statements

-

PIXIT Statements

- Way to activate the registration of FM.
- Description of display of the FM answers from the network.

Foreseen final state of the MS

The MS is in MM-state "idle, updated" with valid TMSI.

Test procedure

By means of appropriate MMI functions, the user requests registration of FM for a remote number. Upon receipt of the REGISTER message, SS answers with the RELEASE COMPLETE message with an unsuccessful FM-result information. Check that the MS provides the appropriate user indication (as described by the manufacturer). Then SS transaction is released. This procedure is executed for all possible error values.

The user requests registration of FM for another remote subscriber. Upon receipt of the operation (in a REGISTER message), SS answers with a RELEASE COMPLETE message with a successful FM-response information. Check that the MS provides the appropriate user indication (as described by the manufacturer). The SS transaction is released.

Then user request again two registrations, upon receipt of the REGISTER message, SS answers with a RELEASE COMPLETE message including a rejection with respectively the problem code "unrecognized operation" or a cause "facility rejected". Check that MS re-attempt the request by using USSD version 1: without the SS version indicator information element included in the REGISTER message.

Maximum Duration of Test

2 minutes.

Expected Sequence

Test steps 1 to 10 are executed for k=1 to 13 with respectively the following error values:

1. Illegal interaction with incoming barring.
2. Unauthorised request.
3. Unknown remote party.
4. FM not subscribed.
5. Remote party already registered.
6. Unauthorised changes to remote party.
7. Illegal interaction with call forwarding.
8. Illegal interaction with call barring.
9. Request to own MSISDN not possible.
10. Forwarded-to number is invalid directory number.
11. Insufficient information.
12. Forwarded-to number is a special code.
13. Conflicting situation with other supplementary services.

Step	Direction	Message	Comments
0	MS		The MS is in idle mode.
1	MS		The MS is made to initiate a registration of FM
2	MS -> SS	CHANNEL REQUEST	With establishment cause "Other procedures which can be completed with an SDCCH"
3	SS -> MS	IMMEDIATE ASSIGNMENT	
4	MS -> SS	CM SERVICE REQUEST	Cause: "supplementary service activation"
5	SS -> MS	CM SERVICE ACCEPT	
6	MS -> SS	REGISTER	Check that the content of this message matches specific message contents.
7	SS -> MS	RELEASE COMPLETE	With an unsuccessful FM-result info with the following error value: k=1: Illegal interaction with incoming barring (code 21) k=2: Unauthorised request (code 22) k=3: Unknown remote party (code 41) k=4: FM not subscribed (code 42) k=5: Remote party already registered (code 61) k=6: Unauthorised changes to remote party (code 64) k=7: Illegal interaction with call forwarding (code 65) k=8: Illegal interaction with call barring (code 66) k=9: Request to own MSISDN not possible (code 67) k=10: Forwarded-to number is invalid directory number (code 80) k=11: Insufficient information (code 81) k=12: Forwarded-to number is a special code (code 82) k=13: Conflicting situation with other supplementary services (code 83) See specific message contents.
8	MS		It is checked that the MS, in a way described by the manufacturer, displays the error.
10	SS -> MS	CHANNEL RELEASE	
15	MS		The MS is made to initiate a registration of FM
16	MS -> SS	CHANNEL REQUEST	With establishment cause "Other procedures which can be completed with an SDCCH"
17	SS -> MS	IMMEDIATE ASSIGNMENT	
18	MS -> SS	CM SERVICE REQUEST	Cause: "supplementary service activation"
19	SS -> MS	CM SERVICE ACCEPT	
20	MS -> SS	REGISTER	Check that the content of this message matches specific message contents.
21	SS -> MS	RELEASE COMPLETE	With a successful FM-result. See specific message contents.
22	MS		It is checked that the MS, in a way described by the manufacturer, displays the positive result.
23	SS -> MS	CHANNEL RELEASE	
30	MS		The MS is made to initiate a registration of FM
31	MS -> SS	CHANNEL REQUEST	With establishment cause "Other procedures which can be completed with an SDCCH"
32	SS -> MS	IMMEDIATE ASSIGNMENT	
33	MS -> SS	CM SERVICE REQUEST	Cause: "supplementary service activation"
34	SS -> MS	CM SERVICE ACCEPT	
35	MS -> SS	REGISTER	Check that the content of this message matches specific message contents.
36	SS -> MS	RELEASE COMPLETE	Including a rejection with the problem code "unrecognized operation"
37	SS -> MS	CHANNEL RELEASE	
38	MS -> SS	CHANNEL REQUEST	With establishment cause "Other procedures which can be completed with an SDCCH"
39	SS -> MS	IMMEDIATE ASSIGNMENT	

Step	Direction	Message	Comments
40	MS -> SS	CM SERVICE REQUEST	Cause: "supplementary service activation" Check that SS version indicator IE is not included. See specific message contents.
41	SS -> MS	CM SERVICE ACCEPT	
42	MS -> SS	REGISTER	
43	SS -> MS	RELEASE COMPLETE	With a successful FM-result. See specific message contents.
44	MS		It is checked that the MS, in a way described by the manufacturer, displays the positive result.
45	SS -> MS	CHANNEL RELEASE	
50	MS		The MS is made to initiate a registration of FM With establishment cause "Other procedures which can be completed with an SDCCH"
51	MS -> SS	CHANNEL REQUEST	
52	SS -> MS	IMMEDIATE ASSIGNMENT	Cause: "supplementary service activation" The SS checks that the content of this message matches specific message contents.
53	MS -> SS	CM SERVICE REQUEST	
54	SS -> MS	CM SERVICE ACCEPT	
55	MS -> SS	REGISTER	
56	SS -> MS	RELEASE COMPLETE	Including a rejection with the cause value Facility rejected. See specific message contents.
57	SS -> MS	CHANNEL RELEASE	
58	MS -> SS	CHANNEL REQUEST	With establishment cause "Other procedures which can be completed with an SDCCH"
59	SS -> MS	IMMEDIATE ASSIGNMENT	Cause: "supplementary service activation"
60	MS -> SS	CM SERVICE REQUEST	
61	SS -> MS	CM SERVICE ACCEPT	Check that SS version indicator IE is not included. See specific message contents.
62	MS -> SS	REGISTER	
63	SS -> MS	RELEASE COMPLETE	With a successful FM-result. See specific message contents.
64	MS		It is checked that the MS, in a way described by the manufacturer, displays the positive result.
65	SS -> MS	CHANNEL RELEASE	

Specific message contents:

REGISTER

Information Element	value/remark
Supplementary service protocol discriminator	Supplementary service (call independent)
Transaction identifier	'1011'B
Message type	As 3GPP TS 24.080
Facility 1C	See below
SS version indicator	As specified in 3GPP TS 24.080 For steps 42 and 62 omitted

For steps 6, 20, 35 and 55, Facility Information Element with Invoke = ProcessUnstructuredSS-Request component type as defined in 3GPP TS 24.080 subclause 3.6.1 table 3.3.

Contents	Value/remark
Facility IE identifier	As 3GPP TS 24.080
Length of FIE contents	depending on the length of ussd-string
Component type tag	Invoke CS/C/tag=1
Component length	depending on the length of ussd-string
InvokeID tag	From 3GPP TS 24.080
Invoke ID length	1
Invoke ID	Arbitrary (1 octet)
Operation Code tag	From 3GPP TS 24.080
Operation Code length	1
Operation Code	UnstructuredSS-Request
Ussd-dataCodingScheme	1 octet long. Alphabet indicator set to "default alphabet". Language indicator set to "undefined"
Ussd-string	For step 6 **214*04965878***# For step 20 **214*04969***# For steps 35 and 55 **214*31245688***#

RELEASE COMPLETE

Information Element	value/remark
Supplementary service protocol discriminator	Supplementary service (call independent)
Transaction identifier	the transaction value is the same as the REGISTER transaction value but the transaction flag is different
Message type	As 3GPP TS 24.080
Cause	For step 56, cause is set to "facility rejected" and FIE is omitted. For steps 7,21,43,63,36 this field is omitted.
Facility Information Element	See below (omitted for step 56)
SS version indicator	As specified in 3GPP TS 24.080

For steps 7, 21, 43 and 63, Facility Information Element with Return result = ProcessUnstructuredSS-Request return result component type as defined in 3GPP TS 24.080 subclause 3.6.1 table 3.6.

Contents	Value/remark
Facility IE identifier	As 3GPP TS 24.080
Length of FIE contents	depending on the length of ussd-string
Component type tag	Return result
Component length	depending on the length of ussd-string
InvokeID tag	From 3GPP TS 24.080
Invoke ID length	1
Invoke ID	The same as the invoke of the ProcessUnstructuredSS-Request
Ussd-dataCodingScheme	1 octet long. Alphabet indicator set to "default alphabet". Language indicator set to "undefined"
Ussd-string	For step 7: value of the error code For steps 21 43 and 63: 01

For step 36, Facility Information Element with Reject = ProcessUnstructuredSS-Request return result component type as defined in 3GPP TS 24.080 subclause 3.6.1 table 3.6.

Contents	Value/remark
Facility IE identifier	As 3GPP TS 24.080
Length of FIE contents	depending on the length of ussd-string
Component type tag	Reject
Component length	depending on the length of ussd-string
InvokeID tag	From 3GPP TS 24.080
Invoke ID length	1
Invoke ID	The same as the invoke of the ProcessUnstructuredSS-Request
Problem Code tag	As 3GPP TS 24.080
Problem Code length	1
General Problem code	Unrecognized operation

31.15.2 Follow Me (FM) / Interrogation

31.15.2.1 Conformance requirement

1. An initiating subscriber (also the FM service supervisor) shall be able to interrogate the Follow Me data of any remote party, for which she is authorised to become initiating subscriber.
2. In case the remote party corresponds to a subscriber the remote party shall be able to interrogate her own Follow Me data stored in the network.
3. As an operator's option additional information (such as passwords) for interrogation may be required from the subscriber. The registration procedure shall transport this information from the subscriber to the network of the remote party. This information shall be coded as a USSD string with a length not exceeding 30 characters.
4. All the messages between MS and the mobile network and internal to the mobile network, which are used for control of Follow Me, are USSD Phase 2 messages.
5. MS shall behave as indicated in the Information flow as indicated in 3GPP TS 23.094, figure 4.1.

References

3GPP TS 22.094 subclauses 6.8 and 7.3.

3GPP TS 23.094 subclauses 4.1, 4.2 and 4.4.

3GPP TS 24.090 subclause 6.1.

31.15.2.2 Test purpose

1. To check that the MS (as initiating subscriber or remote party) correctly requests a supplementary service transaction for interrogation of FM in CHANNEL REQUEST message and in the subsequent CM SERVICE REQUEST.
2. To check that the MS sends a REGISTER message using USSD version 2 and containing the FM-request control message for interrogation.
3. To check that upon receipt of the result or the error of the operation (in a RELEASE COMPLETE message), the MS provides the appropriate user indication (as described by the manufacturer).

31.15.2.3 Method of test

Initial conditions

System Simulator:

1 cell, default parameters.

Mobile Station:

The MS is in MM-state "idle, updated" with valid TMSI and CKSN. The MS is registered to FM with respect to a remote party B.

Specific PICS Statements

-

PIXIT Statements

- Way to activate the interrogation of FM.
- Description of display of the FM answers from the network.

Foreseen final state of the MS

The MS is in MM-state "idle, updated" with valid TMSI.

Test procedure

MS is registered to FM.

By means of appropriate MMI functions, the user requests interrogation of FM for a remote number. Upon receipt of the REGISTER message, SS answers with the RELEASE COMPLETE message with an unsuccessful FM-result in a facility information element. Check that the MS provides the appropriate user indication (was described by the manufacturer). Then SS transaction is released. This procedure is executed for all possible error values.

The user requests interrogation of FM for another remote subscriber. Upon receipt of the operation (in a REGISTER message), SS answers with a RELEASE COMPLETE message with a successful FM-response information. Check that the MS provides the appropriate user indication (as described by the manufacturer). The SS transaction is released.

Maximum Duration of Test

2 minutes.

Expected Sequence

Test steps 1 to 10 are executed for k=1 to 6 with respectively the following error values:

1. Illegal interaction with incoming barring.
2. Unauthorised request.
3. Unknown remote party.
4. FM not subscribed.
5. FM not registered to remote party.
6. Conflicting situation with other supplementary services.

Step	Direction	Message	Comments
0	MS		The MS is in idle mode. MS is registered to FM with respect to a remote party B.
1	MS		The MS is made to initiate an interrogation of FM of remote subscriber other than B.
2	MS -> SS	CHANNEL REQUEST	with establishment cause "Other procedures which can be completed with an SDCCH"
3	SS -> MS	IMMEDIATE ASSIGNMENT	
4	MS -> SS	CM SERVICE REQUEST	cause: "supplementary service activation"
5	SS -> MS	CM SERVICE ACCEPT	
6	MS -> SS	REGISTER	Check that the content of this message matches specific message contents.
7	SS -> MS	RELEASE COMPLETE	With an unsuccessful FM-result info with the following error value: k=1: Illegal interaction with incoming barring (code 21) k=2: Unauthorised request (code 22) k=3: Unknown remote party (code 41) k=4: FM not subscribed (code 42) k=5: FM not registered to remote party (code 62) k=6: Conflicting situation with other supplementary services (code 83) See specific message contents.
8	MS		Check that the MS, in a way described by the manufacturer, displays the error.
10	SS -> MS	CHANNEL RELEASE	
15	MS		The MS is made to initiate an interrogation of FM of remote party B.
16	MS -> SS	CHANNEL REQUEST	With establishment cause "Other procedures which can be completed with an SDCCH"
17	SS -> MS	IMMEDIATE ASSIGNMENT	
18	MS -> SS	CM SERVICE REQUEST	Cause: "supplementary service activation"
19	SS -> MS	CM SERVICE ACCEPT	
20	MS -> SS	REGISTER	Check that the content of this message matches specific message contents.
21	SS -> MS	RELEASE COMPLETE	With a successful FM-result. See specific message contents.
22	MS		Check that the MS, in a way described by the manufacturer, displays the positive result.
23	SS -> MS	CHANNEL RELEASE	

Specific message contents:

REGISTER

Information Element	value/remark
Supplementary service protocol discriminator	Supplementary service (call independent)
Transaction identifier	'1011'B
Message type	As 3GPP TS 24.080
Facility 1C	See below
SS version 7F	As 3GPP TS 24.080

For steps 6 and 20, Facility Information Element with Invoke = ProcessUnstructuredSS-Request component type as defined in 3GPP TS 24.080 subclause 3.6.1 table 3.3.

Contents	Value/remark
Facility IE identifier	As 3GPP TS 24.080
Length of FIE contents	depending on the length of ussd-string
Component type tag	CS/C/tag=1
Component length	depending on the length of ussd-string
InvokeID tag	From 3GPP TS 24.080
Invoke ID length	1
Invoke ID	Arbitrary (1 octet)
Operation Code tag	From 3GPP TS 24.080
Operation Code length	1
Operation Code	ProcessUnstructuredSS-Request
Ussd-dataCodingScheme	1 octet long. Alphabet indicator set to "default alphabet". Language indicator set to "undefined"
Ussd-string	For step 6: #21445896**# For step 20: #21431245688**#

RELEASE COMPLETE

Information Element	value/remark
Supplementary service protocol discriminator	Supplementary service (call independent)
Transaction identifier	the transaction value is the same as the REGISTER transaction value but the transaction flag is different
Message type	As 3GPP TS 24.080
Cause	Omitted.
Facility Information Element	See below
SS version indicator	As specified in 3GPP TS 24.080

For steps 7 and 21, Facility Information Element with Return result = ProcessUnstructuredSS-Request return result component type as defined in 3GPP TS 24.080 subclause 3.6.1 table 3.6.

Contents	Value/remark
Facility IE identifier	As 3GPP TS 24.080
Length of FIE contents	depending on the length of ussd-string
Component type tag	Return result
Component length	depending on the length of ussd-string
InvokeID tag	From 3GPP TS 24.080
Invoke ID length	1
Invoke ID	The same as the invoke of the ProcessUnstructuredSS-Request
Ussd-dataCodingScheme	1 octet long. Alphabet indicator set to "default alphabet". Language indicator set to "undefined"
Ussd-string	For step 7: value of the error code For steps 21: 03 31245688

31.15.3 Follow Me (FM) / Erasure

31.15.3.1 Conformance requirement

A previous FM registration can be erased in either of the following ways:

- The initiating subscriber can specifically erase her previous registration with an appropriate control procedure.
- In case the remote party corresponds to a subscriber the remote party can erase any previous registration with an appropriate control procedure.
- The FM service supervisor can erase any previous registration to any remote party with an appropriate control procedure (forced erasure).

The subscriber who initiates the FM erase request shall be informed of the outcome of the request by the network.

As an operator's option additional information (such as passwords) for erasure may be required from the subscriber. The registration procedure shall transport this information from the subscriber to the network of the remote party. This information shall be coded as a USSD string with a length not exceeding 30 characters.

MS shall behave as indicated in the Information flow as indicated in 3GPP TS 23.094, figure 4.1.

All the messages between MS and the mobile network and internal to the mobile network, which are used for control of Follow Me, are USSD Phase 2 messages.

References

3GPP TS 22.094 subclause 6.4.

3GPP TS 23.094 subclauses 4.1, 4.2 and 4.4.

3GPP TS 24.090 subclause 6.1.

31.15.3.2 Test purpose

1. To check that the MS, acting as an initiating subscriber or as a remote party, correctly requests a supplementary service transaction for erasure of FM in CHANNEL REQUEST message and in the subsequent CM SERVICE REQUEST.
2. To check that the MS as initiating subscriber or remote party sends a REGISTER message containing the FM-request control message for erasure.
3. To check that the MS, acting as a supervisor, correctly requests a supplementary service transaction for erasure of FM in CHANNEL REQUEST message and in the subsequent CM SERVICE REQUEST
4. To check that the MS as supervisor sends a REGISTER message containing the FM-request control message for forced-erasure.
5. To check that upon receipt of the result or the error of the operation (in a RELEASE COMPLETE message), the MS provides the appropriate user indication (as described by the manufacturer).

31.15.3.3 Method of test

Initial conditions

System Simulator:

1 cell, default parameters.

Mobile Station:

The MS is in MM-state "idle, updated" with valid TMSI and CKSN. The MS is registered to FM with respect to a remote party B.

Specific PICS Statements

-

PIXIT Statements

- Way to activate the erasure of FM.
- Description of display of the FM answers from the network.

Foreseen final state of the MS

The MS is in MM-state "idle, updated" with valid TMSI.

Test procedure

MS is registered to FM.

By means of appropriate MMI functions, the user requests erasure of FM for a remote number. Upon receipt of the REGISTER message, SS answers with the RELEASE COMPLETE message with an unsuccessful FM-result information. Check that the MS provides the appropriate user indication (as described by the manufacturer). Then SS transaction is released. This procedure is executed for all possible error values.

The user requests erasure of FM for another remote subscriber. Upon receipt of the operation (in a REGISTER message), SS answers with a RELEASE COMPLETE message with a successful FM-response information. Check that the MS provides the appropriate user indication (as described by the manufacturer). The SS transaction is released.

By means of appropriate MMI functions, the user requests forced-erasure of FM for a remote number. Upon receipt of the REGISTER message, SS answers with the RELEASE COMPLETE message with an unsuccessful FM-result information. Check that the MS provides the appropriate user indication (which is to be described by the manufacturer). Then SS transaction is released. This procedure is executed for all possible error values.

The user requests forced-erasure of FM for another remote subscriber. Upon receipt of the operation (in a REGISTER message), SS answers with a RELEASE COMPLETE message with a successful FM-response information. Check that the MS provides the appropriate user indication (as described by the manufacturer). The SS transaction is released.

Maximum Duration of Test

2 minutes.

Expected Sequence

Test steps 1 to 10 and 25 to 34 are executed for k=1 to 10 with respectively the following error values:

1. Illegal interaction with incoming barring.
2. Unauthorised request.
3. Unknown remote party.
4. FM not subscribed.
5. FM not registered to remote party.
6. Remote party not registered to this MSISDN.
7. Unauthorised changes to remote party.
8. Illegal interaction with call barring.
9. Insufficient information.
10. Inconsistent with registration.

Step	Direction	Message	Comments
0	MS		The MS is in idle mode. MS is registered to FM with respect to a remote party B.
1	MS		The MS is made to initiate erasure of FM for a remote subscriber other than B.
2	MS -> SS	CHANNEL REQUEST	With establishment cause "Other procedures which can be completed with an SDCCH"
3	SS -> MS	IMMEDIATE ASSIGNMENT	
4	MS -> SS	CM SERVICE REQUEST	Cause: "supplementary service activation"
5	SS -> MS	CM SERVICE ACCEPT	
6	MS -> SS	REGISTER	Check that the content of this message matches specific message contents.
7	SS -> MS	RELEASE COMPLETE	With an unsuccessful FM-result info with the following error value: k=1: Illegal interaction with incoming barring (code 21) k=2: Unauthorised request (code 22) k=3: Unknown remote party (code 41) k=4: FM not subscribed (code 42) k=5: FM not registered to remote party (code 62) k=6: Remote party not registered to this MSISDN (code 63) k=7: Unauthorised changes to remote party (code 64) k=8: Illegal interaction with call barring (code 66) k=9: Insufficient information (code 81) k=10: Inconsistent with registration (code 84) See specific message contents.
8	MS		Check that the MS, in a way described by the manufacturer, displays the error.
10	SS -> MS	CHANNEL RELEASE	
15	MS		The MS is made to initiate erasure of FM for remote subscriber B
16	MS -> SS	CHANNEL REQUEST	With establishment cause "Other procedures which can be completed with an SDCCH"
17	SS -> MS	IMMEDIATE ASSIGNMENT	
18	MS -> SS	CM SERVICE REQUEST	Cause: "supplementary service activation"
19	SS -> MS	CM SERVICE ACCEPT	
20	MS -> SS	REGISTER	Check that the content of this message matches specific message contents.
21	SS -> MS	RELEASE COMPLETE	With a successful FM-result. See specific message contents.
22	MS		Check that the MS, in a way described by the manufacturer, displays the positive result.
23	SS -> MS	CHANNEL RELEASE	

Step	Direction	Message	Comments
25	MS		The MS is made to initiate forced erasure
26	MS -> SS	CHANNEL REQUEST	With establishment cause "Other procedures which can be completed with an SDCCH"
27	SS -> MS	IMMEDIATE ASSIGNMENT	
28	MS -> SS	CM SERVICE REQUEST	Cause: "supplementary service activation"
29	SS -> MS	CM SERVICE ACCEPT	
30	MS -> SS	REGISTER	Check that the content of this message matches specific message contents.
31	SS -> MS	RELEASE COMPLETE	With an unsuccessful FM-result info with the following error value: k=1: Illegal interaction with incoming barring (code 21) k=2: Unauthorised request (code 22) k=3: Unknown remote party (code 41) k=4: FM not subscribed (code 42) k=5: FM not registered to remote party (code 62) k=6: Remote party not registered to this MSISDN (code 63) k=7: Unauthorised changes to remote party (code 64) k=8: Illegal interaction with call barring (code 66) k=9: Insufficient information (code 81) k=10: Inconsistent with registration (code 84) See specific message contents.
32	MS		Check that the MS, in a way described by the manufacturer, displays the negative result.
34	SS -> MS	CHANNEL RELEASE	
40	MS		The MS is made to initiate forced erasure
41	MS -> SS	CHANNEL REQUEST	With establishment cause "Other procedures which can be completed with an SDCCH"
42	SS -> MS	IMMEDIATE ASSIGNMENT	
43	MS -> SS	CM SERVICE REQUEST	Cause: "supplementary service activation"
44	SS -> MS	CM SERVICE ACCEPT	
45	MS -> SS	REGISTER	Check that the content of this message matches specific message contents.
46	SS -> MS	RELEASE COMPLETE	With a successful FM-result. See specific message contents.
47	MS		Check that the MS, in a way described by the manufacturer, displays the positive result.
49	SS -> MS	CHANNEL RELEASE	

Specific message contents:

REGISTER

Information Element	value/remark
Supplementary service protocol discriminator	Supplementary service (call independent)
Transaction identifier	'1011'B
Message type	As 3GPP TS 24.080
Facility 1C	See below
SS version 7F	As 3GPP TS 24.080

For steps 6, 20, 30 and 45, Facility Information Element with Invoke = ProcessUnstructuredSS-Request component type as defined in 3GPP TS 24.080 subclause 3.6.1 table 3.3.

Contents	Value/remark
Facility IE identifier	As 3GPP TS 24.080
Length of FIE contents	depending on the length of ussd-string
Component type tag	CS/C/tag=1
Component length	depending on the length of ussd-string
InvokeID tag	From 3GPP TS 24.080
Invoke ID length	1
Invoke ID	Arbitrary (1 octet)
Operation Code tag	From 3GPP TS 24.080
Operation Code length	1
Operation Code	ProcessUnstructuredSS-Request
Ussd-dataCodingScheme	1 octet long. Alphabet indicator set to "default alphabet". Language indicator set to "undefined"
Ussd-string	For step 6: ##214*45896***# For step 20: ##214*31245688***# For steps 30 and 45: ##214*45896*88*0436987*#

RELEASE COMPLETE

Information Element	value/remark
Supplementary service protocol discriminator	Supplementary service (call independent)
Transaction identifier	the transaction value is the same as the REGISTER transaction value but the transaction flag is different
Message type	As 3GPP TS 24.080
Cause	Omitted.
Facility Information Element	See below
SS version indicator	As specified in 3GPP TS 24.080

For steps 7, 21, 31 and 46, Facility Information Element with Return result = ProcessUnstructuredSS-Request return result component type as defined in 3GPP TS 24.080 subclause 3.6.1 table 3.6.

Contents	Value/remark
Facility IE identifier	As 3GPP TS 24.080
Length of FIE contents	depending on the length of ussd-string
Component type tag	Return result
Component length	depending on the length of ussd-string
InvokeID tag	From 3GPP TS 24.080
Invoke ID length	1
Invoke ID	The same as the invoke of the ProcessUnstructuredSS-Request
Ussd-dataCodingScheme	1 octet long. Alphabet indicator set to "default alphabet". Language indicator set to "undefined"
Ussd-string	For steps 7 and 31: value of the error code For steps 21 and 46: 02

32 Testing of speech transcoding functions

The test sequences for speech transcoding and DTX tests, both for input and required output, are defined in 3GPP TS 06.10, clause 5, and 3GPP TS 06.32, clause 4 for the full rate speech codec. For the half rate speech codec the test sequences are defined in 3GPP TS 06.20, clause 5 and 3GPP TS 06.42 clause 7. They are available on floppy disks in IBM/AT MS-DOS format from ETSI publications department.

The Digital Audio Interface (DAI) is described in subclause 36.4.

NOTE: For a definition of the term "traffic frame" used in this clause, refer to 3GPP TS 06.32 and 3GPP TS 06.42.

32.1 Full Rate Downlink speech transcoding

32.1.1 Definition

Downlink speech transcoding transforms the 13 kbit/s net bit stream obtained by channel decoding the incoming bit stream from the air interface to 13 bit linear PCM.

32.1.2 Conformance requirement

The output bit stream from the speech transcoder shall be continuous and bit by bit exactly the same as the predefined output sequence (SEQ01.OUT, SEQ03.OUT, SEQ04.OUT and SEQ05.OUT).

3GPP TS 06.01, clause 2.

3GPP TS 06.10, subclauses 5.2 and 5.2.2.

32.1.3 Test purpose

To verify that the speech transcoding of the MS can transform all predefined sequences (SEQ01.OUT, SEQ03.OUT, SEQ04.OUT and SEQ05.OUT) at 13 kbit/s level to 104 kbit/s (13 bit linear PCM at 8 kHz) level correctly.

32.1.4 Method of test

32.1.4.1 Initial conditions

DTX is off.

The DAI of the MS is connected to the SS and is set to the operating mode "Test of speech decoder/DTX functions (downlink)".

32.1.4.2 Procedure

- a) The SS resets the speech decoder of the MS via the DAI.
- b) The SS sends test sequence SEQ01.COD at 13 kbit/s to the MS via the air interface after passing it through the SS channel encoder.

NOTE: These test sequence files contain 16 bit words for all speech encoded parameters and are justified as described in 3GPP TS 06.10 table 5.1. 76 words are used as input in a period of 20 ms.

- c) The SS records the 104 kbit/s output bit stream from the MS on the digital audio interface.
- d) The test is repeated using the test sequences SEQ03.COD, SEQ04.COD and SEQ05.COD.

32.1.5 Test requirements

The bit stream output shall be continuous and bit by bit exactly the same as the sequence given in the files SEQ01.OUT, SEQ03.OUT, SEQ04.OUT and SEQ05.OUT.

NOTE: These files contain 16 bit words of 13 bit linear PCM left justified.

32.2 Full Rate Downlink receiver DTX functions

32.2.1 Definition

The DTX receiver functions consist of a SID frame detector, comfort noise generator functions and lost frame substitution and muting functions.

32.2.2 Conformance requirement

- 1) The output level of the decoder has to be constant for an input signal consisting of identical speech frames.
3GPP TS 06.10.
- 2/3) When, after the first lost speech frame subsequent speech frames are lost, a muting technique shall be used that will gradually decrease the output level, resulting in the silencing of the output after a maximum of 320 ms. Speech frames with the FACCH flag set provoke a Bad Frame Indication (BFI = 1) and are hence regarded as lost speech frames.
3GPP TS 06.01, clause 6; 3GPP TS 06.11, subclauses 2.1 and 2.2, clause 3 for requirement 2 (first part).
3GPP TS 06.01, clause 6; 3GPP TS 06.11, subclauses 2.1 and 2.2, clause 3; 3GPP TS 06.31, subclauses 1.2.2 and 3.1.1 for requirement 3 (second part).
- 4/5) A valid SID-frame followed by a sequence of lost speech frames shall result in comfort noise generation with constant block amplitude parameters. Speech frames with the FACCH flag set provoke a Bad Frame Indication (BFI = 1) and are hence regarded as lost speech frames.
3GPP TS 06.01, clauses 3 and 5; 3GPP TS 06.12, clause 3 and subclause 3.1.
3GPP TS 06.31, subclauses 1.2.2, 3.1, 3.1.1 and 3.1.2 for requirement 4 (first part).
3GPP TS 06.01, clauses 3, 5 and 6; 3GPP TS 06.11, subclauses 2.1 and 2.2; 3GPP TS 06.12, clause 3 and subclause 3.1.
3GPP TS 06.31, subclauses 1.2.2, 3.1, 3.1.1 and 3.1.2 for requirement 5 (second part).
- 6/7) An invalid SID-frame followed by a sequence of lost speech frames shall result in comfort noise generation, using the set of parameters from the last valid SID-frame. Speech frames with the FACCH flag set provoke a Bad Frame Indication (BFI = 1) and are hence regarded as lost speech frames.
3GPP TS 06.01, clauses 3 and 5; 3GPP TS 06.12, clause 3 and subclause 3.1.
3GPP TS 06.31, subclauses 1.2.2, 3.1, 3.1.1 and 3.1.2 for requirement 6 (first part).
3GPP TS 06.01, clauses 3, 5 and 6; 3GPP TS 06.11, subclauses 2.1 and 2.2; 3GPP TS 06.12, clause 3 and subclause 3.1.
3GPP TS 06.31, subclauses 1.2.2, 3.1, 3.1.1 and 3.1.2 for requirement 7 (second part).
- 8) The energy of the output signal is controlled by the block amplitude parameter, x_{maxc} .
3GPP TS 06.10, subclauses 3.1.20, 3.1.21 and 3.2.1.
- 9/10) The first SID-frame that is expected and not received shall be substituted by the last valid SID-frame and the procedure for valid SID-frames shall be applied. For the second lost SID-frame, a muting technique shall be used that will gradually decrease the output level, resulting in silencing the output after a maximum of 320 ms. Speech frames with the FACCH flag set provoke a Bad Frame Indication (BFI = 1) and are hence regarded as lost speech frames.
3GPP TS 05.08, subclause 8.3; 3GPP TS 06.01, clause 6; 3GPP TS 06.11, subclauses 2.3 and 2.4.
3GPP TS 06.31, subclauses 1.2.2, 3.1.1 and 3.1.2.

32.2.3 Test purpose

- 1) To verify that the signal energy at the output of the decoder is constant with a tolerance of ± 3 dB if a sequence of identical speech frames is applied at the receiver input.
- 2) To verify that the muting function of the receiver is within the required limits if a sequence of lost speech frames is applied at the receiver input.
- 3) To verify that the muting function of the receiver is within the required limits if a sequence of speech frames with the FACCH flag set is applied at the receiver input.
- 4) To verify the function of comfort noise generation when a valid SID-frame is received followed by a sequence of lost speech frames. The signal energy at the output of the decoder shall be constant with a tolerance of ± 3 dB.
- 5) To verify the function of comfort noise generation when a valid SID-frame is received followed by a sequence of speech frames with the FACCH flag set. The signal energy at the output of the decoder shall be constant with a tolerance of ± 3 dB.
- 6) To verify the function of comfort noise generation when an invalid SID-frame is received followed by a sequence of lost speech frames. The signal energy at the output of the decoder shall be constant with a tolerance of ± 3 dB.
- 7) To verify the function of comfort noise generation when an invalid SID-frame is received followed by a sequence of speech frames with the FACCH flag set. The signal energy at the output of the decoder shall be constant with a tolerance of ± 3 dB.
- 8) To verify that the signal energy at the output of the decoder depends on the block amplitude x_{maxc} of the input frames if a sequence of speech frames is applied to the decoder. The signal energy at the output of the decoder shall be constant with a tolerance of ± 3 dB.
- 9) To verify the SID-frame substitution and muting functions on the comfort noise, if two consecutive expected SID-frames are lost with the other frames being lost speech frames.
- 10) To verify the SID-frame substitution and muting functions on the comfort noise, if two consecutive expected SID-frames are lost with the other frames being speech frames with the FACCH flag set.

32.2.4 Method of test

32.2.4.1 Initial conditions

Uplink DTX is off.

The DAI of the MS is connected to the SS and is set to the operating mode "Test of speech decoder/DTX functions (downlink)".

32.2.4.2 Procedure

- a) The SS transmits coded "speech" traffic frames on the air interface after passing them through the SS channel encoder. They contain a special test signal at 13 kbit/s as defined below. All traffic frames are identical with the exception of some frames which are SID frames as defined in 3GPP TS 06.32.
- b) The energy of the PCM signal is evaluated (as a mean square average) at the digital audio interface of the MS at 104 kbit/s level (13 bit, 8 kHz linear PCM) and recorded for each block of 20 ms synchronized to the 20 ms speech frame structure.
- c) The SS transmission of the TDMA frames of the TCH/FS on the air interface is ramped "on" and "off" on a traffic frame by traffic frame basis, taking into account the block diagonal interleaving scheme defined in 3GPP TS 05.03. The first traffic frame in step 1 occurs one frame after the window of the SACCH multiframe (TDMA frame 60 modulo 104), allocated for the SID frame (see 3GPP TS 05.02 and 3GPP TS 05.08). The SACCH will also be transmitted.

NOTE 1: 8 timeslots in 8 consecutive TCH/FS TDMA frames are seen as one traffic frame, and the next traffic frame starts in the middle of the previous one (i.e. after 4 TDMA frames of the previous one) due to the block diagonal interleaving scheme defined in 3GPP TS 05.03.

- d) The special test frame is an encoded "speech" traffic frame of 260 bits obtained from white Gaussian noise band limited to 300 Hz to 3 400 Hz. When repeated, the special test frame results in a humming sound with a fairly constant level when decoded, and is defined in table 32-1.

Table 32-1: Table of special test traffic frame for receiver DTX tests

Encoded parameter	Value			
LARc(1)	38			
LARc(2)	42			
LARc(3)	24			
LARc(4)	20			
LARc(5)	10			
LARc(6)	9			
LARc(7)	5			
LARc(8)	3			
	Sub-block no:			
	0	1	2	3
Grid position (Mc)	1	3	2	0
Block amplitude (xmaxc)	40	40	40	40
LTP gain (Bc)	0	0	0	0
LTP lag (Nc)	40	120	40	120
RPE pulses (xmc)				
- pulse no 1	4	6	6	6
- pulse no 2	4	5	4	3
- pulse no 3	2	1	3	4
- pulse no 4	6	2	1	3
- pulse no 5	3	6	4	1
- pulse no 6	5	1	6	3
- pulse no 7	5	2	5	5
- pulse no 8	5	6	2	1
- pulse no 9	1	3	4	4
- pulse no 10	3	2	4	3
- pulse no 11	5	5	4	5
- pulse no 12	6	1	2	2
- pulse no 13	1	3	4	3

NOTE 2: The signal energy of the decoded special test frame is controlled with the block amplitude parameter (xmaxc). Reducing xmaxc from 40 to 32 reduces the signal energy by 6 dB, and reducing xmaxc from 40 to 24 reduces the signal energy by 12 dB.

- e) The sequence of traffic frames on the air interface is as follows:

e.1) 23 test frames "on".

e.2) 20 frames "off".

e.3) 20 test frames "on".

e.4) 1 SID frame followed by 6 frames "off", another identical SID frame and 23 frames "off". Except for the SID codeword, the SID frames are identical to the test frame.

e.5) 1 different SID frame, however with 2 to 15 errors inserted in the SID codeword, followed by 23 frames "off".

e.6) 20 test frames "on", but with the block amplitude parameter xmaxc = 24.

e.7) 1 SID frame followed by 50 frames "off". Except for the SID codeword, the SID frames are identical to the test frame.

e.8) The whole test is repeated, but the frames "off" are replaced by frames "on" with the FACCH flag set.

32.2.5 Test requirements

- 1) In step e.1), the signal energy shall be fairly constant within ± 3 dB.

- 2) In step e.2), the signal energy shall decrease to less than -60 dBm within 17 frames.
- 3) In step e.4), comfort noise shall be generated. The same requirements as in step e.1) apply.
- 4) In step e.5), the same requirements as in step e.4) apply.
- 5) In step e.6), the same requirements as in step e.1) apply. However, the signal energy shall be 12 dB lower.
- 6) In step e.7), the signal energy shall be fairly constant within ± 3 dB for 28 frames. Then the signal energy shall decrease to less than -60 dBm within 16 frames.
- 7) In step e.8), the same requirements as in all previous steps apply.

32.3 Full Rate Uplink speech transcoding

32.3.1 Definition

Uplink speech transcoding transforms 13 bit linear PCM to the 13 kbit/s net bit stream. This net bit stream is to be channel encoded for transmission on the air interface.

32.3.2 Conformance requirement

The output bit stream from the speech transcoder shall be bit by bit exactly the same as the predefined output sequence (SEQ01.OUT, SEQ02.OUT, SEQ03.OUT and SEQ04.OUT).

3GPP TS 06.01, clause 2.

3GPP TS 06.10, subclauses 5.2 and 5.2.1.

32.3.3 Test purpose

To verify that the speech transcoder on the MS can transform all predefined sequences (SEQ01.INP, SEQ02.INP, SEQ03.INP and SEQ04.INP) at 104 kbit/s (13 bit linear PCM at 8 kHz) level to 13 kbit/s level correctly.

32.3.4 Method of test

32.3.4.1 Initial conditions

Uplink DTX is off.

The DAI of the MS is connected to the SS and is set to the operating mode "Test of speech encoder/DTX functions (uplink)".

32.3.4.2 Procedure

- a) The SS resets the speech decoder on the MS (see subclause 36.4).
- b) The SS sends a test sequence SEQ01.INP to the MS at 104 kbit/s level via the digital audio interface.
NOTE: These files contain 16 bit words for 13 bit linear PCM left justified. See also 3GPP TS 06.10 table 5.1.
- c) The SS records the 13 kbit/s output bit stream obtained by channel decoding the incoming bit stream from the air interface.
- d) The test is repeated using the test sequences SEQ02.INP, SEQ03.INP and SEQ04.INP.

32.3.5 Test requirements

The bit stream output shall be bit by bit exactly the same as the sequence given in the files SEQ01.COD, SEQ02.COD, SEQ03.COD and SEQ04.COD.

NOTE: These files contain 16 bit words of all the 76 parameters in a speech frame justified as in 3GPP TS 06.10 table 5.1. 76 codewords shall occur in a frame of 20 ms.

32.4 Full Rate Uplink transmitter DTX functions

32.4.1 Definition

The VAD/DTX transmitter functions consist of a Voice Activity Detector (VAD) and a surrounding Discontinuous Transmission (DTX) system introducing additional "speech" traffic frames on the air interface compared to those the VAD itself would classify as speech frames containing real speech. The additional traffic frames on the air are introduced due to:

- 1) A "hangover" period at the end of speech bursts in order to be certain that the traffic frames contain only noise and to evaluate the background acoustic noise characteristics when no real speech is present.
- 2) Special traffic frames (SID frames) added on the air at regular intervals containing only the evaluated background acoustic noise characteristics. These frames are used for generation of comfort noise in speaker silence periods on the receiving side.

32.4.2 Conformance requirement

The MS VAD and DTX function allows only those frames to be transmitted that are either marked with SP = 1 or that are properly positioned SID-frames.

3GPP TS 05.08, subclause 8.3; 3GPP TS 06.01, clauses 3 and 4; 3GPP TS 06.31, subclauses 2.1, 2.1.1 and 2.1.2; 3GPP TS 06.32, clauses 1 and 2, subclauses 2.1 and 2.2.8.

32.4.3 Test purpose

To verify that the combination of VAD and DTX operates correctly.

32.4.4 Method of test

32.4.4.1 Initial conditions

A call is set up on a TCH/FS according to the generic call set-up procedure.

Uplink DTX is on.

The DAI of the MS is connected to the SS and is set to the operating mode "Test of speech encoder/DTX functions (uplink)".

32.4.4.2 Procedure.

- a) The SS sends a test sequence SPEC_A1.INP of PCM samples, which are grouped into frames of 20 ms synchronized to the TDMA and traffic frame structure on the air interface, on the digital audio interface in the MS at 104 kbits/s (13 bit, 8 kHz linear PCM).

The start of the test sequences is synchronized with the radio transmission on the air interface so that the first traffic frame on the air occurs just after the traffic frame allocated for the SID frame (TDMA frame 56 modulo 104, see 3GPP TS 05.02 and 3GPP TS 05.08).

NOTE: 8 timeslots in 8 consecutive TCH/FS TDMA frames are seen as one traffic frame and the next traffic frame starts in the middle of the previous one (i.e. after 4 TDMA frames of the previous one) due to the block diagonal interleaving scheme defined in 3GPP TS 05.03.

- b) The SS detects whether or not there is any power transmitted over the radio path on a timeslot basis excluding SACCH frames. The speech frame by speech frame on/off transmission (on = 1) is recorded.
- c) The test is repeated for all test sequences *.INP described in 3GPP TS 06.32 clause 4.

32.4.5 Test requirements

- 1) In step b), the traffic frame on/off sequence recorded shall be bit exact like the sequence of SP flags stored as bit 15 of LAR(2) on the respective reference files *.COD described in 3GPP TS 06.32, with the following exceptions:
 - 1.1) The occurrence of a SID frame in its allowed window within the SACCH multiframe as defined in 3GPP TS 05.08.

- 1.2) The occurrence of a SID frame after 1 or more real speech frames consecutively transmitted on the air.

32.5 Full Rate Speech channel transmission delay

32.5.1 Definition

The total transmission delay within the various elements of a GSM system are specified as round trip delays. For the MS this would be equivalent to applying an RF equivalent of a speech signal to the MS receiver, closing an acoustic path from the ERP to the MRP, detecting the corresponding RF signal at the MS transmitter output and measuring the time interval between the signal originally fed to the MS receiver and that transmitted by the MS transmitter.

This simple approach cannot be demonstrated to be accurate due to the inherent non linear characteristic of the speech transcoder. The overall delay therefore is split into four identifiable and measurable delays. The delays are respectively:

- the downlink delay from RF input to DAI output;
- DAI output to ERP;
- MRP to DAI output; and
- DAI to uplink RF output.

Each delay is defined and its method of test described in the following subclauses.

32.5.2 Conformance requirement

The overall speech channel transmission delay shall be less than 143,9 ms.

3GPP TS 03.50, subclause 3.3.6.1.

32.5.3 Test purpose

To verify that the round trip delay, of a speech channel for a MS, which consists of the sum of:

- the downlink delay from RF input to DAI output;
- DAI output to ERP;
- MRP to DAI output; and
- DAI to uplink RF output;

meets the requirements when using the predefined test sequences SEQ01.COD, SEQ03.COD, SEQ04.COD and SEQ05.COD.

32.5.4 Downlink processing delay

32.5.4.1 Definition

The downlink processing delay is the delay from the first bit of a speech block transmitted from the RF output of the SS up to the last bit of the corresponding speech block received at the DAI on the output of the speech transcoder.

32.5.4.2 Method of test

32.5.4.2.1 Initial conditions

DTX is off.

The DAI of the MS is connected to the SS and is set to the operating mode "Test of speech decoder/DTX functions (downlink)".

32.5.4.2.2 Procedure

- a) The test set up is that described in subclause 32.1 for downlink speech transcoding.

- b) The SS transmits one of the test patterns SEQ01.COD, SEQ03.COD, SEQ04.COD or SEQ05.COD to the MS.
- c) The SS measures for each speech block it transmits the time between the first bit at the air interface and the last bit of that speech block on the DAI. This difference is the delay measured.
- d) Step c) is repeated 20 times and the maximum delay measured in ms is the downlink processing delay TDP.

NOTE: This is to account for the fact that the processing time may not be constant.

32.5.5 Downlink coding delay

32.5.5.1 Definition

The downlink coding delay is defined as the delay between the digital representation of an acoustic signal on the DAI and the corresponding acoustic signal at the ERP.

32.5.5.2 Method of test

32.5.5.2.1 Initial conditions

The DAI of the MS is connected to the SS and is set to the operating mode "Test of acoustic devices and A/D & D/A".

The handset is mounted in the LRGP (see annex 1 of ITU-T Recommendation P.76) and the earpiece is sealed to the knife edge of the artificial ear conforming to ITU-T Recommendation P.51.

32.5.5.2.2 Procedure

- a) The SS generates on the DAI a digital representation of a sine wave with a frequency of 1 000 Hz.
- b) The SS measures the "phase shift" \varnothing_1 , in the range of 0 to 360 degrees, between the equivalent sine wave generated at the DAI and the sine wave at the input to the artificial ear.
- c) The frequency is increased to 1100 Hz and the resulting phase shift \varnothing_2 noted.
- d) The downlink coding delay TDC is calculated from either:

$$\text{TDC} = (\varnothing_2 - \varnothing_1)/36 \text{ ms for } \varnothing_2 > \varnothing_1; \text{ or}$$

$$\text{TDC} = (\varnothing_2 + 360 - \varnothing_1)/36 \text{ ms for } \varnothing_2 < \varnothing_1$$

32.5.6 Uplink processing delay

32.5.6.1 Definition

The uplink processing delay is the delay from the first bit of a speech block on the DAI to the last bit of that speech block being transmitted on the air interface of the MS.

32.5.6.2 Method of test

32.5.6.2.1 Initial conditions

The DAI of the MS is connected to the SS and is set to the operating mode "Test of speech encoder/DTX functions (uplink)".

32.5.6.2.2 Procedure

- a) The test set up is that described in subclause 32.3 for uplink speech transcoding.
- b) The SS sends one of the test patterns SEQ01.INP, SEQ03.INP, SEQ04.INP or SEQ05.INP to the DAI of the MS.
- c) The SS measures the time between the first bit on the DAI, and the last transmitted bit of the block at the air interface for each speech block the SS sends on the DAI. This time difference is the delay measured.
- d) Step c) is repeated 20 times. The maximum delay measured in ms is the uplink coding delay TUP.

NOTE: This is to account for the fact that the processing time may not be constant.

32.5.7 Uplink coding delay

32.5.7.1 Definition

The uplink coding delay is defined as the delay between an acoustic signal at the MRP and the digital representation of that signal on the DAI.

32.5.7.2 Method of test

32.5.7.2.1 Initial conditions

The DAI of the MS is connected to the SS and is set to the operating mode "Test of acoustic devices and A/D & D/A".

The handset is mounted in the LRGP (see annex 1 of ITU-T recommendation P.76) and the earpiece is sealed to the knife edge of the artificial ear conforming to ITU-T recommendation P.51.

32.5.7.2.2 Procedure

- a) The SS generates an acoustic signal at the artificial mouth of the LRGP, being a pure sine wave with a frequency of 1 000 Hz.
- b) The SS measures the "phase shift" \varnothing_1 , in the range of 0 to 360 degrees, between the signal at the MRP and its digital representation on the DAI.
- c) The SS set the generated frequency to 1 100 Hz and measures the resulting phase shift \varnothing_2 .
- d) The uplink coding delay TUC is calculated from either:

$$\text{TUC} = (\varnothing_2 - \varnothing_1)/36 \text{ ms for } \varnothing_2 > \varnothing_1; \text{ or}$$

$$\text{TUC} = (\varnothing_2 + 360 - \varnothing_1)/36 \text{ ms for } \varnothing_2 < \varnothing_1$$

32.5.8 Test requirement

The sum of the delays {TDP + TDC + TUP + TUC} shall be less than 144,9 ms.

NOTE 1: This limit includes an allowance of 4*0,25 ms delay from the DAI to the MS transmission path.

NOTE 2: No allowances have been made for any delays within the measurement system. These must either be calibrated out or subtracted from the individual delays before performing the sum above.

32.6 Half Rate Downlink speech transcoding

32.6.1 Definition

Downlink speech transcoding transforms the 5,6 kbit/s net bit stream obtained by channel decoding the incoming bit stream from the air interface to 104 kbit/s (13 bit linear PCM at 8 kHz) level.

32.6.2 Conformance requirement:

The output bit stream from the speech transcoder shall be continuous and bit by bit exactly the same as the predefined output sequences contained in SEQ01.OUT, SEQ02.OUT, SEQ03.OUT and SEQ04.OUT.

3GPP TS 06.02, clause 5; 3GPP TS 06.20.

32.6.3 Test purpose:

To verify that the speech transcoder of the MS can transform all the predefined sequences (SEQ01.DEC, SEQ02.DEC, SEQ03.DEC and SEQ04.DEC) at 5,6 kbit/s level to 104 kbit/s (13 bit linear PCM at 8 kHz) level correctly.

32.6.4 Method of test

32.6.4.1 Initial conditions

Uplink DTX is off.

The DAI of the MS is connected to the SS and is set to the operating mode "Test of speech decoder/DTX functions (downlink)".

Frequency hopping is on, where the BCCH carrier is part of the hopping sequence. Frequency hopping shall be performed over four carriers using random frequency hopping. Downlink power control shall be activated and a difference of 30 dB between the level of the BCCH carrier and the other carriers adjusted.

NOTE: Frequency hopping is used to ensure that the MS can cope with the reception of bursts (on the BCCH carrier) that have a power level that is different from the rest of the bursts.

32.6.4.2 Procedure

- a) The SS sends a reset pulse to the MS on the digital audio interface. This reset pulse will start the clock output of the MS at 104 kHz (pin 24 of the DAI).
- b) The SS sends test sequence SEQ01.DEC at 5,6 kbit/s to the MS via the air interface after passing it through the SS channel encoder. The speech decoder of the MS is reset by the special reset sequence which is at the beginning of the test sequence.
- c) The SS records the 104 kbit/s output bit stream from the MS on the digital audio interface. The recording shall be triggered by the reception of the encoder homing frame. The encoder homing frame itself shall not be recorded.
- d) The test is repeated using test sequences SEQ02.DEC, SEQ03.DEC and SEQ04.DEC.

32.6.5 Test requirement

The bit stream output shall be continuous and bit by bit exactly the same as the sequence describing the speech data contained in the files SEQ01.OUT, SEQ02.OUT, SEQ03.OUT and SEQ04.OUT. The two encoder homing frames at the beginning of each test sequence *.OUT shall be disregarded for this comparison.

32.7 Half Rate Downlink receiver DTX functions

32.7.1 Definition

The DTX receiver functions consist of a SID frame detector, comfort noise generator functions and lost frame substitution and muting functions.

32.7.2 Conformance requirement

The output bit stream from the speech transcoder shall be continuous and bit by bit exactly the same as the predefined output sequences contained in DTX*.OUT described in 3GPP TS 06.07 subclause 7.

3GPP TS 06.02, clauses 6 and 8; 3GPP TS 06.22; 3GPP TS 06.41.

32.7.3 Test purpose

To verify that the MS generates comfort noise correctly.

32.7.4 Method of test

32.7.4.1 Initial conditions

The DAI of the MS is connected to the SS and is set to the operating mode "Test of speech decoder/DTX functions (downlink)".

Frequency Hopping is on, where the BCCH carrier is part of the hopping sequence. Frequency Hopping shall be done over four carriers using random Frequency Hopping.

NOTE: Frequency Hopping is used to ensure that the MS can cope with the reception of dummy bursts (on the BCCH frequency) during DTX.

32.7.4.2 Procedure

- a) The SS sends a reset pulse to the MS on the digital audio interface. This reset pulse will start the clock output of the MS at 104 kHz (pin 24 of the DAI).
- b) The SS sends test sequence DTX01.DEC at 5,6 kbit/s to the MS via the air interface after passing it through the SS channel encoder. The speech decoder of the MS will be reset by the special reset sequence which is at the beginning of the test sequence.
- c) The SS transmission of the TDMA frames of the TCH/HS on the air interface is ramped "on" and "off" on a traffic frame by traffic frame basis, taking into account the block diagonal interleaving scheme defined in 3GPP TS 05.03. The first traffic frame in step b occurs one frame after the window of the SACCH multiframe (TDMA frame 0 or 52 modulo 104 for subchannel 0 and TDMA frame 1 or 53 modulo 104 for subchannel 1), allocated for the SID frame (see 3GPP TS 05.02 and 3GPP TS 05.08). The SACCH will also be transmitted.
- d) The information whether to ramp the transmitter of the SS "on" or "off" is derived from the sequence of SP-flags contained in the file DTX01.COD (see file format description in 3GPP TS 06.07 clause 5 for the position of the SP-flag).
- e) The SS records the 104 kbit/s output bit stream from the MS on the digital audio interface. The recording shall be triggered by the reception of the encoder homing frame. The encoder homing frame itself is not recorded.
- f) The test is repeated using test sequences *.DEC described in 3GPP TS 06.07 clause 7.

32.7.5 Test requirement

The bit stream output shall be continuous and bit by bit exactly the same as the sequence describing the speech data contained in the files DTX*.OUT described in 3GPP TS 06.07 subclause 7. The two encoder homing frames at the beginning of each test sequence *.OUT shall be disregarded for this comparison.

32.8 Half Rate Uplink speech transcoding

32.8.1 Definition

Uplink speech transcoding transforms 104 kbit/s (13 bit linear PCM at 8 kHz) level to the 5,6 kbit/s net bit stream. This net bit stream is to be channel encoded for transmission on the air interface.

32.8.2 Conformance requirement

The output bit stream from the speech transcoder shall be bit by bit exactly the same as the predefined sequences contained in SEQ01.COD, SEQ02.COD and SEQ03.COD described in 3GPP TS 06.07 clause 6.

3GPP TS 06.02, clause 5; 3GPP TS 06.20.

32.8.3 Test purpose

To verify that the speech transcoder of the MS can transform all the predefined sequences SEQ01.INP, SEQ02.INP and SEQ03.INP at 104 kbit/s (13 bit linear PCM at 8 kHz) level to 5,6 kbit/s level correctly.

32.8.4 Method of test

32.8.4.1 Initial conditions

Uplink DTX is off.

The DAI of the MS is connected to the SS and is set to the operating mode "Test of speech encoder/DTX functions (uplink)".

Frequency hopping is on.

32.8.4.2 Procedure

- a) The SS sends a reset pulse to the MS on the digital audio interface. This reset pulse will start the clock output of the MS at 104 kHz (pin 24 of the DAI).
- b) The SS synchronizes the input of the test sequences via the digital audio interface to the framing of the MS in the uplink. This can be done in two steps as follows:
 - b.1) The SS sends to the MS at 104 kbit/s level via the digital audio interface 13 triplets of input frames, each triplet consisting of 480 samples. The 480 samples of one triplet shall all be identical. The 13 bits of one sample shall all be set to "zero" except for one which is set to "one". The position of the bit within the 13 bits of a sample that is set to "one" shall vary in such a way, that all possible 13 positions are exercised within the 13 triplets of input frames. An example for such a sequence is given in test sequence BITSYNC.INP described in 3GPP TS 06.07 subclause 8. The SS records the 5,6 kbit/s output bit stream obtained by channel decoding the incoming bit stream from the air interface. As soon as the decoder homing frame is detected at the output, the framing of the MS with respect to the 13 bit long input words is known by looking at the corresponding input frame that has caused the decoder homing frame at the output.

NOTE: The encoder homing frame consists of 160 identical samples, each 13 bit long left justified, with the least significant bit set to "one" and all other bits set to "zero" (0008 hex). The speech encoder will go to its predefined home state at the end of the first received encoder homing frame. Consecutive encoder homing frames will produce the decoder homing frame at the output of the speech encoder.

- b.2) Synchronized to the 13 bit framing of the MS, the SS now sends test sequence SEQSYNC.INP described in 3GPP TS 06.07 subclause 8 to the MS at 104 kbit/s level via the digital audio interface. The SS records the 5,6 kbit/s output bit stream obtained by channel decoding the incoming bit stream from the air interface. The recording shall be triggered by the reception of the decoder homing frame. By comparing the first recorded frame that is not a decoder homing frame with the 160 possible output frames contained in sequences SYNC*.COD, the offset of the input to the 20 ms framing of the MS is known.
- c) Synchronized to the 20 ms framing of the MS, the SS sends a test sequence SEQ01.INP to the MS at 104 kbit/s level via the digital audio interface. The speech encoder of the MS is reset by the special homing sequence which is at the beginning of the test sequence.
- d) The SS records the 5,6 kbit/s output bit stream obtained by channel decoding the incoming bit stream from the air interface. The recording shall be triggered by the reception of the decoder homing frame. The decoder homing frame itself is not recorded.
- e) The test is repeated using test sequences SEQ02.INP and SEQ03.INP.

32.8.5 Test requirements

The bit stream output shall be bit by bit exactly the same as the sequences describing the speech parameters contained in the files SEQ01.COD, SEQ02.COD and SEQ03.COD. The two decoder homing frames at the beginning of each test sequence *.COD shall be disregarded for this comparison.

32.9 Half Rate Uplink transmitter DTX functions

32.9.1 Definition

The VAD/DTX transmitter functions consist of a Voice Activity Detector (VAD) that inhibits the transmitter during speech pauses, and a surrounding Discontinuous Transmission (DTX) system introducing Silence Descriptor (SID) frames on the air interface.

32.9.2 Conformance requirement

The MS VAD and DTX function allow only those frames to be transmitted that are either properly positioned SID-frames, SACCH-frames or frames marked with SP-flag = 1.

For the transmitted frames, the output bit stream from the speech transcoder shall be bit by bit exactly the same as the predefined sequences contained in DTX*.COD described in 3GPP TS 06.07 subclause 6.

3GPP TS 05.08, subclause 8.3; 3GPP TS 06.02, clauses 6 and 7; 3GPP TS 06.41; 3GPP TS 06.42.

32.9.3 Test purpose

To verify that the combination of VAD and DTX operates correctly.

32.9.4 Method of test

32.9.4.1 Initial conditions

Uplink DTX is on.

The DAI of the MS is connected to the SS and is set to the operating mode "Test of speech encoder/DTX functions (uplink)".

Frequency Hopping is on.

32.9.4.2 Procedure

- a) The SS sends a reset pulse to the MS on the digital audio interface. This reset pulse will start the clock output of the MS at 104 kHz (pin 24 of the DAI).
- b) The SS synchronizes the input of the test sequences via the digital audio interface to the framing of the MS in the uplink. This can be done in two steps as follows:

- b.1) The SS sends to the MS at 104 kbit/s level via the digital audio interface 13 triplets of input frames, each triplet consisting of 480 samples. The 480 samples of one triplet shall all be identical. The 13 bits of one sample shall all be set to "zero" except for one which is set to "one". The position of the bit within the 13 bits of a sample that is set to "one" shall vary in such a way, that all possible 13 positions are exercised within the 13 triplets of input frames. An example for such a sequence is given in test sequence BITSYNC.INP described in 3GPP TS 06.07 subclause 8. The SS records the 5,6 kbit/s output bit stream obtained by channel decoding the incoming bit stream from the air interface. As soon as the decoder homing frame is detected at the output, the framing of the MS with respect to the 13 bit long input words is known by looking at the corresponding input frame that has caused the decoder homing frame at the output.

NOTE: The encoder homing frame consists of 160 identical samples, each 13 bit long left justified, with the least significant bit set to "one" and all other bits set to "zero" (0008 hex). The speech encoder will go to its predefined home state at the end of the first received encoder homing frame. Consecutive encoder homing frames will produce the decoder homing frame at the output of the speech encoder.

- b.2) Synchronized to the 13 bit framing of the MS, the SS now sends test sequence SEQSYNC.INP described in 3GPP TS 06.07 subclause 8 to the MS at 104 kbit/s level via the digital audio interface. The SS records the 5,6 kbit/s output bit stream obtained by channel decoding the incoming bit stream from the air interface. The recording shall be triggered by the reception of the decoder homing frame. By comparing the first recorded frame that is not a decoder homing frame with the 160 possible output frames contained in sequences SYNC*.COD, the offset of the input to the 20 ms framing of the MS is known.
- c) The SS sends test sequence DTX01.INP of PCM samples described in 3GPP TS 06.07 clause 7 on the digital audio interface in the MS at 104 kbit/s (13 bit linear PCM at 8 kHz). The speech encoder of the MS will be reset by the special homing sequence which is at the beginning of the test sequence.
- d) The start of the test sequence is synchronized with the radio transmission on the air interface so that the first traffic frame on the air caused by the first encoder homing frame in the test sequence occurs just after the traffic frame allocated for the SID frame (TDMA frame 0 or 52 modulo 104 for subchannel 0 and TDMA frame 1 or 53 modulo 104 for subchannel 1), allocated for the SID frame (see 3GPP TS 05.02 and 3GPP TS 05.08).
- e) The SS detects whether or not there is any power transmitted over the radio path on a time slot basis excluding SACCH frames. The speech frame by speech frame on/off transmission (on = 1) is calculated and recorded. The recording shall be triggered by the reception of the decoder homing frame. The flag marking the decoder homing frame itself is not recorded.
- f) The SS records the 5,6 kbit/s output bit stream obtained by channel decoding the incoming bit stream from the air interface. The recording shall be triggered by the reception of the decoder homing frame. The decoder homing frame itself is not recorded.
- g) The test is repeated for all test sequences DTX*.INP described in 3GPP TS 06.07 clause 7.

32.9.5 Test requirements

- 1) The bit stream recorded in step e) shall be continuous and bit by bit exactly the same as the sequence of SP-flags contained in the files DTX*.COD (see file format description in 3GPP TS 06.07 subclause 5 for the position of the SP-flag), except for the bits marking those frames that are SID frames scheduled for transmission according to 3GPP TS 06.41. The first two frames in the reference files *.COD shall be disregarded for this comparison.
- 2) The bit stream recorded in step f) shall be continuous and bit by bit exactly the same as the sequence describing the speech parameters contained in the files *.COD described in 3GPP TS 06.07 subclause 7, except for the bits of the speech frames marked with SP-flag=0. The two decoder homing frames at the beginning of each test sequence *.COD shall be disregarded for this comparison.

32.10 Half Rate Speech channel transmission delay

32.10.1 Definition

The total transmission delay within the various elements of a GSM system are specified as round trip delays. For the MS this would be equivalent to applying an RF equivalent of a speech signal to the MS receiver, closing an acoustic path from the ERP to the MRP, detecting the corresponding RF signal at the MS transmitter output and measuring the time interval between the signal originally fed to the MS receiver and that transmitted by the MS transmitter.

This simple approach cannot be demonstrated to be accurate due to the inherent non linear characteristic of the speech transcoder. The overall delay therefore is split into four identifiable and measurable delays. The delays are respectively:

- the downlink delay from RF input to DAI output;
- DAI output to ERP;
- MRP to DAI output; and
- DAI to uplink RF output.

Each delay is defined and its method of test described in the following subclauses.

32.10.2 Conformance requirement

The overall speech channel transmission delay shall be less than 143,9 ms.

3GPP TS 03.50 subclause 3.3.6.2.

32.10.3 Test purpose

To verify that the round trip delay of a speech channel for a MS which consists of the sum of:

- the downlink delay from RF input to DAI output;
- DAI output to ERP;
- MRP to DAI output; and
- DAI to uplink RF output;

meets the requirements when using the predefined test sequences SEQ01.INP and SEQ01.DEC.

32.10.4 Downlink processing delay

32.10.4.1 Definition

The downlink processing delay is the delay from the first bit of a speech block transmitted from the RF output of the SS up to the last bit of the corresponding speech block received at the DAI on the output of the speech transcoder.

32.10.4.2 Method of test

32.10.4.2.1 Initial conditions

The DAI of the MS is connected to the SS and is set to the operating mode "Test of speech decoder/DTX functions (downlink)".

32.10.4.2.2 Procedure

- a) The test set up is that described in subclause 32.6.4.2 for downlink speech transcoding.
- b) The SS transmits the test pattern SEQ01.DEC described in 3GPP TS 06.07 subclause 6 to the MS.
- c) The SS measures for each speech block it transmits the time between the first bit at the air interface and the last bit of that speech block on the DAI. This time difference is the delay measured.
- d) Step c) is repeated 20 times and the maximum delay measured in ms is the downlink processing delay TDP.

NOTE: This is to account for the fact that the processing time may not be constant.

32.10.5 Downlink coding delay

32.10.5.1 Definition

The downlink coding delay is defined as the delay between the digital representation of an acoustic signal on the DAI and the corresponding acoustic signal at the ERP.

32.10.5.2 Method of test

32.10.5.2.1 Initial conditions

The DAI of the MS is connected to the SS and is set to the operating mode "Test of acoustic devices and A/D & D/A".

The handset is mounted in the LRGP (see annex 1 of ITU-T recommendation P.76) and the earpiece is sealed to the knife edge of the artificial ear conforming to ITU-T recommendation P.51.

32.10.5.2.2 Procedure

- a) The SS generates on the DAI a digital representation of a sine wave with a frequency of 1 000 Hz.
- b) The SS measures the "phase shift" \varnothing_1 , in the range of 0 to 360 degrees, between the equivalent sine wave generated at the DAI and the sine wave at the input to the artificial ear.
- c) The frequency is increased to 1 100 Hz and the resulting phase shift \varnothing_2 noted.
- d) The downlink coding delay TDC is calculated from either:

$$\text{TDC} = (\varnothing_2 - \varnothing_1) \text{ ms}/36 \quad \text{for } \varnothing_2 > \varnothing_1; \text{ or}$$

$$\text{TDC} = (\varnothing_2 + 360 - \varnothing_1) \text{ ms}/36 \quad \text{for } \varnothing_2 < \varnothing_1$$

32.10.6 Uplink processing delay

32.10.6.1 Definition

The uplink processing delay is the delay from the first bit of a speech block on the DAI to the last bit of that speech block being transmitted on the air interface of the MS.

32.10.6.2 Method of test

32.10.6.2.1 Initial conditions

The DAI of the MS is connected to the SS and is set to the operating mode "Test of speech encoder/DTX functions (uplink)".

32.10.6.2.2 Procedure

- a) The test set up is that described in subclause 32.8.4.2 for uplink speech transcoding.
- b) The SS sends one of the test patterns SEQ01.INP described in 3GPP TS 06.07 subclause 6 to the DAI of the MS.
- c) The SS measures the time between the first bit on the DAI, and the last transmitted bit of the block at the air interface for each speech block the SS sends on the DAI. This time difference is the delay measured.
- d) Step c) is repeated 20 times. The maximum delay measured in ms is the uplink coding delay TUP.

NOTE: This is to account for the fact that the processing time may not be constant.

32.10.7 Uplink coding delay

32.10.7.1 Definition

The uplink coding delay is defined as the delay between an acoustic signal at the MRP and the digital representation of that signal on the DAI.

32.10.7.2 Method of test

32.10.7.2.1 Initial conditions

The handset is mounted in the LRGP (see annex 1 of ITU-T recommendation P.76) and the earpiece is sealed to the knife edge of the artificial ear conforming to ITU-T recommendation P.51.

32.10.7.2.2 Procedure

- a) The SS generates an acoustic signal at the artificial mouth of the LRGP, being a pure sine wave with a frequency of 1 000 Hz.
- b) The SS measures the "phase shift" \varnothing_1 , in the range of 0 to 360 degrees, between the signal at the MRP and its digital representation on the DAI.
- c) The SS sets the generated frequency to 1 100 Hz, and measures the resulting phase shift \varnothing_2 .
- d) The uplink coding delay TUC is calculated from either:

$$TDC = (\varnothing_2 - \varnothing_1) \text{ ms}/36 \quad \text{for } \varnothing_2 > \varnothing_1; \text{ or}$$

$$TDC = (\varnothing_2 + 360 - \varnothing_1) \text{ ms}/36 \quad \text{for } \varnothing_2 < \varnothing_1$$

32.10.8 Test requirement

The sum of the delays TDP, TDC, TUP, and TUC shall be less than 144,9 ms.

NOTE: This limit includes an allowance of 4*0,25 ms delay from the DAI to the MS transmission path.

32.11 Intra cell channel change from a TCH/HS to a TCH/FS

32.11.1 Definition

Dual rate MSs support an intra cell channel change from a TCH/HS to a TCH/FS by switching the Speech and channel codec used from HR to FR.

32.11.2 Conformance requirement:

- 1) When commanded to perform an intra cell channel change from a TCH/HS to a TCH/FS, the MS shall switch channels from HR to FR. The maximum time allowed for the MS to perform this switch in rates is 20 ms.

3GPP TS 05.10, subclause 6.8.

- 2) For an intra cell channel change, the time between the end of the last complete speech or data frame or message block sent on the old channel and the time the MS is ready to transmit on the new channel shall be less than 20 ms.

3GPP TS 05.10, subclause 6.8.

32.11.3 Test purpose:

- 1) To verify that the MS encodes speech correctly after performing an intra cell channel change from a TCH/HS to a TCH/FS.
- 2) To verify that the MS, when commanded to perform an intracell channel change to a new ARFCN and/or timeslot number within the same cell, if the starting time is not used in the ASSIGNMENT COMMAND, is ready to transmit on the new channel within 20 ms of the last complete speech frame or message block sent on the old channel.

32.11.4 Method of test

32.11.4.1 Initial conditions

Uplink DTX is off.

The SS sets up a call according to the generic call set up procedure on a HR channel in the low ARFCN range on timeslot 1.

32.11.4.2 Procedure

- a) The SS records the sequence of BFI flags obtained by channel decoding the incoming bit stream from the uplink air interface using the HR channel decoder on the old channel and at the same time records the sequence of BFI flags obtained by channel decoding the incoming bit stream from the uplink air interface using the FR channel decoder on the channel to which the channel change will take place.
- b) The SS sends an ASSIGNMENT COMMAND to the MS allocating a FR channel in the high ARFCN range on timeslot 2, and with a power command of 7. These old and new carriers have a relative frequency tolerance of 0, and a relative timing tolerance of 1/4 bit.
- c) The time at which the sequence of BFI flags at the output of the HR channel decoder performs the first transition from 0 to 1 is registered (t_1). In case of occurrence of speech frames after an RR frame, the next transition of the BFI flag from 0 to 1 after the reception of the RR frame is defined as t_1 .
- d) The time values at which the sequence of BFI flags at the output of the FR channel decoder performs transitions from 1 to 0 are registered. The time t_2 is defined as the time where the BFI flag at the output of the FR channel decoder toggles from 1 to 0 due to a correctly received speech traffic frame received at the channel decoder. Transitions due to the occurrence of an ASSIGNMENT COMPLETE frame or an SABM frame after the reception of good speech frames shall not be considered. If the first frame sent on the new traffic channel was an SABM frame, t_2 is defined as the time the BFI flag toggles from 1 to 0 due to a correctly received speech traffic frame after the reception of the SABM frame.

NOTE: There shall be an allowance of at maximum two transitions for this BFI flag from 0 to 1 and back to zero again after t_2 . These transitions are caused by the SABM frame if it was not the first frame to be sent on the new TCH, or the ASSIGNMENT COMPLETE frame, or both. Since both frames are FACCH frames, each would cause exactly one BFI=1 indications.

- e) The time difference $Dt = t_2 - t_1$ shall be calculated.

32.11.5 Test requirement

- 1) The last transition of the BFI flag at the output of the FR channel decoder from 1 to 0 shall be followed by a sequence of at least 50 zeroes, interrupted by at maximum two transitions to 1, each interruption containing exactly one BFI=1 flag, caused by the SABM or the ASSIGNMENT COMPLETE frames.
- 2) The calculated time difference Dt shall not exceed 13 TDMA frames. If the first frame sent on the new channel was an SABM frame, an additional time difference of 4 frames is allowed. If the last frame sent on the old channel was an RR frame, an additional time difference of 9 frames is allowed.

NOTE: The BFI of the old channel will toggle from 0 to 1 only four frames after the reception of the last bit of the speech frame sent on the old channel. The time between the last bit of the last complete speech or data frame or message block sent on the old channel and the time the MS is ready to transmit on the new channel shall be less than 20 ms (3GPP TS 05.10, subclause 6.8). This time will expire 4 frames and 3 timeslots after the sending of the last bit of the last complete speech frame on the old channel, i.e. the MS may not be able to transmit in the corresponding timeslot in the current frame, but must wait approx. 4 frames until the next allowed frame (FN mod 13 = 0, 4 or 8) is reached.

The next frame could be an idle frame, so the MS must wait for another frame. This equates to 5 frames, after which the MS is able to start transmission on the new channel.

Additionally, 8 frames will be needed due to interleaving until the last bit of the first speech frame on the new channel is received and the BFI flag toggles from 1 to 0.

This makes a total of 13 frames or 60 ms between the frame number when the BFI toggles from 0 to 1 on the old channel and the frame number when the BFI toggles from 1 to 0 on the new channel. See diagram below.

If SABM is the first frame received on the new channel, 4 more frames are allowed.

If RR is the last frame sent on the old channel, additionally 9 more frames are allowed (RR frames plus an idle frame).

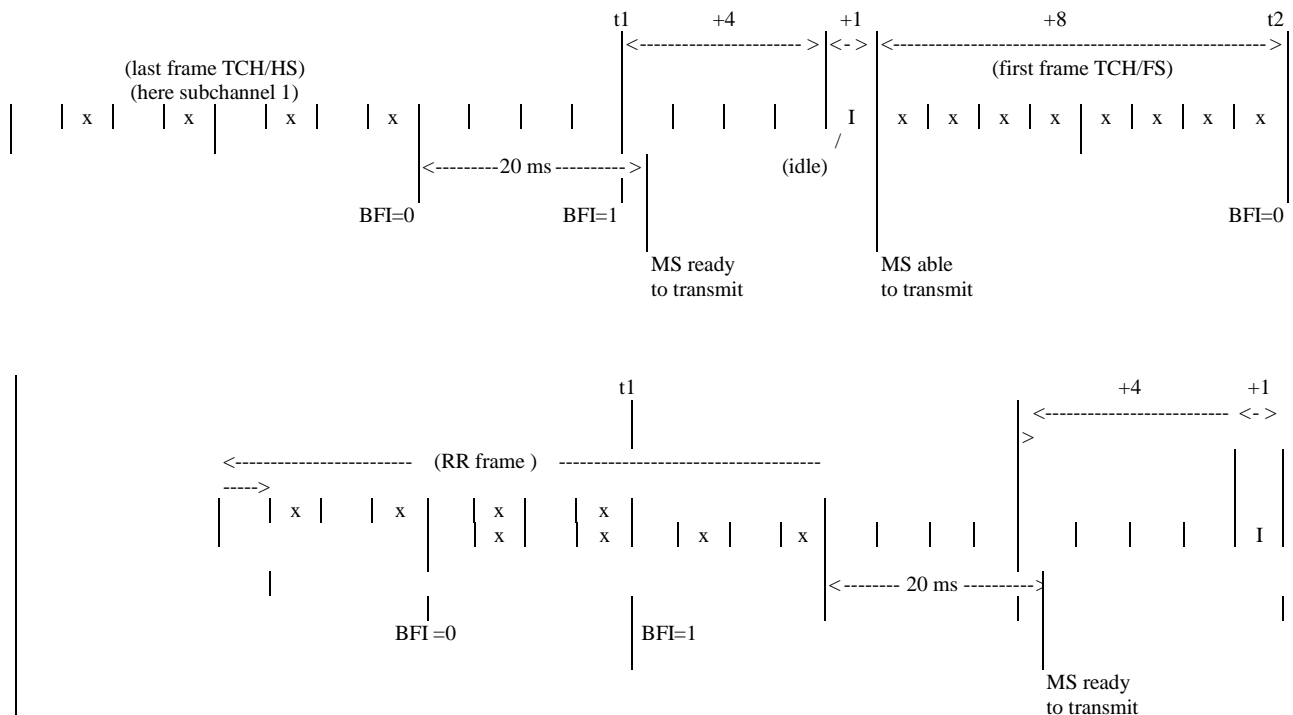

32.12 Intra cell channel change from a TCH/FS to a TCH/HS

32.12.1 Definition

Dual rate MSs support an intra cell channel change from a TCH/FS to a TCH/HS by switching the Speech and channel codec used from FR to HR.

32.12.2 Conformance requirement:

- 1) When commanded to perform an intra cell channel change from a TCH/FS to a TCH/HS, the MS shall switch channels from FR to HR.

3GPP TS 05.10 subclause 6.8.

- 2) For an intra cell channel change, the time between the end of the last complete speech or data frame or message block sent on the old channel and the time the MS is ready to transmit on the new channel shall be less than 20 ms.

3GPP TS 05.10, subclause 6.8.

32.12.3 Test purpose:

- 1) To verify that the MS encodes speech correctly after performing an intra cell channel change from a TCH/FS to a TCH/HS.
- 2) To verify that the MS, when commanded to perform an intra cell channel change to a new ARFCN and/or new timeslot number within the same cell, if the starting time is not used in the ASSIGNMENT COMMAND, is ready to transmit on the new channel within 20 ms of the last complete speech frame or message block sent on an old channel.

32.12.4 Method of test

32.12.4.1 Initial conditions

Uplink DTX is off.

The SS sets up a call according to the generic call set up procedure on a FR channel in the low ARFCN range on timeslot 1.

32.12.4.2 Procedure

- a) The SS records the sequence of BFI flags obtained by channel decoding the incoming bit stream from the uplink air interface using the FR channel decoder on the old channel and at the same time the sequence of BFI flags obtained by channel decoding the incoming bit stream from the uplink air interface using the HR channel decoder on the channel to which the channel change will take place.
- b) The SS sends an ASSIGNMENT COMMAND to the MS allocating a HR channel on sub-channel 0 in the high ARFCN range on timeslot 2, and with a power command of 7. These old and new carriers have a relative frequency tolerance of 0, and a relative timing tolerance of 1/4 bit.
- c) The time at which the sequence of BFI flags at the output of the FR channel decoder performs the first transition from 0 to 1 is registered (t_1). In case of occurrence of speech frames after an RR frame, the next transition of the BFI flag from 0 to 1 after the reception of the RR frame is defined as t_1 .
- d) The time values at which the sequence of BFI flags at the output of the HR channel decoder performs transitions from 1 to 0 are registered. The time t_2 is defined as the time where the BFI flag at the output of the FR channel decoder toggles from 1 to 0 due to a correctly encoded speech traffic frame received at the channel decoder. Transitions due to the occurrence of an ASSIGNMENT COMPLETE frame or and SABM frame after the reception of good speech frames shall not be considered. If the first frame sent on the new traffic channel was an SABM frame, t_2 is defined as the time the BFI flag toggles from 1 to 0 due to a correctly received speech traffic frame after the reception of the SABM frame.

NOTE: There shall be an allowance of at maximum two transitions for this BFI flag from 0 to 1 and back to zero again after t_2 . These transitions are caused by the SABM frame if it was not the first frame to be sent on the new TCH, or the ASSIGNMENT COMPLETE frame, or both. Since both frames are FACCH frames, each would cause exactly two BFI=1 indications.

- e) The time difference $Dt = t_2 - t_1$ shall be calculated.

32.12.5 Test requirement

- 1) The last transition of the BFI flag at the output of the HR channel decoder from 1 to 0 shall be followed by a sequence of at least 50 zeroes, interrupted by at maximum two transitions to 1, each interruption containing exactly two BFI=1 flags, caused by the SABM or the ASSIGNMENT COMPLETE frames.
- 2) The calculated time difference Dt shall not exceed 12 TDMA frames. if the first frame sent on the new channel was an SABM frame, an additional time difference of 9 frames is allowed. If the last frame sent on the old channel was an RR frame, an additional time difference of 5 frames is allowed.

NOTE: The BFI of the old channel will toggle from 0 to 1 only 4 frames after the reception of the last bit of the last speech frame sent on the old channel. The BFI on the old channel will toggle from 0 to 1 only four frames after the reception of the last bit of the last complete speech or data frame or message block sent on the old channel.

The time between the last bit of the last complete speech frame sent on the old channel and the time the MS is ready to transmit on the new channel shall be less than 20 ms (3GPP TS 05.10, subclause 6.8). This time will expire 4 frames and 3 timeslots after the sending of the last bit of the last complete speech frame on the old channel, i.e. the MS may not be able to transmit in the corresponding new timeslot in its current frame, but must wait approx. 4 frames until the next allowed frame (FN mod 13 = 0, 4 or 8) is reached.

The next frame could be an idle frame, so the MS must wait for another frame. This equates to 5 frames, after which the MS is able to start transmission on the new channel.

Additionally, 7 frames will be needed due to interleaving until the last bit of the first speech frame on the new channel is received and the BFI flag toggles from 1 to 0.

This makes a total of 12 frames or 55,4 ms between the frame number when the BFI toggles from 0 to 1 on the old channel and the frame number when the BFI toggles from 1 to 0 on the new channel. See diagram below.

If SABM is the first frame received on the new channel, 9 more frames are allowed.

If RR is the last frame sent on the old channel, 5 more frames are allowed.

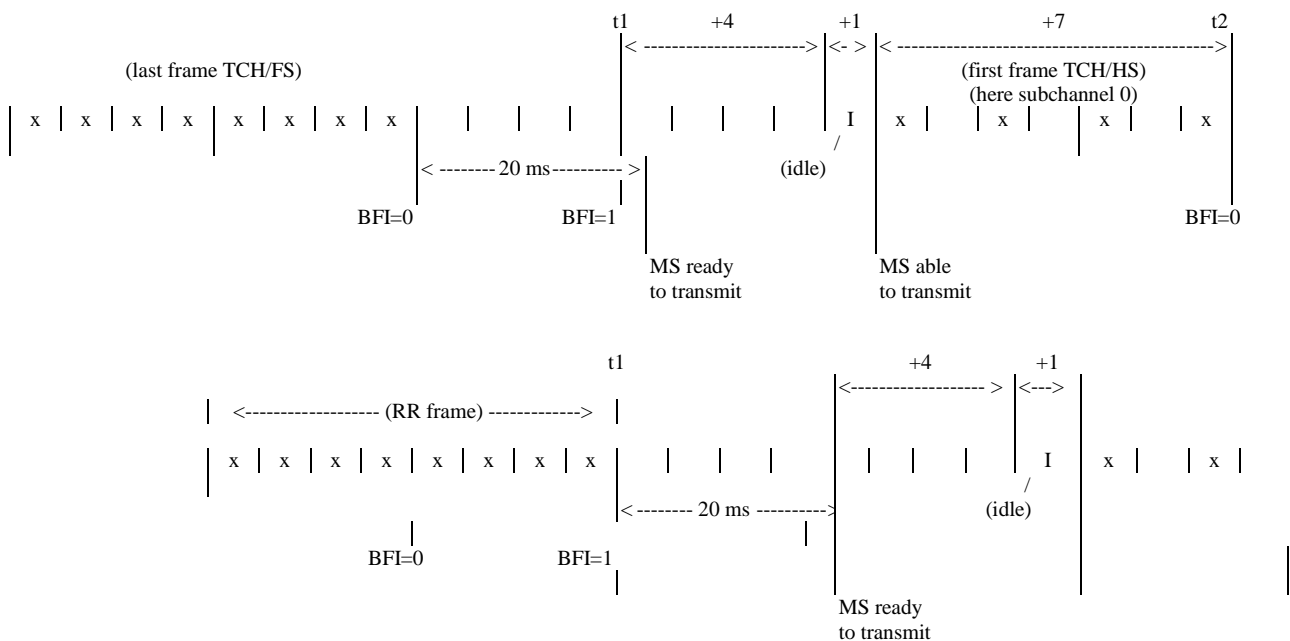

33 Mobile station features

3GPP TS 02.07 defines mandatory and optional MS features. Their presence and appropriate functioning are verified by the following tests.

33.1 Entry and display of called number

33.1.1 Definition

The entry and display of a called number is the ability of a MS to correctly display and signal to the network the user required number.

33.1.2 Conformance requirement

- 1) The number of the called subscriber is included in the Called party BCD number Information element of the SETUP message for an outgoing call.

The "Display of Called number" shall be implemented in an MS where a human interface is provided.

- 2) The "Numbering plan identification" is included in the Called party BCD number Information element of the SETUP message for an outgoing call.

An MS with MMI shall as default use the Numbering Plan Identification ITU-T E164, unless otherwise indicated by the user.

- 3) The "Type of number" is included in the Called party BCD number Information element of the SETUP message for an outgoing call.

An MS with MMI shall, if the "+" is not entered, and a number is entered, set the Type of Number to "unknown".

- 4) The "Type of number" is included in the Called party BCD number Information element of the SETUP message for an outgoing call.

An MS with MMI shall, if the "+" is entered, and a number is entered, set the Type of Number to "International".

33.1.3 Test purpose

- 1) To verify that an MS with human interface, in a SETUP message sent to originate a call, includes the same "Number digits" in the "Called party BCD number" of the SETUP message as displayed.
- 2) To verify that an MS with MMI, when made to establish a call sends a SETUP message, which includes the "Numbering plan identification" in the "Called party BCD number" of the SETUP message for an outgoing call with the value "ISDN/telephony numbering plan (E.164/E.163)".
- 3) To verify that an MS with MMI, when made to establish a call without use of the "+-key" function, sends a SETUP message, which includes the "Type of number" in the "Called party BCD number" of the SETUP message for an outgoing call with the value "unknown".
- 4) To verify that an MS with MMI, implementing the "+-key" function, when made to establish a call with use of the "+-key" function, sends a SETUP message, which includes the "Type of number" in the "Called party BCD number" of the SETUP message for an outgoing call with the value "international number".

33.1.4 Method of test

33.1.4.1 Initial conditions

The MS is registered in a cell of the SS.

33.1.4.2 Procedure

- a) A number (not including "+ function") is entered and then a call is set up.
- b) After the SS has accepted the call the number displayed on the MS and the number received in the SS are compared.
- c) The NPI and TON are examined in the SS.
- d) Steps a) to c) are repeated, but in a), the number entered starts with the "+ function".

NOTE: This test may also be performed automatically using the EMMI.

33.1.5 Test requirements

- 1) In step b), both numbers shall be identical.
- 2) In step c), the NPI shall be "E164" and the TON shall be "unknown".
- 3) In step d), the NPI shall be "E164" and the TON shall be "international".

33.2 Indication of call progress signals

33.2.1 Definition

Void.

33.2.2 Conformance requirement

Void.

33.2.3 Test purpose

Void.

33.2.4 Ringing tone

33.2.4.1 Method of test

- a) According to subclause "Structured procedures, Mobile originating call, early assignment, Method of test", paragraphs a) to j).

33.2.4.2 Requirements

- 1) According to subclause "Structured procedures, Mobile originating call, early assignment, Requirements", paragraphs 1) to 7).
- 2) The ringing tone characteristics shall be as follows:

Tone	Frequency	Tolerance	Type
Ringing tone	425 Hz	15 Hz	Periodic tone on 1 s, silence 4 s

33.2.5 Busy tone

33.2.5.1 Method of test

- a) According to subclause "Structured procedures, Mobile originating call, early assignment, Method of test", paragraphs a) to h).
- b) The SS then sends message DISCONNECT with cause number 17.

Message: DISCONNECT (3GPP TS 04.08 / 3GPP TS 24.008, subclause 9.3.7) to the MS:	
Information element	Comment
Protocol discriminator	CM
Transaction identifier	MS orig.
Message type	
Cause	
- Coding standard	GSM
- Location	User
- Cause value	#17 "user busy"

33.2.5.2 Requirements

- 1) According to subclause "Structured procedures, Mobile originating call, early assignment, Requirements", paragraphs 1) to 5).
- 2) After the reception of DISCONNECT a busy tone shall be generated. The busy tone characteristics shall be as follows:

Tone	Frequency	Tolerance	Type
Busy tone	425 Hz	15 Hz	Periodic tone on 500 ms, silence 500 ms

33.2.6 Congestion tone

33.2.6.1 Method of test

- a) According to subclause "Structured procedures, Mobile originating call, early assignment, Method of test", paragraphs a) to h).
- b) The SS then sends message DISCONNECT with cause number 42.

DISCONNECT message: As in subclause 33.2.3.1 with cause value #42 "Switching equipment congestion" (0101010).

33.2.6.2 Requirements

- 1) According to subclause "Structured procedures, Mobile originating call, early assignment, Requirements", paragraphs 1) to 5).
- 2) After the reception of DISCONNECT a congestion tone shall be generated.
- 3) The congestion tone characteristics shall be as follows:

Tone	Frequency	Tolerance	Type
Congestion tone	425 Hz	15 Hz	Periodic tone on 200 ms, silence 200 ms

33.2.7 Authentication failure tone

33.2.7.1 Method of test

- a) According to subclause "Structured procedures, Mobile originating call, early assignment, Method of test", paragraphs a) to e).
- b) After reception of message AUTHENTICATION RESPONSE the SS sends message AUTHENTICATION REJECT.

Message: AUTHENTICATION REJECT (3GPP TS 04.08 / 3GPP TS 24.008, 9.2.1) to the MS:	
Information element	Comment
Protocol discriminator	MM
Transaction identifier	not relevant
Message type	

33.2.7.2 Requirements

- 1) According to subclause "Structured procedures, Mobile originating call, early assignment, Requirements", paragraphs 1) to 4).
- 2) After reception of AUTHENTICATION REJECT a tone shall be generated indicating authentication failure.
- 3) The authentication failure tone is the error/special information tone with characteristics as follows:

Tone	Frequency	Tolerance	Type
Error/Special	950 Hz	50 Hz	Triple tone tones on 330 ms silence 1,0 s
Information tone	1400 Hz	50 Hz	
	1800 Hz	50 Hz	

33.2.8 Number unobtainable tone

33.2.8.1 Method of test

- a) According to subclause "Structured procedures, Mobile originating call, early assignment, Method of test", paragraphs a) to h).

- b) The SS then sends message DISCONNECT with cause number 1.

DISCONNECT message: As in subclause 33.2.3.1 with cause value #1 "Unassigned (unallocated) number" (000001).

33.2.8.2 Requirements

- 1) According to subclause "Structured procedures, Mobile originating call, early assignment, Requirements", paragraphs 1) to 5).
- 2) After reception of DISCONNECT a tone shall be generated indicating that the called number is unobtainable.

The number unobtainable tone is the error/special information tone with characteristics as in subclause 33.2.7.2.

33.2.9 Call dropped tone

33.2.9.1 Method of test

- a) According to subclause "Structured procedures, Mobile originating call, early assignment, Method of test", paragraphs a) to l). However, it shall be indicated in the system information messages that call re-establishment shall not be attempted (RACH control parameters).
- b) When the call has been established the SS stops transmitting on the TCH/SACCH.

33.2.9.2 Requirements

- 1) According to subclause "Structured procedures, Mobile originating call, early assignment, Requirements", paragraphs 1) to 8).
- 2) After the radio link time-out period has expired a tone shall be generated indicating that the call has been dropped.

The call dropped tone characteristics shall be as follows:

Tone	Frequency	Tolerance	Type
Call dropped tone	425 Hz	15 Hz	Tone on 200 ms, silence 200 ms 3 bursts of on/off

33.3 Network selection / indication

33.3.1 Definition

Network selection and indication is the ability of the MS to correctly select a network and display to the user in accordance with 3GPP TS 02.11 and 3GPP TS 03.22.

Tests concerning the MS behaviour after having received a location updating reject message with specific causes are included in subclause 26.7.4.2.

Tests concerning the MS handling of the forbidden PLMN list are also included in subclause 26.7.4.

33.3.2 Conformance requirement

- 1) Upon switching on, when an IMSI is available and there is no registered PLMN on the SIM, the MS shall select its Home PLMN and perform the cell selection procedure.
- 2) If the MS loses radio coverage for its registered PLMN, and the MS is in automatic PLMN selection mode, it shall attempt to select its Home PLMN.
- 3) If the Registered PLMN is unavailable due to the loss of radio coverage and the MS is in automatic PLMN selection mode and the HPLMN is also unavailable, it shall attempt to select a suitable cell and access the PLMNs in turn, in the order of priority as stored in the SIM.
- 4) If there is no registered PLMN in the SIM or the registered PLMN is unavailable and If the Home PLMN is unavailable and the MS is in automatic PLMN selection mode, it shall attempt to select a suitable cell and

accesses the PLMNs in turn, in the order of priority as stored in the SIM, upon switching on and when the IMSI is available.

- 5) An MS, roaming in a VPLMN whose MCC is the same as the MCC of the IMSI, shall periodically attempt to obtain service on its Home PLMN in automatic mode. For this purpose, a value T minutes, which is the HPLMN search period, may be stored in the SIM; T is either in the range 6 minutes to 8 hours in 6 minutes step or it indicates that no periodic attempt shall be made. If no HPLMN search value is available on the SIM the mobile equipment shall use a default value of 30 minutes.
- 6) At switch on, the MS selects and attempts to perform a Location Update on the Registered PLMN if it exists. If the registered PLMN is a VPLMN of the SIM's home country, the MS shall wait at least 2 minutes before attempting to obtain service on its home PLMN.

33.3.3 Test purpose

- 1) To verify that the MS with SIM containing in the PLMN selector field at least one PLMN different from the Home PLMN and containing no registered PLMN, when in automatic PLMN selection mode, selects its Home PLMN, if available, upon switching on and when the IMSI is available. (This is verified by observation of the location updating procedure).(Steps 1.1 through 1.5).
- 2) To verify that if the MS loses radio coverage for its registered PLMN, and the MS is in automatic PLMN selection mode, it shall attempt to select its Home PLMN. (Steps 1.14C through 1.16C).
- 3) To verify that the MS, when it loses radio coverage for its selected PLMN (i.e. Registered PLMN) and in automatic PLMN selection mode, selects the PLMN with the highest priority among the PLMNs stored on the SIM, if the Home PLMN is unavailable. (Steps 1.10 through 1.12).
- 4) If there is no registered PLMN in the SIM or the registered PLMN is unavailable and If the Home PLMN is unavailable and the MS is in automatic PLMN selection mode, it shall attempt to select a suitable cell and accesses the PLMNs in turn, in the order of priority as stored in the SIM, upon switching on and when the IMSI is available. (Steps 1.22 through 1.25).
- 5) To verify that an MS, roaming in a VPLMN whose MCC is the same as the MCC of the IMSI, shall attempt to obtain service on its Home PLMN in automatic mode with a period of T. To verify that the MS shall not attempt to obtain service on its home PLMN in automatic mode when T is set to "no periodic attempts shall be made". To verify that a default value of 30 min is used when no HPLMN search timer value is available on the SIM. (Steps 1.13 A through 1.15A, 1.13B through 1.15B and 1.13C.)
- 6) To verify that, at switch on, the MS selects and attempts to perform a Location Update on the registered PLMN if it exists. If the registered PLMN is a VPLMN of the SIM's home country, the MS shall wait at least 2 minutes before attempting to obtain service on its home PLMN. (Steps 1.25 through 1.28).

Reference

- | | |
|-----------------------|--------------------------------------|
| Requirements 1, 2, 3: | see 3GPP TS 03.22 subclause 4.4.3.1. |
| Requirements 4: | see 3GPP TS 03.22 subclause 3.1. |
| Requirement 5, 6: | see 3GPP TS 03.22 subclause 4.4.3.3. |

33.3.4 Method of Test

Procedure 1: This procedure applies to both automatic and manual mode for PLMN selection. This procedure is run for each of the following cases:

- case A) Timer T is set to 6 min in the SIM.
- case B) No HPLMN search timer value is available on the SIM.
- case C) Timer T is set to "no periodic attempt to obtain service on the HPLMN shall be made" in the SIM.

Procedure 2: This procedure applies to the manual mode for PLMN selection.

Specific PICS Statements

- Country PLMN/Indication (TSPC_Feat_PLMNind)

PIXIT Statements

-

33.3.4.1 Procedure 1

- 1.1) The MS is set up with a SIM which contains, in the "PLMN selector" data field, a list of 3 PLMN in the priority order PLMN2 (highest priority), PLMN3, PLMN4 (lowest priority). PLMN1 is the Home PLMN of the MS as defined in the IMSI. The "Forbidden PLMN" data field shall contain NULL values. "registered PLMN" data field shall contain Null values.

case A) Timer T is set to 6 min in the SIM.

case B) No HPLMN search timer value is available on the SIM.

case C) Timer T is set to "no periodic attempt to obtain service on the HPLMN shall be made" in the SIM.

- 1.2) The SS transmits 4 BCCH carriers with the following parameters:

	PLMN	Level dB μ Vemf()
Carrier 1	PLMN1 any value for MCC	28
Carrier 2	PLMN2 any value for MCC	33
Carrier 3	PLMN3 with the same MCC as PLMN1	38
Carrier 4	PLMN4 any value for MCC	43

Each carrier has the "IMSI attach" (ATT) flag set in the BCCH data. (The purpose of this is to force the MS to do location updating whenever it is switched on, so that the SS can determine which PLMN has been selected).

The other system information parameters are as in table 33-1.

- 1.3) The MS is brought into the "on" condition with automatic selection mode active.
- 1.4) The SS checks that the MS sends a "location updating request" on carrier 1.
- 1.5) The SS sends a "location updating accept" message to the MS on carrier 1. After 5 s, the MS "selected PLMN indicator" is checked.
- 1.6) The SS switches off carriers 1.
- 1.7) The SS checks that the MS sends a "location updating request" on carrier2.
- 1.8) The SS sends a "location updating accept" message to the MS on carrier 2. After 5 s, the MS "selected PLMN indicator" is checked.
- 1.9) Carrier 2 is turned off.
- 1.10) The SS checks that the MS sends a "location updating request" on carrier 3.
- 1.11) The SS sends a "location updating accept" message on carrier 3. After 5 s, the MS "selected PLMN indicator" is checked.
- 1.12) Carriers 1 and 2 are turned on with the same parameters as in step 1.2) above.

In case A for which T is set to 6 min, take branch A.

In case B for which default value for T is applied take branch B.

In case C for which T is set to "no periodic attempt shall be made", take branch C.

Branch A

- 1.13A) The SS checks that the MS does not send a "location updating request" on either carrier 1 or 2 during 6 minutes after step 1.11 is completed.

1.14A) The SS checks that the MS sends a "location updating request" on channel 1 between 6 and 12 min after step 1.11 is completed.

1.15A) The SS sends a "location updating accept" message on carrier 1. After 5 s, the MS "selected PLMN indicator" is checked.

Branch B

1.13B) The SS checks that the MS does not send a "location updating request" on either carrier 1 or 2 during 30 minutes after step 1.11 is completed.

1.14B) The SS checks that the MS sends a "location updating request" on channel 1 between 30 and 60 min after step 1.11 is completed.

1.15B) The SS sends a "location updating accept" message on carrier 1. After 5 s, the MS "selected PLMN indicator" is checked.

Branch C

1.13C) The SS checks that the MS does not send a "location updating request" on either carrier 1 or 2 during 40 min.

1.14C) The SS switches off carrier 3.

1.15C) The SS checks that the MS sends a "location updating request" on channel 1.

1.16C) The SS sends a "location updating accept" message on carrier 1. After 5 s, the MS "selected PLMN indicator" is checked.

1.17) The SS switches off carrier 1 and switches on carrier 3.

1.18) The SS checks that the MS sends a "location updating request" on carrier 2.

1.19) The SS sends a "location updating accept" message on carrier 2. After 5 s, the MS "selected PLMN indicator" is checked.

1.20) The mobile station is switched off.

1.21) The SS switches off carrier 2.

1.22) The mobile station is switched on.

1.23) The SS checks that the MS sends a "location updating request" on carrier 3.

1.24) The SS sends a "location updating accept" message on carrier 3. After 5 s, the MS "selected PLMN indicator" is checked.

1.25) The MS is switched off.

1.26) The SS switches on carrier 1.

1.27) The mobile station is switched on.

1.28) The SS checks that the MS does not send a "location updating request" on carrier 1. After 2 minutes, the MS "selected PLMN indicator" is checked.

33.3.4.2 Requirements 1

Requirement 1.1) is mandatory for all MS. Requirements 1.2) only apply to MS capable of indicating PLMN.

1.1) The MS shall make a response as indicated in steps 1.4, 1.7, 1.10, 1.13A, 1.13B, 1.14A, 1.14B, 1.15C, 1.18, 1.23 above. In cases 1.4, 1.7, 1.10, 1.15C, 1.18 and 1.23, the MS shall respond within 30 s.

1.2) The selected PLMN shall be indicated:

End of Step	1.5	1.8	1.11	1.15A/B	1.16C
PLMN indicated:	PLMN1	PLMN2	PLMN3	PLMN1	PLMN1
End of Step	119	124	128		
PLMN indicated:	PLMN2	PLMN3	PLMN3		

33.3.4.3 Procedure 2

- 2a) The MS is set up with a SIM which contains NULL values in the "PLMN selector" data field. PLMN1 is the Home PLMN of the MS as defined in the IMSI. The "forbidden PLMN" data field shall contain PLMN3. the "registered PLMN" field is set to PLMN2.
- 2b) The SS transmits 4 BCCH carriers with the following parameters:

	PLMN	Level dB μ Vemf()
Carrier 1	PLMN1	28
Carrier 2	PLMN2	33
Carrier 3	PLMN3	38
Carrier 4	PLMN4	43

Each carrier has the "IMSI attach" (ATT) flag set in the BCCH data. (The purpose of this is to force the MS to do location updating whenever it is switched on, so that the SS can determine which PLMN has been selected.)

The other system information parameters are as in table 33-1.

- 2c) The MS is brought into the "on" condition with manual selection mode active.
- 2d) The SS checks that the MS sends a "location updating request" on carrier 2.

33.3.4.4 Requirements 2

- 2.1) The MS shall make a response as indicated in step 2d). The MS shall respond within 30 s.

Table 33-1: Normal system information fields

Parameter	Reference in 3GPP TS 04.08 / 3GPP TS 24.008 / 3GPP TS 44.018	Abbreviation	Normal setting
Cell Channel Description	10.5.2.1	-	Any values
Max retrans	10.5.2.17	-	1
Tx-integer	10.5.2.17	-	Any value
CELL_BAR_ACCESS	10.5.2.17	CBA	0 (i.e. no barred)
AC CN	10.5.2.17	AC	All 0
RE	10.5.2.17	RE	0 (i.e. re-establishment allowed)
BA ARFCN	10.5.2.13	BA	One entry equal to the ARFCN of the carrier
NCC	10.5.2.15	NCC	Any value
Cell Identity	10.5.1.1	-	Any value
MCC, MNC	10.5.1.3	PLMN	Ref. 33.3.2, 1b) and 33.3.2, 2b)
LAC	10.5.1.3	LAC	1111 (Hex)
ATT, B_AG_BLK_RES,T3212,	10.5.2.8	-	ATT = "1"
CCCH_CONF			Other parameters any values.
BS_PA_MFRMS	10.5.2.8	BPM	5 frames
Cell Options	10.5.2.3	-	Any values
CELL_RESELECT_HYSTERESIS	10.5.2.4	CRH	10 dB
MS_TXPWR_MAX_CCH	10.5.2.4	MTMC	Maximum RF output power of MS.
RXLEV_ACCESS_MIN	10.5.2.4	RAM	-95 dBm

33.4 Invalid and blocked PIN indicators

33.4.1 Definition

-

33.4.2 Conformance requirement

Void.

33.4.3 Test purpose

Void.

33.4.4 Method of test

33.4.4.1 Initial conditions

The MS contains a SIM with the PIN enabled, and the SIM unblocking counter set to zero by previous presentation of the personal unblocking key.

33.4.4.2 Procedure

- a) The MS is switched on.
- b) Three wrong PIN are entered.

Activation may be either manual or via the EMMI.

33.4.5 Test requirements

For the first and second incorrect PIN the MS shall indicate that the PIN code has been rejected.

For the third incorrect PIN the MS shall indicate that the PIN is blocked.

33.5 Service indicator

33.5.1 Definition

-

33.5.2 Conformance requirement

Void.

33.5.3 Test purpose

Void.

33.5.4 Method of test

33.5.4.1 Initial conditions

- a) The MS is in idle mode, unregistered.
- b) The SS shall emulate perfect radio conditions so that the MS is able to register and to set up or receive a call.

33.5.4.2 Procedure

- a) The MS is brought in an active state by either switching it on or by inserting a SIM.

33.5.5 Test requirements

- 1) The successful registration and the good condition shall be indicated by the MS indicator and by the SS.

33.6 Subscription identity management

33.6.1 Definition

Subscription identity management is the ability of the MS to prevent the establishment of MO (except MO emergency calls) and MT calls without a valid subscription.

33.6.2 Conformance requirement

An MS can only be operated, if a valid IMSI is present.

33.6.3 Test purpose

- 1) To verify that during an established call: either
 - 1.1) on removal of the SIM from an MS, the MS will perform an IMSI detach; or
 - 1.2) after removing the power source from the MS, removing the SIM, and restoring the power source to the MS, the MS may perform an IMSI detach.
- 2) To verify that an MS without SIM card will not establish a MO call which is not an emergency call.
- 3) To verify that an MS without SIM card will not accept an incoming call.

33.6.4 Method of test

33.6.4.1 Initial conditions

Void.

33.6.4.2 Procedure

- a) A call is set up.
- b) (Reserved).
- c) Either:
 - (i) the SIM is removed; or
 - (ii) where this is not possible, the power source is removed from the MS, the SIM is removed and the power source is restored to the MS.

The SS observes whether or not the MS performs IMSI detach.

- d) An attempt to establish a MO call is made (not an emergency call).
- e) An attempt to establish a MT call is made.

33.6.5 Test requirements

- 1) Either:
 - 1.1) in step c(i), the MS shall perform an IMSI detach; or
 - 1.2) in step c(ii), the MS may perform an IMSI detach.
- 2) In step d) the MS shall not attempt to set up a new call via the Um interface.
- 3) In step e), the MS shall not respond to the attempt to set up a new call via the Um interface.

33.7 Barring of outgoing calls

33.7.1 Definition

The barring of outgoing calls is an optional feature. It is the ability of the MS to prevent all MO calls except emergency calls.

33.7.2 Conformance requirement

An MS may have an optional facility to bar outgoing calls. Such barring facility shall not prevent the transmission on emergency calls.

33.7.3 Test purpose

To verify that an MS for which a local facility to bar outgoing calls has been declared as being implemented, is able to establish an emergency call if this facility is activated.

33.7.4 Method of test

33.7.4.1 Initial conditions

Void.

33.7.4.2 Procedure

- a) The local facility to bar outgoing calls is activated.
- b) Via MMI, the MS is actioned to establish an emergency call.

33.7.5 Test requirements

- 1) The MS shall establish an emergency call.

33.8 Prevention of unauthorized calls

33.8.1 Definition

The prevention of unauthorized calls is an optional feature in the MS. It is the ability of the MS to prevent unauthorized use by using a key or keyword protection facility. When activated the MS does not prevent the establishment of except emergency calls.

33.8.2 Conformance requirement

An MS may have an optional facility to prevent unauthorized use. Such facility shall not prevent the transmission on emergency calls.

33.8.3 Test purpose

To verify that an MS for which a local facility to prevent unauthorized use has been declared to be implemented, is able to establish an emergency call, if this facility is activated.

33.8.4 Method of test

33.8.4.1 Initial conditions

33.8.4.2 Procedure

- a) The local facility to restrict operation such that the MS can only be operated by using a key or a keyword is activated. The most restrictive situation is created.
- b) Via MMI, the MS is actioned to establish an emergency call.

33.8.5 Test requirements

- 1) The MS shall establish an emergency call.

34 Short message service (SMS)

Ref.: 3GPP TS 03.40, 3GPP TS 04.11 (point to point)
3GPP TS 03.41, 3GPP TS 04.12 (cell broadcast)

34.1 General

The purpose of these tests is to verify that the MS can handle GSM functions when submitting or receiving Short Messages (SM) between MS and a short message service centre as described in 3GPP TS 03.40.

The procedures are based upon services provided by the Mobility Management (MM) sublayer which is not tested in this case.

The SMS comprises three basic services. The SMS point to point services shall work in an active MS at any time independent of whether or not there is a speech or data call in progress. The SMS cell broadcast service only works when the MS is in idle mode.

The manufacturer shall declare whether SMS messages are stored in the SIM and/or the ME. This shall be referred to as the SMS message store in the following tests.

A timeout of 60s is applied throughout the tests with respect to the retransmission of CP-Data messages. This timeout is based on the maximum TRIM + 15s. The 15s is sufficient time to verify that the MS does not initiate more than the maximum number of retransmissions.

Unless otherwise stated default message contents from subclause 26.6.14 applies for GSM 900 and default message contents from subclause 26.6.15 applies for DCS 1 800 and default message contents from subclause 26.6.16 applies for GSM 450 and default message contents from subclause 26.6.17 applies for GSM 480 and default message contents from subclause 26.6.18 applies for PCS 1 900 and default message contents from subclause 26.6.19 applies for GSM 750 and default message contents from subclause 26.6.20 applies for GSM 850 and default message contents from subclause 26.6.21 applies for GSM 710 and default message contents from subclause 26.6.22 applies for T-GSM 810.

For the test cases in section 34.4 the default message contents shall be set as in "GPRS default conditions" clause 40.

34.2 Short message service point to point

34.2.1 SMS mobile terminated

34.2.1.1 Conformance requirements

An active MS shall be able to receive short message TPDU (SMS-DELIVER) at any time, independently of whether or not there is a speech or data call in progress. A report will always be returned to the SC, confirming that the MS has received the short message.

Reference

3GPP TS 03.40; 3.1.

34.2.1.2 Test purpose

To verify the ability of a MS to receive and decode the SMS where provided for the point to point service.

34.2.1.3 Method of test

Initial Conditions

System simulator:

1 cell, default parameters.

Mobile Station:

The MS shall be in "Idle, updated" state.

The SMS message storage shall be empty.

Specific PICS Statements:

- SMS messages are stored in the SIM (TSPC_AddInfo_StoreRcvSMSSIM).
- SMS messages are stored in the ME (TSPC_AddInfo_StoreRcvSMSME).

PIXIT Statements:

- Description of the basic procedures to display a mobile terminated short message.
- Support for call control state U10.

Foreseen Final State of MS

Idle, updated.

Test Procedure

- a) The SS initiates the transmission of a short message using a paging request. Upon response of the MS to the paging the SS assigns an SDCCH, authenticates the MS and activates ciphering. Then the SS establishes SAPI 3 by sending a SABM frame with SAPI 3 on the SDCCH.

When a UA frame (SAPI 3) is received in response, the SS sends a CP-DATA message. The information element of the CP-DATA message will be RP-DATA RPDU (SMS DELIVER TPDU).

- b) The SS waits a maximum of 25 s for the CP-ACK message and then a maximum of 60 s for the CP-DATA message containing the RP-ACK RPDU.
- c) The SS sends a CP-ACK to the MS with no further CP-DATA messages and the SS initiates channel release.
- d) Steps a), b) and c) are repeated but the first CP-DATA message from the MS is not acknowledged. The second CP-DATA message from the MS is acknowledged by a CP-ACK.
- e) Steps a) and b) are repeated. The SS is configured not to send CP-ACK. Then maximum 3 CP-DATA retransmissions may occur. The SS ensures that the MS disconnects the link within 60 s after the first CP-DATA not acknowledged by the SS. The 60 s is sufficient time to wait to verify that the MS does not send more than the maximum allowed (3) CP-DATA retransmissions.
- f) The SMS message store shall be cleared manually by the operator.
- g) A data or speech call is established on a TCH with the SS and the state U10 of call control is entered. The SS sends a SABM frame with SAPI-3 on the SACCH associated to the TCH.

When a UA frame (SAPI-3) is received in response, the SS sends a CP-DATA message. The information element of the CP-DATA message will be RP-DATA RPDU (SMS DELIVER TPDU). The SS waits a maximum of 25 s for the CP-ACK message and then a maximum of 60 s for the CP-DATA message containing the RP-ACK RPDU.

- h) The SS sends a CP-ACK to the MS with no further CP-DATA messages and the SS initiates channel release. The SMS message store shall be cleared manually by the operator.
- i) Steps g) and h) are repeated but the first CP-DATA message from the MS is not acknowledged. The second CP-DATA message from the MS is acknowledged by a CP-ACK.
- j) Step g) is repeated. The SS is configured not to send CP-ACK. Then maximum 3 CP-DATA retransmissions may occur. After a duration of 60 s after the first CP-DATA not acknowledged the SS initiates the channel release. The 60 s is sufficient time to wait to verify that the MS does not send more than the maximum allowed (3) CP-DATA retransmissions (during a call in progress).

- k) A data or speech call is established on a TCH with the SS and the state U10 of call control shall be entered. The SS sends a SABM frame with SAPI-3 on the SACCH associated to the TCH. After the UA response on SAPI-3, the speech call is cleared by the SS with a disconnect message. (The call clearing is continued on the FACCH in parallel to the following exchange of messages related to SMS).

The SS sends a CP-DATA RPDU (SMS DELIVER TPDU) message. The information element of the CP-DATA message is RP-DATA.

The SS waits a maximum of 25 s for the CP-ACK message and then a maximum of 60 s for the CP-DATA message containing the RP-ACK RPDU.

The SS sends a CP-ACK to the MS with no further CP-DATA messages and the SS initiates channel release.

The SMS message store shall be cleared manually by the operator.

- l) A data or speech call is established on a TCH with the SS and the state U10 of call control is entered. The SS sends a SABM frame with SAPI-3 on the SACCH associated to the TCH. After the UA response on SAPI-3, the speech call shall be cleared from the MS. (The call clearing is continued on the FACCH in parallel to the following exchange of messages related to SMS).

The SS sends a CP-DATA message. The information element of the CP-DATA message is RP-DATA RPDU (SMS DELIVER TPDU).

The SS waits a maximum of 25 s for the CP-ACK message and then a maximum of 60 s for the CP-DATA message containing the RP-ACK RPDU.

The SS sends a CP-ACK to the MS with no further CP-DATA messages and the SS initiates channel release.

The SMS message store shall be cleared manually by the operator.

Maximum Duration of Test

20 minutes.

Expected Sequence

Step	Direction	Message	Comments
1	SS -> MS	PAGING REQUEST	
2	MS -> SS	CHANNEL REQUEST	Establishment cause is "Answer to paging"
3	SS -> MS	IMMEDIATE ASSIGNMENT	SS assigns an SDCCH
4	MS -> SS	PAGING RESPONSE	Message is contained in SABM.
5	SS -> MS	AUTHENTICATION REQUEST	
6	MS -> SS	AUTHENTICATION RESPONSE	SRES specifies correct value.
7	SS -> MS	CIPHERING MODE COMMAND	SS starts deciphering after sending the message.
8	MS -> SS	CIPHERING MODE COMPLETE	Shall be sent enciphered. All following messages shall be sent enciphered.
9	SS		SS starts ciphering.
10	SS -> MS	SABM (SAPI=3)	SS establishes SAPI 3
11	MS -> SS	UA (SAPI=3)	MS shall respond to SABM in step 10
12	SS -> MS	CP-DATA	Contains RP-DATA RPDU (SMS DELIVER TPDU)
13	SS		Waits max 25 s for CP-ACK
14	MS -> SS	CP-ACK	
15	SS		Waits max 60 s for RP-ACK RPDU
16	MS -> SS	CP-DATA	Contains RP-ACK RPDU
17	SS -> MS	CP-ACK	
18	MS		There should be no further CP-DATA messages until the MS aborts the RR connection (disconnection of layer 2).
19	MS		The MS shall indicate that an SM has arrived. If the MS provides the functionality to display MT messages, it is checked that the correct message is displayed
20	SS -> MS	PAGING REQUEST	
21	MS -> SS	CHANNEL REQUEST	Establishment cause is "Answer to paging"
22	SS -> MS	IMMEDIATE ASSIGNMENT	SS assigns an SDCCH
23	MS -> SS	PAGING RESPONSE	Message is contained in SABM.
24	SS -> MS	AUTHENTICATION REQUEST	
25	MS -> SS	AUTHENTICATION RESPONSE	SRES specifies correct value.
26	SS -> MS	CIPHERING MODE COMMAND	SS starts deciphering after sending the message.

Step	Direction	Message	Comments
27	MS -> SS	CIPHERING MODE COMPLETE	Shall be sent enciphered. All following messages shall be sent enciphered.
28	SS		SS starts ciphering.
29	SS -> MS	SABM (SAPI=3)	SS establishes SAPI 3
30	MS -> SS	UA (SAPI=3)	The MS shall respond to the SABM
31	SS -> MS	CP-DATA	Contains RP-DATA RPDU (SMS DELIVER TPDU)
32	SS		Waits max 25 s for CP-ACK
33	MS -> SS	CP-ACK	
34	SS		Waits max 60 s for RP-ACK RPDU
35	MS -> SS	CP-DATA	First CP-DATA from MS, contains RP-ACK RPDU
36	SS		First CP-DATA message not acknowledged by SS
37	MS -> SS	CP-DATA	Retransmitted CP-DATA from MS contains RP-ACK RPDU
38	SS -> MS	CP-ACK	Second CP_DATA message is acknowledged
39	MS		There should be no further CP-DATA messages until the MS aborts the RR connection (disconnection of layer 2).
40	MS		The MS shall indicate that an SM has arrived. If the MS provides the functionality to display MT messages, it is checked that the correct message is displayed
41	SS -> MS	PAGING REQUEST	
42	MS -> SS	CHANNEL REQUEST	Establishment cause is "Answer to paging"
43	SS -> MS	IMMEDIATE ASSIGNMENT	SS assigns an SDCCH
44	MS -> SS	PAGING RESPONSE	Message is contained in SABM.
45	SS -> MS	AUTHENTICATION REQUEST	
46	MS -> SS	AUTHENTICATION RESPONSE	SRES specifies correct value.
47	SS -> MS	CIPHERING MODE COMMAND	SS starts deciphering after sending the message.
48	MS -> SS	CIPHERING MODE COMPLETE	Shall be sent enciphered. All following messages shall be sent enciphered.
49	SS		SS starts ciphering.
50	SS -> MS	SABM (SAPI=3)	SS establishes SAPI 3
51	MS -> SS	UA (SAPI=3)	The MS shall respond to the SABM
52	SS -> MS	CP-DATA	Contains RP-DATA RPDU (SMS DELIVER TPDU)
53	SS		Waits max 25 s for CP-ACK
54	MS -> SS	CP-ACK	
55	SS		Waits max 60 s for RP-ACK RPDU
56	MS -> SS	CP-DATA	Contains RP-ACK RPDU
57	SS		First CP-DATA message not acknowledged by SS
58	MS -> SS	CP-DATA	Retransmitted CP-DATA from MS contains RP-ACK RPDU
59	SS		Retransmitted CP-DATA message not acknowledged by SS
60	MS		Depending upon the maximum number of CP-DATA retransmissions implemented, step 58 and 59 may be repeated.
61	MS -> SS	DISC	The main signalling link is released within 60 s after the first CP-DATA message not acknowledged by SS.
62	MS		The MS shall indicate that an SM has arrived. If the MS provides the functionality to display MT messages, it is checked that the correct message is displayed
63	SS		A data or speech call is established on a TCH and the state U10 of call control is entered.
64	SS -> MS	SABM (SAPI=3)	Sent on SACCH associated with the TCH
65	MS -> SS	UA (SAPI=3)	The MS shall respond to the SABM
66	SS -> MS	CP-DATA	Contains RP-DATA RPDU (SMS DELIVER TPDU)
67	SS		Waits max 25 s for CP-ACK
68	MS -> SS	CP-ACK	
69	SS		Waits max 60 s for RP-ACK RPDU
70	MS -> SS	CP-DATA	Contains RP-ACK RPDU

Step	Direction	Message	Comments
71	SS -> MS	CP-ACK	
72-1	SS -> MS	DISCONNECT	Disconnect the active call
72-2	MS -> SS	RELEASE	
72-3	SS -> MS	RELEASE COMPLETE	
72-4	MS		
73	MS		There should be no further CP-DATA messages until the MS aborts the RR connection (disconnection of layer 2)
74	MS		The MS shall indicate that an SM has arrived. If the MS provides the functionality to display MT messages, it is checked that the correct message is displayed
75	SS		Clear the SMS message store
76	SS -> MS	SABM (SAPI=3)	A data or speech call is established on a TCH and the state U10 of call control is entered.
77	MS -> SS	UA (SAPI=3)	Sent on SACCH associated with the TCH
78	SS -> MS	CP-DATA	The MS shall respond to the SABM
79	SS		Contains RP-DATA RPDU (SMS DELIVER TPDU)
80	MS -> SS	CP-ACK	Waits max 25 s for CP-ACK
81	SS		Waits max 60 s for RP-ACK RPDU
82	MS -> SS	CP-DATA	First CP-DATA from MS, contains RP-ACK RPDU
83	SS		First CP-DATA message not acknowledged by SS
84	MS -> SS	CP-DATA	Retransmitted CP-DATA message contains RP-ACK RPDU
85	SS -> MS	CP-ACK	Second CP-DATA message is acknowledged
86-1	SS -> MS	DISCONNECT	Disconnect the active call
86-2	MS -> SS	RELEASE	
86-3	SS -> MS	RELEASE COMPLETE	
86-4	MS		
87	MS		There should be no further CP-DATA messages until the MS aborts the RR connection (disconnection of layer 2)
88	MS		The MS shall indicate that an SM has arrived. If the MS provides the functionality to display MT messages, it is checked that the correct message is displayed
89	SS		Clear the SMS message store
90	SS -> MS	SABM (SAPI=3)	A data or speech call is established on a TCH and the state U10 of call control is entered.
91	MS -> SS	UA (SAPI=3)	Sent on SACCH associated with the TCH
92	SS -> MS	CP-DATA	The MS shall respond to the SABM
93	SS		Contains RP-DATA RPDU (SMS DELIVER TPDU)
94	MS -> SS	CP-ACK	Waits max 25 s for CP-ACK
95	SS		Waits max 60 s for RP-ACK RPDU
96	MS -> SS	CP-DATA	First CP-DATA from MS, contains RP-ACK RPDU
97	SS		First CP-DATA message not acknowledged by SS
98	MS -> SS	CP-DATA	Transmitted CP-DATA message contains RP-ACK RPDU
99	SS		Retransmitted CP-DATA message not acknowledged by SS
100	MS		Depending on the maximum number of CP-DATA retransmissions implemented, step 98-99 may be repeated. The maximum number of retransmissions may however not exceed three.
101	SS -> MS	CHANNEL RELEASE	The main signalling link is released after a duration of 60 s after the first CP-DATA message not acknowledged by SS.
102	MS		The MS shall indicate that an SM has arrived. If the MS provides the functionality to display MT messages, it is checked that the correct message is displayed
103	MS		Clear the SMS message store
104	SS		A data or speech call is established on a TCH and the state U10 of call control is entered.
105	SS -> MS	SABM (SAPI=3)	Sent on SACCH associated with the TCH
106	MS -> SS	UA (SAPI=3)	The MS shall respond to the SABM
107	SS -> MS	DISCONNECT	The speech call is cleared by the SS. The call clearing is continued on the FACCH in parallel to the following exchange of messages related to SMS.
108	SS -> MS	CP-DATA	Contains RP-DATA RPDU (SMS DELIVER TPDU)

Step	Direction	Message	Comments
109	SS		Waits max 25 s for CP-ACK
110	MS -> SS	CP-ACK	<p>Waits max 60 s for RP-ACK RPDU Contains RP-ACK RPDU</p> <p>There should be no further CP-DATA messages until the MS aborts the RR connection (disconnection of layer 2). The MS shall indicate that an SM has arrived. If the MS provides the functionality to display MT messages, it is checked that the correct message is displayed</p> <p>Clear the SMS message store</p> <p>A data or speech call is established on a TCH and the state U10 of call control is entered. Sent on SACCH associated with the TCH</p> <p>The MS shall respond to the SABM</p> <p>The speech call is cleared from the MS.</p> <p>Contains RP-DATA RPDU (SMS DELIVER TPDU)</p> <p>This message is likely to be sent on the FACCH before all of the CP-DATA message has been sent on the SACCH.</p> <p>shall be sent before 25 s after the start of step 121</p> <p>Waits max 60 s for RP-ACK RPDU Contains RP-ACK RPDU</p> <p>There should be no further CP-DATA messages until the MS aborts the RR connection (disconnection of layer 2). The MS shall indicate that an SM has arrived. If the MS provides the functionality to display MT messages, it is checked that the correct message is displayed</p> <p>Clear the SMS message store</p>
111	SS		
112	MS -> SS	CP-DATA	
113	SS -> MS	CP-ACK	
114	MS		
115	MS		
116	MS		
117	SS		
118	SS -> MS	SABM (SAPI=3)	
119	MS -> SS	UA (SAPI=3)	
120	MS -> SS	DISCONNECT	
121	SS -> MS	CP-DATA	
122	SS -> MS	RELEASE	
123	MS -> SS	RELEASE COMPLETE	
124	MS -> SS	CP-ACK	
125	SS		
126	MS -> SS	CP-DATA	
127	SS -> MS	CP-ACK	
128	MS		
129	MS		
130	MS		

NOTE: Time values for SS wait time are chosen sufficiently high to be sure that the MS has enough time to respond to the different messages.

Specific Message Contents:

SMS DELIVER TPDU

Information element	Comment	Value
TP-MTI	SMS DELIVER	"00"B
TP-MMS	more messages are waiting in SC	"0"B
TP-RP	no reply path	"0"B
TP-UDHI	TP-UD contains only the SM	"0"B
TP-SRI	no status report returned	"0"B
TP-OA	an international number coded E.164	
TP-PID	default	"00000000"B
TP-DCS	default alphabet	"00000000"B
TP-SCTS	any legal value (cf. 3GPP TS 03.40)	
TP-UDL	160	
TP-UD (140 octets)	text of message (160 characters)	

NOTE: The 160 characters shall include at least one occurrence of each character in the default alphabet (see 3GPP TS 03.40 annex 2).

34.2.2 SMS mobile originated

34.2.2.1 Conformance requirements

An active MS shall be able to submit short message TPDU (SMS-SUBMIT) at any time, independently of whether or not there is a speech or data call in progress.

Reference

3GPP TS 03.40; subclause 3.1.

34.2.2.2 Test purpose

To verify that the MS is able to correctly send a short message where the SMS is provided for the point to point service. The test also verifies that the MS is capable of simultaneously receive a network originated SM whilst sending a mobile originated SM.

34.2.2.3 Method of test

Initial Conditions

System simulator:

1 cell, default parameters.

Mobile Station:

The MS shall be in "Idle, updated" state.

The SMS message storage shall be empty.

Specific PICS Statements

- SMS messages are stored in the SIM (TSPC_AddInfo_StoreRcvSMSSIM).
- SMS messages are stored in the ME (TSPC_AddInfo_StoreRcvSMSME).

PIXIT Statements

- Description of the basic procedures to display a mobile originated short message.
- Support for call control state U10.
- Maximum length (characters) of a mobile originated short message.

Foreseen Final State of MS

Idle, updated.

Test Procedure

- a) The MS shall be set up to send a SM to the SS. The SS responds to the channel request message by allocating an SDCCCH. The SS answers correctly to the SABM on SAPI 0 and then performs the authentication and ciphering procedures.
- b) The SS responds with a UA frame SAPI-3 to the MS.
- c) The SS responds to the CP-DATA containing RP-DATA RPDU (SMS SUBMIT TPDU) from the MS with a CP-ACK message followed by a CP-DATA message containing the correct RP-ACK RPDU. The SS waits a maximum of 25 s for the CP-ACK message.
- d) The SS sends a channel release message to the MS.
- e) Steps a) and b) are repeated. The SS is configured not to send the CP-ACK message. Then maximum 3 CP-DATA retransmissions may occur. The SS ensures that the MS disconnects the link within 60 s after the first CP-DATA not acknowledged by the SS. The 60 s is sufficient time to wait to verify that the MS does not send more than the maximum CP-DATA retransmissions and that TRIM has expired. Any remaining message in the outbox should be removed prior to the next step. All requests from the MS during this time shall be ignored.
- f) Steps a) and b) are repeated. On receipt of the CP-DATA from the MS the SS sends a CP-ERROR message containing a "Network Failure" cause. Then the SS initiates channel release. Any remaining message in the outbox should be removed prior to the next step. All requests from the MS during this time shall be ignored.

- g) A data or speech call is established on a TCH with the SS and the state U10 of call control is entered. The MS is setup to send an SM to the SS. After the reception of the CM SERVICE REQUEST, the SS sends a CM SERVICE ACCEPT message. The SS responds with a UA frame SAPI-3 to the SABM with SAPI-3 received from the MS.
- h) The SS responds to the CP-DATA containing RP-DATA RPDU (SMS SUBMIT TPDU) from the MS with a CP-ACK message followed by a CP-DATA message containing the correct RP-ACK RPDU. The SS waits a maximum of 25 s for the CP-ACK message. Then the SS sends a channel release message to the MS.
- i) Step g) is repeated. The SS is configured not to send the CP-ACK message or to respond to any other CM requests. Then maximum 3 CP-DATA retransmissions may occur. After a duration of 60 s after the first CP-DATA not acknowledged the SS initiates channel release. The 60 s is sufficient time to wait to verify that the MS does not send more than the maximum CP-DATA retransmissions (during a call in progress). Any remaining message in the outbox should be removed prior to the next step. All requests from the MS during this time shall be ignored.
- j) The SS is configured to receive a mobile originated SM. Steps a) and b) are repeated and, using the end of the CP-DATA message from the MS as a trigger, the SS sends a SM to the MS. In this case a new transaction identifier shall be used in the CP messages of SMS mobile terminated. Any remaining message in the outbox should be removed prior to the next step. All requests from the MS during this time shall be ignored.
- k) The MS is set up to send an SM to the SS. On receipt of the CM SERVICE REQUEST the SS sends a CM SERVICE REJECT message with the reject cause set to "Service Option not supported" or "Service Option temporarily out of order". After 5 s the SS initiates channel release. Any remaining message in the outbox should be removed. All requests from the MS during this time shall be ignored.

Maximum Duration of Test

20 minutes.

Expected Sequence

Step	Direction	Message	Comments
1	MS -> SS	CHANNEL REQUEST	Establishment cause is "Other procedures which can be completed with an SDDCH" NECI = 0
2	SS -> MS	IMMEDIATE ASSIGNMENT	SS assigns an SDCCH
3	MS -> SS	CM SERVICE REQUEST	Message is contained in SABM on SAPI 0. CM service type set to "Short message transfer"
4	SS -> MS	AUTHENTICATION REQUEST	
5	MS -> SS	AUTHENTICATION RESPONSE	SRES specifies correct value.
6	SS -> MS	CIPHERING MODE COMMAND	SS starts deciphering after sending the message.
7	MS -> SS	CIPHERING MODE COMPLETE	Shall be sent enciphered. All following messages shall be sent enciphered.
8	SS		SS starts ciphering.
9	MS -> SS	SABM (SAPI=3)	MS establishes SAPI 3
10	SS -> MS	UA (SAPI=3)	
11	MS -> SS	CP-DATA	Contains RP-DATA RPDU (SMS SUBMIT TPDU)
12	SS -> MS	CP-ACK	
13	SS -> MS	CP-DATA	Contains RP-ACK RPDU
14	SS		Waits max 25 s for CP-ACK
15	MS -> SS	CP-ACK	
16	SS -> MS	CHANNEL RELEASE	The main signalling link is released.
17	MS -> SS	DISC (SAPI=0)	MS shall respond to channel release with a layer 2 DISC frame with SAPI 0
18	MS -> SS	CHANNEL REQUEST	Establishment cause is "Other procedures which can be completed with an SDDCH" (NECI=0)
19	SS -> MS	IMMEDIATE ASSIGNMENT	SS assigns an SDCCH
20	MS -> SS	CM SERVICE REQUEST	Message is contained in SABM on SAPI 0.
21	SS -> MS	AUTHENTICATION REQUEST	
22	MS -> SS	AUTHENTICATION RESPONSE	SRES specifies correct value.
23	SS -> MS	CIPHERING MODE COMMAND	SS starts deciphering after sending the message.
24	MS -> SS	CIPHERING MODE COMPLETE	Shall be sent enciphered. All following messages shall be sent enciphered.
25	SS		SS starts ciphering.

Step	Direction	Message	Comments
26	MS -> SS	SABM (SAPI=3)	MS establishes SAPI 3 Contains RP-DATA RPDU (SMS SUBMIT TPDU) SS configured not to send CP-ACK Retransmitted CP-DATA message
27	SS -> MS	UA (SAPI=3)	
28	MS -> SS	CP-DATA	
29	SS		
30	MS -> SS	CP-DATA	
31	MS		Depending on the maximum number of CP-DATA retransmissions implemented, step 30 may be repeated. The maximum number of retransmissions may however not exceed three.
32a	MS -> SS	DISC (SAPI = 0)	The main signalling link is released within 60 s after the first CP-DATA message not acknowledged by SS.
32b	MS		Any remaining message in the outbox should be removed prior to the next step. All requests from the MS during this time shall be ignored.
33	MS -> SS	CHANNEL REQUEST	Establishment cause is "Other procedures which can be completed with an SDDCH" (NECI=0)
34	SS -> MS	IMMEDIATE ASSIGNMENT	SS assigns an SDCCH
35	MS -> SS	CM SERVICE REQUEST	Message is contained in SABM. CM service type set to "short message transfer"
36	SS -> MS	AUTHENTICATION REQUEST	
37	MS -> SS	AUTHENTICATION RESPONSE	SRES specifies correct value.
38	SS -> MS	CIPHERING MODE COMMAND	SS starts deciphering after sending the message.
39	MS -> SS	CIPHERING MODE COMPLETE	Shall be sent enciphered. All following messages shall be sent enciphered.
40	SS		SS starts ciphering.
41	MS -> SS	SABM (SAPI=3)	MS establishes SAPI 3
42	SS -> MS	UA (SAPI=3)	
43	MS -> SS	CP-DATA	Contains RP-DATA RPDU (SMS SUBMIT TPDU)
44	SS -> MS	CP-ERROR	Sent containing "Network Failure" cause.
45	SS -> MS	CHANNEL RELEASE	The main signalling link is released.
45a	MS -> SS	DISC (SAPI = 0)	MS shall respond to channel release with a layer 2 DISC frame with SAPI 0.
45b	MS		Any remaining message in the outbox should be removed prior to the next step. All requests from the MS during this time shall be ignored.
46	SS		A data or speech call is established on a TCH and the state U10 of call control is entered.
47	MS		The MS is set up to send an SM
48	MS -> SS	CM SERVICE REQUEST	Sent in a layer 2 frame on the FACCH. CM service type set to "short message transfer"
49	SS -> MS	CM SERVICE ACCEPT	
50	MS -> SS	SABM (SAPI=3)	Sent on SACCH associated with the TCH
51	SS -> MS	UA (SAPI=3)	
52	MS -> SS	CP-DATA	Contains RP-DATA RPDU (SMS SUBMIT TPDU)
53	SS -> MS	CP-ACK	
54	SS -> MS	CP-DATA	Contains RP-ACK RPDU
55	SS		Waits max 25 s for CP-ACK
56	MS -> SS	CP-ACK	
57	SS -> MS	CHANNEL RELEASE	The main signalling link is released.
58	MS -> SS	DISC (SAPI =0)	The MS shall respond to channel release with a layer 2 DISC frame with SAPI 0.
59	SS		A data or speech call is established on a TCH and the state U10 of call control is entered.
60	MS -> SS	CM SERVICE REQUEST	Sent in a layer 2 frame on the FACCH. CM service type set to "short message transfer"
61	SS -> MS	CM SERVICE ACCEPT	
62	MS -> SS	SABM (SAPI=3)	Sent on SACCH associated with the TCH
63	SS -> MS	UA (SAPI=3)	
64	MS -> SS	CP-DATA	Contains RP-DATA RPDU (SMS SUBMIT TPDU)
65	SS		SS configured not to send CP-ACK
66	MS -> SS	CP-DATA	Transmitted CP-DATA message
67	MS		Depending on the maximum number of CP-DATA retransmissions implemented, step 66 may be repeated. The maximum number of retransmissions may however not exceed three. Any other CM requests from the MS shall be ignored.

Step	Direction	Message	Comments
68	SS -> MS	CHANNEL RELEASE	The main signalling link is released after a duration of 60 s after the first CP-DATA message not acknowledged by SS.
69 69a	MS -> SS MS	DISC (SAPI =0)	The MS shall respond to channel release Any remaining message in the outbox should be removed prior to the next step. All requests from the MS during this time shall be ignored.
70	MS -> SS	CHANNEL REQUEST	Establishment cause is "Other procedures which can be completed with an SDDCH" (NECI=0)
71	SS -> MS	IMMEDIATE ASSIGNMENT	SS assigns an SDCCH
72	MS -> SS	CM SERVICE REQUEST	Message is contained in SABM. CM service type set to "short message transfer"
73	SS -> MS	AUTHENTICATION REQUEST	
74	MS -> SS	AUTHENTICATION RESPONSE	SRES specifies correct value.
75	SS -> MS	CIPHERING MODE COMMAND	SS starts deciphering after sending the message.
76	MS -> SS	CIPHERING MODE COMPLETE	Shall be sent enciphered. All following messages shall be sent enciphered.
77	SS		SS starts ciphering.
78	MS -> SS	SABM (SAPI=3)	MS establishes SAPI 3
79	SS -> MS	UA (SAPI=3)	
80	MS -> SS	CP-DATA	Contains RP-DATA RPDU (SMS SUBMIT TPDU)
81	SS		The SS sends an SM to the MS triggered by the end of the CP-DATA message from the MS
82	SS -> MS	CP-DATA	Contains RP-DATA RPDU (SMS DELIVER TPDU)
83	MS		The MS shall correctly receive the SM and indicate that a message has arrived. If the MS provides the functionality to display MT messages, it is checked that the correct message is displayed. In the MO case the MS shall send the CP-ACK message with transaction identifier assigned to this transfer. In the MT case the MS shall send a CP-ACK message and a CP-DATA message containing the RP-ACK RPDU. The transaction identifier shall be the same as chosen by the SS for the MT transfer.
83a	MS		Any remaining message in the outbox should be removed prior to the next step. All requests from the MS during this time shall be ignored.
84	MS -> SS	CHANNEL REQUEST	Establishment cause is "Other procedures which can be completed with an SDDCH" (NECI=0)
85	SS -> MS	IMMEDIATE ASSIGNMENT	SS assigns an SDCCH
86	MS -> SS	CM SERVICE REQUEST	Message is contained in SABM. CM service type set to "short message transfer"
87	SS -> MS	CM SERVICE REJ	Reject cause set to "Service Option not supported" or "Service Option temporarily out of order"
88	MS		The MS shall not establish SAPI-3
89	SS -> MS	CHANNEL RELEASE	Sent 5 s after CM SERVICE REJ
90	MS		Any remaining message in the outbox should be removed. All requests from the MS during this time shall be ignored.

NOTE: Time values for SS wait times are chosen sufficiently high to be sure that the MS has enough time to respond to the different messages.

Specific Message Contents:

SMS SUBMIT TPDU

Information element	Comment	Value
TP-MTI	SMS SUBMIT	"01"B
TP-VPF	not checked	
TP-RP	no reply path	"0"B
TP-UDHI	not checked	
TP-SRR	not checked	
TP-MR	not checked	
TP-RD	not checked	
TP-DA	not checked (an E164 number)	
TP-PID	default	"00000000"B
TP-DCS	default alphabet	"00000000"B
TP-VP	not checked	
TP-UDL	as applicable	
TP-UD (140 octets max)	maximum number of characters (text of message) as defined by the manufacturer (see PICS/PIXIT)	

34.2.3 Test of memory full condition and memory available notification:

The Memory Available Notification provides a means for the MS to notify the network that it has memory available to receive one or more short messages. The SMS status field in the SIM contains status information on the "memory available" notification flag.

34.2.3.1 Conformance requirement

1. When a mobile terminated message is Class 2, the MS shall ensure that the message has been transferred to the SMS data field in the SIM before sending an acknowledgement to the SC. The MS shall return a protocol error message if the short message cannot be stored in the SIM and there is other short message storage available in the MS. If all the short message storage in the MS is already in use, the MS shall return "memory capability exceeded".
2. When the MS rejects a short message due to lack of available memory capability the need to transfer notification shall be stored in the SIM.
3. If the memory capability becomes available because memory is cleared, the value of the memory capability exceeded notification flag in the SIM is read. If the flag is set, the MS notifies the network that memory capability is now available. After a positive acknowledgement from the network, the ME unsets the memory capability exceeded notification flag in the SIM.

References

3GPP TS 03.40, subclause 9.2.3.10, 3GPP TS 03.38, clause 4.

3GPP TS 03.40, subclause 10.3 (operation 14).

3GPP TS 03.40, subclause 10.3 (operation 14).

34.2.3.2 Test purpose

1. To verify that the MS sends the correct acknowledgement when its memory in the SIM becomes full.
2. To verify that the MS sends the correct acknowledgement when its memory in the ME and the SIM becomes full, and sets the "memory exceeded" notification flag in the SIM.
3. To verify that the MS performs the "memory available" procedure when its message store becomes available for receiving short messages, and only at this moment.

34.2.3.3 Method of test

Initial conditions

System Simulator:

1 cell, default parameters

Mobile Station:

The MS shall be in the idle updated state.

The SMS message storage shall not be full

The MS shall be connected to the SIM simulator. The following shall be present in the SIM simulator:

- EF_{SMS} with at least one record;
- EF_{SMSstatus}, with SMS "Memory Cap. Exceed" notification flag set to "memory available";
- Service no. 4 (SMS) in EF_{SST} set to allocated and activated.

For storing of Class 1 Short Messages the MS shall be set up to store Short Messages in the ME memory (by way of MMI, as described in PICS/PIXIT statement).

Specific PICS Statements

- SMS messages are stored in the ME (TSPC_AddInfo_StoreRcvSMSME).

PIXIT Statements

- Description of the basic procedures to display a mobile originated short message.

Foreseen Final State of MS

Idle, updated.

Test Procedure

- a) step a) of subclause 34.2.5.3 (test of Class 2 Short Messages) is repeated until the MS sends a negative acknowledgement (RP-ERROR). The SIM simulator shall indicate if the "memory capability exceeded" notification flag has been set on the SIM.
- b) a Class 1 Short Message is sent to the MS.
- c) step b) is repeated until the MS sends a negative acknowledgement (RP-ERROR). The SIM simulator shall indicate if the "memory capability exceeded" notification flag has been set on the SIM.
- d) a Short Message is sent to the MS with the DCS field of the SMS-DELIVER TPDU set to 0.
- e) the SS prompts the operator to read a short message and to remove it from the message store of the MS.
- f) the SS waits for a CHANNEL REQUEST from the MS, and sends an IMMEDIATE ASSIGNMENT allocating an SDCCH.
- g) the SS answers correctly to the SABM on SAPI 0.
- h) the SS answers correctly to the SABM on SAPI 3.
- i) the SS answers to the RP-SMMA from the MS with a CP-DATA containing a RP-ACK RPDU.
- j) after the MS has acknowledged the CP-DATA with a CP-ACK, the SS releases the channel with a CHANNEL RELEASE message. The SIM simulator shall indicate if the "memory capability exceeded" notification flag has been unset on the SIM.
- k) step e) is repeated.

Maximum Duration of Test

-

Expected Sequence

Step	Direction	Message	Comments
------	-----------	---------	----------

Step	Direction	Message	Comments
1	SS -> MS	PAGING REQUEST	
2	MS -> SS	CHANNEL REQUEST	Establishment cause is "Answer to paging"
3	SS -> MS	IMMEDIATE ASSIGNMENT	SS assigns an SDCCH
4	MS -> SS	PAGING RESPONSE	Message is contained in SABM.
5	SS -> MS	AUTHENTICATION REQUEST	
6	MS -> SS	AUTHENTICATION RESPONSE	SRES specifies correct value.
7	SS -> MS	CIPHERING MODE COMMAND	SS starts deciphering after sending the message.
8	MS -> SS	CIPHERING MODE COMPLETE	Shall be sent enciphered. All following messages shall be sent enciphered.
9	SS		SS starts ciphering.
10	SS -> MS	SABM (SAPI=3)	SS establishes SAPI 3
11	MS -> SS	UA (SAPI=3)	
12	SS -> MS	CP-DATA	Contains RP-DATA RPDU (SMS DELIVER TPDU), Class 2 Short Message
13	SS		Waits max 25 s for CP-ACK
14	MS -> SS	CP-ACK	
15	SS		Waits max 60 s for RP-ACK RPDU
16	MS -> SS	CP-DATA	Contains RP-ACK RPDU
17	SS -> MS	CP-ACK	
18	SS -> MS	CHANNEL RELEASE	The main signalling link is released. Step 1-18 is repeated until MS sends a negative acknowledgement (RP-ERROR) in step 16. The RP-ERROR RPDU cause field shall be "Protocol error, unspecified" if there is message capability in the ME, or "Memory capability exceeded" if there is no message capability in the ME. If the total memory store of the MS is full, the ME shall set the "memory capability exceeded" notification flag on the SIM.
19	SS -> MS	PAGING REQUEST	
20	MS -> SS	CHANNEL REQUEST	Establishment cause is "Answer to paging"
21	SS -> MS	IMMEDIATE ASSIGNMENT	SS assigns an SDCCH
22	MS -> SS	PAGING RESPONSE	Message is contained in SABM.
23	SS -> MS	AUTHENTICATION REQUEST	
24	MS -> SS	AUTHENTICATION RESPONSE	SRES specifies correct value.
25	SS -> MS	CIPHERING MODE COMMAND	SS starts deciphering after sending the message.
26	MS -> SS	CIPHERING MODE COMPLETE	Shall be sent enciphered. All following messages shall be sent enciphered.
27	SS		SS starts ciphering.
28	SS -> MS	SABM (SAPI=3)	SS establishes SAPI 3
29	MS -> SS	UA (SAPI=3)	
30	SS -> MS	CP-DATA	Contains RP-DATA RPDU (SMS DELIVER TPDU), Class 1 Short Message
31	SS		Waits max 25 s for CP-ACK
32	MS -> SS	CP-ACK	
33	SS		Waits max 60 s for RP-ACK RPDU
34	MS -> SS	CP-DATA	Shall contain RP-ACK RPDU if there is memory capability in the ME. If not it shall contain RP-ERROR RPDU which cause field shall be "memory capability exceeded". If the total memory store of the MS now becomes full at this step, the ME shall set the "memory cap. exceed" notification flag on the SIM.
35	SS -> MS	CP-ACK	
36	SS -> MS	CHANNEL RELEASE	The main signalling link is released. Step 19-36 is repeated until the MS sends an RP-ERROR. The SIM simulator shall indicate if the "memory capability exceeded" notification flag has been set on the SIM.
37	SS -> MS	PAGING REQUEST	
38	MS -> SS	CHANNEL REQUEST	Establishment cause is "Answer to paging"
39	SS -> MS	IMMEDIATE ASSIGNMENT	SS assigns an SDCCH
40	MS -> SS	PAGING RESPONSE	Message is contained in SABM.
41	SS -> MS	AUTHENTICATION REQUEST	
42	MS -> SS	AUTHENTICATION RESPONSE	SRES specifies correct value.
43	SS -> MS	CIPHERING MODE COMMAND	SS starts deciphering after sending the message.
44	MS -> SS	CIPHERING MODE COMPLETE	Shall be sent enciphered. All following messages shall be sent enciphered.
45	SS		SS starts ciphering.
46	SS -> MS	SABM (SAPI=3)	SS establishes SAPI 3

Step	Direction	Message	Comments
47	MS -> SS	UA (SAPI=3)	Contains RP-DATA RPDU (SMS DELIVER TPDU) with TP-DCS set to 0
48	SS -> MS	CP-DATA	
49	SS		Waits max 25 s for CP-ACK
50	MS -> SS	CP-ACK	Waits max 60 s for RP-ACK RPDU
51	SS		
52	MS -> SS	CP-DATA	Shall contain RP-ERROR RPDU with error cause "memory capability exceeded".
53	SS -> MS	CP-ACK	The main signalling link is released. Prompts the operator to remove one of the short messages from the message store of the MS.
54	SS -> MS	CHANNEL RELEASE	
55	SS		
57	MS -> SS	CHANNEL REQUEST	Establishment cause "Other services which can be completed with an SDCCH" (NECI=0).
58	SS -> MS	IMMEDIATE ASSIGNMENT	SS allocates an SDCCH
59	MS -> SS	CM SERVICE REQUEST	Message is contained in SABM. CM service type information element is set to "Short message transfer".
60	SS -> MS	CM SERVICE ACCEPT (UA)	SAPI 0
61	MS -> SS	SABM (SAPI=3)	MS shall establish SAPI 3
62	SS -> MS	UA (SAPI=3)	Contains RP-SMMA RPDU
63	MS -> SS	CP-DATA	
64	SS -> MS	CP-ACK	Contains RP-ACK RPDU Acknowledge of CP-DATA containing the RP-ACK RPDU. The ME shall unset the "memory capability exceeded" notification flag on the SIM. The main signalling link is released. The SIM simulator shall indicate if the "memory capability exceeded" notification flag has been unset on the SIM. Prompts the operator to remove one of the short messages from the message store of the MS.
65	SS -> MS	CP-DATA	
66	MS -> SS	CP-ACK	
67	SS -> MS	CHANNEL RELEASE	
68	SS		Shall not attempt to send a RP-SMMA RPDU. This is verified by checking that the MS does not send a CHANNEL REQUEST message with the establishment cause "Other services which can be completed with an SDCCH"
69	MS		

NOTE: Time values for SS wait time are chosen sufficiently high to be sure that the MS has enough time to respond to the different messages.

Specific Message Contents:

SMS-DELIVER TPDU in step 12

Information element	Comment	Value
TP-MTI	SMS DELIVER	"00"B
TP-MMS	more messages are waiting in SC	"0"B
TP-RP	no reply path	"0"B
TP-UDHI	TP-UD contains only the SM	"0"B
TP-SRI	no status report returned	"0"B
TP-OA	an international number coded E.164	
TP-PID	default	"00000000"B
TP-DCS	default alphabet, class 2	"11110010"B
TP-SCTS	always set to the current time of the system simulator (cf. 3GPP TS 03.40)	
TP-UDL	160	
TP-UD (140 octets)	text of message (160 characters)	

SMS-DELIVER TPDU in step 30

same as in step 12 except:

TP-DCS	default alphabet, class 1	"11110001"B
--------	---------------------------	-------------

SMS-DELIVER TPDU in step 48

same as in step 12 except:

TP-DCS	default alphabet	"00000000"B
--------	------------------	-------------

34.2.4 Test of the status report capabilities and of SMS-COMMAND:

This test applies to MSs which support the status report capabilities.

34.2.4.1 Conformance requirement

The SMS offers the SC the capabilities of informing the MS of the status of a previously sent mobile originated short message. This is achieved by the SC returning a status report TPDU (SMS-STATUS-REPORT) to the originating MS.

SMS-COMMAND enables an MS to invoke an operation at the SC.

The MS shall increment TP-MR by 1 for each SMS-SUBMIT or SMS-COMMAND being submitted.

References

3GPP TS 03.40; subclause 3.2.9.

3GPP TS 03.40; subclause 9.2.3.6.

34.2.4.2 Test purpose

- 1) To verify that the MS is able to accept a SMS-STATUS-REPORT TPDU.
- 2) To verify that the MS is able to use the SMS-COMMAND functionality correctly and sends an SMS-COMMAND TPDU with the correct TP-Message-Reference.

34.2.4.3 Method of test

Initial conditions

System Simulator:

1 cell, default parameters.

Mobile Station:

The MS shall be in the idle updated state.

Specific PICS Statements

-

PIXIT Statements

-

Foreseen Final State of MS

Idle, updated.

Test Procedure

- a) The MS is made to send a Mobile Originated short message as in steps a) to d) of test 34.2.2 (SMS Mobile originated).
- b) The SS establishes a data link on SAPI-3 with the MS, then sends a CP-DATA message containing a RP-DATA RPDU itself containing an SMS-STATUS-REPORT TPDU.
- c) The SS sends a CHANNEL RELEASE message.
- d) The MS is made to send an SMS-COMMAND message enquiring about the previously submitted short message.

- e) The SS responds to the MS so as to enable it to establish a data link on SAPI-3 on an SDCCH.
- f) The SS acknowledges the CP-DATA message from the MS with a CP-ACK followed by a CP-DATA message containing an RP-ACK RPDU.
- g) After receiving the CP-ACK from the MS, the SS releases the channel by using a CHANNEL RELEASE message.
- h) The MS is made to send an SMS-COMMAND message requiring to delete the previously submitted short message.
- i) steps e) to g) are repeated.

Maximum Duration of Test

-

Expected Sequence

Step	Direction	Message	Comments
1	MS -> SS	CHANNEL REQUEST	Establishment cause is "Other procedures which can be completed with an SDCCH " (NECI=0)
2	SS -> MS	IMMEDIATE ASSIGNMENT	SS assigns an SDCCH
3	MS -> SS	CM SERVICE REQUEST	Message is contained in SABM.
4	SS -> MS	AUTHENTICATION REQUEST	
5	MS -> SS	AUTHENTICATION RESPONSE	SRES specifies correct value.
6	SS -> MS	CIPHERING MODE COMMAND	SS starts deciphering after sending the message.
7	MS -> SS	CIPHERING MODE COMPLETE	Shall be sent enciphered. All following messages shall be sent enciphered.
8	SS		SS starts ciphering.
9	MS -> SS	SABM (SAPI=3)	MS establishes SAPI 3
10	SS -> MS	UA (SAPI=3)	
11	MS -> SS	CP-DATA	Contains RP-DATA RPDU (SMS SUBMIT TPDU)
12	SS -> MS	CP-ACK	
13	SS -> MS	CP-DATA	Contains RP-ACK RPDU
14	SS		Waits max 25 s for CP-ACK
15	MS -> SS	CP-ACK	
16	SS -> MS	CHANNEL RELEASE	The main signalling link is released.
17	SS -> MS	PAGING REQUEST	
18	MS -> SS	CHANNEL REQUEST	Establishment cause is "Answer to paging"
19	SS -> MS	IMMEDIATE ASSIGNMENT	SS assigns an SDCCH
20	MS -> SS	PAGING RESPONSE	Message is contained in SABM.
22	SS -> MS	AUTHENTICATION REQUEST	
23	MS -> SS	AUTHENTICATION RESPONSE	SRES specifies correct value.
24	SS -> MS	CIPHERING MODE COMMAND	SS starts deciphering after sending the message.
25	MS -> SS	CIPHERING MODE COMPLETE	Shall be sent enciphered. All following messages shall be sent enciphered.
26	SS		SS starts ciphering.
27	SS -> MS	SABM (SAPI=3)	SS establishes SAPI 3
28	MS -> SS	UA (SAPI=3)	
29	SS -> MS	CP-DATA	Contains RP-DATA RPDU (SMS-STATUS-REPORT TPDU)
30	MS -> SS	CP-ACK	
31	MS -> SS	CP-DATA	Contains RP-ACK RPDU
32	SS -> MS	CP-ACK	
33	SS -> MS	CHANNEL RELEASE	
34	MS		The MS is made to send an SMS-COMMAND message enquiring about the previously submitted SM
35	MS -> SS	CHANNEL REQUEST	Establishment cause "Other services which can be completed with an SDCCH".
36	SS -> MS	IMMEDIATE ASSIGNMENT	SS assigns an SDCCH
37	MS -> SS	CM SERVICE REQUEST	Message is contained in SABM.
38	SS -> MS	AUTHENTICATION REQUEST	
39	MS -> SS	AUTHENTICATION RESPONSE	SRES specifies correct value.
40	SS -> MS	CIPHERING MODE COMMAND	SS starts deciphering after sending the message.
41	MS -> SS	CIPHERING MODE COMPLETE	Shall be sent enciphered. All following messages shall be sent enciphered.
42	SS		SS starts ciphering.

Step	Direction	Message	Comments
43	MS -> SS	SABM (SAPI=3)	MS establishes SAPI 3
44	SS -> MS	UA (SAPI=3)	
45	MS -> SS	CP-DATA	
46	SS -> MS	CP-ACK	Contains RP-DATA RPDU (SMS-COMMAND TPDU) which shall contain the correct TP-MR
47	SS -> MS	CP-DATA	
48	MS -> SS	CP-ACK	Contains RP-ACK RPDU
49	SS -> MS	CHANNEL RELEASE	
50	MS	The MS is made to send an SMS-COMMAND	message requiring to delete the previously submitted SM.
51	MS -> SS	CHANNEL REQUEST	Establishment cause "Other services which can be completed with an SDCCH". SS assigns an SDCCH Message is contained in SABM.
52	SS -> MS	IMMEDIATE ASSIGNMENT	
53	MS -> SS	CM SERVICE REQUEST	
54	SS -> MS	AUTHENTICATION REQUEST	
55	MS -> SS	AUTHENTICATION RESPONSE	
56	SS -> MS	CIPHERING MODE COMMAND	
57	MS -> SS	CIPHERING MODE COMPLETE	
58	SS		SS starts cipherring.
59	MS -> SS	SABM (SAPI=3)	MS establishes SAPI 3
60	SS -> MS	UA (SAPI=3)	Contains RP-DATA RPDU (SMS-COMMAND TPDU) which shall contain the correct TP-MR
61	MS -> SS	CP-DATA	
62	SS -> MS	CP-ACK	Contains RP-ACK RPDU
63	SS -> MS	CP-DATA	
64	MS -> SS	CP-ACK	
65	SS -> MS	CHANNEL RELEASE	

Specific Message Contents:

SMS SUBMIT TPDU

Information element	Comment Value
TP-MTI	SMS SUBMIT "01"B
TP-VPF	not checked
TP-RP	no reply path "0"B
TP-UDHI	not checked
TP-SRR	status report is requested "1"B
TP-MR	not checked
TP-RD	not checked
TP-DA	not checked (an E164 number)
TP-PID	default "00000000"B
TP-DCS	default alphabet "00000000"B
TP-VP	not checked
TP-UDL	as applicable
TP-UD (140 octets max)	maximum number of characters

SMS-STATUS-REPORT TPDU (SS to MS in step 29):

Information element	Comment Value
TP-MTI	SMS-STATUS-REPORT "10"B
TP-MR	same as previous SMS-SUBMIT
TP-MMS	no more messages "1"B
TP-SRQ	result of SMS-SUBMIT "0"B
TP-RA	same as the Destination address of the SMS-SUBMIT
TP-SCTS	any legal value (cf. 3GPP TS 03.40)
TP-DT	any legal value (cf. 3GPP TS 03.40)
TP-ST	SM received "00000000"B

first SMS-COMMAND TPDU (MS to SS in step 44)

Information element	Comment Value
TP-MTI	SMS-COMMAND "10"B
TP-MR	TP-MR in previous SMS-SUBMIT plus "1"
TP-SRR	status report requested (3GPP TS 03.40 9.2.3.19) "1"B
TP-PID	default "00000000"B
TP-CT	Enquiry relating to previously submitted short message "00000000"B
TP-MN	not checked (TP-MR in previous SMS-SUBMIT)
TP-DA	not checked (an E164 number)
TP-CDL	not checked
TP-CD	not checked

second SMS-COMMAND TPDU (MS to SS in step 60)

Information element	Comment Value
TP-MTI	SMS-COMMAND "10"B
TP-MR	TP-MR in previous SMS-COMMAND plus "1"
TP-SRR	status report not requested "0"B
TP-PID	default "00000000"B
TP-CT	Delete previously submitted short message "00000010"B
TP-MN	not checked (TP-MR in previous SMS-SUBMIT)
TP-DA	not checked (an E164 number)
TP-CDL	not checked
TP-CD	not checked

34.2.5 Test of message class 0 to 3

34.2.5.1 Short message class 0

34.2.5.1.1 Conformance requirement

When a mobile terminated message is class 0 and the MS has the capability of displaying short messages, the MS shall display the message immediately and send an acknowledgement to the SC when the message has successfully reached the MS irrespective of whether there is memory available in the SIM or ME. The message shall not be automatically stored in the SIM or ME.

References

3GPP TS 03.38, clause 4.

34.2.5.1.2 Test purpose

To verify that the MS will accept and display but not store a class 0 message, and that it will accept and display a class 0 message if its message store is full.

NOTE: failure of this test in a mobile could cause it to reject a class 0 message when its SMS memory becomes full. This could lead to unwanted repetitions between the MS and the service centre.

34.2.5.1.3 Method of test

Initial conditions

System Simulator:

1 cell, default parameters.

Mobile Station:

The MS shall be in the idle updated state.

The MS message store shall be empty.

Specific PICS Statements

- SMS messages are stored in the SIM (TSPC_AddInfo_StoreRcvSMSSIM).
- SMS messages are stored in the ME (TSPC_AddInfo_StoreRcvSMSME).

PIXIT Statements

- Description of the basic procedures to display a mobile terminated short message.

Foreseen Final State of MS

Idle, updated.

Test Procedure

- a) The SS sends a class 0 message by using the method described in step a) of subclause 34.2.1 but with the TPDU described in this subclause.
- b) The MS message store shall be filled (for example by using the method of 34.2.3 test of the memory available notification) with the same SMS-DELIVER TPDU except that TP-DCS is set to class 1.
- c) The SS sends a class 0 message as in step a).

Maximum Duration of Test

-

Expected Sequence

Step	Direction	Message	Comments
1	SS -> MS	PAGING REQUEST	
2	MS -> SS	CHANNEL REQUEST	Establishment cause is "Answer to paging"
3	SS -> MS	IMMEDIATE ASSIGNMENT	SS assigns an SDCCH
4	MS -> SS	PAGING RESPONSE	Message is contained in SABM.
5	SS -> MS	AUTHENTICATION REQUEST	
6	MS -> SS	AUTHENTICATION RESPONSE	SRES specifies correct value.
7	SS -> MS	CIPHERING MODE COMMAND	SS starts deciphering after sending the message.
8	MS -> SS	CIPHERING MODE COMPLETE	Shall be sent enciphered. All following messages shall be sent enciphered.
9	SS		SS starts ciphering.
10	SS -> MS	SABM (SAPI=3)	SS establishes SAPI 3
11	MS -> SS	UA (SAPI=3)	
12	SS -> MS	CP-DATA	Contains RP-DATA RPDU (SMS DELIVER TPDU), Class 0 Short Message
13	MS -> SS	CP-ACK	
14	MS -> SS	CP-DATA	Contains RP-ACK RPDU.
15	SS -> MS	CP-ACK	
16	SS -> MS	CHANNEL RELEASE	
17	MS		The content of the short message shall be displayed by the ME. The MS shall not store the message. This can be checked by verifying that it is impossible to retrieve any short messages from the MS message store.
18	SS		The MS message store shall be filled (for example by using the method of 34.2.3) with Class 1 SMS-DELIVER TPDU.
19	SS -> MS	PAGING REQUEST	
20	MS -> SS	CHANNEL REQUEST	Establishment cause is "Answer to paging"
21	SS -> MS	IMMEDIATE ASSIGNMENT	SS assigns an SDCCH
22	MS -> SS	PAGING RESPONSE	Message is contained in SABM.
23	SS -> MS	AUTHENTICATION REQUEST	
24	MS -> SS	AUTHENTICATION RESPONSE	SRES specifies correct value.
25	SS -> MS	CIPHERING MODE COMMAND	SS starts deciphering after sending the message.
26	MS -> SS	CIPHERING MODE COMPLETE	Shall be sent enciphered. All following messages shall be sent enciphered.
27	SS		SS starts ciphering.
28	SS -> MS	SABM (SAPI=3)	SS establishes SAPI 3
29	MS -> SS	UA (SAPI=3)	

Step	Direction	Message	Comments
30	SS -> MS	CP-DATA	Contains RP-DATA RPDU (SMS DELIVER TPDU), Class 0 Short Message
31	MS -> SS	CP-ACK	
32	MS -> SS	CP-DATA	Contains RP-ACK RPDU.
33	SS -> MS	CP-ACK	
34	SS -> MS	CHANNEL RELEASE	The content of the short message shall be displayed by the ME.
35	MS		

Specific Message Contents:

SMS-DELIVER TPDU (containing a class 0 message) (SS to MS):

Information element	Comment	Value
TP-MTI	SMS-DELIVER	"00"B
TP-MMS	more messages are waiting in SC	"0"B
TP-RP	no reply path	"0"B
TP-UDHI	TP-UD contains only the SM	"0"B
TP-SRI	no status report returned	0
TP-OA	an international number coded E.164	
TP-PID	default	"00000000"B
TP-DCS	default alphabet, class 0	"1111 0000"B
TP-SCTS	any legal value (cf. 3GPP TS 03.40)	
TP-UDL	160	
TP-UD (140 octets)	text of message (160 characters)	

SMS-DELIVER TPDU (containing a class 1 message to fill the MS message store) (SS to MS):

Information element	Comment	Value
TP-MTI	SMS-DELIVER	"00"B
TP-MMS	more messages are waiting in SC	"0"B
TP-RP	no reply path	"0"B
TP-UDHI	TP-UD contains only the SM	"0"B
TP-SRI	no status report returned	0
TP-OA	an international number coded E.164	
TP-PID	default	"00000000"B
TP-DCS	default alphabet, class 1	"1111 0001"B
TP-SCTS	any legal value (cf. 3GPP TS 03.40)	
TP-UDL	160	
TP-UD (140 octets)	text of message (160 characters)	

34.2.5.2 Test of class 1 short messages

34.2.5.2.1 Conformance requirement

When a mobile terminated message is class 1, the MS shall send an acknowledgement to the SC when the message has successfully reached the MS and can be stored, either in the ME or in the SIM.

References

3GPP TS 03.38, clause 4.

34.2.5.2.2 Test purpose

This procedure verifies that the MS acts correctly on receiving a class 1 message, i.e. that it stores the message in the ME or SIM and sends an acknowledgement (at RP and CP-Layer).

34.2.5.2.3 Method of test

Initial conditions

System Simulator:

1 cell, default parameters.

Mobile Station:

The MS shall be in the idle updated state.

The MS message store shall not be full.

For storing of class 1 Short Messages, the MS shall be set up to store Short Messages in the ME memory if supported, otherwise the message may be stored in the SIM (by way of MMI, as described in PICS/PIXIT statement).

Specific PICS Statements

- Support for Short message MT/PP (TSPC_Serv_TS21).
- SMS messages are stored in the SIM (TSPC_AddInfo_StoreRcvSMSSIM).
- SMS messages are stored in the ME (TSPC_AddInfo_StoreRcvSMSME).

PIXIT Statements

- Description of the basic procedures to display a mobile terminated short message.

-

Foreseen Final State of MS

Idle, updated.

Test Procedure

- a) the SS delivers a Short Message of class 1 to the MS as specified in subclause 34.2.1, step a).
- b) the Short Message is recalled (e.g. by means of the MMI).

Maximum Duration of Test

-

Expected Sequence

Step	Direction	Message	Comments
1	SS -> MS	PAGING REQUEST	
2	MS -> SS	CHANNEL REQUEST	Establishment cause is "Answer to paging"
3	SS -> MS	IMMEDIATE ASSIGNMENT	SS assigns an SDCCH
4	MS -> SS	PAGING RESPONSE	Message is contained in SABM.
5	SS -> MS	AUTHENTICATION REQUEST	
6	MS -> SS	AUTHENTICATION RESPONSE	SRES specifies correct value.
7	SS -> MS	CIPHERING MODE COMMAND	SS starts deciphering after sending the message.
8	MS -> SS	CIPHERING MODE COMPLETE	Shall be sent enciphered. All following messages shall be sent enciphered.
9	SS		SS starts ciphering.
10	SS -> MS	SABM (SAPI=3)	SS establishes SAPI 3
11	MS -> SS	UA (SAPI=3)	
12	SS -> MS	CP-DATA	Contains RP-DATA RPDU (SMS DELIVER TPDU), Class 1 Short Message
13	MS -> SS	CP-ACK	
14	MS -> SS	CP-DATA	Contains RP-ACK RPDU.
15	SS -> MS	CP-ACK	
16	SS -> MS	CHANNEL RELEASE	
17	MS		The short message shall be recalled and displayed at the MS.

Specific Message Contents:

SMS-DELIVER TPDU (containing a class 1 message) (SS to MS):

Information element	Comment/Value
TP-MTI	SMS-DELIVER "00"B
TP-MMS	more messages are waiting in SC "0"B
TP-RP	no reply path "0"B
TP-UDHI	TP-UD contains only the SM"0"B
TP-SRI	no status report returned0
TP-OA	an international number coded E.164
TP-PID	default "00000000"B
TP-DCS	default alphabet, class 1 "1111 0001"B
TP-SCTS	any legal value (cf. 3GPP TS 03.40)
TP-UDL	160
TP-UD (140 octets)	text of message (160 characters)

34.2.5.3 Test of class 2 short messages

34.2.5.3.1 Definition

Class 2 Short Messages are defined as SIM specific, and the MS shall ensure that a message of this class is stored on the SIM.

34.2.5.3.2 Conformance requirement

When a mobile terminated message is Class 2, the MS shall ensure that the message has been correctly transferred to the SMS data field in the SIM before sending an acknowledgement to the SC. The MS shall return a "protocol error, unspecified" error message if the short message cannot be stored in the SIM and there is other short message storage available at the MS. If all the short message storage at the MS is already in use, the MS shall return "memory capacity exceeded".

Reference(s)

3GPP TS 03.40, subclause 9.2.3.10; 3GPP TS 03.38, clause 4; 3GPP TS 11.11, subclause 10.3.3.

34.2.5.3.3 Test purpose

This procedure verifies that the MS acts correctly on receiving a class 2 message, i.e. that it stores the message correctly in the SIM, and if this is not possible, returns a protocol error message, with the correct error cause, to the network.

There are 2 cases:

- 1) If the MS supports storing of short messages in the SIM and in the ME, and storage in the ME is not full, and the short message cannot be stored in the SIM, the error cause shall be "protocol error, unspecified".
- 2) If the MS supports storing of short messages in the SIM and not in the ME, and storage in the ME is not full, and the short message cannot be stored in the SIM, the error cause shall be "memory capacity exceeded".

NOTE: If the MS supports storing of short messages in the SIM and the ME, and storage in the ME is full, and the short message cannot be stored in the SIM, the error cause shall be "memory capacity exceeded". This case is not tested in this test.

34.2.5.3.4 Test method

Initial conditions

System Simulator:

1 cell, default parameters.

Mobile Station:

The MS shall be in the idle updated state.

The ME message store shall be empty.

The ME shall be connected to the SIM simulator. The following shall be present in the SIM simulator:

- EF_{SMS} with at least two free records and one full record;
- EF_{SMSstatus}, with SMS "Memory Cap. Exceed" notification flag set to "memory available";
- Service no. 4 (SMS) in EF_{SST} set to allocated and activated;

For storing of Class 1 Short Messages the MS shall be set up to store Short Messages in the ME memory (by way of MMI, as described in PICS/PIXIT statement).

Specific PICS Statements

- Support for Short message MT/PP (TSPC_Serv_TS21).
- SMS messages are stored in the SIM (TSPC_AddInfo_StoreRcvSMSSIM).
- SMS messages are stored in the ME (TSPC_AddInfo_StoreRcvSMSME).

PIXIT Statements

Foreseen Final State of MS

Idle, updated.

Test Procedure

- a) the SS delivers a Short Message of class 2 to the MS as specified in subclause 34.2.1, step b).
- b) following an attempt by the ME to store the short message in a free record of EF_{SMS} in the SIM, the SIM simulator returns the status response "OK" ("90 00").
- c) step a) is repeated.
- d) following an attempt by the ME to store the short message in a free record of EF_{SMS} in the SIM, the SIM simulator returns the status response "memory problem" ("92 40").

Note: the ME may retry to store the short message several times to recover the memory problem. The SIM simulator shall return the status response "memory problem" ("92 40") for each attempt, even for a different record.

- e) the SIM simulator indicates if an attempt was made in steps a) and c) to store the messages and if the messages are stored according to the requirement.

Maximum Duration of Test

-

Expected Sequence

Step	Direction	Message	Comments
1	SS -> MS	PAGING REQUEST	
2	MS -> SS	CHANNEL REQUEST	Establishment cause is "Answer to paging"
3	SS -> MS	IMMEDIATE ASSIGNMENT	SS assigns an SDCCH
4	MS -> SS	PAGING RESPONSE	Message is contained in SABM.
5	SS -> MS	AUTHENTICATION REQUEST	
6	MS -> SS	AUTHENTICATION RESPONSE	SRES specifies correct value.
7	SS -> MS	CIPHERING MODE COMMAND	SS starts deciphering after sending the message.
8	MS -> SS	CIPHERING MODE COMPLETE	Shall be sent enciphered. All following messages shall be sent enciphered.
9	SS		SS starts ciphering.
10	SS -> MS	SABM (SAPI=3)	SS establishes SAPI 3
11	MS -> SS	UA (SAPI=3)	
12	SS -> MS	CP-DATA	Contains RP-DATA RPDU (SMS DELIVER TPDU), Class 2 Short Message
13	MS -> SS	CP-ACK	

Step	Direction	Message	Comments
14	ME		The ME shall correctly store the short message in a free record of EFSMS in the SIM, i.e. - the ME shall use a free record - the first byte of the record shall indicate "message received by MS from network" <ul style="list-style-type: none"> - the TS-Service-Centre-Address shall be correctly stored - the TPDU shall be identical to that sent by the SS - bytes following the TPDU shall be set to "FF"
15	SIM		The SIM simulator returns the status response "OK" ("90 00"). The SIM simulator shall indicate if an attempt was made by the ME to store the short message in the SIM. Contains RP-ACK RPDU.
16	MS -> SS	CP-DATA	
16A	SS -> MS	CP-ACK	
17	SS -> MS	CHANNEL RELEASE	
18	SS -> MS	PAGING REQUEST	
19	MS -> SS	CHANNEL REQUEST	Establishment cause is "Answer to paging"
20	SS -> MS	IMMEDIATE ASSIGNMENT	SS assigns an SDCCH
21	MS -> SS	PAGING RESPONSE	Message is contained in SABM.
22	SS -> MS	AUTHENTICATION REQUEST	
23	MS -> SS	AUTHENTICATION RESPONSE	SRES specifies correct value.
24	SS -> MS	CIPHERING MODE COMMAND	SS starts deciphering after sending the message.
25	MS -> SS	CIPHERING MODE COMPLETE	Shall be sent enciphered. All following messages shall be sent enciphered.
26	SS		SS starts ciphering.
27	SS -> MS	SABM (SAPI=3)	SS establishes SAPI 3
28	MS -> SS	UA (SAPI=3)	
29	SS -> MS	CP-DATA	Contains RP-DATA RPDU (SMS DELIVER TPDU), Class 2 Short Message
30	MS -> SS	CP-ACK	
31	ME		The ME shall attempt to store the short message in a free record of EFSMS in the SIM.
32	SIM		The SIM simulator returns the status response "memory problem" ("92 40"). The SIM simulator shall indicate if an attempt was made by the ME to store the short message in the SIM. Note: the ME may retry to store the short message several times to recover the memory problem. The SIM simulator shall return the status response "memory problem" ("92 40") for each attempt, even for a different record.
33	MS -> SS	CP-DATA	Contains RP-ERROR RPDU with error cause "protocol error, unspecified" if the MS supports storing of short messages in the ME, or error cause "memory capacity exceeded" if not.
33A	SS -> MS	CP-ACK	
34	SS -> MS	CHANNEL RELEASE	

Specific Message Contents:

SMS-DELIVER TPDU (containing a class 2 message) (SS to MS):

Information element	Comment Value
TP-MTI	SMS-DELIVER "00"B
TP-MMS	more messages are waiting in SC "0"B
TP-RP	no reply path "0"B
TP-UDHI	TP-UD contains only the SM"0"B
TP-SRI	no status report returned0
TP-OA	an international number coded E.164
TP-PID	default "00000000"B
TP-DCS	default alphabet, class 2 "1111 0010"B
TP-SCTS	any legal value (cf. 3GPP TS 03.40)
TP-UDL	160
TP-UD (140 octets)	text of message (160 characters)

34.2.5.4 Test of class 3 short messages

For further study.

34.2.6 Test of short message type 0 (Ph2, R96...R99 and REL-4)

34.2.6.1 Conformance requirement

When a mobile terminated message is type 0, the MS shall acknowledge receipt of the short message to the SC but may discard its contents.

Note: Ideally the MS is able to receive the type 0 message irrespective of whether there is memory available in the SIM or ME and does not indicate the receipt of the type 0 short message to the user. The message should not be automatically stored in the SIM or ME.

This test shall apply to all MSs that have a Ph2, R96...R99 or REL-4 short message type 0 implementation.

References

3GPP TS 03.40 / 3GPP TS 23.040, subclause 9.2.3.9.

34.2.6.2 Test purpose

To verify that the MS will acknowledge receipt of the short message to the SC. The MS should discard its contents.

NOTE: failure of this test in a mobile could cause it to reject a type 0 message when the network is trying to reach the MS. This could lead to unwanted repetitions between the MS and the service centre.

34.2.6.3 Method of test

Initial conditions

System Simulator:

1 cell, default parameters.

Mobile Station:

The MS shall be in the idle updated state.

Specific PICS Statements

-

PIXIT Statements

-

Foreseen Final State of MS

Idle, updated.

Test Procedure

The SS sends a type 0 message by using the method described in step a) of section 34.2.1 but with the TPDU described in this section.

Maximum Duration of Test

1 minute

Expected Sequence

Step	Direction	Message	Comments
1	SS -> MS	PAGING REQUEST	
2	MS -> SS	CHANNEL REQUEST	Establishment cause is "Answer to paging"
3	SS -> MS	IMMEDIATE ASSIGNMENT	SS assigns an SDCCH
4	MS -> SS	PAGING RESPONSE	Message is contained in SABM.
5	SS -> MS	AUTHENTICATION REQUEST	
6	MS -> SS	AUTHENTICATION RESPONSE	SRES specifies correct value.
7	SS -> MS	CIPHERING MODE COMMAND	SS starts deciphering after sending the message.
8	MS -> SS	CIPHERING MODE COMPLETE	Shall be sent enciphered. All following messages shall be sent enciphered.
9	SS		SS starts ciphering.
10	SS -> MS	SABM (SAPI=3)	SS establishes SAPI 3
11	MS -> SS	UA (SAPI=3)	
12	SS -> MS	CP-DATA	Contains RP-DATA RPDU (SMS DELIVER TPDU), type 0 Short Message
13	MS -> SS	CP-ACK	
14	MS -> SS	CP-DATA	Contains RP-ACK TP-Protocol-Identifier (TP-PID).
15	SS -> MS	CP-ACK	
16	SS -> MS	CHANNEL RELEASE	
17	MS		Ideally the MS is able to receive the type 0 message irrespective of whether there is memory available in the SIM or ME and does not indicate the receipt of the type 0 short message to the user. The message should not be automatically stored in the SIM or ME.

Specific Message Contents:

SMS-DELIVER TPDU (containing a type 0 message) (SS to MS):

Information element	Comment Value
TP-MIT	SMS-DELIVER "00"B
TP-MMS	more messages are waiting in SC "0"B
TP-RP	no reply path "0"B
TP-UDHI	TP-UD contains only the SM"0"B
TP-SRI	no status report returned 0
TP-OA	an international number coded E.164
TP-PID	Type 0: "01000000"B
TP-DCS	default alphabet "0000 0000"B
TP-SCTS	any legal value (cf. 3GPP TS 03.40 / 3GPP TS 23.040)
TP-UDL	160
TP-UD (140 octets)	text of message (160 characters)

34.2.6a Test of short message type 0 (\geq REL 5)

34.2.6a.1 Conformance requirement

When a mobile terminated message is type 0, the MS shall acknowledge receipt of the short message to the SC but shall discard its contents. This means that

- the MS shall be able to receive the type 0 short message irrespective of whether there is memory available in the SIM or ME or not,
- the MS shall not indicate the receipt of the type 0 short message to the user,
- the short message shall neither be stored in the SIM nor ME.

This test shall apply to all MSs that have a \geq REL-5 short message type 0 implementation.

References

3GPP TS 23.040, subclause 9.2.3.9.

34.2.6a.2 Test purpose

To verify that the MS will acknowledge receipt of the short message to the SC. The MS shall discard its contents. This means that

- the MS shall be able to receive the type 0 short message irrespective of whether there is memory available in the SIM or ME or not,
- the MS shall not indicate the receipt of the type 0 short message to the user,
- the short message shall neither be stored in the SIM nor ME.

NOTE: failure of this test in a MS could cause it to reject a type 0 message when the network is trying to reach the MS. This could lead to unwanted repetitions between the MS and the service centre. In addition service affecting restrictions could happen to the customer.

34.2.6a.3 Method of test

Initial conditions

System Simulator:

1 cell, default parameters.

Mobile Station:

The MS shall be in the idle updated state.

the ME- and SIM message store shall be empty.

Specific PICS Statements

-

PIXIT Statements

-

Foreseen Final State of MS

Idle, updated.

Test Procedure

- a) The SS sends a type 0 short message by using the method described in step a) of clause 34.2.1 but with the TPDU described in this section.
- b) The ME- and SIM short message store shall be filled (for example by using the method of clause 34.2.3 test of the memory available notification).
- c) The SS sends a type 0 short message as in step a).

Maximum Duration of Test

5 minutes.

Expected Sequence

Step	Direction	Message	Comments
1	SS -> MS	PAGING REQUEST	Establishment cause is "Answer to paging" SS assigns an SDCCH Message is contained in SABM. SRES specifies correct value. SS starts deciphering after sending the message. Shall be sent enciphered. All following messages shall be sent enciphered. SS starts ciphering. SS establishes SAPI 3 Contains RP-DATA RPDU (SMS DELIVER TPDU), type 0 Short Message Contains RP-ACK TP-Protocol-Identifier (TP-PID). The MS shall discard the type 0 short message. This means that the MS does not indicate the receipt of the type 0 short message to the user. The MS shall not store the message in the SIM or ME. This can be checked by verifying that it is impossible to retrieve any short messages from the ME- and SIM message store.
2	MS -> SS	CHANNEL REQUEST	
3	SS -> MS	IMMEDIATE ASSIGNMENT	
4	MS -> SS	PAGING RESPONSE	
5	SS -> MS	AUTHENTICATION REQUEST	
6	MS -> SS	AUTHENTICATION RESPONSE	
7	SS -> MS	CIPHERING MODE COMMAND	
8	MS -> SS	CIPHERING MODE COMPLETE	
9	SS		
10	SS -> MS	SABM (SAPI=3)	
11	MS -> SS	UA (SAPI=3)	
12	SS -> MS	CP-DATA	
13	MS -> SS	CP-ACK	
14	MS -> SS	CP-DATA	
15	SS -> MS	CP-ACK	
16	SS -> MS	CHANNEL RELEASE	
17	MS		
18	SS		The ME- and SIM message store shall be filled (for example by using the method of clause 34.2.3).
19	SS -> MS	PAGING REQUEST	Establishment cause is "Answer to paging" SS assigns an SDCCH Message is contained in SABM. SRES specifies correct value. SS starts deciphering after sending the message. Shall be sent enciphered. All following messages shall be sent enciphered. SS starts ciphering. SS establishes SAPI 3 Contains RP-DATA RPDU (SMS DELIVER TPDU), type 0 Short Message Contains RP-ACK TP-Protocol-Identifier (TP-PID). The MS shall discard the type 0 short message. This means that the MS does not indicate the receipt of the type 0 short message to the user. The MS shall not store the message in the SIM or ME. This can be checked by verifying that it is impossible to retrieve any short messages from the ME- and SIM message store.
20	MS -> SS	CHANNEL REQUEST	
21	SS -> MS	IMMEDIATE ASSIGNMENT	
22	MS -> SS	PAGING RESPONSE	
23	SS -> MS	AUTHENTICATION REQUEST	
24	MS -> SS	AUTHENTICATION RESPONSE	
25	SS -> MS	CIPHERING MODE COMMAND	
26	MS -> SS	CIPHERING MODE COMPLETE	
27	SS		
28	SS -> MS	SABM (SAPI=3)	
29	MS -> SS	UA (SAPI=3)	
30	SS -> MS	CP-DATA	
31	MS -> SS	CP-ACK	
32	MS -> SS	CP-DATA	
33	SS -> MS	CP-ACK	
34	SS -> MS	CHANNEL RELEASE	
35	MS		

Specific Message Contents:

SMS-DELIVER TPDU (containing a type 0 message) (SS to MS):

Information element	Comment Value
TP-MIT	SMS-DELIVER "00"B
TP-MMS	more messages are waiting in SC "0"B
TP-RP	no reply path "0"B
TP-UDHI	TP-UD contains only the SM"0"B
TP-SRI	no status report returned0
TP-OA	an international number coded E.164
TP-PID	Type 0: "01000000"B
TP-DCS	default alphabet "0000 0000"B
TP-SCTS	any legal value (cf. 3GPP TS 03.40 / 3GPP TS 23.040)
TP-UDL	160
TP-UD (140 octets)	text of message (160 characters)

34.2.7 Test of the replace mechanism for SM type 1-7

34.2.7.1 Definition

This test shall apply to MSs which support:

- Replace Short Messages; and
- display of received Short Messages.

34.2.7.2a Conformance requirement for MS with implementation up to and including Rel. 97

On receipt of a short message, the MS shall check to see if the associated Protocol Identifier contains a Replace Short Message Type code. If such a code is present, then the MS will check the associated SC address (RP-OA) and originating address (TP-OA) and replace any existing stored message having the same Protocol Identifier code, SC address and originating address with the new short message.

Reference(s)

3GPP TS 03.40; subclause 9.2.3.9.

34.2.7.2b Conformance requirement for MS with implementation after Rel.98 and later

On receipt of a short message, the MS shall check to see if the associated Protocol Identifier contains a Replace Short Message Type code. If such a code is present, then the MS will check the originating address and replace any existing stored message having the same Protocol Identifier code and originating address with the new short message and other parameter values. If there is no message to be replaced, the MS shall store the message in the normal way. The MS may also check the SC address as well as the Originating Address. However, in a network which has multiple SCs, it is possible for a Replace Message type for a SM to be sent via different SCs and so it is recommended that the SC address should not be checked by the MS unless the application specifically requires such a check.

Reference(s)

3GPP TS 03.40 / 3GPP TS 23.040, subclause 9.2.3.9.

34.2.7.3 Test purpose

This procedure verifies the correct implementation of the replace mechanism for Replace Short Messages.

NOTE: The test will not check the correct SC address for any releases.

34.2.7.4 Test method

Initial conditions

System Simulator:

1 cell, default parameters.

Mobile Station:

The MS shall be in the idle updated state.

The MS message store shall be empty.

Specific PICS Statements

-

PIXIT Statements

- Description of the basic procedures to display a mobile terminated short message.

Foreseen Final State of MS

Idle, updated.

Test Procedure

- a) two different numbers n and m are drawn randomly between 1 and 7. Two different addresses for TP-Originating-Address (TPOA1 and TPOA2) are drawn.
- b) the SS delivers a short message to the MS as specified in subclause 34.2.1 step a). In the SMS-DELIVER TPDU, the TP-Protocol-Identifier parameter is "Replace Short Message Type n", the TP-Originating-Address is TPOA1, and the RP-Originating-Address is RPOA.
- c) step b) is repeated but with a different TP-Originating-Address (TPOA2), and different contents of TP-User-Data in the SMS-DELIVER TPDU. The other parameters are the same as in step b).
- d) step c) is repeated but with the TP-Protocol-Identifier equal to "Replace Short Message Type m", and contents of TP-User-Data different from the former two messages. The other parameters are the same as in step c).
- e) step d) is repeated but the contents of TP-User-Data are different from that used in step d).
- f) the SS prompts the operator to display the Short Messages stored in the MS.

Maximum Duration of Test

-

Expected Sequence

Step	Direction	Message	Comments
1	SS -> MS	PAGING REQUEST	
2	MS -> SS	CHANNEL REQUEST	Establishment cause is "Answer to paging"
3	SS -> MS	IMMEDIATE ASSIGNMENT	SS assigns an SDCCH
4	MS -> SS	PAGING RESPONSE	Message is contained in SABM.
5	SS -> MS	AUTHENTICATION REQUEST	
6	MS -> SS	AUTHENTICATION RESPONSE	SRES specifies correct value.
7	SS -> MS	CIPHERING MODE COMMAND	SS starts deciphering after sending the message.
8	MS -> SS	CIPHERING MODE COMPLETE	Shall be sent enciphered. All following messages shall be sent enciphered.
9	SS		SS starts ciphering.
10	SS -> MS	SABM (SAPI=3)	SS establishes SAPI 3
11	MS -> SS	UA (SAPI=3)	
12	SS -> MS	CP-DATA	Contains RP-DATA RPDU (SMS DELIVER TPDU) TP-PID is "Replace Short Message Type n", TP-OA is TPOA1 and RP-OA is RPOA
13	MS -> SS	CP-ACK	
14	MS -> SS	CP-DATA	Contains RP-ACK RPDU.
14A	SS -> MS	CP-ACK	
15	SS -> MS	CHANNEL RELEASE	
16	SS -> MS	PAGING REQUEST	
17	MS -> SS	CHANNEL REQUEST	Establishment cause is "Answer to paging"
18	SS -> MS	IMMEDIATE ASSIGNMENT	SS assigns an SDCCH
19	MS -> SS	PAGING RESPONSE	Message is contained in SABM.
20	SS -> MS	AUTHENTICATION REQUEST	

Step	Direction	Message	Comments
21	MS -> SS	AUTHENTICATION RESPONSE	SRES specifies correct value.
22	SS -> MS	CIPHERING MODE COMMAND	SS starts deciphering after sending the message.
23	MS -> SS	CIPHERING MODE COMPLETE	Shall be sent enciphered. All following messages shall be sent enciphered.
24	SS		SS starts ciphering.
25	SS -> MS	SABM (SAPI=3)	SS establishes SAPI 3
26	MS -> SS	UA (SAPI=3)	
27	SS -> MS	CP-DATA	Contains RP-DATA RPDU (SMS DELIVER TPDU) TP-PID is "Replace Short Message Type n", TP-OA is TPOA2 and RP-OA is RPOA, TP-UD different from step 12
28	MS -> SS	CP-ACK	
29	MS -> SS	CP-DATA	Contains RP-ACK RPDU.
29A	SS -> MS	CP-ACK	
30	SS -> MS	CHANNEL RELEASE	
31	SS -> MS	PAGING REQUEST	
32	MS -> SS	CHANNEL REQUEST	Establishment cause is "Answer to paging"
33	SS -> MS	IMMEDIATE ASSIGNMENT	SS assigns an SDCCH
34	MS -> SS	PAGING RESPONSE	Message is contained in SABM.
35	SS -> MS	AUTHENTICATION REQUEST	
36	MS -> SS	AUTHENTICATION RESPONSE	SRES specifies correct value.
37	SS -> MS	CIPHERING MODE COMMAND	SS starts deciphering after sending the message.
38	MS -> SS	CIPHERING MODE COMPLETE	Shall be sent enciphered. All following messages shall be sent enciphered.
39	SS		SS starts ciphering.
40	SS -> MS	SABM (SAPI=3)	SS establishes SAPI 3
41	MS -> SS	UA (SAPI=3)	
42	SS -> MS	CP-DATA	Contains RP-DATA RPDU (SMS DELIVER TPDU) TP-PID is "Replace Short Message Type m", TP-OA is TPOA2 and RP-OA is RPOA, TP-UD different from step 12 and 27
43	MS -> SS	CP-ACK	
44	MS -> SS	CP-DATA	Contains RP-ACK RPDU.
45	SS -> MS	CP-ACK	
46	SS -> MS	CHANNEL RELEASE	
47	SS -> MS	PAGING REQUEST	
48	MS -> SS	CHANNEL REQUEST	Establishment cause is "Answer to paging"
49	SS -> MS	IMMEDIATE ASSIGNMENT	SS assigns an SDCCH
50	MS -> SS	PAGING RESPONSE	Message is contained in SABM.
51	SS -> MS	AUTHENTICATION REQUEST	
52	MS -> SS	AUTHENTICATION RESPONSE	SRES specifies correct value.
53	SS -> MS	CIPHERING MODE COMMAND	SS starts deciphering after sending the message.
54	MS -> SS	CIPHERING MODE COMPLETE	Shall be sent enciphered. All following messages shall be sent enciphered.
55	SS		SS starts ciphering.
56	SS -> MS	SABM (SAPI=3)	SS establishes SAPI 3
57	MS -> SS	UA (SAPI=3)	
58	SS -> MS	CP-DATA	Contains RP-DATA RPDU (SMS DELIVER TPDU) TP-PID is "Replace Short Message Type m", TP-OA is TPOA2 and RP-OA is RPOA, TP-UD different from step 42
59	MS -> SS	CP-ACK	
60	MS -> SS	CP-DATA	Contains RP-ACK RPDU.
61	SS -> MS	CP-ACK	
62	SS -> MS	CHANNEL RELEASE	
63	SS		Prompts the operator to display the Short Messages stored in the MS. Only the Short Messages delivered in step 12, 27 and 58 shall be retrievable and displayed

Specific Message Contents:

SMS-DELIVER TPDU

Information element	Comment	Value
TP-MTI	SMS-DELIVER	"00"B
TP-MMS	no more messages are waiting in SC	"1"B
TP-RP	no Reply Path	"0"B
TP-UDHI	TP-UD contains only the SM	"0"B
TP-SRI	no Status Report returned	"0"B
TP-OA	an international number coded E.164 (see test method description)	
TP-PID	binary 01000xxx, xxx represents n resp. m (see test method description)	
TP-DCS	default alphabet	"00000000"B
TP-SCTS	the time when the message was submitted according to 3GPP TS 03.40	
TP-UDL	160	
TP-UD (140 octets)	text of message (160 characters) (see test method description)	

34.2.8 Test of the reply path scheme

34.2.8.1 Definition

This test applies to MSs which support:

- reply procedures (the class of MSs for which this is mandatory is described in 3GPP TS 03.40, annex 4):
- displaying of received Short Messages: and
- submitting Short Messages.

Steps b) and d) are only executed for MSs which support storing of Short messages.

34.2.8.2 Conformance requirement

When a replying MS receives an original mobile terminated short message it has:

- originating SME = TP-Originating Address in the SMS-DELIVER TPDU;
- original SC = RP-Originating Address in the RP-MT-DATA.

When submitting the reply mobile originated short message, the replying MS should use parameters as follows:

- TP-Destination Address in SMS-SUBMIT TPDU = originating SME;
- RP-Destination Address in RP-MO-DATA = original SC.

Reference(s)

3GPP TS 03.40 annex 4, clauses 5 and 6.

34.2.8.3 Test purpose

This procedure verifies that the MS is able to send a Reply Short Message back to the correct originating SME even if in the meantime it receives another Short Message.

34.2.8.4 Test method

Initial conditions

System Simulator:

1 cell, default parameters.

Mobile Station:

The MS shall be in the idle updated state.

The MS message store shall be empty.

Specific PICS Statements

-

PIXIT Statements

- Description of the basic procedures to display a mobile terminated short message.
- Description of the basic procedures to send a mobile originated short message.

Foreseen Final State of MS

Idle, updated.

Test Procedure

- a) the SS delivers a Short Message as specified in subclause 34.2.1, step b) with TP-Reply-Path set to 1.
- b) step a) is repeated but with:
 - different TP-Originating-Address for the originating SME;
 - different RP-Originating-Address for the original SC; and
 - different message contents TP-User-Data.
- c) one of the two Short Messages is displayed (e.g. by means of the MMI) and the Reply Short Message is submitted (e.g. by means of the MMI).
- d) step c) is repeated for the other Short Message.

Maximum Duration of Test

-

Expected Sequence

Step	Direction	Message	Comments
1	SS -> MS	PAGING REQUEST	
2	MS -> SS	CHANNEL REQUEST	Establishment cause is "Answer to paging"
3	SS -> MS	IMMEDIATE ASSIGNMENT	SS assigns an SDCCH
4	MS -> SS	PAGING RESPONSE	Message is contained in SABM.
5	SS -> MS	AUTHENTICATION REQUEST	
6	MS -> SS	AUTHENTICATION RESPONSE	SRES specifies correct value.
7	SS -> MS	CIPHERING MODE COMMAND	SS starts deciphering after sending the message.
8	MS -> SS	CIPHERING MODE COMPLETE	Shall be sent enciphered. All following messages shall be sent enciphered.
9	SS		SS starts ciphering.
10	SS -> MS	SABM (SAPI=3)	SS establishes SAPI 3
11	MS -> SS	UA (SAPI=3)	
12	SS -> MS	CP-DATA	Contains RP-DATA RPDU (SMS DELIVER TPDU) TP-RP set to 1
13	MS -> SS	CP-ACK	
14	MS -> SS	CP-DATA	Contains RP-ACK RPDU.
14A	SS -> MS	CP-ACK	
15	SS -> MS	CHANNEL RELEASE	
16	SS -> MS	PAGING REQUEST	
17	MS -> SS	CHANNEL REQUEST	Establishment cause is "Answer to paging"
18	SS -> MS	IMMEDIATE ASSIGNMENT	SS assigns an SDCCH
19	MS -> SS	PAGING RESPONSE	Message is contained in SABM.
20	SS -> MS	AUTHENTICATION REQUEST	
21	MS -> SS	AUTHENTICATION RESPONSE	SRES specifies correct value.
22	SS -> MS	CIPHERING MODE COMMAND	SS starts deciphering after sending the message.
23	MS -> SS	CIPHERING MODE COMPLETE	Shall be sent enciphered. All following messages shall be sent enciphered.
24	SS		SS starts ciphering.
25	SS -> MS	SABM (SAPI=3)	SS establishes SAPI 3
26	MS -> SS	UA (SAPI=3)	

Step	Direction	Message	Comments
27	SS -> MS	CP-DATA	Contains RP-DATA RPDU (SMS DELIVER TPDU) TP-OA, RP-OA and TP-UD different from step 12
28	MS -> SS	CP-ACK	
29	MS -> SS	CP-DATA	Contains RP-ACK RPDU.
29A	SS -> MS	CP-ACK	
30	SS -> MS	CHANNEL RELEASE	One of the two Short Messages is displayed and the Reply Short Message is submitted.
31	MS		
32	MS -> SS	CHANNEL REQUEST	
33	SS -> MS	IMMEDIATE ASSIGNMENT	SS assigns an SDCCH Message is contained in SABM.
34	MS -> SS	CM SERVICE REQUEST	
35	SS -> MS	AUTHENTICATION REQUEST	SRES specifies correct value.
36	MS -> SS	AUTHENTICATION RESPONSE	
37	SS -> MS	CIPHERING MODE COMMAND	SS starts deciphering after sending the message. Shall be sent enciphered. All following messages shall be sent enciphered.
38	MS -> SS	CIPHERING MODE COMPLETE	
39	SS		SS starts ciphering.
40	MS -> SS	SABM (SAPI=3)	MS establishes SAPI 3
41	SS -> MS	UA (SAPI=3)	
42	MS -> SS	CP-DATA	Contains RP-DATA RPDU (SMS SUBMIT TPDU) RP-DA = RP-OA corresponding to the message displayed TP-DA = TP-OA corresponding to the message displayed
43	SS -> MS	CP-ACK	Contains RP-ACK RPDU
44	SS -> MS	CP-DATA	
45	SS		Waits max 25 s for CP-ACK
46	MS -> SS	CP-ACK	The main signalling link is released. The other Short Message is displayed and the Reply Short Message is submitted.
47	SS -> MS	CHANNEL RELEASE	
48	MS		
49	MS -> SS	CHANNEL REQUEST	SS assigns an SDCCH Message is contained in SABM.
50	SS -> MS	IMMEDIATE ASSIGNMENT	
51	MS -> SS	CM SERVICE REQUEST	SRES specifies correct value.
52	SS -> MS	AUTHENTICATION REQUEST	
53	MS -> SS	AUTHENTICATION RESPONSE	SS starts deciphering after sending the message. Shall be sent enciphered. All following messages shall be sent enciphered.
54	SS -> MS	CIPHERING MODE COMMAND	
55	MS -> SS	CIPHERING MODE COMPLETE	
56	SS		SS starts ciphering.
57	MS -> SS	SABM (SAPI=3)	MS establishes SAPI 3
58	SS -> MS	UA (SAPI=3)	
59	MS -> SS	CP-DATA	Contains RP-DATA RPDU (SMS SUBMIT TPDU) RP-DA = RP-OA corresponding to the Message displayed TP-DA = TP-OA corresponding to the message displayed
60	SS -> MS	CP-ACK	Contains RP-ACK RPDU
61	SS -> MS	CP-DATA	
62	SS		Waits max 25 s for CP-ACK
63	MS -> SS	CP-ACK	The main signalling link is released.
64	SS -> MS	CHANNEL RELEASE	

Specific Message Contents:

SMS-DELIVER TPDU

Information element	Comment Value
TP-MTI	SMS-DELIVER "00"B
TP-MMS	no more messages are waiting in SC "1"B
TP-RP	Reply Path exists "1"B
TP-UDHI	TP-UD contains only the SM"0"B
TP-SRI	no Status Report returned "0"B
TP-OA	an international number coded E.164 (see test method description)
TP-PID	default "00000000"B
TP-DCS	default alphabet "00000000"B
TP-SCTS	the time when the message was submitted according to 3GPP TS 03.40
TP-UDL	160
TP-UD (140 octets)	text of message (160 characters) (see test method description)

34.2.9 Multiple SMS mobile originated

34.2.9.1 MS in idle mode

This test applies to MS supporting the ability of sending multiple short messages on the same RR connection when there is no call in progress.

34.2.9.1.1 Conformance requirements

For a R99 or earlier MS only:

If another short message or a memory available notification is to be sent, an originating SMR entity in the UE may choose to continue to use the same RRC connection. When the MS chooses to use the same RR connection, then:

- the MS shall transmit a CM SERVICE REQUEST for the new CM connection before the final CP-ACK (e.g. the one that acknowledges the CP-DATA that carried the RP-ACK) for the old MM connection is transmitted;
- before transmission of the first CP-DATA on the new MM connection, the MS shall transmit the CP-ACK for the old MM connection;
- the Transaction Identifier used on the new MM connection shall be different to that used on the old MM connection; and
- the MS shall not initiate establishment of the new MM connection before the final CP-DATA (e.g. the one carrying the RP-ACK) has been received.

For a Rel-4 or later MS only:

In the case of a SMS transfer via the CS domain, when the UE chooses to use the same RR or CS signalling connection, then:

- the UE shall transmit a CM SERVICE REQUEST for the new CM connection before the final CP-ACK (i.e. the one that acknowledges the CP-DATA that carried the RP-ACK) for the old MM connection is transmitted;
- before transmission of the first CP-DATA on the new MM connection, the UE may transmit the CP-ACK for the old MM connection; the UE shall not transmit the final CP-ACK after the new CP-DATA;
- the Transaction Identifier used on the new MM connection shall be different to that used on the old MM connection; and
- the UE shall not initiate establishment of the new MM connection before the final CP-DATA (e.g. the one carrying the RP-ACK) has been received.

References

3GPP TS 03.40; subclause 3.1

3GPP TS 04.11; subclause 5.4

3GPP TS 04.13; subclause 5.6

34.2.9.1.2 Test purpose

To verify that the MS is able to correctly send multiple short messages on the same RR connection when using an SDCCH.

34.2.9.1.3 Method of test

Initial conditions

System simulator:

1 cell, default parameters.

Mobile Station:

The MS shall be in "Idle, updated" state.

The SMS message storage shall be empty.

Specific PICS Statements

- SMS messages are stored in the SIM (TSPC_AddInfo_StoreRcvSMSSIM).
- SMS messages are stored in the ME (TSPC_AddInfo_StoreRcvSMSME).

PIXIT Statements

- Description of how to enter multiple SMS.
- Description of the basic procedures to display a mobile originated short message.

Foreseen final state of MS

Idle, updated.

Test procedure

- a) The MS shall be set up to send 3 short messages as multiple SM to the SS. The SS responds to the channel request message by allocating an SDCCH. The SS answers correctly to the SABM on SAPI 0 and then performs the authentication and ciphering procedures.
- b) The SS responds with a UA frame SAPI-3 to the MS.
- c) The SS responds to the CP-DATA containing RP-DATA RPDU (SMS SUBMIT TPDU) from the MS with a CP-ACK message followed by a CP-DATA message containing the correct RP-ACK RPDU. The Transaction Identifier used on this MM connection is 'x'.
- d) the MS shall transmit a CM SERVICE REQUEST for the new CM connection (for the second short message) before the final CP-ACK (the one that acknowledges the CP-DATA that carried the RP-ACK before) for the old MM connection is transmitted. The MS shall not initiate establishment of the new MM connection before the final CP-DATA (i.e. the one carrying the RP-ACK for the first short message) has been received. Before transmission of the first CP-DATA on the new MM connection:

The MS may transmit the CP-ACK for the old MM connection. The Transaction Identifier used on the new MM connection shall be y, where $y \neq x$ (see step c)). Thereby, the UE can transmit the final CP-ACK after either the sending of the CM SERVICE REQUEST for the new CM connection or the reception of the CM SERVICE ACCEPT for the new CM connection or not to send a CP-ACK at all, thus three cases are possible. These cases are specified using two branches for the transmission of the final CP-ACK where the transmission of the final CP-ACK for the old MM connection is optional. The two branches are specified in

the expected sequence table like A and B respectively. The SS waits for the UE to transmit the final CP-ACK. If received within 5 s then the SS transmits the CM SERVICE ACCEPT and waits for the UE to transmit the first CP-DATA on the new MM connection (branch A). If the final CP-ACK is not received within 5 s then the SS transmits the CM SERVICE ACCEPT and then waits for the UE to send the final CP-ACK (optional) and/or the first CP-DATA on the new MM connection (branch B).

- e) Void.
- f) The SS responds to the CP-DATA containing RP-DATA RPDU (SMS SUBMIT TPDU) from the MS with a CP-ACK message followed by a CP-DATA message containing the correct RP-ACK RPDU.
- g) The MS shall transmit a CM SERVICE REQUEST for the new CM connection (for the third short message) before the final CP-ACK (the one that acknowledges the CP-DATA that carried the RP-ACK before) for the old MM connection is transmitted. Before transmission of the first CP-DATA on the new MM connection:

The MS may transmit the CP-ACK for the old MM connection. The Transaction Identifier used on the new MM connection shall be z, where $z < y$ (see step c)). Thereby, the UE can transmit the final CP-ACK after either the sending of the CM SERVICE REQUEST for the new CM connection or the reception of the CM SERVICE ACCEPT for the new CM connection or not to send a CP-ACK at all, thus three cases are possible. These cases are specified using two branches for the transmission of the final CP-ACK where the transmission of the final CP-ACK for the old MM connection is optional. The two branches are specified in the expected sequence table like A and B respectively. The SS waits for the UE to transmit the final CP-ACK. If received within 5 s then the SS transmits the CM SERVICE ACCEPT and waits for the UE to transmit the first CP-DATA on the new MM connection (branch A). If the final CP-ACK is not received within 5 s then the SS transmits the CM SERVICE ACCEPT and then waits for the UE to send the final CP-ACK (optional) and/or the first CP-DATA on the new MM connection (branch B).

- h) Void
- i) The SS responds to the CP-DATA containing RP-DATA RPDU (SMS SUBMIT TPDU) from the MS with a CP-ACK message followed by a CP-DATA message containing the correct RP-ACK RPDU.
- j) The SS waits a maximum of 5 s after sending CP-DATA for the CP-ACK message from the MS.
- k) The SS sends a Channel Release message to the MS.

Maximum duration of test

5 minutes.

Expected sequence

Step	Direction	Message	Comments
1	MS -> SS	CHANNEL REQUEST	Establishment cause is "Other procedures which can be completed with an SDCCH" NECI = 0 SS assigns an SDCCH Message is contained in SABM on SAPI 0. CM service type set to "Short message transfer"
2	SS -> MS	IMMEDIATE ASSIGNMENT	
3	MS -> SS	CM SERVICE REQUEST	
4	SS -> MS	AUTHENTICATION REQUEST	SRES specifies correct value. SS starts deciphering after sending the message. Shall be sent enciphered. All following messages shall be sent enciphered. SS starts ciphering. MS establishes SAPI 3 on DCCH
5	MS -> SS	AUTHENTICATION RESPONSE	
6	SS -> MS	CIPHERING MODE COMMAND	
7	MS -> SS	CIPHERING MODE COMPLETE	
8	SS		
9	MS -> SS	SABM (SAPI=3)	
10	SS -> MS	UA (SAPI=3)	
11	MS -> SS	CP-DATA	Contains RP-DATA RPDU (SMS SUBMIT TPDU). The Transaction Identifier used in steps 11, 12, 13 and 15 shall be x.
12	SS -> MS	CP-ACK	Contains RP-ACK RPDU CM service type set to "Short message transfer".
13	SS -> MS	CP-DATA	
14	MS -> SS	CM SERVICE REQUEST	

Step	Direction	Message	Comments
15	MS -> SS	CP-ACK	The one that acknowledges the CP-DATA which carried the RP-ACK RPDU. If CP-ACK received then continue at A16. If CP-ACK is not received within 5 s from the CM SERVICE REQUEST was sent in step 14 then goto step B16-1.
Branch A A16	SS -> MS	CM SERVICE ACCEPT	After having sent the CM SERVICE ACCEPT then goto step 17.
Branch B B16-1	SS->MS	CM SERVICE ACCEPT	This branch is chosen if the MS does not send a CP-ACK within 5 s of step 14.
B16-2 (optional)	MS->SS	CP-ACK	The one that acknowledges the CP-DATA which carried the RP-ACK RPDU.
17	MS -> SS	CP-DATA	Contains RP-DATA RPDU (SMS SUBMIT TPDU). The Transaction Identifier used in steps 17, 18, 19 and 21 shall be y where $y < x$ (see step 11).
18	SS -> MS	CP-ACK	Contains RP-ACK RPDU CM service type set to "Short message transfer". The one that acknowledges the CP-DATA which carried the RP-ACK RPDU. If CP-ACK received then continue at A22 If CP-ACK is not received within 5 s from the CM SERVICE REQUEST was sent in step 20 then goto step B22-1.
19	SS -> MS	CP-DATA	
20	MS -> SS	CM SERVICE REQUEST	
21	MS -> SS	CP-ACK	
Branch A A22	SS -> MS	CM SERVICE ACCEPT	
Branch B B22-1	SS->MS	CM SERVICE ACCEPT	This branch is chosen if the MS does not send a CP-ACK within 5 s of step 20.
B22-2 (optional)	MS->SS	CP-ACK	The one that acknowledges the CP-DATA which carried the RP-ACK RPDU
23	MS -> SS	CP-DATA	Contains RP-DATA RPDU (SMS SUBMIT TPDU). The Transaction Identifier used in steps 23, 24, 25 and 26 shall be z, where $z < y$ (see step 17).
24	SS -> MS	CP-ACK	Contains RP-ACK RPDU Shall be sent within 5 s of step 25 The main signalling link is released. MS shall respond to channel release with a layer 2 DISC frame with SAPI 0
25	SS -> MS	CP-DATA	
26	MS -> SS	CP-ACK	
27	SS -> MS	CHANNEL RELEASE	
28	MS -> SS	DISC (SAPI=0)	

Specific message contents:

SMS SUBMIT TPDU

Information element	Comment	Value
TP-MTI	SMS SUBMIT	'01'B
TP-VPF	not checked	
TP-RP	no reply path	'0'B
TP-UDHI	not checked	
TP-SRR	not checked	
TP-MR	not checked	
TP-RD	not checked	
TP-DA	not checked (an E164 number)	
TP-PID	not checked	
TP-DCS	not checked	
TP-VP	not checked	
TP-UDL	as applicable	
TP-UD (140 octets max.)	the user data consist of an arbitrarily chosen amount of octets	

34.2.9.2 MS in active mode

This test applies to MS supporting the ability of sending multiple short messages when there is a call in progress.

34.2.9.2.1 Conformance requirements

For a R99 or earlier MS only:

If another short message or a memory available notification is to be sent, an originating SMR entity in the UE may choose to continue to use the same RRC connection. When the MS chooses to use the same RR connection, then:

- the MS shall transmit a CM SERVICE REQUEST for the new CM connection before the final CP-ACK (e.g. the one that acknowledges the CP-DATA that carried the RP-ACK) for the old MM connection is transmitted;
- before transmission of the first CP-DATA on the new MM connection, the MS shall transmit the CP-ACK for the old MM connection;
- the Transaction Identifier used on the new MM connection shall be different to that used on the old MM connection; and
- the MS shall not initiate establishment of the new MM connection before the final CP-DATA (e.g. the one carrying the RP-ACK) has been received.

For a Rel-4 or later MS only:

In the case of a SMS transfer via the CS domain, when the UE chooses to use the same RR or CS signalling connection, then:

- the UE shall transmit a CM SERVICE REQUEST for the new CM connection before the final CP-ACK (i.e. the one that acknowledges the CP-DATA that carried the RP-ACK) for the old MM connection is transmitted;
- before transmission of the first CP-DATA on the new MM connection, the UE may transmit the CP-ACK for the old MM connection; the UE shall not transmit the final CP-ACK after the new CP-DATA;
- the Transaction Identifier used on the new MM connection shall be different to that used on the old MM connection; and
- the UE shall not initiate establishment of the new MM connection before the final CP-DATA (e.g. the one carrying the RP-ACK) has been received.

References

3GPP TS 03.40; subclause 3.1.

3GPP TS 04.11; subclause 5.4.

3GPP TS 04.13; subclause 5.6.

34.2.9.2.2 Test purpose

To verify that the MS is able to correctly send multiple short messages on the same RR connection when sent parallel to a call.

34.2.9.2.3 Method of test

Initial conditions

System simulator:

1 cell, default parameters.

Mobile Station:

The MS shall be in "Idle, updated" state.

The SMS message storage shall be empty.

Specific PICS Statements

- SMS messages are stored in the SIM (TSPC_AddInfo_StoreRcvSMSSIM).
- SMS messages are stored in the ME (TSPC_AddInfo_StoreRcvSMSME).

PIXIT Statements

- Description of how to enter multiple SMS.
- Description of the basic procedures to display a mobile originated short message.
- Support for state U10 of call control.

Foreseen final state of MS

Idle, updated.

Test procedure

- A data or speech call is established on a TCH with the SS and the state U10 of call control is entered. The MS is set up to send 3 short messages as multiple SM to the SS. After the reception of the CM SERVICE REQUEST, the SS sends a CM SERVICE ACCEPT message. The SS responds with a UA frame SAPI-3 to the SABM with SAPI-3 received from the MS.
- Steps c) to k) of the test procedure in subclause 34.2.9.1.3 are repeated.

Maximum duration of test

5 minutes.

Expected Sequence

Step	Direction	Message	Comments
1	SS		A data or speech call is established on a TCH and the state U10 of call control is entered.
2	MS		The MS is set up to send 3 short messages as multiple SM
3	MS -> SS	CM SERVICE REQUEST	Sent in a layer 2 frame on the FACCH. CM service type set to "short message transfer"
4	SS -> MS	CM SERVICE ACCEPT	
5	MS -> SS	SABM (SAPI=3)	Sent on SACCH associated with the TCH
6	SS -> MS	UA (SAPI=3)	
7	MS -> SS	CP-DATA	Contains RP-DATA RPDU (SMS SUBMIT TPDU). The Transaction Identifier used in steps 7, 8, 9 and 11 shall be x.
8	SS -> MS	CP-ACK	
9	SS -> MS	CP-DATA	Contains RP-ACK RPDU
10	MS -> SS	CM SERVICE REQUEST	Sent in a layer 2 frame on the FACCH. CM service type set to "short message transfer"
11	MS -> SS	CP-ACK	The one that acknowledges the CP-DATA which carried the RP-ACK RPDU. If CP-ACK received then continue at A12. If CP-ACK is not received within 5 s from the CM SERVICE REQUEST was sent in step 10 then goto step B12-1.
Branch A A12	SS -> MS	CM SERVICE ACCEPT	After having sent the CM SERVICE ACCEPT then goto step 13.
Branch B			
B12-1	SS->MS	CM SERVICE ACCEPT	This branch is chosen if the MS does not send a CP-ACK within 5 s of step 10.
B12-2 (optional)	MS->SS	CP-ACK	The one that acknowledges the CP-DATA which carried the RP-ACK RPDU.
13	MS -> SS	CP-DATA	Contains RP-DATA RPDU (SMS SUBMIT TPDU). The Transaction Identifier used in steps 13, 14, 15 and 17 shall be y where y <> x (see step 7).
14	SS -> MS	CP-ACK	

Step	Direction	Message	Comments
15	SS -> MS	CP-DATA	Contains RP-ACK RPDU
16	MS -> SS	CM SERVICE REQUEST	Sent in a layer 2 frame on the FACCH. CM service type set to "short message transfer"
17	MS -> SS	CP-ACK	The one that acknowledges the CP-DATA which carried the RP-ACK RPDU. If CP-ACK received then continue at A18 If CP-ACK is not received within 5 s from the CM SERVICE REQUEST was sent in step 16 then goto step B18-1.
Branch A A18	SS -> MS	CM SERVICE ACCEPT	After having sent the CM SERVICE ACCEPT then goto step 19.
Branch B			
B18-1	SS->MS	CM SERVICE ACCEPT	This branch is chosen if the MS does not send a CP-ACK within 5 s of step 16.
B18-2 (optional)	MS->SS	CP-ACK	The one that acknowledges the CP-DATA which carried the RP-ACK RPDU.
19	MS -> SS	CP-DATA	Contains RP-DATA RPDU (SMS SUBMIT TPDU). The Transaction Identifier used in steps 19, 20, 21 and 22 shall be z, where z <> y (see step 13).
20	SS -> MS	CP-ACK	Contains RP-ACK RPDU Shall be sent within 5.5 s (5 sec + 10% tolerance) of step 21
21	SS -> MS	CP-DATA	
22	MS -> SS	CP-ACK	
23	SS -> MS	CHANNEL RELEASE	The main signalling link is released.
24	MS -> SS	DISC (SAPI = 0)	MS shall respond to channel release with a layer 2 DISC frame with SAPI 0.

Specific Message Contents:

SMS SUBMIT TPDU

Information element	Comment Value
TP-MTI	SMS SUBMIT '01'B
TP-VPF	not checked
TP-RP	no reply path '0'B
TP-UDHI	not checked
TP-SRR	not checked
TP-MR	not checked
TP-RD	not checked
TP-DA	not checked (an E164 number)
TP-PID	not checked
TP-DCS	not checked
TP-VP	not checked
TP-UDL	as applicable
TP-UD (140 octets max.)	the user data consist of an arbitrarily chosen amount of octets

34.3 Short message service cell broadcast

This test applies to all MSs.

34.3.1 Conformance requirements

If the MS supports SMS-CB, it is responsible for recombination of the four blocks received via the radio path into a single block which constitutes the cell broadcast short message.

In idle mode, the MS listens to the BCCH and to the paging sub-channel for the paging group it belongs to. The MS is required to receive and analyse the paging messages and immediate assignment messages sent on the paging subchannel corresponding to its paging subgroup.

Reference

3GPP TS 03.41; clause 8.

3GPP TS 04.08 / 3GPP TS 44.018, subclauses 3.2.1 and 3.3.2.1.

34.3.2 Test purpose

This test verifies that an MS supporting SMS-CB is able to receive SMS-CB messages.

This test verifies that an MS is able to respond to a paging requested during the transmission of a cell broadcast short message.

34.3.3 Test method

Initial conditions

System Simulator:

1 cell, default parameters, except BS_PA_MFRMS = 2.

The SS provides a BCCH/CCCH to support the MS in idle mode.

Periodic location updating is disabled.

Mobile Station:

The MS shall be in the idle updated state.

Specific PICS Statements

-

PIXIT Statements

- Description of the basic procedures to display a cell broadcasted short message.

Foreseen Final State of MS

Idle, updated.

Test Procedure

- Three Cell Broadcast (CB) messages are sent by the SS on the CBCH with serial numbers 0,1,1.
- Step a) is repeated, but the SS pages the MS during the transmission of the second CB message. This shall be achieved by paging the MS immediately after the first block of the CB message has been sent. The SS shall ensure that the page is transmitted on the radio interface prior to the transmission of the 4th block of the CB message.

NOTE: The use of BS_PA_MFRMS = 2 ensures that this can be achieved irrespective of the IMSI.

The MS shall respond to the page.

Maximum Duration of Test

-

Expected Sequence

Since the SMS-CB messages are sent continuously, a table is not applicable in this test.

Specific Message Contents:

Cell broadcast test message content

Information element	Comment Value
Serial Number	"00"B
- Geographical scope	see test procedure
- Message code	"0000000000"B or "0000000001"B
- Update number	as applicable
Message identifier	"0"B
Data Coding Scheme	Default alphabet, English "00000001"B
Page parameter	"0001 0001"B
Contents of message	93 user characters using 93 different characters of default 7 bit coded alphabet

SYSTEM INFORMATION TYPE 4

As default except:

Information element	Value/remark
CBCH Channel Description	SDDCH/4 + SACCH/C4 or CBCH (SDDCH/4)
- Channel type and TDMA offset	time slot zero
- Timeslot number	5 (same as BCC)
- Training sequence code	Single RF channel
- Hopping channel	Channel number 263 (for GSM 450 MS) Channel number 310 (for GSM 480 MS) Channel number 20 (for GSM 900 MS) Channel number 590 (for DCS 1 800 and PCS 1 900 MS) Channel number 457 (for GSM 710, GSM 750 and T-GSM 810 MS) Channel number 147 (for GSM 850 MS)
-Channel selector	
CBCH Mobile Allocation	Not included

34.4 Short message service point to point over GPRS

34.4.1 SMS mobile terminated

34.4.1.1 Definition

34.4.1.2 Conformance requirements

An active MS shall be able to receive a short message TPDU (SMS-DELIVER) at any time, independently of whether or not there is a speech or data call in progress. A report shall always be returned to the SC; either confirming that the MS has received the short message, or informing the SC that it was impossible to deliver the short message TPDU to the MS, including the reason why.

References

3GPP TS 23.040 clauses 3.1, 9.2.3.16.

34.4.1.3 Test purpose

To verify the ability of a MS to receive and decode the SM where provided for the point to point service.

34.4.1.4 Method of test

Initial Conditions

- System simulator:
 - 1 cell, default parameters.
- Mobile Station:
 - the MS shall be in GMM-state "GMM-REGISTERED";

- the SMS message storage shall be empty.

Specific PICS Statements

- SMS messages are stored in the SIM (TSPC_AddInfo_StoreRcvSMSSIM).
- SMS messages are stored in the ME (TSPC_AddInfo_StoreRcvSMSME).

PIXIT Statements

- Support for session management state "PDP-ACTIVE".
- Maximum number of retransmissions of an unacknowledged CP-DATA message.

Test procedure

- The SS sends a CP-DATA message. The information element of the CP-DATA message will be RP-DATA RPDU (SMS DELIVER TPDU).
- The SS waits a maximum of 25 s for the CP-ACK message and then a maximum of 60 s for the CP-DATA message containing the RP-ACK RPDU.
- The SS sends a CP-ACK to the MS with no further CP-DATA messages.
- Steps a), b) and c) are repeated but the first CP-DATA message from the MS is not acknowledged. The second CP-DATA message from the MS is acknowledged by a CP-ACK.
- Steps a) and b) are repeated. The SS is configured not to send CP-ACK. Then maximum 3 CP-DATA retransmissions may occur. The SS check during 60 s that the MS does not send more than the maximum allowed (3) CP-DATA retransmissions.

- The SMS message store shall be cleared manually by the operator.

- A PDP context is established with the SS and the state PDP-ACTIVE of session management is entered.

The SS sends a CP-DATA message. The information element of the CP-DATA message will be RP-DATA RPDU (SMS DELIVER TPDU). The SS waits a maximum of 25 s for the CP-ACK message and then a maximum of 60 s for the CP-DATA message containing the RP-ACK RPDU.

- The SS sends a CP-ACK to the MS with no further CP-DATA. The SMS message store shall be cleared manually by the operator.
- Steps g) and h) are repeated but the first CP-DATA message from the MS is not acknowledged. The second CP-DATA message from the MS is acknowledged by a CP-ACK.

- Step g) is repeated. The SS is configured not to send CP-ACK. Then maximum 3 CP-DATA retransmissions may occur. The SS check during 60 s that the MS does not send more than the maximum allowed (3) CP-DATA retransmissions. (60 s the sufficient wait time while PDP context in progress).

- The SS initiates a PDP context deactivation (The PDP context deactivation is continued in parallel to the following exchange of messages related to SMS).

The SS sends a CP-DATA RPDU (SMS DELIVER TPDU) message. The information element of the CP-DATA message is RP-DATA.

The SS waits a maximum of 25 s for the CP-ACK message and then a maximum of 60 s for the CP-DATA message containing the RP-ACK RPDU.

The SS sends a CP-ACK to the MS with no further CP-DATA.

The SMS message store shall be cleared manually by the operator.

- A PDP context is established with the SS and the state PDP-ACTIVE of session management is entered. The PDP context shall be cleared from the MS. (The PDP context deactivating is continued in parallel to the following exchange of messages related to SMS).

The SS sends a CP-DATA message. The information element of the CP-DATA message is RP-DATA RPDU (SMS DELIVER TPDU).

The SS waits a maximum of 25 s for the CP-ACK message and then a maximum of 60 s for the CP-DATA message containing the RP-ACK RPDU.

The SS sends a CP-ACK to the MS with no further CP-DATA messages.

The SMS message store shall be cleared manually by the operator.

Expected sequence

Step	Direction	Message	Comments
1	MS <- SS	CP-DATA	Contains RP-DATA RPDU (SMS DELIVER TPDU) Waits max 25 s for CP-ACK Waits max 60 s for RP-ACK RPDU Contains RP-ACK RPDU There should be no further CP-DATA message. The MS shall indicate that an SM has arrived.
2	SS		
3	MS -> SS	CP-ACK	
4	SS		
5	MS -> SS	CP-DATA	
6	MS <- SS	CP-ACK	
7	MS		
8	MS		
9	MS <- SS	CP-DATA	Contains RP-DATA RPDU (SMS DELIVER TPDU) Waits max 25 s for CP-ACK Waits max 60 s for RP-ACK RPDU First CP-DATA from MS, contains RP-ACK RPDU First CP-DATA message not acknowledged by SS Retransmitted CP-DATA from MS, contains RP-ACK RPDU Second CP_DATA message is acknowledged There should be no further CP-DATA messages The MS shall indicate that an SM has arrived.
10	SS		
11	MS -> SS	CP-ACK	
12	SS		
13	MS -> SS	CP-DATA	
14	SS		
15	MS -> SS	CP-DATA	
16	MS <- SS	CP-ACK	
17	MS		
18	MS		
19	MS <- SS	CP-DATA	Contains RP-DATA RPDU (SMS DELIVER TPDU) Waits max 25 s for CP-ACK Waits max 60 s for RP-ACK RPDU Contains RP-ACK RPDU First CP-DATA message not acknowledged by SS Retransmitted CP-DATA from MS, contains RP-ACK RPDU Retransmitted CP-DATA message not acknowledged by SS Depending upon the maximum number of CP-DATA retransmissions implemented, step 25 and 26 may be repeated. The SS verifies within 60 s after the first CP-DATA message not acknowledged by SS that the MS does not retransmit more than the maximum allowed. The MS shall indicate that an SM has arrived.
20	SS		
21	MS -> SS	CP-ACK	
22	SS		
23	MS -> SS	CP-DATA	
24	SS		
25		CP-DATA	
26	SS		
27	MS		
28	MS		
29	MS		
30	MS, SS	{PDP Context Activation}	Macro. PDP context activation from the MS. Contains RP-DATA RPDU (SMS DELIVER TPDU) Waits max 25 s for CP-ACK Waits max 60 s for RP-ACK RPDU Contains RP-ACK RPDU Deactivates the existing PDP context. The MS shall indicate that an SM has arrived. Clear the SMS message store Macro. PDP context activation from the MS. Contains RP-DATA RPDU (SMS DELIVER TPDU)
31	MS <- SS	CP-DATA	
32	SS		
33	MS -> SS	CP-ACK	
34	SS		
35	MS -> SS	CP-DATA	
36	MS <- SS	CP-ACK	
37	MS <- SS	DEACTIVATE PDP CONTEXT REQUEST	
38	MS -> SS	DEACTIVATE PDP CONTEXT ACCEPT	
39	MS		
40	MS		
41	MS	{PDP Context Activation}	
42	MS <- SS	CP-DATA	

Step	Direction	Message	Comments
43	SS		Waits max 25 s for CP-ACK
44	MS -> SS	CP-ACK	
45	SS		Waits max 60 s for RP-ACK RPDU
46	MS -> SS	CP-DATA	First CP-DATA from MS, contains RP-ACK RPDU
47	SS		First CP-DATA message not acknowledged by SS
48	MS -> SS	CP-DATA	Retransmitted CP-DATA message, contains RP-ACK RPDU
49	MS <- SS	CP-ACK	Second CP-DATA message is acknowledged
50	MS <- SS	DEACTIVATE PDP CONTEXT REQUEST	Deactivates an existing PDP context.
51	MS -> SS	DEACTIVATE PDP CONTEXT ACCEPT	
52	MS		The MS shall indicate that an SM has arrived.
53	MS		Clear the SMS message store
54	MS	{PDP Context Activation}	Macro. PDP context activation from the MS.
55	MS <- SS	CP-DATA	Contains RP-DATA RPDU (SMS DELIVER TPDU)
56	SS		Waits max 25 s for CP-ACK
57	MS -> SS	CP-ACK	
58	SS		Waits max 60 s for RP-ACK RPDU
59	MS -> SS	CP-DATA	First CP-DATA from MS, contains RP-ACK RPDU
60	SS		First CP-DATA message not acknowledged by SS
61	MS -> SS	CP-DATA	Transmitted CP-DATA message, contains RP-ACK RPDU
62	SS		Retransmitted CP-DATA message not acknowledged by SS
63	MS		Depending on the maximum number of CP-DATA retransmissions implemented, step 61 and 62 may be repeated. The maximum number of retransmissions may however not exceed three.
64	MS		The SS verifies within 60 s after the last CP-DATA retransmission that the MS does not retransmit more than the maximum allowed.
65	MS		The MS shall indicate that an SM has arrived.
66	MS		Clear the SMS message store
67	MS <- SS	CP-DATA	Contains RP-DATA RPDU (SMS DELIVER TPDU)
68	MS <- SS	DEACTIVATE PDP CONTEXT REQUEST	The PDP context is deactivated by the SS. The PDP context deactivating is continued in parallel to the following exchange of messages related to SMS.
69	MS -> SS	DEACTIVATE PDP CONTEXT ACCEPT	This message may be transmitted after this step timing.
70	SS		Waits max 25 s for CP-ACK
71	MS -> SS	CP-ACK	
72	SS		Waits max 60 s for RP-ACK RPDU
73	MS -> SS	CP-DATA	Contains RP-ACK RPDU
74	MS <- SS	CP-ACK	
75	MS		The MS shall indicate that an SM has arrived.
76	MS		Clear the SMS message store
77	MS	{PDP Context Activation}	Macro. PDP context activation from the MS.
78	MS -> SS	DEACTIVATE PDP CONTEXT REQUEST	The PDP context is deactivated by the MS. The PDP context deactivation is continued in parallel to the following
79	MS <- SS	CP-DATA	Contains RP-DATA RPDU (SMS DELIVER TPDU)
80	MS <- SS	DEACTIVATE PDP CONTEXT ACCEPT	
81	SS		Waits max 25 s for CP-ACK
82	MS -> SS	CP-ACK	
83	SS		Waits max 60 s for RP-ACK RPDU
84	MS -> SS	CP-DATA	Contains RP-ACK RPDU
85	MS <- SS	CP-ACK	
86	MS		The MS shall indicate that an SM has arrived.
87	MS		Clear the SMS message store
NOTE: Time values for SS wait time are chosen sufficiently high to be sure that the MS has enough time to respond to the different messages.			

Specific Message Contents

SMS DELIVER TPDU (not containing a type 0 message)

Information element	Comment Value
TP-PID	Different from Type 0: "01000000"B
TP-UDL	160
TP-UD (140 octets)	text of message (160 characters)
NOTE: The 160 characters in TP-UD shall include at least one occurrence of each character in the default alphabet (see 3GPP TS 23.038, clause 6.2.1).	

34.4.2 SMS mobile originated

34.4.2.1 Definition

34.4.2.2 Conformance requirements

A GPRS MS shall be able to submit short message TPDU (SMS-SUBMIT) at any time, independently of whether or not there is a PDP context in progress.

References

3GPP TS 24.011 clause 5.3.2.2.

3GPP TS 23.040 clause 3.1, 9.2.3.16.

34.4.2.3 Test purpose

To verify that a GPRS MS is able to correctly send a short message where the SMS is provided for the point to point service.

34.4.2.4 Method of test

Initial Conditions

- System simulator:
 - 1 cell, default parameters.
- Mobile Station:
 - the MS shall be in GMM-state "GMM-REGISTERED";
 - the SMS message storage shall be empty.

Specific PICS Statements

- Support of SMS over GPRS.
- SMS messages are stored in the SIM (TSPC_AddInfo_StoreRcvSMSSIM).
- SMS messages are stored in the ME (TSPC_AddInfo_StoreRcvSMSME).

PIXIT Statements

- Support for state PDP-ACTIVE of session management.
- Maximum number of retransmissions of an unacknowledged CP-DATA message.

Test procedure

- a) The MS shall be set up to send a short message to the SS. The SS responds to the CP-DATA containing RP-DATA RPDU (SMS SUBMIT TPDU) from the MS with a CP-ACK message followed by a CP-DATA message containing the correct RP-ACK RPDU. The SS waits a maximum of 25 s for CP-ACK message.

- b) The MS shall be set up to send a short message to the SS. This time the SS will not acknowledge the CP-DATA containing RP-DATA RPDU (SMS SUBMIT TPDU) from the MS. The MS retransmits the CP-DATA message. Now, the CP-DATA message will be acknowledged by a CP-ACK from the SS, followed by a CP-DATA message containing the correct RP-ACK RPDU. The SS waits a maximum of 25 s for CP-ACK message.
- c) The MS shall be set up to send a short message to the SS. The SS is configured not to send any CP-ACK to acknowledge the CP-DATA containing RP-DATA RPDU (SMS SUBMIT TPDU) from the MS. Then maximum 3 CP-DATA retransmissions may occur. Following the last CP-DATA retransmission from the MS, the SS checks that the MS does not retransmit more than the maximum allowed.
- d) The MS shall be set up to send a short message to the SS. On receipt of the CP-DATA containing RP-DATA RPDU (SMS SUBMIT TPDU) from the MS, the SS sends a CP-ERROR message containing a "Network Failure" cause. The SS verifies within 60 seconds that the MS does not re-send any CP-DATA messages.
- e) A PDP context is established with the SS and the state PDP-ACTIVE of session management is entered. The MS shall be set up to send a short message to the SS. The SS responds to the CP-DATA containing RP-DATA RPDU (SMS SUBMIT TPDU) from the MS with a CP-ACK message followed by a CP-DATA message containing the correct RP-ACK RPDU. The SS waits a maximum of 25 s for CP-ACK message.
- f) The MS shall be set up to send a short message to the SS. The SS is configured not to send CP-ACK to acknowledge the CP-DATA containing RP-DATA RPDU (SMS SUBMIT TPDU) from the MS. The MS retransmits the CP-DATA message. Now, the CP-DATA message will be acknowledged by a CP-ACK from the SS, followed by a CP-DATA message containing the correct RP-ACK RPDU. The SS waits a maximum of 25 s for CP-ACK message.
- g) The MS shall be set up to send a short message to the SS. The SS is configured not to send any CP-ACK to acknowledge the CP-DATA containing RP-DATA RPDU (SMS SUBMIT TPDU) from the MS. Then maximum 3 CP-DATA retransmissions may occur. Following the last CP-DATA retransmission from the MS, the SS checks that the MS does not retransmit more than the maximum allowed.
- h) The MS shall be set up to send a short message to the SS. On receipt of the CP-DATA containing RP-DATA RPDU (SMS SUBMIT TPDU) from the MS, the SS sends a CP-ERROR message containing a "Network Failure" cause. The SS verifies that within 60 seconds the MS does not re-send any CP-DATA messages.
- i) The MS shall be set up to send a short message to the SS. On receipt of the CP-DATA containing RP-DATA RPDU (SMS SUBMIT TPDU) from the MS, the SS requests the deactivation of the previously active PDP context by sending DEACTIVATE PDP CONTEXT REQUEST, the MS responds with DEACTIVATE PDP CONTEXT ACCEPT. The SS responds with a CP-ACK message followed by a CP-DATA message containing the correct RP-ACK RPDU. The SS waits a maximum of 25 s for CP-ACK message.
- j) A PDP context is established with the SS and the state PDP-ACTIVE of session management is entered. The MS shall be set up to send a short message to the SS. On receipt of the CP-DATA containing RP-DATA RPDU (SMS SUBMIT TPDU) from the MS, the SS requests the deactivation of the previously active PDP context by sending DEACTIVATE PDP CONTEXT REQUEST, the MS responds with DEACTIVATE PDP CONTEXT ACCEPT. This time the SS will not acknowledge the CP-DATA containing RP-DATA RPDU (SMS SUBMIT TPDU) from the MS. The MS retransmits the CP-DATA message. Now, the CP-DATA message will be acknowledged by a CP-ACK from the SS, followed by a CP-DATA message containing the correct RP-ACK RPDU. The SS waits a maximum of 25 s for CP-ACK message.
- k) A PDP context is established with the SS and the state PDP-ACTIVE of session management is entered. The MS shall be set up to send a short message to the SS. On receipt of the CP-DATA containing RP-DATA RPDU (SMS SUBMIT TPDU) from the MS, the SS requests the deactivation of the previously active PDP context by sending DEACTIVATE PDP CONTEXT REQUEST, the MS responds with DEACTIVATE PDP CONTEXT ACCEPT. The SS is configured not to send any CP-ACK to acknowledge the CP-DATA containing RP-DATA RPDU (SMS SUBMIT TPDU) from the MS. Then maximum 3 CP-DATA retransmissions may occur. Depending on the maximum number of automatic repeat, MO SMS sending may be repeated. Following the last CP-DATA retransmission from the MS, the SS checks that the MS does not retransmit more than the maximum allowed.

Expected sequence

Step	Direction	Message	Comments
1	MS		The MS is set up to send an SM.
2	MS → SS	CP-DATA	Contains RP-DATA RPDU (SMS SUBMIT TPDU).
3	SS → MS	CP-ACK	
4	SS → MS	CP-DATA	Contains RP-ACK RPDU.
5	SS		Wait max 25 s for CP-ACK.
6	MS → SS	CP-ACK	
7	MS		The MS is set up to send an SM.
8	MS → SS	CP-DATA	Contains RP-DATA RPDU (SMS SUBMIT TPDU).
9	SS		SS configured not to send CP-ACK.
10	MS → SS	CP-DATA	Retransmitted CP-DATA from MS.
11	SS → MS	CP-ACK	
12	SS → MS	CP-DATA	Contains RP-ACK RPDU.
13	SS		Wait max 25 s for CP-ACK.
14	MS → SS	CP-ACK	
15	MS		The MS is set up to send an SM.
16	MS → SS	CP-DATA	Contains RP-DATA RPDU (SMS SUBMIT TPDU).
17	SS		SS configured not to send any CP-ACK.
18	MS → SS	CP-DATA	Retransmitted CP-DATA from MS.
19	MS		Depending upon the maximum number of CP-DATA retransmissions implemented, step 18 may be repeated. The maximum number of retransmissions shall however not exceed three.
20	SS		The SS verifies within 60 s after the first CP-DATA message not acknowledged by SS that the MS does not retransmit more than the maximum allowed.
21	MS		The MS is set up to send an SM.
22	MS → SS	CP-DATA	Contains RP-DATA RPDU (SMS SUBMIT TPDU).
23	SS → MS	CP-ERROR	Containing "Network Failure" cause.
24			The SS verifies within 60 s after step 22 that the MS does not re-send any CP-DATA messages.
25	MS		A PDP context is established with the SS and the state PDP-ACTIVE of session management is entered.
26	MS		The MS is set up to send an SM.
27	MS → SS	CP-DATA	Contains RP-DATA RPDU (SMS SUBMIT TPDU).
28	SS → MS	CP-ACK	
29	SS → MS	CP-DATA	Contains RP-ACK RPDU.
30	SS		Wait max 25 s for CP-ACK.
31	MS → SS	CP-ACK	
32	MS		The MS is set up to send an SM.
33	MS → SS	CP-DATA	Contains RP-DATA RPDU (SMS SUBMIT TPDU).
34	SS		SS configured not to send CP-ACK.
35	MS → SS	CP-DATA	Retransmitted CP-DATA from MS.
36	SS → MS	CP-ACK	
37	SS → MS	CP-DATA	Contains RP-ACK RPDU.
38	SS		Wait max 25 s for CP-ACK.
39	MS → SS	CP-ACK	
40	MS		The MS is set up to send an SM.
41	MS → SS	CP-DATA	Contains RP-DATA RPDU (SMS SUBMIT TPDU).
42	SS		SS configured not to send any CP-ACK.
Step	Direction	Message	Comments
43	MS → SS	CP-DATA	Retransmitted CP-DATA from MS.

44	MS		Depending upon the maximum number of CP-DATA retransmissions implemented, step 43 may be repeated. The maximum number of retransmissions shall however not exceed three.
45	SS		The SS verifies within 60 s after the first CP-DATA message not acknowledged by SS that the MS does not retransmit more than the maximum allowed.
46	MS		The MS is set up to send an SM.
47	MS → SS	CP-DATA	Contains RP-DATA RPDU (SMS SUBMIT TPDU).
48	SS → MS	CP-ERROR	Containing "Network Failure" cause.
49			The SS verifies within 60 s after step 47 that the MS does not re-send any CP-DATA messages.
50	MS		The MS is set up to send an SM.
51	MS → SS	CP-DATA	Contains RP-DATA RPDU (SMS SUBMIT TPDU).
52	SS → MS	DEACTIVATE PDP CONTEXT REQUEST	The PDP context is deactivated by the SS. The PDP context deactivation is continued in parallel to the following exchange of messages related to SMS.
53	MS → SS	DEACTIVATE PDP CONTEXT ACCEPT	
54	SS → MS	CP-ACK	
55	SS → MS	CP-DATA	Contains RP-ACK RPDU.
56	SS		Wait max 25 s for CP-ACK.
57	MS → SS	CP-ACK	
58	MS		A PDP context is established with the SS and the state PDP-ACTIVE of session management is entered.
59	MS		The MS is set up to send an SM.
60	MS → SS	CP-DATA	Contains RP-DATA RPDU (SMS SUBMIT TPDU).
61	SS → MS	DEACTIVATE PDP CONTEXT REQUEST	The PDP context is deactivated by the SS. The PDP context deactivation is continued in parallel to the following exchange of messages related to SMS.
62	MS → SS	DEACTIVATE PDP CONTEXT ACCEPT	
63	SS		SS configured not to send CP-ACK.
64	MS → SS	CP-DATA	Retransmitted CP-DATA from MS.
65	SS → MS	CP-ACK	
66	SS → MS	CP-DATA	Contains RP-ACK RPDU.
67	SS		Wait max 25 s for CP-ACK.
68	MS → SS	CP-ACK	
69	MS		A PDP context is established with the SS and the state PDP-ACTIVE of session management is entered.
70	MS		The MS is set up to send an SM.
71	MS → SS	CP-DATA	Contains RP-DATA RPDU (SMS SUBMIT TPDU).
72	SS → MS	DEACTIVATE PDP CONTEXT REQUEST	The PDP context is deactivated by the SS. The PDP context deactivation is continued in parallel to the following exchange of messages related to SMS.
73	MS → SS	DEACTIVATE PDP CONTEXT ACCEPT	
74	SS		SS configured not to send any CP-ACK.
Step	Direction	Message	Comments
75	MS → SS	CP-DATA	Retransmitted CP-DATA from MS.

76	MS		Depending upon the maximum number of CP-DATA retransmissions implemented, step 75 may be repeated. The maximum number of retransmissions shall however not exceed three.
77	SS		
NOTE: Time values for SS wait times are chosen sufficiently high to be sure that the MS has enough time to respond to the different messages.			

Specific Message Contents

None.

34.4.3 Test of the status report capabilities and of SMS-COMMAND over GPRS:

This test applies to MSs which support the status report capabilities.

34.4.3.1 Definition

34.4.3.2 Conformance requirement

The SMS offers the SC the capabilities of informing the MS of the status of a previously sent mobile originated short message. This is achieved by the SC returning a status report TPDU (SMS-STATUS-REPORT) to the originating MS.

SMS-COMMAND enables an MS to invoke an operation at the SC.

The MS shall increment TP-MR by 1 for each SMS-SUBMIT or SMS-COMMAND being submitted.

References

- 3GPP TS 23.040 clauses 3.2.9 and 9.2.3.6.

34.4.3.3 Test purpose

- 1) To verify that the MS is able to accept a SMS-STATUS-REPORT TPDU.
- 2) To verify that the MS is able to use the SMS-COMMAND functionality correctly and sends an SMS-COMMAND TPDU with the correct TP-Message-Reference.

34.4.3.4 Method of test

Initial conditions

- System Simulator:
 - 1 cell, default parameters.
- Mobile Station:
 - the MS shall be in GMM-state "GMM-REGISTERED".

Specific PICS Statements

-

PIXIT Statements

-

Test procedure

- a) The MS is made to send a Mobile Originated short message.

- b) The SS sends a CP-DATA message containing a RP-DATA RPDU itself containing an SMS-STATUS-REPORT TPDU.
- c) The MS is made to send an SMS-COMMAND message enquiring about the previously submitted short message.
- d) The SS acknowledges the CP-DATA message from the MS with a CP-ACK followed by a CP-DATA message containing an RP-ACK RPDU.
- e) The MS is made to send an SMS-COMMAND message requiring to delete the previously submitted short message.

Expected sequence

Step	Direction	Message	Comments
1	MS → SS	CP-DATA	Contains RP-DATA RPDU (SMS SUBMIT TPDU) Contains RP-ACK RPDU Waits max 25 s for CP-ACK
2	SS → MS	CP-ACK	
3	SS → MS	CP-DATA	
4	SS		
5	MS → SS	CP-ACK	
6	SS → MS	CP-DATA	Contains RP-DATA RPDU (SMS-STATUS-REPORT TPDU) Contains RP-ACK RPDU
7	MS → SS	CP-ACK	
8	MS → SS	CP-DATA	
9	SS → MS	CP-ACK	
10	MS		The MS is made to send an SMS-COMMAND message enquiring about the previously submitted SM Contains RP-DATA RPDU (SMS-COMMAND TPDU) which shall contain the correct TP-MR Contains RP-ACK RPDU
11	MS → SS	CP-DATA	
12	SS → MS	CP-ACK	
13	SS → MS	CP-DATA	
14	MS → SS	CP-ACK	The MS is made to send an SMS-COMMAND message requiring to delete the previously submitted SM. Contains RP-DATA RPDU (SMS-COMMAND TPDU) which shall contain the correct TP-MR Contains RP-ACK RPDU
15	MS		
16	MS → SS	CP-DATA	
17	SS → MS	CP-ACK	
18	SS → MS	CP-DATA	
19	MS → SS	CP-ACK	

Specific Message Contents

SMS SUBMIT TPDU

Information element	Comment Value
TP-SRR	status report is requested "1"B

SMS-STATUS-REPORT TPDU (SS to MS in step 6):

Information element	Comment Value
TP-MR	same as previous SMS-SUBMIT
TP-MMS	no more messages "1"B
TP-SRQ	result of SMS-SUBMIT "0"B
TP-RA	same as the Destination address of the SMS-SUBMIT
TP-ST	SM received "00000000"B

First SMS-COMMAND TPDU (MS to SS in step 10)

Information element	Comment Value
TP-MR	TP-MR in previous SMS-SUBMIT plus "1"
TP-SRR	status report requested "1"B
TP-CT	Enquiry relating to previously submitted short message "00000000"B
TP-MN	not checked (TP-MR in previous SMS-SUBMIT)

Second SMS-COMMAND TPDU (MS to SS in step 15)

Information element	Comment Value
TP-MR	TP-MR in previous SMS-COMMAND plus "1"
TP-CT	Delete previously submitted short message "00000010"B
TP-MN	not checked (TP-MR in previous SMS-SUBMIT)

34.4.4 Test of capabilities of simultaneously receiving a short message whilst sending a mobile originated short message

34.4.4.1 Definition

34.4.4.2 Conformance requirements

An active MS shall be able to receive a short message TPDU (SMS-DELIVER) at any time, independently of whether or not there is an SMS mobile originated call (SMS-SUBMIT or SMS-COMMAND) in progress.

Reference(s):

3GPP TS 03.40 / 3GPP TS 23.040 clause 3.1, 9.2.3.16.

3GPP TS 04.11 / 3GPP TS 24.011 clause 3.2.

34.4.4.3 Test purpose

The test verifies that the MS is capable of simultaneously receiving a network originated SM whilst sending a mobile originated SM.

34.4.4.4 Method of test

Initial Conditions

System Simulator:

- 1 cell, default parameters.

Mobile Station:

- the MS shall be in GMM-state "GMM-REGISTERED";
- the SMS message storage shall be empty.

Specific PICS Statements

-

PIXIT Statements

Test procedure

The MS is triggered to send an SM to the SS. Upon the reception of the CP-DATA, the SS sends an SM to the MS.

The MS shall use the correct transaction identifiers and correctly receive the SM and indicate that a message has arrived.

Expected sequence

Step	Direction	Message	Comments
1	MS		The MS is triggered to send an SM.
2	MS -> SS	CP-DATA	Contains RP-DATA RPDU (SMS SUBMIT TPDU)
3	SS		The SS sends an SM to the MS triggered by the end of the CP-DATA message from the MS
4	MS <- SS	CP-DATA	Contains RP-DATA RPDU (SMS DELIVER TPDU)
5	MS -> SS	CP-ACK	
6	MS -> SS	CP-DATA	Contains RP-ACK RPDU
7	MS <- SS	CP-ACK	
8	MS <- SS	CP-ACK	
9	MS <-SS	CP-DATA	Contains RP-ACK RPDU
10	MS -> SS	CP-ACK	

Specific Message Contents

None.

34.4.5 Void

34.4.6 Concatenated MO SMS over GPRS

Concatenation allows short messages to be concatenated to form a longer message.

34.4.6.1 Conformance requirement

This facility allows short messages to be concatenated to form a longer message.

The Information-Element-Data field contains information set by the application in the SMS-SUBMIT so that the receiving entity is able to re-assemble the short messages in the correct order. Each concatenated short message contains a reference number, which together with the originating address and Service Centre address allows the receiving entity to discriminate between concatenated short messages sent from different originating SMEs and/or SCs

References

3GPP TS 23.040 Clause 9.2.3.24.1

34.4.6.2 Test purpose

To verify that MS is able to send longer messages (user data exceeding 140 octets) using concatenation feature.

34.4.6.3 Method of test

Initial conditions

System Simulator:

1 cell, default parameters

Mobile Station:

The MS shall be in GMM-state "GMM-REGISTERED"

Specific PICS Statements

-

PIXIT Statements

-

Test procedure

- a) The MS is made to send a short message with user data exceeding 140 octets

- b) Repeat steps c) to e) for $n=1..N$; N is the total number of segments in SM triggered in step a)
- c) MS sends CP-DATA containing RP-DATA with "TP User Data" as n th segment of SM
- d) The SS responds to the CP-DATA in step c) with a CP-ACK message followed by a CP-DATA message containing the correct RP-ACK RPDU
- e) The SS waits a maximum of 25 s for CP-ACK message
- f) Check for 60 s that no CP-DATA is received from the MS.

Maximum Duration of Test

-

Expected sequence

Step	Direction	Message	Comments
1	MS		MS is setup to send SM with user data exceeding 140 octets
2	MS → SS	CP-DATA	Repeat steps 2 to 6 for $n = 1..N$ Contains RP-DATA with "TP User Data" as n th segment of SM. See specific message contents below
3	SS → MS	CP-ACK	
4	SS → MS	CP-DATA	Contains RP-ACK RPDU
5	SS		Waits max 25 s for CP-ACK
6	MS → SS	CP-ACK	Depends on the MS implementation if the CP-ACK is received.
(Optional) 7	SS		Check for 60 s that no CP-DATA is received from the MS.

Specific Message Contents

TP USER DATA (8 bits / 16 bits concatenation reference numbers) in step 2

Information element	Comment Value
UDHL	05 (8 bits) / 06 (16 bits)
IEI	00 (8 bits) / 08 (16 bits)
IEI-Length	03 (8 bits) / 04 (16 bits)
IEI Data	
MR	M , any value between 0 to 255 (8 bits) / 65535 (16 bits)
MAX SEGMENT COUNT	N , Total number of segments
SEQUENCE NUMBER	n , segment number
TP-UD (<=134 (8 bit) / 133 (16 bit) octets)	User data in n th segment of SM

34.4.7 Concatenated MT SMS over GPRS

Concatenation allows short messages to be concatenated to form a longer message

34.4.7.1 Conformance requirement

This facility allows short messages to be concatenated to form a longer message.

The Information-Element-Data field contains information set by the application in the SMS-DELIVER so that the receiving entity is able to re-assemble the short messages in the correct order. Each concatenated short message contains a reference number, which together with the originating address and Service Centre address allows the receiving entity to discriminate between concatenated short messages sent from different originating SMEs and/or SCs

The TP elements in the SMS-DELIVER PDU, apart from TP-UDL and TP-UD, should remain unchanged for each SM that forms part of a concatenated SM; otherwise this may lead to irrational behavior.

References

3GPP TS 23.040 Clause 9.2.3.24.1

34.4.7.2 Test purpose

To verify that MS is able to combine concatenated message segments to form a long message.

34.4.7.3 Method of test

Initial conditions

System Simulator:

1 cell, default parameters

Mobile Station:

The MS shall be in GMM-state "GMM-REGISTERED"

The SMS message storage shall be empty.

Specific PICS Statements

-

PIXIT Statements

-

Test procedure

- a) Repeat steps b) to d) for $n= 1..N$; N is the total number of segments in SM
- b) The SS sends a CP-DATA message. The information element of the CP-DATA message will be RP-DATA (SMS DELIVER TPDU) with "TP User Data" as the n th segment of SM
- c) The SS waits a maximum of 25 s for the CP-ACK message and then a maximum of 60 s for the CP-DATA message containing the RP-ACK RPDU.
- d) The SS sends a CP-ACK to the MS.

Maximum Duration of Test

-

Expected sequence

Step	Direction	Message	Comments
1	SS → MS	CP-DATA	Repeat steps 1 to 4 for $n = 1..N$ RP-DATA with "TP User Data" as the n th segment of SM Wait for CP-ACK for 25 s Waits max 60 s for RP-ACK RPDU SS prompts operator to verify stored long message
2	MS → SS	CP-ACK	
3	MS → SS	CP-DATA	
4	SS → MS	CP-ACK	
5	MS		

Specific Message Contents

TP USER DATA in step 1

Information element	Comment Value
UDHL	05
IEI	00
IEI-Length	03
IEI Data	
MR	00
MAX SEGMENT COUNT	N , Total number of segments
SEQUENCE NUMBER	n , segment number
TP-UD (<=134 octets)	user data equal to 134 octets for $n = 1, N-1$ and user data less than or equal to 134 octets for $n = N$

34.4.8 Short Messaging Service – Handling of unknown, unforeseen, and erroneous protocol data

34.4.8.1 CP Error Handling

34.4.8.1.1 Conformance requirements

- a) The Mobile Station shall ignore a CP message (CP-DATA, CP-ACK, CP-ERROR) received with TI value "111".
 - b) Whenever a CP-ACK message is received specifying a Transaction Identifier which is not associated with an active SM transfer, the mobile station shall discard the message and return a CP-ERROR message with cause #81, "Invalid Transaction Identifier" using the received Transaction Identifier, if an appropriate connection exists
 - c) The Mobile Station shall ignore a CP-ERROR message that is received specifying a Transaction Identifier, which is not associated with an active SM transfer.
 - d) The Mobile Station shall ignore a CP-DATA message that is received specifying a Transaction Identifier which is not associated with an active SM transfer and with transaction identifier flag set to "1".
 - e) If the Mobile Station receives a message with message type not defined for the PD or not implemented by the receiver, it shall ignore the message and return a CP-ERROR message with cause #97 "message type non-existent or not implemented", if an appropriate connection exists.
 - f) If the Mobile Station receives a message not consistent with the protocol state, the Mobile Station shall ignore the message and return a CP-ERROR message with cause #98 "Message type not compatible with the short message protocol state", if an appropriate connection exists.
 - g) When on receipt of a message:
 - h) an "imperative message part" error; or
 - a "missing mandatory IE" error.
- is diagnosed or when a message containing a syntactically incorrect mandatory IE is received, the mobile station shall proceed as follows.
- When the corresponding SM transfer is not seen as successfully transferred, i.e. the transaction is not completed, the mobile station shall ignore the message and return a CP-ERROR message with cause #96 "invalid mandatory information", if an appropriate connection exists.

Reference

3GPP TS 24.011 clause 9.2

34.4.8.1.2 Test purpose

- a) To Verify that MS ignores CP-DATA message with TI value "111".
- b) To verify that MS ignores CP-ACK message with TI value not associated with active SMS transfer and sends CP-ERROR with cause # 81
- c) To verify that MS ignores CP-ERROR with TI value not associated with active SMS transfer
- d) To verify MS response when received CP-DATA with TI value not associated with active SMS transfer and "TI" flag set to '1'B
- e) To verify that MS ignores a message with "message type" not defined for the PD '1001'B and returns CP-ERROR with cause#97
- f) To verify that MS ignores a message not consistent with protocol state and returns CP-ERROR with cause#98
- g) To Verify that MS ignores CP-DATA with "missing mandatory IE" and returns CP-ERROR with cause#96 when the corresponding SM transaction is not completed

34.4.8.1.3 Method of test

Initial Conditions

System simulator:

1 cell, default parameters

Mobile Station:

The MS shall be in GMM-state "GMM-REGISTERED"

Specific PICS Statements

-

PIXIT Statements

-

Test procedure

- a) The SS sends CP-DATA with TI value '111'B. Check for no response from MS for 60 s.
- b) The MS shall be set up to send a short message to the SS. The MS sends CP-DATA containing RP-DATA (SMS SUBMIT PDU). SS send CP-ACK with TI value different from the TI value in CP-DATA received from MS. MS sends CP-ERROR with cause #81 (Invalid Transaction Identifier).
- c) The MS shall be set up to send a short message to the SS. The MS sends CP-DATA containing RP-DATA (SMS SUBMIT PDU). SS send CP-ERROR with TI value different from the TI value in CP-DATA received from MS. SS sends CP-ACK and then CP-DATA containing RP-ACK. The SS waits a maximum of 25 s for the CP-ACK message.
- d) The MS shall be set up to send a short message to the SS. The MS sends CP-DATA containing RP-DATA (SMS SUBMIT PDU). SS sends CP-ACK and then sends CP-DATA with TI value different from the TI value in CP-DATA received from MS. MS shall not send CP-ACK.
- e) SS sends a message with PD value '1001'B and message type '00000010'B. MS sends CP-ERROR with cause #97 (Message type non-existent or not implemented).
- f) The MS shall be set up to send a short message to the SS. MS sends CP-DATA (SMS SUBMIT PDU). SS sends CP-ACK twice. MS sends CP-ERROR with cause #98 (Message type not compatible with the short message protocol state)
- g) The MS shall be set up to send a short message to the SS. MS sends CP-DATA (SMS SUBMIT PDU). SS sends CP-ACK and then sends CP-DATA with "CP-User data" IE missing. MS sends a CP-ERROR message with cause #96 ("invalid mandatory information").

Maximum Duration of Test

10 min

Expected sequence

Step	Direction	Message	Comments
1	SS → MS	CP-DATA	With TI value set to '111'B.
2	SS		Check for no response from the MS for 60 s
3	MS		The MS is set up to send an SM
4	MS → SS	CP-DATA	Containing RP-DATA (SMS SUBMIT PDU)
5	SS → MS	CP-ACK	With TI value different from CP-DATA in step 4.
6	MS → SS	CP-ERROR	Cause #81
			Complete the transaction initiated by MS.
7	MS		The MS is set up to send an SM
8	MS → SS	CP-DATA	Containing RP-DATA (SMS SUBMIT PDU)
9	SS → MS	CP-ERROR	With TI value different from CP-DATA in step 8.
10	SS → MS	CP-ACK	
11	SS → MS	CP-DATA	Containing RP-ACK
12	SS		Wait 25 s for CP-ACK.
13	MS → SS	CP-ACK	
14	MS		The MS is set up to send an SM
15	MS → SS	CP-DATA	Containing RP-DATA (SMS SUBMIT PDU)
16	SS → MS	CP-ACK	
17	SS → MS	CP-DATA	With TI different from CP-DATA in step 15 and containing RP-ACK
18	SS		Check for no CP-ACK within 25 s
			Complete the transaction initiated by MS.
19	SS → MS	CP-Message	Message type '00000010'B and PD '1001'B
20	MS → SS	CP-ERROR	Cause #97
21	MS		The MS is set up to send an SM
22	MS → SS	CP-DATA	Containing RP-DATA (SMS SUBMIT PDU)
23	SS → MS	CP-ACK	
24	SS → MS	CP-ACK	
25	MS → SS	CP-ERROR	Cause #98
			Complete the transaction initiated by MS.
26	MS		The MS is set up to send an SM
27	MS → SS	CP-DATA	Containing RP-DATA (SMS SUBMIT PDU)
28	SS → MS	CP-ACK	
29	SS → MS	CP-DATA	With TI flag set to '1'B, TI value same as the TI value of CP-DATA in step 27 and Missing "CP-User-Data" IE.
30	MS → SS	CP-ERROR	Cause#96
			Complete the transaction initiated by MS.

Specific Message Contents

None

34.4.8.2 RP Error Handling

34.4.8.2.1 Conformance Requirement

- a) Whenever any RP-ACK message is received specifying a Message Reference which is not associated with an active SM transfer, the mobile station shall discard the message and return an RP-ERROR message with cause #81, "Invalid short message transfer reference value" using the received Message Reference, if an appropriate connection exists.
- b) When an RP-ERROR message is received specifying a Message Reference, which is not associated with an active SM transfer, the mobile station shall discard the message.
- c) If the Mobile Station receives a RP-message indicating a value of the message type indicator (MTI) defined as reserved, it shall ignore the message and return an RP-ERROR message with cause #97 "message type non-existent or not implemented", if an appropriate connection exists.
- d) If the Mobile Station receives a message (except RP-ERROR) not consistent with the protocol state, the Mobile Station shall ignore the message and return a RP-ERROR message with cause #98 "Message type not compatible with Short Message protocol state", if an appropriate connection exists.

- e) If the Mobile Station receives an RP-ERROR message not consistent with the protocol state, the Mobile Station shall ignore the message.
- f) When on receipt of a message:
 - an "imperative message part" error; or
 - a "missing mandatory IE" error;
 is diagnosed or when a message containing a syntactically incorrect mandatory IE is received, the mobile station shall (except for the case of a reserved value of the MTI as defined above) proceed as follows:
 - when the message is an RP-DATA or RP-ACK, the mobile station shall ignore the message and return an RP-ERROR message with cause #96 "invalid mandatory information", if an appropriate connection exists.

Reference

3GPP TS 24.011 clause 9.3

34.4.8.2.2 Test Purpose

- a) To verify that MS ignores RP-ACK with message reference which is not associated with active SM transfer and sends RP-ERROR with cause #81, "Invalid short message transfer reference value"
- b) To verify that MS ignores RP-ERROR with message reference which is not associated with active SM transfer
- c) To verify that MS ignores a RP-message with reserved MTI value and sends RP-ERROR with cause #97 "message type non-existent or not implemented"
- d) To verify that MS ignores the RP-ACK when SMR is in idle state and sends RP-ERROR with cause #98 "Message type not compatible with Short Message protocol state"
- e) To verify that MS ignores RP-ERROR when SMR is in idle state
- f) To verify that MS ignores RP-DATA with "missing mandatory IE" and sends RP-ERROR with cause #96, "Invalid mandatory information"

34.4.8.2.3 Method of test

Initial Conditions

System simulator:

1 cell, default parameters

Mobile Station:

The MS shall be in GMM-state "GMM-REGISTERED"

Specific PICS Statements

-

PIXIT Statements

-

Test procedure

- a) The MS shall be set up to send a short message to the SS. MS sends CP-DATA containing RP-DATA (SMS SUBMIT PDU). SS sends CP-ACK and CP-DATA containing RP-ACK with "RP Message Reference (RP-MR)" different from RP-MR in RP_DATA received. MS sends RP-ERROR with cause # 81, "Invalid short message transfer reference value", if an appropriate connection exists
- b) The MS shall be set up to send a short message to the SS. MS sends CP-DATA containing RP-DATA (SMS SUBMIT PDU). SS sends CP-ACK and CP-DATA containing RP-ERROR with "RP Message Reference (RP-MR)" different from RP-MR in RP_DATA received. Check for no CP-ACK 60 s

- c) The SS sends CP-DATA containing RP-Message with TP-MTI value '010'B, "Reserved". MS sends CP-DATA containing RP-ERROR with cause#97, "message type not compatible with short message state"
- d) The SS sends CP-DATA containing RP-ACK when there is no active SMS transfer. MS sends CP-DATA containing RP-ERROR with cause#98, "Message type not compatible with short message protocol state"
- e) The SS sends CP-DATA containing RP-ERROR when there is no active SMS transfer.
- f) The SS sends CP-DATA containing "RP-DATA without RP-User Data IE". MS sends CP-DATA containing RP-ERROR with cause#96, "Invalid mandatory information"

Maximum Duration of Test

10min

Expected sequence

Step	Direction	Message	Comments
1	MS		The MS is set up to send an SM
2	MS → SS	CP-DATA	Containing RP-DATA (SMS SUBMIT PDU)
3	SS → MS	CP-ACK	
4	SS → MS	CP-DATA	Containing RP-ACK with RP-MR different from CP-DATA in step 2
5	MS → SS	CP-ACK	
6 (optional)	MS → SS	CP-DATA	Containing RP-ERROR with cause #81
7 (conditional)	SS->MS	CP-ACK	Send if step 6 is performed
8			Complete the transaction initiated by MS.
9	MS		The MS is set up to send an SM
10	MS → SS	CP-DATA	Containing RP-DATA (SMS SUBMIT PDU)
11	SS → MS	CP-ACK	
12	SS → MS	CP-DATA	Containing RP-ERROR with RP-MR different from CP-DATA in step 10
13	MS → SS	CP-ACK	
14	SS → MS	CP-DATA	Containing RP-ACK with correct RP-MR.
15 (optional)	MS → SS	CP-ACK	
16	SS → MS	CP-DATA	Containing RP-Message with MTI value '010'B
17	MS → SS	CP-ACK	
18	MS → SS	CP-DATA	Containing RP-ERROR with cause #97.
19	SS → MS	CP-ACK	
20	SS → MS	CP-DATA	Containing RP-ACK
21	MS → SS	CP-ACK	
22	MS → SS	CP-DATA	Containing RP-ERROR with cause #98.
23	SS → MS	CP-ACK	
24	SS → MS	CP-DATA	Containing RP-ERROR
25	MS->SS	CP-ACK	
26	SS		Check for no response from MS
27	SS → MS	CP-DATA	Containing RP-DATA without RP-User Data IE.
28	MS → SS	CP-ACK	
29	MS → SS	CP-DATA	Containing RP-ERROR with cause #96
30	SS → MS	CP-ACK	

Specific Message Contents

None

34.5 Default message contents

CP-DATA (including RP-DATA SS->MS)

Protocol Discriminator	SMS messages ("1001"B)
Transaction Identifier	
TI value	any value from the set {0,, 6}
TI flag	0
Message type	00000001
CP-User data	
length indicator	
RP-DATA	max 248 octets
RP-Message Type	001 (RP-DATA SS->MS)
RP-Message Reference	see 3GPP TS 04.11 subclause 8.2.3
RP-Originator Address	see 3GPP TS 04.11 subclause 8.2.5.1
RP-Destination Address	length indicator set to 0
RP-User Data	
length indicator	
TP-DATA	max 233 octets

CP-DATA (including RP-DATA MS->SS)

Protocol Discriminator	SMS messages ("1001"B)
Transaction Identifier	
TI value	any value from the set {0,, 6}
TI flag	0
Message type	00000001
CP-User data	
length indicator	
RP-DATA	max 248 octets
RP-Message Type	000 (RP-DATA MS->SS)
RP-Message Reference	see 3GPP TS 04.11 subclause 8.2.3
RP-Originator Address	length indicator set to 0
RP-Destination Address	see 3GPP TS 04.11 subclause 8.2.5.2
RP-User Data	
length indicator	
TP-DATA	max 233 octets

CP-DATA (including RP-ACK MS->SS)

Protocol Discriminator	SMS messages ("1001"B)
Transaction Identifier	
TI value	
TI flag	
Message type	00000001
CP-User data	
length indicator	
RP-ACK	
RP-Message Type	010 (RP-ACK MS->SS)
RP-Message Reference	see 3GPP TS 04.11 subclause 8.2.3

CP-DATA (including RP-ACK SS->MS)

Protocol Discriminator	SMS messages ("1001"B)
Transaction Identifier	
TI value	
TI flag	
Message type	00000001
CP-User data	
length indicator	
RP-ACK	
RP-Message Type	011 (RP-ACK SS->MS)
RP-Message Reference	see 3GPP TS 04.11 subclause 8.2.3

CP-DATA (including RP-ERROR MS->SS)

Protocol Discriminator	SMS messages ("1001"B)
Transaction Identifier	
TI value	
TI flag	
Message type	00000001
CP-User data	
length indicator	
RP-ERROR	
RP-Message Type	100 (RP-ERROR MS->SS)
RP-Message Reference	see 3GPP TS 04.11 subclause 8.2.3
RP-Cause	see 3GPP TS 04.11 subclause 8.2.5.4
RP_User Data	see 3GPP TS 04.11 subclause 8.2.5.3: optional, may be present or not
Length indicator	
TP-Data	max 233 octets

CP-DATA (including RP-ERROR SS->MS)

Protocol Discriminator	SMS messages ("1001"B)
Transaction Identifier	
TI value	
TI flag	
Message type	00000001
CP-User data	
length indicator	
RP-ERROR	
RP-Message Type	101 (RP-ERROR SS->MS)
RP-Message Reference	see 3GPP TS 04.11 subclause 8.2.3
RP-Cause	see 3GPP TS 04.11 subclause 8.2.5.4
RP_User Data	see 3GPP TS 04.11 subclause 8.2.5.3 : optional, may be present or not
Length indicator	
TP-Data	max 233 octets

CP-DATA (including RP-SMMA MS->SS)

Protocol Discriminator	SMS messages ("1001"B)
Transaction Identifier	
TI value	
TI flag	
Message type	00000001
CP-User data	
length indicator	
RP-SMMA	
RP-Message Type	110 (RP-SMMA MS->SS)
RP-Message Reference	see 3GPP TS 04.11 subclause 8.2.3

CP-ACK

Protocol Discriminator	SMS messages ("1001"B)
Transaction Identifier	
TI value	
TI flag	
Message type	00000100

CP-ERROR

Protocol Discriminator	SMS messages ("1001"B)	
Transaction Identifier		
TI value		
TI flag		
Message type		00010000
CP-Cause		see 3GPP TS 04.11 subclause 8.1.4.2
Cause value		

35 Low battery voltage detection

35.1 Definition

Low battery or shutdown voltage detection is used to trigger inhibition of all RF transmission before the MS supply voltage reaches a level where effective use of the radio frequency spectrum is no longer guaranteed.

35.2 Conformance requirement

1. The MS shall not make ineffective use of the radio frequency spectrum. In no case shall the MS exceed the transmitted levels as defined in 3GPP TS 05.05 for extreme operation.

3GPP TS 05.05, subclause D.2.2.

2. The MS shall inhibit all RF transmission when the power supply voltage is below the manufacturer declared approximate shutdown voltage.

3GPP TS 05.05, subclause D.2.2.

35.3 Test purpose

1. To verify that the MS does not make ineffective use of the RF spectrum.
2. To verify that the MS inhibits all RF transmission when the battery voltage falls below the manufacturer declared shutdown level.

35.4 Method of test

35.4.1 Initial conditions

The SS transmits a BCCH with a location updating time set to 0,1 hours.

The SS sends a paging request message to the MS.

The MS responds with a channel request message.

The SS sends an immediate assignment message establishing an SDCCH.

35.4.2 Procedure

- a) The SS gradually reduces the power supply voltage until the MS ceases the production of RF output.

The RF output spectrum shall be monitored for any anomalies while the supply voltage is being reduced.

NOTE 1: The declared approximate shutdown voltage gives an indication of the voltage where the MS will cease RF output.

NOTE 2: If any anomalies occur, then additional testing using the transmitter tests at the voltage where the anomaly occurred is performed to determine in an objective manner, whether or not the conformance requirement is met.

- c) After 7 minutes, the SS sends a paging message to the MS.

- d) The SS observes whether or not the MS produces any RF output.

This measurement is performed over the relevant transmit band.

The spectrum analyser is set to:

Bandwidth: 3 MHz.

Peak Hold.

- e) The SS modifies the location area of the BCCH.
f) For 7 minutes, the SS observes whether or not the MS produces any RF output.

NOTE 3: It is anticipated that the MS might attempt location updating.

- g) The MS is switched off and on.
h) The SS pages the MS.
i) The SS observes whether or not the MS produces any RF output.

35.5 Test requirement

1. In step a) no anomalies shall occur.
2. In step a), the MS shall cease the production of RF output.
3. In steps d), f) and i), the MS shall not produce any RF output above -30 dBm.

36 Individual equipment type requirements and interworking - special conformance testing functions

Refer to 3GPP TS 04.14 for complete specification

37 to 39 Void

Void

40 GPRS default conditions, message contents and macros

40.1 Default test conditions

The following default test conditions shall apply if not otherwise stated within an individual test description.

The testcases for higher layers shall use the second set of default test conditions for channel combination v), xi) and xiii) as specified in subclause 40.3.

In the tables following, decimal values will normally be used. Where a hexadecimal value is used, it indicated with an "H". A binary value will be indicated with a "B".

For MSs that cannot be configured to send an exact number of octets in RLC data blocks of uplink data transfer, test cases specifying 'uplink transfer of *n* octets data' shall be interpreted as 'uplink transfer of *at least n* octets data', unless otherwise stated in the test case.

Rel-6 network simulation shall apply unless otherwise stated in the test case.

Note 1: In case when NC mode is different from NC2 and PBCCH is not present in the cell and where neighbour cells are indicated in the testcase and are indeed activated, the MS shall read system information on the target cell (e.g. SI3, SI4) for cell reselection calculations. In these cases, the MS may temporarily suspend ongoing TBF (see 3GPP TS 04.60/3GPP TS 44.060 sub-clause 5.5.1.4.2). Test case implementation should take this into account i.e. that blocks or control messages sent by SS are missed during these SI refreshes.

Note 2: In addition:

- When the MS is performing autonomous cell reselection or
- when a PACKET CELL CHANGE ORDER is received by MS and the IMMEDIATE_REL bit is set to "0" or
- when PACKET CELL CHANGE CONTINUE is received by MS and relevant PACKET NEIGHBOUR CELL DATA messages are not received

the MS may continue operation in the old cell and acquire certain system information for the target cell (as per 04.60/44.060). In cases listed above ongoing TBF might be suspended temporarily as well. Test case implementation should take this into account i.e. that blocks or control messages sent by SS are missed during these SI refreshes.

List of affected testcases (by note2):

42.4.2.3.3, 42.4.2.3.4, 42.4.4.1, 42.4.4.2, 42.4.4.5, 42.4.5.1, 42.4.5.2, 42.4.5.4, 42.4.5.5, 42.4.5.6, 42.4.5.7, 42.4.5.9, 42.4.6.1, 42.4.8.1.4, 42.4.8.1.6, , 44.2.1.1.7, 44.2.2.1.8, , 44.2.3.1.1a, 44.2.3.1.6, 44.2.3.1.7, 44.2.3.2.8, 44.2.3.2.9, 44.2.7.3.5, 46.2.2.1.5, 47.3.1.1, 47.3.1.2, 47.3.1.3, 47.3.2.1, 47.3.2.2, 47.3.3.1.1, 47.3.3.1.2, 47.3.4.2, 47.4.1.

Note 3: 'One phase access' test cases may not be fully executed for MS requesting 'Two phases access'.

The resulting step "If the MS requests two phase access the Test Case is terminated" should be interpreted as "Test case is not applicable for the MS".

List of affected testcases (by note 3):

41.2.3.4, 41.2.3.5, 41.2.3.6, 41.2.3.7, 41.2.3.8, 41.2.3.9, 41.2.3.10, 41.2.3.11, 42.1.2.1.8.1.1, 42.1.2.1.8.1.2, 42.1.2.1.8.1.3, 42.1.2.1.8.1.4, 42.1.2.1.8.1.5, 42.1.2.1.8.1.6, 42.1.2.1.8.2.1, 42.1.2.1.8.2.2.

40.1.1 Default settings for cell A

	GSM 900	DCS 1 800
General signalling conditions for all carriers		

	GSM 900	DCS 1 800
Ciphering	Yes	Yes
General RF-conditions for all carriers		
Frequency hopping mode	Non-hopping	Non-hopping
Propagation profile	Static	Static
Downlink Input Level	63 dB μ Vemf()	63 dB μ Vemf()
Uplink output power	Minimum according to MS power class	Minimum according to MS power class
Serving cell, BCCH/CCCH carrier		
Channel ARFCN	20	590
Alternative channels	40 or 60	690 or 830
Serving cell, PDTCH (PBCCH not present), SDCCH, TCH		
Channel ARFCN	30	650
Alternative channels	110 or 115	760 or 850
Power Control Indicator	0	0
Serving cell, PDTCH (PBCCH present)		
Channel ARFCN	same as PBCCH	same as PBCCH
Power Control Indicator	0	0
Neighbouring cells BCCH/CCCH carriers		
Channel ARFCN	5, 80, 90,100, 110,120, 122, 124	515, 600, 700, 780, 810, 870, 875, 885
Alternative channels	15, 85, 95, 105, 115, 126, 128, 130	530, 610, 710, 790, 820, 822, 824, 880
Input level	53 dB μ Vemf()	53 dB μ Vemf()
Network dependent parameters		
Cell identity	0001H	0001H
Mobile country code, MCC	001 (decimal)	001 (decimal)
Mobile network code, MNC	01 (decimal)	01 (decimal)
Location area code, LAC	0001H	0001H
Frequency List	Bit Map 0	Range 512
BCCH allocation sequence number(BA_IND)	0	0
Cell Channel Descriptor	Bit Map 0	Range 512
PLMN colour code, NCC	1	1
BS colour code, BCC	5	5
SMS Cell Broadcast	Not active	Not active
DTX	Not available	Not available
IMSI Attach-detach	MS shall apply IMSI attach and detach procedure	MS shall apply IMSI attach and detach procedure
For Non Combined CCCH_CONF	000 (1 basic physical channel for CCCH)	000 (1 basic physical channel for CCCH)
BS_AG_BLKES_RES	3 blocks reserved	3 blocks reserved
For Combined CCCH_CONF	001 (1 basic physical channel for CCCH)	001 (1 basic physical channel for CCCH)
BS_AG_BLKES_RES	2 blocks reserved	2 blocks reserved
BS_PA_MFRMS	6 multiframes	6 multiframes
CELL_BAR_ACCESS	not barred	not barred
Call-reestablishment (RE)	not allowed	not allowed
Emergency Call allowed	Allowed	allowed
Access Control Class (AC)	access for all classes allowed	access for all classes allowed
Radio_Link_Time-out	8	8
T3212 Periodic	0 periodic updating shall not be used	0 periodic updating shall not be used
Access control parameters		
Max retrans	1	1
TX-integer	5	5
CELL_RESELECT_HYSTE RESIS	12dB	12dB
MS_TXPWR_MAX_CCH	10	10
RXLEV_ACCESS_MIN	Minimum	minimum
NECI	New establishment causes are supported	New establishment causes are supported
ACS (additional reselection param IND)	No additional cell parameters are present in	No additional cell parameters are present in SI messages 7

	GSM 900	DCS 1 800
P1 and C2 parameters POI and POWER OFFSET	SI messages 7 and 8 C2 parameters not present N/A	and 8 C2 parameters not present POWER OFFSET Parameter not present
CELL_BAR_QUALIFY	0	0
CELL_RESELECT_OFFSET	0	0
PENALTY_TIME	0	0
TEMPORARY_OFFSET	0	0
BA ARFCN		
	Both P-GSM and E-GSM ARFCNs are broadcast: GSM ARFCNs 5, 20, 80, 90, 100, 110, 120, 122, 124 broadcast in SI 2 E-GSM ARFCNs 985, 989, 995, 1010, 1014 broadcast in SI 2bis For multiband tests, the ARFCNs 5, 20, 80, 90, 100, 110, 120, 122, 124 are broadcast in SI 2 of GSM cell and in SI 2ter of DCS cell. The ARFCNs 515, 590, 600, 700, 780, 810, 870, 875, 885 are broadcast in SI 2 of DCS cell and in SI 2ter of GSM cell	ARFCNs 515, 590, 600, 700, 780, 810, 870, 875, 885 broadcast in SI 2.
GPRS Parameters		
RA_CODE	00000101	00000101
ACC_BURST_TY	11 bits burst	11 bits burst
CONTROL_ACK_TYPE	RLC/MAC control block	RLC/MAC control block
NETWORK_CONTROL_ORDER	normal MS control	normal MS control
DRX_TIMER_MAX	non-DRX not supported	non-DRX not supported
PC_MEAS_CHAN	BCCH	BCCH
Network Mode of Operation	network operation mode I	network operation mode I
BS_PCC_CHAN	1 PCCCH channel	1 PCCCH channel
BS_PBCCH_BLKs	3 blocks	3 blocks
BS_PAG_BLKs_RES	2 blocks	2 blocks
BS_PRACH_BLKs	1 block	1 block
T3168	2 seconds	2 seconds
T3192	1.5 seconds	1.5 seconds
GPRS Ciphering	Enabled	Enabled

	GSM 700, T-GSM 810	PCS 1 900	GSM 850
General signalling conditions for all carriers			
Ciphering	Yes	Yes	Yes
General RF-conditions for all carriers			
Frequency hopping mode	Non-hopping	Non-hopping	Non-hopping
Propagation profile	Static	Static	Static
Downlink Input Level	63 dBµVemf()	63 dBµVemf()	63 dBµVemf()
Uplink output power	Minimum according to MS power class	Power control level = 10	Minimum according to MS power class
Serving cell, BCCH/CCCH carrier			
Channel ARFCN	457	590	147
Alternative channels	462 or 482	690 or 730	167 or 187
Serving cell, PDTCH (PBCCH not present), SDCCH, TCH			
Channel ARFCN	467	650	157
Alternative channels	487 or 505	750 or 780	197 or 247
Power Control Indicator	0	0	0
Serving cell, PDTCH (PBCCH present)			
Channel ARFCN	same as PBCCH	same as PBCCH	same as PBCCH
Power Control Indicator	0	0	0
Neighbouring cells BCCH/CCCH carriers			

Channel ARFCN	438, 447, 467, 477, 487, 497, 502, 507	515, 600, 655, 700, 710, 740, 780, 810	137, 157, 177, 197, 207, 217, 227, 237
Alternative channels	452, 465, 485, 495, 505, 492, 496, 509	530, 610, 710, 740, 743, 746, 770, 790	142, 212, 222, 232, 236, 239, 242, 249
Input level	53 dB μ Vemf()	53 dB μ Vemf()	53 dB μ Vemf()
Network dependent parameters			
Cell identity	0001H	0001H	0001H
Mobile country code, MCC	001 (decimal)	001 (decimal)	001 (decimal)
Mobile network code, MNC	011 (decimal)	011 (decimal)	011 (decimal)
Location area code, LAC	0001H	0001H	0001H
Frequency List	Range 128	Range 512	Range 128
BCCH allocation sequence number(BA_IND)	0	0	0
Cell Channel Descriptor	Range 128	Range 512	Range 128
PLMN colour code, NCC	1	1	1
BS colour code, BCC	5	5	5
SMS Cell Broadcast DTX	Not active	Not active	Not active
IMSI Attach-detach	Not available	Not available	Not available
IMSI Attach-detach	MS shall apply IMSI attach and detach procedure	MS shall apply IMSI attach and detach procedure	MS shall apply IMSI attach and detach procedure
For Non Combined CCCH_CONF	000 (1 basic physical channel for CCCH)	1 basic physical channel for CCCH	000 (1 basic physical channel for CCCH)
BS_AG_BLK_RES	3 blocks reserved	3 blocks reserved	3 blocks reserved
For Combined CCCH_CONF	001 (1 basic physical channel for CCCH)		001 (1 basic physical channel for CCCH)
BS_AG_BLK_RES	2 blocks reserved		2 blocks reserved
BS_PA_MFRMS	6 multiframe	6 multiframe	6 multiframe
CELL_BAR_ACCESS	not barred	Not barred	not barred
Call-reestablishment (RE)	not allowed	Not allowed	not allowed
Emergency Call allowed	Allowed	Allowed	allowed
Access Control Class (AC)	access for all classes allowed	Access for all classes allowed	access for all classes allowed
Radio_Link_Time-out	8	8	8
T3212 Periodic	0 periodic updating shall not be used	0 periodic updating shall not be used	0 periodic updating shall not be used
Access control parameters			

Max retrans	1	1	1
TX-integer	5	5	5
CELL_RESELECT_HYSTERESIS	12dB	12dB	12dB
MS_TXPWR_MAX_CCH	10	10	10
RXLEV_ACCESS_MIN	Minimum	Minimum	minimum
NECI	New establishment causes are supported	New establishment causes are supported	New establishment causes are supported
ACS (additional reselection param IND)	No additional cell parameters are present in SI messages 7 and 8	No additional cell parameters are present in SI messages 7 and 8	No additional cell parameters are present in SI messages 7 and 8
C2 parameters	C2 parameters not present	C2 parameters not present	C2 parameters not present
POWER_OFFSET	N/A	Parameter not present	N/A
CELL_BAR_QUALIFY	0	0	0
CELL_RESELECT_OFFSET	0	0	0
PENALTY_TIME	0	0	0
TEMPORARY_OFFSET	0	0	0
BA ARFCN			
	ARFCNs 438, 447, 457, 467, 477, 487, 497, 502, 507 broadcast in SI 2	ARFCNs 515, 590, 600, 655, 700, 710, 740, 780, 810 broadcast in SI 2	ARFCNs 137, 147, 157, 177, 197, 207, 217, 227, 237 broadcast in SI 2.
	For multiband tests, the ARFCNs 438, 447, 457, 467, 477, 487, 497, 502, 507 are broadcast in SI 2 of the GSM 700 cell and in SI 2ter of the PCS1900 cell. The 515, 590, 600, 655, 700, 710, 740, 780, 810 are broadcast in SI 2 of the PCS1900 cell and SI 2ter of the GSM700 cell.	For multiband tests, the ARFCNs 137, 147, 157, 177, 197, 207, 217, 227, 237 are broadcast in SI 2 of the GSM 850 cell and SI2ter of the PCS1900 cell. The 515, 590, 600, 655, 700, 710, 740, 780, 810 are broadcast in SI 2 of the PCS1900 cell and SI 2ter of the GSM850 cell.	
GPRS Parameters			
RA_CODE	0000101	0000101	0000101
ACC_BURST_TYPE	11 bits burst	11 bits burst	11 bits burst
CONTROL_ACK_TYPE	RLC/MAC control block	RLC/MAC control block	RLC/MAC control block
NETWORK_CONTROL_ORDER	normal MS control	normal MS control	normal MS control
DRX_TIMER_MAX	non-DRX not supported	non-DRX not supported	non-DRX not supported
PC_MEAS_CHAN	BCCH	BCCH	BCCH
Network Mode of Operation	network operation mode I	network operation mode I	network operation mode I
BS_PCC_CHAN	1 PCCCH channel	1 PCCCH channel	1 PCCCH channel
BS_PBCCH_BLK	3 blocks	3 blocks	3 blocks
BS_PAG_BLK_RES	2 blocks	2 blocks	2 blocks
BS_PRACH_BLK	1 block	1 block	1 block
T3168	2 seconds	2 seconds	2 seconds
T3192	1.5 seconds	1.5 seconds	1.5 seconds
GPRS Ciphering	Enabled	Enabled	Enabled

40.1.2 Default settings for cell B

The default settings for cell B are identical to those of cell A with the following exceptions:

	GSM 900	DCS 1 800
Downlink Input Level	53 dB μ Vemf()	53 dB μ Vemf()
Serving cell, BCCH/CCCH carrier		
Channel ARFCN	5	515
Serving cell, PDTCH (PBCCH not present), SDCCH, TCH		
Channel ARFCN	60	750
Serving cell, PDTCH (PBCCH present)		
Channel ARFCN	same as PBCCH	same as PBCCH
Cell identity	0002H	0002H
Neighbouring cells BCCH/CCCH carriers		
Channel ARFCN	20, 80, 90,100, 110,120,122,124	590, 600, 700, 780, 810, 870, 875, 885
Input level	53 dB μ Vemf()	53 dB μ Vemf()
BA ARFCN		
	Both P-GSM and E-GSM ARFCNs are broadcast: GSM 5, 20, 80, 90,100, 110,120, 122, 124 broadcast in SI 2 E-GSM ARFCNs 985, 989, 995, 1010, 1014 broadcast in SI 2bis For multiband tests, the ARFCNs 5, 20, 80, 90,100, 110,120, 122, 124 are broadcast in SI 2 of GSM cell and in SI 2ter of DCS cell. The ARFCNs 515, 590, 600, 700, 780, 810, 870, 875, 885 are broadcast in SI 2 of DCS cell and in SI 2ter of GSM cell	515, 590, 600, 700, 780, 810, 870, 875, 885 broadcast in SI 2.

	GSM 700, T-GSM 810	PCS 1 900	GSM 850
Downlink Input Level	53 dB μ Vemf()	53 dB μ Vemf()	53 dB μ Vemf()
Serving cell, BCCH/CCCH carrier			
Channel ARFCN	447	515	137
Serving cell, PDTCH (PBCCH not present), SDCCH			
Channel ARFCN	438	755	242
Serving cell, PDTCH (PBCCH present)			
Channel ARFCN	Same as PBCCH	Same as PBCCH	Same as PBCCH
Cell identity	0002H	0002H	0002H
Neighbouring cells BCCH/CCCH carriers			
Channel ARFCN	438, 457, 467, 477, 487, 497, 502, 507	590, 600, 655, 700, 710, 740, 780, 810	147, 157, 177, 197, 207, 217, 227, 237
Input level	53 dB μ Vemf()	53 dB μ Vemf()	53 dB μ Vemf()
BA ARFCN			
	ARFCNs 438, 447, 457, 467, 477, 487, 497, 502, 507, 510 broadcast in SI 2	ARFCNs 515, 590, 600, 655, 700, 710, 740, 780, 810 broadcast in SI 2	ARFCNs 137, 147, 157, 177, 197, 207, 217, 227, 237 broadcast in SI 2.
	For multiband tests, the ARFCNs 438, 447, 457, 467, 477, 487, 497, 502, 507 are broadcast in SI 2 of the GSM 700 cell and SI2ter of the PCS1900 cell. The 515, 590, 600, 655, 700, 710, 740, 780, 810 are broadcast in SI 2 of the PCS1900 cell and SI 2ter of the GSM850 cell.		
		For multiband tests, the ARFCNs 137, 147, 157, 177, 197, 207, 217, 227, 237 are broadcast in SI 2 of the GSM 850 cell and SI2ter of the PCS1900 cell. The 515, 590, 600, 655, 700, 710, 740, 780, 810 are broadcast in SI 2 of the PCS1900 cell and SI 2ter of the GSM850 cell.	

40.1.3 Default settings for cell C

The default settings for cell C are identical to those of cell A with the following exceptions:

	GSM 900	DCS 1 800
Downlink Input Level	53 dB μ Vemf()	53 dB μ Vemf()
Serving cell, BCCH/CCCH carrier		
Channel ARFCN	80	600
Serving cell, PDTCH (PBCCH not present), SDCCH, TCH		
Channel ARFCN	25	675
Serving cell, PDTCH (PBCCH present)		
Channel ARFCN	Same as PBCCH	Same as PBCCH
Cell identity	0003H	0003H
Neighbouring cells BCCH/CCCH carriers		
Channel ARFCN	5, 20, 90,100, 110,120,122,124	515, 590, 700, 780, 810, 870, 875, 885
Input level	53 dB μ Vemf()	53 dB μ Vemf()
BA ARFCN		
	Both P-GSM and E-GSM ARFCNs are broadcast: GSM 5, 20, 80, 90, 100, 110,120, 122, 124 broadcast in SI 2 E-GSM ARFCNs 985, 989, 995, 1010, 1014 broadcast in SI 2bis	ARFCNs 515, 590, 600, 700, 780, 810, 870, 875, 885 broadcast in SI 2.
	For multiband tests, the ARFCNs 5, 20, 80, 90,100, 110,120, 122, 124 are broadcast in SI 2 of GSM cell and in SI 2ter of DCS cell. The ARFCNs 515, 590, 600, 700, 780, 810, 870, 875, 885 are broadcast in SI 2 of DCS cell and in SI 2ter of GSM cell	

	GSM 700, T-GSM 810	PCS 1 900	GSM 850
Downlink Input Level	53 dB μ Vemf()	53 dB μ Vemf()	53 dB μ Vemf()
Serving cell, BCCH/CCCH carrier			
Channel ARFCN	438	600	207
Serving cell, PDTCH (PBCCH not present), SDCCH			
Channel ARFCN	447	675	167
Serving cell, PDTCH (PBCCH present)			
Channel ARFCN	Same as PBCCH	Same as PBCCH	Same as PBCCH
Cell identity	0003H	0003H	0003H
Neighbouring cells BCCH/CCCH carriers			
Channel ARFCN	447, 457, 467, 477, 487, 497, 502, 507	515, 590, 655, 700, 710, 740, 780, 810	137, 147, 157, 177, 197, 217, 227, 237
Input level	53 dB μ Vemf()	53 dB μ Vemf()	53 dB μ Vemf()
BA ARFCN			
	ARFCNs 438, 447, 457, 467, 477, 487, 497, 502, 507 broadcast in SI 2 For multiband tests, the ARFCNs 438, 447, 457, 467, 477, 487, 497, 502, 507 are broadcast in SI 2 of the GSM 700 cell and SI2ter of the PCS1900 cell. The 515, 590, 600, 655, 700, 710, 740, 780, 810 are broadcast in SI 2 of the PCS1900 cell and SI 2ter of the GSM850 cell.	ARFCNs 515, 590, 600, 655, 700, 710, 740, 780, 810 broadcast in SI 2 For multiband tests, the ARFCNs 137, 147, 157, 177, 197, 207, 217, 227, 237 are broadcast in SI 2 of the GSM 850 cell and SI2ter of the PCS1900 cell. The 515, 590, 600, 655, 700, 710, 740, 780, 810 are broadcast in SI 2 of the PCS1900 cell and SI 2ter of the GSM850 cell.	ARFCNs 137, 147, 157, 177, 197, 207, 217, 227, 237 broadcast in SI 2.

40.1.4 Default settings for cell D

The default settings for cell D are identical to those of cell A with the following exceptions:

	GSM 900	DCS 1 800
Downlink Input Level	53 dB μ Vemf()	53 dB μ Vemf()
Serving cell, BCCH/CCCH carrier		
Channel ARFCN	110	700
Serving cell, PDTCH (PBCCH not present), SDCCH, TCH		
Channel ARFCN	35	725
Serving cell, PDTCH (PBCCH present)		
Channel ARFCN	same as PBCCH	same as PBCCH
Cell identity	0004H	0004H
Neighbouring cells BCCH/CCCH carriers		
Channel ARFCN	5, 20, 80, 90,100,120,122,124	515, 590, 600, 700, 780, 810, 870, 875, 885
Input level	53 dB μ Vemf()	53 dB μ Vemf()
BA ARFCN		
	Both P-GSM and E-GSM ARFCNs are broadcast: P-GSM 5, 20, 80, 90, 100, 110, 120, 122, 124 broadcast in SI 2 E-GSM ARFCNs 985, 989, 995, 1010, 1014 broadcast in SI 2bis	ARFCNs 515, 590, 600, 780, 810, 870, 875, 885 broadcast in SI 2.
	For multiband tests, the ARFCNs 5, 20, 80, 90,100, 110, 120, 122, 124 are broadcast in SI 2 of GSM cell and in SI 2ter of DCS cell. The ARFCNs 515, 590, 600, 700, 780, 810, 870, 875, 885 are broadcast in SI 2 of DCS cell and in SI 2ter of GSM cell	

	GSM 700, T-GSM 810	PCS 1 900	GSM 850
Downlink Input Level	53 dB μ Vemf()	53 dB μ Vemf()	53 dB μ Vemf()
Serving cell, BCCH/CCCH carrier			
Channel ARFCN	477	700	217
Serving cell, PDTCH (PBCCH not present), SDCCH			
Channel ARFCN	457	725	222
Serving cell, PDTCH (PBCCH present)			
Channel ARFCN	Same as PBCCH	Same as PBCCH	Same as PBCCH
Cell identity	0004H	0004H	0004H
Neighbouring cells BCCH/CCCH carriers			
Channel ARFCN	438, 447, 457, 467, 487, 497, 502, 507	515, 590, 600, 655, 710, 740, 780, 810	137, 147, 157, 177, 197, 207, 227, 237
Input level	53 dB μ Vemf()	53 dB μ Vemf()	53 dB μ Vemf()
BA ARFCN			
	ARFCNs 438, 447, 457, 467, 477, 487, 497, 502, 507 broadcast in SI 2	ARFCNs 515, 590, 600, 655, 700, 710, 740, 780, 810 broadcast in SI 2	ARFCNs 137, 147, 157, 177, 197, 207, 217, 227, 237 broadcast in SI 2.
	For multiband tests, the ARFCNs 438, 447, 457, 467, 477, 487, 497, 502, 507 are broadcast in SI 2 of the GSM 700 cell and SI2ter of the PCS1900 cell. The 515, 590, 600, 655, 700, 710, 740, 780, 810 are broadcast in SI 2 of the PCS1900 cell and SI 2ter of the GSM850 cell.		
	For multiband tests, the ARFCNs 137, 147, 157, 177, 197, 207, 217, 227, 237 are broadcast in SI 2 of the GSM 850 cell and SI2ter of the PCS1900 cell. The 515, 590, 600, 655, 700, 710, 740, 780, 810 are broadcast in SI 2 of the PCS1900 cell and SI 2ter of the GSM850 cell.		

40.1.5 Default settings for cell E

The default settings for cell E are identical to those of cell A with the following exceptions:

	GSM 900	DCS 1 800
Downlink Input Level	53 dB μ Vemf()	53 dB μ Vemf()
Serving cell, BCCH/CCCH carrier		
Channel ARFCN	90	780
Serving cell, PDTCH (PBCCH not present), SDCCH, TCH		
Channel ARFCN	45	735
Serving cell, PDTCH (PBCCH present)		
Channel ARFCN	Same as PBCCH	Same as PBCCH
Cell identity	0005H	0005H
Neighbouring cells BCCH/CCCH carriers		
Channel ARFCN	5, 20, 80, 100, 110,120,122,124	515, 590, 600, 700, 810, 870, 875, 885
Input level	53 dB μ Vemf()	53 dB μ Vemf()
BA ARFCN		
	Both P-GSM and E-GSM ARFCNs are broadcast: GSM ARFCNs 5, 20, 80, 90, 100, 110,120, 122, 124 broadcast in SI 2 E-GSM ARFCNs 985, 989, 995, 1010, 1014 broadcast in SI 2bis	ARFCNs 515, 590, 600, 700, 780, 810, 870, 875, 885 broadcast in SI 2.
	For multiband tests, the ARFCNs 5, 20, 80, 90, 100, 110,120, 122, 124 are broadcast in SI 2 of GSM cell and in SI 2ter of DCS cell. The ARFCNs 515, 590, 600, 700, 780, 810, 870, 875, 885 are broadcast in SI 2 of DCS cell and in SI 2ter of GSM cell	

	GSM 700, T-GSM 810	PCS 1 900	GSM 850
Downlink Input Level	53 dB μ Vemf()	53 dB μ Vemf()	53 dB μ Vemf()
Serving cell, BCCH/CCCH carrier			
Channel ARFCN	467	780	227
Serving cell, PDTCH (PBCCH not present), SDCCH			
Channel ARFCN	487	735	232
Serving cell, PDTCH (PBCCH present)			
Channel ARFCN	Same as PBCCH	Same as PBCCH	Same as PBCCH
Cell identity	0005H	0005H	0005H
Cell identity	0005H	0005H	0005H
Neighbouring cells BCCH/CCCH carriers			
Channel ARFCN	438, 447, 457, 477, 487, 497, 502, 507	515, 590, 600, 655, 700, 710, 740, 810	137, 147, 157, 177, 197, 207, 217, 237
Input level	53 dB μ Vemf()	53 dB μ Vemf()	53 dB μ Vemf()
BA ARFCN			
	ARFCNs 438, 447, 457, 467, 477, 487, 497, 502, 507 broadcast in SI 2 For multiband tests, the ARFCNs 438, 447, 457, 467, 477, 487, 497, 502, 507 are broadcast in SI 2 of the GSM 700 cell and SI2ter of the PCS1900 cell. The 515, 590, 600, 655, 700, 710, 740, 780, 810 are broadcast in SI 2 of the PCS1900 cell and SI 2ter of the GSM850 cell.	ARFCNs 515, 590, 600, 655, 700, 710, 740, 780, 810 broadcast in SI 2	ARFCNs 137, 147, 157, 177, 197, 207, 217, 227, 237 broadcast in SI 2.
		For multiband tests, the ARFCNs 137, 147, 157, 177, 197, 207, 217, 227, 237 are broadcast in SI 2 of the GSM 850 cell and SI2ter of the PCS1900 cell. The 515, 590, 600, 655, 700, 710, 740, 780, 810 are broadcast in SI 2 of the PCS1900 cell and SI 2ter of the GSM850 cell.	

40.1.6 Default settings for cell F

The default settings for cell F are identical to those of cell A with the following exceptions:

	GSM 900	DCS 1 800
Downlink Input Level	53 dB μ Vemf()	53 dB μ Vemf()
Serving cell, BCCH/CCCH carrier		
Channel ARFCN	120	810
Serving cell, PDTCH (PBCCH not present), SDCCH, TCH		
Channel ARFCN	55	775
Serving cell, PDTCH (PBCCH present)		
Channel ARFCN	Same as PBCCH	Same as PBCCH
Cell identity	0006H	0006H
Neighbouring cells BCCH/CCCH carriers		
Channel ARFCN	5, 20, 80, 90,100, 110,122,124	515, 590, 600, 700, 780, 870, 875, 885
Input level	53 dB μ Vemf()	53 dB μ Vemf()
BA ARFCN		
	Both P-GSM and E-GSM ARFCNs are broadcast: GSM ARFCNs 5, 20, 80, 90,100, 110, 120, 122, 124 broadcast in SI 2 E-GSM ARFCNs 985, 989, 995, 1010, 1014 broadcast in SI 2bis	ARFCNs 515, 590, 600, 700, 780, 810, 870, 875, 885 broadcast in SI 2.
	For multiband tests, the ARFCNs 5, 20, 80, 90,100, 110, 120, 122, 124 are broadcast in SI 2 of GSM cell and in SI 2ter of DCS cell. The ARFCNs 515, 590, 600, 700, 780, 810, 870, 875, 885 are broadcast in SI 2 of DCS cell and in SI 2ter of GSM cell	

	GSM 700, T-GSM 810	PCS 1 900	GSM 850
Downlink Input Level	53 dB μ Vemf()	53 dB μ Vemf()	53 dB μ Vemf()
Serving cell, BCCH/CCCH carrier			
Channel ARFCN	487	810	237
Serving cell, PDTCH (PBCCH not present), SDCCH			
Channel ARFCN	477	775	187
Serving cell, PDTCH (PBCCH present)			
Channel ARFCN	Same as PBCCH	Same as PBCCH	Same as PBCCH
Cell identity	0006H	0006H	0006H
Neighbouring cells BCCH/CCCH carriers			
Channel ARFCN	438, 447, 457, 467, 477, 497, 502, 507	515, 590, 600, 655, 700, 710, 740, 780	137, 147, 157, 177, 197, 207, 217, 227
Input level	53 dB μ Vemf()	53 dB μ Vemf()	53 dB μ Vemf()
BA ARFCN			
	ARFCNs 438, 447, 457, 467, 477, 487, 497, 502, 507 broadcast in SI 2	ARFCNs 515, 590, 600, 655, 700, 710, 740, 780, 810 broadcast in SI 2	ARFCNs 137, 147, 157, 177, 197, 207, 217, 227, 237 broadcast in SI 2.
	For multiband tests, the ARFCNs 438, 447, 457, 467, 477, 487, 497, 502, 507 are broadcast in SI 2 of the GSM 700 cell and SI2ter of the PCS1900 cell. The 515, 590, 600, 655, 700, 710, 740, 780, 810 are broadcast in SI 2 of the PCS1900 cell and SI 2ter of the GSM850 cell.		
		For multiband tests, the ARFCNs 137, 147, 157, 177, 197, 207, 217, 227, 237 are broadcast in SI 2 of the GSM 850 cell and SI2ter of the PCS1900 cell. The 515, 590, 600, 655, 700, 710, 740, 780, 810 are broadcast in SI 2 of the PCS1900 cell and SI 2ter of the GSM850 cell.	

40.2 Default message contents

40.2.1 System Information messages

40.2.1.1 Cell A

With the SYSTEM INFORMATION messages, the information elements are listed in alphabetic order (this is because some information elements occur in several SYSTEM INFORMATION types).

NOTE: BCCH can send 1 instance of SYSTEM INFORMATION 13.

40.2.1.1.1 Contents of information elements in SYSTEM INFORMATION TYPE 1 to 13 messages.

(CBCH) Channel Description	Not present.
(CBCH) Mobile Allocation	Not present.
Cell Channel Description	
- Format identifier	For GSM 900: Bit map 0. For DCS 1 800 and PCS 1 900: Range 512. For GSM 700 and GSM 850: Range 128.
- Cell Allocation ARFCN	For GSM 900: Channel Numbers 10, 37, 40, 50, 60 and 80. For DCS1800: Channel Numbers 520, 530, 540 and 550. For PCS 1 900: Channel Numbers 520, 530, 540 and 550 For GSM 700, T-GSM 810: Channel Numbers 447, 457, 477, 487, 497 and 509. For GSM 850: Channel Numbers 159, 161, 163, 165, 187 and 207.
Cell Identity	
- Cell Identity Value	0001Hex
Cell Options	
- Power Control Indicator	Power Control Indicator is not set.
- DTX Indicator	MS shall not use DTX.
- Radio_Link_Timeout	8 SACCH blocks.
Cell Selection Parameters	
- Cell_Reselect_Hysteresis	12 dB.
- MX_TXPWR_MAX_CCH	Power control level 10.
- ACS	For SI3, spare (set to '0'); for SI4, No additional cell parameters are present in SYSTEM INFORMATION messages 7 and 8.
- NECI	New establishment causes are supported.
- RXLEV_ACCESS_MIN	Minimum level.
Control Channel Description	
- MSCR bit	0 (MSC is R98 or older) For R99 network simulation: 1 (MSC is R99 onwards) MS shall apply IMSI attach and detach procedure.
- Attach-Detach allowed	
For Non Combined	
- BS_AG_BLK_RES	3 blocks reserved for access grant.
- CCCH_CONF	000 (1 basic physical channel used for CCCH, not combined with SDCCHs.)
For Combined	
- BS_AG_BLK_RES	2 blocks reserved for access grant.
- CCCH_CONF	001 (1 basic physical channel used for CCCH, combined with SDCCHs.)
- BS_PA_MFRMS	6 multiframe periods for transmission of paging messages.
- T3212 Time-out value	0
L2 pseudo length	
- System information 1	21
- System information 2	22
- System information 3	18
- System information 4	12
- System information 7	1

<ul style="list-style-type: none"> - System information 8 - System information 13 - System information 14 - System information 15 <p>Location Area Identification</p> <ul style="list-style-type: none"> - Mobile Country Code - Mobile Network Code <p>- Location Area Code</p> <p>Message Type</p> <ul style="list-style-type: none"> - System information 1 - System information 2 - System information 2bis - System information 2ter - System information 3 - System information 4 - System information 5 - System information 5bis - System information 5ter - System information 7 - System information 8 - System information 13 	<p>1 0 0 0</p> <p>001 (Decimal) 01 (Decimal) for GSM 900 and DCS 1 800 011 (Decimal) for GSM 700, T-GSM 810, GSM 850 and PCS 1 900 0001(Hex)</p> <p>00011001 (Binary) 00011010 (Binary) 00000010 (Binary) 00000011 (Binary) 00011011 (Binary) 00011100 (Binary) 00011101 (Binary) 00000101 (Binary) 00000110 (Binary) 00011111 (Binary) 00011000 (Binary) 00000000 (Binary)</p>
<p>SI 14 and SI15 are only applicable for GSM 710 and T-GSM 810 bands (not for GSM 750 band):</p> <ul style="list-style-type: none"> - System information 14 - System information 15 	<p>00000001 (Binary) 01000011 (Binary)</p>
<p>Neighbour Cells Description</p> <ul style="list-style-type: none"> - Format identifier <p>- BCCH Allocation Sequence</p> <p>- BCCH Allocation ARFCN</p> <p>- EXT-IND</p> <p>Neighbour Cells Description</p> <ul style="list-style-type: none"> - Format identifier - BCCH Allocation Sequence - BCCH Allocation ARFCN <p>- EXT-IND</p> <p>Neighbour Cells Description 2</p> <ul style="list-style-type: none"> - Multiband Reporting - Format identifier <p>- BCCH Allocation Sequence</p> <p>- BCCH Allocation ARFCN</p>	<p>For SI 2 For GSM 900: Bit map 0. For DCS 1 800 and PCS 1 900: Range 512. For GSM 700 and GSM 850: Range 128.</p> <p>0</p> <p>For GSM 900: Channel numbers 5, 20, 80, 90, 100, 110, 120, 122 and 124. For DCS 1 800: Channel numbers 515, 590, 600, 700, 780, 810, 870, 875 and 885. For PCS 1 900 Channel numbers 515, 590, 600, 655, 700, 710, 740, 780 and 810. For GSM 700, T-GSM 810: Channel numbers 438, 447, 457, 467, 477, 487, 497, 502 and 507. For GSM 850: Channel numbers 137,147, 157, 177, 197, 207, 217, 227 and 237. For GSM 900, this IE carries only part of the BA. For DCS 1 800, PCS 1 900, GSM 700 and GSM 850, this IE carries complete BA.</p> <p>SI 2bis for GSM 900 For GSM 900: Range 256</p> <p>0</p> <p>For GSM 900: Channel numbers 985, 989, 995, 1010 and 1014. This IE carries only part of the BA.</p> <p>SI2ter 00 (Binary) For GSM 900: Range 512 For DCS 1 800: Range 1024 For PCS 1 900: Range 1024 For GSM 700, T-GSM 810: Range 512 For GSM 850: Range 512</p> <p>0</p> <p>For GSM 900: Channel numbers 515, 590, 600, 700, 780, 810, 870, 875 and 885. For DCS 1800:</p>

	Channel Numbers 5, 20, 80, 90, 100, 110, 120, 122 and 124. For PCS 1900: GSM 850 Channel numbers 137, 147, 157, 177, 197, 207, 217, 227 and 237 (for a GSM 850/PCS 1900 Network); or GSM 700, T-GSM 810 Channel numbers 438, 447, 457, 467, 477, 487, 497, 502 and 507 (for a GSM 700, T-GSM 810 / PCS 1900 Network). For GSM 700, T-GSM 810: Channel numbers 515, 590, 600, 655, 700, 710, 740, 780 and 810. For GSM 850: Channel numbers 515, 590, 600, 655, 700, 710, 740, 780 and 810. 0000 0010
NCC Permitted	
RACH Control Parameters	
- Max Retrans	Max 1 retrans.
- Tx-integer	5 slots used.
- Cell Barred for Access	Cell is not barred.
- Call Reestablishment Allowed	Not allowed.
- Access Control Class	Access is not barred.
- Emergency Call allowed	Yes.
SI 1 Rest Octets	
- {0 1<NCH Position>}	0 (NCH Position not present)
- BandIndicator	L for GSM 700 or T-GSM 810 or GSM 850 or GSM 900 or DCS 1 800 H for PCS 1 900
- spare padding	Spare Padding
SI 2bis Rest Octets	Spare Padding
SI 2ter Rest Octets	Spare Padding
SI 3 Rest Octets	
- Optional Selection Parameters	L (no optional selection parameters)
- Optional Power Offset	L (no optional power offset)
- System Information 2ter Indicator	L (for GSM 700 or T-GSM 810 or GSM 850 or GSM 900 or DCS 1 800 or PCS 1 900 single band tests, no SI2ter exists) Or H (for multiband tests, i.e GSM900/GSM1800 or GSM850/GSM1900, SI2ter does exists)
- Early Classmark Sending Control	H (perform early classmark sending)
- Scheduling if and where	L(no system information type 9)
- GPRS Indicator	H (GPRS supported)
- RA COLOUR	001(Binary)
- SI13 POSITION	On BCCH Norm
- spare padding	Spare Padding
SI 4 Rest Octets	
- Optional Selection Parameters	L (no optional selection parameters)
- Optional Power Offset	L (no optional power offset)
- GPRS Indicator	H (GPRS supported)
- RA COLOUR	001(Binary)
- SI13 POSITION	On BCCH Norm
- spare padding	Spare Padding
SI 7 Rest Octets	Same as SI 4 Rest Octets
SI 8 Rest Octets	Same as SI 4 Rest Octets
SI 13 Rest Octets	For PBCCH present case
-	H (SI 13 Rest Octets are not spare)
- BCCH_CHANGE_MARK	000
- SI_CHANGE_FIELD	0 Update of unspecified message
- {0 1	GPRS Mobile Allocation IE present
- SI13 CHANGE MARK	00
-HSN	000000 Sequence 0
-{0 1<RFL number list>}	0 Number list not present
-{0	0 using MA BITMAP
-MA_LENGTH	000101 (for GSM 700, T-GSM 810, GSM 850 and GSM900).
	000011 (for DCS 1 800 and PCS 1 900).
-MA_BITMAP}	001111 4 belonging (for GSM 700, T-GSM 810,

<ul style="list-style-type: none"> - {0 1 - PSI1_REPEAT_PERIOD - PBCCH Description - Pb - TSC - TN - {00 01 1 MAIO}} <p>For R99/Rel 4/Rel 6 network simulation:</p> <ul style="list-style-type: none"> - Additions in R99 - SGSNR bit - Additions in Rel 4 - SI_STATUS_IND bit - Additions for Rel 6 {LB_MS_TXPWR_MAX_CCH} - LB_MS_TXPWR_MAX_CCH - SI2n_SUPPORT <p>End Rel 6 End Rel 4 End R99</p> <ul style="list-style-type: none"> - spare padding <p>SI 13 Rest Octets</p> <ul style="list-style-type: none"> - - BCCH_CHANGE_MARK - SI_CHANGE_FIELD - {0 1 - SI13 CHANGE MARK -HSN -{0 1<RFL number list>} -{0 -MA_LENGTH <ul style="list-style-type: none"> -MA_BITMAP} <ul style="list-style-type: none"> - {0 1 - RAC -SPGC_CCCH_SUP -PRIORITY_ACCESS_THR -NETWORK_CONTROL_ORDER -GPRS Cell Options -Network Mode of Operation -T3168 -T3192 -DRX_TIMER_MAX -ACCESS_BURST_TYPE -CONTROL_ACK_TYPE -BS_CV_MAX -PAN_DEC -PAN_INC -PAN_MAX -Optional extension information <p>For R99/Rel 4/Rel 6 network simulation:</p> <ul style="list-style-type: none"> Optional extension information - Extension length <ul style="list-style-type: none"> - {0 1 <Extension Information>} - PFC_FEATURE_MODE - DTM_SUPPORT 	<p>GSM 850 and GSM900).</p> <p>1111 4 belonging (for DCS 1 800 and PCS 1 900).</p> <p>1 (PBCCH present in cell)</p> <p>0010 PSI1repeat period = 3 multiframes</p> <p>0000 (0 dB)</p> <p>101</p> <p>100 Timeslot 4</p> <p>1 MAIO</p> <p>000010</p> <p>H</p> <p>1 SGSN is Release '99 onwards</p> <p>H</p> <p>0 PACKET SI STATUS msg not supported</p> <p>H</p> <p>1 LB_MS_TXPWR_MAX_CCH present</p> <p>01010</p> <p>00</p> <p>Spare Padding</p> <p>Only applicable in Testcases specified</p> <p>PBCCH not present</p> <p>H (SI 13 Rest Octets are not spare)</p> <p>000</p> <p>0 Update of unspecified message</p> <p>GPRS Mobile Allocation IE present</p> <p>00</p> <p>000000 Sequence 0</p> <p>0 Number list not present</p> <p>0 using MA BITMAP</p> <p>000101 (for GSM 700, T-GSM 810, GSM 850 and GSM900).</p> <p>000011 (for DCS 1 800 and PCS 1 900).</p> <p>001111 4 belonging (for GSM 700, T-GSM 810, GSM 850 and GSM900).</p> <p>1111 4 belonging (for DCS 1 800 and PCS 1 900).</p> <p>0 (PBCCH not present in cell)</p> <p>00000101(Binary)</p> <p>1 supported</p> <p>11 PA allowed for priority level 1 to 4</p> <p>00 NC0</p> <p>Present</p> <p>NMO I</p> <p>2 seconds</p> <p>1.5 seconds</p> <p>000 Non-DRX not supported</p> <p>1 Use 11 bits access burst</p> <p>1 RLC/MAC control block</p> <p>0111 value 7</p> <p>011 value 3</p> <p>011 value 3</p> <p>010 Max value for counter N3102=12</p> <p>0 Extension information not present</p> <p>1 Extension information present</p> <p>R99: 000011</p> <p>Rel 4: 000101</p> <p>Rel 6: 001001</p> <p>0 EGPRS not supported by the cell.</p> <p>0 Packet Flow Context Procedures not supported</p> <p>Default:</p> <p>0.....The cell does not support DTM procedures</p> <p>For DTM test cases:</p>
---	---

<p>- BSS_PAGING_COORDINATION</p> <p>For Rel 4 network simulation</p> <p>- CCN_ACTIVE</p> <p>- NW_EXT_UTBF</p> <p>For Rel 6 network simulation</p> <p>- MULTIPLE_TBF_CAPABILITY</p> <p>- EXT_UTBF_NO_DATA</p> <p>- DTM_ENHANCEMENTS_CAPABILITY</p> <p>- { 0 1 }</p> <p>End Rel 6</p> <p>End Rel 4</p> <p>End R99</p> <p>-GPRS Power Control Parameters</p> <p>-ALPHA</p> <p>-T_AVG_W</p> <p>-T_AVG_T</p> <p>-PC_MEAS_CHAN</p> <p>-N_AVG_I</p> <p>For R99/Rel 4/Rel 6 network simulation:</p> <p>- Additions in R99</p> <p>- SGSNR bit</p> <p>- Additions in Rel 4</p> <p>- SI_STATUS_IND bit</p> <p>- Additions in Rel 6</p> <p>{LB_MS_TXPWR_MAX_CCH}</p> <p>- LB_MS_TXPWR_MAX_CCH</p> <p>- SI2n_SUPPORT</p> <p>End Rel 6</p> <p>End Rel 4</p> <p>End R99</p> <p>-spare padding</p>	<p>1.....The cell supports DTM procedures</p> <p>0 Circuit-Switched paging coordination not supported in cell</p> <p>0 CCN is disabled in the cell</p> <p>0 Ext UL TBF not supported in the cell</p> <p>0 Cell does not support multiple TBF procedures</p> <p>0 MS shall send a PACKET UPLINK DUMMY CONTROL BLOCK message when there is no other RLC/MAC block ready to send in an uplink radio block allocated by the network</p> <p>0 Cell does not support enhanced DTM CS establishment and enhanced DTM CS release procedures</p> <p>0 -- MBMS procedures not supported by the cell</p> <p>Present</p> <p>0000 Alpha = 0.0</p> <p>01100 value 12</p> <p>01100 value 12</p> <p>0 BCCH</p> <p>0111 value 7</p> <p>H</p> <p>1 SGSN is Release '99 onwards</p> <p>H</p> <p>0 PACKET SI STATUS message not supported</p> <p>H</p> <p>1 LB_MS_TXPWR_MAX_CCH present</p> <p>01010</p> <p>00</p> <p>Spare Padding</p>
<p>SI 14 Rest Octets</p> <p>- SI14_INDEX</p> <p>- SI14_COUNT</p> <p>- DM_CHANGE_MARK</p> <p>- DYNAMIC ARFCN MAPPING Description</p> <p>- GSM_Band</p> <p>- ARFCN_FIRST</p> <p>- BAND_OFFSET</p> <p>- ARFCN_RANGE</p>	<p>Only applicable for GSM 710 and T-GSM 810 bands</p> <p>0</p> <p>0</p> <p>0</p> <p>Present</p> <p>0110 for GSM 710 band</p> <p>0111 for T-GSM 810 band</p> <p>110110110 ARFCN 438</p> <p>000000000</p> <p>1001010 74 channels</p>
<p>SI 15 Rest Octets</p> <p>- SI15_INDEX</p> <p>- SI15_COUNT</p> <p>- DM_CHANGE_MARK</p> <p>- DYNAMIC ARFCN MAPPING</p> <p>- GSM_Band</p> <p>- ARFCN_FIRST</p> <p>- BAND_OFFSET</p> <p>- ARFCN_RANGE</p>	<p>Only applicable for GSM 710 and T-GSM 810 bands</p> <p>0</p> <p>0</p> <p>0</p> <p>Present</p> <p>0110 for GSM 710 band</p> <p>0111 for T-GSM 810 band</p> <p>110110110 ARFCN 438</p> <p>000000000</p> <p>1001010 74 channels</p>

40.2.1.2 Cell B

The contents of SYSTEM INFORMATION TYPE 1 to 13 messages for cell B are identical to those of cell A with the following exceptions:

Cell Channel Description - Format Identifier	For GSM 900: Bit map 0. For DCS 1800 and PCS 1900: Range 512. For GSM 700, T-GSM 810 and GSM 850: Range 128.
- Cell Allocation ARFCN	For GSM 900: Channel Numbers 15, 70, 97, 100, 110, 120 For DCS 1800: Channel numbers 560, 570, 580, 585. For PCS 1900: Channel numbers 560, 570, 580, 585. For GSM 700, T-GSM 810: Channel numbers 439, 441, 443, 445. For GSM 850: Channel numbers 179, 181, 183, 185
Cell Identity - Cell Identity Value	0002H

<p>Neighbour Cells Description</p> <ul style="list-style-type: none"> - Format identifier - BCCH Allocation ARFCN <p>Neighbour Cells Description 2</p> <ul style="list-style-type: none"> - Multiband Reporting - Format identifier - BCCH Allocation Sequence - BCCH Allocation ARFCN <p>SI 13 Rest Octets</p> <ul style="list-style-type: none"> -MA_LENGTH -MA_BITMAP} 	<p>For SI 2</p> <p>For GSM 900: Bit map 0.</p> <p>For DCS 1800 and PCS 1900: Range 512.</p> <p>For GSM 700, T-GSM 810 and GSM 850: Range 128.</p> <p>For GSM 900:</p> <p>Channel numbers 5, 20, 80, 90, 100, 110, 120, 122, 124.</p> <p>For DCS 1800:</p> <p>Channel numbers 515, 590, 600, 700, 780, 810, 870, 875, 885</p> <p>For PCS 1900</p> <p>Channel numbers 515, 590, 600, 655, 700, 710, 740, 780, 810</p> <p>For GSM 700, T-GSM 810:</p> <p>Channel numbers 438, 447, 457, 467, 477, 487, 497, 502, 507</p> <p>For GSM 850:</p> <p>Channel numbers 137, 147, 157, 177, 197, 207, 217, 227, 237</p> <p>SI2ter</p> <p>00 (Binary)</p> <p>For GSM 900: Range 512</p> <p>For DCS 1800: Range 1024</p> <p>For PCS 1900: Range 1024</p> <p>For GSM 700, T-GSM 810: Range 512</p> <p>For GSM 850: Range 512</p> <p>0</p> <p>For GSM 900:</p> <p>Channel numbers 515, 590, 600, 700, 780, 810, 870, 875, 885.</p> <p>For DCS 1800:</p> <p>Channel numbers 5, 20, 80, 90, 100, 110, 120, 122, 124.</p> <p>For PCS 1900:</p> <p>GSM 850 Channel numbers 137, 147, 157, 177, 197, 207, 217, 227, 237 (for a GSM 850/PCS 1900 Network);</p> <p>or</p> <p>GSM 700, T-GSM 810 Channel numbers 438, 447, 457, 467, 477, 487, 497, 502, 507 (for a GSM 700, T-GSM 810 / PCS 1900 Network).</p> <p>For GSM 700, T-GSM 810:</p> <p>Channel numbers 515, 590, 600, 655, 700, 710, 740, 780, 810.</p> <p>For GSM 850:</p> <p>Channel numbers 515, 590, 600, 655, 700, 710, 740, 780, 810.</p> <p>For PBCCH present case or PBCCH not present</p> <p>000101 (for GSM900).</p> <p>000011 (for GSM 700, T-GSM 810, GSM 850, DCS 1800 and PCS 1900).</p> <p>001111 4 belonging (for GSM900).</p> <p>1111 4 belonging (for GSM 700, T-GSM 810, GSM 850, DCS 1800 and PCS 1900).</p>
---	---

40.2.1.3 Cell C

The contents of SYSTEM INFORMATION TYPE 1 to 13 messages for cell C are identical to those of cell A with the following exceptions:

<p>Cell Channel Description</p> <ul style="list-style-type: none"> - Format Identifier <ul style="list-style-type: none"> - Cell Allocation ARFCN 	<p>For GSM 900: Bit map 0. For DCS 1800 and PCS 1900: Range 512. For GSM 700, T-GSM 810 and GSM 850: Range 128. For GSM 900: Channel Numbers 65, 75, 85, 95, 105 and 115. For DCS 1800: Channel numbers 605, 610, 620 and 630 For PCS 1900: Channel numbers 605, 610, 620 and 630 For GSM 700, T-GSM 810: Channel numbers 449, 451, 453, 455 For GSM 850: Channel Numbers 169, 171, 173, 175.</p>
<p>Cell Identity</p> <ul style="list-style-type: none"> - Cell Identity Value <p>Neighbour Cells Description</p> <ul style="list-style-type: none"> - Format identifier <ul style="list-style-type: none"> - BCCH Allocation ARFCN 	<p>0003H For SI 2 For GSM 900: Bit map 0. For DCS 1800 and PCS 1900: Range 512. For GSM 700, T-GSM 810 and GSM 850: Range 128. For GSM 900: Channel numbers 5, 20, 80, 90, 100, 110, 120, 122, 124. For DCS 1800: Channel numbers 515, 590, 600, 700, 780, 810, 870, 875, 885 For PCS 1900 Channel numbers 515, 590, 600, 655, 700, 710, 740, 780, 810 For GSM 700, T-GSM 810: Channel numbers 438, 447, 457, 467, 477, 487, 497, 502, 507 For GSM 850: Channel numbers 137, 147, 157, 177, 197, 207, 217, 227, 237 SI2ter</p>
<p>Neighbour Cells Description 2</p> <ul style="list-style-type: none"> - Multiband Reporting - Format identifier <ul style="list-style-type: none"> - BCCH Allocation Sequence - BCCH Allocation ARFCN 	<p>00 (Binary) For GSM 900: Range 512 For DCS 1800: Range 1024 For PCS 1900: Range 1024 For GSM 700, T-GSM 810: Range 512 For GSM 850: Range 512 0 For GSM 900: Channel numbers 515, 590, 600, 700, 780, 810, 870, 875, 885. For DCS 1800: Channel numbers 5, 20, 80, 90, 100, 110, 120, 122, 124. For PCS 1900: GSM 850 Channel numbers 137, 147, 157, 177, 197, 207, 217, 227, 237 (for a GSM 850/PCS 1900 Network); or GSM 700, T-GSM 810 Channel numbers 438, 447, 457, 467, 477, 487, 497, 502, 507 (for a GSM 700, T-GSM 810 / PCS 1900 Network). For GSM 700, T-GSM 810: Channel numbers 515, 590, 600, 655, 700, 710, 740, 780, 810 For GSM 850: Channel numbers 515, 590, 600, 655, 700, 710, 740, 780, 810 For PBCCH present case or PBCCH not present</p>
<p>SI 13 Rest Octets</p> <ul style="list-style-type: none"> -MA_LENGTH <ul style="list-style-type: none"> -MA_BITMAP} 	<p>000101 (for GSM900). 000011 (for GSM 700, T-GSM 810, GSM 850, DCS 1800 and PCS 1900). 001111 4 belonging (for GSM900). 1111 4 belonging (for GSM 700, T-GSM 810, GSM 850, DCS 1800 and PCS 1900).</p>

40.2.1.4 Cell D

The contents of SYSTEM INFORMATION TYPE 1 to 13 messages for cell D are identical to those of cell A with the following exceptions:

<p>Cell Channel Description</p> <ul style="list-style-type: none"> - Format Identifier <ul style="list-style-type: none"> - Cell Allocation ARFCN 	<p>For GSM 900: Bit map 0. For DCS 1800 and PCS 1900: Range 512. For GSM 700, T-GSM 810 and GSM 850: Range 128. For GSM 900: Channel Numbers 22, 42, 62, 82, 102, 122. For DCS 1800: Channel numbers 640, 655, 660, 670 For PCS 1900: Channel numbers 640, 655, 660, 670 For GSM 700, T-GSM 810: Channel numbers 459, 461, 463, 465 For GSM 850: Channel numbers 139, 141, 143, 145.</p>
<p>Cell Identity</p> <ul style="list-style-type: none"> - Cell Identity Value <p>Neighbour Cells Description</p> <ul style="list-style-type: none"> - Format identifier <ul style="list-style-type: none"> - BCCH Allocation ARFCN 	<p>0004H For SI 2 For GSM 900: Bit map 0. For DCS 1800 and PCS 1900: Range 512. For GSM 700, T-GSM 810 and GSM 850: Range 128. For GSM 900: Channel numbers 5, 20, 80, 90, 100, 110, 120, 122, 124. For DCS 1800: Channel numbers 515, 590, 600, 700, 780, 810, 870, 875, 885 For PCS 1900 Channel numbers 515, 590, 600, 655, 700, 710, 740, 780, 810 For GSM 700, T-GSM 810: Channel numbers 438, 447, 457, 467, 477, 487, 497, 502, 507. For GSM 850: Channel numbers 137, 147, 157, 177, 197, 207, 217, 227, 237</p>
<p>Neighbour Cells Description 2</p> <ul style="list-style-type: none"> - Multiband Reporting - Format identifier <ul style="list-style-type: none"> - BCCH Allocation Sequence - BCCH Allocation ARFCN 	<p>SI2ter 00 (Binary) For GSM 900: Range 512 For DCS 1800: Range 1024 For PCS 1900: Range 1024 For GSM 700, T-GSM 810: Range 512 For GSM 850: Range 512 0 For GSM 900: Channel numbers 515, 590, 600, 700, 780, 810, 870, 875, 885. For DCS 1800: Channel numbers 5, 20, 80, 90, 100, 110, 120, 122, 124. For PCS 1900: GSM 850 Channel numbers 137, 147, 157, 177, 197, 207, 217, 227, 237 (for a GSM 850/PCS 1900 Network); or GSM 700, T-GSM 810 Channel numbers 437, 447, 457, 467, 477, 487, 497, 502, 507. (for a GSM 700, T-GSM 810 / PCS 1900 Network). For GSM 700, T-GSM 810: Channel numbers 515, 590, 600, 655, 700, 710, 740, 780, 810 For GSM 850: Channel numbers 515, 590, 600, 655, 700, 710, 740, 780, 810.</p>
<p>SI 13 Rest Octets</p> <ul style="list-style-type: none"> -MA_LENGTH <ul style="list-style-type: none"> -MA_BITMAP} 	<p>For PBCCH present case or PBCCH not present 000101 (for GSM900). 000011 (for GSM 700, T-GSM 810, GSM 850, DCS 1800 and PCS 1900). 001111 4 belonging (for GSM900). 1111 4 belonging (for GSM 700, T-GSM 810, GSM</p>

	850, DCS 1800 and PCS 1900).
--	------------------------------

40.2.1.5 Cell E

The contents of SYSTEM INFORMATION TYPE 1 to 13 messages for cell E are identical to those of cell A with the following exceptions:

<p>Cell Channel Description</p> <ul style="list-style-type: none"> - Format Identifier <ul style="list-style-type: none"> - Cell Allocation ARFCN 	<p>For GSM 900: Bit map 0. For DCS 1800 and PCS 1900: Range 512. For GSM 700, T-GSM 810 and GSM 850: Range 128. For GSM 900: Channel Numbers 12, 32, 52, 72, 92, 112 For DCS 1800: Channel numbers 680, 690, 705, 710 For PCS 1900: Channel numbers 680, 690, 705, 710 For GSM 700, T-GSM 810: Channel numbers 489, 491, 493, 495 For GSM 850: Channel numbers 149, 151, 153, 155</p>
<p>Cell Identity</p> <ul style="list-style-type: none"> - Cell Identity Value <p>Neighbour Cells Description</p> <ul style="list-style-type: none"> - Format identifier <ul style="list-style-type: none"> - BCCH Allocation ARFCN 	<p>0005H For SI 2 For GSM 900: Bit map 0. For DCS 1800 and PCS 1900: Range 512. For GSM 700, T-GSM 810 and GSM 850: Range 128. For GSM 900: Channel numbers 5, 20, 80, 90, 100, 110, 120, 122, 124. For DCS 1800: Channel numbers 515, 590, 600, 700, 780, 810, 870, 875, 885 For PCS 1900 Channel numbers 515, 590, 600, 655, 700, 710, 740, 780, 810 For GSM 700, T-GSM 810: Channel numbers 438, 447, 467, 457, 477, 487, 497, 502, 507 For GSM 850: Channel numbers 137, 147, 157, 177, 197, 207, 217, 227, 237</p>
<p>Neighbour Cells Description 2</p> <ul style="list-style-type: none"> - Multiband Reporting - Format identifier <ul style="list-style-type: none"> - BCCH Allocation Sequence - BCCH Allocation ARFCN 	<p>SI2ter 00 (Binary) For GSM 900: Range 512 For DCS 1800: Range 1024 For PCS 1900: Range 1024 For GSM 700, T-GSM 810: Range 512 For GSM 850: Range 512 0 For GSM 900: Channel numbers 515, 590, 600, 700, 780, 810 870, 875, 885. For DCS 1800: Channel numbers 5, 20, 80, 90, 100, 110, 120, 122, 124. For PCS 1900: GSM 850 Channel numbers 137, 147, 157, 177, 197, 207, 217, 227, 237 (for a GSM 850/PCS 1900 Network); or GSM 700, T-GSM 810 Channel numbers 438, 447, 457, 467, 477, 487, 497, 502, 507 (for a GSM 700, T-GSM 810 / PCS 1900 Network). For GSM 700, T-GSM 810: Channel numbers 515, 590, 600, 655, 700, 710, 740, 780, 810. For GSM 850: Channel numbers 515, 590, 600, 655, 700, 710, 740, 780, 810.</p>
<p>SI 13 Rest Octets</p> <ul style="list-style-type: none"> -MA_LENGTH <ul style="list-style-type: none"> -MA_BITMAP} 	<p>For PBCCH present case or PBCCH not present 000101 (for GSM900). 000011 (for GSM 700, T-GSM 810, GSM 850, DCS 1800 and PCS 1900). 001111 4 belonging (for GSM900). 1111 4 belonging (for GSM 700, T-GSM 810, GSM</p>

	850, DCS 1800 and PCS 1900).
--	------------------------------

40.2.1.6 Cell F

The contents of SYSTEM INFORMATION TYPE 1 to 13 messages for cell F are identical to those of cell A with the following exceptions:

<p>Cell Channel Description</p> <ul style="list-style-type: none"> - Format Identifier <ul style="list-style-type: none"> - Cell Allocation ARFCN 	<p>For GSM 900: Bit map 0. For DCS 1800 and PCS 1900: Range 512. For GSM 700, T-GSM 810 and GSM 850: Range 128. For GSM 900: Channel Numbers 7, 27, 47, 67, 87, 107 For DCS 1800: Channel numbers 720, 730, 740, 770 For PCS 1900: Channel numbers 720, 730, 740, 750 For GSM 700, T-GSM 810: Channel numbers 479, 481, 483, 485 For GSM 850: Channel numbers 189, 191, 193, 195</p>
<p>Cell Identity</p> <ul style="list-style-type: none"> - Cell Identity Value <p>Neighbour Cells Description</p> <ul style="list-style-type: none"> - Format identifier <ul style="list-style-type: none"> - BCCH Allocation ARFCN 	<p>0006H For SI 2 For GSM 900: Bit map 0. For DCS 1800 and PCS 1900: Range 512. For GSM 700, T-GSM 810 and GSM 850: Range 128. For GSM 900: Channel numbers 5, 20, 80, 90, 100, 110, 120, 122, 124. For DCS 1800: Channel numbers 515, 590, 600, 700, 780, 810, 870, 875, 885 For PCS 1900 Channel numbers 515, 590, 600, 655, 700, 710, 740, 780, 810 For GSM 700, T-GSM 810: Channel numbers 438, 447, 457, 467, 477, 487, 497, 502, 507 For GSM 850: Channel numbers 137, 147, 157, 177, 197, 207, 217, 227, 237</p>
<p>Neighbour Cells Description 2</p> <ul style="list-style-type: none"> - Multiband Reporting - Format identifier <ul style="list-style-type: none"> - BCCH Allocation Sequence - BCCH Allocation ARFCN 	<p>SI2ter 00 (Binary) For GSM 900: Range 512 For DCS 1800: Range 1024 For PCS 1900: Range 1024 For GSM 700, T-GSM 810: Range 512 For GSM 850: Range 512 0 For GSM 900: Channel numbers 515, 590, 600, 700, 780, 810, 870, 875, 885. For DCS 1800: Channel numbers 5, 20, 80, 90, 100, 110, 120, 122, 124. For PCS 1900: GSM 850 Channel numbers 137, 147, 157, 177, 197, 207, 217, 227, 237 (for a GSM 850/PCS 1900 Network); or GSM 700, T-GSM 810 Channel numbers 438, 447, 457, 467, 477, 487, 497, 502, 507 (for a GSM 700, T-GSM 810 / PCS 1900 Network). For GSM 700, T-GSM 810: Channel numbers 515, 590, 600, 655, 700, 710, 740, 780, 810. For GSM 850: Channel numbers 515, 590, 600, 655, 700, 710, 740, 780, 810.</p>
<p>SI 13 Rest Octets</p> <ul style="list-style-type: none"> -MA_LENGTH <ul style="list-style-type: none"> -MA_BITMAP} 	<p>For PBCCH present case or PBCCH not present 000101 (for GSM900). 000011 (for GSM 700, T-GSM 810, GSM 850, DCS 1800 and PCS 1900). 001111 4 belonging (for GSM900). 1111 4 belonging (for GSM 700, T-GSM 810, GSM</p>

850, DCS 1800 and PCS 1900).

40.2.2 Packet System Information messages

40.2.2.1 Cell A

This subclause contains default sets of PSI message contents for two GSM GPRS neighbour cells followed by default sets of PSI message contents for two DCS GPRS neighbour cells. All cells are operating with channel combination xi).

In this subclause all information element values are in binary. Numeric values in comments are in decimal.

40.2.2.1.1 PACKET SYSTEM INFORMATION TYPE 1

This message is transmitted on PBCCH and PACCH. On PACCH it is transmitted in such a way that the mobile station receives PSI1 once in 15 seconds.

MESSAGE_TYPE	110001
PAGE_MODE	00 Normal Paging
PBCCH_CHANGE_MARK	000
PSI_CHANGE_FIELD	0000
PSI1_REPEAT_PERIOD	0010 PSI1 repeat period = 3 mframes
PSI_COUNT_LR	000011 PSI Count Low Rate = 3 (000100 PSI Count Low Rate = 4 when MEASUREMENT_ORDER IE are set to 1 and PSI5 are broadcasted)
{PSI_COUNT_HR}	1 PSI_COUNT_HR present
PSI_COUNT_HR	0011 PSI Count High Rate = 4
MEASUREMENT_ORDER	0 PSI5 not broadcasted (for the Measurement Reporting and Network Controlled cell reselection test cases, the MEASUREMENT_ORDER IE shall be set to 1 and PSI5 shall be broadcasted).
GPRS Cell Options	
- NMO	00 Network Mode 1
- T3168	011 2 seconds
- T3192_VALUE	010 1.5 seconds
- DRX_TIMER_MAX	000
- ACCESS_BURST_TYPE	1 11 bit access burst
- CONTROL_ACK_TYPE	1 RLC/MAC Control block
- BS_CV_MAX	0111
{ PAN parameters}	1 PAN parameters present
- PAN_DEC	001
- PAN_INC	001
- PAN_MAX	000
- Optional extension information	0 Extension information not present
For R99/Rel 4/Rel 6 network simulation:	
Optional extension information	1 Extension information present
- Extension lenght	R99: 000011 Rel 4: 000101 Rel 6: 001001
- {0 1 <Extension Information>}	0 EGPRS not supported by the cell.
- PFC_FEATURE_MODE	0 Packet Flow Context Procedures not supported
- DTM_SUPPORT	Default: 0.....The cell does not support DTM procedures For DTM test cases: 1.....The cell supports DTM procedures
- BSS_PAGING_COORDINATION	0 Circuit-Switched paging coordination not supported in cell
For Rel 4 network simulation	
- CCN_ACTIVE	0 CCN is disabled in the cell
- NW_EXT_UTBF	0 Ext UL TBF not supported in the cell
For Rel 6 network simulation:	
- MULTIPLE_TBF_CAPABILITY	0 Cell does not support multiple TBF procedures
- EXT_UTBF_NO_DATA	0 MS shall send a PACKET UPLINK DUMMY CONTROL BLOCK message when there is no other RLC/MAC block ready to send in an uplink radio block allocated by the network
- DTM_ENHANCEMENTS_CAPABILITY	0 Cell does not support enhanced DTM CS establishment and enhanced DTM CS release procedures
- { 0 1 }	0 -- MBMS procedures not supported by the cell
End Rel 6	
end Rel 4	
end R99	
PRACH Control Parameters	
- ACC_CONTR_CLASS	0000000000000000 All Access Control Classes are allowed
- MAX_RETRANS	00 Maximum 1 retransmission each priority
- S	0001 15 slots between
- TX_INT	0010 4 slots
- {0 1<PERSISTENCE_LEVEL>}	0 persistence level not present
PCCCH Organization Parameters	
- BS_PCC_REL	0 No release pending
- BS_PBCCH_BLKs	10 Blocks B0, B6, B3
- BS_PAG_BLKs_RES	0010 2 blocks reserved
- BS_PRACH_BLKs	0001 1 block (B0) reserved

Global Power Control Parameters	
- ALPHA	0000 $\alpha = 0$
- T_AVG_W	00000 $k = 0$
- T_AVG_T	00000 $k = 0$
- Pb	0000 $P_b = -0dB$
- PC_MEAS_CHAN	0 On BCCH
- INT_MEAS_CHANNEL_LIST_AVAIL	0 PSI4 message not broadcasted
- N_AVG_I	0110
PSI_STATUS_IND	0
For R99/Rel 6 network simulation:	
Additions for Rel.99	1
- MSCR bit	1 MSCR is Release '99 onwards
- SGSNR bit	1 SGSNR is Release '99 onwards
- Band Indicator	0 (for GSM 700, T-GSM 810, GSM 850 GSM 900 and GSM 1800)
	1 (for GSM 1900)
Additions for Rel.6	1
{LB_MS_TXPWR_MAX_CCH}	1 LB_MS_TXPWR_MAX_CCH present
-LB_MS_TXPWR_MAX_CCH	01010
End Rel 6	
End R99	
Padding	Padding bits

40.2.2.1.2 PACKET SYSTEM INFORMATION TYPE 2. Instance 1 of 3

MESSAGE_TYPE	110010
PAGE_MODE	00 Normal Paging
PSI2_CHANGE_MARK	01
PSI2_INDEX	000
PSI2_COUNT	010 Three instances of PSI2
Cell Identification	1 Cell Identification parameters present
-Location Area Identification IE	00001 (ID value 1 represented in 5 octets)
-RAC	00000101
-Cell Identity IE	01 (ID value 1 represented in 2 octets)
Non GPRS Cell Options	1 Non GPRS Cell Options present
-ATT	MS shall apply IMSI attach and detach procedures
-(Timeout for periodic update	1 Timeout value for periodic update included
-T3212	00000000 Timeout value
-NECI	New establishment causes supported
-PWRC	0 Power control indicator
-DTX	10
-RADIO_LINK_TIMEOUT	0001 value 8
For Non Combined	
-BS_AG_BLK_RES	011 3 reserved
-CCCH_CONF	000
For Combined	
-BS_AG_BLK_RES	010 2 reserved
-CCCH_CONF	001
-BS_PA_MFRMS	100 6 multiframe
-MAX_RETRANS	00 1 retransmission allowed
-TX_INTEGER	0010 5 slots used for spread transmission
-EC	0 emergency call allowed
-MS_TXPWR_MAX_CCCH	01010
-(0 1<extension bits>}	0 Extension information not present
For R99 network simulation:	
-(0 1<extension bits>}	1 Extension information present
- extension length	1 2 bits
- ECSC bit	1 Early Classmark Sending is allowed
- 3G ECSR	0 Neither UTRAN nor cdma2000 classmark change
Additions for Rel.99	1
- COMPACT Ctrl Info flag	0
- Additional PSI Messages flag	0
Padding	Padding bits

40.2.2.1.3

PACKET SYSTEM INFORMATION TYPE 2. Instance 2 of 3

MESSAGE_TYPE	110010
PAGE_MODE	00 Normal Paging
PSI2_CHANGE_MARK	01
PSI2_INDEX	001
PSI2_COUNT	010 Three instances of PSI2
Cell Identification	0 Cell Identification parameters not present
Non GPRS Cell Options	0 Non GPRS Cell Options not present
{Reference Frequency Lists}	
-	1 (Reference Frequency struct present)
- RFL_NUMBER	0010 List 2
	GSM 900 GPRS:
- Length of RFL contents	0011 IE length = 3 (128 format)
- RFL contents	10001100 format 10 + spare 00 + format 110 + ARFCN 10
	00000101 ARFCN 37
	00101000 ARFCN 40
	11011001 ARFCN 50
	11101110 ARFCN 60
	10110000 ARFCN 80
	DCS 1 800 and PCS 1 900 GPRS:
- Length of RFL contents	0011 IE length = 3 (512 format)
- RFL contents	10001001 format 10 + spare 00 + format 100 + 1 bit
	00000100 ARFCN 520
	00000101 ARFCN 530
	00111101 ARFCN 540
	10000010 ARFCN 550
	10000000
	GSM 700, T-GSM 810 GPRS
- Length of RFL contents	0011 IE length = 3 (128 format)
- RFL contents	10001100 format 10 + spare 00 + format 110 + ARFCN 447
	11011111 ARFCN 457
	10101000 ARFCN 477
	11011001 ARFCN 487
	01100110 ARFCN 497
	01010000 ARFCN 509
	GSM 850 GPRS:
-Length of RFL contents	0011 IE length = 3 (128 format)
- RFL contents	10001100 format 10 + spare 00 + format 110 + ARFCN159
	01001111 ARFCN 161
	10000110 ARFCN 163
	11111010 ARFCN 165
	10101111 ARFCN 187
	00110000 ARFCN 207
-	0 (end of Reference Frequency List)
{Cell Allocation}	1 (Cell Allocation present)
-RFL_NUMBER	0010 List 2
-	0 (end of Cell Allocation)
{GPRS Mobile Allocations}	1 GPRS Mobile Allocation present
-MA_NUMBER	0001
-HSN	000000 Sequence 0
-{0}1<RFL number list>	1 RFL Number list present
-RFL_NUMBER	0001 List 1
-	0 RFL number list struct not present
-{0	0
-MA_LENGTH	000101 (for GSM 700, T-GSM 810, GSM 850 and GSM900).
	000111 (for DCS 1 800 and PCS 1 900).
-MA_BITMAP	001111 4 belonging (for GSM 700, T-GSM 810, GSM 850 and GSM900).

-	10101010	4 belonging (for DCS 1 800 and PCS 1 900).
{PCCCH Description}	0	End of GPRS Mobile Allocation
- TSC	1	PCCCH description present
-	101	
- MA_NUMBER	1	Hopping PCCCH
-	0010	
- MAIO	1	Start Hopping PCCCH Carrier struct
- TIMESLOT_ALLOCATION	000010	
-	00001000	
-	0	(end of Hopping PCCCH Carrier struct)
-	0	(end of PCCCH description)
For R99 network simulation:		
Additions for Rel.99	1	
- COMPACT Ctrl Info flag	0	
- Additional PSI Messages flag	0	
Padding		Padding bits

40.2.2.1.4 PACKET SYSTEM INFORMATION TYPE 2. Instance 3 of 3

MESSAGE_TYPE	110010	
PAGE_MODE	00	Normal Paging
PSI2_CHANGE_MARK	01	
PSI2_INDEX	010	
PSI2_COUNT	010	Three instances of PSI2
Cell Identification	0	Cell Identification parameters not present
Non GPRS Cell Options	0	Non GPRS Cell Options not present
{Reference Frequency Lists}		
-	1	Reference Frequency struct present
- RFL_NUMBER	0001	List 1
		GSM 900 GPRS:
- Length of RFL contents	0011	IE length = 3 (128 format)
- RFL contents	10001100	format 10 + spare 00 + format 110 + ARFCN 20
	00001010	ARFCN 30
	00011110	ARFCN 40
	11011001	ARFCN 50
	01001011	ARFCN 60
	01011000	ARFCN 70
		DCS 1 800 and PCS 1 900 GPRS :
- Length of RFL contents	0110	IE length = 6 (512 format)
- RFL contents	10001001	format 10 + spare 00 + format 100 + 1 bit
	00101100	ARFCN 600
	00001010	ARFCN 610
	00111011	ARFCN 620
	00000101	ARFCN 630
	00111011	ARFCN 640
	01110110	ARFCN 650
	00010100	ARFCN 660
	00101000	ARFCN 670
		GSM 700, T-GSM 810 GPRS :
- Length of RFL contents	0011	IE length = 3 (128 format)
- RFL contents	10001100	format 10 + spare 00 + format 110 + ARFCN 457
	11100100	ARFCN 467
	10011110	ARFCN 477
	11011001	ARFCN 487
	01001011	ARFCN 497
	01011000	ARFCN 507
		GSM 850 GPRS :
- Length of RFL contents	0011	IE length = 3 (128 format)
- RFL contents	10001100	format 10 + spare 00 + format 110 + ARFCN 147

-	01001001 ARFCN 157
{GPRS Mobile Allocations}	10011110 ARFCN 167
-MA_NUMBER	11011001 ARFCN 177
-HSN	01001011 ARFCN 187
-{0 1<RFL number list>}	01011000 ARFCN 197
-{0	0 End of Reference Frequency Lists
-MA_LENGTH	1 GPRS Mobile Allocation present
	0010
	000000 Sequence 0
	0 Number list not present
	0 MA_Bitmap
	000101 (for GSM 700, T-GSM 810, GSM 850 and GSM900).
	000011 (for DCS 1 800 and PCS 1 900).
	001111 4 belonging (for GSM 700, T-GSM 810, GSM 850 and GSM900).
	1111 4 belonging (for DCS 1 800 and PCS 1 900).
	0 End of GPRS Mobile Allocation
For R99 network simulation:	
Additions for Rel.99	1
- COMPACT Ctrl Info flag	0
- Additional PSI Messages flag	0
Padding	Padding bits

40.2.2.1.5 PACKET SYSTEM INFORMATION TYPE 3.

MESSAGE_TYPE	110011
PAGE_MODE	00 Normal Paging
PSI3_CHANGE_MARK	00
PSI3_BIS_COUNT	0010 Three 3bis messages
Serving Cell parameters	
- CELL_BAR_ACCESS_2	0 Normal reselection
- EXC_ACC	0
- GPRS_RXLEV_ACCESS_MIN	011111 -80dBm
- GPRS_MS_TXPWR_MAX_CCH	01010
- {0 1<HCS Serving Cell parameters>}	1 HCS Serving Cell parameters present
- PRIORITY_CLASS	001
- HCS_THR	00000 -110 dBm
- MULTIBAND_REPORTING	0 – Normal Reporting of six strongest cells
General Cell Selection parameter	
- GPRS_CELL_RESELECT_HYSTERESIS	000 0 dB
- C31_HYST	0 Not used in C31
- C32_QUAL	0
- RANDOM_ACCESS_RETRY	0 No access to other cells
- {0 1<T_RESEL >}	1 present
- T_RESEL	001 10 seconds
- {0 1<RA_RESELECT_HYSTERESIS>}	1 present)
- RA_RESELECT_HYSTERESIS	000 0 dB
Neighbour Cell parameters	1 start of neighbour cell parameters
- START_FREQUENCY	GSM 900 GPRS: Containing ARFCN 5 and 80
	00000001 ARFCN 5 (MSB)
	01 ARFCN 5 (LS 2bits)
	DCS 1 800 and PCS 1 900 GPRS: Containing
	ARFCN 515 and 600
	10000000 ARFCN 515 (MSB)
	11 (LS 2 bits)
	GSM 700, T-GSM 810 GPRS: Containing
	ARFCN 438 and 447
	01101101 ARFCN 438 (MSB)
	10 ARFCN 438 (LS 2 bits)
	GSM 850 GPRS: Containing ARFCN 137 and
	157
	00100010 ARFCN 137 (MSB)
	01 ARFCN 137 (LS 2 bits)
- Cell selection params	
- BSIC	001101
- CELL_BAR_ACCESS_2	0 Normal reselection

- EXC_ACC	0
- SAME_RA_AS_SERVING_CELL	1 same routing area
- {0 1<GPRS_RXLEV_ACCESS_MIN>}	1 GPRS_RXLEV_ACCESS_MIN present
- GPRS_RXLEV_ACCESS_MIN	011111 -80dBm
- GPRS_MS_TXPWR_MAX_CCH	01010
- {0 1<GPRS_TEMPORARY_OFFSET>}	1 GPRS_TEMPORARY_OFFSET present
- GPRS_TEMPORARY_OFFSET	000
- GPRS_PENALTY_TIME	00000
- {0 1<GPRS_RESELECT_OFFSET>}	1 GPRS_RESELECT_OFFSET present
- GPRS_RESELECT_OFFSET	10000 0dB
- {0 1<HCS params>}	1 HCS params present
- GPRS_PRIORITY_CLASS	001
- GPRS_HCS_THR	10100
- {0 1<SI13_PBCCH_LOCATION>}	1 SI13_PBCCH_LOCATION present
0- SI13 1 PBCCH Location	0 SI13 Location
	0 SI13 on BCCH Norm
:NR_OF_REMAINING_CELLS	0001
FREQ_DIFF_LENGTH	GSM 900 GPRS: 110 7 bits
	DCS 1800 GPRS: 110 7 bits
	PCS 1900 GPRS: 110 7 bits
	GSM 850 GPRS: 100 5 bits
	GSM 700, T-GSM 810 GPRS: 011 4 bits
FREQUENCY_DIFF	GSM 900 GPRS: 1001011 (ARFCN 80 – diff 75)
	DCS 1 800 and PCS 1 900 GPRS: 1010101 (ARFCN 600 – diff 85)
	PCS 1900 GPRS: 1010101 (ARFCN 600 – diff 85)
	GSM 700, T-GSM 810 GPRS: 1001 (ARFCN 447 – diff 9)
	GSM 850 GPRS: 10100 (ARFCN 157 – diff 20)
- Cell selection params	001101
- BSIC	0 Normal reselection
- CELL_BAR_ACCESS_2	0
- EXC_ACC	1 same routing area
- SAME_RA_AS_SERVING_CELL	1 GPRS_RXLEV_ACCESS_MIN present
- {0 1<GPRS_RXLEV_ACCESS_MIN>}	010111 -88dBm
- GPRS_RXLEV_ACCESS_MIN	01010
- GPRS_MS_TXPWR_MAX_CCH	0 GPRS_TEMPORARY_OFFSET not present
- {0 1<GPRS_TEMPORARY_OFFSET>}	1 GPRS_RESELECT_OFFSET present
- {0 1<GPRS_RESELECT_OFFSET>}	10000 0dB
- GPRS_RESELECT_OFFSET	0 HCS params not present
- {0 1<HCS params>}	1 SI13_PBCCH_LOCATION present
- {0 1<SI13_PBCCH_LOCATION>}	0 SI13 Location
0- SI13 1 PBCCH Location	0 SI13 on BCCH Norm
- SI13_LOCATION	0
End of Neighbour parameter	0
For R99 network simulation:	
Additions for Rel.98	1
- LSA ID flag	0 not present
- LSA Parameters	0 not present
Additions for Rel.99	1
- Reserved – set to 00	00
- COMPACT Information flag	0 not present
- Reserved – set to 0	0
Padding	Padding bits

40.2.2.1.6 PACKET SYSTEM INFORMATION TYPE 3bis. (Instance 1 of 3)

MESSAGE_TYPE	110100
PAGE_MODE	00 Normal Paging

PSI3_CHANGE_MARK	00
PSI3_BIS_INDEX	0000
PSI3_BIS_COUNT	0010
Neighbour Cell parameters	1 start of neighbour cell parameters
- START_FREQUENCY	GSM 900 GPRS: Containing ARFCN 90 and 120. 00010110 ARFCN 90 (MSB) 10 ARFCN 90 (LS 2 bits) DCS 1 800 GPRS: Containing ARFCN 700 and 870 10101111 ARFCN 700 (MSB) 00 ARFCN 700 (LS 2 bits) PCS 1900 GPRS: Containing ARFCN 655 and 810 10100011 ARFCN 655 (MSB) 11 ARFCN 655 (LS 2 bits) GSM 700, T-GSM 810 GPRS: Containing ARFCN 467 and 497 01110100ARFCN 467 (MSB) 11 ARFCN 467 (LS 2 bits) GSM 850 GPRS: Containing ARFCN 207 and 237 00110011 ARFCN 207 (MSB) 11 ARFCN 207 (LS 2 bits)
- Cell selection params	001101
- BSIC	0 Normal reselection
- CELL_BAR_ACCESS_2	0
-EXT_ACC	0
- SAME_RA_AS_SERVING_CELL	1 same routing area
- {0 1<GPRS_RXLEV_ACCESS_MIN>}	1 GPRS_RXLEV_ACCESS_MIN present
- GPRS_RXLEV_ACCESS_MIN	010110 -89dBm
- GPRS_MS_TXPWR_MAX_CCH	01010
- {0 1<GPRS_TEMPORARY_OFFSET>}	1 GPRS_TEMPORARY_OFFSET present
- GPRS_TEMPORARY_OFFSET	000
- GPRS_PENALTY_TIME	00000
- {0 1<GPRS_RESELECT_OFFSET>}	1 GPRS_RESELECT_OFFSET present
- GPRS_RESELECT_OFFSET	10000 0dB
- {0 1<HCS params>}	1 HCS params present
- GPRS_PRIORITY_CLASS	001
- GPRS_HCS_THR	10100
- {0 1<SI13_PBCCH_LOCATION>}	1 SI13_PBCCH_LOCATION present
0- SI13 1 PBCCH Location	0 SI13 Location
- NR_OF_REMAINING_CELLS	0 SI13 on BCCH Norm
- FREQ_DIFF_LENGTH	0001
	GSM 900 GPRS: 100 5 bits
	DCS 1800 GPRS: 111 8 bits
	PCS 1900 GPRS: 111 8 bits
	GSM 850 GPRS: 100 5 bits
	GSM 700, T-GSM 810 GPRS: 100 5 bits
- FREQUENCY_DIFF	GSM 900 GPRS: 11110 (ARFCN 120 – diff 30) DCS 1 800 GPRS 10101010 (ARFCN 870 - diff 170) PCS 1900 GPRS 10011011 (ARFCN 810 – diff 155) GSM 700, T-GSM 810 GPRS: 11110 (ARFCN 499 – diff 30) GSM 850 GPRS: 11110 (ARFCN 237 – diff 30)
- Cell selection params	001101
- BSIC	0 Normal reselection
- CELL_BAR_ACCESS_2	0
-EXT_ACC	0

- SAME_RA_AS_SERVING_CELL	1 same routing area
- {0 1<GPRS_RXLEV_ACCESS_MIN>}	1 GPRS_RXLEV_ACCESS_MIN present
- GPRS_RXLEV_ACCESS_MIN	010110 -89dBm
- GPRS_MS_TXPWR_MAX_CCH	01010
- {0 1<GPRS_TEMPORARY_OFFSET>}	1 GPRS_TEMPORARY_OFFSET present
- GPRS_TEMPORARY_OFFSET	000
- GPRS_PENALTY_TIME	00000
- {0 1<GPRS_RESELECT_OFFSET>}	1 GPRS_RESELECT_OFFSET present
- GPRS_RESELECT_OFFSET	10000 0dB
- {0 1<HCS params>}	1 HCS params present
- GPRS_PRIORITY_CLASS	001
- GPRS_HCS_THR	10100
- {0 1<SI13_PBCCH_LOCATION>}	1 SI13_PBCCH_LOCATION present
0- SI13 1 PBCCH Location	0 SI13 Location
- SI13_LOCATION	0 SI13 on BCCH norm
-	0 (end of neighbour cell parameters)
0 1<Neighbour Cell parameters 2>	0 Neighbour Cell parameters 2 not present
For R99/Rel 4 network simulation:	
Additions for Rel.98	1
- LSA Parameters	0 not present
Additions for Rel.99	1
- COMPACT NC parameters flag	not present
- Reserved – set to 0	0
End R99	
Additions for Rel 4	1
- CCN Support Description flag	0 off
Padding	Padding bits

40.2.2.1.7 PACKET SYSTEM INFORMATION TYPE 3bis (Instance 2 of 3)

MESSAGE_TYPE	110100
PAGE_MODE	00 Normal Paging
PSI3_CHANGE_MARK	00
PSI3_BIS_INDEX	0001
PSI3_BIS_COUNT	0010
Neighbour Cell parameters	1 start of neighbour cell parameters
- START_FREQUENCY	GSM 900 GPRS: containing ARFCN 100 and 110 00011001 ARFCN 100 (MSB) 00 ARFCN 100 (LS 2 bits) DCS 1 800 GPRS: containing ARFCN 780 and 810 11000011ARFCN 780 (MSB) 00 ARFCN 780 (LS 2 bits) PCS 1 900 GPRS: containing ARFCN 700 and 780 10101111 ARFCN 700 (MSB) 00 ARFCN 700 (LS 2 bits) GSM 700, T-GSM 810 GPRS: containing ARFCN 477 and 487 01110111 ARFCN 477 (MSB) 01 ARFCN 477 (LS 2 bits) GSM 850 GPRS: containing ARFCN 217 and 227 00110110 ARFCN 217 (MSB) 01 ARFCN 217 (LS 2 bits)
- Cell selection params	001101
- BSIC	0 Normal reselection
- CELL_BAR_ACCESS_2	0
- EXT_ACC	1 same routing area
- SAME_RA_AS_SERVING_CELL	1 GPRS_RXLEV_ACCESS_MIN present
- {0 1<GPRS_RXLEV_ACCESS_MIN>}	010110 -89dBm
- GPRS_RXLEV_ACCESS_MIN	01010
- GPRS_MS_TXPWR_MAX_CCH	1 GPRS_TEMPORARY_OFFSET present
- {0 1<GPRS_TEMPORARY_OFFSET>}	000
- GPRS_TEMPORARY_OFFSET	00000
- GPRS_PENALTY_TIME	1 GPRS_RESELECT_OFFSET present
- {0 1<GPRS_RESELECT_OFFSET>}	10000 0dB
- GPRS_RESELECT_OFFSET	1 HCS params present
- {0 1<HCS params>}	001
- GPRS_PRIORITY_CLASS	10100
- GPRS_HCS_THR	1 SI13_PBCCH_LOCATION present
- {0 1<SI13_PBCCH_LOCATION >}	0 SI13 Location
0- SI13 1 PBCCH Location	0 SI13 on BCCH Norm
- PBCCH_LOCATION	0001
- NR_OF_REMAINING_CELLS	GSM 900 GPRS: 011 4 bits
- FREQ_DIFF_LENGTH	DCS 1 800 GPRS: 100 5 bits
	PCS 1900 GPRS: 110 7 bits
	GSM 700, T-GSM 810 GPRS: 011 4 bits
	GSM 850 GPRS: 011 4 bits
	GSM 900 GPRS: 1010 (ARFCN 110 – diff10)
	DCS 1 800 GPRS: 11110 (ARFCN 870 – diff 30)
	PCS 1 900 GPRS: 1010000 (ARFCN 780 – diff 80)
	GSM 700, T-GSM 810 GPRS: 1010 (ARFCN 487 – diff 10)
	GSM 850 GPRS: 1010 (ARFCN 227 – diff 10)
- FREQUENCY_DIFF	
- Cell selection params	001101 (Binary)
- BSIC	0 Normal reselection
- CELL_BAR_ACCESS_2	

- EXT_ACC	0
- SAME_RA_AS_SERVING_CELL	1
- {0 1<GPRS_RXLEV_ACCESS_MIN>}	1 GPRS_RXLEV_ACCESS_MIN present
- GPRS_RXLEV_ACCESS_MIN	010110 -89dBm
- GPRS_MS_TXPWR_MAX_CCH	01010
- {0 1<GPRS_TEMPORARY_OFFSET>}	1 GPRS_TEMPORARY_OFFSET present
- GPRS_TEMPORARY_OFFSET	000
- GPRS_PENALTY_TIME	00000
- {0 1<GPRS_RESELECT_OFFSET>}	1 GPRS_RESELECT_OFFSET present
- GPRS_RESELECT_OFFSET	10000 0dB
- {0 1<HCS params>}	1 HCS params present
- GPRS_PRIORITY_CLASS	001
- GPRS_HCS_THR	10100
- {0 1<SI13_PBCCH_LOCATION >}	1 SI13_PBCCH_LOCATION present
0- SI13 1 PBCCH Location	0 SI13 Location
- SI13_LOCATION	0 SI13 on BCCH norm
-	0 (end of neighbour cell parameters)
0 1<Neighbour Cell parameters 2>	0 Neighbour Cell parameters 2 not present
For R99/Rel 4 network simulation:	
Additions for Rel.98	1
- LSA Parameters	0 not present
Additions for Rel.99	1
- COMPACT NC parameters flag	not present
- Reserved – set to 0	0
End R99	
Additions for Rel 4	1
- CCN Support Description flag	0 off
Padding	Padding bits

40.2.2.1.8 PACKET SYSTEM INFORMATION TYPE 3bis (Instance 3 of 3)

MESSAGE_TYPE	110100
PAGE_MODE	00 Normal Paging
PSI3_CHANGE_MARK	00
PSI3_BIS_INDEX	0010
PSI3_BIS_COUNT	0010
Neighbour Cell parameters	1 start of neighbour cell parameters
- START_FREQUENCY	GSM 900 GPRS: containing ARFCN 122 and 124 00011110 ARFCN 122 (MSB) 10 ARFCN 122 (LS 2 bits) DCS 1 800 GPRS: Containing ARFCN 875 and 885 11011010 ARFCN 875 (MSB) 11 ARFCN 875 (LS 2 bits) PCS 1900 GPRS: Containing ARFCN 710 and 740 10110001 ARFCN 710 (MSB) 10 ARFCN 710 (LS 2 bits) GSM 700, T-GSM 810 GPRS: Containing ARFCN 502 and 507 01111101 ARFCN 502 (MSB) 10 ARFCN 502 (LS 2 bits) GSM 850 GPRS Containing ARFCN 177 and 197 00101100 ARFCN 177 (MSB) 01 ARFCN 177 (LS 2 bits)
- Cell selection params	
- BSIC	001101
- CELL_BAR_ACCESS_2	0 Normal reselection
- EXT_ACC	0
- SAME_RA_AS_SERVING_CELL	1 same routing area
- {0 1<GPRS_RXLEV_ACCESS_MIN>}	1 GPRS_RXLEV_ACCESS_MIN present
- GPRS_RXLEV_ACCESS_MIN	010110 -89dBm
- GPRS_MS_TXPWR_MAX_CCH	01010
- {0 1<GPRS_TEMPORARY_OFFSET>}	1 GPRS_TEMPORARY_OFFSET present
- GPRS_TEMPORARY_OFFSET	000

- GPRS_PENALTY_TIME	00000
- {0 1<GPRS_RESELECT_OFFSET>}	1 GPRS_RESELECT_OFFSET present
- GPRS_RESELECT_OFFSET	10000 0dB
- {0 1<HCS params>}	1 HCS params present
- GPRS_PRIORITY_CLASS	001
- GPRS_HCS_THR	10100
- {0 1< SI13_PBCCH_LOCATION >}	1 SI13_PBCCH_LOCATION present
0- SI13 1 PBCCH Location	0 SI13 Location
	0 SI13 on BCCH Norm
- NR_OF_REMAINING_CELLS	0001
- FREQ_DIFF_LENGTH	GSM 900:
	001 2 bits
	DCS 1 800:
	011 4 bits
	PCS 1900:
	100 5 bits
	GSM 700, T-GSM 810:
	010 3 bits
	GSM 850:
	100 5 bits
- FREQUENCY_DIFF	GSM 900 GPRS:
	10 (ARFCN 124 – diff 2)
	DCS 1 800 GPRS:
	1010 (ARFCN 885 – diff 10)
	PCS 1900 GPRS:
	11110 (ARFCN 740 – diff 30)
	GSM 700, T-GSM 810 GPRS:
	101 (ARFCN 507 – diff 5)
	GSM 850 GPRS:
	10100 (ARFCN 197 – diff 20)
- Cell selection params	
- BSIC	001101 (Binary)
- CELL_BAR_ACCESS_2	0 Normal reselection
- EXT_ACC	0
- SAME_RA_AS_SERVING_CELL	1
- {0 1<GPRS_RXLEV_ACCESS_MIN>}	1 GPRS_RXLEV_ACCESS_MIN present
- GPRS_RXLEV_ACCESS_MIN	010110 -89dBm
- GPRS_MS_TXPWR_MAX_CCH	01010
- {0 1<GPRS_TEMPORARY_OFFSET>}	1 GPRS_TEMPORARY_OFFSET present
- GPRS_TEMPORARY_OFFSET	000
- GPRS_PENALTY_TIME	00000
- {0 1<GPRS_RESELECT_OFFSET>}	1 GPRS_RESELECT_OFFSET present
- GPRS_RESELECT_OFFSET	10000 0dB
- {0 1<HCS params>}	1 HCS params present
- GPRS_PRIORITY_CLASS	001
- GPRS_HCS_THR	10100
- {0 1< SI13_PBCCH_LOCATION >}	1 SI13_PBCCH_LOCATION present
0- SI13 1 PBCCH Location	0 SI13 Location
- SI13_LOCATION	0 SI13 on BCCH norm
-	0 (end of neighbour cell parameters)
0 1<Neighbour Cell parameters 2>	0 Neighbour Cell parameters 2 not present
For R99/Rel 4 network simulation:	
Additions for Rel.98	1
- LSA Parameters	0 not present
Additions for Rel.99	1
- COMPACT NC parameters flag	not present
- Reserved – set to 0	0
End R99	
Additions for Rel 4	1
- CCN Support Description flag	0 off
Padding	Padding bits

40.2.2.1.9 Void

40.2.2.1.10 PACKET SYSTEM INFORMATION TYPE 5.

Note that the following message is only sent if the MEASUREMENT_ORDER IE in PSI1 is set to 1. The MEASUREMENT_ORDER IE in PSI1 shall be set to 1 for the Measurement Reporting and Network Controlled cell reselection test cases.

MESSAGE_TYPE	110110
PAGE_MODE	00 Normal Paging
PSI5_CHANGE_MARK	00
PSI5_INDEX	000
PSI5_COUNT	000
{0 1<NC Measurement Parameters>}	1 NC Measurement Parameters present
- NETWORK_CONTROL_ORDER	00 NC0
- {	1 NC Periods present
- NC_NON_DRX_PERIOD	111
- NC_REPORTING_PERIOD_I	111
- NC_REPORTING_PERIOD_T}	011
0	0
For R99 network simulation:	
Additions for Rel.99	1
- ENH Reporting Parameters flag	0 not present
Padding	Padding bits

40.2.2.1.11 PACKET SYSTEM INFORMATION TYPE 13 (for PBCCH present case).

MESSAGE_TYPE	110111
PAGE_MODE	00 Normal Paging
BCCH_CHANGE_MARK	000
SI_CHANGE_FIELD	0000 Unspecified
{0 1<SI13_CHANGE_MARK>}	1 Present
- SI13_CHANGE_MARK	00
{GPRS Mobile Allocation}	
-HSN	000000 Sequence 0
-{0 1<RFL number list>}	0 Number list not present
-{0	0
-MA_LENGTH	000101 (for GSM 700, T-GSM 810, GSM 850 and GSM900).
	000011 (for DCS 1 800 and PCS 1 900).
	001111 4 belonging (for GSM 700, T-GSM 810, GSM 850 and GSM900).
	1111 4 belonging (for DCS 1 800 and PCS 1 900).
	1 PBCCH present in cell
- PSI1_REPEAT_PERIOD	0010 PSI1 repeat period = 3
PBCCH Description	
- Pb	0110 (-12dB)
- TSC	101
- TN	100
- {0 10 11	11
- MAIO }	000010
Additions for Rel.99/Rel 4/Rel 6	1
- SGSNR bit	1 SGSN is Release '99 onwards
Additions for Rel 4	1
- SI_STATUS_IND bit	0 PACKET SI STATUS msg not supported
Additions for Rel 6	1
{LB_MS_TXPWR_MAX_CCH}	1 LB_MS_TXPWR_MAX_CCH present
- LB_MS_TXPWR_MAX_CCH	01010
- SI2n_SUPPORT	00
End Rel 6	
End Rel 4	
End R99	
Padding	Padding bits

40.2.2.1.12 PACKET SYSTEM INFORMATION TYPE 13 (only applicable in test cases where PBCCH is not present).

This message is transmitted PACCH in such a way that the Mobile station receives PSI13 once in 15 seconds.

MESSAGE_TYPE	110111
PAGE_MODE	00 Normal Paging
BCCH_CHANGE_MARK	000
SI_CHANGE_FIELD	0000 Unspecified
{0 1<SI13_CHANGE_MARK>}	1 Present
- SI13_CHANGE_MARK	00
{GPRS Mobile Allocation}	
-HSN	000000 Sequence 0
-{0 1<RFL number list>}	0 Number list not present
-{0	0
-MA_LENGTH	000101 (for GSM 700, T-GSM 810, GSM 850 and GSM900).
	000011 (for DCS 1 800 and PCS 1 900).
	001111 4 belonging (for GSM 700, T-GSM 810, GSM 850 and GSM900).
	1111 4 belonging (for DCS 1 800 and PCS 1 900).
	0 PBCCH not present in cell
	0000101(Binary)
	1 supported
	11 PA allowed for priority level 1 to 4
	00 NC0
GPRS Cell Options	Same as the GPRS Cell Options as stated in SI13 rest octets for test cases where PBCCH is not present.
GPRS Power Control Parameters	Same as the GPRS Power Control Parameters as stated in SI13 rest octets for test cases where PBCCH is not present.
Additions for Rel.99/Rel 4/Rel 6	1
- SGSN bit	1 SGSN is Release '99 onwards
Additions for Rel 4	1
- SI_STATUS_IND bit	0 PACKET SI STATUS msg not supported
Additions for Rel 6	1
{LB_MS_TXPWR_MAX_CCH}	1 LB_MS_TXPWR_MAX_CCH present
- LB_MS_TXPWR_MAX_CCH	01010
- SI2n_SUPPORT	00
End Rel 6	
End Rel 4	
End R99	
Padding	Padding bits

40.2.2.1.13 PACKET SYSTEM INFORMATION TYPE 14

This message shall be sent when the cell indicates DTM support.

Within the GPRS Cell Options information element include the DTM SUPPORT bit (see 04.60 – 12.24).

MESSAGE_TYPE	111010
PAGE_MODE	00 Normal Paging
{CCCH Access Information}	0 In case PBCCH is not present
	Same content as SI13
{PBCCH Description }	1 In case PBCCH is present
	Same content as PSI1

40.2.2.1.14 PACKET SYSTEM INFORMATION TYPE 8

This message shall be sent for GSM 710 and T-GSM 810 bands.

MESSAGE_TYPE	111001
PAGE_MODE	00 Normal Paging
PSI8_CHANGE_MARK	00
PSI8_INDEX	000
PSI8_COUNT	000
CBCH Channel Description	0 Not present
Additions for Rel.99/Rel 4	1
Dynamic ARFCN Mapping Description	1 Present
- DM_CHANGE_MARK	0 Not present
- DYNAMIC ARFCN MAPPING	1
- GSM_Band	0110 for GSM 710 band
	0111 for T-GSM 810 band
- ARFCN_FIRST	110110110 ARFCN 438
- BAND_OFFSET	00000000
- ARFCN_RANGE	1001010 74 channels
Padding	Padding bits

40.2.2.2 Cell B

The contents of Packet System Information messages for cell B are identical to those of cell A with the following exceptions:

40.2.2.2.1 PACKET SYSTEM INFORMATION TYPE 2. Instance 1 of 3

-Cell Identity IE	02 (ID value 2 represented in 2 octets)
-------------------	---

40.2.2.2.2 PACKET SYSTEM INFORMATION TYPE 2. Instance 2 of 3

<p>{Reference Frequency Lists}</p> <ul style="list-style-type: none"> - Reference Frequency list 2 - Length of RFL Contents - RFL contents - Length of RFL Contents - RFL contents - Length of RFL Contents - RFL contents - Length of RFL Contents - RFL contents - Length of RFL Contents - RFL contents -{0 1<ARFCN index list>}} <p>Padding</p>	<p>0010 List 2</p> <p>GSM 900 GPRS:</p> <p>0011 IE length = 3 (128 format)</p> <p>10001100 format 10 + spare 00 + format 110 + ARFCN 15</p> <p>00000111 ARFCN 70</p> <p>11010101 ARFCN 97</p> <p>11110101 ARFCN 100</p> <p>01000010 ARFCN 110</p> <p>11011000 ARFCN 120</p> <p>DCS 1 800 GPRS :</p> <p>0011 IE length=3(512 format)</p> <p>10001001 format 10 + spare 00 + format 100 + 1 bit</p> <p>00011000 ARFCN 560</p> <p>00000101 ARFCN 570</p> <p>00111101 ARFCN 580</p> <p>10000001 ARFCN 585</p> <p>01000000</p> <p>PCS 1 900 GPRS :</p> <p>0011 IE length=3(512 format)</p> <p>10001001 format 10 + spare 00 + format 100 + 1 bit</p> <p>00011000 ARFCN 560</p> <p>00000101 ARFCN 570</p> <p>00111101 ARFCN 580</p> <p>10000001 ARFCN 585</p> <p>01000000</p> <p>GSM 700, T-GSM 810 GPRS :</p> <p>0010 IE length=2(128 format)</p> <p>10001100 format 10 + spare 00 + format 110 + ARFCN 439</p> <p>11011011 ARFCN 441</p> <p>10000100 ARFCN 443</p> <p>11111000 ARFCN 445</p> <p>00100000</p> <p>GSM 850 GPRS :</p> <p>0010 IE length = 2 (128 format)</p> <p>10001100 format 10 + spare 00 + format 110 + ARFCN 179</p> <p>01011001 ARFCN 181</p> <p>10000100 ARFCN 183</p> <p>11111000 ARFCN 185</p> <p>00100000</p> <p>0 ARFCN index list not present</p>
---	---

40.2.2.2.3

PACKET SYSTEM INFORMATION TYPE 2. Instance 3 of 3

<p>{GPRS Mobile Allocations}</p> <ul style="list-style-type: none"> -MA_NUMBER -HSN -{0 1<RFL number list>} -{0 -MA_LENGTH -MA_BITMAP - 	<p>1 GPRS Mobile Allocation present</p> <p>0010</p> <p>000000 Sequence 0</p> <p>0 Number list not present</p> <p>0 MA_Bitmap</p> <p>000101 (for GSM900).</p> <p>000011 (for GSM 700, T-GSM 810, GSM 850, DCS 1800 and PCS 1900).</p> <p>001111 4 belonging (for GSM900)</p> <p>1111 4 belonging (for GSM 700, T-GSM 810, GSM 850, DCS 1800 and PCS 1900).</p> <p>0 End of GPRS Mobile Allocation</p>
--	--

40.2.2.2.4

PACKET SYSTEM INFORMATION TYPE 3.

Neighbour Cell parameters - START_FREQUENCY	<p>1 start of neighbour cell parameters GSM 900 GPRS: Containing ARFCN 20 and 80 00000101 ARFCN 20 (MSB) 00 ARFCN 20 (LS 2bits) DCS 1800 GPRS: Containing ARFCN 590 and 600 10010011 ARFCN 590 (MSB) 10 (LS 2 bits) PCS 1900 GPRS: Containing ARFCN 590 and 600 10010011 ARFCN 590 (MSB) 10 (LS 2 bits) GSM 700, T-GSM 810 GPRS: Containing ARFCN 438 and 457 01101101 ARFCN 438 (MSB) 10 ARFCN 438 (LS 2 bits) GSM 850 GPRS: Containing ARFCN 147 and 157 00100100 ARFCN 147 (MSB) 11 ARFCN 147 (LS 2 bits)</p>
FREQ_DIFF_LENGTH	<p>GSM 900 GPRS: 101 6 bits DCS 1800 GPRS: 011 4 bits PCS 1900 GPRS: 011 4 bits GSM 850 GPRS: 011 4 bits GSM 700, T-GSM 810 GPRS: 100 5 bits</p>
FREQUENCY_DIFF	<p>GSM 900 GPRS: 111100 (ARFCN 80 – diff 60) DCS 1800GPRS: 1010 (ARFCN 600 – diff 10) PCS 1900 GPRS: 1010 (ARFCN 600 – diff 10) GSM 700, T-GSM 810 GPRS: 10010 (ARFCN 457 – diff 19) GSM 850 GPRS: 1010 (ARFCN 157 – diff 10)</p>

40.2.2.2.5 PACKET SYSTEM INFORMATION TYPE 3bis. (Instance 1 of 3)

Neighbour Cell parameters - START_FREQUENCY	1 start of neighbour cell parameters GSM 900 GPRS: Containing ARFCN 90 and 120. 00010110 ARFCN 90 (MSB) 10 ARFCN 90 (LS 2 bits) DCS 1800 GPRS: Containing ARFCN 780 and 870 11000011 ARFCN 780 (MSB) 00 ARFCN 780 (LS 2 bits) PCS 1900 GPRS: Containing ARFCN 655 and 810 10100010 ARFCN 655 (MSB) 11 ARFCN 655 (LS 2 bits) GSM 700, T-GSM 810 GPRS: Containing ARFCN 467 and 497 01110100 ARFCN 467 (MSB) 11 ARFCN 467 (LS 2 bits) GSM 850 GPRS: Containing ARFCN 207 and 237 00110011 ARFCN 207 (MSB) 11 ARFCN 207 (LS 2 bits)
- FREQ_DIFF_LENGTH	GSM 900 GPRS: 100 5 bits DCS 1800 GPRS: 110 7 bits PCS 1900 GPRS: 111 8 bits GSM 850: 100 5 bits GSM 700, T-GSM 810: 100 5 bits
- FREQUENCY_DIFF	GSM 900 GPRS: 11110 (ARFCN 120 -- diff 30) DCS 1800 GPRS 1011010 (ARFCN 870 - diff 90) PCS 1900 GPRS 10011011 (ARFCN 810 – diff 155) GSM 700, T-GSM 810 GPRS: 11110 (ARFCN 497 – diff 30) GSM 850 GPRS: 11110 (ARFCN 237 – diff 30)

40.2.2.3.2

PACKET SYSTEM INFORMATION TYPE 2. Instance 2 of 3

MESSAGE_TYPE	110010
PAGE_MODE	00 Normal Paging
PSI2_CHANGE_MARK	01
PSI2_INDEX	001
PSI2_COUNT	010 Three instances of PSI2
Cell Identification	0 Cell Identification parameters not present
Non GPRS Cell Options	0 Non GPRS Cell Options not present
{Reference Frequency Lists}	1 (Reference Frequency struct present)
	0010 List 2
	GSM 900 GPRS:
- Length of RFL contents	0011 IE length = 3 (128 format)
- RFL contents	10001100 format 10 + spare 00 + format 110 + ARFCN 65
	00100000 ARFCN 75
	10011110 ARFCN 85
	11011001 ARFCN 95
	01001011 ARFCN 105
	01011000 ARFCN 115
	DCS 1800 and PCS 1900 GPRS:
- Length of RFL contents	0011 IE length = 3 (512 format)
- RFL contents	10001001 format 10 + spare 00 + format 100 + 1 bit
	00101110 ARFCN 605
	10000011 ARFCN 610
	11111101 ARFCN 620
	10000010 ARFCN 630
	10000000
	GSM 700, T-GSM 810 GPRS
- Length of RFL contents	0010 IE length = 2 (128 format)
- RFL contents	10001100 format 10 + spare 00 + format 110 + ARFCN 449
	11100000 ARFCN 451
	10000100 ARFCN 453
	11111000 ARFCN 455
	00100000
	GSM 850 GPRS :
- Length of RFL contents	0010 IE length = 2 (128 format)
- RFL contents	10001100 format 10 + spare 00 + format 110 + ARFCN169
	01010100 ARFCN 171
	10000100 ARFCN 173
	11111000 ARFCN 175
	00100000
-	0 (end of Reference Frequency List)
{Cell Allocation}	1 (Cell Allocation present)
-RFL_NUMBER	0010 List 2
-	0 (end of Cell Allocation)
-	0 End of GPRS Mobile Allocation

40.2.2.3.3 PACKET SYSTEM INFORMATION TYPE 2. Instance 3 of 3

{GPRS Mobile Allocations}	1	GPRS Mobile Allocation present
-MA_NUMBER	0010	
-HSN	000000	Sequence 0
-{0 1<RFL number list>}	0	Number list not present
-{0	0	MA_Bitmap
-MA_LENGTH	000101	(for GSM900).
	000011	(for GSM 700, T-GSM 810, GSM 850, DCS 1800 and PCS 1900).
-MA_BITMAP	001111	4 belonging (for GSM900)
	1111	4 belonging (for GSM 700, T-GSM 810, GSM 850, DCS 1800 and PCS 1900).
-	0	End of GPRS Mobile Allocation

40.2.2.3.4 PACKET SYSTEM INFORMATION TYPE 3.

Neighbour Cell parameters	1	start of neighbour cell parameters
- START_FREQUENCY	GSM 900 GPRS: Containing ARFCN 5 and 20	
	00000001 ARFCN 5 (MSB)	
	01 ARFCN 5 (LS 2bits)	
	DCS 1800 GPRS: Containing ARFCN 515 and 590	
	10000011 ARFCN 515 (MSB)	
	11 (LS 2 bits)	
	PCS 1900 GPRS: Containing ARFCN 515 and 590	
	10000011 ARFCN 515 (MSB)	
	11 (LS 2 bits)	
	GSM 700, T-GSM 810 GPRS: Containing ARFCN 447 and 457	
	01101111 ARFCN 447 (MSB)	
	11 ARFCN 447 (LS 2 bits)	
	GSM 850 GPRS: Containing ARFCN 137 and 147	
	00100010 ARFCN 137 (MSB)	
	01 ARFCN 137 (LS 2 bits)	
FREQ_DIFF_LENGTH	GSM 900 GPRS:	
	011 4 bits	
	DCS 1800 GPRS:	
	110 7 bits	
	PCS 1900 GPRS:	
	110 7 bits	
	GSM 850 GPRS:	
	011 4 bits	
	GSM 700, T-GSM 810 GPRS:	
	011 4 bits	
FREQUENCY_DIFF	GSM 900 GPRS:	
	1111 (ARFCN 20 – diff 15)	
	DCS 1800 GPRS:	
	1001011 (ARFCN 590 – diff 75)	
	PCS 1900 GPRS:	
	1001011 (ARFCN 590 – diff 75)	
	GSM 850 GPRS:	
	1010 (ARFCN 147 – diff 10)	
	GSM 700, T-GSM 810 GPRS:	
	1010 (ARFCN 457 – diff 10)	

40.2.2.3.5 PACKET SYSTEM INFORMATION TYPE 3bis. (Instance 1 of 3)

<p>Neighbour Cell parameters - START_FREQUENCY</p>	<p>1 start of neighbour cell parameters GSM 900 GPRS: Containing ARFCN 90 and 120. 00010110 ARFCN 90 (MSB) 10 ARFCN 90 (LS 2 bits) DCS 1800 GPRS: Containing ARFCN 700 and 870 10101111 ARFCN 700 (MSB) 00 ARFCN 700 (LS 2 bits) PCS 1900 GPRS: Containing ARFCN 655 and 810 10100010 ARFCN 655 (MSB) 11 ARFCN 655 (LS 2 bits) GSM 700, T-GSM 810 GPRS: Containing ARFCN 467 and 497 01110100 ARFCN 467 (MSB) 00 ARFCN 467 (LS 2 bits) GSM 850 GPRS: Containing ARFCN 157 and 237 00100111 ARFCN 157 (MSB) 01 ARFCN 157 (LS 2 bits)</p>
<p>- FREQ_DIFF_LENGTH</p>	<p>GSM 900 GPRS: 100 5 bits DCS 1800 GPRS: 111 8 bits PCS 1900 GPRS: 111 8 bits GSM 850 GPRS: 110 7 bits GSM 700, T-GSM 810 GPRS: 100 5 bits</p>
<p>- FREQUENCY_DIFF</p>	<p>GSM 900 GPRS: 11110 (ARFCN 120 – diff 30) DCS 1800 GPRS 10101010 (ARFCN 870 - diff 170) PCS 1900 GPRS 10100000 (ARFCN 810 – diff 55) GSM 850 GPRS: 1010000 (ARFCN 237 – diff 80) GSM 700, T-GSM 810 GPRS: 11110 (ARFCN 497 – diff 30)</p>

40.2.2.3.6 PACKET SYSTEM INFORMATION TYPE 3bis (Instance 2 of 3)

Neighbour Cell parameters - START_FREQUENCY	1 start of neighbour cell parameters GSM 900 GPRS: containing ARFCN 100 and 110 00011001 ARFCN 100 (MSB) 00 ARFCN 100 (LS 2 bits) DCS 1800 GPRS: containing ARFCN 780 and 810 11000011 ARFCN 780 (MSB) 00 ARFCN 780 (LS 2 bits) PCS 1900 GPRS: containing ARFCN 700 and 780 10101111 ARFCN 700 (MSB) 00 ARFCN 700 (LS 2 bits) GSM 700, T-GSM 810 GPRS: containing ARFCN 477 and 487 01110111 ARFCN 477 (MSB) 01 ARFCN 477 (LS 2 bits) GSM 850 GPRS: containing ARFCN 217 and 227 00110110 ARFCN 217 (MSB) 01 ARFCN 217 (LS 2 bits)
- FREQ_DIFF_LENGTH	GSM 900 GPRS: 011 4 bits DCS 1800 GPRS: 100 5 bits GSM 850 GPRS: 011 4 bits PCS 1900 GPRS: 110 7 bits GSM 700, T-GSM 810 GPRS: 011 4 bits
- FREQUENCY_DIFF	GSM 900 GPRS: 1010 (ARFCN 110 – diff 10) DCS 1800 GPRS: 11110 (ARFCN 810 – diff 30) PCS 1900 GPRS: 1010000 (ARFCN 780 – diff 80) GSM 700, T-GSM 810 GPRS: 1010 (ARFCN 487 – diff 10) GSM 850 GPRS: 1010 (ARFCN 227 – diff 10)

40.2.2.3.7 PACKET SYSTEM INFORMATION TYPE 13 (for PBCCH present or PBCCH not present).

{GPRS Mobile Allocation} -MA_LENGTH	000101 (for GSM900). 000011 (for GSM 700, T-GSM 810, GSM 850, DCS 1800 and PCS 1900).
-MA_BITMAP	001111 4 belonging (for GSM900). 1111 4 belonging (for GSM 700, T-GSM 810, GSM 850, DCS 1800 and PCS 1900).

40.2.2.4 Cell D

The contents of Packet System Information messages for cell D are identical to those of cell A with the following exceptions:

40.2.2.4.1 PACKET SYSTEM INFORMATION TYPE 2. Instance 1 of 3

-Cell Identity IE	04 (ID value 4 represented in 2 octets)
-------------------	---

40.2.2.4.2

PACKET SYSTEM INFORMATION TYPE 2. Instance 2 of 3

MESSAGE_TYPE	110010
PAGE_MODE	00 Normal Paging
PSI2_CHANGE_MARK	01
PSI2_INDEX	001
PSI2_COUNT	010 Three instances of PSI2
Cell Identification	0 Cell Identification parameters not present
Non GPRS Cell Options	0 Non GPRS Cell Options not present
{Reference Frequency Lists}	1 (Reference Frequency struct present)
	0010 List 2
	GSM 900 GPRS:
- Length of RFL contents	0011 IE length = 3 (128 format)
- RFL contents	10001100 format 10 + spare 00 + format 110 + ARFCN 22
	00001011 ARFCN 42
	00111100 ARFCN 62
	10110010 ARFCN 82
	10000110 ARFCN 102
	00110000 ARFCN 122
	DCS 1800 and PCS 1900 GPRS :
- Length of RFL contents	0011 IE length = 3 (512 format)
- RFL contents	10001001 format 10 + spare 00 + format 100 + 1 bit
	01000000 ARFCN 640
	00000101 ARFCN 655
	00111110 ARFCN 660
	11000010 ARFCN 670
	10000000
	GSM 700, T-GSM 810 GPRS
- Length of RFL contents	0010 IE length = 2 (128 format)
- RFL contents	10001100 format 10 + spare 00 + format 110 + ARFCN 459
	11100101 ARFCN 461
	10000100 ARFCN 463
	11111000 ARFCN 465
	00100000
	GSM 850 GPRS:
- Length of RFL contents	0010 IE length = 2 (128 format)
- RFL contents	10001100 format 10 + spare 00 + format 110 + ARFCN 139
	01000101 ARFCN 141
	10000100 ARFCN 143
	11111000 ARFCN 145
	00100000
-	0 (end of Reference Frequency List)
{Cell Allocation}	1 (Cell Allocation present)
-RFL_NUMBER	0010 List 2
-	0 (end of Cell Allocation)

40.2.2.4.3 PACKET SYSTEM INFORMATION TYPE 2. Instance 3 of 3

{GPRS Mobile Allocations}	1	GPRS Mobile Allocation present
-MA_NUMBER	0010	
-HSN	000000	Sequence 0
-{0 1<RFL number list>}	0	Number list not present
-{0	0	MA_Bitmap
-MA_LENGTH	000101	(for GSM900).
	000011	(for GSM 700, T-GSM 810, GSM 850, DCS 1800 and PCS 1900).
-MA_BITMAP	001111	4 belonging (for GSM900)
	1111	4 belonging (for GSM 700, T-GSM 810, GSM 850, DCS 1800 and PCS 1900).
-	0	End of GPRS Mobile Allocation

40.2.2.4.4 PACKET SYSTEM INFORMATION TYPE 3.

Neighbour Cell parameters	1	start of neighbour cell parameters
- START_FREQUENCY	GSM 900 GPRS: Containing ARFCN 5 and 20	
	00000001 ARFCN 5 (MSB)	
	01 ARFCN 5 (LS 2bits)	
	DCS 1800 GPRS: Containing ARFCN 515 and 590	
	10000011 ARFCN 515 (MSB)	
	11 (LS 2 bits)	
	PCS 1900 GPRS: Containing ARFCN 515 and 590	
	10000011 ARFCN 515 (MSB)	
	11 (LS 2 bits)	
	GSM 700, T-GSM 810 GPRS: Containing ARFCN 438 and 447	
	01101101 ARFCN 438 (MSB)	
	10 ARFCN 438 (LS 2 bits)	
	GSM 850 GPRS: Containing ARFCN 137 and 147	
	00100010 ARFCN 137 (MSB)	
	01 ARFCN 137 (LS 2 bits)	
FREQ_DIFF_LENGTH	GSM 900 GPRS:	
	011 4 bits	
	DCS 1800 GPRS:	
	110 7 bits	
	PCS 1900 GPRS:	
	110 7 bits	
	GSM 850 GPRS:	
	011 4 bits	
	GSM 700, T-GSM 810 GPRS:	
	011 4 bits	
FREQUENCY_DIFF	GSM 900 GPRS:	
	1010 (ARFCN 20 – diff 10)	
	DCS 1800GPRS:	
	1000110 (ARFCN 590 – diff 70)	
	PCS 1900 GPRS:	
	1000110 (ARFCN 590 – diff 70)	
	GSM 700, T-GSM 810 GPRS:	
	1001 (ARFCN 447 – diff 9)	
	GSM 850 GPRS:	
	1010 (ARFCN 147 – diff 10)	

40.2.2.4.5 PACKET SYSTEM INFORMATION TYPE 3bis. (Instance 1 of 3)

Neighbour Cell parameters - START_FREQUENCY	<p>1 start of neighbour cell parameters</p> <p>GSM 900 GPRS: Containing ARFCN 80 and 120. 00010100 ARFCN 80 (MSB) 00 ARFCN 80 (LS 2 bits)</p> <p>DCS 1800 GPRS: Containing ARFCN 600 and 810 10010110 ARFCN 600 (MSB) 00 ARFCN 600 (LS 2 bits)</p> <p>PCS 1900 GPRS: Containing ARFCN 600 and 810 10010110 ARFCN 600 (MSB) 00 ARFCN 600 (LS 2 bits)</p> <p>GSM 700, T-GSM 810 GPRS: Containing ARFCN 457 and 497 01110110 ARFCN 457 (MSB) 01 ARFCN 457 (LS 2 bits)</p> <p>GSM 850 GPRS: Containing ARFCN 157 and 237 001010111 ARFCN 157 (MSB) 01 ARFCN 157 (LS 2 bits)</p>
- FREQ_DIFF_LENGTH	<p>GSM 900GPRS: 101 6 bits</p> <p>DCS 1800 GPRS: 111 8 bits</p> <p>PCS 1900 GPRS: 111 8 bits</p> <p>GSM 700, T-GSM 810 : 101 6 bits</p> <p>GSM 850: 110 7 bits</p>
- FREQUENCY_DIFF	<p>GSM 900 GPRS: 101000 (ARFCN 120 – diff 40)</p> <p>DCS 1800 GPRS 11010010 (ARFCN 810 – diff 210)</p> <p>PCS 1900 GPRS 11010010 (ARFCN 810 – diff 210)</p> <p>GSM 700, T-GSM 810 GPRS: 101000 (ARFCN 497 – diff 40)</p> <p>GSM 850 GPRS: 1010000 (ARFCN 237 – diff 80)</p>

40.2.2.4.6 PACKET SYSTEM INFORMATION TYPE 3bis (Instance 2 of 3)

<p>Neighbour Cell parameters</p> <ul style="list-style-type: none"> - START_FREQUENCY - FREQ_DIFF_LENGTH - FREQUENCY_DIFF 	<p>1 start of neighbour cell parameters</p> <p>GSM 900 GPRS: containing ARFCN 90 and 100 00010110 ARFCN 90 (MSB) 10 ARFCN 90 (LS 2 bits)</p> <p>DCS 1800 GPRS: containing ARFCN 780 and 870 11000011 ARFCN 780 (MSB) 00 ARFCN 780 (LS 2 bits)</p> <p>PCS 1900 GPRS: containing ARFCN 655 and 780 10100010 ARFCN 655 (MSB) 10 ARFCN 655 (LS 2 bits)</p> <p>GSM 700, T-GSM 810 GPRS: containing ARFCN 467 and 487 01110100 ARFCN 467 (MSB) 11 ARFCN 467 (LS 2 bits)</p> <p>GSM 850 GPRS: containing ARFCN 207 and 227 00110011 ARFCN 207 (MSB) 11 ARFCN 227 (LS 2 bits)</p> <p>GSM 850 GPRS: 100 5 bits</p> <p>GSM 900 GPRS: 011 4 bits</p> <p>DCS 1800 GPRS: 110 7 bits</p> <p>PCS 1900 GPRS: 111 8 bits</p> <p>GSM 700, T-GSM 810 GPRS: 100 5 bits</p> <p>GSM 900 GPRS: 1010 (ARFCN 100 – diff 10)</p> <p>DCS 1800 GPRS: 1011010 (ARFCN 870 – diff 90)</p> <p>PCS 1900 GPRS: 10000010 (ARFCN 780 – diff 130)</p> <p>GSM 700, T-GSM 810 GPRS: 10100 (ARFCN 487 – diff 20)</p> <p>GSM 850 GPRS: 10100 (ARFCN 227 – diff 20)</p>
--	---

40.2.2.4.7 PACKET SYSTEM INFORMATION TYPE 13 (for PBCCH present or PBCCH not present).

<p>{GPRS Mobile Allocation}</p> <ul style="list-style-type: none"> -MA_LENGTH -MA_BITMAP 	<p>000101 (for GSM900). 000011 (for GSM 700, T-GSM 810, GSM 850, DCS 1800 and PCS 1900).</p> <p>001111 4 belonging (for GSM900). 1111 4 belonging (for GSM 700, T-GSM 810, GSM 850, DCS 1800 and PCS 1900).</p>
--	---

40.2.2.5 Cell E

The contents of Packet System Information messages for cell E are identical to those of cell A with the following exceptions:

40.2.2.5.1 PACKET SYSTEM INFORMATION TYPE 2. Instance 1 of 3

-Cell Identity IE	05 (ID value 5 represented in 2 octets)
-------------------	---

40.2.2.5.2

PACKET SYSTEM INFORMATION TYPE 2. Instance 2 of 3

MESSAGE_TYPE	110010
PAGE_MODE	00 Normal Paging
PSI2_CHANGE_MARK	01
PSI2_INDEX	001
PSI2_COUNT	010 Three instances of PSI2
Cell Identification	0 Cell Identification parameters not present
Non GPRS Cell Options	0 Non GPRS Cell Options not present
{Reference Frequency Lists}	
-	1 (Reference Frequency struct present)
- RFL contents	0010 List 2
- Length of RFL contents	GSM 900 GPRS:
- RFL contents	0011 IE length = 3 (128 format)
	10001100 format 10 + spare 00 + format 110 + ARFCN 12
	00000110 ARFCN 32
	00111100 ARFCN 52
	10110010 ARFCN 72
	10000110 ARFCN 92
	00110000 ARFCN 112
	DCS 1800 and PCS 1900 GPRS :
- Length of RFL contents	0011 IE length = 3 (512 format)
- RFL contents	10001001 format 10 + spare 00 + format 100 + 1 bit
	01010100 ARFCN 680
	00000110 ARFCN 690
	01111100 ARFCN 705
	01000001 ARFCN 710
	01000000
- Length of RFL contents	GSM 700, T-GSM 810 GPRS
- RFL contents	0010 IE length = 2 (128 format)
	10001100 format 10 + spare 00 + format 110 + ARFCN 489
	11110100 ARFCN 491
	10000100 ARFCN 493
	11111000 ARFCN 495
	00100000
- Length of RFL contents	GSM 850 GPRS:
- RFL contents	0010 IE length = 2 (128 format)
	10001100 format 10 + spare 00 + format 110 + ARFCN149
	01001010 ARFCN 151
	10000100 ARFCN 153
	11111000 ARFCN 155
	00100000
-	0 (end of Reference Frequency List)
{Cell Allocation}	1 (Cell Allocation present)
-RFL_NUMBER	0010 List 2
-	0 (end of Cell Allocation)
Padding	Padding bits

40.2.2.5.3 PACKET SYSTEM INFORMATION TYPE 2. Instance 3 of 3

{GPRS Mobile Allocations}	1	GPRS Mobile Allocation present
-MA_NUMBER	0010	
-HSN	000000	Sequence 0
-{0 1<RFL number list>}	0	Number list not present
-{0	0	MA_Bitmap
-MA_LENGTH	000101	(for GSM900).
	000011	(for GSM 700, T-GSM 810, GSM 850, DCS 1800 and PCS 1900).
-MA_BITMAP	001111	4 belonging (for GSM900)
	1111	4 belonging (for GSM 700, T-GSM 810, GSM 850, DCS 1800 and PCS 1900).
-	0	End of GPRS Mobile Allocation

40.2.2.5.4 PACKET SYSTEM INFORMATION TYPE 3.

Neighbour Cell parameters	1	start of neighbour cell parameters
- START_FREQUENCY	GSM 900 GPRS: Containing ARFCN 5 and 20	
	00000001 ARFCN 5 (MSB)	
	01 ARFCN 5 (LS 2bits)	
	DCS 1800 GPRS: Containing ARFCN 515 and 590	
	10000011 ARFCN 515 (MSB)	
	11 (LS 2 bits)	
	PCS 1900 GPRS: Containing ARFCN 515 and 590	
	10000011 ARFCN 515 (MSB)	
	11 (LS 2 bits)	
	GSM 700, T-GSM 810 GPRS: Containing ARFCN 438 and 447	
	01101101 ARFCN 438 (MSB)	
	10 ARFCN 438 (LS 2 bits)	
	GSM 850 GPRS: Containing ARFCN 137 and 147	
	00100010 ARFCN 137 (MSB)	
	01 ARFCN 137 (LS 2 bits)	
FREQ_DIFF_LENGTH	GSM 900 GPRS:	
	011 4 bits	
	DCS 1800 GPRS:	
	110 7 bits	
	PCS 1900 GPRS:	
	110 7 bits	
	GSM 850 GPRS:	
	011 4 bits	
	GSM 700, T-GSM 810 GPRS:	
	011 4 bits	
FREQUENCY_DIFF	GSM 900 GPRS:	
	1010 (ARFCN 20 – diff 10)	
	DCS 1800 GPRS:	
	1000110 (ARFCN 590 – diff 70)	
	PCS 1900 GPRS:	
	1000110 (ARFCN 590 – diff 70)	
	GSM 700, T-GSM 810 GPRS:	
	1001 (ARFCN 447 – diff 9)	
	GSM 850 GPRS:	
	1010 (ARFCN 147 – diff 10)	

40.2.2.5.5 PACKET SYSTEM INFORMATION TYPE 3bis. (Instance 1 of 3)

Neighbour Cell parameters - START_FREQUENCY	1 start of neighbour cell parameters GSM 900 GPRS: Containing ARFCN 80 and 120. 00010100 ARFCN 80 (MSB) 00 ARFCN 80 (LS 2 bits) DCS 1800 GPRS: Containing ARFCN 600 and 810 10010110 ARFCN 600 (MSB) 00 ARFCN 600 (LS 2 bits) PCS 1900 GPRS: Containing ARFCN 600 and 810 10010110 ARFCN 600 (MSB) 00 ARFCN 600 (LS 2 bits) GSM 700, T-GSM 810 GPRS: Containing ARFCN 457 and 497 01110010 ARFCN 457 (MSB) 01 ARFCN 457 (LS 2 bits) GSM 850 GPRS: Containing ARFCN 157 and 237 00100111 ARFCN 157 (MSB) 01 ARFCN 157 (LS 2 bits)
- FREQ_DIFF_LENGTH	GSM 900 GPRS: 101 6 bits DCS 1800 GPRS: 111 8 bits PCS 1900 GPRS: 111 8 bits GSM 700, T-GSM 810: 101 6 bits GSM 850: 110 7 bits
- FREQUENCY_DIFF	GSM 900 GPRS: 101000 (ARFCN 120 – diff 40) DCS 1800 GPRS 11010010 (ARFCN 810 - diff 210) PCS 1900 GPRS 11010010 (ARFCN 810 - diff 210) GSM 700, T-GSM 810 GPRS: 101000 (ARFCN 497 – diff 40) GSM 850 GPRS: 1010000 (ARFCN 237 – diff 80)

40.2.2.5.6 PACKET SYSTEM INFORMATION TYPE 3bis (Instance 2 of 3)

Neighbour Cell parameters - START_FREQUENCY	1 start of neighbour cell parameters GSM 900 GPRS: containing ARFCN 100 and 110 00011001 ARFCN 100 (MSB) 00 ARFCN 100 (LS 2 bits) DCS 1800 GPRS: containing ARFCN 700 and 870 10101111 ARFCN 700 (MSB) 00 ARFCN 700 (LS 2 bits) PCS 1900 GPRS: containing ARFCN 655 and 700 10100010 ARFCN 655(MSB) 10 ARFCN 655 (LS 2 bits) GSM 700, T-GSM 810 GPRS: containing ARFCN 477 and 487 01110111 ARFCN 477 (MSB) 01 ARFCN 477(LS 2 bits) GSM 850 GPRS: containing ARFCN 207 and 217 00110011 ARFCN 207 (MSB) 11 ARFCN 207 (LS 2 bits)
- FREQ_DIFF_LENGTH	GSM 900 GPRS: 011 4 bits DCS 1800 GPRS: 111 8 bits PCS 1900 GPRS: 101 6 bits GSM 850 GPRS: 011 4 bits GSM 700, T-GSM 810 GPRS: 011 4 bits
- FREQUENCY_DIFF	GSM 900 GPRS: 1010 (ARFCN 110 – diff 10) DCS 1800 GPRS: 10101010 (ARFCN 870 – diff 170) PCS 1900 GPRS: 110010 (ARFCN 700 – diff 50) GSM 700, T-GSM 810 GPRS: 1010 (ARFCN 487 – diff 10) GSM 850 GPRS: 1010 (ARFCN 217 – diff 10)

40.2.2.5.7 PACKET SYSTEM INFORMATION TYPE 13 (for PBCCH present or PBCCH not present).

{GPRS Mobile Allocation} -MA_LENGTH	000101 (for GSM900). 000011 (for GSM 700, T-GSM 810, GSM 850, DCS 1800 and PCS 1900).
-MA_BITMAP	001111 4 belonging (for GSM900). 1111 4 belonging (for GSM 700, T-GSM 810, GSM 850, DCS 1800 and PCS 1900).

40.2.2.6 Cell F

The contents of Packet System Information messages for cell F are identical to those of cell A with the following exceptions:

40.2.2.6.1 PACKET SYSTEM INFORMATION TYPE 2. Instance 1 of 3

-Cell Identity IE	06 (ID value 6 represented in 2 octets)
-------------------	---

40.2.2.6.2

PACKET SYSTEM INFORMATION TYPE 2. Instance 2 of 3

MESSAGE_TYPE	110010
PAGE_MODE	00 Normal Paging
PSI2_CHANGE_MARK	01
PSI2_INDEX	001
PSI2_COUNT	010 Three instances of PSI2
Cell Identification	0 Cell Identification parameters not present
Non GPRS Cell Options	0 Non GPRS Cell Options not present
{Reference Frequency Lists}	1 (Reference Frequency struct present)
	0010 List 2
	GSM 900 GPRS:
- Length of RFL contents	0011 IE length = 3 (128 format)
- RFL contents	10001100 format 10 + spare 00 + format 110 + ARFCN 7
	00000011 ARFCN 27
	10111100 ARFCN 47
	10110010 ARFCN 67
	10000110 ARFCN 87
	00110000 ARFCN 107
	DCS 1800 GPRS:
- Length of RFL contents	0011 IE length = 3 (512 format)
- RFL contents	10001001 format 10 + spare 00 + format 100 + 1 bit
	01101000 ARFCN 720
	00000101 ARFCN 730
	00111101 ARFCN 740
	10000111 ARFCN 770
	10000000
	PCS 1900 GPRS:
- Length of RFL contents	0011 IE length = 3 (512 format)
- RFL contents	10001001 format 10 + spare 00 + format 100 + 1 bit
	01101000 ARFCN 720
	00000101 ARFCN 730
	00111101 ARFCN 740
	10000010 ARFCN 750
	10000000
	GSM 700, T-GSM 810 GPRS
- Length of RFL contents	0010 IE length = 2 (128 format)
- RFL contents	10001100 format 10 + spare 00 + format 110 + ARFCN 479
	11101111 ARFCN 481
	10000100 ARFCN 483
	11111000 ARFCN 485
	00100000
	GSM 850 GPRS:
- Length of RFL contents	0010 IE length = 2 (128 format)
- RFL contents	10001100 format 10 + spare 00 + format 110 + ARFCN189
	01011110 ARFCN 191
	10000100 ARFCN 193
	11111000 ARFCN 195
	00100000
-	0 (end of Reference Frequency List)
{Cell Allocation}	1 (Cell Allocation present)
-RFL_NUMBER	0010 List 2
-	0 (end of Cell Allocation)

40.2.2.6.3 PACKET SYSTEM INFORMATION TYPE 2. Instance 3 of 3

{GPRS Mobile Allocations}	1	GPRS Mobile Allocation present
-MA_NUMBER	0010	
-HSN	000000	Sequence 0
-{0 1<RFL number list>}	0	Number list not present
-{0	0	MA_Bitmap
-MA_LENGTH	000101	(for GSM900).
	000011	(for GSM 700, T-GSM 810, GSM 850, DCS 1800 and PCS 1900).
-MA_BITMAP	001111	4 belonging (for GSM900)
	1111	4 belonging (for GSM 700, T-GSM 810, GSM 850, DCS 1800 and PCS 1900).
-	0	End of GPRS Mobile Allocation

40.2.2.6.4 PACKET SYSTEM INFORMATION TYPE 3.

Neighbour Cell parameters	1	start of neighbour cell parameters
- START_FREQUENCY	GSM 900 GPRS: Containing ARFCN 5 and 20	
	0000001 ARFCN 5 (MSB)	
	01 ARFCN 5 (LS 2bits)	
	DCS 1800 GPRS: Containing ARFCN 515 and 590	
	10000000 ARFCN 515 (MSB)	
	11 (LS 2 bits)	
	PCS 1900 GPRS: Containing ARFCN 515 and 590	
	10000000 ARFCN 515 (MSB)	
	11 (LS 2 bits)	
	GSM 700, T-GSM 810 GPRS: Containing ARFCN 438 and 447	
	01101101 ARFCN 438 (MSB)	
	10 ARFCN 437 (LS 2 bits)	
	GSM 850 GPRS: Containing ARFCN 137 and 147	
	00100010 ARFCN 137 (MSB)	
	01 ARFCN 137 (LS 2 bits)	
FREQ_DIFF_LENGTH	GSM 900GPRS:	
	011 4 bits	
	DCS 1800GPRS:	
	110 7 bits	
	PCS 1900 GPRS:	
	110 7 bits	
	GSM 700, T-GSM 810 GPRS:	
	011 4 bits	
	GSM 850 GPRS:	
	011 4 bits	
FREQUENCY_DIFF	GSM 900 GPRS:	
	1111 (ARFCN 20 – diff 15)	
	DCS 1800 GPRS:	
	1001011 (ARFCN 590 – diff 75)	
	PCS 1900 GPRS:	
	1001011 (ARFCN 590 – diff 75)	
	GSM 700, T-GSM 810 GPRS:	
	1001 (ARFCN 447 – diff 9)	
	GSM 850 GPRS:	
	1010 (ARFCN 147 – diff 10)	

40.2.2.6.5 PACKET SYSTEM INFORMATION TYPE 3bis. (Instance 1 of 3)

Neighbour Cell parameters - START_FREQUENCY	1 start of neighbour cell parameters GSM 900 GPRS: Containing ARFCN 80 and 110. 00010100 ARFCN 80 (MSB) 00 ARFCN 80 (LS 2 bits) DCS 1800 GPRS: Containing ARFCN 600 and 780 10010110 ARFCN 600 (MSB) 00 ARFCN 600 (LS 2 bits) PCS 1900 GPRS: Containing ARFCN 600 and 780 10010110 ARFCN 600 (MSB) 00 ARFCN 600 (LS 2 bits) GSM 700, T-GSM 810 GPRS: Containing ARFCN 457 and 497 01110010 ARFCN 457 (MSB) 01 ARFCN 457 (LS 2 bits) GSM 850 GPRS: Containing ARFCN 157 and 227 00100111 ARFCN 157 (MSB) 01 ARFCN 157 (LS 2 bits)
- FREQ_DIFF_LENGTH	GSM GPRS: 100 5 bits DCS 1800 GPRS: 111 8 bits PCS 1900 GPRS: 111 8 bits GSM 700, T-GSM 810: 101 6 bits GSM 850: 110 7 bits
- FREQUENCY_DIFF	GSM 900 GPRS: 11110 (ARFCN 110 – diff 30) DCS 1800 GPRS 10110100 (ARFCN 780 – diff 180) PCS 1900 GPRS 10110100 (ARFCN 780 – diff 180) GSM 700, T-GSM 810 GPRS: 101000 (ARFCN 497 – diff 40) GSM 850 GPRS: 1000110 (ARFCN 247 – diff 70)

40.2.2.6.6 PACKET SYSTEM INFORMATION TYPE 3bis (Instance 2 of 3)

<p>Neighbour Cell parameters</p> <p>- START_FREQUENCY</p> <p>- FREQ_DIFF_LENGTH</p> <p>- FREQUENCY_DIFF</p>	<p>1 start of neighbour cell parameters</p> <p>GSM 900 GPRS: containing ARFCN 90 and 100 00011001 ARFCN 90 (MSB) 00 ARFCN 90 (LS 2 bits)</p> <p>DCS 1800 GPRS: containing ARFCN 700 and 870 10101111 ARFCN 700 (MSB) 00 ARFCN 700 (LS 2 bits)</p> <p>PCS 1900 GPRS: containing ARFCN 655 and 700 10100010 ARFCN 655 (MSB) 10 ARFCN 655 (LS 2 bits)</p> <p>GSM 700, T-GSM 810 GPRS: containing ARFCN 467 and 477 01110100 ARFCN 467 (MSB) 11 ARFCN 467 (LS 2 bits)</p> <p>GSM 850 GPRS: containing ARFCN 207 and 217 00110011 ARFCN 207 (MSB) 11 ARFCN 207 (LS 2 bits)</p> <p>GSM 900 GPRS: 011 4 bits</p> <p>DCS 1800GPRS: 111 8 bits</p> <p>PCS 1900 GPRS: 101 6 bits</p> <p>GSM 850 GPRS: 011 4 bits</p> <p>GSM 700, T-GSM 810 GPRS: 011 4 bits</p> <p>GSM 900 GPRS: 1010 (ARFCN 100 – diff 10)</p> <p>DCS 1800 GPRS: 10101010 (ARFCN 780 – diff 170)</p> <p>PCS 1900 GPRS: 110010 (ARFCN 700 – diff 50)</p> <p>GSM 700, T-GSM 810 GPRS: 1010 (ARFCN 477 – diff 10)</p> <p>GSM 850 GPRS: 1010 (ARFCN 217 – diff 10)</p>
---	---

40.2.2.6.7 PACKET SYSTEM INFORMATION TYPE 13 (for PBCCH present or PBCCH not present).

<p>{GPRS Mobile Allocation}</p> <p>-MA_LENGTH</p> <p>-MA_BITMAP</p>	<p>000101 (for GSM900). 000011 (for GSM 700, T-GSM 810, GSM 850, DCS 1800 and PCS 1900).</p> <p>001111 4 belonging (for GSM900). 1111 4 belonging (for GSM 700, T-GSM 810, GSM 850, DCS 1800 and PCS 1900).</p>
--	---

40.2.3 Default contents of Layer 2 messages

40.2.3.1 PACKET PAGING REQUEST message:

MESSAGE_TYPE	100010
PAGE_MODE	00 Normal Paging
{0 1<PERSISTENCE_LEVEL>}	0 (no persistence level present)
{0 1<NLN>}	0 (no notification list number)
{1 <Repeated Page info>}	1 (start of Repeated Page info)
-	0 (Page request for TBF establishment)
-	0 (PTMSI)
- PTMSI	00000000000000000000000000000000
-	P-TMSI allocated during GPRS attach procedure
-	0 (end of Repeated Page info)
spare padding	Spare Padding

40.2.3.2 PACKET ACCESS REJECT message:

MESSAGE_TYPE	100001
PAGE_MODE	00 Normal Paging
Reject	
-	1 (TLLI not present)
-	0(Packet Request Reference)
- Packet Request Reference	information field sent in PACKET CHANNEL REQUEST and frame number in which PACKET CHANNEL REQUEST was received
-	0 (no waiting indication)
-	0 (end of Reject IE)
spare padding	Spare Padding

40.2.3.3 PACKET QUEUEING NOTIFICATION message:

MESSAGE_TYPE	000110
PAGE_MODE	00 Normal Paging
Packet Request Reference	information field sent in PACKET CHANNEL REQUEST and frame number in which PACKET CHANNEL REQUEST was received
TQI	0010001000100010
spare padding	Spare Padding

40.2.3.4 PACKET UPLINK ASSIGNMENT messages

MESSAGE_TYPE	001010
PAGE_MODE	00 Normal Paging
{0 1< PERSISTENCE_LEVEL >	0 (no persistence level present)
Referenced Address struct	As received from the MS
{ 0 < Global TFI >	
10 < TLLI >	
110 < TQI >	
111 <Packet Request Reference >}	
--Message escape	0
CHANNEL_CODING_COMMAND	CS1
TLLI_BLOCK_CHANNEL_CODING	1
Packet Timing Advance	
{ 0 1< TIMING_ADVANCE_VALUE >	1 (timing advance value)
- TIMING_ADVANCE_VALUE }	30 bit periods
{ 0 1< TIMING_ADVANCE_INDEX >	0 (no timing advance index)
<TIMING_ADVANCE_TIMESLOT_NUMBER > }	
{0 1<Frequency Parameters>}	Not present in case MS is in DTM mode otherwise present when required for channel assignment
For PBCCH not present case:	
< TSC >	Arbitrarily chosen (default 5)
{ 00< ARFCN >}	00 (ARFCN no hopping)
- ARFCN }	As for "Serving cell, PDTCH (PBCCH not present), SDCCH " in section 40.1.1 for the current cell
For PBCCH present case:	
< TSC >	arbitrarily chosen (default 5)
{ 01< indirect encoding: >}	Indirect encoding struct:
<MAIO>	000010
<MA_NUMBER>	0010 (list 2)
0 1 <Change mark flag	0 (change mark not present)
In case of Dynamic Allocation:	
{ 01 < Dynamic Allocation >	Dynamic Allocation struct :
< Extended Dynamic Allocation >	0 (Dynamic allocation)
0 1< P0 >	0
< USF_GRANULARITY >	0 (one block)
{0 1< UPLINK_TFI_ASSIGNMENT >	1 (uplink TFI assignment)
- UPLINK_TFI_ASSIGNMENT }	00000
{0 1< RLC_DATA_BLOCKS_GRANTED >}	0 (no RLC_DATA_BLOCKS_GRANTED, open-ended TBF)
{0 1< TBF_STARTING_TIME >}	0 (no starting time)
{0 1< Timeslot Allocation >	0 (No power control parameters)
	One slot arbitrarily chosen, the following USF_TNx shall be corresponding to the chosen value x (default timeslot 4 assigned)
{0 1< USF_TN0>}	0 (timeslot 0 not assigned)
{0 1< USF_TN1>}	0 (timeslot 1 not assigned)
{0 1< USF_TN2>}	0 (timeslot 2 not assigned)
{0 1< USF_TN3>}	0 (timeslot 3 not assigned)
{0 1< USF_TN4>}	1 (timeslot 4 assigned)
- USF_TN4	arbitrarily chosen (default 000)
{0 1< USF_TN5>}	0 (timeslot 5 not assigned)
{0 1< USF_TN6>}	0 (timeslot 6 not assigned)
{0 1< USF_TN7>}}	0 (timeslot 7 not assigned)
In case of Single Block Allocation:	
{ 10 <Single Block Allocation>	Single Block Allocation struct:
- TIMESLOT_NUMBER	100
	1 (ALPHA, GAMMA_TN present)
{0 1	0
- < ALPHA >	
- < GAMMA_TN > }	
{0 1}	0 (P0, BTS_PWR_CTRL_MODE, PR_MODE not present)
- TBF_STARTING_TIME	0 (Absolute Starting Time, indicating current frame + 104 frames)
-	
For R99 network simulation:	
Additions for Rel.99	1

- Packet Extended TA flag spare padding	0 not present Spare Padding
--	--------------------------------

40.2.3.5 PACKET DOWNLINK ASSIGNMENT message:

MESSAGE_TYPE	000010
PAGE_MODE	00 Normal Paging
{0 1< PERSISTENCE_LEVEL >	0 (no persistence level present)
Referenced Address	
-	1 (address is TLLI)
- TLLI	Same as the value received from MS
MAC_MODE	00 Dynamic Allocation
RLC_MODE	0 Acknowledged mode
CONTROL_ACK	0
TIMESLOT_ALLOCATION	arbitrarily chosen (default timeslot 4)
Packet Timing Advance	
{ 0 1< TIMING_ADVANCE_VALUE >	1 (timing advance value)
- TIMING_ADVANCE_VALUE }	30 bit periods
{ 0 1< TIMING_ADVANCE_INDEX >	0 (no timing advance index)
<TIMING_ADVANCE_TIMESLOT_NUMBER > }	
{0 1<Frequency Parameters>}	Not present in case MS is in DTM mode otherwise present when required for channel assignment
For PBCCH not present case:	
< TSC >	Arbitrarily chosen (default 5)
{ 00< ARFCN > }	00 (ARFCN no hopping)
- ARFCN }	As for "Serving cell, PDTCH (PBCCH not present), SDCCH " in section 40.1.1 for the current cell
For PBCCH present case:	
< TSC >	arbitrarily chosen (default 5)
{ 01< indirect encoding: > }	Indirect encoding struct:
<MAIO>	000010
<MA_NUMBER>	0010 (list 2)
0 1 <Change mark flag	0 (change mark not present)
{0 1<DOWNLINK_TFI_ASSIGNMENT>}	1 (assign downlink TFI)
- DOWNLINK_TFI_ASSIGNMENT	00001(Binary)
{0 1<Power Control Parameters>}	1 (Power Control Parameters present)
- ALPHA	0, 5
- GAMMA for allocated timeslots	For GSM 700, T-GSM 810, GSM 850 and GSM 900: +8 dBm Dor DCS 1800 and PCS 1900: +6 dBm (default timeslot 4)
{0 1<TBF_STARTING_TIME>}	0 (starting time not present)
{0 1<Measurement Mapping>}	0 (no measurement mapping)
For R99 network simulation:	
Additions for Rel.99	1
- EGPRS settings flag	0 not present
- Packet Extended TA flag	0 not present
- COMPACT reduced MA	0 not present
spare padding	Spare Padding

40.2.3.6 PACKET DOWNLINK DUMMY CONTROL BLOCK message:

MESSAGE_TYPE	100101
PAGE_MODE	00 Normal Paging
Persistence Level	1 Persistence Level Present
- PERSISTENCE_LEVEL	0000 Radio Priority 1
- PERSISTENCE_LEVEL	0000 Radio Priority 2
- PERSISTENCE_LEVEL	0000 Radio Priority 3
- PERSISTENCE_LEVEL	0000 Radio Priority 4
Spare padding	Spare Padding

40.2.3.7 Packet Timeslot Reconfigure

PACKET TIMESLOT RECONFIGURE message (dynamic allocation without assigning a new TBF):

<p>MESSAGE_TYPE PAGE_MODE 0<GLOBAL_TFI></p> <p>CHANNEL_CODING_COMMAND Global Packet Timing Advance - {0 1<TIMING_ADVANCE_VALUE>} - TIMING_ADVANCE_VALUE - {0 1<UPLINK_TIMING_ADVANCE_INDEX>} <UPLINK_TIMING_ADVANCE_TIMESLOT_NUMBER></p> <p>- {0 1<DOWNLINK_TIMING_ADVANCE_INDEX>} <DOWNLINK_TIMING_ADVANCE_TIMESLOT_NUMBER></p> <p>DOWNLINK_RLC_MODE CONTROL_ACK {0 1<DOWNLINK_TFI_ASSIGNMENT>} {0 1<UPLINK_TFI_ASSIGNMENT>} DOWNLINK_TIMESLOT_ALLOCATION {0 1<Frequency Parameters>} Dynamic allocation - Extended Dynamic Allocation - {0 1<P0><PR_MODE>} - USF_GRANULARITY - {0 1<RLC_DATA_BLOCKS_GRANTED>} - {0 1<TBF_STARTING_TIME>} - - ALPHA - {0 1<USF_TN0><GAMMA_TN0>} - {0 1<USF_TN1><GAMMA_TN1>} - {0 1<USF_TN2><GAMMA_TN2>} - {0 1<USF_TN3><GAMMA_TN3>} - USF_TN3 - GAMMA_TN3 - {0 1<USF_TN4><GAMMA_TN4>} - {0 1<USF_TN5><GAMMA_TN5>} - {0 1<USF_TN6><GAMMA_TN6>} - {0 1<USF_TN7><GAMMA_TN7>} spare padding</p>	<p>000111 Normal Paging 0 The TFI value of the uplink TBF or downlink TBF which this message applies to (default 00101) 0, message escape arbitrarily chosen from valid values (default CS-1)</p> <p>1 (timing advance value present) 30 bit periods 0 (no uplink timing advance index) The MS stops the operation of the continuous timing advance procedure. 0 (no downlink timing advance index) The MS stops the operation of the continuous timing advance procedure. Same as in the Test PDP context used 0 0 0 arbitrarily chosen from valid values (default 00010000) 0 (use current parameters) 0 0 (Dynamic allocation) 0 0, one block 0 (no RLC_DATA_BLOCKS_GRANTED, open-ended TBF) 0 (no starting time)</p> <p>1 (Timeslot Allocation with Power Control Parameters) one slot arbitrarily chosen and different from current slot, the following USF_TNx and GAMMA_TNx shall be corresponding to the chosen value, default timeslot 3. 0.5 0 (timeslot 0 not assigned) 0 (timeslot 1 not assigned) 0 (timeslot 2 not assigned) 1 (timeslot 3 assigned) arbitrarily chosen and different from current value, default 4 For GSM 700, T-GSM 810, GSM 850 and GSM 900, +8 dBm For DCS 1 800, +6 dBm For PCS 1 900, +6 dBm 0 (timeslot 4 not assigned) 0 (timeslot 5 not assigned) 0 (timeslot 6 not assigned) 0 (timeslot 7 not assigned) Spare Padding</p>
---	---

For assignment of an uplink TBF while a downlink TBF has been established, the address information should be changed to DOWNLINK_TFI of Global_TFI. UPLINK_TFI_ASSIGNMENT is present.

40.2.4 Default contents of Layer 3 messages

This clause contains the default values of L3 messages, which unless indicated otherwise in clause 40, shall be transmitted by the system simulator and which are required to be received from the MS under test.

In this clause, decimal values are normally used. However, sometimes a hexadecimal value, indicated by an "Hex", or a binary value, indicated by a "Binary" is used.

40.2.4.1 ACTIVATE PDP CONTEXT ACCEPT message:

Protocol discriminator	1010 (SM message for GPRS service)
Activate PDP context accept message identity	01000010
Negotiated LLC SAPI	As per corresponding Activate PDP Context Request
Negotiated QoS	Minimum
Radio priority	Arbitrary chosen
Spare half octet	Spare half octet
PDP address	Returned only if PDP address from corresponding Activate PDP Context Request is not static

40.2.4.2 ACTIVATE PDP CONTEXT REJECT message:

Protocol discriminator	1010 (SM message for GPRS service)
Activate PDP context reject message identity	01000011
SM cause	Insufficient resources

40.2.4.3 ATTACH ACCEPT message:

Protocol discriminator	1000 (MM message for GPRS service)
Skip indicator	0000
Attach accept message identity	00000010
Attach result	Copy back attach type (GPRS attach (MS class C))
Force to standby	not indicated (subject to CR)
Periodic RA update timer	timer is deactivated
Radio priority for SMS	priority level 3
Spare half octet	Spare half octet
Routing area identification	
- MCC	001 (decimal)
- MNC	For GSM 900 / DCS 1800: 01 (decimal) For GSM 700 / T-GSM 810 / GSM 850 / PCS 1900: 011 (decimal)
- LAC	0001H
- RAC	05H
P-TMSI signature	P-TMSI signature
Negotiated READY timer value	32 seconds
Allocated P-TMSI	P-TMSI
For R99 network simulation: T3302 value	0

40.2.4.4 ATTACH REJECT message:

Protocol discriminator	MM message for GPRS
Skip indicator	0000
Attach reject message identity	00000100
GMM cause	Regular deactivation
For R99 network simulation: T3302 value	0

40.2.4.5 AUTHENTICATION AND CIPHERING REJECT message:

Protocol discriminator	MM message for GPRS
Skip indicator	0000
Authentication and ciphering reject message identity	00010100

40.2.4.6 AUTHENTICATION AND CIPHERING REQUEST message:

Protocol discriminator	MM message for GPRS
Skip indicator	0000
Authentication and ciphering request message identity	00010010
Ciphering algorithm	Ciphering not used
IMEISV request	not requested
Force to standby	not indicated
A&C reference number	Arbitrary
Authentication parameter RAND	Arbitrary
GPRS ciphering key sequence number	Arbitrary

40.2.4.7 CHANNEL RELEASE message:

Protocol Discriminator	0110 (RR Management).
Skip Indicator	0000
Message Type	00001101
RR Cause	
- RR Cause Value	Normal event.
GPRS RESUMPTION IE	Present (see note below)
- ACK field	1

Note: Only in case the MS performed GPRS suspension procedure prior to the CS session, then the GPRS RESUMPTION IE shall be present in the CHANNEL RELEASE message.

40.2.4.8 DEACTIVATE PDP CONTEXT ACCEPT message:

Protocol discriminator	1010 (SM message for GPRS service)
Deactivate PDP context accept message identity	01010100

40.2.4.9 DETACH ACCEPT message (for mobile terminated detach):

Protocol discriminator	MM message for GPRS
Skip indicator	0000
Detach request message identity	00000110

40.2.4.10 DETACH REQUEST message (mobile terminated detach):

Protocol discriminator	MM message for GPRS
Skip indicator	0000
Detach request message identity	00000101
Detach type	re-attach not required
Force to standby	not indicated

40.2.4.11 GMM INFORMATION message:

Protocol discriminator	MM message for GPRS
Skip indicator	0000
GMM information message identity	00100001

40.2.4.12 GMM STATUS message:

Protocol discriminator	MM message for GPRS
Skip indicator	0000
GMM status message identity	00100000
GMM cause	Arbitrary

40.2.4.13 IDENTITY REQUEST message:

Protocol discriminator	MM message for GPRS
Skip indicator	0000
Identity request message identity	00010101
Identity type	IMSI
Force to standby	not indicated

40.2.4.14 IMMEDIATE ASSIGNMENT messages

40.2.4.14.1 IMMEDIATE ASSIGNMENT message (Packet Downlink Construction):

L2 pseudo length	This is the sum of the lengths of all the information elements present in the message except for the IA rest octets and L2 pseudo length IEs. For the default message the L2 pseudo length is 11.
Protocol Discriminator	RR Management.
Skip Indicator	0000
Message Type	00111111
Page Mode	
- Page Mode	Normal Paging.
Dedicated mode or TBF	
- T/D	Temporary Block Flow
- Downlink	1 Resources assigned in IA Rest Octets
- TMA	0 No meaning
Packet Channel Description	Dependant upon the test case.
Request Reference	Copy of last received by the SS.
Timing Advance	
- Timing advance value	30 bit periods.
Mobile Allocation	
- Length	0
Starting Time	Not present.
IA rest octets	
-	HH
-	01 (Packet Downlink Assignment)
- Packet Downlink Assignment	
- TLLI	(The value received from MS)
-	1
- TFI_ASSIGNMENT	Any value not used before
- RLC_MODE	RLC unacknowledged mode
{0 1 < ALPHA >	1 ALPHA present
- ALPHA }	0.5
- GAMMA	For GSM 700, T-GSM 810, GSM 850 and GSM 900: +8 dBm
	For DCS 1 800 and PCS 1 900: +6 dBm
- POLLING	0 No polling
- TA_VALID	1 Timing Advance value in TA IE is valid
{ 0 1 < TIMING_ADVANCE_INDEX > }	0 Timing Advance Index not present
{ 0 1 < TBF_STARTING_TIME > }	0 TBF Starting Time not present
{0 1}	0 P0, BTS_PWR_CTRL_MODE, PR_MODE not present
- spare padding	Spare Padding

40.2.4.14.2 IMMEDIATE ASSIGNMENT message (Packet Uplink construction):

L2 pseudo length	This is the sum of the lengths of all the information elements present in the message except for the IA rest octets and L2 pseudo length IEs. For the default message the L2 pseudo length is 11.
Protocol Discriminator	RR Management.
Skip Indicator	0000
Message Type	00111111
Page Mode	
- Page Mode	Normal Paging.
Dedicated mode or TBF	
- T/D	1 Temporary Block Flow
- Downlink	0 No meaning
- TMA	0 No meaning
Packet Channel Description	Dependant upon the test case.
Request Reference	Copy of last received by the SS.
Timing Advance	
- Timing advance value	30 bit periods.
Mobile Allocation	
- Length	0
Starting Time	Not present.
IA rest octets	
-	HH
-	00 (Packet Uplink Assignment)
- Packet Uplink Assignment	1
- TFI_ASSIGNMENT	Any value not used before
- POLLING	0
-	0 Dynamic Allocation
- USF	Any value not used before
- USF_GRANULARITY	0 (transmit one RLC block)
{ 0 1 }	0 (P0, BTS_PWR_CTRL_MODE , PR_MODE not present)
- CHANNEL_CODING_COMMAND	00 CS-1 shall be used
- TLLI_BLOCK_CHANNEL_CODING	1 MS shall used the coding scheme as specified by CHANNEL_CODING_COMMAND
{ 0 1 < ALPHA > }	1 ALPHA present
- ALPHA	0.5
- GAMMA	For GSM 700, T-GSM 810, GSM 850 and GSM 900: +8 dBm
	For DCS 1 800 and PCS 1 900: +6 dBm
{ 0 1 < TIMING_ADVANCE_INDEX > }	0 Timing Advance Index not present
{ 0 1 < TBF_STARTING_TIME > }	0 TBF Starting Time not present
- spare padding	Spare Padding

40.2.4.14.3 IMMEDIATE ASSIGNMENT message (Single block allocation construction):

L2 pseudo length	This is the sum of the lengths of all the information elements present in the message except for the IA rest octets and L2 pseudo length IEs. For the default message the L2 pseudo length is 11.
Protocol Discriminator	RR Management.
Skip Indicator	0000
Message Type	00111111
Page Mode	
- Page Mode	Normal Paging.
Dedicated mode or TBF	
- T/D	1 Temporary Block Flow
- Downlink	0 No meaning
- TMA	0 No meaning
Packet Channel Description	Dependant upon the test case.
Request Reference	Copy of last received by the SS.
Timing Advance	
- Timing advance value	30 bit periods.
Mobile Allocation	
- Length	0
Starting Time	Not present.
IA rest octets	
-	HH
-	00 (Packet Uplink Assignment)
- Packet Uplink Assignment	0
{0 1 < ALPHA >}	1 ALPHA present
- ALPHA	0.5
- GAMMA	For GSM 700, T-GSM 810, GSM 850 and GSM 900: +8 dBm
-	For DCS 1 800 and PCS 1 900: +6 dBm
-	01
- TBF_STARTING_TIME	Indicating (current frame + 104)
{ L H }	L (P0, BTS_PWR_CTRL_MODE , PR_MODE not present)
- spare padding	Spare Padding

40.2.4.15 IMMEDIATE ASSIGNMENT EXTENDED message:

L2 pseudo length	This is the sum of the lengths of all the information elements present in the message except for the IAX rest octets and L2 pseudo length IEs. For the default message the L2 pseudo length is 18.
Protocol Discriminator	RR Management.
Skip Indicator	0000
Message Type	00111001
Page Mode	
- Page Mode	Normal Paging.
Channel Description 1	Dependant upon the test case.
Request Reference 1	Pertaining to last Channel Request sent by the MS.
Timing Advance 1	
- Timing advance value	Dependant upon the test case.
Channel Description 2	Dependant upon the test case.
Request Reference 2	Not pertaining to any Channel Requests sent by the MS.
Timing Advance 2	
- Timing advance value	Dependant upon the test case.
Mobile Allocation	
- Length	0
Starting Time	Not present.
IAX rest octets	All bits set to spare.

40.2.4.16 IMMEDIATE ASSIGNMENT REJECT message:

L2 pseudo length	19
Protocol Discriminator	RR Management.
Skip Indicator	0000
Message Type	00111010
Page Mode	
- Page Mode	Normal Paging.
Request Reference 1	Copy of last received by the SS.
Wait Indication 1	0 seconds.
Request Reference 2	Not pertaining to the MS under test.
Wait Indication 2	0 seconds.
Request Reference 3	Not pertaining to the MS under test.
Wait Indication 3	0 seconds.
Request Reference 4	Not pertaining to the MS under test.
Wait Indication 4	0 seconds.
IAR rest octets	All bits set to spare.

40.2.4.17 MODIFY PDP CONTEXT REQUEST message:

Protocol discriminator	1010 (SM message for GPRS service)
Modify PDP context request message identity	01001000
Radio priority	
Spare half octet	Spare half octet
Requested LLC SAPI	As per corresponding Activate PDP Context Request
New QoS	Higher than the minimum QoS

40.2.4.18 PAGING REQUEST TYPE 1 message:

L2 pseudo length	This is the sum of the lengths of all the information elements present in the message except for the P1 rest octets and L2 pseudo length IEs. For the default message the L2 pseudo length is 9.
Protocol Discriminator	RR Management.
Skip Indicator	0000
Message Type	00100001
Page Mode	
- Page Mode	Normal Paging.
Channels needed	
- first channel	00 (indicating packet paging).
- second channel	00 (indicating packet paging).
Mobile Identity 1	
- odd/even indication	Even.
- Type of Identity	P-TMSI.
- Identity Digits	P-TMSI previously allocated to MS.
Mobile Identity 2	Not present.
P1 rest octets	
- {L H<NLN(PCH)>}	L (no Notification List Number(PCH))
- {L H<Priority1>}	L (no priority specified for mobile Id 1)
- {L H<Priority2>}	L (no priority specified for mobile Id 2)
- Packet Page Indication 1	Packet Paging
- Packet Page Indication 2	L
- {L H<Group Call Information>}	L (no Group call Information)
- {L H<NLN status>}	L (no Notification List Number status)
- spare padding	Spare Padding

40.2.4.19 PAGING REQUEST TYPE 2 message:

L2 pseudo length	This is the sum of the lengths of all the information elements present in the message except for the P2 rest octets and L2 pseudo length IEs. For the default message the L2 pseudo length is 11.
Protocol Discriminator	RR Management.
Skip Indicator	0000
Message Type	00100010
Page Mode	
- Page Mode	Normal Paging.
Channels needed	
- first channel	00 (indicating packet paging).
- second channel	00 (indicating packet paging).
Mobile Identity 1	
- TMSI value	P-TMSI previously allocated to MS.
Mobile Identity 2	
- TMSI value	P-TMSI not allocated to MS.
Mobile Identity 3	
- TMSI value	IMSI not relevant to the MS under test
P2 rest octets	
- {L H<CN3>}	H (channel needed for mobile Id 3 present)
- CN3	Indicating packet paging
- {L H<NLN>}	L (no notification list number)
- {L H<Priority1>}	L (no priority specified for mobile Id 1)
- {L H<Priority2>}	L (no priority specified for mobile Id 2)
- {L H<Priority3>}	L (no priority specified for mobile Id 3)
- {L H<NLN status>}	L (no notification list number status)
- Packet Page Indication 3	Packet Paging
- spare padding	Spare Padding

40.2.4.20 PAGING REQUEST TYPE 3 message:

L2 pseudo length	19
Protocol Discriminator	RR Management.
Skip Indicator	0000
Message Type	00100100
Page Mode	
- Page Mode	Normal Paging.
Channels needed	
- first channel	00 (indicating packet paging).
- second channel	00 (indicating packet paging).
Mobile identity 1	
- TMSI value	P-TMSI previously allocated to MS.
Mobile identity 2	
- TMSI value	P-TMSI not allocated to MS.
Mobile identity 3	
- TMSI value	P-TMSI not allocated to MS.
Mobile identity 4	
- TMSI value	P-TMSI not allocated to MS.
P3 rest octets	
- {L H<CN3><CN4>}	H (channel needed for mobile Id 3 and 4 present)
- CN3	Indicating packet paging
- CN4	Indicating packet paging
- {L H<NLN>}	L (no notification list number)
- {L H<Priority1>}	L (no priority specified for mobile Id 1)
- {L H<Priority2>}	L (no priority specified for mobile Id 2)
- {L H<Priority3>}	L (no priority specified for mobile Id 3)
- {L H<Priority4>}	L (no priority specified for mobile Id 4)
- {L H<NLN status>}	L (no notification list number status)
- spare padding	Spare Padding

40.2.4.21 PDCH ASSIGNMENT COMMAND message (downlink):

Information Element	Value/Remarks
Protocol Discriminator	RR Management
Skip indicator	0000 (Binary)
Message Type	00101010 (Binary)
Description of the Channel, after time	
- Channel Description	
- Channel Type and TDMA offset	TCH/F + ACCH's
- Timeslot Number	Slot 2
- Training Sequence Code	Same as the BCC
- Hopping channel	Single RF channel
- ARFCN	Same as BCCH carrier
- RR Packet Downlink Assignment	
- LENGTH_IN_OCTETS	400
- MAC_MODE	00 (Dynamic allocation)
- RLC_MODE	1 (RLC unacknowledged mode)
- TIMESLOT_ALLOCATION	Slot 2
- Packet Timing Advance	
- { 0 1 <TIMING_ADVANCE_VALUE> }	1 (TIMING_ADVANCE_VALUE present)
- TIMING_ADVANCE_VALUE	30 bit periods
- { 0 1 <TIMING_ADVANCE_INDEX> }	0 (TIMING_ADVANCE_INDEX and TIMING_ADVANCE_TIMESLOT_NUMBER not present)
- { 0 1 <Power Control Parameters> }	1 (Power Control Parameters present)
- ALPHA	0.5
- { 0 1 <GAMMA_TN0> }	0 (GAMMA_TN0 not present)
- { 0 1 <GAMMA_TN1> }	0 (GAMMA_TN1 not present)
- { 0 1 <GAMMA_TN2> }	1 (GAMMA_TN2 present)
- GAMMA_TN2	For GSM 700, T-GSM 810, GSM 850 and GSM 900: +8 dBm
	For DCS 1 800 and PCS 1 900: +6 dBm
- { 0 1 <GAMMA_TN3> }	0 (GAMMA_TN3 not present)
- { 0 1 <GAMMA_TN4> }	0 (GAMMA_TN4 not present)
- { 0 1 <GAMMA_TN5> }	0 (GAMMA_TN5 not present)
- { 0 1 <GAMMA_TN6> }	0 (GAMMA_TN6 not present)
- { 0 1 <GAMMA_TN7> }	0 (GAMMA_TN7 not present)
- { 0 1 <DOWNLINK_TFI_ASSIGNMENT> }	1 (Assign downlink TFI)
- DOWNLINK_TFI_ASSIGNMENT	00011 (Binary)
- { 0 1 <MEASUREMENT_STARTING_TI> }	0 (No measurement information)
- N_SPARE_BITS	Spare padding

40.2.4.22 REQUEST PDP CONTEXT ACTIVATION message (mobile originated detach):

Protocol discriminator	1010 (SM message for GPRS service)
Request PDP context activation message identity	01000100
Offered PDP address	Arbitrarily chosen

40.2.4.23 ROUTING AREA UPDATE ACCEPT message:

Protocol discriminator	MM message for GPRS
Skip indicator	0000
Routing area update accept message identity	00001001
Force to standby	not indicated
Update result	RA updated
Periodic RA update timer	Timer is deactivated
Routing area identification	
- MCC	001 (decimal)
- MNC	For GSM 900 / DCS 1800: 01 (decimal)
	For GSM 700 / T-GSM 810 / GSM 850 / PCS 1900: 011 (decimal)
- LAC	0001H
- RAC	05H
For R99 network simulation: T3302 value	0

40.2.4.24 ROUTING AREA UPDATE REJECT message:

Protocol discriminator	MM message for GPRS
Skip indicator	0000
Routing Area Update reject message identity	00001011
GMM cause	Congestion
Force to standby	Not indicated
For R99 network simulation: T3302 value	0

40.2.4.25 RR-CELL CHANGE ORDER message:

Information Element	Value/Remarks
Protocol Discriminator	RR Management
Skip indicator	0000 (Binary)
Message Type	00001000 (Binary)
Cell description	
- PLMN colour code, NCC	1
- BS colour code, BCC	5
- BCCH ARFCN	As for "Serving cell, PDTCH (PBCCCH not present),SDCCH" in section 40.1.1 for the current cell
NC mode for target cell	
- NC mode	00 (binary, NC0 mode)
Spare half octet	Spare Padding

40.2.4.26 SM STATUS message:

Information Element	Value/Remarks
Protocol discriminator	1010 (SM message for GPRS service)
SM status message identity	01010101
SM cause	Arbitrary

40.2.4.27 DETACH ACCEPT message (for mobile originated detach):

Information Element	Value/Remarks
Protocol discriminator	MM message for GPRS
Skip indicator	0000
Detach request message identity	00000110
Force to Standby	001 (indicated)
Spare half octet	Spare Padding

40.2.4.28 DTM Assignment Command

Protocol discriminator	0110
Skip Indicator	0000
Message Type	01001100
Power Command	00001010 FPC not in use, Power control level 10
Description of the CS Channel	
- Channel Description	
- Channel Type and TDMA offset	TCH/F + ACCH's
- Timeslot Number	3
- Training Sequence Code	Same as the BCCH
- Hopping channel	Single RF channel
- ARFCN	default
GPRS broadcast information	
- Length in Octets	5 Octets
- GPRS Cell Options	
- NMO	00 Network Mode 1
- T3168	011 2 seconds
- T3192_VALUE	010 1.5 seconds
- DRX_TIMER_MAX	000
- ACCESS_BURST_TYPE	1 11 bit access burst
- CONTROL_ACK_TYPE	1 RLC/MAC Control block
- BS_CV_MAX	0111
-Optional extension information	0 Extension information not present
For R99/Rel 4 network simulation:	
Optional extension information	1 Extension information present
- Extension length	R99: 000011 Rel 4: 000101 Rel 6: 000111
- {0 1 <Extension Information>}	0 EGPRS not supported by the cell.
- PFC_FEATURE_MODE	0 Packet Flow Context Procedures not supported
- DTM_SUPPORT	1.....The cell supports DTM procedures
- BSS_PAGING_COORDINATION	0 Circuit-Switched paging coordination not supported in cell
end R99	
For Rel 4 network simulation	
- CCN_ACTIVE	0 CCN is disabled in the cell
- NW_EXT_UTBF	0 Ext UL TBF not supported in the cell
For Rel6 network simulation	
- MULTIPLE_TBF_CAPABILITY	0 not supported in the cell
- EXT_UTBF_NODATA	0 not supported in the cell
- GPRS Power Control Parameters	
-ALPHA	0101 Alpha = 0.5
-T_AVG_W	01100 value 12
-T_AVG_T	01100 value 12
-PC_MEAS_CHAN	0 BCCH
-N_AVG_I	0111 value 7
Channel Mode	
- Mode	00000001 (GSM Full Rate)
Description of the Uplink Packet Channel Assignment	
- LENGTH_IN_OCTETS	00000100
- CHANNEL_CODING_COMMAND	CS1
- TLLI_BLOCK_CHANNEL_CODING	1
- Packet Timing Advance	
- { 0 1 <TIMING_ADVANCE_VALUE> }	0 (no timing advance value)
{ 0 1 < Dynamic Allocation >	Dynamic Allocation struct :
< Extended Dynamic Allocation >	0 (Dynamic allocation)
0 1< P0 >	0
< USF_GRANULARITY >	0 (one block)
{0 1< UPLINK_TFI_ASSIGNMENT >	1 (uplink TFI assignment)
- UPLINK_TFI_ASSIGNMENT }	00000
{0 1< RLC_DATA_BLOCKS_GRANTED >}	0 (no RLC_DATA_BLOCKS_GRANTED, open-ended TBF)
{0 1< TBF_STARTING_TIME >}	0 (no starting time)
{0 1< Timeslot Allocation >	0 (Timeslot Allocation)
{0 1< USF_TN0>}	0 (timeslot 0 not assigned)
{0 1< USF_TN1>}	0 (timeslot 1 not assigned)

<pre> {0 1< USF_TN2>} {0 1< USF_TN3>} {0 1< USF_TN4>} - USF_TN4 {0 1< USF_TN5>} {0 1< USF_TN6>} {0 1< USF_TN7>}} Description of the Downlink Packet Channel Assignment - LENGTH_IN_OCTETS - MAC_MODE - RLC_MODE - TIMESLOT_ALLOCATION - Packet Timing Advance { 0 1< TIMING_ADVANCE_VALUE > { 0 1< TIMING_ADVANCE_INDEX > } - {0 1< P0 >} - { 0 1< Power Control Parameters } - { 0 1< DOWNLINK_TFI_ASSIGNMENT > } - DOWNLINK_TFI_ASSIGNMENT - { 0 1< MEASUREMENT_STARTING_TIME >} </pre>	<pre> 0 (timeslot 2 not assigned) 0 (timeslot 3 not assigned) 1 (timeslot 4 assigned) arbitrarily chosen (default 000) 0 (timeslot 5 not assigned) 0 (timeslot 6 not assigned) 0 (timeslot 7 not assigned) 00000101 00 Dynamic Allocation 0 Acknowledged mode 00001000 0 (no timing advance value) 0 (no timing advance index) 0 0 1 00000 0 </pre>
--	---

40.2.4.29 DTM Reject

<pre> Protocol discriminator Skip Indicator Message Type Wait Indication - T3122/T3142 timeout value </pre>	<pre> 0110 0000 01001001 00011110 (30 Seconds) </pre>
---	---

40.2.4.30 Packet Notification

<pre> Protocol discriminator Skip Indicator Message Type P-TMSI - P-TMSI Value </pre>	<pre> 0110 0000 01001110 00000000000000000000000000000000 </pre>
---	--

40.2.4.31 Packet Assignment

Protocol discriminator	0110
Skip Indicator	0000
Message Type	01001011
GPRS broadcast information	
- Length in Octets	00000101
- GPRS Cell Options	
- NMO	00 Network Mode 1
- T3168	011 2 seconds
- T3192	010 1.5 seconds
- DRX_TIMER_MAX	000
- ACCESS_BURST_TYPE	1 11 bit access burst
- CONTROL_ACK_TYPE	1 RLC/MAC Control block
- BS_CV_MAX	0111
-Optional extension information	0 Extension information not present
For R99/Rel 4 network simulation:	
Optional extension information	1 Extension information present
- Extension length	R99: 000011
	Rel 4: 000101
	Rel 6: 000111
- {0 1 <Extension Information>}	0 EGPRS not supported by the cell.
- PFC_FEATURE_MODE	0 Packet Flow Context Procedures not supported
- DTM_SUPPORT	1.....The cell supports DTM procedures
- BSS_PAGING_COORDINATION	0 Circuit-Switched paging coordination not supported in cell
end R99	
For Rel 4 network simulation	
- CCN_ACTIVE	0 CCN is disabled in the cell
- NW_EXT_UTBF	0 Ext UL TBF not supported in the cell
For Rel6 network simulation	
- MULTIPLE_TBF_CAPABILITY	0 not supported in the cell
- EXT_UTBF_NODATA	0 not supported in the cell
- GPRS Power Control Parameters	
- ALPHA	0101 Alpha = 0.5
- T_AVG_W	01100 value 12
- T_AVG_T	01100 value 12
- PC_MEAS_CHAN	0 BCCH
- N_AVG_I ;	0111 value 7
Description of the Uplink Packet Channel Assignment	
- LENGTH_IN_OCTETS	00000101
- CHANNEL_CODING_COMMAND	CS1
- TLLI_BLOCK_CHANNEL_CODING	1
- Packet Timing Advance	
- { 0 1 <TIMING_ADVANCE_VALUE> }	0 (no TIMING_ADVANCE_VALUE present)
- { 0 1< TIMING_ADVANCE_INDEX > }	0 (no timing advance index)
{ 01 < Dynamic Allocation >	01 (Dynamic Allocation struct)
< Extended Dynamic Allocation >	0 (Dynamic allocation)
0 1< P0 >	0
< USF_GRANULARITY >	0 (one block)
{0 1< UPLINK_TFI_ASSIGNMENT >	1 (uplink TFI assignment)
- UPLINK_TFI_ASSIGNMENT }	00000
{0 1< RLC_DATA_BLOCKS_GRANTED >}	0 (no RLC_DATA_BLOCKS_GRANTED, open-ended TBF)
{0 1< TBF_STARTING_TIME >}	0 (no starting time)
{0 1< Timeslot Allocation >	0 (Timeslot Allocation)
{0 1< USF_TN0>}	0 (timeslot 0 not assigned)
{0 1< USF_TN1>}	0 (timeslot 1 not assigned)
{0 1< USF_TN2>}	0 (timeslot 2 not assigned)
{0 1< USF_TN3>}	0 (timeslot 3 not assigned)
{0 1< USF_TN4>}	1 (timeslot 4 assigned)
- USF_TN4	arbitrarily chosen (default 000)
{0 1< USF_TN5>}	0 (timeslot 5 not assigned)
{0 1< USF_TN6>}	0 (timeslot 6 not assigned)
{0 1< USF_TN7>}	0 (timeslot 7 not assigned)
Description of the Downlink Packet Channel Assignment	

- LENGTH_IN_OCTETS	00000101
- MAC_MODE	00 Dynamic Allocation
- RLC_MODE	0 Acknowledged mode
- TIMESLOT_ALLOCATION	00001000
- Packet Timing Advance	
{ 0 1< TIMING_ADVANCE_VALUE >	1 (timing advance value)
- TIMING_ADVANCE_VALUE }	30 bit periods
{ 0 1< TIMING_ADVANCE_INDEX >	0 (no timing advance index)
- TIMING_ADVANCE_INDEX }	
<TIMING_ADVANCE_TIMESLOT_NUMBER>	
}	
- {0 1< P0 >}	0
- { 0 1 < Power Control Parameters }	0
- { 0 1 < DOWNLINK_TFI_ASSIGNMENT > }	1
- DOWNLINK_TFI_ASSIGNMENT	00000
- { 0 1 < MEASUREMENT_STARTING_TIME > }	0

40.2.4.32 Assignment Command

RR management Protocol Discriminator	0110
Skip Indicator	0000
Message Type	00101110
Description of the First Channel, after time	
- Channel Description	
- Channel Type and TDMA offset	TCH/F + ACCH's
- Timeslot Number	3
- Training Sequence Code	Same as the BCCH
- Hopping channel	Single RF channel
- ARFCN	default
Power Command	00001010 FPC not in use, Power control level 10

40.2.4.33 Handover Command

RR management Protocol Discriminator	0110
Skip Indicator	0000
Message Type	00101011
Cell Description	
- Network Colour Code	1
- Base Station Colour Code	5
- BCCH Carrier Number	Dependant upon the test case
Description of the First Channel, after time	
- Channel Description	
- Channel Type and TDMA offset	TCH/F + ACCH's
- Timeslot Number	Dependant upon the test case
- Training Sequence Code	Same as the BCCH
- Hopping channel	Single RF channel
- ARFCN	Dependant upon the test case
Handover Reference	01010101
Power Command and Access Type	00001010 Handover access mandatory, FPC not in use, Power control level 10
Synchronization Indication	
- Report Observed Time Difference	Shall not be included.
- Synchronization Indication	"Non synchronized".
- Normal Cell Indication	Ignore out of range timing advance.

40.2.4.34 Physical Information

Protocol Discriminator	0110
Skip Indicator	0000
Message Type	00101101
Timing advance	30 bit periods.

40.2.4.35 Connect Acknowledge

Protocol Discriminator	0011
Transaction Identifier	
TI value	As used in the SETUP message.
TI flag	0
Message Type	0X001111

40.2.4.36 Location Updating Accept

Protocol Discriminator	0101
Skip Indicator	0000
Location Updating Accept message type	00000010
Location Area Identification	
MCC	001 (decimal)
MNC	01 (decimal) for GSM 900, DCS 1800 011 (decimal) for GSM 700, T-GSM 810, GSM 850, PCS 1900
LAC	0001H

40.2.4.37 System Information Type 6

L2 pseudo length	This is the sum of the lengths of all the information elements present in the message except for the SI 6 rest octets and L2 pseudo length IEs. For the default message the L2 pseudo length is 11.
RR management Protocol Discriminator	0110 (radio resources management messages)
Skip Indicator	0000
System Information Type 6 Message Type	00011110
Cell Identity	Same as the BCCH
Location Area Identification	Same as the BCCH
Cell Options	Same as the BCCH
NCC Permitted	Same as the BCCH
SI 6 Rest Octets	For DTM not present case
- {L H <PCH and NCH info>}	L (no PCH and NCH info)
- {L H <VBS/VGCS options : bit(2)>}	L (no VBS/VGCS options)
- < DTM_support : bit == L >	L (DTM not supported)
< DTM_support : bit == H	
- < Band indicator >	Same as the BCCH
- < implicit spare >	1011
SI 6 Rest Octets	For DTM present case
- {L H <PCH and NCH info>}	L (no PCH and NCH info)
- {L H <VBS/VGCS options : bit(2)>}	L (no VBS/VGCS options)
- < DTM_support : bit == L >	H (DTM supported)
< DTM_support : bit == H	
- < RAC : bit (8) >	Same as the BCCH
- < MAX_LAPDm : bit (3) >	000 (Any message segmented in up to 5 LAPDm frames)
- < Band indicator >	Same as the BCCH
- L H < GPRS_MS_TXPWR_MAX_CCH : bit (5)>	H (GPRS_MS_TXPWR_MAX_CCH present)
GPRS_MS_TXPWR_MAX_CCH	01010
- < implicit spare >	1

40.2.4.38 DTM Information

RR management Protocol Discriminator	0110 (radio resources management messages)
Skip Indicator	0000
DTM Information Message Type	01001101
Routeing Area Identification	Same as the BCCH
DTM Information Rest Octets	
- < LENGTH_IN_OCTETS : bit(8) >	00000011
- < MAX_LAPDm : bit (3) >	000 (Any message segmented in up to 5 LAPDm frames)
- < GPRS_MS_TXPWR_MAX_CCH: bit (5) >	arbitrarily chosen
- < Cell identity: bit (16) >	Cell Identity of the Serving Cell

40.3 Default GPRS Conditions and Message Contents for the Higher Layer Test Cases

This clause details default conditions and messages that shall be used for the higher layer test cases (GPRS Mobility Management, Session Management and SMDCP).

These alternate conditions and messages are derived from the standard defaults via the changes listed in the following sub-clause. They aim to produce default conditions with permitted channel combinations of:

- FCCH+SCH+BCCH+CCCH+SDCCH/4+SACCH/4 (v. from 3GPP TS 05.02 'Permitted Channel Combinations onto a Basic Physical Channel').
- PBCCH+PCCCH+PDTCH+PACCH+PTCCH (xi. from 3GPP TS 05.02 'Permitted Channel Combinations onto a Basic Physical Channel').
- PDTCH+PACCH+PTCCH (xiii. From 3GPP TS 05.02 'Permitted Channel Combinations onto a Basic Physical Channel').

Where values have not been specified the equivalent overall default values should be used. If values need to be removed from the overall defaults then these should be specified as 'OMITTED'.

40.3.1 Default Test Conditions for the Higher Layer Test Cases

Network dependant parameters	
CCCH_CONF	1 basic physical channel for CCCH combined with SDCCH
BS_AG_BLK_RES	0 blocks reserved
BS_PA_MFRMS	5 multiframes
IMSI Attach-detach	IMSI attach / detach not allowed

40.3.2 Default Message for the Higher Layer Test Cases

40.3.2.1 Default Contents of System Information Messages for the Higher Layer Test Cases

Default Contents of Information Elements in SYSTEM INFORMATION TYPE 1 to 13 Messages Used for the Higher Layer Test Cases.

Control Channel Description	
- BS_AG_BLK_RES	0 blocks reserved for access grant.
- CCCH_CONF	1 basic physical channel used for CCCH, combined with SDCCHs.
- BS_PA_MFRMS	5 multiframe periods for transmission of paging messages.
- Attach-Detach allowed	IMSI attach / detach not allowed

Normal Case

SI 13 Rest Octets Routing Area Code(RAC) SPLIT_PG_CYCLE(SPGC_CCCH_SUP) PRIORITY_ACCESS_THR NETWORK_CONTROL_ORDER GPRS Cell Options Network Mode of Operation T3168 T3192 DRX_TIMER_MAX ACCESS_BURST_TYPE CONTROL_ACK_TYPE BS_CV_MAX PAN_DEC PAN_INC PAN_MAX GPRS Power Control Parameters ALPHA T_AVG_W T_AVG_T PC_MEAS_CHAN N_AVG_I INT_MEAS_CHANNEL_LIST_AVAIL	For PBCCH not present case 0000101(Binary) Supported Packet access allowed for priority level 1 to 4 Normal MS control, no measurement reporting NMO I 2 seconds 1.5 seconds Non-DRX not supported 11 bits access burst RLC/MAC control block 7 3 3 010(Binary) 12 12 BCCH 7 Not Available
--	---

Alternate Case

SI 13 Rest Octets PSI1_REPEAT_PERIOD PBCCH Description TSC TN ARFCN	For PBCCH present case 0110 (Binary) Dependant upon the test case Timeslot 4 Non-Hopping Channel As for "Serving cell, PDTCH (PBCCH not present), SDCCH" in section 40.1.1 for the current cell
--	--

40.3.3 Contents Of Packet System Information Messages for the Higher Layer Test Cases

PACKET SYSTEM INFORMATION TYPE 2 Instance 1 of 3 for Higher Layer Test Cases

Non GPRS Cell Options -ATT -BS_AG_BLKRES -CCCH_CONF -BS_PA_MFRMS {PCCCH Description}	1 Non GPRS Cell Options present IMSI attach / detach not allowed 000 0 reserved 001 100 value 5 Same as the PBCCH Description as defined in SI13 Rest Octets
---	---

PACKET SYSTEM INFORMATION TYPE 13

Normal Case

Routing Area Code(RAC) SPLIT_PG_CYCLE(SPGC_CCCH_SUP) PRIORITY_ACCESS_THR NETWORK_CONTROL_ORDER	For PBCCH not present case 00000101(Binary) Supported Packet access allowed for priority level 1 to 4 Normal MS control, no measurement reporting
GPRS Cell Options Network Mode of Operation T3168 T3192 DRX_TIMER_MAX ACCESS_BURST_TYPE CONTROL_ACK_TYPE BS_CV_MAX PAN_DEC PAN_INC PAN_MAX GPRS Power Control Parameters ALPHA T_AVG_W T_AVG_T PC_MEAS_CHAN N_AVG_I INT_MEAS_CHANNEL_LIST_AVAIL	NMO I 2 seconds 1.5 seconds Non-DRX not supported 11 bits access burst RLC/MAC control block 7 3 3 010(Binary) 12 12 BCCH 7 Not Available

Alternate Case

PBCCH Description TSC TN ARFCN	For PBCCH present case 3 Timeslot 2 Non-Hopping Channel As for "Serving cell, PDTCH (PBCCH not present), SDCCH" in section 40.1.1 for the current cell
---	--

40.3.4 Contents of Layer 2 Messages for the Higher Layer Test Cases

PACKET UPLINK ASSIGNMENT message:

{0 1<Frequency Parameters> - Frequency Parameters - ARFCN Single Block Allocation - TIMESLOT_NUMBER	1 (Frequency Parameters present) ARFCN of the PCCCH 01 (Single Block Allocation) 010 1 (ALPHA, GAMMA_TN present)
---	--

PACKET DOWNLINK ASSIGNMENT message:

{0 1<Frequency Parameters> - Frequency Parameters - ARFCN	1 (Frequency Parameters present) ARFCN of the PCCCH
---	--

40.3.5 Contents of Layer 3 Messages for the Higher Layer Test Cases

IMMEDIATE ASSIGNMENT message:

Packet Channel Description - TN - ARFCN	2 (Chosen arbitrarily) ARFCN of the PCCCH
---	--

IMMEDIATE ASSIGNMENT EXTENDED message:

Channel Description 1 - Channel Type and TDMA offset - Timeslot Number - ARFCN	SDCCH/4, with subchannel chosen arbitrarily by the test house. 0 ARFCN of the CCCCH
---	---

40.3.6 Timer tolerance for higher layer test cases

The timers specified in the test cases in section 44, 45 and 46 shall take into account the delay in the establishment of uplink and/or downlink TBF required as per the test sequence. Timer tolerance = Timer Value +/- 10% +/- Delay to establish TBF.

40.4 Macros

40.4.1 Overview

The present document presents macros for GPRS test cases. It is intended to be a working document forming part of the GPRS Test Specifications.

40.4.1.1 Definition

A macro is a name or sentence, possibly followed by an argument list, that is equated to a text to which it is to be expanded, possibly with the substitution of actual arguments.

Macros may be used to simplify the writing and reading of the test cases or to avoid the repetition of common sentences, message contents or message sequences. The macros defined in this subclause can be used throughout the test cases.

The definition of the macros is done in alphabetical order.

40.4.1.2 Syntax

40.4.1.2.1 Message contents

Any macro referencing message contents shall use the following table:

Macro reference (arguments)		
(P)SI	Information Element	Value/Remarks

The table must contain:

Macro reference: word or sentence that gives the name to the macro. It may include a list of arguments with actual values for some IE's.

(P)SI: the System Information and Packet System Information messages whose content is referenced. Several (P)SIs can be referenced in this column. The defined IE value(s) refers to the (P)SI(s) in the same row.

Information Element: IE which value is specified.

Value/Remarks: value and any other comment specific to the IE's. In particular, the mapping between an argument value and its coding shall be specified in this column (see note).

NOTE: If possible, only the meaning of the value will be shown and not the value itself; this avoids updating when the core specifications are modified.

40.4.1.2.2 Message sequence

Any macro referencing message contents shall use the following table:

Step	Direction	Message	Comments
		{ Macro reference }	Macro (arguments)

The table must contain:

Macro reference: word or sentence that gives the name to the macro. It may include a list of arguments with actual values for some parameters used within the macro.

Step: Number of the message. Letters may be used for general values: the same rules as in 3GPP TS 11.10 apply.

Direction: it must be either:

- "MS → SS": for an uplink message or a macro containing only uplink message(s);
- "SS → MS": for a downlink message or a macro containing only downlink message(s);
- "SS ↔ MS": for a macro containing both uplink and downlink message(s);
- "MS": for an action performed on the mobile side; or
- "SS": for an action performed on the system simulator side.

Message: Message name or macro reference.

Comments: any other comment specific to the message. In particular, value of certain bits/fields of the correspondent message.

The symbol ':' can be used to indicate that the previous and following message or sequence of messages (both previous and following must appear) is sent an unknown number of times, probably referenced with a letter on the 'step' column.

40.4.2 Default message contents

40.4.2.1 GPRS not supported

(P)SI	Information Element	Value/Remarks
SI 3 SI 4 SI 7 SI 8	GPRS Indicator	GPRS not supported

40.4.2.2 GPRS supported

(P)SI	Information Element	Value/Remarks
SI 3 SI 4 SI 7 SI 8	GPRS Indicator	GPRS supported

40.4.2.3 GPRS supported using BCCH

(P)SI	Information Element	Value/Remarks
SI 13	[Bit after RA_CODE]	PCCCH not present

40.4.2.4 GPRS supported using PBCCH

(P)SI	Information Element	Value/Remarks
SI 13	[Bit after RA_CODE]	PCCCH present

40.4.2.5 Max retrans set to {1, 2, 4, 7}

(P)SI	Information Element	Value/Remarks
SI 1 SI 2 SI 2bis SI 3 SI 9	RACH Control Parameters - Max retrans	Maximum 1 retransmission, maximum 2 retransmissions, maximum 4 retransmissions or maximum 7 retransmissions

40.4.3 Macro message sequences

40.4.3.1 Acknowledged downlink data

Step	Direction	Message	Comments
	SS ↔ MS	{ Acknowledged downlink data }	Macro
1	SS → MS	{ Downlink data }	Macro
2	MS → SS	PACKET DOWNLINK ACK/NACK	

40.4.3.2 Classmark and measurement

Step	Direction	Message	Comments
	MS → SS	{ Classmark and measurement }	Macro
1a	MS → SS	MEASUREMENT REPORT	
2a	MS → SS	CLASSMARK CHANGE	Mobile Station Classmark 2 and 3
1b	MS → SS	CLASSMARK CHANGE	Mobile Station Classmark 2 and 3
2b	MS → SS	MEASUREMENT REPORT	
3	MS → SS	{ Measurement reporting }	Macro

40.4.3.3 Downlink data

Step	Direction	Message	Comments
	SS → MS	{ Downlink data }	Macro
1	SS → MS	RLC DOWNLINK DATA	FBI bit set to '0'
2	SS → MS	RLC DOWNLINK DATA	
⋮	⋮	⋮	
N	SS → MS	RLC DOWNLINK DATA	$n \geq 1$

40.4.3.4 Downlink data transfer

Step	Direction	Message	Comments
	SS ↔ MS	{ Downlink data transfer }	Macro
a. RLC unacknowledged mode			
1	SS → MS	{ Downlink data }	Macro
2	SS → MS	RLC DOWNLINK DATA	FBI bit set to '1' and valid RRBP field
3	MS → SS	PACKET CONTROL ACKNOWLEDGMENT	In the uplink block specified by the RRBP field
b. RLC acknowledged mode			
1	SS ↔ MS	{ Acknowledged downlink data }	Macro
2	SS ↔ MS	{ Acknowledged downlink data }	Macro
⋮	⋮	⋮	
N	SS ↔ MS	{ Acknowledged downlink data }	Macro. $n \geq 1$
n+1	SS → MS	RLC DOWNLINK DATA	
n+2	SS → MS	RLC DOWNLINK DATA	
⋮	⋮	⋮	
M	SS → MS	RLC DOWNLINK DATA	$m \geq n+1$. FBI bit set to '1' and valid RRBP field
m+1	MS → SS	PACKET DOWNLINK ACK/NACK	In the uplink block specified by the RRBP field. Final Ack Indicator bit set to '1'

40.4.3.5 Measurement reporting

Step	Direction	Message	Comments
	MS → SS	{ Measurement reporting }	Macro
1	MS → SS	MEASUREMENT REPORT	See note
2	MS → SS	MEASUREMENT REPORT	
⋮	⋮	⋮	
N	MS → SS	MEASUREMENT REPORT	$n \geq 1$
NOTE: These messages are sent continuously on the ACCH. As no short messages are sent, this sequence should not be temporarily interrupted by other messages also sent on the same channel. However, other messages may be sent on the main DCCH.			

40.4.3.6 Uplink data transfer

Step	Direction	Message	Comments
	MS ↔ SS	{ Uplink data transfer }	Macro (arguments: see note 4)
1	MS → SS	RLC UPLINK DATA	See notes 1 and 2
2a	MS → SS	RLC UPLINK DATA	See note 3
2b	SS → MS	PACKET UPLINK ACK/NACK	
3a	MS → SS	RLC UPLINK DATA	
3b	SS → MS	PACKET UPLINK ACK/NACK	
⋮	⋮	⋮	n ≥ 1. CV set to '0' Final Ack Indicator bit = '1' and valid RRBP field In the uplink block specified by the RRBP field
N	MS → SS	RLC UPLINK DATA	
N+1	SS → MS	PACKET UPLINK ACK/NACK	
N+2	MS → SS	PACKET CONTROL ACKNOWLEDGEMENT	

NOTE 1: SI bit set to '0' in all data blocks.
 NOTE 2: The SS sends a PACKET UPLINK ACK/NACK message at least every k-1 RLC UPLINK DATA messages, being k the window size with a value of 64 blocks.
 NOTE 3: The field CV in the RLC UPLINK DATA messages verifies:

$$CV' = \text{round}\left(\frac{TBC - BSN' - 1}{NTS}\right)$$

$$CV = \begin{cases} CV' & x \leq BS_CV_MAX \\ 15 & \text{otherwise} \end{cases}$$

where:

- TBC: total number of RLC data blocks that will be transmitted in the TBF;
- BSN': absolute block sequence number of the RLC data block, from 0 to (TBC - 1);
- NTS: number of timeslots assigned to the uplink TBF, with range 1 to 8;
- the function round() rounds upwards to the nearest integer;
- BS_CV_MAX is a parameter broadcast in the system information;
- the division operation is non-integer and results in zero only for (TBC - BSN' - 1) = 0.

NOTE 4: In the case of Dynamic MAC mode, the macro reference in the corresponding test case may contain a certain frequency (in seconds⁻¹ or frames⁻¹) for the SS to indicate the USF allocated to the mobile so that the MS is allowed to transmit. Otherwise, mobile's USF is indicated in every available block.

40.4.3.7 Uplink dynamic allocation one phase access

Step	Direction	Message	Comments
		{Uplink dynamic allocation one phase access}	Macro parameters: n : the number of RLC data block to be transferred, USF_GROANULARITY : 1 or 4 blocks, RLC_DATA_BLOCKS_GRANTED : 9-261 (close-end), or absent (open-end) CHANNEL_CODING_COMMAND : CS-1, -2, -3, -4 TLLI_BLOCK_CHANNEL_CODING : CS-1 or as data block REL_OR_ABS_FN : absolute or relative frame number encoding for starting time TBF_STARTING_TIME
0	MS		Trigger the MS initiating uplink transfer n octets data according to the test PDP context activated
1	MS -> SS	PACKET CHANNEL REQUEST	Received on PRACH.
2	SS -> MS	PACKET UPLINK ASSIGNMENT	uplink dynamic allocation, Sent on PAGCH.

NOTE: After step 2, the MS is not yet in the packet transfer mode. The contention resolution must be completed.

40.4.3.8 Uplink dynamic allocation one phase access with contention resolution

Step	Direction	Message	Comments
		{Uplink dynamic allocation one phase access with contention resolution}	Macro parameters: n : the number of RLC data block to be transferred, USF_GRANULARITY : 1 or 4 blocks, RLC_DATA_BLOCKS_GRANTED : 9-261 (close-end), or absent (open-end) CHANNEL_CODING_COMMAND : CS-1, -2, -3, -4 TLLI_BLOCK_CHANNEL_CODING : CS-1 or as data block REL_OR_ABS_FN : absolute or relative frame number encoding for starting time TBF_STARTING_TIME
0	MS		Trigger the MS initiating uplink transfer n octets data according to the test PDP context activated
1	MS -> SS	PACKET CHANNEL REQUEST	Received on PRACH.
2	SS -> MS	PACKET UPLINK ASSIGNMENT	uplink dynamic allocation, Sent on PAGCH.
3	SS -> MS	PACKET DOWNLINK DUMMY CONTROL BLOCK	Sent on the PACCH of the PDCH, the USF assigned to the MS, on 3 blocks from the last radio block containing the uplink assignment.
4A	MS -> SS	UPLINK RLC DATA BLOCK	For USF_GRANULARITY = 1, containing TLLI in the RLC/MAC header.
4B1	MS -> SS	UPLINK RLC DATA BLOCK	For USF_GRANULARITY = 4, containing TLLI in the RLC/MAC header.
4B2	MS -> SS	UPLINK RLC DATA BLOCK	For USF_GRANULARITY = 4, containing TLLI in the RLC/MAC header.
4B3	MS -> SS	UPLINK RLC DATA BLOCK	For USF_GRANULARITY = 4, containing TLLI in the RLC/MAC header.
4B4	MS -> SS	UPLINK RLC DATA BLOCK	For USF_GRANULARITY = 4, containing TLLI in the RLC/MAC header.
5	SS -> MS	PACKET UPLINK ACK/NACK	Sent on the PACCH, containing TLLI received at step 4.
6			Wait for 3 block periods.

40.4.3.9 Uplink dynamic allocation two phase access

Step	Direction	Message	Comments
		{Uplink dynamic allocation two phase access}	Macro parameters: n: the number of RLC data block to be transferred, USF GRANULARITY : 1 or 4 blocks, RLC_DATA_BLOCKS_GRANTED : 9-261 (close-end), or absent (open-end) CHANNEL_CODING_COMMAND : CS-1, -2, -3, -4 TLLI_BLOCK_CHANNEL_CODING : CS-1 or as data block, TBF_STARTING_TIME
0	MS		Trigger the MS initiating uplink transfer n octets data according to the test PDP context activated
1	MS -> SS	PACKET CHANNEL REQUEST Or CHANNEL REQUEST	Received on PRACH. (PBCCH present case) Received on RACH. (PBCCH not preset case)
2	SS -> MS	PACKET UPLINK ASSIGNMENT Or IMMEDIATE ASSIGNMENT	Single block assignment, to order the MS to follow the two phase access procedure. Sent on PAGCH (PBCCH present case). Sent on AGCH (PBCCH not present case)
3	MS -> SS	PACKET RESOURCE REQUEST	Two phase access procedure. Received on the single block assigned in step 2. If the access type of the PACKET RESOURCE REQUEST specifies "Two Phase Access Req" check that the PEAK_THROUGHPUT, RADIO_PRIORITY and RLC_MODE are compliant with the PDP context used. In case of SMS over GPRS PEAK THROUGHPUT is not checked.
4	SS -> MS	PACKET UPLINK ASSIGNMENT	uplink dynamic allocation, no starting time (as default, otherwise use TBF_STARTING_TIME), Sent on PACCH of the same PDCH assigned in step 2.

40.4.3.10 Completion of uplink RLC data block transfer

Steps 1A - 3A are applied for 1 uplink slot with USF granularity 1 block.

Steps 1B, 2B1-2B4 and 3B are applied for 1 uplink slot with USF granularity 4 blocks.

Steps 1C - 5C are applied for 2 uplink slots with USF granularity 1 block.

Steps 6 - 7 are common to the cases A, B and C.

Step	Direction	Message	Comments
		{Completion of uplink RLC data block transfer}	Macro parameters: USF_GRANULARITY : 1 or 4 blocks, the number of slots assigned in the uplink.
1A,1B	SS -> MS	PACKET UPLINK ACK/NACK	The assigned USF assigned to the MS to the MS.
2A	MS -> SS	UPLINK RLC DATA BLOCK	For USF_GRANULARITY = 1 Received on the assigned PDTCH.
2B1 2B2	MS -> SS MS -> SS	UPLINK RLC DATA BLOCK UPLINK RLC DATA BLOCK or PACKET UPLINK DUMMY CONTROL BLOCK	For USF_GRANULARITY = 4 Received on the assigned PDTCH. Received on the assigned PDTCH
2B3	MS -> SS	UPLINK RLC DATA BLOCK or PACKET UPLINK DUMMY CONTROL BLOCK	Received on the assigned PDTCH
2B4	MS -> SS	UPLINK RLC DATA BLOCK or PACKET UPLINK DUMMY CONTROL BLOCK	Received on the assigned PDTCH
3A,3B			Repeat the steps 1A and 2A or 1B and 2B1-2B4 until the countdown value CV=0 in step 2A or in one of the steps 2B1 - 2B4.
1C	SS -> MS	PACKET UPLINK ACK/NACK	Sent on the PACCH of the PDCH 1, the assigned USF1 addressing the MS.
2C	SS -> MS	PACKET UPLINK ACK/NACK	Sent on the PACCH of the PDCH 2 on the same radio block as step 1C, the assigned USF2 addressing the MS.
3C	MS -> SS	UPLINK RLC DATA BLOCK	Received on the assigned PDTCH 1.
4C	MS -> SS	UPLINK RLC DATA BLOCK	Received on the assigned PDTCH 2.
5C			Repeat steps 1C – 4C until the countdown value CV=0 in step 3C or step 4C.
6	SS -> MS	PACKET UPLINK ACK/NACK	Final Ack Indicator = '1' containing valid RRBP. Sent on the PACCH of the assigned PDCH.
7	MS -> SS	PACKET CONTROL ACKNOWLEDGEMENT	Received on the block specified by RRBP on PACCH of the assigned PDCH.

40.4.3.10.1 PACKET UPLINK ACK/NACK message in step 6:

Ack/Nack Description - FINAL_ACK_INDICATION - STARTING_SEQUENCE_NUMBER - RECEIVED_BLOCK_BITMAP	1 (final ACK) No information, ignored No information, ignored
---	---

40.4.3.11 Void

40.4.3.12 Void

40.4.3.13 Void

40.4.3.14 Downlink TBF establishment

Step	Direction	Message	Comments
		{Downlink TBF establishment}	Macro parameters: RLC mode TBF_STARTING_TIME
1	SS -> MS	PACKET PAGING REQUEST	1 st Repeated Page info contains P-TMSI of the MS. Sent on PPCH.
2	MS -> SS	PACKET CHANNEL REQUEST	ACCESS TYPE = " Page Response ". Received on PRACH.
3	SS -> MS	PACKET UPLINK ASSIGNMENT	Random Reference = pertaining to the message received in step 2. Dynamic allocation, Sent on PAGCH.
4	SS -> MS	PACKET DOWNLINK DUMMY CONTROL BLOCK	Sent on PACCH containing USF assigned to the MS.
5	MS -> SS	UPLINK RLC DATA BLOCK	LLC PDU implicitly indicating paging response, containing TLLI in the RLC/MAC header. Received on uplink PDTCH assigned in step 3.
6	SS -> MS	PACKET UPLINK ACK/NACK	Acknowledge the received RLC data block. Sent on uplink PACCH.
7	MS -> SS	PACKET CONTROL ACKNOWLEDGEMENT	Acknowledge the RLC control message. Received on uplink PACCH.
8	SS -> MS	PACKET DOWNLINK ASSIGNMENT	Downlink Assignment, TLLI value as received. Sent on PPCH. Three macro parameters as assigned in the test cases.

40.4.3.15 PDP Context Activation

Mobile initiated, for LLC mode unacknowledged:

Step	Direction	Message	Comments
		{PDP Context Activation}	
1	MS -> SS	Activate PDP Context Request	
2	SS -> MS	Activate PDP Context Accept	

Mobile initiated, for LLC mode acknowledged:

Step	Direction	Message	Comments
		{PDP Context Activation}	
1	MS -> SS	Activate PDP Context Request	
2	SS -> MS	Activate PDP Context Accept	
3	MS -> SS	SABM	Link establishment (When relevant to the test case, steps 3 and 4 are shown as a part of the test case)
4	SS -> MS	UA	

40.4.3.16 PDP Context Deactivation

Mobile initiated:

Step	Direction	Message	Comments
		{PDP Context Deactivation}	
1	MS -> SS	Deactivate PDP Context Request	
2	SS -> MS	Deactivate PDP Context Accept	

Network initiated:

Step	Direction	Message	Comments
		{PDP Context Deactivation}	
1	SS -> MS	Deactivate PDP Context Request	
2	MS -> SS	Deactivate PDP Context Accept	

40.4.3.17 Inter-SGSN Routing Area Update

Step	Direction	Message	Comments
		{Inter-SGSN Routing Area Update}	
1			Cell B is already activated with a lower signal strength than cell A. The RF level of cell A is lowered until cell B is preferred by the MS.
2	MS -> SS	Routing Area Update Request	The updating type shall be "Combined RA/LA Updating" for Class B mobiles in Network Mode I and "RA Updating" for Class C mobiles supporting GPRS.
3	SS->MS	XID	XID with RESET
4	MS->SS	XID	XID response
5	SS -> MS	Routing Area Update Accept	
6	MS->SS	Routing Area Update Complete	If the Routing Area Update Accept sent in step 5 contains P-TMSI and/or receive N-PDU or new ready timer value, the MS sends Routing Area Update Complete message.

Note: The MS may send an XID command any time. The SS shall send an XID response accepting the values proposed by the MS.

40.4.3.18 PDP Context Modification

This procedure is always initiated by the network.

Step	Direction	Message	Comments
		{PDP Context Modification}	
1	SS -> MS	Modify PDP Context	
2	MS -> SS	Modify PDP Context Accept	

40.4.3.19 Location Update Procedure

This procedure is only initiated by mobile stations that are not operating in class mode C "GPRS".

Step	Direction	Message	Comments
		{Location Update Procedure}	Macro parameters: MOBILE_IDENTITY
1	MS -> SS	LOCATION UPDATE REQUEST	
2	SS -> MS	AUTHENTICATION REQUEST	
3	MS -> SS	AUTHENTICATION RESPONSE	
4	SS -> MS	LOCATION UPDATE ACCEPT	
A5 (optional step)	MS -> SS	TMSI REALLOCATION COMPLETE	Step executed only when assigned mobile identity is of the type TMSI.
5	SS -> MS	CHANNEL RELEASE	GPRS RESUMPTION IE is present and the ACK field is set to 1 (see note below).

Note: Only in case the MS performed GPRS suspension procedure prior to the CS session, then the GPRS RESUMPTION IE shall be present in the CHANNEL RELEASE message.

40.4.3.20 MT Call in GPRS cell

This procedure is initiated by the network while the MS is GPRS attached, one cell is active:

Step	Direction	Message	Comments
		{MT Call while GPRS Attached}	Macro parameters: T : Duration of the call (in seconds) R : Binary acknowledge of a successful resumption of GPRS services
1A	SS -> MS	PACKET PAGING REQUEST	1 st Repeated Page info contains TMSI of the MS, PAGE_MODE = " same as before ", sent on downlink PPCH
1B	SS -> MS	PAGING REQUEST Type 1	Page info contains TMSI of the MS, PAGE_MODE = " same as before ", sent on downlink PCH
2	MS -> SS	CHANNEL REQUEST	
3	SS -> MS	IMMEDIATE ASSIGNMENT	
4	MS -> SS	PAGING RESPONSE	
5	MS -> SS	CLASSMARK CHANGE	This step may be optionally performed by a R97 or R98 MS; this step shall be mandatorily performed by R99 and later MS.
6	MS -> SS	GRPS SUSPENSION REQUEST	
7	SS -> MS	AUTHENTICATION REQUEST	
8	MS -> SS	AUTHENTICATION RESPONSE	
9	SS -> MS	CIPHERING MODE COMMAND	
10	MS -> SS	CIPHERING MODE COMPLETE	
11	SS -> MS	SETUP	
12	MS -> SS	CALL CONFIRMED	
13			If the MS supports immediate connect then branch A applies. If not then branch B applies

14A	MS -> SS	CONNECT	Sent on the old channel
15A	SS -> MS	ASSIGNMENT COMMAND	Timeslot and channel type arbitrarily chosen or PICS dependant
16A	MS -> SS	ASSIGNMENT COMPLETE	Continues at step 20
14B	SS -> MS	ASSIGNMENT COMMAND	Timeslot and channel type arbitrarily chosen or PICS dependant
15B	MS -> SS	ASSIGNMENT COMPLETE	Sent on the new channel.
16B	MS -> SS	ALERTING	
17B	MS		An alerting indication as defined in a PICS/PIXIT statement is given by the MS
18B	MS		The MS is made to accept the call in the way described in a PICS/PIXIT statement
19B	MS -> SS	CONNECT	
20	SS -> MS	CONNECT ACKNOWLEDGE	
21	MS		The appropriate bearer channel is through connected in both directions. The channel is kept open for T seconds
22	SS -> MS	DISCONNECT	
23	MS -> SS	RELEASE	
24	SS -> MS	RELEASE COMPLETE	
25	SS -> MS	CHANNEL RELEASE	The main signalling link is released. Resumption Field is set to R

Note: In step 1x and 10x, the test procedure follows **either** the 'a' branch **or** the 'b' branch.

This procedure is initiated by the network while the MS is GPRS attached, two GPRS cells are active:

Step	Direction	Message	Comments
		{MT Call while GPRS Attached with Handover}	Macro parameters: T : Duration of the call (in seconds) Target Cell : Second cell for handover R : Binary acknowledge of a successful resumption of GPRS services:
1A	SS -> MS	PACKET PAGING REQUEST	1 st Repeated Page info contains TMSI of the MS, PAGE_MODE = " same as before ", sent on downlink PPCH
1B	SS -> MS	PAGING REQUEST Type 1	Page info contains TMSI of the MS, PAGE_MODE = " same as before ", sent on downlink PCH
2	MS -> SS	CHANNEL REQUEST	
3	SS -> MS	IMMEDIATE ASSIGNMENT	
4	MS -> SS	PAGING RESPONSE	
5	MS -> SS	CLASSMARK CHANGE	This step may be optionally performed by a R97 or R98 MS; this step shall be mandatorily performed by R99 and later MS.
6	MS -> SS	GPRS SUSPENSION REQUEST	
7	SS -> MS	AUTHENTICATION REQUEST	
8	MS -> SS	AUTHENTICATION RESPONSE	
9	SS -> MS	CIPHERING MODE COMMAND	
10	MS -> SS	CIPHERING MODE COMPLETE	
11	SS -> MS	SETUP	
12	MS -> SS	CALL CONFIRMED	
13			If the MS supports immediate connect then branch A applies. If the MS does not support immediate connect then branch B applies

14A	MS -> SS	CONNECT	Sent on the old channel
14A	SS -> MS	ASSIGNMENT COMMAND	Timeslot and channel type arbitrarily chosen or PICS dependant
16A	MS -> SS	ASSIGNMENT COMPLETE	Continues at step 20
14B	SS -> MS	ASSIGNMENT COMMAND	Timeslot and channel type arbitrarily chosen or PICS dependant
15B	MS -> SS	ASSIGNMENT COMPLETE	Sent on the new channel.
16B	MS -> SS	ALERTING	
17B	MS		An alerting indication as defined in a PICS/PIXIT statement is given by the MS
18B	MS		The MS is made to accept the call in the way described in a PICS/PIXIT statement
19B	MS -> SS	CONNECT	
20	SS -> MS	CONNECT ACKNOWLEDGE	
21	MS		The appropriate bearer channel is through connected in both directions. Wait for T/2 seconds
22	SS -> MS	HANDOVER COMMAND	Instructs the MS to move to an arbitrarily chosen timeslot on Target Cell
23	MS -> SS	HANDOVER ACCESS	Repeated on every burst of the uplink main DCCH until reception of the PHYSICAL INFORMATION message. Handover reference as included in the HANDOVER COMMAND.
24	SS -> MS	PHYSICAL INFORMATION	
25	MS -> SS	HANDOVER COMPLETE	Sent on the new channel after the establishment of the main signalling link on Target Cell
26	SS		Wait for T/2 seconds
27	SS -> MS	DISCONNECT	
28	MS -> SS	RELEASE	
29	SS -> MS	RELEASE COMPLETE	
30	SS -> MS	CHANNEL RELEASE	The main signalling link is released. Resumption Field is set to R

Note: In step1x and 10x, the test procedure follows **either** the 'a' branch **or** the 'b' branch.

40.4.3.21 Uplink data

Step	Direction	Message	Comments
	MS ↔ SS	{ Uplink data }	Macro (arguments: see note 2)
1	MS → SS	RLC UPLINK DATA	SI bit set to '0'
2a	MS → SS	RLC UPLINK DATA	See notes 1 till the required amount of blocks are received
⋮	⋮	⋮	
2b	SS → MS	PACKET UPLINK ACK/NACK	
⋮	⋮	⋮	
N	MS → SS	RLC UPLINK DATA	
N+1	SS → MS	PACKET UPLINK ACK/NACK	

NOTE 1: The SS sends a PACKET UPLINK ACK/NACK message at least every k-1 RLC UPLINK DATA messages, being k the window size with a value of 64 blocks.

NOTE 2: In the case of Dynamic MAC mode, the macro reference in the corresponding test case may contain a certain frequency (in seconds⁻¹ or frames⁻¹) for the SS to indicate the USF allocated to the mobile so that the MS is allowed to transmit. Otherwise, mobile's USF is indicated in every available block.

40.4.3.22 Bring MS in the active state (U10)

Step	Direction	Message	Comments
		{Bring MS in active state (U10)}	Macro parameters: N : Timeslot used for traffic channel
1	SS -> MS	PAGING REQUEST Type 1	Page info contains IMSI of the MS, sent on downlink PCH
2	MS -> SS	CHANNEL REQUEST	Establishment cause : ANSWER TO PAGING
3	SS -> MS	IMMEDIATE ASSIGNMENT	
4	MS -> SS	PAGING RESPONSE	
5 (Optional)	MS -> SS	CLASSMARK CHANGE	This step may be optionally performed by a R97 or R98 MS; this step shall be mandatorily performed by R99 and later MS.
			If DTM is not supported from the MS or the cell then step 6-1 is performed otherwise step 6-2
6-1	MS -> SS	GRPS SUSPENSION REQUEST	
6-2 (Optional)	MS -> SS	GRPS INFORMATION	The MS send this message to indicate Cell Update. This step is optional for MS with release up to Rel5 and it is mandatory for MS with release from Rel6 onwards.
7	SS -> MS	AUTHENTICATION REQUEST	
8	MS -> SS	AUTHENTICATION RESPONSE	
9	SS -> MS	CIPHERING MODE COMMAND	
10	MS -> SS	CIPHERING MODE COMPLETE	
11	SS -> MS	SETUP	
12	MS -> SS	CALL CONFIRMED	
13			If the MS supports immediate connect then branch A applies. If not then branch B applies
14A	MS -> SS	CONNECT	Sent on the old channel
15A	SS -> MS	ASSIGNMENT COMMAND	Timeslot N used, channel type arbitrarily chosen or PICS dependant
16A	MS -> SS	ASSIGNMENT COMPLETE	Continues at step 20
14B	SS -> MS	ASSIGNMENT COMMAND	Timeslot N used, channel type arbitrarily chosen or PICS dependant
15B	MS -> SS	ASSIGNMENT COMPLETE	Sent on the new channel.
16B	MS -> SS	ALERTING	
17B	MS		An alerting indication as defined in a PICS/PIXIT statement is given by the MS
18B	MS		The MS is made to accept the call in the way described in a PICS/PIXIT statement
19B	MS -> SS	CONNECT	
20	SS -> MS	CONNECT ACKNOWLEDGE	

40.4.3.23 Completion of uplink RLC data block transfer in extended dynamic mode

Step	Direction	Message	Comments
		{Completion of uplink RLC data block transfer in extended dynamic mode}	Macro parameters: USF_GRANULARITY : 1 or 4 blocks, the number of timeslots assigned in the uplink, the lowest numbered timeslot in the PDCH allocation. USF1 is assigned on TN1 (the lowest numbered timeslot), USF2 is assigned on TN2 etc.
1	SS -> MS	PACKET UPLINK ACK/NACK	Assigned USF1 addressing the MS. Sent on the lowest numbered timeslot in the PDCH allocation.
2	MS -> SS	UPLINK RLC DATA BLOCK	The MS shall send one UPLINK RLC DATA BLOCK on each assigned uplink timeslot within the same TDMA frame. For USF_GRANULARITY=4 this is repeated on four consecutive Radio blocks.
3			Repeat steps 1 and 2 until the countdown value CV=0 is received in step 2.
4	SS -> MS	PACKET UPLINK ACK/NACK	Final Ack Indicator = '1' containing valid RRBP. Sent on the lowest numbered timeslot in the PDCH allocation.
5	MS -> SS	PACKET CONTROL ACKNOWLEDGEMENT	Received on the block specified by RRBP on PACCH of the lowest numbered timeslot in the PDCH allocation.

40.4.3.23.1 PACKET UPLINK ACK/NACK message in step 4:

Ack/Nack Description	
- FINAL_ACK_INDICATION	1 (final ACK)
- STARTING_SEQUENCE_NUMBER	No information, ignored
- RECEIVED_BLOCK_BITMAP	No information, ignored

40.5 Test PDP contexts

The following table defines Test PDP contexts required for test cases using packet services (e.g. GPRS, EGPRS, DTM). Test PDP context3 is the default Test PDP context which is used in the test cases where no particular Test PDP contexts are specified. Compression is always turned off if nothing else is stated explicitly in the test case.

Table 40.5 Test PDP contexts

	PDP Context1	PDP Context2	PDP context3	PDP context4
LLC SAPI	SAPI = 3	SAPI = 11	SAPI = 11	SAPI = 9
PDP Type	IP type	IP type	IP type	IP type
PDP Address	static	static	static	static
APN	arbitrarily chosen	arbitrarily chosen	arbitrarily chosen	arbitrarily chosen
Protocol Configuration Options	PPP options	PPP options	PPP options	PPP options
Radio Priority	1	4	4	4
Quality of service settings to be used when testing R98 or earlier MS:				
Reliability Class	5 (RLC unacknowledged) (LLC unacknowledged)	3 (RLC acknowledged) (LLC unacknowledged)	5	3
Delay Class	4 (best effort)	4	4	4
Precedence Class (SS)	2 (normal)	2	2	2
Precedence Class (MS)	Subscribed	Subscribed	Subscribed	Subscribed
Peak Throughput Class	5 (Up to 16 000 octet/s)	5	5	6 (Up to 32 000 octet/s)
Mean Throughput Class (SS)	16 (10 000 000 octet/h)	16	16	16
Mean Throughput Class (MS)	31 (best effort)	31	31	31
Quality of service settings to be used when testing R99 or later MS:				
Traffic Class	Background	Background	Background	Background
Delivery Order	'yes'	'yes'	'yes'	'yes'
Delivery of erroneous SDU	'yes'	'no'	'yes'	'no'
Maximum SDU size	150 (1500 octets)	150	150	150
Maximum bit rate for uplink	128 kbps	128 kbps	128 kbps	256 kbps
Maximum bit rate for downlink	128 kbps	128 kbps	128 kbps	256 kbps
Residual BER	$4 \cdot 10^{-3}$	10^{-5}	$4 \cdot 10^{-3}$	10^{-5}
SDU error ratio	10^{-3}	10^{-4}	10^{-3}	10^{-4}
Transfer delay	0 (not relevant for background class)	0	0	0
Traffic Handling priority	0 (not relevant for background class)	0	0	0
Guaranteed bit rate for uplink	0 (not relevant for background class)	0	0	0
Guaranteed bit rate for downlink	0 (not relevant for background class)	0	0	0
Quality of service settings to be used when testing R5 or later MS:				
Signalling Indication	0	0	0	0

Source Statistics Descriptor	0	0	0	0
Maximum bit rate for downlink (extended)	0	0	0	0
Guaranteed bit rate for downlink (extended)	0	0	0	0

The table continues on the next page.

	PDP context5	PDP context6	PDP Context7	PDP Context 8
LLC SAPI	SAPI = 3	SAPI = 9	SAPI = 9	SAPI = 5
PDP Type	IP type	IP type	IP type	IP type
PDP Address	static	static	static	static
APN	arbitrarily chosen	arbitrarily chosen	arbitrarily chosen	arbitrarily chosen
Protocol Configuration Options	PPP options	PPP options	PPP options	PPP options
Radio Priority	1	4	4	1
Quality of service settings to be used when testing R98 or earlier MS:				
Reliability Class	3	5	5	3 (RLC acknowledged) (LLC unacknowledged) (data protected)
Delay Class	4	4	4	4 (best effort)
Precedence Class (SS)	2	2	2	2 (normal)
Precedence Class (MS)	subscribed	Subscribed	subscribed	Subscribed
Peak Throughput Class	5	6	6	5 (Up to 16 000 octet/s)
Mean Throughput Class (SS)	16	16	16	16 (10 000 000 octet/h)
Mean Throughput Class (MS)	31 (best effort)	31	31	31
Quality of service settings to be used when testing R99 or later MS:				
Traffic Class	Background	Background	Background	Background
Delivery Order	'yes'	'yes'	'yes'	'yes'
Delivery of erroneous SDU	'no'	'yes'	'yes'	'no'
Maximum SDU size	150	150	150	150
Maximum bit rate for uplink	128 kbps	256 kbps	256 kbps	128 kbps
Maximum bit rate for downlink	128 kbps	256 kbps	256 kbps	128 kbps
Residual BER	10^{-5}	$4 \cdot 10^{-3}$	$4 \cdot 10^{-3}$	10^{-5}
SDU error ratio	10^{-4}	10^{-3}	10^{-3}	10^{-4}
Transfer delay	0	0	0	0
Traffic Handling priority	0	0	0	0
Guaranteed bit rate for uplink	0	0	0	0
Guaranteed bit rate for downlink	0	0	0	0
Quality of service settings to be used when testing R5 or later MS:				
<u>Signalling Indication</u>	0	0	0	0
Source Statistics Descriptor	0	0	0	0
Maximum bit rate for downlink (extended)	0	0	0	0
Guaranteed bit rate for downlink (extended)	0	0	0	0

	PDP Context 9	PDP Context 10	PDP Context 11
LLC SAPI	SAPI = 11	SAPI = 5	SAPI = 3
PDP Type	IP type	IP type	IP type
PDP Address	static	static	static
APN	arbitrarily chosen	arbitrarily chosen	arbitrarily chosen
Protocol Configuration Options	PPP options	PPP options	PPP options
Radio Priority	1	1	1
Quality of service settings to be used when testing R98 or earlier MS:			
Reliability Class	3 (RLC acknowledged) (LLC unacknowledged) (data protected)	5 (RLC unacknowledged) (LLC unacknowledged) (data unprotected)	2 (RLC acknowledged) (LLC acknowledged) (data protected)
Delay Class	4 (best effort)	4 (best effort)	4 (best effort)
Precedence Class (SS)	2 (normal)	2	2
Precedence Class (MS)	subscribed	subscribed	subscribed
Peak Throughput Class	5 (Up to 16 000 000 octet/s)	5 (Up to 16 000 000 octet/s)	5 (Up to 16 000 000 octet/s)
Mean Throughput Class (SS)	16 (10 000 000 octet/h)	16 (10 000 000 octet/h)	16 (10 000 000 octet/h)
Mean Throughput Class (MS)	31 (best effort)	31	31
Quality of service settings to be used when testing R99 or later MS:			
Traffic Class	Background	Background	Background
Delivery Order	'yes'	'yes'	'yes'
Delivery of erroneous SDU	'no'	'yes'	'no'
Maximum SDU size	150	150	150
Maximum bit rate for uplink	128 kbps	128 kbps	128 kbps
Maximum bit rate for downlink	128 kbps	128 kbps	128 kbps
Residual BER	10^{-5}	$4 \cdot 10^{-3}$	10^{-5}
SDU error ratio	10^{-4}	10^{-3}	10^{-6}
Transfer delay	0	0	0
Traffic Handling priority	0	0	0
Guaranteed bit rate for uplink	0	0	0
Guaranteed bit rate for downlink	0	0	0
Quality of service settings to be used when testing R5 or later MS:			
<u>Signalling Indication</u>	0	0	0
Source Statistics Descriptor	0	0	0
Maximum bit rate for downlink (extended)	0	0	0
Guaranteed bit rate for downlink (extended)	0	0	0

The table continues on the next page.

	PDP Context 12	PDP Context 13	PDP Context 14
LLC SAPI	SAPI = 9	SAPI = 11	SAPI = 9
PDP Type	IP type	IP type	IP type
PDP Address	static	static	static
APN	arbitrarily chosen	arbitrarily chosen	arbitrarily chosen
Protocol Configuration Options	PPP options	PPP options	PPP options
Radio Priority	1	1	1
Quality of service settings to be used when testing R98 or earlier MS:			
Reliability Class	2 (RLC acknowledged) (LLC acknowledged) (data protected)	2 (RLC acknowledged) (LLC acknowledged) (data protected)	3 (RLC acknowledged) (LLC unacknowledged) (data protected)
Delay Class	4 (best effort)	4 (best effort)	4 (best effort)
Precedence Class (SS)	2 (normal)	2 (normal)	2 (normal)
Precedence Class (MS)	Subscribed	Subscribed	Subscribed
Peak Throughput Class	5 (Up to 16 000 octet/s)	5 (Up to 16 000 octet/s)	5 (Up to 16 000 octet/s)
Mean Throughput Class (SS)	16 (10 000 000 octet/h)	16 (10 000 000 octet/h)	16 (10 000 000 octet/h)
Mean Throughput Class (MS)	31 (best effort)	31	31
Quality of service settings to be used when testing R99 or later MS:			
Traffic Class	Background	Background	Background
Delivery Order	'yes'	'yes'	'yes'
Delivery of erroneous SDU	'no'	'no'	'no'
Maximum SDU size	150	150	150
Maximum bit rate for uplink	128 kbps	128 kbps	128 kbps
Maximum bit rate for downlink	128 kbps	128 kbps	128 kbps
Residual BER	10^{-5}	10^{-5}	10^{-5}
SDU error ratio	10^{-6}	10^{-6}	10^{-4}
Transfer delay	0	0	0
Traffic Handling priority	0	0	0
Guaranteed bit rate for uplink	0	0	0
Guaranteed bit rate for downlink	0	0	0
Quality of service settings to be used when testing R5 or later MS:			
Signalling Indication	0	0	0
Source Statistics Descriptor	0	0	0
Maximum bit rate for downlink (extended)	0	0	0
Guaranteed bit rate for downlink (extended)	0	0	0

Note: For compatibility purposes when performing R98 tests or earlier it is still allowed for the MS to request Precedence Class 2 (normal) and Mean Throughput Class 16 (10 000 000 octets/h).

41 GPRS Paging, TBF establishment/release and DCCH related procedures

41.1 RR / Paging

The paging procedure is used by the network to cause the MS to establish either an RR connection for circuit switched services or a downlink GPRS packet transfer. Normally the MS listens to its paging sub-channel when DRX is used, but this can be modified by the use of different page mode. The correct monitoring of its paging sub-channel on PCCCH or CCCH in different control channel configurations and correct implementation of the paging procedure in the MS are essential. They are the test objectives of this subclause.

41.1.1 RR / Paging / on PCCCH for GPRS service successful

All test cases in this subclause test the MS paging behaviours in a network operating in Mode I.

41.1.1.1 RR / Paging / on PCCCH for GPRS service / normal paging with P-TMSI successful

41.1.1.1.1 Conformance requirements

1. In packet idle mode, the mobile station monitors the relevant paging sub-channels on PCCCH, if such is present in the cell. The determination of the paging group for the mobile station is defined in 3GPP TS 05.02.
2. MS in a specific PCCCH GROUP shall monitor the radio blocks on PCCCH corresponding to the PCCCH GROUP the mobile station belongs to and where paging may appear.
3. A PACKET PAGING REQUEST message on PCCCH may include more than one mobile station identification.
4. In response to a PACKET PAGING REQUEST, the mobile station shall initiate the uplink TBF using a PACKET CHANNEL REQUEST with cause value of 'Page Response'.

References

3GPP TS 04.60, subclauses 5.5.1, 5.5.1.5, 6.1.2, 6.2, 6.2.2 and 6.2.3.

3GPP TS 05.02, subclauses 6.5.1 and 6.5.6.

41.1.1.1.2 Test purpose

To verify that upon receipt of a PACKET PAGING REQUEST message for GPRS service with paging mode set to normal, the MS in packet idle mode, GPRS attached state, is able to determine its PCCCH group and PAGING group and that the MS responds correctly with PACKET CHANNEL REQUEST with cause value of 'Page Response'.

41.1.1.1.3 Method of test

Initial Conditions

System Simulator:

1 cell, CCCH combined with SDCCH, GPRS supported, PCCCH present, Max-Retrans = 2, access burst type = 11 bits, BS_PAG_BLK_RES = 2, BS_PBCCH_BLK = 3, BS_PCC_CHANS = 1, BS_PRACH_BLK = 1 in PSI1.

Mobile Station:

The MS is GPRS attached with a P-TMSI allocated, SPLIT PG CYCLE negotiated. The mobile station is in packet idle mode and has left the Transfer non-DRX mode period, i.e. for a R99 or later MS the system simulator shall wait for a period equivalent to the value of the NON_DRX_TIMER parameter before sending the first paging message to the MS.

Specific PICS Statements

-

PIXIT Statements

-

Test Procedure

The SS sends a PACKET PAGING REQUEST message to the MS. The paging message contains a P-TMSI addressing the MS for TBF establishment. The MS attempts two random accesses for PACKET CHANNEL REQUEST. The SS responses to the 2nd one by assigning an uplink channel. The MS sends a correct LLC PDU containing TLLI in the RLC/MAC header implicitly indicating a paging response.

Maximum Duration of Test

5 minutes.

Expected Sequence

Step	Direction	Message	Comments
1	SS -> MS	PACKET PAGING REQUEST	1 st Repeated Page info for RR connection, 2 nd Repeated Page info contains P-TMSI of the MS for TBF establishment. Sent on PPCH.
2	MS -> SS	PACKET CHANNEL REQUEST	ACCESS TYPE = " Page Response ". Received on PRACH.
3	MS -> SS	PACKET CHANNEL REQUEST	ACCESS TYPE = " Page Response ". Received on PRACH.
4	SS -> MS	PACKET UPLINK ASSIGNMENT	Random Reference = pertaining to the message received in step 3. Sent on PAGCH.
5	SS -> MS	PACKET DOWNLINK DUMMY CONTROL BLOCK	Sent on PACCH containing USF assigned to the MS.
6	MS -> SS	UPLINK RLC DATA BLOCK (not L3 Message)	LLC PDU implicitly indicating paging response, containing TLLI in the RLC/MAC header. Received on uplink PDTCH assigned in step 4.
7	SS -> MS	PACKET UPLINK ACK/NACK	acknowledge the received RLC data block, Final Ack Indicator = '1' , a valid RRBP. Sent on PACCH.
8	MS -> SS	PACKET CONTROL ACKNOWLEDGEMENT	acknowledge the RLC control message. Received on PACCH.

Specific Message Contents

Contents for SYSTEM INFORMATION and PACKET SYSTEM INFORMATION Messages:

RACH Control Parameters - Max Retrans	Max 2 retrans.
--	----------------

PACKET PAGING REQUEST message:

MESSAGE_TYPE	000101
PAGE_MODE	Normal Paging
{L H<PERSISTENCE_LEVEL>}	L (not present)
{L H<NLN>}	L (not present)
{H <Repeated Page info>}	H
-	H (Page request for RR connection establishment)
- CHANNEL_NEEDED	SDDCH
- {L H < eMLPP_PRIORITY }	L (eMLPP_PRIORITY absent)
- { L < TMSI > H < Mobile_identity > }	L (TMSI present)
- TMSI	TMSI not addressing the MS under test
-	L (Page request for TBF establishment)
- { L < PTMSI > H < Mobile_identity > }	L (PTMSI present)
- PTMSI	P-TMSI allocated during GPRS attach procedure
-	L (end of repeated page info)
spare padding	Spare Padding

41.1.1.2 RR / Paging / on PCCCH for GPRS service / normal paging with IMSI successful

41.1.1.2.1 Conformance requirements

Paging for GPRS services using IMSI is an abnormal procedure used for error recovery in the network.

Upon reception of a paging indication for GPRS services using IMSI, the MS shall locally deactivate any active PDP contexts and locally detach from GPRS. The local detach includes deleting any RAI, P-TMSI, P-TMSI signature and GPRS ciphering key sequence number stored, setting the GPRS update status to GU2 NOT UPDATED and changing state to GMM-DEREGISTERED.

References

3GPP TS 24.008, subclause 4.7.9.1.2. 41.1.1.2.2 Test purpose

To verify that the MS is able to respond to PACKET PAGING REQUEST for GPRS service when the MS is addressed with its IMSI and that the MS then performs a GPRS attach or combined GPRS attach procedure.

41.1.1.2.3 Method of test

Initial Conditions

System Simulator:

1 cell, CCCH combined with SDCCH, GPRS supported, PCCCH present, Max-Retrans = 2, access burst type = 11 bits, BS_PAG_BLKES_RES = 3, BS_PBCCH_BLKES = 3, BS_PCC_CHANS = 1, BS_PRACH_BLKES = 1 in PSI1.

Mobile Station:

The MS is GPRS attached with a P-TMSI allocated, SPLIT PG CYCLE negotiated. The mobile station is in packet idle mode and has left the Transfer non-DRX mode period, i.e. for a R99 or later MS the system simulator shall wait for a period equivalent to the value of the NON_DRX_TIMER parameter before sending the first paging message to the MS.

Specific PICS Statements

-

PIXIT Statements

-

Test Procedure

The SS sends a PACKET PAGING REQUEST message containing the IMSI of the MS for TBF establishment. The MS attempts two random accesses for PACKET CHANNEL REQUEST. The SS responds to the 2nd one by assigning an uplink channel for an open-end TBF. The MS sends an LLC PDU containing TLLI in the RLC/MAC header and ATTACH REQUEST, implicitly indicating a paging response. The SS allows the completion of the attach procedure to make sure that MS sends a complete ATTACH REQUEST in answer to paging.

Maximum Duration of Test

5 minutes.

Expected Sequence

Step	Direction	Message	Comments
1	SS -> MS	PACKET PAGING REQUEST	1 st Repeated Page Info for RR connection, 2 nd Repeated Page info contains IMSI of the MS for TBF establishment. Sent on PPCH.
2	MS -> SS	PACKET CHANNEL REQUEST	ACCESS TYPE = " MM Procedure ". Received on PRACH.
3	MS -> SS	PACKET CHANNEL REQUEST	ACCESS TYPE = " MM Procedure ". Received on PRACH.
4	SS -> MS	PACKET UPLINK ASSIGNMENT	Random Reference = pertaining to the message received in step 3. Sent on PAGCH.
5	SS -> MS	PACKET DOWNLINK DUMMY CONTROL BLOCK	Sent on PACCH containing USF assigned to the MS.
6	MS -> SS	UPLINK RLC DATA BLOCK (ATTACH REQUEST)	LLC PDU containing a TLLI and the first part of ATTACH REQUEST, the implicit paging response to step 1. Received on the uplink PDTCH assigned in step 4.
7	MS<->SS	{Completion of the attach procedure}	SS allow the completion of the attach procedure

Specific Message Contents

Contents for SYSTEM INFORMATION and PACKET SYSTEM INFORMATION Messages:

PRACH Control Parameters - MAX_RETRANS	Max 2 retransmission
---	----------------------

PACKET PAGING REQUEST message:

MESSAGE_TYPE	000101
PAGE_MODE	Normal Paging
{0 1<PERSISTENCE_LEVEL>}	0 (not present)
{0 1<NLN>}	0 (not present)
{1 <Repeated Page info>}	1
-	1 (Page request for RR connection establishment)
- 0 < TMSI >	TMSI not addressing the MS under test
- CHANNEL_NEEDED	SDCCH
- {0 1 < eMLPP_PRIORITY}	0 (eMLPP_PRIORITY absent)
-	0 (Page request for TBF establishment)
- { 0 < PTMSI > 1 1 < Length of Mobile Identity contents > < Mobile Identity>}	1 (IMSI present)
-	Length, type, and IMSI value stored on the SIM of the MS (3GPP TS 04.08 / 3GPP TS 24.008, 10.5.5.13 without IEI)
-	0 (end of repeated page info)
spare padding	Spare Padding

PACKET CHANNEL REQUEST message in test step 2 and 3:

Access Type	Mobility Management procedure
Random Reference	Not checked.

41.1.1.3 RR / Paging / on PCCCH for GPRS service / extended paging with P-TMSI successful

41.1.1.3.1 Conformance requirements

1. The network may send page mode information in any downlink message on PCCCH. The page mode information controls possible additional requirements on a mobile station receiving the message.
2. In packet idle mode, the paging sub-channels on PCCCH shall be monitored (by the mobile station) according to the current DRX mode and the values of the PAGING_GROUP parameter defined for the mobile station, and possible page mode information received on PCCCH.
3. The mobile station shall take into account the page mode information received in any message received in a radio block on PCCCH corresponding to one of the paging groups defined by the different PAGING_GROUP values for the mobile station.
4. In the extended paging mode, the mobile station is required in addition (to normal paging) to receive and analyse the possible message in the third block period on PCCCH where paging may occur (PPCH), following the block corresponding to MS's paging group.

References

3GPP TS 04.60, subclauses 5.5.1, 5.5.1.5 and 5.5.1.6.

41.1.1.3.2 Test purpose

1. To verify that the MS operates in the extended page mode when it is ordered by the SS in PACKET PAGING REQUEST which does not address the MS, but on the paging sub-channel corresponding to the MS identity.
2. To verify that the MS operates in the extended page mode when it is ordered by the SS in PACKET UPLINK ASSIGNMENT on the paging sub-channel corresponding to the MS identity.
3. To verify that the MS operates in the extended page mode when it is ordered by the SS in PACKET ACCESS REJECT on the paging sub-channel corresponding to the MS identity.
4. To verify that the MS operates in the extended page mode when it is ordered by the SS in PACKET DOWNLINK ASSIGNMENT on the paging sub-channel corresponding to the MS identity.
5. To verify that the MS operates in the extended page mode when it is ordered by the SS in PACKET QUEUEING NOTIFICATION on the paging sub-channel corresponding to the MS identity.
6. To verify that the MS operates in the extended page mode when it is ordered by the SS in PACKET CELL CHANGE ORDER on the paging sub-channel corresponding to the MS identity.
7. To verify that the MS operates in the extended page mode when it is ordered by the SS in PACKET DOWNLINK DUMMY CONTROL BLOCK on the paging sub-channel corresponding to the MS identity.
8. To verify that the MS operates in the extended page mode when it is ordered by the SS in PACKET PRACH PARAMETERS on the paging sub-channel corresponding to the MS identity.
9. To verify that the MS operates in the extended page mode when it is ordered by the SS in PACKET POLLING REQUEST on the paging sub-channel corresponding to the MS identity.

41.1.1.3.3 Method of test

Initial Conditions

System Simulator:

1 cell, CCCH combined with SDCCH, GPRS supported, PCCCH present, Max-Retrans = 2
BS_PAG_BKLS_RES = 2, BS_PBCCH_BKLS = 4 and BS_PRACH_BKLS = 1 in PSI1.

Mobile Station:

The MS is GPRS attached with a P-TMSI allocated, SPLIT PG CYCLE negotiated. The mobile station is in packet idle mode and has left the Transfer non-DRX mode period, i.e. for a R99 or later MS the system simulator

shall wait for a period equivalent to the value of the NON_DRX_TIMER parameter before sending the first paging message to the MS.

Specific PICS Statements

-

PIXIT Statements

-

Test Procedure

The test is repeated 9 times. Each time at the start, the SS sends one of the relevant messages listed in the corresponding test purpose to carry the Extended Paging mode. The MS is paged for TBF establishment and the paging mode is reset to Normal. After two attempts of the random access from the MS, the SS rejects the access.

Maximum Duration of Test

5 minutes.

Expected Sequence

The test sequence is repeated for $k = 1 \dots 9$.

Step	Direction	Message	Comments
1A	SS -> MS	PACKET PAGING REQUEST	k=1 1 st Repeated Page info contains P-TMSI of another MS, no other Repeated Page info, Page_Mode = " Extended Paging ". Sent on PPCH belonging to the MS.
1B	SS -> MS	PACKET UPLINK ASSIGNMENT	k=2 Random Reference = any random value not used in previous test steps of this test case. Page_Mode = " Extended Paging ". Sent on the paging sub-channel corresponding to the MS identity (PPCH).
1C	SS -> MS	PACKET ACCESS REJECT	k=3 Random Reference = any random value not used in previous test steps of this test case. Page_Mode = " Extended Paging ". Sent on the paging sub-channel corresponding to the MS identity (PPCH).
1D	SS -> MS	PACKET DOWNLINK ASSIGNMENT	k=4 TLLI = any value other than the values used in previous test steps. Page_Mode = " Extended Paging ". Sent on the paging sub-channel corresponding to the MS identity (PPCH).
1E	SS -> MS	PACKET QUEUEING NOTIFICATION	k=5 Random Reference = any random value not used in previous test steps of this test case. Page_Mode = " Extended Paging ". Sent on the paging sub-channel corresponding to the MS identity (PPCH).
1F	SS -> MS	PACKET CELL CHANGE ORDER	k=6 TLLI = any value other than the values used in previous test steps of this test case. Page_Mode = " Extended Paging ". Sent on the paging sub-channel corresponding to the MS identity (PPCH).
1G	SS -> MS	PACKET DOWNLINK DUMMY CONTROL BLOCK	k=7 Page_Mode = " Extended Paging ". Sent on the paging sub-channel corresponding to the MS identity (PPCH).
1H	SS -> MS	PACKET PRACH PARAMETERS	k=8 Page_Mode = " Extended Paging ". Sent on the paging sub-channel corresponding to the MS identity (PPCH).
1I	SS -> MS	PACKET POLLING REQUEST	k=9 TLLI = any value other than the values used in previous test steps of this test case. Page_Mode = " Extended Paging ". Sent on the paging sub-channel corresponding to the MS identity (PPCH).
2	SS -> MS	PACKET PAGING REQUEST	1 st Repeated Page info contains P-TMSI of the MS, no other Repeated Page info, Page_Mode = "Normal Paging". Sent on the third block period on PCCCH where paging may occur (PPCH), following the block corresponding to MS's paging group.
3	MS-> SS	PACKET CHANNEL REQUEST	ACCESS TYPE = " Page Response ". Received on PRACH.
4	MS-> SS	PACKET CHANNEL REQUEST	ACCESS TYPE = " Page Response ". Received on PRACH.
5	SS -> MS	PACKET ACCESS REJECT	Random Reference = pertaining to the message received in step 3. Sent on PAGCH.

Specific Message Contents:

None.

41.1.1.4 RR / Paging / on PCCCH for GPRS service / paging reorganisation successful

41.1.1.4.1 Conformance requirements

1. In the paging reorganisation mode the mobile station shall receive all messages on the PCCCH regardless of the BS_PAG_BLK_RES setting. It is required to receive all PBCCH messages.
2. When the mobile station receives the next message to a (possibly new) PAGING_GROUP defined for the mobile station, subsequent action is defined by the possible page mode information received in that message.
3. When the mobile station selects a new set of PAGING_GROUP values, the initial page mode in the mobile station shall be set to paging reorganisation.
4. The BS_PCC_REL field in PSI1 control channel description indicates, if set = 1, that the last PDCH carrying PCCCH and PBCCH will be released shortly. All mobile stations on PCCCH shall then as soon as this information has been received return to CCCH and there obey the information sent on BCCH as specified in 3GPP TS 04.08 / 3GPP TS 44.018. If the field is set = 0, no channel release is pending.

References

3GPP TS 04.60, subclauses 5.5.1.5 and 11.2.18.

41.1.1.4.2 Test purpose

1. To verify that the MS, after reception of a message with page mode set to "paging reorganisation", answers to paging messages (with page mode set to "normal paging") sent on its old PCCCH in paging blocks which do not belong to the MS's paging sub-channel.
2. To test that the MS correctly determines its new paging sub-channel when the number of allocated PBCCH blocks BS_PBCCH_BLK and the number of reserved blocks BS_PAG_BLK_RES are changed.
3. To test that the MS correctly determines its new paging sub-channel when the number of PCCCH channels is changed.
4. To test that the MS understands the control channel release bit in control channel description.

41.1.1.4.3 Method of test

Initial Conditions

System Simulator:

1 cell, CCCH combined with SDCCH, GPRS supported, PCCCH present, Max-Retrans = 2, access burst type = 8 bits, BS_PAG_BLK_RES = 2, BS_PBCCH_BLK = 3, BS_PRACH_BLK = 1 and BS_PCC_CHAN = 1. SPGC_CCCH_SUP = 0 (SPLIT_PG_CYCLE is not supported on CCCH in the cell).

Mobile Station:

The MS is GPRS attached with a P-TMSI allocated, SPLIT PG CYCLE negotiated. The mobile station is in packet idle mode and has left the Transfer non-DRX mode period, i.e. for a R99 or later MS the system simulator shall wait for a period equivalent to the value of the NON_DRX_TIMER parameter before sending the first paging message to the MS.

Specific PICS Statements

-

PIXIT Statements

-

Test Procedure

The SS sends PACKET PAGING REQUEST on PCCCH and sets Paging Mode to paging reorganisation. The MS is paged on a former access grant block. After receipt the 1st random access from the MS with the correct access type for the paging response, the SS rejects the packet access and sets the paging mode to paging reorganisation.

The test procedure is similarly repeated twice. Each time the SS changes the PCCCH organisation parameters (see the following test sequence). Then the MS is paged. The random access from the MS is rejected by the SS.

The SS resets the default system setting, but sets BS_PCC_REL in PSI1. The MS is then paged on PCH. After the MS starting random access on RACH, the access from the MS is rejected.

NOTE : All the messages sent on PCCCH are sent with page mode "Normal Paging", unless explicitly stated in the testcase. All the L3 messages sent on CCCH are sent with page mode "Normal Paging".

Maximum Duration of Test

5 minutes.

Expected Sequence

Step	Direction	Message	Comments
1	SS -> MS	PACKET PAGING REQUEST	<p>PAGE_MODE = "paging reorganisation", not specific to the MS. Sent on the paging block belonging to the MS. Sent on a former access grant block. Sent before the paging subchannel for MS reoccurs. 1st Repeated Page info contains P-TMSI of the MS, no other Repeated Page info, PAGE_MODE = "Normal paging".</p> <p>ACCESS TYPE = " Page Response ". Received on PRACH.</p> <p>Random Reference = pertaining to the message received in step 3, PAGE_MODE = "Normal Paging", Sent on PAGCH.</p> <p>Sent on the MS's paging sub-channel. Paging fill frame and page mode set to "paging reorganisation".</p> <p>All messages sent on any paging sub-channel are paging fill frame with PAGE_MODE= "Paging Reorganisation".</p>
2	SS -> MS	PACKET PAGING REQUEST	
3	MS-> SS	PACKET CHANNEL REQUEST	
4	SS -> MS	PACKET ACCESS REJECT	
5	SS -> MS	PACKET PAGING REQUEST	
6	SS		<p>Set BS_PBCCH_BLKs = 4 in system information messages and waits at least two PSI1 repeat periods + time required for 64/SPLIT_PG_CYCLE multiframes. NOTE : SS reverts back to sending of fill paging messages with page mode set to "Normal Paging" on paging sub-channels, after the 2 PSI1 repeat period wait.</p> <p>Sent on a new paging block belonging to the MS. 1st Repeated Page info contains P-TMSI of the MS, no other Repeated Page info, PAGE_MODE = "Same as before".</p> <p>ACCESS TYPE = " Page Response ". Received on PRACH.</p> <p>Random Reference = pertaining to the message received in step 8, PAGE_MODE = "Normal Paging", Sent on PAGCH.</p> <p>Sent on the MS's paging sub-channel. Paging fill frame and page mode set to "paging reorganisation".</p> <p>All messages sent on any paging sub-channel are paging fill frame with PAGE_MODE= "Paging Reorganisation".</p>
7	SS -> MS	PACKET PAGING REQUEST	
8	MS-> SS	PACKET CHANNEL REQUEST	
9	SS -> MS	PACKET ACCESS REJECT	
10	SS -> MS	PACKET PAGING REQUEST	
11	SS		<p>Reconfigure the SS channels so that an additional PCCCH on slot ((k-2) mod 8) is set and indicated in the system information. k is the current slot number for PBCCH. Wait at least two PSI1 repeat periods + time required for 64/SPLIT_PG_CYCLE multiframes. NOTE : SS reverts back to sending of fill paging messages with page mode set to "Normal Paging" on paging sub-channels, after the 2 PSI1 repeat period wait.</p> <p>Sent on a new paging block belonging to the MS. 1st Repeated Page info contains P-TMSI of the MS, no other Repeated Page info, PAGE_MODE = "Normal paging".</p> <p>ACCESS TYPE = " Page Response ". Received on PRACH.</p> <p>Random Reference = pertaining to the message received in step 13, PAGE_MODE = "Normal Paging", Sent on PAGCH.</p> <p>Sent on the MS's paging sub-channel. Paging fill frame and page mode set to "paging reorganisation".</p> <p>All messages sent on any paging sub-channel are paging fill frame with PAGE_MODE= "Paging Reorganisation".</p>
12	SS -> MS	PACKET PAGING REQUEST	
13	MS-> SS	PACKET CHANNEL REQUEST	
14	SS -> MS	PACKET ACCESS REJECT	
15	SS -> MS	PACKET PAGING REQUEST	
16	SS		<p>Restore the SS default configuration. and set BS_PCC_REL = 1. Wait at least two PSI1 repeat periods + SI13 repeat period + time required for BS_PA_MFRMS multiframes. SS stops sending all PSIs.</p> <p>Sent on PCH. 1st Mobility Identity contains P-TMSI of the MS, 2nd Mobility Identity absent. Packet Page Indication indicates a packet paging procedure.</p> <p>ACCESS TYPE = "one phase access". Received on RACH.</p>
17	SS -> MS	PAGING REQUEST TYPE 1	
18	MS-> SS	CHANNEL REQUEST	

19	SS -> MS	IMMEDIATE ASSIGNMENT REJECT	Random Reference = pertaining to the message received in step 17, Sent on AGCH.
----	----------	--------------------------------	--

Specific Message Contents:

None.

41.1.2 RR / Paging / on PCCCH for circuit-switched services / paging successful

41.1.2.1 Conformance requirements

1. When answering to a paging message the purpose of which is to trigger the establishment of an RR connection, the mobile station, whatever its MS class mode of operation, shall follow the paging response procedures as specified in 3GPP TS 04.08 / 3GPP TS 44.018.
2. The MS shall enter GPRS ATTACHED.SUSPENDED sub-state when entering dedicated mode and when the MS limitations makes it unable to communicate on GPRS channels. In this sub-state, no user data should be sent and no signalling information shall be sent. The MS shall leave this sub-state when leaving dedicated mode.

References

3GPP TS 04.60, subclause 6.1.4.

3GPP TS 04.08 / 3GPP TS 44.018, subclause 3.3.2.2,
3GPP TS 04.08 / 3GPP TS 24.008, subclause 4.1.3.1.3.2.

41.1.2.2 Test purpose

1. To verify that the MS in packet idle mode, GPRS attached state, is able to determine its PCCCH group and PAGING group, and that the MS responds correctly on RACH with CHANNEL REQUEST containing cause value of 'Page Response' upon receipt of a PACKET PAGING REQUEST message for establishment of an RR connection.
2. To verify that the MS is able to respond to PACKET PAGING REQUEST for establishment of an RR connection when the MS is addressed with its TMSI and, but an another field of the paging message contains an IMSI different from that of the MS.
3. To verify that the MS is able to respond to PACKET PAGING REQUEST for establishment of an RR connection when the MS is addressed with its IMSI.

41.1.2.3 Method of test

Initial Conditions

System Simulator:

1 cell, CCCH combined with SDCCH, GPRS supported, Network mode I, PCCCH present, Max-Retrans = 2, access burst type = 11 bits, BS_PAG_BLKES_RES=2, BS_PBCCH_BLKES=3, BS_PRACH_BLKES=1, BS_PCC_CHANS=1.

Mobile Station:

The MS is GPRS attached with a P-TMSI and a TMSI allocated and SPLIT PG CYCLE negotiated. The mobile station is in packet idle mode and has left the Transfer non-DRX mode period, i.e. for a R99 or later MS the system simulator shall wait for a period equivalent to the value of the NON_DRX_TIMER parameter before sending the first paging message to the MS.

Specific PICS Statements

- GPRS Release (TSPC_MS_GPRS_RELEASE)

PIXIT Statements

-

Test Procedure

The MS is paged with the TMSI on the MS's PPCH sub-channel for RR establishment. After two random accesses from the MS on RACH the SS assigns a SDCCH. The MS responses with PAGING RESPONSE. The test is repeated with PACKET PAGING REQUEST containing the IMSI of the MS.

Maximum Duration of Test

5 minutes.

Expected Sequence

The test sequence is repeated for $k = 1 \dots 2$

Step	Direction	Message	Comments
1A	SS -> MS	PACKET PAGING REQUEST	k=1 1 st Repeated Page info contains TMSI of the MS for RR establishment, Channel needed = any channel. PAGE_MODE = "Normal Paging". The 2 nd Repeated Page info contains a PTMSI not addressing the MS, for TBF establishment. Sent on PPCH belonging to the MS.
1B	SS -> MS	PACKET PAGING REQUEST	k=2 1 st Repeated Page info contains IMSI of the MS, no other Repeated Page info. Channel needed = " any channel ", PAGE_MODE = " Normal Paging ". Sent on PPCH belonging to the MS.
2	MS -> SS	CHANNEL REQUEST	Establishment Cause = " Answer to paging ". Received on RACH. Establishment Cause = " Answer to paging ". Received on RACH. Request Reference = pertaining to the message received in step 3. Sent on AGCH. carried by information field of SABM. Received on assigned SDCCH. This step is optional for a R97 or R98 MS while it is mandatory for R99 and later releases MS. Sent on SDCCH. GPRS resumption acknowledged.
3	MS -> SS	CHANNEL REQUEST	
4	SS -> MS	IMMEDIATE ASSIGNMENT	
5	MS -> SS	PAGING RESPONSE	
6	MS -> SS	CLASSMARK CHANGE	
7	MS -> SS	GRPS SUSPENSION REQUEST	
8	SS -> MS	CHANNEL RELEASE	

Specific Message Contents

Contents for SYSTEM INFORMATION and PACKET SYSTEM INFORMATION Messages:

PRACH Control Parameters - MAX_RETRANS	Max 2 retransmission
---	----------------------

PACKET PAGING REQUEST message in step 1A:

MESSAGE_TYPE	000101
PAGE_MODE	Normal Paging
{L H<PERSISTENCE_LEVEL>}	L (no persistence level present)
{L H<NLN>}	L (no notification list number)
{H <Repeated Page info>}	H (start of Repeated Page info)
-	H (Page request for RR connection establishment)
- CHANNEL_NEEDED	'00', any channel
-	L (no eMLPP_PRIORITY present)
-	L (TMSI)
- TMSI	TMSI allocated to the MS
-	L (Page request for TBF establishment)
- { L < PTMSI > H < Mobile_identity > }	L (PTMSI present)
- PTMS	P-TMSI not addressing the MS
-	L (end of repeated page info)
spare padding	Spare Padding

PACKET PAGING REQUEST message in step 1B:

MESSAGE_TYPE	000101
PAGE_MODE	Normal Paging
{L H<PERSISTENCE_LEVEL>}	L (no persistence level present)
{L H<NLN>}	L (no notification list number)
{H <Repeated Page info>}	H (start of Repeated Page info)
-	H (Page request for RR connection establishment)
- CHANNEL_NEEDED	any channel
-	L (no eMLPP_PRIORITY present)
-	H (mobility identity)
- LENGTH of Mobile Identity	depending on IMSI field
- Mobile identity	Length, type, and IMSI value stored on the SIM of the MS (3GPP TS 04.08 / 3GPP TS 24.008, 10.5.5.13 without IEI)
-	L (end of Repeated Page info)
spare padding	Spare Padding

IMMEDIATE ASSIGNMENT message:

L2 pseudo length	This is the sum of the lengths of all the information elements present in the message except for the IA rest octets and L2 pseudo length IEs. For the default message the L2 pseudo length is 11.
Protocol Discriminator	RR Management.
Skip Indicator	0000
Message Type	00111111
Page Mode	
- Page Mode	Normal Paging.
Packet Response Type and Dedicated mode or TBF	
- Downlink	No meaning
- T/D	dedicated mode resource
- PR Type	immediate assignment procedure for RR connection establishment
Channel Description	
- Channel Type and TDMA offset	SDCCH/4
- TN	Chosen arbitrarily
- TSC	Chosen arbitrarily
-	0
-	00 (Binary)
- ARFCN	For GSM 450: 267 For GSM 480: 315 For GSM 700, T-GSM 810: 470 For GSM 850: 160 For GSM 900: 30 For DCS 1 800: 650 For PCS 1 900: 650
Request Reference	Pertaining to last Channel Request sent by the MS.
Timing Advance	
- Timing advance value	30 bit periods.
Mobile Allocation	
- Length	0
Starting Time	Not present.
IA rest octets	Spare Padding

41.1.3 RR / Paging / on PCCCH / paging ignored

The MS shall ignore paging not addressing to it. If paging is not implemented correctly unnecessary accesses will be provoked on PCCCH which is shared by all MS in a same cell. This kind of the wrong paging behaviour of the same type of MS in a GSM network can block the use of PCCCH and will, therefore, cause an unacceptable degradation of the GSM services to other users of the mobile stations.

41.1.3.1 Conformance requirements

1. MS in a specific PCCCH GROUP shall monitor the radio blocks on PCCCH corresponding to the PCCCH GROUP the mobile station belongs to and where paging may appear.
2. A PACKET PAGING REQUEST message on PCCCH may include more than one mobile station identification.

References

3GPP TS 04.60, subclauses 5.5.1 and 6.1.2.

41.1.3.2 Test purpose

1. To verify that the MS ignores PACKET PAGING REQUEST (for GPRS service) where both P-TMSI and IMSI do not address the MS although the PACKET PAGING REQUEST message is sent on specific PCCCH to which the MS belongs.
2. To verify that the MS ignores PACKET PAGING REQUEST (for circuit-switched service) where both P-TMSI and IMSI do not address the MS although the PACKET PAGING REQUEST message is sent on specific PCCCH to which the MS belongs.

NOTE: The 2nd test purpose is valid for GPRS MS class A and B.

41.1.3.3 Method of test

Initial Conditions

System Simulator:

1 cell, CCCH combined with SDCCH, GPRS supported, PCCCH present, Max-Retrans = 2, access burst type = 8 bits, BS_PAG_BLK_RES = 2, BS_PBCCH_BLK = 3, BS_PRACH_BLK = 1 and BS_PCC_CHAN = 1.

Mobile Station:

The MS is GPRS attached with a P-TMSI allocated and SPLIT PG CYCLE negotiated. If the MS has the class A or B of mode of operation the MS is idle, updated with a TMSI allocated. The mobile station is in packet idle mode and has left the Transfer non-DRX mode period, i.e. for a R99 or later MS the system simulator shall wait for a period equivalent to the value of the NON_DRX_TIMER parameter before sending the first paging message to the MS.

Specific PICS Statements

- GPRS Release (TSPC_MS_GPRS_RELEASE)

PIXIT Statements

-

Test Procedure

The MS is paged for TBF establishment. The MS attempts a random access which is rejected. The MS is paged again for TBF establishment. PACKET PAGING REQUEST contains two mobility identity which do not address the MS. The MS shall not initiate the random access. The same test is repeated, but the MS is paged for RR connection establishment.

Maximum Duration of Test

5 minutes.

Expected Sequence

The test sequence is repeated for $k = 1, 2$. The 2nd time ($k=2$) is executed if the MS has the class A or B of mode of operation.

Step	Direction	Message	Comments
1	SS -> MS	PACKET PAGING REQUEST	1 st Repeated Page info contains P-TMSI of the MS, no other Repeated Page info, Page_Mode = "Normal Paging". Sent on PPCH belonging to the MS. ACCESS TYPE = " Page Response ". Received on PRACH. Random Reference = pertaining to the message received in step 2. Sent on PAGCH.
2	MS-> SS	PACKET CHANNEL REQUEST	
3	SS -> MS	PACKET ACCESS REJECT	
4A	SS -> MS	PACKET PAGING REQUEST	k=1, page for TBF establishment. The two Repeated Page info do not address the MS. Sent on PPCH belonging to the MS.
4B	SS -> MS	PACKET PAGING REQUEST	k=2, page for RR connection. The two Repeated Page info do not address the MS. Channel Needed = "any channel". Sent on PPCH belonging to the MS.
5	SS		Check that there is no response from the MS for 5s.

Specific Message Contents

Contents for SYSTEM INFORMATION and PACKET SYSTEM INFORMATION Messages:

PRACH Control Parameters - ACCESS_BURST_TYPE - MAX_RETRANS	8 bit access burst Max 2 retransmission
--	--

PACKET PAGING REQUEST message in step 4A:

MESSAGE_TYPE	000101
PAGE_MODE	Normal Paging
{L H<PERSISTENCE_LEVEL>}	L (no persistence level present)
{L H<NLN>}	L (no notification list number)
{H <Repeated Page info>}	H (start of Repeated Page info)
-	L (Page request for TBF establishment)
-	L (PTMSI)
- PTMSI	P-TMSI value not the assigned to the MS under test
-	L (Page request for TBF establishment)
-	H (mobility identity)
- LENGTH of Mobile Identity	depending on IMSI field
- Mobile identity	IMSI different from the value stored on the SIM of the MS
-	L (end of Repeated Page info)
spare padding	Spare Padding

PACKET PAGING REQUEST message in step 4B:

MESSAGE_TYPE	000101
PAGE_MODE	Normal Paging
{L H<PERSISTENCE_LEVEL>}	L (no persistence level present)
{L H<NLN>}	L (no notification list number)
{H <Repeated Page info>}	H (start of Repeated Page info)
-	H (Page request for RR connection establishment)
- CHANNEL_NEEDED	any channel
-	L (no eMLPP_PRIORITY present)
-	L (TMSI)
- TMSI	TMSI value not allocated to the MS
-	H (Page request for RR connection establishment)
- CHANNEL_NEEDED	any channel
-	L (no eMLPP_PRIORITY present)
-	H (IMSI)
- LENGTH of Mobile Identity	depending on IMSI field
- Mobile identity	IMSI different from the value stored on the SIM of the MS
-	L (end of Repeated Page info)
spare padding	Spare Padding

41.1.4 RR / Paging / on PACCH for circuit-switched services

This subclause tests the MS paging behaviours in the packet transfer mode in a network operating in Mode I

41.1.4.1 RR / Paging / on PACCH for circuit-switched services/ paging successful

41.1.4.1.1 Conformance requirements

1. Paging initiation using PACCH applies to a mobile station supporting GPRS MS class A or B when such mobile station is in packet transfer mode and when the network operates according to mode I.
2. A mobile station operating in class B mode of operation shall abort the current GPRS data transfer(s) if it was in packet transfer mode, and suspend any GPRS activity until return to idle mode.
3. (For an MS in the mode of operation of class B) when responding to a paging message for other GSM services, the MS shall establish the connection for that incoming service (i.e., enter dedicated mode) and suspend GPRS activity. GPRS activity is resumed upon return to idle mode.

References

3GPP TS 04.60, subclauses 6.1.3 and 6.1.4.

3GPP TS 22.060, subclause 6.1.

41.1.4.1.2 Test purpose

1. To verify that upon receipt of a PACKET PAGING REQUEST message on PACCH for RR establishment, the class B mobile in packet transfer mode is able to respond correctly on RACH with CHANNEL REQUEST containing cause value of 'Page Response'.
2. To verify that the MS is able to respond to PACKET PAGING REQUEST when the MS is addressed with its TMSI and even if another field of PACKET PAGING REQUEST contains an IMSI different from that of the MS.
3. To verify that the MS is able to respond to PACKET PAGING REQUEST when the MS is addressed with its IMSI.

41.1.4.1.3 Method of test

Initial Conditions

System Simulator:

1 cell, CCCH combined with SDCCH, GPRS supported, PCCCH present, Max-Retrans = 2, access burst type = 11 bits, BS_PAG_BLK_RES = 2, BS_PBCCH_BLKS = 3 and BS_PCC_CHANS = 1.

Mobile Station:

The MS is in packet transfer mode.

Specific PICS Statements

-

PIXIT Statements

-

Test Procedure

The MS is in the packet transfer mode. An USF is assigned to the MS. After receiving the first uplink RLC data block from the MS it is paged on PACCH for an RR connection establishment with the allocated TMSI. The MS sends CHANNEL REQUEST for Answer to Paging. The access attempt is rejected.

The test is repeated once. The difference of the second time lies in the PACKET PAGING REQUEST on PACCH containing IMSI instead of TMSI addressing the MS.

Maximum Duration of Test

5 minutes.

Expected Sequence

The test sequence is repeated for $k = 1, 2$.

Step	Direction	Message	Comments
1		{Uplink dynamic allocation two phase access}	n = 440 octets in test PDP context3, without starting time, USF_GRANULARITY = 1 block, RLC_DATA_BLOCKS_GRANTED = open-end TLLI_BLOCK_CHANNEL_CODING: cs1, CHANNEL_CODING_COMMAND: cs1, PEAK_THROUGHPUT_CLASS = 5 (16k octets/s), RADIO_PRIORITY = 4, RLC_MODE = unacknowledged mode.
2	SS -> MS	PACKET DOWNLINK DUMMY CONTROL BLOCK	Sent on the PACCH, the USF assigned to the MS.
3	MS -> SS	UPLINK RLC DATA BLOCK	Received on the assigned PDTCH.
4A	SS -> MS	PACKET PAGING REQUEST	Check that the coding as specified by CHANNEL_CODING_COMMAND, the TFI is correct. k=1, for RR connection 1 st Repeated Page info contains TMSI of the MS, Channel Needed = " TCH/F ", PAGE_MODE = " same as before ", sent on downlink PACCH.
4B	SS -> MS	PACKET PAGING REQUEST	k=2, for RR connection 1 st Repeated Page info contains IMSI of the MS, Channel Needed = " TCH/F ", PAGE_MODE = " same as before ", sent on downlink PACCH.
5	MS -> SS	CHANNEL REQUEST	Establishment Cause = " Answer to Paging ". Received on RACH.
6	SS -> MS	IMMEDIATE ASSIGNMENT REJECT	Request Reference = pertaining to message received in step 5. Sent on AGCH.

41.1.4.2 RR / Paging / on PACCH for circuit-switched services/ paging ignored

The MS shall ignore paging not addressing to it. If paging is not implemented correctly unnecessary accesses will be provoked on the CCCH which is shared by all MSs in a same cell. This kind of the wrong paging behaviour of the same type of MS in a GSM network can block the use of CCCH and will, therefore, cause an unacceptable degradation of the GSM services to other users of the mobile stations.

41.1.4.2.1 Conformance requirements

The MS shall ignore paging not addressing to it.

References

3GPP TS 04.60, clause 6.

41.1.4.2.2 Test purpose

To verify that the MS ignores a PACKET PAGING REQUEST message where both TMSI and IMSI do not address the MS although the PACKET PAGING REQUEST message is sent on PACCH allocated to the MS.

41.1.4.2.3 Method of test

Initial Conditions

System Simulator:

1 cell, CCCH combined with SDCCH, GPRS supported, PCCCH present, Max-Retrans = 2, access burst type = 8 bits, BS_PAG_BLK_RES = 2, BS_PBCCH_BLK = 3, BS_PRACH_BLK = 1 and BS_PCC_CHAN = 1.

Mobile Station:

The MS is in packet transfer mode.

Specific PICS Statements

-

PIXIT Statements

-

Test Procedure

The MS is brought to the packet transfer mode. A PACKET PAGING message not addressing the MS is sent on PACCH for RR connection establishment. It is checked that the MS can continue sending the uplink RLC data blocks and does not attempt any random accesses on RACH for 4s.

Maximum Duration of Test

5 minutes.

Expected Sequence

Step	Direction	Message	Comments
1		{Uplink dynamic allocation two phase access}	n = 440 octets in test PDP context3, without starting time, USF_GRANULARITY = 1 block, RLC_DATA_BLOCKS_GRANTED = open-end TLLI_BLOCK_CHANNEL_CODING: cs1, CHANNEL_CODING_COMMAND: cs1, PEAK_THROUGHPUT_CLASS = 5 (16k octets/s), RADIO_PRIORITY = 4, RLC_MODE = unacknowledged mode.
2	SS -> MS	PACKET DOWNLINK DUMMY CONTROL BLOCK	Sent on the PACCH, the USF assigned to the MS.
3	MS -> SS	UPLINK RLC DATA BLOCK	Received on the assigned PDTCH.
4	SS -> MS	PACKET PAGING REQUEST	Check that the coding as specified by CHANNEL_CODING_COMMAND, the TFI is correct. For RR connection, the two Repeated Page info contain a TMSI and an IMSI not addressing the MS, Channel Needed = " Any Channel ", sent on downlink PACCH.
5	SS -> MS	PACKET DOWNLINK DUMMY CONTROL BLOCK	Sent on PACCH containing USF assigned. It is checked that no CHANNEL REQUEST is sent from the MS on RACH for 4s.
6	MS -> SS	UPLINK RLC DATA BLOCK	
7		{Completion of uplink RLC data block transfer}	

41.1.5 RR / Paging / on CCCH for GPRS service

41.1.5.1 RR / Paging / on CCCH for GPRS service / normal paging

41.1.5.1.1 RR / Paging / on CCCH for GPRS service / normal paging with P-TMSI successful

41.1.5.1.1.1 Conformance requirements

1. The network initiates the paging procedure by sending a paging request message on an appropriate paging sub-channel on CCCH. Paging initiation using a paging sub-channel on CCCH is used when sending paging information to a mobile station and PCCCH is not present in the cell.
2. The mobile station in packet idle mode is required to receive and analyse the paging messages and immediate assignment messages sent on the paging sub-channels on CCCH corresponding to the paging groups determined for it in packet idle mode.
3. A PAGING REQUEST message may include more than one mobile station identification.
4. In a PAGING REQUEST message used for the packet paging procedure, the mobile station shall be identified by the P-TMSI (GPRS TMSI) or its IMSI. If the mobile station is identified by the P-TMSI, it shall indicate the receipt of a paging request to the MM sub-layer.

If the mobile station identified by its IMSI, it shall parse the message for a corresponding *Packet Page Indication* field:

- if the *Packet Page Indication* field indicates a paging procedure for RR connection establishment, or the field is not present in the message, the mobile station shall initiate the immediate assignment procedure;

- if the *Packet Page Indication* field indicates a packet paging procedure, the mobile station shall indicate the receipt of a paging request to the MM sub-layer.

5. The mobile station initiates the packet access procedure by scheduling the sending of CHANNEL REQUEST messages on RACH.

References

3GPP TS 04.08 / 3GPP TS 44.018, subclauses 3.3.2.1.1, 3.5.1.1, 3.5.1.2 and 3.5.2.1.

3GPP TS 05.02, subclause 6.5.6.

41.1.5.1.1.2 Test purpose

1. To verify that the MS in packet idle mode, GPRS attached state, is able to determine its CCCH group and PAGING group and that the MS responds correctly with CHANNEL REQUEST on RACH with cause value of 'packet access' upon receipt of a PAGING REQUEST TYPE 1 message for packet access with paging mode set to normal.
2. To verify that the MS is able to respond to PAGING REQUEST TYPE 1 for packet access when the MS is addressed with its P-TMSI, but another field of the paging message contains an IMSI different from that of the MS.
3. To verify that the MS is able to respond to PAGING REQUEST TYPE 2 for packet access when the MS is addressed with its P-TMSI, but other fields of the paging message contain a TMSI and an IMSI different from that of the MS.
4. To verify that the MS is able to respond to PAGING REQUEST TYPE 3 for packet access when the MS is addressed with its P-TMSI, but other fields of the paging message contain TMSIs different from that of the MS.

41.1.5.1.1.3 Method of test

Initial Conditions

System Simulator:

1 cell, CCCH combined with SDCCH, GPRS supported, PCCCH absent, Max-Retrans = 2, BS_AG_BLK_RES = 2, BS_PA_MFRMS = 6, SPLIT_PG_CYCLE is supported on CCCH in the cell.

Mobile Station:

The MS is GPRS attached with a TMSI and a P-TMSI allocated, SPLIT PG CYCLE negotiated. The mobile station is in packet idle mode and has left the Transfer non-DRX mode period, i.e. for a R99 or later MS the system simulator shall wait for a period equivalent to the value of the NON_DRX_TIMER parameter before sending the first paging message to the MS.

Specific PICS Statements

-

PIXIT Statements

-

Test Procedure

The test is repeated three times. Each time the MS is paged for the packet paging procedure through a different paging request type message. After receiving a CHANNEL REQUEST with the establishment cause 'one phase access', an open-end TBF is assigned. A USF is assigned to the MS to enable it to transfer an uplink RLC data block. The received data block is acknowledged by the SS with , Final Ack Indicator = '1' , a valid RRBP. The MS sends PACKET CONTROL ACKNOWLEDGEMENT.

Maximum Duration of Test

5 minutes.

Expected Sequence

The test sequence is repeated for $k = 1 \dots 3$.

Step	Direction	Message	Comments
1A	SS -> MS	PAGING REQUEST TYPE 1	k=1 1 st Mobile Identity contains P-TMSI of the MS, 2 nd Mobile Identity not present. Sent on PCH.
1B	SS -> MS	PAGING REQUEST TYPE 2	k=2 1 st Mobile Identity contains P-TMSI of the MS, the other two Mobile Identities not addressing the MS. Sent on PCH.
1C	SS -> MS	PAGING REQUEST TYPE 3	k=3 1 st Mobile Identity contains P-TMSI of the MS, the remaining Mobile Identities not addressing the MS. Sent on PCH.
2	MS -> SS	CHANNEL REQUEST	Establishment Cause = "one phase access", received on RACH. Request Reference = pertaining to the message received in step 2. Uplink assignment, sent on AGCH. Sent on PACCH containing USF assigned to the MS. LLC PDU implicitly indicating paging response, containing TLLI in the RLC/MAC header. Received on uplink PDTCH assigned in step 4. acknowledge the received RLC data block, Final Ack Indicator = '1', a valid RRBP. Sent on PACCH. acknowledge the RLC control message. Received on PACCH.
4	SS -> MS	IMMEDIATE ASSIGNMENT	
5	SS -> MS	PACKET DOWNLINK DUMMY CONTROL BLOCK	
6	MS -> SS	UPLINK RLC DATA BLOCK (not L3 Message)	
7	SS -> MS	PACKET UPLINK ACK/NACK	
8	MS -> SS	PACKET CONTROL ACKNOWLEDGEMENT	

Specific Message Contents

IMMEDIATE ASSIGNMENT message in step 4:

Dedicated mode or TBF	TBF
- T/D	0 , no meaning
- Downlink	0, no meaning
- TMA	
Packet Channel Description	'00001' spared
- Channel Type	Chosen arbitrarily
- TN	Chosen arbitrarily
- TSC	0
-	00 (Binary)
- ARFCN	For GSM 450: 267
	For GSM 480: 315
	For GSM 700, T-GSM 810: 470
	For GSM 850: 160
	For GSM 900: 30
	For DCS 1 800: 650
	For PCS 1 900: 650
Request Reference	Pertaining to last Channel Request sent by the MS.
Timing Advance	
- Timing advance value	30 bit periods.
Mobile Allocation	
- Length	0
Starting Time	Not present.
IA rest octets	
-	HH
-	00 (packet uplink assignment)
- Packet Uplink Assignment	
- Assign a TBF	1, Dynamic allocation
- TFI_ASSIGNMENT	chosen arbitrarily
- POLLING	0, no
-	0, dynamic allocation
- USF	chosen arbitrarily
- USF granularity	0, single block
- 0 1 <P0 >	0
- CHANNEL_CODING_COMMAND	00, CS-1
- TLLI_BLOCK_CHANNEL_CODING	00, CS-1
- 0 1 <ALPHA >	1
- ALPHA	0.5
- GAMMA	For GSM 450, +8 dBm
	For GSM 480, +8 dBm
	For GSM 700, T-GSM 810, +8 dBm
	For GSM 850, +8 dBm
	For GSM 900, +8 dBm
	For DCS 1 800, +6 dBm
	For PCS 1 900, +6 dBm
- {0 1<TIMING_ADVANCE_INDEX>}	0 (no timing advance index)
- {0 1<TBF_STARTING_TIME>}	0 (starting time field is absent)
- spare padding	Spare Padding

41.1.5.1.2 RR / Paging / on CCCH for GPRS service / normal paging with IMSI successful

41.1.5.1.2.1 Conformance requirements

1. If the MS was paged by the network with the IMSI (for GPRS service), the MS shall delete any RAI, P-TMSI, P-TMSI signature and GPRS ciphering key sequence number stored. The MS shall then perform a GPRS attach or combined GPRS attach procedure.

References

3GPP TS 04.08 / 3GPP TS 24.008, subclause 4.7.9.1.2.

41.1.5.1.2.2 Test purpose

To verify that the MS is able to respond to PAGING REQUEST TYPE 1 when the MS is addressed with its IMSI with *Packet Page Indication* set to packet paging procedure, and that the MS then performs a GPRS attach or combined GPRS attach procedure.

41.1.5.1.2.3 Method of test

Initial Conditions

System Simulator:

1 cell, CCCH combined with SDCCH, GPRS supported, PCCCH absent, Max-Retrans = 2, BS_AG_BLK_RES = 2, BS_PA_MFRMS = 9.

Mobile Station:

The MS is in GPRS attached with a TMSI and a P-TMSI allocated, SPLIT PG CYCLE negotiated. The mobile station is in packet idle mode and has left the Transfer non-DRX mode period, i.e. for a R99 or later MS the system simulator shall wait for a period equivalent to the value of the NON_DRX_TIMER parameter before sending the first paging message to the MS.

Specific PICS Statements

-

PIXIT Statements

-

Test Procedure

The MS is paged on PCH with IMSI for packet paging procedure. After receiving the CHANNEL REQUEST from the MS a TBF is assigned. The MS sends an LLC PDU containing TLLI in the RLC/MAC header and ATTACH REQUEST, implicitly indicating a paging response. The SS verifies the completeness of ATTACH REQUEST and acknowledges the received RLC data blocks with a valid RRBP and Final Ack indicator = '1'.

Maximum Duration of Test

5 minutes.

Expected Sequence

Step	Direction	Message	Comments
1	SS -> MS	PAGING REQUEST TYPE 1	1 st Mobile Identity contains IMSI of the MS, second Mobile Identity not present. Packet page indication indicates packet paging procedure. Sent on PCH.
2	MS -> SS	CHANNEL REQUEST	Establishment Cause = "one phase packet access". Received on RACH.
3	SS -> MS	IMMEDIATE ASSIGNMENT	For uplink TBF, one phase access.
4	MS -> SS	UPLINK RLC DATA BLOCK (ATTACH REQUEST)	LLC PDU containing a TLLI and the first part of ATTACH REQUEST, the implicit paging response to step 1.
5	SS -> MS	PACKET UPLINK ACK/NACK	Received on the uplink PDTCH assigned in step 3. Contention resolution, acknowledge the received RLC data blocks, No USF assigned. Sent on PACCH.
6	SS -> MS	PACKET DOWNLINK DUMMY CONTROL BLOCK	USF assigned to the MS
7	MS -> SS	UPLINK RLC DATA BLOCK	Repeat step 6 & 7 until the CV = 0 to receive the complete ATTACH REQUEST message
8	SS -> MS	PACKET UPLINK ACK/NACK	Acknowledge the received RLC data blocks. Final Ack Indicator = 1 containing valid RRBP sent on PACCH
9	MS -> SS	PACKET CONTROL ACKNOWLEDGEMENT	acknowledge the RLC control messages. Received on PACCH.

Specific Message Contents

Contents for SYSTEM INFORMATION:

RACH Control Parameters - Max Retrans	Max 2 retransmission
SI 13 Rest Octets - ACC_BURST_TY	8 bit access burst

41.1.5.1.3 RR / Paging / on CCCH for GPRS service / normal paging with P-TMSI ignored

The MS shall ignore paging not addressing to it. If paging is not implemented correctly unnecessary accesses will be provoked on CCCH which is shared by all MS in a same cell. This kind of the wrong paging behaviour of the same type of MS in a GSM network can block the use of CCCH and will, therefore, cause an unacceptable degradation of the both GSM GPRS and circuit-switched services to other users of the mobile stations.

41.1.5.1.3.1 Conformance requirements

In a PAGING REQUEST message used for the packet paging procedure, the mobile station shall be identified by the TMSI (GPRS TMSI) or its IMSI. A PAGING REQUEST message may include more than one mobile station identification.

References

3GPP TS 04.08 / 3GPP TS 44.018, subclauses 3.3.2.1.1 and 3.5.1.1.

41.1.5.1.3.2 Test purpose

To verify that the MS ignores a PAGING REQUEST TYPE 1, 2 messages where both P-TMSI and IMSI do not address the MS although the paging message is sent on the CCCH to which the CCCH_GROUP belongs.

41.1.5.1.3.3 Method of test

Initial Conditions

System Simulator:

1 cell, CCCH combined with SDCCH, GPRS supported, PCCCH absent, Max-Retrans = 2, BS_AG_BLK_RES = 2, BS_PA_MFRMS = 7, .

Mobile Station:

The MS is GPRS attached with a TMSI and a P-TMSI allocated and SPLIT PG CYCLE negotiated. The mobile station is in packet idle mode and has left the Transfer non-DRX mode period, i.e. for a R99 or later MS the system simulator shall wait for a period equivalent to the value of the NON_DRX_TIMER parameter before sending the first paging message to the MS.

Specific PICS Statements

-

PIXIT Statements

-

Test Procedure

The test is repeated twice. Each time a different paging message not addressing the MS is sent on the PCH belonging to the MS. It is checked that the no access attempt is made by the MS for 5 s.

The MS is then paged for packet paging. The MS attempts a random access for GPRS Attach and is allowed to complete the procedure.

Maximum Duration of Test

5 minutes.

Expected Sequence

The test steps 1 - 2 is repeated for k = 1 .. 2.

Step	Direction	Message	Comments
1A	SS -> MS	PAGING REQUEST TYPE 1	k=1, The two packet page indications are set to packet paging procedure. 1st Mobile Identity contains P-TMSI, 2nd Mobile Identity contains IMSI, both Identities do not address the MS. Sent on PCH belonging to the MS.
1B	SS -> MS	PAGING REQUEST TYPE 2	k=2, Packet page indication 3 is set to packet paging procedure. 1st Mobile Identity contains P-TMSI, 2nd Mobile Identity contains P-TMSI, 3rd Identity contains IMSI, all identities not addressing the MS. Sent on PCH belonging to the MS.
2	SS		Check that no CHANNEL REQUEST is sent from the MS for 5s.
3	SS -> MS	PAGING REQUEST TYPE 1	1 st Mobile Identity contains IMSI of the MS, second Mobile Identity not present. Packet page indication indicates packet paging procedure. Sent on PCH belonging to the MS.
4	MS -> SS	CHANNEL REQUEST	Establishment Cause "one phase packet access". Received on RACH.
5	SS<->MS	Completion of macro {GPRS attach procedure}	SS allows MS to complete GPRS attach.

Specific Message Contents

PAGING REQUEST TYPE 1 message:

Mobile Identity 1 - odd/even indication - Type of Identity - Identity Digits Mobile Identity 2 P1 rest octets - Packet Page Indication 1 - Packet Page Indication 2	Even. P-TMSI. P-TMSI value not allocated to MS. IMSI different from the value stored on the SIM. H, Packet Paging H, Packet Paging
--	---

PAGING REQUEST TYPE 2 message:

Mobile Identity 1 - TMSI value P2 rest octets - Packet Page Indication 3	P-TMSI value not allocated to the MS. LLLL H, Packet Paging
---	---

41.1.5.2 RR / Paging / on CCCH for GPRS service / extended paging

41.1.5.2.1 RR / Paging / on CCCH for GPRS service / extended paging with P-TMSI successful

41.1.5.2.1.1 Conformance requirements

The paging and immediate assignment type messages contain a page mode information element. This information element controls possible additional requirements on mobile stations belonging to the paging subgroup corresponding to the paging subchannel the message was sent on. This implies that a given mobile station shall take into account the page mode information element of any message sent on its own paging subchannel whatever the nature of this message (paging messages or immediate assignment messages). This further implies that the mobile station does not take into account page mode information element of messages sent on paging subchannels other than its own paging subchannel. The requirements yielded by the page mode information element are as follows:

- b) extended paging: the mobile station is required in addition to receive and analyse the next but one message on the PCH.

References

3GPP TS 04.18/44.018, subclauses 3.3.2.1.1, 3.5.2.1.2, 9.1.18, 9.1.19 and 9.1.20.

41.1.5.2.1.2 Test purpose

1. To verify that the MS operates in the extended page mode when it is ordered by the SS in PAGING REQUEST TYPE 1 which does not address the MS, but on the paging sub-channel corresponding to the MS identity.
2. To verify that the MS operates in the extended page mode when it is ordered by the SS in PAGING REQUEST TYPE 2 which does not address the MS, but on the paging sub-channel corresponding to the MS identity.
3. To verify that the MS operates in the extended page mode when it is ordered by the SS in PAGING REQUEST TYPE 3 which does not address the MS, but on the paging sub-channel corresponding to the MS identity.
4. To verify that the MS operates in the extended page mode when it is ordered by the SS in IMMEDIATE ASSIGNMENT on the paging sub-channel corresponding to the MS identity.
5. To verify that the MS operates in the extended page mode when it is ordered by the SS in IMMEDIATE ASSIGNMENT EXTENDED on the paging sub-channel corresponding to the MS identity.
6. To verify that the MS operates in the extended page mode when it is ordered by the SS in IMMEDIATE ASSIGNMENT REJECT on the paging sub-channel corresponding to the MS identity.

41.1.5.2.1.3 Method of test

Initial Conditions

System Simulator:

1 cell, GPRS supported, PCCCH absent, Max-Retrans = 2, CCCH_CONF = 1 basic physical channel used for CCCH with non-combined SDCCH, BS_AG_BLK_RES = 3, BS_PA_MFRMS = 8.

Mobile Station:

The MS is GPRS attached with a TMSI and a P-TMSI allocated and SPLIT PG CYCLE negotiated. The mobile station is in packet idle mode and has left the Transfer non-DRX mode period, i.e. for a R99 or later MS the system simulator shall wait for a period equivalent to the value of the NON_DRX_TIMER parameter before sending the first paging message to the MS.

Specific PICS Statements

-

PIXIT Statements

-

Test Procedure

The test is repeated 6 times. Each time a different downlink message is sent on PCH or AGCH for setting the page mode to extended paging. The MS is paged on the next but one page block for the packet paging procedure. The MS starts a random accesses which are rejected by the SS.

Maximum Duration of Test

5 minutes.

Expected Sequence

The test sequence is repeated for $k = 1 \dots 6$.

Step	Direction	Message	Comments
1A	SS -> MS	PAGING REQUEST TYPE 1	k=1, All mobile Identities do not address the MS. Page mode is set to "extended paging". Packet page indication indicates packet paging procedure. Sent on PCH.
1B	SS -> MS	PAGING REQUEST TYPE 2	k=2, All mobile Identities do not address the MS. Page mode is set to "extended paging". Packet page indication indicates packet paging procedure. Sent on PCH.
1C	SS -> MS	PAGING REQUEST TYPE 3	k=3, All mobile Identities do not address the MS. Page mode is set to "extended paging". Channel Needed IE's are coded with 00. Sent on PCH.
1D	SS -> MS	IMMEDIATE ASSIGNMENT	k=4, Page mode is set to "extended paging". Request Reference does not address any request references sent by the MS in previous test steps. Sent on paging channel (PCH).
1E	SS -> MS	IMMEDIATE ASSIGNMENT EXTENDED	Page mode is set to "extended paging". Request Reference does not address any request references sent by the MS in previous test steps. Sent on paging channel (PCH).
1F	SS -> MS	IMMEDIATE ASSIGNMENT REJECT	k=6, Page mode is set to "extended paging". Request Reference does not address any request references sent by the MS in previous test steps. Sent on paging channel (PCH).
2	SS -> MS	PAGING REQUEST TYPE 1	1st Mobile Identity contains P-TMSI of the MS, 2nd Mobile Identity not present. Page mode is set to "normal paging". Packet page indication indicates packet paging procedure. Sent on the next but one subblock on the same CCCH as previous paging message. Establishment Cause = "One phase access". Received on RACH. Establishment Cause "One phase access". Received on RACH. Request Reference = pertaining to the message received in step 4. Page mode is set to "normal paging". Sent on AGCH.
3	MS -> SS	CHANNEL REQUEST	
4	MS -> SS	CHANNEL REQUEST	
5	SS -> MS	IMMEDIATE ASSIGNMENT REJECT	

41.1.5.3 RR / Paging / on CCCH for GPRS service / paging reorganisation

41.1.5.3.1 Conformance requirements

The paging and immediate assignment type messages contain a page mode information element. This information element controls possible additional requirements on mobile stations belonging to the paging subgroup corresponding to the paging subchannel the message was sent on. This implies that a given mobile station shall take into account the page mode information element of any message sent on its own paging subchannel whatever the nature of this message (paging messages or immediate assignment messages). This further implies that the mobile station does not take into account page mode information element of messages sent on paging subchannels other than its own paging subchannel. The requirements yielded by the page mode information element are as follows:

- c) paging reorganization: The mobile station shall receive all messages on the CCCH regardless of the BS-AG-BLKS-RES setting. It is required to receive all BCCH messages. When the mobile station receives the next message to its (possibly new) paging subgroup the subsequent action is defined in the page mode information element in that message.

References

3GPP TS 04.18/44.018, subclause 3.3.2.1.1, 3.5.2.1.2.

3GPP TS 04.60/44.060, subclause 7.1.2.1

41.1.5.3.2 Test purpose

1. To verify that the MS, after reception of a message with page mode set to "paging reorganisation", answers to paging messages (with page mode set to "normal paging") sent on its old CCCH in paging blocks which do not belong to the MS's paging sub-channel.
2. To test that the MS correctly determines its new paging sub-channel when the number of reserved blocks, BS_AG_BLK_RES, and the number of 51-multiframes between transmissions of paging messages for mobile stations of the same paging group BS_PA_MFRMS are changed.
3. To test that the MS correctly determines its new paging sub-channel when the number of basic physical channels for CCCH is changed.
4. To test that the MS correctly determines its new paging sub-channel on PCCCH when PCCCH is established.

41.1.5.3.3 Method of test

Initial Conditions

System Simulator:

1 cell, GPRS supported, PCCCH absent, Max-Retrans = 2, CCCH_CONF = 0 (1 basic physical channel used for CCCH with non-combined SDCCH), BS_AG_BLK_RES = 3, BS_PA_MFRMS = 6. SPGC_CCCH_SUP = 0 (SPLIT_PG_CYCLE is not supported on CCCH in the cell).

Mobile Station:

The MS is GPRS attached with a TMSI and a P-TMSI allocated and SPLIT PG CYCLE negotiated. The mobile station is in packet idle mode and has left the Transfer non-DRX mode period, i.e. for a R99 or later MS the system simulator shall wait for a period equivalent to the value of the NON_DRX_TIMER parameter before sending the first paging message to the MS.

Specific PICS Statements

-

PIXIT Statements

-

Test Procedure

The page mode is set to paging reorganisation. The MS is paged for packet paging procedure through PAGING REQUEST TYPE 1 which is sent before the MS's original paging sub-channel re-occurs, but later than the next paging block of that CCCH. The MS starts the random access. The access attempt is rejected.

The SS changes the CCCH configuration with BS_AG_BLK_RES=2 and BS_PA_MFRMS=5 and waits two SI13 repeat periods, and then sets the page mode to Normal Paging. The MS is paged for packet paging procedure through PAGING REQUEST TYPE 2 sent on the new paging sub-channel. The MS starts the random access. The access attempt is rejected via IMMEDIATE ASSIGNMENT REJECT'. PAGING REQUEST TYPE 1 with paging fill frame and page mode set to "paging reorganisation" is sent.

Two additional CCCHs are activated by the SS. The same test procedure as above is repeated.

The SS restores all default radio parameters (in subclause 40.1), sets a non-combined CCCH and starts to transmitting PSIs on PBCCH. The SS waits two SI3 repeat periods + two PSI1 repeat periods. The MS is paged on PPCH. The random accesses from the MS are observed and are rejected.

NOTE : All the messages sent on PCCCH are sent with page mode "Normal Paging", unless explicitly stated in the testcase. All the L3 messages sent on CCCH are sent with page mode "Normal Paging".

Maximum Duration of Test

5 minutes.

Expected Sequence

Step	Direction	Message	Comments
1	SS -> MS	IMMEDIATE ASSIGNMENT EXTENDED	Page mode set to "paging reorganisation"
2	SS -> MS	PAGING REQUEST TYPE 1	Sent before the MS's original paging sub-channel re-occurs, but later than the next paging block of that CCCH. Page mode set to "normal paging", for packet paging procedure.
3	MS -> SS	CHANNEL REQUEST	Establishment Cause = "one phase access", received on RACH.
4	SS -> MS	IMMEDIATE ASSIGNMENT REJECT	Request Reference = pertaining to the message received in step 3.
5	SS	PAGING REQUEST TYPE 1	Sent on AGCH.
6	SS	PAGING REQUEST TYPE 1	Sent on the MS's paging sub-channel. Paging fill frame and page mode set to "paging reorganisation".
7	SS		All L3 messages sent on any paging sub-channel are paging fill frame specify Paging Reorganisation. Set BS_AG_BLKS_RES=2 and BS_PA_MFRMS=5 in SI's.
8	SS -> MS	PAGING REQUEST TYPE 2	The value of the BCCH_CHANGE_MARK in the SI13 is altered to indicate the changes. SI_CHANGE_FIELD = 3.
9	MS -> SS	CHANNEL REQUEST	Wait two SI13 repeat periods.
10	SS -> MS	IMMEDIATE ASSIGNMENT REJECT	All L3 messages sent on any paging sub-channel are paging fill frame specify Normal Paging.
11	SS	PAGING REQUEST TYPE 1	Wait for the time required for BS_PA_MFRMS Multi-Frames.
12	SS	PAGING REQUEST TYPE 1	1 st Mobile Identity contains P-TMSI of the MS. 2 nd Mobile Identity contains P-TMSI, 3 rd Identity contains IMSI, the last two identities not addressing the MS. Packet page indication indicates packet paging procedure. Page mode = "same as before", sent on the new PCH belonging to the MS.
13	SS		Establishment Cause = "one phase access". Received on RACH.
14	SS -> MS	PAGING REQUEST TYPE 2	Request Reference = pertaining to the message received in step 9.
15	MS -> SS	CHANNEL REQUEST	Sent on the MS's paging sub-channel.
16	SS -> MS	IMMEDIATE ASSIGNMENT REJECT	Paging fill frame and page mode set to "paging reorganisation".
			All L3 messages sent on any paging sub-channel are paging fill frame specify Paging Reorganisation.
			Reconfigure the SS channels so that additional two CCCH's are set on slot 2 and slot 4, Set CCCH_CONF = 4 in SI's.
			The value of the BCCH_CHANGE_MARK in the SI13 is altered to indicate the changes. SI_CHANGE_FIELD = 3.
			Wait two SI13 repeat periods.
			All L3 messages sent on any paging sub-channel are paging fill frame specify Normal Paging.
			Wait for the time required for BS_PA_MFRMS Multi-Frames.
			1 st Mobile Identity contains P-TMSI of the MS. 2 nd Mobile Identity contains P-TMSI, 3 rd Identity contains IMSI, the last two identities not addressing the MS. Packet page indication indicates packet paging procedure. Page mode = "same as before", sent on the new PCH belonging to the MS.
			Establishment Cause = "one phase access". Received on RACH.
			Request Reference = pertaining to the message received in step 15. Sent on AGCH.

17	SS	PAGING REQUEST TYPE 1	Sent on the MS's paging sub-channel. Paging fill frame and page mode set to "paging reorganisation".
18	SS		All L3 messages sent on any paging sub-channel are paging fill frame specify Paging Reorganisation. Restore the SS default radio parameters, so that there is one CCCH and one PBCCH+PCCCH, set CCCH_CONF = 0 in SIs, start PSIs broadcasting. The value of the BCCH_CHANGE_MARK in the SI13 is altered to indicate the changes. SI_CHANGE_FIELD = 0.
19	SS		Wait two SI3 repeat periods + two PS11 repeat periods. All L3 messages sent on any paging sub-channel are paging fill frame specify Normal Paging. Wait for time required for 64/SPLIT_PG_CYCLE multiframes.
20	SS -> MS	PACKET PAGING REQUEST	1st Repeated Page info contains P-TMSI of the MS, no other Repeated Page info. Sent on PPCH.
21	MS-> SS	PACKET CHANNEL REQUEST	ACCESS TYPE = " Page Response ". Received on PRACH.
22	SS -> MS	PACKET ACCESS REJECT	Random Reference = pertaining to the message received in step 21.

Specific Message Contents

41.1.5.4 RR / Paging / on CCCH for GPRS service / default message contents

Contents for SYSTEM INFORMATION and PACKET SYSTEM INFORMATION Messages:

System information Type 13

L2 Pseudo Length	0
RR management Protocol Discriminator	RR
Skip Indicator	0000
System Information Type 13 Message Type	00
SI 13 Rest Octets	
-	H (SI 13 Rest Octets are not spare)
- BCCH_CHANGE_MARK	000
- SI_CHANGE_FIELD	0 Update of unspecified message
- {0 1	0 GPRS Mobile Allocation IE not present
- {0 1	0 (PBCCH not present in cell)
- RAC	00000101(Binary)
-SPGC_CCCH_SUP	1 supported
-PRIORITY_ACCESS_THR	110 PA allowed for priority level 1 to 4
-NETWORK_CONTROL_ORDER	00 NC0
-GPRS Cell Options	Present
-Network Mode of Operation	NMO 1
-T3168	2 seconds
-T3192	1.5 seconds
-DRX_TIMER_MAX	000 Non-DRX not supported
-ACCESS_BURST_TYPE	0 Use 8 bits access burst
-CONTROL_ACK_TYPE	1 RLC/MAC control block
-BS_CV_MAX	0111 value 7
-PAN_DEC	011 value 3
-PAN_INC	011 value 3
-PAN_MAX	010 Max value for counter N3102=12
-Optional extension information	0 Extension information not present
For R99/Rel 4/Rel 6 network simulation:	
Optional extension information	1 Extension information present
- Extension length	R99: 000011
	Rel 4: 000101
	Rel 6: 001001
- {0 1 <Extension Information>}	0 EGPRS not supported by the cell.
- PFC_FEATURE_MODE	0 Packet Flow Context Procedures not supported
- DTM_SUPPORT	Default: 0.....The cell does not support DTM procedures For DTM test cases:

- BSS_PAGING_COORDINATION	1.....The cell supports DTM procedures
For Rel 4 network simulation	0 Circuit-Switched paging coordination not supported in cell
- CNN_ACTIVE	0 CNN is disabled in the cell
- NW_EXT_UTBF	0 Ext UL TBF not supported in the cell
For Rel 6 network simulation	
- MULTIPLE_TBF_CAPABILITY	0 Cell does not support multiple TBF procedures
- EXT_UTBF_NO_DATA	0 MS shall send a PACKET UPLINK DUMMY CONTROL BLOCK message when there is no other RLC/MAC block ready to send in an uplink radio block allocated by the network
- DTM_ENHANCEMENTS_CAPABILITY	0 Cell does not support enhanced DTM CS establishment and enhanced DTM CS release procedures
- { 0 1 }	0 -- MBMS procedures not supported by the cell
End Rel 6	
End Rel 4	
End R99	
-GPRS Power Control Parameters	Present
-ALPHA	0101 Alpha = 0.5
-T_AVG_W	01100 value 12
-T_AVG_T	01100 value 12
-PC_MEAS_CHAN	0 BCCH
-N_AVG_I	0111 value 7
For R99/Rel 4/Rel 6 network simulation:	
- Additions in R99	H
- SGSNR bit	1 SGSN is Release '99 onwards
- Additions in Rel 4	H
- SI_STATUS_IND bit	0 PACKET SI STATUS message not supported
- Additions in Rel 6	H
{LB_MS_TXPWR_MAX_CCH}	1 LB_MS_TXPWR_MAX_CCH present
- LB_MS_TXPWR_MAX_CCH	01010
- SI2n_SUPPORT	00
End Rel 6	
End Rel 4	
End R99	
-spare padding	Spare Padding

41.1.6 RR / Paging / Before T3172 expiry

41.1.6.1 Conformance requirements

On receipt of a PACKET ACCESS REJECT message containing a WAIT_INDICATION field in a Reject structure addressed to the mobile station, where the Packet Request Reference in the Reject structure corresponds to one of its 3 last PACKET CHANNEL REQUEST messages, the mobile station shall stop sending PACKET CHANNEL REQUEST messages, start timer T3172 with the value indicated in the WAIT_INDICATION field. During the time T3172 is running, the mobile station shall ignore all received PACKET PAGING REQUEST messages except paging request to trigger RR connection establishment.

References

3GPP TS 04.60, subclause 7.1.2.2.4.

41.1.6.2 Test purpose

To verify that during the time T3172 is running, the MS ignores all received PACKET PAGING REQUEST messages except paging request to trigger RR connection establishment.

41.1.6.3 Method of test

Initial Conditions

System Simulator:

1 cell, CCCH combined with SDCCH, GPRS supported, PCCCH present, Max-Retrans = 2, access burst type = 11 bits, BS_PAG_BLK_RES = 2, BS_PBCCH_BLK = 3, BS_PCC_CHANS = 1 and BS_PRACH_BLK = 1.

Mobile Station:

The MS is GPRS attached with a P-TMSI allocated, SPLIT PG CYCLE negotiated. The mobile station is in packet idle mode and has left the Transfer non-DRX mode period, i.e. for a R99 or later MS the system simulator shall wait for a period equivalent to the value of the NON_DRX_TIMER parameter before sending the first paging message to the MS.

Specific PICS Statements

- Supporting GPRS MS Class A (TSPC_operation_mode_A)
- Supporting GPRS MS Class B (TSPC_operation_mode_B)
- Supporting GPRS MS Class C (TSPC_operation_mode_C)

PIXIT Statements

-

Test Procedure

The MS is paged for initiation of a random access. The access attempt is rejected with a WAIT_INDICATION = 50 s. in PACKET ACCESS REJECT. The MS is then continuously paged for TBF establishment for 20 s. The SS checks that there is no transmission from the MS on PRACH for 8 s. after having sent PACKET ACCESS REJECT. The MS is paged for an RR connection establishment. The MS of class A or B shall start random accesses for channel request with cause 'one phase access'. The access attempt is rejected.

Maximum Duration of Test

5 minutes.

Expected Sequence

Step	Direction	Message	Comments
1	SS -> MS	PACKET PAGING REQUEST	1 st Repeated Page info contains P-TMSI of the MS, 2 nd Repeated Page info contains IMSI not addressing the MS, for TBF establishment. Sent on PPCH.
2	MS -> SS	PACKET CHANNEL REQUEST	Received on PRACH.
3	SS -> MS	PACKET ACCESS REJECT	Containing WAIT_INDICATION = 50 s. and packet request reference = pertaining to the message received in step 2. Sent on PAGCH.
4	SS -> MS	PACKET PAGING REQUEST	1 st Repeated Page info contains P-TMSI of the MS, 2 nd Repeated Page info contains IMSI not addressing the MS, for TBF establishment. Sent on PPCH.
5	SS		Repeat step 4 for 20 s. and check that there is no transmission from the MS on PRACH for 25 s. after step 4.
6	SS -> MS	PACKET PAGING REQUEST	Step 6 is done not later than 50 secs after step 3. 1 st Repeated Page info contains TMSI of the MS, for RR connection establishment, Channel Needed = " TCH/F ", PAGE_MODE = " normal paging ", sent on PPCH.
8A	MS -> SS		For MS class C of mode of operation
9A			
8B	MS -> SS	CHANNEL REQUEST	For GPRS MS class A and B of mode of operation, answer to paging, received on RACH.
9B	SS -> MS	IMMEDIATE ASSIGNMENT REJECT	Request Reference = pertaining to message received in step 8B. Sent on AGCH.

Specific Message Contents

PACKET ACCESS REJECT message:

MESSAGE_TYPE	000001
PAGE_MODE	Normal Paging
Reject	
-	10 (not TLLI, but packet request reference)
- Packet Request Reference	pertaining to what received in step 3.
-	1 (wait indication)
- WAIT_INDICATION	50
- WAIT_INDICATION_SIZE	0 (units of seconds)
-	0 (end of Reject struct)
spare padding	Spare Padding

41.2 RR procedures on CCCH related to temporary block flow establishment

This clause presents tests for "RR procedures on CCCH related to temporary block flow establishment" which are specified in 3GPP TS 04.08 / 3GPP TS 44.018, subclause 3.5.

Default conditions

The SS default conditions simulate one cell with default settings as defined in the GPRS general defaults section, except:

- SI 13 Rest Octets contains no PCCCH description (PCCCH is not supported by the network).

The MS default initial condition is GPRS attached. Unless otherwise stated, no PDP context is required.

Default message contents and signaling macros are also defined in the GPRS general defaults section, except for those messages and macros specified at the end of this clause.

41.2.1 Permission to access the network

41.2.1.1 Permission to access the network / priority classes

41.2.1.1.1 Conformance requirements

Access to the network is allowed:

- if packet access is allowed in the cell for the priority class associated with the packet transfer, as indicated by the PRIORITY_ACCESS_THR parameter broadcast in SI 13 message.

References

3GPP TS 04.08 / 3GPP TS 44.018 subclause 3.5.2.1.1.

41.2.1.1.2 Test purpose

To verify that the MS accesses the network only if packet access is allowed in the cell for the priority class associated with the packet transfer.

41.2.1.1.3 Method of test

Initial conditions

System Simulator:

Network Mode of Operation is set to NMO II.

Mobile Station:

For PRIORITY_ACCESS_THR >2 MS is GPRS attached, a PDP context has been established (with priority level as specified below).

For PRIORITY_ACCESS_THR <=2 MS is Idle Updated.

Specific PICS Statements

-

PIXIT Statements

-

Test procedure

Specific test parameters:

PRIORITY_ACCESS_THR is chosen from {0, 1, 2, 3, 4, 5, 6, 7}.

priority level is chosen from {1, 2, 3, 4}.

Expected sequence

For PRIORITY_ACCESS_THR >2.

Step	Direction	Message	Comments
1			The MS is triggered to transfer data
2	SS		See verification

Verification:

The SS verifies for 10 s that MS access (or not) to the network according to the PRIORITY_ACCESS_THR values below.

- 0 1 1 packet access is allowed for priority level 1;
- 1 0 0 packet access is allowed for priority level 1 to 2;
- 1 0 1 packet access is allowed for priority level 1 to 3;
- 1 1 0 packet access is allowed for priority level 1 to 4;
- 1 1 1 spare, shall be interpreted as(packet access allowed).

For PRIORITY_ACCESS_THR <=2.

Step	Direction	Message	Comments
1			The MS is triggered to do Attach procedure
2	SS		The SS verifies for 10 s that MS does not try to access to the network.

41.2.2 Initiation of the packet access procedure

41.2.2.1 Initiation of the packet access procedure / establishment causes

41.2.2.1.1 Conformance requirements

The CHANNEL REQUEST messages are sent on RACH and contain the parameters:

- an establishment cause which indicates packet access, and as applicable, a request for one phase packet access or single block packet access;
- a random reference which is drawn randomly from a uniform probability distribution for every new transmission.

If the requested RLC mode is *unacknowledged mode*, the mobile station shall request a single block packet access and attempt a two phase packet access.

If the purpose of the packet access procedure is to send a Page Response, Cell Update, for a GPRS Mobility Management or a GPRS Session Management procedure the mobile station shall request a one phase packet access.

References

3GPP TS 04.08 / 3GPP TS 44.018 subclause 3.5.2.1.2

Justification

41.2.2.1.2 Test purpose

To verify that the CHANNEL REQUEST message sent by the MS contains the correct establishment cause when initiating a packet access procedure.

41.2.2.1.3 Method of test

Initial conditions

System Simulator:

1 cell, CCCH combined with SDCCH.

Mobile Station:

MS is switched off.

Specific PICS Statements

-

PIXIT Statements

-

Test procedure

The MS is triggered to initiate a GPRS attach procedure. The SS verifies that the MS attempts a one phase packet access.

APDP context for RLC unacknowledged is established and the MS is triggered to transfer RLC data blocks. The SS verifies that the MS correctly sets the Establishment Cause in the CHANNEL REQUEST message.

Maximum duration of the test

-

Expected sequence

Step	Direction	Message	Comments
1	MS		MS is switched on and triggered to initiate a GPRS attach procedure.
2	MS -> SS	CHANNEL REQUEST	SS verifies that Establishment Cause is 'one phase'. SS allows MS to complete GPRS attach.
3	SS -> MS	IMMEDIATE ASSIGNMENT	
4	SS <-> MS	Completion of macro {GPRS attach procedure}	
5	MS<->SS		A PDP context is established for RLC unacknowledged data transfer.
6	MS		MS is triggered to transfer data.
7	MS -> SS	CHANNEL REQUEST	SS verifies that Establishment Cause is 'single block access'.
8	SS -> MS	IMMEDIATE ASSIGNMENT REJECT	

41.2.2.2 Random references for single block packet access

41.2.2.2.1 Conformance requirements

The random reference in the CHANNEL REQUEST messages shall be randomly drawn from a uniform probability distribution for every new transmission.

References

3GPP TS 04.08 / 3GPP TS 44.018 subclause 3.5.2.1.2.

41.2.2.2.2 Test purpose

To verify that the MS produces different Random References when accessing the network for single block access.

41.2.2.2.3 Method of test

Initial conditions

System Simulator:

1 cell, CCCH combined with SDCCH, Parameter MAX_RETRANS is set to 4 retransmissions.

Mobile Station:

MS is GPRS attached, a PDP context in RLC unacknowledged mode has been established and the MS is in Packet Idle mode.

Specific PICS Statements

-

PIXIT Statements

-

Test procedure

The MS is triggered to transfer data, it shall attempt a single block packet access (3GPP TS 04.08 / 3GPP TS 44.018 subclause 3.5.2.1.2). The SS does not answer to the access bursts but stores N (= 80) Random References and verifies that the MS uses all possible values (0 ... 7) in its Random Reference.

Justification

The length of the Random Reference is 3 bits for single block packet access (3GPP TS 04.08 / 3GPP TS 44.018 / table 9.9). This test verifies that the MS uses all values (0 ... 7) in its Random Reference.

The probability that in a sequence of N samples one of the possible value does not appear is $8^{-(7/8)^{**}N}$ for large N.

NOTE: The number of samples N has been computed such that the probability of refusing a correct MS is less than 0,02 %.

Maximum duration of the test

-

Expected sequence

Step	Direction	Message	Comments
1	MS		MS is triggered to transfer data.
2	MS -> SS	CHANNEL REQUEST	SS stores the value of Request References
3	MS -> SS	CHANNEL REQUEST	SS stores the value of Request References
4	MS -> SS	CHANNEL REQUEST	SS stores the value of Request References
5	MS -> SS	CHANNEL REQUEST	SS stores the value of Request References
6	MS -> SS	CHANNEL REQUEST	SS stores the value of Request References
7	SS		SS waits 5.5 seconds (Maximum value of T3146 is 5 seconds) Note: Test Case executes Step 8A or 8B depending on MS behaviour. If any CHANNEL REQUEST is received during the wait time, SS continues with Step 8A else SS continues with Step 8B
8A (Conditional)	MS -> SS	CHANNEL REQUEST	SS stores the value of Request References and repeats the Steps 3 to 7.
8B (Conditional)	SS		Repeat Steps 1 to 7
9	MS<->SS		Steps 1 to 8 are repeated until 80 CHANNEL REQUEST messages have been received
10	SS		SS verifies that all Request Reference values (0 to 7) come out in the stored samples.

41.2.2.3 Random references for one phase packet access

41.2.2.3.1 Conformance requirements

The random reference in the CHANNEL REQUEST messages shall be randomly drawn from a uniform probability distribution for every new transmission.

References

3GPP TS 04.08 / 3GPP TS 44.018 subclause 3.5.2.1.2.

41.2.2.3.2 Test purpose

To verify that the MS produces different Random References when accessing the network for one phase access.

41.2.2.3.3 Method of test

Initial conditions

System Simulator: default settings except:

- Parameter MAX_RETRANS is set to 4 retransmissions.
- T3302 = 1 minute, T3212 sent in SI3 is set to 6 minutes.

Mobile Station:

Note: MS may be brought into the required condition by causing it to be triggered to perform GPRS attach and the SS responding with ATTACH REJECT in which T3302 is set to 1 minute and the cause set to "MSC temporarily not reachable". MS treats this as a temporary failure and enters the test sequence by restarting the attach procedure.

Specific PICS Statements

-

PIXIT Statements

-

Test procedure

The MS shall attempt a one phase packet access (3GPP TS 04.08 / 3GPP TS TS 44.018, subclause 3.5.2.1.2). The SS does not answer to the access bursts but stores N (= 80) Random References and verifies that the MS uses all possible values (0 ... 3) in its Random Reference and does not use value '111' as a value of the 3 least significant bits for channel request octet (see 3GPP TS 04.08 / 3GPP TS 44.018 / table 9.9).

Justification

Possible values for Random Reference for one phase packet access are 0 to 3 (value '111' is not allowed). This test verifies that the MS uses all values (0 ... 3) in its Random Reference.

Maximum duration of the test

-

Expected sequence

Step	Direction	Message	Comments
	MS		MS re-starts the Attach Procedure.
1	MS -> SS	CHANNEL REQUEST	SS stores the value of Request References
2	MS -> SS	CHANNEL REQUEST	SS stores the value of Request References
3	MS -> SS	CHANNEL REQUEST	SS stores the value of Request References
4	MS -> SS	CHANNEL REQUEST	SS stores the value of Request References
5	MS -> SS	CHANNEL REQUEST	SS stores the value of Request References
6		{Location Update Procedure}	Step 6 is optional and depends on the mobile implementation.
7	MS<->SS		Macro for Location Updating. Steps 1 to 6 are repeated N/5 = 16 times
8	SS		SS verifies that all Random Reference values (Random Reference field is filled with "x") in the range 0 to 3 come out in the stored samples and that value '111' is not used as a value of the 3 least significant bits for channel request octet.

The Channel Request message is coded as follows (reference 3GPP TS 04.08 / 3GPP TS 44.018 table 9.1.8.1):

011110xx 01111x0x 01111xx0	One phase packet access with request for single timeslot uplink transmission; one PDCH is needed.
----------------------------------	---

41.2.2.4 Initiation of the packet access procedure / timer T3146

41.2.2.4.1 Conformance requirements

Having sent the maximum number of CHANNEL REQUEST messages, the mobile station starts timer T3146. At expiry of timer T3146, the packet access procedure is aborted and a packet access failure is indicated to upper layers.

Reference

3GPP TS 04.08 / 3GPP TS 44.018 subclause 3.5.2.1.2.

41.2.2.4.2 Test purpose

To verify that the MS waits T3146 seconds before aborting the packet access procedure.

41.2.2.4.3 Method of test

Initial conditions

System Simulator: Default settings except:

System Information parameter MAX_RETRANS is set to 2 retransmissions.

CCCH non-combined with SDCCH.

System Information parameter TX_INTEGER in RACH Control Parameters is set to 3.

Mobile Station:

MS is switched off.

Specific PICS Statements

-

PIXIT Statements

-

Test procedure

The MS is triggered to initiate the GPRS attach procedure, the SS waits until the MS sends all M+1 CHANNEL REQUEST messages, where M is the parameter Max Retrans broadcast on BCCH. The SS waits until T3146 seconds elapse and sends an IMMEDIATE ASSIGNMENT which shall be ignored by the MS since the access procedure should be aborted.

The MS shall retry the access procedure (according to 3GPP TS 04.60 subclause 7.1.2.3). Again, the SS waits until the MS sends all M+1 CHANNEL REQUEST messages, and then sends an IMMEDIATE ASSIGNMENT before T3146 seconds elapse. In this case the MS shall correctly send the LLC PDU on the assigned PDCH.

Note:

Timer T3146 (3GPP TS 04.08 / 3GPP TS 44.018, clause 11) depends on parameter TX_INTEGER broadcast on BCCH.

The minimum value of the timer is $2 \cdot S + TX_INTEGER$ slots, where S is given in 3GPP TS 04.08 / 3GPP TS 44.018, table 3.1.

The maximum value of this timer is 5 s (subclause 11.1.1 in 3GPP TS 04.08).

Maximum duration of the test

-

Expected sequence

Step	Direction	Message	Comments
1	MS -> SS	CHANNEL REQUEST	The MS turned on and triggered to initiate the GPRS attach procedure.
2	MS -> SS	CHANNEL REQUEST	
3	MS -> SS	CHANNEL REQUEST	
4	SS		
5	SS -> MS	IMMEDIATE ASSIGNMENT	SS waits 5.5 seconds (Maximum value of T3146 is 5 seconds) for uplink TBF, one phase access. MS shall ignore the message, SS verifies that MS does not send any RLC data or control blocks.
6	SS		
7	MS -> SS	CHANNEL REQUEST	MS attempts a second time to access the network.
8	MS -> SS	CHANNEL REQUEST	
9	MS -> SS	CHANNEL REQUEST	
10	SS		SS waits $T3146 - 0.1 \cdot T3146$ (using minimum value of T3146, which is $2 \cdot S + TX_INTEGER$ slots) for uplink TBF, one phase access.
11	SS -> MS	IMMEDIATE ASSIGNMENT	
12	SS <-> MS	Completion of macro {GPRS attach procedure}	SS allows MS to complete GPRS attach.

The complete test is repeated for:

- TX_INTEGER set to 20; and for

- TX_INTEGER set to 32.

41.2.2.5 Initiation of the packet access procedure / Request Reference

41.2.2.5.1 Conformance requirements

On receipt of an IMMEDIATE ASSIGNMENT message corresponding to one of its 3 last CHANNEL REQUEST messages, the mobile stops sending CHANNEL REQUEST messages and switches to the assigned PDCH.

Reference

3GPP TS 04.08 / 3GPP TS 44.018 subclause 3.5.2.1.3.1.

41.2.2.5.2 Test purpose

1. To verify that the MS continues sending CHANNEL REQUEST messages when receiving an IMMEDIATE ASSIGNMENT containing an incorrect Request Reference.
2. To verify that the MS stops sending CHANNEL REQUEST messages and switches to the assigned PDCH when receiving an IMMEDIATE ASSIGNMENT containing a Request Reference IE corresponding to one of its last 3 CHANNEL REQUEST messages.

41.2.2.5.3 Method of test

Initial conditions

System Simulator:

1 cell, CCCH combined with SDCCH, Parameter MAX_RETRANS is set to 7 retransmissions.

Mobile Station:

The MS is switched off.

Specific PICS Statements

-

PIXIT Statements

-

Test procedure

The MS is triggered to initiate the GPRS attach procedure. After 3 CHANNEL REQUEST messages, the SS sends an IMMEDIATE ASSIGNMENT including an incorrect Request Reference. The SS verifies that the MS continues sending CHANNEL REQUEST messages.

After the 5th CHANNEL REQUEST message the SS sends an IMMEDIATE ASSIGNMENT including a correct Request Reference. The SS verifies that the MS stops sending CHANNEL REQUEST messages, switches to the assigned PDCH and completes the attach procedure.

Maximum duration of the test

-

Expected sequence

Step	Direction	Message	Comments
0	MS		The MS is turned on and triggered to initiate the GPRS attach procedure.
1	MS -> SS	CHANNEL REQUEST	
2	MS -> SS	CHANNEL REQUEST	
3	MS -> SS	CHANNEL REQUEST	
4	SS -> MS	IMMEDIATE ASSIGNMENT	for uplink TBF, one phase access, dynamic allocation and including a Request Reference different from those included in previous CHANNEL REQUEST messages.
5	MS -> SS	CHANNEL REQUEST	MS continues sending CHANNEL REQUEST messages.
6	MS -> SS	CHANNEL REQUEST	
7	SS -> MS	IMMEDIATE ASSIGNMENT	with Request Reference corresponding to step 3. MS shall stop sending further access bursts.
8	MS -> SS	RLC data block (GMM ATTACH REQUEST)	(see message contents in default section)
9	MS<->SS	Completion of macro {GPRS attach procedure}	SS allows MS to complete the attach procedure.

41.2.3 Packet immediate assignment / One phase packet access

41.2.3.1 Two-message assignment / Successful case

41.2.3.1.1 Conformance requirements

If the mobile station receives an IMMEDIATE ASSIGNMENT message and the Dedicated mode or TBF information element indicates that this is the first message in a two-message assignment, the mobile station shall continue to listen to the full CCCH. The network may send a second IMMEDIATE ASSIGNMENT message within two multiframe periods following the first IMMEDIATE ASSIGNMENT, specifying the packet channel description and, if required, a mobile allocation for the assignment.

On receipt of an IMMEDIATE ASSIGNMENT message or, in case of a two-message assignment, a matching pair of IMMEDIATE ASSIGNMENT messages corresponding to one of its 3 last CHANNEL REQUEST messages, the mobile station stops T3146 (if running), stops sending CHANNEL REQUEST messages, and switches to the assigned PDCH.

Reference

3GPP TS 04.08 / 3GPP TS 44.018 subclause 3.5.2.1.3.1.

41.2.3.1.2 Test purpose

To verify that the MS correctly decodes a two-message assignment and switches to the assigned PDCH.

41.2.3.1.3 Method of test

Initial conditions

System Simulator:

1 cell, CCCH combined with SDCCH.

Mobile Station:

MS is switched off.

Specific PICS Statements

-

PIXIT Statements

-

Test procedure

The MS is triggered to initiate the GPRS attach procedure. After reception of CHANNEL REQUEST the SS sends a two-message IMMEDIATE ASSIGNMENT which actually describe a default IMMEDIATE ASSIGNMENT message, except that it is split in two parts: basically, the first part contains the IA Rest Octets, and the second part the Packet Channel Description IE.

The SS verifies that the MS correctly switches to the assigned PDCH and completes GPRS attach.

Maximum duration of the test

-

Expected sequence

Step	Direction	Message	Comments
1	MS		MS is turned on and triggered to initiate the GPRS attach procedure.
2	MS -> SS	CHANNEL REQUEST	
3	SS -> MS	IMMEDIATE ASSIGNMENT	first message of two-message assignment
4	SS -> MS	IMMEDIATE ASSIGNMENT	second message (see specific message contents), sent within two multiframe after step 3.
5	MS<->SS	Completion of macro {GPRS attach procedure}	SS allows MS to complete the GPRS attach procedure.

Specific message contents:

IMMEDIATE ASSIGNMENT (first message)

Information Element	Value
as default except:	
Dedicated mode or TBF:	
- TMA	1 (is first message of a two-message assignment)
- Downlink	0
- T/D	1 (assign a TBF)
Packet Channel Description:	all bits are set to '0'
Request Reference:	as default
Timing Advance:	as default
Starting Time:	not present
IA Rest Octets:	as default

IMMEDIATE ASSIGNMENT (second message)

Information Element	Value
as default except:	
Dedicated mode or TBF:	
- TMA	0
- Downlink	0
- T/D	1 (assign a TBF)
Packet Channel Description:	as default
Request Reference:	as default
Timing Advance:	as default
Starting Time:	not present
IA Rest Octets:	Second Part Packet Assignment

41.2.3.2 Two-message assignment / Failure cases

41.2.3.2.1 Conformance requirements

If the indirect encoding is used, the IMMEDIATE ASSIGNMENT message may contain a CHANGE_MARK_1 field. If that is present, the mobile station shall verify the validity of the SI13_CHANGE_MARK associated with the GPRS mobile allocation to which the message refers, see 3GPP TS 04.60. If the CHANGE_MARK_1 field and the SI13_CHANGE_MARK do not match, the message does not satisfactorily define a PDCH.

The two IMMEDIATE ASSIGNMENT messages in a two-message assignment shall have the same contents of the Request Reference information elements.

If the mobile station does not receive the second IMMEDIATE ASSIGNMENT messages in a two-message assignment within two multiframe periods following the first message, the mobile station shall discard the first IMMEDIATE ASSIGNMENT message received.

Reference

3GPP TS 04.08 / 3GPP TS 44.018 subclause 3.5.2.1.3.1.

41.2.3.2.2 Test purpose

To verify that the MS does not respond to a two-message assignment if:

- CHANGE_MARK_1 does not match SI13 CHANGE_MARK.
- The second IMMEDIATE ASSIGNMENT message is not received within two multiframes after the first - message.
- Request References in both messages do not have same contents.

41.2.3.2.3 Method of test

Initial conditions

System Simulator:

1 cell, CCCH combined with SDCCH, CHANGE_MARK in SI13 is set to 1, TX-INTEGGER = 7.

Mobile Station:

MS is switched off.

Specific PICS Statements

-

PIXIT Statements

-

Test procedure

The MS is triggered to initiate the GPRS attach procedure. After reception of CHANNEL REQUEST the SS sends a two-message IMMEDIATE assignment:

- first attempt: CHANGE_MARK does not match SI13 CHANGE_MARK. MS shall re-initiate packet access (see 3GPP TS 04.08 / 3GPP TS 24.008, subclause 4.7.3.1.5, GPRS attach procedure / Abnormal cases).
- second attempt: the second IMMEDIATE ASSIGNMENT message is not received within two multiframes after the first message. MS shall discard the first IMMEDIATE ASSIGNMENT message received.
- third attempt: Request References in both messages do not have same contents. MS shall re-initiate packet access.

- fourth attempt: the second IMMEDIATE ASSIGNMENT message is received in the last access grant block before the second multiframes after the first message. In this case the MS shall successfully switch to the assigned PDCH and complete the GPRS attach procedure.

Maximum duration of the test

-

Expected sequence

Step	Direction	Message	Comments
1	MS		The MS is triggered to initiate the GPRS attach procedure.
2	MS -> SS	CHANNEL REQUEST	first message of two-message assignment with contents as specified below (see specific message contents). second message (see specific message contents) except: Packet Channel Description IE describes a hopping channel including CHANGE_MARK_1 different from SI13 CHANGE_MARK.
3	SS -> MS	IMMEDIATE ASSIGNMENT	
4	SS -> MS	IMMEDIATE ASSIGNMENT	
5	MS -> SS	CHANNEL REQUEST	MS shall re-initiate packet access first message of two-message assignment (see specific message contents) second message (see specific message contents) sent after two multiframes after the first message.
6	SS -> MS	IMMEDIATE ASSIGNMENT	
7	SS -> MS	IMMEDIATE ASSIGNMENT	
8	MS -> SS	CHANNEL REQUEST	MS shall discard the IMMEDIATE ASSIGNMENT message and continue with Packet Access procedure. first message of two-message assignment (see specific message contents) including a Request Reference corresponding to step 8. second message (see specific message contents) except: Request Reference is different from that in step 8.
9	SS -> MS	IMMEDIATE ASSIGNMENT	
10	SS -> MS	IMMEDIATE ASSIGNMENT	
11	MS -> SS	CHANNEL REQUEST	MS shall re-initiate packet access first message of two-message assignment (see specific message contents) second message (see specific message contents) sent in the last access grant block before the second multiframe after the first message elapses. SS allows MS to complete the GPRS attach procedure.
12	SS -> MS	IMMEDIATE ASSIGNMENT	
13	SS -> MS	IMMEDIATE ASSIGNMENT	
14	MS<->SS	Completion of macro {GPRS attach procedure}	

Specific message contents:

IMMEDIATE ASSIGNMENT (first message)

Information Element	Value
as default except:	
Dedicated mode or TBF:	
- TMA	1 (is first message of a two-message assignment)
- Downlink	0
- T/D	1 (assign a TBF)
Packet Channel Description:	all bits are set to '0'
Request Reference:	as default
Timing Advance:	as default
Starting Time:	not present
IA Rest Octets:	as default

IMMEDIATE ASSIGNMENT (second message)

Information Element	Value
as default except:	
Dedicated mode or TBF:	
- TMA	0
- Downlink	0
- T/D	1 (assign a TBF)
Packet Channel Description:	as default
Request Reference:	as default
Timing Advance:	as default
Starting Time:	not present
IA Rest Octets:	Second Part Packet Assignment

41.2.3.3 Packet uplink assignment / Polling bit set

41.2.3.3.1 Conformance requirement

If the Polling bit is set to 1, MS shall send a PACKET CONTROL ACKNOWLEDGEMENT message (see 04.60) on the assigned PDCH, in the uplink block specified by the TBF Starting Time. In this case the TBF Starting Time is used both to indicate when the assigned PDCH becomes valid and to specify the uplink block.

Reference

3GPP TS 04.08 / 3GPP TS 44.018 subclause 3.5.2.1.3.2.

41.2.3.3.2 Test purpose

To verify that the MS sends a PACKET CONTROL ACKNOWLEDGEMENT message in the correct uplink block if the Polling bit is set in packet uplink assignment construction.

41.2.3.3.3 Method of test

Initial conditions

System Simulator:

1 cell, CCCH combined with SDCCH.

Mobile Station:

MS is switched off.

Specific PICS Statements

- MS operation mode B Yes/No (TSPC_operation_mode_B)
- Automatic GPRS attach procedure at switch on or power on Yes/No (TSPC_AddInfo_on_auto_GPRS_AP)

PIXIT Statements

-

Test procedure

The MS is triggered to initiate the GPRS attach procedure. The SS assigns packet uplink resources in an IMMEDIATE ASSIGNMENT message indicating one phase packet access and with the Polling bit set. The MS shall send a PACKET CONTROL ACKNOWLEDGMENT on the assigned uplink block and then complete the GPRS attach procedure.

Maximum duration of the test

-

Expected sequence

Step	Direction	Message	Comments
1	MS		The MS is powered up or switched on.
2		{Location Update Procedure}	This step is for class B non auto attach mobiles only. Macro. Location Update Procedure initiated from the MS. Parameter mobile identity is IMSI.
3	MS		MS is triggered to initiate GPRS attach.
4	MS -> SS	CHANNEL REQUEST	
5	SS -> MS	IMMEDIATE ASSIGNMENT	for uplink TBF, one phase access and Polling bit set, and arbitrarily chosen TBF starting time in the future.
6	MS -> SS	PACKET CONTROL ACKNOWLEDGEMENT	sent on the block indicated by TBF starting time in step 3.
7	SS<->MS	Completion of macro {GPRS attach procedure}	SS allows MS to complete GPRS attach.

41.2.3.4 One phase packet access / Contention resolution / Successful case

41.2.3.4.1 Conformance requirements

After receiving an IMMEDIATE ASSIGNMENT message in which one phase packet access for an uplink transfer is granted, the mobile station shall start timer T3164 and proceed with the contention resolution at one phase access defined in 3GPP TS 04.60.

Reference

3GPP TS 04.08 / 3GPP TS 44.018 subclause 3.5.2.1.3.2.

3GPP TS 04.60 subclause 7.1.2.3.

41.2.3.4.2 Test purpose

To verify that the MS includes the correct TLLI (Temporary Logical Link Identifier) in the first RLC data blocks until contention resolution is completed.

41.2.3.4.3 Method of test

Initial conditions

System Simulator:

1cell, CCCH combined with SDCCH.

Mobile Station:

MS is GPRS attached, the PDP context 2 has been established and the MS is in Packet Idle mode.

Specific PICS Statements

-

PIXIT Statements

-

Test procedure

The MS is triggered to transfer data. The SS assigns packet uplink resources in an IMMEDIATE ASSIGNMENT message indicating one phase packet access. The MS shall start transferring RLC data blocks including the correct TLLI in the RLC data blocks which are sent preceding the reception of PACKET UPLINK ACK/NACK.

Maximum duration of the test

5 minutes.

Expected sequence

Step	Direction	Message	Comments
0	MS		The MS is triggered to transfer 200 octets of data.
1 1A	MS -> SS	CHANNEL REQUEST	If the MS requests two phase access the Test Case is terminated
2	SS -> MS	IMMEDIATE ASSIGNMENT	For uplink TBF, one phase access
3	MS -> SS	3 RLC data blocks	SS verifies correct TLLI in RLC headers.
4	SS -> MS	PACKET UPLINK ACK/NACK	Including correct TLLI
5	MS<->SS	Completion of macro {Uplink data transfer}	SS allows MS to complete data transfer.

41.2.3.5 One phase packet access / Contention resolution / TLLI mismatch

41.2.3.5.1 Conformance requirement

If the TLLI in the PACKET UPLINK ACK/NACK message differs from that sent by the MS in the RLC block headers, the MS shall immediately stop transmitting on this TBF and re-initiate the packet access procedure unless it has already been repeated 4 times.

Reference

3GPP TS 04.08 / 3GPP TS 44.018 subclause 3.5.2.1.3.2.

3GPP TS 04.60 subclause 7.1.2.3.

41.2.3.5.2 Test purpose

To verify that the MS immediately stops transmitting if it receives a PACKET UPLINK ACK/NACK with incorrect TLLI.

41.2.3.5.3 Method of test

Initial conditions

System Simulator:

1cell, CCCH combined with SDCCH.

Mobile Station:

MS is GPRS attached, the PDP context 2 has been established and the MS is in Packet Idle mode.

Specific PICS Statements

-

PIXIT Statements

-

Test procedure

The MS is triggered to transfer data. The SS assigns packet uplink resources in an IMMEDIATE ASSIGNMENT message indicating one phase packet access. The MS shall start transferring RLC data blocks including the correct TLLI in the first three blocks. The SS acknowledges the RLC block transfer with a PACKET UPLINK ACK/NACK including an incorrect TLLI. The SS shall verify that the MS 'immediately' stops transmitting (see note below) and retries packet access procedure.

NOTE: The MS is allowed to transmit n RLC blocks after the block containing the PACKET UPLINK ACK/NACK message (the exact value of n is specified in 3GPP TS 05.10 subclause 6.11).

Maximum duration of the test

-

Expected sequence

Step	Direction	Message	Comments
0	MS		The MS is triggered to transfer 200 octets of data.
1 1A	MS -> SS	CHANNEL REQUEST	If the MS requests two phase access the Test Case is terminated
2	SS -> MS	IMMEDIATE ASSIGNMENT	For uplink TBF, one phase packet access granted, dynamic allocation.
3	MS -> SS	3 RLC data blocks	SS verifies correct TLLI in RLC headers.
4	SS -> MS	PACKET UPLINK ACK/NACK	Including incorrect TLLI
5	SS		The SS verifies that the MS transmits at most further n (=6) data blocks after step 4 (see Note) before re-initiating packet access.
6	MS -> SS	CHANNEL REQUEST	MS re-initiates packet access procedure.
6A			If the MS requests two phase access the Test Case is terminated
7	SS -> MS	IMMEDIATE ASSIGNMENT	For uplink TBF, one phase packet access granted, dynamic allocation.
8	MS<->SS	Completion of macro {Uplink data transfer}	SS allows MS to complete uplink data transfer.

41.2.3.6 One phase packet access / Contention resolution / Counter N3104

41.2.3.6.1 Conformance requirement

The contention resolution has failed on the mobile station when the counter N3104 has reached its maximum value.

Reference

3GPP TS 04.60 subclause 7.1.2.3

41.2.3.6.2 Test purpose

To verify that the MS correctly sets and considers counter N3104.

NOTE: Counter N3104 is incremented by 1 with each new RLC/MAC block the mobile station sends until the first PACKET UPLINK ACK/NACK message is received.

Its maximum value is $N3104_MAX = 3 * (BS_CV_MAX + 3) * \text{number of uplink timeslots assigned}$, where BS_CV_MAX is broadcast in SI 13 Rest Octets.

41.2.3.6.3 Method of test

Initial conditions

System Simulator: Default settings except:

1 cell, CCCH combined with SDCCH, BS_CV_MAX value in System Information Type 13 arbitrarily chosen in the range 3 to 6.

Mobile Station:

MS is GPRS attached, the PDP context 2 has been established and the MS is in Packet Idle mode.

Specific PICS Statements

-

PIXIT Statements

-

Test procedure

The MS is triggered to transfer 440 octets of data. The SS assigns packet uplink resources in an IMMEDIATE ASSIGNMENT message indicating one phase packet access. The MS shall start transferring RLC data blocks. The SS acknowledges the RLC block transfer with a correct PACKET UPLINK ACK/NACK sent after N3104_MAX data blocks. The SS verifies that the MS stops transmitting and restarts packet access procedure.

At the second attempt, the SS sends PACKET UPLINK ACK/NACK exactly after N3104_MAX - 1 data blocks. The SS verifies that this time the MS does not abort the access procedure and successfully completes uplink transfer.

Maximum duration of the test

-

Expected sequence

Step	Direction	Message	Comments
1 1A	MS -> SS	CHANNEL REQUEST	MS is triggered to transfer 440 data octets. If the MS requests two phase access the Test Case is terminated
2	SS -> MS	IMMEDIATE ASSIGNMENT	For uplink TBF, indicating one phase packet access.
3	SS -> MS	PACKET DOWNLINK DUMMY CONTROL BLOCK	With MS USF
4 5	MS -> SS	RLC data block	Step 3 and 4 are repeated until N3104_MAX data blocks are received.
6 6A	MS -> SS	CHANNEL REQUEST	SS verifies that MS does not send further RLC data blocks and MS re-initiates packet access procedure. If the MS requests two phase access the Test Case is terminated
7	SS -> MS	IMMEDIATE ASSIGNMENT	For uplink TBF, indicating one phase packet access granted.
8	SS -> MS	PACKET DOWNLINK DUMMY CONTROL BLOCK	With MS USF
9 10	MS -> SS	RLC data block	Step 13 and 14 are repeated until N3104_MAX - 1 data blocks are received.
11 12	SS -> MS MS<->SS	PACKET UPLINK ACK/NACK Completion of macro {Uplink data transfer}	SS allows MS to complete uplink data transfer.

41.2.3.7 One phase packet access / Contention resolution / Timer T3166

41.2.3.7.1 Conformance requirement

The contention resolution has failed on the mobile station when the counter N3104 has reached its maximum value, or on expiry of timer T3166.

Reference

3GPP TS 04.60 subclause 7.1.2.3.

41.2.3.7.2 Test purpose

To verify that the MS correctly considers timer T3166.

41.2.3.7.3 Method of test

Initial conditions

System Simulator:

1 cell, CCCH combined with SDCCH, BS_CV_MAX value in System Information Type 13 is set to 6.

Mobile Station:

MS is GPRS attached, the PDP context 2 has been established and the MS is in Packet Idle mode.

Specific PICS Statements

-

PIXIT Statements

-

Test procedure

The MS is triggered to transfer 440 octets of data. The SS assigns packet uplink resources in an IMMEDIATE ASSIGNMENT message indicating one phase packet access and dynamic allocation. The MS shall start transferring RLC data blocks. The SS reduces the block transfer rate by controlling the USF flag. In this way, the SS forces T3166 (with value 5 s) to expire before counter N3104 reaches N3104_MAX (with value 28 blocks for current settings). The SS verifies that the MS stops transmitting and restarts packet access procedure.

At the second attempt, the SS sends PACKET UPLINK ACK/NACK before T3166 seconds. The SS verifies that this time the MS does not abort the access procedure and successfully completes the data transfer.

Maximum duration of the test

5 minutes.

Expected sequence

Step	Direction	Message	Comments
1 1A	MS -> SS	CHANNEL REQUEST	MS is triggered to transfer 440 data octets. If the MS requests two phase access the Test Case is terminated
2	SS -> MS	IMMEDIATE ASSIGNMENT	Indicating one phase packet access granted, dynamic allocation. CS1 shall be used.
3	SS -> MS	PACKET DOWNLINK DUMMY CONTROL BLOCK	USF addressing the MS
4	MS -> SS	RLC data block	
5	SS -> MS	PACKET DOWNLINK DUMMY CONTROL BLOCK	USF not addressing the MS
6	SS -> MS	PACKET DOWNLINK DUMMY CONTROL BLOCK	USF not addressing the MS
7	SS -> MS	PACKET DOWNLINK DUMMY CONTROL BLOCK	USF not addressing the MS
8	SS -> MS	PACKET DOWNLINK DUMMY CONTROL BLOCK	USF not addressing the MS
9	SS -> MS	PACKET DOWNLINK DUMMY CONTROL BLOCK	USF not addressing the MS
10	SS -> MS	PACKET DOWNLINK DUMMY CONTROL BLOCK	USF not addressing the MS
11	SS -> MS	PACKET DOWNLINK DUMMY CONTROL BLOCK	USF not addressing the MS
12	SS -> MS	PACKET DOWNLINK DUMMY CONTROL BLOCK	USF not addressing the MS
13	SS -> MS	PACKET DOWNLINK DUMMY CONTROL BLOCK	USF not addressing the MS
14	SS -> MS	PACKET DOWNLINK DUMMY CONTROL BLOCK	USF not addressing the MS
15	SS -> MS	PACKET DOWNLINK DUMMY CONTROL BLOCK	USF not addressing the MS
16	MS<->SS		Steps 3 to 15 are repeated at most 22 times or until MS does not send further RLC data blocks at step 4. Note: steps 3 to 15 transfer one block every 52 frames, or 240 ms. 22 repetitions require about 5.5 s. (Timer T3166 shall expire)
17 17A	MS -> SS	CHANNEL REQUEST	MS re-initiates packet access procedure. If the MS requests two phase access the Test Case is terminated
18	SS -> MS	IMMEDIATE ASSIGNMENT	Indicating one phase packet access granted, dynamic allocation.
19	MS<->SS		Steps 3 to 15 are repeated 17 times. Note: 17 repetitions require about 4.3 s. (Timer T3166 should not expire)
20 21	SS -> MS MS<->SS	PACKET UPLINK ACK/NACK Completion of macro {Uplink data transfer}	SS allows MS to complete uplink data transfer.

41.2.3.8 One phase packet access / Contention resolution / 4 access repetition attempts

41.2.3.8.1 Conformance requirement

If contention resolution for packet access fails, the mobile station shall reinitiate the packet access procedure unless it has already been repeated 4 times.

Reference

3GPP TS 04.60 subclause 7.1.2.3.

41.2.3.8.2 Test purpose

To verify that the MS attempts the packet access procedure 4 or 5 times.

41.2.3.8.3 Method of test

Initial conditions

System Simulator:

1cell, CCCH combined with SDCCH.

Mobile Station:

MS is GPRS attached, the PDP context 2 has been established and the MS is in Packet Idle mode.

Specific PICS Statements

- GPRS Release (TSPC_MS_GPRS_RELEASE)

PIXIT Statements

-

Test procedure

The MS is triggered to transfer 200 octets of data. The SS assigns packet uplink resources in an IMMEDIATE ASSIGNMENT message indicating one phase packet access. The MS shall start transferring RLC data blocks including the correct TLLI in the first three blocks. The SS acknowledges the RLC block transfer with a PACKET UPLINK ACK/NACK including a TLLI not corresponding to the MS. The SS shall verify that the MS stops transmitting blocks and attempts packet access a total of four or five times.

Note:

The MS is allowed to transmit n RLC blocks after the block containing the PACKET UPLINK ACK/NACK message (the exact value of n is specified in 3GPP TS 05.10 subclause 6.11).

Maximum duration of the test

5 minutes.

Expected sequence

Step	Direction	Message	Comments
1	MS		The MS is triggered to transfer 200 octets of data.
2 2A	MS -> SS	CHANNEL REQUEST	If the MS requests two phase access the Test Case is terminated indicating one phase packet access granted, dynamic allocation. including incorrect TLLI MS aborts packet access procedure, and is allowed to transmit at most n RLC data blocks (see Note above).
3	SS -> MS	IMMEDIATE ASSIGNMENT	
4	MS -> SS	3 RLC data blocks	
5	SS -> MS	PACKET UPLINK ACK/NACK	
6	MS -> SS		
7	MS<->SS		
8	MS<->SS		repetition 2: MS reinitiates a packet access procedure, steps 2 to 6 are repeated.
9	MS<->SS		repetition 3: MS reinitiates a packet access procedure, steps 2 to 6 are repeated.
A10 (optional step)	MS<->SS		If PICS 'Release of GPRS supported' for MS is Release 97, 98, 99 or 4, this step is optional. If PICS 'Release of GPRS supported' for MS is Release 5 or later, this step is not allowed. repetition 4: MS reinitiates a packet access procedure, steps 2 to 6 are repeated.
NOTE: After step A10 the MS may reinitiate a packet access procedure, since higher layers may request to restart the access procedure.			

41.2.3.9 One phase packet access / TBF starting time

41.2.3.9.1 Conformance requirement

In case the packet uplink assignment construction contains a TBF starting time and the mobile station receives the IMMEDIATE ASSIGNMENT message before the TBF starting time has expired, it shall wait until the frame number indicated by the TBF starting time before accessing the channel. If the mobile station receives the message after the TBF starting time has expired, it shall ignore the TBF starting time and may immediately access the channel.

Reference

3GPP TS 04.08 / 3GPP TS 44.018 subclause 3.5.2.1.3.2.

41.2.3.9.2 Test purpose

To verify that the MS correctly considers the TBF Starting Time included in the IMMEDIATE ASSIGNMENT message.

41.2.3.9.3 Method of test

Initial conditions

System Simulator:

1cell, CCCH combined with SDCCH.

Mobile Station:

MS is GPRS attached, the PDP context 2 has been established and the MS is in Packet Idle mode.

Specific PICS Statements

-

PIXIT Statements

-

Test procedure

The MS is triggered to transfer data. The SS assigns packet uplink resources in an IMMEDIATE ASSIGNMENT message indicating one phase packet access and containing a TBF starting time. The MS shall start transferring RLC data blocks after the TBF starting time.

The test is repeated with a TBF starting time in the past. In this case the MS may 'immediately' (see note below) send RLC data blocks .

Note:

The MS shall start transmitting RLC blocks within n blocks after the block containing the IMMEDIATE ASSIGNMENT message (the exact value of n is specified in 3GPP TS 05.10 subclause 6.11).

Maximum duration of the test

-

Expected sequence

Step	Direction	Message	Comments
0	MS		The MS is triggered to transfer 200 octets of data.
1 1A	MS -> SS	CHANNEL REQUEST	If the MS requests two phase access the Test Case is terminated
2	SS -> MS	IMMEDIATE ASSIGNMENT	indicating one phase packet access granted, dynamic allocation, and an arbitrarily chosen TBF Starting Time (indicating a future frame number).
3	SS		SS continually sends PACKET DOWNLINK DUMMY CONTROL BLOCK containing USF assigned to the MS. SS verifies that MS does not transmit for frame numbers below TBF Starting Time.
4	MS -> SS	3 RLC data blocks	SS will verify that first RLC block arrives on first allowed block after TBF Starting Time.
5	SS -> MS	PACKET UPLINK ACK/NACK	Including correct TLLI.
6	MS -> SS	RLC data blocks	
7	SS<->MS	Completion of macro {Uplink data transfer}	SS allows MS to complete data transfer.
8	MS		The MS is triggered again to transfer 200 octets of data.
9 9A	MS -> SS	CHANNEL REQUEST	If the MS requests two phase access the Test Case is terminated
10	SS -> MS	IMMEDIATE ASSIGNMENT	Indicating one phase packet access granted, dynamic allocation and an arbitrarily chosen TBF Starting Time with value less than current frame number.
A11 (Optional step)	MS -> SS	3 RLC data blocks	SS continually sends PACKET DOWNLINK DUMMY CONTROL BLOCK containing USF assigned to the MS. SS verifies that MS starts sending RLC data blocks. The SS shall not check the number of blocks before the MS starts to send RLC blocks.
A12 (Optional step)	SS -> MS	PACKET UPLINK ACK/NACK	Including correct TLLI.
A13 (Optional step)	MS -> SS	RLC data blocks	Go to step 14
B11 (Optional step)	MS -> SS	CHANNEL REQUEST	
B12 (Optional step)			If the MS requests two phase access the Test Case is terminated
B13 (Optional step)	SS -> MS	IMMEDIATE ASSIGNMENT	Go to step 14
C11 (Optional step)			Verify that the MS does not send anything. Go to step 15
14	SS<->MS	Completion of macro {Uplink data transfer}	SS allows MS to complete data transfer.
15			

41.2.3.10 One phase packet access / Timing Advance Index present

41.2.3.10.1 Conformance requirement

If the timing advance index (TAI) is included in the packet uplink assignment construction, the mobile station shall use the continuous update timing advance mechanism, see 3GPP TS 05.10, using PTCCH in the same timeslot as the assigned PDCH.

Reference

3GPP TS 04.08 / 3GPP TS 44.018 subclause 3.5.2.1.3.2.

3GPP TS 03.64 subclause 6.5.7.2.

41.2.3.10.2 Test purpose

To verify that the MS uses the continuous update timing advance mechanism and sends access bursts in the PTCCH slots as determined by the Timing Advance Index (TAI) sent in the IMMEDIATE ASSIGNMENT.

41.2.3.10.3 Method of test

Initial conditions

System Simulator:

1 cell, CCCH combined with SDCCH.

Mobile Station:

MS is GPRS attached, the PDP context 2 has been established and the MS is in Packet Idle mode.

Specific PICS Statements

-

PIXIT Statements

-

Test procedure

The MS is triggered for uplink data transfer. The SS assigns packet uplink resources in an IMMEDIATE ASSIGNMENT message indicating one phase packet access and containing a Timing Advance Index. During TBF transfer, the SS shall verify the access bursts sent by the MS in the PTCCH.

Maximum duration of the test

-

Expected sequence

Step	Direction	Message	Comments
0	MS		The MS is triggered to transfer 440 octets of data.
1 1A	MS -> SS	CHANNEL REQUEST	If the MS requests two phase access the Test Case is terminated
2	SS -> MS	IMMEDIATE ASSIGNMENT	For one phase packet access, dynamic allocation and including Timing Advance Index TAI=0.
3	SS -> MS	PACKET DOWNLINK DUMMY CONTROL BLOCK	Assigning the USF assigned in step 2. Sent on PDTCH, 3 block after the message sent in step 2
4	MS -> SS	RLC data block	
5	SS -> MS	PACKET UPLINK ACK/NACK	Including correct TLLI.
6			Wait for 3 blocks.
7	MS<->SS	Completion of macro {Uplink data transfer}	SS allows MS to complete data transfer. During the data transfer, USF is assigned to MS once in 250ms

Verification

During TBF transfer (steps 3 to 7) the SS monitors access bursts on PTCCH which are located on slots with numbers FN, such that $(FN \bmod (8*52)) = 12$ for TAI = 0 (3GPP TS 03.64 subclause 6.5.7.2 and 3GPP TS 05.02 table 6). The access burst contents shall be '11111111 111'.

The test is repeated once more with an arbitrarily chosen TAI in the range 1 to 15. SS shall verify that the access bursts are sent in the correct PTCCH slots as specified in 3GPP TS 05.02 table 6.

41.2.3.11 One phase packet access / Timing Advance Index not present

41.2.3.11.1 Conformance requirement

If a timing advance index (TAI) field is not included, the continuous update timing advance mechanism shall not be used.

Reference

3GPP TS 04.08 / 3GPP TS 44.018 subclause 3.5.2.1.3.2.

41.2.3.11.2 Test purpose

To verify that the MS does not send any access bursts on PTCCH (i.e. it does not use the continuous update timing advance mechanism) if TAI is not present in the IMMEDIATE ASSIGNMENT message.

41.2.3.11.3 Method of test

Initial conditions

System Simulator:

1 cell, CCCH combined with SDCCH.

Mobile Station:

MS is GPRS attached, the PDP context 2 has been established and the MS is in Packet Idle mode.

Specific PICS Statements

-

PIXIT Statements

-

Test procedure

The MS is triggered to transfer data. The SS assigns packet uplink resources in an IMMEDIATE ASSIGNMENT message not including a Timing Advance Index. During TBF transfer, the SS shall verify that the MS does not send any access bursts in idle frames.

Maximum duration of the test

-

Expected sequence

Step	Direction	Message	Comments
1	MS		The MS is triggered to transfer 440 octets of data.
2 2A	MS -> SS	CHANNEL REQUEST	If the MS requests two phase access the Test Case is terminated
3	SS -> MS	IMMEDIATE ASSIGNMENT	not including Timing Advance Index
4	SS -> MS	PACKET DOWNLINK DUMMY CONTROL BLOCK	Assigning the USF assigned in step 3. Sent on PDTCH, 3 block after the message sent in step 3
5	MS -> SS	RLC data block	
6	SS -> MS	PACKET UPLINK ACK/NACK	Including correct TLLI.
7			Wait for 3 blocks.
8	SS<->MS	Completion of macro {Uplink data transfer}	SS allows MS to complete data transfer. During the data transfer, USF is assigned to MS once in 250ms

Verification

The SS verifies that the MS does not transmit in idle frames during data block transfer (steps 4 to 8). Idle frame numbers are 12, 25, 38 and 51 in the 52-multiframe structure.

41.2.4 Packet immediate assignment / Single block packet access

41.2.4.1 Single block packet access / Packet Resource Request

41.2.4.1.1 Conformance requirement

The network shall use the TBF starting time to indicate the first frame number belonging to the single block period granted for packet access. The mobile station may use that block period to send a PACKET RESOURCE REQUEST message to initiate the two phase access defined in 3GPP TS 04.60, or to send a PACKET MEASUREMENT REPORT message, see 3GPP TS 04.60.

Reference

3GPP TS 04.08 / 3GPP TS 44.018 subclause 3.5.2.1.3.3.

41.2.4.1.2 Test purpose

To verify that the MS sends PACKET RESOURCE REQUEST in the assigned block as indicated by the TBF starting time when it is triggered for uplink transfer.

41.2.4.1.3 Method of test

Initial conditions

System Simulator:

1 cell, CCCH combined with SDCCH.

Mobile Station:

MS is GPRS attached, a PDP context has been established and the MS is in Packet Idle mode.

Specific PICS Statements

-

PIXIT Statements

-

Test procedure

The MS is triggered to initiate uplink data transfer. The SS assigns packet uplink resources for single block in an IMMEDIATE ASSIGNMENT message including a TBF starting time. The SS verifies that the MS sends a PACKET RESOURCE REQUEST at the first allowed block as indicated by the TBF starting frame.

Maximum duration of the test

-

Expected sequence

Step	Direction	Message	Comments
0	MS		The MS is triggered to transfer 200 octets of data.
1	MS -> SS	CHANNEL REQUEST	
2	SS -> MS	IMMEDIATE ASSIGNMENT	
3	MS -> SS	PACKET RESOURCE REQUEST	For uplink TBF, single block assignment for an arbitrarily chosen TBF Starting Time in the future. SS verifies that first block is on first allowed block starting at frame number given by TBF Starting Time.
4	SS -> MS	PACKET ACCESS REJECT	with default contents.

41.2.4.2 Single block packet access / Packet Measurement Report

41.2.4.2.1 Conformance requirement

1. The network shall use the TBF starting time to indicate the first frame number belonging to the single block period granted for packet access. The mobile station may use that block period to send a PACKET RESOURCE REQUEST message to initiate the two phase access defined in 3GPP TS 04.60, or to send a PACKET MEASUREMENT REPORT message, see 3GPP TS 04.60.
2. In packet idle mode, the reporting period is NC_REPORTING_PERIOD_I rounded off to the nearest smaller integer multiple of DRX period if NC_REPORTING_PERIOD_I is greater than DRX period, else, the reporting period is DRX period.

Reference

3GPP TS 04.08 / 3GPP TS 44.018 subclause 3.5.2.1.3.3.

3GPP TS 45.008 (ex 05.08) subclause 10.1.4.1.

41.2.4.2.2 Test purpose

To verify that the MS sends PACKET MEASUREMENT REPORT in the assigned uplink block when performing a measurement report procedure.

Further on, this tests verifies that the MS correctly considers reporting parameter NC_REPORTING_PERIOD_I.

41.2.4.2.3 Method of test

Initial conditions

System Simulator:

1 cell, CCCH combined with SDCCH.

Mobile Station:

MS is GPRS attached, in Ready state and in Packet Idle mode.

Specific PICS Statements

-

PIXIT Statements

-

Foreseen final state of the MS

-

Test procedure

The SS requests the MS via a PACKET MEASUREMENT ORDER to periodically send measurement reports. When the MS attempts a measurement report procedure, the SS assigns a single block for uplink TBF with an arbitrarily chosen TBF starting time (not yet elapsed). The SS verifies that the MS sends PACKET MEASUREMENT REPORT in the assigned block.

Maximum duration of the test

-

Expected sequence

Step	Direction	Message	Comments
1	SS -> MS	IMMEDIATE ASSIGNMENT	for single block downlink assignment on PCH corresponding to MS.
2	SS -> MS	PACKET MEASUREMENT ORDER	Including parameters: NETWORK_CONTROL_ORDER = '01' NC_REPORTING_PERIOD_I = '011' (3.84 s.)
3	MS -> SS	CHANNEL REQUEST	with establishment cause 'single block access'.
4	SS -> MS	IMMEDIATE ASSIGNMENT	for uplink TBF, single block assignment with an arbitrarily chosen TBF starting time in the future in the range 0.5 to 2 seconds.
5	MS -> SS	PACKET MEASUREMENT REPORT	Shall be sent in the assigned block.
6	MS -> SS	CHANNEL REQUEST	SS verifies that the time interval between steps 3 and 6 corresponds to the time +/- 10% which is calculated from the NC_REPORTING_PERIOD_I rounded off to the nearest smaller integer multiple of DRX period if NC_REPORTING_PERIOD_I is greater than DRX period, else, the reporting period is DRX period. (3GPP TS 04.08 § 10.1.4.1)
7	SS -> MS	IMMEDIATE ASSIGNMENT	for uplink TBF, single block assignment with an arbitrarily chosen TBF starting time in the future.
8	MS -> SS	PACKET MEASUREMENT REPORT	Shall be sent in the assigned block.

41.2.5 Packet immediate assignment / Packet access rejection

41.2.5.1 Packet access rejection / wait indication

41.2.5.1.1 Conformance requirement

On receipt of an IMMEDIATE ASSIGNMENT REJECT message corresponding to one of its 3 last CHANNEL REQUEST messages, the mobile station stops sending CHANNEL REQUEST messages, starts timer T3142 with the indicated value, ("wait indication" information element), starts T3146 if it has not already been started, and listens to the downlink CCCH until T3146 expires. During this time, additional IMMEDIATE ASSIGNMENT REJECT messages are ignored, but any immediate assignment corresponding to any other of its 3 last CHANNEL REQUEST messages make the mobile station follow the assignment procedure. If no such immediate assignment is received, the mobile station returns to packet idle mode.

Reference

3GPP TS 04.08 / 3GPP TS 44.018 subclause 3.5.2.1.3.4.

41.2.5.1.2 Test purpose

To verify that the MS stops sending CHANNEL REQUEST messages when receiving an IMMEDIATE ASSIGNMENT REJECT containing a Request Reference IE corresponding to one of its last 3 CHANNEL REQUEST messages.

Further on, the SS verifies that the MS makes a new attempt for uplink transfer only after T3142 seconds ("wait indication" timer) after last IMMEDIATE ASSIGNMENT REJECT elapse.

41.2.5.1.3 Method of test

Initial conditions

System Simulator:

1 cell, CCCH combined with SDCCH, Parameter MAX_RETRANS is set to 7 retransmissions.

Mobile Station: MS is switched off.

Specific PICS Statements

-

PIXIT Statements

-

Foreseen final state of the MS

-

Test procedure

The MS is triggered to initiate the GPRS attach procedure. After reception of 3 CHANNEL REQUEST messages, the SS sends an IMMEDIATE ASSIGNMENT REJECT with correct Request Reference and including a waiting indication (T3142). The SS verifies that the MS stops sending CHANNEL REQUEST messages and does not attempt a new packet access until T3142 seconds elapse.

Maximum duration of the test

-

Expected sequence

Step	Direction	Message	Comments
0	MS		MS is triggered to initiate GPRS attach procedure
1	MS -> SS	CHANNEL REQUEST	
2	MS -> SS	CHANNEL REQUEST	
3	MS -> SS	CHANNEL REQUEST	
4	SS -> MS	IMMEDIATE ASSIGNMENT REJECT	including Request Reference corresponding to the CHANNEL REQUEST in step 1, and waiting time indication with value T3142=50s.
5	SS		SS verifies that MS does not send any further access bursts (see note below).
6	MS -> SS	CHANNEL REQUEST	SS verifies that the access burst does not arrive before $T3142 - 0.1 * T3142 (=45s)$ after last IMMEDIATE ASSIGNMENT REJECT message.
7	SS -> MS	IMMEDIATE ASSIGNMENT	for uplink TBF, one phase access
8	MS<->SS	Completion of macro {GPRS attach procedure}	SS allows MS to complete GPRS attach.

The test is repeated with an arbitrarily chosen value of T3142 in the range 2 to 60 s.

NOTE: The number of frames between successive access bursts considering the default Sys Info parameters used in the test is larger than 58 frames (see 3GPP TS 04.08 / 3GPP TS 44.018, table 3.1). This value is large enough to allow the MS to respond to the IMMEDIATE ASSIGNMENT REJECT message by stopping sending the next access bursts.

41.2.5.2 Packet access rejection / assignment before T3142 expires

41.2.5.2.1 Conformance requirement

On receipt of an IMMEDIATE ASSIGNMENT REJECT message corresponding to one of its 3 last CHANNEL REQUEST messages, the mobile station stops sending CHANNEL REQUEST messages, starts timer T3142 with the

indicated value, ("wait indication" information element), starts T3146 if it has not already been started, and listens to the downlink CCCH until T3146 expires. During this time, additional IMMEDIATE ASSIGNMENT REJECT messages are ignored, but any immediate assignment corresponding to any other of its 3 last CHANNEL REQUEST messages make the mobile station follow the assignment procedure. If no such immediate assignment is received, the mobile station returns to packet idle mode.

Reference

3GPP TS 04.08 / 3GPP TS 44.018 subclause 3.5.2.1.3.4.

41.2.5.2.2 Test purpose

To verify that the MS stops sending CHANNEL REQUEST messages when receiving an IMMEDIATE ASSIGNMENT REJECT and, if an IMMEDIATE ASSIGNMENT containing a correct Request Reference arrives before $T = \min \{T3142, T3146\}$ seconds elapse, then the MS shall accept this assignment (see below for a note on T3146).

41.2.5.2.3 Method of test

Initial conditions

System Simulator: Default settings except:

Parameter MAX_RETRANS is set to 7 retransmissions.

Parameter TX_INTEGER is set to 32.

CCCH combined with SDCCH.

Mobile Station:

MS is switched off.

Specific PICS Statements

-

PIXIT Statements

-

Foreseen final state of the MS

-

Test procedure

The MS is triggered to initiate GPRS attach. After reception of 3 CHANNEL REQUEST messages, the SS sends an IMMEDIATE ASSIGNMENT REJECT with correct Request Reference and including a waiting indication (T3142). The SS verifies that the MS stops sending CHANNEL REQUEST messages.

Before $T = \min \{T3142, T3146\}$ seconds elapse, the SS sends an IMMEDIATE ASSIGNMENT with correct Request Reference. The MS shall switch to the assigned PDCH and transfer the data.

NOTE: T3146 is started when sending the last CHANNEL REQUEST or when receiving the IMMEDIATE ASSIGNMENT REJECT. At its expiry, the packet access is aborted.

The value of T3146 is given by $T+2*S$ (3GPP TS 04.08 / 3GPP TS 24.008, subclause 11.1.1), where T is TX_INTEGER and S is given in 3GPP TS 04.08 / 3GPP TS 44.018, table 3.1. The value of T3146 is 2,15 s. for the current settings.

Maximum duration of the test

-

Expected sequence

Step	Direction	Message	Comments
0	MS		MS is triggered to initiate GPRS attach.
1	MS -> SS	CHANNEL REQUEST	
2	MS -> SS	CHANNEL REQUEST	
3	MS -> SS	CHANNEL REQUEST	
4	SS -> MS	IMMEDIATE ASSIGNMENT REJECT	including Request Reference corresponding to the CHANNEL REQUEST in step 2, and waiting time indication with value T3142 = 2 s.
5			The SS verifies that the MS stops sending CHANNEL REQUEST messages.
6	SS -> MS	IMMEDIATE ASSIGNMENT	sent after 1.5s. (of the last IMMEDIATE ASSIGNMENT REJECT) and including Request Reference corresponding to step 1.
7	SS<->MS	Completion of macro {GPRS attach procedure}	SS allows MS to complete GPRS attach.

41.2.6 Packet downlink assignment procedure using CCCH

41.2.6.1 Initiation of packet downlink assignment procedure / MS listens to correct CCCH block

41.2.6.1.1 Conformance requirement

The network initiates the packet downlink assignment procedure by sending an IMMEDIATE ASSIGNMENT message in unacknowledged mode on the CCCH timeslot corresponding to CCCH group the mobile station belongs to.

On receipt of an IMMEDIATE ASSIGNMENT message [the MS] stops monitoring downlink CCCH and switches to the assigned PDCH and starts listening for downlink RLC/MAC blocks identified by the assigned TFI; it starts timer T3190.

Reference

3GPP TS 04.08 / 3GPP TS 44.018 subclause 3.5.3.1.2.

41.2.6.1.2 Test purpose

To verify that the MS responds to an IMMEDIATE ASSIGNMENT for downlink TBF sent on PCH blocks corresponding to the MS's paging group.

41.2.6.1.3 Method of test

Initial conditions

System Simulator: Default settings except:

Parameters CCCH_CONF, BS_AG_BLK_RES, and BS_PA_MFRMS are arbitrarily chosen.

Mobile Station:

MS is GPRS attached, DRX have been negotiated, MS is in Ready state.

PDP context 2 has been established and the MS is in Packet Idle mode.

Specific PICS Statements

-

PIXIT Statements

-

Test procedure

The SS sends an IMMEDIATE ASSIGNMENT for downlink transfer on a PCH block corresponding to its paging group (see 3GPP TS 05.02 subclause 6.5.2) which depends on Sys Info parameters and the MS's IMSI. The MS shall switch to the assigned PDCH and exercise downlink transfer.

Maximum duration of the test

-

Expected sequence

Step	Direction	Message	Comments
1	SS -> MS	IMMEDIATE ASSIGNMENT	sent on a PCH block corresponding to the MS's paging group, including a packet downlink assignment with correct TLLI.
2	MS<->SS	Completion of macro {Downlink data transfer}	SS completes downlink transfer of 200 octets of data.

41.2.6.2 Initiation of packet downlink assignment procedure / timer T3190

41.2.6.2.1 Conformance requirement

On receipt of an IMMEDIATE ASSIGNMENT message [the MS] stops monitoring downlink CCCH and switches to the assigned PDCH and starts listening for downlink RLC/MAC blocks identified by the assigned TFI; it then starts timer T3190.

If the mobile station does not receive a RLC/MAC block on the assigned PDCHs before timer T3190 expires, then a TBF establishment failure has occurred.

Reference

3GPP TS 04.08 / 3GPP TS 44.018 subclause 3.5.3.1.2.

41.2.6.2.2 Test purpose

To verify that the MS returns to packet idle updated if RLC/MAC blocks are sent after T3190 s, and that the MS correctly receives RLC/MAC blocks if they are sent before T3190 s.

41.2.6.2.3 Method of test

Initial conditions

System Simulator:

1 cell, CCCH combined with SDCCH.

Mobile Station:

MS is GPRS attached, a PDP context has been established and the MS is in Packet Idle mode.

Specific PICS Statements

-

PIXIT Statements

-

Test procedure

The SS assigns a PDCH for downlink transfer but does not send any RLC/MAC blocks until T3190 s have elapsed. The MS shall return to packet idle updated and ignore the RLC/MAC blocks.

To verify that the MS returned to packet idle updated, the SS again assigns a PDCH and sends RLC/MAC blocks before T3190 s elapse. The SS shall successfully transfer all RLC data blocks.

Maximum duration of the test

-

Expected sequence

Step	Direction	Message	Comments
1	SS -> MS	IMMEDIATE ASSIGNMENT	for downlink TBF on a PCH block corresponding to the MS, including a packet downlink assignment. SS waits T3190 + 10% (=5.5s) after the last IMMEDIATE ASSIGNMENT. SS sends data SS verifies for 10s. that the MS does not respond.
2	SS		
3	SS -> MS	RLC data blocks	
4	SS		
5	SS -> MS	IMMEDIATE ASSIGNMENT	SS assigns again a PDCH. SS waits T3190 – 10% (=4.5s) after the last IMMEDIATE ASSIGNMENT SS starts sending 200 octets of data. indicating correct reception of data blocks. SS completes downlink transfer.
6	SS		
7	SS -> MS	RLC data blocks	
8	MS -> SS	PACKET DOWNLINK ACK/NACK	
9	MS<->SS	Completion of macro {Downlink data transfer}	

41.2.6.3 Initiation of packet downlink assignment procedure / TBF starting time

41.2.6.3.1 Conformance requirement

The IMMEDIATE ASSIGNMENT message may indicate a TBF starting time. If the mobile station receives the message before the TBF starting time has expired, it shall wait until the frame number indicated by the TBF starting time, start timer T3190 and switch to the assigned PDCH. If the mobile station receives the message after the TBF starting time has expired, it shall ignore the indicated TBF starting time, immediately start timer T3190 and switch to the assigned PDCH.

Reference

3GPP TS 04.08 / 3GPP TS 44.018 subclause 3.5.3.1.2.

41.2.6.3.2 Test purpose

To verify that the MS correctly considers the TBF starting time during downlink assignment.

41.2.6.3.3 Method of test

Initial conditions

System Simulator:

1 cell, CCCH combined with SDCCH.

Mobile Station:

MS is GPRS attached, a PDP context has been established and the MS is in Packet Idle mode.

Specific PICS Statements

-

PIXIT Statements

-

Test procedure

The SS assigns a PDCH via an IMMEDIATE ASSIGNMENT including a TBF starting time. The SS does not send RLC data blocks after TBF starting time + T3190 elapses. The MS shall return to packed idle updated and ignore the RLC data blocks.

The SS assigns again a PDCH, and this time the SS sends RLC data blocks before TBF starting time + T3190 expires. The MS shall successfully receive the RLC data blocks.

Finally, the SS assigns the third time a PDCH, but including a TBF starting time which expired. The SS immediately sends RLC data blocks which shall be acknowledged by the MS.

Maximum duration of the test

-

Expected sequence

Step	Direction	Message	Comments
1	SS -> MS	IMMEDIATE ASSIGNMENT	including a packet downlink assignment with a TBF Starting Time corresponding to 10s after the current frame number.
2	SS		SS waits 1.1 * (TBF Starting Time + T3190) (=16.5 s) after the last IMMEDIATE ASSIGNMENT.
3	SS -> MS	RLC data block	including Polling bit set and valid RRBP field.
4	SS		SS verifies for that the MS does not respond in the assigned block in step 3.
5	SS -> MS	IMMEDIATE ASSIGNMENT	SS assigns again a PDCH with TBF Starting Time corresponding to 10s after the current frame number.
6	SS		SS waits 0.9 * (TBF Starting Time + T3190) (= 13.5 s) after the last IMMEDIATE ASSIGNMENT.
7	SS -> MS	RLC data block	including Polling bit set and valid RRBP field.
8	MS -> SS	PACKET DOWNLINK ACK/NACK	sent in the assigned block at step 7 indicating correct reception of downlink RLC block.
9	MS<->SS	Completion of macro {Downlink data transfer}	SS completes data transfer.
10	SS -> MS	IMMEDIATE ASSIGNMENT	SS assigns again a PDCH with TBF Starting Time which already elapsed.
11	SS -> MS	RLC data block	sent in the third block after the block containing the message in step 10 (see note below), including Polling bit set and valid RRBP field.
12	MS -> SS	PACKET DOWNLINK ACK/NACK	indicating correct reception of RLC block.
13	MS<->SS	Completion of macro {Downlink data transfer}	SS completes data transfer.

NOTE: The requirements to uplink and downlink assignment reaction times are stated in 3GPP TS 05.10 subclause 6.11: An MS shall be ready to transmit and receive using a new assignment no later than the next occurrence of block $B((x+3) \bmod 12)$ where block $B(x)$ is the last radio block containing the uplink assignment.

41.2.6.4 Initiation of packet downlink assignment procedure / incorrect TFI

41.2.6.4.1 Conformance requirement

On receipt of an IMMEDIATE ASSIGNMENT message [the MS] stops monitoring downlink CCCH and switches to the assigned PDCH and starts listening for downlink RLC/MAC blocks identified by the assigned Temporary Flow Identifier (TFI).

Reference

3GPP TS 04.08 / 3GPP TS 44.018 subclause 3.5.3.1.2.

41.2.6.4.2 Test purpose

To verify that the MS correctly considers the TFI in the RLC/MAC blocks.

41.2.6.4.3 Method of test

Initial conditions

System Simulator:

1 cell, CCCH combined with SDCCH.

Mobile Station:

MS is GPRS attached, a PDP context has been established and the MS is in Packet Idle mode.

Specific PICS Statements

-

PIXIT Statements

-

Test procedure

The SS assigns a PDCH and starts transmitting RLC/MAC blocks with incorrect TFI. The MS shall ignore these RLC/MAC blocks and, after T3190 expires, return to packet idle mode.

To prove that the MS returns to idle mode, the SS assigns again a PDCH, and this time the SS sends RLC/MAC blocks with correct TFI. The MS shall successfully receive the data packets.

Maximum duration of the test

-

Expected sequence

Step	Direction	Message	Comments
1	SS -> MS	IMMEDIATE ASSIGNMENT	for downlink TBF
2	SS -> MS	RLC data block	SS sends RLC blocks with incorrect TFI (i.e. not corresponding to the last IMMEDIATE ASSIGNMENT), including Polling bit set and valid RRBP field.
3	SS		SS verifies that the MS does not respond in the assigned block.
4	SS		SS waits value of T3190 + 10% (=5.5s).
5	SS -> MS	IMMEDIATE ASSIGNMENT	for downlink TBF
6	SS -> MS	RLC data block	with correct TFI, including Polling bit set and valid RRBP field.
7	MS -> SS	PACKET DOWNLINK ACK/NACK	indicating correct reception of RLC block.
8	MS<->SS	Completion of macro {Downlink data transfer}	SS completes downlink transfer.

41.2.7 Single block packet downlink assignment

41.2.7.1 Single block packet downlink assignment / TBF Starting Time

41.2.7.1.1 Conformance requirement

The sending of an RLC/MAC control message to a mobile station in packet idle mode may be initiated by the RR entity on network side using the packet downlink assignment procedure. The procedure is used to assign a single downlink block on a PDCH for the transfer of the RLC/MAC control message.

The packet downlink construction in the IMMEDIATE ASSIGNMENT message shall contain only:

- the TLLI; and
- the TBF starting time.

If the mobile station receives the IMMEDIATE ASSIGNMENT message before the TBF starting time has expired, it shall wait until the frame number indicated by the TBF starting time. The network shall use the TBF starting time to indicate the first frame number belonging to the single block period assigned to the mobile station. The mobile station shall switch to the assigned PDCH and attempt to decode an RLC/MAC control message in the assigned downlink block.

Reference

3GPP TS 04.08 / 3GPP TS 44.018 subclause 3.5.3.2.

41.2.7.1.2 Test purpose

To verify that the MS correctly decodes the RLC control block sent by the network on the assigned downlink block given by TBF starting time in the IMMEDIATE ASSIGNMENT message.

41.2.7.1.3 Method of test

Initial conditions

System Simulator:

1 cell, CCCH combined with SDCCH. The parameter CONTROL_ACK_TYPE in SI13 indicates four access bursts.

Mobile Station:

MS is GPRS attached, in Ready state and in Packet Idle mode.

Specific PICS Statements

-

PIXIT Statements

-

Test procedure

The SS assigns a single block for downlink via an IMMEDIATE ASSIGNMENT message on CCCH including a TBF starting time . The SS sends a PACKET MEASUREMENT ORDER message addressing the MS with Polling Bit set and a valid RRBP field.

The MS shall respond with a PACKET CONTROL ACKNOWLEDGMENT message on the assigned TBF block. This verifies that the MS correctly received the RLC control block sent in the assigned single block TBF.

Maximum duration of the test

-

Expected sequence

Step	Direction	Message	Comments
1	SS -> MS	IMMEDIATE ASSIGNMENT	for single block downlink assignment, including a TBF starting time arbitrarily chosen in the range 0.5 to 50 s. after the current frame number.
2	SS -> MS	PACKET MEASUREMENT ORDER	sent on the block indicated by TBF starting time in step 1, including Polling bit set and valid RRBP field and addressing the MS.
3	MS -> SS	PACKET CONTROL ACKNOWLEDGEMENT	sent on the block indicated by the RRBP field in step 2. 4 access bursts, received on PACCH

41.2.7.2 Single block packet downlink assignment / MS returns to packet idle mode

41.2.7.2.1 Conformance requirement

1. Unless otherwise indicated by the RLC/MAC control message, the mobile station remains in packet idle mode. If the mobile station remains in packet idle mode, it shall continue to monitor downlink CCCH once the block period indicated by the TBF starting time has passed.
2. In packet idle mode, the reporting period is NC_REPORTING_PERIOD_I rounded off to the nearest smaller integer multiple of DRX period if NC_REPORTING_PERIOD_I is greater than DRX period, else, the reporting period is DRX period.

Reference

3GPP TS 04.08 / 3GPP TS 44.018 subclause 3.5.3.2.

3GPP TS 45.008 (ex 05.08) subclause 10.1.4.1.

41.2.7.2.2 Test purpose

To verify that the MS remains in packet idle mode and monitors downlink CCCH once the block period indicated by the TBF starting time has passed.

41.2.7.2.3 Method of test

Initial conditions

System Simulator: Default settings except:

NETWORK_CONTROL_ORDER in SI 13 Rest Octets set to '00' (no measurement reporting).

CCCH combined with SDCCH.

Mobile Station:

MS is GPRS attached in Packet Idle mode.

Specific PICS Statements

-

PIXIT Statements

-

Test procedure

The SS assigns a single block for downlink via an IMMEDIATE ASSIGNMENT message on CCCH including a TBF starting time. The SS sends a PACKET MEASUREMENT ORDER message requesting the MS to periodically send measurement reports.

The SS shall wait until the MS attempts two periodic measurement report procedures, in order to make sure that the MS correctly decoded the PACKET MEASUREMENT ORDER on the assigned single block for downlink.

Maximum duration of the test

-

Expected sequence

Step	Direction	Message	Comments
1	SS -> MS	IMMEDIATE ASSIGNMENT	for single block downlink assignment, including a TBF starting time arbitrarily chosen on the assigned single block. NETWORK_CONTROL_ORDER = '01' NC_REPORTING_PERIOD_I = '100' (7,68 s.)
2	SS -> MS	PACKET MEASUREMENT ORDER	
3	MS -> SS	CHANNEL REQUEST	for uplink TBF, single block assignment
4	SS -> MS	IMMEDIATE ASSIGNMENT	
5	MS -> SS	PACKET MEASUREMENT REPORT	
6	MS -> SS	CHANNEL REQUEST	The SS verifies reporting period: the time interval between CHANNEL REQUESTS messages in steps 3 and 6 corresponds to the time +/- 10% which is calculated from the NC_REPORTING_PERIOD_I rounded off to the nearest smaller integer multiple of DRX period if NC_REPORTING_PERIOD_I is greater than DRX period, else, the reporting period is DRX period. (3GPP TS 04.08 § 10.1.4.1)
7	SS -> MS	IMMEDIATE ASSIGNMENT	for uplink TBF, single block assignment
8	MS -> SS	PACKET MEASUREMENT REPORT	

41.2.8 Macros and default message contents

41.2.8.1 Macros

In order to simplify the process of writing and coding test cases, macros are referenced in the expected signaling tables. These macros provide all additional signaling needed to complete the particular test but are not relevant to its purpose.

41.2.8.1.1 GPRS attach procedure

The following table describes a signaling sequence performing the GPRS attach procedure. Note that there are different possible sequences implementing the GPRS attach procedure.

The macros {Completion of GPRS attach} in the test cases refer to the table below starting at the step required for the particular sequence.

{ GPRS attach procedure }

Step	Direction	Message	Comments
0			MS is triggered to initiate the GPRS attach procedure.
1	MS -> SS	CHANNEL REQUEST	Establishment Cause is 'one phase packet access'. For uplink TBF, single phase access, dynamic allocation. Transporting: ATTACH REQUEST Indicating correct reception of uplink blocks, including RRBP field set. Sent on PACCH
2	SS -> MS	IMMEDIATE ASSIGNMENT	
3	MS -> SS	RLC data blocks	
4	SS -> MS	PACKET UPLINK ACK/NACK	
5	MS -> SS	PACKET CONTROL ACKNOWLEDGMENT	
6	SS -> MS	IMMEDIATE ASSIGNMENT	For downlink TBF, sent 1 s. after setp 5 on AGCH. Transporting: ATTACH ACCEPT. Last block containing a valid RRBP field and FBI set.
7	SS -> MS	RLC data blocks	
8A	MS -> SS	PACKET DOWNLINK ACK/NACK	Including Channel Request Description. Sent on PACH. Transporting: ATTACH COMPLETE Including valid RRBP field
9A	SS -> MS	PACKET UPLINK ASSIGNMENT	
10A	MS -> SS	RLC data blocks	
11A	SS -> MS	PACKET UPLINK ACK/NACK	
12A	MS -> SS	PACKET CONTROL ACKNOWLEDGMENT	
8B	MS -> SS	PACKET DOWNLINK ACK/NACK	Not including Channel Request Description.
9B	MS->SS	CHANNEL REQUEST	For uplink TBF, single phase access, dynamic allocation. Transporting: ATTACH COMPLETE Indicating correct reception of uplink blocks, including RRBP field set.
10B	SS -> MS	IMMEDIATE ASSIGNMENT	
11B	MS -> SS	RLC data blocks	
12B	SS -> MS	PACKET UPLINK ACK/NACK	
13B	MS -> SS	PACKET CONTROL ACKNOWLEDGMENT	

41.2.8.1.2 Uplink data transfer

The following table describes a sequence performing uplink data transfer in acknowledged mode.

{ Uplink data transfer, acknowledged mode }

Step	Direction	Message	Comments
0			A PDP context (in acknowledged RLC mode) has been established. The MS is triggered to send data.
1	MS -> SS	CHANNEL REQUEST	
2	SS -> MS	IMMEDIATE ASSIGNMENT	for uplink TBF, single block access.
3	MS -> SS	PACKET RESOURCE REQUEST	
4	SS -> MS	PACKET UPLINK ASSIGNMENT	for dynamic allocation
5			Steps 6 to 8 are executed 0 to n times as needed.
6	MS -> SS	RLC data block	
7			Step 6 is repeated at most 14 times (resulting in at most 15 uplink data blocks)
8	SS -> MS	PACKET UPLINK ACK/NACK	indicating correct reception of uplink data blocks
9			Countdown procedure: Step 10 is repeated as needed.
10	MS -> SS	RLC data block	The MS shall correctly set the CV value in the RLC header, the last one being 0.
11	SS -> MS	PACKET UPLINK ACK/NACK	indicating correct reception of uplink blocks, and valid RRBP field and Final Ack Indicator set.
12	MS -> SS	PACKET CONTROL ACKNOWLEDGEMENT	

41.2.8.1.3 Downlink data transfer

The following table describes a sequence performing downlink data transfer in acknowledged mode.

{Downlink data transfer, acknowledged mode}

Step	Direction	Message	Comments
0			A PDP context (in acknowledged RLC mode) has been established.
1	SS -> MS	IMMEDIATE ASSIGNMENT	for downlink TBF, sent on CCCH on the correct CCCH block the MS belongs to.
2			Steps 3 to 6 are executed 0 to n times as needed.
3	SS -> MS	RLC data block	
4			Step 3 is repeated at most 14 times
5	SS -> MS	RLC data block	with polling bit set.
6	MS -> SS	PACKET DOWNLINK ACK/NACK	indicating correct reception of downlink data blocks.
7	SS -> MS	RLC data block	
8			Step 7 is repeated as needed.
9	SS -> MS	RLC data block	Last data block with FBI bit set and a valid RRBP field.
10	MS -> SS	PACKET DOWNLINK ACK/NACK	indicating correct reception of downlink data blocks.

41.2.8.2 Default message contents

IMMEDIATE ASSIGNMENT for downlink TBF

Protocol Discriminator	RR Management
Skip Indicator	0000
Message Type	00111111
Page Mode	
- Page Mode	Normal Paging
Dedicated mode or TBF	
- TMA	0 (not a two-message assignment)
- Downlink	0 ('no meaning')
- T/D	1 (assign a Temporary Block Flow)
Packet Channel Description	
- Channel Type	PDCH
- TN	slot 4
- TSC	3
-	0
-	00 (Binary)
- ARFCN	30
Request Reference	Pertaining to last Channel Request sent by the MS.
Timing Advance	
- Timing advance value	30 bit periods.
Mobile Allocation	
- Length	0
Starting Time	Not present.
IA rest octets	
-	HH01 (Packet Downlink Assignment)
- Packet Downlink Assignment	
- TLLI	Corresponding to the value allocated to the MS.
-	1
- TFI_ASSIGNMENT	00001 (binary)
- RLC_MODE	1 (RLC acknowledged mode)
- ALPHA	0.5
- GAMMA	For GSM 700, T-GSM 810: +8 dBm For GSM 850: +8 dBm For GSM 900: +8 dBm For DCS 1 800: +6 dBm For PCS 1 900: +6 dBm
- POLLING	0
- TA_VALID	1 (valid)
- REL_OR_ABS_FN	1
-	0 (TIMING_ADVANCE_INDEX not present)
-	1 (TBF starting time is present)
- TBF_STARTING_TIME	arbitrarily chosen in the future
- spare padding	Spare Padding

IMMEDIATE ASSIGNMENT for downlink single block assignment

Protocol Discriminator	RR Management
Skip Indicator	0000
Message Type	00111111
Page Mode	
- Page Mode	Normal Paging
Dedicated mode or TBF	
- TMA	0 (not a two-message assignment)
- Downlink	0 ('no meaning')
- T/D	1 (assign a Temporary Block Flow)
Packet Channel Description	
- Channel Type	PDCH
- TN	slot 4
- TSC	3
-	0
-	00 (Binary)
- ARFCN	30
Request Reference	Pertaining to last Channel Request sent by the MS.
Timing Advance	
- Timing advance value	30 bit periods.
Mobile Allocation	
- Length	0
Starting Time	Not present.
IA rest octets	
-	HH01 (Packet Downlink Assignment)
- Packet Downlink Assignment	
- TLLI	Corresponding to the value allocated to the MS.
-	0 (parameters TFI_ASSIGNMENT, RLC_MODE, ALPHA, GAMMA, POLLING, TA_VALID and REL_OR_ABS_FN not present)
-	1 (TBF starting time is present)
- TBF_STARTING_TIME	arbitrarily chosen in the future
- spare padding	Spare Padding

IMMEDIATE ASSIGNMENT for uplink TBF, one phase access, dynamic allocation

Protocol Discriminator	RR Management
Skip Indicator	0000
Message Type	00111111
Page Mode	
- Page Mode	Normal Paging
Dedicated mode or TBF	
- TMA	0 ('no meaning')
- Downlink	0 ('no meaning')
- T/D	1 (assign a Temporary Block Flow)
Packet Channel Description	
- Channel Type	PDCH
- TN	slot 4
- TSC	3
-	0
-	00 (Binary)
- ARFCN	30 (decimal)
Request Reference	Pertaining to last Channel Request sent by the MS.
Timing Advance	
- Timing advance value	30 bit periods.
Mobile Allocation	
- Length	0
Starting Time	Not present.
IA rest octets	
-	HH00 (Packet Uplink Assignment)
- Packet Uplink Assignment	
-	1
- TFI_ASSIGNMENT	00001
- POLLING	0
-	0 (Dynamic Allocation)
- USF	001
- USF_GRANULARITY	0 (MS shall transmit one RLC/MAC block)
- CHANNEL_CODING_CMD	01 (CS-2)
- TLLI_BLOCK_CH_CODING	00 (CS-1)
-	1 (ALPHA is present)
- ALPHA	0.5
- GAMMA	For GSM 700, T-GSM 810: +8 dBm For GSM 850: +8 dBm For GSM 900: +8 dBm For DCS 1 800: +6 dBm For PCS 1 900: +6 dBm
-	0 (TIMING_ADVANCE_INDEX not present)
-	1 (TBF_STARTING_TIME is present)
- TBF_STARTING_TIME	arbitrarily chosen in the future
- spare padding	Spare Padding

IMMEDIATE ASSIGNMENT for uplink TBF, single block access

Protocol Discriminator	RR Management
Skip Indicator	0000
Message Type	00111111
Page Mode	
- Page Mode	Normal Paging
Dedicated mode or TBF	
- TMA	0 'no meaning'
- Downlink	0 'no meaning'
- T/D	1 assign a Temporary Block Flow
Packet Channel Description	
- Channel Type	PDCH
- TN	slot 4
- TSC	3
-	0
-	00 (Binary)
- ARFCN	30
Request Reference	Pertaining to last Channel Request sent by the MS.
Timing Advance	
- Timing advance value	30 bit periods.
Mobile Allocation	
- Length	0
Starting Time	Not present.
IA rest octets	
-	HH00 (Packet Uplink Assignment)
- Packet Uplink Assignment	
-	1
- TFI_ASSIGNMENT	00001
- POLLING	0
-	0 (Dynamic Allocation)
- USF	001
- USF_GRANULARITY	0 (MS shall transmit one RLC/MAC block)
- 0	No PR_MODE
- CHANNEL_CODING_CMD	01 (CS-2)
- TLLI_BLOCK_CH_CODING	00 (CS-1)
-	1 (ALPHA is present)
- ALPHA	0.5
- GAMMA	For GSM 700, T-GSM 810: +8 dBm
	For GSM 850: +8 dBm
	For GSM 900: +8 dBm
	For DCS 1 800: +6 dBm
	For PCS 1 900: +6 dBm
-	0 (TIMING_ADVANCE_INDEX not present)
-	1 (TBF_STARTING_TIME is present)
- TBF_STARTING_TIME	arbitrarily chosen in the future
- spare padding	Spare Padding

PAGING REQUEST TYPE 1

Protocol Discriminator	RR Management.
Skip Indicator	0000
Message Type	00100001
Page Mode	
- Page Mode	Normal Paging.
Channels needed	
- first channel	00
- second channel	00
Mobile Identity 1	
- odd/even indication	Even.
- Type of Identity	P-TMSI.
- Identity Digits	P-TMSI previously allocated to MS.
Mobile Identity 2	Not present.
P1 rest octets	
-	L (no Notification List Number(PCH))
-	L (no priority specified for mobile Id 1)
-	L (no priority specified for mobile Id 2)
- Packet Page Indication 1	H
- Packet Page Indication 2	L (Not present)
-	L (no Group call Information)
-	L (no Notification List Number status)
- spare padding	Spare Padding

PACKET UPLINK ASSIGNMENT

MESSAGE_TYPE	001110
PAGE_MODE	Normal Paging
Referenced Address	
-	1 (not Global TFI)
-	1 (not TLLI)
-	1 (not TQI)
-	1 (Packet Request Reference)
- Packet Request Reference	information field sent in PACKET CHANNEL REQUEST and frame number in which PACKET CHANNEL REQUEST was received
CHANNEL_CODING_COMMAND	CS-2 coding
TLLI_BLOCK_CHANNEL_CODING	CS-1 coding
{L H<UPLINK_TFI_ASSIGNMENT>}	H (assign an uplink TFI)
- UPLINK_TFI_ASSIGNMENT	0000110 (uplink TBF identifier)
Packet Timing Advance	
-	1 (timing advance value)
- TIMING_ADVANCE_VALUE	30 bit periods
-	0 (no timing advance index)
{L H<Frequency Parameters>}	H (Frequency Parameters present)
- Frequency Parameters	
- TSC	5
-	00 (no hopping)
- ARFCN	For GSM 700, T-GSM 810: 460
	For GSM 850: 150
	For GSM 900: 30
	For DCS 1 800: 650
	For PCS 1 900: 650
{0 1<List of Reference Frequency lists>}	0 (no reference frequencies)
{0 1<Mobile Allocation list>}	0 (no MA)
Dynamic Allocation	LL (Dynamic Allocation)
-	H (Contention Resolution TLLI is present)
- CONTENTION_RESOLUTION_TLLI	As allocated to the MS
-	H (power control parameters)
- ALPHA	0.5
- GAMMA_TN0	0 (not present)
- GAMMA_TN1	0 (not present)
- GAMMA_TN2	1
- GAMMA_TN2	8 dBm (GSM 700), 8 dBm (T-GSM 810), 8 dBm (GSM 850), 8 dBm (GSM 900), 6 dBm (DCS 1 800), 6 dBm (PCS 1 900)
- GAMMA_TN3	0 (not present)
- GAMMA_TN4	0 (not present)
- GAMMA_TN5	0 (not present)
- GAMMA_TN6	0 (not present)
- GAMMA_TN7	0 (not present)

PACKET DOWNLINK ASSIGNMENT

MESSAGE_TYPE	000100
PAGE_MODE	Normal Paging
Referenced Address	
-	1 (address is TLLI)
- TLLI	as allocated for MS.
MAC_MODE	Dynamic Allocation
RLC_MODE	acknowledged mode
CONTROL_ACK	0
TIMESLOT_ALLOCATION	slot 2
Packet Timing Advance	
-	1 (timing advance value)
- TIMING_ADVANCE_VALUE	30 bit periods
-	0 (no timing advance index)
{L H<Frequency Parameters>}	H (Frequency Parameters present)
- Frequency Parameters	
- TSC	5
-	00 (non-hopping channel)
- ARFCN	For GSM 700, T-GSM 810: 470
	For GSM 850: 160
	For GSM 900: 30
	For DCS 1800: 650
	For PCS 1900: 650
{L H<Power Control Parameters>}	H (Power Control Parameters present)
- ALPHA	0.5
- {0 1<GAMMA_TN0>}	0 (no GAMMA_TN0)
- {0 1<GAMMA_TN1>}	0 (no GAMMA_TN1)
- {0 1<GAMMA_TN2>}	0 (GAMMA_TN2 present)
- GAMMA_TN2	For GSM 700, T-GSM 810: +8 dBm
	For GSM 850, +8 dBm
	For GSM 900, +8 dBm
	For DCS 1800, +6 dBm
	For PCS 1900, +6 dBm
- {0 1<GAMMA_TN3>}	0 (no GAMMA_TN3)
- {0 1<GAMMA_TN4>}	0 (no GAMMA_TN4)
- {0 1<GAMMA_TN5>}	0 (no GAMMA_TN5)
- {0 1<GAMMA_TN6>}	0 (no GAMMA_TN6)
- {0 1<GAMMA_TN7>}	0 (no GAMMA_TN7)
{L H<DOWNLINK_TFI_ASSIGNMENT>}	H (assign downlink TFI)
- DOWNLINK_TFI_ASSIGNMENT	00011(Binary)
{L H<TBF_STARTING_TIME>}	H (TBF Starting Time present)
- TBF_STARTING_TIME	indicating (current frame + 13 frames)
{L H<Measurement Mapping>}	L (no measurement mapping)

41.3 MAC/RLC Release

To bring the MS into active state U10, macro 40.4.3.22 shall be used.

The maximum duration of each test is per default 5 minutes.

41.3.1 TBF Release / Uplink / Normal / MS initiated

41.3.1.1 TBF Release / Uplink / Normal / MS initiated / Acknowledged mode

41.3.1.1.1 Conformance requirements

1. The mobile station initiates release of the uplink TBF by beginning the countdown process. When the mobile station has sent the RLC data block with CV = 0 and there are no elements in the V(B) array set to the value Nacked, it shall start timer T3182 and stop timer T3180, if running. The mobile station shall continue to send RLC data blocks on each assigned uplink data block, according to the algorithm defined in 3GPP TS 04.60, subclause 9.1.3.2.
2. Upon reception of a PACKET UPLINK ACK/NACK message the mobile station shall stop timer T3182.

3. If the PACKET UPLINK ACK/NACK message has the Final Ack Indicator bit set to '1', the mobile station shall transmit the PACKET CONTROL ACKNOWLEDGEMENT message and release the TBF. If there is no ongoing downlink TBF the mobile station shall enter packet idle mode.
4. If the PACKET UPLINK ACK/NACK message requests retransmission of RLC data blocks, the mobile station shall if necessary wait for allocation of uplink resources and then retransmit the RLC data blocks requested, restarting timer T3180 after each block is transmitted. The mobile station shall then start timer T3182 and wait for a PACKET UPLINK ACK/NACK message as above.
5. Upon transition from the packet transfer mode to the packet idle mode, a mobile station shall enter the Transfer non-DRX mode period.
6. Upon a receipt of a commanding message or indication from the network requiring an action by the mobile station, if the reaction time for such action is not specified elsewhere, the mobile station shall begin to perform the required action no later than the next occurrence of block $B((x+6) \bmod 12)$, where block $B(x)$ is the radio block containing the commanding message or indication from the network.

References

3GPP TS 04.60, subclauses 9.3.2.3 and 5.5.1.5.

3GPP TS 05.10, subclause 6.11.4.

41.3.1.1.2 Test purpose

To verify that in RLC acknowledged mode:

1. the MS initiates release of an uplink TBF by beginning countdown process. After $CV = 0$ and no elements in the $V(B)$ array set to the value "Nacked" the MS continues to send RLC data blocks on each assigned uplink data block in the way defined in 3GPP TS 04.60, subclause 9.1.3 and waits for PACKET UPLINK ACK/NACK.
2. the MS retransmits the requested RLC data blocks if the PACKET UPLINK ACK/NACK message requests to do so. The MS then waits for another PACKET UPLINK ACK/NACK message.
3. the MS transmits the PACKET CONTROL ACKNOWLEDGEMENT message and release the TBF upon reception of a PACKET UPLINK ACK/NACK with the Final Ack Indicator bit set to '1'. If there is no ongoing downlink TBF the mobile station shall enter packet idle mode.

41.3.1.1.3 Method of test

Initial Conditions

System Simulator:

1 cell, CCCH combined with SDCCH, $BS_PBCCH_BLKS = 3$, $BS_CV_MAX = 10$.

Mobile Station:

The MS is GPRS attached with a P-TMSI allocated, SPLIT PG CYCLE negotiated and PDP test context2 activated.

Specific PICS Statements

- GPRS Multislotclass (TSPC_Type_GPRS_Multislot_ClassX where $X = 1..45$)

PIXIT Statements

-

Test Procedure

The test has three parts.

1. The MS is triggered to transfer user data. A TBF of dynamic allocation in acknowledged mode with $USF_GRANULARITY = 1$ block is assigned. The countdown values are checked during the RLC data transferring. The SS acknowledges the all received RLC data blocks with the Final Ack Indicator bit set to '1'.

The SS assigns a downlink TBF, transfers a number of downlink data blocks and polls the MS. The MS responds the polling.

2. The MS is assigned a TBF of dynamic allocation in acknowledged mode with USF_GRANULARITY = 4 blocks. The countdown values are checked during the RLC data transferring. The SS acknowledges the all received RLC data blocks with the Final Ack Indicator bit set to '1'.
3. The MS is triggered to transfer user data. A TBF of dynamic allocation on two timeslots in acknowledged mode with USF_GRANULARITY = 4 block is assigned. The countdown values are checked during the RLC data transferring. The SS acknowledges the all received RLC data blocks with the Final Ack Indicator bit set to '1'.

Expected Sequence

Step	Direction	Message	Comments
1		{Uplink dynamic allocation one phase access with contention resolution} or {Uplink dynamic allocation two phase access}	n = 440 octets, USF_GRANULARITY = 1 block, RLC_DATA_BLOCKS_GRANTED = open-end CHANNEL_CODING_COMMAND: CS-1, TLLI_BLOCK_CHANNEL_CODING: '0'B, CS-1. RLC acknowledged mode (PDP context2), without starting time
2	SS -> MS	PACKET DOWNLINK DUMMY CONTROL BLOCK	USF assigned to the MS
3	MS -> SS	UPLINK RLC DATA BLOCK	
4			Repeat step 2 and 3 until the countdown value CV=4.
5	SS -> MS	PACKET UPLINK ACK/NACK	Acknowledge all received data blocks, USF assigned to the MS.
6	MS -> SS	UPLINK RLC DATA BLOCK	Received on the assigned PDTCH. Check that CV=3.
7	SS -> MS	PACKET DOWNLINK DUMMY CONTROL BLOCK	USF assigned to the MS.
8	MS -> SS	UPLINK RLC DATA BLOCK	Check that CV=2.
8a			Repeat steps 7 and 8 two more times and check that first CV =1 block is received and then CV = 0 is received.
9	SS -> MS	PACKET DOWNLINK DUMMY CONTROL BLOCK	USF assigned to the MS.
10	MS -> SS	UPLINK RLC DATA BLOCK	Check that the data block is a retransmission of the data block transmitted in step 6, CV=3.
11	SS -> MS	PACKET DOWNLINK DUMMY CONTROL BLOCK	USF assigned to the MS.
12	MS -> SS	UPLINK RLC DATA BLOCK	Check that the data block is a retransmission of the data block transmitted in step 8.
12a			Repeat steps 11 and 12 two more times and check that first CV =1 block is retransmitted and then CV = 0 is retransmitted.
12b	SS		SS waits BS_CV_MAX periods.
13	SS -> MS	PACKET UPLINK ACK/NACK	Negatively acknowledge the data block with CV = 0.
13a			Wait for 5 block periods.
13b	SS -> MS	PACKET DOWNLINK DUMMY CONTROL BLOCK	Containing USF assigned to MS.
A14 (optional step)	MS -> SS	UPLINK RLC DATA BLOCK	MS may retransmit block with CV=3 if it has already been scheduled while Packet Uplink Ack/Nack is being processed. In this case go to step B14
B14 (optional step)	SS -> MS	PACKET DOWNLINK DUMMY CONTROL BLOCK	USF assigned to the MS.
14	MS -> SS	UPLINK RLC DATA BLOCK	Check that the data block is a retransmission of the data block with CV = 0.
15	SS -> MS	PACKET UPLINK ACK/NACK	Final Ack Indicator = '1' containing a valid RRBP=26. Acknowledge the last two data blocks.
16	MS -> SS	PACKET CONTROL ACKNOWLEDGEMENT	Received on the radio block specified by RRBP
17	SS -> MS	PACKET DOWNLINK ASSIGNMENT	Downlink Assignment, acknowledged mode. Sent on PCCCH.
18	SS -> MS	DOWNLINK RLC DATA BLOCKs	10 downlink data blocks, the data block with FBI = '1' and a valid RRBP

Step	Direction	Message	Comments
19	MS -> SS	PACKET DOWNLINK ACK/NACK	Received on the block specified by RRBp in step 18. Check that the Final Ack indicator = '1'.
20		{Uplink dynamic allocation one phase access with contention resolution} or {Uplink dynamic allocation two phase access}	n = 440 octets, USF_GRANULARITY = 4 blocks, RLC_DATA_BLOCKS_GRANTED = open-end CHANNEL_CODING_COMMAND: CS-1, TLLI_BLOCK_CHANNEL_CODING: '0'B, CS-1. RLC acknowledged mode (PDP context2), without starting time
21	SS -> MS	PACKET DOWNLINK DUMMY CONTROL BLOCK	USF assigned to the MS
22	MS -> SS	UPLINK RLC DATA BLOCK	
23	MS -> SS	UPLINK RLC DATA BLOCK	
24	MS -> SS	UPLINK RLC DATA BLOCK	
25	MS -> SS	UPLINK RLC DATA BLOCK	
26			Regard the steps 21 - 25 as a step block. Repeat the step block until the countdown value CV = 0 in one of data blocks received.
26a	SS		SS waits BS_CV_MAX periods.
27	SS -> MS	PACKET UPLINK ACK/NACK	Acknowledge all received data blocks except for the data blocks which have CV=2, CV=1, or CV=0. Set SSN value in Ack/Nack description equal to the BSN' of the received data block with CV = 2.
27a	SS		Wait for 5 block periods
27b	SS -> MS	PACKET DOWNLINK DUMMY CONTROL BLOCK	USF assigned to the MS
A28 (optional step)	MS -> SS	UPLINK RLC DATA BLOCK	MS may retransmit block with CV=15 if it has already been scheduled before the end of the reaction time
28	MS -> SS	UPLINK RLC DATA BLOCK	Check that the countdown value CV = 2.
29	MS -> SS	UPLINK RLC DATA BLOCK	Check that the countdown value CV = 1.
30	MS -> SS	UPLINK RLC DATA BLOCK	Check that the countdown value CV = 0.
A31 Conditional	MS -> SS	UPLINK RLC DATA BLOCK	This step should be done if step A28 was not executed. Check that the countdown value CV = 2.
31			Wait for BS_CV_MAX block period
32	SS -> MS	PACKET UPLINK ACK/NACK	Negatively acknowledge the data blocks of CV=2, and CV=0. Acknowledge the data block of CV=1
32a	SS		Wait for 5 block periods
32b	SS -> MS	PACKET DOWNLINK DUMMY CONTROL BLOCK	USF assigned to the MS
A33 (optional step)	MS -> SS	UPLINK RLC DATA BLOCK	MS may retransmit block with CV=2 if it has already been scheduled before the end of the reaction time, and if step A31 was NOT executed. MS may retransmit block with CV=1 if it has already been scheduled before the end of the reaction time, and if step A31 WAS executed.
33	MS -> SS	UPLINK RLC DATA BLOCK	Check that the countdown value CV = 2.
34	MS -> SS	UPLINK RLC DATA BLOCK	Check that the countdown value CV = 0.
35	MS -> SS	UPLINK RLC DATA BLOCK	Check that the countdown value CV = 2.
36 Conditional	MS -> SS	UPLINK RLC DATA BLOCK	This step should be done if step A33 was not executed. Check that the countdown value CV = 0.
37	SS -> MS	PACKET UPLINK ACK/NACK	Final Ack Indicator = '1' containing valid RRBp. Sent on PACCH of the assigned PDCH. Acknowledge all data blocks received.
38	MS -> SS	PACKET CONTROL ACKNOWLEDGEMENT	Received on the block specified by RRBp on PACCH of the assigned PDCH.
39	SS -> MS	PACKET DOWNLINK ASSIGNMENT	Downlink Assignment, acknowledged mode. Sent on PCCCH.
40	SS -> MS	DOWNLINK RLC DATA BLOCKS	10 downlink data blocks, the data block with FBI = '1' and a valid RRBp
41	MS -> SS	PACKET DOWNLINK ACK/NACK	Received on the block specified by RRBp in step 40. Check that the Final Ack indicator = '1'.
			The following steps are not applicable to the MS in GPRS multislot class 1, 2, 3, 4, 8, 30, 35 and 40.

Step	Direction	Message	Comments
42		{Uplink dynamic allocation two phase access}	n = 1200 octets, without starting time, USF_GRANULARITY = 4 blocks, RLC_DATA_BLOCKS_GRANTED = open-end, CHANNEL_CODING_COMMAND: cs4 RLC acknowledged mode (PDP context2), Two slots, USF ₀ on TN ₀ and USF ₁ on TN ₁ , are assigned.
43	SS -> MS	PACKET DOWNLINK DUMMY CONTROL BLOCK	Assigned USF ₀ on PDTCH ₀ addressing the MS.
44	SS -> MS	PACKET DOWNLINK DUMMY CONTROL BLOCK	Assigned USF ₁ on PDTCH ₁ addressing the MS, sent on the same TDMA frame as step 43.
45	MS -> SS	UPLINK RLC DATA BLOCKS	Received on the assigned PDTCH ₀ and PDTCH ₁ . Check that the coding as specified in CHANNEL_CODING_COMMAND, the TFI is correct and the block does not contain TLLI.
46	MS -> SS	UPLINK RLC DATA BLOCKS	Received on the assigned PDTCH ₀ and PDTCH ₁ .
47	MS -> SS	UPLINK RLC DATA BLOCKS	Received on the assigned PDTCH ₀ and PDTCH ₁ .
48	MS -> SS	UPLINK RLC DATA BLOCKS	Received on the assigned PDTCH ₀ and PDTCH ₁ .
49			Regard the steps 43 - 48 as a step block. Repeat the step block until the countdown value CV = 0 in one of data blocks received. Check the CV decrement from BS_CV_MAX (10) to 0.
50	SS -> MS	PACKET UPLINK ACK/NACK	Final Ack Indicator = '1' containing a valid RRBP. Sent on PACCH of the assigned PDCH. Acknowledge all data blocks received.
51	MS -> SS	PACKET CONTROL ACKNOWLEDGEMENT	Received on the block specified by RRBP on PACCH of the assigned PDCH.

41.3.1.2 TBF Release / Uplink / Normal / MS initiated / Unacknowledged mode

41.3.1.2.1 Conformance requirements

The mobile station initiates release of the uplink TBF by beginning the countdown process. It indicates the end of the TBF by setting the CV value to 0 and starts timer T3182.

Upon reception of a PACKET UPLINK ACK/NACK message the mobile station shall stop timer T3182. If the PACKET UPLINK ACK/NACK message has the Final Ack Indicator bit set to '1', the mobile station shall transmit the PACKET CONTROL ACKNOWLEDGEMENT message and release the TBF. If there is no ongoing downlink TBF the mobile station shall enter packet idle mode.

If timer T3182 expires the mobile station shall release the TBF as if a PACKET UPLINK ACK/NACK message was received.

References

3GPP TS 04.60, subclause 9.3.3.3.

41.3.1.2.2 Test purpose

To verify that in RLC unacknowledged mode:

1. the MS initiates release of an uplink TBF by beginning the countdown process and indicates the end of the TBF by setting the CV value to 0.
2. the MS transmits the PACKET CONTROL ACKNOWLEDGEMENT message and release the TBF upon reception of a PACKET UPLINK ACK/NACK message with the Final Ack Indicator bit set to '1' after CV=0. If there is no ongoing downlink TBF the mobile station enters packet idle mode.
3. the MS releases the TBF as if a PACKET UPLINK ACK/NACK message was received when timer T3182 expires.

41.3.1.2.3 Method of test

Initial Conditions

System Simulator:

1 cell, CCCH combined with SDCCH, BS_PBCCH_BLKs = 3, BS_CV_MAX = 12.

Mobile Station:

The MS is GPRS attached with a P-TMSI allocated, SPLIT PG CYCLE negotiated and PDP test context3 activated.

Specific PICS Statements

- GPRS Multislotclass (TSPC_Type_GPRS_Multislot_ClassX where X = 1..45)

PIXIT Statements

-

Test Procedure

The test procedure has three parts:

1. The MS is triggered to transfer data. A TBF of dynamic allocation in unacknowledged mode is assigned. The countdown values are checked during the RLC data transferring. The SS acknowledges the all received RLC data blocks with the Final Ack Indicator bit set to '1' and polls the MS. The MS sends PACKET CONTROL ACKNOWLEDGEMENT in response of polling. After 6 blocks the SS assigns a downlink TBF in unacknowledged mode, sends a number downlink data blocks and polls the MS with a valid RRBP. The MS responses the polling.
2. The MS is triggered to transfer data. A TBF of dynamic allocation in unacknowledged mode is assigned. The countdown values are checked during the RLC data transferring. The SS does not acknowledge the received RLC data blocks. After CV = 0 the SS waits for 5.5 s (T3182 expires). Once CV=0 the SS checks that the MS does not transfer further RLC data blocks on the assigned TBF.
3. The MS is triggered to transfer data. A TBF of dynamic allocation on two timeslots in unacknowledged mode is assigned. The countdown values are checked during the RLC data transferring. The SS does not acknowledge the received RLC data blocks. Once CV=0 the SS checks that the MS does not transfer further RLC data blocks on the assigned TBF. The last block may be transmitted twice (once in each slot) or the MS may transmit a PACKET UPLINK DUMMY CONTROL message.

Expected Sequence

Step	Direction	Message	Comments
1		{Uplink dynamic allocation two phase access}	n = 440 octets in RLC unacknowledged mode. (PDP context3)
2	SS->MS	PACKET DOWNLINK DUMMY CONTROL BLOCK	TLLI_BLOCK_CHANNEL_CODING = '0'B, cs-1, CHANNEL_CODING_COMMAND = cs-1. USF assigned to MS
3	MS -> SS	UPLINK RLC DATA BLOCK	Received on assigned PDCH
4			Repeat step 2 and 3 until the countdown value CV=0.
5	SS -> MS	PACKET UPLINK ACK/NACK	Final Ack Indicator = '1' containing a valid RRBp=13, no retransmission needed.
6	MS -> SS	PACKET CONTROL ACKNOWLEDGEMENT	Received on the block specified by RRBp on PACCH of the assigned PDCH.
7	SS->MS	PACKET DOWNLINK DUMMY CONTROL BLOCK	USF assigned to MS
8	SS		Check that no data block is transmitted by the MS in the next radio block.
9	SS -> MS	PACKET DOWNLINK ASSIGNMENT	Downlink Assignment, unacknowledged mode. Sent on PPCH,. Steps 10 – 12 verify whether the MS has entered idle mode.
10	SS -> MS	DOWNLINK RLC DATA BLOCK	
11			Repeat step 10 ten times. In the last data block set FBI = '1' with a valid RRBp.
12	MS -> SS	PACKET CONTROL ACKNOWLEDGEMENT	Received on the block specified by RRBp in step 11.
13		{Uplink dynamic allocation two phase access}	n = 600 octets in RLC unacknowledged mode. (PDP context3)
14	SS->MS	PACKET DOWNLINK DUMMY CONTROL BLOCK	TLLI_BLOCK_CHANNEL_CODING = '1'B, cs1, CHANNEL_CODING_COMMAND = cs1. USF assigned to MS
15	MS -> SS	UPLINK RLC DATA BLOCK	Received on assigned PDCH.
16			Repeat steps 14 and 15 until the countdown value CV=0.
16a	SS->MS	PACKET DOWNLINK DUMMY CONTROL BLOCK	USF assigned to MS to delay start of T3180 by 500ms (SS should ignore any received Rlc data block). This step is repeated until a PACKET UPLINK DUMMY CONTROL BLOCK is received from the MS, but not more than 4 times.
17	SS		Wait 5.5 seconds (starting after the last RLC data block) to allow T3182 expiring
18	SS->MS	PACKET DOWNLINK DUMMY CONTROL BLOCK	USF assigned to MS
19	SS		Check that from no data block is transmitted by the MS. The following steps are not applicable to the MS in GPRS multislot class 1, 2, 3, 4, 8, 30, 35 and 40.

Step	Direction	Message	Comments
20	SS -> MS	{Uplink dynamic allocation two phase access}	n = 2000 octets in RLC unacknowledged mode. (PDP context3) Uplink dynamic allocation CHANNEL_CODING_COMMAND = cs4 Two timeslots are assigned
21	SS->MS	PACKET DOWNLINK DUMMY CONTROL BLOCKS	Sent on PDTCH0 and PDTCH1
22	MS->SS	UPLINK RLC DATA BLOCKS	Received on the assigned PDTCH ₀ and PDTCH ₁ .
23	MS -> SS		Repeat steps 21 and 22 Check the CV decrement from BS_CV_MAX (=12) to 0 in the received data blocks. Last block (CV=0) may be transmitted twice, once in PDTCH ₀ and once in PDTCH ₁ or the MS may transmit a PACKET UPLINK DUMMY CONTROL BLOCK after the last RLC DATA BLOCK
23a	SS->MS	PACKET DOWNLINK DUMMY CONTROL BLOCK	USF assigned to MS to delay start of T3180 by 500ms (SS should ignore any received Rlc data block). This step is repeated until a PACKET UPLINK DUMMY CONTROL BLOCK is received from the MS, but not more than 4 times.
24	SS		Wait 5.5 seconds (starting after the last RLC data block) for T3182 expiry
25	SS->MS	PACKET DOWNLINK DUMMY CONTROL BLOCKS	Sent on PDTCH0 and PDTCH1
26	SS		Verify that no data block is transmitted by the MS

41.3.1.3 TBF Release / Uplink / Normal / MS initiated / Channel coding change during countdown

41.3.1.3.1 Conformance requirements

If the mobile station receives a change in the Channel Coding Command in a PACKET UPLINK ACK/NACK message during the countdown procedure, the mobile station shall act upon the new Channel Coding Command. The mobile station shall then recalculate the CV values for any untransmitted RLC data blocks using the new RLC data block size.

References

3GPP TS 04.60, subclause 9.3.1.

41.3.1.3.2 Test purpose

It is verified that the MS acts upon the new Channel Coding Command and recalculates the CV values for any untransmitted RLC data blocks using the new RLC data block size when the MS receives a change of Channel Coding Command in a PACKET UPLINK ACK/NACK message during the countdown procedure.

41.3.1.3.3 Method of test

Initial Conditions

System Simulator:

1 cell, CCCH combined with SDCCH, BS_PBCCH_BLKs = 3, BS_CV_MAX = 7.

Mobile Station:

The MS is GPRS attached with a P-TMSI allocated, SPLIT PG CYCLE negotiated and PDP context3 activated.

Specific PICS Statements

-

PIXIT Statements

-

Test Procedure

1. The MS is triggered to transfer data. A TBF of dynamic allocation with channel coding CS-4 in unacknowledged mode is assigned. The countdown values are checked during the RLC data transferring.
2. Once CV=7 (BS_CV_MAX) the SS acknowledges the all received RLC data blocks and changes the channel coding to CS-1. In the next received RLC data block CV=15. The countdown values are checked during the RLC data transferring.
3. When CV=7 is reached the SS acknowledges the all received RLC data blocks and changes the channel coding to CS-2. The SS checks the next received RLC data block containing CV=5. The countdown values are checked during the RLC data transferring until CV=0. The SS acknowledges the all received RLC data blocks with the Final Ack Indicator bit set to '1'.

Expected Sequence

Step	Direction	Message	Comments
1		{Uplink dynamic allocation two phase access}	n = 1800 octets, USF_GRANULARITY = 1 block, RLC_DATA_BLOCKS_GRANTED = open-end, CHANNEL_CODING_COMMAND: CS-4, RLC unacknowledged mode (PDP context3), without starting time
2	SS -> MS	PACKET DOWNLINK DUMMY CONTROL BLOCK	USF assigned to the MS
3	SS -> MS	UPLINK RLC DATA BLOCK	
4			Repeat step 2 and 3 until the countdown value CV=7 (BS_CV_MAX).
5	SS -> MS	PACKET UPLINK ACK/NACK	Acknowledge all the received data blocks. CHANNEL_CODING_COMMAND = CS-1. No USF assigned to the MS.
6	SS -> MS	PACKET DOWNLINK DUMMY CONTROL BLOCK	USF assigned to the MS on 3 blocks from the last radio block containing the Packet Uplink Ack/Nack in step 5.
A6 (optional step)	MS -> SS	UPLINK RLC DATA BLOCK	Received on the assigned PDTCH, CV=6. Repeat step 6.
7	MS -> SS	UPLINK RLC DATA BLOCK	Received on the assigned PDTCH. Check that the countdown value CV = 15.
8	SS -> MS	PACKET UPLINK ACK/NACK	Sent on the PACCH of the PDCH assigned in step 2, containing USF assigned to the MS.
9	MS -> SS	UPLINK RLC DATA BLOCK	Received on the assigned PDTCH.
10			Repeat step 8 and 9 until the countdown value CV=7 (BS_CV_MAX).
11	SS -> MS	PACKET UPLINK ACK/NACK	CHANNEL_CODING_COMMAND = CS-2. No USF assigned to the MS.
12	SS -> MS	PACKET DOWNLINK DUMMY CONTROL BLOCK	USF assigned to the MS on 3 blocks from the last radio block containing the uplink assignment.
A12 (optional step)	MS -> SS	UPLINK RLC DATA BLOCK	Received on the assigned PDTCH, CV=6. Repeat step 12.
13	MS -> SS	UPLINK RLC DATA BLOCK	Received on the assigned PDTCH. Check the countdown value CV. In case the MS has sent an UPLINK RLC DATA BLOCK in step A12, CV = 3, otherwise CV = 4
14	SS -> MS	PACKET DOWNLINK DUMMY CONTROL BLOCK	USF assigned to the MS.
15	MS -> SS	UPLINK RLC DATA BLOCK	
16			Repeat step 14 and 15 until the countdown value CV=0.
17	SS -> MS	PACKET UPLINK ACK/NACK	Final Ack Indicator = '1' containing valid RRBP, acknowledge all the received data blocks.
18	MS -> SS	PACKET CONTROL ACKNOWLEDGEMENT	Received on the block specified by RRBP on PACCH of the assigned PDCH.

Specific Message Contents

PACKET UPLINK ACK/NACK message in step 5:

CHANNEL_CODING_COMMAND	CS-1
------------------------	------

PACKET UPLINK ACK/NACK message in step 11:

CHANNEL_CODING_COMMAND	CS-2
------------------------	------

41.3.1.4 TBF release / Uplink / Normal / MS initiated / Whilst in DTM

41.3.1.4.1 Conformance requirements

If the PACKET UPLINK ACK/NACK message has the Final Ack Indicator bit set to '1' and the mobile station does not initiate the establishment of a new uplink TBF according to one of the procedures described above, the mobile station shall transmit the PACKET CONTROL ACKNOWLEDGEMENT message and release the TBF. If the mobile station is operating in half duplex mode and received a downlink assignment during the countdown or while timer T3182 was running, it shall then act on the downlink assignment. If there is no ongoing downlink TBF, the mobile station in packet transfer mode shall return to packet idle mode; the mobile station in dual transfer mode shall return to dedicated mode.

References

3GPP TS 04.60/44.060, sub-clause 9.3.2.4

41.3.1.4.2 Test purpose

To verify that the MS, whilst in DTM, can successfully remove an uplink TBF and return to dedicated mode.

41.3.1.4.3 Method of test

Initial Conditions

System Simulator:

1 cell, DTM supported

Mobile Station:

The MS is in the active state (U10) of a call.

The MS is GPRS attached with a P-TMSI allocated and the PDP context 1 activated.

Specific PICS Statements

-

PIXIT Statements

-

Test Procedure

The MS, whilst in dedicated mode, is triggered to initiate packet uplink transfer data in RLC unacknowledged mode and sends a DTM REQUEST message. On receiving the DTM REQUEST message, requesting uplink resources, the SS assigns the MS PS resource. The SS accomplishes the resource assignment by passing a PACKET ASSIGNMENT message to the MS. On receiving the PACKET ASSIGNMENT message, the MS starts to send RLC DATA BLOCKS to the SS on the assigned PDTCH. At the completion of the 1000 octet transmission the MS releases the TBF. The MS releases the uplink TBF by starting the countdown process. When the MS has sent the RLC data block with CV=0, it continues to send RLC data blocks until the MS receives a PACKET UPLINK ACK/NACK message with the Final Ack Indicator bit set to '1'.

Upon completion of the uplink TBF release, the SS verifies that the MS has correctly returned to dedicated mode.

MS supporting DTM shall complete testing for k=1 and MSs indicating support of single slot DTM shall additionally complete testing for k=2.

Maximum Duration of Test

5 minutes

Expected Sequence

The test sequence is repeated for k = 1,2.

Step	Direction	Message	Comments
1	SS		MS in the active state (U10) of a call on Timeslot N. When: k=1, Channel Type=TCH/F; k=2, Channel Type=TCH/H.
2	MS		Trigger the MS to initiate an uplink packet transfer containing 1000 octets.
3	MS->SS	DTM REQUEST	
4	SS->MS	PACKET ASSIGNMENT	Includes information on the Radio resources provided to the MS. See specific message contents.
5	MS<->SS	{ Uplink data transfer }	Macro
6	MS<->SS	{ Completion of uplink RLC data block transfer }	Macro
7	SS->MS	PACKET UPLINK ACK/NACK	Sent on the PACCH of the PDCH previously assigned, containing USF assigned to the MS.
8	SS		Check that no data block is transmitted by the MS in the radio block next to the radio block in step 7. The SS also verifies that the TCH is also unaffected.

Specific Message Contents

PACKET ASSIGNMENT (Step 4):

k=1;

As default message contents except: RR Packet Uplink Assignment IE - TIMESLOT_ALLOCATION RR Packet Downlink Assignment IE	(N ± 1) MOD 8 Not included
--	-------------------------------

k=2;

As default message contents except: RR Packet Uplink Assignment IE - TIMESLOT_ALLOCATION RR Packet Downlink Assignment IE	N Not included
--	-------------------

41.3.2 TBF Release / Uplink / Normal / Network initiated

41.3.2.1 TBF Release / Uplink / Normal / Network initiated / Acknowledged mode

41.3.2.1.1 Conformance requirements

The network may initiate release of an uplink TBF by transmitting a PACKET TBF RELEASE message to the mobile station on the PACCH. A cause value indicates the reason for release.

If the cause value is "Normal release" the mobile station shall continue to the next LLC PDU boundary, starting the count down procedure at whatever value of CV is appropriate to count down to zero at the LLC PDU boundary, and then release the TBF according to the procedures in 3GPP TS 04.60, subclause 9.3.2.3.

References

3GPP TS 04.60, subclause 8.1.1.4.

41.3.2.1.2 Test purpose

To verify that when the MS, in an uplink TBF of the RLC acknowledged mode, receives a PACKET TBF RELEASE message with cause value "Normal release":

1. the MS continues the TBF to the next LLC PDU boundary;
2. the MS starts the count down procedure at whatever value of CV is appropriate to count down to zero at the LLC PDU boundary;
3. the MS then releases the TBF according to uplink acknowledged mode release procedure.

41.3.2.1.3 Method of test

Initial Conditions

System Simulator:

1 cell, CCCH combined with SDCCH, BS_PBCCH_BLKs = 3, BS_CV_MAX = 7.

Mobile Station:

The MS is GPRS attached with a P-TMSI allocated, SPLIT PG CYCLE negotiated and PDP context2 activated.

Specific PICS Statements

-

PIXIT Statements

-

Test Procedure

1. The MS is triggered to transfer 2000 octets user data. A TBF of dynamic allocation in acknowledged mode is assigned. After the MS transfers several RLC data blocks the SS sends PACKET TBF RELEASE with cause value "Normal release. The length indicator, M and E bit in data block headers are checked during the RLC data transferring until CV=0 to ensure that the MS has transmitted only the RLC data block of the first LLC PDU.

Expected Sequence

Step	Direction	Message	Comments
1		{Uplink dynamic allocation one phase access with contention resolution} or {Uplink dynamic allocation two phase access}	n = 2000 octets (Note: more than one LLC PDU is needed for the test.) USF_GRANULARITY = 1 block, RLC_DATA_BLOCKS_GRANTED = open-end, CHANNEL_CODING_COMMAND: CS-1, TLLI_BLOCK_CHANNEL_CODING: '1'B, CS-1. RLC acknowledged mode (PDP context2), without starting time
2	SS -> MS	PACKET DOWNLINK DUMMY CONTROL BLOCK	USF assigned to the MS.
3	MS -> SS	UPLINK RLC DATA BLOCK	
4			Repeat step 2 and 3 three times
5	SS -> MS	PACKET TBF RELEASE	Sent on the PACCH of the PDCH assigned, USF not assigned to the MS, Global TFI is same as the assigned one in step 1, Uplink_Release = yes, Cause value = "Normal release".
5a	SS		SS waits 3 blocks.
6	SS -> MS	PACKET UPLINK ACK/NACK	USF assigned to the MS, on PACCH of the assigned PDCH in step 1.
7	MS -> SS	UPLINK RLC DATA BLOCK	
8			Repeat step 6 and 7 until the countdown value CV=0 in step 7. Use of the Length indicator, M bit and E bit of the received data headers to determine that only the 1 st LLC PDU is transmitted.
9	SS -> MS	PACKET UPLINK ACK/NACK	Final Ack Indicator = '1' containing valid RRBP. Acknowledge all data blocks.
10	MS -> SS	PACKET CONTROL ACKNOWLEDGEMENT	Received on the block specified by RRBP on PACCH of the assigned PDCH.
11	SS -> MS	PACKET UPLINK ACK/NACK	Sent on the PACCH of the PDCH assigned in step 1, containing USF assigned to the MS.
12	SS		Check that no data block is transmitted by the MS in the next radio block to step 11.

41.3.2.2 TBF Release / Uplink / Normal / Network initiated / Unacknowledged mode

41.3.2.2.1 Conformance requirements

The network may initiate release of an uplink TBF by transmitting a PACKET TBF RELEASE message to the mobile station on the PACCH. A cause value indicates the reason for release.

If the cause value is "Normal release" a mobile station shall continue to the next LLC PDU boundary, starting the count down procedure at whatever value of CV is appropriate to count down to zero at the LLC PDU boundary, and then release the TBF according to the procedures in 3GPP TS 04.60, subclause 9.3.3.3.

References

3GPP TS 04.60, subclauses 8.1.1.4 and 9.3.3.3.

41.3.2.2.2 Test purpose

To verify that when the MS receives a PACKET TBF RELEASE message with cause value "Normal release" during an unacknowledged mode uplink TBF:

1. the MS continues the TBF to the next LLC PDU boundary;
2. the MS starts the count down procedure at whatever value of CV is appropriate to count down to zero at the LLC PDU boundary;
3. the MS then releases the TBF according to uplink unacknowledged mode release procedure.

41.3.2.2.3 Method of test

Initial Conditions

System Simulator:

1 cell, CCCH combined with SDCCH, BS_PBCCH_BLKs = 3, BS_CV_MAX = 15.

Mobile Station:

The MS is GPRS attached with a P-TMSI allocated, SPLIT PG CYCLE negotiated and PDP context3 activated.

Specific PICS Statements

-

PIXIT Statements

-

Test Procedure

1. The MS is triggered to transfer 2000 octets user data. A TBF of dynamic allocation in unacknowledged mode is assigned. After the MS transfers several RLC data blocks the SS sends PACKET TBF RELEASE with cause value "Normal release. The length indicator, M and E bit in data block headers are checked during the RLC data transferring until CV=0 to ensure that the MS has transmitted only the RLC data block of the first LLC PDU.

Expected Sequence

Step	Direction	Message	Comments
1		{Uplink dynamic allocation two phase access}	n = 2000 octets in RLC unacknowledged mode. (PDP context3) (Note: more than one LLC PDU is needed)
2	SS -> MS	PACKET DOWNLINK DUMMY CONTROL BLOCK	TLI_BLOCK_CHANNEL_CODING = '0'B, cs-1, CHANNEL_CODING_COMMAND = cs1. USF Assigned to MS
3	MS -> SS	UPLINK RLC DATA BLOCK	
4			Repeat step 2 and 3 five times.
5	SS -> MS	PACKET TBF RELEASE	Sent on the PACCH of the PDCH assigned, USF not assigned to the MS, Global TFI is same as the assigned one in step 1, Uplink_Release = yes, Cause value = "Normal release".
5a	SS		SS waits 3 blocks.
6	SS -> MS	PACKET UPLINK ACK/NACK	USF assigned to the MS, on PACCH of the assigned PDCH in step 1.
7	MS -> SS	UPLINK RLC DATA BLOCK	
8			Repeat step 6 and 7 until the countdown value CV=0 in step 7. Use of the Length indicator, M bit and E bit of the received data headers to determine that only the 1 st LLC PDU is transmitted.
9	SS -> MS	PACKET UPLINK ACK/NACK	Final Ack Indicator = '1' containing valid RRBP, No retransmission needed. Sent on PACCH of the assigned PDCH.
10	MS -> SS	PACKET CONTROL ACKNOWLEDGEMENT	Received on the block specified by RRBP on PACCH of the assigned PDCH.

41.3.2.3 TBF release / Uplink / Normal / Network initiated / Whilst in DTM

41.3.2.3.1 Conformance requirements

The network may initiate release of an uplink TBF by transmitting a PACKET TBF RELEASE message to the mobile station on the PACCH. A cause value indicates the reason for release.

References

3GPP TS 04.60/44.060, sub-clauses 8.1.1.4

41.3.2.3.2 Test purpose

To verify that the network can successfully remove an uplink TBF, in DTM, returning the MS to dedicated mode.

41.3.2.3.3 Method of test

Initial Conditions

System Simulator:

1 cell, DTM supported.

Mobile Station:

The MS is in the active state (U10) of a call.

The MS is GPRS attached with a P-TMSI allocated and the PDP context 2 activated.

Specific PICS Statements

-

PIXIT Statements

-

Test Procedure

The MS, whilst in dedicated mode, is triggered to initiate packet uplink transfer data in RLC acknowledged mode and sends a DTM REQUEST message. On receiving the DTM REQUEST message, requesting uplink resources, the SS assigns the MS PS resource. The SS accomplishes the resource assignment by passing a PACKET ASSIGNMENT message to the MS. On receiving the PACKET ASSIGNMENT message, the MS starts to send RLC DATA BLOCKS to the SS on the assigned PDTCH. After the MS has transferred several RLC blocks, the SS initiates release of the uplink TBF by sending a PACKET TBF RELEASE message, on the PACCH, to the MS. The MS releases the uplink TBF by starting the countdown process, which completes at the LLC PDU boundary. When the MS has sent the RLC data block with CV=0, it continues to send RLC data blocks until the MS receives a PACKET UPLINK ACK/NACK message with the Final Ack Indicator bit set to '1'.

Upon completion of the uplink TBF release, the SS verifies that only the first LLC PDU has been sent and the MS has correctly returned to dedicated mode.

MS supporting DTM shall complete testing for k=1 and MSs indicating support of singleslot DTM shall additionally complete testing for k=2.

Maximum Duration of Test

5 minutes

Expected Sequence

The test sequence is repeated for $k = 1, 2$.

Step	Direction	Message	Comments
1	SS		MS in the active state (U10) of a call on Timeslot N. When: k=1, Channel Type=TCH/F; k=2, Channel Type=TCH/H.
2	MS		Trigger the MS to initiate an uplink packet transfer containing 2000 octets. (Note: more than one LLC PDU is needed for the test. USF_GRANULARITY = 1 block, RLC_DATA_BLOCKS_GRANTED = open-end, CHANNEL_CODING_COMMAND: CS-1, TLLI_BLOCK_CHANNEL_CODING: '1'B, CS-1. RLC acknowledged mode (PDP context2), without starting time
3	MS->SS	DTM REQUEST	
4	SS->MS	PACKET ASSIGNMENT	Includes information on the Radio resources provided to the MS. See specific message contents.
5	SS->MS	PACKET DOWNLINK DUMMY CONTROL BLOCK	USF assigned to the MS.
6	MS -> SS	UPLINK RLC DATA BLOCK	
7			Repeat step 5 and 6 three times
8	SS->MS	PACKET TBF RELEASE	Sent on the PACCH of the PDCH assigned, USF not assigned to the MS, Global TFI is same as the assigned one in step 2, Uplink_Release = yes, Cause value = "Normal release".
9	SS->MS	PACKET UPLINK ACK/NACK	USF assigned to the MS, on PACCH of the assigned PDCH in step 2.
10	MS->SS	UPLINK RLC DATA BLOCK	
11			Repeat step 9 and 10 until the countdown value CV=0 in step 10. Use of the Length indicator, M bit and E bit of the received data headers to determine that only the 1 st LLC PDU is transmitted. Note: The final RLC data block of a TBF shall have a Length Indicator field corresponding to the final LLC PDU unless this PDU fills the RLC data block precisely without the LI field being added.
12	SS->MS	PACKET UPLINK ACK/NACK	Final Ack Indicator = '1' containing valid RRBP. Acknowledge all data blocks.
13	MS->SS	PACKET CONTROL ACKNOWLEDGEMENT	Received on the block specified by RRBP on PACCH of the assigned PDCH.
14	SS->MS	PACKET UPLINK ACK/NACK	Sent on the PACCH of the PDCH previously assigned, containing USF assigned to the MS.
15	SS		Check that no data block is transmitted by the MS in the radio block next to the radio block in step 14.

Specific Message Contents

PACKET ASSIGNMENT (Step 4):

k=1;

As default message contents except: RR Packet Uplink Assignment IE - TIMESLOT_ALLOCATION RR Packet Downlink Assignment IE	(N ± 1) MOD 8 Not included
--	-------------------------------

k=2;

As default message contents except: RR Packet Uplink Assignment IE - TIMESLOT_ALLOCATION RR Packet Downlink Assignment IE	N Not included
--	-------------------

41.3.3 TBF Release / Uplink / Network initiated / Abnormal release

41.3.3.1 Conformance requirements

The network may initiate release of an uplink TBF by transmitting a PACKET TBF RELEASE message to the mobile station on the PACCH. If the cause value is "Abnormal release" the mobile station shall immediately stop transmitting and follow the abnormal release with random access procedure.

References

3GPP TS 04.60, subclause 8.1.1.4.

41.3.3.2 Test purpose

To verify that the MS immediately stops transmitting and follows the abnormal release with random access procedure when it receives a PACKET TBF RELEASE message on the PACCH with cause value "Abnormal release".

41.3.3.3 Method of test

Initial Conditions

System Simulator:

1 cell, CCCH combined with SDCCH, BS_PBCCH_BLKs = 3, BS_CV_MAX = 9.

Mobile Station:

The MS is GPRS attached with a P-TMSI allocated, SPLIT PG CYCLE negotiated and PDP context2 activated.

Specific PICS Statements

-

PIXIT Statements

-

Test Procedure

The MS is triggered to transfer user data. A TBF of dynamic allocation in acknowledged mode is assigned. After the MS transfers several RLC data blocks the SS sends PACKET TBF RELEASE with cause value "Abnormal release". The MS reinitiates a random access for one or two phase access request.

Expected Sequence

Step	Direction	Message	Comments
1		{Uplink dynamic allocation one phase access with contention resolution} or {Uplink dynamic allocation two phase access}	n = 1200 octets in RLC acknowledged mode. (PDP context2) TLLI_BLOCK_CHANNEL_CODING = '0'B, cs-1, CHANNEL_CODING_COMMAND = cs-1.
2	SS -> MS	PACKET DOWNLINK DUMMY CONTROL BLOCK	USF Assigned to MS
3	MS -> SS	UPLINK RLC DATA BLOCK	Received on the assigned PDTCH.
4			Repeat step 2 and 3 five times.
5	SS -> MS	PACKET TBF RELEASE	Sent on the PACCH of the PDCH assigned, Global TFI is same as the assigned one in step 1, Uplink_Release = yes, Cause value = "Abnormal release".
6	SS -> MS	PACKET DOWNLINK DUMMY CONTROL BLOCK	USF assigned to the MS, on PACCH of the assigned PDCH in step 1. Sent on the next block of that of message sent in step 5. This step is repeated for 5 times. Repetation should be on the consecutive blocks as that of the first.
7	MS -> SS	UPLINK RLC DATA BLOCK	MS is allowed to send max. 5 blocks. Received on the assigned PDTCH.
8	MS -> SS	PACKET CHANNEL REQUEST	Check that the MS does not send more than five blocks. Received on PRACH.

41.3.4 TBF Release / Downlink / Normal / Network initiated

41.3.4.1 TBF Release / Downlink / Normal / Network initiated / Acknowledged mode

41.3.4.1.1 Conformance requirements

If the mobile station receives an RLC data block with the FBI bit set the value '1' and with a valid RRBP field, the mobile station shall transmit a PACKET DOWNLINK ACK/NACK message in the specified uplink block. The mobile station shall continue to monitor all assigned PDCHs.

Whenever the mobile station receives an RLC data block with a valid RRBP and the mobile station has received all RLC data blocks of the TBF, the mobile station shall send the PACKET DOWNLINK ACK/NACK message with the Final Ack Indicator bit set to '1', stop timer T3190 and start or restart timer T3192.

If the mobile station receives more than one RLC data block with the FBI set to '1', it shall accept the data from only the first one of these blocks.

If the mobile station, after sending the PACKET DOWNLINK ACK/NACK message with the Final Ack Indicator bit set to '1', receives a PACKET DOWNLINK ASSIGNMENT or PACKET TIMESLOT RECONFIGURE message with the Control Ack bit set to '1' while timer T3192 is running, the mobile station shall stop timer T3192, consider the previous downlink TBF released and act upon the new assignment.

When timer T3192 expires the mobile station shall stop monitoring its assigned downlink PDCHs. If the mobile station is operating in half duplex mode and received an uplink assignment during the TBF release procedure, the mobile station shall then immediately act upon the assignment. Otherwise, and if there is no ongoing uplink TBF, enter packet idle mode.

References

3GPP TS 04.60, subclause 9.3.2.5.

41.3.4.1.2 Test purpose

To verify that in a downlink TBF of acknowledged mode:

1. The MS sends PACKET DOWNLINK ACK/NACK in the specified uplink block and continues monitoring all assigned PDCHs when it receives an RLC data block with a valid RRBP field and the Final Block Indicator (FBI) = '1'.

2. Whenever the MS receives an RLC data block with a valid RRBP and has received all RLC data blocks of the TBF, it sends PACKET DOWNLINK ACK/NACK with the Final Ack Indicator bit set to '1'.
3. If the MS receives more than one RLC data block with the FBI set to '1', it accepts the data from only the first one of these blocks.
4. While timer T3192 is running, if the MS receives, after sending PACKET DOWNLINK ACK/NACK with the Final Ack Indicator bit set to '1', PACKET DOWNLINK ASSIGNMENT with the Control Ack bit set to '1', the MS acts upon the new downlink assignment.
5. The MS stops monitoring its assigned downlink PDCHs and enters packet idle mode when timer T3192 expires if there is no ongoing uplink TBF.

41.3.4.1.3 Method of test

Initial Conditions

System Simulator:

1 cell, CCCH combined with SDCCH, BS_PBCCH_BLKs = 3, BS_CV_MAX = 15, T3192 = 1,5 s.

Mobile Station:

The MS is GPRS attached with a P-TMSI allocated, SPLIT PG CYCLE negotiated and PDP context2 activated.

Specific PICS Statements

-

PIXIT Statements

-

Test Procedure

1. The MS receives PACKET DOWNLINK ASSIGNMENT on its PPCH. The SS transmits 10 downlink RLC data blocks with consecutive BSN. The SS then transmits a downlink RLC data block with the highest BSN which is ten higher than the BSN of the last RLC data block. The SS sets FBI bit and polls the MS with a valid RRBP in the header of the RLC data block. The MS acknowledges the received data blocks and request a retransmission for the missing 9 data blocks in SSN and RBB fields.
2. The SS sends another 5 RLC data blocks and polls the MS with a valid RRBP. The MS acknowledges the received data blocks and request the retransmission of the missing 4 RLC data blocks. The SS transmits the last 4 RLC data blocks and polls the MS with RRBP=N+26. While the MS is waiting for transmission of the final Acknowledgement the SS transmits a RLC data block which sets FBI bit and has the same BSN value as the highest one in the test procedure 1. The MS ignores the downlink data and acknowledges the entire TBF with FINAL_ACK_INDICATION set. The SS transmits another data block with FBI set and polls the MS. The MS acknowledges the entire TBF with FINAL_ACK_INDICATION set. The SS waits 3 s.
3. The MS receives PACKET DOWNLINK ASSIGNMENT on its PPCH. The SS transmits a number of downlink RLC data blocks, sets FBI bit and polls the MS with a valid RRBP. The MS acknowledges the entire TBF with FINAL_ACK_INDICATION set.
4. The SS sends another PACKET DOWNLINK ASSIGNMENT on the assigned PACCH with Control ACK bit set. The SS transmits a number of downlink RLC data blocks on the new assigned PDTCH, sets FBI bit and polls the MS with a valid RRBP. The MS acknowledges the entire TBF with FINAL_ACK_INDICATION set.

Expected Sequence

Step	Direction	Message	Comments
1	SS -> MS	PACKET DOWNLINK ASSIGNMENT	Downlink Assignment, acknowledged mode. Sent on PPCH.
2	SS -> MS	DOWNLINK RLC DATA BLOCK	Sent on downlink PDTCH assigned.
3			Repeat step 2 nine times, each time BSN is incremented by 1
4	SS -> MS	DOWNLINK RLC DATA BLOCK	One data block with valid RRBp, FBI bit is set. BSN is incremented by 10. The MS has missed 9 consecutive RLC data blocks. BSN of this data block =
5	MS -> SS	PACKET DOWNLINK ACK/NACK	(BSN of the last data block in step 3 + 10) mod 128 Received on the block specified by RRBp in step 4. Check that the Final Ack indicator = '0' and the SSN and RBB values for the 9 missing data blocks .
6	SS -> MS	DOWNLINK RLC DATA BLOCK	BSN of the data block =
7			(BSN of the last data block in step 3 + 1) mod 128 Repeat step 6 three times, each time BSN is incremented by 1 on the basis of the last BSN in step 6
8	SS -> MS	DOWNLINK RLC DATA BLOCK	A valid RRBp, BSN is incremented by 1.
9	MS -> SS	PACKET DOWNLINK ACK/NACK	Received on the block specified by RRBp in step 8. Check that the Final Ack indicator = '0' and SSN and RBB values for the 4 missing data blocks.
10	SS -> MS	DOWNLINK RLC DATA BLOCK	BSN is incremented by 1
11			Repeat step 10 twice
12	SS -> MS	DOWNLINK RLC DATA BLOCK	RRBP.= N+26, BSN is incremented by 1
13	SS -> MS	DOWNLINK RLC DATA BLOCK	FBI bit is set, BSN is same as in step 4, RRBp.= N+26, sent on next radio block from step 12.
14	MS -> SS	PACKET DOWNLINK ACK/NACK	Received on the block specified by RRBp in step 12. Check that the Final Ack indicator = '1'.
15	MS -> SS	PACKET DOWNLINK ACK/NACK	Received on the block specified by RRBp in step 13. Check that the Final Ack indicator = '1'.
16	SS		Wait 2s for expiry of T3192.
17	SS -> MS	DOWNLINK RLC DATA BLOCK	FBI bit is set, a valid RRBp. Sent on downlink PDTCH assigned in step 1.
18	SS		Check that the MS does not respond on RRBp in step 17, the MS is now in packet idle mode.
19	SS -> MS	PACKET DOWNLINK ASSIGNMENT	Downlink Assignment, acknowledged mode. Sent on PCCCH.
20	SS -> MS	DOWNLINK RLC DATA BLOCK	Repeat step 20 ten times
21			One data block with FBI = '1' and valid RRBp.
22	SS -> MS	DOWNLINK RLC DATA BLOCK	Received on the block specified by RRBp in step 22.
23	MS -> SS	PACKET DOWNLINK ACK/NACK	Check that the Final Ack indicator = '1'.
24	SS		Wait for 80% of expiry of T3192 (1.2s)
25	SS -> MS	PACKET DOWNLINK ASSIGNMENT	Downlink Assignment, acknowledged mode. A different slot assigned. Control Ack Bit = 1. Sent on PACCH.
26	SS -> MS	DOWNLINK RLC DATA BLOCK	Repeat step 26 ten times
27			One data block with FBI = '1' and valid RRBp.
28	SS -> MS	DOWNLINK RLC DATA BLOCK	Received on the block specified by RRBp in step 28.
29	MS -> SS	PACKET DOWNLINK ACK/NACK	Check that the Final Ack indicator = '1'.

Specific Message Contents

PACKET DOWNLINK ACK/NACK message in step 15:

Ack/Nack Description - FINAL_ACK_INDICATION - STARTING_SEQUENCE_NUMBER - RECEIVED_BLOCK_BITMAP	1 (final ack) V(R) Acknowledges all data blocks transmitted by the MS
---	---

PACKET DOWNLINK ASSIGNMET message in step 25:

CONTROL_ACK TIMESLOT_ALLOCATION	1 Single slot arbitrarily chosen but different from the value in step 19
{L H<DOWNLINK_TFI_ASSIGNMENT>} - DOWNLINK_TFI_ASSIGNMENT	H (assign downlink TFI) Arbitrarily chosen but different from the value in step 19

41.3.4.2 TBF Release / Downlink / Normal / Network initiated / Unacknowledged mode

41.3.4.2.1 Conformance requirements

The network initiates release of a downlink TBF by sending an RLC data block with the Final Block Indicator (FBI) set to the value '1' and with a valid RRBP field. The RLC data block sent must have the highest BSN' (see 3GPP TS 04.60 subclause 9.3.1) of the downlink TBF. The network shall start timer T3191. The network may retransmit the last block with FBI set to the value '1' and with a valid RRBP field. For each retransmission the timer T3191 is restarted. For each RLC data block with the FBI bit set to '1' and with a valid RRBP field, the mobile station shall transmit the PACKET CONTROL ACKNOWLEDGEMENT message in the uplink block specified by the RRBP field. The mobile station shall continue to read the assigned downlink PDCHs until the block period pointed to by the RRBP. If the mobile station receives more than one RLC data block with the FBI bit set to '1' and with valid RRBP fields that point the same uplink block period, the mobile station shall transmit the PACKET CONTROL ACKNOWLEDGEMENT message only once. The mobile station shall then stop timer T3190, start timer T3192 and continue to monitor all assigned downlink PDCHs. If the mobile station then receives a subsequent RLC data block with a valid RRBP and the FBI bit set to '1', the mobile station shall retransmit the PACKET CONTROL ACKNOWLEDGEMENT message and restart timer T3192.

If the mobile station receives more than one RLC data block with the FBI set to '1', it shall accept the data from only the first one of these blocks.

If the mobile station, after sending the PACKET CONTROL ACKNOWLEDGEMENT message, receives a PACKET DOWNLINK ASSIGNMENT or PACKET TIMESLOT RECONFIGURE message with the Control Ack bit set to '1' while timer T3192 is running, the mobile station shall stop timer T3192, consider the previous downlink TBF released and act upon the new assignment.

When timer T3192 expires the mobile station shall stop monitoring its assigned downlink PDCHs.

References

3GPP TS 04.60, subclauses 9.3.3.5 and 9.3.1.

41.3.4.2.2 Test purpose

To verify that in a downlink TBF of unacknowledged mode:

1. The MS transmits PACKET CONTROL ACKNOWLEDGEMENT in the uplink block specified by the RRBP field whenever it receives an RLC data block with a valid RRBP field and the Final Block Indicator (FBI) set to the value '1'.
2. After sending PACKET CONTROL ACKNOWLEDGEMENT the MS continues to monitor all assigned downlink PDCHs.

3. While timer T3192 is running, if the MS receives, after sending PACKET CONTROL ACKNOWLEDGEMENT, a PACKET DOWNLINK ASSIGNMENT with the Control Ack bit set to '1', the MS acts upon the new downlink assignment.
4. The MS stops monitoring its assigned downlink PDCHs and enters packet idle mode when timer T3192 expires.

41.3.4.2.3 Method of test

Initial Conditions

System Simulator:

1 cell, CCCH combined with SDCCH, BS_PBCCH_BLKs = 3, BS_CV_MAX = 15, T3192 = 1,5 s.

Mobile Station:

The MS is GPRS attached with a P-TMSI allocated, SPLIT PG CYCLE negotiated and PDP context3 activated.

Specific PICS Statements

-

PIXIT Statements

-

Test Procedure

1. The MS receives PACKET DOWNLINK ASSIGNMENT on its PPCH. The SS transmits 11 downlink RLC data blocks with consecutive BSN. The SS then transmits a downlink RLC data block with the BSN which is ten higher than the BSN of the last RLC data block. The SS polls the MS with a valid RRBp in the header of the RLC data block. The MS acknowledges the received data blocks.
2. The SS sends another RLC data block and polls the MS with a valid RRBp and with the FBI bit set. The MS sends PACKET CONTROL ACKNOWLEDGEMENT.
3. The SS resends the last RLC data block and polls the MS with a valid RRBp and with the FBI bit set. The MS sends PACKET CONTROL ACKNOWLEDGEMENT. The SS waits 1.2s and resends the RLC data block and polls the MS with a valid RRBp and with the FBI bit set. The MS responds with PACKET CONTROL ACKNOWLEDGEMENT. The SS waits till T3192 expires. The SS sends a RLC data block with FBI set and a valid RRBp and checks that the MS does not transmit any data block on RRBp block.
4. The MS receives PACKET DOWNLINK ASSIGNMENT on its PPCH. The SS transmits a number of downlink RLC data blocks, sets FBI bit and polls the MS with a valid RRBp. The MS responds with PACKET CONTROL ACKNOWLEDGEMENT.
5. The SS sends another PACKET DOWNLINK ASSIGNMENT on the assigned PACCH with Control ACK bit set. The SS transmits a number of downlink RLC data blocks on the new assigned PDTCH, sets FBI bit and polls the MS with a valid RRBp. The MS responds with PACKET CONTROL ACKNOWLEDGEMENT.

Expected Sequence

Step	Direction	Message	Comments
1	SS -> MS	PACKET DOWNLINK ASSIGNMENT	Unacknowledged mode. Sent on its PPCH.
2	SS -> MS	DOWNLINK RLC DATA BLOCK	Sent on downlink PDTCH assigned.
3			Repeat step 2 ten times, each time BSN is incremented by 1
4	SS -> MS	DOWNLINK RLC DATA BLOCK	One data block with valid RRBP, BSN is incremented by 10. The MS has missed 9 consecutive RLC data blocks. BSN of this data block = (BSN of the last data block in step 3 + 10) mod 128
5	MS -> SS	PACKET DOWNLINK ACK/NACK	Received on the block specified by RRBP in step 4. Check that the Final Ack indicator = '0'
6	SS -> MS	DOWNLINK RLC DATA BLOCK	A valid RRBP, BSN is incremented by 1, FBI bit is set.
7	MS -> SS	PACKET CONTROL ACKNOWLEDGEMENT	Received on the block specified by RRBP in step 6.
8			Repeat step 6 and 7 once Keeping BSN same.
9	SS		Wait 1.2 seconds (T3192 not expired).
10	SS -> MS	DOWNLINK RLC DATA BLOCK	One data block with FBI = '1' and valid RRBP. BSN is same as the BSN of the data block sent in step 6.
11	MS -> SS	PACKET CONTROL ACKNOWLEDGEMENT	Received on the block specified by RRBP in step 10.
12	SS		Wait for expiry of T3192
13	SS -> MS	DOWNLINK RLC DATA BLOCK	One data block with FBI = '1' and valid RRBP. Sent on downlink PDTCH assigned in step 1. BSN is same as the BSN of the data block sent in step 6
14	SS		Check that the MS does not transmit any control block on the RRBP block.
15	SS -> MS	PACKET DOWNLINK ASSIGNMENT	Downlink Assignment, unacknowledged mode sent on PPCH.
16	SS -> MS	DOWNLINK RLC DATA BLOCK	Sent 5 blocks from last block containing PACKET DOWNLINK ASSIGNMENT
17			Repeat step 16 ten times
18	SS -> MS	DOWNLINK RLC DATA BLOCK	One data block with FBI = '1' and valid RRBP.
19	MS -> SS	PACKET CONTROL ACKNOWLEDGEMENT	
20	SS -> MS	PACKET DOWNLINK ASSIGNMENT	Wait 1.2 seconds (T3192 not expired). Downlink Assignment, unacknowledged mode. A different timeslot assigned. Control Ack Bit = 1. Sent on PACCH.
21	SS -> MS	DOWNLINK RLC DATA BLOCK	Sent 5 blocks from last block containing PACKET DOWNLINK ASSIGNMENT
22			Repeat step 21 ten times
23	SS -> MS	DOWNLINK RLC DATA BLOCK	One data block with FBI = '1' and valid RRBP.
24	MS -> SS	PACKET CONTROL ACKNOWLEDGEMENT	Received on the block specified by RRBP in step 23.

PACKET DOWNLINK ASSIGNMENT message in step 20:

RLC_MODE	Unacknowledged mode
CONTROL_ACK	1
{L H<DOWNLINK_TFI_ASSIGNMENT>}	H (assign downlink TFI)
- DOWNLINK_TFI_ASSIGNMENT	Arbitrarily chosen but different from the value in step 15
TIMESLOT_ALLOCATION	Single slot arbitrarily chosen but different from the values already assigned.

41.3.4.3 TBF release / Downlink / Normal / Network initiated / Whilst in DTM

41.3.4.3.1 Conformance requirements

When timer T3192 expires the mobile station shall release the downlink TBF. If the mobile station is operating in half duplex mode and received an uplink assignment during the TBF release procedure, the mobile station shall then immediately act upon the uplink assignment. If there is no ongoing uplink TBF, the mobile station in packet transfer mode shall return to packet idle mode; the mobile station in dual transfer mode shall return to dedicated mode.

References

3GPP TS 04.60/44.060, sub-clauses 9.3.2.6

41.3.4.3.2 Test purpose

To verify that the network can successfully remove a downlink TBF, to a MS in DTM, returning the MS to dedicated mode.

41.3.4.3.3 Method of test

Initial Conditions

System Simulator:

1 cell, DTM supported.

Mobile Station:

The MS is in the active state (U10) of a call.

The MS is GPRS attached with a P-TMSI allocated and the PDP context 2 activated.

Specific PICS Statements

-

PIXIT Statements

-

Test Procedure

Whilst in an active call on timeslot N, the MS receives a PACKET ASSIGNMENT message on the main DCCH, instructing the MS to switch to the designated timeslot. The SS waits a specified time and then starts to transmit to the newly allocated resources. After approximately 500 octets of data has been sent, the SS waits for the time period of T3192, before testing that the MS has dropped out of dual transfer mode by sending a DOWNLINK RLC DATA block with S/P=1 and verify that the MS does not respond.

Upon completion of the downlink TBF release, the SS verifies that the MS has correctly returned to dedicated mode.

MS supporting DTM shall complete testing for k=1 and MSs indicating support of single slot DTM shall additionally complete testing for k=2.

Maximum Duration of Test

5 minutes

Expected Sequence

The test sequence is repeated for k = 1,2.

Step	Direction	Message	Comments
1	SS		MS in the active state (U10) of a call on Timeslot N of cell A. When: k=1, Channel Type = TCH/F; k=2, Channel Type = TCH/H.
2	SS->MS	PACKET ASSIGNMENT	See specific message contents.
3	SS<->MS	{ Downlink data transfer }	Macro – transmitting approximately 500 octets of data.
4	MS->SS	PACKET DL ACK/NACK	FAI = 1
5	SS		Wait for time period of T3192 + 10%.
6	SS->MS	RLC DOWNLINK DATA	S/P bit = 1
7	SS		Verifies that no PACKET DOWNLINK ACK/NACK message is received from MS and that the MS returns correctly to dedicated mode.

Specific Message Contents

PACKET ASSIGNMENT (Step 2):

k=1;

As default message contents except: RR Packet Uplink Assignment IE RR Packet Downlink Assignment IE - TIMESLOT_ALLOCATION	Not included (N ± 1) MOD 8
--	-----------------------------------

k=2;

As default message contents except: RR Packet Uplink Assignment IE RR Packet Downlink Assignment IE - TIMESLOT_ALLOCATION	Not included N
--	-----------------------

41.3.5 PDCH Release

41.3.5.1 Void

41.3.5.2 PDCH Release / With TIMESLOTS_AVAILABLE

41.3.5.2.1 Conformance requirements

When a mobile station receives a PACKET PDCH RELEASE message containing a TIMESLOTS_AVAILABLE field, it shall immediately stop transmitting and receiving on all assigned PDCHs, which are indicated as not present in the TIMESLOTS_AVAILABLE field, remove those PDCHs from its list of assigned PDCHs.

If all of the mobile station's assigned PDCHs are removed from its list of assigned PDCH, and, if an uplink TBF was in progress, the mobile station shall perform an abnormal release with random access. If no uplink TBF was in progress, the mobile station shall perform an abnormal release with return to CCCH or PCCCH.

References

3GPP TS 04.60, subclause 8.2.

41.3.5.2.2 Test purpose

To verify that when the MS receives a PACKET PDCH RELEASE message with a TIMESLOTS_AVAILABLE field indicating that one or more timeslots is no longer available for packet data service:

1. it immediately stops transmitting and receiving on all assigned PDCHs which are not presented in the TIMESLOTS_AVAILABLE field.
2. it performs an abnormal release with random access when all of the MS's assigned PDCHs are removed, and an uplink TBF was in progress.

3. it performs an abnormal release with return to CCCH or PCCCH when all of the MS's assigned PDCHs are removed, and no uplink TBF was in progress.

41.3.5.2.3 Method of test

Initial Conditions

System Simulator:

1 cell, CCCH combined with SDCCH, BS_PBCCH_BLKs = 3, BS_CV_MAX = 15.

Mobile Station:

The MS is GPRS attached with a P-TMSI allocated, SPLIT PG CYCLE negotiated and PDP context2 activated.

Specific PICS Statements

- Multislotclass (TSPC_Type_GPRS_Multislot_ClassX where X = 1..45)

PIXIT Statements

-

Test Procedure

1. The MS is triggered to transfer user data. A TBF on one slot of dynamic allocation in acknowledged mode is assigned. After the MS transfers several RLC data blocks the SS sends PACKET PDCH RELEASE with TIMESLOTS_AVAILABLE indicating no timeslot available. It is checked that the MS initiates a random access for one or two phase access request. A TBF is assigned to the MS to allow it to complete the uplink data transferring.
2. The MS is triggered to transfer user data. A TBF on two consecutive slots of dynamic allocation in acknowledged mode is assigned. After the MS transfers several RLC data blocks the SS sends PACKET PDCH RELEASE with TIMESLOTS_AVAILABLE indicating that only a timeslot is available. The MS uses the available timeslot to complete the uplink data transferring.
3. The MS receives PACKET DOWNLINK ASSIGNMENT on its PPCH. A downlink TBF with a timeslot is assigned. The SS transmits several downlink RLC data blocks. Then SS sends PACKET PDCH RELEASE with TIMESLOTS_AVAILABLE indicating no timeslot available and polls the MS with a valid RRBP for acknowledgement. It is checked that the MS does not react upon the polling.
4. A downlink TBF with two timeslots is assigned. The SS transmits several downlink RLC data blocks. Then SS sends PACKET PDCH RELEASE with TIMESLOTS_AVAILABLE indicating only a timeslot available and polls the MS with a valid RRBP for acknowledgement. It is checked that the MS does not react upon the polling and continues receiving the downlink data on the available timeslot. The SS sends another PACKET PDCH RELEASE with TIMESLOTS_AVAILABLE indicating no timeslot available and polls the MS with a valid RRBP for acknowledgement. It is checked that the MS does not react upon the polling.

Expected Sequence

Step	Direction	Message	Comments
1		{Uplink dynamic allocation one phase access with contention resolution} or {Uplink dynamic allocation two phase access}	n = 1000 octets in RLC acknowledged mode. (Test PDP context2) CHANNEL_CODING_COMMAND = cs4.
2	SS->MS	PACKET DOWNLINK DUMMY CONTROL BLOCK	USF assigned to MS
3	MS -> SS	UPLINK RLC DATA BLOCK	Received data block on the assigned PDTCH.
4	SS		Repeat steps 2 and 3 six times
5	SS -> MS	PACKET PDCH RELEASE	Sent on the PACCH of the PDCH assigned in step 1. With TIMESLOTS_AVAILABLE indicating no timeslot available, RRBP = N + 26.
6	SS		SS checks that no PACKET CONTROL ACKNOWLEDGEMENT is received.
7	SS->MS	PACKET DOWNLINK DUMMY CONTROL BLOCK	USF assigned to MS
8	SS		Verify that no data block is received.
9	MS -> SS	PACKET CHANNEL REQUEST	Received on PRACH.
10	SS -> MS	PACKET UPLINK ASSIGNMENT	Single block assignment, to order the MS making two phase access procedure. Sent on PAGCH.
11	MS -> SS	PACKET RESOURCE REQUEST	Two phase access procedure. Received on the single block assigned in step 10.
12	SS -> MS	PACKET UPLINK ASSIGNMENT	Open-ended uplink dynamic allocation with one time slot, USF_GRANULARITY = single block, CHANNEL_CODING_COMMAND = cs4,
13	SS -> MS	PACKET DOWNLINK DUMMY CONTROL BLOCK	Sent on PACCH of the same PDCH assigned in step 10. Sent on the PACCH of the PDCH assigned in step 12, containing USF assigned to the MS.
14	MS -> SS	UPLINK RLC DATA BLOCK	Received on the assigned PDTCH.
15		{Completion of uplink RLC data block transfer}	
16		{Uplink dynamic allocation one phase access with contention resolution} or {Uplink dynamic allocation two phase access}	The MS of the GPRS multislot class 1, 2, 3, 4, 8, 30, 35 and 40 skips the steps 16 to 38. n = 1100 octets in RLC acknowledged mode. (Test PDP context2), CHANNEL_CODING_COMMAND = cs2 Two timeslots are assigned
17	SS->MS	PACKET DOWNLINK DUMMY CONTROL BLOCKS	USFs assigned to MS. Sent on PDTCH ₆ and PDTCH ₇ .
18	MS -> SS	UPLINK RLC DATA BLOCKS	Received on the assigned PDTCH ₆ and PDTCH ₇ .
19			Repeat step 17 and 18 three times
20	SS -> MS	PACKET PDCH RELEASE	Sent on the PACCH of the PDCH ₆ assigned in step 16 RRBP=N+26 . With TIMESLOTS_AVAILABLE indicating no timeslot available.
21	SS		SS checks that no PACKET CONTROL ACKNOWLEDGEMENT is received.
22	SS-MS	PACKET DOWNLINK DUMMY CONTROL BLOCKS	USFs assigned to MS. Sent on PDTCH ₆ and PDTCH ₇ .
23	SS		Verify that MS stop sending on both PDTCH ₆ and PDTCH ₇
24	MS -> SS	PACKET CHANNEL REQUEST	Received on PRACH.
25	SS -> MS	PACKET UPLINK ASSIGNMENT	Single block assignment, to order the MS making two phase access procedure. Sent on PAGCH.
26	MS -> SS	PACKET RESOURCE REQUEST	Two phase access procedure. Received on the single block assigned in step 25.
27	SS -> MS	PACKET UPLINK ASSIGNMENT	Uplink dynamic allocation CHANNEL_CODING_COMMAND = cs4 Two timeslots
28	SS->MS	PACKET DOWNLINK DUMMY CONTROL BLOCKS	USFs assigned to MS. Sent on PDTCH ₀ and PDTCH ₁ .

Step	Direction	Message	Comments
29	MS -> SS	UPLINK RLC DATA BLOCKS	data blocks received on the assigned PDTCH ₁ and PDTCH ₀ .
30	SS		Repeat steps 28 and 29 three times
31	SS -> MS	PACKET PDCH RELEASE	Sent on the PACCH of the PDCH ₁ assigned in step 27. With TIMESLOTS_AVAILABLE indicating only the timeslot corresponding to PDCH ₀ available.
32	SS->MS	PACKET DOWNLINK DUMMY CONTROL BLOCK	Sent after 6 radio blocks from step 31 on PDCH ₁ , USFs assigned to MS
33	SS		Verify that no data block was received
34	SS->MS	PACKET DOWNLINK DUMMY CONTROL BLOCK	Sent on PDCH ₀ , USFs assigned to MS
35	MS -> SS	UPLINK RLC DATA BLOCK	data block received on PDCH ₀
36	SS		Repeat steps 34 and 35 until the countdown value CV=0,
37	SS -> MS	PACKET UPLINK ACK/NACK	Acknowledge all data blocks. The SS sets Final Ack Indicator = '1' containing a valid RRBP.
38	MS -> SS	PACKET CONTROL ACKNOWLEDGEMENT	Received on the block specified by RRBP on PDCH ₀
39	SS -> MS	PACKET DOWNLINK ASSIGNMENT	Downlink Assignment with one timeslot assigned, acknowledged mode. Sent on PPCH.
40	SS -> MS	DOWNLINK RLC DATA BLOCK	A valid RRBP
41	MS -> SS	PACKET DOWNLINK ACK/NACK	Received on the block specified by RRBP in step 40.
42	SS -> MS	DOWNLINK RLC DATA BLOCK	Repeat the step three times.
43	SS -> MS	PACKET PDCH RELEASE	Sent on the next radio block from step 42 with TIMESLOTS_AVAILABLE indicating no timeslot available.
44	SS -> MS	DOWNLINK RLC DATA BLOCK	Sent on the next radio block from step 43 on PDTCH released, a valid RRBP = N + 21 or 22.
45	SS		Check that no PACKET DOWNLINK ACK/NACK received on the block specified in step 44.
46	SS -> MS	PACKET DOWNLINK ASSIGNMENT	The steps from 46 onwards are applicable to all GPRS multislots except the GPRS multislots class1. Downlink Assignment with timeslot ₁ and timeslot ₀ assigned, acknowledged mode. Sent on PPCH.
47	SS -> MS	DOWNLINK RLC DATA BLOCK	Repeat the step five times. The RLC data blocks are received on PDTCH ₁ and PDTCH ₀ .
48	MS -> SS	PACKET DOWNLINK ACK/NACK	The last data block on PDTCH ₁ containing a valid RRBP. Received on the block specified by RRBP on PDTCH ₁ Check whether all data blocks in step 47 are acknowledged.
49	SS -> MS	PACKET PDCH RELEASE	With TIMESLOTS_AVAILABLE indicating only timeslot ₀ available. Sent on the PACCH of PDCH ₁ .
50	SS -> MS	DOWNLINK RLC DATA BLOCK	Repeat the step five times. The RLC data blocks are received on PDTCH ₀ .
51	MS -> SS	PACKET DOWNLINK ACK/NACK	The last data block on PDTCH ₀ containing a valid RRBP. On the block specified by RRBP on PDTCH ₀ . Check whether all data blocks sent in step 50 are acknowledged.
52	SS -> MS	DOWNLINK RLC DATA BLOCK	One data block with a valid RRBP = N + 26 on PDTCH ₁ .
53	SS		Check that no PACKET DOWNLINK ACK/NACK received on the block specified.
54	SS -> MS	DOWNLINK RLC DATA BLOCK	Repeat the step five times on PDTCH ₀ .
55	SS -> MS	PACKET PDCH RELEASE	With TIMESLOTS_AVAILABLE indicating no timeslot available sent on the next block from step 54.
56	SS -> MS	DOWNLINK RLC DATA BLOCK	Sent on the next radio block of step 55 on PDTCH ₀ , a valid RRBP = N + 21 or 22.
57	SS		Check that no PACKET DOWNLINK ACK/NACK is received on the block specified in step 56.

41.3.6 TBF Release / Extended Uplink

41.3.6.1 TBF Release / Extended Uplink / Recalculation of CV before CV = 0

41.3.6.1.1 Conformance requirements

In an uplink TBF operating in extended uplink TBF mode, the CV shall indicate the current number of RLC data blocks that has not been transmitted in the uplink TBF. The mobile station shall update the TBC value and recalculate the CV for any untransmitted RLC data block in the following cases:

- The RLC entity of the mobile station receives new data from upper layers for transmission in the uplink TBF.

References

3GPP TS 44.060, subclause 9.3.1.3

41.3.6.1.1.2 Test purpose

To verify that MS recalculates the CV when a new PDU is received from upper layers before MS has sent an RLC data block with CV=0.

41.3.6.1.1.3 Method of test

Initial Conditions

System Simulator:

1 cell, NW_EXT_UTBF = 1, BS_CV_MAX = 14

Mobile Station:

MS is in Packet Idle mode, GPRS attached with support of GERAN Feature Package 1 indicated in MS Radio Access Capabilities, and PDP context 2 established.

Specific PICS Statements

-

PIXIT Statements

-

Test Procedure

The MS is triggered to transfer user data. A TBF using dynamic allocation in acknowledged mode is assigned. The SS assigns an USF to MS until MS has sent CV = 14. Then MS is triggered to send more data. SS acknowledges all received data. A new USF is assigned to MS every 4th second. The CV is checked in the data block. If the CV becomes '0' before having been recalculated, the test has failed. Otherwise the uplink TBF is continued and completed.

Expected Sequence

Step	Direction	Message	Comments
1		{Uplink dynamic allocation two phase access}	n = 500 octets, USF_GRANULARITY = 1 block, CHANNEL_CODING_COMMAND: CS-2, RLC acknowledged mode (PDP context2) USF assigned to the MS.
2	SS -> MS	PACKET DOWNLINK DUMMY CONTROL BLOCK	
3	MS -> SS	UPLINK RLC DATA BLOCK	
4			Repeat step 2 and 3 until CV=14 (BS_CV_MAX).
5	MS		Trigger MS to send 400 octets of data.
6	SS -> MS	PACKET UPLINK ACK/NACK	Acknowledge all received data. USF assigned to the MS.
7	MS -> SS	RLC DATA BLOCK	Check CV
8	SS		Wait 4s
9			Repeat step 6 to 8 until CV (as received in step 7) > 14 (successful) or CV = 0 (failed)
10	SS -> MS	PACKET DOWNLINK DUMMY CONTROL BLOCK	USF assigned to the MS
11	MS -> SS	UPLINK RLC DATA BLOCK	
12			Repeat step 10 and 11 until CV=0.
13	SS -> MS	PACKET UPLINK ACK/NACK	Final Ack Indication = 1 containing valid RRB. Sent on PACCH of the assigned PDCH. Acknowledge all data blocks received.
14	MS -> SS	PACKET CONTROL ACKNOWLEDGEMENT	Received on the block specified by RRB on PACCH of the assigned PDCH.

Specific Message Contents

-

41.3.6.2 TBF Release / Extended Uplink / Recalculation of CV after CV = 0

41.3.6.2.1 Conformance requirements

[3GPP TS 44.060, 9.1.3.1]

In the extended uplink TBF mode, if $V(S) = V(A)$ and there is no RLC data block with $BSN = V(S)$ available, the mobile station shall stop sending RLC data blocks. The mobile station shall continue sending RLC data blocks when a RLC data block with $BSN = V(S)$ is available.

[3GPP TS 44.060, 9.3.1.3]

In an uplink TBF operating in extended uplink TBF mode, the CV shall indicate the current number of RLC data blocks that has not been transmitted in the uplink TBF. The mobile station shall update the TBC value and recalculate the CV for any untransmitted RLC data block in the following cases:

- The RLC entity of the mobile station receives new data from upper layers for transmission in the uplink TBF.

[3GPP TS 44.060, 9.3.1b.2]

In extended uplink TBF mode, the uplink TBF may be maintained during temporary inactive periods, where the mobile station has no RLC information to send.

During the temporary inactive periods, the mobile station may stop sending RLC data block, as defined in clause 9.1.3. The network shall continue allocating the mobile station uplink radio blocks during the inactivity period, using the procedures defined in clause 8.1.1 for each medium access mode. Uplink radio blocks shall be allocated as required allowing the mobile station to continue the transfer of RLC data blocks, when a new RLC data block becomes available.

When the mobile station is allocated an uplink radio block and there is no RLC data block ready to send, the mobile station shall send an RLC/MAC control block in each uplink radio block allocated by the network. The priority defined in clause 8.1.1 for different kinds of RLC/MAC blocks apply.

References

3GPP TS 44.060, subclause 9.1.3.1, 9.3.1.3, 9.3.1b.2

41.3.6.2.2 Test purpose

- 1 To verify that MS sends an RLC/MAC control block after fully acknowledgement of transmitted RLC data.
- 2 To verify that MS continues to send RLC data blocks on the current TBF when MS receives new data from upper layers when all RLC data have been fully acknowledged.
- 3 To verify that MS recalculates the CV when a new LLC PDU is received from upper layers after MS has sent a RLC data block with CV=0.

41.3.6.2.3 Method of test

Initial Conditions

System Simulator:

1 cell, NW_EXT_UTBF = 1, BS_CV_MAX = 15

Mobile Station:

MS is in Packet Idle mode, GPRS attached with support of GERAN Feature Package 1 indicated in MS Radio Access Capabilities, and PDP context 2 established.

Specific PICS Statements

-

PIXIT Statements

-

Test Procedure

The MS is triggered to transfer user data. A TBF of dynamic allocation in acknowledged mode is assigned. SS assigns an USF to MS until MS has sent CV = 0. SS acknowledges all received data with Final Ack Indicator bit set to '0'. SS continues to assigns USF to MS. MS shall send a PACKET UPLINK DUMMY CONTROL BLOCK every time. Then MS is triggered to send more data. After one second a new USF is assigned to MS. MS shall send a data block with a recalculated CV. Then the uplink TBF is continued and completed.

Expected Sequence

Step	Direction	Message	Comments
1		{Uplink dynamic allocation two phase access}	n = 500 octets, USF_GRANULARITY = 1 block, CHANNEL_CODING_COMMAND: CS-2, RLC acknowledged mode (PDP context2) USF assigned to the MS.
2	SS -> MS	PACKET DOWNLINK DUMMY CONTROL BLOCK	
3	MS -> SS	UPLINK RLC DATA BLOCK	
4			Repeat step 2 and 3 until CV=0
5	SS -> MS	PACKET UPLINK ACK/NACK	Final Ack Indication = 0. Sent on PACCH of the assigned PDCH. Acknowledge all data blocks received.
6	SS -> MS	PACKET DOWNLINK DUMMY CONTROL BLOCK	USF assigned to the MS
A6 (optional step)	MS -> SS	UPLINK RLC DATA BLOCK	MS may retransmit the block with BSN=0 once if it has already been scheduled while Packet Uplink Ack/Nack is being processed. In this case go to step B6.
B6 (optional step)	SS -> MS	PACKET DOWNLINK DUMMY CONTROL BLOCK	USF assigned to the MS
7	MS -> SS	PACKET UPLINK DUMMY CONTROL BLOCK	
8			Repeat step 6 and 7 five times.
9	MS		Trigger the MS to send 400 octets of data. SS should take care of allocating USF's to the MS in order to prevent the MS from releasing the TBF. If SS receives PACKET UPLINK DUMMY CONTROL BLOCKS, these shall be discarded. If SS receives an UPLINK RLC DATA BLOCK, then verify that the MS has recalculated the CV.
10	SS -> MS	PACKET DOWNLINK DUMMY CONTROL BLOCK	USF assigned to the MS
11	MS -> SS	UPLINK RLC DATA BLOCK	
12			Repeat step 10 and 11 until CV=0
13	SS -> MS	PACKET UPLINK ACK/NACK	Final Ack Indication = 1 containing valid RRBP. Sent on PACCH of the assigned PDCH. Acknowledge all data blocks received.
14	MS -> SS	PACKET CONTROL ACKNOWLEDGEMENT	Received on the block specified by RRBP on PACCH of the assigned PDCH.

Specific Message Contents

41.3.6.3 TBF Release / Extended Uplink / CS change order while CV=0

41.3.6.3.1 Conformance requirements

[3GPP TS 44.060, 9.1.3.1b2]

During a period when the network does not receive any RLC data blocks from the mobile station, the network may periodically send a PACKET UPLINK ACK/NACK message to the mobile station.

[3GPP TS 44.060, 9.1.12]

In the uplink direction the channel coding scheme shall be the commanded channel coding scheme.

[3GPP TS 44.060, 11.2.28]

The Channel Coding Indicator field indicates the channel coding scheme that the mobile station shall use when transmitting on the uplink.

References

3GPP TS 44.060, subclause 9.1.3.1b2,

3GPP TS 44.060, 9.1.12,

3GPP TS 44.060, 11.2.28

41.3.6.3.2 Test purpose

To verify that MS applies the new ordered CS whereas the CS change command has been received while CV = 0.

41.3.6.3.3 Method of test

Initial Conditions

System Simulator:

1 cell, NW_EXT_UTBF = 1, BS_CV_MAX = 15

Mobile Station:

MS is in Packet Idle mode, GPRS attached with support of GERAN Feature Package 1 indicated in MS Radio Access Capabilities, and PDP context 2 established.

Specific PICS Statements

-

PIXIT Statements

-

Test Procedure

The MS is triggered to transfer user data. A TBF of dynamic allocation in acknowledged mode is assigned. SS assigns an USF to MS until MS has sent CV = 0. SS acknowledges all received data with Final Ack Indicator bit set to '0'. SS continues to assign USF to MS. MS sends a PACKET UPLINK DUMMY CONTROL BLOCK every time. Then MS received a new Coding Scheme command while it transmits PACKET UPLINK DUMMY CONTROL BLOCKs. Last, it is triggered to send more data. After one second a new USF is assigned to MS. MS shall send a data block with a recalculated CV. Then the uplink TBF shall be continued and completed with the new commanded CS.

Expected Sequence

Step	Direction	Message	Comments
1		{Uplink dynamic allocation two phase access}	n = 500 octets, USF_GRANULARITY = 1 block, CHANNEL_CODING_COMMAND: CS-2, RLC acknowledged mode (PDP context2) USF assigned to the MS.
2	SS -> MS	PACKET DOWNLINK DUMMY CONTROL BLOCK	
3	MS -> SS	UPLINK RLC DATA BLOCK	
4			Repeat step 2 and 3 until CV=0
5	SS -> MS	PACKET UPLINK ACK/NACK	Final Ack Indication = 0. Sent on PACCH of the assigned PDCH. Acknowledge all data blocks received.
6	SS -> MS	PACKET DOWNLINK DUMMY CONTROL BLOCK	USF assigned to the MS
A6 (optional step)	MS -> SS	UPLINK RLC DATA BLOCK	MS may retransmit the block with BSN=0 once if it has already been scheduled while Packet Uplink Ack/Nack is being processed. In this case go to step B6.
B6 (optional step)	SS -> MS	PACKET DOWNLINK DUMMY CONTROL BLOCK	USF assigned to the MS
7	MS -> SS	PACKET UPLINK DUMMY CONTROL BLOCK	
8			Repeat step 6 and 7 five times.
9	SS -> MS	PACKET UPLINK ACK/NACK	CHANNEL_CODING_COMMAND: CS-3
10	SS -> MS	PACKET DOWNLINK DUMMY CONTROL BLOCK	USF assigned to the MS
11	MS -> SS	PACKET UPLINK DUMMY CONTROL BLOCK	
12	MS		Trigger the MS to send 400 octets of data. SS should take care of allocating USF's to the MS in order to prevent the MS from releasing the TBF. If SS receives PACKET UPLINK DUMMY CONTROL BLOCKs, these shall be discarded. If SS receives an UPLINK RLC DATA BLOCK, then verify that the MS has recalculated the CV.
13	SS -> MS	PACKET DOWNLINK DUMMY CONTROL BLOCK	USF assigned to the MS
14	MS -> SS	UPLINK RLC DATA BLOCK	Verify that the MS uses the new ordered CS.
15			Repeat step 13 and 14 until CV=0
16	SS -> MS	PACKET UPLINK ACK/NACK	Final Ack Indication = 1 containing valid RRBp. Sent on PACCH of the assigned PDCH. Acknowledge all data blocks received.
17	MS -> SS	PACKET CONTROL ACKNOWLEDGEMENT	Received on the block specified by RRBp on PACCH of the assigned PDCH.

Specific Message Contents

PACKET UPLINK ACK NACK (Step 1):

As default message contents except: CHANNEL_CODING_COMMAND	CS-2
---	------

PACKET UPLINK ACK NACK (Step 9):

As default message contents except: CHANNEL_CODING_COMMAND	CS-3
---	------

41.3.6.4 TBF Release / Extended Uplink / TBF reconfigure by PACKET TIMESLOT RECONFIGURE

41.3.6.4.1 Conformance requirements

The mobile station shall attempt to decode every downlink RLC/MAC block on all assigned PDCHs. Whenever the mobile station receives an RLC/MAC block containing an RLC/MAC control block, the mobile station shall attempt to

interpret the message contained therein. If the message addresses the mobile station, the mobile station shall act on the message.

The network may at any time during the uplink TBF initiate a change of resources by sending on the downlink PACCH monitored by the MS, an unsolicited PACKET UPLINK ASSIGNMENT or PACKET TIMESLOT RECONFIGURE message to the mobile station. During the reallocation TFI is allowed to be changed.

During the temporary inactive periods, the mobile station may stop sending RLC data block, as defined in sub-clause 9.1.3. The network shall continue allocating the mobile station uplink radio blocks during the inactivity period, using the procedures defined in sub-clause 8.1.1 for each medium access mode. Uplink radio blocks shall be allocated as required allowing the mobile station to continue the transfer of RLC data blocks, when a new RLC data block becomes available.

When the mobile station is allocated an uplink radio block and there is no RLC data block ready to send for this TBF, the mobile station shall send an RLC/MAC control block in each uplink radio block allocated by the network. The priority defined in sub-clause 8.1.1 for different kinds of RLC/MAC blocks apply.

References

3GPP TS 44.060, subclause 9.3.1b.2

3GPP TS 44.060, subclause 8.1.1.1.1

41.3.6.4.2 Test purpose

To verify that if the MS receives a PACKET TIMESLOT RECONFIGURE while the Uplink TBF is extended, the MS switches to the new assigned channels and continues sending of PACKET DUMMY CONTROL BLOCKs in the uplink.

41.3.6.4.3 Method of test

Initial Conditions

System Simulator:

1 cell, GPRS supported, PCCCH present, NW_EXT_UTBF = 1.

Mobile Station:

MS is in Packet Idle mode, GPRS attached with support of GERAN Feature Package 1 indicated in MS Radio Access Capabilities, and PDP context 2 established.

Specific PICS Statements

-

PIXIT Statements

-

Test Procedure

The MS is triggered to transfer user data. A TBF using dynamic allocation in acknowledged mode is assigned. The SS assigns an USF to MS. SS receives data blocks till CV=0 and acknowledges all the blocks with an UPLINK ACK/NACK setting FAI=0. Then SS checks that if a USF is matched to the MS it sends a UPLINK DUMMY CONTROL BLOCK. SS sends a PACKET TIMESLOT RECONFIGURE, reassigning the timeslot given for Uplink and initiating a downlink TBF. SS checks that the MS is sending a UPLINK DUMMY CONTROL BLOCK on the new channels whenever the USF is matched. SS releases the downlink TBF. SS initiates a data transfer of 200 octets. SS checks that the MS is using the newly assigned channels for doing the data transfer. SS allows the MS to complete the data transfer and releases the TBF.

Expected Sequence

Step	Direction	Message	Comments
1		{Uplink dynamic allocation two phase access}	n = 500 octets, USF_GRANULARITY = 1 block, CHANNEL_CODING_COMMAND: CS-2, RLC acknowledged mode (PDP context2)
2	SS -> MS	PACKET DOWNLINK DUMMY CONTROL BLOCK	USF assigned to the MS.
3	MS -> SS	UPLINK RLC DATA BLOCK	
4			Repeat step 2 and 3 until CV=0
5	SS -> MS	PACKET UPLINK ACK/NACK	Final Ack Indication = 0. Sent on PACCH of the assigned PDCH. Acknowledge all data blocks received.
6	SS -> MS	PACKET DOWNLINK DUMMY CONTROL BLOCK	USF assigned to the MS
A6 (optional step)	MS -> SS	UPLINK RLC DATA BLOCK	MS may retransmit the block with BSN=0 once if it has already been scheduled while Packet Uplink Ack/Nack is being processed. In this case go to step B6.
B6 (optional step)	SS -> MS	PACKET DOWNLINK DUMMY CONTROL BLOCK	USF assigned to the MS
7	MS -> SS	PACKET UPLINK DUMMY CONTROL BLOCK	
8			Repeat step 6 and 7 five times.
9	SS -> MS	PACKET TIMESLOT RECONFIGURE	See Specific message content. Assigning different timeslot, starting a downlink TBF.
10	SS -> MS	DOWNLINK RLC DATA BLOCK	Containing RRBp= N+21 or +22 and USF assigned to the MS. FBI = '1'. Sent on the downlink PDTCH assigned on 3 blocks from the last radio block containing the TIMESLOT RECONFIGURE in step 9.
11	MS -> SS	PACKET UPLINK DUMMY CONTROL BLOCK	Received on the uplink PDTCH assigned in step 9.
12	MS -> SS	PACKET DOWNLINK ACK/NACK	Received on the block of frame number = N+21 or +22, N is the frame number of the first burst of the data block in step 10.

Step	Direction	Message	Comments
13	SS -> MS	PACKET DOWNLINK DUMMY CONTROL BLOCK	USF assigned to the MS
14	MS -> SS	PACKET UPLINK DUMMY CONTROL BLOCK	
15	MS		Trigger the MS to send 200 octets of data. SS should take care of allocating USF's to the MS in order to prevent the MS from releasing the TBF. If SS receives PACKET UPLINK DUMMY CONTROL BLOCKs, these shall be discarded. If SS receives an UPLINK RLC DATA BLOCK, then verify that the MS has recalculated the CV. USF assigned to the MS
16	SS -> MS	PACKET DOWNLINK DUMMY CONTROL BLOCK	Repeat step 16 and 17 until CV=0
17	MS -> SS	UPLINK RLC DATA BLOCK	
18			Final Ack Indication = 1 containing valid RRBp. Sent on PACCH of the assigned PDCH. Acknowledge all data blocks received.
19	SS -> MS	PACKET UPLINK ACK/NACK	
20	MS -> SS	PACKET CONTROL ACKNOWLEDGEMENT	Received on the block specified by RRBp on PACCH of the assigned PDCH.

Specific Message Contents

PACKET TIMESLOT RECONFIGURE message in step 9:

PAGE_MODE	Normal
- Global TFI	0, Global TFI as reference 0, uplink TFI same value as assigned in the uplink in step 1
CHANNEL_CODING_COMMAND	Arbitrarily chosen from valid values
Global packet Timing Advance	
- {0 1<TIMING_ADVANCE_VALUE>}	1 (timing advance value)
- TIMING_ADVANCE_VALUE	30 bit periods
- {0 1<UPLINK_TIMING_ADVANCE_INDEX>	0 (no uplink timing advance index)
<UPLINK_TIMING_ADVANCE_TIMESLOT_NUMBER>}	The MS stops the operation of the continuous timing advance procedure.
- {0 1<DOWNLINK_TIMING_ADVANCE_INDEX>	0 (no downlink timing advance index)
<DOWNLINK_TIMING_ADVANCE_TIMESLOT_NUMBER>}	The MS stops the operation of the continuous timing advance procedure.
DOWNLINK_RLC_MODE	Acknowledged mode
CONTROL_ACK	0
{0 1<DOWNLINK_TFI_ASSIGNMENT>}	1
- GLOBAL_TFI_ASSIGNMENT	Arbitrarily chosen but different from the value for uplink TBF
{0 1<UPLINK_TFI_ASSIGNMENT>}	0
DOWNLINK_TIMESLOT_ALLOCATION	Timeslot 5 assigned
{0 1<Frequency parameters>}	0
Dynamic allocation	0
- Extended Dynamic Allocation	0 (Dynamic allocation)
{0 1<P0>}	0
- USF GRANULARITY	0 (1 RLC block)
- {0 1<RLC_DATA_BLOCKS_GRANTED>}	0 (open-ended TBF)
- {0 1<TBF_STARTING_TIME>}	0 (no starting time)
-	1 (Timeslot Allocation with Power Control Parameters)
- ALPHA	0.5
- {0 1<USF_TN _x ><GAMMA_TN _x >}	000001 (timeslot 5 assigned)
- USF_TN ₅	Arbitrarily chosen but different from current value
- GAMMA_TN ₅	For GSM 700, T-GSM 810, GSM 850 and GSM 900, +8 dBm For DCS 1 800 and PCS 1 900, +6 dBm
	00

41.3.6.5 TBF Release / Extended Uplink / TBF reconfigure by PACKET UPLINK ASSIGNMENT

41.3.6.5.1 Conformance requirements

The mobile station shall attempt to decode every downlink RLC/MAC block on all assigned PDCHs. Whenever the mobile station receives an RLC/MAC block containing an RLC/MAC control block, the mobile station shall attempt to interpret the message contained therein. If the message addresses the mobile station, the mobile station shall act on the message.

The network may at any time during the uplink TBF initiate a change of resources by sending on the downlink PACCH monitored by the MS, an unsolicited PACKET UPLINK ASSIGNMENT or PACKET TIMESLOT RECONFIGURE message to the mobile station. During the reallocation TFI is allowed to be changed.

During the temporary inactive periods, the mobile station may stop sending RLC data block, as defined in sub-clause 9.1.3. The network shall continue allocating the mobile station uplink radio blocks during the inactivity period, using the procedures defined in sub-clause 8.1.1 for each medium access mode. Uplink radio blocks shall be allocated as required allowing the mobile station to continue the transfer of RLC data blocks, when a new RLC data block becomes available.

When the mobile station is allocated an uplink radio block and there is no RLC data block ready to send for this TBF, the mobile station shall send an RLC/MAC control block in each uplink radio block allocated by the network. The priority defined in sub-clause 8.1.1 for different kinds of RLC/MAC blocks apply.

References

3GPP TS 44.060, subclause 9.3.1b.2

3GPP TS 44.060, subclause 8.1.1.1.1

41.3.6.5.2 Test purpose

To verify that if the MS receives a PACKET UPLINK ASSIGNMENT while the Uplink TBF is extended, the MS switches to the new assigned channels and continues sending of PACKET DUMMY CONTROL BLOCKs in the uplink.

41.3.6.5.3 Method of test

Initial Conditions

System Simulator:

1 cell, GPRS supported, PCCCH present, NW_EXT_UTBF = 1.

Mobile Station:

MS is in Packet Idle mode, GPRS attached with support of GERAN Feature Package 1 indicated in MS Radio Access Capabilities, and PDP context 2 established.

Specific PICS Statements

-

PIXIT Statements

-

Test Procedure

The MS is triggered to transfer user data. A TBF using dynamic allocation in acknowledged mode is assigned. The SS assigns an USF to MS. SS receives data blocks till CV=0 and acknowledges all the blocks with an UPLINK ACK/NACK setting FAI=0. Then SS checks that if a USF is matched to the MS it sends a UPLINK DUMMY CONTROL BLOCK. SS sends a PACKET UPLINK ASSIGNMENT, reassigning the timeslot given for Uplink. SS checks that the MS is sending a UPLINK DUMMY CONTROL BLOCK on the new channels whenever the USF is matched. SS initiates a data transfer of 200 octets. SS checks that the MS is using the newly assigned channels for doing the data transfer. SS allows the MS to complete the data transfer and releases the TBF.

Expected Sequence

Step	Direction	Message	Comments
1		{Uplink dynamic allocation two phase access}	n = 500 octets, USF_GRANULARITY = 1 block, CHANNEL_CODING_COMMAND: CS-2, RLC acknowledged mode (PDP context2)
2	SS -> MS	PACKET DOWNLINK DUMMY CONTROL BLOCK	USF assigned to the MS.
3	MS -> SS	UPLINK RLC DATA BLOCK	
4			Repeat step 2 and 3 until CV=0
5	SS -> MS	PACKET UPLINK ACK/NACK	Final Ack Indication = 0. Sent on PACCH of the assigned PDCH. Acknowledge all data blocks received.
6	SS -> MS	PACKET DOWNLINK DUMMY CONTROL BLOCK	USF assigned to the MS
A6 (optional step)	MS -> SS	UPLINK RLC DATA BLOCK	MS may retransmit the block with BSN=0 once if it has already been scheduled while Packet Uplink Ack/Nack is being processed. In this case go to step B6.
B6 (optional step)	SS -> MS	PACKET DOWNLINK DUMMY CONTROL BLOCK	USF assigned to the MS
7	MS -> SS	PACKET UPLINK DUMMY CONTROL BLOCK	
8			Repeat step 6 and 7 five times.
9	SS -> MS	PACKET UPLINK ASSIGNMENT	See Specific message content. Assigning different timeslot.
10	SS -> MS	PACKET DOWNLINK DUMMY CONTROL BLOCK	USF assigned to the MS. Sent after 3 blocks of sending the messages in step 9.
11	MS -> SS	PACKET UPLINK DUMMY CONTROL BLOCK	
12	MS		Trigger the MS to send 200 octets of data. SS should take care of allocating USF's to the MS in order to prevent the MS from releasing the TBF. If SS receives PACKET UPLINK DUMMY CONTROL BLOCKs, these shall be discarded. If SS receives an UPLINK RLC DATA BLOCK, then verify that the MS has recalculated the CV.
13	SS -> MS	PACKET DOWNLINK DUMMY CONTROL BLOCK	USF assigned to the MS
14	MS -> SS	UPLINK RLC DATA BLOCK	
15			Repeat step 13 and 14 until CV=0
16	SS -> MS	PACKET UPLINK ACK/NACK	Final Ack Indication = 1 containing valid RRBP. Sent on PACCH of the assigned PDCH. Acknowledge all data blocks received.
17	MS -> SS	PACKET CONTROL ACKNOWLEDGEMENT	Received on the block specified by RRBP on PACCH of the assigned PDCH.

Specific Message Contents :

PACKET UPLINK ASSIGNMENT message in step 9:

Information Element	value/ remark
Dynamic allocation	01
-	000000
-	1 (Timeslot Allocation with Power Control Parameters for 1 slot assigned)
- ALPHA	0.5
-	000001 (timeslot 5 assigned)
- USF_TN5	Arbitrarily chosen
- GAMMA_TN5	For GSM 900: +8 dBm
	For GSM 400: +8 dBm
	For GSM 850: +8 dBm
	For GSM 700 and T-GSM 810: +8 dBm
	For DCS 1 800: +6dBm
	For PCS 1 900: +6 dBm
-	000000

41.3.6.6 Extended Uplink TBF / Cell Change while in Extended Uplink/ No Packet Neighbouring Cell Data

41.3.6.6.1 Conformance requirements

If CCN is enabled (see sub-clause 5.5.1.1a), the mobile station shall behave as in network control mode NC0 or NC1 up to the point when a new cell has been chosen. It shall then check the CCN_SUPPORTED parameter, if available, that was last received for that cell. This parameter can be sent on BCCH or PBCCH or individually in PACKET MEASUREMENT ORDER or in PACKET CELL CHANGE ORDER messages. If it is available and if it indicates that CCN mode shall be entered towards that cell or if it is not available, then instead of performing the cell change, the mobile station shall start timer T3206 and enter the CCN mode. At the first possible opportunity, the MS shall then, when in CCN mode, inform the network about the proposed cell by sending a PACKET CELL CHANGE NOTIFICATION message, stop timer T3206, start timers T3208 and T3210. The PACKET CELL CHANGE NOTIFICATION message shall contain the ARFCN for the BCCH and the BSIC as identity of the proposed cell. The message shall also contain measurement reports for the proposed cell and for other neighbour cells if available. In CCN mode the mobile station shall continue the data transfer and store neighbour cell system information if received in instances of the PACKET NEIGHBOUR CELL DATA message, but not perform the cell change. At receipt of the first PACKET NEIGHBOUR CELL DATA message or PACKET CELL CHANGE CONTINUE message or PACKET CELL CHANGE ORDER message, the mobile station shall stop the timer T3210. If a mobile station as response to a PACKET CELL CHANGE NOTIFICATION message receives a PACKET CELL CHANGE CONTINUE message without receiving any neighbour cell system information, the mobile station shall stop timer T3208, stop timer T3210 if still running, leave CCN mode and continue cell reselection in NC0/NC1 mode. The network sends first necessary system information for the cell proposed in the PACKET CELL CHANGE NOTIFICATION message, or for any other cell, in one or more instances of the PACKET NEIGHBOUR CELL DATA message and sends then a PACKET CELL CHANGE CONTINUE message. The mobile station shall store the received system information as specified in sub-clause 8.8.1. When the first instance of the PACKET NEIGHBOUR CELL DATA message is received, the mobile station shall stop timer T3210 if still running. When the PACKET CELL CHANGE CONTINUE message is received, the mobile station shall stop timer T3208, leave CCN mode and continue the cell reselection in NC0/NC1 mode. The network sends first necessary system information for the cell proposed in the PACKET CELL CHANGE NOTIFICATION message, or for any other cell, in one or more instances of the PACKET NEIGHBOUR CELL DATA message and sends then a PACKET CELL CHANGE ORDER message. The mobile station shall store the received system information as specified in sub-clause 8.8.1. When the first instance of the PACKET NEIGHBOUR CELL DATA message is received, the mobile station shall stop timer T3210 if still running. When the PACKET CELL CHANGE ORDER message is received, the mobile station shall stop timer T3208, leave CCN mode and follow the procedures as specified for the Packet Cell Change Order (sub-clause 8.4) and in sub-clause 8.8.1.

In extended uplink TBF mode, the uplink TBF may be maintained during temporary inactive periods, where the mobile station has no RLC information to send.

During the temporary inactive periods, the mobile station may stop sending RLC data block, as defined in clause 9.1.3. The network shall continue allocating the mobile station uplink radio blocks during the inactivity period, using the procedures defined in clause 8.1.1 for each medium access mode. Uplink radio blocks shall be allocated as required allowing the mobile station to continue the transfer of RLC data blocks, when a new RLC data block becomes available.

When the mobile station is allocated an uplink radio block and there is no RLC data block ready to send, the mobile station shall send an RLC/MAC control block in each uplink radio block allocated by the network. The priority defined in clause 8.1.1 for different kinds of RLC/MAC blocks apply.

References

3GPP TS 44.060, subclause 8.8.3

3GPP TS 44.060, subclause 9.3.1b.2

41.3.6.6.2 Test purpose

To verify that an MS which is in Extended Uplink TBF, NACC active, changes to the proposed cell while in extending (sending uplink dummy control blocks).

41.3.6.6.3 Method of test

Initial conditions

System Simulator:

2 cells, GPRS supported, CCN Active, PCCCH present, GPRS_RXLEV_ACCESS_MIN = -90dBm, NW_EXT_UTBF = 1.

Cell A: RLA_C = -50 dBm, is active.

Cell B: RLA_C = -60 dBm, is active.

Mobile Station:

MS is in Packet Idle mode, GPRS attached with support of GERAN Feature Package 1 indicated in MS Radio Access Capabilities, and PDP context 2 established.

Specific PICS Statements

-

PIXIT Statements

-

Test procedure

The MS is triggered to initiate packet uplink transfer. SS assigns resources to the MS and it starts to send uplink data that the SS acknowledge. When MS reaches CV=0, it starts sending PACKET UPLINK DUMMY CONTROL BLOCKS. During the uplink the signal strength of Cell A is lowered to -80 dBm. The MS enters CCN mode and sends PACKET CELL CHANGE NOTIFICATION. The MS then continues to send PACKET UPLINK DUMMY CONTROL BLOCKS. While MS is sending PACKET UPLINK DUMMY CONTROL BLOCKS, the SS then sends PACKET CELL CHANGE CONTINUE and the MS change to Cell B. The MS request resources for an uplink in the new cell and complete the uplink transfer in the new cell.

Maximum duration of the test

-

Expected sequence

Step	Direction	Message	Comments
1		{Uplink dynamic allocation two phase access}	n = 500 octets. USF_GRANULARITY = 1 block, RLC_DATA_BLOCKS_GRANTED = open-end TLLI_BLOCK_CHANNEL_CODING: same as channel coding CHANNEL_CODING_COMMAND: cs-1 No starting time present.
2	SS -> MS	PACKET DOWNLINK DUMMY CONTROL BLOCK	USF assigned to the MS
3	MS -> SS	RLC DATA BLOCK	
4			Repeat step 2 and 3 until CV=0
5	SS -> MS	PACKET UPLINK ACK/NACK	Final Ack Indication = 0. Sent on PACCH of the assigned PDCH. Acknowledge all data blocks received.
6	SS -> MS	PACKET DOWNLINK DUMMY CONTROL BLOCK	USF assigned to the MS
A6 (optional step)	MS -> SS	UPLINK RLC DATA BLOCK	MS may retransmit the block with BSN=0 once if it has already been scheduled while Packet Uplink Ack/Nack is being processed. In this case go to step B6.
B6 (optional step)	SS -> MS	PACKET DOWNLINK DUMMY CONTROL BLOCK	USF assigned to the MS
7	MS -> SS	PACKET UPLINK DUMMY CONTROL BLOCK	
8			Repeat steps 6 and 7 five times
9	SS		Lower signal strength of Cell A to -80 dBm.
10	SS -> MS	PACKET UPLINK ACK/NACK	USF assigned to the MS
11	MS -> SS	PACKET UPLINK DUMMY CONTROL BLOCK	
12		Or PACKET CELL CHANGE NOTIFICATION	Step 10 and 11 are repeated until a PACKET CELL CHANGE NOTIFICATION is received in step 11, but no longer than 10 sec. The test has failed if no PACKET CELL CHANGE NOTIFICATION is received in Cell A within 10 sec from Step 9.
13	SS -> MS	PACKET CELL CHANGE CONTINUE	
			The following messages are to be sent and received in Cell B.
14	MS ->SS	PACKET CHANNEL REQUEST	Received on PRACH.
15	SS ->MS	PACKET UPLINK ASSIGNMENT	Single block assignment, to order the MS to follow the two phase access procedure. Sent on PAGCH.
16	MS ->SS	PACKET RESOURCE REQUEST	Received on the single block assigned in step 15. Access type = 'Cell Update' or 'Two Phase Access'.
17	SS ->MS	PACKET UPLINK ASSIGNMENT	Uplink dynamic allocation, no starting time Sent on PACCH of the same PDCH assigned in step 15.
18		{Completion of uplink RLC data block transfer}	MS performs a Cell Update.

Specific message contents

PACKET CELL CHANGE CONTINUE in Step 13

Information element	Value/remark
< PAGE_MODE : bit (2) >	00 (Normal Paging)
0	0
< GLOBAL_TFI : Global TFI IE >	0 <5 bit Uplink TFI>
0 1	1
< ARFCN : bit (10) >	ARFCN of Cell B.
< BSIC : bit (6) >	BSIC of Cell B.
< CONTAINER_ID >	01

41.3.6.7 Extended Uplink TBF / Cell Change failure while in Extended Uplink/ No Packet Neighbouring Cell Data

41.3.6.7.1 Conformance requirements

If CCN is enabled (see sub-clause 5.5.1.1a), the mobile station shall behave as in network control mode NC0 or NC1 up to the point when a new cell has been chosen. It shall then check the CCN_SUPPORTED parameter, if available, that was last received for that cell. This parameter can be sent on BCCH or PBCCH or individually in PACKET MEASUREMENT ORDER or in PACKET CELL CHANGE ORDER messages. If it is available and if it indicates that CCN mode shall be entered towards that cell or if it is not available, then instead of performing the cell change, the mobile station shall start timer T3206 and enter the CCN mode. At the first possible opportunity, the MS shall then, when in CCN mode, inform the network about the proposed cell by sending a PACKET CELL CHANGE NOTIFICATION message, stop timer T3206, start timers T3208 and T3210. The PACKET CELL CHANGE NOTIFICATION message shall contain the ARFCN for the BCCH and the BSIC as identity of the proposed cell. The message shall also contain measurement reports for the proposed cell and for other neighbour cells if available. In CCN mode the mobile station shall continue the data transfer and store neighbour cell system information if received in instances of the PACKET NEIGHBOUR CELL DATA message, but not perform the cell change. At receipt of the first PACKET NEIGHBOUR CELL DATA message or PACKET CELL CHANGE CONTINUE message or PACKET CELL CHANGE ORDER message, the mobile station shall stop the timer T3210. If a mobile station as response to a PACKET CELL CHANGE NOTIFICATION message receives a PACKET CELL CHANGE CONTINUE message without receiving any neighbour cell system information, the mobile station shall stop timer T3208, stop timer T3210 if still running, leave CCN mode and continue cell reselection in NC0/NC1 mode. The network sends first necessary system information for the cell proposed in the PACKET CELL CHANGE NOTIFICATION message, or for any other cell, in one or more instances of the PACKET NEIGHBOUR CELL DATA message and sends then a PACKET CELL CHANGE CONTINUE message. The mobile station shall store the received system information as specified in sub-clause 8.8.1. When the first instance of the PACKET NEIGHBOUR CELL DATA message is received, the mobile station shall stop timer T3210 if still running. When the PACKET CELL CHANGE CONTINUE message is received, the mobile station shall stop timer T3208, leave CCN mode and continue the cell reselection in NC0/NC1 mode. The network sends first necessary system information for the cell proposed in the PACKET CELL CHANGE NOTIFICATION message, or for any other cell, in one or more instances of the PACKET NEIGHBOUR CELL DATA message and sends then a PACKET CELL CHANGE ORDER message. The mobile station shall store the received system information as specified in sub-clause 8.8.1. When the first instance of the PACKET NEIGHBOUR CELL DATA message is received, the mobile station shall stop timer T3210 if still running. When the PACKET CELL CHANGE ORDER message is received, the mobile station shall stop timer T3208, leave CCN mode and follow the procedures as specified for the Packet Cell Change Order (sub-clause 8.4) and in sub-clause 8.8.1.

In extended uplink TBF mode, the uplink TBF may be maintained during temporary inactive periods, where the mobile station has no RLC information to send.

During the temporary inactive periods, the mobile station may stop sending RLC data block, as defined in clause 9.1.3. The network shall continue allocating the mobile station uplink radio blocks during the inactivity period, using the procedures defined in clause 8.1.1 for each medium access mode. Uplink radio blocks shall be allocated as required allowing the mobile station to continue the transfer of RLC data blocks, when a new RLC data block becomes available.

When the mobile station is allocated an uplink radio block and there is no RLC data block ready to send, the mobile station shall send an RLC/MAC control block in each uplink radio block allocated by the network. The priority defined in clause 8.1.1 for different kinds of RLC/MAC blocks apply.

References

3GPP TS 44.060, subclause 8.8.3

3GPP TS 44.060, subclause 9.3.1b.2

41.3.6.7.2 Test purpose

To verify that an MS, which is in Extended Uplink TBF, NACC active, shall revert to the previous TBF, if selected cell disappears from the coverage and MS should still stay in Extended Uplink TBF

41.3.6.7.3 Method of test

Initial conditions

System Simulator:

2 cells, GPRS supported, CCN Active, PCCCH present, GPRS_RXLEV_ACCESS_MIN = -90dBm, NW_EXT_UTBF = 1.

Cell A: RLA_C = -50 dBm, is active.

Cell B: RLA_C = -60 dBm, is active.

Mobile Station:

MS is in Packet Idle mode, GPRS attached with support of GERAN Feature Package 1 indicated in MS Radio Access Capabilities, and PDP context 2 established. Ready timer is deactivated

Specific PICS Statements

-

PIXIT Statements

-

Test procedure

The MS is triggered to initiate packet uplink transfer. SS assigns resources to the MS and it starts to send uplink data that the SS acknowledge. When MS reaches CV=0, it starts sending PACKET UPLINK DUMMY CONTROL BLOCKS. During the uplink the signal strength of Cell A is lowered to -80 dBm. The MS enters CCN mode and sends PACKET CELL CHANGE NOTIFICATION. The MS then continues to send PACKET UPLINK DUMMY CONTROL BLOCKS. While MS is sending PACKET UPLINK DUMMY CONTROL BLOCKS, the SS then sends PACKET CELL CHANGE CONTINUE and the MS change to Cell B. MS tries to access Cell B. SS deactivates Cell B, The MS request resources for an uplink in the old cell.

Maximum duration of the test

-

Expected sequence

Expected sequence

Step	Direction	Message	Comments
1		{Uplink dynamic allocation two phase access}	n = 500 octets. USF_GRANULARITY = 1 block, RLC_DATA_BLOCKS_GRANTED = open-end TLLI_BLOCK_CHANNEL_CODING: same as channel coding CHANNEL_CODING_COMMAND: cs-1 No starting time present.
2	SS -> MS	PACKET DOWNLINK DUMMY CONTROL BLOCK	USF assigned to the MS
3	MS -> SS	RLC DATA BLOCK	
4			Repeat step 2 and 3 until CV=0
5	SS -> MS	PACKET UPLINK ACK/NACK	Final Ack Indication = 0. Sent on PACCH of the assigned PDCH. Acknowledge all data blocks received.
6	SS -> MS	PACKET DOWNLINK DUMMY CONTROL BLOCK	USF assigned to the MS
A6 (optional step)	MS -> SS	UPLINK RLC DATA BLOCK	MS may retransmit the block with BSN=0 once if it has already been scheduled while Packet Uplink Ack/Nack is being processed. In this case go to step B6.
B6 (optional step)	SS -> MS	PACKET DOWNLINK DUMMY CONTROL BLOCK	USF assigned to the MS
7	MS -> SS	PACKET UPLINK DUMMY CONTROL BLOCK	Repeat steps 6 and 7 five times
8			
9	SS		Lower signal strength of Cell A to -80 dBm.
10	SS -> MS	PACKET UPLINK ACK/NACK	USF assigned to the MS
11	MS -> SS	PACKET UPLINK DUMMY CONTROL BLOCK	
		Or PACKET CELL CHANGE NOTIFICATION	Step 10 and 11 are repeated until a PACKET CELL CHANGE NOTIFICATION is received in step 11, but no longer than 10 sec. The test has failed if no PACKET CELL CHANGE NOTIFICATION is received in Cell A within 10 sec from Step 9.
12			
13	SS -> MS	PACKET CELL CHANGE CONTINUE	Allow the MS to try to access Cell B Cell B is deactivated
14	MS -> SS	PACKET CHANNEL REQUEST	
15			
			The following messages are to be sent and received in Cell A.
16	MS -> SS	PACKET CHANNEL REQUEST	Received on PRACH.
17	SS -> MS	PACKET UPLINK ASSIGNMENT	Single block assignment, to order the MS to follow the two phase access procedure. Sent on PAGCH.
18	MS -> SS	PACKET RESOURCE REQUEST	Received on the single block assigned in step 17.
19	SS -> MS	PACKET UPLINK ASSIGNMENT	uplink dynamic allocation, no starting time Sent on PACCH of the same PDCH assigned in step 17.
20		{Completion of uplink RLC data block transfer}	MS performs a Cell Update.

Specific message contents

PACKET CELL CHANGE CONTINUE in Step 13

Information element	Value/remark
< PAGE_MODE : bit (2) > 0	00 (Normal Paging) 0
< GLOBAL_TFI : Global TFI IE > 0 1	0 <5 bit Uplink TFI> 1
< ARFCN : bit (10) >	ARFCN of Cell B.
< BSIC : bit (6) >	BSIC of Cell B.
<CONTAINER_ID>	01

41.3.6.8 Extended Uplink TBF / Cell Change while in Extended Uplink/ With Packet Neighbouring Cell Data

41.3.6.8.1 Conformance requirements

If CCN is enabled (see sub-clause 5.5.1.1a), the mobile station shall behave as in network control mode NC0 or NC1 up to the point when a new cell has been chosen. It shall then check the CCN_SUPPORTED parameter, if available, that was last received for that cell. This parameter can be sent on BCCH or PBCCH or individually in PACKET MEASUREMENT ORDER or in PACKET CELL CHANGE ORDER messages. If it is available and if it indicates that CCN mode shall be entered towards that cell or if it is not available, then instead of performing the cell change, the mobile station shall start timer T3206 and enter the CCN mode. At the first possible opportunity, the MS shall then, when in CCN mode, inform the network about the proposed cell by sending a PACKET CELL CHANGE NOTIFICATION message, stop timer T3206, start timers T3208 and T3210. The PACKET CELL CHANGE NOTIFICATION message shall contain the ARFCN for the BCCH and the BSIC as identity of the proposed cell. The message shall also contain measurement reports for the proposed cell and for other neighbour cells if available. In CCN mode the mobile station shall continue the data transfer and store neighbour cell system information if received in instances of the PACKET NEIGHBOUR CELL DATA message, but not perform the cell change. At receipt of the first PACKET NEIGHBOUR CELL DATA message or PACKET CELL CHANGE CONTINUE message or PACKET CELL CHANGE ORDER message, the mobile station shall stop the timer T3210. If a mobile station as response to a PACKET CELL CHANGE NOTIFICATION message receives a PACKET CELL CHANGE CONTINUE message without receiving any neighbour cell system information, the mobile station shall stop timer T3208, stop timer T3210 if still running, leave CCN mode and continue cell reselection in NC0/NC1 mode. The network sends first necessary system information for the cell proposed in the PACKET CELL CHANGE NOTIFICATION message, or for any other cell, in one or more instances of the PACKET NEIGHBOUR CELL DATA message and sends then a PACKET CELL CHANGE CONTINUE message. The mobile station shall store the received system information as specified in sub-clause 8.8.1. When the first instance of the PACKET NEIGHBOUR CELL DATA message is received, the mobile station shall stop timer T3210 if still running. When the PACKET CELL CHANGE CONTINUE message is received, the mobile station shall stop timer T3208, leave CCN mode and continue the cell reselection in NC0/NC1 mode. The network sends first necessary system information for the cell proposed in the PACKET CELL CHANGE NOTIFICATION message, or for any other cell, in one or more instances of the PACKET NEIGHBOUR CELL DATA message and sends then a PACKET CELL CHANGE ORDER message. The mobile station shall store the received system information as specified in sub-clause 8.8.1. When the first instance of the PACKET NEIGHBOUR CELL DATA message is received, the mobile station shall stop timer T3210 if still running. When the PACKET CELL CHANGE ORDER message is received, the mobile station shall stop timer T3208, leave CCN mode and follow the procedures as specified for the Packet Cell Change Order (sub-clause 8.4) and in sub-clause 8.8.1.

In extended uplink TBF mode, the uplink TBF may be maintained during temporary inactive periods, where the mobile station has no RLC information to send.

During the temporary inactive periods, the mobile station may stop sending RLC data block, as defined in clause 9.1.3. The network shall continue allocating the mobile station uplink radio blocks during the inactivity period, using the procedures defined in clause 8.1.1 for each medium access mode. Uplink radio blocks shall be allocated as required allowing the mobile station to continue the transfer of RLC data blocks, when a new RLC data block becomes available.

When the mobile station is allocated an uplink radio block and there is no RLC data block ready to send, the mobile station shall send an RLC/MAC control block in each uplink radio block allocated by the network. The priority defined in clause 8.1.1 for different kinds of RLC/MAC blocks apply.

References

3GPP TS 44.060, subclause 8.8.3

3GPP TS 44.060, subclause 9.3.1b.2

41.3.6.8.2 Test purpose

To verify that: MS takes into consideration the change of parameter NW_EXT_UTBF in PSI1 (sent in PACKET NEIGHBOUR CELL DATA) and operate in Extended Uplink TBF in the new cell.

41.3.6.8.3 Method of test

Initial conditions

System Simulator:

2 cells, GPRS supported, CCN Active, PCCCH present, GPRS_RXLEV_ACCESS_MIN = -90dBm,.

Cell A: RLA_C = -50 dBm, is active and NW_EXT_UTBF = 0.

Cell B: Supports PACKET PSI STATUS. All Packet System Information is replaced by Packet Downlink Dummy Control Block on PBCCH. This is only made to make it possible to verify that the MS uses the information in Packet Neighbour Cell Data, RLA_C = -60 dBm, is active and NW_EXT_UTBF = 1.

Mobile Station:

MS is in Packet Idle mode, GPRS attached with support of GERAN Feature Package 1 indicated in MS Radio Access Capabilities, and PDP context 2 established.

Specific PICS Statements

-

PIXIT Statements

-

Test procedure

The MS is triggered to initiate packet uplink transfer. SS assigns resources to the MS and it starts to send uplink data that the SS acknowledge. During the uplink the signal strength of Cell A is lowered to – 80 dBm. The MS enters CCN mode and sends PACKET CELL CHANGE NOTIFICATION. SS sends one or more PACKET NEIGHBOUR CELL DATA to the MS (with NW_EXT_UTBF in PSI1 set to 1). The SS then sends PACKET CELL CHANGE CONTINUE and the MS change to Cell B. The MS requests resources for an uplink and asks for the PSI3 and PSI3bis messages by sending PACKET_PSI_STATUS (Note: During the acquisition of BCCH information the MS may send up to three extra PACKET PSI STATUS messages). In the new cell the MS completes the uplink transfer while operating in extended uplink TBF.

Maximum duration of the test

-

Expected sequence

Step	Direction	Message	Comments
1		{Uplink dynamic allocation two phase access}	n = 1200 octets. USF_GRANULARITY = 1 block, RLC_DATA_BLOCKS_GRANTED = open-end TLLI_BLOCK_CHANNEL_CODING: same as channel coding CHANNEL_CODING_COMMAND: cs-1 No starting time present.
2	SS -> MS	PACKET DOWNLINK DUMMY CONTROL BLOCK	USF assigned to the MS
3	MS -> SS	RLC DATA BLOCK	
4			Repeat step 2 and 3 five times
5	SS		Lower signal strength of Cell A to -80 dBm.
6	SS -> MS	PACKET UPLINK ACK/NACK	USF assigned to the MS
7	MS -> SS	RLC DATA BLOCK Or PACKET CELL CHANGE NOTIFICATION	
8			Step 6 and 7 are repeated until a PACKET CELL CHANGE NOTIFICATION is received in step 7, but no longer than 10 sec. The test has failed if no PACKET CELL CHANGE NOTIFICATION is received in Cell A within 10 sec from Step 5.
9	SS -> MS	PACKET NEIGHBOUR CELL DATA	USF assigned to the MS
10	MS -> SS	RLC DATA BLOCK	
11			Step 9 and 10 are repeated until all instances of PACKET NEIGHBOUR CELL DATA are sent (PSI1 with NW_EXT_UTBF = 1 and PSI_STATUS_IND = 1).
12	SS -> MS	PACKET CELL CHANGE CONTINUE	
			The following messages are to be sent and received in Cell B.
13		{Uplink dynamic allocation two phase access}	USF_GRANULARITY = 1 block, RLC_DATA_BLOCKS_GRANTED = open-end TLLI_BLOCK_CHANNEL_CODING: same as channel coding CHANNEL_CODING_COMMAND: cs-1 No starting time present.
14	SS -> MS	PACKET DOWNLINK DUMMY CONTROL BLOCK	USF assigned to the MS. USF is assigned once in 52-multiframes.
15	MS -> SS	RLC DATA BLOCK or PACKET PSI STATUS	
16			Step 14 and 15 are repeated until a PACKET PSI STATUS is received in step 15. The PACKET PSI STATUS shall be sent within 10 sec of accessing the cell. Verify that the MS does not request PSI that was sent in step 9.
17		PACKET SYSTEM INFORMATION Type 3 PACKET SYSTEM INFORMATION Type 3 bis	SS should send PSIs on PACCH. Note: During the acquisition of PBCCH information the MS may send up to three extra PACKET PSI STATUS messages
18	SS -> MS	PACKET DOWNLINK DUMMY CONTROL BLOCK	USF assigned to the MS
19(optional step)	MS -> SS	RLC DATA BLOCK or PACKET RESOURCE REQUEST	

20(conditional step)	SS->MS	PACKET UPLINK ASSIGNMENT	Step 20 is performed only PRR is sent step 19. Contains the same frequency parameter as 2 nd PUA in step 13.
21			Repeat step 18 and 19 until CV=0.
22	SS -> MS	PACKET UPLINK ACK/NACK	Final Ack Indication = 0. Sent on PACCH of the assigned PDCH. Acknowledge all data blocks received.
23	SS -> MS	PACKET DOWNLINK DUMMY CONTROL BLOCK	USF assigned to the MS, sent after 6 blocks from step 22
A23 (optional step)	MS -> SS	UPLINK RLC DATA BLOCK	MS may retransmit the block with BSN=0 once if it has already been scheduled while Packet Uplink Ack/Nack is being processed. In this case go to step B23.
B23 (optional step)	SS -> MS	PACKET DOWNLINK DUMMY CONTROL BLOCK	USF assigned to the MS
24	MS -> SS	PACKET UPLINK DUMMY CONTROL BLOCK	
25			Repeat step 23 and 24 five times.
26	MS		Trigger the MS to send 500 octets of data. SS should take care of allocating USF's to the MS in order to prevent the MS from releasing the TBF
27	SS -> MS	PACKET DOWNLINK DUMMY CONTROL BLOCK	USF assigned to the MS
28	MS -> SS	UPLINK RLC DATA BLOCK	
29			Repeat step 27 and 28 until CV=0
30	SS -> MS	PACKET UPLINK ACK/NACK	Final Ack Indication = 1 containing valid RRBP. Sent on PACCH of the assigned PDCH. Acknowledge all data blocks received.
31	MS -> SS	PACKET CONTROL ACKNOWLEDGEMENT	Received on the block specified by RRBP on PACCH of the assigned PDCH.

Specific message contents

PACKET NEIGHBOUR CELL DATA in Step 9

The message contains the default xPSI_1 with NW_EXT_UTBF = 1 and PSI_STATUS_IND = 1, default PSI_2 and PSI14 for Cell B.

Information element	Value/remark
< PAGE_MODE : bit (2) > 0	00 (Normal Paging) 0
< GLOBAL_TFI : Global TFI IE >	0 <5 bit Uplink TFI>
< CONTAINER_ID : bit (2) >	01 for PSI belonging to Cell B
< SPARE :bit(1)>	0
< CONTAINER_INDEX :bit (5)>	00000 to the index needed to send all PSI1, PSI2 and PSI14 for each cell.
0 1 Container repetition struct	0 No ARFCN or BSIC
< PD : bit(3)>	001, PBCCH (RLC/MAC)

PACKET CELL CHANGE CONTINUE in Step 12

Information element	Value/remark
< PAGE_MODE : bit (2) >	00 (Normal Paging)
0	0
< GLOBAL_TFI : Global TFI IE >	0 <5 bit Uplink TFI>
0 1	1
< ARFCN : bit (10) >	ARFCN of Cell B.
< BSIC : bit (6) >	BSIC of Cell B.
< CONTAINER_ID >	01

41.3.6.9 TBF Release / Extended Uplink / Change of RLC mode / Normal release

41.3.6.9.1 Conformance requirements

During an uplink packet transfer, upper layer may request to transfer another LLC PDU. If the new LLC PDU does not have the same RLC mode as the current uplink TBF but has a higher radio priority, the mobile station shall complete the transmission of the current LLC PDU using the countdown procedure including acknowledgement from the network, if in acknowledged mode.

If the TBF is operated in extended uplink TBF mode (see sub-clause 9.3.1b), the mobile station shall use the procedure in sub-clause 8.1.1.6 for changing RLC mode.

The mobile station shall send a PACKET RESOURCE REQUEST message on PACCH indicating the new RLC mode and start timer T3168.

If timer T3168 expires, the mobile station shall retransmit the PACKET RESOURCE REQUEST message and restart timer T3168.

On receipt of a PACKET RESOURCE REQUEST message, indicating a change of RLC mode, the network shall release the uplink TBF at a point determined by the network, using the procedure defined in sub-clause 9.5.

On receipt of PACKET UPLINK ACK/NACK with Final Ack Indicator set to '1' the mobile station shall stop timer T3168 and after sending the PACKET CONTROL ACK perform the change of RLC mode by establishing a new TBF.

References

3GPP TS 44.060, subclauses 8.1.1.6, 8.1.1.1.2, and 9.5.

41.3.6.9.1.2 Test purpose

To verify that during extended uplink TBF the MS re-establishes the TBF and changes the RLC mode.

41.3.6.9.1.3 Method of test

Initial Conditions

System Simulator:

1 cell, NW_EXT_UTBF = 1, BS_CV_MAX = 14, T3168 timeout value=7 (4s), N201-U=500 for SAPI 3, 5, 9, 11, N201-U=270 for SAPI 7.

Mobile Station:

MS is in Packet Idle mode, GPRS attached with support of GERAN Feature Package 1 indicated in MS Radio Access Capabilities, and PDP context 1 and context 2 established.

Specific PICS Statements

-

PIXIT Statements

-

Test Procedure

An uplink TBF is established and in progress. SS assigns USFs allowing the MS to transmit data blocks. The MS is triggered to transfer 220 octets user data with a different RLC mode and higher radio priority.

The mobile station shall complete the transmission of the current LLC PDU; SS will verify the complete reception of the LLC PDU.

SS acknowledges the LLC PDU with a Packet Uplink Ack/Nack with TBF Est field is set to '1' and Final Ack Indicator bit set to '1'.

The mobile station shall use the same procedures as are used for TBF establishment using two phase starting from the point where the mobile station transmits the PACKET RESOURCE REQUEST message

In case the MS ignores the TBF Est field in the PACKET UPLINK ACK/NACK , the mobile station shall transmit a PACKET CONTROL ACKNOWLEDGEMENT message, release the TBF and shall establish a new TBF using two phase access.

SS assigns a PDCH to the MS. SS assigns USFs allowing the MS to transmit data blocks until the countdown value CV=0.

SS sends a Packet Uplink Ack/Nack with TBF Est field set to '0' and Final Ack Indicator bit set to '1' and the MS is polled. The MS answers with a Packet Control Acknowledgement and the TBF is released.

Maximum Duration of Test

5 minutes.

Expected Sequence

Step	Direction	Message	Comments
1	MS	{Uplink dynamic allocation two phase access}	In PDP context2, n = 220 octets, without starting time, USF_GRANULARITY = 1 block, RLC_DATA_BLOCKS_GRANTED = open-end, TLLI_BLOCK_CHANNEL_CODING: cs1, CHANNEL_CODING_COMMAND: cs1, RADIO_PRIORITY = 4
2	SS -> MS	PACKET DOWNLINK DUMMY CONTROL BLOCK	Sent on the PACCH, the USF assigned to the MS, on 3 blocks from the last radio block containing the uplink assignment.
3	MS -> SS	UPLINK RLC DATA BLOCK	Received on the assigned PDTCH. Check that the coding as specified by CHANNEL_CODING_COMMAND, the TFI, and BSN is correct.
4			Repeat step 2 and 3 three times
5	MS		To trigger the MS to transfer 220 octets: in test PDP context1, unacknowledged RLC mode and Radio Priority = 1
6	SS -> MS	PACKET DOWNLINK DUMMY CONTROL BLOCK	Sent on the PACCH, the USF assigned to the MS.
7	MS -> SS	UPLINK RLC DATA BLOCK Or	Received on the assigned PDTCH. Check that the coding as specified by CHANNEL_CODING_COMMAND, the TFI, and BSN is correct.
			Send PACKET UPLINK ACK/NACK to acknowledge all received datablocks when CV=0 and PACKET RESOURCE REQUEST is not yet received. (Note: MS may retransmit the block with BSN=0 once it has already been scheduled while PACKET UPLINK ACK/NACK is being processed and the new LLC PDU is not ready for the transmission)
		PACKET RESOURCE REQUEST Or	Received on PACCH of the assigned PDCH indicating the change of RLC mode. Check for radio priority level = 1 and RLC mode Unacknowledged RLC mode.
		PACKET UPLINK DUMMY CONTROL BLOCK	The MS is in extended TBF mode.
8			Repeat step 6 and 7 until CV = 0 and a PACKET RESOURCE REQUEST is received.
9	SS -> MS	PACKET UPLINK ACK/NACK	Sent on the PACCH of the PDCH assigned, acknowledging all blocks so far. FINAL_ACK_INDICATION = '1', TBF Est = 1, Valid RRBP.
10	SS		Verify that only one complete LLC PDU has been received.
11 (optional)	MS -> SS	PACKET CONTROL ACKNOWLEDGEMENT	Received on the block specified by RRBP on PACCH of the assigned PDCH. If not received continue with step 14.
12 (conditional)	MS -> SS	PACKET CHANNEL REQUEST	Received on PRACH.
13 (conditional)	SS -> MS	PACKET UPLINK ASSIGNMENT	Single block assignment, to order the MS to follow the two phase access procedure. Sent on PACCH.
14	MS -> SS	PACKET RESOURCE REQUEST	Received on PACCH of the assigned PDCH Check for radio priority level = 1 and RLC mode Unacknowledged RLC mode. Received on the block specified by the single block assignment of step 13 or by the RRBP of step 9.
15	SS -> MS	PACKET UPLINK ASSIGNMENT	Open-ended uplink dynamic allocation, no starting time, USF_GRANULARITY = single block. Sent on PACCH of the assigned PDCH.
16	SS -> MS	PACKET DOWNLINK DUMMY CONTROL BLOCK	The USF assigned to the MS. Sent on PACCH of the assigned PDCH.
17	MS -> SS	UPLINK RLC DATA BLOCK	Received on the PDTCH assigned.
18			Repeat step 16 and 17 until countdown value CV=0.

19	SS -> MS	PACKET UPLINK ACK/NACK	FINAL_ACK_INDICATION = '1', TBF Est = 0, a valid RRBP, acknowledge all received data, sent on PACCH. Received on the block specified by RRBP on PACCH of the assigned PDCH.
20	MS -> SS	PACKET CONTROL ACKNOWLEDGEMENT	

41.3.6.10 TBF Release / Extended Uplink / Change of RLC mode / Abnormal release

41.3.6.10.1 Conformance requirements

During an uplink packet transfer, upper layer may request to transfer another LLC PDU. If the new LLC PDU does not have the same RLC mode as the current uplink TBF but has a higher radio priority, the mobile station shall complete the transmission of the current LLC PDU using the countdown procedure including acknowledgement from the network, if in acknowledged mode. immediately request a resource reallocation for uplink according to the new Radio Priority of the new LLC PDU by sending a PACKET RESOURCE REQUEST message on the PACCH and starting timer T3168.

If the TBF is operated in extended uplink TBF mode (see sub-clause 9.3.1b), the mobile station shall use the procedure in sub-clause 8.1.1.6 for changing RLC mode.

Then the mobile station shall complete the transmission of the current LLC PDU. If the TBF is operated in extended uplink TBF mode, the mobile station shall release the uplink TBF and re-establish a new uplink TBF in order to change the RLC mode

The mobile station shall send a PACKET RESOURCE REQUEST message on PACCH indicating the new RLC mode and start timer T3168.

If timer T3168 expires, the mobile station shall retransmit the PACKET RESOURCE REQUEST message and restart timer T3168.

If timer T3168 expires and the PACKET RESOURCE REQUEST message has already been transmitted four times, the mobile station shall perform an abnormal release with access retry (see sub-clause 8.7.2).

On receipt of a PACKET RESOURCE REQUEST message, indicating a change of RLC mode, the network shall release the uplink TBF at a point determined by the network, using the procedure defined in sub-clause 9.5.

On receipt of PACKET UPLINK ACK/NACK with Final Ack Indicator set to '1' the mobile station shall stop timer T3168 and after sending the PACKET CONTROL ACK perform the change of RLC mode by establishing a new TBF.

References

3GPP TS 44.060, subclauses 8.1.1.6, subclauses 8.1.1.1.2, subclause 9.5.

41.3.6.10.1.2 Test purpose

To verify that during extended uplink TBF the MS perform an abnormal release with access retry after timer T3168 expired and PACKET RESOURCE REQUEST message has been transmitted four times.

41.3.6.10.1.3 Method of test

Initial Conditions

System Simulator:

1 cell, NW_EXT_UTBF = 1, BS_CV_MAX = 14, T3168 timeout value=7 (4s), N201-U=500 for SAPI 3, 5, 9, 11, N201-U=270 for SAPI 7.

Mobile Station:

MS is in Packet Idle mode, GPRS attached with support of GERAN Feature Package 1 indicated in MS Radio Access Capabilities, and PDP context 1 and context 2 established.

Specific PICS Statements

-

PIXIT Statements

-

Test Procedure

An uplink TBF is established and in progress. SS assigns USFs allowing the MS to transmit data blocks until the MS completes the countdown procedure. As soon as the MS is in extended UL TBF mode, the MS is triggered to transfer 220 octets user data with different RLC mode.

The mobile station shall immediately request a resource reallocation for uplink indicating the changed RLC mode applied to the new LLC PDU by sending a PACKET RESOURCE REQUEST message on the PACCH and start timer T3168.

SS keeps assigning USFs, the MS will send Packet Uplink Dummy Control Blocks till T3168 expire. The MS will send a PACKET RESOURCE REQUEST message again on the PACCH and restart timer T3168.

The SS keeps assigning USFs till the MS has transmitted the Packet Resource Request four times.

The MS shall perform an abnormal release with access retry.

The SS will assign new resources to the MS to complete the new TBF.

Maximum Duration of Test

5 minutes.

Expected Sequence

Step	Direction	Message	Comments
1	SS	{Uplink dynamic allocation two phase access}	In PDP context2, n = 220 octets, without starting time, USF_GRANULARITY = 1 block, RLC_DATA_BLOCKS_GRANTED = open-end, TLLI_BLOCK_CHANNEL_CODING: cs1, CHANNEL_CODING_COMMAND: cs1, RADIO_PRIORITY = 4
2	SS -> MS	PACKET DOWNLINK DUMMY CONTROL BLOCK	Sent on the PACCH, the USF assigned to the MS, on 3 blocks from the last radio block containing the uplink assignment.
3	MS -> SS	UPLINK RLC DATA BLOCK	Received on the assigned PDTCH. Check that the coding as specified by CHANNEL_CODING_COMMAND, the TFI is correct.
4			Repeat step 2 and 3 till CV = 0
5	SS -> MS	PACKET UPLINK ACK/NACK	Sent on the PACCH of the PDCH assigned, the USF not assigned to the MS, acknowledging all blocks. FINAL_ACK_INDICATION = '0', TBF Est = 1
6	SS -> MS	PACKET DOWNLINK DUMMY CONTROL BLOCK	USF assigned to the MS, sent after 6 blocks from step 5
A6 (optional step)	MS -> SS	UPLINK RLC DATA BLOCK	MS may retransmit the block with BSN=0 once if it has already been scheduled while Packet Uplink Ack/Nack is being processed. In this case go to step B6.
B6 (optional step)	SS -> MS	PACKET DOWNLINK DUMMY CONTROL BLOCK	USF assigned to the MS
7	MS -> SS	PACKET UPLINK DUMMY CONTROL BLOCK	MS is in extended UL TBF mode.
8	MS		To trigger the MS to transfer 220 octets: in test PDP context1, unacknowledged RLC mode and Radio Priority = 1
9	SS -> MS	PACKET DOWNLINK DUMMY CONTROL BLOCK	USF assigned to the MS
A10 (optional step)	MS -> SS	PACKET UPLINK DUMMY CONTROL BLOCK	MS may transmit while processing the uplink data trigger PACKET UPLINK DUMMY CONTROL BLOCK. In this case repeat step 9 until a PACKET RESOURCE REQUEST is received.
10	MS -> SS	PACKET RESOURCE REQUEST	MS starts T3168. Received on the PACCH of the assigned PDCH, Indicating the change of RLC mode: Check that radio priority level = 1 and Unacknowledged RLC mode.
11	SS -> MS	PACKET UPLINK ACK/NACK	To prevent T3184 from expiring, sent on the PACCH of the PDCH assigned, the USF not assigned to the MS, acknowledging all Blocks. FINAL_ACK_INDICATION = '0', TBF Est = 0
12	SS -> MS	PACKET DOWNLINK DUMMY CONTROL BLOCK	USF assigned to the MS
13	MS -> SS	PACKET UPLINK DUMMY CONTROL BLOCK Or PACKET RESOURCE REQUEST	MS is in extended UL TBF mode Received on the PACCH of the assigned PDCH, Indicating the change of RLC mode: Check that radio priority level = 1 and Unacknowledged RLC mode.
14			Repeat step 12 and 13 until a PACKET RESOURCE REQUEST has been received. Check that the PACKET RESOURCE REQUEST is received within T3168 +/- 10% from the previous PACKET RESOURCE REQUEST.
15			Repeat Step 11 to Step 14 until the PACKET RESOURCE REQUEST has been received a total of 4 times.
16	MS -> SS	PACKET CHANNEL REQUEST	MS shall perform an abnormal release with access retry Received on PRACH for TBF establishment for transferring of the LLC PDU in PDP context1.
17	SS -> MS	PACKET UPLINK	Single block assignment, to force the MS making two-

18	MS -> SS	ASSIGNMENT PACKET RESOURCE REQUEST	phase access procedure. Sent on PAGCH. Received on the single block assigned in step 17. Check that radio priority level = 1, peak throughput class = 5, unacknowledged RLC mode.
19	SS -> MS	PACKET UPLINK ASSIGNMENT	Open-ended uplink dynamic allocation, no starting time, USF_GRANULARITY = single block.
20	SS -> MS	PACKET DOWNLINK DUMMY CONTROL BLOCK	The USF assigned to the MS. Sent on PACCH of PDCH assigned in step 19.
21	MS -> SS	UPLINK RLC DATA BLOCK	Received on the PDTCH assigned.
22			Repeat step 20 and 21 until countdown value CV=0.
23	SS -> MS	PACKET UPLINK ACK/NACK	FINAL_ACK_INDICATION = '1', a valid RRBP, acknowledge all received data, sent on PACCH.
24	MS -> SS	PACKET CONTROL ACKNOWLEDGEMENT	Received on the block specified by RRBP on PACCH of the assigned PDCH.

41.3.7 Default message contents

The default message contents defined in subclause 42.3.4 are applied for the all tests in subclause 41.3.

41.4 Void

41.5 Dual transfer mode

To bring the MS into active state U10, macro 40.4.3.22 shall be used.

41.5.1 PS establishment whilst in dedicated mode

41.5.1.1 Uplink TBF establishment

41.5.1.1.1 Uplink TBF establishment with no reallocation of CS resources

41.5.1.1.1.1 Uplink TBF establishment with no reallocation of CS resources / Successful case / Uplink resources assigned

41.5.1.1.1.1.1 Conformance requirements

While in dedicated mode, the establishment of an uplink packet resource may be initiated by the RR entity of the mobile station using the packet request procedure. The procedure is triggered by a request from upper layers to transfer an LLC PDU; see 3GPP TS 24.007.

On receipt of a DTM REQUEST message the network may allocate an uplink packet resource. The packet uplink resource is assigned to the mobile station in one of the DTM assignment messages:

- DTM ASSIGNMENT COMMAND or
- PACKET ASSIGNMENT.

The PACKET ASSIGNMENT message is only used when the packet resource is a PDCH and no reallocation of the RR connection is needed.

On receipt of:

- DTM ASSIGNMENT COMMAND message or
- PACKET ASSIGNMENT message,

the mobile station shall stop T3148.

- when the network sends a PACKET ASSIGNMENT message, the packet request procedure is completed for the network when assignment message is sent and for the mobile station when it is received.

When the packet request procedure is completed, the mobile station has entered the dual transfer mode.

References

3GPP TS 04.18/44.018 sub-clause 3.4.22.1.1

41.5.1.1.1.1.2 Test purpose

To verify that the MS:

- decodes correctly the Cell's System information, understanding that DTM access is allowed;
- requests an uplink TBF when it has something to send;
- acts upon the PACKET ASSIGNMENT message and then transmitting on the PDCH allocated.

41.5.1.1.1.1.3 Method of test

Initial Conditions

System Simulator:

1 cell, DTM supported

Mobile Station:

The MS is in the active state (U10) of a call.

The MS is in packet idle mode with a P-TMSI allocated and PDP context 1 activated.

Specific PICS Statements

-

PIXIT Statements

-

Test Procedure

The MS, whilst in dedicated mode, is triggered to initiate packet uplink transfer data in RLC unacknowledged mode and sends a DTM REQUEST message. On receipt of the DTM REQUEST message, requesting uplink resources, the SS assigns the MS PS resource. The SS accomplishes the resource assignment by passing a PACKET ASSIGNMENT message to the MS. On receipt of the PACKET ASSIGNMENT message, the MS starts to send RLC DATA BLOCKS to the SS on the assigned PDCH.

The codec to be used in this test is chosen dependent on the capabilities of the MS.

MS supporting DTM shall complete testing for k=1 and MSs indicating support of single slot DTM shall additionally complete testing for k=2.

Maximum Duration of Test

5 minutes

Expected Sequence

The test sequence is repeated for k = 1,2.

Step	Direction	Message	Comments
1	SS		MS in the active state (U10) of a call on Timeslot N. When: k=1, Channel Type=TCH/F; k=2, Channel Type=TCH/H.
2	MS		Trigger the MS to initiate an uplink packet transfer containing 1000 octets.
3	MS->SS	DTM REQUEST	
4	SS->MS	PACKET ASSIGNMENT	SS sends this message such that it is received before Timer T3148 expiry. Includes information on the Radio resources provided to the MS. See specific message contents.
5	MS<->SS	{ Uplink data transfer }	Macro - Completion of the 1000 Octets of Data.

Specific Message Contents

PACKET ASSIGNMENT (Step 4):

k=1;

As default message contents except: RR Packet Uplink Assignment IE - TIMESLOT_ALLOCATION RR Packet Downlink Assignment IE	(N ± 1) MOD 8 Not included
--	-------------------------------

k=2;

As default message contents except: RR Packet Uplink Assignment IE - TIMESLOT_ALLOCATION RR Packet Downlink Assignment IE	N Not included
--	-------------------

41.5.1.1.1.2 Uplink TBF establishment with no reallocation of CS resources / Successful case / Downlink resources assigned

41.5.1.1.1.2.1 Conformance requirements

While in dedicated mode, the establishment of an uplink packet resource may be initiated by the RR entity of the mobile station using the packet request procedure. The procedure is triggered by a request from upper layers to transfer an LLC PDU; see 3GPP TS 24.007.

On receipt of a DTM REQUEST message the network may allocate an uplink packet resource. The packet uplink resource is assigned to the mobile station in one of the DTM assignment messages:

- DTM ASSIGNMENT COMMAND or
- PACKET ASSIGNMENT.

The PACKET ASSIGNMENT message is only used when the packet resource is a PDCH and no reallocation of the RR connection is needed.

On receipt of:

- DTM ASSIGNMENT COMMAND message or
- PACKET ASSIGNMENT message,

the mobile station shall stop T3148.

If the received DTM ASSIGNMENT COMMAND or PACKET ASSIGNMENT message includes uplink packet resources, the mobile station shall proceed with the packet access. If the received message includes downlink packet resources and no uplink packet resources, the mobile station shall abort the packet access procedure and proceed with the procedure specified in clause 3.4.22.3, and then attempt an establishment of uplink TBF, using the applicable procedure specified in 3GPP TS 04.60.

- when the network sends a PACKET ASSIGNMENT message, the packet request procedure is completed for the network when assignment message is sent and for the mobile station when it is received.

When the packet request procedure is completed, the mobile station has entered the dual transfer mode.

If the received PACKET ASSIGNMENT message includes downlink packet resources and no uplink packet resources, the mobile station shall abort the packet access procedure and proceed with the downlink TBF establishment, and then attempt an establishment of uplink TBF.

References

- 3GPP TS 04.18/44.018 sub-clauses 3.4.22.1.1, 3.4.22.3
- 3GPP TS 04.60/44.060 sub-clause 8.1.2.5

41.5.1.1.1.2.2 Test purpose

To verify that the MS:

- decodes correctly the Cell's System information, understanding that DTM access is allowed;
- requests an uplink TBF;
- acts upon the PACKET ASSIGNMENT message containing downlink resources.
- attempts uplink TBF establishment, once the downlink TBF establishment is complete.

41.5.1.1.1.2.3 Method of test

Initial Conditions

System Simulator:

1 cell, DTM supported

Mobile Station:

The MS is in the active state (U10) of a call on cell A.

The MS is in packet idle mode with a P-TMSI allocated and PDP context 1 activated.

Specific PICS Statements

-

PIXIT Statements

-

Test Procedure

The MS, whilst in dedicated mode, is triggered to initiate packet uplink transfer data in RLC unacknowledged mode and sends a DTM REQUEST message. On receipt of the DTM REQUEST message, requesting uplink resources, the SS assigns the MS downlink PS resources using the PACKET ASSIGNMENT message. The MS, upon receipt of the assignment message, aborts the packet access procedure and proceeds with the downlink assignment. When possible the MS requests the uplink TBF establishment. The SS upon receipt of the resource request allocates the MS uplink resources using the PACKET UPLINK ASSIGNMENT message. The MS then starts to send RLC DATA BLOCKS to the SS on the assigned PDTCH.

The codec to be used in this test is chosen dependent on the capabilities of the MS.

MS supporting DTM shall complete testing for k=1 and MSs indicating support of single slot DTM shall additionally complete testing for k=2.

Maximum Duration of Test

5 minutes

Expected Sequence

The test sequence is repeated for $k = 1, 2$.

Step	Direction	Message	Comments
1	SS		MS in the active state (U10) of a call on Timeslot N of cell A. When: k=1, Channel Type=TCH/F; k=2, Channel Type=TCH/H.
2	MS		Trigger the MS to initiate an uplink packet transfer containing 1000 octets.
3	MS->SS	DTM REQUEST	
4	SS->MS	PACKET ASSIGNMENT	SS sends this message such that it is received before Timer T3148 expiry. See specific message contents.
5	SS<->MS	{ Downlink data }	Macro
6	MS->SS	PACKET DOWNLINK ACK/NACK	Channel Request Description IE indicating that uplink resources are required.
7	SS->MS	PACKET UPLINK ASSIGNMENT	When: k=1, Timeslot = T; k=2, Timeslot = N.
8	MS<->SS	{ Uplink data transfer }	Macro - Completion of the 10kB of Data.

Specific Message Contents

PACKET ASSIGNMENT (Step 4):

k=1;

As default message contents except: RR Packet Uplink Assignment IE RR Packet Downlink Assignment IE - TIMESLOT_ALLOCATION	Not included T = (N ± 1) MOD 8
--	---------------------------------------

k=2;

As default message contents except: RR Packet Uplink Assignment IE RR Packet Downlink Assignment IE - TIMESLOT_ALLOCATION	Not included N
--	-----------------------

41.5.1.1.1.3 Uplink TBF establishment with no reallocation of CS resources / Abnormal cases / DTM reject

41.5.1.1.1.3.1 Conformance requirements

On receipt of the DTM REJECT message, the mobile station stops T3148, notifies upper layers of a packet resource establishment failure and starts timer T3142 with the indicated value.

The mobile station is not allowed to make a new attempt for packet access in the same cell until T3142 expires

References

3GPP TS 04.18/44.018 sub-clause 3.4.22.1.1.3.3

41.5.1.1.1.3.2 Test purpose

To verify that when the MS receives a DTM REJECT message, the MS does not attempt to re-acquire uplink packet resources for a period specified by a wait indication (T3142), contained in the DTM REJECT message.

41.5.1.1.1.3.3 Method of test

Initial Conditions

System Simulator:

1 cell, DTM supported

Mobile Station:

The MS is in the active state (U10) of a call on cell A.

The MS is in packet idle mode with a P-TMSI allocated and PDP context 1 activated.

Specific PICS Statements

-

PIXIT Statements

-

Test Procedure

The MS, whilst in dedicated mode, is triggered to initiate packet uplink transfer data in RLC acknowledged mode and sends a DTM REQUEST message. On receipt of the DTM REQUEST message, the SS returns a DTM REJECT message, simulating the inability to allocate the requested packet resource. The DTM REJECT message includes a wait indication (T3142) specifying that the MS is to wait 5 seconds before being allowed to re-request resources. The MS is again prompted to initiate an uplink TBF before the wait indication has expired, it is then tested that the MS does not try to access the network until the Wait Indication has expired. After the Wait Indication has expired, the MS initiates the packet access procedure and sends a DTM REQUEST message.

MS supporting DTM shall complete testing for k=1 and MSs indicating support of single slot DTM shall additionally complete testing for k=2.

Maximum Duration of Test

2 minutes

Expected Sequence

The test sequence is repeated for k = 1,2.

Step	Direction	Message	Comments
1	SS		MS in state U10, utilising Timeslot N for CS connection (Timeslot chosen arbitrarily). When: k=1, Channel Type=TCH/F; k=2, Channel Type=TCH/H.
2	MS		Trigger the MS to initiate an uplink packet transfer containing 1000 octets.
3	MS->SS	DTM REQUEST	
4	SS->MS	DTM REJECT	SS sends this message such that it is received before Timer T3148 expiry. The message contains the "Wait Indication" which is set to 10 seconds.
5	SS		Waits 2 seconds
6	MS		Trigger the MS to initiate an uplink packet transfer containing 1000 octets. If triggering of data involves manual operation, this is to be finished within 5 seconds.
7	SS		Monitors the MS, checking that the MS does not try and establish an uplink TBF until at least 10 seconds after the DTM REJECT message was passed to the MS.
8	MS->SS	DTM REQUEST	Check that this message is sent after the Wait Indication has expired.

41.5.1.1.1.4 Uplink TBF establishment with no reallocation of CS resources / Abnormal cases / Inter System to UTRAN Handover Command

41.5.1.1.1.4.1 Conformance requirements

Only valid for a UTRAN capable MS. In dedicated mode or dual transfer mode, a change to UTRAN channel(s) can be requested by the network RR sublayer. This change is performed through the handover to UTRAN procedure.

If the mobile station receives an INTER SYSTEM TO UTRAN HANDOVER COMMAND message during the packet access procedure, the mobile station shall abort the packet access procedure, stop timer T3148 and proceed with the handover to UTRAN procedure as specified in clause 3.4.4a.

References

3GPP TS 04.18/44.018 sub-clauses 3.4.4a & 3.4.22.1.1.3.2

41.5.1.1.1.4.2 Test purpose

Verifying that the MS aborts the Packet Access procedure and proceed with the handover to UTRAN, upon reception of an INTER SYSTEM TO UTRAN HANDOVER COMMAND message.

41.5.1.1.1.4.3 Method of test

Initial Conditions

System Simulator:

2 cells - Cell 1 is GSM with DTM supported, Cell 2 is UTRAN. The present document sub-clause 26.6.5.1 shall be referenced for the default parameters of cell 1. 3GPP TS 34.108, sub-clause 6.1 shall be referenced for default parameters of Cell 2.

Mobile Station:

The MS is in the active state (U10) of a call.
The MS is GPRS idle with a P-TMSI allocated and the PDP context 1 activated

Specific PICS Statements

-

PIXIT Statements

-

Test Procedure

The SS starts the GSM cell and UTRAN cell with cell selection conditions in favour of GSM cell, the MS selects the GSM cell for camping on. The SS brings the MS into the call active state (CC state U10). The MS is then triggered to initiate packet uplink data transfer in RLC acknowledged mode and sends a DTM REQUEST message. On receiving the DTM REQUEST message, requesting uplink resources, the SS configures the dedicated channel corresponding to the pre-configuration in UTRAN cell, then sends INTERSYSTEM TO UTRAN HANDOVER COMMAND message indicating the dedicated channel of the target cell to the MS through the GSM serving cell. After the MS receives the command it shall configure itself accordingly and switch to the dedicated channel of the UTRAN cell. The SS checks whether the handover is performed by confirming the MS transmits a HANDOVER TO UTRAN COMPLETE message to the SS, on the DCCH of the UTRAN cell. To check that CS call is still active, SS Releases the CS call. To check that PDP context is active, SS sends MODIFY PDP CONTEXT REQUEST in UMTS cell. The MS may or may not accept the QoS and replies to the SS accordingly.

Maximum Duration of Test

5 minutes

Expected Sequence

Step	Direction	Message	Comments
1	SS		MS in state U10, utilising Timeslot N for CS connection (Timeslot chosen arbitrarily)
2	←	MEASUREMENT INFORMATION	
3	→	MEASUREMENT REPORT	Including Measurement Results on the UTRAN cell
4	MS		Trigger the MS to initiate an uplink packet transfer containing 1000 octets.
5	MS->SS	DTM REQUEST	
6	SS->MS	INTER SYSTEM TO UTRAN HANDOVER COMMAND	The message is received before the timer T3148 expires. See specific message contents.
7	MS		The MS accepts the handover command and configures its lower layers using the parameters contained in the INTERSYSTEM TO UTRAN HANDOVER COMMAND
8	SS		The SS waits for uplink physical channel in synchronization
9	MS->SS	HANDOVER TO UTRAN COMPLETE	The SS receives this message on DCCH of cell 2 (UTRAN cell). It implies that the down link physical channel has synchronised with UTRAN.
10	SS		The SS starts integrity protection for CS domain
11	SS->MS	UTRAN MOBILITY INFORMATION	The SS conveys CN system information for the PS domain to the UE in connected mode. See specific message contents.
12	MS->SS	UTRAN MOBILITY_INFORMATION CONFIRM	
13	MS->SS	ROUTING AREA UPDATE REQUEST	
14	SS->MS	AUTHENTICATION AND CIPHERING REQUEST	
15	MS->SS	AUTHENTICATION AND CIPHERING RESPONSE	
16	SS		The SS starts integrity protection for PS domain
17	SS->MS	ROUTING AREA UPDATE ACCEPT	
18			SS Releases the CS call.
19	SS->MS	MODIFY PDP CONTEXT REQUEST	SS requests the modification of a PDP context.
A20	MS->SS	MODIFY PDP CONTEXT ACCEPT	MS behaviour type A: Accept the PDP context modification
B20	MS->SS	DEACTIVATE PDP CONTEXT REQUEST	MS behaviour type B: Initiate the PDP context deactivation. Cause set to 'QoS not accepted'
B20a	SS->MS	DEACTIVATE PDP CONTEXT ACCEPT	MS behaviour type B: Accept the PDP context deactivation
B20b	MS->SS	DETACH REQUEST	MS behaviour type B: A non-auto attach MS may (optionally) send a Detach Request. The SS shall wait up to 'T3390' seconds for the Detach Request.
B20c	SS->MS	DETACH ACCEPT	If the MS transmitted a Detach Request message in step B20b then the SS responds with a Detach Accept message.

Specific message contents

MEASUREMENT INFORMATION

Information Element	Value/remark
< RR short PD : bit >	0
< Message type : bit (5) >	'00101'B
< Short layer 2 header : bit (2) >	'00'B
< BA_IND : bit >	0
< 3G_BA_IND : bit >	0
< MP_CHANGE_MARK : bit >	0
< MI_INDEX : bit (4) >	'0000'B
< MI_COUNT : bit (4) >	'0000'B
< PWRC : bit >	0
< REPORT_TYPE : bit >	1 (Measurement Reporting shall be used)
< REPORTING_RATE : bit >	0 (SACCH rate reporting)
< INVALID_BSIC_REPORTING : bit >	0 (Report on cells with invalid BSIC not allowed)
0 1 < Real Time Difference Description >	0
0 1 < BSIC Description >	0
0 1 < REPORT PRIORITY Description >	0
0 1 < MEASUREMENT Parameters Description >	0
0 1 < extension length >	0
0 1 < 3G Neighbour Cell Description >	1
0 1 < 3G_Wait : bit (3) >	0
0 1 < Index_Start_3G : bit (7) >	0
0 1 < Absolute_Index_Start_EMR : bit (7) >	0
0 1 < UTRAN FDD Description >	1
0 1 < Bandwidth_FDD : bit (3) >	0
1 < Repeated UTRAN FDD Neighbour Cells > ** 0	1
0 < FDD-ARFCN : bit (14) >	0 See TS 34.108, clause 6.1.5, table 6.1.1
< FDD_Indic0 : bit >	0
< NR_OF_FDD_CELLS : bit (5) >	'00001'B
< FDD_CELL_INFORMATION Field >	10 bits Scrambling code according to TS 34.108, clause 6.1.4, Default settings for cell No.1
1 < Repeated UTRAN FDD Neighbour Cells > ** 0	0
0 1 < UTRAN TDD Description >	0
0 1 < CDMA2000 Description >	0
0 1 < 3G MEASUREMENT Parameters Description >	
< Qsearch_C : bit (4) >	'0111'B (Always)
< 3G_SEARCH_PRIO : bit (1) >	1
< FDD_REP_QUANT : bit (1) >	1 (Ec/No)
0 1 < FDD_MULTIRAT_REPORTING : bit (2) >	'1 01'B (Report on 1 UTRAN cell)
0 1 < FDD_REPORTING_OFFSET : bit (3) >	0
0 1 < TDD_MULTIRAT_REPORTING : bit (2) >	0
0 1 < TDD_REPORTING_OFFSET : bit (3) >	0
0 1 < CDMA2000_MULTIRAT_REPORTING : bit (2) >	0
0 1 < CDMA2000_REPORTING_OFFSET : bit (3) >	0

INTERSYSTEM TO UTRAN HANDOVER COMMAND

Information Element	Value/remark
RR management Protocol Discriminator	'0110'B
Skip Indicator	'0000'B
Inter System to UTRAN Handover Command	'01100011'B
Message Type	
Length of Handover to UTRAN Command contents	Octet length of the "Handover to UTRAN Command value part"
Handover to UTRAN Command value part	PER encoded ASN.1 value of type "HandoverToUTRANCommand-v1-IEs", the content is presented in the next table.

Content of "HandoverToUTRANCommand-v1-IEs"

Information Element	Value/remark
New U-RNTI	
- SRNC Identiy	'000000000001'B
- S-RNTI-2	Set to arbitrary value corresponding to DPCH Offset value currently stored in SS
Activation time	now
Ciphering algorithm	The presence of this IE is dependent on IXIT statements in TS 34.123-2. If ciphering is indicated to be active, use UEA1. Else, this IE is omitted
CHOICE specificationMode	Preconfiguration
CHOICE preconfiguration mode	Default configuration
- Default configuration mode	FDD
- Default configuration identity	3 (12.2 kbps speech + 3.4 kbps signalling)
- RAB Info	
- RAB identity	
- GSM-MAP RAB identity	'00000001'B
- CN domain identity	CS domain
- CHOICE Mode specific info	FDD
- UL DPCH info	
- UL DPCH power control info	
- DPCCH power offset	-78dB (i.e. ASN.1 IE value of $-20 (2 + (\text{IE Value} * 4))$)
- PC Preamble	1 frame
- SRB delay	7 frames
- Scrambling code type	Long
- Reduced scrambling code number	0
- Spreading factor	64
- DL common information post	
- DL DPCH info common	
- DL DPCH power control info	
- CHOICE Mode specific info	FDD
- DPC mode	Single TPC
- DL information perRL list	
- Primary CPICH info	
- Primary scrambling code	100
- DL DPCH info perRL	
- pCPICH usage for channelEst	May be used
- DL channelisation code	
- Secondary scrambling code	1
- SF and code number	SF = 128, code number = 0
- Scrambling code change	No code change
- TPC combination index	0
- Frequency info	
- UARFCN uplink(Nu)	Not Present
	Absence of this IE is equivalent to apply the default duplex distance defined for the operating frequency according to TS 25.101
- UARFCN downlink(Nd)	See TS 34.108, clause 6.1.5, table 6.1.1
Maximum allowed UL TX power	See TS 34.108, clause 6.1.5, table 6.1.1

Contents of UTRAN MOBILITY INFORMATION message:

The contents of the UTRAN MOBILITY INFORMATION message in this test case is identical to the default message in TS 34.108, with the following exceptions.

Information Element	Value/remark
Message Type	
Integrity check info	As default
RRC transaction identifier	As default
Integrity protection mode info	As default
Ciphering mode info	As default
New U-RNTI	As default
New C-RNTI	As default
UE Timers and constants in connected mode	As default
CN information info	
- PLMN identity	Not present
- CN common GSM-MAP NAS system information	Not present
- CN domain related information	
- CN domain identity	CS domain
- CN domain specific GSM-MAP NAS system info	
- T3212	30 (periodic updating every 3 hours)
- ATT	1 (MS shall apply IMSI attach and detach procedures)
- CN domain specific DRX cycle length coefficient	7
- CN domain related information	
- CN domain identity	PS domain
- CN domain specific GSM-MAP NAS system info	
- RAC	6 (GERAN and UTRAN cells use different RAC)
- NMO	1 (Network Mode of Operation I)
- CN domain specific DRX cycle length coefficient	7
URA identity	Not present
Downlink counter synchronization info	Not Present

41.5.1.1.1.5 Uplink TBF establishment with no reallocation of CS resources / Abnormal cases / Assignment Command

41.5.1.1.1.5.1 Conformance requirements

If the mobile station receives an ASSIGNMENT COMMAND or HANDOVER COMMAND message during the packet access procedure, the mobile station shall abort the packet access procedure, stop timer T3148 and proceed with the channel assignment procedure as specified in clause 3.4.3 or the handover procedure as specified in clause 3.4.4. The mobile station shall then attempt an establishment of uplink TBF, using the procedure specified in clause 3.4.22.

References

3GPP TS 04.18/44.018 sub-clause 3.4.22.1.1.3.2

41.5.1.1.1.5.2 Test purpose

To verify that the MS aborts the packet access procedure when the MS receives an ASSIGNMENT COMMAND message before the expiry of T3148, completing the channel assignment procedure before re-attempting the establishment of the uplink TBF.

41.5.1.1.1.5.3 Method of test

Initial Conditions

System Simulator:

1 cell, DTM supported

Mobile Station:

The MS is in the active state (U10) of a call.

The MS is in packet idle mode, with a P-TMSI allocated and PDP context 1 activated.

Specific PICS Statements

-

PIXIT Statements

-

Test Procedure

The MS, whilst in dedicated mode, is triggered to initiate packet uplink data transfer in RLC unacknowledged mode and sends a DTM REQUEST message. On receipt of the DTM REQUEST message, requesting uplink resources, the SS reallocates the MS's CS resources using the ASSIGNMENT COMMAND. Once the MS changes to the newly allocated timeslot the MS re-requests PS resources with a DTM REQUEST message. Once the PS resources are allocated, the MS enters DTM.

The codec to be used in this test is chosen dependent on the capabilities of the MS.

MS supporting DTM shall complete testing for k=1 and MSs indicating support of single slot DTM shall additionally complete testing for k=2.

Maximum Duration of Test

5 minutes

Expected Sequence

The test sequence is repeated for k = 1,2.

Step	Direction	Message	Comments
1	MS		MS in state U10, utilising Timeslot N for CS connection (Timeslot chosen arbitrarily)
2	MS		Trigger the MS to initiate an uplink packet transfer containing 1000 octets.
3	MS->SS	DTM REQUEST	
4	SS->MS	ASSIGNMENT COMMAND	This message is sent such that it is received before timer T3148 expires. CS resources changed to (N + 4) MOD 8. When: k=1, Channel Type=TCH/F; k=2, Channel Type=TCH/H.
5	MS->SS	ASSIGNMENT COMPLETE	Sent on the correct channel after establishment of the main signalling link.
6	MS->SS	DTM REQUEST	
7	SS->MS	PACKET ASSIGNMENT	Includes information on the Radio resources provided to the MS. See specific message contents.
8	MS<->SS	{ Uplink data transfer }	Macro - Completion of the 1000 octets of Data.

Specific Message Contents

PACKET ASSIGNMENT (Step 7):

k=1;

As default message contents except: RR Packet Uplink Assignment IE - TIMESLOT_ALLOCATION RR Packet Downlink Assignment IE	((N + 4) ± 1) MOD 8 Not included
--	-------------------------------------

k=2;

As default message contents except: RR Packet Uplink Assignment IE - TIMESLOT_ALLOCATION RR Packet Downlink Assignment IE	(N + 4) MOD 8 Not included
--	-------------------------------

41.5.1.1.1.6 Uplink TBF establishment with no reallocation of CS resources / Abnormal cases / Handover Command

41.5.1.1.1.6.1 Conformance requirements

If the mobile station receives an ASSIGNMENT COMMAND or HANDOVER COMMAND message during the packet access procedure, the mobile station shall abort the packet access procedure, stop timer T3148 and proceed with the channel assignment procedure as specified in clause 3.4.3 or the handover procedure as specified in clause 3.4.4. The mobile station shall then attempt an establishment of uplink TBF, using the procedure specified in clause 3.4.22.

References

3GPP TS 04.18/44.018 sub-clause 3.4.22.1.1.3.2

41.5.1.1.1.6.2 Test purpose

To verify that the MS aborts the packet access procedure when the MS receives a HANDOVER COMMAND message before the expiry of T3148, completing the handover procedure before re-attempting the establishment of the uplink TBF.

41.5.1.1.1.6.3 Method of test

Initial Conditions

System Simulator:

2 Cells, A and B, with same LAI/RAI and both supporting DTM.

Mobile Station:

The MS is in the active state (U10) of a call.

The MS is in packet idle mode with a P-TMSI allocated and PDP context 2 activated

Specific PICS Statements

-

PIXIT Statements

-

Test Procedure

The MS, whilst in dedicated mode, is triggered to initiate packet uplink data transfer in RLC acknowledged mode and sends a DTM REQUEST message. On receipt of the DTM REQUEST message, requesting uplink resources, the SS returns a HANDOVER COMMAND to the MS. The HANDOVER COMMAND instructs the switching of the MS to the newly assigned channel and the establishment of lower layer connections. Once the CS connection is established, the MS returns an HANDOVER COMPLETE message on the new main signalling link. The MS may perform Cell Update by sending the GPRS INFORMATION message containing an empty LLC PDU followed by DTM REQUEST to initiate packet uplink data transfer. If the Cell Update is not performed using GPRS INFORMATION, the MS again sends a DTM REQUEST message to initiate packet uplink data transfer, the SS allocates the MS PS resources and the MS enters DTM.

The codec to be used in this test is chosen dependent on the capabilities of the MS.

MS supporting DTM shall complete testing for k=1 and MSs indicating support of single slot DTM shall additionally complete testing for k=2.

Maximum Duration of Test

5 minutes

Expected Sequence

The test sequence is repeated for k = 1,2.

Step	Direction	Message	Comments
1	SS		MS in state U10, utilising Timeslot N for CS connection (Timeslot chosen arbitrarily) When: k=1, Channel Type=TCH/F; k=2, Channel Type=TCH/H. Trigger the MS to initiate an uplink packet transfer containing 1000 octets.
2	MS		
3	MS->SS	DTM REQUEST	The message is sent such that it is received before the timer T3148 expires. See specific message contents. Repeated on every burst of the uplink main DCCH (and optionally on the SACCH) until reception of PHYSICAL INFORMATION. Handover Reference as included in the HANDOVER COMMAND.
4	SS->MS	HANDOVER COMMAND	
5	MS->SS	HANDOVER ACCESS	
6	SS->MS	PHYSICAL INFORMATION	
6	MS->SS	HANDOVER COMPLETE	
7	SS->MS	DTM INFORMATION	Sent on the correct channel after establishment of the main signalling link.
A8 (optional step)	MS->SS	GPRS INFORMATION	The MS follows either branch A or B . The MS sends an empty LLC PDU to indicate Cell Update.
A9	MS->SS	DTM REQUEST	SS sends this message such that it is received before Timer T3148 expiry. See specific message contents. Macro - Completion of the 1000 octets of Data.
A10	SS->MS	PACKET ASSIGNMENT	
A11	MS<->SS	{ Uplink data transfer }	
B8	MS->SS	DTM REQUEST	
B9	SS->MS	PACKET ASSIGNMENT	Sent on main DCCH. See specific message contents.
B10	SS<->MS	{ Uplink data transfer }	Macro - Completion of the 1000 octets of Data. MS may commence sending of user data immediately after Step B9, or start by sending an empty LLC PDU.

Specific Message Contents

HANDOVER COMMAND (Step 4):

k=1;

As default message contents except: Channel Description - Channel Type and TDMA offset - Timeslot Number Handover reference	TCH/F N' Chosen arbitrarily
---	-----------------------------------

k=2;

As default message contents except: Channel Description - Channel Type and TDMA offset - Timeslot Number Handover reference	TCH/H N' Chosen arbitrarily
---	-----------------------------------

PACKET ASSIGNMENT (Step A10 and B9):

k=1;

As default message contents except: RR Packet Uplink Assignment IE - TIMESLOT_ALLOCATION RR Packet Downlink Assignment IE	(N' ± 1) MOD 8 Not included
--	--------------------------------

k=2;

As default message contents except: RR Packet Uplink Assignment IE - TIMESLOT_ALLOCATION RR Packet Downlink Assignment IE	N' Not included
--	--------------------

41.5.1.1.1.7 Uplink TBF establishment with no reallocation of CS resources / Abnormal cases / Channel Release

41.5.1.1.1.7.1 Conformance requirements

If the MS receives a CHANNEL RELEASE message during the packet access procedure, the MS shall abort the packet access procedure, stop timer T3148 and proceed with the RR connection release procedure. The MS shall then attempt an establishment of the uplink TBF.

References

3GPP TS 04.18/44.018 sub-clauses 3.4.13 & 3.4.22.1.1.3.2

41.5.1.1.1.7.2 Test purpose

To verify that the MS aborts the packet access procedure when the MS receives a CHANNEL RELEASE message before the expiry of T3148, completing the release before re-attempting the establishment of the uplink TBF.

41.5.1.1.1.7.3 Method of test

Initial Conditions

System Simulator:

1 cell, DTM supported

Mobile Station:

The MS is in the active state (U10) of a call.

The MS is in packet idle mode, with a P-TMSI allocated and PDP context 1 activated.

Specific PICS Statements

-

PIXIT Statements

-

Test Procedure

The MS, whilst in dedicated mode, is triggered to initiate packet uplink data transfer in RLC acknowledged mode and sends a DTM REQUEST message. On receipt of the DTM REQUEST message, requesting uplink resources, the SS orders the MS to release the CS connection. The MS releases lower layer resources and then requests uplink packet transfer using normal dynamic allocation two phase access.

Maximum Duration of Test

5 minutes

Expected Sequence

Step	Direction	Message	Comments
1	MS		MS in state U10, utilising Timeslot N for CS connection (Timeslot chosen arbitrarily by test house)
2	MS		Trigger the MS to initiate an uplink packet transfer containing 1000 octets.
3	MS->SS	DTM REQUEST	
4	SS->MS	CHANNEL RELEASE	This message is sent such that it is received before expiry of timer T3148.
5		{Uplink dynamic allocation two phase access}	Macro
6	MS<->SS	{ Uplink data transfer }	Macro - Completion of the 1000 octets of Data.

41.5.1.1.2 Uplink TBF establishment with reallocation of CS resources

41.5.1.1.2.1 Uplink TBF establishment with reallocation of CS resources / Successful case

41.5.1.1.2.1.1 Conformance requirements

Upon receipt of the DTM ASSIGNMENT COMMAND message, the mobile station initiates a local end release of link layer connections, disconnects the physical channels, commands the switching to the assigned channel and initiates the establishment of lower layer connection (this includes the activation of the channel, their connection and the establishment of the main signalling link).

References

3GPP TS 04.18/44.018 sub-clause 3.4.22.1.1.3.1

41.5.1.1.2.1.2 Test purpose

To verify that the MS allows reallocation of its CS resources during the request for PS resources. The resources can either be reallocated to a new timeslot within the same frequency or a new frequency.

41.5.1.1.2.1.3 Method of test

Initial Conditions

System Simulator:

1 cell, DTM supported.

Mobile Station:

The MS is in the active state (U10) of a call.

The MS is in packet idle mode, with a P-TMSI allocated and PDP context 1 activated.

Specific PICS Statements

-

PIXIT Statements

-

Test Procedure

The MS, whilst in dedicated mode, is triggered to initiate packet uplink data transfer and sends a DTM REQUEST message. On receipt of the DTM REQUEST message, requesting uplink resources, the SS reallocates the MS's CS resources and assigns PS resources to the MS. The SS accomplishes the resource assignment by passing a DTM ASSIGNMENT COMMAND message to the MS. Once the MS has received the assignment message, it moves to the new allocation, reconnects the CS resources, passes the ASSIGNMENT COMPLETE message to the SS on the main DCCH and starts to send RLC DATA BLOCKS to the SS on the assigned TBF.

The codec to be used in this test is chosen dependent on the capabilities of the MS.

MS supporting DTM shall complete testing for k=1 and MSs indicating support of single slot DTM shall additionally complete testing for k=2.

Maximum Duration of Test

5 minutes

Expected Sequence

The test sequence is repeated for k = 1,2.

Step	Direction	Message	Comments
1	SS		MS in the active state (U10) of a call on Timeslot N. When: k=1, Channel Type=TCH/F; k=2, Channel Type=TCH/H.
2	MS		Trigger the MS to initiate an uplink packet transfer containing 1000 octets.
3	MS->SS	DTM REQUEST	Sent on main DCCH
4	SS->MS	DTM ASSIGNMENT COMMAND	This message is sent such that it is received before expiry of timer T3148. See specific message contents.
5	MS->SS	ASSIGNMENT COMPLETE	Sent on new main DCCH.
6	MS->SS	{ Uplink Data Transfer }	Macro - Completion of the 1000 octets of Data.

Specific Message Contents

DTM ASSIGNMENT COMMAND (Step 4):

k=1;

As default message contents except: Channel Description IE - Timeslot Number - Channel Type RR Packet Uplink Assignment IE - TIMESLOT_ALLOCATION RR Packet Downlink Assignment IE	N', chosen arbitrarily. TCH/F (N' ± 1) MOD 8 Not included
---	--

k=2;

As default message contents except: Channel Description IE - Timeslot Number - Channel Type RR Packet Uplink Assignment IE - TIMESLOT_ALLOCATION RR Packet Downlink Assignment IE	N', chosen arbitrarily. TCH/H N' Not included
---	--

41.5.1.1.2.2 Uplink TBF establishment with reallocation of CS resources / Abnormal case / Assignment Failure

41.5.1.1.2.2.1 Conformance requirements

If the network commands the mobile station to reallocate the RR connection and the establishment of the main DCCH fails, all the allocated packet resources are released; the mobile station shall revert to the old channel, trigger the establishment of the main DCCH and send a DTM ASSIGNMENT FAILURE message on the main DCCH with cause value "lower layer failure".

References

3GPP TS 04.18/44.018 sub-clause 3.4.22.1.1.5

41.5.1.1.2.2.2 Test purpose

To verify that, if the MS cannot complete the reallocation, then the MS shall revert back to the old resources and re-establish a connection.

41.5.1.1.2.2.3 Method of test

Initial Conditions

System Simulator:

1 cell, DTM supported.

Mobile Station:

The MS is in the active state (U10) of a call.

The MS is in packet idle mode, with a P-TMSI allocated and PDP context 1 activated.

Specific PICS Statements

-

PIXIT Statements

-

Test Procedure

The MS, whilst in dedicated mode, is triggered to initiate packet uplink data transfer and sends a DTM REQUEST message. On receipt of the DTM REQUEST message, requesting uplink resources, the SS reallocates the MS's CS resources to a different frequency band and assigns the new PS resources. The SS accomplishes the resource assignment by passing a DTM ASSIGNMENT COMMAND message to the MS. Once the MS has received the assignment message, it moves to the new allocation, attempts to reconnect the CS resources, but the SS is not receptive to the establishment of the main signalling bearer in the new cell. The MS reverts back to the old CS resources and sends a DTM ASSIGNMENT FAILURE message on the old main DCCH, with cause value set to "lower layer failure". The MS re-initiates the packet access procedure and sends a DTM REQUEST message.

MS supporting DTM shall complete testing for k=1 and MSs indicating support of single slot DTM shall additionally complete testing for k=2.

Maximum Duration of Test

5 minutes

Expected Sequence

The test sequence is repeated for k = 1,2.

Step	Direction	Message	Comments
1	SS		MS in the active state (U10) of a call on Timeslot N. When: k=1, Channel Type=TCH/F; k=2, Channel Type=TCH/H.
2	MS		Trigger the MS to initiate an uplink packet transfer containing 1000 octets.
3	MS->SS	DTM REQUEST	Sent on main DCCH
4	SS->MS	DTM ASSIGNMENT COMMAND	SS sends this message such that it is received before Timer T3148 expiry. See specific message contents
5	MS->SS	DTM ASSIGNMENT FAILURE	Sent on old main DCCH. With message cause value set to "lower layer failure"
6	MS->SS	DTM REQUEST	Sent on main DCCH

Specific Message Contents

DTM ASSIGNMENT COMMAND (Step 4):

k=1;

As default message contents except: Channel Description IE - Timeslot Number - Channel Type RR Packet Uplink Assignment IE - TIMESLOT_ALLOCATION RR Packet Downlink Assignment IE	N' (chosen arbitrarily) TCH/F (N' ± 1) MOD 8 Not included
---	--

k=2;

As default message contents except: Channel Description IE - Timeslot Number - Channel Type RR Packet Uplink Assignment IE - TIMESLOT_ALLOCATION RR Packet Downlink Assignment IE	N' (chosen arbitrarily) TCH/H N' Not included
---	--

41.5.1.1.2.3 Uplink TBF establishment with reallocation of CS resources / Abnormal case / Multislot class violation

41.5.1.1.2.3.1 Void

41.5.1.1.2.3.2 Void

41.5.1.1.2.3.3 Void

41.5.1.1.2.3.4 Uplink TBF establishment with reallocation of CS resources / Abnormal case / Multislot class violation / Singleslot allocation

41.5.1.1.2.3.4.1 Conformance requirements

If a failure occurs on the mobile station side before the packet request procedure is completed, all the allocated packet resources are released, the mobile station remains on the current channel and upper layers are notified (packet resource establishment failure). d) If a DTM ASSIGNMENT COMMAND or PACKET ASSIGNMENT message assigns resources not compliant with the multislot capabilities of the mobile station.

If the mobile station received a DTM ASSIGNMENT COMMAND message before the packet resource establishment failure was detected, the mobile station shall return a DTM ASSIGNMENT FAILURE message with one of the following corresponding cause values:

For Release 6 and later:

d) In case of abnormal case d) above, "protocol error unspecified";

otherwise:

d) In case of abnormal case d) above, "channel mode unacceptable";

References

3GPP TS 04.18/44.018 sub-clause 3.4.22.1.1.5

41.5.1.1.2.3.4.2 Test purpose

If the MS is allocated resources that do not fulfil the MS multislot class indicated in the Classmark (Classmark 3 and MS Radio Access Capabilities), then the MS shall send an ASSIGNMENT FAILURE message to the network indicating this discrepancy. If the MS is allocated resources outside those indicated in the Classmark with an PACKET ASSIGNMENT message the MS shall ignore the message and continue in dedicated mode.

41.5.1.1.2.3.4.3 Method of test

Initial Conditions

System Simulator:

1 cell with DTM supported.

Mobile Station:

The MS is in the active state (U10) of a call, packet idle mode, with a P-TMSI allocated and PDP context 1 activated.

Specific PICS Statements

-

PIXIT Statements

-

Test Procedure

The MS, whilst in dedicated mode, is triggered to initiate packet uplink data transfer and sends a DTM REQUEST message. On receipt of the DTM REQUEST message, requesting uplink resources, the SS commands the MS to reallocate its CS resources and also assigns PS resources to the MS. The resources provided to the MS by the SS fall outside of the MS multislot classmark. The MS transmits the DTM ASSIGNMENT FAILURE message, with cause value set to "protocol error unspecified" in case of release 6 and later or "channel mode unacceptable" / "protocol error unspecified" otherwise, indicating the discrepancy. The SS then reassigns the CS resources of the MS into a full rate channel and then waits for the MS to again request an uplink TBF. Upon reception of the DTM REQUEST message the SS allocates the MS resources using a PACKET ASSIGNMENT message. The SS verifies that the MS ignores this incorrect allocation and maintains the CS connection.

Maximum Duration of Test

5 minutes

Expected Sequence

Step	Direction	Message	Comments
1	SS		MS in the active state (U10) of a call on Timeslot N.
2	MS		Trigger the MS to initiate an uplink packet transfer containing 1000 octets.
3	MS->SS	DTM REQUEST	Sent on main DCCH
4	SS->MS	DTM ASSIGNMENT COMMAND	See specific message contents
5	MS->SS	DTM ASSIGNMENT FAILURE	Sent on old main DCCH. With message cause value set to: - in case of release 6: "protocol error unspecified" - otherwise: "channel mode unacceptable" or "protocol error unspecified".
6	SS->MS	ASSIGNMENT COMMAND	Allocates the MS a TCH/F channel on Timeslot N'.
7	MS->SS	ASSIGNMENT COMPLETE	
8	MS->SS	DTM REQUEST	Sent on main DCCH
9	SS->MS	PACKET ASSIGNMENT	See specific message contents
10	SS		The SS verifies that the MS has maintained the CS connection.

Specific Message Contents

DTM ASSIGNMENT COMMAND (Step 4):

As default message contents except: Channel Description IE - Timeslot Number - Channel Type RR Packet Uplink Assignment IE - TIMESLOT_ALLOCATION RR Packet Downlink Assignment IE	N' (chosen arbitrarily). TCH/H N' Not included
---	---

PACKET ASSIGNMENT (Step 9):

As default message contents except: RR Packet Uplink Assignment IE - TIMESLOT_ALLOCATION RR Packet Downlink Assignment IE	N' + 1 Not included
--	------------------------

41.5.1.1.2.3.5 Uplink TBF establishment with reallocation of CS resources / Abnormal case / Multislot class violation / Incorrect Allocation

41.5.1.1.2.3.5.1 Conformance requirements

If a failure occurs on the mobile station side before the packet request procedure is completed, all the allocated packet resources are released, the mobile station remains on the current channel and upper layers are notified (packet resource establishment failure).

- d) If a DTM ASSIGNMENT COMMAND or PACKET ASSIGNMENT message assigns resources not compliant with the multislot capabilities of the mobile station.

If the mobile station received a DTM ASSIGNMENT COMMAND message before the packet resource establishment failure was detected, the mobile station shall return a DTM ASSIGNMENT FAILURE message with one of the following corresponding cause values:

For Release 6 and later:

- d) In case of abnormal case d) above, "protocol error unspecified";

otherwise:

- d) In case of abnormal case d) above, "channel mode unacceptable";

References

3GPP TS 04.18/44.018 sub-clause 3.4.22.1.1.5

41.5.1.1.2.3.5.2 Test purpose

If the MS is allocated resources that do not fulfil the MS multislot class indicated in the Classmark (Classmark 3 and MS Radio Access Capabilities), then the MS shall send an ASSIGNMENT FAILURE message to the network indicating this discrepancy.

41.5.1.1.2.3.5.3 Method of test

Initial Conditions

System Simulator:

1 cell with DTM supported.

Mobile Station:

The MS is in the active state (U10) of a call, packet idle mode, with a P-TMSI allocated and PDP context 1 activated.

Specific PICS Statements

-

PIXIT Statements

-

Test Procedure

The MS, whilst in dedicated mode, is triggered to initiate packet uplink data transfer and sends a DTM REQUEST message. On receipt of the DTM REQUEST message, requesting uplink resources, the SS commands the MS to reallocate its CS resources and also assigns PS resources to the MS. The resources provided to the MS by the SS fall outside of the MS multislot classmark. The MS transmits the DTM ASSIGNMENT FAILURE message, with cause value set to "protocol error unspecified " in case of release 6 and newer or "channel mode unacceptable" otherwise, indicating the discrepancy.

Maximum Duration of Test

5 minutes

Expected Sequence

Step	Direction	Message	Comments
1	SS		MS in the active state (U10) of a call on Timeslot N.
2	MS		Trigger the MS to initiate an uplink packet transfer containing 1000 octets.
3	MS->SS	DTM REQUEST	Sent on main DCCH
4	SS->MS	DTM ASSIGNMENT COMMAND	This message is sent such that it is received before expiry of timer T3148. See specific message contents
5	MS->SS	DTM ASSIGNMENT FAILURE	Sent on old main DCCH. With message cause value set to "protocol error unspecified " in case of release 6 or "channel mode unacceptable" otherwise.

Specific Message Contents

DTM ASSIGNMENT COMMAND (Step 4):

As default message contents except: Channel Description IE - Timeslot Number - Channel Type RR Packet Uplink Assignment IE - TIMESLOT_ALLOCATION RR Packet Downlink Assignment IE	N' (chosen arbitrarily). TCH/F (N' + 1) MOD 8, (N' + 2) MOD 8 & (N' + 3) MOD 8 Not included
---	--

41.5.1.1.3 Uplink TBF establishment required whilst DTM is not supported in cell

41.5.1.1.3.1 Conformance requirements

While in dedicated mode, the establishment of an uplink packet resource may be initiated by the RR entity of the mobile station using the packet request procedure. The procedure is triggered by a request from upper layers to transfer an LLC PDU; see 3GPP TS 24.007.

Access to the network is allowed:

- if dual transfer mode is supported in the cell.

References

3GPP TS 04.18/44.018 sub-clause 3.4.22.1.1

41.5.1.1.3.2 Test purpose

To verify that the MS:

- understands the SI6 Rest Octets information element, containing the DTM support field, which indicates network support of DTM;
- does not attempt to establish an uplink TBF whilst in DM and in a cell that indicates that DTM is unsupported.

41.5.1.1.3.3 Method of test

Initial Conditions

System Simulator:

- 1 cell with DTM not supported

Mobile Station:

- The MS is in the active state (U10) of a call.
- The MS is in packet idle mode, with a P-TMSI allocated and PDP context 1 activated.

Specific PICS Statements

-

PIXIT Statements

-

Test Procedure

The MS, whilst in dedicated mode, is triggered to initiate uplink packet transfer, whilst the MS has an active call and DTM is not supported in the cell. The MS does not request packet resources from the network until the CS call is complete.

Maximum Duration of Test

5 minutes

Expected Sequence

Step	Direction	Message	Comments
1	SS		MS in the active state (U10) of a call on Timeslot N.
2	MS		Trigger the MS to initiate an uplink packet transfer containing 1000 octets.
3	SS		Check that the MS is not sending a DTM REQUEST.
4	SS		The SS verifies that the MS has maintained the CS connection

41.5.1.2 Downlink TBF establishment

41.5.1.2.1 Whilst in Ready State

41.5.1.2.1.1 Downlink TBF establishment in Ready State / Successful case

41.5.1.2.1.1.1 Conformance requirements

This procedure is only applicable to a mobile station in dedicated mode and with no TBF allocated. If the mobile station already has an ongoing TBF, the establishment of the downlink packet resource is performed on the PACCH; see 3GPP TS 04.60.

The establishment of a downlink packet resource is initiated by the RR entity on the network side using the packet downlink assignment procedure in dedicated mode. The procedure is triggered by a request from upper layers to transfer an LLC PDU; see 3GPP TS 24.007. The request from upper layers specifies a QoS profile, an *RLC mode*, *DRX parameters* and an *MS classmark* associated with the packet transfer.

The network initiates the packet downlink assignment procedure in dedicated mode by sending a DTM assignment message (i.e. DTM ASSIGNMENT COMMAND or a PACKET ASSIGNMENT) in acknowledged mode on the main DCCH.

The completion of the packet downlink assignment procedure while in dedicated mode depends on the actual assignment message used by the network:

- when the network sends a PACKET ASSIGNMENT message, the packet downlink assignment procedure is completed for the network when assignment message is sent and for the mobile station when it is received.

References

3GPP TS 04.18/44.018 sub-clause 3.4.22.3

41.5.1.2.1.1.2 Test purpose

To test that while in dedicated mode and in ready state, the MS can decode and act upon the allocation of downlink packet resources and enter dual transfer mode.

41.5.1.2.1.1.3 Method of test

Initial Conditions

System Simulator:

1 cell, DTM supported.

Mobile Station:

The MS is in the active state (U10) of a call.

The MS is in the GMM READY state, with a P-TMSI allocated and PDP context 1 activated.

Specific PICS Statements

-

PIXIT Statements

-

Test Procedure

Whilst in an active call on timeslot N, the MS receives a PACKET ASSIGNMENT message on the main DCCH, instructing the MS to switch to the designated timeslot. The SS waits a specified time and then starts to transmit to the newly allocated resources. The test procedure is complete when the MS successfully acknowledges the downlink RLC data blocks.

MS supporting DTM shall complete testing for k=1 and MSs indicating support of single slot DTM shall additionally complete testing for k=2.

Maximum Duration of Test

5 minutes

Expected Sequence

The test sequence is repeated for k = 1,2.

Step	Direction	Message	Comments
1	SS		MS in the active state (U10) of a call on Timeslot N of cell A. When: K=1, Channel Type = TCH/F K=2, Channel Type = TCH/H
2	SS->MS	PACKET ASSIGNMENT	See specific message contents.
3	SS		SS Waits T3190 – 50% (2.5s)
4	SS<->MS	{ Downlink data transfer }	Macro – Transmitting 10kB of Data

Specific Message Contents

PACKET ASSIGNMENT (Step 2):

k=1;

As default message contents except: RR Packet Uplink Assignment IE RR Packet Downlink Assignment IE - TIMESLOT_ALLOCATION	Not included (N ± 1) MOD 8
--	-----------------------------------

k=2;

As default message contents except: RR Packet Uplink Assignment IE RR Packet Downlink Assignment IE - TIMESLOT_ALLOCATION	Not included N
--	-----------------------

41.5.1.2.1.2 Downlink TBF establishment in Ready State / Abnormal cases / No cell allocation available

41.5.1.2.1.2.1 Conformance requirements

If a failure occurs on the mobile station side before the packet downlink assignment procedure is completed (packet establishment failure), all the allocated packet resources are released and the mobile station remains on the current channel.

In the following cases a packet resource establishment failure has occurred:

- e) If the mobile station has no current CA and if it needs a CA to analyse the DTM ASSIGNMENT COMMAND message.

If the mobile station received a DTM ASSIGNMENT COMMAND message before the packet resource establishment failure was detected, the mobile station shall return a DTM ASSIGNMENT FAILURE message with one of the following corresponding cause values:

- e) In case of abnormal case e) above, "no cell allocation available";

References

3GPP TS 04.18/44.018 sub-clause 3.4.22.3.3

41.5.1.2.1.2.2 Test purpose

To verify that when the MS is unable analyse a DTM ASSIGNMENT COMMAND message, it returns a DTM ASSIGNMENT FAILURE message with the cause value set to "no cell allocation available".

41.5.1.2.1.2.3 Method of test

Initial Conditions

System Simulator:

1 cell no SYSTEM INFORMATION TYPE 1 message (some other SI message is sent with TC=0),, with GPRS and DTM support.

Mobile Station:

The MS is in the active state (U10) of a call and is also in GMM-READY state.

Specific PICS Statements

-

PIXIT Statements

-

Test Procedure

The SS attempts to assign a PDCH for downlink transfer, with reallocating the MS's current TCH, but the MS has no current cell allocation (taken from BCCH) and is therefore unable to decode the allocation received in the DTM ASSIGNMENT COMMAND message.

Maximum Duration of Test

5 minutes

Expected Sequence

Step	Direction	Message	Comments
1	SS		MS in the active state (U10) of a call on Timeslot N of cell A.
2	SS->MS	DTM ASSIGNMENT COMMAND	Sent on main DCCH in acknowledged mode.
3	MS->SS	DTM ASSIGNMENT FAILURE	Cause = "no cell allocation available"

Specific Message Contents

DTM ASSIGNMENT COMMAND (Step 2):

As default message contents except: Channel Description IE	
- Channel Type and TDMA offset	TCH/F + ACCH's
- Timeslot Number	N (chosen arbitrarily by test house)
- Training Sequence Code	Same as the BCCH
- Hopping channel	1 RF hopping channel
- MAIO	000000
- HSN	000000 Sequence 0
Mobile Allocation IE	Chosen arbitrarily
RR Packet Uplink Assignment IE	Not included
RR Packet Downlink Assignment IE	
- TIMESLOT_ALLOCATION	N

41.5.1.2.2 Whilst in Standby State / Packet Notification

41.5.1.2.2.1 Conformance requirements

3GPP TS 04.18/44.018 sub-clause 3.4.22.2:

Upon receipt of the PACKET NOTIFICATION message, the RR sublayer of the MS indicates the receipt of a packet paging request to the GMM sublayer.

3GPP TS 23.060 sub-clause 8.1.4:

- 4) Upon receipt of a GPRS Paging Request message, the MS shall respond with either any single valid LLC frame (e.g., a Receive Ready or Information frame) that implicitly is interpreted as a page response message by the SGSN. The MS shall not use the LLC NULL frame as a page response. When responding, the MS changes MM state to READY. The Packet Channel Request precedes the response and Packet Immediate Assignment procedures as described in GSM 03.64.

References

3GPP TS 04.18/44.018 sub-clause 3.4.22.2

3GPP TS 23.060 sub-clause 8.1.4

3GPP TS 04.64/44.064 sub-clause 6.4.1.7

41.5.1.2.2.2 Test purpose

To test that an MS in an active call and also in GMM Standby state, can respond to a PACKET NOTIFICATION message sent on the main DCCH, with a Cell Update.

41.5.1.2.2.3 Method of test

Initial Conditions

System Simulator:

1 cell, DTM supported.

Mobile Station:

The MS is in the active state (U10) of a call.

The DTM MS in GMM Standby state, with a P-TMSI allocated and PDP context 1 activated.

Specific PICS Statements

-

PIXIT Statements

-

Test Procedure

The MS, in an active call using timeslot N, upon receipt of a PACKET NOTIFICATION message on the main DCCH returns a bank LLC frame to the SS as Cell Update, drawing the MS into Ready state.

Maximum Duration of Test

5 minutes

Expected Sequence

Step	Direction	Message	Comments
1	SS		MS in the active state (U10) of a call on Timeslot N of cell A.
2	SS->MS	PACKET NOTIFICATION	Sent on main DCCH in acknowledged mode.
3	MS->SS	GPRS INFORMATION	The MS responds with an empty LLC PDU to indicate Cell Update.

41.5.2 CS establishment whilst in packet transfer mode

41.5.2.1 MT CS establishment whilst in packet transfer mode with a downlink TBF established

41.5.2.1.1 Conformance requirements

Paging initiation using PACCH applies when sending a paging request message to a mobile station that is GPRS attached, when the mobile station is in packet transfer mode and the network is able to co-ordinate the paging request with the radio resources allocated for the mobile station on a PDCH. This kind of paging co-ordination shall be provided in network mode of operation I (see 3G TS 23.060). This kind of paging co-ordination may be provided also in network mode of operation II or III. This kind of paging co-ordination shall be provided if the network supports DTM.

When the mobile station responds to a paging request for RR connection establishment, it shall follow the paging response procedures as specified in 3GPP TS 04.18. For that purpose, a mobile station in packet transfer mode or a mobile station that has initiated a packet access procedure may abort any ongoing TBF or the packet access procedure in the following two cases:

- The mobile station requires that the BSS co-ordinates the allocation of radio resources for an RR connection and a simultaneous TBF (GPRS class A mode of operation by means of DTM).

References

3GPP TS 04.60/44.060, sub-clauses 6.1.3, 6.1.4.

41.5.2.1.2 Test purpose

To verify that the MS reacts to CS paging on the PACCH, whilst in packet transfer mode, by releasing the downlink TBF and then establishing an RR connection. It is then tested that once the RR connection is established the MS accepts the re-establishment of the downlink TBF.

41.5.2.1.3 Method of test

Initial Conditions

System Simulator:

- 1 cell, DTM supported.

Mobile Station:

- The MS is in packet idle mode, with a TMSI, P-TMSI allocated and PDP context 1 activated.
- The MS is in the GMM READY state.

Specific PICS Statements

- GPRS Release (TSPC_MS_GPRS_RELEASE)
- Support of Immediate Connect (TSPC_AddInfo_ImmConn)

PIXIT Statements

-

Test Procedure

The MS is brought into packet transfer mode before being paged on the PACCH. Upon receipt of the PACKET PAGING REQUEST message, the MS returns to packet idle mode and initiate the establishment of CS connection. Once the MS has established the CS connection, the SS requests the re-establishment of the PS resources with a PACKET ASSIGNMENT message.

MS supporting DTM shall complete testing for k=1 and MSs indicating support of single slot DTM shall additionally complete testing for k=2.

Maximum Duration of Test

5 minutes

Expected Sequence

The test sequence is repeated for k = 1,2.

Step	Direction	Message	Comments
1		{ Downlink TBF establishment }	Macro
2	SS<->MS	{ Downlink data }	Macro
3	SS->MS	PACKET PAGING REQUEST	1 st Repeated Page info contains IMSI of the MS, PAGE_MODE = " same as before ", sent on downlink PACCH. When: k=1, Channel Needed = "TCH/F"; k=2, Channel Needed = "TCH/H".
4	MS->SS	CHANNEL REQUEST	
5	SS->MS	IMMEDIATE ASSIGNMENT	
6	MS->SS	PAGING RESPONSE	
7	MS->SS	CLASSMARK CHANGE	
8	MS->SS	GPRS INFORMATION	The MS send this message to indicate Cell Update This step is optional for MS with release up to Rel5 and it is mandatory for MS with release from Rel6 onwards.
9	SS->MS	AUTHENTICATION REQUEST	
10	MS->SS	AUTHENTICATION RESPONSE	
11	SS->MS	CIPHERING MODE COMMAND	
12	MS->SS	CIPHERING MODE COMPLETE	
13	SS->MS	SETUP	
	MS->SS	CALL CONFIRMED	
A14			If the MS supports immediate connect then branch A applies. If the MS does not support immediate connect then branch B applies
A15	MS->SS	CONNECT	Sent on the old channel
A16	SS->MS	ASSIGNMENT COMMAND	Timeslot N (chosen arbitrarily). When: K=1, Channel Type = TCH/F; K=2, Channel Type = TCH/H.
A17	MS->SS	ASSIGNMENT COMPLETE	Continues at step 21
B15	SS->MS	ASSIGNMENT COMMAND	Timeslot N (chosen arbitrarily). When: K=1, Channel Type = TCH/F; K=2, Channel Type = TCH/H.
B16	MS->SS	ASSIGNMENT COMPLETE	Sent on the new channel.
B17	MS->SS	ALERTING	
B18	MS		An alerting indication is given by the MS
B19	MS		The MS is made to accept the call .
B20	MS->SS	CONNECT	
21	MS		If the call is a speech call, the TCH shall be through connected in both directions.
22	SS->MS	CONNECT ACKNOWLEDGE	
23	SS->MS	PACKET ASSIGNMENT	See specific message contents
24	SS<->MS	{ Downlink data transfer }	Macro – Transmitting 10kB of Data

Specific Message Contents

PACKET ASSIGNMENT (Step 23):

k=1;

As default message contents except: RR Packet Uplink Assignment IE RR Packet Downlink Assignment IE - TIMESLOT_ALLOCATION	Not included (N ± 1) MOD 8
--	-----------------------------------

k=2;

As default message contents except: RR Packet Uplink Assignment IE RR Packet Downlink Assignment IE - TIMESLOT_ALLOCATION	Not included N
--	-----------------------

41.5.2.2 MT CS establishment whilst in packet transfer mode with a uplink TBF established

41.5.2.2.1 Conformance requirements

3GPP TS 04.60/44.060

Paging initiation using PACCH applies when sending a paging request message to a mobile station that is GPRS attached, when the mobile station is in packet transfer mode and the network is able to co-ordinate the paging request with the radio resources allocated for the mobile station on a PDCH. This kind of paging co-ordination shall be provided in network mode of operation I (see 3G TS 23.060). This kind of paging co-ordination may be provided also in network mode of operation II or III. This kind of paging co-ordination shall be provided if the network supports DTM.

When the mobile station responds to a paging request for RR connection establishment, it shall follow the paging response procedures as specified in 3GPP TS 04.18. For that purpose, a mobile station in packet transfer mode or a mobile station that has initiated a packet access procedure may abort any ongoing TBF or the packet access procedure in the following two cases:

- The mobile station requires that the BSS co-ordinates the allocation of radio resources for an RR connection and a simultaneous TBF (GPRS class A mode of operation by means of DTM).

3GPP TS 03.55

Once on the DCCH, the mobile station may request the re-establishment of the packet resources by sending a DTM Request message. The procedure to re-establish an aborted uplink TBF shall be identical to the MO session request. The procedure to re-establish an aborted downlink TBF shall be identical to the MT session request.

References

3GPP TS 04.60/44.060, sub-clauses 6.1.3, 6.1.4

3GPP TS 03.55, sub-clause 6.1.3

41.5.2.2.2 Test purpose

To verify that the MS reacts to CS paging on the PACCH, whilst in packet transfer mode, by releasing the uplink TBF and then establishing the RR connection. The MS may request the re-establishment of the packet resources by sending a DTM Request message on the DCCH.

41.5.2.2.3 Method of test

Initial Conditions

System Simulator:

1 cell, DTM supported.

Mobile Station:

The MS is in packet idle mode, with a TMSI, P-TMSI allocated and PDP context 1 activated.

The MS is in the GMM READY state.

Specific PICS Statements

- Support of Immediate Connect (TSPC_AddInfo_ImmConn)

PIXIT Statements

-

Test Procedure

The MS is brought into packet transfer mode before being paged on the PACCH. Upon receipt of the PACKET PAGING REQUEST message, the MS returns to packet idle mode and initiates the establishment of a CS connection.

MS supporting DTM shall complete testing for k=1 and MSs indicating support of single slot DTM shall additionally complete testing for k=2.

Maximum Duration of Test

5 minutes

Expected Sequence

The test sequence is repeated for k = 1,2.

Step	Direction	Message	Comments
1	MS		Trigger the MS to initiate an uplink packet transfer containing 1000 octets.
2		{ Uplink dynamic allocation two phase access }	Macro
3	MS<->SS	{ Uplink data }	Macro
4	SS->MS	PACKET PAGING REQUEST	This message to be sent before the termination of the macro.
			1 st Repeated Page info contains IMSI of the MS PAGE_MODE = " same as before ", sent on downlink PACCH When: k=1, Channel Needed = TCH/F; k=2, Channel Needed = TCH/H.
5	MS->SS	CHANNEL REQUEST	
6	SS->MS	IMMEDIATE ASSIGNMENT	
7	MS->SS	PAGING RESPONSE	
8	MS->SS	CLASSMARK CHANGE	
9	MS->SS	GPRS INFORMATION	The MS sends an empty LLC PDU to indicate Cell Update.
Option al step			The MS may send a DTM REQUEST message at any time after the CLASSMARK CHANGE message was sent. The SS shall discard the message.
10	SS ->MS	AUTHENTICATION REQUEST	
11	MS ->SS	AUTHENTICATION RESPONSE	
12	SS ->MS	CIPHERING MODE COMMAND	
13	MS ->SS	CIPHERING MODE COMPLETE	
14	SS->MS	ASSIGNMENT COMMAND	Timeslot N (chosen arbitrarily) When: k=1, Channel Type = TCH/F; k=2, Channel Type = TCH/H;
15	MS->SS	ASSIGNMENT COMPLETE	
16	SS->MS	SETUP	
17	MS->SS	CALL CONFIRMED	
			If the MS supports immediate connect then branch A applies. If the MS does not support immediate connect then branch B applies
A18	MS->SS	CONNECT	Sent on the old channel
B18	MS->SS	ALERTING	
B19	MS->SS	CONNECT	
20	SS->MS	CONNECT ACKNOWLEDGE	

41.5.2.3 MO CS establishment whilst in packet transfer mode with uplink and downlink TBFs established

41.5.2.3.1 Conformance requirements

3GPP TS 04.60/44.060

Paging initiation using PACCH applies when sending a paging request message to a mobile station that is GPRS attached, when the mobile station is in packet transfer mode and the network is able to co-ordinate the paging request with the radio resources allocated for the mobile station on a PDCH. This kind of paging co-ordination shall be provided in network mode of operation I (see 3G TS 23.060). This kind of paging co-ordination may be provided also in network mode of operation II or III. This kind of paging co-ordination shall be provided if the network supports DTM.

When the mobile station responds to a paging request for RR connection establishment, it shall follow the paging response procedures as specified in 3GPP TS 04.18. For that purpose, a mobile station in packet transfer mode or a mobile station that has initiated a packet access procedure may abort any ongoing TBF or the packet access procedure in the following two cases:

- The mobile station requires that the BSS co-ordinates the allocation of radio resources for an RR connection and a simultaneous TBF (GPRS class A mode of operation by means of DTM).

3GPP TS 03.55

Once on the DCCH, the mobile station may request the re-establishment of the packet resources by sending a DTM Request message. The procedure to re-establish an aborted uplink TBF shall be identical to the MO session request. The procedure to re-establish an aborted downlink TBF shall be identical to the MT session request.

References

3GPP TS 04.60/44.060, sub-clauses 6.1.3, 6.1.4

3GPP TS 03.55, sub-clause 6.1.3

41.5.2.3.2 Test purpose

To verify that the MS reacts to MO call whilst in packet transfer mode by releasing both uplink and downlink TBFs and then establishing an RR connection. The MS may request the re-establishment of the packet resources by sending a DTM Request message on the DCCH.

41.5.2.3.3 Method of test

Initial Conditions

System Simulator:

1 cell, DTM supported.

Mobile Station:

The MS is in packet idle mode, with a TMSI, P-TMSI allocated and PDP context 1 activated.

The MS is in the GMM READY state.

Specific PICS Statements

-

PIXIT Statements

-

Test Procedure

The MS is brought into packet transfer mode with the establishment of the uplink TBF and then the SS orders the establishment of a downlink TBF. Once both TBFs are active, the MS is triggered to initiate the establishment of voice

call. The MS returns to packet idle mode and initiates the establishment of a CS connection. MS supporting DTM shall complete testing for k=1 and MSs indicating support of single slot DTM shall additionally complete testing for k=2.

Maximum Duration of Test

5 minutes

Expected Sequence

The test sequence is repeated for k = 1,2.

Step	Direction	Message	Comments
1	MS		Trigger the MS to initiate an uplink packet transfer containing 1000 octets.
2		{ Uplink dynamic allocation two phase access }	Macro
3	MS<->SS	{ Uplink data }	Macro
4	SS->MS	PACKET DOWNLINK ASSIGNMENT	This message to be sent before the termination of the macro.
5	SS<->MS	{ Acknowledged downlink data }	Macro – Transmitting 10.000 octets of Data
6	MS->SS	CHANNEL REQUEST	The MS is made to initiate the establishment of an RR connection as soon as the first downlink packet is acknowledged.
7	SS->MS	IMMEDIATE ASSIGNMENT	
8	MS->SS	CM SERVICE REQUEST	
9	MS->SS	CLASSMARK CHANGE	
10	MS -> SS	GPRS INFORMATION	The MS sends an empty LLC PDU to indicate Cell Update.
Option al step			The MS may send a DTM REQUEST message at any time after the CLASSMARK CHANGE message was sent. The SS shall discard the message.
11	SS -> MS	AUTHENTICATION REQUEST	
12	MS -> SS	AUTHENTICATION RESPONSE	
13	SS -> MS	CIPHERING MODE COMMAND	
14	MS -> SS	CIPHERING MODE COMPLETE	
15	MS->SS	SETUP	
16	SS->MS	ASSIGNMENT COMMAND	Timeslot N (chosen arbitrarily) When: k=1, Channel Type = TCH/F; k=2, Channel Type = TCH/H;
17	MS->SS	ASSIGNMENT COMPLETE	
18	SS->MS	CALL PROCEEDING	
19	SS->MS	ALERTING	
20	MS		An alerting indication is given.
21	SS->MS	CONNECT	
22	MS->SS	CONNECT ACKNOWLEDGE	

41.5.2.4 MO CS establishment whilst in packet transfer mode and DTM is not supported in current cell

41.5.2.4.1 Conformance requirements

The GPRS suspension procedure shall be used to suspend GPRS services:

- a) when the mobile station in a class A mode of operation is handed over to a cell where the support of Class A mode of operation is not possible (e.g. a DTM mobile station entering a cell not supporting DTM)

In case a), when the mobile station concludes that DTM is not supported in the new cell after the handover procedure is completed, it shall initiate the GPRS suspension procedure by sending a GPRS SUSPENSION REQUEST message with the suspension cause set to “DTM not supported in the cell”.

References

3GPP TS 04.18/44.018, sub-clause 3.4.25.3

41.5.2.4.2 Test purpose

When an MS supporting DTM is operating in packet transfer mode in a cell that does not support DTM, the MS may be required to establish a CS connection. Upon receipt of the CS establishment request the MS completes the GPRS suspension procedure, establishes an RR connection and does not re-establish PS resources i.e. it does not enter DTM.

41.5.2.4.3 Method of test

Initial Conditions

System Simulator:

1 cell, DTM not supported, GPRS supported

Mobile Station:

The MS is in packet idle mode with a TMSI, P-TMSI allocated and PDP context 1 activated.

Specific PICS Statements

-

PIXIT Statements

-

Test Procedure

The MS is brought into packet transfer mode. A CS call is established. The MS returns to packet idle mode and initiates the establishment of CS connection. Once the MS has acquired the CS connection, the MS shall not request the re-establishment of the PS resources with a DTM REQUEST message until the CS connection has terminated.

Maximum Duration of Test

5 minutes

Expected Sequence

Step	Direction	Message	Comments
1	MS		Trigger the MS to initiate an uplink packet transfer containing 1000 octets.
2	MS<->SS	{ Uplink dynamic allocation two phase access }	Macro
3	MS<->SS	{ Uplink data }	Macro
4	MS->SS	CHANNEL REQUEST	The MS is made to initiate the establishment of an RR connection as soon as some uplink packets were received. This message to be received before the termination of the macro.
5	SS->MS	IMMEDIATE ASSIGNMENT	
6	MS->SS	CM SERVICE REQUEST	Message is contained in SABM
7	MS->SS	CLASSMARK CHANGE	
8	MS->SS	GPRS SUSPENSION REQUEST	Sent on the mainDCCH with suspension cause set to "DTM not supported in the cell"
9	SS -> MS	AUTHENTICATION REQUEST	
10	MS -> SS	AUTHENTICATION RESPONSE	
11	SS -> MS	CIPHERING MODE COMMAND	
12	MS -> SS	CIPHERING MODE COMPLETE	
13	MS->SS	SETUP	
14	SS->MS	CALL PROCEEDING	
15	SS->MS	ASSIGNMENT COMMAND	
16	MS->SS	ASSIGNMENT COMPLETE	Sent on the correct channel after establishment of the main signalling link
17	SS->MS	ALERTING	
18	SS->MS	CONNECT	
19	MS->SS	CONNECT ACKNOWLEDGE	
20	MS		The appropriate bearer channel is through connected in both directions.
21	SS		Maintain CS connection call for 30 seconds and check that no DTM Request is received
22	SS->MS	CHANNEL RELEASE	With a valid RR cause value and including the GPRS Resumption IE
23	MS		Trigger the MS to initiate an uplink packet transfer containing 1000 octets.
24		{Uplink dynamic allocation one phase access or two phase access }	
25	MS<->SS	{ Uplink data transfer }	Macro

41.5.3 PS establishment whilst in dual transfer mode

41.5.3.1 Uplink TBF establishment with a downlink TBF established

41.5.3.1.1 Uplink TBF establishment with a downlink TBF established and no PS downlink reallocation

41.5.3.1.1.1 Conformance requirements

The mobile station may request establishment of one or more uplink TBFs when there are one or more ongoing downlink TBFs by including a Channel Request Description or the Extended Channel Request Description information element in the (EGPRS) PACKET DOWNLINK ACK/NACK message. Initiation is triggered by a request from upper layers to transfer an upper layer PDU.

When multiple TBF procedures are not supported, the mobile station initiates the packet access procedure by sending the Channel Request Description information element in the (EGPRS) PACKET DOWNLINK ACK/NACK message on the PACCH and starting timer T3168.

On receipt of an (Extended) Channel Request Description information element in the (EGPRS)PACKET DOWNLINK ACK/NACK message, the network may assign radio resources to the mobile station on one or more PDCHs by transmitting an uplink assignment message (e.g. PACKET UPLINK ASSIGNMENT, MULTIPLE TBF UPLINK ASSIGNMENT, PACKET TIMESLOT RECONFIGURE or MULTIPLE TBF TIMESLOT RECONFIGURE message) on the PACCH, or may reject one or more of the requests by sending a PACKET ACCESS

REJECT message on the PACCH. If the PACKET TIMESLOT RECONFIGURE message is sent, then the message shall contain the UPLINK_TFI_ASSIGNMENT field.

On receipt of a PACKET UPLINK ASSIGNMENT or PACKET TIMESLOT RECONFIGURE message the mobile station shall stop timer T3168 and switch to the assigned PDCHs.

References

3GPP TS 04.60/44.060 sub-clause 8.1.2.5

On receipt of the PACKET RESOURCE REQUEST the network shall respond by sending a PACKET UPLINK ASSIGNMENT or PACKET TIMESLOT RECONFIGURE or a PACKET ACCESS REJECT message to the mobile station on the downlink PACCH.

On receipt of a PACKET UPLINK ASSIGNMENT or PACKET TIMESLOT RECONFIGURE message the mobile station shall stop timer T3168 and switch to the assigned PDCHs.

References

3GPP TS 04.60/44.060 sub-clause 8.1.1.1.2

41.5.3.1.1.2 Test purpose

To verify that the MS can be assigned uplink PS resources, when no reallocation of the existing CS and downlink PS resources is required.

41.5.3.1.1.3 Method of test

Initial Conditions

System Simulator:

1 cell, DTM supported.

Mobile Station:

The MS is in the state "idle, updated, GMM-registered, GPRS attached" with a TMSI, P-TMSI allocated and PDP context 1 has been established. The MS is also in the active state (U10) of a call on the cell.

Specific PICS Statements

-

PIXIT Statements

-

Test Procedure

Whilst in an active call on timeslot N, the MS receives a PACKET ASSIGNMENT message on the main DCCH, instructing the MS to switch to a designated timeslot and receive data. The SS then starts to transmit to the newly allocated resources. Before the SS completes transmission of the 1000 octets of data, the MS is triggered to initiate an uplink packet transfer. The SS then sends another RLC Downlink Data block to the MS with the S/P bit set to 1. The MS responds by sending a PACKET DOWNLINK ACK/NACK message to the SS including the Channel Request Description IE. The SS allocates uplink resources to the MS with the PACKET UPLINK ASSIGNMENT message. The test procedure is complete when the SS successfully verifies both uplink and downlink transmission are working in parallel.

MS supporting DTM shall complete testing for k=1 and MSs indicating support of single slot DTM shall additionally complete testing for k=2.

Maximum Duration of Test

5 minutes

Expected Sequence

The test sequence is repeated for $k = 1, 2$.

Step	Direction	Message	Comments
1	SS		MS in the active state (U10) of a call on Timeslot N of cell A. When: k=1, Channel Type = TCH/F; k=2, Channel Type = TCH/H.
2	SS->MS	PACKET ASSIGNMENT	See specific message contents.
3	SS<->MS	{ Downlink data transfer }	Macro – Transmission of 10k octets of data
4	MS		Before the completion of the downlink transmission, the MS is triggered to initiate an uplink packet transfer containing 1000 octets.
5	SS<->MS	{ Downlink data transfer }	RLC Downlink Data - S/P Bit = 1 Continue the { Downlink data transfer } until the MS include the Channel Request Description IE in the PACKET DOWNLINK ACK/NACK.
6	SS->MS	PACKET UPLINK ASSIGNMENT	When: k=1, Timeslot=T; and k=2, Timeslot=N.
7	SS		Verify both uplink and downlink data transmission is functioning correctly.

Specific Message Contents

PACKET ASSIGNMENT (Step 2):

k=1;

As default message contents except: RR Packet Uplink Assignment IE RR Packet Downlink Assignment IE - TIMESLOT_ALLOCATION	Not included T = (N ± 1) MOD 8
--	---------------------------------------

k=2;

As default message contents except: RR Packet Uplink Assignment IE RR Packet Downlink Assignment IE - TIMESLOT_ALLOCATION	Not included N
--	-----------------------

41.5.3.1.2 Uplink TBF establishment with a downlink TBF established and PS downlink reallocation

41.5.3.1.2.1 Conformance requirements

The mobile station may request establishment of an uplink transfer during a downlink TBF by including a Channel Request Description information element in the PACKET DOWNLINK ACK/NACK message. Initiation is triggered by a request from upper layers to transfer a LLC PDU.

The mobile station initiates the packet access procedure by sending the Channel Request Description information element in the PACKET DOWNLINK ACK/NACK message on the PACCH and starting timer T3168.

On receipt of a Channel Request Description information element in the PACKET DOWNLINK ACK/NACK message, the network may assign radio resources to the mobile station on one or more PDCHs by transmitting a PACKET UPLINK ASSIGNMENT or PACKET TIMESLOT RECONFIGURE message on the PACCH, or may reject the request by sending a PACKET ACCESS REJECT message on the PACCH.

On receipt of a PACKET UPLINK ASSIGNMENT or PACKET TIMESLOT RECONFIGURE message the mobile station shall stop timer T3168 and switch to the assigned PDCHs.

References

3GPP TS 04.60/44.060 sub-clause 8.1.1.1.2 – 8.1.2.5

41.5.3.1.2.2 Test purpose

To verify that the MS can be assigned uplink PS resources, when reallocation of the already downlink PS resources is required.

41.5.3.1.2.3 Method of test

Initial Conditions

System Simulator:

1 cell, DTM supported.

Mobile Station:

The MS is in the state "idle, updated, GMM-registered, GPRS attached" with a TMSI, P-TMSI allocated and PDP context 1 has been established. The MS is also in the active state (U10) of a call on the cell.

Specific PICS Statements

-

PIXIT Statements

-

Test Procedure

Whilst in an active call on timeslot N, the MS receives a PACKET ASSIGNMENT message on the main DCCH, instructing the MS to switch to a designated timeslot and receive data. The SS then starts to transmit to the newly allocated resources. Before the SS completes transmission of the 1000 octets of data, the MS is triggered to initiate uplink packet transfer. The SS then sends another RLC Downlink Data block to the MS with the S/P bit set to 1. The MS responds by sending a PACKET DOWNLINK ACK/NACK message to the SS including the Channel Request Description IE. The SS allocates uplink resources and reallocates the downlink resources of the MS with the PACKET TIMESLOT RECONFIGURE message. The test procedure is complete when the SS successfully verifies both uplink and downlink transmission are working in parallel.

Maximum Duration of Test

5 minutes

Expected Sequence

Step	Direction	Message	Comments
1	SS		MS in the active state (U10) of a call on Timeslot N of cell A, utilising a Channel Type set to TCH/F.
2	SS->MS	PACKET ASSIGNMENT	Allocates a Downlink TBF on Timeslot (N - 1) MOD 8.
3	SS<->MS	{ Downlink data transfer }	Macro – Transmission of 10k octets of Data
4	MS		Before the completion of the downlink transmission, the MS is triggered to initiate an uplink packet transfer containing 1000 octets.
5	SS->MS	RLC DOWNLINK DATA	S/P Bit =1
6	MS->SS	PACKET DOWNLINK ACK/NACK	Includes the Channel Request Description IE.
7	SS->MS	PACKET TIMESLOT RECONFIGURE	Where the timeslot is set to Timeslot (N + 1) MOD 8.
8	SS		Verify both uplink and downlink data transmission is functioning correctly.

41.5.3.2 Downlink TBF establishment with a uplink established

41.5.3.2.1 Downlink TBF establishment with a uplink TBF established and no PS uplink reallocation

41.5.3.2.1.1 Conformance requirements

During uplink transfer, the network may initiate a downlink TBF by sending a PACKET DOWNLINK ASSIGNMENT message, or a PACKET TIMESLOT RECONFIGURE, to the mobile station on the PACCH. If a PACKET TIMESLOT RECONFIGURE message is sent, then the message shall contain the DOWNLINK_TFI_ASSIGNMENT field. The multislot restrictions of the mobile station shall be observed.

References

3GPP TS 04.60/44.060 sub-clause 8.1.1.1.3

41.5.3.2.1.2 Test purpose

To verify that a downlink TBF can be established without reallocation of uplink PS resources, whilst maintaining DTM.

41.5.3.2.1.3 Method of test

Initial Conditions

System Simulator:

1 cell, DTM supported

Mobile Station:

The MS is in the active state (U10) of a call.

The MS is GPRS idle with a P-TMSI allocated and the PDP context 1 activated.

Specific PICS Statements

-

PIXIT Statements

-

Test Procedure

The MS, whilst in dedicated mode, is triggered to initiate packet uplink transfer of 1000 octets of data in RLC unacknowledged mode and sends a DTM REQUEST message. On receiving the DTM REQUEST message, requesting uplink resources, the SS assigns the MS an uplink TBF. The SS accomplishes the resource assignment by passing a PACKET ASSIGNMENT message to the MS. On receiving the PACKET ASSIGNMENT message, the MS starts to send RLC DATA BLOCKS to the SS on the assigned PDTCH. Once the MS has sent correctly approximately 500 octets, the SS transmits a PACKET DOWNLINK ASSIGNMENT message allocating the MS downlink packet resources. The test procedure is complete when the SS successfully verifies both uplink and downlink transmission are working in parallel.

MS supporting DTM shall complete testing for k=1 and MSs indicating support of single slot DTM shall additionally complete testing for k=2.

Maximum Duration of Test

5 minutes

Expected Sequence

The test sequence is repeated for k = 1,2.

Step	Direction	Message	Comments
1	SS		MS in the active state (U10) of a call on Timeslot N. When: k=1, Channel Type=TCH/F; k=2, Channel Type=TCH/H.
2	MS		Trigger the MS to initiate an uplink packet transfer containing 1000 octets.
3	MS->SS	DTM REQUEST	
4	SS->MS	PACKET ASSIGNMENT	Includes information on the Radio resources provided to the MS. See specific message contents.
5	MS<->SS	{ Uplink data }	Macro – Approximately 500 Octets
6	SS->MS	PACKET DOWNLINK ASSIGNMENT	When: k=1, Timeslot = $(N \pm 1) \text{ MOD } 8$; k=2, Timeslot =N.
7	SS		Verify both uplink and downlink data transmission is functioning correctly.

Specific Message Contents

PACKET ASSIGNMENT (Step 4):

k=1;

As default message contents except: RR Packet Uplink Assignment IE - TIMESLOT_ALLOCATION RR Packet Downlink Assignment IE	$(N \pm 1) \text{ MOD } 8$ Not included
--	--

k=2;

As default message contents except: RR Packet Uplink Assignment IE - TIMESLOT_ALLOCATION RR Packet Downlink Assignment IE	N Not included
--	-------------------

41.5.3.2.2 Downlink TBF establishment with a uplink TBF established and PS uplink reallocation

41.5.3.2.2.1 Conformance requirements

During uplink transfer, the network may initiate a downlink TBF by sending a PACKET TIMESLOT RECONFIGURE message to the MS on the PACCH. If uplink and downlink TBFs are already established, then the network may send a PACKET TIMESLOT RECONFIGURE message without DOWNLINK_TFI_ASSIGNMENT. The MS shall interpret this as a reassignment of the timeslot allocations of the concurrent uplink and downlink TBFs and the downlink TFI is not changed.

References

3GPP TS 04.60/44.060 sub-clause 8.1.1.1.3

41.5.3.2.2.2 Test purpose

To verify that a downlink TBF can be established with reallocation of the uplink PS resources, whilst maintaining DTM.

41.5.3.2.2.3 Method of test

Initial Conditions

System Simulator:

1 cell, DTM supported

Mobile Station:

The MS is in the active state (U10) of a call

The MS is GPRS idle with a P-TMSI allocated and the PDP context 1 activated.

Specific PICS Statements

-

PIXIT Statements

-

Test Procedure

The MS, whilst in dedicated mode, is triggered to initiate packet uplink transfer of 1000 octets of data and sends a DTM REQUEST message. On receiving the DTM REQUEST message, requesting uplink resources, the SS assigns the MS an uplink TBF. The SS accomplishes the resource assignment by passing a PACKET ASSIGNMENT message to the MS. On receiving the PACKET ASSIGNMENT message, the MS starts to send RLC DATA BLOCKS to the SS on the assigned PDTCH. Once the MS has sent correctly approximately 500 octets, the SS transmits a PACKET TIMESLOT RECONFIGURE message assigning the MS downlink packet resources and reallocating the MS uplink packet resources. The test procedure is complete when the SS successfully verifies both uplink and downlink transmission are working in parallel.

Maximum Duration of Test

5 minutes

Expected Sequence

Step	Direction	Message	Comments
1	SS		MS in the active state (U10) of a call on Timeslot N using TCH/F as a Channel Type.
2	MS		Trigger the MS to initiate an uplink packet transfer containing 1000 octets.
3	MS->SS	DTM REQUEST	
4	SS->MS	PACKET ASSIGNMENT	Allocates a Uplink TBF on Timeslot (N - 1) MOD 8.
5	MS<->SS	{ Uplink data }	Macro – Approximately 500 Octets
6	SS->MS	PACKET TIMESLOT RECONFIGURE	Where the timeslot is set to Timeslot (N + 1) MOD 8.
7	SS		Verify both uplink and downlink data transmission is functioning correctly.

Specific Message Contents

Packet Timeslot Reconfigure (Step 6)

As default message contents except: Global Packet Timing Advance - {0 1<TIMING_ADVANCE_VALUE>} {0 1<DOWNLINK_TFI_ASSIGNMENT> - Downlink TFI Assignment - - {0 1<USF_TN0>} - {0 1<USF_TN1>} - {0 1<USF_TN2>} - {0 1<USF_TN3>} - {0 1<USF_TN4>} - USF_TN4 - {0 1<USF_TN5>} - {0 1<USF_TN6>} - {0 1<USF_TN7>}	0 (timing advance value not present) 1 arbitrarily chosen 0 (Timeslot Allocation without Power Control Parameters) one slot arbitrarily chosen (N+1) and different from current slot (N-1) 0 (timeslot 0 not assigned) 0 (timeslot 1 not assigned) 0 (timeslot 2 not assigned) 0 (timeslot 3 not assigned) 1 (timeslot 4 assigned) arbitrarily chosen (default 000) 0 (timeslot 5 not assigned) 0 (timeslot 6 not assigned) 0(timeslot 7 not assigned)
--	--

41.5.4 Enhanced DTM CS Establishment

41.5.4.1 MT Call Establishment - No Reallocation of PS Resources

41.5.4.1.1 Conformance Requirements

The network initiates the RR connection establishment procedure by sending a PACKET CS COMMAND message to the mobile station on PACCH, encapsulating one of the following RR messages:

- DTM ASSIGNMENT COMMAND message (see sub-clause 8.9.2.1);

The network may allocate both a dedicated channel and radio resources on one or more PDCHs to be used by the mobile station and shall in this case send a DTM ASSIGNMENT COMMAND encapsulated in a PACKET CS COMMAND message. Having sent the DTM ASSIGNMENT COMMAND message, the network starts timer T3107, specified in 3GPP TS 44.018. The allocated dedicated channel shall be of TCH type. The network may also reallocate radio resources (PDCH(s)) in the DTM ASSIGNMENT COMMAND message. If both the RR Packet Uplink Assignment and the RR Packet Downlink Assignment information elements are omitted in the DTM ASSIGNMENT COMMAND the network implicitly indicates that the current radio resources shall be maintained. The mobile station shall act on the DTM ASSIGNMENT COMMAND message as specified in GPP TS 44.018. On receiving an encapsulated DTM ASSIGNMENT COMMAND message, the mobile station shall establish the main signalling link using the procedure described in 3GPP TS 44.018.

References

3GPP TS 44.060, sub-clauses 8.9.1.2, 8.9.2.1

41.5.4.1.2 Test Purpose

To verify that the MS reacts to CS establishment initiated by the NW whilst in packet transfer mode, by establishing an RR connection on the allocated circuit switched resources.

To verify that the MS continues to maintain an ongoing downlink TBF throughout the enhanced DTM CS establishment procedure.

41.5.4.1.3 Method of Test

Initial Conditions

System Simulator:

- 1 cell, Enhanced DTM supported.

Mobile Station:

- The MS is in packet idle mode, with a TMSI, P-TMSI allocated and PDP context 1 activated.
- The MS is in the GMM READY state.

Specific PICS Statements

- Support of Immediate Connect (TSPC_AddInfo_ImmConn)

PIXIT Statements

-

Test Procedure

The MS is brought into packet transfer mode for downlink TBF. The SS initiates the establishment of a mobile terminated circuit switched call by sending an encapsulated DTM ASSIGNMENT COMMAND on the PACCH. Upon receipt of the PACKET CS COMMAND, the MS initiates the establishment of the CS connection. It is checked that the MS maintains the downlink TBF throughout the enhanced DTM CS establishment procedure.

Maximum Duration of Test

5 minutes

Expected Sequence

Step	Direction	Message	Comments
1		{ Downlink TBF establishment }	Macro. A downlink TBF is established on timeslot N.
2	SS<->MS	{ Downlink data }	Macro.
3			It is checked that the MS continues to receive and acknowledge downlink data during Steps 4 to 18 below.
4	SS->MS	PACKET CS COMMAND	Sent on downlink PACCH. Encapsulates a DTM ASSIGNMENT COMMAND. See specific message contents.
5	MS->SS	PAGING RESPONSE	
6	MS->SS	CLASSMARK CHANGE	
7	SS->MS	AUTHENTICATION REQUEST	
8	MS->SS	AUTHENTICATION RESPONSE	
9	SS->MS	CIPHERING MODE COMMAND	
10	MS->SS	CIPHERING MODE COMPLETE	
11	SS->MS	SETUP	
12	MS->SS	CALL CONFIRMED	
			If the MS supports immediate connect then branch A applies. If the MS does not support immediate connect then branch B applies
A13	MS->SS	CONNECT	Continues at Step 17.
B13	MS->SS	ALERTING	
B14	MS		An alerting indication is given by the MS.
B15	MS		The MS is made to accept the call.
B16	MS->SS	CONNECT	
17	MS		The TCH shall be through connected in both directions.
18	SS->MS	CONNECT ACKNOWLEDGE	
19	SS<->MS	{ Downlink data transfer }	Macro.

Specific Message Contents

DTM ASSIGNMENT COMMAND (Step 4):

As default message contents except:	
Channel Description IE	
- TN	N+1 mod 8
- Channel Type	TCH/F
Channel Mode IE	Full Rate Version 1
RR Packet Uplink Assignment IE	Not included
RR Packet Downlink Assignment IE	Not included

41.5.4.2 MT Call Establishment - Reallocation of PS Resources - Allocation of New Downlink TBF

41.5.4.2.1 Conformance Requirements

The network initiates the RR connection establishment procedure by sending a PACKET CS COMMAND message to the mobile station on PACCH, encapsulating one of the following RR messages:

- DTM ASSIGNMENT COMMAND message (see sub-clause 8.9.2.1);

The network may allocate both a dedicated channel and radio resources on one or more PDCHs to be used by the mobile station and shall in this case send a DTM ASSIGNMENT COMMAND encapsulated in a PACKET CS COMMAND message. Having sent the DTM ASSIGNMENT COMMAND message, the network starts timer T3107, specified in 3GPP TS 44.018. The allocated dedicated channel shall be of TCH type. The network may also reallocate radio resources (PDCH(s)) in the DTM ASSIGNMENT COMMAND message. If both the RR Packet Uplink Assignment and the RR Packet Downlink Assignment information elements are omitted in the DTM ASSIGNMENT COMMAND the network implicitly indicates that the current radio resources shall be maintained. The mobile station shall act on the DTM ASSIGNMENT COMMAND message as specified in GPP TS 44.018. On receiving an encapsulated DTM ASSIGNMENT COMMAND message, the mobile station shall establish the main signalling link using the procedure described in 3GPP TS 44.018.

References

3GPP TS 44.060, sub-clauses 8.9.1.2, 8.9.2.1

41.5.4.2.2 Test Purpose

To verify that the MS reacts to CS establishment initiated by the NW whilst in packet transfer mode, by establishing an RR connection on the allocated circuit switched resources.

To verify that the MS continues to maintain an ongoing uplink TBF throughout the enhanced DTM CS establishment procedure.

To verify that the MS reacts to the establishment of a new downlink TBF during the enhanced DTM CS establishment procedure.

41.5.4.2.3 Method of Test

Initial Conditions

System Simulator:

- 1 cell, Enhanced DTM supported.

Mobile Station:

- The MS is in packet idle mode, with a TMSI, P-TMSI allocated and PDP context 1 activated.
- The MS is in the GMM READY state.

Specific PICS Statements

- Support of Immediate Connect (TSPC_AddInfo_ImmConn)

PIXIT Statements

-

Test Procedure

The MS is brought into packet transfer mode for uplink TBF. The SS initiates the establishment of a mobile terminated circuit switched call by sending an encapsulated DTM ASSIGNMENT COMMAND on the PACCH. The encapsulated DTM ASSIGNMENT COMMAND also contains parameters for a new downlink TBF. Upon receipt of the PACKET CS COMMAND, the MS initiates the establishment of the CS connection. It is checked that the MS responds to polling for downlink ack/nack on the new downlink TBF. It is checked that the MS maintains the uplink TBF throughout the enhanced DTM CS establishment procedure.

Maximum Duration of Test

5 minutes

Expected Sequence

Step	Direction	Message	Comments
1	MS		Trigger the MS to initiate an uplink packet transfer containing 1000 octets.
2		{ Uplink dynamic allocation two phase access }	Macro.
3	SS<->MS	{ Uplink data }	An uplink TBF is established on timeslot N.
4			Macro.
5	SS->MS	PACKET CS COMMAND	It is checked that the MS continues to transmit uplink data during Steps 5 to 21 below. Sent on downlink PACCH. Encapsulates a DTM ASSIGNMENT COMMAND. See specific message contents.
6	MS->SS	PAGING RESPONSE	
7	SS<->MS	{ Downlink data }	Macro.
8			It is checked that the MS continues to acknowledge downlink data during Steps 9 to 21 below.
9	MS->SS	CLASSMARK CHANGE	
10	SS->MS	AUTHENTICATION REQUEST	
11	MS->SS	AUTHENTICATION RESPONSE	
12	SS->MS	CIPHERING MODE COMMAND	
13	MS->SS	CIPHERING MODE COMPLETE	
14	SS->MS	SETUP	
15	MS->SS	CALL CONFIRMED	
			If the MS supports immediate connect then branch A applies. If the MS does not support immediate connect then branch B applies
A16	MS->SS	CONNECT	Continues at Step 20.
B16	MS->SS	ALERTING	
B17	MS		An alerting indication is given by the MS.
B18	MS		The MS is made to accept the call.
B19	MS->SS	CONNECT	
20	MS		The TCH shall be through connected in both directions.
21	SS->MS	CONNECT ACKNOWLEDGE	
22	SS<->MS	{ Downlink data transfer }	Macro.
23	SS<->MS	{ Uplink data transfer }	Macro.

Specific Message Contents

DTM ASSIGNMENT COMMAND (Step 5):

As default message contents except:	
Channel Description IE	
- TN	N+1 mod 8
- Channel Type	TCH/F
Channel Mode IE	Full Rate Version 1
RR Packet Uplink Assignment IE	Not included
- UPLINK_TFI_ASSIGNMENT	The value assigned in Step 2.
- USF_TNn	n = N
RR Packet Downlink Assignment IE	
- TIMESLOT ALLOCATION	N
- DOWNLINK_TFI_ASSIGNMENT	Any valid value.

41.5.4.3 MT Call Establishment - Allocation of CS Resources Only - Downlink TBF

41.5.4.3.1 Conformance Requirements

The network initiates the RR connection establishment procedure by sending a PACKET CS COMMAND message to the mobile station on PACCH, encapsulating one of the following RR messages:

- IMMEDIATE ASSIGNMENT message (see sub-clause 8.9.2.2).

The network may allocate only a dedicated channel to the mobile station and shall in this case send an IMMEDIATE ASSIGNMENT encapsulated in a PACKET CS COMMAND message. Having sent the IMMEDIATE ASSIGNMENT message, the network starts timer T3101, specified in 3GPP TS 44.018.

If a mobile station receives an encapsulated IMMEDIATE ASSIGNMENT message which either does not specify a starting time or specifies a starting time which has already elapsed, the mobile station shall immediately:

- perform an abnormal release without retry (see sub-clause 8.7.1), if no uplink TBF is in progress

The mobile station shall abort all TBFs on PDCH(s) in progress and report an RLC/MAC failure to upper layers.

Upon mobile originated or mobile terminated RR connection establishment, on receipt of IMMEDIATE ASSIGNMENT message while in packet transfer mode, the mobile station shall enter dedicated mode.

References

3GPP TS 44.060, sub-clauses 8.9.1.2, 8.9.2.2, 8.7.1

41.5.4.3.2 Test Purpose

To verify that the MS reacts to CS establishment initiated by the NW whilst in packet transfer mode, by establishing an RR connection on the allocated circuit switched resources.

To verify that the MS aborts an ongoing downlink TBF when during the enhanced DTM CS establishment procedure only circuit switched resources are allocated.

41.5.4.3.3 Method of Test

Initial Conditions

System Simulator:

- 1 cell, Enhanced DTM supported.

Mobile Station:

- The MS is in packet idle mode, with a TMSI, P-TMSI allocated and PDP context 1 activated.
- The MS is in the GMM READY state.

Specific PICS Statements

- Support of Immediate Connect (TSPC_AddInfo_ImmConn)

PIXIT Statements

-

Test Procedure

The MS is brought into packet transfer mode for downlink TBF. The SS initiates the establishment of a mobile terminated circuit switched call by sending an encapsulated IMMEDIATE ASSIGNMENT message on the PACCH. Upon receipt of the PACKET CS COMMAND, the MS initiates the establishment of the CS connection. It is checked that the MS no longer responds to polling on the old packet switched resources.

Maximum Duration of Test

5 minutes

Expected Sequence

Step	Direction	Message	Comments
1		{ Downlink TBF establishment }	Macro. A downlink TBF is established.
2	SS<->MS	{ Acknowledged Downlink data }	Macro.
3	SS->MS	PACKET CS COMMAND	Sent on downlink PACCH. Encapsulates an IMMEDIATE ASSIGNMENT message. See specific message contents.
4			It is checked that the MS does not respond to polling on the old PS resources during Steps 5 to 20 below.
5	MS->SS	PAGING RESPONSE	
6	MS->SS	CLASSMARK CHANGE	
7	SS->MS	AUTHENTICATION REQUEST	
8	MS->SS	AUTHENTICATION RESPONSE	
9	SS->MS	CIPHERING MODE COMMAND	
10	MS->SS	CIPHERING MODE COMPLETE	
11	SS->MS	SETUP	
12	MS->SS	CALL CONFIRMED	
			If the MS supports immediate connect then branch A applies. If the MS does not support immediate connect then branch B applies Continues at Step 17.
A13	MS->SS	CONNECT	
B13	MS->SS	ALERTING	
B14	MS		An alerting indication is given by the MS.
B15	MS		The MS is made to accept the call.
B16	MS->SS	CONNECT	
17	SS->MS	ASSIGNMENT COMMAND	See specific message contents.
18	MS->SS	ASSIGNMENT COMPLETE	
19	MS		The TCH shall be through connected in both directions.
20	SS->MS	CONNECT ACKNOWLEDGE	

Specific Message Contents

IMMEDIATE ASSIGNMENT (Step 3):

As default message contents except: Channel Description IE - Channel Type	SDCCH/4
---	---------

ASSIGNMENT COMMAND (Step 17):

As default message contents except: Channel Description IE - Channel Type Channel Mode IE	TCH/F Full Rate Version 1
--	------------------------------

41.5.4.4 MO Call Establishment - No Reallocation of PS Resources

41.5.4.4.1 Conformance Requirements

The mobile station shall initiate the RR connection establishment by sending PACKET CS REQUEST messages on the PACCH.

Upon receipt of a PACKET CS REQUEST message, the network shall answer to the mobile station by encapsulating one of the following RR messages in the PACKET CS COMMAND message, and sending the PACKET CS COMMAND message on PACCH:

- DTM ASSIGNMENT COMMAND message (see sub-clause 8.9.2.1);

The network may allocate both a dedicated channel and radio resources on one or more PDCHs to be used by the mobile station and shall in this case send a DTM ASSIGNMENT COMMAND encapsulated in a PACKET CS

COMMAND message. The allocated dedicated channel shall be of TCH type. If both the RR Packet Uplink Assignment and the RR Packet Downlink Assignment information elements are omitted in the DTM ASSIGNMENT COMMAND the network implicitly indicates that the current radio resources shall be maintained.

References

3GPP TS 44.060, sub-clauses 8.9.1.1.1, 8.9.1.1.2, 8.9.2.1

41.5.4.4.2 Test Purpose

To verify that following the sending of the PACKET CS REQUEST on PACCH whilst in packet transfer mode, the MS establishes an RR connection on the allocated circuit switched resources.

To verify that the MS continues to maintain an ongoing uplink TBF throughout the enhanced DTM CS establishment procedure.

41.5.4.4.3 Method of Test

Initial Conditions

System Simulator:

- 1 cell, Enhanced DTM supported.

Mobile Station:

- The MS is in packet idle mode, with a TMSI, P-TMSI allocated and PDP context 1 activated.
- The MS is in the GMM READY state.

Specific PICS Statements

-

PIXIT Statements

-

Test Procedure

The MS is brought into packet transfer mode for uplink TBF. The user is made to initiate the establishment of a mobile originated circuit switched call. The MS sends the PACKET CS REQUEST message on PACCH. The NW responds by sending an encapsulated DTM ASSIGNMENT COMMAND on the PACCH. The encapsulated DTM ASSIGNMENT COMMAND contains neither the RR Packet Uplink Assignment IE nor the RR Packet Downlink Assignment IE. Upon receipt of the PACKET CS COMMAND, the MS initiates the establishment of the CS connection. It is checked that the MS maintains the uplink TBF throughout the enhanced DTM CS establishment procedure.

Maximum Duration of Test

5 minutes

Expected Sequence

Step	Direction	Message	Comments
1	MS		Trigger the MS to initiate an uplink packet transfer containing 1000 octets.
2		{ Uplink dynamic allocation two phase access }	Macro.
3	SS<->MS	{ Uplink data }	An uplink TBF is established on timeslot N.
4			Macro.
5	MS->SS	PACKET CS REQUEST	The user is made to trigger the establishment of a mobile originated speech call. Sent on uplink PACCH.
6	SS->MS	PACKET CS COMMAND	Establishment Cause = Mobile Originated Speech Call Sent on downlink PACCH.
7			Encapsulates a DTM ASSIGNMENT COMMAND. See specific message contents. It is checked that the MS continues to transmit uplink data during Steps 8 to 19 below.
8	MS->SS	CM SERVICE REQUEST	
9	MS->SS	CLASSMARK CHANGE	
10	SS->MS	AUTHENTICATION REQUEST	
11	MS->SS	AUTHENTICATION RESPONSE	
12	SS->MS	CIPHERING MODE COMMAND	
13	MS->SS	CIPHERING MODE COMPLETE	
14	MS->SS	SETUP	
15	SS->MS	CALL PROCEEDING	
16	SS->MS	ALERTING	
17	SS->MS	CONNECT	
18	MS		The TCH shall be through connected in both directions.
19	MS->SS	CONNECT ACKNOWLEDGE	

Specific Message Contents

DTM ASSIGNMENT COMMAND (Step 6):

As default message contents except: Channel Description IE - TN - Channel Type Channel Mode IE RR Packet Uplink Assignment IE RR Packet Downlink Assignment IE	N+1 mod 8 TCH/F Full Rate Version 1 Not included. Not included.
--	---

41.5.4.5 MO Call Establishment - Reallocation of PS Resources

41.5.4.5.1 Conformance Requirements

The mobile station shall initiate the RR connection establishment by sending PACKET CS REQUEST messages on the PACCH.

Upon receipt of a PACKET CS REQUEST message, the network shall answer to the mobile station by encapsulating one of the following RR messages in the PACKET CS COMMAND message, and sending the PACKET CS COMMAND message on PACCH:

- DTM ASSIGNMENT COMMAND message (see sub-clause 8.9.2.1);

The network may allocate both a dedicated channel and radio resources on one or more PDCHs to be used by the mobile station and shall in this case send a DTM ASSIGNMENT COMMAND encapsulated in a PACKET CS COMMAND message. The allocated dedicated channel shall be of TCH type. The network may also reallocate radio resources (PDCH(s)) in the DTM ASSIGNMENT COMMAND message.

References

3GPP TS 44.060, sub-clauses 8.9.1.1.1, 8.9.1.1.2, 8.9.2.1

41.5.4.5.2 Test Purpose

To verify that following the sending of the PACKET CS REQUEST on PACCH whilst in packet transfer mode, the MS establishes an RR connection on the allocated circuit switched resources.

To verify that the MS continues to maintain an ongoing downlink TBF following the re-allocation of the packet switched resources during the enhanced DTM CS establishment procedure.

41.5.4.5.3 Method of Test

Initial Conditions

System Simulator:

- 1 cell, Enhanced DTM supported.

Mobile Station:

- The MS is in packet idle mode, with a TMSI, P-TMSI allocated and PDP context 1 activated.
- The MS is in the GMM READY state.

Specific PICS Statements

-

PIXIT Statements

-

Test Procedure

The MS is brought into packet transfer mode for downlink TBF. The user is made to initiate the establishment of a mobile originated circuit switched call. The MS sends the PACKET CS REQUEST message on PACCH. The NW responds by sending an encapsulated DTM ASSIGNMENT COMMAND on the PACCH. The encapsulated DTM ASSIGNMENT COMMAND reallocates the packet switched resources for the ongoing downlink TBF. Upon receipt of the PACKET CS COMMAND, the MS initiates the establishment of the CS connection. It is checked that the MS responds to polling on the new packet switched resources.

Maximum Duration of Test

5 minutes

Expected Sequence

Step	Direction	Message	Comments
1		{ Downlink TBF establishment }	Macro. A downlink TBF is established on timeslot N.
2	SS<->MS	{ Acknowledged Downlink data }	Macro.
3			The user is made to trigger the establishment of a mobile originated speech call.
4	MS->SS	PACKET CS REQUEST	Sent on uplink PACCH. Establishment Cause = Mobile Originated Speech Call
5	SS->MS	PACKET CS COMMAND	Sent on downlink PACCH. Encapsulates a DTM ASSIGNMENT COMMAND. See specific message contents.
6			It is checked that the MS responds to polling on the new packet switched resources during Steps 7 to 18 below.
7	MS->SS	CM SERVICE REQUEST	
8	MS->SS	CLASSMARK CHANGE	
9	SS->MS	AUTHENTICATION REQUEST	
10	MS->SS	AUTHENTICATION RESPONSE	
11	SS->MS	CIPHERING MODE COMMAND	
12	MS->SS	CIPHERING MODE COMPLETE	
13	MS->SS	SETUP	
14	SS->MS	CALL PROCEEDING	
15	SS->MS	ALERTING	
16	SS->MS	CONNECT	
17	MS		The TCH shall be through connected in both directions.
18	MS->SS	CONNECT ACKNOWLEDGE	

Specific Message Contents

DTM ASSIGNMENT COMMAND (Step 5):

As default message contents except: Channel Description IE - TN - Channel Type Channel Mode IE RR Packet Uplink Assignment IE RR Packet Downlink Assignment IE - TIMESLOT ALLOCATION - DOWNLINK_TFI_ASSIGNMENT	N+1 mod 8 TCH/F Full Rate Version 1 Not included. N+2 mod 8 The value assigned in Step 1.
--	--

41.5.4.6 MO Call Establishment - Allocation of CS Resources Only - Downlink TBF

41.5.4.6.1 Conformance Requirements

The mobile station shall initiate the RR connection establishment by sending PACKET CS REQUEST messages on the PACCH.

Upon receipt of a PACKET CS REQUEST message, the network shall answer to the mobile station by encapsulating one of the following RR messages in the PACKET CS COMMAND message, and sending the PACKET CS COMMAND message on PACCH:

- IMMEDIATE ASSIGNMENT message (see sub-clause 8.9.2.2);

The network may allocate only a dedicated channel to the mobile station and shall in this case send an IMMEDIATE ASSIGNMENT encapsulated in a PACKET CS COMMAND message.

If a mobile station receives an encapsulated IMMEDIATE ASSIGNMENT message which either does not specify a starting time or specifies a starting time which has already elapsed, the mobile station shall immediately:

- perform an abnormal release without retry (see sub-clause 8.7.1), if no uplink TBF is in progress,

The mobile station shall abort all TBFs on PDCH(s) in progress and report an RLC/MAC failure to upper layers.

Upon mobile originated or mobile terminated RR connection establishment, on receipt of IMMEDIATE ASSIGNMENT message while in packet transfer mode, the mobile station shall enter dedicated mode.

References

3GPP TS 44.060, sub-clauses 8.9.1.1.1, 8.9.1.1.2, 8.9.2.2, 8.7.1

41.5.4.6.2 Test Purpose

To verify that following the sending of the PACKET CS REQUEST on PACCH whilst in packet transfer mode, the MS establishes an RR connection on the allocated circuit switched resources.

To verify that the MS aborts an ongoing downlink TBF when during the enhanced DTM CS establishment procedure only packet switched resources are allocated.

41.5.4.6.3 Method of Test

Initial Conditions

System Simulator:

- 1 cell, Enhanced DTM supported.

Mobile Station:

- The MS is in packet idle mode, with a TMSI, P-TMSI allocated and PDP context 1 activated.
- The MS is in the GMM READY state.

Specific PICS Statements

-

PIXIT Statements

-

Test Procedure

The MS is brought into packet transfer mode for downlink TBF. The user is made to initiate the establishment of a mobile originated circuit switched call. The MS sends the PACKET CS REQUEST message on PACCH. The NW responds by sending an encapsulated IMMEDIATE ASSIGNMENT message on the PACCH. Upon receipt of the PACKET CS COMMAND, the MS initiates the establishment of the CS connection. It is checked that the MS no longer responds to polling on the old packet switched resources.

Maximum Duration of Test

5 minutes

Expected Sequence

Step	Direction	Message	Comments
1		{ Downlink TBF establishment }	Macro. A downlink TBF is established.
2	SS<->MS	{ Acknowledged Downlink data }	Macro.
3			The user is made to trigger the establishment of a mobile originated speech call.
4	MS->SS	PACKET CS REQUEST	Sent on uplink PACCH. Establishment Cause = Mobile Originated Speech Call
5	SS->MS	PACKET CS COMMAND	Sent on downlink PACCH. Encapsulates an IMMEDIATE ASSIGNMENT message. See specific message contents.
6			It is checked that the MS does not respond to polling on the old PS resources during Steps 7 to 20 below.
7	MS->SS	CM SERVICE REQUEST	
8	MS->SS	CLASSMARK CHANGE	
9	SS->MS	AUTHENTICATION REQUEST	
10	MS->SS	AUTHENTICATION RESPONSE	
11	SS->MS	CIPHERING MODE COMMAND	
12	MS->SS	CIPHERING MODE COMPLETE	
13	MS->SS	SETUP	
14	SS->MS	CALL PROCEEDING	
15	SS->MS	ALERTING	
16	SS->MS	CONNECT	
17	SS->MS	ASSIGNMENT COMMAND	See specific message contents.
18	MS->SS	ASSIGNMENT COMPLETE	
19	MS		The TCH shall be through connected in both directions.
20	MS->SS	CONNECT ACKNOWLEDGE	

Specific Message Contents

IMMEDIATE ASSIGNMENT (Step 5):

As default message contents except: Channel Description IE - Channel Type	SDCCH/4
---	---------

ASSIGNMENT COMMAND (Step 17):

As default message contents except: Channel Description IE - Channel Type Channel Mode IE	TCH/F Full Rate Version 1
--	------------------------------

41.5.4.7 MO Call Establishment – IMMEDIATE ASSIGNMENT REJECT

41.5.4.7.1 Conformance Requirements

The mobile station shall initiate the RR connection establishment by sending PACKET CS REQUEST messages on the PACCH. The mobile station is allowed to retransmit the PACKET CS REQUEST message once while timer T3196 is running. The second sending occurrence of this message shall take place at the first suitable opportunity at least 0.75 s after the first transmission of that message.

Upon receipt of a PACKET CS REQUEST message, the network shall answer to the mobile station by encapsulating one of the following RR messages in the PACKET CS COMMAND message, and sending the PACKET CS COMMAND message on PACCH:

- IMMEDIATE ASSIGNMENT REJECT message (see sub-clause 8.9.2.3).

If no dedicated channel is available for assignment, the network may send to the mobile station an IMMEDIATE ASSIGNMENT REJECT message encapsulated in a PACKET CS COMMAND message.

On receipt of the encapsulated IMMEDIATE ASSIGNMENT REJECT message the mobile station shall stop sending PACKET CS REQUEST messages, starts timer T3122 with the indicated value ("wait indication" information element, specified in 3GPP TS 44.018) and continue in packet transfer mode.

The behaviour of the mobile station while timer T3122 is running is specified in 3GPP TS 44.018.

References

3GPP TS 44.060 , sub-clauses 8.9.1.1.1, 8.9.1.1.2, 8.9.2.3

41.5.4.7.2 Test Purpose

To verify that when MS receives IMMEDIATE ASSIGNMENT REJECT encapsulated in Packet CS command it waits until the expiry of T3122 before sending further PACKET CS REQUEST.

To verify that MS continues with the ongoing TBF after receiving IMMEDIATE ASSIGNMENT REJECT.

41.5.4.7.3 Method of Test

Initial Condition

System simulator

- 1 cell, Enhanced DTM supported

Mobile Station:

- The MS is in packet idle mode, with a TMSI, P-TMSI allocated and PDP context 1 activated.
- The MS is in the GMM READY state.

Specific PICS Statements

-

PIXIT Statements

-

Test Procedure

MS is brought into Packet transfer mode for uplink and downlink TBF. The user is made to initiate the establishment of mobile originated call. The MS sends PACKET CS REQUEST message on PACCH. The network responds by sending an encapsulated IMMEDIATE ASSIGNMENT REJECT with the Wait Indication on the PACCH. Upon receipt of PACKET CS COMMAND, the MS waits for T3122 expiry before repeating further request for MO call. It is checked that MS continues to operate on both uplink and downlink TBF.

Maximum Duration of Test

5 minutes

Expected Sequence

Step	Direction	Message	Comments
1		{ Uplink dynamic allocation two phase access }	n = 440 octets, without starting time, USF GRANULARITY = 1 block, RLC_DATA_BLOCKS_GRANTED = open-end TLLI_BLOCK_CHANNEL_CODING: arbitrarily chosen CHANNEL_CODING_COMMAND: cs-1
2	SS -> MS	PACKET DOWNLINK DUMMY CONTROL BLOCK	Assigned USF addressing the MS, sent 3 blocks from the last radio block containing the uplink assignment in step 1.
3	MS->SS	UPLINK RLC DATA BLOCK	Sent on the PACCH, assigning a downlink TBF, MAC mode = dynamic allocation, RLC mode = unacknowledged, single timeslot, no starting time.
4	SS->MS	PACKET DOWNLINK ASSIGNMENT	
5	SS -> MS	DOWNLINK RLC DATA BLOCK	Sent on the downlink PDTCH, 3 blocks from the last radio block containing the downlink assignment. USF assigned to the MS.
6	MS -> SS	UPLINK RLC DATA BLOCK	Received on the uplink PDTCH assigned in step 1.
7			The user is made to trigger the establishment of Mobile originated Speech call.
8	SS->MS	PACKET DOWNLINK DUMMY CONTROL BLOCK	Assigned USF addressing the MS
9	MS -> SS	UPLINK RLC DATA BLOCK OR PACKET CS REQUEST	Uplink data sent on the uplink PDTCH. Or Packet CS Request sent on uplink PACCH Establishment Cause = Mobile Originated Call
10	SS->MS	DOWNLINK RLC DATA BLOCK	SS transmits RLC data block with valid RRBP field (polling).
11	MS->SS	PACKET DOWNLINK ACK/NACK OR PACKET CS REQUEST	MS acknowledges the previously received RLC data blocks. Sent in block specified by RRBP field. Or Packet CS Request sent on uplink PACCH Establishment Cause = Mobile Originated Call
12			Steps 8 to 11 are repeated until a PACKET CS REQUEST is sent by MS.
13	SS->MS	PACKET CS COMMAND	Sent on Downlink PACCH Encapsulates IMMEDIATE ASSIGNMENT REJECT with Waiting time indication value T3122 = 50s
14	SS->MS	PACKET DOWNLINK DUMMY CONTROL BLOCK	Assigned USF addressing the MS
15	MS -> SS	UPLINK RLC DATA BLOCK OR PACKET CS REQUEST	Uplink data sent on the uplink PDTCH. Or Packet CS Request sent on uplink PACCH
16	SS->MS	DOWNLINK RLC DATA BLOCK	SS transmits RLC data block with valid RRBP field (polling).
17	MS->SS	PACKET DOWNLINK ACK/NACK OR PACKET CS REQUEST	MS acknowledges the previously received RLC data blocks. Sent in block specified by RRBP field. Or Packet CS Request sent on uplink PACCH
18			Steps 14 to 17 are repeated until a PACKET CS REQUEST is sent by MS. SS verifies that the PACKET CS REQUEST does not arrive before $T3122 - 0.1 * T3122 (=45s)$ after last IMMEDIATE ASSIGNMENT REJECT message

Specific Message Content

None.

41.5.4.8 MO Call Establishment - Dedicated Channel Establishment Failure

41.5.4.8.1 Conformance Requirements

The network may allocate both a dedicated channel and radio resources on one or more PDCHs to be used by the mobile station and shall in this case send a DTM ASSIGNMENT COMMAND encapsulated in a PACKET CS COMMAND message. Having sent the DTM ASSIGNMENT COMMAND message, the network starts timer T3107, specified in 3GPP TS 44.018. The allocated dedicated channel shall be of TCH type

- If the mobile fails to establish the main signalling link, it shall perform an abnormal release with RR connection establishment retry (see sub-clause 8.7.4).

mobile station shall abort all TBFs in progress and report an RLC/MAC failure to upper layers. The mobile station in packet transfer mode shall return to the CCCH configuration, enter packet idle mode and initiate the establishment of the RR connection as specified in 3GPP TS 44.018.

References

3GPP TS 44.060, sub-clauses 8.7.4,8.9.2.1,8.9.4.1

41.5.4.8.2 Test Purpose

To verify that MS aborts all TBF in progress when it fails to establish the main signalling link after receiving the PACKET CS COMMAND.

To verify that during procedure of establishment of the main DCCH link MS is using the new PS resources re-allocated in PACKET CS COMMAND.

To verify MS initiate establishment of circuit switch connection in CCCH configuration.

41.5.4.8.3 Method of Test

Initial Conditions

System Simulator:

- 1 cell, Enhanced DTM supported.

Mobile Station:

- The MS is in packet idle mode, with a TMSI, P-TMSI allocated and PDP context 1 activated.
- The MS is in the GMM READY state.

Specific PICS Statements

-

PIXIT Statements

-

Test Procedure

The MS is brought into packet transfer mode for uplink and downlink. The user is made to initiate the establishment of mobile originated call. The MS sends PACKET CS REQUEST message on PACCH. The network responds by sending an encapsulated DTM ASSIGNMENT COMMAND which reallocates the PS resources. Upon receipt of PACKET CS COMMAND, the MS initiates establishment of CS connection, meanwhile the uplink and downlink data transfer continues on the new allocated PS resources. There is no response on the main DCCH from the network. The MS establish CS call using CCCH procedure. It is checked that MS neither uses the old PS resources nor the new PS resources.

Maximum Duration of Test

10 minutes

Expected Sequence

Step	Direction	Message	Comments
1		{ Uplink dynamic allocation two phase access }	n = 440 octets, without starting time, USF_GRANULARITY = 1 block, RLC_DATA_BLOCKS_GRANTED = open-end TLLI_BLOCK_CHANNEL_CODING: arbitrarily chosen CHANNEL_CODING_COMMAND: cs-1 An uplink TBF is established on timeslot N.
2	SS -> MS	PACKET DOWNLINK DUMMY CONTROL BLOCK	Assigned USF addressing the MS, sent on 3 blocks from the last radio block containing the uplink assignment in step 1.
3	MS->SS	UPLINK RLC DATA BLOCK	
4	SS->MS	PACKET DOWNLINK ASSIGNMENT	Sent on the PACCH, assigning a downlink TBF, MAC mode = dynamic allocation, RLC mode = unacknowledged, single timeslot, no starting time.
5	SS -> MS	DOWNLINK RLC DATA BLOCK	Sent on the downlink PDTCH on 3 blocks from the last radio block containing the downlink assignment. USF assigned to the MS.
6	MS -> SS	UPLINK RLC DATA BLOCK	Received on the uplink PDTCH assigned in step 1.
7			The user is made to trigger the establishment of Mobile originated Speech call.
8	SS->MS	PACKET DOWNLINK DUMMY CONTROL BLOCK	Assigned USF addressing the MS
9	MS -> SS	UPLINK RLC DATA BLOCK OR PACKET CS REQUEST	Uplink data sent on the uplink PDTCH. Or Packet CS Request sent on uplink PACCH Establishment Cause = Mobile Originated Call
10	SS->MS	DOWNLINK RLC DATA BLOCK	SS transmits RLC data block with valid RRBp field (polling).
11	MS->SS	PACKET DOWNLINK ACK/NACK OR PACKET CS REQUEST	MS acknowledges the previously received RLC data blocks. Sent in block specified by RRBp field. Or Packet CS Request sent on uplink PACCH Establishment Cause = Mobile Originated Call
12			Steps 8 to 11 are repeated until a PACKET CS REQUEST is sent by MS.
13	SS->MS	PACKET CS COMMAND	Send on Downlink PACCH. Encapsulates a DTM ASSIGNMENT COMMAND. See specific message contents.
14			There is no response to MS attempting to establish main DCCH. Verify both uplink and downlink data transmission is functioning correctly on the new PS resources.
15	SS		It is checked that MS neither respond to polling for downlink data nor send uplink data block. This verified on the old and the new PS resources during steps 12 to 27.
16	MS->SS	CHANNEL REQUEST	
17	SS->SS	IMMEDIATE ASSIGNMENT	
18	MS->SS	CM SERVICE REQUEST	
19	MS ->SS	CLASSMARK CHANGE	
20 (Optional step)	MS->SS	GPRS INFORMATION	The MS may send an empty LLC PDU to indicate Cell Update. The MS shall send a DTM REQUEST message .The sending of this message can take place at any time after the CLASSMARK CHANGE message was sent. The SS shall discard the message.
21	SS ->MS	AUTHENTICATION REQUEST	
22	MS ->SS	AUTHENTICATION RESPONSE	
23	SS ->MS	CIPHERING MODE COMMAND	

24	MS ->SS	CIPHERING MODE COMPLETE	
25	MS ->SS	SETUP	
26	SS->MS	ASSIGNMENT COMMAND	Timeslot N (chosen arbitrarily) When: Channel Type = TCH/F;
27	MS->SS	ASSIGNMENT COMPLETE	
28	SS ->MS	CALL PROCEEDING	
29	SS ->MS	ALERTING	
30	SS ->MS	CONNECT	
31	MS		The TCH shall be through connected in both directions.
32	MS ->SS	CONNECT ACKNOWLEDGE	

Specific Message Contents

DTM ASSIGNMENT COMMAND (Step 13):

As default message contents except: Channel Description IE - TN - Channel Type Channel Mode IE RR Packet Uplink Assignment IE - TIMESLOT ALLOCATION - UPLINK_TFI_ASSIGNMENT RR Packet Downlink Assignment IE - TIMESLOT ALLOCATION - DOWNLINK_TFI_ASSIGNMENT	N+1 mod 8 TCH/F Full Rate Version 1 N+2 mod 8 The value assigned in Step 1. N+2 mod 8 Any valid value.
--	--

41.5.5 Enhanced DTM CS Release

41.5.5.1 SI Aquisition - No Reallocation of PS Resources

41.5.5.1.1 Conformance Requirements

If the mobile station and the network support enhanced DTM CS release procedure, the network may delay the release of the RR connection until the mobile station has received the needed system information, in order to maintain the radio resources on the PDCH(s) after the release of the RR connection.

The network initiates enhanced DTM CS release procedure by sending the PACKET CS RELEASE INDICATION message as specified in 3GPP TS 44.060.

On receipt of PACKET CS RELEASE INDICATION message with the ENHANCED_DTM_CS_RELEASE_INDICATION parameter set to indicate that the RR connection is released, the mobile station shall send the PACKET SI STATUS (respectively PACKET PSI STATUS if the PBCCH is present) message on PACCH to indicate which system information messages were stored while in the dual transfer mode by the mobile station. The following system information (respectively packet system information) messages are required to maintain radio resources and enter packet transfer mode after the release of the RR connection:

- PSI1, PSI2 and PSI14 in the *Received PSI Message List*; or respectively
- SI13, SI3 and SI1, if present, in the *Received SI Message List*.

The PSI (respectively SI) messages listed above shall be indicated as the first PSI (respectively SI) messages indicated in the PACKET PSI STATUS (respectively PACKET SI STATUS) messages. If other PSI (respectively SI) messages are indicated in the PACKET PSI STATUS (respectively PACKET SI STATUS) message, the priority order defined in Table 5.5.1.4.3.1 shall apply.

The mobile station is allowed to send the PACKET SI STATUS (respectively PACKET PSI STATUS) message twice and the second sending occurrence of this message shall take place at the first suitable opportunity at least one second after the first transmission of that message. Whenever the mobile station has received all required system information (respectively packet system information) messages, it shall send the PACKET SI STATUS (respectively PACKET PSI STATUS) message at the first suitable opportunity, even if it has already sent the PACKET SI STATUS (respectively PACKET PSI STATUS) twice.

When the network receives the PACKET SI STATUS (respectively PACKET PSI STATUS) message indicating that all required system information (respectively packet system information) messages have been received by the mobile station it shall stop timer T3197, start timer T3109 (see 3GPP TS 44.018) and send the CHANNEL RELEASE message on the main DCCH indicating that the mobile station is allowed to continue in packet transfer mode after the release of the RR connection (see 3GPP TS 44.018).

References

3GPP TS 44.018 sub-clauses 3.4.13.1.1a

3GPP TS 44.060, sub-clauses 5.5.1.1b.5

41.5.5.1.2 Test Purpose

To verify that the MS performs the acquisition of system information in response to the PACKET CS RELEASE INDICATION message from the NW with the ENHANCED_DTM_CS_RELEASE_INDICATION indicating that the RR connection is released.

To verify that during the acquisition of system information procedure performed as part of the Enhanced DTM CS Release procedure, the MS sends the PACKET SI STATUS message no more than twice when acquiring the system information and then once more only when all the required system information has been acquired.

To verify that the MS continues to maintain an ongoing uplink TBF throughout the Enhanced DTM CS Release procedure and once the Enhanced DTM CS Release procedure has been completed.

41.5.5.1.3 Method of Test

Initial Conditions

System Simulator:

- 2 cells A and B with the same MCC/MNC/LAC/RAC, Enhanced DTM supported.

Mobile Station:

- The MS is in the active state (U10) of a call on Cell A.
- The MS is in packet idle mode, with a TMSI, P-TMSI allocated and PDP context 1 activated.

Specific PICS Statements

-

PIXIT Statements

-

Test Procedure

The MS, whilst in dedicated mode, is triggered to initiate packet uplink transfer data in RLC unacknowledged mode and sends a DTM REQUEST message. On receipt of the DTM REQUEST message, requesting uplink resources, the SS assigns the MS PS resource using a PACKET ASSIGNMENT message. Following handover to Cell B, the active speech call is disconnected. The SS sends the PACKET CS RELEASE INDICATION message on PACCH to the MS indicating that the RR connection is going to end. The PACKET CS RELEASE INDICATION indicates that when the RR connection is released the MS maintains its downlink and/or uplink TBF(s). The MS responds with the PACKET SI STATUS message on PACCH which indicates the non receipt of the SI1 and SI3 messages. In response the SS sends the PACKET SERVING CELL SI message on PACCH encapsulating the SI1 message. The MS again sends the PACKET SI STATUS message on PACCH which indicates reception of the SI1 message but not the SI3 message. In response the SS sends the PACKET SERVING CELL SI message on PACCH encapsulating the SI13 message. It is checked that the two PACKET SI STATUS messages from the MS are sent at least 1s apart. Finally the SS sends the PACKET SERVING CELL SI message on PACCH encapsulating the SI3 message. The MS responds with the PACKET SI STATUS message indicating receipt of the SI1 and SI3 messages. The SS sends the CHANNEL RELEASE message on the main DCCH indicating in the Enhanced DTM Release Indication IE that the MS may continue in packet transfer mode. It is checked that the MS continues operating the uplink TBF by sending RLC data blocks on the PS resources.

Maximum Duration of Test

5 minutes

Expected Sequence

Step	Direction	Message	Comments
1	MS		MS in the active state (U10) of a call on Timeslot N. Trigger the MS to initiate an uplink packet transfer containing 1000 octets.
2	MS->SS	DTM REQUEST	
3	SS->MS	PACKET ASSIGNMENT	See specific message contents.
4	SS<->MS	{ Uplink data }	Macro.
5	SS->MS	HANDOVER COMMAND	See specific message contents. The following messages are sent and received on Cell B.
6	MS->SS	HANDOVER ACCESS	Repeated on every burst of the uplink main DCCH (and optionally on the SACCH) until reception of PHYSICAL INFORMATION. Handover Reference as included in the HANDOVER COMMAND.
7	SS->MS	PHYSICAL INFORMATION	
8	MS->SS	HANDOVER COMPLETE	
9	SS->MS	DTM INFORMATION	
10	MS->SS	GPRS INFORMATION	Sent on main DCCH. Contains an empty LLC PDU for Cell Update.
(optional step)			
11	MS->SS	DTM REQUEST	Sent on main DCCH.
12	SS->MS	PACKET ASSIGNMENT	See specific message contents. Step 13 may be performed only if Step 10 has not been performed.
13	MS->SS	LLC PDU	Sent on PDCH. Empty LLC PDU for Cell Update NOTE: The empty LLC PDU may be followed by one or more lower priority LLC PDUs in the same RLC Data Block. Step 14 is performed if an empty LLC PDU was received in Step 13.
(optional step)			
14	MS->SS	PACKET RESOURCE REQUEST	Sent on PDCH. Step 15 is performed if a PACKET RESOURCE REQUEST was received in Step 14.
(conditional step)			
15	SS->MS	PACKET ASSIGNMENT	See specific message contents.
(conditional step)			
16	SS<->MS	{ Uplink data }	Macro.
17			It is checked that the MS continues to transmit uplink data during Steps 18 to 29 below.
18	SS->MS	DISCONNECT	Sent on main DCCH. The active speech call is disconnected.
19	MS->SS	RELEASE	Sent on main DCCH.
20	SS->MS	RELEASE COMPLETE	Sent on main DCCH.
21	SS->MS	PACKET CS RELEASE INDICATION	Sent on PACCH. See specific message contents.
22	MS->SS	PACKET SI STATUS	Sent on PACCH. Indicates non receipt of SI13, SI3 and SI1.
23	SS->MS	PACKET SERVING CELL SI	Sent on PACCH. Contains the SI1 message from Cell B.
24	MS->SS	PACKET SI STATUS	Sent on PACCH. Received at least 1s after Step 22. Indicates reception of SI1. Indicates non receipt of SI13 and SI3.
25	SS->MS	PACKET SERVING CELL SI	Sent on PACCH. Contains the SI13 message from Cell B.
26	SS		The SS waits for 2s and checks that the MS does not repeat the PACKET SI STATUS message.
27	SS->MS	PACKET SERVING CELL SI	Sent on PACCH. Contains the SI3 message from Cell B.
28	MS->SS	PACKET SI STATUS	Sent on PACCH. Indicates reception of SI13, SI3 and SI1.

29	SS->MS	CHANNEL RELEASE	Sent on main DCCH.
30	SS<->MS	{ Uplink data transfer }	See specific message contents. Macro.

Specific Message Contents

PACKET ASSIGNMENT (Step 3, Step 12 and Step 15):

As default message contents except: RR Packet Uplink Assignment IE - TIMESLOT_ALLOCATION RR Packet Downlink Assignment IE	(N ± 1) MOD 8 Not included
--	-------------------------------

HANDOVER COMMAND (Step 5):

Information Element	Value/remark
As default message contents, except: Channel Description - Timeslot Number - Channel Type Cell Description Synchronization Indication - Report Observed Time Difference - Synchronization Indication - Normal Cell Indication	N (chosen arbitrarily) TCH/F Default values from Cell B Shall not be included. "Non synchronized". Ignore out of range timing advance.

PACKET CS RELEASE INDICATION (Step 21):

Information Element	Value/remark
As default message contents, except: - GLOBAL TFI - ENHANCED PACKET CS RELEASE INDICATION	The TFI of the current uplink TBF. 1 (RR connection released) The subsequent message encoding indicates that when the RR connection is released the MS maintains it's downlink and/or uplink TBF(s).

CHANNEL RELEASE (Step 29):

Information Element	Value/remark
As default message contents, except: Enhanced DTM CS Release Indication IE	1 (MS allowed to continue in packet transfer mode)

41.5.5.2 Reallocation of PS Resources for Uplink and Downlink TBFs

41.5.5.2.1 Conformance Requirements

The network may at any time during uplink packet transfer initiate a change of resources by sending on the downlink PACCH monitored by the MS, an unsolicited uplink assignment message (e.g. PACKET UPLINK ASSIGNMENT, MULTIPLE TBF UPLINK ASSIGNMENT, PACKET TIMESLOT RECONFIGURE, MULTIPLE TBF TIMESLOT RECONFIGURE or PACKET CS RELEASE INDICATION message) to the mobile station. During the reallocation, TFI is allowed to be changed.

References

3GPP TS 44.060, sub-clauses 8.1.1.1.2

41.5.5.2.2 Test Purpose

To verify that the MS continues to maintain an ongoing uplink TBF and downlink TBF throughout the Enhanced DTM CS Release procedure.

To verify that the MS correctly implements the reallocation of the PS resources, including a change of TFI, for an ongoing uplink TBF upon completion of the Enhanced DTM CS Release procedure.

To verify that the MS correctly implements the reallocation of the PS resources, including a change of TFI, for an ongoing downlink TBF upon completion of the Enhanced DTM CS Release procedure.

41.5.5.2.3 Method of Test

Initial Conditions

System Simulator:

- 1 cell, Enhanced DTM supported.

Mobile Station:

- The MS is in the active state (U10) of a call.
- The MS is in packet idle mode, with a TMSI, P-TMSI allocated and PDP context 1 activated.

Specific PICS Statements

-

PIXIT Statements

-

Test Procedure

The MS, whilst in dedicated mode, is triggered to initiate packet uplink transfer data in RLC unacknowledged mode and sends a DTM REQUEST message. On receipt of the DTM REQUEST message, requesting uplink resources, the SS assigns the MS PS resource using a PACKET ASSIGNMENT message which also assigns a new downlink TBF. The active speech call is disconnected. The SS sends the PACKET CS RELEASE INDICATION message on PACCH to the MS indicating that the RR connection is going to end. The PACKET CS RELEASE INDICATION indicates that when the RR connection is released the downlink and/or uplink TBFs are reconfigured and reassigns the uplink and downlink TFIs as well as the allocated timeslots. Once any requested SI messages have been sent to the MS, the SS sends the CHANNEL RELEASE message on the main DCCH indicating in the Enhanced DTM Release Indication IE that the MS may continue in packet transfer mode. It is checked that the MS continues operating the uplink and downlink TBFs by sending RLC data blocks on the new PS resources.

Maximum Duration of Test

5 minutes

Expected Sequence

Step	Direction	Message	Comments
1	MS		MS in the active state (U10) of a call on Timeslot N. Trigger the MS to initiate an uplink packet transfer containing 1000 octets.
2	MS->SS	DTM REQUEST	
3	SS->MS	PACKET ASSIGNMENT	See specific message contents.
4	SS<->MS	{ Uplink data }	Macro.
5	SS<->MS	{ Downlink data }	Macro.
6			It is checked that the MS continues to transmit uplink and acknowledge downlink data during Steps 7 to 14 below.
7	SS->MS	DISCONNECT	Sent on main DCCH. The active speech call is disconnected.
8	MS->SS	RELEASE	Sent on main DCCH.
9	SS->MS	RELEASE COMPLETE	Sent on main DCCH.
10	SS->MS	PACKET CS RELEASE INDICATION	Sent on PACCH. See specific message contents.
11	MS->SS	PACKET SI STATUS	Sent on PACCH. Indicates possible non receipt of SI messages. Steps 12 and 13 are performed if the MS indicates non-receipt of required SI messages in Step 11.
12	SS->MS	PACKET SERVING CELL SI	Sent on PACCH. Contains an SI message requested in Step 11.
13			Step 12 is repeated until all requested SI messages have been sent to the MS.
14	SS->MS	CHANNEL RELEASE	Sent on main DCCH. See specific message contents.
15	SS<->MS	{ Uplink data transfer }	Macro.
16	SS<->MS	{ Downlink data transfer }	Macro.

Specific Message Contents

PACKET ASSIGNMENT (Step 3):

As default message contents except: RR Packet Uplink Assignment IE - TIMESLOT_ALLOCATION	(N + 1) MOD 8
RR Packet Downlink Assignment IE - TIMESLOT_ALLOCATION	(N + 1) MOD 8

PACKET CS RELEASE INDICATION (Step 10):

Information Element	Value/remark
As default message contents, except: - ENHANCED PACKET CS RELEASE INDICATION	1 (RR connection released) The subsequent message encoding indicates that when the RR connection is released the downlink and/or uplink TBF(s) are reconfigured.
- Multiple Downlink Assignment	TFI is changed. Timeslot allocation = (N - 1) + (N - 2) MOD 8
- Multiple Uplink Assignment	TFI is changed. Timeslot allocation = (N - 2) MOD 8

CHANNEL RELEASE (Step 14):

Information Element	Value/remark
As default message contents, except: Enhanced DTM CS Release Indication IE	1 (MS allowed to continue in packet transfer mode)

41.5.5.3 Change of LA in NW Mode II

41.5.5.3.1 Conformance Requirements

If the MS and the network in mode II or III support enhanced DTM CS release procedure and the location area of the MS has changed while in dual transfer mode, the MS may perform the enhanced DTM CS release procedure and, after the release of the RR connection, request CS resources via the enhanced DTM CS Establishment procedure for performing the Location Area Update procedure.

References

3GPP TS 43.055, sub-clauses 6.4.4.1

41.5.5.3.2 Test Purpose

To verify that the MS performs the enhanced DTM CS Release procedure when circuit switched resources are released by the NW following a change of location area whilst the MS was in dedicated mode in a network using network mode II.

To verify that following successful completion of the enhanced DTM CS Release procedure the MS performs the enhanced DTM CS Establishment procedure in order to perform the Location Update procedure following a change of location area whilst the MS was in dedicated mode in a network using network mode II.

41.5.5.3.3 Method of Test

Initial Conditions

System Simulator:

- 2 cells, A and B operating in NW Mode II with different LAC, without PBCCHs, both supporting Enhanced DTM.

Mobile Station:

- The MS is in the active state (U10) of a call on Cell A.
- The MS is in packet idle mode, with a TMSI, P-TMSI allocated and PDP context 1 activated.

Specific PICS Statements

-

PIXIT Statements

-

Test Procedure

The MS, whilst in dedicated mode, is triggered to initiate packet uplink data transfer in RLC unacknowledged mode and sends a DTM REQUEST message. On receipt of the DTM REQUEST message, the SS assigns the MS packet switched resources using a PACKET ASSIGNMENT message. Before the MS has completed transmission of the uplink data, the SS orders a handover to Cell B. Following handover to Cell B the non-combined routing area update procedure is performed on the main DCCH. The MS resumes transmission of the uplink data. The active speech call is disconnected. The SS sends the PACKET CS RELEASE INDICATION message on PACCH to the MS indicating that the RR connection is going to end. The PACKET CS RELEASE INDICATION indicates that when the RR connection is released the MS may maintain its uplink TBF. The packet switched resources are not re-allocated. The MS responds with the PACKET SI STATUS message on PACCH. The SS sends the MS any requested SI messages encapsulated within PACKET SERVING CELL SI messages on PACCH. The MS responds with the PACKET SI STATUS message indicating receipt of the required SI messages. The SS sends the CHANNEL RELEASE message on the main DCCH indicating in the Enhanced DTM Release Indication IE that the MS may continue in packet transfer mode. It is checked that the MS continues operating the uplink TBF by sending RLC data blocks on the PS resources. The MS requests circuit switched resources by sending the PACKET CS REQUEST on PACCH. The SS responds with the PACKET CS COMMAND on PACCH which encapsulates a DTM ASSIGNMENT COMMAND. The location update procedure is completed on the assigned circuit switched resources. Prior to sending the CHANNEL RELEASE message on the main DCCH, the SS sends the PACKET CS RELEASE INDICATION message on PACCH to the MS indicating that the RR connection is going to end. The PACKET CS RELEASE INDICATION indicates that when the RR connection is

released the MS may maintain its uplink TBF. The packet switched resources are not re-allocated. The MS responds with the PACKET SI STATUS message on PACCH. The SS sends the MS any requested SI messages encapsulated within PACKET SERVING CELL SI messages on PACCH. The MS responds with the PACKET SI STATUS message indicating receipt of the required SI messages. The SS then sends the CHANNEL RELEASE message on the main DCCH indicating in the Enhanced DTM Release Indication IE that the MS may continue in packet transfer mode. It is checked that the MS continues operating the uplink TBF by sending RLC data blocks on the PS resources.

Maximum Duration of Test

5 minutes

Expected Sequence

Step	Direction	Message	Comments
1	MS		MS in the active state (U10) of a call on Timeslot N. Trigger the MS to initiate an uplink packet transfer containing 1000 octets.
2	MS->SS	DTM REQUEST	
3	SS->MS	PACKET ASSIGNMENT	See specific message contents.
4	SS<->MS	{ Uplink data }	Macro.
5	SS->MS	HANDOVER COMMAND	See specific message contents. The following messages are sent and received on Cell B.
6	MS->SS	HANDOVER ACCESS	Repeated on every burst of the uplink main DCCH (and optionally on the SACCH) until reception of PHYSICAL INFORMATION. Handover Reference as included in the HANDOVER COMMAND.
7	SS->MS	PHYSICAL INFORMATION	
8	MS->SS	HANDOVER COMPLETE	
9	SS->MS	DTM INFORMATION	
10	MS->SS	GPRS INFORMATION	Sent on main DCCH. Contains a ROUTING AREA UPDATE REQUEST message.
11	SS->MS	GPRS INFORMATION	Sent on main DCCH. Contains a ROUTING AREA UPDATE ACCEPT message. Does not allocate MS a new P-TMSI.
12	MS->SS	DTM REQUEST	Sent on main DCCH.
13	SS->MS	PACKET ASSIGNMENT	See specific message contents.
14	SS<->MS	{ Uplink data }	Macro.
15			It is checked that the MS continues to transmit uplink data during Steps 16 to 39 below.
16	SS->MS	DISCONNECT	Sent on main DCCH. The active speech call is disconnected.
17	MS->SS	RELEASE	Sent on main DCCH.
18	SS->MS	RELEASE COMPLETE	Sent on main DCCH.
19	SS->MS	PACKET CS RELEASE INDICATION	Sent on PACCH. See specific message contents.
20	MS->SS	PACKET SI STATUS	Sent on PACCH. Indicates possible non receipt of SI messages. Steps 21 to 23 are performed if the MS indicates non-receipt of required SI messages in Step 20.
21	SS->MS	PACKET SERVING CELL SI	Sent on PACCH. Contains an SI message requested in Step 20.
22			Step 21 is repeated until all requested SI messages have been sent to the MS.
23	MS->SS	PACKET SI STATUS	Sent on PACCH. Indicates reception of SI13, SI3 and SI1.
24	SS->MS	CHANNEL RELEASE	Sent on main DCCH. See specific message contents.
25	MS->SS	PACKET CS REQUEST	Sent on uplink PACCH. Establishment Cause = Location Updating
26	SS->MS	PACKET CS COMMAND	Sent on downlink PACCH. Encapsulates a DTM ASSIGNMENT COMMAND. See specific message contents.
27	MS->SS	LOCATION UPDATE REQUEST	Location Updating Type = normal
28	MS->SS	CLASSMARK CHANGE	
29	SS->MS	AUTHENTICATION REQUEST	
30	MS->SS	AUTHENTICATION RESPONSE	
31	SS->MS	CIPHERING MODE COMMAND	Ciphering = on
32	MS->SS	CIPHERING MODE COMPLETE	
33	SS->MS	LOCATION UPDATE ACCEPT	Does not allocate a new TMSI.
34	SS->MS	PACKET CS RELEASE INDICATION	Sent on PACCH. See specific message contents.
35	MS->SS	PACKET SI STATUS	Sent on PACCH. Indicates possible non receipt of SI messages. Steps 36 to 38 are performed if the MS indicates non-receipt of required SI messages in Step 35.

36	SS->MS	PACKET SERVING CELL SI	Sent on PACCH. Contains an SI message requested in Step 35.
37			Step 36 is repeated until all requested SI messages have been sent to the MS.
38	MS->SS	PACKET SI STATUS	Sent on PACCH. Indicates reception of SI13, SI3 and SI1.
39	SS->MS	CHANNEL RELEASE	Sent on main DCCH. See specific message contents.
40	SS<->MS	{ Uplink data transfer }	Macro - Completion of the 1kB of Data.

Specific Message Contents

PACKET ASSIGNMENT (Step 3 and Step 13):

Information Element	Value/remark
As default message contents except: RR Packet Uplink Assignment IE - TIMESLOT_ALLOCATION RR Packet Downlink Assignment IE	(N ± 1) MOD 8 Not included

HANDOVER COMMAND (Step 5):

Information Element	Value/remark
As default message contents, except: Channel Description - Timeslot Number - Channel Type Cell Description Synchronization Indication - Report Observed Time Difference - Synchronization Indication - Normal Cell Indication	N (chosen arbitrarily) TCH/F Default values from Cell B Shall not be included. "Non synchronized". Ignore out of range timing advance.

PACKET CS RELEASE INDICATION (Step 19 and Step 34):

Information Element	Value/remark
As default message contents, except: - GLOBAL TFI - ENHANCED PACKET CS RELEASE INDICATION	The TFI of the current uplink TBF. 1 (RR connection released) The subsequent message encoding indicates that when the RR connection is released the MS maintains it's uplink TBF.

CHANNEL RELEASE (Step 24 and Step 39):

Information Element	Value/remark
As default message contents, except: Enhanced DTM CS Release Indication IE	1 (MS allowed to continue in packet transfer mode)

DTM ASSIGNMENT COMMAND (Step 26):

Information Element	Value/remark
As default message contents except: Channel Description IE - TN - Channel Type Channel Mode IE RR Packet Uplink Assignment IE RR Packet Downlink Assignment IE	N TCH/F Full Rate Version 1 Not included. Not included.

41.5.5.4 Change of LA in NW Mode I

41.5.5.4.1 Conformance Requirements

If the MS and the network in mode I support enhanced DTM CS release procedure and the location area of the MS has changed while in dual transfer mode, the MS shall send an indication to the network that in this case the enhanced DTM CS release procedure shall not be used. This indication is sent in the PACKET SI STATUS or PACKET PSI STATUS message. After the receipt of the indication the network shall release the RR connection and PS resources. Upon receipt of a CHANNEL RELEASE message the MS shall initiate the Combined RA/LA Update procedure.

References

3GPP TS 43.055, sub-clauses 6.4.4.1

41.5.5.4.2 Test Purpose

To verify that in response to the NW initiating the Enhanced CS Release procedure the MS requests that the procedure shall not be used following a change of location area whilst the MS was in dedicated mode in a network using network mode I.

To verify that following the release of packet and circuit switched resources the MS performs the Combined Routing Area Update procedure following a change of location area whilst the MS was in dedicated mode in a network using network mode I.

41.5.5.4.3 Method of Test

Initial Conditions

System Simulator:

- 2 cells, A and B operating in NW Mode I with different LAC, with PBCCHs, both supporting Enhanced DTM.

Mobile Station:

- The MS is in the active state (U10) of a call on Cell A.
- The MS is in packet idle mode, with a TMSI, P-TMSI allocated and PDP context 1 activated.

Specific PICS Statements

-

PIXIT Statements

-

Test Procedure

The MS, whilst in dedicated mode, is triggered to initiate packet uplink data transfer in RLC unacknowledged mode and sends a DTM REQUEST message. On receipt of the DTM REQUEST message, the SS assigns the MS packet switched resources using a PACKET ASSIGNMENT message. Before the MS has completed transmission of the uplink data, the SS orders a handover to Cell B. Following handover to Cell B the non-combined routing area update procedure is performed on the main DCCH. The MS resumes transmission of the uplink data. The active speech call is disconnected. The SS sends the PACKET CS RELEASE INDICATION message on PACCH to the MS indicating that the RR connection is going to end. The PACKET CS RELEASE INDICATION indicates that when the RR connection is released, the MS may maintain the uplink TBF. The packet switched resources are not re-allocated. The MS responds with the PACKET PSI STATUS message on PACCH in which it requests the release of both packet and circuit switched resources. The SS responds with the CHANNEL RELEASE message which indicates that the MS may not continue in packet transfer mode. It is checked that the MS no longer transmits data on the previously assigned packet switched resources. The MS requests packet switched resources via the PBCCH in order to perform the Combined Routing Area update procedure. Following completion of the Combined Routing Area Update procedure the MS requests packet switched resources via the PBCCH in order to continue with the transfer of user data.

Maximum Duration of Test

5 minutes

Expected Sequence

Step	Direction	Message	Comments
1	MS		MS in the active state (U10) of a call on Timeslot N. Trigger the MS to initiate an uplink packet transfer containing 1000 octets.
2	MS->SS	DTM REQUEST	
3	SS->MS	PACKET ASSIGNMENT	See specific message contents.
4	SS<->MS	{ Uplink data }	Macro.
5	SS->MS	HANDOVER COMMAND	See specific message contents. The following messages are sent and received on Cell B.
6	MS->SS	HANDOVER ACCESS	Repeated on every burst of the uplink main DCCH (and optionally on the SACCH) until reception of PHYSICAL INFORMATION. Handover Reference as included in the HANDOVER COMMAND.
7	SS->MS	PHYSICAL INFORMATION	
8	MS->SS	HANDOVER COMPLETE	
9	SS->MS	DTM INFORMATION	
10	MS->SS	GPRS INFORMATION	Sent on main DCCH. Contains a ROUTING AREA UPDATE REQUEST message.
11	SS->MS	GPRS INFORMATION	Sent on main DCCH. Contains a ROUTING AREA UPDATE ACCEPT message. Does not allocate MS a new P-TMSI.
12	MS->SS	DTM REQUEST	Sent on main DCCH.
13	SS->MS	PACKET ASSIGNMENT	See specific message contents.
14	SS<->MS	{ Uplink data }	Macro.
15			It is checked that the MS continues to transmit uplink data during Steps 16 to 20 below.
16	SS->MS	DISCONNECT	Sent on main DCCH. The active speech call is disconnected.
17	MS->SS	RELEASE	Sent on main DCCH.
18	SS->MS	RELEASE COMPLETE	Sent on main DCCH.
19	SS->MS	PACKET CS RELEASE INDICATION	Sent on PACCH. See specific message contents.
20	MS->SS	PACKET PSI STATUS	Sent on PACCH. PS_REL_REQ = 1 The MS requests release of both packet and circuit switched resources.
21	SS->MS	CHANNEL RELEASE	Sent on main DCCH. See specific message contents.
22	SS		It is checked that the MS no longer transmits data on the packet switched resources assigned at Step 13.
23	MS->SS	ROUTING AREA UPDATE REQUEST	Update type = 'Combined RA/LA updating'
24	SS->MS	ROUTING AREA UPDATE ACCEPT	Update result = 'Combined RA/LA updated' Does not assign a new P-TMSI.
25	MS -> SS	PACKET CHANNEL REQUEST	Received on PRACH
26	SS -> MS	PACKET UPLINK ASSIGNMENT	Single block assignment, to order the MS to follow the two phase access procedure.
27	MS -> SS	PACKET RESOURCE REQUEST	
28	SS -> MS	PACKET UPLINK ASSIGNMENT	uplink dynamic allocation, no starting time
29	SS<->MS	{ Uplink data transfer }	Macro - Completion of the 1kB of Data.

Specific Message Contents

PACKET ASSIGNMENT (Step 3 and Step 13):

As default message contents except: RR Packet Uplink Assignment IE - TIMESLOT_ALLOCATION RR Packet Downlink Assignment IE	(N ± 1) MOD 8 Not included
--	-------------------------------

HANDOVER COMMAND (Step 5):

Information Element	Value/remark
As default message contents, except: Channel Description - Timeslot Number - Channel Type Cell Description Synchronization Indication - Report Observed Time Difference - Synchronization Indication - Normal Cell Indication	N (chosen arbitrarily) TCH/F Default values from Cell B Shall not be included. "Non synchronized". Ignore out of range timing advance.

PACKET CS RELEASE INDICATION (Step 19):

Information Element	Value/remark
As default message contents, except: - GLOBAL TFI - ENHANCED PACKET CS RELEASE INDICATION	The TFI of the current uplink TBF. 1 (RR connection released) The subsequent message encoding indicates that when the RR connection is released the MS maintains it's uplink TBF.

CHANNEL RELEASE (Step 21):

Information Element	Value/remark
As default message contents, except: Enhanced DTM CS Release Indication IE	0 (MS not allowed to continue in packet transfer mode)

42 Test of Medium Access Control (MAC) protocol

42.1 Test of Medium Access Control (MAC) Procedures on PCCCH in idle mode

This subclause presents tests for "Medium Access Control (MAC) Procedures on PCCCH in idle mode" which are specified in 3GPP TS 04.60 clause 7.

Default conditions

The SS default conditions simulate one cell with default settings as defined in the GPRS general default section.

The MS default initial condition is GPRS attached. Unless otherwise stated, no PDP context is required.

The default message contents and signaling macro not specified in the end of this subclause shall be set as in "GPRS default conditions" clause 40. Specific message contents for a test case is specified in each test case.

Conditions or message contents specified in a test case have the highest precedence. In addition, the default message contents described in the end of this subclause override those specified in "GPRS default conditions".

In case the test case not expected "short access" as access type for Packet Channel Request the amount of RLC data specified in the comments in expected sequence is not necessary to be exactly the specified amount of data. It only has to be more than the limit for short access. If the test case need a specific amount of data this is specified in the test case.

42.1.1 Packet Channel Request

42.1.1.1 Packet Channel Request / Message format

42.1.1.1.1 Conformance requirements

There are two formats of the PACKET CHANNEL REQUEST message containing either 8 bits or 11 bits of information. The format to be applied on PRACH is controlled by the parameter ACC_BURST_TYPE that is broadcast on PBCCH.

Reference

3GPP TS 04.60 subclause 7.1.2.1.

42.1.1.1.2 Test purpose

To verify that the mobile station applies the correct PACKET CHANNEL REQUEST message format on PRACH according to the ACC_BURST_TYPE parameter broadcast on PBCCH.

42.1.1.1.3 Method of test

Initial conditions

System Simulator:

1 cell supporting GPRS. The packet system information ACCESS_BURST_TYPE indicates 11 bit access.

Mobile Station:

The MS is switched off. The SIM is updated to the test cell.

Specific PICS Statements

-

PIXIT Statements

-

Test procedure

The MS is powered up or switched on and triggered to perform a GPRS attach. The MS shall send PACKET CHANNEL REQUEST message. The SS verifies that the MS requests 11 bit access format. Switch off the MS.

Change the ACCESS_BURST_TYPE parameter in Packet System Information to 8 bit format and repeat the test procedure. The SS verifies that the MS requests 8 bit access format.

Maximum duration of the test

1 minute.

Expected sequence

Step	Direction	Message	Comments
1	MS		The MS is powered up or switched on and triggered to perform a GPRS attach.
2	MS -> SS	PACKET CHANNEL REQUEST	ACCESS TYPE = "Mobility Management procedure". Received on PRACH.
3	SS		SS verifies the requested access bit format.
4	MS		If possible the MS is powered down or switched off otherwise it has its power source removed and then restored.
5	SS	PACKET SYSTEM INFORMATION Type 1	Change ACCESS_BURST_TYPE to indicate 8 bit access. Sent on PBCCH.
6			Repeat step 1 to 3.

Specific message contents

None.

42.1.1.2 Packet Channel Request / Response to Packet Paging

42.1.1.2.1 Conformance requirements

A mobile station in class A or class B mode of operation shall respond to a PACKET PAGING REQUEST message indicating an RR connection establishment. A mobile station in class B mode of operation may abort the packet access procedure at the receipt of a PACKET PAGING REQUEST message indicating an establishment of a RR connection. PACKET PAGING REQUEST messages indicating a non-RR connection shall be ignored.

Mobile stations in class C mode of operating shall not respond to any type of PACKET PAGING REQUEST messages during the packet access procedure but decode the PERSISTENCE_LEVEL parameter if included in the message.

Reference

3GPP TS 04.60 subclause 7.1.2.1.

42.1.1.2.2 Test purpose

To verify that the mobile station ignores PACKET PAGING REQUEST messages indicating a non-RR connection after scheduling the sending of PACKET CHANNEL REQUEST messages.

To verify that a mobile station in class A or class B mode of operation shall respond to a PACKET PAGING REQUEST message indicating an RR connection establishment after scheduling the sending of PACKET CHANNEL REQUEST messages.

To verify that a mobile station in class C mode of operating shall not respond to any type of PACKET PAGING REQUEST messages during the packet access procedure.

42.1.1.2.3 Method of test

Initial conditions

System Simulator:

1 cell supporting GPRS. The packet system information ACCESS_BURST_TYPE indicates 8 bit access and MAX_RETRANS indicates 7 allowed retransmission.

Mobile Station:

The MS is GPRS attached and in packet idle mode. PDP context 2 has been established.

Specific PICS Statements

- Supporting GPRS MS Class A (TSPC_operation_mode_A)
- Supporting GPRS MS Class B (TSPC_operation_mode_B)
- Supporting GPRS MS Class C (TSPC_operation_mode_C)

PIXIT Statements

-

Test procedure

All MS classes, non-RR connection paging.

The MS is triggered to initiate an uplink packet transfer. When SS has received the first PACKET CHANNEL REQUEST message a PACKET PAGING REQUEST message indicating a non-RR connection shall be sent to the MS. The MS shall ignore the PACKET PAGING REQUEST message and continue to send PACKET CHANNEL REQUEST messages requesting one or two phase access. The SS sends PACKET ACCESS REJECT to end the test case.

MS class A and class B, RR connection paging.

The MS is triggered to initiate an uplink packet transfer. When SS has received the first PACKET CHANNEL REQUEST message a PACKET PAGING REQUEST message indicating a RR connection shall be sent to the MS. The MS may continue the packet access procedure. The MS shall send CHANNEL REQUEST messages with establishment cause = "Answer to paging". SS verify that the MS request RR connection. The SS sends IMMEDIATE ASSIGNMENT REJECT to end the test case.

MS class C, RR connection paging.

The MS is triggered to initiate an uplink packet transfer. When SS has received the first PACKET CHANNEL REQUEST message a PACKET PAGING REQUEST message indicating a RR connection shall be sent to the MS. The MS shall ignore the PACKET PAGING REQUEST message and continue to send PACKET CHANNEL REQUEST messages requesting one or two phase access. The SS sends PACKET ACCESS REJECT to end the test case.

Maximum duration of the test

1 minute.

Expected sequence

All MS classes, non-RR connection paging.

Step	Direction	Message	Comments
1	MS		
2	MS -> SS	PACKET CHANNEL REQUEST	The MS is triggered to send 200 octets data. ACCESS TYPE = "One or Two Phase Access Request". Received on PRACH.
3	SS -> MS	PACKET PAGING REQUEST	Sent on PAGCH for TBF establishment.
4	MS -> SS	PACKET CHANNEL REQUEST	ACCESS TYPE = "One or Two Phase Access Request". Received on PRACH. The SS verifies that the MS continue request One or Two Phase packet Access.
5	SS -> MS	PACKET ACCESS REJECT	Sent on PAGCH.

MS class A and class B, RR connection paging.

Only Network mode I.

Step	Direction	Message	Comments
1	MS		The MS is triggered to send 200 octets data.
2	MS -> SS	PACKET CHANNEL REQUEST	ACCESS TYPE = "One or Two Phase Access Request". Received on PRACH.
3	SS -> MS	PACKET PAGING REQUEST (1)	See specific message contents. Sent on PAGCH for RR connection.
4	MS -> SS	PACKET CHANNEL REQUEST	Optional step: The MS may retransmit the PACKET CHANNEL REQUEST up to MAX_RETRANS .
5	MS -> SS	CHANNEL REQUEST	Establishment cause = "Answer to paging". Received on RACH. The SS verifies that the MS request RR connection.
6	SS -> MS	IMMEDIATE ASSIGNMENT REJECT	

MS class C, RR connection paging.

Step	Direction	Message	Comments
1	MS		The MS is triggered to send 200 octets data.
2	MS -> SS	PACKET CHANNEL REQUEST	ACCESS TYPE = "One or Two Phase Access Request". Received on PRACH.
3	SS -> MS	PACKET PAGING REQUEST (1)	See specific message contents. Sent on PAGCH for RR connection.
4	MS -> SS	PACKET CHANNEL REQUEST	ACCESS TYPE = "One or Two Phase Access Request". Received on PRACH. The SS verifies that the MS request One or Two Phase packet Access.
5	SS -> MS	PACKET ACCESS REJECT	Sent on PAGCH.

Specific message contents

As default messages contents, except:

PACKET PAGING REQUEST (1)

Information element	Value/remark
{1 < Repeated Page info >}	1 (start of Repeated Page info)
{1	1 (page request for RR connection establ.)
{0 < TMSI >	0 (allocated TMSI)
< CHANNEL_NEEDED >	00 (any channel type)
{0 1 < eMLPP_PRIORITY >	1 (page request to trigger RR connection)
-eMLPP_PRIORITY}	000 (no priority specified)

42.1.1.3 void

42.1.1.4 Packet Channel Request / Access persistence control on PRACH

42.1.1.4.1 Packet Channel Request / Access persistence control on PRACH / M+1 attempts

42.1.1.4.1.1 Conformance requirements

The mobile station shall make maximally M + 1 attempts to send a PACKET CHANNEL REQUEST message.

Having made M + 1 attempts to send a PACKET CHANNEL REQUEST, the mobile station shall stop timer T3186 and start timer T3170. At expiry of timer T3170, the packet access procedure shall be aborted, a packet access failure shall be indicated to the upper layer and the mobile station shall return to packet idle mode.

Reference

3GPP TS 04.60 subclause 7.1.2.1.1.

42.1.1.4.1.2 Test purpose

To verify that the mobile station makes a maximum of M + 1 attempts to send a PACKET CHANNEL REQUEST message, M is the parameter MAX_RETRANS broadcast on PBCCH.

To verify that the mobile station aborts the packet access procedure when the network does not respond to the PACKET CHANNEL REQUEST messages.

42.1.1.4.1.3 Method of test

Initial conditions

System Simulator:

1 cell supporting GPRS. The packet system information ACCESS_BURST_TYPE indicates 8 bit access, MAX_RETRANS indicate 1 retransmission, PERSISTENCE_LEVEL P(i)=0 and BS_PRACH_BLKs = 12 (all Blocks reserved for PRACH).

Note : SS sets USF=FREE on the blocks in accordance with the setting of the BS_PRACH_BLKs.

Mobile Station:

The MS is GPRS attached and in packet idle mode.

Specific PICS Statements

-

PIXIT Statements

-

Test procedure

The SS send PACKET PAGING REQUEST message. The MS is expected to send M+1 PACKET CHANNEL REQUEST messages, M is the parameter MAX_RETRANS broadcast on PBCCH. The SS monitors the MS transmission for a period equal to the maximum length of time it can take to send M+1 PACKET CHANNEL REQUEST messages plus the duration of timer T3170. The SS verifies that the MS makes maximally M+1 attempts to send PACKET CHANNEL REQUEST messages in this period. When the SS not respond the MS shall abort the packet access procedure and perform an abnormal release. The SS sends PACKET UPLINK ASSIGNMENT message corresponding to one of its 3 last PACKET CHANNEL REQUEST messages after a time higher than the duration of timer T3170 and the MS shall not respond to the message.

Repeat the test procedure with the different MAX_RETRANS parameters {2, 4, 7} sent in Packet System Information.

Maximum duration of the test

4 minutes.

Expected sequence

Step	Direction	Message	Comments
1	SS -> MS	PACKET PAGING REQUEST	Sent on PPCH.
2	MS -> SS	PACKET CHANNEL REQUEST(n)	n = 1, ..., M+1. ACCESS TYPE = "Page response". Received on PRACH.
.	.	.	
3	SS		The SS waits M+1 PACKET CHANNEL REQUESTs+ timer T3170 + 0.5s. The SS verifies that the MS makes maximally M+1 attempts to send PACKET CHANNEL REQUEST messages in this period.
4	SS -> MS	PACKET UPLINK ASSIGNMENT	Correspond to one of the last 3 messages in step 2. The MS shall not respond to this message. Sent on PAGCH.
5	SS		Change MAX_RETRANS in PSI1 to 2 retransmission.
6			Repeat step 1 to 4 after 35 s.
7	SS		Change MAX_RETRANS in PSI1 to 4 retransmission.
8			Repeat step 1 to 4 after 35 s.
9	SS		Change MAX_RETRANS in PSI1 to 7 retransmission.
10			Repeat step 1 to 4 after 35 s.

Specific message contents

None.

42.1.1.4.2 Packet Channel Request / Access persistence control on PRACH / Persistence level

42.1.1.4.2.1 Conformance requirements

The first attempt to send a PACKET CHANNEL REQUEST message, may be initiated at the first available PRACH block on the PDCH defined by the PCCCH_GROUP for the mobile station (see 3GPP TS 45.002). The mobile station shall choose one of the four TDMA frames within the selected PRACH block randomly with a uniform probability distribution.

For each attempt, the mobile station shall draw a random value R with uniform probability distribution in the set {0, 1, ..., 15}. The mobile station is allowed to transmit a PACKET CHANNEL REQUEST message if P(i), where i is the radio priority of the TBF being established, is less or equal to R.

Reference

3GPP TS 04.60 subclause 7.1.2.1.1.

42.1.1.4.2.2 Test purpose

To verify that for each attempt, the mobile station shall draw a random value R with uniform probability distribution in the set {0, 1, ..., 15}. The mobile station is only allowed to transmit a PACKET CHANNEL REQUEST message if P(i), where i is the radio priority of the TBF being established, is less than or equal to R.

42.1.1.4.2.3 Method of test

Initial conditions

System Simulator:

1 cell supporting GPRS. The packet system information indicates BS_PCC_CHANS = 1, BS_PAG_BLK_RES = 2 and BS_PBCCH_BLK = 3, BS_PRACH_BLK = 12 (all Blocks reserved for PRACH). PERSISTENCE_LEVEL P(i) is set to 0.

Note : SS sets USF=FREE on the blocks in accordance with the setting of the BS_PRACH_BLK.

Mobile Station:

The MS is GPRS attached and in packet idle mode.

Specific PICS Statements

-

PIXIT Statements

-

Test procedure

Specific test parameters:

K equals the value of $120/(MAX_RETRANS+1)$.

MAX_RETRANS is chosen from {1, 2, 4, 7}.

PERSISTENCE_LEVEL P(i) is chosen from {0, 1, 2, ..., 14, 16}.

Counter J is initialized with 0 (total number of received Packet Channel Requests).

The SS sends PACKET PAGING REQUEST message. The MS shall send between 0 and M+1 PACKET CHANNEL REQUEST message indicating page response. The SS verifies that the MS draw a random value R for each attach.

Every received Packet Channel Request in response to Packet Paging Request increment counter J by 1. This test sequence is performed K times.

The test is performed with Persistence level set to at least $P(i)=0$, $P(i)=8$ and $P(i)=16$.

Maximum duration of the test

The execution of one sequence (for one value k): 30 s.

Between two consecutive executions (for k and k+1), the SS must wait for amount of time which is enough to guarantee that the MS is in service (listening to its paging subchannel).

Expected sequence

The sequence is executed for execution counter $k = 1, \dots, K$. After first execution, test is repeated from step 3.

Step	Direction	Message	Comments
1			PACKET SYSTEM INFORMATION TYPE 1 is updated with the P(l) values under test
2			SS waits 35 seconds to make sure MS has acquired the new P(l) values
3	SS -> MS	PACKET PAGING REQUEST	Sent on PPCH.
4	MS -> SS	PACKET CHANNEL REQUEST	N0 := number of received Packet Channel Requests in response to step1; Count for 10 sec. N0; J = J + N0; $0 \leq N0 \leq M+1$; ACCESS TYPE = "Page Response". Received on PRACH.
5	MS -> SS	PACKET CHANNEL REQUEST	
:	:	:	
:	:	:	
M+2	MS -> SS	PACKET CHANNEL REQUEST	
M+3	SS		SS waits for expiry of T3170
M+4	SS		SS waits to allow Cell Reselection

Note:

The 10 s in steps 2 to M+2 is derived from the following consideration:

Answer time for the first Packet Channel Request: 0,7 sec + 8*4,615 ms.

Maximum TDMA frame spread between two successive Packet Channel Requests:

$\max\{S+T-1\} * 4,615\text{ms} = 266 * 4,615\text{ms} \Rightarrow$ maximum time to send M+1 Packet Channel Requests.

$0,7 \text{ sec} + 8 * 4,615\text{ms} + M * 266 * 4,615\text{ms} = 9,33 \text{ s.}$

Verification

According the test procedure J is $B(120; 1-P(i)/16)$ distributed. i.e. we will accept MSs, when the following inequality holds $(1-P(i)/16) - 0,0161 * \sqrt{P(i)*(16-P(i))} \leq J/120 \leq (1-P(i)/16) + 0,0161 * \sqrt{P(i)*(16-P(i))}$

this confidence interval is chosen in such a way that the possibility of non accepting a correct MS is less than 0,5 %.

Remark: If $P(i) = 0$ the above inequality is simplified to $1 \leq J/120 \leq 1$, i.e. $J=120$, i.e. the MS has to answer every PACKET PAGING REQUEST with M+1 PACKET CHANNEL REQUESTS. And if $P(i) = 16$ the above inequality is simplified to $0 \leq J/120 \leq 0$, i.e. $J = 0$, i.e. the MS is not allowed to send PACKET CHANNEL REQUESTS.

Specific message contents

None.

42.1.1.4.3 Packet Channel Request / Access persistence control on PRACH / Successive Attempts

42.1.1.4.3.1 Conformance requirements

The first attempt to send a PACKET CHANNEL REQUEST (respectively EGPRS PACKET CHANNEL REQUEST) message, may be initiated at the first available PRACH block on the PDCH defined by the PCCCH_GROUP for the mobile station (see 3GPP TS 45.002). The mobile station shall choose one of the four TDMA frames within the selected PRACH block randomly with a uniform probability distribution.

For each attempt, the mobile station shall draw a random value R with uniform probability distribution in the set $\{0, 1, \dots, 15\}$. The mobile station is allowed to transmit a PACKET CHANNEL REQUEST message if $P(i)$, where i is the radio priority of the TBF being established, is less or equal to R .

After each attempt, the S and T parameters are used to determine the next TDMA frame in which it may be allowed to make a successive attempt. The number of TDMA frames belonging to the PRACH on the PDCH defined by the PCCCH group for the mobile station between two successive attempts to send a PACKET CHANNEL REQUEST message excluding the TDMA frames potentially containing the messages themselves is a random value drawn for each transmission with uniform probability distribution in the set $\{S, S + 1, \dots, S + T - 1\}$.

Reference

3GPP TS 04.60 subclause 7.1.2.1.1.

42.1.1.4.3.2 Test purpose

To verify that the number of TDMA frames belonging to the PRACH on the PDCH defined by the PCCCH group for the mobile station between two successive attempts to send a PACKET CHANNEL REQUEST message excluding the TDMA frames potentially containing the messages themselves is a random value drawn for each transmission with uniform probability distribution in the set $\{S, S + 1, \dots, S + T - 1\}$.

42.1.1.4.3.3 Method of test

Initial conditions

System Simulator:

1 cell supporting GPRS. The packet system information:

$BS_PCC_CHANS = 1$, $BS_PAG_BLKS_RES = 2$ and $BS_PBCCH_BLKS = 3$. $MAX_RETRANS$ is arbitrarily chosen in the set $\{1, 2, 4, 7\}$.

TX_INT is arbitrarily chosen in the set $\{6, 7, 8, 9, 10, 12, 14, 16, 20, 25, 32, 50\}$.

S is arbitrarily chosen in the set $\{12, 15, 20, 30, 41, 55, 76, 109, 163, 217\}$.

$PERSISTENCE_LEVEL P(i) = 0$.

Note : SS sets $USF=FREE$ on the blocks in accordance with the setting of the BS_PRACH_BLKS .

Mobile Station:

The MS is GPRS attached and in packet idle mode.

Specific PICS Statements

-

PIXIT Statements

-

Test procedure

Specific test parameters:

- K equals the upper rounded value of $230/M$;

The SS sends PACKET PAGING REQUEST message. The MS shall send PACKET CHANNEL REQUEST messages $M+1$ times indicating page response. After each attempt, the S and T parameters are used to determine the next TDMA frame in which it may be allowed to make a successive attempt. The SS measure the number of TDMA frames $f(n,k)$ between each attempt, excluding the slots containing the messages themselves. The SS does not answer the PACKET CHANNEL REQUEST messages $MAX_RETRANS$ times. The SS sends an PACKET ACCESS REJECT message. The test sequence is executed K times.

- M is the value of the parameter $MAX_RETRANS$;
- T is the value of the parameter TX_INT ;
- S is the value of the parameter S .

Maximum duration of the test

The execution of one sequence (for one value k): 10 s.

Between two consecutive executions (for k and $k+1$), the SS must wait for amount of time which is enough to guarantee that the MS is in service (listening to its paging subchannel).

Expected sequence

The sequence is executed for execution counter $k = 1, \dots, K$.

Step	Direction	Message	Comments
1	SS -> MS	PACKET PAGING REQUEST	Sent on PPCH.
2	MS -> SS	PACKET CHANNEL REQUEST	ACCESS TYPE = "Page Response". Received on PRACH.
3	MS -> SS	PACKET CHANNEL REQUEST	Step 3 and 4 are executed for execution counter $n=1, \dots, MAX_RETRANS$. ACCESS TYPE = "Page Response". Received on PRACH.
4	SS		See verification.
5	SS -> MS	PACKET ACCESS REJECT	Sent on PAGCH.

Verification

In step 4 the SS measure the number of TDMA frames belonging to the PRACH on the PDCH defined by the PCCCH group for the MS between two successive attempts to send a PACKET CHANNEL REQUEST message excluding the TDMA frames potentially containing the messages themselves. $f(n,k)$ shall be in the set $\{S, S + 1, \dots, S + T - 1\}$. The SS stores f .

Test:

The following requirement shall be met:

$$\left(\left(\text{sq}(\text{Sum}(S)) + \text{sq}(\text{Sum}(S+1)) + \dots + \text{sq}(\text{Sum}(S+T-1)) \right) * T / (K * M) \right) - (K * M) \leq \frac{1}{2} * \text{sq}(\text{sqrt}(2T-3) + 2,58) + 1,1$$

$\text{Sum}(X) := \text{CARD} \{ k \mid f(n,k) = X \}$:= the number of times that $f(n,k)$ equals X .

The test and the number of sample are chosen in such a way that the possibility of non-accepting a correct MS is less than [0,5 %].

The SS shall schedule the PRACH blocks so that T3186 does not expire in the MS. The SS shall also ensure that the number of PRACH blocks, which are allocated, match the choosen S , TX_INT and $MAX_RETRANS$ values. This ensures that T3186 does not expire in the MS while sending the PACKET CHANNEL REQUEST messages.

Specific message contents

None.

42.1.2 Packet Uplink/Downlink Assignment

42.1.2.1 Packet uplink assignment procedure

42.1.2.1.1 Packet Uplink Assignment / Packet access queuing notification procedure

42.1.2.1.1.1 Packet Uplink Assignment / Packet queuing notification / Stop sending Packet Channel Requests

42.1.2.1.1.1.1 Conformance requirements

On receipt of a PACKET QUEUING NOTIFICATION message corresponding to one of its 3 last PACKET CHANNEL REQUEST messages, the mobile station shall stop timers T3186 and T3170 if running, start timer T3162, and stop sending PACKET CHANNEL REQUEST messages.

Reference

3GPP TS 04.60 subclause 7.1.2.2.2.

42.1.2.1.1.1.2 Test purpose

To verify that the mobile station stops sending PACKET CHANNEL REQUEST messages on receipt of a PACKET QUEUING NOTIFICATION message.

42.1.2.1.1.1.3 Method of test

Initial conditions

System Simulator:

1 cell supporting GPRS. The packet system information MAX_RETRANS indicates 7 allowed retransmission.

Mobile Station:

The MS is switched off. The SIM is updated to the test cell.

Specific PICS Statements

-

PIXIT Statements

-

Test procedure

The MS is powered up or switched on and triggered to perform a GPRS attach. The SS sends PACKET QUEUING NOTIFICATION message corresponding to one of the last three PACKET CHANNEL REQUEST messages. The SS verifies that the MS stops sending PACKET CHANNEL REQUEST messages.

Maximum duration of the test

15 s.

Expected sequence

Step	Direction	Message	Comments
1	MS		The MS is powered up or switched on and triggered to perform a GPRS attach.
2	MS -> SS	PACKET CHANNEL REQUEST	Received on PRACH.
3	MS -> SS	PACKET CHANNEL REQUEST	Received on PRACH.
4	SS -> MS	PACKET QUEUING NOTIFICATION	Corresponding to message in step 2. Sent on PAGCH. The SS verifies during 5 seconds that MS stop sending PACKET CHANNEL REQUEST messages.

Specific message contents

None.

42.1.2.1.1.2 Packet Uplink Assignment / Packet queuing notification / Ignoring Packet Queuing Notification

42.1.2.1.1.2.1 Conformance requirements

If the mobile station receives a PACKET QUEUING NOTIFICATION message while waiting for the TBF Starting Time of a valid PACKET UPLINK ASSIGNMENT message, the mobile station shall ignore the PACKET QUEUING NOTIFICATION.

Reference

3GPP TS 04.60 subclause 7.1.2.2.2.

42.1.2.1.1.2.2 Test purpose

To verify that the mobile station ignores the PACKET QUEUING NOTIFICATION if the mobile station receives a PACKET QUEUING NOTIFICATION message while waiting for the TBF Starting Time of a valid PACKET UPLINK ASSIGNMENT message.

42.1.2.1.1.2.3 Method of test

Initial conditions

System Simulator:

1 cell supporting GPRS.

Mobile Station:

The MS is switched off. The SIM is updated to the test cell.

Specific PICS Statements

-

PIXIT Statements

-

Test procedure

The MS is powered up or switched on and triggered to perform a GPRS attach. The SS sends PACKET UPLINK ASSIGNMENT message containing a TBF Starting Time. While the MS is waiting for the TBF Starting Time the SS sends a PACKET QUEUING NOTIFICATION message. The MS shall ignore PACKET QUEUING NOTIFICATION message and at the frame number indicated by the TBF Starting Time, the MS shall start to send the uplink RLC data in the allocated uplink resources. The SS allows the MS to complete the GPRS attach procedure.

Maximum duration of the test

15 s.

Expected sequence

Step	Direction	Message	Comments
1	MS		The MS is powered up or switched on and triggered to perform a GPRS attach.
2	MS -> SS	PACKET CHANNEL REQUEST	Received on PRACH.
3	SS -> MS	PACKET UPLINK ASSIGNMENT	See specific message contents. Sent on PAGCH.
4	SS -> MS	PACKET QUEUING NOTIFICATION	Sent on PAGCH before starting time in step 3 have elapsed.
5		{GPRS Attach procedure}	Macro. Completion from step 4 in the attach procedure. The SS verifies that the first RLC data block sends according to the indicated starting time in step 3.

Specific message contents

As default messages contents, except:

PACKET UPLINK ASSIGNMENT in step 3

Information element	Value/remark
Dynamic Allocation < TBF_Starting_Time >	[Arbitrarily chosen]

42.1.2.1.1.3 Packet Uplink Assignment / Packet queuing notification / Assigned PDCHs

42.1.2.1.1.3.1 Conformance requirements

On receipt of a PACKET UPLINK ASSIGNMENT message following a PACKET QUEUING NOTIFICATION message, the mobile station shall stop timer T3162, and follow the procedures defined in subclause 7.1.2.2.1.

If the PACKET UPLINK ASSIGNMENT message does not specify a TBF starting time, the mobile station shall switch to the assigned PDCHs, start timer T3164 and proceed with contention resolution of the one phase access procedure according to subclause 7.1.2.3.

Reference

3GPP TS 04.60 subclauses 7.1.2.2.2 and 7.1.2.2.1.

42.1.2.1.1.3.2 Test purpose

To verify that the mobile station switches to the assigned PDCHs on receipt of a PACKET UPLINK ASSIGNMENT message after a PACKET QUEUING NOTIFICATION message.

42.1.2.1.1.3.3 Method of test

Initial conditions

System Simulator:

1 cell supporting GPRS. The packet system information ACCESS_BURST_TYPE indicates 8 bit access.

Mobile Station:

The MS is switched off. The SIM is updated to the test cell.

Specific PICS Statements

-

PIXIT Statements

-

Test procedure

The MS is powered up or switched on and triggered to perform a GPRS attach. The SS send PACKET QUEUING NOTIFICATION message and sends then PACKET UPLINK ASSIGNMENT message. The SS allows the MS to complete the GPRS attach procedure.

Maximum duration of the test

15 s.

Expected sequence

Step	Direction	Message	Comments
1	MS		The MS is powered up or switched on and triggered to perform a GPRS attach procedure.
2	MS -> SS	PACKET CHANNEL REQUEST	Received on PRACH.
3	SS -> MS	PACKET QUEUING NOTIFICATION	Sent on PAGCH.
4	SS -> MS	PACKET UPLINK ASSIGNMENT	Include same TQI as step 3. Sent on PAGCH before timer T3162 expires.
5		{GPRS attach procedure }	Macro. Completion from step 4 in the attach procedure.

Specific message contents

None.

42.1.2.1.1.4 Packet Uplink Assignment / Packet queuing notification / Expiry of timer T3162

42.1.2.1.1.4.1 Conformance requirements

On receipt of a PACKET QUEUING NOTIFICATION message corresponding to one of its 3 last PACKET CHANNEL REQUEST messages the mobile station shall stop timer T3170 and T3186 if running and stop sending PACKET CHANNEL REQUEST messages. On receipt of a PACKET UPLINK ASSIGNMENT message following a PACKET QUEUING NOTIFICATION message, the mobile station shall stop timer T3162 and follow the procedures defined in subclause 7.1.2.2.1. At expiry of timer T3162, the packet access procedure shall be aborted and a packet access failure indicated to the upper layer and the mobile station shall return to packet idle mode.

Reference

3GPP TS 04.60 subclauses 7.1.2.2.2 and 13.1.

42.1.2.1.1.4.2 Test purpose

1. To verify that the MS waits T3162 seconds before aborting the packet access procedure on receipt of a PACKET QUEUING NOTIFICATION message.
2. To verify that the mobile station listening to its paging channel after a time greater than timer T3162.

42.1.2.1.1.4.3 Method of test

Initial conditions

System Simulator:

1 cell supporting GPRS.

Mobile Station:

The MS is GPRS attached and in packet idle mode.

Specific PICS Statements

-

PIXIT Statements

-

Test procedure

The SS page the MS with a PACKET PAGING REQUEST message. The SS sends PACKET QUEUING NOTIFICATION message corresponding to one of its 3 last PACKET CHANNEL REQUEST messages. The SS waits until T3162 seconds elapse and sends an PACKET UPLINK ASSIGNMENT message which shall be ignored by the MS since the access procedure should be aborted.

The SS page the MS with a PACKET PAGING REQUEST message. The SS verifies that the MS respond to the paging request and sends PACKET QUEUING NOTIFICATION message corresponding to one of its 3 last PACKET CHANNEL REQUEST messages. The SS sends a PACKET UPLINK ASSIGNMENT message before T3162 seconds elapse and the MS shall complete the uplink data transfer containing the paging response.

Maximum duration of the test

1 minute.

Expected sequence

Step	Direction	Message	Comments
1	SS -> MS	PACKET PAGING REQUEST	Sent on PPCH.
2	MS -> SS	PACKET CHANNEL REQUEST	ACCESS TYPE = "Page response". Received on PRACH.
3	SS -> MS	PACKET QUEUING NOTIFICATION	Allocate a TQI to the MS. Sent on PAGCH.
4	SS		The SS waits T3162 + 0.1*T3162 .
5	SS -> MS	PACKET UPLINK ASSIGNMENT	Include same TQI as in step 3 and dynamic allocation struct. Sent on PAGCH.
6	SS		The SS verifies for 5 s that the MS does not respond.
7	SS -> MS	PACKET PAGING REQUEST	Sent on PPCH.
8	MS -> SS	PACKET CHANNEL REQUEST	ACCESS TYPE = "Page response". Received on PRACH.
9	SS -> MS	PACKET QUEUING NOTIFICATION	Allocate a TQI to the MS. Sent on PAGCH.
10	SS		The SS waits T3162 - 0.1*T3162 .
11	SS -> MS	PACKET UPLINK ASSIGNMENT	Include same TQI as in step 9, dynamic allocation struct. Sent on PAGCH.
12	MS -> SS	UPLINK RLC DATA BLOCK	LLC PDU implicitly indicating paging response. Received on uplink PDTCH assigned in step 11.
13	SS -> MS	PACKET UPLINK ACK/NACK	Acknowledge the received RLC data block, Final Ack Indicator = "1". Sent on PACCH
14	MS -> SS	PACKET CONTROL ACKNOWLEDGEMENT	Acknowledge the RLC control message. Received on PACCH.

Specific message contents

None.

42.1.2.1.2 Packet Uplink Assignment / Response to packet polling request

42.1.2.1.2.1 Conformance requirements

On receipt of a PACKET POLLING REQUEST message, the mobile station shall respond to the network with the PACKET CONTROL ACKNOWLEDGEMENT message in the reserved uplink radio block specified by the RRBp field.

Reference

3GPP TS 04.60 subclause 7.1.2.2.3.

42.1.2.1.2.2 Test purpose

To verify that the mobile station responds to the Network with a PACKET CONTROL ACKNOWLEDGEMENT message in the reserved uplink radio block specified by the RRBp field on receipt of a PACKET POLLING REQUEST message.

42.1.2.1.2.3 Method of test

Initial conditions

System Simulator:

1 cell supporting GPRS. The packet system information ACCESS_BURST_TYPE indicates 8 bit access and CONTROL_ACK_TYPE indicates four access bursts.

Mobile Station:

The MS is GPRS attached and in packet idle mode. PDP context 2 has been established.

Specific PICS Statements

-

PIXIT Statements

-

Test procedure

The MS is triggered to transfer data. The SS sends a PACKET QUEUING NOTIFICATION message and sends then a PACKET POLLING REQUEST message. On receipt of PACKET POLLING REQUEST message the MS shall respond with PACKET CONTROL ACKNOWLEDGEMENT message as four access bursts. The SS verifies that MS sends the PACKET CONTROL ACKNOWLEDGEMENT and send PACKET UPLINK ASSIGNMENT message including the TQI. The MS then sends the Packet Resource Request and the SS then sends the Packet uplink assignment to complete the uplink data transfer.

Maximum duration of the test

30 s.

Expected sequence

Step	Direction	Message	Comments
1	MS		The MS is triggered to transfer 200 octets data.
2	MS -> SS	PACKET CHANNEL REQUEST	One or Two Phase Access Request Received on PRACH.
3	SS -> MS	PACKET QUEUING NOTIFICATION	Allocate a TQI to the MS. Sent on PAGCH.
4	SS -> MS	PACKET POLLING REQUEST	Include same TQI as step 3. Sent on PAGCH.
5	MS -> SS	PACKET CONTROL ACKNOWLEDGEMENT	Received on the uplink block specified by the RRBp field on PACCH as four access bursts.
6	SS		SS verifies that the message in step 5 was received.
7	SS -> MS	PACKET UPLINK ASSIGNMENT	Include same TQI as step 3, Single block assignment, to order the MS to follow the two phase access procedure. Sent on PAGCH
8	MS -> SS	PACKET RESOURCE REQUEST	Received on one of the blocks assigned in Step 7.
9	SS -> MS	PACKET UPLINK ASSIGNMENT	Dynamic allocation struct and USF_GRANULARITY = four blocks. Sent on PACCH.
10		{Completion of uplink RLC data block transfer}	

Specific message contents

None.

42.1.2.1.3 Packet Uplink Assignment / Packet access reject procedure

42.1.2.1.3.1 Packet Uplink Assignment / Packet access reject / Action during Wait_Indication

42.1.2.1.3.1.1 Conformance requirements

On receipt of a PACKET ACCESS REJECT message containing a Reject structure addressed to the mobile station, where the Packet Request Reference in the Reject structure corresponds to one of its three last PACKET CHANNEL REQUEST messages, the mobile station shall stop sending PACKET CHANNEL REQUEST messages, start timer T3172 with the value indicated in the WAIT_INDICATION field if present, start timer T3170 if it has not already been started and listen to the downlink PCCCH until timer T3170 expires. During this time, the mobile station shall ignore additional PACKET ACCESS REJECT message, but on reception of any PACKET UPLINK ASSIGNMENT message corresponding to any other of its 3 last PACKET CHANNEL REQUEST MESSAGE the mobile station shall stop timers T3170 and T3172 if running and follow the procedure defined in subclause 7.1.2.2.1.

Reference

3GPP TS 04.60 subclause 7.1.2.2.4.

42.1.2.1.3.1.2 Test purpose

To verify that the mobile station stops sending PACKET CHANNEL REQUEST messages on receipt of a PACKET ACCESS REJECT message containing a WAIT_INDICATION field.

To verify that the mobile station ignores additional PACKET ACCESS REJECT messages, but on reception of any PACKET UPLINK ASSIGNMENT message corresponding to any other of its 3 last PACKET CHANNEL REQUEST messages the mobile station shall switch to the assigned PDCHs if the message is received before timer T3170 expire.

42.1.2.1.3.1.3 Method of test

Initial conditions

System Simulator:

1 cell supporting GPRS. The packet system information MAX_RETRANS indicates 7 retransmissions, TX_INT indicates 50 slots to spread transmission, parameter S indicates the value 217 and BS_PRACH_BLKs = 11 (11 Blocks reserved for PRACH).

Mobile Station:

The MS is switched off. The SIM is updated to the test cell.

Specific PICS Statements

-

PIXIT Statements

-

Test procedures

The MS is powered up or switched on and triggered to perform a GPRS attach. The SS sends PACKET ACCESS REJECT message with WAIT_INDICATION field corresponding to one of the last three PACKET CHANNEL REQUEST messages. The SS verifies that the MS does not send further PACKET CHANNEL REQUEST messages. The SS sends a new PACKET ACCESS REJECT message without WAIT_INDICATION field. The SS shall then send a PACKET UPLINK ASSIGNMENT message corresponding to any other of the last three sent PACKET CHANNEL REQUEST messages before the timer T3170 expire ($T+2*S$ TDMA frames). The SS allows the MS to complete the GPRS attach procedure.

Maximum duration of the test

4 min.

Expected sequence

Step	Direction	Message	Comments
1	MS		The MS is powered up or switched on and triggered to perform a GPRS attach.
2	MS -> SS	PACKET CHANNEL REQUEST	Received on PRACH.
3	MS -> SS	PACKET CHANNEL REQUEST	Received on PRACH.
4	MS -> SS	PACKET CHANNEL REQUEST	Received on PRACH.
5	SS -> MS	PACKET ACCESS REJECT	Containing WAIT_INDICATION = 15 seconds and packet request reference = pertaining to message received in step 2. Sent on PAGCH.
6	SS		The SS checks $0,8 \cdot T3170$ that the MS does not send further PACKET CHANNEL REQUEST messages.
7	SS -> MS	PACKET ACCESS REJECT	Without WAIT_INDICATION. Sent $0,8 \cdot T3170$ on PAGCH. The MS shall not consider this message.
8	SS -> MS	PACKET UPLINK ASSIGNMENT	Random Reference = pertaining to message received in step 3. Sent $0,9 \cdot T3170$ on PAGCH.
9		{GPRS attach procedure}	Macro. Completion from step 4 in the attach procedure.

Specific message contents

None.

42.1.2.1.3.2 Packet Uplink Assignment / Packet access reject / No respond

42.1.2.1.3.2.1 Conformance requirements

On receipt of a PACKET ACCESS REJECT message containing a Reject structure addressed to the mobile station, where the Packet Request Reference in the Reject structure corresponds to one of its 3 last PACKET CHANNEL REQUEST messages:

- the mobile station is not allowed to make a new attempt for packet access in the same cell until timer T3172 expires, but may attempt packet access in an other cell after successful cell reselection for radio conditions reasons (see 3GPP TS 05.08). A mobile station in class A or B mode of operation may attempt to enter the dedicated mode in the same cell before timer T3172 has expired. During the timer T3172 is running, the mobile station shall ignore all received PACKET PAGING REQUEST messages except paging request to trigger RR connection establishment.

Reference

3GPP TS 04.60 subclause 7.1.2.2.4.

42.1.2.1.3.2.2 Test purpose

To verify that the mobile station ignores PACKET PAGING REQUEST messages requesting TBF establishment when T3172 is running.

42.1.2.1.3.2.3 Method of test

Initial conditions

System Simulator:

1 cell supporting GPRS. The packet system information ACCESS_BURST_TYPE indicates 8 bit access.

Mobile Station:

The MS is GPRS attached and in packet idle mode.

Specific PICS Statements

-

PIXIT Statements

-

Test procedure

The SS sends a PACKET PAGING REQUEST message. After response from the MS the SS sends PACKET ACCESS REJECT message with WAIT_INDICATION set to a value between 1 to 255 s (see specific message contents). The SS sends then a PACKET UPLINK ASSIGNMENT message after timer T3170 has elapse. The SS verifies that the MS not respond to the message. The SS sends a PACKET PAGING REQUEST message request TBF establishment before the wait indication has elapse. The SS verifies that the MS not respond to the message. The SS sends a PACKET PAGING REQUEST message request TBF establishment after the wait indication has elapse. The SS verifies that the MS respond to the message.

The test procedures shall be repeated with different chosen values of WAIT INDICATION.

Maximum duration of the test

10 minutes.

Expected sequence

Step	Direction	Message	Comments
1	SS -> MS	PACKET PAGING REQUEST	Sent on PPCH.
2	MS -> SS	PACKET CHANNEL REQUEST	Received on PRACH.
3	SS -> MS	PACKET ACCESS REJECT	See specific message contents. Sent on PAGCH.
4	SS -> MS	PACKET UPLINK ASSIGNMENT	Send this message $1,1 \cdot T3170$ on PAGCH.
5	SS		Verify for 5 seconds that the MS does not respond to message in step 4.
6	SS -> MS	PACKET PAGING REQUEST	Request TBF establishment. Send this message after $(0,9 \cdot \text{WAIT INDICATION (step 3)})$ on PPCH.
7	SS		Verify that the MS does not respond to message in step 6.
8	SS -> MS	PACKET PAGING REQUEST	Request TBF establishment. Send this message after $(1,1 \cdot \text{WAIT INDICATION (step 3)})$ on PPCH.
9	MS -> SS	PACKET CHANNEL REQUEST	Received on PRACH.

The test is repeated with different values of WAIT INDICATION, see specific message contents.

Specific message contents

As default messages contents, except:

PACKET ACCESS REJECT in step 3

Information element	Value/remark
< WAIT_INDICATION >	Set values between 1-255, see below.
< WAIT_INDICATION_SIZE >	0 (units of seconds)

Case 1: WAIT_INDICATION = 60.

Case 2: WAIT_INDICATION = 240.

42.1.2.1.3.3 Void

42.1.2.1.4 Packet Uplink Assignment / Packet Uplink Assignment handling

42.1.2.1.4.1 Conformance requirements

On receipt of a PACKET UPLINK ASSIGNMENT message corresponding to one of its 3 last PACKET CHANNEL REQUEST messages, the mobile station shall stop timers T3186 and T3170 if running, stop sending PACKET CHANNEL REQUEST messages.

Reference

3GPP TS 04.60 subclause 7.1.2.2.1.

42.1.2.1.4.2 Test purpose

To verify that the mobile station stops sending PACKET CHANNEL REQUEST messages on receipt of a PACKET UPLINK ASSIGNMENT message.

42.1.2.1.4.3 Method of test

Initial conditions

System Simulator:

1 cell supporting GPRS. The packet system information MAX_RETRANS indicates 7 allowed retransmission.

Mobile Station:

The MS is switched off. The SIM is updated to the test cell.

Specific PICS Statements

-

PIXIT Statements

-

Foreseen final state of the MS

Packet idle mode.

Test procedure

The MS is powered up or switched on and triggered to perform a GPRS attach. The SS send a PACKET UPLINK ASSIGNMENT message corresponding to one of the last 3 PACKET CHANNEL REQUEST messages from the MS. The SS verifies that the MS stops sending PACKET CHANNEL REQUEST messages. The SS allows the MS to complete the GPRS attach procedure.

Maximum duration of the test

15 s.

Expected sequence

Step	Direction	Message	Comments
1	MS		The MS is powered up or switched on and triggered to perform a GPRS attach.
2	MS -> SS	PACKET CHANNEL REQUEST	Received on PRACH.
3	MS -> SS	PACKET CHANNEL REQUEST	Received on PRACH.
4	SS -> MS	PACKET UPLINK ASSIGNMENT	Respond to requests message in step 2. Sent on PAGCH with dynamic allocation struct. The SS shall verify for 4.5 seconds that the MS stops sending packet channel request messages.
5		{GPRS attach procedure }	Macro. Completion from step 4 in the attach procedure.

Specific message contents

None.

42.1.2.1.5 Packet Uplink Assignment / One or two phase access

42.1.2.1.5.1 Conformance requirements

A mobile station that has not indicated Single Block Without TBF Establishment in the PACKET CHANNEL REQUEST message shall perform a two phase access if the Single Block Allocation struct is included in the PACKET UPLINK ASSIGNMENT message, or a one phase access if the Dynamic Allocation is included.

Reference

3GPP TS 04.60 subclause 7.1.2.2.1.

42.1.2.1.5.2 Test purpose

To verify that the mobile station proceeds with one phase access or two phase access according to the parameters in the PACKET UPLINK ASSIGNMENT message.

42.1.2.1.5.3 Method of test

Initial conditions

System Simulator:

1 cell supporting GPRS. The packet system information ACCESS_BURST_TYPE indicates 8 bit access.

Mobile Station:

The MS is switched off. The SIM is updated to the test cell.

Specific PICS Statements

- Switch off on button (TSPC_Feat_OnOff)

PIXIT Statements

-

Test procedures

The MS is powered up or switched on and triggered to perform a GPRS attach. The SS send a PACKET UPLINK ASSIGNMENT message with Dynamic Allocation struct information field, the MS shall proceed with a one-phase access. The SS allows the MS to complete the GPRS attach procedure. Switch off the MS.

The MS is switched on and triggered to perform a GPRS attach. The SS send a PACKET UPLINK ASSIGNMENT message with Single Block Allocation struct information field, the MS shall perform a two-phase access i.e. it should transmit a PACKET RESOURCE REQUEST message on the allocated uplink resource. The SS responds with a PACKET UPLINK ASSIGNMENT message with Dynamic Allocation struct information field. The SS allows the MS to complete the GPRS attach procedure. Switch off the MS.

Maximum duration of the test

2 minutes.

Expected sequences

Step	Direction	Message	Comments
1	MS		The MS is powered up or switched on and triggered to perform a GPRS attach.
2	MS -> SS	PACKET CHANNEL REQUEST	Received on PRACH.
3	SS -> MS	PACKET UPLINK ASSIGNMENT	Dynamic Allocation struct information. Sent on PAGCH.
4		{GPRS attach procedure }	Macro. Completions from step 4 in the attach procedure as one phase access.
5	MS		The MS is switched off or power is removed (see PICS).
6		{GPRS detach procedure }	Macro. Procedure only applies if MS is switched off.
7	MS		The MS is powered up or switched on and triggered to perform a GPRS attach.
8	MS -> SS	PACKET CHANNEL REQUEST	Received on PRACH.
9	SS -> MS	PACKET UPLINK ASSIGNMENT	Single Block Allocation struct information. Sent on PAGCH.
10	MS -> SS	PACKET RESOURCE REQUEST	Received on the single block assigned in step 9.
11	SS -> MS	PACKET UPLINK ASSIGNMENT	Dynamic Allocation struct information. Sent on PACCH.
12		{ GPRS attach procedure }	Macro. Completion from step 4 in the attach procedure.
13	MS		The MS is switched off or power is removed (see PICS).
14		{GPRS detach procedure }	Macro. Procedure only applies if MS is switched off.

Specific message contents

PACKET UPLINK ASSIGNMENT dynamic allocation struct specified in subclause 42.1.3.2.8.

PACKET UPLINK ASSIGNMENT single block allocation struct specified in subclause 42.1.3.2.10.

42.1.2.1.6 Packet Uplink Assignment / Decoding of frequency parameters

42.1.2.1.6.1 Conformance requirements

The mobile station may use information received on PBCCH, BCCH or a previous assignment message to decode the frequency parameters contained in the assignment message. If the mobile station detects an invalid Frequency Parameters information element in the assignment message, it shall abort the procedure, if required initiate a partial acquisition of PBCCH or BCCH, and may then re-initiate this procedure.

When the indirect encoding is used, the network may include a CHANGE_MARK_1 and a CHANGE_MARK_2 in the Frequency Parameters information element. The mobile station shall then verify that it is using a set of PBCCH or BCCH information identified by a PSI or SI *change mark* corresponding to one of the CHANGE_MARK_1 or 2 parameters, for the decoding of the frequency information. If that is not the case, an abnormal condition occurs.

Reference

3GPP TS 04.60 subclauses 7.1.2.2.1 and 5.5.1.7.

42.1.2.1.6.2 Test purpose

To verify that the mobile station uses information received on PBCCH to decode the frequency parameters contained in the assignment message and when the mobile station receives a PACKET UPLINK ASSIGNMENT message with an invalid frequency parameters information element the mobile station shall abort the procedure.

42.1.2.1.6.3 Method of test

Initial conditions

System Simulator:

1 cell supporting GPRS. Packet system information PSI2 including frequency hopping parameters.

Mobile Station:

The MS is switched off. The SIM is updated to the test cell.

Specific PICS Statements

- Switch off on button (TSPC_Feat_OnOff)

PIXIT Statements

-

Test procedure

The MS is powered up or switched on and triggered to perform a GPRS attach. The SS send a PACKET UPLINK ASSIGNMENT message containing frequency parameter information elements. The SS allows the MS to complete the GPRS attach procedure. The MS is switched off, then powered up or switched on again and triggered to perform a GPRS attach. The SS sends PACKET UPLINK ASSIGNMENT message containing an invalid frequency parameter as response to the PACKET CHANNEL REQUEST message from the MS. The SS verifies that the MS aborts the procedure.

Maximum duration of the test

30 s.

Expected sequence

Step	Direction	Message	Comments
1	MS		The MS is powered up or switched on and triggered to perform a GPRS attach.
2	MS -> SS	PACKET CHANNEL REQUEST	Received on PRACH.
3	SS -> MS	PACKET UPLINK ASSIGNMENT	Include frequency parameters see specific message contents. Sent on PAGCH.
4		{GPRS attach procedure}	Macro. Completion from step 4 in the attach procedure.
5	MS		Switch off the MS or power down MS
6		{GPRS detach procedure}	Macro. Procedure only applies if MS is switched off.
7	MS		The MS is powered up or switched on and triggered to perform a GPRS attach.
8	MS -> SS	PACKET CHANNEL REQUEST	Received on PRACH.
9	SS -> MS	PACKET UPLINK ASSIGNMENT	Include invalid frequency parameter see specific message contents. Sent on PAGCH.
10	SS		PACKET DOWNLINK DUMMY CONTROL BLOCK with USF assigned to MS
11	SS		Verify that MS does not send an RLC data block

Specific message contents

As default messages contents, except:

PACKET SYSTEM INFORMATION type 2 in initial condition

Information element	Value/remark
< PSI2_CHANGE_MARK >	01
< PCCCH Description List struct >	
< TSC >	101
{0 1< Hopping PCCCH carriers >	1
< MA_NUMBER	0010 (List 2)
< Hopping PCCCH carriers struct >	
< Hopping PCCCH carriers struct >	
< MAIO >	0010
< TIMESLOT_ALLOCATION	00001000 (timeslot 4)

PACKET UPLINK ASSIGNMENT in step 3

Information element	Value/remark
{0 1< Frequency Parameters > < Frequency Parameters IE > < TSC > < Indirect encoding struct > < MAIO > < MA_NUMBER > {0 1< CHANGE_MARK_1 > - CHANGE_MARK_1} {0 1< CHANGE_MARK_2 >	1 (hopping channel) Same as PSI2. 01 (Indirect encoding) Same as PSI2. Same as PSI2. 1 (CHANGE_MARK_1 present) 01 (same change mark as PSI2_CHANGE_MARK) 0 (no CHANGE_MARK_2)

PACKET UPLINK ASSIGNMENT in step 9

Information element	Value/remark
{0 1< Frequency Parameters > < Frequency Parameters IE > < TSC > < Indirect encoding struct > < MAIO > < MA_NUMBER > {0 1< CHANGE_MARK_1 > - CHANGE_MARK_1} {0 1< CHANGE_MARK_2 >	1 (hopping channel) Same as PSI2. 01 (Indirect encoding) Same as PSI2. Same as PSI2. 1 (CHANGE_MARK_1 present) 00 (which mismatches PSI2_CHANGE_MARK) 0 (no CHANGE_MARK_2)

42.1.2.1.7 Packet Uplink Assignment / Most recently received Packet Uplink Assignment

42.1.2.1.7.1 Conformance requirements

A PACKET UPLINK ASSIGNMENT message may indicate an assignment starting time in the TBF Starting Time parameter. The mobile station shall monitor PCCCH until the point in time denoted by the TBF Starting Time. If while monitoring the PCCCH the mobile station receives more than one PACKET UPLINK ASSIGNMENT message, it shall act upon the most recently received message and shall ignore the previous message.

Reference

3GPP TS 04.60 subclause 7.1.2.2.1.

42.1.2.1.7.2 Test purpose

To verify that the mobile station monitors PCCCH until the point in time denoted by the TBF Starting Time and that the mobile station acts on the most recently received Packet Uplink Assignment.

42.1.2.1.7.3 Method of test

Initial conditions

System Simulator:

1 cell supporting GPRS. The packet system information ACCESS_BURST_TYPE indicates 8 bit access.

Mobile Station:

The MS is switched off. The SIM is updated to the test cell.

Specific PICS Statements

-

PIXIT Statements

-

Test procedure

The MS is powered up or switched on and triggered to perform a GPRS attach. The SS sends PACKET UPLINK ASSIGNMENT message with a TBF starting time. Then send a new PACKET UPLINK ASSIGNMENT message with another TBF starting time and a different timeslot on PCCCH before the first TBF starting time has elapse. The MS shall start to send the RLC data block on the allocated uplink according to the second TBF starting time. The SS allows the MS to complete the GPRS attach procedure.

Maximum duration of the test

15 s.

Expected sequence

Step	Direction	Message	Comments
1	MS		The MS is powered up or switched on and triggered to perform a GPRS attach procedure.
2	MS -> SS	PACKET CHANNEL REQUEST	Received on PRACH.
3	SS -> MS	PACKET UPLINK ASSIGNMENT	See specific message contents. Sent on PAGCH.
4	SS -> MS	PACKET UPLINK ASSIGNMENT	See specific message contents. Sent on PAGCH.
5		{GPRS attach procedure}	Macro. Completion from step 4 in the attach procedure. Sent on allocated uplink resource. The SS verifies that the MS starts to send data according to information in step 4.

Specific message contents

As default messages contents, except:

PACKET UPLINK ASSIGNMENT in step 3

Information element	Value/remark
Dynamic allocation struct	1
< USF_TN3 >	
< TBF_STARTING_TIME >	Arbitrarily chosen, high enough so the next message will be sent before the time has elapsed.

PACKET UPLINK ASSIGNMENT in step 4

Information element	Value/remark
Dynamic allocation struct	1
< USF_TN6 >	
< TBF_STARTING_TIME >	Arbitrarily chosen.

42.1.2.1.8 Packet Uplink Assignment / One phase access

42.1.2.1.8.1 Packet Uplink Assignment / One phase access / Contention Resolution

The contention resolution is completed on the mobile station when the mobile station receives a PACKET UPLINK ACK/NACK message with the same TLLI as the mobile station has included in the RLC header of the first RLC data blocks. The mobile station shall then stop timer T3166 and counter N3104.

At sending of the first RLC data block, the mobile station shall stop timer T3164, set counter N3104 to 1, and start timer T3166. Counter N3104 shall be stepped each time the mobile station sends an RLC data block.

42.1.2.1.8.1.1 Packet Uplink Assignment / One phase access / Contention resolution / Inclusion of TLLI in RLC data blocks

42.1.2.1.8.1.1.1 Conformance requirements

In order to uniquely identify the mobile station when sending on uplink, the RLC Header is extended to include the TLLI of the mobile station until contention resolution is completed on the mobile station side.

All the RLC data blocks of an uplink TBF initiated by one phase access shall each contain a TLLI field in the RLC data block header until the contention resolution is completed on the mobile station side. After the reaction time specified in 3GPP TS 05.10 no other RLC data blocks shall contain a TLLI field.

The TLLI_BLOCK_CHANNEL_CODING parameter in the PACKET UPLINK ASSIGNMENT message indicates whether a RLC data block containing a TLLI field in the RLC data block header shall be encoded using CS-1 or using the channel coding scheme commanded.

The mobile station shall send all other RLC data blocks using the channel coding scheme commanded.

Upon contention resolution during one phase access, the mobile station shall start transmitting RLC data blocks without the TLLI field no later than the next occurrence of block $B((x+3) \bmod 12)$ where block $B(x)$ is the radio block containing the contention resolution message.

Reference

3GPP TS 04.60 subclauses 7.1.2.3 and 8.1.1.

3GPP TS 05.10 subclause 6.11.3.

42.1.2.1.8.1.1.2 Test purpose

1. To verify that in one phase access the first RLC data blocks of an uplink TBF contain a TLLI field in the RLC data block header and that these blocks are encoded according to the TLLI_BLOCK_CHANNEL_CODING parameter specified in the PACKET UPLINK ASSIGNMENT message.
2. To verify that upon contention resolution during one phase access the RLC data blocks not contain a TLLI field and are encoded using the CHANNEL_CODING_COMMAND parameter included in the PACKET_UPLINK_ASSIGNMENT after the contention resolution reaction time.

42.1.2.1.8.1.1.3 Method of test

Initial conditions

System Simulator:

1 cell supporting GPRS. The packet system information ACCESS_BURST_TYPE indicates 8 bit access.

Mobile Station:

The MS is GPRS attached and in packet idle mode. PDP context 2 has been established.

Specific PICS Statements

-

PIXIT Statements

-

Test procedure

The MS is triggered to transfer an LLC PDU. The SS sends PACKET UPLINK ASSIGNMENT message containing Dynamic Allocation struct. The MS shall start to send RLC data and RLC/MAC control blocks on the allocated uplink. The SS allows the MS to send the uplink data transfer. The SS verifies the coding is the scheme specified by TLLI_BLOCK_CHANNEL_CODING, the TFI is correct and the block contains TLLI in the first RLC data blocks. After contention resolution reaction time shall the remaining RLC data blocks contain coding scheme specified by CHANNEL_CODING_COMMAND, the TFI shall be correct and the blocks do not contain TLLI.

Maximum duration of the test

3 minutes.

Expected sequence

Step	Direction	Message	Comments
1	MS		The MS is triggered to initiate packet uplink transfer of an LLC PDU consisting of 500 octets data.
2	MS -> SS	PACKET CHANNEL REQUEST	Received on PRACH.
2A			If the MS requests two phase access the Test Case is terminated
3	SS -> MS	PACKET UPLINK ASSIGNMENT	Dynamic allocation struct, USF_GRANULARITY = one block, Sent on PAGCH.
4	SS -> MS	PACKET DOWNLINK DUMMY CONTROL BLOCK	Sent on the PACCH of the PDCH assigned in step 3, containing USF assigned to the MS.
5	MS -> SS	UPLINK RLC DATA BLOCK	Received on the assigned PDTCH. Check that the coding is the scheme specified by TLLI_BLOCK_CHANNEL_CODING, the TFI is correct and the block contains TLLI.
6	SS		Check that there is no RLC data block transmitted by the MS in the next radio block on PDTCH.
7	SS -> MS	PACKET UPLINK ACK/NACK	Sent on the PACCH of the PDCH and containing an USF not assigned to the MS.
8	SS		Waits 3 blocks.
9	SS -> MS	PACKET DOWNLINK DUMMY CONTROL BLOCK	Sent on the PACCH of the PDCH assigned in step 3, containing USF assigned to the MS.
A9.1 (optional step)	MS -> SS	UPLINK RLC DATA BLOCK	Received on the assigned PDTCH. Check that the coding is the scheme specified by TLLI_BLOCK_CHANNEL_CODING, the TFI is correct and the block contains TLLI.
A9.2 (optional step)	SS -> MS	PACKET DOWNLINK DUMMY CONTROL BLOCK	Sent on the PACCH of the PDCH assigned in step 3, containing USF assigned to the MS.
10	MS -> SS	UPLINK RLC DATA BLOCK	Received on the assigned PDTCH. Check that if the RLC data block is received after the contention resolution reaction time the coding is the scheme specified by CHANNEL_CODING_COMMAND, the TFI is correct and the block does not contain TLLI otherwise the content should be as comments in step 5.
11	SS -> MS	PACKET UPLINK ACK/NACK	Sent on the PACCH of the PDCH assigned in step 3, containing USF assigned to the MS.
12	MS -> SS	UPLINK RLC DATA BLOCK	Received on the assigned PDTCH. Check that the coding is the scheme specified by CHANNEL_CODING_COMMAND, the TFI is correct and the block does not contain TLLI.
13			Repeat steps 11 and 12 until the countdown value CV=0 in step 12.
14	SS -> MS	PACKET UPLINK ACK/NACK	Final Ack Indicator = '1' containing valid RRBP. Sent on PACCH of the assigned PDCH.
15	MS -> SS	PACKET CONTROL ACKNOWLEDGEMENT	Received on the block specified by RRBP on PACCH of the assigned PDCH.

Specific message contents

PACKET UPLINK ASSIGNMET message in step 3:

<pre>{0 < Global TFI > 10 < TLLI > 110 < TQI > 111 < Packet Request Reference >} < CHANNEL_CODING_COMMAND > < TLLI_BLOCK_CHANNEL_CODING ></pre>	<p>111 (Packet Request Reference, information field sent in PACKET CHANNEL REQUEST and frame number in which PACKET CHANNEL REQUEST was received) arbitrarily chosen but different from TLLI_BLOCK_CHANNEL_CODING CS-1</p>
---	--

PACKET UPLINK ACK/NACK message in step 7:

{0 1< CONTENTION_RESOLUTION_TLLI > - CONTENTION_RESOLUTION_TLLI}	1 the value received in step 5.
---	------------------------------------

42.1.2.1.8.1.2 Packet Uplink Assignment / One phase access / Contention resolution / Counter N3104

42.1.2.1.8.1.2.1 Conformance requirements

The contention resolution has failed on the mobile station side when the counter N3104 has reached its maximum value, or on expiry of timer T3166, or if the mobile station receives a PACKET UPLINK ACK/NACK message with the right TFI but with a another TLLI than the mobile station has included in the RLC header of the first RLC data blocks. The mobile station shall then reset the counter N3104, stop timer T3166 if not expired, immediately stop transmitting on this TBF and reinitiate the packet access procedure unless it has already been repeated 4 times.

Reference

3GPP TS 04.60 subclause 7.1.2.3.

42.1.2.1.8.1.2.2 Test purpose

To verify that the mobile station correctly sets and considers counter N3104.

Note

Counter N3104 is incremented by 1 with each new RLC/MAC block the mobile station sends until the first PACKET UPLINK ACK/NACK message is received.

Its maximum value is $N3104_MAX = 3 * (BS_CV_MAX + 3) * \text{no-of-timeslots-assigned}$, where BS_CV_MAX is broadcast in PSII.

42.1.2.1.8.1.2.3 Method of test

Initial conditions

System Simulator:

1 cell supporting GPRS. The packet system information BS_CV_MAX value = 1.

Mobile Station:

The MS is GPRS attached and in packet idle mode. PDP context 2 has been established.

Specific PICS Statements

-

PIXIT Statements

-

Test procedure

The MS is triggered to initiate packet uplink transfer of an LLC PDU. The SS assigns packet uplink resources in a PACKET UPLINK ASSIGNMENT message indicating one phase packet access. The MS shall start transferring RLC data blocks.. The SS verifies that the MS stops transmitting and re-initiates the packet access procedure.

At the second attempt, the SS sends PACKET UPLINK ACK/NACK exactly after N3104_MAX - 1 data blocks. The SS verifies that this time the MS does not abort the access procedure and successfully completes uplink transfer.

Maximum duration of the test

5 minutes.

Expected sequence

Step	Direction	Message	Comments
1	MS		The MS is triggered to initiate packet uplink transfer of an LLC PDU consisting of 500 octets data.
2	MS -> SS	PACKET CHANNEL REQUEST	Received on PRACH.
2A			If the MS requests two phase access the Test Case is terminated
3	SS -> MS	PACKET UPLINK ASSIGNMENT	Indicating one phase packet access granted and CS-1. Sent on PAGCH.
4	MS -> SS	n RLC data blocks	SS receives n = N3104_MAX data blocks. Received on the assigned PDTCH.
5	MS -> SS	PACKET CHANNEL REQUEST	SS verifies that MS does not send further RLC data blocks and MS re-initiates packet access procedure. Received on PRACH.
5A			If the MS requests two phase access the Test Case is terminated
6	SS -> MS	PACKET UPLINK ASSIGNMENT	Indicating one phase packet access granted. Sent on PAGCH.
7	MS -> SS	n-1 RLC data blocks	SS receives N3104_MAX – 1 data blocks. Received on the assigned PDTCH.
8	SS -> MS	PACKET UPLINK ACK/NACK	Sent on PACCH..
9	SS -> MS	PACKET DOWNLINK DUMMY CONTROL BLOCK	Sent at least 3 blocks after step 8. USF assigned
10		{Uplink data transfer }	Macro. Completion of the macro procedure.

Specific message contents

None.

42.1.2.1.8.1.3 Packet Uplink Assignment / One phase access / Contention resolution / Timer T3166

42.1.2.1.8.1.3.1 Conformance requirements

The contention resolution has failed on the mobile station side when the counter N3104 has reached its maximum value, or on expiry of timer T3166, or if the mobile station receives a PACKET UPLINK ACK/NACK message with the right TFI but with a another TLLI than the mobile station has included in the RLC header of the first RLC data blocks. The mobile station shall then reset the counter N3104, stop timer T3166 if not expired, immediately stop transmitting on this TBF and reinitiate the packet access procedure unless it has already been repeated 4 times.

Reference

3GPP TS 04.60 subclause 7.1.2.3.

42.1.2.1.8.1.3.2 Test purpose

To verify that the mobile station correctly considers timer T3166.

42.1.2.1.8.1.3.3 Method of test

Initial conditions

System Simulator:

1 cell supporting GPRS. The packet system information ACCESS_BURST_TYPE indicates 8 bit access and BS_CV_MAX value = 15.

Mobile Station:

The MS is GPRS attached and in packet idle mode. PDP context 2 has been established.

Specific PICS Statements

-

PIXIT Statements

-

Foreseen final state of the MS

Packet idle mode.

Test procedure

The MS is triggered to initiate packet uplink transfer of an LLC PDU. The SS assigns packet uplink resources in a PACKET UPLINK ASSIGNMENT message indicating one phase packet access. The MS shall start transferring RLC data blocks. The SS reduces the block transfer rate by controlling the USF flag. In this way, the SS forces T3166 (with value 5 s.) to expire before counter N3104 reaches N3104_MAX (with value 45 blocks for current settings). The SS verifies that the MS stops transmitting and re-initiates the packet access procedure.

At the second attempt, the SS sends PACKET UPLINK ACK/NACK before T3166 expire. The SS verifies that this time the MS does not abort the access procedure and successfully completes the data transfer.

Maximum duration of the test

5 minutes.

Expected sequence

Step	Direction	Message	Comments
1	MS		The MS is triggered to initiate packet uplink transfer of an LLC PDU consisting of 1000 octets data.
2	MS -> SS	PACKET CHANNEL REQUEST	Received on PRACH.
2A			If the MS requests two phase access the Test Case is terminated
3	SS -> MS	PACKET UPLINK ASSIGNMENT	Indicating one phase packet access granted, CS-1 shall be used and USF_GRANULARITY = one block. Sent on PAGCH.
4	SS -> MS	PACKET DOWNLINK DUMMY CONTROL BLOCK	USF addressing the MS. Sent on PACCH of PDCH assigned in step 3.
5	MS -> SS	RLC data block	Received on the assigned PDTCH.
6	SS -> MS	PACKET DOWNLINK DUMMY CONTROL BLOCK	USF not addressing the MS. Sent on PACCH.
7	SS -> MS	PACKET DOWNLINK DUMMY CONTROL BLOCK	USF not addressing the MS. Sent on PACCH.
8	SS -> MS	PACKET DOWNLINK DUMMY CONTROL BLOCK	USF not addressing the MS. Sent on PACCH.
9	SS -> MS	PACKET DOWNLINK DUMMY CONTROL BLOCK	USF not addressing the MS. Sent on PACCH.
10	SS -> MS	PACKET DOWNLINK DUMMY CONTROL BLOCK	USF not addressing the MS. Sent on PACCH.
11	SS -> MS	PACKET DOWNLINK DUMMY CONTROL BLOCK	USF not addressing the MS. Sent on PACCH.
12	SS -> MS	PACKET DOWNLINK DUMMY CONTROL BLOCK	USF not addressing the MS. Sent on PACCH.
13	SS -> MS	PACKET DOWNLINK DUMMY CONTROL BLOCK	USF not addressing the MS. Sent on PACCH.
14	SS -> MS	PACKET DOWNLINK DUMMY CONTROL BLOCK	USF not addressing the MS. Sent on PACCH.
15	SS -> MS	PACKET DOWNLINK DUMMY CONTROL BLOCK	USF not addressing the MS. Sent on PACCH.
16	SS -> MS	PACKET DOWNLINK DUMMY CONTROL BLOCK	USF not addressing the MS. Sent on PACCH.
17	MS<->SS		Steps 4 to 16 are repeated at most 22 times or until MS does not send further RLC data blocks at step 5. Note: steps 4 to 16 transfer one block every 52 frames, or 240 ms. 22 repetitions require about 5.5 s. (Timer T3166 shall expire).
19	MS -> SS	PACKET CHANNEL REQUEST	MS re-initiates packet access procedure. Received on PRACH.
19A			If the MS requests two phase access the Test Case is terminated
20	SS -> MS	PACKET UPLINK ASSIGNMENT	Indicating one phase packet access granted, CS-1 shall be used and USF_GRANULARITY = one block. Sent on PAGCH.
21	MS<->SS		Steps 4 to 16 are repeated 17 times. Note: 17 repetitions require about 4.3 s. (Timer T3166 should not expire).
22	SS -> MS	PACKET UPLINK ACK/NACK	Sent on PACCH. Assigning USF to the MS.
23		{Uplink data transfer}	Macro. Completion of the TBF procedure.

42.1.2.1.8.1.4 Packet Uplink Assignment / One phase access / Contention resolution / TLLI mismatch

42.1.2.1.8.1.4.1 Conformance requirements

The contention resolution has failed on the mobile station side when the counter N3104 has reached its maximum value, or on expiry of timer T3166, or if the mobile station receives a PACKET UPLINK ACK/NACK message with the right TFI but with a another TLLI than the mobile station has included in the RLC header of the first RLC data blocks. The mobile station shall then reset the counter N3104, stop timer T3166 if not expired, immediately stop transmitting on this TBF and reinitiate the packet access procedure unless it has already been repeated 4 times.

Reference

3GPP TS 04.60 subclause 7.1.2.3.

42.1.2.1.8.1.4.2 Test purpose

To verify that the mobile station reinitiates packet access when it receives a PACKET UPLINK ACK/NACK message with the correct TFI but with a TLLI other than the mobile station has included in the RLC header.

42.1.2.1.8.1.4.3 Method of test

Initial conditions

System Simulator:

1 cell supporting GPRS.

Mobile Station:

The MS is GPRS attached and in packet idle mode. PDP context 2 has been established.

Specific PICS Statements

-

PIXIT Statements

-

Test procedure

The MS is triggered to initiate packet uplink transfer of an LLC PDU. The SS assigns packet uplink resources in a PACKET UPLINK ASSIGNMENT message indicating one phase packet access. The MS shall start transferring RLC data block after SS has assigned USF to the MS. The SS acknowledges the RLC block transfer with a PACKET UPLINK ACK/NACK including correct TFI and incorrect TLLI. The SS continue to assign USF to the MS. The SS shall verify that the MS immediately stops transmitting (see note below) and retries packet access procedure.

At the second attempt, the SS sends PACKET UPLINK ACK/NACK including a correct TLLI. The SS verifies that this time the MS does not abort the access procedure and successfully completes the data transfer.

NOTE: A mobile station, receiving a commanding message in block number N, shall take an "immediate" action as a result of the command, starting in any block from block number N+1 to N+6 (inclusive).

Maximum duration of the test

5 minutes.

Expected sequence

Step	Direction	Message	Comments
1	MS		The MS is triggered to initiate packet uplink transfer of an LLC PDU consisting of 200 octets data.
2	MS -> SS	PACKET CHANNEL REQUEST	Received on PRACH.
2A			If the MS requests two phase access the Test Case is terminated
3	SS -> MS	PACKET UPLINK ASSIGNMENT	Indicating one phase packet access granted, dynamic allocation struct and USF_GRANULARITY = one block. Sent on PAGCH.
4	SS -> MS	PACKET DOWNLINK DUMMY CONTROL BLOCK	Contained USF assigned to the MS.
5	MS -> SS	UPLINK RLC DATA BLOCK	Received on the assigned PDTCH.
6	SS -> MS	PACKET UPLINK ACK/NACK	Assign USF to the MS, include correct TFI and incorrect TLLI. Sent on PACCH.
7	SS -> MS	PACKET DOWNLINK DUMMY CONTROL BLOCK	Execute step 7 six times (see the note below) with USF assigned to the MS or until the MS sends Packet Channel request in step 8. The SS verifies that the MS does not transmit more than 6 uplink RLC data block after step 6 and before step 8.
			NOTE: The first blocks sent in this step should be sent on the block following the message sent in step 6, while other repetition should be on the consecutive blocks.
8	MS -> SS	PACKET CHANNEL REQUEST	MS re-initiates packet access procedure. Received on PRACH.
8A			If the MS requests two phase access the Test Case is terminated
9	SS -> MS	PACKET UPLINK ASSIGNMENT	Indicating one phase packet access granted, dynamic allocation struct and USF_GRANULARITY = one block. Sent on PAGCH.
10	SS -> MS	PACKET DOWNLINK DUMMY CONTROL BLOCK	Contained USF assigned to the MS.
11	MS -> SS	UPLINK RLC DATA BLOCK	Received on the assigned PDTCH.
12	SS -> MS	PACKET UPLINK ACK/NACK	Including correct TLLI. Sent on PACCH. USF Assigned.
13		{Uplink data transfer }	Macro. Completion of the TBF procedure.

42.1.2.1.8.1.5 Packet Uplink Assignment / One phase access / Contention resolution / 3 or 4 access repetition attempts

42.1.2.1.8.1.5.1 Conformance requirement

The contention resolution has failed on the mobile station side when the counter N3104 has reached its maximum value, or on expiry of timer T3166, or if the mobile station receives a PACKET UPLINK ACK/NACK message with the right TFI but with a another TLLI than the mobile station has included in the RLC header of the first RLC data blocks.

The mobile station shall then reset the counter N3104, stop timer T3166 if not expired, immediately stop transmitting on this TBF and reinitiate the packet access procedure unless it has already been repeated 4 times.

Reference

3GPP TS 04.60 subclause 7.1.2.3.

42.1.2.1.8.1.5.2 Test purpose

To verify that the mobile station attempts packet access procedure 4 or 5 times.

42.1.2.1.8.1.5.3 Method of test

Initial conditions

System Simulator:

1 cell supporting GPRS.

Mobile Station:

The MS is GPRS attached and in packet idle mode. PDP context 2 has been established.

Specific PICS Statements

-

PIXIT Statements

-

Test procedure

The MS is triggered to initiate packet uplink transfer of an LLC PDU. The SS assigns packet uplink resources in a PACKET UPLINK ASSIGNMENT message indicating one phase packet access. The MS shall start transferring RLC data blocks after SS has assigned USF to the MS. The SS acknowledges the RLC block transfer with a PACKET UPLINK ACK/NACK including a TLLI not corresponding to the MS. The SS shall verify that the MS stops transmitting blocks and reinitiates packet access. This test sequence shall be attempted four or five times.

Maximum duration of the test

5 minutes.

Expected sequence

Step	Direction	Message	Comments
1	MS		The MS is triggered to initiate packet uplink transfer of an LLC PDU consisting of 200 octets data.
2 2A	MS -> SS	PACKET CHANNEL REQUEST	Received on PRACH. If the MS requests two phase access the Test Case is terminated
3	SS -> MS	PACKET UPLINK ASSIGNMENT	Indicating one phase packet access granted, dynamic allocation struct and USF_GRANULARITY = one block. Sent on PAGCH.
4	SS -> MS	PACKET DOWNLINK DUMMY CONTROL BLOCK	Contained USF assigned to the MS.
5	MS -> SS	UPLINK RLC DATA BLOCK	Received on the assigned PDTCH.
6	SS -> MS	PACKET UPLINK ACK/NACK	USF not assigned to the MS, include a incorrect TLLI. Sent on PACCH.
7	SS		The SS verifies that the MS attempts the packet access procedure from step 2 four or five times.

Specific message contents

None.

42.1.2.1.8.1.6 Packet Uplink Assignment / One phase access / Contention resolution / Retransmission / Inclusion of TLLI in RLC data blocks after completion

42.1.2.1.8.1.6.1 Conformance requirements

The TLLI is used to uniquely identify the mobile station when sending on uplink. Every RLC data block that is sent on the TBF shall include the TLLI of the mobile station, until the contention resolution is completed on the mobile station side. If MCS-7, MCS-8 or MCS-9 is used for the transmission of the TLLI in EGPRS TBF mode (i.e., the RLC/MAC block is carrying two RLC data blocks), the TLLI shall be inserted in both RLC data blocks. The TLLI shall also be included in the PACKET RESOURCE REQUEST and the ADDITIONAL MS RADIO ACCESS CAPABILITIES messages, if those are sent during the contention resolution.

The retransmission of an RLC data block shall include the TLLI (or the TLLI and the PFI field), if the RLC data block was originally transmitted including these fields, also if the retransmission occurs after the completion of the contention resolution.

Reference

3GPP TS 04.60 subclauses 7.1.2.3

3GPP TS 05.10 subclause 6.11.3

42.1.2.1.8.1.6.2 Test purpose

To verify that during one phase access the retransmitted RLC data blocks of an uplink TBF include TLLI field if the RLC data block was originally transmitted including these fields, even after contention resolution is successfully completed.

42.1.2.1.8.1.6.3 Method of test

Initial conditions

System Simulator:

1 cell supporting GPRS.

Mobile Station:

The MS is GPRS attached and in packet idle mode. PDP context 2 has been established.

Specific PICS Statements

-

PIXIT Statements

-

Test procedure

The MS is triggered to transfer 500 octets of data. In response to PACKET CHANNEL REQUEST sent by the MS, the SS sends PACKET UPLINK ASSIGNMENT message containing Dynamic Allocation struct.

SS allocate resources to the MS to transfer 6 RLC data blocks. SS verifies that all the data blocks contain TLLI field. SS sends a Packet Uplink Ack/Nack acknowledging last three RLC data blocks and negatively acknowledging the first three RLC data blocks.

SS verifies MS includes TLLI field in the retransmitted RLC data blocks and that the new RLC data blocks do not contain TLLI field.

Maximum duration of the test

5 minutes.

Expected sequence

Step	Direction	Message	Comments
1	MS		The MS is triggered transfer 500 octets data.
2	MS -> SS	PACKET CHANNEL REQUEST	Received on PRACH.
2A			If the MS requests two phase access the test is terminated.
3	SS -> MS	PACKET UPLINK ASSIGNMENT	Dynamic allocation struct, USF_GRANULARITY = one block, Sent on PAGCH.
4	SS -> MS	PACKET DOWNLINK DUMMY CONTROL BLOCK	Sent on the PACCH of the PDCH assigned in step 3, containing USF assigned to the MS.
5	MS -> SS	UPLINK RLC DATA BLOCK	Received on the assigned PDTCH. Check that the coding is the scheme specified by TLLI_BLOCK_CHANNEL_CODING, the TFI is correct and the block contains TLLI.
6	-		Repeat Step 4 & 5 five times.
7	SS		Wait for BS_CV_MAX block periods after receiving the last GPRS RLC Data Block.
8	SS -> MS	PACKET UPLINK ACK/NACK	Sent on the PACCH of the PDCH assigned. SS acknowledges BSN=3,4 and 5 and negatively acknowledges BSN=0,1 and 2.
9	SS -> MS	PACKET DOWNLINK DUMMY CONTROL BLOCK	Sent on the PACCH of the PDCH assigned in step 3, containing USF assigned to the MS. Sent after 6 blocks of sending the message in step 8.
10A (optional)	MS -> SS	UPLINK RLC DATA BLOCK	The MS may send a new RLC Data Block already in the transmit buffer
10B (optional)	SS -> MS	PACKET DOWNLINK DUMMY CONTROL BLOCK	If optional step 10A is received. Sent on the PACCH of the PDCH assigned in step 3, USF assigned to the MS.
10	MS -> SS	UPLINK RLC DATA BLOCK	Received on the assigned PDTCH. Check that MS retransmits data block with BSN=0 and that the data block contains the correct TLLI.
11	-		Repeat Steps 9 & 10 two times. Verify that MS retransmits data blocks with BSN=1 and BSN=2 and that both the data blocks contain correct TLLI
12	SS -> MS	PACKET DOWNLINK DUMMY CONTROL BLOCK	Sent on the PACCH of the PDCH assigned in step 3, containing USF assigned to the MS.
13	MS -> SS	UPLINK RLC DATA BLOCK	Received on the assigned PDTCH. If optional step 10A was not received, check that MS transmits new RLC data block with BSN=6 , Else check that MS transmits new RLC data block with BSN=7, Check that the data block does not contain TLLI and the RLC Data block contains the correct TFI.
14		{Completion of uplink RLC data block transfer}	

Specific message contents

PACKET UPLINK ASSIGNMENT message in step 3:

{0 < Global TFI > 10 < TLLI > 110 < TQI > 111 < Packet Request Reference >}	111 (Packet Request Reference, information field sent in PACKET CHANNEL REQUEST and frame number in which PACKET CHANNEL REQUEST was received)
< CHANNEL_CODING_COMMAND > < TLLI_BLOCK_CHANNEL_CODING >	CS-2 1

PACKET UPLINK ACK/NACK message in step 8:

{0 1< CONTENTION_RESOLUTION_TLLI > - CONTENTION_RESOLUTION_TLLI}	1 the value received in step 5.
---	------------------------------------

42.1.2.1.8.2 Packet Uplink Assignment / One phase access / Timing Advance

42.1.2.1.8.2.1 Packet Uplink Assignment / One phase access / Timing Advance / TA Index present

42.1.2.1.8.2.1.1 Conformance requirements

If a Timing Advance Index is included in the assignment message, the mobile station shall use the continuous update timing advance mechanism, using its allocation on PTCCH (see 3GPP TS 05.10).

Reference

3GPP TS 04.60 subclause 7.1.2.5.

3GPP TS 03.64 subclause 6.5.7.2.

42.1.2.1.8.2.1.2 Test purpose

To verify that the mobile station uses the continuous update timing advance mechanism and sends access bursts on the PTCCH slots as determined by the Timing Advance Index sent in the PACKET UPLINK ASSIGNMENT message.

42.1.2.1.8.2.1.3 Method of test

Initial conditions

System Simulator:

1 cell supporting GPRS. The packet system information ACCESS_BURST_TYPE indicates 8 bit access.

Mobile Station:

The MS is GPRS attached and in packet idle mode. PDP context 2 has been established.

Specific PICS Statements

-

PIXIT Statements

-

Test procedure

The MS is triggered to initiate uplink data packet transfer. The SS responds with PACKET UPLINK ASSIGNMENT message indicating one phase access and containing a Timing Advance Index. The MS shall start to send data on the allocated uplink. The SS allows the MS to send the uplink data transfer. During the Uplink data transfer, the SS shall verify that the access bursts are sent correctly by the MS in the PTCCH.

Maximum duration of the test

2 minutes.

Expected sequence

Step	Direction	Message	Comments
1	MS		The MS is triggered to initiate packet uplink transfer of an LLC PDU consisting of 2000 octets data.
2	MS -> SS	PACKET CHANNEL REQUEST	Received on PRACH.
2A			If the MS requests two phase access the Test Case is terminated
3	SS -> MS	PACKET UPLINK ASSIGNMENT	Including Timing Advance Index = 0, Dynamic allocation struct. Sent on PAGCH.
4	SS -> MS	PACKET DOWNLINK DUMMY CONTROL BLOCK	Sent on the PACCH, 3 blocks from the last radio block containing the uplink assignment, USF assigned to the MS.
5	MS -> SS	UPLINK RLC DATA BLOCK	Containing TLLI in the RLC/MAC header.
6	SS -> MS	PACKET UPLINK ACK/NACK	Sent on the PACCH, containing correct TLLI. USF assigned.
7		{Uplink data transfer}	Macro. Completion of the TBF procedure. Verification, see below.

Verification

During the uplink data transfer (step 4-7) the SS monitors the access burst on PTCCH which are located on slots with numbers FN, such that $(FN \bmod (8 \cdot 52)) = 12$ for Timing Advance Index = 0 (3GPP TS 03.64 subclause 6.5.7.2 and 3GPP TS 05.02 table 6). The access burst contents shall be MESSAGE_TYPE = 011111 and CTRL_ACK = 11.

The test is repeated with an arbitrarily chosen Timing Advance Index in the range 1 to 15. SS shall verify that the access burst are sent in the correct idle slots as specified in 3GPP TS 05.02 table 6.

Specific message contents

None.

42.1.2.1.8.2.2 Packet Uplink Assignment / One phase access / Timing Advance / TA Index not present

42.1.2.1.8.2.2.1 Conformance requirements

If a Timing Advance Index is included in the assignment message, the mobile station shall use the continuous update timing advance mechanism, using its allocation on PTCCH (see 3GPP TS 05.10). Otherwise, the continuous update timing advance mechanism shall not be used.

Reference

3GPP TS 04.60 subclause 7.1.2.5.

42.1.2.1.8.2.2.2 Test purpose

To verify that the mobile station does not send any access bursts on the PTCCH if Timing Advance Index is not present in the PACKET UPLINK ASSIGNMENT message.

42.1.2.1.8.2.2.3 Method of test

Initial conditions

System Simulator:

1 cell supporting GPRS.

Mobile Station:

The MS is GPRS attached and in packet idle mode. PDP context 2 has been established.

Specific PICS Statements

-

PIXIT Statements

-

Test procedure

The MS is triggered to initiate uplink data transfer. The SS responds with PACKET UPLINK ASSIGNMENT message not including a Timing Advance Index. The MS shall start to send data on the allocated uplink. The SS allows the MS to send the uplink data transfer. During the uplink data transfer, the SS shall verify that the MS not send any access bursts on PTCCH.

Maximum duration of the test

2 minutes.

Expected sequence

Step	Direction	Message	Comments
1	MS		The MS is triggered to initiate packet uplink transfer of an LLC PDU consisting of 440 octets data.
2 2A	MS -> SS	PACKET CHANNEL REQUEST	Received on PRACH. If the MS requests two phase access the Test Case is terminated
3	SS -> MS	PACKET UPLINK ASSIGNMENT	Not include Timing Advance Index. Indicating Dynamic allocation struct. Sent on PAGCH.
4	SS -> MS	PACKET DOWNLINK DUMMY CONTROL BLOCK	Sent on the PACCH, 3 blocks from the last radio block containing the uplink assignment, USF assigned to the MS.
5	MS -> SS	UPLINK RLC DATA BLOCK	Containing TLLI in the RLC/MAC header.
6	SS -> MS	PACKET UPLINK ACK/NACK	Sent on the PACCH, containing correct TLLI. USF assigned.
7		{Uplink data transfer}	Macro. Completion of the TBF procedure. Verification, see below.

Verification

The SS verifies that the MS does not transmit in idle frames during data block transfer (steps 4-7). Idle frame numbers are 12, 25, 38 and 51 in the 52-multiframe structure.

Specific message contents

None.

42.1.2.1.8.2.3 Void

42.1.2.1.9 Packet Uplink Assignment / Two phase access

42.1.2.1.9.1 Packet Uplink Assignment / Two phase access / Packet Resource Request / RLC Octet Count

42.1.2.1.9.1.1 Conformance requirements

The mobile station may indicate the number of octets of user data it has to transfer in the PACKET RESOURCE REQUEST message.

Reference

3GPP TS 04.60 subclause 7.1.3.1.

42.1.2.1.9.1.2 Test purpose

To verify that the mobile station indicates the number of octets of user data that it has to be transferred in the TBF.

42.1.2.1.9.1.3 Method of test

Initial conditions

System Simulator:

1 cell supporting GPRS. The packet system information ACCESS_BURST_TYPE indicates 8 bit access.

Mobile Station:

The MS is GPRS attached and in packet idle mode. PDP context 1 has been established.

Specific PICS Statements

-

PIXIT Statements

-

Test procedure

The MS is triggered to initiate unacknowledged uplink data transfer. The SS shall send PACKET UPLINK ASSIGNMENT message including Single Block Allocation struct information to instruct the MS to send PACKET RESOURCE REQUEST. The MS should perform a two-phase access i.e. the MS shall transmit a PACKET RESOURCE REQUEST message on the allocated uplink resource.

The RLC_OCTET_COUNT field may indicate the number of LLC data octets the MS wishes to transfer.

The SS should then respond with PACKET UPLINK ASSIGNMENT message and the MS should begin transmitting RLC data blocks on the allocated uplink resources. The SS allows the MS to complete the sending of the data.

Maximum duration of the test

2 minutes.

Expected sequence

Step	Direction	Message	Comments
1	MS		The MS is triggered to initiate the transfer of 100 user data octets.
2	MS -> SS	PACKET CHANNEL REQUEST	Two Phase Access Request. Received on PRACH.
3	SS -> MS	PACKET UPLINK ASSIGNMENT	Single block allocation struct. Sent on PAGCH.
4	MS -> SS	PACKET RESOURCE REQUEST	Received on the single block assigned in step 3.
5	SS -> MS	PACKET UPLINK ASSIGNMENT	Dynamic allocation struct. Sent on the PACCH of the assigned PDCH.
6	SS -> MS	PACKET DOWNLINK DUMMY CONTROL BLOCK	Assigning USF to the MS. Sent at least 3 block periods from the assignment in step 5.
7		{Uplink data transfer }	Macro. Completion of the TBF procedure.
8 (optional step)	SS		The SS verifies that the MS has transferred the number of user data octets indicated in step 4 as RLC_OCTET_COUNT value +/- 2 octets.
Note:	If RLC_OCTET_COUNT given by the MS in step 4 takes a value different from 0 then step 8 shall be performed.		

Specific message contents

None.

- 42.1.2.1.9.2 Packet Uplink Assignment / Two phase access / Contention resolution
- 42.1.2.1.9.2.1 Packet Uplink Assignment / Two phase access / Contention resolution / Expiry of timer T3168
 - 42.1.2.1.9.2.1.1 Conformance requirements

The contention resolution has failed on the mobile station side when the mobile station does not receive a PACKET UPLINK ASSIGNMENT message with its TLLI before expiry of timer T3168. The mobile station shall then reinitiate the packet access procedure unless it has already been repeated 4 times. In that case, TBF failure has occurred.

Reference

3GPP TS 04.60 subclause 7.1.3.3.

42.1.2.1.9.2.1.2 Test purpose

To verify that the mobile station reinitiates the packet access procedure after a time equal to timer T3168 and the procedure shall be attempted a total of 4 or 5 times.

42.1.2.1.9.2.1.3 Method of test

Initial conditions

System Simulator:

1 cell supporting GPRS. PSI GPRS Cell Options, T3168 = 7.

Mobile Station:

The MS is GPRS attached and in packet idle mode. PDP context 1 has been established.

Specific PICS Statements

- Release of GPRS supported (TSPC_MS_GPRS_RELEASE)

PIXIT Statements

-

Test procedure

The MS is triggered to initiate unacknowledged uplink data transfer. The SS sends PACKET UPLINK ASSIGNMENT message including Single Block Allocation struct information to order the MS to send PACKET RESOURCE REQUEST message. The MS shall perform a two-phase access i.e. the MS shall transmit a PACKET RESOURCE REQUEST message on the allocated uplink resource. The SS wait for a time greater than timer T3168 so the MS shall reinitiate packet access procedure. This procedure shall be attempted 4 or 5 times.

Maximum duration of the test

2 minutes.

Expected sequence

Step	Direction	Message	Comments
1	MS		The MS is triggered to initiate packet uplink transfer of an LLC PDU consisting of 200 octets data.
2	MS -> SS	PACKET CHANNEL REQUEST	Two Phase Access Request. Received on PRACH.
3	SS -> MS	PACKET UPLINK ASSIGNMENT	Single Block Allocation struct. Sent on PAGCH.
4	MS -> SS	PACKET RESOURCE REQUEST	ACCESS_TYPE = "Two Phase Access Request". Received on the single block assigned in step 3.
5	SS		The SS waits T3168 expiry.
6			The SS verifies that the MS attempts packet access procedure (steps 2-5 are repeated) in total: Four or five times if PICS 'Release of GPRS supported' is Release 97, 98, 99 or 4. Four times if PICS 'Release of GPRS supported' is Release 5 or later.
NOTE: After step 6 the MS may reinitiate a packet access procedure, since higher layers may request to restart the access procedure.			

Specific message contents

None.

42.1.2.1.9.2.2 Packet Uplink Assignment / Two phase access / Contention resolution / TLLI mismatch

The contention resolution is completed on the mobile station side when the mobile station receives a PACKET UPLINK ASSIGNMENT message with the same TLLI as the mobile station has included in the PACKET RESOURCE REQUEST message.

42.1.2.1.9.2.2.1 Conformance requirements

If the failure is due to a TLLI mismatch, or to the expiry of timers T3166 or T3168, or to the fact that the counter N3104 reached its maximum value in the contention resolution procedure, and repetition as described in subclause 7.1.3.3 has been performed, the mobile station shall remain in packet idle mode, notify higher layer (TBF establishment failure), transactions in progress shall be aborted and cell reselection continued.

Reference

3GPP TS 04.60 subclauses 7.1.4 and 7.1.3.3.

42.1.2.1.9.2.2.2 Test purpose

To verify that the MS reinitiates packet access procedure with failure due to a TLLI mismatch in the contention resolution procedure, unless it has already been attempted 4 or 5 times. In that case, TBF failure has occurred.

42.1.2.1.9.2.2.3 Method of test

Initial conditions

System Simulator:

1 cell supporting GPRS. The packet system information ACCESS_BURST_TYPE indicates 8 bit access.

Mobile Station:

The MS is GPRS attached and in packet idle mode. PDP context 1 has been established.

Specific PICS Statements

- Release of GPRS supported (TSPC_MS_GPRS_RELEASE)

PIXIT Statements

-

Test procedure

The MS is triggered to initiate unacknowledged uplink data transfer. The SS responds with PACKET UPLINK ASSIGNMENT message that request two phase access. The MS shall then send PACKET RESOURCE REQUEST message. The SS responds with PACKET UPLINK ASSIGNMENT message with a TLLI different to that the MS has sent in PACKET RESOURCE REQUEST message. The MS shall reinitiate the packet access procedure.

This procedure shall be attempted 4 or 5 times.

Maximum duration of the test

2 minutes.

Expected sequence

Step	Direction	Message	Comments
1	MS		The MS is triggered to initiate packet uplink transfer of an LLC PDU consisting of 200 octets data.
2	MS -> SS	PACKET CHANNEL REQUEST	Two Phase Access Request. Received on PRACH.
3	SS -> MS	PACKET UPLINK ASSIGNMENT	Single Block Allocation struct. Sent on PAGCH.
4	MS -> SS	PACKET RESOURCE REQUEST	ACCESS_TYPE = "Two Phase Access Request". Include TLLI. Received on the single block assigned in step 3.
5	SS -> MS	PACKET UPLINK ASSIGNMENT	Include incorrect TLLI according to step 4. Sent on the PACCH of the assigned PDCH.
6			The SS verifies that the MS attempts packet access procedure (steps 2-5 are repeated) in total: Four or five times if PICS 'Release of GPRS supported' is Release 97, 98, 99 or 4. Four times if PICS 'Release of GPRS supported' is Release 5 or later.
NOTE: After step 6 the MS may reinitiate a packet access procedure, since higher layers may request to restart the access procedure.			

Specific message contents

None.

42.1.2.1.9.3 Packet Uplink Assignment / Two phase access / Packet Resource Request / No respond to Packet Downlink Assignment

42.1.2.1.9.3.1 Conformance requirements

When the mobile station has received a PACKET UPLINK ASSIGNMENT message it shall respond with a PACKET RESOURCE REQUEST message in the allocated single radio block. At sending of the PACKET RESOURCE REQUEST message, the mobile station shall start timer T3168. Further more, the mobile station shall not respond to PACKET DOWNLINK ASSIGNMENT messages while timer T3168 is running.

Reference

3GPP TS 04.60 subclause 7.1.3.1.

42.1.2.1.9.3.2 Test purpose

To verify that the mobile station does not respond to PACKET DOWNLINK ASSIGNMENT messages while timer T3168 is running after sending of the PACKET RESOURCE REQUEST message.

42.1.2.1.9.3.3 Method of test

Initial conditions

System Simulator:

1 cell supporting GPRS. The packet system information ACCESS_BURST_TYPE indicates 8 bit access, T3168 indicates value 7 in GPRS Cell Options.

Mobile Station:

The MS is GPRS attached and in packet idle mode. PDP context 2 has been established.

Specific PICS Statements

-

PIXIT Statements

-

Test procedure

The MS is triggered to initiate uplink data transfer. The SS shall send PACKET UPLINK ASSIGNMENT message including Single Block Allocation struct information to instruct the MS to send PACKET RESOURCE REQUEST. The MS should perform a two-phase access i.e. the MS shall transmit a PACKET RESOURCE REQUEST message on the allocated uplink resource.

While timer T3168 is running the SS send PACKET DOWNLINK ASSIGNMENT message and starts to send data on the allocated downlink before the timer expires. The MS shall not respond to the Downlink data transfer.

The SS should then send PACKET UPLINK ASSIGNMENT message before the timer T3168 expires and the MS should then begin transmitting RLC data blocks on the allocated uplink resources. The SS allows the MS to complete the sending of the data.

Maximum duration of the test

2 minutes.

Expected sequence

Step	Direction	Message	Comments
1	MS		The MS is triggered to initiate packet uplink transfer of an LLC PDU containing 400 octets of data.
2	MS -> SS	PACKET CHANNEL REQUEST	One or Two Phase Access Request. Received on PRACH.
3	SS -> MS	PACKET UPLINK ASSIGNMENT	Single block allocation struct. Sent on PAGCH.
4	MS -> SS	PACKET RESOURCE REQUEST	Received on the single block assigned in step 3.
5	SS -> MS	PACKET DOWNLINK ASSIGNMENT	Sent on PACCH.
6	SS -> MS	DOWNLINK RLC DATA BLOCK	Sent on the assigned PDTCH with poll bit set to 1.
7	SS -> MS	PACKET UPLINK ASSIGNMENT	Verify no response from the MS. Dynamic allocation struct. Sent on the PACCH of the assigned PDCH 0,9* T3168.
8	SS -> MS	PACKET DOWNLINK DUMMY CONTROL BLOCK	Assigning USF to the MS. Sent at least 3 block periods from the assignment in step 7.
9		{Uplink data transfer}	Macro. Completion of the TBF procedure.

Specific message contents

None.

42.1.2.1.10 Packet Uplink Assignment / Abnormal cases

42.1.2.1.10.1 Packet Uplink Assignment / Abnormal cases / Incorrect PDCH assignment

42.1.2.1.10.1.1 Conformance requirements

If the mobile station has been assigned more PDCHs than it supports according to its MS multislot class, the mobile station shall reinitiate the packet access procedure unless it has already been repeated 4 times. In that case, TBF failure has occurred.

Reference

3GPP TS 04.60 subclause 7.1.4.

42.1.2.1.10.1.2 Test purpose

To verify that the mobile station reinitiates the packet access procedure when the mobile station has been assigned more PDCHs than it supports and after 4 or 5 attempts of the packet access procedure the mobile station shall initiate TBF failure.

42.1.2.1.10.1.3 Method of test

Initial conditions

System Simulator:

1 cell supporting GPRS.

Prach Control Parameters: S bit = 12; TX_INT = 2 slots.

Mobile Station:

The MS is switched off. The SIM is updated to the test cell.

Specific PICS Statements

- Release of GPRS supported (TSPC_MS_GPRS_RELEASE)
- GPRS Multislotclass (TSPC_Type_GPRS_Multislot_ClassX where X = 1..45)

PIXIT Statements

-

Test procedure

Convert the MS GPRS Multislot Class to number of uplink timeslot supported.

The MS is powered up or switched on and triggered to perform a GPRS attach. The SS sends PACKET UPLINK ASSIGNMENT message containing more assigned PDCHs than the MS supports according to its GPRS multislot class. The MS shall reinitiate packet access procedure; this procedure shall be attempted 4 or 5 times.

Maximum duration of the test

2 minutes.

Expected sequence

Step	Direction	Message	Comments
1	MS		The MS is powered up or switched on and triggered to perform a GPRS attach. Throughout the remainder of the test, any Channel Requests on RACH are ignored.
2	MS -> SS	PACKET CHANNEL REQUEST	Received on PRACH.
3	SS -> MS	PACKET UPLINK ASSIGNMENT	Assign one more Tx than the MS supported . Sent on PAGCH.
4	SS -> MS	PACKET DOWNLINK DUMMY CONTROL BLOCK	Sent on the third block from the message sent in step 3. Assigning USF to the MS
5			The SS verifies that the MS does not send UPLINK RLC DATA BLOCKS and instead attempts packet access procedure (steps 2-4 are repeated) in total: Four or five times if PICS 'Release of GPRS supported' is Release 97, 98, 99 or 4. Four times if PICS 'Release of GPRS supported' is Release 5 or later
NOTE: After step 5 the MS may reinitiate a packet access procedure, since higher layers may request to restart the access procedure.			

Specific message contents

None.

42.1.2.1.10.2 Packet Uplink Assignment / Abnormal cases / Expiry of timer T3164

42.1.2.1.10.2.1 Conformance requirements

On expiry of timer T3164, the mobile station shall reinitiate the packet access procedure unless it has already been reinitiated 3 times, in which case the mobile station shall return to packet idle mode and notify higher layers.

Reference

3GPP TS 04.60 subclause 7.1.4.

42.1.2.1.10.2.2 Test purpose

To verify that the mobile station reinitiate the packet access procedure when the network have sent a PACKET UPLINK ASSIGNMENT message but the MS has not sent the first block within the time equal to the timer T3164. This packet access procedure shall be reinitiated 3 times.

42.1.2.1.10.2.3 Method of test

Initial conditions

System Simulator:

1 cell supporting GPRS. The packet system information ACCESS_BURST_TYPE indicates 8 bit access.

Mobile Station:

The MS is GPRS attached and in packet idle mode. PDP context 2 has been established.

Specific PICS Statements

-

PIXIT Statements

-

Test procedure

The MS is triggered to initiate uplink data transfer. The SS sends PACKET UPLINK ASSIGNMENT message with a USF assigned to the MS. The SS shall send PACKET DOWNLINK DUMMY CONTROL BLOCK messages with USF not assigned to the MS. T3164 expires. The SS send a PACKET DOWNLINK DUMMY CONTROL BLOCK containing the assigned USF. The SS verifies that the MS does not send a RLC data block. The SS verifies that the MS reinitiate the packet access procedure within 5 seconds of T3164 expiry; this shall be repeated 3 times.

Maximum duration of the test

1 minute.

Expected sequence

Step	Direction	Message	Comments
1	MS		The MS is triggered to initiate packet uplink transfer of an LLC PDU consisting of 200 octets of data.
2	MS -> SS	PACKET CHANNEL REQUEST	One or Two Phase Access Request. Received on PRACH.
3	SS -> MS	PACKET UPLINK ASSIGNMENT	Single block assignment, to order the MS to follow the two phase access procedure. Sent on PAGCH
4	MS -> SS	PACKET RESOURCE REQUEST	Received on the single block assigned assigned in step 3.
5	SS -> MS	PACKET UPLINK ASSIGNMENT	Allocate a USF for the MS. Sent on PACCH.
6	SS -> MS	PACKET DOWNLINK DUMMY CONTROL BLOCKs	Don't contain the assigned USF in step 5. Repeat step 6 for a maximum of 5.5 seconds ($1.1 \cdot T_{3164}$). The MS may send a PACKET CHANNEL REQUEST at any time after $0.9 \cdot T_{3164}$, in this case go to step 9.
7	SS -> MS	PACKET DOWNLINK DUMMY CONTROL BLOCKs	Containing the assigned USF in step 5.
8	SS		Verify the MS does not transmit an RLC data block
9	SS		The SS verifies that the packet access procedure (steps 2-6) is reinitiated three times. The PACKET CHANNEL REQUEST for reinitiation (in step 2) shall be sent within 5 sec of T_{3164} expiry (to cater for T_{3168} - the maximum duration of a packet access procedure).
NOTE: After step 9 the MS may reinitiate a packet access procedure, since higher layers may request to restart the access procedure.			

Specific message contents

None.

42.1.2.1.11 Non DRX Mode on PCCCH

42.1.2.1.11.1 Conformance requirements

The SPLIT_PG_CYCLE and NON_DRX_TIMER parameters control:

- the occurrence of paging blocks on CCCH or PCCCH belonging to the mobile station (SPLIT_PG_CYCLE parameter, see 3GPP TS 05.02) in DRX mode (see 3GPP TS 03.64); and
- the duration of the non-DRX mode period to be applied by the mobile station when it has left the packet transfer mode or the dual transfer mode and then enters the packet idle mode.

There are four cases when the mobile station shall enter a non-DRX mode period.

- 1) At the transition from the packet transfer mode to the packet idle mode, the mobile station shall enter the Transfer non-DRX mode period.
- 2) At the transition from the dual transfer mode to the dedicated mode or packet idle mode, the mobile station shall enter the Transfer non-DRX mode period.

In both cases, the duration of the Transfer non-DRX mode period is determined by value of the NON_DRX_TIMER parameter, requested in the *GPRS attach procedure*, and the value of the DRX_TIMER_MAX parameter broadcast in the cell. The mobile station may use the minimum value of these two parameters.

If the mobile station receives a new value of the DRX_TIMER_MAX parameter during the Transfer non-DRX mode period, the mobile station may wait to apply the new value until the next time the Transfer non-DRX mode period is entered.

- 3) A mobile station operating in NC2 mode shall enter the NC2 non-DRX mode period when it sends an NC measurement report. The duration of this period is defined by the NC_NON_DRX_PERIOD parameter.
- 4) When initiating the MM procedures for *GPRS attach* and *routing area update* defined in 3GPP TS 04.08, the mobile station shall enter the MM non-DRX mode period. This period ends when either of the messages GPRS

ATTACH ACCEPT, GPRS ATTACH REJECT, ROUTING AREA UPDATE ACCEPT or ROUTING AREA UPDATE REJECT is received by the mobile station. This period also ends after timeout when waiting for any of these messages.

Reference

3GPP TS 04.60 subclause 5.5.1.5.

42.1.2.1.11.2 Test purpose

To verify that the mobile station correctly enters and remains in the transfer non-DRX mode period at least for the duration of NON_DRX_TIMER parameter, requested in the GPRS attach procedure, if the DRX_TIMER_MAX parameter, broadcast in the cell is set to maximum value.

42.1.2.1.11.3 Method of test

Initial conditions

System Simulator:

1 cell supporting GPRS. Packet system information PSI1 DRX_TIMER_MAX = 64 s.

Mobile Station:

The MS is switched off. The SIM is updated to the test cell.

Specific PICS Statements

-

PIXIT Statements

-

Test procedure

The MS is powered up or switched on and triggered to perform a GPRS attach. The SS pages the mobile on the PCCCH group of the mobile by sending PACKET PAGING REQUEST message. The mobile shall respond with PACKET CHANNEL REQUEST.

Maximum duration of the test

30 s.

Expected sequence

Step	Direction	Message	Comments
1	MS	{GPRS attach procedure}	The MS is powered up or switched on and triggered to perform a GPRS attach. Ready Timer set to 0 Non-DRX timer value received by the SS in Attach Request message
2			Mobile is in standby state
3	SS -> MS	PACKET PAGING REQUEST	Sent on PCCCH (PCCCH group belonging to the mobile but different paging group) before non-DRX timer expires
4	MS -> SS	PACKET CHANNEL REQUEST	Received on PRACH. Establishment cause = Page Response
5	SS -> MS	PACKET ACCESS REJECT	

Specific message contents

As default messages contents, except:

PACKET SYSTEM INFORMATION type 1 in initial condition

Information element	Value/remark
GPRS Cell Options DRX_TIMER_MAX	111

42.1.2.1.12 Variable PBCCH and PSI Scheduling

42.1.2.1.12.1 Conformance requirements

If PBCCH is present in the serving cell, the mobile station shall receive the PACKET SYSTEM INFORMATION (PSI) messages broadcast on PBCCH. The parameters determining the schedule of PSI messages on PBCCH are provided in the PSI1 message.

When a new cell has been selected where PBCCH is present, the mobile station shall perform a *complete acquisition* of PBCCH messages (see subclause 5.5.1.4). The mobile station shall not perform packet access in the selected cell, or enter the packet transfer mode, until it has:

- acquired the PACKET SYSTEM INFORMATION TYPE 1 (PSI1) message;
- acquired a consistent set of PSI2 messages; and
- made at least one attempt to receive the complete set of PSI messages on PBCCH.

Reference

3GPP TS 04.60 subclause 5.5.1.2.

42.1.2.1.12.2 Test purpose

To verify that the mobile station correctly decodes the parameters determining the schedule of PSI messages from PSI1 message and performs packet access after receiving a complete set of PSI messages on PBCCH.

42.1.2.1.12.3 Method of test

Initial conditions

System Simulator:

1 cell supporting GPRS. PSI1, PSI2, PSI3 and PSI3bis broadcast from the cell. All PSIs except PSI1 broadcast in high repetition rate. Mobile Station:

The MS is switched off. The SIM is updated to the test cell.

Specific PICS Statements

-

PIXIT Statements

-

Test procedure

The MS is powered up or switched on and triggered to perform a GPRS attach. The MS shall perform a packet access by sending PACKET CHANNEL REQUEST. The SS allows the MS to complete the GPRS attach procedure.

Maximum duration of the test

30 s.

Expected sequence

Step	Direction	Message	Comments
1	MS		The MS is powered up or switched on and triggered to perform a GPRS attach.
2	MS -> SS	PACKET CHANNEL REQUEST	Received on PRACH
3	SS -> MS	PACKET UPLINK ASSIGNMENT	Sent on PAGCH
4		{GPRS attach procedure}	Macro. Completion from step 4 in the attach procedure.

The test is repeated for BS_PBCCH_BLKs = 2 and BS_PBCCH_BLKs = 1

Specific message contents

As default messages contents, except:

BS_PBCCH_BLKs = 4

PACKET SYSTEM INFORMATION type 1 in initial condition

Information element	Value/remark
BS_PBCCH_BLKs	11 4 blocks
PSI1_REPEAT_PERIOD	0010 PSI1 repeat period = 3 mframes
PSI_COUNT_LR	000000 PSI Count Low Rate = 0
{PSI_COUNT_HR}	1 PSI_COUNT_HR present
PSI_COUNT_HR	0110 PSI Count High Rate = 7

BS_PBCCH_BLKs = 2

PACKET SYSTEM INFORMATION type 1 in initial condition

Information element	Value/remark
BS_PBCCH_BLKs	01 2 blocks
PSI1_REPEAT_PERIOD	0100 PSI1 repeat period = 5 mframes
PSI_COUNT_LR	000000 PSI Count Low Rate = 0
{PSI_COUNT_HR}	1 PSI_COUNT_HR present
PSI_COUNT_HR	0110 PSI Count High Rate = 7

BS_PBCCH_BLKs = 1

PACKET SYSTEM INFORMATION type 1 in initial condition

Information element	Value/remark
BS_PBCCH_BLKs	00 1 block
PSI1_REPEAT_PERIOD	0111 PSI1 repeat period = 8 mframes
PSI_COUNT_LR	000000 PSI Count Low Rate = 0
{PSI_COUNT_HR}	1 PSI_COUNT_HR present
PSI_COUNT_HR	0110 PSI Count High Rate = 7

42.1.2.1.13 Several PCCCHs supported by the cell

42.1.2.1.13.1 Conformance requirements

The mobile station shall be able to store the frequency information for the PCCCH description corresponding to its own PCCCH_GROUP (see subclause 11.2.19).

The mapping of the PCCCH_GROUPS (numbered from 0 to KC - 1) starts with the lowest numbered PCCCH_GROUP, which is mapped on the lowest numbered timeslot carrying PCCCH on the first (non-hopping or hopping) PCCCH carrier appearing in this construction. The next higher numbered PCCCH_GROUP is mapped on the next (if any) higher numbered timeslot carrying PCCCH on the same carrier, and so on. When all timeslots carrying PCCCH on the first carrier have been used, the next higher numbered PCCCH_GROUP is mapped on the lowest numbered timeslot carrying PCCCH on the next PCCCH carrier appearing in this construction, and so on. The highest numbered PCCCH_GROUP is mapped on the highest numbered timeslot carrying PCCCH on the last PCCCH carrier appearing in this construction.

Reference

3GPP TS 04.60 subclauses 5.5.1.7 and 11.2.19.

42.1.2.1.13.2 Test purpose

To verify that the mobile station reacts correctly when several timeslots are carrying PCCCH in the cell. As for a given frequency parameter, there are several PCCCH channels, the test validates that the mobile station well understood the number of PCCCH as well as the order from the timeslot allocation structure.

42.1.2.1.13.3 Method of test

Initial conditions

System Simulator:

1 cell supporting GPRS. Packet system information PSI2 containing information on multiple PCCCH.

Mobile Station:

The MS is switched off. The SIM is updated to the test cell.

Specific PICS Statements

-

PIXIT Statements

-

Test procedure

The MS is powered up or switched on and triggered to perform a GPRS attach. The SS send a PACKET UPLINK ASSIGNMENT message containing frequency parameter information elements. The SS allows the MS to complete the GPRS attach procedure.

Maximum duration of the test

30 s.

Expected sequence

Step	Direction	Message	Comments
1	MS		The MS is powered up or switched on and triggered to perform a GPRS attach.
2	MS -> SS	PACKET CHANNEL REQUEST	Received on PRACH (PCCCH_GROUP belonging to the mobile)
3	SS -> MS	PACKET UPLINK ASSIGNMENT	Scheduled on PCCCH_GROUP belonging to the mobile. Include frequency parameters see specific message contents.
4		{GPRS attach procedure}	Macro. Completion from step 4 in the attach procedure.

Specific message contents

As default messages contents, except:

SYSTEM INFORMATION TYPE 13 Rest octets in initial condition

PSI1_REPEAT PERIOD	PBCCH present
PBCCH Description	As default
- Pb	As default
- TSC	arbitrarily chosen
- TN	'111' (timeslot 7)
- {01<ARFCN>}	arbitrarily chosen

PACKET SYSTEM INFORMATION type 2 in initial condition

Information element	Value/remark
< PSI2_CHANGE_MARK >	00 (all instances)
< PCCCH Description List struct >	(replacing the PCCCH description in the default message)
< TSC >	same as in SI13
{0 1< Hopping PCCCH carriers >	0
< Non-hopping PCCCH carriers struct >	
< ARFCN	same as in SI13
< TIMESLOT_ALLOCATION	00001001 (timeslots 4 and 7)

PACKET UPLINK ASSIGNMENT in step 3

Information element	Value/remark
{0 1< Frequency Parameters >	1 (frequency parameter present)
< Frequency Parameters IE >	
< TSC >	Same as PSI2.
	00 (ARFCN)
< ARFCN >	Same as PSI2.

42.1.2.1.14 Several Non-hopping PCCCHs supported by the cell, PBCCH on timeslot 0

42.1.2.1.14.1 Conformance requirements

The PCCCH and its different logical channels (PAGCH, PPCH, PNCH) can be mapped dynamically and are identified by the message header. The configuration is partly fixed by some parameters broadcast by the PBCCH and defined in 3GPP TS 05.02 subclause 3.3.2.4:

- BS_PBCCH_BLKs, that defines the number of PBCCH blocks per multiframe, according to the ordered list described in 3GPP TS 05.02 subclause 6.3.2.1, on the PDCH that carries PBCCH;
- BS_PAG_BLKs_RES, that defines the number of blocks in addition to BS_PBCCH_BLKs, according to the ordered list described in 3GPP TS 05.02 subclause 6.3.2.1, where PPCH shall not occur on every PDCH that carries PCCCH.

PCCCH (except PPCH) can be mapped on all blocks except those used for PBCCH.

If PBCCH is allocated on timeslot k , PCCCHs shall be allocated only on timeslots n where $n > k - 4$ and $0 \leq n \leq 7$ in order to provide time for the MS to switch from PBCCH to PCCCH.

Reference

3GPP TS 05.02 subclause 6.3.2.3.4.

42.1.2.1.14.2 Test purpose

To verify that the mobile station reacts correctly when several timeslots are carrying PCCCH in the cell. As for a given frequency parameter, there are several PCCCH channels, the test validates that, for an uplink access, the mobile station correctly takes into account the number of PCCCH as well as their order from the timeslot allocation structure.

42.1.2.1.14.3 Method of test

Initial conditions

System Simulator:

1 cell supporting GPRS. Packet system information PSI2 containing information on multiple PCCCH. The number of timeslot carrying PCCCH (BS_PCC_CHANS) is set to 3. In this test, each PCCCH is on a separate non-hopping carrier. The PBCCH is allocated on timeslot 0.

Mobile Station:

The MS is switched off. The SIM is updated to the test cell.

Specific PICS Statements

-

PIXIT Statements

-

Test procedure

The MS is powered up or switched on and triggered to perform a GPRS attach. The SS sends a PACKET UPLINK ASSIGNMENT message containing frequency parameter information elements. The SS allows the MS to complete the GPRS attach procedure.

Maximum duration of the test

The maximum duration of the test is 30 s.

Expected sequence

Step	Direction	Message	Comments
1	MS		The MS is powered up or switched on and triggered to perform a GPRS attach.
2	MS -> SS	PACKET CHANNEL REQUEST	Received on PRACH (PCCCH_GROUP belonging to the mobile)
3	SS -> MS	PACKET UPLINK ASSIGNMENT	Scheduled on PCCCH_GROUP belonging to the mobile. Include frequency parameters see specific message contents.
4		{GPRS attach procedure}	Macro. Completion from step 4 in the attach procedure.

Specific message contents

As default messages contents, except:

PACKET SYSTEM INFORMATION type 2 in initial condition

Information element	Value/remark
< PSI2_CHANGE_MARK >	00 (all instances)
< PCCCH Description List struct >	
< TSC >	101
{0}1< Hopping PCCCH carriers >	0
< Non-hopping PCCCH carriers struct >	
< ARFCN	ARFCN0 = same as the PBCCH
< TIMESLOT_ALLOCATION	10000000 (note 1)
< ARFCN	ARFCN0+1
< TIMESLOT_ALLOCATION	10000000 (note 1)
< ARFCN	ARFCN0+3
< TIMESLOT_ALLOCATION	00000001 (note 1)
End of Non-Hopping PCCCH Carriers Lists	0

Note 1: for each ARFCN one timeslot shall be chosen. A valid PCCCH timeslot complies with the following rule: if PBCCH is allocated on timeslot k, PCCCH shall be allocated only on timeslots n where $n > k - 4$ and $0 \leq n \leq 7$ in order to provide time for the MS to switch from PBCCH to PCCCH.

Note 2: BS_PCC_CHANS is set to 3.

Note 3: If the PCCCH Description as specified above does not fit into any of the three default instances of PACKET SYSTEM INFORMATION type 2, an additional instance of PSI 2 shall be used to broadcast this information element.

SYSTEM INFORMATION TYPE 13 Rest octets in initial condition.

BCCH_CHANGE_MARK	000
SI_CHANGE_FIELD	0000 Unspecified
{0 1<SI13_CHANGE_MARK>}	1 Present
- SI13_CHANGE_MARK	00
{GPRS Mobile Allocation}	
-HSN	000000 Sequence 0
-{0 1<RFL number list>}	0 Number list not present
-{0	0
-MA_LENGTH	000101 (for GSM 700, T-GSM 810, GSM 850 and GSM900).
	000011 (for DCS 1 800 and PCS 1 900).
	001111 4 belonging (for GSM 700, T-GSM 810, GSM 850 and GSM900).
	1111 4 belonging (for DCS 1 800 and PCS 1 900).
	1 PBCCH present in cell
-MA_BITMAP	0010 PSI1 repeat period = 3
- PSI1_REPEAT_PERIOD	
PBCCH Description	
- Pb	As default
- TSC	101
- TN	000
- {00 01 1	01
- ARFCN }	0000011110 (30) for GSM 900
	1000000000 (512) for DCS 1800 and PCS 1 900
	0010000000 (128) for GSM 850
	0111010011 (467) for GSM 700 and T-GSM 810
Padding	Padding bits

Note 4: the PBCCH position impacts the additional PCCCH timeslot allocation as indicated in note 2.

PACKET UPLINK ASSIGNMENT in step 3

Information element	Value/remark
{0 1< Frequency Parameters >}	1 (frequency parameter present)
< Frequency Parameters IE >	
< TSC >	Same as PSI2.
	00 (ARFCN)
< ARFCN >	Chosen among the ARFCN present in PSI2.

42.1.2.1.15 Several Non-hopping PCCCHs supported by the cell, PBCCH on timeslot 3

42.1.2.1.15.1 Conformance requirements

The same conformance requirements as in 42.1.2.1.14.1 are tested, with a different PCCCH configuration.

Reference

3GPP TS 05.02 subclause 6.3.2.3.4.

42.1.2.1.15.2 Test purpose

To verify that the mobile station reacts correctly when several timeslots are carrying PCCCH in the cell. As for a given frequency parameter, there are several PCCCH channels, the test validates that, for an uplink access, the mobile station understands well the number of PCCCH as well as their order from the timeslot allocation structure.

42.1.2.1.15.3 Method of test

Initial conditions

System Simulator:

1 cell supporting GPRS. Packet system information PSI2 containing information on multiple PCCCH. The number of timeslot carrying PCCCH (BS_PCC_CHANS) is set to 4. In this test, each PCCCH is on a separate non-hopping carrier. The PBCCH is allocated on timeslot 3.

Mobile Station:

The MS is switched off. The SIM is updated to the test cell.

Specific PICS Statements

-

PIXIT Statements

-

Test procedure

The MS is powered up or switched on and triggered to perform a GPRS attach. The SS sends a PACKET UPLINK ASSIGNMENT message containing frequency parameter information elements. The SS allows the MS to complete the GPRS attach procedure.

Maximum duration of the test

The maximum duration of the test is 30 s.

Expected sequence

Step	Direction	Message	Comments
1	MS		The MS is powered up or switched on and triggered to perform a GPRS attach.
2	MS -> SS	PACKET CHANNEL REQUEST	Received on PRACH (PCCCH_GROUP belonging to the mobile)
3	SS -> MS	PACKET UPLINK ASSIGNMENT	Scheduled on PCCCH_GROUP belonging to the mobile. Include frequency parameters see specific message contents.
4		{GPRS attach procedure}	Macro. Completion from step 4 in the attach procedure.

Specific message contents

As default messages contents, except:

PACKET SYSTEM INFORMATION type 2 in initial condition

Information element	Value/remark
< PSI2_CHANGE_MARK >	00 (all instances)
< PCCCH Description List struct >	
< TSC >	101
{0 1< Hopping PCCCH carriers >	0
< Non-hopping PCCCH carriers struct >	
< ARFCN	ARFCN0 = same as the PBCCH
< TIMESLOT_ALLOCATION	00010000 (note 1)
< ARFCN	ARFCN0+2
< TIMESLOT_ALLOCATION	00010000 (note 1)
< ARFCN	ARFCN0+3
< TIMESLOT_ALLOCATION	01000000 (note 1)
< ARFCN	ARFCN0+4
< TIMESLOT_ALLOCATION	00100000 (note 1)
End of Non-Hopping PCCCH Carriers Lists	0

Note 1: for each ARFCN one timeslot shall be chosen. A valid PCCCH timeslot complies with the following rule: if PBCCH is allocated on timeslot k, PCCCH shall be allocated only on timeslots n where $n > k - 4$ and $0 \leq n \leq 7$ in order to provide time for the MS to switch from PBCCH to PCCCH.

Note 2: BS_PCC_CHANS is set to 4.

Note 3: If the PCCCH Description as specified above does not fit into any of the three default instances of PACKET SYSTEM INFORMATION type 2, an additional instance of PSI 2 shall be used to broadcast this information element.

SYSTEM INFORMATION TYPE 13 Rest octets in initial condition.

BCCH_CHANGE_MARK	000
SI_CHANGE_FIELD	0000 Unspecified
{0 1<SI13_CHANGE_MARK>}	1 Present
- SI13_CHANGE_MARK	00
{GPRS Mobile Allocation}	
-HSN	000000 Sequence 0
-{0 1<RFL number list>}	0 Number list not present
-{0	0
-MA_LENGTH	000101 (for GSM 700, T-GSM 810, GSM 850 and GSM900).
	000011 (for DCS 1 800 and PCS 1 900).
	001111 4 belonging (for GSM 700, T-GSM 810, GSM 850 and GSM900).
	1111 4 belonging (for DCS 1 800 and PCS 1 900).
	1 PBCCH present in cell
	0010 PSI1 repeat period = 3
- MA_BITMAP	
- PSI1_REPEAT_PERIOD	
PBCCH Description	
- Pb	As default
- TSC	101
- TN	011
- {00 01 1	01
- ARFCN }	0000011110 (30) for GSM 900
	1000000000 (512) for DCS 1800 and PCS 1 900
	0010000000 (128) for GSM 850
	0111010011 (467) for GSM 700 and T-GSM 810
Padding	Padding bits

Note 4: the PBCCH position impacts the additional PCCCH timeslot allocation as indicated in note 2.

PACKET UPLINK ASSIGNMENT in step 3

Information element	Value/remark
{0 1< Frequency Parameters >}	1 (frequency parameter present)
< Frequency Parameters IE >	
< TSC >	Same as PSI2.
	00 (ARFCN)
< ARFCN >	Chosen among the ARFCN present in PSI2.

42.1.2.1.16 Several Non-hopping PCCCHs supported by the cell, PBCCH on timeslot 7

42.1.2.1.16.1 Conformance requirements

The same conformance requirements as in 42.1.2.1.14.1 are tested, with a different PCCCH configuration.

Reference

3GPP TS 05.02 subclause 6.3.2.3.4.

42.1.2.1.16.2 Test purpose

To verify that the mobile station reacts correctly when several timeslots are carrying PCCCH in the cell. As for a given frequency parameter, there are several PCCCH channels, the test validates that, for an uplink access, the mobile station understands well the number of PCCCH as well as their order from the timeslot allocation structure.

42.1.2.1.16.3 Method of test

Initial conditions

System Simulator:

1 cell supporting GPRS. Packet system information PSI2 containing information on multiple PCCCH. The number of timeslot carrying PCCCH (BS_PCC_CHANS) is set to 3. In this test, each PCCCH is on a separate non-hopping carrier. The PCCCH is allocated on timeslot 7.

Mobile Station:

The MS is switched off. The SIM is updated to the test cell.

Specific PICS Statements

-

PIXIT Statements

-

Test procedure

The MS is powered up or switched on and triggered to perform a GPRS attach. The SS sends a PACKET UPLINK ASSIGNMENT message containing frequency parameter information elements. The SS allows the MS to complete the GPRS attach procedure.

Maximum duration of the test

The maximum duration of the test is 30 s.

Expected sequence

Step	Direction	Message	Comments
1	MS		The MS is powered up or switched on and triggered to perform a GPRS attach.
2	MS -> SS	PACKET CHANNEL REQUEST	Received on PRACH (PCCCH_GROUP belonging to the mobile)
3	SS -> MS	PACKET UPLINK ASSIGNMENT	Scheduled on PCCCH_GROUP belonging to the mobile. Include frequency parameters see specific message contents.
4		{GPRS attach procedure}	Macro. Completion from step 4 in the attach procedure.

Specific message contents

As default messages contents, except:

PACKET SYSTEM INFORMATION type 2 in initial condition

Information element	Value/remark
< PSI2_CHANGE_MARK >	00 (all instances)
< PCCCH Description List struct >	
< TSC >	101
{0 1< Hopping PCCCH carriers >	0
< Non-hopping PCCCH carriers struct >	
< ARFCN	ARFCN0 = same as the PCCCH
< TIMESLOT_ALLOCATION	00000001 (note 1)
< ARFCN	ARFCN0+3
< TIMESLOT_ALLOCATION	00001010 (note 1)
End of Non-Hopping PCCCH Carriers Lists	0

Note 1: for each ARFCN one timeslot shall be chosen. A valid PCCCH timeslot complies with the following rule: if PCCCH is allocated on timeslot k, PCCCH shall be allocated only on timeslots n where $n > k - 4$ and $0 \leq n \leq 7$ in order to provide time for the MS to switch from PCCCH to PCCCH.

Note 2: BS_PCC_CHANS is set to 3.

SYSTEM INFORMATION TYPE 13 Rest octets in initial condition.

BCCH_CHANGE_MARK	000
SI_CHANGE_FIELD	0000 Unspecified
{0 1<SI13_CHANGE_MARK>}	1 Present
- SI13_CHANGE_MARK	00
{GPRS Mobile Allocation}	
-HSN	000000 Sequence 0
-{0 1<RFL number list>}	0 Number list not present
-{0	0
-MA_LENGTH	000101 (for GSM 700, T-GSM 810, GSM 850 and GSM900).
	000011 (for DCS 1 800 and PCS 1 900).
-MA_BITMAP	001111 4 belonging (for GSM 700, T-GSM 810, GSM 850 and GSM900).
	1111 4 belonging (for DCS 1 800 and PCS 1 900).
	1 PBCCH present in cell
- PSI1_REPEAT_PERIOD	0010 PSI1 repeat period = 3
PBCCH Description	
- Pb	As default
- TSC	101
- TN	111
- {00 01 1	01
- ARFCN }	0000011110 (30) for GSM 900
	1000000000 (512) for DCS 1800 and PCS 1 900
	0010000000 (128) for GSM 850
	0111010011 (467) for GSM 700 and T-GSM 810
Padding	Padding bits

Note 3: the PBCCH position impacts the additional PCCCH timeslot allocation as indicated in note 2.

PACKET UPLINK ASSIGNMENT in step 3

Information element	Value/remark
{0 1< Frequency Parameters >}	1 (frequency parameter present)
< Frequency Parameters IE >	
< TSC >	Same as PSI2.
	00 (ARFCN)
< ARFCN >	Chosen among the ARFCN present in PSI2.

42.1.2.1.17 Several Non-hopping PCCCHs supported by the cell, PBCCH on timeslot 4

42.1.2.1.17.1 Conformance requirements

The same conformance requirements as in 42.1.2.1.14.1 are tested, with a different PCCCH configuration.

Reference

3GPP TS 05.02 subclause 6.3.2.3.4.

42.1.2.1.17.2 Test purpose

To verify that the mobile station reacts correctly when several timeslots are carrying PCCCH in the cell. As for a given frequency parameter, there are several PCCCH channels, the test validates that, for an uplink access, the mobile station understands well the number of PCCCH as well as their order from the timeslot allocation structure.

42.1.2.1.17.3 Method of test

Initial conditions

System Simulator:

1 cell supporting GPRS. Packet system information PSI2 containing information on multiple PCCCH. The number of timeslot carrying PCCCH (BS_PCC_CHANS) is set to 2. In this test, the 2 PCCCHs are on the same non-hopping carrier. The PBCCH is allocated on timeslot 4.

Mobile Station:

The MS is switched off. The SIM is updated to the test cell.

Specific PICS Statements

-

PIXIT Statements

-

Test procedure

The MS is powered up or switched on and triggered to perform a GPRS attach. The SS sends a PACKET UPLINK ASSIGNMENT message containing frequency parameter information elements. The SS allows the MS to complete the GPRS attach procedure.

Maximum duration of the test

The maximum duration of the test is 30 s.

Expected sequence

Step	Direction	Message	Comments
1	MS		The MS is powered up or switched on and triggered to perform a GPRS attach.
2	MS -> SS	PACKET CHANNEL REQUEST	Received on PRACH (PCCCH_GROUP belonging to the mobile)
3	SS -> MS	PACKET UPLINK ASSIGNMENT	Scheduled on PCCCH_GROUP belonging to the mobile. Include frequency parameters see specific message contents.
4		{GPRS attach procedure}	Macro. Completion from step 4 in the attach procedure.

Specific message contents

As default messages contents, except:

PACKET SYSTEM INFORMATION type 2 in initial condition

Information element	Value/remark
< PSI2_CHANGE_MARK >	00 (all instances)
< PCCCH Description List struct >	
< TSC >	101
{0 1< Hopping PCCCH carriers >	0
< Non-hopping PCCCH carriers struct >	
< ARFCN	ARFCN0 = same as the PBCCH
< TIMESLOT_ALLOCATION	01001000 (note 1)
End of Non-Hopping PCCCH Carriers Lists	0

Note 1: for each ARFCN one timeslot shall be chosen. A valid PCCCH timeslot complies with the following rule: if PBCCH is allocated on timeslot k, PCCCH shall be allocated only on timeslots n where $n > k - 4$ and $0 \leq n \leq 7$ in order to provide time for the MS to switch from PBCCH to PCCCH.

Note 2: BS_PCC_CHANS is set to 2.

SYSTEM INFORMATION TYPE 13 Rest octets in initial condition.

BCCH_CHANGE_MARK	000
SI_CHANGE_FIELD	0000 Unspecified
{0 1<SI13_CHANGE_MARK>}	1 Present
- SI13_CHANGE_MARK	00
{GPRS Mobile Allocation}	
-HSN	000000 Sequence 0
-{0 1<RFL number list>}	0 Number list not present
-{0	0
-MA_LENGTH	000101 (for GSM 700, T-GSM 810, GSM 850 and GSM900).
	000011 (for DCS 1 800 and PCS 1 900).
	001111 4 belonging (for GSM 700, T-GSM 810, GSM 850 and GSM900).
	1111 4 belonging (for DCS 1 800 and PCS 1 900).
	1 PBCCH present in cell
	0010 PSI1 repeat period = 3
-MA_BITMAP	
	As default
	101
	100
	01
	0000011110 (30) for GSM 900
	1000000000 (512) for DCS 1800 and PCS 1 900
	0010000000 (128) for GSM 850
	0111010011 (467) for GSM 700 and T-GSM 810
	810
	Padding bits
- PSI1_REPEAT_PERIOD	
PBCCH Description	
- Pb	
- TSC	
- TN	
- {00 01 1	
- ARFCN }	
Padding	

Note 3: the PBCCH position impacts the additional PCCCH timeslot allocation as indicated in note 2.

PACKET UPLINK ASSIGNMENT in step 3

Information element	Value/remark
{0 1< Frequency Parameters >}	1 (frequency parameter present)
< Frequency Parameters IE >	
< TSC >	Same as PSI2.
	00 (ARFCN)
< ARFCN >	Chosen among the ARFCN present in PSI2.

42.1.2.1.18 Several Hopping PCCCHs and non-Hopping PCCCHs supported by the cell

42.1.2.1.18.1 Conformance requirements

The same conformance requirements as in 42.1.2.1.14.1 are tested with configuration sets combining Frequency Hopping PCCCHs.

Reference

3GPP TS 05.02 subclause 6.3.2.3.4.

42.1.2.1.18.2 Test purpose

To verify that the mobile station reacts correctly when several timeslots are carrying PCCCH in the cell. As for a given frequency parameter, there are several PCCCH channels, the test validates that, for an downlink access, the mobile station well understood the number of PCCCH as well as the order from the timeslot allocation structure.

42.1.2.1.18.3 Method of test

Initial conditions

System Simulator:

1 cell supporting GPRS. Packet system information PSI2 containing information on multiple PCCCH. The number of timeslot carrying PCCCH (BS_PCC_CHANS) is set to 4; among these BS_PCC_CHANS channels, 2 channels are on the same Mobile allocation but on different MAIO.

Mobile Station:

The MS is switched off. The SIM is updated to the test cell.

Specific PICS Statements

-

PIXIT Statements

-

Test procedure

The MS is powered up or switched on and triggered to perform a GPRS attach. The SS send a PACKET UPLINK ASSIGNMENT message containing frequency parameter information elements. The SS allows the MS to complete the GPRS attach procedure.

Maximum duration of the test

Taking into account a default value of the ready timer set to 32s, the maximum duration of the test is 1 minute.

Expected sequence

Step	Direction	Message	Comments
1	MS		The MS is powered up or switched on and triggered to perform a GPRS attach.
2	MS -> SS	PACKET CHANNEL REQUEST	Received on PRACH (PCCCH_GROUP belonging to the mobile)
3	SS -> MS	PACKET UPLINK ASSIGNMENT	Scheduled on PCCCH_GROUP belonging to the mobile. Include frequency parameters see specific message contents.
4		{GPRS attach procedure}	Macro. Completion from step 4 in the attach procedure.

Specific message contents

As default messages contents, except:

PACKET SYSTEM INFORMATION type 2 in initial condition

Information element	Value/remark
< PSI2_CHANGE_MARK >	00 (all instances)
< PCCCH Description List struct >	
PCCCH Description struct	1
< TSC >	101
{0 1< Hopping PCCCH carriers >	0
< Non-hopping PCCCH carriers struct >	
< ARFCN >	ARFCN0 = same as the PBCCH
< TIMESLOT_ALLOCATION >	01000000
PCCCH Description struct	1
< TSC >	101
{1 < MA number >	
< Hopping PCCCH carriers >	0010
Hopping PCCCH Carriers Lists struct	
< MAIO >	Arbitrarily chosen
< TIMESLOT_ALLOCATION >	01000000 (note 2)
< MAIO >	Arbitrarily chosen
< TIMESLOT_ALLOCATION >	01001000 (note 2)
End of Hopping PCCCH Carriers Lists	0
End of PCCCH Description List	0

Note 1: BS_PCC_CHANS is set to 4.

Note 2: valid PCCCH timeslots comply with the following rule: if PBCCH is allocated on timeslot k, PCCCHs shall be allocated only on timeslots n where $n > k - 4$ and $0 \leq n \leq 7$ in order to provide time for the MS to switch from PBCCH to PCCCH.

Note 3: If the PCCCH Description as specified above does not fit into any of the three default instances of PACKET SYSTEM INFORMATION type 2, an additional instance of PSI 2 shall be used to broadcast this information element.

SYSTEM INFORMATION TYPE 13 Rest octets in initial condition.

BCCH_CHANGE_MARK	000
SI_CHANGE_FIELD	0000 Unspecified
{0 1<SI13_CHANGE_MARK>	1 Present
- SI13_CHANGE_MARK	00
{GPRS Mobile Allocation}	
-HSN	000000 Sequence 0
-{0 1<RFL number list>	0 Number list not present
-{0	0
-MA_LENGTH	000101 (for GSM 700, T-GSM 810, GSM 850 and GSM900).
	000011 (for DCS 1 800 and PCS 1 900).
	001111 4 belonging (for GSM 700, T-GSM 810, GSM 850 and GSM900).
	1111 4 belonging (for DCS 1 800 and PCS 1 900).
	1 PBCCH present in cell
	0010 PSI1 repeat period = 3
-MA_BITMAP	
	As default
	101
	001
	01
	0000011110 (30) for GSM 900
	1000000000 (512) for DCS 1800 and PCS 1 900
	0010000000 (128) for GSM 850
	0111010011 (467) for GSM 700 and T-GSM 810
	810
	Padding bits
- PSI1_REPEAT_PERIOD	
PBCCH Description	
- Pb	
- TSC	
- TN	
- {00 01 1	
- ARFCN }	
Padding	

Note 4: the PBCCH position impacts the additional PCCCH timeslot allocation as indicated in note 2.

PACKET UPLINK ASSIGNMENT in step 3

Information element	Value/remark
{0 1< Frequency Parameters >	1 (frequency parameter present)
< Frequency Parameters IE >	
< TSC >	Same as PSI2.
	00 (ARFCN)
< ARFCN >	Chosen among the ARFCN present in PSI2.

42.1.2.1.19 Packet Uplink/downlink Assignment using Variable Bitmap format / PBCCH Cell

42.1.2.1.19.1 Conformance requirements

RFL contents:

This variable length octet string is the representation of a set of radio frequency channels defining an RFL provided in the PSI2 message. The encoding of the octet string is defined by the *value part* of the type 4 information element *Frequency List*, defined in 3GPP TS 44.018. The allowed formats of the *Frequency List* information element are the *bit map 0*, *1024 range*, *512 range*, *256 range*, *128 range* and *variable bit map* formats.

MA Frequency List contents:

This variable length octet string is the representation of a set of radio frequency channels defining a GPRS mobile allocation. The encoding of the octet string is defined by the *value part* of the type 4 information element *Frequency*

List, defined in 3GPP TS 44.018. The allowed formats of the *Frequency List* information element are the *bit map 0*, *1024 range*, *512 range*, *256 range*, *128 range* and *variable bit map* formats.

References

3GPP TS 44.060 §11.2.19 & §12.8

3GPP TS 44.018 §10.5.2.1 & §10.5.2.13

42.1.2.1.19.2 Test purposes

To verify that a MS understands properly the frequency parameters defined on a PBCCH cell with Variable Bitmap format.

42.1.2.1.19.3 Method of test

Initial Conditions

System Simulator:

1 cell, default setting, PBCCH supported.

Mobile Station:

The MS is switched off.

Specific PICS statements

-

PIXIT statements

-

Test Procedure

The MS is powered up or switched on and a GPRS attach is triggered. The MS should complete the Attach procedure.

The frequency parameters in the PACKET SYSTEM INFORMATION type 2, in the PACKET UPLINK ASSIGNMENT used for the Attach Request procedure and in the PACKET DOWNLINK ASSIGNMENT for the Attach Accept procedure are defined with the Variable Bitmap type. The MS completes the GPRS Attach Procedure.

Maximum Duration of Test

1 minute.

Expected Sequence

Step	Direction	Message	Comments
1			MS is powered up or switched on and is triggered to initiate the GPRS attach procedure.
2	MS -> SS	PACKET CHANNEL REQUEST	Mobility Management procedure request.
3	SS -> MS	PACKET UPLINK ASSIGNMENT	See specific message content
4	SS -> MS	PACKET DOWNLINK DUMMY CONTROL BLOCK	Containing USF assigned to the MS.
5	MS -> SS	UPLINK RLC DATA BLOCK (GMM ATTACH REQUEST)	Steps 4 & 5 are repeated until the MS has sent the complete GMM ATTACH REQUEST message.
6	SS -> MS	PACKET UPLINK ACK/NACK	Containing Final Ack Indicator bit = 1, and valid RRBp field.
7	MS -> SS	PACKET CONTROL ACKNOWLEDGEMENT	Sent in the block assigned by the RRBp field in step 6.
8	SS -> MS	PACKET DOWNLINK ASSIGNMENT	See specific message content
9	SS -> MS	DOWNLINK RLC DATA BLOCKs (GMM ATTACH ACCEPT)	Last block shall contain Final Block Indicator bit = 1, and valid RRBp field.
10	MS -> SS	PACKET DOWNLINK ACK/NACK	Sent in the block assigned by the RRBp field in step 9.
11	MS -> SS	PACKET CHANNEL REQUEST	Mobility Management procedure request.
12	SS -> MS	PACKET UPLINK ASSIGNMENT	Indicate dynamic allocation struct.
13	MS -> SS	PACKET DOWNLINK DUMMY CONTROL BLOCK	Containing USF assigned to the MS.
14	MS -> SS	UPLINK RLC DATA BLOCKs (GMM ATTACH COMPLETE)	
15	MS -> SS	PACKET UPLINK ACK/NACK	Containing Final Ack Indicator bit = 1, and valid RRBp field.
16	MS -> SS	PACKET CONTROL ACKNOWLEDGEMENT	Sent in the block assigned by the RRBp field in step 15.

Specific Message Contents

SYSTEM INFORMATION Type 1 initial conditions (changes):

Cell Channel Description - Format identifier	For GSM 900, GSM 1800, GSM 1900, GSM 700, T-GSM 810, GSM 850: Variable bitmap.
- Cell Allocation ARFCN	For GSM 900: Channel Numbers 10, 37 and 40. For DCS1800 and PCS 1900: Channel Numbers 520, 530, 540 and 550. For GSM 700, T-GSM 810: Channel Numbers 447, 457 and 467. For GSM 850: Channel Numbers 159, 161, 163 and 165.

SYSTEM INFORMATION TYPE 13 initial conditions (changes)

SI 13 Rest Octets - MA_LENGTH	For GSM 700,T-GSM 810 and GSM 900 2 For DCS 1800, PCS 1900 and GSM 850 3
- MA_BITMAP	111 (3 belonging for GSM 700,T-GSM 810 and GSM 900) 1111 (4 belonging for DCS 1800, PCS 1900 and GSM 850)

PACKET SYSTEM INFORMATION Type 2: Instance 2 of 3 in Initial conditions (changes)

{Reference Frequency Lists} - - RFL_NUMBER - Length of RFL contents - RFL contents -	1 (Reference Frequency struct present) 0010 List 2 <i>Coded accordingly</i> For GSM 900, in Variable bit format (10, 37, 40) For DCS 1800 & PCS 1900, in Variable bit format (520, 530, 540, 550) For GSM 700 & T-GSM 810, in Variable bit format (447, 457, 467) For GSM 850, in Variable bit format (159, 161, 163, 165) 0 (end of Reference Frequency List)
{GPRS Mobile Allocation} - MA_LENGTH - MA_BITMAP	3 For GSM 700, T-GSM 810, GSM 850, GSM 900, DCS 1800, PCS1900 1111 (4 belonging for GSM 700, T-GSM 810, GSM 900, DCS 1800, PCS 1900 and GSM 850)

PACKET SYSTEM INFORMATION Type 2: Instance 3 of 3 in Initial conditions (changes)

{Reference Frequency Lists} - - RFL_NUMBER - Length of RFL contents - RFL contents -	1 Reference Frequency struct present 0001 List 1 <i>Coded accordingly</i> For GSM 900, in Variable bit format (30, 50, 60, 70) For DCS 1800 & PCS 1900, in Variable bit format (600, 620, 630, 640) For GSM 700 & T-GSM 810, in Variable bit format (457 ,467, 477,487) For GSM 850, in Variable bit format (147, 157, 167, 177) 0 (end of Reference Frequency List)
{GPRS Mobile Allocation} - MA_LENGTH - MA_BITMAP	For GSM 700, T-GSM 810 and GSM 900 2 For DCS 1800, PCS 1900 and GSM 850 3 111 (3 belonging for GSM 700, T-GSM 810 and GSM 900) 1111 (4 belonging for DCS 1800, PCS 1900 and GSM 850)

PACKET UPLINK ASSIGNMENT message in step 3 (changes)

<pre>{0 1<Frequency Parameters>} - Frequency Parameters - TSC - - MAIO - HSN - MA_LENGTH - MA_BITMAP</pre>	<pre>1 (Frequency Parameters present) Arbitrarily chosen (5) 10 (Direct encoding 1) Arbitrarily chosen '000000' cyclic hopping For GSM 700, T-GSM 810 and GSM 900 2 For DCS 1800, PCS 1900 and GSM 850 3 111 (3 belonging for GSM 700, T-GSM 810 and GSM 900) 1111 (4 belonging for DCS 1800, PCS 1900 and GSM 850)</pre>
---	--

PACKET DOWNLINK ASSIGNMENT message in step 8 (changes)

<pre>{0 1<Frequency Parameters>} - Frequency Parameters - TSC - - MAIO - HSN - Length of MA Frequency List contents - MA Frequency List contents Dynamic allocation</pre>	<pre>1 (Frequency Parameters present) Arbitrarily chosen (5) 11 (Direct encoding 2) Arbitrarily chosen '000000' cyclic hopping - Same CA as the ones defined in PSI2, coded with Variable bitmap 01</pre>
--	---

42.1.2.2 Packet Downlink Assignment

42.1.2.2.1 Packet Downlink Assignment / Response to poll bit

42.1.2.2.1.1 Conformance requirements

In case valid timing advance for the mobile station is not available, the network may use one of the following two methods to trigger the mobile station to transmit a PACKET CONTROL ACKNOWLEDGEMENT:

- if the PACKET DOWNLINK ASSIGNMENT message is not segmented and the CONTROL_ACK_TYPE parameter in the System Information indicates acknowledgement is access bursts, the network may set the poll bit in the PACKET DOWNLINK ASSIGNMENT message.
- if the PACKET DOWNLINK ASSIGNMENT message is segmented or the CONTROL_ACK_TYPE parameter in the System Information does not indicate acknowledgement is access bursts, the network may send PACKET POLLING REQUEST with TYPE_OF_ACK parameter set to access bursts (see subclause 11.2.12).

The mobile station shall always transmit the uplink radio block on the same timeslot as the block where the RRBP was received. After receiving an RLC/MAC block containing a valid RRBP field the mobile station need not monitor the USF in the associated downlink RLC/MAC block appearing just before the uplink block it shall transmit.

Reference

3GPP TS 04.60 subclause 7.2.1.1 and 10.4.5.

42.1.2.2.1.2 Test purpose

To verify that the mobile station sends PACKET CONTROL ACKNOWLEDGEMENT as four access bursts if the network sets the poll bit in the PACKET DOWNLINK ASSIGNMENT message when CONTROL_ACK_TYPE is set to four access bursts.

42.1.2.2.1.3 Method of test

Initial conditions

System Simulator:

1 cell supporting GPRS. The packet system information CONTROL_ACK_TYPE is set to indicate PACKET CONTROL ACKNOWLEDGEMENT format as four access bursts and the ACCESS_BURST_TYPE indicates 11 bit access.

Mobile Station:

The MS is GPRS attached and in packet idle mode and Ready state.

Specific PICS Statements

-

PIXIT Statements

-

Test procedure

The SS initiate a downlink data transfer. The SS sends PACKET DOWNLINK ASSIGNMENT message. The poll bit in the MAC header of the PACKET DOWNLINK ASSIGNMENT message will be set to indicate RRBP field is valid. The MS may delay the establishment of the downlink channels in order to answer the poll request on the common control channel. The SS verifies that the MS sends PACKET CONTROL ACKNOWLEDGEMENT as four access bursts on the timeslot on which it received the polling command.

Maximum duration of the test

2 minutes.

Expected sequence

Step	Direction	Message	Comments
1	SS		The SS initiate a downlink transfer of 200 octets data.
2	SS -> MS	PACKET DOWNLINK ASSIGNMENT	Poll bit in the MAC header is set to indicate a valid RRBP = 1. Sent on PPCH.
3	MS -> SS	PACKET CONTROL ACKNOWLEDGEMENT	As four access bursts. Received on PCCCH.
4	SS		The SS verifies that the MS sends the PACKET CONTROL ACKNOWLEDGEMENT as four access bursts, one per TDMA frame of the uplink radio block.

Specific message contents

None.

42.1.2.2.2 Packet Downlink Assignment / PCCCH monitoring

42.1.2.2.2.1 Conformance requirements

A PACKET DOWNLINK ASSIGNMENT message may indicate an assignment starting time in the TBF Starting Time parameter. The mobile station shall monitor PCCCH until the point in time denoted by the TBF Starting Time. Thereafter it shall switch to the assigned PDCHs. If while monitoring the PCCCH the mobile station receives more than one PACKET DOWNLINK ASSIGNMENT message, it shall act upon the most recently received message and shall ignore the previous message.

Reference

3GPP TS 04.60 subclause 7.2.1.1.

42.1.2.2.2.2 Test purpose

To verify that the mobile station monitors PCCCH until the point in time denoted by the TBF Starting Time.

To verify that the mobile station considers the most recently received PACKET DOWNLINK ASSIGNMENT message.

42.1.2.2.2.3 Method of test

Initial conditions

System Simulator:

1 cell supporting GPRS. The packet system information ACCESS_BURST_TYPE indicates 8 bit access.

Mobile Station:

The MS is GPRS attached and in packet idle mode and Ready state.

Specific PICS Statements

-

PIXIT Statements

-

Test procedure

The SS initiate a downlink data transfer. The SS sends PACKET DOWNLINK ASSIGNMENT message to the MS with a TBF starting time. Then send a new PACKET DOWNLINK ASSIGNMENT message on PCCCH (within the paging group of the MS) with another TBF starting time and a different timeslot before the first starting time has occurred. The SS starts to send RLC/MAC data blocks according to the second PACKET DOWNLINK ASSIGNMENT message. The MS shall send PACKET DOWNLINK ACK/NACK message to indicate correct reception of data blocks.

Maximum duration of the test

2 minutes.

Expected sequence

Step	Direction	Message	Comments
1	SS		The SS initiate a downlink transfer of 200 octets data. See specific message contents. Sent on PPCH.
2	SS -> MS	PACKET DOWNLINK ASSIGNMENT	Sent 3 blocks before TBF starting time in step 2 has elapsed. See specific message contents. Sent on PCCCH.
3	SS -> MS	PACKET DOWNLINK ASSIGNMENT	
4	SS -> MS	DOWNLINK RLC DATA BLOCK	SS sends data starting at frame as indicated by TBF starting time in step 3 on assigned PDTCH.
5	MS -> SS	PACKET DOWNLINK ACK/NACK	Indicating correct reception of downlink data block. Received on PACCH.

Specific message contents

As default messages contents, except:

PACKET DOWNLINK ASSIGNMENT in step 2

Information element	Value/remark
< TIMESLOT_ALLOCATION > {0 1< TBF Starting Time > -TBF_STARTING_TIME}	00010000, allocate timeslot 3. 1 arbitrarily chosen taking into account that the PACKET DOWNLINK ASSIGNMENT message in step 3 will be sent on the PCCCH corresponding to the paging group of the MS

PACKET DOWNLINK ASSIGNMENT in step 3

Information element	Value/remark
< TIMESLOT_ALLOCATION > {0 1< TBF Starting Time > -TBF_STARTING_TIME}	0000010, allocate timeslot 6. 1 arbitrarily chosen different from step 2

42.1.2.2.3 Packet Downlink Assignment / Frequency hopping

42.1.2.2.3.1 Conformance requirements

The mobile station shall use information received on the PBCCH to decode the channel descriptions contained in the assignment. If frequency hopping is applied, the mobile station shall use the last CA received on PBCCH to decode the Mobile Allocation.

Reference

3GPP TS 04.60 subclause 7.2.1.1.

42.1.2.2.3.2 Test purpose

To verify that, if frequency hopping is applied, the mobile station uses the last CA received on PBCCH to decode the Mobile Allocation.

To verify that, if frequency hopping is applied, indirect encoding, direct encoding 1 and direct encoding 2 worked as intend together with the information received on PBCCH.

42.1.2.2.3.3 Method of test

Initial conditions

System Simulator:

1 cell supporting GPRS. PACKET SYSTEM INFORMATION Type 2 (PSI2) sent on PBCCH indicate frequency hopping parameters, see specific message contents.

Mobile Station:

The MS is GPRS attached and in packet idle mode.

Specific PICS Statements

-

PIXIT Statements

-

Test procedure

The SS initiate a downlink data transfer. The SS releases the PBCCH by sending PACKET SYSTEM INFORMATION 1 indicating PBCCH release. The message is sent to the paging group of the MS. The SS send PACKET DOWNLINK ASSIGNMENT message indicating indirect encoding in frequency parameters. The SS shall start to transmit the downlink data to the MS. The MS and SS complete the downlink data transfer. The SS verifies that the MS use the last CA information received on PBCCH to decode the Mobile Allocation. Repeat the test with frequency parameters Direct encoding 1 and Direct encoding 2.

Maximum duration of the test

5 minutes.

Expected sequence

Step	Direction	Message	Comments
1	SS		Change PSI1, PSI2, SI1, and SI13 message contents (see specific message contents)
2	SS	PACKET SYSTEM INFORMATION TYPE 1	BS_PCC_REL = '1'. Sent on PCCCH in the paging group of the MS
3	SS		Wait 35 seconds
4	SS		The SS initiate a downlink transfer of 200 octets data.
5	SS -> MS	PACKET DOWNLINK ASSIGNMENT	Sent on PPCH.
6	SS -> MS	DOWNLINK RLC DATA BLOCKs	Sent on assigned PDTCHs.
7	MS -> SS	PACKET DOWNLINK ACK/NACK	The SS verifies that the MS use the last CA information received on PBCCH. Received on PACCH.

Repeat the test with frequency parameters Direct encoding 1 and Direct encoding 2.

Specific message contents

As default messages contents, except:

PACKET SYSTEM INFORMATION Type 1 in step 2

Information element	Value/remark
<BS_PCC_REL>	'1' (indicating PBCCH is released)

PACKET SYSTEM INFORMATION Type 1 in step 1

Information element	Value/remark
<BS_PCC_REL>	'0' (indicating PBCCH release is not pending)

SYSTEM INFORMATION Type 1 in step 1

- Cell Allocation ARFCN	For GSM 900: Channel Numbers (8, 10, 15, 37, 39, 40, 45, 50). For DCS1800 and PCS 1900: Channel Numbers (518, 520, 525, 530, 535, 540, 545, 550) For GSM 700, T-GSM 810: Channel Numbers (455, 457, 465, 467, 475, 477, 485, 487) For GSM 850: Channel Numbers (145, 159, 160, 161, 162, 163, 164, 165)
-------------------------	--

SYSTEM INFORMATION Type 13 in step 1

-MA_LENGTH	000111	8
-MA_BITMAP	10101010	4 belonging

PACKET SYSTEM INFORMATION Type 2 in step 1

Information element	Value/remark
{0 1< Reference Frequency Lists>	1 Reference Frequency lists present
-RFL_NUMBER	0002 List 2
-Length of RFL contents	As required to encode the cell allocation
-RFL contents}	As per SI 1 above
{0 1<GPRS Mobile Allocations>	1 GPRS Mobile Allocation present
-MA_NUMBER	0010 List 2
-HSN	000000 Sequence 0
-{0 1<RFL number list>}	0 Number list not present
-{0	0
-MA_LENGTH	000111 8 bits
-MA_BITMAP}	10101010 4 belonging

42.1.2.2.4 Packet Downlink Assignment / Response to Packet Polling

42.1.2.2.4.1 Conformance requirements

In case valid timing advance for the mobile station is not available, the network may use one of the following two methods to trigger the mobile station to transmit a PACKET CONTROL ACKNOWLEDGEMENT:

- if the PACKET DOWNLINK ASSIGNMENT message is not segmented and the CONTROL_ACK_TYPE parameter in the System Information indicates acknowledgement is access bursts, the network may set the poll bit in the PACKET DOWNLINK ASSIGNMENT message.
- if the PACKET DOWNLINK ASSIGNMENT message is segmented or the CONTROL_ACK_TYPE parameter in the System Information does not indicate acknowledgement is access bursts, the network may send PACKET POLLING REQUEST with TYPE_OF_ACK parameter set to access bursts (see subclause 11.2.12).

On receipt of a PACKET POLLING REQUEST message, the mobile station shall respond to the network with the PACKET CONTROL ACKNOWLEDGEMENT message in the block period specified by the RRBP field. If the MS has received a PACKET DOWNLINK ASSIGNMENT message with no starting time or with a starting time that has already elapsed, the PACKET POLLING REQUEST message shall be sent on PACCH. Otherwise the PACKET POLLING REQUEST message shall be sent on PAGCH.

Reference

3GPP TS 04.60 subclauses 7.2.1.3 and 7.2.1.1.

42.1.2.2.4.2 Test purpose

To verify that on receipt of a PACKET POLLING REQUEST message, the mobile station responds with PACKET CONTROL ACKNOWLEDGEMENT message in the block period specified by the RRBP field.

42.1.2.2.4.3 Method of test

Initial conditions

System Simulator:

1 cell supporting GPRS. The packet system information CONTROL_ACK_TYPE is set to not indicate acknowledgement as four access bursts and ACCESS_BURST_TYPE indicate 8 bit access.

Mobile Station:

The MS is GPRS attached and in packet idle mode and Ready state.

Specific PICS Statements

-

PIXIT Statements

-

Test procedure

The SS initiate a downlink data transfer. The SS sends PACKET DOWNLINK ASSIGNMENT message to the MS with a TBF starting time. The SS sends a PACKET POLLING REQUEST message containing a valid RRBP field. The SS verifies that the MS sends a PACKET CONTROL ACKNOWLEDGEMENT message in the block period specified by the RRBP field. The SS sends PACKET PDCH RELEASE message to the MS. The SS initiate a downlink data transfer. The SS sends PACKET DOWNLINK ASSIGNMENT message to the MS without TBF starting time. The SS sends a PACKET POLLING REQUEST message containing a valid RRBP field. The SS verifies that the MS sends a PACKET CONTROL ACKNOWLEDGEMENT message in the block period specified by the RRBP field.

Maximum duration of the test

5 minutes.

Expected sequence

Step	Direction	Message	Comments
1	SS		The SS initiate a downlink transfer of 200 octets data.
2	SS -> MS	PACKET DOWNLINK ASSIGNMENT	See specific message contents. Sent on PPCH.
3	SS -> MS	PACKET POLLING REQUEST	Sent on PACCH after TBF starting time in step 2 has elapsed. See specific message contents.
4	MS -> SS	PACKET CONTROL ACKNOWLEDGEMENT	The SS verifies that the MS send this message in the block period specified by the RRBP field as four access bursts. Received on PACCH.
5	SS -> MS	PACKET PDCH RELEASE	Sent on PACCH.
6	SS		Wait 20 s.
7	SS		The SS initiate a downlink transfer of 200 octets data.
8	SS -> MS	PACKET DOWNLINK ASSIGNMENT	See specific message contents. Sent on PPCH.
9	SS -> MS	PACKET POLLING REQUEST	Sent on PACCH. See specific message contents.
10	MS -> SS	PACKET CONTROL ACKNOWLEDGEMENT	The SS verifies that the MS send this message in the block period specified by the RRBP field as four access bursts. Received on PACCH.

Specific message contents

As default messages contents, except:

PACKET DOWNLINK ASSIGNMENT in step 2

Information element	Value/remark
< TIMESLOT_ALLOCATION >	00000100, allocate timeslot 5.
{0 1< TBF Starting Time > -TBF_STARTING_TIME}	1 arbitrarily chosen

PACKET DOWNLINK ASSIGNMENT in step 8

Information element	Value/remark
< TIMESLOT_ALLOCATION >	00000001, allocate timeslot 7.
{0 1< TBF Starting Time >}	0 (No TBF starting time)

PACKET POLLING REQUEST in step 3 and 9

Information element	Value/remark
RRBP in MAC header	Set to 1
S/P in MAC header	Set to 1 : RRBP field is valid
< MESSAGE_TYPE >	000100
< PAGE_MODE	Normal Paging
{ 0 < Global TFI >	
10 < TLLI >	0 (Global TFI)
110 < TQI >}	
1	DOWNLINK TFI Present
DOWNLINK TFI	As allocated in the PACKET DOWNLINK ASSIGNMENT message in Step 2 and Step 8 respectively
< TYPE_OF_ACK >	0 as four access bursts

42.1.2.2.5 Packet Downlink Assignment / Abnormal cases

42.1.2.2.5.1 Packet Downlink Assignment / Abnormal cases / Incorrect PDCH assignment

42.1.2.2.5.1.1 Conformance requirements

If the mobile station has been assigned more PDCHs than it supports according to its MS multislot class, the mobile station shall return to packet idle mode.

Reference

3GPP TS 04.60 subclause 7.2.2.

42.1.2.2.5.1.2 Test purpose

To verify that the mobile station return to packet idle mode if the mobile station is assigned more PDCHs than it supports according to its GPRS multislot class.

42.1.2.2.5.1.3 Method of test

Initial conditions

System Simulator:

1 cell supporting GPRS.

Mobile Station:

The MS is GPRS attached and in packet idle mode and Ready state.

Specific PICS Statements

- GPRS Multislotclass (TSPC_Type_GPRS_Multislot_ClassX where X = 1..45)

PIXIT Statements

-

Test procedure

Convert MS GPRS Multislot Class to number of downlink timeslot supported.

The SS initiated a downlink data transfer. The SS sends PACKET DOWNLINK ASSIGNMENT message containing one more assigned Rx than the MS supports according to its GPRS multislot class. The SS sends RLC data blocks. The SS verify that the MS not respond to the RLC data blocks sent by SS. Verify that the MS return to packet idle mode.

The SS sends PACKET DOWNLINK ASSIGNMENT message again containing correct GPRS multislot class. The SS starts to send RLC data blocks and the MS complete the downlink data transfer.

Maximum duration of the test

2 minutes.

Expected sequence

Step	Direction	Message	Comments
1	SS		The SS initiate a downlink transfer of 200 octets data.
2	SS -> MS	PACKET DOWNLINK ASSIGNMENT	Assign one more Rx timeslot than the MS support. Sent on PPCH.
3	SS		Wait for three block periods.
4	SS -> MS	DOWNLINK RLC DATA BLOCK	Sent on assigned PDTCHs. With valid RRBP field
5	SS		Verify for 500 msec that the MS does not respond.
6	SS -> MS	PACKET DOWNLINK ASSIGNMENT	Assign Rx timeslot according to the MS GPRS multislot class. Sent on PPCH.
7	SS -> MS	DOWNLINK RLC DATA BLOCK	If the MS supports multislot class 1,2,3, 5 or 9: Sent on assigned PDTCH with a valid RRBP field in the highest numbered PDTCH. Sent after 3 block periods of the message sent in step 6. Continue with step 8.
7A	SS -> MS	DOWNLINK RLC DATA BLOCK	Else : Sent on all assigned PDTCHs. Sent after 3 block periods of the message sent in step 6. Continue with step 7A Only one RLC data block is sent on the second highest numbered PDTCH. A valid RRBP is indicated.
8	MS -> SS	PACKET DOWNLINK ACK/NACK	The SS verifies that the MS indicating correct reception of downlink data blocks. Received on PACCH.

Specific message contents

None.

42.1.2.2.5.2 Packet Downlink Assignment / Abnormal cases / Expiry of timer T3190

42.1.2.2.5.2.1 Conformance requirements

When receiving the PACKET DOWNLINK ASSIGNMENT message and after waiting the TBF Starting Time when applicable, the mobile station starts timer T3190. The timer is reset when receiving the first valid RLC/MAC block.

On expiry of timer T3190, the mobile station shall return to packet idle mode.

Reference

3GPP TS 04.60 subclauses 7.2.1.1 and 7.2.2.

42.1.2.2.5.2.2 Test purpose

To verify that the mobile station aborts the TBF and returns to packet idle mode if a valid RLC block is not received within the duration of timer T3190.

42.1.2.2.5.2.3 Method of test

Initial conditions

System Simulator:

1 cell supporting GPRS. The packet system information ACCESS_BURST_TYPE indicates 8 bit access.

Mobile Station:

The MS is GPRS attached and in packet idle mode and Ready state.

Specific PICS Statements

-

PIXIT Statements

-

Test procedure

The SS initiate a downlink data transfer. The SS sends PACKET DOWNLINK ASSIGNMENT message to the MS. The SS wait to send RLC data blocks for a time greater than timer T3190. The SS verifies that the MS not respond to the RLC data blocks sent by SS.

The SS reinitiate the sending of downlink data transfer. The SS sends PACKET DOWNLINK ASSIGNMENT message again and starts to send RLC data blocks after a time less than timer T3190. The MS shall complete the downlink data transfer.

Maximum duration of the test

2 minutes.

Expected sequence

Step	Direction	Message	Comments
1	SS		The SS initiate a downlink transfer of 200 octets data.
2	SS -> MS	PACKET DOWNLINK ASSIGNMENT	Not indicating any TBF Starting Time. Sent on PPCH.
3	SS		The SS waits timer T3190 + 0.1*T3190.
4	SS -> MS	DOWNLINK RLC DATA BLOCK	Sent on assigned PDTCHs with a valid RRBP field.
5	SS		Verify for 10 s that the MS not respond.
6	SS -> MS	PACKET DOWNLINK ASSIGNMENT	Reinitiate the downlink data transfer. Sent on PPCH.
7	SS		The SS waits timer T3190 – 0.1*T3190.
8	SS -> MS	DOWNLINK RLC DATA BLOCK	Sent on assigned PDTCHs with a valid RRBP field.
9	MS -> SS	PACKET DOWNLINK ACK/NACK	Indicating correct reception of downlink data blocks. SS verifies that ACK/NACK is sent from the MS.

Specific message contents

None.

42.1.2.2.6 Packet Downlink Assignment Timing Advance / TA value field not provided

42.1.2.2.6.1 Conformance requirements

For the case where a TIMING_ADVANCE_VALUE field is not provided in the assignment message, the mobile station is not allowed to send normal bursts on the uplink until it receives a valid timing advance either through the continuous timing advance procedure or in a PACKET TIMING ADVANCE/POWER CONTROL message.

Reference

3GPP TS 04.60 subclause 7.1.2.5.

42.1.2.2.6.2 Test purpose

To verify that the mobile station does not send normal bursts on the uplink until it receives a valid timing advance in a PACKET POWER CONTROL/TIMING ADVANCE message if Timing Advance Value field is not provided in the PACKET DOWNLINK ASSIGNMENT message.

42.1.2.2.6.3 Method of test

Initial conditions

System Simulator:

1 cell supporting GPRS.

Mobile Station:

The MS is GPRS attached and in packet idle mode. PDP context 2 has been established.

Specific PICS Statements

-

PIXIT Statements

-

Test procedure

The SS initiates downlink data transfer. The SS does not include Timing Advance in the PACKET DOWNLINK ASSIGNMENT. The SS poll MS by sending an RLC DATA BLOCK. SS verifies for 2 seconds that MS did not answer to poll and then send a PACKET POWER CONTROL/TIMING ADVANCE message with a valid timing advance information. The SS verifies that the MS does not send any normal burst on the uplink until the SS sends a valid timing advance.

Maximum duration of the test

2 minutes.

Expected sequence

Step	Direction	Message	Comments
1	MS		
2		PACKET DOWNLINK ASSIGNMENT	The SS initiate a downlink transfer of 200 octets data. Send on PPCH. No Timing Advance Value
3	SS->MS SS -> MS	DOWNLINK RLC DATA BLOCK	Sent on assigned PDTCHs with a valid RRBp field. Final Block Indicator is set to 0.
4	SS		SS verifies that the MS does not send any normal burst on the uplink.
5	SS -> MS	PACKET POWER CONTROL/TIMING ADVANCE	Include a valid Timing Advance information. Sent on PACCH.
6	SS->MS	DOWNLINK RLC DATA BLOCK	Sent on assigned PDTCHs with a valid RRBp field. Final Block Indicator is set to 0.
7	MS->SS	PACKET DOWNLINK ACK/NACK	The SS verifies that the MS indicating correct reception of downlink data blocks. Received on PACCH.

Specific message contents

None.

42.1.3 Macro and default message contents

42.1.3.1 Macro

In order to simplify the process of writing and coding test cases, macros are referenced in the expected signaling tables. These macros provide all additional signaling needed to complete the particular test but are not relevant to its purpose. This Macro is only applicable to test case in subclauses 42.1.1 and 42.1.2.

42.1.3.1.1 GPRS attach procedure

The following table describes a signaling sequence performing the GPRS attach procedure when PCCCH is present. Note that there are different possible sequences implementing the GPRS attach procedure. In this case we use dynamic allocation and simultaneous uplink and downlink TBFs.

{GPRS attach procedure}

Step	Direction	Message	Comments
1			MS is triggered to initiate the GPRS attach procedure.
2	MS -> SS	PACKET CHANNEL REQUEST	Mobility Management procedure request.
3	SS -> MS	PACKET UPLINK ASSIGNMENT	Indicate dynamic allocation struct.
4	SS -> MS	PACKET DOWNLINK DUMMY CONTROL BLOCK	Containing USF assigned to the MS.
5	MS -> SS	UPLINK RLC DATA BLOCK (GMM ATTACH REQUEST)	Steps 4 & 5 are repeated until the MS has sent the complete GMM ATTACH REQUEST message.
6	SS -> MS	PACKET UPLINK ACK/NACK	Containing Final Ack Indicator bit = 1, and valid RRBP field.
7	MS -> SS	PACKET CONTROL ACKNOWLEDGEMENT	Sent in the block assigned by the RRBP field in step 6.
8	SS -> MS	PACKET DOWNLINK ASSIGNMENT	Assign a downlink TBF, "MAC mode" = dynamic allocation.
9	SS -> MS	DOWNLINK RLC DATA BLOCKs (GMM ATTACH ACCEPT)	Containing USF assigned to the MS. Last block shall contain Final Block Indicator bit = 1, and valid RRBP field.
10	MS -> SS	PACKET DOWNLINK ACK/NACK	Sent in the block assigned by the RRBP field in step 9.
11	MS -> SS	PACKET CHANNEL REQUEST	Mobility Management procedure request.
12	SS -> MS	PACKET UPLINK ASSIGNMENT	Indicate dynamic allocation struct.
13	SS -> MS	PACKET DOWNLINK DUMMY CONTROL BLOCK	Containing USF assigned to the MS.
14	MS -> SS	UPLINK RLC DATA BLOCKs (GMM ATTACH COMPLETE)	
15	SS -> MS	PACKET UPLINK ACK/NACK	Containing Final Ack Indicator bit = 1, and valid RRBP field.
16	MS -> SS	PACKET CONTROL ACKNOWLEDGEMENT	Sent in the block assigned by the RRBP field in step 15.

42.1.3.1.2 Uplink data transfer, dynamic allocation

The following table describes a sequence performing uplink data transfer with one phase access dynamic allocation when PCCCH is present.

{Uplink data transfer, dynamic allocation}

Step	Direction	Message	Comments
1			PDP context 2 has been established. The MS is triggered to send data.
2	MS -> SS	PACKET CHANNEL REQUEST	One phase access, dynamic allocation struct. Containing USF assigned to the MS.
3	SS -> MS	PACKET UPLINK ASSIGNMENT	
4	SS -> MS	PACKET DOWNLINK DUMMY CONTROL BLOCK	
5	MS -> SS	UPLINK RLC DATA BLOCK(S)	
6	SS -> MS	PACKET UPLINK ACK/NACK	If USF_GRANULARITY = four blocks, 4 RLC data blocks will be sent. Containing USF assigned to the MS. and contention resolution TLLI
7	MS -> SS	UPLINK RLC DATA BLOCK(S) Or PACKET UPLINK DUMMY CONTROL BLOCK(S)	If USF_GRANULARITY = four blocks, 4 blocks will be sent in any combination of UPLINK RLC DATA BLOCK and PACKET UPLINK DUMMY CONTROL BLOCK
8	SS -> MS	PACKET UPLINK ACK/NACK	Containing USF assigned to the MS.
9	MS -> SS	UPLINK RLC DATA BLOCK(S)	If USF_GRANULARITY = four blocks, 4 RLC data blocks will be sent.
10			Repeat step 8 and 9 until the countdown value CV=0 in step 9.
11	SS -> MS	PACKET UPLINK ACK/NACK	Final Ack Indicator = 1 containing valid RRBP.
12	MS -> SS	PACKET CONTROL ACKNOWLEDGEMENT	It can either be received in Access bursts or in RLC/MAC Control block format depending upon the setting of CONTROL_ACK_TYPE in PSI1.

42.1.3.1.3 GPRS detach procedure

The following table describes a signalling sequence performing the GPRS detach procedure when PCCCH is present.

{GPRS detach procedure}

Step	Direction	Message	Comments
1	MS -> SS	PACKET CHANNEL REQUEST	Indicate dynamic allocation struct. Containing USF assigned to the MS.
2	SS -> MS	PACKET UPLINK ASSIGNMENT	
3	SS -> MS	PACKET DOWNLINK DUMMY CONTROL BLOCK	
4	MS -> SS	UPLINK RLC DATA BLOCKS (GMM DETACH REQUEST)	Containing Final Ack Indicator bit = 1, and valid RRBP field.
5	SS -> MS	PACKET UPLINK ACK/NACK	
6	MS -> SS	PACKET CONTROL ACKNOWLEDGEMENT	

42.1.3.2 Default Messages

These default message contents override those specified in "GPRS default conditions" but messages specified in a test case have always the highest precedence.

42.1.3.2.1 PACKET CHANNEL REQUEST message:

< Access Type >	"One phase access request" or "Two phase access request"
< Multislot class >	Not checked
< Radio priority >	Not checked
< Random Reference >	Not checked.

42.1.3.2.2 PACKET CONTROL ACKNOWLEDGEMENT message:

< MESSAGE_TYPE >	000001
< TLLI >	not checked
< CTRL_ACK >	not checked
< padding bits >	Spare Padding

42.1.3.2.3 PACKET DOWNLINK ACK/NACK message:

< MESSAGE_TYPE >	000010
< DOWNLINK_TFI >	pertaining to the downlink TBF
< Ack/Nack Description >	
< FINAL_ACK_INDICATION >	0 (not final ack)
< STARTING_SEQUENCE_NUMBER >	not checked
< RECEIVED_BLOCK_BITMAP >	not checked
{0 1 < Channel Request Description >}	0 (no channel request)
< Channel Quality Report >	
< C_VALUE >	not checked
< RXQUAL >	not checked
< SIGN_VAR >	not checked
{0 1<_LEVEL_TN0>}	not checked
{0 1<_LEVEL_TN1>}	not checked
{0 1<_LEVEL_TN2>}	not checked
{0 1<_LEVEL_TN3>}	not checked
{0 1<_LEVEL_TN4>}	not checked
{0 1<_LEVEL_TN5>}	not checked
{0 1<_LEVEL_TN6>}	not checked
{0 1<_LEVEL_TN7>}	not checked
< padding bits >	Spare Padding

42.1.3.2.4 PACKET DOWNLINK ASSIGNMET message:

< MESSAGE_TYPE >	000010
< PAGE_MODE >	Normal Paging
{0 1< PERSISTENCE_LEVEL >}	0 (no persistence level present)
{ 0 < Global TFI 10 < TLLI >}	10 (address is TLLI) same as the value received from MS
< MAC_MODE >	Dynamic Allocation
< RLC_MODE >	acknowledged mode
< CONTROL_ACK >	0
< TIMESLOT_ALLOCATION >	single slot arbitrarily chosen from valid values (default slot 2)
< Packet Timing Advance >	
{0 1< TIMING_ADVANCE_VALUE >}	1 (timing advance value)
- TIMING_ADVANCE_VALUE	30 bit periods
{0 1<DOWNLINK_TIMING_ADVANCE_INDEX>	0 (no timing advance index)
{0 1 < P0 >	0 (no power control parameter)
{0 1< Frequency Parameters >}	1 (Frequency Parameters present)
< TSC >	value arbitrarily chosen from valid values (default 5)
{ 00 < ARFCN >}	00 (ARFCN no hopping)
- ARFCN	For GSM 900: 30 For DCS 1 800: 650 For PCS 1 900: 650 For GSM 700, T-GSM 810: 467 For GSM 850: 157
{0 1< DOWNLINK_TFI_ASSIGNMENT >}	1 (assign downlink TFI)
< DOWNLINK_TFI_ASSIGNMENT >	arbitrarily chosen from valid values (default 3)
{0 1< Power Control Parameters >}	1 (Power Control Parameters present)
< ALPHA >	0.5
{0 1< GAMMA_TN0 >}	depending on the value in TIMESLOT_ALLOCATION (default 0 no GAMMA_TN0)
{0 1< GAMMA_TN1 >}	depending on the value in TIMESLOT_ALLOCATION (default 0 no GAMMA_TN1)
{0 1< GAMMA_TN2 >}	depending on the value in TIMESLOT_ALLOCATION (default 1 GAMMA_TN2)
- GAMMA_TN2	For GSM 700, T-GSM 810, GSM 850 and GSM 900, +8 dBm For DCS 1 800, +6 dBm For PCS 1 900, +6 dBm
{0 1< GAMMA_TN3 >}	depending on the value in TIMESLOT_ALLOCATION (default 0 no GAMMA_TN0)
{0 1< GAMMA_TN4 >}	depending on the value in TIMESLOT_ALLOCATION (default 0 no GAMMA_TN4)
{0 1< GAMMA_TN5 >}	depending on the value in TIMESLOT_ALLOCATION (default 0 no GAMMA_TN5)
{0 1< GAMMA_TN6 >}	depending on the value in TIMESLOT_ALLOCATION (default 0 no GAMMA_TN6)
{0 1< GAMMA_TN7 >}	depending on the value in TIMESLOT_ALLOCATION (default 0 no GAMMA_TN7)
{0 1< TBF_STARTING_TIME >}	0 (no starting time present)
{0 1< Measurement Mapping >}	0 (no measurement mapping)
< padding bits >	Spare Padding

42.1.3.2.5 PACKET PAGING REQUEST message:

< MESSAGE_TYPE >	100010
< PAGE_MODE >	00 (Normal Paging)
{0 1< PERSISTENCE_LEVEL >}	0 (no persistence level present)
{0 1< NLN >}	0 (no notification list number)
{1< Repeated Page info>}	1 (start of Repeated Page info)
{0	0 (Page request for TBF establishment)
{0< PTMSI >	0 (PTMSI)
- PTMSI	P-TMSI allocated during GPRS attach procedure
< padding bits >	Spare Padding

42.1.3.2.6 PACKET RESOURCE REQUEST message (two phase access):

< MESSAGE_TYPE >	000101
{0 1< ACCESS_TYPE >}	1 (response to single block assignment)
- ACCESS_TYPE	00 (two phase access)
{0< Global TFI >}	1 (TLLI)
1 < TLLI >}	
- TLLI	not checked
{0 1< MS Radio Access Capability >}	1 (MS Radio Access Capability)
- MS Radio Access Capability	not checked
< Channel Request Description >	
- PEAK_THROUGHPUT_CLASS	not checked
- RADIO_PRIORITY	not checked
- RLC_MODE	not checked
- LLC_PDU_TYPE	1 (not SACK or ACK)
- RLC_OCTET_COUNT	not checked
{0 1< CHANGE_MARK >}	not checked
< C_VALUE >	not checked
{0 1< SIGN_VAR >}	not checked
{0 1< I_LEVEL_TN0 >}	not checked
{0 1< I_LEVEL_TN1 >}	not checked
{0 1< I_LEVEL_TN2 >}	not checked
{0 1< I_LEVEL_TN3 >}	not checked
{0 1< I_LEVEL_TN4 >}	not checked
{0 1< I_LEVEL_TN5 >}	not checked
{0 1< I_LEVEL_TN6 >}	not checked
{0 1< I_LEVEL_TN7 >}	not checked
< padding bits >	Spare Padding

42.1.3.2.7 PACKET UPLINK ACK/NACK message:

< MESSAGE_TYPE >	001001
< UPLINK_TFI >	same as the TFI value of the TBF which the message applies
< CHANNEL_CODING_COMMAND >	same as the coding scheme of the TBF which the message applies
< Ack/Nack Description >	
< FINAL_ACK_INDICATION >	0 (not a final ACK)
< STARTING_SEQUENCE_NUMBER >	V(R)
< RECEIVED_BLOCK_BITMAP >	acknowledges all data blocks transmitted by the MS
{0 1< CONTENTION_RESOLUTION_TLLI >}	0 (no contention resolution TLLI)
{0 1< Packet Timing Advance >}	0 (no packet timing advance)
{0 1< Power Control Parameters >}	0 (no power control parameters)
< padding bits >	Spare Padding

42.1.3.2.8 PACKET UPLINK ASSIGNMENT message (dynamic allocation)

< MESSAGE_TYPE >	001010
< PAGE_MODE >	Normal Paging
{0 1< PERSISTENCE_LEVEL >	0 (no persistence level present)
Referenced Address struct	
{ 0 < Global TFI >	
10 < TLLI >	10 (TLLI, the value received from the MS)
110 < TQI >	
111 < Packet Request Reference >	
< CHANNEL_CODING_COMMAND >	arbitrarily chosen from the valid values (default CS-1)
< TLLI_BLOCK_CHANNEL_CODING >	arbitrarily chosen but different from CHANNEL_CODING_COMMAND
< Packet Timing Advance >	
{ 0 1< TIMING_ADVANCE_VALUE >	1 (timing advance value)
- TIMING_ADVANCE_VALUE }	30 bit periods
{ 0 1< TIMING_ADVANCE_INDEX >	0 (no timing advance index)
<TIMING_ADVANCE_TIMESLOT_NUMBER > }	
{0 1< Frequency Parameters >	1 (Frequency Parameters present)
< TSC >	arbitrarily chosen (default 5)
{ 00< ARFCN >	00 (ARFCN no hopping)
- ARFCN }	For GSM 900: 30
	For DCS 1 800: 650
	For PCS 1 900: 650
	For GSM 700, T-GSM 810: 467
	For GSM 850: 157
{ 01 < Dynamic Allocation >	01 (Dynamic allocation)
< Extended Dynamic Allocation >	0 (Dynamic allocation)
{ 0 1< P0 >	1
-P0	0 dB
< PR_MODE : bit (1) > }	0 (PR mode A)
< USF_GRANULARITY >	0 (one block)
{0 1< UPLINK_TFI_ASSIGNMENT >	1 (uplink TFI assignment)
- UPLINK_TFI_ASSIGNMENT }	arbitrarily chosen (default 00101)
{0 1< RLC_DATA_BLOCKS_GRANTED >}	0 (no RLC_DATA_BLOCKS_GRANTED, open-ended TBF)
	0 (no starting time)
{0 1< TBF_STARTING_TIME >}	1 (Timeslot Allocation with Power Control Parameters)
{0 1< Timeslot Allocation >	one slot arbitrarily chosen and the following USF_TNx and GAMMA_TNx shall be corresponding to the chosen value (default slot 2)
	0.5
< ALPHA >	0 (timeslot 0 not assigned)
{0 1< USF_TN0><GAMMA_TN0 >}	0 (timeslot 1 not assigned)
{0 1< USF_TN1><GAMMA_TN1 >}	1 (timeslot 2 assigned)
{0 1< USF_TN2><GAMMA_TN2 >	arbitrarily chosen (default 101)
- USF_TN2	For GSM 700, T-GSM 810, GSM 850 and GSM 900, +8 dBm
- GAMMA_TN2 }	For DCS 1 800, +6 dBm
	For PCS 1 900, +6 dBm
{0 1< USF_TN3><GAMMA_TN3 >}	0 (timeslot 3 not assigned)
{0 1< USF_TN4><GAMMA_TN4 >}	0 (timeslot 4 not assigned)
{0 1< USF_TN5><GAMMA_TN5 >}	0 (timeslot 5 not assigned)
{0 1< USF_TN6><GAMMA_TN6 >}	0 (timeslot 6 not assigned)
{0 1< USF_TN7><GAMMA_TN7>}}	0 (timeslot 7 not assigned)
< padding bits >	Spare Padding

42.1.3.2.9 Void

42.1.3.2.10 PACKET UPLINK ASSIGNMENT message (single block allocation):

<pre> < MESSAGE_TYPE > < PAGE_MODE > {0 1< PERSISTENCE_LEVEL > Referenced Address struct { 0 < Global TFI > 10 < TLLI > 110 < TQI > 111 <Packet Request Reference >} < CHANNEL_CODING_COMMAND > < TLLI_BLOCK_CHANNEL_CODING > < Packet Timing Advance > - {0 1< TIMING_ADVANCE_VALUE > - TIMING_ADVANCE_VALUE } - {0 1< TIMING_ADVANCE_INDEX> <TIMING_ADVANCE_TIMESLOT_NUMBER >} {0 1< Frequency Parameters > < TSC > { 00< ARFCN >} - ARFCN} { 10 < Single Block Allocation > < TIMESLOT_NUMBER > {0 1 < ALPHA > < GAMMA_TN >} {0 1 < P0 > < BTS_PWR_CTRL_MODE > < PR_MODE: bit (1) > } < TBF_STARTING_TIME > < padding bits > </pre>	<pre> 001010 Normal Paging 111 (Packet Request Reference, information field sent in PACKET CHANNEL REQUEST and frame number in which PACKET CHANNEL REQUEST was received) arbitrarily chosen (default CS-1) arbitrarily chosen but different from CHANNEL_CODING_COMMAND 1 (timing advance value) 30 bit periods 0 (no timing advance index) 1 (Frequency Parameters present) arbitrarily chosen (default 5) 00 (ARFCN no hopping) For GSM 900: 30 For DCS 1 800: 650 For PCS 1 900: 650 For GSM 700, T-GSM 810: 467 For GSM 850: 157 10 (Single block allocation) arbitrarily chosen (default slot 2) 1 (power control parameters) 0.5 For GSM 700, GSM 850 and GSM 900, +8 dBm For DCS 1 800, +6 dBm For PCS 1 900, +6 dBm 1 (downlink power control parameters) 0 dB 0 (mode A) 0 (PR mode A) 0 (Absolute Starting Time, indicating current frame + 104 frames) Spare padding </pre>
---	--

42.2 Fixed Allocation in Packet Transfer Mode

42.2.1 Generic procedures to bring the MS into uplink transfer mode

For most test cases in subclause 42.2.2 the test starts when the MS is in packet uplink transfer mode. This subclause defines several generic test procedures to establish an uplink TBF and to bring the MS into the packet transfer mode. Fixed allocation MAC mode is used for the uplink RLC data block transfer.

Before one of the generic test procedures is used, it is necessary in a test to describe the way to trigger the MS for the relevant uplink access.

42.2.1.1 One phase access

The tables below describe message exchanges which bring the MS into the packet uplink transfer mode with the one phase access procedure. In fixed allocation, the one phase access procedure always indicates an open-ended TBF, because the SS does not know how much data the MS intends to transfer.

Table 42.2.1.1/1a: Generic procedure for MS entering uplink transfer mode, one phase access, fixed allocation, open-ended TBF (PBCCH present)

Step	Direction	Message	Comments
1	MS -> SS	PACKET CHANNEL REQUEST	Received on PRACH. 11-bit, one phase access requested.
2	SS -> MS	PACKET UPLINK ASSIGNMENT	Uplink fixed allocation. More than one block is allocated, which indicates open-ended TBF. Sent on PAGCH. The fixed allocation parameters are indicated in each test case which uses this generic procedure.
3	MS -> SS	UPLINK RLC DATA BLOCK	Received on the assigned PDTCH. Check that the coding is the scheme specified by TLLI_BLOCK_CHANNEL_CODING, the TFI is correct and the block contains TLLI.
4	SS -> MS	PACKET UPLINK ACK/NACK	With contention resolution TLLI, Sent on the PACCH of the PDCH assigned in step 2.

Table 42.2.1.1/1b: Generic procedure for MS entering uplink transfer mode, one phase access, fixed allocation, open-ended TBF (PBCCH not present)

Step	Direction	Message	Comments
1	MS -> SS	CHANNEL REQUEST	Received on RACH. "One phase packet access with request for single timeslot uplink transmission" requested.
2	SS -> MS	IMMEDIATE ASSIGNMENT	Uplink fixed allocation. More than one block is allocated, which indicates open-ended TBF. Sent on AGCH. The fixed allocation parameters are indicated in each test case which uses this generic procedure.
3	MS -> SS	UPLINK RLC DATA BLOCK	Received on the assigned PDTCH. Check that the coding is the scheme specified by TLLI_BLOCK_CHANNEL_CODING, the TFI is correct and the block contains TLLI.
4	SS -> MS	PACKET UPLINK ACK/NACK	With contention resolution TLLI, Sent on the PACCH of the PDCH assigned in step 2.

42.2.1.2 Two phase access

The tables below describe message exchanges which bring the MS into the packet uplink transfer mode by two phase access procedure.

Note that the value of RLC_OCTET_COUNT in step 3 in each procedure is MS implementation dependent. Therefore, it is MS implementation dependent whether the TBF is open-ended or closed-ended.

Also, the MS may send additional PACKET RESOURCE REQUEST messages at any time after the initial PACKET UPLINK ASSIGNMENT. This is MS implementation dependent.

Table 42.2.1.2/1a: Generic procedure for MS entering uplink transfer mode, two phase access, fixed allocation, open-ended uplink TBF (PBCCH present)

Step	Direction	Message	Comments
1	MS -> SS	PACKET CHANNEL REQUEST	Received on PRACH. 11-bit, two phase access requested.
2	SS -> MS	PACKET UPLINK ASSIGNMENT	Single block assignment, to force the MS into a two phase access procedure. Sent on PAGCH.
3	MS -> SS	PACKET RESOURCE REQUEST	Two phase access procedure. RLC_OCTET_COUNT = 0. Received on the single block assigned in step 2. Check that the PEAK_THROUGHPUT, RADIO_PRIORITY and RLC_MODE are compliant with the PDP context used.
4	SS -> MS	PACKET UPLINK ASSIGNMENT	Open-ended uplink fixed allocation. Sent on PACCH of the same PDCH assigned in step 2. The fixed allocation parameters are indicated in each test case that uses this generic procedure.
5	MS -> SS	UPLINK RLC DATA BLOCK	Received on the assigned PDTCH. Check that the coding is the scheme specified by CHANNEL_CODING_COMMAND in step 4, and the TFI is correct.

Table 42.2.1.2/1b: Generic procedure for MS entering uplink transfer mode, two phase access, fixed allocation, open-ended uplink TBF (PBCCH not present)

Step	Direction	Message	Comments
1	MS -> SS	CHANNEL REQUEST	Received on RACH. "Single block packet access; one block period on a PDCH is needed for two phase packet access" requested.
2	SS -> MS	IMMEDIATE ASSIGNMENT	Single block assignment, to force the MS into a two phase access procedure. Sent on AGCH.
3	MS -> SS	PACKET RESOURCE REQUEST	Two phase access procedure. RLC_OCTET_COUNT = 0. Received on the single block assigned in step 2. Check that the PEAK_THROUGHPUT, RADIO_PRIORITY and RLC_MODE are compliant with the PDP context used.
4	SS -> MS	PACKET UPLINK ASSIGNMENT	Open-ended uplink fixed allocation. Sent on PACCH of the same PDCH assigned in step 2. The fixed allocation parameters are indicated in each test case that uses this generic procedure.
5	MS -> SS	UPLINK RLC DATA BLOCK	Received on the assigned PDTCH. Check that the coding is the scheme specified by CHANNEL_CODING_COMMAND in step 4, and the TFI is correct.

Table 42.2.1.2/2a: Generic procedure for MS entering uplink transfer mode, two phase access, Fixed allocation, close-ended uplink TBF (PBCCH present)

Step	Direction	Message	Comments
1	MS -> SS	PACKET CHANNEL REQUEST	Received on PRACH. 11-bit two phase access requested.
2	SS -> MS	PACKET UPLINK ASSIGNMENT	Single block assignment, to force the MS into a two phase access procedure. Sent on PAGCH.
3	MS -> SS	PACKET RESOURCE REQUEST	Two phase access procedure. RLC_OCTET_COUNT <> 0. Received on the single block assigned in step 2. Check that the PEAK_THROUGHPUT, RADIO_PRIORITY and RLC_MODE are compliant with the PDP context used.
4	SS -> MS	PACKET UPLINK ASSIGNMENT	Close-ended uplink fixed allocation, Sent on PACCH of the same PDCH assigned in step 2. The fixed allocation parameters are indicated in each test case that uses this generic procedure.
5	MS -> SS	UPLINK RLC DATA BLOCK	Received on the assigned PDCH. Check that the coding is the scheme specified by CHANNEL_CODING_COMMAND in step 4, and the TFI is correct.

Table 42.2.1.2/2b: Generic procedure for MS entering uplink transfer mode, two phase access, Fixed allocation, close-ended uplink TBF (PBCCH not present)

Step	Direction	Message	Comments
1	MS -> SS	CHANNEL REQUEST	Received on RACH. "Single block packet access; one block period on a PDCH is needed for two phase packet access" requested.
2	SS -> MS	IMMEDIATE ASSIGNMENT	Single block assignment, to force the MS into a two phase access procedure. Sent on AGCH.
3	MS -> SS	PACKET RESOURCE REQUEST	Two phase access procedure. RLC_OCTET_COUNT <> 0. Received on the single block assigned in step 2. Check that the PEAK_THROUGHPUT, RADIO_PRIORITY and RLC_MODE are compliant with the PDP context used.
4	SS -> MS	PACKET UPLINK ASSIGNMENT	Close-ended uplink fixed allocation, Sent on PACCH of the same PDCH assigned in step 2. The fixed allocation parameters are indicated in each test case that uses this generic procedure.
5	MS -> SS	UPLINK RLC DATA BLOCK	Received on the assigned PDCH. Check that the coding is the scheme specified by CHANNEL_CODING_COMMAND in step 4, and the TFI is correct.

42.2.2 Fixed Allocation / Uplink Transfer

42.2.2.1 Fixed Allocation / Uplink Transfer / Normal operation

42.2.2.1.1 Fixed Allocation / Uplink Transfer / Normal operation / Blocks

42.2.2.1.1.1 Void

42.2.2.1.1.2 Conformance Requirement

If the BLOCKS_OR_BLOCK_PERIODS field indicates blocks, then the bits in the ALLOCATION_BITMAP correspond to radio blocks. Bits are included in the bitmap only for radio blocks on assigned PDCHs. Each bit in the bitmap indicates whether the corresponding radio block is assigned to the fixed allocation. The mobile station shall transmit an RLC/MAC block in each radio block assigned by the ALLOCATION_BITMAP.

References

3GPP TS 04.60, subclauses 8.1.1.3.1 and 11.2.29.

42.2.2.1.1.3 Test purpose

To verify that when BLOCK_OR_BLOCK_PERIODS field is 0 in the PACKET UPLINK ASSIGNMENT, the MS transmits RLC/MAC blocks strictly according to radio blocks allocated in ALLOCATION_BITMAP array.

42.2.2.1.1.4 Method of test

Initial Conditions

System Simulator:

1 cell, GPRS supported, PCCCH present

Mobile Station:

The MS is in the state "idle, GMM-registered" with a P-TMSI allocated, SPLIT PG CYCLE negotiated, and PDP context 3 activated.

Specific PICS Statements

-

PIXIT Statements

-

Test Procedure

MS is triggered to begin an uplink data transfer. Verify that the MS sends uplink RLC data blocks only in the blocks specified by the ALLOCATION_BITMAP.

Maximum Duration of Test

5 minutes.

Expected Sequence

Step	Direction	Message	Comments
1	MS		Trigger the MS to initiate an uplink packet transfer containing 1000 octets.
2			Bring the MS into packet uplink transfer mode by the generic procedure defined in the table 42.2.1.2/1a or 42.2.1.2/2a.
3	MS -> SS	UPLINK RLC DATA BLOCK	Received on the assigned PDTCH.
4	SS		Repeat step 3 until CV=0. The MS may send a PACKET RESOURCE REQUEST message during the current allocation. The SS shall ignore the request.
5	SS -> MS	PACKET UPLINK ACK/NACK	Verify MS is treating each bit in the ALLOCATION_BITMAP as a block, and only using timeslots allocated in ALLOCATION_BITMAP. Containing valid RRBP. Sent on PACCH.
6	MS -> SS	PACKET CONTROL ACKNOWLEDGEMENT	Received on the block specified by RRBP on PACCH of the assigned PDCH.

Specific Message Contents

PACKET UPLINK ASSIGNMENT message as part of macro in step 2:

Fixed Allocation - TIMESLOT ALLOCATION - BLOCKS_OR_BLOCK_PERIODS - ALLOCATION_BITMAP_LENGTH - ALLOCATION_BITMAP	One timeslot is assigned 0 – blocks Length of ALLOCATION_BITMAP (exactly 60 bits are set to 1)
---	---

PACKET UPLINK ACK/NACK message in step 5:

Ack/Nack Description - FINAL_ACK_INDICATION - STARTING_SEQUENCE_NUMBER - RECEIVED_BLOCK_BITMAP	1 (final ACK) V(R) Acknowledge all data blocks transmitted by the MS
---	--

42.2.2.1.2 Fixed Allocation / Uplink Transfer / Normal operation / Block Periods

42.2.2.1.2.1 Void

42.2.2.1.2.2 Conformance requirements

If the BLOCKS_OR_BLOCK_PERIODS field (=1) indicates block periods, then the bits in the bitmap indicate which block periods are assigned to the allocation. The mobile station shall transmit an RLC/MAC block on each timeslot assigned in the TIMESLOT_ALLOCATION field in each block period assigned to the allocation.

References

3GPP TS 04.60, subclauses 8.1.1.3.1 and 11.2.29.

42.2.2.1.2.3 Test purpose

Verify that when BLOCK_OR_BLOCK_PERIODS parameter is set to 1, the MS transmits RLC/MAC blocks strictly according to timeslots allocated in TIMESLOT_ALLOCATION array and block periods allocated in the ALLOCATION_BITMAP array.

42.2.2.1.2.4 Method of test

Initial Conditions

System Simulator:

1 cell, GPRS supported, PCCCH present.

Mobile Station:

The MS is in the state "idle, GMM-registered" with a P-TMSI allocated, SPLIT PG CYCLE negotiated, and PDP context 3 activated.

Specific PICS Statements

-

PIXIT Statements

-

Test Procedure

1. MS is triggered to begin an uplink data transfer. Verify that the MS sends uplink RLC data blocks only in the block periods specified by the ALLOCATION_BITMAP.
2. MS is triggered to begin an uplink data transfer. Verify that the MS sends uplink RLC data blocks in each timeslot allocated to the MS in the TIMESLOT_ALLOCATION, if the bit for this block period in the ALLOCATION_BITMAP is set to 1.

Maximum Duration of Test

5 minutes.

Expected Sequence – Procedure 1

Step	Direction	Message	Comments
1	MS		Trigger the MS to initiate an uplink packet transfer containing 1000 octets.
2			Bring the MS into packet uplink transfer mode by the generic procedure defined in the table 42.2.1.2/1a or 42.2.1.2/2a.
3	MS -> SS	UPLINK RLC DATA BLOCK	Received on the assigned PDTCH. Check the TFI is correct.
4	SS		Verify that step 3 is repeated until current allocation is exhausted. The MS may send a PACKET RESOURCE REQUEST message during the current allocation. The SS shall ignore the request. Verify MS is treating each bit in the ALLOCATION_BITMAP as a block period, and only using timeslots allocated in TIMESLOT_ALLOCATION.
5	SS -> MS	PACKET UPLINK ACK/NACK	Sent when current allocation is exhausted. Containing valid RRBP. Sent on PACCH.
6	MS -> SS	PACKET CONTROL ACKNOWLEDGEMENT	Received on the block specified by RRBP on PACCH of the assigned PDCH.

Expected Sequence – Procedure 2

Step	Direction	Message	Comments
1	MS		Trigger the MS to initiate an uplink packet transfer containing 1000 octets.
2			Bring the MS into packet uplink transfer mode by the generic procedure defined in the table 42.2.1.2/1a or 42.2.1.2/2a.
3	MS -> SS	UPLINK RLC DATA BLOCK	Received on the assigned PDTCH. Check the TFI is correct.
4	SS		Verify that step 3 is repeated until current allocation is exhausted. The MS may send a PACKET RESOURCE REQUEST message during the current allocation. The SS shall ignore the request. Verify MS is treating each bit in the ALLOCATION_BITMAP as a block period, and only using timeslots allocated in TIMESLOT_ALLOCATION.
5	SS -> MS	PACKET UPLINK ACK/NACK	Sent when current allocation is exhausted. Containing valid RRBP. Sent on PACCH.
6	MS -> SS	PACKET CONTROL ACKNOWLEDGEMENT	Received on the block specified by RRBP on PACCH of the assigned PDCH.

Specific Message Contents

PACKET UPLINK ASSIGNMENT message as part of macro in step 2 (Procedure 1):

Fixed Allocation - TIMESLOT_ALLOCATION - BLOCKS_OR_BLOCK_PERIODS - ALLOCATION_BITMAP_LENGTH - ALLOCATION_BITMAP	One timeslot is assigned 1 – block periods 25 exactly 10 bits (out of 25) are set to 1
---	---

PACKET UPLINK ASSIGNMENT message as part of macro in step 2 (Procedure 2):

Fixed Allocation - TIMESLOT_ALLOCATION - BLOCKS_OR_BLOCK_PERIODS - ALLOCATION_BITMAP_LENGTH - ALLOCATION_BITMAP	Two timeslots assigned 1 – block periods 25 exactly 10 bits (out of 25) are set to 1
---	---

PACKET UPLINK ACK/NACK message in step 5:

Ack/Nack Description - FINAL_ACK_INDICATION - STARTING_SEQUENCE_NUMBER - RECEIVED_BLOCK_BITMAP	1 (final ACK) V(R) Acknowledge all data blocks transmitted by the MS
---	--

42.2.2.2 Fixed Allocation / Uplink Transfer / Operation with TS_OVERRIDE for single-slot TX

42.2.2.2.1 Void

42.2.2.2.2 Conformance requirements

The network may also specify a TS_OVERRIDE indication in the PACKET UPLINK ACK/NACK. TS_OVERRIDE applies to the next allocation after the current allocation expires. The TS_OVERRIDE field is a bitmap with a bit corresponding to each timeslot. For each bit set in the TS_OVERRIDE, the mobile shall disregard the ALLOCATION_BITMAP for that timeslot and shall transmit on all uplink radio blocks for that timeslot for the duration of the next allocation. If a bit is not set in the TS_OVERRIDE field, then the ALLOCATION_BITMAP shall apply to that timeslot.

References

3GPP TS 04.60, subclause 8.1.1.3.2.2.

42.2.2.2.3 Test purpose

To verify that this new allocation begins immediately after the current allocation ends and uses the most recently received ALLOCATION_BITMAP in consultation with TS_OVERRIDE as the following:

1. Until the next allocation begins, the mobile disregards the TS_OVERRIDE field.
2. For each bit set in the TS_OVERRIDE, the mobile disregards the ALLOCATION_BITMAP for that timeslot and transmits on all uplink radio blocks for that timeslot for the duration of the next allocation.
3. If a bit is not set in the TS_OVERRIDE field, then the ALLOCATION_BITMAP applies to that timeslot.

42.2.2.2.4 Method of test

Initial Conditions

System Simulator:

1 cell, GPRS supported, PCCCH present.

Mobile Station:

The MS is in the state "idle, GMM-registered" with a P-TMSI allocated, SPLIT PG CYCLE negotiated and PDP context2 activated.

Specific PICS Statements

-

PIXIT Statements

-

Test Procedure

MS is triggered to begin an uplink data transfer. Verify that the MS sends uplink RLC data blocks only in the radio blocks specified by the ALLOCATION_BITMAP. Network sends a repeat allocation with TS_OVERRIDE corresponding to the assigned timeslot. Verify the MS finishes the current allocation as specified in the bitmap, then begins the new allocation with the application of TS_OVERRIDE.

Maximum Duration of Test

5 minutes.

Expected Sequence

Step	Direction	Message	Comments
1	MS		Trigger the MS to initiate an uplink packet transfer containing 1000 octets.
2			Bring the MS into packet uplink transfer mode by the generic procedure defined in the table 42.2.1.2/1a or 42.2.1.2/2a.
3	MS -> SS	RLC DATA BLOCK	MS transmits RLC block only when TBF starting time occurs
4	SS -> MS	PACKET UPLINK ACK/NACK	TS_OVERRIDE corresponding to the one slot allocated to the MS in step 2. (Repeat allocation)
5			Step 3 is repeated 4 times. (Allowing the MS to exhaust the allocation in step 2.) Verify the MS obeys the allocation bitmap assigned in step 2 and ignores TS_OVERRIDE.
6	MS -> SS	RLC DATA BLOCKS	At the next natural allocation boundary. Verify the MS is transmitting in every block (due to application of TS_OVERRIDE)
7	SS		After the MS exhausts the second allocation, verify the network has received exactly 11 RLC data blocks after step 5.

Specific Message Contents

PACKET UPLINK ASSIGNMENT message in step 2 :

Fixed allocation - TIMESLOT ALLOCATION - BLOCKS_OR_BLOCK_PERIODS - ALLOCATION_BITMAP_LENGTH - ALLOCATION_BITMAP	One timeslot is assigned 0 – blocks 11 010101010
---	---

PACKET UPLINK ACK/NACK message in step 4:

Fixed allocation - TS_OVERRIDE	<8 bits, with only the bit corresponding to the assigned timeslot set to '1'>
-----------------------------------	---

42.2.2.3 Fixed Allocation / Uplink Transfer / Operation with TS_OVERRIDE for multi-slot TX

42.2.2.3.1 Void

42.2.2.3.2 Conformance requirements

The network may also specify a TS_OVERRIDE indication in the PACKET UPLINK ACK/NACK. TS_OVERRIDE applies to the next allocation after the current allocation expires. The TS_OVERRIDE field is a bitmap with a bit corresponding to each timeslot. For each bit set in the TS_OVERRIDE, the mobile shall disregard the ALLOCATION_BITMAP for that timeslot and shall transmit on all uplink radio blocks for that timeslot for the duration of the next allocation. If a bit is not set in the TS_OVERRIDE field, then the ALLOCATION_BITMAP shall apply to that timeslot.

References

3GPP TS 04.60, subclause 8.1.1.3.2.2.

42.2.2.3.3 Test purpose

To verify that this new allocation begins immediately after the old allocation ends and uses the most recently received ALLOCATION_BITMAP in consultation with TS_OVERRIDE as the following:

1. Until the next allocation begins, the mobile disregards the TS_OVERRIDE field.
2. For each bit set in the TS_OVERRIDE, the mobile disregards the ALLOCATION_BITMAP for that timeslot and transmits on all uplink radio blocks for that timeslot for the duration of the next allocation.
3. If a bit is not set in the TS_OVERRIDE field, then the ALLOCATION_BITMAP applies to that timeslot.

42.2.2.3.4 Method of test

Initial Conditions

System Simulator:

1 cell, GPRS supported, PCCCH present.

Mobile Station:

The MS is in the state "idle, GMM-registered" with a P-TMSI allocated, SPLIT PG CYCLE negotiated and PDP context2 activated.

Specific PICS Statements

-

PIXIT Statements

-

Test Procedure

MS is triggered to begin an uplink data transfer on 2 timeslots. Verify that the MS sends uplink RLC data blocks only in the radio blocks specified by the ALLOCATION_BITMAP. Network sends a repeat allocation with TS_OVERRIDE corresponding to one of the assigned timeslots. Verify the MS finishes the current allocation as specified in the bitmap, then begins the new allocation with the application of TS_OVERRIDE.

Maximum Duration of Test

5 minutes.

Expected Sequence

Step	Direction	Message	Comments
1	MS		Trigger the MS to initiate an uplink packet transfer containing 1000 octets.
2			Bring the MS into packet uplink transfer mode by the generic procedure defined in the table 42.2.1.2/1a or 42.2.1.2/2a.
3	MS -> SS	RLC DATA BLOCKS	MS starts transmitting RLC blocks on 2 timeslots only when TBF starting time occurs
4	SS -> MS	PACKET UPLINK ACK/NACK	TS_OVERRIDE corresponding to one of the slots allocated to the MS in step 2. (Repeat allocation)
5			Step 3 is repeated 4 times. (Allowing the MS to exhaust the allocation in step 2.)
6	MS -> SS	RLC DATA BLOCKS	Verify the MS obeys the allocation bitmap assigned in step 2 and ignores TS_OVERRIDE. At the next natural allocation boundary.
7	SS		Verify the MS is transmitting in every block on one assigned timeslot (due to application of TS_OVERRIDE), plus following the application bitmap for the other assigned timeslot. After the MS exhausts the second allocation, verify the network has received exactly 14 RLC data blocks after step 5.

Specific Message Contents

PACKET UPLINK ASSIGNMENT message in step 2 :

Fixed allocation	
- TIMESLOT ALLOCATION	Two timeslots assigned
- BLOCKS_OR_BLOCK_PERIODS	0 – blocks
- ALLOCATION_BITMAP_LENGTH	18
- ALLOCATION_BITMAP	001100110011001111

PACKET UPLINK ACK/NACK message in step 4:

Fixed allocation	
- TS_OVERRIDE	<8 bits, with only one bit corresponding to one of the assigned timeslots set to '1'>

42.2.2.4 Fixed Allocation / Uplink Transfer / T3184 Expiry

42.2.2.4.1 Void

42.2.2.4.2 Conformance requirements

A mobile station operating with a fixed allocation shall start or restart timer T3184 upon reception of a PACKET UPLINK ACK/NACK message. If timer T3184 expires, the mobile station shall perform an abnormal release with cell re-selection.

[To perform abnormal release with cell re-selection] the mobile station shall abort all TBFs in progress. If access to another cell is allowed, i.e. the RANDOM_ACCESS_RETRY bit is set, the mobile station shall perform abnormal cell reselection (see 3GPP TS 05.08) and initiate establishment of an uplink TBF as defined in subclause 7.1 on the new cell. The mobile station shall not reselect back to the original cell for T_RESEL seconds if another suitable cell is available. The parameters RANDOM_ACCESS_RETRY and T_RESEL (default value 5 s) are broadcast in PSI 3.

If access to another cell is not allowed, i.e. the RANDOM_ACCESS_RETRY bit is not set, or if no neighbour cells are available, the mobile station shall go to the CCCH or PCCCH and report an RLC/MAC failure to the higher layer.

References

3GPP TS 04.60, subclauses 9.3.2.2 and 9.4.2.

42.2.2.4.3 Test purpose

1. To verify that the mobile starts timer T3184 upon reception of PACKET UPLINK ACK/NACK message during the mobile's transmission if the timer is not running.
2. To verify that the mobile restarts timer T3184 upon reception of PACKET UPLINK ACK/NACK message during the mobile's transmission if the timer is running.
3. To verify that upon expiry of timer T3184, the mobile performs an abnormal release procedure with cell re-selection by initiating establishment of an uplink TBF on a new cell. (This is the case where RANDOM_ACCESS_RETRY bit is set.)

42.2.2.4.4 Method of test

Initial Conditions

System Simulator:

2 cells, GPRS supported, PCCCH present, PBCCH present.

Mobile Station:

The MS is in the state "idle, GMM-registered" with a P-TMSI allocated, SPLIT PG CYCLE negotiated and PDP context3 activated.

Specific PICS Statements

-

PIXIT Statements

-

Test Procedure

MS is triggered to begin an uplink data transfer. Periodic PACKET UPLINK ACK/NACK messages are sent to verify that the T3184 timer is restarted at the correct times, and to verify that when the T3184 timer expires, the MS performs an abnormal release with cell re-selection.

Maximum Duration of Test

5 minutes.

Expected Sequence

Step	Direction	Message	Comments
1	MS		Trigger the MS to initiate an uplink packet transfer containing 1000 octets.
2			Bring the MS into packet uplink transfer mode on cell A by the generic procedure defined in the table 42.2.1.2/1a or 42.2.1.2/2a.
3	MS -> SS	RLC DATA BLOCK	Cell A: MS transmits RLC block only when TBF starting time occurs
4			Step 3 is repeated 4 times. (Allowing the MS to exhaust the allocation in step 2.)
5	SS -> MS	PACKET UPLINK ACK/NACK	Cell A: No REPEAT_ALLOCATION or ALLOCATION_BITMAP - MS starts timer T3184
6	SS		Wait (0.8 * T3184) seconds Verify no access on Cell A or Cell B.
7	SS -> MS	PACKET UPLINK ACK/NACK	Cell A: With REPEAT_ALLOCATION - MS restarts T3184
8	MS -> SS	RLC DATA BLOCK	Cell A: MS transmits RLC blocks according to repeat allocation until allocation is exhausted.
9	MS -> SS	PACKET CHANNEL REQUEST	Cell B: Sent more than T3184 - (.1*T3184) seconds after step 7.

Specific Message Contents

PACKET SYSTEM INFORMATION MESSAGE 3 (throughout):

RANDOM_ACCESS_RETRY	1 – Retry allowed
---------------------	-------------------

PACKET UPLINK ASSIGNMENT message in step 2 :

Fixed allocation - TIMESLOT ALLOCATION - BLOCKS_OR_BLOCK_PERIODS - ALLOCATION_BITMAP_LENGTH - ALLOCATION_BITMAP	One timeslot assigned 0 – blocks 10 0101011100
---	---

PACKET UPLINK ACK/NACK message in step 5:

Fixed allocation - Repeat Allocation - ALLOCATION_BITMAP	<not present> <not present>
--	--------------------------------

PACKET UPLINK ACK/NACK message in step 7:

Fixed allocation - Repeat Allocation	1
---	---

42.2.2.5 Fixed Allocation / Uplink Transfer / T3188

All T3168 tests assigns a bit map that is long enough to guarantee that the MS will not return to idle mode before the test is finished.

The MS is supposed to send the PACKET RESOURCE REQUEST at the beginning of the allocation (during the first half of the allocation bitmap) see 3GPP TS 04.60 subclause 8.1.1.3.2.1

42.2.2.5.1 Fixed Allocation / Uplink Transfer / T3188/Expiry

42.2.2.5.1.1 Void

42.2.2.5.1.2 Conformance requirements

If the mobile station exhausts its assigned fixed allocation and has more RLC data blocks to transmit, it shall start timer T3188 and monitor the downlink of all assigned PDCHs

If timer T3188 expires, the mobile station shall perform an abnormal release with random access (see subclause 8.7.2).

References

3GPP TS 04.60, subclause 8.1.1.3.2.3.

42.2.2.5.1.3 Test purpose

Verify that when the current fixed allocation is exhausted, the MS starts T3188. Verify that if T3188 expires, the MS performs abnormal release with random access and not perform a cell reselection.

42.2.2.5.1.4 Method of test

Initial Conditions

System Simulator:

2 cells, GPRS supported, PCCCH not present.

Mobile Station:

The MS is in the state "idle, GMM-registered" with a P-TMSI allocated, SPLIT PG CYCLE negotiated, and PDP context 3 activated.

Specific PICS Statements

-

PIXIT Statements

-

Test Procedure

1. MS is triggered to begin an uplink data transfer.
2. T3188 expires and MS performs abnormal release with random access.

Maximum Duration of Test

5 minutes.

Expected Sequence

Step	Direction	Message	Comments
1	MS		Trigger the MS to initiate an uplink packet transfer containing 1000 octets.
2			Bring the MS into packet uplink transfer mode on cell A by the generic procedure defined in the table 42.2.1.2/1b or 42.2.1.2/2b.
3	MS -> SS	RLC DATA BLOCK	Cell A: MS transmits RLC block only when TBF starting time occurs
4			Step 3 is repeated 4 times. (Allowing the MS to exhaust the allocation in step 2.) - MS starts timer T3188
5	SS -> MS	PACKET UPLINK ACK/NACK	Cell A: No REPEAT_ALLOCATION or ALLOCATION_BITMAP
6	MS -> SS	CHANNEL REQUEST	Cell A: Sent at least T3188 – (.1*T3188) seconds after step 4.
7	SS		Verify no access on Cell B.

Specific Message Contents

PACKET UPLINK ASSIGNMENT message in step 2 :

Fixed allocation - TIMESLOT ALLOCATION - BLOCKS_OR_BLOCK_PERIODS - ALLOCATION_BITMAP_LENGTH - ALLOCATION_BITMAP	One timeslot assigned 0 – blocks 10 0101011100
---	---

42.2.2.5.2 Fixed Allocation / Uplink Transfer / T3188/Stop with Packet Uplink Assignment

42.2.2.5.2.1 Void

42.2.2.5.2.2 Conformance requirements

If the mobile station exhausts its assigned fixed allocation and has more RLC data blocks to transmit, it shall start timer T3188 and monitor the downlink of all assigned PDCHs. If the mobile station receives an assignment message containing a fixed allocation, the mobile station shall stop timer T3188 and use the new allocation at the assigned starting time.

References

3GPP TS 04.60, subclause 8.1.1.3.2.3.

42.2.2.5.2.3 Test purpose

Verify that when the current fixed allocation is exhausted, the MS starts T3188. Verify that T3188 is stopped when a PACKET UPLINK ASSIGNMENT is received.

42.2.2.5.2.4 Method of test

Initial Conditions

System Simulator:

2 cells, GPRS supported, PCCCH not present.

Mobile Station:

The MS is in the state "idle, GMM-registered" with a P-TMSI allocated, SPLIT PG CYCLE negotiated, and PDP context 3 activated.

Specific PICS Statements

-

PIXIT Statements

-

Test Procedure

1. MS is triggered to begin an uplink data transfer. When the MS exhausts the current allocation, it shall start T3188.
2. When a Packet Uplink Assignment is received, verify that the MS uses the new allocation and stops T3188.

Maximum Duration of Test

5 minutes.

Expected Sequence

Step	Direction	Message	Comments
1	MS		Trigger the MS to initiate an uplink packet transfer containing 1000 octets.
2			Bring the MS into packet uplink transfer mode on cell A by the generic procedure defined in the table 42.2.1.2/1b or 42.2.1.2/2b.
3	MS -> SS	RLC DATA BLOCK	Cell A: MS transmits RLC block only when TBF starting time occurs
4			Step 3 is repeated 4 times. (Allowing the MS to exhaust the allocation in step 2.)
5	SS -> MS	PACKET UPLINK ACK/NACK	- MS starts timer T3188 Cell A: No REPEAT_ALLOCATION or ALLOCATION_BITMAP
6	SS		Wait (.8 * T3188) seconds
7	SS -> MS	PACKET UPLINK ASSIGNMENT	Verify no access on Cell A or Cell B. Cell A: With ALLOCATION_BITMAP. Sent within T3188 of step 4.
8A (optional)	MS -> SS	RLC DATA BLOCK	- MS stops T3188 Cell A: MS may start transmitting RLC blocks according to new allocation.
9A (optional)	MS -> SS	PACKET RESOURCE REQUEST	MS requests additional resources
10A (optional)	MS -> SS	RLC DATA BLOCKS	Cell A: MS transmitting RLC blocks until allocation is exhausted.

Specific Message Contents

PACKET UPLINK ASSIGNMENT message in step 2 and step 7:

Fixed allocation - TIMESLOT ALLOCATION - BLOCKS_OR_BLOCK_PERIODS - ALLOCATION_BITMAP_LENGTH - ALLOCATION_BITMAP	One timeslot assigned 0 – blocks 10 0101011100
---	---

42.2.2.5.3 Fixed Allocation / Uplink Transfer / T3188/Stop with Packet Uplink Ack/Nack with REPEAT_ALLOCATION

42.2.2.5.3.1 Void

42.2.2.5.3.2 Conformance requirements

If the mobile station exhausts its assigned fixed allocation and has more RLC data blocks to transmit, it shall start timer T3188 and monitor the downlink of all assigned PDCHs.

If the mobile station receives a PACKET UPLINK ACK/NACK with a REPEAT ALLOCATION after its current allocation has been exhausted, it shall stop timer T3188, wait until the next repeated allocation boundary and then begin transmitting using the repeated ALLOCATION_BITMAP.

References

3GPP TS 04.60, subclause 8.1.1.3.2.3.

42.2.2.5.3.3 Test purpose

Verify that when the current fixed allocation is exhausted, the MS starts T3188. Verify that T3188 is stopped when a PACKET UPLINK ACK/NACK with REPEAT_ALLOCATION is received.

42.2.2.5.3.4 Method of test

Initial Conditions

System Simulator:

2 cells, GPRS supported, PCCCH not present.

Mobile Station:

The MS is in the state "idle, GMM-registered" with a P-TMSI allocated, SPLIT PG CYCLE negotiated, and PDP context 3 activated.

Specific PICS Statements

-

PIXIT Statements

-

Test Procedure

1. MS is triggered to begin an uplink data transfer. When the MS exhausts the current allocation, it shall start T3188.
2. When a Packet Uplink Ack/Nack with ALLOCATION_BITMAP is received, verify that the MS uses the new allocation and stops T3188.

Maximum Duration of Test

5 minutes.

Expected Sequence

Step	Direction	Message	Comments
1	MS		Trigger the MS to initiate an uplink packet transfer containing 1000 octets.
2			Bring the MS into packet uplink transfer mode on cell A by the generic procedure defined in the table 42.2.1.2/1b or 42.2.1.2/2b.
3	MS -> SS	RLC DATA BLOCK	Cell A: MS transmits RLC block only when TBF starting time occurs
4			Step 3 is repeated 4 times. (Allowing the MS to exhaust the allocation in step 2.)
5	SS -> MS	PACKET UPLINK ACK/NACK	Cell A: No REPEAT_ALLOCATION or ALLOCATION_BITMAP
6	SS		- MS starts timer T3188 Wait (.8*T3188) seconds
7	SS -> MS	PACKET UPLINK ACK/NACK	Verify no access on Cell A or Cell B. Cell A: With REPEAT_ALLOCATION
8	MS -> SS	RLC DATA BLOCK	- MS stops T3188 Cell A: MS transmits RLC blocks according to new allocation until allocation is exhausted.

Specific Message Contents

PACKET UPLINK ASSIGNMENT message in step 2:

Fixed allocation	
- TIMESLOT ALLOCATION	One timeslot assigned
- BLOCKS_OR_BLOCK_PERIODS	0 – blocks
- ALLOCATION_BITMAP_LENGTH	10
- ALLOCATION_BITMAP	0101011100

PACKET UPLINK ACK/NACK message in step 7:

Fixed allocation	
- Repeat Allocation	1

42.2.2.6 Fixed Allocation / Uplink Transfer / MS requests new resources/ T3168

If the MS requests a closed-ended TBF, and does not send PACKET RESOURCE REQUEST at any time during the test, then the test is considered "passed" for that MS. However, a "pass" for one T3168 test should not be considered as a "pass" for all T3168 tests, as the MS operation is not constrained to one particular implementation method for all executions.

If the MS requests an open-ended TBF at the start of the test, then the test is performed as written.

It is MS implementation dependent whether to start the TBF in open-ended mode (where MS will send periodic PRRs), or in closed-ended mode (where the MS may optionally send a PRR to convert the TBF to open-ended mode). The purpose of T3168 is to test operation when the MS sends PRR and then waits for new uplink resources to be assigned. If the MS does not send a PRR, then T3168 is not applicable.

42.2.2.6.1 Fixed Allocation / Uplink Transfer / MS requests new resources/ T3168/Expiry

42.2.2.6.1.1 Void

42.2.2.6.1.2 Conformance requirements

At sending of the PACKET RESOURCE REQUEST message, the mobile station shall start timer T3168.

On receipt of a PACKET UPLINK ASSIGNMENT or PACKET TIMESLOT RECONFIGURE message the mobile station shall stop timer T3168 and switch to the assigned PDCHs.

On expiry of timer T3168, the mobile station shall retransmit the PACKET RESOURCE REQUEST message unless the PACKET RESOURCE REQUEST message has already been transmitted four times in which case the mobile station shall perform an abnormal release with random access.

If no PACKET UPLINK ASSIGNMENT or PACKET TIMESLOT RECONFIGURE message is received before the mobile station has completed its currently assigned TBFs the mobile station shall stop timer T3168 and return to packet idle mode (listening to its paging channel).

On receipt of a PACKET ACCESS REJECT message, the mobile station shall stop timer T3168 if running and return to packet idle mode. Before initiating a new packet access procedure the mobile station shall decode the PRACH Control Parameters if they are broadcast.

References

3GPP TS 04.60, subclauses 7.1.3.1, 8.1.1.3.2, 8.7.2 and 12.24.

42.2.2.6.1.3 Test purpose

Verify that when T3168 expires, the MS retransmits the PACKET RESOURCE REQUEST again (up to four times total). Verify that when T3168 expires after the fourth transmission of the PACKET RESOURCE REQUEST, that the MS performs abnormal release with random access.

42.2.2.6.1.4 Method of test

Initial Conditions

System Simulator:

1 cell, GPRS supported, PCCCH present.

Mobile Station:

The MS is in the state "idle, GMM-registered" with a P-TMSI allocated, SPLIT PG CYCLE negotiated, and PDP context 2 activated.

Specific PICS Statements

-

PIXIT Statements

-

Test Procedure

1. MS is triggered to begin an uplink data transfer and enters a open-ended TBF.
2. Before the current allocation expires, MS sends PACKET RESOURCE REQUEST.
3. When T3168 expires, MS resends PACKET RESOURCE REQUEST (up to 4 times)
4. When T3168 expires the fourth time, MS performs abnormal release with random access.

Maximum Duration of Test

5 minutes.

Expected Sequence

Step	Direction	Message	Comments
1	MS		Trigger the MS to initiate an uplink packet transfer containing 2500 octets.
2			Bring the MS into packet uplink transfer mode by the generic procedure defined in the table 42.2.1.1/1a.
3	MS -> SS	RLC DATA BLOCKS	MS transmits RLC blocks only when TBF starting time occurs
4	MS -> SS	PACKET RESOURCE REQUEST	MS requests additional resources - MS starts timer T3168
5	MS -> SS	RLC DATA BLOCKS	MS continues to transmit RLC data blocks according to allocation from step 2.
6	MS -> SS	PACKET RESOURCE REQUEST	MS requests additional resources - This is sent T3168 seconds after previous PRR. - MS re-starts timer T3168
7			Steps 5 and 6 are repeated 2 more times such that a total of 4 PRRs are sent.
8	MS -> SS	PACKET CHANNEL REQUEST	Verify MS sends Random Access

NOTE: the MS may not send PACKET CHANNEL REQUEST in step 8 (the first allocation is exhausted and the MS return to idle mode before expiry of T3168 the fourth time).

Specific Message Contents

PACKET SYSTEM INFORMATION MESSAGE 1 (throughout):

T3168	0 (.5 second)
-------	---------------

PACKET UPLINK ASSIGNMENT message in step 2 shall be a two part PACKET UPLINK ASSIGNMENT:

Fixed allocation - TIMESLOT ALLOCATION - BLOCKS_OR_BLOCK_PERIODS - ALLOCATION_BITMAP_LENGTH - ALLOCATION_BITMAP	One timeslot assigned 0 – blocks 120 Exactly 100 bits are set to 1 (this allocation is exhausted after sending 4 PRR)
---	--

42.2.2.6.2 Fixed Allocation / Uplink Transfer / MS requests new resources/ T3168/Stop with Packet Uplink Assignment

42.2.2.6.2.1 Void

42.2.2.6.2.2 Conformance requirements

At sending of the PACKET RESOURCE REQUEST message, the mobile station shall start timer T3168.

On receipt of a PACKET UPLINK ASSIGNMENT or PACKET TIMESLOT RECONFIGURE message the mobile station shall stop timer T3168 and switch to the assigned PDCHs.

References

3GPP TS 04.60, subclauses 7.1.3.1, 8.1.1.3.2 and 12.24.

42.2.2.6.2.3 Test purpose

Verify that when PACKET UPLINK ASSIGNMENT is received, MS stops T3168.

42.2.2.6.2.4 Method of test

Initial Conditions

System Simulator:

1 cell, GPRS supported, PCCCH present.

Mobile Station:

The MS is in the state "idle, GMM-registered" with a P-TMSI allocated, SPLIT PG CYCLE negotiated, and PDP context 2 activated.

Specific PICS Statements

-

PIXIT Statements

-

Test Procedure

1. MS is triggered to begin an uplink data transfer and enters a open-ended TBF.
2. Before the current allocation expires, MS sends PACKET RESOURCE REQUEST.
3. Prior to T3168 expiring, MS receives a new allocation.

Maximum Duration of Test

5 minutes.

Expected Sequence

Step	Direction	Message	Comments
1	MS		Trigger the MS to initiate an uplink packet transfer containing 2500 octets.
2			Bring the MS into packet uplink transfer mode by the generic procedure defined in the table 42.2.1.1/1a.
3	MS -> SS	RLC DATA BLOCKS	MS transmits RLC blocks only when TBF starting time occurs
4	MS -> SS	PACKET RESOURCE REQUEST	MS requests additional resources
5	MS -> SS	RLC DATA BLOCKS	- MS starts timer T3168 MS continues to transmit RLC data blocks according to allocation from step 2.
6	SS -> MS	PACKET UPLINK ASSIGNMENT	Sent (.8*T3168) seconds after step 4. - MS stops timer T3168
7	MS		Step 5 is repeated until current allocation is exhausted.
8	MS		MS starts to use the new allocation from step 6 at the next allocation boundary.

Specific Message Contents

PACKET SYSTEM INFORMATION MESSAGE 1 (throughout):

T3168	0 (0.5 seconds)
-------	-----------------

PACKET UPLINK ASSIGNMENT message in step 2 and step 6.

Fixed allocation - TIMESLOT ALLOCATION - BLOCKS_OR_BLOCK_PERIODS - ALLOCATION_BITMAP_LENGTH - ALLOCATION_BITMAP	One timeslot assigned 0 – blocks 120 Exactly 100 bits are set to 1.
---	--

42.2.2.6.3 Fixed Allocation / Uplink Transfer / MS requests new resources/ T3168/Stop with Packet Uplink Ack/Nack with REPEAT_ALLOCATION

42.2.2.6.3.1 Void

42.2.2.6.3.2 Conformance requirements

At sending of the PACKET RESOURCE REQUEST message, the mobile station shall start timer T3168.

References

3GPP TS 04.60, subclauses 7.1.3.1 and 12.24.

42.2.2.6.3.3 Test purpose

Verify that when PACKET UPLINK ACK/NACK is received, the MS stops T3168.

42.2.2.6.3.4 Method of test

Initial Conditions

System Simulator:

1 cell, GPRS supported, PCCCH present.

Mobile Station:

The MS is in the state "idle, GMM-registered" with a P-TMSI allocated, SPLIT PG CYCLE negotiated, and PDP context 2 activated.

Specific PICS Statements

-

PIXIT Statements

-

Test Procedure

1. MS is triggered to begin an uplink data transfer and enters a open-ended TBF.
2. Before the current allocation expires, MS sends PACKET RESOURCE REQUEST.
3. Prior to T3168 expiring, MS receives a REPEAT_ALLOCATION.

Maximum Duration of Test

5 minutes.

Expected Sequence

Step	Direction	Message	Comments
1	MS		Trigger the MS to initiate an uplink packet transfer containing 2500 octets.
2			Bring the MS into packet uplink transfer mode by the generic procedure defined in the table 42.2.1.1/1a.
3	MS -> SS	RLC DATA BLOCKS	MS transmits RLC blocks only when TBF starting time occurs
4	MS -> SS	PACKET RESOURCE REQUEST	MS requests additional resources
5	MS -> SS	RLC DATA BLOCKS	- MS starts timer T3168 MS continues to transmit RLC data blocks according to allocation from step 2.
6	SS -> MS	PACKET UPLINK ACK/NACK	Sent (.8*T3168) seconds after step 4. - MS stops timer T3168
7	MS		Step 5 is repeated until current allocation is exhausted.
8	MS		MS starts to use the new allocation from step 6 at the next allocation boundary.

Specific Message Contents

PACKET SYSTEM INFORMATION MESSAGE 1 (throughout):

T3168	0 (0.5 seconds)
-------	-----------------

PACKET UPLINK ASSIGNMENT message in step 2:

Fixed allocation	
- TIMESLOT ALLOCATION	One timeslot assigned
- BLOCKS_OR_BLOCK_PERIODS	0 – blocks
- ALLOCATION_BITMAP_LENGTH	120
- ALLOCATION_BITMAP	Exactly 100 bits are set to 1

PACKET UPLINK ACK/NACK message in step 6:

REPEAT_ALLOCATION	1
-------------------	---

42.2.2.6.4 Fixed Allocation / Uplink Transfer / MS requests new resources/ T3168/Stop with Packet Access Reject

42.2.2.6.4.1 Void

42.2.2.6.4.2 Conformance requirements

At sending of the PACKET RESOURCE REQUEST message, the mobile station shall start timer T3168.

On receipt of a PACKET ACCESS REJECT message, the mobile station shall stop timer T3168 if running and indicate a packet access failure to upper layer.

Upon receipt of a PACKET ACCESS REJECT message, the mobile station shall stop timer T3168, if running, release the TBF using the procedures in 9.3.2.3 or 9.3.3.3, such that the countdown ends within the current allocation. Then, if the mobile station has additional RLC data blocks to transfer, it shall initiate a new establishment procedure on the RACH or PRACH, or using a PACKET DOWNLINK ACK/NACK if during a downlink TBF.

References

3GPP TS 04.60, subclauses 8.1.1.3.2, 8.1.1.3.2.4 and 12.24.

42.2.2.6.4.3 Test purpose

Verify that when PACKET ACCESS REJECT is received, the MS does not complete the current allocation.

42.2.2.6.4.4 Method of test

Initial Conditions

System Simulator:

1 cell, GPRS supported, PCCCH present.

Mobile Station:

The MS is in the state "idle, GMM-registered" with a P-TMSI allocated, SPLIT PG CYCLE negotiated, and PDP context 2 activated.

Specific PICS Statements

-

PIXIT Statements

-

Test Procedure

1. MS is triggered to begin an uplink data transfer and enters a open-ended TBF.
2. Before the current allocation expires, MS sends PACKET RESOURCE REQUEST.
3. Prior to T3168 expiring, MS receives a PACKET ACCESS REJECT.
4. MS finishes the countdown procedure before the end of the current allocation.

Maximum Duration of Test

5 minutes.

Expected Sequence

Step	Direction	Message	Comments
1	MS		Trigger the MS to initiate an uplink packet transfer containing 2500 octets.
2			Bring the MS into packet uplink transfer mode by the generic procedure defined in the table 42.2.1.1/1a.
3	MS -> SS	RLC DATA BLOCKS	MS transmits RLC blocks only when TBF starting time occurs
4	MS -> SS	PACKET RESOURCE REQUEST	MS requests additional resources - MS starts timer T3168
5	MS -> SS	RLC DATA BLOCKS	MS continues to transmit RLC data blocks according to allocation from step 2.
6	SS -> MS	PACKET ACCESS REJECT	Sent (.8*T3168) seconds after step 4 on PACCH. - No waiting time - MS stops timer T3168
7	SS		Verify MS ends the countdown procedure within the current allocation. (MS may choose to initiate access again.)

Specific Message Contents

PACKET SYSTEM INFORMATION MESSAGE 1 (throughout):

T3168	0 (0.5 seconds)
-------	-----------------

PACKET UPLINK ASSIGNMENT message in step 2:

Fixed allocation - TIMESLOT ALLOCATION - BLOCKS_OR_BLOCK_PERIODS - ALLOCATION_BITMAP_LENGTH - ALLOCATION_BITMAP	One timeslot assigned 0 – blocks 120 Exactly 100 bits are set to 1.
---	--

42.2.2.6.5 Fixed Allocation / Uplink Transfer / MS requests new resources/ T3168/Continue with Packet Uplink Ack/Nack without REPEAT_ALLOCATION and without ALLOCATION_BITMAP

42.2.2.6.5.1 Void

42.2.2.6.5.2 Conformance requirements

At sending of the PACKET RESOURCE REQUEST message, the mobile station shall start timer T3168.

On expiry of timer T3168, the mobile station shall retransmit the PACKET RESOURCE REQUEST message unless the PACKET RESOURCE REQUEST message has already been transmitted four times in which case the mobile station shall perform an abnormal release with random access.

References

3GPP TS 04.60, subclauses 8.1.1.3.2 and 12.24.

42.2.2.6.5.3 Test purpose

Verify that when MS receives a PACKET UPLINK ACK/NACK without an allocation, T3168 continues to run, and then expires, causing the MS to transmit the PACKET RESOURCE REQUEST again.

42.2.2.6.5.4 Method of test

Initial Conditions

System Simulator:

1 cell, GPRS supported, PCCCH present.

Mobile Station:

The MS is in the state "idle, GMM-registered" with a P-TMSI allocated, SPLIT PG CYCLE negotiated, and PDP context 2 activated.

Specific PICS Statements

-

PIXIT Statements

-

Test Procedure

1. MS is triggered to begin an uplink data transfer and enters a open-ended TBF.
2. Before the current allocation expires, MS sends PACKET RESOURCE REQUEST.
3. MS receives a PACKET UPLINK ACK/NACK with no REPEAT_ALLOCATION and no ALLOCATION_BITMAP. When T3168 expires, MS resends PACKET RESOURCE REQUEST.

Maximum Duration of Test

5 minutes.

Expected Sequence

Step	Direction	Message	Comments
1	MS		Trigger the MS to initiate an uplink packet transfer containing 2500 octets.
2			Bring the MS into packet uplink transfer mode by the generic procedure defined in the table 42.2.1.1/1a.
3	MS -> SS	RLC DATA BLOCKS	MS transmits RLC blocks only when TBF starting time occurs
4	MS -> SS	PACKET RESOURCE REQUEST	MS requests additional resources - MS starts timer T3168
5	MS -> SS	RLC DATA BLOCKS	MS continues to transmit RLC data blocks according to allocation from step 2.
6	SS -> MS	PACKET UPLINK ACK/NACK	No resources assigned - This is sent within (.2*T3168) after previous PRR.
7	MS -> SS	PACKET RESOURCE REQUEST	MS requests additional resources - This is sent T3168 +/- (.1*T3168) after previous PRR. - MS re-starts timer T3168

Specific Message Contents

PACKET SYSTEM INFORMATION MESSAGE 1 (throughout):

T3168	0 (0.5 second)
-------	----------------

PACKET UPLINK ASSIGNMENT message in step 2:

Fixed allocation - TIMESLOT ALLOCATION - BLOCKS_OR_BLOCK_PERIODS - ALLOCATION_BITMAP_LENGTH - ALLOCATION_BITMAP	One timeslot assigned 0 – blocks 120 Exactly 100 bits are set to 1.
---	--

42.2.2.7 Fixed Allocation / Uplink Transfer / MS requests new resources/ Successful

42.2.2.7.1 Fixed Allocation / Uplink Transfer / MS requests new resources/
Successful/ Packet Uplink Assignment with ALLOCATION_BITMAP

42.2.2.7.1.1 Void

42.2.2.7.1.2 Conformance requirements

At sending of the PACKET RESOURCE REQUEST message, the mobile station shall start timer T3168.

On receipt of a PACKET UPLINK ASSIGNMENT or PACKET TIMESLOT RECONFIGURE message the mobile station shall stop timer T3168 and switch to the assigned PDCHs.

References

3GPP TS 04.60, subclause 8.1.1.3.2.

42.2.2.7.1.3 Test purpose

Verify that when PACKET UPLINK ASSIGNMENT is received, MS switches to new resources after current allocation is exhausted.

42.2.2.7.1.4 Method of test

Initial Conditions

System Simulator:

1 cell, GPRS supported, PCCCH present.

Mobile Station:

The MS is in the state "idle, GMM-registered" with a P-TMSI allocated, SPLIT PG CYCLE negotiated, and PDP context 2 activated.

Specific PICS Statements

-

PIXIT Statements

-

Test Procedure

1. MS is triggered to begin an uplink data transfer and enters a open-ended TBF.
2. Before the current allocation expires, MS sends PACKET RESOURCE REQUEST.
3. Prior to T3168 expiring, MS receives a PACKET UPLINK ASSIGNMENT (with ALLOCATION_BITMAP).

Maximum Duration of Test

5 minutes.

Expected Sequence

Step	Direction	Message	Comments
1	MS		Trigger the MS to initiate an uplink packet transfer containing 2500 octets.
2			Bring the MS into packet uplink transfer mode by the generic procedure defined in the table 42.2.1.1/1a.
3	MS -> SS	RLC DATA BLOCKS	MS transmits RLC blocks only when TBF starting time occurs
4	MS -> SS	PACKET RESOURCE REQUEST	MS requests additional resources (can come at any time during the allocation)
5	MS -> SS	RLC DATA BLOCKS	MS continues to transmit RLC data blocks according to allocation from step 2.
6	SS -> MS	PACKET UPLINK ASSIGNMENT	Sent (.5*T3168) after step 4.
7	MS		Step 5 is repeated until current allocation is exhausted.
8	MS		MS uses allocation from step 6. The MS may send a PACKET RESOURCE REQUEST message during the current allocation. The SS shall ignore the request.

Specific Message Contents

PACKET SYSTEM INFORMATION MESSAGE 1 (throughout):

T3168	0 (0.5 second)
-------	----------------

PACKET UPLINK ASSIGNMENT message in step 2 and step 6:

Fixed allocation - TIMESLOT ALLOCATION - BLOCKS_OR_BLOCK_PERIODS - ALLOCATION_BITMAP_LENGTH - ALLOCATION_BITMAP	One timeslot assigned 0 – blocks 120 Exactly 100 bits are set to 1.
---	--

42.2.2.7.2 Fixed Allocation / Uplink Transfer / MS requests new resources/ Successful/Multiple Packet Uplink Assignments

42.2.2.7.2.1 Void

42.2.2.7.2.2 Conformance requirements

Upon receipt of a complete uplink assignment containing an ALLOCATION_BITMAP, the mobile station shall begin transmitting on the new resources at the indicated TBF Starting Time. If there is a conflict between a previous allocation and the new allocation, the new allocation shall take precedence.

References

3GPP TS 04.60, subclause 8.1.1.3.2.2.

42.2.2.7.2.3 Test purpose

Verify that when the new PACKET UPLINK ASSIGNMENT is received, MS switches to new resources at the starting time if there is a conflict with the current assignment.

42.2.2.7.2.4 Method of test

Initial Conditions

System Simulator:

1 cell, GPRS supported, PCCCH present.

Mobile Station:

The MS is in the state "idle, GMM-registered" with a P-TMSI allocated, SPLIT PG CYCLE negotiated, and PDP context 2 activated.

Specific PICS Statements

-

PIXIT Statements

-

Test Procedure

1. MS is triggered to begin an uplink data transfer and enters a open-ended TBF.
2. Before the current allocation expires, MS sends PACKET RESOURCE REQUEST.
3. MS receives a PACKET UPLINK ASSIGNMENT with starting time prior to the end of the current allocation.

Maximum Duration of Test

5 minutes.

Expected Sequence

Step	Direction	Message	Comments
1	MS		Trigger the MS to initiate an uplink packet transfer containing 2500 octets.
2			Bring the MS into packet uplink transfer mode by the generic procedure defined in the table 42.2.1.1/1a.
3	MS -> SS	RLC DATA BLOCKS	MS transmits RLC blocks only when TBF starting time occurs
4	MS -> SS	PACKET RESOURCE REQUEST	MS requests additional resources (can come at any time during the allocation)
5	MS -> SS	RLC DATA BLOCKS	MS continues to transmit RLC data blocks according to allocation from step 2.
6	SS -> MS	PACKET UPLINK ASSIGNMENT	Sent .5 second after step 4. - Starting time conflicts with current allocation.
7	MS -> SS	RLC_DATA_BLOCKS	Verify MS sends no more than 6 data blocks after step 6 using the allocation from step 2.
8	MS -> SS	RLC DATA BLOCKS	MS uses new allocation from step 6 at the starting time specified in step 6. The MS may send a PACKET RESOURCE REQUEST message during the current allocation. The SS shall ignore the request.

Specific Message Contents

PACKET SYSTEM INFORMATION MESSAGE 1 (throughout):

T3168	1 (1second)
-------	-------------

PACKET UPLINK ASSIGNMENT message in step 2:

Fixed allocation - TIMESLOT ALLOCATION - BLOCKS_OR_BLOCK_PERIODS - ALLOCATION_BITMAP_LENGTH - ALLOCATION_BITMAP	One timeslot assigned 0 – blocks 120 Exactly 100 bits are set to 1.
---	--

PACKET UPLINK ASSIGNMENT message in step 6:

Starting_time Fixed allocation - TIMESLOT ALLOCATION - BLOCKS_OR_BLOCK_PERIODS - ALLOCATION_BITMAP_LENGTH - ALLOCATION_BITMAP	<26 frames after current frame> One timeslot assigned <different from previous> 0 – blocks 48 Exactly 40 bits are set to 1.
--	---

42.2.2.7.3 Fixed Allocation / Uplink Transfer / MS requests new resources/
Successful/Packet Uplink Ack/Nack with ALLOCATION_BITMAP

42.2.2.7.3.1 Void

42.2.2.7.3.2 Conformance requirements

Upon receipt of the PACKET RESOURCE REQUEST or PACKET DOWNLINK ACK/NACK with a Channel Request Description IE, the network shall continue the TBF by sending a PACKET UPLINK ASSIGNMENT or PACKET UPLINK ACK/NACK containing a fixed allocation to the mobile station, or shall end the TBF by sending a PACKET ACCESS REJECT message. Alternatively, the network may end the TBF by sending an uplink assignment containing a fixed allocation with the FINAL_ALLOCATION bit set to 1.

Upon receipt of a uplink assignment containing an ALLOCATION_BITMAP, the mobile station shall begin transmitting on the new resources at the indicated TBF Starting Time. If there is a conflict between a previous allocation and the new allocation, the new allocation shall take precedence.

References

3GPP TS 04.60, subclause 8.1.1.3.2.2.

42.2.2.7.3.3 Test purpose

Verify that the MS uses the new ALLOCATION_BITMAP from the PACKET UPLINK ACK/NACK message.

42.2.2.7.3.4 Method of test

Initial Conditions

System Simulator:

1 cell, GPRS supported, PCCCH present.

Mobile Station:

The MS is in the state "idle, GMM-registered" with a P-TMSI allocated, SPLIT PG CYCLE negotiated, and PDP context 2 activated.

Specific PICS Statements

-

PIXIT Statements

-

Test Procedure

1. MS is triggered to begin an uplink data transfer and enters a open-ended TBF.
2. Before the current allocation expires, MS sends PACKET RESOURCE REQUEST.
3. After the current allocation expires, MS receives a new allocation in a PACKET UPLINK ACK/NACK.

Maximum Duration of Test

5 minutes.

Expected Sequence

Step	Direction	Message	Comments
1	MS		Trigger the MS to initiate an uplink packet transfer containing 1500 octets.
2			Bring the MS into packet uplink transfer mode by the generic procedure defined in the table 42.2.1.1/1a.
3	MS -> SS	RLC DATA BLOCKS	MS transmits RLC blocks only when TBF starting time occurs
4	MS -> SS	PACKET RESOURCE REQUEST	MS requests additional resources (can come at any time during the allocation)
5	MS -> SS	RLC DATA BLOCKS	MS continues to transmit RLC data blocks according to allocation from step 2, until current allocation is exhausted.
6	SS -> MS	PACKET UPLINK ACK/NACK	Sent 1 second after step 4, with new ALLOCATION_BITMAP.
7	MS		MS starts to use the new allocation from step 6 at the indicated TBF Starting Time. The MS may send a PACKET RESOURCE REQUEST message during the current allocation. The SS shall ignore the request.

Specific Message Contents

PACKET UPLINK ASSIGNMENT message in step 2:

Fixed allocation - TIMESLOT ALLOCATION - BLOCKS_OR_BLOCK_PERIODS - ALLOCATION_BITMAP_LENGTH - ALLOCATION_BITMAP	One timeslot assigned 0 – blocks 48 Exactly 40 bits are set to 1.
---	--

PACKET UPLINK ACK/NACK message in step 6:

Fixed allocation - TIMESLOT ALLOCATION - BLOCKS_OR_BLOCK_PERIODS - ALLOCATION_BITMAP_LENGTH - ALLOCATION_BITMAP	One timeslot assigned <different from previous> 0 – blocks 16 Exactly 16 bits are set to 1.
---	--

42.2.2.7.4 Fixed Allocation / Uplink Transfer / MS requests new resources/ Successful/Multiple Packet Uplink Ack/Nack with ALLOCATION_BITMAP

42.2.2.7.4.1 Void

42.2.2.7.4.2 Conformance requirements

Upon receipt of a PACKET UPLINK ACK/NACK with a REPEAT_ALLOCATION, the mobile station shall start a new allocation when the current allocation ends. This new allocation shall begin immediately after the current allocation ends and shall use the most recently received ALLOCATION_BITMAP. If the mobile station receives multiple PACKET UPLINK ACK/NACK messages with REPEAT_ALLOCATION during an allocation, the mobile shall repeat the ALLOCATION_BITMAP only once.

References

3GPP TS 04.60, subclause 8.1.1.3.2.2.

42.2.2.7.4.3 Test purpose

Verify that the MS uses the ALLOCATION_BITMAP currently being used as the allocation bitmap that applies to the REPEAT_ALLOCATION.

42.2.2.7.4.4 Method of test

Initial Conditions

System Simulator:

1 cell, GPRS supported, PCCCH present.

Mobile Station:

The MS is in the state "idle, GMM-registered" with a P-TMSI allocated, SPLIT PG CYCLE negotiated, and PDP context 2 activated.

Specific PICS Statements

-

PIXIT Statements

-

Test Procedure

1. MS is triggered to begin an uplink data transfer and enters a open-ended TBF.

2. Before current allocation expires, MS sends PACKET RESOURCE REQUEST.
3. MS receives a series of PACKET UPLINK ACK/NACK messages before the current allocation expires, containing a new allocation, followed by a repeat allocation, followed by a different new allocation, followed by a repeat allocation.

Maximum Duration of Test

5 minutes.

Expected Sequence

Step	Direction	Message	Comments
1	MS		Trigger the MS to initiate an uplink packet transfer containing 2500 octets.
2			Bring the MS into packet uplink transfer mode by the generic procedure defined in the table 42.2.1.1/1a.
3	MS -> SS	RLC DATA BLOCKS	MS transmits RLC blocks only when TBF starting time occurs
4	MS -> SS	PACKET RESOURCE REQUEST	MS requests additional resources (can come at any time during the allocation)
5	MS -> SS	RLC DATA BLOCKS	MS continues to transmit RLC data blocks according to allocation from step 2.
6	SS -> MS	PACKET UPLINK ACK/NACK	Sent 1 second after step 4, with new ALLOCATION_BITMAP.
7	SS -> MS	PACKET UPLINK ACK/NACK	REPEAT_ALLOCATION
8	SS -> MS	PACKET UPLINK ACK/NACK	Different ALLOCATION_BITMAP than step 6.
9	SS -> MS	PACKET UPLINK ACK/NACK	REPEAT_ALLOCATION (This repeat only applies to the allocation in progress.)
10	MS		Step 5 is repeated until current allocation is exhausted.
11	MS		MS starts to repeat the allocation from step 2 at the next allocation boundary. The MS may send a PACKET RESOURCE REQUEST message during the current allocation. The SS shall ignore the request.

Specific Message Contents

PACKET UPLINK ASSIGNMENT message in step 2:

Fixed allocation - TIMESLOT ALLOCATION - BLOCKS_OR_BLOCK_PERIODS - ALLOCATION_BITMAP_LENGTH - ALLOCATION_BITMAP	One timeslot assigned 0 – blocks 120 Exactly 100 bits are set to 1.
---	--

PACKET UPLINK ACK/NACK message in step 6:

Fixed allocation - TIMESLOT ALLOCATION - BLOCKS_OR_BLOCK_PERIODS - ALLOCATION_BITMAP_LENGTH - ALLOCATION_BITMAP	One timeslot assigned <different from previous> 0 – blocks 16 Exactly 16 bits are set to 1. <different from previous>
---	--

PACKET UPLINK ACK/NACK message in step 7 and 9:

REPEAT_ALLOCATION	1
-------------------	---

PACKET UPLINK ACK/NACK message in step 8:

Fixed allocation - TIMESLOT ALLOCATION - BLOCKS_OR_BLOCK_PERIODS - ALLOCATION_BITMAP_LENGTH - ALLOCATION_BITMAP	One timeslot assigned <different from steps 2 and 6> 0 – blocks 16 Exactly 10 bits are set to 1. <different from previous>
---	---

42.2.2.7.5 Fixed Allocation / Uplink Transfer / MS requests new resources/
Successful/Multiple Packet Uplink Ack/Nack with REPEAT_ALLOCATION

42.2.2.7.5.1 Void

42.2.2.7.5.2 Conformance requirements

Upon receipt of a PACKET UPLINK ACK/NACK with a REPEAT_ALLOCATION, the mobile station shall start a new allocation when the current allocation ends. This new allocation shall begin immediately after the current allocation ends and shall use the most recently received ALLOCATION_BITMAP. If the mobile station receives multiple PACKET UPLINK ACK/NACK messages with REPEAT_ALLOCATION during an allocation, the mobile shall repeat the ALLOCATION_BITMAP only once.

References

3GPP TS 04.60, subclause 8.1.1.3.2.2.

42.2.2.7.5.3 Test purpose

Verify that the MS repeats the current allocation only once.

42.2.2.7.5.4 Method of test

Initial Conditions

System Simulator:

1 cell, GPRS supported, PCCCH present.

Mobile Station:

The MS is in the state "idle, GMM-registered" with a P-TMSI allocated, SPLIT PG CYCLE negotiated, and PDP context 2 activated.

Specific PICS Statements

-

PIXIT Statements

-

Test Procedure

1. MS is triggered to begin an uplink data transfer and enters a open-ended TBF.
2. Before current allocation expires, MS sends PACKET RESOURCE REQUEST.
3. MS receives a series of PACKET UPLINK ACK/NACK messages before the current allocation expires, each containing a repeat allocation.
4. MS responds at the next allocation boundary by using the previous allocation but only once.

Maximum Duration of Test

5 minutes.

Expected Sequence

Step	Direction	Message	Comments
1	MS		Trigger the MS to initiate an uplink packet transfer containing 2500 octets.
2			Bring the MS into packet uplink transfer mode by the generic procedure defined in the table 42.2.1.1/1a.
3	MS -> SS	RLC DATA BLOCKS	MS transmits RLC blocks only when TBF starting time occurs
4	MS -> SS	PACKET RESOURCE REQUEST	MS requests additional resources (sent sometime during current allocation)
5	MS -> SS	RLC DATA BLOCKS	MS continues to transmit RLC data blocks according to allocation from step 2.
6	SS -> MS	PACKET UPLINK ACK/NACK	Sent (.5*T3168) after step 4, with REPEAT_ALLOCATION.
7	SS -> MS	PACKET UPLINK ACK/NACK	REPEAT_ALLOCATION
8	SS -> MS	PACKET UPLINK ACK/NACK	REPEAT_ALLOCATION
9	MS		Step 5 is repeated until current allocation is exhausted.
10	MS		MS starts to repeat the allocation from step 2 at the next allocation boundary. The MS may send a PACKET RESOURCE REQUEST message during the current allocation. The SS shall ignore the request. Verify that the allocation in step 2 is repeated only once

Specific Message Contents

PACKET SYSTEM INFORMATION MESSAGE 1 (throughout):

T3168	1 (1second)
-------	-------------

PACKET UPLINK ASSIGNMENT message in step 2:

Fixed allocation	
- TIMESLOT ALLOCATION	One timeslot assigned
- BLOCKS_OR_BLOCK_PERIODS	0 – blocks
- ALLOCATION_BITMAP_LENGTH	120
- ALLOCATION_BITMAP	Exactly 100 bits are set to 1.

PACKET UPLINK ACK/NACK message in step 6,7 and 8:

REPEAT_ALLOCATION	1
-------------------	---

42.2.2.8 Fixed Allocation / Uplink Transfer / MS requests new resources/ Failure

42.2.2.8.1 Fixed Allocation / Uplink Transfer / MS requests new resources/ Failure/ Packet Access Reject

42.2.2.8.1.1 Void

42.2.2.8.1.2 Conformance requirements

On receipt of a PACKET ACCESS REJECT message , the mobile station shall stop timer T3168 if running and indicate a packet access failure to upper layer.

References

3GPP TS 04.60, subclause 8.1.1.3.2.

42.2.2.8.1.3 Test purpose

Verify that the MS returns to packet idle mode when PACKET ACCESS REJECT is received.

42.2.2.8.1.4 Method of test

Initial Conditions

System Simulator:

1 cell, GPRS supported, PCCCH not present.

Mobile Station:

The MS is in the state "idle, GMM-registered" with a P-TMSI allocated, SPLIT PG CYCLE negotiated, and PDP context 2 activated.

Specific PICS Statements

-

PIXIT Statements

-

Test Procedure

1. MS is triggered to begin an uplink data transfer and enters a open-ended TBF.
2. Before current allocation expires, MS sends PACKET RESOURCE REQUEST.
3. After the current allocation expires, MS receives a PACKET ACCESS REJECT message.
4. MS returns to packet idle mode.

Maximum Duration of Test

5 minutes.

Expected Sequence

Step	Direction	Message	Comments
1	MS		Trigger the MS to initiate an uplink packet transfer containing 1000 octets.
2			Bring the MS into packet uplink transfer mode by the generic procedure defined in the table 42.2.1.1/1b.
3	MS -> SS	RLC DATA BLOCKS	MS transmits RLC blocks only when TBF starting time occurs
4	MS -> SS	PACKET RESOURCE REQUEST	MS requests additional resources
5	SS -> MS	PACKET ACCESS REJECT	Sent after expiration of the current allocation
6	SS		Verify that MS is not transmitting on the previous PDCH. The MS may request additional resources on the RACH channel before the expiration of T3188

Specific Message Contents

IMMEDIATE ASSIGNMENT message in step 2:

Fixed allocation	
- TIMESLOT ALLOCATION	One timeslot assigned
- ALLOCATION_BITMAP_LENGTH	30
- ALLOCATION_BITMAP	Exactly 30 bits are set to 1.

42.2.2.8.2 Fixed Allocation / Uplink Transfer / MS requests new resources/ Failure/Packet Access Reject with WAIT_INDICATION during allocation in progress

42.2.2.8.2.1 Void

42.2.2.8.2.2 Conformance requirements

Upon receipt of a PACKET ACCESS REJECT message, the mobile station shall stop timer T3188, if running, release the TBF using the procedures in 9.3.2.3 or 9.3.3.3, such that the countdown ends within the current allocation. Then, if the mobile station has additional RLC data blocks to transfer, it shall initiate a new uplink TBF establishment.

If the PACKET ACCESS REJECT message contains a WAIT_INDICATION field in a Reject structure addressed to the mobile station, the mobile station shall

- start timer T3172 and if the mobile station has additional RLC data blocks to transmit, it shall initiate a new TBF establishment procedure on the RACH or PRACH, but the mobile station is not allowed to make a new attempt for packet access in the same cell until timer T3172 expires, it may, however, attempt packet access in an other cell after successful cell reselection. A mobile station in GPRS MS class A or B mode of operation may attempt to enter the dedicated mode in the same cell before timer T3172 has expired. During the time T3172 is running, the mobile station shall ignore all received PACKET PAGING REQUEST messages except paging request to trigger RR connection establishment.

The value of the WAIT_INDICATION field (i.e. timer T3172) relates to the cell from which it was received.

References

3GPP TS 04.60, subclauses 8.1.1.3.2 and 8.1.1.3.2.4.

42.2.2.8.2.3 Test purpose

Verify that the MS waits T3172 before sending additional PACKET RESOURCE REQUEST messages, when PACKET ACCESS REJECT is received with a WAIT_INDICATION.

42.2.2.8.2.4 Method of test

Initial Conditions

System Simulator:

1 cell, GPRS supported, PCCCH present.

Mobile Station:

The MS is in the state "idle, GMM-registered" with a P-TMSI allocated, SPLIT PG CYCLE negotiated, and PDP context 2 activated.

Specific PICS Statements

-

PIXIT Statements

-

Test Procedure

1. MS is triggered to begin an uplink data transfer and enters a open-ended TBF.
2. Before current allocation expires, MS sends PACKET RESOURCE REQUEST.
3. Before the current allocation expires, MS receives a PACKET ACCESS REJECT message.
4. MS waits T3172 before sending additional PACKET RESOURCE REQUEST messages.

Maximum Duration of Test

5 minutes.

Expected Sequence

Step	Direction	Message	Comments
1	MS		Trigger the MS to initiate an uplink packet transfer containing 2500 octets.
2			Bring the MS into packet uplink transfer mode by the generic procedure defined in the table 42.2.1.1/1a.
3	MS -> SS	RLC DATA BLOCKS	MS transmits RLC blocks only when TBF starting time occurs
4	MS -> SS	PACKET RESOURCE REQUEST	MS requests additional resources
5	MS -> SS	RLC DATA BLOCK	MS continues to transmit RLC data blocks according to allocation from step 2.
6	SS -> MS	PACKET ACCESS REJECT	Sent (.5*T3168) after step 4. - MS starts T3172
7	MS -> SS	RLC DATA BLOCK	Verify that the MS ends the countdown procedure within the current allocation
8	MS -> SS	PACKET CHANNEL REQUEST	Sent more than 2 seconds after step 6.

Specific Message Contents

PACKET UPLINK ASSIGNMENT message in step 2:

Fixed allocation - TIMESLOT ALLOCATION - BLOCKS_OR_BLOCK_PERIODS - ALLOCATION_BITMAP_LENGTH - ALLOCATION_BITMAP	One timeslot assigned 0 – blocks 120 Exactly 100 bits are set to 1.
---	--

PACKET ACCESS REJECT message in step 6:

WAIT_INDICATION WAIT_INDICATION_SIZE	2 0 – WAIT_INDICATION in units of seconds
---	--

42.2.2.9 Fixed Allocation / Uplink Transfer / Network initiates new resources

42.2.2.9.1 Void

42.2.2.9.2 Conformance requirements

The network may at any time during the uplink TBF initiate a change of resources by sending on the downlink PACCH monitored by the MS, an unsolicited PACKET UPLINK ASSIGNMENT or PACKET TIMESLOT RECONFIGURE, or an uplink resource reassignment in a PACKET UPLINK ACK/NACK message to the mobile station.

References

3GPP TS 04.60, subclause 8.1.1.3.2.

42.2.2.9.3 Test purpose

Verify that the MS obeys unsolicited PACKET UPLINK ASSIGNMENT message during an uplink TBF.

42.2.2.9.4 Method of test

Initial Conditions

System Simulator:

1 cell, GPRS supported, PCCCH not present.

Mobile Station:

The MS is in the state "idle, GMM-registered" with a P-TMSI allocated, SPLIT PG CYCLE negotiated, and PDP context 3 activated.

Specific PICS Statements

-

PIXIT Statements

-

Test Procedure

1. MS is triggered to begin an uplink data transfer and enters a open-ended TBF.
2. Before current allocation expires, SS sends unsolicited PACKET UPLINK ASSIGNMENT.
3. After the current allocation expires, MS uses the newly assigned resources.

Maximum Duration of Test

5 minutes.

Expected Sequence

Step	Direction	Message	Comments
1	MS		Trigger the MS to initiate an uplink packet transfer containing 1500 octets.
2			Bring the MS into packet uplink transfer mode by the generic procedure defined in the table 42.2.1.2/1b.
3	MS -> SS	RLC DATA BLOCK	MS transmits RLC block only when TBF starting time occurs
4	MS -> SS	RLC DATA BLOCKS	MS continues to transmit RLC data blocks according to allocation from step 2.
4A	MS -> SS	PACKET RESOURCE REQUEST	Optional: MS may request new resources. If this occurs, SS proceeds with step 4B.
4B	SS -> MS	PACKET UPLINK ASSIGNMENT	Assign uplink resources in response to MS request.
5	SS -> MS	PACKET UPLINK ASSIGNMENT	Unsolicited – sent on PACCH. Different from step 4B.
6	MS -> SS	RLC DATA BLOCK	MS continues to transmit RLC data blocks according to allocation from step 2, until the allocation is exhausted.
7	MS -> SS	RLC DATA BLOCK	MS starts to use the new allocation from step 5 at the given starting time.

Specific Message Contents

PACKET UPLINK ASSIGNMENT message in step 2:

Fixed allocation - TIMESLOT ALLOCATION - BLOCKS_OR_BLOCK_PERIODS - ALLOCATION_BITMAP_LENGTH - ALLOCATION_BITMAP	One timeslot assigned 0 – blocks <any suitable value > Exactly 40 bits are set to 1.
---	---

PACKET UPLINK ASSIGNMENT message in step 5:

Fixed allocation - TIMESLOT ALLOCATION - BLOCKS_OR_BLOCK_PERIODS - ALLOCATION_BITMAP_LENGTH - ALLOCATION_BITMAP Starting Time	One timeslot assigned <different than previous> 0 – blocks <any suitable value > Exactly 40 bits are set to 1. 100 frames after current allocation expires
--	--

42.2.2.10 Fixed Allocation / Uplink Transfer / PACCH operation

42.2.2.10.1 Fixed Allocation / Uplink Transfer / PACCH operation/ Normal Operation

42.2.2.10.1.1 Void

42.2.2.10.1.2 Conformance requirements

A mobile station shall monitor one PDCH in the allocation for downlink PACCH except during the measurement gap. The network shall indicate that PDCH on uplink resource assignment (DOWNLINK_CONTROL_TIMESLOT parameter) according to MS multislot class.

References

3GPP TS 04.60, subclause 8.1.1.3.4 and annex D.

3GPP TS 05.02, clause B.1.

42.2.2.10.1.3 Test purpose

Verify that the MS monitors the correct PDCH for PACCH during an uplink TBF.

42.2.2.10.1.4 Method of test

Initial Conditions

System Simulator:

1 cell, GPRS supported, PCCCH not present.

Mobile Station:

The MS is in the state "idle, GMM-registered" with a P-TMSI allocated, SPLIT PG CYCLE negotiated, and PDP context 3 activated.

Specific PICS Statements

-

PIXIT Statements

-

Test Procedure

1. MS is triggered to begin an uplink data transfer and enters an open-ended TBF on 2 timeslots.
2. MS receives PACKET POLLING REQUEST on the PDCH corresponding to its downlink PACCH.
3. MS responds to the poll by sending PACKET CONTROL ACKNOWLEDGEMENT.

Maximum Duration of Test

5 minutes.

Expected Sequence

Step	Direction	Message	Comments
1	MS		Trigger the MS to initiate an uplink packet transfer containing 1000 octets.
2			Bring the MS into packet uplink transfer mode by the generic procedure defined in the table 42.2.1.2/1b.
3	MS -> SS	RLC DATA BLOCK	MS transmits RLC block only when TBF starting time occurs
4	MS -> SS	RLC DATA BLOCK	MS continues to transmit RLC data blocks according to allocation from step 2.
5	SS -> MS	PACKET POLLING REQUEST	Sent on PACCH, PDCH 0.
6	MS -> SS	PACKET CONTROL ACKNOWLEDGEMENT	Sent in next but two block (N + 13) after step 5, on PDCH 0.
7	MS -> SS	RLC DATA BLOCKS	MS continues to transmit RLC data blocks according to allocation from step 2, until the allocation is exhausted.

Specific Message Contents

PACKET UPLINK ASSIGNMENT message in step 2:

Fixed allocation	
- TIMESLOT ALLOCATION	Two timeslot assigned (0 and 1)
- BLOCKS_OR_BLOCK_PERIODS	0 – blocks
- ALLOCATION_BITMAP_LENGTH	<any suitable value >
- ALLOCATION_BITMAP	Exactly 40 bits are set to 1.
- DOWNLINK_CONTROL_TIMESLOT	000

PACKET POLLING REQUEST message in step 5:

RRBP	0
TYPE_OF_ACK	1 (Respond with RLC/MAC control block)
TFI	Addressing this MS

42.2.2.10.2 Fixed Allocation / Uplink Transfer / PACCH operation/ PACCH message addressed to another MS

42.2.2.10.2.1 Void

42.2.2.10.2.2 Conformance Requirements

A mobile station shall monitor one PDCH in the allocation for downlink PACCH except during the measurement gap. The network shall indicate that PDCH on uplink resource assignment (DOWNLINK_CONTROL_TIMESLOT parameter) according to MS multislot class.

References

3GPP TS 04.60, subclause 8.1.1.3.4 and annex D.

3GPP TS 05.02, clause B.1.

42.2.2.10.2.3 Test purpose

Verify that the MS ignores the PACCH message if addressed to another MS.

42.2.2.10.2.4 Method of test

Initial Conditions

System Simulator:

1 cell, GPRS supported, PCCCH not present.

Mobile Station:

The MS is in the state "idle, GMM-registered" with a P-TMSI allocated, SPLIT PG CYCLE negotiated, and PDP context 3 activated.

Specific PICS Statements

-

PIXIT Statements

-

Test Procedure

1. MS is triggered to begin an uplink data transfer and enters a open-ended TBF on 2 timeslots.
2. MS receives PACKET POLLING REQUEST on the PDCH corresponding to its downlink PACCH, addressed to another MS.
3. MS does not respond to the poll.

Maximum Duration of Test

5 minutes.

Expected Sequence

Step	Direction	Message	Comments
1	MS		Trigger the MS to initiate an uplink packet transfer containing 1000 octets.
2			Bring the MS into packet uplink transfer mode by the generic procedure defined in the table 42.2.1.2/1b.
3	MS -> SS	RLC DATA BLOCK	MS transmits RLC block only when TBF starting time occurs
4	MS -> SS	RLC DATA BLOCK	MS continues to transmit RLC data blocks according to allocation from step 2.
5	SS -> MS	PACKET POLLING REQUEST	Sent on PACCH, PDCH 0.
6	MS -> SS	RLC DATA BLOCKS	MS continues to transmit RLC data blocks according to allocation from step 2, until the allocation is exhausted. - Verify no PACKET CONTROL ACKNOWLEDGEMENT is sent by MS.

Specific Message Contents

PACKET UPLINK ASSIGNMENT message in step 2:

Fixed allocation - TIMESLOT ALLOCATION - BLOCKS_OR_BLOCK_PERIODS - ALLOCATION_BITMAP_LENGTH - ALLOCATION_BITMAP - DOWNLINK_CONTROL_TIMESLOT	Two timeslots assigned (0 and 1) 0 – blocks <any suitable value > Exactly 40 bits are set to 1. 000
--	---

PACKET POLLING REQUEST message in step 5:

TYPE_OF_ACK TFI	1 (Respond with RLC/MAC control block) Not matching this MS.
--------------------	---

42.2.2.10.3 Fixed Allocation/ Uplink Transfer / Abnormal cases / PACCH timeslot removed

42.2.2.10.3.1 Void

42.2.2.10.3.2 Conformance requirements

If an uplink TBF in fixed allocation mode was in progress and if one of timeslots that are being released is its downlink PACCH timeslot, the mobile station shall temporarily read all downlink blocks that it is able to decode according to its

multislot capability, on all of its remaining assigned PDCHs, and act upon any RLC/MAC control message that is addressed to it, until another downlink PACCH timeslot is assigned. If the mobile station's multislot capability does not allow it to monitor the downlink of any of its assigned PDCHs, it shall perform an abnormal release with random access.

References

3GPP TS 04.60, subclause 8.2.

3GPP TS 05.02, clause B.1.

42.2.2.10.3.3 Test purpose

Verify that the MS monitors the correct PDCH for PACCH during an uplink TBF after the previously assigned downlink PACCH timeslot is released.

42.2.2.10.3.4 Method of test

Initial Conditions

System Simulator:

1 cell, GPRS supported, PCCCH not present.

Mobile Station:

The MS is in the state "idle, GMM-registered" with a P-TMSI allocated, SPLIT PG CYCLE negotiated, and PDP context 3 activated.

Specific PICS Statements

-

PIXIT Statements

-

Test Procedure

1. MS is triggered to begin an uplink data transfer (via CCCH) and enters a open-ended TBF on 2 timeslots, with one timeslot assigned for its downlink PACCH.
2. MS receives PACKET PDCH RELEASE message on its assigned PACCH.
3. MS receives PACKET POLLING REQUEST on the PDCH that was just released, corresponding to its downlink PACCH.
4. MS does not respond to the poll.
5. MS receives PACKET POLLING REQUEST on another downlink PDCH to which it is assigned.
6. MS responds to the poll.

Maximum Duration of Test

5 minutes.

Expected Sequence

Step	Direction	Message	Comments
1	MS		Trigger the MS to initiate an uplink packet transfer containing 1000 octets.
2			Bring the MS into packet uplink transfer mode by the generic procedure defined in the table 42.2.1.2/1b.
3	MS -> SS	RLC DATA BLOCK	MS transmits RLC block only when TBF starting time occurs
4	MS -> SS	RLC DATA BLOCK	MS continues to transmit RLC data blocks according to allocation from step 2.
5	SS -> MS	PACKET PDCH RELEASE	Sent on PACCH, PDCH 0.
6	SS -> MS	PACKET POLLING REQUEST	Sent on PACCH, PDCH 0.
7	MS -> SS	RLC DATA BLOCKS	MS continues to transmit RLC data blocks according to allocation from step 2, but without any transmission on PDCH 0. - Verify no PACKET CONTROL ACKNOWLEDGEMENT is sent by MS on PDCH0.
8	SS -> MS	PACKET POLLING REQUEST	Sent on PACCH, PDCH 1.
9	MS -> SS	PACKET CONTROL ACKNOWLEDGEMENT	Sent in next but two block (N + 13) after step 8, on PDCH 1.
10	MS -> SS	RLC DATA BLOCKS	MS continues to transmit RLC data blocks according to allocation from step 2, until the allocation is exhausted.

Specific Message Contents

PACKET UPLINK ASSIGNMENT message in step 2:

Fixed allocation	
- TIMESLOT ALLOCATION	Two timeslots assigned (0 and 1)
- BLOCKS_OR_BLOCK_PERIODS	0 – blocks
- ALLOCATION_BITMAP_LENGTH	<any suitable value >
- ALLOCATION_BITMAP	Exactly 40 bits are set to 1.
- DOWNLINK_CONTROL_TIMESLOT	000

PACKET POLLING REQUEST message in step 6 and 8:

RRBP	0
TYPE_OF_ACK	1 (Respond with RLC/MAC control block)
TFI	matching this MS

PACKET PDCH RELEASE message in step 5:

PAGE_MODE	00 – Normal Paging
TIMESLOTS_AVAILABLE	<not present>

42.2.2.11 Fixed Allocation/ Uplink Transfer / Abnormal cases

42.2.2.11.1 Fixed Allocation/ Uplink Transfer / Abnormal cases / Assignment without fixed allocation

42.2.2.11.1.1 Void

42.2.2.11.1.2 Conformance requirements

If the mobile station receives an assignment message containing an allocation other than a fixed allocation, the mobile station shall perform an abnormal release with random access.

References

3GPP TS 04.60, subclause 8.1.1.3.2.5.

42.2.2.11.1.3 Test purpose

Verify that an MS in a fixed allocation uplink transfer performs an abnormal release with random access when an assignment message without a fixed allocation is received.

42.2.2.11.1.4 Method of test

Initial Conditions

System Simulator:

2 cells, GPRS supported, PCCCH not present.

Mobile Station:

The MS is in the state "idle, GMM-registered" with a P-TMSI allocated, SPLIT PG CYCLE negotiated, and PDP context 3 activated.

Specific PICS Statements

-

PIXIT Statements

-

Test Procedure

1. MS is triggered to begin an uplink data transfer (via CCCH) and enters a fixed allocation open-ended TBF.
2. Before the current allocation expires, MS sends PACKET RESOURCE REQUEST.
3. Prior to T3168 expiring, MS receives a new allocation containing dynamic allocation.
4. MS performs an abnormal release with random access.

Maximum Duration of Test

5 minutes.

Expected Sequence

Step	Direction	Message	Comments
1	MS		Trigger the MS to initiate an uplink packet transfer containing 1000 octets.
2			Bring the MS into packet uplink transfer mode on cell A by the generic procedure defined in the table 42.2.1.2/1b.
3	MS -> SS	RLC DATA BLOCK	Cell A: MS transmits RLC block only when TBF starting time occurs
4	MS -> SS	RLC DATA BLOCK	MS continues to transmit RLC data blocks according to allocation from step 2.
5	SS -> MS	PACKET UPLINK ASSIGNMENT	Cell A: With Dynamic Allocation. Sent on PACCH.
6	SS		Verify MS does not send more than 2 RLC data blocks from previous allocation.
7	MS -> SS	CHANNEL REQUEST	Verify Ms does not access cell B. Cell A: Random access

Specific Message Contents

PACKET UPLINK ASSIGNMENT message in step 2:

Fixed allocation - TIMESLOT ALLOCATION - BLOCKS_OR_BLOCK_PERIODS - ALLOCATION_BITMAP_LENGTH - ALLOCATION_BITMAP	One timeslot assigned 0 – blocks <any suitable value > Exactly the 40 first bits are set to 1.
---	---

PACKET UPLINK ASSIGNMENT message in step 5:

Dynamic Allocation structure	<any dynamic allocation>
------------------------------	--------------------------

42.2.2.11.2 Fixed Allocation/ Uplink Transfer / Abnormal cases / Frequency not supported

42.2.2.11.2.1 Void

42.2.2.11.2.2 Conformance requirements

If the mobile station receives a PACKET UPLINK ASSIGNMENT message containing a Frequency Parameters information element specifying a frequency that is in a frequency band not supported by the mobile station then the mobile station shall perform an abnormal release with random access.

References

3GPP TS 04.60, subclause 8.1.1.1.2.1.

42.2.2.11.2.3 Test purpose

Verify that an MS in a fixed allocation uplink transfer performs an abnormal release with random access when an assignment message specifying an unsupported frequency is received.

42.2.2.11.2.4 Method of test

Initial Conditions

System Simulator:

2 cells, GPRS supported, PCCCH not present.

Mobile Station:

The MS is in the state "idle, GMM-registered" with a P-TMSI allocated, SPLIT PG CYCLE negotiated, and PDP context 3 activated.

Specific PICS Statements

-

PIXIT Statements

-

Test Procedure

1. MS is triggered to begin an uplink data transfer (via CCCH) and enters a fixed allocation open-ended TBF.
2. Before the current allocation expires, MS sends PACKET RESOURCE REQUEST.
3. Prior to T3168 expiring, MS receives a new allocation containing Frequency Parameters IE with frequency not supported by the MS.
4. MS performs an abnormal release with random access.

Maximum Duration of Test

5 minutes.

Expected Sequence

Step	Direction	Message	Comments
1	MS		Trigger the MS to initiate an uplink packet transfer containing 1000 octets.
2			Bring the MS into packet uplink transfer mode on cell A by the generic procedure defined in the table 42.2.1.2/1b.
3	MS -> SS	RLC DATA BLOCK	Cell A: MS transmits RLC block only when TBF starting time occurs
4	MS -> SS	RLC DATA BLOCK	MS continues to transmit RLC data blocks according to allocation from step 2.
5	SS -> MS	PACKET UPLINK ASSIGNMENT	Cell A: With frequency not supported by the MS. Sent on PACCH.
6	SS		Verify MS does not send more than 2 RLC data blocks from previous allocation.
7	MS -> SS	CHANNEL REQUEST	Verify MS does not access cell B. Cell A: Random access

Specific Message Contents

PACKET UPLINK ASSIGNMENT message in step 2:

Fixed allocation - TIMESLOT ALLOCATION - BLOCKS_OR_BLOCK_PERIODS - ALLOCATION_BITMAP_LENGTH - ALLOCATION_BITMAP	One timeslot assigned 0 – blocks <any suitable value > Exactly the 40 first bits are set to 1.
---	---

PACKET UPLINK ASSIGNMENT message in step 5:

Frequency Parameters IE - ARFCN	<some frequency not supported by the MS>
------------------------------------	--

42.2.2.11.3 Fixed Allocation/ Uplink Transfer / Abnormal cases / Invalid MA_NUMBER

42.2.2.11.3.1 Void

42.2.2.11.3.2 Conformance Requirement

If a mobile station receives a PACKET UPLINK ASSIGNMENT or PACKET TIMESLOT RECONFIGURE message and detects an invalid Frequency Parameters information element in the message, it shall perform an abnormal release. If PCCCH is present in the cell the mobile station shall perform an abnormal release with system information (see subclause 8.7.3).

The MA_NUMBER shall use the following coding:

MA_NUMBER = 0–13 shall be used to reference a GPRS mobile allocation received in a PSI2 message;

MA_NUMBER = 14 shall be used to reference a GPRS mobile allocation received in a SI13 or PSI13 message;

MA_NUMBER = 15 shall be used to reference a GPRS mobile allocation received in a previous assignment message using the direct encoding.

References

3GPP TS 04.60, subclauses 8.1.1.3.2.5 and 5.5.1.7.

42.2.2.11.3.3 Test purpose

Verify that an MS in a fixed allocation uplink transfer performs an abnormal release with random access when an assignment message specifying an invalid MA_NUMBER as part of the Frequency Parameters IE is received.

42.2.2.11.3.4 Method of test

Initial Conditions

System Simulator:

2 cells, GPRS supported, PCCCH not present, no PSI2 broadcast in the cell.

Mobile Station:

The MS is in the state "idle, GMM-registered" with a P-TMSI allocated, and PDP context 3 activated.

Specific PICS Statements

-

PIXIT Statements

-

Test Procedure

1. MS is triggered to begin an uplink data transfer and enters a fixed allocation open-ended TBF.
2. Before the current allocation expires, MS sends PACKET RESOURCE REQUEST.
3. Prior to T3168 expiring, MS receives a new allocation containing Frequency Parameters IE with MA_NUMBER not supported. (PSI2 is not present.)
4. MS performs an abnormal release with random access.

Maximum Duration of Test

5 minutes.

Expected Sequence

Step	Direction	Message	Comments
1	MS		Trigger the MS to initiate an uplink packet transfer containing 1000 octets.
2			Bring the MS into packet uplink transfer mode on cell A by the generic procedure defined in the table 42.2.1.2/1b.
3	MS -> SS	RLC DATA BLOCK	Cell A: MS transmits RLC block only when TBF starting time occurs
4	MS -> SS	RLC DATA BLOCK	MS continues to transmit RLC data blocks according to allocation from step 2.
5	SS -> MS	PACKET UPLINK ASSIGNMENT	Cell A: With unsupported MA_NUMBER.
6	SS		Verify MS does not transmit more than 2 RLC data blocks from previous allocation.
7	MS -> SS	CHANNEL REQUEST	Verify MS does not access cell B. Cell A: Random access

Specific Message Contents

PACKET UPLINK ASSIGNMENT message in step 2:

Fixed allocation - TIMESLOT ALLOCATION - BLOCKS_OR_BLOCK_PERIODS - ALLOCATION_BITMAP_LENGTH - ALLOCATION_BITMAP	One timeslot assigned 0 – blocks <any suitable value > Exactly the 40 first bits are set to 1.
---	---

PACKET UPLINK ASSIGNMENT message in step 5:

Frequency Parameters IE - ARFCN - MA_NUMBER	<some frequency supported by the MS> 0 - a GPRS mobile allocation received in a PSI2 message
---	---

42.2.3 Fixed Allocation / Uplink Transfer with Downlink TBF Establishment

42.2.3.1 Fixed Allocation / Uplink Transfer with Downlink TBF Establishment/T3190

42.2.3.1.1 Fixed Allocation / Uplink Transfer with Downlink TBF Establishment/ T3190/Half-Duplex

42.2.3.1.1.1 Void

42.2.3.1.1.2 Conformance Requirement

During an uplink fixed allocation TBF, the network may initiate a downlink TBF by sending the PACKET DOWNLINK ASSIGNMENT or PACKET TIMESLOT RECONFIGURE message on the PACCH.

The downlink radio resource is assigned to the mobile station in a PACKET DOWNLINK ASSIGNMENT or PACKET TIMESLOT RECONFIGURE message. The assigned timeslot configuration of the simultaneous uplink and downlink TBF must be compliant with the mobile station's multislot class, and must allow the performing of neighbour cell power measurements as described in subclause 8.1.2.7.

On receipt of an assignment message the mobile station shall follow the procedure below.

If the mobile station is assigned to operate in half duplex mode, the network shall wait for the mobile station to finish its current uplink resource allocation, and for the TBF starting time to elapse, if present, before sending RLC data blocks on the downlink.

Whenever a mobile station operating on an uplink TBF in half duplex mode receives a complete assignment on the PACCH the mobile station shall complete the currently assigned fixed allocation. If the uplink TBF is not completed the mobile station shall, after expiry of the TBF starting time, if present, or if the TBF starting time has already expired, save the RLC state variables associated with the uplink TBF and suspend and save the state of the following timers :

T3182 - Wait for Acknowledgement;

T3184 - No Ack/Nack Received;

T3188 - Allocation Exhausted.

Whenever a mobile station operating on an uplink TBF in half duplex mode receives a complete downlink assignment on the PACCH and has previously saved the state of the downlink TBF and has not since entered idle mode, the mobile station shall restore the saved downlink RLC state variables and timer values.

The mobile station shall then act upon the PACKET DOWNLINK ASSIGNMENT or PACKET TIMESLOT RECONFIGURE message.

When receiving the PACKET DOWNLINK ASSIGNMENT message and after waiting the TBF Starting Time when applicable, the mobile station starts timer T3190. The timer is reset when receiving the first valid RLC/MAC block.

References

3GPP TS 04.60, subclauses 8.1.1.3.5 and 7.2.1.1.

42.2.3.1.1.3 Test purpose

Verify that an MS operating an uplink TBF in half duplex mode can correctly respond to a PACKET DOWNLINK ASSIGNMENT by completing the current fixed allocation and then act upon the PACKET DOWNLINK ASSIGNMENT. Verify that the MS receives downlink RLC data blocks when the first one is received within T3190.

42.2.3.1.1.4 Method of test

Initial Conditions

System Simulator:

2 cells, GPRS supported, PCCCH not present.

Mobile Station:

The MS is in the state "idle, GMM-registered" with a P-TMSI allocated, SPLIT PG CYCLE negotiated, and PDP context 3 activated.

Specific PICS Statements

-

PIXIT Statements

-

Test Procedure

1. MS is triggered to begin an uplink data transfer and enters a fixed allocation open-ended TBF in half duplex mode. This is a TBF with 2 timeslots uplink with the assignment forcing the MS into half duplex mode. In this mode, the MS is not required to read the downlink PACCH, except when there are gaps in the uplink allocation.
2. Before the current allocation expires, the MS receives a PACKET DOWNLINK ASSIGNMENT on the PACCH, during a gap in the uplink allocation.
3. After the current allocation expires, the MS acts on the PACKET DOWNLINK ASSIGNMENT and receives the first RLC data block within T3190. During the downlink TBF, the MS does not continue the uplink TBF or request new resources.

Maximum Duration of Test

5 minutes.

Expected Sequence

Step	Direction	Message	Comments
1	MS		Trigger the MS to initiate an uplink packet transfer containing 1000 octets.
2			Bring the MS into packet uplink transfer mode on cell A by the generic procedure defined in the table 42.2.1.2/1b or 42.2.1.2/2b.
3	MS -> SS	RLC DATA BLOCK	MS transmits RLC block only when TBF starting time occurs
4	MS -> SS	RLC DATA BLOCKS	MS continues to transmit RLC data blocks according to allocation from step 2.
5	SS -> MS	PACKET DOWNLINK ASSIGNMENT	With starting time after current uplink allocation expires.
6	MS -> SS	RLC DATA BLOCKS	Verify MS continues to transmit RLC data blocks from previous allocation until the allocation is exhausted.
7	MS		Waits until starting time in step 5 arrives. - MS starts T3190
8	SS -> MS	RLC DATA BLOCK	Sent (.8*T3190) seconds after step 7.
9	SS -> MS	RLC DATA BLOCKS	SS transmits RLC data blocks
10	SS		Verify MS does not request new uplink resources, or continue the uplink TBF during the downlink.
11	SS -> MS	RLC DATA BLOCK	SS transmits RLC data block with valid RRBp field (polling).
12	MS -> SS	PACKET DOWNLINK ACK/NACK	MS acknowledges the previously received RLC data blocks. Sent in block specified by RRBp field.

Specific Message Contents

PACKET UPLINK ASSIGNMENT message in step 2:

Fixed allocation - HALF_DUPLEX_MODE - TIMESLOT ALLOCATION - BLOCKS_OR_BLOCK_PERIODS - ALLOCATION_BITMAP_LENGTH - ALLOCATION_BITMAP	1 – half duplex TBF Two timeslots assigned 0 – blocks <any suitable value > Allocates 100 RLC blocks, with periodic gaps to receive PACCH.
---	--

PACKET DOWNLINK ASSIGNMENT message in step 5:

- TIMESLOT ALLOCATION Frequency Parameters IE - TBF_STARTING_TIME	Six timeslots assigned <some AFN after the current fixed allocation bitmap expires>
---	--

42.2.3.1.2 Fixed Allocation / Uplink Transfer with Downlink TBF Establishment/ T3190/Non Half-Duplex

42.2.3.1.2.1 Void

42.2.3.1.2.2 Conformance Requirement

During an uplink fixed allocation TBF, the network may initiate a downlink TBF by sending the PACKET DOWNLINK ASSIGNMENT or PACKET TIMESLOT RECONFIGURE message on the PACCH.

The downlink radio resource is assigned to the mobile station in a PACKET DOWNLINK ASSIGNMENT or PACKET TIMESLOT RECONFIGURE message. The assigned timeslot configuration of the simultaneous uplink and downlink TBF must be compliant with the mobile station's multislot class, and must allow the performing of neighbour cell power measurements as described in subclause 8.1.2.7.

On receipt of an assignment message the mobile station shall follow the procedure below.

If the mobile station is not assigned to operate half duplex mode, the mobile station shall, after expiry of the TBF starting time, if present, act upon the complete downlink assignment, and start timer T3190.

The mobile station shall then act upon the PACKET DOWNLINK ASSIGNMENT or PACKET TIMESLOT RECONFIGURE message.

When receiving the PACKET DOWNLINK ASSIGNMENT message and after waiting the TBF Starting Time when applicable, the mobile station starts timer T3190. The timer is reset when receiving the first valid RLC/MAC block.

References

3GPP TS 04.60, subclauses 8.1.1.3.5 and 7.2.1.1.

42.2.3.1.2.3 Test purpose

Verify that an MS operating an uplink TBF in non half duplex mode can correctly respond to a PACKET DOWNLINK ASSIGNMENT by acting upon the PACKET DOWNLINK ASSIGNMENT during the uplink TBF. Verify that the MS receives downlink RLC data blocks when the first one is received within T3190.

42.2.3.1.2.4 Method of test

Initial Conditions

System Simulator:

2 cells, GPRS supported, PCCCH not present.

Mobile Station:

The MS is in the state "idle, GMM-registered" with a P-TMSI allocated, SPLIT PG CYCLE negotiated, and PDP context 3 activated.

Specific PICS Statements

-

PIXIT Statements

-

Test Procedure

1. MS is triggered to begin an uplink data transfer and enters a fixed allocation open-ended TBF in non half duplex mode. This is a TBF with 2 timeslots uplink with the assignment forcing the MS into non half duplex mode. In this mode, the MS reads the downlink PACCH on the natural timeslot.
2. Before the current allocation expires, the MS receives a PACKET DOWNLINK ASSIGNMENT on the PACCH, with starting time before the current allocation expires.
3. Before the current allocation expires, the MS acts on the PACKET DOWNLINK ASSIGNMENT and receives the first RLC data block within T3190. During the downlink TBF, the MS continues the uplink TBF.

Maximum Duration of Test

5 minutes.

Expected Sequence

Step	Direction	Message	Comments
1	MS		Trigger the MS to initiate an uplink packet transfer containing 1000 octets.
2			Bring the MS into packet uplink transfer mode on cell A by the generic procedure defined in the table 42.2.1.2/1b or 42.2.1.2/2b.
3	MS -> SS	RLC DATA BLOCK	MS transmits RLC block only when TBF starting time occurs
4	MS -> SS	RLC DATA BLOCKS	MS continues to transmit RLC data blocks according to allocation from step 2.
5	SS -> MS	PACKET DOWNLINK ASSIGNMENT	With starting time before current uplink allocation expires. Sent on assigned PACCH.
6	MS -> SS	RLC DATA BLOCKS	Verify MS continues to transmit RLC data blocks from previous allocation until the starting time in step 5 arrives.
7	MS		.- MS starts T3190
8	MS -> SS	RLC DATA BLOCKS	Verify MS continues to transmit RLC data blocks from previous allocation.
9	SS -> MS	RLC DATA BLOCK	Sent 4.5sec after step 7.
10	SS -> MS	RLC DATA BLOCKS	SS transmits RLC data blocks
11	SS -> MS	RLC DATA BLOCK	SS transmits RLC data block with valid RRBp field (polling).
12	MS -> SS	PACKET DOWNLINK ACK/NACK	MS acknowledges the previously received RLC data blocks. Sent in block specified by RRBp field.
13	SS		Verify MS continues the uplink TBF from the previous allocation, during the downlink TBF.

Specific Message Contents

PACKET UPLINK ASSIGNMENT message in step 2:

Fixed allocation	
- HALF_DUPLEX_MODE	0 – non half duplex TBF
- TIMESLOT_ALLOCATION	Two timeslots assigned - PDCH2 and PDCH3
- BLOCKS_OR_BLOCK_PERIODS	0 – blocks
- ALLOCATION_BITMAP_LENGTH	<any suitable value >
- ALLOCATION_BITMAP	Allocates 100 RLC blocks

PACKET DOWNLINK ASSIGNMENT message in step 5:

TIMESLOT_ALLOCATION Frequency Parameters IE - TBF_STARTING_TIME	3 timeslots assigned – PDCH1, PDCH2 and PDCH3 (multislot class is not violated) <some AFN before the current fixed allocation bitmap expires>
---	--

42.2.3.2 Fixed Allocation / Uplink Transfer with Downlink TBF Establishment/ Ending uplink TBF

42.2.3.2.1 Fixed Allocation / Uplink Transfer with Downlink TBF Establishment/ Ending uplink TBF/ Half-Duplex

42.2.3.2.1.1 Void

42.2.3.2.1.2 Conformance Requirement

The network may initiate release of an uplink TBF by transmitting a PACKET TBF RELEASE message to the mobile station on the PACCH. A cause value indicates the reason for release.

If the cause value is "Normal release" the mobile station shall continue to the next LLC PDU boundary, starting the count down procedure (see subclause 9.3.1) at whatever value of CV is appropriate to count down to zero at the LLC PDU boundary, and then release the TBF according to the procedures in subclauses 9.3.2.3 or 9.3.3.3.

If the PACKET UPLINK ACK/NACK message has the Final Ack Indicator bit set to '1', the mobile station shall transmit the PACKET CONTROL ACKNOWLEDGEMENT message and release the TBF. If the mobile station is operating in half duplex mode and received a downlink assignment during the countdown or while timer T3182 was running, it shall then act on the downlink assignment.

References

3GPP TS 04.60, subclauses 8.1.1.4 and 9.3.2.3.

42.2.3.2.1.3 Test purpose

Verify that an MS operating an uplink TBF in half duplex mode can correctly respond to a PACKET TBF RELEASE message to end the uplink TBF before starting the downlink TBF.

42.2.3.2.1.4 Method of test

Initial Conditions

System Simulator:

2 cells, GPRS supported, PCCCH not present.

Mobile Station:

The MS is in the state "idle, GMM-registered" with a P-TMSI allocated, SPLIT PG CYCLE negotiated, and PDP context 3 activated.

Specific PICS Statements

-

PIXIT Statements

-

Test Procedure

1. MS is triggered to begin an uplink data transfer and enters a fixed allocation open-ended TBF in half duplex mode.
2. Before the current allocation expires, the MS receives a PACKET TBF RELEASE.

3. During the countdown procedure, the MS receives a PACKET DOWNLINK ASSIGNMENT.
4. After the uplink TBF is ended, the MS acts on the PACKET DOWNLINK ASSIGNMENT and begins the downlink TBF.

Maximum Duration of Test

5 minutes.

Expected Sequence

Step	Direction	Message	Comments
1	MS		Trigger the MS to initiate an uplink packet transfer containing 500 octets.
2			Bring the MS into packet uplink transfer mode on cell A by the generic procedure defined in the table 42.2.1.2/1b.
3	MS -> SS	RLC DATA BLOCK	MS transmits RLC block only when TBF starting time occurs
4	MS -> SS	RLC DATA BLOCKS	MS continues to transmit RLC data blocks according to allocation from step 2.
5	SS -> MS	PACKET DOWNLINK ASSIGNMENT	With starting time after current uplink allocation expires.
6	MS -> SS	RLC DATA BLOCKS	Verify MS continues to transmit RLC data blocks from previous allocation.
7	SS -> MS	PACKET TBF RELEASE	Release of the uplink TBF. Sent when 200 octets left to send in the PDU. Cause value – normal release
8	MS -> SS	RLC DATA BLOCKS	MS starts countdown procedure so that uplink TBF ends at the LLC PDU boundary. Any extra remaining bytes are filled with 2B.
9	SS		Verify MS does not request new uplink resources, or continue the uplink TBF during the downlink.
10	SS -> MS	RLC DATA BLOCKS	SS transmits RLC data blocks after the starting time
11	SS -> MS	RLC DATA BLOCK	SS transmits RLC data block with valid RRBp field (polling).
12	MS -> SS	PACKET DOWNLINK ACK/NACK	MS acknowledges the previously received RLC data blocks. Sent in block specified by RRBp field.
13	SS		SS ends the downlink TBF

Specific Message Contents

PACKET UPLINK ASSIGNMENT message in step 2:

Fixed allocation - HALF_DUPLEX_MODE - TIMESLOT_ALLOCATION - BLOCKS_OR_BLOCK_PERIODS - ALLOCATION_BITMAP_LENGTH - ALLOCATION_BITMAP	1 – half duplex TBF Two timeslots assigned 0 – blocks <any suitable value > Allocates 100 RLC blocks, with periodic gaps to receive PACCH.
---	--

PACKET DOWNLINK ASSIGNMENT message in step 5:

TIMESLOT_ALLOCATION Frequency Parameters IE - TBF_STARTING_TIME	6 timeslots assigned <some AFN after the current fixed allocation bitmap expires>
---	--

PACKET TBF RELEASE message in step 7:

Cause Value UPLINK_RELEASE	0000 – Normal release 1 – Uplink TBF is released
-------------------------------	---

42.2.3.2.2 Fixed Allocation / Uplink Transfer with Downlink TBF Establishment/ Ending uplink TBF/ Non Half-Duplex

42.2.3.2.2.1 Void

42.2.3.2.2.2 Conformance Requirement

During an uplink fixed allocation TBF, the network may initiate a downlink TBF by sending the PACKET DOWNLINK ASSIGNMENT or PACKET TIMESLOT RECONFIGURE message on the PACCH.

The downlink radio resource is assigned to the mobile station in a PACKET DOWNLINK ASSIGNMENT or PACKET TIMESLOT RECONFIGURE message. The assigned timeslot configuration of the simultaneous uplink and downlink TBF must be compliant with the mobile station's multislot class, and must allow the performing of neighbour cell power measurements as described in subclause 8.1.2.7.

On receipt of an assignment message the mobile station shall follow the procedure below.

If the mobile station is not assigned to operate half duplex mode, the mobile station shall, after expiry of the TBF starting time, if present, act upon the complete downlink assignment, and start timer T3190.

The mobile station shall then act upon the PACKET DOWNLINK ASSIGNMENT or PACKET TIMESLOT RECONFIGURE message.

When receiving the PACKET DOWNLINK ASSIGNMENT message and after waiting the TBF Starting Time when applicable, the mobile station starts timer T3190. The timer is reset when receiving the first valid RLC/MAC block.

References

3GPP TS 04.60, subclauses 8.1.1.3.5 and 7.2.1.1.

42.2.3.2.3.3 Test purpose

Verify that an MS operating an uplink and downlink TBF in non half duplex mode can correctly respond to a PACKET TBF RELEASE by using the countdown procedure.

42.2.3.2.3.4 Method of test

Initial Conditions

System Simulator:

2 cells, GPRS supported, PCCCH not present.

Mobile Station:

The MS is in the state "idle, GMM-registered" with a P-TMSI allocated, SPLIT PG CYCLE negotiated, and PDP context 3 activated.

Specific PICS Statements

-

PIXIT Statements

-

Test Procedure

1. MS is triggered to begin an uplink data transfer and enters a fixed allocation open-ended TBF in non half duplex mode.
2. Before the current allocation expires, the MS receives a PACKET DOWNLINK ASSIGNMENT on the PACCH, with starting time before the current allocation expires.
3. Before the starting time occurs, the MS receives a PACKET TBF RELEASE.

4. The MS starts the downlink TBF during the countdown procedure, and ends the uplink TBF when the countdown procedure is over.

Maximum Duration of Test

5 minutes.

Expected Sequence

Step	Direction	Message	Comments
1	MS		Trigger the MS to initiate an uplink packet transfer containing 1000 octets.
2			Bring the MS into packet uplink transfer mode on cell A by the generic procedure defined in the table 42.2.1.2/1b or 42.2.1.2/2b.
3	MS -> SS	RLC DATA BLOCK	MS transmits RLC block only when TBF starting time occurs
4	MS -> SS	RLC DATA BLOCKS	MS continues to transmit RLC data blocks according to allocation from step 2.
5	SS -> MS	PACKET DOWNLINK ASSIGNMENT	With starting time before current uplink allocation expires. Sent on assigned PACCH.
6	MS -> SS	RLC DATA BLOCKS	Verify MS continues to transmit RLC data blocks from previous allocation.
7	SS -> MS	PACKET TBF RELEASE	Release of the uplink TBF. Sent when 200 octets left to send in the PDU. Cause value – normal release
8	MS -> SS	RLC DATA BLOCKS	MS starts countdown procedure so that uplink TBF ends at the LLC PDU boundary.
9	SS -> MS	RLC DATA BLOCKS	SS transmits RLC data blocks at the starting time
10	SS -> MS	PACKET UPLINK ACK/NACK	Final Ack = 1
11	MS -> SS	PACKET CONTROL ACKNOWLEDGEMENT	
12	MS -> SS	PACKET DOWNLINK ACK/NACK	Verify MS sends at least one Ack/Nack to verify it is receiving downlink RLC data blocks.

Specific Message Contents

PACKET UPLINK ASSIGNMENT message in step 2:

Fixed allocation	
- HALF_DUPLEX_MODE	0 – non half duplex TBF
- TIMESLOT_ALLOCATION	Two timeslots assigned – PDCH2 and PDCH3
- BLOCKS_OR_BLOCK_PERIODS	0 – blocks
- ALLOCATION_BITMAP_LENGTH	<any suitable value >
- ALLOCATION_BITMAP	Allocates 100 RLC blocks

PACKET DOWNLINK ASSIGNMENT message in step 5:

TIMESLOT_ALLOCATION	3 timeslots assigned – PDCH1, PDCH2 and PDCH3 (multislot class is not violated)
Frequency Parameters IE	
- TBF_STARTING_TIME	<some AFN before the current fixed allocation bitmap expires>

42.2.3.3 Fixed Allocation/ Uplink Transfer with Downlink TBF Establishment/ Abnormal cases

42.2.3.3.1 Fixed Allocation/ Uplink Transfer with Downlink TBF Establishment/ Abnormal cases / Violation of multi-slot capabilities

42.2.3.3.1.1 Void

42.2.3.3.1.2 Conformance Requirement

During an uplink fixed allocation TBF, the network may initiate a downlink TBF by sending the PACKET DOWNLINK ASSIGNMENT or PACKET TIMESLOT RECONFIGURE message on the PACCH.

- If the information in the PACKET TIMESLOT RECONFIGURE does not properly specify an uplink and downlink PDCH or violates the mobile station's multislot capabilities, the mobile station shall perform an abnormal release with random access (see subclause 8.7.2).

Abnormal Release with Random Access:

The mobile station shall abort all TBFs in progress and its associated resources, return to the CCCH or PCCCH and initiate establishment of a new uplink TBF as defined in subclause 7.1.

References

3GPP TS 04.60, subclauses 8.1.1.3.5, 8.1.1.3.5.1 and 8.7.2.

42.2.3.3.1.3 Test purpose

Verify that an MS in an uplink TBF performs abnormal release with random access upon receipt of a PACKET TIMESLOT RECONFIGURE message that violates its multislot capabilities.

42.2.3.3.1.4 Method of test

Initial Conditions

System Simulator:

2 cells, GPRS supported, PCCCH not present.

Mobile Station:

The MS is in the state "idle, GMM-registered" with a P-TMSI allocated, SPLIT PG CYCLE negotiated, and PDP context 3 activated.

Specific PICS Statements

-

PIXIT Statements

-

Test Procedure

1. MS is triggered to begin an uplink data transfer and enters a fixed allocation open-ended TBF in non half duplex mode on one PDCH.
2. Before the current allocation expires, the MS receives a PACKET TIMESLOT RECONFIGURE message on the PACCH, with downlink assignment violating its multislot class capabilities.
3. MS performs abnormal release (stops the uplink TBF in progress) with random access.

Maximum Duration of Test

5 minutes.

Expected Sequence

Step	Direction	Message	Comments
1	MS		Trigger the MS to initiate an uplink packet transfer containing 1000 octets.
2			Bring the MS into packet uplink transfer mode on cell A by the generic procedure defined in the table 42.2.1.2/1b.
3	MS -> SS	RLC DATA BLOCK	MS transmits RLC block only when TBF starting time occurs
4	MS -> SS	RLC DATA BLOCKS	MS continues to transmit RLC data blocks according to allocation from step 2.
5	SS -> MS	PACKET TIMESLOT RECONFIGURE	With downlink assignment violating the multislot class capabilities of the MS.
6	SS		Verify MS does not transmit on previously assigned PDCH.
7	MS -> SS	CHANNEL REQUEST	Sent on cell A.

Specific Message Contents

Based on the multislot class of the MS, assign uplink and downlink timeslots as follows in order to violate the multislot class of the MS by violating the Ttb parameter.

Multislot Class	RX slots assigned	TX slots assigned
1	1	0
2	2, 3	2
3	0, 1	0
4	1, 2, 3	1
5	1, 2	0, 1
6	1, 2, 3	1
7	1, 2, 3	1
8	2, 3, 4, 5	3
9	1, 2, 3	1, 2
10	1, 2, 3, 4	2
11	1, 2, 3, 4	2
12	1, 2, 3, 4	2

PACKET UPLINK ASSIGNMENT message in step 2:

Fixed allocation - HALF_DUPLEX_MODE - TIMESLOT ALLOCATION - BLOCKS_OR_BLOCK_PERIODS - ALLOCATION_BITMAP_LENGTH - ALLOCATION_BITMAP	0 – non half duplex TBF <see above chart> 0 – blocks <any suitable value > Allocates 100 RLC blocks
---	---

PACKET TIMESLOT RECONFIGURE message in step 5:

DOWNLINK_TIMESLOT_ALLOCATION Frequency Parameters IE - TBF_STARTING_TIME	<see above chart> <some AFN before the current fixed allocation bitmap expires>
--	--

42.2.3.3.2 Fixed Allocation/ Uplink Transfer with Downlink TBF Establishment/ Abnormal cases / No defined PDCH

42.2.3.3.2.1 Void

42.2.3.3.2.2 Conformance Requirement

During an uplink fixed allocation TBF, the network may initiate a downlink TBF by sending the PACKET DOWNLINK ASSIGNMENT or PACKET TIMESLOT RECONFIGURE message on the PACCH.

- If the information available in the mobile station, after the reception of a PACKET DOWNLINK ASSIGNMENT message does not satisfactorily define a PDCH, the mobile station shall ignore the PACKET DOWNLINK ASSIGNMENT message.

References

3GPP TS 04.60, subclause 8.1.1.3.5 and 8.1.1.3.5.1.

42.2.3.3.2.3 Test purpose

Verify that an MS in an uplink TBF ignores a PACKET DOWNLINK ASSIGNMENT message that does not define a PDCH.

42.2.3.3.2.4 Method of test

Initial Conditions

System Simulator:

2 cells, GPRS supported, PCCCH not present.

Mobile Station:

The MS is in the state "idle, GMM-registered" with a P-TMSI allocated, SPLIT PG CYCLE negotiated, and PDP context 3 activated.

Specific PICS Statements

-

PIXIT Statements

-

Test Procedure

1. MS is triggered to begin an uplink data transfer and enters a fixed allocation open-ended TBF in non half duplex mode on one PDCH.
2. Before the current allocation expires, the MS receives a PACKET DOWNLINK ASSIGNMENT message on the PACCH, with no defined PDCH.
3. MS continues uplink TBF and does not begin a downlink TBF.

Maximum Duration of Test

5 minutes.

Expected Sequence

Step	Direction	Message	Comments
1	MS		Trigger the MS to initiate an uplink packet transfer containing 1000 octets.
2			Bring the MS into packet uplink transfer mode on cell A by the generic procedure defined in the table 42.2.1.2/1b or 42.2.1.2/2b.
3	MS -> SS	RLC DATA BLOCK	MS transmits RLC block only when TBF starting time occurs
4	MS -> SS	RLC DATA BLOCKS	MS continues to transmit RLC data blocks according to allocation from step 2.
5	SS -> MS	PACKET DOWNLINK ASSIGNMENT	With insufficiently defined PDCH in the message.
6	MS -> SS	RLC DATA BLOCKS	MS continues to transmit RLC data blocks according to allocation from step 2.

Specific Message Contents

PACKET UPLINK ASSIGNMENT message in step 2:

Fixed allocation - HALF_DUPLEX_MODE - TIMESLOT_ALLOCATION - BLOCKS_OR_BLOCK_PERIODS - ALLOCATION_BITMAP_LENGTH - ALLOCATION_BITMAP	0 – non half duplex TBF One timeslot assigned 0 – blocks <any suitable value > Allocates 100 RLC blocks
---	---

PACKET DOWNLINK ASSIGNMENT message in step 5:

DOWNLINK_TIMESLOT_ALLOCATION Frequency Parameters IE - ARFCN	<one timeslot, such that multislot class is not violated> 300 (invalid ARFCN)
--	--

42.2.4 Fixed Allocation / Downlink Transfer with Uplink TBF Establishment

42.2.4.1 Void

42.2.4.2 Fixed Allocation/ Downlink Transfer with Uplink TBF Establishment/ Packet Uplink Assignment

42.2.4.2.1 Fixed Allocation/ Downlink Transfer with Uplink TBF Establishment/ Packet Uplink Assignment/ Non half-duplex

42.2.4.2.1.1 Void

42.2.4.2.1.2 Conformance Requirement

The mobile station may request establishment of an uplink transfer during a downlink TBF by including a Channel Request Description information element in the PACKET DOWNLINK ACK/NACK message. Initiation is triggered by a request from upper layers to transfer a LLC PDU. The request from upper layers specifies a Radio Priority to be associated with the packet transfer. Upon such a request:

- if access to the network is allowed, according to the latest values for authorized special access classes that the mobile station has received (see subclause 7.1.1), the mobile station shall initiate the packet access procedure.
- otherwise, the RR sublayer in the mobile station shall reject the request.

The mobile station initiates the packet access procedure by sending the Channel Request Description information element in the PACKET DOWNLINK ACK/NACK message on the PACCH and starting timer T3168.

On receipt of a PACKET UPLINK ASSIGNMENT or PACKET TIMESLOT RECONFIGURE message the mobile station shall follow the procedure below. On reception of a complete uplink assignment the mobile station shall stop timer T3168.

If the mobile station is not assigned to operate half duplex mode, the mobile station shall, after expiry of the TBF starting time, if present, act upon the complete uplink assignment.

The mobile station shall then switch to the assigned uplink PDCHs and begin to send RLC data blocks on the assigned PDCH(s). The TLLI shall not be included in any of the uplink RLC data blocks in that case.

References

3GPP TS 04.60, subclause 8.1.2.5.

42.2.4.2.1.3 Test purpose

Verify that during a downlink TBF, when the MS requests uplink resources, that the MS obeys the uplink assignment while maintaining the downlink TBF.

42.2.4.2.1.4 Method of test

Initial Conditions

System Simulator:

2 cells, GPRS supported, PCCCH present.

Mobile Station:

The MS is in the state "idle, GMM-registered" with a P-TMSI allocated, SPLIT PG CYCLE negotiated, and PDP context 3 activated.

Specific PICS Statements

-

PIXIT Statements

-

Test Procedure

1. MS receives a PACKET DOWNLINK ASSIGNMENT message on its assigned PCCCH, containing no starting time.
2. SS transmits downlink RLC data blocks for the downlink allocation, 1 in 10 specifying RRBP field (polling).
3. MS responds by sending PACKET DOWNLINK ACK/NACK messages in response to the polls.
4. MS is triggered to begin an uplink transfer.
5. MS sends next PACKET DOWNLINK ACK/NACK message with a Channel Request Description field.
6. MS receives a PACKET UPLINK ASSIGNMENT message.
7. MS acts on the PACKET UPLINK ASSIGNMENT, and enters a concurrent TBF.

Maximum Duration of Test

5 minutes.

Expected Sequence

Step	Direction	Message	Comments
1	SS -> MS	PACKET DOWNLINK ASSIGNMENT	Triggers the MS to switch to assigned PDCH. (no starting time)
2	SS -> MS	RLC DATA BLOCKS	Starting 3 blocks after the previous message, on assigned PDCH, addressed to MS, 1 in 10 with valid RRB field (polling).
3	MS -> SS	PACKET DOWNLINK ACK/NACK	MS acknowledges the previously received RLC data blocks.
4			Steps 2 and 3 are repeated throughout until step 8.
5	MS		MS is triggered to begin an uplink data transfer.
6	MS -> SS	PACKET DOWNLINK ACK/NACK	Message contains Channel Request Description IE. - MS starts timer T3168
7			Steps 2 and 3 are repeated until the next Channel Request Description is sent in step 8.
8	SS -> MS	PACKET UPLINK ASSIGNMENT	Sent (0.5*T3168) seconds after step 7. Allocates one uplink PDCH.
9	MS -> SS	RLC DATA BLOCK	Verify MS sends data block on uplink resource assigned in step 8 at the starting time.
10	SS -> MS	RLC DATA BLOCK	In same block as step 9: with valid RRB field (polling)
11	MS -> SS	RLC DATA BLOCKS	Verify MS sends data block on uplink resource assigned in step 8 (next block following step 9).
12	MS -> SS	PACKET DOWNLINK ACK/NACK	In block specified by step 10. (4 th block of allocation assigned in step 8)
13	SS		Verify no uplink data sent by MS in 5 th and 6 th blocks of allocation assigned in step 8.
14	MS -> SS	RLC DATA BLOCK	Sent in 7 th block of uplink allocation assigned in step 8.
15	SS -> MS	RLC DATA BLOCK	Sent in 7 th block of allocation (same block as step 14) With valid RRB field (polling).
16	MS -> SS	RLC DATA BLOCK	Sent in 8 th and 9 th block of uplink allocation assigned in step 8.
17	MS -> SS	PACKET DOWNLINK ACK/NACK	Sent in 10 th block of allocation, in response to poll from step 15.

PACKET DOWNLINK ASSIGNMENT message in step 1:

TIMESLOT_ALLOCATION	10000000
TBF STARTING TIME	<IE not present>

PACKET UPLINK ASSIGNMENT message in step 8:

TBF STARTING TIME	<some suitable value within 100 frames of current frame>
Fixed allocation	
- TIMESLOT ALLOCATION	10000000
- BLOCKS_OR_BLOCK_PERIODS	0 – blocks
- ALLOCATION_BITMAP_LENGTH	10
- ALLOCATION_BITMAP	0111000011

DOWNLINK RLC DATA BLOCK in step 10 and 15:

RRBP	00 – Response shall be sent by MS in N+13 frames.
S/P	1 – RRB field is valid

42.2.4.2.2 Fixed Allocation/ Downlink Transfer with Uplink TBF Establishment/ Packet Uplink Assignment/ Half-duplex

42.2.4.2.2.1 Void

42.2.4.2.2.2 Conformance Requirement

The mobile station may request establishment of an uplink transfer during a downlink TBF by including a Channel Request Description information element in the PACKET DOWNLINK ACK/NACK message. Initiation is triggered by a request from upper layers to transfer a LLC PDU. The request from upper layers specifies a Radio Priority to be associated with the packet transfer. Upon such a request:

- if access to the network is allowed, according to the latest values for authorized special access classes that the mobile station has received (see subclause 7.1.1), the mobile station shall initiate the packet access procedure;
- otherwise, the RR sublayer in the mobile station shall reject the request.

The mobile station initiates the packet access procedure by sending the Channel Request Description information element in the PACKET DOWNLINK ACK/NACK message on the PACCH and starting timer T3168.

On receipt of a PACKET UPLINK ASSIGNMENT or PACKET TIMESLOT RECONFIGURE message the mobile station shall follow the procedure below. On reception of a complete uplink assignment the mobile station shall stop timer T3168.

If the mobile station is assigned to operate in half duplex mode, the mobile station shall, after expiry of the TBF starting time, if present, stop the downlink TBF, save the RLC state variables associated with the downlink TBF and save the state of the following timers:

T3190 - Wait for Valid Downlink Data Received from the Network.

T3192 - Wait for Release of the TBF after reception of the final block.

The mobile station shall then switch to the assigned uplink PDCHs and begin to send RLC data blocks on the assigned PDCH(s). The TLLI shall not be included in any of the uplink RLC data blocks in that case.

References

3GPP TS 04.60, subclause 8.1.2.5.

42.2.4.2.2.3 Test purpose

Verify that during a downlink TBF, when the MS requests additional resources, that the MS stops the downlink TBF when the uplink TBF is assigned to operate in half-duplex mode.

42.2.4.2.2.4 Method of test

Initial Conditions

System Simulator:

2 cells, GPRS supported, PCCCH present.

Mobile Station:

The MS is in the state "idle, GMM-registered" with a P-TMSI allocated, SPLIT PG CYCLE negotiated, and PDP context 3 activated.

Specific PICS Statements

-

PIXIT Statements

-

Test Procedure

1. MS receives a PACKET DOWNLINK ASSIGNMENT message on its assigned PCCCH, containing no starting time.
2. SS transmits downlink RLC data blocks for the downlink allocation, 1 in 10 specifying RRBP field (polling).
3. MS responds by sending PACKET DOWNLINK ACK/NACK messages in response to each poll.
4. MS is triggered to begin an uplink transfer.
5. MS sends next PACKET DOWNLINK ACK/NACK message with a Channel Request Description field.
6. MS receives a PACKET UPLINK ASSIGNMENT message.
7. MS acts on the PACKET UPLINK ASSIGNMENT, by stopping the downlink TBF, and starting the uplink TBF.

Maximum Duration of Test

5 minutes.

Expected Sequence

Step	Direction	Message	Comments
1	SS -> MS	PACKET DOWNLINK ASSIGNMENT	Triggers the MS to switch to assigned PDCH. (no starting time)
2	SS -> MS	RLC DATA BLOCKS	Starting 3 blocks after the previous message, on assigned PDCH, addressed to MS, 1 in 10 with valid RRBP field (polling).
3	MS -> SS	PACKET DOWNLINK ACK/NACK	MS acknowledges the previously received RLC data blocks.
4			Steps 2 and 3 are repeated throughout until step 8.
5	MS		MS is triggered to begin an uplink data transfer.
6	MS -> SS	PACKET DOWNLINK ACK/NACK	Message contains Channel Request Description IE - MS starts timer T3168
7			Steps 2 and 3 are repeated as often as necessary until step 8.
8	SS -> MS	PACKET UPLINK ASSIGNMENT	Sent (.5*T3168) seconds after step 7. Allocates one uplink PDCH.
9	MS -> SS	RLC DATA BLOCK	Verify MS sends data block on uplink resource assigned in step 8 at the starting time.
10	SS -> MS	RLC DATA BLOCK	In same block as step 9: with valid RRBP field (polling)
11	MS -> SS	RLC DATA BLOCK	Verify MS sends data block on uplink resource assigned in step 8 (next block following step 9).
12	SS		Verify MS does not send DOWNLINK ACK/NACK in response to downlink data block in step 10.
13	SS		Verify no uplink data sent by MS in 5 th and 6 th blocks of allocation assigned in step 8.
14	MS -> SS	RLC DATA BLOCK	Sent in 7 th block of uplink allocation assigned in step 8.
15	SS -> MS	RLC DATA BLOCK	Sent in 7 th block of allocation (same block as step 14) With valid RRBP field (polling).
16	MS -> SS	RLC DATA BLOCKS	Sent in 8 th and 9 th block of uplink allocation assigned in step 8.
17	SS		Verify MS does not send DOWNLINK ACK/NACK in response to downlink data block in step 15.

PACKET DOWNLINK ASSIGNMENT message in step 1:

TIMESLOT_ALLOCATION	10000000
TBF STARTING TIME	<IE not present>

PACKET UPLINK ASSIGNMENT message in step 8:

TBF STARTING TIME	<some suitable value within 100 frames of current frame>
Fixed allocation	
- HALF_DUPLEX_MODE	1 – MS operates in half-duplex mode
- TIMESLOT_ALLOCATION	10000000
- BLOCKS_OR_BLOCK_PERIODS	0 – blocks
- ALLOCATION_BITMAP_LENGTH	10
- ALLOCATION_BITMAP	0111000011

DOWNLINK RLC DATA BLOCK in step 10 and 15:

RRBP	00 – Response shall be sent by MS in N+13 frames.
S/P	1 – RRBP field is valid

42.2.4.3 Fixed Allocation/ Downlink Transfer with Uplink TBF Establishment/ Packet Timeslot Reconfigure

42.2.4.3.1 Fixed Allocation/ Downlink Transfer with Uplink TBF Establishment/ Packet Timeslot Reconfigure/ Starting time with AFN encoding

42.2.4.3.1.1 Void

42.2.4.3.1.2 Conformance Requirement

The mobile station may request establishment of an uplink transfer during a downlink TBF by including a Channel Request Description information element in the PACKET DOWNLINK ACK/NACK message. Initiation is triggered by a request from upper layers to transfer a LLC PDU. The request from upper layers specifies a Radio Priority to be associated with the packet transfer. Upon such a request:

- if access to the network is allowed, according to the latest values for authorized special access classes that the mobile station has received (see subclause 7.1.1), the mobile station shall initiate the packet access procedure;
- otherwise, the RR sublayer in the mobile station shall reject the request.

The mobile station initiates the packet access procedure by sending the Channel Request Description information element in the PACKET DOWNLINK ACK/NACK message on the PACCH and starting timer T3168.

On receipt of a PACKET UPLINK ASSIGNMENT or PACKET TIMESLOT RECONFIGURE message the mobile station shall follow the procedure below. On reception of a complete uplink assignment the mobile station shall stop timer T3168.

If the mobile station is not assigned to operate half duplex mode, the mobile station shall, after expiry of the TBF starting time, if present, act upon the complete uplink assignment.

The mobile station shall then switch to the assigned uplink PDCHs and begin to send RLC data blocks on the assigned PDCH(s). The TLLI shall not be included in any of the uplink RLC data blocks in that case.

References

3GPP TS 04.60, subclause 8.1.2.5.

42.2.4.3.1.3 Test purpose

Verify that during a downlink TBF, when the MS requests uplink resources, that the MS obeys the PACKET TIMESLOT RECONFIGURE message at the starting time and enters the uplink TBF.

42.2.4.3.1.4 Method of test

Initial Conditions

System Simulator:

2 cells, GPRS supported, PCCCH present.

Mobile Station:

The MS is in the state "idle, GMM-registered" with a P-TMSI allocated, SPLIT PG CYCLE negotiated, and PDP context 3 activated.

Specific PICS Statements

-

PIXIT Statements

-

Test Procedure

1. MS receives a PACKET DOWNLINK ASSIGNMENT message on its assigned PCCCH, containing no starting time.
2. SS transmits downlink RLC data blocks for the downlink allocation, 1 in 10 specifying RRBP field (polling).
3. MS responds by sending PACKET DOWNLINK ACK/NACK messages in response to each poll.
4. MS is triggered to begin an uplink transfer.
5. MS sends next PACKET DOWNLINK ACK/NACK message with a Channel Request Description field.
6. MS receives a PACKET TIMESLOT RECONFIGURE message.
7. MS acts on the PACKET TIMESLOT RECONFIGURE at the appropriate starting time and enters a concurrent TBF.

Maximum Duration of Test

5 minutes.

Expected Sequence

Step	Direction	Message	Comments
1	SS -> MS	PACKET DOWNLINK ASSIGNMENT	Triggers the MS to switch to assigned PDCH. (no starting time)
2	SS -> MS	RLC DATA BLOCKS	
3	MS -> SS	PACKET DOWNLINK ACK/NACK	Starting 3 blocks after the previous message, on assigned PDCH, addressed to MS, 1 in 10 with valid RRB field (polling). MS acknowledges the previously received RLC data blocks.
4			
5	MS		Steps 2 and 3 are repeated throughout until step 8.
6	MS -> SS	PACKET DOWNLINK ACK/NACK	MS is triggered to begin an uplink data transfer. Message contains Channel Request Description IE. - MS starts timer T3168
7			Steps 2 and 3 are repeated as often as necessary until step 8.
8	SS -> MS	PACKET TIMESLOT RECONFIGURE	Sent (0.5*T3168) seconds after step 7. Allocates one uplink PDCH.
9	MS -> SS	RLC DATA BLOCK	Verify MS sends data block on uplink resource assigned in step 8 at the starting time.
10	SS -> MS	RLC DATA BLOCK	In same block as step 9: with valid RRB field (polling)
11	MS -> SS	RLC DATA BLOCK	Verify MS sends data block on uplink resource assigned in step 8 (next block following step 9).
12	MS -> SS	PACKET DOWNLINK ACK/NACK	In block specified by step 10. (4 th block of allocation assigned in step 8)
13	SS		Verify no uplink data sent by MS in 5 th and 6 th blocks of allocation assigned in step 8.
14	MS -> SS	RLC DATA BLOCK	Sent in 7 th block of uplink allocation assigned in step 8.
15	SS -> MS	RLC DATA BLOCK	Sent in 7 th block of allocation (same block as step 14) With valid RRB field (polling).
16	MS -> SS	RLC DATA BLOCKS	Sent in 8 th and 9 th block of uplink allocation assigned in step 8.
17	MS -> SS	PACKET DOWNLINK ACK/NACK	Sent in 10 th block of allocation, in response to poll from step 15.

PACKET DOWNLINK ASSIGNMENT message in step 1:

TIMESLOT_ALLOCATION	10000000
TBF STARTING TIME	<IE not present>

PACKET TIMESLOT RECONFIGURE message in step 8:

TBF STARTING TIME	0 – AFN encoding
- AFN	<some AFN within 50 frames of current AFN>
Fixed allocation	
- TIMESLOT_ALLOCATION	10000000
- BLOCKS_OR_BLOCK_PERIODS	0 – blocks
- ALLOCATION_BITMAP_LENGTH	10
- ALLOCATION_BITMAP	0111000011
Downlink Allocation	Same as already assigned

DOWNLINK RLC DATA BLOCK in step 10 and 15:

RRBP	00 – Response shall be sent by MS in N+13 frames.
S/P	1 – RRB field is valid

42.2.4.3.2 Fixed Allocation/ Downlink Transfer with Uplink TBF Establishment/ Packet Timeslot Reconfigure/ Starting time with relative encoding

42.2.4.3.2.1 Void

42.2.4.3.2.2 Conformance Requirement

The mobile station may request establishment of an uplink transfer during a downlink TBF by including a Channel Request Description information element in the PACKET DOWNLINK ACK/NACK message. Initiation is triggered by a request from upper layers to transfer a LLC PDU. The request from upper layers specifies a Radio Priority to be associated with the packet transfer. Upon such a request:

- if access to the network is allowed, according to the latest values for authorized special access classes that the mobile station has received (see subclause 7.1.1), the mobile station shall initiate the packet access procedure;
- otherwise, the RR sublayer in the mobile station shall reject the request.

The mobile station initiates the packet access procedure by sending the Channel Request Description information element in the PACKET DOWNLINK ACK/NACK message on the PACCH and starting timer T3168.

On receipt of a PACKET UPLINK ASSIGNMENT or PACKET TIMESLOT RECONFIGURE message the mobile station shall follow the procedure below. On reception of a complete uplink assignment the mobile station shall stop timer T3168.

If the mobile station is not assigned to operate half duplex mode, the mobile station shall, after expiry of the TBF starting time, if present, act upon the complete uplink assignment.

The mobile station shall then switch to the assigned uplink PDCHs and begin to send RLC data blocks on the assigned PDCH(s). The TLLI shall not be included in any of the uplink RLC data blocks in that case.

References

3GPP TS 04.60, subclause 8.1.2.5.

42.2.4.3.2.3 Test purpose

Verify that during a downlink TBF, when the MS requests uplink resources, that the MS obeys the PACKET TIMESLOT RECONFIGURE message at the starting time and enters the uplink TBF.

42.2.4.3.2.4 Method of test

Initial Conditions

System Simulator:

2 cells, GPRS supported, PCCCH present.

Mobile Station:

The MS is in the state "idle, GMM-registered" with a P-TMSI allocated, SPLIT PG CYCLE negotiated, and PDP context 3 activated.

Specific PICS Statements

-

PIXIT Statements

-

Test Procedure

1. MS receives a PACKET DOWNLINK ASSIGNMENT message on its assigned PCCCH, containing no starting time.
2. SS transmits downlink RLC data blocks for the downlink allocation, 1 in 10 specifying RRB field (polling).

3. MS responds by sending PACKET DOWNLINK ACK/NACK messages in response to each poll.
4. MS is triggered to begin an uplink transfer.
5. MS sends next PACKET DOWNLINK ACK/NACK message with a Channel Request Description field.
6. MS receives a PACKET TIMESLOT RECONFIGURE message.
7. MS acts on the PACKET TIMESLOT RECONFIGURE message at the starting time and enters a concurrent TBF.

Maximum Duration of Test

5 minutes.

Expected Sequence

Step	Direction	Message	Comments
1	SS -> MS	PACKET DOWNLINK ASSIGNMENT	Triggers the MS to switch to assigned PDCH. (no starting time)
2	SS -> MS	RLC DATA BLOCKS	Starting 3 blocks after the previous message, on assigned PDCH, addressed to MS, 1 in 10 with valid RRBP field (polling).
3	MS -> SS	PACKET DOWNLINK ACK/NACK	MS acknowledges the previously received RLC data blocks.
4			Steps 2 and 3 are repeated throughout until step 8.
5	MS		MS is triggered to begin an uplink data transfer.
6	MS -> SS	PACKET DOWNLINK ACK/NACK	Message contains Channel Request Description IE. - MS starts timer T3168
7			Steps 2 and 3 are repeated as often as necessary until step 8.
8	SS -> MS	PACKET TIMESLOT RECONFIGURE	Sent (0.5*T3168) seconds after step 7. Allocates one uplink PDCH.
9	MS -> SS	RLC DATA BLOCKS	Verify MS sends data block on uplink resource assigned in step 8 at the starting time.
10	SS -> MS	RLC DATA BLOCK	In same block as step 9: with valid RRBP field (polling)
11	MS -> SS	RLC DATA BLOCK	Verify MS sends data block on uplink resource assigned in step 8 (next block following step 9).
12	MS -> SS	PACKET DOWNLINK ACK/NACK	In block specified by step 10. (4 th block of allocation assigned in step 8)
13	SS		Verify no uplink data sent by MS in 5 th and 6 th blocks of allocation assigned in step 8.
14	MS -> SS	RLC DATA BLOCK	Sent in 7 th block of uplink allocation assigned in step 8.
15	SS -> MS	RLC DATA BLOCK	Sent in 7 th block of allocation (same block as step 14) With valid RRBP field (polling).
16	MS -> SS	RLC DATA BLOCKS	Sent in 8 th and 9 th block of uplink allocation assigned in step 8.
17	MS -> SS	PACKET DOWNLINK ACK/NACK	Sent in 10 th block of allocation, in response to poll from step 15.

PACKET DOWNLINK ASSIGNMENT message in step 1:

TIMESLOT_ALLOCATION	10000000
TBF STARTING TIME	<IE not present>

PACKET TIMESLOT RECONFIGURE message in step 8:

TBF STARTING TIME	1 – Relative FN encoding
- AFN	<some AFN within 50 frames of current AFN>
Fixed allocation	
- TIMESLOT_ALLOCATION	10000000
- BLOCKS_OR_BLOCK_PERIODS	0 – blocks
- ALLOCATION_BITMAP_LENGTH	10
- ALLOCATION_BITMAP	0111000011

DOWNLINK RLC DATA BLOCK in step 10 and 15:

RRBP S/P	00 – Response shall be sent by MS in N+13 frames. 1 – RRBP field is valid
-------------	--

42.2.4.4 Void

42.2.5 Default message contents

42.2.5.1 Default message contents

The following default values of messages and the default contents of messages defined in clause 40 are used in subclause 42.2. Unless indicated otherwise in subclause 42.2 these shall be transmitted by the system simulator.

In this clause, decimal values are normally used. However, sometimes a hexadecimal value, indicated by an "Hex", or a binary value, indicated by a "Binary" is used.

Get rid of all uplink messages.

PACKET CHANNEL REQUEST message:

Access Type	"One phase access request" or "Two phase access request"
Multislot class	Not checked
Radio priority	Not checked
Random Reference	Not checked.

PACKET CONTROL ACKNOWLEDGEMENT message:

MESSAGE_TYPE	000001
TLLI	not checked
CTRL_ACK	not checked
spare padding	Spare Padding

PACKET DOWNLINK ASSIGNMENT message:

MESSAGE_TYPE	000100
PAGE_MODE	Normal Paging
Referenced Address	
-	1 (address is TLLI)
- TLLI	same as the value received from MS
MAC_MODE	Fixed Allocation
RLC_MODE	acknowledged mode
CONTROL_ACK	0
TIMESLOT_ALLOCATION	Assigns slot 0
REL_OR_ABS_FN	Absolute FN
Packet Timing Advance	
- {0 1<TIMING_ADVANCE_VALUE>}	1 (timing advance value)
- TIMING_ADVANCE_VALUE	30 bit periods
- {0 1<TIMING_ADVANCE_INDEX>	0 (no timing advance index)
<TIMING_ADVANCE_TIMESLOT_NUMBER >}	
{L H<Frequency Parameters>}	1 (Frequency Parameters present)
- Frequency Parameters	
- TSC	value arbitrarily chosen from valid values (default 5)
-	00 (ARFCN no hopping)
- ARFCN	For GSM 900, 30
	For DCS 1 800, 650
	For PCS 1 900, 650
	For GSM 700, 467
	For GSM 850, 157
{L H<Power Control Parameters>}	H (Power Control Parameters present)
- ALPHA	0.5
- {0 1<GAMMA_TN0>}	depending on the value in TIMESLOT_ALLOCATION
	(default 0 no GAMMA_TN0)
- {0 1<GAMMA_TN1>}	depending on the value in TIMESLOT_ALLOCATION
	(default 0 no GAMMA_TN1)
- {0 1<GAMMA_TN2>}	depending on the value in TIMESLOT_ALLOCATION
	(default 1 GAMMA_TN2)
- GAMMA_TN2	For GSM 700, GSM 850 and GSM 900, +8 dBm
	For DCS 1 800, +6 dBm
	For PCS 1 900, +6 dBm
- {0 1<GAMMA_TN3>}	depending on the value in TIMESLOT_ALLOCATION
	(default 0 no GAMMA_TN0)
- {0 1<GAMMA_TN4>}	depending on the value in TIMESLOT_ALLOCATION
	(default 0 no GAMMA_TN4)
- {0 1<GAMMA_TN5>}	depending on the value in TIMESLOT_ALLOCATION
	(default 0 no GAMMA_TN5)
- {0 1<GAMMA_TN6>}	depending on the value in TIMESLOT_ALLOCATION
	(default 0 no GAMMA_TN6)
- {0 1<GAMMA_TN7>}	depending on the value in TIMESLOT_ALLOCATION
	(default 0 no GAMMA_TN7)
{L H<DOWNLINK_TFI_ASSIGNMENT>}	H (assign downlink TFI)
- DOWNLINK_TFI_ASSIGNMENT	arbitrarily chosen from valid values (default 3)
{L H<TBF_STARTING_TIME>}	H (starting time present)
- TBF_STARTING_TIME	indicating (current frame + 13 frames)
{L H<Measurement Mapping>}	L (no measurement mapping)
Spare padding	Spare Padding

PACKET DOWNLINK DUMMY CONTROL BLOCK message:

MESSAGE_TYPE	010000
PAGE_MODE	Normal Paging
Spare padding	Spare Padding

PACKET PAGING REQUEST message:

MESSAGE_TYPE	000101
PAGE_MODE	Normal Paging
{L H<PERSISTENCE_LEVEL>}	L (no persistence level present)
{L H<NLN>}	L (no notification list number)
{H <Repeated Page info>}	H (start of Repeated Page info)
-	L (Page request for TBF establishment)
-	L (PTMSI)
- PTMSI	P-TMSI allocated during GPRS attach procedure
-	L (end of Repeated Page info)
Spare padding	Spare Padding

PACKET TIMESLOT RECONFIGURE message:

MESSAGE_TYPE	001011
GLOBAL_TFI	the TFI value of the uplink TBF or downlink TBF which this message applies (default 00101)
CHANNEL_CODING_COMMAND	arbitrarily chosen from valid values (default CS-1)
Global Packet Timing Advance	
- {0 1<TIMING_ADVANCE_VALUE>}	1 (timing advance value)
- TIMING_ADVANCE_VALUE	30 bit periods
- {0 1<UPLINK_TIMING_ADVANCE_INDEX>	0 (no uplink timing advance index)
<UPLINK_TIMING_ADVANCE_TIMESLOT_NUMBER>}	
- {0 1<DOWNLINK_TIMING_ADVANCE_INDEX>	0 (no downlink timing advance index)
<DOWNLINK_TIMING_ADVANCE_TIMESLOT_NUMBER>}	
DOWNLINK_RLC_MODE	unacknowledged mode
CONTROL_ACK	0
{L H<GLOBAL_TFI_ASSIGNMENT>	L (not assign new TFI)
<REL_OR_ABS_FN>}	
DOWNLINK_TIMESLOT_ALLOCATION	arbitrarily chosen from valid values (default 2)
{L H<Frequency Parameters>}	L (use current parameters)
	H (Fixed allocation)
Fixed Allocation	
- Uplink timeslot allocation	0 – uplink timeslot allocation
- FINAL_ALLOCATION	0
- DOWNLINK_CONTROL_TIMESLOT	000 – PDCH0.
- Starting Frame Number Desc IE	0 (AFN encoding) (indicating current frame + 104)
- BLOCKS_OR_BLOCK_PERIODS	1 – Block Periods
spare padding	Spare Padding

PACKET UPLINK ACK/NACK message:

MESSAGE_TYPE	001101
UPLINK_TFI	same as the TFI value of the TBF which the message applies
CHANNEL_CODING_COMMAND	same as the coding scheme of the TBF which the message applies
Ack/Nack Description	
- FINAL_ACK_INDICATION	0 (not a final ACK)
- STARTING_SEQUENCE_NUMBER	V(R)
- RECEIVED_BLOCK_BITMAP	acknowledges all data blocks transmitted by the MS
{L H<CONTENTION_RESOLUTION_TLLI>}	L (no contention resolution TLLI)
{L H<Packet Timing Advance>}	L (no packet timing advance)
{L H<Power Control Parameters>}	L (no power control parameters)
{L H<Fixed Allocation parameters>}	L (no fixed allocation parameters present)
spare padding	Spare Padding

PACKET UPLINK ASSIGNMENT message (fixed allocation):

MESSAGE_TYPE	001110
PAGE_MODE	Normal Paging
Referenced Address	
-	1 (not Global TFI)
-	0 (TLLI)
- TLLI	the value received from the MS
CHANNEL_CODING_COMMAND	arbitrarily chosen from the valid values (default CS-1)
TLLI_BLOCK_CHANNEL_CODING	arbitrarily chosen but different from CHANNEL_CODING_COMMAND
REL_OR_ABS_FN	Absolute FN
Packet Timing Advance	
- {0 1}<TIMING_ADVANCE_VALUE>	1 (timing advance value)
- TIMING_ADVANCE_VALUE	30 bit periods
- {0 1}<TIMING_ADVANCE_INDEX>	0 (no timing advance index)
<TIMING_ADVANCE_TIMESLOT_NUMBER >	
{L H}<Frequency Parameters>	H (Frequency Parameters present)
- Frequency Parameters	
- TSC	arbitrarily chosen (default 5)
-	00 (ARFCN no hopping)
- ARFCN	For GSM 900, 30
	For DCS 1 800, 650
	For GSM 700, 467
	For GSM 850, 157
	H (Fixed allocation)
Fixed Allocation:	
- Uplink timeslot allocation	0 – uplink timeslot allocation
- FINAL_ALLOCATION	0
- DOWNLINK_CONTROL_TIMESLOT	000 – PDCH0.
- Starting Frame Number Desc IE	0 (AFN encoding) (indicating current frame + 104)
- BLOCKS_OR_BLOCK_PERIODS	1 – Block Periods
spare padding	Spare Padding

PACKET UPLINK ASSIGNMENT message (single block allocation):

MESSAGE_TYPE	001110
PAGE_MODE	Normal Paging
Referenced Address	
-	1 (not Global TFI)
-	1 (not TLLI)
-	1 (not TQI)
-	1 (Packet Request Reference)
- Packet Request	information field sent in PACKET CHANNEL REQUEST and frame number in which PACKET CHANNEL REQUEST was received
Reference	arbitrarily chosen (default CS-1)
CHANNEL_CODING_COMMAND	arbitrarily chosen but different from CHANNEL_CODING_COMMAND
TLLI_BLOCK_CHANNEL_CODING	Absolute FN
REL_OR_ABS_FN	
Packet Timing Advance	
- {0}1<TIMING_ADVANCE_VALUE>	1 (timing advance value)
- TIMING_ADVANCE_VALUE	30 bit periods
- {0}1<TIMING_ADVANCE_INDEX>	0 (no timing advance index)
<TIMING_ADVANCE_TIMESLOT_NUMBER >	
{L H<Frequency Parameters>	H (Frequency Parameters present)
- Frequency Parameters	
- TSC	arbitrarily chosen (default 5)
-	00 (ARFCN no hopping)
- ARFCN	For GSM 900, 30
	For DCS 1 800, 650
	For PCS 1 900, 650
	For GSM 700, 467
	For GSM 850, 157
	LH (Single block allocation)
Single block allocation	
- TIMESLOT_NUMBER	arbitrarily chosen (default slot 2)
-	H (power control parameters)
- ALPHA	0.5
- GAMMA_TN	For GSM 700, GSM 850 and GSM 900, +8 dBm
	For DCS 1 800, +6 dBm
	For PCS 1 900, +6 dBm
- TBF_STARTING_TIME	indicating (current frame + 91 frames)
spare pending	Spare pending

PACKET POWER CONTROL/TIMING ADVANCE message

MESSAGE_TYPE	000101
PAGE_MODE	Normal Paging
Referenced Address	
-	1 (not Global TFI)
-	0 (TLLI)
- TLLI	the value received from the MS
Message escape	0
Global Power Control Parameters	0 (no Global power Control parameters)
Global Packet Timing Advance	
- {0 1<TIMING_ADVANCE_VALUE>}	1 (timing advance value)
- TIMING_ADVANCE_VALUE	30 bit periods
- {0 1<TIMING_ADVANCE_INDEX>	0 (no timing advance index)
<TIMING_ADVANCE_TIMESLOT_NUMBER >}	

ATTACH ACCEPT message:

Protocol discriminator	1000 (MM message for GPRS service)
Skip indicator	0000
Attach accept message identity	00000010
Attach result	For MS class A and B, Combined GPRS/IMSI attached For MS class C, GPRS only attached
Force to standby	not indicated
Periodic RA update timer	timer is deactivated
Radio priority for SMS	priority level 3
Spare half octet	Spare half octet
Routing area identification	
- MCC	001 (decimal)
- MNC	01 (decimal)
- LAC	0001H
- RAC	05H
P-TMSI signature	P-TMSI signature
Negotiated READY timer value	32 seconds
Allocated P-TMSI	P-TMSI
MS identity	TMSI

ATTACH COMPLETE message:

Protocol discriminator	MM message for GPRS
Skip indicator	0000
Attach complete message identity	00000011
Force to standby	not checked
Spare half octet	Spare half octet

42.3 Dynamic Allocation in Packet Transfer Mode

42.3.1 Dynamic Allocation / Uplink Transfer

42.3.1.1 Dynamic Allocation / Uplink Transfer / Normal

42.3.1.1.1 Dynamic Allocation / Uplink Transfer / Normal / Successful

42.3.1.1.1.1 Conformance requirements

1. The mobile station shall set the TFI field of each uplink RLC data block to the TFI value assigned to the mobile station in the PACKET UPLINK ASSIGNMENT or PACKET TIMESLOT RECONFIGURE message.
2. Whenever the mobile station detects an assigned USF value on an assigned PDCH, the mobile station shall transmit either a single RLC/MAC block or a sequence of four RLC/MAC blocks on the same PDCH in the next block period(s). The time relation between an uplink block, which the mobile station shall use for transmission,

and the occurrence of the USF value is defined in 3GPP TS 05.02. The number of RLC/MAC blocks to transmit is controlled by the USF_GRANULARITY parameter characterising the uplink TBF.

3. At two-phase access the mobile station does not include its TLLI in any RLC data block.

References

3GPP TS 04.60, subclauses 8.1.1, 8.1.1.1 and 7.1.3.3.

3GPP TS 05.02, subclause 6.3.2.2.1.

42.3.1.1.1.2 Test purposes

To verify that the MS:

1. depending on the parameter USF_GRANULARITY, transmits one or a sequence of four RLC/MAC data block(s) in the next block period(s) on the PDCH on which it has detected its corresponding assigned USF.
2. includes the assigned TFI in each uplink RLC data blocks.
3. does not include its TLLI in any RLC data block at two phase access.

42.3.1.1.1.3 Method of test

Initial Conditions

System Simulator:

1 cell, default setting, BS_PBCCH_BLKs = 3.

Mobile Station:

The MS is GPRS attached with a P-TMSI allocated and the test PDP context3 activated.

Specific PICS Statements

-

PIXIT Statements

-

Test Procedure

The MS is triggered to initiate packet uplink transfer data in RLC unacknowledged mode. The SS orders the MS to have two-phase access, in PACKET UPLINK ASSIGNMENT message the USF_GRANULARITY is set to 4 blocks. The SS sends the assigned USF assigned to the MS and checks that a sequence of four RLC/MAC data blocks in the next radio block period is received, and that each data block contains the correct TFI, but without TLLI. The SS assigns the USF assigned to the MS again. The check is repeated. The procedure is going on until the MS completes the packet data transfer.

The above test procedure is repeated once for USF_GRANULARITY set to one block.

Maximum Duration of Test

5 minutes.

Expected Sequence

Step	Direction	Message	Comments
1		{Uplink dynamic allocation two phase access}	n =600 octets, without starting time, USF_GRANULARITY = 4 blocks, RLC_DATA_BLOCKS_GRANTED = open-end
2	SS -> MS	PACKET DOWNLINK DUMMY CONTROL BLOCK	CHANNEL_CODING_COMMAND: arbitrarily chosen. Sent on the PACCH, the USF assigned to the MS, on 3 blocks from the last radio block containing the uplink assignment.
3	MS -> SS	UPLINK RLC DATA BLOCK	Received on the assigned PDTCH. Check that the coding as specified by CHANNEL_CODING_COMMAND, the TFI is correct and the block does not contain TLLI.
4	MS -> SS	UPLINK RLC DATA BLOCK	Received on the assigned PDTCH in the next radio block to step 3. Check that the coding as specified by CHANNEL_CODING_COMMAND, the TFI is correct and the block does not contain TLLI.
5	MS -> SS	UPLINK RLC DATA BLOCK	Received on the assigned PDTCH in the next radio block to step 4. Check that the coding is the scheme specified by CHANNEL_CODING_COMMAND, the TFI is correct and the block does not contain TLLI.
6	MS -> SS	UPLINK RLC DATA BLOCK	Received on the assigned PDTCH in the next radio block to step 5. Check that the coding as specified by CHANNEL_CODING_COMMAND, the TFI is correct and the block does not contain TLLI.
7	SS -> MS	PACKET UPLINK ACK/NACK	Sent on the PACCH of the PDCH, the USF not addressing the MS.
8	SS		Check that no RLC data blocks are transmitted from the MS in the next radio block to step 7.
9	SS -> MS	PACKET DOWNLINK DUMMY CONTROL BLOCK	The USF assigned to the MS.
10	MS -> SS	UPLINK RLC DATA BLOCK	Received on the assigned PDTCH.
11	MS -> SS	UPLINK RLC DATA BLOCK	Received on the assigned PDTCH in the next radio block to step 10. Check that the TFI is correct.
12	MS -> SS	UPLINK RLC DATA BLOCK	Received on the assigned PDTCH in the next radio block to step 11. Check that the TFI is correct.
13	MS -> SS	UPLINK RLC DATA BLOCK	Received on the assigned PDTCH in the next radio block to step 12. Check that the TFI is correct.
14		{Completion of uplink RLC data block transfer}	USF_GRANULARITY = 4 blocks
15		{Uplink dynamic allocation two phase access}	Similar parameter values to step 1 Except USF_GRANULARITY = 1 blocks
16	SS -> MS	PACKET DOWNLINK DUMMY CONTROL BLOCK	Sent on the PACCH of the PDCH, the USF assigned to the MS on 3 blocks from the last radio block containing the uplink assignment.
17	MS -> SS	UPLINK RLC DATA BLOCK	Received on the assigned PDTCH. Check that the coding as specified in CHANNEL_CODING_COMMAND, the TFI is correct and the block does not contain TLLI.
18	SS -> MS	PACKET UPLINK ACK/NACK	Sent on the PACCH, the USF not addressing the MS.
19	SS		Check that no RLC data blocks are transmitted from the MS in the next radio block to step 18.
20	SS -> MS	PACKET UPLINK ACK/NACK	Sent on a PDCH with any different time slot as the assigned PDCH, the USF assigned to the MS.
21	SS		Check that no RLC data block is transmitted from the MS on the next radio block to step 20.
22	SS -> MS	PACKET DOWNLINK DUMMY CONTROL BLOCK	Sent on the PACCH of the PDCH, the USF assigned to the MS.
23	MS -> SS	UPLINK RLC DATA BLOCK	Received on the assigned PDTCH. Check that the coding as specified in CHANNEL_CODING_COMMAND, the TFI is correct and the block does not contain TLLI.
24		{Completion of uplink RLC data block transfer}	USF_GRANULARITY = 1 block

42.3.1.1.2 Void

42.3.1.1.3 Dynamic Allocation / Uplink Transfer / Normal / Starting frame number encoding

42.3.1.1.3.1 Conformance requirements

1. In case of dynamic allocation, if no uplink TBF is in progress, the MS needs not monitor the USF field until the TDMA frame number occurs. When the indicated TDMA frame number occurs, the mobile station shall immediately begin to monitor the USF field and use the new assigned uplink TBF parameters when its USF occurs.
2. If an uplink TBF is already in progress, the MS shall continue to use the parameters of the existing TBF until the TDMA frame number occurs. When the indicated TDMA frame number occurs, the mobile station shall immediately begin to monitor the USF field and use the new assigned uplink TBF parameters when its USF occurs.
3. In case of single block allocation, the mobile station shall use the assigned timeslot during the RLC/MAC block whose first TDMA burst occurs in the indicated TDMA frame number.
4. If the mobile station is in packet transfer mode during the block immediately before the starting time and the lowest numbered PDCH assigned to the MS is different immediately before and after the starting time then the mobile station shall be ready to receive or transmit no later than one radio block from the starting time
5. If the Starting FN (in absolute frame number encoding) is not aligned to the start of a block period and the mobile station is in packet transfer mode during the TDMA immediately before the Starting FN, then the mobile station shall align the starting time to the next block boundary and continue to use the currently assigned allocation up to the next block boundary.

References

3GPP TS 04.60, subclauses 11.2.29, 12.21 and 12.21.1.

42.3.1.1.3.2 Test purposes

To verify that the MS, in transfer mode:

1. correctly uses the starting frame number description in PACKET UPLINK ASSIGNMENT, and in all subsequent RLC/MAC control messages which are sent on the uplink TBF;
2. is ready to receive or transmit no later than one radio block from the starting time;
3. is able to align the starting time to the next block boundary and continue to use the currently assigned allocation up to the next block boundary.

42.3.1.1.3.3 Method of test

Initial Conditions

System Simulator:

1 cell, default setting, BS_PBCCH_BLKs = 3.

Mobile Station:

The MS is GPRS attached with a P-TMSI allocated and the test PDP context3 activated.

Specific PICS Statements

-

PIXIT Statements

-

Test Procedure

The MS is triggered to initiate packet uplink transfer 440 octets in the RLC unacknowledged mode. The PACKET UPLINK ASSIGNMENT message contains a starting time encoded in absolute frame number format for the single block allocation. It is checked that the MS uses the time slot at the assigned frame number. In the two-phase access a starting time is included in PACKET UPLINK ASSIGNMENT. The assigned USF is on a radio block before the starting time. The MS does not react upon that. The assigned USF is on one block after the starting time. The MS sends a RLC data block.

The test procedure is repeated once. The starting time is encoded in relative frame number format.

Maximum Duration of Test

5 minutes.

Expected Sequence

The expected sequence is repeated once. In the 2nd execution the starting frame numbers in the specific message contents are encoded in the relative format.

Step	Direction	Message	Comments
1		{Uplink dynamic allocation two phase access}	n = 440 octets, USF_GRANULARITY = 1 block, RLC_DATA_BLOCKS_GRANTED = open-end TLLI_BLOCK_CHANNEL_CODING: same as channel coding CHANNEL_CODING_COMMAND: cs-3 The 1st PACKET UPLINK ASSIGNMENT contains starting time specified in absolute frame number encoding, current frame + 1001. It is checked that PACKET RESOURCE REQUEST in the macro is sent at the starting time. The 2 nd PACKET UPLINK ASSIGNMENT contains starting time specified in absolute frame number encoding, current frame + 91, The timeslot TN ₇ assigned.
2	SS -> MS	PACKET DOWNLINK DUMMY CONTROL BLOCK	The USF assigned to the MS, Sent on one radio block before the starting time.
3	SS		Check that there is no RLC data block sent by the MS on the assigned PDTCH.
4	SS -> MS	PACKET DOWNLINK DUMMY CONTROL BLOCK	The USF assigned to the MS. Sent on one block after the starting time.
5	MS -> SS	UPLINK RLC DATA BLOCK	Received on the assigned PDTCH. Check that the coding is the scheme specified by CHANNEL_CODING_COMMAND in step 1, and TFI is correct.
6		{Completion of uplink RLC data block transfer}	

42.3.1.1.4 Dynamic Allocation / Uplink Transfer / Normal / Starting time

42.3.1.1.4.1 Conformance requirements

- 1 If a TBF starting time information element is present and no uplink TBF is in progress, but a downlink TBF is in progress, the mobile station shall wait until the starting time before beginning to monitor the USFs. While waiting for the starting time, the mobile station shall monitor the assigned PDCHs.
- 2 If an uplink TBF is already in progress, the mobile station shall continue to use the assigned parameters of the uplink TBF until the TDMA frame number indicated by the TBF starting time occurs. At that time the mobile station shall immediately begin to use the newly assigned uplink TBF parameters.
- 3 While waiting for the frame number indicated by the TBF starting time if the mobile station receives another uplink assignment, the mobile station shall act upon the most recently received uplink assignment and shall ignore the previous uplink assignment.

- 4 An MS shall be ready to transmit and receive using a new assignment no later than the next occurrence of block $B((x+3) \bmod 12)$ where block $B(x)$ is the last radio block containing the assignment message. This applies also for the reception of the first USF for dynamic uplink assignment.

References

3GPP TS 04.60, subclause 8.1.1.1, 3GPP TS 45.010 subclause 6.11.1.

42.3.1.1.4.2 Test purposes

To verify that after the MS receives an uplink assignment with starting time:

1. if a downlink TBF is in progress and no uplink TBF is in progress it monitors the assigned PDCHs while waiting for the starting time. If another uplink assignment received while waiting, the mobile station acts upon that and ignores the previous uplink assignment.
2. if an uplink TBF is already in progress, it continues to use the assigned parameters of the uplink TBF until the TDMA frame number indicated by the TBF starting time occurs. While waiting for the frame number indicated by the TBF starting time the mobile station receives another uplink assignment, the mobile station acts upon that and ignores the previous uplink assignment. As soon as the starting time occurs the MS immediately begins to use the newly assigned uplink TBF parameters.

42.3.1.1.4.3 Method of test

Initial Conditions

System Simulator:

1 cell, default setting, BS_PBCCH_BLKs = 3.

Mobile Station:

The MS is GPRS attached with a P-TMSI allocated and the test PDP context2 activated.

Specific PICS Statements

-

PIXIT Statements

-

Test Procedure

A downlink TBF is established and in progress. An uplink TBF is established with a starting time which does not yet elapse. The SS sends two downlink data blocks before the starting time to the MS and signals the assigned TBF addressing the MS for uplink transfer. It is checked that no uplink RLC data blocks are sent by the MS. The SS sends PACKET TIMESLOT RECONFIGURE on three radio blocks before the starting time, assigning a new starting time. Two downlink data blocks are then sent to the MS before the new starting time occurs. Each data block contains one of the assigned USFs addressing the MS. It is checked that no uplink data blocks are sent from the MS. After the new starting time elapses the SS sends a downlink data block containing the USF assigned to the MS. The MS sends an uplink data block. The MS is brought to Idle mode.

Subsequently an uplink TBF is established. The SS sends PACKET UPLINK ASSIGNMENT assigning a reconfigured PDCH with a starting time and a new USF associated. Before the starting time the SS signals the USF of the ongoing TBF addressing the MS. The SS receives an uplink data block from the MS. The SS sends UPLINK ASSIGNMENT on three radio blocks before the starting time, assigning a new reconfigured PDCH with a starting time and a different USF associated. The later assignment overwrites the earlier one.. While waiting for the frame number of the newly assigned starting time the SS signals the USF of the previous assignment on both the ongoing PDCH and on the previous assigned PDCH. The MS ignores it. The SS signals the USF of the ongoing TBF addressing the MS. An uplink data block can be received. On one radio block before the starting time the SS signals the later assigned USF assigned to the MS on the later assigned PDCH. No uplink data block is received. On one radio block after the starting time the SS signals the just expired USF. No uplink data block is received. Then the SS signals the valid USF assigned to the MS. An uplink data block is received.

Maximum Duration of Test

5 minutes.

Expected Sequence

Step	Direction	Message	Comments
1		{Downlink TBF establishment}	RLC mode: acknowledged, without starting time
2	SS -> MS	DOWNLINK RLC DATA BLOCK	The data block contains FBI=0 and a valid RRBP, sent on the third block after the last radio block containing the downlink assignment.
3	MS -> SS	PACKET DOWNLINK ACK/NACK	Received on the specified RRBP of downlink PACCH.
4	MS		The MS is triggered to send 440 octets of user data.
5	SS -> MS	DOWNLINK RLC DATA BLOCK	The data block contains FBI=0 and a valid RRBP.
6	MS -> SS	PACKET DOWNLINK ACK/NACK	Received on the specified RRBP of downlink PACCH. Contains Channel Request Description IE. Note : If the triggering of the uplink access involves a manual operation taking more than 5s to complete, steps 5 and 6 are repeated (until the MS does include the Channel Request Description IE) at least once every 5s in order to keep the downlink transfer active.
7	SS -> MS	PACKET UPLINK ASSIGNMENT	USF_GRANULARITY = 1 block, RLC_DATA_BLOCKS_GRANTED = open-end CHANNEL_CODING_COMMAND: arbitrarily chosen. TBF Starting Time : starting time ₁ , the current frame + 104 frames, encoded in absolute frame number. The uplink TBF is assigned on the same timeslot as the downlink TBF.
8	SS -> MS	DOWNLINK RLC DATA BLOCK	FBI=0, the assigned USF ₁ to the MS. Sent on downlink PDTCH, 12 data blocks (52 TDMA frames) before the starting time ₁ .
9	SS -> MS	DOWNLINK RLC DATA BLOCK	FBI=0, the assigned USF ₁ to the MS. Sent on downlink PDTCH, 5 blocks before the starting time ₁ , a valid RRBP = N+13.
10	MS -> SS	PACKET DOWNLINK ACK/NACK	Received on the specified RRBP on downlink PACCH.
11	SS -> MS	PACKET TIMESLOT RECONFIGURE	Assigned USF ₁ addressing the MS, sent on three blocks before the starting time ₁ . Assigned a new USF ₂ on the same timeslot, with starting time ₂ , current frame + 104 frames in relative frame number encoding.
12	SS -> MS	DOWNLINK RLC DATA BLOCK	On 4 blocks from the last radio block containing the uplink assignment in step 11, with FBI=0, the assigned previous USF ₁ addressing the MS. Sent on downlink PDTCH.

Step	Direction	Message	Comments
13	SS -> MS	DOWNLINK RLC DATA BLOCK	One data block with FBI=0, the assigned USF ₂ addressing the MS. Sent on downlink PDTCH, one radio block before the starting time ₂ .
14	SS		Check that from the step 4 onwards till the starting time ₂ , there is no RLC data block sent by the MS on the assigned uplink PDTCH.
15	SS -> MS	DOWNLINK RLC DATA BLOCK	One data block with FBI=0, a valid RRBP, the assigned USF ₂ addressing the MS. Sent on downlink PDTCH, on the frame number specified in the starting time ₂ .
16	MS -> SS	UPLINK RLC DATA BLOCK	Received on the assigned uplink PDTCH.
17	MS -> SS	PACKET DOWNLINK ACK/NACK	Received on the specified RRBP of downlink PACCH.
18	SS -> MS	DOWNLINK RLC DATA BLOCK	One data block with FBI=1 and a valid RRBP. Sent on downlink PDTCH.
19	MS -> SS	PACKET DOWNLINK ACK/NACK	Received on the specified RRBP of the downlink PACCH.
20		{Completion of uplink RLC data block transfer}	
21		{Uplink dynamic allocation two phase access}	n = 440 octets, without starting time, USF_GRANULARITY = 1 block, RLC_DATA_BLOCKS_GRANTED = open-end TLLI_BLOCK_CHANNEL_CODING: arbitrarily chosen CHANNEL_CODING_COMMAND: cs-1
22	SS -> MS	PACKET DOWNLINK DUMMY CONTROL BLOCK	The timeslot TN ₃ assigned Assigned USF ₁ addressing the MS, sent on 3 blocks from the last radio block containing the uplink assignment in step 21.
23	MS -> SS	UPLINK RLC DATA BLOCK	Check that the coding is cs1, the TFI is correct.
24	SS -> MS	PACKET UPLINK ACK/NACK	Assigned USF ₁ addressing the MS.
25	MS -> SS	UPLINK RLC DATA BLOCK	Received on the assigned PDTCH.
26		PACKET UPLINK ASSIGNMENT	Assign an uplink TBF on the timeslot TN ₂ , containing new TFI ₂ , USF ₂ , starting time ₃ , current frame + 117 in relative encoding. Sent on PACCH assigned.
27		PACKET UPLINK ACK/NACK	USF ₁ addressing the MS, sent on 5 radio blocks before the starting time ₃ , on PACCH assigned in step 21.
28		UPLINK RLC DATA BLOCK	Check that the coding is cs1, the TFI is correct.
29	SS -> MS	PACKET UPLINK ASSIGNMENT	Assign a TBF on the timeslot TN ₁ , containing new TFI ₃ , USF ₃ , cs-3 coding, starting time ₄ , current frame + 325 in relative encoding. Sent on three radio blocks before the starting time ₃ , on PACCH assigned in step 21.
30	SS -> MS	PACKET UPLINK ACK/NACK	USF ₂ addressing the MS, sent on 4 blocks from the last radio block containing the uplink assignment in step 29 on the PACCH assigned in step 26.
31	SS		Check that no data block is sent from the MS on the assigned radio block on the PDTCH assigned in step 26.
32	SS -> MS	PACKET DOWNLINK DUMMY CONTROL BLOCK	USF ₁ addressing the MS, sent on 5 radio blocks before the starting time ₄ , on PACCH assigned in step 21.
33	MS -> SS	UPLINK RLC DATA BLOCK	Check that the coding is cs1, the TFI is correct.
34	SS -> MS	PACKET DOWNLINK DUMMY CONTROL BLOCK	The USF ₃ addressing the MS, sent on one radio block before the starting time ₄ , on PACCH assigned in step 26.
35	SS -> MS	PACKET DOWNLINK DUMMY CONTROL BLOCK	The USF ₁ addressing the MS, sent on one radio block after the starting time ₄ , on PACCH assigned in step 21.
36	SS		Check that no data blocks are sent from the MS on the radio blocks assigned in steps 34 and 35, or any intermediate radio blocks, on any of the three PDTCHs assigned
37	SS -> MS	PACKET UPLINK ACK/NACK	Containing USF ₃ . Sent on PACCH of PDCH assigned in step 29.
38	MS -> SS	UPLINK RLC DATA BLOCK	Received on the PDTCH assigned in step 29. Use coding cs-1.
(optional step)			If step 38 is performed, then step 39 must be performed.
39(optional step)	SS -> MS	PACKET UPLINK ACK/NACK	Only performed if step 38 is performed Containing USF ₃ . Sent on PACCH of PDCH assigned in step 29.
40	MS -> SS	UPLINK RLC DATA BLOCK	Received on the PDTCH assigned in step 29. Check that the coding cs-3 and TFI ₃ are correct.
41		{Completion of uplink RLC data block transfer}	

42.3.1.1.5 Void

42.3.1.1.6 Dynamic Allocation / Uplink Transfer / Normal / T3180 expiry

42.3.1.1.6.1 Conformance requirements

When the mobile station transmits an RLC/MAC block to the network, it shall start timer T3180. When the mobile station detects an assigned USF value on an assigned PDCH, the mobile station shall reset timer T3180. If timer T3180 expires, the mobile station shall perform the abnormal release with random access procedure.

References

3GPP TS 04.60, subclause 8.1.1.1.

42.3.1.1.6.2 Test purposes

To verify that

1. Timer T3180 will not expire as long as an USF for the MS under test is detected in the downlink blocks within the defined time period of the timer. (It is implicitly verified).
2. Timer T3180 expires if no USF for the MS under test is detected during a time period longer than T3180.
3. The MS performs an abnormal release with random access procedure after T3180 expires.

42.3.1.1.6.3 Method of test

Initial Conditions

System Simulator:

1 cell, default setting, BS_PBCCH_BLKs = 3.

Mobile Station:

The MS is GPRS attached with a P-TMSI allocated and the test PDP context3 activated.

Specific PICS Statements

-

PIXIT Statements

-

Test Procedure

An uplink TBF is established and in progress. After the MS sends an uplink data block the SS repeatedly sends PACKET UPLINK ACK/NACK containing any USF and any TFI which do not address the MS for 4.5s. Before T3180 times out the SS signals the USF assigned to the MS. The MS sends a data block. Then the SS repeatedly sends PACKET UPLINK ACK/NACK containing any USF and any TFI which do not address the MS until receiving PACKET CHANNEL REQUEST from the MS for establishment of a new TBF.

Maximum Duration of Test

5 minutes.

Expected Sequence

Step	Direction	Message	Comments
1		{Uplink dynamic allocation two phase access}	n = 220 octets, without starting time, USF_GRANULARITY = 1 block, RLC_DATA_BLOCKS_GRANTED = open-end CHANNEL_CODING_COMMAND: arbitrarily chosen.
2	SS -> MS	PACKET DOWNLINK DUMMY CONTROL BLOCK	The USF assigned to the MS sent on 3 blocks from the last radio block containing the uplink assignment.
3	MS -> SS	UPLINK RLC DATA BLOCK	Received on the assigned PDTCH. Check that the TFI is correct.
4	SS -> MS	PACKET UPLINK ACK/NACK	Sent on the PACCH of the PDCH assigned in step 2, the USF assigned to the MS.
5	MS -> SS	UPLINK RLC DATA BLOCK	Received on the assigned PDTCH. Check that the TFI is correct.
6	SS -> MS	PACKET UPLINK ACK/NACK	Sent on the PACCH, containing a different TFI and USF from the assigned ones to the MS.
7	SS		Repeat step 6 every 5 radio blocks for 4.5 s. (T3180 * 90%) the SS signals different USFs on the assigned PDCH, but none of them addressing the MS.
8	SS -> MS	PACKET UPLINK ACK/NACK	Sent on the PACCH of the PDCH assigned in step 2, the USF assigned to the MS.
9	MS -> SS	UPLINK RLC DATA BLOCK	Received on the assigned PDTCH. Check that the TFI is correct.
10	SS		Repeat step 6 every 5 radio blocks until step 11 occurs. The maximum period for the repetition is of 8s (5s timer + two PSI1 periods). None of the signalled USFs addresses the MS on the assigned PDCH.
11	MS -> SS	PACKET CHANNEL REQUEST	Received on PRACH within 7.5 seconds (T3180 * 110% + PSI1 repeat period) from step 9.
12	SS -> MS	PACKET UPLINK ASSIGNMENT	Single block assignment, to order the MS making two-phase access procedure. Sent on PAGCH.
13	MS -> SS	PACKET RESOURCE REQUEST	Two phase access procedure. Received on the single block assigned in step 12.
14	SS -> MS	PACKET UPLINK ASSIGNMENT	Open-ended uplink dynamic allocation, no starting time, USF_GRANULARITY = single block, Sent on PACCH of the same PDCH assigned in step 12.
15	SS -> MS	PACKET DOWNLINK DUMMY CONTROL BLOCK	The USF assigned to the MS. Sent on PACCH of PDCH assigned in step 14.
16	MS -> SS	UPLINK RLC DATA BLOCK	Received on the assigned PDTCH. Check that the coding scheme is that specified in step 14 by CHANNEL_CODING_COMMAND and the TFI is correct.
17		{Completion of uplink RLC data block transfer}	

Specific Message Contents

PACKET UPLINK ASSIGNMENT message in step 14:

CHANNEL_CODING_COMMAND	Arbitrarily chosen
Dynamic allocation	01
- Extended Dynamic Allocation	0 (Dynamic allocation)
-	0
- USF granularity	0 (1 block)
- {0 1<UPLINK_TFI_ASSIGNMENT>}	1 (uplink TFI assignment)
- UPLINK_TFI	00000
- {0 1<RLC_DATA_BLOCKS_GRANTED>}	0 (no RLC_DATA_BLOCKS_GRANTED, open-ended TBF)
- {0 1<TBF_STARTING_TIME>}	0 (no starting time)
-	0 (Timeslot Allocation Parameters)
	one slot arbitrarily chosen but different from the value in step 2

42.3.1.1.7 Dynamic Allocation / Uplink Transfer / Normal / PACCH operation

42.3.1.1.7.1 Conformance requirements

1. The mobile station shall attempt to decode every downlink RLC/MAC block on all assigned PDCHs. Whenever the mobile station receives an RLC/MAC block containing an RLC/MAC control block, the mobile station shall attempt to interpret the message contained therein. If the message addresses the mobile station, the mobile station shall act on the message. The mobile station shall not transmit an RLC data block in any uplink radio block allocated via the polling mechanism.
2. PACKET POLLING REQUEST is sent on the PCCCH or PACCH by the network to the mobile station to solicit a PACKET CONTROL ACKNOWLEDGEMENT message from the mobile station.
3. In downlink RLC/MAC control blocks, the TFI identifies the Temporary Block Flow (TBF) to which the RLC/MAC control message contained in the downlink RLC/MAC control block relates. If present, this field indicates the mobile station to which the control message is addressed, and all other mobile stations shall ignore the control message. If this field is present and the contents of the control message also contain a TFI addressing the mobile station, the mobile station shall ignore the TFI in the control message contents.

References

3GPP TS 04.60, subclauses 8.1.1.1.1, 11.2.12 and 10.4.10.

42.3.1.1.7.2 Test purposes

To verify that:

1. The MS attempts to decode every downlink RLC/MAC block on all assigned PDCHs whenever the MS receives an RLC/MAC block containing an RLC/MAC control block, the MS attempts to interpret the message contained therein, such as Payload type and TFI in the optional fields. If the message addresses the MS, it acts upon the message.
2. When receiving PACKET POLLING REQUEST on PACCH the MS responds with four PACKET CONTROL ACKNOWLEDGEMENT messages of access burst format and does not transmit an RLC data block in any uplink radio block allocated via the polling mechanism.

42.3.1.1.7.3 Method of test

Initial Conditions

System Simulator:

1 cell, default setting, BS_PBCCH_BLKs = 3.

Mobile Station:

The MS is GPRS attached with a P-TMSI allocated and the test PDP context3 activated.

Specific PICS Statements

-

PIXIT Statements

-

Test Procedure

A TBF is established. It is polled with PACKET POLLING REQUEST containing a global TFI not addressing the MS. The assigned USF addresses the MS. The MS transmits a data block. The SS polls the MS with PACKET POLLING REQUEST containing any global TFI not addressing the MS. The message has optional octets where TFI does address the MS. The MS responds with PACKET CONTROL ACKNOWLEDGEMENT four times in access burst formats. The SS polls again the MS with PACKET POLLING REQUEST containing the global TFI addressing the MS. The MS responds with PACKET CONTROL ACKNOWLEDGEMENT four times in access burst formats.

Maximum Duration of Test

5 minutes.

Expected Sequence

Step	Direction	Message	Comments
1		{Uplink dynamic allocation two phase access}	n = 440 octets, without starting time, USF_GRANULARITY = 1 block, RLC_DATA_BLOCKS_GRANTED = open-end CHANNEL_CODING_COMMAND: arbitrarily chosen.
2	SS -> MS	PACKET POLLING REQUEST	the USF assigned to the MS, the TFI in the message not addressing the MS, no optional octets in RLC/MAC header, a valid RRBP
3	MS -> SS	UPLINK RLC DATA BLOCK	Check the TFI is correct as assigned in step 1.
4	SS -> MS	PACKET POLLING REQUEST	NOT the USF assigned to the MS, the global TFI in the message contents NOT addressing the MS, Payload type indicates the RLC/MAC header containing optional octets where TFI DOES address the MS, RBSN='0'. TYPE_OF_ACK = '0', a valid RRBP=N+13
5	MS -> SS	PACKET CONTROL ACKNOWLEDGEMENT	4 access bursts. Received on PACCH, CTRL_ACK = '10'.
6	SS -> MS	PACKET POLLING REQUEST	Not the USF assigned to the MS. The global TFI in the message contents addressing the MS. Payload type indicates the RLC/MAC header containing optional octets where TFI not addressing the MS. a valid RRBP
7	SS		Check the MS ignores the polling .
8	SS -> MS	PACKET POLLING REQUEST	Not the USF assigned to the MS. the Global TFI addresses the MS, RLC/MAC header containing no optional octets. TYPE_OF_ACK = '0', a valid RRBP
9	MS -> SS	PACKET CONTROL ACKNOWLEDGEMENT	4 access bursts, received on PACCH.
10		{Completion of uplink RLC data block transfer}	

42.3.1.1.8 Dynamic Allocation / Uplink Transfer / Normal / Two uplink timeslots

42.3.1.1.8.1 Conformance requirements

Mobile station belonging to multislot class 3, 5, 6, 7 and 9 to 29 shall support at least two transmit timeslots per TDMA frame (refer to 3GPP TS 05.02, clause B.1).

References

3GPP TS 05.02, clause B.1.

42.3.1.1.8.2 Test purposes

To verify that an MS belonging to GPRS multislot class 5, 6, 7 and 9 to 29 supports an uplink TBF using two timeslots per TDMA frame.

42.3.1.1.8.3 Method of test

Initial Conditions

System Simulator:

1 cell, default setting, BS_PBCCH_BLKs = 3.

Mobile Station:

The MS is GPRS attached with a P-TMSI allocated and the test PDP context2 activated.

Specific PICS Statements

-

PIXIT Statements

-

Test Procedure

The MS is triggered to initiate packet uplink transfer data in RLC acknowledged mode. The SS orders the MS to use two-phase access procedure, in PACKET UPLINK ASSIGNMENT two timeslots are assigned. On the same TDMA frame the SS signals to the MS the assigned USFs addressing the MS on the two assigned PDTCHs. It is checked that the two RLC/MAC data blocks in the next radio block period are received on the respective PDTCH channels and that each data block contains the correct TFI without TLLI.

The SS acknowledges the received data and assigns the USFs addressing the MS. The check is repeated. The same procedure is going on until the MS completes the packet data transfer.

Maximum Duration of Test

5 minutes.

Expected Sequence

Step	Direction	Message	Comments
1		{Uplink dynamic allocation two phase access}	n = 440 octets, without starting time, USF_GRANULARITY = 1 block, RLC_DATA_BLOCKS_GRANTED = open-end CHANNEL_CODING_COMMAND: arbitrarily. Two timeslots, USF ₀ on TN ₀ and USF ₁ on TN ₁ , are assigned.
2	SS -> MS	PACKET DOWNLINK DUMMY CONTROL BLOCK	Assigned USF ₀ on PDTCH ₀ addressing the MS on 3 blocks from the last radio block containing the uplink assignment.
3	SS -> MS	PACKET DOWNLINK DUMMY CONTROL BLOCK	Assigned USF ₁ on PDTCH ₁ addressing the MS, sent on the same TDMA frame as step 2.
4	MS -> SS	UPLINK RLC DATA BLOCK	Received on the assigned PDTCH ₀ . Check that the coding as specified in CHANNEL_CODING_COMMAND, the TFI is correct and the block does not contain TLLI.
5	MS -> SS	UPLINK RLC DATA BLOCK	Received on the assigned PDTCH ₁ on the same TDMA frame as step 4. Check that the coding as specified in CHANNEL_CODING_COMMAND, the TFI is correct and the block does not contain TLLI.
6	SS -> MS	PACKET UPLINK ACK/NACK	Assigned USF ₀ on PDTCH ₀ addressing the MS.
7	SS -> MS	PACKET UPLINK ACK/NACK	Assigned USF ₁ on PDTCH ₁ addressing the MS, sent on the same TDMA frame as step 6.
8	MS -> SS	UPLINK RLC DATA BLOCK	Received on the assigned PDTCH ₀ . Check that the coding as specified in CHANNEL_CODING_COMMAND, the TFI is correct and the block does not contain TLLI.
9	MS -> SS	UPLINK RLC DATA BLOCK	Received on the assigned PDTCH ₁ , on the same TDMA frame as step 8. Check that the coding as specified in CHANNEL_CODING_COMMAND, the TFI is correct and the block does not contain TLLI.
10		{Completion of uplink RLC data block transfer}	

Specific Message Contents

None

42.3.1.1.9 Dynamic Allocation / Uplink Transfer / Normal / Frequency parameters

42.3.1.1.9.1 Conformance requirements

1. Frequency parameters are included in the assignment messages (i.e., PACKET DOWNLINK ASSIGNMENT, PACKET UPLINK ASSIGNMENT, or PACKET TIMESLOT RECONFIGURE) and define the radio frequency channels or set of radio frequency channels the mobile station is to use during the assigned TBF. The first assignment message, sent to the mobile station when it enters packet transfer mode, shall include the frequency parameters. Subsequent assignment messages, sent to the mobile station during packet transfer mode, may omit the frequency parameters. If a mobile station receives a subsequent assignment message, during packet transfer mode, without the frequency parameters, the mobile station shall continue to use the previously assigned frequency parameters.
2. The frequency parameters may use an ARFCN defining a non-hopping radio frequency channel, or use the indirect encoding, direct encoding 1 or direct encoding 2 defining a hopping radio frequency channel.
3. The indirect encoding defines the assigned set of radio frequency channels by referencing information stored within the mobile station. Such information may be received on PBCCH or BCCH or be received in a previous assignment message using one of the direct encoding options. An MA_NUMBER identifies which of up to eight stored sets of frequency parameters is to be used.
4. When the indirect encoding is used, the network may include a CHANGE_MARK_1 and a CHANGE_MARK_2 in the Frequency Parameters information element. The mobile station shall then verify that it is using a set of PBCCH or BCCH information identified by a PSI or SI *change mark* corresponding to one of the CHANGE_MARK_1 or 2 parameters, for the decoding of the frequency information. If that is not the case, an abnormal condition occurs.
5. The direct encoding defines the assigned set of radio frequency channels by using information contained within the assignment message. The direct encoding 1 references the cell allocation or reference frequency lists received on PBCCH for the decoding of this information. The direct encoding 2 is self contained. When the direct encoding 1 or 2 is used, the mobile station shall store the received GPRS mobile allocation for possible later reference in an assignment message using the indirect encoding.

References

3GPP TS 04.60, subclauses 5.5.1.7, 11.2.19, 12.8 and 12.10a.

42.3.1.1.9.2 Test purposes

To verify that:

1. The MS in the packet transfer mode understands correctly the frequency parameters in the indirect encoding format in PACKET UPLINK ASSIGNMENT and PACKET TIMESLOT RECONFIGURATION, and correctly uses the information received on PBCCH in the consistent set of PSI2 messages for the assigned TBF.
2. The MS in the packet transfer mode understands and uses correctly the frequency parameters in the direct encoding 1 and 2 formats in PACKET UPLINK ASSIGNMENT and PACKET TIMESLOT RECONFIGURATION and stores the received GPRS mobile allocation for a possible later reference in an assignment message using the indirect encoding.

42.3.1.1.9.3 Method of test

Initial Conditions

System Simulator:

1 cell, default setting, BS_PBCCH_BLKs = 3, PSI_COUNT_HR = 8 (binary value '0111'), PSI1_REPEAT_PERIOD = 4 (binary value '11', the initial SI1, SI13, PSI1, and the 1st consistent set of PSI2 including 6 instances (see specific message contents). The PSI2s are transmitted with the high repetition rate group.

Mobile Station:

The MS is GPRS attached with a P-TMSI allocated and the test PDP context3 activated.

Specific PICS Statements

-

PIXIT Statements

-

Test Procedure

The test sequence is repeated three times. Each time before starting, PSI1 and the consistent set of PSI2 are firstly broadcast. The MS is given 35s for reading partially the modified PSI1 and PSI2s.

The test sequence consists of seven resource assignments to the MS. The MS is triggered to initiate packet uplink transfer 5K octets in the RLC unacknowledged mode. Each assignment (either via PACKET UPLINK ASSIGNMENT, or via PACKET TIMESLOT RECONFIGURATION) contains a specific frequency parameter. The MS is allowed to transfer 30 radio blocks data on the assigned hopping PDCH. It is checked that coding cs1 and TFI are correct in the received data. The frequency hopping check on the assigned PDCH takes about 3 minutes.

Test parameters:

For GSM 900, CA in SI1 includes the frequencies:

(10, 17, 20, 26, 34, 42, 45, 46, 52, 59, 66, 73, 74, 76, 108, 114).

For DCS1800, CA in SI1 includes the frequency:

(739,743, 746, 749, 756, 758, 761,764, 771, 779, 782, 791, 798, 829, 832, 844).

For PCS1900, CA in SI1 includes the frequency:

(718, 721, 724, 727, 734, 739,743, 746, 749, 756, 758, 761,764, 771, 779, 782).

For GSM700, T-GSM 810, CA in SI1 includes the frequency:

(447, 454, 457, 463, 471, 479, 482 ,483 ,489, 496, 498, 500, 501, 502, 503, 506, 508).

For GSM850, CA in SI1 includes the frequency:

(137, 144, 147, 153, 161, 169, 172, 173, 179, 186, 193, 200, 201, 202, 203, 235, 241).

The algorithm for the calculation of array CA (j, k) and MA (j, k) are following:

P-GSM 900:

For k = 1, 2, 3:

$ca_{PGSM}(1, k)$ is set to 64.

An arbitrary subset $CA_{PGSM}(1, k)$ of the set $\{1, \dots, 124\}$ containing $ca_{PGSM}(1, k)$ elements is drawn.

An element B of the set $CA_{PGSM}(1, k)$ is arbitrarily chosen.

An arbitrary value $ca_{PGSM}(2, k)$ in the range 20, ..., 63 is chosen.

An arbitrary subset $CA_{PGSM}(2, k)$ of the set $\{1, \dots, 124\}$ with $ca_{PGSM}(2, k)$ elements and containing B is chosen.

An arbitrary value $ca_{PGSM}(3, k)$ in the range 4, ..., 19 is chosen.

An arbitrary subset $CA_{PGSM}(3, k)$ of the set $\{1, \dots, 124\}$ with $ca_{PGSM}(3, k)$ elements and containing B is chosen.

For j = 1,2,3, values $ma_{PGSM}(j, k)$ in the range j, ..., $ca_{PGSM}(j, k)-1$ and values $MAIO_{PGSM}(j, k)$ in the range 0, ..., $ma_{PGSM}(j, k)-1$ are arbitrarily chosen.

Subsets $MA_{PGSM}(j, k)$ of $CA_{PGSM}(j, k)$ not containing B and having $ma(j, k)$ elements are arbitrarily chosen.

DCS 1 800:

For $k = 1, 2, 3$:

$ca_{DCS}(1, k)$ is set to 64.

An arbitrary subset $CA_{DCS}(1, k)$ of the set $\{700, \dots, 810\}$ containing $ca_{DCS}(1, k)$ elements is chosen.

An element B of the set $CA_{DCS}(1, k)$ is arbitrarily chosen.

An arbitrary value $ca_{DCS}(2, k)$ in the range $17, \dots, 63$ is chosen.

An arbitrary subset $CA_{DCS}(2, k)$ of the set $\{700, \dots, 810\}$ with $ca_{DCS}(2, k)$ elements and containing B is chosen.

An arbitrary value $ca_{DCS}(3, k)$ in the range $4, \dots, 16$ is chosen.

An arbitrary subset $CA_{DCS}(3, k)$ of the set $\{700, \dots, 810\}$ with $ca_{DCS}(3, k)$ elements and containing B is chosen.

For $j = 1, 2, 3$, values $ma_{DCS}(j, k)$ in the range $j, \dots, ca_{DCS}(j, k) - 1$ and values $MAIO_{DCS}(j, k)$ in the range $0, \dots, ma_{DCS}(j, k) - 1$ are arbitrarily chosen.

Subsets $MA_{DCS}(j, k)$ of $CA_{DCS}(j, k)$ not containing B and having $ma_{DCS}(j, k)$ elements are arbitrarily chosen.

PCS 1 900:

For $k = 1, 2, 3$:

$ca_{PCS}(1, k)$ is set to 64.

An arbitrary subset $CA_{PCS}(1, k)$ of the set $\{700, \dots, 810\}$ containing $ca_{PCS}(1, k)$ elements is chosen.

An element B of the set $CA_{PCS}(1, k)$ is arbitrarily chosen.

An arbitrary value $ca_{PCS}(2, k)$ in the range $17, \dots, 63$ is chosen.

An arbitrary subset $CA_{PCS}(2, k)$ of the set $\{700, \dots, 810\}$ with $ca_{PCS}(2, k)$ elements and containing B is chosen.

An arbitrary value $ca_{PCS}(3, k)$ in the range $4, \dots, 16$ is chosen.

An arbitrary subset $CA_{PCS}(3, k)$ of the set $\{700, \dots, 810\}$ with $ca_{PCS}(3, k)$ elements and containing B is chosen.

For $j = 1, 2, 3$, values $ma_{PCS}(j, k)$ in the range $j, \dots, ca_{PCS}(j, k) - 1$ and values $MAIO_{PCS}(j, k)$ in the range $0, \dots, ma_{PCS}(j, k) - 1$ are arbitrarily chosen.

Subsets $MA_{PCS}(j, k)$ of $CA_{PCS}(j, k)$ not containing B and having $ma_{PCS}(j, k)$ elements are arbitrarily chosen.

GSM 700, T-GSM 810:

For $k = 1, 2, 3$:

$Ca_{700}(1, k)$ is set to 64.

An arbitrary subset $CA_{700}(1, k)$ of the set $\{438, \dots, 511\}$ containing $ca_{700}(1, k)$ elements is drawn.

An element B of the set $CA_{700}(1, k)$ is arbitrarily chosen.

An arbitrary value $ca_{700}(2, k)$ in the range $17, \dots, 63$ is chosen.

An arbitrary subset $CA_{700}(2, k)$ of the set $\{438, \dots, 511\}$ with $ca_{700}(2, k)$ elements and containing B is chosen.

An arbitrary value $ca_{700}(3, k)$ in the range $4, \dots, 16$ is chosen.

An arbitrary subset $CA_{700}(3, k)$ of the set $\{438, \dots, 511\}$ with $ca_{700}(3, k)$ elements and containing B is chosen.

For $j = 1, 2, 3$, values $ma_{700}(j, k)$ in the range $j, \dots, ca_{700}(j, k) - 1$ and values $MAIO_{700}(j, k)$ in the range $0, \dots, ma_{700}(j, k) - 1$ are arbitrarily chosen.

Subsets $MA_{700}(j, k)$ of $CA_{700}(j, k)$ not containing B and having $ma(j, k)$ elements are arbitrarily chosen.

GSM 850:

For $k = 1, 2, 3$:

$ca_{850}(1, k)$ is set to 64.

An arbitrary subset $CA_{850}(1, k)$ of the set $\{128, \dots, 251\}$ containing $ca_{850}(1, k)$ elements is drawn.

The difference between the maximum and minimum ARFCNs in $CAGSM850(1, k)$ shall be less than 112.

An element B of the set $CA_{850}(1, k)$ is arbitrarily chosen.

An arbitrary value $ca_{850}(2, k)$ in the range $17, \dots, 63$ is chosen.

An arbitrary subset $CA_{850}(2, k)$ of the set $\{128, \dots, 251\}$ with $ca_{850}(2, k)$ elements and containing B is chosen.

An arbitrary value $ca_{850}(3, k)$ in the range $4, \dots, 16$ is chosen.

An arbitrary subset $CA_{850}(3, k)$ of the set $\{128, \dots, 251\}$ with $ca_{850}(3, k)$ elements and containing B is chosen.

For $j = 1, 2, 3$, values $ma_{850}(j, k)$ in the range $j, \dots, ca_{850}(j, k) - 1$ and values $MAIO_{850}(j, k)$ in the range $0, \dots, ma_{850}(j, k) - 1$ are arbitrarily chosen.

Subsets $MA_{850}(j, k)$ of $CA_{850}(j, k)$ not containing B and having $ma(j, k)$ elements are arbitrarily chosen.

GSM 700, T-GSM 810, GSM 850, GSM 900 and DCS 1 800 and PCS 1 900

$T(1) = 91$.

$T(2) = 52$.

$T(3) =$ An arbitrary value chosen in the range $13, \dots, 312$.

Maximum Duration of Test

70 minutes.

Expected Sequence

This sequence is performed for $k = 1, 2, 3$:

Step	Direction	Message	Comments
1		{Uplink dynamic allocation two phase access}	$n = 5K$ octets in RLC unacknowledged mode, without starting time, USF_GRANULARITY = 1 block, RLC_DATA_BLOCKS_GRANTED = open-end TLLI_BLOCK_CHANNEL_CODING: cs1, CHANNEL_CODING_COMMAND: cs1 The 2 nd PACKET UPLINK ASSIGNMENT contains a specific frequency parameter in indirect encoding.
2	SS -> MS	PACKET DOWNLINK DUMMY CONTROL BLOCK	Assigned USF on PDTCH addressing the MS on 3 blocks from the last radio block containing the uplink assignment.
3	MS -> SS	UPLINK RLC DATA BLOCK	Received on the assigned PDTCH. Check that the coding as specified in CHANNEL_CODING_COMMAND, the TFI is correct and the block does not contain TLLI.
4	SS -> MS	PACKET UPLINK ACK/NACK	Assigned USF assigned to the MS, sent on the next radio block of step 3.
5			Repeat step 3, 4 for 30 times. The last PACKET UPLINK ACK/NACK does not contain the assigned USF.
6	SS -> MS	PACKET UPLINK ASSIGNMENT	Assign a new PDCH with the frequency parameter in direct encoding 1 referred to the CA in SI1.
7	SS -> MS	PACKET DOWNLINK DUMMY CONTROL BLOCK	Assigned USF assigned to the MS on the new PDTCH, on 3 blocks from the last radio block containing the uplink assignment.

Step	Direction	Message	Comments
8	MS -> SS	UPLINK RLC DATA BLOCK	Received on the assigned PDTCH. Check that the coding as specified in CHANNEL_CODING_COMMAND, the TFI is correct and the block does not contain TLLI.
9	SS -> MS	PACKET UPLINK ACK/NACK	Assigned USF assigned to the MS, sent on the next radio block of step 8.
10			Repeat step 8, 9 for 30 times. The last PACKET UPLINK ACK/NACK does not contain the assigned USF.
11	SS -> MS	PACKET UPLINK ASSIGNMENT	Assign a new PDCH with the frequency parameter in indirect encoding referred to CA(1, k).
12	SS -> MS	PACKET DOWNLINK DUMMY CONTROL BLOCK	Sent on the PACCH of the PDCH assigned in step 11 after the starting time, the USF assigned to the MS.
13	MS -> SS	UPLINK RLC DATA BLOCK	Received on the assigned PDTCH.
14	SS -> MS	PACKET UPLINK ACK/NACK	Sent on the PACCH of the PDCH assigned in step 11, the USF assigned to the MS.
15			Repeat step 13, 14 for 30 times. The last PACKET UPLINK ACK/NACK does not contain the assigned USF.
16	SS -> MS	PACKET UPLINK ASSIGNMENT	Assign a PDCH with the frequency parameter in indirect encoding, MA referred to the number 9.
17	SS -> MS	PACKET DOWNLINK DUMMY CONTROL BLOCK	Assigned USF assigned to the MS on the new PDTCH.
18	MS -> SS	UPLINK RLC DATA BLOCK	Received on the assigned PDTCH. Check that the coding as specified in CHANNEL_CODING_COMMAND, the TFI is correct and the block does not contain TLLI.
19	SS -> MS	PACKET UPLINK ACK/NACK	Sent on the PACCH of the PDCH assigned in step 16, the USF assigned to the MS.
20			Repeat step 18, 19 for 30 times. The last PACKET UPLINK ACK/NACK does not contain the assigned USF.
21	SS -> MS	PACKET UPLINK ASSIGNMENT	Assign a new PDCH with the frequency parameter in direct encoding 2 referred to CA(3, k).
22	SS -> MS	PACKET DOWNLINK DUMMY CONTROL BLOCK	Sent on the PACCH of the PDCH assigned in step 21 after the starting time, the USF assigned to the MS.
23	MS -> SS	UPLINK RLC DATA BLOCK	Received on the assigned PDTCH.
24	SS -> MS	PACKET UPLINK ACK/NACK	Sent on the PACCH of the PDCH assigned in step 21, the USF assigned to the MS.
25			Repeat step 23, 24 for 30 times. The last PACKET UPLINK ACK/NACK does not contain the assigned USF.
26	SS -> MS	PACKET UPLINK ASSIGNMENT	Assign a new PDCH with the frequency parameter in indirect encoding referred to CA(2, k).
27	SS -> MS	PACKET DOWNLINK DUMMY CONTROL BLOCK	Sent on the PACCH of the PDCH assigned in step 26 after the starting time, the USF assigned to the MS.
28	MS -> SS	UPLINK RLC DATA BLOCK	Received on the assigned PDTCH.
29	SS -> MS	PACKET UPLINK ACK/NACK	Sent on the PACCH of the PDCH assigned in step 26, the USF assigned to the MS.
30			Repeat step 28, 29 for 30 times. The last PACKET UPLINK ACK/NACK does not contain the assigned USF.
31	SS -> MS	PACKET UPLINK ASSIGNMENT	Assign a new PDCH with the frequency parameter in indirect encoding referred to the MA numbered 15.
32	SS -> MS	PACKET DOWNLINK DUMMY CONTROL BLOCK	Sent on the PACCH of the PDCH assigned in step 31, the USF assigned to the MS.
33	MS -> SS	UPLINK RLC DATA BLOCK	Received on the assigned PDTCH.
34		{Completion of uplink RLC data block transfer}	

For $k=1$, $T(k) = T(1)$,
 $k=2$, $T(k) = T(2)$,
 $k=3$, $T(k) = T(3)$.

Specific Message Contents

SI 13 Rest octets:

PAGE_MODE	Normal paging
BCCH_CHANGE_MARK	As default
SI_CHANGE_FIELD	Updated of unknown SI message type
{0 1<SI13_CHANGE_MARK>}	1, '10'
GPRS Mobile Allocation	
- HSN	'000000', cyclic hopping
- {0 1<RFL number list>}	0, referring to the Cell Channel Description in System Information Type 1.
	10, MA including all ARFCNs of Cell Channel Description in System Information Type 1, ARFCN index list absent.
- {1 0 1<ARFCN index list>}	1, PBCCH present
PSI_REPEAT_PERIOD	'11' PSI_REPEAT_PERIOD = 4
PBCCH Description	
- Pb	As default
- TSC	'101'
- TN	'001', slot 1
- {11<MAIO>}	11, '00011'

The PACKET SYSTEM INFORMATION TYPE 1 message

PAGE_MODE	Normal paging
PBCCH_CHANGE_MARK	(k + 5) mod 7
PSI_CHANGE_FIELD	'0000'
PSI_REPEAT_PERIOD	'0011' (PSI_REPEAT_PERIOD = 4)
PSI_COUNT_LR	'000011' (3 PSI3bis message instances in LR group)
{ 0 1 PSI_COUNT_HR }	1 (PSI_COUNT_HR present)
- PSI_COUNT_HR	'0111' (8 PSI messages in HR group, PSI2 instances and the PSI3)
	other fields as default)

Three sets of PACKET SYSTEM INFORMATION TYPE 2 are transmitted (k = 1 ... 3).

The 1st set (k=1) of PACKET SYSTEM INFORMATION TYPE 2 messages

The 1st PSI2 instance:

PAGE_MODE	Normal paging
PSI2_CHANGE_MARK	(k + 1) mod 4
PSI2_INDEX	0
PSI2_COUNT	6 (total of 7 instances of PSI2 messages)
{0 1<Cell Identification>}	1, as default
{0 1<Non GPRS Cell Options>}	1, as default
{0 1<Reference Frequency Lists>}	0
{0 1<Cell Allocation>}	1
- 1<RFL_NUMBER>	1, 0
- 1<RFL_NUMBER>	1, 1
-	0 (end of cell allocation List)
{0 1<GPRS Mobile Allocation>}	0
{0 1<PCCCH Description>}	1
	1, begin of PCCCH description structure
TSC	'101' same as PBCCH
1< MA_NUMBER >	'1', 9
1< Hopping PCCCH carrier struct>	1, begin of Hopping PCCCH carrier struct
MAIO	3, same as PBCCH
TIMESLOT_ALLOCATION	'01000000' (TN1 same as PBCCH)
	0, end of Hopping PCCCH carrier struct
	0, end of PCCCH description structure

The 2nd PSI2 instance:

PAGE_MODE	Normal paging
PSI2_CHANGE_MARK	$(k + 1) \bmod 4$
PSI2_INDEX	1
PSI2_COUNT	6 (total of 7 instances of PSI2 messages)
{0}1<Cell Identification>	0
{0}1<Non GPRS Cell Options>	0
{0}1<Reference Frequency Lists>	1
-	1
- RFL_NUMBER	0
- Length of RFL contents	
- RFL contents	For GSM 900, in 128 Range format , (10, 17, 20, 26, 42, 45, 59, 66, 76, 108) For DCS 1800, in 256 format, (739,743, 746, 749, 758, 761, 779, 782, 829, 832) For PCS 1900, in 256 format, (718,721, 724, 727, 739, 743, 756, 758, 771, 779) For GSM 700, T-GSM 810, in 128 format. (447, 454, 457, 463, 479, 482, 496, 498, 503, 505) For GSM 850, in 128 format, (137, 144, 147, 153, 169, 172, 186, 193, 203, 235)
-	1 (0 for PCN and PCS)
- RFL_NUMBER	1
- Length of RFL contents	
- RFL contents	For GSM 900, in 128 Range format , (17, 34, 45, 46, 52, 59, 73, 74, 108, 114) For GSM 700, T-GSM810, in 128 format, (454, 471, 482, 483, 489, 496, 500, 501, 506, 508)
-	0 (end of Reference frequency List)
{0}1<Cell Allocation>	0
{0}1<GPRS Mobile Allocation>	0
-	0 (end of ARFCN index lists)
{0}1<PCCCH Description>	0

The 3rd PSI2 instance:

PAGE_MODE	Normal paging
PSI2_CHANGE_MARK	$(k + 1) \bmod 4$
PSI2_INDEX	2
PSI2_COUNT	6 (total of 7 instances of PSI2 messages)
{0}1<Cell Identification>	0
{0}1<Non GPRS Cell Options>	0
{0}1<Reference Frequency Lists>	
-	0 (not present)
{0}1<Cell Allocation>	0
{0}1<GPRS Mobile Allocation>	1
- MA_NUMBER	2
- GPRS Mobile Allocation	
- HSN	Arbitrarily chosen, greater than 0
- {0}1< RFL number list>	1

- RFL_NUMBER	1
-	1 (ARFCN index list)
- {0 1< ARFCN index list>}	1
- ARFCN_INDEX	For GSM: 45 For DCS 1 800: 761 For PCS 1 900: 743 For GSM 700, T-GSM 810: 482 For GSM 850: 172
- {0 1< ARFCN index list>}	1
- ARFCN_INDEX	For GSM: 74 For DCS 1 800: 798 For PCS 1 900: 764 For GSM 700, T-GSM 810: 501 For GSM 850: 201
-	0 (end of ARFCN index lists)
{0 1<GPRS Mobile Allocation>	1
- MA_NUMBER	1
- GPRS Mobile Allocation	Arbitrarily chosen, greater than 0
- HSN	1
- {0 1< RFL number list>}	1
- RFL_NUMBER	1 (ARFCN index list)
-	1
- {0 1< ARFCN index list>}	1
- ARFCN_INDEX	For GSM: 17 For DCS 1 800: 743 For PCS 1 900: 721 For GSM 700, T-GSM 810: 454 For GSM 850: 144
- {0 1< ARFCN index list>}	1
- ARFCN_INDEX	For GSM: 74 For DCS 1 800: 798 For PCS 1 900: 764 For GSM 700, T-GSM 810: 501 For GSM 850: 201
-	0 (end of ARFCN index lists)
{0 1<PCCCH Description>}	0

The 4th PSI2 instance:

PAGE_MODE	Normal paging
PSI2_CHANGE_MARK	(k + 1) mod 4
PSI2_INDEX	3
PSI2_COUNT	6 (total of 7 instances of PSI2 messages)
{0 1<Cell Identification>}	0
{0 1<Non GPRS Cell Options>}	0
{0 1<Reference Frequency Lists>}	1
-	1
- RFL_NUMBER	2
- Length of RFL contents	For GSM 900: frequencies in CA _{pgsm} (1, k) coded by Bitmap 0 format
- RFL contents	For DCS 1800: frequencies in CA _{dcs} (1, k) coded by variable bit map format For PCS 1900: frequencies in CA _{pcc} (1, k) coded by variable bit map format For GSM 700, T-GSM 810: frequencies in CA ₇₀₀ (1, k) coded by 128 Range format For GSM 850: frequencies in CA ₈₅₀ (1, k) coded by variable bit map format
-	0 (end of Reference frequency Lists)
{0 1<Cell Allocation>}	0
{0 1<GPRS Mobile Allocations>}	0
-	
{0 1<PCCCH Description>}	0

The 5th PSI2 instance:

PAGE_MODE	Normal paging
PSI2_CHANGE_MARK	$(k + 1) \bmod 4$
PSI2_INDEX	4
PSI2_COUNT	6 (total of 7 instances of PSI2 messages)
{0}1<Cell Identification>	0
{0}1<Non GPRS Cell Options>	0
{0}1<Reference Frequency Lists>	1
-	1
- RFL_NUMBER	3
- Length of RFL contents	
- RFL contents	For GSM 900: frequencies in $CA_{pgsm}(2, k)$ coded by 128 Range format For DCS 1800: frequencies in $CA_{dcs}(2, k)$ coded by variable bit map format For PCS 1900: frequencies in $CA_{pcs}(2, k)$ coded by variable bit map format For GSM 700, T-GSM 810: frequencies in $CA_{700}(2, k)$ coded by 128 Range format For GSM 850: frequencies in $CA_{850}(2, k)$ coded by 128 Range format
-	0 (end of Reference frequency Lists)
{0}1<Cell Allocation>	0
{0}1<GPRS Mobile Allocations>	0

The 6th PSI2 instance:

PAGE_MODE	Normal paging
PSI2_CHANGE_MARK	$(k + 1) \bmod 4$
PSI2_INDEX	5
PSI2_COUNT	6 (total of 7 instances of PSI2 messages)
{0}1<Cell Identification>	0
{0}1<Non GPRS Cell Options>	0
{0}1<Reference Frequency Lists>	0 for GSM900 1 for DCS1800 1 for PCS1900 1 for GSM 850
-	1
- RFL_NUMBER	1
- Length of RFL contents	
- RFL contents	For DCS1800 in 512 format (743, 756, 761, 764, 771, 779, 791, 798, 832, 844) For PCS1900 in 512 format (721, 734, 743, 746, 749, 756, 761, 764, 779, 782) For GSM 850, in 128 format, (144, 161, 172, 173, 179, 186, 200, 201, 202, 235, 241)
{0}1<Cell Allocation>	0
{0}1<GPRS Mobile Allocation>	1
- MA_NUMBER	9
- GPRS Mobile Allocation	
- HSN	'000000', cyclic hopping
- {0}1< RFL number list>	0 ,referring to the Cell Allocation given in PSI2
- {0}1< ARFCN index list>	10, MA including all ARFCNs of the Cell Allocation given in PSI2
{0}1<PCCCH Description>	0 (end of GPRS Mobile Allocations) 0

The 7th PSI2 Instance

PAGE_MODE	Normal paging
PSI2_CHANGE_MARK	$(k + 1) \bmod 4$
PSI2_INDEX	6
PSI2_COUNT	6 (total of 7 instances of PSI2 messages)
{0 1<Cell Identification>}	0
{0 1<Non GPRS Cell Options>}	0
{0 1<Reference Frequency Lists>}	0
{0 1<Cell Allocation>}	0
{0 1<GPRS Mobile Allocation>	1
- MA_NUMBER	3
- GPRS Mobile Allocation	
- HSN	Arbitrarily chosen
- {0 1< RFL number list>}	1
- RFL_NUMBER	2 corresponding to CA(1,k)
-	0 (MA Bitmap)
- MA_LENGTH	
- MA_BITMAP	For GSM 900 corresponding to MA _{pgsm} (1,k) For DCS 1800 corresponding to MA _{dcs} (1,k) For PCS 1900 corresponding to MA _{pcc} (1,k) For GSM 700, T-GSM 810 corresponding to MA ₇₀₀ (1,k) For GSM 850 corresponding to MA ₈₅₀ (1,k)
- {0 1< Structure flag>	1 (Further one)
- MA_NUMBER	4
- GPRS Mobile Allocation	
- HSN	Arbitrarily chosen
- {0 1< RFL number list>}	1
- RFL_NUMBER	3 corresponding to CA(2,k)
-	0 (MA Bitmap)
- MA_LENGTH	
- MA_BITMAP	For GSM 900 corresponding to MA _{pgsm} (2,k) For DCS 1800 corresponding to MA _{dcs} (2,k) For PCS 1900 corresponding to MA _{pcc} (2,k) For GSM 700, T-GSM 810 corresponding to MA ₇₀₀ (2,k) For GSM 850 corresponding to MA ₈₅₀ (2,k)
{0 1<PCCCH Description>	0

The 2nd (k=2) and 3rd (k=3) set of PACKET SYSTEM INFORMATION TYPE 2 messages

The consistent set of PSI2 messages in the two sets are identical to the 1st set except the value k (k = 2, 3) and the corresponding values CA_{pgsm}(1, k), CA_{pgsm}(2, k), MA_{pgsm}(1, k), MA_{pgsm}(2, k), CA_{dcs}(1, k), CA_{dcs}(2, k), MA_{dcs}(1, k), MA_{dcs}(2, k), CA_{pcc}(1, k), CA_{pcc}(2, k), MA_{pcc}(1, k), MA_{pcc}(2, k), CA₇₀₀(1, k), CA₇₀₀(2, k), MA₇₀₀(1, k), MA₇₀₀(2, k), CA₈₅₀(1, k), CA₈₅₀(2, k), MA₈₅₀(1, k), MA₈₅₀(2, k).

The 2nd PACKET UPLINK ASSIGNMENT message in step 1 (the macro):

{0 1<Frequency Parameters>}	1 (frequency parameters present)
- TSC	5
-	01 (indirect encoding)
- MAIO	5
- MA_NUMBER	1
- {0 1<CHANGE_MARK_1>}	1 (present)
- CHANGE_MARK_1	k mod 4
- {0 1<CHANGE_MARK_2>}	1
- CHANGE_MARK_2	(k + 1) mod 4
Dynamic allocation	01
-	0, timeslot allocation
- USF_TN1	01, TN1 assigned
- USF_TN1	110
- USF_TN2	0
- USF_TN3	0
- USF_TN4	
- USF_TN5	
- USF_TN6	
- USF_TN7	

PACKET UPLINK ASSIGNMENT message in step 6:

{0 1<Frequency Parameters>}	1 (frequency parameters present)
- TSC	'101', same as PBCCH
-	10 (direct encoding 1)
- MAIO	5
- HSN	'000000', cyclic hopping
- {0 1<RFL number list>}	0, refer to CA in PSI2
- {1 0 1<ARFCN index list>}	10, MA including all ARFCNs in CA, ARFCN index list absent.
Dynamic allocation	01
-	0, timeslot allocation
- USF_TN0 - USF_TN5	0000001, TN6 assigned
- USF_TN6	110
- USF_TN7	0

PACKET UPLINK ASSIGNMENT message in step 16:

{0 1<Frequency Parameters>}	1 (frequency parameters present)
- TSC	'011', '101' same as PBCCH
-	01 (indirect encoding)
- MAIO	5
- MA_NUMBER	9 (referring to PSI2)
- {0 1<CHANGE_MARK_1>}	1 (present)
- CHANGE_MARK_1	k mod 4
- {0 1<CHANGE_MARK_2>}	1
- CHANGE_MARK_2	(k + 1) mod 4
Dynamic allocation	01 (Dynamic allocation)
-	0, timeslot allocation
- USF_TN0 - USF_TN5	0000001, TN6 assigned
- USF_TN6	110
- USF_TN7	0

PACKET UPLINK ASSIGNMENT message in step 11:

<ul style="list-style-type: none"> {0 1<Frequency Parameters> - TSC - - MAIO - - MA_NUMBER - {0 1<CHANGE_MARK_1> - CHANGE_MARK_1 - {0 1<CHANGE_MARK_2> Dynamic allocation - Extended Dynamic Allocation - {0 1<PO> - {0 1<RLC_DATA_BLOCKS_GRANTED> - {0 1<TBF_STARTING_TIME> - Starting Number Description - - - USF_TN₀ - GAMMA_TN₀ - 	<ul style="list-style-type: none"> 1 (frequency parameters presents) 01 (indirect encoding) For GSM 900: MAIO_{pgsm}(1, k) For DCS 1800: MAIO_{dcs}(1, k) For PCS 1900: MAIO_{pcs}(1, k) For GSM 700, T-GSM 810: MAIO₇₀₀(1, k) For GSM 850: MAIO₈₅₀(1, k) 3, referred to MA_{pgsm}(1, k) / MA_{dcs}(1, k) / MA_{pcs}(1, k) / MA₇₀₀(1, k) / MA₈₅₀(1, k) 1 (k + 1) mod 4 0 0 0 (Dynamic allocation) 0 0 (open-ended TBF) 1 0, absolute encoding (current frame + T(k)) modulo 42 432 1 (Timeslot Allocation with Power Control Parameters) 1, assign timeslot 0 For GSM 700, T-GSM 810, GSM 850, GSM 900, +8 dBm For DCS 1 800, +6 dBm For PCS 1 900, +6 dBm 0000000, no other timeslots assigned
--	--

PACKET UPLINK ASSIGNMENT message in step 21:

<p>{0 1<Frequency Parameters>} - TSC - - MAIO - HSN - Length of MA Frequency List contents - MA Frequency List contents Dynamic allocation - Extended Dynamic Allocation - {0 1<P0>} - {0 1<RLC_DATA_BLOCKS_GRANTED>} - {0 1<TBF_STARTING_TIME>} - Starting Number Description - - - USF_TN₂ - GAMMA_TN₂ -</p>	<p>1 (frequency parameters presents) 11 (direct encoding 2) For GSM 900 MAIO_{pgsm}(3, k) For DCS 1800 MAIO_{dcs}(3, k) For PCS 1900 MAIO_{pcc}(3, k) For GSM 700, T-GSM 810 MAIO₇₀₀(3, k) For GSM 850 MAIO₈₅₀(3, k) Arbitrarily chosen GSM 900: referred to CA_{pgsm}(3, k) and MA_{pgsm}(3, k) in bit map 0 format. DCS 1800: referred to CA_{dcs}(3, k) and MA_{dcs}(3, k), k=1, in 1024 range format, k=2, in 512 range format, k=3, in 256 range format. PCS 1900: referred to CA_{pcc}(3, k) and MA_{pcc}(3, k), k=1, in 1024 range format, k=2, in 512 range format, k=3, in 256 range format. GSM 700, T-GSM 810: referred to CA₇₀₀(3, k) and MA₇₀₀(3, k) in 128 Range format. GSM 850: referred to CA₈₅₀(3, k) and MA₈₅₀(3, k) in 128 Range format. 0 0 (Dynamic allocation) 0 0 (open-ended TBF) 1 0, absolute encoding (current frame + T(k)) modulo 42 432 1 (Timeslot Allocation with Power Control Parameters) 001, assign timeslot 2 For GSM 700, T-GSM 810, GSM 850 and GSM 900, +8 dBm For DCS 1 800, +6 dBm For PCS 1 900, +6 dBm 00000, no other timeslots assigned</p>
---	--

PACKET UPLINK ASSIGNMENT message in step 26:

<pre> {0 1<Frequency Parameters> - TSC - - MAIO - MA_NUMBER - {0 1<CHANGE_MARK_1>} - CHANGE_MARK_1 - {0 1<CHANGE_MARK_2>} Dynamic allocation - Extended Dynamic Allocation - {0 1<P0>} - {0 1<RLC_DATA_BLOCKS_GRANTED>} - {0 1<TBF_STARTING_TIME>} - Starting Number Description - - - USF_TN₃ - GAMMA_TN₃ - </pre>	<pre> 1 (frequency parameters presents) 01 (indirect encoding) For GSM 900: MAIO_{pgsm}(2, k) For DCS 1800: MAIO_{dcs}(2, k) For PCS 1900: MAIO_{pccs}(2, k) For GSM 700, T-GSM 810: MAIO₇₀₀(2, k) For GSM 850: MAIO₈₅₀(2, k) 4, referred to MA_{pgsm}(2, k) / MA_{dcs}(2, k) / MA_{pccs}(2, k) / MA₇₀₀(2, k) / MA₈₅₀(2, k) 1 (k + 1) mod 4 0 0 0 (Dynamic allocation) 0 0 (open-ended TBF) 1 0, absolute encoding (current frame + T(k)) modulo 42 432 1 (Timeslot Allocation with Power Control Parameters) 0001, assign timeslot 3 For GSM 700, T-GSM 810, GSM 850, GSM 900, +8 dBm For DCS 1 800, +6 dBm For PCS 1 900, +6 dBm 0000, no other timeslots assigned </pre>
---	---

PACKET UPLINK ASSIGNMENT message in step 31:

<pre> {0 1<Frequency Parameters> - TSC - - MAIO - MA_NUMBER - {0 1<CHANGE_MARK_1>} - {0 1<CHANGE_MARK_2>} Dynamic allocation - Extended Dynamic Allocation - {0 1<P0>} - {0 1<RLC_DATA_BLOCKS_GRANTED>} - {0 1<TBF_STARTING_TIME>} - Starting Number Description - - - USF_TN₆ - GAMMA_TN₆ - </pre>	<pre> 1 (frequency parameters presents) 01 (indirect encoding) For GSM 900: MAIO_{pgsm}(3, k) For DCS 1800: MAIO_{dcs}(3, k) For PCS 1900: MAIO_{pccs}(3, k) For GSM 700, T-GSM 810: MAIO₇₀₀(3, k) For GSM 850: MAIO₈₅₀(3, k) 15, referred to MA_{pgsm}(3, k) / MA_{dcs}(3, k) / MA_{pccs}(3, k) / MA₇₀₀(3, k) / MA₈₅₀(3, k) 0 0 0 0 (Dynamic allocation) 0 0 (open-ended TBF) 1 0, absolute encoding (current frame + T(k)) modulo 42 432 1 (Timeslot Allocation with Power Control Parameters) 0000001, assign timeslot 6 For GSM 700, T-GSM 810, GSM 850 and GSM 900, +8 dBm For DCS 1 800, +6 dBm For DCS 1900, +3 dBm 0, no other timeslots assigned </pre>
---	--

42.3.1.1.10 Dynamic Allocation / Uplink Transfer / Normal / USF assigned with MCS-1 to MCS-4

42.3.1.1.10.1 Conformance requirements

In 44.060 it is stated: "If dynamic or extended dynamic allocation is used, a mobile station in GPRS TBF mode shall be able to detect the USF that assigns the uplink to that mobile station. The network shall use GMSK modulation, i.e. either CS-1 to CS-4 or MCS-1 to MCS-4, in those blocks."

In 45.003 it is stated: "For the coding schemes CS-2 to CS-4 and MCS-1 to MCS-4, the first three bits (USF-bits) of the data block are encoded such that the first twelve coded bits are representing the same bit pattern, irrespective of the coding scheme, depending only on the USF-bits. For these coding schemes, the USF-bits can therefore always be decoded from these twelve bits in the same way."

According to these two requirements, a MS in GPRS TBF mode shall detect an assigned USF value on an assigned PDCH when the network sends the USF in a EGPRS RLC/MAC block coded with MCS-1 to MCS-4.

References

3GPP TS 44.060, subclauses 5.2.4a.

3GPP TS 45.003, subclauses 5.1.

42.3.1.1.10.2 Test purposes

To verify that a MS in GPRS TBF mode in uplink detects the assigned USFs when the network assigns these USFs with data blocks coded with MCS-1 to MCS-4.

42.3.1.1.10.3 Method of test

Initial Conditions

System Simulator:

1 cell, default setting, BS_PBCCH_BLKs = 3.

Mobile Station:

The MS is GPRS attached with a P-TMSI allocated and the test PDP context3 activated.

Specific PICS Statements

-

PIXIT Statements

-

Test Procedure

The MS is triggered to initiate a packet uplink data transfer in RLC acknowledged mode on one PDCH. The SS orders the MS to have a two-phase access, in PACKET UPLINK ASSIGNMENT message with the USF_GRANULARITY set to 1 block.

The SS sends on the assigned PDCH an EGPRS data block coded with MCS-1 containing the USF value assigned to the MS on the corresponding PDCH. The SS checks that the MS sends in response on the assigned PDCH the expected data block.

The test is repeated by the SS using EGPRS data blocks coded successively with MCS-2, MCS-3 and MCS-4 to assign the USF to the MS.

Then the data transfer is completed.

Maximum Duration of Test

1 minute.

Expected Sequence

Step	Direction	Message	Comments
1		{Uplink dynamic allocation two phase access}	n =200 octets, without starting time, USF_GRANULARITY = 1 block, RLC_DATA_BLOCKS_GRANTED = open-end, TLLI_BLOCK_CHANNEL_CODING: CS-1, CHANNEL_CODING_COMMAND: CS-1, No starting time.
2	SS -> MS	DOWNLINK EGPRS RLC DATA BLOCK	Sent on the PDTCH assigned to the MS. The data block is coded with MCS-1 and contains the USF assigned to the MS.
3	MS -> SS	UPLINK RLC DATA BLOCK	Received on the assigned PDTCH in the next radio block to step 2. Check that the TFI and the data are coded with CS-1.
4	SS -> MS	DOWNLINK EGPRS RLC DATA BLOCK	Sent on the PDTCH assigned to the MS. The data block is coded with MCS-2 and contains the USF assigned to the MS.
5	MS -> SS	UPLINK RLC DATA BLOCK	Received on the assigned PDTCH in the next radio block to step 4. Check that the TFI and the data are coded with CS-1..
6	SS -> MS	DOWNLINK EGPRS RLC DATA BLOCK	Sent on the PDTCH assigned to the MS. The data block is coded with MCS-3 and contains the USF assigned to the MS.
7	MS -> SS	UPLINK RLC DATA BLOCK	Received on the assigned PDTCH in the next radio block to step 6. Check that the TFI and the data are coded with CS-1.
8	SS -> MS	DOWNLINK EGPRS RLC DATA BLOCK	Sent on the PDTCH assigned to the MS. The data block is coded with MCS-4 and contains the USF assigned to the MS.
9	MS -> SS	UPLINK RLC DATA BLOCK	Received on the assigned PDTCH in the next radio block to step 8. Check that the TFI and the data are coded with CS-1.
10	SS -> MS	PACKET UPLINK ACK/NACK	Sent on the PACCH of the PDCH, the USF not addressing the MS.
11		{Completion of uplink RLC data block transfer}	USF_GRANULARITY = 1 block; 1 slot assigned in uplink.

42.3.1.2 Dynamic Allocation / Uplink Transfer / Abnormal

42.3.1.2.1 Void

42.3.1.2.2 Dynamic Allocation / Uplink Transfer / Abnormal / with cell reselection in acknowledged mode

42.3.1.2.2.1 Conformance requirements

Upon detecting the stall condition the mobile station shall start timer T3182. If timer T3182 expires, the mobile station shall decrement counter N3102 by PAN_DEC, and perform an abnormal release with random access.

When $N3102 \leq 0$ is reached, the mobile station shall perform an abnormal release with cell re-selection.

References

3GPP TS 04.60/44.060, subclause 9.3.2.2 and 9.3.2.3.

42.3.1.2.2.2 Test purposes

To verify that while in uplink acknowledged mode operation the MS performs an abnormal release with cell reselection if the $N3102 \leq 0$ is reached.

42.3.1.2.2.3 Method of test

Initial Conditions

System Simulator:

2 cells, GPRS supported, PCCCH present, Max-Retrans = 2, access burst type = 11 bits, BS_PAG_BLKES_RES = 2, BS_PBCCH_BLKES = 3, BS_PCC_CHANS = 1, BS_PRACH_BLKES = 1, PAN_MAX = 1, PAN_DEC = 5 and PAN_INC = 2.

Cell A:

PSI_3 of Cell A contains:

GPRS_RESELECT_OFFSET(B) = -20 dB, RANDOM_ACCESS_RETRY = 1.

Cell B:

PSI_3 of Cell B contains :

GPRS_RESELECT_OFFSET(A) = 10 dB.

Mobile Station:

The MS is GPRS attached on cell A, a P-TMSI allocated and test PDP context2 activated.

Specific PICS Statements

-

PIXIT Statements

-

Test Procedure

The MS is triggered to initiate packet uplink transfer 2000 octets in the RLC acknowledged mode on cell A. After a successful uplink PDCH assignment the SS sends PACKET DOWNLINK DUMMY indicating the assigned USF assigned to the MS. The MS sends a RLC radio block. The SS allows the MS to transfer so many data blocks without acknowledgement until the stall indication bit is set.

The MS requests the necessary radio resources by PACKET CHANNEL REQUEST on cell A. The SS assigns a new PDCH to the MS. The SS sends PACKET DOWNLINK DUMMY indicating the assigned USF assigned to the MS. The MS sends a RLC radio block. The SS allows the MS to transfer so many data blocks without acknowledgement until the stall indication bit is set.

The MS requests the necessary radio resources by PACKET CHANNEL REQUEST on cell B. The SS then assigns a new PDCH to the MS for completion of the requested uplink data transfer.

Maximum Duration of Test

5 minutes.

Expected Sequence

Step	Direction	Message	Comments
1		{Uplink dynamic allocation two phase access}	The following messages received on cell A. n = 2000 octets in RLC acknowledged mode (Test PDP context2), without starting time, USF_GRANULARITY = 1 block, RLC_DATA_BLOCKS_GRANTED = open-end TLLI_BLOCK_CHANNEL_CODING: cs1, CHANNEL_CODING_COMMAND: cs1
2	SS -> MS	PACKET DOWNLINK DUMMY CONTROL BLOCK	USF assigned to the MS on 3 blocks from the last radio block containing the uplink assignment.
3	MS -> SS	UPLINK RLC DATA BLOCK	Received on the assigned PDTCH. Check that the coding and the TFI are correct.
4			Repeat step 2 and 3 in total of 65 times.
4-1	SS -> MS	PACKET DOWNLINK DUMMY CONTROL BLOCK	Sent on the PACCH of the assigned PDCH . USF assigned to the MS.
4-2	MS -> SS	UPLINK RLC DATA BLOCK	Received on the assigned PDTCH.
5	MS -> SS	PACKET CHANNEL REQUEST	Received on PRACH of cell A.
6	SS -> MS	PACKET UPLINK ASSIGNMENT	Single block assignment, to order the MS making two-phase access procedure. Sent on PAGCH.
7	MS -> SS	PACKET RESOURCE REQUEST	Two phase access procedure. Received on the single block assigned.
8	SS -> MS	PACKET UPLINK ASSIGNMENT	Open-ended uplink dynamic allocation, no starting time, Sent on PAGCH.
9	SS -> MS	PACKET DOWNLINK DUMMY CONTROL BLOCK	USF assigned to the MS. on 3 blocks from the last radio block containing the uplink assignment.
10	MS -> SS	UPLINK RLC DATA BLOCK	Received on the assigned PDTCH.
11			Repeat step 9 and 10 in total of 65 times.
11-1	SS -> MS	PACKET DOWNLINK DUMMY CONTROL BLOCK	Sent on the PACCH of the assigned PDCH . USF assigned to the MS.
11-2	MS -> SS	UPLINK RLC DATA BLOCK	Received on the assigned PDTCH.
12	MS -> SS	PACKET CHANNEL REQUEST	The following messages received on cell B. Received on PRACH of cell B.
13	SS		SS stops transmitting cell A
14	SS -> MS	PACKET UPLINK ASSIGNMENT	Single block assignment, to order the MS making two-phase access procedure. Sent on PAGCH.
15	MS -> SS	PACKET RESOURCE REQUEST	Received on the single block assigned, ACCESS TYPE = Two Phase Access Request or Cell update.
16	SS -> MS	PACKET UPLINK ASSIGNMENT	Open-ended uplink dynamic allocation, no starting time, Sent on PAGCH.
17	SS -> MS	PACKET DOWNLINK DUMMY CONTROL BLOCK	USF assigned to the MS. on 3 blocks from the last radio block containing the uplink assignment.
18	MS -> SS	UPLINK RLC DATA BLOCK	Received on the assigned PDTCH. (Data block might contain empty LLC PDU for Cell Update. In that case the SS shall accept Packet Resource Request from MS and respond with Packet Uplink Assignment.)
19		{Completion of uplink RLC data block transfer}	NOTE: The empty LLC PDU may be accompanied by another low priority RLC data block (with Packet Resource Request and Packet Uplink Assignment as required), in order to ensure that the radio resources are used efficiently.

42.3.1.2.3 Dynamic Allocation / Uplink Transfer / Abnormal / with cell reselection in unacknowledged mode

42.3.1.2.3.1 Conformance requirements

If the mobile station transmits k RLC data blocks without receiving a Packet Ack/Nack message the mobile station shall start timer T3182. If timer T3182 expires, the mobile station shall decrement counter N3102 by PAN_DEC, and perform an abnormal release with random access.

When $N3102 \leq 0$ is reached, the mobile station shall perform an abnormal release with cell re-selection.

References

3GPP TS 04.60, subclause 9.3.3.2.

42.3.1.2.3.2 Test purposes

To verify that while in uplink unacknowledged mode operation the MS performs an abnormal release with cell reselection if the $N3102 \leq 0$ is reached.

42.3.1.2.3.3 Method of test

Initial Conditions

System Simulator:

2 cells, GPRS supported, PCCCH present, Max-Retrans = 2, access burst type = 11 bits, BS_PAG_BLKES_RES = 2, BS_PBCCH_BLKES = 3, BS_PCC_CHANS = 1, BS_PRACH_BLKES = 1, PAN_MAX = 1, PAN_DEC = 5 and PAN_INC = 2.

Cell A:

PSI_3 of Cell A contains :

GPRS_RESELECT_OFFSET(B) = -20 dB, RANDOM_ACCESS_RETRY = 1.

Cell B:

PSI_3 of Cell B contains :

GPRS_RESELECT_OFFSET(A) = 10 dB.

Mobile Station:

The MS is GPRS attached with cell A, a P-TMSI allocated and Test PDP context3 activated.

Specific PICS Statements

-

PIXIT Statements

-

Test Procedure

The MS is triggered to initiate packet uplink transfer 3500 octets in the RLC unacknowledged mode on cell A. After a successful uplink PDCH assignment the SS sends PACKET DOWNLINK DUMMY indicating the assigned USF assigned to the MS. The MS sends a RLC radio block. The SS allows the MS to transfer 64 data blocks without acknowledgement.

The MS requests the necessary radio resources by PACKET CHANNEL REQUEST on cell A. The SS assigns a new PDCH to the MS. The SS sends PACKET DOWNLINK DUMMY indicating the assigned USF assigned to the MS. The MS sends a RLC radio block. The SS allows the MS to transfer 64 data blocks without acknowledgement.

A MS might perform a cell change due to T3182 expiry and hence the MS should then perform Cell Update procedure. The MS sends PACKET CHANNEL REQUEST with the Access Type = „Cell Update“ (on cell B). The SS sends

PACKET UPLINK ASSIGNMENT to assign a TBF. The SS assigns USF to the MS by sending PACKET DOWNLINK DUMMY CONTROL BLOCK. The MS sends the empty LLC PDU for Cell Update. The SS acknowledges the received block by sending PACKET UPLINK ACK/NACK.

If the MS perform Cell Update : The MS is triggered to initiate packet uplink transfer 1500, the MS requests the necessary radio resources by PACKET CHANNEL REQUEST on cell B. The SS then assigns a new PDCH to the MS for completion of the requested uplink data transfer.

If the MS does not perform Cell Update: MS sends PACKET CHANNEL REQUEST, to send the uplink data on cell B. The SS then assigns a new PDCH to the MS for completion of the requested uplink data transfer.

Maximum Duration of Test

5 minutes.

Expected Sequence

Step	Direction	Message	Comments
1		{Uplink dynamic allocation two phase access}	The following messages received on cell A. n = 3500 octets in RLC unacknowledged mode (Test PDP context3), without starting time, USF GRANULARITY = 1 block, RLC_DATA_BLOCKS_GRANTED = open-end TLLI_BLOCK_CHANNEL_CODING: cs1, CHANNEL_CODING_COMMAND: cs1
2	SS -> MS	PACKET DOWNLINK DUMMY CONTROL BLOCK	Sent on the PACCH of the PDCH assigned in step 1, the USF assigned to the MS.
3	MS -> SS	UPLINK RLC DATA BLOCK	Received on the assigned PDCH. Check that the coding and the TFI are correct.
4			Repeat step 2 and 3 in total of 64 times.
4-1	SS -> MS	PACKET DOWNLINK DUMMY CONTROL BLOCK	Sent on the PACCH of the assigned PDCH . USF assigned to the MS.
4-2	MS -> SS	UPLINK RLC DATA BLOCK	Received on the assigned PDCH.
5	SS		Wait 5s after step 4 for T3182 time-out.
6	MS -> SS	PACKET CHANNEL REQUEST	Received on PRACH of cell A.
7	SS -> MS	PACKET UPLINK ASSIGNMENT	Single block assignment, to order the MS making two-phase access procedure. Sent on PAGCH.
8	MS -> SS	PACKET RESOURCE REQUEST	Two phase access procedure. Received on the single block assigned.
9	SS -> MS	PACKET UPLINK ASSIGNMENT	Open-ended uplink dynamic allocation, no starting time, Sent on PAGCH.
10	SS -> MS	PACKET DOWNLINK DUMMY CONTROL BLOCK	The USF assigned to the MS, sent after three blocks of the assignment sent in step 9.
11	MS -> SS	UPLINK RLC DATA BLOCK	Received on the assigned PDCH.
12			Repeat step 10 and 11 in total of 64 times.
12-1	SS -> MS	PACKET DOWNLINK DUMMY CONTROL BLOCK	Sent on the PACCH. USF assigned to the MS.
12-2	MS -> SS	UPLINK RLC DATA BLOCK	Received on the assigned PDCH.
13	SS		Wait for 5 seconds after step 12 for T3182 time-out. The following messages received on cell B.

14 (optional step)	MS -> SS	PACKET CHANNEL REQUEST	'Cell Update'
14-1 (conditional step)	SS		SS stops transmitting Cell A.
15 (conditional step)	SS -> MS	PACKET UPLINK ASSIGNMENT	Sent on PAGCH. Assigning Single Block , to order the MS making two-phase access procedure
16 (conditional step)	MS -> SS	PACKET RESOURCE REQUEST	"Cell Update" access type. Received on the single block assigned.
17 (conditional step)	SS -> MS	PACKET UPLINK ASSIGNMENT	Open-ended uplink dynamic allocation, no starting time, Sent on PAGCH.
18 (conditional step)	SS	{Completion of uplink RLC data transfer }	For the empty LLC frame serving as cell update
19 (conditional step)			Trigger MS for 1500 octets
20	MS -> SS	PACKET CHANNEL REQUEST	Received on PRACH of cell B.
21	SS		SS stops transmitting Cell A (if not already done in step 14-1)
22	SS -> MS	PACKET UPLINK ASSIGNMENT	Single block assignment, to order the MS making two-phase access procedure. Sent on PAGCH.
23	MS -> SS	PACKET RESOURCE REQUEST	Two phase access procedure. Received on the single block assigned.
24	SS -> MS	PACKET UPLINK ASSIGNMENT	Open-ended uplink dynamic allocation, no starting time, Sent on PAGCH.
25	SS -> MS	PACKET DOWNLINK DUMMY CONTROL BLOCK	The USF assigned to the MS. Sent on PACCH of PDCH assigned. Sent after three blocks of the message sent in step 24.
26	MS -> SS	UPLINK RLC DATA BLOCK	Received on the assigned PDTCH.
27		{Completion of uplink RLC data block transfer}	

Note: if optional step 14 is performed, then steps 14-1, 15, 16 ...and 19 are conditionally.

42.3.2 Dynamic Allocation / Uplink Transfer with Downlink TBF establishment (concurrent)

42.3.2.1 Dynamic Allocation / Uplink Transfer with Downlink TBF establishment / Normal

42.3.2.1.1 Dynamic Allocation / Uplink Transfer with Downlink TBF establishment / Normal / Successful

42.3.2.1.1.1 Conformance requirements

During uplink transfer, the network may initiate a downlink TBF by sending a PACKET DOWNLINK ASSIGNMENT message, or a PACKET TIMESLOT RECONFIGURE, to the mobile station on the PACCH. If a PACKET TIMESLOT RECONFIGURE message is sent, then the message shall contain the DOWNLINK_TFI_ASSIGNMENT field. On receipt of an assignment message, and after the TBF starting time, if present, the mobile station shall switch to the assigned PDCHs. The operation of the downlink TBF follows the procedures in 3GPP TS 04.60, subclause 8.1.2 with the following additions:

1. If a timer or counter expiry causes the uplink TBF to be aborted in the mobile station, the mobile station shall also abort the downlink TBF and perform an abnormal release with random access.
2. If uplink and downlink TBFs are already established, then the network may send a PACKET TIMESLOT RECONFIGURE message without DOWNLINK_TFI_ASSIGNMENT. The mobile station shall interpret this as

a reassignment of the timeslot allocations of the concurrent uplink and downlink TBFs and the downlink TFI is not changed.

References

3GPP TS 04.60, subclauses 8.1.1.1.3 and 8.1.2.

42.3.2.1.1.2 Test purposes

To verify that during uplink transfer:

1. The MS switches to the assigned PDCHs when the network initiates a downlink TBF by sending PACKET DOWNLINK ASSIGNMENT or PACKET TIMESLOT RECONFIGURE to the MS on PACCH.
2. When the MS receives PACKET TIMESLOT RECONFIGURE without DOWNLINK_TFI_ASSIGNMENT in the case of uplink and downlink TBFs established already, the MS interprets this message as a reassignment of the timeslot allocations of the concurrent uplink and downlink TBFs.
3. The MS also aborts the downlink TBF and performs an abnormal release with random access if a timer or a counter expiry causes the uplink TBF to be aborted in the MS.

42.3.2.1.1.3 Method of test

Initial Conditions

System Simulator:

1 cell, default setting, BS_PBCCH_BLKs = 3.

Mobile Station:

The MS is GPRS attached with a P-TMSI allocated and the test PDP context3 activated.

Specific PICS Statements

-

PIXIT Statements

-

Test Procedure

An uplink TBF is established and in progress. After the MS sends an uplink data block the SS assigns a downlink TBF on the same timeslot as the uplink TBF. The SS sends a downlink data block with polling for acknowledgement and the assigned USF assigned to the MS for the MS, and indicates FBI=1 for the final data block. The MS sends an uplink data block and acknowledges the received downlink data block on the correct frame. The SS waits 2s for the MS releasing the downlink PDCH. The SS sends PACKET TIMESLOT RECONFIGURE assigning a new downlink PDCH. A downlink data block is sent, the assigned USF assigned to the MS and the MS is polled for acknowledgement. The MS sends an uplink data block and acknowledges the last received downlink data block on the correct frame.

The SS sends PACKET TIMESLOT RECONFIGURE without DOWNLINK_TFI_ASSIGNMENT replacing the existing uplink and downlink PDCH with another pair of concurrent PDCH. A downlink data block is sent on the replaced PDCH and the MS is polled for acknowledgement. The MS shall not react upon it. Another downlink data block is sent on the assigned PDCH, the assigned USF assigned to the MS and the MS is polled for acknowledgement. The MS sends an uplink data block and acknowledges the received downlink data block on the correct frame.

The SS sends downlink data blocks with USF not addressing the MS until receives PACKET CHANNEL REQUEST.

Maximum Duration of Test

5 minutes.

Expected Sequence

Step	Direction	Message	Comments
------	-----------	---------	----------

Step	Direction	Message	Comments
1		{Uplink dynamic allocation two phase access}	n = 440 octets, without starting time, USF_GRANULARITY = 1 block, RLC_DATA_BLOCKS_GRANTED = open-end CHANNEL_CODING_COMMAND: arbitrarily chosen.
2	SS -> MS	PACKET DOWNLINK DUMMY CONTROL BLOCK	The assigned USF assigned to the MS on 3 blocks from the last radio block containing the uplink assignment.
3	MS -> SS	UPLINK RLC DATA BLOCK	
4	SS -> MS	PACKET DOWNLINK ASSIGNMENT	Sent on the PACCH, assigning a downlink TBF, MAC mode = dynamic allocation, RLC mode = unacknowledged, single timeslot, TFI ₂ , no starting time.
5	SS -> MS	DOWNLINK RLC DATA BLOCK	Containing RRBp= N+13 and USF assigned to the MS. FBI = '1'. Sent on the downlink PDTCH on 3 blocks from the last radio block containing the downlink assignment.
6	MS -> SS	UPLINK RLC DATA BLOCK	Received on the uplink PDTCH assigned in step 1.
7	MS -> SS	PACKET CONTROL ACK	Received on the frame number = N+13, N is the frame number of the first burst of the data block in step 5.
8	SS -> MS	PACKET UPLINK ACK/NACK	Containing USF assigned to the MS
9	MS -> SS	UPLINK RLC DATA BLOCK	Received on the uplink PDTCH assigned in step 1.
10	SS		Wait 2 s for T3192 timeout.
11	SS -> MS	PACKET TIMESLOT RECONFIGURE	Sent on the PACCH of the PDCH assigned in step 1. Assign a downlink TBF, MAC mode = dynamic allocation, RLC mode = unacknowledged, single slot, TFI ₂ , no starting time.
12	SS -> MS	DOWNLINK RLC DATA BLOCK	Containing RRBp= N+21 or +22 and USF assigned to the MS. FBI = '0'. Sent on the downlink PDTCH assigned on 3 blocks from the last radio block containing the downlink assignment in step 11.
13	MS -> SS	UPLINK RLC DATA BLOCK	Received on the uplink PDTCH assigned in step 1.
14	MS -> SS	PACKET DOWNLINK ACK/NACK	Received on the block of frame number = N+21 or +22, N is the frame number of the first burst of the data block in step 12.
15	SS -> MS	PACKET TIMESLOT RECONFIGURE	Without DOWNLINK_TFI_ASSIGNMENT, Assign new uplink and downlink time slots, no starting time, sent on the PACCH of the PDCH assigned in step 11.
16	SS -> MS	DOWNLINK RLC DATA BLOCK	Containing USF assigned to the MS. Sent on the downlink PDTCH assigned in step 11 on 3 blocks from the last radio block containing the assignment in step 15.
17	SS		Check that neither data blocks, nor control blocks are sent by the MS within the next seven radio blocks.
18	SS -> MS	DOWNLINK RLC DATA BLOCK	Containing a valid RRBp= N+26 and USF assigned to the MS. Sent on the downlink PDTCH assigned in step 15.
19	MS -> SS	UPLINK RLC DATA BLOCK	Received on the uplink PDTCH assigned in step 15.
20	MS -> SS	PACKET DOWNLINK ACK/NACK	Received on the block of frame number = N+26, N is the frame number of the first burst of the data block in step 18, on the PACCH of the downlink PDCH.
21	SS -> MS	DOWNLINK RLC DATA BLOCK	USF not addressing the MS.
22	SS -> MS		Repeat step 21 until receives PACKET CHANNEL REQUEST in step 23.
23	MS -> SS	PACKET CHANNEL REQUEST	Received on PRACH within 7.5 seconds (T3180 * 110% + PSI1 repeat period, 2 s) from step 20.
24	SS -> MS	PACKET UPLINK ASSIGNMENT	Single block assignment,
25	MS -> SS	PACKET RESOURCE REQUEST	Two phase access procedure. Received on the single block assigned in step 24.
26	SS -> MS	PACKET UPLINK ASSIGNMENT	Open-ended uplink dynamic allocation, no starting time, USF_GRANULARITY = 4 blocks, Sent on PACCH of the same PDCH assigned in step 24.
27	SS -> MS	PACKET DOWNLINK DUMMY CONTROL BLOCK	The USF assigned to the MS. Sent on PACCH of PDCH assigned on 3 blocks from the last radio block containing the uplink assignment in step 26.
28	MS -> SS	UPLINK RLC DATA BLOCK	Received 4 consecutive data blocks
29		{Completion of uplink RLC data block transfer}	

Specific Message Contents

PACKET DOWNLINK ASSIGNMET message in step 4:

PAGE_MODE {0 1<PERSISTENCE_LEVEL>} - Global TFI	Normal 0 0, Global TFI as reference 0, uplink TFI same value as assigned in the uplink in step 1
MAC_MODE	Dynamic allocation
RLC_MODE	Unacknowledged
CONTROL_ACK	0
TIMESLOT_ALLOCATION	same slot number as assigned in the uplink TBF
Packet Timing Advance	
- {0 1<TIMING_ADVANCE_VALUE>} - TIMING_ADVANCE_VALUE	1 30 bit periods
- {0 1<TIMING_ADVANCE_INDEX> <TIMING_ADVANCE_TIMESLOT_NUMBER >}	0 (no timing advance index)
{0 1<P0><BTS_PWR_CTR_MODE >}	0
{0 1<Frequency Parameters>}	0 (no Frequency Parameters present)
{0 1<DOWNLINK_TFI_ASSIGNMENT>} - DOWNLINK_TFI_ASSIGNMENT	1 (assign downlink TFI) arbitrarily chosen from valid values but different from the value for uplink TBF
{0 1<Power Control Parameters>}	0 (no Power Control Parameters present)
{0 1<TBF_STARTING_TIME>}	0 (no starting time)
{0 1<Measurement Mapping>}	0 (no starting time)

PACKET TIMESLOT RECONFIGURE message in step 11:

PAGE_MODE - Global TFI	Normal 0, Global TFI as reference 0, uplink TFI same value as assigned in the uplink in step 1
CHANNEL_CODING_COMMAND	Arbitrarily chosen from valid values
Global packet Timing Advance	
- {0 1<TIMING_ADVANCE_VALUE>} - TIMING_ADVANCE_VALUE	1 (timing advance value) 30 bit periods
- {0 1<UPLINK_TIMING_ADVANCE_INDEX> <UPLINK_TIMING_ADVANCE_TIMESLOT_NUMBER>}	0 (no uplink timing advance index) The MS stops the operation of the continuous timing advance procedure.
- {0 1<DOWNLINK_TIMING_ADVANCE_INDEX> <DOWNLINK_TIMING_ADVANCE_TIMESLOT_NUMBE R>}	0 (no downlink timing advance index) The MS stops the operation of the continuous timing advance procedure.
DOWNLINK_RLC_MODE	Unacknowledged mode
CONTROL_ACK	0
{0 1<DOWNLINK_TFI_ASSIGNMENT>} - GLOBAL_TFI_ASSIGNMENT	1 (assign a new TFI for downlink TBF) Arbitrarily chosen but different from the value for uplink TBF
{0 1<UPLINK_TFI_ASSIGNMENT>}	0
DOWNLINK_TIMESLOT_ALLOCATION	Same as the slot of the uplink TBF
{0 1<Frequency parameters>}	0
{0 <Dynamic allocation> 1<Fixed allocation>}	See note

PACKET TIMESLOT RECONFIGURE message in step 15:

PAGE_MODE	Normal
- Global TFI	0, Global TFI as reference 0, uplink TFI same value as assigned in the uplink in step 1
CHANNEL_CODING_COMMAND	Arbitrarily chosen from valid values
Global packet Timing Advance	
- {0 1<TIMING_ADVANCE_VALUE>}	1 (timing advance value)
- TIMING_ADVANCE_VALUE	30 bit periods
- {0 1<UPLINK_TIMING_ADVANCE_INDEX>	0 (no uplink timing advance index)
<UPLINK_TIMING_ADVANCE_TIMESLOT_NUMBER>}	The MS stops the operation of the continuous timing advance procedure.
- {0 1<DOWNLINK_TIMING_ADVANCE_INDEX>	0 (no downlink timing advance index)
<DOWNLINK_TIMING_ADVANCE_TIMESLOT_NUMBER>}	The MS stops the operation of the continuous timing advance procedure.
DOWNLINK_RLC_MODE	Unacknowledged mode
CONTROL_ACK	0
{0 1<DOWNLINK_TFI_ASSIGNMENT>}	0
{0 1<UPLINK_TFI_ASSIGNMENT>}	0
DOWNLINK_TIMESLOT_ALLOCATION	Timeslot 5 assigned
{0 1<Frequency parameters>}	0
Dynamic allocation	0
- Extended Dynamic Allocation	0 (Dynamic allocation)
{0 1<P0>}	0
- USF GRANULARITY	0 (1 RLC block)
- {0 1<RLC_DATA_BLOCKS_GRANTED>}	0 (open-ended TBF)
- {0 1<TBF_STARTING_TIME>}	0 (no starting time)
-	1 (Timeslot Allocation with Power Control Parameters)
- ALPHA	0.5
- {0 1<USF_TNx><GAMMA_TNx>}	000001 (timeslot 5 assigned)
- USF_TN ₅	Arbitrarily chosen but different from current value
- GAMMA_TN ₅	For GSM 700, T-GSM 810, GSM 850 and GSM 900, +8 dBm For DCS 1 800 and PCS 1 900, +6 dBm
	00

42.3.2.1.2 Dynamic Allocation / Uplink Transfer with Downlink TBF establishment / Normal / Multislot capabilities

42.3.2.1.2.1 Conformance requirements

1. Mobile station belonging to multislot class 2, 3, 4, 5, 6, 8, 9, 10, 19 and 24 shall support as many uplink and downlink timeslots as indicated in 3GPP TS 05.02 clause B.1.
2. If transmission of the PACKET CONTROL ACKNOWLEDGEMENT would result in more than the maximum Tx timeslots per TDMA frame allowed by the multislot class, transmission of the highest numbered PDCH(s) shall be omitted.

References

3GPP TS 05.02, clause B.1.

3GPP TS 04.60, subclause 8.6.

42.3.2.1.2.2 Test purposes

To verify that the GPRS multislot MS supports as many uplink and downlink TBFs per TDMA frame as indicated. Especially, it is verified that the Type 1 MS in a GPRS multislot class declared has the capability of supporting:

1. T_{tb} , the minimum number of slots allowed between the end of the previous transmit or receive TS and the next transmit TS when measurement is to be performed for type 1 MS;
2. T_{ra} , the minimum number of slots allowed between the previous transmit or receive TS and the next receive TS when measurement is to be performed for type 1 MS;

3. the maximum number of Rx and Tx supported;
4. the sum of slots supported.

It is also verified that the MS of a GPRS multislot class transmits PACKET CONTROL ACKNOWLEDGEMENT when polled, and omits the transmission of the highest numbered PDCH(s) if the transmission would result in more than the maximum Tx timeslots per TDMA frame allowed by the multislot class.

42.3.2.1.2.3 Method of test

Initial Conditions

System Simulator:

1 cell, default setting, BS_PBCCH_BLKs = 3.

Mobile Station:

The MS is GPRS attached with a P-TMSI allocated and the test PDP context3 activated.

Specific PICS Statements

- TSPC_Type_GPRS_Multislot_ClassX (where X = 1..45)

PIXIT Statements

-

Test Procedure

The following GPRS multislot configurations are tested in the test case:

- Class 2 and 3 support two downlink timeslots and one uplink timeslot, $T_{tb}=2$, $T_{ra}=3$;
- Class 4 and 6 support three downlink timeslots and one uplink timeslot, $T_{tb}=1$, $T_{ra}=3$;
- Class 5 and 9 supports two downlink timeslots and two uplink timeslots, $T_{tb}=1$, $T_{ra}=3$;
- Class 8 and 10 support four downlink timeslots and one uplink timeslot, $T_{tb}=1$, $T_{ra}=2$;
- Class 19 and 24 support five downlink timeslots and one uplink timeslot, $T_{tb}=1$, $T_{ra}=2$.

In the multislot configurations all assigned channels are frequency hopped except for the class 19 and 24 test where non-hopping channels are assigned for PDCHs. The class 3, 6, 9 and 10 are tested in a reduced uplink configuration.

According to the multislot configurations an uplink TBF with one or two timeslots assigned is established and in progress. The SS establishes a concurrent downlink TBF with multiple timeslots assigned.

On the 1st radio block the SS sends downlink data in the maximum capability allowed under the configuration, signals to the MS the assigned USFs addressing the MS and polls the MS. On the 2nd radio block the MS sends RLC data in response of the addressing the MS USFs. On the 6th radio block the SS sends downlink data in the maximum capability allowed under the configuration and signals to the MS the assigned USFs addressing the MS. On the 7th radio block the MS responses PACKET DOWNLINK ACK/NACK and sends RLC data in response of one of the USFs addressing the MS if the configuration is allowed.

The basic test procedure is repeated until CV=1. The SS sends the last RLC data block with FBI=1 and polls the MS for acknowledgement. The SS sends PACKET UPLINK ACK/NACK setting FINAL_ACK_INDICATION=1. The MS sends two separate PACKET CONTROL ACKNOWLEDGEMENT messages to release the uplink and downlink TBFs.

Maximum Duration of Test

5 minutes.

Expected Sequence for GPRS multislot class 2 and class 3 (2 downlink timeslots + 1 uplink timeslot)

Step	Direction	Message	Comments
1		{Uplink dynamic allocation two phase access}	n = 440 octets, without starting time, USF GRANULARITY = 1 block, RLC_DATA_BLOCKS_GRANTED = open-end TLLI_BLOCK_CHANNEL_CODING: cs1 CHANNEL_CODING_COMMAND: cs1 An uplink timeslot is assigned (see specific message contents).
2	SS -> MS	PACKET DOWNLINK DUMMY CONTROL BLOCK	The USF assigned to the MS. Sent on PACCH of PDCH assigned in step 1. Received on the uplink PDTCH.
3	MS -> SS	UPLINK RLC DATA BLOCK	
4	SS -> MS	PACKET DOWNLINK ASSIGNMENT	
5	SS -> MS	DOWNLINK RLC DATA BLOCK	Sent on PACCH of the uplink PDCH. Assigning a downlink TBF, MAC mode = dynamic allocation, RLC mode = unacknowledged mode, TFI _d (different from the uplink one), no starting time, assigning TN ₁ and TN ₂ . Sent on TN ₁ of the downlink PDTCH, RRBP invalid.
6	SS -> MS	DOWNLINK RLC DATA BLOCK	
7	MS -> SS	UPLINK RLC DATA BLOCK	Sent on TN ₂ of the downlink PDTCH, a valid RRBP = N + 26, the assigned USF assigned to the MS, on the same radio block as step 5. Received on the uplink PDTCH, on the next radio block from step 6.
8	SS -> MS	DOWNLINK RLC DATA BLOCK	Sent on TN ₁ of the downlink PDTCH, RRBP invalid, on five radio blocks after step 6.
9	SS -> MS	DOWNLINK RLC DATA BLOCK	Sent on TN ₂ of the downlink PDTCH, the assigned USF assigned to the MS and RRBP invalid, on the same radio block as in step 8. Note: The next uplink radio will not be used for the uplink data. It is reserved for a control block answering the polling in step 6.
10	MS -> SS	PACKET DOWNLINK ACK/NACK	Received on the RRBP block on TN ₂ specified in step 6. Repeat step 5 to 10, until CV=0 in step 7.
11			
12	SS -> MS	DOWNLINK RLC DATA BLOCK	Sent on TN ₂ with FBI = 1 and a valid RRBP=N+26.
13	SS -> MS	PACKET UPLINK ACK/NACK	FINAL_ACK_INDICATION = 1. Sent on TN ₂ PACCH of the uplink PDCH. With a valid RRBP=N+13
14	MS -> SS	PACKET CONTROL ACKNOWLEDGEMENT	CTRL_ACK = 11. The MS releases the uplink TBF.
15	MS -> SS	PACKET CONTROL ACKNOWLEDGEMENT	Received on the block specified by RRBP in step 12. CTRL_ACK = 11. The MS releases the downlink TBF.

Specific Message Contents

PACKET UPLINK ASSIGNMENT message in step 1 (in macro):

CHANNEL_CODING_COMMAND	CS-1
TLLI_BLOCK_CHANNEL_CODING	CS-1
Dynamic allocation	01
-	000000
-	1 (Timeslot Allocation with Power Control Parameters for 1 slot assigned)
- ALPHA	0.5
-	001 (timeslot 2 assigned)
- USF_TN2	Arbitrarily chosen
- GAMMA_TN2	For GSM 700, T-GSM 810, GSM 850 and GSM 900, +8 dBm
-	For DCS 1 800 and PCS 1 900, +6 dBm
-	00000

PACKET DOWNLINK ASSIGNMET message in step 4:

PAGE_MODE	Normal
{0 1<PERSISTENCE_LEVEL>}	0
- Global TFI	0, Global TFI as reference
MAC_MODE	0, uplink TFI
RLC_MODE	same value as assigned in the uplink in step 1
CONTROL_ACK	Dynamic allocation
TIMESLOT_ALLOCATION	Unacknowledged
Packet Timing Advance	0
- {0 1<TIMING_ADVANCE_VALUE>}	Timeslot 1 and 2 assigned
- TIMING_ADVANCE_VALUE	1
- {0 1<TIMING_ADVANCE_INDEX>	30 bit periods
<TIMING_ADVANCE_TIMESLOT_NUMBER >}	0 (no timing advance index)
{0 1<P0><BTS_PWR_CTR_MODE >}	0
{0 1<Frequency Parameters>}	0 (no Frequency Parameters present)
{0 1<DOWNLINK_TFI_ASSIGNMENT>}	1 (assign downlink TFI)
- DOWNLINK_TFI_ASSIGNMENT	Arbitrarily chosen from valid values but different from the value for uplink TBF
{0 1<Power Control Parameters>}	0 (no Power Control Parameters present)
{0 1<TBF_STARTING_TIME>}	0 (no starting time)
{0 1<Measurement Mapping>}	0 (no starting time)

Expected Sequence for GPRS multislots class 4 and 6 (3 downlink timeslots + 1 uplink timeslot)

Step	Direction	Message	Comments
1		{Uplink dynamic allocation two phase access}	n = 330 octets, without starting time, USF_GRANULARITY = 1 block, RLC_DATA_BLOCKS_GRANTED = open-end TLLI_BLOCK_CHANNEL_CODING: cs1 CHANNEL_CODING_COMMAND: cs1 An uplink timeslot is assigned (see specific message contents).
2	SS -> MS	PACKET DOWNLINK DUMMY CONTROL BLOCK	The USF assigned to the MS. Sent on PACCH of PDCH assigned in step 1. Received on the uplink PDTCH.
3	MS -> SS	UPLINK RLC DATA BLOCK	
4	SS -> MS	PACKET DOWNLINK ASSIGNMENT	
5	SS -> MS	DOWNLINK RLC DATA BLOCK	Sent on TN ₁ of the downlink PDTCH, RRBP invalid. Sent on TN ₂ of the downlink PDTCH, the assigned USF assigned to the MS and a valid RRBP = N +26, on the same radio block as step 5. Sent on TN ₃ of the downlink PDTCH, RRBP invalid, on the same radio block as step 5. Received on the uplink PDTCH, on the next radio block from step 5. Sent on TN ₁ of the downlink PDTCH, RRBP invalid, on five radio blocks after step 6. Sent on TN ₂ of the downlink PDTCH, the assigned USF assigned to the MS and an invalid RRBP, on the same radio block as step 9. Note: The next uplink radio block will not be used for the uplink data. It is reserved for a control block answering the polling in step 6. Sent on TN ₃ of the downlink PDTCH, RRBP invalid, on the same radio block as step 9. Received on the RRBP block on TN ₂ specified in step 6. Repeat step 5 to 12, until CV=0 in step 8. Sent on TN ₂ with FBI = 1 and a valid RRBP=N+26. FINAL_ACK_INDICATION = 1. Sent on PACCH of the uplink PDCH. With a valid RRBP=N+13 CTRL_ACK = 11. The MS releases the uplink TBF. Received on the block specified by RRBP in step 14. CTRL_ACK = 11. The MS releases the downlink TBF.
6	SS -> MS	DOWNLINK RLC DATA BLOCK	
7	SS -> MS	DOWNLINK RLC DATA BLOCK	
8	MS -> SS	UPLINK RLC DATA BLOCK	
9	SS -> MS	DOWNLINK RLC DATA BLOCK	
10	SS -> MS	DOWNLINK RLC DATA BLOCK	
11	SS -> MS	DOWNLINK RLC DATA BLOCK	
12	MS -> SS	PACKET DOWNLINK ACK/NACK	
13			
14	SS -> MS	DOWNLINK RLC DATA BLOCK	
15	SS -> MS	PACKET UPLINK ACK/NACK	
16	MS -> SS	PACKET CONTROL ACKNOWLEDGEMENT	
17	MS -> SS	PACKET CONTROL ACKNOWLEDGEMENT	

Specific Message Contents

PACKET UPLINK ASSIGNMENT message in step 1 (in macro):

Same as in the test for the multiclass 2 and 3.

PACKET DOWNLINK ASSIGNMET message in step 4:

Same as in the test for the multiclass 2 and 3 except.

TIMESLOT_ALLOCATION	Timeslot 1, 2 and 3 assigned
---------------------	------------------------------

Expected Sequence for GPRS multislot class 5, 9 (2 downlink timeslots + 2 uplink timeslots)

Step	Direction	Message	Comments
1		{Uplink dynamic allocation two phase access}	n = 440 octets, without starting time, USF_GRANULARITY = 1 block, RLC_DATA_BLOCKS_GRANTED = open-end TLLI_BLOCK_CHANNEL_CODING: cs1 CHANNEL_CODING_COMMAND: cs1 Two uplink timeslots are assigned (see specific message contents).
2	SS -> MS	PACKET DOWNLINK DUMMY CONTROL BLOCK	The USF ₁ assigned to the MS. Sent in TN ₁ on PACCH of PDCH assigned in step 1.
3	SS -> MS	PACKET DOWNLINK DUMMY CONTROL BLOCK	The USF ₂ assigned to the MS. Sent in TN ₂ on the same radio block as step 2, on PACCH of PDCH assigned in step 1.
4	MS -> SS	UPLINK RLC DATA BLOCK	Received on TN ₁ on the PDTCH assigned in step 1.
5	MS -> SS	UPLINK RLC DATA BLOCK	Received on TN ₂ , on the same radio block as step 4, on PDTCH assigned in step 1.
6	SS -> MS	PACKET DOWNLINK ASSIGNMENT	Sent on PACCH of PDCH assigned in step 1. Assign a downlink TBF, MAC mode = dynamic allocation, RLC mode = unacknowledged mode, TFI _d , no starting time, assigning the timeslots TN ₁ and TN ₂ .
7	SS -> MS	DOWNLINK RLC DATA BLOCK	Sent on TN ₁ of the downlink PDTCH, RRBP invalid, the assigned USF ₁ addressing the MS.
8	SS -> MS	DOWNLINK RLC DATA BLOCK	Sent on TN ₂ of the downlink PDTCH, a valid RRBP = N + 26, the assigned USF ₂ addressing the MS, on the same radio block as step 7.
9	MS -> SS	UPLINK RLC DATA BLOCK	Received on TN ₁ on the next radio block from step 7.
10	MS -> SS	UPLINK RLC DATA BLOCK	Received on TN ₂ on the next radio block from step 7.
11	SS -> MS	DOWNLINK RLC DATA BLOCK	Sent on TN ₁ of the downlink PDTCH on five radio blocks after step 7, an invalid RRBP, the assigned USF ₁ addressing the MS.
12	SS -> MS	DOWNLINK RLC DATA BLOCK	Sent on TN ₂ of the downlink PDTCH on same radio block as step 11, an invalid RRBP, the assigned USF ₂ addressing the MS.
13	MS -> SS	UPLINK RLC DATA BLOCK	Received on TN ₁ on the PDTCH assigned in step 1.
14	MS -> SS	PACKET DOWNLINK ACK/NACK	Received on the RRBP block on TN ₂ specified in step 8.
15			Repeat step 7 to 14, until CV=0 in step 9, 10 or 13.
16	SS -> MS	DOWNLINK RLC DATA BLOCK	Sent on TN ₁ with FBI = 1 and a valid RRBP=N+26.
17	SS -> MS	PACKET UPLINK ACK/NACK	FINAL_ACK_INDICATION = 1. Sent on PACCH of the uplink PDCH. With a valid RRBP=N+13
18	MS -> SS	PACKET CONTROL ACKNOWLEDGEMENT	CTRL_ACK = 11. The MS releases the uplink TBF.
19	MS -> SS	PACKET CONTROL ACKNOWLEDGEMENT	Received on the block specified by RRBP in step 16. CTRL_ACK = 11. The MS releases the downlink TBF.

Specific Message Contents

PACKET UPLINK ASSIGNMENT message in step 1 (in macro):

Same as in the test for the multiclass 2 and 3 except.

-	1 (Timeslot Allocation with Power Control Parameters for two slots assigned)
- ALPHA	0.5
-	01 (timeslot 1 assigned)
- USF_TN1	Arbitrarily chosen
- GAMMA_TN1	For GSM 700, T-GSM 810, GSM 850 and GSM 900, +8 dBm
	For DCS 1 800 and PCS 1 900, +6 dBm
- {0 1<USF_TN2><GAMMA_TN2>}	1 (timeslot 2 assigned)
- USF_TN2	Arbitrarily chosen but different from USF_TN ₁
- GAMMA_TN2	For GSM 700, T-GSM 810, GSM 850 and GSM 900, +8 dBm
	For DCS 1 800 and PCS 1 900, +6 dBm
-	00000

PACKET DOWNLINK ASSIGNMET message in step 10:

Same as in the test for the multiclass 2 and 3.

Expected Sequence for GPRS multislot class 8, 10 (4 downlink timeslots + 1 uplink timeslot)

Step	Direction	Message	Comments
1		{Uplink dynamic allocation two phase access}	n = 220 octets, without starting time, USF_GRANULARITY = 1 block, RLC_DATA_BLOCKS_GRANTED = open-end TLLI_BLOCK_CHANNEL_CODING: cs1 CHANNEL_CODING_COMMAND: cs1 1 uplink timeslot is assigned (see specific message contents).
2	SS -> MS	PACKET DOWNLINK DUMMY CONTROL BLOCK	The USF assigned to the MS. Sent in TN ₃ on PACCH of PDCH assigned in step 1.
3	MS -> SS	UPLINK RLC DATA BLOCK	Received on TN ₃ on the PDTCH.
4	SS -> MS	PACKET DOWNLINK ASSIGNMENT	Sent on PACCH of PDCH assigned in step 1. Assign a downlink TBF, MAC mode = dynamic allocation, RLC mode = unacknowledged mode, four slots TN ₁ – TN ₄ , TFI _d , no starting time.
5	SS -> MS	DOWNLINK RLC DATA BLOCK	Sent on TN ₁ of the PDTCH assigned in step 4, with an invalid RRBp
6	SS -> MS	DOWNLINK RLC DATA BLOCK	Sent on TN ₂ of the PDTCH assigned in step 4, an invalid RRBp on the same radio block as step 5.
7	SS -> MS	DOWNLINK RLC DATA BLOCK	Sent on TN ₃ of the PDTCH assigned in step 4, the assigned USF assigned to the MS, a valid RRBp = N + 26, on the same radio block as step 5.
8	SS -> MS	DOWNLINK RLC DATA BLOCK	Sent on TN ₄ of the PDTCH assigned in step 4, an invalid RRBp, on the same radio block as step 5.
9	MS -> SS	UPLINK RLC DATA BLOCK	Received on TN ₃ on the PDTCH assigned in step 1, on the next radio block from step 5.
10	SS -> MS	DOWNLINK RLC DATA BLOCK	Sent on TN ₁ of the PDTCH assigned in step 4, with an invalid RRBp, on five radio blocks after step 5.
11	SS -> MS	DOWNLINK RLC DATA BLOCK	Sent on TN ₂ of the PDTCH assigned in step 4, an invalid RRBp, on the same radio block as step 10.
12	SS -> MS	DOWNLINK RLC DATA BLOCK	Sent on TN ₃ of the PDTCH assigned in step 4, the assigned USF assigned to the MS, on the same radio block as step 10. Note: The next uplink radio block will not be used for the uplink data. It is reserved for a control block answering the polling in step 7.
13	SS -> MS	DOWNLINK RLC DATA BLOCK	Sent on TN ₄ of the PDTCH assigned in step 4, an invalid RRBp, on the same radio block as step 10.
14	MS -> SS	PACKET DOWNLINK ACK/NACK	Received on the RRBp block of TN ₃ specified in step 7, on the next radio block from step 10.
15			Repeat step 5 to 14, until CV=0 in step 9.
16	SS -> MS	DOWNLINK RLC DATA BLOCK	Sent on TN ₃ with FBI = 1 and a valid RRBp=N+26.
17	SS -> MS	PACKET UPLINK ACK/NACK	FINAL_ACK_INDICATION = 1. Sent on PACCH of the uplink PDCH. With a valid RRBp=N+13
18	MS -> SS	PACKET CONTROL ACKNOWLEDGEMENT	CTRL_ACK = 11. The MS releases the uplink TBF.
19	MS -> SS	PACKET CONTROL ACKNOWLEDGEMENT	Received on the block specified by RRBp in step 16. CTRL_ACK = 11. The MS releases the downlink TBF.

Specific Message Contents

PACKET UPLINK ASSIGNMENT message in step 1:

Same as in the test for the multiclass 2 and 3 except that instead of timeslot 2, the timeslot 3 is assigned.

PACKET DOWNLINK ASSIGNMET message in step 4:

Same as in the test for the multiclass 2 and 3 except 4 timeslots assigned.

TIMESLOT_ALLOCATION	TN ₁ – TN ₄ assigned
---------------------	--

Expected Sequence for GPRS multislot class 19, 24 (5 downlink + 2 uplink timeslots)

Step	Direction	Message	Comments
1		{Uplink dynamic allocation two phase access}	n = 160 octets, without starting time, without frequency hopping, USF_GRANULARITY = 1 block, RLC_DATA_BLOCKS_GRANTED = open-end TLLI_BLOCK_CHANNEL_CODING: cs1 CHANNEL_CODING_COMMAND: cs1 1 uplink timeslot is assigned (see specific message contents).
2	SS -> MS	PACKET DOWNLINK DUMMY CONTROL BLOCK	The assigned USF assigned to the MS, sent in TN ₃ on PACCH of PDCH assigned in step 1.
3	MS -> SS	UPLINK RLC DATA BLOCK	Received on TN ₃ on the PDTCH assigned in step 1.
4	SS -> MS	PACKET DOWNLINK ASSIGNMENT	Sent on PACCH of PDCH assigned in step 1. Assign a downlink TBF, MAC mode = dynamic allocation, RLC mode = unacknowledged mode, TN ₁ – TN ₅ assigned, TFI _d , no starting time.
5	SS - MS	DOWNLINK RLC DATA BLOCK	Sent on TN ₁ of the PDTCH assigned in step 4, with an invalid RRBP.
6	SS - MS	DOWNLINK RLC DATA BLOCK	Sent on TN ₂ of the PDTCH assigned in step 4, with an invalid RRBP, on the same radio block as step 5.
7	SS - MS	DOWNLINK RLC DATA BLOCK	Sent on TN ₃ of the PDTCH assigned in step 4, the assigned USF assigned to the MS, a valid RRBP = N + 26, on the same radio block as step 5.
8	SS - MS	DOWNLINK RLC DATA BLOCK	Sent on TN ₄ of the PDTCH assigned in step 4, with an invalid RRBP, on the same radio block as step 5.
9	SS - MS	DOWNLINK RLC DATA BLOCK	Sent on TN ₅ of the PDTCH assigned in step 4, with an invalid RRBP, on the same radio block as step 5.
10	MS -> SS	UPLINK RLC DATA BLOCK	Received on TN ₃ on the PDTCH assigned in step 5, on the next radio block from step 5.
11	SS - MS	DOWNLINK RLC DATA BLOCK	Sent on TN ₁ of the PDTCH assigned in step 4, with an invalid RRBP on five radio blocks after step 5.
12	SS - MS	DOWNLINK RLC DATA BLOCK	Sent on TN ₂ of the PDTCH assigned in step 4, with an invalid RRBP on the same radio block as step 11.
13	SS - MS	DOWNLINK RLC DATA BLOCK	Sent on TN ₃ of the PDTCH assigned in step 4, the assigned USF assigned to the MS, with an invalid RRBP on the same radio block as step 11. Note: The next uplink radio block will not be used for the uplink data. It is reserved for a control block answering the polling in step 7.
14	SS - MS	DOWNLINK RLC DATA BLOCK	Sent on TN ₄ of the PDTCH assigned in step 4, with an invalid RRBP on the same radio block as step 11.
15	SS - MS	DOWNLINK RLC DATA BLOCK	Sent on TN ₅ of the PDTCH assigned in step 4, with an invalid RRBP on the same radio block as step 11.
16	MS -> SS	PACKET DOWNLINK ACK/NACK	Received on the RRBP block of TN ₃ specified in step 7.
17			Repeat step 5 to 16, until CV=0 in step 10.
18	SS -> MS	DOWNLINK RLC DATA BLOCK	Sent on TN ₃ with FBI = 1 and a valid RRBP=N+26.
19	SS -> MS	PACKET UPLINK ACK/NACK	FINAL_ACK_INDICATION = 1. Sent on PACCH of the uplink PDCH. With a valid RRBP=N+13
20	MS -> SS	PACKET CONTROL ACKNOWLEDGEMENT	CTRL_ACK = 11. The MS releases the uplink TBF.
21	MS -> SS	PACKET CONTROL ACKNOWLEDGEMENT	Received on the block specified by RRBP in step 16. CTRL_ACK = 11. The MS releases the downlink TBF.

Specific Message Contents

PACKET UPLINK ASSIGNMENT message in step 1:

Same as in the test for the multiclass 2 and 3 except.

{0 1<Frequency Parameters>}	1 (frequency parameters presents)
- TSC	6
-	00, non hopping
- ARFCN	For GSM 900: 30
	For DCS 1800 and PCS 1 900: 650
	For GSM700, T-GSM 810: 467
	For GSM 850: 157
Dynamic allocation	01
- {0 1<USF_TN0>} ... {0 1<USF_TN3>}	0001
- USF_TN3	arbitrarily chosen
-	0000, none of the other timeslots assigned.

PACKET DOWNLINK ASSIGNMET message in step 4:

Same as in the test for the multiclass 2 and 3 except 5 timeslots assigned.

TIMESLOT_ALLOCATION	TN ₁ – TN ₅ assigned
---------------------	--

42.3.2.2 Dynamic Allocation / Uplink Transfer with Downlink TBF establishment / Abnormal

42.3.2.2.1 Dynamic Allocation / Uplink Transfer with Downlink TBF establishment / Abnormal / with random access

42.3.2.2.1.1 Conformance requirements

1. If a failure occurs on the mobile station side before the new TBF has been successfully established, the newly reserved resources are released.
2. If the information in the PACKET TIMESLOT RECONFIGURE does not properly specify an uplink and downlink PDCH or violates the mobile station's multislot capabilities, the mobile station shall perform an abnormal release with random access.
3. If uplink and downlink TBFs are not already established and the PACKET TIMESLOT RECONFIGURE message does not include a DOWNLINK_TFI_ASSIGNMENT field, then the mobile station shall perform an abnormal release with random access.
4. If a failure in the PACKET TIMESLOT RECONFIGURE is due to any other reason, the mobile station shall abort the procedure and perform an abnormal release with random access.
5. If the mobile station receives a PACKET UPLINK ASSIGNMENT or PACKET TIMESLOT RECONFIGURE message specifying frequencies that are not all in one frequency band then the mobile station shall perform an abnormal release with random access.
6. To perform an abnormal release with random access, the mobile station shall abort all TBFs in progress and its associated resources, return to the CCCH or PCCCH and initiate establishment of a new uplink TBF.

References

3GPP TS 04.60, subclauses 8.1.1.1.3.1, 8.1.1.1.2.1 and 8.7.2.

42.3.2.2.1.2 Test purposes

To verify that the MS, in downlink TBF establishment during uplink transfer, performs an abnormal release with random access, when the information in the PACKET TIMESLOT RECONFIGURE:

1. does not properly specify an uplink and downlink PDCH;
2. violates the mobile station's GPRS multislot capabilities;
3. does not include a DOWNLINK_TFI_ASSIGNMENT field;
4. has a failure due to any other reason other than the reasons listed above.

42.3.2.2.1.3 Method of test

Initial Conditions

System Simulator:

1 cell, default setting, BS_PBCCH_BLKs = 3.

Mobile Station:

The MS is GPRS attached with a P-TMSI allocated and the test PDP context3 activated.

Specific PICS Statements

- TSPC_Type_GPRS_Multislot_ClassX (where X = 1..45)

PIXIT Statements

-

Test Procedure

An uplink TBF is established and in progress. The SS sends PACKET TIMESLOT RECONFIGURE for establishment a downlink TBF. A failure occurs at the mobile station side before the new downlink TBF has been successfully established. The MS starts a random access for uplink establishment. The SS assigns a new uplink PDCH to the MS. The SS signals the USF of the preceding uplink TBF addressing the MS on the preceding PDCH which shall have been released by the MS. It is checked that no RLC data block is received on the next three radio blocks. The SS signals the assigned USF assigned to the MS on the uplink PDCH assigned. The MS sends a RLC data block.

The test procedure is repeated 4 times. The message contents of PACKET TIMESLOT RECONFIGURE are varied as defined below.

1st execution, improper PDCH: hopping frequencies not all in one band.

2nd execution, violating the GPRS multislot capabilities.

3rd execution, no DOWNLINK_TFI_ASSIGNMENT.

4th execution, CONTROL_ACK = '1' (shall be set to '0' as the SS has not yet sent the final downlink RLC data block).

Maximum Duration of Test

10 minutes.

Expected Sequence

The sequence is repeated 4 times. The 2nd execution is not applicable for the MS GPRS multislot class 18 and 29.

Step	Direction	Message	Comments
1		{Uplink dynamic allocation two phase access}	n = 220 octets, without starting time, USF_GRANULARITY = 1 block, RLC_DATA_BLOCKS_GRANTED = open-end CHANNEL_CODING_COMMAND: arbitrarily chosen.
2	SS -> MS	PACKET DOWNLINK DUMMY CONTROL BLOCK	The assigned USF assigned to the MS
3	MS -> SS	UPLINK RLC DATA BLOCK	Received on the assigned PDTCH. Check that the coding and the TFI are correct.
4	SS -> MS	PACKET TIMESLOT RECONFIGURE	See specific message contents.
5	MS -> SS	PACKET CHANNEL REQUEST	Received on PRACH.
6	SS -> MS	PACKET UPLINK ASSIGNMENT	Single block assignment, to force the MS making the two-phase access procedure. Sent on PAGCH.
7	MS -> SS	PACKET RESOURCE REQUEST	Two phase access procedure. Received on the single block assigned in step 6.
8	SS -> MS	PACKET UPLINK ASSIGNMENT	Open-ended uplink dynamic allocation, no starting time, USF_GRANULARITY = single block, the assigned slot and USF different from TN ₂ (as in the default)
9	SS -> MS	PACKET DOWNLINK DUMMY CONTROL BLOCK	The USF assigned to the MS in step 1, sent on TN ₂ , on PACCH in step 1.
10	SS		Check that no RLC data block is received on the next three radio blocks from step 9.
11	SS -> MS	PACKET DOWNLINK DUMMY CONTROL BLOCK	The USF assigned to the MS sent on the PACCH assigned in step 8.
12	MS -> SS	UPLINK RLC DATA BLOCK	Received on the correct radio block of the assigned PDTCH.
13		{Completion of uplink RLC data block transfer}	

Specific Message Contents

PACKET TIMESLOT RECONFIGURE message in step 4 (1st execution)

PAGE_MODE	Normal
GLOBAL_TFI	0, the TFI value of the uplink TBF assigned 0
CHANNEL_CODING_COMMAND	arbitrarily chosen from valid values
DOWNLINK_RLC_MODE	unacknowledged mode
CONTROL_ACK	0
{0 1<DOWNLINK_TFI_ASSIGNMENT> - DOWNLINK_TFI_ASSIGNMENT	1 (assign TFI to the downlink TBF) arbitrarily chosen but different from the value for the uplink TBF
{0 1<UPLINK_TFI_ASSIGNMENT>	0
DOWNLINK_TIMESLOT_ALLOCATION	The same timeslot as the uplink
{0 1<Frequency Parameters>	1 (frequency parameters)
- TSC	Any valid value
-	11 (Direct encoding 2)
- MAIO	arbitrarily chosen from (0, 1, 2,...,9)
- HSN	arbitrarily chosen
- Length of MA Frequency List contents	10
- MA Frequency List contents	containing ARFCNs 10, 20, 40, 80, 90, 137, 447, 520, 590, 600, 700, 780 by range 1024 format
Dynamic allocation	0
- Extended Dynamic Allocation {0 1<P0>}	0 (Dynamic allocation)
- USF GRANULARITY	0
- {0 1<RLC_DATA_BLOCKS_GRANTED>}	0 (1 RLC block)
- {0 1<RLC_DATA_BLOCKS_GRANTED>}	0 (open-ended TBF)
- {0 1<TBF_STARTING_TIME>}	0 (no starting time)
-	0 (Timeslot Allocation)
- {0 1<USF_TNx>	001 (timeslot 2 assigned)
- USF_TN ₂	Arbitrarily chosen but different from the current value 00000

PACKET TIMESLOT RECONFIGURE message in step 4 (2nd execution)

PAGE_MODE	Normal
GLOBAL_TFI	0, the TFI value of the uplink TBF assigned 0
CHANNEL_CODING_COMMAND	arbitrarily chosen from valid values
DOWNLINK_RLC_MODE	unacknowledged mode
CONTROL_ACK	0
{0 1<DOWNLINK_TFI_ASSIGNMENT> - DOWNLINK_TFI_ASSIGNMENT	1 (assign TFI to the downlink TBF) arbitrarily chosen but different from the value for the uplink TBF
{0 1<UPLINK_TFI_ASSIGNMENT>	0
DOWNLINK_TIMESLOT_ALLOCATION	Timeslots 0-7 assigned
{0 1<Frequency Parameters>	0
Dynamic allocation	0
- Extended Dynamic Allocation {0 1<P0>}	0 (Dynamic allocation)
- USF GRANULARITY	0
- {0 1<RLC_DATA_BLOCKS_GRANTED>}	0 (1 RLC block)
- {0 1<RLC_DATA_BLOCKS_GRANTED>}	0 (open-ended TBF)
- {0 1<TBF_STARTING_TIME>}	0 (no starting time)
-	0 (Timeslot Allocation)
- {0 1<USF_TN0>}	1, a valid value
- {0 1<USF_TN1>}	1, a valid value
- {0 1<USF_TN2>}	1, a valid value
- {0 1<USF_TN3>}	1, a valid value
- {0 1<USF_TN4>}	1, a valid value
- {0 1<USF_TN5>}	1, a valid value
- {0 1<USF_TN6>}	1, a valid value
- {0 1<USF_TN7>}	1, a valid value

PACKET TIMESLOT RECONFIGURE message in step 4 (3rd execution)

PAGE_MODE	Normal
GLOBAL_TFI	0, the TFI value of the uplink TBF assigned
	0
CHANNEL_CODING_COMMAND	arbitrarily chosen from valid values
DOWNLINK_RLC_MODE	unacknowledged mode
CONTROL_ACK	0
{0 1}<DOWNLINK_TFI_ASSIGNMENT>	0, no DOWNLINK_TFI_ASSIGNMENT
{0 1}<UPLINK_TFI_ASSIGNMENT>	0
DOWNLINK_TIMESLOT_ALLOCATION	The same timeslot as the uplink
{0 1}<Frequency Parameters>	0
Dynamic allocation	0
- Extended Dynamic Allocation	0 (Dynamic allocation)
{0 1}<P0>	0
- USF GRANULARITY	0 (1 RLC block)
- {0 1}<RLC_DATA_BLOCKS_GRANTED>	0 (open-ended TBF)
- {0 1}<TBF_STARTING_TIME>	0 (no starting time)
-	0 (Timeslot Allocation)
- {0 1}<USF_TNx>	001 (timeslot 2 assigned)
- USF_TN ₂	Arbitrarily chosen but different from the current value
	00000

PACKET TIMESLOT RECONFIGURE message in step 4 (4th execution):

Same as in 3rd execution except.

CONTROL_ACK	1
-------------	---

42.3.2.2.2 Dynamic Allocation / Uplink Transfer with Downlink TBF establishment / Abnormal / Continuation of normal operation

42.3.2.2.2.1 Conformance requirements

1. If a failure occurs on the mobile station side before the new TBF has been successfully established, the newly reserved resources are released.
2. If a failure in the PACKET DOWNLINK ASSIGNMENT is due to any reason, the mobile station shall abort the procedure and continue the normal operation of the uplink TBF.

References

3GPP TS 04.60, subclauses 8.1.1.1.3.1 and 8.7.

42.3.2.2.2.2 Test purposes

To verify that the MS aborts the downlink TBF establishment and continues the normal operation of the uplink TBF when the PACKET DOWNLINK ASSIGNMENT fails due to any reason in downlink TBF establishment during uplink transfer.

42.3.2.2.2.3 Method of test

Initial Conditions

System Simulator:

1 cell, default setting, BS_PBCCH_BLKs = 3.

Mobile Station:

The MS is GPRS attached with a P-TMSI allocated and the test PDP context3 activated.

Specific PICS Statements

-

PIXIT Statements

-

Test Procedure

An uplink TBF is established and in progress. The SS sends PACKET DOWNLINK ASSIGNMENT assigning a downlink TBF while a fault occurs in the downlink assignment message.

The SS sends a downlink RLC data block on the downlink PDCH assigned and polls the MS for acknowledgement. It is checked that no PACKET DOWNLINK ACK/NACK is received. The SS signals the assigned USF assigned to the MS on the uplink PDCH assigned. The MS sends a RLC data block.

Maximum Duration of Test

5 minutes.

Expected Sequence

Step	Direction	Message	Comments
1		{Uplink dynamic allocation two phase access}	n = 440 octets, without starting time, USF_GRANULARITY = 1 block, RLC_DATA_BLOCKS_GRANTED = open-end CHANNEL_CODING_COMMAND: arbitrarily chosen.
2	SS -> MS	PACKET DOWNLINK DUMMY CONTROL BLOCK	The assigned USF assigned to the MS
3	MS -> SS	UPLINK RLC DATA BLOCK	Received on the assigned PDTCH.
4	SS -> MS	PACKET DOWNLINK ASSIGNMENT	See specific message contents
5	SS -> MS	DOWNLINK RLC DATA BLOCK	Containing RRBP= N+13, Sent on the downlink PDTCH assigned in step 4. TFI is set to the uplink one;
6	SS		.
7	SS -> MS	PACKET UPLINK ACK/NACK	Check that no PACKET DOWNLINK ACK/NACK received on the block of frame number = N+13, N is the frame number of the first burst of the data block in step 5. The USF assigned to the MS. Sent on PACCH of the uplink PDCH assigned.
8	MS -> SS	UPLINK RLC DATA BLOCK	Received on the assigned PDTCH.
9		{Completion of uplink RLC data block transfer}	

Specific Message Contents

PACKET DOWNLINK ASSIGNMET message in step 4:

Referenced Address	
- TFI	0 (address is Global TFI)
{0 1<DOWNLINK_TFI_ASSIGNMENT>}	same as the value for uplink TBF L (no downlink TFI assignment)

42.3.3 Dynamic Allocation / Resource reallocation

42.3.3.1 Dynamic Allocation / Resource reallocation / Successful

During an uplink packet transfer, upper layer may request to transfer another LLC PDU with a different Radio Priority, a different peak throughput class or a different RLC mode than the current one, the MS may require the allocation of new uplink resources.

42.3.3.1.1 Dynamic Allocation / Resource reallocation / Successful / Higher throughput class or higher radio priority

42.3.3.1.1.1 Conformance requirements

1. During an uplink packet transfer, upper layer may request to transfer another LLC PDU. If the mobile station has not started the countdown procedure and the new LLC PDU has the same RLC mode as the current uplink TBF and either a higher radio priority or the same radio priority but a higher peak throughput class, the mobile station shall immediately request a resource reallocation for uplink according to the new Radio Priority and peak throughput class of the new LLC PDU by sending a PACKET RESOURCE REQUEST message on the PACCH and starting timer T3168.
2. Then the mobile station shall complete the transmission of the current LLC PDU.
3. After the transmission of the PACKET RESOURCE REQUEST message with the reason for changing the priority or peak throughput class of an assigned uplink TBF the mobile station shall continue to use the currently assigned uplink TBF assuming that the requested priority or peak throughput class is already assigned to that TBF.

References

3GPP TS 04.60 subclause 8.1.1.1.2.

42.3.3.1.1.2 Test purposes

It is verified that:

1. Having an uplink TBF in progress without starting the countdown procedure, the MS will immediately send PACKET RESOURCE REQUEST if upper layer requests to transfer another LLC PDU which has the same RLC mode as the current uplink TBF and either a higher radio priority or the same radio priority but a higher peak throughput class.
2. After the request of the resource reallocation for uplink the MS completes the transmission of the current LLC PDU independent of whether or not a new resource is allocated.
3. After the transmission of the PACKET RESOURCE REQUEST the MS continues to use the currently assigned uplink TBF.

42.3.3.1.1.3 Method of test

Initial Conditions

System Simulator:

1 cell, default setting, BS_PBCCH_BLKs = 3, T3168 timeout value=7 (4s), BS_CV_MAX = 1, N201-U=500 for SAPI 3, 5, 9, 11, N201-U=270 for SAPI 7.

Mobile Station:

The MS is GPRS attached with a P-TMSI allocated, SPLIT PG CYCLE negotiated:

- Test PDP context3 and context6 activated;

Specific PICS Statements

-

PIXIT Statements

-

Test Procedure

An uplink TBF is established and in progress. The MS is triggered to transfer data with a higher throughput in the same RLC mode and the same radio priority.

The MS sends PACKET RESOURCE REQUEST. The current TBF is maintained and SS assigns the USFs allowing the MS transmit more data blocks. It is verified that the MS completes the transmission of the current LLC PDU and then starts transmitting a new LLC PDU with the higher throughput. A new PDCH is assigned to MS to complete the RLC data block transferring.

The test procedure is executed twice. In the 2nd execution, after the MS requests a resource reallocation for transferring the data block with a higher throughput a new PDCH is assigned. It is verified that the MS switches on the new PDCH, completes the transmission of the current LLC PDU and then starts transmitting a new LLC PDU with the higher throughput.

Maximum Duration of Test

5 minutes.

Expected Sequence

The test sequence is executed twice for $k = 1$ and 2.

When $k=1$ testing that the MS continues to use the currently assigned uplink TBF, while $k=2$ testing that the MS to use newly assigned the resource to complete transmission of the current PDU before starting transmission the PDU with a higher radio priority or a higher throughput.

Step	Direction	Message	Comments
1		{Uplink dynamic allocation two phase access}	n = 440 octets in test PDP context3, without starting time, USF_GRANULARITY = 1 block, RLC_DATA_BLOCKS_GRANTED = open-end TLLI_BLOCK_CHANNEL_CODING: cs1, CHANNEL_CODING_COMMAND: cs1, PEAK_THROUGHPUT_CLASS = 5 (16k octets/s), RADIO_PRIORITY = 4, RLC_MODE = unacknowledged mode.
2	SS -> MS	PACKET DOWNLINK DUMMY CONTROL BLOCK	Sent on the PACCH, the USF assigned to the MS.
3	MS -> SS	UPLINK RLC DATA BLOCK	Received on the assigned PDTCH.
4	MS		Check that the coding as specified by CHANNEL_CODING_COMMAND, the TFI is correct. To trigger the MS to transfer 440 octets with the peak throughput class 6 (32k octets/s) in the same RLC mode and the same radio priority as the current uplink TBF (test PDP context6).
5	SS -> MS	PACKET DOWNLINK DUMMY CONTROL BLOCK	Sent on the PACCH, the USF assigned to the MS.
6	MS -> SS	PACKET RESOURCE REQUEST OR UPLINK RLC DATA BLOCK	PACKET RESOURCE REQUEST received on the PACCH of the assigned PDCH, radio priority level = 4, peak throughput class = 6, unacknowledged mode.
6-1			OR UPLINK RLC DATA BLOCK received on the assigned PDTCH. Check that the coding and the TFI are correct. Repeat Steps 5,6 until PACKET RESOURCE REQUEST is received at Step 6.
7	SS -> MS	PACKET DOWNLINK DUMMY CONTROL BLOCK	Sent on the PACCH of the PDCH assigned, the USF assigned to the MS.
8	MS -> SS	UPLINK RLC DATA BLOCK OR PACKET RESOURCE REQUEST	UPLINK RLC DATA BLOCK received on the assigned PDTCH. Check that the coding and the TFI are correct. OR Retransmitted PACKET RESOURCE REQUEST received on the PACCH.
9	SS		For k=1 Repeat step 7 and 8 until the 2 nd LLC PDU in PDP context6 is started. Observe the Length indicator, M bit and E bit of the received data headers. For k=2 Continue to step 10.
10	SS -> MS	PACKET UPLINK ACK/NACK	Sent on the PACCH of the PDCH assigned, acknowledge all received data, without setting FINAL_ACK_INDICATION.
11	SS -> MS	PACKET UPLINK ASSIGNMENT	Sent on PACCH of the PDCH assigned in step 1, assigning a new PDCH.
12	SS -> MS	PACKET DOWNLINK DUMMY CONTROL BLOCK	Sent on the PACCH of the PDCH assigned in step 11, the USF assigned to the MS.
13	MS -> SS	UPLINK RLC DATA BLOCK	Received on the PDTCH assigned in step 11.
14		{Completion of uplink RLC data block transfer}	For k=1, as defined in the macro. For k=2, Observe the Length indicator, M bit and E bit of the received data headers. Check that the MS completes firstly the transmission of the 1 st LLC PDU in PDP context3 and then transmits the 2 nd LLC PDU in PDP context6.

Specific Message Contents

PACKET RESOURCE REQUEST message in step 6:

Channel Request Description	
- PEAK_THROUGHPUT_CLASS	6
- RADIO_PRIORITY	4
- RLC_MODE	Unacknowledged mode
- LLC_PDU_TYPE	1 (not SACK or ACK)
- RLC_OCTET_COUNT	Any value

PACKET UPLINK ASSIGNMENT message in step 11:

PAGE_MODE	Normal
{0}1<PERSISTENCE_LEVEL>	0
- Uplink TFI	0, Global TFI Same as the current value
CHANNEL_CODING_COMMAND	0
TLLI_BLOCK_CHANNEL_CODING	CS-1
<Packet Timing Advance>	CS-1
{0}1<Frequency Parameters>	As default
Dynamic allocation	0
-	01
-	000000
-	0 (Timeslot Allocation)
-	00000001 (timeslot 7 assigned)
- USF_TN7	Arbitrarily chosen

42.3.3.1.2 Dynamic Allocation / Resource reallocation / Successful / Lower throughput class

42.3.3.1.2.1 Conformance requirements

1. During an uplink packet transfer, upper layer may request to transfer another LLC PDU. If the new LLC PDU has the same RLC mode as the current uplink TBF and either a lower Radio Priority or the same radio priority but a lower peak throughput class, the mobile station shall first complete the sending of the LLC PDU in transfer.
2. When the sending of LLC PDUs at the higher Radio Priority or the same radio priority but higher peak throughput class stops, without waiting for the acknowledgement from the network if in RLC acknowledged mode, the mobile station shall then perform the request of a resource reallocation for uplink for any remaining LLC PDU(s) by sending a PACKET RESOURCE REQUEST message on the PACCH and start timer T3168.

References

3GPP TS 04.60, subclause 8.1.1.1.2.

42.3.3.1.2.2 Test purposes

To verify that during an uplink packet transfer, upper layer requests to transfer another LLC PDU and the new LLC PDU has the same RLC mode as the current uplink TBF and either a lower Radio Priority or the same radio priority but a lower peak throughput class.

1. The MS first complete the sending of the LLC PDU in transfer, including acknowledgement from the network if in RLC acknowledged mode.
2. After the sending of LLC PDUs at the higher Radio Priority or the same radio priority but higher peak throughput class stops, the MS performs the request of a resource reallocation for uplink for any remaining LLC PDU(s).

42.3.3.1.2.3 Method of test

Initial Conditions

System Simulator:

1 cell, default setting, BS_PBCCH_BLKs = 3, T3168 timeout value=7 (4s), BS_CV_MAX = 1, N201-U=500 for SAPI 3, 5, 9, 11, N201-U=270 for SAPI 7.

Mobile Station:

The MS is GPRS attached with a P-TMSI allocated, SPLIT PG CYCLE negotiated:

- Test PDP context2 and context4 activated;

Specific PICS Statements

-

PIXIT Statements

-

Test Procedure

An uplink TBF is established and in progress. The MS is triggered to transfer data with a lower throughput or a lower radio priority in the same RLC mode.

The current TBF is maintained and SS assigns the USFs allowing the MS to transmit more data blocks. It is verified that the MS completes the transmission of the current LLC PDU and then sends PACKET RESOURCE REQUEST.

Maximum Duration of Test

5 minutes.

Expected Sequence

Step	Direction	Message	Comments
1		{Uplink dynamic allocation two phase access}	In PDP context4, n = 880 octets, without starting time, USF_GRANULARITY = 1 block, RLC_DATA_BLOCKS_GRANTED = open-end TLLI_BLOCK_CHANNEL_CODING: cs1, CHANNEL_CODING_COMMAND: cs1, PEAK_THROUGHPUT_CLASS = 6, RADIO_PRIORITY = 4, RLC_MODE = acknowledged mode.
2	SS -> MS	PACKET DOWNLINK DUMMY CONTROL BLOCK	Sent on the PACCH, the USF assigned to the MS.
3	MS -> SS	UPLINK RLC DATA BLOCK	Received on the assigned PDTCH.
4	MS		Check that the coding as specified by CHANNEL_CODING_COMMAND, the TFI is correct. To trigger the MS to transfer 220 octets with the test PDP context2 in the same RLC mode as the current uplink TBF.
5	SS -> MS	PACKET DOWNLINK DUMMY CONTROL BLOCK	Sent on the PACCH of the PDCH assigned, the USF assigned to the MS.
6-1	MS -> SS	UPLINK RLC DATA BLOCK	Received on the assigned PDTCH. Check that the coding and the TFI are correct.
6-2	MS -> SS	PACKET RESOURCE REQUEST	Received on the PACCH of the assigned PDCH, acknowledged mode.
7	SS		Repeat step 5 and 6-1 until PACKET RESOURCE REQUEST in 6-2, instead of a RLC data block in 6-1, is received. Observe the Length indicator, M bit and E bit of the received data headers. Check that the transmission of the LLC PDU(s) with higher peak throughput class is completed.
8	SS -> MS	PACKET UPLINK ACK/NACK	Sent on the PACCH of the PDCH assigned, acknowledge all received data
9	SS -> MS	PACKET UPLINK ASSIGNMENT	Sent on PACCH of the PDCH assigned in step 1, assigning a new PDCH.
10	SS -> MS	PACKET DOWNLINK DUMMY CONTROL BLOCK	Sent on the PACCH of the PDCH assigned in step 10, the USF assigned to the MS.
11	MS -> SS	UPLINK RLC DATA BLOCK	Received on the PDTCH assigned in step 10.
12		{Completion of uplink RLC data block transfer}	
13	MS		Switch off

Specific Message Contents

PACKET RESOURCE REQUEST message in step 6-2:

Channel Request Description	
- PEAK_THROUGHPUT_CLASS	For branch A: 5 For branch B: any allowed value
- RADIO_PRIORITY	For branch A: 4 For branch B: 1
- RLC_MODE	acknowledged mode
- LLC_PDU_TYPE	1 (not SACK or ACK)
- RLC_OCTET_COUNT	Any allowed value

PACKET UPLINK ASSIGNMENT message in step 9:

Same as in subclause 42.3.3.1.1.3, step 11.

42.3.3.1.3 Dynamic Allocation / Resource reallocation / Successful / Different RLC mode and higher radio priority

42.3.3.1.3.1 Conformance requirements

During an uplink packet transfer, upper layer may request to transfer another LLC PDU. If the new LLC PDU does not have the same RLC mode as the current uplink TBF but has a higher radio priority, the mobile station shall complete the transmission of the current LLC PDU using the countdown procedure including acknowledgement from the network, if in RLC acknowledged mode. The mobile station shall then release the TBF and establish a new uplink TBF for transmission of the new LLC PDU. When the sending of LLC PDUs with a higher radio priority is completed using the countdown procedure, including acknowledgement from the network if in RLC acknowledged mode, the mobile station shall try to establish an uplink TBF for the transmission of any remaining LLC PDU(s).

References

3GPP TS 04.60, subclause 8.1.1.1.2.

42.3.3.1.3.2 Test purposes

To verify that during an uplink packet transfer, upper layer requests to transfer another LLC PDU and the new LLC PDU has a different RLC mode from the current uplink TBF but has a higher radio priority.

1. The mobile station completes the transmission of the current LLC PDU using the countdown procedure including acknowledgement from the network, if in RLC acknowledged mode.
2. Then the MS releases the TBF and establishes a new uplink TBF for transmission of the new LLC PDU.
3. When the sending of the new LLC PDUs with a higher radio priority is completed using the countdown procedure, including acknowledgement from the network if in RLC acknowledged mode, the mobile station tries to establish an uplink TBF for the transmission of any remaining LLC PDU(s).

42.3.3.1.3.3 Method of test

Initial Conditions

System Simulator:

1 cell, default setting, BS_PBCCH_BLKs = 3, T3168 timeout value=7 (4s), N201-U=500 for SAPI 3, 5, 9, 11, N201-U=270 for SAPI 7.

Mobile Station:

The MS is GPRS attached with a P-TMSI allocated, SPLIT PG CYCLE negotiated:

- Test PDP context1 and context2 activated;

Specific PICS Statements

-

PIXIT Statements

-

Test Procedure

An uplink TBF is established and in progress. The MS is triggered to transfer 220 octets user data with a higher throughput or a higher radio priority, but in a different RLC mode.

SS assigns the USFs allowing the MS transmit more data blocks until the MS complete the countdown procedure. It is verified that the MS has transmitted only one LLC PDU.

Random accesses are received from the MS for packet channel request. SS assigns a PDCH to it. SS assigns USFs addressing to the MS allowing more data blocks are transmitted by the MS until the countdown value CV=0.

The MS requests more resources through random accesses of channel requests for the remaining LLC PDU in the initial test PDP context. SS starts a two-phase dynamic allocation. It is checked that the values of

PEAK_THROUGHPUT_CLASS, RADIO_PRIORITY and RLC_MODE requested by the MS in the PACKET RESOURCE REQUEST are in consistence with the initial test PDP context2.

Maximum Duration of Test

5 minutes.

Expected Sequence

Step	Direction	Message	Comments
1	MS	{Uplink dynamic allocation two phase access}	In PDP context2, n = 880 octets, without starting time, USF_GRANULARITY = 1 block, RLC_DATA_BLOCKS_GRANTED = open-end TLLI_BLOCK_CHANNEL_CODING: cs1, CHANNEL_CODING_COMMAND: cs1, PEAK_THROUGHPUT_CLASS = 5, RADIO_PRIORITY = 4, RLC_MODE = acknowledged mode. Sent on the PACCH, the USF assigned to the MS.
2	SS -> MS	PACKET DOWNLINK DUMMY CONTROL BLOCK	
3	MS -> SS	UPLINK RLC DATA BLOCK	Received on the assigned PDTCH.
4	MS		Check that the coding as specified by CHANNEL_CODING_COMMAND, the TFI is correct. To trigger the MS to transfer 220 octets in test PDP context1, unacknowledged RLC mode and a higher radio priority.
5	SS -> MS	PACKET DOWNLINK DUMMY CONTROL BLOCK	Sent on the PACCH of the PDCH assigned, the USF assigned to the MS.
6	MS -> SS	UPLINK RLC DATA BLOCK	Received on the assigned PDTCH. Check that the coding and the TFI are correct.
7	SS		Repeat step 5 and 6 until countdown value CV=0. Observe the Length indicator, M bit and E bit of the received data headers. Check that transmitted is only the 1 st LLC PDU, Note: the 1 st LLC PDU is in PDP context2, the 2 nd LLC PDU is waiting for transferring.
8	SS -> MS	PACKET UPLINK ACK/NACK	FINAL_ACK_INDICATION = '1'. Acknowledge all received data, containing valid RRBP, sent on PACCH.
9	MS -> SS	PACKET CONTROL ACKNOWLEDGEMENT	Received on the block specified by RRBP on PACCH of the assigned PDCH.
10	MS -> SS	PACKET CHANNEL REQUEST	Received on PRACH for TBF establishment for transferring of the LLC PDU in PDP context1.
11	SS -> MS	PACKET UPLINK ASSIGNMENT	Single block assignment, to force the MS making two-phase access procedure. Sent on PAGCH.
12	MS -> SS	PACKET RESOURCE REQUEST	Received on the single block assigned in step 11. Check that radio priority level = 1, peak throughput class = 5, unacknowledged RLC mode.
13	SS -> MS	PACKET UPLINK ASSIGNMENT	Open-ended uplink dynamic allocation, no starting time, USF_GRANULARITY = single block. Sent on PACCH of the same PDCH assigned in step 11.
14	SS -> MS	PACKET DOWNLINK DUMMY CONTROL BLOCK	The USF assigned to the MS. Sent on PACCH of PDCH assigned in step 13.
15	MS -> SS	UPLINK RLC DATA BLOCK	Received on the PDTCH assigned.
16			Repeat step 14 and 15 until countdown value CV=0. Check the the amount of data is consistent with what was indicated by the MS in step 4.
17	SS -> MS	PACKET UPLINK ACK/NACK	FINAL_ACK_INDICATION = '1', a valid RRBP, acknowledge all received data, sent on PACCH.
18	MS -> SS	PACKET CONTROL ACKNOWLEDGEMENT	Received on the block specified by RRBP on PACCH of the assigned PDCH.
19	MS -> SS	PACKET CHANNEL REQUEST	Received on PRACH, TBF establishment for transmission of a remaining LLC PDU in PDP context2.
20	SS -> MS	PACKET UPLINK ASSIGNMENT	Single block assignment, to force the MS making two-phase access procedure. Sent on PAGCH.
21	MS -> SS	PACKET RESOURCE REQUEST	Received on the single block assigned in step 20. Check that PEAK_THROUGHPUT_CLASS = 5, RADIO_PRIORITY = 4, RLC_MODE = acknowledged mode.
22	SS -> MS	PACKET UPLINK ASSIGNMENT	Open-ended uplink dynamic allocation, no starting time, USF_GRANULARITY = single block. Sent on PACCH of the same PDCH assigned in step 20.
23	SS -> MS	PACKET DOWNLINK DUMMY CONTROL BLOCK	The USF assigned to the MS. Sent on PACCH of PDCH assigned in step 20.
24	MS -> SS	UPLINK RLC DATA BLOCK	Received on the PDTCH assigned in step 20.

Step	Direction	Message	Comments
25	SS		Repeat step 23 and 24 until countdown value CV=0. Observe the Length indicator, M bit and E bit of the received data headers.
26	SS -> MS	PACKET UPLINK ACK/NACK	Check that only one LLC PDU is transmitted. Note: the 2nd ^t LLC PDU in PDP context2. FINAL_ACK_INDICATION = '1'. Acknowledge all received data, containing valid RRBP, sent on PACCH.
27	MS -> SS	PACKET CONTROL ACKNOWLEDGEMENT	Received on the block specified by RRBP on PACCH of the assigned PDCH.

Specific Message Contents

PACKET UPLINK ASSIGNMET message in step 13:

Same as in subclause 42.3.3.1.1.3, step 11.

42.3.3.2 Dynamic Allocation / Resource reallocation / Abnormal

42.3.3.2.1 Dynamic Allocation / Resource reallocation / Abnormal / T3168 expiry

42.3.3.2.1.1 Conformance requirements

On expiry of timer T3168 the mobile station shall retransmit the PACKET RESOURCE REQUEST message unless the PACKET RESOURCE REQUEST has already been transmitted four times in which case the mobile station shall return to packet idle mode and indicate a packet access failure to upper layer.

References

3GPP TS 04.60, subclause 8.1.1.1.2.

42.3.3.2.1.2 Test purposes

To verify that during uplink resource reallocation on expiry of timer T3168:

1. The MS retransmits the PACKET RESOURCE REQUEST message unless the PACKET RESOURCE REQUEST has already been transmitted four times;
2. The MS returns to idle mode after PACKET RESOURCE REQUEST has been transmitted four times.

42.3.3.2.1.3 Method of test

Initial Conditions

System Simulator:

1 cell, default setting, BS_PBCCH_BLKs = 3, CONTROL_ACK_TYPE = 0, T3168 timeout value=0 (0.5s), BS_CV_MAX = 1, N201-U=500 for SAPI 3, 5, 9, 11, N201-U=270 for SAPI 7.

Mobile Station:

The MS is GPRS attached with a P-TMSI allocated, SPLIT PG CYCLE negotiated:

- Test PDP context2 and context5 activated;

-

Specific PICS Statements

-

PIXIT Statements

-

Test Procedure

An uplink TBF is established and in progress. The MS is triggered to transfer data with a higher radio priority in the same RLC mode.

The MS sends PACKET RESOURCE REQUEST. The current TBF is maintained and SS assigns the USFs allowing the MS transmit more data blocks, but does not answers to the requested resources. The MS repeatedly sends PACKET RESOURCE REQUEST three times after T3168 expires each time.

SS waits 0,55 s after receiving the 4th PACKET RESOURCE REQUEST and then sends PACKET DOWNLINK ASSIGNMENT and polls the MS. The MS answers with PACKET DOWNLINK ACK/NACK.

Maximum Duration of Test

5 minutes.

Expected Sequence

Step	Direction	Message	Comments
1	MS	{Uplink dynamic allocation two phase access}	In PDP context2, n = 220 octets, without starting time, USF_GRANULARITY = 1 block, RLC_DATA_BLOCKS_GRANTED = open-end TLLI_BLOCK_CHANNEL_CODING: cs1, CHANNEL_CODING_COMMAND: cs1, PEAK_THROUGHPUT_CLASS = 5, RADIO_PRIORITY = 4, RLC_MODE = acknowledged mode.
2	SS -> MS	PACKET DOWNLINK DUMMY CONTROL BLOCK	Sent on the PACCH, the USF assigned to the MS.
3	MS -> SS	UPLINK RLC DATA BLOCK	Received on the assigned PDTCH.
4	MS		Check that the coding as specified by CHANNEL_CODING_COMMAND, the TFI is correct. To trigger the MS to transfer 440 octets with the peak throughput class 5 (16k octets/s) and the radio priority 1 in acknowledge RLC mode of the PDP context5.
5	SS -> MS	PACKET DOWNLINK DUMMY CONTROL BLOCK	Sent on the PACCH, the USF assigned to the MS.
6	MS -> SS	UPLINK RLC DATA BLOCK or PACKET RESOURCE REQUEST	Received on the PDCH assigned
7			Repeat steps 5 and 6 until reception of PACKET RESOURCE REQUEST (ensure that countdown procedure did not start before that MS requests additional resources)
8			Repeat steps 5 – 7 twice, Note: the 1 st LLC PDU may be sent out and the sending 2 nd PDU in the PDP context5 is started Check that the coding as specified by CHANNEL_CODING_COMMAND, the TFI is correct for all received UPLINK RLC DATA BLOCK.
9	SS -> MS	PACKET UPLINK ACK/NACK	Sent on the PACCH of the PDCH assigned, acknowledge all received data. USF assigned to MS
10	MS -> SS	UPLINK RLC DATA BLOCK or PACKET RESOURCE REQUEST	Received on the PDCH assigned, the 4 th time to send PACKET RESOURCE REQUEST.
11	SS -> MS	PACKET DOWNLINK DUMMY CONTROL BLOCK	Sent on the PACCH, the USF assigned to the MS.
12			Repeat steps 10 and 11 until reception of PACKET RESOURCE REQUEST (ensure that countdown procedure did not start before that MS requests additional resources)
13	SS -> MS	PACKET DOWNLINK ASSIGNMENT	Sent 0,55s after receiving Packet Resource Request in step 10 on PCCCH, a valid RRBP=N+13. If MS sends Packet Channel Request SS should reject this by giving Packet Access Reject with WAIT_INDICATION= 20 sec.
14	MS -> SS	PACKET CONTROL ACKNOWLEDGEMENT	As four access bursts, received on PCCCH.

Specific Message Contents

PACKET RESOURCE REQUEST message in step 6 and 10:

Channel Request Description	
- PEAK_THROUGHPUT_CLASS	5
- RADIO_PRIORITY	1
- RLC_MODE	acknowledged mode
- LLC_PDU_TYPE	1 (not SACK or ACK)
- RLC_OCTET_COUNT	Any allowed value

42.3.3.2.2 Dynamic Allocation / Resource reallocation / Abnormal / Invalid assignment

42.3.3.2.2.1 Conformance requirements

1. If the mobile station receives a PACKET UPLINK ASSIGNMENT or PACKET TIMESLOT RECONFIGURE message and detects an invalid Frequency Parameters information element in the message, the mobile station shall perform an abnormal release with system information (see sub-clause 8.7.3), performing a partial acquisition of system information messages containing frequency information.
2. If the mobile station receives a PACKET UPLINK ASSIGNMENT or PACKET TIMESLOT RECONFIGURE message specifying frequencies that are not all in one frequency band then the mobile station shall perform an abnormal release with random access.
3. If the mobile station receives a PACKET UPLINK ASSIGNMENT message containing a Frequency Parameters information element specifying a frequency that is in a frequency band not supported by the mobile station then the mobile station shall perform an abnormal release with random access.

References

3GPP TS 04.60, subclause 8.1.1.1.2.1.

42.3.3.2.2.2 Test purposes

To verify that during uplink resource reallocation:

1. The MS performs an abnormal release with random access if it receives a PACKET UPLINK ASSIGNMENT or PACKET TIMESLOT RECONFIGURE message specifying frequencies that are not all in one frequency band.
2. The MS performs an abnormal release with random access if it receives a PACKET UPLINK ASSIGNMENT message containing a Frequency Parameters information element specifying a frequency in the frequency band not supported.
3. The MS performs an abnormal release with system information if it receives a PACKET UPLINK ASSIGNMENT or PACKET TIMESLOT RECONFIGURE message containing an Invalid Frequency Parameters information element.

42.3.3.2.2.3 Method of test

Initial Conditions

System Simulator:

1 cell, default setting, BS_PBCCH_BLKs = 3, BS_CV_MAX = 1, N201-U=500 for SAPI 3, 5, 9, 11, N201-U=270 for SAPI 7.

Mobile Station:

The MS is GPRS attached with a P-TMSI allocated, SPLIT PG CYCLE negotiated:

- Test PDP context2 and context5 activated;

Specific PICS Statements

- Support of Standard GSM Band (P-GSM) (TSPC_Type_GSM_P_Band)

- Support of DCS 1800 band (TSPC_Type_DCS_Band)
- Support of GSM 700 band (TSPC_Type_GSM_700_Band)
- Support of GSM 850 band (TSPC_Type_GSM_850_Band)
- Support of T GSM 810 band (TSPC_Type_T_GSM_810_Band)

PIXIT Statements

-

Test Procedure

An uplink TBF is established and in progress. The MS is triggered to transfer data with a higher radio priority in the same RLC mode. The MS sends PACKET RESOURCE REQUEST. SS sends PACKET UPLINK ASSIGNMENT or PACKET TIMESLOT RECONFIGURE containing an invalid assignment ($k=1\dots 5$, see step 6 in expected sequences).

It is checked that the MS starts random accesses.

Maximum Duration of Test

10 minutes.

Expected Sequence

The test sequence is executed in total five times, k = 1 ... 5. The 5th execution is applicable to the single band MS, but not to the multi-band one.

Step	Direction	Message	Comments
1	MS	{Uplink dynamic allocation two phase access}	In PDP context2, n = 220 octets, without starting time, USF_GRANULARITY = 1 block, RLC_DATA_BLOCKS_GRANTED = open-end TLLI_BLOCK_CHANNEL_CODING: cs1, CHANNEL_CODING_COMMAND: cs1, PEAK_THROUGHPUT_CLASS = 5, RADIO_PRIORITY = 4, RLC_MODE = acknowledged mode.
2	SS -> MS	PACKET DOWNLINK DUMMY CONTROL BLOCK	Sent on the PACCH, the USF assigned to the MS.
3	MS -> SS	UPLINK RLC DATA BLOCK	Received on the assigned PDTCH.
4	MS		Check that the coding as specified by CHANNEL_CODING_COMMAND, the TFI is correct. To trigger the MS to transfer 440 octets with the peak throughput class 5 (16k octets/s) and the radio priority 1 in acknowledge RLC mode of the PDP context5.
5-1	SS -> MS	PACKET UPLINK ACK/NACK	Sent on the PACCH, the USF assigned to the MS.
5	MS -> SS	UPLINK RLC DATA BLOCK or PACKET RESOURCE REQUEST	Received on the PACCH of the PDCH assigned.
6-1			Repeat steps 5-1 and 5 until reception of PACKET RESOURCE REQUEST (ensure that countdown procedure did not start before that MS requests additional resources)
6 k=1	SS -> MS	PACKET UPLINK ASSIGNMENT	Assign a frequency hopping PDCH, but not all frequencies are in one frequency band.
6 k=2	SS -> MS	PACKET TIMESLOT RECONFIGURE	Assign a frequency hopping PDCH, but not all frequencies are in one frequency band.
6 k=3	SS -> MS	PACKET UPLINK ASSIGNMENT	Assign a frequency hopping PDCH, the MA_NUMBER and MA_CHANGE_MARK_1 mismatch the values of MA_NUMBER and MA_CHANGE_MARK stored in the MS.
6 k=4	SS -> MS	PACKET TIMESLOT RECONFIGURE	Assign a frequency hopping PDCH, the MA_NUMBER and MA_CHANGE_MARK_1 mismatch the values of MA_NUMBER and MA_CHANGE_MARK stored in the MS.
6 k=5	SS -> MS	PACKETUPLINK ASSIGNMENT	Assigned ARFCN on PDCH is not in the frequency band supported by the MS.
7	MS -> SS	PACKET CHANNEL REQUEST	Received on PRACH.

Specific Message Contents

PACKET UPLINK ASSIGNMET message in step 6 for k=1:

{0 1<Frequency Parameters> - Frequency Parameters - TSC - - MAIO - HSN - Length of MA Frequency List contents - MA Frequency List contents Dynamic allocation	1 (Frequency Parameters present) Arbitrarily chosen 11 (Direct encoding 2) Arbitrarily chosen Arbitrarily chosen 12 octets Contain following ARFCNs in 1024 range format: 20, 40, 80, 90, 137, 447, 520, 590, 600, 700 01 As default
---	--

PACKET TIMESLOT RECONFIGURE message in step 6 for k=2:

Information Element	value/ remark
PAGE_MODE	Normal
- Global TFI	0, Global TFI as reference 0, uplink TFI same value as assigned in the uplink in step 1
CHANNEL_CODING_COMMAND	00 (CS-1)
Global Packet Timing Advance	1 (timing advance value)
{ 0 1<TIMING_ADVANCE_VALUE > - TIMING_ADVANCE_VALUE }	30 bit periods
- {0 1<UPLINK_TIMING_ADVANCE_INDEX> <UPLINK_TIMING_ADVANCE_TIMESLOT_NUMBER>}	0 (no uplink timing advance index)
- {0 1<DOWNLINK_TIMING_ADVANCE_INDEX> <DOWNLINK_TIMING_ADVANCE_TIMESLOT_NUMBER>}	0 (no downlink timing advance index)
DOWNLINK_RLC_MODE	Acknowledged mode
CONTROL_ACK	0
{0 1<DOWNLINK_TFI_ASSIGNMENT> - DOWNLINK_TFI_ASSIGNMENT	1 (assign downlink TFI) 00001(Binary)
{0 1<UPLINK_TFI_ASSIGNMENT > DOWNLINK_TIMESLOT_ALLOCATION	0
{0 1<Frequency Parameters> - Frequency Parameters	Same timeslot as the uplink TBF H (hopping channel)
- TSC	Arbitrarily chosen
-	11 (Direct encoding 2)
- MAIO	Arbitrarily chosen
- HSN	Arbitrarily chosen
- Length of MA Frequency List	12 octets
- Contents	
- MA Frequency List contents	Contain following ARFCNs in 1024 range format: 20, 40, 80, 90, 520, 590, 600, 700
Dynamic allocation	0 As default

PACKET UPLINK ASSIGNMET message in step 6 for k=3:

{0 1<Frequency Parameters> - Frequency Parameters	1 (Frequency Parameters present)
- TSC	Arbitrarily chosen
-	01 (Indirect encoding)
- MAIO	Arbitrarily chosen
- MA_NUMBER	Arbitrarily select a value that does not present in PSI2 message and different from 14 and 15
- {0 1<CHANGE_MARK_1> - CHANGE_MARK_1	1 (present) Arbitrarily select a value that mismatches PSI2_CHANGE_MARK
- {0 1<CHANGE_MARK_2> - CHANGE_MARK_2	1 (CHANGE_MARK_2 present) Arbitrarily select a value that is different from CHANGE_MARK_1 and mismatches PSI2_CHANGE_MARK
Dynamic allocation	01 As default

PACKET TIMESLOT RECONFIGURE message in step 6 for k=4:

Information Element	value/ remark
PAGE_MODE	Normal
- Global TFI	0, Global TFI as reference 0, uplink TFI same value as assigned in the uplink in step 1
CHANNEL_CODING_COMMAND	00 (CS-1)
Global Packet Timing Advance	1 (timing advance value)
{ 0 1<TIMING_ADVANCE_VALUE > - TIMING_ADVANCE_VALUE }	30 bit periods
- {0 1<UPLINK_TIMING_ADVANCE_INDEX> <UPLINK_TIMING_ADVANCE_TIMESLOT_NUMBER>}	0 (no uplink timing advance index)
- {0 1<DOWNLINK_TIMING_ADVANCE_INDEX> <DOWNLINK_TIMING_ADVANCE_TIMESLOT_NUMBER>}	0 (no downlink timing advance index)
DOWNLINK_RLC_MODE	Acknowledged mode
CONTROL_ACK	0
{0 1<DOWNLINK_TFI_ASSIGNMENT> - DOWNLINK_TFI_ASSIGNMENT	1 (assign downlink TFI) 00001(Binary)
{0 1<UPLINK_TFI_ASSIGNMENT >	0
DOWNLINK_TIMESLOT_ALLOCATION	Same timeslot as the uplink TBF
{0 1<Frequency Parameters> - Frequency Parameters	1 (hopping channel)
- TSC	Arbitrarily chosen
-	01 (Indirect encoding)
- MAIO	Arbitrarily chosen
- MA_NUMBER	Arbitrarily select a value that does not present in PSI2 message and different from 14 and 15
- {0 1<CHANGE_MARK_1> - CHANGE_MARK_1	1 (CHANGE_MARK_1 present)
- {0 1<CHANGE_MARK_2>	Arbitrarily choose a value which mismatches PSI2_CHANGE_MARK
Dynamic allocation	0 (no CHANGE_MARK_2) 0 As default

PACKET UPLINK ASSIGNMET message in step 6 for k=5:

{0 1<Frequency Parameters> - Frequency Parameters	1 (Frequency Parameters present)
- TSC	Arbitrarily chosen
-	00 (ARFCN no hopping)
- ARFCN	For GSM 900: 650 For DCS 1 800: 30 For GSM 700, T-GSM 810: 650 For GSM 850: 650
Dynamic allocation	01 (Dynamic allocation) As default

42.3.3.3 Dynamic Allocation / Resource reallocation / Reject

42.3.3.3.1 Conformance requirements

1. On receipt of a PACKET ACCESS REJECT message, the mobile station shall stop timer T3168 if running and indicate a packet access failure to upper layers. If no downlink TBF exists, the mobile station shall return to packet idle mode.
2. If the PACKET ACCESS REJECT message contains a WAIT_INDICATION field in a Reject structure addressed to the mobile station, the mobile station shall start timer T3172 and if the mobile station has additional RLC data blocks to transmit, it shall initiate a new TBF establishment procedure on the RACH or PRACH, but the mobile station is not allowed to make a new attempt for packet access in the same cell until timer T3172 expires, it may, however, attempt packet access in an other cell after successful cell reselection. A mobile station in GPRS MS class A or B mode of operation may attempt to enter the dedicated mode in the same cell before timer T3172 has expired. During the time T3172 is running, the mobile station shall ignore all received PACKET PAGING REQUEST messages except paging request to trigger RR connection establishment.

References

3GPP TS 04.60, subclause 8.1.1.1.2.

42.3.3.3.2 Test purposes

To verify that during the uplink resource reallocation:

1. The MS returns to packet idle mode when it receives PACKET ACCESS REJECT without WAIT_INDICATION.
2. On receipt of a PACKET ACCESS REJECT with a WAIT_INDICATION the MS waits until T3172 expires. The MS, if having another RLC data blocks to transmit, initiates a new TBF establishment procedure on the PRACH.

42.3.3.3.3 Method of test

Initial Conditions

System Simulator:

1 cell, default setting, BS_PBCCH_BLKs = 3, BS_CV_MAX = 1, N201-U=500 for SAPI 3, 5, 9, 11, N201-U=270 for SAPI 7.

Mobile Station:

The MS is GPRS attached with a P-TMSI allocated, SPLIT PG CYCLE negotiated:

- Test PDP context2 and context5 activated;

Specific PICS Statements

-

PIXIT Statements

-

Test Procedure

An uplink TBF is established and in progress. The MS is triggered to transfer data with a higher radio priority in the same RLC mode.

The MS sends PACKET RESOURCE REQUEST. SS sends PACKET ACCESS REJECT without containing WAIT_INDICATION. The MS may attempt a new random access because of the user data from the upper layer.

The test procedure is repeated once. The difference between the two executions is that in the 2nd execution, PACKET ACCESS REJECT contains WAIT_INDICATION. The MS may start the random access after T3172 expires.

Maximum Duration of Test

5 minutes.

Expected Sequence

The test sequence is executed twice for k = 1 ... 2.

Step	Direction	Message	Comments
1	MS	{Uplink dynamic allocation two phase access}	In PDP context2, n = 220 octets, without starting time, USF_GRANULARITY = 1 block, RLC_DATA_BLOCKS_GRANTED = open-end TLLI_BLOCK_CHANNEL_CODING: cs1, CHANNEL_CODING_COMMAND: cs1, PEAK_THROUGHPUT_CLASS = 5, RADIO_PRIORITY = 4, RLC_MODE = acknowledged mode.

Step	Direction	Message	Comments
2	SS -> MS	PACKET DOWNLINK DUMMY CONTROL BLOCK	Sent on the PACCH, the USF assigned to the MS.
3	MS -> SS	UPLINK RLC DATA BLOCK	Received on the assigned PDTCH.
4	MS		Check that the coding as specified by CHANNEL_CODING_COMMAND, the TFI is correct. To trigger the MS to transfer 440 octets with the peak throughput class 5 (16k octets/s) and the radio priority 1 in acknowledge RLC mode of the PDP context5.
5	SS -> MS	PACKET DOWNLINK DUMMY CONTROL BLOCK	Sent on the PACCH, the USF assigned to the MS.
5-1	MS -> SS	UPLINK RLC DATA BLOCK or PACKET RESOURCE REQUEST	Received on the PACCH of the PDCH assigned
5-2			Repeat steps 5 and 5-1 until reception of PACKET RESOURCE REQUEST (ensure that countdown procedure did not start before that MS requests additional resources)
6	SS -> MS	PACKET DOWNLINK DUMMY CONTROL BLOCK	Sent on the PACCH, the USF assigned to the MS.
7	MS -> SS	UPLINK RLC DATA BLOCK	Received on the assigned PDTCH.
8	SS -> MS	PACKET ACCESS REJECT	Check that the coding as specified by CHANNEL_CODING_COMMAND, the TFI is correct. Sent on the PACCH of the PDCH, including the same address reference received from step 5-1 addressing the MS, For k = 1 without WAIT_INDICATION For k = 2 with WAIT_INDICATION.
9(option al step)	MS -> SS	PACKET CHANNEL REQUEST	Optionally received on PRACH, depending on the MS implementation. For k=2, check that the random access is received not before 4,5s from step 8

Specific Message Contents

PACKET ACCESS REJECT message in step 8 for k=1:

MESSAGE_TYPE	1 00001
PAGE_MODE	Normal Paging
Reject	
-	0 (TLLI)
- TLLI	the same value as the TLLI received
-	0 (no WAIT_INDICATION)
-	0

PACKET ACCESS REJECT message in step 8 for k=2:

MESSAGE_TYPE	1 00001
PAGE_MODE	Normal Paging
Reject	
-	0 (TLLI)
- TLLI	The same value as the TLLI received
-	1 (WAIT_INDICATION present)
- WAIT_INDICATION	5 s
- WAIT_INDICATION_SIZE	0 (units of seconds)
-	0 (end of reject IE)

PACKET RESOURCE REQUEST message in step 5:

Information Element	value/ remark
Channel Request Description	
- PEAK_THROUGHPUT_CLASS	5
- RADIO_PRIORITY	1
- RLC_MODE	Acknowledged mode
- LLC_PDU_TYPE	1 (not SACK or ACK)
- RLC_OCTET_COUNT	Any allowed value

42.3.3.4 Dynamic Allocation / Resource reallocation / Successful / Lower Coding Scheme Command

42.3.3.4.1 Void

42.3.3.4.2 Conformance requirements

1. On receipt of a PACKET UPLINK ASSIGNMENT or PACKET TIMESLOT RECONFIGURE message the mobile station shall stop timer T3168 and switch to the assigned PDCHs (3GPP TS 04.60 sub-clause 8.1.1.1).
2. The transmitter shall transmit the oldest RLC data block whose corresponding element in V(B) indexed relative to V(A) has the value NACKED. As each RLC data block is transmitted the corresponding element in V(B) is set to the value PENDING_ACK, (3GPP TS 04.60 sub-clause 9.1.3.2).
3. If all RLC data blocks whose corresponding element in V(B) has the value PENDING_ACK have been transmitted once, the process shall be repeated beginning with the oldest RLC data block (3GPP TS 04.60 subclause 9.1.3.2).
4. In GPRS TBF mode, once an RLC data block has been transmitted over the physical link, should it be necessary to re-transmit the RLC data block, it shall be re-transmitted using the same channel coding scheme, BSN, and CV as it had in the previous transmission (3GPP TS 04.60 sub-clause 9.1.11)

References

3GPP TS 04.60, sub-clauses 8.1.1.1, 9.1.3.2, 9.1.11.

42.3.3.4.3 Test purposes

Verify that an MS switches to the newly assigned PDCH, retransmits unacknowledged RLC data blocks with the previous CS, transmits no more than one RLC data block with the previous CS and then applies the new CS command only to the new RLC data blocks.

42.3.3.4.4 Method of test

Initial Conditions

System Simulator:

1 cell, GPRS supported, PCCCH present.

Mobile Station:

The MS is in the state "idle, GMM-registered" with a P-TMSI allocated, SPLIT PG CYCLE negotiated, has a PDP context 2 activated. One LLC frame of 225 octets (which fits in 3 CS-4 blocks and 3 CS-1 blocks, or 2 CS-4 blocks and 6 CS-1 blocks) are to be sent by the MS.

Specific PICS Statements

-

PIXIT Statements

-

Test Procedure

- 1) The MS receives a PACKET UPLINK ASSIGNMENT message on its assigned PCCCH, containing a CS command set to CS4.
- 2) The SS transmits a USF assigned to the MS.
- 3) The MS responds by sending an uplink RLC data block.
- 4) the TLLI is sent in a Packet Uplink Ack/Nack in order to solve the contention.
- 5) The MS detects that the contention is solved.
- 6) The SS transmits another PACKET UPLINK ASSIGNMENT message on PACCH, containing new resources and a CS command set to CS1.
- 7) The MS transmits uplink RLC data blocks on the newly assigned resources: unacknowledged RLC data blocks or pending RLC data blocks are retransmitted using the previous CS; no more than one new RLC data block shall then be sent with the previous CS, and subsequent new RLC data blocks are transmitted using the new CS.
- 8) All blocks are acknowledged by the SS and the TBF is released.

Maximum Duration of Test

3 minutes.

Expected Sequence

Step	Direction	Message	Comments
1			MS is in the state "idle, GMM-registered" with a P-TMSI allocated, SPLIT PG CYCLE negotiated, has a PDP context activated
2	MS -> SS	PACKET CHANNEL REQUEST	Received on PRACH.
3	SS -> MS	PACKET UPLINK ASSIGNMENT	Triggers the MS to switch to PDCH0. (no starting time); CS4 is commanded.
4	SS -> MS	PACKET DOWNLINK DUMMY CONTROL BLOCK	3 blocks after the previous message, one USF addressing the MS is sent on PACCH according to allocation from step 3.
5	MS -> SS	RLC DATA BLOCK	
6	SS -> MS	Packet Uplink Ack/Nack	The SS transmits the MS TLLI in order to solve the contention and indicates that the 1 st RLC data block has been received.
7	SS -> MS	PACKET DOWNLINK DUMMY CONTROL BLOCK	3 blocks after the previous message, one USF addressing the MS is sent on PACCH according to allocation from step 3.
8	MS -> SS	UPLINK RLC DATA BLOCK	
7a (optional)	SS -> MS	PACKET DOWNLINK DUMMY CONTROL BLOCK	If the data block contains the TLLI perform optional steps 7a and 8a, otherwise continue with step 9. 3 blocks after the previous message, one USF addressing the MS is sent on PACCH according to allocation from step 3.
8a (optional)	MS -> SS	UPLINK RLC DATA BLOCK	
9	SS -> MS	PACKET UPLINK ACK/NACK	MS sends the 2 nd RLC data block sent on PDCH0 using CS4. The SS indicates that the 2 nd RLC data block has not been received.
10	SS -> MS	PACKET UPLINK ASSIGNMENT	Triggers the MS to switch to PDCH1. (no starting time) CS1 is commanded.
11	SS -> MS	PACKET DOWNLINK DUMMY CONTROL BLOCK	3 blocks after the previous message, a USF is addressed to MS according to allocation from step 9.
12	MS -> SS	RLC DATA BLOCK	MS sends a RLC data block on PDCH1.
13	SS -> MS	PACKET DOWNLINK DUMMY CONTROL BLOCK	The SS continues transmitting USF according to allocation from step 9.
14	MS -> SS	RLC DATA BLOCK	Verify that no more than one new RLC data block shall then be sent with the previous CS: at the latest the 4 th RLC data block of the TBF is sent with CS1. The SS verifies that CS4 is used for the 2 nd RLC data block, and that CS1 is used at the latest for the 4 th RLC data block and the subsequent blocks. The 3 rd RLC data block may be sent using the previous CS or the new one.
15			Repeat steps 12 and 13 until all the RLC data blocks have been sent, i.e 6 times
16	SS -> MS	Packet Uplink Ack/Nack	The SS indicates that every data blocks have been received.
17		{Completion of uplink data transfer}	Macro

Specific Message Contents

PACKET UPLINK ASSIGNMENT message in step 3:

TIMESLOT_ALLOCATION	<one timeslot assigned – PDCH0>
CHANNEL_CODING_COMMAND	11 (CS-4)
TLLI_BLOCK_CHANNEL_CODING	1 (the mobile station shall use the value commanded in the CHANNEL_CODING_COMMAND or EGPRS_CHANNEL_CODING_COMMAND field)
TBF STARTING TIME	<IE not present>

PACKET UPLINK ASSIGNMENT message in step 9:

TIMESLOT_ALLOCATION	<one timeslot assigned – PDCH1>
CHANNEL_CODING_COMMAND	00 (CS-1)
TLLI_BLOCK_CHANNEL_CODING	1 (the mobile station shall use the value commanded in the CHANNEL_CODING_COMMAND or EGPRS_CHANNEL_CODING_COMMAND field)
TBF STARTING TIME	<IE not present>

42.3.4 Default message contents

The following default values of messages and the default contents of messages are defined for subclause 42.3. They, unless indicated otherwise in subclause 42.3, shall be transmitted by the system simulator and are required to be received from the MS under test.

In this clause, decimal values are normally used. However, sometimes a hexadecimal value, indicated by an "Hex", or a binary value, indicated by a "Binary" is used.

All macro definitions are referred to subclause 40.5 and test PDP contexts are referred to subclause 40.6.

The default initial conditions used in subclause 42.3 are that PBCCH is present.

PACKET DOWNLINK ASSIGNMENT message:

MESSAGE_TYPE	000010
PAGE_MODE	Normal Paging
{0 1<PERSISTENCE_LEVEL>}	0
-	10 (address is TLLI)
- TLLI	same value as received from MS since GPRS attached
MAC_MODE	0, message escape
RLC_MODE	Dynamic Allocation
CONTROL_ACK	acknowledged mode
TIMESLOT_ALLOCATION	0
Packet Timing Advance	single slot arbitrarily chosen from valid values, default slot 2
- {0 1<TIMING_ADVANCE_VALUE>}	1 (presence of the timing advance value)
- TIMING_ADVANCE_VALUE	30 bit periods
- {0 1<TIMING_ADVANCE_INDEX>	0 (no timing advance index)
<TIMING_ADVANCE_TIMESLOT_NUMBER >}	
- {0 1<P0><BTS_PWR_CTRL_MODE>}	0
{0 1<Frequency Parameters>}	1 (Frequency Parameters present)
- Frequency Parameters	
- TSC	Value arbitrarily chosen from valid values (default 5)
-	01 (indirect encoding)
- MAIO	Value arbitrarily chosen
- MA_NUMBER	Value arbitrarily chosen from PSI2s defined
- {0 1<CHANGE_MARK_1>	0
{0 1<CHANGE_MARK_2>}}	
{0 1<DOWNLINK_TFI_ASSIGNMENT>}	1 (assign downlink TFI)
- DOWNLINK_TFI_ASSIGNMENT	Arbitrarily chosen from valid values (default 3)
{0 1<Power Control Parameters>}	1 (Power Control Parameters present)
- ALPHA	0.5
- {0 1<GAMMA_TN0>}	Depending on the value in TIMESLOT_ALLOCATION (default 0 no GAMMA_TN0)
- {0 1<GAMMA_TN1>}	Depending on the value in TIMESLOT_ALLOCATION (default 0 no GAMMA_TN1)
- {0 1<GAMMA_TN2>}	Depending on the value in TIMESLOT_ALLOCATION (default 1 GAMMA_TN2)
- GAMMA_TN2	For GSM 700, T-GSM 810, GSM 850 and GSM 900: +8 dBm
- {0 1<GAMMA_TN3>}	For DCS 1 800: +6 dBm
- {0 1<GAMMA_TN4>}	For PCS 1 900: +6 dBm
- {0 1<GAMMA_TN5>}	Depending on the value in TIMESLOT_ALLOCATION (default 0 no GAMMA_TN0)
- {0 1<GAMMA_TN6>}	Depending on the value in TIMESLOT_ALLOCATION (default 0 no GAMMA_TN4)
- {0 1<GAMMA_TN7>}	Depending on the value in TIMESLOT_ALLOCATION (default 0 no GAMMA_TN5)
{0 1<TBF_STARTING_TIME>}	Depending on the value in TIMESLOT_ALLOCATION (default 0 no GAMMA_TN6)
- TBF_STARTING_TIME	Depending on the value in TIMESLOT_ALLOCATION (default 0 no GAMMA_TN7)
{0 1<Measurement Mapping>}	1 (starting time present)
spare padding	0, absolute frame number encoding, indicating (current frame + 13 frames)
	0 (no measurement mapping)
	Spare Padding

PACKET DOWNLINK DUMMY CONTROL BLOCK message:

MESSAGE_TYPE	1 00101
PAGE_MODE	Normal Paging
{0 1<PERSISTENCE_LEVEL>}	0
spare padding	Spare Padding

PACKET PAGING REQUEST message:

MESSAGE_TYPE	1 00010
PAGE_MODE	Normal Paging
{0 1<PERSISTENCE_LEVEL>}	0 (no persistence level present)
{0 1<NLN>}	0 (no notification list number)
{1 <Repeated Page info>}	1 (start of Repeated Page info)
-	0 (Page request for TBF establishment)
-	0 (PTMSI)
- PTMSI	P-TMSI allocated during GPRS attach procedure
-	0 (end of Repeated Page info)
spare padding	Spare Padding

PACKET TIMESLOT RECONFIGURE message (dynamic allocation without assigning a new TBF):

MESSAGE_TYPE	000111
PAGE_MODE	Normal Paging
0<GLOBAL_TFI>	0 The TFI value of the uplink TBF or downlink TBF which this message applies to (default 00101)
CHANNEL_CODING_COMMAND	0, message escape
Global Packet Timing Advance	arbitrarily chosen from valid values (default CS-1)
- {0 1<TIMING_ADVANCE_VALUE>}	1 (timing advance value present)
- TIMING_ADVANCE_VALUE	30 bit periods
- {0 1<UPLINK_TIMING_ADVANCE_INDEX>}	0 (no uplink timing advance index)
<UPLINK_TIMING_ADVANCE_TIMESLOT_NUMBER>	The MS stops the operation of the continuous timing advance procedure.
- {0 1<DOWNLINK_TIMING_ADVANCE_INDEX>}	0 (no downlink timing advance index)
<DOWNLINK_TIMING_ADVANCE_TIMESLOT_NUMBER>	The MS stops the operation of the continuous timing advance procedure.
DOWNLINK_RLC_MODE	Same as in the Test PDP context used
CONTROL_ACK	0
{0 1<DOWNLINK_TFI_ASSIGNMENT>}	0
{0 1<UPLINK_TFI_ASSIGNMENT>}	0
DOWNLINK_TIMESLOT_ALLOCATION	arbitrarily chosen from valid values (default 00010000)
{0 1<Frequency Parameters>}	0 (use current parameters)
Dynamic allocation	0
- Extended Dynamic Allocation	0 (Dynamic allocation)
- {0 1<P0><PR_MODE>}	0
- USF_GRANULARITY	0, one block
- {0 1<RLC_DATA_BLOCKS_GRANTED>}	0 (no RLC_DATA_BLOCKS_GRANTED, open-ended TBF)
- {0 1<TBF_STARTING_TIME>}	1 (starting time)
- TBF_STARTING_TIME	1, relative frame number encoding
-	indicating current frame + 104 by absolute encoding
- ALPHA	1 (Timeslot Allocation with Power Control Parameters)
- {0 1<USF_TN0><GAMMA_TN0>}	one slot arbitrarily chosen and different from current slot,
- {0 1<USF_TN1><GAMMA_TN1>}	the following USF_TNx and GAMMA_TNx shall be
- {0 1<USF_TN2><GAMMA_TN2>}	corresponding to the chosen value, default timeslot 3.
- {0 1<USF_TN3><GAMMA_TN3>}	0.5
- USF_TN3	0 (timeslot 0 not assigned)
- GAMMA_TN3	0 (timeslot 1 not assigned)
-	0 (timeslot 2 not assigned)
-	1 (timeslot 3 assigned)
-	arbitrarily chosen and different from current value,
-	default 4
-	For GSM 700, T-GSM 810, GSM 850 and GSM 900: +8 dBm
-	For DCS 1 800: +6 dBm
-	For PCS 1 900: +6 dBm
- {0 1<USF_TN4><GAMMA_TN4>}	0 (timeslot 4 not assigned)
- {0 1<USF_TN5><GAMMA_TN5>}	0 (timeslot 5 not assigned)
- {0 1<USF_TN6><GAMMA_TN6>}	0 (timeslot 6 not assigned)
- {0 1<USF_TN7><GAMMA_TN7>}	0(timeslot 7 not assigned)
spare padding	Spare Padding

For assignment of an uplink TBF while a downlink TBF has been established, the address information should be changed to DOWNLINK_TFI of Global_TFI. UPLINK_TFI_ASSIGNMENT is present.

PACKET UPLINK ACK/NACK message:

MESSAGE_TYPE	001001
PAGE_MODE	Normal Paging
UPLINK_TFI	00, same as the TFI value of the TBF which the message applies
CHANNEL_CODING_COMMAND	0, message escape same coding scheme as in the assigned TBF which the message applies to
Ack/Nack Description	
- FINAL_ACK_INDICATION	0 (not a final ACK)
- STARTING_SEQUENCE_NUMBER	V(R)
- RECEIVED_BLOCK_BITMAP	acknowledge the all data blocks transmitted by the MS
{0 1<CONTENTION_RESOLUTION_TLLI>}	0 (no contention resolution TLLI)
{0 1<Packet Timing Advance>}	0 (no packet timing advance)
{0 1<Power Control Parameters>}	0 (no power control parameters)
{0 1<Extension bits>}	0 (no extension bits present)
spare padding	Spare Padding

PACKET UPLINK ASSIGNMENT message (two-phase dynamic allocation assigning a TBF):

MESSAGE_TYPE	001010
PAGE_MODE	Normal Paging
{0 1<PERSISTENCE_LEVEL>}	0 (no persistence level present)
- Address information	10 (TLLI)
- TLLI	The value received from the MS
CHANNEL_CODING_COMMAND	0, message escape
TLLI_BLOCK_CHANNEL_CODING	Arbitrarily chosen from the valid values (default CS-1)
Packet Timing Advance	'0'B, cs-1
- {0 1<TIMING_ADVANCE_VALUE>}	1 (timing advance value)
- TIMING_ADVANCE_VALUE	30 bit periods
- {0 1<TIMING_ADVANCE_INDEX>	0 (no timing advance index)
<TIMING_ADVANCE_TIMESLOT_NUMBER >	
{0 1<Frequency Parameters>}	1 (Frequency Parameters present)
- Frequency Parameters	
- TSC	Arbitrarily chosen (default 5)
-	01 (indirect encoding)
- MAIO	Value arbitrarily chosen
- MA_NUMBER	Value arbitrarily chosen from PSI2s defined (default 0001)
- {0 1<CHANGE_MARK_1>	0
{0 1<CHANGE_MARK_2>}}	
Dynamic allocation	01
- Extended Dynamic Allocation	0 (Dynamic allocation)
- {0 1<P0><PR_MODE>}	0
- USF_GRANULARITY	0, one block
- {0 1<UPLINK_TFI_ASSIGNMENT>}	1 (uplink TFI assignment)
- UPLINK_TFI_ASSIGNMENT	Arbitrarily chosen (default 00101)
- {0 1<RLC_DATA_BLOCKS_GRANTED>}	0 (no RLC_DATA_BLOCKS_GRANTED, open-ended TBF)
- {0 1<TBF_STARTING_TIME>}	0 (no starting time)
-	1 (Timeslot Allocation with Power Control Parameters)
	one slot arbitrarily chosen and the following USF_TNx and GAMMA_TNx shall be corresponding to the chosen value, default timeslot 2 assigned)
- ALPHA	0.5
- {0 1<USF_TN0><GAMMA_TN0>}	0 (timeslot 0 not assigned)
- {0 1<USF_TN1><GAMMA_TN1>}	0 (timeslot 1 not assigned)
- {0 1<USF_TN2><GAMMA_TN2>}	1 (timeslot 2 assigned)
- USF_TN2	Arbitrarily chosen (default 101)
- GAMMA_TN2	For GSM 700, T-GSM 810, GSM 850 and GSM 900: +8 dBm
	For DCS 1 800: +6 dBm
	For PCS 1 900: +6 dBm
- {0 1<USF_TN3><GAMMA_TN3>}	0 (timeslot 3 not assigned)
- {0 1<USF_TN4><GAMMA_TN4>}	0 (timeslot 4 not assigned)
- {0 1<USF_TN5><GAMMA_TN5>}	0 (timeslot 5 not assigned)
- {0 1<USF_TN6><GAMMA_TN6>}	0 (timeslot 6 not assigned)
- {0 1<USF_TN7><GAMMA_TN7>}	0 (timeslot 7 not assigned)
spare padding	Spare Padding

1. For one-phase uplink assignment, the Packet Request reference is used for addressing the MS.
2. For re-assignment of an uplink TBF, the address information should be changed to UPLINK_TFI of Global_TFI. UPLINK_TFI_ASSIGNMENT is absent.
3. For assignment of an uplink TBF while a downlink TBF has been established, the address information should be changed to DOWNLINK_TFI of Global_TFI. UPLINK_TFI_ASSIGNMENT is present.

PACKET UPLINK ASSIGNMENT message (single block allocation):

MESSAGE_TYPE	001010
PAGE_MODE	Normal Paging
{0 1<PERSISTENCE_LEVEL>}	0 (no persistence level present) 111 (Packet Request Reference)
-	As received in PACKET CHANNEL REQUEST
- RANDOM_ACCESS_INFORMATION value	The frame number which PACKET CHANNEL REQUEST was received on
- FRAME_NUMBER	0, message escape
CHANNEL_CODING_COMMAND	Arbitrarily chosen from the valid values (default CS-1)
TLLI_BLOCK_CHANNEL_CODING	'0'B
Packet Timing Advance	
- {0 1<TIMING_ADVANCE_VALUE>}	1 (timing advance value)
- TIMING_ADVANCE_VALUE	30 bit periods
- {0 1<TIMING_ADVANCE_INDEX>	0 (no timing advance index)
<TIMING_ADVANCE_TIMESLOT_NUMBER >}	
{0 1<Frequency Parameters>}	1 (Frequency Parameters present)
- Frequency Parameters	
- TSC	Arbitrarily chosen (default 5)
-	00 (ARFCN no hopping)
- ARFCN	For GSM 900: 30 For DCS 1 800: 650 For PCS 1 900: 650 For GSM 700, T-GSM 810: 467 For GSM 850: 157
Single block allocation	10
- TIMESLOT_NUMBER	Arbitrarily chosen (default slot 2)
- {0 1<ALPHA><GAMMA_TN>}	1
- ALPHA	0.5
- GAMMA_TN	For GSM 700, T-GSM 810, GSM 850 and GSM 900: +8 dBm For DCS 1 800: +6 dBm For PCS 1 900: +6 dBm
- {0 1<P0> <BTS_PWR_CTRL_MODE><PR_MODE>}	0
- TBF_STARTING_TIME	1, relative frame number encoding indicating current frame + 91 by absolute encoding
spare pending	Spare pending

ATTACH ACCEPT message:

Protocol discriminator	1000
Skip indicator	0000
Attach accept message identity	00000010
Attach result	For MS class A and B, Combined GPRS/IMSI attached For MS class C, GPRS only attached
Force to standby	not indicated
Periodic RA update timer	Timer is deactivated
Radio priority for SMS	Priority level 3
Spare half octet	Spare half octet
Routing area identification	
- MCC	001 (decimal)
- MNC	01 (decimal)
- LAC	0001H
- RAC	05H
P-TMSI signature	P-TMSI signature
Negotiated READY timer value	32 seconds
Allocated P-TMSI	P-TMSI
MS identity	TMSI
GMM cause	Omit

42.4 Measurement reports and Cell change order procedures

This subclause presents tests for "Measurement Reports and Cell Change Order Procedures" which are specified in 3GPP TS 04.60/3GPP TS 44.060 subclauses 5.6 and 8.4.

In the testcases which have uplink data transfer while in NC2, the USF needs to be assigned very frequently so that the measurement reports will be received by the SS within the 10% tolerance.

Default conditions

Default message contents and signalling macros are defined in the GPRS general defaults section, except for those messages and macros specified at the end of this subclause.

42.4.1 Measurement reports

42.4.1.1 Network Control measurement reporting / Uplink / Normal case

42.4.1.1.1 Conformance requirement

The behaviour of the mobile station is controlled by the NETWORK_CONTROL_ORDER parameter in a PACKET MEASUREMENT ORDER message. The reporting periods are indicated in the NC_REPORTING_PERIOD_T field of the PACKET MEASUREMENT ORDER message. The mobile station shall apply to the timer T3158 the NC_REPORTING_PERIOD_T when in packet transfer mode.

The procedure for NC measurement report sending shall be initiated by the mobile station at the expiry of the NC measurement report interval timer T3158. At expiry of the timer T3158 the mobile station shall restart the timer T3158, perform the measurements and send the PACKET MEASUREMENT REPORT message containing the 'NC measurement report struct' on PACCH.

A mobile station in mode NC1 may receive a new indicated reporting period or change packet mode while timer T3158 is active. If the new indicated reporting period is less than the time to expiry of timer T3158, the mobile station shall immediately restart timer T3158 with the new indicated reporting period. Otherwise, the timer T3158 shall continue to run.

42.4.1.1.2 Test Purpose

To verify that the MS sends the measurement report of the NC measurements according to the indicated reporting periods, when the T3158 expires.

To verify that the MS restarts the timer T3158 when it expires.

Reference

3GPP TS 04.60, subclauses 5.6.1 and 8.3.

42.4.1.1.3 Method of test

Initial conditions

System Simulator:

1 cell, GPRS supported.

Mobile Station:

MS is in Packet Idle mode and GPRS attached.

PDP context 2 established.

Specific PICS Statements

-

PIXIT Statements

-

Foreseen final state of the MS

- MS is in transfer mode.

Test procedure

MS is brought into uplink packet transfer mode. SS sends a PACKET MEASUREMENT ORDER message. MS sends continuously data blocks and PACKET MEASUREMENT REPORT messages according to the indicated reporting period. A PACKET MEASUREMENT ORDER message is sent again with new reporting period. MS sends data blocks and PACKET MEASUREMENT REPORT messages according to the new reporting period.

Maximum duration of the test

-

Expected sequence

Step	Direction	Message	Comments
1		{Uplink dynamic allocation one phase access with contention resolution } or {Uplink dynamic allocation two phase access}	Macro parameters: USF_GRANULARITY: 1 RLC_DATA_BLOCKS_GRANTED: absent (open-end) CHANNEL_CODING_COMMAND: CS-1 TLLI_BLOCK_CHANNEL_CODING: CS-1
2	SS->MS	PACKET MEASUREMENT ORDER	-Sent on PACCH. -Contains NETWORK_CONTROL_ORDER and NC_REPORTING_PERIOD_T See specific message contents USF assigned to the MS
3	SS->MS	PACKET DOWNLINK DUMMY CONTROL BLOCK	
4	MS -> SS	RLC data block	MS sends data
5	SS -> MS	PACKET UPLINK ACK/NACK	Sent on PACCH, USF assigned to MS
6			Repeat steps 4 and 5 until the MS sends a PACKET MEASUREMENT REPORT message in response to step 5.
7	MS->SS	PACKET MEASUREMENT REPORT	- Sent on PACCH. - Contains the "NC measurement report struct" on PACCH USF assigned to the MS
8	SS->MS	PACKET DOWNLINK DUMMY CONTROL BLOCK	
9	MS -> SS	RLC data block	MS sends data.
10	SS -> MS	PACKET UPLINK ACK/NACK	Sent on PACCH., USF assigned to MS
11			Repeat steps 9 and 10 until the MS sends a PACKET MEASUREMENT REPORT message in response to step 10.
12	MS->SS	PACKET MEASUREMENT REPORT	- Sent on PACCH. - Contains the "NC measurement report struct" on PACCH. SS verifies that the time interval between steps 7 and 12 corresponds to the indicated reporting period +/- 10%. USF assigned to the MS
13	SS->MS	PACKET DOWNLINK DUMMY CONTROL BLOCK	
14	MS -> SS	RLC data block	MS sends data.
15	SS -> MS	PACKET UPLINK ACK/NACK	Sent on PACCH.
16	SS ->MS	PACKET MEASUREMENT ORDER	- Sent on PACCH. -Contains NETWORK_CONTROL_ORDER and NC_REPORTING_PERIOD_T with new reporting period, which is greater than time to expiry of the timer T3158. See specific message contents USF assigned to the MS
17	SS->MS	PACKET DOWNLINK DUMMY CONTROL BLOCK	
18	MS -> SS	RLC data block	MS sends data.
19	SS -> MS	PACKET UPLINK ACK/NACK	Sent on PACCH, USF assigned to MS
20			Repeat steps 18 and 19 until the MS sends a PACKET MEASUREMENT REPORT message in response to step 19.
21	MS->SS	PACKET MEASUREMENT REPORT	- Sent on PACCH. - Contains the "NC measurement report struct" on PACCH. SS verifies that the time interval between steps 12 and 21 corresponds to the old reporting period +/- 10%. USF assigned to the MS
22	SS->MS	PACKET DOWNLINK DUMMY CONTROL BLOCK	
23	MS -> SS	RLC data blocks	MS sends data.
24	SS -> MS	PACKET UPLINK ACK/NACK	Sent on PACCH, USF assigned to MS
25			Repeat steps 23 and 24 until the MS sends a PACKET MEASUREMENT REPORT message in response to step 24.

26	MS->SS	PACKET MEASUREMENT REPORT	- Sent on PACCH. - Contains the "NC measurement report struct" on PACCH. SS verifies that the time interval between steps 21 and 26 corresponds to the new reporting period +/- 10%.
----	--------	---------------------------	--

Specific message contents

PACKET MEASUREMENT ORDER in step 2:

NC Measurement parameters NETWORK_CONTROL_ORDER NC_REPORTING_PERIOD_T	01 (NC1) 001 (0,96 s)
---	--------------------------

PACKET MEASUREMENT ORDER in step 16:

NC Measurement parameters NETWORK_CONTROL_ORDER NC_REPORTING_PERIOD_T	01 (NC1) 100 (7,68 s)
---	--------------------------

42.4.1.2 Network Control measurement reporting / Idle mode / New cell reselection

42.4.1.2.1 Conformance requirement

The procedure for measurement report sending shall be initiated by the mobile station at expiry of the NC measurement report interval timer T3158. At expiry of the timer T3158 the mobile station shall restart the expired timer T3158, perform the measurements and initiate the packet access. The packet access procedure is initiated by the RR entity in the mobile station with access type 'Single block without TBF establishment' indicated in the PACKET CHANNEL REQUEST message. The radio resource is assigned to the mobile station in a PACKET UPLINK ASSIGNMENT message sent on any PACCH on the same PCCCH on which the network has received the PACKET CHANNEL REQUEST message.

When receiving a PACKET UPLINK ASSIGNMENT message the mobile station shall send PACKET MEASUREMENT REPORT in the allocated radio block on the assigned PDCH and immediately switch back to the PCCCH in non-DRX mode. No TBF is established and the network shall not acknowledge the reception of the PACKET MEASUREMENT REPORT.

A mobile station may reselect a new cell or may be ordered to reselect a new cell while timer T3158 is active. If time to expiry of timer T3158 is greater than the indicated reporting period for the new cell, the mobile station shall immediately restart timer T3158 with the indicated reporting period for the new cell. Otherwise the timer T3158 shall continue to run.

42.4.1.2.2 Test Purpose

To verify that if the MS reselects a new cell while timer T3158 is active, and the time to expiry of timer T3158 is greater than the indicated reporting period for the new cell, the MS shall immediately restart timer T3158 with the indicated reporting period for the new cell.

To verify that if the MS reselects a new cell while timer T3158 is active, and the time to expiry of timer T3158 is shorter than the indicated reporting period for the new cell, the timer T3158 shall continue to run.

Reference

3GPP TS 04.60, subclauses 7.3 and 5.6.1.

42.4.1.2.3 Method of test

Initial conditions

System Simulator:

3 cells (cell A, cell B, cell C), activated at power-on, GPRS supported, PCCCH is present.

READY Timer is Set to 4 minutes.

Mobile Station:

MS is in Packet Idle mode and GPRS attached.

the Ready Timer is running.

Specific PICS Statements

-

PIXIT Statements

-

Foreseen final state of the MS

- MS is in idle mode.

Test procedure

SS sends PACKET MEASUREMENT ORDER message to MS. SS sends PACKET CELL CHANGE ORDER message to MS with new reporting period before the old reporting period has expired. MS initiates a packet access and sends the PACKET MEASUREMENT REPORT to SS. Another measurement report is sent before new PACKET CELL CHANGE ORDER message with new reporting period is sent to MS. Two more measurement reports are sent using correct reporting periods.

Maximum duration of the test

-

Expected sequence

Step	Direction	Message	Comments
1	SS->MS	PACKET MEASUREMENT ORDER	-Sent on PCCCH. -Contains NETWORK_CONTROL_ORDER and NC_REPORTING_PERIOD_I of cell A See specific message contents
2	MS ->SS	PACKET CHANNEL REQUEST	'Single block without TBF establishment.'
3	SS -> MS	PACKET UPLINK ASSIGNMENT	Sent on PAGCH.
4	MS ->SS	PACKET MEASUREMENT REPORT	Sent on the allocated PDCH. The SS verifies that measurement results for cells B and C are included.
5	SS->MS	PACKET CELL CHANGE ORDER	-Sent on PCCCH. - Commands the MS to cell B. -Contains NETWORK_CONTROL_ORDER, NC_REPORTING_PERIOD_T and NC_REPORTING_PERIOD_I of cell B with new reporting period, which is shorter than remaining time of the old reporting period. See specific message contents
6	MS ->SS	PACKET CHANNEL REQUEST	To the new cell. 'Cell Update' Note: The SS should take into account that the MS can start timer 3158 with the new timer values for NC_REPORTING_PERIOD either after step5 or step6.
7	SS -> MS	PACKET UPLINK ASSIGNMENT	Sent on PAGCH.
8	SS -> MS	PACKET DOWNLINK DUMMY CONTROL BLOCK	Sent on PACCH containing USF assigned to the MS.
9	MS ->SS	UPLINK RLC DATA BLOCK	LLC PDU implicitly indicating Cell Update
10	SS -> MS	PACKET UPLINK ACK/NACK	Acknowledge the received RLC data block, Final Ack Indicator = '1', a valid RRBP. Sent on PACCH.
11	MS -> SS	PACKET CONTROL ACKNOWLEDGEMENT	Acknowledge the RLC control message. Received on PACCH.
12	MS ->SS	PACKET CHANNEL REQUEST	To the new cell. 'Single block without TBF establishment.'
13	SS -> MS	PACKET UPLINK ASSIGNMENT	SS verifies that PACKET CHANNEL REQUEST arrives at the end of correct reporting period. Sent on PAGCH.
14	MS ->SS	PACKET MEASUREMENT REPORT	Sent on the allocated PDCH. The SS verifies that measurement results for cells A and C are included.
15	MS ->SS	PACKET CHANNEL REQUEST	'Single block without TBF establishment.'
16	SS -> MS	PACKET UPLINK ASSIGNMENT	SS verifies that PACKET CHANNEL REQUEST arrives at the end of correct reporting period. Sent on PAGCH.
17	MS ->SS	PACKET MEASUREMENT REPORT	Sent on the allocated PDCH.
18	SS->MS	PACKET CELL CHANGE ORDER	-Sent on PCCCH. - Commands to MS to cell C. -Contains NETWORK_CONTROL_ORDER, NC_REPORTING_PERIOD_T and NC_REPORTING_PERIOD_I of cell C with new reporting period, which is longer than remaining time of the old reporting period. See specific message contents
19	MS ->SS	PACKET CHANNEL REQUEST	To the new cell. 'Cell Update'
20	SS -> MS	PACKET UPLINK ASSIGNMENT	Sent on PAGCH.
21	SS -> MS	PACKET DOWNLINK DUMMY CONTROL BLOCK	Sent on PACCH containing USF assigned to the MS.
22	MS ->SS	UPLINK RLC DATA BLOCK	LLC PDU implicitly indicating Cell Update
23	SS -> MS	PACKET UPLINK ACK/NACK	Acknowledge the received RLC data block, Final Ack Indicator = '1', a valid RRBP. Sent on PACCH.

24	MS -> SS	PACKET CONTROL ACKNOWLEDGEMENT	Acknowledge the RLC control message. Received on PACCH.
25	MS ->SS	PACKET CHANNEL REQUEST	'Single block without TBF establishment.' SS verifies that PACKET CHANNEL REQUEST arrives at the end of correct reporting period.
26	SS -> MS	PACKET UPLINK ASSIGNMENT	Sent on PAGCH.
27	MS ->SS	PACKET MEASUREMENT REPORT	Sent on the allocated PDCH. The SS verifies that measurement results for cells A and B are included.
28	MS ->SS	PACKET CHANNEL REQUEST	'Single block without TBF establishment.' SS verifies that PACKET CHANNEL REQUEST arrives at the end of correct reporting period.
29	SS -> MS	PACKET UPLINK ASSIGNMENT	Sent on PAGCH.
30	MS ->SS	PACKET MEASUREMENT REPORT	Sent on the allocated PDCH. The SS verifies that measurement results for cells A and B are included.

Specific message contents

PACKET MEASUREMENT ORDER in step 1:

NC Measurement parameters	
NETWORK_CONTROL_ORDER	10 (NC2)
NC_REPORTING_PERIOD_I	111 (61.44s)
NC_FREQUENCY_LIST	0 (not present)

PACKET CELL CHANGE ORDER in step 5:

IMMEDIATE_REL	1
ARFCN, BSIC	as specified for cell B
NC Measurement parameters	
NETWORK_CONTROL_ORDER	10 (NC2)
NC_REPORTING_PERIOD_I	110 (30.72s)
NC_REPORTING_PERIOD_T	110 (30.72s)
NC_FREQUENCY_LIST	0 (not present)

PACKET CELL CHANGE ORDER in step 18:

IMMEDIATE_REL	1
ARFCN, BSIC	as specified for cell C
NC Measurement parameters	
NETWORK_CONTROL_ORDER	10 (NC2)
NC_REPORTING_PERIOD_I	111 (61.44s)
NC_REPORTING_PERIOD_T	111 (61.44s)
NC_FREQUENCY_LIST	0 (not present)

42.4.1.3 Network Control measurement reporting / Downlink transfer / Normal case

42.4.1.3.1 Conformance requirement

The procedure for NC measurement report sending shall be initiated by the mobile station at the expiry of the NC measurement report interval timer T3158. At expiry of the timer T3158 the mobile station shall restart the timer T3158, perform the measurements and send the PACKET MEASUREMENT REPORT message containing the 'NC measurement report struct' on PACCH.

Following a downlink TBF establishment, the PACKET MEASUREMENT REPORT message shall not be sent on the uplink PACCH associated with this TBF until two PACKET DOWNLINK ACK/NACK messages has been sent to the network.

The mobile station shall transmit an RLC/MAC control message other than a PACKET DOWNLINK ACK/NACK message at most every second time it is polled.

42.4.1.3.2 Test Purpose

To verify that the MS sends the measurement report of the NC measurements according to the indicated reporting periods, when the T3158 expires.

To verify that the MS restarts the timer T3158 when it expires.

To verify that the MS sends at least two PACKET DOWNLINK ACK/NACK messages before transmitting a PACKET MEASUREMENT REPORT message upon entering transfer state.

Reference

3GPP TS 04.60, subclauses 8.1.2.2, 8.3 and 5.6.1.

42.4.1.3.3 Method of test

Initial conditions

System Simulator:

1 cell, GPRS supported.

Mobile Station:

MS is in Packet Idle mode and GPRS attached.

PDP context 2 established.

Specific PICS Statements

-

PIXIT Statements

-

Foreseen final state of the MS

- MS is in transfer mode.

Test procedure

MS is brought into downlink packet transfer mode. SS sends a PACKET MEASUREMENT ORDER message. SS sends data blocks and MS answers with PACKET DOWNLINK ACK/NACK. When reporting period has expired and at least two PACKET DOWNLINK ACK/NACK messages has been sent, MS sends a PACKET MEASUREMENT REPORT message. SS sends data blocks continuously and MS sends PACKET MEASUREMENT REPORT messages when reporting period has expired and at least one PACKET DOWNLINK ACK/NACK messages have been sent after the last PACKET MEASUREMENT REPORT message.

Maximum duration of the test

-

Expected sequence

Step	Direction	Message	Comments
1	SS->MS	PACKET DOWNLINK ASSIGNMENT	Sent on the PCCCH.
2	SS->MS	PACKET MEASUREMENT ORDER	-Sent on PACCH. -Contains NETWORK_CONTROL_ORDER and NC_REPORTING_PERIOD_T See specific message contents
3	SS		Wait for 0.5 seconds.
4	SS -> MS	10 RLC data blocks	SS sends data, last block is polling.
5	MS -> SS	PACKET DOWNLINK ACK/NACK	Sent on PACCH.
6	SS->MS	10 RLC data blocks	SS sends data, last block is polling.
7	MS -> SS	PACKET DOWNLINK ACK/NACK	Sent on PACCH.
8	SS->MS	10 RLC data blocks	SS sends data, last block is polling.
9	MS->SS	PACKET MEASUREMENT REPORT	- Sent on PACCH. - Contains the "NC measurement report struct" on PACCH
10	SS		Wait for 0.5 seconds.
11	SS -> MS	10 RLC data blocks	SS sends data, last block is polling.
12	MS -> SS	PACKET DOWNLINK ACK/NACK	Sent on PACCH.
13	SS -> MS	10 RLC data blocks	SS sends data, last block is polling.
14	MS->SS	PACKET MEASUREMENT REPORT	- Sent on PACCH. - Contains the "NC measurement report struct" on PACCH
15	SS -> MS	10 RLC data blocks	SS sends data, last block is polling.
16	MS -> SS	PACKET DOWNLINK ACK/NACK	Sent on PACCH.
17	SS->MS	PACKET MEASUREMENT ORDER	- Sent on PACCH. -Contains NETWORK_CONTROL_ORDER and NC_REPORTING_PERIOD_T with new reporting period. See specific message contents
18	SS		Wait for 0.5 seconds.
19	SS -> MS	10 RLC data blocks	SS sends data, last block is polling.
20	MS -> SS	PACKET MEASUREMENT REPORT	Sent on PACCH. - Contains the "NC measurement report struct" on PACCH
21	SS		Wait for 0.5 seconds.
22	SS -> MS	10 RLC data blocks	SS sends data, last block is polling.
23	MS->SS	PACKET DOWNLINK ACK/NACK	- Sent on PACCH.
24	SS		Wait for 1.0 s.
25	SS -> MS	10 RLC data blocks	SS sends data, last block is polling.
26	MS -> SS	PACKET MEASUREMENT REPORT	Sent on PACCH. - Contains the "NC measurement report struct" on PACCH
27	SS -> MS	10 RLC data blocks	SS sends data, last block is polling.
28	MS -> SS	PACKET DOWNLINK ACK/NACK	- Sent on PACCH.

Specific message contents

PACKET MEASUREMENT ORDER in step 2:

NC Measurement parameters NETWORK_CONTROL_ORDER NC_REPORTING_PERIOD_T	01 (NC1) 000 (0,48 s)
---	--------------------------

PACKET MEASUREMENT ORDER in step 17:

NC Measurement parameters NETWORK_CONTROL_ORDER NC_REPORTING_PERIOD_T	01 (NC1) 001 (0,96 s)
---	--------------------------

42.4.1.4 Network Control measurement reporting / Uplink transfer / Continuation in Idle mode.

42.4.1.4.1 Conformance requirement

The procedure for NC measurement report sending shall be initiated by the mobile station at the expiry of the NC measurement report interval timer T3158. At expiry of the timer T3158 the mobile station shall restart the timer T3158, perform the measurements and send the PACKET MEASUREMENT REPORT message containing the 'NC measurement report struct' on PACCH.

A set of measurement reporting parameters (NETWORK_CONTROL_ORDER and NC_REPORTING_PERIOD(s)) is broadcast on PBCCH. The parameters may also be sent individually to an MS on PCCCH or PACCH, in which case it overrides the broadcast parameters. The individual parameters are valid until the RESET command is sent to the MS or there is a downlink signalling failure or the MS goes to the Standby state.

Reference

3GPP TS 04.60, subclauses 8.1.2.2, 8.3 and 5.6.1.

3GPP TS 05.08, subclause 10.1.4

42.4.1.4.2 Test Purpose

To verify that if the NC parameters are changed while in packet transfer mode, the MS continues to use the changed parameters after returning to packet idle mode.

42.4.1.4.3 Method of test

Initial conditions

System Simulator:

1 cell, GPRS supported. PCCCH present.

Mobile Station:

MS is GPRS attached with a P-TMSI allocated, SPLIT PG CYCLE negotiated.

PDP context 2 established.

Specific PICS Statements

- MS GPRS Release (TSPC_MS_GPRS_RELEASE)

PIXIT Statements

-

Test procedure

MS is brought into uplink packet transfer mode. SS commands MS to NC2 with PACKET MEASUREMENT ORDER. SS checks that the MS is sending the PACKET MEASUREMENT REPORT at the expiry of the reporting period. SS allows the MS to complete the data transfer. SS checks that after entering packet idle mode MS continues being in NC2 mode by receiving the PACKET MEASUREMENT REPORT.

The test is repeated twice for k=1, and k=2.

K=1:

READY TIMER is set to 2 min, NC_REPORTING_PERIOD_I set to 61.44 sec and NC_REPORTING_PERIOD_T set to 1.92 sec.

K=2:

READY TIMER is set to 30 sec, NC_REPORTING_PERIOD_I set to 7.68 sec and NC_REPORTING_PERIOD_T set to 1.92 sec.

Maximum duration of the test

-

Expected sequence

Step	Direction	Message	Comments
1	SS->MS	{ Uplink dynamic allocation one phase access with contention resolution } or {Uplink dynamic allocation two phase access}	Macro parameters: 500 : the number of RLC data block to be transferred, USF_GRANULARITY : 1 RLC_DATA_BLOCKS_GRANTED : absent (open-end) CHANNEL_CODING_COMMAND : CS-1 TLLI_BLOCK_CHANNEL_CODING : CS-1
2	SS->MS	PACKET MEASUREMENT ORDER	-Sent on PACCH. - For K = 1 and K =2 NETWORK_CONTROL_ORDER, NC_REPORTING_PERIOD_T and NC_REPORTING_PERIOD_I are Specified. See specific message Contents
3	SS -> MS	PACKET DOWNLINK DUMMY CONTROL BLOCK	USF assigned to the MS in step 1.
4a	MS -> SS	RLC data block	Received on PDTCH assigned in step 1.
4b	MS -> SS	PACKET MEASUREMENT REPORT	
5	SS -> MS	PACKET UPLINK ACK/NACK	Sent on PACCH. Acknowledging the received block.
6			Repeat steps 3-5 until the MS completes the data transfer of all the octets triggered in step 1. The last PACKET UPLINK ACK/NACK is sent with valid RRBP and FAI = 1. SS verifies that the time interval between two consecutive PACKET MEASUREMENT REPORTS is as per REPORTING_PERIOD_T of PMO sent in Step 2.
7	MS -> SS	PACKET CONTROL ACKNOWLEDGEMENT	Received on PACCH.
8	MS ->SS	PACKET CHANNEL REQUEST	'Single block without TBF establishment.' For Rel4 and earlier MS: SS verifies that either Rel5 requirements are fulfilled OR:PACKET CHANNEL REQUEST arrives : - After NC_REPORTING_PERIOD_T from last execution of step 4b for first PACKET CHANNEL REQUEST. Note: When the MS enters Idle mode, the Packet Channel Request may be delayed by one Paging block of the MS. - After NC_REPORTING_PERIOD_I from last PACKET CHANNEL REQUESTs (step 8) for following PACKET CHANNEL REQUEST(s). For Rel5 and later MS: SS verifies that PACKET CHANNEL REQUEST arrives : - After NC_REPORTING_PERIOD_I from step 7 After NC_REPORTING_PERIOD_I from last PACKET CHANNEL REQUEST (step 8) for following PACKET CHANNEL REQUEST(s). Sent on PAGCH.
9	SS -> MS	PACKET UPLINK ASSIGNMENT	Sent on PAGCH.
10	MS ->SS	PACKET MEASUREMENT REPORT	Received on the allocated PDCH.
11	SS		Steps 8-10 will be repeated till the READY TIMER expires. Check for NC_REPORTING_PERIOD_I that the MS stops sending Packet Measurement Reports
Note: in step 4x, the MS shall perform either the 'a' branch or the 'b' branch.			

Specific message contents

PACKET MEASUREMENT ORDER in step 2:

For K = 1:

NC Measurement parameters NETWORK_CONTROL_ORDER NC_REPORTING_PERIOD_I NC_REPORTING_PERIOD_T	10 (NC2) 111 (61.44 s) 010 (1.92 s)
--	---

For K = 2:

NC Measurement parameters NETWORK_CONTROL_ORDER NC_REPORTING_PERIOD_I NC_REPORTING_PERIOD_T	10 (NC2) 100 (7.68 s) 010 (1.92 s)
--	--

42.4.1.5 Network Control measurement reporting / Idle mode / DSC failure/ reselection.

42.4.1.5.1 Conformance requirement

The procedure for NC measurement report sending shall be initiated by the mobile station at the expiry of the NC measurement report interval timer T3158. At expiry of the timer T3158 the mobile station shall restart the timer T3158, perform the measurements and send the PACKET MEASUREMENT REPORT message containing the 'NC measurement report struct' on PACCH.

A set of measurement reporting parameters (NETWORK_CONTROL_ORDER and NC_REPORTING_PERIOD(s)) is broadcast on PBCCH. The parameters may also be sent individually to an MS on PCCCH or PACCH, in which case it overrides the broadcast parameters. The individual parameters are valid until the RESET command is sent to the MS or there is a downlink signalling failure or the MS goes to the Standby state.

The MS shall only perform autonomous cell re-selection when the reselection is triggered by a downlink signalling failure as defined in subclause 6.5 or a random access failure as defined in 3GPP TS 04.18 and 3GPP TS 04.60.

Reference

3GPP TS 04.60, subclauses 8.1.2.2, 8.3 and 5.6.1.

3GPP TS 05.08, subclause 10.1.4

42.4.1.5.2 Test Purpose

To verify that while in NC2, MS performs autonomous cell reselection when the reselection is triggered by the downlink signalling failure.

42.4.1.5.3 Method of test

Initial conditions

System Simulator:

2 cell, GPRS supported. PCCCH present in both the cells.

Parameter	Carrier1	Carrier2
RF Signal Level (dBm)	-60	-70
NETWORK_CONTROL_ORDER	NC2	NC2
NC_REPORTING_PERIOD	110 (30.72 sec)	110 (30.72 sec)
HCS_THR (dBm)		-80

Mobile Station:

MS is GPRS attached on cell A (Carrier 1) with a P-TMSI allocated, SPLIT PG CYCLE negotiated. Ready timer is set to 2 min.

Specific PICS Statements

-

PIXIT Statements

-

Test procedure

MS is in packet idle mode in cell A (Carrier 1). MS sends a PACKET CHANNEL REQUEST for the measurement report. SS assigns resources for it. MS sends a PACKET MEASUREMENT REPORT. SS receives one more PACKET MEASUREMENT REPORT by repeating the above steps. SS starts sending the corrupted blocks on the MS PPCH channel in such a way that $DSC < 0$. SS checks that the MS does reselection to cell B.

Maximum duration of the test

5 min.

Expected sequence

Step	Direction	Message	Comments
1	MS->SS	PACKET CHANNEL REQUEST	ACCESS TYPE = 'Single block without TBF establishment.' Received on PRACH. Received on cell A
2	SS->MS	PACKET UPLINK ASSIGNMENT	Sent on PAGCH, assigning a single block.
3	MS ->SS	PACKET MEASUREMENT REPORT	Received on the allocated PDCH.
4			Steps 1-3 are repeated once.
5	SS		SS Verifies that the measurement results for cells A, B are included in the PACKET MEASUREMENT REPORT.
6	SS		SS starts sending the corrupted data on successive paging blocks of the MS until $DSC < 0$. Then it reverts to sending of the normal data.
7	MS -> SS	PACKET CHANNEL REQUEST	Received on cell B. Establishment cause: Cell update

Specific message contents

None.

42.4.2 Cell change order procedures

42.4.2.1 Cell change order procedure / Uplink transfer

42.4.2.1.1 Cell change order procedure / Uplink transfer / Normal case

42.4.2.1.1.1 Conformance requirement

The cell change order procedure is started by sending a PACKET CELL CHANGE ORDER message to the mobile station on the PCCCH or PACCH. Upon receipt of the PACKET CELL CHANGE ORDER message the mobile station shall start timer T3174.

When a cell reselection is made controlled by the network, the mobile station shall act upon the IMMEDIATE_REL value which has been received in the Packet Cell Change Order: if required, the mobile station shall abort any TBF in progress by immediately ceasing to decode the downlink, ceasing to transmit on the uplink, stopping all RLC/MAC timers except for timers related to measurement reporting. The mobile station shall then switch to the identified specified new cell and shall obey the relevant RLC/MAC procedures on this new cell.

42.4.2.1.1.2 Test Purpose

To verify the when NC2 is commanded, the MS sends PACKET MEASUREMENT REPORT messages, in which both the serving and non-serving cells are reported.

To verify that when the cell change order procedure is started by sending a PACKET CELL CHANGE ORDER message with the IMMEDIATE_REL value set to 1, the MS shall abort any TBF in progress and stop transmitting.

To verify that the MS shall switch to the new cell.

Reference

3GPP TS 04.60, subclauses 8.4 and 5.5.1.1.

42.4.2.1.1.3 Method of test

Initial conditions

System Simulator:

2 cells (cell A and cell B), activated at power-on, GPRS supported.

Mobile Station:

MS is in Packet Idle mode and GPRS attached.

PDP context 2 established.

Specific PICS Statements

-

PIXIT Statements

-

Foreseen final state of the MS

- MS is in transfer mode.

Test procedure

MS is brought into uplink packet transfer mode. SS commands MS to NC2 with PACKET MEASUREMENT ORDER. SS waits for a PACKET MEASUREMENT REPORT to contain measurement results for both cell A and cell B. SS sends a PACKET CELL CHANGE ORDER message. SS checks that there is no traffic on the old cell. MS switches to the new cell and re-establishes the uplink TBF.

Maximum duration of the test

-

Expected sequence

Step	Direction	Message	Comments
1		{ Uplink dynamic allocation one phase access with contention resolution } or {Uplink dynamic allocation two phase access}	Macro parameters: 400 : the number of RLC data block to be transferred, USF_GRANULARITY : 1 RLC_DATA_BLOCKS_GRANTED : absent (open-end) CHANNEL_CODING_COMMAND : CS-1 TLLI_BLOCK_CHANNEL_CODING : CS-1
1a		PACKET DOWNLINK DUMMY CONTROL BLOCK	USF assigned to the MS in step 1
2	MS -> SS	RLC data blocks	MS sends data
3	SS -> MS	PACKET UPLINK ACK/NACK	Sent on PACCH.
4	SS->MS	PACKET MEASUREMENT ORDER	Sent on PACCH, 3 block periods from the PACKET UPLINK ACK/NACK in step 3. - Contains NETWORK_CONTROL_ORDER and NC_REPORTING_PERIOD See specific message contents USF assigned to the MS.
5a	MS->SS	RLC data block	
5b	MS->SS	PACKET MEASUREMENT REPORT	
6	SS		Repeat step 5 (periodically assign USF to the MS) until measurement results for cell B are included in the PACKET MEASUREMENT REPORT message.
7	SS -> MS	PACKET CELL CHANGE ORDER	Sent on the PACCH. IMMEDIATE_REL bit is set to "1" Contains -BSIC + BCCH frequency of cell B. -The network control order, NC2 - USF assigned to the MS in step 1 See specific message contents
8	SS		Check that no more than six data blocks are transmitted from the MS on the old channel.
9		{ Uplink dynamic allocation one phase access with contention resolution } or {Uplink dynamic allocation two phase access}	USF_GRANULARITY : 1 RLC_DATA_BLOCKS_GRANTED : absent (open-end) CHANNEL_CODING_COMMAND : CS-1 TLLI_BLOCK_CHANNEL_CODING : CS-1 These macros are to be used from the step 1 onwards. This Macro is to be performed on the cell B.
10	SS -> MS	PACKET DOWNLINK DUMMY CONTROL BLOCK	USF assigned to the MS in step 9.
11	MS -> SS	RLC data blocks	MS sends data
12	SS -> MS	PACKET UPLINK ACK/NACK	Sent on PACCH.

Note: in step 5x, the MS shall perform **either** the 'a' branch **or** the 'b' branch.

Specific message contents

PACKET MEASUREMENT ORDER in step 4:

Global TFI	TFI of the uplink TBF
NC Measurement parameters	
NETWORK_CONTROL_ORDER	10 (NC2)
NC_REPORTING_PERIOD_I	111 (61.44 sec)
NC_REPORTING_PERIOD_T	010 (1.92 sec)
NC_FREQUENCY_LIST	0 (not present)

PACKET CELL CHANGE ORDER in step 7:

Global TFI	TFI of the uplink TBF
IMMEDIATE_REL	1
ARFCN, BSIC	specified for cell B
NC Measurement parameters	
NETWORK_CONTROL_ORDER	10 (NC2)
NC_REPORTING_PERIOD_I	111 (61.44 sec)
NC_REPORTING_PERIOD_T	100 (7.68 sec)
NC_FREQUENCY_LIST	0 (not present)

42.4.2.1.2 Void

42.4.2.1.3 Cell change order procedure / Uplink transfer / Failure cases / REJECT from the new cell

42.4.2.1.3.1 Conformance requirement

42.4.2.1.3.1.1 Conformance requirement for Rel-5 and earlier

If a PACKET ACCESS REJECT message is received from the new cell, the mobile station shall start timer T3176, return to the old cell and send a PACKET CELL CHANGE FAILURE message to the network.

If the mobile station was in uplink packet transfer before the cell change, the mobile station shall establish a new uplink TBF and send the PACKET CELL CHANGE FAILURE message on this TBF. The mobile station shall then resume its uplink transfer on this TBF.

Reference

3GPP TS 04.60/44.060, subclause 8.4.1.

42.4.2.1.3.1.2 Conformance requirement for Rel-6 and later

In the following cases, the mobile station shall determine that the network controlled cell reselection procedure has failed:

- Access is denied in the new cell (i.e., the mobile station receives an IMMEDIATE ASSIGNMENT REJECT, a PACKET ASSIGNMENT REJECT or, in a UTRAN cell, an RRC CONNECTION REJECT message). *Cause*: “Immediate Assign Reject or Packet Access Reject on target cell”.

The mobile station shall send a PACKET CELL CHANGE FAILURE message with the appropriate cause value to the network in the old cell and stop timer T3176. The PACKET CELL CHANGE FAILURE message may be sent on PACCH when the mobile station is in packet transfer mode or MAC-Shared state. Alternatively, the mobile station may initiate random access with access type “single block without TBF establishment” (PCCCH) / “single block packet access” (CCCH) and send the PACKET CELL CHANGE FAILURE message using an allocated single uplink block.

Reference

3GPP TS 44.060, subclause 8.4.2.

42.4.2.1.3.2 Test Purpose

To verify that the mobile station sends a PACKET CELL CHANGE FAILURE message to the network from the old cell, if a PACKET ACCESS REJECT message is received from the new cell.

42.4.2.1.3.3 Method of test

Initial conditions

System Simulator:

2 cells (cell A, cell B), activated at power-on, GPRS supported.

Mobile Station:

MS is in Packet Idle mode and GPRS attached.

PDP context 2 established.

Specific PICS Statements

-

PIXIT Statements

-

Foreseen final state of the MS

- MS is in Transfer mode.

Test procedure

MS is brought into uplink packet transfer mode. SS sends the PACKET CELL CHANGE ORDER message to the MS. MS sends the PACKET CHANNEL REQUEST. SS sends PACKET ACCESS REJECT message. MS returns to the old cell and sends PACKET CELL CHANGE FAILURE message to the network.

Maximum duration of the test

-

Expected sequence

Step	Direction	Message	Comments
1		{Uplink dynamic allocation two phase access}	Macro parameters: USF_GRANULARITY: 1 RLC_DATA_BLOCKS_GRANTED: absent (open-end) CHANNEL_CODING_COMMAND: CS-1 LLI_BLOCK_CHANNEL_CODING: CS-1
2	SS->MS	PACKET MEASUREMENT ORDER	Sent on PACCH, 3 block periods after contention resolution in step 1 has been completed. - Contains NETWORK_CONTROL_ORDER and NC_REPORTING_PERIOD. See specific message contents
3	SS->MS	PACKET DOWNLINK DUMMY CONTROL BLOCK	USF assigned to the MS
4a	MS -> SS	RLC data blocks	MS sends data
4b	MS -> SS	PACKET MEASUREMENT REPORT	
5	SS -> MS	PACKET UPLINK ACK/NACK	Sent on PACCH.
6	SS		Repeat steps 3-5 until measurement results for cell B are included in the PACKET MEASUREMENT REPORT message.
7	SS -> MS	PACKET CELL CHANGE ORDER	Sent on the PACCH. Contains -BSIC + BCCH frequency -The network control order See specific message contents
8	MS -> SS	PACKET CHANNEL REQUEST	To the new cell. 'One Phase Access Request', 'Two Phase Access Request' or 'Cell Update'
9	SS -> MS	PACKET ACCESS REJECT	Received from the new cell
10	MS -> SS	PACKET CHANNEL REQUEST	To the old cell. Sent within 15 seconds from the PACKET ACCESS REJECT in step 9. Access Type 'One Phase Access Request', 'Two Phase Access Request', 'Cell Update' or 'Single Block Without TBF Establishment'. The Branch 'a' will be performed when Access Type was 'Single Block Without TBF Establishment', otherwise branch 'b' will be performed.
11a	SS -> MS	PACKET UPLINK ASSIGNMENT	Sent on PAGCH. Single block assignment.
12a	MS -> SS	PACKET CELL CHANGE FAILURE	Error cause:" Packet Access Reject on target cell " See specific message content
13a	MS -> SS	PACKET CHANNEL REQUEST	To the old cell. 'One Phase Access Request', 'Two Phase Access Request' or 'Cell Update'
14a	SS -> MS	PACKET UPLINK ASSIGNMENT	Sent on the PAGCH. Single block allocation (forcing two phase access)
15a	MS -> SS	PACKET RESSOURCE REQUEST	Send on the assigned block.
16a	SS -> MS	PACKET UPLINK ASSIGNMENT	Sent on PAGCH. Dynamic allocation
11b	SS -> MS	PACKET UPLINK ASSIGNMENT	Sent on the PAGCH. Single block allocation (forcing two phase access)
12b	MS -> SS	PACKET RESSOURCE REQUEST	Send on the assigned block.
13b	SS -> MS	PACKET UPLINK ASSIGNMENT	Sent on PAGCH. Dynamic allocation.
14b	SS->MS	PACKET DOWNLINK DUMMY CONTROL BLOCK	USF assigned to the MS
15b	MS -> SS	PACKET CELL CHANGE FAILURE	Error cause:" Packet Access Reject on target cell " See specific message content
17	SS->MS	PACKET DOWNLINK DUMMY CONTROL BLOCK	USF assigned to the MS

			If the first received RLC Data Block in current TBF contains an empty LLC PDU, the SS shall accept Packet Resource Request from MS and respond with Packet Uplink Assignment. The USF shall be assigned once more to the MS.
			NOTE: The empty LLC PDU may be accompanied by another low priority RLC data block (with Packet Resource Request and Packet Uplink Assignment as required), in order to ensure that the radio resources are used efficiently. MS sends data
18a	MS -> SS	RLC data blocks	
18b	MS -> SS	PACKET MEASUREMENT REPORT	
19	SS -> MS	PACKET UPLINK ACK/NACK	Sent on PACCH if step 18a was executed.
Note:			In steps 4x, steps 11x-16x and 18x the MS shall perform either the 'a' branch or the 'b' branch.

Specific message contents

PACKET MEASUREMENT ORDER in step 2:

Global TFI	TFI of the uplink TBF
NC Measurement parameters	
NETWORK_CONTROL_ORDER	10 (NC2)
NC_REPORTING_PERIOD_I	111 (61.44 sec)
NC_REPORTING_PERIOD_T	010 (1.92 sec)
NC_FREQUENCY_LIST	0 (not present)

PACKET CELL CHANGE ORDER in step 7:

Global TFI	TFI of the uplink TBF
IMMEDIATE_REL	1
ARFCN, BSIC	specified for cell B
NC Measurement parameters	
NETWORK_CONTROL_ORDER	10 (NC2)
NC_REPORTING_PERIOD_I	111 (61.44 sec)
NC_REPORTING_PERIOD_T	100 (7.68 sec)
NC_FREQUENCY_LIST	0 (not present)

PACKET CELL CHANGE FAILURE in step 12a/15b:

Packet Cell Change Failure message content:	
CAUSE	0010

42.4.2.1.4 Cell change order procedure / Uplink transfer / Failure cases / Contention resolution failure

42.4.2.1.4.1 Conformance requirement

42.4.2.1.4.1.1 Conformance requirement for Rel-5 and earlier

If the contention resolution procedure fails on the new cell, then the mobile station shall start timer T3176 and return to the old cell. The mobile station shall send a PACKET CELL CHANGE FAILURE message to the network.

If the mobile station was in uplink packet transfer before the cell change, the mobile station shall establish a new uplink TBF and send the PACKET CELL CHANGE FAILURE message on this TBF. The mobile station shall then resume its uplink transfer on this TBF.

References

3GPP TS 04.60/44.060, subclause 8.4.1

42.4.2.1.4.1.2 Conformance requirement for Rel-6 and later

The mobile station shall regard the network controlled cell reselection procedure as successfully completed when it has performed access and successfully completed contention resolution in the new cell.

In the following cases, the mobile station shall determine that the network controlled cell reselection procedure has failed:

- The mobile station is unable to synchronise to the new cell (see 3GPP TS 45.008) or the timer T3174 expires before a successful completion of the network controlled cell reselection procedure. *Cause*: 'No response on target cell'.

If the mobile station determines that the network controlled cell reselection procedure has failed, the mobile station shall stop timer T3174 (if it is still running) and start timer T3176. The mobile station shall return to the old cell, where it may trigger a cell update or other GMM specific procedure. In case the mobile station synchronised and attempted to access the new cell before returning to the old cell, the mobile station shall trigger a cell update or other GMM specific procedure, as appropriate according to the GMM requirements (see 3GPP TS 24.008).

The mobile station shall send a PACKET CELL CHANGE FAILURE message with the appropriate cause value to the network in the old cell and stop timer T3176. The PACKET CELL CHANGE FAILURE message may be sent on PACCH when the mobile station is in packet transfer mode or MAC-Shared state. Alternatively, the mobile station may initiate random access with access type 'single block without TBF establishment' (PCCCH) / 'single block packet access' (CCCH) and send the PACKET CELL CHANGE FAILURE message using an allocated single uplink block.

References

3GPP TS 44.060, subclauses 8.4.1 and 8.4.2

42.4.2.1.4.2 Test Purpose

To verify that the mobile station initiates a random access to the old cell, if the contention resolution procedure fails on the new cell.

42.4.2.1.4.3 Method of test

Initial conditions

System Simulator:

2 cells (cell A, cell B), activated at power-on, GPRS supported.

Mobile Station:

MS is in Packet Idle mode and GPRS attached. Ready timer is set to 44 seconds

PDP context established.

Specific PICS Statements

-

PIXIT Statements

-

Foreseen final state of the MS

- MS is in Transfer mode.

Test procedure

MS is brought into uplink packet transfer mode. SS sends the PACKET CELL CHANGE ORDER message to the MS. MS sends the PACKET CHANNEL REQUEST to the new cell. Contention resolution procedure fails in the new cell. While timer T3174 is running the MS may re-initiate the packet access procedure on the new cell. MS initiates a random access to the old cell and sends PACKET CELL CHANGE FAILURE message to the network.

Maximum duration of the test

-

Expected sequence

Step	Direction	Message	Comments
1		{Uplink dynamic allocation two phase access}	MS is brought into uplink packet transfer mode and contention resolution is completed. Macro parameters: USF_GRANULARITY: 1 RLC_DATA_BLOCKS_GRANTED: absent (open-end) CHANNEL_CODING_COMMAND: CS-1 TLLI_BLOCK_CHANNEL_CODING: CS-1
2	SS -> MS	PACKET MEASUREMENT ORDER	Sent on PACCH, 3 block periods after contention resolution in step 1 has been completed. - Contains NETWORK_CONTROL_ORDER and NC_REPORTING_PERIOD. See specific message contents USF assigned to the MS
3	SS -> MS	PACKET DOWNLINK DUMMY CONTROL BLOCK	
4a	MS -> SS	RLC data blocks	MS sends data
4b	MS -> SS	PACKET MEASUREMENT REPORT	
5	SS -> MS	PACKET UPLINK ACK/NACK	Sent on PACCH.
6	SS		Repeat steps 3-5 until measurement results for cell B are included in the PACKET MEASUREMENT REPORT message.
7	SS -> MS	PACKET CELL CHANGE ORDER	Sent on the PCCCH or PACCH. Contains -BSIC + BCCH frequency -The network control order See specific message contents.
8	MS -> SS	PACKET CHANNEL REQUEST	To the new cell. 'One Phase Access Request' or 'Two Phase Access Request' or 'Cell Update' If MS request 'One Phase Access Request' or 'Cell Update' branch A shall apply, otherwise branch B applies.
9A	SS -> MS	PACKET UPLINK ASSIGNMENT	Sent on the PAGCH. Dynamic allocation
10A	SS -> MS	PACKET DOWNLINK DUMMY CONTROL BLOCK	USF assigned to the MS. Sent at earliest 3 block periods from the PACKET UPLINK ASSIGNMENT in step 9.
11A	MS -> SS	RLC data block	The data block contains the TLLI. The TLLI should be the same in each RLC data block header.
12A	SS -> MS	PACKET UPLINK ACK/NACK	Or The RLC data serves as cell update. Contention resolution procedure fails in the new cell. Message has wrong TLLI. Sequence continues on step 13
9B	SS -> MS	PACKET UPLINK ASSIGNMENT	Sent on the PAGCH. Single block allocation.
10B	MS -> SS	PACKET RESSOURCE REQUEST	Send on the assigned block.
11B	SS -> MS	PACKET UPLINK ASSIGNMENT	Sent on the PAGCH. Dynamic allocation, Message has wrong TLLI. While timer T3174 is running the MS may re-initiate the packet access procedure on the new cell using one of the access types specified in step 8. In this case steps 9A to 12A or 9B to 11B are repeated. The SS verifies that no PACKET CHANNEL REQUEST is received on cell B after expiry of timer T3174.

13	MS -> SS	PACKET CHANNEL REQUEST	To the old cell. Within 15 seconds from PACKET UPLINK ACK/NACK in step 12A or the PACKET UPLINK ASSIGNMENT in step 11B. 'One Phase Access Request' or 'Two Phase Access Request' or 'Cell Update' or 'Single block without TBF establishment'. If MS requests 'Single block without TBF establishment' branch A shall apply, otherwise branch B applies.
14A	SS -> MS	PACKET UPLINK ASSIGNMENT	Sent on PAGCH. Single block assignment.
15A	MS -> SS	PACKET CELL CHANGE FAILURE	Presence of error code should be checked, value should be '0001' (No response on target cell)
16A	MS -> SS	PACKET CHANNEL REQUEST	To the old cell. 'One Phase Access Request' or 'Two Phase Access Request' or 'Cell Update'.
17A	SS -> MS	PACKET UPLINK ASSIGNMENT	Sent on the PAGCH. Single block allocation (forcing two phase access).
18A	MS -> SS	PACKET RESSOURCE REQUEST	Send on the assigned block.
19A	SS -> MS	PACKET UPLINK ASSIGNMENT	Sent on the PAGCH. Dynamic allocation. Sequence continues in step 20.
14B	SS -> MS	PACKET UPLINK ASSIGNMENT	Sent on the PAGCH. Single block allocation (forcing two phase access).
15B	MS -> SS	PACKET RESSOURCE REQUEST	Send on the assigned block.
16B	SS -> MS	PACKET UPLINK ASSIGNMENT	Sent on the PAGCH. Dynamic allocation,
17B	SS->MS	PACKET DOWNLINK DUMMY CONTROL BLOCK	USF assigned to the MS
18B	MS -> SS	PACKET CELL CHANGE FAILURE	Presence of error code should be checked, value should be '0001' (No response on target cell)
20	SS -> MS	PACKET DOWNLINK DUMMY CONTROL BLOCK	USF assigned to the MS
21	MS -> SS	RLC data block	MS sends data
22	SS -> MS	PACKET UPLINK ACK/NACK	Sent on PACCH.

Note: In step 4x, 9x to 12x and 14x to 19x the MS shall perform **either** the 'a' branch **or** the 'b' branch.

Specific message contents

PACKET MEASUREMENT ORDER in step 2:

Global TFI	TFI of the uplink TBF
NC Measurement parameters	
NETWORK_CONTROL_ORDER	10 (NC2)
NC_REPORTING_PERIOD_I	111 (61.44 sec)
NC_REPORTING_PERIOD_T	010 (1.92 sec)
NC_FREQUENCY_LIST	0 (not present)

PACKET CELL CHANGE ORDER in step 7:

Global TFI	TFI of the uplink TBF
IMMEDIATE_REL	1
ARFCN, BSIC	specified for cell B
NC Measurement parameters	
NETWORK_CONTROL_ORDER	10 (NC2)
NC_REPORTING_PERIOD_I	111 (61.44 sec)
NC_REPORTING_PERIOD_T	110 (30.72 sec)
NC_FREQUENCY_LIST	0 (not present)

42.4.2.1.5 Void

42.4.2.1.6 Cell change order procedure / Uplink transfer / Failure cases / Frequency not implemented

42.4.2.1.6.1 Conformance requirement

If the network message instructs the mobile station to use a frequency that it is not capable of using, the mobile station shall send a PACKET CELL CHANGE FAILURE message with cause "frequency not implemented" and remain on the current PDCH(s).

42.4.2.1.6.2 Test Purpose

To verify that the mobile station returns a PACKET CELL CHANGE FAILURE message, if the ordered frequency cannot be used.

Reference

3GPP TS 04.60, subclause 8.4.2.

42.4.2.1.6.3 Method of test

System Simulator:

1 cell, GPRS supported.

Mobile Station:

MS is in Packet Idle mode and GPRS attached.

PDP context established.

Specific PICS Statements

-

PIXIT Statements

-

Foreseen final state of the MS

- MS is in Transfer mode.

Test procedure

MS is brought into uplink packet transfer mode. SS sends the PACKET CELL CHANGE ORDER message. MS is not capable of using the ordered frequency and sends a PACKET CELL CHANGE FAILURE message to the network. MS shall remain on the current PDCH(s).

Maximum duration of the test

-

Expected sequence

Step	Direction	Message	Comments
1		{Uplink dynamic allocation two phase access}	MS is brought into uplink packet transfer mode. Macro parameters: USF_GRANULARITY: 1 RLC_DATA_BLOCKS_GRANTED: absent (open-end) CHANNEL_CODING_COMMAND: CS-1 TLLI_BLOCK_CHANNEL_CODING: CS-1 USF assigned to the MS
2	SS -> MS	PACKET DOWNLINK DUMMY CONTROL BLOCK	
3	MS -> SS	RLC data blocks	MS sends data
4	SS -> MS	PACKET UPLINK ACK/NACK	Sent on PACCH.
5	SS -> MS	PACKET CELL CHANGE ORDER	Contains -BSIC + BCCH frequency -The network control order MS is not capable of using the ordered frequency.
6	SS -> MS	PACKET DOWNLINK DUMMY CONTROL BLOCK	USF assigned to the MS
7	MS -> SS	PACKET CELL CHANGE FAILURE	Sent on the PACCH. Error cause "frequency not implemented". See specific message content.
8	MS		MS shall remain on the current PDCH(s).
9	SS -> MS	PACKET DOWNLINK DUMMY CONTROL BLOCK	USF assigned to the MS
10	MS -> SS	RLC data blocks	MS sends data
11	SS -> MS	PACKET UPLINK ACK/NACK	Sent on PACCH.

Specific message contents

PACKET CELL CHANGE FAILURE in step 7:

Packet Cell Change Failure message content: CAUSE	0000
--	------

42.4.2.2 Cell change order procedure / Downlink transfer

42.4.2.2.1 Cell change order procedure / Downlink transfer / Normal case

42.4.2.2.1.1 Conformance requirement

The cell change order procedure is started by sending a PACKET CELL CHANGE ORDER message to the mobile station on the PCCCH or PACCH. Upon receipt of the PACKET CELL CHANGE ORDER message the mobile station shall start timer T3174.

When a cell reselection is made controlled by the network, the mobile station shall act upon the IMMEDIATE_REL value which has been received in the Packet Cell Change Order: if required, the mobile station shall abort any TBF in progress by immediately ceasing to decode the downlink, ceasing to transmit on the uplink, stopping all RLC/MAC timers except for timers related to measurement reporting. The mobile station shall then switch to the identified specified new cell and shall obey the relevant RLC/MAC procedures on this new cell.

42.4.2.2.1.2 Test Purpose

To verify that when NC2 is commanded, the MS sends PACKET MEASUREMENT REPORT messages, in which both the serving and non-serving cells are reported.

To verify that the cell change order procedure is started when the MS receives a PACKET CELL CHANGE ORDER message.

To verify that the MS switches to the new cell.

To verify that the MS correctly performs a cell update.

To verify that the MS uses the established downlink TBF on the new cell.

Reference

3GPP TS 04.60, subclauses 8.4 and 5.5.1.1.

42.4.2.2.1.3 Method of test

Initial conditions

System Simulator:

2 cells (cell A, cell B), activated at power-on, GPRS supported.

Mobile Station:

MS is in Packet Idle mode and GPRS attached.

PDP context established.

Specific PICS Statements

-

PIXIT Statements

-

Foreseen final state of the MS

- MS is in Transfer mode.

Test procedure

MS is brought into downlink packet transfer mode. SS sends a PACKET CELL CHANGE ORDER message. MS switches to the new cell and SS establishes a new downlink TBF.

Maximum duration of the test

-

Expected sequence

Step	Direction	Message	Comments
1	SS->MS	PACKET DOWNLINK ASSIGNMENT	Sent on the PCCCH.
2	SS->MS	PACKET MEASUREMENT ORDER	Sent on PACCH, 3 block periods from the PACKET DOWNLINK ASSIGNMENT in step 1. - Contains NETWORK_CONTROL_ORDER and NC_REPORTING_PERIOD. See specific message contents
3	SS->MS	10 RLC data blocks	SS sends data, last block is polling.
4a	MS->SS	PACKET DOWNLINK ACK/NACK	Sent on PACCH.
4b	MS->SS	PACKET MEASUREMENT REPORT	Sent on PACCH.
5	SS		Repeat steps 3-4 until measurement results for cell B are included in the PACKET MEASUREMENT REPORT message. The SS verifies that for the first 2 polls, PACKET DOWNLINK ACK/NACK messages are sent by the MS.
6	SS->MS	PACKET CELL CHANGE ORDER	Sent on the PACCH. IMMEDIATE_REL bit is set to "1" Contains -BSIC + BCCH frequency of cell B -The network control order, NC2 See specific message contents
7	MS->SS	PACKET CHANNEL REQUEST	To the new cell. 'Cell Update'
8	SS->MS	PACKET UPLINK ASSIGNMENT	Sent on PACCH.
9	MS->SS	RLC data block	Sent on the PDCH. The RLC data also serves as cell update.
10	SS->MS	PACKET UPLINK ACK/NACK	Sent on the PACCH with valid RRBP.
11	MS->SS	PACKET CONTROL ACK	
12	SS		The SS waits 2 sec for expiring timer T3158 which was set in PACKET MEASUREMENT ORDER message in step 2; If the MS does not send a PACKET CHANNEL REQUEST for sending a PACKET MEASUREMENT REPORT continue with step 14
13a	MS->SS	PACKET CHANNEL REQUEST	Single Block without TBF establishment
13b	SS->MS	PACKET UPLINK ASSIGNMENT	
13c	MS->SS	PACKET MEASUREMENT REPORT	
14	SS->MS	PACKET DOWNLINK ASSIGNMENT	Sent on PCCCH. On the new cell. Addressing the MS with TLLI.
15	SS->MS	10 RLC data blocks	SS sends data, last block is polling.
16	MS->SS	PACKET DOWNLINK ACK/NACK	Sent on PACCH.

Note 1: in step 4x, the MS shall perform **either** the 'a' branch **or** the 'b' branch.

Note 2: steps 13a-c are performed only when MS tries to send a PACKET MEASUREMENT REPORT after expiring of T3158 in step 12

Specific message contents

PACKET MEASUREMENT ORDER in step 2:

Global TFI	TFI of the downlink TBF
NC Measurement parameters	
NETWORK_CONTROL_ORDER	10 (NC2)
NC_REPORTING_PERIOD_I	111 (61.44 sec)
NC_REPORTING_PERIOD_T	010 (1.92 sec)
NC_FREQUENCY_LIST	0 (not present)

PACKET CELL CHANGE ORDER in step 6:

Global TFI	TFI of the downlink TBF
IMMEDIATE_REL	1
ARFCN, BSIC	specified for cell B
NC Measurement parameters	
NETWORK_CONTROL_ORDER	10 (NC2)
NC_REPORTING_PERIOD_I	111 (61.44 sec)
NC_REPORTING_PERIOD_T	100 (7.68 sec)
NC_FREQUENCY_LIST	0 (not present)

42.4.2.2.2 Cell change order procedure / Downlink transfer / Failure cases / REJECT from the new cell

42.4.2.2.2.1 Conformance requirement

If a PACKET ACCESS REJECT message is received from the new cell, the mobile station shall start timer T3176, return to the old cell and send a PACKET CELL CHANGE FAILURE message to the network.

If the mobile station was in downlink packet transfer mode before the cell change, the mobile station shall initiate a random access to the old cell, with access type "single block without TBF establishment", and then transmit the PACKET CELL CHANGE FAILURE message on the single block.

42.4.2.2.2.2 Test Purpose

To verify that the mobile station sends a PACKET CELL CHANGE FAILURE message to the network in the old cell, if a PACKET ACCESS REJECT message is received from the new cell.

Reference

3GPP TS 04.60, subclause 8.4.1.

42.4.2.2.2.3 Method of test

Initial conditions

System Simulator:

2 cells (cell A, cell B), activated at power-on GPRS supported.

Mobile Station:

MS is in Packet Idle mode and GPRS attached. Ready Timer is deactivated.

PDP context 2 established.

Specific PICS Statements

-

PIXIT Statements

-

Foreseen final state of the MS

- MS is in idle mode.

Test procedure

MS is brought into downlink packet transfer mode. SS sends the PACKET CELL CHANGE ORDER message to the MS. MS sends the PACKET CHANNEL REQUEST. SS sends PACKET ACCESS REJECT message. MS returns to the old cell and sends PACKET CELL CHANGE FAILURE message to the network.

Maximum duration of the test

-

Expected sequence

Step	Direction	Message	Comments
1	SS -> MS	PACKET DOWNLINK ASSIGNMENT	Sent on the PCCCH.
2	SS->MS	PACKET MEASUREMENT ORDER	Sent on PACCH, 3 block periods from the PACKET DOWNLINK ASSIGNMENT in step 1.
3	SS -> MS	10 RLC data blocks	- Contains NETWORK_CONTROL_ORDER and NC_REPORTING_PERIOD. See specific message contents SS sends data, last block is polling.
4a	MS -> SS	PACKET DOWNLINK ACK/NACK	Sent on PACCH.
4b	MS->SS	PACKET MEASUREMENT REPORT	Sent on PACCH.
5	SS		Repeat steps 3-4 until measurement results for cell B are included in the PACKET MEASUREMENT REPORT message. The SS verifies that for the first 2 polls, PACKET DOWNLINK ACK/NACK messages are sent by the MS.
6	SS -> MS	PACKET CELL CHANGE ORDER	Sent on the PACCH. IMMEDIATE_REL bit is set to "1" Contains -BSIC + BCCH frequency of cell B. -The network control order, NC2
7	MS -> SS	PACKET CHANNEL REQUEST	See specific message contents To the new cell. 'Cell Update'
8	SS -> MS	PACKET ACCESS REJECT	Received from the new cell
9a	MS -> SS	PACKET CHANNEL REQUEST	To the old cell within 15 seconds from the PACKET ACCESS REJECT in step 8. 'Single block without TBF establishment.'
10a	SS -> MS	PACKET UPLINK ASSIGNMENT	Sent on PAGCH, single block allocation
11a	MS -> SS	PACKET CELL CHANGE FAILURE	Single block. Error cause:" Packet Access Reject on target cell " See specific message content
9b	MS -> SS	PACKET CHANNEL REQUEST	To the old cell within 15 seconds from the PACKET ACCESS REJECT in step 8. 'Cell Update'
10b	SS -> MS	PACKET UPLINK ASSIGNMENT	Sent on PAGCH, dynamic allocation
11b	SS->MS	PACKET DOWNLINK DUMMY CONTROL BLOCK	Sent on PACCH, at earlier 3 block periods for the PACKET UPLINK ASSIGNMENT in step 10b. Assigns USF allocated to the MS
12b	MS -> SS	PACKET CELL CHANGE FAILURE	Error cause:" Packet Access Reject on target cell " See specific message content
13b	SS->SS	PACKET DOWNLINK DUMMY CONTROL BLOCK	Sent on PACCH
14b	MS->SS	RLC data block	Assigns an USF allocated to the MS empty LLC PDU serving as cell update, CV=0
15b	SS->MS	PACKET UPLINK ACK/NACK	FAI =1, S/P=1. Including the TLLI of the MS.
16b	MS->SS	PACKET CONTROL ACKNOWLEDGEMENT	

Note: in step 4x and 9x to 11x/16x, the MS shall perform **either** the ‘a’ branch **or** the ‘b’ branch.

Specific message contents

PACKET MEASUREMENT ORDER in step 2:

Global TFI	TFI of the downlink TBF
NC Measurement parameters	
NETWORK_CONTROL_ORDER	10 (NC2)
NC_REPORTING_PERIOD_I	111 (61.44 sec)
NC_REPORTING_PERIOD_T	010 (1.92 sec)
NC_FREQUENCY_LIST	0 (not present)

PACKET CELL CHANGE ORDER in step 6:

Global TFI	TFI of the downlink TBF
IMMEDIATE_REL	1
ARFCN, BSIC	specified for cell B
NC Measurement parameters	
NETWORK_CONTROL_ORDER	10 (NC2)
NC_REPORTING_PERIOD_I	111 (61.44 sec)
NC_REPORTING_PERIOD_T	100 (7.68 sec)
NC_FREQUENCY_LIST	0 (not present)

PACKET CELL CHANGE FAILURE in step 11a or 12b:

Packet Cell Change Failure message content: CAUSE	0010 (Packet Access Reject on target cell)
--	--

42.4.2.2.3 Cell change order procedure / Downlink transfer / Failure cases / Frequency not implemented

42.4.2.2.3.1 Conformance requirement

If the network message instructs the mobile station to use a frequency that it is not capable of using, the mobile station shall send a PACKET CELL CHANGE FAILURE message and remain on the current PDCH(s).

42.4.2.2.3.2 Test Purpose

To verify that the mobile station returns a PACKET CELL CHANGE FAILURE message if it is not capable of using the ordered frequency.

Reference

3GPP TS 04.60, subclause 8.4.2.

42.4.2.2.3.3 Method of test

Initial conditions

System Simulator:

1 cell, GPRS supported.

Mobile Station:

MS is in Packet Idle mode and GPRS attached.

PDP context established.

Specific PICS Statements

-

PIXIT Statements

-

Foreseen final state of the MS

- MS is in idle mode.

Test procedure

MS is brought into downlink packet transfer mode. SS sends the PACKET CELL CHANGE ORDER message. The ordered frequency is not capable of using. The MS sends a PACKET CELL CHANGE FAILURE message to the network.

Maximum duration of the test

-

Expected sequence

Step	Direction	Message	Comments
1	SS->MS	PACKET DOWNLINK ASSIGNMENT	Sent on the PCCCH.
2	SS->MS	10 RLC data blocks	SS sends data, last block is polling.
3	MS->SS	PACKET DOWNLINK ACK/NACK	Sent on PACCH.
4	SS->MS	PACKET CELL CHANGE ORDER	Sent on the PACCH. Contains -BSIC + BCCH frequency -The network control order The frequency is not capable of using.
5	SS->MS	RLC data block	Data block with polling.
A6	MS->SS	PACKET DOWNLINK ACK/NACK	Sent on PACCH. Channel Request Description to establish UL-TBF in order to send Cell Update
A7	SS->MS	PACKET UPLINK ASSIGNMENT	Sent on PACCH.
A8	MS->SS	PACKET CELL CHANGE FAILURE	Sent on PACCH. Error cause: "Frequency not implemented". See specific message content.
A9	MS->SS	RLC data block	LLC PDU implicitly indicating Cell Update
A10	SS->MS	PACKET UPLINK ACK/NACK	Acknowledge the received RLC data block, Final Ack Indicator = '1', a valid RRBP. Send on PACCH.
B6	MS->SS	PACKET CELL CHANGE FAILURE	Sent on PACCH. Error cause: "Frequency not implemented". See specific message content.

Note: Branch A is performed only in case MS wants to do a Cell Update. Branch B is performed if MS does not do a Cell Update.

Specific message contents

PACKET CELL CHANGE FAILURE in step A8 and B6:

Packet Cell Change Failure message content: CAUSE	0000 (Frequency not implemented)
--	----------------------------------

42.4.2.3 Cell change order procedure / Simultaneous uplink and downlink transfer

42.4.2.3.1 Cell change order procedure / Simultaneous uplink and downlink transfer / Normal case

42.4.2.3.1.1 Conformance requirement

The cell change order procedure is started by sending a PACKET CELL CHANGE ORDER message to the mobile station on the PCCCH or PACCH. Upon receipt of the PACKET CELL CHANGE ORDER message the mobile station shall start timer T3174.

When a cell reselection is made controlled by the network, the mobile station shall act upon the IMMEDIATE_REL value which has been received in the Packet Cell Change Order: if required, the mobile station shall abort any TBF in progress by immediately ceasing to decode the downlink, ceasing to transmit on the uplink, stopping all RLC/MAC timers except for timers related to measurement reporting. The mobile station shall then switch to the identified specified new cell and shall obey the relevant RLC/MAC procedures on this new cell.

When cell reselection is controlled by the network, the mobile station in packet transfer mode shall act upon the IMMEDIATE_REL value: it may continue its operation in the old serving cell, as in mobile steered cell reselection, or it shall immediately abort its TBF if it is indicated by the IMMEDIATE_REL value.

Under no circumstances, operations in the old cell shall be continued more than 5 s after a cell reselection has been determined.

42.4.2.3.1.2 Test Purpose

To verify that when the cell change order procedure is started by sending a PACKET CELL CHANGE ORDER message, the MS shall abort any TBF in progress and stop transmitting.

To verify that the MS shall switch to the new cell.

To verify that the MS shall act upon the IMMEDIATE_REL value.

Reference

3GPP TS 04.60, subclauses 5.5.1.1, 8.4 and 8.4.1.

42.4.2.3.1.3 Method of test

Initial conditions

System Simulator:

2 cells (cell A, cell B), activated at power-on, GPRS supported.

Mobile Station:

MS is in Packet Idle mode and GPRS attached.

PDP context 2 established.

Specific PICS Statements

-

PIXIT Statements

-

Foreseen final state of the MS

- MS is in simultaneous uplink and downlink packet transfer mode.

Test procedure

MS is brought into simultaneous uplink and downlink packet transfer mode. SS sends a PACKET CELL CHANGE ORDER message with IMMEDIATE_REL value set to 1 to force the mobile to release all ongoing TBFs. MS switches to the new cell and simultaneous uplink and downlink TBF is re-established.

SS sends a PACKET CELL CHANGE ORDER message with IMMEDIATE_REL value set to 0. The MS continues its operation in the old serving cell.

Maximum duration of the test

-

Expected sequence

Step	Direction	Message	Comments
1		{ Uplink dynamic allocation one phase access with contention resolution } or {Uplink dynamic allocation two phase access}	Macro parameters: 400 : the number of RLC data block to be transferred, USF_GRANULARITY : 1 RLC_DATA_BLOCKS_GRANTED : absent (open-end) CHANNEL_CODING_COMMAND : CS-1 TLLI_BLOCK_CHANNEL_CODING: CS-1
2	SS->MS	PACKET MEASUREMENT ORDER	Sent on PACCH, at earliest 3 block periods after contention resolution for the uplink TBF is completed. - Contains NETWORK_CONTROL_ORDER and NC_REPORTING_PERIOD. See specific message contents
3	SS -> MS	PACKET DOWNLINK ASSIGNMENT	Sent on the PACCH. USF assigned to the MS in step 1
4	MS -> SS	RLC data block	MS sends data.
5	SS->MS	PACKET DOWNLINK DUMMY CONTROL BLOCK	Sent on PACCH, USF assigned to the MS in step 1
6a	MS -> SS	RLC data block	MS sends data.
6b	MS->SS	PACKET MEASUREMENT REPORT	
7	SS -> MS	PACKET UPLINK ACK/NACK	Sent on PACCH.
8	SS -> MS	10 RLC data blocks	SS sends data, last block is polling.
9a	MS -> SS	PACKET DOWNLINK ACK/NACK	Sent on PACCH.
9b	MS -> SS	PACKET MEASUREMENT REPORT	
10	SS		Repeat steps 5-9 until measurement results for cell B are included in the PACKET MEASUREMENT REPORT message
11	SS -> MS	PACKET CELL CHANGE ORDER	Sent on the PACCH. Contains -BSIC + BCCH frequency -The network control order-NC2 -USF IMMEDIATE_REL bit is set to 1. See specific message content.
12	SS		USF assigned to the MS in step 1 Check that no more than six data blocks are transmitted from the MS on old channel SS assigns USFs to the MS in PACKET DOWNLINK DUMMY CONTROL BLOCKS
13		{ Uplink dynamic allocation one phase access with contention resolution } or {Uplink dynamic allocation two phase access}	Macro parameters: USF_GRANULARITY : 1 RLC_DATA_BLOCKS_GRANTED : absent (open-end) CHANNEL_CODING_COMMAND : CS-1 TLLI_BLOCK_CHANNEL_CODING: CS-1
14	SS->MS	PACKET DOWNLINK DUMMY CONTROL BLOCK	USF assigned to the MS in step 13
15	MS->SS	RLC data block	MS sends data. The RLC data also serves as cell update.
16	SS -> MS	PACKET UPLINK ACK/NACK	Sent on PACCH. If the first received RLC Data Block in current TBF contain an empty LLC PDU, The SS shall accept Packet Resource Request from MS and respond with Packet Uplink Assignment. The USF shall be assigned once more to the MS.NOTE: The empty LLC PDU may be accompanied by another low priority RLC data block (with Packet Resource Request and Packet Uplink Assignment or Packet Timeslot Reconfigure as required), in order to ensure that the radio resources are used efficiently.
17	SS -> MS	PACKET DOWNLINK ASSIGNMENT	Sent on PACCH. On the new cell.
18	SS -> MS	10 RLC data block	SS sends data, last block is polling.

19a	MS -> SS	PACKET DOWNLINK ACK/NACK	Sent on PACCH.
19b	MS -> SS	PACKET MEASUREMENT REPORT	
20	SS->MS		USF assigned to the MS in step 13
21a	MS -> SS	PACKET UPLINK ACK/NACK	
21b	MS->SS	RLC data block	MS sends data.
22	SS	PACKET MEASUREMENT REPORT	Repeat steps 18-21 until measurement results for cell A are included in the PACKET MEASUREMENT REPORT message
23	SS -> MS	PACKET CELL CHANGE ORDER	Sent on the PACCH. Contains –BSIC + BCCH frequency -The network control order – NC2 -USF IMMEDIATE_REL bit is not set. See specific message contents. USF assigned to the MS in step 13
24a	MS -> SS	RLC data block	MS sends data.
24b	MS->SS	PACKET MEASUREMENT REPORT	
25	SS -> MS	PACKET UPLINK ACK/NACK	Sent on PACCH. USF assigned to the MS in step 13
26			Steps 24 and 25 are optional and can be repeated, but not more than 5 seconds.
27		{ Uplink dynamic allocation one phase access with contention resolution } or {Uplink dynamic allocation two phase access}	Macro parameters: USF_GRANULARITY: 1 RLC_DATA_BLOCKS_GRANTED: absent (open-end) CHANNEL_CODING_COMMAND: CS-1 LLI_BLOCK_CHANNEL_CODING: CS-1
28	SS->MS	PACKET DOWNLINK DUMMY CONTROL BLOCK	USF assigned to the MS in step 27 The SS shall accept here or later in the sequence a Measurement Report sent by the MS due to expiry of T3158. The USF shall be assigned once more to the MS.
29	MS -> SS	RLC data block	MS sends data. The RLC data also serves as cell update.
30	SS -> MS	PACKET UPLINK ACK/NACK	Sent on PACCH.
31	SS -> MS	PACKET DOWNLINK ASSIGNMENT	Sent on PACCH. On the new cell.
32	SS -> MS	10 RLC data blocks	SS sends data, last block is polling.
33	MS -> SS	PACKET DOWNLINK ACK/NACK	Sent on PACCH.
34	SS->MS	PACKET DOWNLINK DUMMY CONTROL BLOCK	USF assigned to the MS in step 27 If the first received RLC Data Block in current TBF contain an empty LLC PDU, The SS shall accept Packet Resource Request from MS and respond with Packet Uplink Assignment or Packet Timeslot Reconfigure. The USF shall be assigned once more to the MS. NOTE: The empty LLC PDU may be accompanied by another low priority RLC data block (with Packet Resource Request and Packet Uplink Assignment or Packet Timeslot Reconfigure as required), in order to ensure that the radio resources are used efficiently.
35a	MS -> SS	RLC data block	MS sends data.
35b	MS -> SS	PACKET MEASUREMENT REPORT	
36	SS -> MS	PACKET UPLINK ACK/NACK	Sent on PACCH.

Note: in step 6x, 9x, 19x, 21x, 24x and 35x, the MS shall perform **either** the ‘a’ branch **or** the ‘b’ branch.

Specific message contents

PACKET MEASUREMENT ORDER in step 2:

Global TFI	TFI of the uplink TBF
NC Measurement parameters	
NETWORK_CONTROL_ORDER	10 (NC2)
NC_REPORTING_PERIOD_I	111 (61.44 sec)
NC_REPORTING_PERIOD_T	010 (1.92 sec)
NC_FREQUENCY_LIST	0 (not present)

PACKET CELL CHANGE ORDER in Step 11:

Global TFI	TFI of the uplink TBF
IMMEDIATE_REL	1 (Immediate abort of operation in the old cell is required.)
ARFCN, BSIC	Specified for cell B
NC measurement parameters	
NETWORK_CONTROL_ORDER	10 (NC2)
NC_REPORTING_PERIOD_I	111 (61.44 sec)
NC_REPORTING_PERIOD_T	011 (3.84 sec)
NC_FREQUENCY_LIST	0 (not present)

PACKET CELL CHANGE ORDER in Step 23:

Global TFI	TFI of the uplink TBF
IMMEDIATE_REL	0 (No immediate abort of operation in the old cell is required)
ARFCN, BSIC	Specified for cell A
NC measurement parameters	
NETWORK_CONTROL_ORDER	10 (NC2)
NC_REPORTING_PERIOD_I	111 (61.44 sec)
NC_REPORTING_PERIOD_T	100 (7.68 sec)
NC_FREQUENCY_LIST	0 (not present)

42.4.2.3.2 Void

42.4.2.3.3 Packet Measurement order procedure / Downlink transfer / Normal case/
Dedicated parameters

42.4.2.3.3.1 Conformance requirement

A set of measurement reporting parameters (NETWORK_CONTROL_ORDER and NC_REPORTING_PERIOD(s)) is broadcast on PBCCH. The parameters may also be sent individually to an MS on PCCCH or PACCH, in which case it overrides the broadcast parameters. The individual parameters are valid until the RESET command is sent to the MS or there is a downlink signalling failure or the MS goes to the Standby state.

References

3GPP TS 05.08, subclause 10.1.4.

42.4.2.3.3.2 Test Purpose

To verify that the individual parameters are used by the MS instead of broadcast NC parameters when the MS receives a PACKET MEASUREMENT ORDER message.

To verify that the broadcast parameter NETWORK_CONTROL_ORDER are used by the MS instead of individual parameters when the MS receives a PACKET MEASUREMENT ORDER message containing the RESET field.

42.4.2.3.3.3 Method of test

Initial conditions

System Simulator:

2 cells, GPRS supported.

Parameter	Carrier1	Carrier2
RF Signal Level (dBm)	-80	-100
GPRS_RXLEV_ACCE SS_MIN	-100	-100
NETWORK_CONTROL_ORDER	NC0	NC0
C1	20	0
C32	20	0

System simulator:

2 cells, GPRS supported, Carrier 1 is active. Carrier 2 is on at low level -100dBm (in order to prevent sync reading suspension due to unsuccessful synchronization attempts). PBCCH is present on Carrier 1, PBCCH is not present on Carrier 2. NETWORK_CONTROL_ORDER is set to NC0 on both PBCCH of Carrier 1 and BCCH of Carrier 2. CTRL_ACK_TYPE=0 in PSII.

Mobile Station:

MS is in Packet Idle mode and GPRS attached, Ready_Timer = 2 min.

PDP context established.

Specific PICS Statements

-

PIXIT Statements

-

Foreseen final state of the MS

- MS is in Packet Idle mode.

Test procedure

The MS is brought into downlink packet transfer mode on carrier 1. The SS sends a PACKET MEASUREMENT ORDER message, setting NETWORK_CONTROL_ORDER to NC2. The SS activates carrier 2 with higher RF signal strength than carrier 1. The MS shall stay camping in the cell of Carrier 1. During the transfer, the SS sends a PACKET MEASUREMENT ORDER message, setting NETWORK_CONTROL_ORDER to RESET. The MS shall reselect carrier 2 since NC0 is indicated in the broadcast parameters and the C32 on Carrier 2 is higher than C32 in Carrier 1.

Maximum duration of the test

3 minutes

Expected Sequence

Step	Direction	Message	Comments
1	MS		The MS is GPRS attached and has activated a PDP context (see PICS) on carrier 1.
2	SS -> MS	PACKET DOWNLINK ASSIGNMENT	Triggers the MS to monitor the assigned PDCH. With a valid RRBP.
3	MS -> SS	PACKET CONTROL ACK	Sent in the block specified by RRBP field in step 2 as four access bursts
4	SS->MS	PACKET MEASUREMENT ORDER	Sent on PACCH of carrier 1 PMO message contains Network Control Order set to NC2 and NC_REPORTING_PERIOD_T set to 0.96s.
5	SS->MS	10 RLC data blocks	SS sends data, the last block contains a valid RRBP.
6a	MS->SS	PACKET DOWNLINK ACK/NACK	Sent on PACCH.
6b	MS->SS	PACKET MEASUREMENT REPORT	Sent on PACCH.
7			Change carrier 2 level to -60dBm
8			Repetition of steps 5 and 6a/6b for 15s. During this period the SS verifies that the MS remains in Packet Transfer mode on carrier 1 and that no Channel Request is sent on carrier 2 (for Cell update).
9	SS->MS	PACKET MEASUREMENT ORDER	Sent on PACCH of carrier 1 within (0.8 * T3190) seconds after step 8. PMO message contains NETWORK_CONTROL_ORDER valued to RESET
10	MS -> SS	CHANNEL REQUEST	Verify MS has camped on carrier 2

Note: In step 6x, the MS shall perform **either** the ‘a’ branch **or** the ‘b’ branch.

Specific message contents

PACKET MEASUREMENT ORDER in step 4:

PACKET MEASUREMENT ORDER message content: NETWORK_CONTROL_ORDER NC_REPORTING_PERIOD_T	10 (NC2) 001 (0.96s)
---	-------------------------

PACKET MEASUREMENT ORDER in step 9:

PACKET MEASUREMENT ORDER message content: NETWORK_CONTROL_ORDER	11 (RESET)
--	------------

42.4.2.3.4 Packet Measurement order procedure / Downlink transfer / Normal case/ Routing Area Update/ NMO II

42.4.2.3.4.1 Conformance requirement

The cell change order procedure is started by sending a PACKET CELL CHANGE ORDER message to the mobile station on the PCCCH or PACCH. Upon receipt of the PACKET CELL CHANGE ORDER message the mobile station shall start timer T3174.

When a cell reselection is made controlled by the network, the mobile station shall act upon the IMMEDIATE_REL value which has been received in the Packet Cell Change Order: if required, the mobile station shall abort any TBF in progress by immediately ceasing to decode the downlink, ceasing to transmit on the uplink, stopping all RLC/MAC timers except for timers related to measurement reporting. The mobile station shall then switch to the identified specified new cell and shall obey the relevant RLC/MAC procedures on this new cell.

To initiate the normal routing area updating procedure, the MS sends the message ROUTING AREA UPDATE REQUEST to the network, starts timer T3330 and changes to state GMM-ROUTING-AREA-UPDATING-INITIATED. The message ROUTING AREA UPDATE REQUEST shall contain the P-TMSI signature when received within a previous ATTACH ACCEPT or ROUTING AREA UPDATE ACCEPT message.

If the routing area updating request has been accepted by the network, a ROUTING AREA UPDATE ACCEPT message shall be sent to the MS. The network may assign a new P-TMSI and/or a new P-TMSI signature for the MS. If a new P-TMSI and/or P-TMSI signature have been assigned to the MS, it/they shall be included in the ROUTING AREA UPDATE ACCEPT message together with the routing area identification.

42.4.2.3.4.2 References

3GPP TS 04.60, subclauses 8.4 and 5.5.1.1.

3GPP TS 04.08 / 3GPP TS 24.008 subclause 4.7.5.1.

42.4.2.3.4.3 Test Purpose

To test the behaviour of the MS when the network triggers a Packet Cell Change Order to a cell belonging to another routing area, whereas the network mode of operation II is active, i.e:

To verify that the cell change order procedure is started when the MS receives a PACKET CELL CHANGE ORDER message.

To verify that the MS switches to the new cell.

To verify that the MS uses the established downlink TBF on the new cell.

To verify that the MS performs the Normal Routing Area Update procedure.

42.4.2.3.4.4 Method of test

Initial conditions

System simulator:

2 cells, GPRS supported, Carrier 1 is active, at -60dBm. Carrier 2 is on, at low level -70dBm (in order to prevent sync reading suspension due to unsuccessful synchronization attempts). PBCCH is not present on Cell A (Carrier 1), and not present on Cell B (Carrier 2). NETWORK_CONTROL_ORDER is set to NC0, and Network Mode of Operation is set to NMO 2, on both Carrier 1 and Carrier 2. Cell A in MCC1/MNC1/LAC1/RAC1, cell B in MCC1/MNC1/LAC1/RAC2.

Mobile Station:

MS is in Packet Idle mode and GPRS attached.

PDP context established.

Specific PICS Statements

-

PIXIT Statements

-

42.4.2.3.4.5 Void

42.4.2.3.4.6 Foreseen final state of the MS

- MS is in Transfer mode on carrier 2.

42.4.2.3.4.7 Test procedure

The MS is brought into downlink packet transfer mode on carrier 1 in Cell A. The SS sends a PACKET MEASUREMENT ORDER message, setting NETWORK_CONTROL_ORDER to NC2. The SS raises carrier 2 (Cell B) with higher RF signal strength than carrier 1. The MS shall stay camping in the cell A.

During the transfer, the SS sends a PACKET CELL CHANGE ORDER message. The MS shall reselect carrier 2, MS will send a ROUTING AREA UPDATE REQUEST message and SS establishes a new downlink TBF

The SS accepts the P-TMSI and returns ROUTING AREA UPDATE ACCEPT message without any P-TMSI. Further communication MS - SS is performed by the P-TMSI.

NOTE: During the UL TBF, T3158 may expire and thus PACKET MEASUREMENT REPORT is sent there. The SS shall be prepared for this.

42.4.2.3.4.8 Maximum duration of the test

4 minutes

42.4.2.3.4.9 Expected Sequence

Step	Direction	Message	Comments
1	MS		The MS is GPRS attached and has activated a PDP context (see PICS) on carrier 1.
2	SS -> MS	IMMEDIATE ASSIGNMENT	sent on a PCH block corresponding to the MS's paging group, including a packet downlink assignment Triggers the MS to monitor the assigned PDCH.
3	SS->MS	PACKET MEASUREMENT ORDER	Sent on PACCH of carrier 1 PMO message contains Network Control Order set to NC2 and NC_REPORTING_PERIOD_T set to 0.48s. The SS shall accept PACKET MEASUREMENT REPORT messages during the TBF, while the MS is in NC2 mode.
4	SS->MS	12 RLC data blocks	SS sends data, the last block contains a valid RRB. P.
5	MS->SS	PACKET DOWNLINK ACK/NACK	Sent on PACCH.
6	SS->MS	12 RLC data blocks	SS sends data, the last block contains a valid RRB. P.
7	MS->SS	PACKET DOWNLINK ACK/NACK	Sent on PACCH.
8	SS->MS	12 RLC data blocks	SS sends data, the last block contains a valid RRB. P.
9a	MS->SS	PACKET DOWNLINK ACK/NACK	Sent on PACCH.
9b	MS->SS	PACKET MEASUREMENT REPORT	At NC_REPORTING_PERIOD_T expiry instead of PACKET DOWNLINK ACK/NACK, the MS sends the PACKET MEASUREMENT REPORT, which contains the "NC measurement report struct", on the PACCH.
10			Repetition of steps 8 and 9 until Measurement for Cell B are included in PACKET MEASUREMENT REPORT message.
11			Raise the carrier 2 level to -50dBm
12			The MS still camps on carrier 1 and remains in Packet Transfer
13	SS->MS	PACKET CELL CHANGE ORDER	Check that no CHANNEL REQUEST is received on cell B. Sent on the PACCH. Contains -BSIC + BCCH frequency Network control order = NC2
14	MS->SS	CHANNEL REQUEST	To the new cell.
15	SS->MS	IMMEDIATE ASSIGNMENT	Sent on AGCH. Assigning a uplink TBF.
16	MS -> SS	ROUTING AREA UPDATE REQUEST	Update type = 'RA updating' Routing area identity = RAI-1
17	SS->MS	IMMEDIATE ASSIGNMENT	Sent on CCCH. On the new cell. Assigns a Downlink TBF.
18	SS -> MS	ROUTING AREA UPDATE ACCEPT	Addressing the MS with TLLI. Update result = 'RA updated' Routing area identity = RAI-2
19	MS->SS	CHANNEL REQUEST	Received on RACH .
20	SS->MS	IMMEDIATE ASSIGNMENT	Sent on AGCH. Assigning a uplink TBF.
20	MS -> SS	ROUTING AREA UPDATE COMPLETE	
21	SS -> MS	IMMEDIATE ASSIGNMENT	Sent on PCH. Addressing the MS with TLLI.
22	SS->MS	10 RLC data blocks	SS sends data, last block is polling.
23	MS->SS	PACKET DOWNLINK ACK/NACK	Sent on PACCH.

Note: 9b is chosen depending at NC_REPORTING_PERIOD_T expiry, otherwise 9a is chosen.

42.4.2.3.4.10 Specific message contents

PACKET MEASUREMENT ORDER in step 3:

PACKET MEASUREMENT ORDER message content: NETWORK_CONTROL_ORDER NC_REPORTING_PERIOD_T	0010 (NC2) 000 (0.48s)
---	---------------------------

42.4.2.3.5 Packet Measurement order procedure / Downlink transfer / Normal case/ Routing Area Update/ NMO I

42.4.2.3.5.1 Conformance requirement

The cell change order procedure is started by sending a PACKET CELL CHANGE ORDER message to the mobile station on the PCCCH or PACCH. Upon receipt of the PACKET CELL CHANGE ORDER message the mobile station shall start timer T3174.

When a cell reselection is made controlled by the network, the mobile station shall act upon the IMMEDIATE_REL value which has been received in the Packet Cell Change Order: if required, the mobile station shall abort any TBF in progress by immediately ceasing to decode the downlink, ceasing to transmit on the uplink, stopping all RLC/MAC timers except for timers related to measurement reporting. The mobile station shall then switch to the identified specified new cell and shall obey the relevant RLC/MAC procedures on this new cell.

To initiate a combined routing area updating procedure the MS sends the message ROUTING AREA UPDATE REQUEST to the network, starts timer T3330 and changes to state GMM-ROUTING-UPDATING-INITIATED and MM LOCATION UPDATING PENDING. The value of the update type IE in the message shall indicate "combined RA/LA updating". If for the last attempt to update the registration of the location area a MM specific procedure was performed, the value of the update type IE in the ROUTING AREA UPDATE REQUEST message shall indicate "combined RA/LA updating with IMSI attach". Furthermore the MS shall include the TMSI status IE if no valid TMSI is available.

References

3GPP TS 04.60, subclauses 8.4 and 5.5.1.1.

3GPP TS 04.08 / 3GPP TS 24.008 subclause 4.7.5.2.

42.4.2.3.5.2 Test Purpose

To test the behaviour of the MS when the network triggers a Packet Cell Change Order to a cell belonging to another routing area, whereas the network mode of operation 1 is active, i.e:

To verify that the cell change order procedure is started when the MS receives a PACKET CELL CHANGE ORDER message.

To verify that the MS switches to the new cell.

To verify that the MS uses the established downlink TBF on the new cell.

To verify that the MS performs the Combined Routing Area Update procedure.

42.4.2.3.5.3 Method of test

Initial conditions

System simulator:

2 cells, GPRS supported, Carrier 1 is active, at -60dBm. Carrier 2 is on, at low level -70dBm (in order to prevent sync reading suspension due to unsuccessful synchronization attempts). PBCCH is present on Cell A (Carrier 1), and present on Cell B (Carrier 2). NETWORK_CONTROL_ORDER is set to NC0, and Network Mode of Operation is set to NMO I, on both PBCCH of Carrier 1 and PBCCH of Carrier 2. Cell A in MCC1/MNC1/LAC1/RAC1, cell B in MCC1/MNC1/LAC1/RAC2.

Mobile Station:

MS is in Packet Idle mode and GPRS attached (P-TMSI 1, P-TMSI signature 1). Ready timer deactivated.

PDP context established.

Specific PICS Statements

-

PIXIT Statements

-

42.4.2.3.5.4 Void

42.4.2.3.5.5 Foreseen final state of the MS

- MS is in Transfer mode on carrier 2.

42.4.2.3.5.6 Test procedure

The MS is brought into downlink packet transfer mode on carrier 1 in Cell A. The SS sends a PACKET MEASUREMENT ORDER message, setting NETWORK_CONTROL_ORDER to NC2. The SS raises carrier 2 (Cell B) with higher RF signal strength than carrier 1. The MS shall stay camping in the cell A.

During the transfer, the SS sends a PACKET CELL CHANGE ORDER message. The MS shall reselect carrier 2.

In Cell B, the MS sends a ROUTING AREA UPDATE REQUEST message. The SS accepts the P-TMSI signature and returns ROUTING AREA UPDATE ACCEPT message without any P-TMSI nor any new TMSI but Force to Standby set. Further communication MS-SS is performed by the old P-TMSI.

NOTE: during the UL TBF, T3158 may expire and thus PACKET MEASUREMENT REPORT is sent there. The SS shall be prepared for this.

Maximum duration of the test

4 minutes

Expected Sequence

Step	Direction	Message	Comments
1	SS -> MS	PACKET DOWNLINK ASSIGNMENT	Triggers the MS to monitor the assigned PDCH.
2	SS->MS	PACKET MEASUREMENT ORDER	Sent on PACCH of carrier 1 PMO message contains Network Control Order set to NC2 and NC_REPORTING_PERIOD_T set to 0.96s. The SS shall accept PACKET MEASUREMENT REPORT messages during the TBF, while the MS is in NC2 mode.
3	SS->MS	12 RLC data blocks	SS sends data, the last block contains a valid RRB. P.
4	MS->SS	PACKET DOWNLINK ACK/NACK	Sent on PACCH.
5	SS->MS	12 RLC data blocks	SS sends data, the last block contains a valid RRB. P.
6	MS->SS	PACKET DOWNLINK ACK/NACK	Sent on PACCH.
7	SS->MS	12 RLC data blocks	SS sends data, the last block contains a valid RRB. P.
8a	MS->SS	PACKET DOWNLINK ACK/NACK	Sent on PACCH.
8b	MS->SS	PACKET MEASUREMENT REPORT	At NC_REPORTING_PERIOD_T expiry instead of PACKET DOWNLINK ACK/NACK, the MS sends the PACKET MEASUREMENT REPORT, which contains the "NC measurement report struct", on the PACCH.
9			Repeat steps 7 and 8 until measurement results for cell B are included in the PACKET MEASUREMENT REPORT message.
10			Raise the carrier 2 level to -50dBm
11			The MS still camps on carrier 1 and remains in Packet Transfer
12	SS->MS	PACKET CELL CHANGE ORDER	Check that no CHANNEL REQUEST is received on cell B. Sent on the PACCH. Contains -BSIC + BCCH frequency Network control order = NC2 The following messages are to be sent and received in Cell B.
13	MS -> SS	ROUTING AREA UPDATE REQUEST	Update type = 'Combined RA/LA updating' P-TMSI-1 signature Routing area identity = RAI1
14	SS -> MS	ROUTING AREA UPDATE ACCEPT	Update result = 'Combined RA/LA updated' No P-TMSI No TMSI Routing area identity = RAI-2 Negotiated Ready Timer not included Force to standby IE set
15	SS -> MS	PACKET DOWNLINK ASSIGNMENT	Sent on PPCH. On the new cell. Addressing the MS with TLLI derived from P-TMSI-1. Triggers the MS to monitor the assigned PDCH.
16	SS->MS	10 RLC data blocks	SS sends data, last block is polling.
17	MS->SS	PACKET DOWNLINK ACK/NACK	Sent on PACCH.

Note: 8b is chosen depending on NC_REPORTING_PERIOD_T expiry, otherwise 8a is chosen.

Specific message contents

PACKET MEASUREMENT ORDER in step 2:

PACKET MEASUREMENT ORDER message content: NETWORK_CONTROL_ORDER NC_REPORTING_PERIOD_T	0010 (NC2) 001 (0.96s)
---	---------------------------

42.4.2.3.6 MT CS establishment whilst in NC2 with a downlink TBF established

42.4.2.3.6.1 Conformance requirements

The behaviour of the mobile station is controlled by the NETWORK_CONTROL_ORDER parameter in a PACKET MEASUREMENT ORDER message. The reporting periods are indicated in the NC_REPORTING_PERIOD_T field of the PACKET MEASUREMENT ORDER message. The mobile station shall apply to the timer T3158 the NC_REPORTING_PERIOD_T when in packet transfer mode.

The procedure for NC measurement report sending shall be initiated by the mobile station at the expiry of the NC measurement report interval timer T3158. At expiry of the timer T3158 the mobile station shall restart the timer T3158, perform the measurements and send the PACKET MEASUREMENT REPORT message containing the 'NC measurement report struct' on PACCH.

Paging initiation using PACCH applies when sending a paging request message to a mobile station that is GPRS attached, when the mobile station is in packet transfer mode and the network is able to co-ordinate the paging request with the radio resources allocated for the mobile station on a PDCH. This kind of paging co-ordination shall be provided in network mode of operation I (see 3G TS 23.060). This kind of paging co-ordination may be provided also in network mode of operation II or III. This kind of paging co-ordination shall be provided if the network supports DTM.

When the mobile station responds to a paging request for RR connection establishment, it shall follow the paging response procedures as specified in 3GPP TS 04.18. For that purpose, a mobile station in packet transfer mode or a mobile station that has initiated a packet access procedure may abort any ongoing TBF or the packet access procedure in the following two cases:

- The mobile station requires that the BSS co-ordinates the allocation of radio resources for an RR connection and a simultaneous TBF (GPRS class A mode of operation by means of DTM).

42.4.2.3.6.2 References

3GPP TS 04.60/44.060, sub-clauses 6.1.3, 6.1.4.

3GPP TS 04.60, subclauses 5.6.1 and 8.3.

42.4.2.3.6.3 Test purpose

To verify that the MS sends the measurement report of the NC measurements according to the indicated reporting periods, when the T3158 expires. To verify that the MS reacts to CS paging on the PACCH, whilst the MS was in packet transfer mode and NC2, by releasing the downlink TBF and then establishing an RR connection.

42.4.2.3.6.4 Method of test

42.4.2.3.6.5 Initial Conditions

System Simulator:

2 cells, GPRS supported, NMO I activated, CTRL_ACK_TYPE=0 in PSI1.

Mobile Station:

The MS is in packet idle mode, with a TMSI, P-TMSI allocated and PDP context 1 activated.

Specific PICS Statements

- GPRS Release Supported (TSPC_MS_GPRS_RELEASE)
- Support of Immediate Connect (TSPC_AddInfo_ImmConn)

PIXIT Statements

-

42.4.2.3.6.6 Void

42.4.2.3.6.7 Test Procedure

The MS is brought into packet transfer mode. SS sends a PACKET MEASUREMENT ORDER message. SS sends continuously data blocks and regularly polls so that PACKET MEASUREMENT REPORT messages are sent by the MS according to the indicated reporting period, before being paged on the PACCH. Upon receipt of the PACKET PAGING REQUEST message, the MS returns to packet idle mode and initiate the establishment of CS connection.

NOTE: carrier 2 is activated in order to prevent synchronisation reading suspension due to unsuccessful synchronization attempts.

42.4.2.3.6.8 Maximum Duration of Test

5 minutes

42.4.2.3.6.9 Expected Sequence

Step	Direction	Message	Comments
1	MS		The MS is GPRS attached and has activated a PDP context (see PICS) on carrier 1.
2	SS -> MS	PACKET DOWNLINK ASSIGNMENT	Triggers the MS to monitor the assigned PDCH. With a valid RRBP.
3	MS -> SS	PACKET CONTROL ACK	Sent in the block specified by RRBP field in step 2 as four access bursts
4	SS->MS	PACKET MEASUREMENT ORDER	Sent on PACCH of carrier 1 PMO message contains Network Control Order set to NC2 and NC_REPORTING_PERIOD_T set to 0.48s.
5	SS->MS	12 RLC data blocks	SS sends data, the last block contains a valid RRBP.
6	MS->SS	PACKET DOWNLINK ACK/NACK	Sent on PACCH.
7	SS->MS	12 RLC data blocks	SS sends data, the last block contains a valid RRBP.
8	MS->SS	PACKET DOWNLINK ACK/NACK	Sent on PACCH.
9	SS->MS	12 RLC data blocks	SS sends data, the last block contains a valid RRBP.
10a	MS->SS	PACKET DOWNLINK ACK/NACK	Sent on PACCH.
10b	MS->SS	PACKET MEASUREMENT REPORT	At NC_REPORTING_PERIOD_T expiry instead of PACKET DOWNLINK ACK/NACK, the MS sends the PACKET MEASUREMENT REPORT, which contains the "NC measurement report struct", on the PACCH.
11			Repetition of steps 9 and 10 during 5s
12			
13	SS->MS	PACKET PAGING REQUEST	Raise carrier 2 changing the carrier level to -70dBm 1 st Repeated Page info contains IMSI of the MS, PAGE_MODE = " same as before ", sent on downlink PACCH.
14	MS->SS	CHANNEL REQUEST	
15	SS->MS	IMMEDIATE ASSIGNMENT	
16	MS->SS	PAGING RESPONSE	
17	MS -> SS	CLASSMARK CHANGE	This step may be optionally performed by a R97 or R98 MS; this step shall be mandatorily performed by R99 and later MS.
18	MS -> SS	GRPS SUSPENSION REQUEST	
19	SS -> MS	AUTHENTICATION REQUEST	
20	MS -> SS	AUTHENTICATION RESPONSE	
21	SS -> MS	CIPHERING MODE COMMAND	
22	MS -> SS	CIPHERING MODE COMPLETE	

23	SS->MS	SETUP	
24	MS->SS	CALL CONFIRMED	
A25	MS->SS	CONNECT	If the MS supports immediate connect then branch A applies. If the MS does not support immediate connect then branch B applies Sent on the old channel Timeslot N (chosen arbitrarily).
A26	SS->MS	ASSIGNMENT COMMAND	
A27	MS->SS	ASSIGNMENT COMPLETE	Continues at step 31 Timeslot N (chosen arbitrarily).
B25	SS->MS	ASSIGNMENT COMMAND	
B26	MS->SS	ASSIGNMENT COMPLETE	Sent on the new channel.
B27	MS->SS	ALERTING	
B28	MS		An alerting indication is given by the MS The MS is made to accept the call.
B29	MS		
B30	MS->SS	CONNECT	
31	SS->MS	CONNECT ACKNOWLEDGE	
32	MS		The appropriate bearer channel is through connected in both directions.

42.4.2.3.6.10 Specific Message Contents

None.

42.4.2.3.7 MT CS establishment whilst in NC2 with a uplink TBF established

42.4.2.3.7.1 Conformance requirements

The behaviour of the mobile station is controlled by the NETWORK_CONTROL_ORDER parameter in a PACKET MEASUREMENT ORDER message. The reporting periods are indicated in the NC_REPORTING_PERIOD_T field of the PACKET MEASUREMENT ORDER message. The mobile station shall apply to the timer T3158 the NC_REPORTING_PERIOD_T when in packet transfer mode.

The procedure for NC measurement report sending shall be initiated by the mobile station at the expiry of the NC measurement report interval timer T3158. At expiry of the timer T3158 the mobile station shall restart the timer T3158, perform the measurements and send the PACKET MEASUREMENT REPORT message containing the 'NC measurement report struct' on PACCH.

Paging initiation using PACCH applies when sending a paging request message to a mobile station that is GPRS attached, when the mobile station is in packet transfer mode and the network is able to co-ordinate the paging request with the radio resources allocated for the mobile station on a PDCH. This kind of paging co-ordination shall be provided in network mode of operation I (see 3G TS 23.060). This kind of paging co-ordination may be provided also in network mode of operation II or III. This kind of paging co-ordination shall be provided if the network supports DTM.

When the mobile station responds to a paging request for RR connection establishment, it shall follow the paging response procedures as specified in 3GPP TS 04.18. For that purpose, a mobile station in packet transfer mode or a mobile station that has initiated a packet access procedure may abort any ongoing TBF or the packet access procedure in the following two cases:

- The mobile station requires that the BSS co-ordinates the allocation of radio resources for an RR connection and a simultaneous TBF (GPRS class A mode of operation by means of DTM).

42.4.2.3.7.2 References

3GPP TS 04.60/44.060, sub-clauses 6.1.3, 6.1.4

3GPP TS 04.60, subclauses 5.6.1 and 8.3.

Test purpose

To verify that the MS sends packet measurement reports of the NC measurements according to the indicated reporting periods when T3158 expires. To verify that the MS reacts to CS paging on the PACCH,

whilst the MS was in packet transfer mode and NC2, by releasing the uplink TBF and then establishing the RR connection.

42.4.2.3.7.3 Method of test

42.4.2.3.7.4 Initial Conditions

System Simulator:

2 cells, GPRS supported, NMO I activated.

Mobile Station:

The MS is in packet idle mode, with a TMSI, P-TMSI allocated and PDP context 2activated.

NOTE: carrier 2 is activated in order to prevent synchronisation reading suspension due to unsuccessful synchronization attempts.

Specific PICS Statements

- GPRS Release Supported (TSPC_MS_GPRS_RELEASE)
- Support of Immediate Connect (TSPC_AddInfo_ImmConn)

42.4.2.3.7.5 Foreseen final state of the MS

- MS is in RR dedicated mode.

42.4.2.3.7.6 Void

42.4.2.3.7.7 Test Procedure

The MS is brought into packet transfer mode. SS sends a PACKET MEASUREMENT ORDER message. MS sends continuously data blocks and PACKET MEASUREMENT REPORT messages according to the indicated reporting period, before being paged on the PACCH. Upon receipt of the PACKET PAGING REQUEST message, the MS returns to packet idle mode and initiates the establishment of a CS connection.

42.4.2.3.7.8 Maximum Duration of Test

10 minutes

42.4.2.3.7.9 Expected Sequence

Step	Direction	Message	Comments
1		{Uplink dynamic allocation two phase access}	Macro parameters: n: 1000 octets USF_GRANULARITY: 1 block RLC_DATA_BLOCKS_GRANTED: absent (open-end) CHANNEL_CODING_COMMAND: CS-1 TLLI_BLOCK_CHANNEL_CODING: CS-1 TBF_STARTING_TIME: Without
2	SS->MS	PACKET MEASUREMENT ORDER	Sent on PACCH of carrier 1 PMO message contains Network Control Order set to NC2 and NC_REPORTING_PERIOD_T set to 1.92s.
3	SS->MS	PACKET DOWNLINK DUMMY CONTROL BLOCK	USF assigned to the MS
4a	MS -> SS	RLC data block	MS sends data
4b	MS -> SS	PACKET MEASUREMENT REPORT	- Sent on PACCH. - Contains the "NC measurement report struct" on PACCH
5	SS -> MS	PACKET UPLINK ACK/NACK	Sent on PACCH
6			Steps 4 to 6 are repeated until at least two PACKET MEASUREMENT REPORTs are received.. SS verifies that the time interval between two consecutive PACKET MEASUREMENT REPORTS is as per NC_REPORTING_PERIOD_T of PMO sent in Step 2.
7	SS->MS	PACKET PAGING REQUEST	1 st Repeated Page info contains IMSI of the MS PAGE_MODE = " same as before ", sent on downlink PACCH
8	MS->SS	CHANNEL REQUEST	
9	SS->MS	IMMEDIATE ASSIGNMENT	
10	MS->SS	PAGING RESPONSE	
11	MS -> SS	CLASSMARK CHANGE	This step may be optionally performed by a R97 or R98 MS; this step shall be mandatorily performed by a R99 or later MS
12	MS -> SS	GRPS SUSPENSION REQUEST	
13	SS -> MS	AUTHENTICATION REQUEST	
14	MS -> SS	AUTHENTICATION RESPONSE	
15	SS -> MS	CIPHERING MODE COMMAND	
16	MS -> SS	CIPHERING MODE COMPLETE	
17	SS->MS	SETUP	
18	MS->SS	CALL CONFIRMED	If the MS supports immediate connect then branch c applies. If the MS does not support immediate connect then branch d applies
19c	MS->SS	CONNECT	Sent on the old channel
20c	SS->MS	ASSIGNMENT COMMAND	Timeslot N (chosen arbitrarily).
21c	MS->SS	ASSIGNMENT COMPLETE	Sequence continues on step 25
19d	SS->MS	ASSIGNMENT COMMAND	Timeslot N (chosen arbitrarily).
20d	MS->SS	ASSIGNMENT COMPLETE	Sent on the new channel
21d	MS->SS	ALERTING	
22d	MS		An alerting indication as defined in a PICS/PIXIT statement is given by the MS
23d	MS		The MS is made to accept the call in the way described in a PICS/PIXIT statement
24d	MS->SS	CONNECT	
25	SS->MS	CONNECT ACKNOWLEDGE	
26	MS		The appropriate bearer channel is through connected in both directions.

Note: in step 4x, the MS shall perform either the 'a' branch or the 'b' branch.

42.4.2.3.7.10 Specific Message Contents

None.

42.4.3 Macros and Default Message contents

42.4.3.1 Macros

In order to simplify the process of writing and coding test cases, macros are referenced in the expected signalling tables. These macros provide all additional signalling needed to complete the particular test but are not relevant to its purpose.

42.4.3.1.1 Void

42.4.3.1.2 Void

42.4.3.2 Default Messages

42.4.3.2.1 PACKET CELL CHANGE ORDER message

MESSAGE_TYPE	0000 01
PAGE_MODE	00 Normal Paging
Referenced Address	10 (address is TLLI)
-	same as the value received from MS
- TLLI	1 (Immediate release of the on-going TBF.)
IMMEDIATE_REL	For GSM 900: 00 0001 0100 (ARFCN 20)
ARFCN	For DCS 1 800 and PCS 1 900: 10 0100 1110 (ARFCN 590)
	For GSM 700, T-GSM 810: 01 1100 1001 (ARFCN 457)
	For GSM 850: 00 1001 0011 (ARFCN 147)
BSIC	For GSM 700, T-GSM 810, GSM 850 and GSM 900: 001101
	For DCS 1 800 and PCS 1 900: 001101
NC Measurement Parameters	
NETWORK_CONTROL_ORDER	0 0 NC0
{ 0 1 < NC_NON_DRX_PERIOD	0 No additional NC parameters
< NC_REPORTING_PERIOD_I	
< NC_REPORTING_PERIOD_T }	
NC Frequency list struct	
{ 0 1 < NC_FREQUENCY_LIST }	0 No NC_FREQUENCY_LIST
< padding bits >	Spare Padding

42.4.3.2.2 PACKET CELL CHANGE FAILURE message

MESSAGE_TYPE	0000 00
TLLI	same as the value received from MS
ARFCN	For GSM 900: 00 0001 0100 (ARFCN 20)
	For DCS 1 800 and PCS 1 900: 10 0100 1110 (ARFCN 590)
	For GSM 700, T-GSM 810: 01 1100 1001 (ARFCN 457)
	For GSM 850: 00 1001 0011 (ARFCN 147)
BSIC	For GSM 700, T-GSM 810, GSM 850 and GSM 900: 001101
	For DCS 1 800 and PCS 1 900: 001101
CAUSE	0 0 0 1 No response on target cell
spare padding	Spare Padding

42.4.3.2.3 PACKET MEASUREMENT ORDER message

MESSAGE_TYPE	0000 11
PAGE_MODE	00 Normal Paging
TLLI	10 (address is TLLI)
-	Same as the value received from MS
PMO_INDEX	0 0 0 first message
PMO_COUNT	0 0 0 one message expected
{ 0 1 < NC Measurement Parameters }	1 NC Measurement Parameters available
NC Measurement Parameters	
NETWORK_CONTROL_ORDER	0 1 NC1
{ 0 1 < NC_NON_DRX_PERIOD	1 Additional NC parameters available
< NC_REPORTING_PERIOD_I	NC_NON_DRX_PERIOD = 000
< NC_REPORTING_PERIOD_T }	(No non-DRX mode after a measurement report has been sent)
	NC_REPORTING_PERIOD_I = 111
	(61.44 sec)
	NC_REPORTING_PERIOD_T = 011
	(3.84 sec)
{ 0 1 < NC_FREQUENCY_LIST }	0 No NC Frequency list struct available
< padding bits >	Spare Padding

42.4.4 Cell Change Order Procedures without PBCCH

42.4.4.1 Network Controlled Cell Reselection – Packet Measurement Order Procedure

42.4.4.1.1 Conformance requirement

A cell re-selection command may be sent from the network to an MS. When the MS receives the command, it shall immediately re-select the cell according to the included cell description and change the network control mode according to the command.

Reference:

3GPP TS 04.60 subclause 8.4.0.

3GPP TS 05.08 subclause 10.1.4.2.

42.4.4.1.2 Test purpose

To verify that when the Network initiates the Packet Measurement Order Procedure, the MS correctly interprets the Packet Measurement Order Message, changes the network control mode and acts accordingly.

42.4.4.1.3 Method of test

Initial conditions

Parameter	Carrier1	Carrier2	Carrier3
RF Signal Level (dBm)	-70	-80	-50
GPRS_RXLEV_ACCE SS_MIN	-100	-100	-100
NETWORK_CONTRO L_ORDER	NC2	NC2	NC2
C1	30	20	50
C2	30	20	50

System simulator:

3 cells, GPRS supported, PBCCH not present (Carrier 1 & 2 is active. Carrier 3 is off).

Mobile Station:

MS is GPRS attached on carrier 1 (with Ready timer value unit set to '111' in the ATTACH ACCEPT message, thus the MS is always in Ready state).

Specific PICS Statements

-

PIXIT Statements

-

Test Procedure

The SS establishes single block down link TBF and then initiates the Packet Measurement Order Procedure on carrier 1 with the Packet Measurement Order (PMO) changing NC2 to NC0. The MS shall reselect to carrier 3 and initiate channel request procedure.

The SS shall accept PACKET MEASUREMENT REPORT from the MS anytime during GPRS attach procedure

Expected Sequence

Step	Direction	Message	Comments
1	SS		Activate carrier 3
2 (optional step)	MS->SS	CHANNEL REQUEST	ACCESS TYPE ='Single block without TBF establishment.' Received on RACH carrier 1.
3(optional step)	SS->MS	IMMEDIATE ASSIGNMENT	Sent on AGCH, assigning a single block carrier 1.
4(optional step)	MS ->SS	PACKET MEASUREMENT REPORT	Received on the allocated PDCH.
5	SS->MS	IMMEDIATE ASSIGNMENT	SS establishes a single block down link TBF on carrier 1.
6	SS->MS	PACKET MEASUREMENT ORDER	Sent on PACCH of carrier 1. PMO message contains Network Control Order 0
7	MS->SS	CHANNEL REQUEST	Verify MS sends channel request on carrier 3 within 30 s of step 6.
8	SS->MS	IMMEDIATE ASSIGNMENT REJECT.	Network sends immediate assignment reject on carrier 3.

42.4.4.2 Network Controlled Cell Reselection/validity of reselection parameters/MS enters standby state

42.4.4.2.1 Conformance requirement

A set of measurement reporting parameters (NETWORK_CONTROL_ORDER and NC_REPORTING_PERIOD(s)) is broadcast on PBCCH. The parameters may also be sent individually to an MS on PCCCH or PACCH, in which case it overrides the broadcast parameters. The individual parameters are valid until the RESET command is sent to MS., there is a downlink signaling failure or the MS enters Standby State.

Reference:

3GPP TS 05.08 subclause 10.1.4.

42.4.4.2.2 Test purpose

To verify that the measurement reporting parameters are valid till the MS enters the standby state.

42.4.4.2.3 Method of test

Initial conditions

Parameter	Carrier1	Carrier2
RF Signal Level (dBm)	-80	-70
GPRS_RXLEV_ACCE SS_MIN	-100	-100
NETWORK_CONTRO L_ORDER	NC0	NC2
C1	20	30
C32	20	30

System simulator:

2 cells (cell A, cell B), GPRS supported, PBCCH not present (Carrier 1 is active. Carrier 2 is off)

Mobile Station:

MS is off.

Specific PICS Statements

-

PIXIT Statements

-

Test Procedure

The SS establishes single block down link TBF and then initiates the Packet Measurement Order Procedure on carrier 1 with the Packet Measurement Order (PMO) changing NC0 to NC2. The SS activates carrier 2 with higher RF signal strength than carrier 1. After the Ready Timer expires in the mobile, the MS shall reselect carrier 2 as NC2 is not applicable in standby mode.

Expected Sequence

Step	Direction	Message	Comments
1	MS		The MS is powered up or switched on and initiates an attach.
2	MS -> SS	ATTACH REQUEST	
3	SS -> MS	ATTACH ACCEPT	Ready timer set to 60 s. Mobile identity = P-TMSI-1 P-TMSI-1 signature
4	MS->SS	ATTACH COMPLETE	Apply the new Ready Timer value.
5	SS->MS	IMMEDIATE ASSIGNMENT	SS establishes a single block downlink assignment procedure on carrier 1.
6	SS->MS	PACKET MEASUREMENT ORDER	Sent on PACCH of carrier 1 PMO message contains Network Control Order 2
7	SS		Activate carrier 2
8	SS		Wait for 30 s
9	SS->MS	PAGING REQUEST TYPE 1	MS paged continuously on carrier 2
10	SS		Verify no response from MS on carrier 2 for 25 seconds.
11	SS		Wait for 36 s
12	SS-> MS	PAGING REQUEST TYPE 1	MS paged on carrier 2
13	MS -> SS	CHANNEL REQUEST	Verify MS has camped on carrier 2

Specific message contents

PACKET MEASUREMENT ORDER in step 6:

NC Measurement parameters	
NETWORK_CONTROL_ORDER	10 (NC2)
NC_REPORTING_PERIOD_I	111 (61.44 sec)
NC_REPORTING_PERIOD_T	010 (1.92 sec)
NC_FREQUENCY_LIST	0 (not present)

42.4.4.3 Network Control measurement reporting / Idle mode / Returning to Broadcast parameters

42.4.4.3.1 Conformance requirement

The procedure for NC measurement report sending shall be initiated by the mobile station at the expiry of the NC measurement report interval timer T3158. At expiry of the timer T3158 the mobile station shall restart the timer T3158, perform the measurements and send the PACKET MEASUREMENT REPORT message containing the 'NC measurement report struct' on PACCH.

A set of measurement reporting parameters (NETWORK_CONTROL_ORDER and NC_REPORTING_PERIOD(s)) is broadcast on PBCCH. The parameters may also be sent individually to an MS on PCCCH or PACCH, in which case it overrides the broadcast parameters. The individual parameters are valid until the RESET command is sent to the MS or there is a downlink signalling failure or the MS goes to the Standby state.

Reference

3GPP TS 04.60, subclauses 8.1.2.2, 8.3 and 5.6.1.

3GPP TS 05.08, subclause 10.1.4

42.4.4.3.2 Test Purpose

To verify that individual parameters are valid only until the MS goes to Stand-by State. MS returns to broadcast parameters once it enters the Stand-by State and uses the broadcast parameters if it again goes to ready state.

42.4.4.3.3 Method of test

Initial conditions

System Simulator:

1 cell, GPRS supported.

Mobile Station:

MS is GPRS attached with a P-TMSI allocated, SPLIT PG CYCLE negotiated

PDP context 2 established.

Specific PICS Statements

-

PIXIT Statements

-

Test procedure

SS assigns a single block downlink TBF to MS and sends PACKET MEASUREMENT ORDER changing the NC mode from NC0 to NC2. SS then receives PACKET MEASUREMENT REPORTS until the READY TIMER expires. SS then waits for 30 sec and checks that the MS is not sending any more PACKET MEASUREMENT REPORTs. SS pages the MS to bring the MS into ready state and receives the page response by giving the uplink TBF. SS then assigns a downlink TBF and checks that the MS is not sending any PACKET MEASUREMENT REPORTs.

Maximum duration of the test

-

Expected sequence

Step	Direction	Message	Comments
1	SS -> MS	IMMEDIATE ASSIGNMENT	SS establishes a single block downlink TBF. Sent on the blocks assigned in step 1. PMO message contains Network Control Order 2 (See the specific message content)
2	SS -> MS	PACKET MEASUREMENT ORDER	
3	MS -> SS	CHANNEL REQUEST	With establishment cause 'single block access'. After the second execution of the step: SS verifies that CHANNEL REQUEST arrives after NC_REPORTING_PERIOD_I from last measurement report.
4	SS -> MS	IMMEDIATE ASSIGNMENT	
5	MS -> SS	PACKET MEASUREMENT REPORT	Single block assignment with an arbitrarily chosen TBF starting time in the future in the range 0.5 to 1seconds. Received on the assigned block. Steps 3-5 are repeated until the expiry of READY TIMER.
6	SS		
7	SS		SS waits for 30 sec, checks that the MS is not sending any more measurement reports. Page info contains P-TMSI of the MS. Sent on PCH.
8	SS -> MS	PAGING REQUEST TYPE 1	
9	MS->SS	CHANNEL REQUEST	Establishment cause = "One phase access". Received on RACH. Random Reference = pertaining to the message received in step 9. Dynamic allocation for RLC data blocks, Sent on AGCH.
10	SS -> MS	IMMEDIATE ASSIGNMENT	
11	SS->MS	PACKET DOWNLINK DUMMY CONTROL BLOCK	USF assigned to the MS
12	MS -> SS	UPLINK RLC DATA BLOCK	
13	SS -> MS	PACKET UPLINK ACK/NACK	LLC PDU implicitly indicating paging response, containing TLLI in the RLC/MAC header. Received on uplink PDTCH assigned in step 10. Acknowledge the received RLC data block, with FAI=1, Containing contention resolution TLLI. Sent on uplink PACCH. Valid RRBP. Received on uplink PACCH.
14	MS ->SS	PACKET CONTROL ACKNOWLEDGEMENT	
15	SS -> MS	IMMEDIATE ASSIGNMENT	SS initiates a data transfer of 1000 octets. Sent on PCH. Downlink Assignment, TLLI value as received. Sent on PCH. SS completes downlink transfer of 1000 octets of data. SS checks that the MS has not sent any PACKET MEASUREMENT REPORT during the TBF.
16	MS ->SS	Completion of macro {Downlink data transfer}	

Specific message contents

PACKET MEASUREMENT ORDER in step 2:

NC Measurement parameters	
NETWORK_CONTROL_ORDER	10 (NC2)
NC_REPORTING_PERIOD_I	100 (7.68 s)
NC_REPORTING_PERIOD_T	000 (0.48 s)

42.4.4.4 Void

42.4.4.5 Network Control measurement reporting / Idle mode / Reselection due to RA failure

42.4.4.5.1 Conformance Requirement

Having made $M + 1$ attempts to send a PACKET CHANNEL REQUEST (respectively EGPRS PACKET CHANNEL REQUEST) message, the mobile station shall stop timer T3186 and start timer T3170. At expiry of timer T3170, the packet access procedure shall be aborted, a random access failure shall be indicated to upper layer and the mobile station shall perform autonomous cell re-selection according to 3GPP TS 43.022.

The MS shall only perform autonomous cell re-selection when the reselection is triggered by a downlink signalling failure as defined in subclause 6.5 or a random access failure as defined in 3GPP TS 44.018 and 3GPP TS 44.060.

Reference

3GPP TS 44.060, subclause 3.5.2.1.2.

3GPP TS 45.008, subclause 10.1.4

42.4.4.5.2 Test Purpose

To verify that while in NC2, MS performs autonomous cell reselection when the reselection is triggered by the random access failure.

42.4.4.5.3 Method of test

Initial conditions

System Simulator:

2 cell, GPRS supported.

Parameter	Carrier1	Carrier2
RF Signal Level (dBm)	-60	-70
NETWORK_CONTROL_ORDER	NC2	NC2
NC_REPORTING_PERIOD_I	Default	Default

Mobile Station:

MS is GPRS attached with a P-TMSI allocated, SPLIT PG CYCLE negotiated. Ready timer is set to 5 min.

PDP context 2 established.

Specific PICS Statements

-

PIXIT Statements

-

Test procedure

MS is in packet idle mode on carrier 1. MS sends a CHANNEL REQUEST for sending the measurement report. SS assigns resources for it. MS sends a PACKET MEASUREMENT REPORT. MS is triggered to send uplink data. MS sends ($MAX_RETRANS + 1$) CHANNEL REQUESTs. SS does not respond to it. SS checks that after sending $M + 1$ channel requests MS does reselection and reselects to carrier 2.

Maximum duration of the test

Expected sequence

Step	Direction	Message	Comments
1	SS -> MS	IMMEDIATE ASSIGNMENT	SS establishes a single block downlink TBF. Sent on the blocks assigned in step 1. PMO message contains Network Control Order 2 (See the specific message content)
2	SS -> MS	PACKET MEASUREMENT ORDER	
3	MS->SS	CHANNEL REQUEST	With establishment cause 'single block access'. Sent on AGCH, assigning a single block. Received on the allocated PDCH. The SS verifies that the measurement results for cells A, B are included in it. Steps 3-5 repeated once again. SS Checks that the measurements of cell A and B are included in the PACKET MEASUREMENT REPORT. MS is triggered to send 1000 octets of uplink data. With establishment cause 'one phase access' or 'two phase access' With establishment cause 'one phase access' or 'two phase access' MS sends M+1 CHANNEL REQUESTS but SS does not respond to it. Received on cell B.
4	SS->MS	IMMEDIATE ASSIGNMENT	
5	MS ->SS	PACKET MEASUREMENT REPORT	
6			
7	SS		
8	MS		
9	MS -> SS	CHANNEL REQUEST	
10	MS ->SS	CHANNEL REQUEST	
11	SS		
12	MS -> SS	CHANNEL REQUEST	

Specific message contents

PACKET MEASUREMENT ORDER in step 2:

NC Measurement parameters	
NETWORK_CONTROL_ORDER	10 (NC2)
NC_REPORTING_PERIOD_I	110 (30.72 s)
NC_REPORTING_PERIOD_T	000 (0.48 s)

42.4.5 Network Assisted Cell Change

42.4.5.1 Network Assisted Cell Change / Expiry of T3206

42.4.5.1.1 Conformance requirements

[3GPP TS 44.060, 8.1.3]

If CCN is enabled (see subclause 5.5.1.1a, 3GPP TS 44.160 subclause 5.4.1.3), the mobile station shall behave as in network control mode NC0 or NC1 up to the point when a new cell has been chosen. It shall then check the CCN_SUPPORTED parameter, if available, that was last received for that cell. This parameter can be sent on BCCH or PBCCH or individually in PACKET MEASUREMENT ORDER or PACKET CELL CHANGE ORDER messages.

If it is available and if it indicates that CCN mode shall not be entered towards that cell, then the mobile station shall perform the cell change and not enter CCN mode.

If it is available and if it indicates that CCN mode shall be entered towards that cell or if it is not available, then instead of performing the cell change, the mobile station shall start timer T3206 and enter the CCN mode. At the first possible opportunity, the MS shall then, when in CCN mode, inform the network about the proposed cell by sending a PACKET CELL CHANGE NOTIFICATION message, stop timer T3206, start timers T3208 and T3210. The PACKET CELL CHANGE NOTIFICATION message shall contain the ARFCN for the BCCH and the BSIC as identity of the proposed cell. The message shall also contain measurement reports for the proposed cell and for other neighbour cells if available. In CCN mode the mobile station shall continue the data transfer and store neighbour cell system information if received in instances of the PACKET NEIGHBOUR CELL DATA message, but not

perform the cell change. At receipt of the first PACKET NEIGHBOUR CELL DATA message or PACKET CELL CHANGE CONTINUE message or PACKET CELL CHANGE ORDER message, the mobile station shall stop the timer T3210.

The mobile station shall retransmit the PACKET CELL CHANGE NOTIFICATION message once at the first possible opportunity when the timer T3210 expires.

The mobile station shall leave CCN mode when either CCN is no longer enabled (towards all neighbour cells with the CCN_ACTIVE bit or towards the cell that had been re-selected) or when the network has responded with a PACKET CELL CHANGE CONTINUE or PACKET CELL CHANGE ORDER message or when either of the timers T3206 or T3208 have expired.

References

3GPP TS 44.060, subclause 8.8.3

42.4.5.1.2 Test purpose

To verify that the MS leaves the CCN mode and continues cell reselection in NC0 mode when T3206 expires.

42.4.5.1.3 Method of test

Initial conditions

System Simulator:

2 cells, GPRS supported, CCN Active, PCCCH not present.

GPRS ready timer T3314 = infinity

Cell A: RLA_C = -50 dBm

Cell B: RLA_C = -60 dBm

Mobile Station:

MS is in Packet Idle mode, GPRS attached with support of GERAN Feature Package 1 indicated in MS Radio Access Capabilities, and PDP context 2 established.

Specific PICS Statements

-

PIXIT Statements

-

Test procedure

SS establishes a downlink data transfer. SS then waits 4 seconds and lower the signal strength of Cell A to -80 dBm. The MS will enter CCN mode, and when T3206 expires it will leave CCN mode and continue cell reselection in NC0 mode. The MS change cell and perform a Cell update in the new cell.

Maximum duration of the test

-

Expected sequence

Step	Direction	Message	Comments
1		{Downlink TBF establishment}	RLC mode: acknowledged, without starting time.
2	SS -> MS	DOWNLINK RLC DATA BLOCK	No valid RRBP
3	SS		SS waits 4 seconds.
4	SS -> MS	DOWNLINK RLC DATA BLOCK	No valid RRBP
5			Lower signal strength of Cell A to – 80 dBm.
6	SS		SS waits 4 seconds.
7	SS -> MS	DOWNLINK RLC DATA BLOCK	No valid RRBP
			Step 6 and 7 are repeated until the MS access Cell B, but no longer than for 15 seconds.
			The test has failed if the MS has not accessed Cell B within 15 sec from Step 5.
			The following messages are to be sent and received in Cell B.
8		{Uplink dynamic allocation one phase access}	USF_GRANULARITY = 1 block, RLC_DATA_BLOCKS_GRANTED = open-end TLLI_BLOCK_CHANNEL_CODING: same as channel coding CHANNEL_CODING_COMMAND: cs-1 No starting time present.
9		{Completion of uplink RLC data block transfer}	MS performs a Cell Update.

Specific message contents

None.

42.4.5.2 Network Assisted Cell Change / No Packet Neighbouring Cell Data and Packet Cell Change Continue

42.4.5.2.1 Conformance requirements

[3GPP TS 44.060, 8.1.1]

The mobile station shall transmit RLC/MAC blocks with the following priority:

- RLC/MAC control blocks containing a Packet Cell Change Notification message;
- Other RLC/MAC control blocks, except Packet Uplink Dummy Control Blocks;
- RLC data blocks;
- RLC/MAC control blocks containing Packet Uplink Dummy Control Blocks.

[3GPP TS 44.060, 8.1.2.2]

Whenever the mobile station receives an RLC data block addressed to itself and with a valid RRBP field in the RLC data block header (i.e., is polled), the mobile station shall transmit a PACKET DOWNLINK ACK/NACK message in the uplink radio block specified by the RRBP field whatever the BSN value of the received RLC data block, unless another RLC/MAC control message is waiting to be transmitted, in which case the other RLC/MAC control message shall be sent. Among the other RLC/MAC control blocks the PACKET CELL CHANGE NOTIFICATION message shall be sent with highest priority. However, the mobile station shall transmit an RLC/MAC control message other than a PACKET DOWNLINK ACK/NACK message at most every second time it is polled. Furthermore the mobile station shall not transmit an RLC/MAC control message other than a PACKET DOWNLINK ACK/NACK message if the PACKET DOWNLINK ACK/NACK message would contain a Final Ack Indicator or Channel Request Description IE. The mobile station shall not send a PACKET CONTROL ACKNOWLEDGEMENT message unless otherwise specified.

[44.060, 8.8.3]

After receiving a PACKET CELL CHANGE NOTIFICATION message from the mobile station the network can behave in different ways as described below.

- 1) The network responds with a PACKET CELL CHANGE CONTINUE message.
If a mobile station as response to a PACKET CELL CHANGE NOTIFICATION message receives a PACKET CELL CHANGE CONTINUE message without receiving any neighbour cell system information, the mobile station shall stop timer T3208, stop timer T3210 if still running, leave CCN mode and continue cell reselection in NC0/NC1 mode.

References

3GPP TS 44.060, subclause 8.1.1, 8.1.2.2 and 8.8.3

42.4.5.2.2 Test purpose

- 1) To verify that MS sends a PACKET CELL CHANGE NOTIFICATION when it enters CCN mode.
- 2) To verify that MS leaves CCN mode and continues cell reselection in NC0 mode when a PACKET CELL CHANGE CONTINUE is received when no PACKET NEIGHBOUR CELL DATA has been received.

42.4.5.2.3 Method of test

Initial conditions

System Simulator:

2 cells, GPRS supported, CCN Active, PCCCH not present.

GPRS ready timer T3314 = infinity

Cell A: RLA_C = -50 dBm

Cell B: RLA_C = -60 dBm

Mobile Station:

MS is in Packet Idle mode, GPRS attached with support of GERAN Feature Package 1 indicated in MS Radio Access Capabilities, and PDP context 2 established.

Specific PICS Statements

-

PIXIT Statements

-

Test procedure

SS establishes a downlink TBF and sends 4 RLC data blocks, the last one containing FBI = 0 and a valid RRBP. The MS sends a PACKET DOWNLINK ACK/NACK. The signal strength of Cell A is lowered to - 80 dBm. The downlink continues until MS sends PACKET CELL CHANGE NOTIFICATION. SS sends PACKET CELL CHANGE CONTINUE and verifies that the MS change to Cell B and does a Cell Update.

Maximum duration of the test

-

Expected sequence

Step	Direction	Message	Comments
1		{Downlink TBF establishment}	RLC mode: acknowledged, without starting time.
2	SS -> MS	DOWNLINK RLC DATA BLOCK	The data block contains FBI=0 and a valid RRBP.
3	SS -> MS	DOWNLINK RLC DATA BLOCK	
4	SS -> MS	DOWNLINK RLC DATA BLOCK	
5	SS -> MS	DOWNLINK RLC DATA BLOCK	
6	MS -> SS	PACKET DOWNLINK ACK/NACK	
7			The data block contains FBI=0 and a valid RRBP.
8	SS -> MS	DOWNLINK RLC DATA BLOCK	
9	SS -> MS	DOWNLINK RLC DATA BLOCK	
10	SS -> MS	DOWNLINK RLC DATA BLOCK	
11	SS -> MS	DOWNLINK RLC DATA BLOCK	
12	MS -> SS	PACKET DOWNLINK ACK/NACK Or PACKET CELL CHANGE NOTIFICATION	Step 8 to 12 are repeated until a PACKET CELL CHANGE NOTIFICATION is received in step 12, but no longer than 15 sec. The test has failed if no PACKET CELL CHANGE NOTIFICATION is received in Cell A within 15 sec from Step 7.
13			
14	SS -> MS	PACKET CELL CHANGE CONTINUE	
			The following messages are to be sent and received in Cell B.
15		{Uplink dynamic allocation one phase access}	USF_GRANULARITY = 1 block, RLC_DATA_BLOCKS_GRANTED = open-end TLLI_BLOCK_CHANNEL_CODING: same as channel coding CHANNEL_CODING_COMMAND: cs-1 No starting time present. MS performs a Cell Update.
16		{Completion of uplink RLC data block transfer}	

Specific message contents

PACKET CELL CHANGE CONTINUE in Step 14

Information element	Value/remark
< PAGE_MODE : bit (2) >	00
0	0
< GLOBAL_TFI : Global TFI IE >	1 <5 bit Downlink TFI>
0 1	1
< ARFCN : bit (10) >	ARFCN of Cell B.
< BSIC : bit (6) >	BSIC of Cell B.
< CONTAINER_ID : bit (2) >	00

42.4.5.3 Network Assisted Cell Change / Packet Neighbour Cell Data and Packet Cell Change Continue

42.4.5.3.1 Conformance requirements

[3GPP TS 44.060, 5.5.1.4.3]

A mobile station supporting the Network Assisted Cell Change procedures shall implement the request for acquisition of system information (see clause 5.5.1.1a).

The PACKET PSI STATUS (respectively PACKET SI STATUS) message shall indicate the present status of PSI (respectively SI) messages stored in or requested but not received by the mobile station. The mobile station shall include as many PSI (respectively SI) message types that fit into the *Received PSI Message List* (respectively *Received SI Message List*) construction in the PACKET PSI STATUS (respectively PACKET SI STATUS) message and that meet the following criteria: The PACKET PSI STATUS (respectively PACKET SI STATUS) message is sent on PACCH when the mobile station is in packet transfer mode. The first sending of this message during the acquisition of PBCCH (respectively BCCH) information shall take place at the first suitable opportunity after the acquisition is initiated:

- The PSI (respectively SI) message type is relevant for the mobile station, based on the features the mobile station supports (e.g. non-GSM and multi-RAT capabilities); and
- In case of optional PSI (respectively SI) messages types, the PSI (respectively SI) message type shall be indicated by the network as present on PBCCH (respectively BCCH).

If the presence of an optional PSI (respectively SI) message type cannot be determined, based on the information received, the mobile station shall assume that the optional PSI (respectively SI) message type is present.

NOTE 1: On PBCCH, the presence of optional PSI messages is indicated in PSI1 and PSI2.

NOTE 2: On BCCH, SI2, SI3, SI4 and, if present, SI9 indicate the presence of optional SI messages, except SI1. The presence of SI1 can be determined by reading the BCCH Norm block at TC = 0.

The message type value for these PSI (respectively SI) messages shall be included in the *Received PSI Message List* (respectively *Received SI Message List*) in the PACKET PSI STATUS (respectively PACKET SI STATUS) message. The network may use this information to determine which PSI (respectively SI) message types the mobile station is able to receive and the present status of the PSI (respectively SI) messages stored in the mobile station.

[3GPP TS 44.060 8.8.3]

After receiving a PACKET CELL CHANGE NOTIFICATION message from the mobile station the network can behave in different ways as described below.

- 2) The network sends first necessary system information for the cell proposed in the PACKET CELL CHANGE NOTIFICATION message, or for any other cell, in one or more instances of the PACKET NEIGHBOUR CELL DATA message and sends then a PACKET CELL CHANGE CONTINUE message.
The mobile station shall store the received system information as specified in clause 8.8.1. When the first instance of the PACKET NEIGHBOUR CELL DATA message is received, the mobile station shall stop timer T3210 if still running. When the PACKET CELL CHANGE CONTINUE message is received, the mobile station shall stop timer T3208, leave CCN mode and continue the cell reselection in NC0/NC1 mode.

References

3GPP TS 44.060, subclause 5.5.1.4.3 and 8.8.3

42.4.5.3.2 Test purpose

1. To verify that MS leaves CCN mode and continues cell reselection in NC0 mode when a PACKET CELL CHANGE CONTINUE is received after a PACKET NEIGHBOUR CELL DATA has been received.
2. To verify that MS uses the Packet System Information received in PACKET NEIGHBOUR CELL DATA when accessing the new cell.
3. To verify that MS requests remaining Packet System Information messages when having accessed the new cell by sending PACKET PSI STATUS.

42.4.5.3.3 Method of test

Initial conditions

System Simulator:

3 cells, GPRS supported, CCN Active, PCCCH present, GPRS_RXLEV_ACCESS_MIN = -90dBm.

Cell A: The indication of Cell C is removed in SI2, PSI3 and PSI3bis neighbour cell descriptions. RLA_C = -50 dBm. PSI1 in PACKET NEIGHBOUR CELL DATA shall have CCN_ACTIVE enabled.

Cell B: Supports PACKET PSI STATUS. All Packet System Information is exchanged to Packet Downlink Dummy Control Block on PBCCH. This is only made to make it possible to verify that the MS uses the information in Packet Neighbour Cell Data. RLA_C = -60 dBm

Cell C: The cell is not active at the start of the test.

Mobile Station:

MS is in Packet Idle mode, GPRS attached with support of GERAN Feature Package 1 indicated in MS Radio Access Capabilities, and PDP context 2 established.

Specific PICS Statements

-

PIXIT Statements

-

Test procedure

The MS is triggered to initiate packet uplink transfer. SS assigns resources to the MS and it starts to send uplink data that the SS acknowledges. During the uplink the signal strength of Cell A is lowered to – 80 dBm. The MS enters CCN mode and sends PACKET CELL CHANGE NOTIFICATION. The MS then continues to send uplink data. SS sends one or more PACKET NEIGHBOUR CELL DATA to the MS. The SS then sends PACKET CELL CHANGE CONTINUE and the MS changes to Cell B.

The MS requests resources for an uplink in the new cell. The MS then requests the remaining PSI messages by sending PACKET PSI STATUS (Note: During the acquisition of PBCCH information the MS may send up to three extra PACKET PSI STATUS messages). SS verifies that the MS indicates that it has received the PSI sent in PACKET NEIGHBOUR CELL DATA. SS sends the missing PSI on PACCH of Cell B to the MS during the uplink.

To ensure that the MS has received the requested PSI, Cell A is deactivated and Cell C is activated with signal strength set to 65dBm. The signal strength of cell B is lowered to – 80 dBm. The MS enters CCN mode and sends PACKET CELL CHANGE NOTIFICATION. The SS then sends PACKET CELL CHANGE CONTINUE and the MS change to Cell C. The MS requests resources for an uplink in the new cell and re-establishes and completes the uplink transfer in the new cell.

Maximum duration of the test

-

Expected sequence

Step	Direction	Message	Comments
1		{Uplink dynamic allocation one phase access or two phase access}	n = 10000 octets. USF_GRANULARITY = 1 block, RLC_DATA_BLOCKS_GRANTED = open-end TLLI_BLOCK_CHANNEL_CODING: same as channel coding CHANNEL_CODING_COMMAND: cs-1 No starting time present.
2	SS -> MS	PACKET DOWNLINK DUMMY CONTROL BLOCK	USF assigned to the MS
3	MS -> SS	RLC DATA BLOCK	
4	SS -> MS	PACKET UPLINK ACK/NACK	
5	SS		Lower signal strength of Cell A to -80 dBm.
6	SS -> MS	PACKET DOWNLINK DUMMY CONTROL BLOCK	USF assigned to the MS
7	MS -> SS	RLC DATA BLOCK Or PACKET CELL CHANGE NOTIFICATION	
8	SS -> MS	PACKET UPLINK ACK/NACK	USF assigned to the MS
9			Steps 7 and 8 are repeated until a PACKET CELL CHANGE NOTIFICATION is received in step 7, but no longer than 10 sec. The test has failed if no PACKET CELL CHANGE NOTIFICATION is received in Cell A within 10 sec from Step 5.
10	SS -> MS	PACKET DOWNLINK DUMMY CONTROL BLOCK	USF assigned to the MS
11	MS -> SS	RLC DATA BLOCK	
12	SS -> MS	PACKET NEIGHBOUR CELL DATA	See specific message contents
13			Steps 10 to 12 are repeated until all instances of PACKET NEIGHBOUR CELL DATA are sent.
14	SS -> MS	PACKET CELL CHANGE CONTINUE	See specific message contents
			The following messages are to be sent and received in Cell B.
15		{Uplink dynamic allocation one phase access or two phase access}	USF_GRANULARITY = 1 block, RLC_DATA_BLOCKS_GRANTED = open-end TLLI_BLOCK_CHANNEL_CODING: same as channel coding CHANNEL_CODING_COMMAND: cs-1 No starting time present.
16	SS -> MS	PACKET DOWNLINK DUMMY CONTROL BLOCK	USF assigned to the MS
			MSs specifying "One Phase Access" or "Two Phase Access" in the PACKET CHANNEL REQUEST in Step 15 perform Steps A17 to A19. MSs specifying "Cell Update" in the PACKET CHANNEL REQUEST or PACKET RESOURCE REQUEST in Step 15 perform Steps B17 to B20.
A17	MS -> SS	RLC DATA BLOCK Or PACKET PSI STATUS	
A18	SS -> MS	PACKET UPLINK ACK/NACK	USF assigned to the MS

A19			Steps A17 and A18 are repeated until a PACKET PSI STATUS is received in step A17. The Packet PSI Status shall be sent within 10 sec of accessing the cell. Verify that the MS not requests PSI that was sent in step 12. Note: During the acquisition of PBCCH information the MS may send up to three extra PACKET PSI STATUS messages.
B17	MS -> SS	RLC DATA BLOCK Or PACKET PSI STATUS Or PACKET RESOURCE REQUEST	
			Step B18 is performed only if a PACKET RESOURCE REQUEST is received in Step B17.
B18	SS -> MS	PACKET UPLINK ASSIGNMENT	Repeats the PDTCH assignment given in Step 15. Send PACKET DOWNLINK DUMMY CONTROL BLOCK with USF assigned to the MS and continue with step B17
B19	SS -> MS	PACKET UPLINK ACK/NACK	USF assigned to the MS
B20			Steps B17 to B19 are repeated until both a PACKET PSI STATUS and an RLC DATA BLOCK have been received in step B17. The Packet PSI Status shall be sent within 10 sec of accessing the cell. Verify that the MS not requests PSI that was sent in step 12. If the RLC DATA BLOCK with BSN = 0 received in step B17 contains an empty LLC PDU as the first LLC PDU, then Steps B17 to B19 are repeated until a PACKET RESOURCE REQUEST is received at Step B17. In this case, the empty LLC PDU may be followed by one or more lower priority LLC PDUs in the same RLC Data Block Note: During the acquisition of PBCCH information the MS may send up to three extra PACKET PSI STATUS messages.
21	SS -> MS	PACKET SYSTEMINFO TYPE 3 PACKET SYSTEMINFO TYPE 3bis	SS should send the PSIs on PACCH.
22	SS		Cell A is deactivated and Cell C is activated and set to -65 dBm.
23	SS -> MS	PACKET DOWNLINK DUMMY CONTROL BLOCK	USF assigned to the MS
24	MS -> SS	RLC DATA BLOCK Or PACKET PSI STATUS	
25	SS -> MS	PACKET UPLINK ACK/NACK	USF assigned to the MS
26	SS		Repeat steps 24 and 25 for 10 seconds allowing MS to identify BSIC for cell C.
27	SS		Lower signal strength of Cell B to -80 dBm.
28	MS -> SS	RLC DATA BLOCK Or PACKET CELL CHANGE NOTIFICATION	
29	SS -> MS	PACKET UPLINK ACK/NACK	USF assigned to the MS
30			Step 28 and 29 are repeated until a PACKET CELL CHANGE NOTIFICATION is received in step 28, but no longer than 10 sec.
			The test has failed if no PACKET CELL CHANGE NOTIFICATION is received in Cell B within 10 sec from Step 27.

31	SS -> MS	PACKET CELL CHANGE CONTINUE	See specific message contents
			The following messages are to be sent and received in Cell C.
32		{Uplink dynamic allocation one phase access or two phase access}	USF_GRANULARITY = 1 block, RLC_DATA_BLOCKS_GRANTED = open-end TLLI_BLOCK_CHANNEL_CODING: same as channel coding CHANNEL_CODING_COMMAND: cs-1 No starting time present.
33	SS -> MS	PACKET DOWNLINK DUMMY CONTROL BLOCK	USF assigned to the MS
			MSs specifying "One Phase Access" or "Two Phase Access" in the PACKET CHANNEL REQUEST in Step 32 perform Steps A34 to A35. MSs specifying "Cell Update" in the PACKET CHANNEL REQUEST or PACKET RESOURCE REQUEST in Step 32 perform Steps B34 to B37.
A34	MS -> SS	RLC DATA BLOCK	
A35	SS -> MS	PACKET UPLINK ACK/NACK	USF assigned to the MS
B34	MS -> SS	RLC DATA BLOCK Or PACKET RESOURCE REQUEST	
			Step B35 is performed only if a PACKET RESOURCE REQUEST is received in Step B34.
B35	SS -> MS	PACKET UPLINK ASSIGNMENT	Repeats the PDTCH assignment given in Step 32. Send PACKET DOWNLINK DUMMY CONTROL BLOCK with USF assigned to the MS and continue with step B34.
B36	SS -> MS	PACKET UPLINK ACK/NACK	USF assigned to the MS
B37			- At step B34, if the RLC DATA BLOCK received with BSN = 0 contains an empty LLC PDU as the first LLC PDU, then Steps B34 to B36 are repeated until a PACKET RESOURCE REQUEST is received at Step B34. In this case, the empty LLC PDU may be followed by one or more lower priority LLC PDUs in the same RLC Data Block.
38		Completion of {Uplink dynamic allocation}	

Specific message contents

PACKET NEIGHBOUR CELL DATA in Step 12

The message contains the default PSI_1, PSI_2 and PSI_14 for Cell B.

Information element	Value/remark
< PAGE_MODE : bit (2) >	00 (Normal Paging)
0	0
< GLOBAL_TFI : Global TFI IE >	0 <5 bit Uplink TFI>
< CONTAINER_ID : bit (2) >	01 for PSI belonging to Cell B
< SPARE :bit(1)>	0
< CONTAINER_INDEX :bit (5)>	00000 to the index needed to send all PSI messages.
0 1	0 No ARFCN or BSIC
Container repetition struct	
< PD : bit(3)>	001, PBCCH (RLC/MAC)

PACKET CELL CHANGE CONTINUE in Step 14

Information element	Value/remark
< PAGE_MODE : bit (2) > 0	00 (Normal Paging) 0
< GLOBAL_TFI : Global TFI IE > 0 1	0 <5 bit Uplink TFI> 1
< ARFCN : bit (10) >	ARFCN of Cell B.
< BSIC : bit (6) >	BSIC of Cell B.
< CONTAINER_ID >	01

PACKET CELL CHANGE CONTINUE in Step 31

Information element	Value/remark
< PAGE_MODE : bit (2) > 0	00 (Normal Paging) 0
< GLOBAL_TFI : Global TFI IE > 0 1	0 <5 bit Uplink TFI> 0

42.4.5.4 Network Assisted Cell Change / Packet Neighbour Cell Data and Packet Cell Change Order

42.4.5.4.1 Conformance requirements

[3GPP TS 44.060, 5.5.1.4.3]

A mobile station supporting the Network Assisted Cell Change procedures shall implement the request for acquisition of system information (see clause 5.5.1.1a).

The PACKET PSI STATUS (respectively PACKET SI STATUS) message shall indicate the present status of PSI (respectively SI) messages stored in or requested but not received by the mobile station. The mobile station shall include as many PSI (respectively SI) message types that fit into the *Received PSI Message List* (respectively *Received SI Message List*) construction in the PACKET PSI STATUS (respectively PACKET SI STATUS) message and that meet the following criteria: The PACKET PSI STATUS (respectively PACKET SI STATUS) message is sent on PACCH when the mobile station is in packet transfer mode. The first sending of this message during the acquisition of PBCCH (respectively BCCH) information shall take place at the first suitable opportunity after the acquisition is initiated:

- The PSI (respectively SI) message type is relevant for the mobile station, based on the features the mobile station supports (e.g. non-GSM and multi-RAT capabilities); and
- In case of optional PSI (respectively SI) messages types, the PSI (respectively SI) message type shall be indicated by the network as present on PBCCH (respectively BCCH).

If the presence of an optional PSI (respectively SI) message type cannot be determined, based on the information received, the mobile station shall assume that the optional PSI (respectively SI) message type is present.

NOTE 1: On PBCCH, the presence of optional PSI messages is indicated in PSI1 and PSI2.

NOTE 2: On BCCH, SI2, SI3, SI4 and, if present, SI9 indicate the presence of optional SI messages, except SI1. The presence of SI1 can be determined by reading the BCCH Norm block at TC = 0.

The message type value for these PSI (respectively SI) messages shall be included in the *Received PSI Message List* (respectively *Received SI Message List*) in the PACKET PSI STATUS (respectively PACKET SI STATUS) message. The network may use this information to determine which PSI (respectively SI) message types the mobile station is able to receive and the present status of the PSI (respectively SI) messages stored in the mobile station.

[3GPP TS 44.060, 8.8.3]

After receiving a PACKET CELL CHANGE NOTIFICATION message from the mobile station the network can behave in different ways as described below.

- 3) The network sends first necessary system information for the cell proposed in the PACKET CELL CHANGE NOTIFICATION message, or for any other cell, in one or more instances of the PACKET

NEIGHBOUR CELL DATA message and sends then a PACKET CELL CHANGE ORDER message.

The mobile station shall store the received system information as specified in clause 8.8.1. When the first instance of the PACKET NEIGHBOUR CELL DATA message is received, the mobile station shall stop timer T3210 if still running. When the PACKET CELL CHANGE ORDER message is received, the mobile station shall stop timer T3208, leave CCN mode and follow the procedures as specified for the Packet Cell Change Order (clause 8.4) and in clause 8.8.1.

References

3GPP TS 44.060, subclause 5.5.1.4.3 and 8.8.3

42.4.5.4.2 Test purpose

1. To verify that the MS applies CCN when CCN is indicated in SI13 of the serving cell by sending a PACKET CELL CHANGE NOTIFICATION when deciding to make a cell reselection.
2. To verify that MS leaves CCN mode when it receives a PACKET CELL CHANGE ORDER and follows the procedures as specified in the PACKET CELL CHANGE ORDER.
3. To verify that MS uses the System Information received in PACKET NEIGHBOUR CELL DATA when accessing the new cell.
4. To verify that MS requests remaining System Information messages when having accessed the new cell by sending PACKET SI STATUS.

42.4.5.4.3 Method of test

Initial conditions

System Simulator:

3 cells, GPRS supported, CCN Active in SI13, PCCCH not present.

GPRS ready timer T3314 = infinity

Cell A: The indication of Cell C is removed in SI2. RLA_C = -50 dBm

Cell B: Supports PACKET SI STATUS. No System Information is broadcast on the BCCH, except SI3. This is only made to make it possible to verify that the MS uses the information in Packet Neighbour Cell Data. RLA_C = -60 dBm

Cell C: The cell is not active at the start of the test.

Mobile Station:

MS is in Packet Idle mode, GPRS attached with support of GERAN Feature Package 1 indicated in MS Radio Access Capabilities, and PDP context 2 established.

Specific PICS Statements

-

PIXIT Statements

-

Test procedure

The MS is triggered to initiate packet uplink transfer. SS assigns resources to the MS and it starts to send uplink data that the SS acknowledges. During the uplink the signal strength of cell A is lowered to -80 dBm. The MS enters CCN mode and sends PACKET CELL CHANGE NOTIFICATION. The MS then continues to send uplink data. SS sends a complete set of PACKET NEIGHBOUR CELL DATA with SI1, SI3 and SI13 of Cell B to the MS. The SS then sends a PACKET CELL CHANGE ORDER that orders the MS to change to Cell B.

The MS requests resources for an uplink in the Cell B and continues the uplink. The MS then requests the remaining SI messages by sending PACKET SI STATUS (Note: During the acquisition of BCCH information the MS may send up to three extra PACKET SI STATUS messages). SS verifies that the MS indicates that it has received the SI sent in

PACKET NEIGHBOUR CELL DATA. SS sends the missing SI to the MS in PACKET SERVING CELL DATA messages during the uplink.

To ensure that the MS has received the requested SI, Cell A is deactivated and Cell C is activated with signal strength set to – 50 dBm. The signal strength of cell B is lowered to – 80 dBm. The MS enters CCN mode and sends PACKET CELL CHANGE NOTIFICATION. The SS then sends PACKET CELL CHANGE ORDER and the MS changes to Cell C. The MS requests resources for an uplink in the new cell and re-establishes and completes the uplink transfer in the new cell.

Maximum duration of the test

-

Expected sequence

Step	Direction	Message	Comments
1		{Uplink dynamic allocation one phase access or two phase access }	n = 10000 octets. USF_GRANULARITY = 1 block, RLC_DATA_BLOCKS_GRANTED = open-end TLLI_BLOCK_CHANNEL_CODING: same as channel coding CHANNEL_CODING_COMMAND: cs-1 No starting time present.
2	SS -> MS	PACKET DOWNLINK DUMMY CONTROL BLOCK	USF assigned to the MS
3	MS -> SS	RLC DATA BLOCK	
4	SS -> MS	PACKET UPLINK ACK/NACK	
5	SS		Lower signal strength of Cell A to –80 dBm.
6	SS -> MS	PACKET DOWNLINK DUMMY CONTROL BLOCK	USF assigned to the MS
7	MS -> SS	RLC DATA BLOCK Or PACKET CELL CHANGE NOTIFICATION	
8	SS -> MS	PACKET UPLINK ACK/NACK	USF assigned to the MS
9			Steps 7 and 8 are repeated until a PACKET CELL CHANGE NOTIFICATION is received in step 7, but no longer than 15 sec. The test has failed if no PACKET CELL CHANGE NOTIFICATION is received in Cell A within 15 sec from Step 5.
10	SS -> MS	PACKET DOWNLINK DUMMY CONTROL BLOCK	USF assigned to the MS
11	MS -> SS	RLC DATA BLOCK	
12	SS -> MS	PACKET NEIGHBOUR CELL DATA	See specific message contents
13			Step 10 to 12 are repeated until all instances of PACKET NEIGHBOUR CELL DATA are sent.
14	SS -> MS	PACKET CELL CHANGE ORDER	See specific message contents
			The following messages are to be sent and received in Cell B.
15		{Uplink dynamic allocation one phase access or two phase access }	USF_GRANULARITY = 1 block, RLC_DATA_BLOCKS_GRANTED = open-end TLLI_BLOCK_CHANNEL_CODING: same as channel coding CHANNEL_CODING_COMMAND: cs-1 No starting time present.
16	SS -> MS	PACKET DOWNLINK DUMMY CONTROL BLOCK	USF assigned to the MS

17	MS -> SS	RLC DATA BLOCK Or PACKET SI STATUS Or PACKET RESOURCE REQUEST	<p>Step 18 is performed only if a PACKET RESOURCE REQUEST is received in Step 17.</p> <p>Repeats the PDTCH assignment given in Step 15.</p> <p>Send PACKET DOWNLINK DUMMY CONTROL BLOCK with USF assigned to the MS and continue with step 17</p> <p>USF assigned to the MS</p> <p>Steps 17 to 19 are repeated until both a PACKET SI STATUS and an RLC Data Block are received in step 17.</p> <p>The Packet SI Status shall be sent within 10 sec of accessing the cell. Verify that the MS not requests SI that was sent in step 12.</p> <p>Note: During the acquisition of BCCH information the MS may send up to three extra PACKET SI STATUS messages</p> <p>If the RLC DATA BLOCK with BSN = 0 received in Step 17 contains an empty LLC PDU as the first LLC PDU, Steps 17 to 19 are further repeated until a PACKET RESOURCE REQUEST is received in Step 17.</p> <p>NOTE: The empty LLC PDU may be accompanied by another low priority RLC data block (with Packet Resource Request and Packet Uplink Assignment or Packet Timeslot Reconfigure as required), in order to ensure that the radio resources are used efficiently.</p> <p>See specific message contents</p> <p>Step 21 is repeated until all instances of PACKET SERVING CELL DATA are sent.</p> <p>Cell A is deactivated and Cell C is activated and set to – 50 dBm.</p> <p>Lower signal strength of Cell B to –80 dBm.</p> <p>USF assigned to the MS</p>
18	SS -> MS	PACKET UPLINK ASSIGNMENT	
19	SS -> MS	PACKET UPLINK ACK/NACK	
20			
21	SS -> MS	PACKET SERVING CELL DATA	
22			
23	SS		
24	SS		
25	SS -> MS	PACKET DOWNLINK DUMMY CONTROL BLOCK	

26	MS -> SS	RLC DATA BLOCK Or PACKET CELL CHANGE NOTIFICATION Or PACKET SI STATUS	
27 28	SS -> MS	PACKET UPLINK ACK/NACK	USF assigned to the MS Steps 26 and 27 are repeated until a PACKET CELL CHANGE NOTIFICATION is received in step 26, but no longer than 15 sec. The test has failed if no PACKET CELL CHANGE NOTIFICATION is received in Cell B within 15 sec from Step 24.
29	SS -> MS	PACKET CELL CHANGE ORDER	See specific message contents
			The following messages are to be sent and received in Cell C.
30		{Uplink dynamic allocation one phase access or two phase access }	USF_GRANULARITY = 1 block, RLC_DATA_BLOCKS_GRANTED = open- end TLLI_BLOCK_CHANNEL_CODING: same as channel coding CHANNEL_CODING_COMMAND: cs-1 No starting time present.
31	SS -> MS	PACKET DOWNLINK DUMMY CONTROL BLOCK	USF assigned to the MS
32	MS -> SS	RLC DATA BLOCK Or PACKET RESOURCE REQUEST	
			Step 33 is performed only if a PACKET RESOURCE REQUEST is received in Step 32.
33	SS -> MS	PACKET UPLINK ASSIGNMENT	Repeats the PDTCH assignment given in Step 30. Send PACKET DOWNLINK DUMMY CONTROL BLOCK with USF assigned to the MS and continue with step 32.
34	SS -> MS	PACKET UPLINK ACK/NACK	USF assigned to the MS
35			If the RLC DATA BLOCK with BSN = 0 received in Step 32 contains an empty LLC PDU as the first LLC PDU, Steps 32 to 34 are repeated until a PACKET RESOURCE REQUEST is received in Step 32. NOTE: The empty LLC PDU may be accompanied by another low priority RLC data block (with Packet Resource Request and Packet Uplink Assignment or Packet Timeslot Reconfigure as required), in order to ensure that the radio resources are used efficiently.
36		Completion of {Uplink dynamic allocation}	

Specific message contents

PACKET NEIGHBOUR CELL DATA in Step 12

The message contains the default SI1, SI3 and SI13 for Cell B.

Information element	Value/remark
< PAGE_MODE : bit (2) >	00 (Normal Paging)
< GLOBAL_TFI : Global TFI IE >	0 <5 bit Uplink TFI>
< CONTAINER_ID : bit (2) >	01 for SI belonging to Cell B
< SPARE :bit(1)>	0
< CONTAINER INDEX :bit (5)>	00000 to the index needed to send all SI messages
0 1	0 No ARFCN or BSIC
Container repetition struct	
< PD : bit(3)>	000, BCCH (LAPDm)

PACKET CELL CHANGE ORDER in Step 14

Information element	Value/remark
< PAGE_MODE : bit (2) >	00 (Normal Paging)
0 10	0
< GLOBAL_TFI : Global TFI IE >	<5 bit Uplink TFI>
0 1	0
< IMMEDIATE_REL >	1 (Immediate abort of operation in the old cell is required)
< ARFCN >	ARFCN of Cell B
< BSIC >	BSIC of Cell B
< NETWORK_CONTROL_ORDER : bit(2) >	00 (NC0)
0 1	0
0 1 < NC_FREQUENCY_LIST >	0
Null 0 1	1 Additions in R98
Null 0 1	0 LSA Parameters not included
Null 0 1	1 Additions in R99
< ENH Measurement parameters >	
{ 0 < BA_IND : bit > < 3G_BA_IND : bit > 1	000
< PSI3_CHANGE_MARK : bit(2) > }	
< PMO_IND : bit >	0
< REPORT_TYPE : bit >	1
< REPORTING_RATE : bit >	0
< INVALID_BSIC_REPORTING : bit >	0
0 1 < 3G Neighbour Cell Description >	0 (not present)
0 1 < GPRS REP PRIORITY Description >	0 (not present)
0 1 < GPRS MEASUREMENT Parameters Description >	0 (not present)
0 1 < GPRS 3G MEASUREMENT Parameters Description >	0 (not present)
Null 0 1	1 Additions in Rel4
< CCN_ACTIVE : bit (1) >	1
0 1 < CONTAINER_ID : bit (2) >	1
< CONTAINER_ID : bit (2) >	01(The same as PACKET NEIGHBOUR CELL DATA in Step 12)
0 1 < CCN Support Description >	0
< padding bits >	

PACKET SERVING CELL DATA in Step 21

The message contains the default SI2, SI2bis (when indicated in SI2) and SI4 for Cell B.

Information element	Value/remark
< MESSAGE_TYPE : bit (6) >	001101
< PAGE_MODE : bit (2) >	00 (Normal Paging)
0 < GLOBAL_TFI : Global TFI IE >	0 <5 bit Uplink TFI>
< spare : bit (4) >	0000
< CONTAINER INDEX :bit (5)>	00000 to the index needed to send all SI messages
Container repetition struct	
< PD : bit(3)>	000, BCCH (LAPDm)

PACKET CELL CHANGE ORDER in Step 29

Information element	Value/remark
< PAGE_MODE : bit (2) >	00 (Normal Paging)
0 10	0
< GLOBAL_TFI : Global TFI IE >	<5 bit Uplink TFI>
0 1	0
< IMMEDIATE_REL >	1 (Immediate abort of operation in the old cell is required)
< ARFCN >	ARFCN of Cell C
< BSIC >	BSIC of Cell C
< NETWORK_CONTROL_ORDER : bit(2) >	00 (NC0)
0 1	0
0 1 < NC_FREQUENCY_LIST >	0
Null 0 1	1 Additions in R98
Null 0 1	0 LSA Parameters not included
Null 0 1	1 Additions in R99
< ENH Measurement parameters >	
{ 0 < BA_IND : bit > < 3G_BA_IND : bit > 1	000
< PSI3_CHANGE_MARK : bit(2) > }	
< PMO_IND : bit >	0
< REPORT_TYPE : bit >	1
< REPORTING_RATE : bit >	0
< INVALID_BSIC_REPORTING : bit >	0
0 1 < 3G Neighbour Cell Description >	0 (not present)
0 1 < GPRS REP PRIORITY Description >	0 (not present)
0 1 < GPRS MEASUREMENT Parameters Description >	0 (not present)
0 1 < GPRS 3G MEASUREMENT Parameters Description >	0 (not present)
Null 0 1	1 Additions in Rel4
< CCN_ACTIVE : bit (1) >	1
0 1 < CONTAINER_ID : bit (2) >	0
0 1 < CCN Support Description >	0
< padding bits >	

42.4.5.5 Network Assisted Cell Change / Expiry of T3208 and T3210

42.4.5.5.2 Conformance requirements

[3GPP TS 44.060, 8.8.3]

After receiving a PACKET CELL CHANGE NOTIFICATION message from the mobile station the network can behave in different ways as described below.

- 5) No network response
When timer T3210 expires, the mobile station shall retransmit once the PACKET CELL CHANGE NOTIFICATION message at the first possible opportunity.
When timer T3208 expires, the mobile station shall leave CCN mode and continue cell reselection in NC0/NC1 mode as described in clause 5.5.1.1 and in [15].

References

3GPP TS 44.060, subclause 8.8.3

42.4.5.5.2 Test purpose

1. To verify that the MS retransmits the PACKET CELL CHANGE NOTIFICATION when T3210 expires 300 ms after no reception of any PACKET NEIGHBOUR CELL DATA, PACKET CELL CHANGE CONTINUE, PACKET MEASUREMENT ORDER or PACKET CELL CHANGE ORDER.
2. To verify that MS leaves CCN mode when T3208 expires and continues cell reselection in NC0 mode.

42.4.5.5.3 Method of test

Initial conditions

System Simulator:

2 cells, GPRS supported, CCN Active in SI13, PCCCH not present.

Cell A: RLA_C = -50 dBm

Cell B: RLA_C = -60 dBm

Mobile Station:

MS is in Packet Idle mode, GPRS attached with support of GERAN Feature Package 1 indicated in MS Radio Access Capabilities, and PDP context 2 established.

Specific PICS Statements

-

PIXIT Statements

-

Test procedure

The MS is triggered to initiate packet uplink transfer. SS assigns resources to the MS and it starts to send uplink data that the SS acknowledge. During the uplink the signal strength of Cell A is lowered to – 80 dBm. The MS enters CCN mode and sends PACKET CELL CHANGE NOTIFICATION and starts timer T3208 and T3210. The MS then continues to send uplink data. When timer T3210 expires, the MS retransmits PACKET CELL CHANGE NOTIFICATION once. When timer T3208 expires, the MS leaves CCN mode and performs cell reselection in NCO mode. The MS change to Cell B and complete the upload.

Maximum duration of the test

-

Expected sequence

Step	Direction	Message	Comments
1		{Uplink dynamic allocation one phase access or two-phase access}	n = 5000 octets. USF_GRANULARITY = 1 block, RLC_DATA_BLOCKS_GRANTED = open-end TLLI_BLOCK_CHANNEL_CODING: same as channel coding CHANNEL_CODING_COMMAND: cs-1 No starting time present. USF assigned to the MS
2	SS -> MS	PACKET DOWNLINK DUMMY CONTROL BLOCK	
3	MS -> SS	RLC DATA BLOCK	
4	SS -> MS	PACKET UPLINK ACK/NACK	USF NOT assigned to the MS
5	SS		Lower signal strength of Cell A to -80 dBm.
6	SS->MS	PACKET DOWNLINK DUMMY CONTROL BLOCK	USF assigned to the MS
7	MS -> SS	RLC DATA BLOCK Or PACKET CELL CHANGE NOTIFICATION	
8	SS -> MS	PACKET UPLINK ACK/NACK	PCCN Sending = 0 (First sending) USF assigned to the MS
9			Step 7 and 8 are repeated until the first PACKET CELL CHANGE NOTIFICATION is received in step 7, but no longer than 15 sec. The test has failed if no PACKET CELL CHANGE NOTIFICATION is received in Cell A within 15 sec from Step 5.
10	SS->MS	PACKET DOWNLINK DUMMY CONTROL BLOCK	USF assigned to the MS
11	MS -> SS	RLC DATA BLOCK Or PACKET CELL CHANGE NOTIFICATION	Sent at expiry of T3210. PCCN Sending = 1 (Second sending) SS shall schedule USF often enough so T3210 timer requirement can be met.
12	SS -> MS	PACKET UPLINK ACK/NACK	USF assigned to the MS
13			Step 11 and 12 are repeated until a PACKET CELL CHANGE NOTIFICATION is received in step 11. It is verify that the PACKET CELL CHANGE NOTIFICATION was sent after expiry of T3210 - 10% from the previous PCCN received in Step 7.
14	SS->MS	PACKET DOWNLINK DUMMY CONTROL BLOCK	USF assigned to the MS
15	MS -> SS	RLC DATA BLOCK	
16	SS -> MS	PACKET UPLINK ACK/NACK	USF assigned to the MS
17			Steps 15 and 16 are repeated for at least T3208 (0.96 sec) from the first PCCN sending (in step 7) but no more than 5 sec.
18	SS		SS verifies that no more RLC DATA BLOCKS are received from the MS.
			The following messages are to be sent and received in Cell B.
19		{Uplink dynamic allocation one phase or two-phase access}	USF_GRANULARITY = 1 block, RLC_DATA_BLOCKS_GRANTED = open-end TLLI_BLOCK_CHANNEL_CODING: same as channel coding CHANNEL_CODING_COMMAND: cs-1 No starting time present.
20	SS -> MS	PACKET DOWNLINK DUMMY CONTROL BLOCK	USF assigned to the MS
21	MS -> SS	RLC DATA BLOCK Or PACKET RESOURCE REQUEST	
			Step 22 is performed only if a PACKET RESOURCE REQUEST is received in Step

			21.
22	SS -> MS	PACKET UPLINK ASSIGNMENT	Repeats the PDTCH assignment given in Step 19. Send PACKET DOWNLINK DUMMY CONTROL BLOCK with USF assigned to the MS and continue with step 21.
23	SS -> MS	PACKET UPLINK ACK/NACK	USF assigned to the MS
24			If the RLC DATA BLOCK with BSN = 0 received in Step 21 contains an empty LLC PDU as the first LLC PDU, Steps 21 to 23 are repeated until a PACKET RESOURCE REQUEST is received in Step 21. NOTE: The empty LLC PDU may be accompanied by another low priority RLC data block (with Packet Resource Request and Packet Uplink Assignment or Packet Timeslot Reconfigure as required), in order to ensure that the radio resources are used efficiently.
25		{Completion of uplink RLC data block transfer}	

Specific message contents

None.

42.4.5.6 Network Assisted Cell Change / Entering packet idle mode

42.4.5.6.1 Conformance requirements

[3GPP TS 44.060, 8.8.3]

The CCN mode is only valid in Packet Transfer Mode. If the mobile station is in CCN mode when entering packet idle mode, the mobile station shall stop the timers T3206 and T3208, stop timer T3210 if still running, leave CCN mode and continue the cell reselection procedure according to the NC0/NC1 procedures. If PACKET NEIGHBOUR CELL DATA messages are received on the PACCH before entering packet idle mode and the cell identity parameters are included, this information may then be used at the next cell change.

References

3GPP TS 44.060, subclause 8.8.3

42.4.5.6.2 Test purpose

To verify that the MS continues according to the normal packet idle mode cell reselection procedures when leaving CCN mode and entering packet idle mode.

42.4.5.6.3 Method of test

Initial conditions

System Simulator:

2 cells, GPRS supported, CCN Active in SI13, PCCCH not present.

GPRS ready timer T3314 = infinity

T3192 = 0 ms

Mobile Station:

MS is in Packet Idle mode, GPRS attached with support of GERAN Feature Package 1 indicated in MS Radio Access Capabilities, and PDP context 2 established.

Cell A: RLA_C = -50 dBm

Cell B: RLA_C = -60 dBm

Specific PICS Statements

-

PIXIT Statements

-

Test procedure

SS establishes a downlink TBF and sends 4 RLC data blocks, the last one containing FBI = 0 and a valid RRBP. The MS sends a PACKET DOWNLINK ACK/NACK. The signal strength of Cell A is lowered to -80 dBm. The downlink continues until MS sends PACKET CELL CHANGE NOTIFICATION. SS sends a RLC block that contains FBI = 1 and a valid RRBP. The MS sends a PACKET DOWNLINK ACK/NACK containing FINAL_ACK_INDICATION = 1. The MS leaves CCN mode and enters packet idle mode and performs cell reselection in NC0 mode. The MS performs a Cell update in the new cell.

Maximum duration of the test

-

Expected sequence

Step	Direction	Message	Comments
1		{Downlink TBF establishment}	RLC mode: acknowledged, without starting time.
2	SS -> MS	DOWNLINK RLC DATA BLOCK	
3	SS -> MS	DOWNLINK RLC DATA BLOCK	
4	SS -> MS	DOWNLINK RLC DATA BLOCK	
5	SS -> MS	DOWNLINK RLC DATA BLOCK	The data block contains FBI=0 and a valid RRBP.
6	MS -> SS	PACKET DOWNLINK ACK/NACK	Received on the specified RRBP of downlink PACCH.
7			Lower signal strength of Cell A to -80 dBm.
8	SS -> MS	DOWNLINK RLC DATA BLOCK	
9	SS -> MS	DOWNLINK RLC DATA BLOCK	
10	SS -> MS	DOWNLINK RLC DATA BLOCK	
11	SS -> MS	DOWNLINK RLC DATA BLOCK	The data block contains FBI=0 and a valid RRBP.
12	MS -> SS	PACKET DOWNLINK ACK/NACK Or PACKET CELL CHANGE NOTIFICATION	
13			Steps 8 to 12 are repeated until a PACKET CELL CHANGE NOTIFICATION is received in step 12, but no longer than 15 sec. The test has failed if no PACKET CELL CHANGE NOTIFICATION is received in Cell A within 15 sec from Step 7.
14	SS -> MS	DOWNLINK RLC DATA BLOCK	The data block contains FBI=1 and a valid RRBP.
15	MS -> SS	PACKET DOWNLINK ACK/NACK	Received on the specified RRBP of downlink PACCH and contains FINAL_ACK_INDICATION = 1.
			The following messages are to be sent and received in Cell B.
16		{Uplink dynamic allocation one phase access}	USF_GRANULARITY = 1 block, RLC_DATA_BLOCKS_GRANTED = open-end TLLI_BLOCK_CHANNEL_CODING: same as channel coding CHANNEL_CODING_COMMAND: cs-1 No starting time present.
17		{Completion of uplink RLC data block transfer}	MS performs a Cell Update.

Specific message contents

None.

42.4.5.7 Network Assisted Cell Change / CCN not supported towards target cell

42.4.5.7.1 Conformance requirements

The SI2quater message may also contain information, the CCN Support description, to be used when CCN is enabled in the serving cell, see 3GPP TS 44.060. This CCN Support description is associated with the Neighbour Cell list (see 3.4.1.2.1.3) having the same BA_IND value and 3G_BA_IND value. Each CCN_SUPPORTED bit of this field relates to indices of the Neighbour Cell list, starting with index 0. The CCN Support description may be received before the corresponding Neighbour Cell list.

Indices exceeding the value 95 or the number of cells in the Neighbour Cell List shall be ignored. If there are fewer indices than the number of cells in the Neighbour Cell List, the value 0 shall be assumed for the missing bits.

When this information is not present but CCN is enabled in the serving cell, the mobile station shall assume that CCN is enabled towards all neighbour cells.

References

3GPP TS 44.018, subclause 3.4.1.2.1.8

42.4.5.7.2 Test purpose

To verify that the MS does not apply CCN on a target cell when the CCN support description not is set for that cell.

42.4.5.7.3 Method of test

Initial conditions

System Simulator:

2 cells, GPRS supported, PCCCH not present.

Cell A: CCN Active. SI3 indicates SI2quater broad cast on BCCH norm. SI2quater contains a CCN Support Description indicating that CCN not is supported towards Cell B. RLA_C = -50 dBm

Cell B: CCN Active. RLA_C = -60 dBm

Mobile Station:

MS is in Packet Idle mode, GPRS attached with support of GERAN Feature Package 1 indicated in MS Radio Access Capabilities, and PDP context 2 established.

Specific PICS Statements

-

PIXIT Statements

-

Test procedure

The MS is given time to read all SI including SI2quater in idle mode.

The MS is triggered to initiate packet uplink transfer. SS assigns resources to the MS and it starts to send uplink data that the SS acknowledge. During the uplink the signal strength of Cell A is lowered to – 80 dBm. The MS enters CCN mode but does not send any PACKET CELL CHANGE NOTIFICATION. The MS continues to send uplink data. After w while, the MS selects cell B. The MS requests resources for an uplink in cell B and completes the uplink transfer.

Maximum duration of the test

-

Expected sequence

Step	Direction	Message	Comments
1		{Uplink dynamic allocation one phase access or two phase access}	n = 5000 octets. USF_GRANULARITY = 1 block, RLC_DATA_BLOCKS_GRANTED = open-end TLLI_BLOCK_CHANNEL_CODING: same as channel coding CHANNEL_CODING_COMMAND: cs-1 No starting time present. USF assigned to the MS.
2	SS->MS	PACKET DOWNLINK DUMMY CONTROL BLOCK	
3	MS -> SS	RLC DATA BLOCK	
4	SS -> MS	PACKET UPLINK ACK/NACK	
5	SS		Lower signal strength of Cell A to -80 dBm.
6	SS->MS	PACKET DOWNLINK DUMMY CONTROL BLOCK	USF assigned to the MS.
7	MS -> SS	RLC DATA BLOCK	
8	SS -> MS	PACKET UPLINK ACK/NACK	
9			USF assigned to the MS . Step 7 and 8 are repeated until the MS access Cell B, but no longer than 18 sec. The test has failed if the MS sends data after 18 sec from Step 5. The test has failed if a PACKET CELL CHANGE NOTIFICATION is received in Cell A or if the MS has not accessed Cell B within 20 sec from Step 5.
			The following messages are to be sent and received in Cell B.
10		{Uplink dynamic allocation one phase access or two phase access}	USF_GRANULARITY = 1 block, RLC_DATA_BLOCKS_GRANTED = open-end TLLI_BLOCK_CHANNEL_CODING: same as channel coding CHANNEL_CODING_COMMAND: cs-1 No starting time present. USF assigned to the MS
11	SS -> MS	PACKET DOWNLINK DUMMY CONTROL BLOCK	
12	MS -> SS	RLC DATA BLOCK Or PACKET RESOURCE REQUEST	
			Step 13 is performed only if a PACKET RESOURCE REQUEST is received in Step 12.
13	SS -> MS	PACKET UPLINK ASSIGNMENT	Repeats the PDTCH assignment given in Step 10. Send PACKET DOWNLINK DUMMY CONTROL BLOCK with USF assigned to the MS and continue with step 12.
14	SS -> MS	PACKET UPLINK ACK/NACK	USF assigned to the MS
15			If the RLC DATA BLOCK with BSN = 0 received in Step 12 contains an empty LLC PDU as the first LLC PDU, Steps 12 to 14 are repeated until a PACKET RESOURCE REQUEST is received in Step 12. NOTE: The empty LLC PDU may be accompanied by another low priority RLC data block (with Packet Resource Request and Packet Uplink Assignment or Packet Timeslot Reconfigure as required), in order to ensure that the radio resources are used efficiently.
16		Completion of {Uplink dynamic allocation}	

Specific message contents

SYSTEM INFORMATION TYPE 2QUATER with a CCN support description based on the BA list in SI2

Information Element	Value/remark
< RR management Protocol Discriminator bit (4) >	'0110'B
< Skip Indicator : bit (4) >	'0000'B
< Message type : bit (8) >	'0000 0111'B
< SI2 quarter Rest Octets >	
< BA_IND : bit >	Same BA_IND as for SI2
< 3G_BA_IND : bit >	0
< MP_CHANGE_MARK : bit >	0
< SI2quarter_INDEX : bit (4) >	'0000'B
< SI2quarter_COUNT : bit (4) >	'0000'B
0 1 < Measurement_Parameters Description >	0
0 1 < GPRS_Real Time Difference Description >	0
0 1 < GPRS_BSIC Description >	0
0 1 < GPRS_REPORT PRIORITY Description >	0
0 1 < GPRS_Measurement_Parameters Description >	0
0 1 < NC Measurement Parameters >	0
0 1 < extension length : bit (8) >	1 '0000 1111'B (extension length 15)
< SI2q Extension Information >	
0 1 < CCN Support Description >	1
< Number_Cells : bit (7) >	'000 1000'B (8 neighbours)
{ CCN_SUPPORTED : bit } * (val(Number_Cells)) ;	'1000 0000'B Bitmap will all index but the index corresponding to Cell 2 set to 1 (indicating CCN not supported)
0 1 < 3G Neighbour Cell Description >	0
0 1 < 3G Measurement_Parameters Description >	0
0 1 < GPRS_3G_MEASUREMENT Parameters Description >	0

42.4.5.8 Network Assisted Cell Change / NC mode change

42.4.5.8.1 Conformance requirements

[3GPP TS 44.060, 8.8.3 & 4)]

The network orders the mobile station into NC2 mode.

A mobile station may in response to a PACKET CELL CHANGE NOTIFICATION message sent to the network receive a PACKET MEASUREMENT ORDER message indicating NC2 mode. When the mobile station receives the NC2 order it shall leave CCN mode, stop timer T3208, stop timer T3210 if still running, and go into NC2 mode.

References

3GPP TS 44.060, subclause 8.8.3

42.4.5.8.2 Test purpose

To verify that the MS leaves the CCN mode and enters NC2 mode on receipt of Packet Measurement Order and the NC2 parameters.

42.4.5.8.3 Method of test

Initial conditions

System Simulator:

2 cells, GPRS supported, CCN Active, PCCCH present, GPRS_RXLEV_ACCESS_MIN = -90dBm.

GPRS ready timer T3314 = infinity

Cell A: RLA_C = -50 dBm

Cell B: RLA_C = -60 dBm

Mobile Station:

MS is in Packet Idle mode, GPRS attached with support of GERAN Feature Package 1 indicated in MS Radio Access Capabilities, and PDP context 2 established.

Specific PICS Statements

-

PIXIT Statements

-

Test procedure

SS establishes a downlink TBF and sends 4 RLC data blocks, the last one containing FBI = 0 and a valid RRBP. The MS sends a PACKET DOWNLINK ACK/NACK. The signal strength of Cell A is lowered to - 80 dBm. The downlink continues until MS sends PACKET CELL CHANGE NOTIFICATION. SS sends PACKET MEASUREMENT ORDER setting NC2 and then sends RLC data blocks, regularly polling the MS with a valid RRBP, and verifies that the MS has entered NC2 mode: the MS leaves CCN mode, starts reporting measurements and does not perform any cell reselection on its own as required in NC2.

Expected sequence

Step	Direction	Message	Comments
1		{Downlink TBF establishment}	RLC mode: acknowledged, without starting time.
2	SS -> MS	DOWNLINK RLC DATA BLOCK	The data block contains FBI=0 and a valid RRBP.
3	SS -> MS	DOWNLINK RLC DATA BLOCK	
4	SS -> MS	DOWNLINK RLC DATA BLOCK	
5	SS -> MS	DOWNLINK RLC DATA BLOCK	
6	MS -> SS	PACKET DOWNLINK ACK/NACK	
7			Lower signal strength of Cell A to -80 dBm.
8	SS -> MS	DOWNLINK RLC DATA BLOCK	The data block contains FBI=0 and a valid RRBP.
9	SS -> MS	DOWNLINK RLC DATA BLOCK	
10	SS -> MS	DOWNLINK RLC DATA BLOCK	
11	SS -> MS	DOWNLINK RLC DATA BLOCK	
12	MS -> SS	PACKET DOWNLINK ACK/NACK Or PACKET CELL CHANGE NOTIFICATION	
13			Step 8 to 12 are repeated until a PACKET CELL CHANGE NOTIFICATION is received in step 12, but no longer than 10 sec. The test has failed if no PACKET CELL CHANGE NOTIFICATION is received in Cell A within 10 sec from Step 7.
14	SS->MS	PACKET MEASUREMENT ORDER	-Sent on PACCH. -Contains NETWORK_CONTROL_ORDER and NC_REPORTING_PERIOD_T See specific message contents
15	SS -> MS	10 RLC data blocks	SS sends data, last block is polling.
16	MS -> SS	PACKET DOWNLINK ACK/NACK Or PACKET MEASUREMENT REPORT	Sent on PACCH. PACKET MEASUREMENT REPORT Contains the "NC measurement report struct" on PACCH
17			Repeat steps 15 to 16 until two PMRs are received.
18	SS -> MS	10 RLC data blocks	SS sends data, last block is polling.
19	MS -> SS	PACKET DOWNLINK ACK/NACK Or PACKET MEASUREMENT REPORT	Sent on PACCH. PACKET MEASUREMENT REPORT Contains the "NC measurement report struct" on PACCH
20			Repeat steps 18 to 19 during 10s.
21	SS -> MS	DOWNLINK RLC DATA BLOCK	FBI bit set to '1' and valid RRBP field
22	MS -> SS	PACKET DOWNLINK ACK/NACK	In the uplink block specified by the RRBP field. Final Ack Indicator bit set to '1'

Specific message contents

PACKET MEASUREMENT ORDER in step 14:

NC Measurement parameters NETWORK_CONTROL_ORDER NC_REPORTING_PERIOD_T	10 (NC2) 001 (0,96 s)
---	--------------------------

42.4.5.9 Network Assisted Cell Change / NC mode change / Packet Neighbour Cell Data

42.4.5.9.1 Conformance requirements

[3GPP TS 44.060, 8.8.3 & 4)]

The network orders the mobile station into NC2 mode.

A mobile station may in response to a PACKET CELL CHANGE NOTIFICATION message sent to the network receive a PACKET MEASUREMENT ORDER message indicating NC2 mode. When the mobile station receives the NC2 order it shall leave CCN mode, stop timer T3208, stop timer T3210 if still running, and go into NC2 mode.

When the NC2 mode has been ordered, the network may send PACKET NEIGHBOUR CELL DATA messages on the PACCH before sending the PACKET CELL CHANGE ORDER to the mobile station.

42.4.5.9.2 References

3GPP TS 44.060, subclause 5.5.1.4.3 and 8.8.3

42.4.5.9.3 Test purpose

1. To verify that MS leaves CCN mode when it receives a PACKET MEASUREMENT ORDER activating NC2 and follows the NC2 procedures.
2. To verify that MS uses the System Information received in PACKET NEIGHBOUR CELL DATA when accessing the new cell.
3. To verify that MS requests remaining System Information messages when having accessed the new cell by sending PACKET SI STATUS.

42.4.5.9.4 Method of test

42.4.5.9.4.1 Initial conditions

System Simulator:

3 cells, GPRS supported, CCN Active in SI13, PCCCH not present.

GPRS ready timer T3314 = infinity

Cell A: The indication of Cell C is removed in SI2. RLA_C = -50 dBm

Cell B: Supports PACKET SI STATUS. No System Information is broadcast on the BCCH, except SI3. This is only made to make it possible to verify that the MS uses the information in Packet Neighbour Cell Data. RLA_C = -60 dBm. PSI13 shall be transmitted during transfer mode on cell B to prevent any TBF suspension.

Cell C: The cell is not active at the start of the test.

Mobile Station:

MS is in Packet Idle mode, GPRS attached with support of GERAN Feature Package 1 indicated in MS Radio Access Capabilities, and PDP context 2 established.

Specific PICS Statements

-

PIXIT Statements

-

42.4.5.9.4.2 Void

42.4.5.9.4.3 Test procedure

The MS is triggered to initiate packet uplink transfer. SS assigns resources to the MS and the MS starts to send uplink data that the SS acknowledges. During the uplink transfer, the signal strength of cell A is lowered to – 80 dBm. The MS enters CCN mode and sends PACKET CELL CHANGE NOTIFICATION. The MS then continues to send uplink data.

SS sends a Packet Measurement Order providing the MS with NC2 parameters. MS starts sending Packet Measurement Reports. SS then sends a complete set of PACKET NEIGHBOUR CELL DATA with SI1, SI3 and SI13 of Cell B to the MS. SS then sends a PACKET CELL CHANGE ORDER that orders the MS to change to Cell B.

The MS requests resources for an uplink transfer in Cell B and continues the uplink transfer. The MS then requests the remaining SI messages by sending PACKET SI STATUS (Note: During the acquisition of BCCH information the MS may send up to three extra PACKET SI STATUS messages). SS verifies that the MS indicates that it has received the SI sent in PACKET NEIGHBOUR CELL DATA. SS sends the missing SI to the MS in PACKET SERVING CELL DATA messages during the uplink transfer.

To ensure that the MS has received the requested SI, Cell A is deactivated and Cell C is activated with signal strength set to – 60 dBm. The signal strength of cell B is lowered to – 80 dBm. The MS enters CCN mode and sends PACKET CELL CHANGE NOTIFICATION. The SS then sends PACKET CELL CHANGE ORDER and the MS changes to Cell C. The MS requests resources for an uplink transfer in the new cell and re-establishes and completes the uplink transfer in the new cell.

Expected sequence

Step	Direction	Message	Comments
1		{uplink dynamic allocation one phase access} or {uplink dynamic allocation two phase access}	n = 10000 octets. USF_GRANULARITY = 1 block, RLC_DATA_BLOCKS_GRANTED = open-end TLLI_BLOCK_CHANNEL_CODING: same as channel coding CHANNEL_CODING_COMMAND: cs-1 No starting time present.
2	SS -> MS	PACKET DOWNLINK DUMMY CONTROL BLOCK	USF assigned to the MS.
3	MS -> SS	RLC DATA BLOCK	
4	SS -> MS	PACKET UPLINK ACK/NACK	
5	SS		Lower signal strength of Cell A to -80 dBm.
6	SS -> MS	PACKET DOWNLINK DUMMY CONTROL BLOCK	USF assigned to the MS.
7	MS -> SS	RLC DATA BLOCK Or PACKET CELL CHANGE NOTIFICATION	
8	SS -> MS	PACKET UPLINK ACK/NACK	USF assigned to the MS.
9			Steps 7 and 8 are repeated until a PACKET CELL CHANGE NOTIFICATION is received in step 7, but no longer than 15 sec. The test has failed if no PACKET CELL CHANGE NOTIFICATION is received in Cell A within 15 sec from Step 5.
10	SS->MS	PACKET MEASUREMENT ORDER	-Sent on PACCH. -Contains NETWORK_CONTROL_ORDER and NC_REPORTING_PERIOD_T See specific message contents
11	SS -> MS	PACKET DOWNLINK DUMMY CONTROL BLOCK	USF assigned to the MS.
12	MS -> SS	RLC data block OR PACKET MEASUREMENT REPORT	MS sends data Or PACKET MEASUREMENT REPORT - Sent on PACCH. - Contains the "NC measurement report struct" on PACCH
13			Repeat steps 11 to 12 during T3158+2s
14	SS -> MS	PACKET DOWNLINK DUMMY CONTROL BLOCK	USF assigned to the MS.
15	MS -> SS	RLC data block or PACKET MEASUREMENT REPORT	MS sends data or a PACKET MEASUREMENT REPORT
16	SS -> MS	PACKET NEIGHBOUR CELL DATA	See specific message contents
17			Step 14 to 16 are repeated until all instances of PACKET NEIGHBOUR CELL DATA are sent.
18	SS -> MS	PACKET CELL CHANGE ORDER	See specific message contents
			The following messages are to be sent and received in Cell B.
19		{uplink dynamic allocation one phase access} or {uplink dynamic allocation twophase access}	USF_GRANULARITY = 1 block, RLC_DATA_BLOCKS_GRANTED = open-end TLLI_BLOCK_CHANNEL_CODING: same as channel coding CHANNEL_CODING_COMMAND: cs-1 No starting time present.
20	SS -> MS	PACKET DOWNLINK DUMMY CONTROL BLOCK	USF assigned to the MS.

21	MS -> SS	RLC DATA BLOCK Or PACKET SI STATUS Or PACKET RESOURCE REQUEST	<p>Step 22 is performed only if a PACKET RESOURCE REQUEST is received in Step 21.</p> <p>Repeats the PDTCH assignment given in Step 19.</p> <p>Send PACKET DOWNLINK DUMMY CONTROL BLOCK with USF assigned to the MS and continue with step 21.</p> <p>USF assigned to the MS</p> <p>Steps 21 to 23 are repeated until both a PACKET SI STATUS and an RLC Data Block are received in step 21.</p> <p>The Packet SI Status shall be sent within 10 sec of accessing the cell. Verify that the MS not requests SI that was sent in step 16.</p> <p>Note: During the acquisition of BCCH information the MS may send up to three extra PACKET SI STATUS messages.</p> <p>If the RLC DATA BLOCK with BSN = 0 received in Step 21 contains an empty LLC PDU as the first LLC PDU, Steps 21 to 23 are further repeated until a PACKET RESOURCE REQUEST is received in Step 21.</p> <p>NOTE: The empty LLC PDU may be accompanied by another low priority RLC data block (with Packet Resource Request and Packet Uplink Assignment or Packet Timeslot Reconfigure as required), in order to ensure that the radio resources are used efficiently.</p> <p>See specific message contents</p> <p>Step 25 is repeated until all instances of PACKET SERVING CELL DATA are sent.</p> <p>Cell A is deactivated and Cell C is activated and set to -60 dBm.</p> <p>Lower signal strength of Cell B to -80 dBm.</p> <p>USF assigned to the MS.</p> <p>USF assigned to the MS.</p> <p>Steps 30 and 31 are repeated until a PACKET CELL CHANGE NOTIFICATION is received in step 30, but no longer than 15 sec.</p> <p>The test has failed if no PACKET CELL CHANGE NOTIFICATION is received in Cell B within 15 sec from Step 28.</p> <p>See specific message contents</p> <p>The following messages are to be sent and received in Cell C.</p>	
22	SS -> MS	PACKET UPLINK ASSIGNMENT		
23 24	SS -> MS	PACKET UPLINK ACK/NACK		
25 26	SS -> MS	PACKET SERVING CELL DATA		
27	SS			
28	SS			
29	SS -> MS	PACKET DOWNLINK DUMMY CONTROL BLOCK		
30	MS -> SS	RLC DATA BLOCK Or PACKET CELL CHANGE NOTIFICATION Or PACKET SI STATUS		
31 32	SS -> MS	PACKET UPLINK ACK/NACK		
33	SS -> MS	PACKET CELL CHANGE ORDER		

34		{uplink dynamic allocation one phase access} or {uplink dynamic allocation two phase access}	USF_GRANULARITY = 1 block, RLC_DATA_BLOCKS_GRANTED = open-end TLLI_BLOCK_CHANNEL_CODING: same as channel coding CHANNEL_CODING_COMMAND: cs-1 No starting time present. USF assigned to the MS
35	SS -> MS	PACKET DOWNLINK DUMMY CONTROL BLOCK	
36	MS -> SS	RLC DATA BLOCK Or PACKET RESOURCE REQUEST	
			Step 37 is performed only if a PACKET RESOURCE REQUEST is received in Step 36.
37	SS -> MS	PACKET UPLINK ASSIGNMENT	Repeats the PDTCH assignment given in Step 34. Send PACKET DOWNLINK DUMMY CONTROL BLOCK with USF assigned to the MS and continue with step 36..
38	SS -> MS	PACKET UPLINK ACK/NACK	USF assigned to the MS
39			If the RLC DATA BLOCK with BSN = 0 received in Step 36 contains an empty LLC PDU as the first LLC PDU, Steps 36 to 38 are repeated until a PACKET RESOURCE REQUEST is received in Step 36. NOTE: The empty LLC PDU may be accompanied by another low priority RLC data block (with Packet Resource Request and Packet Uplink Assignment or Packet Timeslot Reconfigure as required), in order to ensure that the radio resources are used efficiently.
40		Completion of {Uplink dynamic allocation}	

Specific message contents

PACKET MEASUREMENT ORDER in step 10:

NC Measurement parameters NETWORK_CONTROL_ORDER NC_REPORTING_PERIOD_T 0 1 < EXT Measurement Parameters > Null 0 1 Null 0 1 Null 0 1 < ENH Measurement parameters > { 0 < BA_IND : bit > < 3G_BA_IND : bit > 1 < PSI3_CHANGE_MARK : bit(2) > } < PMO_IND : bit > < REPORT_TYPE : bit > < REPORTING_RATE : bit > < INVALID_BSIC_REPORTING : bit > 0 1 < 3G Neighbour Cell Description > 0 1 < GPRS REP PRIORITY Description > 0 1 < GPRS MEASUREMENT Parameters Description > 0 1 < GPRS 3G MEASUREMENT Parameters Description > Null 0 1 < CCN_ACTIVE : bit (1) > 0 1 < CCN Support Description > < padding bits >	10 (NC2) 000 (0,48 s) 0 1 Additions in R98 0 LSA Parameters not included 1 Additions in R99 000 0 1 0 0 0 (not present) 0 (not present) 0 (not present) 0 (not present) 1 Additions in Rel-4 1 0
---	---

PACKET NEIGHBOUR CELL DATA in Step 16:

The message contains the default SI1, SI3 and SI13 for Cell B.

Information element	Value/remark
< PAGE_MODE : bit (2) >	00 (Normal Paging)
< GLOBAL_TFI : Global TFI IE >	0 <5 bit Uplink TFI>
< CONTAINER_ID : bit (2) >	01 for SI belonging to Cell B
< SPARE :bit(1)>	0
< CONTAINER INDEX :bit (5)>	00000 to the index needed to send all SI messages
0 1	0 No ARFCN or BSIC
Container repetition struct	
< PD : bit(3)>	000, BCCH (LAPDm)

PACKET CELL CHANGE ORDER in Step 18

Information element	Value/remark
< PAGE_MODE : bit (2) >	00 (Normal Paging)
0 10	0
< GLOBAL_TFI : Global TFI IE >	<5 bit Uplink TFI>
0 1	0
< IMMEDIATE_REL >	1 (Immediate abort of operation in the old cell is required)
< ARFCN >	ARFCN of Cell B
< BSIC >	BSIC of Cell B
< NETWORK_CONTROL_ORDER : bit(2) >	00 (NC0)
0 1	0
0 1 < NC_FREQUENCY_LIST >	0
Null 0 1	1 Additions in R98
Null 0 1	0 LSA Parameters not included
Null 0 1	1 Additions in R99
< ENH Measurement parameters >	
{ 0 < BA_IND : bit > < 3G_BA_IND : bit > 1	000
< PSI3_CHANGE_MARK : bit(2) > }	
< PMO_IND : bit >	0
< REPORT_TYPE : bit >	1
< REPORTING_RATE : bit >	0
< INVALID_BSIC_REPORTING : bit >	0
0 1 < 3G Neighbour Cell Description >	0 (not present)
0 1 < GPRS REP PRIORITY Description >	0 (not present)
0 1 < GPRS MEASUREMENT Parameters Description >	0 (not present)
0 1 < GPRS 3G MEASUREMENT Parameters Description >	0 (not present)
Null 0 1	1 Additions in Rel-4
< CCN_ACTIVE : bit (1) >	1
0 1 < CONTAINER_ID : bit (2) >	1
CONTAINER_ID : bit (2)	01(The same as Packet Neighbour Cell Data in step 16)
0 1 < CCN Support Description >	0
< padding bits >	

PACKET SERVING CELL DATA in Step 25

The message contains the default SI2, SI2bis (when indicated in SI2) and SI4 for Cell B.

Information element	Value/remark
< MESSAGE_TYPE : bit (6) >	001101
< PAGE_MODE : bit (2) >	00 (Normal Paging)
0 < GLOBAL_TFI : Global TFI IE >	0 <5 bit Uplink TFI>
< spare : bit (4) >	0000
< CONTAINER INDEX :bit (5)>	00000 to the index needed to send all SI messages
Container repetition struct	
< PD : bit(3)>	000, BCCH (LAPDm)

Note: the System Information provides with the Cell C description.

PACKET CELL CHANGE ORDER in Step 33

Information element	Value/remark
< PAGE_MODE : bit (2) >	00 (Normal Paging)
0 10	0
< GLOBAL_TFI : Global TFI IE >	<5 bit Uplink TFI>
0 1	0
< IMMEDIATE_REL >	1 (Immediate abort of operation in the old cell is required)
< ARFCN >	ARFCN of Cell C
< BSIC >	BSIC of Cell C
< NETWORK_CONTROL_ORDER : bit(2) >	00 (NC0)
0 1	0
0 1 < NC_FREQUENCY_LIST >	0
Null 0 1	1 Additions in R98
Null 0 1	0 LSA Parameters not included
Null 0 1	1 Additions in R99
< ENH Measurement parameters >	
{ 0 < BA_IND : bit > < 3G_BA_IND : bit > 1	000
< PSI3_CHANGE_MARK : bit(2) > }	
< PMO_IND : bit >	0
< REPORT_TYPE : bit >	1
< REPORTING_RATE : bit >	0
< INVALID_BSIC_REPORTING : bit >	0
0 1 < 3G Neighbour Cell Description >	0 (not present)
0 1 < GPRS REP PRIORITY Description >	0 (not present)
0 1 < GPRS MEASUREMENT Parameters Description >	0 (not present)
0 1 < GPRS 3G MEASUREMENT Parameters Description >	0 (not present)
Null 0 1	1 Additions in Rel-4
< CCN_ACTIVE : bit (1) >	1
0 1 < CONTAINER_ID : bit (2) >	0
0 1 < CCN Support Description >	0
< padding bits >	

42.4.6 Packet Enhanced Measurement Report (PEMR)

42.4.6.1 Network Control PEMR – Activation with SI Messages

42.4.6.1.1 Conformance requirement

- 1 The behavior of the mobile station is controlled by the parameter NETWORK_CONTROL_ORDER broadcast in the PSI5 message on PBCCH, in the SI13 and SI2quater messages on the BCCH and in the PSI13 message on PACCH.

When in mode NC1 or NC2, the mobile station shall perform the NC measurements as defined in 3GPP TS 05.08. The reporting periods are indicated in the NC_REPORTING_PERIOD_I and NC_REPORTING_PERIOD_T field of the PSI5, the SI2quater, the PACKET CELL CHANGE ORDER or the PACKET MEASUREMENT ORDER message

On expiry of timer T3158, the mobile station shall restart timer T3158 with the indicated reporting period, perform the measurements and send either the PACKET MEASUREMENT REPORT message or the PACKET ENHANCED MEASUREMENT REPORT to the network. The condition for sending the PACKET ENHANCED MEASUREMENT REPORT message instead of the PACKET MEASUREMENT REPORT message is based on the REPORT_TYPE parameter and if the MS has received BSIC information for all cells.

- 2 In packet idle mode, the reporting period is NC_REPORTING_PERIOD_I rounded off to the nearest smaller integer multiple of DRX period if NC_REPORTING_PERIOD_I is greater than DRX period, else, the reporting period is DRX period

Reference:

3GPP TS 04.60 / 3GPP TS 44.060 subclause 5.6.1

3GPP TS 05.08 / 3GPP TS 45.008 subclause 10.1.4.1

42.4.6.1.2 Test purpose

To verify that the MS sends PEMR following the report type and according to the indicated reporting periods covering GSM neighbour list specified in SI2quater.

42.4.6.1.3 Method of test

Initial conditions

Transmitter	RF Signal Level (dBm)	NCC	BCC	Cell Identity
Serving, S1	-60	1	3	0001H
Neighbour, N1	-70	1	5	0002H

The ARFCN of the serving and neighbouring cell is selected from the default defined in section 40.

System simulator:

2 GPRS cells configured as GPRS cells with SI2 quater giving all adjacent cell configuration and GPRS PEMR parameters. SI13 and SI2quater indicate that Network Control Order is NC2. BCCH allocation sequence number(BA_IND) = 1

Mobile Station:

MS is Idle Updated

Specific PICS Statements

-

PIXIT Statements

-

Foreseen final state of the MS

- MS is idle updated

Test procedure

MS is powered on and Attach procedure is completed. The negotiated Ready Timer value in ATTACH ACCEPT indicates the ready timer function is active for 60 seconds. When the measurement reporting time becomes valid, the MS sends a CHANNEL REQUEST message indicating 'Single block packet access' on RACH. The network shall then respond with an IMMEDIATE ASSIGNMENT message granting a 'single block access' on a PDCH. The mobile station shall then send the PACKET ENHANCED MEASUREMENT REPORT message in the allocated radio block on the assigned PDCH as indicated in the Measurement Parameters struct.

Maximum duration of the test

3 minutes

Expected Sequence

Step	Direction	Message	Comments
1		{Attach procedure}	-MS is GPRS attached with PTMSI allocated
2	MS->SS	CHANNEL REQUEST	-Ready timer is set to 60 seconds
3	SS -> MS	IMMEDIATE ASSIGNMENT	-Sent on RACH.
4	MS -> SS	PACKET ENHANCED MEASUREMENT REPORT	-Cause 'Single block packet access'
5			Sent on the allocated PDCH
			Repeat steps 2, 3 and 4 until expiry of the Ready timer.
			The SS verifies that the interval between two subsequent PEMR messages corresponds to the reporting period +/- 10%.
			The reporting period is calculated from NC_REPORTING_PERIOD_I rounded off to the nearest smaller integer multiple of DRX period if NC_REPORTING_PERIOD_I is greater than DRX period, else, the reporting period is DRX period.
6	SS		Verify that the mobile stops sending PEMR after Ready timer expiry.

Specific Message Contents

System Information 3 Rest Octets

SI2quarter_POSITION	0 (message is sent on BCCH Norm)
---------------------	----------------------------------

of the PSI5, the SI2quarter, the PACKET CELL CHANGE ORDER or the PACKET MEASUREMENT ORDER message

On expiry of timer T3158, the mobile station shall restart timer T3158 with the indicated reporting period, perform the measurements and send either the PACKET MEASUREMENT REPORT message or the PACKET ENHANCED MEASUREMENT REPORT to the network. The condition for sending the PACKET ENHANCED MEASUREMENT REPORT message instead of the PACKET MEASUREMENT REPORT message is based on the REPORT_TYPE parameter and if the MS has received BSIC information for all cells.

- 2 In packet idle mode, the reporting period is NC_REPORTING_PERIOD_I rounded off to the nearest smaller integer multiple of DRX period if NC_REPORTING_PERIOD_I is greater than DRX period, else, the reporting period is DRX period

Reference:

3GPP TS 04.60 / 3GPP TS 44.060 subclause 5.6.1

3GPP TS 05.08 / 3GPP TS 45.008 subclause 10.1.4.1

42.4.6.2.2 Test purpose

To verify that the MS sends PEMR following the report type and according to the indicated reporting periods specified in PSI5.

42.4.6.2.3 Method of test

Initial conditions

Transmitter	RF Signal Level (dBm)	NCC	BCC	Cell Identity
Serving, S1	-60	1	3	0001H
Neighbour, N1	-70	1	5	0002H

The ARFCN of the serving and neighbouring cell is selected from the default defined in section 40.

System simulator:

2 GPRS cells configured as GPRS cells with PSI3 giving adjacent cell configuration and PSI5 specifies GPRS PEMR parameters. Network Control Order is NC2.

Mobile Station:

MS is Idle Updated

Specific PICS Statements

-

PIXIT Statements

-

Foreseen final state of the MS

- MS is idle updated

Test procedure

MS is powered on and Attach procedure is completed. The negotiated Ready Timer value in ATTACH ACCEPT indicates the ready timer function is active for 60 seconds. When the measurement reporting time becomes valid, the MS sends a PACKET CHANNEL REQUEST message indicating 'Single block without TBF establishment' on PRACH. The network shall then respond with either a PACKET UPLINK ASSIGNMENT message granting a 'Single block without TBF establishment' on a PDCH. The mobile station shall then send the PACKET ENHANCED MEASUREMENT REPORT message in the allocated radio block on the assigned PDCH as indicated in the Measurement Information struct.

Maximum duration of the test

3 minutes

Expected Sequence

Step	Direction	Message	Comments
1		{Attach procedure}	-MS is GPRS attached with PTMSI allocated
2	MS->SS	PACKET CHANNEL REQUEST	-Ready timer is set to 60 seconds
3	SS -> MS	PACKET UPLINK ASSIGNMENT	-Cause 'Single block without TBF establishment'
4	MS -> SS	PACKET ENHANCED MEASUREMENT REPORT	Sent on the allocated PDCH
5			Repeat steps 2, 3 and 4 until expiry of the Ready timer. The SS verifies that the interval between two subsequent PEMR messages corresponds to the reporting period +/- 10%. The reporting period is calculated from NC_REPORTING_PERIOD_I rounded off to the nearest smaller integer multiple of DRX period if NC_REPORTING_PERIOD_I is greater than DRX period, else, the reporting period is DRX period.
6	SS		Verify that the mobile stops sending PEMR after Ready timer expiry.

Specific Message Contents

PACKET SYSTEM INFORMATION TYPE 5

NC Measurement parameter struct	
Network Control Order	10 (NC2)
NC_NON_DRX_PERIOD	111
NC_REPORTING_PERIOD_I	101(15.36secs)
NC_REPORTING_PERIOD_T	101(15.36secs)
ENH Reporting parameter struct	
Report Type	Enhanced measurement report
Reporting Rate	0
INVALID BSIC REPORTING	No
GPRS measurement parameter struct	
Multiband reporting	00
Serving band reporting	1
SCALE_ORD	0
900_REPORTING_OFFSET	0

42.4.6.3 Network Control PEMR – Packet Measurement Order

42.4.6.3.1 Conformance requirement

- 1 The behavior of the mobile station is controlled by the parameter NETWORK_CONTROL_ORDER broadcast in the PSI5 message on PBCCH, in the SI13 and SI2quater messages on the BCCH and in the PSI13 message on PACCH.

When in mode NC1 or NC2, the mobile station shall perform the NC measurements as defined in 3GPP TS 05.08. The reporting periods are indicated in the NC_REPORTING_PERIOD_I and NC_REPORTING_PERIOD_T field of the PSI5, the SI2quater, the PACKET CELL CHANGE ORDER or the PACKET MEASUREMENT ORDER message

On expiry of timer T3158, the mobile station shall restart timer T3158 with the indicated reporting period, perform the measurements and send either the PACKET MEASUREMENT REPORT message or the PACKET ENHANCED MEASUREMENT REPORT to the network. The condition for sending the PACKET ENHANCED MEASUREMENT REPORT message instead of the

PACKET MEASUREMENT REPORT message is based on the REPORT_TYPE parameter and if the MS has received BSIC information for all cells.

- 2 In packet idle mode, the reporting period is NC_REPORTING_PERIOD_I rounded off to the nearest smaller integer multiple of DRX period if NC_REPORTING_PERIOD_I is greater than DRX period, else, the reporting period is DRX period

Reference:

3GPP TS 04.60 / 3GPP TS 44.060 subclause 5.6.1

3GPP TS 05.08 / 3GPP TS 45.008 subclause 10.1.4.1

42.4.6.3.2 Test purpose

To verify that the MS sends PEMR following the report type and according to the indicated reporting period specified in Packet Measurement Order.

42.4.6.3.3 Method of test

Initial conditions

Transmitter	RF Signal Level (dBm)	NCC	BCC	Cell Identity
Serving, S1	-60	1	3	0001H
Neighbour, N1	-70	1	5	0002H

The ARFCN of the serving and neighbouring cell is selected from the default defined in section 40.

System simulator:

2 GPRS cells configured as GPRS cells with PSI3 giving adjacent cell configuration.

Mobile Station:

MS is Idle Updated

Specific PICS Statements

-

PIXIT Statements

-

Foreseen final state of the MS

- MS is idle updated

Test procedure

MS is powered on and Attach procedure is completed. The negotiated Ready Timer value in ATTACH ACCEPT indicates the ready timer function is active for 32 seconds. A Packet Measurement Order is sent to the MS changing the scale order parameter as well as measurement reporting period. When the measurement reporting time becomes valid, the MS sends a PACKET CHANNEL REQUEST message indicating 'Single block without TBF establishment' on PRACH. The network shall then respond with either a PACKET UPLINK ASSIGNMENT message granting a 'Single block without TBF establishment' on a PDCH. The mobile station shall then send the PACKET ENHANCED MEASUREMENT REPORT message in the allocated radio block on the assigned PDCH as indicated in the Measurement Information struct.

Maximum duration of the test

3 minutes

Expected Sequence

Step	Direction	Message	Comments
1		{Attach procedure}	-MS is GPRS attached with PTMSI allocated
2	SS->MS	PACKET MEASUREMENT ORDER	-Ready timer is set to 32 seconds -Scale Order changed to 1
3	MS->SS	PACKET CHANNEL REQUEST	-Measurement Reporting time changed to 7.68 secs -Cause 'Single block without TBF establishment'
4	SS -> MS	PACKET UPLINK ASSIGNMENT	Sent on the allocated PDCH Scale = 1 Repeat steps 3, 4 and 5 until expiry of the Ready timer. The SS verifies that the interval between two subsequent PEMR messages corresponds to the reporting period +/- 10%. The reporting period is calculated from NC_REPORTING_PERIOD_I rounded off to the nearest smaller integer multiple of DRX period if NC_REPORTING_PERIOD_I is greater than DRX period, else, the reporting period is DRX period.
5	MS -> SS	PACKET ENHANCED MEASUREMENT REPORT	
6			
7	SS		Verify that the mobile stops sending PEMR after Ready timer expiry.

Specific Message Contents

PACKET SYSTEM INFORMATION TYPE 5

NC Measurement parameter struct	
Network Control Order	10 (NC2)
NC_NON_DRX_PERIOD	111
NC_REPORTING_PERIOD_I	101(15.36secs)
NC_REPORTING_PERIOD_T	101(15.36secs)
ENH Reporting parameter struct	
Report Type	0 Enhanced measurement report
Reporting Rate	0
INVALID BSIC REPORTING	No
GPRS measurement parameter struct	
Multiband reporting	00
Serving band reporting	1
SCALE_ORD	0
900_REPORTING_OFFSET	0

PACKET MEASUREMENT ORDER in step 2:

NC Measurement parameters	
NETWORK_CONTROL_ORDER	10 (NC2)
NC_REPORTING_PERIOD_I	100 (7.68s)
Enhanced Measurement Parameter Struct	
Report_Type	0 Enhanced measurement report
GPRS REP Priority Description	0 (default)
GPRS Measurement Parameter Description Struct	
Multiband reporting	00
Serving band reporting	1
SCALE_ORD	1
900_REPORTING_OFFSET	0
900_REPORTING_THRESHOLD	0

42.4.6.4 Network Control PEMR – Uplink Data Transfer

42.4.6.4.1 Conformance requirement

The behaviour of the mobile station is controlled by the parameter NETWORK_CONTROL_ORDER broadcast in the PSI5 message on PBCCH, in the SI13 and SI2quater messages on the BCCH and in the PSI13 message on PACCH. Alternatively, the network may send the NETWORK_CONTROL_ORDER parameters in a PACKET MEASUREMENT ORDER or in a PACKET CELL CHANGE ORDER message on PCCCH or PACCH to a particular mobile station .

When in mode NC1 or NC2, the mobile station shall perform the NC measurements as defined in 3GPP TS 05.08. The reporting periods are indicated in the NC_REPORTING_PERIOD_I and NC_REPORTING_PERIOD_T field of the PSI5, the SI2quater, the PACKET CELL CHANGE ORDER or the PACKET MEASUREMENT ORDER message

The procedure for NC measurement report sending shall be initiated by the mobile station at expiry of the NC measurement report interval timer T3158. At expiry of the timer T3158 the mobile station shall restart the timer T3158, perform the measurements and send either the PACKET MEASUREMENT REPORT message containing the 'NC measurement report struct' or the PACKET ENHANCED MEASUREMENT REPORT on PACCH.

42.4.6.4.2 Test Purpose

To verify that the MS sends PEMR during uplink packet transfer according to the indicated reporting type and reporting periods specified in PSI5.

To verify that the MS sends PEMR during uplink packet transfer according to the indicated reporting type and reporting period specified in Packet Measurement Order.

Reference

3GPP TS 04.60, subclauses 5.6.1, 8.3 and 8.5.

42.4.6.4.3 Method of test

Initial conditions

Transmitter	RF Signal Level (dBm)	NCC	BCC	Cell Identity
Serving, S1	-60	1	3	0001H
Neighbour, N1	-70	1	5	0002H

The ARFCN of the serving and neighbouring cell is selected from the default defined in section 40.

System simulator:

2 cells configured as GPRS cells with PSI3 giving adjacent cell configuration and PSI5 giving GPRS PEMR parameters. Network Control Order is NC2.

Mobile Station:

MS is in Packet Idle mode and GPRS attached.

PDP context 2 established.

Specific PICS Statements

-

PIXIT Statements

-

Foreseen final state of the MS

- MS is in transfer mode.

Test procedure

MS is brought into uplink packet transfer mode. MS sends data blocks until T3158 is expired and then sends PACKET ENHANCED MEASUREMENT REPORT. SS sends a PACKET MEASUREMENT ORDER message with new reporting parameters. MS sends continuously data blocks and PACKET ENHANCED MEASUREMENT REPORT messages according to the indicated reporting period in PACKET MEASUREMENT ORDER

The SS shall accept PACKET ENHANCED MEASUREMENT REPORT from the MS anytime during GPRS attach and PDP Context activation procedures.

Maximum duration of the test

-

Expected sequence

Step	Direction	Message	Comments
1		{Uplink dynamic allocation one phase access with contention resolution } or {Uplink dynamic allocation two phase access}	MS is brought into uplink packet transfer mode. Macro parameters: USF_GRANULARITY : 1 RLC_DATA_BLOCKS_GRANTED : absent (open-end) CHANNEL_CODING_COMMAND : CS-1 TLLI_BLOCK_CHANNEL_CODING : CS-1
2	SS->MS	PACKET DOWNLINK DUMMY CONTROL BLOCK	USF assigned to the MS
3	MS -> SS	RLC data block	MS sends data
4	SS -> MS	PACKET UPLINK ACK/NACK	Sent on PACCH, USF assigned to MS
5			Repeat steps 3 and 4 until PACKET ENHANCED MEASUREMENT REPORT is received.
6	MS->SS	PACKET ENHANCED MEASUREMENT REPORT	Sent on PACCH.
7	SS->MS	PACKET DOWNLINK DUMMY CONTROL BLOCK	USF assigned to the MS
8	MS -> SS	RLC data block	MS sends data
9	SS -> MS	PACKET UPLINK ACK/NACK	Sent on PACCH, USF assigned to MS
10			Repeat steps 8 and 9 until PACKET ENHANCED MEASUREMENT REPORT is received.
11	MS->SS	PACKET ENHANCED MEASUREMENT REPORT	- Sent on PACCH. SS verifies that the time interval between steps 6 and 11 corresponds to the reporting period T3158 (indicated in PSI5) +/- 10%.
12	SS->MS	PACKET DOWNLINK DUMMY CONTROL BLOCK	USF assigned to the MS
13	MS -> SS	RLC data block	MS sends data.
14	SS -> MS	PACKET UPLINK ACK/NACK	Sent on PACCH, USF not assigned to MS
15	SS -> MS	PACKET MEASUREMENT ORDER	- Sent on PACCH. -Contains NETWORK_CONTROL_ORDER and NC_REPORTING_PERIOD_T with new reporting period. See specific message contents
16	SS->MS	PACKET DOWNLINK DUMMY CONTROL BLOCK	USF assigned to the MS
17	MS -> SS	RLC data block	MS sends data.
18	SS -> MS	PACKET UPLINK ACK/NACK	Sent on PACCH, USF assigned to MS
19			Repeat steps 17 and 18 until PACKET ENHANCED MEASUREMENT REPORT is received.
20	MS->SS	PACKET ENHANCED MEASUREMENT REPORT	- Sent on PACCH.
21	SS->MS	PACKET DOWNLINK DUMMY CONTROL BLOCK	USF assigned to the MS
22	MS -> SS	RLC data block	MS sends data.
23	SS -> MS	PACKET UPLINK ACK/NACK	Sent on PACCH, USF assigned to MS
24			Repeat steps 22 and 23 until PACKET ENHANCED MEASUREMENT REPORT is received.
25	MS->SS	PACKET ENHANCED MEASUREMENT REPORT	- Sent on PACCH. SS verifies that the time interval between steps 20 and 25 corresponds to the new reporting period T3158 (indicated in PMO) +/- 10%.
26			Repeat steps 21 to 25 till completion of the uplink data transfer.

Specific message contents

PACKET SYSTEM INFORMATION TYPE 5

NC Measurement parameter struct	
Network Control Order	10 (NC2)
NC_NON_DRX_PERIOD	111
NC_REPORTING_PERIOD_I	100(7.68 s)
NC_REPORTING_PERIOD_T	011(3.84 s)
ENH Reporting parameter struct	
Report Type	0 Enhanced measurement report
Reporting Rate	0
INVALID BSIC REPORTING	No
GPRS measurement parameter struct	
Multiband reporting	00
Serving band reporting	1
SCALE_ORD	0
900_REPORTING_OFFSET	0

PACKET MEASUREMENT ORDER in step 15:

NC Measurement parameters	
NETWORK_CONTROL_ORDER	10 (NC2)
NC_REPORTING_PERIOD_T	001 (0.96 s)
Enhanced Measurement Parameter Struct	
Report_Type	0 Enhanced measurement report
GPRS REP Priority Description	0 (default)
GPRS Measurement Parameter Description Struct	
Multiband reporting	00
Serving band reporting	1
SCALE_ORD	1
900_REPORTING_OFFSET	0
900_REPORTING_THRESHOLD	0

42.4.6.5 Network Control PEMR – Downlink Data Transfer

42.4.6.5.1 Conformance requirement

The behaviour of the mobile station is controlled by the parameter NETWORK_CONTROL_ORDER broadcast in the PSI5 message on PBCCH, in the SI13 and SI2quater messages on the BCCH and in the PSI13 message on PACCH. Alternatively, the network may send the NETWORK_CONTROL_ORDER parameters in a PACKET MEASUREMENT ORDER or in a PACKET CELL CHANGE ORDER message on PCCCH or PACCH to a particular mobile station.

When in mode NC1 or NC2, the mobile station shall perform the NC measurements as defined in 3GPP TS 05.08. The reporting periods are indicated in the NC_REPORTING_PERIOD_I and NC_REPORTING_PERIOD_T field of the PSI5, the SI2quater, the PACKET CELL CHANGE ORDER or the PACKET MEASUREMENT ORDER message

The procedure for NC measurement report sending shall be initiated by the mobile station at expiry of the NC measurement report interval timer T3158. At expiry of the timer T3158 the mobile station shall restart the timer T3158, perform the measurements and send either the PACKET MEASUREMENT REPORT message containing the 'NC measurement report struct' or the PACKET ENHANCED MEASUREMENT REPORT on PACCH.

Following a downlink TBF establishment, the PACKET MEASUREMENT REPORT or PACKET ENHANCED MEASUREMENT REPORT message shall not be sent on the uplink PACCH associated with this TBF until two PACKET DOWNLINK ACK/NACK messages has been sent to the network.

Reference

3GPP TS 44.060, subclauses 5.6.1, 8.3 and 8.5.

42.4.6.5.2 Test Purpose

To verify that the MS sends PEMR during downlink packet transfer according to the indicated reporting type and reporting periods specified in PSI5.

To verify that the MS sends PEMR during downlink packet transfer according to the indicated reporting type and reporting period specified in Packet Measurement Order.

42.4.6.5.3 Method of test

Initial conditions

Transmitter	RF Signal Level (dBm)	NCC	BCC	Cell Identity
Serving, S1	-60	1	3	0001H
Neighbour, N1	-70	1	5	0002H

The ARFCN of the serving and neighbouring cell is selected from the default defined in section 40.

System simulator:

2 cells configured as GPRS cells with PSI3 giving adjacent cell configuration and PSI5 giving GPRS PEMR parameters. Network Control Order is NC2.

Mobile Station:

MS is in Packet Idle mode and GPRS attached, Ready timer deactivated.

PDP context 2 established.

Specific PICS Statements

-

PIXIT Statements

-

Foreseen final state of the MS

- MS is in transfer mode.

Test procedure

MS is brought into downlink packet transfer mode. SS sends data blocks and MS answers with PACKET DOWNLINK ACK/NACK. When reporting period has expired and at least two PACKET DOWNLINK ACK/NACK messages have been sent, MS sends a PACKET ENHANCED MEASUREMENT REPORT message. SS sends data blocks continuously and MS sends PACKET ENHANCED MEASUREMENT REPORT messages when reporting period has expired and at least one PACKET DOWNLINK ACK/NACK message has been sent after the last PACKET ENHANCED MEASUREMENT REPORT message.

The SS shall accept PACKET ENHANCED MEASUREMENT REPORT from the MS anytime during GPRS attach and PDP Context activation procedures.

Maximum duration of the test

-

Expected sequence

Step	Direction	Message	Comments
1	SS->MS	PACKET DOWNLINK ASSIGNMENT	Sent on the PCCCH.
2	SS		Wait for 0.5 seconds.
3	SS -> MS	10 RLC data blocks	SS sends data, last block is polling.
4	MS -> SS	PACKET DOWNLINK ACK/NACK	Sent on PACCH.
5	SS->MS	10 RLC data blocks	SS sends data, last block is polling.
6	MS -> SS	PACKET DOWNLINK ACK/NACK	Sent on PACCH.
7	SS->MS	10 RLC data blocks	SS sends data, last block is polling.
8	MS->SS	PACKET ENHANCED MEASUREMENT REPORT	- Sent on PACCH.
9	SS		Wait for 0.5 seconds.
10	SS -> MS	10 RLC data blocks	SS sends data, last block is polling.
11	MS -> SS	PACKET DOWNLINK ACK/NACK	Sent on PACCH.
12	SS -> MS	10 RLC data blocks	SS sends data, last block is polling.
13	MS->SS	PACKET ENHANCED MEASUREMENT REPORT	- Sent on PACCH.
14	SS -> MS	10 RLC data blocks	SS sends data, last block is polling.
15	MS -> SS	PACKET DOWNLINK ACK/NACK	Sent on PACCH.
16	SS->MS	PACKET MEASUREMENT ORDER	- Sent on PACCH. -Contains NETWORK_CONTROL_ORDER and NC_REPORTING_PERIOD_T with new reporting period. See specific message contents
17	SS		Wait for 1 sec
18	SS -> MS	10 RLC data blocks	SS sends data, last block is polling.
19	MS -> SS	PACKET ENHANCED MEASUREMENT REPORT	Sent on PACCH.
20	SS -> MS	10 RLC data blocks	SS sends data, last block is polling.
21	MS->SS	PACKET DOWNLINK ACK/NACK	- Sent on PACCH.
22	SS		Wait for 1sec.
23	SS -> MS	10 RLC data blocks	SS sends data, last block is polling.
24	MS->SS	PACKET ENHANCED MEASUREMENT REPORT	- Sent on PACCH.
25			Wait for 1 sec
26	SS -> MS	10 RLC data blocks	SS sends data, last block is polling.
27	MS -> SS	PACKET DOWNLINK ACK/NACK	Sent on PACCH.

Specific message contents

PACKET SYSTEM INFORMATION TYPE 5

NC Measurement parameter struct	
Network Control Order	10 (NC2)
NC_NON_DRX_PERIOD	111
NC_REPORTING_PERIOD_I	100(7.68 s)
NC_REPORTING_PERIOD_T	000(0.48 s)
ENH Reporting parameter struct	
Report Type	0 Enhanced measurement report
Reporting Rate	0
INVALID BSIC REPORTING	No
GPRS measurement parameter struct	
Multiband reporting	00
Serving band reporting	1
SCALE_ORD	0
900_REPORTING_OFFSET	0

PACKET MEASUREMENT ORDER in step 16:

NC Measurement parameters	
NETWORK_CONTROL_ORDER	10 (NC2)
NC_REPORTING_PERIOD_T	001 (0.96 s)
Enhanced Measurement Parameter Struct	
Report_Type	0 Enhanced measurement report
GPRS REP Priority Description	0 (default)
GPRS Measurement Parameter	
Description Struct	
Multiband reporting	00
Serving band reporting	1
SCALE_ORD	1
900_REPORTING_OFFSET	0
900_REPORTING_THRESHOLD	0

42.4.6.6 Network Control PEMR / Packet Cell Change Order

42.4.6.6.1 Conformance requirement

For (NC) measurement reporting, the Mobile Station shall use PACKET ENHANCED MEASUREMENT REPORT messages instead of PACKET MEASUREMENT REPORT messages if that is indicated by the parameter REPORT_TYPE and if at least one BSIC is allocated to each frequency in the BA(GPRS) list.

Reference:

3GPP TS 04.60 / 3GPP TS 44.060 5.6.1

42.4.6.6.2 Test purpose

To verify that the MS sends PEMR following the report type specified in Packet cell Change Order.

42.4.6.6.3 Method of test

Initial conditions

Transmitter	RF Signal Level (dBm)	NCC	BCC	Cell Identity
Serving, S1	-60	1	3	0001H
Neighbour, N1	-70	1	5	0002H

The ARFCN of the serving and neighbouring cell is selected from the default defined in section 40.

System simulator:

2 GPRS cells A and B, configured as GPRS cells with PSI3/3bis giving all adjacent cell configuration and GPRS PEMR parameters. In both cells, PSI5 indicates that Network Control Order is NC2 and that PMR shall be used.

Mobile Station:

MS is Idle Updated and GPRS attached. Ready timer set to 1min.

Specific PICS Statements

-

PIXIT Statements

-

Foreseen final state of the MS

- MS is idle updated

Test procedure

MS is brought into downlink transfer mode. SS sends data blocks and MS answers with DOWNLINK ACK/NACK until at least one PACKET MEASUREMENT REPORT has been received.

SS sends then a PACKET CELL CHANGE ORDER message to MS ordering the MS to select Cell-B and to use NC2 and PEMR.

The MS performs a cell update.

MS is brought into downlink transfer mode. SS sends data blocks and MS answers with DOWNLINK ACK/NACK until at least one PACKET ENHANCED MEASUREMENT REPORT has been received.

Maximum duration of the test

3 minutes

Expected Sequence

Step	Direction	Message	Comments
1	SS -> MS	PACKET DOWNLINK ASSIGNMENT	Sent on the PCCCH.
2	SS		Wait for 0.5 seconds.
3	SS -> MS	10 RLC data blocks	SS sends data, last block is polling.
4	MS -> SS	PACKET DOWNLINK ACK/NACK	
5	SS -> MS	10 RLC data blocks	SS sends data, last block is polling.
6	MS -> SS	PACKET DOWNLINK ACK/NACK or PACKET MEASUREMENT REPORT	
7			Repeat steps 5 and 6 for max 4s until at least one PACKET MEASUREMENT REPORT has been received.
8	SS->MS	PACKET CELL CHANGE ORDER	Commanding the MS to select Cell-B: See specific message contents
9			The following messages are to be sent and received in Cell B.
10	MS ->SS	PACKET CHANNEL REQUEST	Establishment cause = 'Cell Update'
11	SS -> MS	PACKET UPLINK ASSIGNMENT	Sent on PAGCH. Open-ended Dynamic Allocation.
12	SS -> MS	PACKET DOWNLINK DUMMY CONTROL BLOCK	Sent on PACCH containing USF assigned to the MS.
13	MS ->SS	UPLINK RLC DATA BLOCK	LLC PDU implicitly indicating Cell Update.
14	SS -> MS	PACKET UPLINK ACK/NACK	Acknowledge the received RLC data block(s), Final Ack Indicator = '1', a valid RRBP.
15	MS -> SS	PACKET CONTROL ACKNOWLEDGEMENT	
16	SS		Wait for 0.5 seconds.
17	SS -> MS	PACKET DOWNLINK ASSIGNMENT	Sent on the PCCCH.
18	SS		Wait for 0.5 seconds.
19	SS -> MS	10 RLC data blocks	SS sends data, last block is polling.
20	MS -> SS	PACKET DOWNLINK ACK/NACK	
21	SS -> MS	10 RLC data blocks	SS sends data, last block is polling.
22	MS -> SS	PACKET DOWNLINK ACK/NACK or PACKET ENHANCED MEASUREMENT REPORT	

23			Repeat steps 21 and 22 for max 1s until at least one PACKET ENHANCED MEASUREMENT REPORT has been received.
24	SS -> MS	RLC data block	Last data block with FBI bit set and a valid RRBP field.
25	MS -> SS	PACKET DOWNLINK ACK/NACK	Indicating correct reception of downlink data blocks.

Specific Message Contents

PACKET CELL CHANGE ORDER in step 8

TLLI	As assigned to the MS
IMMEDIATE_REL	1 (Immediate release of the on-going TBF.)
ARFCN, BSIC	as specified for cell B
NC Measurement parameters	
NETWORK_CONTROL_ORDER	10 (NC2)
NC_NON_DRX_PERIOD	111
NC_REPORTING_PERIOD_I	100(7.68 s)
NC_REPORTING_PERIOD_T	000(0.48 s)
Enhanced Measurement Parameter Struct	
PMO_IND	0
REPORT_TYPE	0 Enhanced measurement report
REPORTING_RATE	0
INVALID_BSIC_REPORTING	0
3G Neighbour Cell Description	0
GPRS REP Priority Description	0
GPRS Measurement Parameter Description	0
GPRS 3G Measurement Parameter Description	0

42.4.6.7 Network Control PEMR / Packet Enhanced Measurement Report / Measurement reporting with PBCCH / Invalid BSIC

42.4.6.7.1 Void

42.4.6.7.2 Conformance Requirements

When ordered to send measurement reports, the MS shall continuously monitor all carriers in BA(GPRS) or as indicated by the parameter NC_FREQUENCY_LIST and the BCCH carrier of the serving cell.

For each carrier, the measured received signal level (RXLEV) shall be the average of the received signal level measurement samples in dBm taken on that carrier within the reporting period. The reporting period is defined as follows:

- in packet idle mode, the reporting period is NC_REPORTING_PERIOD_I rounded off to the nearest smaller integer multiple of DRX period if NC_REPORTING_PERIOD_I is greater than DRX period, else, the reporting period is DRX period;
- in packet transfer mode, the reporting period is indicated in NC_REPORTING_PERIOD_T.

In averaging, measurements made during previous reporting periods shall always be discarded. The start of the first reporting period may be random.

After each reporting period, the MS shall send a measurement report to BSS. The MS shall then discard any previous measurement report, which it has not been able to send. Provided that the MS has received BSIC for all GSM neighbour cells, the parameter REPORT_TYPE indicates if the MS shall use Packet Measurement Report (normal reporting) or Packet Enhanced Measurement Report (enhanced reporting). The measurement report shall contain:

- RXLEV for the serving cell;
- in packet idle mode, the average interference level γ_{ch} for the serving cell measured on the monitored PCCCH if a valid value is available;

- received signal level for the non-serving cells:
 - For normal measurement reporting, carriers shall be reported if they are among the 6 strongest carriers and BSIC is successfully decoded and allowed, i.e. either equal to the BSIC of the list or with allowed NCC part of BSIC. In the latter case, which applies for BA(BCCH) where no BSIC is given, the decoded BSIC shall be included in the report. In the case of a multiband MS, the MS shall report the number of strongest BCCH carriers in each band as indicated by the parameter MULTIBAND_REPORTING, broadcast on PBCCH, or if PBCCH does not exist, on BCCH;
 - For Enhanced Measurement Reporting, cells shall be reported if they are among the at least 6 strongest carriers, and BSIC is successfully decoded and valid or, if indicated by the parameter INVALID_BSIC_REPORTING, with known and allowed NCC part;
- BSIC_SEEN (only for Enhanced Measurement Reporting).
Indicates if a GSM cell with invalid BSIC and allowed NCC part of the BSIC is one of the at least six strongest cells.

References

3GPP 04.60, subclause 11.2.4

3GPP 04.60, subclause 11.2.9b

3GPP 04.60, subclause 11.2.23

3GPP 05.08, subclause 8.4.8

3GPP 05.08, subclause 10.1.4.1

42.4.6.7.3 Test purpose

To verify that the MS shall send PACKET ENHANCED MEASUREMENT REPORT messages with reports on cells with "invalid BSIC" when "Invalid_BSIC_Reporting" allows cells with the NCC part of BSIC (sent directly to MS and sent by packet system broadcast information).

42.4.6.7.4 Method of test

Initial Conditions

System Simulator

4 cells, GPRS supported,

Cell A: Active with BSIC of "010101". PBCCH available; PSI5 indicates that Network Control Order is NC0. Invalid_BSIC_Reporting set to "Report on cells with invalid BSIC and allowed NCC part of BSIC is not allowed". Neighbour list must include the frequencies of cells B, C and D with respective BSICs of "010110", "010111" and "001001"..

Cell B: Active cell with BSIC of "010110". PBCCH available; PSI5 indicates that Network Control Order is NC2. Invalid_BSIC_Reporting set to "Report on cells with invalid BSIC and allowed NCC part of BSIC is allowed". Neighbour list must include the frequencies of cells A, C and D with respective BSICs of "010101", "010111" and "001001".

Cell C: Active cell with BSIC of "010001", without PBCCH

Cell D: Active cell with BSIC of "010010", without PBCCH

Mobile Station

MS is GPRS attached to Cell A; MS has an active PDP context; MS is in packet idle mode.

Specific PICS Statements

-

PIXIT Statements

-

Foreseen final state of the MS

- Packet Idle mode

Test procedure

The TBF has to be established. When the TBF is in progress, the SS sends a PACKET MEASUREMENT ORDER message on the PACCH of the TBF. In this message the Enhanced Measurement parameters must be included with the REPORT_TYPE bit set to '0' (The MS shall use the PACKET ENHANCED MEASUREMENT REPORT message for (NC) reporting). Also with Invalid_BSIC_Reporting set to "Report on cells with invalid BSIC and allowed NCC part of BSIC is allowed". Verify that the MS sends a PACKET ENHANCED MEASUREMENT REPORT message. The report should contain a report of cells with half invalid BSIC. After the PACKET ENHANCED MEASUREMENT REPORT message is received, the SS sends a PACKET CELL CHANGE ORDER message. MS switches to the new cell and re-establishes the uplink TBF. Data transfer continues. Verify that the MS sends a PACKET ENHANCED MEASUREMENT REPORT message. The report should contain a report of cells with half invalid BSIC. Data transfer is completed.

Expected sequence

Step	Direction	Message	Comments
1	MS<->SS	{ Uplink TBF establishment two phase access }	The MS must be triggered to send 2500 octets of data. The contention resolution is completed in this step.
2	SS->MS	PACKET MEASUREMENT ORDER	Start the measurement procedure on the MS side. In this message the Enhanced Measurement parameters are included (see specific message contents).
3	SS->MS	PACKET DOWNLINK DUMMY CONTROL BLOCK	Send the assigned USF to the MS.
4a	MS->SS	UPLINK RLC data block	
4b	MS->SS	PACKET ENHANCED MEASUREMENT REPORT	- Sent on PACCH. - Contains the "NC measurement report struct" on PACCH (see specific message contents).
5	SS		Steps 3 and 4 are repeated until PACKET ENHANCED MEASUREMENT REPORT is received.
6	SS->MS	PACKET CELL CHANGE ORDER	- Sent on PACCH. - Commands the MS to cell B. - NETWORK_CONTROL_ORDER with a value of "reset".
7	MS->SS	PACKET CHANNEL REQUEST	On cell B.
8	SS->MS	PACKET UPLINK ASSIGNMENT	Sent on PAGCH. Single block allocation.
9	MS->SS	PACKET RESOURCE REQUEST	Sent on the assigned block.
10	SS->MS	PACKET UPLINK ASSIGNMENT	Sent on PAGCH. Dynamic allocation.
11	SS->MS	PACKET DOWNLINK DUMMY CONTROL BLOCK	Sent on PACCH containing USF assigned to the MS.
12a	MS->SS	UPLINK RLC data block	
12b	MS->SS	PACKET ENHANCED MEASUREMENT REPORT	- Sent on PACCH. - Contains the "NC measurement report struct" on PACCH (see specific message contents).
13	SS		Steps 11 and 12 are repeated until PACKET ENHANCED MEASUREMENT REPORT is received.
14	MS<->SS	{ Complete uplink data transfer }	After this step the MS is back in packet idle mode. While completing this macro the MS may send PACKET ENHANCED MEASUREMENT REPORTs upon expiry of the timer T3158.

Note: in step 4x and 12x the MS shall perform **either** the 'a' branch **or** the 'b' branch.

Specific message contents

PACKET MEASUREMENT ORDER (step 2)

Information Element	Value/Remark
REPORT_TYPE (in Enhanced Measurement Parameters struct)	0 (The MS shall use the PACKET ENHANCED MEASUREMENT REPORT message for (NC) reporting)
NETWORK_CONTROL_ORDER	NC2
NC_REPORTING_PERIOD_T	1 (0,96 s)
INVALID_BSIC_REPORTING (in in Enhanced Measurement Parameters struct)	1 (Report on cells with invalid BSIC and allowed NCC part of BSIC is allowed. In this case NCC_PERMITTED is required.)

PACKET ENHANCED MEASUREMENT REPORT (steps 4b and 12b)

Information Element	Value/Remark
BSIC_Seen (in NC Measurement Report struct)	1 (GSM cell with invalid BSIC and allowed NCC part of BSIC is one of the six strongest)
BCCH-FREQ-NCELL (in Repeated Invalid_BSIC_Information struct)	Frequency of Cell C
BSIC (in Repeated Invalid_BSIC_Information struct)	BSIC of Cell C

42.4.7 Inter-RAT (GPRS to UTRAN) Cell Change Order

42.4.7.1 Inter-RAT Cell Change Order (Known Cell) – Uplink Data Transfer

42.4.7.1.1 Conformance requirement

For a multi-RAT mobile station, the PACKET CELL CHANGE ORDER message may contain information on a 3G target cell, together with the IMMEDIATE_REL parameter; in the case of UTRAN establishment of UTRAN channel(s) and subsequent measurement reporting are defined in 3GPP TS 25.331.

Upon receipt of the PACKET CELL CHANGE ORDER message the mobile station shall start timer T3174 and apply the cell reselection procedure defined in subclause 5.5.1.1. with the additional rule that an immediate abort of operation in the old cell may be required by the network through the IMMEDIATE_REL field, except for the acknowledgement, by means of a PACKET CONTROL ACKNOWLEDGEMENT message, of a valid RRBP field possibly included in the PACKET CELL CHANGE ORDER message. The mobile station shall obey the PACKET CELL CHANGE ORDER message irrespective of whether or not the mobile station has any knowledge of the relative synchronisation of the target cell to the serving cell. A UTRAN capable mobile station shall obey the command irrespective of whether the cell is known or not known (see 3GPP TS 25.133 and 3GPP TS 25.123).

For a multi-RAT mobile station, the PACKET CELL CHANGE ORDER message may contain information on a 3G target cell, together with the IMMEDIATE_REL parameter; in the case of UTRAN establishment of UTRAN channel(s) and subsequent measurement reporting are defined in 3GPP TS 25.331.

- The UE shall:

- 1> set the variable ESTABLISHMENT_CAUSE to "Inter-RAT cell change order";

NOTE: This value of ESTABLISHMENT_CAUSE has priority over the cause requested by upper layers.

- 1> initiate an RRC connection establishment procedure as specified in subclause 8.1.3.

For a UTRAN target cell, the mobile station regards the procedure as completed when it has received a successful response to its RRC Connection Request message, see 3GPP TS 25.331. It shall then stop timer T3174.

42.4.7.1.2 Test Purpose

To verify when NC2 is commanded, the MS sends PACKET ENHANCED MEASUREMENT REPORT messages, in which both the serving and non-serving cells are reported.

To verify that when the cell change order procedure is started by sending a PACKET CELL CHANGE ORDER message with the IMMEDIATE_REL value set to 1, the MS shall abort any TBF in progress and stop transmitting.

To verify that the MS switches to the commanded UTRAN cell.

Reference

3GPP TS 04.60, subclause 8.4.

3GPP TS 25.331 subclause 8.3.10

42.4.7.1.3 Method of test

Initial conditions

System simulator:

2 cells - Cell A is GPRS, Cell B is UTRAN (activated at power ON)

3GPP TS 34.108, subclause 6.1 shall be referenced for default parameters of Cell 2.

3GPP TS 34.123-3, subclause 8.3.2 shall be referenced for configuring channels on Cell 2.

Mobile Station:

MS is in Packet Idle mode and GPRS attached.

PDP context 2 established.

Specific PICS Statements

-

PIXIT Statements

-

Foreseen final state of the MS

- MS is in CELL_DCH state.

Test procedure

MS is brought into uplink packet transfer mode. SS commands MS to NC2 with PACKET MEASUREMENT ORDER. SS waits for a PACKET ENHANCED MEASUREMENT REPORT to contain measurement results for both cell A and cell B. SS sends a PACKET CELL CHANGE ORDER message. SS checks that there is no traffic on the old cell. MS switches to the UTRAN cell and re-establishes the data transfer.

Maximum duration of the test

-

Expected sequence

Step	Direction	Message	Comments
1			MS is brought into uplink packet transfer mode. TBF is active from steps 1-6. In order to keep TBF active, sufficient data is to be injected to MS.
2	MS -> SS	PACKET MEASUREMENT ORDER	MS sends Uplink data
3	SS ->MS		- Sent on PACCH. -Contains NETWORK_CONTROL_ORDER and NC_REPORTING_PERIOD_T See specific message contents
4a	MS -> SS	PACKET ENHANCED MEASUREMENT REPORT	MS sends Uplink data.
4b	MS->SS		- Sent on PACCH. - Contains the "NC measurement report struct" on PACCH
5			Repeat steps 4a/4b until the information on UTRAN cell is included in the PEMR.
6	SS -> MS	PACKET CELL CHANGE ORDER	Sent on the PACCH. IMMEDIATE_REL bit is set to "1" Contains -Details of cell B (UTRAN cell). See specific message contents
7	MS->SS	RRC CONNECTION REQUEST	Received on Cell B (UTRAN cell) CCCH. Establishment Cause = Inter-RAT cell change order
8	SS->MS	RRC CONNECTION SETUP	Sent on CCCH
9	MS->SS	RRC CONNECTION SETUP COMPLETE	Sent on DCCH (Mobile is in CELL_DCH state)

Specific message contents

PACKET MEASUREMENT ORDER in step 5:

NC Measurement parameters	
NETWORK_CONTROL_ORDER	10 (NC2)
NC_REPORTING_PERIOD_T	010 (1.92 s)
Enhanced Measurement Parameter Struct	
Report_Type	0 Enhanced measurement report
3G Neighbour Cell Description	1
UTRAN FDD Description	1
0 1 < Bandwidth_FDD	0 (use present FDD band width)
Repeated UTRAN FDD Neighbour Cells	
FDD-ARFCN	ref 34.108
FDD_Indic0	0
NR_OF_FDD_CELLS	1

PACKET CELL CHANGE ORDER in Step 9

Information element	Value/remark
< PAGE_MODE : bit (2) >	00 (Normal Paging)
0 10	0
< GLOBAL_TFI : Global TFI IE >	<5 bit Uplink TFI>
0 1	1
Message escape	00
< IMMEDIATE_REL >	1 (Immediate abort of operation in the old cell is required)
3G-target cell struct	
0 1	1
< FDD-ARFCN : bit (14) >	ref 34.108
< Diversity : bit >	0 (Diversity not applied in the cell)
0 1 < Bandwidth_FDD : bit (3) >	0 (use present FDD band width)
< SCRAMBLING_CODE : bit (9) >	Ref 34.108

| < padding bits > |

42.4.7.2 Inter-RAT Cell Change Order (Unknown Cell) – Uplink Data Transfer

42.4.7.2.1 Conformance requirement

For a multi-RAT mobile station, the PACKET CELL CHANGE ORDER message may contain information on a 3G target cell, together with the IMMEDIATE_REL parameter; in the case of UTRAN establishment of UTRAN channel(s) and subsequent measurement reporting are defined in 3GPP TS 25.331.

Upon receipt of the PACKET CELL CHANGE ORDER message the mobile station shall start timer T3174 and apply the cell reselection procedure defined in subclause 5.5.1.1. with the additional rule that an immediate abort of operation in the old cell may be required by the network through the IMMEDIATE_REL field, except for the acknowledgement, by means of a PACKET CONTROL ACKNOWLEDGEMENT message, of a valid RRBP field possibly included in the PACKET CELL CHANGE ORDER message. The mobile station shall obey the PACKET CELL CHANGE ORDER message irrespective of whether or not the mobile station has any knowledge of the relative synchronisation of the target cell to the serving cell. A UTRAN capable mobile station shall obey the command irrespective of whether the cell is known or not known (see 3GPP TS 25.133 and 3GPP TS 25.123).

For a multi-RAT mobile station, the PACKET CELL CHANGE ORDER message may contain information on a 3G target cell, together with the IMMEDIATE_REL parameter; in the case of UTRAN establishment of UTRAN channel(s) and subsequent measurement reporting are defined in 3GPP TS 25.331.

- The UE shall:

1> set the variable ESTABLISHMENT_CAUSE to "Inter-RAT cell change order";

NOTE: This value of ESTABLISHMENT_CAUSE has priority over the cause requested by upper layers.

1> initiate an RRC connection establishment procedure as specified in subclause 8.1.3.

For a UTRAN target cell, the mobile station regards the procedure as completed when it has received a successful response to its RRC Connection Request message, see 3GPP TS 25.331. It shall then stop timer T3174.

42.4.7.2.2 Test Purpose

To verify that when the cell change order procedure is started by sending a PACKET CELL CHANGE ORDER message with the IMMEDIATE_REL value set to 1, the MS shall abort any TBF in progress and stop transmitting.

To verify that the MS switches to the commanded UTRAN cell.

Reference

3GPP TS 04.60, subclause 8.4.

3GPP TS 25.331 subclause 8.3.10

42.4.7.2.3 Method of test

Initial conditions

System simulator:

2 cells - Cell A is GPRS (NC2), Cell B is UTRAN (activated at power ON)

3GPP TS 34.108, subclause 6.1 shall be referenced for default parameters of Cell 2.

3GPP TS 34.123-3, subclause 8.3.2 shall be referenced for configuring channels on Cell 2.

Mobile Station:

MS is in Packet Idle mode and GPRS attached.

PDP context 2 established.

Specific PICS Statements

-

PIXIT Statements

-

Foreseen final state of the MS

- MS is in CELL_DCH state.

Test procedure

MS is brought into uplink packet transfer mode. SS sends a PACKET CELL CHANGE ORDER message. SS checks that there is no traffic on the old cell. MS switches to the UTRAN cell and re-establishes the data transfer.

Maximum duration of the test

-

Expected sequence

Step	Direction	Message	Comments
1			MS is brought into uplink packet transfer mode. TBF is active from steps 1-3. In order to keep TBF active, sufficient data is to be injected to MS.
2	MS -> SS		MS sends Uplink data
3	SS -> MS	PACKET CELL CHANGE ORDER	Sent on the PACCH. IMMEDIATE_REL bit is set to "1" Contains -Details of cell B (UTRAN cell). See specific message contents
4	MS->SS	RRC CONNECTION REQUEST	Received on Cell B (UTRAN cell) CCCH. Establishment Cause = Inter-RAT cell change order
5	SS->MS	RRC CONNECTION SETUP	Sent on CCCH
6	MS->SS	RRC CONNECTION SETUP COMPLETE	Sent on DCCH (Mobile is in CELL_DCH state)

Specific message contents

PACKET CELL CHANGE ORDER in Step 5

Information element	Value/remark
< PAGE_MODE : bit (2) >	00 (Normal Paging)
0 10	0
< GLOBAL_TFI : Global TFI IE >	<5 bit Uplink TFI>
0 1	1
Message escape	00
< IMMEDIATE_REL >	1 (Immediate abort of operation in the old cell is required)
3G-target cell struct	
0 1	1
< FDD-ARFCN : bit (14) >	ref 34.108
< Diversity : bit >	0 (Diversity not applied in the cell)
0 1 < Bandwidth_FDD : bit (3) >	0 (use present FDD band width)
< SCRAMBLING_CODE : bit (9) >	Ref 34.108
< padding bits >	

42.4.7.3 Inter-RAT Cell Change Order (Known Cell) – Downlink Data Transfer

42.4.7.3.1 Conformance requirement

For a multi-RAT mobile station, the PACKET CELL CHANGE ORDER message may contain information on a 3G target cell, together with the IMMEDIATE_REL parameter; in the case of UTRAN establishment of UTRAN channel(s) and subsequent measurement reporting are defined in 3GPP TS 25.331.

Upon receipt of the PACKET CELL CHANGE ORDER message the mobile station shall start timer T3174 and apply the cell reselection procedure defined in subclause 5.5.1.1. with the additional rule that an immediate abort of operation in the old cell may be required by the network through the IMMEDIATE_REL field, except for the acknowledgement, by means of a PACKET CONTROL ACKNOWLEDGEMENT message, of a valid RRBP field possibly included in the PACKET CELL CHANGE ORDER message. The mobile station shall obey the PACKET CELL CHANGE ORDER message irrespective of whether or not the mobile station has any knowledge of the relative synchronisation of the target cell to the serving cell. A UTRAN capable mobile station shall obey the command irrespective of whether the cell is known or not known (see 3GPP TS 25.133 and 3GPP TS 25.123).

For a multi-RAT mobile station, the PACKET CELL CHANGE ORDER message may contain information on a 3G target cell, together with the IMMEDIATE_REL parameter; in the case of UTRAN establishment of UTRAN channel(s) and subsequent measurement reporting are defined in 3GPP TS 25.331.

- The UE shall:

1> set the variable ESTABLISHMENT_CAUSE to "Inter-RAT cell change order";

NOTE: This value of ESTABLISHMENT_CAUSE has priority over the cause requested by upper layers.

1> initiate an RRC connection establishment procedure as specified in subclause 8.1.3.

For a UTRAN target cell, the mobile station regards the procedure as completed when it has received a successful response to its RRC Connection Request message, see 3GPP TS 25.331. It shall then stop timer T3174.

42.4.7.3.2 Test Purpose

To verify that when the cell change order procedure is started when the MS receives PACKET CELL CHANGE ORDER message with the IMMEDIATE_REL value set to 1.

To verify that the MS switches to the commanded UTRAN cell.

Reference

3GPP TS 04.60, subclause 8.4.

3GPP TS 25.331 subclause 8.3.10

42.4.7.3.3 Method of test

Initial conditions

System simulator:

2 cells - Cell A is GPRS, Cell B is UTRAN (activated at power ON)

3GPP TS 34.108, subclause 6.1 shall be referenced for default parameters of Cell 2.

3GPP TS 34.123-3, subclause 8.3.2 shall be referenced for configuring channels on Cell 2.

Mobile Station:

MS is in Packet Idle mode and GPRS attached.

PDP context established.

Specific PICS Statements

-

PIXIT Statements

-

Foreseen final state of the MS

- MS is in CELL_DCH state.

Test procedure

MS is brought into downlink packet transfer mode. SS commands MS to NC2 with PACKET MEASUREMENT ORDER. SS waits for a PACKET ENHANCED MEASUREMENT REPORT to contain measurement results for both cell A and cell B. SS sends a PACKET CELL CHANGE ORDER message. MS switches to the UTRAN cell and completes the cell change order procedure.

Maximum duration of the test

-

Expected sequence

Step	Direction	Message	Comments
1	SS->MS	PACKET DOWNLINK ASSIGNMENT	Sent on the PCCCH.
2	SS->MS	PACKET MEASUREMENT ORDER	- Sent on PACCH. -Contains NETWORK_CONTROL_ORDER and NC_REPORTING_PERIOD_T See specific message contents
3	SS->MS		SS sends downlink data,
4	MS->SS	PACKET ENHANCED MEASUREMENT REPORT	Sent on PACCH.
5	SS		Repeat steps 3-4 until measurement results for cell B are included in the PACKET ENHANCED MEASUREMENT REPORT message The TBF is maintained during the procedure.
6	SS->MS	PACKET CELL CHANGE ORDER	Sent on the PACCH. IMMEDIATE_REL bit is set to "1" Contains -Details of cell B (UTRAN cell). See specific message contents
7	MS->SS	RRC CONNECTION REQUEST	Received on Cell B (UTRAN cell) CCCH. Establishment Cause = Inter-RAT cell change order
8	SS->MS	RRC CONNECTION SETUP	Sent on CCCH
9	MS->SS	RRC CONNECTION SETUP COMPLETE	Sent on DCCH (Mobile is in CELL_DCH state)

Specific message contents

PACKET MEASUREMENT ORDER in step 2:

NC Measurement parameters	
NETWORK_CONTROL_ORDER	10 (NC2)
NC_REPORTING_PERIOD_T	010 (1.92 s)
Enhanced Measurement Parameter Struct	
Report_Type	0 Enhanced measurement report
3G Neighbour Cell Description	1
UTRAN FDD Description	1
0 1 < Bandwidth_FDD	0 (use present FDD band width)
Repeated UTRAN FDD Neighbour Cells	
FDD-ARFCN	ref 34.108
FDD_Indic0	0
NR_OF_FDD_CELLS	1

PACKET CELL CHANGE ORDER in Step 6

Information element	Value/remark
< PAGE_MODE : bit (2) >	00 (Normal Paging)
0 10	0
< GLOBAL_TFI : Global TFI IE >	<5 bit Uplink TFI>
0 1	1
Message escape	00
< IMMEDIATE_REL >	1 (Immediate abort of operation in the old cell is required)
3G-target cell struct	
0 1	1
< FDD-ARFCN : bit (14) >	ref 34.108
< Diversity : bit >	0 (Diversity not applied in the cell)
0 1 < Bandwidth_FDD : bit (3) >	0 (use present FDD band width)
< SCRAMBLING_CODE : bit (9) >	Ref 34.108
< padding bits >	

42.4.7.4 Inter-RAT Cell Change Order (Known Cell) – Simultaneous uplink and downlink transfer

42.4.7.4.1 Conformance requirement

For a multi-RAT mobile station, the PACKET CELL CHANGE ORDER message may contain information on a 3G target cell, together with the IMMEDIATE_REL parameter; in the case of UTRAN establishment of UTRAN channel(s) and subsequent measurement reporting are defined in 3GPP TS 25.331.

Upon receipt of the PACKET CELL CHANGE ORDER message the mobile station shall start timer T3174 and apply the cell reselection procedure defined in subclause 5.5.1.1. with the additional rule that an immediate abort of operation in the old cell may be required by the network through the IMMEDIATE_REL field, except for the acknowledgement, by means of a PACKET CONTROL ACKNOWLEDGEMENT message, of a valid RRBP field possibly included in the PACKET CELL CHANGE ORDER message. The mobile station shall obey the PACKET CELL CHANGE ORDER message irrespective of whether or not the mobile station has any knowledge of the relative synchronisation of the target cell to the serving cell. A UTRAN capable mobile station shall obey the command irrespective of whether the cell is known or not known (see 3GPP TS 25.133 and 3GPP TS 25.123).

For a multi-RAT mobile station, the PACKET CELL CHANGE ORDER message may contain information on a 3G target cell, together with the IMMEDIATE_REL parameter; in the case of UTRAN establishment of UTRAN channel(s) and subsequent measurement reporting are defined in 3GPP TS 25.331.

- The UE shall:

- 1> set the variable ESTABLISHMENT_CAUSE to "Inter-RAT cell change order";

NOTE: This value of ESTABLISHMENT_CAUSE has priority over the cause requested by upper layers.

- 1> initiate an RRC connection establishment procedure as specified in subclause 8.1.3.

For a UTRAN target cell, the mobile station regards the procedure as completed when it has received a successful response to its RRC Connection Request message, see 3GPP TS 25.331. It shall then stop timer T3174.

42.4.7.4.2 Test Purpose

To verify that when the cell change order procedure is started by sending a PACKET CELL CHANGE ORDER message with the IMMEDIATE_REL value set to 1, the MS shall abort any TBF in progress and stop transmitting.

To verify that the MS switches to the commanded UTRAN cell.

Reference

3GPP TS 04.60, subclause 8.4.

3GPP TS 25.331 subclause 8.3.10

42.4.7.4.3 Method of test

Initial conditions

System simulator:

2 cells - Cell A is GPRS, Cell B is UTRAN (activated at power ON)

3GPP TS 34.108, subclause 6.1 shall be referenced for default parameters of Cell 2.

3GPP TS 34.123-3, subclause 8.3.2 shall be referenced for configuring channels on Cell 2.

Mobile Station:

MS is in Packet Idle mode and GPRS attached.

PDP context established.

Specific PICS Statements

-

PIXIT Statements

-

Foreseen final state of the MS

- MS is in CELL_DCH state.

Test procedure

MS is brought into simultaneous uplink and downlink packet transfer mode. SS commands MS to NC2 with PACKET MEASUREMENT ORDER. SS waits for a PACKET ENHANCED MEASUREMENT REPORT to contain measurement results for both cell A and cell B. SS sends a PACKET CELL CHANGE ORDER message with IMMEDIATE_REL value set to 1 to force the mobile to release all ongoing TBFs. MS switches to the UTRAN cell and completes the cell change order procedure.

Maximum duration of the test

-

Expected sequence

Step	Direction	Message	Comments
1			MS is brought into uplink packet transfer mode. TBF is active from steps 1-6. In order to keep TBF active, sufficient data is to be injected to MS.
2	SS ->MS	PACKET MEASUREMENT ORDER	- Sent on PACCH. -Contains NETWORK_CONTROL_ORDER and NC_REPORTING_PERIOD_T See specific message contents
3	SS -> MS	PACKET DOWNLINK ASSIGNMENT	Sent on the PACCH.
4a	MS -> SS		MS sends Uplink data.
4b	MS->SS	PACKET ENHANCED MEASUREMENT REPORT	
5	SS -> MS		SS sends downlink data,
6	SS		Repeat steps 4-5 until measurement results for cell B are included in the PACKET ENHANCED MEASUREMENT REPORT message
7	SS -> MS	PACKET CELL CHANGE ORDER	Sent on the PACCH. IMMEDIATE_REL bit is set to "1" Contains -Details of cell B (UTRAN cell). See specific message contents
8	MS->SS	RRC CONNECTION REQUEST	Received on Cell B (UTRAN cell) CCCH. Establishment Cause = Inter-RAT cell change order
9	SS->MS	RRC CONNECTION SETUP	Sent on CCCH
10	MS->SS	RRC CONNECTION SETUP COMPLETE	Sent on DCCH (Mobile is in CELL_DCH state)

Specific message contents

PACKET MEASUREMENT ORDER in step 2:

NC Measurement parameters	
NETWORK_CONTROL_ORDER	10 (NC2)
NC_REPORTING_PERIOD_T	010 (1.92 s)
Enhanced Measurement Parameter Struct	
Report_Type	0 Enhanced measurement report
3G Neighbour Cell Description	1
UTRAN FDD Description	1
0 1 < Bandwidth_FDD	0 (use present FDD band width)
Repeated UTRAN FDD Neighbour Cells	
FDD-ARFCN	ref 34.108
FDD_Indic0	0
NR_OF_FDD_CELLS	1

PACKET CELL CHANGE ORDER in Step 11

Information element	Value/remark
< PAGE_MODE : bit (2) >	00 (Normal Paging)
0 10	0
< GLOBAL_TFI : Global TFI IE >	<5 bit Uplink TFI>
0 1	1
Message escape	00
< IMMEDIATE_REL >	1 (Immediate abort of operation in the old cell is required)
3G-target cell struct	
0 1	1
< FDD-ARFCN : bit (14) >	ref 34.108
< Diversity : bit >	0 (Diversity not applied in the cell)
0 1 < Bandwidth_FDD : bit (3) >	0 (use present FDD band width)
< SCRAMBLING_CODE : bit (9) >	Ref 34.108

| < padding bits > |

42.4.7.5 Inter-RAT (GPRS to UTRAN) Cell Change Order (Known cell) / Failure

42.4.7.5.1 Inter-RAT (GPRS to UTRAN) Cell Change Order (Known cell) / Failure / Uplink transfer / T3174 expiry

42.4.7.5.1.1 Conformance requirement

In the following cases, the mobile station shall determine that the network controlled cell reselection procedure has failed:

- The PACKET CELL CHANGE ORDER message commands the mobile station to a frequency in a frequency band not supported by the mobile station. *Cause*: “frequency not implemented”.
- The PACKET CELL CHANGE ORDER message is received while a circuit switched connection is on going. *Cause*: “on-going CS connection”.
- In *A/Gb mode*, the PACKET CELL CHANGE ORDER message is received and the GMM READY timer (see 3GPP TS 24.008) is not running (i.e., mobile station in GMM STAND-BY state). *Cause*, if the GMM READY timer has a negotiated value equal to zero: “Forced to the Standby State”. *Cause*, if the GMM READY timer has a negotiated value greater than zero: “MS in GMM Standby state”.
- Access is denied in the new cell (i.e., the mobile station receives an IMMEDIATE ASSIGNMENT REJECT, a PACKET ASSIGNMENT REJECT or, in a UTRAN cell, an RRC CONNECTION REJECT message). *Cause*: “Immediate Assign Reject or Packet Access Reject on target cell”.
- The mobile station is unable to synchronise to the new cell (see 3GPP TS 45.008) or the timer T3174 expires before a successful completion of the network controlled cell reselection procedure. *Cause*: “No response on target cell”.
- Due to any other reason (e.g. unknown or unsupported target cell information). In this case the MS shall set the ARFCN and BSIC fields to the value zero and set the cause to value “frequency not implemented”.

If the mobile station determines that the network controlled cell reselection procedure has failed, the mobile station shall stop timer T3174 (if it is still running) and start timer T3176. The mobile station shall return to the old cell, where it may trigger a cell update or other GMM specific procedure. In case the mobile station synchronised and attempted to access the new cell before returning to the old cell, the mobile station shall trigger a cell update or other GMM specific procedure, as appropriate according to the GMM requirements (see 3GPP TS 24.008).

The mobile station shall send a PACKET CELL CHANGE FAILURE message with the appropriate cause value to the network in the old cell and stop timer T3176. The PACKET CELL CHANGE FAILURE message may be sent on PACCH when the mobile station is in packet transfer mode, dual transfer mode or MAC-Shared state. Alternatively, the mobile station may initiate random access with access type “single block without TBF establishment” (PCCCH) / “single block packet access” (CCCH) and send the PACKET CELL CHANGE FAILURE message using an allocated single uplink block.

Reference

3GPP TS 044.060, subclause 8.4.2

42.4.7.5.1.2 Test Purpose

To verify that an MS in uplink packet transfer mode when commanded by a PACKET CELL CHANGE ORDER, reports a PACKET CELL CHANGE FAILURE on the old GPRS cell due to the expiry of T3174 before receiving response to RRC CONNECTION REQUEST on target UTRAN cell.

42.4.7.5.1.3 Method of test

Initial conditions

System Simulator:

- 2 cells, Cell A, GPRS Supported on PBCCH, NC2.
- Cell B is a UTRAN cell. UTRAN cell is the better cell of the two cells. It is activated after MS is GPRS attached to Cell A. 3GPP TS 34.108, subclause 6.1 shall be referenced for default parameters of Cell B except that T300 and N300 are to be set to the maximum values (8000 milliseconds for T300 and 7 for N300). 3GPP TS 34.123-3, subclause 8.3.2 shall be referenced for configuring channels on Cell B.
- 3G Neighbour Cell Description of Cell A refers to the UTRAN Cell B. XXX_MUTIRAT_REPORTING is set to 1. REPORT_TYPE is set to indicate the usage of Packet Enhanced Measurement Report.

Mobile Station:

- MS is in Packet Idle mode and GPRS attached on Cell A.
- PDP context 2 established

Specific PICS Statements

-

PIXIT Statements

-

Foreseen final state of the MS

- MS is in Packet transfer mode in the GPRS cell.

Test procedure

MS is brought into uplink packet transfer mode. MS sends PEMR with UTRAN cell information. SS sends the PACKET CELL CHANGE ORDER message giving a UTRAN cell description to the MS. MS sends RRC Connection Request on the UTRAN cell. The SS does not respond to the request and timer T3174 expires. MS returns to the old cell, sends a PACKET CELL CHANGE FAILURE message to the SS and continues data transfer on the old cell.

Maximum duration of the test

-

Expected sequence

Step	Direction	Message	Comments
1	SS	{Uplink dynamic allocation one phase access}	Initiate uplink transfer of 1500 octets. The TBF is active at steps 2-3 and 7-9.
2a	MS -> SS	Uplink data	MS sends uplink data.
2b	MS -> SS	PACKET ENHANCED MEASUREMENT REPORT	Sent on PACCH. Contains NC Measurement Report struct.
3			Repeat steps 2a and 2b until UTRAN cell information is sent in PEMR.
4	SS -> MS	PACKET CELL CHANGE ORDER	Sent on the PACCH. Contains Description of the UTRAN cell. See specific message contents.
5	MS -> SS	RRC CONNECTION REQUEST	To the UTRAN cell.
6	SS		SS does not respond to the request until timer T3174 has expired. During this period MS will retransmit RRC CONNECTION REQUEST after the expiry of T300.
7	MS -> SS	PACKET CHANNEL REQUEST	After the expiry of T3174, to the old cell within 15 sec.
8	SS -> MS	PACKET UPLINK ASSIGNMENT	Sent on PACCH, Dynamic allocation
9	MS -> SS	PACKET CELL CHANGE FAILURE	Sent when USF is allocated to the MS. Error cause: " No response on target cell "
11			See specific message contents (MS may perform ROUTING AREA UPDATE procedure)

Note: MS will send Packet Enhanced Measurement Report at the expiry of T3158 during the entire test case.

Specific message contents

PACKET CELL CHANGE ORDER in Step 3

Information element	Value/remark
< PAGE_MODE : bit (2) > 0 10	00 (Normal Paging) 0
< GLOBAL_TFI : Global TFI IE > 0 1	< Uplink TFI> 1
Message escape	00
< IMMEDIATE_REL > 3G-target cell struct	1 (Immediate abort of operation in the old cell is required)
0 1	1
< FDD-ARFCN : bit (14) >	ref 34.108
< Diversity : bit >	0 (Diversity not applied in the cell)
0 1 < Bandwidth_FDD : bit (3) >	0 (use present FDD band width)
< SCRAMBLING_CODE : bit (9) >	Ref 34.108
< padding bits >	

PACKET CELL CHANGE FAILURE in step 9:

Packet Cell Change Failure message content: CAUSE	0001(No response on target cell)
--	----------------------------------

42.4.7.5.2 Inter-RAT (GPRS to UTRAN) Cell Change Order (Known cell) / Failure / Downlink transfer / REJECT from target UTRAN cell with Inter-RAT info set to GSM.

42.4.7.5.2.1 Conformance requirement

In the following cases, the mobile station shall determine that the network controlled cell reselection procedure has failed:

- The PACKET CELL CHANGE ORDER message commands the mobile station to a frequency in a frequency band not supported by the mobile station. *Cause*: “frequency not implemented”.
- The PACKET CELL CHANGE ORDER message is received while a circuit switched connection is on going. *Cause*: “on-going CS connection”.
- In *A/Gb mode*, the PACKET CELL CHANGE ORDER message is received and the GMM READY timer (see 3GPP TS 24.008) is not running (i.e., mobile station in GMM STAND-BY state). *Cause*, if the GMM READY timer has a negotiated value equal to zero: “Forced to the Standby State”. *Cause*, if the GMM READY timer has a negotiated value greater than zero: “MS in GMM Standby state”.
- Access is denied in the new cell (i.e., the mobile station receives an IMMEDIATE ASSIGNMENT REJECT, a PACKET ASSIGNMENT REJECT or, in a UTRAN cell, an RRC CONNECTION REJECT message). *Cause*: “Immediate Assign Reject or Packet Access Reject on target cell”.
- The mobile station is unable to synchronise to the new cell (see 3GPP TS 45.008) or the timer T3174 expires before a successful completion of the network controlled cell reselection procedure. *Cause*: “No response on target cell”.
- Due to any other reason (e.g. unknown or unsupported target cell information). In this case the MS shall set the ARFCN and BSIC fields to the value zero and set the cause to value “frequency not implemented”.

If the mobile station determines that the network controlled cell reselection procedure has failed, the mobile station shall stop timer T3174 (if it is still running) and start timer T3176. The mobile station shall return to the old cell, where it may trigger a cell update or other GMM specific procedure. In case the mobile station synchronised and attempted to access the new cell before returning to the old cell, the mobile station shall trigger a cell update or other GMM specific procedure, as appropriate according to the GMM requirements (see 3GPP TS 24.008).

The mobile station shall send a PACKET CELL CHANGE FAILURE message with the appropriate cause value to the network in the old cell and stop timer T3176. The PACKET CELL CHANGE FAILURE message may be sent on PACCH when the mobile station is in packet transfer mode, dual transfer mode or MAC-Shared state. Alternatively, the mobile station may initiate random access with access type "single block without TBF establishment" (PCCCH) / "single block packet access" (CCCH) and send the PACKET CELL CHANGE FAILURE message using an allocated single uplink block.

Reference

3GPP TS 04.60, Chapter 8.4.2

42.4.7.5.2.2 Test Purpose

To verify that an MS in downlink packet transfer mode when commanded by a PACKET CELL CHANGE ORDER, reports PACKET CELL CHANGE FAILURE on the old GPRS cell if an RRC CONNECTION REJECT with Inter-RAT info set to GSM is received on the target UTRAN cell.

42.4.7.5.2.3 Method of test

Initial conditions

System Simulator:

- 2 cells, Cell A, GPRS Supported on PBCCH, NC2. Cell B is a UTRAN cell. Cell Selection conditions favour Cell A. 3G Neighbour Cell Description of Cell A refers to UTRAN Cell B. XXX_MUTIRAT_REPORTING is set to 1. REPORT_TYPE is set to indicate the usage of Packet Enhanced Measurement Report.
- 3GPP TS 34.108, subclause 6.1 shall be referenced for default parameters of Cell B.
- 3GPP TS 34.123-3, subclause 8.3.2 shall be referenced for configuring channels on Cell B.

Mobile Station:

- MS is in Packet Idle mode and GPRS attached on cell A.
- PDP context 2 established

Specific PICS Statements

-

PIXIT Statements

-

Foreseen final state of the MS

- MS idle in GPRS cell

Test procedure

MS is brought into downlink packet transfer mode. MS sends PEMR with UTRAN cell information. SS sends the PACKET CELL CHANGE ORDER message to the MS. MS tries to establish RRC connection with UTRAN cell. SS sends the RRC Connection Reject including Inter-RAT info set to "GSM". MS returns to the old cell and sends PACKET CELL CHANGE FAILURE message to the network. It is verified that the MS can continue downlink transfer on the old cell once a downlink TBF is established.

Maximum duration of the test

-

Expected sequence

Step	Direction	Message	Comments
1	SS -> MS	PACKET DOWNLINK ASSIGNMENT	Sent on PPCH.
2a	SS -> MS	Downlink data	SS sends downlink data.
2b	MS -> SS	PACKET ENHANCED MEASUREMENT REPORT	Sent on PACCH when USF is assigned to the MS. Contains NC Measurement Report struct.
3			Repeat steps 2a and 2b until UTRAN cell information is sent in PEMR.
4	SS -> MS	PACKET CELL CHANGE ORDER	Sent on the PACCH. Contains description of UTRAN cell. See specific message contents.
5	MS -> SS	RRC CONNECTION REQUEST	On the target UTRAN cell.
6	SS -> MS	RRC CONNECTION REJECT	Received from the Target UTRAN cell, including a Inter-RAT info set to GSM
7	MS -> SS	PACKET CHANNEL REQUEST	To the old cell within 15 sec from message sent in step 6.
8	SS -> MS	PACKET UPLINK ASSIGNMENT	Sent on PAGCH
9	MS -> SS	PACKET CELL CHANGE FAILURE	Error cause:" Packet Access Reject on target cell " See specific message content
10			(MS may perform ROUTING AREA UPDATE procedure)
10	SS -> MS	PACKET DOWNLINK ASSIGNMENT	Sent on PPCH.
11	SS -> MS	Downlink data	SS sends downlink data.

Note: MS will send Packet Enhanced Measurement Report at the expiry of T3158 during the entire test case.

Specific message contents

PACKET CELL CHANGE ORDER in Step 3

Information element	Value/remark
< PAGE_MODE : bit (2) >	00 (Normal Paging)
0 10	0
< GLOBAL_TFI : Global TFI IE >	< Uplink TFI>
0 1	1
Message escape	00
< IMMEDIATE_REL >	1 (Immediate abort of operation in the old cell is required)
3G-target cell struct	
0 1	1
< FDD-ARFCN : bit (14) >	ref 34.108
< Diversity : bit >	0 (Diversity not applied in the cell)
0 1 < Bandwidth_FDD : bit (3) >	0 (use present FDD band width)
< SCRAMBLING_CODE : bit (9) >	Ref 34.108
< padding bits >	

RRC CONNECTION REJECT in step 5:

Redirectioninfo InterRATInfo	GSM
---------------------------------	-----

PACKET CELL CHANGE FAILURE in step 8:

Packet Cell Change Failure message content: CAUSE	0010 (Packet Access Reject on target cell)
--	--

42.4.8 NC2 Procedures

42.4.8.1 NC2 and DRX

42.4.8.1.1 NC2 and DRX / NC_NON_DRX_PERIOD / Respect of NC2 non-DRX mode period

42.4.8.1.1.1 Conformance requirement

There are four cases when the mobile station shall enter a non-DRX mode period.

- 1) At the transition from the packet transfer mode to the packet idle mode, the mobile station shall enter the Transfer non-DRX mode period.
- 2) At the transition from the dual transfer mode to the dedicated mode or packet idle mode, the mobile station shall enter the Transfer non-DRX mode period.

In both cases, the duration of the Transfer non-DRX mode period is determined by value of the NON_DRX_TIMER parameter, requested in the *GPRS attach procedure*, and the value of the DRX_TIMER_MAX parameter broadcast in the cell. The mobile station may use the minimum value of these two parameters.

If the mobile station receives a new value of the DRX_TIMER_MAX parameter during the Transfer non-DRX mode period, the mobile station may wait to apply the new value until the next time the Transfer non-DRX mode period is entered.

- 3) A mobile station operating in NC2 mode shall enter the NC2 non-DRX mode period when it sends an NC measurement report. The duration of this period is defined by the NC_NON_DRX_PERIOD parameter.
- 4) When initiating the MM procedures for *GPRS attach* and *routing area update* defined in 3GPP TS 04.08, the mobile station shall enter the MM non-DRX mode period. This period ends when either of the messages GPRS ATTACH ACCEPT, GPRS ATTACH REJECT, ROUTING AREA UPDATE ACCEPT or ROUTING AREA UPDATE REJECT is received by the mobile station. This period also ends after timeout when waiting for any of these messages.

The non-DRX mode periods defined above run independent of each other and may overlap. The non-DRX mode periods have effect only in packet idle mode. In packet idle mode, the mobile station shall be in non-DRX mode during any of the non-DRX mode periods. Otherwise, the mobile station in packet idle mode may be in DRX mode.

42.4.8.1.1.2 Test Purpose

To verify that an MS in Idle mode enters and remains in the non-drx mode only for the duration of NC2 non-DRX mode period which is equal to NC_NON_DRX_PERIOD parameter, when it sends a NC measurement report

Reference

3GPP TS 04.60, sub-clause 5.5.1.5.

42.4.8.1.1.3 Method of test

Initial conditions

System Simulator:

1 cell, GPRS supported, PCCCH is present.

Mobile Station:

MS is in Packet Idle mode and GPRS attached.

Test PDP context 2 established.

Specific PICS Statements

-

PIXIT Statements

-

Test procedure

SS sends a PACKET MEASUREMENT ORDER message to MS. NETWORK_CONTROL_ORDER is commanded to be NC2. NC_NON_DRX_PERIOD is commanded to be 1.92 Sec.

At the end of reporting period, MS sends a PACKET MEASUREMENT REPORT to the SS. After receiving the PACKET MEASUREMENT REPORT message, SS waits for $0.8 * NC_NON_DRX_PERIOD$ and sends a PACKET PAGING REQUEST message addressing the MS, in a Paging sub-channel not belonging to MS paging subgroup.

SS verifies that MS responds to the Paging.

SS waits for $1.1 * NC_NON_DRX_PERIOD$ and sends a PACKET PAGING REQUEST message addressing the MS, in a Paging sub-channel not belonging to MS paging subgroup.

SS verifies that MS does not respond to the Paging.

Maximum duration of the test

5 min

Expected sequence

Step	Direction	Message	Comments
1	SS->MS	PACKET MEASUREMENT ORDER	-Sent on PPCH. See specific message contents
2	MS ->SS	PACKET CHANNEL REQUEST	Establishment cause = 'Single block without TBF establishment'
3	SS -> MS	PACKET UPLINK ASSIGNMENT	Sent on PAGCH. Allocating a single block to the MS to transmit Packet Measurement Report message.
4	MS ->SS	PACKET MEASUREMENT REPORT	Received on the allocated PDCH.
5	SS		Wait for $0.8 \cdot NC_NON_DRX_PERIOD$
6	SS->MS	PACKET PAGING REQUEST	Sent on a PPCH not belonging to the MS paging subgroup. 1 st Repeated Page info contains P-TMSI of the MS. No other Repeated Page info Page Mode = 'Normal Paging'.
7	MS ->SS	PACKET CHANNEL REQUEST	Received on PRACH Establishment Cause = 'Page Response'
8	SS -> MS	PACKET ACCESS REJECT	Sent on PAGCH. Packet request reference = pertaining to the message received in step 7.
9	MS ->SS	PACKET CHANNEL REQUEST	Establishment cause = 'Single block without TBF establishment'
10	SS -> MS	PACKET UPLINK ASSIGNMENT	Sent on PAGCH. Allocating a single block to the MS to transmit Packet Measurement Report message.
11	MS ->SS	PACKET MEASUREMENT REPORT	Received on the allocated PDCH.
12	SS		Wait until $1.1 \cdot NC_NON_DRX_PERIOD$ after Step 11.
13	SS->MS	PACKET PAGING REQUEST	Sent on a PPCH not belonging to the MS paging subgroup. 1 st Repeated Page info contains P-TMSI of the MS. No other Repeated Page info Page Mode = 'Normal Paging'.
14	SS		SS verifies that MS does not respond to the paging in Step 13

Specific message contents

PACKET MEASUREMENT ORDER in step 1:

NC Measurement parameters	
NETWORK_CONTROL_ORDER	10 (NC2)
NC_REPORTING_PERIOD_I	100 (7.68 sec)
NC_NON_DRX_PERIOD	111 (1.92 sec)
NC_FREQUENCY_LIST	0 (not present)

42.4.8.1.2 NC2 and DRX / NC_NON_DRX_PERIOD / NC2 non-DRX mode period ordered in Packet Cell Change Order

42.4.8.1.2.1 Conformance requirement

A mobile station operating in NC2 mode shall enter the NC2 non-DRX mode period when it sends an NC measurement report. The duration of this period is defined by the NC_NON_DRX_PERIOD parameter.

The non-DRX mode periods have effect only in packet idle mode. In packet idle mode, the mobile station shall be in non-DRX mode during any of the non-DRX mode periods. Otherwise, the mobile station in packet idle mode may be in DRX mode.

The behaviour of the mobile station is controlled by the parameter NETWORK_CONTROL_ORDER broadcast in the PSI5 message on PBCCH, in the SI13 and SI2quater messages on the BCCH and in the PSI13 message on PACCH. Alternatively, the network may send the NETWORK_CONTROL_ORDER parameters in a PACKET MEASUREMENT ORDER or in a PACKET CELL CHANGE ORDER message on PCCCH or PACCH to a particular mobile station. The parameter NETWORK_CONTROL_ORDER may have one of the values NC0, NC1, NC2 or RESET.

When in mode NC1 or NC2, the mobile station shall perform the NC measurements as defined in 3GPP TS 05.08. The reporting periods are indicated in the NC_REPORTING_PERIOD_I and NC_REPORTING_PERIOD_T field of the PSI5, the SI2quater, the PACKET CELL CHANGE ORDER or the PACKET MEASUREMENT ORDER message. If NC_NON_DRX_PERIOD, NC_REPORTING_PERIOD_I or NC_REPORTING_PERIOD_T have not been received by the mobile station the default values shall be used. The mobile station shall apply to the timer T3158 either the NC_REPORTING_PERIOD_I when in packet idle mode or the NC_REPORTING_PERIOD_T when in packet transfer mode.

A mobile station in packet idle mode shall take into account the page mode information in any message received in a radio block on PCCCH corresponding to its paging group. The mobile station shall not take into account the page mode information in a message received in any other radio block than those corresponding to its paging group. The requirements yielded by the page mode information are as follows:

- *normal paging*: no additional requirements;

[...]

- *paging reorganization*: The mobile station shall receive all messages on the PCCCH regardless of the BS_PAG_BLK_RES setting. It is required to receive all PBCCH messages. When the mobile station receives the next message to its (possibly new) paging group, subsequent action is defined by the page mode information in that message;

Reference

3GPP TS 04.60, sub-clauses 5.5.1.5, 5.5.1.6, 5.6.1

42.4.8.1.2.2 Test Purpose

To verify that when an MS selects a new cell as ordered using a PACKET CELL CHANGE ORDER message, the MS takes into consideration and respects the NC_NON_DRX_PERIOD parameter sent in a PACKET CELL CHANGE ORDER message in the new cell.

42.4.8.1.2.3 Method of test

Initial conditions

System Simulator:

2 cells, GPRS supported, PCCCH present.

Mobile Station:

MS is GPRS attached in Cell-A and is in Packet Idle mode. Ready Timer set to 5 min.

Test PDP context 2 established.

Specific PICS Statements

-

PIXIT Statements

-

Test procedure

SS sends a PACKET MEASUREMENT ORDER message to MS ordering the MS to send measurement, the MS starts sending measurements. SS continues receiving measurements until measurement results of cell B are included. SS sends then a PACKET CELL CHANGE ORDER message to MS ordering the MS to select Cell-B. NETWORK_CONTROL_ORDER is commanded to be NC2. NC_NON_DRX_PERIOD for Cell-B is commanded to be 1.2 Sec.

MS selects Cell-B.

At the end of reporting period, MS sends a PACKET MEASUREMENT REPORT to the SS on Cell-B, this is done twice. After receiving the second PACKET MEASUREMENT REPORT message, the SS waits for $0.8 * NC_NON_DRX_PERIOD$ and sends a PACKET PAGING REQUEST message addressing the MS, in a Paging sub-channel not belonging to MS paging subgroup.

SS verifies that MS responds to the Paging.

At the end of next reporting period, MS sends a PACKET MEASUREMENT REPORT to the SS on Cell-B. After receiving the PACKET MEASUREMENT REPORT message, the SS waits for $1.1 * NC_NON_DRX_PERIOD$ and sends a PACKET PAGING REQUEST message addressing the MS, in a Paging sub-channel not belonging to MS paging subgroup.

SS verifies that MS does not respond to the Paging.

Maximum duration of the test

5 min

Expected sequence

Step	Direction	Message	Comments
1	SS->MS	PACKET MEASUREMENT ORDER	-Sent on PCCCH. See specific message contents
2	MS ->SS	PACKET CHANNEL REQUEST	-Cause 'Single block without TBF establishment'
3	SS->MS	PACKET UPLINK ASSIGNMENT	
4	MS ->SS	PACKET MEASUREMENT REPORT	
5			Repeat steps 2-4 until measurement results for cell B are included in the PACKET MEASUREMENT REPORT message.
6	SS->MS	PACKET CELL CHANGE ORDER	-Sent on PCCCH. - Commanding the MS to select Cell-B See specific message contents
			The following messages are to be sent and received in Cell B.
7	MS ->SS	PACKET CHANNEL REQUEST	Received on PRACH. Establishment cause = 'Cell Update'
8	SS -> MS	PACKET UPLINK ASSIGNMENT	Sent on PAGCH. Open-ended Dynamic Allocation.
9	SS -> MS	PACKET DOWNLINK DUMMY CONTROL BLOCK	Sent on PACCH containing USF assigned to the MS.
10	MS ->SS	UPLINK RLC DATA BLOCK	LLC PDU implicitly indicating Cell Update
11	SS -> MS	PACKET UPLINK ACK/NACK	Acknowledge the received RLC data block(s), Final Ack Indicator = '1' , a valid RRBP. Sent on PACCH.
12	MS -> SS	PACKET CONTROL ACKNOWLEDGEMENT	Received on PACCH.
13	MS ->SS	PACKET CHANNEL REQUEST	Establishment cause = 'Single block without TBF establishment.'
14	SS -> MS	PACKET UPLINK ASSIGNMENT	Sent on PAGCH. Allocating a single block to the MS to transmit Packet Measurement Report message.
15	MS ->SS	PACKET MEASUREMENT REPORT	Received on the allocated PDCH Step 13-16 are repeated once.
15bis			Wait for 0.8*NC_NON_DRX_PERIOD
16	SS		
17	SS->MS	PACKET PAGING REQUEST	Sent on a PPCH not belonging to the MS paging subgroup. 1 st Repeated Page info contains P-TMSI of the MS. No other Repeated Page info Page Mode = 'Normal Paging'.
18	MS ->SS	PACKET CHANNEL REQUEST	Received on PRACH Establishment Cause = 'Page Response'
19	SS -> MS	PACKET ACCESS REJECT	Sent on PAGCH. Packet request reference = pertaining to the message received in step 18. Without WAIT_INDICATION IE
20	MS ->SS	PACKET CHANNEL REQUEST	Establishment cause = 'Single block without TBF establishment.' SS verifies that PACKET CHANNEL REQUEST arrives at the end of correct reporting period.

21	SS -> MS	PACKET UPLINK ASSIGNMENT	Sent on PAGCH. Allocating a single block to the MS to transmit Packet Measurement Report message.
22	MS ->SS	PACKET MEASUREMENT REPORT	Received on the allocated PDCH
23	SS		Wait for 1.1*NC_NON_DRX_PERIOD
24	SS->MS	PACKET PAGING REQUEST	Sent on a PPCH not belonging to the MS paging subgroup. 1 st Repeated Page info contains P-TMSI of the MS. No other Repeated Page info Page Mode = 'Normal Paging'.
25	SS		SS verifies that MS does not respond to Paging in Step 24.

Specific message contents

PACKET MEASUREMENT ORDER in step 1:

NC Measurement parameters	
NETWORK_CONTROL_ORDER	10 (NC2)
NC_REPORTING_PERIOD_I	100 (7.68s)

PACKET CELL CHANGE ORDER in step 6

TLLI	As assigned to the MS
IMMEDIATE_REL	1
ARFCN, BSIC	as specified for cell B
NC Measurement parameters	
NETWORK_CONTROL_ORDER	10 (NC2)
NC_REPORTING_PERIOD_I	101 (15.36 s)
NC_NON_DRX_PERIOD	101 (1.2 sec)
NC_FREQUENCY_LIST	0 (not present)

42.4.8.1.3 NC2 and DRX / NC_NON_DRX_PERIOD / NC2 non-DRX mode period broadcast in PSI5

42.4.8.1.3.1 Conformance requirement

A mobile station operating in NC2 mode shall enter the NC2 non-DRX mode period when it sends an NC measurement report. The duration of this period is defined by the NC_NON_DRX_PERIOD parameter.

The non-DRX mode periods have effect only in packet idle mode. In packet idle mode, the mobile station shall be in non-DRX mode during any of the non-DRX mode periods. Otherwise, the mobile station in packet idle mode may be in DRX mode.

When in mode NC1 or NC2, the mobile station shall perform the NC measurements as defined in 3GPP TS 05.08. The reporting periods are indicated in the NC_REPORTING_PERIOD_I and NC_REPORTING_PERIOD_T field of the PSI5, the SI2quarter, the PACKET CELL CHANGE ORDER or the PACKET MEASUREMENT ORDER message. If NC_NON_DRX_PERIOD, NC_REPORTING_PERIOD_I or NC_REPORTING_PERIOD_T have not been received by the mobile station the default values shall be used. The mobile station shall apply to the timer T3158 either the NC_REPORTING_PERIOD_I when in packet idle mode or the NC_REPORTING_PERIOD_T when in packet transfer mode.

If no parameters have been brought from the old cell, and until individual measurement parameters are received in the new cell, the mobile station shall use the broadcast measurement parameters from PSI5 if a PBCCH is allocated in the cell or SI2quarter if a PBCCH is not allocated in the cell or use the default parameter values.

A mobile station in packet idle mode shall take into account the page mode information in any message received in a radio block on PCCCH corresponding to its paging group. The mobile station shall not take into account the page mode information in a message received in any other radio block than those corresponding to its paging group. The requirements yielded by the page mode information are as follows:

- *normal paging*: no additional requirements;

[...]

- *paging reorganization*: The mobile station shall receive all messages on the PCCCH regardless of the BS_PAG_BLK_RES setting. It is required to receive all PBCCH messages. When the mobile station receives the next message to its (possibly new) paging group, subsequent action is defined by the page mode information in that message;

Reference

3GPP TS 04.60, sub-clauses 5.5.1.5, 5.5.1.6, 5.6.1

42.4.8.1.3.2 Test Purpose

To verify that when an MS selects a new cell and if no parameters have been brought from the old cell, the MS uses the broadcast measurement parameter NC_NON_DRX_PERIOD from PSI5 if PBCCH is allocated in the new cell.

42.4.8.1.3.3 Method of test

Initial conditions

System Simulator:

2 cells, GPRS supported, PCCCH present.

(See specific message contents)

Mobile Station:

MS is GPRS attached in Cell-A and is in Packet Idle mode. Ready Timer set to 5 min.

Test PDP context 2 established.

Specific PICS Statements

-

PIXIT Statements

-

Test procedure

SS sends a PACKET MEASUREMENT ORDER message to MS ordering the MS to send measurement, the MS starts sending measurements. SS continues receiving measurements until measurement results of cell B are included. SS sends then a PACKET CELL CHANGE ORDER message to MS ordering the MS to select Cell-B. NETWORK_CONTROL_ORDER is commanded to be NC2. Measurement parameters are omitted from the message.

MS selects Cell-B.

At the end of reporting period as specified in PSI5 message broadcast in Cell-B, MS sends a PACKET MEASUREMENT REPORT to the SS on Cell-B, this is done twice. After receiving the second PACKET MEASUREMENT REPORT message, the SS waits for $0.8 * NC_NON_DRX_PERIOD$ period as specified in PSI5 message broadcast in Cell-B and sends a PACKET PAGING REQUEST message addressing the MS, in a Paging sub-channel not belonging to MS paging subgroup.

SS verifies that MS responds to the Paging.

At the end of next reporting period, MS sends a PACKET MEASUREMENT REPORT to the SS on Cell-B. After receiving the PACKET MEASUREMENT REPORT message, the SS waits for $1.1 * NC_NON_DRX_PERIOD$ and

sends a PACKET PAGING REQUEST message addressing the MS, in a Paging sub-channel not belonging to MS paging subgroup.

SS verifies that MS does not respond to the Paging.

Maximum duration of the test

5 min

Expected sequence

Step	Direction	Message	Comments
1	SS->MS	PACKET MEASUREMENT ORDER	-Sent on PCCCH. See specific message contents
2	MS ->SS	PACKET CHANNEL REQUEST	-Cause 'Single block without TBF establishment'
3	SS->MS	PACKET UPLINK ASSIGNMENT	
4	MS ->SS	PACKET MEASUREMENT REPORT	
5			Repeat steps 2-4 until measurement results for cell B are included in the PACKET MEASUREMENT REPORT message.
6	SS->MS	PACKET CELL CHANGE ORDER	-Sent on PCCCH. - Commanding the MS to select Cell-B See specific message contents
			The following messages are to be sent and received in Cell B.
7	MS ->SS	PACKET CHANNEL REQUEST	Received on PRACH. Establishment cause = 'Cell Update'
8	SS -> MS	PACKET UPLINK ASSIGNMENT	Sent on PAGCH. Open-ended Dynamic Allocation.
9	SS -> MS	PACKET DOWNLINK DUMMY CONTROL BLOCK	Sent on PACCH containing USF assigned to the MS.
10	MS ->SS	UPLINK RLC DATA BLOCK	LLC PDU implicitly indicating Cell Update
11	SS -> MS	PACKET UPLINK ACK/NACK	Acknowledge the received RLC data block(s), Final Ack Indicator = '1' , a valid RRBP. Sent on PACCH.
12	MS -> SS	PACKET CONTROL ACKNOWLEDGEMENT	Received on PACCH.
13	MS ->SS	PACKET CHANNEL REQUEST	Establishment cause = 'Single block without TBF establishment.'
14	SS -> MS	PACKET UPLINK ASSIGNMENT	Sent on PAGCH. Allocating a single block to the MS to transmit PACKET MEASUREMENT REPORT message.
15	MS ->SS	PACKET MEASUREMENT REPORT	Received on the allocated PDCH
15bis			Step 13-16 are repeated once.
16	SS		Wait for $0.8 \cdot NC_NON_DRX_PERIOD$ broadcast in PSI5
17	SS->MS	PACKET PAGING REQUEST	Sent on a PPCH not belonging to the MS paging subgroup. 1 st Repeated Page info contains P-TMSI of the MS. No other Repeated Page info Page Mode = 'Normal Paging'.
18	MS ->SS	PACKET CHANNEL REQUEST	Received on PRACH Establishment Cause = 'Page Response'
19	SS -> MS	PACKET ACCESS REJECT	Sent on PAGCH. Packet request reference = pertaining to the message received in step 18.
20	MS ->SS	PACKET CHANNEL REQUEST	Establishment cause = 'Single block without TBF establishment.' SS verifies that PACKET CHANNEL REQUEST arrives at the end of correct reporting period.
21	SS -> MS	PACKET UPLINK ASSIGNMENT	Sent on PAGCH. Allocating a single block to the MS to transmit PACKET MEASUREMENT REPORT message.
22	MS ->SS	PACKET MEASUREMENT REPORT	Received on the allocated PDCH
23	SS		Wait for $1.1 \cdot NC_NON_DRX_PERIOD$ broadcast in PSI5

24	SS->MS	PACKET PAGING REQUEST	Sent on a PPCH not belonging to the MS paging subgroup. 1 st Repeated Page info contains P-TMSI of the MS. No other Repeated Page info Page Mode = 'Normal Paging'. SS verifies that MS does not respond to Paging in Step 24.
25	SS		

Specific message contents

Packet System Information Type 1 (Cell-B)

PSI_COUNT_LR	4
MEASUREMENT_ORDER	1

Packet System Information Type 5 (Cell-B)

NETWORK_CONTROL_ORDER	10 (NC2)
NC_NON_DRX_PERIOD	101 (1,2 sec.)
NC_REPORTING_PERIOD_I	101 (15,36 sec)

PACKET MEASUREMENT ORDER in step 1:

NC Measurement parameters	
NETWORK_CONTROL_ORDER	10 (NC2)
NC_REPORTING_PERIOD_I	100 (7.68s)

PACKET CELL CHANGE ORDER in step 6

TLLI	As assigned to the MS
IMMEDIATE_REL	1
ARFCN, BSIC	as specified for cell B
NC Measurement parameters	
NETWORK_CONTROL_ORDER	11 (Reset)
NC_FREQUENCY_LIST	0 (Measurement parameters not present)
	0 (Not present)

42.4.8.1.4 NC2 and DRX / NC_NON_DRX_PERIOD / NC2 non-DRX mode period broadcast in SI2Quater

42.4.8.1.4.1 Conformance requirement

A mobile station operating in NC2 mode shall enter the NC2 non-DRX mode period when it sends an NC measurement report. The duration of this period is defined by the NC_NON_DRX_PERIOD parameter.

The non-DRX mode periods have effect only in packet idle mode. In packet idle mode, the mobile station shall be in non-DRX mode during any of the non-DRX mode periods. Otherwise, the mobile station in packet idle mode may be in DRX mode.

When in mode NC1 or NC2, the mobile station shall perform the NC measurements as defined in 3GPP TS 05.08. The reporting periods are indicated in the NC_REPORTING_PERIOD_I and NC_REPORTING_PERIOD_T field of the PSI5, the SI2quater, the PACKET CELL CHANGE ORDER or the PACKET MEASUREMENT ORDER message. If NC_NON_DRX_PERIOD, NC_REPORTING_PERIOD_I or NC_REPORTING_PERIOD_T have not been received by the mobile station the default values shall be used. The mobile station shall apply to the timer T3158 either the NC_REPORTING_PERIOD_I when in packet idle mode or the NC_REPORTING_PERIOD_T when in packet transfer mode.

If no parameters have been brought from the old cell, and until individual measurement parameters are received in the new cell, the mobile station shall use the broadcast measurement parameters from PSI5 if a PBCCH is allocated in the cell or SI2quater if a PBCCH is not allocated in the cell or use the default parameter values.

The mobile station in idle mode is required to receive and analyse the paging messages and immediate assignment messages sent on the paging subchannel corresponding to its paging subgroup, as specified in 3GPP TS 05.02.

[...]

This implies that a given mobile station shall take into account the page mode information element of any message sent on its own paging subchannel whatever the nature of this message (paging messages or immediate assignment messages). This further implies that the mobile station does not take into account page mode information element of messages sent on paging subchannels other than its own paging subchannel. The requirements yielded by the page mode information element are as follows:

- normal paging: no additional requirements;

[...]

- paging reorganization: The mobile station shall receive all messages on the CCCH regardless of the BS-AG-BLKS-RES setting. It is required to receive all BCCH messages. When the mobile station receives the next message to its (possibly new) paging subgroup the subsequent action is defined in the page mode information element in that message.

Reference

3GPP TS 04.60, sub-clauses 5.5.1.5, 5.6.1

3GPP TS 04.08, sub-clauses 3.3.2.1.1

42.4.8.1.4.2 Test Purpose

To verify that when an MS selects a new cell and if no parameters have been brought from the old cell, the MS uses the broadcast measurement parameter NC_NON_DRX_PERIOD from SI2quater if PBCCH is not allocated in the new cell.

42.4.8.1.4.3 Method of test

Initial conditions

System Simulator:

2 cells, GPRS supported

For Cell A

PCCCH present

For Cell-B

PCCCH not present

SI2quater transmitted (Rest Octet as described in the Specific Message Contents).

Mobile Station:

MS is GPRS attached in Cell-A and is in Packet Idle mode. Ready Timer set to 5 min.

Test PDP context 2 established.

Specific PICS Statements

-

PIXIT Statements

-

Test procedure

SS sends a PACKET MEASUREMENT ORDER message to MS ordering the MS to send measurement, the MS starts sending measurements. SS continues receiving measurements until measurement results of cell B are included. SS sends then a PACKET CELL CHANGE ORDER message to MS ordering the MS to select Cell-B. NETWORK_CONTROL_ORDER is commanded to be NC2. Measurement parameters are omitted from the message.

MS selects Cell-B.

At the end of reporting period as specified in SI2quarter message broadcast in Cell-B, MS sends a PACKET MEASUREMENT REPORT to the SS on Cell-B, this is done twice. After receiving the second PACKET MEASUREMENT REPORT message, the SS waits for $0.8 * NC_NON_DRX_PERIOD$ period as specified in SI2quarter message broadcast in Cell-B and sends a PAGING REQUEST TYPE 1 message addressing the MS, in a Paging sub-channel not belonging to MS paging subgroup.

SS verifies that MS responds to the Paging.

At the end of next reporting period, MS sends a PACKET MEASUREMENT REPORT to the SS on Cell-B. After receiving the PACKET MEASUREMENT REPORT message, the SS waits for $1.1 * NC_NON_DRX_PERIOD$ and sends a PAGING REQUEST TYPE 1 message addressing the MS, in a Paging sub-channel not belonging to MS paging subgroup.

SS verifies that MS does not respond to the Paging.

Maximum duration of the test

5 min

Expected sequence

Step	Direction	Message	Comments
1	SS->MS	PACKET MEASUREMENT ORDER	-Sent on PCCCH. See specific message contents
2	MS ->SS	PACKET CHANNEL REQUEST	-Cause 'Single block without TBF establishment'
3	SS->MS	PACKET UPLINK ASSIGNMENT	
4	MS ->SS	PACKET MEASUREMENT REPORT	
5			Repeat steps 2-4 until measurement results for cell B are included in the PACKET MEASUREMENT REPORT message.
6	SS->MS	PACKET CELL CHANGE ORDER	-Sent on PCCCH. - Commanding the MS to select Cell-B See specific message contents
			The following messages are to be sent and received in Cell B.
7	MS ->SS	CHANNEL REQUEST	Establishment cause = 'one phase access'. Received on RACH. Sent on AGCH. Open-ended Dynamic Allocation. Sent on PACCH containing USF assigned to the MS. LLC PDU implicitly indicating Cell Update Acknowledge the received RLC data block(s), Final Ack Indicator = '1', a valid RRBP. Sent on PACCH. Received on PACCH. Establishment Cause = 'Single block packet access' Sent on AGCH. Single block Allocation. Received on the allocated PDCH Step 13-16 are repeated once. Wait for 0.8*NC_NON_DRX_PERIOD broadcast in SI2quarter Sent on PCH not belonging to the MS paging subgroup. 1 st Mobility Identity contains P-TMSI of the MS, 2 nd Mobility Identity not present. Page Mode = 'Normal Paging'. Packet Page Indication indicates a packet paging procedure. Establishment Cause = 'one phase access'. Received on RACH. Random Reference = pertaining to the message received in step 18, Sent on AGCH. Establishment Cause = 'Single block packet access' SS verifies that the CHANNEL REQUEST arrives at the end of correct reporting period. Sent on AGCH. Single block Allocation. Received on the allocated PDCH Wait for 1.1*NC_NON_DRX_PERIOD broadcast in SI2quarter
8	SS -> MS	IMMEDIATE ASSIGNMENT	
9	SS -> MS	PACKET DOWNLINK DUMMY CONTROL BLOCK	
10	MS ->SS	UPLINK RLC DATA BLOCK	
11	SS -> MS	PACKET UPLINK ACK/NACK	
12	MS -> SS	PACKET CONTROL ACKNOWLEDGEMENT	
13	MS ->SS	CHANNEL REQUEST	
14	SS -> MS	IMMEDIATE ASSIGNMENT	
15	MS ->SS	PACKET MEASUREMENT REPORT	
15bis			
16	SS		
17	SS->MS	PAGING REQUEST TYPE 1	
18	MS-> SS	CHANNEL REQUEST	
19	SS -> MS	IMMEDIATE ASSIGNMENT REJECT	
20	MS ->SS	CHANNEL REQUEST	
21	SS -> MS	IMMEDIATE ASSIGNMENT	
22	MS ->SS	PACKET MEASUREMENT REPORT	
23	SS		

24	SS->MS	PAGING REQUEST TYPE 1	Sent on a PCH not belonging to the MS paging subgroup. 1 st Mobility Identity contains P-TMSI of the MS, 2 nd Mobility Identity not present. Page Mode = 'Normal Paging'. Packet Page Indication indicates a packet paging procedure. SS verifies that MS does not respond to Paging in Step 24.
25	SS		

Specific message contents

-

System Information Type 2quarter (Cell-B)

BA_IND	0
3G_BA_IND	0
MP_CHANGE_MARK	0
SI2quarter_INDEX	0
SI2quarter_COUNT	0
Measurement_Parameters Description	0 (Not present)
GPRS_Real Time Difference Description	0 (Not present)
GPRS_BSIC Description	0 (Not present)
GPRS_MEASUREMENT_Parameters Description	1 (Present)
REPORT_TYPE	1 (Normal)
REPORTING_RATE	0 (Normal)
INVALID_BSIC_REPORTING	0 (No)
MULTIBAND_REPORTING	00
SERVING_BAND_REPORTING	00
SCALE_ORD	00
	00000 (No reporting Threshold or Reporting Offset)
NC Measurement Parameters	
NETWORK_CONTROL_ORDER	10 (NC2)
NC_NON_DRX_PERIOD	101 (1.2 sec)
NC_REPORTING_PERIOD_I	101 (15.36 sec)
extension length	0 (Not present)
3G Neighbour Cell Description	0 (Not present)
3G Measurement Parameters Description	0 (Not present)
GPRS_3G_MEASUREMENT Parameters Description	0 (Not present)

System Information Type 13 (Cell-B)

NETWORK_CONTROL_ORDER	10 (NC2)
-----------------------	----------

PACKET MEASUREMENT ORDER in step 1:

NC Measurement parameters	
NETWORK_CONTROL_ORDER	10 (NC2)
NC_REPORTING_PERIOD_I	100 (7.68s)

PACKET CELL CHANGE ORDER in step 6

TLLI	As assigned to the MS
IMMEDIATE_REL	1
ARFCN, BSIC	as specified for cell B
NC Measurement parameters	
NETWORK_CONTROL_ORDER	11 (RESET)
	0 (Measurement parameters not present)
NC_FREQUENCY_LIST	0 (Not present)

42.4.8.1.5 NC2 and DRX / NC_NON_DRX_PERIOD / NC2 non-DRX mode period / PBCCH present / Default Value

42.4.8.1.5.1 Conformance requirement

A mobile station operating in NC2 mode shall enter the NC2 non-DRX mode period when it sends an NC measurement report. The duration of this period is defined by the NC_NON_DRX_PERIOD parameter.

The non-DRX mode periods have effect only in packet idle mode. In packet idle mode, the mobile station shall be in non-DRX mode during any of the non-DRX mode periods. Otherwise, the mobile station in packet idle mode may be in DRX mode.

When in mode NC1 or NC2, the mobile station shall perform the NC measurements as defined in 3GPP TS 05.08. The reporting periods are indicated in the NC_REPORTING_PERIOD_I and NC_REPORTING_PERIOD_T field of the PSI5, the SI2quater, the PACKET CELL CHANGE ORDER or the PACKET MEASUREMENT ORDER message. If NC_NON_DRX_PERIOD, NC_REPORTING_PERIOD_I or NC_REPORTING_PERIOD_T have not been received by the mobile station the default values shall be used. The mobile station shall apply to the timer T3158 either the NC_REPORTING_PERIOD_I when in packet idle mode or the NC_REPORTING_PERIOD_T when in packet transfer mode.

If no parameters have been brought from the old cell, and until individual measurement parameters are received in the new cell, the mobile station shall use the broadcast measurement parameters from PSI5 if a PBCCH is allocated in the cell or SI2quater if a PBCCH is not allocated in the cell or use the default parameter values.

A mobile station in packet idle mode shall take into account the page mode information in any message received in a radio block on PCCCH corresponding to its paging group. The mobile station shall not take into account the page mode information in a message received in any other radio block than those corresponding to its paging group. The requirements yielded by the page mode information are as follows:

- *normal paging*: no additional requirements;

[...]

- *paging reorganization*: The mobile station shall receive all messages on the PCCCH regardless of the BS_PAG_BLK_RES setting. It is required to receive all PBCCH messages. When the mobile station receives the next message to its (possibly new) paging group, subsequent action is defined by the page mode information in that message;

Reference

3GPP TS 04.60, sub-clauses 5.5.1.5, 5.5.1.6, 5.6.1

42.4.8.1.5.2 Test Purpose

To verify that when an MS selects a new cell and if no parameters have been brought from the old cell, the MS uses the default value of NC_NON_DRX_PERIOD parameter if NC Measurement Parameters are not included in the PSI5 broadcast in the new cell.

42.4.8.1.5.3 Method of test

Initial conditions

System Simulator:

2 cells, GPRS supported, PCCCH present.

(See specific message contents)

Mobile Station:

MS is GPRS attached in Cell-A and is in Packet Idle mode. Ready Timer set to 5 min.

Test PDP context 2 established.

Specific PICS Statements

-

PIXIT Statements

-

Test procedure

SS sends a PACKET MEASUREMENT ORDER message to MS ordering the MS to send measurement, the MS starts sending measurements. SS continues receiving measurements until measurement results of cell B are included. SS sends then a PACKET CELL CHANGE ORDER message to MS ordering the MS to select Cell-B. NETWORK_CONTROL_ORDER is commanded to be NC2. Measurement parameters are omitted from the message.

MS selects Cell-B. At the end of reporting period as specified in PSI5 message broadcast in Cell-B, MS sends a PACKET MEASUREMENT REPORT to the SS on Cell-B. After receiving the PACKET MEASUREMENT REPORT message, the SS waits for $0.8 * NC_NON_DRX_PERIOD$ period as specified in PSI5 message broadcast in Cell-B and sends a PACKET PAGING REQUEST message addressing the MS, in a Paging sub-channel not belonging to MS paging subgroup.

SS verifies that MS responds to the Paging.

At the end of next reporting period, MS sends a PACKET MEASUREMENT REPORT to the SS on Cell-B. After receiving the PACKET MEASUREMENT REPORT message, the SS waits for $1.1 * NC_NON_DRX_PERIOD$ and sends a PACKET PAGING REQUEST message addressing the MS, in a Paging sub-channel not belonging to MS paging subgroup.

SS verifies that MS does not respond to the Paging.

Maximum duration of the test

5 min

Expected sequence

Step	Direction	Message	Comments
1	SS->MS	PACKET MEASUREMENT ORDER	-Sent on PCCCH. See specific message contents
2	MS ->SS	PACKET CHANNEL REQUEST	-Cause 'Single block without TBF establishment'
3	SS->MS	PACKET UPLINK ASSIGNMENT	
4	MS ->SS	PACKET MEASUREMENT REPORT	
5			Repeat steps 2-4 until measurement results for cell B are included in the PACKET MEASUREMENT REPORT message.
6	SS->MS	PACKET CELL CHANGE ORDER	-Sent on PCCCH. - Commanding the MS to select Cell-B See specific message contents
			The following messages are to be sent and received in Cell B.
7	MS ->SS	PACKET CHANNEL REQUEST	Received on PRACH. Establishment cause = 'Cell Update'
8	SS -> MS	PACKET UPLINK ASSIGNMENT	Sent on PAGCH. Open-ended Dynamic Allocation.
9	SS -> MS	PACKET DOWNLINK DUMMY CONTROL BLOCK	Sent on PACCH containing USF assigned to the MS.
10	MS ->SS	UPLINK RLC DATA BLOCK	LLC PDU implicitly indicating Cell Update
11	SS -> MS	PACKET UPLINK ACK/NACK	Acknowledge the received RLC data block(s), Final Ack Indicator = '1' , a valid RRBP. Sent on PACCH.
12	MS -> SS	PACKET CONTROL ACKNOWLEDGEMENT	Received on PACCH.
13	MS ->SS	PACKET CHANNEL REQUEST	Establishment cause = 'Single block without TBF establishment.'
14	SS -> MS	PACKET UPLINK ASSIGNMENT	Sent on PAGCH. Allocating a single block to the MS to transmit PACKET MEASUREMENT REPORT message.
15	MS ->SS	PACKET MEASUREMENT REPORT	Received on the allocated PDCH
16	SS		Wait for 0.8*(NC_NON_DRX_PERIOD default value = 0.48 sec)
17	SS->MS	PACKET PAGING REQUEST	Sent on a PPCH not belonging to the MS paging subgroup. 1 st Repeated Page info contains P-TMSI of the MS. No other Repeated Page info Page Mode = 'Normal Paging'.
18	MS ->SS	PACKET CHANNEL REQUEST	Received on PRACH Establishment Cause = 'Page Response'
19	SS -> MS	PACKET ACCESS REJECT	Sent on PAGCH. Packet request reference = pertaining to the message received in step 18.

20	MS ->SS	PACKET CHANNEL REQUEST	Establishment cause = 'Single block without TBF establishment.' SS verifies that PACKET CHANNEL REQUEST arrives at the end of default reporting period.
21	SS -> MS	PACKET UPLINK ASSIGNMENT	Sent on PAGCH. Allocating a single block to the MS to transmit PACKET MEASUREMENT REPORT message.
22	MS ->SS	PACKET MEASUREMENT REPORT	Received on the allocated PDCH
23	SS		Wait for 1.1*(NC_NON_DRX_PERIOD default value = 0.48 sec)
24	SS->MS	PACKET PAGING REQUEST	Sent on a PPCH not belonging to the MS paging subgroup. 1 st Repeated Page info contains P-TMSI of the MS. No other Repeated Page info Page Mode = 'Normal Paging'.
25	SS		SS verifies that MS does not respond to Paging in Step 24.

Specific message contents

Packet System Information Type 1 (Cell-B)

PSI_COUNT_LR	4
MEASUREMENT_ORDER	1

Packet System Information Type 5 (Cell-B)

NC Measurement Parameters struct	0 (Not present)
----------------------------------	-----------------

PACKET MEASUREMENT ORDER in step 1:

NC Measurement parameters	10 (NC2)
NETWORK_CONTROL_ORDER	0 (Measurement parameters not present)
NC_FREQUENCY_LIST	0 (Not present)

PACKET CELL CHANGE ORDER in step 6

TLLI	As assigned to the MS
IMMEDIATE_REL	1
ARFCN, BSIC	as specified for cell B
NC Measurement parameters	10 (NC2)
NETWORK_CONTROL_ORDER	0 (Measurement parameters not present)
NC_FREQUENCY_LIST	0 (Not present)

42.4.8.1.6 NC2 and DRX / NC_NON_DRX_PERIOD / NC2 non-DRX mode period / PBCCH absent / Default Value

42.4.8.1.6.1 Conformance requirement

A mobile station operating in NC2 mode shall enter the NC2 non-DRX mode period when it sends an NC measurement report. The duration of this period is defined by the NC_NON_DRX_PERIOD parameter.

The non-DRX mode periods have effect only in packet idle mode. In packet idle mode, the mobile station shall be in non-DRX mode during any of the non-DRX mode periods. Otherwise, the mobile station in packet idle mode may be in DRX mode.

When in mode NC1 or NC2, the mobile station shall perform the NC measurements as defined in 3GPP TS 05.08. The reporting periods are indicated in the NC_REPORTING_PERIOD_I and NC_REPORTING_PERIOD_T field of the PSI5, the SI2quater, the PACKET CELL CHANGE ORDER or the PACKET MEASUREMENT ORDER message. If NC_NON_DRX_PERIOD, NC_REPORTING_PERIOD_I or NC_REPORTING_PERIOD_T have not been received by the mobile station the default values shall be used. The mobile station shall apply to the timer T3158 either the NC_REPORTING_PERIOD_I when in packet idle mode or the NC_REPORTING_PERIOD_T when in packet transfer mode.

If no parameters have been brought from the old cell, and until individual measurement parameters are received in the new cell, the mobile station shall use the broadcast measurement parameters from PSI5 if a PBCCH is allocated in the cell or SI2quater if a PBCCH is not allocated in the cell or use the default parameter values.

The mobile station in idle mode is required to receive and analyse the paging messages and immediate assignment messages sent on the paging subchannel corresponding to its paging subgroup, as specified in 3GPP TS 05.02.

[...]

This implies that a given mobile station shall take into account the page mode information element of any message sent on its own paging subchannel whatever the nature of this message (paging messages or immediate assignment messages). This further implies that the mobile station does not take into account page mode information element of messages sent on paging subchannels other than its own paging subchannel. The requirements yielded by the page mode information element are as follows:

- normal paging: no additional requirements;

[...]

- paging reorganization: The mobile station shall receive all messages on the CCCH regardless of the BS-AG-BLKS-RES setting. It is required to receive all BCCH messages. When the mobile station receives the next message to its (possibly new) paging subgroup the subsequent action is defined in the page mode information element in that message.

Reference

3GPP TS 04.60, sub-clauses 5.5.1.5, 5.6.1

3GPP TS 04.08, sub-clauses 3.3.2.1.1

42.4.8.1.6.2 Test Purpose

To verify that when an MS selects a new cell and if no parameters have been brought from the old cell, the MS uses the default value of NC_NON_DRX_PERIOD parameter if NC Measurement Parameters are not included in the SI2quater broadcast in the new cell.

42.4.8.1.6.3 Method of test

Initial conditions

System Simulator:

2 cells, GPRS supported

For Cell A

PCCCH present

For Cell-B

PCCCH not present

SI2quater transmitted (Rest Octet as described in the Specific Message Contents).

Mobile Station:

MS is GPRS attached in Cell-A and is in Packet Idle mode. Ready timer set to 5 min.

Test PDP context 2 established.

Specific PICS Statements

-

PIXIT Statements

-

Test procedure

SS sends a PACKET MEASUREMENT ORDER message to MS ordering the MS to send measurement, the MS starts sending measurements. SS continues receiving measurements until measurement results of cell B are included. SS sends then a PACKET CELL CHANGE ORDER message to MS ordering the MS to select Cell-B. NETWORK_CONTROL_ORDER is commanded to be NC2. Measurement parameters are omitted from the message.

MS selects Cell-B.

At the end of reporting period as specified in SI2quater message broadcast in Cell-B, MS sends a PACKET MEASUREMENT REPORT to the SS on Cell-B. After receiving the PACKET MEASUREMENT REPORT message, the SS waits for $0.8 * NC_NON_DRX_PERIOD$ period as specified in SI2quater message broadcast in Cell-B and sends a PAGING REQUEST TYPE 1 message addressing the MS, in a Paging sub-channel not belonging to MS paging subgroup.

SS verifies that MS responds to the Paging.

At the end of next reporting period, MS sends a PACKET MEASUREMENT REPORT to the SS on Cell-B. After receiving the PACKET MEASUREMENT REPORT message, the SS waits for $1.1 * NC_NON_DRX_PERIOD$ and sends a PAGING REQUEST TYPE 1 message addressing the MS, in a Paging sub-channel not belonging to MS paging subgroup.

SS verifies that MS does not respond to the Paging.

Maximum duration of the test

5 min

Expected sequence

Step	Direction	Message	Comments
1	SS->MS	PACKET MEASUREMENT ORDER	-Sent on PCCCH. See specific message contents
2	MS ->SS	PACKET CHANNEL REQUEST	-Cause 'Single block without TBF establishment'
3	SS->MS	PACKET UPLINK ASSIGNMENT	
4	MS ->SS	PACKET MEASUREMENT REPORT	
5			Repeat steps 2-4 until measurement results for cell B are included in the PACKET MEASUREMENT REPORT message.
6	SS->MS	PACKET CELL CHANGE ORDER	-Sent on PCCCH. - Commanding the MS to select Cell-B See specific message contents
			The following messages are to be sent and received in Cell B.
7	MS ->SS	CHANNEL REQUEST	ACCESS TYPE = 'one phase access'. Received on RACH.
8	SS -> MS	IMMEDIATE ASSIGNMENT	Sent on AGCH. Open-ended Dynamic Allocation.
9	SS -> MS	PACKET DOWNLINK DUMMY CONTROL BLOCK	Sent on PACCH containing USF assigned to the MS.
10	MS ->SS	UPLINK RLC DATA BLOCK	LLC PDU implicitly indicating Cell Update
11	SS -> MS	PACKET UPLINK ACK/NACK	Acknowledge the received RLC data block(s), Final Ack Indicator = '1' , a valid RRBP. Sent on PACCH.
12	MS -> SS	PACKET CONTROL ACKNOWLEDGEMENT	Received on PACCH.
13	MS ->SS	CHANNEL REQUEST	. Establishment Cause = 'Single block packet access'
14	SS -> MS	IMMEDIATE ASSIGNMENT	Sent on AGCH. Single block Allocation.
15	MS ->SS	PACKET MEASUREMENT REPORT	Received on the allocated PDCH
16	SS		Wait for 0.8*(NC_NON_DRX_PERIOD default value = 0.48 sec)
17	SS->MS	PAGING REQUEST TYPE 1	Sent on PCH not belonging to the MS paging subgroup. 1 st Mobility Identity contains P-TMSI of the MS, 2 nd Mobility Identity not present. Page Mode = 'Normal Paging'. Packet Page Indication indicates a packet paging procedure.
18	MS-> SS	CHANNEL REQUEST	Establishment Cause = 'one phase access'. Received on RACH.
19	SS -> MS	IMMEDIATE ASSIGNMENT REJECT	Random Reference = pertaining to the message received in step 18, Sent on AGCH.

20	MS ->SS	CHANNEL REQUEST	Establishment Cause = 'Single block packet access' SS verifies that the CHANNEL REQUEST arrives at the end of correct reporting period.
21	SS -> MS	IMMEDIATE ASSIGNMENT	Sent on AGCH. Single block Allocation.
22	MS ->SS	PACKET MEASUREMENT REPORT	Received on the allocated PDCH
23	SS		Wait for 1.1*(NC_NON_DRX_PERIOD default value = 0.48 sec)
24	SS->MS	PAGING REQUEST TYPE 1	Sent on a PCH not belonging to the MS paging subgroup. 1 st Mobility Identity contains P-TMSI of the MS, 2 nd Mobility Identity not present. Page Mode = "Normal Paging". Packet Page Indication indicates a packet paging procedure.
25	SS		SS verifies that MS does not respond to Paging in Step 24.

Specific message contents

System Information Type 2quater (Cell-B)

BA_IND	0
3G_BA_IND	0
MP_CHANGE_MARK	0
SI2quater_INDEX	0
SI2quater_COUNT	0
Measurement_Parameters Description	0 (Not present)
GPRS_Real Time Difference Description	0 (Not present)
GPRS_BSIC Description	0 (Not present)
GPRS_MEASUREMENT_Parameters Description	1 (Present)
REPORT_TYPE	1 (Normal)
REPORTING_RATE	0 (Normal)
INVALID_BSIC_REPORTING	0 (No)
MULTIBAND_REPORTING	00
SERVING_BAND_REPORTING	00
SCALE_ORD	00
	00000 (No reporting Threshold or Reporting Offset)
NC Measurement Parameters	0 (Not present)
extension length	0 (Not present)
3G Neighbour Cell Description	0 (Not present)
3G Measurement Parameters Description	0 (Not present)
GPRS_3G_MEASUREMENT Parameters Description	0 (Not present)

System Information Type 13 (Cell-B)

NETWORK_CONTROL_ORDER	10 (NC2)
-----------------------	----------

PACKET MEASUREMENT ORDER in step 1:

NC Measurement parameters NETWORK_CONTROL_ORDER	10 (NC2) 0 (Measurement parameters not present)
NC_FREQUENCY_LIST	0 (Not present)

PACKET CELL CHANGE ORDER in step 6

TLLI	As assigned to the MS
IMMEDIATE_REL	1
ARFCN, BSIC	as specified for cell B
NC Measurement parameters NETWORK_CONTROL_ORDER	10 (NC2) 0 (Measurement parameters not present)
NC_FREQUENCY_LIST	0 (Not present)

42.4.8.2 User Data vs Measurement Report Sending / Conflict situation

42.4.8.2.1 User Data Vs Measurement Report Sending / Conflict situation / DL TBF Establishment and Packet Access for Measurement Report Sending

42.4.8.2.1.1 Conformance requirement

When in mode NC1 or NC2, the mobile station shall perform the NC measurements as defined in 3GPP TS 05.08. The reporting periods are indicated in the NC_REPORTING_PERIOD_I and NC_REPORTING_PERIOD_T field of the PSI5, the SI2quater, the PACKET CELL CHANGE ORDER or the PACKET MEASUREMENT ORDER message.

The mobile station shall apply to the timer T3158 either the NC_REPORTING_PERIOD_I when in packet idle mode or the NC_REPORTING_PERIOD_T when in packet transfer mode.

On expiry of timer T3158, the mobile station shall restart timer T3158 with the indicated reporting period, perform the measurements and send either the PACKET MEASUREMENT REPORT message or the PACKET ENHANCED MEASUREMENT REPORT to the network.

A mobile station in mode NC1 or NC2 may receive a new indicated reporting period or change packet mode while timer T3158 is active. If the new indicated reporting period is less than the time to expiry of timer T3158, the mobile station shall immediately restart timer T3158 with the new indicated reporting period. Otherwise, the timer T3158 shall continue to run.

If the mobile station receives a PACKET DOWNLINK ASSIGNMENT message while it is waiting for a response to a PACKET CHANNEL REQUEST (respectively EGPRS PACKET CHANNEL REQUEST) message, it shall abort the packet access procedure and respond to the PACKET DOWNLINK ASSIGNMENT message

Following a downlink TBF establishment, the PACKET MEASUREMENT REPORT or PACKET ENHANCED MEASUREMENT REPORT message shall not be sent on the uplink PACCH associated with this TBF until two PACKET DOWNLINK ACK/NACK messages has been sent to the network.

42.4.8.2.1.2 Test Purpose

- a To verify that the MS aborts Packet Access Procedure if it receives a PACKET DOWNLINK ASSIGNMENT establishing a DL TBF while waiting for a response to PACKET CHANNEL REQUEST to send a Measurement Report.
- b To verify that MS sends a PACKET MEASUREMENT REPORT on UL PACCH during the DL TBF.

Reference

3GPP TS 04.60, sub-clauses 5.6.1, 7.1.2.1.1, 8.3

42.4.8.2.1.3 Method of test

Initial conditions

System Simulator:

1 cell, GPRS supported, PCCCH present.

Mobile Station:

MS is GPRS attached and is in Packet Idle mode.

Test PDP context 2 established.

Specific PICS Statements

-

PIXIT Statements

-

Test procedure

SS sends a PACKET MEASUREMENT ORDER message to MS. NETWORK_CONTROL_ORDER is commanded to be NC2.

At the end of reporting period MS sends PACKET CHANNEL REQUEST to send a PACKET MEASUREMENT REPORT.

While the MS is performing Packet access procedure, SS initiates a Downlink TBF by sending a PACKET DOWNLINK ASSIGNMENT message on the PPCH.

SS verifies that MS aborts the Packet Access procedure.

The MS is polled during the downlink TBF. SS verifies that MS sends PACKET DOWNLINK ACK/NACK for the first two polls and sends a PACKET MEASUREMENT REPORT for the third poll.

Maximum duration of the test

5 min

Expected sequence

Step	Direction	Message	Comments
1	SS->MS	PACKET MEASUREMENT ORDER	-Sent on PCCCH. See specific message contents
2	MS ->SS	PACKET CHANNEL REQUEST	Establishment Cause = 'Single block without TBF establishment'
3	SS -> MS	PACKET DOWNLINK ASSIGNMENT	Sent on PPCH. Addressing the MS using TLLI
4	SS		SS verifies for 1 sec that MS stops sending PACKET CHANNEL REQUESTs.
5	SS -> MS	DOWNLINK RLC DATA BLOCK	Sent on the assigned PDCH. Addressing the MS.
6			Repeat Step 5 10 times
7	SS -> MS	DOWNLINK RLC DATA BLOCK	Sent on the assigned PDCH. Addressing the MS. With a valid RRBp.
8	MS -> SS	PACKET DOWNLINK ACK/NACK	Received on the PACCH block allocated in Step 7.
9			Repeat Step 5 to 8 once
10	SS -> MS	DOWNLINK RLC DATA BLOCK	Sent on the assigned PDCH. Addressing the MS. With a valid RRBp.
11	MS ->SS	PACKET MEASUREMENT REPORT	Received on the PACCH block allocated in Step 10.

Specific message contents

PACKET MEASUREMENT ORDER in step 1:

NC Measurement parameters	
NETWORK_CONTROL_ORDER	10 (NC2)
NC_REPORTING_PERIOD_I	001 (0.96 sec)
NC_REPORTING_PERIOD_T	001 (0.96 sec)
NC_NON_DRX_PERIOD	010 (0.48 sec) (default value)
NC_FREQUENCY_LIST	0 (not present)

42.4.8.2.2 User Data vs Measurement Report Sending / Conflict situation / Expiry of T3192 and T3158

42.4.8.2.2.1 Conformance requirement

The mobile station shall apply to the timer T3158 either the NC_REPORTING_PERIOD_I when in packet idle mode or the NC_REPORTING_PERIOD_T when in packet transfer mode.

On expiry of timer T3158, the mobile station shall restart timer T3158 with the indicated reporting period, perform the measurements and send either the PACKET MEASUREMENT REPORT message or the PACKET ENHANCED MEASUREMENT REPORT to the network.

A mobile station in mode NC1 or NC2 may receive a new indicated reporting period or change packet mode while timer T3158 is active. If the new indicated reporting period is less than the time to expiry of timer T3158, the mobile

station shall immediately restart timer T3158 with the new indicated reporting period. Otherwise, the timer T3158 shall continue to run.

42.4.8.2.2.2 Test Purpose

To verify that if T3158 expires before the MS leaves Downlink Packet Transfer mode, the MS waits till T3192 expires before it initiate a Packet Access procedure to send PACKET MEASUREMENT REPORT message.

Reference

3GPP TS 04.60, sub-clauses 5.6.1, 9.3.2.6

42.4.8.2.2.3 Method of test

Initial conditions

System Simulator:

1 cell, GPRS supported, PCCCH present.

T3192 set to 1500 msec in GPRS_CELL_OPTIONS

Mobile Station:

MS is GPRS attached and is in Packet Idle mode. Ready Timer set to 5 min.

Test PDP context 2 established.

Specific PICS Statements

-

PIXIT Statements

-

Test procedure

SS establishes a downlink TBF.

While the TBF is active SS sends a PACKET MEASUREMENT ORDER message to MS. NETWORK_CONTROL_ORDER is commanded to be NC2. . At the end of reporting period MS sends a PACKET MEASUREMENT REPORT.

SS sends a Downlink RLC Data block with FBI set to '1' after $0.8 \cdot \text{NC_REPORTING_PERIOD_T}$ with a valid RRBP. SS verifies that MS sends a PACKET DOWNLINK ACK/NACK with FAI set to '1'.

SS waits till T3158 expire at the MS and sends Downlink RLC Data block with FBI set to '1' with a valid RRBP. SS verifies that MS again sends a PACKET DOWNLINK ACK/NACK with FAI set to '1'.

SS verifies that MS initiate a Packet Access procedure to send PACKET MEASUREMENT REPORT, immediately after the expiry of T3192.

Maximum duration of the test

5 min

Expected sequence

Step	Direction	Message	Comments
1	SS->MS	PACKET DOWNLINK ASSIGNMENT	Sent on PPCH. Addressing the MS using TLLI. Allocating downlink TBF.
2	SS->MS	DOWNLINK RLC DATA BLOCK	Addressing the MS. With a valid RRBP.
3	MS -> SS	PACKET DOWNLINK ACK/NACK	Received on the PACCH block allocated in Step 2.
4	SS->MS	PACKET MEASUREMENT ORDER	-Sent on PACCH. See specific message contents
5	SS->MS	DOWNLINK RLC DATA BLOCK	Addressing the MS. With a valid RRBP.
6	MS -> SS	PACKET DOWNLINK ACK/NACK	Received on the PACCH block allocated in Step 5.
7			Repeat Step 5 and Step 6 until PACKET MEASUREMENT REPORT is received instead of PACKET DOWNLINK ACK/NACK in Step 6.
8	SS		SS waits for 0.8*NC_REPORTING_PERIOD_T after receiving PACKET MEASUREMENT REPORT in Step 7
9	SS->MS	DOWNLINK RLC DATA BLOCK	With FBI set to '1' With a valid RRBP.
10	MS -> SS	PACKET DOWNLINK ACK/NACK	Received on the PACCH block allocated in Step 9. SS verifies that FAI is set to '1'.
11	SS		SS waits until 1.1*NC_REPORTING_PERIOD_T after receiving PACKET MEASUREMENT REPORT in Step 7 is elapsed.
12	SS->MS	DOWNLINK RLC DATA BLOCK	With FBI set to '1' With a valid RRBP N+13.
13	MS -> SS	PACKET DOWNLINK ACK/NACK	Received on the PACCH block allocated in Step 12. SS verifies that FAI is set to '1'.
14	MS -> SS	PACKET CHANNEL REQUEST	Establishment Cause = 'Single block without TBF establishment' SS verifies that PACKET CHANNEL REQUEST arrives later than T3192 msec from Step 13.
15	SS->MS	PACKET ACCESS REJECT	Sent on PAGCH. Packet request reference = pertaining to the message received in step 14

Specific message contents

PACKET MEASUREMENT ORDER in step 4:

NC Measurement parameters	
NETWORK_CONTROL_ORDER	10 (NC2)
NC_REPORTING_PERIOD_T	010 (1.92 sec)
NC_REPORTING_PERIOD_I	011 (3.84 sec)
NC_NON_DRX_PERIOD	010 (0.48 sec) (<i>default value</i>)
NC_FREQUENCY_LIST	0 (not present)

42.4.8.2.3 User Data vs Measurement Report Sending / Conflict situation / Expiry of T3182 and T3158

42.4.8.2.3.1 Conformance requirement

The mobile station shall apply to the timer T3158 either the NC_REPORTING_PERIOD_I when in packet idle mode or the NC_REPORTING_PERIOD_T when in packet transfer mode.

On expiry of timer T3158, the mobile station shall restart timer T3158 with the indicated reporting period, perform the measurements and send either the PACKET MEASUREMENT REPORT message or the PACKET ENHANCED MEASUREMENT REPORT to the network.

A mobile station in mode NC1 or NC2 may receive a new indicated reporting period or change packet mode while timer T3158 is active. If the new indicated reporting period is less than the time to expiry of timer T3158, the mobile station shall immediately restart timer T3158 with the new indicated reporting period. Otherwise, the timer T3158 shall continue to run.

The mobile station shall transmit RLC/MAC blocks with the following priority:

- RLC/MAC control blocks, except Packet Uplink Dummy Control Blocks
- RLC data blocks
- RLC/MAC control blocks containing Packet Uplink Dummy Control Blocks

42.4.8.2.3.2 Test Purpose

To verify that if T3158 expires before the MS leaves Uplink Packet Transfer mode and after MS has started T3182

- 1 the MS will send a PACKET MEASUREMENT REPORT to the SS if uplink resource is allocated before the expiry of T3182.
- 2 the MS will initiate a Packet Access procedure after T3182 is stopped, if no uplink resource is allocated to the MS while T3182 is running.

Reference

3GPP TS 04.60, sub-clauses 5.6.1, 8.1.1, 9.3.2.6

42.4.8.2.3.3 Method of test

Initial conditions

System Simulator:

1 cell, GPRS supported, PCCCH present.

Mobile Station:

MS is GPRS attached and is in Packet Idle mode. Ready Timer set to 5 min.

Test PDP context2 established.

Specific PICS Statements

-

PIXIT Statements

-

Test procedure

An uplink TBF is established.

While the TBF is active SS sends a PACKET MEASUREMENT ORDER message to MS. NETWORK_CONTROL_ORDER is commanded to be NC2. NC_REPORTING_PERIOD_T is chosen to be less than T3182.

The USF allocation is controlled by the SS so that T3158 is running when MS sends RLC Data block with CV=0

At the end of reporting period MS sends a PACKET MEASUREMENT REPORT.

SS sends a PACKET DOWNLINK DUMMY CONTROL BLOCK after the expiry of T3158 and while T3182 is running. SS verifies that MS sends a PACKET MEASUREMENT REPORT in the allocated radio block.

SS waits till T3158 expires while T3182 is still running. SS sends a PACKET UPLINK ACK/NACK with FAI set to '1'.

SS verifies that MS sends a PACKET CONTROL ACK and releases the TBF.

SS verifies that MS initiates a Packet Access procedure to send PACKET MEASUREMENT REPORT after releasing the TBF.

Maximum duration of the test

5 min

Expected sequence

Step	Direction	Message	Comments
1		{Uplink dynamic allocation two phase access}	Macro parameters: N=400 octets USF_GRANULARITY: 1 RLC_DATA_BLOCKS_GRANTED: absent (open-end) CHANNEL_CODING_COMMAND: CS-1 TLLI_BLOCK_CHANNEL_CODING: CS-1
2	SS->MS	PACKET DOWNLINK DUMMY CONTROL BLOCK	USF assigned to the MS
3	MS -> SS	Uplink RLC Data block	Received on the assigned PDCH.
4	SS->MS	PACKET MEASUREMENT ORDER	Sent on PACCH. USF not assigned to MS See specific message contents
5	SS		Wait for 3 block periods
6	SS->MS	PACKET UPLINK ACK/NACK	Sent on PACCH, USF assigned to MS
7	MS -> SS	Uplink RLC Data block	Received on the assigned PDCH.
8			Repeat Steps 5 to 7 until a PACKET MEASUREMENT REPORT is received instead of Uplink RLC Data block in Step 7 Note: Each execution of Steps 5 to 7 takes about 100 msec.
9	SS -> MS	PACKET UPLINK ACK/NACK	Sent on PACCH, USF assigned to MS
10	MS -> SS	Uplink RLC Data block	Received on the assigned PDCH.
11			Repeat Steps 9 and 10 until the data block with CV=0 is received. SS should allow the MS the send one PACKET MEASUREMENT REPORT instead of an Uplink RLC Data block in step 10
12	SS		Wait until 1.1* NC_REPORTING_PERIOD_T after last PACKET MEASUREMENT REPORT was received (step 7 or 10).
13	SS -> MS	PACKET DOWNLINK DUMMY CONTROL BLOCK	Sent on PACCH, USF assigned to MS
14	MS ->SS	PACKET MEASUREMENT REPORT	Received on the assigned PDCH.
15	SS		Wait until 1.1* NC_REPORTING_PERIOD_T after last PACKET MEASUREMENT REPORT was received (step 14).
16	SS -> MS	PACKET UPLINK ACK/NACK	Sent on PACCH, FAI set to '1', with a valid RRBP.
17	MS ->SS	PACKET CONTROL ACKNOWLEDGEMENT	Received on the allocated PACCH block.
18	MS -> SS	PACKET CHANNEL REQUEST	Access Type = 'Single block without TBF establishment'
19	SS->MS	PACKET ACCESS REJECT	Sent on PAGCH. Packet request reference = pertaining to the message received in step 18

Specific message contents

PACKET MEASUREMENT ORDER in step 4:

NC Measurement parameters	
NC_REPORTING_PERIOD_T	001 (0.96 sec)
NC_REPORTING_PERIOD_I	011 (3.84 sec)
NC_FREQUENCY_LIST	0 (not present)

42.4.8.2.4 User Data vs Measurement Report Sending / Conflict situation / Random Access procedure for PMR sending and User Data transmission

42.4.8.2.4.1 Conformance requirement

The behaviour of the mobile station is controlled by the parameter NETWORK_CONTROL_ORDER broadcast in the PSI5 message on PBCCH, in the SI13 and SI2quater messages on the BCCH and in the PSI13 message on PACCH. Alternatively, the network may send the NETWORK_CONTROL_ORDER parameters in a PACKET MEASUREMENT ORDER or in a PACKET CELL CHANGE ORDER message on PCCCH or PACCH to a particular mobile station. The parameter NETWORK_CONTROL_ORDER may have one of the values NC0, NC1, NC2 or RESET

On expiry of timer T3158, the mobile station shall restart timer T3158 with the indicated reporting period, perform the measurements and send either the PACKET MEASUREMENT REPORT message or the PACKET ENHANCED MEASUREMENT REPORT to the network.

The sending of an RLC/MAC control message other than the PACKET RESOURCE REQUEST message from a mobile station in packet idle mode to the network may be initiated by the RR entity on the mobile station side using the packet access procedure. If access to the network is allowed, the packet access is done using the single block packet access option.

Further action depends on the RLC/MAC control message sent by the mobile station. Unless otherwise indicated by the RLC/MAC control message, the mobile station remains in packet idle mode.

42.4.8.2.4.2 Test Purpose

To verify that if the MS is triggered to send user data while random access procedure is ongoing to send a PACKET MEASUREMENT REPORT message, the MS will continue the random access procedure, send the PACKET MEASUREMENT REPORT message, will return to Idle mode and then will initiate a random access procedure to send user data.

Reference

3GPP TS 04.60, sub-clause 5.6.1

3GPP TS 04.18, sub-clause 3.5.2.2

42.4.8.2.4.3 Method of test

Initial conditions

System Simulator:

1 cell, GPRS supported, PCCCH absent.

CCCH combined with SDCCH. Max Retrans = 7, TX-INTEGER = 32

SI2quater present

SI2quater transmitted (Rest Octets as described in the Specific Message Contents)

Mobile Station:

MS is GPRS attached and is in Packet Idle mode.

Test PDP context3 established.

Specific PICS Statements

-

PIXIT Statements

-

Test procedure

At the end of reporting period MS initiates a random access procedure to send PACKET MEASUREMENT REPORT. After receiving the first CHANNEL REQUEST message, the MS is triggered to send User data.

SS verifies that MS continues sending CHANNEL REQUEST messages for sending PACKET MEASUREMENT REPORT. SS allocates uplink resource to the MS to send PACKET MEASUREMENT REPORT. SS verifies that after sending the PACKET MEASUREMENT REPORT message, the MS initiates a random access procedure to send the user data triggered.

Maximum duration of the test

5 min

Expected sequence

Step	Direction	Message	Comments
1	MS -> SS	CHANNEL REQUEST	Establishment Cause = 'Single block packet access'
2	MS		Trigger the MS to send 500 octets data within 6 seconds
3	MS -> SS	CHANNEL REQUEST	Establishment Cause = 'Single block packet access'
4	MS -> SS	CHANNEL REQUEST	Establishment Cause = 'Single block packet access'
5	MS -> SS	CHANNEL REQUEST	Establishment Cause = 'Single block packet access'
6	MS -> SS	CHANNEL REQUEST	Establishment Cause = 'Single block packet access'
7	MS -> SS	CHANNEL REQUEST	Establishment Cause = 'Single block packet access'
8	MS -> SS	CHANNEL REQUEST	Establishment Cause = 'Single block packet access'
9	SS -> MS	IMMEDIATE ASSIGNMENT	Sent on AGCH. Request reference = pertaining to the message received in step 8. Single block Allocation.
10	MS ->SS	PACKET MEASUREMENT REPORT	Received on the allocated PDCH
11	MS -> SS	CHANNEL REQUEST	Establishment Cause = 'Single block packet access'
12	SS -> MS	IMMEDIATE ASSIGNMENT	Sent on AGCH. Single block Allocation.
13	MS ->SS	PACKET RESOURCE REQUEST	Received on the allocated PDCH
14	SS -> MS	PACKET ACCESS REJECT	Sent on the PACCH of the allocated PDCH. Addressing the MS using TLLI.

Specific message contents

SI2quarter Rest Octets

BA_IND	0
3G_BA_IND	0
MP_CHANGE_MARK	0
SI2quarter_INDEX	0
SI2quarter_COUNT	0
Measurement_Parameters Description	0 (Not present)
GPRS_Real Time Difference Description	0 (Not present)
GPRS_BSIC Description	0 (Not present)
GPRS_MEASUREMENT_Parameters Description	1 (Present)
REPORT_TYPE	1 (Normal)
REPORTING_RATE	0 (Normal)
INVALID_BSIC_REPORTING	0 (No)
MULTIBAND_REPORTING	00
SERVING_BAND_REPORTING	00
SCALE_ORD	00
	00000 (No reporting Threshold or Reporting Offset)
NC Measurement Parameters	
NETWORK_CONTROL_ORDER	10 (NC2)
NC_NON_DRX_PERIOD	101 (1.2 sec)
NC_REPORTING_PERIOD_I	100 (7.68 sec)
NC_REPORTING_PERIOD_T	100 (7.68 sec)
extension length	0 (Not present)
3G Neighbour Cell Description	0 (Not present)
3G Measurement Parameters Description	0 (Not present)
GPRS_3G_MEASUREMENT Parameters Description	0 (Not present)

System Information Type 13

NETWORK_CONTROL_ORDER	10 (NC2)
-----------------------	----------

42.4.8.3 Network Control measurement reporting and Dedicated connection

42.4.8.3.1 Network Control measurement reporting / Dedicated connection / Timer Ready expiry

42.4.8.3.1.1 Conformance requirement

42.4.8.3.1.1.1 Conformance requirement for R97 and R98 MS

When the mobile station leaves the MM Ready state, the timer T3158 shall be stopped and no more measurement reports shall be sent to the network.

Reference

3GPP TS 04.60, subclauses 5.6.1

42.4.8.3.1.1.2 Conformance requirement for R99 and later MS

The parameter values NC1 and NC2 only apply in Ready state. In Standby state, the MS shall always use normal MS control independent of the ordered NC mode.

A set of measurement reporting parameters (NETWORK_CONTROL_ORDER and NC_REPORTING_PERIOD(s)) is broadcast on PBCCH. The parameters may also be sent individually to an MS on PCCCH or PACCH, in which case it

overrides the broadcast parameters. The individual parameters are valid until the RESET command is sent to the MS or there is a downlink signalling failure or the MS goes to the Standby state or the MS enters dedicated mode.

Reference

3GPP TS 05.08, subclause 10.1.4

42.4.8.3.1.2 Test Purpose

To verify that some R97 or R98 MS involved in NC measurement reporting, stops its reporting if the Ready Timer expires within a dedicated connection.

For some R97 or R98 MS and for R99 or later MS, the NC measurement reporting is stopped when entering a dedicated connection.

42.4.8.3.1.3 Method of test

Initial conditions

System Simulator:

1 cell, GPRS supported. PBCCH not supported. Default Ready Timer (44s)

Mobile Station:

The MS is in packet idle mode, with a TMSI, P-TMSI allocated

Specific PICS Statements

- Release of GPRS Supported (TSPC_MS_GPRS_RELEASE)
- Support of Immediate Connect (TSPC_AddInfo_ImmConn)

PIXIT Statements

-

Foreseen final state of the MS

- MS is in standby state

Test procedure

MS is in packet idle mode, SS sends a PACKET MEASUREMENT ORDER message to change NC reporting parameters. The MS sends measurement reports according to the new NC parameters. The MS is then paged on its paging channel. Upon receipt of the PAGING REQUEST TYPE 1 message, the MS initiate the establishment of CS connection. The call lasts for 1 minute, thus the Ready Timer expires during the dedicated connection. At the end of the call, no more measurement should be sent by the MS.

Maximum duration of the test

-

Expected sequence

Step	Direction	Message	Comments
1	SS -> MS	IMMEDIATE ASSIGNMENT	SS establishes a single block downlink TBF.
2	SS -> MS	PACKET MEASUREMENT ORDER	Sent on the blocks assigned in step 1. PMO message contains Network Control Order 2 (See the specific message content)
3	MS -> SS	CHANNEL REQUEST	With establishment cause 'single block access'.
4	SS -> MS	IMMEDIATE ASSIGNMENT	Single block assignment with an arbitrarily chosen TBF starting time in the future in the range 0.5 to 1seconds.
5	MS -> SS	PACKET MEASUREMENT REPORT	Received on the assigned block.
6		{MT Call while GPRS Attach}	Macro parameters: T : 60 seconds R : 1, Resumption GPRS done Ready Timer expires before the end of the CS call
7	MS		Stand-by state
8	SS		Verify that no more PMR are sent by the MS.

Specific message contents

PACKET MEASUREMENT ORDER in step 2:

NC Measurement parameters NETWORK_CONTROL_ORDER NC_REPORTING_PERIOD_I	10 (NC2) 110 (30,72 s)
---	---------------------------

42.4.8.3.2 Network Control measurement reporting / Dedicated connection / Different NC parameters / No T3158 expiry

42.4.8.3.2.1 Conformance requirement

When in mode NC1 or NC2, the mobile station shall perform the NC measurements as defined in 3GPP TS 05.08. The reporting periods are indicated in the NC_REPORTING_PERIOD_I and NC_REPORTING_PERIOD_T field of the PSI5, the SI2quater, the PACKET CELL CHANGE ORDER or the PACKET MEASUREMENT ORDER message. If NC_NON_DRX_PERIOD, NC_REPORTING_PERIOD_I or NC_REPORTING_PERIOD_T have not been received by the mobile station the default values shall be used.

The measurement results shall be sent to the network using the procedures specified in sub-clause 7.3 for packet idle mode, and in sub-clause 8.3 for packet transfer mode.

On expiry of timer T3158, the mobile station shall restart timer T3158 with the indicated reporting period, perform the measurements and send either the PACKET MEASUREMENT REPORT message or the PACKET ENHANCED MEASUREMENT REPORT to the network

Reference

3GPP TS 04.60/44.060, subclause 5.6.1

42.4.8.3.2.1.1 Conformance requirement specific for R99 or later MS

A set of measurement reporting parameters (NETWORK_CONTROL_ORDER and NC_REPORTING_PERIOD(s)) is broadcast on PBCCH. The parameters may also be sent individually to an MS on PCCCH or PACCH, in which case it overrides the broadcast parameters. The individual parameters are valid until the RESET command is sent to the MS or there is a downlink signalling failure or the MS goes to the Standby state or the MS enters dedicated mode.

Reference

3GPP TS 05.08, subclause 10.1.4

42.4.8.3.2.2 Test Purpose

To verify that a MS involved in NC measurement reporting on a NC2 cell, continue its measurement reporting after a dedicated call, with the same NC parameters for some R97 or R98 MS, and with the broadcasted parameters for other R97 or R98 MS and for R99 and later MS.

42.4.8.3.2.3 Method of test

Initial conditions

System Simulator:

1 cell, GPRS supported, PBCCH present, NC2, Ready Timer set to 5 minutes

Mobile Station:

The MS is in packet idle mode, with a TMSI, P-TMSI allocated

Specific PICS Statements

- Release of GPRS Supported (TSPC_MS_GPRS_RELEASE)
- Support of Immediate Connect (TSPC_AddInfo_ImmConn)

PIXIT Statements

-

Foreseen final state of the MS

- MS is in packet idle mode

Test procedure

MS is in packet idle mode, on a NC2 Cell, and receive a PACKET MEASUREMENT ORDER to override the NC parameters broadcasted in PSI5. The MS sends PACKET MEASUREMENT REPORT based on T3158 calculation done on the NC parameters of the PACKET MEASUREMENT ORDER. The MS is then paged on its paging channel. Upon receipt of the PACKET PAGING REQUEST message, the MS initiate the establishment of CS connection. SS stops the call after 5 seconds in order to avoid T3158 expiry during the dedicated connection (for R97 MS).

R97 MS should either continue to send PACKET MEASUREMENT REPORT every T3158, calculated with the NC parameters sent in the PACKET MEASUREMENT ORDER, or , like R99 and later release MS, restart the NC measurement reporting but with T3158 based on the broadcasted parameters sent in the PACKET SYSTEM INFORMATION 5.

Maximum duration of the test

-

Expected sequence

Step	Direction	Message	Comments
1	SS->MS	PACKET MEASUREMENT ORDER	-Sent on PPCH. -Contains NETWORK_CONTROL_ORDER and NC_REPORTING_PERIOD_I See specific message contents
2	MS ->SS	PACKET CHANNEL REQUEST	'Single block without TBF establishment.'
3	SS -> MS	PACKET UPLINK ASSIGNMENT	Sent on PAGCH.
4	MS ->SS	PACKET MEASUREMENT REPORT	Sent on the allocated PDCH.
5	MS ->SS	PACKET CHANNEL REQUEST	'Single block without TBF establishment.'
6	SS		Verify that PRACH in step 5 is sent T3158 +/-10% after step 2. T3158 calculated using NC parameters sent in the PMO in step 1.
7	SS -> MS	PACKET UPLINK ASSIGNMENT	Sent on PAGCH.
8	MS ->SS	PACKET MEASUREMENT REPORT	Sent on the allocated PDCH.
9		{MT Call while GPRS Attach}	Macro parameters: T : 5 seconds R : 1, Resumption GPRS done No T3158 expiry (for R97 MS) during CS call
10	MS		MS in packet idle mode
11	MS ->SS	PACKET CHANNEL REQUEST	'Single block without TBF establishment.'
12A	SS		For R97, verify that PRACH in step 11 is sent T3158 after step 5. T3158 calculated using NC parameters sent in the PMO in step 1.
12B	SS		For R99 MS and later release, no timing check.
13	SS -> MS	PACKET UPLINK ASSIGNMENT	Sent on PAGCH.
14	MS ->SS	PACKET MEASUREMENT REPORT	Sent on the allocated PDCH.
15	MS ->SS	PACKET CHANNEL REQUEST	'Single block without TBF establishment.'
16	SS		Verify that PRACH in step 15 is sent T3158 +/-10% after step 11. For some R97 MS: T3158 calculated using NC parameters sent in the PMO in step 1. For all other MS: T3158 calculated using NC parameters sent on PCCCH See specific PSI5 message contents
17	SS -> MS	PACKET UPLINK ASSIGNMENT	Sent on PAGCH.
18	MS ->SS	PACKET MEASUREMENT REPORT	Sent on the allocated PDCH.
Note: In step 12x, the test procedure follows same branch, either the 'a' branch or the 'b' branch.			

Specific message contents

PACKET MEASUREMENT ORDER in step 1:

NC Measurement parameters NETWORK_CONTROL_ORDER NC_REPORTING_PERIOD_I	10 (NC2) 110(30.72secs)
---	----------------------------

PACKET SYSTEM INFORMATION TYPE 5:

NC Measurement parameter struct Network Control Order NC_NON_DRX_PERIOD NC_REPORTING_PERIOD_I NC_REPORTING_PERIOD_T	10 (NC2) 111 101 (15,36 s) 100 (7,68 s)
---	--

42.4.8.3.3 Network Control measurement reporting / Dedicated connection / Handover / No T3158 expiry

42.4.8.3.3.1 Conformance requirement

The behaviour of the mobile station is controlled by the parameter NETWORK_CONTROL_ORDER broadcast in the PSI5 message on PBCCH, in the SI13 message on the BCCH and in the PSI13 message on PACCH. Alternatively, the network may send the NETWORK_CONTROL_ORDER parameters in a PACKET MEASUREMENT ORDER or in a PACKET CELL CHANGE ORDER message on PCCCH or PACCH to a particular mobile station. The parameter NETWORK_CONTROL_ORDER may have one of the values NC0, NC1, NC2 or RESET, see 3GPP TS 05.08.

When in mode NC1 or NC2, the mobile station shall perform the NC measurements as defined in 3GPP TS 05.08. The reporting periods are indicated in the NC_REPORTING_PARAMETER_I and NC_REPORTING_PARAMETER_T field of the PSI5, the PACKET CELL CHANGE ORDER or the PACKET MEASUREMENT ORDER message. If no PBCCH is allocated in the cell or if no individual order has been received by the mobile station, the default values of the parameters NC_NON_DRX_PERIOD, NC_REPORTING_PARAMETER_I and NC_REPORTING_PARAMETER_T shall be used. The mobile station shall apply to the timer T3158 either the NC_REPORTING_PARAMETER_I when in packet idle mode or the NC_REPORTING_PARAMETER_T when in packet transfer mode. The measurement results shall be sent to the network using the procedures specified in subclause 7.3 for packet idle mode, and in subclause 8.3 for packet transfer mode.

A mobile station may reselect a new cell or may be ordered to reselect a new cell with mode NC1 or NC2 while timer T3158 is active. If time to expiry of timer T3158 is greater than the indicated reporting period for the new cell, the mobile station shall immediately restart timer T3158 with the indicated reporting period for the new cell. Otherwise, the timer T3158 shall continue to run.

A set of measurement reporting parameters (NETWORK_CONTROL_ORDER and NC_REPORTING_PERIOD(s)) is broadcast on PBCCH. The parameters may also be sent individually to an MS on PCCCH or PACCH, in which case it overrides the broadcast parameters. The individual parameters are valid until the RESET command is sent to the MS or there is a downlink signalling failure or the MS goes to the Standby state.

Reference

3GPP TS 04.60/44.060, subclause 5.6.1

3GPP TS 05.08, subclause 10.1.4

42.4.8.3.3.1.1 Conformance requirement specific for R99 or later MS

A set of measurement reporting parameters (NETWORK_CONTROL_ORDER and NC_REPORTING_PERIOD(s)) is broadcast on PBCCH. The parameters may also be sent individually to an MS on PCCCH or PACCH, in which case it overrides the broadcast parameters. The individual parameters are valid until the RESET command is sent to the MS or there is a downlink signalling failure or the MS goes to the Standby state or the MS enters dedicated mode.

Reference

3GPP TS 05.08, subclause 10.1.4

42.4.8.3.3.2 Test Purpose

To verify that a MS involved in NC measurement reporting and making a handover to a new NC2 cell, uses the broadcasted NC reporting parameters of its new serving cell for its NC measurement reporting.

42.4.8.3.3.3 Method of test

Initial conditions

System Simulator:

2 cells (cell A and cell B), GPRS supported, NC2, PBCCH present, Ready Timer set to 5 minutes

Mobile Station:

The MS is in packet idle mode, with a TMSI, P-TMSI allocated

Specific PICS Statements

- Release of GPRS Supported (TSPC_MS_GPRS_RELEASE)
- Support of Immediate Connect (TSPC_AddInfo_ImmConn)

PIXIT Statements

-

Foreseen final state of the MS

- MS is in packet idle mode

Test procedure

MS is in packet idle mode, on a NC2 cell A, and sends PACKET MEASUREMENT REPORT based on T3158 calculation done on the broadcasted parameters. The MS is then paged on its paging channel. Upon receipt of the PACKET PAGING REQUEST message, the MS initiate the establishment of CS connection. During the call, SS triggers the MS to do a handover to cell B. SS stops the call after 15 second in order to avoid T3158 expiry during the dedicated connection (for R97 MS).

As cell B has a NETWORK CONTROL ORDER set to NC2, all MS shall then restart measurement reporting by sending PACKET MEASUREMENT REPORT every T3158. The reporting timer is calculated with the NC parameters broadcasted in the second cell on PACKET SYSTEM INFORMATION 5.

Maximum duration of the test

-

Expected sequence

Step	Direction	Message	Comments
1	MS ->SS	PACKET CHANNEL REQUEST	'Single block without TBF establishment.'
2	SS -> MS	PACKET UPLINK ASSIGNMENT	Sent on PAGCH.
3	MS ->SS	PACKET MEASUREMENT REPORT	Sent on the allocated PDCH.
4	MS ->SS	PACKET CHANNEL REQUEST	'Single block without TBF establishment.'
5	SS		Verify that PRACH in step 4 is sent T3158 +/-10% after step 1. T3158 calculated using NC parameters broadcasted in cell A See specific PSI5 message content
6	SS -> MS	PACKET UPLINK ASSIGNMENT	Sent on PAGCH.
7	MS ->SS	PACKET MEASUREMENT REPORT	Sent on the allocated PDCH.
8		{MT Call while GPRS Attach with handover}	Macro parameters: T : 15 seconds Target Cell : Cell B R : 1, Resumption GPRS done No T3158 expiry (for R97 MS) during CS call
9	MS->SS	PACKET CHANNEL REQUEST	Sent on cell B For Cell Update.
10	SS->MS	PACKET UPLINK ASSIGNMENT	Sent on PAGCH.
11	SS->MS	PACKET DOWNLINK DUMMY CONTROL BLOCK	Sent on PACCH containing USF assigned to the MS at least 3 Blocks after step 10.
12	MS->SS	RLC data block	Sent on the PDCH. The RLC data also serves as cell update.
13	SS->MS	PACKET UPLINK ACK/NACK	Sent on the PACCH with valid RRBP.
14	MS->SS	PACKET CONTROL ACK	
15	MS		MS in packet idle mode on cell B All following messages should be sent on cell B
16	MS ->SS	PACKET CHANNEL REQUEST	'Single block without TBF establishment.'
17	SS -> MS	PACKET UPLINK ASSIGNMENT	Sent on PAGCH.
18	MS ->SS	PACKET MEASUREMENT REPORT	Sent on the allocated PDCH.
19	MS ->SS	PACKET CHANNEL REQUEST	'Single block without TBF establishment.'
20	SS		Verify that PRACH in step 19 is sent T3158 +/-10% after step 16. T3158 calculated using NC parameters broadcasted in cell B See specific PSI5 message content
21	SS -> MS	PACKET UPLINK ASSIGNMENT	Sent on PAGCH.
22	MS ->SS	PACKET MEASUREMENT REPORT	Sent on the allocated PDCH.

Specific message contents

PACKET SYSTEM INFORMATION TYPE 5 for Cell A

NC Measurement parameter struct	
Network Control Order	10 (NC2)
NC_NON_DRX_PERIOD	111
NC_REPORTING_PERIOD_I	110 (30,72 s)
NC_REPORTING_PERIOD_T	100 (7,68 s)

PACKET SYSTEM INFORMATION TYPE 5 for Cell B

NC Measurement parameter struct	
Network Control Order	10 (NC2)
NC_NON_DRX_PERIOD	111
NC_REPORTING_PERIOD_I	101 (15,36 s)

42.4.8.3.4 Network Control measurement reporting / Dedicated connection / Different NC parameters / T3158 expiry

42.4.8.3.4.1 Conformance requirement

When in mode NC1 or NC2, the mobile station shall perform the NC measurements as defined in 3GPP TS 05.08. The reporting periods are indicated in the NC_REPORTING_PERIOD_I and NC_REPORTING_PERIOD_T field of the PSI5, the SI2quarter, the PACKET CELL CHANGE ORDER or the PACKET MEASUREMENT ORDER message. If NC_NON_DRX_PERIOD, NC_REPORTING_PERIOD_I or NC_REPORTING_PERIOD_T have not been received by the mobile station the default values shall be used.

The measurement results shall be sent to the network using the procedures specified in sub-clause 7.3 for packet idle mode, and in sub-clause 8.3 for packet transfer mode.

On expiry of timer T3158, the mobile station shall restart timer T3158 with the indicated reporting period, perform the measurements and send either the PACKET MEASUREMENT REPORT message or the PACKET ENHANCED MEASUREMENT REPORT to the network.

After each reporting period, the MS shall send a measurement report to BSS (see 3GPP TS 04.60). The MS shall then discard any previous measurement report, which it has not been able to send.

Reference

3GPP TS 04.60/44.060, subclause 5.6.1

3GPP TS 05.08, subclause 10.1.4.1

42.4.8.3.4.1.1 Conformance requirement specific for R99 or later MS

A set of measurement reporting parameters (NETWORK_CONTROL_ORDER and NC_REPORTING_PERIOD(s)) is broadcast on PBCCH. The parameters may also be sent individually to an MS on PCCCH or PACCH, in which case it overrides the broadcast parameters. The individual parameters are valid until the RESET command is sent to the MS or there is a downlink signalling failure or the MS goes to the Standby state or the MS enters dedicated mode.

Reference

3GPP TS 05.08, subclause 10.1.4

42.4.8.3.4.2 Test Purpose

To verify that some R97 or R98 MS involved in NC measurement reporting, sends only its latest PACKET MEASUREMENT REPORT when many reporting periods had expired during a CS call on the same cell.

To verify that some other R97 or R98 MS and R99 and later releases MS stop their measurement reporting with the dedicated call and do not restart it if the broadcasted parameters give a NETWORK CONTROL ORDER set to NC0.

42.4.8.3.4.3 Method of test

Initial conditions

System Simulator:

2 cells, GPRS supported, NC0, Ready Timer set to 5 minutes

Mobile Station:

The MS is in packet idle mode, with a TMSI, P-TMSI allocated

Specific PICS Statements

- Release of GPRS Supported (TSPC_MS_GPRS_RELEASE)
- Support of Immediate Connect (TSPC_AddInfo_ImmConn)

PIXIT Statements

-

Foreseen final state of the MS

- MS is in packet idle mode

Test procedure

MS is in packet idle mode, on a NC0 Cell, and receive a PACKET MEASUREMENT ORDER changing the Network Control Order to NC2. The MS sends PACKET MEASUREMENT REPORT based on T3158 calculation done on the NC parameters of the PACKET MEASUREMENT ORDER, including measurement done on its neighbor, cell B. 15 seconds after the second PACKET MEASUREMENT ORDER the MS is paged on its paging channel. Upon receipt of the PAGING REQUEST TYPE 1 message, the MS initiate the establishment of CS connection. After 30 seconds the cell B transmission is cut and the call lasts for 55 seconds more.

Some R97 or R98 MS and the R99 and later release MS should then be back on CCCH parameters and not trigger any PACKET MEASUREMENT REPORT anymore.

Other R97 or R98 MS should continue to send PACKET MEASUREMENT REPORT every T3158, calculated with the NC parameters sent in the PACKET MEASUREMENT ORDER. As the T3158 timer has expired 3 times during the dedicated connection (once before Cell B has been cut, twice after), and that the MS shall send only its latest PACKET MEASUREMENT REPORT, the first one sent after the dedicated call should not contain any Cell B measurement.

Maximum duration of the test

-

Expected sequence

Step	Direction	Message	Comments
1	SS -> MS	IMMEDIATE ASSIGNMENT	for single block downlink assignment on PCH corresponding to MS.
2	SS -> MS	PACKET MEASUREMENT ORDER	Sent on the block assigned in step 1 Contains NETWORK_CONTROL_ORDER and NC_REPORTING_PERIOD_I See specific message contents
3	MS -> SS	CHANNEL REQUEST	with establishment cause 'single block access'.
4	SS -> MS	IMMEDIATE ASSIGNMENT	for uplink TBF, single block assignment with an arbitrarily chosen TBF starting time in the future in the range 0.5 to 2 seconds.
5	MS -> SS	PACKET MEASUREMENT REPORT	Shall be sent in the assigned block.
6	MS -> SS	CHANNEL REQUEST	With establishment cause 'single block access'.
7	SS		Verify that the RACH in step 6 is sent T3158 +/-10% after step 3 T3158 calculated using NC parameters sent in step 1
8	SS -> MS	IMMEDIATE ASSIGNMENT	for uplink TBF, single block assignment with an arbitrarily chosen TBF starting time in the future in the range 0.5 to 2 seconds.
9	MS -> SS	PACKET MEASUREMENT REPORT	Shall be sent in the assigned block.
10	SS		Wait for 15 sec.
11		{MT Call while GPRS Attach}	Macro parameters: T : 85 seconds R : 1, Resumption GPRS done 3 times T3158 expiry (for R97 MS) during CS call After 30 second stop Cell B transmission.
12	MS		MS in packet idle mode Some R97 or R98 MS and the R99 and later releases MS should follow 'A' branch Other R97 or R98 MS should follow 'B' branch
13A	SS		No messages should be sent by MS.
13B	MS -> SS	CHANNEL REQUEST	with establishment cause 'single block access'.
14B	SS -> MS	IMMEDIATE ASSIGNMENT	for uplink TBF, single block assignment with an arbitrarily chosen TBF starting time in the future in the range 0.5 to 2 seconds.
15B	MS -> SS	PACKET MEASUREMENT REPORT	Shall be sent in the assigned block.
16B	SS		PMR in step 15B should be sent when MS recover GPRS. Verify that Cell B measurements are not sent.
17B	MS -> SS	CHANNEL REQUEST	with establishment cause 'single block access'.
18B	SS		RACH in step 17B should be sent 4*T3158 +/-10% after step 6 T3158 calculated using NC parameters sent in step 2
19B	SS -> MS	IMMEDIATE ASSIGNMENT	for uplink TBF, single block assignment with an arbitrarily chosen TBF starting time in the future in the range 0.5 to 2 seconds.
20B	MS -> SS	PACKET MEASUREMENT REPORT	Shall be sent in the assigned block.
Note: In step 13x, the test procedure follows either the 'a' branch or the 'b' branch.			

PACKET MEASUREMENT ORDER in step 1:

NC Measurement parameters NETWORK_CONTROL_ORDER NC_REPORTING_PERIOD_I	10 (NC2) 110(30.72secs)
---	----------------------------

42.4.8.3.5 Network Control measurement reporting / Dedicated connection / Handover / T3158 expiry

42.4.8.3.5.1 Conformance requirement

42.4.8.3.5.1.1 Conformance requirement for R97 and R98 MS

The behaviour of the mobile station is controlled by the parameter NETWORK_CONTROL_ORDER broadcast in the PSI5 message on PBCCH, in the SI13 message on the BCCH and in the PSI13 message on PACCH. Alternatively, the network may send the NETWORK_CONTROL_ORDER parameters in a PACKET MEASUREMENT ORDER or in a PACKET CELL CHANGE ORDER message on PCCCH or PACCH to a particular mobile station. The parameter NETWORK_CONTROL_ORDER may have one of the values NC0, NC1, NC2 or RESET, see 3GPP TS 05.08.

When in mode NC1 or NC2, the mobile station shall perform the NC measurements as defined in 3GPP TS 05.08. The reporting periods are indicated in the NC_REPORTING_PARAMETER_I and NC_REPORTING_PARAMETER_T field of the PSI5, the PACKET CELL CHANGE ORDER or the PACKET MEASUREMENT ORDER message. If no PBCCH is allocated in the cell or if no individual order has been received by the mobile station, the default values of the parameters NC_NON_DRX_PERIOD, NC_REPORTING_PARAMETER_I and NC_REPORTING_PARAMETER_T shall be used. The mobile station shall apply to the timer T3158 either the NC_REPORTING_PARAMETER_I when in packet idle mode or the NC_REPORTING_PARAMETER_T when in packet transfer mode. The measurement results shall be sent to the network using the procedures specified in subclause 7.3 for packet idle mode, and in subclause 8.3 for packet transfer mode.

A set of measurement reporting parameters (NETWORK_CONTROL_ORDER and NC_REPORTING_PERIOD(s)) is broadcast on PBCCH. The parameters may also be sent individually to an MS on PCCCH or PACCH, in which case it overrides the broadcast parameters. The individual parameters are valid until the RESET command is sent to the MS or there is a downlink signalling failure or the MS goes to the Standby state.

After each reporting period, the MS shall send a measurement report to BSS (see 3GPP TS 04.60). The MS shall then discard any previous measurement report, which it has not been able to send.

Reference

3GPP TS 04.60/44.060, subclause 5.6.1

3GPP TS 05.08, subclauses 10.1.4 and 10.1.4.1

42.4.8.3.5.1.2 Conformance requirement for R99 and later MS

A set of measurement reporting parameters (NETWORK_CONTROL_ORDER and NC_REPORTING_PERIOD(s)) is broadcast on PBCCH. The parameters may also be sent individually to an MS on PCCCH or PACCH, in which case it overrides the broadcast parameters. The individual parameters are valid until the RESET command is sent to the MS or there is a downlink signalling failure or the MS goes to the Standby state or the MS enters dedicated mode.

Reference

3GPP TS 05.08, subclauses 10.1.4

42.4.8.3.5.2 Test Purpose

To verify that some R97 MS involved in NC measurement reporting, and making a handover during a dedicated connection do not send any buffered PACKET MEASUREMENT REPORT when many reporting periods had expired during a CS call on the first cell. They shall restart their measurement reporting on the new serving cell only if the broadcasted parameters allow it.

For other R97 MS and for R99 or later MS, the NC measurement reporting is stopped when entering a dedicated connection. At the end of the CS call, after a handover, it shall restart its measurement reporting on the new serving cell only if the broadcasted parameters allow it.

42.4.8.3.5.3 Method of test

Initial conditions

System Simulator:

1 cell (Cell A), GPRS supported, PBCCH present, NC2, Ready Timer set to 5 minutes

1 cell (Cell B), GPRS supported, PBCCH present, NC0, Ready Timer set to 5 minutes

Mobile Station:

The MS is in packet idle mode, with a TMSI, P-TMSI allocated

Specific PICS Statements

- Release of GPRS Supported (TSPC_MS_GPRS_RELEASE)
- Support of Immediate Connect (TSPC_AddInfo_ImmConn)

PIXIT Statements

-

Foreseen final state of the MS

- MS is in packet idle mode

Test procedure

MS is in packet idle mode, on a NC2 Cell, and receive a PACKET MEASUREMENT ORDER. The MS then sends PACKET MEASUREMENT REPORT based on T3158 calculation done with the NC parameters in the PACKET MEASUREMENT ORDER. The MS is then paged on its paging channel. Upon receipt of the PACKET PAGING REQUEST message, the MS initiate the establishment of CS connection. During the call, after 30 seconds in order to have T3158 expiry during the dedicated connection (for some R97 MS), SS triggers the MS to do a handover to the second cell. SS stops the call after 30 seconds on the new serving cell, cell B.

As cell B has a NETWORK CONTROL ORDER set to NC0, no MS should send any measurement reporting, even if some PACKET MEASUREMENT REPORT were not sent when the MS was camped on cell A (before the handover during the dedicated connection)

After 1 minute, a PACKET MEASUREMENT ORDER is then sent to the MS camped on cell B. The SS verifies that the PACKET MEASUREMENT REPORT sent by the MS is including cell A measurements and is not a previous PACKET MEASUREMENT REPORT not sent in cell A.

Maximum duration of the test

-

Expected sequence

Step	Direction	Message	Comments
1	SS->MS	PACKET MEASUREMENT ORDER	-Sent on PPCH. -Contains NETWORK_CONTROL_ORDER and NC_REPORTING_PERIOD_I See specific message contents
2	MS -> SS	PACKET CHANNEL REQUEST	'Single block without TBF establishment.'
3	SS -> MS	PACKET UPLINK ASSIGNMENT	Sent on PAGCH.
4	MS -> SS	PACKET MEASUREMENT REPORT	Sent on the allocated PDCH.
5	MS -> SS	PACKET CHANNEL REQUEST	'Single block without TBF establishment.'
6	SS		Verify that PRACH in step 5 is sent T3158 +/-10% after step 2. T3158 calculated using NC parameters received in the PMO in step 1
7	SS -> MS	PACKET UPLINK ASSIGNMENT	Sent on PAGCH.
8	MS -> SS	PACKET MEASUREMENT REPORT	Sent on the allocated PDCH.
9		{MT Call while GPRS Attach with handover}	Macro parameters: T : 60 seconds Target Cell : Cell B R : 1, Resumption GPRS done After the completion of the Handover procedure, cell A power is reduced to - 80 dBm
10	MS->SS	PACKET CHANNEL REQUEST	Sent on cell B For Cell Update.
11	SS->MS	PACKET UPLINK ASSIGNMENT	Sent on PAGCH.
12	SS->MS	PACKET DOWNLINK DUMMY CONTROL BLOCK	Sent on PACCH containing USF assigned to the MS at least 3 Blocks after step 11.
13	MS->SS	RLC data block	Sent on the PDCH. The RLC data also serves as cell update.
14	SS->MS	PACKET UPLINK ACK/NACK	Sent on the PACCH with valid RRBP.
15	MS->SS	PACKET CONTROL ACK	
16	MS		MS in packet idle mode on cell B
17	SS		No action done for 1 minute
18	SS -> MS	PACKET MEASUREMENT ORDER	-Sent on PPCH. -Contains NETWORK_CONTROL_ORDER and NC_REPORTING_PERIOD_I See specific message contents
19	MS -> SS	PACKET CHANNEL REQUEST	'Single block without TBF establishment.'
20	SS -> MS	PACKET UPLINK ASSIGNMENT	Sent on PAGCH.
21	MS -> SS	PACKET MEASUREMENT REPORT	Sent on the allocated PDCH.
22	SS		Verify that PMR in step 21 includes Cell A measurement.

Specific message contents

PACKET MEASUREMENT ORDER in step 1:

NC Measurement parameters	
NETWORK_CONTROL_ORDER	10 (NC2)
NC_REPORTING_PERIOD_I	101(15.36secs)

PACKET MEASUREMENT ORDER in step 18:

NC Measurement parameters	
NETWORK_CONTROL_ORDER	10 (NC2)
NC_REPORTING_PERIOD_I	110(30.72secs)

PACKET SYSTEM INFORMATION TYPE 5 for Cell A

NC Measurement parameter struct	
Network Control Order	10 (NC2)
NC_REPORTING_PERIOD_T	100 (7,68 s)

42.4.8.3.6 Network Control measurement reporting / Dedicated connection / Assignment Reject/

42.4.8.3.6.1 Conformance requirement

When in mode NC1 or NC2, the mobile station shall perform the NC measurements as defined in 3GPP TS 05.08. The reporting periods are indicated in the NC_REPORTING_PERIOD_I and NC_REPORTING_PERIOD_T field of the PSI5, the SI2quarter, the PACKET CELL CHANGE ORDER or the PACKET MEASUREMENT ORDER message. If NC_NON_DRX_PERIOD, NC_REPORTING_PERIOD_I or NC_REPORTING_PERIOD_T have not been received by the mobile station the default values shall be used.

The measurement results shall be sent to the network using the procedures specified in sub-clause 7.3 for packet idle mode, and in sub-clause 8.3 for packet transfer mode.

On expiry of timer T3158, the mobile station shall restart timer T3158 with the indicated reporting period, perform the measurements and send either the PACKET MEASUREMENT REPORT message or the PACKET ENHANCED MEASUREMENT REPORT to the network

On receipt of an IMMEDIATE ASSIGNMENT REJECT message corresponding to one of its 3 last CHANNEL REQUEST messages, the mobile station, stops sending CHANNEL REQUEST messages, starts timer T3122 with the indicated value, ("wait indication" information element), starts T3126 if it has not already been started, and listens to the downlink CCCH until T3126 expires.

The Wait Indication IE (i.e. T3122) relates to the cell from which it was received.

The mobile station in packet idle mode (only applicable to mobile station supporting GPRS) may initiate packet access in the same cell before T3122 has expired, see 3GPP TS 04.60 and sub-clause 3.5.2.1.3.4.

After T3122 expiry, no CHANNEL REQUEST message shall be sent as a response to a page until a PAGING REQUEST message for the mobile station is received.

Reference

3GPP TS 04.60/44.060, subclause 5.6.1

3GPP TS 04.08/44.018, subclause 3.3.1.1.3.2

42.4.8.3.6.2 Test Purpose

To verify that if a MS involved in NC measurement reporting is paged for CS connection but receives an IMMEDIATE ASSIGNMENT REJECT to its CHANNEL REQUEST sent in response to the paging, the MS continues its NC measurement reporting.

42.4.8.3.6.3 Method of test

Initial conditions

System Simulator:

1 cell, GPRS supported, PBCCH present, NC0, Ready Timer set to 5 minutes

Mobile Station:

The MS is in packet idle mode, with a TMSI, P-TMSI allocated

Specific PICS Statements

-

PIXIT Statements

-

Foreseen final state of the MS

- MS is in packet idle mode

Test procedure

MS is in packet idle mode, on a NC0 Cell, and receive a PACKET MEASUREMENT ORDER to override the NC parameters broadcasted. The MS sends PACKET MEASUREMENT REPORT based on T3158 calculation done on the NC parameters of the PACKET MEASUREMENT ORDER. The MS is then paged on its paging channel. Upon receipt of the PACKET PAGING REQUEST message, the MS sends a CHANNEL REQUEST but the SS denies the dedicated connection by sending an IMMEDIATE ASSIGNMENT REJECT with a wait indication (T3122) of 20 seconds.

The MS does not enter any dedicated connection and should so continue its NC reporting measurement, even if T3122 is not expired at T3158 expiry.

Maximum duration of the test

-

Expected sequence

Step	Direction	Message	Comments
1	SS->MS	PACKET MEASUREMENT ORDER	-Sent on PPCH. -Contains NETWORK_CONTROL_ORDER and NC_REPORTING_PERIOD_I See specific message contents
2	MS ->SS	PACKET CHANNEL REQUEST	'Single block without TBF establishment.'
3	SS -> MS	PACKET UPLINK ASSIGNMENT	Sent on PAGCH.
4	MS ->SS	PACKET MEASUREMENT REPORT	Sent on the allocated PDCH.
5	MS ->SS	PACKET CHANNEL REQUEST	'Single block without TBF establishment.'
6	SS		Verify that PRACH in step 5 is sent T3158 +/-10% after step 2. T3158 calculated using NC parameters sent in the PMO in step 1.
7	SS -> MS	PACKET UPLINK ASSIGNMENT	Sent on PAGCH.
8	MS ->SS	PACKET MEASUREMENT REPORT	Sent on the allocated PDCH.
9	SS -> MS	PACKET PAGING REQUEST	1 st Repeated Page info contains TMSI of the MS, PAGE_MODE = " same as before ", sent on downlink PPCH
10	MS -> SS	CHANNEL REQUEST	Response to paging
11	SS -> MS	IMMEDIATE ASSIGNMENT REJECT	Request Reference = pertaining to the message received in step 10. Wait indication 20 seconds Sent on AGCH.
12	MS ->SS	PACKET CHANNEL REQUEST	'Single block without TBF establishment.'
13	SS -> MS	PACKET UPLINK ASSIGNMENT	Sent on PAGCH.
14	MS ->SS	PACKET MEASUREMENT REPORT	Sent on the allocated PDCH.

PACKET MEASUREMENT ORDER in step 1:

NC Measurement parameters	
NETWORK_CONTROL_ORDER	10 (NC2)
NC_REPORTING_PERIOD_I	101 (15.36secs)

42.4.8.4 Network Control measurement reporting / NC_FREQUENCY_LIST

42.4.8.4.1 Network Control measurement reporting / NC_FREQUENCY_LIST / NC_FREQUENCY_LIST in Packet measurement order.

42.4.8.4.1.1 Conformance requirement

The GSM Neighbour Cell list may be modified by "NC Frequency List" in a PACKET CELL CHANGE ORDER message (in which case the reference list is given on the new cell) or one or more instances of the PACKET MEASUREMENT ORDER message with the same BA_IND value or PSI3_CHANGE_MARK value.

The "NC Frequency List" may add cells to the GSM Neighbour Cell list (see sub-clause 11.2.4 and 11.2.9b, "PACKET CELL CHANGE ORDER" and "PACKET MEASUREMENT ORDER"). These cells shall be added at the end of the GSM Neighbour Cell list and indexed in the order of occurrence within the PACKET CELL CHANGE ORDER

message or ascending instances of the PACKET MEASUREMENT ORDER message. The list of added cells may contain GPRS cell re-selection parameters.

The "NC Frequency List" may delete frequencies from the BA(GPRS) list (see 11.2.9b). The frequencies to be removed are identified by their indices in the BA(GPRS). In this case all cells associated with the removed frequencies shall be removed from the GSM Neighbour Cell list. Removed cells/frequencies shall keep their indices but no measurements or reporting shall be performed. If the index points to a cell that does not exist, this shall not be considered as an error.

When ordered to send measurement reports, the MS shall continuously monitor all carriers in BA(GPRS) or as indicated by the parameter NC_FREQUENCY_LIST and the BCCH carrier of the serving cell. The measurement requirements are defined in subclause 10.1.1 for the actual packet mode.

Reference

3GPP TS 04.60, subclause 5.6.1.

3GPP TS 05.08, subclause 10.1.4

42.4.8.4.1.2 Test Purpose

To verify that if the NC_FREQUENCY_LIST is included in the PACKET MEASUREMENT ORDER, MS updates the neighbour cell list and uses the updated list for the measurement reporting and reselection.

42.4.8.4.1.3 Method of test

Initial conditions

System Simulator:

3 cells, GPRS supported.

Cell A (in case of GSM900 only): BS_PA_MFRMS = 2 (4 multi frames)

Initial conditions

Parameter	Cell A	Cell B	Cell C
	Carrier 1	Carrier 2	Carrier 3
Channel Type Carried	BCCH	BCCH	BCCH
RF Signal Level (dBm)	-60	-75	-75
Serving Cell Parameters			
NETWORK_CONTROL_ORDER	NC0	NC0	NC0

NOTE 1: All cells support GPRS. None of the cells support PBCCH.

NOTE 2: Cell C is not a part of BA(GPRS) on cell A. Cell B is part of BA(GPRS) on cell A.

Mobile Station:

MS is in Packet Idle mode and GPRS attached, Ready Timer Deactivated.

Specific PICS Statements

-

PIXIT Statements

-

Test procedure

SS sends a PACKET MEASUREMENT ORDER to MS, changing the NC mode to NC2. SS receives few measurement reports. SS checks that the measurements of cell B are included in the measurement report while that of the Cell C are not included in it. SS transmits a PACKET MEASUREMENT ORDER including NC_FREQUENCY_LIST, adding Cell C while removing cell B. SS receives few measurement reports and checks that

MS now includes cell C in the PACKET MEASUREMENT REPORT, while the measurements of the cell B are not included in it. SS reduces the signal strength of cell A to -85dBm . The signal strengths of cells B and C are increased to -50dBm and -60dBm respectively, making cell B better than cell C for cell reselection. SS changes the NC mode to NC0 by sending a PACKET MEASUREMENT ORDER. SS checks that the MS has done the reselection to cell C even though the cell B was better as the cell B is not a part of the measurement list.

Maximum duration of the test

-

Expected sequence

Step	Direction	Message	Comments
1	SS->MS	IMMEDIATE ASSIGNMENT	for single block downlink assignment on PCH corresponding to MS.
2	SS->MS	PACKET MEASUREMENT ORDER	-Sent on blocks assigned in step 1 NETWORK_CONTROL_ORDER is set to NC2. NC_REPORTING_PERIOD_T and NC_REPORTING_PERIOD_I are specified.
3	MS ->SS	CHANNEL REQUEST	See specific message contents with establishment cause 'single block access'. Received on RACH.
4	SS->MS	IMMEDIATE ASSIGNMENT	for uplink TBF, single block assignment with an arbitrarily chosen TBF starting time in the future in the range 0.5 to 2 seconds.
5	MS ->SS	PACKET MEASUREMENT REPORT	Received on the allocated PDCH.
6			Steps 3-5 are repeated twice. SS Verifies that the measurement results for cells A, B are included in the PACKET MEASUREMENT REPORT, while the measurements of cell C is not included in it as the cell C is not a part of BA(GPRS) on cell A.
7	SS->MS	IMMEDIATE ASSIGNMENT	for single block downlink assignment on PCH corresponding to MS.
8	SS->MS	PACKET MEASUREMENT ORDER	Sent on block assigned in step 7. NETWORK_CONTROL_ORDER is set to NC2. NC_REPORTING_PERIOD_T and NC_REPORTING_PERIOD_I are specified. NC_FREQUENCY_LIST is included. This list adds cell C while deletes cell B from the measurement list.
9	MS ->SS	CHANNEL REQUEST	See specific message contents with establishment cause 'single block access'. Received on RACH.
10	SS->MS	IMMEDIATE ASSIGNMENT	for uplink TBF, single block assignment with an arbitrarily chosen TBF starting time in the future in the range 0.5 to 2 seconds.
11	MS ->SS	PACKET MEASUREMENT REPORT	Received on the allocated PDCH.
12			Steps 9-11 are repeated twice. SS Verifies that the measurement results for cells A, C are included in, at least, the last PACKET MEASUREMENT REPORT, while the measurements of cell B is not included in it. Previous PACKET MEASUREMENT REPORT may not include cell C (but should not include cell B), due to the new BSIC synchronization.
13	SS		Reduce the signal strength of cell A to – 85dBm and increase the signal strength of cell B to –50dBm and cell C to –60 dBm.
14	SS->MS	IMMEDIATE ASSIGNMENT	for single block downlink assignment on PCH corresponding to MS.
15	SS->MS	PACKET MEASUREMENT ORDER	Sent on block assigned in step 14. NETWORK_CONTROL_ORDER is set to NC0. See specific message contents
16	MS->SS	CHANNEL REQUEST	Establishment Cause is 'one phase packet access'. Received on cell C.

Specific message contents

SYSTEM INFORMATION TYPE 2 of Cell A:

Neighbour Cells Description	
-----------------------------	--

<p>- Format identifier</p> <p>- BCCH Allocation Sequence</p> <p>- BCCH Allocation ARFCN</p> <p>- EXT-IND</p>	<p>For GSM 900: Bit map 0. For DCS 1 800 and PCS 1 900: Range 512. For GSM 700, T-GSM 810 and GSM 850: Range 128. 0 For GSM 900: Channel numbers 5, 20, 90, 100, 110, 120, 122 and 124. For DCS 1 800: Channel numbers 515, 590, 700, 780, 810, 870, 875 and 885. For PCS 1 900 Channel numbers 515, 590, 655, 700, 710, 740, 780 and 810. For GSM 700, T-GSM 810: Channel numbers 437, 447, 467, 477, 487, 497, 502 and 507. For GSM 850: Channel numbers 137, 147, 157, 177, 197, 217, 227 and 237. For GSM 900, this IE carries only part of the BA. For DCS 1 800, PCS 1 900, GSM 700, T-GSM 810 and GSM 850, this IE carries complete BA.</p>
--	---

PACKET MEASUREMENT ORDER in step 2:

<p>NC Measurement parameters</p> <p>NETWORK_CONTROL_ORDER</p> <p>NC_REPORTING_PERIOD_I</p> <p>NC_REPORTING_PERIOD_T</p>	<p>10 (NC2)</p> <p>100 (7.68 s)</p> <p>011 (3.84 s)</p>
---	---

PACKET MEASUREMENT ORDER in step 8:

MESSAGE_TYPE	0000 11
PAGE_MODE	00 Normal Paging
TLLI	10 (address is TLLI)
-	Same as the value received from MS
PMO_INDEX	0 0 0 first message
PMO_COUNT	0 0 0 one message expected
{ 0 1 < NC Measurement Parameters }	1 NC Measurement Parameters available
NC Measurement Parameters	
NETWORK_CONTROL_ORDER	10 NC2
{ 0 1 < NC_NON_DRX_PERIOD	1 Additional NC parameters available
< NC_REPORTING_PERIOD_I	NC_NON_DRX_PERIOD = 000
< NC_REPORTING_PERIOD_T }	(No non-DRX mode after a measurement report has been sent)
	NC_REPORTING_PERIOD_I = 100
	(7.68 sec)
	NC_REPORTING_PERIOD_T = 011
	(3.84 sec)
	1 NC Frequency list struct available
{ 0 1 < NC_FREQUENCY_LIST }	
NC Frequency list	
{ 0 1 { < NR_OF_REMOVED_FREQ	
NR_OF_REMOVED_FREQ	1 Frequencies have been removed (cell B (1 st entry in the BA(GPRS) is removed))
REMOVED_FREQ_INDEX	00000
{ 1 < List of added Frequency struct	000000
Add Frequency list	
START_FREQUENCY	Adding the cell C
	00 1010 0000 (ARFCN 80, for GSM 900)
	10 0101 1000 (ARFCN 600, for DCS1800, PCS1900)
	01 1011 0101 (ARFCN 437, for GSM 700, T-GSM 810)
	00 1100 1111 (ARFCN 207, for GSM 850)
	001101
	1 cell selection parameters available
BSIC	
{ 0 1 < Cell selection params	
Cell selection params	
EXC_ACC	0
CELL_BAR_ACCESS_2	0 normal reselection
SAME_RA_AS_SERVING_CELL	1 same RA as serving cell
{ 0 1 < GPRS_RXLEV_ACCESS_MIN }	1 GPRS_RXLEV_ACCESS_MIN present
GPRS_RXLEV_ACCESS_MIN	010101 -90dBm
GPRS_MS_TXPWR_MAX_CCH	01010
{ 0 1 < GPRS_TEMPORARY_OFFSET }	1 GPRS_TEMPORARY_OFFSET present
GPRS_TEMPORARY_OFFSET	000
GPRS_PENALTY_TIME	0000
{ 0 1 < GPRS_RESELECT_OFFSET }	1 GPRS_RESELECT_OFFSET present
GPRS_RESELECT_OFFSET	10000 0dBm
{ 0 1 < HCS params }	1 HCS params present
GPRS_PRIORITY_CLASS	000
GPRS_HCS_THR	10100
{ 0 1 < SI13_PBCCH_LOCATION }	1 SI13_PBCCH_LOCATION present
{ 0 < SI13_LOCATION }	0
SI13_LOCATION	0 SI13 is sent on BCCH norm
NR_OF_FREQUENCIES	0000
FREQ_DIFF_LENGTH	000
} 0	End of list
< padding bits >	Spare Padding

PACKET MEASUREMENT ORDER in step 15:

MESSAGE_TYPE	0000 11
PAGE_MODE	00 Normal Paging
TLLI	10 (address is TLLI)
-	Same as the value received from MS
PMO_INDEX	0 0 0 first message
PMO_COUNT	0 0 0 one message expected
{ 0 1 < NC Measurement Parameters }	1 NC Measurement Parameters available
NC Measurement Parameters	
NETWORK_CONTROL_ORDER	00 NC0
{ 0 1 < NC_NON_DRX_PERIOD	0 No Additional NC parameters available
< NC_REPORTING_PERIOD_I	
< NC_REPORTING_PERIOD_T }	
{ 0 1 < NC_FREQUENCY_LIST }	1 NC Frequency list struct available
NC Frequency list	
{ 0 1 { < NR_OF_REMOVED_FREQ	1 Frequencies have been removed (cell B (1 st entry
	in the BA(GPRS) is removed))
	00000
	000000
NR_OF_REMOVED_FREQ	
REMOVED_FREQ_INDEX	
{ 1 < List of added Frequency struct	
Add Frequency list	Adding the cell C
START_FREQUENCY	00 1010 0000 (ARFCN 80, for GSM 900)
	10 0101 1000 (ARFCN 600, for DCS1800,
	PCS1900)
	01 1011 0101 (ARFCN 437, for GSM 700, T-GSM
	810)
	00 1100 1111 (ARFCN 207, for GSM 850)
	001101
	1 cell selection parameters available
BSIC	0
{ 0 1 < Cell selection params	0 normal reselection
Cell selection params	1 same RA as serving cell
EXC_ACC	1 GPRS_RXLEV_ACCESS_MIN present
CELL_BAR_ACCESS_2	010101 -90dBm
SAME_RA_AS_SERVING_CELL	01010
{ 0 1 < GPRS_RXLEV_ACCESS_MIN }	1 GPRS_TEMPORARY_OFFSET present
GPRS_RXLEV_ACCESS_MIN	000
GPRS_MS_TXPWR_MAX_CCH	0000
{ 0 1 < GPRS_TEMPORARY_OFFSET }	1 GPRS_RESELECT_OFFSET present
GPRS_TEMPORARY_OFFSET	10111 +16dBm
GPRS_PENALTY_TIME	1 HCS params present
{ 0 1 < GPRS_RESELECT_OFFSET }	000
GPRS_RESELECT_OFFSET	10100
{ 0 1 < HCS params }	1 SI13_PBCCH_LOCATION present
GPRS_PRIORITY_CLASS	0
GPRS_HCS_THR	0 SI13 is sent on BCCH norm
{ 0 1 < SI13_PBCCH_LOCATION }	0000
{ 0 < SI13_LOCATION }	000
SI13_LOCATION	End of list
NR_OF_FREQUENCIES	Spare Padding
FREQ_DIFF_LENGTH	
} 0	
< padding bits >	

42.4.8.4.2 Network Control measurement reporting / NC_FREQUENCY_LIST / NC_FREQUENCY_LIST in Packet Cell Change Order.

42.4.8.4.2.1 Conformance requirement

The GSM Neighbour Cell list may be modified by "NC Frequency List" in a PACKET CELL CHANGE ORDER message (in which case the reference list is given on the new cell) or one or more instances of the PACKET MEASUREMENT ORDER message with the same BA_IND value or PSI3_CHANGE_MARK value.

The "NC Frequency List" may add cells to the GSM Neighbour Cell list (see sub-clause 11.2.4 and 11.2.9b, "PACKET CELL CHANGE ORDER" and "PACKET MEASUREMENT ORDER"). These cells shall be added at the end of the GSM Neighbour Cell list and indexed in the order of occurrence within the PACKET CELL CHANGE ORDER

message or ascending instances of the PACKET MEASUREMENT ORDER message. The list of added cells may contain GPRS cell re-selection parameters.

The "NC Frequency List" may delete frequencies from the BA(GPRS) list (see 11.2.9b). The frequencies to be removed are identified by their indices in the BA(GPRS). In this case all cells associated with the removed frequencies shall be removed from the GSM Neighbour Cell list. Removed cells/frequencies shall keep their indices but no measurements or reporting shall be performed. If the index points to a cell that does not exist, this shall not be considered as an error.

When ordered to send measurement reports, the MS shall continuously monitor all carriers in BA(GPRS) or as indicated by the parameter NC_FREQUENCY_LIST and the BCCH carrier of the serving cell. The measurement requirements are defined in subclause 10.1.1 for the actual packet mode.

Reference

3GPP TS 04.60, subclause 5.6.1.

3GPP TS 05.08, subclause 10.1.4

42.4.8.4.2.2 Test Purpose

To verify that if the NC_FREQUENCY_LIST is included in the PACKET CELL CHANGE ORDER, MS acts on it and uses the changed frequency list for the measurement reporting and reselection in the new cell.

42.4.8.4.2.3 Method of test

Initial conditions

System Simulator:

3 cells, GPRS supported.

Initial conditions

Parameter	Cell A		Cell B		Cell C
	Carrier 1	Carrier 2	Carrier 3	Carrier 4	Carrier 5
Channel Type Carried	BCCH	PBCCH	BCCH	PBCCH	BCCH
RF Signal Level (dBm)	-60	-60	-75	-75	-75
Serving Cell Parameters					
NETWORK_CONTROL_ORDER		NC0		NC0	NC0

NOTE 1: All cells support GPRS. Cell A,B support PCCCH. Cell C does not support PCCCH in the cell.

Mobile Station:

MS is in Packet Idle mode and GPRS attached on Cell A, Ready Timer deactivated.

Specific PICS Statements

-

PIXIT Statements

-

Test procedure

SS sends a PACKET MEASUREMENT ORDER to MS changing the NC mode to NC2. SS receives few measurement reports. SS sends a PACKET CELL CHANGE ORDER including NC_FREQUENCY_LIST, asking the MS to move to cell B. NC_FREQUENCY_LIST in the PACKET CELL CHANGE ORDER deletes the cell A from the BA(GPRS). On the cell B after doing the cell update, SS receives few measurement reports and checks that MS includes cell C in the PACKET MEASUREMENT REPORT, while the measurements of the cell A are not included in it. The signal strengths of cells A and C is increased to -50dBm -60 dBm respectively making Cell A is better than cell C for cell reselection. SS changes the NC mode to NC0 by sending a PACKET MEASUREMENT ORDER. SS checks

that the MS has done the reselection to cell C even though the cell A was better as the cell A is not a part of the measurement.

Maximum duration of the test

-

Expected sequence

Step	Direction	Message	Comments
1	SS->MS	PACKET MEASUREMENT ORDER	-Sent on PPCH. NETWORK_CONTROL_ORDER is set to NC2. NC_REPORTING_PERIOD_T and NC_REPORTING_PERIOD_I are specified.
2	MS ->SS	PACKET CHANNEL REQUEST	See specific message contents ACCESS TYPE ='Single block without TBF establishment.' Received on PRACH.
3	SS->MS	PACKET UPLINK ASSIGNMENT	Sent on PAGCH, assigning a single block.
4	MS ->SS	PACKET MEASUREMENT REPORT	Received on the allocated PDCH.
5			Steps 2-4 are repeated twice. SS Verifies that the measurement of cells B and C are included in the PACKET MEASUREMENT REPORT.
6	SS->MS	PACKET CELL CHANGE ORDER	Sent on PPCH, sent to order MS to go to cell B. NETWORK_CONTROL_ORDER in the new cell is set to NC2. NC_REPORTING_PERIOD_T and NC_REPORTING_PERIOD_I are specified. NC_FREQUENCY_LIST is included. This list deletes cell A. See specific message content.
7	MS ->SS	PACKET CHANNEL REQUEST	To the new cell. 'Cell Update'
8	SS -> MS	PACKET UPLINK ASSIGNMENT	Sent on PAGCH.
9	SS -> MS	PACKET DOWNLINK DUMMY CONTROL BLOCK	Sent on PACCH containing USF assigned to the MS.
10	MS ->SS	UPLINK RLC DATA BLOCK	LLC PDU implicitly indicating Cell Update
11	SS -> MS	PACKET UPLINK ACK/NACK	Acknowledge the received RLC data block, Final Ack Indicator = '1', a valid RRBP. Sent on PACCH.
12	MS -> SS	PACKET CONTROL ACKNOWLEDGEMENT	Acknowledge the RLC control message. Received on PACCH.
13	MS ->SS	PACKET CHANNEL REQUEST	ACCESS TYPE ='Single block without TBF establishment.' Received on PRACH.
14	SS->MS	PACKET UPLINK ASSIGNMENT	Sent on PAGCH, assigning a single block.
15	MS ->SS	PACKET MEASUREMENT REPORT	Received on the allocated PDCH.
16			Steps 13-15 are repeated twice. SS Verifies that the measurement results for cell C is included in 2 nd and 3 rd PACKET MEASUREMENT REPORT, while the measurements of cell A isnot included in any of the PACKET MEASUREMENT REPORT
17	SS		Increase the signal strength of cell A to – 50dBm and cell C to –60 dBm.
18	SS->MS	PACKET MEASUREMENT ORDER	Sent on PPCH. NETWORK_CONTROL_ORDER is set to NC0. See specific message contents
19	MS->SS	CHANNEL REQUEST	Establishment Cause is 'one phase packet access'. Received on cell C.

Specific message contents

PACKET MEASUREMENT ORDER in step 1:

NC Measurement parameters NETWORK_CONTROL_ORDER NC_REPORTING_PERIOD_I NC_REPORTING_PERIOD_T	10 (NC2) 100 (7.68 s) 011 (3.84 s)
--	--

PACKET CELL CHANGE ORDER in step 6:

MESSAGE_TYPE PAGE_MODE Referenced Address - - TLLI IMMEDIATE_REL ARFCN BSIC NC Measurement Parameters NETWORK_CONTROL_ORDER { 0 1 < NC_NON_DRX_PERIOD < NC_REPORTING_PERIOD_I < NC_REPORTING_PERIOD_T }	0000 01 00 Normal Paging 10 (address is TLLI) Same as the value received from MS 0 For GSM 900: 00 0000 0101 (ARFCN 5) For DCS 1 800 and PCS 1 900: 10 0000 0011 (ARFCN 515) For GSM 700, T-GSM 810: 01 1110 1111 (ARFCN 447) For GSM 850: 00 1000 1001 (ARFCN 137) 001101
NC Frequency list struct { 0 1 < NC_FREQUENCY_LIST }	1 0 NC2 1 Additional NC parameters available NC_NON_DRX_PERIOD = 000 (No non-DRX mode after a measurement report has been sent) NC_REPORTING_PERIOD_I = 100 (7.68 sec) NC_REPORTING_PERIOD_T = 011 (3.84 sec)
NC Frequency list { 0 1 { < NR_OF_REMOVED_FREQ NR_OF_REMOVED_FREQ REMOVED_FREQ_INDEX { 1 < List of added Frequency struct} < padding bits >	1 NC_FREQUENCY_LIST present 1 Frequencies have been removed (cell A (1 st entry in the BA(GPRS) of cell B is removed)) 00000 000000 0 No Added Frequency struct Spare Padding

PACKET MEASUREMENT ORDER in step 18:

MESSAGE_TYPE	0000 11
PAGE_MODE	00 Normal Paging
TLLI	10 (address is TLLI)
-	Same as the value received from MS
PMO_INDEX	0 0 0 first message
PMO_COUNT	0 0 0 one message expected
{ 0 1 < NC Measurement Parameters }	1 NC Measurement Parameters available
NC Measurement Parameters	
NETWORK_CONTROL_ORDER	10 NC0
{ 0 1 < NC_NON_DRX_PERIOD	0 No Additional NC parameters available
< NC_REPORTING_PERIOD_I	
< NC_REPORTING_PERIOD_T }	
{ 0 1 < NC_FREQUENCY_LIST }	1 NC Frequency list struct available
NC Frequency list	
{ 0 1 { < NR_OF_REMOVED_FREQ	1 Frequencies have been removed (cell A (1 st entry
	in the BA(GPRS) is removed))
NR_OF_REMOVED_FREQ	00000
REMOVED_FREQ_INDEX	000000
} 1 < List of added Frequency struct	0 No Add frequency list
} 0	End of list
< padding bits >	Spare Padding

42.4.8.4.3 Network Control measurement reporting / NC_FREQUENCY_LIST / PMO with empty NC_FREQUENCY_LIST/ Return to BA(GPRS).

42.4.8.4.3.1 Conformance requirement

The “NC Frequency List” may add cells to the GSM Neighbour Cell list (see sub-clause 11.2.4 and 11.2.9b, “PACKET CELL CHANGE ORDER” and “PACKET MEASUREMENT ORDER”). These cells shall be added at the end of the GSM Neighbour Cell list and indexed in the order of occurrence within the PACKET CELL CHANGE ORDER message or ascending instances of the PACKET MEASUREMENT ORDER message. The list of added cells may contain GPRS cell re-selection parameters.

In case the same cell (ARFCN+BSIC) or the same ARFCN without BSIC occur more than once in the resulting GSM Neighbour Cell list, each occurrence shall be assigned an index but only the cell with the highest index shall be used for cell re-selection and referred to in measurement reports.

The “NC Frequency List” may delete frequencies from the BA(GPRS) list (see 11.2.9b). The frequencies to be removed are identified by their indices in the BA(GPRS). In this case all cells associated with the removed frequencies shall be removed from the GSM Neighbour Cell list. Removed cells/frequencies shall keep their indices but no measurements or reporting shall be performed. If the index points to a cell that does not exist, this shall not be considered as an error.

A parameter NC_FREQUENCY_LIST may also be sent individually to an MS on PCCCH or PACCH. This list adds/deletes frequencies to the BA(GPRS) both for cell re-selection and for measurement reports. For added frequencies, the corresponding cell re-selection parameters may be included. If no cell re-selection parameters are given for a particular cell, that cell shall only be used in mode NC2. The list is valid until an empty list is sent to the MS.

Reference

3GPP 04.60, subclause 5.6.3.2

3GPP 05.08, subclause 10.1.4

42.4.8.4.3.2 Test Purpose

To verify that MS involved in measurement reporting reverts to BA(GPRS) on reception of PMO with empty NC_FREQUENCY_LIST list.

42.4.8.4.3.3 Method of test

Initial Conditions

System Simulator:

- 3 cells. Cell B is part of BA(GPRS) of Cell A. Cell C is not a part of the BA(GPRS) of Cell A. None of the cells support PBCCH.
Cell A (in case of GSM900 only): BS_PA_MFRMS = 2 (4 multi frames)

Mobile Station:

- The MS is in GPRS attached with a TMSI and a P-TMSI allocated on Cell A, Ready Timer deactivated.

Specific PICS Statements

-

PIXIT Statements

-

Test Procedure

SS sends a PACKET MEASUREMENT ORDER message (including the NC_FREQUENCY_LIST) Changing the NC mode to NC2, deleting the cell B, while adding the cell C in the measurement list. SS checks that the measurements of the cell C are included in the Packet measurement report while that of Cell B are not included. The SS sends a PACKET MEASUREMENT ORDER message with an empty NC_FREQUENCY_LIST. SS checks that the MS starts sending the measurements of cell B while stops sending the measurements of the cell C.

Maximum Duration of Test

-

Expected Sequence

Step	Direction	Message	Comments
1	SS->MS	IMMEDIATE ASSIGNMENT	for single block downlink assignment on PCH corresponding to MS.
2	SS -> MS	PACKET MEASUREMENT ORDER	Sent on block assigned in step 1. See specific message content
3	MS -> SS	CHANNEL REQUEST	with establishment cause 'single block access'. Received on RACH.
4	SS -> MS	IMMEDIATE ASSIGNMENT	for uplink TBF, single block assignment with an arbitrarily chosen TBF starting time in the future in the range 0.5 to 2 seconds.
5	MS -> SS	PACKET MEASUREMENT REPORT	-Sent on allocated PDCH -Contains "NC measurement report Struct"
6			Steps 3-5 are repeated twice. SS Verifies that the measurement results for cells A, C are included in, at least, the last PACKET MEASUREMENT REPORT, while the measurements of cell B is not included in it. Previous PACKET MEASUREMENT REPORT may not include cell C (but should not include cell B), due to the new BSIC synchronization.
7	SS->MS	IMMEDIATE ASSIGNMENT	for single block downlink assignment on PCH corresponding to MS.
8	SS -> MS	PACKET MEASUREMENT ORDER	-Sent on block assigned in step 1 See specific message content Empty NC_FREQUENCY_LIST list
9	MS -> SS	CHANNEL REQUEST	with establishment cause 'single block access'. Received on RACH.
10	SS -> MS	IMMEDIATE ASSIGNMENT	for uplink TBF, single block assignment with an arbitrarily chosen TBF starting time in the future in the range 0.5 to 2 seconds.
11	MS -> SS	PACKET MEASUREMENT REPORT	-Sent on allocated PDCH -Contains "NC measurement report Struct"
12			Steps 9-11 are repeated twice. SS Verifies that the measurement results for cells A, B are included in, at least, the last PACKET MEASUREMENT REPORT, while the measurements of cell C is not included in it. Previous PACKET MEASUREMENT REPORT may not include cell B (but should not include cell C), due to the new BSIC synchronization.

Specific message contents:

SYSTEM INFORMATION TYPE 2 of Cell A:

Neighbour Cells Description - Format identifier - BCCH Allocation Sequence - BCCH Allocation ARFCN	For SI 2 For GSM 900: Bit map 0. For DCS 1 800 and PCS 1 900: Range 512. For GSM 700, T-GSM 810 and GSM 850: Range 128. 0 For GSM 900: Channel numbers 5, 20, 90, 100, 110, 120, 122 and 124. For DCS 1 800: Channel numbers 515, 590, 700, 780, 810, 870, 875 and 885. For PCS 1 900 Channel numbers 515, 590, 655, 700, 710, 740, 780 and 810. For GSM 700, T-GSM 810: Channel numbers 437, 447, 467, 477, 487, 497, 502 and 507. For GSM 850: Channel numbers 137,147, 157, 177, 197, 217, 227 and
---	---

<p>- EXT-IND</p>	<p>237. For GSM 900, this IE carries only part of the BA. For DCS 1 800, PCS 1 900, GSM 700, T-GSM 810 and GSM 850, this IE carries complete BA.</p>
------------------	--

PACKET MEASUREMENT ORDER in step 2:

<p>NC Measurement parameters NETWORK_CONTROL_ORDER NC_REPORTING_PERIOD_I NC_FREQUENCY_LIST REMOVED_FREQ_LIST NR_OF_REMOVED_FREQ REMOVED_FREQ_INDEX Add Frequency list struct START_FREQUENCY BSIC Cell Selection Params NR_OF_FREQUENCIES</p>	<p>10 (NC2) '100' (7,68 s) 1 1 00000 000000 – Remove Cell B 1 GSM 900 GPRS: Containing ARFCN 80 of Cell C 00010100 ARFCN 80 (MSB) 00 ARFCN 80 (LS 2bits) DCS 1 800 and PCS 1 900 GPRS: Containing ARFCN 600 for Cell C 10010110 ARFCN 600 (MSB) 00 (LS 2 bits) GSM 700, T-GSM 810 GPRS: Containing ARFCN 447 01101111 ARFCN 447(MSB) 11 ARFCN 447(LS 2 bits) GSM 850 GPRS: Containing ARFCN 207 00110011 ARFCN 207 (MSB) 11 ARFCN 207 (LS 2 bits) 001101 0 00000</p>
--	--

PACKET MEASUREMENT ORDER in step 8:

<p>NC Measurement parameters NETWORK_CONTROL_ORDER NC_REPORTING_PERIOD_I NC_FREQ_LIST</p>	<p>10 (NC2) '100' (7,68s) 0 (NC Frequency list not present)</p>
--	---

42.4.8.4.4 Network Control measurement reporting / NC_FREQUENCY_LIST / Changes in BA(GPRS)/ Return to BA(GPRS).

42.4.8.4.4.1 Conformance requirement

A parameter NC_FREQUENCY_LIST may also be sent individually to an MS on PCCCH or PACCH. This list adds/deletes frequencies to the BA(GPRS) both for cell re-selection and for measurement reports. For added frequencies, the corresponding cell re-selection parameters may be included. The list is valid until an empty list is sent to the MS, there is a downlink signalling failure or the MS selects a new cell or the BA(GPRS) that is modified by the NC_FREQUENCY_LIST changes or the MS enters dedicated mode. A list given by Packet Cell Change Order applies in the new cell. The lists may also include cells with other radio access technologies.

Reference

3GPP 05.08, subclause 10.1.4

42.4.8.4.4.2 Test Purpose

To verify that MS returns to BA(GPRS) if BA(GPRS) on which the NC_FREQ_LIST is built, is changed.

42.4.8.4.4.3 Method of test

Initial Conditions

System Simulator:

- 3 cells. Cell B is part of BA(GPRS) on cell A. Cell C is not a part of the BA(GPRS).
- BCCH/CCCH carrier of cell C is set to ARFCN 157 for 850 band.

Mobile Station:

The MS is in GPRS attached with a TMSI and a P-TMSI allocated on Cell A. READY TIMER is set to 5 min.

Specific PICS Statements

-

PIXIT Statements

-

Test Procedure

SS sends a PACKET MEASUREMENT ORDER message (including the NC_FREQUENCY_LIST) Changing the NC mode to NC2, deleting the cell B, while adding the cell C in the measurement list. SS checks that the measurements of the cell C are included in the Packet measurement report while that of Cell B are not included. The SS Changes the BA(GPRS) given on the broadcast channels. SS waits for 35 seconds. SS checks that the MS reverts back to sending of the measurements of cell B while stops sending the measurements of the cell C.

Maximum Duration of Test

-

Expected Sequence

Step	Direction	Message	Comments
1	SS -> MS	PACKET MEASUREMENT ORDER	Sent on PPCH. See specific message content
2	MS -> SS	PACKET CHANNEL REQUEST	'Single block without TBF establishment.'
3	SS -> MS	PACKET UPLINK ASSIGNMENT	Sent on PAGCH. Single block assignment
4	MS -> SS	PACKET MEASUREMENT REPORT	-Sent on allocated PDCH -Contains "NC measurement report Struct"
5	SS		Steps 2-4 are repeated twice. SS Verifies that the measurement results for cells A, C are included in, at least, the last PACKET MEASUREMENT REPORT, while the measurements of cell B is not included in it. Previous PACKET MEASUREMENT REPORT may not include cell C (but should not include cell B), due to the new BSIC synchronization.
6	SS		SS Changes BA(GPRS) list broadcast on PBCCH See Specific message content SS waits for 35 seconds While waiting, MS may send measurement reports, in that case repeat steps 2-4.
7	MS -> SS	PACKET CHANNEL REQUEST	'Single block without TBF establishment.'
8	SS -> MS	PACKET UPLINK ASSIGNMENT	-Sent on PAGCH Single block assignment
9	MS -> SS	PACKET MEASUREMENT REPORT	-Sent on allocated PDCH -Contains "NC measurement report Struct" SS verifies that measurement reports for Cell B are included and not of Cell C.

Specific message contents

Default PACKET SYSTEM INFORMATION TYPE 3 of Cell A.:

Neighbour Cell parameters	1 start of neighbour cell parameters
---------------------------	--------------------------------------

<p>- START_FREQUENCY</p> <p>- Cell selection params</p> <ul style="list-style-type: none"> - BSIC - CELL_BAR_ACCESS_2 - EXC_ACC - SAME_RA_AS_SERVING_CELL - {0 1<GPRS_RXLEV_ACCESS_MIN>} <ul style="list-style-type: none"> - GPRS_RXLEV_ACCESS_MIN - GPRS_MS_TXPWR_MAX_CCH - {0 1<GPRS_TEMPORARY_OFFSET>} <ul style="list-style-type: none"> - GPRS_TEMPORARY_OFFSET - GPRS_PENALTY_TIME - {0 1<GPRS_RESELECT_OFFSET>} <ul style="list-style-type: none"> - GPRS_RESELECT_OFFSET - {0 1<HCS params>} <ul style="list-style-type: none"> - GPRS_PRIORITY_CLASS - GPRS_HCS_THR - {0 1<SI13_PBCCH_LOCATION>} <ul style="list-style-type: none"> 0- SI13 1 PBCCH Location <p>:NR_OF_REMAINING_CELLS</p> <p>FREQ_DIFF_LENGTH</p> <p>FREQUENCY_DIFF</p> <p>- Cell selection params</p> <ul style="list-style-type: none"> - BSIC - CELL_BAR_ACCESS_2 - EXC_ACC - SAME_RA_AS_SERVING_CELL - {0 1<GPRS_RXLEV_ACCESS_MIN>} <ul style="list-style-type: none"> - GPRS_RXLEV_ACCESS_MIN - GPRS_MS_TXPWR_MAX_CCH - {0 1<GPRS_TEMPORARY_OFFSET>} <ul style="list-style-type: none"> - GPRS_TEMPORARY_OFFSET - {0 1<GPRS_RESELECT_OFFSET>} <ul style="list-style-type: none"> - GPRS_RESELECT_OFFSET - {0 1<HCS params>} <ul style="list-style-type: none"> - GPRS_PRIORITY_CLASS - GPRS_HCS_THR - {0 1<SI13_PBCCH_LOCATION>} <ul style="list-style-type: none"> 0- SI13 1 PBCCH Location 	<p>GSM 900 GPRS: Containing ARFCN 5 and 84 00000001 ARFCN 5 (MSB) 01 ARFCN 5 (LS 2bits) DCS 1 800 and PCS 1 900 GPRS: Containing ARFCN 515 and 604 10000000 ARFCN 515 (MSB) 11 (LS 2 bits) GSM 700, T-GSM 810 GPRS: Containing ARFCN 437 and 445 01101101 ARFCN 437 (MSB) 01 ARFCN 437 (LS 2 bits) GSM 850 GPRS: Containing ARFCN 137 and 159 00100010 ARFCN 137 (MSB) 01 ARFCN 137 (LS 2 bits)</p> <p>001101 0 Normal reselection 0 1 same routing area 1 GPRS_RXLEV_ACCESS_MIN present 011111 -80dBm 01010 1 GPRS_TEMPORARY_OFFSET present 000 00000 1 GPRS_RESELECT_OFFSET present 10000 0dB 1 HCS params present 001 10100 1 SI13_PBCCH_LOCATION present 0 SI13 Location 0 SI13 on BCCH Norm 0001 GSM 900 GPRS: 110 7 bits DCS 1800 GPRS: 110 7 bits PCS 1900 GPRS: 110 7 bits GSM 850 GPRS: 100 5 bits GSM 700, T-GSM 810 GPRS: 011 4 bits GSM 900 GPRS: 1001111 (ARFCN 84 – diff 79) DCS 1 800 and PCS 1 900 GPRS: 1011001 (ARFCN 604 – diff 89) PCS 1900 GPRS: 1011001 (ARFCN 604 – diff 89) GSM 700, T-GSM 810 GPRS: 1000 (ARFCN 445 – diff 8) GSM 850 GPRS: 10110 (ARFCN 159 – diff 22)</p> <p>001101 0 Normal reselection 0 1 same routing area 1 GPRS_RXLEV_ACCESS_MIN present 011111 -80dBm 01010 0 GPRS_TEMPORARY_OFFSET not present 1 GPRS_RESELECT_OFFSET present 10000 0dB 0 HCS params not present 1 SI13_PBCCH_LOCATION present</p>
---	---

0- SI13 1 PBCCH Location SI13_LOCATION	0 SI13 Location 0 SI13 on BCCH Norm
--	--

PACKET MEASUREMENT ORDER in step 1:

NC Measurement parameters NETWORK_CONTROL_ORDER NC_REPORTING_PERIOD_I NC_FREQUENCY_LIST REMOVED_FREQ_LIST NR_OF_REMOVED_FREQ REMOVED_FREQ_INDEX Add Frequency list struct START_FREQUENCY BSIC Cell Selection Params NR_OF_FREQUENCIES	10 (NC2) '100' (7,68 s) 1 1 00000 000000 – Remove Cell B 1 GSM 900 GPRS: Containing ARFCN 80 of Cell C 00010100 ARFCN 80 (MSB) 00 ARFCN 80 (LS 2bits) DCS 1 800 and PCS 1 900 GPRS: Containing ARFCN 600 for Cell C 10010110 ARFCN 600 (MSB) 00 (LS 2 bits) GSM 700, T-GSM 810 GPRS: Containing ARFCN 447 01101111 ARFCN 447(MSB) 11 ARFCN 447(LS 2 bits) GSM 850 GPRS: Containing ARFCN 157 00100111 ARFCN 157(MSB) 01 ARFCN 157(LS 2 bits) 001101 0 00000
---	---

PACKET SYSTEM INFORMATION TYPE 3 in step 6.

Neighbour Cell parameters - START_FREQUENCY - Cell selection params - BSIC - CELL_BAR_ACCESS_2 - EXC_ACC - SAME_RA_AS_SERVING_CELL - {0 1<GPRS_RXLEV_ACCESS_MIN>} - GPRS_RXLEV_ACCESS_MIN - GPRS_MS_TXPWR_MAX_CCH - {0 1<GPRS_TEMPORARY_OFFSET>} - GPRS_TEMPORARY_OFFSET - GPRS_PENALTY_TIME - {0 1<GPRS_RESELECT_OFFSET>} - GPRS_RESELECT_OFFSET - {0 1<HCS params>}	1 start of neighbour cell parameters GSM 900 GPRS: Containing ARFCN 5 and 86 00000001 ARFCN 5 (MSB) 01 ARFCN 5 (LS 2bits) DCS 1 800 and PCS 1 900 GPRS: Containing ARFCN 515 and 606 10000000 ARFCN 515 (MSB) 11 (LS 2 bits) GSM 700, T-GSM 810 GPRS: Containing ARFCN 435 and 449 01101101 ARFCN 435 (MSB) 01 ARFCN 435 (LS 2 bits) GSM 850 GPRS: Containing ARFCN 137 and 160 00100010 ARFCN 137 (MSB) 01 ARFCN 137 (LS 2 bits) 001101 0 Normal reselection 0 1 same routing area 1 GPRS_RXLEV_ACCESS_MIN present 011111 -80dBm 01010 1 GPRS_TEMPORARY_OFFSET present 000 00000 1 GPRS_RESELECT_OFFSET present 10000 0dB 1 HCS params present
--	---

- GPRS_PRIORITY_CLASS	001
- GPRS_HCS_THR	10100
- {0 1<SI13_PBCCH_LOCATION>}	1 SI13_PBCCH_LOCATION present
0- SI13 1 PBCCH Location	0 SI13 Location
	0 SI13 on BCCH Norm
:NR_OF_REMAINING_CELLS	0001
FREQ_DIFF_LENGTH	GSM 900 GPRS:
	110 7 bits
	DCS 1800 GPRS:
	110 7 bits
	PCS 1900 GPRS:
	110 7 bits
	GSM 850 GPRS:
	100 5 bits
	GSM 700, T-GSM 810 GPRS:
	011 4 bits
FREQUENCY_DIFF	GSM 900 GPRS:
	1010001 (ARFCN 86 – diff 81)
	DCS 1 800 and PCS 1 900 GPRS:
	1011011 (ARFCN 606 – diff 91)
	PCS 1900 GPRS:
	1011011 (ARFCN 606 – diff 91)
	GSM 700, T-GSM 810 GPRS:
	1100 (ARFCN 449 – diff 12)
	GSM 850 GPRS:
	10111 (ARFCN 160 – diff 23)
- Cell selection params	Same as default contents as for ARFCN 80

Note : At Step 6, PSI_CHANGE_FIELD, PBCCH_CHANGE_MARK and PSI3_CHANGE_MARK should be incremented by one to reflect that PSI3 info is changed.

42.4.8.4.5 Network Control measurement reporting / NC_FREQUENCY_LIST / Dedicated connection/ Return to BA(GPRS)

42.4.8.4.5.1 Conformance requirement

The procedure for measurement report sending shall be initiated by the mobile station at expiry of either the NC measurement report interval timer T3158 or the EM measurement report interval timer T3178. At expiry of the timer T3158 or T3178 the mobile station shall restart the expired timer T3158 or T3178, perform the measurements and initiate the packet access.

The procedure for measurement report sending is initiated by the mobile station either on PCCCH (subclause 7.3.1) or, if a packet control channel not exists, on CCCH (subclause 7.3.2).

If the mobile station initiates an RR connection establishment, the timers T3158 and T3178 shall be stopped and no measurement reports shall be sent. When the RR connection is released and if the mobile station has not changed cell, the measurement reporting procedure shall be restarted.

In a cell with a PBCCH allocated, if PSI3_CHANGE_MARK is changed, the mobile station shall re-read and rebuild the GSM Neighbour Cell list.

Reference

- 3GPP 04.60, subclause 7.3
- 3GPP 04.60, subclause 5.6.3.2

42.4.8.4.5.2 Test Purpose

To verify that MS involved in measurement reporting successfully returns to BA(GPRS) broadcast on PBCCH after a dedicated connection.

42.4.8.4.5.3 Method of test

Initial Conditions

System Simulator:

- 3 cells. Cell B are part of BA(GPRS) on cell A. Cell C is not a part of the BA(GPRS) on both cell A and cell B.
- Ready Timer Deactivated on all cells.
- BCCH/CCCH carrier of cell C is set to ARFCN 157 for 850 band.

Mobile Station:

The MS is in GPRS attached with a TMSI and a P-TMSI allocated.

Specific PICS Statements

- Support of Immediate Connect (TSPC_AddInfo_ImmConn)

PIXIT Statements

-

Test Procedure

SS sends a PACKET MEASUREMENT ORDER message (including the NC_FREQUENCY_LIST) changing the NC mode to NC2, deleting the cell B, while adding the cell C to the measurement list. SS checks that the measurements of the cell C are included in the third Packet measurement report while that of Cell B are not included. The SS Pages MS for a CS call. SS establishes a call with MS. After 5 seconds releases the call. SS reduces the signal strength of the cell A, in such a way that the cell B and C are better than cell A. Cell C is better than cell B. SS checks that the MS does the reselection to cell B, even though cell C is better. This way we will check that the MS returns to broadcast parameters after a dedicated connection.

Maximum Duration of Test

-

Expected Sequence

Step	Direction	Message	Comments
1	SS -> MS	PACKET MEASUREMENT ORDER	Sent on PPCH. See specific message content
2	MS -> SS	PACKET CHANNEL REQUEST	'Single block without TBF establishment.'
3	SS -> MS	PACKET UPLINK ASSIGNMENT	Sent on PAGCH. Single block assignment
4	MS -> SS	PACKET MEASUREMENT REPORT	-Sent on allocated PDCH -Contains "NC measurement report Struct"
5	SS		Steps 2-4 are repeated twice. SS Verifies that the measurement results for cells A, C are included in, at least, the last PACKET MEASUREMENT REPORT, while the measurements of cell B is not included in it. Previous PACKET MEASUREMENT REPORT may not include cell C (but should not include cell B), due to the new BSIC synchronization.
6		{MT Call while GPRS Attach}	Macro parameters: T : 5 seconds R : 1, Resumption GPRS done
7	SS		SS changes the signal strength of Cell B and Cell C such that Cell B and Cell C are better than Cell A
8	MS -> SS	PACKET CHANNEL REQUEST	Received on Cell B 'Cell Update'
9	SS -> MS	PACKET UPLINK ASSIGNMENT	Sent on PAGCH. Assigning Single Block , to order the MS making two-phase access procedure
10	MS -> SS	PACKET RESOURCE REQUEST	Received on the single block assigned.
11	SS -> MS	PACKET UPLINK ASSIGNMENT	Open-ended uplink dynamic allocation, no starting time, Sent on PAGCH.
12	SS	{Completion of uplink RLC data transfer }	For the empty LLC frame serving as cell update

Specific message contents:

Default PACKET SYSTEM INFORMATION TYPE 3 of Cell A.:

<p>Neighbour Cell parameters - START_FREQUENCY</p> <p>- Cell selection params - BSIC - CELL_BAR_ACCESS_2 - EXC_ACC - SAME_RA_AS_SERVING_CELL - {0 1<GPRS_RXLEV_ACCESS_MIN>} - GPRS_RXLEV_ACCESS_MIN - GPRS_MS_TXPWR_MAX_CCH - {0 1<GPRS_TEMPORARY_OFFSET>} - GPRS_TEMPORARY_OFFSET - GPRS_PENALTY_TIME - {0 1<GPRS_RESELECT_OFFSET>} - GPRS_RESELECT_OFFSET - {0 1<HCS params>} - GPRS_PRIORITY_CLASS - GPRS_HCS_THR - {0 1<SI13_PBCCH_LOCATION>} 0- SI13 1 PBCCH Location</p> <p>:NR_OF_REMAINING_CELLS FREQ_DIFF_LENGTH</p> <p>FREQUENCY_DIFF</p> <p>- Cell selection params - BSIC - CELL_BAR_ACCESS_2 - EXC_ACC - SAME_RA_AS_SERVING_CELL - {0 1<GPRS_RXLEV_ACCESS_MIN>} - GPRS_RXLEV_ACCESS_MIN - GPRS_MS_TXPWR_MAX_CCH</p>	<p>1 start of neighbour cell parameters GSM 900 GPRS: Containing ARFCN 5 and 84 00000001 ARFCN 5 (MSB) 01 ARFCN 5 (LS 2bits) DCS 1 800 and PCS 1 900 GPRS: Containing ARFCN 515 and 604 10000000 ARFCN 515 (MSB) 11 (LS 2 bits) GSM 700, T-GSM 810 GPRS: Containing ARFCN 437 and 445 01101101 ARFCN 437 (MSB) 01 ARFCN 437 (LS 2 bits) GSM 850 GPRS: Containing ARFCN 137 and 159 00100010 ARFCN 137 (MSB) 01 ARFCN 137 (LS 2 bits)</p> <p>001101 0 Normal reselection 0 1 same routing area 1 GPRS_RXLEV_ACCESS_MIN present 011111 -80dBm 01010 1 GPRS_TEMPORARY_OFFSET present 000 00000 1 GPRS_RESELECT_OFFSET present 10000 0dB 1 HCS params present 001 10100 1 SI13_PBCCH_LOCATION present 0 SI13 Location 0 SI13 on BCCH Norm 0001 GSM 900 GPRS: 110 7 bits DCS 1800 GPRS: 110 7 bits PCS 1900 GPRS: 110 7 bits GSM 850 GPRS: 100 5 bits GSM 700, T-GSM 810 GPRS: 011 4 bits GSM 900 GPRS: 1001111 (ARFCN 84 – diff 79) DCS 1 800 and PCS 1 900 GPRS: 1011001 (ARFCN 604 – diff 89) PCS 1900 GPRS: 1011001 (ARFCN 604 – diff 89) GSM 700, T-GSM 810 GPRS: 1000 (ARFCN 445 – diff 8) GSM 850 GPRS: 10110 (ARFCN 159 – diff 22)</p> <p>001101 0 Normal reselection 0 1 same routing area 1 GPRS_RXLEV_ACCESS_MIN present 011111 -80dBm 01010</p>
---	---

- {0 1<GPRS_TEMPORARY_OFFSET>}	0 GPRS_TEMPORARY_OFFSET not present
- {0 1<GPRS_RESELECT_OFFSET>}	1 GPRS_RESELECT_OFFSET present
- GPRS_RESELECT_OFFSET	10000 0dB
- {0 1<HCS params>}	0 HCS params not present
- {0 1<SI13_PBCCH_LOCATION>}	1 SI13_PBCCH_LOCATION present
0- SI13 1 PBCCH Location	0 SI13 Location
SI13_LOCATION	0 SI13 on BCCH Norm

PACKET MEASUREMENT ORDER in step 1:

NC Measurement parameters	
NETWORK_CONTROL_ORDER	10 (NC2)
NC_REPORTING_PERIOD_I	'100' (7,68 s)
NC_FREQUENCY_LIST	1
REMOVED_FREQ_LIST	1
NR_OF_REMOVED_FREQ	00000
REMOVED_FREQ_INDEX	000000 – Remove Cell B
Add Frequency list struct	1
START_FREQUENCY	GSM 900 GPRS: Containing ARFCN 80 of Cell C 00010100 ARFCN 80 (MSB) 00 ARFCN 80 (LS 2bits)
	DCS 1 800 and PCS 1 900 GPRS: Containing ARFCN 600 for Cell C 10010110 ARFCN 600 (MSB)
	00 (LS 2 bits)
	GSM 700, T-GSM 810 GPRS: Containing ARFCN 447 01101111 ARFCN 447(MSB)
	11 ARFCN 447(LS 2 bits)
	GSM 850 GPRS: Containing ARFCN 157 00100111 ARFCN 157(MSB) 01 ARFCN 157(LS 2 bits)
BSIC	001101
Cell Selection Params	0
NR_OF_FREQUENCIES	00000

42.4.8.4.6 Network Control measurement reporting / NC_FREQUENCY_LIST / PMO sent in multiple instances.

42.4.8.4.6.1 Conformance requirement

If the mobile station receives a PACKET MEASUREMENT ORDER message (full set of instances) with changed PMO_IND parameter value, any old "NC frequency list" shall be deleted. If the last PACKET MEASUREMENT ORDER message (full set of instances) does not contain a "NC frequency list" (no added or deleted frequencies) the mobile station shall return to BA(GPRS).

MS receives NC_FREQUENCY_LIST in multiple instances by adding and deleting a cell in each of these instances. SS verifies that MS constructs Frequency list and checks PACKET MEASUREMENT REPORTS of these cells are included

Reference

3GPP TS 05.08 Sec 10.1.4

3GPP TS 04.60 Sec 5.6.1

42.4.8.4.6.2 Test Purpose

To verify that when instances of PACKET MEASUREMENT ORDER is sent including NC_FREQUENCY_LIST MS has to construct this frequency list and include the cells in the PACKET MEASUREMENT REPORTS.

42.4.8.4.6.3 Method of test

Initial conditions

System Simulator:

3 cells, GPRS supported, PBCCH present in Cell A. PBCCH is absent in cells B and C.

Cell A in NC2. Cell B is part of BA(GPRS) on cell A. Cell C is not a part of the BA(GPRS).

Mobile Station:

MS is in Packet Idle mode and GPRS attached on Cell A.

PDP context 2 established.

Specific PICS Statements

-

PIXIT Statements

-

Foreseen final state of the MS

- MS is in transfer mode.

Test procedure

SS receives few PACKET MEASUREMENT REPORTS. SS checks that the measurements of the cell B are included in the Packet measurement report while that of Cell C is not included.

SS sends a PACKET MEASUREMENT ORDER message (including the NC_FREQUENCY_LIST) in 2 instances. It deletes the cell B in instance 1, while adds the cell C in instance 2.

SS checks that the measurements of the cell C are included in the Packet measurement report while that of Cell B are not included.

Maximum duration of the test

-

Expected sequence

Step	Direction	Message	Comments
1		{Uplink dynamic allocation one phase access with contention resolution} Or {Uplink dynamic allocation two phase access}	Macro parameters: 4000 : the number of RLC data block to be transferred, USF_GRANULARITY : 1 RLC_DATA_BLOCKS_GRANTED : absent (open-end) CHANNEL_CODING_COMMAND : CS-1 TLLI_BLOCK_CHANNEL_CODING : CS-1 USF assigned to the MS in step 1.
2a	SS -> MS	PACKET DOWNLINK DUMMY CONTROL BLOCK	Sent on PACCH. USF assigned to the MS in step 1. The SS acks all the received RLC data blocks.
2b	SS -> MS	PACKET UPLINK ACK/NACK	
3a	MS->SS	RLC data block	Repeat step 2-3 (periodically assign USF to the MS) until measurement results for cell B are included. Every 10 th repetition, step 2b shall be performed instead of step 2a. SS checks that measurements of Cell C are not included in any of the PACKET MEASUREMENT REPORT message received.
3b	MS->SS	PACKET MEASUREMENT REPORT	
4	SS		
5	SS -> MS	PACKET MEASUREMENT ORDER	
6a	SS -> MS	PACKET DOWNLINK DUMMY CONTROL BLOCK	See specific message contents USF assigned to the MS in step 1.
6b	SS -> MS	PACKET UPLINK ACK/NACK	Sent on PACCH. USF assigned to the MS in step 1. The SS acks all the received RLC data blocks.
7a	MS->SS	RLC data block	Repeat step 6-7 (periodically assign USF to the MS) until measurement results for cell C are included while that of Cell B are not included in the PACKET MEASUREMENT REPORT message. Every 10 th repetition, step 6b shall be performed instead of step 6a.
7b	MS->SS	PACKET MEASUREMENT REPORT	
8	SS		
Note1:	in step 3x and 7x, the MS shall perform either the 'a' branch or the 'b' branch.		
Note2:	in step 2x and 6x, the MS shall perform either the 'a' branch or the 'b' branch. Every 10 th execution of the test step, the 'b' branch shall be performed.		

Specific message contents

PACKET MEASUREMENT ORDER in step 5 (1st Instance):

MESSAGE_TYPE	0000 11
PAGE_MODE	00 Normal Paging
flag	0 (TFI)
UplinkDownlink flag	0 (Uplink)
Uplink TFI	as assigned in step 01
PMO_INDEX	0 0 0 first message
PMO_COUNT	0 0 1 two messages expected
{ 0 1 < NC Measurement Parameters }	1 NC Measurement Parameters available
NC Measurement Parameters	
NETWORK_CONTROL_ORDER	10 NC2
{ 0 1 < NC_NON_DRX_PERIOD	1 Additional NC parameters available
< NC_REPORTING_PERIOD_I	NC_NON_DRX_PERIOD = 000
< NC_REPORTING_PERIOD_T }	(No non-DRX mode after a measurement report has been sent)
	NC_REPORTING_PERIOD_I = 100
	(7.68 sec)
	NC_REPORTING_PERIOD_T = 011
	(3.84 sec)
{ 0 1 < NC_FREQUENCY_LIST }	1 NC Frequency list struct available
NC Frequency list	
{ 0 1 { < NR_OF_REMOVED_FREQ	1 Frequencies have been removed (cell B (1 st entry in the BA(GPRS) is removed))
NR_OF_REMOVED_FREQ	00000
REMOVED_FREQ_INDEX	000000
{ 1 < List of added Frequency struct	0 No Added Frequency list
} 0	End of list
< padding bits >	Spare Padding

PACKET MEASUREMENT ORDER in step 5 (2nd Instance):

MESSAGE_TYPE	0000 11
PAGE_MODE	00 Normal Paging
Flag	0 (TFI)
UplinkDownlink flag	0 (Uplink)
Uplink TFI	as assigned in step 01
TLLI	no TLLI included
-	
PMO_INDEX	0 0 1 second message of two messages
PMO_COUNT	0 0 1 two messages expected
{ 0 1 < NC Measurement Parameters }	1 NC Measurement Parameters available
NC Measurement Parameters	
NETWORK_CONTROL_ORDER	10 NC2
{ 0 1 < NC_NON_DRX_PERIOD	1 Additional NC parameters available
< NC_REPORTING_PERIOD_I	NC_NON_DRX_PERIOD = 000
< NC_REPORTING_PERIOD_T }	(No non-DRX mode after a measurement report has been sent)
	NC_REPORTING_PERIOD_I = 100
	(7.68 sec)
	NC_REPORTING_PERIOD_T = 011
	(3.84 sec)
	1 NC Frequency list struct available
{ 0 1 < NC_FREQUENCY_LIST }	
NC Frequency list	
{ 0 1 { < NR_OF_REMOVED_FREQ	
REMOVED_FREQ_INDEX}	0 No Frequencies Removed
{ 1 < List of added Frequency struct	
Add Frequency list	Adding the cell C in Instance 2
START_FREQUENCY	00 1010 0000 (ARFCN 80, for GSM 900)
	10 0101 1000 (ARFCN 600, for DCS1800,
	PCS1900)
	01 1011 0101 (ARFCN 437, for GSM 700, T-GSM
	810)
	00 1100 1111 (ARFCN 207, for GSM 850)
	001101
	1 cell selection parameters available
BSIC	
{ 0 1 < Cell selection params	
Cell selection params	
EXC_ACC	0
CELL_BAR_ACCESS_2	0 normal reselection
SAME_RA_AS_SERVING_CELL	1 same RA as serving cell
{ 0 1 < GPRS_RXLEV_ACCESS_MIN }	1 GPRS_RXLEV_ACCESS_MIN present
GPRS_RXLEV_ACCESS_MIN	010101 -90dBm
GPRS_MS_TXPWR_MAX_CCH	01010
{ 0 1 < GPRS_TEMPORARY_OFFSET }	1 GPRS_TEMPORARY_OFFSET present
GPRS_TEMPORARY_OFFSET	000
GPRS_PENALTY_TIME	0000
{ 0 1 < GPRS_RESELECT_OFFSET }	1 GPRS_RESELECT_OFFSET present
GPRS_RESELECT_OFFSET	10000 0dBm
{ 0 1 < HCS params }	1 HCS params present
GPRS_PRIORITY_CLASS	000
GPRS_HCS_THR	10100
{ 0 1 < SI13_PBCCH_LOCATION }	1 SI13_PBCCH_LOCATION present
{ 0 < SI13_LOCATION }	0
SI13_LOCATION	0 SI13 is sent on BCCH norm
NR_OF_FREQUENCIES	0000
FREQ_DIFF_LENGTH	000
} 0	End of list
< padding bits >	Spare Padding

42.4.8.4.7 Network Control measurement reporting / NC_FREQUENCY_LIST / same cell present twice in the list.

42.4.8.4.7.1 Conformance requirement

The "NC Frequency List" may add cells to the GSM Neighbour Cell list . These cells shall be added at the end of the GSM Neighbour Cell list and indexed in the order of occurrence within the PACKET CELL CHANGE ORDER

message or ascending instances of the PACKET MEASUREMENT ORDER message. The list of added cells may contain GPRS cell re-selection parameters.

In case the same cell (ARFCN+BSIC) or the same ARFCN without BSIC occur more than once in the resulting GSM Neighbour Cell list, each occurrence shall be assigned an index but only the cell with the highest index shall be used for cell re-selection and referred to in measurement reports.

Reference

3GPP TS 04.60, subclause 5.6.1.

42.4.8.4.7.2 Test Purpose

To verify that if a same cell (ARFCN+BSIC) occurs more than once in the Neighbour cell list; MS reports the cell with the highest index.

42.4.8.4.7.3 Method of test

Initial conditions:

System Simulator:

2 cells, GPRS supported. PCCCH present in cell A and not in cell B.

Mobile Station:

The MS is GPRS attached, in Packet Idle Mode.

Specific PICS Statements

-

PIXIT Statements

-

Test procedure

SS sends a PACKET MEASUREMENT ORDER message (including the NC_FREQUENCY_LIST) Changing the NC mode to NC2, adding the cell B to the Neighbour cell list.

SS checks that the MS is reporting the cell B, with the highest index number for the cell given by the NC_FREQUENCY_LIST.

Maximum duration of the test

5 min.

Expected sequence

Step	Direction	Message	Comments
1	SS->MS	PACKET MEASUREMENT ORDER	Sent on PCCCH. See specific message contents.
2	MS->SS	PACKET CHANNEL REQUEST	ACCESS TYPE ='Single block without TBF establishment.' Received on PRACH.
3	SS->MS	PACKET UPLINK ASSIGNMENT	Sent on PAGCH, assigning a single block.
4	MS ->SS	PACKET MEASUREMENT REPORT	Received on the allocated PDCH. Check that the MS reports the measurements for cell B with the highest Index . See specific message contents.

Specific message contents

Step 1: Packet Measurement Order

MESSAGE_TYPE PAGE_MODE TLLI - PMO_INDEX PMO_COUNT { 0 1 < NC Measurement Parameters } NC Measurement Parameters NETWORK_CONTROL_ORDER { 0 1 < NC_NON_DRX_PERIOD < NC_REPORTING_PERIOD_I < NC_REPORTING_PERIOD_T } { 0 1 < NC_FREQUENCY_LIST } NC Frequency list { 0 1 { < NR_OF_REMOVED_FREQ { 1 < List of added Frequency struct Add Frequency list START_FREQUENCY BSIC { 0 1 < Cell selection params Cell selection params EXC_ACC CELL_BAR_ACCESS_2 SAME_RA_AS_SERVING_CELL { 0 1 < GPRS_RXLEV_ACCESS_MIN } GPRS_RXLEV_ACCESS_MIN GPRS_MS_TXPWR_MAX_CCH { 0 1 < GPRS_TEMPORARY_OFFSET } GPRS_TEMPORARY_OFFSET GPRS_PENALTY_TIME { 0 1 < GPRS_RESELECT_OFFSET } GPRS_RESELECT_OFFSET { 0 1 < HCS params } GPRS_PRIORITY_CLASS GPRS_HCS_THR { 0 1 < SI13_PBCCH_LOCATION } { 0 < SI13_LOCATION } SI13_LOCATION NR_OF_FREQUENCIES FREQ_DIFF_LENGTH	0000 11 00 Normal Paging 10 (address is TLLI) Same as the value received from MS 0 0 0 first message 0 0 0 one message expected 1 NC Measurement Parameters available 1 0 NC2 1 Additional NC parameters available NC_NON_DRX_PERIOD = 000 (No non-DRX mode after a measurement report has been sent) NC_REPORTING_PERIOD_I = 100 (7.68 sec) NC_REPORTING_PERIOD_T = 011 (3.84 sec) 1 NC Frequency list struct available 0 No frequencies to be removed 00 0000 0101 (ARFCN 5, for GSM 900) 01 1011 1111 (ARFCN 447, for GSM 700, T-GSM 810) 00 1000 1001 (ARFCN 137, for GSM 850) 10 0000 0011 (ARFCN 515,for PCS 1900) 10 0000 0011 (ARFCN 515, for DCS 1800) 001101 1 cell selection parameters available 0 0 normal reselection 1 same RA as serving cell 1 GPRS_RXLEV_ACCESS_MIN present 011111 -80dBm 01010 1 GPRS_TEMPORARY_OFFSET present 000 0000 1 GPRS_RESELECT_OFFSET present 10000 0dBm 1 HCS params present 000 10100 1 SI13_PBCCH_LOCATION present 0 0 SI13 is sent on BCCH norm 0000 000
---	--

Step 4: Packet Measurement Report

FREQUENCY_N	001000(Corresponding to Cell B's Highest Index)
-------------	---

42.4.8.5 NC2 and DTM

42.4.8.5.1 Ignoring Packet Measurement Order and Packet Cell Change Order whilst in DTM

42.4.8.5.1.1 Conformance requirements

An MS in network control mode NC1 or NC2 may enter an exceptional case if a circuit switched connection is established, which takes precedence over GPRS cell re-selection. This includes an MS operating in DTM.

References

3GPP TS 45.008, sub-clause 10.1.4.3

42.4.8.5.1.2 Test purpose

To verify that the MS operating in DTM ignores Packet Measurement Order and Packet Cell Change Order.

42.4.8.5.1.3 Method of test

Initial Conditions

System Simulator:

2 cells with default parameter: A, B with same LAI, both supporting GPRS DTM

Mobile Station:

The MS is in the active state (U10) of a call on Timeslot N (chosen arbitrarily) of cell A and has the PDP context 1 activated.

Specific PICS Statements

-

PIXIT Statements

-

Test Procedure

The MS, whilst in dedicated mode, is triggered to initiate packet uplink transfer data in RLC unacknowledged mode and sends a DTM REQUEST message. On receiving the DTM REQUEST message, requesting uplink resources, the SS assigns the MS PS resource. The SS accomplishes the resource assignment by passing a PACKET ASSIGNMENT message to the MS. On receiving the PACKET ASSIGNMENT message, the MS starts to send RLC DATA BLOCKS to the SS on the assigned PDTCH. Right after the beginning a PACKET UPLINK ACK/NACK is send from the SS to reset T3182 on MS side. Then the SS sends a PACKET CELL CHANGE ORDER to the MS containing BSIC and the BCCH frequency of cell B. The SS maintains the CS call and checks that no CHANNEL REQUESTS on cell B received. Then the transmission is completed.

Maximum Duration of Test

5 minutes

Expected Sequence

The test sequence is repeated for k = 1,2.

Step	Direction	Message	Comments
1	SS		MS in the active state (U10) of a call on Timeslot N. When: k=1, Channel Type=TCH/F; k=2, Channel Type=TCH/H.
2	MS		Trigger the MS to initiate an uplink packet transfer containing 2000 octets.
3	MS -> SS	DTM REQUEST	See specific message contents Macro Sent on PACCH: Contains -BSIC + BCCH frequency of cell B. -The network control order, NC2 See specific message contents SS maintaining the CS call and check for 3 seconds that MS is not sending any Channel Requests on cell B Macro - Completion of the 2.000 octets of Data
4	SS -> MS	PACKET ASSIGNMENT	
5	SS<->MS	{Uplink Data}	
6	SS -> MS	PACKET CELL CHANGE ORDER	
7	SS<->MS	{ Uplink data transfer }	

Specific Message Contents

PACKET ASSIGNMENT (Step 4):

k=1:

Information Element	Value/remark
As default message contents except: RR Packet Uplink Assignment IE RR Packet Downlink Assignment IE - TIMESLOT_ALLOCATION	Not included (N ± 1) MOD 8

k=2:

Information Element	Value/remark
As default message contents except: RR Packet Uplink Assignment IE RR Packet Downlink Assignment IE - TIMESLOT_ALLOCATION	Not included N

PACKET CELL CHANGE ORDER (Step 7):

Global TFI	TFI of the uplinkTBF
IMMEDIATE_REL	1
ARFCN, BSIC	specified for cell B
NC Measurement parameters	
NETWORK_CONTROL_ORDER	10 (NC2)
NC_REPORTING_PERIOD_I	111 (61.44 sec)
NC_REPORTING_PERIOD_T	100 (7.68 sec)
NC_FREQUENCY_LIST	0 (not present)

42.5 Downlink Transfer

42.5.1 Downlink Transfer / Normal Operation

42.5.1.1 Downlink Transfer/ Normal Operation / Relative Encoding TBF starting time

42.5.1.1.1 Void

42.5.1.1.2 Conformance Requirement

The allocated radio resource is assigned to the mobile station in a PACKET DOWNLINK ASSIGNMENT message to the mobile station. The PACKET DOWNLINK ASSIGNMENT message is transmitted on an appropriate paging subchannel on PCCCH, considering the DRX parameters valid for each targeted mobile (see 3GPP TS 05.02). The multislot capabilities of the mobile station must be considered.

A PACKET DOWNLINK ASSIGNMENT message may indicate an assignment starting time in the TBF Starting Time parameter. The mobile station shall monitor PCCCH until the point in time denoted by the TBF Starting Time. Thereafter it shall switch to the assigned PDCHs. If while monitoring the PCCCH the mobile station receives more than one PACKET DOWNLINK ASSIGNMENT message, it shall act upon the most recently received message and shall ignore the previous message.

The Packet downlink assignment procedure is completed when the mobile station receives a valid RLC/MAC block. The mobile station has entered the packet transfer mode.

References

3GPP TS 04.60, subclauses 7.2.1.1, 7.2.1.2 and 10.4.5.

42.5.1.1.3 Test purpose

Verify that an MS switches to the assigned PDCH at the relative-encoded starting time.

42.5.1.1.4 Method of test

Initial Conditions

System Simulator:

1 cell, GPRS supported, PCCCH present.

Mobile Station:

The MS is in the state "idle, GMM-registered" with a P-TMSI allocated, SPLIT PG CYCLE negotiated, and PDP context 2 activated.

Specific PICS Statements

-

PIXIT Statements

-

Test Procedure

1. MS receives a PACKET DOWNLINK ASSIGNMENT message on its assigned PCCCH, containing a starting time with relative encoding.
2. Before the starting time, SS transmits a downlink RLC data block.
3. MS ignores the block.
4. At the starting time block, the MS receives a downlink RLC data block with polling indicated.
5. MS responds by sending a PACKET DOWNLINK ACK/NACK.

Maximum Duration of Test

5 minutes.

Expected Sequence

Step	Direction	Message	Comments
1	SS -> MS	PACKET DOWNLINK ASSIGNMENT	Triggers the MS to wait until the starting time before monitoring the assigned PDCH. Without valid RRBP. 3 blocks before the starting time, with valid RRBP field, on assigned PDCH, addressed to MS.
2	SS -> MS	RLC DATA BLOCK	
3	SS		Verify the MS does not respond to the previous RLC block, and that the MS does not transmit on the PACCH of the assigned PDCH.
4	SS -> MS	RLC DATA BLOCK	At the starting time, with valid RRBP field.
5	MS -> SS	PACKET DOWNLINK ACK/NACK	MS acknowledges on PACCH the RLC data block sent at the starting time.
6		{Completion of downlink data transfer}	Macro

Specific Message Contents

PACKET DOWNLINK ASSIGNMENT message in step 1:

TIMESLOT_ALLOCATION	<one timeslot assigned>
PACKET TIMING ADVANCE	Timing Advance Value as default
TBF STARTING TIME	1 - Relative frame number encoding:
- Starting Frame Number Description IE	arbitrarily chosen in the future

DOWNLINK RLC DATA BLOCKS (various steps):

RRBP S/P (MAC Header)	00 – Response shall be sent by MS in N+13 frames. 1 – RRBP field is valid
--------------------------	--

42.5.1.2 Downlink Transfer/ Normal Operation / Without TBF starting time

42.5.1.2.1 Void

42.5.1.2.2 Conformance Requirement

The allocated radio resource is assigned to the mobile station in a PACKET DOWNLINK ASSIGNMENT message to the mobile station. The PACKET DOWNLINK ASSIGNMENT message is transmitted on an appropriate paging subchannel on PCCCH, considering the DRX parameters valid for each targeted mobile (see 3GPP TS 05.02). The multislot capabilities of the mobile station must be considered.

1. On receipt of a PACKET DOWNLINK ASSIGNMENT message, the mobile station shall switch to the assigned PDCHs.
2. The Packet downlink assignment procedure is completed when the mobile station receives a valid RLC/MAC block. The mobile station has entered the packet transfer mode.
3. If the MS is required to transmit a PACKET CONTROL ACKNOWLEDGEMENT subsequent to a PACKET DOWNLINK ASSIGNMENT, the MS shall be ready to receive on the new assignment no later than the next occurrence of block B((x+2) mod 12) where block B(x) is radio block containing the PACKET CONTROL ACKNOWLEDGEMENT.

References

3GPP TS 04.60, subclauses 7.2.1.1, 7.2.1.2 and 10.4.5.

3GPP TS 05.10, subclause 6.11.1.

42.5.1.2.3 Test purpose

Verify that an MS switches to the assigned PDCH when assigned to it without a starting time, within 3 blocks.

42.5.1.2.4 Method of test

Initial Conditions

System Simulator:

1 cell, GPRS supported, PCCCH present, CTRL_ACK_TYPE=0 in PSI1.

Mobile Station:

The MS is in the state "idle, GMM-registered" with a P-TMSI allocated, SPLIT PG CYCLE negotiated, and PDP context 3 activated.

Specific PICS Statements

-

PIXIT Statements

-

Test Procedure

1. MS receives a PACKET DOWNLINK ASSIGNMENT message on its assigned PCCCH, containing no starting time.
2. SS transmits a downlink RLC data block.
3. MS responds by sending a PACKET DOWNLINK ACK/NACK.

Maximum Duration of Test

5 minutes.

Expected Sequence

Step	Direction	Message	Comments
1	SS -> MS	PACKET DOWNLINK ASSIGNMENT	Triggers the MS to switch to the assigned PDCH. (no starting time)
2	MS->SS	PACKET CONTROL ACK	With valid RRBP field 4 access bursts. Sent in the block specified by RRBP field in step 1.
3	SS -> MS	RLC DATA BLOCK	2 blocks after the previous message, with valid RRBP field, on assigned PDCH, addressed to MS.
4	MS -> SS	PACKET DOWNLINK ACK/NACK	MS acknowledges on PACCH the RLC data block sent in step 3.
5		{Completion of downlink data transfer}	Macro

Specific Message Contents

PACKET DOWNLINK ASSIGNMENT message in step 1:

TIMESLOT_ALLOCATION	<one timeslot assigned>
PACKET TIMING ADVANCE	Timing Advance Value as default
TBF STARTING TIME	<IE not present>

DOWNLINK RLC DATA BLOCKS (various steps):

RRBP	00 – Response shall be sent by MS in N+13 frames.
S/P	1 – RRBP field is valid

42.5.2 Downlink Transfer / Polling

42.5.2.1 Downlink Transfer/ Polling/ Normal operation/RLC data block

42.5.2.1.1 Void

42.5.2.1.2 Conformance Requirement

Whenever the mobile station receives an RLC data block addressed to itself and with a valid RRBP field in the RLC data block header (i.e., is polled), the mobile station shall transmit a PACKET DOWNLINK ACK/NACK message in the uplink radio block specified by the RRBP field whatever the BSN value of the received RLC data block, unless another RLC/MAC control message is waiting to be transmitted, in which case the other RLC/MAC control message shall be sent.

The RRBP value specifies a single uplink block in which the mobile station shall transmit either a PACKET CONTROL ACKNOWLEDGEMENT message or a PACCH block to the network. If the RRBP field is received as part of an RLC/MAC block containing an RLC/MAC control block containing any message except Packet Paging Request, Packet Access Reject, and Packet Queueing Notification, the mobile station shall transmit a PACKET CONTROL ACKNOWLEDGEMENT message in the uplink radio block specified. If the RRBP field is received as part of an RLC/MAC block containing an RLC/MAC control block containing a Packet Paging Request, Packet Access Reject, or Packet Queueing Notification message, the mobile station shall ignore this RRBP field. The mobile station shall only react on RLC/MAC control blocks containing a valid RRBP field if the mobile station is unambiguously addressed either in the downlink RLC/MAC control block header or in the control message itself.

References

3GPP TS 04.60, subclauses 8.1.2.2 and 10.4.5.

42.5.2.1.3 Test purpose

Verify that an MS responds to a poll with a PACKET DOWNLINK ACK/NACK message in the block specified by the RRBP field.

42.5.2.1.4 Method of test

Initial Conditions

System Simulator:

1 cell, GPRS supported, PCCCH present.

Mobile Station:

The MS is in the state "idle, GMM-registered" with a P-TMSI allocated, SPLIT PG CYCLE negotiated, and PDP context 3 activated.

Specific PICS Statements

-

PIXIT Statements

-

Test Procedure

1. MS receives a PACKET DOWNLINK ASSIGNMENT message on its assigned PCCCH, containing no starting time.
2. SS transmits a downlink RLC data block.
3. MS responds by sending a PACKET DOWNLINK ACK/NACK in the block specified by the RRBP field of the RLC data block.

Maximum Duration of Test

5 minutes.

Expected Sequence

Step	Direction	Message	Comments
1	SS -> MS	PACKET DOWNLINK ASSIGNMENT	Triggers the MS to switch to assigned PDCH.
2	SS -> MS	RLC DATA BLOCK	3 blocks after the previous message, with valid RRBP field, on assigned PDCH, addressed to MS.
3	MS -> SS	PACKET DOWNLINK ACK/NACK	MS acknowledges the RLC DATA BLOCK 26 frames after step 2.
4		{Completion of downlink data transfer}	Macro

Specific Message Contents

PACKET DOWNLINK ASSIGNMENT message in step 1:

TIMESLOT_ALLOCATION	<one timeslot assigned>
PACKET TIMING ADVANCE	Timing Advance Value = as default
TBF STARTING TIME	<IE not present>

DOWNLINK RLC DATA BLOCK in step 2:

RRBP	11 – Response shall be sent by MS in N+26 frames.
S/P	1 – RRBP field is valid

42.5.2.2 Downlink Transfer/ Polling/ Packet Polling Request/ Access Burst format

42.5.2.2.1 Void

42.5.2.2.2 Conformance Requirement

The network may send to the mobile station a PACKET POLLING REQUEST message. If the MS has received a PACKET DOWNLINK ASSIGNMENT message with no starting time or with a starting time that has already elapsed, the PACKET POLLING REQUEST message shall be sent on PACCH. Otherwise the PACKET POLLING message shall be sent on PAGCH. The mobile station shall be addressed by its TLLI or TFI.

On receipt of a PACKET POLLING REQUEST message, the mobile station shall respond to the network with the PACKET CONTROL ACKNOWLEDGEMENT message in the reserved uplink radio block specified by the RRBP field. The reserved block is considered as a one block PACCH allocation.

References

3GPP TS 04.60, subclause 7.2.1.3.

42.5.2.2.3 Test purpose

Verify that an MS responds to a PACKET POLLING REQUEST message (requesting access burst format) with a PACKET CONTROL ACKNOWLEDGEMENT message in access burst format.

42.5.2.2.4 Method of test

Initial Conditions

System Simulator:

1 cell, GPRS supported, PCCCH present.

Mobile Station:

The MS is in the state "idle, GMM-registered" with a P-TMSI allocated, SPLIT PG CYCLE negotiated, and PDP context 3 activated.

Specific PICS Statements

-

PIXIT Statements

-

Test Procedure

1. MS receives a PACKET DOWNLINK ASSIGNMENT message on its assigned PCCCH, containing no starting time.
2. SS transmits downlink RLC data blocks.
3. SS transmits a PACKET POLLING REQUEST message, requesting access burst format.
4. MS responds by sending a PACKET CONTROL ACKNOWLEDGE message in access burst format.

Maximum Duration of Test

5 minutes.

Expected Sequence

Step	Direction	Message	Comments
1	SS -> MS	PACKET DOWNLINK ASSIGNMENT	Triggers the MS to switch to assigned PDCH.
2	SS -> MS	RLC DATA BLOCKS	Starting 3 blocks after the previous message, on assigned PDCH, addressed to MS.
3	SS -> MS	PACKET POLLING REQUEST	Requesting access burst format
4	MS -> SS	PACKET CONTROL ACKNOWLEDGEMENT	MS acknowledges using 11-bit access burst format.
5		{Completion of downlink data transfer}	Macro

Specific Message Contents

PACKET DOWNLINK ASSIGNMENT message in step 1:

TIMESLOT_ALLOCATION	<one timeslot assigned>
TBF STARTING TIME	<IE not present>

PACKET POLLING REQUEST in step 3:

TYPE_OF_ACK Global TFI (downlink)	0 – MS response sent as 4 access bursts Addressing MS
--------------------------------------	--

PACKET CONTROL ACKNOWLEDGMENT access bursts in step 4:

MESSAGE_TYPE	1111 1100 1
CTRL_ACK	11

42.5.2.3 Downlink Transfer/ Polling/ Packet Polling Request/ Control block format

42.5.2.3.1 Void

42.5.2.3.2 Conformance Requirement

The network may send to the mobile station a PACKET POLLING REQUEST message. If the MS has received a PACKET DOWNLINK ASSIGNMENT message with no starting time or with a starting time that has already elapsed, the PACKET POLLING REQUEST message shall be sent on PACCH. Otherwise the PACKET POLLING message shall be sent on PAGCH. The mobile station shall be addressed by its TLLI or TFI.

On receipt of a PACKET POLLING REQUEST message, the mobile station shall respond to the network with the PACKET CONTROL ACKNOWLEDGEMENT message in the reserved uplink radio block specified by the RRBp field. The reserved block is considered as a one block PACCH allocation.

References

3GPP TS 04.60, subclause 7.2.1.3.

42.5.2.3.3 Test purpose

Verify that an MS responds to a PACKET POLLING REQUEST message (requesting control block format) with a PACKET CONTROL ACKNOWLEDGEMENT message in control block format, in the uplink block specified by the RRBp field.

42.5.2.3.4 Method of test

Initial Conditions

System Simulator:

1 cell, GPRS supported, PCCCH present.

Mobile Station:

The MS is in the state "idle, GMM-registered" with a P-TMSI allocated, SPLIT PG CYCLE negotiated, and PDP context 3 activated.

Specific PICS Statements

-

PIXIT Statements

-

Test Procedure

1. MS receives a PACKET DOWNLINK ASSIGNMENT message on its assigned PCCCH, containing no starting time.
2. SS transmits downlink RLC data blocks.
3. SS transmits a PACKET POLLING REQUEST message, requesting control block format.
4. MS responds by sending a PACKET CONTROL ACKNOWLEDGE message in control block format.

Maximum Duration of Test

5 minutes.

Expected Sequence

Step	Direction	Message	Comments
1	SS -> MS	PACKET DOWNLINK ASSIGNMENT	Triggers the MS to switch to assigned PDCH.
2	SS -> MS	RLC DATA BLOCKS	Starting 3 blocks after the previous message, on assigned PDCH, addressed to MS.
3	SS -> MS	PACKET POLLING REQUEST	Requesting control block format; RRBp field specifies N+21 (or N+22 frames)
4	MS -> SS	PACKET CONTROL ACKNOWLEDGEMENT	MS acknowledges in the uplink block N+21 (or N+22 frames)
5		{Completion of downlink data transfer}	Macro

Specific Message Contents

PACKET DOWNLINK ASSIGNMENT message in step 1:

TIMESLOT_ALLOCATION	<one timeslot assigned>
PACKET TIMING ADVANCE	Timing Advance Value as default
TBF STARTING TIME	<IE not present>

PACKET POLLING REQUEST in step 3:

RRBP	10 – MS response sent in N+21 or N+22 frames
S/P	1 – RRBp field is valid
TYPE_OF_ACK	1 – MS response sent in RLC/MAC control block
TFI	Addressing MS

PACKET CONTROL ACKNOWLEDGMENT in step 4:

TLLI (32)	<of this MS>
CTRL_ACK	11

42.5.3 Downlink Transfer / T3190 Expiry / Initial allocation

42.5.3.1 Downlink Transfer/ T3190 Expiry / Initial allocation / Restart with valid RLC data block

42.5.3.1.1 Void

42.5.3.1.2 Conformance Requirement

When receiving the PACKET DOWNLINK ASSIGNMENT message and after waiting the TBF Starting Time when applicable, the mobile station starts timer T3190. The timer is reset when receiving the first valid RLC/MAC block.

On expiry of timer T3190, the mobile station shall abort the procedure and return to packet idle mode.

If the mobile station receives a valid RLC data block addressed to itself, the mobile station shall reset and restart timer T3190. If timer T3190 expires, the mobile station shall perform an abnormal release with return to CCCH or PCCCH (see subclause 8.7.1).

References

3GPP TS 04.60, subclauses 7.2.1.1, 8.1.2.1 and 10.4.5.

42.5.3.1.3 Test purpose

Verify that an MS starts T3190 when receiving the PACKET DOWNLINK ASSIGNMENT, resets and restarts the timer when a valid RLC/MAC block is received, and returns to packet idle mode when T3190 expires.

42.5.3.1.4 Method of test

Initial Conditions

System Simulator:

1 cell, GPRS supported, PCCCH present.

Mobile Station:

The MS is in the state "idle, GMM-registered" with a P-TMSI allocated, SPLIT PG CYCLE negotiated, and PDP context 3 activated.

Specific PICS Statements

-

PIXIT Statements

-

Test Procedure

1. MS receives a PACKET DOWNLINK ASSIGNMENT message on its assigned PCCCH, containing relative-encoded starting time.
2. $(0.8 * T3190)$ seconds after the starting time occurs, the SS transmits a downlink RLC data block with polling indicated.
3. MS sends PACKET DOWNLINK ACK/NACK on PACCH in response to the RLC data block.
4. $(1.2 * T3190)$ seconds after the previous downlink RLC data block, the SS transmits another downlink RLC data block with polling indicated.
5. The MS ignores the downlink block (because it has already returned to packet idle mode upon expiry of T3190).

Maximum Duration of Test

5 minutes.

Expected Sequence

Step	Direction	Message	Comments
1	SS -> MS	PACKET DOWNLINK ASSIGNMENT	Triggers the MS to switch to the assigned PDCH and start T3190 at the starting time indicated. Sent on assigned PDCH, (T3190*0.8) seconds after expiry of the TBF Starting Time indicated in Step 1, with valid RRBP field, addressed to MS. T3190 is then restarted.
2	SS -> MS	RLC DATA BLOCK	
3	MS -> SS	PACKET DOWNLINK ACK/NACK RLC DATA BLOCK	MS acknowledges the previous RLC data block.
4	SS -> MS		Sent on assigned PDCH, (T3190*1.2) seconds after step 2, with valid RRBP field, addressed to MS.
5	SS		Verify the MS does not respond to the previous RLC block, and that the MS does not transmit on the PACCH of the assigned PDCH.
6	SS->MS	PACKET DOWNLINK ASSIGNMENT	Sent on assigned packet paging channel. This is to verify the MS is in packet idle mode with no starting time.
7	SS->MS	RLC DATA BLOCK	Sent on assigned PDCH, (T3190*0.8) seconds after step 6, with valid RRBP field, addressed to MS.
8	MS -> SS	PACKET DOWNLINK ACK/NACK	MS acknowledges the previous RLC data block.
9		{Completion of downlink data transfer}	Macro

Specific Message Contents

PACKET DOWNLINK ASSIGNMENT message in step 1:

TIMESLOT_ALLOCATION TBF STARTING TIME - Starting Frame Number Description IE	<one timeslot assigned> 1 - Relative frame number encoding: 0000000101101 – k=45: first frame of block is N+199 or N+200
--	--

DOWNLINK RLC DATA BLOCKS (various steps):

RRBP S/P	00 – Response shall be sent by MS in N+13 frames. 1 – RRBP field is valid
-------------	--

42.5.4 Downlink Transfer / T3190 Expiry / Resource reallocation

42.5.4.1 Downlink Transfer/ T3190 Expiry / Resource reallocation / Without TBF starting time

42.5.4.1.1 Void

42.5.4.1.2 Conformance Requirement

On receipt of a PACKET DOWNLINK ASSIGNMENT or PACKET TIMESLOT RECONFIGURE message, and after the TBF starting time, if present, the mobile station shall switch to the assigned PDCHs. Upon switching to the new PDCHs the mobile station shall restart timer T3190.

When the mobile station receives an RLC/MAC block addressed to itself on any of the new assigned resources it shall restart timer T3190. If timer T3190 expires, the mobile station shall perform an abnormal release with return to CCCH or PCCCH (see subclause 8.7.1).

References

3GPP TS 04.60, subclause 8.1.2.4.

42.5.4.1.3 Test purpose

Verify that an MS switches to the newly assigned PDCH when no starting time is present, and release the PDCH when T3190 expires.

42.5.4.1.4 Method of test

Initial Conditions

System Simulator:

1 cell, GPRS supported, PCCCH present.

Mobile Station:

The MS is in the state "idle, GMM-registered" with a P-TMSI allocated, SPLIT PG CYCLE negotiated, and PDP context 3 activated.

Specific PICS Statements

-

PIXIT Statements

-

Test Procedure

1. MS receives a PACKET DOWNLINK ASSIGNMENT message on its assigned PCCCH, containing no starting time.
2. SS transmits a downlink RLC data block.
3. MS responds by sending a PACKET DOWNLINK ACK/NACK.
4. SS transmits another PACKET DOWNLINK ASSIGNMENT message on PACCH, containing no starting time.
5. (T3190 * 1.2) seconds later, SS transmits a downlink RLC data block on the newly assigned resources.
6. MS ignores the downlink block (because it has already returned to packet idle mode because T3190 expired).
7. SS transmits another PACKET DOWNLINK ASSIGNMENT message on PCCCH, containing no starting time.
8. (T3190 * 0.8) seconds later, SS transmits a downlink RLC data block on the newly assigned resources.
9. MS responds by sending a PACKET DOWNLINK ACK/NACK.

Maximum Duration of Test

5 minutes.

Expected Sequence

Step	Direction	Message	Comments
1	SS -> MS	PACKET DOWNLINK ASSIGNMENT	Triggers the MS to switch to PDCH0. (no starting time)
2	SS -> MS	RLC DATA BLOCK	3 blocks after the previous message, with valid RRBp field, on assigned PDCH0, addressed to MS.
3	MS -> SS	PACKET DOWNLINK ACK/NACK	MS acknowledges on PACCH the RLC data block sent on PDCH0.
4	SS -> MS	RLC DATA BLOCKS	SS continues to transmit RLC data blocks according to allocation from step 1.
5	SS -> MS	PACKET DOWNLINK ASSIGNMENT	Triggers the MS to switch to PDCH1. (no starting time)
6	SS -> MS	RLC DATA BLOCK	(T3190 * 1.2) seconds after the previous message, with valid RRBp field, on PDCH1, addressed to MS.
7	SS		Verify the MS does not transmit on the PACCH of PDCH1.
8	SS->MS	PACKET DOWNLINK ASSIGNMENT	Sent on assigned packet paging channel (no starting time). This is to verify the MS is in packet idle mode.
9	SS->MS	RLC DATA BLOCK	Sent on assigned PDCH, (T3190*0.8) seconds after step 8, with valid RRBp field, addressed to MS.
10	MS -> SS	PACKET DOWNLINK ACK/NACK	MS acknowledges the previous RLC data block.
11		{Completion of downlink data transfer}	Macro

Specific Message Contents

PACKET DOWNLINK ASSIGNMENT message in step 1:

TIMESLOT_ALLOCATION	<one timeslot assigned – PDCH0>
PACKET TIMING ADVANCE	Timing Advance Value as default
TBF STARTING TIME	<IE not present>

PACKET DOWNLINK ASSIGNMENT message in step 5:

TIMESLOT_ALLOCATION	<one timeslot assigned – PDCH1>
TBF STARTING TIME	<IE not present>

PACKET DOWNLINK ASSIGNMENT message in step 8:

TIMESLOT_ALLOCATION	<one timeslot assigned – PDCH1>
TBF STARTING TIME	<IE not present>

DOWNLINK RLC DATA BLOCKS (various steps):

RRBP	00 – Response shall be sent by MS in N+13 frames.
S/P	1 – RRBp field is valid

42.5.4.2 Downlink Transfer/ T3190 Expiry / Resource reallocation / With TBF starting time

42.5.4.2.1 Void

42.5.4.2.2 Conformance Requirement

On receipt of a PACKET DOWNLINK ASSIGNMENT or PACKET TIMESLOT RECONFIGURE message, and after the TBF starting time, if present, the mobile station shall switch to the assigned PDCHs. Upon switching to the new PDCHs the mobile station shall restart timer T3190.

When the mobile station receives an RLC/MAC block addressed to itself on any of the new assigned resources it shall restart timer T3190. If timer T3190 expires, the mobile station shall perform an abnormal release with return to CCCH or PCCCH (see subclause 8.7.1).

References

3GPP TS 04.60, subclause 8.1.2.4.

42.5.4.2.3 Test purpose

Verify that an MS switches to the newly assigned PDCH at the starting time given, and returns to packet idle mode when T3190 expires.

42.5.4.2.4 Method of test

Initial Conditions

System Simulator:

1 cell, GPRS supported, PCCCH present.

Mobile Station:

The MS is in the state "idle, GMM-registered" with a P-TMSI allocated, SPLIT PG CYCLE negotiated, and PDP context 3 activated.

Specific PICS Statements

-

PIXIT Statements

-

Test Procedure

1. MS receives a PACKET DOWNLINK ASSIGNMENT message on its assigned PCCCH, containing no starting time.
2. SS transmits a downlink RLC data block.
3. MS responds by sending a PACKET DOWNLINK ACK/NACK.
4. SS transmits another PACKET DOWNLINK ASSIGNMENT message on PACCH, containing a starting time.
5. (T3190 * 1,2) seconds later, SS transmits a downlink RLC data block on the newly assigned resources.
6. MS ignores the downlink block (because it has already returned to packet idle mode because T3190 expired).

Maximum Duration of Test

5 minutes.

Expected Sequence

Step	Direction	Message	Comments
1	SS -> MS	PACKET DOWNLINK ASSIGNMENT	Triggers the MS to switch to PDCH0. (no starting time)
2	SS -> MS	RLC DATA BLOCK	3 blocks after the previous message, with valid RRB field, on assigned PDCH0, addressed to MS.
3	MS -> SS	PACKET DOWNLINK ACK/NACK	MS acknowledges on PACCH the RLC data block sent on PDCH0.
4	SS -> MS	RLC DATA BLOCKS	SS continues to transmit RLC data blocks according to allocation from step 1.
5	SS -> MS	PACKET DOWNLINK ASSIGNMENT	Triggers the MS to switch to PDCH1 at the given starting time.
6	SS -> MS	RLC DATA BLOCK	(T3190 * 1.2)seconds after the starting time in the previous message, with valid RRB field, on PDCH1, addressed to MS.
7	SS		Verify the MS does not transmit on the PACCH of PDCH1.
8	SS->MS	PACKET DOWNLINK ASSIGNMENT	Sent on assigned packet paging channel. This is to verify the MS is in packet idle mode.
9	SS->MS	RLC DATA BLOCK	Sent on assigned PDCH, (T3190*0.8) seconds after step 6, with valid RRB field, addressed to MS.
10	MS -> SS	PACKET DOWNLINK ACK/NACK	MS acknowledges the previous RLC data block.
11		{Completion of downlink data transfer}	Macro

Specific Message Contents

PACKET DOWNLINK ASSIGNMENT message in step 1:

TIMESLOT_ALLOCATION	<one timeslot assigned – PDCH0>
PACKET TIMING ADVANCE	Timing Advance Value as default
TBF STARTING TIME	<IE not present>

PACKET DOWNLINK ASSIGNMENT message in step 5:

TIMESLOT_ALLOCATION	<one timeslot assigned – PDCH1>
TBF STARTING TIME	1 - Relative frame number encoding:
- Starting Frame Number Description IE	000000101101 – k=45: first frame of block is N+199 or N+200

DOWNLINK RLC DATA BLOCKS (various steps):

RRBP	00 – Response shall be sent by MS in N+13 frames.
S/P	1 – RRB field is valid

42.5.4.3 Downlink Transfer/ T3190 Expiry / Resource reallocation / Restart with valid RLC data block

42.5.4.3.1 Void

42.5.4.3.2 Conformance Requirement

On receipt of a PACKET DOWNLINK ASSIGNMENT or PACKET TIMESLOT RECONFIGURE message, and after the TBF starting time, if present, the mobile station shall switch to the assigned PDCHs. Upon switching to the new PDCHs the mobile station shall restart timer T3190.

When the mobile station receives an RLC/MAC block addressed to itself on any of the new assigned resources it shall restart timer T3190. If timer T3190 expires, the mobile station shall perform an abnormal release with return to CCCH or PCCCH (see subclause 8.7.1).

References

3GPP TS 04.60, subclause 8.1.2.4.

42.5.4.3.3 Test purpose

Verify that an MS switches to the newly assigned PDCH at the starting time given, and returns to packet idle mode when T3190 expires.

42.5.4.3.4 Method of test

Initial Conditions

System Simulator:

GPRS supported, PCCCH present

Mobile Station:

The MS is in the state "idle, GMM-registered" with a P-TMSI allocated, SPLIT PG CYCLE negotiated, and PDP context 3 activated.

Specific PICS Statements

-

PIXIT Statements

-

Test Procedure

1. MS receives a PACKET DOWNLINK ASSIGNMENT message on its assigned PCCCH, containing no starting time.
2. SS transmits a downlink RLC data block.
3. MS responds by sending a PACKET DOWNLINK ACK/NACK.
4. SS transmits another PACKET DOWNLINK ASSIGNMENT message on PACCH, containing a starting time.
5. (T3190 * 0,8) seconds later, SS transmits a downlink RLC data block on the newly assigned resources.
6. MS responds by sending a PACKET DOWNLINK ACK/NACK.
7. (T3190 * 1,2) seconds later, SS transmits a downlink RLC data block (using the same resources).
8. MS ignores the downlink block (because it has already returned to packet idle mode because T3190 expired).

Maximum Duration of Test

5 minutes.

Expected Sequence

Step	Direction	Message	Comments
1	SS -> MS	PACKET DOWNLINK ASSIGNMENT	Triggers the MS to switch to PDCH0. (no starting time)
2	SS -> MS	RLC DATA BLOCK	3 blocks after the previous message, with valid RRBp field, on assigned PDCH0, addressed to MS.
3	MS -> SS	PACKET DOWNLINK ACK/NACK	MS acknowledges on PACCH the RLC data block.
4	SS -> MS	RLC DATA BLOCKS	SS continues to transmit RLC data blocks according to allocation from step 1.
5	SS -> MS	PACKET DOWNLINK ASSIGNMENT	Triggers the MS to switch to PDCH1 at the given starting time.
6	SS -> MS	RLC DATA BLOCK	(T3190 * 0.8) seconds after the starting time in the previous message, with valid RRBp field, on PDCH1, addressed to MS.
7	MS -> SS	PACKET DOWNLINK ACK/NACK	MS acknowledges on PACCH the RLC data block.
8	SS -> MS	RLC DATA BLOCK	(T3190 * 1.2) seconds after the message sent in step 6, with valid RRBp field, on PDCH1, addressed to MS.
9	SS		Verify the MS does not transmit on the PACCH of PDCH1.

Specific Message Contents

PACKET DOWNLINK ASSIGNMENT message in step 1:

TIMESLOT_ALLOCATION	<one timeslot assigned – PDCH0>
TBF STARTING TIME	<IE not present>

PACKET DOWNLINK ASSIGNMENT message in step 5:

TIMESLOT_ALLOCATION	<one timeslot assigned – different than previous – PDCH1>
TBF STARTING TIME	1 – Relative frame number encoding:
- Starting Frame Number Description IE	0000000101101 – k=45: first frame of block is N+199 or N+200

DOWNLINK RLC DATA BLOCKS (various steps):

RRBP	00 – Response shall be sent by MS in N+13 frames.
S/P	1 – RRBp field is valid

42.5.5 Downlink Transfer / Reestablishment

42.5.5.1 Downlink Transfer/ Reestablishment/ T3192 Expiry

42.5.5.1.1 Void

42.5.5.1.2 Conformance Requirement

After the network has initiated the release of a downlink TBF and the mobile station has received all the RLC blocks, the mobile station shall send the PACKET DOWNLINK ACK/NACK message with the Final Ack Indicator bit set to '1', start timer T3192 and continue to monitor all assigned PDCHs.

If the network receives a PACKET DOWNLINK ACK/NACK message with the Final Ack Indicator bit set to '1' and has new data to transmit for the mobile station, the network may establish a new downlink TBF for the mobile station by sending the PACKET DOWNLINK ASSIGNMENT or PACKET TIMESLOT RECONFIGURE message with the Control Ack bit set to '1' on PACCH.

If the mobile station, after sending the PACKET DOWNLINK ACK/NACK message with the Final Ack Indicator bit set to '1', receives a PACKET DOWNLINK ASSIGNMENT or PACKET TIMESLOT RECONFIGURE message with

the Control Ack bit set to '1' while timer T3192 is running, the mobile station shall stop timer T3192, consider the previous downlink TBF released and act upon the new assignment.

When timer T3192 expires the mobile station shall release the downlink TBF. If the mobile station is operating in half duplex mode and received an uplink assignment during the TBF release procedure, the mobile station shall then immediately act upon the uplink assignment. If there is no ongoing uplink TBF, the mobile station in packet transfer mode shall return to packet idle mode; the mobile station in dual transfer mode shall return to dedicated mode. The DRX mode procedures shall be applied, as specified in subclause 5.5.1.5.

References

3GPP TS 04.60, subclauses 8.1.2.4 and 9.3.2.6.

42.5.5.1.3 Test purpose

Verify that after a downlink TBF is released, MS returns to packet idle mode when T3192 expires.

42.5.5.1.4 Method of test

Initial Conditions

System Simulator:

1 cell, GPRS supported, PCCCH present.

Mobile Station:

The MS is in the state "idle, GMM-registered" with a P-TMSI allocated, SPLIT PG CYCLE negotiated, and PDP context 2 activated.

Specific PICS Statements

-

PIXIT Statements

-

Test Procedure

1. MS receives a PACKET DOWNLINK ASSIGNMENT message on its assigned PCCCH, containing no starting time.
2. SS transmits downlink RLC data blocks for the downlink allocation.
3. SS transmits a downlink RLC data block, with valid RRBP field (polling), with Final Block indicator set to 1.
4. MS responds by sending a PACKET DOWNLINK ACK/NACK with Final Ack indicator set to 1 and starting T3192.
5. When T3192 expires, MS returns to packet idle mode.
6. SS transmits a downlink RLC data block (using previous resources).
7. MS ignores this block, because it has returned to packet idle mode.
8. SS transmits a PACKET DOWNLINK ASSIGNMENT, followed by RLC data blocks for the downlink allocation.
9. MS responds with a PACKET DOWNLINK ACK/NACK.

Maximum Duration of Test

5 minutes.

Expected Sequence

Step	Direction	Message	Comments
1	SS -> MS	PACKET DOWNLINK ASSIGNMENT	Triggers the MS to switch to assigned PDCH. (no starting time)
2	SS -> MS	RLC DATA BLOCKS	Starting 3 blocks after the previous message, on assigned PDCH, addressed to MS.
3	SS -> MS	RLC DATA BLOCK	With valid RRBp field, addressed to MS, with Final Block indication set to 1.
4	MS -> SS	PACKET DOWNLINK ACK/NACK	MS acknowledges the previously received RLC data blocks, with final ack set to 1. MS starts T3192
5	SS		Wait (T3192 * 0.7) seconds
6			Repeat steps 3 and 4.
7	SS		Wait (T3192 * 1.2) seconds.
8	SS -> MS	RLC DATA BLOCK	On previously assigned PDCH. With valid RRBp field, addressed to MS.
9	SS		Verify no response from MS on previously assigned PDCH.
10	SS -> MS	PACKET DOWNLINK ASSIGNMENT	Triggers the MS to switch to assigned PDCH (no starting time)
11	SS -> MS	RLC DATA BLOCK	With valid RRBp field, addressed to MS, on new resources assigned in step 10.
12	MS -> SS	PACKET DOWNLINK ACK/NACK	MS acknowledges the previously received RLC data block.
13		{Completion of downlink RLC data block transfer}	Macro

Specific Message Contents

PACKET DOWNLINK ASSIGNMENT message in step 1:

TIMESLOT_ALLOCATION	<one timeslot assigned>
TBF STARTING TIME	<IE not present>
PACKET TIMING ADVANCE	Timing Advance value = 0

PACKET DOWNLINK ASSIGNMENT message in step 8:

TIMESLOT_ALLOCATION	<one timeslot assigned – different than previous>
TBF STARTING TIME	<IE not present>

GPRS Cell Options IE (throughout, on sys-infos):

T3192	010 – 1500 msec timeout value
-------	-------------------------------

DOWNLINK RLC DATA BLOCK in step 3:

RRBP	00 – Response shall be sent by MS in N+13 frames.
S/P	1 – RRBp field is valid
FBI	1

PACKET DOWNLINK ACK/NACK in step 4:

Ack/Nack Description IE - FINAL_ACK_INDICATION	1
--	---

42.5.5.2 Downlink Transfer/ Reestablishment/ Packet Downlink Assignment

42.5.5.2.1 Void

42.5.5.2.2 Conformance Requirement

After the network has initiated the release of a downlink TBF and the mobile station has received all the RLC blocks, the mobile station shall send the PACKET DOWNLINK ACK/NACK message with the Final Ack Indicator bit set to '1', start timer T3192 and continue to monitor all assigned PDCHs.

If the network receives a PACKET DOWNLINK ACK/NACK message with the Final Ack Indicator bit set to '1' and has new data to transmit for the mobile station, the network may establish a new downlink TBF for the mobile station by sending the PACKET DOWNLINK ASSIGNMENT or PACKET TIMESLOT RECONFIGURE message with the Control Ack bit set to '1' on PACCH.

If the mobile station, after sending the PACKET DOWNLINK ACK/NACK message with the Final Ack Indicator bit set to '1', receives a PACKET DOWNLINK ASSIGNMENT or PACKET TIMESLOT RECONFIGURE message with the Control Ack bit set to '1' while timer T3192 is running, the mobile station shall stop timer T3192, consider the previous downlink TBF released and act upon the new assignment.

References

3GPP TS 04.60, subclause 8.1.2.4.

42.5.5.2.3 Test purpose

Verify that after a downlink TBF is released, MS acts on a PACKET DOWNLINK ASSIGNMENT message.

42.5.5.2.4 Method of test

Initial Conditions

System Simulator:

GPRS supported, PCCCH present

Mobile Station:

The MS is in the state "idle, GMM-registered" with a P-TMSI allocated, SPLIT PG CYCLE negotiated, and PDP context 2 activated.

Specific PICS Statements

-

PIXIT Statements

-

Test Procedure

1. MS receives a PACKET DOWNLINK ASSIGNMENT message on its assigned PCCCH, containing no starting time.
2. SS transmits downlink RLC data blocks for the downlink allocation.
3. SS transmits a downlink RLC data block, with valid RRBP field (polling), with Final Block indicator set to 1.
4. MS responds by sending a PACKET DOWNLINK ACK/NACK with Final Ack indicator set to 1.
5. SS transmits a PACKET DOWNLINK ASSIGNMENT, assigning a new PDCH. CONTROL_ACK is set to 1.
6. SS transmits a downlink RLC data block on newly assigned PDCH, with valid RRBP field.
7. MS responds by sending a PACKET DOWNLINK ACK/NACK.

Maximum Duration of Test

5 minutes.

Expected Sequence

Step	Direction	Message	Comments
1	SS -> MS	PACKET DOWNLINK ASSIGNMENT	Triggers the MS to switch to assigned PDCH. (no starting time)
2	SS -> MS	RLC DATA BLOCKS	Starting 3 blocks after the previous message, on assigned PDCH, addressed to MS.
3	SS -> MS	RLC DATA BLOCK	With valid RRBP field, addressed to MS, with Final Block indication set to 1.
4	MS -> SS	PACKET DOWNLINK ACK/NACK	MS acknowledges the previously received RLC data blocks, with final ack set to 1.
5	SS		Wait (T3192 * 0.8) seconds
6	SS -> MS	PACKET DOWNLINK ASSIGNMENT	Sent on PACCH. Triggers the MS to switch to a new PDCH. (no starting time) CONTROL_ACK is set to '1'.
7	SS -> MS	RLC DATA BLOCK	6 blocks after step 6, on PDCH assigned in step 6. With valid RRBP field, addressed to MS.
8	MS -> SS	PACKET DOWNLINK ACK/NACK	MS acknowledges the previously received RLC data blocks.
9		{Completion of downlink RLC data block transfer}	Macro

Specific Message Contents

PACKET DOWNLINK ASSIGNMENT message in step 1:

TIMESLOT_ALLOCATION	<one timeslot assigned>
TBF STARTING TIME	<IE not present>
PACKET TIMING ADVANCE	Timing Advance value = 0

PACKET DOWNLINK ASSIGNMENT message in step 6:

CONTROL_ACK	1
TIMESLOT_ALLOCATION	<one timeslot assigned – different than previous assignment>
TBF STARTING TIME	<IE not present>

GPRS Cell Options IE (throughout, on sys-infos):

T3192	010 – 1500 msec timeout value
-------	-------------------------------

DOWNLINK RLC DATA BLOCK in step 3:

RRBP	00 – Response shall be sent by MS in N+13 frames.
S/P	1 – RRBP field is valid
FBI	1

PACKET DOWNLINK ACK/NACK in step 4:

Ack/Nack Description IE - FINAL_ACK_INDICATION	1
--	---

42.5.5.3 Downlink Transfer/ Reestablishment/ Invalid Frequency Parameters IE

42.5.5.3.1 Void

42.5.5.3.2 Conformance Requirement

After the network has initiated the release of a downlink TBF and the mobile station has received all the RLC blocks, the mobile station shall send the PACKET DOWNLINK ACK/NACK message with the Final Ack Indicator bit set to '1', start timer T3192 and continue to monitor all assigned PDCHs.

If the network receives a PACKET DOWNLINK ACK/NACK message with the Final Ack Indicator bit set to '1' and has new data to transmit for the mobile station, the network may establish a new downlink TBF for the mobile station by sending the PACKET DOWNLINK ASSIGNMENT or PACKET TIMESLOT RECONFIGURE message with the Control Ack bit set to '1' on PACCH.

If the mobile station, after sending the PACKET DOWNLINK ACK/NACK message with the Final Ack Indicator bit set to '1', receives a PACKET DOWNLINK ASSIGNMENT or PACKET TIMESLOT RECONFIGURE message with the Control Ack bit set to '1' while timer T3192 is running, the mobile station shall stop timer T3192, consider the previous downlink TBF released and act upon the new assignment.

- If a mobile station receives a PACKET DOWNLINK ASSIGNMENT or PACKET TIMESLOT RECONFIGURE message and detects an invalid Frequency Parameters information element in the message, it shall perform an abnormal release. If PCCCH is present in the cell the mobile station shall perform an abnormal release with system information (see subclause 8.7.3). If PCCCH is not present, the mobile station shall perform an abnormal release with random access (see subclause 8.7.2).

If the inconsistency is due to an invalid PSI or SI change mark associated with the referred GPRS mobile allocation or an undefined MA_NUMBER in the range 0 ñ 14, the mobile station shall initiate a partial acquisition of PBCCH or BCCH information (see 5.5.1.4). It shall then obtain the PSI2 or SI13 information, which is concerned.

References

3GPP TS 04.60, subclauses 8.1.2.4, 8.1.2.4.1, and 12.8.1

42.5.5.3.3 Test purpose

Verify that after a downlink TBF is released, MS returns to packet idle mode if a PACKET DOWNLINK ASSIGNMENT with invalid frequency parameters IE is received.

42.5.5.3.4 Method of test

Initial Conditions

System Simulator:

GPRS supported, PCCCH present

Mobile Station:

The MS is in the state "idle, GMM-registered" with a P-TMSI allocated, SPLIT PG CYCLE negotiated, and PDP context 2 activated.

Specific PICS Statements

-

PIXIT Statements

-

Test Procedure

1. MS receives a PACKET DOWNLINK ASSIGNMENT message on its assigned PCCCH, containing no starting time.

2. SS transmits downlink RLC data blocks for the downlink allocation.
3. SS transmits a downlink RLC data block, with valid RRBP field (polling), with Final Ack indicator set to 1.
4. MS responds by sending a PACKET DOWNLINK ACK/NACK.
5. SS transmits a PACKET DOWNLINK ASSIGNMENT, assigning a new PDCH, but with invalid frequency parameters.
6. SS transmits a downlink RLC data block on previously assigned PDCH, with valid RRBP field.
7. MS ignores the block because it has returned to packet idle mode.

Maximum Duration of Test

5 minutes.

Expected Sequence

Step	Direction	Message	Comments
1	SS -> MS	PACKET DOWNLINK ASSIGNMENT	Triggers the MS to switch to assigned PDCH. (no starting time)
2	SS -> MS	RLC DATA BLOCKS	Starting 3 blocks after the previous message, on assigned PDCH, addressed to MS.
3	SS -> MS	RLC DATA BLOCK	With valid RRBP field, addressed to MS, with Final Block indication set to 1.
4	MS -> SS	PACKET DOWNLINK ACK/NACK	MS acknowledges the previously received RLC data blocks.
5	SS	PACKET SYSTEM INFORMATION 1	Sent on PACCH, with default contents (i.e. no change to the initial PSI1). This is done in order to start new 30 second period for the autonomous PSI1 refresh
6	SS		Wait 1 seconds
7	SS -> MS	PACKET DOWNLINK ASSIGNMENT	Sent on PACCH. Triggers the MS to switch to a new PDCH. (no starting time)
8	SS		Invalid frequency parameters (undefined MA_NUMBER) in the message. CONTROL_ACK bit is set to '1'. Increment PBCCH_CHANGE_MARK by one. PSI_CHANGE_FIELD indicates changes in PSI2. Change the PSI2_CHANGE_MARK and the Reference Frequency List 1 in PSI2 (3 rd instance) to contain a subset of Cell Allocation. Also change the definition of MA 1 to select one frequency of the Reference Frequency List 1.
9	SS -> MS	RLC DATA BLOCK	Sent on the PDCH assigned in step 1, 3 block periods after the assignment on step 7. With valid RRBP field, addressed to MS.
10	SS		Verify MS does not transmit on previously assigned PDCH.
11	SS -> MS	PACKET DOWNLINK ASSIGNMENT	Sent 5 s after step 9. These steps verify the MS immediately has re-read the sys-infos, and is using the new PSI2 parameters.
12	SS -> MS	RLC DATA BLOCK	With valid RRBP field, addressed to MS.
13	MS -> SS	PACKET DOWNLINK ACK/NACK	MS acknowledges the previously received RLC data block.
14		{Completion of downlink RLC data block transfer}	Macro

Specific Message Contents

PACKET DOWNLINK ASSIGNMENT message in step 1:

TIMESLOT_ALLOCATION	<one timeslot assigned>
TBF STARTING TIME	<IE not present>

PACKET DOWNLINK ASSIGNMENT message in step 7:

CONTROL_ACK	1 (Assigning a new TBF to a MS for which T3192 is running)
TIMESLOT_ALLOCATION	<one timeslot assigned – different than previous assignment>
TBF STARTING TIME	<IE not present>
Frequency Parameters IE -	Indirect encoding
- MAIO	0
- MA_NUMBER	7 (undefined in the consistent set of PSI2 messages)

PACKET DOWNLINK ASSIGNMENT message in step 11:

TIMESLOT_ALLOCATION	<one timeslot assigned>
TBF STARTING TIME	<IE not present>
Frequency Parameters IE	Indirect encoding
- MAIO	0
- MA_NUMBER	1
- CHANGE_MARK_1	As set in step 8

GPRS Cell Options IE (throughout, on sys-infos):

T3192	010 – 1500 msec timeout value
-------	-------------------------------

DOWNLINK RLC DATA BLOCK in step 3:

RRBP	00 – Response shall be sent by MS in N+13 frames.
S/P	1 – RRBP field is valid
FBI	1

PACKET DOWNLINK ACK/NACK in step 4:

Ack/Nack Description IE - FINAL_ACK_INDICATION	1
---	---

42.6 MAC Modes whilst in DTM

42.6.1 Exclusive allocation in single-slot configuration

42.6.1.1 Conformance requirements

The exclusive allocation shall be used in dual transfer mode during single slot operation with a half-rate PDCH.

When mobile station has received the uplink assignment and granted the right to transmit using exclusive allocation, the mobile station shall start timer T3184 and transmit an RLC/MAC block in every uplink radio block on the PDCHs assigned for the TBF. The timer T3184 shall be restarted every time the mobile station receives a PACKET UPLINK ACK/NACK message.

If the mobile station has an RR connection to the network on a half-rate TCH, the network may assign a downlink TBF using the other sub-channel of the same timeslot for a half-rate PDCH (see 3GPP TS 05.02). In this case, the downlink assignment message shall be encoded with a timeslot allocation including the timeslot number for the half-rate TCH and the half-rate PDCH and only that timeslot number. The mobile station shall interpret this allocation as an allocation of a half-rate PDCH.

If the mobile station has an RR connection to the network on a half-rate TCH, the network may assign an uplink TBF using the other sub-channel of the same timeslot for a half-rate PDCH (see 3GPP TS 05.02)

References

3GPP TS 04.60/44.060 sub-clauses 5.2.4, 8.1.1.3a.1, 11.2.7.1 & 11.2.29.1

42.6.1.2 Test purpose

To guarantee that the MS transmits an RLC/MAC block in every uplink radio block on the PDCH assigned for the single-slot TBF, ignoring the USF indicator in the downlink radio block corresponding to the uplink PDCH/H channel.

42.6.1.3 Method of test

Initial Conditions

System Simulator:

1 cell, GPRS supported, DTM supported, PCCCH present.

Mobile Station:

The MS is in the active state (U10) of a call.

The MS is in packet idle mode, with a P-TMSI allocated and PDP context 1 activated.

Specific PICS Statements

-

PIXIT Statements

-

The MS is in a active CS call with an assigned TCH/H. The MS is triggered to initiate an uplink TBF and the MS is allocated the same timeslot for use in a uplink TBF. The MS interprets this as a command to use a combined TCH/H and exclusive mode PDCH/H in a single Timeslot. The SS verifies that the MS sends uplink RLC blocks in each block in the PDCH/H

Maximum Duration of Test

5 minutes

Expected Sequence

Step	Direction	Message	Comments
1	SS		MS in the active state (U10) of a call on Timeslot N, with Channel Type=TCH/H
2	MS		Trigger the MS to initiate an uplink packet transfer containing 1000 octets of data.
3	MS->SS	DTM REQUEST	
4	SS->MS	PACKET ASSIGNMENT	SS sends this message such that it is received before Timer T3148 expiry.
5	MS<->SS	{ Uplink data transfer }	Macro – Test completes when 1000 octets of data is received.

Specific Message Contents

PACKET ASSIGNMENT (Step 4):

As default message contents except: RR Packet Uplink Assignment IE - TIMESLOT_ALLOCATION RR Packet Downlink Assignment IE	N Not included
--	-------------------

42.6.2 Void

42.6.3 Void

42.7 Packet assignment/ TA Value

42.7.1 Packet Assignment / TA Value/TA present in second Packet downlink assignment

42.7.1.1 Conformance requirements

Initial timing advance can be provided in the PACKET DOWNLINK ASSIGNMENT as Timing Advance Value field. In case valid timing advance for the mobile station is not available, the network may set the poll bit in the PACKET DOWNLINK ASSIGNMENT to request four access bursts.

Reference

3GPP TS 04.60 subclause 7.2.1.1.

42.7.1.2 Test purpose

To verify that the mobile station does not send normal bursts on the uplink until it receives a valid timing advance in a PACKET DOWNLINK ASSIGNMENT message in case of Timing Advance Value field is not provided in the previous PACKET DOWNLINK ASSIGNMENT message.

42.7.1.3 Method of test

Initial conditions

System Simulator:

1 cell supporting GPRS. The packet system information CONTROL_ACK_TYPE indicates four access bursts.

Mobile Station:

The MS is GPRS attached and in packet idle mode. PDP context 2 has been established.

Specific PICS Statements

-

PIXIT Statements

-

Test procedure

The SS initiates a downlink data transfer. The SS sends PACKET DOWNLINK ASSIGNMENT message (without TA value) to the MS with a TBF starting time with poll set. MS sends PACKET CONTROL ACKNOWLEDGMENT as four access bursts. SS verifies that the MS does not send any normal burst on the uplink. Then SS sends a new PACKET DOWNLINK ASSIGNMENT message on PACCH (containing TA value). The SS sends an RLC/MAC data block. The MS shall send PACKET DOWNLINK ACK/NACK message to indicate correct reception of data block.

Maximum duration of the test

2 minutes.

Expected sequence

Step	Direction	Message	Comments
1	SS		The SS initiate a downlink transfer of 200 octets data.
2	SS -> MS	PACKET DOWNLINK ASSIGNMENT	No Timing Advance Value, starting time not elapsed. Sent on PPCH. RRBP valid. The starting time is set to point to a frame number at least 2 block periods onwards from the indicated RRBP.
3	MS->SS	PACKET CONTROL ACKNOWLEDGMENT	Received on the specified RRBP in step 2 as four access bursts
4	SS -> MS	DOWNLINK RLC DATA BLOCK	SS sends data starting at frame as indicated by TBF starting time in step 2 on assigned PDTCH. RRBP valid. BSN=0.
5	SS		SS waits 1 s and verifies that the MS not send any normal burst on the uplink.
6	SS -> MS	PACKET DOWNLINK ASSIGNMENT	Sent on the PACCH assigned in step 2. Containing Timing Advance Value.
7	SS -> MS	DOWNLINK RLC DATA BLOCK	SS sends data on assigned PDTCH in step 6. RRBP valid. BSN=1.
8	MS -> SS	PACKET DOWNLINK ACK/NACK	Indicating correct reception of both downlink RLC data blocks (BSN=0, and BSN=1). Received on PACCH.

Specific message contents

None

42.7.2 Packet Assignment / TA Value/TA not present in Packet uplink assignment sent On the PACCH

42.7.2.1 Conformance requirements

If TIMING_ADVANCE_VALUE field is not provided in the assignment message, the mobile station shall use its previous timing advance (either assigned in the previous IMMEDIATE ASSIGNMENT message received on AGCH or in the previous PACKET UPLINK ASSIGNMENT message received on PAGCH, or got through the continuous timing advance procedure).

Reference

3GPP TS 04.60 subclause 7.1.3.5.

42.7.2.2 Test purpose

To verify that the mobile station considers the previous timing advance contained in the PACKET UPLINK ASSIGNMENT allocating the single block allocation for sending the PACKET RESOURCE REQUEST message. When receiving the PACKET UPLINK ASSIGNMENT for the uplink TBF allocation without Timing advance, MS shall use the timing advance value given in the initial PACKET UPLINK ASSIGNMENT message.

42.7.2.3 Method of test

Initial conditions

System Simulator:

1cell, supporting GPRS.

Mobile Station:

The MS is GPRS attached and in packet idle mode. PDP context 2 has been established.

Specific PICS Statements

-

PIXIT Statements

-

Test procedure

The MS initiates an uplink data transfer. The SS sends PACKET UPLINK ASSIGNMENT with timing advance included with a single block allocation forcing two-phase access procedure. As response to the PACKET RESOURCE REQUEST message, the SS sends PACKET UPLINK ASSIGNMENT message on PACCH (not containing TA value). The MS shall complete the transfer of the uplink data.

Maximum duration of the test

2 minutes.

Expected sequence

Step	Direction	Message	Comments
1	MS		The MS is triggered to initiate packet uplink transfer of an LLC PDU consisting of 500 octets data.
2	MS -> SS	PACKET CHANNEL REQUEST	Received on PRACH.
3	SS -> MS	PACKET UPLINK ASSIGNMENT	Single block assignment, to order the MS to follow the two phase access procedure. Sent on PACCH. Including timing advance value.
4	MS -> SS	PACKET RESOURCE REQUEST	Two phase access procedure. Received on the single block assigned in step 3.
5	SS -> MS	PACKET UPLINK ASSIGNMENT	uplink dynamic allocation, no starting time, no timing advance value. Sent on PACCH of the same PDCH assigned in step 3.
6	SS	{Uplink data transfer}	Macro. Completion of the data transfer procedure.

Specific message contents

None

42.7.3 Packet Assignment / TA Value/ PACKET POWER CONTROL/TIMING ADVANCE during contention resolution

42.7.3.1 Conformance requirements

For a R97 and R98 MS only:

During the contention resolution, the mobile station may receive a non-distribution RLC/MAC control message addressing the mobile station by TLLI or the TFI value associated with the uplink TBF, other than the PACKET UPLINK ACK/NACK message. The mobile station may act on the other non-distribution messages, using the procedure defined for that message when it is received in packet transfer mode during operation on an uplink TBF (see clause 8).

For a R99 or later MS only:

During the contention resolution, the mobile station shall not accept a PACKET MEASUREMENT ORDER message, a PACKET CELL CHANGE ORDER message and a PACKET POWER CONTROL/TIMING ADVANCE message addressing the mobile station with the TFI value associated with the uplink TBF.

Reference:

For a R97 and R98 MS only:

3GPP TS 04.60 subclause 7.1.2.3.

For a R99 or later MS only:

3GPP TS 04.60/44.060 subclause 7.1.2.3a.

42.7.3.2 Test purpose

For a R97 and R98 MS only:

To verify that during contention resolution the mobile station may accept the PACKET POWER CONTROL/TIMING ADVANCE addressed with TFI.

For a R99 or later MS only:

To verify that during contention resolution the mobile station does not accept PACKET POWER CONTROL/TIMING ADVANCE addressed with TFI.

42.7.3.3 Method of test

Initial conditions

System Simulator:

1 cell supporting GPRS.

Mobile Station:

The MS is GPRS attached and in packet idle mode. PDP context 2 has been established.

Specific PICS Statements

- Release of GPRS Supported (TSPC_MS_GPRS_RELEASE)

PIXIT Statements

-

Test procedure

For a R97 and R98 MS only:

The MS is triggered to initiate uplink data transfer. The SS responds with PACKET UPLINK ASSIGNMENT message that request one phase access and includes a Timing Advance Value field. The SS shall wait 2 seconds and then sends a PACKET POWER CONTROL/TIMING ADVANCE message with a valid timing advance information. The MS may accept this message even though the contention resolution was not solved. It is verified that the uplink transfer is successfully completed.

For a R99 or later MS only:

The MS is triggered to initiate uplink data transfer. The SS responds with PACKET UPLINK ASSIGNMENT message that request one phase access and includes a Timing Advance Value field. The SS shall wait 2 seconds and then sends a PACKET POWER CONTROL/TIMING ADVANCE message with a valid timing advance information. The MS shall not consider this message since the contention resolution was not solved. It is verified that the uplink transfer is successfully completed.

Maximum duration of the test

2 minutes.

Expected sequence

Step	Direction	Message	Comments
1	MS		The MS is triggered to initiate packet uplink transfer of an LLC PDU consisting of 500 octets data.
2	MS -> SS	PACKET CHANNEL REQUEST	Received on PRACH.
3	SS -> MS	PACKET UPLINK ASSIGNMENT	Including Timing Advance Value. Indicating Dynamic allocation struct. Sent on PAGCH.
4	SS	PACKET DOWNLINK DUMMY CONTROL BLOCK	Assigning USF to the MS. Sent at least 3 block periods from the assignment in step 3.
5	MS->SS	RLC DATA BLOCK	with TLLI included
6	SS -> MS	PACKET POWER CONTROL/TIMING ADVANCE	Include a valid Timing Advance Index. Sent on PACCH. Addressing MS with TFI assigned in step 3.
7A	SS		For R97/R98 terminals: SS waits 3 s. The MS may send access bursts on the PTCCH/U.
7B	SS		For R99 and later terminals: SS waits 3 s and verifies that the MS does not send access burst on the PTCCH/U.
8	SS->MS	PACKET UPLINK ACK/NACK	Including the TFI and TLLI of the MS, finishing the contention resolution. Assigning USF to the MS.
9	SS	{Uplink data transfer }	Macro. Completion of the macro procedure.

Note: Step 7A is performed for R97/R98 terminals. Step 7B is performed for R99 and later terminals.

Specific message contents

None.

42.7.4 Packet Assignment / TA Value/TAI present/ multislots capabilities

42.7.4.1 Conformance requirements

If the PDCH containing the mobile station's only assigned TAI value is removed, the mobile station shall, if it is performing an uplink TBF, perform an abnormal release with access retry.

Reference

3GPP TS 04.60 subclause 8.7.

42.7.4.2 Test purpose

To verify that if the PDCH containing the mobile station's only assigned TAI value is removed, the mobile station shall, if it is performing an uplink TBF, perform an abnormal release with access retry.

42.7.4.3 Method of test

Initial conditions

System Simulator:

1 cell supporting GPRS. PSI1, ACCESS_BURST_TYPE indicates 8 bits access.

Mobile Station:

The MS is GPRS attached and in packet idle mode. PDP context 2 has been established.

Specific PICS Statements

-

PIXIT Statements

-

Test procedure

The MS is triggered to initiate uplink data packet transfer. The SS responds with PACKET UPLINK ASSIGNMENT message indicating one phase access and containing a Timing Advance Index. The MS shall start to send data on the allocated uplink. The SS allows the MS to send the uplink data transfer. During the uplink data transfer, the SS shall verify that the access bursts are sent correctly (by the MS) in the PTCCH. Then PDCH containing the mobile station's only assigned TAI value is removed. Verify that MS perform an abnormal release with access retry.

Maximum duration of the test

2 minutes.

Expected sequence

Step	Direction	Message	Comments
1	MS		The MS is triggered to initiate packet uplink transfer of 2000 octets data.
2	MS -> SS	PACKET CHANNEL REQUEST	Received on PRACH.
3	SS -> MS	PACKET UPLINK ASSIGNMENT	Including Timing Advance Index = 0 (on TN0), Dynamic allocation struct. Sent on PAGCH. Assigning TN0 and TN1 USF assigned to MS, sent on TN0
4	MS->SS	PACKET DOWNLINK DUMMY CONTROL BLOCK	
5	MS->SS	UPLINK RLC DATA BLOCK	Received on PDCH0
6	SS->MS	PACKET UPLINK ACK/NACK	With correct TLLI (to complete the contention resolution).
7	SS->MS	PACKET DOWNLINK DUMMY CONTROL BLOCKS	USFs assigned to MS on TN0 and TN1
8	MS->SS	UPLINK RLC DATA BLOCKS	Received on both PDCH0 and PDCH1
9	SS		Repeat steps 7 and 8 20 times.
10	SS->MS	PACKET PDCH RELEASE	Sent on PACCH of PDCH0 with TIMESLOTS_AVAILABLE indicating that only timeslot 1 is available
11	SS		Verify that MS did not continue on both PDCH0 and PDCH1 (max 6 blocks should be received)
12	MS->SS	PACKET CHANNEL REQUEST	MS re-initiates the packet access procedure

Verification

During the uplink data transfer (steps 3 to 9) the SS monitors the access burst on PTCCH which are located on slots with numbers FN, such that $(FN \bmod (8 \cdot 52)) = 12$ for Timing Advance Index = 0 (3GPP TS 03.64 subclause 6.5.7.2 and 3GPP TS 05.02 table 6). The access burst contents shall be MESSAGE_TYPE = 011111 and CTRL_ACK = 11.

Specific message contents

None.

42.7.5 Packet Assignment / TA Value/ Update of TA using PACKET POWER CONTROL/TIMING ADVANCE

42.7.5.1 Conformance requirements

The timing advance could be updated using a PACKET POWER CONTROL /TIMING ADVANCE message.

Reference

3GPP TS 04.60 subclause 7.2.2.1.

42.7.5.2 Test purpose

To verify that the mobile station is able to use the updated value received in a PACKET POWER CONTROL/TIMING ADVANCE message.

42.7.5.3 Method of test

Initial conditions

System Simulator:

1 cell supporting GPRS.

Mobile Station:

The MS is GPRS attached and in packet idle mode. PDP context 2 has been established.

Specific PICS Statements

-

PIXIT Statements

-

Test procedure

The MS is triggered to initiate uplink data transfer. The SS responds with PACKET UPLINK ASSIGNMENT message that request one phase access with Timing Advance Value field (=30bits). After contention resolution SS sends a PACKET POWER CONTROL/TIMING ADVANCE message with TA different from the assigned one. The SS verifies that MS is able to use the value received in PACKET POWER CONTROL/TIMING ADVANCE.

Maximum duration of the test

2 minutes.

Expected sequence

Step	Direction	Message	Comments
1	MS		The MS is triggered to initiate packet uplink transfer of an LLC PDU consisting of 500 octets data.
2	MS -> SS	PACKET CHANNEL REQUEST	Received on PRACH.
3	SS -> MS	PACKET UPLINK ASSIGNMENT	Timing Advance Value=30. Indicating Dynamic allocation struct. Sent on PAGCH.
4	SS->MS	PACKET DOWNLINK DUMMY CONTROL BLOCK	Sent on PACCH with USF assigned to MS
5	MS->SS	UPLINK RLC DATA BLOCK	Received on the assigned PDTCH.
6	SS->MS	PACKET UPLINK ACK/NACK	Sent on the PACCH with correct TLLI.
7	SS -> MS	PACKET POWER CONTROL/TIMING ADVANCE	Include a valid Timing Advance information. Sent on PACCH. Addressing MS with TFI assigned in step 3. With TA different from the previous value.
8	SS -> MS	PACKET DOWNLINK DUMMY CONTROL BLOCK	(Change SS TA parameters) Sent on PACCH with USF assigned to MS.
9	MS -> SS	UPLINK RLC DATA BLOCK	Sent on the PACCH with correct TLLI. Verify that MS uses the updated value sent in message of step 7.
10	SS<-> MS	Completion of macro {Uplink data transfer}	

Specific message contents

None.

42.7.6 Packet Uplink Assignment / One phase access / Timing Advance / TA Index present

42.7.6.1 Conformance requirements

If a Timing Advance Index is included in the assignment message, the mobile station shall use the continuous update timing advance mechanism, using its allocation on PTCCH (see 3GPP TS 05.10). If MS receives an other value of TAI in a PACKET POWER CONTROL /TIMING ADVANCE message, it shall use it.

Reference

3GPP TS 04.60 subclause 7.1.2.5.

3GPP TS 03.64 subclause 6.5.7.2.

42.7.6.2 Test purpose

To verify that the mobile station is able to update Timing Advance Index when received as part of PACKET POWER CONTROL /TIMING ADVANCE

42.7.6.3 Method of test

Initial conditions

System Simulator:

1 cell supporting GPRS. PSI1, ACCESS_BURST_TYPE indicates 8 bits access.

Mobile Station:

The MS is GPRS attached and in packet idle mode. PDP context 2 has been established.

Specific PICS Statements

-

PIXIT Statements

-

Test procedure

The MS is triggered to initiate uplink data packet transfer. The SS responds with PACKET UPLINK ASSIGNMENT message indicating one phase access and containing a Timing Advance Index. The MS shall start to send data on the allocated uplink. The SS allows the MS to send the uplink data transfer. During the Uplink data transfer, the SS shall verify that MS sends access bursts correctly in the PTCCH frames. The SS completes the contention resolution by including the TLLI of the MS in the PACKET UPLINK ACK/NACK message. Then SS sends PACKET POWER CONTROL /TIMING ADVANCE with new Timing advance index. Then SS verifies that MS uses correctly these values.

Maximum duration of the test

2 minutes.

Expected sequence

Step	Direction	Message	Comments
1	MS		The MS is triggered to initiate packet uplink transfer of 2000 octets data.
2	MS -> SS	PACKET CHANNEL REQUEST	Received on PRACH.
3	SS -> MS	PACKET UPLINK ASSIGNMENT	Including Timing Advance Index = 0, Dynamic allocation struct. Sent on PAGCH. USF assigned to MS.
4	SS->MS	PACKET DOWNLINK DUMMY CONTROL BLOCK	
5	MS->SS	UPLINK RLC DATA BLOCK	Received on the PDTCH
6	SS->MS	PACKET UPLINK ACK/NACK	USF assigned to MS. Including the TLLI of MS in the CONTENTION_RESOLUTION_TLLI field
7	MS->SS	UPLINK RLC DATA BLOCK	Received on the PDTCH
8			Repeat steps 6 and 7 20 times; excluding the TLLI for the contention resolution in step 6.
9	SS -> MS	PACKET POWER CONTROL/TIMING ADVANCE	Include a different Timing Advance Index (=2). Sent on PACCH 6 blocks before the MS PTCCH channel. Addressing MS with TFI assigned in step 3.
10	SS->MS	PACKET DOWNLINK DUMMY CONTROL BLOCK	USF assigned to MS. Sent after the 4 multiframes and 3 blocks of sending the message in step 9.
11		{Uplink data transfer}	Macro. Completion of data transfer. Verification, see below.

Verification

During the uplink data transfer in steps 3 to 8 the SS monitors the access burst on PTCCH which are located on slots with numbers FN, such that $(FN \bmod (8*52)) = 12$ for Timing Advance Index = 0 (3GPP TS 03.64/6.5.7.2 and 3GPP TS 05.02 table 6). The access burst contents shall be MESSAGE_TYPE = 011111 and CTRL_ACK = 11.

During the uplink transfer in steps 9 to 11 the SS continues monitoring the access burst on PTCCH such that $(FN \bmod (8*52)) = 64$ (TAI =2).

Specific message contents

None.

42.7.7 Packet Uplink Assignment / One phase access / Timing Advance / TA value field not provided

42.7.7.1 Conformance requirements

For the case where a TIMING_ADVANCE_VALUE field is not provided in the assignment message, the mobile station is not allowed to send normal bursts on the uplink until it receives a valid timing advance either through the continuous timing advance procedure or in a PACKET TIMING ADVANCE/POWER CONTROL message.

Reference

3GPP TS 04.60 subclause 7.1.2.5.

42.7.7.2 Test purpose

To verify that the mobile station does not send normal bursts on the uplink until it receives a valid timing advance in a PACKET POWER CONTROL/TIMING ADVANCE message if Timing Advance Value field is not provided in the PACKET UPLINK ASSIGNMENT message.

To verify that MS is able to send access bursts when TA is not included.

42.7.7.3 Method of test

Initial conditions

System Simulator:

1 cell supporting GPRS. The packet system information CONTROL_ACK_TYPE indicates four access bursts.

Mobile Station:

The MS is GPRS attached and in packet idle mode. PDP context 2 has been established.

Specific PICS Statements

-

PIXIT Statements

-

Test procedure

The MS is triggered to initiate uplink data transfer. The SS responds with PACKET UPLINK ASSIGNMENT message that request one phase access and does not include Timing Advance Value field. The SS shall wait 2 seconds and then sends PACKET POLLING REQUEST indicating four access bursts. After receiving the access bursts SS calculate the correct timing advance and send a PACKET UPLINK ASSIGNMENT with TA included. The MS shall start to send data on the allocated uplink. The SS allows the MS to send the uplink data transfer.

Maximum duration of the test

2 minutes.

Expected sequence

1	MS		The MS is triggered to initiate packet uplink transfer of an LLC PDU consisting of 500 octets data.
2	MS -> SS	PACKET CHANNEL REQUEST	Received on PRACH.
3	SS -> MS	PACKET UPLINK ASSIGNMENT	No Timing Advance Value. Indicating Dynamic allocation struct. Sent on PAGCH.
4	SS		SS waits 2 s and verifies that the MS does not send any normal burst on the uplink.
5	SS->MS	PACKET POLLING REQUEST	With TFI uplink, indicating four access bursts
6	MS->SS	PACKET CONTROL ACKNOWLEDGEMENT	Send on the RRBP specified in step 5
7	SS->MS	PACKET UPLINK ASSIGNMENT	Including Timing Advance Value. Indicating Dynamic allocation struct. Sent on PACCH.
8	SS -> MS	PACKET DOWNLINK DUMMY CONTROL BLOCK	Sent on the PACCH, 3 blocks from the last radio block containing the uplink assignment, USF assigned to the MS.
9	MS -> SS	UPLINK RLC DATA BLOCK	Containing TLLI in the RLC/MAC header.
10	SS -> MS	PACKET UPLINK ACK/NACK	Sent on the PACCH, containing TLLI received at step 9. USF assigned.
11		{Uplink data transfer}	Completion of the TBF procedure.

Specific message contents

None.

42.8 Dynamic allocation/ Downlink Transfer with Uplink TBF Establishment/ T3168

42.8.1 Dynamic Allocation/ Downlink Transfer with Uplink TBF Establishment/ T3168/ Expiry

42.8.1.1 Conformance Requirement

The mobile station may request establishment of an uplink transfer during a downlink TBF by including a Channel Request Description information element in the PACKET DOWNLINK ACK/NACK message Initiation is triggered by a request from upper layers to transfer a LLC PDU. The request from upper layers specifies a Radio Priority to be associated with the packet transfer. Upon such a request:

- if access to the network is allowed, according to the latest values for authorized special access classes that the mobile station has received (see subclause 7.1.1), the mobile station shall initiate the packet access procedure;
- otherwise, the RR sublayer in the mobile station shall reject the request.

The mobile station initiates the packet access procedure by sending the Channel Request Description information element in the PACKET DOWNLINK ACK/NACK message on the PACCH and starting timer T3168.

- If timer T3168 expires, the mobile station shall retransmit the Channel Request Description information element in the next PACKET DOWNLINK ACK/NACK message unless it has been transmitted four times in which case the mobile station shall perform an abnormal release with random access. If the downlink TBF is released, including expiry of timer T3192, before expiry of timer T3168 the mobile station shall stop timer T3168 and perform an abnormal release with random access.
- Abnormal Release with Random Access: The mobile station shall abort all TBFs in progress and its associated resources, return to the CCCH or PCCCH and initiate establishment of a new uplink TBF as defined in subclause 7.1.

References

3GPP TS 04.60, subclauses 8.1.2.5 and 8.7.2.

42.8.1.2 Test purpose

Verify that during a downlink TBF, when the MS requests uplink resources, that the MS makes the request 4 times. Verify that if uplink resources are not assigned within T3168, the MS performs abnormal release with random access.

42.8.1.3 Method of test

Initial Conditions

System Simulator:

1 cell, GPRS supported, PCCCH present.

Mobile Station:

The MS is in the state "idle, GMM-registered" with a P-TMSI allocated, SPLIT PG CYCLE negotiated, and PDP context 3 activated.

Specific PICS Statements

-

PIXIT Statements

-

Test Procedure

1. MS receives a PACKET DOWNLINK ASSIGNMENT message on its assigned PCCCH, containing no starting time.
2. SS transmits downlink RLC data blocks for the downlink allocation, 1 in 10 specifying RRBP field (polling).
3. MS responds by sending PACKET DOWNLINK ACK/NACK messages in response to the polls.
4. MS is triggered to begin an uplink transfer.
5. MS sends next PACKET DOWNLINK ACK/NACK message with a Channel Request Description field, and starts timer T3168.
6. When T3168 expires, MS repeats the Channel Request Description request. (This step is done 3 times, for a total of 4 Channel Request Descriptions.)
7. MS sends PACKET CHANNEL REQUEST again after returning to packet idle mode.

Maximum Duration of Test

5 minutes.

Expected Sequence

Step	Direction	Message	Comments
1	SS -> MS	PACKET DOWNLINK ASSIGNMENT	Triggers the MS to switch to assigned PDCH. (no starting time)
2	SS -> MS	RLC DATA BLOCKS	Sent on assigned PDCH, addressed to MS, 1/10 with valid RRBP field (polling).
3	MS -> SS	PACKET DOWNLINK ACK/NACK	MS acknowledges the previously received RLC data blocks.
4			Steps 2 and 3 are repeated throughout
5	MS		MS is triggered to begin an uplink data transfer.
6	MS -> SS	PACKET DOWNLINK ACK/NACK	Message contains Channel Request Description IE. - MS starts timer T3168
7			Steps 2 and 3 are repeated until the next Channel Request Description is sent in step 8.
8	MS -> SS	PACKET DOWNLINK ACK/NACK	MS requests additional resources (message contains Channel Request Description IE) - Sent more than T3168 seconds after previous request for additional resources - MS re-starts timer T3168
9			Steps 7 and 8 are repeated 2 more times such that a total of 4 Channel Request Descriptions are sent.
10	MS -> SS	PACKET CHANNEL REQUEST	Sent after T3168 seconds after step 8 is executed the last time.

PACKET SYSTEM INFORMATION MESSAGE 1 (throughout):

T3168	1 (1 second)
-------	--------------

42.8.2 Dynamic Allocation/ Downlink Transfer with Uplink TBF Establishment/ T3168/ Stop with Packet Uplink Assignment

42.8.2.1 Conformance Requirement

The mobile station may request establishment of an uplink transfer during a downlink TBF by including a Channel Request Description information element in the PACKET DOWNLINK ACK/NACK message. Initiation is triggered by a request from upper layers to transfer a LLC PDU. The request from upper layers specifies a Radio Priority to be associated with the packet transfer. Upon such a request:

- if access to the network is allowed, according to the latest values for authorized special access classes that the mobile station has received (see subclause 7.1.1), the mobile station shall initiate the packet access procedure.
- otherwise, the RR sublayer in the mobile station shall reject the request.

The mobile station initiates the packet access procedure by sending the Channel Request Description information element in the PACKET DOWNLINK ACK/NACK message on the PACCH and starting timer T3168.

On receipt of a PACKET UPLINK ASSIGNMENT or PACKET TIMESLOT RECONFIGURE message the mobile station shall follow the procedure below. On reception of a complete uplink assignment the mobile station shall stop timer T3168.

References

3GPP TS 04.60, subclause 8.1.2.5.

42.8.2.2 Test purpose

Verify that during a downlink TBF, when the MS requests additional resources, that the MS stops timer T3168 when a PACKET UPLINK ASSIGNMENT is received.

42.8.2.3 Method of test

Initial Conditions

System Simulator:

1 cell, GPRS supported, PCCCH present.

Mobile Station:

The MS is in the state "idle, GMM-registered" with a P-TMSI allocated, SPLIT PG CYCLE negotiated, and PDP context 3 activated.

Specific PICS Statements

-

PIXIT Statements

-

Test Procedure

1. MS receives a PACKET DOWNLINK ASSIGNMENT message on its assigned PCCCH, containing no starting time.
2. SS transmits downlink RLC data blocks for the downlink allocation, 1 in 10 specifying RRBP field (polling).
3. MS responds by sending PACKET DOWNLINK ACK/NACK messages in response to the polls.
4. MS is triggered to begin an uplink transfer.
5. MS sends next PACKET DOWNLINK ACK/NACK message with a Channel Request Description field, and starts timer T3168.
6. When T3168 expires, MS repeats the Channel Request Description request.
7. MS receives a PACKET UPLINK ASSIGNMENT message with a starting time such that more Channel Requests could be sent before the starting time.
8. MS does not repeat the Channel Request Description request.

Maximum Duration of Test

5 minutes.

Expected Sequence

Step	Direction	Message	Comments
1	SS -> MS	PACKET DOWNLINK ASSIGNMENT	Triggers the MS to switch to assigned PDCH. (no starting time)
2	SS -> MS	RLC DATA BLOCKS	Sent on assigned PDCH, addressed to MS, 1/10 with valid RRB field (polling).
3	MS -> SS	PACKET DOWNLINK ACK/NACK	MS acknowledges the previously received RLC data blocks.
4			Steps 2 and 3 are repeated throughout
5	MS		MS is triggered to begin an uplink data transfer.
6	MS -> SS	PACKET DOWNLINK ACK/NACK	Message contains Channel Request Description IE. - MS starts timer T3168
7			Steps 2 and 3 are repeated until the next Channel Request Description is sent in step 8.
8	MS -> SS	PACKET DOWNLINK ACK/NACK	MS requests additional resources (message contains Channel Request Description IE) - Sent after T3168seconds after previous request for additional resources - MS re-starts timer T3168
9	SS -> MS	PACKET UPLINK ASSIGNMENT	Sent (.5*T3168) seconds after step 8. Allocates one uplink timeslot (same timeslot as the downlink assignment) With valid RRB field (polling). With starting time T3168*2 seconds from now.
10	MS -> SS	PACKET CONTROL ACK	Received according to RRB in step 9
11			Steps 2 and 3 are repeated until (1.5*T3168) seconds after step 9. Verify MS does not send additional Channel Request Description IE.

PACKET SYSTEM INFORMATION MESSAGE 1 (throughout):

T3168	1 (1 second)
-------	--------------

42.8.3 Dynamic Allocation/ Downlink Transfer with Uplink TBF Establishment/ T3168/ Packet Access Reject/ With WAIT_INDICATION

42.8.3.1 Conformance Requirement

The mobile station may request establishment of an uplink transfer during a downlink TBF by including a Channel Request Description information element in the PACKET DOWNLINK ACK/NACK message. Initiation is triggered by a request from upper layers to transfer a LLC PDU. The request from upper layers specifies a Radio Priority to be associated with the packet transfer. Upon such a request:

- if access to the network is allowed, according to the latest values for authorized special access classes that the mobile station has received (see subclause 7.1.1), the mobile station shall initiate the packet access procedure;
- otherwise, the RR sublayer in the mobile station shall reject the request.

The mobile station initiates the packet access procedure by sending the Channel Request Description information element in the PACKET DOWNLINK ACK/NACK message on the PACCH and starting timer T3168.

On receipt of a PACKET ACCESS REJECT message containing a WAIT_INDICATION field in a Reject structure addressed to the mobile station, the mobile station shall stop timer T3168 and start timer T3172 with the indicated value (Wait Indication). The mobile station is not allowed to make a new attempt for packet access in the same cell until timer T3172 expires, but may attempt packet access in an other cell after successful cell reselection.

References

3GPP TS 04.60, subclause 8.1.2.5.

42.8.3.2 Test purpose

Verify that during a downlink TBF, when the MS requests uplink resources, that the MS obeys a PACKET ACCESS REJECT message with WAIT_INDICATION by waiting the specified time before any possible subsequent attempt to request uplink resources.

42.8.3.3 Method of test

Initial Conditions

System Simulator:

1 cells, GPRS supported, PCCCH present.

Mobile Station:

The MS is in the state "idle, GMM-registered" with a P-TMSI allocated, SPLIT PG CYCLE negotiated, and PDP context 3 activated.

Specific PICS Statements

-

PIXIT Statements

-

Test Procedure

1. MS receives a PACKET DOWNLINK ASSIGNMENT message on its assigned PCCCH, containing no starting time.
2. SS transmits downlink RLC data blocks for the downlink allocation, 1 in 10 specifying RRBP field (polling).
3. MS responds by sending PACKET DOWNLINK ACK/NACK messages in response to each poll.
4. MS is triggered to begin an uplink transfer.
5. MS sends next PACKET DOWNLINK ACK/NACK message with a Channel Request Description field.
6. MS receives a PACKET ACCESS REJECT message with WAIT_INDICATION.
7. MS acts on the PACKET ACCESS REJECT by waiting the indicated time.
8. MS shall not include the channel request description IE before T3172 expiry

Maximum Duration of Test

5 minutes.

Expected Sequence

Step	Direction	Message	Comments
1	SS -> MS	PACKET DOWNLINK ASSIGNMENT	Triggers the MS to switch to assigned PDCH. (no starting time)
2	SS -> MS	RLC DATA BLOCKS	Sent on assigned PDCH, addressed to MS, 1/10 with valid RRB field (polling).
3	MS -> SS	PACKET DOWNLINK ACK/NACK	MS acknowledges the previously received RLC data blocks.
4			Steps 2 and 3 are repeated throughout until step 7.
5	MS		MS is triggered to begin an uplink data transfer.
6	MS -> SS	PACKET DOWNLINK ACK/NACK	Message contains Channel Request Description IE. - MS starts timer T3168
7	SS -> MS	PACKET ACCESS REJECT	Sent (0.5 * T3168) seconds after step 6. - MS starts T3172
8	SS->MS	RLC DATA BLOCK	With RRB field valid
9	MS->SS	PACKET DOWNLINK ACK/NACK	Verify that Channel Request Description IE is not present
10			Repeat steps 8 and 9 until T3172 expiry.

PACKET ACCESS REJECT message in step 8:

TLLI	Addressing this MS
WAIT_INDICATION	2
WAIT_INDICATION_SIZE	0 – WAIT_INDICATION in units of seconds

42.8.4 Dynamic Allocation/ Downlink Transfer with Uplink TBF Establishment/ T3168/ Packet Access Reject/ No WAIT_INDICATION

42.8.4.1 Conformance Requirement

The mobile station may request establishment of an uplink transfer during a downlink TBF by including a Channel Request Description information element in the PACKET DOWNLINK ACK/NACK message. Initiation is triggered by a request from upper layers to transfer a LLC PDU. The request from upper layers specifies a Radio Priority to be associated with the packet transfer. Upon such a request:

- if access to the network is allowed, according to the latest values for authorized special access classes that the mobile station has received (see subclause 7.1.1), the mobile station shall initiate the packet access procedure;
- otherwise, the RR sublayer in the mobile station shall reject the request.

The mobile station initiates the packet access procedure by sending the Channel Request Description information element in the PACKET DOWNLINK ACK/NACK message on the PACCH and starting timer T3168.

On receipt of a PACKET ACCESS REJECT message that contains a Reject structure addressed to the mobile station, the mobile station shall stop timer T3168 and indicate a packet access failure to upper layer.

References

3GPP TS 04.60, subclause 8.1.2.5.

42.8.4.2 Test purpose

Verify that during a downlink TBF, when the MS requests uplink resources, that the MS obeys a PACKET ACCESS REJECT message without WAIT_INDICATION.

42.8.4.3 Method of test

Initial Conditions

System Simulator:

GPRS supported, PCCCH present.

Mobile Station:

The MS is in the state "idle, GMM-registered" with a P-TMSI allocated, SPLIT PG CYCLE negotiated, and PDP context 3 activated.

Specific PICS Statements

-

PIXIT Statements

-

Test Procedure

1. MS receives a PACKET DOWNLINK ASSIGNMENT message on its assigned PCCCH, containing no starting time.
2. SS transmits downlink RLC data blocks for the downlink allocation, 1 in 10 specifying RRB field (polling).
3. MS responds by sending PACKET DOWNLINK ACK/NACK messages in response to each poll.
4. MS is triggered to begin an uplink transfer.
5. MS sends next PACKET DOWNLINK ACK/NACK message with a Channel Request Description field.
6. MS receives a PACKET ACCESS REJECT message without WAIT_INDICATION.

Maximum Duration of Test

5 minutes.

Expected Sequence

Step	Direction	Message	Comments
1	SS -> MS	PACKET DOWNLINK ASSIGNMENT	Triggers the MS to switch to assigned PDCH. (no starting time)
2	SS -> MS	RLC DATA BLOCKS	Sent on assigned PDCH, addressed to MS, 1/10 with valid RRB field (polling).
3	MS -> SS	PACKET DOWNLINK ACK/NACK	MS acknowledges the previously received RLC data blocks.
4			Steps 2 and 3 are repeated throughout until step 7.
5	MS		MS is triggered to begin an uplink data transfer.
6	MS -> SS	PACKET DOWNLINK ACK/NACK	Message contains Channel Request Description IE. - MS starts timer T3168
7	SS -> MS	PACKET ACCESS REJECT	Sent (0.5*T3168) seconds after step 6 (no wait time).
8	SS -> MS	RLC DATA BLOCKS	Sent on assigned downlink PDCH, addressed to MS, 1 in 10 with valid RRB field (polling).
9	MS -> SS	PACKET DOWNLINK ACK/NACK	Verify MS respond to poll.

PACKET ACCESS REJECT message in step 7:

TLLI	Addressing this MS
WAIT_INDICATION	<not present>

42.8.5 Dynamic Allocation/ Downlink Transfer with Uplink TBF Establishment/T3168/Packet Access Reject/With Polling

42.8.5.1 Conformance Requirement

If the RRB field is received as part of an RLC/MAC block containing an RLC/MAC control block containing any message except Packet Paging Request, Packet Access Reject, and Packet Queueing Notification, the mobile station shall transmit a PACKET CONTROL ACKNOWLEDGEMENT message in the uplink radio block specified. If the RRB field is received as part of an RLC/MAC block containing an RLC/MAC control block containing a Packet

Paging Request, Packet Access Reject, or Packet Queueing Notification message, the mobile station shall ignore this RRBP field.

References

3GPP TS 04.60, subclause 10.4.5.

42.8.5.2 Test purpose

Verify that during a downlink TBF, when the MS requests uplink resources, that the MS ignores a poll in a PACKET ACCESS REJECT message.

42.8.5.3 Method of test

Initial Conditions

System Simulator:

GPRS supported, PCCCH present.

Mobile Station:

The MS is in the state "idle, GMM-registered" with a P-TMSI allocated, SPLIT PG CYCLE negotiated, and PDP context 3 activated.

Specific PICS Statements

-

PIXIT Statements

-

Test Procedure

1. MS receives a PACKET DOWNLINK ASSIGNMENT message on its assigned PCCCH, containing no starting time.
2. SS transmits downlink RLC data blocks for the downlink allocation, 1 in 10 specifying RRBP field (polling).
3. MS responds by sending PACKET DOWNLINK ACK/NACK messages in response to each poll.
4. MS is triggered to begin an uplink transfer.
5. MS sends next PACKET DOWNLINK ACK/NACK message with a Channel Request Description field.
6. MS receives a PACKET ACCESS REJECT message without WAIT_INDICATION and with RRBP field indicating polling.
7. MS ignores the poll request.

Maximum Duration of Test

5 minutes.

Expected Sequence

Step	Direction	Message	Comments
1	SS -> MS	PACKET DOWNLINK ASSIGNMENT	Triggers the MS to switch to assigned PDCH. (no starting time)
2	SS -> MS	RLC DATA BLOCKS	Sent on assigned PDCH, addressed to MS, 1/10 with valid RRBP field (polling).
3	MS -> SS	PACKET DOWNLINK ACK/NACK	MS acknowledges the previously received RLC data blocks.
4			Steps 2 and 3 are repeated throughout until step 8.
5	MS		MS is triggered to begin an uplink data transfer.
6	MS -> SS	PACKET DOWNLINK ACK/NACK	Message contains Channel Request Description IE. - MS starts timer T3168
7	SS -> MS	PACKET ACCESS REJECT	Sent (0.5*T3168) seconds after step 6 (no wait time), with valid RRBP field (polling).
8			Verify that MS did not answer to poll in step 7

PACKET ACCESS REJECT message in step 8:

RRBP	00 – Response shall be sent by MS in N+13 frames.
S/P (MAC Header)	1 – RRBP field is valid
WAIT_INDICATION	<not present>

42.9 Extended Dynamic Allocation in Packet Transfer Mode

42.9.1 Default message contents

All default conditions, message contents and macros are defined in section 40, except for the messages as described in this subclause. These messages are applicable to the whole section 42.9, they shall be transmitted by the system simulator and are required to be received by the MS under test.

In this clause, decimal values are normally used. However, sometimes a hexadecimal value, indicated by an "Hex", or a binary value, indicated by a "Binary" is used.

The default initial conditions used in subclause 42.9 are that PBCCH is present.

PACKET DOWNLINK ASSIGNMENT message:

MESSAGE_TYPE	000010
PAGE_MODE	Normal Paging
{0 1<PERSISTENCE_LEVEL>}	0
-	10 (address is TLLI)
- TLLI	same value as received from MS since GPRS attached
MAC_MODE	0, message escape
RLC_MODE	Extended Dynamic Allocation
CONTROL_ACK	acknowledged mode
TIMESLOT_ALLOCATION	0
Packet Timing Advance	single slot arbitrarily chosen from valid values, default slot 2
- {0 1<TIMING_ADVANCE_VALUE>}	1 (presence of the timing advance value)
- TIMING_ADVANCE_VALUE	30 bit periods
- {0 1<TIMING_ADVANCE_INDEX>	0 (no timing advance index)
<TIMING_ADVANCE_TIMESLOT_NUMBER >}	
- {0 1<P0><BTS_PWR_CTRL_MODE>}	0
{0 1<Frequency Parameters>}	1 (Frequency Parameters present)
- Frequency Parameters	
- TSC	Value arbitrarily chosen from valid values (default 5)
-	01 (indirect encoding)
- MAIO	Value arbitrarily chosen
- MA_NUMBER	Value arbitrarily chosen from PSI2s defined
- {0 1<CHANGE_MARK_1>	0
{0 1<CHANGE_MARK_2>}}	
{0 1<DOWNLINK_TFI_ASSIGNMENT>}	1 (assign downlink TFI)
- DOWNLINK_TFI_ASSIGNMENT	Arbitrarily chosen from valid values (default 3)
{0 1<Power Control Parameters>}	1 (Power Control Parameters present)
- ALPHA	0.5
- {0 1<GAMMA_TN0>}	Depending on the value in TIMESLOT_ALLOCATION (default 0 no GAMMA_TN0)
- {0 1<GAMMA_TN1>}	Depending on the value in TIMESLOT_ALLOCATION (default 0 no GAMMA_TN1)
- {0 1<GAMMA_TN2>}	Depending on the value in TIMESLOT_ALLOCATION (default 1 GAMMA_TN2)
- GAMMA_TN2	For GSM 700, T-GSM 810, GSM 850 and GSM 900, +8 dBm
- {0 1<GAMMA_TN3>}	For DCS 1 800, +6 dBm
- {0 1<GAMMA_TN4>}	For PCS 1 900, +6 dBm
- {0 1<GAMMA_TN5>}	Depending on the value in TIMESLOT_ALLOCATION (default 0 no GAMMA_TN0)
- {0 1<GAMMA_TN6>}	Depending on the value in TIMESLOT_ALLOCATION (default 0 no GAMMA_TN4)
- {0 1<GAMMA_TN7>}	Depending on the value in TIMESLOT_ALLOCATION (default 0 no GAMMA_TN5)
{0 1<TBF_STARTING_TIME>}	Depending on the value in TIMESLOT_ALLOCATION (default 0 no GAMMA_TN6)
- TBF_STARTING_TIME	Depending on the value in TIMESLOT_ALLOCATION (default 0 no GAMMA_TN7)
{0 1<Measurement Mapping>}	1 (starting time present)
spare padding	0, absolute frame number encoding, indicating (current frame + 13 frames)
	0 (no measurement mapping)
	Spare Padding

PACKET TIMESLOT RECONFIGURE message (dynamic allocation without assigning a new TBF):

MESSAGE_TYPE	000111
PAGE_MODE	Normal Paging
0<GLOBAL_TFI>	0 The TFI value of the uplink TBF or downlink TBF which this message applies to (default 00101)
CHANNEL_CODING_COMMAND	0, message escape arbitrarily chosen from valid values (default CS-1)
Global Packet Timing Advance	
- {0 1<TIMING_ADVANCE_VALUE>}	1 (timing advance value present)
- TIMING_ADVANCE_VALUE	30 bit periods
- {0 1<UPLINK_TIMING_ADVANCE_INDEX>	0 (no uplink timing advance index)
<UPLINK_TIMING_ADVANCE_TIMESLOT_NUMBER>}	The MS stops the operation of the continuous timing advance procedure.
- {0 1<DOWNLINK_TIMING_ADVANCE_INDEX>	0 (no downlink timing advance index)
<DOWNLINK_TIMING_ADVANCE_TIMESLOT_NUMBER>}	The MS stops the operation of the continuous timing advance procedure.
DOWNLINK_RLC_MODE	Same as in the Test PDP context used
CONTROL_ACK	0
{0 1<DOWNLINK_TFI_ASSIGNMENT>	0
{0 1<UPLINK_TFI_ASSIGNMENT>	0
DOWNLINK_TIMESLOT_ALLOCATION	arbitrarily chosen from valid values (default 00010000)
{0 1<Frequency Parameters>}	0 (use current parameters)
Dynamic allocation	0
- Extended Dynamic Allocation	1 (Extended Dynamic Allocation)
- {0 1<P0><PR_MODE>}	0
- USF_GRANULARITY	0, one block
- {0 1<RLC_DATA_BLOCKS_GRANTED>}	0 (no RLC_DATA_BLOCKS_GRANTED, open-ended TBF)
- {0 1<TBF_STARTING_TIME>}	1 (starting time)
- TBF_STARTING_TIME	1, relative frame number encoding indicating current frame + 104 by absolute encoding
-	1 (Timeslot Allocation with Power Control Parameters) one slot arbitrarily chosen and different from current slot, the following USF_TNx and GAMMA_TNx shall be corresponding to the chosen value, default timeslot 3.
- ALPHA	0.5
- {0 1<USF_TN0><GAMMA_TN0>}	0 (timeslot 0 not assigned)
- {0 1<USF_TN1><GAMMA_TN1>}	0 (timeslot 1 not assigned)
- {0 1<USF_TN2><GAMMA_TN2>}	0 (timeslot 2 not assigned)
- {0 1<USF_TN3><GAMMA_TN3>}	1 (timeslot 3 assigned)
- USF_TN3	arbitrarily chosen and different from current value, (default 4)
- GAMMA_TN3	For GSM 700, T-GSM 810, GSM 850 and GSM 900, +8 dBm For DCS 1 800, +6 dBm For PCS 1 900, +6 dBm
- {0 1<USF_TN4><GAMMA_TN4>}	1 (timeslot 4 assigned)
- USF_TN4	Arbitrarily chosen (default 3) but it must be different than USF_TN3
- GAMMA_TN4	For GSM 700, T-GSM 810, GSM 850 and GSM 900, +8 dBm For DCS 1 800, +6 dBm For PCS 1 900, +6 dBm
- {0 1<USF_TN5><GAMMA_TN5>}	1 (timeslot 5 assigned), if the MS supports at least 3 timeslots uplink
- USF_TN5	0 (timeslot 5 not assigned), if the MS supports only 2 timeslots uplink
- GAMMA_TN5	Only if timeslot 5 is assigned Arbitrarily chosen (default 2) but it must be different to USF_TN3 and USF_TN4 For GSM 700, T-GSM 810, GSM 850 and GSM 900, +8 dBm For DCS 1 800, +6 dBm For PCS 1 900, +6 dBm

- {0 1<USF_TN6><GAMMA_TN6>}	1 (timeslot 6 assigned), if the MS supports at least 4 timeslots uplink 0 (timeslot 6 not assigned), if the MS supports less than 4 timeslots uplink
- USF_TN6	Only if timeslot 6 is assigned arbitrarily chosen (default 1) but it must be different to USF_TN3, USF_TN4 and USF_TN5
- GAMMA_TN6	For GSM 700, T-GSM 810, GSM 850 and GSM 900, +8 dBm For DCS 1 800, +6 dBm For PCS 1 900, +6 dBm
- {0 1<USF_TN7><GAMMA_TN7>}	0 (timeslot 7 not assigned)
spare padding	Spare Padding

For assignment of an uplink TBF while a downlink TBF has been established, the address information should be changed to DOWNLINK_TFI of Global_TFI. UPLINK_TFI_ASSIGNMENT is present.

PACKET UPLINK ASSIGNMENT message (two-phase dynamic allocation assigning a TBF):

MESSAGE_TYPE	001010
PAGE_MODE	Normal Paging
{0 1<PERSISTENCE_LEVEL>}	0 (no persistence level present)
- Address information	10 (TLLI)
- TLLI	The value received from the MS
CHANNEL_CODING_COMMAND	0, message escape
TLLI_BLOCK_CHANNEL_CODING	Arbitrarily chosen from the valid values (default CS-1)
Packet Timing Advance	'0'B, cs-1
- {0 1<TIMING_ADVANCE_VALUE>}	1 (timing advance value)
- TIMING_ADVANCE_VALUE	30 bit periods
- {0 1<TIMING_ADVANCE_INDEX>	0 (no timing advance index)
<TIMING_ADVANCE_TIMESLOT_NUMBER >	
{0 1<Frequency Parameters>}	1 (Frequency Parameters present)
- Frequency Parameters	
- TSC	Arbitrarily chosen (default 5)
-	01 (indirect encoding)
- MAIO	Value arbitrarily chosen
- MA_NUMBER	Value arbitrarily chosen from PSI2s defined (default 0001)
- {0 1<CHANGE_MARK_1>	0
{0 1<CHANGE_MARK_2>}}	
Dynamic allocation	01
- Extended Dynamic Allocation	1 (Extended Dynamic allocation)
- {0 1<P0><PR_MODE>}	0
- USF_GRANULARITY	0, one block
- {0 1<UPLINK_TFI_ASSIGNMENT>}	1 (uplink TFI assignment)
- UPLINK_TFI_ASSIGNMENT	Arbitrarily chosen (default 00101)
- {0 1<RLC_DATA_BLOCKS_GRANTED>}	0 (no RLC_DATA_BLOCKS_GRANTED, open-ended TBF)
- {0 1<TBF_STARTING_TIME>}	0 (no starting time)
-	1 (Timeslot Allocation with Power Control Parameters)
	one slot arbitrarily chosen and the following USF_TNx and GAMMA_TNx shall be corresponding to the chosen value, default timeslot 2 assigned)
- ALPHA	0.5
- {0 1<USF_TN0><GAMMA_TN0>}	0 (timeslot 0 not assigned)
- {0 1<USF_TN1><GAMMA_TN1>}	0 (timeslot 1 not assigned)
- {0 1<USF_TN2><GAMMA_TN2>}	1 (timeslot 2 assigned)
- USF_TN2	Arbitrarily chosen (default 5)
- GAMMA_TN2	For GSM 700, T-GSM 810, GSM 850 and GSM 900, +8 dBm
	For DCS 1 800, +6 dBm
	For PCS 1 900, +6 dBm
- {0 1<USF_TN3><GAMMA_TN3>}	1 (timeslot 3 assigned)
- USF_TN3	Arbitrarily chosen (default 6) but it must be different than USF_TN2
- GAMMA_TN3	For GSM 700, T-GSM 810, GSM 850 and GSM 900, +8 dBm
	For DCS 1 800, +6 dBm
	For PCS 1 900, +6 dBm
- {0 1<USF_TN4><GAMMA_TN4>}	1 (timeslot 4 assigned), if the MS supports at least 3 timeslots uplink
	0 (timeslot 4 not assigned), if the MS supports only 2 timeslots uplink
- USF_TN4	Only if timeslot 4 is assigned
	Arbitrarily chosen (default 4) but it must be different to USF_TN2 and USF_TN3
- GAMMA_TN4	Only if timeslot 4 is assigned
	For GSM 700, T-GSM 810, GSM 850 and GSM 900, +8 dBm
	For DCS 1 800, +6 dBm
	For PCS 1 900, +6 dBm

- {0 1<USF_TN5><GAMMA_TN5>}	1 (timeslot 5 assigned), if the MS supports at least 4 timeslots uplink 0 (timeslot 5 not assigned), if the MS supports less than 4 timeslots uplink
- USF_TN5	Only if timeslot 5 is assigned Arbitrarily chosen (default 3) but it must be different to USF_TN2, USF_TN3 and USF_TN4
- GAMMA_TN5	Only if timeslot 5 is assigned For GSM 700, T-GSM 810, GSM 850 and GSM 900, +8 dBm For DCS 1 800, +6 dBm For PCS 1 900, +6 dBm
- {0 1<USF_TN6><GAMMA_TN6>}	0 (timeslot 6 not assigned)
- {0 1<USF_TN7><GAMMA_TN7>}	0 (timeslot 7 not assigned)
spare padding	Spare Padding

1. For one-phase uplink assignment, the Packet Request reference is used for addressing the MS.
2. For re-assignment of an uplink TBF, the address information should be changed to UPLINK_TFI of Global_TFI. UPLINK_TFI_ASSIGNMENT is absent.
3. For assignment of an uplink TBF while a downlink TBF has been established, the address information should be changed to DOWNLINK_TFI of Global_TFI. UPLINK_TFI_ASSIGNMENT is present.

42.9.2 Extended Dynamic Allocation / Uplink Transfer

42.9.2.1 Extended Dynamic Allocation / Uplink Transfer / Normal

42.9.2.1.1 Extended Dynamic Allocation / Uplink Transfer / Normal / Successful

42.9.2.1.1.1 Conformance requirements

The mobile station shall monitor the downlink PDCHs corresponding to (i.e. with the same timeslot number as) its assigned uplink PDCHs starting with the lowest numbered PDCH, then the next lowest numbered PDCH, etc., up to the one corresponding to the highest numbered assigned uplink PDCH.

Whenever the mobile station detects an assigned USF value on an assigned PDCH, the mobile station shall transmit either a single RLC/MAC block or a sequence of four RLC/MAC blocks on the same PDCH and all higher numbered assigned PDCHs. The time relation between an uplink block, which the mobile station shall use for transmission, and the occurrence of the USF value is defined in 3GPP TS 45.002. The number of RLC/MAC blocks to transmit on each PDCH is controlled by the USF_GRANULARITY parameter characterising the uplink TBF. The mobile station shall ignore the USF on those higher numbered PDCHs during the block period where the assigned USF value is detected.

References

3GPP TS 44.060, subclauses 8.1.1.2.1

42.9.2.1.1.2 Test purposes

To verify that the MS:

When the MS receives the assigned USF of the lowest assigned PDCH, it transmits RLC/MAC data block on the same and all higher PDCHs in the next TDMA frame.

42.9.2.1.1.3 Method of test

Initial Conditions

System Simulator:

1 cell, default setting,

Mobile Station:

The MS is GPRS attached with a P-TMSI allocated and the test PDP context 2 activated.

Specific PICS Statements

- The GPRS multislot class supported (TSPC_Type_GPRS_Multislot_ClassX, where X = 1..45)

PIXIT Statements

-

Test Procedure

The MS is triggered to initiate packet uplink transfer data in RLC acknowledged mode. The SS orders the MS to use two-phase access procedure, in PACKET UPLINK ASSIGNMENT. Up to 4 timeslots are assigned, according to the mobile multislot class (TS 5.02 Annex B.1).

1) The SS signals to the MS the assigned USF addressing the MS on the lowest assigned PDTCH. It is checked that the MS sends RLC/MAC data blocks in the next radio block period on all assigned PDTCH and that each data block contains the correct TFI without TLLI.

The SS acknowledges the received data and assigns the USF addressing the MS. The check is repeated.

The same procedure is going on until the MS completes the packet data transfer.

2) The SS signals to the MS the assigned USF addressing the MS on the highest assigned PDTCH. It is checked that the MS sends RLC/MAC data blocks in the next radio block period only on the highest assigned PDTCH and that each data block contains the correct TFI without TLLI.

The SS acknowledges the received data and assigns the USF addressing the MS. The check is repeated.

The same procedure is going on until the MS completes the packet data transfer.

Maximum Duration of Test

5 minutes.

Expected Sequence

Step	Direction	Message	Comments
1		{Uplink dynamic allocation two phase access}	n = 1500 octets, without starting time, Up to 4 timeslots are assigned according to MS multislots class (TS 5.02 Annex B.1) : <ul style="list-style-type: none"> - USF₁ on TN₁, - USF₂ on TN₂, - USF₃ on TN₃, - USF₄ on TN₄, Default PACKET UPLINK ASSIGNMENT message content for EDA defined in sub-clause 42.9.1 shall be used.
2	SS -> MS	PACKET DOWNLINK DUMMY CONTROL BLOCK	Assigned USF ₁ on PACCH ₁ addressing the MS on 3 blocks from the last radio block containing the uplink assignment.
3	SS -> MS	PACKET DOWNLINK DUMMY CONTROL BLOCK	USF on PACCH ₂ is not addressing the MS, sent on the same TDMA frame as step 2.
4	SS -> MS	PACKET DOWNLINK DUMMY CONTROL BLOCK	This step is optional; it is performed only if 3 timeslots at least have been assigned in step 1. USF on PACCH ₃ is not addressing the MS, sent on the same TDMA frame as step 2.
5	SS -> MS	PACKET DOWNLINK DUMMY CONTROL BLOCK	This step is optional; it is performed only if 4 timeslots have been assigned in step 1. USF on PACCH ₄ is not addressing the MS, sent on the same TDMA frame as step 2.
6	MS -> SS	UPLINK RLC DATA BLOCK	Received on the assigned PDTCH ₁ .
7	MS -> SS	UPLINK RLC DATA BLOCK	Received on the assigned PDTCH ₂ on the same TDMA frame as step 6.
8	MS -> SS	UPLINK RLC DATA BLOCK	This step is optional; it is performed only if 3 timeslots at least have been assigned in step 1. Received on the assigned PDTCH ₃ on the same TDMA frame as step 6.
9	MS -> SS	UPLINK RLC DATA BLOCK	This step is optional; it is performed only if 4 timeslots have been assigned in step 1. Received on the assigned PDTCH ₄ on the same TDMA frame as step 6.
10	SS -> MS	PACKET UPLINK ACK/NACK	Assigned USF ₁ on PACCH ₁ addressing the MS.
11	SS -> MS	PACKET DOWNLINK DUMMY CONTROL BLOCK	USF on PACCH ₂ is not addressing the MS, sent on the same TDMA frame as step 10
12	SS -> MS	PACKET DOWNLINK DUMMY CONTROL BLOCK	This step is optional; it is performed only if 3 timeslots at least have been assigned in step 1. USF on PACCH ₃ is not addressing the MS, sent on the same TDMA frame as step 10
13	SS -> MS	PACKET DOWNLINK DUMMY CONTROL BLOCK	This step is optional; it is performed only if 4 timeslots have been assigned in step 1. USF on PACCH ₄ is not addressing the MS, sent on the same TDMA frame as step 10
14	MS -> SS	UPLINK RLC DATA BLOCK	Received on the assigned PDTCH ₁ .
15	MS -> SS	UPLINK RLC DATA BLOCK	Received on the assigned PDTCH ₂ on the same TDMA frame as step 14
16	MS -> SS	UPLINK RLC DATA BLOCK	This step is optional; it is performed only if 3 timeslots at least have been assigned in step 1. Received on the assigned PDTCH ₃ on the same TDMA frame as step 14.
17	MS -> SS	UPLINK RLC DATA BLOCK	This step is optional; it is performed only if 4 timeslots have been assigned in step 1. Received on the assigned PDTCH ₄ on the same TDMA frame as step 14.
18		{Completion of uplink RLC data block transfer in extended dynamic mode}	

19		{Uplink dynamic allocation two phase access}	n = 1500 octets, without starting time, Up to 4 timeslots are assigned according to MS multislots class (TS 5.02 Annex B.1): - USF ₁ on TN ₁ , - USF ₂ on TN ₂ , - USF ₃ on TN ₃ , - USF ₄ on TN ₄ , Default PACKET UPLINK ASSIGNMENT message content for EDA defined in sub-clause 42.9.1 shall be used.
20	SS -> MS	PACKET DOWNLINK DUMMY CONTROL BLOCK	USF on PACCH ₁ is not addressing the MS
21	SS -> MS	PACKET DOWNLINK DUMMY CONTROL BLOCK	This step is optional; it is performed only if 3 timeslots at least have been assigned in step 19. USF on PACCH ₂ is not addressing the MS, sent on the same TDMA frame as step 20.
22	SS -> MS	PACKET DOWNLINK DUMMY CONTROL BLOCK	This step is optional; it is performed only if 4 timeslots have been assigned in step 19. USF on PACCH ₃ is not addressing the MS, sent on the same TDMA frame as step 20.
23	SS -> MS	PACKET DOWNLINK DUMMY CONTROL BLOCK	Assigned USF _N on PACCH _N addressing the MS, where N is the number of assigned timeslots in step 19, sent on the same TDMA frame as step 20.
24	MS->SS		It is checked that no UPLINK RLC DATA BLOCK messages are received on the assigned PDTCH ₁ to PDTCH _{N-1} .
25	MS -> SS	UPLINK RLC DATA BLOCK	Received only on the assigned PDTCH _N .
26	SS -> MS	PACKET UPLINK ACK/NACK	USF on PACCH ₁ is not addressing the MS
27	SS -> MS	PACKET DOWNLINK DUMMY CONTROL BLOCK	This step is optional; it is performed only if 3 timeslots at least have been assigned in step 19. USF on PACCH ₂ is not addressing the MS, sent on the same TDMA frame as step 26.
28	SS -> MS	PACKET DOWNLINK DUMMY CONTROL BLOCK	This step is optional; it is performed only if 4 timeslots have been assigned in step 19. USF on PACCH ₃ is not addressing the MS, sent on the same TDMA frame as step 26.
29	SS -> MS	PACKET DOWNLINK DUMMY CONTROL BLOCK	Assigned USF _N on PACCH _N addressing the MS, where N is the number of assigned timeslots in step 19, sent on the same TDMA frame as step 26.
30	MS->SS		It is checked that no UPLINK RLC DATA BLOCK messages are received on the assigned PDTCH ₁ to PDTCH _{N-1} .
31	MS -> SS	UPLINK RLC DATA BLOCK	Received only on the assigned PDTCH _N
32		{Completion of uplink RLC data block transfer in extended dynamic mode}	

Specific Message Contents

None.

42.9.2.1.2 Extended Dynamic Allocation / Uplink Transfer / Normal / USF_GRANULARITY = 4 blocks

42.9.2.1.2.1 Conformance requirements

The number of RLC/MAC blocks to transmit on each PDCH is controlled by the USF_GRANULARITY parameter characterising the uplink TBF. The mobile station shall ignore the USF on those higher numbered PDCHs during the block period where the assigned USF value is detected. In addition, if USF_GRANULARITY is set to four blocks allocation, it may ignore the USF on all other PDCHs during the first three block periods in which the mobile station has been granted permission to transmit. As specified in 3GPP TS 45.002, the USF corresponding to the last three blocks of a four blocks allocation shall be set to an unused value for each PDCH on which the mobile station has been granted permission to transmit.

References

3GPP TS 44.060, subclauses 8.1.1.2.1

42.9.2.1.2.2 Test purposes

To verify that the MS:

Manages the USF_GRANULARITY when an uplink TBF is established in Extended Dynamic allocation mode.

42.9.2.1.2.3 Method of test

Initial Conditions

System Simulator:

1 cell, default setting,

Mobile Station:

The MS is GPRS attached with a P-TMSI allocated and the test PDP context2 activated.

Specific PICS Statements

-

PIXIT Statements

-

Test Procedure

The MS is triggered to initiate packet uplink transfer data in RLC acknowledged mode. The SS orders the MS to use two-phase access procedure, in PACKET UPLINK ASSIGNMENT. 2 uplink timeslots are assigned.

- 1) The SS signals the assigned USF addressing the MS on the lowest assigned PDCH. It is checked that the MS sends RLC/MAC data blocks in the next 4 radio block periods on all assigned PDCHs and that each data block contains the correct TFI without TLLI.
- 2) The SS acknowledges the received data and assigns the USF addressing the MS. It is checked that the MS sends RLC/MAC data blocks in the next 4 radio block periods on all assigned PDCHs, except for the block allocated via the polling mechanism it is checked that the MS sends PACKET CONTROL ACKNOWLEDGEMENT.
- 3) In the last block period of the above procedure, the SS signals the assigned USF addressing the MS on the lowest assigned PDCH. It is checked that the MS sends RLC/MAC data blocks in the next 4 radio block periods on all assigned PDCH and that each data block contains the correct TFI without TLLI.
- 4) The same procedure is going on until the MS completes the packet data transfer.

Maximum Duration of Test

5 minutes.

Expected Sequence

Step	Direction	Message	Comments
1		{Uplink dynamic allocation two phase access}	n = 1500 octets, without starting time, 2 timeslots are assigned - USF ₁ on PDCH ₁ , - USF ₂ on PDCH ₂ , - USF_GRANULARITY = 1 (4 blocks) Default PACKET UPLINK ASSIGNMENT message content for EDA defined in sub-clause 42.9.1 shall be used.
2	SS -> MS	PACKET DOWNLINK DUMMY CONTROL BLOCK	USF ₁ on block N ₁ of PACCH ₁ is addressing the MS (must be at least 3 blocks after the block containing the uplink assignment.)
3	SS -> MS	PACKET DOWNLINK DUMMY CONTROL BLOCK	USF on block N ₁ of PACCH ₂ is NOT addressing the MS.
4	MS -> SS	UPLINK RLC DATA BLOCK	Received on block N ₁ +1 of PDTCH ₁
5	MS -> SS	UPLINK RLC DATA BLOCK	Received on block N ₁ +1 of PDTCH ₂
6	MS -> SS	UPLINK RLC DATA BLOCK	Received on block N ₁ +2 of PDTCH ₁
7	MS -> SS	UPLINK RLC DATA BLOCK	Received on block N ₁ +2 of PDTCH ₂
8	MS -> SS	UPLINK RLC DATA BLOCK	Received on block N ₁ +3 of PDTCH ₁
9	MS -> SS	UPLINK RLC DATA BLOCK	Received on block N ₁ +3 of PDTCH ₂
10	MS -> SS	UPLINK RLC DATA BLOCK	Received on block N ₁ +4 of PDTCH ₁
11	MS -> SS	UPLINK RLC DATA BLOCK	Received on block N ₁ +4 of PDTCH ₂
12	SS -> MS	PACKET UPLINK ACK/NACK	Acknowledge all received data blocks, on block N ₂ of PACCH ₁ With: S/P=1, RRBP = 0, and USF ₁
13	MS -> SS	UPLINK RLC DATA BLOCK	Received on block N ₂ +1 of PDTCH ₁
14	MS -> SS	UPLINK RLC DATA BLOCK	Received on block N ₂ +1 of PDTCH ₂
15	MS -> SS	UPLINK RLC DATA BLOCK	Received on block N ₂ +2 of PDTCH ₁
16	MS -> SS	UPLINK RLC DATA BLOCK	Received on block N ₂ +2 of PDTCH ₂
17	MS -> SS	PACKET CONTROL ACKNOWLEDGEMENT	Received on block N ₂ +3 of PACCH ₁
18	MS -> SS	UPLINK RLC DATA BLOCK	Received on block N ₂ +3 of PDTCH ₂
19	SS -> MS	PACKET DOWNLINK DUMMY CONTROL BLOCK	USF ₁ on block N ₂ + 4 of PACCH ₁ is addressing the MS.
20	MS -> SS	UPLINK RLC DATA BLOCK	Received on block N ₂ +4 of PDTCH ₁
21	MS -> SS	UPLINK RLC DATA BLOCK	Received on block N ₂ +4 of PDTCH ₂
22	MS -> SS	UPLINK RLC DATA BLOCK	Received on block N ₂ +5 of PDTCH ₁
23	MS -> SS	UPLINK RLC DATA BLOCK	Received on block N ₂ +5 of PDTCH ₂
24	MS -> SS	UPLINK RLC DATA BLOCK	Received on block N ₂ +6 of PDTCH ₁
25	MS -> SS	UPLINK RLC DATA BLOCK	Received on block N ₂ +6 of PDTCH ₂
26	MS -> SS	UPLINK RLC DATA BLOCK	Received on block N ₂ +7 of PDTCH ₁
27	MS -> SS	UPLINK RLC DATA BLOCK	Received on block N ₂ +7 of PDTCH ₂
28	MS -> SS	UPLINK RLC DATA BLOCK	Received on block N ₂ +8 of PDTCH ₁
29	MS -> SS	UPLINK RLC DATA BLOCK	Received on block N ₂ +8 of PDTCH ₂
30		{Completion of uplink RLC data block transfer in extended dynamic mode}	

Specific Message Contents

None

42.9.2.1.3 Extended Dynamic Allocation / Uplink Transfer / Normal / Allocation via polling mechanism

42.9.2.1.3.1 Conformance requirements

During the block period where an uplink radio block is allocated on a PDCH via the polling mechanism (see sub-clause 10.4.4), the mobile station shall monitor for the assigned USF on the downlink PDCHs corresponding to its assigned uplink PDCHs starting with the lowest numbered assigned PDCH up to the highest numbered PDCH which is feasible when taking into account the PDCH's allocated for transmission in the block period and the switching requirements of the mobile station multislot class (see 3GPP TS 45.002)

The mobile station shall either transmit the uplink radio block on the same timeslot as the block where the RRBP was received or, if an UPLINK_CONTROL_TIMESLOT is assigned to the mobile station, the mobile station shall transmit the uplink radio block on this UPLINK_CONTROL_TIMESLOT. After receiving an RLC/MAC block containing a valid RRBP field the mobile station need not monitor the USF in the associated downlink RLC/MAC block appearing just before the uplink block it shall transmit. However, when Extended Dynamic Allocation or Shifted USF operation is used, corresponding USF monitoring procedure shall apply as described in sub-clause 8.1.1.2.1 and sub-clause 8.1.1.2.4 respectively.

References

3GPP TS 44.060, subclauses 8.1.1.2.1, 10.4.5

42.9.2.1.3.2 Test purposes

To verify that the MS:

The MS sends the uplink control block allocated on the PDCH via the polling mechanism, while continuing to monitor the correct USFs.

42.9.2.1.3.3 Method of test

Initial Conditions

System Simulator:

1 cell, default setting,

Mobile Station:

The MS is GPRS attached with a P-TMSI allocated and the test PDP context2 activated.

Specific PICS Statements

- The GPRS multislot class supported (TSPC_Type_GPRS_Multislot_ClassX, where X = 1..45)

PIXIT Statements

-

Test Procedure

The MS is triggered to initiate packet uplink transfer data in RLC acknowledged mode. The SS orders the MS to use two-phase access procedure, in PACKET UPLINK ASSIGNMENT. Up to 3 timeslots are assigned, according to the mobile multi-slot class (3GPP TS 45.002 Annex B.1).

1) The SS signals to the MS the assigned USF addressing the MS on the lowest assigned PDCH. It is checked that the MS sends the RLC/MAC data blocks in the next radio block period on all assigned PDCHs and that each data block contains the correct TFI without TLLI.

The SS acknowledges the received data with PACKET UPLINK ACK/NACK message with polling.

2) On the block before the transmission of PACKET CONTROL ACKNOWLEDGEMENT the SS signals to the MS the assigned USF addressing the MS on the lowest assigned PDCH.

On the same block as the transmission of PACKET CONTROL ACKNOWLEDGEMENT the SS signals to the MS the assigned USF addressing the MS on the lowest assigned PDCH.

It is checked that the MS sends the PACKET CONTROL ACKNOWLEDGEMENT on the lowest assigned PDCH and RLC/MAC data blocks on all other assigned PDCH and that each data block contains the correct TFI without TLLI.

It is checked that the MS sends RLC/MAC data blocks on the next radio block period on all assigned PDCH and that each data block contains the correct TFI without TLLI.

The SS acknowledges the received data with PACKET UPLINK ACK/NACK message with polling.

3) On the same block as the transmission of PACKET CONTROL ACKNOWLEDGEMENT the SS signals to the MS the assigned USF addressing the MS on the second assigned PDCH. It is checked that the MS sends PACKET

CONTROL ACKNOWLEDGEMENT on the lowest assigned PDCH and in the next block period the MS sends RLC/MAC data blocks on all assigned PDCHs except the first assigned PDCH and that each data block contains the correct TFI without TLLI.

The SS acknowledges the received data with PACKET UPLINK ACK/NACK message with polling.

4) This sequence is applicable only for MS multislot classes class 7, 11, 12, 20 to 23, 25 to 29, 33, 34, 38, 39.

On the same block as the transmission of PACKET CONTROL ACKNOWLEDGEMENT the SS signals to the MS the assigned USF addressing the MS on the third assigned PDCH. It is checked that the MS sends PACKET CONTROL ACKNOWLEDGEMENT on the lowest assigned PDCH and no RLC/MAC data blocks are sent.

5) Successfully complete the packet data transfer.

Maximum Duration of Test

5 minutes.

Expected Sequence

Step	Direction	Message	Comments
1		{Uplink dynamic allocation two phase access}	n = 1500 octets, without starting time, Up to 3 timeslots are assigned according to MS multi-slot class (TS 5.02 Annex B.1) : - USF ₁ on PDCH ₁ , - USF ₂ on PDCH ₂ , - USF ₃ on PDCH ₃ ,
2	SS -> MS	PACKET DOWNLINK DUMMY CONTROL BLOCK	USF ₁ on block N ₁ of PACCH ₁ is addressing the MS (must be at least 3 blocks after the block containing the uplink assignment.)
3	MS -> SS	UPLINK RLC DATA BLOCK	Received on block N ₁ +1 of PDTCH ₁
4	MS -> SS	UPLINK RLC DATA BLOCK	Received on block N ₁ +1 of PDTCH ₂
5	MS -> SS	UPLINK RLC DATA BLOCK	This step is optional, it is performed only if 3 timeslots have been allocated in step 1 Received on block N ₁ +1 of PDTCH ₃
6	SS -> MS	PACKET UPLINK ACK/NACK	Acknowledge all received data blocks, on block N ₂ of PACCH ₁ With: S/P=1, RRB _P = 0 USF is NOT addressing the MS
7	SS -> MS	PACKET DOWNLINK DUMMY CONTROL BLOCK	USF ₁ on block N ₂ +2 of PACCH ₁ is addressing the MS
8	SS -> MS	PACKET DOWNLINK DUMMY CONTROL BLOCK	USF ₁ on block N ₂ +3 of PACCH ₁ is addressing the MS
9	MS -> SS	PACKET CONTROL ACKNOWLEDGEMENT	Received on block N ₂ +3 of PACCH ₁
10	MS -> SS	UPLINK RLC DATA BLOCK	Received on block N ₂ +3 of PDTCH ₂
11	MS -> SS	UPLINK RLC DATA BLOCK	This step is optional, it is performed only if 3 timeslots have been allocated in step 1 Received on block N ₂ +3 of PDTCH ₃
12	MS -> SS	UPLINK RLC DATA BLOCK	Received on block N ₂ +4 of PDTCH ₁
13	MS -> SS	UPLINK RLC DATA BLOCK	Received on block N ₂ +4 of PDTCH ₂
14	MS -> SS	UPLINK RLC DATA BLOCK	This step is optional, it is performed only if 3 timeslots have been allocated in step 1 Received on block N ₂ +4 of PDTCH ₃
15	SS -> MS	PACKET UPLINK ACK/NACK	Acknowledge all received data blocks, on block N ₃ of PACCH ₁ With: S/P=1, RRB _P = 0 USF is NOT addressing the MS
16	SS -> MS	PACKET DOWNLINK DUMMY CONTROL BLOCK	USF on block N ₃ +3 of PACCH ₁ is NOT addressing the MS
17	SS -> MS	PACKET DOWNLINK DUMMY CONTROL BLOCK	USF ₂ on block N ₃ +3 of PACCH ₂ is addressing the MS
18	MS -> SS	PACKET CONTROL ACKNOWLEDGEMENT	Received on block N ₃ +3 of PACCH ₁
19	MS -> SS	UPLINK RLC DATA BLOCK	Received on block N ₃ +4 of PDTCH ₂
20	MS -> SS	UPLINK RLC DATA BLOCK	This step is optional, it is performed only if 3 timeslots have been allocated in step 1 Received on block N ₃ +4 of PDTCH ₃
			The steps below are applicable only for the MS multi-slot class 7, 11, 12, 20 to 23, 25 to 29, 33, 34, 38, 39
21	SS -> MS	PACKET UPLINK ACK/NACK	Acknowledge all received data blocks, on block N ₄ of PACCH ₁ With: S/P=1, RRB _P = 0 USF is NOT addressing the MS
22	SS -> MS	PACKET DOWNLINK DUMMY CONTROL BLOCK	USF on block N ₄ +3 of PACCH ₁ is NOT addressing the MS
23	SS -> MS	PACKET DOWNLINK DUMMY CONTROL BLOCK	USF on block N ₄ +3 of PACCH ₂ is NOT addressing the MS
24	SS -> MS	PACKET DOWNLINK DUMMY CONTROL BLOCK	USF ₃ on block N ₄ +3 of PACCH ₃ is addressing the MS
25	MS -> SS	PACKET CONTROL ACKNOWLEDGEMENT	Received on block N ₄ +3 of PACCH ₁

26			Verify that the MS does not transmit any RLC data block
27		{Completion of uplink RLC data block transfer in extended dynamic mode}	

Specific Message Contents

None

42.9.2.1.4 Extended Dynamic Allocation / Uplink Transfer / Normal / PACCH operation in downlink

42.9.2.1.4.1 Conformance requirements

The mobile station shall attempt to decode every downlink RLC/MAC block on the lowest numbered timeslot in the PDCH allocation. Whenever the mobile station receives a RLC/MAC block containing a RLC/MAC control block, the mobile station shall attempt to interpret the message contained therein. If the message addresses the mobile station, the mobile station shall act on the message.

The network shall transmit all PACCH messages on the PDCH carried on the lowest numbered timeslot in the allocation. Additionally for the concurrent TBF case, the network may transmit PACCH messages on any of the common timeslots assigned to the downlink and uplink PDCH allocation.

Whenever the mobile station detects an assigned USF value on any assigned PDCH, the mobile station may transmit a PACCH block on the same PDCH in the next block period. The mobile station shall not transmit a RLC data block in any uplink radio block allocated via the polling mechanism.

References

3GPP TS 44.060, subclause 8.1.1.2.2.

42.9.2.1.4.2 Test purposes

To verify that a MS having an uplink GPRS TBF with Extended Dynamic Allocation MAC mode:

1. Decodes and interprets correctly all RLC/MAC blocks containing RLC/MAC control blocks sent by the network on the lowest numbered timeslot in the PDCH allocation when there is no concurrent downlink TBF.
2. Decodes and interprets correctly all RLC/MAC blocks containing RLC/MAC control blocks sent by the network on the lowest numbered timeslot in the PDCH allocation or on any of the common timeslots assigned to the downlink and uplink PDCH allocation when there is a concurrent downlink TBF.
3. Does not transmit a RLC data block in any uplink radio block allocated via the polling mechanism.

42.9.2.1.4.3 Method of test

Initial Conditions

System Simulator:

1 cell, default setting.

Mobile Station:

The MS is GPRS attached with a P-TMSI allocated and the test PDP context 2 activated.

Specific PICS Statements

- The GPRS multislot class supported (TSPC_Type_GPRS_Multislot_ClassX, where X = 1..45)

PIXIT Statements

-

Test Procedure

The MS is triggered to initiate a packet uplink data transfer in RLC acknowledged mode and with Extended Dynamic Allocation MAC mode. The SS orders the MS to use two-phase access procedure.

- 1) At this point in time the MS has an uplink GPRS TBF established with Extended Dynamic Allocation MAC mode. It may receive RLC/MAC blocks containing RLC/MAC control blocks for the uplink TBF on the PDCH carried on the lowest numbered timeslot in the allocation.

To test that the MS decodes and interprets correctly all RLC/MAC blocks containing RLC/MAC control blocks sent by the network on the lowest numbered timeslot in the PDCH allocation when there is no concurrent downlink TBF the SS process as follow:

- The SS sends on on the lowest numbered timeslot in the PDCH allocation a PACKET DOWNLINK ASSIGNMENT message to establish a concurrent downlink GPRS TBF with the Extended Dynamic Allocation MAC mode. The SS checks that the MS sends in response a PACKET CONTROL ACKNOWLEDGEMENT message on the lowest numbered timeslot in the PDCH allocation.
- 2) At this point in time the MS has an uplink TBF and a downlink GPRS TBF established with Extended Dynamic Allocation MAC mode. It may receive RLC/MAC blocks containing RLC/MAC control blocks for the uplink GPRS TBF on the PDCH carried on the lowest numbered timeslot in the uplink PDCH allocation or on any of the common timeslots assigned to the downlink and uplink PDCH allocation.

To test, in case there is a concurrent downlink GPRS TBF, that the MS decodes and interprets correctly all RLC/MAC blocks containing RLC/MAC control blocks sent by the network on the PDCH carried on the lowest numbered timeslot in the uplink PDCH allocation or on any of the common timeslots assigned to the downlink and uplink PDCH allocation, the SS process as follow:

- The MS is triggered to transfer 64+1 (window size +1) GPRS RLC data blocks without acknowledgement from SS in such a way that the window is stalled.
 - The SS sends on the PDCH carried on the lowest numbered timeslot in the uplink PDCH allocation a PACKET UPLINK ACK/NACK message acknowledging only the oldest GPRS RLC data block. Then the MS is triggered to transfer one GPRS RLC data block. If the MS has correctly decoded the PACKET UPLINK ACK/NACK message, the BSN of the GPRS RLC data block shall be the next in sequence expected BSN.
 - The SS sends on one of the common timeslots assigned to the downlink and uplink PDCH allocation a PACKET UPLINK ACK/NACK message acknowledging only the oldest GPRS RLC data block. Then the MS is triggered to transfer one GPRS RLC data block. If the MS has correctly decoded the PACKET UPLINK ACK/NACK message, the BSN of the GPRS RLC data block shall be the next in sequence expected BSN. The test is repeated with all PDCHs common for both reception and transmission.
- 3) To test that the MS does not transmit a GPRS RLC data block in any uplink radio block allocated via the polling mechanism the SS process as follow:
 - The SS sends on one of the common timeslots assigned to the downlink and uplink PDCH allocation a PACKET UPLINK ACK/NACK message containing the TFI value assigned to the uplink TBF and a valid RRBP. On the block period preceding the block period where the polling response to the PACKET UPLINK ACK/NACK message should be received, the SS assigns an USF to the MS on the lowest numbered timeslot of the uplink PDCH allocation. The SS checks that during the block period where the polling response should be received, the MS responds to the polling with a PACKET CONTROL ACKNOWLEDGEMENT message sent on the PDCH where the polling request was sent and sends RLC data blocks on the other PDCHs of the uplink PDCH allocation. The test is repeated with all PDCHs common for both reception and transmission.

Then the data transfer is completed.

The following table gives the number of timeslots allocated for the uplink and downlink TBFs during the test according to the multislot class (see 45.002 annex B.1):

Multislot class	Number of PDCHs for the downlink TBF	Number of PDCHs for the uplink TBF
3	1	2
5	2	2
6	2	2
7	2	2
9	3	2
10	3	2
11	3	2
12	3	2
13	3	3
14	4	4
15	5	5
16	6	6
17	7	7
18	8	8
19	6	2
20	6	3
21	6	4
22	6	4
23	6	6
24	8	2
25	8	3
26	8	4
27	8	4
28	8	6
29	8	8
31	4	2
32	3	3
33	3	3
34	3	3
36	4	2
37	3	3
38	3	3
39	3	3
41	5	2
42	4	3
43	4	3
44	4	3
45	4	3

NOTE: The multislot class of the MS under test may impose that the highest PDCH of the uplink allocation is not a member of the downlink allocation. In this case the SS shall transmit a downlink RLC data block on a PDCH common to the downlink and uplink PDCH allocation at least every 5 seconds to avoid expiry of timer T3190.

Maximum Duration of Test

1 minute.

Expected Sequence

Step	Direction	Message	Comments
1		{Uplink dynamic allocation two phase access}	Default PACKET UPLINK ASSIGNMENT message content for EDA defined in sub-clause 42.9.1 shall be used. n = 1500 octets, without starting time,
2	SS -> MS	PACKET DOWNLINK ASSIGNMENT	Default PACKET DOWNLINK ASSIGNMENT message content for EDA defined in sub-clause 42.9.1 shall be used. Sent on the PACCH of the lowest PDCH of the uplink PDCH allocation. Including the Polling bit set and a valid RRBP field. Including the TFI assigned to the uplink TBF.
3	MS -> SS	PACKET CONTROL ACKNOWLEDGEMENT	Received on the PACCH of the lowest PDCH of the uplink PDCH allocation.
4	SS		The SS verifies that the MS sends the PACKET CONTROL ACKNOWLEDGEMENT message, on the uplink radio block specified by the RRBP of the lowest PDCH of the uplink PDCH allocation.
5	SS -> MS	DOWNLINK GPRS RLC DATA BLOCK	Sent on the highest PDCH of the uplink PDCH allocation. Including the USF assigned to the MS on the highest PDCH of the uplink PDCH allocation. Including an invalid RRBP.
6	MS -> SS	UPLINK GPRS RLC DATA BLOCK	Received on the highest PDCH of the uplink PDCH allocation. SI=0
7			Repeat steps 5 and 6 for BSN=1 to 63. SS doesn't acknowledge any of the GPRS RLC data blocks with BSN from 0 to 63 (see note below).
8	SS -> MS	DOWNLINK GPRS RLC DATA BLOCK	Sent on the highest PDCH of the uplink PDCH allocation. Including the USF assigned to the MS on the highest PDCH of the uplink PDCH allocation. Including an invalid RRBP.
9	MS -> SS	UPLINK GPRS RLC DATA BLOCK	Received on the highest PDCH of the uplink PDCH allocation. SI=1
10	SS->MS	PACKET UPLINK ACK/NACK	SS acknowledges the oldest GPRS RLC data block. Sent on the PACCH of the lowest PDCH of the uplink PDCH allocation. Including the TFI assigned to the uplink TBF. Including an USF not assigned to the MS on this PDCH. Wait for 6 blocks with no assigned USF
11	SS -> MS	DOWNLINK GPRS RLC DATA BLOCK	Sent on the highest PDCH of the uplink PDCH allocation. Including the USF assigned to the MS on the highest PDCH of the uplink PDCH allocation. Including an invalid RRBP.
12	MS -> SS	UPLINK GPRS RLC DATA BLOCK	Received on the highest PDCH of the uplink PDCH allocation.
13	SS		The steps 11 and 12 are repeated k times <=8 until V(R) has been incremented by one (i.e. the MS has correctly understood the PACKET UPLINK ACK/NACK).
14	SS -> MS	DOWNLINK GPRS RLC DATA BLOCK	Sent on the highest PDCH of the uplink PDCH allocation. Including the USF assigned to the MS on the highest PDCH of the uplink PDCH allocation. Including an invalid RRBP.
15	MS -> SS	UPLINK GPRS RLC DATA BLOCK	Received on the highest PDCH of the uplink PDCH allocation.
16			The steps 14 and 15 are repeated until a RLC DATA BLOCK with SI=1 is received (see note below).

17	SS->MS	PACKET UPLINK ACK/NACK	SS acknowledges the oldest GPRS RLC data block. Sent on a PDCH common to the downlink and uplink PDCH allocation. Including the TFI of the uplink TBF. Including an USF not assigned to the MS on this PDCH. Wait for 6 blocks with no assigned USF
18	SS -> MS	DOWNLINK GPRS RLC DATA BLOCK	Sent on the highest PDCH of the uplink PDCH allocation. Including the USF assigned to the MS on this PDCH. Including an invalid RRBP.
19	MS -> SS	UPLINK GPRS RLC DATA BLOCK	Received on the highest PDCH of the uplink PDCH allocation.
20	SS		The steps 18 and 19 are repeated k times ≤ 8 until V(R) has been incremented by one (i.e. the MS has correctly understood the PACKET UPLINK ACK/NACK).
21	SS -> MS	DOWNLINK GPRS RLC DATA BLOCK	Sent on the highest PDCH of the uplink PDCH allocation. Including the USF assigned to the MS on the highest PDCH of the uplink PDCH allocation. Including an invalid RRBP.
22	MS -> SS	UPLINK GPRS RLC DATA BLOCK	Received on the highest PDCH of the uplink PDCH allocation.
23			The steps 21 and 22 are repeated until a RLC DATA BLOCK with SI=1 is received (see note below).
24			The steps 17, 18, 19, 20, 21, 22 and 23 are repeated for each PDCH common to the downlink and uplink PDCH allocation.
25	SS->MS	PACKET UPLINK ACK/NACK	SS acknowledges all RLC data block. Sent on a PDCH common to the downlink and uplink PDCH allocation. Including the Polling bit set and a valid RRBP field Including the TFI assigned to the uplink TBF.
26	SS -> MS	DOWNLINK GPRS RLC DATA BLOCK	Sent on the lowest PDCH of the uplink PDCH allocation on the block period preceding the response to the polling requested in step 25. Including the USF assigned to the MS on this PDCH.
27	MS -> SS	UPLINK GPRS RLC/MAC BLOCK	Received during the block period where the polling response should be sent. An UPLINK RLC CONTROL BLOCK should be received on the PDCH where the MS is polled or an UPLINK RLC DATA BLOCK should be received on the other PDCHs.
28			The step 27 is repeated a number of times equal to the number of PDCHs of the uplink PDCH allocation to get all RLC/MAC BLOCK sent by the MS.
29	SS		Verify that the MS did not transmit a RLC data block on the reserved uplink radio block specified by the RRBP on the PDCH where it has been polled. A PACKET CONTROL ACKNOWLEDGEMENT shall be transmitted instead. Verify that the MS has transmitted RLC data blocks on the other PDCHs.
30			The steps 25, 26, 27, 28 and 29 are repeated for each PDCH common to the downlink and uplink PDCH allocation.
31	SS -> MS	DOWNLINK GPRS RLC DATA BLOCK	Sent on a PDCH common to the downlink and uplink PDCH allocation. Including a valid RRBP and FBI = 1. Including an USF not assigned to the MS on this PDCH.
32	MS -> SS	PACKET DOWNLINK ACK/NACK	
33		{Completion of uplink RLC data block transfer in extended dynamic mode}	

NOTE: If the multislot class of the MS under test imposes that the highest PDCH of the uplink allocation is not a member of the downlink allocation, the SS shall transmit a downlink RLC data block on a PDCH common to the downlink and uplink PDCH allocation at least every 5 seconds to avoid expiry of timer T3190. The RLC data block shall be transmitted including an invalid RRBP and an USF not assigned to the MS on this PDCH.

42.9.2.1.5 Extended Dynamic Allocation / Uplink Transfer / Normal / Polling for PDAN

42.9.2.1.5.1 Conformance requirements

In case of simultaneous uplink and downlink TBFs and extended dynamic allocation, the network may apply polling in downlink RLC data blocks only when sent on a PDCH common for both reception and transmission. A mobile station operating with extended dynamic allocation need to respond to polling in downlink RLC data blocks only when received on a PDCH common for both reception and transmission.

References

3GPP TS 44.060, subclause 8.1.2.2.

42.9.2.1.5.2 Test purposes

To verify, in case the MS has a simultaneous uplink and downlink GPRS TBF with Extended Dynamic Allocation MAC mode, that the MS responds to polling when it is polled on blocks belonging to PDCHs common for both reception and transmission.

42.9.2.1.5.3 Method of test

Initial Conditions

System Simulator:

1 cell, default setting.

Mobile Station:

The MS is GPRS attached with a P-TMSI allocated and the test PDP context 2 activated.

Specific PICS Statements

- The GPRS multislot class supported (TSPC_Type_GPRS_Multislot_ClassX, where X = 1..45)

PIXIT Statements

-

Test Procedure

The MS is triggered to initiate a packet uplink data transfer in RLC acknowledged mode and with Extended Dynamic Allocation MAC mode. The SS orders the MS to use two-phase access procedure. Then a concurrent downlink GPRS TBF is established. The PDCH allocation for the downlink and uplink TBFs is chosen to maximise the number of PDCHs common for both reception and transmission.

The SS sends on a PDCH common for both reception and transmission a GPRS RLC data block with polling and checks that the MS responds with a PACKET DOWNLINK ACK/NACK acknowledging the GPRS RLC data block in the uplink radio block specified by RRBP. The test is repeated on all PDCHs common for both reception and transmission.

The following table gives the number of timeslots allocated for the uplink and downlink TBFs during the test according to the multislot class (see 45.002 annex B.1):

Multislot class	Number of PDCHs for the downlink TBF	Number of PDCHs for the uplink TBF
3	1	2
5	2	2
6	2	2
7	2	2
9	3	2
10	3	2
11	3	2
12	3	2
13	3	3
14	4	4
15	5	5
16	6	6
17	7	7
18	8	8
19	6	2
20	6	3
21	6	4
22	6	4
23	6	6
24	8	2
25	8	3
26	8	4
27	8	4
28	8	6
29	8	8
31	4	2
32	3	3
33	3	3
34	3	3
36	4	2
37	3	3
38	3	3
39	3	3
41	5	2
42	4	3
43	4	3
44	4	3
45	4	3

Maximum Duration of Test

1 minute.

Expected Sequence

Step	Direction	Message	Comments
1		{Uplink dynamic allocation two phase access}	Default PACKET UPLINK ASSIGNMENT message content for EDA defined in sub-clause 42.9.1 shall be used. n = 20 octets, without starting time
2	SS -> MS	PACKET DOWNLINK ASSIGNMENT	Default PACKET DOWNLINK ASSIGNMENT message content for EDA defined in sub-clause 42.9.1 shall be used. Sent on the PACCH of the lowest PDCH of the uplink PDCH allocation. Including the polling bit set and a valid RRBP field. Including the TFI assigned to the uplink TBF.
3	MS -> SS	PACKET CONTROL ACKNOWLEDGEMENT	Received on the PACCH of the lowest PDCH of the uplink PDCH allocation.
4	SS -> MS	DOWNLINK GPRS RLC DATA BLOCK	Sent on a PDCH common to the downlink and uplink PDCH allocation. Including the Polling bit set and a valid RRBP field. Including the TFI assigned to the uplink TBF.
5	MS -> SS	PACKET DOWNLINK ACK/NACK	Received on the same PDCH and on the uplink radio block specified by the RRBP.
6	SS		The SS verifies that the MS sends a PACKET DOWNLINK ACK/NACK acknowledging the GPRS RLC data block.
7			The steps 4, 5 and 6 are repeated with each PDCH common to the downlink and uplink PDCH allocation.
8		{Completion of uplink RLC data block transfer in extended dynamic mode}	

42.9.2.2 Extended Dynamic Allocation / Uplink Transfer / Configuration Change

42.9.2.2.1 Extended Dynamic Allocation / Uplink Transfer / configuration change / Changes in the Allocation from Dynamic to Extended Dynamic.

42.9.2.2.1.1 Conformance requirements

When the mobile station receives an uplink assignment (e.g. PACKET UPLINK ASSIGNMENT, MULTIPLE TBF UPLINK ASSIGNMENT, PACKET TIMESLOT RECONFIGURE or MULTIPLE TBF TIMESLOT RECONFIGURE) that does not contain a TBF starting time, the mobile station shall begin monitoring the assigned PDCHs for the assigned USF value for each assigned PDCH within the reaction time defined in 3GPP TS 45.010. If a TBF starting time information element is present and no uplink TBFs are in progress, but one or more downlink TBFs are in progress, the mobile station shall wait until the starting time before beginning to monitor the USFs and using the newly assigned uplink TBF parameters. While waiting for the starting time, the mobile station shall monitor the assigned PDCHs. If a TBF starting time information element is present and one or more uplink TBFs are already in progress, the mobile station shall continue to use the assigned parameters of the ongoing uplink TBFs until the TDMA frame number indicated by the TBF starting time occurs, at which time the mobile station shall immediately begin to use the newly assigned uplink TBF parameters. The mobile station shall continue to use the newly assigned parameters of each uplink TBF until the TBF is either released or reconfigured. If while waiting for the frame number indicated by the TBF starting time the mobile station receives another uplink assignment, the mobile station shall act upon the most recently received uplink assignment and shall ignore the previous uplink assignment.

References

3GPP TS 44.060, subclauses 8.1.1.1

42.9.2.2.1.2 Test purposes

To verify that the MS while on Uplink TBF in Dynamic Allocation mode receives a PACKET UPLINK ASSIGNMENT giving an extended Dynamic Allocation mode continues the TBF in Extended Dynamic Allocation.

42.9.2.2.1.3 Method of test

Initial Conditions

System Simulator:

1 cell, default settings.

Mobile Station:

The MS is GPRS attached with a P-TMSI allocated and the test PDP context 2 activated.

Specific PICS Statements

- The GPRS multislot class supported (TSPC_Type_GPRS_Multislot_ClassX, where X = 1..45)

PIXIT Statements

-

Test Procedure

The MS is triggered to initiate packet uplink transfer data in RLC acknowledged mode. The SS orders the MS to use two-phase access procedure. In PACKET UPLINK ASSIGNMENT SS assigns a dynamic allocation TBF. Upto 2 timeslots are assigned, according to the mobile multislot class (TS 5.02 Annex B.1).

After receiving some data SS reconfigures the TBF to an Extended Dynamic allocation TBF giving upto 4 timeslots according to the mobile multislot class (TS 5.02 Annex B.1), giving PACKET UPLINK ASSIGNMENT. SS checks that MS has started using the TBF in Extended Dynamic allocation mode by giving the USFs only on the lower numbered PDCH and receiving the data on all the higher numbered PDCH.

Maximum Duration of Test

5 minutes.

Expected Sequence

Step	Direction	Message	Comments
1		{Uplink dynamic allocation two phase access}	N = 1500 octets, without starting time, Assigning the TBF in dynamic mode. <u>Up to 2 timeslots are assigned according to MS multislot class (TS 05.02 Annex B.1):</u> - USF ₁ on TN ₁ , - USF ₂ on TN ₂ ,
2	SS -> MS	PACKET DOWNLINK DUMMY CONTROL BLOCK	Assigned USF ₁ on PACCH ₁ addressing the MS sent on 3 blocks from the last radio block containing the uplink assignment.
3	SS -> MS	PACKET DOWNLINK DUMMY CONTROL BLOCK	This step is optional; it is performed only if 2 timeslots have been assigned in step 1. Assigned USF ₂ on PACCH ₂ addressing the MS sent on the same TDMA frame as step 2.
4	MS -> SS	UPLINK RLC DATA BLOCK	Received on the assigned PDTCH ₁ .
5	MS -> SS	UPLINK RLC DATA BLOCK	This step is optional; it is performed only if 2 timeslots have been assigned in step 1. Received on the assigned PDTCH ₂ on the same TDMA frame as in step 4.
6	SS -> MS	PACKET UPLINK ACK/NACK	Assigned USF ₁ on PACCH ₁ addressing the MS.
7	SS -> MS	PACKET DOWNLINK DUMMY CONTROL BLOCK	This step is optional; it is performed only if 2 timeslots have been assigned in step 1. USF on PACCH ₂ is not addressing the MS, sent on the same TDMA frame as step 6
8	MS -> SS	UPLINK RLC DATA BLOCK	Received on the assigned PDTCH ₁ .
9			This step is optional; it is performed only if 2 timeslots have been assigned in step 1. Check that the MS does not send the data on the PDTCH ₂ as the USF sent on the PACCH ₂ in step 7 is not addressing to the MS.
10	SS -> MS	PACKET UPLINK ASSIGNMENT	Sent on PACCH ₁ addressing the MS, without starting time, assigning extended dynamic allocation. <u>Up to 4 timeslots are assigned according to MS multislot class (TS 05.02 Annex B.1):</u> - USF ₁ on TN ₁ , - USF ₂ on TN ₂ , - USF ₃ on TN ₃ , - USF ₄ on TN ₄ ,
11	SS -> MS	PACKET DOWNLINK DUMMY CONTROL BLOCK	Assigned USF ₁ on PACCH ₁ addressing the MS on 3 blocks from the last radio block containing the uplink assignment in step 10.
12	SS -> MS	PACKET DOWNLINK DUMMY CONTROL BLOCK	USF on PACCH ₂ is not addressing the MS, sent on the same TDMA frame as step 11.
13	SS -> MS	PACKET DOWNLINK DUMMY CONTROL BLOCK	This step is optional; it is performed only if 3 timeslots at least have been assigned in step 10. USF on PACCH ₃ is not addressing the MS, sent on the same TDMA frame as step 11.
14	SS -> MS	PACKET DOWNLINK DUMMY CONTROL BLOCK	This step is optional; it is performed only if 4 timeslots have been assigned in step 10. USF on PACCH ₄ is not addressing the MS, sent on the same TDMA frame as step 11.
15	MS -> SS	UPLINK RLC DATA BLOCK	Received on the assigned PDTCH ₁ .
16	MS -> SS	UPLINK RLC DATA BLOCK	Received on the assigned PDTCH ₂ on the same TDMA frame as step 15.
17	MS -> SS	UPLINK RLC DATA BLOCK	This step is optional; it is performed only if 3 timeslots at least have been assigned in step 10. Received on the assigned PDTCH ₃ on the same TDMA frame as step 15.
18	MS -> SS	UPLINK RLC DATA BLOCK	This step is optional; it is performed only if 4 timeslots have been assigned in step 10. Received on the assigned PDTCH ₄ on the same TDMA frame as step 15.

19	SS -> MS	PACKET UPLINK ACK/NACK	Assigned USF ₁ on PACCH ₁ addressing the MS.
20	SS -> MS	PACKET DOWNLINK DUMMY CONTROL BLOCK	USF on PACCH ₂ is not addressing the MS, sent on the same TDMA frame as step 19
21	SS -> MS	PACKET DOWNLINK DUMMY CONTROL BLOCK	This step is optional; it is performed only if 3 timeslots at least have been assigned in step 10. USF on PACCH ₃ is not addressing the MS, sent on the same TDMA frame as step 19
22	SS -> MS	PACKET DOWNLINK DUMMY CONTROL BLOCK	This step is optional; it is performed only if 4 timeslots have been assigned in step 10. USF on PACCH ₄ is not addressing the MS, sent on the same TDMA frame as step 19
23	MS -> SS	UPLINK RLC DATA BLOCK	Received on the assigned PDTCH ₁ .
24	MS -> SS	UPLINK RLC DATA BLOCK	Received on the assigned PDTCH ₂ on the same TDMA frame as step 23
25	MS -> SS	UPLINK RLC DATA BLOCK	This step is optional; it is performed only if 3 timeslots at least have been assigned in step 10. Received on the assigned PDTCH ₃ on the same TDMA frame as step 23.
26	MS -> SS	UPLINK RLC DATA BLOCK	This step is optional; it is performed only if 4 timeslots have been assigned in step 10. Received on the assigned PDTCH ₄ on the same TDMA frame as step 23.
27		{Completion of uplink RLC data block transfer in extended dynamic mode}	

Specific Message Contents

None.

42.9.2.2.2 Extended Dynamic Allocation / Uplink Transfer / configuration change / Changes in the Allocation from Extended Dynamic to Dynamic.

42.9.2.2.2.1 Conformance requirements

When the mobile station receives an uplink assignment (e.g. PACKET UPLINK ASSIGNMENT, MULTIPLE TBF UPLINK ASSIGNMENT, PACKET TIMESLOT RECONFIGURE or MULTIPLE TBF TIMESLOT RECONFIGURE) that does not contain a TBF starting time, the mobile station shall begin monitoring the assigned PDCHs for the assigned USF value for each assigned PDCH within the reaction time defined in 3GPP TS 45.010. If a TBF starting time information element is present and no uplink TBFs are in progress, but one or more downlink TBFs are in progress, the mobile station shall wait until the starting time before beginning to monitor the USFs and using the newly assigned uplink TBF parameters. While waiting for the starting time, the mobile station shall monitor the assigned PDCHs. If a TBF starting time information element is present and one or more uplink TBFs are already in progress, the mobile station shall continue to use the assigned parameters of the ongoing uplink TBFs until the TDMA frame number indicated by the TBF starting time occurs, at which time the mobile station shall immediately begin to use the newly assigned uplink TBF parameters. The mobile station shall continue to use the newly assigned parameters of each uplink TBF until the TBF is either released or reconfigured. If while waiting for the frame number indicated by the TBF starting time the mobile station receives another uplink assignment, the mobile station shall act upon the most recently received uplink assignment and shall ignore the previous uplink assignment.

References

3GPP TS 44.060, subclauses 8.1.1.1

42.9.2.2.2.2 Test purposes

To verify that the MS while on Uplink TBF in Extended Dynamic Allocation mode receives a PACKET UPLINK ASSIGNMENT giving a Dynamic Allocation mode continues the TBF in Dynamic Allocation.

42.9.2.2.2.3 Method of test

Initial Conditions

System Simulator:

1 cell, default settings.

Mobile Station:

The MS is GPRS attached with a P-TMSI allocated and the test PDP context 2 activated.

Specific PICS Statements

- The GPRS multislot class supported (TSPC_Type_GPRS_Multislot_ClassX, where X = 1..45)

PIXIT Statements

-

Test Procedure

The MS is triggered to initiate packet uplink transfer data in RLC acknowledged mode. The SS orders the MS to use two-phase access procedure. In PACKET UPLINK ASSIGNMENT SS assigns an extended dynamic allocation TBF. Upto 4 timeslots are assigned, according to the mobile multislot class (TS 5.02 Annex B.1).

After receiving some data SS reconfigures the TBF to a Dynamic Allocation giving upto 2 timeslots according to the mobile multislot class (TS 5.02 Annex B.1), by giving a PACKET UPLINK ASSIGNMENT. SS checks that MS has started using the TBF now in dynamic allocation mode by checking that the MS is sending data only on the timeslot where the USF is assigned.

Maximum Duration of Test

5 minutes.

Expected Sequence

Step	Direction	Message	Comments
1		{Uplink dynamic allocation two phase access}	N = 1500 octets, without starting time, Assigning the TBF in extended dynamic mode. <u>Up to 4 timeslots are assigned according to MS multislot class (TS 05.02 Annex B.1) :</u> <ul style="list-style-type: none"> - USF₁ on TN₁, - USF₂ on TN₂, - USF₃ on TN₃, - USF₄ on TN₄,
2	SS -> MS	PACKET DOWNLINK DUMMY CONTROL BLOCK	Assigned USF ₁ on PACCH ₁ addressing the MS. Sent on third block from the last radio block containing the uplink assignment in step 1.
3	SS -> MS	PACKET DOWNLINK DUMMY CONTROL BLOCK	USF on PACCH ₂ is not addressing the MS, sent on the same TDMA frame as step 2.
4	SS -> MS	PACKET DOWNLINK DUMMY CONTROL BLOCK	This step is optional; it is performed only if 3 timeslots at least have been assigned in step 1. USF on PACCH ₃ is not addressing the MS, sent on the same TDMA frame as step 2.
5	SS -> MS	PACKET DOWNLINK DUMMY CONTROL BLOCK	This step is optional; it is performed only if 4 timeslots have been assigned in step 1. USF on PACCH ₄ is not addressing the MS, sent on the same TDMA frame as step 2.
6	MS -> SS	UPLINK RLC DATA BLOCK	Received on the assigned PDTCH ₁ .
7	MS -> SS	UPLINK RLC DATA BLOCK	Received on the assigned PDTCH ₂ on the same TDMA frame as step 6.
8	MS -> SS	UPLINK RLC DATA BLOCK	This step is optional; it is performed only if 3 timeslots at least have been assigned in step 1. Received on the assigned PDTCH ₃ on the same TDMA frame as step 6.
9	MS -> SS	UPLINK RLC DATA BLOCK	This step is optional; it is performed only if 4 timeslots have been assigned in step 1. Received on the assigned PDTCH ₄ on the same TDMA frame as step 6.
10	SS -> MS	PACKET UPLINK ACK/NACK	Assigned USF ₁ on PACCH ₁ addressing the MS.
11	SS -> MS	PACKET DOWNLINK DUMMY CONTROL BLOCK	USF on PACCH ₂ is not addressing the MS, sent on the same TDMA frame as step 10
12	SS -> MS	PACKET DOWNLINK DUMMY CONTROL BLOCK	This step is optional; it is performed only if 3 timeslots at least have been assigned in step 1. USF on PACCH ₃ is not addressing the MS, sent on the same TDMA frame as step 10
13	SS -> MS	PACKET DOWNLINK DUMMY CONTROL BLOCK	This step is optional; it is performed only if 4 timeslots have been assigned in step 1. USF on PACCH ₄ is not addressing the MS, sent on the same TDMA frame as step 10
14	MS -> SS	UPLINK RLC DATA BLOCK	Received on the assigned PDTCH ₁ .
15	MS -> SS	UPLINK RLC DATA BLOCK	Received on the assigned PDTCH ₂ on the same TDMA frame as step 14
16	MS -> SS	UPLINK RLC DATA BLOCK	This step is optional; it is performed only if 3 timeslots at least have been assigned in step 1. Received on the assigned PDTCH ₃ on the same TDMA frame as step 14.
17	MS -> SS	UPLINK RLC DATA BLOCK	This step is optional; it is performed only if 4 timeslots have been assigned in step 1. Received on the assigned PDTCH ₄ on the same TDMA frame as step 14.
18		PACKET UPLINK ASSIGNMENT	Reconfigures the TBF. <u>Up to 2 timeslots are assigned according to MS multislot class (TS 05.02 Annex B.1) :</u> <ul style="list-style-type: none"> - USF₁ on TN₁, - USF₂ on TN₂,

19	SS -> MS	PACKET DOWNLINK DUMMY CONTROL BLOCK	Assigned USF ₁ on PACCH ₁ addressing the MS. Sent on third block from the last radio block containing the uplink assignment.
20	SS -> MS	PACKET DOWNLINK DUMMY CONTROL BLOCK	This step is optional; it is performed only if 2 timeslots have been assigned in step 18. Assigned USF ₂ on PACCH ₂ addressing the MS sent on the same TDMA frame as step 19.
21	MS -> SS	UPLINK RLC DATA BLOCK	Received on the assigned PDTCH ₁ .
22	MS -> SS	UPLINK RLC DATA BLOCK	This step is optional; it is performed only if 2 timeslots have been assigned in step 18. Received on the assigned PDTCH ₂ on the same TDMA frame as step 21.
23	SS -> MS	PACKET UPLINK ACK/NACK	Assigned USF ₁ on PACCH ₁ addressing the MS.
24	SS -> MS	PACKET DOWNLINK DUMMY CONTROL BLOCK	This step is optional; it is performed only if 2 timeslots have been assigned in step 18. USF on PACCH ₂ is not addressing the MS, sent on the same TDMA frame as step 23
25	MS -> SS	UPLINK RLC DATA BLOCK	Received on the assigned PDTCH ₁ .
26			This step is optional; it is performed only if 2 timeslots have been assigned in step 18. Check that the MS does not send the data on the PDTCH ₂ as the USF sent on the PACCH ₂ , step 24 is not addressing to the MS.
27		{Completion of uplink RLC data block transfer}	

Specific Message Contents

None.

42.9.2.2.3 Extended Dynamic Allocation / Uplink Transfer / configuration change / Reduction in number of uplink slots using PACKET UPLINK ASSIGNMENT.

42.9.2.2.3.1 Conformance requirements

When the mobile station receives an uplink assignment (e.g. PACKET UPLINK ASSIGNMENT, MULTIPLE TBF UPLINK ASSIGNMENT, PACKET TIMESLOT RECONFIGURE or MULTIPLE TBF TIMESLOT RECONFIGURE) that does not contain a TBF starting time, the mobile station shall begin monitoring the assigned PDCHs for the assigned USF value for each assigned PDCH within the reaction time defined in 3GPP TS 45.010. If a TBF starting time information element is present and no uplink TBFs are in progress, but one or more downlink TBFs are in progress, the mobile station shall wait until the starting time before beginning to monitor the USFs and using the newly assigned uplink TBF parameters. While waiting for the starting time, the mobile station shall monitor the assigned PDCHs. If a TBF starting time information element is present and one or more uplink TBFs are already in progress, the mobile station shall continue to use the assigned parameters of the ongoing uplink TBFs until the TDMA frame number indicated by the TBF starting time occurs, at which time the mobile station shall immediately begin to use the newly assigned uplink TBF parameters. The mobile station shall continue to use the newly assigned parameters of each uplink TBF until the TBF is either released or reconfigured. If while waiting for the frame number indicated by the TBF starting time the mobile station receives another uplink assignment, the mobile station shall act upon the most recently received uplink assignment and shall ignore the previous uplink assignment.

References

3GPP TS 44.060, subclauses 8.1.1.1

42.9.2.2.3.2 Test purposes

To verify that the MS:

While in extended Dynamic mode TBF, if the number of slots allocated is reduced by using PACKET UPLINK ASSIGNMENT, then MS adheres to the new allocation properly.

42.9.2.2.3.3 Method of test

Initial Conditions

System Simulator:

1 cell, default setting,

Mobile Station:

The MS is GPRS attached with a P-TMSI allocated and the test PDP context 2 activated.

Specific PICS Statements

- The GPRS multislot class supported (TSPC_Type_GPRS_Multislot_ClassX, where X = 1..45)

PIXIT Statements

-

Test Procedure

The MS is triggered to initiate packet uplink transfer data in RLC acknowledged mode. The SS orders the MS to use two-phase access procedure. In PACKET UPLINK ASSIGNMENT SS assigns a extended dynamic allocation TBF. Upto 4 timeslots are assigned, according to the mobile multislot class (TS 5.02 Annex B.1).

After receiving some data, SS reconfigures the TBF to a have one slot less then given earlier, giving PACKET UPLINK ASSIGNMENT. SS checks that MS using the new timeslot configuration properly.

Maximum Duration of Test

5 minutes.

Expected Sequence

Step	Direction	Message	Comments
1		{Uplink dynamic allocation two phase access}	N = 1500 octets, without starting time, Assigning the TBF in extended dynamic mode. <u>Up to 4 timeslots are assigned according to MS multislot class (TS 05.02 Annex B.1) :</u> <ul style="list-style-type: none"> - USF₁ on TN₁, - USF₂ on TN₂, - USF₃ on TN₃, - USF₄ on TN₄,
2	SS -> MS	PACKET DOWNLINK DUMMY CONTROL BLOCK	Assigned USF ₁ on PACCH ₁ addressing the MS. Sent on third block from the last radio block containing the uplink assignment.
3	SS -> MS	PACKET DOWNLINK DUMMY CONTROL BLOCK	USF on PACCH ₂ is not addressing the MS, sent on the same TDMA frame as step 2.
4	SS -> MS	PACKET DOWNLINK DUMMY CONTROL BLOCK	This step is optional; it is performed only if 3 timeslots at least have been assigned in step 1. USF on PACCH ₃ is not addressing the MS, sent on the same TDMA frame as step 2.
5	SS -> MS	PACKET DOWNLINK DUMMY CONTROL BLOCK	This step is optional; it is performed only if 4 timeslots have been assigned in step 1. USF on PACCH ₄ is not addressing the MS, sent on the same TDMA frame as step 2.
6	MS -> SS	UPLINK RLC DATA BLOCK	Received on the assigned PDTCH ₁ .
7	MS -> SS	UPLINK RLC DATA BLOCK	Received on the assigned PDTCH ₂ on the same TDMA frame as step 6.
8	MS -> SS	UPLINK RLC DATA BLOCK	This step is optional; it is performed only if 3 timeslots at least have been assigned in step 1. Received on the assigned PDTCH ₃ on the same TDMA frame as step 6.
9	MS -> SS	UPLINK RLC DATA BLOCK	This step is optional; it is performed only if 4 timeslots have been assigned in step 1. Received on the assigned PDTCH ₄ on the same TDMA frame as step 6.
10	SS -> MS	PACKET UPLINK ACK/NACK	Assigned USF ₁ on PACCH ₁ addressing the MS.
11	SS -> MS	PACKET DOWNLINK DUMMY CONTROL BLOCK	USF on PACCH ₂ is not addressing the MS, sent on the same TDMA frame as step 10
12	SS -> MS	PACKET DOWNLINK DUMMY CONTROL BLOCK	This step is optional; it is performed only if 3 timeslots at least have been assigned in step 1. USF on PACCH ₃ is not addressing the MS, sent on the same TDMA frame as step 10
13	SS -> MS	PACKET DOWNLINK DUMMY CONTROL BLOCK	This step is optional; it is performed only if 4 timeslots have been assigned in step 1. USF on PACCH ₄ is not addressing the MS, sent on the same TDMA frame as step 10
14	MS -> SS	UPLINK RLC DATA BLOCK	Received on the assigned PDTCH ₁ .
15	MS -> SS	UPLINK RLC DATA BLOCK	Received on the assigned PDTCH ₂ on the same TDMA frame as step 14
16	MS -> SS	UPLINK RLC DATA BLOCK	This step is optional; it is performed only if 3 timeslots at least have been assigned in step 1. Received on the assigned PDTCH ₃ on the same TDMA frame as step 14.
17	MS -> SS	UPLINK RLC DATA BLOCK	This step is optional; it is performed only if 4 timeslots have been assigned in step 1. Received on the assigned PDTCH ₄ on the same TDMA frame as step 14.
18	SS -> MS	PACKET UPLINK ASSIGNMENT	SS reconfigures the TBF. Assignment assigns a starting time of 104 frames. This assignment reduces the number of slots by one as compared to the earlier allocation given in step 1. the highest numbered PDCH assigned in step 1 is removed from the allocation.
19	SS -> MS	PACKET DOWNLINK DUMMY CONTROL BLOCK	Assigned USF ₁ on PACCH ₁ addressing the MS. Send on 3 blocks before the starting time given in step 18.

20	SS -> MS	PACKET DOWNLINK DUMMY CONTROL BLOCK	USF on PACCH ₂ is not addressing the MS, sent on the same TDMA frame as step 19.
21	SS -> MS	PACKET DOWNLINK DUMMY CONTROL BLOCK	This step is optional; it is performed only if 3 timeslots at least have been assigned in step 1. USF on PACCH ₃ is not addressing the MS, sent on the same TDMA frame as step 19.
22	SS -> MS	PACKET DOWNLINK DUMMY CONTROL BLOCK	This step is optional; it is performed only if 4 timeslots have been assigned in step 1. USF on PACCH ₄ is not addressing the MS, sent on the same TDMA frame as step 19.
23	MS -> SS	UPLINK RLC DATA BLOCK	Received on the assigned PDTCH ₁ .
24	MS -> SS	UPLINK RLC DATA BLOCK	Received on the assigned PDTCH ₂ on the same TDMA frame as step 23.
25	MS -> SS	UPLINK RLC DATA BLOCK	This step is optional; it is performed only if 3 timeslots at least have been assigned in step 1. Received on the assigned PDTCH ₃ on the same TDMA frame as step 23.
26	MS -> SS	UPLINK RLC DATA BLOCK	This step is optional; it is performed only if 4 timeslots have been assigned in step 1. Received on the assigned PDTCH ₄ on the same TDMA frame as step 23.
27	SS -> MS	PACKET DOWNLINK DUMMY CONTROL BLOCK	Assigned USF addressing the MS. Sent on the highest numbered PDCH assigned in step 1. Send on next block of the one specified by the starting time in step 18. USF on the other lowered numbered PDCHs are not addressing the MS.
28			SS checks that the MS does not send any uplink data block in next block of the message sent in step 27.
29	SS -> MS	PACKET DOWNLINK DUMMY CONTROL BLOCK	USF on PACCH ₁ is addressing the MS.
30	SS -> MS	PACKET DOWNLINK DUMMY CONTROL BLOCK	This step is optional; it is performed only if at least 2 timeslots have been assigned in step 18. USF on PACCH ₂ is not addressing the MS. Sent on the same TDMA frame as step 29.
31	SS -> MS	PACKET DOWNLINK DUMMY CONTROL BLOCK	This step is optional; it is performed only if at least 3 timeslots have been assigned in step 18. USF on PACCH ₃ is not addressing the MS, sent on the same TDMA frame as step 29.
32	MS -> SS	UPLINK RLC DATA BLOCK	Received on the assigned PDTCH ₁ .
33	MS -> SS	UPLINK RLC DATA BLOCK	This step is optional; it is performed only if at least 2 timeslots have been assigned in step 18. Received on the assigned PDTCH ₂ on the same TDMA frame as step 32.
34	MS -> SS	UPLINK RLC DATA BLOCK	This step is optional; it is performed only if at least 3 timeslots have been assigned in step 18. Received on the assigned PDTCH ₃ on the same TDMA frame as step 32.
35		{Completion of uplink RLC data block transfer in extended dynamic mode}	

Specific Message Contents

None.

42.9.2.2.4 Extended Dynamic Allocation / Uplink Transfer / configuration change / Reduction in number of uplink slots using PACKET PDCH RELEASE.

42.9.2.2.4.1 Conformance requirements

When the mobile station receives an uplink assignment (e.g. PACKET UPLINK ASSIGNMENT, MULTIPLE TBF UPLINK ASSIGNMENT, PACKET TIMESLOT RECONFIGURE or MULTIPLE TBF TIMESLOT RECONFIGURE) that does not contain a TBF starting time, the mobile station shall begin monitoring the assigned PDCHs for the assigned USF value for each assigned PDCH within the reaction time defined in 3GPP TS 45.010. If a TBF starting time information element is present and no uplink TBFs are in progress, but one or more downlink TBFs

are in progress, the mobile station shall wait until the starting time before beginning to monitor the USFs and using the newly assigned uplink TBF parameters. While waiting for the starting time, the mobile station shall monitor the assigned PDCHs. If a TBF starting time information element is present and one or more uplink TBFs are already in progress, the mobile station shall continue to use the assigned parameters of the ongoing uplink TBFs until the TDMA frame number indicated by the TBF starting time occurs, at which time the mobile station shall immediately begin to use the newly assigned uplink TBF parameters. The mobile station shall continue to use the newly assigned parameters of each uplink TBF until the TBF is either released or reconfigured. If while waiting for the frame number indicated by the TBF starting time the mobile station receives another uplink assignment, the mobile station shall act upon the most recently received uplink assignment and shall ignore the previous uplink assignment.

References

3GPP TS 44.060, subclauses 8.1.1.1

42.9.2.2.4.2 Test purposes

To verify that the MS:

While in extended Dynamic mode TBF, if the number of slots allocated is reduced by using PACKET PDCH RELEASE, then MS adheres to the new allocation properly.

42.9.2.2.4.3 Method of test

Initial Conditions

System Simulator:

1 cell, default setting,

Mobile Station:

The MS is GPRS attached with a P-TMSI allocated and the test PDP context 2 activated.

Specific PICS Statements

- The GPRS multislot class supported (TSPC_Type_GPRS_Multislot_ClassX, where X = 1..45)

PIXIT Statements

-

Test Procedure

The MS is triggered to initiate packet uplink transfer data in RLC acknowledged mode. The SS orders the MS to use two-phase access procedure. In PACKET UPLINK ASSIGNMENT SS assigns a extended dynamic allocation TBF. Upto 4 timeslots are assigned, according to the mobile multislot class (TS 5.02 Annex B.1).

After receiving some data, SS reconfigures the TBF to a have one slot less then given earlier, giving PACKET PDCH RELEASE. SS checks that MS using the new timeslot configuration properly.

Maximum Duration of Test

5 minutes.

Expected Sequence

Step	Direction	Message	Comments
1		{Uplink dynamic allocation two phase access}	N = 1500 octets, without starting time, Assigning the TBF in extended dynamic mode. <u>Up to 4 timeslots are assigned according to MS multislot class (TS 05.02 Annex B.1) :</u> <ul style="list-style-type: none"> - USF₁ on TN₁, - USF₂ on TN₂, - USF₃ on TN₃, - USF₄ on TN₄,
2	SS -> MS	PACKET DOWNLINK DUMMY CONTROL BLOCK	Assigned USF ₁ on PACCH ₁ addressing the MS. Sent on third block from the last radio block containing the uplink assignment.
3	SS -> MS	PACKET DOWNLINK DUMMY CONTROL BLOCK	USF on PACCH ₂ is not addressing the MS, sent on the same TDMA frame as step 2.
4	SS -> MS	PACKET DOWNLINK DUMMY CONTROL BLOCK	This step is optional; it is performed only if 3 timeslots at least have been assigned in step 1. USF on PACCH ₃ is not addressing the MS, sent on the same TDMA frame as step 2.
5	SS -> MS	PACKET DOWNLINK DUMMY CONTROL BLOCK	This step is optional; it is performed only if 4 timeslots have been assigned in step 1. USF on PACCH ₄ is not addressing the MS, sent on the same TDMA frame as step 2.
6	MS -> SS	UPLINK RLC DATA BLOCK	Received on the assigned PDTCH ₁ .
7	MS -> SS	UPLINK RLC DATA BLOCK	Received on the assigned PDTCH ₂ on the same TDMA frame as step 6.
8	MS -> SS	UPLINK RLC DATA BLOCK	This step is optional; it is performed only if 3 timeslots at least have been assigned in step 1. Received on the assigned PDTCH ₃ on the same TDMA frame as step 6.
9	MS -> SS	UPLINK RLC DATA BLOCK	This step is optional; it is performed only if 4 timeslots have been assigned in step 1. Received on the assigned PDTCH ₄ on the same TDMA frame as step 6.
10	SS -> MS	PACKET UPLINK ACK/NACK	Assigned USF ₁ on PACCH ₁ addressing the MS.
11	SS -> MS	PACKET DOWNLINK DUMMY CONTROL BLOCK	USF on PACCH ₂ is not addressing the MS, sent on the same TDMA frame as step 10
12	SS -> MS	PACKET DOWNLINK DUMMY CONTROL BLOCK	This step is optional; it is performed only if 3 timeslots at least have been assigned in step 1. USF on PACCH ₃ is not addressing the MS, sent on the same TDMA frame as step 10
13	SS -> MS	PACKET DOWNLINK DUMMY CONTROL BLOCK	This step is optional; it is performed only if 4 timeslots have been assigned in step 1. USF on PACCH ₄ is not addressing the MS, sent on the same TDMA frame as step 10
14	MS -> SS	UPLINK RLC DATA BLOCK	Received on the assigned PDTCH ₁ .
15	MS -> SS	UPLINK RLC DATA BLOCK	Received on the assigned PDTCH ₂ on the same TDMA frame as step 14
16	MS -> SS	UPLINK RLC DATA BLOCK	This step is optional; it is performed only if 3 timeslots at least have been assigned in step 1. Received on the assigned PDTCH ₃ on the same TDMA frame as step 14.
17	MS -> SS	UPLINK RLC DATA BLOCK	This step is optional; it is performed only if 4 timeslots have been assigned in step 1. Received on the assigned PDTCH ₄ on the same TDMA frame as step 14.
18	SS -> MS	PACKET PDCH RELEASE	TIMESLOT_AVAILABLE indicating that the number of slots available is reduced by 1. Highest numbered timeslot assigned in step 1 is released.
19	SS -> MS	PACKET DOWNLINK DUMMY CONTROL BLOCK	Assigned USF addressing the MS. Sent on the PDCH released in step 18. It is sent on the 7 th block from the message sent in step 18.

20			SS checks that the MS does not send any uplink data block in next block of the message sent in step 19.
21	SS -> MS	PACKET DOWNLINK DUMMY CONTROL BLOCK	USF on PACCH ₁ is addressing the MS.
22	SS -> MS	PACKET DOWNLINK DUMMY CONTROL BLOCK	This step is optional; it is performed only if at least 2 timeslots are available after PDCH release in step 18. USF on PACCH ₂ is not addressing the MS. Sent on the same TDMA frame as step 21.
23	SS -> MS	PACKET DOWNLINK DUMMY CONTROL BLOCK	This step is optional; it is performed only if at least 3 timeslots are available after PDCH release in step 18. USF on PACCH ₃ is not addressing the MS, sent on the same TDMA frame as step 21.
24	MS -> SS	UPLINK RLC DATA BLOCK	Received on the assigned PDTCH ₁ .
25	MS -> SS	UPLINK RLC DATA BLOCK	This step is optional; it is performed only if at least 2 timeslots are available after PDCH release in step 18. Received on the assigned PDTCH ₂ on the same TDMA frame as step 24.
26	MS -> SS	UPLINK RLC DATA BLOCK	This step is optional; it is performed only if at least 3 timeslots are available after PDCH release in step 18. Received on the assigned PDTCH ₃ on the same TDMA frame as step 24.
27		{Completion of uplink RLC data block transfer in extended dynamic mode}	

Specific Message Contents

None.

42.9.2.2.5 Extended Dynamic Allocation / Uplink Transfer / configuration change / Increase in number of uplink slots.

42.9.2.2.5.1 Conformance requirements

When the mobile station receives an uplink assignment (e.g. PACKET UPLINK ASSIGNMENT, MULTIPLE TBF UPLINK ASSIGNMENT, PACKET TIMESLOT RECONFIGURE or MULTIPLE TBF TIMESLOT RECONFIGURE) that does not contain a TBF starting time, the mobile station shall begin monitoring the assigned PDCHs for the assigned USF value for each assigned PDCH within the reaction time defined in 3GPP TS 45.010. If a TBF starting time information element is present and no uplink TBFs are in progress, but one or more downlink TBFs are in progress, the mobile station shall wait until the starting time before beginning to monitor the USFs and using the newly assigned uplink TBF parameters. While waiting for the starting time, the mobile station shall monitor the assigned PDCHs. If a TBF starting time information element is present and one or more uplink TBFs are already in progress, the mobile station shall continue to use the assigned parameters of the ongoing uplink TBFs until the TDMA frame number indicated by the TBF starting time occurs, at which time the mobile station shall immediately begin to use the newly assigned uplink TBF parameters. The mobile station shall continue to use the newly assigned parameters of each uplink TBF until the TBF is either released or reconfigured. If while waiting for the frame number indicated by the TBF starting time the mobile station receives another uplink assignment, the mobile station shall act upon the most recently received uplink assignment and shall ignore the previous uplink assignment.

References

3GPP TS 44.060, subclauses 8.1.1.1

42.9.2.2.5.2 Test purposes

To verify that the MS:

While in extended Dynamic mode TBF, if the number of slots is increased then MS adheres to the new allocation properly.

42.9.2.2.5.3 Method of test

Initial Conditions

System Simulator:

1 cell, default setting,

Mobile Station:

The MS is GPRS attached with a P-TMSI allocated and the test PDP context 2 activated.

Specific PICS Statements

- The GPRS multislot class supported (TSPC_Type_GPRS_Multislot_ClassX, where X = 1..45)

PIXIT Statements

-

Test Procedure

The MS is triggered to initiate packet uplink transfer data in RLC acknowledged mode. The SS orders the MS to use two-phase access procedure. In PACKET UPLINK ASSIGNMENT SS assigns a extended dynamic allocation TBF. Upto 3 timeslots are assigned, One slot less than the allowed by MS multislot class (TS 5.02 Annex B.1).

After receiving some data SS reconfigures the TBF to a have one slot more then given earlier, by giving PACKET UPLINK ASSIGNMENT. The new slot assigned is assigned towards the lower end. SS checks that MS using the MS is using the new timeslot configuration properly.

Maximum Duration of Test

10 minutes.

Expected Sequence

Step	Direction	Message	Comments
1		{Uplink dynamic allocation two phase access}	N = 1500 octets, without starting time, Assigning the TBF in extended dynamic mode. <u>One slot less (Up to 3 timeslots are assigned) than the allowed limit according to MS multislot class (TS 05.02 Annex B.1):</u> <ul style="list-style-type: none"> - USF₂ on TN₂, - USF₃ on TN₃, - USF₄ on TN₄,
2	SS -> MS	PACKET DOWNLINK DUMMY CONTROL BLOCK	Assigned USF ₂ on PACCH ₂ addressing the MS on 3 blocks from the last radio block containing the uplink assignment.
3	SS -> MS	PACKET DOWNLINK DUMMY CONTROL BLOCK	This step is optional; it is performed only if 2 timeslots at least have been assigned in step 1. USF on PACCH ₃ is not addressing the MS, sent on the same TDMA frame as step 2.
4	SS -> MS	PACKET DOWNLINK DUMMY CONTROL BLOCK	This step is optional; it is performed only if 3 timeslots at least have been assigned in step 1. USF on PACCH ₄ is not addressing the MS, sent on the same TDMA frame as step 2.
5	MS -> SS	UPLINK RLC DATA BLOCK	Received on the assigned PDTCH ₂ .
6	MS -> SS	UPLINK RLC DATA BLOCK	This step is optional; it is performed only if 2 timeslots at least have been assigned in step 1. Received on the assigned PDTCH ₃ on the same TDMA frame as step 5.
7	MS -> SS	UPLINK RLC DATA BLOCK	This step is optional; it is performed only if 3 timeslots at least have been assigned in step 1. Received on the assigned PDTCH ₄ on the same TDMA frame as step 5.
8	SS -> MS	PACKET UPLINK ACK/NACK	Assigned USF ₂ on PACCH ₂ addressing the MS.
9	SS -> MS	PACKET DOWNLINK DUMMY CONTROL BLOCK	This step is optional; it is performed only if 2 timeslots at least have been assigned in step 1. USF on PACCH ₃ is not addressing the MS, sent on the same TDMA frame as step 8.
10	SS -> MS	PACKET DOWNLINK DUMMY CONTROL BLOCK	This step is optional; it is performed only if 3 timeslots at least have been assigned in step 1. USF on PACCH ₄ is not addressing the MS, sent on the same TDMA frame as step 8.
11	MS -> SS	UPLINK RLC DATA BLOCK	Received on the assigned PDTCH ₂ .
12	MS -> SS	UPLINK RLC DATA BLOCK	This step is optional; it is performed only if 2 timeslots at least have been assigned in step 1. Received on the assigned PDTCH ₃ on the same TDMA frame as step 11
13	MS -> SS	UPLINK RLC DATA BLOCK	This step is optional; it is performed only if 3 timeslots at least have been assigned in step 1. Received on the assigned PDTCH ₄ on the same TDMA frame as step 11.
14	SS -> MS	PACKET UPLINK ASSIGNMENT	SS reconfigures the TBF. Assignment assigns a starting time of 104 frames. Number of slots is increased by one from the earlier allocation given in step 1. The slot is assigned at the lower end, i.e. TN ₁ is assigned with USF ₁ associated with it.
15	SS -> MS	PACKET DOWNLINK DUMMY CONTROL BLOCK	Assigned USF ₁ on PACCH ₁ addressing the MS. Send on three blocks before the starting time given in step 14.
16	SS -> MS	PACKET DOWNLINK DUMMY CONTROL BLOCK	Assigned USF ₂ on PACCH ₂ addressing the MS. Send on three blocks before the starting time given in step 14.
17	SS -> MS	PACKET DOWNLINK DUMMY CONTROL BLOCK	This step is optional; it is performed only if 2 timeslots at least have been assigned in step 1. USF on PACCH ₃ is not addressing the MS, sent on the same TDMA frame as step 15.

18	SS -> MS	PACKET DOWNLINK DUMMY CONTROL BLOCK	This step is optional; it is performed only if 3 timeslots at least have been assigned in step 1. USF on PACCH ₄ is not addressing the MS, sent on the same TDMA frame as step 15.
19			SS checks that the MS does not send any data block on PDTCH ₁ .
20	MS -> SS	UPLINK RLC DATA BLOCK	Received on the assigned PDTCH ₂ .
21	MS -> SS	UPLINK RLC DATA BLOCK	This step is optional; it is performed only if 2 timeslots at least have been assigned in step 1 Received on the assigned PDTCH ₃ on the same TDMA frame as step 20.
22	MS -> SS	UPLINK RLC DATA BLOCK	This step is optional; it is performed only if 3 timeslots at least have been assigned in step 1. Received on the assigned PDTCH ₄ on the same TDMA frame as step 20.
23	SS -> MS	PACKET DOWNLINK DUMMY CONTROL BLOCK	Assigned USF addressing the MS. Sent on the lowest numbered PDCH assigned in step 14. Send on the next block of the block given by starting time in step 14. USF on the other PDCHs are not addressing the MS.
24	MS -> SS	UPLINK RLC DATA BLOCK	Received on the assigned PDTCH ₁ .
25	MS -> SS	UPLINK RLC DATA BLOCK	Received on the assigned PDTCH ₂ on the same TDMA frame as step 24.
26	MS -> SS	UPLINK RLC DATA BLOCK	This step is optional; it is performed only if 3 timeslots at least have been assigned in step 14. Received on the assigned PDTCH ₃ on the same TDMA frame as step 24.
27	MS -> SS	UPLINK RLC DATA BLOCK	This step is optional; it is performed only if 4 timeslots have been assigned in step 14. Received on the assigned PDTCH ₄ on the same TDMA frame as step 24.
28		{Completion of uplink RLC data block transfer in extended dynamic mode}	

Specific Message Contents

None.

42.9.3 Extended Dynamic Allocation / Shifted USF

42.9.3.1 Extended Dynamic Allocation / Shifted USF / Normal

42.9.3.1.1 Extended Dynamic Allocation / Shifted USF / Normal / PACCH management

42.9.3.1.1.1 Conformance requirements

When Shifted USF operation is used, PACCH operation shall be as described in sub-clause 8.1.1.2.2 except that the network shall transmit all PACCH messages on the PDCH carried on the second lowest numbered timeslot in the allocation, and the mobile station shall attempt to decode every downlink RLC/MAC block on the second lowest numbered timeslot in the PDCH allocation.

References

3GPP TS 44.060, sub-clause 8.1.1.2.4.

42.9.3.1.1.2 Test purposes

To verify that when the MS is configured for a multi-slot uplink data transfer with shifted USF operation in use, it will decode a PACCH message sent to the MS on the second lowest numbered timeslot in the PDCH assignment.

42.9.3.1.1.3 Method of test

Initial Conditions

System Simulator:

1 cell, default setting,

Mobile Station:

The MS is GPRS attached with a P-TMSI allocated and the test PDP context 2 activated.

Specific PICS Statements

- The GPRS multislot class supported (TSPC_Type_GPRS_Multislot_ClassX, where X = 1..45)

PIXIT Statements

-

Test Procedure

The MS is triggered to initiate packet uplink transfer in RLC acknowledged mode, with Extended Dynamic Allocation MAC mode. The SS orders the MS to use two-phase access procedure, in a PACKET UPLINK ASSIGNMENT. The maximum number of UL timeslots is assigned, according to the mobile multislot class (TS 45.002 Annex B.1).

The SS sends to the MS a PACKET DOWNLINK ASSIGNMENT message on the second lowest numbered timeslot in the PDCH assignment, together with a valid RRBP and the TFI assigned to the uplink TBF. It is checked that the MS responds with a PACKET CONTROL ACKNOWLEDGEMENT on the same timeslot.

The SS completes the data transfer.

Maximum Duration of Test

1 minute.

Expected Sequence

Step	Direction	Message	Comments
1		{Uplink dynamic allocation two phase access}	n = 40 octets, without starting time, Up to 6 consecutive timeslots are assigned according to MS multislot class (TS 45.002 Annex B.1): - USF ₁ on TN ₁ , - USF ₂ on TN ₂ , (USF ₂ ≠ USF ₁) - up to ... - USF _N on TN _N , where N = 5 or 6.
2	SS -> MS	PACKET DOWNLINK ASSIGNMENT	Sent on the PACCH of PDCH ₂ , 3 blocks on from the last radio block containing the uplink assignment. Includes the Polling bit set, and a valid RRBP field. Includes the TFI assigned to the uplink TBF. The timeslot assigned is TN ₂ . The USF is not addressing the MS.
3	MS-SS	PACKET CONTROL ACKNOWLEDGEMENT	Sent on the PACCH of PDCH ₂ , and on the radio block specified by the RRBP.
4		{ Completion of uplink RLC data block transfer in extended dynamic mode }	Using all assigned PDTCHs.

Specific Message Contents

None

42.9.3.1.2 Extended Dynamic Allocation / Shifted USF / Normal / USF assignment on 2nd PDCH

42.9.3.1.2.1 Conformance requirements

When Shifted USF operation is used, the USF for the first assigned PDCH shall be sent on the second assigned PDCH. The MS shall monitor the second assigned PDCH for the USF corresponding to both the first assigned PDCH and the second assigned PDCH. If the USF corresponding to the first assigned PDCH is detected then the mobile station shall transmit on the first assigned PDCH and all higher numbered assigned PDCHs. Otherwise, operation shall be as described in sub-clause 8.1.1.2.1.

The USF value corresponding to the first assigned PDCH shall be different from the USF value corresponding to the second assigned PDCH.

References

3GPP TS 44.060, subclauses 8.1.1.2.4

42.9.3.1.2.2 Test purposes

To verify that the MS:

In a multi-slot uplink data transfer with shifted USF operation in use, the USF for the 1st and 2nd assigned PDCH's are monitored and detected by the MS on the 2nd assigned PDCH, and otherwise operation is as for normal Extended Dynamic Allocation.

42.9.3.1.2.3 Method of test

Initial Conditions

System Simulator:

1 cell, default setting,

Mobile Station:

The MS is GPRS attached with a P-TMSI allocated and the test PDP context 2 activated.

Specific PICS Statements

- The GPRS multislot class supported (TSPC_Type_GPRS_Multislot_ClassX, where X = 1..45)

PIXIT Statements

-

Test Procedure

The MS is triggered to initiate packet uplink transfer in RLC acknowledged mode, and with Extended Dynamic Allocation MAC mode. The SS orders the MS to use two-phase access procedure, in PACKET UPLINK ASSIGNMENT. The maximum number of UL timeslots is assigned, according to the mobile multislot class (TS 45.002 Annex B.1).

For one block period, the SS allocates blocks on all but the two lowest-numbered assigned PDCHs, by signalling to the MS the USF assigned to the third PDCH using the third PDCH. It is checked that the MS sends RLC data blocks on all but the two lowest-numbered assigned PDCHs.

For the next block period, the SS increases the number of PDCHs allocated to the MS, and allocates blocks on all but the lowest PDCH, by signalling to the MS the USF assigned to the second PDCH using the second PDCH. It is checked that the MS sends RLC data blocks on all but the lowest-numbered assigned PDCH.

For the next block period, the SS increases the number of PDCHs again, and allocates blocks on all assigned PDCHs, by signalling to the MS the USF assigned to the first PDCH, but using the second PDCH. It is checked that the MS sends RLC data blocks on all PDCHs.

The MS completes the packet data transfer.

Maximum Duration of Test

5 minutes.

Expected Sequence

Step	Direction	Message	Comments
1		{Uplink dynamic allocation two phase access}	n = 1500 octets, without starting time, Up to 6 consecutive timeslots are assigned according to MS multislot class (TS 45.002 Annex B.1): - USF ₁ on TN ₁ , - USF ₂ on TN ₂ , (USF ₂ ≠ USF ₁) - up to ... - USF _N on TN _N , where N = 5 or 6.
2	SS -> MS	PACKET DOWNLINK DUMMY CONTROL BLOCK	Sent on the PACCH of PDCH ₃ , 3 blocks on from the last radio block containing the uplink assignment; the assigned USF ₃ is addressing the MS.
3	SS -> MS	PACKET DOWNLINK DUMMY CONTROL BLOCKS	Sent on the PACCH of PDCH ₁ , PDCH ₂ and PDCH ₄ to PDCH _N on the same block period as step 2; the USF is not addressing the MS.
4	MS -> SS	UPLINK RLC DATA BLOCKS	Received on the assigned PDTCH ₃ to PDTCH _N
5	SS -> MS	PACKET DOWNLINK DUMMY CONTROL BLOCK	Sent on the PACCH of PDCH ₂ ; the assigned USF ₂ is addressing the MS.
6	SS -> MS	PACKET DOWNLINK DUMMY CONTROL BLOCKS	Sent on the PACCH of PDCH ₁ and PDCH ₃ to PDCH _N on the same block period as step 5; the USF is not addressing the MS.
7	MS -> SS	UPLINK RLC DATA BLOCKS	Received on the assigned PDTCH ₂ to PDTCH _N
8	SS -> MS	PACKET DOWNLINK DUMMY CONTROL BLOCK	Sent on the PACCH of PDCH ₂ ; the assigned USF ₁ is addressing the MS.
9	SS -> MS	PACKET DOWNLINK DUMMY CONTROL BLOCKS	Sent on the PACCH of PDCH ₁ and PDCH ₃ to PDCH _N on the same block period as step 8; the USF is not addressing the MS.
10	MS -> SS	UPLINK RLC DATA BLOCKS	Received on all assigned PDTCH ₁ to PDTCH _N
11		{ Completion of uplink RLC data block transfer in extended dynamic mode }	Using all assigned PDTCHs.

Specific Message Contents

None

42.9.3.1.3 Extended Dynamic Allocation / Shifted USF / Normal / Release of 2nd PDCH

42.9.3.1.3.1 Conformance requirements

- (1) If a PACKET PDCH RELEASE message releases the second PDCH in the current timeslot configuration of a mobile station using Shifted USF operation then the first timeslot shall be considered released. If any PDCHs remain in the new timeslot configuration then normal USF operation shall continue starting on the lowest available timeslot.
- (2) If the current timeslot configuration requires Shifted USF operation (see sub-clause 8.1.1.2.4) and the PACKET PDCH RELEASE message modifies the configuration in such a way that Shifted USF operation is no longer required then normal USF operation shall apply after a suitable reaction time as defined in 3GPP TS 45.010.
- (3) Upon a receipt of a commanding message or indication from the network requiring an action by the mobile station, if the reaction time for such action is not specified elsewhere, the mobile station shall begin to perform the required action no later than the next occurrence of block B((x+6) mod 12), where block B(x) is the radio block containing the commanding message or indication from the network.

References

- (1) 3GPP TS 44.060, subclause 8.1.1.2.4.
- (2) 3GPP TS 44.060, clause 8.2
- (3) 3GPP TS 45.010, clause 6.11.4

42.9.3.1.3.2 Test purposes

To verify that when the MS is performing a multi-slot uplink data transfer with shifted USF operation in use, and a PACKET PDCH RELEASE message is received that releases the second PDCH, then the MS will:

- stop transmitting on the first and second PDCH within the required reaction time, and
- continue data transfer using normal USF operation with Extended Dynamic Allocation and using the remaining available timeslots.

42.9.3.1.3.3 Method of test

Initial Conditions

System Simulator:

1 cell, default setting,

Mobile Station:

The MS is GPRS attached with a P-TMSI allocated and the test PDP context 2 activated.

Specific PICS Statements

- The GPRS multislot class supported (TSPC_Type_GPRS_Multislot_ClassX, where X = 1..45)

PIXIT Statements

-

Test Procedure

The MS is triggered to initiate packet uplink transfer in RLC acknowledged mode. The SS orders the MS to use two-phase access procedure, in a PACKET UPLINK ASSIGNMENT. The maximum number of UL timeslots is assigned, according to the mobile multislot class (TS 45.002 Annex B.1).

The SS signals to the MS the USF assigned to the lowest PDTCH on the second PDCH, and, in the next block period, it is checked that the MS sends RLC/MAC data blocks on all assigned PDTCH.

The SS sends a PACKET PDCH RELEASE message with TIMESLOTS_AVAILABLE indicating that the second lowest assigned PDCH timeslots is not available for packet data. For that block period, and the next five block periods, the SS continues signals to the MS the USF assigned to the lowest PDTCH on the second PDCH, and also the USF assigned to the third PDTCH on the corresponding PACCH.

On the sixth block period following the PACKET PDCH RELEASE message, it is checked that the MS has stopped transmitting on the two lowest timeslots, but continues to transmit on the remaining timeslots.

The SS completes the data transfer using the remaining timeslots.

Maximum Duration of Test

5 minutes.

Expected Sequence

Step	Direction	Message	Comments
1		{Uplink dynamic allocation two phase access}	n = 2000 octets, without starting time, Up to 6 consecutive timeslots are assigned according to MS multislot class (TS 45.002 Annex B.1): - USF ₁ on TN ₁ , - USF ₂ on TN ₂ , (USF ₂ ≠ USF ₁) - up to ... - USF _N on TN _N , where N = 5 or 6.
2	SS -> MS	PACKET DOWNLINK DUMMY CONTROL BLOCKS	Sent on the PACCH of PDCH ₁ to PDCH _N , 3 blocks on from the last radio block containing the uplink assignment; the USF values are: PACCH ₁ - USF is not addressing the MS. PACCH ₂ - assigned USF ₁ is addressing the MS. PACCH ₃ - USF is not addressing the MS. up to ... PACCH _N - USF is not addressing the MS.
3	MS -> SS	UPLINK RLC DATA BLOCKS	Received on all assigned PDTCH ₁ to PDTCH _N
4	SS -> MS	PACKET PDCH RELEASE	Sent on the PACCH of PDCH ₂ on the same block period as step 3; the assigned USF ₁ is addressing the MS.
5	SS -> MS	PACKET DOWNLINK DUMMY CONTROL BLOCKS	Sent on the PACCH of PDCH ₁ and PDCH ₃ to PDCH _N , on the same block period as step 3; the USF values are: PACCH ₁ - USF is not addressing the MS. PACCH ₃ - assigned USF ₃ is addressing the MS. PACCH ₄ - USF is not addressing the MS. up to ... PACCH _N - USF is not addressing the MS.
6	MS -> SS	UPLINK RLC DATA BLOCKS	RLC data blocks may optionally be received on PDTCH ₁ and PDTCH ₂ . RLC data blocks are mandatorily received on assigned PDTCH ₃ to PDTCH _N
7	SS -> MS	PACKET DOWNLINK DUMMY CONTROL BLOCK	Sent on the PACCH of PDCH ₁ to PDCH _N , on the same block period as step 6; the USF values are: PACCH ₁ - USF is not addressing the MS. PACCH ₂ - assigned USF ₁ is addressing the MS. PACCH ₃ - assigned USF ₃ is addressing the MS. PACCH ₄ - USF is not addressing the MS. up to ... PACCH _N - USF is not addressing the MS.
8	SS,MS		Steps 6 and 7 are repeated four times more.
9	MS -> SS	UPLINK RLC DATA BLOCKS	RLC data blocks are received on assigned PDTCH ₃ to PDTCH _N only. No RLC data blocks are received on PDTCH ₁ and PDTCH ₂ .
10		{ Completion of uplink RLC data block transfer in extended dynamic mode }	Using PDTCH ₃ to PDTCH _N

Specific Message Contents

PACKET PDCH RELEASE (Step 4):

- PAGE MODE	Indicating "Same as before"
- TIMESLOTS_AVAILABLE	Indicating that TN ₁ and TN ₃ to TN _N are available for GPRS. TN ₂ is not available.

43 RLC Test Cases

Default conditions and messages

The default conditions, message contents and macros not specified in this subclause must be set as in clause 40.

Initial conditions

Unless otherwise indicated, the initial conditions for all acknowledged mode tests, as a minimum, are as follows. Other initial conditions may apply. In the event of conflict between initial conditions stated here and those stated in a test case, the test case shall take precedence.

- The MS is GPRS attached.
- A PDP context has been established with RLC acknowledged mode operation.

43.1 Acknowledged Mode

43.1.1 Acknowledged mode / Uplink TBF

43.1.1.1 Acknowledged mode / Uplink TBF / Send state variable V(S)

43.1.1.1.1 Conformance requirements

1. The send state variable, V(S), can take on the values 0 through 127. Each RLC data block contains a block sequence number (BSN) field that is 7 bits in length. At the time that an in-sequence RLC data block is designated for transmission, the value of BSN is set equal to the value of the send state variable.
2. V(S) shall be set to the value 0 at the beginning of each TBF in which the RLC endpoint is the transmitter.
3. The value of V(S) shall be incremented by 1 after transmission of the RLC data block with BSN = V(S).

References

3GPP TS 04.60, subclause 9.1.1.

43.1.1.1.2 Test purpose

1. To verify that the mobile station sets the V(S) to 0 at the beginning of each TBF.
2. To verify that the mobile station increases the V(S) by 1 after transmission of the RLC data block with BSN set to V(S).
3. To verify that the mobile station wraps the V(S) to 0 after 127.

43.1.1.1.3 Method of test

Initial Conditions

System Simulator:

1 cell, default setting, PBCCH not present.

Mobile Station:

The MS is GPRS updated with a P-TMSI allocated, SPLIT PG CYCLE negotiated and the test PDP context2 activated.

Specific PICS Statements

-

PIXIT Statements

-

Test Procedure

The MS is made to send RLC data blocks. SS checks that the BSN in the RLC data block:

1. is set to the value 0 at the beginning of each TBF in which the mobile station is the transmitter;
2. is incremented by 1 in each subsequent RLC data block in the TBF; and
3. takes on all values in the range 0 to 127 and then back to 0.

Maximum Duration of Test

5 minutes.

Expected Sequence

Step	Direction	Message	Comments
1		{ Uplink dynamic allocation two phase access}	n = 3500 octets, USF_GRANULARITY = 1 block CHANNEL_CODING_COMMAND: cs1
2	SS -> MS	PACKET DOWNLINK DUMMY CONTROL BLOCK	Sent on the PACCH of the PDCH assigned, containing USF assigned to the MS.
3	MS -> SS	UPLINK RLC DATA BLOCK	Received on the assigned PDTCH SS verifies that the BSN starts from 0.
4	SS -> MS	PACKET UPLINK ACK/NACK	SS acknowledges each RLC data block, RBB set to 1, containing USF assigned to the MS
5	MS -> SS	UPLINK RLC DATA BLOCK	Received on the assigned PDTCH SS verifies that the BSN is updated according to $BSN(n) = (BSN(n-1) + 1) \text{ mod } 128$
6	-	Steps 4 & 5 are repeated atleast 128 times	The PACCH of the PDCH assigned in step 2, containing USF assigned to the MS.
7		{ Completion of uplink RLC data block transfer}	

43.1.1.2 Acknowledged mode / Uplink TBF / Transmit window size

43.1.1.2.1 Conformance requirements

1. $V(S)$ shall not exceed $V(A)$ modulo 128 by more than the maximum allowed number of outstanding RLC data blocks k (window size k is defined in 3GPP TS 04.60 subclause 9.1.9).
2. If $V(S) = V(A) + k$ modulo 128 (i.e., the transmit window is stalled), the mobile station shall set the stall indicator to 1 in each RLC data block transmitted and transmit the oldest RLC data block whose corresponding element in $V(B)$ has the value PENDING_ACK, then the next oldest RLC data block whose corresponding element in $V(B)$ has the value PENDING_ACK, etc.

References

3GPP TS 04.60, subclauses 9.1.1, 9.1.3 and 9.1.9.

43.1.1.2.2 Test purpose

1. To verify that the mobile station sets the stall indicator to 1 in each RLC data block transmitted once the transmit window is stalled.
2. To verify that the mobile station retransmits data blocks that are pending acknowledgment.
3. To verify that the mobile station retransmits unacknowledged RLC data blocks in correct order while the transmit window is stalled.

43.1.1.2.3 Method of test

Initial Conditions

System Simulator:

1 cell, default setting, PBCCH not present.

Mobile Station:

The MS is GPRS updated with a P-TMSI allocated, SPLIT PG CYCLE negotiated and the test PDP Context2 activated.

Specific PICS Statements

-

PIXIT Statements

-

Test Procedure

The MS transmits k (window size) blocks without acknowledgement from SS. Confirm that the MS:

- a) sets the stall indicator bit once the window is stalled; and
- b) retransmits blocks that are pending acknowledgement, oldest first.

Maximum Duration of Test

5 minutes.

Expected Sequence

Step	Direction	Message	Comments
1		{ Uplink dynamic allocation two phase access}	n = 1500 octets USF_GRANULARITY = 1 block CHANNEL_CODING_COMMAND: cs1
2	SS -> MS	PACKET DOWNLINK DUMMY CONTROL BLOCK	Sent on the PACCH of the PDCH, containing USF assigned to the MS.
3	MS -> SS	UPLINK RLC DATA BLOCK	Received on the assigned PDTCH SI=0
4			Repeat steps 2 and 3 for BSN=1 to 63. SS doesn't acknowledge any of the data blocks with BSN from 0 to 63
5	SS -> MS	PACKET DOWNLINK DUMMY CONTROL BLOCK	Sent on the PACCH of the PDCH assigned, USF assigned to the MS.
6	MS -> SS	UPLINK RLC DATA BLOCK	Received on the assigned PDTCH SI=1
7			Repeat steps 5 & 6 for BSN = 1 to 63 until all unacknowledged blocks are retransmitted. SS verifies that the unacknowledged data blocks are retransmitted with SI field set to 1. SS verifies that in the retransmitted blocks the BSN is from 0 to 63
8	SS->MS	Packet Uplink Ack/Nack	SS acknowledges all the data blocks USF not assigned to the MS
9			Wait for 6 blocks with no assigned USF
10	SS -> MS	PACKET DOWNLINK DUMMY CONTROL BLOCK	Sent on the PACCH of the PDCH assigned, USF assigned to the MS.
A11 (optional step)	MS -> SS	UPLINK RLC DATA BLOCK	Received on the assigned PDTCH, BSN = 0 Repeat step 10
11	MS -> SS	UPLINK RLC DATA BLOCK	Received on the assigned PDTCH
12	SS		Verify that MS is not retransmitting any acknowledged blocks Verify transmitted data blocks are BSNs 64 and higher
13		{ Completion of uplink RLC data block transfer}	

43.1.1.3 Acknowledged mode / Uplink TBF / Acknowledge state variable V(A)

43.1.1.3.1 Conformance requirements

1. The Acknowledge state variable V(A) contains the BSN value of the oldest RLC data block that has not been positively acknowledged by its peer. V(A) can take on the values 0 through 127.
2. V(A) shall be set to the value 0 at the beginning of each TBF in which the RLC endpoint is the transmitter.
3. The value of V(A) shall be updated from the values received from its peer in the received block bitmap (RBB) of the Packet Ack/Nack message (see subclause 9.1.8).

References

3GPP TS 04.60, subclauses 9.1.2 and 9.1.8.

43.1.1.3.2 Test purpose

1. To verify that the mobile station correctly decodes the RBB and updates the values of V(A).

43.1.1.3.3 Method of test

Initial Conditions

System Simulator:

1 cell, default setting, PBCCH not present.

Mobile Station:

The MS is GPRS updated with a P-TMSI allocated, SPLIT PG CYCLE negotiated and the test PDP Context2 activated.

Specific PICS Statements

-

PIXIT Statements

-

Test Procedure

1. The mobile station transmits k (window size) blocks without acknowledgement from SS. SS then acknowledges the first N blocks. The MS retransmits the negatively acknowledged data blocks with BSN from N to 63 and then it transmits N more new data blocks (from 64 to $N+63$).
2. The test is performed for the values of $N = 10, 15$ and 20 .

Maximum Duration of Test

5 minutes.

Expected Sequence

Step	Direction	Message	Comments
1		{ Uplink dynamic allocation two phase access}	n = 3000 octets USF_GRANULARITY = 1 block CHANNEL_CODING_COMMAND: cs1
2	SS -> MS	PACKET DOWNLINK DUMMY CONTROL BLOCK	Sent on the PACCH of the PDCH, containing USF assigned to the MS.
3	MS -> SS	UPLINK RLC DATA BLOCK	Received on the assigned PDTCH SI=0
4			Repeat steps 2 and 3 for BSN=1 to 63. SS doesn't acknowledge any of the data blocks with BSN from 0 to 63
5	SS -> MS	PACKET DOWNLINK DUMMY CONTROL BLOCK	Sent on the PACCH of the PDCH assigned, USF assigned to the MS.
6	MS -> SS	UPLINK RLC DATA BLOCK	Received on the assigned PDTCH SI=1
7			Repeat steps 5 and 6 until unacknowledged data blocks (BSN = 0 to 30) are retransmitted with SI field set to 1
8			Wait BS_CV_MAX periods without granting USF.
9	SS -> MS	PACKET UPLINK ACK/NACK	SS acknowledges first N (=10) RLC data blocks, RBB set to 1 and negatively acknowledges all the other data blocks from BSN=N to BSN=63 with RBB set to 0 USF not assigned to the MS
10			Wait for 6 blocks with no USF
11	SS -> MS	PACKET DOWNLINK DUMMY CONTROL BLOCK	Sent on the PACCH of the PDCH assigned, USF assigned to the MS.
A12 (optional step)	MS -> SS	UPLINK RLC DATA BLOCK	MS may retransmit block BSN = 31 if it has already been scheduled while Packet Uplink Ack/Nack is being processed.
A13 (optional step)	SS->MS	PACKET DOWNLINK DUMMY CONTROL BLOCK	Sent on the PACCH of the PDCH assigned, USF assigned to the MS.
12	MS -> SS	UPLINK RLC DATA BLOCK	Received on the assigned PDTCH BSN = N & SI = 0
13	SS -> MS	PACKET DOWNLINK DUMMY CONTROL BLOCK	Sent on the PACCH of the PDCH assigned, USF assigned to the MS.
14	MS -> SS	UPLINK RLC DATA BLOCK	Received on the assigned PDTCH
15	SS		Repeat steps 13 and 14 until all negatively acknowledged data blocks are retransmitted followed by new data blocks SS verifies that the negatively acknowledged data blocks are retransmitted before new data blocks are sent, by verifying that RLC data blocks with BSN from N to 63 are received subsequently first, then RLC data blocks with BSN from 64 to 63+N are received.
16		{ Completion of uplink RLC data block transfer}	
17	-	-	The procedure is repeated for different values of N

43.1.1.4 Acknowledged mode / Uplink TBF / Negatively acknowledged RLC data blocks

43.1.1.4.1 Conformance requirements

1. The transmitter shall transmit the oldest RLC data block whose corresponding element in V(B) indexed relative to V(A) has the value NACKED.
2. If $[V(S) < V(A) + k]$ modulo 128 and no RLC data blocks have a corresponding element in V(B) with the value NACKED, the RLC data block with BSN = V(S) shall be transmitted.
3. As each RLC data block is transmitted the corresponding element in V(B) shall be set to the value PENDING_ACK.

References

3GPP TS 04.60, subclause 9.1.3.

43.1.1.4.2 Test purpose

1. To verify that the mobile station retransmits Nacked data blocks before transmission of new information.
2. To verify that the mobile station retransmits Nacked blocks in order of age, older first.
3. To verify that the mobile station only retransmit Nacked blocks once per negative acknowledgment.

43.1.1.4.3 Method of test

Initial Conditions

System Simulator:

1 cell, default setting, , PBCCH not present, BS_CV_MAX = 0.

Mobile Station:

The MS is GPRS updated with a P-TMSI allocated, SPLIT PG CYCLE negotiated and the test PDP Context2 activated.

Specific PICS Statements

-

PIXIT Statements

-

Test Procedure

The MS is made to transmit RLC data blocks. The SS randomly negatively acknowledges RLC data blocks. The MS retransmits the negatively acknowledged RLC data blocks, oldest first before transmitting new RLC data blocks.

The SS does not send further acknowledgements. The MS does not retransmit the previously negatively acknowledged RLC data blocks.

Maximum Duration of Test

5 minutes.

Expected Sequence

Step	Direction	Message	Comments
1		{ Uplink dynamic allocation two phase access}	n = 3000 octets USF_GRANULARITY = 1 block CHANNEL_CODING_COMMAND: cs1
2	SS -> MS	PACKET DOWNLINK DUMMY CONTROL BLOCK	Sent on the PACCH of the PDCH assigned, USF assigned to the MS.
3	MS -> SS	UPLINK RLC DATA BLOCK	Received on the assigned PDTCH
4			Repeat steps 2 and 3 until received data block BSN = 30
5	SS -> MS	PACKET UPLINK ACK/NACK	SS acknowledges RLC data blocks with BSN 10 to 30, RBB set to 1 and negatively acknowledges the rest with RBB set to 0 USF not assigned to the MS
6			Wait for 6 blocks with no USF
7	SS -> MS	PACKET DOWNLINK DUMMY CONTROL BLOCK	Sent on the PACCH of the PDCH assigned, USF assigned to the MS.
A8 (optional step)	MS -> SS	UPLINK RLC DATA BLOCK	MS may retransmit block BSN = 31 if it has already been scheduled while Packet Uplink Ack/Nack is being processed. In this case repeat step 7
8	MS -> SS	UPLINK RLC DATA BLOCK	Received on the assigned PDTCH BSN = 0..9
9	SS		Repeat steps 7 & 8 ten (11 in case mobile sends BSN = 31 in step A8) times SS verifies that the Nacked data blocks are received before new data block once per negative acknowledgment. After these data blocks new data block BSN=31 (32 if MS sends BSN = 31 earlier in step A8) should be received
10	SS -> MS	PACKET UPLINK ACK/NACK	SS acknowledges retransmitted (BSN 0..9) RLC data blocks, RBB set to 1
11	SS -> MS	PACKET DOWNLINK DUMMY CONTROL BLOCK	Sent on the PACCH of the PDCH, containing USF assigned to the MS.
12	MS -> SS	UPLINK RLC DATA BLOCK	Received on the assigned PDTCH
13	SS		Repeat steps 11 and 12 until the stall indication bit is set in the data block received in step 12. SS verifies that acknowledged blocks are not retransmitted
14	SS -> MS	PACKET UPLINK ACK/NACK	SS negatively acknowledges RLC data blocks with BSN 55 to 60, RBB set to 0 and acknowledges the rest with RBB set to 1 USF not assigned to the MS
15			Wait for 6 blocks with no USF.
16	SS -> MS	PACKET DOWNLINK DUMMY CONTROL BLOCK	Sent on the PACCH of the PDCH assigned, USF assigned to the MS.
A17	MS -> SS	UPLINK RLC DATA BLOCK	MS may retransmit block BSN = 32 (or 33) if it has already been scheduled while Packet Uplink Ack/Nack is being processed.
A18	SS -> MS	PACKET DOWNLINK DUMMY CONTROL BLOCK	Sent on the PACCH of the PDCH assigned, USF assigned to the MS.
17	MS -> SS	UPLINK RLC DATA BLOCK	Received on the assigned PDTCH BSN = 55..60
18	SS		Repeat steps 16 & 17 until all Nacked blocks are received SS verifies that the Nacked data blocks are received before new data blocks once per negative acknowledgment.
19		{Completion of uplink RLC data block transfer}	

43.1.1.5 Acknowledged mode / Uplink TBF / Invalid Negative Acknowledgment

43.1.1.5.1 Conformance requirements

For a R97 and R98 MS only:

1. If the mobile station is the transmitter, it shall set an instance of timer T3198 for each RLC data block sent (subclause 9.1.3 3GPP TS 04.60).
2. The timer T3198 shall have the expiry value set to BS_CV_MAX block periods (subclause 9.1.3 3GPP TS 04.60).
3. The mobile station shall not modify the element in the acknowledge state array, V(B), corresponding to an RLC data block that cannot be validly negatively acknowledged (subclause 9.1.8 3GPP TS 04.60).

For a R99 or later MS only:

If the RLC transmitter is on the mobile station side, the bit contains the value '0' and the number of block periods between the end of the block period used for the last transmission of the corresponding RLC data block and the beginning of the block period containing the Packet Uplink Ack/Nack message is less than $(\max(\text{BS_CV_MAX}, 1) - 1)$ (i.e., the RLC data block was recently (re)transmitted and thus can not be validly negatively acknowledged in this particular Packet Uplink Ack/Nack message), the element in V(B) shall not be modified.

References

3GPP TS 04.60, subclauses 9.1.3 and 9.1.8.

43.1.1.5.2 Test purpose

To verify the correct response of the mobile station to an invalid negative acknowledgement.

43.1.1.5.3 Method of test

Initial Conditions

System Simulator:

1 cell, default setting, , PBCCH not present, BS_CV_MAX = 15.

Mobile Station:

The MS is GPRS updated with a P-TMSI allocated, SPLIT PG CYCLE negotiated and the test PDP Context2 activated.

Specific PICS Statements

- GPRS Release (TSPC_MS_GPRS_RELEASE)

PIXIT Statements

-

Test Procedure

The MS is made to send RLC data blocks. The SS negatively acknowledges some RLC data blocks within BS_CV_MAX block periods. The MS shall not retransmit the RLC data blocks that were negatively acknowledged.

Maximum Duration of Test

5 minutes.

Expected Sequence

Step	Direction	Message	Comments
1		{ Uplink dynamic allocation two phase access}	n = 440 octets USF_GRANULARITY = 1 block CHANNEL_CODING_COMMAND: cs1
2	SS -> MS	PACKET DOWNLINK DUMMY CONTROL BLOCK	Sent on the PACCH of the PDCH assigned, USF assigned to the MS.
3	MS -> SS	UPLINK RLC DATA BLOCK	Received on the assigned PDTCH BSN = 0
4	SS -> MS	PACKET DOWNLINK DUMMY CONTROL BLOCK	Sent on the PACCH of the PDCH assigned, USF assigned to the MS.
5	MS -> SS	UPLINK RLC DATA BLOCK	Received on the assigned PDTCH BSN = 1
6	SS -> MS	PACKET DOWNLINK DUMMY CONTROL BLOCK	Sent on the PACCH of the PDCH assigned, USF assigned to the MS.
7	MS -> SS	UPLINK RLC DATA BLOCK	Received on the assigned PDTCH BSN = 2
8	SS -> MS	PACKET DOWNLINK DUMMY CONTROL BLOCK	Sent on the PACCH of the PDCH assigned, USF assigned to the MS.
9	MS -> SS	UPLINK RLC DATA BLOCK	Received on the assigned PDTCH BSN =3
10	SS -> MS	PACKET DOWNLINK DUMMY CONTROL BLOCK	Sent on the PACCH of the PDCH assigned, USF assigned to the MS.
11	MS -> SS	UPLINK RLC DATA BLOCK	Received on the assigned PDTCH BSN =4
			Wait for BS_CV_MAX block period of Block BSN = 0 to expire
12	SS -> MS	PACKET UPLINK ACK/NACK	SS negatively acknowledges blocks BSN = 0 and BSN =3, RBB = 0 and acknowledges blocks BSN = 1, BSN = 2 and BSN = 4, RBB = 1, SSN = 5. USF not assigned to the MS
13			Wait for 6 blocks with no USF.
14	SS -> MS	PACKET DOWNLINK DUMMY CONTROL BLOCK	Sent on the PACCH of the PDCH assigned, USF assigned to the MS.
A15 (optional step)	MS -> SS	UPLINK RLC DATA BLOCK	MS may transmit block BSN = 5 if it has already been scheduled while Packet Uplink Ack/Nack is being processed. In this case repeat step 14
15	MS -> SS	UPLINK RLC DATA BLOCK	Received on the assigned PDTCH SS verifies that data block BSN = 0 is retransmitted
16	SS -> MS	PACKET DOWNLINK DUMMY CONTROL BLOCK	Sent on the PACCH of the PDCH assigned, USF assigned to the MS.
17	MS -> SS	UPLINK RLC DATA BLOCK	Received on the assigned PDTCH SS verifies that data block BSN = 3 is not retransmitted New data block received with BSN = 5 (6 if mobile sends BSN=5 earlier in step A15)
18		{ Completion of uplink RLC data block transfer}	

43.1.1.6 Acknowledged mode / Uplink TBF / Decoding of Received Block Bitmap

43.1.1.6.1 Conformance requirements

For each bit in the RBB whose corresponding BSN value is within the transmit window, if the bit contains the value '1', the corresponding element in V(B) indexed relative to SSN shall be set to the value ACKED. If the bit contains the value '0', the element in V(B) shall be set to the value NACKED. A bit within the RBB whose corresponding BSN is not within the transmit window, shall be ignored.

References

3GPP TS 04.60, subclause 9.1.8.

43.1.1.6.2 Test purpose

1. To verify the decoding of the received block bitmap of the Packet Uplink Ack/Nack message.

43.1.1.6.3 Method of test

Initial Conditions

System Simulator:

1 cell, default setting, PBCCH not present.

Mobile Station:

The MS is GPRS updated with a P-TMSI allocated, SPLIT PG CYCLE negotiated and the test PDP Context2 activated.

Specific PICS Statements

-

PIXIT Statements

-

Test Procedure

The MS is made to send RLC data blocks. The SS negatively acknowledges one or more RLC data blocks after BS_CV_MAX block periods. The MS retransmits these blocks.

The SS negatively acknowledges data blocks outside the transmit window. The MS ignores these negative acknowledgments.

Maximum Duration of Test

5 minutes.

Expected Sequence

Step	Direction	Message	Comments
1		{ Uplink dynamic allocation two phase access}	n = 4000 octets USF_GRANULARITY = 1 block CHANNEL_CODING_COMMAND: cs1
2	SS -> MS	PACKET DOWNLINK DUMMY CONTROL BLOCK	Sent on the PACCH of the PDCH assigned, USF assigned to the MS.
3	MS -> SS	UPLINK RLC DATA BLOCK	Received on the assigned PDTCH
4			Repeat steps 2 and 3 until received data block BSN = 19 SS doesn't acknowledge any of the data blocks with BSN from 0 to 19
5			Wait BS_CV_MAX periods without granting USF.
6	SS -> MS	PACKET UPLINK ACK/NACK	SS negatively acknowledges RLC data block with BSN 0, RBB set to 0 and acknowledges data blocks with BSN from 1 to 19, RBB set to 1 USF not assigned to the MS
7			Wait for 6 blocks with no USF.
8	SS -> MS	PACKET DOWNLINK DUMMY CONTROL BLOCK	Sent on the PACCH of the PDCH assigned, USF assigned to the MS.
A9 (optional step)	MS -> SS	UPLINK RLC DATA BLOCK	MS may transmit block BSN = 20 if it has already been scheduled while Packet Uplink Ack/Nack is being processed. In this case repeat step 8
9	MS -> SS	UPLINK RLC DATA BLOCK	Received on the assigned PDTCH SS verifies that the Nacked data block (BSN = 0) is received before new data blocks

Step	Direction	Message	Comments
10	SS -> MS	PACKET DOWNLINK DUMMY CONTROL BLOCK	Sent on the PACCH of the PDCH, containing USF assigned to the MS.
11	MS -> SS	UPLINK RLC DATA BLOCK	Received on the assigned PDTCH
12			Repeat steps 10 and 11 until BSN=63 SS doesn't acknowledge any of the data blocks until BSN = 63
13	SS -> MS	PACKET UPLINK ACK/NACK	SS acknowledges all RLC data blocks with RBB set to 1
14			Wait for 6 blocks with no USF.
15	SS -> MS	PACKET DOWNLINK DUMMY CONTROL BLOCK	Sent on the PACCH of the PDCH assigned, USF assigned to the MS.
A16 (optional step)	MS -> SS	UPLINK RLC DATA BLOCK	MS may transmit block BSN = 0 (or BSN = 20 if step A09 was performed) if it has already been scheduled while Packet Uplink Ack/Nack is being processed. In this case repeat step 15
16	MS -> SS	UPLINK RLC DATA BLOCK	Received on the assigned PDTCH SS receives new data block with BSN = 64
17	SS -> MS	PACKET DOWNLINK DUMMY CONTROL BLOCK	Sent on the PACCH of the PDCH, containing USF assigned to the MS.
18	MS -> SS	UPLINK RLC DATA BLOCK	Received on the assigned PDTCH
19			Repeat steps 17 and 18 until BSN=80 SS doesn't acknowledge any of the data blocks
20			Wait BS_CV_MAX periods without granting USF.
21	SS -> MS	PACKET UPLINK ACK/NACK	SS negatively acknowledges RLC data block with bit corresponding to BSN 50 in RBB set to 0 and all other bits set to 1 USF not assigned to the MS
22			Wait for 6 blocks with no USF.
23	SS -> MS	PACKET DOWNLINK DUMMY CONTROL BLOCK	Sent on the PACCH of the PDCH, containing USF assigned to the MS.
24	MS -> SS	UPLINK RLC DATA BLOCK	Received on the assigned PDTCH
25	SS		Repeat steps 23 and 24 until BSN=127 SS verifies that the MS ignored negative acknowledgment outside the window and sends new data blocks BSN=81 to 127
26		{ Completion of uplink RLC data block transfer }	

43.1.2 Acknowledged mode / Downlink TBF

43.1.2.1 Acknowledged mode / Downlink TBF / Receive state variable V(R)

43.1.2.1.1 Conformance requirements

1. In RLC acknowledged mode, each RLC endpoint receiver shall have an associated receive state variable V(R). The receive state variable denotes the BSN of the next in-sequence RLC data block expected to be received.
2. The mobile station shall set V(R) to the value 0 at the beginning of each TBF in which the RLC endpoint is the receiver.

References

3GPP TS 04.60, subclause 9.1.5.

43.1.2.1.2 Test purpose

1. To verify correct initialisation of the receive state variable, V(R).
2. To verify the receive state variable, V(R) is set to the next in sequence RLC data block expected to be received.

43.1.2.1.3 Method of test

Initial Conditions

System Simulator:

1 cell, default setting, PBCCH not present.

Mobile Station:

The MS is GPRS updated with a P-TMSI allocated, SPLIT PG CYCLE negotiated and the test PDP Context2 activated.

Specific PICS Statements

-

PIXIT Statements

-

Test Procedure

SS establishes a downlink TBF and sends RLC data blocks with BSN values between 0 to N in sequence. The MS is polled in each RLC data block by setting the S/P bit. SS verifies that the SSN in the Packet Downlink Ack/Nack messages sent by the MS are set to [BSN+1] modulo 128. SS then sends RLC data block with random BSN N1 that holds a value between [N+1] modulo 128 and [N+64] modulo 128. The MS is polled in the last RLC data block by setting the S/P bit. SS verifies that the SSN in the Packet Downlink Ack/Nack message sent by the MS is set to [N1+1] modulo 128.

The test is performed for the values of N = 1, 10, 63, 64, 126, 127.

Maximum Duration of Test

5 minutes.

Expected Sequence

Step	Direction	Message	Comments
1		{Downlink TBF establishment}	Macro parameters: Acknowledged mode
2	SS -> MS	DOWNLINK RLC DATA BLOCK	MS is polled S/P bit '1' RRBP 00
3	MS -> SS	Packet Downlink Ack/ Nack	SS verifies that SSN = [BSN + 1] modulo 128
4			Repeat steps 2 and 3 until BSN = N
5	SS -> MS	DOWNLINK RLC DATA BLOCK	BSN = N1 a random number between [N+1] mod 128 and [N+64] modulo 128 MS is polled S/P bit '1' RRBP 00
6	MS -> SS	Packet Downlink Ack/ Nack	SS verifies that SSN = [N1+1] modulo 128.

43.1.2.2 Acknowledged mode / Downlink TBF / Receive window state variable V(Q)

43.1.2.2.1 Conformance requirements

In RLC acknowledged mode, each RLC endpoint receiver shall have an associated receive window state variable, V(Q). The mobile station shall set V(Q) to the value 0 at the beginning of each TBF in which the RLC endpoint is the receiver.

The value of V(Q) shall be updated when the RLC receiver receives the RLC data block whose BSN is equal to V(Q).

References

3GPP TS 04.60, subclause 9.1.6.

43.1.2.2.2 Test purpose

1. To verify that V(Q) is not updated when data blocks with BSN not equal to V(Q) are received.

43.1.2.2.3 Method of test

Initial Conditions

System Simulator:

1 cell, default setting, PBCCH not present.

Mobile Station:

The MS is GPRS updated with a P-TMSI allocated, SPLIT PG CYCLE negotiated and the test PDP Context2 activated.

Specific PICS Statements

-

PIXIT Statements

-

Test Procedure

SS establishes a downlink TBF and sends an RLC data block with BSN value N (N in the range 1..63) and polls the MS. The MS shall accept the block and sends a Packet Downlink Ack/Nack message. SS verifies that SSN is set to [N+1] and RBB bit corresponding to N is set to 1. SS sends another RLC data block to the MS with BSN value 64 and polls the MS. SS verifies that the SSN and RBB fields in the Packet Downlink Ack/Nack message sent by the MS are not updated.

Maximum Duration of Test

5 minutes.

Expected Sequence

Step	Direction	Message	Comments
1		{Downlink TBF establishment}	Macro parameters: Acknowledged mode
2	SS -> MS	DOWNLINK RLC DATA BLOCK	BSN = N (N is in the range of [1..63]) polls the MS
3	MS -> SS	Packet Downlink Ack/ Nack	SSN value should be [N+1] RBB set for block N
4	SS -> MS	DOWNLINK RLC DATA BLOCK	BSN = 64, polls the MS
5	MS -> SS	Packet Downlink Ack/ Nack	SSN value should be [N+1]. No change in RBB
6	SS -> MS	DOWNLINK RLC DATA BLOCK	BSN = 0, polls the MS
7	MS -> SS	Packet Downlink Ack/ Nack	SSN value should be [N+1]. RBB updated
8	SS -> MS	DOWNLINK RLC DATA BLOCK	BSN = 64, polls the MS
9	MS -> SS	Packet Downlink Ack/ Nack	SSN value should be 65.

43.1.2.3 Acknowledged mode / Downlink TBF / Re-assembly of RLC data blocks

43.1.2.3.1 Conformance requirements

RLC data blocks shall be collected at the receiver until all RLC data blocks comprising an LLC PDU have been received. The RLC headers shall be removed from each RLC data block at this time and the RLC data units re-assembled into an LLC PDU and passed to the next higher layer.

References

3GPP TS 04.60, subclause 9.1.11.

43.1.2.3.2 Test purpose

To verify the correct re-assembly of the RLC data blocks.

43.1.2.3.3 Method of test

Initial Conditions

System Simulator:

1 cell, default setting, PBCCH not present.

Mobile Station:

The MS is GPRS updated with a P-TMSI allocated, SPLIT PG CYCLE negotiated and PDP Context 12 is activated.

Specific PICS Statements

-

PIXIT Statements

-

Test Procedure

SS establishes a downlink TBF and sends several data blocks in random sequence , but within the range of transmit and receive window.

Maximum Duration of Test

5 minutes.

Expected Sequence

Step	Direction	Message	Comments
1		{Downlink TBF establishment}	Macro parameters: Acknowledged mode
2	SS -> MS	DOWNLINK RLC DATA BLOCK	A bit set (A=1) in LLC frame SS sends datablocks in random sequence
3			Repeat step 2 until all the data blocks in one LLC frame is transmitted
4	MS -> SS	Packet Downlink Ack/ Nack	
5		{Uplink dynamic allocation two phase access}	USF_GRANULARITY = 1 block
6	SS -> MS	PACKET DOWNLINK DUMMY CONTROL BLOCK	Sent on the PACCH of the PDCH assigned, USF assigned to the MS.
7	MS -> SS	UPLINK RLC DATA BLOCK	LLC Supervisory frame (RR) acknowledging a valid LLC frame
8		{ Completion of uplink RLC data block transfer}	

43.1.2.4 Acknowledged mode / Downlink TBF / Re-assembly / Length Indicator

43.1.2.4.1 Conformance requirements

1. The Extension (E) bit is used to indicate the presence of an optional extension octet in the RLC data block header. The More (M) bit is used to indicate the presence of an LLC frame following the current LLC frame. The M bit, the E bit, and the Length Indicator, are used to delimit LLC frames within a TBF.
2. The Length Indicator (LI) field is six bits in length and shall be encoded as a binary number. The value 0 shall indicate that no LLC frame boundary does exist, that the M bit shall be ignored and that the E bit shall be interpreted as having the value 1.
3. A singular case occurs when the end of the LLC PDU would fit within the RLC data block but the addition of the Length Indicator octet (to indicate the LLC PDU boundary) causes the LLC PDU to extend into the next RLC data block. In this case, this additional LI field shall take the value 0 whatever is the length of the last but one LLC PDU segment.

References

3GPP TS 04.60, subclause 9.1.11 and clause B.2.

43.1.2.4.2 Test purpose

To verify the correct decoding of RLC data block length indication, more(M) and extension(E) bit fields during re-assembly of LLC frames into RLC data blocks.

43.1.2.4.3 Method of test

Initial Conditions

System Simulator:

1 cell, default setting, PBCCH not present.

Mobile Station:

The MS is GPRS updated with a P-TMSI allocated, SPLIT PG CYCLE negotiated and PDP Context 12 activated.

Specific PICS Statements

-

PIXIT Statements

-

Test Procedure

SS establishes a downlink TBF and sends data blocks containing two LLC frames (A bit set) with length indicator encoded. The MS is expected to decode these fields and re-assemble LLC frames correctly.

The size of the first LLC frame is 15 octets and second is 24 octets.

Maximum Duration of Test

5 minutes.

Expected Sequence

Step	Direction	Message	Comments
1		{Downlink TBF establishment}	Macro parameters: Acknowledged mode
2	SS -> MS	DOWNLINK RLC DATA BLOCK	15 octets of first LLC frame and 4 octets of second LLC frame Length Indicator = 15, M = 1, E = 1 A bit set (A = 1) in both LLC frames
3	SS -> MS	DOWNLINK RLC DATA BLOCK	19 octets from second LLC frame Length indicator = 0, M = 0, E = 1
4	SS -> MS	DOWNLINK RLC DATA BLOCK	1 octet from second LLC frame Length indicator = 1, M = 0, E = 1, FBI = 1
5	MS -> SS	PACKET DOWNLINK ACK/NACK	Optionally Including channel request description
6		{Uplink dynamic allocation two phase access}	USF_GRANULARITY = 1 block
7	SS -> MS	PACKET DOWNLINK DUMMY CONTROL BLOCK	Sent on the PACCH of the PDCH assigned, USF assigned to the MS.
8	MS -> SS	UPLINK RLC DATA BLOCK	LLC Supervisory frame (RR) acknowledging first LLC frame. If this UPLINK RLC DATA BLOCK contains a second RR frame acknowledging the second LLC frame steps A9 and B9 should be skipped.
A9 (Optional)	SS -> MS	PACKET DOWNLINK DUMMY CONTROL BLOCK	Sent on the PACCH of the PDCH assigned, USF assigned to the MS.
B9 (Optional)	MS -> SS	UPLINK RLC DATA BLOCK	LLC Supervisory frame (RR) acknowledging second LLC frame
9		{Completion of uplink RLC data block transfer}	

Note: If the negotiated window size is less than 2, the testcase ends at the PDP context activation and link establishment.

43.2 Control Blocks

43.2.1 Control Blocks Re-assembly

43.2.1.1 Conformance requirements

The network may segment RLC/MAC control messages into one or two RLC/MAC control blocks depending on the length of the RLC/MAC control message.

RLC/MAC control blocks shall be collected at the receiver until all RLC/MAC control blocks comprising a RLC/MAC control message have been received. The receiving side shall determine the length of the RLC/MAC control message contents by interpreting the RLC/MAC control block contents.

References

3GPP TS 04.60, subclauses 9.1.11a, 9.1.11b and 9.1.2.

43.2.1.2 Test purpose

To verify that the MS re-assembles a RLC control message If it spans across more than one RLC control block.

43.2.1.3 Method of test

Initial Conditions

System Simulator:

1 cell, default setting, PBCCH not present.

Mobile Station:

The MS is switched off.

Specific PICS Statements

-

PIXIT Statements

-

Test Procedure

The MS is switched on and triggered to perform a GPRS attach. The SS sends a PACKET UPLINK ASSIGNMENT message that spans more than one RLC control block. The PACKET UPLINK ASSIGNMENT message contains Dynamic Allocation struct (Timeslot allocation with power control parameters included) and frequency parameters with direct encoding 2 struct information fields. The SS verifies that RLC data blocks containing Attach Request message are received from the MS.. Switch off the MS.

Maximum Duration of Test

5 minutes.

Expected sequence

Step	Direction	Message	Comments
1	MS		The MS is switched on and triggered to perform a GPRS attach.
2	MS -> SS	CHANNEL REQUEST	
3	SS -> MS	IMMEDIATE ASSIGNMENT	Indicating two phase access
4	MS -> SS	PACKET RESOURCE REQUEST	
5	SS -> MS	PACKET UPLINK ASSIGNMENT	Frequency Parameter direct encoding 2 information element. Dynamic Allocation struct information element (Timeslot allocation and Power Control parameters included) Payload type = 10, Sent on PACCH.(See section below)
6	SS -> MS	PACKET DOWNLINK DUMMY CONTROL BLOCK	USF assigned to the MS
7	MS -> SS	UPLINK RLC DATA BLOCKS	Attach Request received on PDTCH assigned in step 5

Specific Message Contents

PACKET UPLINK ASSIGNMENT message in step 5:

MESSAGE_TYPE	001010
PAGE_MODE	Normal Paging
Referenced Address	
-	10 (TLLI)
CHANNEL_CODING_COMMAND	CS-1 coding
TLLI_BLOCK_CHANNEL_CODING	use value indicated in CHANNEL_CODING_COMMAND
Packet Timing Advance	
-	1 (timing advance value)
- TIMING_ADVANCE_VALUE	30 bit periods
-	0 (no timing advance index)
{L H<Frequency Parameters>}	H (Frequency Parameters present)
- Frequency Parameters	
- TSC	5
Direct Encoding Struct 2	11 (Direct Encoding Struct 2)
MAIO	arbitrarily chosen
HSN	arbitrarily chosen
Length of MA Frequency list contents	Length of frequency list chosen according to length of MA Frequency list contents
MA Frequency list contents	For GSM 900, in bitmap 0 format, (10, 30, 40, 50, 60, 70) For DCS 1800 and PCS 1900, in range 512, (520, 530, 540, 550, 560, 570, 580, 600, 610) For GSM 700, T-GSM 810 in Range 512, (447, 462, 467,475, 477, 480,485, 492,498, 504) For GSM 850, in Range 512, (137, 157, 167, 177, 187, 197, 207, 217, 227) 0 (Dynamic Allocation)
Dynamic Allocation	
- Extended_Dynamic_Allocation	0
P0 Bit	0 (off)
USF Granularity	0 (one block)
{L H<UPLINK_TFI_ASSIGNMENT>}	1 (assign an uplink TFI)
- UPLINK_TFI_ASSIGNMENT	00000 (uplink TBF identifier)
{0 1 RLC Data Blocks Granted}	0
{0 1 TBF Starting time description}	1
TBF Starting time	arbitrarily chosen
TIMESLOT_ALLOCATION with Power Control Parameters	1
ALPHA	0.5
-{0 1 USF_TN0 GAMMA_TN0}	0 (timeslot 0 not assigned)
-{0 1 USF_TN1 GAMMA_TN0}	0 (timeslot 1 not assigned)
-{0 1 USF_TN2 GAMMA_TN0}	0 (timeslot 2 not assigned)
-{0 1 USF_TN3 GAMMA_TN0}	0 (timeslot 3 not assigned)
- USF_TN4	1 (timeslot 4 assigned)
USF_TN4	000
- GAMMA_TN4	00100
-{0 1 USF_TN5 GAMMA_TN0}	0 (timeslot 5 not assigned)
-{0 1 USF_TN6 GAMMA_TN0}	0 (timeslot 6 not assigned)
-{0 1 USF_TN7 GAMMA_TN0}	0 (timeslot 7 not assigned)
For R99 network simulation:	
Additions for Rel.99	1
- Packet Extended TA flag	0 not present
spare padding	Spare Padding

43.3 Default Message Contents and Macros

43.3.1 Message Contents

none

43.3.2 Macros

43.3.2.1 Macro for uplink dynamic allocation two phase access (PBCCH not present)

Step	Direction	Message	Comments
		{Uplink dynamic allocation two phase access}	Macro parameters: n: the number of data octets to be transferred, USF_GRANULARITY: 1 or 4 blocks, RLC_DATA_BLOCKS_GRANTED: 9-261 (close-end), or absent (open-end) CHANNEL_CODING_COMMAND: CS-1, -2, -3, -4 TBF_STARTING_TIME
0	MS		Trigger the MS initiating uplink transfer n octets data according to the test PDP context activated
1	MS -> SS	CHANNEL REQUEST	Received on RACH.
2	SS -> MS	IMMEDIATE ASSIGNMENT	Single block assignment, to order the MS to follow the two phase access procedure. Sent on AGCH.
3	MS -> SS	PACKET RESOURCE REQUEST	Two phase access procedure. Received on the single block assigned in step 2. Check that the PEAK_THROUGHPUT, RADIO_PRIORITY and RLC_MODE are compliant with the PDP context used.
4	SS -> MS	PACKET UPLINK ASSIGNMENT	uplink dynamic allocation, no starting time (as default, otherwise use TBF_STARTING_TIME), Sent on PACCH of the same PDCH assigned in step 2.

43.3.2.2 Macro for downlink TBF establishment (PBCCH not present)

Step	Direction	Message	Comments
		{Downlink TBF establishment}	Macro parameters: TBF_STARTING_TIME
1	SS -> MS	PAGING REQUEST	Page info contains P-TMSI of the MS. Sent on PCH.
2	MS -> SS	CHANNEL REQUEST	Establishment cause = "One phase access". Received on RACH.
3	SS -> MS	IMMEDIATE ASSIGNMENT	Random Reference = pertaining to the message received in step 2. Dynamic allocation for RLC data blocks, Sent on AGCH.
4	MS -> SS	UPLINK RLC DATA BLOCK	LLC PDU implicitly indicating paging response, containing TLLI in the RLC/MAC header. Received on uplink PDTCH assigned in step 3.
5	SS -> MS	PACKET UPLINK ACK/NACK	Acknowledge the received RLC data block. Sent on uplink PACCH.
6	MS -> SS	PACKET CONTROL ACKNOWLEDGEMENT	Acknowledge the RLC control message. Received on uplink PACCH.
7	SS -> MS	IMMEDIATE ASSIGNMENT	Downlink Assignment, TLLI value as received. Sent on PCH. Macro parameter as assigned in the test case.

44 Test case requirements for GPRS mobility management

44.1 Default conditions and default messages

Note that only the layer 3 messages are described in the document. The mapping of the layer 3 messages to lower layers and the use of logical channels is not described in the present document.

The default conditions and default message contents not specified in this clause must be set as in "GPRS default conditions". The normal and alternative higher layer test configurations are equally valid.

Below is a list of the RAI values and the corresponding RAC, LAC and MCC used in the test cases:

- RAI-1: MCC1/MNC1/LAC1/RAC1 (Used if only one cell);
- RAI-2: MCC2/MNC1/LAC1/RAC1;
- RAI-3: MCC1/MNC1/LAC2/RAC1;
- RAI-4: MCC1/MNC1/LAC1/RAC2;
- RAI-5: MCC1/MNC1/LAC1/RAC3;
- RAI-6: MCC2/MNC1/LAC2/RAC1;
- RAI-7: MCC2/MNC1/LAC1/RAC2;
- RAI-8: MCC1/MNC2/LAC1/RAC1;
- RAI-9: MCC1/MNC2/LAC2/RAC1;
- RAI10: MCC1/MNC2/LAC1/RAC2.

If the mobile station initial condition specifies that the mobile has a valid IMSI but the initial condition does not mention P-TMSI, than that shall be interpreted as that the mobile has no valid P-TMSI.

44.2 Elementary procedures of GPRS mobility management

The tests are based on 3GPP TS 04.08 / 3GPP TS 24.008.

44.2.1 GPRS attach procedure

This procedure is used to indicate for the network that the IMSI is available for traffic by establishment of a GMM context.

44.2.1.1 Normal GPRS attach

The normal GPRS attach procedure is a GMM procedure used by GPRS MSs of MS operation mode B or C to IMSI attach for GPRS services only.

44.2.1.1.1 GPRS attach / accepted

44.2.1.1.1.1 Conformance requirement

- 1) If the network accepts the GPRS attach procedure (signalled by an IMSI) and allocates a P-TMSI, the MS shall acknowledge the P-TMSI and continue communication with the P-TMSI.
- 2) If the network accepts the GPRS attach procedure (signalled by P-TMSI) and reallocates a new P-TMSI, the MS shall acknowledge the new P-TMSI and continue communication with the new P-TMSI.
- 3) If the network accepts the GPRS attach procedure (signalled by a P-TMSI) from the MS without reallocation of the old P-TMSI, the MS shall continue communication with the old P-TMSI.

Reference(s):

3GPP TS 04.08 / 3GPP TS 24.008 subclause 4.7.3.1.

44.2.1.1.1.2 Test purpose

To test the behaviour of the MS if the network accepts the GPRS attach procedure.

The following cases are identified:

- 1) P-TMSI / P-TMSI signature is allocated;
- 2) P-TMSI / P-TMSI signature is reallocated;
- 3) Old P-TMSI / P-TMSI signature is not changed.

44.2.1.1.1.3 Method of test

Initial conditions

System Simulator:

One cell operating in network operation mode III.

Mobile Station:

The MS has a valid IMSI. MS is Idle Updated.

Specific PICS statements:

- MS operation mode B (TSPC_operation_mode_B).
- MS operation mode C (TSPC_operation_mode_C).
- Switch off on button (TSPC_Feat_OnOff).
- Automatic GPRS attach procedure at switch on or power on (TSPC_AddInfo_on_auto_GPRS_AP).

PIXIT statements:

-

Test procedure

- 1) The MS sends an ATTACH REQUEST message with identity IMSI. The SS allocates a P-TMSI and returns ATTACH ACCEPT message with a P-TMSI. The MS acknowledge the P-TMSI by sending ATTACH COMPLETE message. Further communication MS - SS is performed by the new P-TMSI.
- 2) The MS sends an ATTACH REQUEST message with identity P-TMSI. The SS reallocates a new P-TMSI and returns ATTACH ACCEPT message with the new P-TMSI. The MS acknowledge the P-TMSI by sending ATTACH COMPLETE message. Further communication MS - SS is performed by the new P-TMSI. The MS will not answer signalling addressed to the old P-TMSI.
- 3) The MS sends an ATTACH REQUEST message with identity P-TMSI. The SS accepts the P-TMSI and returns ATTACH ACCEPT message without any P-TMSI. Further communication MS - SS is performed by the old P-TMSI.

Maximum duration of test

10 minutes.

Expected sequence

Step	Direction	Message	Comments
1	MS		The MS is set in MS operation mode C (see PICS). If MS operation mode C not supported, goto step 26.

Step	Direction	Message	Comments
2	MS		The MS is powered up or switched on and initiates an attach (see PICS).
3	MS -> SS	ATTACH REQUEST	Attach type = 'GPRS attach' Mobile identity = IMSI
4	SS -> MS	ATTACH ACCEPT	Attach result = 'GPRS only attached' Mobile identity = P-TMSI-2 P-TMSI-2 signature Routing area identity = RAI-1
5	MS -> SS	ATTACH COMPLETE	
6	SS -> MS		SS pages the MS with Mobile identity = P-TMSI-2 and paging order for TBF establishment according to the channel combination of the cell.
7	MS -> SS		Verify that the MS initiates a TBF connection and sends an UPLINK RLC Data Block as a paging response.
8	MS		The MS is switched off or power is removed (see PICS).
9	MS -> SS	DETACH REQUEST	Message not sent if power is removed. Detach type = 'power switched off, GPRS detach'
10	MS		The MS is powered up or switched on and initiates an attach (see PICS).
11	MS -> SS	ATTACH REQUEST	Attach type = 'GPRS attach' Mobile identity = P-TMSI-2 Routing area identity = RAI-1
12	SS -> MS	ATTACH ACCEPT	Attach result = 'GPRS only attached' Mobile identity = P-TMSI-1 P-TMSI-1 signature Routing area identity = RAI-1
13	MS -> SS	ATTACH COMPLETE	
14	SS -> MS	GMM INFORMATION	Message sent with P-TMSI-1
14b	MS -> SS	GMM STATUS	Message sent in case the MS does not support reception of GMM information message Cause #97
15	SS -> MS		SS pages the MS with Mobile identity = P-TMSI-2 and paging order for TBF establishment according to the channel combination of the cell.
16	MS		No response from the MS to the request. This is checked for 10 s.
17	MS		The MS is switched off or power is removed (see PICS).
18	MS -> SS	DETACH REQUEST	Message not sent if power is removed. Detach type = 'power switched off, GPRS detach'
19	MS		The MS is powered up or switched on and initiates an attach (see PICS).
20	MS -> SS	ATTACH REQUEST	Attach type = 'GPRS attach' Mobile identity = P-TMSI-1 Routing area identity = RAI-1
21	SS -> MS	ATTACH ACCEPT	No new mobile identity assigned. P-TMSI and P-TMSI signature not included. Routing area identity = RAI-1 Attach result = 'GPRS only attached' Negotiated Ready timer value IE should not be included.
22	SS -> MS		Force to standby indicator set SS pages the MS with Mobile identity = P-TMSI-1 and paging order for TBF establishment according to the channel combination of the cell.
23	MS -> SS		Verify that the MS initiates a TBF connection and sends an UPLINK RLC Data Block as a paging response.

Step	Direction	Message	Comments
24	MS		The MS is switched off or power is removed (see PICS).
25	MS -> SS	DETACH REQUEST	Message not sent if power is removed. Detach type = 'power switched off, GPRS detach'
26 27	SS MS		The SS is set in network operation mode II. The MS is set in MS operation mode B (see PICS) and the test is repeated from step 2 to step 25.

Specific message contents

None.

44.2.1.1.2 GPRS attach / rejected / IMSI invalid / illegal MS

44.2.1.1.2.1 Conformance requirements

- 1) If the network rejects a GPRS attach procedure from the Mobile Station with the cause 'Illegal MS', the Mobile Station shall consider SIM invalid for GPRS services until power is switched off or SIM is removed.
- 2) If the network rejects a GPRS attach procedure from the Mobile Station with the cause 'Illegal MS' the Mobile Station shall delete the stored RAI, GPRS-CKSN, P-TMSI and P-TMSI signature.
- 3) If the network rejects a GPRS attach procedure from the Mobile Station with the cause 'Illegal MS' the Mobile Station shall delete the LAI.

Reference(s):

3GPP TS 04.08 / 3GPP TS 24.008 subclause 4.7.3.1.

44.2.1.1.2.2 Test purpose

To test the behaviour of the MS if the network rejects the GPRS attach procedure of the MS with the cause 'illegal MS'.

44.2.1.1.2.3 Method of test

Initial conditions

System Simulator:

Three cells (not simultaneously activated), cell A with MCC1/MNC1/LAC1/RAC1, cell B in MCC1/MNC1/LAC2/RAC1, cell C in MCC2/MNC1/LAC1/RAC1.

All three cells are operating in network operation mode II (in case of MS operation mode B), or in network operation mode III (in case of MS operation mode C).

Mobile Station:

The MS has a valid P-TMSI-1 and RAI-1. MS is Idle Updated on cell A.

Specific PICS statements:

- MS operation mode C (TSPC_operation_mode_C).
- MS operation mode B (TSPC_operation_mode_B) (only if mode C not supported).
- Switch off on button (TSPC_Feat_OnOff).
- Automatic GPRS attach procedure at switch on or power on (TSPC_AddInfo_on_auto_GPRS_AP).

PIXIT statements:

-

Test procedure

The SS rejects a GPRS attach with the cause value 'Illegal MS'. The SS checks that the MS does not perform GPRS attach in the same or another PLMN.

Maximum duration of test

5 minutes.

Expected sequence

Step	Direction	Message	Comments
1	MS		The following messages are sent and shall be received on cell A. The MS is set in MS operation mode C or B (see PICS).
2	SS		The SS is set in network operation mode II or III and activates cell A.
3	MS		The MS is powered up or switched on and initiates an attach (see PICS). Cell A is preferred by the MS.
4	MS -> SS	ATTACH REQUEST	Attach type = 'GPRS attach' Mobile identity = P-TMSI-1 Routing area identity = RAI-1
5	SS -> MS	ATTACH REJECT	GMM cause = 'Illegal MS'.
6	SS		The following messages are sent and shall be received on cell B. The SS deactivates cell A and activates cell B.
7	MS		Cell B is preferred by the MS.
8	MS		No ATTACH REQUEST sent to the SS (SS waits 30 seconds).
9	MS		The MS initiates an attach by MMI or by AT command.
10	MS		No ATTACH REQUEST sent to the SS (SS waits 30 seconds).
11	SS		The following messages are sent and shall be received on cell C. The SS deactivates cell B and activates cell C.
12	MS		Cell C is preferred by the MS.
13	MS		No ATTACH REQUEST sent to the SS (SS waits 30 seconds).
14	MS		The MS initiates an attach by MMI or by AT command.
15	MS		No ATTACH REQUEST sent to the SS (SS waits 30 seconds).
16	MS		If possible (see PICS) switch off is performed. Otherwise the power is removed.
17	MS		The MS is powered up or switched on. Step 18 is only performed for NW Mode II / MS Operation Mode B.
18		{Location Update Procedure}	Macro. Location Update Procedure initiated from the MS. Parameter mobile identity is IMSI.
19	MS		The MS initiates an attach (see PICS).
20	MS -> SS	ATTACH REQUEST	Attach type = 'GPRS attach' Mobile identity = IMSI
21	SS -> MS	ATTACH ACCEPT	Attach result = 'GPRS only attached' Mobile identity = P-TMSI-1 P-TMSI-1 signature Routing area identity = RAI-2
22	MS -> SS	ATTACH COMPLETE	
23	MS		The MS is switched off or power is removed (see PICS).
24	MS -> SS	DETACH REQUEST	Message not sent if power is removed. Detach type = 'power switched off, GPRS detach'

Specific message contents

None.

44.2.1.1.3 GPRS attach / rejected / IMSI invalid / GPRS services not allowed

44.2.1.1.3.1 Conformance requirement

- 1) If the network rejects a GPRS attach procedure from the Mobile Station with the cause 'GPRS services not allowed', the Mobile Station shall consider SIM invalid for GPRS services until power is switched off or SIM is removed.
- 2) If the network rejects a GPRS attach procedure from the Mobile Station with the cause 'GPRS services not allowed' the Mobile Station shall delete the stored RAI, GPRS-CKSN, P-TMSI and P-TMSI signature.

Reference(s):

3GPP TS 04.08 / 3GPP TS 24.008 subclause 4.7.3.1.

44.2.1.1.3.2 Test purpose

To test the behaviour of the MS if the network rejects the GPRS attach procedure of the MS with the cause 'GPRS services not allowed' (no valid GPRS-subscription for the IMSI).

44.2.1.1.3.3 Method of test

Initial conditions

System Simulator:

Two cells (not simultaneously activated), cell A in MCC1/MNC1/LAC1/RAC1 (HPLMN) and cell B in MCC2/MNC1/LAC1/RAC1.

Both cells are operating in network operation mode II.

Mobile Station:

The MS has a valid P-TMSI-1 and RAI-1. MS is Idle Updated on cell A.

Specific PICS statements:

- MS operation mode C (TSPC_operation_mode_C).
- MS operation mode B (TSPC_operation_mode_B).
- SIM removal possible without powering down (TSPC_AddInfo_SIMRmv).
- Switch off on button (TSPC_Feat_OnOff).
- Automatic GPRS attach procedure at switch on or power on (TSPC_AddInfo_on_auto_GPRS_AP).

PIXIT statements:

-

Test procedure

The SS rejects a normal attach with the cause value 'GPRS services not allowed'. The SS checks that the MS does not perform GPRS attach in another PLMN.

Maximum duration of test

10 minutes.

Expected sequence

Step	Direction	Message	Comments
1	SS		The following messages are sent and shall be received on cell A.
2	MS		The SS activates cell A.
3	MS		The MS is set in MS operation mode C (see PICS). If MS operation mode C not supported, goto step 19.
4	MS -> SS	ATTACH REQUEST	The MS is powered up or switched on and initiates an attach (see PICS). Cell A is preferred by the MS.
5	SS -> MS	ATTACH REJECT	Attach type = 'GPRS attach' Mobile identity = P-TMSI-1 Routing area identity = RAI-1 GMM cause = 'GPRS services not allowed'
6	SS		The following messages are sent and shall be received on cell B.
7	MS		The SS deactivates cell A and activates cell B. Cell B is preferred by the MS.
8		{Location Update Procedure}	Step 8 is only performed for NW Mode II / MS Operation Mode B. Macro. MOBILE_IDENTITY set to IMSI. Location Update Procedure initiated from the MS.
9			The MS initiates an attach automatically (see PICS), by MMI or AT commands.
10	MS		No ATTACH REQUEST sent to the SS (SS waits 30 seconds).
11	MS		If possible (see PICS) SIM removal is performed. Otherwise if possible (see PICS) switch off is performed. Otherwise the power is removed.
12	MS		The MS gets the SIM replaced, is powered up or switched on and initiates an attach (see PICS).
13	MS -> SS	ATTACH REQUEST	Attach type = 'GPRS attach'
14	SS -> MS	ATTACH ACCEPT	Mobile identity = IMSI Attach result = 'GPRS only attached'
15	MS -> SS	ATTACH COMPLETE	Mobile identity = P-TMSI-1 P-TMSI-1 signature Routing area identity = RAI-2
16	MS		The MS is switched off or power is removed (see PICS).
17	MS -> SS	DETACH REQUEST	Message not sent if power is removed. Detach type = 'power switched off, GPRS detach'
18			The SS deactivates cell B and activates cell A.
19	MS		The MS is set in MS operation mode B (see PICS) and the test is repeated from step 3 to step 17.

Specific message contents

None.

44.2.1.1.4 GPRS attach / rejected / PLMN not allowed

44.2.1.1.4.1 Conformance requirement

- 1) If the network rejects a GPRS attach procedure from the Mobile Station with the cause 'PLMN not allowed' the Mobile Station shall:
 - 1.1 not perform GPRS attach when switched on in the same routing area or location area;
 - 1.2 not perform GPRS attach when in the same PLMN and when that PLMN is not selected manually;
 - 1.3 delete the stored RAI, GPRS-CKSN, P-TMSI and P-TMSI signature;
 - 1.4 store the PLMN in the 'forbidden PLMN' list.
- 2) If the network rejects a GPRS attach procedure from the Mobile Station with the cause 'PLMN not allowed' the Mobile Station shall perform GPRS attach when a new PLMN is entered.
- 3) If the network rejects a GPRS attach procedure from the Mobile Station with the cause 'PLMN not allowed' and if after that the PLMN from which this rejection was received, is manually selected, the Mobile Station shall perform a GPRS attach procedure.

Reference(s):

3GPP TS 04.08 / 3GPP TS 24.008 subclause 4.7.3.1.

44.2.1.1.4.2 Test purpose

To test the behaviour of the MS if the network rejects the GPRS attach procedure of the MS with the cause 'PLMN not allowed'.

44.2.1.1.4.3 Method of test

44.2.1.1.4.3.1 Test procedure 1

Initial conditions

System Simulator:

Four cells (not simultaneously activated), cell A in MCC1/MNC2/LAC1/RAC1, cell B in MCC1/MNC2/LAC1/RAC1, cell C in MCC1/MNC2/LAC2/RAC1 and cell D in MCC2/MNC1/LAC1/RAC1.

- All four cells are operating in network operation mode II (in case of MS operation mode B), or in network operation mode III (in case of MS operation mode C). The PLMN of the four cells should NOT be that of the Mobile Station Home PLMN.

Mobile Station:

The MS has a valid P-TMSI-1 and RAI-8. MS is Idle Updated on cell A.

Specific PICS statements:

- MS operation mode C (TSPC_operation_mode_C).
- MS operation mode B (TSPC_operation_mode_B) (only if mode C not supported).
- Switch off on button (TSPC_Feat_OnOff).
- Automatic GPRS attach procedure at switch on or power on (TSPC_AddInfo_on_auto_GPRS_AP).

PIXIT statements:

-

Test procedure

The SS rejects a GPRS attach with the cause value 'PLMN not allowed'. The SS checks that the MS does not perform GPRS attach if activated in the same routing area or location area and performs GPRS attach only when a new PLMN is entered.

Maximum duration of test

10 minutes.

Expected sequence

Step	Direction	Message	Comments
1	SS MS		The following messages are sent and shall be received on cell A. The MS is set in MS operation mode C or B (see PICS).
2	SS		The SS is set in network operation mode II or III and activates cell A.
3	MS		The MS is powered up or switched on and initiates an attach (see PICS). Cell A is preferred by the MS.
4	MS -> SS	ATTACH REQUEST	Attach type = 'GPRS attach' Mobile identity = P-TMSI-1 Routing area identity = RAI-8
5	SS -> MS	ATTACH REJECT	GMM cause = 'PLMN not allowed' No ATTACH REQUEST sent to SS (SS waits 30 seconds).
6	MS		
7	SS		The following messages are sent and shall be received on cell B. The SS deactivates cell A and activates cell B.
8	MS		Cell B is preferred by the MS.
9	MS		No ATTACH REQUEST sent to SS (SS waits 30 seconds).
10	SS		The following messages are sent and shall be received on cell C. The SS deactivates cell B and activates cell C.
11	MS		Cell C is preferred by the MS.
12	MS		No ATTACH REQUEST sent to SS (SS waits 30 seconds).
13	SS		The following messages are sent and shall be received on cell D. The SS deactivates cell C and activates cell D.
14	MS		Cell D is preferred by the MS.
15		{Location Update Procedure}	Step 15 is only performed for NW Mode II / MS Operation Mode B. Macro. MOBILE_IDENTITY set to IMSI. Location Update Procedure initiated from the MS.
16	MS		The MS initiates an attach automatically, by MMI or by AT command.
17	MS -> SS	ATTACH REQUEST	Attach type = 'GPRS attach' Mobile identity = IMSI
18	SS -> MS	ATTACH ACCEPT	Attach result = 'GPRS only attached' Mobile identity = P-TMSI-1 P-TMSI-1 signature Routing area identity = RAI-2
19	MS -> SS	ATTACH COMPLETE	
20	MS		The MS is switched off or power is removed (see PICS).
21	MS -> SS	DETACH REQUEST	Message not sent if power is removed. Detach type = 'power switched off, GPRS detach'

Specific message contents

None.

44.2.1.1.4.3.2 Test procedure 2

Initial conditions

System Simulator:

One cell operating in network operation mode II: MCC2/MNC1/LAC1/RAC1. The PLMN of the cell should NOT be that of the Mobile Station Home PLMN.

Mobile Station:

The MS has a valid P-TMSI-1 and RAI-2. MS is Idle Updated on cell A.

Specific PICS statements:

- MS operation mode C (TSPC_operation_mode_C).
- MS operation mode B (TSPC_operation_mode_B) (only if mode C not supported).
- Switch off on button (TSPC_Feat_OnOff).
- Automatic GPRS attach procedure at switch on or power on (TSPC_AddInfo_on_auto_GPRS_AP).

PIXIT statements:

-

Test procedure

The SS rejects a GPRS attach with the cause value 'PLMN not allowed'. The subscribers access rights is changed to allow GPRS attach. Then the PLMN from which this rejection was received is manually selected and the SS check that a GPRS attach is performed.

Maximum duration of test

5 minutes.

Expected sequence

Step	Direction	Message	Comments
1	MS		The MS is set in MS operation mode C or B (see PICS).
2	MS		The MS is powered up or switched on and initiates an attach (see PICS).
3	MS -> SS	ATTACH REQUEST	Attach type = 'GPRS attach' Mobile identity = P-TMSI-1 Routing area identity = RAI-2
4	SS -> MS	ATTACH REJECT	GMM cause = 'PLMN not allowed'
5	MS		No ATTACH REQUEST sent to SS (SS waits 30 seconds)
6	MS		The current PLMN is selected manually. Step 7 is only performed for MS Operation Mode B.
7		{Location Update Procedure}	Macro. MOBILE IDENTITY set to IMSI. Location Update Procedure initiated from the MS.
8	MS		The MS initiates an attach automatically, by MMI or by AT command.
9	MS -> SS	ATTACH REQUEST	Attach type = 'GPRS attach' Mobile identity = IMSI
10	SS -> MS	ATTACH ACCEPT	Attach result = 'GPRS only attached' Mobile identity = P-TMSI-1 P-TMSI-1 signature Routing area identity = RAI-2
11	MS -> SS	ATTACH COMPLETE	
12	MS		The MS is switched off or power is removed (see PICS).
13	MS -> SS	DETACH REQUEST	Message not sent if power is removed. Detach type = 'power switched off, GPRS detach'

Specific message contents

None.

44.2.1.1.5 GPRS attach / rejected / roaming not allowed in this location area

44.2.1.1.5.1 Conformance requirement

- 1) If the network rejects a GPRS attach procedure from the Mobile Station with the cause 'roaming not allowed in this location area' the Mobile Station shall:
 - 1.1 not perform GPRS attach when in the same location area;
 - 1.2 delete the stored RAI, GPRS-CKSN, P-TMSI and P-TMSI signature;
 - 1.3 store the LA in the 'forbidden location areas for roaming' list;
 - 1.4 perform GPRS attach when a new location area is entered;
 - 1.5 Periodically search for its HPLMN.
- 2) The mobile station shall reset the list of 'Forbidden location areas for roaming' when switched off or when the SIM is removed.
- 3) The MS shall be capable of storing at least 6 entries in the list of 'Forbidden location areas for roaming'.

Reference(s):

3GPP TS 04.08 / 3GPP TS 24.008 subclause 4.7.3.1.

44.2.1.1.5.2 Test purpose

Test purpose 1

To test that on receipt of a rejection using the 'roaming not allowed in this location area' cause code, the MS ceases trying to attach on that location area. Successful GPRS attach procedure is possible in other location areas.

Test purpose 2

To test that if the MS is switched off or the SIM is removed the list of 'forbidden location areas for roaming' is cleared.

Test purpose 3

To test that at least 6 entries can be held in the list of 'forbidden location areas for roaming' (the requirement in 3GPP TS 04.08 / 3GPP TS 24.008 is to store at least 10 entries. This is not fully tested by the third procedure).

Test purpose 4

To test that if a cell of the Home PLMN is available then the MS returns to it in preference to any other available cell.

44.2.1.1.5.3 Method of test

44.2.1.1.5.3.1 Test procedure 1

Initial conditions

System Simulator:

Three cells (not simultaneously activated), cell A in MCC2/MNC1/LAC1/RAC1 (Not HPLMN), cell B in MCC2/MNC1/LAC2/RAC1 (Not HPLMN) and cell C in MCC2/MNC1/LAC1/RAC2 (Not HPLMN).

All three cells are operating in network operation mode III.

Mobile Station:

The MS has a valid P-TMSI-1 and RAI-2. MS is Idle Updated on cell A.

Specific PICS statements:

- MS operation mode C (TSPC_operation_mode_C).
- MS operation mode B (TSPC_operation_mode_B).
- Switch off on button (TSPC_Feat_OnOff).
- Automatic GPRS attach procedure at switch on or power on (TSPC_AddInfo_on_auto_GPRS_AP).

PIXIT statements:

-

Test procedure

The SS rejects a GPRS attach with the cause value 'Roaming not allowed in this area'. A new attempt for a GPRS attach is not possible. Successful GPRS attach / detach procedures are performed in another location area. A new attempt for a GPRS attach is performed in the 1st location area. This attempt shall not succeed, as the LA is on the forbidden list.

Maximum duration of test

10 minutes.

Expected sequence

Step	Direction	Message	Comments
1	SS MS		The following messages are sent and shall be received on cell A. The MS is set in MS operation mode C (see PICS). If MS operation mode C not supported, go to step 21.
2	SS		The SS activates cell A.
3	MS		The MS is powered up or switched on and initiates an attach (see PICS). Cell A is preferred by the MS.
4	MS -> SS	ATTACH REQUEST	Attach type = 'GPRS attach' Mobile identity = P-TMSI-1 Routing area identity = RAI-2
5	SS -> MS	ATTACH REJECT	GMM cause = 'Roaming not allowed in this area'
6	MS		No ATTACH REQUEST sent to SS (SS waits 30 seconds).
7	SS		The following messages are sent and shall be received on cell B.
8	MS		The SS Deactivates cell A and activates cell B. Cell B is preferred by the MS.
9		{Location Update Procedure}	Step 9 is only performed for NW Mode II / MS Operation Mode B. Macro. Location Update Procedure initiated from the MS. Parameter mobile identity is IMSI.
10	MS		The MS initiates an attach automatically, by MMI or by AT command.
11	MS -> SS	ATTACH REQUEST	Attach type = 'GPRS attach' Mobile identity = IMSI
12	SS -> MS	ATTACH ACCEPT	Attach result = 'GPRS only attached' Mobile identity = P-TMSI-1 P-TMSI-1 signature Routing area identity = RAI-6
13	MS -> SS	ATTACH COMPLETE	
14	MS		The MS initiates a GPRS detach (without power off) by MMI or by AT command .
15	MS -> SS	DETACH REQUEST	Detach type = 'normal detach, GPRS detach'
16	SS -> MS	DETACH ACCEPT	
17	SS		The following messages are sent and shall be received on cell C.
18	MS		The SS deactivates cell B and activates cell C. Cell C is preferred by the MS.
19	MS		No LOCATION UPDATE REQUEST sent to SS (SS waits 30 seconds). Initiate GPRS Attach by MMI or AT command. Check that the No ATTACH REQUEST is sent to the SS (SS waits for 30 seconds). The MS is switched off or power is removed (see PICS).
20	SS		The SS deactivates cell C.
21	SS		The SS is set in network operation mode II.
22	MS		The MS is set in MS operation mode B, if supported (see PICS) and the test is repeated from step 2 to step 20.

Specific message contents

None.

44.2.1.1.5.3.2 Test procedure 2

Initial conditions

System Simulator:

One cell in MCC2/MNC1/LAC1/RAC1 (Not HPLMN) operating in network operation mode II.

Mobile Station:

The MS has a valid P-TMSI-1 and RAI-2. MS is Idle Updated.

Specific PICS statements:

- MS operation mode C (TSPC_operation_mode_C).
- MS operation mode B (TSPC_operation_mode_B) (only if mode C not supported).
- Switch off on button (TSPC_Feat_OnOff).

Automatic GPRS attach procedure at switch on or power on (TSPC_AddInfo_on_auto_GPRS_AP).

PIXIT statements:

-

Test procedure

The SS rejects a GPRS attach updating with the cause value 'Roaming not allowed in this area'. The MS is switched off for 10 s and switched on again. The SS check that a GPRS attach is possible on the cell on which the GPRS attach had been rejected.

If SIM removal is possible without switching off: The SS rejects a GPRS attach with the cause value 'Roaming not allowed in this area'. The SIM is removed and inserted in the MS. The SS check that a GPRS attach is possible on the cell on which the GPRS attach had been rejected.

Maximum duration of test

5 minutes.

Expected sequence

Step	Direction	Message	Comments
1	MS		If MS operation mode C is supported, the MS is set in MS operation mode C (see PICS). If MS operation mode C is not supported, the MS is set in MS operation mode B.
2	MS		The MS is powered up or switched on and initiates an attach (see PICS).
3	MS -> SS	ATTACH REQUEST	Attach type = 'GPRS attach' Mobile identity = P-TMSI-1 Routing area identity = RAI-2
4	SS -> MS	ATTACH REJECT	GMM cause = 'Roaming not allowed in this area'
5	MS		No ATTACH REQUEST sent to the SS (SS waits 30 seconds).
6	MS		If possible (see PICS) switch off is performed. Otherwise the power is removed.
7	MS		The MS is powered up or switched on and initiates an attach (see PICS). Step 8 is only performed for NW Mode II / MS Operation Mode B.
8		{Location Update Procedure}	Macro. Location Update Procedure initiated from the MS. Parameter mobile identity is IMSI.
9	MS -> SS	ATTACH REQUEST	Attach type = 'GPRS attach' Mobile identity = IMSI
10	SS -> MS	ATTACH ACCEPT	Attach result = 'GPRS only attached' Mobile identity = P-TMSI-1 P-TMSI-1 signature Routing area identity = RAI-2
11	MS -> SS	ATTACH COMPLETE	
12	MS		The MS is switched off or power is removed (see PICS).
13	MS -> SS	DETACH REQUEST	Message not sent if power is removed. Detach type = 'power switched off, GPRS detach'

Specific message contents

None.

44.2.1.1.5.3.3 Test procedure 3

Initial conditions

System Simulator:

Six cells (not simultaneously activated), cell A in MCC2/MNC1/LAC1/RAC1 (Not HPLMN), cell B in MCC2/MNC1/LAC2/RAC1 (Not HPLMN), cell C in MCC2/MNC1/LAC3/RAC1 (Not HPLMN), cell D in MCC2/MNC1/LAC4/RAC1 (Not HPLMN), cell E in MCC2/MNC1/LAC5/RAC1 (Not HPLMN), cell F in MCC2/MNC1/LAC6/RAC1 (Not HPLMN).

All six cells are operating in network operation mode II (in case of MS operation mode B), or in network operation mode III (in case of MS operation mode C).

Mobile Station:

The MS has a valid P-TMSI-1 and RAI-2. MS is Idle Updated on cell A.

Specific PICS statements:

- MS operation mode C (TSPC_operation_mode_C).
- MS operation mode B (TSPC_operation_mode_B) (only if mode C not supported).
- Switch off on button (TSPC_Feat_OnOff).

- Automatic GPRS attach procedure at switch on or power on (TSPC_AddInfo_on_auto_GPRS_AP).

PIXIT statements:

-

Test procedure

The SS rejects a GPRS attach with the cause value 'Roaming not allowed in this area'. This is done for 6 different location areas. Then the SS checks that the MS does not attempt to perform an attach procedure on the non-allowed location areas.

Different types of MS may use different methods to periodically clear the list of forbidden areas (e.g. every day at 12 am) for roaming. If the list is cleared while the test is being run, it may be necessary to re-run the test.

Maximum duration of test

20 minutes.

Expected sequence

Step	Direction	Message	Comments
1	SS		The following messages are sent and shall be received on cell A.
2	SS		The SS is set in network operation mode II or III and activates cell A.
3	MS		The MS is set in MS operation mode C or B (see PICS).
4	MS		The MS is powered up or switched on and initiates an attach (see PICS). Cell A is preferred by the MS.
4	MS -> SS	ATTACH REQUEST	Attach type = 'GPRS attach' Mobile identity = P-TMSI-1 Routing area identity = RAI-2
5	SS -> MS	ATTACH REJECT	GMM cause = 'Roaming not allowed in this area'
6	MS		No ATTACH REQUEST sent to SS (SS waits 30 seconds)
7	SS		The following messages are sent and shall be received on cell B.
8	SS		The SS deactivates cell A and activates cell B. Cell B is preferred by the MS.
9	MS		Step 9 is only performed for NW Mode II / MS Operation Mode B.
9		{Location Update Procedure}	Macro. Location Update Procedure initiated from the MS. Parameter mobile identity is IMSI.
10	MS		The MS initiates an attach automatically, by MMI or by AT command.
11	MS -> SS	ATTACH REQUEST	Attach type = 'GPRS attach' Mobile identity = IMSI
12	SS -> MS	ATTACH REJECT	GMM cause = 'Roaming not allowed in this area'
13	MS		No ATTACH REQUEST sent to SS (SS waits 30 seconds).
14	SS		The following messages are sent and shall be received on cell C.
15	SS		The SS deactivates cell B and activates cell C. Cell C is preferred by the MS.
16	MS		Step 16 is only performed for NW Mode II / MS Operation Mode B.
16		{Location Update Procedure}	Macro. Location Update Procedure initiated from the MS. Parameter mobile identity is IMSI.
17	MS		The MS initiates an attach automatically, by MMI or by AT command.
18	MS -> SS	ATTACH REQUEST	Attach type = 'GPRS attach' Mobile identity = IMSI
19	SS -> MS	ATTACH REJECT	GMM cause = 'Roaming not allowed in this area'

Step	Direction	Message	Comments
20	MS		No ATTACH REQUEST sent to SS (SS waits 30 seconds).
21	SS		The following messages are sent and shall be received on cell D.
22	MS		The SS deactivates cell C and activates cell D. Cell D is preferred by the MS.
23		{Location Update Procedure}	Step 23 is only performed for NW Mode II / MS Operation Mode B.
24	MS		Macro. Location Update Procedure initiated from the MS. Parameter mobile identity is IMSI.
25	MS -> SS	ATTACH REQUEST	The MS initiates an attach automatically, by MMI or by AT command.
26	SS -> MS	ATTACH REJECT	Attach type = 'GPRS attach' Mobile identity = IMSI
27	MS		GMM cause = 'Roaming not allowed in this area' No ATTACH REQUEST sent to SS (SS waits 30 seconds).
28	SS		The following messages are sent and shall be received on cell E.
29	MS		The SS deactivates cell D and activates cell E. Cell E is preferred by the MS.
30		{Location Update Procedure}	Step 30 is only performed for NW Mode II / MS Operation Mode B.
31	MS		Macro. Location Update Procedure initiated from the MS. Parameter mobile identity is IMSI.
32	MS -> SS	ATTACH REQUEST	The MS initiates an attach automatically, by MMI or by AT command.
33	SS -> MS	ATTACH REJECT	Attach type = 'GPRS attach' Mobile identity = IMSI
34	MS		GMM cause = 'Roaming not allowed in this area' No ATTACH REQUEST sent to SS (SS waits 30 seconds).
35	SS		The following messages are sent and shall be received on cell F.
36	MS		The SS deactivates cell E and activates cell F. Cell F is preferred by the MS.
37		{Location Update Procedure}	Step 37 is only performed for NW Mode II / MS Operation Mode B.
38	MS		Macro. Location Update Procedure initiated from the MS. Parameter mobile identity is IMSI.
39	MS -> SS	ATTACH REQUEST	The MS initiates an attach automatically, by MMI or by AT command.
40	SS -> MS	ATTACH REJECT	Attach type = 'GPRS attach' Mobile identity = IMSI
41	MS		GMM cause = 'Roaming not allowed in this area' No ATTACH REQUEST sent to SS (SS waits 30 seconds)
42	SS		The following messages are sent and shall be received on cell E.
43	SS		The SS deactivates cell F and activates cell E. Cell E is preferred by the MS.
44	MS		The MS initiates an attach automatically, by MMI or by AT command.
45	MS		No ATTACH REQUEST or LOCATION UPDATE REQUEST is sent to SS (SS waits 30 seconds).
46	SS		The following messages are sent and shall be received on cell C.
47	SS		The SS deactivates cell E and activates cell C. Cell C is preferred by the MS.
48	MS		The MS initiates an attach automatically, by MMI or by AT command.

Step	Direction	Message	Comments
49	MS		No ATTACH REQUEST or LOCATION UPDATE REQUEST is sent to SS (SS waits 30 seconds).
50	SS		The following messages are sent and shall be received on cell A. The SS deactivates cell C and activates cell A. Cell A will be preferred by the MS. The MS initiates an attach automatically, by MMI or by AT command. No ATTACH REQUEST or LOCATION UPDATE REQUEST is sent to SS (SS waits 30 seconds).
51	SS		
52	MS		
53	MS		

Specific message contents

None.

44.2.1.1.5.3.4 Test procedure 4

Initial conditions

System Simulator:

Two cells, cell A in MCC2/MNC1/LAC1/RAC1 (not HPLMN) and cell B in MCC1/MNC1/LAC1/RAC1 (HPLMN).

Both cells are operating in network operation mode II (in case of MS operation mode B), or in network operation mode III (in case of MS operation mode C).

Mobile Station:

The MS has a valid P-TMSI-1 and RAI-2. MS is Idle Updated on cell A.

Specific PICS statements:

- MS operation mode C (TSPC_operation_mode_C).
- MS operation mode B (TSPC_operation_mode_B) (only if mode C not supported).
- Switch off on button (TSPC_Feat_OnOff).
- Automatic GPRS attach procedure at switch on or power on (TSPC_AddInfo_on_auto_GPRS_AP).

PIXIT statements:

-

Test procedure

The SS rejects a GPRS attach with the cause value 'Roaming not allowed in this area'. Two cells are then available. The cell with the weakest level belongs to the HPLMN. It is checked that the MS returns to its HPLMN.

Maximum duration of test

5 minutes.

Expected sequence

Step	Direction	Message	Comments
1	SS MS		The following messages are sent and shall be received on cell A. The MS is set in MS operation mode C or B (see PICS).
2	SS		The SS is set in network operation mode II or III and activates cell A.
3	MS		The MS is powered up or switched on and initiates an attach (see PICS). Cell A is preferred by the MS.
4	MS -> SS	ATTACH REQUEST	Attach type = 'GPRS attach' Mobile identity = P-TMSI-1 Routing area identity = RAI-2
5	SS -> MS	ATTACH REJECT	GMM cause = 'Roaming not allowed in this area'
6	MS		No ATTACH REQUEST sent to SS (SS waits 30 seconds).
7	SS		The following messages are sent and shall be received on cell B. Activate cell B with a lower signal strength than cell A.
8	MS		The RF level of cell A is lowered until cell B is preferred by the MS. Step 9 is only performed for NW Mode II / MS Operation Mode B
9		{Location Update Procedure}	Macro. Location Update Procedure initiated from the MS. Parameter mobile identity is IMSI.
10	MS		The MS initiates an attach automatically, by MMI or by AT command.
11	MS -> SS	ATTACH REQUEST	Attach type = 'GPRS attach' Mobile identity = IMSI
12	SS -> MS	ATTACH ACCEPT	Attach result = 'GPRS only attached' Mobile identity = P-TMSI-1 P-TMSI-1 signature Routing area identity = RAI-1
13	MS -> SS	ATTACH COMPLETE	
14	MS		The MS is switched off or power is removed (see PICS).
15	MS -> SS	DETACH REQUEST	Message not sent if power is removed. Detach type = 'power switched off, GPRS detach'

Specific message contents

None.

44.2.1.1.6 GPRS attach / abnormal cases / access barred due to access class control

44.2.1.1.6.1 Conformance requirement

- 1) The MS shall not perform GPRS attach procedure, but stays in the current serving cell and applies normal cell reselection process.
- 2) The Mobile Station shall perform the GPRS attach procedure when:
 - 2.1 Access is granted.
 - 2.2 Cell is changed.

Reference(s):

3GPP TS 04.08 / 3GPP TS 24.008 subclause 4.7.3.1.

44.2.1.1.6.2 Test purpose

Test purpose 1

To test the behaviour of the MS in case of access class control (access is granted).

Test purpose 2

To test the behaviour of the MS in case of access class control (cell is changed).

44.2.1.1.6.3 Method of test

44.2.1.1.6.3.1 Test procedure 1

Initial conditions

An access class x (0-15) is arbitrarily chosen. The SIM is programmed with this access class x. Communication with mobile stations using access class x is initially indicated to be barred.

System Simulator:

One cell operating in network operation mode III.

Access class x barred.

Mobile Station:

The MS has a valid P-TMSI-1 and RAI-1. MS is Idle Updated.

Specific PICS statements:

- MS operation mode C (TSPC_operation_mode_C).
- MS operation mode B (TSPC_operation_mode_B)
- Switch off on button (TSPC_Feat_OnOff).
- Automatic GPRS attach procedure at switch on or power on (TSPC_AddInfo_on_auto_GPRS_AP).

PIXIT statements:

-

Test procedure

The SS indicates access class x barred. A GPRS attach procedure is not performed.

The SS indicates that access class x is not barred. A GPRS attach procedure is performed.

Maximum duration of test

10 minutes.

Expected sequence

Step	Direction	Message	Comments
1	MS		The SIM is programmed with access class x.
2	MS		The MS is set in MS operation mode C or B (see PICS). If MS operation mode C not supported, goto step 12.
3	MS		The MS is powered up or switched on and attempts to initiate an attach (see PICS).
4	MS		No ATTACH REQUEST sent to SS, as access class x is barred (SS waits 30 seconds).
5	SS		The access class x is not barred anymore.
6	MS		The MS initiates a GPRS attach either automatically or manually (see PICS).
7	MS -> SS	ATTACH REQUEST	Attach type = 'GPRS attach' Mobile identity = P-TMSI-1 Routing area identity = RAI-1
8	SS -> MS	ATTACH ACCEPT	Attach result = 'GPRS only attached' Mobile identity = P-TMSI-2 P-TMSI-2 signature Routing area identity = RAI-1
9	MS -> SS	ATTACH COMPLETE	
10	MS		The MS is switched off or power is removed (see PICS).
11	MS -> SS	DETACH REQUEST	Message not sent if power is removed. Detach type = 'power switched off, GPRS detach'
12	SS		The SS is set in network operation mode II.
13	MS		The MS is set in MS operation mode B (see PICS) and the test is repeated from step 3 to step 11.

Specific message contents

None.

44.2.1.1.6.3.2 Test procedure 2

Initial conditions

An access class x (0-15) is arbitrarily chosen. The SIM is programmed with this access class x. Communication with mobile stations using access class x is indicated to be barred on cell A.

System Simulator:

Two cells, cell A in MCC1/MNC1/LAC1/RAC1 has access class x barred, cell B in MCC1/MNC1/LAC1/RAC1 has access class x not barred.

Both cells are operating in network operation mode II (in case of MS operation mode B), or in network operation mode III (in case of MS operation mode C).

Mobile Station:

The MS has a valid P-TMSI-2 and RAI-1. MS is Idle Updated on cell A.

Specific PICS statements:

- MS operation mode C (TSPC_operation_mode_C).
- MS operation mode B (TSPC_operation_mode_B) (only if mode C not supported).
- Switch off on button (TSPC_Feat_OnOff).
- Automatic GPRS attach procedure at switch on or power on (TSPC_AddInfo_on_auto_GPRS_AP).

PIXIT statements:

-

Test procedure

The SS indicates access class x barred. A GPRS attach procedure is not performed.

A cell change is performed into a cell where access class x is not barred. A GPRS attach procedure is performed.

Maximum duration of test

10 minutes.

Expected sequence

Step	Direction	Message	Comments
1	MS SS		The SIM is programmed with access class x. The following messages are sent and shall be received on cell A.
2	SS		The SS is set in network operation mode II or III and activates cell A.
3	MS		The MS is set in MS operation mode C or B (see PICS).
4	MS		The MS is powered up or switched on and attempts to initiate an attach (see PICS).
5	MS		No ATTACH REQUEST sent to SS, as access class x is barred (SS waits 30 seconds).
6	SS		The following messages are sent and shall be received on cell B.
7	MS		Activate cell B with a lower signal strength than cell A. The RF level of cell A is lowered until cell B is preferred by the MS.
8	MS -> SS	ATTACH REQUEST	The MS initiates an attach either automatically or manually (see PICS). Attach type = 'GPRS attach' Mobile identity = P-TMSI-2 Routing area identity = RAI-1
9	SS -> MS	ATTACH ACCEPT	Attach result = 'GPRS only attached' Mobile identity = P-TMSI-1 P-TMSI-1 signature Routing area identity = RAI-1
10	MS -> SS	ATTACH COMPLETE	
11	MS		The MS is switched off or power is removed (see PICS).
12	MS -> SS	DETACH REQUEST	Message not sent if power is removed. Detach type = 'power switched off, GPRS detach'

Specific message contents

None.

44.2.1.1.7 GPRS attach / abnormal cases / change of cell into new routing area

44.2.1.1.7.1 Conformance requirement

When a change of cell into a new routing area is performed before ATTACH ACCEPT message is received by the MS, the MS shall abort the GPRS attach procedure and re-initiate it immediately.

Reference(s):

3GPP TS 04.08 / 3GPP TS 24.008 subclause 4.7.3.1.

44.2.1.1.7.2 Test purpose

To test the behaviour of the MS in case of procedure collision.

44.2.1.1.7.3 Method of test

Initial conditions

System Simulator:

Two cells, cell A in MCC1/MNC1/LAC1/RAC1 and cell B in MCC1/MNC1/LAC1/RAC2.

Both cells are operating in network operation mode II (in case of MS operation mode B), or in network operation mode III (in case of MS operation mode C).

Mobile Station:

The MS has a valid P-TMSI-1 and RAI-1. MS is Idle Updated on cell A.

Specific PICS statements:

- MS operation mode C (TSPC_operation_mode_C).
- MS operation mode B (TSPC_operation_mode_B) (only if mode C not supported).
- Switch off on button (TSPC_Feat_OnOff).
- Automatic GPRS attach procedure at switch on or power on (TSPC_AddInfo_on_auto_GPRS_AP).

PIXIT statements:

-

Test procedure

If the MS automatically performs a GPRS Attach on power on, is the attach procedure performed and then is the MS triggered to perform a normal GPRS Detach.

Sufficient time is given for the MS to identify the neighbour cell before the MS is triggered to initiate a GPRS attach procedure. The ATTACH ACCEPT message is delayed from the SS. The MS performs a cell reselection to a cell in a new routing area. The MS shall re-initiate a GPRS attach procedure in the new routing area.

Maximum duration of test

5 minutes.

Expected sequence

Step	Direction	Message	Comments
	SS		The following messages are sent and shall be received on cell A.
1	MS		The MS is set in MS operation mode C or B (see PICS).
2	SS		The SS is set in network operation mode II or III and activates cell A and B. The RF level of cell A is -50 dBm and cell B - 60 dBm.
3	MS		The MS is powered up or switched on and initiates an attach (see PICS). Cell A is preferred by the MS.
4			Go to step 10 if the MS <u>not</u> automatically performs a GPRS attach when switched on.
5	MS -> SS	ATTACH REQUEST	Attach type = 'GPRS attach' Mobile identity = P-TMSI-1 Routing area identity = RAI-1
6	SS -> MS	ATTACH ACCEPT	No new mobile identity assigned. P-TMSI and P-TMSI signature not included. Attach result = 'GPRS only attached' Routing area identity = RAI-1 Negotiated Ready timer value IE should not be included
7	MS		Force to standby indicator set
8	MS -> SS	DETACH REQUEST	Trigger the MS to perform a GPRS detach
9	SS -> MS	DETACH ACCEPT	Detach type = 'normal detach, GPRS detach'
10			Wait 20 sec.
11	MS		The MS is triggered to initiate a GPRS Attach.
12	MS -> SS	ATTACH REQUEST	Attach type = 'GPRS attach' Mobile identity = P-TMSI-1 Routing area identity = RAI-1
13	SS		No response to the ATTACH REQUEST message is given by the SS.
			The following messages are sent and shall be received on cell B.
14	SS		The RF level of cell A is lowered to -100 dBm.
15	MS		The MS automatically re-initiates the attach in the new cell.
16	MS -> SS	ATTACH REQUEST	Attach type = 'GPRS attach' Mobile identity = P-TMSI-1 Routing area identity = RAI-1
17	SS -> MS	ATTACH ACCEPT	No new mobile identity assigned. P-TMSI and P-TMSI signature not included. Attach result = 'GPRS only attached' Routing area identity = RAI-4 Negotiated Ready timer value IE should not be included
18	MS		Force to standby indicator set
19	MS -> SS	DETACH REQUEST	The MS is switched off or power is removed (see PICS). Message not sent if power is removed. Detach type = 'power switched off, GPRS detach'

Specific message contents

None.

44.2.1.1.8 GPRS attach / abnormal cases / power off

44.2.1.1.8.1 Conformance requirement

When power is switched off before ATTACH ACCEPT message is received by the MS, the MS shall abort the GPRS attach procedure and perform a GPRS detach procedure.

Reference(s):

3GPP TS 04.08 / 3GPP TS 24.008 subclause 4.7.3.1.

44.2.1.1.8.2 Test purpose

To test the behaviour of the MS in case of procedure collision.

44.2.1.1.8.3 Method of test

Initial conditions

System Simulator:

One cell operating in network operation mode III.

Mobile Station:

The MS has a valid P-TMSI-1 and RAI-1. MS is Idle Updated.

Specific PICS statements:

- MS operation mode C (TSPC_operation_mode_C).
- MS operation mode B (TSPC_operation_mode_B).
- Switch off on button (TSPC_Feat_OnOff).-
- Automatic GPRS attach procedure at switch on or power on (TSPC_AddInfo_on_auto_GPRS_AP).

PIXIT statements:

-

Test procedure

The MS is switched off after initiating an attach procedure. A GPRS detach is automatically performed by the MS before power is switched off.

Maximum duration of test

5 minutes.

Expected sequence

Step	Direction	Message	Comments
1	MS		The MS is set in MS operation mode C (see PICS). If MS operation mode C not supported, goto step 7.
2	MS		The MS is powered up or switched on and initiates an attach (see PICS).
3	MS -> SS	ATTACH REQUEST	Attach type = 'GPRS attach' Mobile identity = P-TMSI-1 Routing area identity = RAI-1
4	SS		No response to the ATTACH REQUEST message is given by the SS.
5	MS		The MS is powered off and initiates a GPRS detach (with power off)
6	MS -> SS	DETACH REQUEST	Detach type = 'power switched off, GPRS detach'
7	SS		The SS is set in network operation mode II.
8	MS		The MS is set in MS operation mode B (see PICS) and the test is repeated from step 2 to step 6.

Specific message contents

None.

44.2.1.1.9 GPRS attach / abnormal cases / GPRS detach procedure collision

44.2.1.1.9.1 Conformance requirement

- 1) When a DETACH REQUEST message is received by the MS (Detach type 're-attach not required') while waiting for an ATTACH ACCEPT message, the MS shall terminate the GPRS attach procedure and continue with the GPRS detach procedure.
- 2) When a DETACH REQUEST message is received by the MS (Detach type 're-attach required') while waiting for an ATTACH ACCEPT message, the MS shall ignore the GPRS detach procedure and continue with the GPRS attach procedure.

Reference(s):

3GPP TS 04.08 / 3GPP TS 24.008 subclause 4.7.3.1.

44.2.1.1.9.2 Test purpose

To test the behaviour of the MS in case of procedure collision.

44.2.1.1.9.3 Method of test

Initial conditions

System Simulator:

One cell operating in network operation mode II.

Mobile Station:

The MS has a valid P-TMSI-1 and RAI-1. MS is Idle Updated.

Specific PICS statements:

- MS operation mode C (TSPC_operation_mode_C).
- MS operation mode B (TSPC_operation_mode_B) (only if mode C not supported).
- Switch off on button (TSPC_Feat_OnOff).
- Automatic GPRS attach procedure at switch on or power on (TSPC_AddInfo_on_auto_GPRS_AP).
- Re-attach automatically when the network commands a detach with no cause value (TSPC_AddInfo_GPRS_Attach_on_NW_Detach_NoCause).

PIXIT statements:

-

Test procedure

The MS initiates a GPRS attach procedure. The SS does not answer the GPRS attach procedure, but initiates a GPRS detach procedure (Detach type 're-attach not required'). The MS shall terminate the GPRS attach procedure and continue with the GPRS detach procedure.

The MS initiates a GPRS attach procedure. The SS does not answer the GPRS attach procedure, but initiates a GPRS detach procedure (Detach type 're-attach required'). The MS shall ignore the GPRS detach procedure and continue with the GPRS attach.

Maximum duration of test

5 minutes.

Expected sequence

Step	Direction	Message	Comments
1	MS		The MS is set in MS operation mode C or B (see PICS).
2	MS		The MS is powered up or switched on and initiates an attach (see PICS).
3	MS -> SS	ATTACH REQUEST	Attach type = 'GPRS attach' Mobile identity = P-TMSI-1 Routing area identity = RAI-1
4	SS		The SS ignores the ATTACH REQUEST message and initiates a detach procedure.
5	SS -> MS	DETACH REQUEST	Detach type = 're-attach not required'
6	MS -> SS	DETACH ACCEPT	
7	MS		The MS is attached by MMI or AT command if the MS does not re-attach automatically upon receiving a network initiated detach with no cause value, (See PICS).
8	MS -> SS	ATTACH REQUEST	Attach type = 'GPRS attach' Mobile identity = P-TMSI-1 Routing area identity = RAI-1
9	SS		The SS ignores the ATTACH REQUEST message and initiates a detach procedure.
10	SS-> MS	DETACH REQUEST	Detach type = 're-attach required'
11	MS		The MS ignores the DETACH REQUEST message and continue with the attach procedure.
12	SS -> MS	ATTACH ACCEPT	Attach result = 'GPRS only attached' Mobile identity = P-TMSI-2 P-TMSI-2 signature Routing area identity = RAI-1
13	MS -> SS	ATTACH COMPLETE	
14	MS		The MS is switched off or power is removed (see PICS).
15	MS -> SS	DETACH REQUEST	Message not sent if power is removed. Detach type = 'power switched off, GPRS detach'

Specific message contents

None.

44.2.1.1.10 GPRS attach / rejected / GPRS services not allowed in this PLMN

44.2.1.1.10.1 Conformance requirement

If the network rejects a GPRS attach procedure from the Mobile Station with the cause 'GPRS services not allowed in this PLMN':

1. The MS shall delete any RAI, P-TMSI, P-TMSI signature, and GPRS ciphering key sequence number stored, shall set the GPRS update status to GU3 ROAMING NOT ALLOWED (and shall store it according to section 4.1.3.2) and shall change to state GMM-DEREGISTERED.
2. The MS shall store the PLMN identity in the "forbidden PLMNs for GPRS service" list. A GPRS MS operating in MS operation mode C shall perform a PLMN selection instead of a cell selection.
3. A GPRS MS operating in MS operation mode A or B in network operation mode II or III, is still IMSI attached for CS services in the network.

Reference(s):

3GPP TS 04.08 / 3GPP TS 24.008 subclause 4.7.3.1.

44.2.1.1.10.2 Test purpose

To test the behavior of the MS if the network rejects the GPRS attach procedure of the MS with the cause 'GPRS services not allowed in this PLMN'.

44.2.1.1.10.3 Method of test

Initial conditions

System Simulator:

Two cells (not simultaneously activated), cell A in MCC1/MNC2/LAC1/RAC1, cell B in MCC2/MNC1/LAC1/RAC1.

All two cells are operating in network operation mode II (in case of MS operation mode B), or in network operation mode III (in case of MS operation mode C).. The PLMN of the two cells should NOT be that of the Mobile Station Home PLMN.

Mobile Station:

The MS has a valid TMSI-1, P-TMSI-1 and RAI-8. MS is Idle Updated on Cell A.

Specific PICS statements:

- MS operation mode B (TSPC_operation_mode_B)
- MS operation mode C (TSPC_operation_mode_C). (only if mode B not supported).
- Switch off on button (TSPC_Feat_OnOff).
- Automatic GPRS attach procedure at switch on or power on (TSPC_AddInfo_on_auto_GPRS_AP).

PIXIT statements:

-

Test procedure

The SS rejects a GPRS attach with the cause value 'GPRS services not allowed in this PLMN'. The SS checks that the MS does not perform GPRS attach if activated in the same PLMN and performs GPRS attach only when a new PLMN is entered.

Maximum duration of test

10 minutes.

Expected Sequence

Step	Direction	Message	Comments
	SS		The following messages are sent and shall be received on cell A.
1	MS		The MS is set in MS operation mode B or C (see PICS).
2	SS		The SS is set in network operation mode II or III and activates cell A.
3	MS		The MS is powered up or switched on and initiates an attach (see PICS).
4	MS -> SS	ATTACH REQUEST	Attach type = 'GPRS attach' Mobile identity = P-TMSI-1
5	SS -> MS	ATTACH REJECT	Routing area identity = RAI-8 GMM cause = ' GPRS services not allowed in this PLMN '
6	MS		No ATTACH REQUEST sent to SS (SS waits 30 seconds)
7	MS		Steps 7, 8 and 9 are only performed for NW Mode II / MS Operation Mode B.
8			SS pages the MS with mobile identity of TMSI-1 and paging order for RR connection according to the channel combination of the cell.
9			Verify that the MS initiates a RR connection and sends a PAGING RESPONSE
9	SS		SS releases the RR connection.
10	SS		SS pages the MS with Mobile identity = P-TMSI-1 and paging order for TBF establishment according to the channel combination of the cell.
11	MS		No response from the MS to the request. This is checked for 10 seconds.
12	SS		The following messages are sent and shall be received on cell B.
13	MS		The SS deactivates cell A and activates cell B. Cell B is preferred by the MS.
14		{Location Update Procedure}	Step 14 is only performed for NW Mode II / MS Operation Mode B. Location Update Procedure initiated from the MS.
15	MS		The MS initiates an attach automatically, by MMI or by AT command.
16	MS -> SS	ATTACH REQUEST	Attach type = 'GPRS attach' Mobile identity = IMSI
17	SS -> MS	ATTACH ACCEPT	Attach result = 'GPRS only attached' Mobile identity = P-TMSI-2 P-TMSI-2 signature
18	MS -> SS	ATTACH COMPLETE	Routing area identity = RAI-2
19	SS		The following messages are sent and shall be received on cell A.
20	MS		The SS deactivates cell B and activates cell A again. Cell A is preferred by the MS.
21		{Location Update Procedure}	Step 21 is only performed for NW Mode II / MS Operation Mode B. Location Update Procedure initiated from the MS.
22			Verify No ATTACH REQUEST sent to SS (SS waits 30 seconds) in case auto attach
23	MS		The MS initiates an attach by MMI or by AT command.
24			Verify No ATTACH REQUEST sent to SS (SS waits 30 seconds)
25	MS		The MS is switched off or power is removed (see PICS).

Specific message contents

None.

44.2.1.2 Combined GPRS attach

The combined GPRS attach procedure is a GMM procedure used by GPRS MSs of MS operation mode A or B to IMSI attach for GPRS or non-GPRS services. In order to use the combined GPRS attach procedure, the network must be in network operation mode I. All Combined GPRS test case are only applicable when the MS operates in Class- A or B mode.

44.2.1.2.1 Combined GPRS attach / GPRS and non-GPRS attach accepted

44.2.1.2.1.1 Conformance requirement

- 1) If the network accepts the combined GPRS attach procedure (signalled by an IMSI) and allocates a P-TMSI, the MS shall acknowledge the P-TMSI and continue communication with the P-TMSI.
- 2) If the network accepts the combined GPRS attach procedure (signalled by P-TMSI) and reallocates a new P-TMSI, the MS shall acknowledge the new P-TMSI and continue communication with the new P-TMSI.
- 3) If the network accepts the combined GPRS attach procedure (signalled by a P-TMSI) from the MS without reallocation of the previously used P-TMSI, the MS shall continue communication with the previously used P-TMSI.
- 4) If the network accepts the combined GPRS attach procedure and determines that IMSI shall be used in CS operations, the MS shall continue communication with the IMSI for CS operations.
- 5) If the network accepts the combined GPRS attach procedure and determines that a TMSI shall be used in CS operations, the MS shall continue communication with the TMSI for CS operations.

Reference(s):

3GPP TS 04.08 / 3GPP TS 24.008 subclause 4.7.3.2.

44.2.1.2.1.2 Test purpose

To test the behaviour of the MS if the network accepts the GPRS attach procedure.

The following cases are identified:

- 1) P-TMSI / P-TMSI signature is allocated;
- 2) P-TMSI / P-TMSI signature is reallocated;
- 3) Old P-TMSI / P-TMSI signature is not changed;
- 4) Mobile terminating CS call is allowed with IMSI;
- 5) Mobile terminating CS call is not allowed with TMSI.

44.2.1.2.1.3 Method of test

Initial conditions

System Simulator:

One cell operating in network operation mode I.

Mobile Station:

The MS has a valid IMSI. MS is Idle Updated.

Specific PICS statements:

- MS operation mode B (TSPC_operation_mode_B)

- MS operation mode A (TSPC_operation_mode_A).
- Switch off on button (TSPC_Feat_OnOff).
- Automatic GPRS attach procedure at switch on or power on (TSPC_AddInfo_on_auto_GPRS_AP).

PIXIT statements:

-

Test procedure

- 1) The MS sends an ATTACH REQUEST message with identity IMSI. The SS allocates a P-TMSI and returns ATTACH ACCEPT message with a P-TMSI. The MS acknowledge the P-TMSI by sending ATTACH COMPLETE message. Further communication MS - SS is performed by the new P-TMSI. For CS calls, the IMSI is used.
- 2) The MS is CS paged in order to verify that the IMSI is used for CS calls.
- 3) The MS is GPRS paged in order to verify that the new P-TMSI is used for GPRS services.
- 4) The MS sends an ATTACH REQUEST message with identity P-TMSI. The SS allocates a new P-TMSI and returns ATTACH ACCEPT message with the new P-TMSI and a new TMSI. The MS acknowledge the P-TMSI and the TMSI by sending ATTACH COMPLETE message. Further communication MS - SS is performed by the new P-TMSI. For CS calls, the new TMSI is used. The MS is CS paged in order to verify that the new TMSI is used for CS services.
- 5) The MS is GPRS paged in order to verify that the new P-TMSI is used for GPRS services. The MS will not answer signalling addressed to the old P-TMSI.
- 6) The MS sends an ATTACH REQUEST message with identity P-TMSI. The SS accepts the P-TMSI and returns ATTACH ACCEPT message without any P-TMSI. Further communication MS - SS is performed by the previously used P-TMSI.
- 7) The MS is GPRS paged in order to verify that the previously used P-TMSI is used for GPRS services.

Maximum duration of test

10 minutes.

Expected sequence

Step	Direction	Message	Comments
1	MS		The MS is set in MS operation mode B (see PICS).
2	MS		The MS is powered up or switched on and initiates an attach (see PICS).
3	MS -> SS	ATTACH REQUEST	Attach type = 'Combined GPRS / IMSI attach' or 'GPRS attach while IMSI attached' Mobile identity = IMSI
4	SS -> MS	ATTACH ACCEPT	TMSI status = no valid TMSI available Attach result = 'Combined GPRS / IMSI attached' Mobile identity = P-TMSI-1 P-TMSI-1 signature Mobile identity = IMSI
5	MS -> SS	ATTACH COMPLETE	Routing area identity = RAI-1
6	SS		SS pages the MS with mobile identity of IMSI and paging order for RR connection according to the channel combination of the cell.
7	MS		Verify that the MS initiates a RR connection and sends a PAGING RESPONSE with mobile identity with IMSI.

Step	Direction	Message	Comments
8	SS		SS releases the RR connection, indicating a successful resumption of GPRS services and pages the MS with mobile identity of P-TMSI-1 and paging order for TBF establishment according to the channel combination of the cell. Comment: A TBF will be established on lower layers.
9	MS		Verify that the MS initiates a TBF connection and sends an UPLINK RLC DATA BLOCK as a response to the paging request. Comment: The TBF will be released on lower layers.
10	MS		The MS is switched off or power is removed (see PICS).
11	MS -> SS	DETACH REQUEST	Message not sent if power is removed. Detach type = 'power switched off, combined GPRS / IMSI detach'
12	MS		The MS is powered up or switched on and initiates an attach (see PICS).
13	MS -> SS	ATTACH REQUEST	Attach type = 'Combined GPRS / IMSI attach' or 'GPRS attach while IMSI attached' Mobile identity = P-TMSI-1 TMSI status = no valid TMSI available Routing area identity = RAI-1
14	SS -> MS	ATTACH ACCEPT	Attach result = 'Combined GPRS / IMSI attached' Mobile identity = P-TMSI-2 P-TMSI-2 signature Mobile identity = TMSI-1 Routing area identity = RAI-1
15	MS -> SS	ATTACH COMPLETE	Message sent with P-TMSI-2
16	SS -> MS	GMM INFORMATION	Message sent in case the MS does not support reception of GMM information message
16b	MS -> SS	GMM STATUS	Cause #97
17	SS		SS pages the MS with mobile identity of TMSI-1 and paging order for RR connection according to the channel combination of the cell.
18	MS		Verify that the MS initiates a RR connection and sends a PAGING RESPONSE with mobile identity with TMSI-1.
19	SS		SS releases the RR connection, indicating a successful resumption of GPRS services and pages the MS with mobile identity of P-TMSI-2 and paging order for TBF establishment according to the channel combination of the cell.
20	MS		Verify that the MS initiates a TBF connection and sends an UPLINK RLC DATA BLOCK as a response to the paging request.
21	SS		SS pages the MS with mobile identity of P-TMSI-1 and paging order for TBF establishment according to the channel combination of the cell.
22	MS		No response from the MS to the request. This is checked for 10 s.
23	MS		The MS is switched off or power is removed (see PICS).
24	MS -> SS	DETACH REQUEST	Message not sent if power is removed. Detach type = 'power switched off, combined GPRS / IMSI detach'
25	MS		The MS is powered up or switched on and initiates an attach (see PICS).

Step	Direction	Message	Comments
26	MS -> SS	ATTACH REQUEST	Attach type = 'Combined GPRS / IMSI attach' or 'GPRS attach while IMSI attached' Mobile identity = P-TMSI-2 Routing area identity = RAI-1
27	SS -> MS	ATTACH ACCEPT	No new mobile identity assigned. TMSI and P-TMSI not included. Attach result = 'Combined GPRS / IMSI attached' P-TMSI-3 signature Routing area identity = RAI-1 Negotiated Ready timer value IE should not be included
28	SS		Force to standby indicator set SS pages the MS with mobile identity of P-TMSI-2 and paging order for TBF establishment according to the channel combination of the cell.
29	MS		Verify that the MS initiates a TBF connection and sends an UPLINK RLC DATA BLOCK as a response to the paging request.
30	MS		The MS is switched off or power is removed (see PICS).
31	MS -> SS	DETACH REQUEST	Message not sent if power is removed. Detach type = 'power switched off, combined GPRS / IMSI detach'

Specific message contents

None.

44.2.1.2.2 Combined GPRS attach / GPRS only attach accepted

44.2.1.2.2.1 Conformance requirement

- 1) If the network accepts the combined GPRS attach procedure, but GMM cause code 'IMSI unknown in HLR' is sent to the MS the Mobile Station shall delete the stored TMSI, LAI and CKSN. The Mobile Station shall consider SIM invalid for non-GPRS services until power is switched off or SIM is removed.
- 2) If the network accepts the combined GPRS attach procedure, but GMM cause code 'MSC temporarily not reachable', 'Network failure' or 'Congestion' is sent to the MS, an MS operation mode B MS may perform an MM IMSI attach procedure.

Reference(s):

3GPP TS 04.08 / 3GPP TS 24.008 subclause 4.7.3.2.

44.2.1.2.2.2 Test Purpose

Test purpose 1

To test the behaviour of the MS if the network accepts the GPRS attach procedure with indication GPRS only, GMM cause 'IMSI unknown in HLR'.

Test purpose 2

To test the behaviour of the MS if the network accepts the GPRS attach procedure with indication GPRS only, GMM cause 'MSC temporarily not reachable', 'Network failure' or 'Congestion'.

44.2.1.2.2.3 Method of test

44.2.1.2.2.3.1 Test Procedure 1

Initial conditions

System Simulator:

One cell operating in network operation mode I.

Mobile Station:

The MS has a valid IMSI. MS is Idle Updated.

Specific PICS statements:

- MS operation mode B (TSPC_operation_mode_B)
- MS operation mode A (TSPC_operation_mode_A).
- Switch off on button (TSPC_Feat_OnOff).
- Automatic GPRS attach procedure at switch on or power on (TSPC_AddInfo_on_auto_GPRS_AP).

PIXIT statements:

-

Test procedure

The MS sends an ATTACH REQUEST message with identity IMSI. The SS allocates a P-TMSI and returns ATTACH ACCEPT message with a P-TMSI. GMM cause 'IMSI unknown in HLR' is indicated from SS. Further communication MS - SS is performed by the P-TMSI. CS services are not possible.

Maximum duration of test

5 minutes.

Expected sequence

Step	Direction	Message	Comments
1	MS		The MS is set in MS operation mode B.
2	MS		The MS is powered up or switched on and initiates an attach (see PICS).
3	MS -> SS	ATTACH REQUEST	Attach type = 'Combined GPRS / IMSI attach' or 'GPRS attach while IMSI attached' Mobile identity = IMSI
4	SS -> MS	ATTACH ACCEPT	TMSI status = no valid TMSI available Attach result = 'GPRS only attached' Mobile identity = P-TMSI-1 P-TMSI-1 signature GMM cause = 'IMSI unknown in HLR' Routing area identity = RAI-1
5	MS -> SS	ATTACH COMPLETE	
6	SS -> MS		SS pages MS with Mobile identity = IMSI according to the channel combination of the cell.
7	MS		Paging order is for RR-connection. The MS shall not initiate an RR connection. This is checked during 3 seconds.
8	MS		The MS is switched off or power is removed (see PICS).
9	MS -> SS	DETACH REQUEST	Message not sent if power is removed. Detach type = 'power switched off, GPRS detach'

Specific message contents

None.

44.2.1.2.2.3.2 Test Procedure 2

Initial conditions

System Simulator:

One cell operating in network operation mode I. T3212 is set to 6 minutes.

Mobile Station:

The MS has a valid TMSI, P-TMSI and RAI. MS is Idle Updated.

Specific PICS statements:

- MS operation mode B (TSPC_operation_mode_B)
- MS operation mode A (TSPC_operation_mode_A).
- Automatic MM IMSI attach procedure at switch-on/power-on (TSPC_AddInfo_auto_MM_IMSI_AP_on_off).
- Switch off on button Yes/No (TSPC_Feat_OnOff).
- Automatic GPRS attach procedure at switch on or power on (TSPC_AddInfo_on_auto_GPRS_AP).

PIXIT statements:

-

Test procedure

The MS sends an ATTACH REQUEST message. The SS allocates a P-TMSI and returns ATTACH ACCEPT message with a P-TMSI. GMM cause 'MSC temporarily not reachable', 'Network failure' or 'Congestion' is indicated from SS. The cause code is arbitrarily chosen. The MS sends a ROUTING AREA UPDATE REQUEST message. The SS returns a ROUTING AREA UPDATE ACCEPT message. GMM cause 'MSC temporarily not reachable', 'Network failure' or 'Congestion' is indicated from SS. The cause code is arbitrarily chosen. The ROUTING AREA UPDATE procedure is repeated four times. An MS operation mode B MS may then perform an MM IMSI attach procedure (according to the PICS statement). Further communication MS - SS is performed by the P-TMSI. The existence of a signalling channel is verified by a request for mobile identity.

Maximum duration of test

15 minutes.

Expected sequence

Dependent whether the option 'Automatic MM IMSI attach procedure at switch-on/power-on' is supported or not, the steps 1-19 or 20-39 apply depending on manufacturer (see PICS).

Step	Direction	Message	Comments
1	MS		The MS is set in MS operation mode B and no automatic MM IMSI attach procedure is indicated (see PICS).
2	MS		The MS is powered up or switched on and initiates an attach (see PICS).
3	MS -> SS	ATTACH REQUEST	Attach type = 'Combined GPRS / IMSI attach' or 'GPRS attach while IMSI attached' Mobile identity = P-TMSI-1 Routing area identity = RAI-1 TMSI status = valid TMSI available or IE is omitted
4	SS -> MS	ATTACH ACCEPT	Attach result = 'GPRS only attached' Mobile identity = P-TMSI-2 P-TMSI-2 signature Routing area identity = RAI-1 GMM cause = 'MSC temporarily not reachable', 'Network failure' or 'Congestion' (arbitrarily chosen)
5	MS -> SS	ATTACH COMPLETE	
7	MS -> SS	ROUTING AREA UPDATE REQUEST	Update type = 'Combined RA / LA updating with IMSI attach' P-TMSI-2 signature Routing area identity = RAI-1

Step	Direction	Message	Comments
8	SS -> MS	ROUTING AREA UPDATE ACCEPT	No new mobile identity assigned. P-TMSI not included. Update result = 'RA updated' P-TMSI-3 signature Routing area identity = RAI-1 GMM cause = 'MSC temporarily not reachable', 'Network failure' or 'Congestion' (arbitrarily chosen) Force to standby indicator set.
10	MS -> SS	ROUTING AREA UPDATE REQUEST	Update type = 'Combined RA / LA updating with IMSI attach' P-TMSI-3 signature Routing area identity = RAI-1
11	SS -> MS	ROUTING AREA UPDATE ACCEPT	No new mobile identity assigned. P-TMSI not included. Update result = 'RA updated' P-TMSI-4 signature Routing area identity = RAI-1 GMM cause = 'MSC temporarily not reachable', 'Network failure' or 'Congestion' (arbitrarily chosen) Force to standby indicator set.
12	MS -> SS	ROUTING AREA UPDATE REQUEST	Update type = 'Combined RA / LA updating with IMSI attach' P-TMSI-4 signature Routing area identity = RAI-1
13	SS		The SS verifies that the time between the previous routing area update accept and routing area update request is T3311 (+/- 10%)
14	SS -> MS	ROUTING AREA UPDATE ACCEPT	No new mobile identity assigned. P-TMSI not included. Update result = 'RA updated' P-TMSI-5 signature Routing area identity = RAI-1 GMM cause = 'MSC temporarily not reachable', 'Network failure' or 'Congestion' (arbitrarily chosen) Force to standby indicator set.
16	MS -> SS	ROUTING AREA UPDATE REQUEST	Update type = 'Combined RA / LA updating with IMSI attach' P-TMSI-5 signature Routing area identity = RAI-1
17	SS -> MS	ROUTING AREA UPDATE ACCEPT	No new mobile identity assigned. P-TMSI not included. Update result = 'RA updated' P-TMSI-6 signature Routing area identity = RAI-1 GMM cause = 'MSC temporarily not reachable', 'Network failure' or 'Congestion' (arbitrarily chosen) Force to standby indicator set.
18	MS		The MS is switched off or power is removed (see PICS).
19	MS -> SS	DETACH REQUEST	Message not sent if power is removed. Detach type = 'power switched off, GPRS detach'. Stop the sequence.
20	MS		Automatic MM IMSI attach procedure is indicated (see PICS).
21	MS		The MS is powered up or switched on and initiates an attach (see PICS).
22	MS -> SS	ATTACH REQUEST	Attach type = 'Combined GPRS / IMSI attach' or 'GPRS attach while IMSI attached' Mobile identity = P-TMSI-1 Routing area identity = RAI-1 TMSI status = valid TMSI available or IE is omitted

Step	Direction	Message	Comments
23	SS -> MS	ATTACH ACCEPT	No new mobile identity assigned. P-TMSI not included. Attach result = 'GPRS only attached' P-TMSI-2 signature Routing area identity = RAI-1 GMM cause = 'MSC temporarily not reachable', 'Network failure' or 'Congestion' (arbitrarily chosen) Negotiated Ready timer value IE should not be included.
24	MS -> SS	ROUTING AREA UPDATE REQUEST	Force to standby indicator set. Update type = 'Combined RA / LA updating with IMSI attach' P-TMSI-2 signature Routing area identity = RAI-1
25	SS -> MS	ROUTING AREA UPDATE ACCEPT	No new mobile identity assigned. P-TMSI not included. Update result = 'RA updated' P-TMSI-3 signature Routing area identity = RAI-1 GMM cause = 'MSC temporarily not reachable', 'Network failure' or 'Congestion' (arbitrarily chosen) Force to standby indicator set.
26	MS -> SS	ROUTING AREA UPDATE REQUEST	Update type = 'Combined RA / LA updating with IMSI attach' P-TMSI-3 signature Routing area identity = RAI-1
27	SS -> MS	ROUTING AREA UPDATE ACCEPT	No new mobile identity assigned. P-TMSI not included. Update result = 'RA updated' P-TMSI-4 signature Routing area identity = RAI-1 GMM cause = 'MSC temporarily not reachable', 'Network failure' or 'Congestion' (arbitrarily chosen) Force to standby indicator set.
28	MS -> SS	ROUTING AREA UPDATE REQUEST	Update type = 'Combined RA / LA updating with IMSI attach' P-TMSI-4 signature Routing area identity = RAI-1
29	SS		The SS verifies that the time between the previous routing area update accept and routing area update request is T3311 (+/- 10%)
30	SS -> MS	ROUTING AREA UPDATE ACCEPT	No new mobile identity assigned. P-TMSI not included. Update result = 'RA updated' P-TMSI-5 signature Routing area identity = RAI-1 GMM cause = 'MSC temporarily not reachable', 'Network failure' or 'Congestion' (arbitrarily chosen) Force to standby indicator set.
31	MS -> SS	ROUTING AREA UPDATE REQUEST	Update type = 'Combined RA / LA updating with IMSI attach' P-TMSI-5 signature Routing area identity = RAI-1
32	SS		The SS verifies that the time between the previous routing area update accept and routing area update request is T3311 (+/- 10%)

Step	Direction	Message	Comments
33	SS -> MS	ROUTING AREA UPDATE ACCEPT	No new mobile identity assigned. P-TMSI not included. Update result = 'RA updated' P-TMSI-6 signature Routing area identity = RAI-1 GMM cause = 'MSC temporarily not reachable', 'Network failure' or 'Congestion' (arbitrarily chosen) Force to standby indicator set.
34 (optional step)		{Location Update Procedure}	Macro. Location Update Procedure may be initiated from the MS. Parameter is TMSI-1. Steps 35, 36 and 37 are only performed if the MS has performed the Location Update Procedure in step 34.
35	SS -> MS		SS pages MS with Mobile identity = TMSI-1 and Paging order is for RR-connection.
36	MS -> SS		Verify that the MS initiates a RR connection and sends a PAGING RESPONSE with Mobile identity = TMSI-1
37	SS		SS releases the RR connection and indicate the successfully resumption of GPRS services.
38	MS		The MS is switched off or power is removed (see PICS).
39	MS -> SS	DETACH REQUEST	Message not sent if power is removed.

Specific message contents

SYSTEM INFORMATION TYPE 3 (Cell A) in Test Procedure 2:

Information element	Value/remark
As default message contents except:	
Control Channel Description T3212 timeout value	6 min

In case of PBCCH present:

PACKET SYSTEM INFORMATION TYPE 2 (Insatnce 1) (Cell A) in Test Procedure 2:

Non GPRS Cell Options -T3212	1 Non GPRS Cell Options present 00000001 (T3212 Timeout value = 6 mins)
---------------------------------	--

Note: An R97 MS will use this value to set T3302.

ATTACH ACCEPT and ROUTING AREA UPDATE ACCEPT in Test Procedure 2:

Information Element	Value/remark
As default message contents except: T3302 value	6 min

Note: This IE is only read by MSs supporting R99 and onwards.

44.2.1.2.3 Combined GPRS attach / GPRS attach while IMSI attach

44.2.1.2.3.1 Void

44.2.1.2.3.2 Conformance requirement

If the GPRS MS is already attached for non-GPRS services by the MM specific attach procedure, but wants to perform an attach for GPRS services, the combined GPRS attach procedure is performed.

Reference(s):

3GPP TS 04.08 / 3GPP TS 24.008 subclause 4.7.3.2.

44.2.1.2.3.3 Test Purpose

To test the behaviour of the MS if GPRS attach performed while IMSI attached.

44.2.1.2.3.4 Method of test

Initial conditions

System Simulator:

One cell operating in network operation mode I. ATT flag is set.

Mobile Station:

The MS has a valid TMSI-1, P-TMSI-1 and RAI-1.

Specific PICS statements:

- MS operation mode B (TSPC_operation_mode_B)
- MS operation mode A (TSPC_operation_mode_A).
- Switch off on button (TSPC_Feat_OnOff).
- Automatic GPRS attach procedure at switch on or power on (TSPC_AddInfo_on_auto_GPRS_AP).

PIXIT statements:

-

Test procedure

The MS attaches for non-GPRS services. The MS does not answer to paging orders for GPRS. The MS attaches for GPRS services. Paging orders for GPRS are answered.

Maximum duration of test

5 minutes.

Expected sequence

Step	Direction	Message	Comments
1	MS		The MS is set in MS operation mode B (see PICS) and configured not to perform a GPRS attach.
2	MS		The MS is powered up or switched on. No GPRS attach is performed (see PICS).
3	MS	{Location Update Procedure}	Macro. Location Update Procedure initiated from the MS. Parameter mobile identity is TMSI-1.
4	SS -> MS		SS pages the MS with mobile identity P-TMSI-1 and paging order for TBF establishment according to the channel combination of the cell.
5	MS		No response from the MS to the request. This is checked for 10 s.
6	MS		The MS is triggered to perform a GPRS attach (in combination with IMSI attach).
7	MS -> SS	ATTACH REQUEST	Attach type = 'GPRS attach while IMSI attached' or 'Combined GPRS/IMSI attach' Mobile identity =P-TMSI-1 Routing area identity = RAI-1
8	SS -> MS	ATTACH ACCEPT	Attach result = 'Combined GPRS / IMSI attached' No new mobile identity assigned. TMSI and P-TMSI not included P-TMSI-2 signature Routing area identity = RAI-1 Negotiated Ready timer value IE should not be included.
9	SS -> MS		Force to standby indicator set. SS pages the MS with mobile identity P-TMSI-1 and paging order for TBF establishment according to the channel combination of the cell.
10	MS		Verify that the MS initiates a TBF connection and sends an UPLINK RLC DATA BLOCK as a response to the paging request.
11	MS		The MS is switched off or power is removed (see PICS).
12	MS -> SS	DETACH REQUEST	Message not sent if power is removed. Detach type = 'power switched off, combined GPRS / IMSI detach'

Specific message contents

None.

44.2.1.2.4 Combined GPRS attach / rejected / IMSI invalid / illegal ME

44.2.1.2.4.1 Conformance requirement

- 1) If the network rejects a combined GPRS attach procedure from the Mobile Station with the cause 'Illegal ME', the Mobile Station shall consider SIM invalid for GPRS and non-GPRS services until power is switched off or SIM is removed.
- 2) If the network rejects a combined GPRS attach procedure from the Mobile Station with the cause 'Illegal ME', the Mobile Station shall delete the stored TMSI, LAI, CSKN, RAI, GPRS-CSKN, P-TMSI and P-TMSI signature.

Reference(s):

3GPP TS 04.08 / 3GPP TS 24.008 subclause 4.7.3.2.

44.2.1.2.4.2 Test purpose

To test the behaviour of the MS if the network rejects the combined GPRS attach procedure of the MS with the cause 'Illegal ME'.

44.2.1.2.4.3 Method of test

Initial conditions

System Simulator:

Three cells (not simultaneously activated), cell A in MCC1/MNC1/LAC1/RAC1, cell B in MCC1/MNC1/LAC1/RAC2, cell C in MCC2/MNC1/LAC1/RAC1.

All three cells are operating in network operation mode I.

Mobile Station:

The MS has a valid TMSI-1, P-TMSI-1 and RAI-1. MS is Idle Updated on cell A.

Specific PICS statements:

- MS operation mode B (TSPC_operation_mode_B)
- MS operation mode A (TSPC_operation_mode_A).
- SIM removal possible without powering down (TSPC_AddInfo_SIMRmv).
- Switch off on button (TSPC_Feat_OnOff).
- Automatic GPRS attach procedure at switch on or power on Yes/No (TSPC_AddInfo_on_auto_GPRS_AP).

PIXIT statements:

-

Test procedure

The SS rejects a GPRS attach with the cause value 'Illegal ME'. The SS checks that the MS does not perform GPRS attach in the same or another PLMN. CS services are not possible as the SIM is blocked for CS services. GPRS services are not possible as the SIM is blocked for GPRS services.

Maximum duration of test

5 minutes.

Expected sequence

Step	Direction	Message	Comments
1	SS		The following messages are sent and shall be received on cell A.
2	MS		The SS activates cell A.
3	MS		The MS is set in MS operation mode B (see PICS).
4	MS -> SS	ATTACH REQUEST	The MS is powered up or switched on and initiates an attach (see PICS). Cell A is preferred by the MS. Attach type = 'Combined GPRS / IMSI attach' or 'GPRS attach while IMSI attached' Mobile identity = P-TMSI-1 Routing area identity = RAI-1 TMSI status = valid TMSI available or IE is omitted
5	SS -> MS	ATTACH REJECT	GMM cause 'Illegal ME'.
6	SS -> MS		SS pages the MS with mobile identity of TMSI-1 and paging order for RR connection according to the channel combination of the cell.
7	MS		The MS shall not initiate an RR connection. This is checked during 3 seconds.
8	SS -> MS		SS pages the MS with mobile identity of IMSI and paging order for RR connection according to the channel combination of the cell.
9	MS		The MS shall not initiate an RR connection. This is checked during 3 seconds.
10	SS -> MS		SS pages the MS with mobile identity of P-TMSI-1 and paging order for TBF establishment according to the channel combination of the cell.
11	MS		No response from the MS to the request. This is checked for 10 s.
12	SS		The following messages are sent and shall be received on cell B.
13	MS		The SS deactivates cell A and activates cell B.
14	MS		Cell B is preferred by the MS.
15	SS -> MS		No ATTACH REQUEST sent to the SS (SS waits 30 seconds).
16	MS		SS pages the MS with mobile identity of IMSI and paging order for RR connection according to the channel combination of the cell. The MS shall not initiate an RR connection. This is checked during 3 seconds.
17	SS		The following messages are sent and shall be received on cell C.
18	MS		The SS deactivates cell B and activates cell C.
19	MS		Cell C is preferred by the MS.
20	SS -> MS		No ATTACH REQUEST sent to the SS (SS waits 30 seconds).
21	MS		SS pages the MS with mobile identity of IMSI and paging order for RR connection according to the channel combination of the cell. No response from the MS to the request. This is checked for 10seconds.
22	MS		If possible (see PICS) SIM removal is performed. Otherwise if possible (see PICS) switch off is performed. Otherwise the power is removed.

Step	Direction	Message	Comments
23	MS		The MS gets the SIM replaced, is powered up or switched on. Step 22 is only performed for non-auto attach MS.
24		{Location Update Procedure}	Macro. Location Update Procedure initiated from the MS. Parameter Mobile identity is IMSI.
25	MS		MS initiates an attach automatically (see PICS), via MMI or AT commands.
26	MS -> SS	ATTACH REQUEST	Attach type = 'Combined GPRS / IMSI attach' or 'GPRS attach while IMSI attached' Mobile identity = IMSI
27	SS -> MS	ATTACH ACCEPT	TMSI status = no valid TMSI available Attach result = 'Combined GPRS / IMSI attached' Mobile identity = P-TMSI-1 P-TMSI-1 signature Mobile identity = TMSI-1 Routing area identity = RAI-2
28	MS -> SS	ATTACH COMPLETE	
29	SS -> MS		SS pages the MS with mobile identity of TMSI-1 and paging order for RR connection according to the channel combination of the cell.
30	MS -> SS		Verify that the MS initiates a RR connection and sends a PAGING RESPONSE with mobile identity with TMSI-1.
31	SS		SS releases the RR connection indicating a successful resumption of GPRS services.
32	MS		The MS is switched off or power is removed (see PICS).
33	MS -> SS	DETACH REQUEST	Message not sent if power is removed. Detach type = 'power switched off, combined GPRS / IMSI detach'

Specific message contents

None.

44.2.1.2.5 Combined GPRS attach / rejected / GPRS services and non-GPRS services not allowed

44.2.1.2.5.1 Conformance requirement

- 1) If the network rejects a combined GPRS attach procedure from the Mobile Station with the cause 'GPRS services and non-GPRS services not allowed', the Mobile Station shall consider SIM invalid for GPRS and non-GPRS services until power is switched off or SIM is removed.
- 2) If the network rejects a combined GPRS attach procedure from the Mobile Station with the cause 'GPRS services and non-GPRS services not allowed', the Mobile Station shall delete the stored TMSI, LAI, CSKN, RAI, GPRS-CKSN, P-TMSI and P-TMSI signature.

Reference(s):

3GPP TS 04.08 / 3GPP TS 24.008 subclause 4.7.3.2.

44.2.1.2.5.2 Test purpose

To test the behaviour of the MS if the network rejects the combined GPRS attach procedure of the MS with the cause 'GPRS services and non-GPRS services not allowed'.

44.2.1.2.5.3 Method of test

Initial conditions

System Simulator:

Two cells (not simultaneously activated), cell A in MCC1/MNC1/LAC1/RAC1 and cell B in MCC2/MNC1/LAC1/RAC1.

Both cells are operating in network operation mode I.

Mobile Station:

The MS has a valid TMSI, P-TMSI and RAI. MS is Idle Updated on cell A.

Specific PICS statements:

- MS operation mode B (TSPC_operation_mode_B)
- MS operation mode A (TSPC_operation_mode_A).
- Switch off on button (TSPC_Feat_OnOff).
- Automatic GPRS attach procedure at switch on or power on (TSPC_AddInfo_on_auto_GPRS_AP).

PIXIT statements:

-

Test procedure

The SS rejects a GPRS attach with the cause value 'GPRS services and non-GPRS services not allowed'. The SS checks that the MS does not perform GPRS attach in the same or another PLMN. CS services are not possible as the SIM is blocked for CS services. GPRS services are not possible as the SIM is blocked for GPRS services.

Maximum duration of test

5 minutes.

Expected sequence

Step	Direction	Message	Comments
1	SS		The following messages are sent and shall be received on cell A.
2	MS		The SS activates cell A.
3	MS		The MS is set in MS operation mode B (see PICS).
4	MS -> SS	ATTACH REQUEST	The MS is powered up or switched on and initiates an attach (see PICS). Cell A is preferred by the MS. Attach type = 'Combined GPRS / IMSI attach' or 'GPRS attach while IMSI attached' Mobile identity =P-TMSI-1 Routing area identity = RAI-1 TMSI status = valid TMSI available or IE is omitted
5	SS -> MS	ATTACH REJECT	GMM cause 'GPRS services and non-GPRS services not allowed'
6	MS		No LOCATION UPDATING REQ with type 'IMSI attach' is sent to the SS (SS waits 30 seconds).
7	SS -> MS		SS pages the MS with mobile identity IMSI and paging order for RR connection according to the channel combination of the cell.
8	MS		The MS shall not initiate an RR connection. This is checked during 3 seconds.
9	SS -> MS		SS pages the MS with mobile identity P-TMSI-1 and paging order for TBF establishment according to the channel combination of the cell.
10	MS		No response from the MS to the request. This is checked for 10 s
11	SS		The SS deactivates cell A and activates cell B.
12	MS		Cell B is preferred by the MS.
13	MS		No ATTACH REQUEST sent to the SS (SS waits 30 seconds).
14	SS -> MS		No LOCATION UPDATING REQ with type 'IMSI attach' is sent to the SS (SS waits 30 seconds).
15	MS		SS pages the MS with mobile identity IMSI and paging order for RR connection according to the channel combination of the cell.
16	SS -> MS		The MS shall not initiate an RR connection. This is checked during 3 seconds.
17	MS		SS pages the MS with mobile identity P-TMSI-1 and paging order for TBF establishment according to the channel combination of the cell.
18	MS		No response from the MS to the request. This is checked for 10seconds. If possible (see PICS) switch off is performed. Otherwise the power is removed.

Step	Direction	Message	Comments
19	MS		The MS is powered up or switched on. Step 20 is only performed for non-auto attach MS.
20		{Location Update Procedure}	Macro. Location Update Procedure initiated from the MS. Parameter mobile identity is IMSI.
21	MS		MS initiates an attach automatically (see PICS), via MMI or AT commands.
22	MS -> SS	ATTACH REQUEST	Attach type = 'Combined GPRS / IMSI attach' or 'GPRS attach while IMSI attached' Mobile identity = IMSI
23	SS -> MS	ATTACH ACCEPT	TMSI status = no valid TMSI available Attach result = 'Combined GPRS / IMSI attached' Mobile identity = P-TMSI-1 P-TMSI-1 signature Mobile identity = TMSI-1 Routing area identity = RAI-2
24	MS -> SS	ATTACH COMPLETE	
25	SS -> MS		SS pages the MS with mobile identity TMSI-1 and paging order for RR connection according to the channel combination of the cell.
26	MS -> SS		Verify that the MS initiates a RR connection and sends a PAGING RESPONSE with mobile identity with TMSI-1.
27	SS		SS releases the RR connection indicating a successful resumption of GPRS services.
28	SS -> MS		SS pages the MS with mobile identity P-TMSI-1 and paging order for TBF establishment according to the channel combination of the cell.
29	MS		Verify that the MS initiates a TBF connection and sends an UPLINK RLC DATA BLOCK as a response to the paging request.
30	MS		The MS is switched off or power is removed (see PICS).
31	MS -> SS	DETACH REQUEST	Message not sent if power is removed. Detach type = 'power switched off, combined GPRS / IMSI detach'

Specific message contents

None.

44.2.1.2.6 Combined GPRS attach / rejected / GPRS services not allowed

44.2.1.2.6.1 Conformance requirement

- 1) If the network rejects a combined GPRS attach procedure from the Mobile Station with the cause 'GPRS services not allowed', the Mobile Station shall consider SIM invalid for GPRS services until power is switched off or SIM is removed.
- 2) If the network rejects a combined GPRS attach procedure from the Mobile Station with the cause 'GPRS services not allowed' the Mobile Station shall delete the stored RAI, GPRS-CKSN, P-TMSI and P-TMSI signature.
- 3) A GPRS class B MS shall perform an MM IMSI attach procedure.

Reference(s):

3GPP TS 04.08 / 3GPP TS 24.008 subclause 4.7.3.2.

44.2.1.2.6.2 Test purpose

To test the behaviour of the MS if the network rejects the GPRS attach procedure of the MS with the cause 'GPRS services not allowed'.

44.2.1.2.6.3 Method of test

Initial conditions

System Simulator:

Two cells (not simultaneously activated), cell A in MCC1/MNC1/LAC1/RAC1 and cell B in MCC2/MNC1/LAC1/RAC1.

Both cells are operating in network operation mode I.

ATT flag set to 1.

Mobile Station:

The MS has a valid TMSI, P-TMSI-1 and RAI-1. MS is Idle Updated on cell A.

Specific PICS statements:

- MS operation mode B (TSPC_operation_mode_B)
- MS operation mode A (TSPC_operation_mode_A).
- Switch off on button (TSPC_Feat_OnOff).
- Automatic GPRS attach procedure at switch on or power (TSPC_AddInfo_on_auto_GPRS_AP).

PIXIT statements:

-

Test procedure

The SS rejects a normal attach with the cause value 'GPRS services not allowed'. The SS checks that the MS does not perform GPRS attach. GPRS services are not possible. After receiving the ATTACH REJECT message from the SS the mobile can react in several ways, due to an ambiguity in the core specification. Part 3 of the conformance requirements can be interpreted in the following ways:

1. The MS shall in any case perform a Location Update with the update type set to IMSI attach.
2. The MS shall perform the IMSI attach by means of a explicit Location update procedure only if the conditions specified for the IMSI attach procedure in 3GPP TS 04.08 / 3GSP TS 24.008, subclause 4.4.3 are fulfilled.
3. The MS shall perform a Location Update with the update type set either to IMSI attach or normal updating.

Because all three options are allowed a GPRS class B MS may perform an MM IMSI attach. Therefore step 8 in the expected sequence is an optional step.

Maximum duration of test

10 minutes.

Expected sequence

Step	Direction	Message	Comments
1	MS		The following messages are sent and shall be received on cell A. The MS is set in MS operation mode B (see PICS).
2	SS		The SS activates cell A.
3	MS		The MS is powered up or switched on. Step 4 is only performed for non-auto attach MS.
4	MS	{Location Update Procedure}	Macro. Location Update Procedure initiated from the MS. Parameter mobile identity is TMSI-1.
5			MS initiates an attach automatically (see PICS), via MMI or AT commands.
6	MS -> SS	ATTACH REQUEST	Attach type = 'Combined GPRS / IMSI attach' or 'GPRS attach while IMSI attached' Mobile identity =P-TMSI-1 Routing area identity = RAI-1
7	SS -> MS	ATTACH REJECT	GMM cause 'GPRS services not allowed'
8	MS	{Location Update Procedure}	Macro. Location Update Procedure initiated from the MS. Parameter mobile identity is TMSI-2.
9	SS -> MS		SS pages the MS with mobile identity of TMSI-2 or TMSI-1 for MS which did not perform step 8 and paging order for RR connection on CCCH.
10	MS -> SS		Verify that the MS initiates a RR connection and sends a PAGING RESPONSE with mobile identity TMSI-2 or TMSI-1 for MS which did not perform step 8.
11	SS		SS releases the RR connection.
12	SS		The following messages are sent and shall be received on cell B. The SS deactivates cell A and activates cell B. Cell B is preferred by the MS.
13	MS		
14		{Location Update Procedure}	Macro. Location Update Procedure initiated from the MS. Parameter mobile identity is TMSI-1.
15	SS -> MS		SS pages the MS with mobile identity of TMSI-1 and paging order for RR connection according to the channel combination of the cell.
16	MS -> SS		Verify that the MS initiates a RR connection and sends a PAGING RESPONSE with mobile identity TMSI-1.
17			SS releases the RR connection.
18	SS -> MS		SS pages the MS with mobile identity of P-TMSI-1 and paging order for TBF establishment according to the channel combination of the cell.
19	MS		No response from the MS to the request. This is checked for 10seconds.
20	MS		If possible (see PICS) switch off is performed. Otherwise the power is removed.
21	MS	{IMSI Detach}	Macro. If switch off is performed then MS performs IMSI detach.

Step	Direction	Message	Comments
22	MS		The MS is powered up or switched on. Step 23 is only performed for non-auto attach MS.
23	MS	{Location Update Procedure}	Macro. Location Update Procedure initiated from the MS. Parameter mobile identity is TMSI-1.
24			MS initiates an attach automatically (see PICS), via MMI or AT commands.
25	MS -> SS	ATTACH REQUEST	Attach type = 'Combined GPRS / IMSI attach' or 'GPRS attach while IMSI attached'
26	SS -> MS	ATTACH ACCEPT	Mobile identity = IMSI Attach result = 'Combined GPRS / IMSI attached' Mobile identity = P-TMSI-1 P-TMSI-1 signature Mobile identity = TMSI-2 Routing area identity = RAI-2
27	MS -> SS	ATTACH COMPLETE	
28	SS -> MS		SS pages the MS with mobile identity of TMSI-2 and paging order for RR connection according to the channel combination of the cell.
29	MS -> SS		Verify that the MS initiates a RR connection and sends a PAGING RESPONSE with mobile identity TMSI-2
30	SS		SS releases the RR connection indicating a successful resumption of GPRS services.
31	MS		The MS is switched off or power is removed (see PICS).
32	MS -> SS	DETACH REQUEST	Message not sent if power is removed. Detach type = 'power switched off, combined GPRS / IMSI detach'

Specific message contents

None.

44.2.1.2.7 Combined GPRS attach / rejected / location area not allowed

44.2.1.2.7.1 Conformance requirement

- 1) If the network rejects a combined GPRS attach procedure from the Mobile Station with the cause 'location area not allowed' the Mobile Station shall:
 - 1.1 not perform combined GPRS attach when in the same location area;
 - 1.2 delete the stored LAI, CKSN, TMSI, RAI, GPRS-CKSN, P-TMSI and P-TMSI signature;
 - 1.3 store the LA in the 'forbidden location areas for regional provision of service'.
- 2) If the network rejects a combined GPRS attach procedure from the Mobile Station with the cause 'location area not allowed' the Mobile Station shall:
 - 2.1 perform combined GPRS attach when a new location area is entered;
 - 2.2 delete the list of forbidden LAs when power is switched off.

Reference(s):

3GPP TS 04.08 / 3GPP TS 24.008 subclauses 4.7.3.2.

44.2.1.2.7.2 Test purpose

To test the behaviour of the MS if the network rejects the combined GPRS attach procedure with the cause 'Location Area not allowed'.

To test that the MS deletes the list of forbidden LAs when power is switched off.

44.2.1.2.7.3 Method of test

Initial conditions

System Simulator:

Three cells (not simultaneously activated), cell A in MCC1/MNC1/LAC1/RAC1, cell B in MCC1/MNC1/LAC1/RAC2, cell C in MCC1/MNC1/LAC2/RAC1.

All cells are operating in network operation mode I.

Mobile Station:

The MS has a valid TMSI, P-TMSI and RAI. MS is Idle Updated on cell A.

Specific PICS statements:

- MS operation mode B (TSPC_operation_mode_B)
- MS operation mode A (TSPC_operation_mode_A).
- Switch off on button (TSPC_Feat_OnOff).
- Automatic GPRS attach procedure at switch on or power on (TSPC_AddInfo_on_auto_GPRS_AP).
- GPRS attach attempted automatically due to outstanding request (TSPC_AddInfo_GPRS_Attach_Attempt_Outstanding).

PIXIT statements:

-

Test procedure

The SS rejects a combined GPRS attach with the cause value 'Location Area not allowed'. The SS checks that the MS does not perform combined GPRS attach while in the location area, performs GPRS attach when a new location area is entered and deletes the list of forbidden LAs when switched off. CS services are not possible unless an IMSI attach procedure is performed.

Different types of MS may use different methods to periodically clear the list of forbidden location areas (e.g. every day at 12 am). If the list is cleared while the test is being run, it may be necessary to re-run the test.

Maximum duration of test

10 minutes.

Expected sequence

Step	Direction	Message	Comments
	SS		The following messages are sent and shall be received on cell A.
1	SS		The SS activates cell A.
2	MS		The MS is set in MS operation mode B (see PICS).
3	MS		The MS is powered up or switched on and initiates an attach (see PICS). Cell A is preferred by the MS.
4	MS -> SS	ATTACH REQUEST	Attach type = 'Combined GPRS / IMSI attach' or 'GPRS attach while IMSI attached' Mobile identity = P-TMSI-1 Routing area identity = RAI-1
5	SS -> MS	ATTACH REJECT	GMM cause 'Location Area not allowed'
6	MS		No LOCATION UPDATING REQ with type 'IMSI attach' is sent to the SS (SS waits 30 seconds).
7	SS -> MS		SS pages the MS with mobile identity TMSI and paging order for RR connection according to the channel combination of the cell.

Step	Direction	Message	Comments
8	MS		The MS shall not initiate an RR connection.
9	SS -> MS		This is checked during 3 seconds. SS pages the MS with mobile identity P-TMSI-1 and paging order for TBF establishment according to the channel combination of the cell.
10	MS		No response from the MS to the request. This is checked for 10 s
11	SS		The following messages are sent and shall be received on cell B.
12	MS		The SS deactivates cell A and activates cell B.
13	MS		Cell B is preferred by the MS.
14	SS -> MS		No ATTACH REQUEST or LOCATION UPDATING REQ is sent to SS (SS waits 60 seconds)
15	MS		SS pages the MS with mobile identity P-TMSI-1 and paging order for TBF establishment according to the channel combination of the cell.
16	MS		No response from the MS to the request. This is checked for 10seconds.
17	MS		The MS initiates an attach by MMI or AT command. No attach is performed by the MS. This is checked for 10 s.
18	SS		The following messages are sent and shall be received on cell C.
19	MS		The SS deactivates cell B and activates cell C.
20		{Location Update Procedure}	Cell C is preferred by the MS.
21	MS		Steps 20 and 21 are only performed by an MS which will not initiate a GPRS attach automatically due to outstanding request (see PICS). Macro. Location Update Procedure initiated from the MS. Parameter Mobile identity is IMSI.
22	MS -> SS	ATTACH REQUEST	MS initiates an attach via MMI or AT commands.
23	SS -> MS	ATTACH ACCEPT	Attach type = 'Combined GPRS / IMSI attach' or 'GPRS attach while IMSI attached' Mobile identity = IMSI TMSI status = no valid TMSI available Attach result = 'Combined GPRS / IMSI attached' Mobile identity = P-TMSI1 P-TMSI-1 signature Mobile identity = TMSI-1 Routing area identity = RAI-3
24	MS -> SS	ATTACH COMPLETE	
25	SS -> MS		SS pages the MS with mobile identity TMSI-1 and paging order for RR connection according to the channel combination of the cell.
26	MS		Verify that the MS initiates a RR connection and sends a PAGING RESPONSE with mobile identity TMSI-1.
27	SS		SS releases the RR connection indicating a successful resumption of GPRS services.
28	SS -> MS		SS pages the MS with mobile identity P-TMSI-1 and paging order for TBF establishment according to the channel combination of the cell.
29	MS		Verify that the MS initiates a TBF connection and sends an UPLINK RLC DATA BLOCK as a response to the paging request.
30	MS		The MS is switched off or power is removed (see PICS).

Step	Direction	Message	Comments
31	MS -> SS	DETACH REQUEST	Message not sent if power is removed. Detach type = 'power switched off, combined GPRS / IMSI detach'
32	MS	{Location Update Procedure}	The following messages are sent and shall be received on cell B.
33	MS		The SS deactivates cell C and activates cell B. Cell B is preferred by the MS.
34			The MS is powered up or switched on. Step 34 is only performed for non-auto attach MS.
35	MS		Macro. Location Update Procedure initiated from the MS. Parameter mobile identity is TMSI-1.
36	MS -> SS		MS initiates an attach automatically (see PICS), via MMI or AT commands.
36	MS -> SS	ATTACH REQUEST	Attach type = 'Combined GPRS / IMSI attach' or 'GPRS attach while IMSI attached' Mobile identity = P-TMSI-1 Routing area identity = RAI-3
37	SS -> MS	ATTACH ACCEPT	Attach result = 'Combined GPRS / IMSI attached' Mobile identity = P-TMSI-2 P-TMSI-2 signature Mobile identity = TMSI-2 Routing area identity = RAI-4
38	MS -> SS	ATTACH COMPLETE	SS pages the MS with mobile identity TMSI-2 and paging order for RR connection according to the channel combination of the cell.
39	SS -> MS		
40	MS		Verify that the MS initiates a RR connection and sends a PAGING RESPONSE with mobile identity TMSI-2.
41	SS		SS releases the RR connection indicating a successful resumption of GPRS services.
42	SS -> MS		SS pages the MS with mobile identity P-TMSI-2 and paging order for TBF establishment according to the channel combination of the cell.
43	MS		Verify that the MS initiates a TBF connection and sends an UPLINK RLC DATA BLOCK as a response to the paging request.
44	MS		The MS is switched off or power is removed (see PICS).
45	MS -> SS	DETACH REQUEST	Message not sent if power is removed. Detach type = 'power switched off, combined GPRS / IMSI detach'

Specific message contents

None.

44.2.1.2.8 Combined GPRS attach / abnormal cases / attempt counter check / miscellaneous reject causes

44.2.1.2.8.1 Conformance requirement

- 1) When a combined GPRS attach procedure is rejected with the attach attempt counter less than five, the Mobile Station shall repeat the combined GPRS attach procedure after T3311 timeout.
- 2) When a combined GPRS attach procedure is rejected with the attach attempt counter five, the Mobile Station shall delete the stored TMSI, LAI, CKSN, P-TMSI, P-TMSI signature, GPRS CKSN and RAI and start T3302.
- 3) When the T3302 expire, a new combined GPRS attach procedure shall be initiated.

- GMM cause codes that can be selected are:
 - 'IMSI unknown in HLR';
 - 'MS identity cannot be derived by the network';
 - 'Network failure';
 - 'Congestion';
 - 'retry upon entry into a new cell';
 - 'Semantically incorrect message';
 - 'Invalid mandatory information';
 - 'Message type non-existent or not implemented';
 - 'Message type not compatible with the protocol state';
 - 'Information element non-existent or not implemented';
 - 'Conditional IE error';
 - 'Message not compatible with the protocol state';
 - 'Protocol error, unspecified';

Reference(s):

3GPP TS 04.08 / 3GPP TS 24.008 subclause 4.7.3.2.

44.2.1.2.8.2 Test purpose

To test the behaviour of the MS with respect to the attach attempt counter.

44.2.1.2.8.3 Method of test**Initial conditions****System Simulator:**

One cell operating in network operation mode I. T3302 is set to 12 minutes.

Mobile Station:

The MS has a valid TMSI, P-TMSI and RAI. MS is Idle Updated.

Specific PICS statements:

- MS operation mode B (TSPC_operation_mode_B)
- MS operation mode A (TSPC_operation_mode_A).
- Automatic GPRS attach procedure at switch on or power on (TSPC_AddInfo_on_auto_GPRS_AP).
- Switch off on button (TSPC_Feat_OnOff).

PIXIT statements:

-

Test procedure

The MS initiates a combined GPRS attach procedure (attach attempt counter zero). The SS rejects the attach with an arbitrarily chosen cause code. The attach attempt counter is incremented and T3311 is started.

The MS initiates a new combined GPRS attach procedure (attach attempt counter one) after T3311 expires. The SS rejects the attach with an arbitrarily chosen cause code. The attach attempt counter is incremented and T3311 is started.

The MS initiates a new combined GPRS attach procedure (attach attempt counter two) after T3311 expires. The SS rejects the attach with an arbitrarily chosen cause code. The attach attempt counter is incremented and T3311 is started.

The MS initiates a new combined GPRS attach procedure (attach attempt counter three) after T3311 expires. The SS rejects the attach with an arbitrarily chosen cause code. The attach attempt counter is incremented and T3311 is started.

The MS initiates a new combined GPRS attach procedure (attach attempt counter four) after T3311 expires. The SS rejects the attach with an arbitrarily chosen cause code. The attach attempt counter is incremented and T3311 is not started, as the attach attempt counter is five. T3302 is started.

The MS initiates a combined GPRS attach procedure with attach attempt counter zero after T3302 expires without P-TMSI, P-TMSI signature, GPRS CKSN and RAI.

Maximum duration of test

20 minutes.

Expected sequence

Step	Direction	Message	Comments
1	MS		The MS is set in MS operation mode B (see PICS).
2	MS		The MS is powered up or switched on and initiates an attach (see PICS).
3	MS -> SS	ATTACH REQUEST	Attach type = 'Combined GPRS / IMSI attach' or 'GPRS attach while IMSI attached' Mobile identity =P-TMSI-1 Routing area identity = RAI-1
4	SS -> MS	ATTACH REJECT	Arbitrarily chosen GMM cause
5	MS -> SS	ATTACH REQUEST	Attach type = 'Combined GPRS / IMSI attach' or 'GPRS attach while IMSI attached' Mobile identity = P-TMSI-1 Routing area identity = RAI-1
6	SS		The SS verifies that the time between the attach reject and attach request is T3311 (+/- 10%)
7	SS -> MS	ATTACH REJECT	Arbitrarily chosen GMM cause
8	MS -> SS	ATTACH REQUEST	Attach type = 'Combined GPRS / IMSI attach' or 'GPRS attach while IMSI attached' Mobile identity = P-TMSI-1 Routing area identity = RAI-1
9	SS		The SS verifies that the time between the attach reject and attach request is T3311 (+/- 10%)
10	SS -> MS	ATTACH REJECT	Arbitrarily chosen GMM cause
11	MS -> SS	ATTACH REQUEST	Attach type = 'Combined GPRS / IMSI attach' or 'GPRS attach while IMSI attached' Mobile identity = P-TMSI-1 Routing area identity = RAI-1
12	SS		The SS verifies that the time between the attach reject and attach request is T3311 (+/- 10%)
13	SS -> MS	ATTACH REJECT	Arbitrarily chosen GMM cause
14	MS -> SS	ATTACH REQUEST	Attach type = 'Combined GPRS / IMSI attach' or 'GPRS attach while IMSI attached' Mobile identity =P-TMSI-1 Routing area identity = RAI-1
15	SS		The SS verifies that the time between the attach reject and attach request is T3311 (+/- 10%)
16	SS -> MS	ATTACH REJECT	Arbitrarily chosen GMM cause
17	MS	{Location Update Procedure}	Macro. Location Update Procedure may be initiated from the MS. Parameter mobile identity is IMSI.
(optional step)			
18	SS -> MS		SS pages the MS with mobile identity of P-TMSI-1 and paging order for TBF establishment according to the channel combination of the cell.
19	MS		No response from the MS to the request. This is checked for 10seconds.
20	MS -> SS	ATTACH REQUEST	Attach type = 'Combined GPRS/IMSI attach' or 'GPRS attach while IMSI attached' Mobile identity = IMSI TMSI status =no valid TMSI available
21	SS		The SS verifies that the MS does not attempt to attach for T3302 (+/- 10%).

Step	Direction	Message	Comments
22	SS -> MS	ATTACH ACCEPT	Attach result = 'Combined GPRS / IMSI attached' Mobile identity P-TMSI-1 P-TMSI signature Mobile identity = TMSI-1 Routing area identity = RAI-1
23	MS -> SS	ATTACH COMPLETE	SS pages the MS with mobile identity of TMSI-1 and paging order for RR connection according to the channel combination of the cell.
24	SS -> MS		
25	MS -> SS		Verify that the MS initiates a RR connection and sends a PAGING RESPONSE with mobile identity with TMSI-1.
26	SS		SS releases the RR connection indicating a successful resumption of GPRS services.
27	SS -> MS		SS pages the MS with mobile identity of P-TMSI-1 and paging order for TBF establishment according to the channel combination of the cell.
28	MS		Verify that the MS initiates a TBF connection and sends an UPLINK RLC DATA BLOCK as a response to the paging request.
29	MS		The MS is switched off or power is removed (see PICS).
30	MS -> SS	DETACH REQUEST	Message not sent if power is removed. Detach type = 'power switched off, combined GPRS / IMSI detach'

Specific message contents

None.

44.2.1.2.9 Combined GPRS attach / abnormal cases / GPRS detach procedure collision

44.2.1.2.9.1 Conformance requirement

44.2.1.2.9.1 Conformance requirement

- 1) When a DETACH REQUEST message is received by the MS (Detach type 're-attach not required') while waiting for an ATTACH ACCEPT message or ATTACH REJECT message, the MS shall terminate the combined GPRS attach procedure and continue with the combined GPRS detach procedure.
- 2) When a DETACH REQUEST message is received by the MS (Detach type 're-attach required') while waiting for an ATTACH ACCEPT message or ATTACH REJECT message, the MS shall ignore the combined GPRS detach procedure and continue with the combined GPRS attach procedure.

Reference(s):

3GPP TS 04.08 / 3GPP TS 24.008 subclause 4.7.3.2.

44.2.1.2.9.2 Test purpose

To test the behaviour of the MS in case of procedure collision.

44.2.1.2.9.3 Method of test

Initial conditions

System Simulator:

One cell operating in network operation mode I.

Mobile Station:

The MS has a valid TMSI, P-TMSI and RAI. MS is Idle Updated.

Specific PICS statements:

- MS operation mode B (TSPC_operation_mode_B)
- MS operation mode A (TSPC_operation_mode_A).
- Switch off on button (TSPC_Feat_OnOff).
- Automatic GPRS attach procedure at switch on or power on (TSPC_AddInfo_on_auto_GPRS_AP).
- Re-attach automatically when the network commands a detach with no cause value (TSPC_AddInfo_GPRS_Attach_on_NW_Detach_NoCause).

PIXIT statements:

-

Test procedure

The MS initiates a combined GPRS attach procedure. The SS does not answer the combined GPRS attach procedure, but initiates a combined GPRS detach procedure (Detach type 're-attach not required'). The MS shall terminate the combined GPRS attach procedure and continue with the combined GPRS detach procedure.

The MS initiates a combined GPRS attach procedure. The SS does not answer the combined GPRS attach procedure, but initiates a combined GPRS detach procedure (Detach type 're-attach required'). The MS shall ignore the combined GPRS detach procedure and continue with the combined GPRS attach. CS services are also possible.

Maximum duration of test

5 minutes.

Expected sequence

Step	Direction	Message	Comments
1	MS		The MS is set in MS operation mode B (see PICS).
2	MS		The MS is powered up or switched on and initiates an attach (see PICS).
3	MS -> SS	ATTACH REQUEST	Attach type = 'Combined GPRS / IMSI attach' or 'GPRS attach while IMSI attached' Mobile identity = P-TMSI-1 Routing area identity = RAI-1
4	SS		The SS ignores the ATTACH REQUEST message and initiates a detach procedure.
5	SS -> MS	DETACH REQUEST	Detach type = 're-attach not required'
6	MS -> SS	DETACH ACCEPT	
7	MS		The MS is attached by MMI or AT command if the MS does not re-attach automatically upon receiving a network initiated detach with no cause value, (see PIXIT).
8	MS -> SS	ATTACH REQUEST	Attach type = 'Combined GPRS / IMSI attach' or 'GPRS attach while IMSI attached' Mobile identity = P-TMSI-1 Routing area identity = RAI-1
9	SS		The SS ignores the ATTACH REQUEST message and initiates a detach procedure.
10	SS -> MS	DETACH REQUEST	Detach type = 're-attach required'
11	MS		The MS ignores the DETACH REQUEST message and continue with the attach procedure
12	SS -> MS	ATTACH ACCEPT	Attach result = 'Combined GPRS / IMSI attached' Mobile identity = P-TMSI-2 P-TMSI-2 signature Mobile identity = TMSI-2 Routing area identity = RAI-1
13	MS -> SS	ATTACH COMPLETE	
14	SS -> MS		SS pages the MS with mobile identity of TMSI-2 and paging order for RR connection according to the channel combination of the cell.
15	MS -> SS		Verify that the MS initiates a RR connection and sends a PAGING RESPONSE with mobile identity with TMSI-2.
16	SS		SS releases the RR connection indicating a successful resumption of GPRS services.
17	SS -> MS		SS pages the MS with mobile identity of P-TMSI-2 and paging order for TBF establishment according to the channel combination of the cell.
18	MS		Verify that the MS initiates a TBF connection and sends an UPLINK RLC DATA BLOCK as a response to the paging request.
19	MS		The MS is switched off or power is removed (see PICS).
20	MS -> SS	DETACH REQUEST	Message not sent if power is removed. Detach type = 'power switched off, combined GPRS / IMSI detach'

Specific message contents

None.

44.2.2 GPRS detach procedure

This procedure is used to indicate for the network that the IMSI is not available for traffic. The GMM context is removed.

44.2.2.1 MS initiated GPRS detach procedure

44.2.2.1.1 GPRS detach / power off / accepted

44.2.2.1.1.1 Conformance requirement

The MS detaches the IMSI for GPRS services if the MS is switched off.

Reference(s):

3GPP TS 04.08 / 3GPP TS 24.008 subclause 4.7.4.1.

44.2.2.1.1.2 Test purpose

To test the behaviour of the MS for the detach procedure.

44.2.2.1.1.3 Method of test

Initial conditions

System Simulator:

One cell operating in network operation mode II.

Mobile Station:

The MS has a valid P-TMSI-1 and RAI-1. MS is Idle Updated.

Specific PICS statements:

- MS operation mode C (TSPC_operation_mode_C).
- MS operation mode B (TSPC_operation_mode_B).
- Switch off on button (TSPC_Feat_OnOff).
- Automatic GPRS attach procedure at switch on or power on (TSPC_AddInfo_on_auto_GPRS_AP).

PIXIT statements:

-

Test procedure

The MS performs a GPRS attach procedure.

The MS sends a DETACH REQUEST message to the SS.

Maximum duration of test

5 minutes.

Expected sequence

Step	Direction	Message	Comments
1	MS		The MS is set in MS operation mode C (see PICS). If MS operation mode C not supported, goto step 8.
2	MS		The MS is powered up or switched on and initiates an attach (see PICS).
3	MS -> SS	ATTACH REQUEST	Attach type = 'GPRS attach' Mobile identity = P-TMSI-1 Routing area identity = RAI-1
4	SS -> MS	ATTACH ACCEPT	Attach result = 'GPRS only attached' Mobile identity = P-TMSI-2 P-TMSI-2 signature Routing area identity = RAI-1
5	MS -> SS	ATTACH COMPLETE	
6	MS		The MS is switched off (see PICS).
7	MS -> SS	DETACH REQUEST	Detach type = 'power switched off, GPRS detach'
8	MS		The MS is set in MS operation mode B (see PICS) and the test is repeated from step 2 to step 7.

Specific message contents

None.

44.2.2.1.2 GPRS detach / accepted

44.2.2.1.2.1 Conformance requirement

- 1) The MS detaches the IMSI for GPRS services if the MS is ordered to do so with MMI or AT commands.
- 2) (For R99 or after MS only) Upon completion of the subsequent attach, routing area update, service request or detach procedure the used P-TMSI signature shall be deleted.

Reference(s):

3GPP TS 04.08 / 3GPP TS 24.008 subclause 4.7.4.1.

3GPP TS 24.008 subclause 4.7.1.3 (additional reference for R99 or after MS only)

44.2.2.1.2.2 Test purpose

To test the behaviour of the MS for the detach procedure, including treatment of P-TMSI signature by R99 and after MS.

44.2.2.1.2.3 Method of test

Initial conditions

System Simulator:

One cell operating in network operation mode III.

Mobile Station:

The MS has a valid P-TMSI-1 and RAI-1. MS is Idle Updated.

Specific PICS statements:

- MS operation mode C (TSPC_operation_mode_C).
- MS operation mode B (TSPC_operation_mode_B).
- Switch off on button (TSPC_Feat_OnOff).

- Automatic GPRS attach procedure at switch on or power on (TSPC_AddInfo_on_auto_GPRS_AP).
- MS GPRS release(TSPC_MS_GPRS_RELEASE)

PIXIT statements:

-

Test procedure

The MS performs a GPRS attach procedure.

The MS sends a DETACH REQUEST message to the SS.

The SS signal to the MS, but no response is received, as the signalling link is disconnected.

The MS performs a GPRS attach procedure.

The MS sends a DETACH REQUEST message to the SS.

Maximum duration of test

5 minutes.

Expected sequence

Step	Direction	Message	Comments
1	MS		The MS is set in MS operation mode C (see PICS). If MS operation mode C not supported, goto step 17.
2	MS		The MS is powered up or switched on and initiates an attach (see PICS).
3	MS -> SS	ATTACH REQUEST	Attach type = 'GPRS attach' Mobile identity = P-TMSI-1 Routing area identity = RAI-1
4	SS -> MS	ATTACH ACCEPT	Attach result = 'GPRS only attached' Mobile identity = P-TMSI-1 P-TMSI-1 signature Routing area identity = RAI-1 Negotiated Ready timer value IE should not be included Force to standby indicator set
5	MS->SS	ATTACH COMPLETE	
6	MS		The MS initiates a GPRS detach (without power off) by MMI or AT command.
7	MS -> SS	DETACH REQUEST	Detach type = 'normal detach, GPRS detach'
8	SS -> MS	DETACH ACCEPT	
9	SS -> MS		SS pages the MS with Mobile identity = P-TMSI-1 and paging order for TBF establishment according to the channel combination of the cell.
10	MS		No response from the MS to the request. This is checked for 10 s.
11	MS		The MS initiates an attach by MMI or AT commands
12	MS	ATTACH REQUEST	Attach type = 'GPRS attach' Mobile identity = P-TMSI-1 (If MS is to R99 or after then P-TMSI-1 signature shall not be present) Routing area identity = RAI-1
13	SS -> MS	ATTACH ACCEPT	No new mobile identity assigned Attach result = 'GPRS only attached' Routing area identity = RAI-1 Negotiated Ready timer value IE should not be included Force to standby indicator set
14	MS		The MS initiates a GPRS detach (without power off) by MMI or AT command.

15	MS -> SS	DETACH REQUEST	Detach type = 'normal detach, GPRS detach'
16	SS -> MS	DETACH ACCEPT	
17	SS		The SS is set in network operation mode II.
18	MS		The MS is set in MS operation mode B (see PICS) and the test is repeated from step 2 to step 16.

Specific message contents

None.

44.2.2.1.3 GPRS detach / abnormal cases / attempt counter check / procedure timeout

44.2.2.1.3.1 Conformance requirement

- 1) When a T3321 timeout has occurred during a GPRS detach procedure with the retransmission counter less than five, the Mobile Station shall repeat the GPRS detach procedure.
- 2) When a T3321 timeout has occurred during a GPRS detach procedure with the retransmission counter five, the Mobile Station shall not repeat the procedure.

Reference(s):

3GPP TS 04.08 / 3GPP TS 24.008 subclause 4.7.4.1.

44.2.2.1.3.2 Test purpose

To test the behaviour of the MS with respect to the retransmission counter.

44.2.2.1.3.3 Method of test

Initial conditions

System Simulator:

One cell operating in network operation mode III.

Mobile Station:

The MS has a valid P-TMSI-1 and RAI-1. MS is Idle Updated.

Specific PICS statements:

- MS operation mode C (TSPC_operation_mode_C).
- MS operation mode B (TSPC_operation_mode_B).
- Automatic GPRS attach procedure at switch on or power on (TSPC_AddInfo_on_auto_GPRS_AP).
- Switch off on button (TSPC_Feat_OnOff).

PIXIT statements:

-

Test procedure

The MS initiates a GPRS detach procedure. The SS does not answer with DETACH ACCEPT message before T3321 timeout. The retransmission counter is set to one.

The MS initiates a new GPRS detach procedure (retransmission counter one) after T3321 expires. The SS does not answer with DETACH ACCEPT message before T3321 timeout. The retransmission counter is incremented.

The MS initiates a new GPRS detach procedure (retransmission counter two) after T3321 expires. The SS does not answer with DETACH ACCEPT message before T3321 timeout. The retransmission counter is incremented.

The MS initiates a new GPRS detach procedure (retransmission counter three) after T3321 expires. The SS does not answer with DETACH ACCEPT message before T3321 timeout. The retransmission counter is incremented.

The MS initiates a new GPRS detach procedure (retransmission counter four) after T3321 expires. The SS does not answer with DETACH ACCEPT message before T3321 timeout. The retransmission counter is incremented.

The MS then deletes the logical link since the retransmission has been repeated four times.

The MS performs a new GPRS attach procedure.

Maximum duration of test

8 minutes.

Expected sequence

Step	Direction	Message	Comments
1	MS		The MS is set in MS operation mode C (see PICS). If MS operation mode C not supported, goto step 25.
2	MS		The MS is powered up or switched on and initiates an attach (see PICS).
3	MS -> SS	ATTACH REQUEST	Attach type = 'GPRS attach' Mobile identity = P-TMSI-1 Routing area identity = RAI-1
4	SS -> MS	ATTACH ACCEPT	No new mobile identity assigned. P-TMSI and P-TMSI signature not included. Attach result = 'GPRS only attached' Routing area identity = RAI-1 Negotiated Ready timer value IE should not be included
5	MS		Force to standby indicator set The MS initiates a GPRS detach (without power off) by MMI or AT command.
6	MS -> SS	DETACH REQUEST	Detach type = 'normal detach, GPRS detach'
7	SS		No response is given from the SS.
8	SS		The SS verifies that the time between the detach requests is T3321 seconds (+/- 10%)
9	MS -> SS	DETACH REQUEST	Detach type = 'normal detach, GPRS detach'
10	SS		No response is given from the SS.
11	SS		The SS verifies that the time between the detach requests is T3321 seconds (+/- 10%)
12	MS -> SS	DETACH REQUEST	Detach type = 'normal detach, GPRS detach'
13	SS		No response is given from the SS.
14	SS		The SS verifies that the time between the detach requests is T3321 seconds (+/- 10%)
15	MS -> SS	DETACH REQUEST	Detach type = 'normal detach, GPRS detach'
16	SS		No response is given from the SS.
17	SS		The SS verifies that the time between the detach requests is T3321 seconds (+/- 10%)
18	MS -> SS	DETACH REQUEST	Detach type = 'normal detach, GPRS detach'
19	SS		No response is given from the SS within 40 seconds and SS verifies that the MS will not send a DETACH REQUEST again.
20	MS		Initiate a GPRS attach
21	MS -> SS	ATTACH REQUEST	Attach type = 'GPRS attach' Mobile identity = P-TMSI-1 Routing area identity = RAI-1
22	SS -> MS	ATTACH ACCEPT	No new mobile identity assigned. P-TMSI and P-TMSI signature not included. Attach result = 'GPRS only attached' Routing area identity = RAI-1 Negotiated Ready timer value IE should not be included Force to standby indicator set
23			MS is switched off or power is removed (see PICS)
24	MS -> SS	DETACH REQUEST	Message not sent if power is removed. Detach type = 'power switched off, GPRS detach'
25	SS		The SS is set in network operation mode II.
26	MS		The MS is set in MS operation mode B (see PICS) and the test is repeated from step 2 to step 24.

Specific message contents

None.

44.2.2.1.4 GPRS detach / abnormal cases / GMM common procedure collision

44.2.2.1.4.1 Conformance requirement

When any of the GMM common messages P-TMSI REALLOCATION COMMAND, GMM STATUS or GMM INFORMATION is received by the MS while waiting for a DETACH ACCEPT message with detach cause different from "power off", the MS shall ignore the GMM common message.

Reference(s):

3GPP TS 04.08 / 3GPP TS 24.008 subclause 4.7.4.1.

44.2.2.1.4.2 Test purpose

To test the behaviour of the MS in case of procedure collision.

44.2.2.1.4.3 Method of test

Initial conditions

System Simulator:

One cell operating in network operation mode II.

Mobile Station:

The MS has a valid IMSI. MS is Idle Updated.

Specific PICS statements:

- MS operation mode C (TSPC_operation_mode_C).
- MS operation mode B (TSPC_operation_mode_B) (only if mode C not supported).
- Switch off on button (TSPC_Feat_OnOff).
- Automatic GPRS attach procedure at switch on or power on (TSPC_AddInfo_on_auto_GPRS_AP).

PIXIT statements:

-

Test procedure

The following test procedure is repeated for sequence counter k = 1, 2, 3:

- The MS performs a GPRS attach.
- The MS initiates a GPRS detach. The SS initiates a P-TMSI REALLOCATION COMMAND message (k = 1), a GMM STATUS message (k = 2) and a GMM INFORMATION message (k = 3). The MS shall ignore the GMM common messages and continue with the GPRS detach procedure. The sending of the P-TMSI REALLOCATION COMMAND message (k = 1), the GMM STATUS message (k = 2), the GMM INFORMATION message (k = 3) and the DETACH ACCEPT message shall be completed within Timer T3321 -10%.
- The SS signal to the MS, but no response is received, as the signalling link is disconnected.

Maximum duration of test

5 minutes.

Expected sequence

The test sequence is repeated for $k = 1 \dots 3$

Step	Direction	Message	Comments
1	MS		The MS is set in MS operation mode C or B (see PICS).
2	MS		The MS is powered up or switched on and initiates an attach (see PICS).
3	MS -> SS	ATTACH REQUEST	Attach type = 'GPRS attach'
4	SS -> MS	ATTACH ACCEPT	Mobile identity = IMSI Attach result = 'GPRS only attached'
5	MS -> SS	ATTACH COMPLETE	Mobile identity = P-TMSI-1 P-TMSI-1 signature Routing area identity = RAI-1
6	MS		The MS initiates a detach (without power off) by MMI or AT command.
7	MS -> SS	DETACH REQUEST	Detach type = 'normal detach, GPRS detach'
8A	SS		The SS sends a P-TMSI REALLOCATION COMMAND message
(k=1) 9A	SS -> MS	P-TMSI REALLOCATION COMMAND	
(k=1) 10A	MS		The MS ignores the message. This is verified for 10 seconds.
(k=1) 8B	SS		The SS sends a GMM STATUS message
(k=2) 9B	SS -> MS	GMM STATUS	
(k=2) 10B	MS		The MS ignores the message. This is verified for 10 seconds.
(k=2) 8C	SS		The SS sends a GMM INFORMATION message
(k=3) 9C	SS -> MS	GMM INFORMATION	
(k=3) 10C	MS		The MS ignores the message which is verified for 10 seconds or, if GMM INFORMATION message not implemented, sends a GMM STATUS with GMM Cause 'Message type non-existent or not implemented'.
11	SS -> MS	DETACH ACCEPT	The SS responds to the DETACH REQUEST
12	SS -> MS	PAGING REQUEST TYPE 1	Mobile identity = P-TMSI-1 Paging order is for TBF establishment.
13	MS		No response from the MS to the request. This is checked for 10 s.
NOTE: Steps 8x, 9x, 10x and 11 shall be completed within Timer T3321 -10%.			

Specific message contents

None.

44.2.2.1.5 GPRS detach / power off / accepted

44.2.2.1.5.1 Conformance requirement

The MS detach the IMSI for GPRS and non-GPRS services.

Reference(s):

3GPP TS 04.08 / 3GPP TS 24.008 subclause 4.7.4.1.

44.2.2.1.5.2 Test purpose

To test the behaviour of the MS for the detach procedure.

44.2.2.1.5.3 Method of test

Initial conditions

System Simulator:

One cell operating in network operation mode I.

Mobile Station:

The MS has a valid IMSI. MS is Idle Updated.

Specific PICS statements:

- MS operation mode A (TSPC_operation_mode_A).
- MS operation mode B (TSPC_operation_mode_B).
- Switch off on button (TSPC_Feat_OnOff).
- Automatic GPRS attach procedure at switch on or power on (TSPC_AddInfo_on_auto_GPRS_AP).

PIXIT statements:

-

Test procedure

The MS performs a combined GPRS attach procedure (for GPRS and non-GPRS services).

The MS sends a DETACH REQUEST message to the SS. The MS then deletes the logical link.

Maximum duration of test

5 minutes.

Expected sequence

Step	Direction	Message	Comments
1	MS		The MS is set in MS operation mode B (see PICS).
2	MS		The MS is powered up or switched on and initiates an attach (see PICS).
3	MS -> SS	ATTACH REQUEST	Attach type = 'Combined GPRS / IMSI attach' or 'GPRS attach while IMSI attached' Mobile identity = IMSI
4	SS -> MS	ATTACH ACCEPT	TMSI status = no valid TMSI available Attach result = 'Combined GPRS / IMSI attached' Mobile identity = P-TMSI-1 P-TMSI-1 signature Routing area identity = RAI-1
5	MS -> SS	ATTACH COMPLETE	
6	MS		The MS is switched off (see PICS).
7	MS -> SS	DETACH REQUEST	Detach type = 'power switched off, combined GPRS / IMSI detach'

Specific message contents

None.

44.2.2.1.6 GPRS detach / accepted / GPRS/IMSI detach

44.2.2.1.6.1 Conformance requirement

The MS detach the IMSI for GPRS and non-GPRS services.

Reference(s):

3GPP TS 04.08 / 3GPP TS 24.008 subclause 4.7.4.1.

44.2.2.1.6.2 Test purpose

To test the behaviour of the MS for the detach procedure.

44.2.2.1.6.3 Method of test

Initial conditions

System Simulator:

One cell operating in network operation mode I.

Mobile Station:

The MS has a valid IMSI. MS is Idle Updated.

Specific PICS statements:

- MS operation mode B (TSPC_operation_mode_B)
- Switch off on button (TSPC_Feat_OnOff).
- Automatic GPRS attach procedure at switch on or power on (TSPC_AddInfo_on_auto_GPRS_AP).

PIXIT statements:

-

Test procedure

The MS performs a combined GPRS attach procedure (for GPRS and non-GPRS services).

The MS sends a DETACH REQUEST message to the SS. When the MS receives the DETACH ACCEPT, the MS then deletes the logical link.

The SS signal to the MS, but no response is received, as the signalling link is disconnected.

Maximum duration of test

5 minutes.

Expected sequence

Step	Direction	Message	Comments
1	MS		The MS is set in MS operation mode B (see PICS).
2	MS		The MS is powered up or switched on and initiates an attach (see PICS).
3	MS -> SS	ATTACH REQUEST	Attach type = 'Combined GPRS / IMSI attach' or 'GPRS attach while IMSI attached' Mobile identity = IMSI
4	SS -> MS	ATTACH ACCEPT	TMSI status = no valid TMSI available Attach result = 'Combined GPRS / IMSI attached' Mobile identity = P-TMSI-1 P-TMSI-1 signature Mobile identity = TMSI-1 Routing area identity = RAI-1
5	MS -> SS	ATTACH COMPLETE	
6	MS		The MS initiates a detach (without power off) by MMI or AT command.
7	MS -> SS	DETACH REQUEST	Detach type = 'normal detach, combined GPRS / IMSI detach'
8	SS -> MS	DETACH ACCEPT	
9	SS -> MS		SS pages the MS with mobile identity P-TMSI-1 and paging order for TBF establishment according to the channel combination of the cell.
10	MS		No response from the MS to the request. This is checked for 10 s.
11	SS -> MS		SS pages the MS with mobile identity IMSI and paging order for RR connection according to the channel combination of the cell.
12	MS		The MS shall not initiate an RR connection. This is checked during 3 seconds.

Specific message contents

None.

44.2.2.1.7 GPRS detach / accepted / IMSI detach

44.2.2.1.7.1 Conformance requirement

The MS shall detach for CS services.

Reference(s):

3GPP TS 04.08 / 3GPP TS 24.008 subclause 4.7.4.1.

44.2.2.1.7.2 Test purpose

To test the behaviour of the MS for the detach procedure.

44.2.2.1.7.3 Method of test

Initial conditions

System Simulator:

One cell operating in network operation mode I.

Mobile Station:

The MS has a valid IMSI. MS is Idle Updated.

Specific PICS statements:

- MS operation mode B (TSPC_operation_mode_B)
- Switch off on button (TSPC_Feat_OnOff).
- Automatic GPRS attach procedure at switch on or power on (TSPC_AddInfo_on_auto_GPRS_AP).

PIXIT statements:

-

Test procedure

The MS performs a combined GPRS attach procedure (for GPRS and non-GPRS services).

The MS performs an GPRS detach (for non-GPRS services).

CS services are not possible.

The MS attach for non-GPRS services by a routing area update procedure and CS services are again possible.

Maximum duration of test

5 minutes.

Expected sequence

Step	Direction	Message	Comments
1	MS		The MS is set in MS operation mode B (see PICS).
2	MS		The MS is powered up or switched on and initiates an attach (see PICS).
3	MS -> SS	ATTACH REQUEST	Attach type = 'Combined GPRS / IMSI attach' or 'GPRS attach while IMSI attached' Mobile identity = IMSI
4	SS -> MS	ATTACH ACCEPT	TMSI status = no valid TMSI available Attach result = 'Combined GPRS / IMSI attached' Mobile identity = P-TMSI-1 P-TMSI-1 signature Mobile identity = TMSI-1 Routing area identity = RAI-1
5	MS -> SS	ATTACH COMPLETE	
6	MS		The MS initiates a detach for non-GPRS services without power off.
7	MS -> SS	DETACH REQUEST	Detach type = 'normal detach, IMSI detach'
8	SS -> MS	DETACH ACCEPT	
9	SS -> MS		SS pages the MS with mobile identity P-TMSI-1 and paging order for TBF establishment according to the channel combination of the cell.
10	MS		Verify that the MS initiates a TBF connection and sends an UPLINK RLC DATA BLOCK as a response to the paging request.
11	SS -> MS		SS pages the MS with mobile identity TMSI-1 and paging order for RR connection according to the channel combination of the cell.
12	MS		The MS shall not initiate an RR connection. This is checked during 3 seconds.
13	MS		The MS initiates an attach for non-GPRS services by a RA update procedure.
14	MS -> SS	ROUTING AREA UPDATE REQUEST	Update type = "combined RA/LA updating with IMSI attach"
15	SS -> MS	ROUTING AREA UPDATE ACCEPT	Routing area identity = RAI-1 Update result = 'Combined RA/LA updated' Mobile identity = P-TMSI-2 P-TMSI-2 signature Mobile identity = TMSI-1 Routing area identity = RAI-1
16	MS -> SS	ROUTING AREA UPDATE COMPLETE	
17	SS -> MS		SS pages the MS with mobile identity TMSI-1 and paging order for RR connection according to the channel combination of the cell.
18	MS		Verify that the MS initiates a RR connection and sends a PAGING RESPONSE with mobile identity TMSI-1.
19	SS		SS releases the RR connection indicating a successful resumption of GPRS services.
20	MS		The MS is switched off or power is removed (see PICS).
21	MS -> SS	DETACH REQUEST	Message not sent if power is removed. Detach type = 'power switched off, combined GPRS / IMSI detach'

Specific message contents

None.

44.2.2.1.8 GPRS detach / abnormal cases / change of cell into new routing area

44.2.2.1.8.1 Conformance requirement

When a change of cell into a new routing area is performed before DETACH ACCEPT message is received by the MS, the MS shall abort the GPRS detach procedure and re-initiate it after the routing area update procedure.

Reference(s):

3GPP TS 04.08 / 3GPP TS 24.008 subclause 4.7.4.1.

44.2.2.1.8.2 Test purpose

To test the behaviour of the MS in case of procedure collision.

44.2.2.1.8.3 Method of test

Initial conditions

System Simulator:

Two cells, cell A in MCC1/MNC1/LAC1/RAC1 and cell B in MCC1/MNC1/LAC1/RAC2.

Both cells are operating in network operation mode I.

Mobile Station:

The MS has a valid IMSI. MS is Idle Updated on cell A.

Specific PICS statements:

- MS operation mode B (TSPC_operation_mode_B)
- Switch off on button (TSPC_Feat_OnOff).
- Automatic GPRS attach procedure at switch on or power on (TSPC_AddInfo_on_auto_GPRS_AP).

PIXIT statements:

-

Test procedure

The MS performs a combined GPRS attach procedure (for GPRS and non-GPRS services).

Sufficient time is given for the MS to identify the neighbour cell before the MS is triggered to initiate a GPRS detach procedure. The DETACH ACCEPT message is delayed from the SS. The MS performs a cell reselection to a cell in a new routing area and performs a routing area update procedure.

The Ms shall re-initiate a GPRS detach procedure when the routing area update procedure is finished.

The MS deletes the logical link.

Maximum duration of test

5 minutes.

Expected sequence

Step	Direction	Message	Comments
	SS		The following messages are sent and shall be received on cell A.
1	SS		The SS activates cell A and B. The RF level of cell A is -50 dBm and cell B -60 dBm.
2	MS		The MS is set in MS operation mode B (see PICS).
3	MS		The MS is powered up or switched on and initiates an attach (see PICS). Cell A is preferred by the MS.
4	MS -> SS	ATTACH REQUEST	Attach type = 'Combined GPRS / IMSI attach' or 'GPRS attach while IMSI attached' Mobile identity = IMSI
5	SS -> MS	ATTACH ACCEPT	TMSI status = no valid TMSI available Attach result = 'Combined GPRS / IMSI attached' Mobile identity = P-TMSI-1 P-TMSI-1 signature Mobile identity = TMSI-1 Routing area identity = RAI-1
6	MS -> SS	ATTACH COMPLETE	
7	SS		Wait 30 sec
8	MS		The MS initiates a GPRS detach (without power off) by MMI or AT command.
9	MS -> SS	DETACH REQUEST	Detach type = 'normal detach, combined GPRS / IMSI detach'
10	SS		No response to the DETACH REQUEST message is given by the SS
			The following messages are sent and shall be received on cell B.
11	SS		The RF level of cell A is lowered to -100 dBm.
12	MS		The MS performs a RA update in the new cell.
13	MS -> SS	ROUTING AREA UPDATE REQUEST	Update type = 'Combined RA/LA updating' P-TMSI-1 signature Routing area identity = RAI-1 TMSI status = valid TMSI available or IE omitted
14	SS -> MS	ROUTING AREA UPDATE ACCEPT	Update result = 'Combined RA/LA updated' Mobile identity = P-TMSI-2 P-TMSI-2 signature Routing area identity = RAI-4
15	MS -> SS	ROUTING AREA UPDATE COMPLETE	
16	MS -> SS	DETACH REQUEST	The detach is automatically re-attempted. Detach type = 'normal detach, combined GPRS / IMSI detach'
17	SS -> MS	DETACH ACCEPT	

Specific message contents

None.

44.2.2.1.9 GPRS detach / abnormal cases / GPRS detach procedure collision

44.2.2.1.9.1 Conformance requirement

When a DETACH REQUEST is received by the MS while waiting for a DETACH ACCEPT message, the MS shall answer the network initiated GPRS detach procedure.

Reference(s):

3GPP TS 04.08 / 3GPP TS 24.008 subclause 4.7.4.1.

44.2.2.1.9.2 Test purpose

To test the behaviour of the MS in case of procedure collision.

44.2.2.1.9.3 Method of test

Initial conditions

System Simulator:

One cell operating in network operation mode I.

Mobile Station:

The MS has a valid IMSI. MS is Idle Updated.

Specific PICS statements:

- MS operation mode B (TSPC_operation_mode_B)
- Switch off on button (TSPC_Feat_OnOff).
- Automatic GPRS attach procedure at switch on or power on (TSPC_AddInfo_on_auto_GPRS_AP).

PIXIT statements:

-

Test procedure

The MS performs a combined GPRS attach procedure (for GPRS and non-GPRS services).

The MS initiates a GPRS detach. The SS does not answer the detach procedure, but initiates a detach procedure (cause re-attach not required). The MS shall continue with the network initiated detach procedure.

The MS deletes the logical link.

GPRS and CS services are not possible.

Maximum duration of test

5 minutes.

Expected sequence

Step	Direction	Message	Comments
1	MS		The MS is set in MS operation mode B (see PICS).
2	MS		The MS is powered up or switched on and initiates an attach (see PICS).
3	MS -> SS	ATTACH REQUEST	Attach type = 'Combined GPRS / IMSI attach' or 'GPRS attach while IMSI attached' Mobile identity = IMSI
4	SS -> MS	ATTACH ACCEPT	TMSI status = no valid TMSI available Attach result = 'Combined GPRS / IMSI attached' Mobile identity = P-TMSI-1 P-TMSI-1 signature Mobile identity = TMSI-1 Routing area identity = RAI-1
5	MS -> SS	ATTACH COMPLETE	
6	MS		The MS initiates a GPRS detach (without power off) by MMI or AT command.
7	MS -> SS	DETACH REQUEST	Detach type = 'normal detach, combined GPRS / IMSI detach'
8	SS -> MS	DETACH REQUEST	Detach type = 're-attach not required', GMM cause = 'GPRS services and non-GPRS services not allowed'
9	MS -> SS	DETACH ACCEPT	The MS answers the network initiated detach.
10	SS -> MS		SS pages the MS with mobile identity P-TMSI-1 and paging order for TBF establishment according to the channel combination of the cell.
11	MS		No response from the MS to the request. This is checked for 10 s.
12	SS -> MS		SS pages the MS with mobile identity TMSI-1 and paging order for RR connection according to the channel combination of the cell.
13	MS		The MS shall not initiate an RR connection. This is checked during 3 seconds.

Specific message contents

None.

44.2.2.2 Network initiated GPRS detach procedure

44.2.2.2.1 GPRS detach / re-attach not required / accepted

44.2.2.2.1.1 Conformance requirement

The MS detach the IMSI for GPRS services.

Reference(s):

3GPP TS 04.08 / 3GPP TS 24.008 subclause 4.7.4.2.

44.2.2.2.1.2 Test purpose

To test the behaviour of the MS for the detach procedure.

44.2.2.2.1.3 Method of test

Initial conditions

System Simulator:

One cell operating in network operation mode II (in case of MS operation mode B), or in network operation mode III (in case of MS operation mode C).

Mobile Station:

The MS has a valid IMSI. MS is Idle Updated.

Specific PICS statements:

- MS operation mode C (TSPC_operation_mode_C).
- MS operation mode B (TSPC_operation_mode_B) (only if mode C not supported).
- Switch off on button (TSPC_Feat_OnOff).
- Automatic GPRS attach procedure at switch on or power on (TSPC_AddInfo_on_auto_GPRS_AP).

PIXIT statements:

-

Test procedure

The MS performs a GPRS attach procedure.

The SS sends a DETACH REQUEST message to the MS. The MS then deletes the logical link.

The SS signal to the MS, but no response is received, as the signalling link is disconnected.

Maximum duration of test

5 minutes.

Expected sequence

Step	Direction	Message	Comments
1	SS		The SS is set in network operation mode II or III.
2	MS		The MS is set in MS operation mode B or C (see PICS).
3	MS		The MS is powered up or switched on and initiates an attach (see PICS).
4	MS -> SS	ATTACH REQUEST	Attach type = 'GPRS attach' Mobile identity = IMSI
5	SS -> MS	ATTACH ACCEPT	Attach result = 'GPRS only attached' Mobile identity = P-TMSI-1 P-TMSI-1 signature Routing area identity = RAI-1
6	MS -> SS	ATTACH COMPLETE	
7	SS -> MS	DETACH REQUEST	Detach type = 're-attach not required'
8	MS -> SS	DETACH ACCEPT	
9	SS -> MS		SS pages MS with Mobile identity = P-TMSI-1 and paging order for TBF establishment according to the channel combination of the cell.
10 optional	MS -> SS	ATTACH REQUEST	Attach type = 'GPRS Attach' Mobile identity = P-TMSI-1
11	MS		No response from the MS to the request of step 9. This is checked for 10 s.

Specific message contents

None.

44.2.2.2.2 GPRS detach / rejected / IMSI invalid / GPRS services not allowed

44.2.2.2.1 Conformance requirement

- 1) If the network performs a GPRS detach procedure with the cause 'GPRS services not allowed', the Mobile Station shall consider SIM invalid for GPRS services until power is switched off or SIM is removed.
- 2) If the network performs a GPRS detach procedure with the cause 'GPRS services not allowed' the Mobile Station shall delete the stored RAI, GPRS-CKSN, P-TMSI and P-TMSI signature.

Reference(s):

3GPP TS 04.08 / 3GPP TS 24.008 subclause 4.7.4.2.

44.2.2.2.2.2 Test purpose

To test the behaviour of the MS if the network orders a GPRS detach procedure with the cause 'GPRS services not allowed' (no valid GPRS-subscription for the IMSI).

44.2.2.2.2.3 Method of test

Initial conditions

System Simulator:

Two cells (not simultaneously activated), cell A in MCC1/MNC1/LAC1/RAC1 (HPLMN) and cell B in MCC2/MNC1/LAC1/RAC1.

Both cells are operating in network operation mode II.

Mobile Station:

The MS has a valid P-TMSI-1 and RAI-1. MS is Idle Updated on cell A.

Specific PICS statements:

- MS operation mode C (TSPC_operation_mode_C).
- MS operation mode B (TSPC_operation_mode_B).
- SIM removal possible without powering down (TSPC_AddInfo_SIMRmv).
- Switch off on button (TSPC_Feat_OnOff).
- Automatic GPRS attach procedure at switch on or power on (TSPC_AddInfo_on_auto_GPRS_AP).

PIXIT statements:

-

Test procedure

The SS performs a detach with the cause value 'GPRS services not allowed'. The SS checks that the MS does not perform GPRS attach in another PLMN.

Maximum duration of test

10 minutes.

Expected sequence

Step	Direction	Message	Comments
1	SS		The following messages are sent and shall be received on cell A.
2	MS		The SS activates cell A.
3	MS		The MS is set in MS operation mode C (see PICS). If MS operation mode C not supported, goto step 22.
4	MS -> SS	ATTACH REQUEST	The MS is powered up or switched on and initiates an attach (see PICS). Cell A is preferred by the MS.
5	SS -> MS	ATTACH ACCEPT	Attach type = 'GPRS attach' Mobile identity = P-TMSI-1 Routing area identity = RAI-1 Attach result = 'GPRS only attached' Mobile identity = P-TMSI-2 P-TMSI-2 signature Routing area identity = RAI-1
6	MS -> SS	ATTACH COMPLETE	
7	SS -> MS	DETACH REQUEST	Detach type = 're-attach not required' Cause = 'GPRS services not allowed'
8	MS -> SS	DETACH ACCEPT	
9	SS		The following messages are sent and shall be received on cell B.
10	MS		The SS deactivates cell A and activates cell B. Cell B is preferred by the MS.
11		{Location Update Procedure}	Step 11 is only performed for MS Operation Mode B. Macro. Location Update Procedure initiated from the MS. Parameter mobile identity is IMSI.
12			The MS initiates an attach automatically (see PICS), by MMI or AT commands.
13	MS		No ATTACH REQUEST sent to the SS (SS waits 30 seconds).
14	MS		If possible (see PICS) SIM removal is performed. Otherwise if possible (see PICS) switch off is performed. Otherwise the power is removed.
15	MS		The MS gets the SIM replaced, is powered up or switched on and initiates an attach (see PICS).
16	MS -> SS	ATTACH REQUEST	Attach type = 'GPRS attach' Mobile identity = IMSI
17	SS -> MS	ATTACH ACCEPT	Attach result = 'GPRS only attached' Mobile identity = P-TMSI-1 P-TMSI-1 signature Routing area identity = RAI-2
18	MS -> SS	ATTACH COMPLETE	
19	MS		The MS is switched off or power is removed (see PICS).
20	MS -> SS	DETACH REQUEST	Message not sent if power is removed. Detach type = 'power switched off, GPRS detach'
21			The SS deactivates cell B and activates cell A.
22	MS		The MS is set in MS operation mode B (see PICS) and the test is repeated from step 3 to step 20.

Specific message contents

None.

44.2.2.2.3 GPRS detach / IMSI detach / accepted

44.2.2.2.3.1 Conformance requirement

The MS detach the IMSI for GPRS services.

Reference(s):

3GPP TS 04.08 / 3GPP TS 24.008 subclause 4.7.4.2.

44.2.2.2.3.2 Test purpose

To test the behaviour of the MS for the detach procedure.

44.2.2.2.3.3 Method of test

Initial conditions

System Simulator:

One cell operating in network operation mode I.

Mobile Station:

The MS has a valid IMSI. MS is Idle Updated.

Specific PICS statements:

- MS operation mode B (TSPC_operation_mode_B)
- MS operation mode A (TSPC_operation_mode_A).
- Switch off on button (TSPC_Feat_OnOff).
- Automatic GPRS attach procedure at switch on or power on (TSPC_AddInfo_on_auto_GPRS_AP).

PIXIT statements:

-

Test procedure

The MS performs a combined GPRS attach procedure (for GPRS and non-GPRS services).

The SS sends a DETACH REQUEST message to the MS. The MS then performs an IMSI detach (detach for non-GPRS services).

The SS signal to the MS, but no response is received, as the signalling link is disconnected.

The MS attach for non-GPRS services by a routing area update procedure. Both GPRS and CS services are possible.

Maximum duration of test

5 minutes.

Expected sequence

Step	Direction	Message	Comments
1	MS		The MS is set in MS operation mode B (see PICS).
2	MS		The MS is powered up or switched on and initiates an attach (see PICS).
3	MS -> SS	ATTACH REQUEST	Attach type = 'Combined GPRS / IMSI attach' or 'GPRS attach while IMSI attached' Mobile identity = IMSI
4	SS -> MS	ATTACH ACCEPT	TMSI status = no valid TMSI available Attach result = 'Combined GPRS / IMSI attached' Mobile identity = P-TMSI-1 P-TMSI-1 signature Mobile identity = IMSI Routing area identity = RAI-1
5	MS -> SS	ATTACH COMPLETE	
6	SS		The SS initiates a detach for non-GPRS services.
7	SS -> MS	DETACH REQUEST	Detach type = 'IMSI detach'
8	MS -> SS	DETACH ACCEPT	
9	MS		The MS initiates an attach for non-GPRS services (see PICS).
10	MS -> SS	ROUTING AREA UPDATE REQUEST	Update type = 'Combined RA/LA updating with IMSI attach' P-TMSI-1 signature Routing area identity = RAI-1 TMSI status = no valid TMSI available
11	SS -> MS	ROUTING AREA UPDATE ACCEPT	Update result = 'Combined RA/LA updating' Mobile identity = P-TMSI-2 P-TMSI-2 signature Mobile identity = TMSI-1 Routing area identity = RAI-1
12	MS -> SS	ROUTING AREA UPDATE COMPLETE	
13	SS -> MS		SS pages the MS with mobile identity TMSI-1 and paging order for RR connection according to the channel combination of the cell.
14	MS		Verify that the MS initiates a RR connection and sends a PAGING RESPONSE with mobile identity TMSI-1.
15	SS		SS releases the RR connection indicating a successful resumption of GPRS services.
16	MS		The MS is switched off or power is removed (see PICS).
17	MS -> SS	DETACH REQUEST	Message not sent if power is removed. Detach type = 'power switched off, combined GPRS / IMSI detach'

Specific message contents

None.

44.2.2.2.4 GPRS detach / re-attach requested / accepted

44.2.2.2.4.1 Conformance requirement

When receiving the DETACH REQUEST message and the detach type IE indicates "re-attach required", the MS shall deactivate the PDP contexts and deactivate the logical link(s), if any. The MS shall then send a DETACH ACCEPT message to the network and shall change state to GMM-DEREGISTERED. The MS shall, after the completion of the GPRS detach procedure, initiate a GPRS attach procedure. The MS should also activate PDP context(s) to replace any previously active PDP contexts.

NOTE: In some cases, user interaction may be required and then the MS cannot activate the PDP context(s) automatically.

A GPRS MS operating in MS operation mode A or B in network operation mode I, which receives an DETACH REQUEST message with detach type indicating "re-attach required" or "re-attach not required" and no cause code, is only detached for GPRS services in the network.

.

Reference(s):

3GPP TS 04.08 / 3GPP TS 24.008 subclause 4.7.4.2.2.

44.2.2.2.4.2 Test purpose

To test the behaviour of the MS for the detach procedure in case automatic re-attach.

44.2.2.2.4.3 Method of test

Initial conditions

System Simulator:

One cell in operating in network operation mode I.

Mobile Station:

The MS has a valid TMSI, P-TMSI and RAI. MS is Idle Updated.

Specific PICS statements:

- MS operation mode B (TSPC_operation_mode_B)
- MS operation mode A (TSPC_operation_mode_A).
- Switch off on button (TSPC_Feat_OnOff).
- Automatic GPRS attach procedure at switch on or power on (TSPC_AddInfo_on_auto_GPRS_AP).

PIXIT statements:

-

Test procedure

The MS performs a combined GPRS attach procedure (for GPRS and non-GPRS services).

The SS sends a DETACH REQUEST message to the MS with cause re-attach. The MS then detaches for GPRS services. The MS automatically performs a new combined GPRS attach procedure with Attach Type "GPRS attach while IMSI attached" (for GPRS services) and GPRS and CS services are again possible.

Maximum duration of test

5 minutes.

Expected sequence

Step	Direction	Message	Comments
1	MS		The MS is set in MS operation mode B (see PICS).
2	MS		The MS is powered up or switched on and initiates an attach (see PICS).
3	MS -> SS	ATTACH REQUEST	Attach type = 'Combined GPRS / IMSI attach' or 'GPRS attach while IMSI attached' Mobile identity = P-TMSI-1
4	SS -> MS	ATTACH ACCEPT	Routing area identity = RAI-1 Attach result = 'Combined GPRS / IMSI attached' Mobile identity = TMSI-1
5	MS -> SS	ATTACH COMPLETE	Routing area identity = RAI-1 No new P-TMSI and P-TMSI signature assigned
6	SS		The SS initiates a detach with re-attach.
7	SS -> MS	DETACH REQUEST	Detach type = 're-attach required', GMM cause omitted
8	MS -> SS	DETACH ACCEPT	
9	MS -> SS	ATTACH REQUEST	Attach type = 'Combined GPRS / IMSI attach' or 'GPRS attach while IMSI attached' Mobile identity = P-TMSI-1
10	SS -> MS	ATTACH ACCEPT	Routing area identity = RAI-1 Attach result = 'Combined GPRS / IMSI attached' Mobile identity = TMSI-1 Mobile identity = P-TMSI-2 P-TMSI-2 signature
11	MS -> SS	ATTACH COMPLETE	Routing area identity = RAI-1
12	SS -> MS		SS pages the MS with mobile identity P-TMSI-2 and paging order for TBF establishment according to the channel combination of the cell.
13	MS		Verify that the MS initiates a TBF connection and sends an UPLINK RLC DATA BLOCK as a response to the paging request.
14	SS -> MS		SS pages the MS with mobile identity TMSI-1 and paging order for RR connection according to the channel combination of the cell.
15	MS		Verify that the MS initiates a RR connection and sends a PAGING RESPONSE with mobile identity TMSI-1.
16	SS		SS releases the RR connection indicating a successful resumption of GPRS services.
17	MS		The MS is switched off or power is removed (see PICS).
18	MS -> SS	DETACH REQUEST	Message not sent if power is removed. Detach type = 'power switched off, combined GPRS / IMSI detach'

Specific message contents

None.

44.2.2.2.5 GPRS detach / rejected / location area not allowed

44.2.2.2.5.1 Conformance requirement

44.2.2.2.5.1.1 Conformance requirement for a R97 and R98 MS

- 1) If the network performs a GPRS detach procedure with the cause 'location area not allowed' the Mobile Station shall:
 - 1.1 not perform combined GPRS attach when in the same location area;
 - 1.2 delete any RAI or LAI, P-TMSI, P-TMSI signature and GPRS ciphering key sequence number;
 - 1.3 store the LAI in the list of in the 'forbidden location areas for regional provision of service';
 - 1.4 delete any TMSI, LAI and ciphering key sequence number for GPRS MS operating in MS operation mode A or B.
- 2) If the network performs a GPRS detach procedure with the cause 'location area not allowed' the Mobile Station shall:
 - 2.1 perform combined GPRS attach when a new location area is entered;
 - 2.2 delete the list of forbidden LAs when power is switched off.

Reference(s):

3GPP TS 04.08 subclauses 4.7.4.2.

44.2.2.2.5.1.2 Conformance requirement for a R99 or later MS

- 1) If the network performs a GPRS detach procedure with the cause 'location area not allowed' the Mobile Station shall:
 - 1.1 not perform combined GPRS attach when in the same location area;
 - 1.2 delete any RAI, P-TMSI, P-TMSI signature and GPRS ciphering key sequence number;
 - 1.3 store the LAI in the list of 'forbidden location areas for regional provision of service';
 - 1.4 delete any TMSI, LAI and ciphering key sequence number if the MS is IMSI attached and if no RR connection exists or if the MS is operating in MS operation mode A and an RR connection exists when the RR connection is subsequently released.
- 2) If the network performs a GPRS detach procedure with the cause 'location area not allowed' the Mobile Station shall:
 - 2.1 perform combined GPRS attach when a new location area is entered;
 - 2.2 delete the list of forbidden LAs when power is switched off.

Reference(s):

3GPP TS 24.008 subclauses 4.7.4.2.

44.2.2.2.5.2 Test purpose

To test the behaviour of the MS if the network orders the GPRS detach procedure with the cause 'Location Area not allowed'.

To test that the MS deletes the list of forbidden LAs when power is switched off.

44.2.2.2.5.3 Method of test

Initial conditions

System Simulator:

Three cells (not simultaneously activated), cell A in MCC2/MNC1/LAC1/RAC1 (Not HPLMN), cell B in MCC2/MNC1/LAC1/RAC2 (Not HPLMN), cell C in MCC2/MNC1/LAC2/RAC1 (Not HPLMN).

All cells are operating in network operation mode I.

Mobile Station:

The MS has a valid IMSI. MS is Idle Updated on cell A.

Specific PICS statements:

- MS operation mode B (TSPC_operation_mode_B)
- MS operation mode A (TSPC_operation_mode_A).
- Switch off on button (TSPC_Feat_OnOff).
- Automatic GPRS attach procedure at switch on or power on (TSPC_AddInfo_on_auto_GPRS_AP).
- GPRS attach attempted automatically due to outstanding request (TSPC_AddInfo_GPRS_Attach_Attempt_Outstanding).

PIXIT statements:

-

Test procedure

The SS orders a GPRS detach with the cause value 'Location Area not allowed'. The SS checks that the MS does not perform combined GPRS attach while in the location area, performs GPRS attach when a new location area is entered and deletes the list of forbidden LAs when switched off. CS services are not possible unless an IMSI attach procedure is performed.

Different types of MS may use different methods to periodically clear the list of forbidden location areas (e.g. every day at 12am). If the list is cleared while the test is being run, it may be necessary to re-run the test.

Maximum duration of test

10 minutes.

Expected sequence

Step	Direction	Message	Comments
	SS		The following messages are sent and shall be received on cell A.
1	SS		The SS activates cell A.
2	MS		The MS is set in MS operation mode B (see PICS).
3	MS		The MS is powered up or switched on and initiates an attach (see PICS). Cell A is preferred by the MS.
4	MS -> SS	ATTACH REQUEST	Attach type = 'Combined GPRS / IMSI attach' or 'GPRS attach while IMSI attached' Mobile identity = IMSI
5	SS -> MS	ATTACH ACCEPT	TMSI status = no valid TMSI available Attach result = 'Combined GPRS / IMSI attached' Mobile identity = P-TMSI-1 P-TMSI-1 signature Mobile identity = TMSI-1 Routing area identity = RAI-2
6	MS -> SS	ATTACH COMPLETE	
7	SS -> MS	DETACH REQUEST	Detach type = 're-attach not required' Cause 'Location Area not allowed'
8	MS -> SS	DETACH ACCEPT	
9	MS		No LOCATION UPDATING REQ with type 'IMSI attach' is sent to the SS (SS waits 30 seconds).

Step	Direction	Message	Comments
10	SS -> MS		SS pages the MS with mobile identity TMSI-1 and paging order for RR connection according to the channel combination of the cell.
11	MS		The MS shall not initiate an RR connection. This is checked during 3 seconds.
12	SS -> MS		SS pages the MS with mobile identity P-TMSI-1 and paging order for TBF establishment according to the channel combination of the cell.
13	MS -> SS		No response from the MS to the request. This is checked for 10 s
14	SS		The following messages are sent and shall be received on cell B.
15	MS		The SS deactivates cell A and activates cell B. Cell B is preferred by the MS.
16	MS		The MS initiates an attach automatically, by MMI or by AT command.
17	MS		No ATTACH REQUEST sent to SS (SS waits 30 seconds)
18	MS		No LOCATION UPDATING REQ with type 'IMSI attach' is sent to the SS (SS waits 30 seconds).
19	SS -> MS		SS pages the MS with mobile identity TMSI-1 and paging order for RR connection according to the channel combination of the cell.
20	MS		The MS shall not initiate an RR connection. This is checked during 3 seconds.
21	SS -> MS		SS pages the MS with mobile identity P-TMSI-1 and paging order for TBF establishment according to the channel combination of the cell.
22			No response from the MS to the request. This is checked for 10 s
23	SS		The following messages are sent and shall be received on cell C.
24	MS		The SS deactivates cell B and activates cell C. Cell C is preferred by the MS. Steps 25 and 26 are only performed by an MS which will not initiate a GPRS attach automatically due to outstanding request (see PICS)
25 (conditional)		{Location Update Procedure}	Macro. Location Update Procedure initiated from the MS. Parameter mobile identity is IMSI.
26 (conditional)	MS		MS initiates an attach via MMI or AT command.
27	MS -> SS	ATTACH REQUEST	Attach type = 'Combined GPRS / IMSI attach' or 'GPRS attach while IMSI attached' Mobile identity = IMSI
28	SS -> MS	ATTACH ACCEPT	TMSI status = no valid TMSI available Attach result = 'Combined GPRS / IMSI attached' Mobile identity = P-TMSI1 P-TMSI-1 signature Mobile identity = TMSI-1 Routing area identity = RAI-6
29	MS -> SS	ATTACH COMPLETE	
30	SS -> MS		SS pages the MS with mobile identity TMSI-1 and paging order for RR connection according to the channel combination of the cell.
31	MS		Verify that the MS initiates a RR connection and sends a PAGING RESPONSE with mobile identity TMSI-1.
32	SS		SS releases the RR connection indicating a successful resumption of GPRS services.

Step	Direction	Message	Comments
33	SS -> MS		SS pages the MS with mobile identity P-TMSI-1 and paging order for TBF establishment according to the channel combination of the cell.
34	MS		Verify that the MS initiates a TBF connection and sends an UPLINK RLC DATA BLOCK as a response to the paging request.
35	MS		The MS is switched off or power is removed (see PICS).
36	MS -> SS	DETACH REQUEST	Message not sent if power is removed. Detach type = 'power switched off, combined GPRS / IMSI detach'
37	MS		The following messages are sent and shall be received on cell B. The SS deactivates cell C and activates cell B. Cell B is preferred by the MS.
38	MS		The MS is powered up or switched on. Step 39 is only performed for non-auto attach MS.
39		{Location Update Procedure}	Macro. Location Update Procedure initiated from the MS. Parameter mobile identity is TMSI-1.
40	MS		MS initiates an attach automatically (see PICS), via MMI or AT commands.
41	MS -> SS	ATTACH REQUEST	Attach type = 'Combined GPRS / IMSI attach' or 'GPRS attach while IMSI attached' Mobile identity = P-TMSI-1
42	SS -> MS	ATTACH ACCEPT	Routing area identity = RAI-6 Attach result = 'Combined GPRS / IMSI attached' Mobile identity = P-TMSI-2 P-TMSI-2 signature Mobile identity = TMSI-2
43	MS -> SS	ATTACH COMPLETE	Routing area identity = RAI-7
44	SS -> MS		SS pages the MS with mobile identity TMSI-2 and paging order for RR connection according to the channel combination of the cell.
45	MS		Verify that the MS initiates a RR connection and sends a PAGING RESPONSE with mobile identity TMSI-2.
46	SS		SS releases the RR connection indicating a successful resumption of GPRS services.
47	SS -> MS		SS pages the MS with mobile identity P-TMSI-2 and paging order for TBF establishment according to the channel combination of the cell.
48	MS		Verify that the MS initiates a TBF connection and sends an UPLINK RLC DATA BLOCK as a response to the paging request.
49	MS		The MS is switched off or power is removed (see PICS).
50	MS -> SS	DETACH REQUEST	Message not sent if power is removed. Detach type = 'power switched off, combined GPRS / IMSI detach'

Specific message contents

None.

44.2.2.2.6 GPRS detach / rejected / GPRS services not allowed in this PLMN

44.2.2.2.6.1 Conformance requirement

If the network performs a GPRS detach procedure with the cause 'GPRS services not allowed in this PLMN' the Mobile Station shall:

1. The MS shall delete any RAI, P-TMSI, P-TMSI signature, and GPRS ciphering key sequence number stored, shall set the GPRS update status to GU3 ROAMING NOT ALLOWED (and shall store it according to section 4.1.3.2) and shall change to state GMM-DEREGISTERED.
2. The MS shall store the PLMN identity in the "forbidden PLMNs for GPRS service" list.
3. A GPRS MS operating in MS operation mode A or B in network operation mode I shall set the timer T3212 to its initial value and restart it, if it is not already running.
4. A GPRS MS operating in MS operation mode A or B, is still IMSI attached for CS services in the network.

Reference(s):

3GPP TS 04.08 / 3GPP TS 24.008 subclause 4.7.4.2.2

44.2.2.2.6.2 Test purpose

To test the behavior of the MS if the network orders the GPRS detach procedure with the cause 'GPRS services not allowed in this PLMN.

44.2.2.2.6.3 Method of test

Initial conditions

System Simulator:

Two cells (not simultaneously activated), cell A in MCC1/MNC2/LAC1/RAC1, cell B in MCC2/MNC1/LAC1/RAC1.

All two cells are operating in network operation mode II (in case of MS operation mode B), or in network operation mode III (in case of MS operation mode C).. The PLMN of the two cells should NOT be that of the Mobile Station Home PLMN.

Mobile Station:

The MS has a valid TMSI-1, P-TMSI-1 and RAI-8. MS is Idle Updated on Cell A.

Specific PICS statements:

- MS operation mode B (TSPC_operation_mode_B)
- MS operation mode C (TSPC_operation_mode_C) (only if mode B not supported).
- Switch off on button (TSPC_Feat_OnOff).
- Automatic GPRS attach procedure at switch on or power on (TSPC_AddInfo_on_auto_GPRS_AP).

PIXIT statements:

-

Test procedure

The SS orders a GPRS detach with the cause value 'GPRS services not allowed in this PLMN'. The SS checks that the MS responds to RR paging (in case of MS operation mode B) and does not respond to packet paging, does not perform periodic ROUTING AREA UPDATE procedure in this PLMN and performs periodic ROUTING AREA UPDATE procedure when new PLMN is entered.

T3312: set to 6 minutes.

Maximum duration of test

20 minutes.

Expected sequence

Step	Direction	Message	Comments
	SS		The following messages are sent and shall be received on cell A.
1	MS		The MS is set in MS operation mode B or C (see PICS).
2	SS		The SS is set in network operation mode II or III and activates cell A.
3	MS		The MS is powered up or switched on and initiates an attach (see PICS).
4	MS -> SS	ATTACH REQUEST	Attach type = 'GPRS attach' Mobile identity = P-TMSI-1
5	SS -> MS	ATTACH ACCEPT	Routing area identity = RAI-8 Attach result = 'GPRS only attached' Mobile identity = P-TMSI-2 P-TMSI-2 signature Routing area identity = RAI-8 T3312 = 6 minutes
6	MS -> SS	ATTACH COMPLETE	
7	SS -> MS	DETACH REQUEST	Cause = 'GPRS services not allowed in this PLMN'
8	MS -> SS	DETACH ACCEPT	
9	SS -> MS		Steps 9, 10 and 11 are only performed for NW Mode II / MS Operation Mode B. SS pages the MS with mobile identity of TMSI-1 and paging order for RR connection according to the channel combination of the cell.
10	MS -> SS		Verify that the MS initiates a RR connection and sends a PAGING RESPONSE with mobile identity TMSI-1.
11	SS		SS releases the RR connection.
12			SS pages the MS with Mobile identity = P-TMSI-2 and paging order for TBF establishment according to the channel combination of the cell.
13			No response from the MS to the request. This is checked for 10 seconds.
14			No ROUTING AREA UPDATE REQUEST sent to the SS (SS waits Ready Timer Period (T3314) + Periodic Routing Area Updating timer (T3312) (+10%)).
15	SS		The following messages are sent and shall be received on cell B.
16	MS		The SS deactivates cell A and activates cell B. Cell B is preferred by the MS.
17		{Location Update Procedure}	Step 17 is only performed for NW Mode II / MS Operation Mode B. Location Update Procedure initiated from the MS.
	MS		The MS initiates an attach automatically, by MMI or by AT command.
18	MS -> SS	ATTACH REQUEST	Attach type = 'GPRS attach' Mobile identity = IMSI
19	SS -> MS	ATTACH ACCEPT	Attach result = 'GPRS only attached' Mobile identity = P-TMSI-2 P-TMSI-2 signature Routing area identity = RAI-2 T3312 = 6 minutes
20	MS -> SS	ATTACH COMPLETE	
21	SS		The SS verifies that the time between the Attach and the periodic RA updating is Ready Timer Period (T3314) + Periodic Routing Area Updating timer (T3312) (+/- 10%)
22	MS -> SS	ROUTING AREA UPDATING REQUEST	Update type = 'Periodic updating' P-TMSI-2 signature Routing area identity = RAI-2

23	SS -> MS	ROUTING AREA UPDATING ACCEPT	No new mobile identity assigned. P-TMSI and TMSI not included. Update result = 'RAUpdated' Negotiated Ready timer value IE should not be included. Force to standby indicator set
24	MS		The MS is switched off or power is removed (see PICS).
25	MS -> SS	DETACH REQUEST	Message not sent if power is removed. Detach type = 'power switched off,

Specific message contents

None.

44.2.3 Routing area updating procedure

This procedure is used to update the actual routing area of an MS in the network.

44.2.3.1 Normal routing area updating

The routing area updating procedure is a GMM procedure used by GPRS MSs of MS operation mode B or C that are IMSI attached for GPRS services only.

44.2.3.1.1 Routing area updating / accepted

44.2.3.1.1.1 Conformance requirement

- 1) If the network accepts the routing area updating procedure and reallocates a P-TMSI, the MS shall acknowledge the new P-TMSI and continue communication with the new P-TMSI.
- 2) If the network accepts the routing area updating procedure from the MS without reallocation of the old P-TMSI, the MS shall continue communication with the old P-TMSI.

Reference(s):

3GPP TS 04.08 / 3GPP TS 24.008 subclause 4.7.5.1.

44.2.3.1.1.2 Test purpose

To test the behaviour of the MS if the network accepts the routing area updating procedure.

The following cases are identified:

- 1) P-TMSI / P-TMSI signature is reallocated;
- 2) Old P-TMSI / P-TMSI signature is not changed.

44.2.3.1.1.3 Method of test

Initial conditions

System Simulator:

Two cells, cell A in MCC1/MNC1/LAC1/RAC1, cell B in MCC1/MNC1/LAC1/RAC2.

Both cells are operating in network operation mode II.

Mobile Station:

The MS has a valid IMSI. MS is Idle Updated on cell A.

Specific PICS statements:

- MS operation mode B (TSPC_operation_mode_B).

- MS operation mode C (TSPC_operation_mode_C).
- Switch off on button (TSPC_Feat_OnOff).
- Automatic GPRS attach procedure at switch on or power on (TSPC_AddInfo_on_auto_GPRS_AP).

PIXIT statements:

-

Test procedure

- 1) The MS sends a ROUTING AREA UPDATE REQUEST message. The SS reallocates the P-TMSI and returns ROUTING AREA UPDATE ACCEPT message with a new P-TMSI. The MS acknowledge the new P-TMSI by sending ROUTING AREA UPDATING COMPLETE message. Further communication MS - SS is performed by the new P-TMSI. The MS will not answer signalling addressed to the old P-TMSI.
- 2) The MS sends a ROUTING AREA UPDATING REQUEST message. The SS accepts the P-TMSI and returns ROUTING AREA UPDATING ACCEPT message without any P-TMSI. Further communication MS - SS is performed by the P-TMSI.

Maximum duration of test

10 minutes.

Expected sequence

Step	Direction	Message	Comments
1	SS		The following messages are sent and shall be received on cell A.
2	MS		The SS activates cell A but not cell B.
3	MS		The MS is set in MS operation mode C (see PICS). If MS operation mode C not supported, goto step 22.
4	MS -> SS	ATTACH REQUEST	The MS is powered up or switched on and initiates an attach (see PICS). Attach type = 'GPRS attach'
5	SS -> MS	ATTACH ACCEPT	Mobile identity = IMSI Attach result = 'GPRS only attached'
6	MS -> SS	ATTACH COMPLETE	Mobile identity = P-TMSI-2 P-TMSI-2 signature Routing area identity = RAI-1
7	SS		The following messages are sent and shall be received on cell B.
8	MS -> SS	ROUTING AREA UPDATING REQUEST	Activate cell B with a lower signal strength than cell A The RF level of cell A is lowered until cell B is preferred by the MS. Update type = 'RA updating'
9	SS -> MS	ROUTING AREA UPDATING ACCEPT	P-TMSI-2 signature Routing area identity = RAI-1
10	MS -> SS	ROUTING AREA UPDATING COMPLETE	Update result = 'RA updated'
11	SS->MS	GMM INFORMATION	Mobile identity = P-TMSI-1
11b	MS->SS	GMM STATUS	P-TMSI-1 signature
12	SS -> MS	PAGING REQUEST TYPE 1	Routing area identity = RAI-4 Message sent in case the MS does not support reception of GMM information message. Cause #97
13	MS		Mobile identity = P-TMSI-2 Paging order is for TBF establishment. No response from the MS to the request. This is checked for 10 s.
14	SS		The following messages are sent and shall be received on cell A.
15	MS		The RF level of cell B is lowered until cell A is preferred by the MS.
16	MS -> SS	ROUTING AREA UPDATING REQUEST	Cell A is preferred by the MS. Update type = 'RA updating'
17	SS -> MS	ROUTING AREA UPDATING ACCEPT	P-TMSI-1 signature Routing area identity = RAI-4 No new mobile identity assigned.
18	SS -> MS	PAGING REQUEST TYPE 1	P-TMSI not included. Update result = 'RA updated'
19	MS -> SS	UPLINK RLC DATA BLOCK	P-TMSI-2 signature Routing area identity = RAI-1
20	MS		Mobile identity = P-TMSI-1 Paging order is for TBF establishment.
21	MS -> SS	DETACH REQUEST	LLC PDU implicitly indicating paging response. The MS is switched off or power is removed (see PICS). Message not sent if power is removed.
22	MS		Detach type = 'power switched off, GPRS detach' The MS is set in MS operation mode B (see PICS), reset the RF level of Cell A to default state, deactivate Cell B and the test is repeated from step 3 to step 21.

Specific message contents

None.

44.2.3.1.1a Routing area updating / accepted / old P-TMSI

44.2.3.1.1a.1 Conformance requirement

Upon receipt of a GMM message containing a new P-TMSI the MS shall consider the new P-TMSI and new RAI and also the old P-TMSI and old RAI as valid in order to react to paging requests and downlink transmission of LLC frames.

Reference(s):

3GPP TS 04.08 / 3GPP TS 24.008 subclause 4.7.1.5.1.

44.2.3.1.1a.2 Test purpose

To test the validity of old and new P-TMSI the network accepts the routing area updating procedure.

44.2.3.1.1a.3 Method of test

Initial conditions

System Simulator:

Two cells, cell A in MCC1/MNC1/LAC1/RAC1, cell B in MCC1/MNC1/LAC1/RAC2.

Both cells are operating in network operation mode II.

Mobile Station:

The MS has a valid IMSI. MS is Idle Updated on cell A.

Specific PICS statements:

- MS operation mode B (TSPC_operation_mode_B).
- MS operation mode C (TSPC_operation_mode_C).
- Switch off on button (TSPC_Feat_OnOff).
- Automatic GPRS attach procedure at switch on or power on (TSPC_AddInfo_on_auto_GPRS_AP).

PIXIT statements:

-

Test procedure

The MS sends a ROUTING AREA UPDATE REQUEST message. The SS reallocates the P-TMSI and returns ROUTING AREA UPDATE ACCEPT message with a new P-TMSI. The MS acknowledge the new P-TMSI by sending ROUTING AREA UPDATING COMPLETE message. The MS will answer signalling addressed to the old P-TMSI and to the new P-TMSI. The SS sends a GMM INFORMATION MESSAGE. The MS will answer signalling addressed only to the new P-TMSI.

Maximum duration of test

10 minutes.

Expected sequence

Step	Direction	Message	Comments
1	SS		The following messages are sent and shall be received on cell A.
2	MS		The SS activates cell A but not cell B.
3	MS		The MS is set in MS operation mode C (see PICS). If MS operation mode C not supported, goto step 23.
4	MS -> SS	ATTACH REQUEST	The MS is powered up or switched on and initiates an attach (see PICS). Attach type = 'GPRS attach'
5	SS -> MS	ATTACH ACCEPT	Mobile identity = IMSI Attach result = 'GPRS only attached'
6	MS -> SS	ATTACH COMPLETE	Mobile identity = P-TMSI-2 P-TMSI-2 signature Routing area identity = RAI-1
7	SS		The following messages are sent and shall be received on cell B.
8	MS -> SS	ROUTING AREA UPDATING REQUEST	Activate cell B with a lower signal strength than cell A The RF level of cell A is lowered until cell B is preferred by the MS. Update type = 'RA updating'
9	SS -> MS	ROUTING AREA UPDATING ACCEPT	P-TMSI-2 signature Routing area identity = RAI-1
10	MS -> SS	ROUTING AREA UPDATING COMPLETE	Update result = 'RA updated'
11	SS -> MS	PAGING REQUEST TYPE 1	Mobile identity = P-TMSI-1 P-TMSI-1 signature Routing area identity = RAI-4
12	MS -> SS		Mobile identity = P-TMSI-2 Paging order is for TBF establishment.
13	SS -> MS	PAGING REQUEST TYPE 1	Verify that the MS initiates a TBF connection and sends an UPLINK RLC DATA BLOCK as a response to the paging request. Message not ciphered
14	MS -> SS		Mobile identity = P-TMSI-1 Paging order is for TBF establishment.
15	SS->MS	GMM INFORMATION	Verify that the MS initiates a TBF connection and sends an UPLINK RLC DATA BLOCK as a response to the paging request. Message not ciphered
16	MS->SS	GMM STATUS	Message sent in case the MS does not support reception of GMM information message. Cause #97
17	SS -> MS	PAGING REQUEST TYPE 1	Mobile identity = P-TMSI-2 Paging order is for TBF establishment.
18	MS		No response from the MS to the request. This is checked for 10 s.
19	SS -> MS	PAGING REQUEST TYPE 1	Mobile identity = P-TMSI-1 Paging order is for TBF establishment.
20	MS -> SS		Verify that the MS initiates a TBF connection and sends an UPLINK RLC DATA BLOCK as a response to the paging request. Message not ciphered
21	MS		The MS is switched off or power is removed (see PICS).
22	MS -> SS	DETACH REQUEST	Message not sent if power is removed. Detach type = 'power switched off, GPRS detach'

23	MS	The MS is set in MS operation mode B (see PICS), reset the RF level of Cell A to default state, deactivate Cell B and the test is repeated from step 3 to step 22.
----	----	--

Specific message contents

None.

44.2.3.1.2 Routing area updating / rejected / IMSI invalid / illegal ME

44.2.3.1.2.1 Conformance requirement

- 1) If the network rejects a routing area updating procedure from the Mobile Station with the cause 'Illegal ME', the Mobile Station shall consider SIM invalid for GPRS services until power is switched off or SIM is removed.
- 2) If the network rejects a routing area updating procedure from the Mobile Station with the cause 'Illegal ME', the Mobile Station shall delete the stored RAI, GPRS-CKSN, P-TMSI and P-TMSI signature.

Reference(s):

3GPP TS 04.08 / 3GPP TS 24.008 subclause 4.7.5.1.

44.2.3.1.2.2 Test purpose

To test the behaviour of the MS if the network rejects the routing area updating procedure of the MS with the cause 'Illegal ME'.

44.2.3.1.2.3 Method of test

Initial conditions

System Simulator:

Three cells (not simultaneously activated), cell A in MCC1/MNC1/LAC1/RAC1, cell B in MCC1/MNC1/LAC1/RAC2, cell C in MCC2/MNC1/LAC1/RAC1.

All three cells are operating in network operation mode II (in case of MS operation mode B), or in network operation mode III (in case of MS operation mode C).

Mobile Station:

The MS has a valid P-TMSI-1 and RAI-1. MS is Idle Updated on cell A.

Specific PICS statements:

- MS operation mode C (TSPC_operation_mode_C).
- MS operation mode B (TSPC_operation_mode_B) (only if mode C not supported).
- SIM removal possible without powering down (TSPC_AddInfo_SIMRmv).
- Switch off on button (TSPC_Feat_OnOff).
- Automatic GPRS attach procedure at switch on or power on (TSPC_AddInfo_on_auto_GPRS_AP).

PIXIT statements:

-

Test procedure

The SS rejects a routing area updating with the cause value 'Illegal ME'. The SS checks that the MS does not perform GPRS attach in the same or another PLMN.

Maximum duration of test

5 minutes.

Expected sequence

Step	Direction	Message	Comments
1	MS		The following messages are sent and shall be received on cell A. The MS is set in MS operation mode C or B (see PICS).
2	SS		The SS is set in network operation mode II or III and activates cell A.
3	MS		The MS is powered up or switched on and initiates an attach (see PICS). Cell A is preferred by the MS.
4	MS -> SS	ATTACH REQUEST	Attach type = 'GPRS attach' Mobile identity = P-TMSI-1 Routing area identity = RAI-1
5	SS -> MS	ATTACH ACCEPT	No new mobile identity assigned. P-TMSI and P-TMSI signature not included. Attach result = 'GPRS only attached' Routing area identity = RAI-1 Negotiated Ready timer value IE should not be included Force to standby indicator set
6	SS		The following messages are sent and shall be received on cell B. Activate cell B with a lower signal strength than cell A. The RF level of cell A is lowered until cell B is preferred by the MS.
7	MS		Cell B is preferred by the MS.
8	MS -> SS	ROUTING AREA UPDATE REQUEST	Update type = 'RA updating' Routing area identity = RAI-1
9	SS -> MS	ROUTING AREA UPDATE REJECT	GMM cause = 'Illegal ME'
10	SS -> MS		SS page MS with Mobile identity = P-TMSI-1 and paging order for TBF establishment according to the channel combination of the cell.
11	MS		No response from the MS to the request. This is checked for 10 s.
12	SS		The following messages are sent and shall be received on cell C. The SS deactivates both cell A and cell B. The SS activates cell C.
13	MS		Cell C is preferred by the MS.
14	MS		No ATTACH REQUEST sent to the SS (SS waits 30 seconds).
15	MS		If possible (see PICS) SIM removal is performed. Otherwise if possible (see PICS) switch off is performed. Otherwise the power is removed.
16	MS		The MS gets the SIM replaced, is powered up or switched on and initiates an attach (see PICS).
17		{Location Update Procedure}	Step 17 is only performed by MS in operation mode B Macro. Location Update Procedure initiated from the MS. Parameter mobile identity is IMSI.

Step	Direction	Message	Comments
18	MS -> SS	ATTACH REQUEST	Attach type = 'GPRS attach' Mobile identity = IMSI Attach result = 'GPRS only attached' Mobile identity = P-TMSI-1 P-TMSI-1 signature Routing area identity = RAI-2 The MS is switched off or power is removed (see PICS). Message not sent if power is removed. Detach type = 'power switched off, GPRS detach'
19	SS -> MS	ATTACH ACCEPT	
20	MS -> SS	ATTACH COMPLETE	
21	MS		
22	MS -> SS	DETACH REQUEST	

Specific message contents

None.

44.2.3.1.3 Routing area updating / rejected / MS identity cannot be derived by the network

44.2.3.1.3.1 Conformance requirement

If the network rejects a routing area updating procedure from the Mobile Station with the cause 'MS identity cannot be derived by the network', the Mobile Station shall delete the stored RAI, GPRS-CKSN, P-TMSI and P-TMSI signature.

Depending on the manufacturer the MS may or may not perform a GPRS attach procedure.

Reference(s):

3GPP TS 04.08 / 3GPP TS 24.008 subclause 4.7.5.1.

44.2.3.1.3.2 Test purpose

To test the behaviour of the MS if the network rejects the routing area updating procedure of the MS with the cause 'MS identity cannot be derived by the network'.

44.2.3.1.3.3 Method of test

Initial conditions

System Simulator:

Two cells (not simultaneously activated), cell A in MCC1/MNC1/LAC1/RAC1, cell B in MCC1/MNC1/LAC1/RAC2.

Both cells are operating in network operation mode II (in case of MS operation mode B), or in network operation mode III (in case of MS operation mode C).

Mobile Station:

The MS has a valid P-TMSI-1 and RAI-1. MS is Idle Updated on cell A.

Specific PICS statements:

- MS operation mode C (TSPC_operation_mode_C).
- MS operation mode B (TSPC_operation_mode_B) (only if mode C not supported).
- Automatic attach procedure when MS identity cannot be derived by the network (TSPC_AddInfo_auto_AP_no_MS ID).
- Switch off on button (TSPC_Feat_OnOff).
- Automatic GPRS attach procedure at switch on or power on (TSPC_AddInfo_on_auto_GPRS_AP).

PIXIT statements:

-

Test procedure

The SS rejects a normal routing area updating with the cause value 'MS identity cannot be derived by the network'. The MS detach locally. A new GPRS attach may be performed.

Maximum duration of test

5 minutes.

Expected sequence

Step	Direction	Message	Comments
1	SS		The following messages are sent and shall be received on cell A.
2	MS		The SS is set in network operation mode II or III and activates cell A.
3	MS		The MS is set in MS operation mode C or B (see PICS).
4	MS -> SS	ATTACH REQUEST	The MS is powered up or switched on and initiates an attach (see PICS). Cell A is preferred by the MS.
5	SS -> MS	ATTACH ACCEPT	Attach type = 'GPRS attach' Mobile identity = P-TMSI-1 Routing area identity = RAI-1
6	MS -> SS	ATTACH COMPLETE	Attach result = 'GPRS only attached' Mobile identity = P-TMSI-2 P-TMSI-2 signature Routing area identity = RAI-1
7	SS		The following messages are sent and shall be received on cell B.
8	MS		Activate cell B with a lower signal strength than cell A. The RF level of cell A is lowered until cell B is preferred by the MS.
9	MS -> SS	ROUTING AREA UPDATE REQUEST	Cell B is preferred by the MS. Update type = 'RA updating' P-TMSI-2 signature
10	SS -> MS	ROUTING AREA UPDATE REJECT	Routing area identity = RAI-1
11	MS		GMM cause = 'MS identity cannot be derived by the network'
12	MS		If an automatic attach procedure by the MS is not possible when the MS identity cannot be derived by the network (see PICS) goto step 19.
13	MS -> SS	ATTACH REQUEST	An Automatic GPRS attach procedure is initiated (see PICS).
14	SS -> MS	ATTACH ACCEPT	Attach type = 'GPRS attach' Mobile identity = IMSI
15	MS -> SS	ATTACH COMPLETE	Attach result = 'GPRS only attached' Mobile identity = P-TMSI-1 P-TMSI-1 signature Routing area identity = RAI-4
16	MS		The MS is switched off or power is removed (see PICS).
17	MS -> SS	DETACH REQUEST	Message not sent if power is removed.
18			Detach type = 'power switched off, GPRS detach' Stop the sequence
19	SS -> MS		SS page MS with Mobile identity = P-TMSI-2 and paging order for TBF establishment according to the channel combination of the cell.
20	MS		No response from the MS to the request, as the MS has detached locally. This is checked for 10 s.

Specific message contents

None.

44.2.3.1.4 Routing area updating / rejected / location area not allowed

44.2.3.1.4.1 Conformance requirement

- 1) If the network rejects a routing area updating procedure from the Mobile Station with the cause 'location area not allowed' the Mobile Station shall:
 - 1.1 not perform GPRS attach when in the same location area;
 - 1.2 delete the stored RAI, GPRS-CKSN, P-TMSI and P-TMSI signature;
 - 1.3 store the LA in the 'forbidden location areas for regional provision of service'.
- 2) If the network rejects a routing area updating procedure from the Mobile Station with the cause 'location area not allowed' the Mobile Station shall:
 - 2.1 perform GPRS attach when a new location area is entered;
 - 2.2 delete the list of forbidden LAs after switch off (power off).

Reference(s):

3GPP TS 04.08 / 3GPP TS 24.008 subclauses 4.7.5.1.

44.2.3.1.4.2 Test purpose

To test the behaviour of the MS if the network rejects the routing area updating procedure of the MS with the cause 'Location Area not allowed'.

To test that the MS deletes the list of forbidden LAs when power is switched off.

44.2.3.1.4.3 Method of test

Initial conditions

System Simulator:

Three cells (not simultaneously activated), cell A in MCC1/MNC1/LAC1/RAC1, cell B in MCC1/MNC1/LAC1/RAC2, cell C in MCC1/MNC1/LAC2/RAC1.

All cells are operating in network operation mode III.

Mobile Station:

The MS has a valid IMSI. MS is Idle Updated on cell C.

Specific PICS statements:

- MS operation mode B (TSPC_operation_mode_B).
- MS operation mode C (TSPC_operation_mode_C).
- SIM removal possible without powering down (TSPC_AddInfo_SIMRmv).
- Switch off on button (TSPC_Feat_OnOff).
- Automatic GPRS attach procedure at switch on or power on (TSPC_AddInfo_on_auto_GPRS_AP).

PIXIT statements:

-

Test procedure

The SS rejects a routing area updating with the cause value 'Location Area not allowed'. The SS checks that the MS does not perform GPRS attach while in the location area, performs GPRS attach when a new location area is entered and deletes the list of forbidden LAs when switched off.

Different types of MS may use different methods to periodically clear the list of forbidden location areas (e.g. every day at 12 am). If the list is cleared while the test is being run, it may be necessary to re-run the test.

Maximum duration of test

15 minutes.

Expected sequence

Step	Direction	Message	Comments
1	SS MS		The following messages are sent and shall be received on cell C. The MS is set in MS operation mode C (see PICS). If MS operation mode C not supported, goto step 42.
2	SS		The SS activates cell C.
3	MS		The MS is powered up or switched on and initiates an attach (see PICS). Cell C is preferred by the MS.
4	MS -> SS	ATTACH REQUEST	Attach type = 'GPRS attach' Mobile identity = IMSI
5	SS -> MS	ATTACH ACCEPT	Attach result = 'GPRS only attached' Mobile identity = P-TMSI-1 P-TMSI-1 signature
6	MS -> SS	ATTACH COMPLETE	Routing area identity = RAI-3
7	SS		The following messages are sent and shall be received on cell B.
8	SS		The SS deactivates cell C and activates cell B. Cell B is preferred by the MS.
9			The following step is only performed for MS Operation Mode B.
10		{Location Update Procedure}	Macro. Location Update Procedure initiated from the MS. Parameter mobile identity is IMSI.
11	MS -> SS	ROUTING AREA UPDATE REQUEST	Update type = 'RA updating' P-TMSI-1 signature
12	SS -> MS	ROUTING AREA UPDATE REJECT	Routing area identity = RAI-3 GMM cause = 'Location Area not allowed'
13	SS -> MS		SS pages MS with Mobile identity = P-TMSI-1 and paging order for TBF establishment according to the channel combination of the cell.
14	MS		No response from the MS to the request. This is checked for 10 s.
15			The following messages are sent and shall be received on cell A.
16	SS		The SS deactivates cell B and activates cell A. Cell A is preferred by the MS.
17	MS		No ATTACH REQUEST sent to SS
18	MS		(SS waits 30 seconds)
19			The following messages are sent and shall be received on cell C.
20	SS		The SS deactivates cell A and activates cell C. Cell C is preferred by the MS.
21	MS		The following step is only performed for MS Operation Mode B.
22			Macro. Location Update Procedure initiated from the MS. Parameter mobile identity is IMSI.
23	MS	{Location Update Procedure}	The MS initiates a GPRS attach either automatically or manually (see PICS).
24	MS -> SS	ATTACH REQUEST	Attach type = 'GPRS attach' Mobile identity = IMSI
25	SS -> MS	ATTACH ACCEPT	Attach result = 'GPRS only attached' Mobile identity = P-TMSI-2 P-TMSI-2 signature
26	MS -> SS	ATTACH COMPLETE	Routing area identity = RAI-3

Step	Direction	Message	Comments
27A 28A-1 28A-2	MS MS -> SS SS -> MS	DETACH REQUEST DETACH ACCEPT	If SIM removal is possible (see PICS), perform steps 27A, 28A-1, 28A-2. Otherwise if switch off is possible (see PICS) perform steps 27B, 28B. Otherwise perform step 27C. SIM removal is performed. Detach type = 'GPRS detach' Detach type = 'GPRS detach'
27B 28B 27C	MS MS -> SS MS	DETACH REQUEST	Switch off is performed. Detach type = 'power switched off, GPRS detach' Power is removed.
29 30 31 32	MS MS -> SS SS -> MS MS -> SS	ATTACH REQUEST ATTACH ACCEPT ATTACH COMPLETE	The MS gets the SIM replaced, is powered up or switched on and initiates an attach (see PICS). Attach type = 'GPRS attach' Mobile identity = P-TMSI-2 Routing area identity = RAI-3 Attach result = 'GPRS only attached' Mobile identity = P-TMSI-1 P-TMSI-1 signature Routing area identity = RAI-3
33 34 35 36 37 38 39 40 41	SS MS -> SS SS -> MS MS MS -> SS	{Location Update Procedure} ROUTING AREA UPDATE REQUEST ROUTING AREA UPDATE ACCEPT DETACH REQUEST	The following messages are sent and shall be received on cell A. The SS deactivates cell C and activates cell A. Cell A is preferred by the MS. The following step is only performed for MS Operation Mode B. Macro. Location Update Procedure initiated from the MS. Parameter mobile identity is IMSI. Update type = 'RA updating' P-TMSI-1 signature Routing area identity = RAI-3 No new mobile identity assigned. P-TMSI and P-TMSI signature not included. Update result = 'RA updated' Routing area identity = RAI-1 Negotiated Ready Timer IE is not included Force to standby indicator set The MS is switched off or power is removed (see PICS). Message not sent if power is removed. Detach type = 'power switched off, GPRS detach'
42 43	SS MS		The SS is set in network operation mode II. The MS is set in MS operation mode B (see PICS), cell A is switched off and the test is repeated from step 2 to step 41.

Specific message contents

None.

44.2.3.1.5 Routing area updating / abnormal cases / attempt counter check / miscellaneous reject causes

44.2.3.1.5.1 Conformance requirement

- 1) When a routing area updating procedure is rejected with the routing area updating attempt counter less than five, the Mobile Station shall repeat the routing area updating procedure after T3311 timeout.
- 2) When a routing area updating procedure is rejected with the routing area updating attempt counter five, the Mobile Station shall start timer T3302.
- 3) When the T3302 expires, a new routing area updating procedure shall be initiated.

Reference(s):

3GPP TS 04.08 / 3GPP TS 24.008 subclause 4.7.5.1.

44.2.3.1.5.2 Test purpose

To test the behaviour of the MS with respect to the routing area updating attempt counter.

44.2.3.1.5.3 Method of test

Initial conditions

System Simulator:

Two cells (not simultaneously activated), cell A in MCC1/MNC1/LAC1/RAC1, cell B in MCC1/MNC1/LAC1/RAC2. T3302 is set to 12 minutes. The ATT-flag shall indicate that the MS should use IMSI attach/detach procedures.

Both cells are operating in network operation mode II (in case of MS operation mode B), or in network operation mode III (in case of MS operation mode C).

Mobile Station:

The MS has a valid P-TMSI-1 and RAI-1. MS has a valid IMSI and is Idle Updated on cell A.

Specific PICS statements:

- MS operation mode C (TSPC_operation_mode_C).
- MS operation mode B (TSPC_operation_mode_B) (only if mode C not supported).
- Switch off on button (TSPC_Feat_OnOff).
- Automatic GPRS attach procedure at switch on or power on (TSPC_AddInfo_on_auto_GPRS_AP).

PIXIT statements:

-

Test procedure

The MS initiates a routing area updating procedure (routing area updating attempt counter zero). The SS rejects the routing area updating procedure with a GMM cause 'congestion' code. The routing area updating attempt counter is incremented and T3311 is started.

The MS initiates a new routing area updating procedure (routing area updating attempt counter one) after T3311 expires. The SS rejects the routing area updating procedure with a GMM cause 'congestion' code. The routing area updating attempt counter is incremented and T3311 is started.

The MS initiates a new routing area updating procedure (attempt counter two) after T3311 expires. The SS rejects the routing area updating procedure with a GMM cause 'congestion' code. The routing area updating attempt counter is incremented and T3311 is started.

The MS initiates a new routing area updating procedure (attempt counter three) after T3311 expires. The SS rejects the routing area updating procedure with a GMM cause 'congestion' code. The routing area updating attempt counter is incremented and T3311 is started.

The MS initiates a new routing area updating procedure (attempt counter four) after T3311 expires. The SS rejects the routing area updating procedure with a GMM cause 'congestion' code. The routing area updating attempt counter is incremented but T3311 is not started, as the routing area updating attempt counter is five. T3302 is started.

The MS initiates a routing area updating procedure with routing area updating attempt counter zero after T3302 expires with the stored P-TMSI, P-TMSI signature, GPRS CKSN and RAI.

Maximum duration of test

15 minutes.

Expected sequence

Step	Direction	Message	Comments
1	SS MS		The following messages are sent and shall be received on cell A. The MS is set in MS operation mode C or B (see PICS).
2	SS		The SS is set in network operation mode II or III and activates cell A.
3	MS		The MS is powered up or switched on and initiates an attach (see PICS). Cell A is preferred by the MS.
4			The following step is only performed for MS Operation Mode B.
5		{Location Update Procedure}	Macro. Location Update Procedure initiated from the MS. Location updating type = "IMSI Attach". Parameter mobile identity is IMSI. T3212 is started at the end of the procedure.
6	MS -> SS	ATTACH REQUEST	Attach type = 'GPRS attach' Mobile identity = P-TMSI-1
7	SS -> MS	ATTACH ACCEPT	Routing area identity = RAI-1 No new mobile identity assigned. P-TMSI not included. Attach result = 'GPRS only attached' P-TMSI-2 signature Routing area identity = RAI-1 Negotiated Ready timer value IE should not be included. Force to standby indicator set
8			The following messages are sent and shall be received on cell B.
9	SS		Activate cell B with a lower signal strength than cell A. The RF level of cell A is lowered until cell B is preferred by the MS.
10	SS		Cell B is preferred by the MS.
11	MS -> SS	ROUTING AREA UPDATE REQUEST	Update type = 'RA updating' P-TMSI-2 signature Routing area identity = RAI-1
12	SS -> MS	ROUTING AREA UPDATE REJECT	GMM cause = 'Congestion'
13	MS -> SS	ROUTING AREA UPDATE REQUEST	Update type = 'RA updating' P-TMSI-2 signature Routing area identity = RAI-1
14	SS		The SS verifies that the time between the routing area update reject and the routing area update request is T3311 (+/- 10%)
15	SS -> MS	ROUTING AREA UPDATE REJECT	GMM cause = 'Congestion'
16	MS -> SS	ROUTING AREA UPDATE REQUEST	Update type = 'RA updating' P-TMSI-2 signature Routing area identity = RAI-1
17	SS		The SS verifies that the time between the previous routing area update reject and the previous routing area update request is T3311 (+/- 10%)
18	SS -> MS	ROUTING AREA UPDATE REJECT	GMM cause = 'Congestion'
19	MS -> SS	ROUTING AREA UPDATE REQUEST	Update type = 'RA updating' P-TMSI-2 signature Routing area identity = RAI-1
20	SS		The SS verifies that the time between the previous routing area update reject and the previous routing area update request is T3311 (+/- 10%)
21	SS -> MS	ROUTING AREA UPDATE REJECT	GMM cause = 'Congestion'

Step	Direction	Message	Comments
22	MS -> SS	ROUTING AREA UPDATE REQUEST	Update type = 'RA updating' P-TMSI-2 signature Routing area identity = RAI-1
23	SS		The SS verifies that the time between the previous routing area update reject and the previous routing area update request is T3311 (+/- 10%)
24	SS -> MS	ROUTING AREA UPDATE REJECT	GMM cause = 'Congestion'
25	SS		The SS verifies that the MS does not attempt to initiate a RAU procedure for T3302 (+/- 10%).
26			The following step is only performed for MS Operation Mode B.
27		{Location Update Procedure}	Macro. Location Update Procedure initiated from the MS when T3212 expires. Location updating type 'Periodic Updating'. Parameter mobile identity is IMSI.
28	MS -> SS	ROUTING AREA UPDATE REQUEST	Update type = 'RA updating' P-TMSI-2 signature Routing area identity = RAI-1
29	SS -> MS	ROUTING AREA UPDATE ACCEPT	Update result = 'RA updated' Mobile identity = P-TMSI-2 P-TMSI-3 signature Routing area identity = RAI-4
30	MS -> SS	ROUTING AREA UPDATE COMPLETE	
31	MS		The MS is switched off or power is removed (see PICS).
32	MS -> SS	DETACH REQUEST	Message not sent if power is removed. Detach type = 'power switched off, GPRS detach' An IMSI Detach must be performed for an MS in Operation Mode B either before or after the GPRS Detach. If an IMSI Detach is performed before the GPRS Detach then the following also applies: <ul style="list-style-type: none"> - The MS performs a GPRS Suspension Procedure in order to send the IMSI Detach while still attached for GPRS Services. - The SS must include the Resumption IE in the subsequent Channel Release to allow resumption of the GMM context so GPRS Detach can be performed

Specific message contents

SYSTEM INFORMATION TYPE 3 (Cell A):

Information element	Value/remark
As default message contents except:	
Control Channel Description T3212 timeout value	12 min

Note: An R97 MS will use this value to set T3302.

ATTACH ACCEPT and ROUTING AREA UPDATE REJECT:

Information Element	Value/remark
As default message contents except: T3302 value	12 min

Note: This IE is only read by MS's supporting R99 and onwards.

44.2.3.1.6 Routing area updating / abnormal cases / change of cell into new routing area

44.2.3.1.6.1 Conformance requirement

When a change of cell into a new routing area is performed before the routing area updating procedure is finished, the MS shall abort the routing area updating procedure and re-initiate it in the new routing area.

Reference(s):

3GPP TS 04.08 / 3GPP TS 24.008 subclause 4.7.5.1.

44.2.3.1.6.2 Test purpose

To test the behaviour of the MS in case of procedure collision.

44.2.3.1.6.3 Method of test

Initial conditions

System Simulator:

Three cells, cell A in MCC1/MNC1/LAC1/RAC1, cell B in MCC1/MNC1/LAC1/RAC2 and cell C In MCC1/MNC1/LAC1/RAC3.

All cells are operating in network operation mode II (in case of MS operation mode B), or in network operation mode III (in case of MS operation mode C).

Mobile Station:

The MS has a valid P-TMSI-1 and RAI-1. MS is Idle Updated on cell A.

Specific PICS statements:

- MS operation mode C (TSPC_operation_mode_C).
- MS operation mode B (TSPC_operation_mode_B).
- Switch off on button (TSPC_Feat_OnOff).
- Automatic GPRS attach procedure at switch on or power on (TSPC_AddInfo_on_auto_GPRS_AP).

PIXIT statements:

-

Test procedure

The MS initiates a routing area updating procedure. The ROUTING AREA UPDATE ACCEPT message is delayed from the SS. The MS performs a cell update into a new routing area. The MS shall re-initiate a routing area updating procedure in the new routing area.

Maximum duration of test

5 minutes.

Expected sequence

Step	Direction	Message	Comments
1	SS MS		The following messages are sent and shall be received on cell A. The MS is set in MS operation mode C (see PICS). If MS operation mode C not supported, goto step 18.
2	SS		The SS activates cell A, B and C. The RF level of cell A is -50 dBm, cell B - 60 dBm and cell C - 70 dBm.
3	MS		The MS is powered up or switched on and initiates an attach (see PICS). Cell A is preferred by the MS.
4	MS -> SS	ATTACH REQUEST	Attach type = 'GPRS attach' Mobile identity = P-TMSI-1 Routing area identity = RAI-1
5	SS -> MS	ATTACH ACCEPT	Attach result = 'GPRS only attached' Mobile identity = P-TMSI-2 P-TMSI-2 signature Routing area identity = RAI-1
6 7	MS -> SS	ATTACH COMPLETE	Wait 30 sec to let the MS identify the neighbour cells B and C.
8 9 10	SS SS MS -> SS	ROUTING AREA UPDATE REQUEST	The following messages are sent and shall be received on cell B. The RF level of cell A is lowered to -100 dBm. Cell B is preferred by the MS. Update type = 'RA updating' P-TMSI-2 signature Routing area identity = RAI-1
11	SS		No response to the ROUTING AREA UPDATING REQUEST message is given by the SS
12	SS		The following messages are sent and shall be received on cell C. The RF level of cell B is lowered to -100 dBm. The following message may be sent and shall be received on cell B.
13 Optional step	MS -> SS	ROUTING AREA UPDATE REQUEST	Update type = 'RA updating' P-TMSI-2 signature Routing area identity = RAI-1
14	SS		Cell C is preferred by the MS.
15	MS -> SS	ROUTING AREA UPDATE REQUEST	Update type = 'RA updating' P-TMSI-2 signature Routing area identity = RAI-1
16	SS -> MS	ROUTING AREA UPDATE ACCEPT	Update result = 'RA updated' Mobile identity = P-TMSI-2 P-TMSI-3 signature Routing area identity = RAI-5
17	MS -> SS	ROUTING AREA UPDATE COMPLETE	
18	MS		The MS is switched off or power is removed (see PICS).
19	MS -> SS	DETACH REQUEST	Message not sent if power is removed. Detach type = 'power switched off, GPRS detach'
20 21	SS MS		The SS is set in network operation mode II. The MS is set in MS operation mode B (see PICS), and the test is repeated from step 2 to step 19.

Specific message contents

None.

44.2.3.1.7 Routing area updating / abnormal cases / change of cell during routing area updating procedure

44.2.3.1.7.1 Conformance requirement

When a change of cell within a new routing area is performed before the routing area updating procedure is finished, the MS shall perform the cell update before the routing area updating procedure is finished.

Reference(s):

3GPP TS 04.08 / 3GPP TS 24.008 subclause 4.7.5.1.

44.2.3.1.7.2 Test purpose

To test the behaviour of the MS in case of procedure collision.

44.2.3.1.7.3 Method of test

Initial conditions

System Simulator:

Three cells, cell A in MCC1/MNC1/LAC1/RAC1, cell B in MCC1/MNC1/LAC1/RAC2 and cell C in MCC1/MNC1/LAC1/RAC2.

All three cells are operating in network operation mode II (in case of MS operation mode B), or in network operation mode III (in case of MS operation mode C).

Mobile Station:

The MS has a valid P-TMSI-1 and RAI-1. MS is Idle Updated on cell A.

Specific PICS statements:

- MS operation mode C (TSPC_operation_mode_C) (only if mode B not supported).
- MS operation mode B (TSPC_operation_mode_B).
- Switch off on button (TSPC_Feat_OnOff).
- Automatic GPRS attach procedure at switch on or power on (TSPC_AddInfo_on_auto_GPRS_AP).

PIXIT statements:

-

Test procedure

The MS initiates a routing area updating procedure. The ROUTING AREA UPDATE ACCEPT message is delayed from the SS. The MS performs a cell update within the routing area. The MS then waits for the ROUTING AREA UPDATE ACCEPT message.

Maximum duration of test

5 minutes.

Expected sequence

Step	Direction	Message	Comments
1	SS MS		The following messages are sent and shall be received on cell A. The MS is set in MS operation mode C or B (see PICS).
2	SS		The SS is set in network operation mode II or III and activates cell A, B and C. The RF level of cell A is -50 dBm, cell B - 60 dBm and cell C - 70 dBm.
3	MS		The MS is powered up or switched on and initiates an attach (see PICS). Cell A is preferred by the MS.
4	MS -> SS	ATTACH REQUEST	Attach result = 'GPRS attach' Mobile identity = P-TMSI-1 Routing area identity = RAI-1
5	SS -> MS	ATTACH ACCEPT	No new mobile identity assigned. P-TMSI-1 included. Attach result = 'GPRS only attached' P-TMSI-2 signature Routing area identity = RAI-1
6	MS -> SS	ATTACH COMPLETE	
7			Wait 30 sec to let the MS identify the neighbour cells B and C.
8	SS		The following messages are sent and shall be received on cell B.
9	SS		The RF level of cell A is lowered to -100 dBm.
10	MS -> SS	ROUTING AREA UPDATE REQUEST	Cell B is preferred by the MS. Update type = 'RA updating' P-TMSI-2 signature Routing area identity = RAI-1
11	SS		No response to the ROUTING AREA UPDATE REQUEST message is given by the SS
12	SS		The following messages are sent and shall be received on cell C.
13	MS -> SS	ROUTING AREA UPDATING REQUEST	The RF level of cell B is lowered to -100 dBm. The following message may be sent and shall be received on cell B. Update type = 'RA updating' P-TMSI-2 signature Routing area identity = RAI-1
14	SS		Cell C is preferred by the MS.
15	MS -> SS	UPLINK RLC DATA BLOCK	LLC PDU implicitly indicating cell update.
16	MS -> SS	ROUTING AREA UPDATING REQUEST	Update type = 'RA updating' P-TMSI-2 signature Routing area identity = RAI-1
17	SS -> MS	ROUTING AREA UPDATE ACCEPT	Update result = 'RA updated' Mobile identity = P-TMSI-2 P-TMSI-3 signature Routing area identity = RAI-4
18	MS -> SS	ROUTING AREA UPDATE COMPLETE	
19	MS		The MS is switched off or power is removed (see PICS).
20	MS -> SS	DETACH REQUEST	Message not sent if power is removed. Detach type = 'power switched off, GPRS detach'

Specific message contents

None.

44.2.3.1.8 Routing area updating / abnormal cases / P-TMSI reallocation procedure collision

44.2.3.1.8.1 Conformance requirement

When a P-TMSI REALLOCATION COMMAND message is received by the MS while waiting for a ROUTING AREA UPDATE ACCEPT message, the MS shall ignore the P-TMSI reallocation procedure and continue with the routing area updating procedure.

Reference(s):

3GPP TS 04.08 / 3GPP TS 24.008 subclause 4.7.5.1.

44.2.3.1.8.2 Test purpose

To test the behaviour of the MS in case of procedure collision.

44.2.3.1.8.3 Method of test

Initial conditions

System Simulator:

Two cells (not simultaneously activated), cell A in MCC1/MNC1/LAC1/RAC1 and cell B in MCC1/MNC1/LAC1/RAC2.

Both cells are operating in network operation mode II (in case of MS operation mode B), or in network operation mode III (in case of MS operation mode C).

Mobile Station:

The MS has a valid IMSI. MS is Idle Updated on cell A.

Specific PICS statements:

- MS operation mode C (TSPC_operation_mode_C).
- MS operation mode B (TSPC_operation_mode_B) (only if mode C not supported).
- Switch off on button (TSPC_Feat_OnOff).
- Automatic GPRS attach procedure at switch on or power on (TSPC_AddInfo_on_auto_GPRS_AP).

PIXIT statements:

-

Test procedure

The MS initiates a routing area updating procedure. The SS does not answer the routing area updating procedure, but initiates a P-TMSI reallocation procedure. The MS shall ignore the P-TMSI reallocation procedure and continue with the routing area updating procedure.

Maximum duration of test

5 minutes.

Expected sequence

Step	Direction	Message	Comments
1	SS MS		The following messages are sent and shall be received on cell A. The MS is set in MS operation mode C or B (see PICS).
2	SS		The SS is set in network operation mode II or III and activates cell A.
3	MS		The MS is powered up or switched on and initiates an attach (see PICS). Cell A is preferred by the MS.
4	MS -> SS	ATTACH REQUEST	Attach result = 'GPRS attach' Mobile identity = IMSI
5	SS -> MS	ATTACH ACCEPT	Attach result = 'GPRS only attached' Mobile identity = P-TMSI-1 P-TMSI-1 signature Routing area identity = RAI-1
6	MS -> SS	ATTACH COMPLETE	
7	SS		The following messages are sent and shall be received on cell B. Activate cell B with a lower signal strength than cell A. The RF level of cell A is lowered until cell B is preferred by the MS.
8	SS		Cell B is preferred by the MS.
9	MS -> SS	ROUTING AREA UPDATE REQUEST	Update type = 'RA updating' P-TMSI-1 signature Routing area identity = RAI-1
10	SS -> MS	P-TMSI REALLOCATION COMMAND	Mobile identity = P-TMSI-1 P-TMSI-1 signature Routing area identity = RAI-1
11	MS		The MS ignores the P-TMSI reallocation command.
12	SS -> MS	ROUTING AREA UPDATE ACCEPT	Update result = 'RA updated' Mobile identity = P-TMSI-2 P-TMSI-2 signature Routing area identity = RAI-4
13	MS -> SS	ROUTING AREA UPDATE COMPLETE	
14	MS		The MS is switched off or power is removed (see PICS).
15	MS -> SS	DETACH REQUEST	Message not sent if power is removed. Detach type = 'power switched off, GPRS detach'

Specific message contents

None.

44.2.3.2 Combined routing area updating

The combined routing area updating procedure is a GMM procedure used by GPRS MSs of MS operation mode A or B that are IMSI attached for GPRS and non-GPRS services. In order to use the combined routing area updating procedure, the network must operate in network operation mode I.

44.2.3.2.1 Combined routing area updating / combined RA/LA accepted

44.2.3.2.1.1 Conformance requirement

- 1) If the network accepts the combined routing area updating procedure and reallocates a P-TMSI, the MS shall acknowledge the new P-TMSI and continue communication with the new P-TMSI.
- 2) If the network accepts the combined routing area updating procedure from the MS without reallocation of the old P-TMSI, the MS shall continue communication with the old P-TMSI.

Reference(s):

3GPP TS 04.08 / 3GPP TS 24.008 subclause 4.7.5.2.

44.2.3.2.1.2 Test purpose

To test the behaviour of the MS if the network accepts the combined routing area updating procedure.

The following cases are identified:

- 1) P-TMSI / P-TMSI signature is reallocated;
- 2) Old P-TMSI / P-TMSI signature is not changed;
- 3) Mobile terminating CS call is allowed with IMSI;
- 4) Mobile terminating CS call is allowed with TMSI.

44.2.3.2.1.3 Method of test

Initial conditions

System Simulator:

Two cells, cell A in MCC1/MNC1/LAC1/RAC1, cell B in MCC1/MNC1/LAC1/RAC2.

Both cells operating in network operation mode I.

Mobile Station:

The MS has a valid IMSI. MS is Idle Updated on cell A.

Specific PICS statements:

- MS operation mode B (TSPC_operation_mode_B)- MS operation mode A (TSPC_operation_mode_A).
- Switch off on button (TSPC_Feat_OnOff).
- Automatic GPRS attach procedure at switch on or power on (TSPC_AddInfo_on_auto_GPRS_AP).

PIXIT statements:

-

Test procedure

- 1) A combined GPRS attach procedure is performed. The MS sends a ROUTING AREA UPDATE REQUEST message. The SS reallocates the P-TMSI, unassigns the TMSI and returns ROUTING AREA UPDATE ACCEPT message with a new P-TMSI and IMSI. The MS acknowledge the new P-TMSI by sending ROUTING AREA UPDATING COMPLETE message. Further communication MS - SS is performed by the new P-TMSI. For CS calls, the IMSI is used.
- 2) The MS is CS paged in order to verify that the IMSI is used for CS calls.
- 3) The MS sends an ROUTING AREA UPDATING REQUEST message. The SS accepts the P-TMSI signature and returns ROUTING AREA UPDATING ACCEPT message without any P-TMSI and with a new TMSI. The MS acknowledge the new TMSI by sending ROUTING AREA UPDATING COMPLETE message. Further communication MS-SS is performed by the old P-TMSI. For CS calls, the new TMSI is used.
- 4) The MS is CS paged in order to verify that the TMSI is used for CS calls.

Maximum duration of test

15 minutes.

Expected sequence

Step	Direction	Message	Comments
1	MS		The MS is set in MS operation mode B (see PICS).
2	MS		The MS is powered up or switched on and initiates an attach (see PICS).
3	MS -> SS	ATTACH REQUEST	Attach type = 'Combined GPRS / IMSI attach' or 'GPRS attach while IMSI attached' Mobile identity = IMSI
4	SS -> MS	ATTACH ACCEPT	TMSI status = no valid TMSI available Attach result = 'Combined GPRS / IMSI attached' Mobile identity = P-TMSI-2 P-TMSI-2 signature
5	MS -> SS	ATTACH COMPLETE	Routing area identity = RAI-1
6	SS		The following messages are sent and shall be received on cell B. Activate cell B with a lower signal strength than cell A. The RF level of cell A is lowered until cell B is preferred by the MS.
7	MS -> SS	ROUTING AREA UPDATING REQUEST	Update type = 'Combined RA/LA updating' P-TMSI-2 signature
8	SS -> MS	ROUTING AREA UPDATING ACCEPT	Routing area identity = RAI-1 TMSI status = no valid TMSI available Update result = 'Combined RA/LA updated' Mobile identity = P-TMSI-1 P-TMSI-1 signature
9	MS -> SS	ROUTING AREA UPDATING COMPLETE	Mobile identity = IMSI
10	SS -> MS		Routing area identity = RAI-4 SS pages the MS with mobile identity P-TMSI-1 and paging order for TBF establishment according to the channel combination of the cell.
11	MS		Verify that the MS initiates a TBF connection and sends an UPLINK RLC DATA BLOCK as a response to the paging request.
12	SS -> MS		SS pages the MS with mobile identity IMSI and paging order for RR connection according to the channel combination of the cell.
13	MS		Verify that the MS initiates a RR connection and sends a PAGING RESPONSE with mobile identity IMSI.
14	SS		SS releases the RR connection indicating a successful resumption of GPRS services.

Step	Direction	Message	Comments
15	SS		The following messages are sent and shall be received on cell A. The RF level of cell A is increased and the RF level of cell B is lowered until cell A is preferred by the MS.
16	MS -> SS	ROUTING AREA UPDATING REQUEST	Update type = 'Combined RA/LA updating' P-TMSI-1 signature Routing area identity = RAI-4 TMSI status = no valid TMSI available
17	SS -> MS	ROUTING AREA UPDATING ACCEPT	Update result = 'Combined RA/LA updated' No P-TMSI Mobile identity = TMSI-1 Routing area identity = RAI-1
18	MS -> SS	ROUTING AREA UPDATING COMPLETE	
19	SS -> MS		SS pages the MS with mobile identity P-TMSI-1 and paging order for TBF establishment according to the channel combination of the cell.
20	MS		Verify that the MS initiates a TBF connection and sends an UPLINK RLC DATA BLOCK as a response to the paging request.
21	SS -> MS		SS pages the MS with mobile identity TMSI-1 and paging order for RR connection according to the channel combination of the cell.
22	MS		Verify that the MS initiates a RR connection and sends a PAGING RESPONSE with mobile identity TMSI-1.
23	SS		SS releases the RR connection indicating a successful resumption of GPRS services.
24	SS -> MS		SS pages the MS with mobile identity P-TMSI-2 and paging order for TBF establishment according to the channel combination of the cell.
25	MS		No response from the MS to the request. This is checked for 10 s.
26	MS		The MS is switched off or power is removed (see PICS).
27	MS -> SS	DETACH REQUEST	Message not sent if power is removed. Detach type = 'power switched off, combined GPRS / IMSI detach'

Specific message contents

None.

44.2.3.2.2 Combined routing area updating / MS in CS operation at change of RA

44.2.3.2.2.1 Conformance requirement

GPRS MS that is in an ongoing CS transaction at change of routing area shall initiate the routing area updating procedure only after the CS transaction has been released.

Reference(s):

3GPP TS 04.08 / 3GPP TS 24.008 subclause 4.7.5.2.

44.2.3.2.2.2 Test purpose

To test the behaviour of the MS when using the combined routing area updating procedure in cases where the MS is CS connected at change of RA.

44.2.3.2.2.3 Method of test

Initial conditions

System Simulator:

Two cells, cell A in MCC1/MNC1/LAC1/RAC1, cell B in MCC1/MNC1/LAC1/RAC2.

Both cells operating in network operation mode I.

Mobile Station:

The MS has a valid IMSI. MS is Idle Updated on cell A.

Specific PICS statements:

- MS operation mode B (TSPC_operation_mode_B)- Switch off on button (TSPC_Feat_OnOff).
- Automatic GPRS attach procedure at switch on or power on (TSPC_AddInfo_on_auto_GPRS_AP).

PIXIT statements:

-

Test procedure

A combined GPRS attach procedure is performed. The MS initiates a CS call. The routing area change. MS will not send a ROUTING AREA UPDATE REQUEST message until the CS operation is terminated.

Maximum duration of test

15 minutes.

Expected sequence

Step	Direction	Message	Comments
1	MS		The MS is set in MS operation mode B (see PICS).
2	MS		The MS is powered up or switched on and initiates an attach (see PICS).
3	MS -> SS	ATTACH REQUEST	Attach type = 'Combined GPRS / IMSI attach' or 'GPRS attach while IMSI attached' Mobile identity = IMSI
4	SS -> MS	ATTACH ACCEPT	TMSI status = no valid TMSI available Attach result = 'Combined GPRS / IMSI attached' Mobile identity = P-TMSI-2 P-TMSI-2 signature Routing area identity = RAI-1
5	MS -> SS	ATTACH COMPLETE	
6	MS		A CS call is initiated.
7	SS		Activate cell B with the same signal strength as cell A.
8	SS -> MS		Handover commanded by SS on to DCCH of cell B
9	MS		The following messages are sent and shall be received on cell B.
10	MS		No RA updating procedure is initiated.
11	MS -> SS	ROUTING AREA UPDATING REQUEST	This is checked for 60 seconds. The CS call is terminated Update type = 'Combined RA/LA updating with IMSI attach' P-TMSI-2 signature Routing area identity = RAI-1 TMSI status = no valid TMSI available
12	SS -> MS	ROUTING AREA UPDATING ACCEPT	Update result = 'Combined RA/LA updated' Mobile identity = P-TMSI-1 P-TMSI-1 signature Mobile identity = IMSI Routing area identity = RAI-4
13	MS -> SS	ROUTING AREA UPDATING COMPLETE	
14	SS -> MS		SS pages the MS with mobile identity P-TMSI-1 and paging order for TBF establishment according to the channel combination of the cell.
15	MS		Verify that the MS initiates a TBF connection and sends an UPLINK RLC DATA BLOCK as a response to the paging request.
16	SS -> MS		SS pages the MS with mobile identity IMSI and paging order for RR connection according to the channel combination of the cell.
17	MS		Verify that the MS initiates a RR connection and sends a PAGING RESPONSE with mobile identity IMSI.
18	SS		SS releases the RR connection.
19	MS		The MS is switched off or power is removed (see PICS).
20	MS -> SS	DETACH REQUEST	Message not sent if power is removed. Detach type = 'power switched off, combined GPRS / IMSI detach'

Specific message contents

None.

44.2.3.2.3 Combined routing area updating / RA only accepted

44.2.3.2.3.1 Conformance requirement

- 1) If the network accepts the combined GPRS attach procedure, but GMM cause code 'IMSI unknown in HLR' is sent to the MS the Mobile Station shall delete the stored TMSI, LAI and CKSN. The Mobile Station shall consider SIM invalid for non-GPRS services until power is switched off or SIM is removed.
- 2) If the network accepts the combined GPRS attach procedure, but GMM cause code 'MSC temporarily not reachable', 'Network failure' or 'Congestion' is sent to the MS, an MS operation mode B MS may perform an MM IMSI attach procedure.

Reference(s):

3GPP TS 04.08 / 3GPP TS 24.008 subclause 4.7.5.2.

44.2.3.2.3.2 Test Purpose

Test purpose 1

To test the behaviour of the MS if the network accepts the routing area updating procedure with indication RA only, GMM cause 'IMSI unknown in HLR'.

Test purpose 2

To test the behaviour of the MS if the network accepts the routing area updating procedure with indication RA only, GMM cause 'MSC temporarily not reachable', 'Network failure' or 'Congestion'.

44.2.3.2.3.3 Method of test

44.2.3.2.3.3.1 Test Procedure 1

Initial conditions

System Simulator:

Two cells (not simultaneously activated), cell A in MCC1/MNC1/LAC1/RAC1, cell B in MCC1/MNC1/LAC1/RAC2.

Both cells operating in network operation mode I.

Mobile Station:

The MS has a valid IMSI. MS is Idle Updated on cell A.

Specific PICS statements:

- MS operation mode B (TSPC_operation_mode_B)- MS operation mode A (TSPC_operation_mode_A).
- Switch off on button (TSPC_Feat_OnOff).
- Automatic GPRS attach procedure at switch on or power on (TSPC_AddInfo_on_auto_GPRS_AP).

PIXIT statements:

-

Test procedure

After attach, the MS sends an ROUTING AREA UPDATE REQUEST message. The SS allocates a P-TMSI and returns ROUTING AREA UPDATE ACCEPT message with a P-TMSI. GMM cause 'IMSI unknown in HLR' is indicated from SS. Further communication MS - SS is performed by the P-TMSI. CS services are not possible.

Maximum duration of test

5 minutes.

Expected sequence

Step	Direction	Message	Comments
1	MS		The MS is set in MS operation mode B (see PICS).
2	MS		The MS is powered up or switched on and initiates an attach (see PICS).
3	MS -> SS	ATTACH REQUEST	Attach type = 'Combined GPRS / IMSI attach' or 'GPRS attach while IMSI attached' Mobile identity = IMSI
4	SS -> MS	ATTACH ACCEPT	TMSI status = no valid TMSI available Attach result = 'Combined GPRS / IMSI attached' Mobile identity = P-TMSI-2 P-TMSI-2 signature Routing area identity = RAI-1
5	MS -> SS	ATTACH COMPLETE	
6	SS		The following messages are sent and shall be received on cell B. Activate cell B with a lower signal strength than cell A. The RF level of cell A is lowered until cell B is preferred by the MS.
7	MS -> SS	ROUTING AREA UPDATING REQUEST	Update type = 'Combined RA/LA updating' P-TMSI-2 signature Routing area identity = RAI-1
8	SS -> MS	ROUTING AREA UPDATING ACCEPT	TMSI status = no valid TMSI available Update result = 'RA updated' Mobile identity = P-TMSI-1 P-TMSI-1 signature Routing area identity = RAI-4 GMM cause = 'IMSI unknown in HLR'
9	MS -> SS	ROUTING AREA UPDATING COMPLETE	
10	SS -> MS		SS pages the MS with mobile identity P-TMSI-1 and paging order for TBF establishment according to the channel combination of the cell.
11	MS		Verify that the MS initiates a TBF connection and sends an UPLINK RLC DATA BLOCK as a response to the paging request.
12	SS -> MS		SS pages the MS with mobile identity IMSI and paging order for RR connection according to the channel combination of the cell.
13	MS		The MS shall not initiate an RR connection. This is checked during 3 seconds.
14	MS		The MS is switched off or power is removed (see PICS).
15	MS -> SS	DETACH REQUEST	Message not sent if power is removed. Detach type = 'power switched off, GPRS detach'

Specific message contents

None.

44.2.3.2.3.3.2 Test Procedure 2

Initial conditions

System Simulator:

Two cells (not simultaneously activated), cell A in MCC1/MNC1/LAC1/RAC1, cell B in MCC1/MNC1/LAC1/RAC2.

Both cells operating in network operation mode I. T3212 is set to 6 minutes.

Mobile Station:

The MS has a valid IMSI. MS is Idle Updated on cell A.

Specific PICS statements:

- MS operation mode B (TSPC_operation_mode_B)- MS operation mode A (TSPC_operation_mode_A).
- Automatic MM IMSI attach procedure at switch-on/power-on (TSPC_AddInfo_auto_MM_IMSI_AP_on_off).
- Switch off on button (TSPC_Feat_OnOff).
- Automatic GPRS attach procedure at switch on or power on (TSPC_AddInfo_on_auto_GPRS_AP).

PIXIT statements:

-

Test procedure

After attach, the MS sends an ROUTING AREA UPDATE REQUEST message . The SS allocates a new P-TMSI signature and returns ROUTING AREA UPDATE ACCEPT message. GMM cause 'MSC temporarily not reachable', 'Network failure' or 'Congestion' is indicated from SS. The cause code is arbitrarily chosen. This procedure is repeated until the routing area updating attempt counter is equal to five. An MS operation mode B MS may perform an MM IMSI attach procedure (according to the PICS statement). Further communication MS - SS is performed by the P-TMSI. The existence of a signalling channel is verified by a request for mobile identity. It is further verified that the MS after a succesful IMSI attach procedure can perform CS services.

Maximum duration of test

10 minutes.

Expected sequence

Dependent whether the option Automatic MM IMSI attach procedure at switch-on/power-on ' is not supported or not, the steps 1-28 or 29-62 apply depending on manufacturer (see PICS).

Step	Direction	Message	Comments
1	MS		The following messages are sent and shall be received on cell A The MS is set in MS operation mode B and no automatic MM IMSI attach procedure is indicated (see PICS).
2	MS		The MS is powered up or switched on and initiates an attach (see PICS).
3	MS -> SS	ATTACH REQUEST	Attach type = 'Combined GPRS / IMSI attach' or 'GPRS attach while IMSI attached' Mobile identity = IMSI
4	SS -> MS	ATTACH ACCEPT	TMSI status = no valid TMSI available Attach result = 'Combined GPRS / IMSI attached' Mobile identity = P-TMSI-2 P-TMSI-2 signature Routing area identity = RAI-1
5	MS -> SS	ATTACH COMPLETE	
6	SS		The following messages are sent and shall be received on cell B. Activate cell B with a lower signal strength than cell A. The RF level of cell A is lowered until cell B is preferred by the MS.
7	MS -> SS	ROUTING AREA UPDATING REQUEST	Update type = 'Combined RA/LA updating' P-TMSI-2 signature Routing area identity = RAI-1
8	SS -> MS	ROUTING AREA UPDATING ACCEPT	TMSI status = no valid TMSI available Update result = 'RA updated' Mobile identity = P-TMSI-1 P-TMSI-1 signature Routing area identity = RAI-4 GMM cause = 'MSC temporarily not reachable', 'Network failure' or 'Congestion' (arbitrarily chosen)
9	MS -> SS	ROUTING AREA UPDATING COMPLETE	
10			The routing area updating attempt counter =1. The combined routing area updating procedure is reinitialized at the expiry of T3311
11	MS -> SS	ROUTING AREA UPDATING REQUEST	Update type = 'Combined RA/LA updating with IMSI Attach' P-TMSI-1 signature Routing area identity = RAI-4 TMSI status = no valid TMSI available
12	SS -> MS	ROUTING AREA UPDATING ACCEPT	Update result = 'RA updated' Mobile identity = P-TMSI-1 P-TMSI-1 signature Routing area identity = RAI-4 GMM cause = 'MSC temporarily not reachable', 'Network failure' or 'Congestion' (arbitrarily chosen)
13	MS -> SS	ROUTING AREA UPDATING COMPLETE	
14			The routing area updating attempt counter =2. The combined routing area updating procedure is reinitialized at the expiry of T3311
15	MS -> SS	ROUTING AREA UPDATING REQUEST	Update type = 'Combined RA/LA updating with IMSI Attach' P-TMSI-1 signature Routing area identity = RAI-4 TMSI status = no valid TMSI available

Step	Direction	Message	Comments
16	SS -> MS	ROUTING AREA UPDATING ACCEPT	Update result = 'RA updated' Mobile identity = P-TMSI-1 P-TMSI-1 signature Routing area identity = RAI-4 GMM cause = 'MSC temporarily not reachable', 'Network failure' or 'Congestion' (arbitrarily chosen)
17	MS -> SS	ROUTING AREA UPDATING COMPLETE	
18			The routing area updating attempt counter =3. The combined routing area updating procedure is reinitialized at the expiry of T3311
19	MS -> SS	ROUTING AREA UPDATING REQUEST	Update type = 'Combined RA/LA updating with IMSI Attach' P-TMSI-1signature Routing area identity = RAI-4 TMSI status = no valid TMSI available
20	SS -> MS	ROUTING AREA UPDATING ACCEPT	Update result = 'RA updated' Mobile identity = P-TMSI-1 P-TMSI-1 signature Routing area identity = RAI-4 GMM cause = 'MSC temporarily not reachable', 'Network failure' or 'Congestion' (arbitrarily chosen)
21	MS -> SS	ROUTING AREA UPDATING COMPLETE	
22			The routing area updating attempt counter =4. The combined routing area updating procedure is reinitialized at the expiry of T3311
23	MS -> SS	ROUTING AREA UPDATING REQUEST	Update type = 'Combined RA/LA updating with IMSI Attach' P-TMSI-1 signature Routing area identity = RAI-4 TMSI status = no valid TMSI available
24	SS -> MS	ROUTING AREA UPDATING ACCEPT	Update result = 'RA updated' Mobile identity = P-TMSI-1 P-TMSI-1 signature Routing area identity = RAI-4 GMM cause = 'MSC temporarily not reachable', 'Network failure' or 'Congestion' (arbitrarily chosen)
25	MS -> SS	ROUTING AREA UPDATING COMPLETE	
26			The routing area updating attempt counter =5. It is verified for 30 seconds that the combined routing area updating procedure is not reinitialized.
27	MS		The MS is switched off or power is removed (see PICS).
28	MS -> SS	DETACH REQUEST	Message not sent if power is removed. Stop the sequence.
29			The following messages are sent and shall be received on cell B
30	MS		The MS is set in MS operation mode B and Automatic MM IMSI attach procedure is indicated (see PICS).
31	MS		The MS is powered up or switched on and initiates an attach (see PICS).
32	MS -> SS	ATTACH REQUEST	Attach type = 'Combined GPRS / IMSI attach' or 'GPRS attach while IMSI attached' Mobile identity = IMSI TMSI status = no valid TMSI available

Step	Direction	Message	Comments
33	SS -> MS	ATTACH ACCEPT	Attach result = 'Combined GPRS / IMSI attached' Mobile identity = P-TMSI-2 P-TMSI-2 signature Routing area identity = RAI-4
34	MS -> SS	ATTACH COMPLETE	
35			The following messages are sent and shall be received on cell A.
36	SS		Activate cell A with a lower signal strength than cell B. The RF level of cell B is lowered until cell A is preferred by the MS.
37	MS -> SS	ROUTING AREA UPDATING REQUEST	Update type = 'Combined RA/LA updating' P-TMSI-2 signature Routing area identity = RAI-4 TMSI status = no valid TMSI available
38	SS -> MS	ROUTING AREA UPDATING ACCEPT	Update result = 'RA updated' Mobile identity = P-TMSI-1 P-TMSI-1 signature Routing area identity = RAI-1 GMM cause = 'MSC temporarily not reachable', 'Network failure' or 'Congestion' (arbitrarily chosen)
39	MS -> SS	ROUTING AREA UPDATING COMPLETE	
40			The routing area updating attempt counter =1. The combined routing area updating procedure is reinitialized at the expiry of T3311
41	MS -> SS	ROUTING AREA UPDATING REQUEST	Update type = 'Combined RA/LA updating with IMSI Attach' P-TMSI-1 signature Routing area identity = RAI-1 TMSI status = no valid TMSI available
42	SS -> MS	ROUTING AREA UPDATING ACCEPT	Update result = 'RA updated' Mobile identity = P-TMSI-1 P-TMSI-1 signature Routing area identity = RAI-1 GMM cause = 'MSC temporarily not reachable', 'Network failure' or 'Congestion' (arbitrarily chosen)
43	MS -> SS	ROUTING AREA UPDATING COMPLETE	
44			The routing area updating attempt counter =2. The combined routing area updating procedure is reinitialized at the expiry of T3311
45	MS -> SS	ROUTING AREA UPDATING REQUEST	Update type = 'Combined RA/LA updating with IMSI Attach' P-TMSI-1 signature Routing area identity = RAI-1 TMSI status = no valid TMSI available
46	SS -> MS	ROUTING AREA UPDATING ACCEPT	Update result = 'RA updated' Mobile identity = P-TMSI-1 P-TMSI-1 signature Routing area identity = RAI-1 GMM cause = 'MSC temporarily not reachable', 'Network failure' or 'Congestion' (arbitrarily chosen)
47	MS -> SS	ROUTING AREA UPDATING COMPLETE	
48			The routing area updating attempt counter =3. The combined routing area updating procedure is reinitialized at the expiry of T3311
49	MS -> SS	ROUTING AREA UPDATING REQUEST	Update type = 'Combined RA/LA updating with IMSI Attach' P-TMSI-1 signature Routing area identity = RAI-1 TMSI status = no valid TMSI available

Step	Direction	Message	Comments
50	SS -> MS	ROUTING AREA UPDATING ACCEPT	Update result = 'RA updated' Mobile identity = P-TMSI-1 P-TMSI-1 signature Routing area identity = RAI-1 GMM cause = 'MSC temporarily not reachable', 'Network failure' or 'Congestion' (arbitrarily chosen)
51	MS -> SS	ROUTING AREA UPDATING COMPLETE	
52			The routing area updating attempt counter =4. The combined routing area updating procedure is reinitialized at the expiry of T3311
53	MS -> SS	ROUTING AREA UPDATING REQUEST	Update type = 'Combined RA/LA updating with IMSI Attach' P-TMSI-1 signature Routing area identity = RAI-1 TMSI status = no valid TMSI available
54	SS -> MS	ROUTING AREA UPDATING ACCEPT	Update result = 'RA updated' No new P-TMSI is assigned Routing area identity = RAI-1 GMM cause = 'MSC temporarily not reachable', 'Network failure' or 'Congestion' (arbitrarily chosen)
55 56 (optional step)	MS	{Location Update Procedure}	The routing area updating attempt counter =5. Macro. Location Update Procedure may be initiated from the MS. Parameter mobile identity is TMSI-1. Steps 57, 58 and 59 are only performed if the MS has performed the Location Update Procedure in step 56.
57	SS -> MS		SS pages the MS with mobile identity TMSI-1 and paging order for RR connection according to the channel combination of the cell.
58	MS		Verify that the MS initiates a RR connection and sends a PAGING RESPONSE with mobile identity TMSI-1.
59	SS		SS releases the RR connection indicating a successful resumption of GPRS services.
60	MS		The MS is switched off or power is removed (see PICS).
61	MS -> SS	DETACH REQUEST	Message not sent if power is removed.

Specific message contents

SYSTEM INFORMATION TYPE 3 (Cell A) in Test Procedure 2:

Information element	Value/remark
As default message contents except:	
Control Channel Description T3212 timeout value	6 min

In case of PBCCH present:

PACKET SYSTEM INFORMATION TYPE 2 (Insatnce 1) (Cell A) in Test Procedure 2:

Non GPRS Cell Options -T3212	1 Non GPRS Cell Options present 00000001 (T3212 Timeout value = 6 mins)
---------------------------------	--

Note: An R97 MS will use this value to set T3302.

ATTACH ACCEPT and ROUTING AREA UPDATE ACCEPT in Test Procedure 2:

Information Element	Value/remark
As default message contents except: T3302 value	6 min

Note: This IE is only read by MS's supporting R99 and onwards.

44.2.3.2.4 Combined routing area updating / rejected / PLMN not allowed

44.2.3.2.4.1 Conformance requirement

- 1) If the network rejects a combined routing area updating procedure from the Mobile Station with the cause 'PLMN not allowed' the Mobile Station shall:
 - 1.1. not perform combined GPRA attach when switched on in the same location area or PLMN;
 - 1.2. delete the stored RAI, GPRS-CKSN, P-TMSI, P-TMSI signature, TMSI CKSN and LAI;
 - 1.3. store the PLMN in the 'forbidden PLMN list'.

Reference(s):

3GPP TS 04.08 / 3GPP TS 24.008 subclause 4.7.5.2.

44.2.3.2.4.2 Test purpose

To test the behaviour of the MS if the network rejects the combined routing area updating procedure of the MS with the cause 'PLMN not allowed'.

44.2.3.2.4.3 Method of test

Initial conditions

System Simulator:

Four cells (not simultaneously activated), cell A in MCC1/MNC2/LAC1/RAC1, cell B in MCC1/MNC2/LAC1/RAC2, cell C in MCC1/MNC2/LAC2/RAC1 and cell D in MCC2/MNC1/LAC1/RAC1.

All four cells are operating in network operation mode I.

Mobile Station:

The MS has a valid IMSI. MS is Idle Updated on cell A.

Specific PICS statements:

- MS operation mode B (TSPC_operation_mode_B)- MS operation mode A (TSPC_operation_mode_A).
- Switch off on button (TSPC_Feat_OnOff).
- Automatic GPRS attach procedure at switch on or power on (TSPC_AddInfo_on_auto_GPRS_AP).
- GPRS attach attempted automatically due to outstanding request (TSPC_AddInfo_GPRS_Attach_Attempt_Outstanding).

PIXIT statements:

-

Test Procedure

The SS rejects a combined routing area updating with the cause value 'PLMN not allowed'. The SS checks that the MS does not perform GPRS attach if activated in the same PLMN. The SS checks that the MS does not perform IMSI attach if activated in the same PLMN.

Maximum duration of test

10 minutes.

Expected sequence

Step	Direction	Message	Comments
1	SS		The following messages are sent and shall be received on cell A.
2	SS		The SS activates cell A.
3	MS -> SS	ATTACH REQUEST	The MS is powered up or switched on and initiates an attach (see PICS). Attach type = 'Combined GPRS / IMSI attach' or 'GPRS attach while IMSI attached' Mobile identity = IMSI
4	SS -> MS	ATTACH ACCEPT	TMSI status = no valid TMSI available Attach result = 'Combined GPRS / IMSI attached' Mobile identity = P-TMSI-2 P-TMSI-2 signature Routing area identity = RAI-8
5	MS -> SS	ATTACH COMPLETE	Mobile identity = TMSI-1
6	SS		The following messages are sent and shall be received on cell B.
7	MS		Activate cell B with a lower signal strength than cell A. The RF level of cell A is lowered until cell B is preferred by the MS.
8	MS -> SS	ROUTING AREA UPDATING REQUEST	Cell B is preferred by the MS. Update type = 'Combined RA/LA updating' P-TMSI-2 signature
9	SS -> MS	ROUTING AREA UPDATING REJECT	Routing area identity = RAI-8 GMM cause = 'PLMN not allowed'
10	MS		The MS initiates an attach by MMI or AT command.
11	MS		No ATTACH REQUEST sent to SS
12	SS -> MS		(SS waits 30 seconds). SS pages the MS with mobile identity P-TMSI-2 and paging order for TBF establishment according to the channel combination of the cell.
13	MS		No response from the MS to the request. This is checked for 10 s.
14	SS		The following messages are sent and shall be received on cell C.
15	MS		The SS deactivates cell B and activates cell C.
16	MS		Cell C is preferred by the MS.
17	MS		The MS initiates an attach by MMI or by AT command.
18	SS -> MS		No ATTACH REQUEST sent to SS (SS waits 30 seconds). SS pages the MS with mobile identity TMSI-1 and paging order for RR connection according to the channel combination of the cell.
19	MS		The MS shall not initiate an RR connection. This is checked during 3 seconds.
20	SS		The following messages are sent and shall be received on cell A.
21	MS		The SS deactivates cell C and activates cell A.
22	MS		Cell A is preferred by the MS.
23	MS		The MS initiates an attach by MMI or by AT command.
24	SS -> MS		No ATTACH REQUEST sent to SS (SS waits 30 seconds). SS pages the MS with mobile identity P-TMSI-2 and paging order for TBF establishment according to the channel combination of the cell.
25	MS		No response from the MS to the request. This is checked for 10 s.

Step	Direction	Message	Comments
26	SS		The following messages are sent and shall be received on cell D.
27	MS		The SS deactivates cell A and activates cell D. Cell D is preferred by the MS.
28 (conditional)		{Location Update Procedure}	Steps 28 and 29 are only performed by an MS which will not initiate a GPRS attach automatically due to outstanding request (see PICS)
29 (conditional)	MS		Macro. Location Update Procedure initiated from the MS.
30	MS -> SS	ATTACH REQUEST	MS initiates an attach via MMI or AT commands.
31	SS -> MS	ATTACH ACCEPT	Attach type = 'Combined GPRS / IMSI attach' or 'GPRS attach while IMSI attached' Mobile identity = IMSI TMSI status = no valid TMSI available Attach result = 'Combined GPRS / IMSI attached' Mobile identity = P-TMSI-1 P-TMSI-1 signature Routing area identity = RAI-2 Mobile identity = IMSI
32	MS -> SS	ATTACH COMPLETE	
33	MS		The MS is switched off or power is removed (see PICS).
34	MS -> SS	DETACH REQUEST	Message not sent if power is removed. Detach type = 'power switched off, combined GPRS / IMSI detach'

Specific message contents

None.

44.2.3.2.5 Combined routing area updating / rejected / roaming not allowed in this location area

44.2.3.2.5.1 Conformance requirement

For a R97 and R98 MS only:

- 1) If the network rejects a combined routing area updating procedure from the Mobile Station with the cause 'roaming not allowed in this location area' the Mobile Station:
 - 1.1 shall not perform combined GPRS attach when in the same location area;
 - 1.2 shall delete the stored RAI, GPRS-CKSN, P-TMSI P-TMSI signature, TMSI, CKSN and LAI;
 - 1.3 shall store the LA in the 'forbidden location areas for roaming';
 - 1.4 may perform combined GPRS attach when a new location area is entered.
- 2) The mobile station shall reset the list of 'Forbidden location areas for roaming' when switched off or when the SIM is removed.

For a R99 or later MS only:

- 1) If the network rejects a combined routing area updating procedure from the Mobile Station with the cause 'roaming not allowed in this location area' the Mobile Station:
 - 1.1 shall not perform combined GPRS attach when in the same location area;
 - 1.2 shall store the LA in the 'forbidden location areas for roaming';

1.3 shall perform a routing area update when entering in a new location area if the LAI or the PLMN identity is not contained in any of the lists "forbidden LAs for roaming", "forbidden LAs for regional provision of service", "forbidden PLMNs for GPRS service" or "forbidden PLMNs" and the current update status is different from "IDLE NO IMSI".

2) The mobile station shall reset the list of 'Forbidden location areas for roaming' when switched off or when the SIM is removed.

Reference(s):

3GPP TS 04.08 / 3GPP TS 24.008 subclause 4.7.5.2.

Additional references for R99 or after MS only, TS 23.122 subclause 4.5.2.

44.2.3.2.5.2 Test purpose

Test purpose 1

To test that on receipt of a rejection using the 'Roaming not allowed in this area' cause code, the MS ceases trying a routing area updating procedure on that location area. Successful combined routing area updating procedure is possible in other location areas.

Test purpose 2

To test that if the MS is switched off or the SIM is removed the list of 'forbidden location areas for roaming' is cleared.

44.2.3.2.5.3 Method of test

44.2.3.2.5.3.1 Test procedure 1

Initial conditions

System Simulator:

Two cells, cell A in MCC2/MNC1/LAC1/RAC1 (RAI-2), cell B in MCC2/MNC1/LAC2/RAC1 (RAI-6).

Both cells are operating in network operation mode I.

Mobile Station:

The MS has a valid IMSI. MS is Idle Updated on cell A.

Specific PICS statements:

- MS operation mode B (TSPC_operation_mode_B)- MS operation mode A (TSPC_operation_mode_A).
- Switch off on button (TSPC_Feat_OnOff).
- Automatic GPRS attach procedure at switch on or power on (TSPC_AddInfo_on_auto_GPRS_AP).
- GPRS attach attempted automatically due to outstanding request (TSPC_AddInfo_GPRS_Attach_Attempt_Outstanding).
- MS GPRS release (TSPC_MS_GPRS_RELEASE)

PIXIT statements:

-

Test procedure

The SS rejects a combined routing area updating with the cause value 'Roaming not allowed in this area'. A new attempt for a combined GPRS attach is not possible.

For a R97 and R98 MS only, successful combined GPRS attach procedure is performed in another location area.

For a R99 or after MS only, successful combined routing area updating procedure is performed in another location area.

The MS is moved back to the 1st location area. A combined routing area updating shall not be performed, as the LA is on the forbidden list.

Maximum duration of test

10 minutes.

Expected sequence

Step	Direction	Message	Comments
	SS		The following messages are sent and shall be received on cell A.
1	SS		The SS activates cell A.
2	MS		The MS is powered up or switched on and initiates an attach (see PICS).
3	MS -> SS	ATTACH REQUEST	Attach type = 'Combined GPRS / IMSI attach' or 'GPRS attach while IMSI attached' Mobile identity = IMSI
4	SS -> MS	ATTACH ACCEPT	TMSI status = no valid TMSI available Attach result = 'Combined GPRS / IMSI attached' Mobile identity = P-TMSI-2 P-TMSI-2 signature Routing area identity = RAI-2
5	MS -> SS	ATTACH COMPLETE	Mobile identity = TMSI-1
	SS		The following messages are sent and shall be received on cell B.
6	SS		Activate cell B with a lower signal strength than cell A. The RF level of cell A is lowered until cell B is preferred by the MS.
7	MS		Cell B is preferred by the MS.
8	MS -> SS	ROUTING AREA UPDATING REQUEST	Update type = 'Combined RA/LA updating' P-TMSI-2 signature Routing area identity = RAI-2
9	SS -> MS	ROUTING AREA UPDATING REJECT	The RF level of cell A is lowered until cell A is no more suitable. GMM cause = 'Roaming not allowed in this area'
10	MS		The MS initiates an attach by MMI or by AT command.
11	MS		This step is only performed for a R97 and R98 mobile. No ATTACH REQUEST sent to SS (SS waits 30 seconds).
12	SS -> MS		This step is only performed for a R97 and R98 mobile. SS pages the MS with mobile identity P-TMSI-2 and paging order for TBF establishment according to the channel combination of the cell.
13	MS		No response from the MS to the request. This is checked for 10 s.
14	SS -> MS		SS pages the MS with mobile identity TMSI and paging order for RR connection according to the channel combination of the cell.
15	MS		The MS shall not initiate an RR connection. This is checked during 3 seconds.
16	SS		The following messages are sent and shall be received on cell A.
17	MS		The RF level of cell A is increased and the RF level of cell B is lowered until cell A is preferred by the MS.
18	MS	{Location Update Procedure}	Cell A is preferred by the MS. Macro. Location Update Procedure initiated from the MS.
(optional)			Step 19 is performed by an MS which will not initiate a GPRS attach automatically due to outstanding request (see PICS).
A19	MS		MS initiates an attach via MMI or AT commands. This step is only performed for a R97 and R98 mobile.
(conditional)			

Step	Direction	Message	Comments
A20	MS -> SS	ATTACH REQUEST	Attach type = 'Combined GPRS / IMSI attach' or 'GPRS attach while IMSI attached' Mobile identity = IMSI TMSI status = no valid TMSI available (See note)
A21	SS -> MS	ATTACH ACCEPT	Attach result = 'Combined GPRS / IMSI attached' Mobile identity = P-TMSI-1 P-TMSI-1 signature Routing area identity = RAI-2 Mobile identity = TMSI-1
A22	MS -> SS	ATTACH COMPLETE	Update type = 'Combined RA/LA updating' or 'Combined RA/LA updating with IMSI attach' P-TMSI-2 signature Routing area identity = RAI-2 (See note) Update result = 'Combined RA/LA updated' Mobile identity = P-TMSI-1 P-TMSI-1 signature Routing area identity = RAI-2 Mobile identity = TMSI-1
B20	MS -> SS	ROUTING AREA UPDATING REQUEST	
B21	SS -> MS	ROUTING AREA UPDATE ACCEPT	
B22	MS -> SS	ROUTING AREA UPDATE COMPLETE	
23	SS -> MS		SS pages the MS with mobile identity TMSI-1 and paging order for RR connection according to the channel combination of the cell. Verify that the MS initiates a RR connection and sends a PAGING RESPONSE with mobile identity TMSI-1. SS releases the RR connection indicating a successful resumption of GPRS services. SS pages the MS with mobile identity P-TMSI-1 and paging order for TBF establishment according to the channel combination of the cell. Verify that the MS initiates a TBF connection and sends an UPLINK RLC DATA BLOCK as a response to the paging request.
24	MS		
25	SS		
26	SS -> MS		
27	MS		
28	SS		The following messages are sent and shall be received on cell B. The RF level of cell B is increased and the RF level of cell A is lowered until cell B is preferred by the MS. No ROUTING AREA UPDATING REQUEST sent to SS (SS waits 30 seconds). SS pages the MS with mobile identity P-TMSI-2 and paging order for TBF establishment according to the channel combination of the cell. No response from the MS to the request. This is checked for 10 s.
29	MS		
30	SS -> MS		
31	MS		
NOTE: An R97 and R98 MS follows the steps in the order specified as A. An R99 or later MS follows the steps in the order specified as B.			

Specific message contents

None.

44.2.3.2.5.3.2 Test procedure 2

Initial conditions

System Simulator:

Two cells, cell A in MCC2/MNC1/LAC1/RAC1, cell B in MCC2/MNC1/LAC2/RAC1.

Both cells are operating in network operation mode I.

Mobile Station:

The MS has a valid IMSI. MS is Idle Updated on cell A.

Specific PICS statements:

- MS operation mode B (TSPC_operation_mode_B)- MS operation mode A (TSPC_operation_mode_A).
- SIM removal possible without powering down (TSPC_AddInfo_SIMRmv).
- Switch off on button (TSPC_Feat_OnOff).
- Automatic GPRS attach procedure at switch on or power on (TSPC_AddInfo_on_auto_GPRS_AP).
- MS GPRS release (TSPC_MS_GPRS_RELEASE).

PIXIT statements:

-

Test procedure

The SS rejects a combined routing area updating with the cause value 'Roaming not allowed in this area'. The MS is switched off for 10 s and switched on again. The SS checks that a combined GPRS attach is possible on the cell on which the previous combined routing area updating had been rejected.

For a R97 and R98 MS only, the Mobile identity is IMSI for the combined GPRS attach.

For a R99 or after MS only, the Mobile identity is either IMSI or P-TMSI for the combined GPRS attach.

If SIM removal is possible without switching off: The SS rejects a routing area updating with the cause value 'Roaming not allowed in this area'. The SIM is removed and inserted in the MS. The SS checks that a GPRS attach procedure and routing area updating procedure is possible on the cell on which the routing area updating had previously been rejected.

Maximum duration of test

10 minutes.

Expected sequence

Step	Direction	Message	Comments
	SS		The following messages are sent and shall be received on cell A.
1	SS		The SS activates cell A.
2	MS		The MS is powered up or switched on and initiates an attach (see PICS).
3	MS -> SS	ATTACH REQUEST	Attach type = 'Combined GPRS / IMSI attach' or 'GPRS attach while IMSI attached' Mobile identity =IMSI
4	SS -> MS	ATTACH ACCEPT	TMSI status = no valid TMSI available Attach result = 'Combined GPRS / IMSI attached' Mobile identity = P-TMSI-2 P-TMSI-2 signature Routing area identity = RAI-2
5	MS -> SS	ATTACH COMPLETE	Mobile identity = TMSI-1
			The following messages are sent and shall be received on cell B.
6	SS		Activate cell B with a lower signal strength than cell A. The RF level of cell A is lowered until cell B is preferred by the MS.
7	MS		Cell B is preferred by the MS.
8	MS -> SS	ROUTING AREA UPDATING REQUEST	Update type = 'Combined RA/LA updating' P-TMSI-2 signature Routing area identity = RAI-2
9	SS -> MS	ROUTING AREA UPDATING REJECT	The RF level of cell A is lowered until cell A is no more suitable. GMM cause = 'Roaming not allowed in this area'
10	MS		The MS initiates an attach by MMI or by AT command.
11	MS		No ATTACH REQUEST sent to SS (SS waits 30 seconds).
12	SS -> MS		SS pages the MS with mobile identity P-TMSI-2 and paging order for TBF establishment according to the channel combination of the cell.
13	MS		No response from the MS to the request. This is checked for 10 s.
14	SS -> MS		SS pages the MS with mobile identity TMSI and paging order for RR connection according to the channel combination of the cell.
15	MS		The MS shall not initiate an RR connection. This is checked during 3 seconds.
16	MS		If possible (see PICS) SIM removal is performed. Otherwise if possible (see PICS) switch off is performed. Otherwise the power is removed.
17	MS		The MS gets the SIM replaced, is powered up or switched on. Step 18 is only performed for non-auto attach MS.
18		{Location Update Procedure}	Macro. Location Update Procedure initiated from the MS.
19	MS		MS initiates an attach automatically (see PICS), via MMI or AT commands.
A20	MS -> SS	ATTACH REQUEST	Attach type = 'Combined GPRS / IMSI attach' or 'GPRS attach while IMSI attached' Mobile identity =IMSI TMSI status = no valid TMSI available (See note)
B20	MS -> SS	ATTACH REQUEST	Attach type = 'Combined GPRS / IMSI attach' or 'GPRS attach while IMSI attached' Mobile identity =IMSI or P-TMSI (See note)

Step	Direction	Message	Comments
21	SS -> MS	ATTACH ACCEPT	Attach result = 'Combined GPRS / IMSI attached' Mobile identity = P-TMSI-1 P-TMSI-1 signature Routing area identity = RAI-6 Mobile identity = TMSI-1
22	MS -> SS	ATTACH COMPLETE	SS pages the MS with mobile identity TMSI-1 and paging order for RR connection according to the channel combination of the cell. Verify that the MS initiates a RR connection and sends a PAGING RESPONSE with mobile identity TMSI-1. SS releases the RR connection indicating a successful resumption of GPRS services. SS pages the MS with mobile identity P-TMSI-1 and paging order for TBF establishment according to the channel combination of the cell. Verify that the MS initiates a TBF connection and sends an UPLINK RLC DATA BLOCK as a response to the paging request. The MS is switched off or power is removed (see PICS). Message not sent if power is removed. Detach type = 'power switched off, combined GPRS/IMSI detach'
23	SS -> MS		
24	MS		
25	SS		
26	SS -> MS		
27	MS		
28	MS		
29	MS -> SS		
NOTE: An R97 and R98 MS shall perform step A20. An R99 or later MS shall perform step B20.			

Specific message contents

None.

44.2.3.2.6 Combined routing area updating / abnormal cases / access barred due to access class control

44.2.3.2.6.1 Conformance requirement

- 1) The MS shall not perform combined routing area updating procedure, but stays in the current serving cell and applies normal cell reselection process.
- 2) The Mobile Station shall perform the combined routing area updating procedure when:
 - 2.1 Access is granted.
 - 2.2 Cell is changed.

Reference(s):

3GPP TS 04.08 / 3GPP TS 24.008 subclause 4.7.5.2.

44.2.3.2.6.2 Test purpose

Test purpose 1

To test the behaviour of the MS in case of access class control (access is granted).

Test purpose 2

To test the behaviour of the MS in case of access class control (cell is changed).

44.2.3.2.6.3 Method of test

44.2.3.2.6.3.1 Test procedure 1

Initial conditions

An access class x (0-15) is arbitrarily chosen. The SIM is programmed with this access class x. Communication with mobile stations using access class x is initially indicated to be barred on Cell B.

System Simulator:

Two cells (not simultaneously activated), cell A in MCC1/MNC1/LAC1/RAC1 has Access Class x not barred, cell B in MCC1/MNC/LAC1/RAC2 has Access Class x barred.

Both cells are operating in network operation mode I.

Access class x barred.

Mobile Station:

The MS has a valid IMSI. MS is Idle Updated on cell A.

Specific PICS statements:

- MS operation mode B (TSPC_operation_mode_B)- MS operation mode A (TSPC_operation_mode_A).
- Switch off on button (TSPC_Feat_OnOff).
- Automatic GPRS attach procedure at switch on or power on (TSPC_AddInfo_on_auto_GPRS_AP).

PIXIT statements:

-

Test procedure

A GPRS attach procedure is performed. The routing area is changed. The SS indicates access class x barred. A routing area updating procedure is not performed.

The SS indicates that access class x is not barred. A routing area updating procedure is performed.

Maximum duration of test

10 minutes.

Expected sequence

Step	Direction	Message	Comments
1	SS		The following messages are sent and shall be received on cell A.
2	SS MS		The SS activates cell A. The MS is powered up or switched on and initiates an attach (see PICS).
3	MS -> SS	ATTACH REQUEST	Attach type = 'Combined GPRS / IMSI attach' or 'GPRS attach while IMSI attached' Mobile identity = IMSI
4	SS -> MS	ATTACH ACCEPT	TMSI status = no valid TMSI available Attach result = 'Combined GPRS / IMSI attached' Mobile identity = P-TMSI-2 P-TMSI-2 signature Routing area identity = RAI-1
5	MS -> SS	ATTACH COMPLETE	Mobile identity = IMSI
6	SS		The following messages are sent and shall be received on cell B.
7	MS		Activate cell B with a lower signal strength than cell A. The RF level of cell A is lowered until cell B is preferred by the MS.
8	SS		No ROUTING AREA UPDATE REQUEST sent to SS, as access class x is barred (SS waits 30 seconds).
9	MS -> SS	ROUTING AREA UPDATING REQUEST	The access class x is not barred anymore. The value of the BCCH_CHANGE_MARK in the SI13 is altered to indicate the access class change. Update type = 'Combined RA/LA updating' P-TMSI-2 signature Routing area identity = RAI-1
10	SS -> MS	ROUTING AREA UPDATING ACCEPT	TMSI status = no valid TMSI available Update result = 'Combined RA/LA updated' Mobile identity = P-TMSI-1 P-TMSI-1 signature Mobile identity = TMSI-1
11	MS -> SS	ROUTING AREA UPDATING COMPLETE	Routing area identity = RAI-4
12	MS		The MS is switched off or power is removed (see PICS).
13	MS -> SS	DETACH REQUEST	Message not sent if power is removed. Detach type = 'power switched off, combined GPRS/IMSI detach'

Specific message contents

None.

44.2.3.2.6.3.2 Test procedure 2

Initial conditions

An access class x (0-15) is arbitrarily chosen. The SIM is programmed with this access class x. Communication with mobile stations using access class x is indicated to be barred on cell B.

System Simulator:

Three cells (not simultaneously activated), cell A in MCC1/MNC1/LAC1/RAC1 has access class x not barred, cell B in MCC1/MNC1/LAC1/RAC2 has access class x barred, cell C in MCC1/MNC1/LAC1/RAC2 has access class x not barred.

All three cells are operating in network operation mode I.

Mobile Station:

The MS has a valid IMSI. MS is Idle Updated on cell A.

Specific PICS statements:

- MS operation mode B (TSPC_operation_mode_B)- MS operation mode A (TSPC_operation_mode_A).
- Switch off on button (TSPC_Feat_OnOff).
- Automatic GPRS attach procedure at switch on or power on (TSPC_AddInfo_on_auto_GPRS_AP).

PIXIT statements:

-

Test procedure

A GPRS attach procedure is performed. The routing area is changed. The SS indicates access class x barred. A routing area updating procedure is not performed.

A cell change is performed into a cell where access class x is not barred. A routing area updating procedure is performed.

Maximum duration of test

10 minutes.

Expected sequence

Step	Direction	Message	Comments
1	SS		The following messages are sent and shall be received on cell A.
2	SS MS		The SS activates cell A. The MS is powered up or switched on and initiates an attach (see PICS).
3	MS -> SS	ATTACH REQUEST	Attach type = 'Combined GPRS / IMSI attach' or 'GPRS attach while IMSI attached' Mobile identity = IMSI
4	SS -> MS	ATTACH ACCEPT	TMSI status = no valid TMSI available Attach result = 'Combined GPRS / IMSI attached' Mobile identity = P-TMSI-2 P-TMSI-2 signature Routing area identity = RAI-1
5	MS -> SS	ATTACH COMPLETE	Mobile identity = IMSI
6	SS		The following messages are sent and shall be received on cell B.
7	MS		Activate cell B with a lower signal strength than cell A. The RF level of cell A is lowered until cell B is preferred by the MS. No ROUTING AREA UPDATING REQUEST sent to SS, as access class x is barred (SS waits 30 seconds).
8	SS		The following messages are sent and shall be received on cell C.
9	MS -> SS	ROUTING AREA UPDATING REQUEST	Activate cell C with a lower signal strength than cell B. The RF level of cell B is lowered until cell C is preferred by the MS. Update type = 'Combined RA/LA updating' P-TMSI-2 signature Routing area identity = RAI-1
10	SS -> MS	ROUTING AREA UPDATING ACCEPT	TMSI status = no valid TMSI available Update result = 'Combined RA/LA updated' Mobile identity = P-TMSI-1 P-TMSI-1 signature Mobile identity = TMSI-1
11	MS -> SS	ROUTING AREA UPDATING COMPLETE	Routing area identity = RAI-4
12	MS		The MS is switched off or power is removed (see PICS).
13	MS -> SS	DETACH REQUEST	Message not sent if power is removed. Detach type = 'power switched off, combined GPRS/IMSI detach'

Specific message contents

None.

44.2.3.2.7 Combined routing area updating / abnormal cases / attempt counter check / procedure timeout

44.2.3.2.7.1 Conformance requirement

- 1) When a T3330 timeout has occurred during a routing area updating procedure, the Mobile Station shall repeat the routing area updating procedure after T3330 timeout until the procedure is repeated five times.
- 2) When a routing area updating procedure is repeated five times, the routing area updating attempt counter is incremented and five more routing area updating procedures are performed. This procedure is repeated until the routing area updating attempt counter is five, the Mobile Station shall then start timer T3302.
- 3) When the T3302 expire, a new routing area updating procedure shall be initiated.

Reference(s):

3GPP TS 04.08 / 3GPP TS 24.008 subclause 4.7.5.2.

44.2.3.2.7.2 Test purpose

To test the behaviour of the MS with respect to the routing area updating attempt counter.

44.2.3.2.7.3 Method of test

Initial conditions

System Simulator:

Two cells (not simultaneously activated), cell A in MCC1/MNC1/LAC1/RAC1, cell B in MCC1/MNC/LAC1/RAC2. T3302 is set to 12 minutes.

Both cells are operating in network operation mode I.

Mobile Station:

The MS has a valid IMSI. MS is Idle Updated on cell A.

Specific PICS statements:

- MS operation mode B (TSPC_operation_mode_B)- MS operation mode A (TSPC_operation_mode_A).
- Switch off on button (TSPC_Feat_OnOff).
- Automatic GPRS attach procedure at switch on or power on (TSPC_AddInfo_on_auto_GPRS_AP).

PIXIT statements:

-

Test procedure

The MS initiates a routing area updating procedure (routing area updating attempt counter zero). The SS does not answer with ROUTING AREA UPDATE ACCEPT message before T3330 timeout. The MS restarts the routing area updating procedure four times. The SS never answers with ROUTING AREA UPDATE ACCEPT message before T3330 timeout. After five consecutive routing area update procedures, the routing area updating attempt counter is incremented and T3311 is started.

The MS initiates a new routing area updating procedure (routing area updating attempt counter one) after T3311 expires. The SS does not answer with ROUTING AREA UPDATE ACCEPT message before T3330 timeout. The MS restarts the routing area updating procedure four times. The SS never answers with ROUTING AREA UPDATE ACCEPT message before T3330 timeout. After five consecutive routing area update procedures, the routing area updating attempt counter is incremented and T3311 is started.

The MS initiates a new routing area updating procedure (routing area updating attempt counter two) after T3311 expires. The SS does not answer with ROUTING AREA UPDATE ACCEPT message before T3330 timeout. The MS restarts the routing area updating procedure four times. The SS never answers with ROUTING AREA UPDATE ACCEPT message before T3330 timeout. After five consecutive routing area update procedures, the routing area updating attempt counter is incremented and T3311 is started.

The MS initiates a new routing area updating procedure (routing area updating attempt counter three) after T3311 expires. The SS does not answer with ROUTING AREA UPDATE ACCEPT message before T3330 timeout. The MS restarts the routing area updating procedure four times. The SS never answers with ROUTING AREA UPDATE ACCEPT message before T3330 timeout. After five consecutive routing area update procedures, the routing area updating attempt counter is incremented and T3311 is started.

The MS initiates a new routing area updating procedure (routing area updating attempt counter four) after T3311 expires. The SS does not answer with ROUTING AREA UPDATE ACCEPT message before T3330 timeout. The MS restarts the routing area updating procedure four times. The SS never answers with ROUTING AREA UPDATE ACCEPT message before T3330 timeout. After five consecutive routing area update procedures, the routing area updating attempt counter is incremented and as the routing area updating attempt counter is five. T3302 is started.

The MS may perform a Location Update procedure.

The MS initiates a routing area updating procedure with routing area updating attempt counter zero after T3302 expires with the stored P-TMSI, P-TMSI signature, GPRS CKSN and RAI.

Maximum duration of test

30 minutes.

Expected sequence

Step	Direction	Message	Comments
1	SS		The following messages are sent and shall be received on cell A.
2	MS		The SS activates cell A.
3	MS -> SS	ATTACH REQUEST	The MS is powered up or switched on and initiates an attach (see PICS). Attach type = 'Combined GPRS / IMSI attach' or 'GPRS attach while IMSI attached' Mobile identity = IMSI
4	SS -> MS	ATTACH ACCEPT	TMSI status = no valid TMSI available Attach result = 'Combined GPRS / IMSI attached' Mobile identity = P-TMSI-2 P-TMSI-2 signature Routing area identity = RAI-1
5	MS -> SS	ATTACH COMPLETE	Mobile identity = IMSI
6	SS		The following messages are sent and shall be received on cell B.
7	MS		The SS deactivates cell A and activates cell B. Cell B is preferred by the MS.
8	MS -> SS	ROUTING AREA UPDATING REQUEST	k= 1 Update type = 'Combined RA/LA updating' P-TMSI-2 signature Routing area identity = RAI-1 TMSI status = no valid TMSI available routing area updating attempt counter = k (k is not visible. It is only used for clarifying the sequence.) Retransmission counter = 0
9	SS		No response is given from the SS.
10	SS		The SS verifies that the time between the RA update requests is T3330 seconds (+/- 10%)
11	MS -> SS	ROUTING AREA UPDATING REQUEST	Update type = 'Combined RA/LA updating' P-TMSI-2 signature Routing area identity = RAI-1 TMSI status = no valid TMSI available routing area updating attempt counter = k Retransmission counter = 1
12	SS		No response is given from the SS.
13	SS		The SS verifies that the time between the RA update requests is T3330 seconds (+/- 10%)
14	MS -> SS	ROUTING AREA UPDATING REQUEST	Update type = 'Combined RA/LA updating' P-TMSI-2 signature Routing area identity = RAI-1 TMSI status = no valid TMSI available routing area updating attempt counter = k Retransmission counter = 2

Step	Direction	Message	Comments
15	SS		No response is given from the SS.
16	SS		The SS verifies that the time between the RA update requests is T3330 seconds (+/- 10%)
17	MS -> SS	ROUTING AREA UPDATING REQUEST	Update type = 'Combined RA/LA updating' P-TMSI-2 signature Routing area identity = RAI-1 TMSI status = no valid TMSI available routing area updating attempt counter = k Retransmission counter = 3
18	SS		No response is given from the SS.
19	SS		The SS verifies that the time between the RA update requests is T3330 seconds (+/- 10%)
20	MS -> SS	ROUTING AREA UPDATING REQUEST	Update type = 'Combined RA/LA updating' P-TMSI-2 signature Routing area identity = RAI-1 TMSI status = no valid TMSI available routing area updating attempt counter = k Retransmission counter = 4
21	SS		No response is given from the SS.
22	SS		The SS verifies that the time between the RA update requests is T3311 + T3330 seconds (+/- 10%)
23	SS		Step 8 - 22 is repeated four times with k = 2, k = 3, k = 4 and k = 5
24	MS	{Location Update Procedure}	Optional step: The MS may perform a normal location updating procedure.
25	SS		The SS verifies that the time between the RA update requests is T3302 minutes + T3330 seconds (+/- 10%)
26	MS -> SS	ROUTING AREA UPDATING REQUEST	P-TMSI-2 signature Routing area identity = RAI-1 TMSI status = no valid TMSI available
27	SS -> MS	ROUTING AREA UPDATING ACCEPT	Update result = 'Combined RA/LA updated' Mobile identity = P-TMSI-1 P-TMSI-1 signature Mobile identity = IMSI Routing area identity = RAI-4
28	MS -> SS	ROUTING AREA UPDATING COMPLETE	
29	MS		The MS is switched off or power is removed (see PICS).
30	MS -> SS	DETACH REQUEST	Message not sent if power is removed. Detach type = 'power switched off, combined GPRS/IMSI detach'

Specific message contents

SYSTEM INFORMATION TYPE 3 (Cell A):

Information element	Value/remark
As default message contents except:	
Control Channel Description T3212 timeout value	12 min

In case of PBCCH present:

PACKET SYSTEM INFORMATION TYPE 2 (Insatnce 1) (Cell A) in Test Procedure 2:

Non GPRS Cell Options -T3212	1 Non GPRS Cell Options present 00000010 (T3212 Timeout value = 12 mins)
---------------------------------	---

Note: An R97 MS will use this value to set T3302.

ATTACH ACCEPT:

Information Element	Value/remark
As default message contents except: T3302 value	12 min

Note: This IE is only read by MS's supporting R99 and onwards.

44.2.3.2.8 Combined routing area updating / abnormal cases / change of cell into new routing area

44.2.3.2.8.1 Conformance requirement

When a change of cell into a new routing area is performed before the routing area updating procedure is finished, the MS shall abort the routing area updating procedure and re-initiate it in the new routing area.

Reference(s):

3GPP TS 04.08 / 3GPP TS 24.008 subclause 4.7.5.2.

44.2.3.2.8.2 Test purpose

To test the behaviour of the MS in case of procedure collision.

44.2.3.2.8.3 Method of test

Initial conditions

System Simulator:

Three cells, cell A in MCC1/MNC1/LAC1/RAC1, cell B in MCC1/MNC1/LAC1/RAC2, cell C in MCC1/MNC1/LAC1/RAC3.

All three cells are operating in network operation mode I.

Mobile Station:

The MS has a valid IMSI. MS is Idle Updated on cell A.

Specific PICS statements:

- MS operation mode B (TSPC_operation_mode_B)- MS operation mode A (TSPC_operation_mode_A).
- Switch off on button (TSPC_Feat_OnOff).
- Automatic GPRS attach procedure at switch on or power on (TSPC_AddInfo_on_auto_GPRS_AP).

PIXIT statements:

-

Test procedure

The MS initiates a routing area updating procedure. The ROUTING AREA UPDATE ACCEPT message is delayed from the SS. The MS performs a cell update into a new routing area. The Ms shall re-initiate a routing area updating procedure in the new routing area. The MS shall not increment the attempt counter.

Maximum duration of test

10 minutes.

Expected sequence

Step	Direction	Message	Comments
1	SS		The following messages are sent and shall be received on cell A.
2	SS		The SS activates cell A, B and C. The RF level of cell A is -50 dBm, cell B - 60 dBm and cell C - 70 dBm.
3	MS -> SS	ATTACH REQUEST	The MS is powered up or switched on and initiates an attach (see PICS). Attach type = 'Combined GPRS / IMSI attach' or 'GPRS attach while IMSI attached' Mobile identity = IMSI
4	SS -> MS	ATTACH ACCEPT	TMSI status = no valid TMSI available Attach result = 'Combined GPRS / IMSI attached' Mobile identity = P-TMSI-2 P-TMSI-2 signature Routing area identity = RAI-1
5	MS -> SS	ATTACH COMPLETE	Mobile identity = IMSI
6			Wait 30 sec to let the MS identify the neighbour cells B and C.
7	SS		The following messages are sent and shall be received on cell B.
8	MS		The RF level of cell A is lowered to -100 dBm. Cell B is preferred by the MS.
9	MS -> SS	ROUTING AREA UPDATING REQUEST	Update type = 'Combined RA/LA updating' P-TMSI-2 signature Routing area identity = RAI-1
10	SS		TMSI status = no valid TMSI available No response id given from the SS.
11	MS		The following messages are sent and shall be received on cell C.
12	MS -> SS	ROUTING AREA UPDATE REQUEST	The RF level of cell B is lowered to -100 dBm. The following message may be sent and shall be received on cell B. Update type = 'Combined RA/LA updating' P-TMSI-2 signature Routing area identity = RAI-1
13	MS		TMSI status = no valid TMSI available
14	MS -> SS	ROUTING AREA UPDATING REQUEST	Cell C is preferred by the MS. Update type = 'Combined RA/LA updating' P-TMSI-2 signature Routing area identity = RAI-1
15	SS -> MS	ROUTING AREA UPDATING ACCEPT	TMSI status = no valid TMSI available Update result = 'Combined RA/LA updated' Mobile identity = P-TMSI-1 P-TMSI-1 signature Mobile identity = IMSI
16	MS -> SS	ROUTING AREA UPDATING COMPLETE	Routing area identity = RAI-5
17	MS		The MS is switched off or power is removed (see PICS).
18	MS -> SS	DETACH REQUEST	Message not sent if power is removed. Detach type = 'power switched off, combined GPRS/IMSI detach'

Specific message contents

None.

44.2.3.2.9 Combined routing area updating / abnormal cases / change of cell during routing area updating procedure

44.2.3.2.9.1 Conformance requirement

When a change of cell within new routing area is performed before the routing area updating procedure is finished, the MS shall perform the cell update before the routing area updating procedure is finished.

Reference(s):

3GPP TS 04.08 / 3GPP TS 24.008 subclause 4.7.5.2.

44.2.3.2.9.2 Test purpose

To test the behaviour of the MS in case of procedure collision.

44.2.3.2.9.3 Method of test

Initial conditions

System Simulator:

Three cells, cell A in MCC1/MNC1/LAC1/RAC1, cell B in MCC1/MNC1/LAC1/RAC2, cell C in MCC1/MNC1/LAC1/RAC2.

All three cells are operating in network operation mode I.

Mobile Station:

The MS has a valid IMSI. MS is Idle Updated on cell A.

Specific PICS statements:

- MS operation mode B (TSPC_operation_mode_B)- MS operation mode A (TSPC_operation_mode_A).
- Switch off on button (TSPC_Feat_OnOff).
- Automatic GPRS attach procedure at switch on or power on (TSPC_AddInfo_on_auto_GPRS_AP).

PIXIT statements:

-

Test procedure

The MS initiates a routing area updating procedure. The ROUTING AREA UPDATE ACCEPT message is delayed from the SS. The MS performs a cell update within the routing area. The MS then waits for the ROUTING AREA UPDATE ACCEPT message.

Maximum duration of test

10 minutes.

Expected sequence

Step	Direction	Message	Comments
1	SS		The following messages are sent and shall be received on cell A.
2	SS		The SS activates cell A, B and C. The RF level of cell A is –50 dBm, cell B – 60 dBm and cell C – 70 dBm.
3	MS -> SS	ATTACH REQUEST	The MS is powered up or switched on and initiates an attach (see PICS). Attach type = 'Combined GPRS / IMSI attach' or 'GPRS attach while IMSI attached' Mobile identity = IMSI
4	SS -> MS	ATTACH ACCEPT	TMSI status = no valid TMSI available Attach result = 'Combined GPRS / IMSI attached' Mobile identity = P-TMSI-2 P-TMSI-2 signature Routing area identity = RAI-1
5	MS -> SS	ATTACH COMPLETE	Mobile identity = IMSI
6			Wait 30 sec to let the MS identify the neighbour cells B and C.
7	SS		The following messages are sent and shall be received on cell B.
8	MS		The RF level of cell A is lowered to –100 dBm. Cell B is preferred by the MS.
9	MS -> SS	ROUTING AREA UPDATING REQUEST	Update type = 'Combined RA/LA updating' P-TMSI-2 signature Routing area identity = RAI-1
10	SS		TMSI status = no valid TMSI available No response is given from the SS.
11	MS		The following messages are sent and shall be received on cell C.
12	MS -> SS	ROUTING AREA UPDATING REQUEST	The RF level of cell B is lowered to –100 dBm. The following message may be sent and shall be received on cell B. Update type = 'Combined RA/LA updating' P-TMSI-2 signature Routing area identity = RAI-1 TMSI status = no valid TMSI available Cell C is preferred by the MS.
13	MS		Cell C is preferred by the MS.
14	MS -> SS	UPLINK RLC DATA BLOCK	LLC PDU implicitly indicating cell update.
15	MS -> SS	ROUTING AREA UPDATING REQUEST	Update type = 'Combined RA/LA updating' P-TMSI-2 signature Routing area identity = RAI-1 TMSI status = no valid TMSI available
16	SS -> MS	ROUTING AREA UPDATING ACCEPT	Update result = 'Combined RA/LA updated' Mobile identity = P-TMSI-1 P-TMSI-1 signature Mobile identity = IMSI Routing area identity = RAI-4
17	MS -> SS	ROUTING AREA UPDATING COMPLETE	
18	MS		The MS is switched off or power is removed (see PICS).
19	MS -> SS	DETACH REQUEST	Message not sent if power is removed. Detach type = 'power switched off, combined GPRS/IMSI detach'

Specific message contents

None.

44.2.3.2.10 Combined routing area updating / abnormal cases / GPRS detach procedure collision

44.2.3.2.10.1 Conformance requirement

- 1) When a detach request is received with cause 'GPRS detach' or 'combined GPRS/IMSI detach' by the MS while waiting for a ROUTING AREA UPDATE ACCEPT message, the MS shall terminate the routing area updating procedure and continue with the GPRS detach procedure.
- 2) When a detach request is received with cause 'IMSI detach' by the MS while waiting for a ROUTING AREA UPDATE ACCEPT message, the MS shall ignore the detach request and continue with the routing area updating procedure.

Reference(s):

3GPP TS 04.08 / 3GPP TS 24.008 subclause 4.7.5.2.

44.2.3.2.10.2 Test purpose

To test the behaviour of the MS in case of procedure collision.

44.2.3.2.10.3 Method of test

44.2.3.2.10.3.1 Test procedure 1

Initial conditions

System Simulator:

Two cells, cell A in MCC1/MNC1/LAC1/RAC1, cell B in MCC1/MNC1/LAC1/RAC2.

Both cells are operating in network operation mode I.

Mobile Station:

The MS has a valid IMSI. MS is Idle Updated on cell A.

Specific PICS statements:

- MS operation mode B (TSPC_operation_mode_B)- MS operation mode A (TSPC_operation_mode_A).
- Switch off on button (TSPC_Feat_OnOff).
- Automatic GPRS attach procedure at switch on or power on (TSPC_AddInfo_on_auto_GPRS_AP).

PIXIT statements:

-

Test procedure

The MS initiates a routing area updating procedure. The SS does not answer the routing area updating procedure, but initiates a GPRS detach procedure with cause 'GPRS detach' or 'combined GPRS/IMSI detach'. The MS shall terminate the routing area updating procedure and continue with the GPRS detach procedure.

Maximum duration of test

10 minutes.

Expected sequence

Step	Direction	Message	Comments
1	SS		The following messages are sent and shall be received on cell A.
2	SS MS		The SS activates cell A. The MS is powered up or switched on and initiates an attach (see PICS).
3	MS -> SS	ATTACH REQUEST	Attach type = 'Combined GPRS / IMSI attach' or 'GPRS attach while IMSI attached' Mobile identity = IMSI
4	SS -> MS	ATTACH ACCEPT	TMSI status = no valid TMSI available Attach result = 'Combined GPRS / IMSI attached' Mobile identity = P-TMSI-2 P-TMSI-2 signature Routing area identity = RAI-1
5	MS -> SS	ATTACH COMPLETE	Mobile identity = IMSI
6	SS		The following messages are sent and shall be received on cell B.
7	MS		Activate cell B with a lower signal strength than cell A. The RF level of cell A is lowered until cell B is preferred by the MS.
8	MS -> SS	ROUTING AREA UPDATING REQUEST	Cell B is preferred by the MS. Update type = 'Combined RA/LA updating' P-TMSI-2 signature
9	SS		Routing area identity = RAI-1 TMSI status = no valid TMSI available The SS ignores the ROUTING AREA UPDATING REQUEST message and initiates a detach procedure.
10	SS -> MS	DETACH REQUEST	Detach type = 're-attach not required'
11	MS -> SS	DETACH ACCEPT	

Specific message contents

None.

44.2.3.2.10.3.2 Test procedure 2

Initial conditions

System Simulator:

Two cells, cell A in MCC1/MNC1/LAC1/RAC1, cell B in MCC1/MNC1/LAC1/RAC2.

Both cells are operating in network operation mode I.

Mobile Station:

The MS has a valid IMSI. MS is Idle Updated on cell A.

Specific PICS statements:

- MS operation mode B (TSPC_operation_mode_B)- MS operation mode A (TSPC_operation_mode_A).
- Switch off on button (TSPC_Feat_OnOff).
- Automatic GPRS attach procedure at switch on or power on (TSPC_AddInfo_on_auto_GPRS_AP).

PIXIT statements:

-

Test procedure

The MS initiates a routing area updating procedure. The SS does not answer the routing area updating procedure, but initiates a GPRS detach procedure with cause 'IMSI detach'. The MS shall ignore the detach procedure and continue with the routing area updating procedure.

Maximum duration of test

10 minutes.

Expected sequence

Step	Direction	Message	Comments
1	SS		The following messages are sent and shall be received on cell A.
2	SS MS		The SS activates cell A. The MS is powered up or switched on and initiates an attach (see PICS).
3	MS -> SS	ATTACH REQUEST	Attach type = 'Combined GPRS / IMSI attach' or 'GPRS attach while IMSI attached' Mobile identity = IMSI
4	SS -> MS	ATTACH ACCEPT	TMSI status = no valid TMSI available Attach result = 'Combined GPRS / IMSI attached' Mobile identity = P-TMSI-2 P-TMSI-2 signature Routing area identity = RAI-1
5	MS -> SS	ATTACH COMPLETE	Mobile identity = IMSI
6	SS		The following messages are sent and shall be received on cell B.
7	MS		Activate cell B with a lower signal strength than cell A. The RF level of cell A is lowered until cell B is preferred by the MS.
8	MS -> SS	ROUTING AREA UPDATING REQUEST	Cell B is preferred by the MS. Update type = 'Combined RA/LA updating' P-TMSI-2 signature
9	SS		Routing area identity = RAI-1 TMSI status = no valid TMSI available The SS ignores the ROUTING AREA UPDATING REQUEST message and initiates a detach procedure.
10	SS -> MS	DETACH REQUEST	Detach type = 'IMSI detach'
11	MS		The MS ignores the DETACH REQUEST message and continue the routing area updating procedure.
12	SS -> MS	ROUTING AREA UPDATING ACCEPT	Update result = 'Combined RA/LA updated' Mobile identity = P-TMSI-1 P-TMSI-1 signature
13	MS -> SS	ROUTING AREA UPDATING COMPLETE	Mobile identity = IMSI Routing area identity = RAI-4
14	MS		The MS is switched off or power is removed (see PICS).
15	MS -> SS	DETACH REQUEST	Message not sent if power is removed. Detach type = 'power switched off, combined GPRS/IMSI detach'

Specific message contents

None.

44.2.3.3 Periodic routing area updating

44.2.3.3.1 Periodic routing area updating / accepted

44.2.3.3.1.1 Conformance requirement

The Mobile Station shall perform a periodic routing area update procedure after a T3312 timeout.

Reference(s):

3GPP TS 04.08 / 3GPP TS 24.008 subclause 4.7.2.2 and 4.7.5.1.

44.2.3.3.1.2 Test purpose

To test the behaviour of the MS with respect to the periodic routing area updating procedure.

44.2.3.3.1.3 Method of test

Initial conditions

System Simulator:

One cell operating in network operation mode II (in case of MS operation mode B), or in network operation mode III (in case of MS operation mode C).

Mobile Station:

The MS has a valid P-TMSI-1 and RAI-1. MS is Idle Updated.

Specific PICS statements:

- MS operation mode C (TSPC_operation_mode_C).
- MS operation mode B (TSPC_operation_mode_B).
- Switch off on button (TSPC_Feat_OnOff).
- Automatic GPRS attach procedure at switch on or power on (TSPC_AddInfo_on_auto_GPRS_AP).

PIXIT statements:

-

Test procedure

The MS initiates a GPRS attach procedure with identity P-TMSI. The SS reallocates the P-TMSI and returns ATTACH ACCEPT message with a new P-TMSI and timer T3312. The MS acknowledge the new P-TMSI by sending ATTACH COMPLETE message. A routing area updating procedure is performed at T3312 timeout.

T3312; set to 6 minutes.

Maximum duration of test

20 minutes.

Expected sequence

Step	Direction	Message	Comments
1	SS		The MS is set in MS operation mode C (see PICS). If MS operation mode C not supported, goto step 11.
2	MS		The MS is powered up or switched on and initiates an attach (see PICS).
3	MS -> SS	ATTACH REQUEST	Attach type = 'GPRS attach' Mobile identity = P-TMSI-1 Routing area identity = RAI-1
4	SS -> MS	ATTACH ACCEPT	Attach result = 'GPRS only attached' Mobile identity = P-TMSI-2 P-TMSI-2 signature Routing area identity = RAI-1 T3312 = 6 minutes
5	MS -> SS	ATTACH COMPLETE	
6	MS -> SS	ROUTING AREA UPDATING REQUEST	Update type = 'Periodic updating' P-TMSI-2 signature Routing area identity = RAI-1
7	SS		The SS verifies that the time between the attach and the periodic RA updating is Ready Timer Period (T3314) + Periodic Routing Area Updating timer (T3312) (+/- 10%)
8	SS -> MS	ROUTING AREA UPDATING ACCEPT	No new mobile identity assigned. P-TMSI not included. Update result = 'RA updated' P-TMSI-3 signature Routing area identity = RAI-1 Negotiated Ready Timer IE is not included
9	MS		Force to standby indicator set The MS is switched off or power is removed (see PICS).
10	MS -> SS	DETACH REQUEST	Message not sent if power is removed. Detach type = 'power switched off, GPRS detach'
11			The SS is set in network operation mode II.
12	MS		The MS is set in MS operation mode B (see PICS) and the test is repeated from step 3 to step 10.

Specific message contents

None.

44.2.3.3.2 Periodic routing area updating / accepted / T3312 default value

44.2.3.3.2.1 Conformance requirement

The Mobile Station shall perform a periodic routing area update procedure after a T3312 timeout.

Reference(s):

3GPP TS 04.08 / 3GPP TS 24.008 subclause 4.7.2.2 and 4.7.5.2.

44.2.3.3.2.2 Test purpose

To test the behaviour of the MS with respect to the periodic routing area updating procedure.

44.2.3.3.2.3 Method of test

Initial conditions

System Simulator:

One cell operating in network operation mode I.

Mobile Station:

The MS has a valid P-TMSI-1 and RAI-1. MS is Idle Updated.

Specific PICS statements:

- MS operation mode B (TSPC_operation_mode_B)
- Switch off on button (TSPC_Feat_OnOff).
- Automatic GPRS attach procedure at switch on or power on (TSPC_AddInfo_on_auto_GPRS_AP).

PIXIT statements:

-

Test procedure

The MS initiates a combined GPRS attach procedure. The SS reallocates the P-TMSI and returns ATTACH ACCEPT message with a new P-TMSI. The MS acknowledge the new P-TMSI by sending ATTACH COMPLETE message. After 54 minutes, a periodic routing area updating procedure is initiated by the MS.

T3312; default value 54 minutes.

Maximum duration of test

60 minutes.

Expected sequence

Step	Direction	Message	Comments
1	MS		The MS is powered up or switched on and initiates an attach (see PICS).
2	MS -> SS	ATTACH REQUEST	Attach type = 'Combined GPRS / IMSI attach' or 'GPRS attach while IMSI attached' Mobile identity = P-TMSI-1 Routing area identity = RAI-1
3	SS -> MS	ATTACH ACCEPT	Attach result = 'Combined GPRS /IMSI attached' Mobile identity = P-TMSI-2 P-TMSI-2 signature Mobile identity = TMSI-1 Routing area identity = RAI-1 T3312 = 54 min
4	MS -> SS	ATTACH COMPLETE	
5	MS -> SS	ROUTING AREA UPDATING REQUEST	Update type = 'Periodic updating' P-TMSI-2 signature Routing area identity = RAI-1 TMSI status = valid TMSI available or IE not present
6	SS		The SS verifies that the time between the attach and the periodic RA updating is Ready Timer Period (T3314) + Periodic Routing Area Updating timer (T3312) (+/- 10%)
7	SS -> MS	ROUTING AREA UPDATING ACCEPT	No new mobile identity assigned. P-TMSI and TMSI not included. Update result = 'RAUpdated' P-TMSI-3 signature Routing area identity = RAI-1 Negotiated Ready Timer IE is not included Force to standby indicator set
8	MS		The MS is switched off or power is removed (see PICS).
9	MS -> SS	DETACH REQUEST	Message not sent if power is removed. Detach type = 'power switched off, combined GPRS/IMSI detach'

Specific message contents

None.

44.2.3.3.3 Periodic routing area updating / no cell available / network mode I

44.2.3.3.3.1 Conformance requirement

If the MS is both IMSI attached for GPRS and non-GPRS services, and if the MS lost coverage of the registered PLMN and timer T3312 expires; if the MS returns to coverage in a cell that supports GPRS and the network is in network operation mode I, then the MS shall perform a combined routing area update procedure indicating 'combined RA/LA updating with IMSI attach'.

Reference(s):

3GPP TS 04.08 / 3GPP TS 24.008 subclauses 4.7.2.2 and 4.7.5.1..

44.2.3.3.3.2 Test purpose

To test the behaviour of the MS with respect to the periodic routing area updating procedure.

44.2.3.3.3.3 Method of test

Initial conditions

System Simulator:

Two cells, cell A in MCC1/MNC1/LAC1/RAC1, cell B in MCC1/MNC1/LAC1/RAC2.

Cell A is operating in network operation mode II and cell B is in network operation mode I.

Mobile Station:

The MS has a valid TMSI-1, P-TMSI-1 and RAI-1. MS is Idle Updated on cell A.

Specific PICS statements:

- MS operation mode B (TSPC_operation_mode_B)
- Switch off on button (TSPC_Feat_OnOff).
- Automatic GPRS attach procedure at switch on or power on (TSPC_AddInfo_on_auto_GPRS_AP).

PIXIT statements:

-

Test procedure

The MS initiates a GPRS attach procedure. The SS reallocates the P-TMSI and returns ATTACH ACCEPT message with a new P-TMSI and timer T3312. The MS acknowledge the new P-TMSI by sending ATTACH COMPLETE message. GPRS radio contact is distorted before T3312 timeout. GPRS radio contact is established again (after T3312 timeout), and a routing area updating procedure is performed immediately.

T3312; set to 6 minutes.

Maximum duration of test

15 minutes.

Expected sequence

Step	Direction	Message	Comments
	SS		The following messages are sent and shall be received on cell A.
1	SS		The SS activates cell A.
2	SS		The MS is set in MS operation mode B (see PICS).
3	MS		The MS is powered up or switched on and initiates an attach (see PICS).
4	MS -> SS	ATTACH REQUEST	Attach type = 'GPRS attach' Mobile identity = P-TMSI-1
5	SS -> MS	ATTACH ACCEPT	Routing area identity = RAI-1 Attach result = 'GPRS only attached' Mobile identity = P-TMSI-2 P-TMSI-2 signature Routing area identity = RAI-1 T3312 = 6 minutes
6	MS -> SS	ATTACH COMPLETE	
7	SS		After 5 minutes, the signal strength is lowered until the MS has lost contact with the SS.
8	SS		Wait 2 minutes.
			The following messages are sent and shall be received on cell B.
9	SS		The SS activates cell B.
10	MS		Cell B is preferred by the MS.
11	MS		The MS immediately starts a combined RA updating procedure
12	MS -> SS	ROUTING AREA UPDATING REQUEST	Update type = 'Combined RA/LA updating with IMSI attach' P-TMSI-2 signature Routing area identity = RAI-1 TMSI status = valid TMSI available or IE is omitted
13	SS -> MS	ROUTING AREA UPDATING ACCEPT	Update result = 'Combined RA/LA updated' Mobile identity = P-TMSI-3 P-TMSI-3 signature Mobile identity = TMSI-2 Routing area identity = RAI-4
14	MS -> SS	ROUTING AREA UPDATE COMPLETE	
15	MS		The MS is switched off or power is removed (see PICS).
16	MS -> SS	DETACH REQUEST	Message not sent if power is removed. Detach type = 'power switched off, combined GPRS / IMSI detach'

Specific message contents

None.

44.2.3.3.4 Periodic routing area updating / no cell available

44.2.3.3.4.1 Conformance requirement

If the MS is both IMSI attached for GPRS and non-GPRS services, and if the MS lost coverage of the registered PLMN and timer T3312 expires; if the MS returns to coverage in a cell that supports GPRS and the network is in network operation mode II, then the MS shall perform a periodic routing area update procedure and a periodic location update procedure.

Reference(s):

3GPP TS 04.08 / 3GPP TS 24.008 subclauses 4.7.2.2 and 4.7.5.2.

44.2.3.3.4.2 Test purpose

To test the behaviour of the MS with respect to the periodic routing area updating procedure.

44.2.3.3.4.3 Method of test

Initial conditions

System Simulator:

One cell operating in network operation mode II.

Mobile Station:

The MS has a valid P-TMSI-1 and RAI-1. MS is Idle Updated.

Specific PICS statements:

- MS operation mode B (TSPC_operation_mode_B)
- Switch off on button (TSPC_Feat_OnOff).
- Automatic GPRS attach procedure at switch on or power on (TSPC_AddInfo_on_auto_GPRS_AP).

PIXIT statements:

-

Test procedure

The MS initiates a GPRS attach procedure. The SS reallocates the P-TMSI and returns ATTACH ACCEPT message with a new P-TMSI and timer T3312. The MS acknowledge the new P-TMSI by sending ATTACH COMPLETE message. GPRS radio contact is distorted before T3312 timeout. GPRS radio contact is established again (after T3312 timeout), and a periodic routing area updating procedure is performed immediately (no periodic location update procedure is performed as T3212=0).

T3312; set to 6 minutes.

Maximum duration of test

15 minutes.

Expected sequence

Step	Direction	Message	Comments
1	MS		The MS is powered up or switched on and initiates an attach (see PICS).
2	MS -> SS	ATTACH REQUEST	Attach type = 'GPRS attach' Mobile identity = P-TMSI-1 Routing area identity = RAI-1
3	SS -> MS	ATTACH ACCEPT	Attach result = 'GPRS only attached' Mobile identity = P-TMSI-2 P-TMSI-2 signature Routing area identity = RAI-1 T3312 = 6 minutes
4	MS -> SS	ATTACH COMPLETE	
5	SS		After 5 minutes, the signal strength is lowered until the MS have lost contact with the SS.
6	SS		After 2 minutes, the signal strength is increased until the MS have got contact with the SS.
7	MS		The MS immediately start the periodic RA updating procedure
8	MS -> SS	ROUTING AREA UPDATING REQUEST	Update type = 'Periodic updating' P-TMSI-2 signature Routing area identity = RAI-1
9	SS -> MS	ROUTING AREA UPDATING ACCEPT	No new mobile identity assigned. P-TMSI not included. Update result = 'RAupdated' P-TMSI-3 signature Routing area identity = RAI-1 Negotiated Ready Timer IE is not included Force to standby indicator set
10	MS		The MS is switched off or power is removed (see PICS).
11	MS -> SS	DETACH REQUEST	Message not sent if power is removed. Detach type = 'power switched off, GPRS detach'

Specific message contents

None.

44.2.4 P-TMSI reallocation

44.2.4.1 Conformance requirement

- 1) A Mobile Station shall acknowledge a new P-TMSI when explicitly allocated.
- 2) The P-TMSI shall be updated on the SIM when the Mobile Station is correctly deactivated in accordance with the manufacturer's instructions.
- 3) A Mobile Station shall use the given P-TMSI in further communication with the network.

Reference(s):

3GPP TS 04.08 / 3GPP TS 24.008 subclause 4.7.6.

44.2.4.2 Test Purpose

To verify that the MS is able to receive and acknowledge a new P-TMSI by means of an explicit P-TMSI reallocation procedure.

To verify that the MS has stored the P-TMSI in a non-volatile memory.

The implicit reallocation procedure is tested in the attach procedure.

44.2.4.3 Method of test

Initial conditions

System Simulator:

One cell operating in network operation mode II.

Mobile Station:

The MS has a valid IMSI. MS is Idle Updated.

Specific PICS statements:

- MS operation mode B (TSPC_operation_mode_B).
- MS operation mode C (TSPC_operation_mode_C) (only if mode B not supported).
- Switch off on button (TSPC_Feat_OnOff).
- Automatic GPRS attach procedure at switch on or power on (TSPC_AddInfo_on_auto_GPRS_AP).

PIXIT statements:

-

Test procedure

An explicit P-TMSI reallocation procedure is performed (P-TMSI reallocation command sent from the SS and acknowledged from the MS by P-TMSI reallocation complete). The MS is GPRS detached and switched off. Its power supply is interrupted for 10 s. The power supply is resumed and then the MS is switched on. A GPRS attach procedure is performed with the given P-TMSI as identity.

Maximum duration of test

10 minutes.

Expected sequence

Step	Direction	Message	Comments
1	MS		The MS is set in MS operation mode B (see PICS). If MS operation mode B not supported set the MS in operation mode C.
2	MS		The MS is powered up or switched on and initiates an attach (see PICS).
3	MS -> SS	ATTACH REQUEST	Attach type = 'GPRS attach'
4	SS -> MS	ATTACH ACCEPT	Mobile identity = IMSI Attach result = 'GPRS only attached'
5	MS -> SS	ATTACH COMPLETE	Mobile identity = P-TMSI-1
6	SS -> MS	P-TMSI REALLOCATION COMMAND	P-TMSI-1 signature Routing area identity = RAI-1
7	MS -> SS	P-TMSI REALLOCATION COMPLETE	Mobile identity = P-TMSI-2
8	MS		P-TMSI-2 signature Routing area identity = RAI-1
9	MS -> SS	DETACH REQUEST	The MS is switched off or power is removed (see PICS). Message not sent if power is removed. Detach type = 'power switched off, GPRS detach'
10	MS		Ensure the power is removed from the MS for at least 10 s
11	MS		The MS is powered up or switched on and initiates an attach (see PICS).
12	MS -> SS	ATTACH REQUEST	Attach type = 'GPRS attach'
13	SS -> MS	ATTACH ACCEPT	Mobile identity = P-TMSI-2 Routing area identity = RAI-1 No new mobile identity assigned. P-TMSI not included. Attach result = 'GPRS only attached'
14	SS -> MS	PAGING REQUEST TYPE 1	P-TMSI-3 signature Routing area identity = RAI-1 Negotiated Ready timer value IE should not be included Force to standby indicator set
15	MS -> SS	UPLINK RLC DATA BLOCK	Mobile identity = P-TMSI-2 Paging order is for TBF establishment. LLC PDU implicitly indicating paging response.
16	MS		The MS is switched off or power is removed (see PICS).
17	MS -> SS	DETACH REQUEST	Message not sent if power is removed. Detach type = 'power switched off, GPRS detach'

Specific message contents

None.

44.2.5 GPRS authentication and ciphering

44.2.5.1 Test of authentication

The purpose of this procedure is to verify the user identity. A correct response is essential to guarantee the establishment of the connection. If not, the connection will drop.

44.2.5.1.1 Authentication accepted

44.2.5.1.1.1 Conformance requirement

A Mobile Station shall correctly respond in an authentication and ciphering procedure by sending a response with the SRES information field set to the same value as the one produced by the authentication and ciphering algorithm in the network.

Reference(s):

3GPP TS 04.08 / 3GPP TS 24.008 subclause 4.7.7.

44.2.5.1.1.2 Test purpose

To test the behaviour of the MS if the network accepts the authentication and ciphering procedure.

44.2.5.1.1.3 Method of test

Initial conditions

System Simulator:

Two cells (not simultaneously activated), cell A in MCC1/MNC1/LAC1/RAC1, cell B in MCC1/MNC1/LAC1/RAC2.

Both cells are operating in network operation mode II.

Mobile Station:

The MS has a valid IMSI. MS is Idle Updated on cell A.

Specific PICS statements:

- MS operation mode B (TSPC_operation_mode_B).
- MS operation mode C (TSPC_operation_mode_C).
- Switch off on button (TSPC_Feat_OnOff).
- Automatic GPRS attach procedure at switch on or power on (TSPC_AddInfo_on_auto_GPRS_AP).

PIXIT statements:

-

Test procedure

A GPRS attach is performed, and the SS initiates an authentication and ciphering procedure.

The SS checks the value SRES sent by the MS in the AUTHENTICATION AND CIPHERING RESPONSE message.

The MS initiates a routing area updating procedure and the SS checks the value of the GPRS Ciphering Key Sequence Number sent by the MS in the ROUTING AREA REQUEST message.

Maximum duration of test

10 minutes.

Expected sequence

Step	Direction	Message	Comments
1	SS		The following messages are sent and shall be received on cell A.
2	MS		The SS activates cell A. The MS is set in MS operation mode C (see PICS). If MS operation mode C not supported, goto step 18.
3	MS		The MS is powered up or switched on and initiates an attach (see PICS).
4	MS -> SS	ATTACH REQUEST	Attach type = 'GPRS attach' Mobile identity = IMSI
5	SS -> MS	AUTHENTICATION AND CIPHERING REQUEST	Request authentication. Set GPRS-CKSN-1
6	MS -> SS	AUTHENTICATION AND CIPHERING RESPONSE	RAND SRES
7	SS		The SS checks the SRES value.
8	SS -> MS	ATTACH ACCEPT	Attach result = 'GPRS only attached' Mobile identity = P-TMSI-2 P-TMSI-2 signature
9	MS -> SS	ATTACH COMPLETE	Routing area identity = RAI-1
10	SS		The following messages are sent and shall be received on cell B. Activate cell B with a lower signal strength than cell A. The RF level of cell A is lowered until cell B is preferred by the MS.
11	MS -> SS	ROUTING AREA UPDATING REQUEST	Update type = 'RA updating' P-TMSI-2 signature Routing area identity = RAI-1 GPRS-CKSN-1
12	SS		The value of GPRS-CKSN is checked
13	SS -> MS	ROUTING AREA UPDATING ACCEPT	Update result = 'RA updated' Mobile identity = P-TMSI-1 P-TMSI-1 signature Routing area identity = RAI-4
14	MS -> SS	ROUTING AREA UPDATING COMPLETE	
15	MS		The MS is switched off or power is removed (see PICS).
16	MS -> SS	DETACH REQUEST	Message not sent if power is removed. Detach type = 'power switched off, GPRS detach'
17	SS		Reset the RF level of cell A to default state. Deactivate cell B.
18	MS		The MS is set in MS operation mode B (see PICS) and the test is repeated from step 3 to step 16.

Specific message contents

None.

44.2.5.1.2 Authentication rejected

44.2.5.1.2.1 Conformance requirement

1. Upon receipt of an AUTHENTICATION AND CIPHERING REJECT message, the MS shall set the GPRS update status to GU3 ROAMING NOT ALLOWED and shall delete the P-TMSI, P-TMSI signature, RAI and GPRS ciphering key sequence number stored.
2. The SIM shall be considered as invalid until switching off or the SIM is removed.
3. If the AUTHENTICATION AND CIPHERING REJECT message is received, the MS shall abort any GMM procedure, shall stop the timers T3310 and T3330 (if running) and shall enter state GMM-DEREGISTERED.

Reference(s):

3GPP TS 04.08 / 3GPP TS 24.008 subclause 4.7.7.5.

44.2.5.1.2.2 Test purpose

To test the behaviour of the MS if the network rejects the authentication and ciphering procedure.

44.2.5.1.2.3 Method of test

Initial conditions

System Simulator:

Two cells (not simultaneously activated), cell A in MCC1/MNC1/LAC1/RAC1, cell B in MCC1/MNC1/LAC1/RAC2.

Both cells are operating in network operation mode II.

Mobile Station:

The MS has a valid IMSI. MS is Idle Updated on cell A.

Specific PICS statements:

- MS operation mode B (TSPC_operation_mode_B).
- MS operation mode C (TSPC_operation_mode_C).
- Switch off on button (TSPC_Feat_OnOff).
- Automatic GPRS attach procedure at switch on or power on (TSPC_AddInfo_on_auto_GPRS_AP).

PIXIT statements:

-

Test procedure

The test sequence is repeated for $k = 1, 2$.

A complete GPRS attach procedure is performed. The SS rejects the following authentication and ciphering procedure. The MS is paged with its former P-TMSI and shall not respond.

The Cell is changed into a new Routing Area.

The SS checks that the MS does not perform normal routing area updating.

The SS then checks that the MS does not perform a GPRS attach.

The SS checks that the MS does not perform a GPRS detach if switched off.

The MS is switched on or powered up. The SS checks that the MS performs a GPRS Attach procedure.

Maximum duration of test

10 minutes.

Expected sequence

The test sequence is repeated for $k = 1, 2$.

For $k = 1$, the MS is set in MS operation mode C. If MS operation mode C not supported then $k = 2$.

For $k = 2$ the MS is set in MS operation mode B.

Step	Direction	Message	Comments
1	SS		The following messages are sent and shall be received on cell A.
2	MS		The SS activates cell A.
3	MS -> SS	ATTACH REQUEST	The MS is powered up or switched on and initiates an attach (see PICS). Attach type = 'GPRS attach' Mobile identity = IMSI
4	SS -> MS	ATTACH ACCEPT	Attach result = 'GPRS only attached' Mobile identity = P-TMSI-1 P-TMSI-1 signature Routing area identity = RAI-1
5	MS -> SS	ATTACH COMPLETE	
6	SS -> MS	AUTHENTICATION AND CIPHERING REQUEST	Request authentication. Set GPRS-CKSN-1 RAND
7	MS -> SS	AUTHENTICATION AND CIPHERING RESPONSE	SRES
8	SS -> MS	AUTHENTICATION AND CIPHERING REJECT	
9	SS -> MS		The SS pages the MS with mobile identity P-TMSI-1 and paging order for TBF establishment according to the channel combination of the cell.
10	MS		No response from the MS to the request. This is checked for 10 s.
11	SS		The following messages are sent and shall be received on cell B.
12	MS		The SS deactivates cell A and activates cell B.
13	MS		Cell B is preferred by the MS.
14	MS		No ROUTING AREA UPDATING REQUEST sent to the SS (SS waits 30 seconds).
15	MS		If possible (see PICS) the MS initiates an attach by MMI or by AT command.
16	MS		No ATTACH REQUEST sent to the SS (SS waits 30 seconds).
17	SS		The MS is switched off (see PICS).
18			No DETACH REQUEST sent to the SS (SS waits 30 seconds).
19		{Location Update Procedure}	The MS is powered up or switched on. Step 19 is only performed for k =2
19a			Macro. Location Update Procedure initiated from the MS. Parameter mobile identity is IMSI.
20	MS -> SS	ATTACH REQUEST	MS initiates an attach (see PICS). Attach type = 'GPRS only attached' Mobile identity = IMSI
21	SS -> MS	ATTACH ACCEPT	Attach result = 'GPRS attach' Mobile identity = P-TMSI-1 P-TMSI-1 signature Routing area identity = RAI-4
22	MS -> SS	ATTACH COMPLETE	
23	MS		The MS is switched off or power is removed. (see PICS)
24	MS -> SS	DETACH REQUEST	Message not sent if power is removed.
25	MS		If k=1 then the test is repeated for k=2.

Specific message contents

None.

44.2.5.2 Test of ciphering mode setting

The purpose of this procedure is to let the network to trigger the start and stop of stream ciphering.

The SS shall start and synchronise ciphering and deciphering according to 3GPP TS 03.20. The bitstream shall be generated by algorithm GEA/1.

44.2.5.2.1 Ciphering mode / start ciphering

44.2.5.2.1.1 Conformance requirements

1. When the MS receives the AUTHENTICATION AND CIPHERING REQUEST message during the attach procedure, with Ciphering indicator information element set to 'ciphering mode off', the Mobile Station shall:
 - 1.1. responds with an AUTHENTICATION AND CIPHERING RESPONSE message;
 - 1.2. not start ciphering.
2. When the MS receives the AUTHENTICATION AND CIPHERING REQUEST message during the routing area updating procedure, with Ciphering indicator information element set to 'ciphering mode on', the Mobile Station shall:
 - 2.1. responds with an AUTHENTICATION AND CIPHERING RESPONSE message;
 - 2.2. start ciphering and deciphering with the algorithm indicated by the Ciphering algorithm information element;
 - 2.3. the ciphering uses the cipher key determined during the authentication procedure.

Reference(s):

3GPP TS 04.08 / 3GPP TS 24.008 subclause 4.7.7.

44.2.5.2.1.2 Test purpose

To test the behaviour of the MS if the network accepts the authentication and ciphering procedure with ciphering.

44.2.5.2.1.3 Method of test

Initial conditions

System Simulator:

Two cells (not simultaneously activated), cell A in MCC1/MNC1/LAC1/RAC1, cell B in MCC1/MNC1/LAC1/RAC2.

Both cells are operating in network operation mode II.

Mobile Station:

The MS has a valid IMSI. MS is Idle Updated on cell A.

Specific PICS statements:

- MS operation mode B (TSPC_operation_mode_B).
- MS operation mode C (TSPC_operation_mode_C).
- Switch off on button (TSPC_Feat_OnOff).
- Automatic GPRS attach procedure at switch on or power on (TSPC_AddInfo_on_auto_GPRS_AP).
- Supported encryption Algorithm : GEA2 (TSPC_Feat_GEA2)
- Supported encryption Algorithm : GEA3 (TSPC_Feat_GEA3)PIXIT statements:
-

Test procedure

A GPRS attach is performed. Authentication procedure without ciphering is performed.

The MS initiates a routing area updating procedure, and the SS initiates an authentication and ciphering procedure to start ciphering. GEA1, GEA2 or GEA3 encryption is used depending on the execution counter K.

The test is performed for all GEAx encryption algorithm supported by the MS.

Maximum duration of test

15 minutes.

Expected sequence

The sequence is performed for execution counter K=1 and optionally for K=2 when the MS supports GEA2 and optionally for K=3 when the MS supports GEA3.

Step	Direction	Message	Comments
1	SS		The following messages are sent and shall be received on cell A.
2	MS		The SS activates cell A.
3	MS		The MS is set in MS operation mode C (see PICS). If MS operation mode C not supported, goto step 28.
4	MS -> SS	ATTACH REQUEST	The MS is powered up or switched on and initiates an attach (see PICS). Attach type = 'GPRS attach' Mobile identity = IMSI Message not ciphered
5	SS -> MS	AUTHENTICATION AND CIPHERING REQUEST	Request authentication. Ciphering off Set GPRS-CKSN-1 RAND Message not ciphered
6	MS -> SS	AUTHENTICATION AND CIPHERING RESPONSE	SRES Message not ciphered
7	SS -> MS	ATTACH ACCEPT	Attach result = 'GPRS only attached' Mobile identity = P-TMSI-2 P-TMSI-2 signature Routing area identity = RAI-1 Message not ciphered
8	MS -> SS	ATTACH COMPLETE	Message not ciphered
9	SS -> MS	PAGING REQUEST TYPE 1	Mobile identity = P-TMSI-2 Paging order is for TBF establishment. Message not ciphered
10	MS -> SS	UPLINK RLC DATA BLOCK	LLC PDU implicitly indicating paging response. Message not ciphered
11	SS		The following messages are sent and shall be received on cell B. Activate cell B with a lower signal strength than cell A. The RF level of cell A is lowered until cell B is preferred by the MS.
12	MS -> SS	ROUTING AREA UPDATING REQUEST	Update type = 'RA updating' P-TMSI-2 signature Routing area identity = RAI-1 Message not ciphered
13	SS -> MS	AUTHENTICATION AND CIPHERING REQUEST	Request authentication. Ciphering on with encryption: GEA1 for K=1, GEA2 for K=2, GEA3 for K=3. Set GPRS-CKSN-2 RAND Message not ciphered
14	MS -> SS	AUTHENTICATION AND CIPHERING RESPONSE	SRES Message not ciphered

Step	Direction	Message	Comments
15	SS -> MS	ROUTING AREA UPDATING ACCEPT	Update result = 'RA updated' Mobile identity = P-TMSI-1 P-TMSI-1 signature Routing area identity = RAI-4 Message ciphered
16	MS -> SS	ROUTING AREA UPDATING COMPLETE	Message ciphered
17	SS -> MS	PAGING REQUEST TYPE 1	Mobile identity = P-TMSI-1 Paging order is for TBF establishment. Message not ciphered
18	MS -> SS	UPLINK RLC DATA BLOCK	LLC PDU implicitly indicating paging response. Message may be ciphered depending on the type of LLC PDU that are sent. The 'E' bit is therefore not checked.
19	SS -> MS	P-TMSI REALLOCATION COMMAND	Mobile identity = P-TMSI-2 P-TMSI-2 signature Routing area identity = RAI-4 Message ciphered
20	MS -> SS	P-TMSI REALLOCATION COMPLETE	Message ciphered
21	SS -> MS	IDENTITY REQUEST	Identity type = IMEI Message not ciphered
22	MS -> SS	IDENTITY RESPONSE	Mobile identity = IMEI Message not ciphered
23	SS -> MS	P-TMSI REALLOCATION COMMAND	Mobile identity = P-TMSI-1 P-TMSI-1 signature Routing area identity = RAI-4 Message ciphered
24	MS -> SS	P-TMSI REALLOCATION COMPLETE	Message ciphered
25	MS		The MS is switched off or power is removed (see PICS).
26	MS -> SS	DETACH REQUEST	Message not sent if power is removed. Detach type = 'power switched off, GPRS detach' Message ciphered
27	SS		Cell B is powered down and Cell A is restored to full power.
28	MS		The MS is set in MS operation mode B (see PICS) and the test is repeated from step 3 to step 26.

Note that due to the test of ciphering, it is in this test case indicated whether each message is ciphered or not.

Specific message contents

None.

44.2.5.2.2 Ciphering mode / stop ciphering

44.2.5.2.2.1 Conformance requirements

1. When the MS receives the AUTHENTICATION AND CIPHERING REQUEST message during the attach procedure, with Ciphering indicator information element set to 'ciphering mode on', the Mobile Station shall:
 - 1.1. responds with an AUTHENTICATION AND CIPHERING RESPONSE message;
 - 1.2. start ciphering and deciphering with the algorithm indicated by the Ciphering algorithm information element;
 - 1.3. the ciphering uses the cipher key determined during the authentication procedure.
2. When the MS receives the AUTHENTICATION AND CIPHERING REQUEST message during the routing area updating procedure, with Ciphering indicator information element set to 'ciphering mode off', the Mobile Station shall:

- 2.1. responds with an AUTHENTICATION AND CIPHERING RESPONSE message;
- 2.2. stop ciphering.

Reference(s):

3GPP TS 04.08 / 3GPP TS 24.008 subclause 4.7.7.

44.2.5.2.2.2 Test purpose

To test the behaviour of the MS if the network accepts the authentication and ciphering procedure without ciphering.

44.2.5.2.2.2 Method of test**Initial conditions****System Simulator:**

Two cells, cell A in MCC1/MNC1/LAC1/RAC1, cell B in MCC1/MNC1/LAC1/RAC2.

Both cells are operating in network operation mode II.

Mobile Station:

The MS has a valid IMSI. MS is Idle Updated on cell A.

Specific PICS statements:

- MS operation mode B (TSPC_operation_mode_B).
- MS operation mode C (TSPC_operation_mode_C).
- Switch off on button (TSPC_Feat_OnOff).
- Automatic GPRS attach procedure at switch on or power on (TSPC_AddInfo_on_auto_GPRS_AP).

PIXIT statements:

-

Test procedure

A GPRS attach is performed, and the SS initiates an authentication and ciphering procedure to start ciphering.

A RA updating procedure is initiated, and authentication procedure without ciphering is performed. Ciphering is turned off.

Maximum duration of test

15 minutes.

Expected sequence

Step	Direction	Message	Comments
1	MS		The following messages are sent and shall be received on cell A. The MS is set in MS operation mode C (see PICS). If MS operation mode C not supported, goto step 22.
2	SS		The SS activates cell A.
3	MS		The MS is powered up or switched on and initiates an attach (see PICS).
4	MS -> SS	ATTACH REQUEST	Attach type = 'GPRS attach' Mobile identity = IMSI Message not ciphered
5	SS -> MS	AUTHENTICATION AND CIPHERING REQUEST	Request authentication. Ciphering on Set GPRS-CKSN-1 RAND Message not ciphered
6	MS -> SS	AUTHENTICATION AND CIPHERING RESPONSE	SRES Message not ciphered
7	SS -> MS	ATTACH ACCEPT	Attach result = 'GPRS only attached' Mobile identity = P-TMSI-2 P-TMSI-2 signature Routing area identity = RAI-1 Message ciphered
8	MS -> SS	ATTACH COMPLETE	Message ciphered
9	SS -> MS		The SS pages the MS with mobile identity P-TMSI-2 and paging order for TBF establishment according to the channel combination of the cell. Message not ciphered
10	MS -> SS		Verify that the MS initiates a TBF connection And sends an UPLINK RLC DATA BLOCK as a Response to the paging request. Message may or may not be ciphered
11	SS		The following messages are sent and shall be received on cell B. Activate cell B with a lower signal strength than cell A. The RF level of cell A is lowered until cell B is preferred by the MS.
12	MS -> SS	ROUTING AREA UPDATING REQUEST	Update type = 'RA updating' P-TMSI-2 signature Routing area identity = RAI-1 Message not ciphered
13	SS -> MS	AUTHENTICATION AND CIPHERING REQUEST	Request authentication. Ciphering off Set GPRS-CKSN-2 RAND Message not ciphered
14	MS -> SS	AUTHENTICATION AND CIPHERING RESPONSE	SRES Message not ciphered
15	SS -> MS	ROUTING AREA UPDATING ACCEPT	Update result = 'RA updated' Mobile identity = P-TMSI-1 P-TMSI-1 signature Routing area identity = RAI-4 Message not ciphered
16	MS -> SS	ROUTING AREA UPDATING COMPLETE	Message not ciphered
17	SS -> MS		The SS pages the MS with mobile identity P-TMSI-1 and paging order for TBF establishment according to the channel combination of the cell. Message not ciphered
18	MS -> SS		Verify that the MS initiates a TBF connection And sends an UPLINK RLC DATA BLOCK as a Response to the paging request. Message not ciphered

Step	Direction	Message	Comments
19	MS		The MS is switched off or power is removed (see PICS).
20	MS -> SS	DETACH REQUEST	Message not sent if power is removed. Detach type = 'power switched off, GPRS detach' Message not ciphered
21	SS		Cell B is switched off and Cell A is restored to full power.
22	MS		The MS is set in MS operation mode B (see PICS) and the test is repeated from step 3 to step 20.

Note that due to the test of ciphering, it is in this test case indicated whether each message is ciphered or not.

Specific message contents

None.

44.2.5.2.3 Ciphering mode / IMEISV request

44.2.5.2.3.1 Conformance requirements

- 1 When the MS receives the AUTHENTICATION AND CIPHERING REQUEST message during the attach procedure, with Ciphering indicator information element set to 'ciphering mode on' and 'IMEISV requested', the Mobile Station shall:
 - 1.1 responds with an AUTHENTICATION AND CIPHERING RESPONSE message;
 - 1.2 include IMEISV;
 - 1.3 start ciphering and deciphering with the algorithm indicated by the Ciphering algorithm information element;
 - 1.4 the ciphering uses the cipher key determined during the authentication procedure.
- 2 When the MS receives the AUTHENTICATION AND CIPHERING REQUEST message during the routing area updating procedure, with Ciphering indicator information element set to 'ciphering mode off' and 'IMEISV not requested', the Mobile Station shall:
 - 2.1 responds with an AUTHENTICATION AND CIPHERING RESPONSE message;
 - 2.2 not include IMEISV;
 - 2.3 not start ciphering.

Reference(s):

3GPP TS 04.08 / 3GPP TS 24.008 subclause 4.7.7.

44.2.5.2.3.2 Test purpose

To test the behaviour of the MS with respect to return IMEISV on request only.

44.2.5.2.3.3 Method of test

Initial conditions

System Simulator:

Two cells, cell A in MCC1/MNC1/LAC1/RAC1, cell B in MCC1/MNC1/LAC1/RAC2.

Both cells are operating in network operation mode II.

Mobile Station:

The MS has a valid IMSI. MS is Idle Updated on cell A.

Specific PICS statements:

- MS operation mode B (TSPC_operation_mode_B).
- MS operation mode C (TSPC_operation_mode_C).
- Switch off on button (TSPC_Feat_OnOff).
- Automatic GPRS attach procedure at switch on or power on (TSPC_AddInfo_on_auto_GPRS_AP).

PIXIT statements:

-

Test procedure

A GPRS attach is performed, and the SS initiates an authentication and ciphering procedure. IMEISV is requested.

The MS initiates a routing area updating procedure, and the SS initiates a new authentication and ciphering procedure without requesting IMEISV.

Maximum duration of test

15 minutes.

Expected sequence

Step	Direction	Message	Comments
1	MS		The following messages are sent and shall be received on cell A. The MS is set in MS operation mode C (see PICS). If MS operation mode C not supported, goto step 21.
2	SS		The SS activates cell A.
3	MS		The MS is powered up or switched on and initiates an attach (see PICS).
4	MS -> SS	ATTACH REQUEST	Attach type = 'GPRS attach' Mobile identity = IMSI Message not ciphered
5	SS -> MS	AUTHENTICATION AND CIPHERING REQUEST	Request authentication. Ciphering on IMEISV requested Message not ciphered
6	MS -> SS	AUTHENTICATION AND CIPHERING RESPONSE	SRES Mobile identity = IMEISV Message not ciphered
7	SS -> MS	ATTACH ACCEPT	Attach result = 'GPRS only attached' Mobile identity = P-TMSI-2 P-TMSI-2 signature Routing area identity = RAI-1 Message ciphered
8	MS -> SS	ATTACH COMPLETE	Message ciphered
9	SS -> MS		The SS pages the MS with mobile identity P-TMSI-2 and paging order for TBF establishment according to the channel combination of the cell. Message not ciphered
10	MS -> SS		Verify that the MS initiates a TBF connection and sends an UPLINK RLC DATA BLOCK as a response to the paging request. Message may or may not be ciphered
11	SS		The following messages are sent and shall be received on cell B. Activate cell B with a lower signal strength than cell A The RF level of cell A is lowered until cell B is preferred by the MS.
12	MS -> SS	ROUTING AREA UPDATING REQUEST	Update type = 'RA updating' P-TMSI-2 signature Routing area identity = RAI-1 Message not ciphered
13	SS -> MS	AUTHENTICATION AND CIPHERING REQUEST	Request authentication. Ciphering off IMEISV not requested Message not ciphered
14	MS -> SS	AUTHENTICATION AND CIPHERING RESPONSE	SRES No IMEISV included Message not ciphered
15	SS -> MS	ROUTING AREA UPDATING ACCEPT	Update result = 'RA updated' Mobile identity = P-TMSI-1 P-TMSI-1 signature Routing area identity = RAI-4 Message not ciphered
16	MS -> SS	ROUTING AREA UPDATING COMPLETE	Message not ciphered
17	SS -> MS		The SS pages the MS with mobile identity P-TMSI-1 and paging order for TBF establishment according to the channel combination of the cell. Message not ciphered
18	MS -> SS		Verify that the MS initiates a TBF connection and sends an UPLINK RLC DATA BLOCK as a response to the paging request. Message not ciphered

Step	Direction	Message	Comments
19	MS		The MS is switched off or power is removed (see PICS).
20	MS -> SS	DETACH REQUEST	Message not sent if power is removed. Detach type = 'power switched off, GPRS detach' Message not ciphered
21	MS		The MS is set in MS operation mode B (see PICS), cell B is switched off, Cell A is restored to full power and the test is repeated from step 3 to step 20.

Note that due to the test of ciphering, it is in this test case indicated whether each message is ciphered or not.

Specific message contents

None.

44.2.6 Identification procedure

The purpose of this procedure is to check that the MS gives its identity as requested by the network. If this procedure does not work, it will not be possible for the network to rely on the identity claimed by the MS.

44.2.6.1 General Identification

44.2.6.1.1 Conformance requirement

- 1) When requested by the network the Mobile Station shall send its IMSI.
- 2) When requested by the network the Mobile Station shall send its IMEI as stored in the Mobile Equipment.
- 3) When requested by the network the Mobile Station shall send its IMEISV as stored in the Mobile Equipment.

Reference(s):

3GPP TS 04.08 / 3GPP TS 24.008 subclauses 4.7.8.

44.2.6.1.2 Test purpose

To verify that the MS sends identity information as requested by the system. The following identities can be requested: IMSI, IMEI and IMEISV.

44.2.6.1.3 Method of test

Initial conditions

System Simulator:

One cell operating in network mode II.

Mobile Station:

The MS has a valid IMSI.. MS is Idle Updated.

Specific PICS statements:

- MS operation mode B (TSPC_operation_mode_B).
- MS operation mode C (TSPC_operation_mode_C).
- Switch off on button (TSPC_Feat_OnOff).
- Automatic GPRS attach procedure at switch on or power on (TSPC_AddInfo_on_auto_GPRS_AP).

PIXIT statements:

-

Test procedure

The SS requests identity information from the MS:

- IMSI;
- IMEI;
- IMEISV.

Maximum duration of test

10 minutes.

Expected sequence

Step	Direction	Message	Comments
1	SS		The MS is set in MS operation mode C (see PICS). If MS operation mode C not supported, goto step 14.
2	MS		The MS is powered up or switched on and initiates an attach (see PICS).
3	MS -> SS	ATTACH REQUEST	Attach type = 'GPRS attach'
4	SS -> MS	ATTACH ACCEPT	Mobile identity = IMSI Attach result = 'GPRS only attached'
			Mobile identity = P-TMSI-1 P-TMSI-1 signature Routing area identity = RAI-1
5	MS -> SS	ATTACH COMPLETE	
6	SS -> MS	IDENTITY REQUEST	Identity type = IMSI
7	MS -> SS	IDENTITY RESPONSE	Mobile identity = IMSI
8	SS -> MS	IDENTITY REQUEST	Identity type = IMEI
9	MS -> SS	IDENTITY RESPONSE	Mobile identity = IMEI
10	SS -> MS	IDENTITY REQUEST	Identity type = IMEISV
11	MS -> SS	IDENTITY RESPONSE	Mobile identity = IMEISV
12	MS		The MS is switched off or power is removed (see PICS).
13	MS -> SS	DETACH REQUEST	Message not sent if power is removed. Detach type = 'power switched off, GPRS detach'
14	MS		The MS is set in MS operation mode B (see PICS) and the test is repeated from step 2 to step 13.

Specific message contents

None.

44.2.7 GMM READY timer handling

The READY timer, T3314 is used in the MS and in the network per each assigned P-TMSI to control the cell updating and paging procedure.

When the READY timer is running the MS shall perform cell update each time a new cell is selected (see 3GPP TS 03.22 [3]). If a routing area border is crossed a routing area updating procedure shall be performed instead of a cell update.

44.2.7.1 Conformance requirement

- 1) When the READY timer is running the MS shall perform cell update each time a new cell is selected.
- 2) The READY timer shall be restarted in the MS when the GMM entity receives an indication from lower layers that user data or GMM or SM signalling messages have been transmitted.
- 3) The READY timer shall be stopped when force to standby is received in a signalling message from the network, after successful completion of the signalling procedure.

- 4) if the negotiated READY timer value indicates that the ready timer function is deactivated, then the MS shall behave as if READY timer never expires (i.e. the MS remains in READY state all the time).
- 5) If the READY timer length is set to zero, the MS shall immediately be forced into STANDBY state .MS shall not perform cell update.

Reference(s):

3GPP TS 04.08 / 3GPP TS 24.008 subclause 4.7.2.1.

44.2.7.2 Test Purpose

To verify the functionality of the READY timer.

44.2.7.3 Method of test**44.2.7.3.1 Test procedure 1****Initial conditions****System Simulator:**

Two cells (not simultaneously activated), cell A in MCC1/MNC1/LAC1/RAC1, cell B in MCC1/MNC1/LAC1/RAC1.

Both cells are operating in network operation mode II.

Mobile Station:

The MS has a valid IMSI.. MS is Idle Updated on cell A.

Specific PICS statements:

- MS operation mode B (TSPC_operation_mode_B).
- MS operation mode C (TSPC_operation_mode_C) (only if mode B not supported).
- Switch off on button (TSPC_Feat_OnOff).
- Automatic GPRS attach procedure at switch on or power on (TSPC_AddInfo_on_auto_GPRS_AP).

PIXIT statements:

-

Test procedure

An attach is performed. The SS negotiates T3314. The MS selects a new cell within the old RA. A cell update is performed.

T3314; set to 60 s.

Maximum duration of test

5 minutes.

Expected sequence

Step	Direction	Message	Comments
1	SS		The following messages are sent and shall be received on cell A. The SS activates cell A.
2	MS		
3	MS -> SS	ATTACH REQUEST	The MS is set in MS operation mode B (see PICS). If MS operation mode B not supported set the MS in operation mode C. The MS is powered up or switched on and initiates an attach (see PICS). Attach type = 'GPRS attach' Mobile identity = IMSI Attach result = 'GPRS only attached' Mobile identity = P-TMSI-2 P-TMSI-2 signature Routing area identity = RAI-1 T3314 = 60 seconds
4	SS -> MS	ATTACH ACCEPT	
5	MS -> SS	ATTACH COMPLETE	
6	SS		The following messages are sent and shall be received on cell B. Activate cell B with a lower signal strength than cell A The RF level of cell A is lowered until cell B is preferred by the MS. LLC PDU implicitly indicating cell update. The MS is switched off or power is removed (see PICS). Message not sent if power is removed. Detach type = 'power switched off, GPRS detach'
7	MS -> SS	UPLINK RLC DATA BLOCK	
8	MS		
9	MS -> SS	DETACH REQUEST	

Specific message contents

None.

44.2.7.3.2 Test procedure 2

Initial conditions

System Simulator:

Two cells (not simultaneously activated), cell A in MCC1/MNC1/LAC1/RAC1, cell B in MCC1/MNC1/LAC1/RAC1.

Both cells are operating in network operation mode II.

Mobile Station:

The MS has a valid IMSI.. MS is Idle Updated on cell A.

Specific PICS statements:

- MS operation mode C (TSPC_operation_mode_C).
- MS operation mode B (TSPC_operation_mode_B) (only if mode C not supported).
- Switch off on button (TSPC_Feat_OnOff).
- Automatic GPRS attach procedure at switch on or power on (TSPC_AddInfo_on_auto_GPRS_AP).

PIXIT statements:

-

Test procedure

An attach is performed. The SS negotiates T3314. A page is responded by the MS. The MS selects a new cell within the old RA. A cell update is performed, as T3314 is reset by the paging response.

T3314; set to 60 s.

Maximum duration of test

5 minutes.

Expected sequence

Step	Direction	Message	Comments
1	SS		The following messages are sent and shall be received on cell A.
2	MS		The SS activates cell A. The MS is set in MS operation mode C (see PICS). If MS operation mode C not supported set the MS in operation mode B. The MS is powered up or switched on and initiates an attach (see PICS).
3	MS -> SS	ATTACH REQUEST	Attach type = 'GPRS attach'
4	SS -> MS	ATTACH ACCEPT	Mobile identity = IMSI Attach result = 'GPRS only attached'
5	MS -> SS	ATTACH COMPLETE	Mobile identity = P-TMSI-2 P-TMSI-2 signature Routing area identity = RAI-1 T3314 = 60 seconds
6	SS		No action for 90 seconds
7	SS -> MS	PAGING REQUEST TYPE 1	Mobile identity = P-TMSI-2 Paging order is for TBF establishment.
8	MS -> SS	UPLINK RLC DATA BLOCK	LLC PDU implicitly indicating paging response. T3314 reset.
9	SS		The following messages are sent and shall be received on cell B. Activate cell B with a lower signal strength than cell A The RF level of cell A is lowered until cell B is preferred by the MS.
10	MS -> SS	UPLINK RLC DATA BLOCK	LLC PDU implicitly indicating cell update.
11	MS		The MS is switched off or power is removed (see PICS).
12	MS -> SS	DETACH REQUEST	Message not sent if power is removed. Detach type = 'power switched off, GPRS detach'

Specific message contents

None.

44.2.7.3.3 Test procedure 3

Initial conditions

System Simulator:

Two cells (not simultaneously activated), cell A in MCC1/MNC1/LAC1/RAC1, cell B in MCC1/MNC1/LAC1/RAC1.

Both cells are operating in network operation mode II.

Mobile Station:

The MS has a valid IMSI.. MS is Idle Updated on cell A.

Specific PICS statements:

- MS operation mode B (TSPC_operation_mode_B).
- MS operation mode C (TSPC_operation_mode_C) (only if mode B not supported).
- Switch off on button (TSPC_Feat_OnOff).
- Automatic GPRS attach procedure at switch on or power on (TSPC_AddInfo_on_auto_GPRS_AP).

PIXIT statements:

-

Test procedure

An attach is performed. The SS indicates 'force to standby'. The MS selects a new cell within the old RA. No cell update is performed as the MS is in STANDBY state.

Maximum duration of test

5 minutes.

Expected sequence

Step	Direction	Message	Comments
1	SS		The following messages are sent and shall be received on cell A.
2	MS		The SS activates cell A. The MS is set in MS operation mode B (see PICS). If MS operation mode B not supported set the MS in operation mode C.
3	MS -> SS	ATTACH REQUEST	The MS is powered up or switched on and initiates an attach (see PICS). Attach type = 'GPRS attach'
4	SS -> MS	ATTACH ACCEPT	Mobile identity = IMSI Attach result = 'GPRS only attached'
5	MS -> SS	ATTACH COMPLETE	Mobile identity = P-TMSI-2 P-TMSI-2 signature Routing area identity = RAI-1 Force to standby indicator set
6	SS		The following messages are sent and shall be received on cell B. Activate cell B with a lower signal strength than cell A The RF level of cell A is lowered until cell B is preferred by the MS.
7	SS		The SS verifies for 45 seconds that no cell update is received, as the MS is in STANDBY state
8	MS		The MS is switched off or power is removed (see PICS).
9	MS -> SS	DETACH REQUEST	Message not sent if power is removed. Detach type = 'power switched off, GPRS detach'

Specific message contents

None.

44.2.7.3.4 Test procedure 4

Initial conditions

System Simulator:

Two cells (not simultaneously activated), cell A in MCC1/MNC1/LAC1/RAC1, cell B in MCC1/MNC1/LAC1/RAC1.

Both cells are operating in network operation mode II.

Mobile Station:

The MS has a valid IMSI.. MS is Idle Updated on cell A.

Specific PICS statements:

- MS operation mode C (TSPC_operation_mode_C).
- MS operation mode B (TSPC_operation_mode_B) (only if mode C not supported).
- Switch off on button (TSPC_Feat_OnOff).
- Automatic GPRS attach procedure at switch on or power on (TSPC_AddInfo_on_auto_GPRS_AP).

PIXIT statements:

-

Test procedure

An attach is performed. The SS negotiates T3314. The MS selects a new cell within the old RA. A cell update is performed.

T3314; set to deactivated.

Maximum duration of test

5 minutes.

Expected sequence

Step	Direction	Message	Comments
1 2	SS MS		The following messages are sent and shall be received on cell A. The SS activates cell A. The MS is set in MS operation mode C (see PICS). If MS operation mode C not supported set the MS in operation mode B. The MS is powered up or switched on and initiates an attach (see PICS).
3	MS -> SS	ATTACH REQUEST	Attach type = 'GPRS attach'
4	SS -> MS	ATTACH ACCEPT	Mobile identity = IMSI Attach result = 'GPRS only attached'
5	MS -> SS	ATTACH COMPLETE	Mobile identity = P-TMSI-2 P-TMSI-2 signature Routing area identity = RAI-1 T3314 deactivated
6	SS		The following messages are sent and shall be received on cell B. Activate cell B with a lower signal strength than cell A The RF level of cell A is lowered until cell B is preferred by the MS.
7 8	MS -> SS SS	UPLINK RLC DATA BLOCK	LLC PDU implicitly indicating cell update. No action for 120 seconds.
9	SS		The following messages are sent and shall be received on cell A. The RF level of cell A is increased and the RF level of cell B is lowered until cell A is preferred by the MS.
10 11	MS -> SS MS	UPLINK RLC DATA BLOCK	LLC PDU implicitly indicating cell update. The MS is switched off or power is removed (see PICS).
12	MS -> SS	DETACH REQUEST	Message not sent if power is removed. Detach type = 'power switched off, GPRS detach'

Specific message contents

None.

44.2.7.3.5 Test procedure 5

Initial conditions

System Simulator:

Two cells (not simultaneously activated), cell A in MCC1/MNC1/LAC1/RAC1, cell B in MCC1/MNC1/LAC1/RAC1.

Both cells are operating in network operation mode II.

Mobile Station:

The MS has a valid IMSI.. MS is Idle Updated on cell A.

Specific PICS statements:

- MS operation mode B (TSPC_operation_mode_B).
- MS operation mode C (TSPC_operation_mode_C) (only if mode B not supported).
- Switch off on button (TSPC_Feat_OnOff).
- Automatic GPRS attach procedure at switch on or power on (TSPC_AddInfo_on_auto_GPRS_AP).

PIXIT statements:

-

Test procedure

If the READY timer length is set to zero, the MS shall immediately be forced into STANDBY state.

No cell update is performed as the MS is in STANDBY state.

Maximum duration of test

5 minutes.

Expected sequence

Step	Direction	Message	Comments
1	SS		The following messages are sent and shall be received on cell A.
2	MS		The SS activates cell A. The MS is set in MS operation mode B (see PICS). If MS operation mode B not supported set the MS in operation mode C.
3	MS -> SS	ATTACH REQUEST	The MS is powered up or switched on and initiates an attach (see PICS). Attach type = 'GPRS attach' Mobile identity = IMSI
4	SS -> MS	ATTACH ACCEPT	R99 MS shall include Revision Level Indicator='99 or later' Attach result = 'GPRS only attached' Mobile identity = P-TMSI-2 P-TMSI-2 signature Routing area identity = RAI-1
5	MS -> SS	ATTACH COMPLETE	T3314 = 0 seconds
6	SS		The following messages are sent and shall be received on cell B. Activate cell B with a lower signal strength than cell A The RF level of cell A is lowered until cell B is preferred by the MS.
7	SS		The SS verifies for 45 seconds that no cell update is received, as the MS is in STANDBY state
8	MS		The MS is switched off or power is removed (see PICS).
9	MS -> SS	DETACH REQUEST	Message not sent if power is removed. Detach type = 'power switched off, GPRS detach' R99 MS shall include Mobile identity = P-TMSI-2 P-TMSI-2 signature

Specific message contents

None.

44.2.8 DTM mobility management

44.2.8.1 Change of cell between two LAs in idle mode

44.2.8.1.1 Change of cell between two LAs in idle mode / RAU completes first

44.2.8.1.1.1 Conformance requirements

RA update and LA update procedures shall be supported in parallel in the main DCCH with SAPI 0. This helps reduce the congestion caused by GPRS signalling on GPRS TCHs that naturally exists in cells on the border of a RA or RA/LA without noticeably affecting the QoS of the CS connection.

In network mode of operation II and III, whenever a Class-A MS determines that it shall perform both a LA update and an RA update it shall initiate the LA update and then initiate the RA update.

A MS supporting the «GPRS» option whose CHANNEL REQUEST message contained a packet access establishment cause shall obey an IMMEDIATE ASSIGNMENT message to a channel which is to be used in dedicated mode.

References

3GPP TS 03.55/43.055, sub-clause 6.4.1

3GPP TS 23.060, sub-clause 6.9.1

3GPP TS 04.18/44.018, sub-clause 3.3.1.3

44.2.8.1.1.2 Test purpose

To verify that both Location Updating and Routing Area Updating procedures are completed in parallel and also to guarantee that the GPRS mobile obeys a command to use the SDCCH for signalling.

44.2.8.1.1.3 Method of test

Initial Conditions

System Simulator:

2 cells, A and B with different LAIs, both operating in network operation mode II and both support DTM.

Mobile Station:

The MS is in packet idle mode with a TMSI and P-TMSI allocated.

Specific PICS statements:

-

PIXIT statements:

-

Test Procedure

Once the MS is camped on cell A in the first LA, the SS commences the test by lowering the RF level of cell A below that of cell B prompting the MS to complete cell reselection. Once cell B has been selected by the MS, the MS initiates the Location Updating and Routing Area Updating procedures. The SS responds to the ROUTING AREA UPDATE REQUEST message with a ROUTING AREA UPDATE ACCEPT message and then completes the Location Updating procedure by replying with a LOCATION UPDATING ACCEPT message to the LOCATION UPDATING REQUEST sent by the MS. The SS then releases the RR connection.

Maximum Duration of Test

5 minutes

Expected Sequence

Step	Direction	Message	Comments
1	SS		The RF level of cell A is lowered until the MS selects cell B.
2	MS->SS	CHANNEL REQUEST	"Establishment cause": Location updating.
3	SS->MS	IMMEDIATE ASSIGNMENT	Allocates an SDCCH to the MS.
4	MS->SS	LOCATION UPDATING REQUEST	SS verifies that all signalling sent on the main DCCH is transmitted on the allocated SDCCH.
5	MS->SS	GPRS INFORMATION	Contains the ROUTING AREA UPDATE REQUEST message. SS verifies that all signalling sent on the main DCCH is transmitted on the allocated SDCCH
6	SS->MS	GPRS INFORMATION	Contains the ROUTING AREA UPDATE ACCEPT message
7	SS->MS	LOCATION UPDATING ACCEPT	
8	SS->MS	CHANNEL RELEASE	

44.2.8.1.2 Change of cell between two LAs in idle mode / LAU completes first / SS releases channel

44.2.8.1.2.1 Conformance requirements

RA update and LA update procedures shall be supported in parallel in the main DCCH with SAPI 0. This helps reduce the congestion caused by GPRS signalling on GPRS TCHs that naturally exists in cells on the border of a RA or RA/LA without noticeably affecting the QoS of the CS connection.

In network mode of operation II and III, whenever a Class-A MS determines that it shall perform both a LA update and an RA update it shall initiate the LA update and then initiate the RA update.

References

3GPP TS 03.55/43.055, sub-clause 6.4.1

3GPP TS 23.060 sub-clause 6.9.1

44.2.8.1.2.2 Test purpose

To verify that:

- both Location Updating and Routing Area Updating procedures are completed in parallel.
- the MS can complete the Routing Area Updating procedure on TBFs when the channel is removed.
- the GPRS mobile obeys a command to use a TCH/F for signalling.

44.2.8.1.2.3 Method of test

Initial Conditions

System Simulator:

2 cells, A and B with different LAIs, both operating in network operation mode II and both support DTM.

Mobile Station:

The MS is in "idle" state with a TMSI and P-TMSI allocated.

Specific PICS statements:

-

PIXIT statements:

-

Test Procedure

Once the MS is camped on cell A in the first LA, the SS commences the test by lowering the RF level of cell A below that of cell B prompting the MS to complete cell reselection. Cell B is selected by the MS and then initiates Location Updating and Routing Area Updating procedures. The SS completes the Location Updating Procedure by responding to the LOCATION UPDATING REQUEST message with a LOCATION UPDATING ACCEPT message. The SS then releases the RR connection. After the RR connection has been released, the SS establishes a downlink TBF, and transmits a ROUTING AREA UPDATE ACCEPT message reallocating the P-TMSI of the MS. The MS initiates the establishment of an uplink TBF, to complete the Routing Area Updating procedure by sending a ROUTING AREA UPDATE COMPLETE message and accepts the new P-TMSI.

Maximum Duration of Test

5 minutes

Expected Sequence

Step	Direction	Message	Comments
1	SS		The RF level of cell A is lowered until the MS selects cell B.
2	MS->SS	CHANNEL REQUEST	"Establishment cause": Location updating.
3	SS->MS	IMMEDIATE ASSIGNMENT	Allocates a TCH/F to the MS.
4	MS->SS	LOCATION UPDATING REQUEST	SS verifies that all signalling sent on the main DCCH is transmitted on the allocated TCH.
5	MS->SS	GPRS INFORMATION	Contains the ROUTING AREA UPDATE REQUEST message. SS verifies that all signalling sent on the main DCCH is transmitted on the allocated TCH.
6	SS->MS	LOCATION UPDATING ACCEPT	
7	SS->MS	CHANNEL RELEASE	
8			A downlink TBF is then established to allow the RAU ACCEPT message to be returned to the MS.
9	SS->MS	ROUTING AREA UPDATE ACCEPT	Allocates a new P-TMSI. See specific message contents.
10			An uplink TBF is then established to allow the RAU COMPLETE message to be returned by the MS.
11	MS->SS	ROUTING AREA UPDATE COMPLETE	

Specific message contents

ROUTING AREA UPDATE ACCEPT (Step 9):

Information Element	Value/remark
As default message contents except: - Allocated P-TMSI - Type of Identity - P-TMSI value	P-TMSI 12345678 (Hex)

44.2.8.1.3 Change of cell between two LAs in idle mode / LAU completes first / SS maintains channel

44.2.8.1.3.1 Conformance requirements

RA update and LA update procedures shall be supported in parallel in the main DCCH with SAPI 0. This helps reduce the congestion caused by GPRS signalling on GPRS TCHs that naturally exists in cells on the border of a RA or RA/LA without noticeably affecting the QoS of the CS connection.

In network mode of operation II and III, whenever a Class-A MS determines that it shall perform both a LA update and an RA update it shall initiate the LA update and then initiate the RA update.

References

3GPP TS 03.55/43.055, sub-clause 6.4.1

3GPP TS 23.060, sub-clause 6.5.1

44.2.8.1.3.2 Test purpose

To guarantee that the MS can complete the Routing Area Updating procedure on the main DCCH, if the network maintains the CS connection after the Location Updating procedure is completed.

44.2.8.1.3.3 Method of test

Initial Conditions

System Simulator:

2 cells, A and B with different LAIs, both operating in network operation mode II and both support DTM.

Mobile Station:

The MS is in "idle" state with a TMSI and P-TMSI allocated.

Specific PICS statements:

-

PIXIT statements:

-

Test Procedure

Once the MS is camped on cell A in the first LA, the SS commences the test by lowering the RF level of cell A below that of cell B prompting the MS to complete cell reselection. Cell B is selected by the MS and then initiates Location Updating and Routing Area Updating procedures. The SS completes the Location Updating Procedure by responding to the LOCATION UPDATING REQUEST message with a LOCATION UPDATING ACCEPT message. The SS then waits 5 seconds before continuing the test. The SS then transmits a ROUTING AREA UPDATE ACCEPT message reallocating the P-TMSI of the MS. The MS completes the Routing Area Updating procedure by transmitting a ROUTING AREA UPDATE COMPLETE message on the main DCCH, accepting the new P-TMSI.

Maximum Duration of Test

5 minutes

Expected Sequence

Step	Direction	Message	Comments
1	SS		The RF level of cell A is lowered until the MS selects cell B.
2	MS->SS	CHANNEL REQUEST	"Establishment cause": Location updating.
3	SS->MS	IMMEDIATE ASSIGNMENT	
4	MS->SS	LOCATION UPDATING REQUEST	
5	MS->SS	GPRS INFORMATION	Contains the ROUTING AREA UPDATE REQUEST message.
6	SS->MS	LOCATION UPDATING ACCEPT	
7			The SS waits 5 seconds, maintaining the main DCCH.
8	SS->MS	GPRS INFORMATION	Contains the ROUTING AREA UPDATE ACCEPT message, reallocating the MSs P-TMSI. See specific message contents.
9	MS->SS	GPRS INFORMATION	Contains the ROUTING AREA UPDATE COMPLETE message.
10	SS->MS	CHANNEL RELEASE	

Specific message contents

ROUTING AREA UPDATE ACCEPT (Step 8):

Information Element	Value/remark
As default message contents except: - Allocated P-TMSI - Type of Identity - P-TMSI value	P-TMSI C2345678 (Hex)

44.2.8.2 Void

44.2.9 Network Identity and Timezone (NITZ)

44.2.9.1 NITZ and GPRS procedures

44.2.9.1.1 NITZ / GPRS / Timezone, Time and DST Handling

44.2.9.1.1.1 Conformance requirement

The feature Network Identities and Timezone shall make it possible for a serving PLMN to transfer its current identity, universal time, DST and LTZ to MSs, and for the MS to store and use this information. Each one of these elements is optional. The feature significantly enhances roaming as it enables the accurate indication of network identities that are either newer than the ME or have changed their name since the ME was manufactured or sold. Additionally time and timezone information can be utilised by MEs as desired.

The serving PLMN shall make Local Time Zone (LTZ) available to the MS as an offset from Universal Time in units of 15 minutes.

When the LTZ is compensated for DST (summertime), the serving PLMN shall provide a DST parameter to indicate this. The adjustment for DST can be +1h or +2h.

The Time Zone code enables the receiver to calculate the equivalent time in GMT from the other semi-octets in the Service-Centre-Time-Stamp, or indicate the time zone (GMT, GMT+1H etc.), or perform other similar calculations as required by the implementation. The value contained in the Time Zone field must take into account daylight saving time, such that when the sending entity changes from regular (winter) time to daylight saving (summer) time, there is a change to the value in the Time Zone field.

The mobile station should assume that this time zone applies to the routing area the MS is currently in. The mobile station shall not assume that the time information is accurate.

If the local time zone has been adjusted for Daylight Saving Time, the network shall indicate this by including the IE Network Daylight Saving Time.

Reference(s):

3GPP TS 02.42 / 3GPP TS 22.042 subclause 4

3GPP TS 03.40 / 3GPP TS 23.040 subclause 9.2.3.11

3GPP TS 04.08 / 3GPP TS 24.008 subclause 9.4.19.4

44.2.9.1.1.2 Test purpose

To verify that a MS supporting any of the NITZ Time related feature (Local Time Zone, Universal Time and DST IE (and thus GMM Information)) is able to handle them properly.

44.2.9.1.1.3 Method of test

Initial conditions

System Simulator:

Two cells operating in network operation mode I, cell A in MCC1/MNC1/LAC1/RAC1 (RAI-1), cell B in MCC1/MNC1/LAC1/RAC2 (RAI-4).

Mobile Station:

The MS has a valid IMSI. MS is Idle Updated.

Specific PICS statements:

- Switch off on button (TSPC_Feat_OnOff).
- Automatic GPRS attach procedure at switch on or power on (TSPC_AddInfo_on_auto_GPRS_AP).
- Use of NITZ DST (TSPC_NITZ_DST)
- Use of NITZ Universal Time for PLMN (TSPC_NITZ_Universal_Time)
- Use of NITZ Local Time Zone for PLMN (TSPC_NITZ_Time_Zone)

PIXIT statements:

-

Test procedure

Following the GPRS attachment on Cell A, SS sends its local time and date (on GMT+1, Winter Time) using the GMM INFORMATION Message to the MS. The operator verifies then the parameters and/or the time and date stored in the MS.

The MS is then moved to a second cell (Cell B), and after a ROUTING AREA UPDATE procedure, the time is changed to “Summer Time” with the DST IE using a GMM INFORMATION Message. The operator verifies then the parameters and/or the time and date stored in the MS and switches Off the MS

The MS is re-attached on Cell A, the Time Zone is then changed, no DST present (GMT+2, Winter Time), using GMM INFORMATION message. The operator verifies then the parameters and/or the time stored on the MS

Maximum duration of test

-

Expected sequence

Step	Direction	Message	Comments
1	MS		The MS is powered up or switched on and initiates an attach (see PICS).
2	MS -> SS	ATTACH REQUEST	Attach type = 'Combined GPRS / IMSI attach' or 'GPRS attach while IMSI attached'
3	SS -> MS	ATTACH ACCEPT	Mobile identity = IMSI Attach result = 'Combined GPRS / IMSI attached'
4	MS -> SS	ATTACH COMPLETE	Mobile identity = P-TMSI-2 P-TMSI-2 signature Routing area identity = RAI-1
5	SS ->MS	GMM INFORMATION	Universal Time IE is included : “< Current Year >/03/08 05:15:00” for Local Time “+ 1 hour” for Timezone No DST or Local Time Zone IE included See specific message content

Step	Direction	Message	Comments
6	MS		<p>Operator Action : The use of the supported Fields is checked: Universal Time: Year: < Current Year > Month: March Day: 8th Hour: 5 Hours Minute: 15 Minutes Timezone: GMT+1 Local Time Zone: Not sent DST: Daylight Saving Time not in use (i.e. winter time) cf note</p>
7	SS		<p>Activate cell B with a lower signal strength than cell A. The RF level of cell A is lowered until cell B is preferred by the MS.</p>
8	MS -> SS	ROUTING AREA UPDATING REQUEST	<p>Update type = 'Combined RA/LA updating' P-TMSI-2 signature Routing area identity = RAI-1</p>
9	SS -> MS	ROUTING AREA UPDATING ACCEPT	<p>Update result = 'Combined RA/LA updated' Mobile identity = P-TMSI-1 P-TMSI-1 signature Routing area identity = RAI-4</p>
10	MS -> SS	ROUTING AREA UPDATING COMPLETE	
11	SS ->MS	GMM INFORMATION	<p>Local Time Zone IE and DST IE are included : "+ 2 hours" for Timezone (including DST) "+ 1 hour" for DST See specific message content</p>
12	MS		<p>Operator Action : The use of the supported Fields is checked: Universal Time Year: < Current Year > Month: March Day: 8th Hour: 6 Hours Minutes: 15 Minutes Timezone: GMT+1 Local Time Zone Timezone: GMT+1 (DST included) DST: Daylight Saving Time in use (i.e. "summer time") cf note</p>
13	SS		<p>The RF level of cell B is lowered and the RF level of cell A is increased until cell A is preferred by the MS.</p>
14	MS -> SS	ROUTING AREA UPDATING REQUEST	<p>Update type = 'Combined RA/LA updating' P-TMSI-1 signature Routing area identity = RAI-4</p>
15	SS -> MS	ROUTING AREA UPDATING ACCEPT	<p>Update result = 'Combined RA/LA updated' Mobile identity = P-TMSI-2 P-TMSI-2 signature Routing area identity = RAI-1</p>
16	MS -> SS	ROUTING AREA UPDATING COMPLETE	
17	SS ->MS	GMM INFORMATION	<p>Only Local Time Zone IE is included : "+ 2 hours" for Timezone No DST IE included See specific message content</p>

Step	Direction	Message	Comments
18	MS		Operator Action : The use of the supported Fields is checked: Universal Time: Year: < Current Year > Month: March Day: 8 th Hour: 6 Hours Minutes: 15 Minutes Timezone: GMT+2 Local Time Zone: Timezone: GMT+2 DST: Daylight Saving Time not in use (i.e. winter time) cf note

Note: In step 6, 12 and 18 the “minute” is not so relevant and can be higher than “15” depending on operator’s action time.

The check of Timezone and DST is done implicitly by checking the time only in case MS does not support the display of these two fields.

Current Year is derived by the SS.

Specific message contents

GMM Information on step 5:

Information element	Value/remark
Universal Time IE	47
Year	40 - < Current Year >
Month	30 - March
Day	80 - 8 th
Hour	40 - 4 hours
Minute	51 - 15 Minutes
Second	00 - 0 second
Time Zone	40 - GMT+1 (4*15 minutes+ 0*15 minutes DST)

GMM Information on step 11:

Information element	Value/remark
Local Time Zone IE	46
Time Zone	80 - GMT+1+1(4*15 minutes+ 4*15 minutes DST)
Daylight Saving Time IE	49
Length of DST Content	1
Value	1 - + 1 hour (summer time)

GMM Information on step 17:

Information element	Value/remark
Local Time Zone IE	46
Time Zone	80 - GMT+2 (8*15 minutes+ 0*15 minutes DST)

44.2.9.1.2 NITZ / GPRS / NITZ Parameters / Storage / Deletion

44.2.9.1.2.1 Conformance requirement

The feature Network Identities and Timezone shall make it possible for a serving PLMN to transfer its current identity, universal time, DST and LTZ to MSs, and for the MS to store and use this information. Each one of these elements is optional. The feature significantly enhances roaming as it enables the accurate indication of network identities that are

either newer than the ME or have changed their name since the ME was manufactured or sold. Additionally time and timezone information can be utilised by MEs as desired.

When using the default character set (see TS 23.038 [4]), the serving PLMN shall make both a "short" and a "long" name available to the MS. As an alternative or, in addition, to the default character set, the serving PLMN can make a name available in UCS2. The MS shall be free to choose one of these names depending upon its own characteristics and/or limitations, such as those of its display.

Switching off the MS should not cause the updated name of the network(s) to be deleted.

Reference(s):

3GPP TS 02.42 / 3GPP TS 22.042 subclause 4 and 6.2

44.2.9.1.2.2 Test purpose

To verify that a MS supporting any of the NITZ Name related feature (Short or Full PLMN name and thus GMM Information) is able to handle the names properly and does not erase the PLMN name sent using NITZ procedure at switch off.

44.2.9.1.2.3 Method of test

Initial conditions

System Simulator:

One cell operating in network operation mode I.

Mobile Station:

The MS has a valid IMSI. MS is Idle Updated.

Specific PICS statements:

- Switch off on button (TSPC_Feat_OnOff).
 - Automatic GPRS attach procedure at switch on or power on (TSPC_AddInfo_on_auto_GPRS_AP).
 - Use of NITZ Full name for PLMN (TSPC_NITZ_Full_Name)
 - Use of NITZ Short name for PLMN (TSPC_NITZ_Short_Name)
- PIXIT statements:
-

Test procedure

Following the GPRS attachment, SS sends a Short and a Full Name for the PLMN using the GMM INFORMATION Message to the MS. The operator verifies then the parameters stored in the MS.

The MS is then switched Off. The MS is re-attached after switching on, and the operator verifies then that the names are still stored/used in the MS.

Maximum duration of test

5 minutes

Expected sequence

Step	Direction	Message	Comments
1	MS		The MS is powered up or switched on and initiates an attach (see PICS).
2	MS -> SS	ATTACH REQUEST	Attach type = 'Combined GPRS / IMSI attach' or 'GPRS attach while IMSI attached'
3	SS -> MS	ATTACH ACCEPT	Attach result = 'Combined GPRS / IMSI'

Step	Direction	Message	Comments
4	MS -> SS	ATTACH COMPLETE GMM INFORMATION	attached' Mobile identity = P-TMSI-2 P-TMSI-2 signature
5	SS ->MS		Full Name for Network and Short Name for Network IE are included : "NITZ Deletion PLMN" for Full Name "NITZ PLMN" for Short Name See specific message content
6	MS		Operator Action : Verify that the names are stored and handled correctly according to Specific PICS Statements: "NITZ Deletion PLMN" for Full name and/or "NITZ PLMN" for Short name
7	MS		The MS is switched off or power is removed (see PICS).
8	MS -> SS		DETACH REQUEST Message not sent if power is removed. Detach type = 'power switched off, combined GPRS / IMSI detach'
9	MS	ATTACH REQUEST	The MS is powered up or switched on and initiates an attach (see PICS). Attach type = 'Combined GPRS / IMSI attach' or 'GPRS attach while IMSI attached'
10	MS -> SS		No new mobile identity assigned. P-TMSI and P-TMSI signature not included. Attach result = 'Combined GPRS / IMSI attached'
11	SS -> MS		Operator Action : Verify that the same names are still stored and handled correctly according to Specific PICS Statements: "NITZ Deletion PLMN" for Full name and/or "NITZ PLMN" for Short name
12	MS		

Specific message contents

GMM Information on step 5:

Information element	Value/remark
Full Name IE	43
Length	11 (17 octets)
Ext	1 - - - - - (Spare Bit)
Coding scheme	- 0 0 0 - - - - (Cell Broadcast data coding scheme, GSM default alphabet, language unspecified)
Add CI	- - - - 0 - - - (Initials Country not included)
Spare Bit in final Octet	- - - - - 0 1 0 (Bit 7 and 8 of last Octet are set to '0')
Text String	CE 24 55 0B 22 96 D9 65 7A FA ED 06 41 99 4D 27 ("NITZ Deletion PLMN")
Short Name IE	45
Length	09 (9 octets)
Ext	1 x x x x x x x (Spare Bit)
Coding scheme	x 0 0 0 x x x x (Cell Broadcast data coding scheme, GSM default alphabet, language unspecified)
Add CI	x x x x 0 x x x (Initials Country not included)
Spare Bit in final Octet	x x x x x 0 0 1 (Bit 8 of last Octet is set to '0')
Text String	CE 24 55 0B 82 32 9B 4E ("NITZ PLMN")

44.2.9.1.3 NITZ / GPRS / MM and GMM Signaling

44.2.9.1.3.1 Conformance requirement

The feature Network Identities and Timezone shall make it possible for a serving PLMN to transfer its current identity, universal time, DST and LTZ to MSs, and for the MS to store and use this information. Each one of these elements is

optional. The feature significantly enhances roaming as it enables the accurate indication of network identities that are either newer than the ME or have changed their name since the ME was manufactured or sold. Additionally time and timezone information can be utilised by MEs as desired.

When using the default character set (see TS 23.038 [4]), the serving PLMN shall make both a "short" and a "long" name available to the MS. As an alternative or, in addition, to the default character set, the serving PLMN can make a name available in UCS2. The MS shall be free to choose one of these names depending upon its own characteristics and/or limitations, such as those of its display.

It is expected that the MS will display the most up to date information transferred to it.

Reference(s):

3GPP TS 02.42 / 3GPP TS 22.042 subclause 4 and 6.2

44.2.9.1.3.2 Test purpose

To verify that a MS supporting NITZ (any of the Fields) is able to handle both MM INFORMATION and GMM INFORMATION messages and that parameters set in the latest message override the previous ones.

44.2.9.1.3.3 Method of test

Initial conditions

System Simulator:

Two cells operating in network operation mode I (not simultaneously activated), cell A in MCC1/MNC1/LAC1/RAC1 (RAI-1), cell B in MCC1/MNC1/LAC1/RAC2 (RAI-4).

Mobile Station:

The MS has a valid IMSI. MS is Idle Updated.

Specific PICS statements:

- Switch off on button (TSPC_Feat_OnOff).
- Automatic GPRS attach procedure at switch on or power on (TSPC_AddInfo_on_auto_GPRS_AP).
- Use of NITZ DST (TSPC_NITZ_DST)
- Use of NITZ Full name for PLMN (TSPC_NITZ_Full_Name)
- Use of NITZ Short name for PLMN (TSPC_NITZ_Short_Name)
- Use of NITZ Universal Time for PLMN (TSPC_NITZ_Universal_Time)
- Use of NITZ Local Time Zone for PLMN (TSPC_NITZ_Time_Zone)

PIXIT statements:

-

Test procedure

Following its GPRS Attachment procedure, the MS receives from SS, through the GMM INFORMATION a complete set of NITZ parameters (PLMN long name, short name, and Universal time with local time adjustment). The operator verifies then the names used and the time and date stored in the MS (according to specific PICS Statements).

The MS is then paged on its paging group with its IMSI. SS verifies that the MS sends a PAGING RESPONSE. SS sends back a MM INFORMATION message changing the NITZ PLMN names (short and full names) and the local time information.

The operator verifies then that the new NITZ names are used and the time information changed (if supported).

The serving cell is then lowered and the MS triggers a ROUTING AREA UPDATE procedure on the second cell. Following this procedure, SS sends some new NITZ PLMN names (full and short) using the GMM INFORMATION message.

The operator verifies then that the new NITZ names are used, if supported, and, if possible, that the time information is not changed.

Maximum duration of test

5 minutes

Expected sequence:

Step	Direction	Message	Comments
1	MS		The MS is powered up or switched on and initiates an attach (see PICS).
2	MS -> SS	ATTACH REQUEST	Attach type = 'Combined GPRS / IMSI attach' or 'GPRS attach while IMSI attached' Mobile identity = IMSI
3	SS -> MS	ATTACH ACCEPT	Attach result = 'Combined GPRS / IMSI attached' Routing area identity = RAI-1 Mobile identity = P-TMSI-2 P-TMSI-2 signature
4	MS -> SS	ATTACH COMPLETE	
5	SS ->MS	GMM INFORMATION	Full Name for Network, Short Name for Network and Universal Time IE are included : "NITZ GMM PLMN" for Full Name "GMM PLMN" for Short Name "< Current Year >/03/08 05:15:00" for Local Time "+ 1 hour" for Timezone No DST or Local Time Zone IE included See specific message content
6	MS		Operator Action : Verify that the names and time are stored and handled correctly according to specific PICS Statements: "NITZ GMM PLMN" for Full name and/or "GMM PLMN" for Short name The use of the supported Fields is checked: Universal Time: Year: < Current Year > Month: March Day: 8 th Hour: 5 Hours Minute: 15 Minutes Timezone: GMT+1 Local Time Zone: Not Sent DST: Daylight Saving Time not in use (i.e. "winter time" cf note

Step	Direction	Message	Comments
7	SS -> MS		SS pages the MS with mobile identity IMSI and paging order for RR connection according to the channel combination of the cell.
8	MS		Verify that the MS initiates a RR connection and sends a PAGING RESPONSE with mobile identity IMSI.
9	SS -> MS	MM INFORMATION	Full Name for Network, Short Name for Network, Local Time Zone and DST IE are included : "NITZ MM PLMN" for Full Name "MM PLMN" for Short Name "+ 2 hours" for Timezone (including DST) "+ 1 hour" for DST See specific message content
10	SS		SS releases the RR connection and indicates the successfully resumption of GPRS services.
11			Operator Action : Verify that the names and time are stored and handled correctly according to specific PICS Statements: "NITZ MM PLMN" for Full name and/or "MM PLMN" for Short name The use of the supported Fields is checked: Universal Time: Year: < Current Year > Month: March Day: 8 th Hour: 6 Hours Minute: 15 Minutes Timezone: GMT+1 Local Time Zone: Timezone: GMT+1 (including DST) DST: Daylight Saving Time in use (i.e. "summer time") cf note
12	SS		The SS deactivates cell A and activates cell B.
13	MS -> SS	ROUTING AREA UPDATING REQUEST	Update type = 'Combined RA/LA updating' P-TMSI-2 signature Routing area identity = RAI-1
14	SS -> MS	ROUTING AREA UPDATING ACCEPT	Update result = 'Combined RA/LA updated' Mobile identity = P-TMSI-1 P-TMSI-1 signature Routing area identity = RAI-4
15	MS -> SS	ROUTING AREA UPDATING COMPLETE	
16	SS ->MS	GMM INFORMATION	Full Name for Network and Short Name for Network IE are included : "NITZ GMM PLMN" for Full Name "GMM PLMN" for Short Name See specific message content
17	MS		Operator Action : Verify that the names and time are stored and handled correctly according to specific PICS Statements: "NITZ GMM PLMN" for Full name and/or "GMM PLMN" for Short name if possible, verify that no change is done on the time information

Note: In step 6, 11 and 17 the "minute" is not so relevant and can be higher than "15" depending on operator's action time.

The check of Timezone and DST is done implicitly by checking the time only in case MS does not support the display of these two fields.

Current Year is derived by the SS.

Specific message contents

GMM Information on step 5:

Information element	Value/remark
Full Name IE	43
Length	0D (13 octets)
Ext	1 x x x x x x x (Spare Bit)
Coding scheme	x 0 0 0 x x x x (Cell Broadcast data coding scheme, GSM default alphabet, language unspecified)
Add CI	x x x x 0 x x x (Initials Country not included)
Spare Bit in final Octet	x x x x x 1 0 1 (Bit 4 to 8 of last Octet are set to '0')
Text String	CE 24 55 0B 3A 36 9B 20 28 B3 E9 04 ("NITZ GMM PLMN")
Short Name IE	45
Length	08 (8 octets)
Ext	1 x x x x x x x (Spare Bit)
Coding scheme	x 0 0 0 x x x x (Cell Broadcast data coding scheme, GSM default alphabet, language unspecified)
Add CI	x x x x 0 x x x (Initials Country not included)
Spare Bit in final Octet	x x x x x 0 0 0 ("no information about the number of spare bits in last octet")
Text String	C7 66 13 04 65 36 9D ("GMM PLMN")
Universal Time IE	47
Year	40 - < Current Year >
Month	30 - March
Day	80 - 8 th
Hour	40 - 4 hours
Minute	51 - 15 Minutes
Second	00 - 0 second
Time Zone	40 - GMT+1 (4*15 minutes+ 0*15 minutes DST)

MM Information on step 9:

Information element	Value/remark
Full Name IE	43
Length	0C (12 octets)
Ext	1 x x x x x x x (Spare Bit)
Coding scheme	x 0 0 0 x x x x (Cell Broadcast data coding scheme, GSM default alphabet, language unspecified)
Add CI	x x x x 0 x x x (Initials Country not included)
Spare Bit in final Octet	x x x x x 1 0 0 (Bit 5 to 8 of last Octet are set to '0')
Text String	CE 24 55 0B 6A 36 41 50 66 D3 09 ("NITZ MM PLMN")
Short Name IE	45
Length	08 (8 octets)
Ext	1 x x x x x x x (Spare Bit)
Coding scheme	x 0 0 0 x x x x (Cell Broadcast data coding scheme, GSM default alphabet, language unspecified)
Add CI	x x x x 0 x x x (Initials Country not included)
Spare Bit in final Octet	x x x x x 1 1 1 (Bit 2 to 8 of last Octet are set to '0')
Text String	CD 26 08 CA 6C 3A 01 ("MM PLMN")
Local Time Zone IE	46
Time Zone	80 - GMT+1+1(4*15 minutes+ 4*15 minutes DST)
Daylight Saving Time IE	49
Length of DST Content	1
Value	1 - + 1 hour (summer time)

GMM Information on step 16:

Information element	Value/remark
Full Name IE	43
Length	0D (13 octets)
Ext	1 x x x x x x x (Spare Bit)
Coding scheme	x 0 0 0 x x x x (Cell Broadcast data coding scheme, GSM default alphabet, language unspecified)
Add CI	x x x x 0 x x x (Initials Country not included)
Spare Bit in final Octet	x x x x x 1 0 1 (Bit 4 to 8 of last Octet are set to '0')
Text String	CE 24 55 0B 3A 36 9B 20 28 B3 E9 04 ("NITZ GMM PLMN")
Short Name IE	45
Length	08 (8 octets)
Ext	1 x x x x x x x (Spare Bit)
Coding scheme	x 0 0 0 x x x x (Cell Broadcast data coding scheme, GSM default alphabet, language unspecified)
Add CI	x x x x 0 x x x (Initials Country not included)
Spare Bit in final Octet	x x x x x 0 0 0 ("no information about the number of spare bits in last octet")
Text String	C7 66 13 04 65 36 9D ("GMM PLMN")

44.2.10 MS Radio Access Capability Interrogation

This procedure allows the network to request the MS to supply its radio access capability information to the network.

44.2.10.1 Conformance requirements

In state GMM-DEREGISTERED, the MS initiates the GPRS attach procedure by sending an ATTACH REQUEST message to the network, starts timer T3310 and enters state GMM-REGISTERED-INITIATED.

The ATTACH REQUEST message contains the MS Radio Access capability information element.

The purpose of the *MS RA capability* information element is to provide the radio part of the network with information concerning radio aspects of the mobile station. The contents might affect the manner in which the network handles the operation of the mobile station.

The *MS RA capability* is a type 4 information element, with a maximum length of 52 octets.

DARP is contained in the Release 6 specifications. In order to implement an MS conforming to Release 99 but supporting DARP, it is necessary for the MS to additionally conform to some parts of the Release 6 specifications, such as the radio frequency requirements for DARP and some signalling extensions relating to the MS Classmark and radio access capabilities.

References

3GPP TS 04.08 / 3GPP TS 24.008 subclauses 4.7.3.1.1, 9.4.1 and 10.5.5.12a.

3GPP TS 05.15 / 3GPP TS 45.015

44.2.10.2 Test purpose

To verify that the MS supplies all its radio access capabilities and Network MS Capabilities, when attaching to the network for GPRS services.

44.2.10.3 Method of test

44.2.10.3.1 Initial Conditions

System Simulator:

One cell operating in network operation mode II (in case of MS operation mode B), or in network operation mode III (in case of MS operation mode C).

Mobile Station:

The MS has a valid IMSI. MS is Idle Updated.

Specific PICS statements:

- Switch off on button (TSPC_Feat_OnOff).
- Automatic GPRS attach procedure at switch on or power on (TSPC_AddInfo_on_auto_GPRS_AP).

PIXIT statements:

- Contents of MS Radio Access Capability.

Maximum duration of test

3 minutes.

44.2.10.3.2 Test procedure

The MS sends an ATTACH REQUEST message with identity IMSI. The SS allocates a P-TMSI and returns ATTACH ACCEPT message with a P-TMSI. The MS acknowledge the P-TMSI by sending ATTACH COMPLETE message.

Expected sequence

Step	Direction	Message	Comments
1	MS		The MS is powered up or switched on and initiates an attach procedure (see PICS).
2	MS -> SS	ATTACH REQUEST	Attach type = 'GPRS attach' Mobile identity = IMSI
3	SS -> MS	ATTACH ACCEPT	Contents as defined for default message. Attach result = 'GPRS only attached' Mobile identity = P-TMSI-2 P-TMSI-2 signature
4	MS -> SS	ATTACH COMPLETE	Routing area identity = RAI-1

Specific message Contents

Contents of ATTACH REQUEST message:

Protocol discriminator	1000 (MM message for GPRS service)
Skip indicator	0000
Attach request message identity	00000001
MS network capability	See PICS/PIXIT.
MS Radio Access capability	See PICS/PIXIT.
	Note for R99 and onwards a MS that supports "Downlink Advance Receiver Performance" shall include the Downlink Advanced Receiver Performance indication.

44.2.11 Cell Notification

44.2.11.1 Conformance Requirement

When the READY timer is running or has been deactivated the MS shall perform cell update each time a new cell is selected.

When the READY timer has expired the MS shall:

- perform the routing area updating procedure when a routing area border is crossed;
- not perform a cell update when a new cell is selected.

The READY timer is started:

- in the MS when the GMM entity receives an indication from lower layers that an LLC frame other than LLC NULL frame has been transmitted on the radio interface; and

- in the network when the GMM entity receives an indication from lower layers that an LLC frame other than LLC NULL frame has been successfully received by the network.

If a new READY timer value is negotiated, the MS shall upon the reception of the ATTACH ACCEPT or ROUTING AREA UPDATE ACCEPT message perform a initial cell update (either by transmitting a LLC frame or, if required, a ATTACH COMPLETE or ROUTING AREA UPDATE COMPLETE message), in order to apply the new READY timer value immediately. If both the network and the MS supports the Cell Notification, the initial cell update shall use any LLC frame except the LLC NULL frame.

In A/Gb mode, if the ATTACH ACCEPT message contains the Cell Notification information element, then the MS shall start to use the LLC NULL frame to perform cell updates.

In A/Gb mode, if the ROUTING AREA UPDATE ACCEPT message contains the Cell Notification information element, then the MS shall start to use the LLC NULL frame to perform cell updates.

44.2.11.2 Test Purpose

Test purpose 1

The MS shall start to use the LLC NULL frame to perform cell updates following receipt of an ATTACH ACCEPT message containing the Cell Notification information element.

Test purpose 2

The MS shall start to use the LLC NULL frame to perform cell updates following receipt of a ROUTING AREA UPDATE ACCEPT message containing the Cell Notification information element.

Reference(s):

3GPP TS 04.08 / 3GPP TS 24.008 subclauses 4.7.2.1.1, 4.7.3.1.3, 4.7.5.1.3

44.2.11.3 Method of Test

44.2.11.3.1 Test Procedure 1 – Ready Timer Behaviour

Initial Conditions

System Simulator:

Two cells (not simultaneously activated), Cell A in MCC1/MNC1/LAC1/RAC1, Cell B in MCC1/MNC1/LAC1/RAC1.

Both cells are operating in network operation mode II.

Mobile Station:

The MS has a valid IMSI. MS is switched off.

Specific PICS statements:

- MS operation mode B (TSPC_operation_mode_B).
- MS operation mode C (TSPC_operation_mode_C) (only if mode B not supported).
- Switch off on button (TSPC_Feat_OnOff).
- Automatic GPRS attach procedure at switch on or power on (TSPC_AddInfo_on_auto_GPRS_AP).

PIXIT statements:

-

Test Procedure

The MS switches on and performs GPRS ATTACH on Cell A. Cell Notification is indicated in the ATTACH ACCEPT message. The MS is made to re-select to Cell B whilst the READY timer is still running. The MS performs Cell Update / Cell Notification on Cell B by sending an LLC NULL frame. The SS then waits for the READY TIMER to expire.

The MS is made to re-select to Cell A. It is checked that the MS does not perform Cell Update / Cell Notification. The MS is paged to confirm the cell-reselection to Cell A.

NOTE: the READY timer is not reset following the cell update from Cell A to Cell B but is runs uninterrupted since being started following transmission of the ATTACH COMPLETE message in the initial Cell Update - during the GPRS ATTACH Procedure on Cell A. The value of the ready timer is chosen such that if the MS were to have erroneously re-set the READY timer following the Cell Update from Cell A to Cell B it would perform a Cell Update when returning to Cell B from Cell A.

Maximum Duration of Test

10 minutes.

Expected Sequence

Step	Direction	Message	Comments
			The following messages are sent and shall be received on Cell A.
1	SS		The SS activates Cell A.
2	MS		The MS is set in MS operation mode B (see PICS). If MS operation mode B not supported set the MS in operation mode C. The MS is powered up or switched on and initiates an attach (see PICS).
3	MS -> SS	ATTACH REQUEST	Attach type = 'GPRS attach'
4	SS -> MS	ATTACH ACCEPT	Attach result = 'GPRS only attached' Mobile identity = P-TMSI-2 P-TMSI-2 signature Routing area identity = RAI-1 T3314 = 3 mins Cell Notification IE = Present
5	MS -> SS	ATTACH COMPLETE	
6	SS		The SS waits for 1.5 mins. The following messages are sent and shall be received on Cell B.
7	SS		Activate Cell B with a lower signal strength than Cell A The RF level of Cell A is lowered until Cell B is preferred by the MS.
8	MS -> SS	UPLINK RLC DATA BLOCK	Contains the LLC NULL frame. Received within T3314 of Step 5.
9	SS		The SS waits for 1.5 minutes for the READY timer to expire. The following messages are sent and shall be received on Cell A.
10	SS		The RF level of cell A is increased until cell A is preferred by the MS.
11	SS		The SS checks that no LLC frame is received on Cell A for a period equivalent to T3314 following Step 8.
12	SS -> MS	PAGING REQUEST TYPE 1	Mobile identity = P-TMSI-2 Paging order is for TBF establishment.
13	MS -> SS	UPLINK RLC DATA BLOCK	LLC PDU implicitly indicating paging response.

Specific Message Contents

None.

44.2.11.3.2 Test Procedure 2 – Use of LLC NULL Frame

Initial Conditions

System Simulator:

Three cells (not simultaneously activated), Cell A in MCC1/MNC1/LAC1/RAC1, Cell B in MCC1/MNC1/LAC1/RAC2 and Cell C in MCC1/MNC1/LAC1/RAC2.

All cells are operating in network operation mode II.

Mobile Station:

The MS has a valid IMSI and P-TMSI-1 stored. MS is switched off.

Specific PICS statements:

- MS operation mode C (TSPC_operation_mode_C).
- MS operation mode B (TSPC_operation_mode_B) (only if mode C not supported).
- Switch off on button (TSPC_Feat_OnOff).
- Automatic GPRS attach procedure at switch on or power on (TSPC_AddInfo_on_auto_GPRS_AP).

PIXIT statements:

-

Test Procedure

The MS switches on and performs GPRS ATTACH on Cell A. In the ATTACH ACCEPT message the SS assigns a new (non-default) value for the READY timer but does not assign a new P-TMSI. Cell Notification is indicated in the ATTACH ACCEPT message. The MS performs an initial Cell Update by sending an LLC frame. It is checked that the MS does not send the LLC NULL frame. The MS is made to re-select to Cell B. The MS sends a ROUTING AREA UPDATE REQUEST. The SS sends a ROUTING AREA UPDATE ACCEPT message assigning a new value for the Ready timer but does not assign a new P-TMSI. Cell Notification is indicated in the ROUTING AREA UPDATE ACCEPT message. The MS performs an initial Cell Update by sending an LLC frame. It is checked that the MS does not send the LLC NULL frame. Before the Ready timer expires, the MS is made to re-select to Cell C. The MS performs Cell Update / Cell Notification by sending an LLC NULL frame.

NOTE : The SS does not assign a new value of P-TMSI in either the ATTACH ACCEPT or ROUTING AREA UPDATE ACCEPT messages to prevent the sending of ATTACH COMPLETE and ROUTING AREA UPDATE COMPLETE messages by the MS which would obscure possible erroneous use of the LLC NULL frame for the initial cell update by the MS.

Maximum Duration of Test

5 minutes.

Expected Sequence

Step	Direction	Message	Comments
			The following messages are sent and shall be received on Cell A.
1	SS		The SS activates Cell A.
2	MS		The MS is set in MS operation mode C (see PICS). If MS operation mode C not supported set the MS in operation mode B. The MS is powered up or switched on and initiates an attach (see PICS).
3	MS -> SS	ATTACH REQUEST	Attach type = 'GPRS attach' Mobile identity = P-TMSI-1
4	SS -> MS	ATTACH ACCEPT	Attach result = 'GPRS only attached' Routing area identity = RAI-1 T3314 = 3 mins Allocated P-TMSI = Not Included Cell Notification IE = Present
5	MS -> SS	UPLINK RLC DATA BLOCK	LLC PDU for initial cell update. Must not contain the LLC NULL frame.
			The following messages are sent and shall be received on Cell B.
6	SS		Activate Cell B with a lower signal strength than Cell A The RF level of Cell A is lowered until Cell B is preferred by the MS.
7	MS -> SS	ROUTING AREA UPDATING REQUEST	Update type = 'RA updating' Routing area identity = RAI-1
8	SS -> MS	ROUTING AREA UPDATING ACCEPT	Update result = 'RA updated' Routing area identity = RAI-4 T3314 = 4 mins Allocated P-TMSI = Not Included Cell Notification IE = Present
9	MS -> SS	UPLINK RLC DATA BLOCK	LLC PDU for initial cell update. Must not contain the LLC NULL frame.
			The following messages are sent and shall be received on Cell C.
10	SS		Activate Cell C with a lower signal strength than Cell B. The RF level of Cell B is lowered until Cell C is preferred by the MS.
11	MS -> SS	UPLINK RLC DATA BLOCK	Contains the LLC NULL frame. Received within T3314 of Step 9.

Specific Message Contents

None.

45 Session Management Procedures

45.1 Definition

-

45.2 PDP context activation

45.2.1 Initiated by the mobile station

45.2.1.1 Attach initiated by context activation/QoS Offered by Network is the QoS Requested

45.2.1.1.1 Conformance requirement

PDP context activation shall initiate GPRS Attach by the MS when the MS is GPRS Detached.

In order to request a PDP context activation, the MS sends an ACTIVATE PDP CONTEXT REQUEST message to the network. If the QoS offered by the network is the same as the QoS requested by the mobile, then upon receipt of the message ACTIVATE PDP CONTEXT ACCEPT the MS shall stop timer T3380 and shall initiate establishment of the logical link with the offered QoS.

Reference

3GPP TS 04.08 / 3GPP TS 24.008 subclauses 6.1.1 and 6.1.3.1.1.

45.2.1.1.2 Test purpose

To check the MS initiates a GPRS ATTACH if one is not already active. To test the behaviour of the MS when the network responds to a PDP context activation request with the requested QoS.

45.2.1.1.3 Method of test

Specific PICS statements:

- GPRS Auto Attach (TSPC_AddInfo_on_auto_GPRS_AP)

PIXIT statements:

-Initial conditions

System Simulator:

1 cell, default parameters.

Mobile Station:

The MS is in GMM-state "GMM-DEREGISTERED, normal service" with valid P-TMSI and CKSN.

Test procedure

If the MS is attached, it should be triggered to initiate a GPRS detach procedure. A context activation is then requested by the user. On receipt of the ACTIVATE PDP CONTEXT REQUEST message a ACTIVATE PDP CONTEXT ACCEPT is returned by the SS with the same requested QoS. The contents of the ACTIVATE PDP CONTEXT REQUEST message shall then be checked. The SS then waits for T3380 +10% seconds to ensure T3380 has been stopped and no more ACTIVATE PDP CONTEXT REQUEST messages are sent by the MS. The SS then sends a MODIFY PDP CONTEXT REQUEST message to which the MS shall reply with a MODIFY PDP CONTEXT ACCEPT message to ensure the context has been set up.

Expected sequence

Step	Direction	Message	Comments
1	MS		If MS is not configured for GPRS auto attachment (see PICS), go to step 5. The MS initiates a GPRS detach (without power off) by MMI or by AT command.
2	MS		
3	MS -> SS	DETACH REQUEST	Detach type = 'normal detach, GPRS detach' Initiate a context activation Request attach Accept attach Negotiated Ready timer value IE should not be included Force to standby indicator set
4	SS -> MS	DETACH ACCEPT	
5	MS		
6	MS -> SS	ATTACH REQUEST	
7	SS -> MS	ATTACH ACCEPT	
8	MS -> SS	ACTIVATE PDP CONTEXT REQUEST	
9	SS -> MS	ACTIVATE PDP CONTEXT ACCEPT	
10	SS		Wait for T3380 +10% seconds to ensure no further activate request messages come from the MS Send a modify request for the activated context Accept the modification request to show context is activated
11	SS -> MS	MODIFY PDP CONTEXT REQUEST	
12	MS -> SS	MODIFY PDP CONTEXT ACCEPT	

Specific message contents

As default except:

Activate PDP Context Request

Information Element	Value/remark
Transaction identifier	In the range 0-6
Transaction identifier flag	0
NSAPI	In the range 5-15
Requested LLC SAPI	3, 5, 9 or 11
Requested QoS	Arbitrarily chosen
Requested PDP address	Arbitrarily chosen

Activate PDP Context Accept

Information Element	Value/remark
Transaction identifier	As above
Transaction identifier flag	1
Negotiated LLC SAPI	As above
Negotiated QoS	As above
Radio priority level	Arbitrarily chosen
Spare half octet	0

Modify PDP Context Request

Information Element	Value/remark
Transaction identifier	As above
Transaction identifier flag	1
Radio priority level	As above
Spare half octet	0
Requested LLC SAPI	As above
New QoS	As above

Modify PDP Context Accept

Information Element	Value/remark
Transaction identifier	As above
Transaction identifier flag	0

45.2.1.2 QoS Offered by Network is a lower QoS

45.2.1.2.1 QoS Accepted by MS

45.2.1.2.1.1 Conformance requirement

In order to request a PDP context activation, the MS sends an ACTIVATE PDP CONTEXT REQUEST message to the network. If the QoS offered by the network is acceptable to mobile, then upon receipt of the message ACTIVATE PDP CONTEXT ACCEPT the MS shall initiate establishment of the logical link with the offered QoS.

Reference

3GPP TS 04.08 / 3GPP TS 24.008 subclause 6.1.3.1.1.

45.2.1.2.1.2 Test purpose

To test the behaviour of the MS when the network responds to a PDP context activation request with a lower QoS than that requested.

45.2.1.2.1.3 Method of test

Specific PICS statements:

-

PIXIT statements:

-

Initial conditions

System Simulator:

1 cell, default parameters.

Mobile Station:

The MS is in GMM-state "GMM-REGISTERED, normal service" with valid P-TMSI and CKSN.

Test procedure

The requested QoS and Minimum QoS are set. A context activation is requested by the user. On receipt of the ACTIVATE PDP CONTEXT REQUEST message a ACTIVATE PDP CONTEXT ACCEPT is returned by the SS with a QoS lower than the requested but higher than or equal to the minimum. The SS then sends a MODIFY PDP CONTEXT REQUEST message and the MS shall respond with a MODIFY PDP CONTEXT ACCEPT message to confirm the context is active.

Maximum duration of test

5 minutes.

Expected sequence

Step	Direction	Message	Comments
1	MS		Initiate a context activation
2	MS -> SS	ACTIVATE PDP CONTEXT REQUEST	Request a pdp context activation
3	SS -> MS	ACTIVATE PDP CONTEXT ACCEPT	Accept a pdp context activation
4	SS -> MS	MODIFY PDP CONTEXT REQUEST	Send a modify request for the activated context
5	MS -> SS	MODIFY PDP CONTEXT ACCEPT	Accept the modification request to show context is activated

Specific message contents

As default except:

Activate PDP Context Request

Information Element	Value/remark
Transaction identifier	In the range 0-6
Transaction identifier flag	0
NSAPI	In the range 5-15
Requested LLC SAPI	3, 5, 9 or 11
Requested QoS	Arbitrarily chosen

Activate PDP Context Accept

Information Element	Value/remark
Transaction identifier	As above
Transaction identifier flag	1
Negotiated LLC SAPI	As above
Negotiated QoS	At least one value lower than in above but higher than or equal to minimum
Radio priority level	Arbitrarily chosen
Spare half octet	0
PDP address	omitted

Modify PDP Context Request

Information Element	Value/remark
Transaction identifier	As above
Transaction identifier flag	1
Radio priority level	As above
Spare half octet	0
Requested LLC SAPI	As above
New QoS	As above

Modify PDP Context Accept

Information Element	Value/remark
Transaction identifier	As above
Transaction identifier flag	0

45.2.1.2.2 QoS Rejected by MS

45.2.1.2.2.1 Conformance requirement

In order to request a PDP context activation, the MS sends an ACTIVATE PDP CONTEXT REQUEST message to the network.

Upon receipt of the message **ACTIVATE PDP CONTEXT ACCEPT** offering a QoS which is not acceptable to the mobile, the MS shall initiate the PDP context deactivation procedure.

Reference

3GPP TS 04.08 / 3GPP TS 24.008 subclause 6.1.3.1.1.

45.2.1.2.2.2 Test purpose

To test the behaviour of the MS when the QoS offered by the network in response to a PDP context activation request is not acceptable to the MS.

45.2.1.2.2.3 Method of test

Specific PICS statements:

-

PIXIT statements:

-

Initial conditions

System Simulator:

1 cell, default parameters.

Mobile Station:

The MS is in GMM-state "GMM-REGISTERED, normal service" with valid P-TMSI and CKSN.

Test procedure

The requested QoS and Minimum QoS are set. A context activation is requested by the user. On receipt of the **ACTIVATE PDP CONTEXT REQUEST** message an **ACTIVATE PDP CONTEXT ACCEPT** message is returned by the SS with a QoS lower than the minimum. The MS shall then send a **DEACTIVATE PDP CONTEXT REQUEST** message. A **DEACTIVATE PDP CONTEXT ACCEPT** message will be sent in return by the SS.

Maximum duration of test

5 minutes.

Expected sequence

Step	Direction	Message	Comments
1	MS		Initiate a context activation
2	MS -> SS	ACTIVATE PDP CONTEXT REQUEST	Request a pdp context activation (with static PDP address)
3	SS -> MS	ACTIVATE PDP CONTEXT ACCEPT	Accept the pdp context activation
4	MS -> SS	DEACTIVATE PDP CONTEXT REQUEST	Deactivate the pdp context
5	SS -> MS	DEACTIVATE PDP CONTEXT ACCEPT	Accept the pdp context deactivation

Specific message contents

As default except:

Activate PDP Context Request

Information Element	Value/remark
Transaction identifier	In the range 0-6
Transaction identifier flag	0
NSAPI	In the range 5-15
Requested LLC SAPI	3, 5, 9 or 11
Requested QoS	Arbitrarily chosen
Requested PDP address	Arbitrarily chosen

Activate PDP Context Accept

Information Element	Value/remark
Transaction identifier	As above
Transaction identifier flag	1
Negotiated LLC SAPI	As above
Negotiated QoS	At least one value lower than in above and lower than minimum
Radio priority level	Arbitrarily chosen
Spare half octet	0

Deactivate PDP Context Request

Information Element	Value/remark
Transaction identifier	As above
Transaction identifier flag	0
SM cause	QoS not acceptable

Deactivate PDP Context Accept

Information Element	Value/remark
Transaction identifier	As above
Transaction identifier flag	1

45.2.2 PDP context activation requested by the network, successful and unsuccessful

Applicability

This test needs to take into account the number of contexts supported by the MS to be able to test the response when all contexts are activated and the network tries to initiate a new context.

45.2.2.1 Conformance requirement

- 1) Upon receipt of a REQUEST PDP CONTEXT ACTIVATION message:
 - If the MS accepts the request the MS shall then initiate the PDP context activation procedure.
 - If the MS rejects the request, the MS shall send a REQUEST PDP CONTEXT ACTIVATION REJECT message with one of the following causes:
 - #26: insufficient resources;
 - #31: activation rejected, unspecified;
 - #40: feature not supported; or
 - #95 – 111: protocol errors.
- 2) The MS shall not ignore the request.

- 3) If the MS accepts the request, the ACTIVATE PDP CONTEXT REQUEST message sent by the MS shall contain the parameters requested by the network in the REQUEST PDP CONTEXT ACTIVATION message, except for the offered QoS which may be changed by the MS.
- 4) Whenever a REQUEST PDP CONTEXT ACTIVATION message is received by the MS specifying a transaction identifier relating to a PDP context not in state PDP-INACTIVE, the MS shall locally deactivate the old PDP context relating to the received transaction identifier. Furthermore, the MS shall continue with the activation procedure of a new PDP context as indicated in the received message.

Reference

3GPP TS 04.08 / 3GPP TS 24.008 subclauses 6.1.3.1.2, 6.1.3.1.4 and 8.3.2 (f).

45.2.2.2 Test purpose

To test the behaviour of the MS upon receipt of a context activation request from the network.

45.2.2.3 Method of test

Specific PICS statements:

-

PIXIT statements:

- Number of network initiated PDP contexts supported

Initial conditions

System Simulator:

1 cell, default parameters.

Mobile Station:

The MS is in GMM-state "GMM-REGISTERED, normal service" with valid P-TMSI and CKSN.

Case 1

For an MS that supports PDP Context Activation requested by the network.

Test procedure

A REQUEST PDP CONTEXT ACTIVATION message is sent by the SS. On receipt of the ACTIVATE PDP CONTEXT REQUEST message an ACTIVATE PDP CONTEXT ACCEPT message is returned by the SS. This is repeated until the maximum number of contexts supported by the MS are activated. If the MS cannot support seven PDP contexts then one greater than the maximum supported by the MS should be requested. In response to this activation request the MS shall return a REQUEST PDP CONTEXT ACTIVATION REJECT message with cause set to 'insufficient resources', 'feature not supported', 'activation rejected, unspecified' or 'protocol errors' using cause values #26, #31, #40 or #95-#111. A REQUEST PDP CONTEXT ACTIVATION message is then sent using a currently activated context transaction identifier. The MS shall activate this context in place of the previous context.

Maximum duration of test

5 minutes.

Expected sequence

Step	Direction	Message	Comments
1	SS -> MS	REQUEST PDP CONTEXT ACTIVATION	Request a pdp context activation request
2	MS -> SS	ACTIVATE PDP CONTEXT REQUEST	Request a pdp context activation
3	SS -> MS	ACTIVATE PDP CONTEXT ACCEPT	Accept the pdp context activation
4	SS		Steps 1-3 are repeated for Min(number of Network Initiated contexts supported, 7) NOTE: If all 7 contexts are supported steps 5 and 6 should not be performed
5	SS -> MS	REQUEST PDP CONTEXT ACTIVATION	Request a pdp context activation request
6	MS -> SS	REQUEST PDP CONTEXT ACTIVATION REJECT	The context activation request is rejected with cause 'insufficient resources', 'feature not supported', 'activation rejected, unspecified' or 'protocol errors' using cause values #26, #31, #40 or #95-111.
7	SS -> MS	REQUEST PDP CONTEXT ACTIVATION	Request a pdp context activation request for an existing context
8	MS -> SS	ACTIVATE PDP CONTEXT REQUEST	Request a pdp context activation to replace the existing context
9	SS -> MS	ACTIVATE PDP CONTEXT ACCEPT	Accept the pdp context activation

Case 2

For an MS that does not support PDP Context Activation requested by the network.

Test procedure

A REQUEST PDP CONTEXT ACTIVATION message is sent by the SS. The MS shall then send an REQUEST PDP CONTEXT ACTIVATION REJECT message with cause set to 'insufficient resources' or 'feature not supported' or 'activation rejected, unspecified' or 'protocol errors'.

Maximum duration of test

5 minutes.

Expected sequence

Step	Direction	Message	Comments
1	SS -> MS	REQUEST PDP CONTEXT ACTIVATION	Request a pdp context activation request
2	MS -> SS	REQUEST PDP CONTEXT ACTIVATION REJECT	Reject the pdp context activation request with cause 'insufficient resources', 'feature not supported', 'activation rejected, unspecified' or 'protocol errors' using cause values #26, #31, #40 or #95-111.

Specific message contents

As default except:

Request PDP Context Activation

Information Element	Value/remark
Transaction identifier	In the range 0-6
Transaction identifier flag	0
Offered PDP address	Arbitrarily chosen

Activate PDP Context Request

Information Element	Value/remark
Transaction identifier	As above
Transaction identifier flag	1
NSAPI	In the range 5-15
Requested LLC SAPI	3, 5, 9 or 11
Requested QoS	Arbitrarily chosen
Requested PDP address	As above

Activate PDP Context Accept

Information Element	Value/remark
Transaction identifier	As above
Transaction identifier flag	0
Negotiated LLC SAPI	As above
Negotiated QoS	As above
Radio priority level	Arbitrarily chosen
Spare half octet	0

Request PDP Context Activation Reject

Information Element	Value/remark
Transaction identifier	As above
Transaction identifier flag	1
PDP address	As above
SM cause	'insufficient resources' or 'feature not supported' or 'activation rejected, unspecified' or 'protocol errors'

45.2.3 Void

45.2.4 Abnormal cases

45.2.4.1 T3380 Expiry

45.2.4.1.1 Conformance requirement

- 1) On the first expiry of the timer T3380, the MS shall resend the PDP CONTEXT ACTIVATION REQUEST.
- 2) On the second expiry of the timer T3380, the MS shall resend the PDP CONTEXT ACTIVATION REQUEST.
- 3) On the third expiry of the timer T3380, the MS shall resend the PDP CONTEXT ACTIVATION REQUEST.
- 4) On the fourth expiry of the timer T3380, the MS shall resend the PDP CONTEXT ACTIVATION REQUEST.
- 5) On the fifth expiry of the timer T3380, the MS shall release all resources possibly allocated for this invocation and shall abort the procedure; no automatic PDP context activation re-attempt shall be performed.

Reference

3GPP TS 04.08 / 3GPP TS 24.008 subclause 6.1.3.1.5.

45.2.4.1.2 Test purpose

To test the behaviour of the MS when the network does not reply to PDP CONTEXT ACTIVATION REQUEST

45.2.4.1.3 Method of test

Specific PICS statements:

-

PIXIT statements:

-

Initial conditions

System Simulator:

1 cell, default parameters.

Mobile Station:

The MS is in GMM-state "GMM-REGISTERED, normal service" with valid P-TMSI and CKSN.

Test procedure

A context activation is requested by the user. The MS shall send the ACTIVATE PDP CONTEXT REQUEST message five times with $T3380 \pm 10\%$ seconds between each message. After this no further ACTIVATE PDP CONTEXT REQUEST messages shall be sent by the MS.

Maximum duration of test

5 minutes.

Expected sequence

Step	Direction	Message	Comments
1	MS		Initiate a context activation
2	MS -> SS	ACTIVATE PDP CONTEXT REQUEST	Request a pdp context activation
3	SS		$T3380 \pm 10\%$ seconds
4	MS -> SS	ACTIVATE PDP CONTEXT REQUEST	Request a pdp context activation
5	SS		$T3380 \pm 10\%$ seconds
6	MS -> SS	ACTIVATE PDP CONTEXT REQUEST	Request a pdp context activation
7	SS		$T3380 \pm 10\%$ seconds
8	MS -> SS	ACTIVATE PDP CONTEXT REQUEST	Request a pdp context activation
9	SS		$T3380 \pm 10\%$ seconds
10	MS -> SS	ACTIVATE PDP CONTEXT REQUEST	Request a pdp context activation
11	SS		Wait for $T3380 + 10\%$ seconds to ensure no further ACTIVATE PDP CONTEXT REQUEST messages are sent by the MS

Specific message contents

As default except:

Activate PDP Context Request

Information Element	Value/remark
Transaction identifier	In the range 0-6
Transaction identifier flag	0
NSAPI	In the range 5-15
Requested LLC SAPI	3, 5, 9 or 11
Requested QoS	Arbitrarily chosen
Requested PDP address	Arbitrarily chosen

45.2.4.2 Collision of MS initiated and network requested PDP context activation

45.2.4.2.1 Conformance requirement

In the event of collision between MS initiated and network initiated PDP context activation requests, the MS shall discard the REQUEST PDP CONTEXT ACTIVATION message and shall wait for an ACTIVATE PDP CONTEXT ACCEPT message.

Reference

3GPP TS 04.08 / 3GPP TS 24.008 subclause 6.1.3.1.5.

45.2.4.2.2 Test purpose

To test the behaviour of the MS when there is a collision between an MS initiated and network requested PDP context activation.

45.2.4.2.3 Method of test

Specific PICS statements:

-

PIXIT statements:

-

Initial conditions

System Simulator:

1 cell, default parameters.

Mobile Station:

The MS is in GMM-state "GMM-REGISTERED, normal service" with valid P-TMSI and CKSN.

Case 1

For an MS that supports PDP Context Activation requested by the network.

Test procedure

A context activation is requested by the user with a static PDP address. After receipt of the ACTIVATE PDP CONTEXT REQUEST message the SS sends a REQUEST PDP CONTEXT ACTIVATION message followed by an ACTIVATE PDP CONTEXT ACCEPT message in a time less than T3380 (Use T3380/2). The MS shall send no messages within this time.

Maximum duration of test

5 minutes.

Expected sequence

Step	Direction	Message	Comments
1	MS		Initiate a context activation
2	MS -> SS	ACTIVATE PDP CONTEXT REQUEST	Request a pdp context activation
3	SS -> MS	REQUEST PDP CONTEXT ACTIVATION	Request a pdp context activation request
4	SS		Wait for T3380/2 seconds to ensure MS does not resend ACTIVATE PDP CONTEXT REQUEST
5	SS -> MS	ACTIVATE PDP CONTEXT ACCEPT	Accept the pdp context activation

Case 2

For an MS that does not support PDP Context Activation requested by the network.

Test procedure

A context activation is requested by the user. After receipt of the ACTIVATE PDP CONTEXT REQUEST message the SS sends a REQUEST PDP CONTEXT ACTIVATION message. The MS shall send a REQUEST PDP CONTEXT ACTIVATION REJECT message with cause set to 'insufficient resources' or 'feature not supported' or 'activation rejected, unspecified' or 'protocol errors'. The SS then sends an ACTIVATE PDP CONTEXT ACCEPT.

Maximum duration of test

5 minutes.

Expected sequence

Step	Direction	Message	Comments
1	MS		Initiate a context activation
2	MS -> SS	ACTIVATE PDP CONTEXT REQUEST	Request a pdp context activation
3	SS -> MS	REQUEST PDP CONTEXT ACTIVATION	Request a pdp context activation request
4	MS -> SS	REQUEST PDP CONTEXT ACTIVATION REJECT	The context activation request is rejected with cause 'insufficient resources', 'feature not supported', 'activation rejected, unspecified' or 'protocol errors' using cause values #26, #31, #40 or #95-111.
5	SS -> MS	ACTIVATE PDP CONTEXT ACCEPT	Accept the pdp context activation

Specific message contents

As default except:

Activate PDP Context Request

Information Element	Value/remark
Transaction identifier	In the range 0-6
Transaction identifier flag	0
NSAPI	In the range 5-15
Requested LLC SAPI	3, 5, 9 or 11
Requested QoS	Arbitrarily chosen
Requested PDP address	Static
APN	Arbitrarily chosen

Request PDP Context Activation

Information Element	Value/remark
Transaction identifier	In the range 0-6
Transaction identifier flag	0
Offered PDP address	As requested by the MS
APN	As requested by the MS (Case 1) Different from requested by the MS (Case 2)

Activate PDP Context Accept

Information Element	Value/remark
Transaction identifier	As above
Transaction identifier flag	1
Negotiated LLC SAPI	As above
Negotiated QoS	As above
Radio priority level	Arbitrarily chosen
Spare half octet	0

Request PDP Context Activation Reject

Information Element	Value/remark
Transaction identifier	As above
Transaction identifier flag	1
SM cause	'insufficient resources' or 'feature not supported' or 'activation rejected, unspecified' or 'protocol errors'

45.2.4.3 Network initiated PDP context activation request for an already activated PDP context (on the MS side)

45.2.4.3.1 Definition

45.2.4.3.2 Conformance requirement

If the MS receives a REQUEST PDP CONTEXT ACTIVATION message with the same combination of APN, PDP type and PDP address as an already activated PDP context, the MS shall deactivate the existing PDP context and, if any, all the linked PDP contexts (matching the combination of APN, PDP type and PDP address) locally without notification to the network and proceed with the requested PDP context activation.

Reference

3GPP TS 24.008 clause 6.1.3.1.5 d).

45.2.4.3.3 Test purpose

To test the behaviour of the MS when it detects a network initiated PDP context activation for the PDP context already activated on the MS side.

45.2.4.3.4 Method of test

Initial conditions

System Simulator:

1 cell, default parameters.

Mobile Station:

The MS is in GMM-state "GMM-REGISTERED, normal service" with valid P-TMSI and CKSN.

Specific PICS statements:

- Network requested pdp context activation supported (TSPC_AddInfo_N_req_PDP_CA)

PIXIT statements:

-

Test procedure

A PDP context activation is requested by the user. SS accepts PDP context activation. Secondary PDP context activation is requested by the user. SS accepts secondary PDP context activation. SS sends a REQUEST PDP CONTEXT ACTIVATION message with the same combination of APN, PDP type and PDP address as an already activated PDP context. 2 cases are expected:

Case A (MS supports "Network requested PDP context activation"):

The MS deactivates the existing PDP context and linked secondary PDP context (matching the combination of APN, PDP type and PDP address) locally without notification to the SS and proceeds with the requested PDP context activation.

Case B (MS does not support "Network requested PDP context activation"):

The MS sends REQUEST PDP CONTEXT ACTIVATION REJECT message with cause set to 'insufficient resources' or 'feature not supported' or 'activation rejected, unspecified' or 'protocol errors' and the existing PDP contexts stay still active.

Expected sequence

Step	Direction	Message	Comments
1	MS		Initiate a context activation
2	MS -> SS	ACTIVATE PDP CONTEXT REQUEST	MS requests a PDP context activation
3	SS -> MS	ACTIVATE PDP CONTEXT ACCEPT	SS accepts the PDP context activation
4	MS -> SS	ACTIVATE SECONDARY PDP CONTEXT REQUEST	MS requests a secondary PDP context activation
5	SS -> MS	ACTIVATE SECONDARY PDP CONTEXT ACCEPT	SS accepts the secondary PDP context activation
6	SS -> MS	REQUEST PDP CONTEXT ACTIVATION	SS requests a PDP context activation with the same combination of APN, PDP type and PDP address as the activated PDP context If the MS supports "Network requested PDP context activation" branch A is performed, otherwise branch B is performed.
7A	MS		MS locally deactivates the activated PDP context and the secondary PDP context
8A	MS -> SS	ACTIVATE PDP CONTEXT REQUEST	MS replies with a Request PDP context activation
9A	SS -> MS	ACTIVATE PDP CONTEXT ACCEPT	SS accepts the PDP context activation
10A	SS -> MS	MODIFY PDP CONTEXT REQUEST	Request the modification of the secondary PDP context
11A	MS -> SS	SM STATUS	Cause set to #81. This verifies that the secondary PDP context was locally deactivated.
12A	SS -> MS	MODIFY PDP CONTEXT REQUEST	Request the modification of the first PDP context
13A	MS -> SS	SM STATUS	Cause set to #81. This verifies that the first PDP context was locally deactivated.
7B	MS -> SS	REQUEST PDP CONTEXT ACTIVATION REJECT	The context activation request is rejected with cause 'insufficient resources', 'feature not supported', 'activation rejected, unspecified' or 'protocol errors' using cause values #26, #31, #40 or #95-111.
8B	SS -> MS	MODIFY PDP CONTEXT REQUEST	Request the modification of the secondary PDP context
9B	MS -> SS	MODIFY PDP CONTEXT ACCEPT	MS Accepts PDP context modification.

Specific message contents

None.

45.2.5 Secondary PDP context activation procedures

45.2.5.1 Successful Secondary PDP Context Activation Procedure Initiated by the MS

45.2.5.1.1 QoS Offered by Network is the QoS Requested

45.2.5.1.1.1 Definition

45.2.5.1.1.2 Conformance requirement

In order to request a PDP context activation with the same PDP address and APN as an already active PDP context, the MS shall send an ACTIVATE SECONDARY PDP CONTEXT REQUEST message to the network, enter the state PDP-ACTIVE-PENDING and start timer T3380. The message shall contain the selected NSAPI. The MS shall ensure that the selected NSAPI is not currently being used by another Session Management entity in the MS. The message shall also include a QoS profile, a requested LLC SAPI and the Linked TI. The QoS profile is the requested QoS.

Reference

3GPP TS 24.008 clauses 6.1.3.2 and 6.1.3.2.1.

45.2.5.1.1.3 Test purpose

To test the behaviour of the MS when SS responds to a Secondary PDP context activation request with the requested QoS.

45.2.5.1.1.4 Method of test

Initial conditions

System Simulator:

1 cell, default parameters.

Mobile Station:

The MS is in GMM-state "GMM-REGISTERED, normal service" with valid P-TMSI and CKSN.

Specific PICS statements:

-

PIXIT statements:

-

Test procedure

A PDP context activation is requested by the MS and accepted by the SS. Secondary PDP context activation is requested by the MS. On receipt of the ACTIVATE SECONDARY PDP CONTEXT REQUEST message an ACTIVATE SECONDARY PDP CONTEXT ACCEPT is returned by the SS with the same requested QoS. The SS then waits for T3380 seconds to ensure T3380 has been stopped and no more ACTIVATE SECONDARY PDP CONREXT REQUEST messages are sent by the MS. The SS then sends a MODIFY PDP CONTEXT REQUEST message to which the MS shall reply with a MODIFY PDP CONTEXT ACCEPT message to ensure the PDP context has been activated.

Expected sequence

Step	Direction	Message	Comments
1	MS		Initiate a PDP context activation
2	MS -> SS	ACTIVATE PDP CONTEXT REQUEST	Activate a PDP context
3	SS -> MS	ACTIVATE PDP CONTEXT ACCEPT	Accept the PDP context
4	MS		Initiate a secondary PDP context activation
5	MS -> SS	ACTIVATE SECONDARY PDP CONTEXT REQUEST	Request a Secondary PDP context activation. The requested QoS shall be different from 'Best effort'. Check that TFT filed is present in message and <i>TFT operation</i> is "Create a new TFT".
6	SS -> MS	ACTIVATE SECONDARY PDP CONTEXT ACCEPT	Accept the Secondary PDP context activation, the QoS is set to the requested QoS.
7	SS		Wait for T3380 seconds to ensure no further activate request messages come from the MS
8	SS -> MS	MODIFY PDP CONTEXT REQUEST	SS sends a modify request to MS for the activated context
9	MS -> SS	MODIFY PDP CONTEXT ACCEPT	The MS accepts the modification request from the network to show context is activated

Specific message contents

45.2.5.1.2 QoS Offered by Network is a lower QoS

45.2.5.1.2.1 QoS accepted by MS

45.2.5.1.2.1.1 Definition

-

45.2.5.1.2.1.2 Conformance requirement

In order to request a PDP context activation with the same PDP address and APN as an already active PDP context, the MS shall send an ACTIVATE SECONDARY PDP CONTEXT REQUEST message to the network, enter the state PDP-ACTIVE-PENDING and start timer T3380. The message shall contain the selected NSAPI. The MS shall ensure that the selected NSAPI is not currently being used by another Session Management entity in the MS. The message shall also include a QoS profile, a requested LLC SAPI and the Linked TI. The QoS profile is the requested QoS.

Upon receipt of the message ACTIVATE SECONDARY PDP CONTEXT ACCEPT, the MS shall stop timer T3380 and enter the state PDP-ACTIVE. If the offered QoS parameters received from the network differ from the QoS requested by the MS, the MS shall either accept the negotiated QoS or initiate the PDP context deactivation procedure.

In GSM the MS shall initiate establishment of the logical link for the LLC SAPI indicated by the network with the offered QoS and selected radio priority level if no logical link has been already established for that SAPI. If the LLC SAPI indicated by the network can not be supported by the MS, the MS shall initiate the PDP context deactivation procedure.

Reference

3GPP TS 24.008 clauses 6.1.3.2 and 6.1.3.2.1.

45.2.5.1.2.1.3 Test purpose

To test the behaviour of the MS when the SS responds to a Secondary PDP context activation request with a lower QoS than that requested.

45.2.5.1.2.1.4 Method of test

Initial conditions

System Simulator:

1 cell, default parameters.

Mobile Station:

The MS is in GMM-state "GMM-REGISTERED, normal service" with valid P-TMSI and CKSN.

Specific PICS statements:

-

PIXIT statements:

-

Test procedure

The requested QoS and Minimum QoS are set. A PDP context activation is requested by the MS and accepted by the SS. Secondary context activation is requested by the user. On receipt of the ACTIVATE SECONDARY PDP CONTEXT REQUEST message an ACTIVATE SECONDARY PDP CONTEXT ACCEPT is returned by the SS with a QoS lower than the requested but higher than or equal to the minimum. The SS then sends a MODIFY PDP CONTEXT REQUEST message and the MS shall respond with a MODIFY PDP CONTEXT ACCEPT message to confirm the context is active.

Expected sequence

Step	Direction	Message	Comments
1	MS		Initiate a PDP context activation
2	MS -> SS	ACTIVATE PDP CONTEXT REQUEST	Activate a PDP context
3	SS -> MS	ACTIVATE PDP CONTEXT ACCEPT	Accept the PDP context
4	MS		Initiate a secondary PDP context activation
5	MS -> SS	ACTIVATE SECONDARY PDP CONTEXT REQUEST	Request a Secondary PDP context activation. The requested QoS shall be different from 'Best effort'. Check that TFT filed is present in message and <i>TFT operation</i> is "Create a new TFT".
6	SS -> MS	ACTIVATE SECONDARY PDP CONTEXT ACCEPT	Accept a Secondary PDP context activation, the QoS is lower than the requested QoS and higher than minimum QoS.
7	SS -> MS	MODIFY PDP CONTEXT REQUEST	Send a modify request to MS for the activated context
8	MS -> SS	MODIFY PDP CONTEXT ACCEPT	Accept the modification request from network to show context is activated

Specific message contents

None.

45.2.5.1.2.2 QoS rejected by MS

45.2.5.1.2.2.1 Definition

-

45.2.5.1.2.2.2 Conformance requirement

In order to request a PDP context activation with the same PDP address and APN as an already active PDP context, the MS shall send an ACTIVATE SECONDARY PDP CONTEXT REQUEST message to the network, enter the state PDP-ACTIVE-PENDING and start timer T3380. The message shall contain the selected NSAPI. The MS shall ensure that the selected NSAPI is not currently being used by another Session Management entity in the MS. The message shall also include a QoS profile, a requested LLC SAPI and the Linked TI. The QoS profile is the requested QoS.

Upon receipt of the message ACTIVATE SECONDARY PDP CONTEXT ACCEPT, the MS shall stop timer T3380 and enter the state PDP-ACTIVE. If the offered QoS parameters received from the network differ from the QoS requested by the MS, the MS shall either accept the negotiated QoS or initiate the PDP context deactivation procedure.

In GSM the MS shall initiate establishment of the logical link for the LLC SAPI indicated by the network with the offered QoS and selected radio priority level if no logical link has been already established for that SAPI. If the LLC SAPI indicated by the network can not be supported by the MS, the MS shall initiate the PDP context deactivation procedure.

Reference

3GPP TS 24.008 clauses 6.1.3.2 and 6.1.3.2.1.

45.2.5.1.2.2.3 Test purpose

To test the behaviour of the MS when the SS responds to a Secondary PDP context activation request with a lower QoS than that requested and not acceptable by the MS.

45.2.5.1.2.2.4 Method of test

Initial conditions

System Simulator:

1 cell, default parameters.

Mobile Station:

The MS is in GMM-state "GMM-REGISTERED, normal service" with valid P-TMSI and CKSN.

Specific PICS statements:

-

PIXIT statements:

-

Test procedure

The requested QoS and Minimum QoS are set. PDP context activation is requested by the user and accepted by the SS. Secondary PDP context activation is requested by the user. On receipt of the ACTIVATE SECONDARY PDP CONTEXT REQUEST message an ACTIVATE SECONDARY PDP CONTEXT ACCEPT message is returned by the SS with the QoS lower than the minimum. The MS shall then send a DEACTIVATE PDP CONTEXT REQUEST message for the secondary PDP context. A DEACTIVATE PDP CONTEXT ACCEPT message will be sent in return by the SS.

Expected sequence

Step	Direction	Message	Comments
1	MS		Initiate a PDP context activation
2	MS -> SS	ACTIVATE PDP CONTEXT REQUEST	Activate a PDP context
3	SS -> MS	ACTIVATE PDP CONTEXT ACCEPT	Accept the PDP context
4	MS		Initiate a secondary PDP context activation
5	MS -> SS	ACTIVATE SECONDARY PDP CONTEXT REQUEST	Request a Secondary PDP context activation Check that TFT filed is present in message and <i>TFT operation</i> is "Create a new TFT".
6	SS -> MS	ACTIVATE SECONDARY PDP CONTEXT ACCEPT	Accept the Secondary PDP context activation with QoS lower than Minimum QoS
7	MS -> SS	DEACTIVATE PDP CONTEXT REQUEST	Request deactivation of the secondary PDP context SM Cause = #37, 'QoS not accepted'
8	SS -> MS	DEACTIVATE PDP CONTEXT ACCEPT	Tear down indicator IE shall not be included Accept the PDP context deactivation

Specific message contents

None

45.2.5.2 Unsuccessful Secondary PDP Context Activation Procedure Initiated by the MS

45.2.5.2.1 Definition

45.2.5.2.2 Conformance requirement

Upon receipt of an ACTIVATE SECONDARY PDP CONTEXT REQUEST message, the network may reject the MS initiated PDP context activation by sending an ACTIVATE SECONDARY PDP CONTEXT REJECT message to the MS.

Upon receipt of an ACTIVATE SECONDARY PDP CONTEXT REJECT message, the MS shall stop timer T3380 and enter the state PDP-INACTIVE.

Reference

3GPP TS 24.008 clauses 6.1.3.2 and 6.1.3.2.2.

45.2.5.2.3 Test purpose

To test the behaviour of the MS when network rejects the MS initiated Secondary PDP context activation.

45.2.5.2.4 Method of test

Initial conditions

System Simulator:

1 cell, default parameters.

Mobile Station:

The MS is in GMM-state "GMM-REGISTERED, normal service" with valid P-TMSI and CKSN.

Specific PICS statements:

-

PIXIT statements:

-

Test procedure

A PDP context activation is requested by the user and accepted by the SS. Secondary context activation is requested by the user. On receipt of the ACTIVATE SECONDARY PDP CONTEXT REQUEST message from the MS, an ACTIVATE SECONDARY PDP CONTEXT REJECT with cause #43 'unknown PDP context' is returned by the SS. SS shall wait for T3380 seconds to ensure that the MS sends no more ACTIVATE SECONDARY PDP CONTEXT REQUEST messages.

Expected sequence

Step	Direction	Message	Comments
1	MS		Initiate a PDP context activation
2	MS -> SS	ACTIVATE PDP CONTEXT REQUEST	Activate a PDP context
3	SS -> MS	ACTIVATE PDP CONTEXT ACCEPT	Accept the PDP context
4	MS		Initiate a secondary PDP context activation
5	MS -> SS	ACTIVATE SECONDARY PDP CONTEXT REQUEST	Request a Secondary PDP context activation.
6	SS -> MS	ACTIVATE SECONDARY PDP CONTEXT REJECT	Check that TFT filed is present in message and <i>TFT operation</i> is "Create a new TFT". SS rejects the Secondary PDP context activation with cause '#43: unknown PDP context'
7	SS		Wait for T3380 seconds to ensure no further ACTIVATE SECONDARY PDP CONTEXT REQUEST messages come from the MS

Specific message contents

None.

45.2.5.3 Abnormal cases

45.2.5.3.1 T3380 Expiry

45.2.5.3.1.1 Definition

45.2.5.3.1.2 Conformance requirement

- 1) On the first expiry of the timer T3380, the MS shall re-send the ACTIVATE SECONDARY PDP CONTEXT REQUEST.
- 2) On the second expiry of the timer T3380, the MS shall re-send the ACTIVATE SECONDARY PDP CONTEXT REQUEST.
- 3) On the third expiry of the timer T3380, the MS shall re-send the ACTIVATE SECONDARY PDP CONTEXT REQUEST.
- 4) On the fourth expiry of the timer T3380, the MS shall re-send the ACTIVATE SECONDARY PDP CONTEXT REQUEST.
- 5) On the fifth expiry of the timer T3380, the MS shall release all resources possibly allocated for this invocation and shall abort the procedure; no automatic secondary PDP context activation re-attempt shall be performed.

Reference

3GPP TS 24.008 clause 6.1.3.2.3 a).

45.2.5.3.1.3 Test purpose

To test the behaviour of the MS when the SS does not reply to ACTIVATE SECONDARY PDP CONTEXT REQUEST message.

45.2.5.3.1.4 Method of test

Initial conditions

System Simulator:

1 cell, default parameters.

Mobile Station:

The MS is in GMM-state "GMM-REGISTERED, normal service" with valid P-TMSI and CKSN.

Specific PICS statements:

-

PIXIT statements:

-

Test procedure

A PDP context is activated by the user and accepted by the SS. Secondary PDP context activation is requested by the user. The MS shall send ACTIVATE SECONDARY PDP CONTEXT REQUEST message five times with T3380 seconds between each message. After this, no further ACTIVATE SECONDARY PDP CONTEXT REQUEST messages shall be sent by the MS.

Expected sequence

Step	Direction	Message	Comments
1	MS		Initiate a PDP context activation
2	MS -> SS	ACTIVATE PDP CONTEXT REQUEST	Activate a PDP context
3	SS -> MS	ACTIVATE PDP CONTEXT ACCEPT	Accept the PDP context
4	MS		Initiate a secondary PDP context activation
5	MS -> SS	ACTIVATE SECONDARY PDP CONTEXT REQUEST	Request a Secondary PDP context activation
6	SS		T3380 +10% seconds
7	MS -> SS	ACTIVATE SECONDARY PDP CONTEXT REQUEST	Request the Secondary PDP context activation
8	SS		T3380 +10% seconds
9	MS -> SS	ACTIVATE SECONDARY PDP CONTEXT REQUEST	Request the Secondary PDP context activation
10	SS		T3380 +10% seconds
11	MS -> SS	ACTIVATE SECONDARY PDP CONTEXT REQUEST	Request the Secondary PDP context activation
12	SS		T3380 +10% seconds
13	MS -> SS	ACTIVATE SECONDARY PDP CONTEXT REQUEST	Request the Secondary PDP context activation
14	SS		Wait for T3380 +10% seconds to ensure no further ACTIVATE SECONDARY PDP CONTEXT REQUEST messages are sent by the MS

Specific message contents

None.

45.3 PDP context modification procedure

45.3.1 Network initiated PDP context modification

45.3.1.1 Conformance requirement

1) Upon receipt of a MODIFY PDP CONTEXT REQUEST message.

- If the MS can accept the modification requested, the MS shall reply with the MODIFY PDP CONTEXT ACCEPT message.
- If the MS is unable to accept the modification requested, the MS shall initiate the PDP context deactivation procedure for the NSAPI that has been indicated in the message MODIFY PDP CONTEXT REQUEST - the

reject cause IE value of the DEACTIVATE PDP CONTEXT REQUEST message shall indicate "QoS not accepted".

- 2) The MS shall either accept the modification request or deactivate the PDP context, it shall not ignore the modification request.

Reference

3GPP TS 04.08 / 3GPP TS 24.008 subclause 6.1.3.2.

45.3.1.2 Test purpose

To test the behaviour of the MS upon receipt of a MODIFY PDP CONTEXT REQUEST message.

45.3.1.3 Method of test

Specific PICS statements:

-

PIXIT statements:

-

Initial conditions

System Simulator:

1 cell, default parameters.

Mobile Station:

The MS is in GMM-state "GMM-REGISTERED, normal service" with valid P-TMSI and CKSN.

Test procedure

A PDP context is activated by the user and accepted by the SS. A MODIFY PDP CONTEXT REQUEST message is then sent to the MS with a QoS that is acceptable to the MS (higher than or equal to the minimum QoS set in the MS). The MS shall send a MODIFY PDP CONTEXT ACCEPT message in return. A MODIFY PDP CONTEXT REQUEST message is then sent to the MS with a QoS that is not acceptable to the MS (lower than the minimum QoS set in the MS). The MS shall send a DEACTIVATE PDP CONTEXT REQUEST message in return.

Maximum duration of test

5 minutes.

Expected sequence

Step	Direction	Message	Comments
1	MS		Initiate a context activation
2	MS -> SS	ACTIVATE PDP CONTEXT REQUEST	Activate a PDP context
3	SS -> MS	ACTIVATE PDP CONTEXT ACCEPT	Accept the PDP context
4	SS -> MS	MODIFY PDP CONTEXT REQUEST	Request the modification of a pdp context
5	MS -> SS	MODIFY PDP CONTEXT ACCEPT	Accept the pdp context modification
6	SS -> MS	MODIFY PDP CONTEXT REQUEST	Request the modification of a pdp context
7	MS -> SS	DEACTIVATE PDP CONTEXT REQUEST	Reject the pdp context modification by deactivating the pdp context. Cause set to 'QoS not acceptable'
8	SS -> MS	DEACTIVATE PDP CONTEXT ACCEPT	Accept the pdp context deactivation

Specific message contents

As default except:

Activate PDP Context Request

Information Element	Value/remark
Transaction identifier	In the range 0-6
Transaction identifier flag	0
NSAPI	In the range 5-15
Requested LLC SAPI	3, 5, 9 or 11
Requested QoS	Arbitrarily chosen
Requested PDP address	Arbitrarily chosen

Activate PDP Context Accept

Information Element	Value/remark
Transaction identifier	As above
Transaction identifier flag	1
Negotiated LLC SAPI	As above
Negotiated QoS	As above
Radio priority level	Arbitrarily chosen
Spare half octet	0

Modify PDP Context Request (used in step 4)

Information Element	Value/remark
Transaction identifier	As above
Transaction identifier flag	1
Radio priority level	As above
Spare half octet	0
Requested LLC SAPI	As above
New QoS	Higher than or equal to the minimum QoS and lower than the requested QoS.

Modify PDP Context Request (used in step 6)

Information Element	Value/remark
Transaction identifier	As above
Transaction identifier flag	1
Radio priority level	As above
Spare half octet	0
Requested LLC SAPI	As above
New QoS	Lower than the minimum QoS

Modify PDP Context Accept

Information Element	Value/remark
Transaction identifier	As above
Transaction identifier flag	0

Deactivate PDP Context Request

Information Element	Value/remark
Transaction identifier	As above
Transaction identifier flag	0
SM cause	QoS not acceptable

Deactivate PDP Context Accept

Information Element	Value/remark
Transaction identifier	As above
Transaction identifier flag	1

45.3.2 MS initiated PDP context modification

45.3.2.1 MS initiated PDP Context Modification accepted by network

45.3.2.1.1 Definition

-

45.3.2.1.2 Conformance requirement

In order to initiate the procedure, the MS sends the MODIFY PDP CONTEXT REQUEST message to the network, enters the state PDP-MODIFY-PENDING and starts timer T3381. The message may contain the requested new QoS and/or the TFT and the requested LLC SAPI (used in GSM).

Upon receipt of the MODIFY PDP CONTEXT REQUEST message, the network may reply with the MODIFY PDP CONTEXT ACCEPT message in order to accept the context modification. The reply message may contain the negotiated QoS and the radio priority level based on the new QoS profile and the negotiated LLC SAPI, that shall be used in GSM by the logical link.

Upon receipt of the MODIFY PDP CONTEXT ACCEPT message, the MS shall stop the timer T3381. If the offered QoS parameters received from the network differs from the QoS requested by the MS, the MS shall either accept the negotiated QoS or initiate the PDP context deactivation procedure.

Reference

3GPP TS 24.008 clauses 6.1.3.3 and 6.1.3.3.2.

45.3.2.1.3 Test purpose

To test the behaviour of the MS upon receipt of a MODIFY PDP CONTEXT ACCEPT message from the network with

- Requested QoS;
- QoS higher than or equal to the minimum QoS set in the MS;
- QoS lower than the minimum QoS set in the MS.

45.3.2.1.4 Method of test

Initial conditions

System Simulator:

1 cell, default parameters.

Mobile Station:

The MS is in GMM-state "GMM-REGISTERED, normal service" with valid P-TMSI and CKSN.

Specific PICS statements:

-

PIXIT statements:

-

Test procedure

The requested QoS and Minimum QoS are set. A PDP context is activated by the user and accepted by the SS. The MS initiates a PDP context modification by sending a MODIFY PDP CONTEXT REQUEST message with new QoS. The SS accepts the context modification and replies with the MODIFY PDP CONTEXT ACCEPT message with the QoS requested.

The MS initiates new PDP context modification with higher QoS. The SS is unable to provide requested QoS, so it replies by sending MODIFY PDP CONTEXT ACCEPT message with new QoS that is lower than requested but still acceptable to the MS (higher than or equal to the minimum QoS set in the MS).

The MS initiates new PDP context modification with new QoS. The SS is unable to provide requested QoS, so it replies by sending MODIFY PDP CONTEXT ACCEPT message with QoS that is not acceptable to the MS (lower than the minimum QoS set in the MS). The MS shall send a DEACTIVATE PDP CONTEXT REQUEST message in return and SS shall respond with a DEACTIVATE PDP CONTEXT ACCEPT message.

Expected sequence

Step	Direction	Message	Comments
1	MS		Initiate a PDP context activation
2	MS -> SS	ACTIVATE PDP CONTEXT REQUEST	Activate a PDP context
3	SS -> MS	ACTIVATE PDP CONTEXT ACCEPT	Accept the PDP context
4	MS -> SS	MODIFY PDP CONTEXT REQUEST	Request the modification of a PDP context, with new QoS
5	SS -> MS	MODIFY PDP CONTEXT ACCEPT	Accept the PDP context modification with QoS requested
6	MS -> SS	MODIFY PDP CONTEXT REQUEST	Request the modification of a PDP context, with new QoS
7	SS -> MS	MODIFY PDP CONTEXT ACCEPT	Accept the PDP context modification with QoS higher than the minimum QoS set in MS
8	MS -> SS	MODIFY PDP CONTEXT REQUEST	Request the modification of a PDP context, with new QoS
9	SS -> MS	MODIFY PDP CONTEXT ACCEPT	Accept the PDP context modification with QoS lower than the minimum QoS set in MS
10	MS -> SS	DEACTIVATE PDP CONTEXT REQUEST	Initiate the PDP context deactivation. Cause set to 'QoS not acceptable'
11	SS -> MS	DEACTIVATE PDP CONTEXT ACCEPT	Accept the PDP context deactivation

Specific message contents

None.

45.3.2.2 MS initiated PDP Context Modification not accepted by the network

45.3.2.2.1 Definition

45.3.2.2.2 Conformance requirement

In order to initiate the procedure, the MS sends the MODIFY PDP CONTEXT REQUEST message to the network, enters the state PDP-MODIFY-PENDING and starts timer T3381. The message may contain the requested new QoS and/or the TFT and the requested LLC SAPI (used in GSM).

Upon receipt of a MODIFY PDP CONTEXT REQUEST message, the network may reject the MS initiated PDP context modification request by sending a MODIFY PDP CONTEXT REJECT message to the MS. The message shall contain a cause code that typically indicates one of the following:

- # 26: insufficient resources;
- # 32: Service option not supported;
- # 41: semantic error in the TFT operation;
- # 42: syntactical error in the TFT operation;
- # 44: semantic errors in packet filter(s);
- # 45: syntactical errors in packet filter(s);
- # 95 - 111: protocol errors.

Upon receipt of a MODIFY PDP CONTEXT REJECT message, the MS shall stop timer T3381 and enter the state PDP-ACTIVE.

Reference

3GPP TS 24.008 clauses 6.1.3.3, 6.1.3.3.2 and 6.1.3.3.3.

45.3.2.2.3 Test purpose

To test the behaviour of the MS upon receipt of a MODIFY PDP CONTEXT REJECT message from the network.

45.3.2.2.4 Method of test

Initial conditions

System Simulator:

- 1 cell, default parameters.

Mobile Station:

- The MS is in GMM-state "GMM-REGISTERED, normal service" with valid P-TMSI and CKSN.

Specific PICS statements:

-

PIXIT statements:

-

Test procedure

A PDP context is activated by the user and accepted by the SS. The MS initiates a PDP context modification by sending a MODIFY PDP CONTEXT REQUEST message. The SS rejects the context modification and replies with the MODIFY PDP CONTEXT REJECT with cause set to # 26: insufficient resources.

Expected sequence

Step	Direction	Message	Comments
1	MS		Initiate a PDP context activation
2	MS -> SS	ACTIVATE PDP CONTEXT REQUEST	Activate a PDP context
3	SS -> MS	ACTIVATE PDP CONTEXT ACCEPT	Accept the PDP context
4	MS -> SS	MODIFY PDP CONTEXT REQUEST	Request the modification of a PDP context
5	SS -> MS	MODIFY PDP CONTEXT REJECT	SS rejects PDP context modification SM cause set to # 26: 'insufficient resources'
6	SS		Wait for T3381 seconds to ensure no further MODIFY PDP CONTEXT REQUEST messages are sent by the MS

Specific message contents

None.

45.3.3 Abnormal cases

45.3.3.1 T3381 Expiry

45.3.3.1.1 Definition

45.3.3.1.2 Conformance requirement

On the first expiry of timer T3381, the MS shall resend the MODIFY PDP CONTEXT REQUEST message reset and restart timer T3381. This retransmission is repeated four times, i.e. on the fifth expiry of timer T3381, the MS may continue to use the previously negotiated QoS or it may initiate the PDP context deactivation procedure.

Reference

3GPP TS 24.008 clause 6.1.3.3.4 a) case: In the MS.

45.3.3.1.3 Test purpose

To test the behaviour of the MS when SS does not reply to MODIFY PDP CONTEXT REQUEST message.

45.3.3.1.4 Method of test

Initial conditions

System Simulator:

1 cell, default parameters.

Mobile Station:

The MS is in GMM-state "GMM-REGISTERED, normal service" with valid P-TMSI and CKSN.

Specific PICS statements:

-

PIXIT statements:

-

Test procedure

A PDP context activation is requested by the user and accepted by the SS. The MS shall send MODIFY PDP CONTEXT REQUEST message five times with T3381 seconds between each message. After this no further MODIFY PDP CONTEXT REQUEST messages shall be sent by the MS.

Expected sequence

Step	Direction	Message	Comments
1	MS		Initiate a PDP context activation
2	MS -> SS	ACTIVATE PDP CONTEXT REQUEST	Activate a PDP context
3	SS -> MS	ACTIVATE PDP CONTEXT ACCEPT	Accept the PDP context activation
4	MS -> SS	MODIFY PDP CONTEXT REQUEST	Request modification of the PDP context, with new QoS
5	SS		T3381 ±10% seconds
6	MS -> SS	MODIFY PDP CONTEXT REQUEST	Request modification of the PDP context, with new QoS
7	SS		T3381 ±10% seconds
8	MS -> SS	MODIFY PDP CONTEXT REQUEST	Request modification of the PDP context, with new QoS
9	SS		T3381 ±10% seconds
10	MS -> SS	MODIFY PDP CONTEXT REQUEST	Request modification of the PDP context, with new QoS
11	SS		T3381 ±10% seconds
12	MS -> SS	MODIFY PDP CONTEXT REQUEST	Request modification of the PDP context, with new QoS
13	SS		Wait for T3381 +10% seconds to ensure no further MODIFY PDP CONTEXT REQUEST messages are sent by the MS. The MS may initiate PDP context deactivation procedure.

Specific message contents

None.

45.3.3.2 Collision of MS and network initiated PDP context modification procedures

45.3.3.2.1 Definition

45.3.3.2.2 Conformance requirement

A collision of a MS and network initiated PDP context modification procedures is identified by the MS if a MODIFY PDP CONTEXT REQUEST message is received from the network after the MS has sent a MODIFY PDP CONTEXT REQUEST message itself, and both messages contain the same TI and the MS has not yet received a MODIFY PDP CONTEXT ACCEPT message from the network.

In the case of such a collision, the network initiated PDP context modification shall take precedence over the MS initiated PDP context modification. The MS shall terminate internally the MS initiated PDP context modification procedure, enter the state PDP-Active and proceed with the network initiated PDP context modification procedure by sending a MODIFY PDP CONTEXT ACCEPT message. The network shall ignore the MODIFY PDP CONTEXT REQUEST message received in the state PDP-MODIFY-PENDING. The network shall proceed with the network initiated PDP context modification procedure as if no MODIFY PDP CONTEXT REQUEST message was received from the MS.

Reference

3GPP TS 24.008 clause 6.1.3.3.4 b).

45.3.3.2.3 Test purpose

To test behaviour of the MS when it identifies collision of the MS and SS initiated PDP context modification with the same TI.

45.3.3.2.4 Method of test

Initial conditions

System Simulator:

1 cell, default parameters.

Mobile Station:

The MS is in GMM-state "GMM-REGISTERED, normal service" with valid P-TMSI and CKSN.

Specific PICS statements:

-

PIXIT statements:

-

Test procedure

A PDP context is activated by the user and accepted by the SS. The MS initiates a PDP context modification by sending a MODIFY PDP CONTEXT REQUEST message. Then the SS initiates the PDP context modification by sending MODIFY PDP CONTEXT REQUEST message with the same TI. The MS shall reply to the SS initiated PDP context modification procedure by sending MODIFY PDP CONTEXT ACCEPT message with the same TI.

Expected sequence

Step	Direction	Message	Comments
1	MS		Initiate a PDP context activation
2	MS -> SS	ACTIVATE PDP CONTEXT REQUEST	Activate a PDP context
3	SS -> MS	ACTIVATE PDP CONTEXT ACCEPT	Accept the PDP context activation
4	MS -> SS	MODIFY PDP CONTEXT REQUEST	Request modification of the PDP context, with new QoS
5	SS -> MS	MODIFY PDP CONTEXT REQUEST	Request modification of the PDP context with the same TI
6	MS		MS identifies collision, terminates internally the MS initiated PDP context modification procedure
7	MS -> SS	MODIFY PDP CONTEXT ACCEPT	Accept SS initiated PDP context modification. The TI flag set to 0.
8	SS		Wait for T3381 +10% seconds from Step 4 to ensure no further MODIFY PDP CONTEXT REQUEST messages are sent by the MS

Specific message contents

Activate PDP Context Request (used in step 2)

Information Element	Value/remark
Transaction identifier	In the range 0-6
Transaction identifier flag	0
NSAPI	In the range 5-15
Requested LLC SAPI	3, 5, 9 or 11
Requested QoS	Arbitrarily chosen
Requested PDP address	Arbitrarily chosen

Modify PDP Context Request (MS to Network direction) (used in step 4)

Information Element	Value/remark
Transaction identifier	As above
Transaction identifier flag	0

Modify PDP Context Request (Network to MS direction) (used in step 5)

Information Element	Value/remark
Transaction identifier	As above
Transaction identifier flag	1

Modify PDP Context Accept (used in step 7)

Information Element	Value/remark
Transaction identifier	As above
Transaction identifier flag	0

45.4 PDP context deactivation procedure

45.4.1 PDP context deactivation initiated by the MS

45.4.1.1 Conformance requirement

The message contains the transaction identifier in use for the PDP context to be deactivated and a cause code that typically indicates one of the following causes:

- #26: insufficient resources;
- #36: regular PDP context deactivation; or
- #37: QoS not accepted.

Upon receipt of the DEACTIVATE PDP CONTEXT ACCEPT message, the MS shall stop timer T3390.

- Whenever any session management message except REQUEST PDP CONTEXT ACTIVATION or SM-STATUS is received by the MS specifying a transaction identifier which is not recognised as relating to an active context or to a context that is in the process of activation or deactivation the MS shall send a SM-STATUS message with cause #81 "invalid transaction identifier value" using the received transaction identifier value and remain in the PDP-INACTIVE state.

Reference

3GPP TS 04.08 / 3GPP TS 24.008 subclauses 6.1.3.3.1 and 8.3.2 (b).

45.4.1.2 Test purpose

To test the behaviour of the MS upon receipt of a DEACTIVATE PDP CONTEXT ACCEPT message from the network.

45.4.1.3 Method of test

Specific PICS statements:

-

PIXIT statements:

-

Initial conditions

System Simulator:

1 cell, default parameters.

Mobile Station:

The MS is in GMM-state "GMM-REGISTERED, normal service" with valid P-TMSI and CKSN.

Test procedure

A PDP context is activated by the user and accepted by the SS. The context deactivation is then requested by the user. The MS shall send a DEACTIVATE PDP CONTEXT REQUEST message to the SS. The SS shall then reply with a DEACTIVATE PDP CONTEXT ACCEPT message. The SS shall then wait for T3390 +10% seconds to ensure T3390 has been stopped and that no further messages are sent from the MS. If the MS did not initiate detach procedure, the SS shall then send a MODIFY PDP CONTEXT REQUEST for the deactivated context and the MS shall reply with an SM STATUS message with cause #81 'transaction identifier not known'.

Maximum duration of test

5 minutes.

Expected sequence

Step	Direction	Message	Comments
1	MS		Initiate a context activation
2	MS -> SS	ACTIVATE PDP CONTEXT REQUEST	Activate a pdp context
3	SS -> MS	ACTIVATE PDP CONTEXT ACCEPT	Accept the pdp context
4	MS		Initiate a context deactivation
5	MS -> SS	DEACTIVATE PDP CONTEXT REQUEST	Request a deactivation of a pdp context
6	SS -> MS	DEACTIVATE PDP CONTEXT ACCEPT	Accept the pdp context deactivation
7	SS		Wait for T3390 +10% seconds to ensure no further deactivate request messages are sent Note: The MS may initiate Detach procedure during this time.
8A	MS -> SS	DETACH REQUEST	
9A	SS -> MS	DETACH ACCEPT	
8B	SS -> MS	MODIFY PDP CONTEXT REQUEST	Send a modify request for the deactivated context.
9B	MS -> SS	SM STATUS	Cause set to #81

Note: Branch 'A' is applicable if the MS initiates Detach procedure after the PDP context is deactivated. Otherwise branch 'B' is applicable.

Specific message contents

As default except:

Activate PDP Context Request

Information Element	Value/remark
Transaction identifier	In the range 0-6
Transaction identifier flag	0
NSAPI	In the range 5-15
Requested LLC SAPI	3, 5, 9 or 11
Requested QoS	Arbitrarily chosen
Requested PDP address	Arbitrarily chosen

Activate PDP Context Accept

Information Element	Value/remark
Transaction identifier	As above
Transaction identifier flag	1
Negotiated LLC SAPI	As above
Negotiated QoS	As above
Radio priority level	Arbitrarily chosen
Spare half octet	0

Deactivate PDP Context Request

Information Element	Value/remark
Transaction identifier	As above
Transaction identifier flag	0
SM cause	Regular Deactivation

Deactivate PDP Context Accept

Information Element	Value/remark
Transaction identifier	As above
Transaction identifier flag	1

Modify PDP Context Request

Information Element	Value/remark
Transaction identifier	As above
Transaction identifier flag	1
Radio priority level	As above
Spare half octet	0
Requested LLC SAPI	As above
New QoS	As above

SM Status

Information Element	Value/remark
Transaction identifier	As above
Transaction identifier flag	0
SM Cause	#81

45.4.2 PDP context deactivation initiated by the network

45.4.2.1 Conformance requirement

The MS shall, upon receipt of the DEACTIVATE PDP CONTEXT REQUEST message, reply with a DEACTIVATE PDP CONTEXT ACCEPT message.

- Whenever any session management message except REQUEST PDP CONTEXT ACTIVATION or SM-STATUS is received by the MS specifying a transaction identifier which is not recognised as relating to an active context or to a context that is in the process of activation or deactivation the MS shall send a SM-STATUS message with cause #81 "invalid transaction identifier value" using the received transaction identifier value and remain in the PDP-INACTIVE state.

Reference

3GPP TS 04.08 / 3GPP TS 24.008 subclauses 6.1.3.3.2 and 8.3.2 (b).

45.4.2.2 Test purpose

To test the behaviour of the MS upon receipt of a DEACTIVATE PDP CONTEXT REQUEST message from the network.

45.4.2.3 Method of test

Specific PICS statements:

-

PIXIT statements:

-

Initial conditions

System Simulator:

1 cell, default parameters.

Mobile Station:

The MS is in GMM-state "GMM-REGISTERED, normal service" with valid P-TMSI and CKSN.

Test procedure

A PDP context is activated by the user and accepted by the SS. A DEACTIVATE PDP CONTEXT REQUEST message is then sent by the SS. The MS shall reply with a DEACTIVATE PDP CONTEXT ACCEPT message. If the MS did not initiate detach procedure, the SS shall then send a MODIFY PDP CONTEXT REQUEST for the deactivated context and the MS shall reply with an SM STATUS message with cause #81 'transaction identifier not known'.

Maximum duration of test

5 minutes.

Expected sequence

Step	Direction	Message	Comments
1	MS		Initiate a context activation
2	MS -> SS	ACTIVATE PDP CONTEXT REQUEST	Activate a PDP context
3	SS -> MS	ACTIVATE PDP CONTEXT ACCEPT	Accept the PDP context
4	SS -> MS	DEACTIVATE PDP CONTEXT REQUEST	Request a deactivation of a pdp context
5	MS -> SS	DEACTIVATE PDP CONTEXT ACCEPT	Accept the pdp context deactivation.
			Wait for 10 seconds. The MS may initiate Detach procedure.
6A	MS -> SS	DETACH REQUEST	
6B	SS -> MS	MODIFY PDP CONTEXT REQUEST	Send a modify request for the deactivated context.
7B	MS -> SS	SM STATUS	Cause set to #81

Note: Branch 'A' is applicable if the MS initiates Detach procedure after the PDP context is deactivated. Otherwise branch 'B' is applicable.

Specific message contents

As default except:

Activate PDP Context Request

Information Element	Value/remark
Transaction identifier	In the range 0-6
Transaction identifier flag	0
NSAPI	In the range 5-15
Requested LLC SAPI	3, 5, 9 or 11
Requested QoS	Arbitrarily chosen
Requested PDP address	Arbitrarily chosen

Activate PDP Context Accept

Information Element	Value/remark
Transaction identifier	As above
Transaction identifier flag	1
Negotiated LLC SAPI	As above
Negotiated QoS	As above
Radio priority level	Arbitrarily chosen
Spare half octet	0

Deactivate PDP Context Request

Information Element	Value/remark
Transaction identifier	As above
Transaction identifier flag	1
SM cause	Regular Deactivation

Deactivate PDP Context Accept

Information Element	Value/remark
Transaction identifier	As above
Transaction identifier flag	0

Modify PDP Context Request

Information Element	Value/remark
Transaction identifier	As above
Transaction identifier flag	1
Radio priority level	As above
Spare half octet	0
Requested LLC SAPI	As above
New QoS	As above

SM Status

Information Element	Value/remark
Transaction identifier	As above
Transaction identifier flag	0
SM Cause	#81

45.4.3 Abnormal cases

45.4.3.1 T3390 Expiry

45.4.3.1.1 Conformance requirement

- 1) On the first expiry of timer T3390, the MS shall resend the message DEACTIVATE PDP CONTEXT REQUEST.
- 2) On the second expiry of timer T3390, the MS shall resend the message DEACTIVATE PDP CONTEXT REQUEST.
- 3) On the third expiry of timer T3390, the MS shall resend the message DEACTIVATE PDP CONTEXT REQUEST.
- 4) On the fourth expiry of timer T3390, the MS shall resend the message DEACTIVATE PDP CONTEXT REQUEST.
- 5) On the fifth expiry of timer T3390, the MS shall release all resources allocated and shall erase the PDP context related data.

Reference

3GPP TS 04.08 / 3GPP TS 24.008 subclause 6.1.3.3.3.

45.4.3.1.2 Test purpose

To test the behaviour of the MS when the network does not reply to a DEACTIVATE PDP CONTEXT REQUEST message from the MS.

45.4.3.1.3 Method of test

Specific PICS statements:

-

PIXIT statements:

-

Initial conditions

System Simulator:

1 cell, default parameters.

Mobile Station:

The MS is in GMM-state "GMM-REGISTERED, normal service" with valid P-TMSI and CKSN.

Test procedure

A PDP context is activated by the user and accepted by the SS. A context deactivation is then requested by the user. The MS shall send a DEACTIVATE PDP CONTEXT REQUEST message five times with $T3390 \pm 10\%$ seconds between each message. $T3390 + 10\%$ seconds after the fifth message the SS shall send a MODIFY PDP CONTEXT REQUEST message for the deactivated context and the MS shall reply with SM STATUS with cause set to #81 'Transaction identifier not known'.

Maximum duration of test

5 minutes.

Expected sequence

Step	Direction	Message	Comments
1	MS		Initiate a context activation
2	MS -> SS	ACTIVATE PDP CONTEXT REQUEST	Activate a PDP context
3	SS -> MS	ACTIVATE PDP CONTEXT ACCEPT	Accept the PDP context
4	MS		Initiate a context deactivation
5	MS -> SS	DEACTIVATE PDP CONTEXT REQUEST	Request a deactivation of a pdp context
6	SS		T3390 ±10% seconds
7	MS -> SS	DEACTIVATE PDP CONTEXT REQUEST	Request a deactivation of a pdp context
8	SS		T3390 ±10% seconds
9	MS -> SS	DEACTIVATE PDP CONTEXT REQUEST	Request a deactivation of a pdp context
10	SS		T3390 ±10% seconds
11	MS -> SS	DEACTIVATE PDP CONTEXT REQUEST	Request a deactivation of a pdp context
12	SS		T3390 ±10% seconds
13	MS -> SS	DEACTIVATE PDP CONTEXT REQUEST	Request a deactivation of a pdp context
14	SS		Wait T3390 +10% seconds
15	SS -> MS	MODIFY PDP CONTEXT REQUEST	Try to modify the deactivated context.
16	MS -> SS	SM STATUS	Cause set to #81

Specific message contents

As default except:

Activate PDP Context Request

Information Element	Value/remark
Transaction identifier	In the range 0-6
Transaction identifier flag	0
NSAPI	In the range 5-15
Requested LLC SAPI	3, 5, 9 or 11
Requested QoS	Arbitrarily chosen
Requested PDP address	Arbitrarily chosen

Activate PDP Context Accept

Information Element	Value/remark
Transaction identifier	As above
Transaction identifier flag	1
Negotiated LLC SAPI	As above
Negotiated QoS	As above
Radio priority level	Arbitrarily chosen
Spare half octet	0

Deactivate PDP Context Request

Information Element	Value/remark
Transaction identifier	As above
Transaction identifier flag	0
SM cause	Regular Deactivation

Modify PDP Context Request

Information Element	Value/remark
Transaction identifier	As above
Transaction identifier flag	1
Radio priority level	As above
Spare half octet	0
Requested LLC SAPI	As above
New QoS	As above

SM Status

Information Element	Value/remark
Transaction identifier	As above
Transaction identifier flag	0
SM Cause	#81

45.4.3.2 Collision of MS and network initiated PDP context deactivation requests

45.4.3.2.1 Conformance requirement

If the MS and the network initiated PDP context deactivation requests collide, the MS and the network shall each reply with the message DEACTIVATE PDP CONTEXT ACCEPT and shall stop timer T3390 and T3395, respectively.

Reference

3GPP TS 04.08 / 3GPP TS 24.008 subclause 6.1.3.3.3.

45.4.3.2.2 Test purpose

To test the behaviour of the MS when there is a collision between an MS initiated and a network initiated context deactivation.

45.4.3.2.3 Method of test

Specific PICS statements:

-

PIXIT statements:

-

Initial conditions

System Simulator:

1 cell, default parameters.

Mobile Station:

The MS is in GMM-state "GMM-REGISTERED, normal service" with valid P-TMSI and CKSN.

Test procedure

A PDP context is activated by the user and accepted by the SS. A context deactivation is then requested by the user. Upon receipt of the DEACTIVATE PDP CONTEXT REQUEST message the SS sends a DEACTIVATE PDP CONTEXT REQUEST message. The MS shall reply with only one DEACTIVATE PDP CONTEXT ACCEPT message. Upon receipt of this message the SS sends a DEACTIVATE PDP CONTEXT ACCEPT message.

Maximum duration of test

5 minutes.

Expected sequence

Step	Direction	Message	Comments
1	MS		Initiate a context activation
2	MS -> SS	ACTIVATE PDP CONTEXT REQUEST	Activate a PDP context
3	SS -> MS	ACTIVATE PDP CONTEXT ACCEPT	Accept the PDP context
4	MS		Initiate a context deactivation
5	MS -> SS	DEACTIVATE PDP CONTEXT REQUEST	Request a deactivation of a pdp context
6	SS -> MS	DEACTIVATE PDP CONTEXT REQUEST	Request a deactivation of a pdp context
7	MS -> SS	DEACTIVATE PDP CONTEXT ACCEPT	Accept the pdp context deactivation
8	SS -> MS	DEACTIVATE PDP CONTEXT ACCEPT	Accept the pdp context deactivation

Specific message contents

As default except:

Activate PDP Context Request

Information Element	Value/remark
Transaction identifier	In the range 0-6
Transaction identifier flag	0
NSAPI	In the range 5-15
Requested LLC SAPI	3, 5, 9 or 11
Requested QoS	Arbitrarily chosen
Requested PDP address	Arbitrarily chosen

Activate PDP Context Accept

Information Element	Value/remark
Transaction identifier	As above
Transaction identifier flag	1
Negotiated LLC SAPI	As above
Negotiated QoS	As above
Radio priority level	Arbitrarily chosen
Spare half octet	0

Deactivate PDP Context Request (used in step 5)

Information Element	Value/remark
Transaction identifier	As above
Transaction identifier flag	0
SM cause	Regular Deactivation

Deactivate PDP Context Request (used in step 6)

Information Element	Value/remark
Transaction identifier	As above
Transaction identifier flag	1
SM cause	Regular Deactivation

Deactivate PDP Context Accept (used in step 7)

Information Element	Value/remark
Transaction identifier	As above
Transaction identifier flag	0

Deactivate PDP Context Accept (used in step 8)

Information Element	Value/remark
Transaction identifier	As above
Transaction identifier flag	1

45.4.4 PDP context deactivation initiated by the network / Tear down indicator

45.4.4.1 Conformance requirement

The PDP context deactivation may be initiated by the MS or by the network. The *tear down indicator* information element may be included in the DEACTIVATE PDP CONTEXT REQUEST message in order to indicate whether only the PDP context associated with this specific TI or all active PDP contexts sharing the same PDP address as the PDP context associated with this specific TI shall be deactivated. If the *tear down indicator* information element is not included in the DEACTIVATE PDP CONTEXT REQUEST message, only the PDP context associated with this specific TI shall be deactivated.

The Tear down indicator IE is included in the message in order to indicate whether only the PDP context associated with this specific TI or all active PDP contexts sharing the same PDP address as the PDP context associated with this specific TI shall be deactivated.

Reference

3GPP TS 24.008 subclauses 6.1.3.4, 8.3.2 (b) and 9.5.14.1.

45.4.4.2 Test purpose

To test the behaviour of the MS upon receipt of a DEACTIVATE PDP CONTEXT REQUEST message from the network including Tear down indicator IE.

45.4.4.3 Method of test

Specific PICS statements:

-

PIXIT statements:

-

Initial conditions

System Simulator:

1 cell, default parameters.

Mobile Station:

The MS is in GMM-state "GMM-REGISTERED, normal service" with valid P-TMSI and CKSN.

Test procedure

A PDP context is activated by the user and accepted by the SS. A Secondary PDP context is activated by the user and accepted by the SS. A DEACTIVATE PDP CONTEXT REQUEST message is then sent by the SS indicating the TI of second PDP context and including Tear down indicator IE. The MS shall reply with a DEACTIVATE PDP CONTEXT ACCEPT message. The SS shall then send a MODIFY PDP CONTEXT REQUEST including the TI of second PDP context and the MS shall reply with an SM STATUS message with cause #81 'transaction identifier not known'. The SS shall then send a MODIFY PDP CONTEXT REQUEST including the TI of the first PDP context and the MS shall reply with an SM STATUS message with cause #81 'transaction identifier not known'.

Maximum duration of test

5 minutes.

Expected sequence

Step	Direction	Message	Comments
1	MS		Initiate a context activation
2	MS -> SS	ACTIVATE PDP CONTEXT REQUEST	Activate a PDP context
3	SS -> MS	ACTIVATE PDP CONTEXT ACCEPT	Accept the PDP context
4	MS		Initiate a secondary PDP context activation
5	MS -> SS	ACTIVATE SECONDARY PDP CONTEXT REQUEST	Request a Secondary PDP context activation
6	SS -> MS	ACTIVATE SECONDARY PDP CONTEXT ACCEPT	Accept the Secondary PDP context activation
7	SS -> MS	DEACTIVATE PDP CONTEXT REQUEST	Request a deactivation of a pdp context. Include TI of second PDP context and Tear down indicator flag set to 1.
8	MS -> SS	DEACTIVATE PDP CONTEXT ACCEPT	Accept the pdp context deactivation. TI is the same as step 7.
9	SS -> MS	MODIFY PDP CONTEXT REQUEST	Send a modify request including the TI of second PDP context.
10	MS -> SS	SM STATUS	Cause set to #81
11	SS -> MS	MODIFY PDP CONTEXT REQUEST	Send a modify request including the TI of first PDP context.
12	MS -> SS	SM STATUS	Cause set to #81

Specific message contents

None.

45.5 Unknown or Unforeseen Transaction Identifier/Non-semantic Mandatory Information Element Errors

45.5.1 Error cases

45.5.1.1 Conformance requirement

45.5.1.1.1 Conformance requirement for release 98 and earlier MS

The mobile station shall reject a session management message other than SM-STATUS received with TI value "111" by immediately sending an SM-STATUS message with TI value "111". For a session management message received with TI different from "111", the following procedures shall apply:

- Whenever any session management message except REQUEST PDP CONTEXT ACTIVATION or SM-STATUS is received by the MS specifying a transaction identifier which is not recognised as relating to an active context or to a context that is in the process of activation or deactivation or has been [recently] deactivated, the MS shall send a SM-STATUS message with cause #81 "invalid transaction identifier value" using the received transaction identifier value and remain in the PDP-INACTIVE state.
- When a REQUEST PDP CONTEXT ACTIVATION message is received with a transaction identifier flag set to "1", this message shall be ignored.

When on receipt of a message:

- an "imperative message part" error; or
- a "missing mandatory IE" error;

is diagnosed or when a message containing:

- a syntactically incorrect mandatory IE; or
- an IE unknown in the message, but encoded as "comprehension required"; or
- an out of sequence IE encoded as "comprehension required";

is received, the mobile station shall proceed as follows:

- If the message was an SM message the SM-STATUS message with cause # 96 "invalid mandatory information" shall be returned.
- If a mobile station receives a GMM message or SM message with message type not defined for the PD or not implemented by the receiver, it shall return a status message (GMM STATUS or SM STATUS depending on the protocol discriminator) with cause #97 'message type non-existent or not implemented'.
- If the mobile station receives a message not compatible with the protocol state, the mobile station shall ignore the message except for the fact that, if an RR connection exists, it returns a status message (STATUS, MM STATUS depending on the protocol discriminator) with cause #98 "Message type not compatible with protocol state". When the message was a GMM message the GMM-STATUS message with cause #98 "Message type not compatible with protocol state" shall be returned. When the message was a SM message the SM-STATUS message with cause #98 'Message type not compatible with protocol state' shall be returned.
- Other syntactic errors.

This subclause applies to the analysis of the value part of an information element. It defines the following terminology:

- An IE is defined to be syntactically incorrect in a message if it contains at least one value defined as 'reserved', or if its value part violates syntactic rules given in the specification of the value part. However it is not a syntactical error that a type 4 standard IE specifies in its length indicator a greater length than possible according to the value part specification: extra bits are ignored.

Reference

3GPP TS 04.08 subclauses 8.3.2 and 8.5.

3GPP TS 04.07 subclause 11.4.2.

45.5.1.1.2 Conformance requirement for release 99 and later MS

The mobile station and network shall ignore a session management message with TI EXT bit = 0. Otherwise, the following procedures shall apply:

- Whenever any session management message except REQUEST PDP CONTEXT ACTIVATION or SM-STATUS is received by the MS specifying a transaction identifier which is not recognized as relating to an active context or to a context that is in the process of activation or deactivation, the MS shall send a SM-STATUS message with cause #81 "invalid transaction identifier value" using the received transaction identifier value including the extension octet and remain in the PDP-INACTIVE state.
- When REQUEST PDP CONTEXT ACTIVATION message is received with a transaction identifier flag set to "1", this message shall be ignored.

When on receipt of a message,

- an "imperative message part" error; or
- a "missing mandatory IE" error;

is diagnosed or when a message containing:

- a syntactically incorrect mandatory IE; or
- an IE unknown in the message, but encoded as "comprehension required" (see 3GPP TS 24.007); or
- an out of sequence IE encoded as "comprehension required" (see 3GPP TS 24.007) is received,

the mobile station shall proceed as follows:

If the message is not one of the messages listed in subclauses 8.5.1, 8.5.2, 8.5.3, 8.5.4 and 8.5.5 a) or b), the mobile station shall ignore the message except for the fact that, if an RR connection exists, it shall return a status message (STATUS, MM STATUS depending on the protocol discriminator) with cause # 96 "Invalid mandatory information". If the message was a GMM message the GMM-STATUS message with cause #96 "Invalid

mandatory information" shall be returned. If the message was an SM message the SM-STATUS message with cause # 96 "invalid mandatory information" shall be returned.

- the network shall proceed as follows:

When the message is not one of the messages listed in subclause 8.5.3 b), c), d) or e) and 8.5.5 a) or c), the network shall either:

- try to treat the message (the exact further actions are implementation dependent), or
- ignore the message except that it should return a status message (STATUS, or MM STATUS (depending on the protocol discriminator), GMM STATUS, or SM STATUS) with cause # 96 "Invalid mandatory information".

This subclause applies to the analysis of the value part of an information element. It defines the following terminology:

- An IE is defined to be syntactically incorrect in a message if it contains at least one value defined as 'reserved', or if its value part violates syntactic rules given in the specification of the value part. However it is not a syntactical error that a type 4 standard IE specifies in its length indicator a greater length than possible according to the value part specification: extra bits are ignored.

Reference

3GPP TS 24.008 subclauses 6.1, 8.3.2, 8.5 and 9.5.2.1.

3GPP TS 24.007 subclause 11.4.2.

45.5.1.2 Test Purpose

To test the behaviour of the MS when messages with unknown or unforeseen transaction identifiers or non-semantic mandatory information element errors occur.

45.5.1.3 Method of test

Specific PICS statements:

- MS GPRS Release (TSPC_MS_GPRS_RELEASE)

PIXIT statements:

-

Initial conditions

System Simulator:

1 cell, default parameters.

Mobile Station:

The MS is in GMM-state "GMM-REGISTERED, normal service" with valid P-TMSI and CKSN.

Test procedure

A PDP context activation is requested by the SS with the transaction identifier set to '1'. The MS shall not respond to this request.

A PDP context is then activated from the MS with a Static PDP Address. An invalid accept message is then sent by the SS. The MS shall then send an SM STATUS message. After the MS has sent an ACTIVATE PDP CONTEXT REQUEST message the SS sends a MODIFY PDP CONTEXT REQUEST message with the same transaction identifier. The MS shall reply with an SM STATUS message with the cause set to #98 'Message type not compatible with protocol state'.

After T3380 has expired $\pm 10\%$ seconds the MS shall send another ACTIVATE PDP CONTEXT REQUEST message. The SS sends back a Session Management message with an unknown message type. The MS shall reply with an SM STATUS message with the cause set to #97 'Message type non-existent or not implemented'.

After a further T3380 has expired the MS shall send another ACTIVATE PDP CONTEXT REQUEST message $\pm 10\%$ seconds. Another invalid accept message is sent by the SS.

After a further T3380 has expired $\pm 10\%$ seconds a valid accept message with QoS length greater than 3 is sent by the SS. This shall be accepted by the MS.

A deactivate message is then sent from the SS coded with the extension mechanism for TI. Therefore the TIO value is set to 111 and the transaction identifier extension TIE is set to an unused value greater than 6 (no reserved value). A MS implemented release 98 or earlier should reply with an SM STATUS message with transaction identifier set to '111'. A Rel.99 MS shall reply with an SM STATUS message with cause #81 'invalid transaction identifier value'.

A deactivate message is then sent from the SS with a different transaction identifier to the one used in the activate request message sent by the MS. The MS shall reply with an SM STATUS message with cause #81 'invalid transaction identifier value'.

Two invalid modification messages are then sent to the MS in turn. The MS shall respond each time with an SM-STATUS message with cause # 96 "invalid mandatory information".

Maximum duration of test

5 minutes.

Expected sequence

Step	Direction	Message	Comments
1	SS -> MS	REQUEST PDP CONTEXT ACTIVATION	Request the activation of a PDP context with the transaction identifier flag set to "1"
2	SS		Wait 30 seconds to ensure MS does not request context activation
3	MS		Initiate a context request
4	MS -> SS	ACTIVATE PDP CONTEXT REQUEST	Activate a PDP context from the MS (Static PDP Address)
5	SS -> MS	ACTIVATE PDP CONTEXT ACCEPT	Unknown IE encoded as 'comprehension required'
6	MS -> SS	SM STATUS	Cause set to #96
7	MS -> SS	ACTIVATE PDP CONTEXT REQUEST	Activate a PDP context from the MS (auto-generated) This message shall be sent within T3380 seconds $\pm 10\%$ from the last ACTIVATE PDP CONTEXT REQUEST message
8	SS -> MS	MODIFY PDP CONTEXT REQUEST	Request the modification of the PDP context
9	MS -> SS	SM STATUS	Cause set to #98 'Message type not compatible with protocol state'.
10	MS -> SS	ACTIVATE PDP CONTEXT REQUEST	Activate a PDP context from the MS (auto-generated) This message shall be sent within T3380 seconds $\pm 10\%$ from the last ACTIVATE PDP CONTEXT REQUEST message
11	SS -> MS	UNKNOWN MESSAGE	Message with unknown message type
12	MS -> SS	SM STATUS	Cause set to #97 'message type non-existent or not implemented'.
13	MS -> SS	ACTIVATE PDP CONTEXT REQUEST	Activate a PDP context from the MS (auto-generated) This message shall be sent within T3380 seconds $\pm 10\%$ from the last ACTIVATE PDP CONTEXT REQUEST message
14	SS -> MS	ACTIVATE PDP CONTEXT ACCEPT	Out of sequence IE encoded as 'comprehension required'
15	MS -> SS	SM STATUS	Cause set to #96
16	MS -> SS	ACTIVATE PDP CONTEXT REQUEST	Activate a PDP context from the MS (auto-generated) This message shall be sent within T3380 seconds $\pm 10\%$ from the last ACTIVATE PDP CONTEXT REQUEST message
17	SS -> MS	ACTIVATE PDP CONTEXT ACCEPT	Accept the PDP context
			Step 18A, 19A is performed for release 98 and earlier MS and step 18B, 19B for release 99 and later MS implementation
18A	SS -> MS	DEACTIVATE PDP CONTEXT REQUEST	TI set to "111"
18B	SS -> MS	DEACTIVATE PDP CONTEXT REQUEST	TIO=111 and TIE=not used value greater than 6
19A	MS -> SS	SM STATUS	TI set to "111", cause value not checked
19B	MS->SS	SM STATUS	with cause #81 "invalid transaction identifier value"
20	SS -> MS	DEACTIVATE PDP CONTEXT REQUEST	Try to deactivate the context with a different transaction identifier to that used to activate the context
21	MS -> SS	SM STATUS	Cause set to # 81
22	SS -> MS	MODIFY PDP CONTEXT REQUEST	Request the modification of the PDP context
23	MS -> SS	SM STATUS	Cause set to # 96
24	SS -> MS	MODIFY PDP CONTEXT REQUEST	Request the modification of the PDP context
25	MS -> SS	SM STATUS	Cause set to # 96

Specific message contents

As default except:

Request PDP Context Activation

Information Element	Value/remark
Transaction identifier	In the range 0-6
Transaction identifier flag	1
Offered PDP address	Arbitrarily chosen

Activate PDP Context Request

Information Element	Value/remark
Transaction identifier	In the range 0-6
Transaction identifier flag	0
NSAPI	In the range 5-15
Requested LLC SAPI	3, 5, 9 or 11
Requested QoS	Arbitrarily chosen
Requested PDP address	Arbitrarily chosen (Static PDP Address)

Activate PDP Context Accept (used in step 5)

Information Element	Value/remark
Transaction identifier	As above
Transaction identifier flag	1
Negotiated LLC SAPI	As above
Negotiated QoS	As above
Radio priority level	Arbitrarily chosen
Spare half octet	0
PDP address	omitted
'Comprehension required IE'	0Fh NOTE: first four bits encoded as 'comprehension required'

Activate PDP Context Accept (used in step 14)

Information Element	Value/remark
Transaction identifier	As above
Transaction identifier flag	1
Negotiated LLC SAPI	As above
Negotiated QoS	As above
Radio priority level	Arbitrarily chosen
Spare half octet	0
PDP address	omitted
'Comprehension required IE'	07h NOTE: first four bits encoded as 'comprehension required'
Protocol configuration options	Minimum length with Configuration protocol of 'PPP'

Activate PDP Context Accept (used in step 17)

Information Element	Value/remark
Transaction identifier	As above
Transaction identifier flag	1
Negotiated LLC SAPI	As above
Negotiated QoS	As above but For R97 and R98 : Length set to 5 and 2 extra octets set to 0 after the normal QoS octets For R99 and Rel-4 : Length set to 13 and 2 extra octets set to 0 after the normal QoS octets For Rel-5 and later: Length set to 16 and 2 extra octets set to 0 after the normal QoS octets
Radio priority level	Arbitrarily chosen
Spare half octet	0
PDP address	omitted

Deactivate PDP Context Request (used in step 18)

Information Element	Value/remark
Transaction identifier	111
Transaction identifier flag	1
SM cause	24h, regular deactivation

Deactivate PDP Context Request (used in step 20)

Information Element	Value/remark
Transaction identifier	In the range 0-6, but different from the TI in the Activate PDP Context Request message
Transaction identifier flag	1
SM cause	24h, regular deactivation

Modify PDP Context Request (used in step 22)

Information Element	Value/remark
Transaction identifier	As in step 17
Transaction identifier flag	1
Radio priority level	As above
Spare half octet	0
Requested LLC SAPI	As above
New QoS	This IE will NOT be present

Modify PDP Context Request (used in step 24)

Information Element	Value/remark
Transaction identifier	As in step 17
Transaction identifier flag	1
Radio priority level	As above
Spare half octet	0
Requested LLC SAPI	Fh, NOTE: this is a reserved value
New QoS	Arbitrary value

46 LLC and SMDCP Tests

46.1 LLC Tests

This subclause contains the test case requirements for Logical Link Control (LLC) procedures in the General Packet Radio Service (GPRS).

46.1.1 Default Conditions

The default values of LLC layer parameters are as per "Table 9: LLC layer parameter default values" in clause 8.9.8 of 3GPP TS 04.64. It is possible that the MS negotiates values different from what is given in the table. In the case where the negotiated value affects the test operation, this is noted in the test.

- The MS default initial condition is that it is GPRS attached and ciphering disabled.

Unless stated otherwise, the default conditions shall apply. N_{MS} denotes the frames sent from the MS and N_{SS} denotes the frames sent from the SS.

Unless stated otherwise the timer T3192 should be set to 80ms.

For all timers, a measurement tolerance of $\pm 10\%$ shall be applied.

The MS may send an XID command any time. The SS shall send an XID response accepting the values proposed by the MS, unless stated otherwise in the test case.

46.1.2 Test cases

46.1.2.1 Unacknowledged data transfer

46.1.2.1.1 Data transmission in protected mode

46.1.2.1.1.1 Conformance requirement

LLC has two modes of operation - acknowledged and unacknowledged. In the unacknowledged mode of operation, layer3 information is transmitted in numbered Unconfirmed Information (UI) frames. The UI frames are not acknowledged at the LLC layer. Neither error recovery nor reordering mechanisms is defined, but transmission and format errors are detected. Duplicate UI frames are discarded.

In the protected mode of unacknowledged operation, the FCS field protects the frame header and the information field.

Unacknowledged mode of operation is defined for all SAPIs that are not reserved.

Reference

3GPP TS 04.64, subclause 4.3.

46.1.2.1.1.2 Test purpose

To verify that the MS performs unacknowledged data transfer for SAPIs 3, 5 and 11 in the protected mode to the network

46.1.2.1.1.3 Method of test

Initial conditions

The MS shall be GPRS attached with ciphering enabled. Encryption GEA1, GEA2 or GEA3 is used depending on the execution counter K.

Specific PICS statements:

- Supported encryption Algorithm : GEA2 (TSPC_Feat_GEA2)
- Supported encryption Algorithm : GEA3 (TSPC_Feat_GEA3)

PIXIT statements:

-

Test procedure

During GPRS attach ciphering GEA1, GEA2 or GEA3 is activated depending on the execution counter K.

During GPRS attach and PDP context activation, the GMM messages are sent and received by the LLC layer at the MS using UI frames in the unacknowledged mode, on SAPI 1. This implicitly verifies bi-directional unacknowledged data transmission on SAPI 1.

After the PDP context is activated, the MS is made to initiate unacknowledged data transfer on SAPI 3. MS shall transmit UI frames with the E and PM bits set to 1, indicating that encryption and protection are on. Transmit 5 000 octets from the MS.

Repeat the test case for SAPIs 5 and 11.

The test is performed for all GEAX encryption algorithmn supported by the MS.

Maximum duration of the test

10 minutes.

Expected sequence

The sequence is performed for execution counter K=1 and optionally for K=2 when the MS supports GEA2 and optionally for K=3 when the MS supports GEA3.

Step	Direction	Message	Comments
1		{PDP Context Activation}	Macro. PDP context activation from the MS. The PDP context used here is PDP context 5.
2			Initiate data transfer of 5000 octets from the MS.
3	MS -> SS	UI frame	Verify that the number of octets in the UI frame does not exceed N201-U. Verify that E=1 and PM=1, PD=0, C/R = 0 and the FCS is correct. Check whether the SAPI is 3, 5 or 11 when data is sent from the MS on these SAPIs. Verify that the sequence numbers are correct and that there are no duplicate or missing frames
4			Repeat step 3 until 5000 octets are sent.
5			Repeat the test case for SAPIs 5 and 11. The PDP context used for SAPI 5 is PDP Context 8 and the one for SAPI 11 is PDP Context 9.

46.1.2.1.2 Data transmission in unprotected mode

46.1.2.1.2.1 Conformance requirement

LLC has two modes of operation - acknowledged and unacknowledged. In the unacknowledged mode of operation, layer3 information is transmitted in numbered Unconfirmed Information (UI) frames. The UI frames are not acknowledged at the LLC layer. Neither error recovery nor reordering mechanisms is defined, but transmission and format errors are detected. Duplicate UI frames are discarded.

In the unprotected mode of unacknowledged operation, the FCS field protects the frame header and the first N202 octets of the information field

Unacknowledged mode of operation is defined for all SAPIs that are not reserved.

Reference

3GPP TS 04.64, subclause 4.3.

46.1.2.1.2.2 Test purpose

To verify that the MS performs unacknowledged data transfer without protection in the correct manner, on SAPIs 5 and 9.

46.1.2.1.2.3 Method of test

Initial conditions

-

Specific PICS statements:

-

PIXIT statements:

-

Test procedure

After the PDP context is activated, the MS initiates unacknowledged data transfer on SAPI 5. The MS shall transmit UI frames with the E and PM bits set to 0, indicating that encryption and protection are off.

Repeat the test case for SAPI 9.

Maximum duration of the test

3 minutes.

Expected sequence

Step	Direction	Message	Comments
1		{PDP Context Activation}	Macro.Initiate PDP context activation from the MS. Use PDP context 10.
2			Initiate unacknowledged data transfer for 5000 octets, from the MS.
3	MS -> SS	UI frame	Verify that the number of octets received at the MS in the UI frame does not exceed N201-U. Verify that E=0 and PM=0, PD=0, C/R = 0 and the FCS is correct. Verify that SAPI = 5 for the first run of the test case and SAPI=9 for the second run of the test case. Verify that the sequence numbers are correct and that there are no duplicate frames.
4	MS -> SS		Repeat step 3 until data transfer is complete.
5		.	Repeat the test case with PDP Context 6. This will use SAPI 9.

46.1.2.1.3 Reception of I frame in ADM

46.1.2.1.3.1 Conformance requirement

The DM unnumbered response shall be used by an LLE to report to its peer entity that the LLE is in a state such that ABM operation cannot be performed. An LLE shall transmit a DM response to any valid command received that it cannot action.

No information field is permitted within the DM response.

Reference

3GPP TS 04.64, clause 6.4.1.4.

46.1.2.1.3.2 Test purpose

To verify that the MS sends a DM response if an I frame is received while in unacknowledged mode.

46.1.2.1.3.3 Method of test

Initial conditions

-

Specific PICS statements:

-

PIXIT statements:

-

Test procedure

After sending data to the MS in unacknowledged mode, send an I frame from the SS. The MS shall send a DM response to indicate that it cannot perform an ABM operation.

Maximum duration of the test

3 minutes.

Expected sequence

Step	Direction	Message	Comments
1		{PDP Context Activation}	Macro. Initiate PDP context activation from the MS. Use PDP context 1.
2			Initiate unacknowledged data transfer for 2000 octets, from the SS.
3	SS -> MS	UI frame	
4			Repeat step 3 until 1500 octets are transmitted.
5	SS -> MS	I frame	Send an I Command frame (C/R bit set to 1) from the SS
6	MS -> SS	DM response	Verify that the MS sends a DM response with F = 0.
7			Repeat step 3 until all 2000 octets are transmitted. The MS must not send anymore DM frames.

46.1.2.2 Acknowledged data transfer

46.1.2.2.1 Link establishment

46.1.2.2.1.1 Link establishment from MS to SS

46.1.2.2.1.1.1 Conformance requirement

In the acknowledged operation, layer 3 information is transmitted in numbered Information (I) frames. The I frames are acknowledged at the LLC layer. Error recovery and reordering procedures based on retransmission of unacknowledged I frames are specified.

Acknowledged operation requires that ABM operation has been initiated by an establishment procedure using the Set Asynchronous Balanced Mode (SABM) command.

Acknowledged operation is allowed for all SAPIs that are not reserved except SAPIs 1 and 7 for Release 97-98 and 1, 2, 7 and 8 for Release 99.

Reference

3GPP TS 04.64, subclauses 4.4 and 8.5.2.

46.1.2.2.1.1.2 Test purpose

To test the establishment of acknowledged mode data transfer from the MS to the SS.

46.1.2.2.1.1.3 Method of test

Initial conditions

-

Specific PICS statements:

-

PIXIT statements:

-

Test procedure

Initiate acknowledged data transfer from the MS on SAPI 3. Verify that the MS establishes a link before initiating data transfer.

Initiate data transfer from the MS and ensure that the data sent from the MS is received at the SS.

Maximum duration of the test

5 minutes.

Expected sequence

Step	Direction	Message	Comments
1		{PDP Context Activation}	Macro. Initiate PDP context activation from the MS using PDP Context11.
2	MS -> SS	SABM	Verify that P/F =1.
3	SS -> MS	UA	Send UA from the SS before T200 can expire at the MS. Verify that the MS does not resend SABM.
4			Initiate data transfer of 5000 octets from the MS.
5	MS -> SS	I + S	
6	SS -> MS	RR	Acknowledge whenever requested by the MS. Ensure that the MS does not retransmit the data.
7			Repeat steps 5 and 6 until data transfer is completed

46.1.2.2.1.2 Link establishment from SS to MS

46.1.2.2.1.2.1 Conformance requirement

In the acknowledged operation, layer 3 information is transmitted in numbered Information (I) frames. The I frames are acknowledged at the LLC layer. Error recovery and reordering procedures based on retransmission of unacknowledged I frames are specified.

Acknowledged operation requires that ABM operation has been initiated by an establishment procedure using the Set Asynchronous Balanced Mode (SABM) command.

Acknowledged operation is allowed for all SAPIs that are not reserved except SAPIs 1 and 7.

An LLE shall initiate a request for release of the ABM operation by transmitting a DISC command with the P bit set to 1.

An LLE receiving a DISC command while in ABM state shall transmit a UA response with the F bit set to the same binary value as the P bit in the received DISC command.

Reference

3GPP TS 04.64, subclauses 4.4 and 8.5.2.

46.1.2.2.1.2.2 Test purpose

To test the establishment and release of acknowledged mode data transfer from the SS to the MS.

46.1.2.2.1.2.3 Method of test

Initial conditions

-

Specific PICS statements:

-

PIXIT statements:

-

Test procedure

Initiate PDP context activation from the MS . Do a PDP context modification from the SS, which will make the SS initiate a link establishment.

Initiate acknowledged data transfer from the SS on SAPI 9. Verify that the MS responds with a UA.

Initiate data transfer from the SS and ensure that the data sent from the SS is received at the MS.

Terminate data transfer from the SS.

Maximum duration of the test

3 minutes.

Expected sequence

Step	Direction	Message	Comments
1		{PDP Context Activation}	Macro. Initiate PDP context activation from the MS using PDP Context 10.
2		{PDP Context Modification}	Macro. Initiate PDP context modification from the SS using PDP Context 12.
3	SS -> MS	SABM	Send SABM with P/F = 1.
4	MS -> SS	UA	Verify that UA is received before the T200 timer at the SS expires.
5			Initiate data transfer of 2000 octets from the SS.
6	SS -> MS	I + S	Set the A bit to 1 in each I+S frame.
A7(optional step)	MS -> SS	RNR	The MS can send an RNR. Stop data transmission until the MS sends an RR.
7	MS -> SS	RR	Verify that the MS sends an RR for each frame.
8			Repeat steps 6 and 7 until 2000 octets are sent.
9	SS -> MS	DISC	Send DISC from the SS.
10	MS -> SS	UA	

46.1.2.2.1.3 Loss of UA frame

46.1.2.2.1.3.1 Conformance requirement

If timer T200 expires before the UA or DM response with the F bit set to 1 is received, the LLE shall:

- retransmit the SABM command;
- set timer T200;
- increment the retransmission counter.

Reference

3GPP TS 04.64, subclause 8.5.1.3.

46.1.2.2.1.3.2 Test purpose

To test the MS response to the loss of a UA frame during link establishment.

46.1.2.2.1.3.3 Method of test

Initial conditions

-

Specific PICS statements:

-

PIXIT statements:

-

Test procedure

Initiate link establishment for acknowledged data transfer from the MS, for SAPI 9. When the SS receives the SABM frame, do not send a response.

After the MS sends another SABM, respond with a UA from the SS and send some frames from the SS to ensure that the link is established.

Maximum duration of the test

3 minutes.

Expected sequence

Step	Direction	Message	Comments
1		{PDP Context Activation}	Macro. Initiate PDP context activation from the MS using PDP context 12.
2	MS -> SS	SABM	Verify that P/F = 1.
3	MS -> SS	SABM	Do not send UA from the SS. Verify that MS sends another SABM with P/F = 1 after T200 seconds, with the same SAPI that it sent in the first SABM .
4	SS -> MS	UA	Send UA from the SS before T200 for that SAPI expires at the MS.
5			Initiate sending 5 I+S frames from the SS.
6	SS -> MS	I+S	Set the A bit to 1 in all the I+S frames.
A7 (optional step)	MS -> SS	RNR	The MS may send an RNR. If it does, stop transmitting from the SS until the MS sends an RR.
7	MS -> SS	RR	Verify that the MS receives and acknowledges all the frames by sending an RR for each I+S frame received.
8			Repeat steps 6 and 7 until 5 I+S frames are sent from the SS.

46.1.2.2.1.4 Total loss of UA frame

46.1.2.2.1.4.1 Conformance requirement

If timer T200 expires before the UA or DM response with the F bit set to 1 is received, the LLE shall:

- retransmit the SABM command;
- set timer T200;
- increment the retransmission counter.

Reference

3GPP TS 04.64, subclause 8.5.1.3.

46.1.2.2.1.4.2 Test purpose

To verify that:

- the MS attempts to establish a link N200 times after sending the first SABM.

46.1.2.2.1.4.3 Method of test

Initial conditions

-

Specific PICS statements:

-

PIXIT statements:

-

Test procedure

Initiate link establishment from the MS by sending a SABM frame, for SAPI 11. At the SS, ignore the SABM from the MS.

The MS shall wait for time-out of timer T200 and then send a new SABM frame.

At the SS, ignore the SABM frame sent by the MS. Wait until the MS sends N200 + 1 SABM frames in all.

Maximum duration of the test

5 minutes.

Expected sequence

Step	Direction	Message	Comments
1		{PDP Context Activation}	Macro. Initiate PDP context activation from the MS, using PDP Context 13.
2	MS -> SS	SABM	Verify that P/F = 1, SAPI = 11.
3	MS -> SS	SABM	Do not send UA from the SS. Verify that MS sends another SABM with P/F = 1 after T200 seconds, with the same SAPI that it sent in the first SABM .
4			Perform step 3 N200 times. Ensure that the MS sends N200 + 1 SABM frames in step 2 and steps 3 only.

46.1.2.2.1.5 DM response

46.1.2.2.1.5.1 Conformance requirement

The DM unnumbered response shall be used by an LLE to report to its peer that the LLE is in such a state that ABM operation cannot be performed.

Upon reception of the DM response with the F bit set to 1, the originator of the SABM command shall enter the ADM state.

If the originator of the establishment procedure receives an LL-RELEASE.indication with Cause "DM received", it shall inform the SM sub-layer using the SNSM-STATUS.request primitive with Cause "DM received". SM shall then deactivate all PDP contexts for that SAPI requiring acknowledged peer-to-peer LLC operation.

Reference

3GPP TS 04.64, subclauses 6.4.1.4 and 8.5.1.2.

3GPP TS 04.65, subclause 6.2.1.4.

46.1.2.2.1.5.2 Test purpose

To verify that a link is not established with the MS when a DM response is sent in response to a SABM command.

46.1.2.2.1.5.3 Method of test

Initial conditions

-

Specific PICS statements:

-

PIXIT statements:

-

Test procedure

Initiate pdp context activation from the MS on SAPI 3. From the SS, send a DM with the F bit set to 1.

Verify that the MS deactivated the PDP Context.

Maximum duration of the test

3 minutes.

Expected sequence

Step	Direction	Message	Comments
1		{PDP Context Activation}	Macro. Initiate PDP context activation using PDP Context 11.
2	MS -> SS	SABM	Verify that P/F =1 in the SABM sent from the MS.
3	SS -> MS	DM	Send DM with F=1 from the SS before T200 can expire at the MS. Wait for 2 * T200 seconds after the transmission of DM and verify that the MS does not resend SABM in this period.
4		{PDP Context De-Activation}	Verify that the MS initiates PDP Context Deactivation. MS may initiate this deactivation during 2*T200 sec wait given in step 3.

46.1.2.2.2 MS sends I+S frames

46.1.2.2.2.1 Checking N(S)

46.1.2.2.2.1.1 Conformance requirement

Having either transmitted the UA response to a received SABM command or received the UA response to a transmitted SABM command, I frames and supervisory frames may be transmitted and received. I frames shall be transmitted in ascending N(S) order.

When there is an opportunity to transmit a frame, then the LLE shall do one of the following in the order of priority:

- If there are any I frames marked for retransmission and if the LLE is not in the peer receive busy condition, then the LLE shall increment by 1 the retransmission count variable for the I frame with lowest send sequence number N(S). If the retransmission count variable does not exceed the value of N200, then the LLE shall retransmit the frame.
- If the LLE has a new frame to retransmit, if $V(S) < V(A) + k$ and if the LLE is not in the peer receiver busy condition, then the new I frame shall be transmitted.
- If the LLE has an acknowledgement to transmit, then the LLE shall transmit an S frame.

Reference

3GPP TS 04.64, subclauses 8.6 and 8.6.1.

46.1.2.2.2.1.2 Test purpose

To verify that the MS handles the send sequence number N(S) correctly.

46.1.2.2.2.1.3 Method of test

Initial conditions

-

Specific PICS statements:

-

PIXIT statements:

-

Test procedure

Initiate data transfer from the MS on SAPI 3. Send 515 I+S frames continuously. The value of N(S) shall begin from 0 and increment by 1 mod (512) for each frame.

Acknowledge each I frame by sending an RR frame to the MS, in sequence.

Maximum duration of the test

30 minutes.

Expected sequence

Step	Direction	Message	Comments
1		{PDP Context Activation}	Macro. Initiate a PDP context activation using PDP Context 11, from the MS.
2			Initiate data transfer, from the MS.
3	MS -> SS	I+S frame	N(S) = 0 for the first frame.
4	SS -> MS	S frame with RR	Respond whenever acknowledgement is requested.
5			Repeat steps 3 and 4 until all 515 I+S frames have been transmitted from the MS. Verify that : the MS does not retransmit any frame. N(S) begins with 0 and is incremented by 1 mod (512).

NOTE: The application will resend data until all data have been sent.

46.1.2.2.2.2 Busy condition at the peer, with RR sent for resumption of transmission

46.1.2.2.2.2.1 Conformance requirement

The receive not ready (RNR) command shall be used by an LLE to indicate a busy condition. The value of N(R) in the RNR frame acknowledges I frames numbered up to and including N(R) - 1. Subsequent frames, if any, shall not be considered confirmed.

After receiving a valid RNR frame, the LLE shall:

- set a peer receiver busy condition;
- not transmit or retransmit any frames to the peer LLE;
- treat the N(R) contained in the received RNR as an acknowledgement for all the I frames that have been (re-)transmitted, up to and including N(R)- 1 and set its V(A) to the value of N(R) contained in the RNR frame;
- set T201 to initiate the inquiry process; and

- reset the retransmission count variable.

If timer T201 expires, the LLE shall:

- if the value of the retransmission count variable is less than N200:
 - transmit an appropriate supervisory frame with an A bit set to 1;
 - set timer T201; and
 - add one to its retransmission count variable.

The LLE receiving the supervisory frame with the A bit set to 1 shall respond, at the earliest opportunity, with an appropriate supervisory frame (see subclause 8.6.4.1) to indicate whether or not its own receiver busy condition still exists.

Upon receipt of the supervisory frame, the LLE shall reset timer T201, and:

- if the frame is an RR, ACK or SACK frame:
 - the peer receiver busy condition shall be cleared;
 - if timer T201 was active before the peer receiver busy condition was set, and if the associated I frame is still not acknowledged, then timer T201 shall be set and associated with the same I frame; and
 - the LLE may transmit new I frames or retransmit I frames as defined in subclauses 8.6.1 or 8.6.3, respectively.

The busy peer shall respond at the earliest opportunity, with an appropriate supervisory frame.

- If the highest numbered I frame was received with $N(S)=V(R)$, the appropriate supervisory frame is the RR frame.

Reference

3GPP TS 04.64, subclauses 6.4.3.4 and 8.6.4.

46.1.2.2.2.2.2 Test purpose

To verify that the MS:

- Handles busy condition when an RNR is sent from the SS;
- Resumes transmission upon reception of an RR.

46.1.2.2.2.2.3 Method of test

Initial conditions

-

Specific PICS statements:

-

PIXIT statements:

-

Test procedure

The MS is made to send 1 I+S frame on SAPI 9.

The SS does not acknowledge the received I+S frame, when sending as response a supervisory RNR frame.

Immediately after the first RNR frame, the MS shall stop sending I+S frames and start the retransmission timer T201.

After T201 seconds, the MS shall send an RR frame with the A bit set to 1.

The SS responds with a RNR frame.

Within T201 after the second RNR frame, the SS transmit an RR frame to resume transmission.

Immediately after the RR frame, the MS shall start the retransmission of the I+S frame from the point at which it ceased to receive acknowledgement.

Maximum duration of the test

5 minutes.

Expected sequence

Step	Direction	Message	Comments
1		{PDP Context Activation}	Macro. Initiate PDP context activation from the MS using PDP Context 12. Negotiate a value of at least 1 minute for T201.
2			Initiate data transfer of 1 octet of data in acknowledged mode from the MS.
3	MS -> SS	I+S frame	Send 1 octet of data. N(S) = 0 for the first frame
4	SS -> MS	RNR frame	After sending an RNR frame with N(R) = 0 verify that the MS does not send any I + S frames during the next T201 seconds .
5	MS -> SS	RR frame	MS sends an RR frame at T201 after step 4. Verify that the A bit is set to 1.
6	SS -> MS	RNR frame	
7	SS -> MS	RR	Send within T201 after step 6 an RR from the SS with N(R) = 0
8	MS -> SS	I + S	Verify that the MS starts retransmission of the I+S frame from the point at which it had stopped sending, that is, from N(S) = 0
9	SS -> MS	RR	Acknowledge the I + S frame transmitted by the MS.

46.1.2.2.2.3 Busy condition at the peer, with ACK sent for resumption of transmission

46.1.2.2.2.3.1 Conformance requirement

The receive not ready (RNR) command shall be used by an LLE to indicate a busy condition. The value of N(R) in the RNR frame acknowledges I frames numbered up to and including N(R) - 1 . Subsequent frames, if any, shall not be considered confirmed.

After receiving a valid RNR frame, the LLE shall:

- set a peer receiver busy condition;
- not transmit or retransmit any frames to the peer LLE;
- treat the N(R) contained in the received RNR as an acknowledgement for all the I frames that have been (re-)transmitted, up to and including N(R)- 1 and set its V(A) to the value of N(R) contained in the RNR frame;
- set T201 to initiate the inquiry process; and
- reset the retransmission count variable.

If timer T201 expires, the LLE shall:

- if the value of the retransmission count variable is less than N200:
 - transmit an appropriate supervisory frame with an A bit set to 1;
 - set timer T201; and
 - add one to its retransmission count variable.

The LLE receiving the supervisory frame with the A bit set to 1 shall respond, at the earliest opportunity, with an appropriate supervisory frame (see subclause 8.6.4.1) to indicate whether or not its own receiver busy condition still exists.

Upon receipt of the supervisory frame, the LLE shall reset timer T201, and:

- if the frame is an RR, ACK or SACK frame:
 - the peer receiver busy condition shall be cleared;
 - if timer T201 was active before the peer receiver busy condition was set, and if the associated I frame is still not acknowledged, then timer T201 shall be set and associated with the same I frame; and
 - the LLE may transmit new I frames or retransmit I frames as defined in subclauses 8.6.1 or 8.6.3, respectively.

The busy peer shall respond at the earliest opportunity, with an appropriate supervisory frame.

- If the highest numbered frame was received with $N(S) = V(R) + 1$, the appropriate frame is the ACK frame.

Reference

3GPP TS 04.64, subclauses 6.4.3.4 and 8.6.4.

46.1.2.2.2.3.2 Test purpose

To verify that the MS:

- Handles busy condition when an RNR is sent from the SS;
- Resumes transmission upon reception of an ACK.

46.1.2.2.2.3.3 Method of test

Initial conditions

-

Specific PICS statements:

-

PIXIT statements:

-

Test procedure

The MS is made to send I+S frames continuously on SAPI 9. The SS acknowledges the received I+S frames with supervisory RR frames.

After receiving the last transmitted frame, the SS responds with a supervisory RNR frame. The RNR frame will indicate that all frames except the one before and the last one have been received.

Immediately after the first RNR frame, the MS shall stop sending I+S frames and start the retransmission timer T201.

After T201 seconds, send an ACK frame from the SS, which acknowledges the last received I+S frame.

Immediately after the ACK frame, the MS shall retransmit the unacknowledged frame $N(S)=N_{MS}-2$.

Maximum duration of the test

5 minutes.

Expected sequence

Step	Direction	Message	Comments
1		{PDP Context Activation}	Macro. PDP context activation from the MS with PDP Context 12. If the mobile negotiates a window size kU less than 3, this test shall end at this step.
2			Initiate acknowledged mode data transmission from the MS.
3	MS -> SS	I+S frame	N(S)=0 for the first frame
4	SS -> MS	RR frame	Acknowledge when requested.
5			Repeat steps 3 and 4. The N(S) of the frames shall range from N(S) = 0 until N(S) = $N_{MS} - 3 \text{ mod } 512$.
6	MS -> SS	I+S frames	The MS sends the I+S frames with N(S) = $N_{MS} - 2$ and N(S) = $N_{MS} - 1$
7	SS -> MS	RNR frame	After sending RNR frame with N(R) = $N_{MS} - 2 \text{ mod } 512$, wait for T201 seconds at the SS.
7a (Optional)	MS -> SS	I+S frames	MS may send few I+S frames before the RNR frame is received completely at the mobile. SS does not acknowledge them.
8	MS -> SS	RR frame	MS sends an RR frame after T201 times out.
9	SS -> MS	RNR frame	
10	SS -> MS	ACK	Send an ACK from the SS with N(R) = $N_{MS} - 2 \text{ mod } 512$ within T201 after step 9.
11	MS -> SS	I + S frame	Verify that the MS sends an I+S frame with N(S) = $N_{MS} - 2 \text{ mod } 512$.
12	SS -> MS	RR	Acknowledge all the frames transmitted by the MS so far with N(R) = N_{MS} .

46.1.2.2.2.4 SACK frame

46.1.2.2.2.4.1 Conformance requirement

On receipt of a valid SACK frame, the LLE shall consider all I frames with the corresponding bit set to 1 in the SACK bitmap as acknowledged.

Reference

3GPP TS 04.64, subclause 8.6.3.2.

46.1.2.2.2.4.2 Test purpose

To verify that the MS considers only the frames as indicated by the SACK bitmap have been received correctly and that it retransmits the frames that have not been acknowledged.

46.1.2.2.2.4.3 Method of test

Initial conditions

-

Specific PICS statements:

-

PIXIT statements:

-

Test procedure

$N_{MS} \geq 1$.

Initiate data transfer from the MS and send frames from N(S) = 0 to N(S) = N_{MS} , where $N_{MS} = kU - 1$.

If N_{MS} is even, do not acknowledge an arbitrarily chosen sequence of $N_{MS}/2$ frames and acknowledge the other frames by using SACK.

If N_{MS} is odd, do not acknowledge an arbitrarily chosen sequence of $(N_{MS} - 1)/2$ frames and acknowledge the other frames by using SACK.

Verify that the MS retransmits the not-acknowledged frames.
Acknowledge the retransmitted frames.

Maximum duration of the test

3 minutes.

Expected sequence

Step	Direction	Message	Comments
1		{PDP Context Activation}	Macro. PDP context activation from the MS with PDP Context 11. If the mobile negotiates a window size kU less than 2, this test shall end at this step.
2			Initiate acknowledged mode data transfer from the MS.
3	MS -> SS	I+S frames	$N(S) = 0$ for the first frame
4			Repeat step 3, with $N(S)$ incremented by 1 for each step. These must be repeated until an I+S frame with the A bit set to 1 is received at the SS and at least $N_{MS} + 1$ I+S frames were transmitted.
5	SS -> MS	SACK	If N_{MS} is even, do not acknowledge an arbitrarily chosen sequence of $N_{MS} / 2$ frames and acknowledge the other frames by using SACK. If N_{MS} is odd, do not acknowledge an arbitrarily chosen sequence of $(N_{MS} - 1)/2$ frames and acknowledge the other frames by using SACK.
6	MS -> SS	I+S frames	Verify that the MS retransmits the not acknowledged frames.
7	SS -> MS	RR	Acknowledge all the frames. $N(R) = N_{MS} + 1$

46.1.2.2.3 Reception of I + S frames at the MS

46.1.2.2.3.1 Checking $N(R)$

46.1.2.2.3.1.1 Conformance requirement

Whenever an LLE receives a frame with the A bit set to 1, it shall transmit an I+S or S frame.

In ABM mode, all I frames and Supervisory frames contain $N(R)$, the expected send sequence number of the next in-sequence received I frame. At the time that a frame of the above type is designated for transmission, the value of $N(R)$ is equal to the value of the receive state variable $V(R)$. $N(R)$ indicates that the LLE transmitting the $N(R)$ has correctly received all I frames numbered up to and including $N(R) - 1$.

Reference

3GPP TS 04.64, subclauses 6.3.5.4.5 and 8.6.3.1.

46.1.2.2.3.1.2 Test purpose

To verify that the MS transmits acknowledgements with the correct $N(R)$.

46.1.2.2.3.1.3 Method of test

Initial conditions

-

Specific PICS statements:

-

PIXIT statements:

-

Test procedure

Send I+S frames continuously from the SS. Send more than 512 frames. The delay between two I+S frames should be less than T201.

Do not send any data from the MS.

When the MS sends RR frames, check the value of N(R) to verify that it indicates that all frames sent from the SS has been acknowledged.

Maximum duration of the test

30 minutes.

Expected sequence

Step	Direction	Message	Comments
1		{PDP Context Activation}	Macro. Initiate PDP context activation from the MS using PDP Context 11.
2			Initiate acknowledged mode data transfer from the SS.
3	SS -> MS	I+S frame	
4	SS -> MS	I+S frame	The last I+S frame shall have its $N(S) = N_{SS} + i \text{ mod } 512$. Set the A bit to 1 in the last frame of each window and the last frame sent from the SS.
A5 (optional step)	MS -> SS	RR	Verify whether the RR frames received from the MS have the correct N(R) values. Verify whether all the I+S frames sent from the SS have been acknowledged.
B5 (optional step)	MS -> SS	RNR	The SS shall wait for an RR frame before it sends the next I+S frame.
			The MS may not send an RR if the A bit is not set in step 4.
6			Repeat from step 4 515 times.
7			At the end of the test, all the frames sent shall have been acknowledged.

46.1.2.2.3.2 MS handling busy condition during bi-directional data transfer

46.1.2.2.3.2.1 Conformance requirement

The receive not ready (RNR) command shall be used by an LLE to indicate a busy condition. The value of N(R) in the RNR frame acknowledges I frames numbered up to and including N(R) - 1. Subsequent frames, if any, shall not be considered confirmed.

After receiving a valid RNR frame, the LLE shall:

- set a peer receiver busy condition;
- not transmit or retransmit any frames to the peer LLE;
- treat the N(R) contained in the received RNR as an acknowledgement for all the I frames that have been (re-)transmitted, up to and including N(R)- 1 and set its V(A) to the value of N(R) contained in the RNR frame;
- set T201 to initiate the inquiry process; and
- reset the retransmission count variable.

The busy peer shall respond at the earliest opportunity, with an appropriate supervisory frame.

- If the highest numbered frame was received with $N(S) = V(R) + 1$, the appropriate frame is the ACK frame.

Reference

3GPP TS 04.64, subclauses 6.4.3.4 and 8.6.4.

46.1.2.2.3.2.2 Test purpose

To verify that the MS handles peer receiver busy condition when it is transmitting to the SS and receiving data from the SS.

46.1.2.2.3.2.3 Method of test

Initial conditions

-

Specific PICS statements:

-

PIXIT statements:

-

Test procedure

Send 1 octet of data from the MS.

Send 1 I+S frame from the SS, containing 1 octet of data.

Send an RNR from the SS to indicate receiver busy condition, after 1 frame ($N(S) = 0$) has been received at the SS. The $N(R)$ value that is sent in the RNR frame is 0.

Verify that the MS stops transmission of I+S frames.

T201 seconds after sending the RNR frame, send an RR frame from the SS with $N(R) = 0$ to request the MS to resume transmission.

Verify that the MS resumes transmission. The frame sent from the MS should have its $N(S) = 0$.

Verify that the MS sends acknowledgements for all the I+S frames transmitted from the SS.

Maximum duration of the test

10 minutes.

Expected sequence

Step	Direction	Message	Comments
1		{PDP Context Activation}	Macro.Initiate PDP context activation from the MS using PDP Context 12.
2			Initiate acknowledged mode data transfer of 1 octet from the MS and the SS.
3	MS -> SS	I+S frame	$N(S) = 0$ for the first frame
4	SS -> MS	I+S frame	A bit set to 1.
5	SS -> MS	RNR frame	Do not acknowledge the first I+S frame received at the SS. $N(R) = 0$.
A6 (optional step)	MS -> SS	RNR frame	The MS may repeat this step In this case, the MS shall send an RR frame for resumption of transmission.
6	MS -> SS	RR	Acknowledgement to the I+S frame sent in step 4. This could have been sent by the MS already directly after step 4.
7	MS -> SS	RR	Verify that the MS sends this after T201 seconds after step 5. The MS shall not resend the I+S frame sent in step 3.
8	SS -> MS	RR	$N(R) = 0$. Send this to resume transmission from the MS.
9	MS -> SS	I+S	Verify that the MS - resends the I+S frame sent in step 3.
10	SS -> MS	RR	Acknowledge the frame transmitted by the MS.

46.1.2.2.3.3 SACK frame

46.1.2.2.3.3.1 Conformance requirement

The SACK supervisory frame shall be used by an LLE to acknowledge single or multiple frames. Frames up to and including $N(R) - 1$, and frames indicated by the SACK bitmap, have been received correctly.

If the LLE is in the own receiver busy condition, the appropriate supervisory frame is the RNR frame. Otherwise, if the highest numbered frame was received with $N(S) = V(R)$, the appropriate supervisory frame is the RR frame. Otherwise, if the highest numbered I frame was received with $N(S) = V(R) + 1$, the appropriate supervisory frame is the ACK frame. Otherwise, the appropriate supervisory frame is the SACK frame.

Reference

3GPP TS 04.64, subclauses 6.4.3.3 and 8.6.4.1.

46.1.2.2.3.3.2 Test purpose

To verify whether the MS sends a SACK frame when it is required and that the SACK frame has the correct bits set.

46.1.2.2.3.3.3 Method of test

Initial conditions

-

Specific PICS statements:

-

PIXIT statements:

-

Test procedure

$N_{MS} = 20$, for this test case.

Initiate data transfer from the SS and send frames from $N(S) = 0$ to $N(S) = N_{MS} - 3$. The A bit shall be set to 1 for all frames sent. Wait till all the frames are acknowledged. Send the frame with $N(S) = N_{MS}$ with the A bit set to 1. Verify that the MS acknowledges all the frames until $N_{MS} - 3$ using RR and negatively acknowledges the other frames ($N_{MS} - 2$ and $N_{MS} - 1$) by using SACK. Retransmit the frames $N_{MS} - 2$ and $N_{MS} - 1$ with A bit set to 1. Verify that the MS acknowledges the retransmitted frames.

Maximum duration of the test

3 minutes.

Expected sequence

Step	Direction	Message	Comments
1		{PDP Context Activation}	Macro. Initiate PDP context activation with PDP Context 12. If the negotiated window size is less than 3, the test shall end at this step.
2			Initiate acknowledged mode data transfer from the SS.
3	SS -> MS	I+S frame	$N(S) = 0$ for the first frame, A bit = 1.
-	-	-	
A4 (Optional step)	MS -> SS	RNR frame	The MS can optionally send an RNR frame. If it does, do not send data until the MS sends an RR.
4	MS -> SS	RR frame	$N(R) = 1$ for the first frame
5			Repeat steps 3 and 4 with the $N(S)$ and $N(R)$ values incremented by 1 for each step and with A = 1 for the I+S frame . The last RR frame shall have its $N(R) = N_{MS} - 2$.
6	SS -> MS	I+S frame	Send with $N(S) = N_{MS}$, A bit = 1.
A7 (Optional step)	MS -> SS	RNR	$N(R) = N_{MS} - 2$. In this case the SS shall not transmit anything until the MS sends a SACK.
7	MS -> SS	SACK	Verify that the MS does not acknowledge the frames $N_{MS} - 2$ and $N_{MS} - 1$ and acknowledges the other frames (N_{MS}) using SACK.
8	SS -> MS	I+S frame	Retransmit the frame $N_{MS} - 2$ with A bit = 1.
A9 (Optional step)	MS -> SS	RNR	In this case, the SS shall not transmit anything until the MS sends an ACK.
9	MS -> SS	ACK	
10	SS -> MS	I+S	$N(S) = N_{MS} - 1$, A bit = 1.
A11	MS -> SS	RR	$N(R) = N_{MS} + 1$
B11	MS -> SS	RNR	The RNR shall indicate that the MS has received all the frames sent from the SS. $N(R) = N_{MS} + 1$

46.1.2.2.3.4 ACK frame

46.1.2.2.3.4.1 Conformance requirement

Whenever an LLE receives a frame with the A bit set to 1, it shall transmit an I+S or S frame.

The ACK supervisory frame shall be used by an LLE to acknowledge a single or multiple I frames. Frames up to and including $N(R) - 1$, and frame $N(R) + 1$, have been received correctly.

Reference

3GPP TS 04.64, subclauses 6.4.3.2 and 8.6.3.1.

46.1.2.2.3.4.2 Test purpose

To verify that the MS transmits an ACK frame when frames up to and including $N(R) - 1$ and frame $N(R) + 1$ have been received correctly.

46.1.2.2.3.4.3 Method of test

Initial conditions

-

Specific PICS statements:

-

PIXIT statements:

-

Test procedure

For this test case, $N_{SS} = 20$.

Send I+S frames with $N(S) = 0$ to $N(S) = N_{SS} - 2$ from the SS. The delay between two I+S frames should be less than T201. Set the A bit to 1 in frames 0 to $N_{SS} - 2$. Verify that the MS sends an RR frame as acknowledgement for these frames. Send the frame with A=1. Do not send frame $N_{SS} - 1$. Verify that the MS sends an ACK frame, indicating that N_{SS} and $N_{SS} - 2$ have been received and that $N_{SS} - 1$ has not been received. Now send a frame from the SS with $N(S) = N_{SS} - 1$, with A=1. Verify that the MS acknowledges all the frames received so far, including this frame, with an RR.

Maximum duration of the test

5 minutes.

Expected sequence

Step	Direction	Message	Comments
1		{PDP Context Activation}	Macro. Initiate PDP context activation with PDP Context 13.
2			Initiate acknowledged mode data transmission from the SS.
3	SS -> MS	I+S frame	A = 1
A4 (Optional step)	MS -> SS	RNR	If the MS sends an RNR, do not transmit data until it has sent an RR.
4	MS -> SS	RR	
5			Repeat steps 3 to 5 until frames 0 to $N_{SS} - 2$ have been sent. Verify that RR frames are sent to acknowledge frames from $N(S) = 0$ until $N(S) = N_{SS} - 2$.
6	SS -> MS	I+S frame	Send the frame N_{SS} with A=1. Do not send the frame with $N(S) = N_{SS} - 1$.
A7 (Optional step)	MS -> SS	RNR	$N(R) = N_{SS} - 2$. If the MS sends an RNR, do not transmit data until it sends an ACK.
7	MS -> SS	ACK	Verify that an ACK frame is sent to acknowledge the frames $N_{SS} - 2$ and N_{SS} , with $N(R) = N_{SS} - 1$
8	SS -> MS	I+S frame	$N(S) = N_{SS} - 1$, with A=1.
A9 (Optional step)	MS -> SS	RNR	Verify that $N(R) = N_{SS} + 1$
9	MS -> SS	RR	Verify that an RR frame is received to acknowledge frame $N_{SS} - 1$ with $N(R) = N_{SS} + 1$

46.1.2.2.4 Link Reestablishment

46.1.2.2.4.1 Reestablishment due to reception of SABM

46.1.2.2.4.1.1 Conformance requirement

The criteria for re-establishing the ABM mode of operation are defined in this clause by the following conditions:

- the receipt, while in the ABM state, of a SABM;
- the receipt of an LL-ESTABLISH-REQ primitive from layer 3;
- the occurrence of N200 retransmission failures;
- the occurrence of a frame rejection condition; and
- the receipt of an unsolicited DM response with F bit set to 0 while in ABM state.

In Asynchronous Balanced Mode, only I frames contain $N(S)$, the send sequence number of transmitted I frames. At the time that an in-sequence I frame is designated for transmission, the value of $N(S)$ is set equal to the value of the send state variable $V(S)$.

An LLE receiving a SABM command, if it is able to enter the ABM state, shall:

- inform layer 3 using the LL-ESTABLISH-IND primitive;

- if the received SABM command contains a Layer-3 Parameters XID parameter, wait for the receipt of an LL-ESTABLISH-RES primitive from layer 3;
- respond with a UA response with the F bit set to the same binary value as the P bit in the received SABM command (i.e., F=1);
- reset timer T200 if active;
- set V(S), V(R), V(A), and B to 0;
- enter the ABM state;
- clear all existing exception conditions; and
- clear any existing peer receiver busy condition.

Reference

3GPP TS 04.64, subclauses 8.7.1, 6.3.5.4.3 and 8.5.1.2.

46.1.2.2.4.1.2 Test purpose

To verify whether the MS initiates reestablishment of the link if it receives a SABM while in ABM state.

46.1.2.2.4.1.3 Method of test

Initial conditions

-

Specific PICS statements:

-

PIXIT statements:

-

Test procedure

After establishing a link, initiate data transfer from the MS. After receiving 1 frame from the MS, send a SABM from the SS and verify whether the MS responds with a UA. After the link is re-established, verify that the MS resumes data transmission.

Maximum duration of the test

5 minutes.

Expected sequence

Step	Direction	Message	Comments
1		{PDP Context Activation}	Macro. Initiate PDP context establishment from the MS, using PDP Context 12. Negotiate kU = 1.
2			Initiate acknowledged mode data transfer of 2000 octets from the MS.
3	MS -> SS	I + S	
4	SS -> MS	RR	Acknowledge one frame.
5	MS -> SS	I + S	N(S) = 1.
6	SS -> MS	SABM	After receiving 2 frame from the MS, send a SABM from the SS to re-establish the link.
7	MS -> SS	UA	Verify that the MS responds with a UA.
8	MS -> SS	I+S	Verify that that N(S) begins from 0.
9	SS -> MS	RR	Acknowledge the frame sent from the MS.
10			Repeat steps 8 and 9 until all the frames from the MS are transmitted.

46.1.2.2.4.2 Reestablishment due to N200 failures

46.1.2.2.4.2.1 Conformance requirement

The criteria for re-establishing the ABM mode of operation are defined in this clause by the following conditions:

- the receipt, while in the ABM state, of a SABM;
- the receipt of an LL-ESTABLISH-REQ primitive from layer 3;
- the occurrence of N200 retransmission failures;
- the occurrence of a frame rejection condition; and
- the receipt of an unsolicited DM response with F bit set to 0 while in ABM state.

In case of a re-establishment, all NSAPIs mapped to the affected SAPI shall enter the recovery state and all buffered N-PDUs (i.e. the ones whose complete reception has not been acknowledged and the ones that have not been transmitted yet) shall be transmitted starting with the oldest N-PDU when the link is re-established

Reference

3GPP TS 04.64, clause 8.7.1.

3GPP TS 04.65, subclauses 5.1.2.3, 5.1.2.5 and 6.2.1.2.

46.1.2.2.4.2.2 Test purpose

To verify whether the MS initiates reestablishment of the link when there is an N200 retransmission failure.

46.1.2.2.4.2.3 Method of test

Initial conditions

-

Specific PICS statements:

-

PIXIT statements:

-

Test procedure

After establishing a link, initiate data transfer from the MS, to send 1 octet of data. Do not acknowledge the data frame sent from the SS. The MS shall retransmit the frame N200 times. Wait for $(N200 * T201)$ seconds and see if the MS initiates link reestablishment by sending a SABM. After the link is re-established verify that the MS resumes data transmission.

Maximum duration of the test

5 minutes.

Expected sequence

Step	Direction	Message	Comments
1		{PDP Context Activation}	Macro.Initiate PDP context activation from the MS using PDP context 11.
2			Initiate acknowledged mode data transfer from the MS.
3	MS -> SS	I + S	Send 1 octet of data. Do not acknowledge this frame from the SS.
4	MS -> SS	I + S	Verify that the MS retransmits the I+S frame N200 times and that it does not send any SABM frames during retransmission. SS does not acknowledge any of these frames.
5	MS -> SS	SABM	Verify that the MS sends a SABM and that it stops sending anymore data to the SS. Verify that this occurs after T201 seconds after the last I+S frame in step 4.
6	SS -> MS	UA	
7	MS -> SS	I+S	Verify that the MS resumes transmission of data from step 2.
8	SS -> MS	RR	Acknowledge the frame transmitted from the MS.

46.1.2.2.4.3 Reestablishment due to reception of DM

46.1.2.2.4.3.1 Conformance requirement

The criteria for re-establishing the ABM mode of operation are defined in this clause by the following conditions:

- the receipt, while in the ABM state, of a SABM;
- the receipt of an LL-ESTABLISH-REQ primitive from layer 3;
- the occurrence of N200 retransmission failures;
- the occurrence of a frame rejection condition; and
- the receipt of an unsolicited DM response with F bit set to 0 while in ABM state.

In case of a re-establishment, all NSAPIs mapped to the affected SAPI shall enter the recovery state and all buffered N-PDUs (i.e. the ones whose complete reception has not been acknowledged and the ones that have not been transmitted yet) shall be transmitted starting with the oldest N-PDU when the link is re-established.

Reference

3GPP TS 04.64, subclause 8.7.1.

3GPP TS 04.65, subclauses 5.1.2.3, 5.1.2.5 and 6.2.1.2.

46.1.2.2.4.3.2 Test purpose

To verify whether the MS initiates reestablishment of the link if it receives a DM while in ABM state.

46.1.2.2.4.3.3 Method of test

Initial conditions

-

Specific PICS statements:

-

PIXIT statements:

-

Test procedure

After establishing a link, initiate data transfer from the MS . After receiving 3 frames from the MS, send a DM with F=0 from the SS and verify whether the MS responds with a SABM. After the link is re-established, verify that the MS resumes data transmission.

Maximum duration of the test

5 minutes.

Expected sequence

Step	Direction	Message	Comments
1		{PDP Context Activation}	Macro. Initiate PDP context activation from the MS, using PDP context 12.
2			Initiate acknowledged mode data transfer of 8000 octets from the MS.
3	MS -> SS	I + S	
4	SS -> MS	RR	Send RR frames as acknowledgements from the SS.
5			Repeat steps 3 and 4 once.
6	MS -> SS	I+S	
7	SS -> MS	DM	Send a DM with the F bit set to 0 from the SS.
			Discard all the I+S frames received at the SS.
8	MS -> SS	SABM	Verify that the MS re-establishes the link with a SABM
9	SS -> MS	UA	Respond with a UA
10	MS -> SS	I+S	Verify that the MS resumes data transmission , with N(S) set to 0, only for the first frame sent after resumption of transmission.
11	SS -> MS	RR	Acknowledge all frames sent from the MS.
12			Repeat steps 10 and 11 until all the frames from the MS are transmitted.

46.1.2.3 Collision of commands and responses

46.1.2.3.1 Collision of SABM

46.1.2.3.1.1 Conformance requirement

If the transmitted and received unnumbered commands are SABM commands and a Layer-3 Parameters XID parameter is present in both or in neither, then the SABM command transmitted by the SGSN shall be ignored and treated as not transmitted. The LLE in the SGSN shall send the UA response at the earliest possible opportunity if it is able to enter ABM.

Reference

3GPP TS 04.64 subclause 8.5.5.1

46.1.2.3.1.2 Test purpose

To verify that the MS ignores a SABM command received from the SS when it (the MS) is waiting for a UA response, when a Layer-3 Parameters XID parameter is present in both.

46.1.2.3.1.3 Method of test

Initial conditions

-

Specific PICS statements:

-

PIXIT statements:

-

Test procedure

Initiate link establishment from the MS by sending a SABM with Layer-3 Parameters XID parameter present. Upon reception of the SABM at the SS, send a SABM with Layer-3 Parameters XID parameter present. Verify that the MS ignores the SABM sent by the SS. Wait for T200 seconds at the SS after receiving the SABM from the MS see if the MS resends the SABM. After reception of the SABM, respond with a UA. Initiate data transmission from the MS. Acknowledge all the frames sent from the MS.

Maximum duration of the test

3 minutes.

Expected sequence

Step	Direction	Message	Comments
1		{PDP Context Activation}	Macro. Initiate PDP context activation from the MS with PDP Context 11.
2	MS -> SS	SABM	Verify that P/F = 1. A layer-3 XID parameter shall be present in the SABM received from the MS.
3	SS -> MS	SABM	Send a SABM with P/F =1 to simulate collision. Send the SABM from the SS with a layer 3 XID parameter.
4	MS -> SS	SABM	Ensure that the MS resends the SABM.
5	SS -> MS	UA	Send UA from the SS before T200 can expire at the MS.
6	MS -> SS	I + S	Initiate data transfer from the MS.
7	SS -> MS	RR	Send a supervisory frame as acknowledgement. Wait for T201 seconds to ensure that the MS does not retransmit the data.

46.1.2.3.2 Collision of SABM and DISC

46.1.2.3.2.1 Conformance requirement

If the transmitted and received unnumbered commands are a SABM and DISC command, the LLEs shall issue a DM response at the earliest possible opportunity. Upon receipt of a DM response with the F bit set to 1, the LLE shall enter the ADM state and notify layer3 by means of the appropriate primitive.

Reference

3GPP TS 04.64, subclauses 8.5.5.2 and 8.5.4.

46.1.2.3.2.2 Test purpose

To verify that when the MS receives a DISC after sending a SABM, it shall send a DM response to the SS. Upon reception of a DM response, it shall enter the ADM state.

46.1.2.3.2.3 Method of test

Initial conditions

-

Specific PICS statements:

-

PIXIT statements:

-

Test procedure

Initiate link establishment from the MS by sending a SABM command. Send a DISC command in response to this from the SS. Verify that the MS sends a DM and upon reception of a DM from the SS, it enters the ADM state. The MS might try to re-establish ABM directly, or after sending numbered frames from the SS verify that the MS does not acknowledge them and answers with a DM.

Maximum duration of the test

3 minutes.

Expected sequence

Step	Direction	Message	Comments
1		{PDP Context Activation}	Macro. Initiate PDP context activation from the MS using PDP Context 12.
2	MS -> SS	SABM	Verify that P/F = 1.
3	SS -> MS	DISC	Send DISC from the SS before T200 can expire at the MS.
4	MS -> SS	DM	
5	SS -> MS	DM	Send DM with F=1
			Branch A, B or C is executed
A6 (Optional)	MS -> SS	DEACTIVATE PDP CONTEXT REQUEST	MS may deactivate the pdp context
A7 (Conditional)	SS -> MS	DEACTIVATE PDP CONTEXT ACCEPT	
B6 (Optional)	MS -> SS	SABM	The MS may try to re-establish ABM.
C6 (Optional)	SS -> MS	I+S	Send an I+S Command (C/R bit set to 1)frame from the SS.
C7 (Conditional)	MS -> SS	DM	The MS shall send a DM as response to the I+S frame with the F bit set to 0.

46.1.2.3.3 Collision of SABM and XID commands

46.1.2.3.3.1 Conformance requirement

If the transmitted unnumbered command is a SABM command and the received unnumbered command is an XID command, then the LLE shall ignore the received XID command.

Reference

3GPP TS 04.64 subclause 8.5.5.2.

46.1.2.3.3.2 Test purpose

To verify that the MS ignores the XID command if it collides with a SABM command.

46.1.2.3.3.3 Method of test

Initial conditions

-

Specific PICS statements:

-

PIXIT statements:

-

Test procedure

When the MS initiates link establishment using a SABM, send an XID command. Verify that the XID command is ignored.

Maximum duration of the test

3 minutes.

Expected sequence

Step	Direction	Message	Comments
1		{PDP Context Activation}	Macro. Initiate PDP context activation from the MS using PDP Context 12.
2	MS -> SS	SABM	Verify that P/F = 1.
3	SS -> MS	XID	Send an XID command without layer3 parameters.
4	MS -> SS	SABM	Ensure that the MS does not send an XID response and resends the SABM.
5	SS -> MS	UA	Send UA from the SS before T200 can expire at the MS. Wait for T200 seconds after the transmission of UA to ensure that the MS does not send an XID response.

46.1.2.4 Unsolicited response frames

46.1.2.4.1 Unsolicited DM

46.1.2.4.1.1 Conformance requirement

When a DM response with the F bit set to 0 is received by an LLE, a collision between a transmitted SABM or DISC command and the unsolicited DM response may have occurred.

A DM response with the F bit set to 0 colliding with a SABM or DISC shall be ignored.

An LLE shall ignore a DM response received with F=0 when it is in the Local Establishment state.

Reference

3GPP TS 04.64 subclauses 8.5.6 and 8.8.4.

46.1.2.4.1.2 Test purpose

To verify that the MS ignores a DM response sent with F=0 when LLC is in the Local Establishment state.

46.1.2.4.1.3 Method of test

Initial conditions

-

Specific PICS statements:

-

PIXIT statements:

-

Test procedure

Send SABM with P/F = 1 from the MS to establish a link. Send a DM response with F=0 from the SS, in response to this. Verify that the MS ignores this DM response and sends SABM after expiry of T200. Respond with UA from the SS after receiving SABM. Send 1 I+S frame from the SS and verify that the MS acknowledges it.

Maximum duration of the test

3 minutes.

Expected sequence

Step	Direction	Message	Comments
1		{PDP Context Activation}	Macro. Initiate PDP context activation from the MS with PDP Context 11.
2	MS -> SS	SABM	Initiate data transfer from the MS. Verify that P/F = 1.
3	SS -> MS	DM	Send a DM response with F=0
4	MS -> SS	SABM	Ensure that the second SABM is sent.
5	SS -> MS	UA	Send UA from the SS before T200 expires at the MS.
6	SS -> MS	I+S frame	Send one I+S frame from the SS.
A7 (Optional step)	MS -> SS	RNR	Verify that the RNR acknowledges the frame transmitted in step 6.
7	MS -> SS	RR frame	Verify that the MS acknowledges the I+S frame transmitted from the SS.

46.1.2.5 FRMR frames

46.1.2.5.1 Sending FRMR due to undefined command control field

46.1.2.5.1.1 Conformance requirement

The FRMR unnumbered response may be received by an LLE as a report of a frame rejection condition not recoverable by retransmission of the identical frame:

- receipt of a command or response control field that is undefined or not implemented;
- receipt of a supervisory or unnumbered frame with incorrect length; or
- receipt of an I frame with an information field that exceeds the maximum established length.

Upon occurrence of a frame rejection condition, the LLME shall issue an LLGMM-STATUS-IND primitive; and the LLE shall:

- discard the frame causing the frame rejection condition;
- transmit a FRMR response frame; and
- if the LLE is in ABM operation, initiate re-establishment.

Reference

3GPP TS 04.64, subclauses 6.4.1.5 and 8.8.2.

46.1.2.5.1.2 Test purpose

To verify that if the MS receives a frame with a command control field that is not implemented, it sends an FRMR frame and re-establishes the link.

46.1.2.5.1.3 Method of test

Initial conditions

-

Specific PICS statements:

-

PIXIT statements:

-

Test procedure

After establishing a link, initiate data transfer from the MS. After receiving the first frame, send a supervisory frame from the SS to acknowledge the last I+S frame received. In this set the first byte of the S frame control field to 1110 0000. Verify whether the MS sends an FRMR. After the link is re-established, verify that the MS resumes data transmission.

Maximum duration of the test

5 minutes.

Expected sequence

Step	Direction	Message	Comments
1		{PDP Context Activation}	Macro. Initiate PDP context activation from the MS with PDP context 11.
2			Initiate acknowledged mode data transfer of 1 octet from the MS.
3	MS -> SS	I + S	
4	SS -> MS		After receiving the first I+S frame, send a frame, with the contents of the control field as 1110 0000.
5	MS -> SS	FRMR	Verify that the control field of the frame sent in step 4 is sent back in the FRMR response. Verify that the value of V(S) received is 1. W3 shall be set to 1. W1 and W2 shall be set to 0. W4 shall be set to 1.
6	MS -> SS	SABM	Verify that the MS re-establishes the link with a SABM and that it stops sending anymore data to the SS.
7	SS -> MS	UA	Respond with a UA
8	MS -> SS	I+S	Verify that the MS resumes data transmission, with N(S)=0, for the first frame transmitted
9	SS -> MS	RR	Acknowledge all frames sent from the MS.

46.1.2.5.2 Sending FRMR due to reception of an S frame with incorrect length

46.1.2.5.2.1 Conformance requirement

The FRMR unnumbered response may be received by an LLE as a report of a frame rejection condition not recoverable by retransmission of the identical frame:

- receipt of a command or response control field that is undefined or not implemented;
- receipt of a supervisory or unnumbered frame with incorrect length; or
- receipt of an I frame with an information field that exceeds the maximum established length.

Upon occurrence of a frame rejection condition whilst in ABM operation, the LLME shall issue an LLGMM-STATUS-IND primitive; and the LLE shall initiate re-establishment.

Reference

3GPP TS 04.64, subclauses 6.4.1.5 and 8.8.2.

46.1.2.5.2.2 Test purpose

To verify that if the MS receives an S frame with incorrect length, it sends an FRMR frame and re-establishes the link.

46.1.2.5.2.3 Method of test

Initial conditions

-

Specific PICS statements:

-

PIXIT statements:

-

Test procedure

After establishing a link, initiate data transfer from the MS. Send an RR with incorrect length, from the SS, when an I+S frame from the MS with the A bit set is received. Verify whether the MS sends an FRMR. After the link is re-established, verify that the MS resumes data transmission.

Maximum duration of the test

5 minutes.

Expected sequence

Step	Direction	Message	Comments
1		{PDP Context Activation}	Macro. Initiate PDP context activation from the MS with PDP context 12.
2			Initiate acknowledged mode data transfer from the MS with a sufficient amount of data so that an I+S frame with the A bit set to 1 is sent by the MS.
3	MS -> SS	I + S	
4			Repeat step 3 until a frame with the A bit set to 1 is received.
5	SS -> MS	RR	There shall be an extra octet in this RR frame, before the FCS. The RR frame shall appear as follows: Address field (1 octet) Control field (2 octets) Extra field (1 octet) FCS (3 octets)
			SS shall discard I+S frames received from the MS.
6	MS -> SS	FRMR	Verify that the control field of the RR message is sent back in the FRMR response. W1, W3 and W4 shall be set to 1. The content of W2 shall not be checked.
7	MS -> SS	SABM	Verify that the MS re-establishes the link with a SABM and that it stops sending anymore data to the SS.
8	SS -> MS	UA	Respond with a UA
9	MS -> SS	I+S	Verify that the MS resumes transmission of data.
10	SS -> MS	RR	Acknowledge all frames sent from the MS.
11			Repeat 9 and 10 until all the frames from the MS are transmitted and acknowledged.

46.1.2.5.3 Sending FRMR due to reception of an I frame information field exceeding the maximum length

46.1.2.5.3.1 Conformance requirement

The FRMR unnumbered response may be received by an LLE as a report of a frame rejection condition not recoverable by retransmission of the identical frame:

- receipt of a command or response control field that is undefined or not implemented;
- receipt of a supervisory or unnumbered frame with incorrect length; or
- receipt of an I frame with an information field that exceeds the maximum established length.

Upon occurrence of a frame rejection condition whilst in ABM operation, the LLME shall issue an LLGMM-STATUS-IND primitive; and the LLE shall initiate re-establishment.

Reference

3GPP TS 04.64, subclauses 6.4.15 and 8.8.2.

46.1.2.5.3.2 Test purpose

To verify that if the MS receives an I frame with an information field that exceeds the maximum established length, it sends an FRMR frame and re-establishes the link.

46.1.2.5.3.3 Method of test

Initial conditions

-

Specific PICS statements:

-

PIXIT statements:

-

Test procedure

After establishing a link, initiate data transfer from the SS. After sending 5 frames from the SS, send an I+S frame with length greater than N201-I, from the SS. Verify whether the MS sends an FRMR. After the link is re-established, send frames from the SS with N(S) = 0 until N(S) = 5. Verify that the MS acknowledges all the data sent.

Maximum duration of the test

5 minutes.

Expected sequence

Step	Direction	Message	Comments
1		{PDP Context Activation}	Macro. Initiate PDP context activation from the MS using PDP context 11,
2			Initiate acknowledged mode data transfer from the SS.
3	SS -> MS	I + S	A = 1
A4 (Optional step)	MS -> SS	RNR	If the MS sends an RNR, do not transmit data until it sends an RR.
4	MS -> SS	RR	Send RR frames as acknowledgements from the MS.
5			Repeat steps 3 and 4 until 5 frames are sent from the SS.
6	SS -> MS	I + S	Send an I+S frame with the information field length greater than N201-I, from the SS .
7	MS -> SS	FRMR	Verify that the control field of the I+S message is sent back in the FRMR response. Also verify that the value of V(R) indicates all the frames sent so far except the erroneous I+S frame have been received. W2 and W4 shall be set to 1. W1, W3 shall be set to 0.
8	MS -> SS	SABM	Verify that the MS re-establishes the link with a SABM .
9	SS -> MS	UA	Respond with a UA
10	SS -> MS	I+S	Send data from the SS.
A11 (Optional step)	MS -> SS	RNR	If the MS sends an RNR , do not transmit data until it has sent an RR.
B11 (Optional step)	MS -> SS	RR	Verify that all the frames sent from the SS are acknowledged.
12			Repeat 10 and 11 until all the frames from the SS are transmitted and acknowledged.

46.1.2.5.4 Frame reject condition during establishment of ABM

46.1.2.5.4.1 Conformance requirement

The FRMR unnumbered response may be received by an LLE as a report of a frame rejection condition not recoverable by retransmission of the identical frame:

- receipt of a command or response control field that is undefined or not implemented;
- receipt of a supervisory or unnumbered frame with incorrect length; or
- receipt of an I frame with an information field that exceeds the maximum established length.

Upon occurrence of a frame rejection condition whilst in ABM operation, the LLME shall issue an LLGMM-STATUS-IND primitive; and the LLE shall initiate re-establishment.

Upon occurrence of a frame rejection condition during establishment of or release from ABM operation, or whilst in ADM state, the LLE shall discard the frame.

Reference

3GPP TS 04.64, subclauses 6.4.15 and 8.8.2.

46.1.2.5.4.2 Test purpose

To verify that if the MS receives a U frame with its frame type not implemented during ABM establishment, it shall ignore the message.

46.1.2.5.4.3 Method of test

Initial conditions

-

Specific PICS statements:

-

PIXIT statements:

-

Test procedure

Initiate link establishment from the MS by sending a SABM. Send an invalid U frame as response. Check if the MS resends the SABM. Respond with a UA. Initiate data transfer from the MS and acknowledge all the frames sent from the MS.

Maximum duration of the test

5 minutes.

Expected sequence

Step	Direction	Message	Comments
1		{PDP Context Activation}	Macro. Initiate PDP context activation from the MS using PDP Context 13.
2	MS -> SS	SABM	Verify that P/F = 1.
3	SS -> MS	Invalid U frame	Send a U frame with its control field M4 M3 M2 M1 = 0010
4	MS -> SS	FRMR	
5	MS -> SS	SABM	Ensure that the MS resends SABM
6	SS -> MS	UA	
7	MS -> SS	I + S	Initiate data transfer from the MS.
8	SS -> MS	RR	Acknowledge all frames sent from the MS.

46.1.2.6 Multiple Connections

46.1.2.6.1 Simultaneous acknowledged and unacknowledged data transfer on the same SAPI

46.1.2.6.1.1 Conformance requirement

The purpose of LLC is to convey information between layer-3 entities in the MS and SGSN. Specifically, LLC shall support:

- multiple MSs, at the Um interface;
- multiple layer-3 entities within the MS.

Reference

3GPP TS 04.64, subclause 4.2.

46.1.2.6.1.2 Test purpose

To verify that LLC supports simultaneous acknowledged and unacknowledged data transfer in the same direction on the same SAPI.

46.1.2.6.1.3 Method of test

Initial conditions

-

Specific PICS statements:

-

PIXIT statements:

-

Test procedure

Initiate acknowledged data transfer from the MS on SAPI 3. Send 300 frames continuously. The value of N(S) shall begin from 0 and increment by 1 mod (512) for each frame. Initiate unacknowledged data transfer from the MS on the same SAPI within 1 minute from initiation of the acknowledged data transfer.

Acknowledge all the I frames sent from the SS by sending RR frames to the MS.

Maximum duration of the test

20 minutes.

Expected sequence

Step	Direction	Message	Comments
1		{PDP Context Activation}	Macro. Initiate PDP context activation on PDP context 11 and 5 from the MS. - For PDP context 11, SS negotiates a value of 140 for N201-I. - For PDP context 5, SS triggers an XID negotiation to set N201-U to 140.
2			Initiate acknowledged mode data transfer from the MS.
3	MS -> SS	I+S frame	N(S) = 0 for the first frame
4	SS -> MS	S frame with RR	Send RR only when A bit = 1.
5			Initiate unacknowledged mode data transfer of 200 UI frames (using PDP context 5) from the MS within 1 minute from step2.
6	MS -> SS	I+S frame	
7	SS -> MS	RR	Send RR only when A bit = 1.
8	MS -> SS	UI	
9			Repeat from step 6 until 300 I+S frames of acknowledged data and 200 UI frames of unacknowledged data are transmitted. I Verify that : The MS does not retransmit any frame. N(S) begins with 0 and is incremented by 1 mod (512) for each transmission N(U) begins with 0 and is incremented by 1 mod (512) for each transmission

46.1.2.6.2 Simultaneous acknowledged and unacknowledged data transfer on different SAPIs

46.1.2.6.2.1 Conformance requirement

The purpose of LLC is to convey information between layer-3 entities in the MS and SGSN. Specifically, LLC shall support:

- multiple MSs, at the Um interface;
- multiple layer-3 entities within the MS.

Reference

3GPP TS 04.64, subclause 4.2.

46.1.2.6.2.2 Test purpose

To verify that LLC supports simultaneous acknowledged and unacknowledged data transfer on different SAPIs in different directions.

46.1.2.6.2.3 Method of test

Initial conditions

-

Specific PICS statements:

-

PIXIT statements:

-

Test procedure

Initiate unacknowledged data transfer from the MS on SAPI 5. Initiate acknowledged data transfer from the SS on SAPI 3 after the first *i* frames have been received from the MS. Send 300 I+S frames continuously from the SS. The value of N(S) shall begin from 0 and increment by 1 mod (512) for each frame.

Verify that the MS acknowledges all the I frames sent from the SS. Verify that the UI frames are received at the SS in sequence.

Maximum duration of the test

15 minutes.

Expected sequence

Step	Direction	Message	Comments
1		{PDP Context Activation}	Macro. Initiate PDP context activation on PDP Contexts 8 and 11 from the MS. For PDP context 8, SS triggers an XID negotiation to set N201-U to 140.
2			Initiate unacknowledged mode data transfer of 200 UI frames octets from the MS.
3	MS -> SS	UI frame	
4			Initiate acknowledged mode data transfer of 300 I+S frames octets from the SS.
5	SS -> MS	I+S frame	Start sending I+S frames after i UI frames have been received. Set the A bit to 1 when the window is full and for the last I+S frame.
A6	MS -> SS	UI frame	
B6	MS -> SS	RNR	If the MS sends an RNR, the SS shall resume transmission only after it transmits a SACK, RR or an ACK.
C6	MS -> SS	SACK	The SS shall retransmit the unacknowledged frames.
D6	MS -> SS	ACK	The SS shall retransmit the unacknowledged frames.
E6	MS -> SS	S frame with RR	Verify that the MS acknowledges all the frames sent from the SS.
			The MS may not send any frame if the A bit was not set in step 5.
7			Repeat steps 5 and 6 until all 300 I+S frames have been transmitted for the acknowledged mode from the SS and 200 UI frames for the unacknowledged mode to the SS. Verify that : -The MS acknowledges all I+S frames sent. -The MS sends all UI frames in the correct sequence.

46.1.2.7 XID Negotiation

46.1.2.7.1 Negotiation initiated by the SS during ABM, for T200 and N200

46.1.2.7.1.1 Conformance requirement

The negotiation procedure is one-step, i.e., one side shall start the process by sending an XID command, offering a certain set of parameters from the applicable parameter repertoire the sending entity wants to negotiate, proposing values within the allowed range. In return, the other side shall send an XID response, either confirming these requested values, or offering higher or lower ones in their place.

XID frames shall always be used with the P/F bit set to 1.

T200, N200 and N201-U can be negotiated in ADM and ABM.

Reference

3GPP TS 04.64, subclause 6.4.1.6.

46.1.2.7.1.2 Test purpose

To verify that when the SS initiates XID negotiations with a certain value of T200 and N200, the MS complies with the final negotiated values

46.1.2.7.1.3 Method of test

Initial conditions

-

Specific PICS statements:

-

PIXIT statements:

-

Test procedure

Initiate XID negotiation from the SS, with N200 = 4 and T200 = 10 s. The MS will send an XID response. Initiate data transfer from the MS. Verify that the MS complies with the values of T200 and N200 that were agreed upon.

Maximum duration of the test

5 minutes.

Expected sequence

Step	Direction	Message	Comments
1		{PDP Context Activation}	Macro. Initiate PDP context activation from the MS for PDP Context 11
2	SS -> MS	XID	XID command with N200 = 4, T200 = 10 s. Check if the P/F bit is set to 1.
3	MS -> SS	XID	XID response. Check if the P/F bit is set to 1. The values, if received in this message shall be the negotiated values, else the values are deemed to be confirmed.
4			Initiate acknowledged mode data transfer of 1 octet from the MS.
5	MS -> SS	I + S	
6			Do not respond with an RR.
7	MS -> SS	I+S	Verify that the MS resends the I+S frame every T200 seconds N200 times.
8	MS -> SS	SABM	Verify that the MS sends a SABM to re-establish the link
9	SS -> MS	UA	Respond with a UA within T200 seconds.

46.1.2.7.2 Negotiation initiated by the SS during ADM, for N201-I

46.1.2.7.2.1 Conformance requirement

The negotiation procedure is one-step, i.e., one side shall start the process by sending an XID command, offering a certain set of parameters from the applicable parameter repertoire the sending entity wants to negotiate, proposing values within the allowed range. In return, the other side shall send an XID response, either confirming these requested values, or offering higher or lower ones in their place.

XID frames shall always be used with the P/F bit set to 1.

N201-I, mD, mU, kD and kU can be negotiated to any value in Range in ADM. In ABM, N201-I, mD, mU, kD and kU can only be negotiated to the same or higher value as previously used.

Reference

3GPP TS 04.64, subclause 6.4.1.6.

46.1.2.7.2.2 Test purpose

To verify that when the SS initiates XID negotiations with a certain value of N201-I during ADM, the MS complies with the final negotiated values.

46.1.2.7.2.3 Method of test

Initial conditions

-

Specific PICS statements:

-

PIXIT statements:

-

Test procedure

Initiate PDP context activation from the MS and in the UA response from the SS send a value of 140 for N201-I. If the MS responds with an XID command, in the XID response, give N201-I = 140.

Initiate data transfer from the SS. Send an I+S frame of length N201-I with the A bit set to 1. Verify that the MS acknowledges this I+S frame.

The next I+S frame sent from the SS shall be of length N201-I + 1. Verify that the MS sends FRMR and re-establishes the link.

Maximum duration of the test

5 minutes.

Expected sequence

Step	Direction	Message	Comments
1		{PDP Context Activation}	Macro. Initiate PDP context activation from the MS using PDP Context 11.
2	MS -> SS	SABM	
3	SS -> MS	UA	Set N201-I = 140 in the UA sent. If the MS sends an XID command with a different value of N201-I, send back a response with N201-I = 140.
4	SS -> MS	I+S	Send an I+S frame from the SS with length N201-I with the A bit set to 1.
A5 (optional step)	MS -> SS	RNR	If the MS sends an RNR, verify that the RNR acknowledges the frame sent in step 4. Do not transmit the next I+S frame to the SS until the MS sends an RR.
5	MS -> SS	RR	Verify that the MS responds with an RR.
6	SS -> MS	I+S	The length of this I+S frame shall be N201-I + 1. Set the A bit to 1.
7	MS -> SS	FRMR	Verify that the control field of the I+S message is sent back in the FRMR response. Also verify that the value of V(R) indicates all the frames sent so far except the erroneous I+S frame have been received. W2 and W4 shall be set to 1. W1 and W3 shall be set to 0.
8	MS -> SS	SABM	Verify that the MS re-establishes the link with a SABM.
9	SS -> MS	UA	Respond with a UA within T200 seconds.

46.1.2.7.3 Negotiation initiated by the SS (using SABM, for IOV-I)

46.1.2.7.3.1 Conformance requirement

The negotiation procedure is one-step, i.e., one side shall start the process by sending an XID command, offering a certain set of parameters from the applicable parameter repertoire the sending entity wants to negotiate, proposing values within the allowed range. In return, the other side shall send an XID response, either confirming these requested values, or offering higher or lower ones in their place.

XID frames shall always be used with the P/F bit set to 1.

LLC layer and layer-3 parameters may be negotiated with the exchange of XID frames or with the exchange of SABM and UA frames. After successful negotiations of SABM and UA frames, the LLE shall be in ABM mode of operation.

IOV-I shall only be negotiated with SABM and UA frames. IOV-UI and IOV-I shall only be transmitted in the downlink direction.

Reference

3GPP TS 04.64, subclauses 6.4.1.6 and 8.5.3.

46.1.2.7.3.2 Test purpose

To verify that when the SS sends IOV-I to the MS in a SABM, the MS shall cipher its output using this value of IOV-I.

46.1.2.7.3.3 Method of test

Initial conditions

The MS shall be GPRS attached with ciphering enabled. Encryption GEA1, GEA2 or GEA3 is used depending on the execution counter K.

Specific PICS statements:

- Supported encryption Algorithm : GEA2 (TSPC_Feat_GEA2)
- Supported encryption Algorithm : GEA3 (TSPC_Feat_GEA3)

PIXIT statements:

-

Test procedure

During GPRS attach ciphering GEA1, GEA2 or GEA3 is activated depending on the execution counter K.

Initiate link establishment from the SS. In the SABM command, send a new value of IOV-I, different from the default used. Send 1000 octets from the MS and verify that the frames have been ciphered as per the new value of IOV-I.

The test is performed for all GEAx encryption algorithmn supported by the MS.

Maximum duration of the test

5 minutes.

Expected sequence

The sequence is performed for execution counter K=1 and optionally for K=2 when the MS supports GEA2 and optionally for K=3 when the MS supports GEA3.

Step	Direction	Message	Comments
1		{PDP Context Activation}	Macro. Initiate PDP context activation from the MS using PDP Context 11.
2		{PDP Context Modification}	Macro. Initiate PDP context modification to PDP Context 13 from the SS.
3	SS->MS	DISC	Initiate the release of LLC link by sending DISC on SAPI 3 and receive UA or DM from MS.
4	MS->SS	UA or DM	
5	SS -> MS	SABM	With IOV-I = $2^{27} * 10$.
6	MS -> SS	UA	
6a			Initiate data transfer from the MS. Send 1000 octets.
7	MS -> SS	I+S	
8	SS -> MS	RR	Verify that ciphering is as per the new value of IOV-I. The SS shall check this by analyzing the FCS. Acknowledge all the I+S frames received in step 7.
8a			Repeat the steps 7-8 till the data transfer is complete.
9	SS -> MS	I + S	Initiate data transfer from the SS. Send 1 I+S frame with A=1
A10	MS -> SS	RNR	Verify that the MS acknowledges the frame sent in step 9.
B10	MS -> SS	RR	Verify that the MS acknowledges the frames.

46.1.2.7.4 Negotiation initiated by the SS (during ADM, for N201-U)

46.1.2.7.4.1 Conformance requirement

The negotiation procedure is one-step, i.e., one side shall start the process by sending an XID command, offering a certain set of parameters from the applicable parameter repertoire the sending entity wants to negotiate, proposing values within the allowed range. In return, the other side shall send an XID response, either confirming these requested values, or offering higher or lower ones in their place.

XID frames shall always be used with the P/F bit set to 1.

T200, N200 and N201-U can be negotiated in ADM and ABM.

N201-U is used for U and UI frames.

Reference

3GPP TS 04.64, subclauses 6.4.1.6 and 8.9.5.

46.1.2.7.4.2 Test purpose

To verify that when the SS initiates XID negotiations with a certain value of N201-U during ADM, the MS complies with the final negotiated values.

46.1.2.7.4.3 Method of test

Initial conditions

-

Specific PICS statements:

-

PIXIT statements:

-

Test procedure

Initiate XID negotiation from the SS, with N201-U = 140. The MS shall send an XID response. The value of N201-U shall either be not present in the XID response or set to 140.

Initiate data transfer from the MS. Verify that the length of the UI frames sent from the MS never exceeds the negotiated value of N201-U.

Maximum duration of the test

5 minutes.

Expected sequence

Step	Direction	Message	Comments
1		{PDP Context Activation}	Macro. Initiate PDP context activation from the MS using PDP Context 9.
2	SS -> MS	XID	XID command with N201-U = 140
3	MS -> SS	XID	XID response. Check if the P/F bit is set to 1. The N201-U value, if received in this message shall be set to 140, else the value is deemed to be confirmed.
4			Initiate unacknowledged data transfer of 1000 octets from the MS.
5	MS -> SS	UI	Verify that the frame length does not exceed the negotiated value of N201-U.
6			Repeat step 5 until 1000 octets have been sent from the MS.

46.1.2.7.5 Negotiation initiated by the SS (during ADM, for IOV-UI)

46.1.2.7.5.1 Conformance requirement

The negotiation procedure is one-step, i.e., one side shall start the process by sending an XID command, offering a certain set of parameters from the applicable parameter repertoire the sending entity wants to negotiate, proposing values within the allowed range. In return, the other side shall send an XID response, either confirming these requested values, or offering higher or lower ones in their place.

XID frames shall always be used with the P/F bit set to 1.

IOV-UI shall only be negotiated in ADM. IOV-UI and IOV-I shall only be transmitted in the downlink direction.

IOV-UI is associated with a TLLI.

Reference

3GPP TS 04.64, subclauses 6.4.1.6, 8.5.3 and 8.9.

3GPP TS 04.08 subclause 4.7.12.

46.1.2.7.5.2 Test purpose

To verify that when the SS sends IOV-UI to the MS in an XID command:

- The MS shall cipher its output using this value of IOV-UI.
- This value of IOV-UI shall be applicable for all SAPIs using this TLLI.
- Identity Response sent from the MS shall not be ciphered.

46.1.2.7.5.3 Method of test

Initial conditions

-

Specific PICS statements:

- Supported encryption Algorithm : GEA2 (TSPC_Feat_GEA2)
- Supported encryption Algorithm : GEA3 (TSPC_Feat_GEA3)

PIXIT statements:

-

Test procedure

Send a value of IOV-UI from the SS, different from the default used. Send 1 000 octets from the MS and verify that the frames have been ciphered as per the new value of IOV-UI.

Send 1 000 octets from the MS on SAPI 11. Verify that the frames have been ciphered as per the new value of IOV-UI.

The test is performed for all GEAx encryption algorithmn supported by the MS.

Maximum duration of the test

3 minutes.

Expected sequence

The sequence is performed for execution counter K=1 and optionally for K=2 when the MS supports GEA2 and optionally for K=3 when the MS supports GEA3.

Step	Direction	Message	Comments
1		{PDP Context Activation}	Macro. Initiate a PDP context activation from the MS using PDP Context 10.
2	SS -> MS	UI [Authentication and Ciphering Request]	Send the Authentication and Ciphering Request from the SS to start ciphering using the following encryption algorithmn: GEA1 for K=1, GEA2 for K=2, GEA3 for K=3.
3	MS -> SS	UI [Authentication and Ciphering Response]	
4	SS -> MS	XID	XID command with IOV-UI = 5000.
5	MS -> SS	XID	Verify that the MS accepts this value of IOV-UI by sending an XID response. Verify the XID response received. If the MS has requested for a new set of XID parameters, verify that the values requested are within range.
6			Initiate unacknowledged data transfer of 1000 octets from the MS.
7	MS -> SS	UI	Verify that these frames have been ciphered as per the new value of IOV-UI.
8	SS -> MS	UI [Identity Request]	This UI frame must not be sent ciphered.
9	MS -> SS	UI [Identity Response]	This UI frame shall not be ciphered. The E bit shall not be set to 1.
10		{PDP Context Deactivation}	Macro. Deactivate PDP Context 10.
A11 (Optional step)			If the MS performs a GMM detach the SS completes the Detach procedure.
11		{PDP Context Activation}	Macro. Activate PDP Context 9. If the MS is detached in step A11, GPRS-re-attachment shall be performed.
A12 (Conditional step)			If the MS is re-attached in step 11, then step 2, 3, 4 and 5 shall be repeated to set IOV-UI parameter and restart ciphering.
12			Initiate a data transfer of 1000 octets from the MS on SAPI 11 for the same value of TLLI as before.
13	MS -> SS	UI	Verify that ciphering is as per the new value of IOV-UI.

46.1.2.7.6 Negotiation initiated by the SS (during ABM, for Reset)

Send Reset during unacknowledged mode data transfer and check if N(S) begins from 0.

46.1.2.7.6.1 Conformance requirement

The negotiation procedure is one-step, i.e., one side shall start the process by sending an XID command, offering a certain set of parameters from the applicable parameter repertoire the sending entity wants to negotiate, proposing values within the allowed range. In return, the other side shall send an XID response, either confirming these requested values, or offering higher or lower ones in their place.

XID frames shall always be used with the P/F bit set to 1.

Reset shall only be negotiated with an XID frame, and only transmitted in the downlink direction. If Reset is present in an XID frame, it shall be the first parameter in the XID information field.

The Reset parameter shall be used, in the SGSN originating Reset and the MS receiving Reset, to:

- set all LLC layer parameters to the default values given in table 9;
- change any LLEs in ABM state to ADM state;
- set the unconfirmed state variable V(U) to value 0;
- set the unconfirmed receive state variable V(UR) to 0;

- set the OCs for unacknowledged information transfer to 0.

The Reset parameter shall be treated before any additional XID parameters present in the same XID frame.

Reference

3GPP TS 04.64, subclauses 6.4.1.6 and 8.5.3.1.

46.1.2.7.6.2 Test purpose

To verify that when the SS sends the Reset parameter to the MS in an XID:

- it sets all LLC layer parameters to the default values;
- change any LLEs in ABM state to ADM state;
- set the unconfirmed state variable $V(U)$ to value 0;
- set the unconfirmed receive state variable $V(UR)$ to 0;
- set the OCs for unacknowledged information transfer to 0.

46.1.2.7.6.3 Method of test

Initial conditions

System simulator

The System Simulator shall support two cells, each in a different SGSN Routing Area.

Mobile station:

The MS shall be GPRS attached with ciphering enabled.

Specific PICS statements:

-

PIXIT statements:

-

Test procedure

For this test case, $N_{MS} = N_{SS} = 10$.

Initiate unacknowledged data transfer from the MS. Send N_{MS} UI frames.

Initiate unacknowledged data transfer from the SS. Send N_{SS} UI frames.

During PDP context activation for Context 11, initiate XID negotiation from the SS, with $N200 = 4$ and $T200 = 10$, if it is not done by the MS or if the MS tries to negotiate with $N200 < 4$ and $T200 < 10$, otherwise accept the values proposed by the MS. Initiate data transfer from the MS. Do not acknowledge the first frame sent from the MS and verify that the MS complies with the values of $T200$ and $N200$ that were agreed upon.

Initiate inter-SGSN Routing Area Update from the MS, which will make the SS send an XID command with the Reset parameter. Send I+S frames from the MS, with the A bit set to 1. Do not acknowledge the first I+S frame. Verify that the MS sends the I+S frame $N200$ times, every $T201$ seconds. Verify that the values of $N200$ and $T201$ are the default values.

Initiate unacknowledged data transfer from the MS for the same SAPI and for the same TLLI used before sending Reset from the SS. Verify that the frames are numbered from 0 and not from N_{MS} . Verify that the frames can be decrypted using $OC = 0$.

Maximum duration of the test

10 minutes.

Expected sequence

Step	Direction	Message	Comments
1		{PDP Context Activation}	Macro. Initiate PDP context activation from the MS using PDP Context 9.
2	MS -> SS	UI frame	
3			Repeat step 2 until N_{MS} frames are sent.
4	SS -> MS	UI frame	
5			Repeat step 4 until N_{SS} frames are sent.
6		{PDP Context Activation}	Macro. Initiate PDP context activation from the MS for PDP Context 11.
7	MS -> SS	SABM	If the MS negotiates N_{200} and T_{200} , then accept the proposed values if $N_{200} \geq 4$ and $T_{200} \geq 10$.
8	SS -> MS	UA	Send $N_{200} = 4$, $T_{200} = 10$ s in the UA response, if the MS does not negotiate N_{200} and T_{200} , or if the values of N_{200} and T_{200} proposed by the MS are not accepted by the SS in step 7.
9			Initiate acknowledged mode data transfer of 1 octet from the MS.
10	MS -> SS	I + S	
11			Do not respond with an RR. Verify that the MS retransmits the I+S frame every T_{200} seconds N_{200} times.
12	MS -> SS	SABM	Verify that the MS sends a SABM to re-establish the link
13	SS -> MS	UA	Respond with a UA within T_{200} seconds.
14		{Inter-SGSN Routing Area Update}	Macro. Initiate Inter-SGSN Routing Area Update from the MS. (This procedure sends XID reset). The MS shall reselect the new cell and do a Routing Area Update with the new SGSN.
15	SS->MS	SABM	Send N_{200} and T_{200} with values higher than the ones negotiated in step 7 and 8.
16	MS-> SS	UA	
17	MS -> SS	I + S	Resume data transfer from the MS.
18			Do not respond with an RR from the SS. Check that the MS retransmits the frame after T_{201} seconds, N_{200} times. T_{201} and N_{200} shall be as per the values negotiated, if any, after link re-establishment and not as per the values of N_{200} and T_{200} negotiated before sending a Reset, in step 8.
19	MS -> SS	SABM	Verify that the MS sends a SABM to re-establish the link
20	SS -> MS	UA	Respond with a UA within T_{200} seconds.
21	MS -> SS	UI	Initiate unacknowledged data transfer from the MS and send 50 octets for the same SAPI and for the same TLLI used before sending Reset from the SS. Verify that these frames have been ciphered with $OC = 0$ and are numbered from 0 and not from N_{MS} .

46.1.2.7.7 XID command with unrecognised type field

46.1.2.7.7.1 Conformance requirement

If a SABM or XID command with an invalid XID information field is received, then the SABM or XID command, respectively, shall be ignored.

If a SABM or XID command with unrecognised type field is received, then this parameter shall be ignored.

Reference

3GPP TS 04.64, subclause 8.5.3.3.

46.1.2.7.7.2 Test purpose

To test the MS response to an XID command with an unrecognised type field.

46.1.2.7.7.3 Method of test

Initial conditions

-

Specific PICS statements:

-

PIXIT statements:

-

Test procedure

Send an XID frame from the SS with N200 = 5 and another parameter with type = 15. Verify that the MS responds with an XID response. Send an I+S frame from the MS with the A bit set to 1. Do not respond with an RR. Verify that the MS retransmits the I+S frame N200 times, every T201 seconds, with N200 taking the negotiated value.

Maximum duration of the test

3 minutes.

Expected sequence

Step	Direction	Message	Comments
1		{PDP Context Activation}	Macro. Initiate a PDP context from the MS using PDP Context 11.
2	SS -> MS	XID	Send an XID command with N200 = 5 and an XID parameter with its type = 15, length =4 and value = 1500.
3	MS -> SS	XID	Verify the XID response received. If the MS has requested for a new XID value, verify that the new values are within range the sense of negotiation is correct The values received in the XID response shall be regarded as the final negotiated values.
4			Initiate acknowledged mode data transfer of 1 octet from the MS.
5	MS -> SS	I+S	Send an I+S frame from the MS with the A bit set to 1. Do not acknowledge the frame from the SS. Verify that The MS sends an I+S frame every T201 seconds, N200 times.
6	MS -> SS	SABM	Verify that the MS re-establishes the link by sending a SABM, after all retransmissions are complete.
7	SS -> MS	UA	Respond with a UA

46.1.2.7.8 XID Response with out of range values

46.1.2.7.8.1 Conformance requirement

If UA or XID response with an invalid XID information field is received, then the UA or XID response shall be ignored, the SABM or XID command shall be retransmitted, and the retransmission counter shall be incremented.

Reference

3GPP TS 04.64, subclause 8.5.3.3.

46.1.2.7.8.2 Test purpose

To test the MS response to an XID response with the N201-I value out of range.

46.1.2.7.8.3 Method of test

Initial conditions

-

Specific PICS statements:

-

PIXIT statements:

-

Test procedure

Send an XID frame within SABM, from the MS with layer3 parameters. Respond from the SS with an XID, with N201-I = 1600. Verify that the MS ignores this response and resends the SABM with the XID command. Now accept the XID values received at the SS. Send an I+S frame with length less than N201-I and the A bit set to 1 and verify that the MS responds with an RR. Send an I+S frame from the SS with its length larger than the maximum negotiated value of N201-I and verify that the MS sends an FRMR and re-establishes the link.

Maximum duration of the test

3 minutes.

Expected sequence

Step	Direction	Message	Comments
1		{PDP Context Activation}	Macro. Initiate PDP context activation from the MS, using PDP context 11.
2	MS -> SS	SABM[XID]	XID command with layer3 parameters, sent with SABM.
3	SS -> MS	UA[XID]	Send an XID response in UA, with N201-I = 1600
4	MS -> SS	SABM[XID]	Verify that the MS resends the SABM command.
5	SS -> MS	UA[XID]	Send UA accepting all the XID values.
6	SS -> MS	I+S	Send an I+S frame with the maximum negotiated value of N201-I, with the A bit set to 1.
A7 (optional step)	MS -> SS	RNR	If the MS sends an RNR, verify that the RNR acknowledges the frame sent in step 6. Do not transmit the next I+S frame to the SS until the MS sends an RR.
7	MS -> SS	RR	Verify that the MS responds with an RR
8	SS -> MS	I+S	Send an I+S frame with length = N201 - I + 1, with the A bit set to 1.
9	MS -> SS	FRMR	Verify that the MS responds with an FRMR
10	MS -> SS	SABM	Verify that the MS initiates link re-establishment
11	SS -> MS	UA	Respond with a UA.

46.2 SNDCP Tests

This clause contains the test case requirements for Subnetwork Dependent Convergence Protocol(SNDCP) procedures in the General Packet Radio Service (GPRS).

46.2.1 Default Conditions

- The MS default initial condition is that it is GPRS attached.
- Data and header compression are off.

The N-PDU size shall be more than the negotiated values of N201-U and N201-I so that segmentation at SNDCP is ensured. Unless stated otherwise, the default conditions shall apply.

If the MS sends an XID command with XID parameters any time before a data transfer, the SS shall send an XID response, accepting the values proposed by the MS.

46.2.2 Test cases

46.2.2.1 Data transfer

46.2.2.1.1 Mobile originated normal data transfer with LLC in acknowledged mode

46.2.2.1.1.1 Conformance requirement

The SNDCP entity shall initiate acknowledged data transmission only if the PDP context for the NSAPI identified in the SN-DATA.request has been activated and if acknowledged LLC operation has been established.

The N-PDU number in acknowledged mode is a number assigned to each N-PDU received by SNDCP through an SN-DATA.request. N-PDU numbers for different NSAPIs shall be assigned independently. The N-PDU number shall be included in the SNDCP header of the first segment of an N-PDU.

Upon reception of an SN-DATA.request, the SNDCP entity shall assign to the N-PDU received the current value of the Send N-PDU number as the N-PDU number, increment the Send N-PDU number by 1, perform the compression and segmentation functions, then forward the SN-PDU(s) in LL-DATA.request to the LLC layer. The N-PDU shall be stored into a buffer in the SNDCP entity. The buffered N-PDU shall be deleted when the SN-DATA PDU carrying the last segment of the N-PDU is confirmed by an LL-DATA.confirm primitive.

A (possibly compressed) N-PDU shall be segmented into one or more SN-PDUs. The length of each SN-PDU shall not be greater than N201-I (for acknowledged mode) or N201-U (for unacknowledged mode).

Reference

3GPP TS 04.65, subclauses 6.9.1 and 6.7.1.1.

46.2.2.1.1.2 Test purpose

To verify that:

- The MS sends the N-PDU number in the first segment of every N-PDU.
- The MS increments the N-PDU number properly.
- The size of a segment must not be greater than N201-I.

46.2.2.1.1.3 Method of test

Initial conditions

-

Specific PICS statements:

-

PIXIT statements:

-

Test procedure

Activation of PDP context 13 is initiated from MS.

Verify that the first segment of the first N-PDU received has N-PDU number 0. Acknowledge all the segments received from the MS. For the subsequent N-PDUs received, verify that the N-PDU number is incremented properly.

Repeat the test case for PDP contexts 11 and 12.

Maximum duration of the test

10 minutes.

Expected sequence

Step	Direction	Message	Comments
1		{PDP Context Activation}	Macro. Initiate PDP context activation from the MS. The PDP context used here is PDP context 13.
2			Initiate data transfer of 5000 octets from the MS .
3	MS -> SS	SN-DATA PDU	Verify that the number of octets in the SN-DATA PDU does not exceed N201-I. Verify that the first SN-DATA PDU received has M=1, T=0, F=1, X = 0, DCOMP = PCOMP = 0, N-PDU number = 0.
4			Verify that the last segment of every N-PDU received has M=0, T=0, and F=0. Note: Final SN-DATA-PDU could have M=0, T=0 and F=1, if the last N-PDU is too short to be segmented
5			Verify that for the subsequent N-PDUs, the N-PDU number is incremented properly
6			Repeat step 3 to 5 until data transfer is completed.
7			Repeat the test case for SAPIs 3 and 9. The PDP context used for SAPI 3 is PDP Context 11 and the one for SAPI 9 is PDP Context 12.

46.2.2.1.2 Mobile originated normal data transfer with LLC in unacknowledged mode

46.2.2.1.2.1 Conformance requirement

The SNDSCP entity shall initiate unacknowledged data transmission only if the PDP context for the NSAPI identified in the SN-DATA.request has been activated. The SNDSCP entity may initiate unacknowledged data transmission even if the acknowledged peer-to-peer operation is not established for that NSAPI. The N-PDU number in unacknowledged mode is a number assigned to each N-PDU received by SNDSCP through an SN-UNITDATA.request. N-PDU numbers for different NSAPIs shall be assigned independently. The N-PDU number shall be included in the SNDSCP header of every SN-UNITDATA PDU.

A variable, the Send N-PDU number (unacknowledged), shall be maintained for each NSAPI using unacknowledged peer-to-peer LLC operation. When an NSAPI using unacknowledged peer-to-peer LLC operation is activated, the Send N-PDU number (unacknowledged) shall be set to 0. The Send N-PDU number (unacknowledged) shall also be set as described in subclauses 5.1.2.1 and 5.1.2.22. Modulo 4096 operation shall be applied to the Send N-PDU number (unacknowledged).

Upon reception of an SN-UNITDATA request, the SNDSCP entity shall assign the current value of the Send N-PDU number (unacknowledged) as the N-PDU number of the N-PDU received, increment Send N-PDU number (unacknowledged) by 1, compress and segment the information, then forward the SN-PDU(s) in LL-UNITDATA.request to the LLC layer. The N-PDU shall be deleted immediately after the data has been delivered to the LLC layer.

A (possibly compressed) N-PDU shall be segmented into one or more SN-PDUs. The length of each SN-PDU shall not be greater than N201-I (for acknowledged mode) or N201-U (for unacknowledged mode).

The segment number is a sequence number assigned to each SN-UNITDATA PDU. The sequence number shall set to 0 in the first SN-UNITDATA PDU of an N-PDU, and incremented by 1 for each subsequent SN-UNITDATA PDU. Modulo 16 operation is applied. N-PDU number is included in every SN-UNITDATA PDU.

The SNDSCP entity shall perform the mapping function of SN_UNITDATA primitives onto LL_UNITDATA primitives

Reference

3GPP TS 04.65, subclauses 6.9.2, 6.7.1.1, 6.7.3 and 5.2.

46.2.2.1.2.2 Test purpose

To verify that:

- The MS sends the N-PDU number in every segment of every N-PDU.
- The MS increments the N-PDU number and segment number properly and modulo 16 operation is applied.
- The size of a segment shall not be greater than N201-U.
- The MS maps the SN_UNITDATA PDUs onto SAPIs allocated by Network.

46.2.2.1.2.3 Method of test

Initial conditions

-

Specific PICS statements:

-

PIXIT statements:

-

Test procedure

PDP context 10 is initiated from MS.

Initiate unacknowledged data transfer from MS.

Verify that the first segment of the first N-PDU received has N-PDU number 0. For the subsequent N-PDUs received, verify that the N-PDU number is incremented properly.

Verify that the SN-UNITDATA PDUs are numbered correctly.

Verify the SAPI number on which the data PDU is received.

Verify that Modulo 16 operation is applied.

Maximum duration of the test

2 minutes.

Expected sequence

Step	Direction	Message	Comments
1		{PDP Context Activation}	Macro. Initiate PDP context activation from the MS. The PDP context used here is PDP context 10.
2	SS -> MS	XID	XID command with N201-U = 140.
3	MS -> SS	XID	XID response.
4			Initiate data transfer of 5000 octets (with each N-PDU being more than 140 octets) from the MS.
5	MS -> SS	SN-UNITDATA PDU	Verify that the number of octets in the SN-UNITDATA PDU does not exceed N201-U. Verify that the first SN-UNITDATA PDU received has M=1, T=1, F=1, X = 0, DCOMP = PCOMP = 0, N-PDU number = 0, segment = 0.
6	SS		Verify that the segment number is incremented properly for every SN-PDU. Verify that the last segment of every N-PDU received has M=0, T=1, and F=0. The last N-PDU may not be segmented; the F bit shall not be checked.
7	SS		Verify that for the subsequent N-PDUs, the N-PDU number is incremented properly and N-PDU number is present in every SN-UNITDATA PDU
8	SS		Verify the SAPI number in the received LLC frame header
9			Repeat steps 5 to 8 until data transfer is completed. Verify modulo 16 operation is applied for the 17th segment of SN-UNITDATA PDU, Note: This check of 'Modulo 16 operation' is to be done only if; the NPDUs are having 17 or more segments.

46.2.2.1.3 Usage of acknowledged mode for data transmission before and after PDP Context modification, on different SAPIs

46.2.2.1.3.1 Conformance Requirement

Upon reception of the SNSM-MODIFY.indication from the SM sublayer:

- the SNDCP entity shall, if necessary, establish the acknowledged peer-to-peer LLC operation for the indicated SAPI (the establishment criteria and procedure are described in subclause 6.2.1);
- the SNDCP entity shall also, if necessary, release the acknowledged peer-to-peer LLC operation for the originally-assigned SAPI (the release criteria and procedure are described in subclause 6.2.2); In addition, if the newly-assigned SAPI is different from the original SAPI:
 - LL-DATA.indication, LL-DATA.confirm and LL-UNITDATA.indication received on the old SAPI shall be ignored;
 - LL-DATA.request and LL-UNITDATA.request shall be sent on the new SAPI; and
 - if acknowledged peer-to-peer LLC operation is used both before and after the receipt of the SNSM-MODIFY. indication, then all buffered N-PDUs (i.e., the ones whose complete reception has not been acknowledged and the ones that have not been transmitted yet) shall be transmitted starting from the oldest N-PDU.

Reference

3GPP TS 04.65, subclause 5.1.2.23.

46.2.2.1.3.2 Test purpose

To verify that after the PDP context modification:

- the MS resumes acknowledged data transfer correctly with the oldest N-PDU which is buffered after a PDP context modification.

46.2.2.1.3.3 Method of test

Initial conditions

-

Specific PICS statements:

-

PIXIT statements:

-

Test procedure

PDP Context 11 is initiated from MS.

After the first N-PDU is correctly received in acknowledged mode, the last segment of the second N-PDU (N-PDU number=1) is not acked and a PDP context modification is initiated from SS to PDP context 12, ie: using SAPI 9 in acknowledged mode.

After the modification procedure is complete, the first SN-DATA PDU received shall have the N-PDU number 1. The N-PDU received shall be the same as the last one before the modification procedure was triggered.

Maximum duration of the test

2 minutes.

Expected sequence

Step	Direction	Message	Comments
1		{PDP Context Activation}	Macro. Initiate PDP context activation from the MS. Use PDP context 11.
2			Initiate acknowledged data transfer for 5000 octets, from the MS.
3	MS -> SS	SN-DATA PDU	Verify that the number of octets in the SN-DATA PDU does not exceed N201-l. Verify that the first SN-DATA PDU received has M=1, T=0, F=1, X = 0, DCOMP = PCOMP = 0, N-PDU number = 0.
4			Verify that the last segment of the first N-PDU received has M=0, T=0, and F=0. The last segment of last N-PDU may be not segmented; the F bit shall not be checked.
5			Receive the next N-PDU, N-PDU = 1 by following steps 3 and 4. Do not acknowledge the last segment of the N-PDU.
6		{PDP Context Modification}	Macro. Initiate PDP context modification procedure from the SS. Use PDP context 12 (ie: using SAPI 9 in acknowledged mode)
7	SS->MS	DISC	Initiate the release of LLC link by sending DISC on SAPI 3 and receive UA or DM from MS.
8	MS->SS	UA or DM	
9	SS->MS	SABM	Initiate the establishment of LLC link by sending SABM on SAPI 9 and receive UA from MS.
10	MS->SS	UA	
11	MS -> SS	SN-DATA PDU	Verify that the number of octets in the SN-DATA PDU does not exceed N201-l. Verify that the first SN-DATA PDU received has M=1, T=0, F=1, X = 0, DCOMP = PCOMP = 0. Verify that the N-PDU received has N-PDU number = 1.
12			Verify that the last segment of every N-PDU received has M=0, T=0, and F=0. The last segment of last N-PDU may be not segmented; the F bit shall not be checked.
13			Verify that for the subsequent N-PDUs, the N-PDU number is incremented properly
14			Repeat steps 11 to 13 until data transfer is completed.

46.2.2.1.4 Reset indication during unacknowledged mode

46.2.2.1.4.1 Conformance Requirement

Upon receipt of the LL-RESET.indication, the SNDCCP layer shall:

- reset all SNDCCP XID parameters to their default values;
- in the MS, for every NSAPI using unacknowledged peer-to-peer LLC operation, set the Send N-PDU number (unacknowledged) to 0.

Reference

3GPP TS 04.65, subclause 5.1.2.1.

46.2.2.1.4.2 Test purpose

To verify that the MS resets the Send N-PDU number to 0 on link reset during an unacknowledged mode data transfer.

46.2.2.1.4.3 Method of test

Initial conditions

-

Specific PICS statements:

-

PIXIT statements:

-

Test procedure

PDP Context 8 is initiated from MS.

An XID command is sent with reset from SS during unacknowledged data transfer, after receiving N-PDU number 2 from MS. The next N-PDU number from MS shall be 0.

Maximum duration of the test

2 minutes.

Expected sequence

Step	Direction	Message	Comments
1		{PDP Context Activation}	Macro. Initiate PDP context activation from the MS. Use PDP context 8.
2			Initiate unacknowledged data transfer using sufficient amount of data (for example 150000 octets) to be sure that at step 8 the MS still has available N-PDUs for transmission subsequent to XID procedure at step 6 and step 7.
3	MS -> SS	SN-UNITDATA PDU	Verify that the number of octets in the SN-UNITDATA PDU does not exceed N201-U. Verify that the first SN-UNITDATA PDU received has M=1, T=1, F=1, X = 0, DCOMP = PCOMP = 0, N-PDU number = 0, sequence number = 0.
4			Verify that the last segment of the first N-PDU received has M=0, T=1, and F=0.
5			Receive the N-PDUs from the MS until N-PDU number becomes 2
6	SS->MS	XID	Initiate the XID command from SS with reset Discard all UI frames received.
7	MS->SS	XID	XID response
8	MS -> SS	SN-UNITDATA PDU	Verify that the number of octets in the SN-UNITDATA PDU does not exceed N201-U. Verify that the first SN-UNITDATA PDU received after link reset has M=1, T=1, F=1, X = 0, DCOMP = PCOMP = 0, N-PDU number = 0, segment number = 0.

46.2.2.1.5 Reset indication during acknowledged mode

46.2.2.1.5.1 Conformance Requirement

Upon receipt of the LL-RESET.indication, the SNDTCP layer shall:

- reset all SNDTCP XID parameters to their default values;
- for every NSAPI using acknowledged peer-to-peer LLC operation, enter the recovery state and suspend the transmission of SN-PDUs until an SNSM-SEQUENCE.indication primitive is received for the NSAPI.

Reference

3GPP TS 04.65, subclause 5.1.2.1.

46.2.2.1.5.2 Test purpose

To verify that the MS suspends the data transfer in acknowledged mode on link reset and resume when indicated by the SS.

46.2.2.1.5.3 Method of test

Initial conditions

Two cells , cell A and B need to be supported.B is in a routing area (in a new SGSN) and location area different from that of A. The power level of cell A shall be higher than that of cell B so that the MS selects cell A.

Specific PICS statements:

-

PIXIT statements:

-

Test procedure

PDP Context 13 is initiated from MS.

Acknowledge the first 2 N-PDUs received from MS during the data transfer.

Initiate an inter SGSN Routing Area Update procedure from MS. An XID command is sent with reset from SS, after receiving N-PDU number N from MS. Specify the Receive N-PDU number to be 3 in the Routing Area Update Accept message. Verify that the data transfer is resumed and the MS sends the complete N-PDU with N-PDU number 3.

Maximum duration of the test

2 minutes.

Expected sequence

Step	Direction	Message	Comments
1		{PDP Context Activation}	Macro. Initiate PDP context activation from the MS. Use PDP context 13.
2			Initiate acknowledged data transfer for 7000 octets, from the MS.
3	MS -> SS	SN-DATA PDU	Verify that the number of octets in the SN-DATA PDU does not exceed N201-I. Verify that the first SN-DATA PDU received has M=1, T=0, F=1, X = 0, DCOMP = PCOMP = 0,N-PDU number = 0.
4			Verify that the last segment of the first N-PDU received has M=0, T=0, and F=0.
5			Receive the N-PDUs from the MS until N-PDU number becomes 1 and acknowledge all the segments completely.
6			Receive the N-PDUs 2 and 3 from the MS and do not acknowledge the last SN-PDU of N-PDU 3..
7		{Inter-SGSN Routing Area Update}	Macro.Initiate a cell change requesting the MS to move to cell B. Initiate an inter SGSN Routing Area Update procedure from SS. Send the Receive N-PDU number as 3 in the Routing Area Update Accept message. Note: After changing the signal strength and before receiving the RAU REQUEST, MS may send some more SN-DATA PDUs. These PDUs are not acknowledged in cell A.
8	SS->MS	SABM	
9	MS->SS	UA	
10	MS -> SS	SN-DATA PDU	Verify that the number of octets in the SN-DATA PDU does not exceed N201-I. Verify that the first SN-DATA PDU received has M=1, T=0, F=1, X = 0, DCOMP = PCOMP = 0, N-PDU number = 3. Last N-PDU may be not segmented; in which case the M bit shall not be checked.
11			Repeat step 10 until data transfer is completed.

46.2.2.2 Segmentation

46.2.2.2.1 LLC link re-establishment on reception of SN-DATA PDU with F=0 in ack mode in the Receive First Segment state

46.2.2.2.1.1 Conformance Requirement

Receive First Segment state:

- If an SN-DATA PDU is received with the F bit set to 0, the SN-DATA PDU shall be discarded, and the acknowledged LLC operation shall be re-established for the SAPI used.

Reference

3GPP TS 04.65, subclause 6.7.4.1.

46.2.2.2.1.2 Test purpose

To verify that the MS re-establishes the LLC SAPI on reception of an SN-DATA PDU with F=0 as the first segment in the acknowledged mode data transfer.

46.2.2.2.1.3 Method of test

Initial conditions

-

Specific PICS statements:

-

PIXIT statements:

-

Test procedure

PDP Context 13 is initiated from MS.

An acknowledged mode data transfer is started from SS with the first SN_DATA PDU with F=0.

Verify that the MS shall re-establish the LLC SAPI 11.

Maximum duration of the test

2 minutes.

Expected sequence

Step	Direction	Message	Comments
1		{PDP Context Activation}	Macro. Initiate PDP context activation from the MS. Use PDP context 13.
2			Initiate acknowledged data transfer for 5000 octets, from the SS.
3	SS -> MS	SN-DATA PDU	Send the first SN-DATA PDU with M=1, T=0, F=0, X = 0, DCOMP = PCOMP = 0, N-PDU number = 0 .
4	MS->SS	SABM	MS re-establishes the LLC SAPI 11
5	SS->MS	UA	
6	SS -> MS	SN-DATA PDU	Send the first SN-DATA PDU with M=1, T=0, F=1, X = 0, DCOMP = PCOMP = 0, N-PDU number = 0
7			Repeat step 6 until data transfer is completed. Verify that all SN-DATA PDUs are acknowledged.

46.2.2.2.2 LLC link re-establishment on receiving second segment with F=1 and with different PCOMP and DCOMP values in the acknowledged mode data transfer

46.2.2.2.2.1 Conformance Requirement

Receive Subsequent Segment state:

- If an SN-DATA PDU is received with the F bit set to 1, and if DCOMP, PCOMP or N-PDU number is different from those in the first segment, then the SN-DATA PDU and all previous segments belonging to the same N-PDU shall be discarded, and the acknowledged LLC operation shall be re-established for the SAPI used.

Reference

3GPP TS 04.65, subclause 6.7.4.2.

46.2.2.2.2.2 Test purpose

To verify that the MS re-establishes the LLC SAPI on reception of the second SN-DATA PDU with F=1 and with PCOMP and DCOMP values different from those of the previous segment, in the second segment in acknowledged mode data transfer.

46.2.2.2.2.3 Method of test

Initial conditions

-

Specific PICS statements:

-

PIXIT statements:

-

Test procedure

PDP Context 13 is initiated from MS.

AN acknowledged mode data transfer is started from SS with the first SN_DATA PDU with F=1. Send the second SN-DATA PDU from SS with F=1 and with PCOMP and DCOMP values different from those in the first segment.

Verify that the MS shall re-establish the LLC SAPI 11.

Maximum duration of the test

2 minutes.

Expected sequence

Step	Direction	Message	Comments
1		{PDP Context Activation}	Macro. Initiate PDP context activation from the MS. Use PDP context 13.
2			Initiate acknowledged data transfer for 5000 octets, from the SS.
3	SS -> MS	SN-DATA PDU	Send the first SN-DATA PDU with M=1, T=0, F=1, X = 0, DCOMP = PCOMP = 0, N-PDU number = 0.
4	SS->MS	SN-DATA PDU	Send the second SN-DATA PDU with M=1, T=0, F=1, X = 0, DCOMP = PCOMP = 1, N-PDU number = 0.
5	MS->SS	SABM	Re-establishment of LLC link on SAPI 11.
6	SS->MS	UA	
7	SS -> MS	SN-DATA PDU	Send the first SN-DATA PDU with M=1, T=0, F=1, X = 0, DCOMP = PCOMP = 0, N-PDU number = 0
8			Repeat step 7 until data transfer is completed. Verify that all SN-DATA PDUs are acknowledged.

46.2.2.2.3 Single segment N-PDU from MS

46.2.2.2.3.1 Conformance Requirement

- The F bit in the SNDCP header shall be set to 1 for the first segment, and 0 for all subsequent segments. For unacknowledged peer-to-peer LLC operation, DCOMP and PCOMP shall be included in the header when the F bit is set to 1, and shall not be included when the F bit is set to 0. For acknowledged peer-to-peer LLC operation, DCOMP, PCOMP and N-PDU number shall be included in the header when the F bit is set to 1, and shall not be included when the F bit is set to 0.
- The M bit in the SNDCP header shall be set to 0 for the last segment, and 1 for all previous segments. If only one SN-PDU is generated for an N-PDU, the F bit shall be set to 1 and the M bit set to 0.

Reference

3GPP TS 04.65, subclause 6.7.1.1.

46.2.2.2.3.2 Test purpose

To verify that for a single segment N-PDU, the MS shall send the SN_UNITDATA PDU with F=1 and M=0 during unacknowledged data transfer.

46.2.2.2.3.3 Method of test

Initial conditions

-

Specific PICS statements:

-

PIXIT statements:

-

Test procedure

PDP Context 10 is initiated from MS.

An unacknowledged mode data transfer is started from MS for a data size less than N201-U. Verify that the MS sends the SN-UNITDATA PDU with M=0 and F=1.

Maximum duration of the test

2 minutes.

Expected sequence

Step	Direction	Message	Comments
1		{PDP Context Activation}	Macro. Initiate PDP context activation from the MS. Use PDP context 10.
2			Initiate unacknowledged data transfer for 1 octet, from the MS.
3	MS -> SS	SN-UNITDATA PDU	Verify that the single SN-UNITDATA PDU is received with M=0 and F=1.

46.2.2.3 Link Release

46.2.2.3.1 LLC link release on receiving DM from the SS during link establishment

46.2.2.3.1.1 Conformance Requirement

If the originator of the establishment procedure receives an LL-RELEASE.indication with Cause "DM received", it shall inform the SM sub-layer using the SNSM-STATUS.request primitive with Cause "DM received". SM shall then deactivate all PDP contexts for that SAPI requiring acknowledged peer-to-peer LLC operation.

Reference

3GPP TS 04.65, subclause 6.2.1.4.

46.2.2.3.1.2 Test purpose

To verify that in MS, the LLC SAPI is released and the PDP context is deactivated on reception of DM response from SS during link establishment.

46.2.2.3.1.3 Method of test

Initial conditions

-

Specific PICS statements:

-

PIXIT statements:

-

Test procedure

PDP Context 13 is initiated from MS.

A DM response is sent from SS, after receiving a SABM from the MS for link establishment. The MS shall release the LLC SAPI 11 and the PDP context for the NSAPI shall be deactivated.

Maximum duration of the test

2 minutes.

Expected sequence

Step	Direction	Message	Comments
1		{PDP Context Activation}	Macro. Initiate PDP context activation from the MS. Use PDP context 13.
2	MS -> SS	SABM	SABM sent for link establishment during PDP context activation
3	SS->MS	DM	Initiate a DM response with F=1 from the SS.
4			Verify that the MS initiates PDP Context Deactivation.

46.2.2.4 XID negotiation

46.2.2.4.1 Response from MS on receiving XID request from the SS

46.2.2.4.1.1 Conformance Requirement

The XID negotiation is a one-step procedure; i.e., the initiating end proposes parameter values, and the responding end either accepts these or offers different values in their place according to the XID negotiation rules described in the present document; the rules limit the range of parameter values as well as the sense of negotiation. The initiating end accepts (or rejects) the values in the response; this concludes the negotiation.

A bit set to 0 means that the compression entity is not applicable to the corresponding NSAPI. A bit set to 1 means that the compression entity is applicable to the corresponding NSAPI.

Reference

3GPP TS 04.65, subclause 6.8.1.

46.2.2.4.1.2 Test purpose

To verify that:

- the MS which does not support compression, responds with applicable NSAPI field with 0 for an XID request from the SS with some compression entity;
- the MS which supports compression responds with the applicable NSAPI field set to 1 for an XID request from the SS with some compression entity.

46.2.2.4.1.3 Method of test

Initial conditions

-

Specific PICS statements:

- MS supporting compression has compression turned on (TSPC_AddInfo_GPRS_Data_Compr and/or TSPC_AddInfo_GPRS_Header_Compr).
- Support of GPRS header compression algorithm type RFC 1144 (TSPC_AddInfo_GPRS_Header_Compr_Type_RFC1144)
- Support of GPRS header compression algorithm type RFC 2507 (TSPC_AddInfo_GPRS_Header_Compr_Type_RFC2507)
- Support of ROHC algorithm type RFC 3241 (TSPC_AddInfo_ROHC_Type_RFC3241)
- Support of ROHC algorithm type RFC 3242 (TSPC_AddInfo_ROHC_Type_RFC3242)
- Support of ROHC algorithm type RFC 3408 (TSPC_AddInfo_ROHC_Type_RFC3408)
- Support of ROHC algorithm type RFC 3095 (TSPC_AddInfo_ROHC_Type_RFC3095)

PIXIT statements:

-

Test procedure

PDP Context 13 is initiated from MS. The MS supporting compression will also trigger an XID negotiation. Modify the PDP Context to PDP Context 12 from the SS.

After PDP context modification, trigger compression by sending an XID Request from SS including a L3-parameter with some compression entity for the NSAPI assigned for the PDP context.

The MS which does not support compression or has a lack of resources shall respond with XID response setting the applicable NSAPI field set to 0, indicating that compression is not supported/wanted.

The MS which support compression and has compression turned on shall respond with XID response setting the applicable NSAPI field set to 1, indicating that compression is supported. The MS may choose to not include an SNDCP XID parameter in its response (implicit response), which is equivalent to responding with the value proposed by the SS.

Maximum duration of the test

2 minutes.

Expected sequence

Step	Direction	Message	Comments
1		{PDP Context Activation}	Macro. Initiate PDP context activation from the MS. Use PDP context 13. The MS supporting compression will also trigger an XID negotiation.
2		{PDP Context Modification}	Macro. Initiate PDP Context Modification from the SS. The new context is PDP Context 12. If the MS supports compression, SS triggers an XID negotiation in order to remove the PDP Context from the Applicable NSAPIs of the compression entities negotiated in step 1.
3	SS->MS	DISC	Initiate the release of LLC link by sending DISC on SAPI 11 and receive UA or DM from MS.
4	MS->SS	UA or DM	
5	SS->MS	SABM	Initiate the establishment of LLC link by sending SABM on SAPI 9 and receive UA from MS.
6	MS->SS	UA	
7	SS -> MS	XID Request	In the layer3 XID parameters, send a PCOMP entity with parameter type = 2, entity number = 1 and algorithm type, which the MS supports or 0 if the MS does not have support of header compression, a DCOMP entity with parameter type = 1, entity number = 1 and algorithm type = 0. In the applicable NSAPI field, set the bit for the NSAPI assigned for the PDP context.
A8	MS -> SS	XID Response	Verify that the MS which does not support compression, has compression turned off or has a lack of resources responds with the assigned NSAPI field set to 0.
B8	MS -> SS	XID Response	Verify that the MS which supports compression and has compression turned on responds either with the assigned NSAPI field set to 1 or without including the relevant L3 XID parameter (implicit response).
9			Initiate acknowledged data transfer for 5000 octets, from the MS.
10	MS -> SS	SN-DATA PDU	Verify that the number of octets in the SN-DATA PDU does not exceed N201-I.
A11			For mobiles which do not support compression, verify that the first SN-DATA PDU received has M=1, T=0, F=1, X = 0, DCOMP = PCOMP = 0, N-PDU number = 0.
B11			For mobiles which support compression such that the SN-DATA-PDU needs to be segmented, verify that the first SN-DATA PDU received has M=1, T=0, F=1, X = 0, DCOMP = the negotiated value (assuming that data is compressible), PCOMP = the negotiated value (assuming that data contains a valid TCP/IP header) or 0 (data did not contain a valid TCP/IP header), N-PDU number = 0.
C11			For mobiles which support compression such that the SN-DATA-PDU does not need to be segmented, verify that the first SN-DATA PDU received has M=0, T=0, F=1, X = 0, DCOMP = the negotiated value (assuming that data is compressible), PCOMP = the negotiated value (assuming that data contains a valid TCP/IP header)) or 0 (data did not contain a valid TCP/IP header), N-PDU number = 0. Go to step 13.
A12, B12			Verify that the last segment of the first N-PDU received has M=0, T=0, and F=0. The last segment of last N-PDU may be not segmented; the F bit shall not be checked.
13			Verify that for the subsequent N-PDUs, the N-PDU number is incremented properly
14			Repeat step 10 to 13 until data transfer is complete.

46.2.2.4.2 Response from MS on receiving an XID request from the SS with an unassigned entity number

46.2.2.4.2.1 Conformance Requirement

In the originating SNDCP XID block, if an unassigned entity number is included with the P bit set to 0, then the Applicable NSAPIs field in the response shall be set to 0.

Reference

3GPP TS 04.65, subclause 6.8.3.

46.2.2.4.2.2 Test purpose

To verify that in the originating SNDCP XID block, if an unassigned entity number is included with the P bit set to 0, the Applicable NSAPIs field in the response shall be set to 0.

46.2.2.4.2.3 Method of test

Initial conditions

-

Specific PICS statements:

-

PIXIT statements:

-

Test procedure

PDP Context 11 is initiated from MS.

Send an XID command from the SS with P bit set to 0, with an unassigned entity number.

The MS shall respond with XID response setting the applicable NSAPI field set to 0, indicating that compression is not supported.

Maximum duration of the test

2 minutes.

Expected sequence

Step	Direction	Message	Comments
1		{PDP Context Activation}	Macro. Initiate PDP context activation from the MS. Use PDP context 11.
2	SS -> MS	XID	In the layer3 XID parameters, send a PCOMP entity with parameter type = 2. Set the P bit to 0 and the entity number to a number not assigned.
3	MS -> SS	XID	Verify that the MS responds with the assigned NSAPI field set to 0.

46.2.2.4.3 Response from MS on receiving an XID response from the SS with unrecognised type field

46.2.2.4.3.1 Conformance Requirement

If the responding SNDCP XID block includes a parameter with unrecognised Type field, unsupported length, an out-of-range value or a value violating the sense of negotiation, a parameter type 1 or 2 which violates the rules in subclause 6.8.1, a parameter with duplicated instances, contains prohibited changes (see subclauses 6.5.1.2 and 6.6.1.2) to the parameters of compression entities used with acknowledged peer-to-peer LLC operation when the SNDCP XID block is sent on LL-XID primitives, or a compression field with the P bit set to 1, then the originator shall ignore the block and reinitiate the negotiation.

Reference

3GPP TS 04.65, subclause 6.8.3.

46.2.2.4.3.2 Test purpose

To verify that in the XID response, if an unrecognised type field is specified, the originator shall ignore the block and reinitiate XID negotiation.

46.2.2.4.3.3 Method of test

Initial conditions

-

Specific PICS statements:

-

PIXIT statements:

-

Test procedure

PDP Context 11 is initiated from MS.

In the response to SABM, in the UA, send SNDCP parameter type = 30.

The MS shall resend the SABM command or send an XID command.

Maximum duration of the test

2 minutes.

Expected sequence

Step	Direction	Message	Comments
1		{PDP Context Activation}	Macro. Initiate PDP context activation from the MS. Use PDP context 11.
2	MS -> SS	SABM	
3	SS -> MS	UA	Include an SNDCP XID parameter with parameter type = 30.
4	MS -> SS	XID Command Or SABM command	Verify that the MS sends an XID Command or resends the SABM command

46.2.2.5 LLC link release on receiving "Invalid XID response" from the network during link establishment procedure

46.2.2.5.1 Conformance Requirement

If the originator of the establishment procedure receives an LL-RELEASE.indication with Cause "Invalid XID response", it shall inform the SM sub-layer using the SNSM-STATUS.request primitive with Cause "Invalid XID response". SM shall then deactivate all PDP contexts for that SAPI.

Reference

3GPP TS 04.65, subclause 6.2.1.4.

3GPP TS 04.64, subclause 8.5.3.3.

46.2.2.5.2 Test purpose

To verify that in the MS, the PDP context is deactivated on reception of "Invalid XID response" from network during link establishment.

46.2.2.5.3 Method of test

Initial conditions

-

Specific PICS statements:

-

PIXIT statements:

-

Test procedure

Activation of PDP Context 13 is initiated from MS.

The MS sends a SABM from the MS for link establishment.

The SS responds to the SABM with a UA with Invalid XID information field.

The MS shall ignore this response and re-transmit the SABM N200 times.

The SS shall respond with the UA with Invalid XID information, N200 times.

Verify that the MS releases the LLC SAPI and the PDP context for the SAPI is deactivated.

Maximum duration of the test

3 minutes.

Expected sequence

Step	Direction	Message	Comments
1		{PDP Context Activation}	Macro. Initiate PDP context activation from the MS. Use PDP context 13.
2	MS -> SS	SABM	SABM sent for link establishment during PDP context activation
3	SS->MS	UA	In response to the SABM , SS sends UA with an Invalid XID information field . MS shall ignore this response and Re-transmit the SABM N200 times.
4			Repeat steps 2 and 3 N200 times. (Send UA with Invalid XID parameters in response to SABM received N200 times.)
5		{PDP Context De-Activation}	Verify that the MS initiates PDP Context Deactivation.

47 Dual Transfer Mode

The default cell configuration for section 47 for the system simulator is the "PBCCH not present" case unless stated explicitly in the test case initial conditions.

To bring the MS into active state U10, macro 40.4.3.22 shall be used.

47.1 Reallocation of CS resources

47.1.1 Reallocation of CS resources / Assignment Command

47.1.1.1 Conformance requirements

While in dual transfer mode an inter-frequency change of channel can be performed through the dedicated channel assignment procedure.

Upon receipt of the ASSIGNMENT COMMAND message, the MS shall abandon the packet resource immediately, enter dedicated mode and then initiate a local end release of link layer connections and disconnects the physical channels. The MS then commands the switching to the assigned channels and initiates the establishment of lower layer connections.

After the main signalling link is successfully established, the MS returns an ASSIGNMENT COMPLETE message, specifying cause "normal event", to the network on the main DCCH.

The sending of this message on the MS side and its receipt on the network side allow the resumption of the transmission of signalling layer messages other than those belonging to RR management which include the Packet Assignment signalling to re-establish DTM.

References

3GPP TS 04.18 / 44.018, sub-clause 3.4.3

47.1.1.2 Test purpose

To verify that the channel assignment procedure can completely modify the physical channel configuration of the MS within the current frequency band and that the MS can re-establish successfully the PS resources.

47.1.1.3 Method of test

Initial Conditions

System Simulator:

1 cell, Cell A, with both TCH of cell activated and DTM supported.

Mobile Station:

The MS is in the active state (U10) of a call, on cell A, with a TMSI and P-TMSI allocated and the PDP context 2 activated but no allocated TBFs.

Specific PICS statements

-

PIXIT statements

-

Test Procedure

Once the MS is in DTM, the SS attempts to modify the resources of the MS. The MS is allocated a timeslot, in the same frequency band, on the current cell. The re-allocation of the MS resources is realised by the MS receiving an ASSIGNMENT COMMAND message from the SS. The ASSIGNMENT COMMAND message instructs the switching of the MS to the newly assigned channel and initiates the establishment of lower layer connections. The establishment of the lower layer connections includes the activation of the channels, the connection to the channels and the establishment of the main signalling link. Once the CS connection is established, the MS should return an ASSIGNMENT COMPLETE message on the new main signalling link. The SS then sends the PACKET ASSIGNMENT message to the MS over the main signalling link to establish the packet resources and the MS enters DTM.

MS supporting DTM shall complete test for k=1 and MSs indicating support of single slot DTM shall additionally complete testing for k=2.

Maximum Duration of Test

5 minutes

Expected Sequence

The test sequence is repeated for k = 1, 2.

Step	Direction	Message	Comments
1	SS		MS in state U10, on Timeslot N (chosen arbitrarily), utilising default TCH of cell and either: k=1, Channel Type = TCH/F; or k=2, Channel Type = TCH/H.
2	SS->MS	PACKET ASSIGNMENT	See specific message contents
3	SS<->MS	{ Acknowledged downlink data }	Macro – Transmitting 10,000 octets of Data
4	SS->MS	ASSIGNMENT COMMAND	This message to be sent before the termination of the macro. Allocating resources on Timeslot N' (chosen arbitrarily) utilising the first alternative TCH of Cell A and either: k=1, Channel Type = TCH/F; or k=2, Channel Type = TCH/H.
5	MS->SS	ASSIGNMENT COMPLETE	Sent on the correct channel after establishment of the main signalling link.
6	SS->MS	PACKET ASSIGNMENT	See specific message contents
7	SS<->MS	{ Downlink Data Transfer }	Macro – Completion of the 10,000 octets of Data.

Specific Message Contents

PACKET ASSIGNMENT (Step 2):

k=1:

Information Element	Value/remark
As default message contents except: RR Packet Uplink Assignment IE RR Packet Downlink Assignment IE - TIMESLOT_ALLOCATION	Not included (N ± 1) MOD 8

k=2:

Information Element	Value/remark
As default message contents except: RR Packet Uplink Assignment IE RR Packet Downlink Assignment IE - TIMESLOT_ALLOCATION	Not included N

PACKET ASSIGNMENT (Step 6):

k=1:

Information Element	Value/remark
As default message contents except: RR Packet Uplink Assignment IE RR Packet Downlink Assignment IE - TIMESLOT_ALLOCATION	Not included (N' ± 1) MOD 8

k=2:

Information Element	Value/remark
As default message contents except: RR Packet Uplink Assignment IE RR Packet Downlink Assignment IE - TIMESLOT_ALLOCATION	Not included N'

47.1.2 Reallocation of CS resources / Handover Command

47.1.2.1 Conformance requirements

While in dual transfer mode an intra-cell change of channel can be performed, when requested by the network, through the handover procedure.

Upon receipt of the HANOVER COMMAND message, the MS shall immediately abandon the packet resources entering dedicated mode. Once the packet resources have been released the MS initiates the release of link layer connections and disconnects the physical channels. The MS then commands the switching to the assigned channels and initiates the establishment of lower layer connections.

After the main signalling link is successfully established, the MS returns a HANOVER COMPLETE message to the network on the main DCCH, then the TBFs can be re-established using the Packet Assignment procedure.

References

3GPP TS 04.18/44.018, sub-clauses 3.4.4.1, 3.4.4.3 & 3.4.23

47.1.2.2 Test purpose

To verify that when the MS changes the CS resources to a different timeslot in the same frequency band using the Handover procedure, the MS successfully re-establishes the CS and PS resources.

47.1.2.3 Method of test

Initial Conditions

System Simulator:

1 cell, DTM supported.

Mobile Station:

The MS is in the active state (U10) of a call, on cell A, with a TMSI and P-TMSI allocated and the PDP context 1 activated but no allocated TBFs.

Specific PICS statements

-

PIXIT statements

-

Test Procedure

Once the MS is in DTM, the SS attempts to modify the resources of the MS by allocating a different timeslot, in the same frequency band, on the current cell. The re-allocation of the MS resources is realised by the MS receiving a HANOVER COMMAND message from the SS. The HANOVER COMMAND message instructs the switching of the MS to the newly assigned channel and the establishment of lower layer connections. Once the CS connection is established, the MS should return a HANOVER COMPLETE message on the new main signalling link. Once the MS has successfully completed the handover procedure to the cell, the SS sends the DTM INFORMATION message, informing the MS of the cell parameters. The PACKET ASSIGNMENT message is then sent to the MS over the main signalling link to establish the packet resources and the MS re-enters DTM.

MS supporting DTM shall complete test for k=1 and MSs indicating support of single slot DTM shall additionally complete testing for k=2.

Maximum Duration of Test

5 minutes

Expected Sequence

The test sequence is repeated for k = 1,2.

Step	Direction	Message	Comments
1	SS		MS in state U10, on Timeslot N (chosen arbitrarily), utilising either: k=1, Channel Type = TCH/F; or k=2, Channel Type = TCH/H.
2	SS->MS	PACKET ASSIGNMENT	See specific message contents
3	SS<->MS	{ Acknowledged downlink data }	Macro – Transmitting 10kB of Data
4	SS->MS	HANOVER COMMAND	This message to be sent before the termination of the macro. Timeslot (N + 4) MOD 8 and either: k=1, Channel Type = TCH/F; or k=2, Channel Type = TCH/H.
5	MS->SS	HANOVER COMPLETE	Sent on the new channel after establishment of the main signalling link
6	SS->MS	DTM INFORMATION	Contains the cell parameters
7	SS->MS	PACKET ASSIGNMENT	See specific message contents
8	SS<->MS	{ Downlink Data Transfer }	Macro – Completion of the 10kB of Data.

Specific Message Contents

PACKET ASSIGNMENT (Step 2):

k=1:

Information Element	Value/remark
As default message contents except: RR Packet Uplink Assignment IE RR Packet Downlink Assignment IE - TIMESLOT_ALLOCATION	Not included (N ± 1) MOD 8

k=2:

Information Element	Value/remark
As default message contents except: RR Packet Uplink Assignment IE RR Packet Downlink Assignment IE - TIMESLOT_ALLOCATION	Not included N

PACKET ASSIGNMENT (Step 7):

k=1:

Information Element	Value/remark
As default message contents except: RR Packet Uplink Assignment IE RR Packet Downlink Assignment IE - TIMESLOT_ALLOCATION	Not included $((N + 4) \pm 1) \text{ MOD } 8$

k=2:

Information Element	Value/remark
As default message contents except: RR Packet Uplink Assignment IE RR Packet Downlink Assignment IE - TIMESLOT_ALLOCATION	Not included $(N + 4) \text{ MOD } 8$

47.1.3 Intra frequency reallocation of CS resources / DTM Assignment Command

47.1.3.1 Conformance requirements

In dual transfer mode an intracell change of channel can be requested by upper layers for changing the channel type, or decided by the RR sublayer, e.g. for an internal handover or for the reallocation of all the resources of the mobile station. The purpose is to modify completely the physical channel configuration of the mobile station without frequency redefinition or change in synchronization while staying in the same cell.

Upon receipt of the DTM ASSIGNMENT COMMAND message, the mobile station initiates a local end release of link layer connections, disconnects the physical channels, commands the switching to the assigned channel and initiates the establishment of lower layer connection (this includes the activation of the channel, their connection and the establishment of the main signalling link).

NOTE: This conformance requirement was taken from Rel-5 specifications, but it is also a requirement on R99 and Rel-4 MS.

References

3GPP TS 44.018, sub-clause 3.4.23.2

47.1.3.2 Test purpose

To verify that the MS can reallocate both the CS connection and PS resources to different timeslot(s) within the same frequency band, having received the DTM ASSIGNMENT COMMAND message.

47.1.3.3 Method of test

Initial Conditions

System Simulator:

1 cell, DTM supported.

Mobile Station:

The MS is in the active state (U10) of a call.

The MS is in GMM Ready state with a P-TMSI allocated and the PDP context 1 activated.

Specific PICS statements

-

PIXIT statements

-

Test Procedure

Once the MS is in DTM, the SS attempts to modify the resources of the MS. The SS allocates the MS a different timeslot configuration, in the same frequency band, on the current cell. The re-allocation of the MS resources is realised by the MS receiving a DTM ASSIGNMENT COMMAND from the SS. On receipt of the DTM ASSIGNMENT COMMAND message, the MS initiates a local end release of link layer connections, disconnects the physical channels. After the MS has switched to the assigned channel, the MS initiates the establishment of lower layer connection, the activation of the channel and the establishment of the main signalling link. The MS returns an ASSIGNMENT COMPLETE message on the new signalling link.

MS supporting DTM shall complete testing for k=1, and indicating support of single slot DTM shall complete testing for k=2.

Maximum Duration of Test

5 minutes

Expected Sequence

The test sequence is repeated for k = 1,2.

Step	Direction	Message	Comments
1	SS		MS in state U10, on Timeslot N (chosen arbitrarily), utilising a default TCH of cell and either: k=1, Channel Type = TCH/F; or k=2, Channel Type = TCH/H.
2	SS->MS	PACKET ASSIGNMENT	Assigning downlink resources on Timeslot N+1.
3	SS<->MS	{ Downlink data transfer }	Macro – Transmitting 2.000 octets of Data
4	SS->MS	DTM ASSIGNMENT COMMAND	This message is sent after approximately 1.000 octets have been successfully transmitted. See specific message contents.
5	MS->SS	ASSIGNMENT COMPLETE	
6	SS<->MS	{ Downlink data transfer }	Macro – Completion of the 2.000 octet transmission.
7	SS		Verify that the CS connection is still through connected on the new Timeslot.

Specific Message Contents

DTM ASSIGNMENT COMMAND (Step 4):

k=1:

As default message contents except: Description of the CS Channel	
- Timeslot number	$(N + 4) \text{ MOD } 8$
- Channel Type	TCH/F
RR Packet Uplink Assignment IE	Not included
RR Packet Downlink Assignment IE	
- TIMESLOT_ALLOCATION	$((N + 4) \pm 1) \text{ MOD } 8$

k=2:

As default message contents except: Description of the CS Channel - Timeslot number - Channel Type RR Packet Uplink Assignment IE RR Packet Downlink Assignment IE - TIMESLOT_ALLOCATION	(N + 4) mod 8 TCH/H Not included (N + 4) MOD 8
--	---

47.1.4 Inter frequency reallocation of CS resources / DTM Assignment Command

47.1.4.1 Conformance requirements

In dual transfer mode an intracell change of channel can be requested by upper layers for changing the channel type, or decided by the RR sublayer, e.g. for an internal handover or for the reallocation of all the resources of the mobile station. The purpose is to modify completely the physical channel configuration of the mobile station without frequency redefinition or change in synchronization while staying in the same cell.

Upon receipt of the DTM ASSIGNMENT COMMAND message, the mobile station initiates a local end release of link layer connections, disconnects the physical channels, commands the switching to the assigned channel and initiates the establishment of lower layer connection (this includes the activation of the channel, their connection and the establishment of the main signalling link).

NOTE: This conformance requirement was taken from Rel-5 specifications, but it is also a requirement on R'99 and Rel-4 MS.

References

3GPP TS 44.018, sub-clause 3.4.23.2

47.1.4.2 Test purpose

To verify that the MS, can reallocate both the CS connection and PS resources to a different frequency band, having received the DTM ASSIGNMENT COMMAND message while in DTM.

47.1.4.3 Method of test

Initial Conditions

System Simulator:

1 cell, Cell A, with both TCH of cell activated and DTM supported. TCH2 allocated in a different frequency band and added to the Cell Channel Description in SII.

Mobile Station:

The MS is in the active state (U10) of a call, on cell A, with a TMSI and P-TMSI allocated and the PDP context 1 activated but no allocated TBFs.

Specific PICS statements

-

PIXIT statements

-

Test Procedure

Once the MS is in DTM, the SS attempts to modify the resources of the MS. The MS is allocated a new timeslot, in a different frequency band. The re-allocation of the MS resources is realised by the MS receiving a DTM ASSIGNMENT COMMAND from the SS. On receipt of the DTM ASSIGNMENT COMMAND message, the MS initiates a local end release of link layer connections and disconnects the physical channels. After the MS has switched to the assigned channel, the MS initiates the establishment of lower layer connection, the activation of the channel and the establishment of the main signalling link. The MS returns an ASSIGNMENT COMPLETE message on the new signalling link and continues transmitting on the uplink TBF.

MS supporting DTM shall complete testing for k=1 MSs indicating support of single slot DTM shall complete testing for k=2.

Maximum Duration of Test

5 minutes

Expected Sequence

The test sequence is repeated for k = 1,2.

Step	Direction	Message	Comments
1	SS		MS in state U10, on Timeslot N (chosen arbitrarily), utilising either: k=1, Channel Type = TCH/F; or k=2, Channel Type = TCH/H.
2	MS		Trigger the MS to initiate an uplink packet transfer containing 2 000 octets.
3	MS->SS	DTM REQUEST	
4	SS->MS	PACKET ASSIGNMENT	See specific message contents.
5	SS<->MS	{ Uplink data }	Macro – Transmitting 2 000 octets of data.
6	SS->MS	DTM ASSIGNMENT COMMAND	This message to be sent before the termination of the macro. The SS instructs the MS to utilise the first alternative TCH of Cell A in a different Band supported by the MS and see specific message contents for other changes to default message.
7	MS->SS	ASSIGNMENT COMPLETE	
8	SS<->MS	{ Uplink data transfer }	Macro – completion of 2 000 octets of data upload.
9	SS		Verify that the CS connection is still through connected on the new Timeslot.

Specific Message Contents

PACKET ASSIGNMENT (Step 4):

k=1:

Information Element	Value/remark
As default message contents except: RR Packet Uplink Assignment IE - TIMESLOT_ALLOCATION RR Packet Downlink Assignment IE	(N ± 1) MOD 8 Not included

k=2:

Information Element	Value/remark
As default message contents except: RR Packet Uplink Assignment IE - TIMESLOT_ALLOCATION RR Packet Downlink Assignment IE	N Not included

DTM ASSIGNMENT COMMAND (Step 6):

As default message contents except: Description of the CS Channel - Timeslot number - Channel Type RR Packet Uplink Assignment IE - TIMESLOT_ALLOCATION RR Packet Downlink Assignment IE	N TCH/F (N ± 1) MOD 8 Not included
--	---

For GSM 850 and PCS 1900 only :

SYSTEM INFORMATION TYPE 1:

As default message contents except: SI 1 Rest Octets - Band Indicator	H (ARFCN indicates 1900 band)
---	-------------------------------

SYSTEM INFORMATION TYPE 6:

As default message contents except: SI 6 Rest Octets - Band Indicator	H (ARFCN indicates 1900 band)
---	-------------------------------

47.2 Release of CS resources

47.2.1 Mobile originating CS release

41.2.1.1 Conformance requirements

If the MS is operating in DTM when the RR connection release is requested by the MS, the radio resources allocated on a PDCH are released, the MS returns to the PCCCH or CCCH configuration, packet idle mode. The MS aborts the RR connection by initiating a normal release of the main signalling link, performing local end releases on all other signalling links, disconnecting all traffic channels and aborts all the packet resources.

References

3GPP TS 04.18/44.018, sub-clauses 3.4.13.1 and 3.4.13.3

47.2.1.2 Test purpose

To verify that after the MS releases the CS connection, the PS resources are correctly re-established.

47.2.1.3 Method of test

Initial Conditions

System Simulator:

1 cell, DTM supported.

Mobile Station:

The MS is in the active state (U10) of a call.

The MS is GPRS attached with a P-TMSI allocated and the PDP context 1 activated.

Specific PICS statements

-

PIXIT statements

-

Test Procedure

The MS is in dedicated mode when it is triggered to initiate uplink data transfer. The MS sends a DTM REQUEST message to the SS requesting uplink resources. The SS assigns the required resources and waits until approximately half the uplink data has been passed to the SS before triggering the MS to release the CS resources. The MS initiates the signalling required to release the channel by sending a DISCONNECT message. Once the resources have been cleared the MS requests the establishment of an uplink TBF and completes the data transmission.

MS supporting DTM shall complete testing for k=1 and MSs indicating support of single slot DTM shall additionally complete testing for k=2.

Maximum Duration of Test

5 minutes

Expected Sequence

The test sequence is repeated for k = 1,2.

1	SS		MS in the active state (U10) of a call on Timeslot N. When: k=1, Channel Type=TCH/F; k=2, Channel Type=TCH/H.
2	MS		Trigger the MS to initiate an uplink packet transfer containing 10k octets.
3	MS->SS	DTM REQUEST	
4	SS->MS	PACKET ASSIGNMENT	See specific message contents.
5	MS<->SS	{ Uplink data }	Macro
6	MS		The MS is triggered to initiate the release of the CS connection when approximately 5k octets have been received.
7	MS->SS	DISCONNECT	
8	SS->MS	RELEASE	
9	MS->SS	RELEASE COMPLETE	
10	SS->MS	CHANNEL RELEASE	
11	MS<->SS	{ Uplink dynamic allocation two phase access }	Macro
12	MS<->SS	{ Completion of uplink RLC data block transfer }	Macro – Completion of the 10k octet transmission.

Specific Message Contents

PACKET ASSIGNMENT (Step 4):

k=1:

Information Element	Value/remark
As default message contents except: RR Packet Uplink Assignment IE - TIMESLOT_ALLOCATION RR Packet Downlink Assignment IE	(N ± 1) MOD 8 Not included

k=2:

Information Element	Value/remark
As default message contents except: RR Packet Uplink Assignment IE - TIMESLOT_ALLOCATION RR Packet Downlink Assignment IE	N Not included

47.3 Handover

47.3.1 Handover to same routing area

47.3.1.1 Handover to same routing area whilst in dedicated mode & MM Ready / Completed on the main DCCH

47.3.1.1.1 Conformance requirements

3GPP TS 04.18, sub-clause 3.4.26:

While in dedicated mode, upper layers in the mobile station or in the network may request the transport of GPRS information transparently over the radio interface. This procedure is only applicable when:

- the information from upper layers is signalling information; and
- the GTTP length of the message is below the maximum indicated by the network.

In any other case, the RR procedures related to packet resource establishment while in dedicated mode apply.

The information from upper layers shall be carried inside the GTTP Information message. The GTTP Information message contains:

- the TLLI of the MS; and
- the LLC PDU.

The GTTP messages are sent using "normal" priority at the data link layer.

3GPP TS 23.060, sub-clause 6.9.1.1

A cell update takes place when the MS enters a new cell inside the current RA and the MS is in READY state. If the RA has changed, a routing area update is executed instead of a cell update.

References

3GPP TS 04.18, sub-clause 3.4.26

3GPP TS 23.060, sub-clause 6.9.1.1

3GPP TS 04.64 / 44.064, sub-clause 6.4.1.7.

47.3.1.1.2 Test purpose

To verify that when the network completes the CS handover of the MS to a different cell, the MS sends a cell update on the main DCCH in the new cell.

47.3.1.1.3 Method of test

Initial Conditions

System Simulator:

2 cells, A and B both in the same Location Area and Routing Area. Both cells shall be activated. Cell A shall be the strongest.

Mobile Station:

The MS is in GMM Ready state with a P-TMSI allocated. The value of the Ready Timer is chosen such that the MS is in the Ready State when handed to the new cell.

Specific PICS statements

-

PIXIT statements

-

Test Procedure

The MS is camped on cell A in packet idle mode

The MS is brought to dedicated mode. A HANOVER COMMAND message instructs the switching of the MS to the newly assigned channel and the establishment of lower layer connections. Once the CS connection is established, the MS should return a HANOVER COMPLETE message on the new main signalling link. The MS shall then send the GPRS INFORMATION message on the main DCCH including an empty LLC frame to indicate Cell Update.

Maximum Duration of Test

5 minutes

Expected Sequence

Step	Direction	Message	Comments
1	SS		MS in the active state (U10) of a call on Timeslot N. When: Channel Type=TCH/F;
3	SS->MS	HANDOVER COMMAND	Instructs the MS to do handover to Cell B
4	MS->SS	HANDOVER ACCESS	Repeated on every burst of the uplink main DCCH (and optionally on the SACCH) until reception of PHYSICAL INFORMATION. Handover Reference as included in the HANDOVER COMMAND.
5	SS-MS	PHYSICAL INFORMATION	
6	MS->SS	HANDOVER COMPLETE	
7	SS->MS	DTM INFORMATION	
8	MS->SS	GPRS INFORMATION	The MS sends an empty LLC frame to indicate Cell Update.

Specific Message Contents

HANDOVER COMMAND (Step 3):

Information Element	Value/remark
As default message contents, except: Channel Description - Timeslot Number - Channel Type Cell Description Synchronization Indication - Report Observed Time Difference - Synchronization Indication - Normal Cell Indication	N (chosen arbitrarily) TCH/F Default values from Cell B Shall not be included. "Non synchronized". Ignore out of range timing advance.

47.3.1.2 Handover to same routing area whilst in DTM with downlink TBF Established

47.3.1.2.1 Conformance requirements

The handover procedure includes the:

- abortion of the downlink packet resources;
- disconnection and the deactivation of previously assigned channels and their release (layer 1);
- activation of the new channels, and their connection if applicable;
- triggering of the establishment of data link connection for SAPI = 0 on the new channels.

References

3GPP TS 04.18 / 44.018, sub-clause 3.4.4.

47.3.1.2.2 Test purpose

To verify that the downlink packet resources can be successfully aborted, then re-established in the new cell after the handover of CS resources.

47.3.1.2.3 Method of test

Initial Conditions

System Simulator:

2 cells, A and B with same LAI, default parameters and both support DTM.

Mobile Station:

The MS is in the active state (U10) of a call on Timeslot N (chosen arbitrarily) of cell A.

The MS is in GMM Ready state with a P-TMSI allocated and the PDP context 2 activated. The value of the Ready Timer is chosen such that the MS is in the Ready State when handed to the new cell.

Specific PICS statements

-

PIXIT statements

-

Test Procedure

After the MS is in DTM with an active downlink TBF, the SS initiates the Handover procedure. Once the MS has successfully completed the handover procedure to the new cell, the SS sends the DTM INFORMATION message, informing the MS of new cell parameters. The MS performs the Cell Update procedure using an empty LLC PDU on the main DCCH. The MS shall then accept the establishment of a downlink TBF, initiated by the SS with a PACKET ASSIGNMENT message.

MS supporting DTM shall complete test for k=1 and MSs indicating support of single slot DTM shall additionally complete testing for k=2.

Maximum Duration of Test

5 minutes

Expected Sequence

The test sequence is repeated for k = 1,2.

Step	Direction	Message	Comments
1	SS		MS in active state (U10) of a call and when: k=1, Channel Type = TCH/F; k=2, Channel Type = TCH/H.
2	SS->MS	PACKET ASSIGNMENT	See specific message contents.
3	SS<->MS	{ Acknowledged downlink data }	Macro – Transmitting 10kB of Data
4	SS->MS	HANDOVER COMMAND	This message to be sent before the termination of the macro. See specific message contents.
5	MS->SS	HANDOVER ACCESS	Repeated on every burst of the uplink main DCCH (and optionally on the SACCH) until reception of PHYSICAL INFORMATION. Handover Reference as included in the HANDOVER COMMAND.
6	SS->MS	PHYSICAL INFORMATION	
7	MS->SS	HANDOVER COMPLETE	
8	SS->MS	DTM INFORMATION	
9	MS->SS	GPRS INFORMATION	The MS sends an empty LLC frame to indicate Cell Update.
10	SS->MS	PACKET ASSIGNMENT	See specific message contents.
11	SS<->MS	{ Acknowledged downlink data }	Macro - Completion of the 10kB of Data.

Specific Message Contents

PACKET ASSIGNMENT (Step 2):

k=1:

Information Element	Value/remark
As default message contents except: RR Packet Uplink Assignment IE RR Packet Downlink Assignment IE - TIMESLOT_ALLOCATION	Not included (N ± 1) MOD 8

k=2:

Information Element	Value/remark
As default message contents except: RR Packet Uplink Assignment IE RR Packet Downlink Assignment IE - TIMESLOT_ALLOCATION	Not included N

HANDOVER COMMAND (Step 4):

k=1:

Information Element	Value/remark
As default message contents, except: Channel Description - Timeslot Number - Channel Type Cell Description Synchronization Indication - Report Observed Time Difference - Synchronization Indication - Normal Cell Indication	N (chosen arbitrarily) TCH/F Default values from Cell B Shall not be included. "Non synchronized". Ignore out of range timing advance.

k=2:

Information Element	Value/remark
As default message contents, except: Channel Description - Timeslot Number - Channel Type Cell Description Synchronization Indication - Report Observed Time Difference - Synchronization Indication - Normal Cell Indication	N' (chosen arbitrarily) TCH/H Default values from Cell B Shall not be included. "Non synchronized". Ignore out of range timing advance.

PACKET ASSIGNMENT (Step 10):

k=1:

Information Element	Value/remark
As default message contents except: RR Packet Uplink Assignment IE RR Packet Downlink Assignment IE - TIMESLOT_ALLOCATION	Not included (N' ± 1) MOD 8

k=2:

Information Element	Value/remark
As default message contents except: RR Packet Uplink Assignment IE RR Packet Downlink Assignment IE - TIMESLOT_ALLOCATION	Not included N'

47.3.1.3 Handover to same routing area whilst in DTM with both DL & UL TBFs

47.3.1.3.1 Handover to same routing area whilst in DTM with both DL & UL TBFs /
Successful case

47.3.1.3.1.1 Conformance requirements

The handover procedure includes:

- the abortion of the downlink and uplink packet resources;
- the disconnection and the deactivation of previously assigned channels and their release (layer 1);
- the activation of the new channels, and their connection if applicable;
- the triggering of the establishment of data link connection for SAPI = 0 on the new channels.

Then if DTM is supported in the new cell, the downlink and uplink TBF should be re-established if still required.

References

3GPP TS 04.18/44.018, sub-clause 3.4.4

47.3.1.3.1.2 Test purpose

To verify that when no errors occur in the CS handover to a different cell in the same routing area, the MS shall successfully re-establish the CS connection and the downlink and uplink PS resources.

47.3.1.3.1.3 Method of test

Initial Conditions

System Simulator:

2 cells, A and B with same LAI, DTM supported, default parameters.

Mobile Station:

The MS is in the active state (U10) of a call on Timeslot N (chosen arbitrarily) of cell A and has the PDP context 1 activated.

Specific PICS statements

-

PIXIT statements

-

Test Procedure

After the MS is in DTM with both uplink and downlink TBFs active, the SS initiates the Handover procedure. Once the MS has successfully completed the handover procedure to the new cell, the SS sends the DTM INFORMATION message, informing the MS of new cell parameters. The MS may perform the Cell Update procedure by sending a GPRS INFORMATION message containing an empty LLC PDU on the main DCCH. The MS shall then request the establishment of an uplink TBF with the DTM Request message and the SS assigns an uplink TBF.

The MS supporting DTM shall complete testing k=1 and MSs indicating support of single slot DTM shall additionally complete testing for k=2.

Maximum Duration of Test

5 minutes

Expected Sequence

The test sequence is repeated for $k = 1, 2$.

Step	Direction	Message	Comments
1	SS		MS in active state (U10) of a call and when: k=1, Channel Type = TCH/F; k=2, Channel Type = TCH/H.
2	MS		Trigger the MS to initiate an uplink packet transfer containing 2kB of data.
3	MS->SS	DTM REQUEST	
4	SS->MS	PACKET ASSIGNMENT	When: k=1, Timeslot = $(N \pm 1) \text{ MOD } 8$; k=2, Timeslot = N
5	SS<->MS	{ Uplink data transfer }	Macro
6	SS->MS	PACKET DOWNLINK ASSIGNMENT	This message to be sent before the termination of the macro. When: k=1, Timeslot = $(N \pm 1) \text{ MOD } 8$; k=2, Timeslot = N.
7	SS->MS	RLC DOWNLINK DATA	S/P Bit =1
8	MS->SS	PACKET DOWNLINK ACK/NACK	
9	SS->MS	HANDOVER COMMAND	See specific message contents.
10	MS->SS	HANDOVER ACCESS	Repeated on every burst of the uplink main DCCH (and optionally on the SACCH) until reception of PHYSICAL INFORMATION. Handover Reference as included in the HANDOVER COMMAND.
11	SS->MS	PHYSICAL INFORMATION	
12	MS->SS	HANDOVER COMPLETE	
13	SS->MS	DTM INFORMATION	
14 (optional step)	MS->SS	GPRS INFORMATION	Sent on main DCCH. Contains an empty LLC PDU for Cell Update.
15	MS->SS	DTM REQUEST	Sent on main DCCH.
16	SS->MS	PACKET ASSIGNMENT	See specific message contents.
			Step 17 may be performed only if Step 14 has not been performed.
17 (optional step)	MS->SS	LLC PDU	Sent on PDCH. Empty LLC PDU for Cell Update NOTE: The empty LLC PDU may be followed by one or more lower priority LLC PDUs in the same RLC Data Block.
18 (conditional step)	MS->SS	PACKET RESOURCE REQUEST	Sent on PDCH. (Step is performed if Empty LLC PDU received in step 17)
19 (conditional step)	SS->MS	PACKET ASSIGNMENT	See specific message contents. (Step is performed if in step 18 PACKET RESOURCE REQUEST was received)
20	SS<->MS	{ Uplink data transfer }	Macro - Completion of the 2kB of Data.

Specific Message Contents

HANDOVER COMMAND (Step 8):

k=1:

Information Element	Value/remark
As default message contents, except: Channel Description - Timeslot Number Cell Description Synchronization Indication - Report Observed Time Difference - Synchronization Indication - Normal Cell Indication	N (chosen arbitrarily) Default values from Cell B Shall not be included. "Non synchronized". Ignore out of range timing advance.

k=2:

Information Element	Value/remark
As default message contents, except: Channel Description - Timeslot Number - Channel Type Cell Description Synchronization Indication - Report Observed Time Difference - Synchronization Indication - Normal Cell Indication	N (chosen arbitrarily) TCH/H Default values from Cell B Shall not be included. "Non synchronized". Ignore out of range timing advance.

PACKET ASSIGNMENT (Step 16):

k=1:

Information Element	Value/remark
As default message contents except: RR Packet Uplink Assignment IE - TIMESLOT_ALLOCATION RR Packet Downlink Assignment IE	(N ± 1) MOD 8 Not included

k=2:

Information Element	Value/remark
As default message contents except: RR Packet Uplink Assignment IE - TIMESLOT_ALLOCATION RR Packet Downlink Assignment IE	N Not included

47.3.1.3.2 Handover to same routing area whilst in DTM with both DL & UL TBFs / Abnormal case / Handover Failure

47.3.1.3.2.1 Conformance requirements

If a lower layer failure happens on the new channel before the HANOVER COMPLETE message has been sent, the MS deactivates the new channels, reactivates the old channels, reconnects the TCHs if any and triggers the establishment of the main signalling link. It then sends a HANOVER FAILURE message on the main signalling link and resumes normal operation as if no handover attempt had occurred.

References

3GPP TS 04.18/44.018, sub-clause 3.4.4.4

47.3.1.3.2.2 Test purpose

To verify that if an error occurs when attempting handover to a different cell, the MS shall abort all CS operations in the new cell and successfully attempt to re-establish CS and uplink PS resources in the old cell.

47.3.1.3.2.3 Method of test

Initial Conditions

System Simulator:

2 cells, A and B, DTM supported, default parameters.

Mobile Station:

The MS is in the active state (U10) of a call on Timeslot N (chosen arbitrarily) of cell A and has the PDP context 1 activated.

Specific PICS statements

-

PIXIT statements

-

Test Procedure

After the MS is in DTM with both uplink and downlink TBFs active, the SS initiates the Handover procedure. If the SS does not accept the MS on the new channel, the MS shall revert back to the original channel in the old cell. The MS shall then send a HANOVER FAILURE message on the main DCCH in the old cell. The MS then shall request the establishment of an uplink TBF with the Packet Request procedure and the SS assigns an uplink TBF followed by a downlink TBF.

The MS supporting DTM shall complete testing k=1 and MSs indicating support of single slot DTM shall additionally complete testing for k=2.

Maximum Duration of Test

5 minutes

Expected Sequence

The test sequence is repeated for $k = 1, 2$.

Step	Direction	Message	Comments
1	SS		MS in active state (U10) of a call and when:
2	MS		$k=1$, Channel Type = TCH/F; $k=2$, Channel Type = TCH/H. Trigger the MS to initiate an uplink packet transfer containing 2kB of data.
3	MS->SS	DTM REQUEST	
4	SS->MS	PACKET ASSIGNMENT	When: $k=1$, Timeslot = $T = (N \pm 1) \text{ MOD } 8$; $k=2$, Timeslot = N .
5	SS<->MS	{ Uplink data }	Macro – Transmitting 2kB of data.
6	SS->MS	PACKET DOWNLINK ASSIGNMENT	This message to be sent before the termination of the macro. When: $k=1$, Timeslot = T ; $k=2$, Timeslot = N . S/P bit = 1
7	SS->MS	RLC DOWNLINK DATA	
8	MS->SS	PACKET DOWNLINK ACK/NACK	
9	SS->MS	HANDOVER COMMAND	See specific message contents.
10	MS->SS	HANDOVER ACCESS	Handover Reference as included in the HANDOVER COMMAND. Message repeated multiple times. Sent on Cell B.
11	MS->SS	HANDOVER FAILURE	Sent on Cell A.
12	MS->SS	GPRS INFORMATION	The MS sends an empty LLC PDU to indicate Cell Update.
Option al step			
13	MS->SS	DTM REQUEST	
14	SS->MS	PACKET ASSIGNMENT	See specific message contents.
15	SS<->MS	{ Uplink data transfer }	Macro - Completion of the 2kB of Data.

Specific Message Contents

HANDOVER COMMAND (Step 9):

$k=1$:

Information Element	Value/remark
As default message contents, except:	
Channel Description	
- Timeslot Number	$(N + 4) \text{ MOD } 8$ (chosen arbitrarily)
Cell Description	Default values from Cell B
Synchronization Indication	
- Report Observed Time Difference	Shall not be included.
- Synchronization Indication	"Non synchronized".
- Normal Cell Indication	Ignore out of range timing advance.

$k=2$:

Information Element	Value/remark
As default message contents, except:	
Channel Description	
- Timeslot Number	$(N + 4) \text{ MOD } 8$ (chosen arbitrarily)
- Channel Type	TCH/H
Cell Description	Default values from Cell B
Synchronization Indication	
- Report Observed Time Difference	Shall not be included.
- Synchronization Indication	"Non synchronized".
- Normal Cell Indication	Ignore out of range timing advance.

PACKET ASSIGNMENT (Step 14):

k=1:

Information Element	Value/remark
As default message contents except: RR Packet Uplink Assignment IE - TIMESLOT_ALLOCATION RR Packet Downlink Assignment IE	T Not included

k=2:

Information Element	Value/remark
As default message contents except: RR Packet Uplink Assignment IE - TIMESLOT_ALLOCATION RR Packet Downlink Assignment IE	N Not included

47.3.2 Handover to different routing area whilst in DM

47.3.2.1 Handover to different routing area whilst in DM / Performed on main DCCH / RAU complete before CS release

47.3.2.1.1 Conformance requirements

During a CS connection, an MS in class-B mode of operation (GSM only) cannot perform GPRS attach nor routing area updates, only MSs in class-A mode of operation can perform these procedures.

A GPRS MS in MS operation mode A shall perform the normal routing area update procedure during an ongoing circuit-switched transaction.

References

3GPP TS 23.060 sub-clause 6.3.1

3GPP TS 24.008 sub-clause 4.7.5.2.1

47.3.2.1.2 Test purpose

To verify that when the MS completes the CS handover, to a cell in a different routing area, the MS performs a RA update on the main DCCH.

47.3.2.1.3 Method of test

Initial Conditions

System Simulator:

2 cells, A and B with different RAIs and both support DTM.

Mobile Station:

The MS is in the active state (U10) of a call on cell A.

Specific PICS statements

-

PIXIT statements

-

Test Procedure

Once the MS is in an active call on cell A, the MS is instructed to change to a new cell in a different Routing Area, where the main signalling link is established. After the voice call has been correctly re-established, the MS completes the Routing Area Updating procedure on the main DCCH. The SS reallocates the P-TMSI of the MS in the ROUTING AREA UPDATE ACCEPT message, prompting the MS to acknowledge this change with the ROUTING AREA UPDATE COMPLETE message.

Maximum Duration of Test

5 minutes

Expected Sequence

Step	Direction	Message	Comments
1	SS		MS in state U10, on an arbitrarily chosen timeslot of cell A.
2	SS->MS	HANDOVER COMMAND	Instructs the MS to move to an arbitrarily chosen timeslot on cell B.
3	MS->SS	HANDOVER ACCESS	Repeated on every burst of the uplink main DCCH (and optionally on the SACCH) until reception of the PHYSICAL INFORMATION message. Handover reference as included in the HANDOVER COMMAND.
4	SS->MS	PHYSICAL INFORMATION	
5	MS->SS	HANDOVER COMPLETE	Sent on the new channel after the establishment of the main signalling link.
6	SS->MS	DTM INFORMATION	
7	MS->SS	GPRS INFORMATION	Contains the ROUTING AREA UPDATE REQUEST message.
8	SS->MS	GPRS INFORMATION	Contains the ROUTING AREA UPDATE ACCEPT message. Allocates a new P-TMSI, (C2345678Hex).
9	MS->SS	GPRS INFORMATION	Contains the ROUTING AREA UPDATE COMPLETE message. See specific message contents.

Specific message contents

ROUTING AREA UPDATE ACCEPT (Step 8):

Information Element	Value/remark
As default message contents except: - Allocated P-TMSI - Type of Identity - P-TMSI value	P-TMSI C2345678Hex

47.3.2.2 Handover to different routing area whilst in DM / Performed on main DCCH / CS release before RAU complete

47.3.2.2.1 Conformance requirements

During a CS connection, an MS in class-B mode of operation (GSM only) cannot perform GPRS attach nor routing area updates, only MSs in class-A mode of operation can perform these procedures.

A GPRS MS in MS operation mode A shall perform the normal routing area update procedure during an ongoing circuit-switched transaction.

References

3GPP TS 23.060 sub-clause 6.3.1

3GPP TS 24.008 sub-clause 4.7.5.2.1

47.3.2.2.2 Test purpose

To verify that when the MS completes the CS handover, to a cell in a different routing area, the MS attempts to complete the RA update on the main DCCH, but the CS resources are released and the RA update procedure is completed on new TBFs.

47.3.2.2.3 Method of test

Initial Conditions

System Simulator:

2 cells, A and B operating in NW Mode II with same LAI but different RAI and both support DTM. SI13 is broadcasted in such a way that it is received by the MS at least every 4 sec.

Mobile Station:

The MS is in the active state (U10) of a call on cell A.

The MS is in GMM Ready state with a P-TMSI allocated.

Specific PICS statements

-

PIXIT statements

-

Test Procedure

Once the MS is in an active call on cell A, the MS is then instructed to change to a new cell in a different Routing Area, where the main signalling link is established. After the voice call has been correctly re-established the MS initiates the Routing Area Updating procedure on the main DCCH. When the SS has successfully received the ROUTING AREA UPDATE REQUEST message, the SS releases the DCCH with a CHANNEL RELEASE command. The SS then establishes a downlink TBF to allow the ROUTING AREA UPDATE ACCEPT message to be sent to the MS. The MS responds to the ROUTING AREA UPDATE ACCEPT message, acknowledging the new P-TMSI allocated, by sending a ROUTING AREA UPDATE COMPLETE message.

Maximum Duration of Test

5 minutes

Expected Sequence

Step	Direction	Message	Comments
1	SS		MS in state U10, on an arbitrarily chosen timeslot of cell A. The RF level of cell A is lowered until cell B is preferred by the SS.
2	SS->MS	HANDOVER COMMAND	Instructs the MS to move to an arbitrarily chosen timeslot on cell B.
3	MS->SS	HANDOVER ACCESS	Repeated on every burst of the uplink main DCCH (and optionally on the SACCH) until reception of the PHYSICAL INFORMATION message. Handover reference as included in the HANDOVER COMMAND.
4	SS->MS	PHYSICAL INFORMATION	
5	MS->SS	HANDOVER COMPLETE	Sent on the new channel after the establishment of the main signalling link.
6	SS->MS	DTM INFORMATION	Sent on main DCCH.
7	MS->SS	GPRS INFORMATION	Contains the ROUTING AREA UPDATE REQUEST message
			All RAU REQUEST LAPDm frames shall be acknowledged by the SS.
8	SS->MS	CHANNEL RELEASE	
9			The SS waits at least two SI13 repeat periods.
10	SS		A downlink TBF is then established to allow the RAU ACCEPT message to be returned to the MS.
11	SS->MS	ROUTING AREA UPDATE ACCEPT	Allocating the MS a new P-TMSI (C2345678Hex).
12	MS->SS	ROUTING AREA UPDATE COMPLETE	See specific message contents.

Specific message contents

ROUTING AREA UPDATE ACCEPT (Step 11):

Information Element	Value/remark
As default message contents except: - Allocated P-TMSI - Type of Identity - P-TMSI value	P-TMSI C2345678Hex

47.3.3 Handover to different routing area whilst in DTM

47.3.3.1 Handover to different routing area whilst in DTM / Performed on TBFs

47.3.3.1.1 Handover to different routing area whilst in DTM / Performed on TBFs / RAU complete before CS release

47.3.3.1.1.1 Conformance requirements

In dedicated mode or dual transfer mode, an intercell or an intracell change of channel can be requested by the network RR sublayer. This change may be performed through the handover procedure.

Upon receipt of the HANDOVER COMMAND message, the mobile station initiates, the release of link layer connections, disconnects the physical channels (including the packet resources, if in class A mode of operation), commands the switching to the assigned channels and initiates the establishment of lower layer connections (this includes the activation of the channels, their connection and the establishment of the data links).

In, GSM, user data transmission in the MS shall be suspended during the routing area updating procedure; user data reception shall be possible.

References

3GPP TS 04.18/44.018 sub-clause 3.4.4

3GPP TS 24.008 sub-clause 4.7.5

47.3.3.1.1.2 Test purpose

To verify that a MS in DTM can complete Handover to a cell in a different routing area, where the RA update procedure is performed on TBFs, before the CS resources are released.

47.3.3.1.1.3 Method of test

Initial Conditions

System Simulator:

2 cells, A and B with same LAI but different RAI, both supporting DTM and with default parameters.

Mobile Station:

The MS is in the active state (U10) of a call, on Timeslot N (chosen arbitrarily) of cell A, with a TMSI and P-TMSI allocated and the PDP context 1 activated but no allocated TBFs.

Specific PICS statements

-

PIXIT statements

-

Test Procedure

A MS in dedicated mode with an active CS call is triggered to establish an uplink TBF. The MS sends a DTM REQUEST message appealing for uplink resources. Upon receiving the DTM request message the SS allocates uplink resources. Once the MS has entered DTM and has had at least ten RLC data blocks acknowledged, the SS sends a HANDOVER COMMAND message to the MS and completes the Handover procedure to a cell in the new RA. The Handover procedure is complete by the MS sending a HANDOVER COMPLETE message to the SS. Once the Handover procedure is complete the SS sends the MS a DTM INFORMATION message, providing the MS with the minimum information required to establish packet resources with the cell. The MS having received the DTM INFORMATION message indicating DTM support in the current cell, initiates the RA Update procedure. The RAU procedure is initiated by sending the ROUTING AREA UPDATE REQUEST message, encapsulated in GTTP, on the main DCCH. The SS completes the RA Update procedure by returning a ROUTING AREA UPDATE ACCEPT message on the main DCCH without re-allocating the P-TMSI. The MS can then again initiate the establishment of an uplink TBF.

MS supporting DTM shall complete test for k=1 and MSs indicating support of single slot DTM shall additionally complete testing for k=2.

Maximum Duration of Test

5 minutes

Expected Sequence

The test sequence is repeated for k = 1,2.

Step	Direction	Message	Comments
1	SS		MS in active state (U10) of a call and when: k=1, Channel Type = TCH/F; k=2, Channel Type = TCH/H.
2	MS		Trigger the MS to initiate an uplink packet transfer containing 2kB of data.
3	MS->SS	DTM REQUEST	
4	SS->MS	PACKET ASSIGNMENT	See specific message contents.
5	SS<->MS	{Uplink Data}	Macro – Transmitting approximatively 1kBof Data.
6	SS->MS	HANDOVER COMMAND	See specific message contents.
7	MS->SS	HANDOVER ACCESS	Repeated on every burst of the uplink main DCCH (and optionally on the SACCH) until reception of PHYSICAL INFORMATION. Handover Reference as included in the HANDOVER COMMAND.
8	SS->MS	PHYSICAL INFORMATION	Sent after reception of n HANDOVER ACCESS messages. See specific message contents.
9	MS->SS	HANDOVER COMPLETE	
10	SS->MS	DTM INFORMATION	
11	MS->SS	GPRS INFORMATION	It shall contain a ROUTING AREA UPDATE REQUEST message
12	SS->MS	GPRS INFORMATION	It contains a ROUTING AREA UPDATE ACCEPT message. Does not allocate MS a new P-TMSI.
13	MS->SS	DTM REQUEST	
14	SS->MS	PACKET ASSIGNMENT	See specific message contents.
15	SS<->MS	{ Uplink data transfer }	Macro - Completion of the 2kB of Data.

Specific Message Contents

PACKET ASSIGNMENT (Step 4):

k=1:

Information Element	Value/remark
As default message contents except: RR Packet Uplink Assignment IE - TIMESLOT_ALLOCATION RR Packet Downlink Assignment IE	(N ± 1) MOD 8 Not included

k=2:

Information Element	Value/remark
As default message contents except: RR Packet Uplink Assignment IE - TIMESLOT_ALLOCATION RR Packet Downlink Assignment IE	N Not included

HANDOVER COMMAND (Step 6):

k=1:

Information Element	Value/remark
As default message contents, except: Channel Description - Timeslot Number - Channel Type Synchronisation Indication - Report Observed Time Difference - Synchronization Indication - Normal Cell Indication	N' (chosen arbitrarily) TCH/F Shall not be included. "Non synchronized". Ignore out of range timing advance.

k=2:

Information Element	Value/remark
As default message contents, except: Channel Description - Timeslot Number - Channel Type Synchronisation Indication - Report Observed Time Difference - Synchronization Indication - Normal Cell Indication	N' (chosen arbitrarily) TCH/H Shall not be included. "Non synchronized". Ignore out of range timing advance.

PACKET ASSIGNMENT (Step 14):

k=1:

Information Element	Value/remark
As default message contents except: RR Packet Uplink Assignment IE - TIMESLOT_ALLOCATION RR Packet Downlink Assignment IE	(N' ± 1) MOD 8 Not included

k=2:

Information Element	Value/remark
As default message contents except: RR Packet Uplink Assignment IE - TIMESLOT_ALLOCATION RR Packet Downlink Assignment IE	N' Not included

47.3.3.1.2 Handover to different routing area whilst in DTM / Performed on TBFs / CS release before RAU complete

47.3.3.1.2.1 Conformance requirements

In dedicated mode or dual transfer mode, an intercell or an intracell change of channel can be requested by the network RR sublayer. This change may be performed through the handover procedure.

Upon receipt of the HANDOVER COMMAND message, the mobile station initiates, the release of link layer connections, disconnects the physical channels (including the packet resources, if in class A mode of operation), commands the switching to the assigned channels and initiates the establishment of lower layer connections (this includes the activation of the channels, their connection and the establishment of the data links).

In, GSM, user data transmission in the MS shall be suspended during the routing area updating procedure; user data reception shall be possible.

References

3GPP TS 04.18/44.018 sub-clause 3.4.4

3GPP TS 24.008 sub-clause 4.7.5

47.3.3.1.2.2 Test purpose

To verify that a MS in DTM can complete the Handover procedure to a cell in a different routing area, where the RA update is performed on TBFs, but the CS resources are released before the completion of the update. The MS then has to complete the update on new TBFs.

47.3.3.1.2.3 Method of test

Initial Conditions

System Simulator:

2 cells, A and B operating in NW Mode II with same LAI but different RAI, both supporting DTM, with default parameters. SI13 is broadcasted in such a way that it is received by the MS at least every 4 sec.

Mobile Station:

The MS is in the active state (U10) of a call, on Timeslot N of cell A, with a TMSI and P-TMSI allocated and the PDP context 1 activated but no allocated TBFs.

Specific PICS statements

-

PIXIT statements

-

Test Procedure

A MS in dedicated mode with an active CS call is triggered to establish an uplink TBF. The MS sends a DTM REQUEST message appealing for uplink resources. Upon receiving the DTM request message the SS allocates uplink resources. Once the MS has entered DTM and has had at least ten RLC data blocks acknowledged, the SS sends a HANDOVER COMMAND message to the MS and completes the Handover procedure to a cell in a new RA. The Handover procedure is completed by the MS sending a HANDOVER COMPLETE message to the SS. Once the Handover procedure is complete the SS sends the MS a DTM INFORMATION message, providing the MS with the minimum information required to establish packet resources with the cell. The MS having received the DTM INFORMATION message indicating DTM support in the current cell, initiates the RA Update procedure. The RA Update procedure is initiated by the MS sending the ROUTING AREA UPDATE REQUEST message, encapsulated in GTTP, on the main DCCH. The SS then releases the CS connection to the MS and allocates downlink PS resources to the MS with a PACKET DOWNLINK ASSIGNMENT message. The SS then completes the RAU procedure by sending the RAU ACCEPT message to the MS, allowing the MS to request uplink PS resources.

MS supporting DTM shall complete test for $k=1$ and MSs indicating support of single slot DTM shall additionally complete testing for $k=2$.

Maximum Duration of Test

5 minutes

Expected Sequence

The test sequence is repeated for $k = 1, 2$.

Step	Direction	Message	Comments
1	SS		MS in active state (U10) of a call and when: k=1, Channel Type = TCH/F; k=2, Channel Type = TCH/H.
2	MS		Trigger the MS to initiate an uplink packet transfer containing 2kB of data.
3	MS->SS	DTM REQUEST	
4	SS->MS	PACKET ASSIGNMENT	See specific message contents.
5	SS<->MS	{ Uplink data transfer }	Macro – Transmitting 2kB of Data
6	SS->MS	HANDOVER COMMAND	This message to be sent before the termination of the macro. See specific message contents.
7	MS->SS	HANDOVER ACCESS	Repeated on every burst of the uplink main DCCH (and optionally on the SACCH) until reception of PHYSICAL INFORMATION. Handover Reference as included in the HANDOVER COMMAND.
8	SS->MS	PHYSICAL INFORMATION	Sent after reception of n HANDOVER ACCESS messages. See specific message contents.
9	MS->SS	HANDOVER COMPLETE	
10	SS->MS	DTM INFORMATION	
11	MS->SS	GPRS INFORMATION	It shall contain a ROUTING AREA UPDATE REQUEST message. All RAU REQUEST LAPDm frames shall be acknowledged by the SS.
12	SS->MS	CHANNEL RELEASE	The TCH is released.
13			The SS waits at least two SI13 repeat periods.
14			A downlink TBF is then established to allow the RAU ACCEPT message to be returned the MS.
15	SS->MS	ROUTING AREA UPDATE ACCEPT	Does not allocate MS a new P-TMSI.
16		{ Uplink dynamic allocation two phase access }	Macro
17	SS<->MS	{ Uplink data transfer }	Macro - Completion of the 2kB of Data.

Specific Message Contents

PACKET ASSIGNMENT (Step 4):

k=1:

Information Element	Value/remark
As default message contents except: GPRS Broadcast Information IE - GPRS Cell Options IE - NMO RR Packet Uplink Assignment IE - TIMESLOT_ALLOCATION RR Packet Downlink Assignment IE	01 (Network Mode of Operation II) (N ± 1) MOD 8 Not included

k=2:

Information Element	Value/remark
As default message contents except: GPRS Broadcast Information IE - GPRS Cell Options IE - NMO RR Packet Uplink Assignment IE - TIMESLOT_ALLOCATION RR Packet Downlink Assignment IE	01 (Network Mode of Operation II) N Not included

HANDOVER COMMAND (Step 6):

k=1:

Information Element	Value/remark
As default message contents, except: Channel Description - Timeslot Number - Channel Type Synchronisation Indication - Report Observed Time Difference - Synchronization Indication - Normal Cell Indication	N' (chosen arbitrarily) TCH/F Shall not be included. "Non synchronized". Ignore out of range timing advance.

k=2:

Information Element	Value/remark
As default message contents, except: Channel Description - Timeslot Number - Channel Type Synchronisation Indication - Report Observed Time Difference - Synchronization Indication - Normal Cell Indication	N' (chosen arbitrarily) TCH/H Shall not be included. "Non synchronized". Ignore out of range timing advance.

47.3.4 Handover to UTRAN while in DTM

47.3.4.1 Handover to UTRAN while in DTM / Downlink TBF

47.3.4.1.1 Conformance requirements

Once the mobile station enters the dual transfer mode, the existent procedures apply (see 3GPP TS 44.060). Some exceptions to the existent procedures while in dedicated mode are:

- When the mobile station receives a HANDOVER COMMAND, HANDOVER TO UTRAN COMMAND, HANDOVER TO CDMA2000 COMMAND, HANDOVER TO IU MODE COMMAND or ASSIGNMENT COMMAND message, it shall abandon the packet resource immediately, enter dedicated mode and perform the handover or assignment procedure, respectively.

After the successful completion of the handover from an GSM cell to an UMTS cell, an MS which has performed the GPRS suspension procedure in Gb mode (see 3GPP TS 04.18) (i.e. an MS in MS operation mode B or an DTM MS in a GSM cell that does not support DTM) shall perform a normal RA update procedure in the UMTS cell in order to resume the GPRS services in the network, before sending any other signalling messages or user data.

References

3GPP TS 04.18/44.018 sub-clause 3.4.23.1

3GPP TS 24.008 sub-clause 4.7.1.7

47.3.4.1.2 Test purpose

Verifying that the MS aborts Packet resources while in DTM and proceeds with the handover to UTRAN, upon reception of an INTER SYSTEM TO UTRAN HANDOVER COMMAND message.

47.3.4.1.3 Method of test

Initial Conditions

System Simulator:

2 cells - Cell 1 is GSM with DTM supported, Cell 2 is UTRAN. The present document sub-clause 26.6.5.1 shall be referenced for the default parameters of cell 1. 3GPP TS 34.108, sub-clause 6.1 shall be referenced for default parameters of Cell 2.

Mobile Station:

The MS is in the active state (U10) of a call.

The MS is GPRS idle with a P-TMSI allocated and the PDP context 1 activated

Specific PICS statements

-

PIXIT statements

-

Test Procedure

The SS starts the GSM cell and UTRAN cell and brings the MS into the call active state of Cell 1(CC state U10). The SS sends a PACKET ASSIGNMENT message to the MS on the main DCCH, instructing the MS to switch to the designated timeslot. The SS waits a specified time and then starts to transmit to the newly allocated resources. The SS configures the UTRAN dedicated channel corresponding to the default-configuration 3. After approximately 5k octets of data has been sent, the SS sends a MEASUREMENT INFORMATION to trigger the MS to perform measurements on the UTRAN cell. The SS verifies that the MS include the UTRAN cell in the MEASUREMENT REPORT and then sends INTERSYSTEM TO UTRAN HANDOVER COMMAND message indicating the dedicated channel of the target cell to the MS through the GSM serving cell. After the MS receives the command it shall configure itself accordingly and switch to the dedicated channel of UTRAN cell. The SS checks whether the handover has been performed, by verifying that the MS transmits the HANDOVER TO UTRAN COMPLETE message to the SS through DCCH of the UTRAN cell. The MS then performs the Routing Area Updating procedure, initiated with the transmission of a ROUTING AREA UPDATE REQUEST message. The SS completes the procedure by sending a ROUTING AREA UPDATE COMPLETE message to the MS. The SS establishes a radio bearer to the MS with the RADIO BEARER SETUP and RADIO BEARER SETUP COMPLETE messages. To check that PDP context is active, SS sends MODIFY PDP CONTEXT REQUEST in UMTS cell. The MS may or may not accept the QoS and replies to the SS accordingly.

Maximum Duration of Test

5 minutes

Expected Sequence

Note: Default message contents for UMTS signalling can be found in 3GPP TS 34.108 sub-clause 9.1.

Step	Direction	Message	Comments
1	SS		MS in state U10, utilising Timeslot N and TCH/F channel type for the CS connection on Cell 1 (Timeslot chosen arbitrarily)
2	SS->MS	PACKET ASSIGNMENT	Assigning downlink packet resources on Timeslot N+1 to the MS.
3	MS<->SS	{ Downlink data transfer }	Macro
4	SS		The SS configures the dedicated channel with the configuration: conversational/speech/UL:12.2 DL:12.2 kbps/CS RAB + UL:3.4 DL3.4 kbps SRBs in UTRAN cell.
5	SS		Waits until approximately 5k octets is sent to the MS
6	←	MEASUREMENT INFORMATION	
7	→	MEASUREMENT REPORT	Including Measurement Results on the UTRAN cell in Step 6. Received within 5 sec + 10% from Step 6.
8	SS->MS	INTER SYSTEM TO UTRAN HANDOVER COMMAND	See specific message contents.
9	MS		The MS accepts the handover command and configures its lower layers using the parameters contained in the INTERSYSTEM TO UTRAN HANDOVER COMMAND
10	SS		The SS waits for uplink physical channel in synchronisation
11	MS->SS	HANDOVER TO UTRAN COMPLETE	The SS receives this message on DCCH of Cell 2 (UTRAN cell). It implies that the down link physical channel has synchronised with UTRAN.
12	SS		The SS starts integrity protection for CS domain
13	SS->MS	UTRAN MOBILITY INFORMATION	The SS conveys CN system information for the PS domain to the UE in connected mode. See specific message contents.
14	MS->SS	UTRAN MOBILITY_INFORMATION CONFIRM	
15	MS->SS	ROUTING AREA UPDATE REQUEST	
16	SS->MS	AUTHENTICATION AND CIPHERING REQUEST	
17	MS->SS	AUTHENTICATION AND CIPHERING RESPONSE	
18	SS		The SS starts integrity protection for PS domain
19	SS->MS	ROUTING AREA UPDATE ACCEPT	
20	SS->MS	RADIO BEARER SETUP	PS RAB establishment
21	MS->SS	RADIO BEARER SETUP COMPLETE	
22			SS Releases the CS call.
23	SS->MS	MODIFY PDP CONTEXT REQUEST	SS requests the modification of a PDP context.
A24	MS->SS	MODIFY PDP CONTEXT ACCEPT	MS behaviour type A: Accept the PDP context modification
B24	MS->SS	DEACTIVATE PDP CONTEXT REQUEST	MS behaviour type B: Initiate the PDP context deactivation. Cause set to 'QoS not accepted'
B24a	SS->MS	DEACTIVATE PDP CONTEXT ACCEPT	MS behaviour type B: Accept the PDP context deactivation.
B24b	MS->SS	DETACH REQUEST	MS behaviour type B: A non-auto attach MS may (optionally) send a Detach Request. The SS shall wait up to 'T3390' seconds for the Detach Request.
B24c	SS->MS	DETACH ACCEPT	If the MS transmitted a Detach Request message in step B24b then the SS responds with a Detach Accept message.

Specific message contents

MEASUREMENT INFORMATION

Information Element	Value/remark
< RR short PD : bit >	0
< Message type : bit (5) >	'00101'B
< Short layer 2 header : bit (2) >	'00'B
< BA_IND : bit >	0
< 3G_BA_IND : bit >	0
< MP_CHANGE_MARK : bit >	0
< MI_INDEX : bit (4) >	'0000'B
< MI_COUNT : bit (4) >	'0000'B
< PWRC : bit >	0
< REPORT_TYPE : bit >	1 (Measurement Reporting shall be used)
< REPORTING_RATE : bit >	0 (SACCH rate reporting)
< INVALID_BSIC_REPORTING : bit >	0 (Report on cells with invalid BSIC not allowed)
0 1 < Real Time Difference Description >	0
0 1 < BSIC Description >	0
0 1 < REPORT PRIORITY Description >	0
0 1 < MEASUREMENT Parameters Description >	0
0 1 < extension length >	0
0 1 < 3G Neighbour Cell Description >	1
0 1 < 3G_Wait : bit (3) >	0
0 1 < Index_Start_3G : bit (7) >	0
0 1 < Absolute_Index_Start_EMR : bit (7) >	0
0 1 < UTRAN FDD Description >	1
0 1 < Bandwidth_FDD : bit (3) >	0
1 < Repeated UTRAN FDD Neighbour Cells > ** 0	1
0 < FDD-ARFCN : bit (14) >	0 See TS 34.108, clause 6.1.5, table 6.1.1
< FDD_Indic0 : bit >	0
< NR_OF_FDD_CELLS : bit (5) >	'00001'B
< FDD_CELL_INFORMATION Field >	10 bits Scrambling code according to TS 34.108, clause 6.1.4, Default settings for cell No.1
1 < Repeated UTRAN FDD Neighbour Cells > ** 0	0
0 1 < UTRAN TDD Description >	0
0 1 < CDMA2000 Description >	0
0 1 < 3G MEASUREMENT Parameters Description >	
< Qsearch_C : bit (4) >	'0111'B (Always)
< 3G_SEARCH_PRIO : bit (1) >	1
< FDD_REP_QUANT : bit (1) >	1 (Ec/No)
0 1 < FDD_MULTIRAT_REPORTING : bit (2) >	'1 01'B (Report on 1 UTRAN cell)
0 1 < FDD_REPORTING_OFFSET : bit (3) >	0
0 1 < TDD_MULTIRAT_REPORTING : bit (2) >	0
0 1 < TDD_REPORTING_OFFSET : bit (3) >	0
0 1 < CDMA2000_MULTIRAT_REPORTING : bit (2) >	0
0 1 < CDMA2000_REPORTING_OFFSET : bit (3) >	0

INTERSYSTEM TO UTRAN HANDOVER COMMAND

Information Element	Value/remark
RR management Protocol Discriminator	'0110'B
Skip Indicator	'0000'B
Inter System to UTRAN Handover Command Message Type	'01100011'B
Length of Handover to UTRAN Command contents	Octet length of the "Handover to UTRAN Command value part"
Handover to UTRAN Command value part	PER encoded ASN.1 value of type "HandoverToUTRANCommand-r3-IEs", the content is presented in the next table.

Content of "HandoverToUTRANCommand-r3-IEs" (in tabular format)

Information Element	Value/remark
New U-RNTI - SRNC Identity - S-RNTI-2	'000000000001'B Set to arbitrary value corresponding to DPCH Offset value currently stored in SS
Ciphering algorithm	The presence of this IE is dependent on IXIT statements in TS 34.123-2. If ciphering is indicated to be active, use UEA1. Else, this IE is omitted
CHOICE specification mode CHOICE preconfiguration mode - Default configuration mode - Default configuration identity - RAB Info - RAB identity (GSM-MAP) - CN domain identity - NAS Synchronisation Indicator - Uplink DPCH info - Uplink DPCH power control info - CHOICE mode - DPCCH power offset - PC Preamble - SRB delay	Preconfiguration Default configuration FDD 3 (12.2 kbps speech + 3.4 kbps signalling) '00000001'B CS domain Not Present FDD -78dB (i.e. ASN.1 IE value of $-20 (2 + (\text{IE Value} * 4))$) 1 frame 7 frames

<ul style="list-style-type: none"> - CHOICE mode - Scrambling code type - Reduced scrambling code number - Spreading factor - Downlink information common for all radio links - Downlink DPCH info common for all RL - Downlink DPCH power control information <ul style="list-style-type: none"> - CHOICE Mode - DPC mode - Downlink information per radio link list - Downlink information for each radio link <ul style="list-style-type: none"> - CHOICE mode <ul style="list-style-type: none"> - Primary CPICH info - Primary scrambling code - Downlink DPCH info for each radio link <ul style="list-style-type: none"> - CHOICE mode - CHOICE mode <ul style="list-style-type: none"> - Primary CPICH usage for channel estimation - Secondary scrambling code - CHOICE Spreading factor - Code number - Scrambling code change - TPC combination index - Frequency info - UARFCN uplink(Nu) - UARFCN downlink(Nd) 	<p>FDD Long 0 64</p> <p>FDD Single TPC 1</p> <p>FDD</p> <p>See TS 34.108, clause titled "Default settings for cell No.1 (FDD)" in clause 6.1</p> <p>FDD FDD Primary CPICH may be used</p> <p>1 128 0 No code change 0</p> <p>Not Present Absence of this IE is equivalent to apply the default duplex distance defined for the operating frequency according to TS 25.101</p> <p>See TS 34.108, clause 6.1.5, table 6.1.1</p>
Maximum allowed UL TX power	See TS 34.108, clause 6.1.5, table 6.1.1

Contents of UTRAN MOBILITY INFORMATION message:

The contents of the UTRAN MOBILITY INFORMATION message in this test case is identical to the default message in TS 34.108, with the following exceptions.

Information Element	Value/remark
Message Type	
Integrity check info	As default
RRC transaction identifier	As default
Integrity protection mode info	As default
Ciphering mode info	As default
New U-RNTI	As default
New C-RNTI	As default
UE Timers and constants in connected mode	As default
CN information info	
- PLMN identity	Not present
- CN common GSM-MAP NAS system information	Not present
- CN domain related information	
- CN domain identity	CS domain
- CN domain specific GSM-MAP NAS system info	
- T3212	30 (periodic updating every 3 hours)
- ATT	1 (MS shall apply IMSI attach and detach procedures)
- CN domain specific DRX cycle length coefficient	7
- CN domain related information	
- CN domain identity	PS domain
- CN domain specific GSM-MAP NAS system info	
- RAC	6 (GERAN and UTRAN cells use different RAC)
- NMO	1 (Network Mode of Operation I)
- CN domain specific DRX cycle length coefficient	7
URA identity	Not present
Downlink counter synchronization info	Not Present

47.3.4.2 Handover to UTRAN while in DTM / Uplink TBF

47.3.4.2.1 Conformance requirements

Once the mobile station enters the dual transfer mode, the existent procedures apply (see 3GPP TS 44.060). Some exceptions to the existent procedures while in dedicated mode are:

- When the mobile station receives a HANOVER COMMAND, HANOVER TO UTRAN COMMAND, HANOVER TO CDMA2000 COMMAND, HANOVER TO IU MODE COMMAND or ASSIGNMENT COMMAND message, it shall abandon the packet resource immediately, enter dedicated mode and perform the handover or assignment procedure, respectively.

After the successful completion of the handover from an GSM cell to an UMTS cell, an MS which has performed the GPRS suspension procedure in Gb mode (see 3GPP TS 04.18) (i.e. an MS in MS operation mode B or an DTM MS in a GSM cell that does not support DTM) shall perform a normal RA update procedure in the UMTS cell in order to resume the GPRS services in the network, before sending any other signalling messages or user data.

References

3GPP TS 04.18/44.018 sub-clause 3.4.23.1

3GPP TS 24.008 sub-clause 4.7.1.7

47.3.4.2.2 Test purpose

Verifying that the MS aborts Packet resources while in DTM and proceeds with the handover to UTRAN, upon reception of an INTER SYSTEM TO UTRAN HANOVER COMMAND message.

47.3.4.2.3 Method of test

Initial Conditions

System Simulator:

2 cells - Cell 1 is GSM with DTM supported, Cell 2 is UTRAN. The present document sub-clause 26.6.5.1 shall be referenced for the default parameters of cell 1. 3GPP TS 34.108, sub-clause 6.1 shall be referenced for default parameters of Cell 2.

Mobile Station:

The MS is in the active state (U10) of a call.

The MS is GPRS idle with a P-TMSI allocated and the PDP context 1 activated

Specific PICS statements

-

PIXIT statements

-

Test Procedure

The SS starts the GSM cell and UTRAN and brings the MS into the call active state (CC state U10). The MS is then triggered to initiate packet uplink data transfer in RLC acknowledged mode and sends a DTM REQUEST message. On receipt of the DTM REQUEST message, requesting uplink resources, the SS sends a PACKET ASSIGNMENT message to the MS on the main DCCH, instructing the MS to switch to the designated timeslot. The SS waits a specified time and then starts to transmit to the newly allocated resources. The SS configures the UTRAN dedicated channel corresponding to the default-configuration 3. After approximately 5k octets of data has been sent, sent, the SS sends a MEASUREMENT INFORMATION to trigger the MS to perform measurements on the UTRAN cell. The SS verifies that the MS include the UTRAN cell in the MEASUREMENT REPORT and then sends an INTERSYSTEM TO UTRAN HANOVER COMMAND message, indicating the dedicated channel of the target cell to the MS, through the GSM serving cell. After the MS receives the command it shall configure itself accordingly and switch to the dedicated channel of UTRAN cell. The SS checks whether the handover has been performed, by verifying that the MS transmits a HANOVER TO UTRAN COMPLETE message to the SS through the DCCH of the UTRAN cell. The MS then optionally attempt to resume the packet resources with the transmission of a SERVICE REQUEST message. The

radio bearer is then established and the SS sends a SERVICE ACCEPT message to the MS instructing the MS to use the bearer for packet transmission. To check that PDP context is active, SS sends MODIFY PDP CONTEXT REQUEST in UMTS cell. The MS may or may not accept the QoS and replies to the SS accordingly.

Maximum Duration of Test

5 minutes

Expected Sequence

Note: Default message contents for UMTS signalling can be found in 3GPP TS 34.108 sub-clause 9.1.

Step	Direction	Message	Comments
1	SS		MS in state U10, utilising Timeslot N and TCH/F channel type for the CS connection on Cell 1 (Timeslot chosen arbitrarily)
2			Trigger the MS to initiate an uplink packet transfer containing 10k octets.
3	MS->SS	DTM REQUEST	
4	SS->MS	PACKET ASSIGNMENT	Assigning uplink packet resources on Timeslot N+1 to the MS.
5	MS<->SS	{ Uplink data transfer }	Macro
6	SS		The SS configures the dedicated channel with the configuration: conversational/speech/UL:12.2 DL:12.2 kbps/CS RAB + UL:3.4 DL3.4 kbps SRBs in UTRAN cell.
7	SS		Waits until approximately 5k octets have been successfully transmitted.
8	←	MEASUREMENT INFORMATION	
9	→	MEASUREMENT REPORT	Including Measurement Results on the UTRAN cell in Step 8
10	SS->MS	INTER SYSTEM TO UTRAN HANDOVER COMMAND	Received within 5 sec + 10% from Step 8. See specific message contents.
11	MS		The MS accepts the handover command and configures its lower layers using the parameters contained in the INTERSYSTEM TO UTRAN HANDOVER COMMAND
12	SS		The SS waits for uplink physical channel in synchronisation
13	MS->SS	HANDOVER TO UTRAN COMPLETE	The SS receives this message on DCCH of cell 2 (UTRAN cell). It implies that the downlink physical channel has synchronised with UTRAN.
14	SS		The SS starts integrity protection for CS domain
15	SS->MS	UTRAN MOBILITY INFORMATION	The SS conveys CN system information for the PS domain to the UE in connected mode. See specific message contents.
16	MS->SS	UTRAN MOBILITY_INFORMATION CONFIRM	
17	MS->SS	ROUTING AREA UPDATE REQUEST	
18	SS->MS	AUTHENTICATION AND CIPHERING REQUEST	
19	MS->SS	AUTHENTICATION AND CIPHERING RESPONSE	
20	SS		The SS starts integrity protection for PS domain
21	SS->MS	ROUTING AREA UPDATE ACCEPT	
22	MS->SS	SERVICE REQUEST	MS may optionally perform step 22 to 25.
23	SS->MS	RADIO BEARER SETUP	PS RAB establishment
24	MS->SS	RADIO BEARER SETUP COMPLETE	
25	SS->MS	SERVICE ACCEPT	The SS accepts the SERVICE REQUEST message, indicating the newly established RAB is to be used for the uplink packet session.
26			SS Releases the CS call.
27	SS->MS	MODIFY PDP CONTEXT REQUEST	SS requests the modification of a PDP context.
A28	MS->SS	MODIFY PDP CONTEXT ACCEPT	MS behaviour type A: Accept the PDP context modification
B28	MS->SS	DEACTIVATE PDP CONTEXT REQUEST	MS behaviour type B: Initiate the PDP context deactivation. Cause set to 'QoS not accepted'
B28a	SS->MS	DEACTIVATE PDP CONTEXT ACCEPT	MS behaviour type B: Accept the PDP context deactivation.
B28b	MS->SS	DETACH REQUEST	MS behaviour type B: A non-auto attach MS may (optionally) send a Detach Request. The SS shall wait up to 'T3390' seconds for the Detach Request.
B28c	SS->MS	DETACH ACCEPT	If the MS transmitted a Detach Request message in step B28b then the SS responds with a Detach Accept message.

Specific message contents

MEASUREMENT INFORMATION

Information Element	Value/remark
< RR short PD : bit >	0
< Message type : bit (5) >	'00101'B
< Short layer 2 header : bit (2) >	'00'B
< BA_IND : bit >	0
< 3G_BA_IND : bit >	0
< MP_CHANGE_MARK : bit >	0
< MI_INDEX : bit (4) >	'0000'B
< MI_COUNT : bit (4) >	'0000'B
< PWRC : bit >	0
< REPORT_TYPE : bit >	1 (Measurement Reporting shall be used)
< REPORTING_RATE : bit >	0 (SACCH rate reporting)
< INVALID_BSIC_REPORTING : bit >	0 (Report on cells with invalid BSIC not allowed)
0 1 < Real Time Difference Description >	0
0 1 < BSIC Description >	0
0 1 < REPORT PRIORITY Description >	0
0 1 < MEASUREMENT Parameters Description >	0
0 1 < extension length >	0
0 1 < 3G Neighbour Cell Description >	1
0 1 < 3G_Wait : bit (3) >	0
0 1 < Index_Start_3G : bit (7) >	0
0 1 < Absolute_Index_Start_EMR : bit (7) >	0
0 1 < UTRAN FDD Description >	1
0 1 < Bandwidth_FDD : bit (3) >	0
1 < Repeated UTRAN FDD Neighbour Cells > ** 0	1
0 < FDD-ARFCN : bit (14) >	0 See TS 34.108, clause 6.1.5, table 6.1.1
< FDD_Indic0 : bit >	0
< NR_OF_FDD_CELLS : bit (5) >	'00001'B
< FDD_CELL_INFORMATION Field >	10 bits Scrambling code according to TS 34.108, clause 6.1.4, Default settings for cell No.1
1 < Repeated UTRAN FDD Neighbour Cells > ** 0	0
0 1 < UTRAN TDD Description >	0
0 1 < CDMA2000 Description >	0
0 1 < 3G MEASUREMENT Parameters Description >	
< Qsearch_C : bit (4) >	'0111'B (Always)
< 3G_SEARCH_PRIO : bit (1) >	1
< FDD_REP_QUANT : bit (1) >	1 (Ec/No)
0 1 < FDD_MULTIRAT_REPORTING : bit (2) >	'1 01'B (Report on 1 UTRAN cell)
0 1 < FDD_REPORTING_OFFSET : bit (3) >	0
0 1 < TDD_MULTIRAT_REPORTING : bit (2) >	0
0 1 < TDD_REPORTING_OFFSET : bit (3) >	0
0 1 < CDMA2000_MULTIRAT_REPORTING : bit (2) >	0
0 1 < CDMA2000_REPORTING_OFFSET : bit (3) >	0

INTERSYSTEM TO UTRAN HANDOVER COMMAND

Information Element	Value/remark
RR management Protocol Discriminator	'0110'B
Skip Indicator	'0000'B
Inter System to UTRAN Handover Command Message Type	'01100011'B
Length of Handover to UTRAN Command contents	Octet length of the "Handover to UTRAN Command value part"
Handover to UTRAN Command value part	PER encoded ASN.1 value of type "HandoverToUTRANCommand-r3-IEs", the content is presented in the next table.

Content of "HandoverToUTRANCommand-r3-IEs" (in tabular format)

Information Element	Value/remark
New U-RNTI - SRNC Identiy - S-RNTI-2	'000000000001'B Set to arbitrary value corresponding to DPCH Offset value currently stored in SS
Ciphering algorithm	The presence of this IE is dependent on IXIT statements in TS 34.123-2. If ciphering is indicated to be active, use UEA1. Else, this IE is omitted
CHOICE specification mode CHOICE preconfiguration mode - Default configuration mode - Default configuration identity - RAB Info - RAB identity (GSM-MAP) - CN domain identity - NAS Synchronisation Indicator - Uplink DPCH info - Uplink DPCH power control info - CHOICE mode - DPCCH power offset - PC Preamble - SRB delay	Preconfiguration Default configuration FDD 3 (12.2 kbps speech + 3.4 kbps signalling) '00000001'B CS domain Not Present FDD -78dB (i.e. ASN.1 IE value of $-20 (2 + (\text{IE Value} * 4))$) 1 frame 7 frames

<ul style="list-style-type: none"> - CHOICE mode - Scrambling code type - Reduced scrambling code number - Spreading factor - Downlink information common for all radio links - Downlink DPCH info common for all RL - Downlink DPCH power control information <ul style="list-style-type: none"> - CHOICE Mode - DPC mode - Downlink information per radio link list - Downlink information for each radio link <ul style="list-style-type: none"> - CHOICE mode <ul style="list-style-type: none"> - Primary CPICH info - Primary scrambling code - Downlink DPCH info for each radio link <ul style="list-style-type: none"> - CHOICE mode - CHOICE mode <ul style="list-style-type: none"> - Primary CPICH usage for channel estimation - Secondary scrambling code - CHOICE Spreading factor - Code number - Scrambling code change - TPC combination index - Frequency info <ul style="list-style-type: none"> - UARFCN uplink(Nu) - UARFCN downlink(Nd) 	<p>FDD Long 0 64</p> <p>FDD Single TPC 1</p> <p>FDD</p> <p>See TS 34.108, clause titled "Default settings for cell No.1 (FDD)" in clause 6.1</p> <p>FDD FDD Primary CPICH may be used</p> <p>1 128 0 No code change 0</p> <p>Not Present Absence of this IE is equivalent to apply the default duplex distance defined for the operating frequency according to TS 25.101</p> <p>See TS 34.108, clause 6.1.5, table 6.1.1</p>
Maximum allowed UL TX power	See TS 34.108, clause 6.1.5, table 6.1.1

Contents of UTRAN MOBILITY INFORMATION message:

The contents of the UTRAN MOBILITY INFORMATION message in this test case is identical to the default message in TS 34.108, with the following exceptions.

Information Element	Value/remark
Message Type	
Integrity check info	As default
RRC transaction identifier	As default
Integrity protection mode info	As default
Ciphering mode info	As default
New U-RNTI	As default
New C-RNTI	As default
UE Timers and constants in connected mode	As default
CN information info	
- PLMN identity	Not present
- CN common GSM-MAP NAS system information	Not present
- CN domain related information	
- CN domain identity	CS domain
- CN domain specific GSM-MAP NAS system info	
- T3212	30 (periodic updating every 3 hours)
- ATT	1 (MS shall apply IMSI attach and detach procedures)
- CN domain specific DRX cycle length coefficient	7
- CN domain related information	
- CN domain identity	PS domain
- CN domain specific GSM-MAP NAS system info	
- RAC	6 (GERAN and UTRAN cells use different RAC)
- NMO	1 (Network Mode of Operation I)
- CN domain specific DRX cycle length coefficient	7
URA identity	Not present
Downlink counter synchronization info	Not Present

47.4 Session Management

47.4.1 PDP Context Activation / Performed on main DCCH and TBFs

47.4.1.1 Conformance requirements

MAX_LAPDm (3 bit field)

This field indicates the maximum number of LAPDm frames on which a layer 3 can be segmented into and be sent on the main DCCH. It is coded as described in the SI 6 Rest Octets IE.

The parameter N201 is the maximum number of octets which are partially or entirely available for the information field of a frame.

The maximum number of octets partially or entirely available for the information field (N201) is:

- for frames of format A and B:
 - for the SACCH: N201 = 18;
 - for the FACCH and SDCCH: N201 = 20.
- for frames of format Bbis:
 - for BCCH, AGCH, NCH and PCH: N201 = 23;
- for frames of format Bter:
 - for the SACCH: N201 = 21;
 - for the FACCH and SDCCH: N201 = 23;
- for frames of format B4:
 - for the SACCH: N201 = 19.

The network should not use the main DCCH to send messages that exceed the maximum length specified for the uplink. The mobile station, however, shall not reject messages that exceed the maximum length.

References

3GPP TS 04.18/44.018, sub-clause 10.5.2.11a

3GPP TS 04.06/44.006, sub-clauses 2.1, 5.8.3

3GPP TS 03.55 sub-clause 4.1.1

47.4.1.2 Test purpose

To verify that:

- a) the MS uses the main DCCH when the message size is less than the product of MAX_LAPDm and N201;
- b) the MS uses an uplink TBFs when the message size is greater than the product of MAX_LAPDm and N201;
- c) the MS does not discard a frame when the network uses the main DCCH when the MS is in DTM;
- d) when the network exceeds the maximum LAPDm frame size in transmitting to the MS, the MS does not discard the message and continues to act upon the message.

47.4.1.3 Method of test

Initial Conditions

System Simulator:

2 cells, A and B with same LAI but different RAI, both supporting DTM and with default parameters.

MAX_LAPDm = 000 (Allowing any PS message segmented in up to 5 LAPDm frames)

Network Mode of Operation II

Mobile Station:

The MS is in the active state (U10) of a call, on Timeslot N (chosen arbitrarily) of cell A, with a TMSI and P-TMSI allocated but no allocated TBFs or activated PDP context.

The MS is set to use the following as an APN:

APN Network Identifier = "THIS-APN-HAS-TO-BE-63-OCTETS-IN-LENGTH-AND-IS-ENCODED-IN-ASCII-"

APN Operator Identifier = "OPERATOR-NAME.OPERATOR-GROUP.GPRS"

Note: The APN has been chosen to ensure that the ACTIVATE PDP CONTEXT REQUEST message is over the threshold for main DCCH use, forcing the MS not to use the main DCCH for this signalling message.

Specific PICS statements

-

PIXIT statements

-

Test Procedure

An MS in dedicated mode on cell A is ordered to complete the Handover procedure to cell B. Once the MS has successfully completed the handover procedure to the cell, the SS sends the DTM INFORMATION message, informing the MS of the cell parameters and then the MS completes the Routing Area Updating procedure on the main DCCH. The MS is then triggered to activate a PDP context. The MS has to establish an uplink TBF to be able to send the ACTIVATE PDP CONTEXT REQUEST because the message size is greater than is allowed on the main DCCH. The SS responds with the ACTIVATE PDP CONTEXT ACCEPT message on the main DCCH. After the MS has received the ACTIVATE PDP CONTEXT ACCEPT message optional can perform an XID negotiation procedure, the SS sends, on the main DCCH, a GMM INFORMATION message to the MS, with an incorrect message type included in the header. The MS responds to this unknown message type with a GMM STATUS message.

Maximum Duration of Test

5 minutes

Expected Sequence

Step	Direction	Message	Comments
1	SS		MS in state U10, on an arbitrarily chosen Timeslot N of cell A, k=1, Channel Type = TCH/F; or k=2, Channel Type = TCH/H.
2	SS		SS waits 10 seconds, maintaining the CS call.
3	SS->MS	HANDOVER COMMAND	Instructs MS to Handover to Timeslot N of the cell B, utilising a TCH/F.
4	MS->SS	HANDOVER ACCESS	Repeated on every burst of the uplink main DCCH (and optionally on the SACCH) until reception of PHYSICAL INFORMATION. Handover Reference as included in the HANDOVER COMMAND.
5	SS->MS	PHYSICAL INFORMATION	
6	MS->SS	HANDOVER COMPLETE	
7	SS->MS	DTM INFORMATION	Contains the cell parameters
8	MS->SS	GPRS INFORMATION	Containing a ROUTING AREA UPDATE REQUEST message.
9	SS->MS	GPRS INFORMATION	Containing a ROUTING AREA UPDATE ACCEPT message. Does not allocate MS a new P-TMSI. Negotiated Ready timer value IE should not be included. Force to standby indicator set
10	SS		MS triggered to request PDP context activation.
11	MS->SS	DTM REQUEST	The MS requests the transition into DTM, to send the ACTIVATE PDP CONTEXT REQUEST message which requires more LAPDm frames than allowed for use of the main DCCH for PS signalling.
12	SS->MS	PACKET ASSIGNMENT	The SS allocates uplink resources to the MS, k=1: on Timeslot $(N \pm 1) \text{ MOD } 8$. k=2: on Timeslot $N \text{ MOD } 8$.
13	MS->SS	ACTIVATE PDP CONTEXT REQUEST	Requests PDP context activation. This message is sent on the allocated uplink PDCH.
14	SS->MS	GPRS INFORMATION	Contains the ACTIVATE PDP CONTEXT ACCEPT message. Although the SS should establish a downlink TBF to send this message, as the MS is in DTM, the MS shall be able to receive this message on the main DCCH. Steps 15 to 19 are performed only if MS requests XID negotiation procedure after PDP context activation. SS waits 5 s for the request of the optional XID procedure. Steps 15 and 16 are only performed if MS is not in DTM mode any more.
15 (optional)	MS->SS	DTM REQUEST	The MS requests the transition into DTM, to send the XID REQUEST message
16 (optional)	SS->MS	PACKET ASSIGNMENT	The SS allocates uplink resources to the MS, k=1: on Timeslot $(N \pm 1) \text{ MOD } 8$. k=2: on Timeslot $N \text{ MOD } 8$.
17 (optional)	MS->SS	XID REQUEST	
18 (optional)	SS->MS	PACKET ASSIGNMENT	The SS allocates downlink resources to the MS, k=1: on Timeslot $(N + 1) \text{ MOD } 8$. k=2: on Timeslot $N \text{ MOD } 8$.
19 (optional)	SS->MS	XID RESPONSE	
20	SS->MS	GPRS INFORMATION	Contains the GMM INFORMATION message. This message is over the size that is allowed for transmission on the main DCCH, but it is a requirement that the MS shall be able to receive an 'oversized' message on the main DCCH.
21	MS->SS	GPRS INFORMATION	Contains the GMM STATUS message: Message cause #97 shall be returned by the MS to indicate the message received is of unknown message type.

Specific Message Contents

k=1

PACKET ASSIGNMENT (Step 12 and Step 16):

As default message contents except: GPRS broadcast information - GPRS Cell Options - NMO RR Packet Uplink Assignment IE - TIMESLOT_ALLOCATION RR Packet Downlink Assignment IE	01 Network Mode 2 (N±1) MOD 8 Not included
--	--

PACKET ASSIGNMENT (Step 18):

As default message contents except: GPRS broadcast information - GPRS Cell Options - NMO RR Packet Uplink Assignment IE RR Packet Downlink Assignment IE - TIMESLOT_ALLOCATION	01 Network Mode 2 Not included (N±1) MOD 8
--	--

k=2:

PACKET ASSIGNMENT (Step 12 and Step 16):

As default message contents except: GPRS broadcast information - GPRS Cell Options - NMO RR Packet Uplink Assignment IE - TIMESLOT_ALLOCATION RR Packet Downlink Assignment IE	01 Network Mode 2 N MOD 8 Not included
--	--

PACKET ASSIGNMENT (Step 18):

As default message contents except: GPRS broadcast information - GPRS Cell Options - NMO RR Packet Uplink Assignment IE RR Packet Downlink Assignment IE - TIMESLOT_ALLOCATION	01 Network Mode 2 Not included N MOD 8
--	--

GMM INFORMATION (Step 20):

As default message contents except: GMM Information message identity Full name for network IE - Network Name IEI - Length of Network Name contents - Coding Scheme - Add CI - Number of spare bits in last octet - Text String	00111111 43 161 000 0 0 0123456789abcdef0123456789abcdef0123456789abcd ef0123456789abcdef0123456789abcdef0123456789abc def0123456789abcdef0123456789abcdef0123456789ab cdef0123456789abcdef
--	--

48 to 49 Void

Void.

50 EGPRS Default Conditions, Message Contents and Macros

The following clause 50 details default conditions, messages and macros that shall be used for the EGPRS test cases. These conditions, messages and macros are derived from the "GPRS default conditions, message contents and macros" (see clause 40). In the following subclauses only those parameters are listed which deviate from the "GPRS default conditions, message contents and macros".

Where values have not been specified the equivalent overall GPRS default values (see subclause 40.1) should be used. If values need to be removed from the overall GPRS defaults then these should be specified as 'OMITTED'.

In case of ambiguity EGPRS settings take precedence over GPRS settings.

50.1 EGPRS Default Test Conditions

Since GPRS and EGPRS make use of the same channel combinations subclause 40.1 applies to both GPRS and EGPRS.

Note : 'One phase access' test cases may not be fully executed for MS requesting 'Two phases access'.

The resulting step "If the MS requests two phase access the Test Case is terminated" should be interpreted as "Test case is not applicable for the MS".

List of affected testcases (by this note):

51.2.3.1, 51.2.3.2, 51.2.3.3, 51.2.3.4, 51.2.3.5, 51.2.3.6, 51.2.3.7, 51.2.3.8, 51.2.3.9, 51.2.3.10, 51.2.3.11, 52.1.2.1.8.1.1, 52.1.2.1.8.1.2, 52.1.2.1.8.1.3, 52.1.2.1.8.1.4, 52.1.2.1.8.1.5, 52.1.2.1.8.1.6, 52.1.2.1.8.1.7, 52.1.2.1.8.1.8, 52.1.2.1.8.2.1, 52.1.2.1.8.2.2, 52.8.1.1, 52.8.1.2, 52.8.1.3, 52.8.1.4, 52.8.1.5, 52.8.1.6, 52.8.1.7, 52.8.1.8, 52.8.1.9, 52.8.1.10, 52.8.1.11, 52.8.1.12.

50.2 EGPRS Default Message Contents.

50.2.1 EGPRS System Information Messages

The EGPRS system information messages for cell A, B, C, D, E, F are identical to the corresponding GPRS system information messages for cell A, B, C, D, E, F (see subclauses 40.2.1.1 to 40.2.1.6), except the settings in the system information messages as given in the tables below.

SYSTEM INFORMATION TYPE 13:

SI 13 Rest Octets: GPRS Cell Options IE: Extension Information - Extension length - {0 1 <Extension Information>} - EGPRS_PACKET_CHANNEL_REQUEST - BEP_PERIOD - PFC_FEATURE_MODE - DTM_SUPPORT - BSS_PAGING_COORDINATION For Rel 4 network simulation - CNN_ACTIVE - NW_EXT_UTBF For Rel 6 network simulation - MULTIPLE_TBF_CAPABILITY - EXT_UTBF_NO_DATA - DTM_ENHANCEMENTS_CAPABILITY - {0 1} End Rel 6 End Rel 4	R99: 001000 Rel 4: 001010 Rel 6: 001110 1 EGPRS supported by the cell. 0 Use of EGPRS PACKET CHANNEL REQUEST_message for uplink TBF establishment. 0110 0 Packet Flow Context Procedures not supported 0 Cell does not support DTM procedures. 0 Circuit-Switched paging coordination not supported in cell 0 CNN is disabled in the cell 0 Ext UL TBF not supported in the cell 0 Cell does not support multiple TBF procedures 0 MS shall send a PACKET UPLINK DUMMY CONTROL BLOCK message when there is no other RLC/MAC block ready to send in an uplink radio block allocated by the network 0 Cell does not support enhanced DTM CS establishment and enhanced DTM CS release procedures 0 -- MBMS procedures not supported by the cell
---	--

50.2.2 EGPRS Packet System Information messages

50.2.2.1 Cell A

The EGPRS packet system information messages for cell A, B, C, D, E, F are identical to the corresponding GPRS packet system information messages for cell A, B, C, D, E, F (see subclauses 40.2.2.1 to 40.2.2.6), except the settings in the packet system information messages as given in the tables below.

PACKET SYSTEM INFORMATION TYPE 1:

<p>GPRS Cell Options IE: Extension Information - Extension length</p> <p>- {0 1 <Extension Information>} - EGPRS_PACKET_CHANNEL_REQUEST</p> <p>- BEP_PERIOD - PFC_FEATURE_MODE - DTM_SUPPORT - BSS_PAGING_COORDINATION</p> <p>For Rel 4 network simulation - CNN_ACTIVE - NW_EXT_UTBF</p> <p>For Rel 6 network simulation - MULTIPLE_TBF_CAPABILITY - EXT_UTBF_NO_DATA</p> <p>- DTM_ENHANCEMENTS_CAPABILITY</p> <p>- { 0 1 }</p> <p>End Rel 6 End Rel 4</p>	<p>R99: 001000 Rel 4: 001010 Rel 6: 001110</p> <p>1 EGPRS supported by the cell. 0 Use of EGPRS PACKET CHANNEL REQUEST_message for uplink TBF establishment. 0110 0 Packet Flow Context Procedures not supported 0 Cell does not support DTM procedures. 0 Circuit-Switched paging coordination not supported in cell</p> <p>0 CNN is disabled in the cell 0 Ext UL TBF not supported in the cell</p> <p>0 Cell does not support multiple TBF procedures 0 MS shall send a PACKET UPLINK DUMMY CONTROL BLOCK message when there is no other RLC/MAC block ready to send in an uplink radio block allocated by the network 0 Cell does not support enhanced DTM CS establishment and enhanced DTM CS release procedures 0 -- MBMS procedures not supported by the cell</p>
--	---

50.2.3 EGPRS default contents of Layer 2 messages

The EGPRS default contents of Layer 2 messages are identical to the GPRS default contents of Layer 2 messages (see subclause 40.1.2.3) with the following exception in the tables given below. In these tables only those layer 2 messages are listed differing in specific EGPRS information elements (IE's) from the corresponding GPRS IE's.

NOTE: In this subclause all information element values are in binary. Numeric values written within quotes are in decimal.

50.2.3.1 PACKET UPLINK ASSIGNMENT message

MESSAGE_TYPE	001010
PAGE_MODE	00 Normal Paging
Persistence Level	0 No Persistence Level Present
Referenced Address struct { 0 < Global TFI > 10 < TLLI > 110 < TQI > 111 <Packet Request Reference >}	As received from the MS
{0 1 Message escape bit}	1
{00 EGPRS message contents}	00 EGPRS messages contents present
- {0 1 CONTENTION_RESOLUTION_TLLI}	0 not present
- {0 1 COMPACT reduced MA}	0 reduced COMPACT Mobile Allocation list not present
- EGPRS Modulation and Coding Scheme	Dependant upon test case (Default MCS_1)
- Resegment	0 Retransmitted RLC data blocks shall not be resegmented
- EGPRS Window Size	Dependant upon test case (Default 64)
- {0 1 Access Technologies Request}	0 Access technologie Request Info not present
- ARAC RETRANSMISSION REQUEST	0 retransmission of an ADDITIONAL MS RADIO ACCESS CAPABILITIES message is not requested
TLLI_BLOCK_CHANNEL_CODING	1
{0 1 BEP_PERIOD2}	0 BEP_PERIOD2 not present
Packet Timing Advance	
{ 0 1 < TIMING_ADVANCE_VALUE > - TIMING_ADVANCE_VALUE }	1 Timing Advance Value present 30 bit periods
{ 0 1< TIMING_ADVANCE_INDEX > <TIMING_ADVANCE_TIMESLOT_NUMBER > }	0 (no timing advance index)
{0 1 Packet Extended Timing Advance}	0 Packet Extended TA for GSM 400 not present
{0 1<Frequency Parameters>}	Not present in case MS is in DTM mode otherwise present when required for channel assignment
For PBCCH not present case: < TSC > { 00< ARFCN > - ARFCN }	Arbitrarily chosen (default 101) 00 (ARFCN no hopping) As for "Serving cell, PDTCH (PBCCH not present), SDCCH " in section 40.1.1 for the current cell
For PBCCH present case: < TSC > { 01< indirect encoding: > <MAIO> <MA_NUMBER> 0 1 <Change mark flag	arbitrarily chosen (default 101) Indirect encoding struct: 000010 0010 (list 2) 0 (change mark not present)
In case of Dynamic Allocation: Dynamic Allocation	01 Dynamic Allocation
EXTENDED_DYNAMIC_ALLOCATION	0 dynamic allocation only
{ 0 1 < P0 >}	0 downlink power control is not used
USF_GRANULARITY	0 MS shall transmit only one RLC/MAC block
{ 0 1 < UPLINK_TFI_ASSIGNMENT >}	1 assign uplink TFI
- UPLINK_TFI_ASSIGNMENT	00000
{ 0 1 < RLC_DATA_BLOCKS_GRANTED > }	0 open-ended TBF
{ 0 1 < TBF Starting Time > }	0 No starting time present
Timeslot Allocation	0 Timeslot Allocation without Power Control Parameters
	One slot arbitrarily chosen, the following USF_TNx shall be corresponding to the chosen value x (default timeslot 4 assigned)
- { 0 1 < USF_TN0 > }	0 USF not assigned
- { 0 1 < USF_TN1 > }	0 USF not assigned
- { 0 1 < USF_TN2 > }	0 USF not assigned
- { 0 1 < USF_TN3 > }	0 USF not assigned
- { 0 1 < USF_TN4 > }	1 USF not assigned

<p>- USF_TN4 - { 0 1 < USF_TN5 > } - { 0 1 < USF_TN6 > } - { 0 1 < USF_TN7 > }</p> <p>In case of Multiblock allocation</p> <p>< TIMESLOT_NUMBER > { 0 1 < ALPHA > < GAMMA_TN > } { 0 1 < P0 > < BTS_PWR_CTRL_MODE > < PR_MODE > } < TBF Starting Time ></p> <p>< NUMBER OF RADIO BLOCKS ALLOCATED > spare padding</p>	<p>Arbitrarily chosen (default 000) 0 USF not assigned 0 USF not assigned 0 USF not assigned</p> <p>100 0 (ALPHA and GAMMA_TN not present)</p> <p>0 P0, BTS_PWR_CTRL_MODE , PR_MODE not present</p> <p>0 (Absolute Starting Time, indicating current frame + 104 frames) 00 Spare Padding</p>
---	---

50.2.3.2 PACKET DOWNLINK ASSIGNMENT message

MESSAGE_TYPE	000010
PAGE_MODE	00 Normal Paging
Persistence Level	0 (no Persistence Level Present)
Referenced Address	
-	1 (address is TLLI)
- TLLI	Same as the value received from MS
MAC_MODE	00 Dynamic Allocation
RLC_MODE	0 Acknowledged mode
CONTROL_ACK	0
TIMESLOT_ALLOCATION	arbitrarily chosen (default timeslot 4)
Packet Timing Advance	
{ 0 1< TIMING_ADVANCE_VALUE >	1 (timing advance value)
- TIMING_ADVANCE_VALUE }	30 bit periods
{ 0 1< TIMING_ADVANCE_INDEX >	0 (no timing advance index)
<TIMING_ADVANCE_TIMESLOT_NUMBE	
R > }	
{0 1<Frequency Parameters>}	Not present in case MS is in DTM mode otherwise present when required for channel assignment
For PBCCH not present case:	
< TSC >	Arbitrarily chosen (default 5)
{ 00< ARFCN >	00 (ARFCN no hopping)
- ARFCN }	As for "Serving cell, PDTCH (PBCCH not present), SDCCCH " in section 40.1.1 for the current cell
For PBCCH present case:	
< TSC >	arbitrarily chosen (default 5)
{ 01< indirect encoding: >}	Indirect encoding struct:
<MAIO>	000010
<MA_NUMBER>	0010 (list 2)
0 1 <Change mark flag	0 (change mark not present)
{0 1<DOWNLINK_TFI_ASSIGNMENT>}	1 (assign downlink TFI)
- DOWNLINK_TFI_ASSIGNMENT	00001
{0 1<Power Control Parameters>}	1 (Power Control Parameters present)
- ALPHA	0.5
- GAMMA for allocated timeslots	For DCS 1800 and PCS 1900: +6 dBmFor all other bands: +8 dBm
	(default timeslot 4)
{0 1<TBF_STARTING_TIME>}	0 (starting time not present)
{0 1<Measurement Mapping>}	0 (no measurement mapping)
{null 0 1 Additional contents for Release 99}	1 Additional contents for Release 99 present
- EGPRS Window Size	Dependant upon test case (Default 64)
- LINK_QUALITY_MEASUREMENT	00 MS reports BEP and interferer meas.
_MODE	
- {0 1 Packet Extended Timing Advance}	0 Packet Extended TA for GSM 400 not present
- {0 1 BEP_PERIOD2}	0 BEP_PERIOD2 not present
Spare padding	Spare Padding

50.2.4 EGPRS Default contents of Layer 3 messages

This subclause contains the default values of L3 messages, which unless indicated otherwise in clause 40 and 50 resp., shall be transmitted by the system simulator and which are required to be received from the MS under test.

The EGPRS default contents of Layer 3 messages are identical to the GPRS default contents of Layer 3 messages (see subclause 40.1.2.3) with the following exception in the tables given below. In these tables only those layer 3 messages are listed differing in specific EGPRS information elements (IE's) from the corresponding GPRS IE's.

NOTE: In this subclause all information element values are in binary. Numeric values written within quotes are in decimal.

50.2.4.1 IMMEDIATE ASSIGNMENT messages

50.2.4.1.1 IMMEDIATE ASSIGNMENT message (Packet Downlink Construction)

<p>L2 pseudo length</p> <p>Protocol Discriminator</p> <p>Skip Indicator</p> <p>Message Type</p> <p>Page Mode</p> <ul style="list-style-type: none"> - Page Mode <p>Packet Response Type and Dedicated mode or TBF</p> <ul style="list-style-type: none"> - T/D - Downlink - TMA <p>Packet Channel Description</p> <p>Request Reference</p> <p>Timing Advance</p> <ul style="list-style-type: none"> - Timing advance value <p>Mobile Allocation</p> <ul style="list-style-type: none"> - Length <p>Starting Time</p> <p>IA rest octets</p> <ul style="list-style-type: none"> - Packet Downlink Assignment - TLLI - - TFI_ASSIGNMENT - RLC_MODE <p>{0 1 < ALPHA ></p> <ul style="list-style-type: none"> - ALPHA - GAMMA <ul style="list-style-type: none"> - POLLING <ul style="list-style-type: none"> - TA_VALID <p>Presence of following bit fields indicate EGPRS</p> <p>TBF mode</p> <ul style="list-style-type: none"> - EGPRS Window Size - LINK_QUALITY_MEASUREMENT_MODE - {0 1 BEP_PERIOD2} - spare padding 	<p>This is the sum of the lengths of all the information elements present in the message except for the IA rest octets and L2 pseudo length IEs. For the default message the L2 pseudo length is 11.</p> <p>RR Management.</p> <p>0000</p> <p>00111111</p> <p>Normal Paging.</p> <p>Temporary Block Flow</p> <p>1 Resources assigned in IA Rest Octets</p> <p>0 No meaning</p> <p>Dependant upon the test case.</p> <p>Copy of last received by the SS.</p> <p>"30" bit periods.</p> <p>0</p> <p>Not present.</p> <p>HH</p> <p>01 Packet Downlink Assignment present (The value received from MS)</p> <p>1</p> <p>Any value not used before</p> <p>RLC unacknowledged mode</p> <p>1 ALPHA present</p> <p>"0.5"</p> <p>For DCS 1800 and PCS 1900: +6 dBm</p> <p>For all other bands: +8 dBm</p> <p>0 No Packet Control Acknowledgment is required from MS</p> <p>1 Timing Advance value in TA IE is valid</p> <p>H EGPRS TBF mode applied</p> <p>Dependant upon test case (Default 64)</p> <p>00 MS reports neither BEP nor interferer meas.</p> <p>0 BEP_PERIOD2 not present</p> <p>Spare Padding</p>
--	---

50.2.4.1.2 IMMEDIATE ASSIGNMENT message (Packet Uplink construction):

L2 pseudo length	This is the sum of the lengths of all the information elements present in the message except for the IA rest octets and L2 pseudo length IEs. For the default message the L2 pseudo length is 11.
Protocol Discriminator	RR Management.
Skip Indicator	0000
Message Type	00111111
Page Mode	
- Page Mode	Normal Paging.
Dedicated mode or TBF	
- T/D	1 Temporary Block Flow
- Downlink	0 No meaning
- TMA	0 No meaning
Packet Channel Description	Dependant upon the test case.
Request Reference	0111 1111
Timing Advance	
- Timing advance value	30 bit periods.
Mobile Allocation	
- Length	0
Starting Time	Not present.
IA rest octets	
-	LH
-	00 (EGPRS Packet Uplink Assignment)
< Extended RA >	Copy of the five LSB of the last EGPRS PACKET CHANNEL REQUEST received.
{ 0 1 < Access Technologies Request : Access Technologies Request struct > }	0
- Packet Uplink Assignment	1
- TFI_ASSIGNMENT	Any value not used before
- POLLING	0
-	0 Dynamic Allocation
- USF	Any value not used before
- USF_GRANULARITY	0 (transmit one RLC block)
{ 0 1 }	0 (P0, PR_MODE not present)
-EGPRS_CHANNEL_CODING_COMMAND	Dependant on testcase (Default MCS_1)
- TLLI_BLOCK_CHANNEL_CODING	1 MS shall used the coding scheme as specified by EGPRS_CHANNEL_CODING_COMMAND
{ 0 1 < BEP_PERIOD2 > }	0 (BEP_PERIOD2 not present)
- RESEGMENT	1 Resegmentation on uplink retransmissions allowed (type I ARQ)
- EGPRS Window Size	Dependant on testcase (Default 64)
{ 0 1 < ALPHA > }	1 ALPHA present
- ALPHA	0.5
- GAMMA	
{ 0 1 < TIMING_ADVANCE_INDEX > }	For DCS 1800 and PCS 1900: +6 dBm
{ 0 1 < TBF_STARTING_TIME > }	For all other bands: +8 dBm
- spare padding	0 Timing Advance Index not present
	0 TBF Starting Time not present
	Spare Padding

50.2.4.1.3 IMMEDIATE ASSIGNMENT message (Multiblock allocation construction):

L2 pseudo length	This is the sum of the lengths of all the information elements present in the message except for the IA rest octets and L2 pseudo length IEs. For the default message the L2 pseudo length is 11.
Protocol Discriminator	RR Management.
Skip Indicator	0000
Message Type	00111111
Page Mode	
- Page Mode	Normal Paging.
Dedicated mode or TBF	
- T/D	1 Temporary Block Flow
- Downlink	0 No meaning
- TMA	0 No meaning
Packet Channel Description	Dependant upon the test case.
Request Reference	0111 1111
Timing Advance	
- Timing advance value	30 bit periods.
Mobile Allocation	
- Length	0
Starting Time	Not present.
IA rest octets	
-	LH
-	00 (EGPRS Packet Uplink Assignment)
< Extended RA >	Copy of the five LSB of the last EGPRS PACKET CHANNEL REQUEST received.
{ 0 1 < Access Technologies Request : Access Technologies Request struct > }	0
- Packet Uplink Assignment	0 (Multiblock assignment)
{ 0 1 < ALPHA > }	1 ALPHA present
- ALPHA	0.5
- GAMMA	For DCS 1800 and PCS 1900: +6 dBm
- TBF_STARTING_TIME	For all other bands: +8 dBm
NUMBER OF RADIO BLOCKS ALLOCATED	Indicating (current frame + 104)
{ L H }	00
- spare padding	L (P0, BTS_PWR_CTRL_MODE , PR_MODE not present)
	Spare Padding

50.2.4.2 IMMEDIATE ASSIGNMENT REJECT message

L2 pseudo length	19
Protocol Discriminator	RR Management.
Skip Indicator	0000
Message Type	00111010
Page Mode	
- Page Mode	Normal Paging.
Request Reference 1	0111 1111
Wait Indication 1	0 seconds.
Request Reference 2	Not pertaining to the MS under test.
Wait Indication 2	0 seconds.
Request Reference 3	Not pertaining to the MS under test.
Wait Indication 3	0 seconds.
Request Reference 4	Not pertaining to the MS under test.
Wait Indication 4	0 seconds.
IAR rest octets	
- { 0 1 < Extended RA 1 : bit (5) > }	1 coded as the 5 least significant bits of the initiating EGPRS PACKET CHANNEL REQUEST message
- { 0 1 < Extended RA 2 : bit (5) > }	0 Not present.
- { 0 1 < Extended RA 3 : bit (5) > }	0 Not present.
- { 0 1 < Extended RA 4 : bit (5) > }	0 Not present.
- spare padding	Spare Padding

50.2.4.3 PDCH ASSIGNMENT COMMAND message (downlink)

Information Element	Value/Remarks
Protocol Discriminator	RR Management
Skip indicator	0000
Message Type	00101010
Description of the Channel, after time	
- Channel Description	
- Channel Type and TDMA offset	TCH/F + ACCH's
- Timeslot Number	Slot 2 ¹
- Training Sequence Code	Same as the BCC
- Hopping channel	Single RF channel
- ARFCN	Same as BCCH carrier
- RR Packet Downlink Assignment	
- LENGTH_IN_OCTETS	"400"
- MAC_MODE	00 (Dynamic allocation)
- RLC_MODE	1 (RLC unacknowledged mode)
- TIMESLOT_ALLOCATION	Slot 2
- Packet Timing Advance	
- { 0 1	1 (TIMING_ADVANCE_VALUE present)
-<TIMING_ADVANCE_VALUE> }	
- TIMING_ADVANCE_VALUE	"30" bit periods
- { 0 1	0 (TIMING_ADVANCE_INDEX and
<TIMING_ADVANCE_INDEX> }	TIMING_ADVANCE_TIMESLOT_NUMBER not present)
- { 0 1 <P0> }	0 (Downlink power control parameters not present)
- { 0 1 <Power Control Parameters> }	1 (Uplink Power Control Parameters present)
- ALPHA	"0.5"
- { 0 1 <GAMMA_TN0> }	0 (GAMMA_TN0 not present)
- { 0 1 <GAMMA_TN1> }	0 (GAMMA_TN1 not present)
- { 0 1 <GAMMA_TN2> }	1 (GAMMA_TN2 present)
- GAMMA_TN2	For GSM 700, T-GSM 810, GSM 850 and GSM 900: +8 dBm
	For DCS 1800 and PCS 1900: +6 dBm
- { 0 1 <GAMMA_TN3> }	0 (GAMMA_TN3 not present)
- { 0 1 <GAMMA_TN4> }	0 (GAMMA_TN4 not present)
- { 0 1 <GAMMA_TN5> }	0 (GAMMA_TN5 not present)
- { 0 1 <GAMMA_TN6> }	0 (GAMMA_TN6 not present)
- { 0 1 <GAMMA_TN7> }	0 (GAMMA_TN7 not present)
- { 0 1 <DOWNLINK_TFI_ASSIGNMENT> }	1 (Assign downlink TFI)
- DOWNLINK_TFI_ASSIGNMENT	00011
- { 0 1 <MEASUREMENT_STARTING_TIME> }	0 (No measurement information)
Presence of following bit fields indicate EGPRS	1 EGPRS TBF mode applied
TBF mode	
- EGPRS Window Size	Dependant upon test case
- LINK_QUALITY_MEASUREMENT_MODE	00 MS reports neither BEP nor interferer meas.
- {0 1 Packet Extended Timing Advance}	0 Packet Extended TA for GSM 400 not present
- SPARE_BITS	Spare padding

50.2.4.4 DTM Assignment Command

For R99/Rel 4 network simulation: Optional extension information - {0 1 <Extension Information>} end R99	1 Extension information present 1 EGPRS supported by the cell.
---	---

50.3 Default EGPRS Conditions, Message Contents and Macros for the Higher Layer Test Cases

Since the EGPRS higher layers (LLC, GPRS Mobility Management, Session Management and SNDCP) are identical with the GPRS higher layers the same test cases shall also apply to EGPRS.

50.4 EGPRS Macros

50.4.1 Overview

The following subclause presents macros for EGPRS test cases. Definition and syntax (see subclauses 40.4.1.1 and 40.4.1.2) of the macros for EGPRS test cases are identical to the definition and syntax of the macros of the GPRS test cases.

50.4.2 EGPRS Default Message Contents

The EGPRS default message contents of the macros for the EGPRS test cases are identical to the GPRS default message contents of the macros for the GPRS test cases (see subclause 40.4.2).

50.4.3 EGPRS Macro Message Sequences

The macros for EGPRS test cases are identical to the macros for the GPRS test cases (see subclause 40.4.) with the following exceptions in the tables given below. In these tables only those EGPRS macro sequences are listed differing from the corresponding GPRS macro sequences.

50.4.3.1 Acknowledged downlink data

Step	Direction	Message	Comments
	SS ↔ MS	{ Acknowledged downlink data }	Macro
1	SS → MS	{ Downlink data }	Macro
2	MS → SS	EGPRS PACKET DOWNLINK ACK/NACK	

50.4.3.2 Downlink data transfer

Step	Direction	Message	Comments
	SS ↔ MS	{ Downlink data transfer }	Macro
a. RLC unacknowledged mode			
1	SS → MS	{ Downlink data }	Macro
2	SS → MS	RLC DOWNLINK DATA	FBI bit set to '1' and valid RRBP field
3	MS → SS	PACKET CONTROL ACKNOWLEDGMENT	In the uplink block specified by the RRBP field
b. RLC acknowledged mode			
1	SS ↔ MS	{ Acknowledged downlink data }	Macro
2	SS ↔ MS	{ Acknowledged downlink data }	Macro
⋮	⋮	⋮	
N	SS ↔ MS	{ Acknowledged downlink data }	Macro. $n \geq 1$
n+1	SS → MS	RLC DOWNLINK DATA	
n+2	SS → MS	RLC DOWNLINK DATA	
⋮	⋮	⋮	
M	SS → MS	RLC DOWNLINK DATA	$m \geq n+1$. FBI bit set to '1' and valid RRBP field
m+1	MS → SS	EGPRS PACKET DOWNLINK ACK/NACK	In the uplink block specified by the RRBP field. Final Ack Indicator bit set to '1'

50.4.3.3 Uplink data transfer

Step	Direction	Message	Comments
	MS ↔ SS	{ Uplink data transfer }	Macro (arguments: see note 4)
1	MS → SS	RLC UPLINK DATA	See notes 1 and 2
2a	MS → SS	RLC UPLINK DATA	See note 3
2b	SS → MS	PACKET UPLINK ACK/NACK	
3a	MS → SS	RLC UPLINK DATA	
3b	SS → MS	PACKET UPLINK ACK/NACK	
⋮	⋮	⋮	n ≥ 1. CV set to '0' Final Ack Indicator bit = '1' and valid RRBP field In the uplink block specified by the RRBP field
N	MS → SS	RLC UPLINK DATA	
N+1	SS → MS	PACKET UPLINK ACK/NACK	
N+2	MS → SS	PACKET CONTROL ACKNOWLEDGEMENT	
<p>NOTE 1: SI bit set to '0' in all data blocks.</p> <p>NOTE 2: The SS sends a PACKET UPLINK ACK/NACK message at least every k-1 RLC UPLINK DATA messages, being k the window size with a value according to the number of timeslots allocated in the direction (uplink or downlink) of the TBF operating in EGPRS TBF mode, see 3GPP TS 44.060.</p> <p>NOTE 3: The field CV in the RLC UPLINK DATA messages verifies:</p> $\text{Let integer } x = \text{round} \left(\frac{TBC - BSN' - 1}{NTS \times K} \right)$ $\text{then, } CV = \begin{cases} x, & \text{if } x \leq BS_CV_MAX, \\ 15, & \text{otherwise} \end{cases}$ <p>where:</p> <ul style="list-style-type: none"> - TBC: total number of RLC data blocks that will be transmitted in the TBF; - BSN': absolute block sequence number of the RLC data block, from 0 to (TBC - 1); - NTS: number of timeslots assigned to the uplink TBF, with range 1 to 8; - K = 2 when commanded MCS is MCS-7, MCS-8 or MCS-9 otherwise K=1. - the function round() rounds upwards to the nearest integer; - BS_CV_MAX is a parameter broadcast in the system information; - the division operation is non-integer and results in zero only for (TBC - BSN' - 1) = 0. <p>NOTE 4: In the case of Dynamic MAC mode, the macro reference in the corresponding test case may contain a certain frequency (in seconds⁻¹ or frames⁻¹) for the SS to indicate the USF allocated to the mobile so that the MS is allowed to transmit. Otherwise, mobile's USF is indicated in every available block.</p> <p>NOTE 5: When an EGPRS RLC/MAC block for data transfer consists of two RLC data blocks, the CV of the RLC/MAC header refers to the second RLC data block.</p>			

50.4.3.4 Uplink dynamic allocation one phase access

Step	Direction	Message	Comments
		{Uplink dynamic allocation one phase access}	Macro parameters: n : the number of RLC data block to be transferred, USF GRANULARITY : 1 or 4 blocks, RLC_DATA_BLOCKS_GRANTED : 9-261 (close-end), or absent (open-end) EGPRS Channel Coding Command : MCS-1, -2, -3, -4, -5, -6, -6, -7, -8, -9 or MCS-5-7, MCS-6-9 Resegment Bit: incremental redundancy on/off in uplink direction Window Size : according to number of allocated timeslots TLI_BLOCK_CHANNEL_CODING : MCS-1 or as data block REL_OR_ABS_FN : absolute or relative frame number encoding for starting time TBF_STARTING_TIME
0	MS		Trigger the MS initiating uplink transfer n octets data according to the test PDP context activated
1	MS -> SS	EGPRS PACKET CHANNEL REQUEST	Received on PRACH.
2	SS -> MS	PACKET UPLINK ASSIGNMENT	uplink dynamic allocation, Sent on PAGCH.
NOTE: After step 2, the MS is not yet in the packet transfer mode. The contention resolution must be completed.			

50.4.3.5 Uplink dynamic allocation one phase access with contention resolution

Step	Direction	Message	Comments
		{Uplink dynamic allocation one phase access with contention resolution}	Macro parameters: n : the number of RLC data block to be transferred, USF_GRANULARITY : 1 or 4 blocks, RLC_DATA_BLOCKS_GRANTED : 9-261 (close-end), or absent (open-end) EGPRS Channel Coding Command : MCS-1, -2, -3, -4, -5, -6, -6, -7, -8, -9 or MCS-5-7, MCS-6-9 Resegment Bit : incremental redundancy on/off in uplink direction Window Size : according to number of allocated timeslots TLLI_BLOCK_CHANNEL_CODING : MCS-1 or as data block REL_OR_ABS_FN : absolute or relative frame number encoding for starting time TBF_STARTING_TIME
0	MS		Trigger the MS initiating uplink transfer n octets data according to the test PDP context activated
1	MS -> SS	EGPRS PACKET CHANNEL REQUEST	Received on PRACH.
2	SS -> MS	PACKET UPLINK ASSIGNMENT	uplink dynamic allocation, Sent on PAGCH.
3	SS -> MS	PACKET DOWNLINK DUMMY CONTROL BLOCK	Sent on the PACCH of the PDCH, the USF assigned to the MS, on 3 blocks from the last radio block containing the uplink assignment.
4A	MS -> SS	UPLINK RLC DATA BLOCK	For USF_GRANULARITY = 1, containing TLLI in the RLC/MAC header.
4B1	MS -> SS	UPLINK RLC DATA BLOCK	For USF_GRANULARITY = 4, containing TLLI in the RLC/MAC header.
4B2	MS -> SS	UPLINK RLC DATA BLOCK	For USF_GRANULARITY = 4, containing TLLI in the RLC/MAC header.
4B3	MS -> SS	UPLINK RLC DATA BLOCK	For USF_GRANULARITY = 4, containing TLLI in the RLC/MAC header.
4B4	MS -> SS	UPLINK RLC DATA BLOCK	For USF_GRANULARITY = 4, containing TLLI in the RLC/MAC header.
5	SS -> MS	PACKET UPLINK ACK/NACK	Sent on the PACCH, containing TLLI received at step 4.

50.4.3.6 Uplink dynamic allocation two phase access

Step	Direction	Message	Comments
		{Uplink dynamic allocation two phase access}	Macro parameters: n : the number of RLC data block to be transferred, Multiblock Allocation Struct , USF_GRANULARITY : 1 or 4 blocks, RLC_DATA_BLOCKS_GRANTED : 9-261 (close-end), or absent (open-end) EGPRS Channel Coding Command : MCS-1, -2, -3, -4, -5, -6, -6, -7, -8, -9 or MCS-5-7, MCS-6-9 Resegment Bit : incremental redundancy on/off in uplink direction Window Size : according to number of allocated timeslots TLLI_BLOCK_CHANNEL_CODING : MCS-1 or as data block, TBF_STARTING_TIME
0	MS		Trigger the MS initiating uplink transfer n octets data according to the test PDP context activated
1	MS -> SS	EGPRS PACKET CHANNEL REQUEST Or CHANNEL REQUEST Or EGPRS PACKET CHANNEL REQUEST	Received on PRACH. (PBCCH present case) Received on RACH. (PBCCH not preset case)
2	SS -> MS	PACKET UPLINK ASSIGNMENT	Multi block assignment using Multiblock Allocation Struct, to order the MS to follow the two phase access procedure. Sent on PAGCH. (PBCCH present case)
3	MS -> SS	IMMEDIATE ASSIGNMENT PACKET RESOURCE REQUEST	Sent on AGCH (PBCCH not present case) Two phase access procedure. Received on the multi block assigned in step 2. EGPRS capability indicated in the MS Radio Access Capability IE. If the access type of the PACKET RESOURCE REQUEST specifies "Two Phase Access Req" check that the PEAK_THROUGHPUT, RADIO_PRIORITY and RLC_MODE are compliant with the PDP context used. In case of SMS over GPRS PEAK THROUGHPUT is not checked.
4	SS -> MS	PACKET UPLINK ASSIGNMENT	uplink dynamic allocation, no starting time (as default, otherwise use TBF_STARTING_TIME), Sent on PACCH of the same PDCH assigned in step 2.

50.4.3.7 Void

50.4.3.8 Void

50.4.3.9 Void

50.4.3.10 Downlink TBF establishment

Step	Direction	Message	Comments
		{Downlink TBF establishment}	Macro parameters: RLC mode TBF_STARTING_TIME Window Size: according to number of allocated timeslots
1	SS -> MS	PACKET PAGING REQUEST	1 st Repeated Page info contains P-TMSI of the MS. Sent on PPCH.
2	MS -> SS	PACKET CHANNEL REQUEST	ACCESS TYPE = " Page Response ". Received on PRACH.
3	SS -> MS	PACKET UPLINK ASSIGNMENT	Random Reference = pertaining to the message received in step 2. Dynamic allocation, Sent on PAGCH.
4	SS -> MS	PACKET DOWNLINK DUMMY CONTROL BLOCK	Sent on PACCH containing USF assigned to the MS.
5	MS -> SS	UPLINK RLC DATA BLOCK	LLC PDU implicitly indicating paging response, containing TLLI in the RLC/MAC header. Received on uplink PDTCH assigned in step 3.
6	SS -> MS	PACKET UPLINK ACK/NACK	Acknowledge the received RLC data block. Sent on uplink PACCH.
7	MS -> SS	PACKET CONTROL ACKNOWLEDGEMENT	Acknowledge the RLC control message. Received on uplink PACCH.
8	SS -> MS	PACKET DOWNLINK ASSIGNMENT	Downlink Assignment, TLLI value as received. Sent on PPCH. Three macro parameters as assigned in the test cases. EGPRS TBF mode indicated.

50.4.3.10A Uplink data

Step	Direction	Message	Comments
	MS ↔ SS	{ Uplink data }	Macro (arguments: see note 2)
1	MS → SS	RLC UPLINK DATA	SI bit set to '0'
2a	MS → SS	RLC UPLINK DATA	See notes 1
⋮	⋮	⋮	
2b	SS → MS	PACKET UPLINK ACK/NACK	
⋮	⋮	⋮	till the required amount of blocks are received
N	MS → SS	RLC UPLINK DATA	
N+1	SS → MS	PACKET UPLINK ACK/NACK	
NOTE 1: The SS sends a PACKET UPLINK ACK/NACK message at least every k-1 RLC UPLINK DATA messages, being k the window size with a value of 64 blocks.			
NOTE 2: In the case of Dynamic MAC mode, the macro reference in the corresponding test case may contain a certain frequency (in seconds ⁻¹ or frames ⁻¹) for the SS to indicate the USF allocated to the mobile so that the MS is allowed to transmit. Otherwise, mobile's USF is indicated in every available block.			

50.4.3.11 GPRS Attach using EGPRS messages on CCCH

The following table describes a signalling sequence performing the GPRS attach procedure. Note that there are different possible sequences implementing the GPRS attach procedure.

The macros {Completion of GPRS attach} in the test cases refer to the table below starting at the step required for the particular sequence.

NOTE: EGPRS PACKET CHANNEL REQUEST shall be used in the following cases

- If Release of EGPRS supported is Release 4 or above.
- If Support of EGPRS Packet Access enhancement is True for a R99 MS.

CHANNEL REQUEST shall be used if support of EGPRS Packet Access enhancement is False for a R99 MS.

{GPRS attach procedure}

Step	Direction	Message	Comments
0			MS is triggered to initiate the GPRS attach procedure.
1	MS -> SS	CHANNEL REQUEST Or EGPRS PACKET CHANNEL REQUEST	Establishment Cause is 'One Phase', if it is CHANNEL REQUEST; Establishment Cause is 'signalling'; if it is EGPRS PACKET CHANNEL REQUEST.
2	SS -> MS	IMMEDIATE ASSIGNMENT	For uplink TBF, one phase access, dynamic allocation. Assigns GPRS TBF if CHANNEL REQUEST is received in step 1. Assigns EGPRS TBF if EGPRS PACKET CHANNEL REQUEST is received in step 1.
3	MS -> SS	(EGPRS) RLC data blocks	Transporting: ATTACH REQUEST
4	SS -> MS	PACKET UPLINK ACK/NACK	Indicating correct reception of uplink blocks, including RRBP field set.
5	MS -> SS	PACKET CONTROL ACKNOWLEDGMENT	Sent on PACCH
6	SS -> MS	IMMEDIATE ASSIGNMENT	For downlink TBF in EGPRS TBF Mode, sent 1 s. after setp 5 on AGCH.
7	SS -> MS	EGPRS RLC data blocks	Transporting: ATTACH ACCEPT. Last block containing a valid RRBP field and FBI set.
8A	MS -> SS	EGPRS PACKET DOWNLINK ACK/NACK	Including Channel Request Description.
9A	SS -> MS	PACKET UPLINK ASSIGNMENT	Sent on PACCH.
10A	MS -> SS	EGPRS RLC data blocks	Transporting: ATTACH COMPLETE
11A	SS -> MS	PACKET UPLINK ACK/NACK	Including valid RRBP field
12A	MS -> SS	PACKET CONTROL ACKNOWLEDGMENT	
8B	MS -> SS	EGPRS PACKET DOWNLINK ACK/NACK	Not including Channel Request Description.
9B	MS->SS	CHANNEL REQUEST Or EGPRS PACKET CHANNEL REQUEST	Establishment Cause is 'One Phase', if it is CHANNEL REQUEST; Establishment Cause is 'signalling'; if it is EGPRS PACKET CHANNEL REQUEST.
10B	SS -> MS	IMMEDIATE ASSIGNMENT	For uplink TBF, one phase access, dynamic allocation. Assigns GPRS TBF if CHANNEL REQUEST is received in step 1. Assigns EGPRS TBF if EGPRS PACKET CHANNEL REQUEST is received in step 1.
11B	MS -> SS	(EGPRS) RLC data blocks	Transporting: ATTACH COMPLETE
12B	SS -> MS	PACKET UPLINK ACK/NACK	Indicating correct reception of uplink blocks, including RRBP field set.
13B	MS -> SS	PACKET CONTROL ACKNOWLEDGMENT	

50.4.3.12 GPRS Attach using EGPRS messages on PCCCH

The following table describes a signalling sequence performing the GPRS attach procedure when PCCCH is present. Note that there are different possible sequences implementing the GPRS attach procedure. In this case we use dynamic allocation and simultaneous uplink and downlink TBFs.

The macros {Completion of GPRS attach} in the test cases refer to the table below starting at the step required for the particular sequence.

NOTE: EGPRS PACKET CHANNEL REQUEST shall be used in the following cases

- a. If Release of EGPRS supported is Release 4 or above.
- b. If Support of EGPRS Packet Access enhancement is True for a R99 MS.

PACKET CHANNEL REQUEST shall be used if support of EGPRS Packet Access enhancement is False for a R99 MS.

{GPRS attach procedure}

Step	Direction	Message	Comments
1			MS is triggered to initiate the GPRS attach procedure.
2	MS -> SS	PACKET CHANNEL REQUEST Or EGPRS PACKET CHANNEL REQUEST	Establishment Cause is 'MM Procedure', if it is PACKET CHANNEL REQUEST; Establishment Cause is 'signalling'; if it is EGPRS PACKET CHANNEL REQUEST.
3	SS -> MS	PACKET UPLINK ASSIGNMENT	Indicate dynamic allocation struct. Assigns GPRS TBF if PACKET CHANNEL REQUEST is received in step 1. Assigns EGPRS TBF if EGPRS PACKET CHANNEL REQUEST is received in step 1.
4	SS -> MS	PACKET DOWNLINK DUMMY CONTROL BLOCK	Containing USF assigned to the MS.
5	MS -> SS	(EGPRS) UPLINK RLC DATA BLOCK (GMM ATTACH REQUEST)	Steps 4 & 5 are repeated until the MS has sent the complete GMM ATTACH REQUEST message.
6	SS -> MS	PACKET UPLINK ACK/NACK	Containing Final Ack Indicator bit = 1, and valid RRBp field.
7	MS -> SS	PACKET CONTROL ACKNOWLEDGEMENT	Sent in the block assigned by the RRBp field in step 6.
8	SS -> MS	PACKET DOWNLINK ASSIGNMENT	Assign a downlink TBF in EGPRS TBF Mode, "MAC mode" = dynamic allocation.
9	SS -> MS	EGPRS DOWNLINK RLC DATA BLOCKS	Containing USF assigned to the MS. Last block shall contain Final Block Indicator bit = 1, and valid RRBp field.
10A	MS -> SS	EGPRS PACKET DOWNLINK ACK/NACK	Sent in the block assigned by the RRBp field in step 9 Including Channel Request Description.
11A	SS -> MS	PACKET UPLINK ASSIGNMENT	Assigning EGPRS TBF, Sent on PACCH.
12A	SS -> MS	PACKET DOWNLINK DUMMY CONTROL BLOCK	Containing USF assigned to the MS.
13A	MS -> SS	EGPRS RLC data blocks	Transporting: ATTACH COMPLETE
14A	SS -> MS	PACKET UPLINK ACK/NACK	Including valid RRBp field
15A	MS -> SS	PACKET CONTROL ACKNOWLEDGMENT	
10B	MS -> SS	EGPRS PACKET DOWNLINK ACK/NACK	Not including Channel Request Description.
11B	MS -> SS	PACKET CHANNEL REQUEST Or EGPRS PACKET CHANNEL REQUEST	Establishment Cause is 'MM Procedure', if it is PACKET CHANNEL REQUEST; Establishment Cause is 'signalling'; if it is EGPRS PACKET CHANNEL REQUEST.
12B	SS -> MS	PACKET UPLINK ASSIGNMENT	Indicate dynamic allocation struct. Assigns GPRS TBF if PACKET CHANNEL REQUEST is received in step 1. Assigns EGPRS TBF if EGPRS PACKET CHANNEL REQUEST is received in step 1.
13B	SS -> MS	PACKET DOWNLINK DUMMY CONTROL BLOCK	Containing USF assigned to the MS.
14B	MS -> SS	(EGPRS) UPLINK RLC DATA BLOCK (GMM ATTACH COMPLETE)	
15B	SS -> MS	PACKET UPLINK ACK/NACK	Containing Final Ack Indicator bit = 1, and valid RRBp field.
16B	MS -> SS	PACKET CONTROL ACKNOWLEDGEMENT	Sent in the block assigned by the RRBp field in step 15.

50.4.3.13 PDP Context Activation On CCCH

The following table describes a signalling sequence performing the PDP Context Activation.

The macros {Completion of PDP Context Activation} in the test cases refer to the table below starting at the step required for the particular sequence.

NOTE: EGPRS PACKET CHANNEL REQUEST shall be used in the following cases

- a. If Release of EGPRS supported is Release 4 or above.
- b. If Support of EGPRS Packet Access enhancement is True for a R99 MS.

CHANNEL REQUEST shall be used if support of EGPRS Packet Access enhancement is False for a R99 MS.

{PDP Context Activation procedure}

Step	Direction	Message	Comments
0			MS is triggered to initiate the PDP Context Activation procedure with specific Test PDP Context Number specified in testcase.
1	MS -> SS	CHANNEL REQUEST Or EGPRS PACKET CHANNEL REQUEST	Establishment Cause is 'One Phase', if it is CHANNEL REQUEST; Establishment Cause is 'signalling', if it is EGPRS PACKET CHANNEL REQUEST.
2	SS -> MS	IMMEDIATE ASSIGNMENT	For uplink TBF, one phase access, dynamic allocation; Assigns GPRS TBF if CHANNEL REQUEST is received in step 1. Assigns EGPRS TBF if EGPRS PACKET CHANNEL REQUEST is received in step 1.
3	MS -> SS	RLC data blocks	Transporting: ACTIVATE PDP CONTEXT REQUEST
4	SS -> MS	PACKET UPLINK ACK/NACK	Indicating correct reception of uplink blocks, including RRBp field set.
5	MS -> SS	PACKET CONTROL ACKNOWLEDGMENT	Sent on PACCH
6	SS -> MS	IMMEDIATE ASSIGNMENT	For downlink TBF in EGPRS Mode, sent 1 s. After step 5 on AGCH.
7	SS -> MS	EGPRS RLC data blocks	Transporting: ACTIVATE PDP CONTEXT ACCEPT. Last block containing a valid RRBp field and FBI set.
8A	MS -> SS	EGPRS PACKET DOWNLINK ACK/NACK	Not including Channel Request Description.
9A	MS->SS	EGPRS PACKET CHANNEL REQUEST	Following step are required only if the Test PDP context is for LLC Acknowledge mode.
10A	SS -> MS	IMMEDIATE ASSIGNMENT	For uplink TBF in EGPRS TBF Mode, one phase access, dynamic allocation.
11A	MS -> SS	RLC data blocks	Transporting: SABM
12A	SS -> MS	PACKET UPLINK ACK/NACK	Indicating correct reception of uplink blocks, including RRBp field set.
13A	MS -> SS	PACKET CONTROL ACKNOWLEDGMENT	
			Following Path will be taken only if the Test PDP Context is for LLC Acknowledge mode.
8B	MS -> SS	EGPRS PACKET DOWNLINK ACK/NACK	Including Channel Request Description.
9B	SS -> MS	PACKET UPLINK ASSIGNMENT	Sent on PACCH.
10B	MS -> SS	RLC data blocks	Transporting: SABM
11B	SS -> MS	PACKET UPLINK ACK/NACK	Including valid RRBp field
12B	MS -> SS	PACKET CONTROL ACKNOWLEDGMENT	
13B			
14	SS -> MS	IMMEDIATE ASSIGNMENT	For downlink TBF in EGPRS Mode, sent 1 s. After step 13 on AGCH.
15	SS -> MS	EGPRS RLC data blocks	Transporting: UA. Last block containing a valid RRBp field and FBI set.
16	MS -> SS	EGPRS PACKET DOWNLINK ACK/NACK	

50.4.3.14 PDP Context Activation On PCCCH

The following table describes a signalling sequence performing the PDP Context Activation.

The macro {Completion of PDP Context Activation} in the test cases refer to the table below starting at the step required for the particular sequence.

NOTE: EGPRS PACKET CHANNEL REQUEST shall be used in the following cases

- a. If Release of EGPRS supported is Release 4 or above.
- b. If Support of EGPRS Packet Access enhancement is True for a R99 MS.

PACKET CHANNEL REQUEST shall be used if support of EGPRS Packet Access enhancement is False for a R99 MS.

{PDP Context Activation procedure}

Step	Direction	Message	Comments
0			MS is triggered to initiate the PDP Context Activation procedure with specific Test PDP Context Number specified in testcase.
1	MS -> SS	PACKET CHANNEL REQUEST Or EGPRS PACKET CHANNEL REQUEST	Establishment Cause is 'MM Procedure', if it is PACKET CHANNEL REQUEST; Establishment Cause is 'signalling'; if it is EGPRS PACKET CHANNEL REQUEST.
3	SS -> MS	PACKET UPLINK ASSIGNMENT	For uplink TBF, one phase access, dynamic allocation; Assigns GPRS TBF if PACKET CHANNEL REQUEST is received in step 1. Assigns EGPRS TBF if EGPRS PACKET CHANNEL REQUEST is received in step 1.
4	SS -> MS	PACKET DOWNLINK DUMMY CONTROL BLOCK	Containing USF assigned to the MS.
5	MS -> SS	UPLINK RLC DATA BLOCK	Steps 4 & 5 are repeated until the MS has sent the complete ACTIVATE PDP CONTEXT REQUEST message.
6	SS -> MS	PACKET UPLINK ACK/NACK	Containing Final Ack Indicator bit = 1, and valid RRBp field.
7	MS -> SS	PACKET CONTROL ACKNOWLEDGEMENT	Sent in the block assigned by the RRBp field in step 6.
8	SS -> MS	PACKET DOWNLINK ASSIGNMENT	Assigning downlink TBF in EGPRS Mode, "MAC mode" = dynamic allocation.
9	SS -> MS	EGPRS DOWNLINK RLC DATA BLOCKs	Transporting ACTIVATE PDP CONTEXT ACCEPT.
10A	MS -> SS	EGPRS PACKET DOWNLINK ACK/NACK	Last block shall contain Final Block Indicator bit = 1, and valid RRBp field. Sent in the block assigned by the RRBp field in step 9. Not Including Channel request Description. Following step are required only if the Test PDP context is for LLC Acknowledge mode.
11A	MS -> SS	EGPRS PACKET CHANNEL REQUEST	
12A	SS -> MS	PACKET UPLINK ASSIGNMENT	Indicate dynamic allocation struct.
13A	SS -> MS	PACKET DOWNLINK DUMMY CONTROL BLOCK	Containing USF assigned to the MS.
14A	MS -> SS	EGPRS UPLINK RLC DATA BLOCK	Steps 12A & 13A are repeated until the MS has sent the complete SABM message.
15A	SS -> MS	PACKET UPLINK ACK/NACK	Containing Final Ack Indicator bit = 1, and valid RRBp field.
16A	MS -> SS	PACKET CONTROL ACKNOWLEDGEMENT	Sent in the block assigned by the RRBp field in step 15.
			Following Path will be taken only if the Test PDP Context is for LLC Acknowledge mode.
10B	MS -> SS	EGPRS PACKET DOWNLINK ACK/NACK	Including Channel Request Description.
11B	SS -> MS	PACKET UPLINK ASSIGNMENT	Sent on PACCH.
12B	SS -> MS	PACKET DOWNLINK DUMMY CONTROL BLOCK	Containing USF assigned to the MS.
13B	MS -> SS	RLC data blocks	Steps 4 & 5 are repeated until the MS has sent the complete SABM message.
14B	SS -> MS	PACKET UPLINK ACK/NACK	Including valid RRBp field
15B	MS -> SS	PACKET CONTROL ACKNOWLEDGMENT	
16B			
17	SS -> MS	PACKET DOWNLINK ASSIGNMENT	Assigning downlink TBF in EGPRS Mode, "MAC mode" = dynamic allocation.

18	SS -> MS	EGPRS DOWNLINK RLC DATA BLOCKs	Transporting UA Last block shall contain Final Block Indicator bit = 1, and valid RRBP field.
19	MS -> SS	EGPRS PACKET DOWNLINK ACK/NACK	Sent in the block assigned by the RRBP field in step 9. Not Including Channel request Description.

50.5 Test PDP contexts

The PDP contexts used in the EGPRS dynamic allocation and EGPRS RLC testcases are identical to the PDP contexts used in the GPRS dynamic allocation and RLC testcases (see 40.5) with the following exception in the table given below.

Test PDP context30 is the default Test PDP context which is used in the test cases where no particular Test PDP contexts are specified. Compression is always turned off if nothing else is stated explicitly in the test case.

NOTE: In this subclause all information element values are in decimal.

Table 50.5: Test PDP contexts

	PDP Context30	PDP Context31
LLC SAPI	SAPI = 3	SAPI =9
Reliability Class	5 (RLC unacknowledged) (LLC unacknowledged)	3 (RLC acknowledged) (LLC unacknowledged)
Delay Class	4 (best effort)	4 (best effort)
Precedence Class	2 (normal)	2 (normal)
Peak Throughput Class	6 (32 000 octet/s)	7 (64 000 octet/s)
Mean Throughput Class	17 (20 000 000 octet/h)	17 (20 000 000 octet/h)
PDP Type	IP type	IP type
PDP Address	Static	Static
APN	Arbitrarily chosen	Arbitrarily chosen
Protocol Configuration Options	PPP options	PPP options
Radio Priority	1	1
Traffic Class	Background	Background
Delivery Order	'yes'	'yes'
Delivery of erroneous SDU	'yes'	'no'
Maximum SDU size	150	150
Maximum bit rate for uplink	256 kbps	512 kbps
Maximum bit rate for downlink	256 kbps	512 kbps
Residual BER	$4 \cdot 10^{-3}$	10^{-5}
SDU error ratio	10^{-3}	10^{-4}
Transfer delay	0 (not relevant for background class)	0
Traffic Handling priority	0 (not relevant for background class)	0
Guaranteed bit rate for uplink	0 (not relevant for background class)	0
Guaranteed bit rate for downlink	0 (not relevant for background class)	0
Quality of service settings to be used when testing R5 or later MS		
Signalling Indication	0	0
Source Statistics Descriptor	0	0
Maximum bit rate for downlink (extended)	0	0
Guaranteed bit rate for downlink (extended)	0	0

51 EGPRS Paging, TBF establishment/release and DCCH related procedures

51.1 RR / Paging

The paging procedure is used by the network to cause the MS to establish either an RR connection for circuit switched services or a downlink TBF for EGPRS packet transfer. Normally the MS listens to its paging sub-channel when DRX is used, but this can be modified by the use of different page mode. The correct monitoring of its paging sub-channel on PCCCH or CCCH in different control channel configurations and correct implementation of the paging procedure in the MS are essential. They are the test objectives of this clause.

NOTE 1:

A R99 MS may optionally use either a Channel Request message or an EGPRS Packet Channel Request to answer to Packet Paging by the SS on CCCH.

In case the MS uses a Channel Request to respond to a Paging Request message on CCCH, the SS shall include GPRS specific message contents in the corresponding Immediate Assignment / Immediate Assignment Reject message.

In case the MS uses EGPRS Channel Request to respond to a Paging Request message on CCCH, the SS shall include EGPRS specific message contents in the corresponding Immediate Assignment / Immediate Assignment Reject message.

NOTE 2:

A R99 MS may optionally use either a Packet Channel Request message or an EGPRS Packet Channel Request to answer to Packet Paging by the SS on PCCCH.

In case the MS uses Packet Channel Request to respond to a Packet Paging Request message on PCCCH, the SS shall include GPRS specific message contents in the corresponding Packet Uplink Assignment / Packet Access Reject message

In case the MS uses EGPRS Packet Channel Request to respond to a Packet Paging Request message on PCCCH, the SS shall include EGPRS specific message contents in the corresponding Packet Uplink Assignment / Packet Access Reject message

51.1.1 RR / Paging / on PCCCH for EGPRS service successful

All test cases in this subclause test the MS paging behaviours in a network operating in Mode I.

51.1.1.1 RR / Paging / on PCCCH for EGPRS service / normal paging with P-TMSI successful

51.1.1.1.1 Conformance requirements

1. In packet idle mode, the mobile station monitors the relevant paging sub-channels on PCCCH, if such is present in the cell. The determination of the paging group for the mobile station is defined in 3GPP 05.02.
2. MS in a specific PCCCH GROUP shall monitor the radio blocks on PCCCH corresponding to the PCCCH GROUP the mobile station belongs to and where paging may appear.
3. A PACKET PAGING REQUEST message on PCCCH may include more than one mobile station identification.
4. In response to a PACKET PAGING REQUEST, the mobile station shall initiate the uplink TBF using a PACKET CHANNEL REQUEST with cause value of 'Page Response'.

References

3GPP TS 04.60/44.060, subclauses 5.5.1, 5.5.1.5, 6.1.2, 6.2, 6.2.2 and 6.2.3, 7.1.2.1.

3GPP TS 05.02, subclauses 6.5.1 and 6.5.6.

51.1.1.1.2 Test purpose

To verify that upon receipt of a PACKET PAGING REQUEST message with paging mode set to normal, the MS in packet idle mode, GPRS attached state, is able to determine its PCCCH group and PAGING group and that the MS responds correctly with PACKET CHANNEL REQUEST with cause value of 'Page Response' or EGPRS PACKET CHANNEL REQUEST with cause value of 'Signalling'. (see NOTE)

51.1.1.1.3 Method of test

Initial Conditions

System Simulator:

1 cell, CCCH combined with SDCCH, EGPRS supported, PCCCH present, Max-Retrans = 2, access burst type = 11 bits, BS_PAG_BLK_RES = 2, BS_PBCCH_BLK = 3, BS_PCC_CHANS = 1, BS_PRACH_BLK = 1 in PSII.

Mobile Station:

The MS is GPRS attached with a P-TMSI allocated, SPLIT PG CYCLE negotiated. The mobile station is in packet idle mode and has left the Transfer non-DRX mode period, i.e. the system simulator shall wait for a period equivalent to the value of the NON_DRX_TIMER parameter before sending the first paging message to the MS.

Specific PICS Statements

- Release of EGPRS Supported (TSPC_MS_EGPRS_RELEASE)
- Support of EGPRS Packet Access Enhancement (TSPC_EGPRS_ENHANC)

PIXIT Statements

-

Test Procedure

The SS sends a PACKET PAGING REQUEST message to the MS. The paging message contains a P-TMSI addressing the MS for TBF establishment. The MS attempts two random accesses for PACKET CHANNEL REQUEST/EGPRS PACKET CHANNEL REQUEST. The SS responds to the 2nd one by assigning an uplink channel. The MS sends a correct LLC PDU containing TLLI in the RLC/MAC header implicitly indicating a paging response.

Maximum Duration of Test

5 minutes.

NOTE:

EGPRS PACKET CHANNEL REQUEST shall be used to respond to Packet Paging Request in the following cases

- a. If Release of EGPRS supported is Release 4 or above.
- b. If Support of EGPRS Packet Access enhancement is True for a R99 MS.

PACKET CHANNEL REQUEST shall be used to respond to Packet Paging Request if Support of EGPRS Packet Access enhancement is False for a R99 MS.

Expected Sequence

Step	Direction	Message	Comments
1	SS -> MS	PACKET PAGING REQUEST	1 st Repeated Page info for RR connection, 2 nd Repeated Page info contains P-TMSI of the MS for TBF establishment. Sent on PPCH.
2	MS -> SS	PACKET CHANNEL REQUEST/ EGPRS PACKET CHANNEL REQUEST (see NOTE)	In case PACKET CHANNEL REQUEST is received ACCESS TYPE = " Page Response ". Received on PRACH. In case EGPRS PACKET CHANNEL REQUEST is received ACCESS TYPE = " Signalling ". Received on PRACH.
3	MS -> SS	PACKET CHANNEL REQUEST/ EGPRS PACKET CHANNEL REQUEST (see NOTE)	In case PACKET CHANNEL REQUEST is received ACCESS TYPE = " Page Response ". Received on PRACH. In case EGPRS PACKET CHANNEL REQUEST is received ACCESS TYPE = " Signalling ". Received on PRACH.
4	SS -> MS	PACKET UPLINK ASSIGNMENT	Random Reference = pertaining to the message received in step 3. Sent on PAGCH.
5	SS -> MS	PACKET DOWNLINK DUMMY CONTROL BLOCK	Sent on PACCH containing USF assigned to the MS.
6	MS -> SS	(EGPRS) UPLINK RLC DATA BLOCK (without L3 Message)	LLC PDU implicitly indicating paging response, containing TLLI in the RLC/MAC header. Received on uplink PDTCH assigned in step 4.
7	SS -> MS	PACKET UPLINK ACK/NACK	acknowledge the received RLC data block, Final Ack Indicator = '1' , a valid RRBP. Sent on PACCH.
8	MS -> SS	PACKET CONTROL ACKNOWLEDGEMENT	acknowledge the RLC control message. Received on PACCH.

Specific Message Contents

Contents for SYSTEM INFORMATION and PACKET SYSTEM INFORMATION Messages:

Information Element	value/ remark
RACH Control Parameters - Max Retrans	Max 2 retrans.

PACKET PAGING REQUEST message:

Information Element	value/ remark
MESSAGE_TYPE	100010
PAGE_MODE	Normal Paging
{L H<PERSISTENCE_LEVEL>}	L (not present)
{L H<NLN>}	L (not present)
{H <Repeated Page info>}	H
-	H (Page request for RR connection establishment)
- CHANNEL_NEEDED	SDDCH
- {L H < eMLPP_PRIORITY}	L (eMLPP_PRIORITY absent)
- { L < TMSI > H < Mobile_identity > }	L (TMSI present)
- TMSI	TMSI not addressing the MS under test
-	L (Page request for TBF establishment)
- { L < PTMSI > H < Mobile_identity > }	L (PTMSI present)
- PTMSI	P-TMSI allocated during GPRS attach procedure
-	L (end of repeated page info)
spare padding	Spare Padding

51.1.1.2 RR / Paging / on PCCCH for EGPRS service / normal paging with IMSI successful

51.1.1.2.1 Conformance requirements

Paging for GPRS services using IMSI is an abnormal procedure used for error recovery in the network.

The network may initiate paging using IMSI if the P-TMSI is not available due to a network failure.

In GSM, to initiate the procedure the GMM entity in the network requests the RR sublayer to start paging (see 3GPP TS 04.18 and 3GPP TS 04.60).

Upon reception of a paging indication for GPRS services using IMSI, the MS shall locally deactivate any active PDP contexts and locally detach from GPRS. The local detach includes deleting any RAI, P-TMSI, P-TMSI signature and GPRS ciphering key sequence number stored, setting the GPRS update status to GU2 NOT UPDATED and changing state to GMM-DEREGISTERED.

After performing the local detach, the MS shall then perform a GPRS attach or combined GPRS attach procedure.

After performing the attach, a MS should activate PDP context(s) to replace any previously active PDP context(s).

References

3GPP TS 24.008, subclause 4.7.9.1.2.

3GPP TS 04.60/44.060, subclause 7.1.2.1

51.1.1.2.2 Test purpose

To verify that the MS is able to respond to PACKET PAGING REQUEST for EGPRS service when the MS is addressed with its IMSI and that the MS then performs a GPRS attach or combined GPRS attach procedure.

51.1.1.2.3 Method of test

Initial Conditions

System Simulator:

1 cell, CCCH combined with SDCCH, EGPRS supported, PCCCH present, Max-Retrans = 2, access burst type = 11 bits, BS_PAG_BLKES_RES = 3, BS_PBCCH_BLKES = 3, BS_PCC_CHANS = 1, BS_PRACH_BLKES = 1 in PSI1.

Mobile Station:

The MS is GPRS attached with a P-TMSI allocated, SPLIT PG CYCLE negotiated. The mobile station is in packet idle mode and has left the Transfer non-DRX mode period, i.e. the system simulator shall wait for a period equivalent to the value of the NON_DRX_TIMER parameter before sending the first paging message to the MS.

Specific PICS Statements

- Release of EGPRS Supported (TSPC_MS_EGPRS_RELEASE)
- Support of EGPRS Packet Access Enhancement (TSPC_EGPRS_ENHANC)

PIXIT Statements

-

Test Procedure

The SS sends a PACKET PAGING REQUEST message containing the IMSI of the MS for TBF establishment. The MS attempts two random accesses for PACKET CHANNEL REQUEST/EGPRS PACKET CHANNEL REQUEST. The SS responds to the 2nd one by assigning an uplink channel for an open-end TBF. The MS sends an LLC PDU containing TLLI in the RLC/MAC header and ATTACH REQUEST, implicitly indicating a paging response. The SS allows the completion of the attach procedure to make sure that MS sends a complete ATTACH REQUEST in answer to paging.

Maximum Duration of Test

5 minutes.

NOTE:

EGPRS PACKET CHANNEL REQUEST shall be used to respond to Packet Paging Request in the following cases

- a. If Release of EGPRS supported is Release 4 or above.
- b. If Support of EGPRS Packet Access enhancement is True for a R99 MS.

PACKET CHANNEL REQUEST shall be used to respond to Packet Paging Request if Support of EGPRS Packet Access enhancement is False for a R99 MS.

Expected Sequence

Step	Direction	Message	Comments
1	SS -> MS	PACKET PAGING REQUEST	1 st Repeated Page Info for RR connection, 2 nd Repeated Page info contains IMSI of the MS for TBF establishment. Sent on PPCH.
2	MS -> SS	PACKET CHANNEL REQUEST/ EGPRS PACKET CHANNEL REQUEST (see NOTE)	In case PACKET CHANNEL REQUEST is received ACCESS TYPE = " MM Procedure ". Received on PRACH. In case EGPRS PACKET CHANNEL REQUEST is received
3	MS -> SS	PACKET CHANNEL REQUEST/ EGPRS PACKET CHANNEL REQUEST (see NOTE)	ACCESS TYPE = " Signalling ". Received on PRACH. In case PACKET CHANNEL REQUEST is received ACCESS TYPE = " MM Procedure ". Received on PRACH. In case EGPRS PACKET CHANNEL REQUEST is received
4	SS -> MS	PACKET UPLINK ASSIGNMENT	ACCESS TYPE = " Signalling ". Received on PRACH. Random Reference = pertaining to the message received in step 3. Sent on PAGCH. In case EGPRS PACKET CHANNEL REQUEST is received
5	SS -> MS	PACKET DOWNLINK DUMMY CONTROL BLOCK	Message escape: 1 (define EGPRS message contents); EGPRS Channel Coding Command: MCS1;
6	MS -> SS	(EGPRS) UPLINK RLC DATA BLOCK (including ATTACH REQUEST)	In case PACKET CHANNEL REQUEST is received Message escape: 0 (define GPRS message contents); Sent on PACCH containing USF assigned to the MS.
7	MS <-> SS	{Completion of the attach procedure}	LLC PDU containing a TLLI and the first part of ATTACH REQUEST, the implicit paging response to step 1. Received on the uplink PDTCH assigned in step 4. SS allow the completion of the attach procedure

Specific Message Contents

Contents for SYSTEM INFORMATION and PACKET SYSTEM INFORMATION Messages:

Information Element	value/ remark
PRACH Control Parameters - MAX_RETRANS	Max 2 retransmission

PACKET PAGING REQUEST message:

Information Element	value/ remark
MESSAGE_TYPE	100010
PAGE_MODE	Normal Paging
{0 1<PERSISTENCE_LEVEL>}	0 (not present)
{0 1<NLN>}	0 (not present)
{1 <Repeated Page info>}	1
-	1 (Page request for RR connection establishment)
- 0 < TMSI >	TMSI not addressing the MS under test
- CHANNEL_NEEDED	SDCCH
- {0 1 < eMLPP_PRIORITY}	0 (eMLPP_PRIORITY absent)
-	0 (Page request for TBF establishment)
- { 0 < PTMSI > 1 1 < Length of Mobile Identity contents > < Mobile Identity>}	1 (IMSI present)
-	Length, type, and IMSI value stored on the SIM of the MS (3GPP 24.008, 10.5.5.13 without IEI)
-	0 (end of repeated page info)
spare padding	Spare Padding

PACKET CHANNEL REQUEST message in test step 2 and 3:

Information Element	value/ remark
Access Type	Mobility Management procedure
Random Reference	Not checked.

51.1.1.3 RR / Paging / on PCCCH for EGPRS service / extended paging with P-TMSI successful

51.1.1.3.1 Conformance requirements

1. The network may send page mode information in any downlink message on PCCCH. The page mode information controls possible additional requirements on a mobile station receiving the message.
2. In packet idle mode, the paging sub-channels on PCCCH shall be monitored (by the mobile station) according to the current DRX mode and the values of the PAGING_GROUP parameter defined for the mobile station, and possible page mode information received on PCCCH.
3. The mobile station shall take into account the page mode information received in any message received in a radio block on PCCCH corresponding to one of the paging groups defined by the different PAGING_GROUP values for the mobile station.
4. In the extended paging mode, the mobile station is required in addition (to normal paging) to receive and analyse the possible message in the third block period on PCCCH where paging may occur (PPCH), following the block corresponding to MS's paging group.

References

3GPP TS 04.60/44.060, subclauses 5.5.1, 5.5.1.5 and 5.5.1.6, 7.1.2.1.

51.1.1.3.2 Test purpose

1. To verify that the MS operates in the extended page mode when it is ordered by the SS in PACKET PAGING REQUEST which does not address the MS, but on the paging sub-channel corresponding to the MS identity.
2. To verify that the MS operates in the extended page mode when it is ordered by the SS in PACKET UPLINK ASSIGNMENT on the paging sub-channel corresponding to the MS identity.
3. To verify that the MS operates in the extended page mode when it is ordered by the SS in PACKET ACCESS REJECT on the paging sub-channel corresponding to the MS identity.
4. To verify that the MS operates in the extended page mode when it is ordered by the SS in PACKET DOWNLINK ASSIGNMENT on the paging sub-channel corresponding to the MS identity.

5. To verify that the MS operates in the extended page mode when it is ordered by the SS in PACKET QUEUEING NOTIFICATION on the paging sub-channel corresponding to the MS identity.
6. To verify that the MS operates in the extended page mode when it is ordered by the SS in PACKET CELL CHANGE ORDER on the paging sub-channel corresponding to the MS identity.
7. To verify that the MS operates in the extended page mode when it is ordered by the SS in PACKET DOWNLINK DUMMY CONTROL BLOCK on the paging sub-channel corresponding to the MS identity.
8. To verify that the MS operates in the extended page mode when it is ordered by the SS in PACKET PRACH PARAMETERS on the paging sub-channel corresponding to the MS identity.
9. To verify that the MS operates in the extended page mode when it is ordered by the SS in PACKET POLLING REQUEST on the paging sub-channel corresponding to the MS identity.

51.1.1.3.3 Method of test

Initial Conditions

System Simulator:

1 cell, CCCH combined with SDCCH, EGPRS supported, PCCCH present, Max-Retrans = 2
BS_PAG_BLK_RES = 2, BS_PBCCH_BLKS = 4 and BS_PRACH_BLKS = 1 in PSI1.

Mobile Station:

The MS is GPRS attached with a P-TMSI allocated, SPLIT PG CYCLE negotiated. The mobile station is in packet idle mode and has left the Transfer non-DRX mode period, i.e. the system simulator shall wait for a period equivalent to the value of the NON_DRX_TIMER parameter before sending the first paging message to the MS.

Specific PICS Statements

- Release of EGPRS Supported (TSPC_MS_EGPRS_RELEASE)
- Support of EGPRS Packet Access Enhancement (TSPC_EGPRS_ENHANC)

PIXIT Statements

-

Test Procedure

The test is repeated 9 times. Each time at the start, the SS sends one of the relevant messages listed in the corresponding test purpose to carry the Extended Paging mode. The MS is paged for TBF establishment and the paging mode is reset to Normal. After two attempts of the random access from the MS, the SS rejects the access.

Maximum Duration of Test

5 minutes.

NOTE:

EGPRS PACKET CHANNEL REQUEST shall be used to respond to Packet Paging Request in the following cases

- a. If Release of EGPRS supported is Release 4 or above.
- b. If Support of EGPRS Packet Access enhancement is True for a R99 MS.

PACKET CHANNEL REQUEST shall be used to respond to Packet Paging Request if Support of EGPRS Packet Access enhancement is False for a R99 MS.

Expected Sequence

The test sequence is repeated for $k = 1 \dots 9$.

Step	Direction	Message	Comments
1A	SS -> MS	PACKET PAGING REQUEST	k=1 1 st Repeated Page info contains P-TMSI of another MS, no other Repeated Page info, Page_Mode = " Extended Paging ". Sent on PPCH belonging to the MS.
1B	SS -> MS	PACKET UPLINK ASSIGNMENT	k=2 Random Reference = any random value not used in previous test steps of this test case. Page_Mode = " Extended Paging ". Sent on the paging sub-channel corresponding to the MS identity (PPCH).
1C	SS -> MS	PACKET ACCESS REJECT	k=3 Random Reference = any random value not used in previous test steps of this test case. Page_Mode = " Extended Paging ". Sent on the paging sub-channel corresponding to the MS identity (PPCH).
1D	SS -> MS	PACKET DOWNLINK ASSIGNMENT	k=4 TLLI = any value other than the values used in previous test steps. Page_Mode = " Extended Paging ". Sent on the paging sub-channel corresponding to the MS identity (PPCH).
1E	SS -> MS	PACKET QUEUEING NOTIFICATION	k=5 Random Reference = any random value not used in previous test steps of this test case. Page_Mode = " Extended Paging ". Sent on the paging sub-channel corresponding to the MS identity (PPCH).
1F	SS -> MS	PACKET CELL CHANGE ORDER	k=6 TLLI = any value other than the values used in previous test steps of this test case. Page_Mode = " Extended Paging ". Sent on the paging sub-channel corresponding to the MS identity (PPCH).
1G	SS -> MS	PACKET DOWNLINK DUMMY CONTROL BLOCK	k=7 Page_Mode = " Extended Paging ". Sent on the paging sub-channel corresponding to the MS identity (PPCH).
1H	SS -> MS	PACKET PRACH PARAMETERS	k=8 Page_Mode = " Extended Paging ". Sent on the paging sub-channel corresponding to the MS identity (PPCH).
1I	SS -> MS	PACKET POLLING REQUEST	k=9 TLLI = any value other than the values used in previous test steps of this test case. Page_Mode = " Extended Paging ". Sent on the paging sub-channel corresponding to the MS identity (PPCH).
2	SS -> MS	PACKET PAGING REQUEST	1 st Repeated Page info contains P-TMSI of the MS, no other Repeated Page info, Page_Mode = "Normal Paging". Sent on the third block period on PCCCH where paging may occur (PPCH), following the block corresponding to MS's paging group.
3	MS-> SS	PACKET CHANNEL REQUEST/ EGPRS PACKET CHANNEL REQUEST (see NOTE)	In case PACKET CHANNEL REQUEST is received ACCESS TYPE = " Page Response ". Received on PRACH. In case EGPRS PACKET CHANNEL REQUEST is received
4	MS-> SS	PACKET CHANNEL REQUEST/ EGPRS PACKET CHANNEL REQUEST (see NOTE)	ACCESS TYPE = " Signalling ". Received on PRACH. In case PACKET CHANNEL REQUEST is received ACCESS TYPE = " Page Response ". Received on PRACH. In case EGPRS PACKET CHANNEL REQUEST is received
5	SS -> MS	PACKET ACCESS REJECT	ACCESS TYPE = " Signalling ". Received on PRACH. Random Reference = pertaining to the message received in step 3. Sent on PAGCH.

Specific Message Contents

None.

51.1.1.4 RR / Paging / on PCCCH for EGPRS service / paging reorganisation successful

51.1.1.4.1 Conformance requirements

1. In the paging reorganisation mode the mobile station shall receive all messages on the PCCCH regardless of the BS_PAG_BLKs_RES setting. It is required to receive all PBCCH messages.
2. When the mobile station receives the next message to a (possibly new) PAGING_GROUP defined for the mobile station, subsequent action is defined by the possible page mode information received in that message.
3. When the mobile station selects a new set of PAGING_GROUP values, the initial page mode in the mobile station shall be set to paging reorganisation.
4. The BS_PCC_REL field in PSI1 control channel description indicates, if set = 1, that the last PDCH carrying PCCCH and PBCCH will be released shortly. All mobile stations on PCCCH shall then as soon as this information has been received return to CCCH and there obey the information sent on BCCH as specified in 3GPP TS 24.008. If the field is set = 0, no channel release is pending.

References

3GPP TS 04.60/44.060, subclauses 5.5.1.5, 7.1.2.1 and 11.2.18.

51.1.1.4.2 Test purpose

1. To verify that the MS, after reception of a message with page mode set to "paging reorganisation", answers to paging messages (with page mode set to "normal paging") sent on its old PCCCH in paging blocks which do not belong to the MS's paging sub-channel.
2. To test that the MS correctly determines its new paging sub-channel when the number of allocated PBCCH blocks BS_PBCCH_BLKs and the number of reserved blocks BS_PAG_BLKs_RES are changed.
3. To test that the MS correctly determines its new paging sub-channel when the number of PCCCH channels is changed.
4. To test that the MS understands the control channel release bit in control channel description.

51.1.1.4.3 Method of test

Initial Conditions

System Simulator:

1 cell, CCCH combined with SDCCH, EGPRS supported, PCCCH present, Max-Retrans = 2, access burst type = 8 bits, BS_PAG_BLKs_RES = 2, BS_PBCCH_BLKs = 3, BS_PRACH_BLKs = 1 and BS_PCC_CHANS = 1. SPGC_CCCH_SUP = 0 (SPLIT_PG_CYCLE is not supported on CCCH in the cell).

Mobile Station:

The MS is GPRS attached with a P-TMSI allocated, SPLIT PG CYCLE negotiated. The mobile station is in packet idle mode and has left the Transfer non-DRX mode period, i.e. the system simulator shall wait for a period equivalent to the value of the NON_DRX_TIMER parameter before sending the first paging message to the MS.

Specific PICS Statements

- Release of EGPRS Supported (TSPC_MS_EGPRS_RELEASE)
- Support of EGPRS Packet Access Enhancement (TSPC_EGPRS_ENHANC)

PIXIT Statements

-

Test Procedure

The SS sends PACKET PAGING REQUEST on PCCCH and sets Paging Mode to paging reorganisation. The MS is paged on a former access grant block. After receipt the 1st random access from the MS with the correct access type for the paging response, the SS rejects the packet access and sets the paging mode to paging reorganisation.

The test procedure is similarly repeated twice. Each time the SS changes the PCCCH organisation parameters (see the following test sequence). Then the MS is paged. The random access from the MS is rejected by the SS.

The SS resets the default system setting, but sets BS_PCC_REL. The MS is then paged on PCH. After the MS starting random access on RACH, the access from the MS is rejected.

Maximum Duration of Test

5 minutes.

NOTE:

EGPRS PACKET CHANNEL REQUEST shall be used to respond to Paging and Packet Paging Request in the following cases

- a. If Release of EGPRS supported is Release 4 or above.
- b. If Support of EGPRS Packet Access enhancement is True for a R99 MS.

PACKET CHANNEL REQUEST shall be used to respond to Packet Paging Request if support of EGPRS Packet Access enhancement is False for a R99 MS.

CHANNEL REQUEST shall be used to respond to Paging Request if support of EGPRS Packet Access enhancement is False for a R99 MS.

NOTE : All the messages sent on PCCCH are sent with page mode "Normal Paging", unless explicitly stated in the testcase. All the L3 messages sent on CCCH are sent with page mode "Normal Paging".

Expected Sequence

Step	Direction	Message	Comments
1	SS -> MS	PACKET PAGING REQUEST	<p>PAGE_MODE = "paging reorganisation", not specific to the MS. Sent on the paging block belonging to the MS. Sent on a former access grant block. Sent before the paging subchannel reoccurs for the MS. 1st Repeated Page info contains P-TMSI of the MS, no other Repeated Page info, PAGE_MODE = "Normal paging".</p> <p>In case PACKET CHANNEL REQUEST is received ACCESS TYPE = " Page Response ". Received on PRACH.</p> <p>In case EGPRS PACKET CHANNEL REQUEST is received ACCESS TYPE = " Signalling ". Received on PRACH. Random Reference = pertaining to the message received in step 3, PAGE_MODE = "Normal Paging", Sent on PAGCH.</p> <p>Sent on the MS's paging sub-channel. Paging fill frame and page mode set to "paging reorganisation".</p> <p>All the messages sent on the paging subchannel are sent with PAGE_MODE = "paging reorganisation"</p>
2	SS -> MS	PACKET PAGING REQUEST	
3	MS-> SS	PACKET CHANNEL REQUEST/ EGPRS PACKET CHANNEL REQUEST (see NOTE)	
4	SS -> MS	PACKET ACCESS REJECT	
5	SS -> MS	PACKET PAGING REQUEST	
6	SS		<p>Set BS_PBCCH_BLKs = 4 in system information messages and waits at least two PSI1 repeat periods + time required for 64/SPLIT_PG_CYCLE multiframes.</p> <p>NOTE : SS reverts back to sending of fill paging messages with page mode set to "Normal Paging" on paging sub-channels, after the 2 PSI1 repeat period wait.</p>
7	SS -> MS	PACKET PAGING REQUEST	<p>Sent on a new paging block belonging to the MS. 1st Repeated Page info contains P-TMSI of the MS, no other Repeated Page info, PAGE_MODE = "Same as before".</p> <p>In case PACKET CHANNEL REQUEST is received ACCESS TYPE = " Page Response ". Received on PRACH.</p> <p>In case EGPRS PACKET CHANNEL REQUEST is received ACCESS TYPE = " Signalling ". Received on PRACH. Random Reference = pertaining to the message received in step 8, PAGE_MODE = "Normal Paging", Sent on PAGCH.</p> <p>Sent on the MS's paging sub-channel. Paging fill frame and page mode set to "paging reorganisation".</p> <p>All the messages sent on the paging subchannel are sent with PAGE_MODE = "paging reorganisation"</p>
8	MS-> SS	PACKET CHANNEL REQUEST/ EGPRS PACKET CHANNEL REQUEST (see NOTE)	
9	SS -> MS	PACKET ACCESS REJECT	
10	SS -> MS	PACKET PAGING REQUEST	
11	SS		
12	SS -> MS	PACKET PAGING REQUEST	<p>Sent on a new paging block belonging to the MS. 1st Repeated Page info contains P-TMSI of the MS, no other Repeated Page info, PAGE_MODE = "Normal paging".</p> <p>In case PACKET CHANNEL REQUEST is received ACCESS TYPE = " Page Response ". Received on PRACH.</p> <p>In case EGPRS PACKET CHANNEL REQUEST is received ACCESS TYPE = " Signalling ". Received on PRACH. Random Reference = pertaining to the message received in step 13, PAGE_MODE = "Normal Paging", Sent on PAGCH.</p>
13	MS-> SS	PACKET CHANNEL REQUEST/ EGPRS PACKET CHANNEL REQUEST (see NOTE)	
14	SS -> MS	PACKET ACCESS REJECT	

15	SS -> MS	PACKET PAGING REQUEST	Sent on the MS's paging sub-channel. Paging fill frame and page mode set to "paging reorganisation". All the messages sent on the paging subchannel are sent with PAGE_MODE = "paging reorganisation"
16	SS		Restore the SS default configuration. and set BS_PCC_REL = 1 and wait at least two PSI1 repeat periods + SI13 repeat period + time required for BS_PA_MFRMS multiframes. SS stops sending all PSIs.
17	SS -> MS	PAGING REQUEST TYPE 1	Sent on PCH. 1 st Mobility Identity contains P-TMSI of the MS, 2 nd Mobility Identity absent. Packet Page Indication indicates a packet paging procedure.
18	MS-> SS	CHANNEL REQUEST/ EGPRS PACKET CHANNEL REQUEST (see NOTE)	In case CHANNEL REQUEST is received ACCESS TYPE = "one phase access". Received on RACH. In case EGPRS PACKET CHANNEL REQUEST is received
19	SS -> MS	IMMEDIATE ASSIGNMENT REJECT	ACCESS TYPE = " Signalling ". Received on RACH. Random Reference = pertaining to the message received in step 17, Sent on AGCH.

Specific Message Contents

None.

51.1.2 RR / Paging / on PCCCH for circuit-switched services / paging successful

51.1.2.0 Void

51.1.2.1 Conformance requirements

1. When answering to a paging message the purpose of which is to trigger the establishment of an RR connection, the mobile station, whatever its MS class mode of operation, shall follow the paging response procedures as specified in 3GPP TS 24.008.
2. The MS shall enter GPRS ATTACHED.SUSPENDED sub-state when entering dedicated mode and when the MS limitations makes it unable to communicate on GPRS channels. In this sub-state, no user data should be sent and no signalling information shall be sent. The MS shall leave this sub-state when leaving dedicated mode.

References

3GPP TS 04.60, subclause 6.1.4.

3GPP TS 24.008, subclauses 3.3.2.2 and 4.1.3.1.3.2.

51.1.2.2 Test purpose

1. To verify that the MS in packet idle mode, GPRS attached state, is able to determine its PCCCH group and PAGING group, and that the MS responds correctly on RACH with CHANNEL REQUEST containing cause value of 'Page Response' upon receipt of a PACKET PAGING REQUEST message for establishment of an RR connection.
2. To verify that the MS is able to respond to PACKET PAGING REQUEST for establishment of an RR connection when the MS is addressed with its TMSI and, but an another field of the paging message contains an IMSI different from that of the MS.
3. To verify that the MS is able to respond to PACKET PAGING REQUEST for establishment of an RR connection when the MS is addressed with its IMSI.

51.1.2.3 Method of test

Initial Conditions

System Simulator:

1 cell, CCCH combined with SDCCH, EGPRS supported, Network mode I, PCCCH present, Max-Retrans = 2, access burst type = 11 bits, BS_PAG_BLKES_RES=2, BS_PBCCH_BLKES=3, BS_PRACH_BLKES=1, BS_PCC_CHANES=1

Mobile Station:

The MS is GPRS attached with a P-TMSI and a TMSI allocated and SPLIT PG CYCLE negotiated. The mobile station is in packet idle mode and has left the Transfer non-DRX mode period, i.e. the system simulator shall wait for a period equivalent to the value of the NON_DRX_TIMER parameter before sending the first paging message to the MS.

Specific PICS Statements

-

PIXIT Statements

-

Test Procedure

The MS is paged with the TMSI on the MS's PPCH sub-channel for RR establishment. After two random accesses from the MS on RACH the SS assigns a SDCCH. The MS responds with PAGING RESPONSE. The test is repeated with PACKET PAGING REQUEST containing the IMSI of the MS.

Maximum Duration of Test

5 minutes.

Expected Sequence

The test sequence is repeated for k = 1 ... 2

Step	Direction	Message	Comments
1A	SS -> MS	PACKET PAGING REQUEST	k=1 1 st Repeated Page info contains TMSI of the MS for RR establishment, Channel needed = any channel. PAGE_MODE = "Normal Paging". The 2 nd Repeated Page info contains a PTMSI not addressing the MS, for TBF establishment. Sent on PPCH belonging to the MS.
1B	SS -> MS	PACKET PAGING REQUEST	k=2 1 st Repeated Page info contains IMSI of the MS, no other Repeated Page info. Channel needed = " any channel ", PAGE_MODE = " Normal Paging ". Sent on PPCH belonging to the MS.
2	MS -> SS	CHANNEL REQUEST	Establishment Cause = " Answer to paging ". Received on RACH. Establishment Cause = " Answer to paging ". Received on RACH. Request Reference = pertaining to the message received in step 3. Sent on AGCH. carried by information field of SABM. Received on assigned SDCCH. Received on assigned SDCCH. Sent on SDCCH. GPRS resumption acknowledged
3	MS -> SS	CHANNEL REQUEST	
4	SS -> MS	IMMEDIATE ASSIGNMENT	
5	MS -> SS	PAGING RESPONSE	
6	MS->SS	CLASSMARK CHANGE	
7	MS -> SS	GRPS SUSPENSION REQUEST	
8	SS -> MS	CHANNEL RELEASE	

Specific Message Contents

Contents for SYSTEM INFORMATION and PACKET SYSTEM INFORMATION Messages:

Information Element	value/ remark
PRACH Control Parameters - MAX_RETRANS	Max 2 retransmission

PACKET PAGING REQUEST message in step 1A:

Information Element	value/ remark
MESSAGE_TYPE	100010
PAGE_MODE	Normal Paging
{L H<PERSISTENCE_LEVEL>}	L (no persistence level present)
{L H<NLN>}	L (no notification list number)
{H <Repeated Page info>}	H (start of Repeated Page info)
-	H (Page request for RR connection establishment)
- CHANNEL_NEEDED	'00', any channel
-	L (no eMLPP_PRIORITY present)
-	L (TMSI)
- TMSI	TMSI allocated to the MS
-	L (Page request for TBF establishment)
- { L < PTMSI > H < Mobile_identity > }	L (PTMSI present)
- PTMSI	P-TMSI not addressing the MS
-	L (end of repeated page info)
spare padding	Spare Padding

PACKET PAGING REQUEST message in step 1B:

Information Element	value/ remark
MESSAGE_TYPE	100010
PAGE_MODE	Normal Paging
{L H<PERSISTENCE_LEVEL>}	L (no persistence level present)
{L H<NLN>}	L (no notification list number)
{H <Repeated Page info>}	H (start of Repeated Page info)
-	H (Page request for RR connection establishment)
- CHANNEL_NEEDED	any channel
-	L (no eMLPP_PRIORITY present)
-	H (mobility identity)
- LENGTH of Mobile Identity	Depending on IMSI field
- Mobile identity	Length, type, and IMSI value stored on the SIM of the MS (3GPP 24.008, 10.5.5.13 without IEI)
-	L (end of Repeated Page info)
spare padding	Spare Padding

IMMEDIATE ASSIGNMENT message:

Information Element	value/ remark
L2 pseudo length	This is the sum of the lengths of all the information elements present in the message except for the IA rest octets and L2 pseudo length IEs. For the default message the L2 pseudo length is 11.
Protocol Discriminator	RR Management.
Skip Indicator	0000
Message Type	00111111
Page Mode	
- Page Mode	Normal Paging.
Packet Response Type and Dedicated mode or TBF	
- Downlink	No meaning
- T/D	Dedicated mode resource
- PR Type	Immediate assignment procedure for RR connection establishment
Channel Description	
- Channel Type and TDMA offset	SDCCH/4
- TN	Chosen arbitrarily
- TSC	Chosen arbitrarily
-	0
-	00 (Binary)
- ARFCN	For GSM 450: 267 For GSM 480: 315 For GSM 700, T-GSM 810: 450 For GSM 850: 190 For GSM 900: 30 For DCS 1 800: 650 For PCS 1 900: 650
Request Reference	Pertaining to last Channel Request sent by the MS.
Timing Advance	
- Timing advance value	30 bit periods.
Mobile Allocation	
- Length	0
Starting Time	Not present.
IA rest octets	Spare Padding

51.1.3 RR / Paging / on PCCCH / paging ignored

The MS shall ignore paging not addressing to it. If paging is not implemented correctly unnecessary accesses will be provoked on PCCCH which is shared by all MS in a same cell. This kind of the wrong paging behaviour of the same type of MS in a GSM network can block the use of PCCCH and will, therefore, cause an unacceptable degradation of the GSM services to other users of the mobile stations.

51.1.3.1 Conformance requirements

1. MS in a specific PCCCH GROUP shall monitor the radio blocks on PCCCH corresponding to the PCCCH GROUP the mobile station belongs to and where paging may appear.
2. A PACKET PAGING REQUEST message on PCCCH may include more than one mobile station identification.

References

3GPP TS 04.60/44.060, subclauses 5.5.1 and 6.1.2, 7.1.2.1.

51.1.3.2 Test purpose

1. To verify that the MS ignores PACKET PAGING REQUEST (for EGPRS service) where both P-TMSI and IMSI do not address the MS although the PACKET PAGING REQUEST message is sent on specific PCCCH to which the MS belongs.
2. To verify that the MS ignores PACKET PAGING REQUEST (for circuit-switched service) where both P-TMSI and IMSI do not address the MS although the PACKET PAGING REQUEST message is sent on specific PCCCH to which the MS belongs.

NOTE: The 2nd test purpose is valid for GPRS MS class A and B.

51.1.3.3 Method of test

Initial Conditions

System Simulator:

1 cell, CCCH combined with SDCCH, EGPRS supported, PCCCH present, Max-Retrans=2, access burst type=8 bits, BS_PAG_BLKES_RES=2, BS_PBCCH_BLKES =3, BS_PRACH_BLKES= 1 and BS_PCC_CHANES=1.

Mobile Station:

The MS is GPRS attached with a P-TMSI allocated and SPLIT PG CYCLE negotiated. If the MS has the class A or B of mode of operation the MS is idle, updated with a TMSI allocated. The mobile station is in packet idle mode and has left the Transfer non-DRX mode period, i.e. the system simulator shall wait for a period equivalent to the value of the NON_DRX_TIMER parameter before sending the first paging message to the MS.

Specific PICS Statements

- Support of GPRS Operation Mode A (TSPC_operation_mode_A)
- Support of GPRS Operation Mode B (TSPC_operation_mode_B)
- Support of GPRS Operation Mode C (TSPC_operation_mode_C)
- Release of EGPRS Supported (TSPC_MS_EGPRS_RELEASE)
- Support of EGPRS Packet Access Enhancement (TSPC_EGPRS_ENHANC)

PIXIT Statements

-

Test Procedure

The MS is paged for TBF establishment. The MS attempts a random access which is rejected. The MS is paged again for TBF establishment. PACKET PAGING REQUEST contains two mobility identity which do not address the MS. The MS shall not initiate the random access. The same test is repeated, but the MS is paged for RR connection establishment.

Maximum Duration of Test

5 minutes.

NOTE:

EGPRS PACKET CHANNEL REQUEST shall be used to respond to Paging and Packet Paging Request for TBF Establishment in the following cases

- a. If Release of EGPRS supported is Release 4 or above.
- b. If Support of EGPRS Packet Access enhancement is True for a R99 MS.

PACKET CHANNEL REQUEST shall be used to respond to Packet Paging Request for TBF Establishment if support of EGPRS Packet Access enhancement is False for a R99 MS.

Expected Sequence

The test sequence is repeated for k = 1, 2. The 2nd time (k=2) is executed if the MS has the class A or B of mode of operation.

Step	Direction	Message	Comments
1	SS -> MS	PACKET PAGING REQUEST	1 st Repeated Page info contains P-TMSI of the MS, no other Repeated Page info, Page_Mode = "Normal Paging". Sent on PPCH belonging to the MS.
2	MS-> SS	PACKET CHANNEL REQUEST/ EGPRS PACKET CHANNEL REQUEST (see NOTE)	In case PACKET CHANNEL REQUEST is received ACCESS TYPE = " Page Response ". Received on PRACH. In case EGPRS PACKET CHANNEL REQUEST is received ACCESS TYPE = " Signalling ". Received on PRACH.
3	SS -> MS	PACKET ACCESS REJECT	Random Reference = pertaining to the message received in step 2. Sent on PAGCH.
4A	SS -> MS	PACKET PAGING REQUEST	k=1, page for TBF establishment. The two Repeated Page info do not address the MS. Sent on PPCH belonging to the MS.
4B	SS -> MS	PACKET PAGING REQUEST	k=2, page for RR connection. The two Repeated Page info do not address the MS. Channel Needed = "any channel". Sent on PPCH belonging to the MS.
5	SS		Check that there is no response from the MS for 5s.

Specific Message Contents

Contents for SYSTEM INFORMATION and PACKET SYSTEM INFORMATION Messages:

Information Element	value/ remark
PRACH Control Parameters - ACCESS_BURST_TYPE - MAX_RETRANS	8 bit access burst Max 2 retransmission

PACKET PAGING REQUEST message in step 4A:

Information Element	value/ remark
MESSAGE_TYPE	100010
PAGE_MODE	Normal Paging
{L H<PERSISTENCE_LEVEL>}	L (no persistence level present)
{L H<NLN>}	L (no notification list number)
{H <Repeated Page info>}	H (start of Repeated Page info)
-	L (Page request for TBF establishment)
-	L (PTMSI)
- PTMSI	P-TMSI value not the assigned to the MS under test
-	L (Page request for TBF establishment)
-	H (mobility identity)
- LENGTH of Mobile Identity	depending on IMSI field
- Mobile identity	IMSI different from the value stored on the SIM of the MS
-	L (end of Repeated Page info)
spare padding	Spare Padding

PACKET PAGING REQUEST message in step 4B:

Information Element	value/ remark
MESSAGE_TYPE	100010
PAGE_MODE	Normal Paging
{L H<PERSISTENCE_LEVEL>}	L (no persistence level present)
{L H<NLN>}	L (no notification list number)
{H <Repeated Page info>}	H (start of Repeated Page info)
-	H (Page request for RR connection establishment)
- CHANNEL_NEEDED	any channel
-	L (no eMLPP_PRIORITY present)
-	L (TMSI)
- TMSI	TMSI value not allocated to the MS
-	H (Page request for RR connection establishment)
- CHANNEL_NEEDED	any channel
-	L (no eMLPP_PRIORITY present)
-	H (IMSI)
- LENGTH of Mobile Identity	depending on IMSI field
- Mobile identity	IMSI different from the value stored on the SIM of the MS
-	L (end of Repeated Page info)
spare padding	Spare Padding

51.1.4 RR / Paging / on PACCH for circuit-switched services

This subclause tests the MS paging behaviours in the packet transfer mode in a network operating in Mode I.

51.1.4.1 RR / Paging / on PACCH for circuit-switched services/ paging successful

51.1.4.1.1 Conformance requirements

1. Paging initiation using PACCH applies to a mobile station supporting GPRS MS class A or B when such mobile station is in packet transfer mode and when the network operates according to mode I.
2. A mobile station operating in class B mode of operation shall abort the current EGPRS data transfer(s) if it was in packet transfer mode, and suspend any EGPRS activity until return to idle mode.
3. (For an MS in the mode of operation of class B) when responding to a paging message for other GSM services, the MS shall establish the connection for that incoming service (i.e. enter dedicated mode) and suspend EGPRS activity. EGPRS activity is resumed upon return to idle mode.

References

3GPP TS 04.60, subclauses 6.1.3 and 6.1.4.

3GPP TS 22.060, subclause 6.1.

51.1.4.1.2 Test purpose

1. To verify that upon receipt of a PACKET PAGING REQUEST message on PACCH for RR establishment, the class B mobile in packet transfer mode is able to respond correctly on RACH with CHANNEL REQUEST containing cause value of 'Page Response'.
2. To verify that the MS is able to respond to PACKET PAGING REQUEST when the MS is addressed with its TMSI and even if another field of PACKET PAGING REQUEST contains an IMSI different from that of the MS.
3. To verify that the MS is able to respond to PACKET PAGING REQUEST when the MS is addressed with its IMSI.

51.1.4.1.3 Method of test

Initial Conditions

System Simulator:

1 cell, CCCH combined with SDCCH, EGPRS supported, PCCCH present, Max-Retrans = 2, access burst type = 11 bits, BS_PAG_BLK_RES = 2, BS_PBCCH_BLK = 3 and BS_PCC_CHAN = 1.

Mobile Station:

The MS is in packet transfer mode.

Specific PICS Statements

-

PIXIT Statements

-

Test Procedure

The MS is in the packet transfer mode. An USF is assigned to the MS. After receiving the first uplink RLC data block from the MS it is paged on PACCH for an RR connection establishment with the allocated TMSI. The MS sends CHANNEL REQUEST for Answer to Paging. The access attempt is rejected.

The test is repeated once. The difference of the second time lies in the PACKET PAGING REQUEST on PACCH containing IMSI instead of TMSI addressing the MS.

Maximum Duration of Test

5 minutes.

Expected Sequence

The test sequence is repeated for k = 1, 2

Step	Direction	Message	Comments
1		{Uplink dynamic allocation two phase access}	n = 440 octets in test PDP context3, without starting time, USF_GRANULARITY = 1 block, RLC_DATA_BLOCKS_GRANTED = open-end EGPRS Channel Coding Command: MCS-1 EGPRS Window Size: 64 PEAK_THROUGHPUT_CLASS = 5 (16k octets/s), RADIO_PRIORITY = 4, RLC_MODE = unacknowledged mode.
2	SS -> MS	PACKET DOWNLINK DUMMY CONTROL BLOCK	Sent on the PACCH, the USF assigned to the MS.
3	MS -> SS	UPLINK RLC DATA BLOCK	Received on the assigned PDTCH.
4A	SS -> MS	PACKET PAGING REQUEST	Check that the coding as specified by CHANNEL_CODING_COMMAND, the TFI is correct. k=1, for RR connection 1 st Repeated Page info contains TMSI of the MS, Channel Needed = " TCH/F ", PAGE_MODE = " same as before ", sent on downlink PACCH.
4B	SS -> MS	PACKET PAGING REQUEST	k=2, for RR connection 1 st Repeated Page info contains IMSI of the MS, Channel Needed = " TCH/F ", PAGE_MODE = " same as before ", sent on downlink PACCH.
5	MS -> SS	CHANNEL REQUEST	Establishment Cause = " Answer to Paging ". Received on RACH.
6	SS -> MS	IMMEDIATE ASSIGNMENT REJECT	Request Reference = pertaining to message received in step 5. Sent on AGCH.

51.1.4.2 RR / Paging / on PACCH for circuit-switched services/ paging ignored

The MS shall ignore paging not addressing to it. If paging is not implemented correctly unnecessary accesses will be provoked on the CCCH which is shared by all MSs in a same cell. This kind of the wrong paging behaviour of the same type of MS in a GSM network can block the use of CCCH and will, therefore, cause an unacceptable degradation of the GSM services to other users of the mobile stations.

51.1.4.2.1 Conformance requirements

The MS shall ignore paging not addressing to it.

References

3GPP TS 04.60, clause 6.

51.1.4.2.2 Test purpose

To verify that the MS ignores a PACKET PAGING REQUEST message where both TMSI and IMSI do not address the MS although the PACKET PAGING REQUEST message is sent on PACCH allocated to the MS.

51.1.4.2.3 Method of test

Initial Conditions

System Simulator:

1 cell, CCCH combined with SDCCH, EGPRS supported, PCCCH present, Max-Retrans = 2, access burst type = 8 bits, BS_PAG_BLK_RES = 2, BS_PBCCH_BLK = 3, BS_PRACH_BLK = 1 and BS_PCC_CHAN = 1.

Mobile Station:

The MS is in packet transfer mode.

Specific PICS Statements

-

PIXIT Statements

-

Test Procedure

The MS is brought to the packet transfer mode. A PACKET PAGING message not addressing the MS is sent on PACCH for RR connection establishment. It is checked that the MS can continue sending the uplink RLC data blocks and does not attempt any random accesses on RACH for 10 s.

Maximum Duration of Test

5 minutes.

Expected Sequence

Step	Direction	Message	Comments
1		{Uplink dynamic allocation two phase access}	n = 2000 octets in test PDP context3, without starting time, EGPRS Channel Coding Command: MCS-1 EGPRS Window Size: 64 TIMESLOT_ALLOCATION: One timeslot assigned TBF Starting Time: Arbitrarily chosen
2	SS -> MS	PACKET DOWNLINK DUMMY CONTROL BLOCK	Sent on the PACCH, the USF assigned to the MS.
3	MS -> SS	EGPRS UPLINK RLC DATA BLOCK	Received on the assigned PDTCH. Check that the coding as specified by EGPRS CHANNEL_CODING_COMMAND, and the TFI are correct.
4	SS -> MS	PACKET PAGING REQUEST	For RR connection, the two Repeated Page info contain a TMSI and an IMSI not addressing the MS, Channel Needed = " Any Channel ", sent on downlink PACCH.
5	SS -> MS	PACKET UPLINK ACK/NACK	Sent on PACCH. US assigned to the MS. Acknowledging all data blocks received.
6	MS -> SS	EGPRS UPLINK RLC DATA BLOCK	
7			Repeat Step 5 and Step 6 for at least 10 s. Verify that MS does not send CHANNEL REQUEST during this time.
8		{Completion of uplink RLC data block transfer}	

Specific Message Contents

None.

51.1.5 RR / Paging / on CCCH for EGPRS service

51.1.5.1 RR / Paging / on CCCH for EGPRS service / normal paging

51.1.5.1.1 RR / Paging / on CCCH for EGPRS service / normal paging with P-TMSI successful

51.1.5.1.1.1 Conformance requirements

1. The network initiates the paging procedure by sending a paging request message on an appropriate paging sub-channel on CCCH. Paging initiation using a paging sub-channel on CCCH is used when sending paging information to a mobile station and PCCCH is not present in the cell.
2. The mobile station in packet idle mode is required to receive and analyse the paging messages and immediate assignment messages sent on the paging sub-channels on CCCH corresponding to the paging groups determined for it in packet idle mode.
3. A PAGING REQUEST message may include more than one mobile station identification.
4. In a PAGING REQUEST message used for the packet paging procedure, the mobile station shall be identified by the P-TMSI (GPRS TMSI) or its IMSI. If the mobile station is identified by the P-TMSI, it shall indicate the receipt of a paging request to the MM sub-layer.

If the mobile station identified by its IMSI, it shall parse the message for a corresponding *Packet Page Indication* field:

- if the *Packet Page Indication* field indicates a paging procedure for RR connection establishment, or the field is not present in the message, the mobile station shall initiate the immediate assignment procedure;
- if the *Packet Page Indication* field indicates a packet paging procedure, the mobile station shall indicate the receipt of a paging request to the MM sub-layer.

5. The mobile station initiates the packet access procedure by scheduling the sending of CHANNEL REQUEST messages on RACH.

References

3GPP TS 24.008, subclauses 3.3.2.1.1, 3.5.1.1, 3.5.1.2 and 3.5.2.1.

3GPP TS 05.02, subclause 6.5.6.

3GPP TS 04.18/44.018, subclause 3.5.2.1.2

51.1.5.1.1.2 Test purpose

1. To verify that the MS in packet idle mode, GPRS attached state, is able to determine its CCCH group and PAGING group and that the MS responds correctly with CHANNEL REQUEST/EGPRS PACKET CHANNEL REQUEST on RACH with cause value of 'packet access' upon receipt of a PAGING REQUEST TYPE 1 message for packet access with paging mode set to normal.
2. To verify that the MS is able to respond to PAGING REQUEST TYPE 1 for packet access when the MS is addressed with its P-TMSI, but another field of the paging message contains an IMSI different from that of the MS.
3. To verify that the MS is able to respond to PAGING REQUEST TYPE 2 for packet access when the MS is addressed with its P-TMSI, but other fields of the paging message contain a TMSI and an IMSI different from that of the MS.
4. To verify that the MS is able to respond to PAGING REQUEST TYPE 3 for packet access when the MS is addressed with its P-TMSI, but other fields of the paging message contain TMSIs different from that of the MS.

51.1.5.1.1.3 Method of test

Initial Conditions

System Simulator:

1 cell, CCCH combined with SDCCH, EGPRS supported, PCCCH absent, Max-Retrans = 2, BS_AG_BLK_RES = 2, BS_PA_MFRMS = 6, SPLIT_PG_CYCLE is supported on CCCH in the cell.

Mobile Station:

The MS is GPRS attached with a TMSI and a P-TMSI allocated, SPLIT PG CYCLE negotiated. The mobile station is in packet idle mode and has left the Transfer non-DRX mode period, i.e. the system simulator shall wait for a period equivalent to the value of the NON_DRX_TIMER parameter before sending the first paging message to the MS.

Specific PICS Statements

- Release of EGPRS Supported (TSPC_MS_EGPRS_RELEASE)
- Support of EGPRS Packet Access Enhancement (TSPC_EGPRS_ENHANC)

PIXIT Statements

-

Test Procedure

The test is repeated three times. Each time the MS is paged for the packet paging procedure through a different paging request type message. After receiving a CHANNEL REQUEST with the establishment cause 'one phase access', or an EGPRS PACKET CHANNEL REQUEST with the establishment cause 'signalling' an open-end TBF is assigned. A USF is assigned to the MS to enable it to transfer an uplink RLC data block. The received data block is acknowledged by the SS with , Final Ack Indicator = '1' , a valid RRBP. The MS sends PACKET CONTROL ACKNOWLEDGEMENT.

Maximum Duration of Test

5 minutes.

NOTE:

EGPRS PACKET CHANNEL REQUEST shall be used to respond to Paging Request for TBF Establishment in the following cases

- a. If Release of EGPRS supported is Release 4 or above.
- b. If Support of EGPRS Packet Access enhancement is True for a R99 MS.

CHANNEL REQUEST shall be used to respond to Paging Request for TBF Establishment if support of EGPRS Packet Access enhancement is False for a R99 MS.

Expected Sequence

The test sequence is repeated for $k = 1 \dots 3$.

Step	Direction	Message	Comments
1A	SS -> MS	PAGING REQUEST TYPE 1	k=1 1 st Mobile Identity contains P-TMSI of the MS, 2 nd Mobile Identity not present. Sent on PCH.
1B	SS -> MS	PAGING REQUEST TYPE 2	k=2 1 st Mobile Identity contains P-TMSI of the MS, the other two Mobile Identities not addressing the MS. Sent on PCH.
1C	SS -> MS	PAGING REQUEST TYPE 3	k=3 1 st Mobile Identity contains P-TMSI of the MS, the remaining Mobile Identities not addressing the MS. Sent on PCH.
2	MS -> SS	CHANNEL REQUEST/ EGPRS PACKET CHANNEL REQUEST (see NOTE)	In case CHANNEL REQUEST is received Establishment Cause = "one phase access", received on RACH. In case EGPRS PACKET CHANNEL REQUEST is received ACCESS TYPE = " Signalling ". Received on RACH.
3	SS -> MS	IMMEDIATE ASSIGNMENT	Request Reference = pertaining to the message received in step 2. Uplink assignment, sent on AGCH.
4	SS -> MS	PACKET DOWNLINK DUMMY CONTROL BLOCK	Sent on PACCH containing USF assigned to the MS.
5	MS -> SS	(EGPRS) UPLINK RLC DATA BLOCK (not L3 Message)	LLC PDU implicitly indicating paging response, containing TLLI in the RLC/MAC header. Received on uplink PDTCH assigned in step 4.
6	SS -> MS	PACKET UPLINK ACK/NACK	acknowledge the received RLC data block, Final Ack Indicator = '1' , a valid RRBP. Sent on PACCH.
7	MS -> SS	PACKET CONTROL ACKNOWLEDGEMENT	acknowledge the RLC control message. Received on PACCH.

Specific Message Contents

IMMEDIATE ASSIGNMENT message in step 3 in case CHANNEL REQUEST is received in Step 2:

Information Element	value/ remark
Dedicated mode or TBF	TBF
- T/D	0 , no meaning
- Downlink	0, no meaning
- TMA	
Packet Channel Description	
- Channel Type	'00001' spared
- TN	Chosen arbitrarily
- TSC	Chosen arbitrarily
-	0
-	00 (Binary)
- ARFCN	For GSM 450: 267 For GSM 480: 315 For GSM 700, T-GSM 810: 450 For GSM 850: 190 For GSM 900: 30 For DCS 1 800: 650 For PCS 1 900: 650
Request Reference	Pertaining to last Channel Request sent by the MS.
Timing Advance	
- Timing advance value	30 bit periods.
Mobile Allocation	
- Length	0
Starting Time	Not present.
IA rest octets	
-	HH
-	00 (packet uplink assignment)
- Packet Uplink Assignment	
- Assign a TBF	1, Dynamic allocation
- TFI_ASSIGNMENT	chosen arbitrarily
- POLLING	0, no
-	0, dynamic allocation
- USF	chosen arbitrarily
- USF granularity	0, single block
- 0 1 <P0 >	0
- CHANNEL_CODING_COMMAND	00, CS-1
- TLLI_BLOCK CHANNEL_CODING	00, CS-1
- 0 1 <ALPHA >	1
- ALPHA	0.5
- GAMMA	For GSM 450: +8 dBm For GSM 480: +8 dBm For GSM 700, T-GSM 810: +8 dBm For GSM 850: +8 dBm For GSM 900: +8 dBm For DCS 1 800: +6 dBm For PCS 1 900: +6 dBm
- {0 1<TIMING_ADVANCE_INDEX>}	0 (no timing advance index)
- {0 1<TBF_STARTING_TIME>}	0
- spare padding	Spare Padding

IMMEDIATE ASSIGNMENT message in step 3 in case EGPRS PACKET CHANNEL REQUEST is received in Step 2:

Information Element	value/ remark
Dedicated mode or TBF	TBF
- T/D	0, no meaning
- Downlink	0, no meaning
- TMA	
Packet Channel Description	
- Channel Type	'00001' spared
- TN	Chosen arbitrarily
- TSC	Chosen arbitrarily
-	0
-	00 (Binary)
- ARFCN	For GSM 450: 267 For GSM 480: 315 For GSM 700, T-GSM 810: 450 For GSM 850: 190 For GSM 900: 30 For DCS 1 800: 650 For PCS 1 900: 650
Request Reference	0x7f
Timing Advance	
- Timing advance value	30 bit periods.
Mobile Allocation	
- Length	0
Starting Time	Not present.
IA rest octets	
-	LH
-	00 (EGPRS packet uplink assignment)
-EGPRS Packet Uplink Assignment	
- Extended RA	Corresponding to the last EGPRS Packet Channel Request sent by the MS.
- Assign a TBF	1, Dynamic allocation
- TFI_ASSIGNMENT	chosen arbitrarily
- POLLING	0, no
-	0, dynamic allocation
- USF	chosen arbitrarily
- USF granularity	0, single block
- 0 1 <P0 >	0
- EGPRS CHANNEL_CODING_COMMAND	MCS-1
- TLLI_BLOCK CHANNEL_CODING	0
- 0 1 <ALPHA >	1
- ALPHA	0.5
- GAMMA	For GSM 450: +8 dBm For GSM 480: +8 dBm For GSM 700, T-GSM 810: +8 dBm For GSM 850: +8 dBm For GSM 900: +8 dBm For DCS 1 800: +6 dBm For PCS 1 900: +6 dBm
- {0 1<TIMING_ADVANCE_INDEX>}	0 (no timing advance index)
- {0 1<TBF_STARTING_TIME>}	0
- spare padding	Spare Padding

51.1.5.1.2 RR / Paging / on CCCH for EGPRS service / normal paging with IMSI successful

51.1.5.1.2.1 Conformance requirements

1. If the MS was paged by the network with the IMSI (for EGPRS service), the MS shall delete any RAI, P-TMSI, P-TMSI signature and GPRS ciphering key sequence number stored. The MS shall then perform a GPRS attach or combined GPRS attach procedure.

References

3GPP TS 24.008, subclause 4.7.9.1.2.

3GPP TS 04.18/44.018, subclause 3.5.2.1.2

51.1.5.1.2.2 Test purpose

To verify that the MS is able to respond to PAGING REQUEST TYPE 1 when the MS is addressed with its IMSI with *Packet Page Indication* set to packet paging procedure, and that the MS then performs a GPRS attach or combined GPRS attach procedure.

51.1.5.1.2.3 Method of test

Initial Conditions

System Simulator:

1 cell, CCCH combined with SDCCH, EGPRS supported, PCCCH absent, Max-Retrans = 2, BS_AG_BLK_RES = 2, BS_PA_MFRMS = 9.

Mobile Station:

The MS is in GPRS attached with a TMSI and a P-TMSI allocated, SPLIT PG CYCLE negotiated. The mobile station is in packet idle mode and has left the Transfer non-DRX mode period, i.e. the system simulator shall wait for a period equivalent to the value of the NON_DRX_TIMER parameter before sending the first paging message to the MS.

Specific PICS Statements

- Release of EGPRS Supported (TSPC_MS_EGPRS_RELEASE)
- Support of EGPRS Packet Access Enhancement (TSPC_EGPRS_ENHANC)

PIXIT Statements

-

Test Procedure

The MS is paged on PCH with IMSI for packet paging procedure. After receiving the CHANNEL REQUEST/EGPRS PACKET CHANNEL REQUEST from the MS a TBF is assigned. The MS sends an LLC PDU containing TLLI in the RLC/MAC header and ATTACH REQUEST, implicitly indicating a paging response. The SS verifies the completeness of ATTACH REQUEST and acknowledges the received RLC data blocks with a valid RRBP and Final Ack indicator = '1'.

Maximum Duration of Test

5 minutes.

NOTE:

EGPRS PACKET CHANNEL REQUEST shall be used to respond to Paging Request for TBF Establishment in the following cases

- a. If Release of EGPRS supported is Release 4 or above.
- b. If Support of EGPRS Packet Access enhancement is True for a R99 MS.

CHANNEL REQUEST shall be used to respond to Paging Request for TBF Establishment if support of EGPRS Packet Access enhancement is False for a R99 MS.

Expected Sequence

Step	Direction	Message	Comments
1	SS -> MS	PAGING REQUEST TYPE 1	1 st Mobile Identity contains IMSI of the MS, second Mobile Identity not present. Packet page indication indicates packet paging procedure. Sent on PCH.
2	MS -> SS	CHANNEL REQUEST/EGPRS PACKET CHANNEL REQUEST (see NOTE)	In case CHANNEL REQUEST is received Establishment Cause = = "one phase packet access". Received on RACH. In case EGPRS PACKET CHANNEL REQUEST is received ACCESS TYPE = " Signalling ". Received on RACH.
3	SS -> MS	IMMEDIATE ASSIGNMENT	For uplink TBF, one phase access.
4	MS -> SS	(EGPRS) UPLINK RLC DATA BLOCK (ATTACH REQUEST)	LLC PDU containing a TLLI and the first part of ATTACH REQUEST, the implicit paging response to step 1.
5	SS -> MS	PACKET UPLINK ACK/NACK	Received on the uplink PDTCH assigned in step 3. Contention resolution, acknowledge the received RLC data blocks, No USF assigned. Sent on PACCH.
6	SS -> MS	PACKET DOWNLINK DUMMY CONTROL BLOCK	USF assigned to the MS
7	MS -> SS	(EGPRS) UPLINK RLC DATA BLOCK	.Repeat step 6 & 7 until the CV = 0 to receive the complete ATTACH REQUEST message
8	SS -> MS	PACKET UPLINK ACK/NACK	Acknowledge the received RLC data blocks. Final Ack indicator = '1', containing valid RRBP, sent on PACCH
9	MS -> SS	PACKET CONTROL ACKNOWLEDGEMENT	Acknowledge the RLC control messages. Received on PACCH.

Specific Message Contents

Contents for SYSTEM INFORMATION and PACKET SYSTEM INFORMATION Messages:

Information Element	value/ remark
RACH Control Parameters - Max Retrans	Max 2 retransmission

51.1.5.1.3 RR / Paging / on CCCH for EGPRS service / normal paging with P-TMSI ignored

The MS shall ignore paging not addressing to it. If paging is not implemented correctly unnecessary accesses will be provoked on CCCH which is shared by all MS in a same cell. This kind of the wrong paging behaviour of the same type of MS in a GSM network can block the use of CCCH and will, therefore, cause an unacceptable degradation of the both GSM EGPRS and circuit-switched services to other users of the mobile stations.

51.1.5.1.3.1 Conformance requirements

Paging initiation using the paging subchannel on CCCH is used when sending paging information to a mobile station in idle mode. It is also used when sending paging information to a mobile station in packet idle mode, if PCCCH is not present in the cell.

In a PAGING REQUEST message used for the packet paging procedure, the mobile station shall be identified by the P-TMSI (GPRS TMSI) or its IMSI. If the mobile station is identified by the P-TMSI, it shall proceed as specified in 3GPP TS 04.18, subclause 3.5.1.2.

References

3GPP TS 04.18/44.018, subclauses 3.3.2.1.1 and 3.5.1.1, 3.5.2.1.2.

51.1.5.1.3.2 Test purpose

To verify that the MS ignores a PAGING REQUEST TYPE 1, 2 messages where both P-TMSI and IMSI do not address the MS although the paging message is sent on the CCCH to which the CCCH_GROUP belongs.

51.1.5.1.3.3 Method of test

Initial Conditions

System Simulator:

1 cell, CCCH combined with SDCCH, EGPRS supported, PCCCH absent, Max-Retrans = 2, BS_AG_BLK_RES = 2, BS_PA_MFRMS = 7.

Mobile Station:

The MS is GPRS attached with a TMSI and a P-TMSI allocated and SPLIT PG CYCLE negotiated. The mobile station is in packet idle mode and has left the Transfer non-DRX mode period, i.e. the system simulator shall wait for a period equivalent to the value of the NON_DRX_TIMER parameter before sending the first paging message to the MS.

Specific PICS Statements

- Release of EGPRS Supported (TSPC_MS_EGPRS_RELEASE)
- Support of EGPRS Packet Access Enhancement (TSPC_EGPRS_ENHANC)

PIXIT Statements

-

Test Procedure

The test is repeated twice. Each time a different paging message not addressing the MS is sent on the PCH belonging to the MS. It is checked that the no access attempt is made by the MS for 5 s.

The MS is then paged for packet paging. The MS attempts a random access which is rejected.

Maximum Duration of Test

5 minutes.

NOTE:

EGPRS PACKET CHANNEL REQUEST shall be used to respond to Paging Request for TBF Establishment in the following cases

- a. If Release of EGPRS supported is Release 4 or above.
- b. If Support of EGPRS Packet Access enhancement is True for a R99 MS.

CHANNEL REQUEST shall be used to respond to Paging Request for TBF Establishment if support of EGPRS Packet Access enhancement is False for a R99 MS.

Expected Sequence

The test steps 1 - 2 is repeated for k = 1 .. 2

Step	Direction	Message	Comments
1A	SS -> MS	PAGING REQUEST TYPE 1	k=1, The two packet page indications are set to packet paging procedure. 1st Mobile Identity contains P-TMSI, 2nd Mobile Identity contains IMSI, both Identities do not address the MS. Sent on PCH belonging to the MS.
1B	SS -> MS	PAGING REQUEST TYPE 2	k=2, Packet page indication 3 is set to packet paging procedure. 1st Mobile Identity contains P-TMSI, 2nd Mobile Identity contains P-TMSI, 3rd Identity contains IMSI, all identities not addressing the MS. Sent on PCH belonging to the MS.
2	SS		Check that no CHANNEL REQUEST/EGPRS PACKET CHANNEL REQUEST is sent from the MS for 5s.
3	SS -> MS	PAGING REQUEST TYPE 1	1 st Mobile Identity contains IMSI of the MS, second Mobile Identity not present. Packet page indication indicates packet paging procedure. Sent on PCH belonging to the MS.
4	MS -> SS	CHANNEL REQUEST/EGPRS PACKET CHANNEL REQUEST (see NOTE)	In case CHANNEL REQUEST is received Establishment Cause "one phase packet access". Received on RACH. In case EGPRS PACKET CHANNEL REQUEST is received
5	SS -> MS	IMMEDIATE ASSIGNMENT REJECT	ACCESS TYPE = " Signalling ". Received on RACH. Random Reference = pertaining to the message received in step 4.

Specific Message Contents

PAGING REQUEST TYPE 1 message:

Information Element	value/ remark
Mobile Identity 1 - odd/even indication - Type of Identity - Identity Digits	Even. P-TMSI. P-TMSI value not allocated to MS.
Mobile Identity 2	IMSI different from the value stored on the SIM.
P1 rest octets - Packet Page Indication 1 - Packet Page Indication 2	H, Packet Paging H, Packet Paging

PAGING REQUEST TYPE 2 message:

Information Element	value/ remark
Mobile Identity 1 - TMSI value	P-TMSI value not allocated to the MS.
P2 rest octets - Packet Page Indication 3	LLLL H, Packet Paging

51.1.5.2 RR / Paging / on CCCH for EGPRS service / extended paging

51.1.5.2.1 RR / Paging / on CCCH for EGPRS service / extended paging with P-TMSI successful

51.1.5.2.1.1 Conformance requirements

The paging and immediate assignment type messages contain a page mode information element. This information element controls possible additional requirements on mobile stations belonging to the paging subgroup corresponding to the paging subchannel the message was sent on. This implies that a given mobile station shall take into account the page mode information element of any message sent on its own paging subchannel whatever the nature of this message (paging messages or immediate assignment messages). This further implies that the mobile station does not take into account page mode information element of messages sent on paging subchannels other than its own paging subchannel. The requirements yielded by the page mode information element are as follows:

- b) extended paging: the mobile station is required in addition to receive and analyse the next but one message on the PCH.

References

3GPP TS 04.18/44.018, subclauses 3.3.2.1.1, 3.5.2.1.2, 9.1.18, 9.1.19 and 9.1.20.

51.1.5.2.1.2 Test purpose

1. To verify that the MS operates in the extended page mode when it is ordered by the SS in PAGING REQUEST TYPE 1 which does not address the MS, but on the paging sub-channel corresponding to the MS identity.
2. To verify that the MS operates in the extended page mode when it is ordered by the SS in PAGING REQUEST TYPE 2 which does not address the MS, but on the paging sub-channel corresponding to the MS identity.
3. To verify that the MS operates in the extended page mode when it is ordered by the SS in PAGING REQUEST TYPE 3 which does not address the MS, but on the paging sub-channel corresponding to the MS identity.
4. To verify that the MS operates in the extended page mode when it is ordered by the SS in IMMEDIATE ASSIGNMENT on the paging sub-channel corresponding to the MS identity.
5. To verify that the MS operates in the extended page mode when it is ordered by the SS in IMMEDIATE ASSIGNMENT EXTENDED on the paging sub-channel corresponding to the MS identity.
6. To verify that the MS operates in the extended page mode when it is ordered by the SS in IMMEDIATE ASSIGNMENT REJECT on the paging sub-channel corresponding to the MS identity.

51.1.5.2.1.3 Method of test

Initial Conditions

System Simulator:

1 cell, EGPRS supported, PCCCH absent, Max-Retrans = 2, CCCH_CONF = 1 basic physical channel used for CCCH with non-combined SDCCH, BS_AG_BLK_RES = 3, BS_PA_MFRMS = 8.

Mobile Station:

The MS is GPRS attached with a TMSI and a P-TMSI allocated and SPLIT PG CYCLE negotiated. The mobile station is in packet idle mode and has left the Transfer non-DRX mode period, i.e. the system simulator shall wait for a period equivalent to the value of the NON_DRX_TIMER parameter before sending the first paging message to the MS.

Specific PICS Statements

- Release of EGPRS Supported (TSPC_MS_EGPRS_RELEASE)
- Support of EGPRS Packet Access Enhancement (TSPC_EGPRS_ENHANC)

PIXIT Statements

-

Test Procedure

The test is repeated 6 times. Each time a different downlink message is sent on PCH or AGCH for setting the page mode to extended paging. The MS is paged on the next but one page block for the packet paging procedure. The MS starts a random accesses which are rejected by the SS.

Maximum Duration of Test

5 minutes.

NOTE:

EGPRS PACKET CHANNEL REQUEST shall be used to respond to Paging Request for TBF Establishment in the following cases

- a. If Release of EGPRS supported is Release 4 or above.
- b. If Support of EGPRS Packet Access enhancement is True for a R99 MS.

CHANNEL REQUEST shall be used to respond to Paging Request for TBF Establishment if support of EGPRS Packet Access enhancement is False for a R99 MS.

Expected Sequence

The test sequence is repeated for $k = 1 \dots 6$

Step	Direction	Message	Comments
1A	SS -> MS	PAGING REQUEST TYPE 1	k=1, All mobile Identities do not address the MS. Page mode is set to "extended paging". Packet page indication indicates packet paging procedure. Sent on PCH.
1B	SS -> MS	PAGING REQUEST TYPE 2	k=2, All mobile Identities do not address the MS. Page mode is set to "extended paging". Packet page indication indicates packet paging procedure. Sent on PCH.
1C	SS -> MS	PAGING REQUEST TYPE 3	k=3, All mobile Identities do not address the MS. Page mode is set to "extended paging". Channel Needed IE's are coded with 00. Sent on PCH.
1D	SS -> MS	IMMEDIATE ASSIGNMENT	k=4, Page mode is set to "extended paging". Request Reference does not address any request references sent by the MS in previous test steps. Sent on paging channel (PCH).
1E	SS -> MS	IMMEDIATE ASSIGNMENT EXTENDED	Page mode is set to "extended paging". Request Reference does not address any request references sent by the MS in previous test steps. Sent on paging channel (PCH).
1F	SS -> MS	IMMEDIATE ASSIGNMENT REJECT	k=6, Page mode is set to "extended paging". Request Reference does not address any request references sent by the MS in previous test steps. Sent on paging channel (PCH).
2	SS -> MS	PAGING REQUEST TYPE 1	1st Mobile Identity contains P-TMSI of the MS, 2nd Mobile Identity not present. Page mode is set to "normal paging". Packet page indication indicates packet paging procedure. Sent on the next but one subblock on the same CCCH as previous paging message.
3	MS -> SS	CHANNEL REQUEST/EGPRS PACKET CHANNEL REQUEST (see NOTE)	In case CHANNEL REQUEST is received Establishment Cause = "One phase access". Received on RACH. In case EGPRS PACKET CHANNEL REQUEST is received
4	MS -> SS	CHANNEL REQUEST/EGPRS PACKET CHANNEL REQUEST (see NOTE)	ACCESS TYPE = " Signalling ". Received on RACH. In case CHANNEL REQUEST is received Establishment Cause "One phase access". Received on RACH. In case EGPRS PACKET CHANNEL REQUEST is received
5	SS -> MS	IMMEDIATE ASSIGNMENT REJECT	ACCESS TYPE = " Signalling ". Received on RACH. Request Reference = pertaining to the message received in step 4. Page mode is set to "normal paging". Sent on AGCH.

51.1.5.3 RR / Paging / on CCCH for EGPRS service / paging reorganisation

51.1.5.3.1 Conformance requirements

The paging and immediate assignment type messages contain a page mode information element. This information element controls possible additional requirements on mobile stations belonging to the paging subgroup corresponding to the paging subchannel the message was sent on. This implies that a given mobile station shall take into account the page mode information element of any message sent on its own paging subchannel whatever the nature of this message (paging messages or immediate assignment messages). This further implies that the mobile station does not take into account page mode information element of messages sent on paging subchannels other than its own paging subchannel. The requirements yielded by the page mode information element are as follows:

- c) paging reorganization: The mobile station shall receive all messages on the CCCH regardless of the BS-AG-BLKS-RES setting. It is required to receive all BCCH messages. When the mobile station receives the

next message to its (possibly new) paging subgroup the subsequent action is defined in the page mode information element in that message.

References

3GPP TS 04.18/44.018, subclause 3.3.2.1.1, 3.5.2.1.2.

3GPP TS 04.60/44.060, subclause 7.1.2.1

51.1.5.3.2 Test purpose

1. To verify that the MS, after reception of a message with page mode set to "paging reorganisation", answers to paging messages (with page mode set to "normal paging") sent on its old CCCH in paging blocks which do not belong to the MS's paging sub-channel.
2. To test that the MS correctly determines its new paging sub-channel when the number of reserved blocks, BS_AG_BLK_RES, and the number of 51-multiframes between transmissions of paging messages for mobile stations of the same paging group BS_PA_MFRMS are changed.
3. To test that the MS correctly determines its new paging sub-channel when the number of basic physical channels for CCCH is changed.
4. To test that the MS correctly determines its new paging sub-channel on PCCCH when PCCCH is established.

51.1.5.3.3 Method of test

Initial Conditions

System Simulator:

1 cell, EGPRS supported, PCCCH absent, Max-Retrans = 2, CCCH_CONF = 0 (1 basic physical channel used for CCCH with non-combined SDCCH), BS_AG_BLK_RES = 3, BS_PA_MFRMS = 6. SPGC_CCCH_SUP = 0 (SPLIT_PG_CYCLE is not supported on CCCH in the cell).

Mobile Station:

The MS is GPRS attached with a TMSI and a P-TMSI allocated and SPLIT PG CYCLE negotiated. The mobile station is in packet idle mode and has left the Transfer non-DRX mode period, i.e. the system simulator shall wait for a period equivalent to the value of the NON_DRX_TIMER parameter before sending the first paging message to the MS.

Specific PICS Statements

- Release of EGPRS Supported (TSPC_MS_EGPRS_RELEASE)
- Support of EGPRS Packet Access Enhancement (TSPC_EGPRS_ENHANC)

PIXIT Statements

-

Test Procedure

The page mode is set to paging reorganisation. The MS is paged for packet paging procedure through PAGING REQUEST TYPE 1 which is sent before the MS's original paging sub-channel re-occurs, but later than the next paging block of that CCCH. The MS starts the random access. The access attempt is rejected.

The SS changes the CCCH configuration with BS_AG_BLK_RES=2 and BS_PA_MFRMS=5 and waits two SI13 repeat periods, and then sets the page mode to Normal Paging. The MS is paged for packet paging procedure through PAGING REQUEST TYPE 2 sent on the new paging sub-channel. The MS starts the random access. The access attempt is rejected via IMMEDIATE ASSIGNMENT REJECT. PAGING REQUEST TYPE 1 with paging fill frame and page mode set to "paging reorganisation" is sent.

Two additional CCCHs are activated by the SS. The same test procedure as above is repeated.

The SS restores all default radio parameters (in subclause 40.1), sets a non-combined CCCH and starts to transmitting PSIs on PBCCH. The SS waits two SI3 repeat periods + two PSI1 repeat periods. The MS is paged on PPCH. The random accesses from the MS are observed and are rejected.

Maximum Duration of Test

5 minutes.

NOTE:

EGPRS PACKET CHANNEL REQUEST shall be used to respond to Paging and Packet Paging Request for TBF Establishment in the following cases

- a. If Release of EGPRS supported is Release 4 or above.
- b. If Support of EGPRS Packet Access enhancement is True for a R99 MS.

PACKET CHANNEL REQUEST shall be used to respond to Packet Paging Request for TBF Establishment if support of EGPRS Packet Access enhancement is False for a R99 MS.

CHANNEL REQUEST shall be used to respond to Paging Request for TBF Establishment if support of EGPRS Packet Access enhancement is False for a R99 MS.

NOTE : All the messages sent on PCCCH are sent with page mode "Normal Paging", unless explicitly stated in the testcase. All the L3 messages sent on CCCH are sent with page mode "Normal Paging".

Expected Sequence

Step	Direction	Message	Comments
1	SS -> MS	IMMEDIATE ASSIGNMENT EXTENDED	Page mode set to "paging reorganisation"
2	SS -> MS	PAGING REQUEST TYPE 1	Sent before the MS's original paging sub-channel re-occurs, but later than the next paging block of that CCCH. Page mode set to "normal paging", for packet paging procedure.
3	MS -> SS	CHANNEL REQUEST/EGPRS PACKET CHANNEL REQUEST (see NOTE)	In case CHANNEL REQUEST is received Establishment Cause = "one phase access", received on RACH. In case EGPRS PACKET CHANNEL REQUEST is received
4	SS -> MS	IMMEDIATE ASSIGNMENT REJECT	ACCESS TYPE = " Signalling ". Received on RACH. Request Reference = pertaining to the message received in step 3.
5	SS	PAGING REQUEST TYPE 1	Sent on AGCH. Sent on the MS's paging sub-channel. Paging fill frame and page mode set to "paging reorganisation". All L3 messages sent on any paging sub-channel are paging fill frame specify Paging Reorganisation.
6	SS		Set BS_AG_BLKS_RES=2 and BS_PA_MFRMS=5 in SI's. The value of the BCCH_CHANGE_MARK in the SI13 is altered to indicate the changes. SI_CHANGE_FIELD = 3.
7	SS		Wait two SI13 repeat periods. All L3 messages sent on any paging sub-channel are paging fill frame specify Normal Paging.
8	SS -> MS	PAGING REQUEST TYPE 2	Wait for the time required for BS_PA_MFRMS Multi-Frames. 1 st Mobile Identity contains P-TMSI of the MS. 2nd Mobile Identity contains P-TMSI, 3 rd Identity contains IMSI, the last two identities not addressing the MS. Packet page indication indicates packet paging procedure. Page mode = "same as before", sent on the new PCH belonging to the MS.
9	MS -> SS	CHANNEL REQUEST/EGPRS PACKET CHANNEL REQUEST (see NOTE)	In case CHANNEL REQUEST is received Establishment Cause = "one phase access". Received on RACH. In case EGPRS PACKET CHANNEL REQUEST is received
10	SS -> MS	IMMEDIATE ASSIGNMENT REJECT	ACCESS TYPE = " Signalling ". Received on RACH. Request Reference = pertaining to the message received in step 9.
11	SS	PAGING REQUEST TYPE 1	Sent on the MS's paging sub-channel. Paging fill frame and page mode set to "paging reorganisation". All L3 messages sent on any paging sub-channel are paging fill frame specify Paging Reorganisation.
12	SS		Reconfigure the SS channels so that additional two CCCH's are set on slot 2 and slot 4, Set CCCH_CONF = 4 in SI's. The value of the BCCH_CHANGE_MARK in the SI13 is altered to indicate the changes. SI_CHANGE_FIELD = 3.
13	SS		Wait two SI13 repeat periods. All L3 messages sent on any paging sub-channel are paging fill frame specify Normal Paging.
14	SS -> MS	PAGING REQUEST TYPE 2	Wait for the time required for BS_PA_MFRMS Multi-Frames. 1 st Mobile Identity contains P-TMSI of the MS. 2nd Mobile Identity contains P-TMSI, 3 rd Identity contains IMSI, the last two identities not addressing the MS. Packet page indication indicates packet paging procedure. Page mode = "same as before", sent on the new PCH belonging to the MS.

15	MS -> SS	CHANNEL REQUEST/EGPRS PACKET CHANNEL REQUEST (see NOTE)	In case CHANNEL REQUEST is received Establishment Cause = "one phase access". Received on RACH. In case EGPRS PACKET CHANNEL REQUEST is received ACCESS TYPE = " Signalling ". Received on RACH.
16	SS -> MS	IMMEDIATE ASSIGNMENT REJECT	Request Reference = pertaining to the message received in step 15. Sent on AGCH.
17	SS	PAGING REQUEST TYPE 1	Sent on the MS's paging sub-channel. Paging fill frame and page mode set to "paging reorganisation". All L3 messages sent on any paging sub-channel are paging fill frame specify Paging Reorganisation.
18	SS		Restore the SS default radio parameters, so that there is one CCCH and one PBCCH+PCCCH, set CCCH_CONF = 0 in SIs, start PSIs broadcasting. The value of the BCCH_CHANGE_MARK in the SI13 is altered to indicate the changes. SI_CHANGE_FIELD = 0.
19	SS		Wait two SI3 repeat periods + two PS11 repeat periods. All L3 messages sent on any paging sub-channel are paging fill frame specify Normal Paging. Wait for time required for 64/SPLIT_PG_CYCLE multiframe.
20	SS -> MS	PACKET PAGING REQUEST	1st Repeated Page info contains P-TMSI of the MS, no other Repeated Page info. Sent on PPCH.
21	MS-> SS	PACKET CHANNEL REQUEST/EGPRS PACKET CHANNEL REQUEST (see NOTE)	In case PACKET CHANNEL REQUEST is received ACCESS TYPE = " Page Response ". Received on PRACH. In case EGPRS PACKET CHANNEL REQUEST is received
22	SS -> MS	PACKET ACCESS REJECT	ACCESS TYPE = " Signalling ". Received on RACH. Random Reference = pertaining to the message received in step 21.

Specific Message Contents

None.

51.1.5.4 RR / Paging / on CCCH for EGPRS service / default message contents

Void

51.1.6 RR / Paging / Before T3172 expiry

51.1.6.1 Conformance requirements

On receipt of a PACKET ACCESS REJECT message containing a WAIT_INDICATION field in a Reject structure addressed to the mobile station, where the Packet Request Reference in the Reject structure corresponds to one of its 3 last PACKET CHANNEL REQUEST messages, the mobile station shall stop sending PACKET CHANNEL REQUEST messages, start timer T3172 with the value indicated in the WAIT_INDICATION field. During the time T3172 is running, the mobile station shall ignore all received PACKET PAGING REQUEST messages except paging request to trigger RR connection establishment.

References

3GPP TS 04.60/44.060, subclause 7.1.2.1, 7.1.2.2.4.

51.1.6.2 Test purpose

To verify that during the time T3172 is running, the MS ignores all received PACKET PAGING REQUEST messages except paging request to trigger RR connection establishment.

51.1.6.3 Method of test

Initial Conditions

System Simulator:

1 cell, CCCH combined with SDCCH, EGPRS supported, PCCCH present, Max-Retrans = 2, access burst type = 11 bits, BS_PAG_BLK_RES = 2, BS_PBCCH_BLK = 3, BS_PCC_CHANS = 1 and BS_PRACH_BLK = 1.

Mobile Station:

The MS is GPRS attached with a P-TMSI allocated, SPLIT PG CYCLE negotiated. The mobile station is in packet idle mode and has left the Transfer non-DRX mode period, i.e. the system simulator shall wait for a period equivalent to the value of the NON_DRX_TIMER parameter before sending the first paging message to the MS.

Specific PICS Statements

- Support of GPRS Operation Mode A (TSPC_operation_mode_A)
- Support of GPRS Operation Mode B (TSPC_operation_mode_B)
- Support of GPRS Operation Mode C (TSPC_operation_mode_C)
- Release of EGPRS Supported (TSPC_MS_EGPRS_RELEASE)
- Support of EGPRS Packet Access Enhancement (TSPC_EGPRS_ENHANC)

PIXIT Statements

-

Test Procedure

The MS is paged for initiation of a random access. The access attempt is rejected with a WAIT_INDICATION = 50 s. in PACKET ACCESS REJECT. The MS is then continuously paged for TBF establishment for 20s. The SS checks that there is no transmission from the MS on PRACH for 8 s. after having sent PACKET ACCESS REJECT. The MS is paged for an RR connection establishment. The MS of class A or B shall start random accesses for channel request with cause 'answer to paging'. The access attempt is rejected.

Maximum Duration of Test

5 minutes.

NOTE:

EGPRS PACKET CHANNEL REQUEST shall be used to respond to Paging and Packet Paging Request for TBF Establishment in the following cases

- a. If Release of EGPRS supported is Release 4 or above.
- b. If Support of EGPRS Packet Access enhancement is True for a R99 MS.

PACKET CHANNEL REQUEST shall be used to respond to Packet Paging Request for TBF Establishment if support of EGPRS Packet Access enhancement is False for a R99 MS.

Expected Sequence

Step	Direction	Message	Comments
1	SS -> MS	PACKET PAGING REQUEST	1 st Repeated Page info contains P-TMSI of the MS, 2 nd Repeated Page info contains IMSI not addressing the MS, for TBF establishment. Sent on PPCH.
2	MS -> SS	PACKET CHANNEL REQUEST/EGPRS PACKET CHANNEL REQUEST (see NOTE)	Received on PRACH.
3	SS -> MS	PACKET ACCESS REJECT	Containing WAIT_INDICATION = 50 s. and packet request reference = pertaining to the message received in step 2. Sent on PAGCH.
4	SS -> MS	PACKET PAGING REQUEST	1 st Repeated Page info contains P-TMSI of the MS, 2 nd Repeated Page info contains IMSI not addressing the MS, for TBF establishment. Sent on PPCH.
5	SS		Repeat step 4 for 20 s. and check that there is no transmission from the MS on PRACH for 25 s. after step 4.
6	SS -> MS	PACKET PAGING REQUEST	Step 6 is done not later than 50 secs after step 3. 1 st Repeated Page info contains TMSI of the MS, for RR connection establishment, Channel Needed = " TCH/F ", PAGE_MODE = " normal paging ", sent on PPCH.
8A 9A	MS -> SS		For MS class C of mode of operation
8B 9B	MS -> SS SS -> MS	CHANNEL REQUEST IMMEDIATE ASSIGNMENT REJECT	For GPRS MS class A and B of mode of operation, answer to paging, received on RACH. Request Reference = pertaining to message received in step 8B. Sent on AGCH.

Specific Message Contents

PACKET ACCESS REJECT message:

Information Element	value/ remark
MESSAGE_TYPE	100001
PAGE_MODE	Normal Paging
Reject	
-	10 (not TLLI, but packet request reference)
- Packet Request Reference	pertaining to what received in step 3.
-	1 (wait indication)
- WAIT_INDICATION	50
- WAIT_INDICATION_SIZE	0 (units of seconds)
-	0 (end of Reject struct)
spare padding	Spare Padding

51.2 RR procedures on CCCH related to temporary block flow establishment

This clause presents tests for "RR procedures on CCCH related to temporary block flow establishment" which are specified in 3GPP TS 04.18 subclause 3.5.

Default conditions

The SS default conditions simulate one cell with default settings as defined in the EGPRS general defaults section, except:

- SI 13 Rest Octets contains no PCCCH description (PCCCH is not supported by the network).

The MS default initial condition is GPRS/EGPRS attached. Unless otherwise stated, no PDP context is required.

Default message contents and signaling macros are also defined in the GPRS general defaults section, except for those messages and macros specified at the end of this clause.

51.2.1 Permission to access the network

51.2.1.1 Permission to access the network / priority classes

51.2.1.1.1 Conformance requirements

Access to the network is allowed:

- if packet access is allowed in the cell for the priority class associated with the packet transfer, as indicated by the PRIORITY_ACCESS_THR parameter broadcast in SI 13 message.

References

3GPP TS 04.18 subclause 3.5.2.1.1.

51.2.1.1.2 Test purpose

To verify that the MS accesses the network only if packet access is allowed in the cell for the priority class associated with the packet transfer.

51.2.1.1.3 Method of test

Initial conditions

System Simulator:

Network Mode of Operation is set to NMO II

Mobile Station:

For PRIORITY_ACCESS_THR >2 MS is GPRS attached, a PDP context has been established and the MS is in Packet Idle mode.

For PRIORITY_ACCESS_THR <=2 MS is Idle Updated

Specific PICS Statements

-

PIXIT Statements

-

Test procedure

For PRIORITY_ACCESS_THR >2 MS is triggered to transfer data. The SS verifies that the MS accesses the network as appropriate.

For PRIORITY_ACCESS_THR <=2 MS is triggered to perform an attach procedure. The SS verifies that the MS does not try to access the Network.

Specific test parameters:

- PRIORITY_ACCESS_THR is chosen from {0, 1, 2, 3, 4, 5, 6, 7}.
- priority level is chosen from { 1, 2, 3, 4 }

Expected sequence

For PRIORITY_ACCESS_THR >2

Step	Direction	Message	Comments
1			The MS is triggered to transfer data
2	SS		See verification

Verification:

The SS verifies for 10 s that MS access (or not) to the network according to the PRIORITY_ACCESS_THR values below.

- 0 1 1 packet access is allowed for priority level 1;
- 1 0 0 packet access is allowed for priority level 1 to 2;
- 1 0 1 packet access is allowed for priority level 1 to 3;
- 1 1 0 packet access is allowed for priority level 1 to 4;
- 1 1 1 spare, shall be interpreted as (packet access allowed).

For PRIORITY_ACCESS_THR <=2

Step	Direction	Message	Comments
1			The MS is triggered to do Attach procedure
2	SS		The SS verifies for 10 s that MS does not try to access to the network.

51.2.2 Initiation of the packet access procedure

51.2.2.1 Initiation of the packet access procedure / establishment causes

51.2.2.1.1 Conformance requirements

The CHANNEL REQUEST or EGPRS PACKET CHANNEL REQUEST messages are sent on RACH and contain the parameters:

- an establishment cause which indicates packet access, and as applicable, a request for one phase packet access or single block packet access for a CHANNEL REQUEST (clause 9.1.8), or a request for one phase access or two phase access or short access or sending of signalling data for an EGPRS PACKET CHANNEL REQUEST (see 3GPP TS 04.60);
- a random reference which is drawn randomly from an uniform probability distribution for every new transmission.

References

3GPP TS 04.18/44.018 subclause 3.5.2.1.2.

Justification

51.2.2.1.2 Test purpose

To verify that the CHANNEL REQUEST or EGPRS PACKET CHANNEL REQUEST message sent by the MS contains the correct establishment cause or Access Type when initiating a packet access procedure.

51.2.2.1.3 Method of test

Initial conditions

System Simulator:

1 cell, CCCH combined with SDCCH.

Mobile Station:

MS is GPRS attached.

Specific PICS Statements

-

PIXIT Statements

-

Test procedure

If the MS supports PDP context, the MS is triggered to initiate a PDP Context Activation procedure for RLC unacknowledged mode. The SS verifies that the MS attempts either a one phase packet access by sending a CHANNEL REQUEST or by sending an EGPRS PACKET CHANNEL REQUEST with Access Type 'signalling'.

The MS is triggered to transfer RLC data blocks. The SS verifies that the MS correctly sets the Access Type in the EGPRS PACKET CHANNEL REQUEST message.

Maximum duration of the test

5 minutes.

Expected sequence

Step	Direction	Message	Comments
1	MS		MS is triggered to initiate a PDP Context Activation 3.
2	MS -> SS	CHANNEL REQUEST or: EGPRS PACKET CHANNEL REQUEST	SS verifies that Establishment Cause is 'one phase' if the MS has sent a CHANNEL REQUEST. SS verifies that Access Type is 'signalling' if the MS has sent an EGPRS PACKET CHANNEL REQUEST.
3	SS <->MS	{Completion of PDP Context Activation Procedure}	Macro completion from step 2.
4	MS		MS is triggered to transfer data.
5	MS -> SS	EGPRS PACKET CHANNEL REQUEST	SS verifies that Access Type is 'two phase access'.
6	SS -> MS	IMMEDIATE ASSIGNMENT REJECT	

Specific Message Contents:

None.

51.2.2.2 Random references for two phase packet access

51.2.2.2.1 Conformance requirements

The CHANNEL REQUEST or EGPRS PACKET CHANNEL REQUEST messages are sent on RACH and contain the parameters:

- an establishment cause which indicates packet access, and as applicable, a request for one phase packet access or single block packet access for a CHANNEL REQUEST (clause 9.1.8), or a request for one phase access or two phase access or short access or sending of signalling data for an EGPRS PACKET CHANNEL REQUEST (see 3GPP TS 04.60);
- a random reference which is drawn randomly from a uniform probability distribution for every new transmission.

References

3GPP TS 04.18/44.018 subclause 3.5.2.1.2.

51.2.2.2.2 Test purpose

To verify that the MS produces different Random References when accessing the network for two phase access.

51.2.2.2.3 Method of test

Initial conditions

System Simulator:

1 cell, CCCH combined with SDCCH, Parameter MAX_RETRANS is set to 4 retransmissions.

Mobile Station:

MS is GPRS attached, a PDP context in RLC unacknowledged mode has been established and the MS is in Packet Idle mode.

Specific PICS Statements

-

PIXIT Statements

-

Test procedure

The MS is triggered to transfer data, it shall attempt a Two Phase packet access (3GPP TS 04.18 / 3.5.2.1.2). The SS does not answer to the access bursts but stores N (= 80) Random References and verifies that the MS uses all possible values (0 ... 7) in its Random Reference.

Justification

The length of the Random Reference is 3 bits two phase packet access (3GPP TS 04.18 / table 9.9). This test verifies that the MS uses all values (0 ... 7) in its Random Reference.

The probability that in a sequence of N samples one of the possible value does not appear is $8 \cdot (7/8)^{N-1}$ for large N.

Note

The number of samples N has been computed such that the probability of refusing a correct MS is less than 0,02 %.

Maximum duration of the test

5 minutes.

Expected sequence

Step	Direction	Message	Comments
1	MS		MS is triggered to transfer data. (Two phase Packet Access)
2	MS -> SS	EGPRS PACKET CHANNEL REQUEST	SS stores the value of Request References
3	MS -> SS	EGPRS PACKET CHANNEL REQUEST	SS stores the value of Request References
4	MS -> SS	EGPRS PACKET CHANNEL REQUEST	SS stores the value of Request References
5	MS -> SS	EGPRS PACKET CHANNEL REQUEST	SS stores the value of Request References
6	MS -> SS	EGPRS PACKET CHANNEL REQUEST	SS stores the value of Request References
7	SS		SS waits 5.5 seconds (Maximum value of T3146 is 5 seconds) Note: Test Case executes Step 8A or 8B depending on MS behaviour. If any EGPRS PACKET CHANNEL REQUEST received during the wait time, SS continue with Step 8A else SS continue with Step 8B
8A (Conditional)	MS -> SS	EGPRS PACKET CHANNEL REQUEST	SS stores the value of Request References and repeats the Steps 3 to 7.
8B (Conditional)	SS		Repeat Steps 1 to 7
-9	MS<->SS		Steps 1 to 8 are repeated until 80 EGPRS PACKET CHANNEL REQUEST messages have been received.
-10	SS		SS verifies that all Request Reference values (0 to 7) come out in the stored samples.

51.2.2.3 Random references for one phase packet access and for Access Type 'signalling'

51.2.2.3.1 Conformance requirements

The CHANNEL REQUEST or EGPRS PACKET CHANNEL REQUEST messages are sent on RACH and contain the parameters:

- an establishment cause which indicates packet access, and as applicable, a request for one phase packet access or single block packet access for a CHANNEL REQUEST (clause 9.1.8), or a request for one phase access or two phase access or short access or sending of signalling data for an EGPRS PACKET CHANNEL REQUEST (see 3GPP TS 04.60);
- a random reference which is drawn randomly from a uniform probability distribution for every new transmission.

References

3GPP TS 04.18/44.018 subclause 3.5.2.1.2.

51.2.2.3.2 Test purpose

To verify that the MS produces different Random References when accessing the network for one phase access or with Access Type 'signalling'.

51.2.2.3.3 Method of test

Initial conditions

System Simulator: default settings except:

Parameter MAX_RETRANS is set to 4 retransmissions.

T3302 = 1 minute

Mobile Station:

Note: MS may be brought into the required condition by causing it to be triggered to perform GPRS attach and the SS responding with ATTACH REJECT in which T3302 is set to 1 minute and the cause set to "MSC temporarily not reachable". MS treats this as a temporary failure and enters the test sequence by restarting the attach procedure.

Specific PICS Statements

-

PIXIT Statements

-

Test procedure

The MS shall attempt either a one phase packet access using Channel Request or Access Type signalling using Egprs Packet Channel Request. The SS does not answer to the access bursts but stores N (N=80 in case of Channel Request and N=380 in case of Egprs Packet Channel Request) Random References and verifies that the MS uses all possible values in its Random Reference.

Possible values in case of Channel Request are 0...3 and not using value '111' as a value of the 3 least significant bits for channel request octet (see 3GPP TS 04.18/Table 9.1.8.1)

Possible values in case of Egprs Packet Channel Request are 0...31 (see 3GPP TS 04.60 / 11.2.5a and 3GPP TS 04.18/Table 9.1.8.1).

Justification

In case of Channel Request:

Possible values for Random Reference for one phase packet access are 0 to 3 (value '111' is not allowed). This test verifies that the MS uses all values (0 ... 3) in its Random Reference.

In case of Egprs Packet Channel Request

Possible values for Random Reference for signalling are 0 to 31. This test verifies that the MS uses all values (0 ... 31) in its Random Reference.

Maximum duration of the test

45 minutes .

Expected sequence

Step	Direction	Message	Comments
1	MS -> SS	CHANNEL REQUEST or: EGPRS PACKET CHANNEL REQUEST	MS re-starts the Attach Procedure. SS stores the value of Request References
2	MS -> SS	CHANNEL REQUEST or: EGPRS PACKET CHANNEL REQUEST	SS stores the value of Request References
3	MS -> SS	CHANNEL REQUEST or: EGPRS PACKET CHANNEL REQUEST	SS stores the value of Request References
4	MS -> SS	CHANNEL REQUEST or: EGPRS PACKET CHANNEL REQUEST	SS stores the value of Request References
5	MS -> SS	CHANNEL REQUEST or: EGPRS PACKET CHANNEL REQUEST	SS stores the value of Request References
6	MS<->SS	{Location Update Procedure}	Step 6 is optional and depends on the mobile implementation.
7			Macro for Location Updating. Steps 1 to 6 are repeated N/5 times Note: N=80 in case Channel Request is used by MS N=380 in case Egprs Packet Channel Request is used by MS.
8	SS		In case of Channel Requests: SS verifies that all Random Reference values (Random Reference field is filled with "x") in the range 0 to 3 come out in the stored samples and that value '111' is not used as a value of the 3 least significant bits for channel request octet. In case of Egprs Packet Channel Requests: SS verifies that all Random Reference values in the range 0 to 31 come out in the stored samples.

The Channel Request message is coded as follows (reference 3GPP TS 04.08 / 3GPP TS 44.018 table 9.9):

011110xx One phase packet access with request for single timeslot uplink.
01111x0x transmission; one PDCH is needed.
01111xx0 [TBD]

51.2.2.4 Initiation of the packet access procedure / timer T3146

51.2.2.4.1 Conformance requirements

Having sent the maximum number of EGPRS PACKET CHANNEL REQUEST messages, the mobile station starts timer T3146. At expiry of timer T3146, the packet access procedure is aborted and a packet access failure is indicated to upper layers.

Reference

3GPP TS 04.18 subclause 3.5.2.1.2.

51.2.2.4.2 Test purpose

To verify that the MS waits T3146 seconds before aborting the packet access procedure.

51.2.2.4.3 Method of test

Initial conditions

System Simulator: Default settings except:

System Information parameter MAX_RETRANS is set to 2 retransmissions.

CCCH non-combined with SDCCH.

System Information parameter TX_INTEGER in RACH Control Parameters is set to 3.

Mobile Station:

MS is GPRS attached, PDP Context 31 is activated and the MS is in packet idle mode.

Specific PICS Statements

-

PIXIT Statements

-

Test procedure

The MS is triggered to initiate uplink data transfer. The SS waits until the MS sends all M+1 EGPRS PACKET CHANNEL REQUEST messages, and then sends an IMMEDIATE ASSIGNMENT before minimum value of T3146 seconds elapse. In this case the MS shall correctly send the LLC PDU on the assigned PDCH.

The MS is triggered again to initiate uplink data transfer, the SS waits until the MS sends all M+1 EGPRS PACKET CHANNEL REQUEST messages, where M is the parameter Max Retrans broadcast on BCCH. The SS waits until the maximum value of T3146 seconds elapse and sends an IMMEDIATE ASSIGNMENT which shall be ignored by the MS since the access procedure should be aborted.

Note:

Timer T3146 (3GPP TS 04.18 clause 11) depends on parameter TX_INTEGER broadcast on BCCH.

The minimum value of the timer is $2*S+TX_INTEGER$ slots, where S is given in 3GPP TS 04.08 / 3GPP TS 44.018, Table 3.1.

The maximum value of this timer is 5 seconds. (Subclause 11.1.1 in 04.08)

Maximum duration of the test

5 minutes.

Expected sequence

Step	Direction	Message	Comments
1	MS -> SS	EGPRS PACKET CHANNEL REQUEST	The MS is triggered to initiate uplink data transfer..
2	MS -> SS	EGPRS PACKET CHANNEL REQUEST	One or Two Phase Access Request.
3	MS -> SS	EGPRS PACKET CHANNEL REQUEST	One or Two Phase Access Request.
4	SS		SS waits T3146 - 0.1*T3146 (using minimum value of T3146, which is 2*S + TX_INTEGER slots)
5	SS -> MS	IMMEDIATE ASSIGNMENT	Multi block assignment using Multiblock Allocation Struct, to order the MS to follow the two-phase access procedure. Sent on AGCH.
6	MS -> SS	PACKET RESOURCE REQUEST	Received on the single block assigned in step 5.
7	SS -> MS	PACKET UPLINK ASSIGNMENT	Uplink dynamic allocation. Sent on PACCH.
8	SS <->MS	Completion of macro {Uplink data transfer }	SS allows MS to complete the uplink data transfer.
9	MS -> SS	EGPRS PACKET CHANNEL REQUEST	The MS is triggered a second time to initiate uplink data transfer.
10	MS -> SS	EGPRS PACKET CHANNEL REQUEST	One or Two Phase Access Request
11	MS -> SS	EGPRS PACKET CHANNEL REQUEST	One or Two Phase Access Request
12	SS		SS waits 5.5 seconds (Maximum value of T3146 is 5 seconds)
13	SS -> MS	IMMEDIATE ASSIGNMENT	Multi block assignment using Multiblock Allocation Struct, to order the MS to follow the two-phase access procedure. Sent on AGCH.
14	SS		MS shall ignore the message, SS verifies that MS does not send PACKET RESOURCE REQUEST.
15	MS		Note: Depending upon the MS implementation the upper layers may have reinitiated the access procedure during the wait time at step 12. So SS shall ignore any EGPRS PACKET CHANNEL REQUEST received. Switch Off

The complete test is repeated for:

- TX_INTEGER set to 20 (MS shall set timer T3146 to 1.1s); and for
- TX_INTEGER set to 32 (MS shall set timer T3146 to 2.1s).

51.2.2.5 Initiation of the packet access procedure / Request Reference

51.2.2.5.1 Conformance requirements

On receipt of an IMMEDIATE ASSIGNMENT message corresponding to one of its 3 last EGPRS PACKET CHANNEL REQUEST messages, the mobile stops sending EGPRS PACKET CHANNEL REQUEST messages and switches to the assigned PDCH.

Reference

3GPP TS 04.18 subclause 3.5.2.1.3.1.

51.2.2.5.2 Test purpose

1. To verify that the MS continues sending EGPRS PACKET CHANNEL REQUEST messages when receiving an IMMEDIATE ASSIGNMENT containing an incorrect Request Reference.
2. To verify that the MS stops sending EGPRS PACKET CHANNEL REQUEST messages and switches to the assigned PDCH when receiving an IMMEDIATE ASSIGNMENT containing a Request Reference IE corresponding to one of its last 3 EGPRS PACKET CHANNEL REQUEST messages.

51.2.2.5.3 Method of test

Initial conditions

System Simulator:

1 cell, CCCH combined with SDCCH, Parameter MAX_RETRANS is set to 7 retransmissions.

Mobile Station:

MS is GPRS attached, PDP Context 31 is activated and the MS is in packet idle mode.

Specific PICS Statements

-

PIXIT Statements

-

Test procedure

The MS is triggered to initiate uplink data transfer. After 3 EGPRS PACKET CHANNEL REQUEST messages, the SS sends an IMMEDIATE ASSIGNMENT including an incorrect Request Reference. The SS verifies that the MS continues sending EGPRS PACKET CHANNEL REQUEST messages.

After the 5th EGPRS PACKET CHANNEL REQUEST message the SS sends an IMMEDIATE ASSIGNMENT including a correct Request Reference. The SS verifies that the MS stops sending EGPRS PACKET CHANNEL REQUEST messages, switches to the assigned PDCH and completes the uplink data transfer.

Maximum duration of the test

5 minutes.

Expected sequence

Step	Direction	Message	Comments
0	MS		The MS is triggered to transfer 200 octets of data.
1	MS -> SS	EGPRS PACKET CHANNEL REQUEST	One or Two Phase Access Request.
2	MS -> SS	EGPRS PACKET CHANNEL REQUEST	One or Two Phase Access Request.
3	MS -> SS	EGPRS PACKET CHANNEL REQUEST	One or Two Phase Access Request.
4	SS -> MS	IMMEDIATE ASSIGNMENT	Multi block assignment using Multiblock Allocation Struct, to order the MS to follow the two-phase access procedure. Sent on AGCH and including a Request Reference different from those included in previous EGPRS PACKET CHANNEL REQUEST messages.
5	MS -> SS	EGPRS PACKET CHANNEL REQUEST	MS continues sending EGPRS PACKET CHANNEL REQUEST messages. One or Two Phase Access Request.
6	MS -> SS	EGPRS PACKET CHANNEL REQUEST	One or Two Phase Access Request.
7	SS -> MS	IMMEDIATE ASSIGNMENT	Multi block assignment using Multiblock Allocation Struct, to order the MS to follow the two-phase access procedure. Sent on AGCH. With Request Reference corresponding to step 3. MS shall stop sending further access bursts.
8	MS -> SS	PACKET RESOURCE REQUEST	Received on the single block assigned in step 7.
9	SS -> MS	PACKET UPLINK ASSIGNMENT	Uplink dynamic allocation. Sent on PACCH.
10	MS<->SS	Completion of macro {Uplink data transfer}	SS allows MS to complete the uplink data transfer.

Specific Message Contents:

None.

51.2.2.6 Two phase packet access / establishment cause

51.2.2.6.1 Conformance requirement

if the SI 13 indicates that the cell is EGPRS capable and EGPRS PACKET CHANNEL REQUEST on RACH is not supported in the cell, the EGPRS mobile station shall use the 8 bit CHANNEL REQUEST message and shall initiate a two phase access request.

Reference

3GPP TS 04.18 3.5.2.1.3.4.

51.2.2.6.2 Test purpose

To verify that the mobile station sends CHANNEL REQUEST using two-phase packet access.

51.2.2.6.3 Method of test

Initial conditions

System Simulator: Default settings except:

SI13 indicating that EGPRS_PACKET_CHANNEL_REQUEST is not supported in the cell

Mobile Station:

MS is GPRS attached, a PDP context has been established and the MS is in Packet Idle mode.

Specific PICS Statements

-

PIXIT Statements

-

Test procedure

The MS is triggered to initiate acknowledged uplink data transfer. The SS shall verify that CHANNEL REQUEST indicates two-phase access.

Maximum duration of the test

2 minutes.

Expected sequence

Step	Direction	Message	Comments
1	MS		The MS is triggered to initiate the transfer of 200 user data octets.
2	MS -> SS	CHANNEL REQUEST	Two Phase Access Request. Received on RACH.
3	SS -> MS	IMMEDIATE ASSIGNMENT	Single block allocation struct. Sent on AGCH.
4	MS -> SS	PACKET RESOURCE REQUEST	Received on the single block assigned in step 3.
5	SS -> MS	PACKET UPLINK ASSIGNMENT	Dynamic allocation struct MCS1. Sent on the PACCH of the assigned PDCH.
6		{Uplink data transfer, dynamic allocation}	Macro. Completion from step 4 in the TBF procedure.

Specific message contents

None.

51.2.3 Packet immediate assignment / One phase packet access

51.2.3.1 Two-message assignment / Successful case

51.2.3.1.1 Conformance requirements

If the mobile station receives an IMMEDIATE ASSIGNMENT message and the Dedicated mode or TBF information element indicates that this is the first message in a two-message assignment, the mobile station shall continue to listen to the full CCCH. The network may send a second IMMEDIATE ASSIGNMENT message within two multiframe periods following the first IMMEDIATE ASSIGNMENT, specifying the packet channel description and, if required, a mobile allocation for the assignment.

On receipt of an IMMEDIATE ASSIGNMENT message or, in case of a two-message assignment, a matching pair of IMMEDIATE ASSIGNMENT messages corresponding to one of its 3 last EGPRS PACKET CHANNEL REQUEST messages, the mobile station stops T3146 (if running), stops sending EGPRS PACKET CHANNEL REQUEST messages, and switches to the assigned PDCH.

Reference

3GPP TS 04.18 subclause 3.5.2.1.3.1.

51.2.3.1.2 Test purpose

To verify that the MS correctly decodes a two-message assignment and switches to the assigned PDCH.

51.2.3.1.3 Method of test

Initial conditions

System Simulator:

1 cell, CCCH combined with SDCCH.

Mobile Station:

MS is GPRS attached, PDP Context 31 is activated and the MS is in packet idle mode.

Specific PICS Statements

-

PIXIT Statements

-

Test procedure

The MS is triggered to initiate uplink data transfer. After reception of EGPRS PACKET CHANNEL REQUEST the SS sends a two-message IMMEDIATE ASSIGNMENT which actually describe a default IMMEDIATE ASSIGNMENT message, except that it is split in two parts: basically, the first part contains the IA Rest Octets, and the second part the Packet Channel Description IE.

The SS verifies that the MS correctly switches to the assigned PDCH and completes the uplink data transfer.

Maximum duration of the test

5 minutes.

Expected sequence

Step	Direction	Message	Comments
1	MS		The MS is triggered to transfer 200 octets of data.
2 2A	MS -> SS	EGPRS PACKET CHANNEL REQUEST	If the MS requests two phase access the Test Case is terminated first message of two-message assignment second message (see specific message contents), sent within two multiframe after step 3. SS allows MS to complete the uplink data transfer.
3	SS -> MS	IMMEDIATE ASSIGNMENT	
4	SS -> MS	IMMEDIATE ASSIGNMENT	
5	MS<->SS	Completion of macro {Uplink data transfer}	

Specific message contents:

IMMEDIATE ASSIGNMENT (first message)

Information Element	Value
as default except:	
Dedicated mode or TBF:	
- TMA	1 (is first message of a two-message assignment)
- Downlink	0
- T/D	1 (assign a TBF)
Packet Channel Description:	all bits are set to '0'
Request Reference:	as default
Timing Advance:	as default
Starting Time:	not present
IA Rest Octets:	as default

IMMEDIATE ASSIGNMENT (second message)

Information Element	Value
as default except:	
Dedicated mode or TBF:	
- TMA	0
- Downlink	0
- T/D	1 (assign a TBF)
Packet Channel Description:	as default
Request Reference:	as default
Timing Advance:	as default
Starting Time:	not present
IA Rest Octets:	Second Part Assignment.

51.2.3.2 Two-message assignment / Failure cases

51.2.3.2.1 Conformance requirements

If the indirect encoding is used, the IMMEDIATE ASSIGNMENT message may contain a CHANGE_MARK_1 field. If that is present, the mobile station shall verify the validity of the SI13_CHANGE_MARK associated with the GPRS mobile allocation to which the message refers, see 3GPP TS 04.60. If the CHANGE_MARK_1 field and the SI13_CHANGE_MARK do not match, the message does not satisfactorily define a PDCH.

The two IMMEDIATE ASSIGNMENT messages in a two-message assignment shall have the same contents of the Request Reference information elements.

If the mobile station does not receive the second IMMEDIATE ASSIGNMENT messages in a two-message assignment within two multiframe periods following the first message, the mobile station shall discard the first IMMEDIATE ASSIGNMENT message received.

If the information available in the mobile station, after the reception of an IMMEDIATE ASSIGNMENT message or the second IMMEDIATE ASSIGNMENT message of a two-message assignment, does not satisfactorily define a PDCH, a TBF establishment failure has occurred.

Reference

3GPP TS 04.18 subclauses 3.5.2.1.3.1 and 3.5.2.1.5.

51.2.3.2.2 Test purpose

To verify that the MS does not respond to a two-message assignment if:

- CHANGE_MARK_1 does not match SI13 CHANGE_MARK.
- the second IMMEDIATE ASSIGNMENT message is not received within two multiframes after the first - message.
- Request References in both messages do not have same contents.

51.2.3.2.3 Method of test

Initial conditions

System Simulator:

1 cell, CCCH combined with SDCCH, CHANGE_MARK in SI13 is set to 1, TX-INTEGGER = 7.

MAX_RETRANS = 7.

Mobile Station:

MS is GPRS attached, PDP Context 31 is activated and the MS is in packet idle mode.

Specific PICS Statements

-

PIXIT Statements

-

Test procedure

The MS is triggered to initiate uplink data transfer. After reception of EGPRS PACKET CHANNEL REQUEST the SS sends a two-message IMMEDIATE assignment:

- **first attempt:** CHANGE_MARK_1 does not match SI13 CHANGE_MARK, leading to TBF establishment failure. (see 3GPP TS 04.18 subclause 3.5.2.1.5).
- **second attempt:** the second IMMEDIATE ASSIGNMENT message is not received within two multiframes after the first message. The MS shall discard the assignment and continue with packet access.
- **third attempt:** Request References in both messages do not have same contents. MS shall re-initiate packet access.
- **fourth attempt:** the second IMMEDIATE ASSIGNMENT message is received in the last access grant block before the second multiframes after the first message. In this case the MS shall successfully switch to the assigned PDCH and complete the uplink data transfer.

Maximum duration of the test

5 minutes.

Expected sequence

Step	Direction	Message	Comments
1	MS		The MS is triggered to initiate uplink data transfer.
2	MS -> SS	EGPRS PACKET CHANNEL REQUEST	
2A			If the MS requests two phase access the Test Case is terminated
3	SS -> MS	IMMEDIATE ASSIGNMENT	first message of two-message assignment with contents as specified below (see specific message contents).
4	SS -> MS	IMMEDIATE ASSIGNMENT	second message (see specific message contents) except: Packet Channel Description IE describes a hopping channel including CHANGE_MARK_1 different from SI13 CHANGE_MARK. Step 4a is an optional test step and is depending on the MS implementation. If the SS doesn't receive EGPRS PACKET CHANNEL REQUEST message within 5 sec step 4a applies.
4a (optional test step)			The MS is triggered to initiate uplink data transfer.
5	MS -> SS	EGPRS PACKET CHANNEL REQUEST	MS shall initiate packet access
5A			If the MS requests two phase access the Test Case is terminated
6	SS -> MS	IMMEDIATE ASSIGNMENT	first message of two-message assignment (see specific message contents)
7	SS -> MS	IMMEDIATE ASSIGNMENT	second message (see specific message contents) sent after two multiframe after the first message.
8	MS -> SS	EGPRS PACKET CHANNEL REQUEST	The MS shall discard the assignment and continue with packet access.
8A			If the MS requests two phase access the Test Case is terminated
9	SS -> MS	IMMEDIATE ASSIGNMENT	first message of two-message assignment (see specific message contents) including a Request Reference corresponding to step 8.
10	SS -> MS	IMMEDIATE ASSIGNMENT	second message (see specific message contents) except: Request Reference is different from that in step 8.
11	MS -> SS	EGPRS PACKET CHANNEL REQUEST	MS shall re-initiate packet access
11A			If the MS requests two phase access the Test Case is terminated
12	SS -> MS	IMMEDIATE ASSIGNMENT	first message of two-message assignment (see specific message contents)
13	SS -> MS	IMMEDIATE ASSIGNMENT	second message (see specific message contents) sent in the last access grant block before the second multiframe after the first message elapses.
14	MS<->SS	Completion of macro { Uplink data transfer}	SS allows MS to complete the uplink data transfer.

Specific message contents:

IMMEDIATE ASSIGNMENT (first message)

Information Element	Value
as default except:	
Dedicated mode or TBF:	
- TMA	1 (is first message of a two-message assignment)
- Downlink	0
- T/D	1 (assign a TBF)
Packet Channel Description:	all bits are set to '0'
Request Reference:	as default
Timing Advance:	as default
Starting Time:	not present
IA Rest Octets:	as default

IMMEDIATE ASSIGNMENT (second message)

Information Element	Value
as default except:	
Dedicated mode or TBF:	
- TMA	0
- Downlink	0
- T/D	1 (assign a TBF)
Packet Channel Description:	as default
Request Reference:	as default (0111 1111)
Timing Advance:	as default
Starting Time:	not present
IA Rest Octets:	HH { 1 < Second Part Packet Assignment > }
< Second Part Packet Assignment > ::=	
{ H { 1 Extended RA > }	
	Last five bits of the EGPRS Packet Channel Request received.

51.2.3.3 Packet uplink assignment / Polling bit set

51.2.3.3.1 Conformance requirement

If the Polling bit is set to 1, MS shall send a PACKET CONTROL ACKNOWLEDGEMENT message (see 04.60) on the assigned PDCH, in the uplink block specified by the TBF Starting Time. In this case the TBF Starting Time is used both to indicate when the assigned PDCH becomes valid and to specify the uplink block.

Reference

3GPP TS 04.18 subclause 3.5.2.1.3.2.

51.2.3.3.2 Test purpose

To verify that the MS sends a PACKET CONTROL ACKNOWLEDGEMENT message in the correct uplink block if the Polling bit is set in packet uplink assignment construction.

51.2.3.3.3 Method of test

Initial conditions

System Simulator:

1 cell, CCCH combined with SDCCH.

Mobile Station:

MS is GPRS attached, PDP Context 31 is activated and the MS is in packet idle mode.

Specific PICS Statements

-

PIXIT Statements

-

Test procedure

The MS is triggered to initiate uplink data transfer. The SS assigns packet uplink resources in an IMMEDIATE ASSIGNMENT message indicating one phase packet access and with the Polling bit set. The MS shall send a PACKET CONTROL ACKNOWLEDGMENT on the assigned uplink block and then complete the uplink data transfer.

Maximum duration of the test

5 minutes.

Expected sequence

Step	Direction	Message	Comments
1	MS		MS is triggered to initiate uplink data transfer.
2	MS -> SS	EGPRS PACKET CHANNEL REQUEST	
2A			If the MS requests two phase access the Test Case is terminated for uplink TBF, one phase access and Polling bit set, and arbitrarily chosen TBF starting time in the future. sent on the block indicated by TBF starting time in step 3. SS allows MS to complete the uplink data transfer.
3	SS -> MS	IMMEDIATE ASSIGNMENT	
4	MS -> SS	PACKET CONTROL ACKNOWLEDGEMENT	
5	SS<->MS	Completion of macro {Uplink data transfer}	

Specific Message Contents:

IMMEDIATE ASSIGNMENT, Step 3:

Information Element	value/ remark
EGPRS Window Size	192 Max Window size for 1 TS

51.2.3.4 One phase packet access / Contention resolution / Successful case

51.2.3.4.1 Conformance requirements

After receiving an IMMEDIATE ASSIGNMENT message in which one phase packet access for an uplink transfer is granted, the mobile station shall start timer T3164 and proceed with the contention resolution at one phase access defined in 3GPP TS 04.60.

Reference

3GPP TS 04.18 subclause 3.5.2.1.3.2.

3GPP TS 04.60 subclause 7.1.2.3.

51.2.3.4.2 Test purpose

To verify that the MS includes the correct TLLI (Temporary Logical Link Identifier) in the first RLC data blocks until contention resolution is completed.

51.2.3.4.3 Method of test

Initial conditions

System Simulator:

1cell, CCCH combined with SDCCH.

Mobile Station:

MS is GPRS attached, PDP context 31 has been established and the MS is in Packet Idle mode.

Specific PICS Statements

-

PIXIT Statements

-

Test procedure

The MS is triggered to transfer data. The SS assigns packet uplink resources in an IMMEDIATE ASSIGNMENT message indicating one phase packet access. The MS shall start transferring RLC data blocks including the correct TLLI in the RLC data blocks which are sent preceding the reception of PACKET UPLINK ACK/NACK.

Maximum duration of the test

5 minutes.

Expected sequence

Step	Direction	Message	Comments
0	MS		The MS is triggered to transfer 200 octets of data.
1	MS -> SS	EGPRS PACKET CHANNEL REQUEST	
1A			If the MS requests two phase access the Test Case is terminated
2	SS -> MS	IMMEDIATE ASSIGNMENT	For uplink TBF, one phase access
3	MS -> SS	3 RLC data blocks	SS verifies correct TLLI in RLC headers.
4	SS -> MS	PACKET UPLINK ACK/NACK	Including correct TLLI
5	MS<->SS	Completion of macro {Uplink data transfer}	SS allows MS to complete data transfer.

Specific Message Contents:

IMMEDIATE ASSIGNMENT, Step 2:

Information Element	value/ remark
EGPRS Window Size	192 Max Window size for 1 TS

51.2.3.5 One phase packet access / Contention resolution / TLLI mismatch

51.2.3.5.1 Conformance requirement

If the TLLI in the PACKET UPLINK ACK/NACK message differs from that sent by the MS in the RLC block headers, the MS shall immediately stop transmitting on this TBF and re-initiate the packet access procedure unless it has already been repeated 4 times.

Reference

3GPP TS 04.18 subclause 3.5.2.1.3.2.

3GPP TS 04.60 subclause 7.1.2.3.

51.2.3.5.2 Test purpose

To verify that the MS immediately stops transmitting if it receives a PACKET UPLINK ACK/NACK with incorrect TLLI.

51.2.3.5.3 Method of test

Initial conditions

System Simulator:

1cell, CCCH combined with SDCCH.

Mobile Station:

MS is GPRS attached, PDP context 31 has been established and the MS is in Packet Idle mode.

Specific PICS Statements

-

PIXIT Statements

-

Test procedure

The MS is triggered to transfer data. The SS assigns packet uplink resources in an IMMEDIATE ASSIGNMENT message indicating one phase packet access. The MS shall start transferring RLC data blocks including the correct TLLI in the first three blocks. The SS acknowledges the RLC block transfer with a PACKET UPLINK ACK/NACK including an incorrect TLLI. The SS shall verify that the MS 'immediately' stops transmitting (see note below) and retries packet access procedure.

NOTE: The MS is allowed to transmit n RLC blocks after the block containing the PACKET UPLINK ACK/NACK message (the exact value of n is specified in 3GPP TS 05.10 subclause 6.11).

Maximum duration of the test

5 minutes.

Expected sequence

Step	Direction	Message	Comments
0	MS		The MS is triggered to transfer 200 octets of data.
1	MS -> SS	EGPRS PACKET CHANNEL REQUEST	
1A			If the MS requests two phase access the Test Case is terminated
2	SS -> MS	IMMEDIATE ASSIGNMENT	For uplink TBF, one phase packet access granted, dynamic allocation.
3	MS -> SS	3 RLC data blocks	SS verifies correct TLLI in RLC headers.
4	SS -> MS	PACKET UPLINK ACK/NACK	Including incorrect TLLI
5	SS		The SS verifies that the MS transmits at most further n (=6) data blocks after step 4 (see Note) before re-initiating packet access.
6	MS -> SS	EGPRS PACKET CHANNEL REQUEST	MS re-initiates packet access procedure.
6A			If the MS requests two phase access the Test Case is terminated
7	SS -> MS	IMMEDIATE ASSIGNMENT	For uplink TBF, one phase packet access granted, dynamic allocation.
8	MS<->SS	Completion of macro {Uplink data transfer}	SS allows MS to complete uplink data transfer.

Specific Message Contents:

IMMEDIATE ASSIGNMENT, Steps 2 and 7:

Information Element	value/ remark
EGPRS Window Size	192 Max Window size for 1 TS

51.2.3.6 One phase packet access / Contention resolution / Counter N3104

51.2.3.6.1 Conformance requirement

The contention resolution has failed on the mobile station when the counter N3104 has reached its maximum value.

Reference

3GPP TS 04.60 subclause 7.1.2.3.

51.2.3.6.2 Test purpose

To verify that the MS correctly sets and considers counter N3104.

NOTE: Counter N3104 is incremented by 1 with each new RLC/MAC block the mobile station sends until the first PACKET UPLINK ACK/NACK message is received.

Its maximum value is $N3104_MAX = 3 * (BS_CV_MAX + 3) * \text{no-of-timeslots-assigned}$, where BS_CV_MAX is broadcast in SI 13 Rest Octets.

51.2.3.6.3 Method of test

Initial conditions

System Simulator: Default settings except:

1 cell, CCCH combined with SDCCH, BS_CV_MAX value in System Information Type 13 arbitrarily chosen in the range 3 to 10.

Mobile Station:

MS is GPRS attached, PDP context 31 has been established and the MS is in Packet Idle mode.

Specific PICS Statements

-

PIXIT Statements

-

Test procedure

The MS is triggered to transfer 1000 octets of data. The SS assigns packet uplink resources in an IMMEDIATE ASSIGNMENT message indicating one phase packet access. SS assigns radio resource to the MS. The MS shall start transferring RLC data blocks. The SS verifies that the MS sends N3104_MAX data blocks. The SS verifies that the MS stops transmitting after sending N3104_MAX radio blocks and restarts packet access procedure.

At the second attempt, the SS sends PACKET UPLINK ACK/NACK exactly after N3104_MAX - 1 data blocks. The SS verifies that this time the MS does not abort the access procedure and successfully completes uplink transfer.

Maximum duration of the test

5 minutes.

Expected sequence

Step	Direction	Message	Comments
1	MS -> SS	EGPRS PACKET CHANNEL REQUEST	MS is triggered to transfer 1000 data octets.
1A			If the MS requests two phase access the Test Case is terminated
2	SS -> MS	IMMEDIATE ASSIGNMENT	for uplink TBF, indicating one phase packet access With MS USF
3	SS -> MS	PACKET DOWNLINK DUMMY CONTROL BLOCK	
4	MS -> SS	RLC data block	
5			Step 3 and 4 are repeated until N3104_MAX data blocks are received.
6	MS -> SS	EGPRS PACKET CHANNEL REQUEST	SS verifies that MS does not send further RLC data blocks and that MS re-initiates packet access procedure.
6A			If the MS requests two phase access the Test Case is terminated
7	SS -> MS	IMMEDIATE ASSIGNMENT	For uplink TBF, indicating one phase packet access granted. With MS USF
8	SS -> MS	PACKET DOWNLINK DUMMY CONTROL BLOCK	
9	MS -> SS	RLC data block	
			Step 8 and 9 are repeated until N3104_MAX – 1 data blocks are received.
10	SS -> MS	PACKET UPLINK ACK/NACK	SS allows MS to complete uplink data transfer.
11	MS->SS	Completion of macro {Uplink data transfer}	

Specific Message Contents:

IMMEDIATE ASSIGNMENT, Steps 2 and 8:

Information Element	value/ remark
EGPRS Window Size	192 Max Window size for 1 TS

51.2.3.7 One phase packet access / Contention resolution / Timer T3166

51.2.3.7.1 Conformance requirement

The contention resolution has failed on the mobile station when the counter N3104 has reached its maximum value, or on expiry of timer T3166.

Reference

3GPP TS 04.60 subclause 7.1.2.3.

51.2.3.7.2 Test purpose

To verify that the MS correctly considers timer T3166.

51.2.3.7.3 Method of test

Initial conditions

System Simulator:

1 cell, CCCH combined with SDCCH, BS_CV_MAX value in System Information Type 13 is set to 15.

Mobile Station:

MS is GPRS attached, PDP context 31 has been established and the MS is in Packet Idle mode.

Specific PICS Statements

-

PIXIT Statements

-

Test procedure

The MS is triggered to transfer 1 000 octets of data. The SS assigns packet uplink resources in an IMMEDIATE ASSIGNMENT message indicating one phase packet access and dynamic allocation. The MS shall start transferring RLC data blocks. The SS reduces the block transfer rate by controlling the USF flag. In this way, the SS forces T3166 (with value 5 s.) to expire before counter N3104 reaches N3104_MAX (with value 45 blocks for current settings). The SS verifies that the MS stops transmitting and restarts packet access procedure.

At the second attempt, the SS sends PACKET UPLINK ACK/NACK before T3166 seconds. The SS verifies that this time the MS does not abort the access procedure and successfully completes the data transfer.

Maximum duration of the test

5 minutes.

Expected sequence

Step	Direction	Message	Comments
1	MS -> SS	EGPRS PACKET CHANNEL REQUEST	MS is triggered to transfer 1000 data octets.
1A			If the MS requests two phase access the Test Case is terminated
2	SS -> MS	IMMEDIATE ASSIGNMENT	Indicating one phase packet access granted, dynamic allocation. MCS1 shall be used.
3	SS -> MS	PACKET DOWNLINK DUMMY CONTROL BLOCK	USF addressing the MS
4	MS -> SS	RLC data block	
5	SS -> MS	PACKET DOWNLINK DUMMY CONTROL BLOCK	USF not addressing the MS
6	SS -> MS	PACKET DOWNLINK DUMMY CONTROL BLOCK	USF not addressing the MS
7	SS -> MS	PACKET DOWNLINK DUMMY CONTROL BLOCK	USF not addressing the MS
8	SS -> MS	PACKET DOWNLINK DUMMY CONTROL BLOCK	USF not addressing the MS
9	SS -> MS	PACKET DOWNLINK DUMMY CONTROL BLOCK	USF not addressing the MS
10	SS -> MS	PACKET DOWNLINK DUMMY CONTROL BLOCK	USF not addressing the MS
11	SS -> MS	PACKET DOWNLINK DUMMY CONTROL BLOCK	USF not addressing the MS
12	SS -> MS	PACKET DOWNLINK DUMMY CONTROL BLOCK	USF not addressing the MS
13	SS -> MS	PACKET DOWNLINK DUMMY CONTROL BLOCK	USF not addressing the MS
14	SS -> MS	PACKET DOWNLINK DUMMY CONTROL BLOCK	USF not addressing the MS
15	SS -> MS	PACKET DOWNLINK DUMMY CONTROL BLOCK	USF not addressing the MS
16	MS<->SS		Steps 3 to 15 are repeated at most 22 times or until MS does not send further RLC data blocks at step 4. Note: steps 3 to 15 transfer one block every 52 frames, or 240 ms. 22 repetitions require about 5.5 s. (Timer T3166 shall expire)
17	MS -> SS	EGPRS PACKET CHANNEL REQUEST	MS re-initiates packet access procedure.
17A			If the MS requests two phase access the Test Case is terminated
18	SS -> MS	IMMEDIATE ASSIGNMENT	Indicating one phase packet access granted, dynamic allocation.
19	MS<->SS		Steps 3 to 15 are repeated 17 times. Note: 17 repetitions require about 4.3 s. (Timer T3166 should not expire)
20	SS -> MS	PACKET UPLINK ACK/NACK	
21	MS<->SS	Completion of macro {Uplink data transfer}	SS allows MS to complete uplink data transfer.

Specific Message Contents:

IMMEDIATE ASSIGNMENT, Steps 2 and 18:

Information Element	value/ remark
EGPRS Window Size	192 Max Window size for 1 TS

51.2.3.8 One phase packet access / Contention resolution / 4 access repetition attempts

51.2.3.8.1 Conformance requirement

If contention resolution for packet access fails, the mobile station shall reinitiate the packet access procedure unless it has already been repeated 4 times.

Reference

3GPP TS 04.60/44.060 subclause 7.1.2.3.

51.2.3.8.2 Test purpose

To verify that the MS attempts the packet access initiation 4 or 5 times.

51.2.3.8.3 Method of test

Initial conditions

System Simulator:

1cell, CCCH combined with SDCCH.

Mobile Station:

MS is GPRS attached, PDP context 31 has been established and the MS is in Packet Idle mode.

Specific PICS Statements

- Release of EGPRS Supported (TSPC_MS_EGPRS_RELEASE)

PIXIT Statements

-

Test procedure

The MS is triggered to transfer 200 octets of data. The SS assigns packet uplink resources in an IMMEDIATE ASSIGNMENT message indicating one phase packet access. The MS shall start transferring RLC data blocks including the correct TLLI in the first three blocks. The SS acknowledges the RLC block transfer with a PACKET UPLINK ACK/NACK including a TLLI not corresponding to the MS. The SS shall verify that the MS stops transmitting blocks and attempts packet access a total of four or five times.

Note:

The MS is allowed to transmit n RLC blocks after the block containing the PACKET UPLINK ACK/NACK message (the exact value of n is specified in 3GPP TS 05.10 subclause 6.11).

Maximum duration of the test

5 minutes.

Expected sequence

Step	Direction	Message	Comments
1	MS		The MS is triggered to transfer 200 octets of data.
2	MS -> SS	EGPRS PACKET CHANNEL REQUEST	
2A			If the MS requests two phase access the Test Case is terminated
3	SS -> MS	IMMEDIATE ASSIGNMENT	indicating one phase packet access granted, dynamic allocation.
4	MS -> SS	3 RLC data blocks	
5	SS -> MS	PACKET UPLINK ACK/NACK	including incorrect TLLI
6	MS -> SS		MS aborts packet access procedure, and is allowed to transmit at most n RLC data blocks (see Note above).
7	MS<->SS		repetition 1: MS shall reinitiate a packet access procedure, steps 2 to 6 are repeated.
8	MS<->SS		repetition 2: MS reinitiates a packet access procedure, steps 2 to 6 are repeated.
9	MS<->SS		repetition 3: MS reinitiates a packet access procedure, steps 2 to 6 are repeated.
10 (optional step)	MS<->SS		If PICS 'Release of EGPRS supported' for MS is Release 99 or 4, this step is optional. If PICS 'Release of EGPRS supported' for MS is Release 5 or later, this step is not allowed. repetition 4: MS reinitiates a packet access procedure, steps 2 to 6 are repeated.
NOTE: After step 10 the MS may reinitiate a packet access procedure, since higher layers may request to restart the access procedure.			

Specific Message Contents:

IMMEDIATE ASSIGNMENT, Step 3:

Information Element	value/ remark
EGPRS Window Size	192 Max Window size for 1 TS

51.2.3.9 One phase packet access / TBF starting time

51.2.3.9.1 Conformance requirement

In case the packet uplink assignment construction contains a TBF starting time and the mobile station receives the IMMEDIATE ASSIGNMENT message before the TBF starting time has expired, it shall wait until the frame number indicated by the TBF starting time before accessing the channel. If the mobile station receives the message after the TBF starting time has expired, it shall ignore the TBF starting time and may immediately access the channel.

Reference

3GPP TS 04.18 subclause 3.5.2.1.3.2.

3GPP TS 04.60 subclause 8.1.1.5.

51.2.3.9.2 Test purpose

To verify that the MS correctly considers the TBF Starting Time included in the IMMEDIATE ASSIGNMENT message.

51.2.3.9.3 Method of test

Initial conditions

System Simulator:

1cell, CCCH combined with SDCCH.

Mobile Station:

MS is GPRS attached, PDP context 31 has been established and the MS is in Packet Idle mode.

Specific PICS Statements

-

PIXIT Statements

-

Test procedure

The MS is triggered to transfer data. The SS assigns packet uplink resources in an IMMEDIATE ASSIGNMENT message indicating one phase packet access and containing a TBF starting time. The MS may start transferring RLC data blocks at the exact frame specified by the TBF starting time.

The test is repeated with a TBF starting time in the past. In this case the MS shall 'immediately' (see note below) send RLC data blocks.

NOTE: The MS shall start transmitting RLC blocks within n blocks after the block containing the IMMEDIATE ASSIGNMENT message (the exact value of n is specified in 3GPP TS 05.10 subclause 6.11).

Maximum duration of the test

5 minutes.

Expected sequence

Step	Direction	Message	Comments
0	MS		The MS is triggered to transfer 200 octets of data.
1	MS -> SS	EGPRS PACKET CHANNEL REQUEST	
1A			If the MS requests two phase access the Test Case is terminated
2	SS -> MS	IMMEDIATE ASSIGNMENT	indicating one phase packet access granted, dynamic allocation and an arbitrarily chosen TBF Starting Time (indicating a future frame number).
3	SS		SS continually sends PACKET DOWNLINK DUMMY CONTROL BLOCK containing USF assigned to the MS. SS verifies that MS does not transmit for frame numbers below TBF Starting Time.
4	MS -> SS	3 RLC data blocks	SS verifies that first RLC block arrives on first allowed block after TBF Starting Time.
5	SS -> MS	PACKET UPLINK ACK/NACK	Including correct TLLI.
6	MS -> SS	RLC data blocks	
7	SS<->MS	Completion of macro {Uplink data transfer}	SS allows MS to complete data transfer.
8	MS		The MS is triggered again to transfer 200 octets of data.
9	MS -> SS	EGPRS PACKET CHANNEL REQUEST	
9A			If the MS requests two phase access the Test Case is terminated
10	SS -> MS	IMMEDIATE ASSIGNMENT	Indicating one phase packet access granted, dynamic allocation and an arbitrarily chosen TBF Starting Time with value less than current frame number.
A11 (Optional step)	MS -> SS	3 RLC data blocks	SS continually sends PACKET DOWNLINK DUMMY CONTROL BLOCK containing USF assigned to the MS. SS verifies that MS starts sending RLC data blocks. The SS shall not check the number of blocks before the MS starts to send RLC blocks.
A12 (Optional step)	SS -> MS	PACKET UPLINK ACK/NACK	Including correct TLLI.
A13 (Optional step)	MS -> SS	RLC data blocks	Go to step 14
B11 (Optional step)	MS -> SS	EGPRS PACKET CHANNEL REQUEST	
B12 (Optional step)			If the MS requests two phase access the Test Case is terminated
B13 (Optional step)	SS -> MS	IMMEDIATE ASSIGNMENT	Go to step 14
C11 (Optional step)			Verify that the MS does not send anything. Go to step 15
14	SS<->MS	Completion of macro {Uplink data transfer}	SS allows MS to complete data transfer.
15			

Specific Message Contents:

IMMEDIATE ASSIGNMENT, Steps 2, 10 and B13:

Information Element	value/ remark
EGPRS Window Size	192 Max Window size for 1 TS

51.2.3.10 One phase packet access / Timing Advance Index present

51.2.3.10.1 Conformance requirement

If the timing advance index (TAI) is included in the packet uplink assignment construction, the mobile station shall use the continuous update timing advance mechanism, see 3GPP TS 05.10, using PTCCH in the same timeslot as the assigned PDCH.

Reference

3GPP TS 04.18 subclause 3.5.2.1.3.2.

3GPP TS 03.64 subclause 6.5.7.2.

51.2.3.10.2 Test purpose

To verify that the MS uses the continuous update timing advance mechanism and sends access bursts in the PTCCH slots as determined by the Timing Advance Index (TAI) sent in the IMMEDIATE ASSIGNMENT.

51.2.3.10.3 Method of test

Initial conditions

System Simulator:

1 cell, CCCH combined with SDCCH.

Mobile Station:

MS is GPRS attached, PDP context 31 has been established and the MS is in Packet Idle mode.

Specific PICS Statements

-

PIXIT Statements

-

Test procedure

The MS is triggered for uplink data transfer. The SS assigns packet uplink resources in an IMMEDIATE ASSIGNMENT message indicating one phase packet access and containing a Timing Advance Index. During TBF transfer, the SS shall verify the access bursts sent by the MS in the PTCCH.

Maximum duration of the test

5 minutes.

Expected sequence

Step	Direction	Message	Comments
1	MS		The MS is triggered to transfer 440 octets of data.
2 2A	MS -> SS	EGPRS PACKET CHANNEL REQUEST	If the MS requests two phase access the Test Case is terminated
3	SS -> MS	IMMEDIATE ASSIGNMENT	For one phase packet access, dynamic allocation and including Timing Advance Index TAI=0.
4	SS -> MS	PACKET DOWNLINK DUMMY CONTROL BLOCK	Assigning the USF assigned in step 3. Sent on PDTCH, 3 block after the message sent in step 3
5	MS -> SS	RLC data block	
6	SS -> MS	PACKET UPLINK ACK/NACK	Including correct TLLI.
7			Wait for 3 blocks.
8	MS<->SS	Completion of macro {Uplink data transfer}	SS allows MS to complete data transfer. During the data transfer, USF is assigned to MS once in 250ms

Verification

During TBF transfer (steps 4 to 8) the SS monitors access bursts on PTCCH which are located on slots with numbers FN, such that $(FN \bmod (8 \cdot 52)) = 12$ for TAI = 0 (3GPP TS 03.64/6.5.7.2 and 3GPP TS 05.02/Table 6). The access burst contents shall be '1111111111'.

The test is repeated once more with an arbitrarily chosen TAI in the range 1 to 15. SS shall verify that the access bursts are sent in the correct PTCCH slots as specified in 3GPP TS 05.02 table 6.

51.2.3.11 One phase packet access / Timing Advance Index not present

51.2.3.11.1 Conformance requirement

If a timing advance index (TAI) field is not included, the continuous update timing advance mechanism shall not be used.

Reference

3GPP TS 04.18 subclause 3.5.2.1.3.2.

51.2.3.11.2 Test purpose

To verify that the MS does not send any access bursts on PTCCH (i.e. it does not use the continuous update timing advance mechanism) if TAI is not present in the IMMEDIATE ASSIGNMENT message.

51.2.3.11.3 Method of test

Initial conditions

System Simulator:

1 cell, CCCH combined with SDCCH.

Mobile Station:

MS is GPRS attached, PDP context 31 has been established and the MS is in Packet Idle mode.

Specific PICS Statements

-

PIXIT Statements

-

Test procedure

The MS is triggered to transfer data. The SS assigns packet uplink resources in an IMMEDIATE ASSIGNMENT message not including a Timing Advance Index. During TBF transfer, the SS shall verify that the MS does not send any access bursts in idle frames.

Maximum duration of the test

5 minutes.

Expected sequence

Step	Direction	Message	Comments
1	MS		The MS is triggered to transfer 440 octets of data.
2 2A	MS -> SS	EGPRS PACKET CHANNEL REQUEST	If the MS requests two phase access the Test Case is terminated
3	SS -> MS	IMMEDIATE ASSIGNMENT	
4	SS -> MS	PACKET DOWNLINK DUMMY CONTROL BLOCK	Assigning the USF assigned in step 3. Sent on PDTCH, 3 block after the message sent in step 3
5	MS -> SS	RLC data block	Including correct TLLI. Wait for 3 blocks.
6	SS -> MS	PACKET UPLINK ACK/NACK	
7			
8	SS<->MS	Completion of macro {Uplink data transfer}	SS allows MS to complete data transfer. During the data transfer, USF is assigned to MS once in 250ms

Verification

The SS verifies that the MS does not transmit in idle frames during data block transfer (steps 4 to 8). Idle frame numbers are 12, 25, 38 and 51 in the 52-multiframe structure.

Specific Message Contents:

IMMEDIATE ASSIGNMENT, Step 3:

Information Element	value/ remark
EGPRS Window Size	192 Max Window size for 1 TS

51.2.4 Packet immediate assignment / Multiblock packet access

51.2.4.1 Multiblock packet access / Packet Resource Request

51.2.4.1.1 Conformance requirement

The network shall use the TBF starting time to indicate the first frame number belonging to the multiblock period granted for packet access. If a multiple block packet access is granted, it forces the mobile station to perform a two phase packet access.

Reference

3GPP TS 04.18 subclauses 3.5.2.1.3.1 and 3.5.2.1.3.3a.

51.2.4.1.2 Test purpose

To verify that the MS sends PACKET RESOURCE REQUEST in the assigned block as indicated by the TBF starting time when it is triggered for uplink transfer.

51.2.4.1.3 Method of test

Initial conditions

System Simulator:

1 cell, CCCH combined with SDCCH.

Mobile Station:

MS is GPRS attached, a PDP context has been established and the MS is in Packet Idle mode.

Specific PICS Statements

-

PIXIT Statements

-

Test procedure

The MS is triggered to initiate uplink data transfer. The SS assigns packet uplink resources for multiblock in an IMMEDIATE ASSIGNMENT message including a TBF starting time. The SS verifies that the MS sends a PACKET RESOURCE REQUEST at the first allowed block as indicated by the TBF starting frame.

Maximum duration of the test

5 minutes.

Expected sequence

Step	Direction	Message	Comments
0	MS		The MS is triggered to transfer 200 octets of data.
1	MS -> SS	EGPRS PACKET CHANNEL REQUEST	
2	SS -> MS	IMMEDIATE ASSIGNMENT	For uplink TBF, multiblock assignment for an arbitrarily chosen TBF Starting Time in the future.
3	MS -> SS	PACKET RESOURCE REQUEST	SS verifies that first block is on first allowed block starting at frame number given by TBF Starting Time.
4	SS -> MS	PACKET ACCESS REJECT	with default contents.

Specific Message Contents:

IMMEDIATE ASSIGNMENT, Step 2:

Information Element	value/ remark
Number of radio blocks allocated	00

51.2.4.2 Void

51.2.5 Packet immediate assignment / Packet access rejection

51.2.5.1 Packet access rejection / wait indication

51.2.5.1.1 Conformance requirement

On receipt of an IMMEDIATE ASSIGNMENT REJECT message corresponding to one of its 3 last CHANNEL REQUEST messages, the mobile station stops sending CHANNEL REQUEST messages, starts timer T3142 with the indicated value, ("wait indication" information element), starts T3146 if it has not already been started, and listens to the downlink CCCH until T3146 expires. During this time, additional IMMEDIATE ASSIGNMENT REJECT messages are ignored, but any immediate assignment corresponding to any other of its 3 last CHANNEL REQUEST messages make the mobile station follow the assignment procedure. If no such immediate assignment is received, the mobile station returns to packet idle mode.

Reference

3GPP TS 04.18 subclause 3.5.2.1.3.4.

51.2.5.1.2 Test purpose

To verify that the MS stops sending CHANNEL REQUEST or EGPRS PACKET CHANNEL REQUEST messages when receiving an IMMEDIATE ASSIGNMENT REJECT containing a Request Reference IE corresponding to one of its last 3 CHANNEL REQUEST or EGPRS PACKET CHANNEL REQUEST messages.

Further on, the SS verifies that the MS makes a new attempt for uplink transfer only after T3142 seconds ("wait indication" timer) after last IMMEDIATE ASSIGNMENT REJECT elapse.

51.2.5.1.3 Method of test

Initial conditions

System Simulator:

1 cell, CCCH combined with SDCCH, Parameter MAX_RETRANS is set to 7 retransmissions.

Mobile Station:

MS is switched off.

Specific PICS Statements

- Release of EGPRS Supported (TSPC_MS_EGPRS_RELEASE)
- Support of EGPRS Packet Access Enhancement (TSPC_EGPRS_ENHANC)

PIXIT Statements

-

Test procedure

The MS is triggered to initiate the GPRS attach procedure. After reception of 3 CHANNEL REQUEST or EGPRS PACKET CHANNEL REQUEST messages, the SS sends an IMMEDIATE ASSIGNMENT REJECT with correct Request Reference and including a waiting indication (T3142). The SS verifies that the MS stops sending CHANNEL REQUEST or EGPRS PACKET CHANNEL REQUEST messages and does not attempt a new packet access until T3142 seconds elapse.

Maximum duration of the test

5 minutes.

NOTE:

EGPRS PACKET CHANNEL REQUEST shall be used in the following cases

- a. If Release of EGPRS supported is Release 4 or above.
- b. If Support of EGPRS Packet Access enhancement is True for a R99 MS.

CHANNEL REQUEST shall be used if support of EGPRS Packet Access enhancement is False for a R99 MS.

Expected sequence

Step	Direction	Message	Comments
0	MS		MS is triggered to initiate GPRS attach procedure.
1	MS -> SS	CHANNEL REQUEST	
		or; EGPRS PACKET CHANNEL REQUEST	
2	MS -> SS	CHANNEL REQUEST	
		or; EGPRS PACKET CHANNEL REQUEST	
3	MS -> SS	CHANNEL REQUEST	
		or; EGPRS PACKET CHANNEL REQUEST	
4	SS -> MS	IMMEDIATE ASSIGNMENT REJECT	including Request Reference corresponding to the (EGPRS PACKET) CHANNEL REQUEST in step 1, and waiting time indication with value T3142=50s.
5	SS		SS verifies that MS does not send any further access bursts (see note below).
6	MS -> SS	CHANNEL REQUEST	SS verifies that the access burst does not arrive before $T3142 - 0.1 * T3142 (=45s)$ after last IMMEDIATE ASSIGNMENT REJECT message.
		or; EGPRS PACKET CHANNEL REQUEST	
7	SS -> MS	IMMEDIATE ASSIGNMENT	for uplink TBF, one phase access
8	MS<->SS	Completion of macro {GPRS attach procedure}	SS allows MS to complete GPRS attach.

The test is repeated with an arbitrarily chosen value of T3142 in the range 2 to 60 s.

NOTE: The number of frames between successive access bursts considering the default Sys Info parameters used in the test is larger than 58 frames (see 3GPP TS 04.08 / 3GPP TS 44.018 table 3.1). This value is large enough to allow the MS to respond to the IMMEDIATE ASSIGNMENT REJECT message by stopping sending the next access bursts.

Specific Message Contents:

none

51.2.5.2 Packet access rejection / assignment before T3142 expires

51.2.5.2.1 Conformance requirement

On receipt of an IMMEDIATE ASSIGNMENT REJECT message corresponding to one of its 3 last EGPRS PACKET CHANNEL REQUEST messages, the mobile station stops sending EGPRS PACKET CHANNEL REQUEST messages, starts timer T3142 with the indicated value, ("wait indication" information element), starts T3146 if it has not already been started, and listens to the downlink CCCH until T3146 expires. During this time, additional IMMEDIATE ASSIGNMENT REJECT messages are ignored, but any immediate assignment corresponding to any other of its 3 last EGPRS PACKET CHANNEL REQUEST messages make the mobile station follow the assignment procedure. If no such immediate assignment is received, the mobile station returns to packet idle mode.

Reference

3GPP TS 04.18, subclause 3.5.2.1.3.4.

51.2.5.2.2 Test purpose

To verify that the MS stops sending EGPRS PACKET CHANNEL REQUEST messages when receiving an IMMEDIATE ASSIGNMENT REJECT and, if an IMMEDIATE ASSIGNMENT containing a correct Request Reference arrives before $T = \min \{T3142, T3146\}$ seconds elapse, then the MS shall accept this assignment. (See below for a note on T3146).

51.2.5.2.3 Method of test

Initial conditions

System Simulator: Default settings except:

Parameter MAX_RETRANS is set to 7 retransmissions.

Parameter TX_INTEGER is set to 32.

CCCH combined with SDCCH.

Mobile Station:

MS is GPRS attached, PDP context 31 has been established and the MS is in Packet Idle mode.

Specific PICS Statements

-

PIXIT Statements

-

Test procedure

The MS is triggered to transfer data. After reception of 3 EGPRS PACKET CHANNEL REQUEST messages, the SS sends an IMMEDIATE ASSIGNMENT REJECT with correct Request Reference and including a waiting indication (T3142). The SS verifies that the MS stops sending EGPRS PACKET CHANNEL REQUEST messages.

Before $T = \min \{T3142, T3146\}$ seconds elapse, the SS sends an IMMEDIATE ASSIGNMENT with correct Request Reference. The MS shall switch to the assigned PDCH and transfer the data.

Note on T3146:

NOTE: T3146 is started when sending the last EGPRS PACKET CHANNEL REQUEST or when receiving the IMMEDIATE ASSIGNMENT REJECT. At its expiry, the packet access is aborted.

The value of T3146 is given by $T+2*S$ (3GPP TS 04.08 / 3GPP TS 44.018, clause 11.1.1), where T is TX_INTEGER and S is given in 3GPP TS 04.08 / 3GPP TS 44.018, Table 3.1. The value of T3146 is 2.15 s. for the current settings.

Maximum duration of the test

5 minutes.

Expected sequence

Step	Direction	Message	Comments
0	MS		MS is triggered to transfer 200 octets.
1	MS -> SS	EGPRS PACKET CHANNEL REQUEST	
2	MS -> SS	EGPRS PACKET CHANNEL REQUEST	
3	MS -> SS	EGPRS PACKET CHANNEL REQUEST	
4	SS -> MS	IMMEDIATE ASSIGNMENT REJECT	including Request Reference corresponding to the EGPRS PACKET CHANNEL REQUEST in step 2, and waiting time indication with value T3142 = 2 s.
5			The SS verifies that the MS stops sending EGPRS PACKET CHANNEL REQUEST messages.
6	SS -> MS	IMMEDIATE ASSIGNMENT	sent after 1.5s. (of the last IMMEDIATE ASSIGNMENT REJECT) and including Request Reference corresponding to step 1.
7	SS<->MS	Completion of macro {Uplink data transfer }	SS allows MS to complete the uplink data transfer.

Specific Message Contents:

IMMEDIATE ASSIGNMENT, Step 6:

Information Element	value/ remark
EGPRS Window Size	192 Max Window size for 1 TS

51.2.5.3 Packet access rejection / Interpretation of Extended RA i / Correct value of Extended RA i

51.2.5.3.1 Conformance requirement

On receipt of an IMMEDIATE ASSIGNMENT REJECT message corresponding to one of its 3 last EGPRS PACKET CHANNEL REQUEST messages, the mobile station stops sending EGPRS PACKET CHANNEL REQUEST messages, starts timer T3142 with the indicated value, ("wait indication" information element), starts T3146 if it has not already been started, and listens to the downlink CCCH until T3146 expires. During this time, additional IMMEDIATE ASSIGNMENT REJECT messages are ignored, but any immediate assignment corresponding to any other of its 3 last EGPRS PACKET CHANNEL REQUEST messages make the mobile station follow the assignment procedure. If no such immediate assignment is received, the mobile station returns to packet idle mode.

The IMMEDIATE ASSIGNMENT REJECT message is sent on the CCCH by the network to up to four mobile stations to indicate that no channel is available for assignment.

When set to the value '0111 1111', the RA information of the Request Reference i IE indicates that an Extended RA i field may be included in the IAR Rest Octets. The mobile station shall use the information in the Extended RA i field to identify the Immediate Assignment Reject message corresponding to an EGPRS Packet Channel Request message. If the Extended RA i field is not included, the mobile station shall assume that the Request Reference i IE does not correspond to the EGPRS Packet Channel Request message.

Reference

3GPP TS 04.18, subclause 3.5.2.1.3.4.,9.1.20

51.2.5.3.2 Test purpose

To verify that the MS correctly decode a Request Reference i IE when set to value 0111 1111 and decode the corresponding Extended RA i field in a IMMEDIATE ASSIGNMENT REJECT message.

51.2.5.3.3 Method of test

Initial conditions

System Simulator: Default settings except:

Parameter MAX_RETRANS is set to 7 retransmissions.

Parameter TX_INTEGER is set to 32.

CCCH combined with SDCCH.

Mobile Station:

MS is GPRS attached, PDP context 31 has been established and the MS is in Packet Idle mode.

Specific PICS Statements

-

PIXIT Statements

-

Test procedure

The MS is triggered to transfer data. After reception of 3 EGPRS PACKET CHANNEL REQUEST messages, the SS sends an IMMEDIATE ASSIGNMENT REJECT message with Request Reference 3 having the value '0111 1111' and including a waiting indication (T3142). The correct Extended RA value is st in Extended RA 3 field. The SS verifies that the MS stops sending EGPRS PACKET CHANNEL REQUEST messages.

Before $T = \min \{T3142, T3146\}$ seconds elapse, the SS sends an IMMEDIATE ASSIGNMENT with another value of Extended RA. The SS verifies that the MS switch to the assigned PDCH and transfer the data.

Note on T3146:

NOTE: T3146 is started when sending the last EGPRS PACKET CHANNEL REQUEST or when receiving the IMMEDIATE ASSIGNMENT REJECT. At its expiry, the packet access is aborted.

The value of T3146 is given by $T+2*S$ (3GPP TS 04.08 / 3GPP TS 44.018, clause 11.1.1), where T is TX_INTEGER and S is given in 3GPP TS 04.08 Table 3.1 / 3GPP TS 44.018, Table 3.3.1.1.2.1. The value of T3146 is 2.28 s for the current settings.

Maximum duration of the test

5 minutes.

Expected sequence

Step	Direction	Message	Comments
0	MS		MS is triggered to transfer 200 octets.
1	MS -> SS	EGPRS PACKET CHANNEL REQUEST	
2	MS -> SS	EGPRS PACKET CHANNEL REQUEST	
3	MS -> SS	EGPRS PACKET CHANNEL REQUEST	
4	SS -> MS	IMMEDIATE ASSIGNMENT REJECT	Including Request Reference 3 '0111 1111' and Extended RA 3 corresponding to the last EGPRS PACKET CHANNEL REQUEST received. All other Request Reference have value '0000 0000'
5			WAIT INDICATION(T3142=2secs.) The SS verifies that the MS stops sending EGPRS PACKET CHANNEL REQUEST messages.
6	SS -> MS	IMMEDIATE ASSIGNMENT	sent after 1.5s. (of the last IMMEDIATE ASSIGNMENT REJECT) and including the Request Reference '0111 1111' and same Extended RA as included in Step 2 (Extended RA 2).
7	SS -> MS	PACKET DOWNLINK DUMMY CONTROL BLOCK	Including Dynamic Allocation Struct. Sent on the PACCH of the PDTCH assigned. USF assigned to the MS
8	MS -> SS	EGPRS UPLINK RLC DATA BLOCK	Verify that TFI is correct.
9	SS -> MS	PACKET UPLINK ACK/NACK	Acknowledging the data block. Including the TLLI as received in the data block in step 8.
10	SS<->MS	Completion of macro {Uplink data transfer }	SS allows MS to complete the uplink data transfer.

Specific Message Contents:

IMMEDIATE ASSIGNMENT, Step 6:

Information Element	value/ remark
EGPRS Window Size	192 Max Window size for 1 TS

51.2.5.4 Packet access rejection / Interpretation of Extended RA i / Extended RA i not included

51.2.5.4.1 Conformance requirement

On receipt of an IMMEDIATE ASSIGNMENT REJECT message corresponding to one of its 3 last EGPRS PACKET CHANNEL REQUEST messages, the mobile station stops sending EGPRS PACKET CHANNEL REQUEST messages, starts timer T3142 with the indicated value, ("wait indication" information element), starts T3146 if it has not already been started, and listens to the downlink CCCH until T3146 expires. During this time, additional IMMEDIATE ASSIGNMENT REJECT messages are ignored, but any immediate assignment corresponding to any other of its 3 last EGPRS PACKET CHANNEL REQUEST messages make the mobile station follow the assignment procedure. If no such immediate assignment is received, the mobile station returns to packet idle mode.

The IMMEDIATE ASSIGNMENT REJECT message is sent on the CCCH by the network to up to four mobile stations to indicate that no channel is available for assignment.

When set to the value '0111 1111', the RA information of the Request Reference i IE indicates that an Extended RA i field may be included in the IAR Rest Octets. The mobile station shall use the information in the Extended RA i field to identify the Immediate Assignment Reject message corresponding to an EGPRS Packet Channel Request message. If the Extended RA i field is not included, the mobile station shall assume that the Request Reference i IE does not correspond to the EGPRS Packet Channel Request message.

Reference

3GPP TS 04.18, subclause 3.5.2.1.3.4.,9.1.20

51.2.5.4.2 Test purpose

To verify that MS ignores the IMMEDIATE ASSIGNMENT REJECT message if Extended RA i field corresponding to a Request Reference i 0111 1111 is not included in the IMMEDIATE ASSIGNMENT REJECT message.

51.2.5.4.3 Method of test

Initial conditions

System Simulator: Default settings except:

Parameter MAX_RETRANS is set to 7 retransmissions.

Parameter TX_INTEGER is set to 32.

CCCH combined with SDCCH.

Mobile Station:

MS is GPRS attached, PDP context 31 has been established and the MS is in Packet Idle mode.

Specific PICS Statements

-

PIXIT Statements

-

Test procedure

The MS is triggered to transfer data. After reception of 3 EGPRS PACKET CHANNEL REQUEST messages, the SS sends an IMMEDIATE ASSIGNMENT REJECT message with Request Reference 3 having the value '0111 1111' and including a waiting indication (T3142). The Extended RA 3 field is not included in the message. The SS verifies that the MS ignores the IMMEDIATE ASSIGNMENT REJECT message and continue sending EGPRS PACKET CHANNEL REQUEST messages.

Maximum duration of the test

5 minutes.

Expected sequence

Step	Direction	Message	Comments
0	MS		MS is triggered to transfer 200 octets.
1	MS -> SS	EGPRS PACKET CHANNEL REQUEST	
2	MS -> SS	EGPRS PACKET CHANNEL REQUEST	
3	MS -> SS	EGPRS PACKET CHANNEL REQUEST	
4	SS -> MS	IMMEDIATE ASSIGNMENT REJECT	Including Request Reference 3 '0111 1111' and no Extended RA 3 present. All other Request Reference have value '0000 0000'
5	MS -> SS	EGPRS PACKET CHANNEL REQUEST	WAIT INDICATION (T3142=2secs.) The SS verifies that the MS ignores IMMEDIATE ASSIGNMENT REJECT message and continue sending EGPRS PACKET CHANNEL REQUEST message.
6	SS -> MS	IMMEDIATE ASSIGNMENT	Including the Request Reference '0111 1111' and Extended RA corresponding to EGPRS PACKET CHANNEL REQUEST received in Step 5. Including Dynamic Allocation Struct.
7	SS -> MS	PACKET DOWNLINK DUMMY CONTROL BLOCK	Sent on the PACCH of the PDTCH assigned. USF assigned to the MS
8	MS -> SS	EGPRS UPLINK RLC DATA BLOCK	Verify that TFI is correct.
9	SS -> MS	PACKET UPLINK ACK/NACK	Acknowledging the data block. Including the TLLI as received in the data block in step 8.
10	SS<->MS	Completion of macro {Uplink data transfer}	SS allows MS to complete the uplink data transfer.

Specific Message Contents:

IMMEDIATE ASSIGNMENT, Step 6:

Information Element	value/ remark
EGPRS Window Size	192 Max Window size for 1 TS

51.2.6 Packet downlink assignment procedure using CCCH

51.2.6.1 Initiation of packet downlink assignment procedure / MS listens to correct CCCH block

51.2.6.1.1 Conformance requirement

The network initiates the packet downlink assignment procedure by sending an IMMEDIATE ASSIGNMENT message in unacknowledged mode on the CCCH timeslot corresponding to CCCH group the mobile station belongs to.

On receipt of an IMMEDIATE ASSIGNMENT message [the MS] stops monitoring downlink CCCH and switches to the assigned PDCH and starts listening for downlink RLC/MAC blocks identified by the assigned TFI; it starts timer T3190.

Reference

3GPP TS 04.18 subclause 3.5.3.1.2.

51.2.6.1.2 Test purpose

To verify that the MS responds to an IMMEDIATE ASSIGNMENT for downlink TBF sent on PCH blocks corresponding to the MS's paging group.

51.2.6.1.3 Method of test

Initial conditions

System Simulator:

EGPRS supported.

Default settings except:

Parameters CCCH_CONF, BS_AG_BLK_RES, and BS_PA_MFRMS are arbitrarily chosen.

Mobile Station:

MS is GPRS attached, DRX have been negotiated, MS is in Ready state.

A PDP context has been established and the MS is in Packet Idle mode.

Specific PICS Statements

-

PIXIT Statements

-

Test procedure

The SS sends an IMMEDIATE ASSIGNMENT for downlink transfer on a PCH block corresponding to its paging group (see 3GPP TS 05.02 subclause 6.5.2) which depends on Sys Info parameters and the MS's IMSI. The MS shall switch to the assigned PDCH and exercise downlink transfer.

Maximum duration of the test

NA

Expected sequence

Step	Direction	Message	Comments
1	SS -> MS	IMMEDIATE ASSIGNMENT	sent on a PCH block corresponding to the MS's paging group, including a packet downlink assignment with correct TLLI.
2	MS<->SS	Completion of macro {Downlink data transfer}	SS completes downlink transfer of 200 octets of data.

Specific Message Contents:

IMMEDIATE ASSIGNMENT, Step 1:

Information Element	value/ remark
EGPRS Window Size	192 Max Window size for 1 TS
Link Quality Measurement Mode	00

51.2.6.2 Initiation of packet downlink assignment procedure / timer T3190

51.2.6.2.1 Conformance requirement

On receipt of an IMMEDIATE ASSIGNMENT message [the MS] stops monitoring downlink CCCH and switches to the assigned PDCH and starts listening for downlink RLC/MAC blocks identified by the assigned TFI; it then starts timer T3190.

If the mobile station does not receive a RLC/MAC block on the assigned PDCHs before timer T3190 expires, then a TBF establishment failure has occurred.

Reference

3GPP TS 04.18 subclause 3.5.3.1.2.

51.2.6.2.2 Test purpose

To verify that the MS returns to packet idle updated if RLC/MAC blocks are sent after T3190 seconds, and that the MS correctly receives RLC/MAC blocks if they are sent before T3190 seconds.

51.2.6.2.3 Method of test

Initial conditions

System Simulator:

1 cell, CCCH combined with SDCCH.

EGPRS Supported.

Mobile Station:

MS is GPRS attached, PDP context 31 has been established and the MS is in Packet Idle mode.

Specific PICS Statements

-

PIXIT Statements

-

Test procedure

The SS assigns a PDCH for downlink transfer but does not send any RLC/MAC blocks until T3190 seconds have elapsed. The MS shall return to packet idle updated and ignore the RLC/MAC blocks.

To verify that the MS returned to packet idle updated, the SS again assigns a PDCH and sends RLC/MAC blocks before T3190 seconds elapse. The SS shall successfully transfer all RLC data blocks.

Maximum duration of the test

5 minutes.

Expected sequence

Step	Direction	Message	Comments
1	SS -> MS	IMMEDIATE ASSIGNMENT	for downlink TBF on a PCH block corresponding to the MS, including a packet downlink assignment. SS waits T3190 + 10% (=5.5s) after the last IMMEDIATE ASSIGNMENT. SS sends data SS verifies for 10s. that the MS does not respond.
2	SS		
3	SS -> MS	RLC data blocks	
4	SS		
5	SS -> MS	IMMEDIATE ASSIGNMENT	SS assigns again a PDCH. SS waits T3190 - 10% (=4.5s) after the last IMMEDIATE ASSIGNMENT SS starts sending 200 octets of data, including FB=0, RRPB valid value, ESPB set indicating correct reception of data blocks. SS completes downlink transfer.
6	SS		
7	SS -> MS	RLC data blocks	
8	MS -> SS	EGPRS PACKET DOWNLINK ACK/NACK	
9	MS<->SS	Completion of macro {Downlink data transfer}	

Specific Message Contents:

IMMEDIATE ASSIGNMENT message:

	Information Element	value/ remark
Steps 1 & 5	EGPRS Window Size	192 Max Window size for 1 TS
Steps 1 & 5	Link Quality Measurement Mode	00
Steps 1 & 5	RLC_MODE	RLC acknowledged mode

EGPRS DOWNLINK ACK/NACK in Step 8

	Information Element	value/ remark
	ACK/NACK Description IE	
	MS_OUT_OF_MEMORY IE	0
	EGPRS Channel Quality Report IE	
	Final_Ack_Indicator	0

51.2.6.3 Initiation of packet downlink assignment procedure / TBF starting time

51.2.6.3.1 Conformance requirement

The IMMEDIATE ASSIGNMENT message may indicate a TBF starting time. If the mobile station receives the message before the TBF starting time has expired, it shall wait until the frame number indicated by the TBF starting time, start timer T3190 and switch to the assigned PDCH. If the mobile station receives the message after the TBF starting time has expired, it shall ignore the indicated TBF starting time, immediately start timer T3190 and switch to the assigned PDCH.

Reference

3GPP TS 04.18 subclause 3.5.3.1.2.

51.2.6.3.2 Test purpose

To verify that the MS correctly considers the TBF starting time during downlink assignment.

51.2.6.3.3 Method of test

Initial conditions

System Simulator:

1 cell, CCCH combined with SDCCH.

EGPRS Supported.

Mobile Station:

MS is GPRS attached, a PDP context has been established and the MS is in Packet Idle mode.

Specific PICS Statements

-

PIXIT Statements

-

Test procedure

The SS assigns a PDCH via an IMMEDIATE ASSIGNMENT including a TBF starting time. The SS does not send RLC data blocks after TBF starting time + T3190 elapses. The MS shall return to packet idle updated and ignore the RLC data blocks.

The SS assigns again a PDCH, and this time the SS sends RLC data blocks before TBF starting time + T3190 expires. The MS shall successfully receive the RLC data blocks.

Finally, the SS assigns the third time a PDCH, but including a TBF starting time which expired. The SS immediately sends RLC data blocks which shall be acknowledged by the MS.

Maximum duration of the test

5 minutes.

Expected sequence

Step	Direction	Message	Comments
1	SS -> MS	IMMEDIATE ASSIGNMENT	including a packet downlink assignment with a TBF Starting Time corresponding to 10s after the current frame number.
2	SS		SS waits $1.1 * (TBF \text{ Starting Time} + T3190)$ (=16.5 s) after the last IMMEDIATE ASSIGNMENT.
3	SS -> MS	RLC data block	including Polling bit set and valid RRBP field.
4	SS		SS verifies for that the MS does not respond in the assigned block in step 3.
5	SS -> MS	IMMEDIATE ASSIGNMENT	SS assigns again a PDCH with TBF Starting Time corresponding to 10s after the current frame number.
6	SS		SS waits $0.9 * (TBF \text{ Starting Time} + T3190)$ (= 13.5 s) after the last IMMEDIATE ASSIGNMENT.
7	SS -> MS	RLC data block	including Polling bit set and valid RRBP field.
8	MS -> SS	EGPRS PACKET DOWNLINK ACK/NACK	sent in the assigned block at step 7 indicating correct reception of downlink RLC block.
9	MS<->SS	Completion of macro {Downlink data transfer}	SS completes data transfer.
10	SS -> MS	IMMEDIATE ASSIGNMENT	SS assigns again a PDCH with TBF Starting Time which already elapsed.
11	SS -> MS	RLC data block	sent in the third block after the block containing the message in step 10 (see note below), including Polling bit set and valid RRBP field.
12	MS -> SS	EGPRS PACKET DOWNLINK ACK/NACK	indicating correct reception of RLC block.
13	MS<->SS	Completion of macro {Downlink data transfer}	SS completes data transfer.

Specific Message Contents:

IMMEDIATE ASSIGNMENT message:

	Information Element	value/ remark
Steps 1 & 5	EGPRS Window Size	192 Max Window size for 1 TS
Steps 1 & 5	Link Quality Measurement Mode	00

EGPRS DOWNLINK ACK/NACK in Step 8

Information Element	value/ remark
ACK/NACK Description IE	
MS_OUT_OF_MEMORY IE	0
EGPRS Channel Quality Report IE	
Final_Ack_Indicator	0

NOTE: The requirements to uplink and downlink assignment reaction times are stated in 3GPP TS 05.10 subclause 6.11: An MS shall be ready to transmit and receive using a new assignment no later than the next occurrence of block $B((x+3) \bmod 12)$ where block $B(x)$ is the last radio block containing the uplink assignment.

51.2.6.4 Initiation of packet downlink assignment procedure / incorrect TFI

51.2.6.4.1 Conformance requirement

On receipt of an IMMEDIATE ASSIGNMENT message [the MS] stops monitoring downlink CCCH and switches to the assigned PDCH and starts listening for downlink RLC/MAC blocks identified by the assigned Temporary Flow Identifier (TFI).

Reference

3GPP TS 04.18 subclause 3.5.3.1.2.

51.2.6.4.2 Test purpose

To verify that the MS correctly considers the TFI in the RLC/MAC blocks.

51.2.6.4.3 Method of test

Initial conditions

System Simulator:

1 cell, CCCH combined with SDCCH.

EGPRS Supported.

Mobile Station:

MS is GPRS attached, a PDP context has been established and the MS is in Packet Idle mode.

Specific PICS Statements

-

PIXIT Statements

-

Test procedure

The SS assigns a PDCH and starts transmitting RLC/MAC blocks with incorrect TFI. The MS shall ignore these RLC/MAC blocks and, after T3190 expires, return to packet idle mode.

To prove that the MS returns to idle mode, the SS assigns again a PDCH, and this time the SS sends RLC/MAC blocks with correct TFI. The MS shall successfully receive the data packets.

Maximum duration of the test

5 minutes.

Expected sequence

Step	Direction	Message	Comments
1	SS -> MS	IMMEDIATE ASSIGNMENT	for downlink TBF
2	SS -> MS	RLC data block	SS sends RLC blocks with incorrect TFI (i.e. not corresponding to the last IMMEDIATE ASSIGNMENT), including Polling bit set and valid RRBp field.
3	SS		SS verifies that the MS does not respond in the assigned block.
4	SS		SS waits value of T3190 + 10% (=5.5s).
5	SS -> MS	IMMEDIATE ASSIGNMENT	for downlink TBF
6	SS -> MS	RLC data block	with correct TFI, including Polling bit set and valid RRBp field.
7	MS -> SS	EGPRS PACKET DOWNLINK ACK/NACK	indicating correct reception of RLC block.
8	MS<->SS	Completion of macro {Downlink data transfer}	SS completes downlink transfer.

Specific Message Contents:

IMMEDIATE ASSIGNMENT message:

	Information Element	value/ remark
Steps 1 & 5	EGPRS Window Size	192 Max Window size for 1 TS
Steps 1 & 5	Link Quality Measurement Mode	00

EGPRS DOWNLINK ACK/NACK in Step 7

Information Element	value/ remark
ACK/NACK Description IE	
MS_OUT_OF_MEMORY IE	0
EGPRS Channel Quality Report IE	
Final_Ack_Indicator	0

51.3 MAC/RLC Release

The maximum duration of each test is per default 5 minutes.

51.3.1 TBF Release / Uplink / Normal / MS initiated

51.3.1.1 TBF Release / Uplink / Normal / MS initiated / Acknowledged mode

51.3.1.1.1 Conformance requirements

1. The MS initiates release of the uplink TBF by beginning the countdown process. When the MS has sent the RLC data block with CV = 0 and there are no elements in the V(B) array set to the value Nacked, it shall start timer T3182 and stop timer T3180, if running. The MS shall continue to send RLC data blocks on each assigned uplink data block, according to the algorithm defined in 3GPP TS 04.60, subclause 9.1.3.2.
2. Upon reception of a PACKET UPLINK ACK/NACK message the MS shall stop timer T3182.
3. If the PACKET UPLINK ACK/NACK message has the Final Ack Indicator bit set to '1', the MS shall transmit the PACKET CONTROL ACKNOWLEDGEMENT message and release the TBF. If there is no ongoing downlink TBF the MS shall enter packet idle mode.
4. If the PACKET UPLINK ACK/NACK message requests retransmission of RLC data blocks, the MS shall if necessary wait for allocation of uplink resources and then retransmit the RLC data blocks requested, restarting timer T3180 after each block is transmitted. The MS shall then start timer T3182 and wait for a PACKET UPLINK ACK/NACK message as above.

5. Upon transition from the packet transfer mode to the packet idle mode, a MS shall enter the Transfer non-DRX mode period.
6. Upon a receipt of a commanding message or indication from the network requiring an action by the MS, if the reaction time for such action is not specified elsewhere, the MS shall begin to perform the required action no later than the next occurrence of block $B((x+6) \bmod 12)$, where block $B(x)$ is the radio block containing the commanding message or indication from the network.

References

3GPP TS 04.60, subclauses 9.3.2.3 and 5.5.1.5.

3GPP TS 05.10, subclause 6.11.4.

51.3.1.1.2 Test purpose

To verify that in RLC acknowledged mode:

1. the MS initiates release of an uplink TBF by beginning countdown process. After $CV = 0$ and no elements in the $V(B)$ array set to the value "Nacked" the MS continues to send RLC data blocks on each assigned uplink data block in the way defined in 3GPP TS 04.60, subclause 9.1.3 and waits for PACKET UPLINK ACK/NACK.
2. the MS retransmits the requested RLC data blocks if the PACKET UPLINK ACK/NACK message requests to do so. The MS then waits for another PACKET UPLINK ACK/NACK message.
3. the MS transmits the PACKET CONTROL ACKNOWLEDGEMENT message and release the TBF upon reception of a PACKET UPLINK ACK/NACK with the Final Ack Indicator bit set to '1'. If there is no ongoing downlink TBF the MS shall enter packet idle mode.

51.3.1.1.3 Method of test

Initial Conditions

System Simulator:

EGPRS supported.

cell, default setting, $BS_PBCCH_BLKS = 3$, $BS_CV_MAX = 10$.

Mobile Station:

The MS is GPRS attached with a P-TMSI allocated, SPLIT PG CYCLE negotiated and PDP test context2 activated.

Specific PICS Statements

- EGPRS Multislotclass (TSPC_Type_EGPRS_Multislot_ClassX where $X = 1..45$)

PIXIT Statements

-

Test Procedure

The test has three parts.

1. The MS is triggered to transfer user data. A TBF of dynamic allocation in acknowledged mode with $USF_GRANULARITY = 1$ block is assigned. The countdown values are checked during the RLC data transferring. The SS acknowledges the all received RLC data blocks with the Final Ack Indicator bit set to '1'. The SS assigns a downlink TBF, transfers a number of downlink data blocks and polls the MS. The MS responses the polling.
2. The MS is assigned a TBF of dynamic allocation in acknowledged mode with $USF_GRANULARITY = 4$ blocks. The countdown values are checked during the RLC data transferring. The SS acknowledges the all received RLC data blocks with the Final Ack Indicator bit set to '1'.

3. The MS is triggered to transfer user data. A TBF of dynamic allocation on two timeslots in acknowledged mode with USF_GRANULARITY = 4 block is assigned. The countdown values are checked during the RLC data transferring.

The SS acknowledges the all received RLC data blocks with the Final Ack Indicator bit set to '1'.

Expected Sequence

Step	Direction	Message	Comments
1		{Uplink dynamic allocation one phase access with contention resolution} Or {Uplink dynamic allocation two phase access}	N = 440 octets, USF_GRANULARITY = 1 block, EGPRS_CHANNEL_CODING_COMMAND: MCS-1, Resegment bit = 1, TLLI_BLOCK_CHANNEL_CODING: '0'B, MCS-1. RLC acknowledged mode (PDP context2), without starting time
2	SS -> MS	PACKET DOWNLINK DUMMY CONTROL BLOCK	USF assigned to the MS
3	MS -> SS	EGPRS UPLINK RLC DATA BLOCK	
4			Repeat step 2 and 3 until the countdown value CV=4.
5	SS -> MS	PACKET UPLINK ACK/NACK	Acknowledge all received data blocks, USF assigned to the MS. PREEMPTIVE_TRANSMISSION_BIT=1
6	MS -> SS	EGPRS UPLINK RLC DATA BLOCK	Received on the assigned PDTCH. Check that CV=3.
7	SS -> MS	PACKET DOWNLINK DUMMY CONTROL BLOCK	USF assigned to the MS.
8	MS -> SS	EGPRS UPLINK RLC DATA BLOCK	Check that CV=2.
8a			Repeat steps 7 and 8 two more times and check that first CV =1 block is received and then CV = 0 is received.
9	SS -> MS	PACKET DOWNLINK DUMMY CONTROL BLOCK	USF assigned to the MS.
10	MS -> SS	EGPRS UPLINK RLC DATA BLOCK	Check that the data block is a retransmission of the data block transmitted in step 6, CV=3.
11	SS -> MS	PACKET DOWNLINK DUMMY CONTROL BLOCK	USF assigned to the MS.
12	MS -> SS	EGPRS UPLINK RLC DATA BLOCK	Check that the data block is a retransmission of the data block transmitted in step 8.
12a			Repeat steps 11 and 12 two more times and check that first CV =1 block is retransmitted and then CV = 0 is retransmitted
12b	SS		SS waits BS_CV_MAX periods
13	SS -> MS	PACKET UPLINK ACK/NACK	Negatively acknowledge the data block transmitted with CV = 0. PREEMPTIVE_TRANSMISSION_BIT=1
13a			Wait for 5 radio block periods.
13b	SS -> MS	PACKET DOWNLINK DUMMY CONTROL BLOCK	Containing USF assigned to MS.
A14 (optional step)	MS -> SS	UPLINK RLC DATA BLOCK	MS may retransmit block with CV=3 if it has already been scheduled while Packet Uplink Ack/Nack is being processed. In this case go to step B14
B14 (optional step)	SS -> MS	PACKET DOWNLINK DUMMY CONTROL BLOCK	USF assigned to the MS.
14	MS -> SS	EGPRS UPLINK RLC DATA BLOCK	Check that the data block is a retransmission of the data block transmitted with CV = 0.
15	SS -> MS	PACKET UPLINK ACK/NACK	Final Ack Indicator = '1' containing a valid RRB=26. Acknowledge the last two data blocks. PREEMPTIVE_TRANSMISSION_BIT=1
16	MS -> SS	PACKET CONTROL ACKNOWLEDGEMENT	Received on the radio block specified by RRB
17	SS -> MS	PACKET DOWNLINK ASSIGNMENT	Downlink Assignment, acknowledged mode. Sent on PCCCH.
18	SS -> MS	EGPRS DOWNLINK RLC DATA BLOCKS	10 downlink data blocks, the data block with FBI = '1' and a valid RRB

Step	Direction	Message	Comments
19	MS -> SS	EGPRS PACKET DOWNLINK ACK/NACK	Received on the block specified by RRBP in step 18. Check that the Final Ack indicator = '1'.
20		{Uplink dynamic allocation one phase access with contention resolution} or {Uplink dynamic allocation two phase access}	N = 440 octets, USF_GRANULARITY = 4 blocks, EGPRS_CHANNEL_CODING_COMMAND: MCS-1, Resegment bit = 1, TLLI_BLOCK_CHANNEL_CODING: '0'B, MCS-1. RLC acknowledged mode (PDP context2), without starting time PREEMPTIVE_TRANSMISSION_BIT=1(Applicable only in case of one phase access with contention resolution)
21	SS -> MS	PACKET DOWNLINK DUMMY CONTROL BLOCK	USF assigned to the MS
22	MS -> SS	EGPRS UPLINK RLC DATA BLOCK	
23	MS -> SS	EGPRS UPLINK RLC DATA BLOCK	
24	MS -> SS	EGPRS UPLINK RLC DATA BLOCK	
25	MS -> SS	EGPRS UPLINK RLC DATA BLOCK	
25A (optional step)	SS -> MS	PACKET UPLINK ACK/NACK	Acknowledge all received data blocks. PREEMPTIVE_TRANSMISSION_BIT=1. This step should be executed only if two phase access has been performed at step20.
26			Regard the steps 21 - 25 as a step block. Repeat the step block until the countdown value CV = 0 in one of data blocks received.
26a	SS		SS waits BS_CV_MAX periods after reception of Data block with CV=0
27	SS -> MS	PACKET UPLINK ACK/NACK	Acknowledge all received data blocks except for the data blocks which have CV=2, CV=1, and CV=0. Set SSN value in Ack/Nack description equal to the BSN' of the received data block with CV = 1. PREEMPTIVE_TRANSMISSION_BIT=1
27a	SS		Wait for 5 block periods
27b	SS -> MS	PACKET DOWNLINK DUMMY CONTROL BLOCK	USF assigned to the MS
A28 (optional step)	MS -> SS	UPLINK RLC DATA BLOCK	MS may retransmit block with CV=15 if it has already been scheduled before the end of the reaction time.
28	MS -> SS	EGPRS UPLINK RLC DATA BLOCK	Check that the countdown value CV = 2.
29	MS -> SS	EGPRS UPLINK RLC DATA BLOCK	Check that the countdown value CV = 1.
30	MS -> SS	EGPRS UPLINK RLC DATA BLOCK	Check that the countdown value CV = 0.
31A (optional step)	MS -> SS	EGPRS UPLINK RLC DATA BLOCK	If Optional Step A28 is received, then this step shall be bypassed. (USF Granularity=1 and 4 blocks already received) Check that the countdown value CV = 2.
31	SS		SS waits BS_CV_MAX periods.
32	SS -> MS	PACKET UPLINK ACK/NACK	Negatively acknowledge the data blocks of CV=2, and CV=0. Acknowledge the data block of CV=1. PREEMPTIVE_TRANSMISSION_BIT=1
32a	SS		Wait for 5 block periods
32b	SS -> MS	PACKET DOWNLINK DUMMY CONTROL BLOCK	USF assigned to the MS
33A (optional step)	MS -> SS	EGPRS UPLINK RLC DATA BLOCK	Optional Step . The MS may transmit the Data block already in the transmit buffer with CV=1 if 31A was received or CV=2 if 31A was not received.
33	MS -> SS	EGPRS UPLINK RLC DATA BLOCK	Check that the countdown value CV = 2.
34	MS -> SS	EGPRS UPLINK RLC DATA BLOCK	Check that the countdown value CV = 0.

Step	Direction	Message	Comments
35	MS -> SS	EGPRS UPLINK RLC DATA BLOCK	Check that the countdown value CV = 2.
36A (optional step)	MS -> SS	EGPRS UPLINK RLC DATA BLOCK	If Optional Step 33A is received, then this step shall be bypassed. (USF Granularity=1 and 4 blocks already received) Check that the countdown value CV = 0.
37	SS -> MS	PACKET UPLINK ACK/NACK	Final Ack Indicator = '1' containing valid RRBP. Sent on PACCH of the assigned PDCH. Acknowledge all data blocks received. PREEMPTIVE_TRANSMISSION_BIT=1
38	MS -> SS	PACKET CONTROL ACKNOWLEDGEMENT	Received on the block specified by RRBP on PACCH of the assigned PDCH.
39	SS -> MS	PACKET DOWNLINK ASSIGNMENT	Downlink Assignment, acknowledged mode. Sent on PCCCH.
40	SS -> MS	EGPRS DOWNLINK RLC DATA BLOCKS	10 downlink data blocks, the data block with FBI = '1' and a valid RRBP
41	MS -> SS	EGPRS PACKET DOWNLINK ACK/NACK	Received on the block specified by RRBP in step 40. Check that the Final Ack indicator = '1'.
			The following steps are not applicable to the MS in EGPRS multislot class 1, 2, 3, 4, 8, 30, 35 and 40.
42		{Uplink dynamic allocation two phase access}	N = 1000 octets, without starting time, USF_GRANULARITY = 4 blocks, RLC_DATA_BLOCKS_GRANTED = open-end, EGPRS_CHANNEL_CODING_COMMAND: MCS-4, Resegment bit = 1, RLC acknowledged mode (PDP context2), Two slots, USF ₀ on TN ₀ and USF ₁ on TN ₁ , are assigned.
43	SS -> MS	PACKET DOWNLINK DUMMY CONTROL BLOCK	Assigned USF ₀ on PDTCH ₀ addressing the MS.
44	SS -> MS	PACKET DOWNLINK DUMMY CONTROL BLOCK	Assigned USF ₁ on PDTCH ₁ addressing the MS, sent on the same TDMA frame as step 43.
45	MS -> SS	EGPRS UPLINK RLC DATA BLOCKS	Received on the assigned PDTCH ₀ and PDTCH ₁ . Check that the coding as specified in EGPRS_CHANNEL_CODING_COMMAND, the TFI is correct and the block does not contain TLLI.
46	MS -> SS	EGPRS UPLINK RLC DATA BLOCKS	Received on the assigned PDTCH ₀ and PDTCH ₁ .
47	MS -> SS	EGPRS UPLINK RLC DATA BLOCKS	Received on the assigned PDTCH ₀ and PDTCH ₁ .
48	MS -> SS	EGPRS UPLINK RLC DATA BLOCKS	Received on the assigned PDTCH ₀ and PDTCH ₁ .
49			Regard the steps 43 - 48 as a step block. Repeat the step block until the countdown value CV = 0 in one of data blocks received. Check the CV decrement from BS_CV_MAX (10) to 0.
50	SS -> MS	PACKET UPLINK ACK/NACK	Final Ack Indicator = '1' containing a valid RRBP. Sent on PACCH of the assigned PDCH. Acknowledge all data blocks received. PREEMPTIVE_TRANSMISSION_BIT=1
51	MS -> SS	PACKET CONTROL ACKNOWLEDGEMENT	Received on the block specified by RRBP on PACCH of the assigned PDCH.

51.3.1.2 TBF Release / Uplink / Normal / MS initiated / Unacknowledged mode

51.3.1.2.1 Conformance requirements

The MS initiates release of the uplink TBF by beginning the countdown process. It indicates the end of the TBF by setting the CV value to 0 and starts timer T3182.

Upon reception of a PACKET UPLINK ACK/NACK message the MS shall stop timer T3182. If the PACKET UPLINK ACK/NACK message has the Final Ack Indicator bit set to '1', the MS shall transmit the PACKET CONTROL ACKNOWLEDGEMENT message and release the TBF. If there is no ongoing downlink TBF the MS shall enter packet idle mode.

If timer T3182 expires the MS shall release the TBF as if a PACKET UPLINK ACK/NACK message was received.

References

3GPP TS 04.60, subclause 9.3.3.3.

51.3.1.2.2 Test purpose

To verify that in RLC unacknowledged mode:

1. the MS initiates release of an uplink TBF by beginning the countdown process and indicates the end of the TBF by setting the CV value to 0.
2. the MS transmits the PACKET CONTROL ACKNOWLEDGEMENT message and release the TBF upon reception of a PACKET UPLINK ACK/NACK message with the Final Ack Indicator bit set to '1' after CV=0. If there is no ongoing downlink TBF the MS enters packet idle mode.
3. the MS releases the TBF as if a PACKET UPLINK ACK/NACK message was received when timer T3182 expires.

51.3.1.2.3 Method of test

Initial Conditions

System Simulator:

EGPRS supported.

1 cell, default setting, BS_PBCCH_BLKs = 3, BS_CV_MAX = 12.

Mobile Station:

The MS is GPRS attached with a P-TMSI allocated, SPLIT PG CYCLE negotiated and PDP test context3 activated.

Specific PICS Statements

- EGPRS Multislotclass (TSPC_Type_EGPRS_Multislot_ClassX where X = 1..45)

PIXIT Statements

-

Test Procedure

The test procedure has three parts.

1. The MS is triggered to transfer data. A TBF of dynamic allocation in unacknowledged mode is assigned. The countdown values are checked during the RLC data transferring. The SS acknowledges the all received RLC data blocks with the Final Ack Indicator bit set to '1' and polls the MS. The MS sends PACKET CONTROL ACKNOWLEDGEMENT in response of polling. After 6 blocks the SS assigns a downlink TBF in unacknowledged mode, sends a number downlink data blocks and polls the MS with a valid RRBP. The MS responses the polling.
2. The MS is triggered to transfer data. A TBF of dynamic allocation in unacknowledged mode is assigned. The countdown values are checked during the RLC data transferring. The SS does not acknowledge the received RLC data blocks. After CV = 0 the SS waits for 5.5s (T3182 expires). Once CV=0 the SS checks that the MS does not transfer further RLC data blocks on the assigned TBF.
3. The MS is triggered to transfer data. A TBF of dynamic allocation on two timeslots in unacknowledged mode is assigned. The countdown values are checked during the RLC data transferring. The SS does not acknowledge the received RLC data blocks. Once CV=0 the SS checks that the MS does not transfer further RLC data blocks on the assigned TBF. The last block may be transmitted twice (once in each slot) or the MS may transmit a PACKET UPLINK DUMMY CONTROL message..

Expected Sequence

Step	Direction	Message	Comments
------	-----------	---------	----------

Step	Direction	Message	Comments
1		{Uplink dynamic allocation two phase access}	n = 440 octets in RLC unacknowledged mode. (PDP context3) TLLI_BLOCK_CHANNEL_CODING = '0'B, MCS-1, EGPRS_CHANNEL_CODING_COMMAND = MCS-1, Resegment bit = 1. USF assigned to MS
2	SS->MS	PACKET DOWNLINK DUMMY CONTROL BLOCK	
3	MS -> SS	EGPRS UPLINK RLC DATA BLOCK	
4			Repeat step 2 and 3 until the countdown value CV=0.
5	SS -> MS	PACKET UPLINK ACK/NACK	Final Ack Indicator = '1' containing a valid RRB=13, no retransmission needed. PREEMPTIVE_TRANSMISSION_BIT=1
6	MS -> SS	PACKET CONTROL ACKNOWLEDGEMENT	Received on the block specified by RRB on PACCH of the assigned PDCH.
7	SS->MS	PACKET DOWNLINK DUMMY CONTROL BLOCK	<u>USF assigned to MS</u>
8	SS		Check that no data block is transmitted by the MS in the next radio blocks.
9	SS -> MS	PACKET DOWNLINK ASSIGNMENT	Downlink Assignment, unacknowledged mode. Sent on PPCH, Steps 10 – 12 verify whether the MS has entered idle mode.
10	SS -> MS	EGPRS DOWNLINK RLC DATA BLOCK	
11			Repeat step 10 ten times. In the last data block set FBI = '1' with a valid RRB.
12	MS -> SS	PACKET CONTROL ACKNOWLEDGEMENT	Received on the block specified by RRB in step 11.
13		{Uplink dynamic allocation two phase access}	n = 600 octets in RLC unacknowledged mode. (PDP context3) TLLI_BLOCK_CHANNEL_CODING = '1'B, MCS-1, EGPRS_CHANNEL_CODING_COMMAND = MCS-1, Resegment bit = 1. <u>USF assigned to MS</u>
14	SS->MS	PACKET DOWNLINK DUMMY CONTROL BLOCK	
15	MS -> SS	EGPRS UPLINK RLC DATA BLOCK	Received on the assigned PDCH.
16			Repeat step 14 and 15 until the countdown value CV=0.
16 a	SS->MS	PACKET DOWNLINK DUMMY CONTROL BLOCK	USF assigned to MS to delay start of T3180 by 500ms (SS should ignore any received Rlc data block). This step is repeated until a PACKET UPLINK DUMMY CONTROL BLOCK is received from the MS, but not more than 4 times.
17	SS		Wait 5.5 seconds (starting after the last RLC data block) to allow T3182 expiring
18	SS->MS	PACKET DOWNLINK DUMMY CONTROL BLOCK	USF assigned to MS
19	SS		Check that no data block is transmitted by the MS.
			The following steps are not applicable to the MS in EGPRS multislot class 1, 2, 3, 4, 8, 30, 35 and 40.
20	SS -> MS	{Uplink dynamic allocation two phase access}	n = 1200 octets in RLC unacknowledged mode. (PDP context3) Uplink dynamic allocation EGPRS_CHANNEL_CODING_COMMAND = MCS-4, Resegment bit = 1, Two timeslots are assigned
21	SS->MS	PACKET DOWNLINK DUMMY CONTROL BLOCKS	Sent on PDTCH0 and PDTCH1
22	MS->SS	EGPRS UPLINK RLC DATA BLOCKS	Received on the assigned PDTCH ₁ and PDTCH ₀ .

Step	Direction	Message	Comments
23	SS		Repeat steps 21 and 22 Check the CV decrement from BS_CV_MAX (=12) to 0 in the received data blocks. Last block (CV=0) may be transmitted twice, once in PDTCH ₀ and once in PDTCH ₁ or the MS may transmit a PACKET UPLINK DUMMY CONTROL BLOCK after the last EGPRS RLC DATA BLOCK
23 a	SS->MS	PACKET DOWNLINK DUMMY CONTROL BLOCK	USF assigned to MS to delay start of T3180 by 500ms (SS should ignore any received Rlc data block). This step is repeated until a PACKET UPLINK DUMMY CONTROL BLOCK is received from the MS, but not more than 4 times.
24	SS		Wait 5.5 seconds (starting after the last RLC data block) for T3182 expiry
25	SS->MS	PACKET DOWNLINK DUMMY CONTROL BLOCKS	Sent on PDTCH0 and PDTCH1
26	SS		Verify that no data block is transmitted by the MS

51.3.1.3 TBF Release / Uplink / Normal / MS initiated / Channel coding change during countdown

51.3.1.3.1 Conformance requirements

If the MS receives a change in the EGPRS Channel Coding Command in a PACKET UPLINK ACK/NACK message during the countdown procedure, the MS shall act upon the new EGPRS Channel Coding Command. The MS shall then recalculate the CV values for any untransmitted RLC data blocks using the new RLC data block size.

References

3GPP TS 04.60, subclause 9.3.1.

51.3.1.3.2 Test purpose

It is verified that the MS acts upon the new EGPRS Channel Coding Command and recalculates the CV values for any untransmitted RLC data blocks using the new RLC data block size when the MS receives a change of EGPRS Channel Coding Command in a PACKET UPLINK ACK/NACK message during the countdown procedure.

51.3.1.3.3 Method of test

Initial Conditions

System Simulator:

EGPRS supported.

1 cell, default setting, BS_PBCCH_BLKs = 3, BS_CV_MAX = 7.

Mobile Station:

The MS is GPRS attached with a P-TMSI allocated, SPLIT PG CYCLE negotiated and PDP context3 activated.

Specific PICS Statements

-

PIXIT Statements

-

Test Procedure

1. The MS is triggered to transfer data. A TBF of dynamic allocation with channel coding MCS-4 in unacknowledged mode is assigned. The countdown values are checked during the RLC data transferring.

2. Once CV=7 (BS_CV_MAX) the SS acknowledges the all received RLC data blocks and changes the channel coding to MCS-1. In the next received RLC data block CV=15. The countdown values are checked during the RLC data transferring.
3. When CV=7 is reached the SS acknowledges the all received RLC data blocks and changes the channel coding to MCS-2. The SS checks the next received RLC data block containing CV=5 or 4 or 3 as the case may be. The countdown values are checked during the RLC data transferring until CV=0. The SS acknowledges all received RLC data blocks with the Final Ack Indicator bit set to '1'.

Expected Sequence

Step	Direction	Message	Comments
1		{Uplink dynamic allocation two phase access}	n = 1800 octets, USF GRANULARITY = 1 block, EGPRS_CHANNEL_CODING_COMMAND = MCS-4, Resegment bit = 1. RLC unacknowledged mode (PDP context3), without starting time
2	SS -> MS	PACKET DOWNLINK DUMMY CONTROL BLOCK	USF assigned to the MS
3	MS-> SS	EGPRS UPLINK RLC DATA BLOCK	Received on the assigned PDTCH.
4			Repeat step 2 and 3 until the countdown value CV=7 (BS_CV_MAX).
5	SS -> MS	PACKET UPLINK ACK/NACK	Acknowledge all received data blocks, EGPRS_CHANNEL_CODING_COMMAND = MCS-1, Resegment bit = 1. PREEMPTIVE_TRANSMISSION_BIT=1 SS will then wait for 6 blocks with no USF
6	SS->MS	PACKET DOWNLINK DUMMY CONTROL BLOCK	USF assigned to the MS
A6 (optional step)	MS -> SS	EGPRS UPLINK RLC DATA BLOCK	MS may transmit a previously queued RLC block with the old coding scheme MCS-4 and CV=6
B6 (optional step)	SS->MS	PACKET DOWNLINK DUMMY CONTROL BLOCK	USF assigned to the MS. This step is executed in case step A6 is executed
7	MS -> SS	EGPRS UPLINK RLC DATA BLOCK	Received on the assigned PDTCH. Check that the countdown value CV = 15.
8	SS -> MS	PACKET UPLINK ACK/NACK	Sent on the PACCH of the PDCH assigned in step 2, containing USF assigned to the MS. PREEMPTIVE_TRANSMISSION_BIT=1
9	MS -> SS	EGPRS UPLINK RLC DATA BLOCK	Received on the assigned PDTCH.
10			Repeat step 8 and 9 until the countdown value CV=7 (BS_CV_MAX).
11	SS -> MS	PACKET UPLINK ACK/NACK	EGPRS_CHANNEL_CODING_COMMAND = MCS-2, Resegment bit = 1. PREEMPTIVE_TRANSMISSION_BIT=1 SS will then wait for 6 blocks with no USF
12	SS->MS	PACKET DOWNLINK DUMMY CONTROL BLOCK	USF assigned to the MS
A12 (optional step)	MS -> SS	EGPRS UPLINK RLC DATA BLOCK	MS may transmit a previously queued RLC block with the old coding scheme MCS-1 and CV=6
B12 (optional step)	SS->MS	PACKET DOWNLINK DUMMY CONTROL BLOCK	USF assigned to the MS. This step is executed in case step A12 is executed
13	MS -> SS	EGPRS UPLINK RLC DATA BLOCK	Received on the assigned PDTCH. Check the countdown value CV. In case the MS has sent an EGPRS UPLINK RLC DATA BLOCK in step A12, CV = 3 or 4, otherwise CV = 4 or 5.
14	SS -> MS	PACKET DOWNLINK DUMMY CONTROL BLOCK	USF assigned to the MS.
15	MS -> SS	EGPRS UPLINK RLC DATA BLOCK	Received on the assigned PDTCH.
16			Repeat step 14 and 15 until the countdown value CV=0.
17	SS -> MS	PACKET UPLINK ACK/NACK	Final Ack Indicator = '1' containing valid RRBP, acknowledge the all received data blocks. PREEMPTIVE_TRANSMISSION_BIT=1
18	MS -> SS	PACKET CONTROL ACKNOWLEDGEMENT	Received on the block specified by RRBP on PACCH of the assigned PDCH.

Specific Message Contents

PACKET UPLINK ACK/NACK message in step 5:

Information Element	value/ remark
EGPRS_CHANNEL_CODING_COMMAND	MCS-1

PACKET UPLINK ACK/NACK message in step 11:

Information Element	value/ remark
EGPRS_CHANNEL_CODING_COMMAND	MCS-2

51.3.2 TBF Release / Uplink / Normal / Network initiated

51.3.2.1 TBF Release / Uplink / Normal / Network initiated / Acknowledged mode

51.3.2.1.1 Conformance requirements

The network may initiate release of an uplink TBF by transmitting a PACKET TBF RELEASE message to the mobile station on the PACCH. A cause value indicates the reason for release.

If the cause value is "Normal release" the mobile station shall continue to the next LLC PDU boundary, starting the count down procedure at whatever value of CV is appropriate to count down to zero at the LLC PDU boundary, and then release the TBF according to the procedures in 3GPP TS 04.60, subclause 9.3.2.3.

References

3GPP TS 04.60, subclause 8.1.1.4.

51.3.2.1.2 Test purpose

To verify that when the MS, in an uplink TBF of the RLC acknowledged mode, receives a PACKET TBF RELEASE message with cause value "Normal release":

1. the MS continues the TBF to the next LLC PDU boundary;
2. the MS starts the count down procedure at whatever value of CV is appropriate to count down to zero at the LLC PDU boundary;
3. the MS then releases the TBF according to uplink acknowledged mode release procedure.

51.3.2.1.3 Method of test

Initial Conditions

System Simulator:

EGPRS supported.

1 cell, default setting, BS_PBCCH_BLKs = 3, BS_CV_MAX = 7.

Mobile Station:

The MS is GPRS attached with a P-TMSI allocated, SPLIT PG CYCLE negotiated and PDP context 2 activated.

Specific PICS Statements

-

PIXIT Statements

-

Test Procedure

1. The MS is triggered to transfer 2000 octets user data. A TBF of dynamic allocation in acknowledged mode is assigned. After the MS transfers several RLC data blocks the SS sends PACKET TBF RELEASE with cause value "Normal release. The length indicator and E bit in data block headers are checked during the RLC data transferring until CV=0 to ensure that the MS has transmitted only the RLC data block of the first LLC PDU.

Expected Sequence

Step	Direction	Message	Comments
1		{Uplink dynamic allocation one phase access with contention resolution} or {Uplink dynamic allocation two phase access}	n = 2000 octets (Note: more than one LLC PDU is needed for the test.) USF_GRANULARITY = 1 block, EGPRS_CHANNEL_CODING_COMMAND: MCS-1, TLLI_BLOCK_CHANNEL_CODING: '1'B, MCS-1. RLC acknowledged mode (PDP context2), without starting time
2	SS -> MS	PACKET DOWNLINK DUMMY CONTROL BLOCK	USF assigned to the MS.
3	MS -> SS	EGPRS UPLINK RLC DATA BLOCK	
4			Repeat step 2 and 3 three times
5	SS -> MS	PACKET TBF RELEASE	Sent on the PACCH of the PDCH assigned, USF not assigned to the MS, Global TFI is same as the assigned one in step 1, Uplink_Release = yes, Cause value = "Normal release".
5a	SS		SS waits 3 blocks.
6	SS -> MS	PACKET UPLINK ACK/NACK	USF assigned to the MS, on PACCH of the assigned PDCH in step 1. PREEMPTIVE_TRANSMISSION_BIT=1
7	MS -> SS	EGPRS UPLINK RLC DATA BLOCK	
8			Repeat step 6 and 7 until the countdown value CV=0 in step 7. Use of the Length indicator and E bit of the received data headers to determine that only the 1 st LLC PDU is transmitted.
9	SS -> MS	PACKET UPLINK ACK/NACK	Final Ack Indicator = '1' containing valid RRBP. Acknowledge all data blocks. PREEMPTIVE_TRANSMISSION_BIT=1
10	MS -> SS	PACKET CONTROL ACKNOWLEDGEMENT	Received on the block specified by RRBP on PACCH of the assigned PDCH.
11	SS -> MS	PACKET UPLINK ACK/NACK	Sent on the PACCH of the PDCH assigned in step 1, containing USF assigned to the MS. PREEMPTIVE_TRANSMISSION_BIT=1
12	SS		Check that no data block is transmitted by the MS in the next radio block to step 11.

51.3.2.2 TBF Release / Uplink / Normal / Network initiated / Unacknowledged mode

51.3.2.2.1 Conformance requirements

The network may initiate release of an uplink TBF by transmitting a PACKET TBF RELEASE message to the mobile station on the PACCH. A cause value indicates the reason for release.

If the cause value is "Normal release" a mobile station shall continue to the next LLC PDU boundary, starting the count down procedure at whatever value of CV is appropriate to count down to zero at the LLC PDU boundary, and then release the TBF according to the procedures in 3GPP TS 04.60, subclause 9.3.3.3.

References

3GPP TS 04.60, subclauses 8.1.1.4 and 9.3.3.3.

51.3.2.2.2 Test purpose

To verify that when the MS receives a PACKET TBF RELEASE message with cause value "Normal release" during an unacknowledged mode uplink TBF:

1. the MS continues the TBF to the next LLC PDU boundary;
2. the MS starts the count down procedure at whatever value of CV is appropriate to count down to zero at the LLC PDU boundary;
3. the MS then releases the TBF according to uplink unacknowledged mode release procedure.

51.3.2.2.3 Method of test

Initial Conditions

System Simulator:

EGPRS supported.

1 cell, default setting, BS_PBCCH_BLKs = 3, BS_CV_MAX = 15.

Mobile Station:

The MS is GPRS attached with a P-TMSI allocated, SPLIT PG CYCLE negotiated and PDP context3 activated.

Specific PICS Statements

-

PIXIT Statements

-

Test Procedure

1. The MS is triggered to transfer 2000 octets user data. A TBF of dynamic allocation in unacknowledged mode is assigned. After the MS transfers several RLC data blocks the SS sends PACKET TBF RELEASE with cause value "Normal release. The length indicator, M and E bit in data block headers are checked during the RLC data transferring until CV=0 to ensure that the MS has transmitted only the RLC data block of the first LLC PDU.

Expected Sequence

Step	Direction	Message	Comments
1		{Uplink dynamic allocation two phase access}	n = 2000 octets in RLC unacknowledged mode. (PDP context3)
2	SS -> MS	PACKET DOWNLINK DUMMY CONTROL BLOCK	TLLI_BLOCK_CHANNEL_CODING = '0'B, MCS-1, EGPRS_CHANNEL_CODING_COMMAND = MCS-1.
3	MS -> SS	EGPRS UPLINK RLC DATA BLOCK	USF Assigned to MS
4			Repeat step 2 and 3 five times.
5	SS -> MS	PACKET TBF RELEASE	Sent on the PACCH of the PDCH assigned, USF not assigned to the MS, Global TFI is same as the assigned one in step 1, Uplink_Release = yes, Cause value = "Normal release".
5a	SS		SS waits 3 blocks.
6	SS -> MS	PACKET UPLINK ACK/NACK	USF assigned to the MS, on PACCH of the assigned PDCH in step 1.
7	MS -> SS	EGPRS UPLINK RLC DATA BLOCK	
8			Repeat steps 6 and 7 until the countdown value CV=0 in step 7.
9	SS -> MS	PACKET UPLINK ACK/NACK	Use of the Length indicator and E bit of the received data headers to determine that only the 1 st LLC PDU is transmitted.
10	MS -> SS	PACKET CONTROL ACKNOWLEDGEMENT	Final Ack Indicator = '1' containing valid RRBp, No retransmission needed. Sent on PACCH of the assigned PDCH. PREEMPTIVE_TRANSMISSION_BIT=1
			Received on the block specified by RRBp on PACCH of the assigned PDCH.

51.3.3 TBF Release / Uplink / Network initiated / Abnormal release

51.3.3.1 Conformance requirements

The network may initiate release of an uplink TBF by transmitting a PACKET TBF RELEASE message to the mobile station on the PACCH. If the cause value is "Abnormal release" the mobile station shall immediately stop transmitting and follow the abnormal release with random access procedure.

References

3GPP TS 04.60, subclause 8.1.1.4.

51.3.3.2 Test purpose

To verify that the MS immediately stops transmitting and follows the abnormal release with random access procedure when it receives a PACKET TBF RELEASE message on the PACCH with cause value "Abnormal release".

51.3.3.3 Method of test

Initial Conditions

System Simulator:

EGPRS supported.

1 cell, default setting, BS_PBCCH_BLKs = 3, BS_CV_MAX = 9.

Mobile Station:

The MS is GPRS attached with a P-TMSI allocated, SPLIT PG CYCLE negotiated and PDP context2 activated.

Specific PICS Statements

-

PIXIT Statements

-

Test Procedure

The MS is triggered to transfer user data. A TBF of dynamic allocation in acknowledged mode is assigned. After the MS transfers several RLC data blocks the SS sends PACKET TBF RELEASE with cause value "Abnormal release". The MS reinitiates a random access for one or two phase access request.

Expected Sequence

Step	Direction	Message	Comments
1		{Uplink dynamic allocation one phase access with contention resolution} or {Uplink dynamic allocation two phase access}	n = 1200 octets in RLC acknowledged mode. (PDP context2) TLLI_BLOCK_CHANNEL_CODING = '0'B, MCS-1, EGPRS CHANNEL_CODING_COMMAND = MCS-1.
2	SS -> MS	PACKET DOWNLINK DUMMY CONTROL BLOCK	USF Assigned to MS
3	MS -> SS	EGPRS UPLINK RLC DATA BLOCK	Received on the assigned PDTCH.
4			Repeat steps 2 and 3 five times.
5	SS -> MS	PACKET TBF RELEASE	Sent on the PACCH of the PDCH assigned, Global TFI is same as the assigned one in step 1, Uplink_Release = yes, Cause value = "Abnormal release".
6	SS -> MS	PACKET DOWNLINK DUMMY CONTROL BLOCK	USF assigned to the MS, on PACCH of the assigned PDCH in step 1. Sent on the next block of that of message sent in step 5. This step is repeated for 5 times. Repetation should be on the consecutive blocks as that of the first.
7	MS -> SS	EGPRS UPLINK RLC DATA BLOCK	MS is allowed to send max. 5 blocks. Received on the assigned PDTCH.
8	MS -> SS	EGPRS PACKET CHANNEL REQUEST	Check that the MS does not send more than five blocks. Received on PRACH.

51.3.4 TBF Release / Downlink / Normal / Network initiated

51.3.4.1 TBF Release / Downlink / Normal / Network initiated / Acknowledged mode

51.3.4.1.1 Conformance requirements

If the mobile station receives an RLC data block with the FBI bit set the value '1' and with a valid RRBP field, the mobile station shall transmit a EGPRS PACKET DOWNLINK ACK/NACK message in the specified uplink block. The mobile station shall continue to monitor all assigned PDCHs.

Whenever the mobile station receives an RLC data block with a valid RRBP and the mobile station has received all RLC data blocks of the TBF, the mobile station shall send the PACKET DOWNLINK ACK/NACK message with the Final Ack Indicator bit set to '1', stop timer T3190 and start or restart timer T3192.

If the mobile station receives more than one RLC data block with the FBI set to '1', it shall accept the data from only the first one of these blocks.

If the mobile station, after sending the EGPRS PACKET DOWNLINK ACK/NACK message with the Final Ack Indicator bit set to '1', receives a PACKET DOWNLINK ASSIGNMENT or PACKET TIMESLOT RECONFIGURE message with the Control Ack bit set to '1' while timer T3192 is running, the mobile station shall stop timer T3192, consider the previous downlink TBF released and act upon the new assignment.

When timer T3192 expires the mobile station shall stop monitoring its assigned downlink PDCHs. If the mobile station is operating in half duplex mode and received an uplink assignment during the TBF release procedure, the mobile station shall then immediately act upon the assignment. Otherwise, and if there is no ongoing uplink TBF, enter packet idle mode.

References

3GPP TS 04.60, subclause 9.3.2.5.

51.3.4.1.2 Test purpose

To verify that in a downlink TBF of acknowledged mode:

1. The MS sends EGPRS PACKET DOWNLINK ACK/NACK in the specified uplink block and continues monitoring all assigned PDCHs when it receives an RLC data block with a valid RRBP field and the Final Block Indicator (FBI) = '1'.

2. Whenever the MS receives an RLC data block with a valid RRBP and has received all RLC data blocks of the TBF, it sends EGPRS PACKET DOWNLINK ACK/NACK with the Final Ack Indicator bit set to '1'.
3. If the MS receives more than one RLC data block with the FBI set to '1', it accepts the data from only the first one of these blocks.
4. While timer T3192 is running, if the MS receives, after sending EGPRS PACKET DOWNLINK ACK/NACK with the Final Ack Indicator bit set to '1', PACKET DOWNLINK ASSIGNMENT with the Control Ack bit set to '1', the MS acts upon the new downlink assignment.
5. The MS stops monitoring its assigned downlink PDCHs and enters packet idle mode when timer T3192 expires if there is no ongoing uplink TBF.

51.3.4.1.3 Method of test

Initial Conditions

System Simulator:

EGPRS supported.

1 cell, default setting, BS_PBCCH_BLKs = 3, BS_CV_MAX = 15.

Mobile Station:

The MS is GPRS attached with a P-TMSI allocated, SPLIT PG CYCLE negotiated and PDP context2 activated.

Specific PICS Statements

-

PIXIT Statements

-

Test Procedure

1. The MS receives PACKET DOWNLINK ASSIGNMENT on its PPCH. The SS transmits 10 downlink RLC data blocks with consecutive BSN. The SS then transmits a downlink RLC data block with the highest BSN which is ten higher than the BSN of the last RLC data block. The SS sets FBI bit and polls the MS with a valid RRBP in the header of the RLC data block. The MS acknowledges the received data blocks and request a retransmission for the missing 9 data blocks in SSN and RBB fields.
2. The SS sends another 5 RLC data blocks and polls the MS with a valid RRBP. The MS acknowledges the received data blocks and request the retransmission of the missing 4 RLC data blocks. The SS transmits the last 4 RLC data blocks and polls the MS with RRBP=N+26. While the MS waiting for transmission of the final Acknowledgement the SS transmits a RLC data block which sets FBI bit and has same BSN as in the first FBI set beforehand. The MS ignores the downlink data and acknowledges the entire TBF with FINAL_ACK_INDICATION set. The SS transmits another data block with FBI set and polls the MS. The MS acknowledges the entire TBF with FINAL_ACK_INDICATION set. The SS waits 3 s.
3. The MS receives PACKET DOWNLINK ASSIGNMENT on its PPCH. The SS transmits a number of downlink RLC data blocks, sets FBI bit and polls the MS with a valid RRBP. The MS acknowledges the entire TBF with FINAL_ACK_INDICATION set.
4. The SS sends another PACKET DOWNLINK ASSIGNMENT on the assigned PACCH with Control ACK bit set. The SS transmits a number of downlink RLC data blocks on the new assigned PDTCH, sets FBI bit and polls the MS with a valid RRBP. The MS acknowledges the entire TBF with FINAL_ACK_INDICATION set.

Expected Sequence

Step	Direction	Message	Comments
1	SS -> MS	PACKET DOWNLINK ASSIGNMENT	Downlink Assignment, acknowledged mode. Sent on PPCH.
2	SS -> MS	EGPRS DOWNLINK RLC DATA BLOCK	Sent on downlink PDTCH assigned.
3			Repeat step 2 nine times, each time BSN is incremented by 1
4	SS -> MS	EGPRS DOWNLINK RLC DATA BLOCK	One data block with valid RRBP, FBI bit is set. BSN is incremented by 10. The MS has missed 9 consecutive RLC data blocks. BSN of this data block =
5	MS -> SS	EGPRS PACKET DOWNLINK ACK/NACK	(BSN of the last data block in step 3 + 10) mod 2048 Received on the block specified by RRBP in step 4. Check that the Final Ack indicator = '0' and the SSN and RBB values for the 9 missing data blocks .
6	SS -> MS	EGPRS DOWNLINK RLC DATA BLOCK	BSN of the data block =
7			(BSN of the last data block in step 3 + 1) mod 2048 Repeat step 6 three times, each time BSN is incremented by 1 on the basis of the last BSN in step 6
8	SS -> MS	EGPRS DOWNLINK RLC DATA BLOCK	A valid RRBP, BSN is incremented by 1.
9	MS -> SS	EGPRS PACKET DOWNLINK ACK/NACK	Received on the block specified by RRBP in step 8. Check that the Final Ack indicator = '0' and SSN and RBB values for the 4 missing data blocks.
10	SS -> MS	EGPRS DOWNLINK RLC DATA BLOCK	BSN is incremented by 1
11			Repeat step 10 twice
12	SS -> MS	EGPRS DOWNLINK RLC DATA BLOCK	RRBP.= N+26, BSN is incremented by 1
13	SS -> MS	EGPRS DOWNLINK RLC DATA BLOCK	FBI bit is set, BSN is same as in step 4, RRBP.= N+26, sent on next radio block from step 12.
14	MS -> SS	EGPRS PACKET DOWNLINK ACK/NACK	Received on the block specified by RRBP in step 12. Check that the Final Ack indicator = '1'.
15	MS -> SS	EGPRS PACKET DOWNLINK ACK/NACK	Received on the block specified by RRBP in step 13. Check that the Final Ack indicator = '1'.
16	SS		Wait for expiry of T3192
17	SS -> MS	EGPRS DOWNLINK RLC DATA BLOCK	FBI bit is set, a valid RRBP. Sent on downlink PDTCH assigned in step 1.
18	SS		Check that the MS does not respond on RRBP in step 17, the MS is now in packet idle mode.
19	SS -> MS	PACKET DOWNLINK ASSIGNMENT	Downlink Assignment, acknowledged mode. Sent on PCCCH.
20	SS -> MS	EGPRS DOWNLINK RLC DATA BLOCK	
21			Repeat step 20 ten times
22	SS -> MS	EGPRS DOWNLINK RLC DATA BLOCK	One data block with FBI = '1' and valid RRBP.
23	MS -> SS	EGPRS PACKET DOWNLINK ACK/NACK	Received on the block specified by RRBP in step 22. Check that the Final Ack indicator = '1'.
24	SS		Wait for 80% of expiry of T3192
25	SS -> MS	PACKET DOWNLINK ASSIGNMENT	Downlink Assignment, acknowledged mode. A different slot assigned. Control Ack Bit = 1. Sent on PACCH.
26	SS -> MS	EGPRS DOWNLINK RLC DATA BLOCK	
27			Repeat step 26 ten times
28	SS -> MS	EGPRS DOWNLINK RLC DATA BLOCK	One data block with FBI = '1' and valid RRBP.
29	MS -> SS	EGPRS PACKET DOWNLINK ACK/NACK	Received on the block specified by RRBP in step 28. Check that the Final Ack indicator = '1'.

Specific Message Contents

EGPRS PACKET DOWNLINK ACK/NACK message in step 15:

Information Element	value/ remark
Ack/Nack Description	
- FINAL_ACK_INDICATION	1 (final ack)
- STARTING_SEQUENCE_NUMBER	V(R)
- RECEIVED_BLOCK_BITMAP	Acknowledges all data blocks transmitted by the MS

PACKET DOWNLINK ASSIGNMET message in step 25:

Information Element	value/ remark
CONTROL_ACK	1
TIMESLOT_ALLOCATION	Single slot arbitrarily chosen but different from the value in step 19
{L H<DOWNLINK_TFI_ASSIGNMENT>}	H (assign downlink TFI)
- DOWNLINK_TFI_ASSIGNMENT	Arbitrarily chosen but different from the value in step 19

51.3.4.2 TBF Release / Downlink / Normal / Network initiated / Unacknowledged mode

51.3.4.2.1 Conformance requirements

For each RLC data block with the FBI bit set to '1' and with a valid RRBP field, the mobile station shall transmit the PACKET CONTROL ACKNOWLEDGEMENT message in the uplink block specified by the RRBP field. The mobile station shall continue to read the assigned downlink PDCHs until the block period pointed to by the RRBP. If the mobile station receives more than one RLC data block with the FBI bit set to '1' and with valid RRBP fields that point the same uplink block period, the mobile station shall transmit the PACKET CONTROL ACKNOWLEDGEMENT message only once. The mobile station shall then stop timer T3190, start timer T3192 and continue to monitor all assigned downlink PDCHs. If the mobile station then receives a subsequent RLC data block with a valid RRBP and the FBI bit set to '1', the mobile station shall retransmit the PACKET CONTROL ACKNOWLEDGEMENT message and restart timer T3192.

If the mobile station receives more than one RLC data block with the FBI set to '1', it shall accept the data from only the first one of these blocks.

If the mobile station, after sending the PACKET CONTROL ACKNOWLEDGEMENT message, receives a PACKET DOWNLINK ASSIGNMENT or PACKET TIMESLOT RECONFIGURE message with the Control Ack bit set to '1' while timer T3192 is running, the mobile station shall stop timer T3192, consider the previous downlink TBF released and act upon the new assignment.

When timer T3192 expires the mobile station shall stop monitoring its assigned downlink PDCHs.

References

3GPP TS 04.60, subclause 9.3.3.5.

51.3.4.2.2 Test purpose

To verify that in a downlink TBF of unacknowledged mode:

1. The MS transmits PACKET CONTROL ACKNOWLEDGEMENT in the uplink block specified by the RRBP field whenever it receives an RLC data block with a valid RRBP field and the Final Block Indicator (FBI) set to the value '1'.
2. After sending PACKET CONTROL ACKNOWLEDGEMENT the MS continues to monitor all assigned downlink PDCHs.
3. While timer T3192 is running, if the MS receives, after sending the PACKET CONTROL ACKNOWLEDGEMENT, a PACKET DOWNLINK ASSIGNMENT with the Control Ack bit set to '1', the MS acts upon the new downlink assignment.
4. The MS stops monitoring its assigned downlink PDCHs and enters packet idle mode when timer T3192 expires.

51.3.4.2.3 Method of test

Initial Conditions

System Simulator:

EGPRS supported.

1 cell, default setting, BS_PBCCH_BLKs = 3, BS_CV_MAX = 15, T3192 = 1,5 s.

Mobile Station:

The MS is GPRS attached with a P-TMSI allocated, SPLIT PG CYCLE negotiated and PDP context3 activated.

Specific PICS Statements

-

PIXIT Statements

-

Test Procedure

1. The MS receives PACKET DOWNLINK ASSIGNMENT on its PPCH. The SS transmits 11 downlink RLC data blocks with consecutive BSN. The SS then transmits a downlink RLC data block with the BSN which is ten higher than the BSN of the last RLC data block. The SS polls the MS with a valid RRBp in the header of the RLC data block. The MS acknowledges the received data blocks.
2. The SS sends another RLC data block and polls the MS with a valid RRBp and with the FBI bit set. The MS sends PACKET CONTROL ACKNOWLEDGEMENT.
3. The SS resends the RLC data block and polls the MS with a valid RRBp and with the FBI bit set. The MS sends PACKET CONTROL ACKNOWLEDGEMENT. The SS waits 1.2s and resends the RLC data block and polls the MS with a valid RRBp and with the FBI bit set. The MS responds with PACKET CONTROL ACKNOWLEDGEMENT. The SS waits till T3192 expires. . The SS resends the RLC data block with FBI set and a valid RRBp and checks that the MS does not transmit any data block on RRBp block.
4. The SS sends a PACKET DOWNLINK ASSIGNMENT on the PPCH of the MS. The SS transmits a number of downlink RLC data blocks, sets FBI bit and polls the MS with a valid RRBp. The MS shall respond with PACKET CONTROL ACKNOWLEDGEMENT.
5. The SS sends PACKET DOWNLINK ASSIGNMENT on the assigned PACCH with Control ACK bit set. The SS transmits a number of downlink RLC data blocks on the new assigned PDTCH, sets FBI bit and polls the MS with a valid RRBp. The MS shall respond with PACKET CONTROL ACKNOWLEDGEMENT.

Expected Sequence

Step	Direction	Message	Comments
1	SS -> MS	PACKET DOWNLINK ASSIGNMENT	Unacknowledged mode. Sent on its PPCH.
2	SS -> MS	EGPRS DOWNLINK RLC DATA BLOCK	Sent on downlink PDTCH assigned.
3			Repeat step 2 ten times, each time BSN is incremented by 1
4	SS -> MS	EGPRS DOWNLINK RLC DATA BLOCK	One data block with valid RRBP, BSN is incremented by 10. The MS has missed 9 consecutive RLC data blocks. BSN of this data block =
5	MS -> SS	EGPRS PACKET DOWNLINK ACK/NACK	(BSN of the last data block in step 3 + 10) mod 2048 Received on the block specified by RRBP in step 4. Check that the Final Ack indicator = '0'
6	SS -> MS	EGPRS DOWNLINK RLC DATA BLOCK	A valid RRBP, BSN is incremented by 1, FBI bit is set.
7	MS -> SS	PACKET CONTROL ACKNOWLEDGEMENT	Received on the block specified by RRBP in step 6.
8			Repeat step 6 and 7 once; keeping the BSN same
9	SS		Wait 1,2 seconds (T3192 not expired).
10	SS -> MS	EGPRS DOWNLINK RLC DATA BLOCK	One data block with FBI = '1' and valid RRBP, BSN is same as the BSN of the data block sent in step 6.
11	MS -> SS	PACKET CONTROL ACKNOWLEDGEMENT	Received on the block specified by RRBP in step 10.
12	SS		Wait for expiry of T3192
13	SS -> MS	EGPRS DOWNLINK RLC DATA BLOCK	One data block with the same BSN as in Step 6, with FBI = '1' and valid RRBP. Sent on downlink PDTCH assigned in step 1.
14	SS		Check that the MS does not transmit any Control block on the block identified by the RRBP .
15	SS -> MS	PACKET DOWNLINK ASSIGNMENT	Downlink Assignment, unacknowledged mode, a different timeslot assigned. Sent on PPCH.
16	SS -> MS	EGPRS DOWNLINK RLC DATA BLOCK	Sent 5 blocks from last block containing PACKET DOWNLINK ASSIGNMENT
17			Repeat step 16 ten times
18	SS -> MS	EGPRS DOWNLINK RLC DATA BLOCK	One data block with FBI = '1' and valid RRBP.
19	MS -> SS	PACKET CONTROL ACKNOWLEDGEMENT	
20	SS -> MS	PACKET DOWNLINK ASSIGNMENT	Wait 1,2 seconds (T3192 not expired). Downlink Assignment, unacknowledged mode. A different timeslot assigned. Control Ack Bit = 1. Sent on PACCH.
21	SS -> MS	EGPRS DOWNLINK RLC DATA BLOCK	Sent 5 blocks from last block containing PACKET DOWNLINK ASSIGNMENT
22			Repeat step 21 ten times
23	SS -> MS	EGPRS DOWNLINK RLC DATA BLOCK	One data block with FBI = '1' and valid RRBP.
24	MS -> SS	PACKET CONTROL ACKNOWLEDGEMENT	Received on the block specified by RRBP in step 23.

PACKET DOWNLINK ASSIGNMENT message in step 20:

Information Element	value/ remark
RLC_MODE	Unacknowledged mode
CONTROL_ACK	1
{LJH<DOWNLINK_TFI_ASSIGNMENT>}	H (assign downlink TFI)
- DOWNLINK_TFI_ASSIGNMENT	Arbitrarily chosen but different from the value in step 15
TIMESLOT_ALLOCATION	Single slot arbitrarily chosen but different from the values already assigned.

51.3.5 PDCH Release

51.3.5.1 Void

51.3.5.2 PDCH Release / With TIMESLOTS_AVAILABLE

51.3.5.2.1 Conformance requirements

When a mobile station receives a PACKET PDCH RELEASE message containing a TIMESLOTS_AVAILABLE field, it shall immediately stop transmitting and receiving on all assigned PDCHs, which are indicated as not present in the TIMESLOTS_AVAILABLE field, remove those PDCHs from its list of assigned PDCHs.

If all of the mobile station's assigned PDCHs are removed from its list of assigned PDCH, and, if an uplink TBF was in progress, the mobile station shall perform an abnormal release with random access. If no uplink TBF was in progress, the mobile station shall perform an abnormal release with return to CCCH or PCCCH.

References

3GPP TS 04.60, subclause 8.2.

51.3.5.2.2 Test purpose

To verify that when the MS receives a PACKET PDCH RELEASE message with a TIMESLOTS_AVAILABLE field indicating that one or more timeslots is no longer available for packet data service:

1. it immediately stops transmitting and receiving on all assigned PDCHs which are not presented in the TIMESLOTS_AVAILABLE field.
2. it performs an abnormal release with random access when all of the MS's assigned PDCHs are removed, and an uplink TBF was in progress.
3. it performs an abnormal release with return to CCCH or PCCCH when all of the MS's assigned PDCHs are removed, and no uplink TBF was in progress.

51.3.5.2.3 Method of test

Initial Conditions

System Simulator:

EGPRS supported.

1 cell, default setting, BS_PBCCH_BLKs = 3, BS_CV_MAX = 15.

Mobile Station:

The MS is GPRS attached with a P-TMSI allocated, SPLIT PG CYCLE negotiated and PDP context2 activated.

Specific PICS Statements

- EGPRS Multislotclass (TSPC_Type_EGPRS_Multislot_ClassX where X = 1..45)

PIXIT Statements

-

Test Procedure

1. The MS is triggered to transfer user data. A TBF on one slot of dynamic allocation in acknowledged mode is assigned. After the MS transfers several RLC data blocks the SS sends PACKET PDCH RELEASE with TIMESLOTS_AVAILABLE indicating no timeslot available. It is checked that the MS initiates a random access for one or two phase access request. A TBF is assigned to the MS to allow it to complete the uplink data transferring.
2. The MS is triggered to transfer user data. A TBF on two consecutive slots of dynamic allocation in acknowledged mode is assigned. After the MS transfers several RLC data blocks the SS sends PACKET PDCH

RELEASE with TIMESLOTS_AVAILABLE indicating that only a timeslot is available and the assigned downlink control timeslot is no more available. The MS uses the available timeslot to complete the uplink data transferring.

3. The MS receives PACKET DOWNLINK ASSIGNMENT on its PPCH. A downlink TBF with a timeslot is assigned. The SS transmits several downlink RLC data blocks. Then SS sends PACKET PDCH RELEASE with TIMESLOTS_AVAILABLE indicating no timeslot available and polls the MS with a valid RRBP for acknowledgement. It is checked that the MS does not react upon the polling.
4. A downlink TBF with two timeslots is assigned. The SS transmits several downlink RLC data blocks. Then SS sends PACKET PDCH RELEASE with TIMESLOTS_AVAILABLE indicating only a timeslot available and polls the MS with a valid RRBP for acknowledgement. It is checked that the MS does not react upon the polling and continues receiving the downlink data on the available timeslot. The SS sends another PACKET PDCH RELEASE with TIMESLOTS_AVAILABLE indicating no timeslot available and polls the MS with a valid RRBP for acknowledgement. It is checked that the MS does not react upon the polling.

Expected Sequence

Step	Direction	Message	Comments
1		{Uplink dynamic allocation one phase access with contention resolution} or {Uplink dynamic allocation two phase access}	n = 1000 octets in RLC acknowledged mode. (Test PDP context2) EGPRS CHANNEL_CODING_COMMAND = MCS-4.
2	SS->MS	PACKET DOWNLINK DUMMY CONTROL BLOCK	USF assigned to MS
3	MS -> SS	EGPRS UPLINK RLC DATA BLOCKS	Received data block on the assigned PDTCH.
4	SS		Repeat steps 2 and 3 five times
5	SS -> MS	PACKET PDCH RELEASE	Sent on the PACCH of the PDCH assigned in step 1. With TIMESLOTS_AVAILABLE indicating no timeslot available, RRBP = N + 26.
6	SS		SS checks that no PACKET CONTROL ACKNOWLEDGEMENT is received.
7	SS->MS	PACKET DOWNLINK DUMMY CONTROL BLOCK	USF assigned to MS
8	SS		Verify that no data block is received.
9	MS -> SS	EGPRS PACKET CHANNEL REQUEST	Received on PRACH.
10	SS -> MS	PACKET UPLINK ASSIGNMENT	Multiblock assignment, to order the MS making two phase access procedure. Sent on PAGCH.
11	MS -> SS	PACKET RESOURCE REQUEST	Two phase access procedure. Received on the single block assigned in step 10.
12	SS -> MS	PACKET UPLINK ASSIGNMENT	Open-ended uplink dynamic allocation with one time slot, USF_GRANULARITY = single block, EGPRS CHANNEL_CODING_COMMAND = MCS-4, Sent on PACCH of the same PDCH assigned in step 10.
13	SS -> MS	PACKET DOWNLINK DUMMY CONTROL BLOCK	Sent on the PACCH of the PDCH assigned in step 12, containing USF assigned to the MS.
14	MS -> SS	EGPRS UPLINK RLC DATA BLOCK	Received on the assigned PDTCH.
15		{Completion of uplink RLC data block transfer}	
16		{Uplink dynamic allocation one phase access with contention resolution} or {Uplink dynamic allocation two phase access}	The MS of the EGPRS multislot class 1, 2, 3, 4, 8, 30, 35 and 40 skips the steps 16 to 38 n = 1100 octets in RLC acknowledged mode. (Test PDP context2), EGPRS CHANNEL_CODING_COMMAND = MCS-2 Two timeslots
17	SS->MS	PACKET DOWNLINK DUMMY CONTROL BLOCKS	USFs assigned to MS. Sent on PDTCH ₆ and PDTCH ₇ .
18	MS -> SS	EGPRS UPLINK RLC DATA BLOCK	Received on the assigned PDTCH ₆ and PDTCH ₇ .
19			Repeat step 17 and 18 three times
20	SS -> MS	PACKET PDCH RELEASE	Sent on the PACCH of the PDCH ₆ assigned in step 16. With TIMESLOTS_AVAILABLE indicating no timeslot available RRBP=N+26.
21	SS		SS checks that no PACKET CONTROL ACKNOWLEDGEMENT is received.
22	SS->MS	PACKET DOWNLINK DUMMY CONTROL BLOCKS	USFs assigned to MS. Sent on PDTCH ₆ and PDTCH ₇
23	SS		Verify that MS stop sending on both PDTCH ₆ and PDTCH ₇
24	MS -> SS	EGPRS PACKET CHANNEL REQUEST	Received on PRACH.
25	SS -> MS	PACKET UPLINK ASSIGNMENT	Multiblock assignment, to order the MS making two phase access procedure. Sent on PAGCH.
26	MS -> SS	PACKET RESOURCE REQUEST	Two phase access procedure. Received on the single block assigned in step 25.

Step	Direction	Message	Comments
27	SS -> MS	PACKET UPLINK ASSIGNMENT	Uplink dynamic allocation EGPRS CHANNEL_CODING_COMMAND = MCS-4
28	SS->MS	PACKET DOWNLINK DUMMY CONTROL BLOCKS	Two timeslots assigned USFs assigned to MS. Sent on PDTCH ₀ and PDTCH ₁ .
29	MS -> SS	EGPRS UPLINK RLC DATA BLOCKS	data blocks received on the assigned PDTCH ₁ and PDTCH ₀ .
30	SS		Repeat steps 28 and 29 three times
31	SS -> MS	PACKET PDCH RELEASE	Sent on the PACCH of the PDCH ₁ assigned in step 27. With TIMESLOTS_AVAILABLE indicating only the timeslot corresponding to PDCH ₀ available.
32	SS->MS	PACKET DOWNLINK DUMMY CONTROL BLOCK	Sent after 6 radio blocks from step 31 on PDCH ₁ , USFs assigned to MS
33	SS		Verify that no data block was received
34	SS->MS	PACKET DOWNLINK DUMMY CONTROL BLOCK	Sent on PDCH ₀ , USFs assigned to MS
35	MS -> SS	EGPRS UPLINK RLC DATA BLOCK	Received on the assigned PDTCH ₀ .
36			Repeat step 34 and 35 until the countdown value CV=0
37	SS -> MS	PACKET UPLINK ACK/NACK	Acknowledge all data blocks received RLC data blocks . Sent on PACCH ₀ . PREEMPTIVE_TRANSMISSION_BIT=1
38	MS -> SS	PACKET CONTROL ACKNOWLEDGEMENT	Received on the block specified by RRBp on PDCH ₀
39	SS -> MS	PACKET DOWNLINK ASSIGNMENT	Downlink Assignment with one timeslot assigned, acknowledged mode. Sent on PPCH.
40	SS -> MS	EGPRS DOWNLINK RLC DATA BLOCK	A valid RRBp
41	MS -> SS	EGPRS PACKET DOWNLINK ACK/NACK	Received on the block specified by RRBp in step 40.
42	SS -> MS	EGPRS DOWNLINK RLC DATA BLOCK	Repeat the step three times.
43	SS -> MS	PACKET PDCH RELEASE	Sent on the next radio block from step 42 with TIMESLOTS_AVAILABLE indicating no timeslot available.
44	SS -> MS	EGPRS DOWNLINK RLC DATA BLOCK	Sent on the next radio block from step 43 on PDTCH released, a valid RRBp = N + 21 or 22.
45	SS		Check that no EGPRS PACKET DOWNLINK ACK/NACK received on the block specified in step 44. The steps from 46 onwards are applicable to all EGPRS multislot classes except the EGPRS multislot class1.
46	SS -> MS	PACKET DOWNLINK ASSIGNMENT	Downlink Assignment with timeslot ₁ and timeslot ₀ assigned, acknowledged mode. Sent on PPCH.
47	SS -> MS	EGPRS DOWNLINK RLC DATA BLOCK	Repeat the step five times. The RLC data blocks are received on PDTCH ₁ and PDTCH ₀ .
48	MS -> SS	EGPRS PACKET DOWNLINK ACK/NACK	The last data block on PDTCH ₁ containing a valid RRBp. Received on the block specified by RRBp on PDTCH ₇ Check whether all data blocks in step 47 are acknowledged.
49	SS -> MS	PACKET PDCH RELEASE	With TIMESLOTS_AVAILABLE indicating only timeslot ₀ available. Sent on the PACCH of PDCH ₁ .
50	SS -> MS	EGPRS DOWNLINK RLC DATA BLOCK	Repeat the step five times. The RLC data blocks are received on PDTCH ₀ . The last data block on PDTCH ₀ containing a valid RRBp.
51	MS -> SS	EGPRS PACKET DOWNLINK ACK/NACK	On the block specified by RRBp on PDTCH ₀ . Check whether all data blocks sent in step 50 are acknowledged.
52	SS -> MS	EGPRS DOWNLINK RLC DATA BLOCK	One data block with a valid RRBp = N + 26 on PDTCH ₇ .
53	SS		Check that no EGPRS PACKET DOWNLINK ACK/NACK received on the block specified.
54	SS -> MS	EGPRS DOWNLINK RLC DATA BLOCK	Repeat the step five times on PDTCH ₀ .
55	SS -> MS	PACKET PDCH RELEASE	With TIMESLOTS_AVAILABLE indicating no timeslot available sent on the next block from step 54.

Step	Direction	Message	Comments
56	SS -> MS	EGPRS DOWNLINK RLC DATA BLOCK	Sent on the next radio block of step 55 on PDTCH ₀ , a valid RRBP = N + 21 or 22.
57	SS		Check that no EGPRS PACKET DOWNLINK ACK/NACK is received on the block specified in step 56.

Specific Message Contents:

PACKET UPLINK ASSIGNMENT, Steps 6 and 18:

Information Element	Information Element	value/ remark	value/remark
Number of radio blocks allocated		00	

51.3.6 TBF Release / Extended Uplink

51.3.6.1 TBF Release / Extended Uplink / Recalculation of CV before CV = 0

51.3.6.1.1 Conformance requirements

In an uplink TBF operating in extended uplink TBF mode, the CV shall indicate the current number of RLC data blocks that has not been transmitted in the uplink TBF. The mobile station shall update the TBC value and recalculate the CV for any untransmitted RLC data block in the following cases:

- The RLC entity of the mobile station receives new data from upper layers for transmission in the uplink TBF.

References

3GPP TS 44.060, subclause 9.3.1.3

51.3.6.1.2 Test purpose

To verify that MS recalculates the CV when a new PDU is received from upper layers before MS has sent an RLC data block with CV=0.

51.3.6.1.3 Method of test

Initial Conditions

System Simulator:

1 cell, NW_EXT_UTBF = 1, BS_CV_MAX = 14

Mobile Station:

MS is in Packet Idle mode, GPRS attached with support of GERAN Feature Package 1 indicated in MS Radio Access Capabilities, and PDP context 2 established.

Specific PICS Statements

-

PIXIT Statements

-

Test Procedure

The MS is triggered to transfer user data. A TBF using dynamic allocation in acknowledged mode is assigned. The SS assigns an USF to MS until MS has sent CV = 14. Then MS is triggered to send more data. SS acknowledges all received data. A new USF is assigned to MS every 4th second. The CV is checked in the data block. If the CV becomes '0' before having been recalculated, the test has failed. Otherwise the uplink TBF is continued and completed.

Expected Sequence

Step	Direction	Message	Comments
1		{Uplink dynamic allocation two phase access}	n = 500 octets, USF_GRANULARITY = 1 block, EGPRS_CHANNEL_CODING_COMMAND: MCS-2, RLC acknowledged mode (PDP context2) USF assigned to the MS.
2	SS -> MS	PACKET DOWNLINK DUMMY CONTROL BLOCK	
3	MS -> SS	EGPRS UPLINK RLC DATA BLOCK	
4			Repeat step 2 and 3 until CV=14 (BS_CV_MAX).
5	MS		Trigger MS to send 400 octets of data.
6	SS -> MS	PACKET UPLINK ACK/NACK	Acknowledge all received data. USF assigned to the MS.
7	MS -> SS	EGPRS UPLINK RLC DATA BLOCK	Check CV
8	SS		Wait 4s
9			Repeat step 6 to 8 until CV (as received in step 7) > 14 (successful) or CV = 0 (failed)
10	SS -> MS	PACKET DOWNLINK DUMMY CONTROL BLOCK	USF assigned to the MS
11	MS -> SS	EGPRS UPLINK RLC DATA BLOCK	
12			Repeat step 10 and 11 until CV=0.
13	SS -> MS	PACKET UPLINK ACK/NACK	Final Ack Indication = 1 containing valid RRBP. Sent on PACCH of the assigned PDCH. Acknowledge all data blocks received.
14	MS -> SS	PACKET CONTROL ACKNOWLEDGEMENT	Received on the block specified by RRBP on PACCH of the assigned PDCH.

Specific Message Contents

-

51.3.6.2 TBF Release / Extended Uplink / Recalculation of CV after CV = 0

51.3.6.2.1 Conformance requirements

[3GPP TS 44.060, 9.1.3.1]

In the extended uplink TBF mode, if $V(S) = V(A)$ and there is no RLC data block with $BSN = V(S)$ available, the mobile station shall stop sending RLC data blocks. The mobile station shall continue sending RLC data blocks when a RLC data block with $BSN = V(S)$ is available.

[3GPP TS 44.060, 9.3.1.3]

In an uplink TBF operating in extended uplink TBF mode, the CV shall indicate the current number of RLC data blocks that has not been transmitted in the uplink TBF. The mobile station shall update the TBC value and recalculate the CV for any untransmitted RLC data block in the following cases:

- The RLC entity of the mobile station receives new data from upper layers for transmission in the uplink TBF.

[3GPP TS 44.060, 9.3.1b.2]

In extended uplink TBF mode, the uplink TBF may be maintained during temporary inactive periods, where the mobile station has no RLC information to send.

During the temporary inactive periods, the mobile station may stop sending RLC data block, as defined in clause 9.1.3. The network shall continue allocating the mobile station uplink radio blocks during the inactivity period, using the procedures defined in clause 8.1.1 for each medium access mode. Uplink radio blocks shall be allocated as required allowing the mobile station to continue the transfer of RLC data blocks, when a new RLC data block becomes available.

When the mobile station is allocated an uplink radio block and there is no RLC data block ready to send, the mobile station shall send an RLC/MAC control block in each uplink radio block allocated by the network. The priority defined in clause 8.1.1 for different kinds of RLC/MAC blocks apply.

References

3GPP TS 44.060, subclause 9.1.3.1, 9.3.1.3, 9.3.1b.2

51.3.6.2.2 Test purpose

- 1 To verify that MS sends an RLC/MAC control block after fully acknowledgement of transmitted RLC data.
- 2 To verify that MS continues to send RLC data blocks on the current TBF when MS receives new data from upper layers when all RLC data have been fully acknowledged.
- 3 To verify that MS recalculates the CV when a new LLC PDU is received from upper layers after MS has sent a RLC data block with CV=0.

51.3.6.2.3 Method of test

Initial Conditions

System Simulator:

1 cell, NW_EXT_UTBF = 1, BS_CV_MAX = 15

Mobile Station:

MS is in Packet Idle mode, GPRS attached with support of GERAN Feature Package 1 indicated in MS Radio Access Capabilities, and PDP context 2 established.

Specific PICS Statements

-

PIXIT Statements

-

Test Procedure

The MS is triggered to transfer user data. A TBF of dynamic allocation in acknowledged mode is assigned. SS assigns an USF to MS until MS has sent CV = 0. SS acknowledges all received data with Final Ack Indicator bit set to '0'. SS continues to assigns USF to MS. MS shall send a PACKET UPLINK DUMMY CONTROL BLOCK every time. Then MS is triggered to send more data. After one second a new USF is assigned to MS. MS shall send a data block with a recalculated CV. Then the uplink TBF is continued and completed.

Expected Sequence

Step	Direction	Message	Comments
1		{Uplink dynamic allocation two phase access}	n = 500 octets, USF_GRANULARITY = 1 block, EGPRS_CHANNEL_CODING_COMMAND: MCS-2, RLC acknowledged mode (PDP context2)
2	SS -> MS	PACKET DOWNLINK DUMMY CONTROL BLOCK	USF assigned to the MS.
3	MS -> SS	EGPRS UPLINK RLC DATA BLOCK	
4			Repeat step 2 and 3 until CV=0
5	SS -> MS	PACKET UPLINK ACK/NACK	Final Ack Indication = 0. Sent on PACCH of the assigned PDCH. Acknowledge all data blocks received.
6	SS -> MS	PACKET DOWNLINK DUMMY CONTROL BLOCK	USF assigned to the MS
A6 (optional step)	MS -> SS	EGPRS UPLINK RLC DATA BLOCK	MS may retransmit the block with BSN=0 once if it has already been scheduled while Packet Uplink Ack/Nack is being processed. In this case go to step B6.
B6 (optional step)	SS -> MS	PACKET DOWNLINK DUMMY CONTROL BLOCK	USF assigned to the MS
7	MS -> SS	PACKET UPLINK DUMMY CONTROL BLOCK	
8			Repeat step 6 and 7 five times.
9	MS		Trigger the MS to send 400 octets of data. SS should take care of allocating USF's to the MS in order to prevent the MS from releasing the TBF. If SS receives PACKET UPLINK DUMMY CONTROL BLOCKs, these shall be discarded. If SS receives an UPLINK RLC DATA BLOCK, then verify that the MS has recalculated the CV.
10	SS -> MS	PACKET DOWNLINK DUMMY CONTROL BLOCK	USF assigned to the MS
11	MS -> SS	EGPRS UPLINK RLC DATA BLOCK	
12			Repeat step 10 and 11 until CV=0
13	SS -> MS	PACKET UPLINK ACK/NACK	Final Ack Indication = 1 containing valid RRBp. Sent on PACCH of the assigned PDCH. Acknowledge all data blocks received.
14	MS -> SS	PACKET CONTROL ACKNOWLEDGEMENT	Received on the block specified by RRBp on PACCH of the assigned PDCH.

Specific Message Contents

51.3.6.3 TBF Release / Extended Uplink / MCS change order while CV=0

51.3.6.3.1 Conformance requirements

[3GPP TS 44.060, 9.1.3.1b2]

During a period when the network does not receive any RLC data blocks from the mobile station, the network may periodically send a PACKET UPLINK ACK/NACK message to the mobile station.

[3GPP TS 44.060, 9.1.11]

The modulation and coding scheme may be changed following the procedures described in sub-clause 9.3.2.1

[3GPP TS 44.060, 9.3.2.1]

The selection of MCS is controlled by the network.

[3GPP TS 44.060, 12.10.d: EGPRS modulation and coding scheme]

This information element defines the modulation and coding scheme to be used.

References

3GPP TS 44.060, subclause 9.1.3.1b2

3GPP TS 44.060, 9.1.11

3GPP TS 44.060, 9.3.2.1

51.3.6.3.2 Test purpose

To verify that MS applies the new ordered MCS whereas the MCS change command has been received while CV = 0.

51.3.6.3.3 Method of test

Initial Conditions

System Simulator:

1 cell, NW_EXT_UTBF = 1, BS_CV_MAX = 15

Mobile Station:

MS is in Packet Idle mode, GPRS attached with support of GERAN Feature Package 1 indicated in MS Radio Access Capabilities, and PDP context 2 established.

Specific PICS Statements

-

PIXIT Statements

-

Test Procedure

The MS is triggered to transfer user data. A TBF of dynamic allocation in acknowledged mode is assigned. SS assigns an USF to MS until MS has sent CV = 0. SS acknowledges all received data with Final Ack Indicator bit set to '0'. SS continues to assign USF to MS. MS sends a PACKET UPLINK DUMMY CONTROL BLOCK every time. Then MS received a new Modulation and Coding Scheme command while it transmits PACKET UPLINK DUMMY CONTROL BLOCKs. Last, it is triggered to send more data. After one second a new USF is assigned to MS. MS shall send a data block with a recalculated CV. Then the uplink TBF shall be continued and completed with the new commanded MCS.

Expected Sequence

Step	Direction	Message	Comments
1		{Uplink dynamic allocation two phase access}	n = 500 octets, USF_GRANULARITY = 1 block, EGPRS_CHANNEL_CODING_COMMAND: MCS-3, RLC acknowledged mode (PDP context2) USF assigned to the MS.
2	SS -> MS	PACKET DOWNLINK DUMMY CONTROL BLOCK	
3	MS -> SS	EGPRS UPLINK RLC DATA BLOCK	
4			Repeat step 2 and 3 until CV=0
5	SS -> MS	PACKET UPLINK ACK/NACK	Final Ack Indication = 0. Sent on PACCH of the assigned PDCH. Acknowledge all data blocks received.
6	SS -> MS	PACKET DOWNLINK DUMMY CONTROL BLOCK	USF assigned to the MS
A6 (optional step)	MS -> SS	EGPRS UPLINK RLC DATA BLOCK	MS may retransmit the block with BSN=0 once if it has already been scheduled while Packet Uplink Ack/Nack is being processed. In this case go to step B6.
B6 (optional step)	SS -> MS	PACKET DOWNLINK DUMMY CONTROL BLOCK	USF assigned to the MS
7	MS -> SS	PACKET UPLINK DUMMY CONTROL BLOCK	
8			Repeat step 6 and 7 five times.
9	SS -> MS	PACKET UPLINK ACK/NACK	EGPRS_CHANNEL_CODING_COMMAND: MCS-4
10	SS -> MS	PACKET DOWNLINK DUMMY CONTROL BLOCK	USF assigned to the MS
11	MS -> SS	PACKET UPLINK DUMMY CONTROL BLOCK	
12	MS		Trigger the MS to send 400 octets of data. SS should take care of allocating USF's to the MS in order to prevent the MS from releasing the TBF. If SS receives PACKET UPLINK DUMMY CONTROL BLOCKs, these shall be discarded. If SS receives an UPLINK RLC DATA BLOCK, then verify that the MS has recalculated the CV.
13	SS -> MS	PACKET DOWNLINK DUMMY CONTROL BLOCK	USF assigned to the MS
14	MS -> SS	EGPRS UPLINK RLC DATA BLOCK	Verify that the MS uses the new ordered MCS.
15			Repeat step 13 and 14 until CV=0
16	SS -> MS	PACKET UPLINK ACK/NACK	Final Ack Indication = 1 containing valid RRBP. Sent on PACCH of the assigned PDCH. Acknowledge all data blocks received.
17	MS -> SS	PACKET CONTROL ACKNOWLEDGEMENT	Received on the block specified by RRBP on PACCH of the assigned PDCH.

Specific Message Contents

Specific Message Contents

PACKET UPLINK ACK NACK (Step 1):

As default message contents except: EGPRS_CHANNEL_CODING_COMMAND	MCS-3
---	-------

PACKET UPLINK ACK NACK (Step 9):

As default message contents except: EGPRS_CHANNEL_CODING_COMMAND	MCS-4
---	-------

51.3.6.4 TBF Release / Extended Uplink / TBF reconfigure by PACKET TIMESLOT RECONFIGURE

51.3.6.4.1 Conformance requirements

The mobile station shall attempt to decode every downlink RLC/MAC block on all assigned PDCHs. Whenever the mobile station receives an RLC/MAC block containing an RLC/MAC control block, the mobile station shall attempt to interpret the message contained therein. If the message addresses the mobile station, the mobile station shall act on the message.

The network may at any time during the uplink TBF initiate a change of resources by sending on the downlink PACCH monitored by the MS, an unsolicited PACKET UPLINK ASSIGNMENT or PACKET TIMESLOT RECONFIGURE message to the mobile station. During the reallocation TFI is allowed to be changed.

During the temporary inactive periods, the mobile station may stop sending RLC data block, as defined in sub-clause 9.1.3. The network shall continue allocating the mobile station uplink radio blocks during the inactivity period, using the procedures defined in sub-clause 8.1.1 for each medium access mode. Uplink radio blocks shall be allocated as required allowing the mobile station to continue the transfer of RLC data blocks, when a new RLC data block becomes available.

When the mobile station is allocated an uplink radio block and there is no RLC data block ready to send for this TBF, the mobile station shall send an RLC/MAC control block in each uplink radio block allocated by the network. The priority defined in sub-clause 8.1.1 for different kinds of RLC/MAC blocks apply.

References

3GPP TS 44.060, subclause 9.3.1b.2

3GPP TS 44.060, subclause 8.1.1.1.1

51.3.6.4.2 Test purpose

To verify that if the MS receives a PACKET TIMESLOT RECONFIGURE while the Uplink TBF is extended, the MS switches to the new assigned channels and continues sending of PACKET DUMMY CONTROL BLOCKs in the uplink.

51.3.6.4.3 Method of test

Initial Conditions

System Simulator:

1 cell, EGPRS supported, PCCCH present, NW_EXT_UTBF = 1.

Mobile Station:

MS is in Packet Idle mode, GPRS attached with support of GERAN Feature Package 1 indicated in MS Radio Access Capabilities, and PDP context 2 established.

Specific PICS Statements

-

PIXIT Statements

-

Test Procedure

The MS is triggered to transfer user data. A TBF using dynamic allocation in acknowledged mode is assigned. The SS assigns an USF to MS. SS receives data blocks till CV=0 and acknowledges all the blocks with an UPLINK ACK/NACK setting FAI=0. Then SS checks that if a USF is matched to the MS it sends a UPLINK DUMMY CONTROL BLOCK. SS sends a PACKET TIMESLOT RECONFIGURE, reassigning the timeslot given for Uplink

and initiating a downlink TBF. SS checks that the MS is sending a UPLINK DUMMY CONTROL BLOCK on the new channels whenever the USF is matched. SS releases the downlink TBF. SS initiates a data transfer of 200 octets. SS checks that the MS is using the newly assigned channels for doing the data transfer. SS allows the MS to complete the data transfer and releases the TBF.

Expected Sequence

Step	Direction	Message	Comments
1		{Uplink dynamic allocation two phase access}	n = 500 octets, USF_GRANULARITY = 1 block, EGPRS_CHANNEL_CODING_COMMAND: MCS-2, RLC acknowledged mode (PDP context2)
2	SS -> MS	PACKET DOWNLINK DUMMY CONTROL BLOCK	USF assigned to the MS.
3	MS -> SS	EGPRS UPLINK RLC DATA BLOCK	
4			Repeat step 2 and 3 until CV=0
5	SS -> MS	PACKET UPLINK ACK/NACK	Final Ack Indication = 0. Sent on PACCH of the assigned PDCH. Acknowledge all data blocks received.
6	SS -> MS	PACKET DOWNLINK DUMMY CONTROL BLOCK	USF assigned to the MS
A6 (optional step)	MS -> SS	EGPRS UPLINK RLC DATA BLOCK	MS may retransmit the block with BSN=0 once if it has already been scheduled while Packet Uplink Ack/Nack is being processed. In this case go to step B6.
B6 (optional step)	SS -> MS	PACKET DOWNLINK DUMMY CONTROL BLOCK	USF assigned to the MS
7	MS -> SS	PACKET UPLINK DUMMY CONTROL BLOCK	
8			Repeat step 6 and 7 five times.
9	SS -> MS	PACKET TIMESLOT RECONFIGURE	See Specific message content. Assigning different timeslot, starting a downlink TBF.
10	SS -> MS	EGPRS DOWNLINK RLC DATA BLOCK	Containing RRBp= N+21 or +22 and USF assigned to the MS. FBI = '1'. Sent on the downlink PDCH assigned on 3 blocks from the last radio block containing the TIMESLOT RECONFIGURE in step 9.
11	MS -> SS	PACKET UPLINK DUMMY CONTROL BLOCK	Received on the uplink PDCH assigned in step 9.
12	MS -> SS	EGPRS PACKET DOWNLINK ACK/NACK	Received on the block of frame number = N+21 or +22, N is the frame number of the first burst of the data block in step 10.

Step	Direction	Message	Comments
13	SS -> MS	PACKET DOWNLINK DUMMY CONTROL BLOCK	USF assigned to the MS
14	MS -> SS	PACKET UPLINK DUMMY CONTROL BLOCK	
15	MS		
16	SS -> MS	PACKET DOWNLINK DUMMY CONTROL BLOCK	Trigger the MS to send 200 octets of data. SS should take care of allocating USF's to the MS in order to prevent the MS from releasing the TBF. If SS receives PACKET UPLINK DUMMY CONTROL BLOCKs, these shall be discarded. If SS receives an UPLINK RLC DATA BLOCK, then verify that the MS has recalculated the CV. USF assigned to the MS
17	MS -> SS	EGPRS UPLINK RLC DATA BLOCK	
18			Repeat step 16 and 17 until CV=0
19	SS -> MS	PACKET UPLINK ACK/NACK	
20	MS -> SS	PACKET CONTROL ACKNOWLEDGEMENT	Final Ack Indication = 1 containing valid RRBp. Sent on PACCH of the assigned PDCH. Acknowledge all data blocks received. Received on the block specified by RRBp on PACCH of the assigned PDCH.

Specific Message Contents

PACKET TIMESLOT RECONFIGURE message in step 9:

Information Element	value/ remark
PAGE_MODE	Normal
- Global TFI	0, Global TFI as reference 0, uplink TFI same value as assigned in the uplink in step 1
EGPRS CHANNEL CODING COMMAND	Arbitrarily chosen from valid values
Resegment	1
{0}1<Downlink EGPRS window size>	0
{0}1<Uplink EGPRS window size>	0
<Link quality measurement mode>	00
Global packet Timing Advance	
- {0}1<TIMING_ADVANCE_VALUE>	1 (timing advance value)
- TIMING_ADVANCE_VALUE	30 bit periods
- {0}1<UPLINK_TIMING_ADVANCE_INDEX>	0 (no uplink timing advance index)
<UPLINK_TIMING_ADVANCE_TIMESLOT_NUMBER>	The MS stops the operation of the continuous timing advance procedure.
- {0}1<DOWNLINK_TIMING_ADVANCE_INDEX>	0 (no downlink timing advance index)
<DOWNLINK_TIMING_ADVANCE_TIMESLOT_NUMBER>	The MS stops the operation of the continuous timing advance procedure.
R>	
DOWNLINK_RLC_MODE	Acknowledged mode
CONTROL_ACK	0
{0}1<DOWNLINK_TFI_ASSIGNMENT>	1
- GLOBAL_TFI_ASSIGNMENT	Arbitrarily chosen but different from the value for uplink TBF
{0}1<UPLINK_TFI_ASSIGNMENT>	0
DOWNLINK_TIMESLOT_ALLOCATION	Timeslot 5 assigned
{0}1<Frequency parameters>	0
Dynamic allocation	0
- Extended Dynamic Allocation	0 (Dynamic allocation)
{0}1<P0>	0
- USF GRANULARITY	0 (1 RLC block)
- {0}1<RLC_DATA_BLOCKS_GRANTED>	0 (open-ended TBF)
- {0}1<TBF_STARTING_TIME>	0 (no starting time)
-	1 (Timeslot Allocation with Power Control Parameters)
- ALPHA	0.5
- {0}1<USF_TNx><GAMMA_TNx>	000001 (timeslot 5 assigned)
- USF_TN ₅	Arbitrarily chosen but different from current value

- GAMMA_TN ₅	For GSM 900: +8 dBm For GSM 400: +8 dBm For GSM 850: +8 dBm For GSM 700 and T-GSM 810: +8 dBm For DCS 1 800: +6 dBm For PCS 1 900: +6 dBm 00
-------------------------	--

51.3.6.5 TBF Release / Extended Uplink / TBF reconfigure by PACKET UPLINK ASSIGNMENT

51.3.6.5.1 Conformance requirements

The mobile station shall attempt to decode every downlink RLC/MAC block on all assigned PDCHs. Whenever the mobile station receives an RLC/MAC block containing an RLC/MAC control block, the mobile station shall attempt to interpret the message contained therein. If the message addresses the mobile station, the mobile station shall act on the message.

The network may at any time during the uplink TBF initiate a change of resources by sending on the downlink PACCH monitored by the MS, an unsolicited PACKET UPLINK ASSIGNMENT or PACKET TIMESLOT RECONFIGURE message to the mobile station. During the reallocation TFI is allowed to be changed.

During the temporary inactive periods, the mobile station may stop sending RLC data block, as defined in sub-clause 9.1.3. The network shall continue allocating the mobile station uplink radio blocks during the inactivity period, using the procedures defined in sub-clause 8.1.1 for each medium access mode. Uplink radio blocks shall be allocated as required allowing the mobile station to continue the transfer of RLC data blocks, when a new RLC data block becomes available.

When the mobile station is allocated an uplink radio block and there is no RLC data block ready to send for this TBF, the mobile station shall send an RLC/MAC control block in each uplink radio block allocated by the network. The priority defined in sub-clause 8.1.1 for different kinds of RLC/MAC blocks apply.

References

3GPP TS 44.060, subclause 9.3.1b.2

3GPP TS 44.060, subclause 8.1.1.1.1

51.3.6.5.2 Test purpose

To verify that if the MS receives a PACKET UPLINK ASSIGNMENT while the Uplink TBF is extended, the MS switches to the new assigned channels and continues sending of PACKET DUMMY CONTROL BLOCKs in the uplink.

51.3.6.5.3 Method of test

Initial Conditions

System Simulator:

1 cell, EGPRS supported, PCCCH present , NW_EXT_UTBF = 1.

Mobile Station:

MS is in Packet Idle mode, GPRS attached with support of GERAN Feature Package 1 indicated in MS Radio Access Capabilities, and PDP context 2 established.

Specific PICS Statements

-

PIXIT Statements

-

Test Procedure

The MS is triggered to transfer user data. A TBF using dynamic allocation in acknowledged mode is assigned. The SS assigns an USF to MS. SS receives data blocks till CV=0 and acknowledges all the blocks with an UPLINK ACK/NACK setting FAI=0. Then SS checks that if a USF is matched to the MS it sends a UPLINK DUMMY CONTROL BLOCK. SS sends a PACKET UPLINK ASSIGNMENT, reassigning the timeslot given for Uplink. SS checks that the MS is sending a UPLINK DUMMY CONTROL BLOCK on the new channels whenever the USF is matched. SS initiates a data transfer of 200 octets. SS checks that the MS is using the newly assigned channels for doing the data transfer. SS allows the MS to complete the data transfer and releases the TBF.

Expected Sequence

Step	Direction	Message	Comments
1		{Uplink dynamic allocation two phase access}	n = 500 octets, USF_GRANULARITY = 1 block, EGPRS_CHANNEL_CODING_COMMAND: MCS-2, RLC acknowledged mode (PDP context2)
2	SS -> MS	PACKET DOWNLINK DUMMY CONTROL BLOCK	USF assigned to the MS.
3	MS -> SS	EGPRS UPLINK RLC DATA BLOCK	
4			Repeat step 2 and 3 until CV=0
5	SS -> MS	PACKET UPLINK ACK/NACK	Final Ack Indication = 0. Sent on PACCH of the assigned PDCH. Acknowledge all data blocks received.
6	SS -> MS	PACKET DOWNLINK DUMMY CONTROL BLOCK	USF assigned to the MS
A6 (optional step)	MS -> SS	EGPRS UPLINK RLC DATA BLOCK	MS may retransmit the block with BSN=0 once if it has already been scheduled while Packet Uplink Ack/Nack is being processed. In this case go to step B6.
B6 (optional step)	SS -> MS	PACKET DOWNLINK DUMMY CONTROL BLOCK	USF assigned to the MS
7	MS -> SS	PACKET UPLINK DUMMY CONTROL BLOCK	
8			Repeat step 6 and 7 five times.
9	SS -> MS	PACKET UPLINK ASSIGNMENT	See Specific message content. Assigning different timeslot.
10	SS -> MS	PACKET DOWNLINK DUMMY CONTROL BLOCK	USF assigned to the MS. Sent after 3 blocks of sending the messages in step 9.
11	MS -> SS	PACKET UPLINK DUMMY CONTROL BLOCK	
12	MS		Trigger the MS to send 200 octets of data. SS should take care of allocating USF's to the MS in order to prevent the MS from releasing the TBF. If SS receives PACKET UPLINK DUMMY CONTROL BLOCKS, these shall be discarded. If SS receives an UPLINK RLC DATA BLOCK, then verify that the MS has recalculated the CV.
13	SS -> MS	PACKET DOWNLINK DUMMY CONTROL BLOCK	USF assigned to the MS
14	MS -> SS	EGPRS UPLINK RLC DATA BLOCK	
15			Repeat step 13 and 14 until CV=0
16	SS -> MS	PACKET UPLINK ACK/NACK	Final Ack Indication = 1 containing valid RRBP. Sent on PACCH of the assigned PDCH. Acknowledge all data blocks received.
17	MS -> SS	PACKET CONTROL ACKNOWLEDGEMENT	Received on the block specified by RRBP on PACCH of the assigned PDCH.

Specific Message Contents :

PACKET UPLINK ASSIGNMENT message in step 9:

Information Element	value/ remark
Dynamic allocation	01
-	000000
-	1 (Timeslot Allocation with Power Control Parameters for 1 slot assigned)
- ALPHA	0.5
-	000001 (timeslot 5 assigned)
- USF_TN5	Arbitrarily chosen
- GAMMA_TN5	For GSM 900: +8 dBm
	For GSM 400: +8 dBm
	For GSM 850: +8 dBm
	For GSM 700 and T-GSM 810: +8 dBm
	For DCS 1 800: +6dBm
	For PCS 1 900: +6 dBm
-	00000

51.3.6.6 Extended Uplink TBF / Cell Change while in Extended Uplink/ No Packet Neighbouring Cell Data

51.3.6.6.1 Conformance requirements

If CCN is enabled (see sub-clause 5.5.1.1a), the mobile station shall behave as in network control mode NC0 or NC1 up to the point when a new cell has been chosen. It shall then check the CCN_SUPPORTED parameter, if available, that was last received for that cell. This parameter can be sent on BCCH or PBCCH or individually in PACKET MEASUREMENT ORDER or in PACKET CELL CHANGE ORDER messages. If it is available and if it indicates that CCN mode shall be entered towards that cell or if it is not available, then instead of performing the cell change, the mobile station shall start timer T3206 and enter the CCN mode. At the first possible opportunity, the MS shall then, when in CCN mode, inform the network about the proposed cell by sending a PACKET CELL CHANGE NOTIFICATION message, stop timer T3206, start timers T3208 and T3210. The PACKET CELL CHANGE NOTIFICATION message shall contain the ARFCN for the BCCH and the BSIC as identity of the proposed cell. The message shall also contain measurement reports for the proposed cell and for other neighbour cells if available. In CCN mode the mobile station shall continue the data transfer and store neighbour cell system information if received in instances of the PACKET NEIGHBOUR CELL DATA message, but not perform the cell change. At receipt of the first PACKET NEIGHBOUR CELL DATA message or PACKET CELL CHANGE CONTINUE message or PACKET CELL CHANGE ORDER message, the mobile station shall stop the timer T3210. If a mobile station as response to a PACKET CELL CHANGE NOTIFICATION message receives a PACKET CELL CHANGE CONTINUE message without receiving any neighbour cell system information, the mobile station shall stop timer T3208, stop timer T3210 if still running, leave CCN mode and continue cell reselection in NC0/NC1 mode. The network sends first necessary system information for the cell proposed in the PACKET CELL CHANGE NOTIFICATION message, or for any other cell, in one or more instances of the PACKET NEIGHBOUR CELL DATA message and sends then a PACKET CELL CHANGE CONTINUE message. The mobile station shall store the received system information as specified in sub-clause 8.8.1. When the first instance of the PACKET NEIGHBOUR CELL DATA message is received, the mobile station shall stop timer T3210 if still running. When the PACKET CELL CHANGE CONTINUE message is received, the mobile station shall stop timer T3208, leave CCN mode and continue the cell reselection in NC0/NC1 mode. The network sends first necessary system information for the cell proposed in the PACKET CELL CHANGE NOTIFICATION message, or for any other cell, in one or more instances of the PACKET NEIGHBOUR CELL DATA message and sends then a PACKET CELL CHANGE ORDER message. The mobile station shall store the received system information as specified in sub-clause 8.8.1. When the first instance of the PACKET NEIGHBOUR CELL DATA message is received, the mobile station shall stop timer T3210 if still running. When the PACKET CELL CHANGE ORDER message is received, the mobile station shall stop timer T3208, leave CCN mode and follow the procedures as specified for the Packet Cell Change Order (sub-clause 8.4) and in sub-clause 8.8.1.

In extended uplink TBF mode, the uplink TBF may be maintained during temporary inactive periods, where the mobile station has no RLC information to send.

During the temporary inactive periods, the mobile station may stop sending RLC data block, as defined in clause 9.1.3. The network shall continue allocating the mobile station uplink radio blocks during the inactivity period, using the procedures defined in clause 8.1.1 for each medium access mode. Uplink radio blocks shall be allocated as required allowing the mobile station to continue the transfer of RLC data blocks, when a new RLC data block becomes available.

When the mobile station is allocated an uplink radio block and there is no RLC data block ready to send, the mobile station shall send an RLC/MAC control block in each uplink radio block allocated by the network. The priority defined in clause 8.1.1 for different kinds of RLC/MAC blocks apply.

References

3GPP TS 44.060, subclause 8.8.3

3GPP TS 44.060, subclause 9.3.1b.2

51.3.6.6.2 Test purpose

To verify that an MS which is in Extended Uplink TBF, NACC active, changes to the proposed cell while in extending (sending uplink dummy control blocks).

51.3.6.6.3 Method of test

Initial conditions

System Simulator:

2 cells, EGPRS supported, CCN Active, PCCCH present, GPRS_RXLEV_ACCESS_MIN = -90dBm, NW_EXT_UTBF = 1.

Cell A: RLA_C = -50 dBm, is active.

Cell B: RLA_C = -60 dBm, is active.

Mobile Station:

MS is in Packet Idle mode, GPRS attached with support of GERAN Feature Package 1 indicated in MS Radio Access Capabilities, and PDP context 2 established.

Specific PICS Statements

-

PIXIT Statements

-

Test procedure

The MS is triggered to initiate packet uplink transfer. SS assigns resources to the MS and it starts to send uplink data that the SS acknowledge. When MS reaches CV=0, it starts sending PACKET UPLINK DUMMY CONTROL BLOCKS. During the uplink the signal strength of Cell A is lowered to -80 dBm. The MS enters CCN mode and sends PACKET CELL CHANGE NOTIFICATION. The MS then continues to send PACKET UPLINK DUMMY CONTROL BLOCKS. While MS is sending PACKET UPLINK DUMMY CONTROL BLOCKS, the SS then sends PACKET CELL CHANGE CONTINUE and the MS change to Cell B. The MS request resources for an uplink in the new cell and complete the uplink transfer in the new cell.

Maximum duration of the test

-

Expected sequence

Step	Direction	Message	Comments
1		{Uplink dynamic allocation two phase access}	n = 500 octets. USF_GRANULARITY = 1 block, RLC_DATA_BLOCKS_GRANTED = open-end TLLI_BLOCK_CHANNEL_CODING: same as channel coding EGPRS_CHANNEL_CODING_COMMAND: MCS-1 No starting time present.
2	SS -> MS	PACKET DOWNLINK DUMMY CONTROL BLOCK	USF assigned to the MS
3	MS -> SS	EGPRS UPLINK RLC DATA BLOCK	
4			Repeat step 2 and 3 until CV=0
5	SS -> MS	PACKET UPLINK ACK/NACK	Final Ack Indication = 0. Sent on PACCH of the assigned PDCH. Acknowledge all data blocks received.
6	SS -> MS	PACKET DOWNLINK DUMMY CONTROL BLOCK	USF assigned to the MS
A6 (optional step)	MS -> SS	EGPRS UPLINK RLC DATA BLOCK	MS may retransmit the block with BSN=0 once if it has already been scheduled while Packet Uplink Ack/Nack is being processed. In this case go to step B6.
B6 (optional step)	SS -> MS	PACKET DOWNLINK DUMMY CONTROL BLOCK	USF assigned to the MS
7	MS -> SS	PACKET UPLINK DUMMY CONTROL BLOCK	Repeat steps 6 and 7 five times
8			
9	SS		Lower signal strength of Cell A to -80 dBm.
10	SS -> MS	PACKET UPLINK ACK/NACK	USF assigned to the MS
11	MS -> SS	PACKET UPLINK DUMMY CONTROL BLOCK	
12		Or PACKET CELL CHANGE NOTIFICATION	Step 10 and 11 are repeated until a PACKET CELL CHANGE NOTIFICATION is received in step 11, but no longer than 10 sec. The test has failed if no PACKET CELL CHANGE NOTIFICATION is received in Cell A within 10 sec from Step 9.
13	SS -> MS	PACKET CELL CHANGE CONTINUE	
			The following messages are to be sent and received in Cell B.
14	MS ->SS	EGPRS PACKET CHANNEL REQUEST	Multiblock allocation, to order the MS to follow the two phase access procedure. Sent on PAGCH.
15	SS ->MS	PACKET UPLINK ASSIGNMENT	Single block assignment, to order the MS to follow the two phase access procedure. Sent on PAGCH.
16	MS ->SS	PACKET RESOURCE REQUEST	Received on the single block assigned in step 15. Access type = 'Cell Update' or 'Two Phase Access'
17	SS ->MS	PACKET UPLINK ASSIGNMENT	uplink dynamic allocation, no starting time Sent on PACCH of the same PDCH assigned in step 15.
18		{Completion of uplink RLC data block transfer}	MS performs a Cell Update.

Specific message contents

PACKET CELL CHANGE CONTINUE in Step 13

Information element	Value/remark
< PAGE_MODE : bit (2) > 0	00 (Normal Paging) 0
< GLOBAL_TFI : Global TFI IE > 0 1	0 <5 bit Uplink TFI> 1
< ARFCN : bit (10) >	ARFCN of Cell B.
< BSIC : bit (6) >	BSIC of Cell B.
< CONTAINER_ID >	01

51.3.6.7 Extended Uplink TBF / Cell Change failure while in Extended Uplink/ No Packet Neighbouring Cell Data

51.3.6.7.1 Conformance requirements

If CCN is enabled (see sub-clause 5.5.1.1a), the mobile station shall behave as in network control mode NC0 or NC1 up to the point when a new cell has been chosen. It shall then check the CCN_SUPPORTED parameter, if available, that was last received for that cell. This parameter can be sent on BCCH or PBCCH or individually in PACKET MEASUREMENT ORDER or in PACKET CELL CHANGE ORDER messages. If it is available and if it indicates that CCN mode shall be entered towards that cell or if it is not available, then instead of performing the cell change, the mobile station shall start timer T3206 and enter the CCN mode. At the first possible opportunity, the MS shall then, when in CCN mode, inform the network about the proposed cell by sending a PACKET CELL CHANGE NOTIFICATION message, stop timer T3206, start timers T3208 and T3210. The PACKET CELL CHANGE NOTIFICATION message shall contain the ARFCN for the BCCH and the BSIC as identity of the proposed cell. The message shall also contain measurement reports for the proposed cell and for other neighbour cells if available. In CCN mode the mobile station shall continue the data transfer and store neighbour cell system information if received in instances of the PACKET NEIGHBOUR CELL DATA message, but not perform the cell change. At receipt of the first PACKET NEIGHBOUR CELL DATA message or PACKET CELL CHANGE CONTINUE message or PACKET CELL CHANGE ORDER message, the mobile station shall stop the timer T3210. If a mobile station as response to a PACKET CELL CHANGE NOTIFICATION message receives a PACKET CELL CHANGE CONTINUE message without receiving any neighbour cell system information, the mobile station shall stop timer T3208, stop timer T3210 if still running, leave CCN mode and continue cell reselection in NC0/NC1 mode. The network sends first necessary system information for the cell proposed in the PACKET CELL CHANGE NOTIFICATION message, or for any other cell, in one or more instances of the PACKET NEIGHBOUR CELL DATA message and sends then a PACKET CELL CHANGE CONTINUE message. The mobile station shall store the received system information as specified in sub-clause 8.8.1. When the first instance of the PACKET NEIGHBOUR CELL DATA message is received, the mobile station shall stop timer T3210 if still running. When the PACKET CELL CHANGE CONTINUE message is received, the mobile station shall stop timer T3208, leave CCN mode and continue the cell reselection in NC0/NC1 mode. The network sends first necessary system information for the cell proposed in the PACKET CELL CHANGE NOTIFICATION message, or for any other cell, in one or more instances of the PACKET NEIGHBOUR CELL DATA message and sends then a PACKET CELL CHANGE ORDER message. The mobile station shall store the received system information as specified in sub-clause 8.8.1. When the first instance of the PACKET NEIGHBOUR CELL DATA message is received, the mobile station shall stop timer T3210 if still running. When the PACKET CELL CHANGE ORDER message is received, the mobile station shall stop timer T3208, leave CCN mode and follow the procedures as specified for the Packet Cell Change Order (sub-clause 8.4) and in sub-clause 8.8.1.

In extended uplink TBF mode, the uplink TBF may be maintained during temporary inactive periods, where the mobile station has no RLC information to send.

During the temporary inactive periods, the mobile station may stop sending RLC data block, as defined in clause 9.1.3. The network shall continue allocating the mobile station uplink radio blocks during the inactivity period, using the procedures defined in clause 8.1.1 for each medium access mode. Uplink radio blocks shall be allocated as required allowing the mobile station to continue the transfer of RLC data blocks, when a new RLC data block becomes available.

When the mobile station is allocated an uplink radio block and there is no RLC data block ready to send, the mobile station shall send an RLC/MAC control block in each uplink radio block allocated by the network. The priority defined in clause 8.1.1 for different kinds of RLC/MAC blocks apply.

References

3GPP TS 44.060, subclause 8.8.3

3GPP TS 44.060, subclause 9.3.1b.2

51.3.6.7.2 Test purpose

To verify that an MS, which is in Extended Uplink TBF, NACC active, shall revert to the previous TBF, if selected cell disappears from the coverage and MS should still stay in Extended Uplink TBF

51.3.6.7.3 Method of test

Initial conditions

System Simulator:

2 cells, EGPRS supported, CCN Active, PCCCH present, GPRS_RXLEV_ACCESS_MIN = -90dBm, NW_EXT_UTBF = 1.

Cell A: RLA_C = -50 dBm, is active.

Cell B: RLA_C = -60 dBm, is active.

Mobile Station:

MS is in Packet Idle mode, GPRS attached with support of GERAN Feature Package 1 indicated in MS Radio Access Capabilities, and PDP context 2 established. Ready timer is deactivated.

Specific PICS Statements

-

PIXIT Statements

-

Test procedure

The MS is triggered to initiate packet uplink transfer. SS assigns resources to the MS and it starts to send uplink data that the SS acknowledge. When MS reaches CV=0, it starts sending PACKET UPLINK DUMMY CONTROL BLOCKS. During the uplink the signal strength of Cell A is lowered to -80 dBm. The MS enters CCN mode and sends PACKET CELL CHANGE NOTIFICATION. The MS then continues to send PACKET UPLINK DUMMY CONTROL BLOCKS. While MS is sending PACKET UPLINK DUMMY CONTROL BLOCKS, the SS then sends PACKET CELL CHANGE CONTINUE and the MS change to Cell B. MS tries to access Cell B. SS deactivates Cell B, The MS request resources for an uplink in the old cell.

Maximum duration of the test

-

Expected sequence

Expected sequence

Step	Direction	Message	Comments
1		{Uplink dynamic allocation two phase access}	n = 500 octets. USF_GRANULARITY = 1 block, RLC_DATA_BLOCKS_GRANTED = open-end TLLI_BLOCK_CHANNEL_CODING: same as channel coding EGPRS_CHANNEL_CODING_COMMAND: MCS-1 No starting time present.
2	SS -> MS	PACKET DOWNLINK DUMMY CONTROL BLOCK	USF assigned to the MS
3	MS -> SS	EGPRS UPLINK RLC DATA BLOCK	
4			Repeat step 2 and 3 until CV=0
5	SS -> MS	PACKET UPLINK ACK/NACK	Final Ack Indication = 0. Sent on PACCH of the assigned PDCH. Acknowledge all data blocks received.
6	SS -> MS	PACKET DOWNLINK DUMMY CONTROL BLOCK	USF assigned to the MS
A6 (optional step)	MS -> SS	EGPRS UPLINK RLC DATA BLOCK	MS may retransmit the block with BSN=0 once if it has already been scheduled while Packet Uplink Ack/Nack is being processed. In this case go to step B6.
B6 (optional step)	SS -> MS	PACKET DOWNLINK DUMMY CONTROL BLOCK	USF assigned to the MS
7	MS -> SS	PACKET UPLINK DUMMY CONTROL BLOCK	Repeat steps 6 and 7 five times
8			
9	SS		Lower signal strength of Cell A to -80 dBm.
10	SS -> MS	PACKET UPLINK ACK/NACK	USF assigned to the MS
11	MS -> SS	PACKET UPLINK DUMMY CONTROL BLOCK	
12		Or PACKET CELL CHANGE NOTIFICATION	Step 10 and 11 are repeated until a PACKET CELL CHANGE NOTIFICATION is received in step 11, but no longer than 10 sec. The test has failed if no PACKET CELL CHANGE NOTIFICATION is received in Cell A within 10 sec from Step 9.
13	SS -> MS	PACKET CELL CHANGE CONTINUE	Allow the MS to try to access Cell B Cell B is deactivated
14	MS -> SS	EGPRS PACKET CHANNEL REQUEST	
15			
			The following messages are to be sent and received in Cell A.
16	MS -> SS	EGPRS PACKET CHANNEL REQUEST	Received on PRACH.
17	SS -> MS	PACKET UPLINK ASSIGNMENT	Multiblock allocation , to order the MS to follow the two phase access procedure. Sent on PAGCH.
18	MS -> SS	PACKET RESOURCE REQUEST	Received on the single block assigned in step 17.
19	SS -> SS	PACKET UPLINK ASSIGNMENT	Uplink dynamic allocation, no starting time, Sent on PACCH of the same PDCH assigned in step 17.
20		{Completion of uplink RLC data block transfer}	MS performs a Cell Update.

Specific message contents

PACKET CELL CHANGE CONTINUE in Step 13

Information element	Value/remark
< PAGE_MODE : bit (2) > 0	00 (Normal Paging) 0
< GLOBAL_TFI : Global TFI IE > 0 1	0 <5 bit Uplink TFI> 1
< ARFCN : bit (10) >	ARFCN of Cell B.
< BSIC : bit (6) >	BSIC of Cell B.
< CONTAINER_ID >	01

51.3.6.8 Extended Uplink TBF / Cell Change while in Extended Uplink/ With Packet Neighbouring Cell Data

51.3.6.8.1 Conformance requirements

If CCN is enabled (see sub-clause 5.5.1.1a), the mobile station shall behave as in network control mode NC0 or NC1 up to the point when a new cell has been chosen. It shall then check the CCN_SUPPORTED parameter, if available, that was last received for that cell. This parameter can be sent on BCCH or PBCCH or individually in PACKET MEASUREMENT ORDER or in PACKET CELL CHANGE ORDER messages. If it is available and if it indicates that CCN mode shall be entered towards that cell or if it is not available, then instead of performing the cell change, the mobile station shall start timer T3206 and enter the CCN mode. At the first possible opportunity, the MS shall then, when in CCN mode, inform the network about the proposed cell by sending a PACKET CELL CHANGE NOTIFICATION message, stop timer T3206, start timers T3208 and T3210. The PACKET CELL CHANGE NOTIFICATION message shall contain the ARFCN for the BCCH and the BSIC as identity of the proposed cell. The message shall also contain measurement reports for the proposed cell and for other neighbour cells if available. In CCN mode the mobile station shall continue the data transfer and store neighbour cell system information if received in instances of the PACKET NEIGHBOUR CELL DATA message, but not perform the cell change. At receipt of the first PACKET NEIGHBOUR CELL DATA message or PACKET CELL CHANGE CONTINUE message or PACKET CELL CHANGE ORDER message, the mobile station shall stop the timer T3210. If a mobile station as response to a PACKET CELL CHANGE NOTIFICATION message receives a PACKET CELL CHANGE CONTINUE message without receiving any neighbour cell system information, the mobile station shall stop timer T3208, stop timer T3210 if still running, leave CCN mode and continue cell reselection in NC0/NC1 mode. The network sends first necessary system information for the cell proposed in the PACKET CELL CHANGE NOTIFICATION message, or for any other cell, in one or more instances of the PACKET NEIGHBOUR CELL DATA message and sends then a PACKET CELL CHANGE CONTINUE message. The mobile station shall store the received system information as specified in sub-clause 8.8.1. When the first instance of the PACKET NEIGHBOUR CELL DATA message is received, the mobile station shall stop timer T3210 if still running. When the PACKET CELL CHANGE CONTINUE message is received, the mobile station shall stop timer T3208, leave CCN mode and continue the cell reselection in NC0/NC1 mode. The network sends first necessary system information for the cell proposed in the PACKET CELL CHANGE NOTIFICATION message, or for any other cell, in one or more instances of the PACKET NEIGHBOUR CELL DATA message and sends then a PACKET CELL CHANGE ORDER message. The mobile station shall store the received system information as specified in sub-clause 8.8.1. When the first instance of the PACKET NEIGHBOUR CELL DATA message is received, the mobile station shall stop timer T3210 if still running. When the PACKET CELL CHANGE ORDER message is received, the mobile station shall stop timer T3208, leave CCN mode and follow the procedures as specified for the Packet Cell Change Order (sub-clause 8.4) and in sub-clause 8.8.1.

In extended uplink TBF mode, the uplink TBF may be maintained during temporary inactive periods, where the mobile station has no RLC information to send.

During the temporary inactive periods, the mobile station may stop sending RLC data block, as defined in clause 9.1.3. The network shall continue allocating the mobile station uplink radio blocks during the inactivity period, using the procedures defined in clause 8.1.1 for each medium access mode. Uplink radio blocks shall be allocated as required allowing the mobile station to continue the transfer of RLC data blocks, when a new RLC data block becomes available.

When the mobile station is allocated an uplink radio block and there is no RLC data block ready to send, the mobile station shall send an RLC/MAC control block in each uplink radio block allocated by the network. The priority defined in clause 8.1.1 for different kinds of RLC/MAC blocks apply.

References

3GPP TS 44.060, subclause 8.8.3

3GPP TS 44.060, subclause 9.3.1b.2

51.3.6.8.2 Test purpose

To verify that: MS takes into consideration the change of parameter NW_EXT_UTBF in PSI1 (sent in PACKET NEIGHBOUR CELL DATA) and operate in Extended Uplink TBF in the new cell.

51.3.6.8.3 Method of test

Initial conditions

System Simulator:

2 cells, EGPRS supported, CCN Active, PCCCH present, GPRS_RXLEV_ACCESS_MIN = -90dBm,.

Cell A: RLA_C = -50 dBm, is active and NW_EXT_UTBF = 0.

Cell B: Supports PACKET PSI STATUS. All Packet System Information is replaced by Packet Downlink Dummy Control Block on PBCCH. This is only made to make it possible to verify that the MS uses the information in Packet Neighbour Cell Data, RLA_C = -60 dBm, is active and NW_EXT_UTBF = 1.

Mobile Station:

MS is in Packet Idle mode, GPRS attached with support of GERAN Feature Package 1 indicated in MS Radio Access Capabilities, and PDP context 2 established.

Specific PICS Statements

-

PIXIT Statements

-

Test procedure

The MS is triggered to initiate packet uplink transfer. SS assigns resources to the MS and it starts to send uplink data that the SS acknowledge. During the uplink the signal strength of Cell A is lowered to - 80 dBm. The MS enters CCN mode and sends PACKET CELL CHANGE NOTIFICATION. SS sends one or more PACKET NEIGHBOUR CELL DATA to the MS (with NW_EXT_UTBF in PSI1 set to 1). The SS then sends PACKET CELL CHANGE CONTINUE and the MS change to Cell B. The MS requests resources for an uplink and asks for PSI3 and PSI3bis messages by sending PACKET_PSI_STATUS (Note: During the acquisition of BCCH information the MS may send up to three extra PACKET PSI STATUS messages). In the new cell the MS completes the uplink transfer while operating in extended uplink TBF.

Maximum duration of the test

-

Expected sequence

Step	Direction	Message	Comments
1		{Uplink dynamic allocation two phase access}	n = 1200 octets. USF_GRANULARITY = 1 block, RLC_DATA_BLOCKS_GRANTED = open-end TLLI_BLOCK_CHANNEL_CODING: same as channel coding EGPRS_CHANNEL_CODING_COMMAND: MCS-1 No starting time present.
2	SS -> MS	PACKET DOWNLINK DUMMY CONTROL BLOCK	USF assigned to the MS Repeat step 2 and 3 five times Lower signal strength of Cell A to -80 dBm. USF assigned to the MS Step 6 and 7 are repeated until a PACKET CELL CHANGE NOTIFICATION is received in step 7, but no longer than 10 sec. The test has failed if no PACKET CELL CHANGE NOTIFICATION is received in Cell A within 10 sec from Step 5. USF assigned to the MS Step 9 and 10 are repeated until all instances of PACKET NEIGHBOUR CELL DATA are sent (PSI1 with NW_EXT_UTBF = 1 and PSI_STATUS_IND = 1). The following messages are to be sent and received in Cell B.
3	MS -> SS	EGPRS UPLINK RLC DATA BLOCK	
4			
5	SS		
6	SS -> MS	PACKET UPLINK ACK/NACK	
7	MS -> SS	EGPRS UPLINK RLC DATA BLOCK Or PACKET CELL CHANGE NOTIFICATION	
8			
9	SS -> MS	PACKET NEIGHBOUR CELL DATA	
10	MS -> SS	EGPRS UPLINK RLC DATA BLOCK	
11			
12	SS -> MS	PACKET CELL CHANGE CONTINUE	
13		{Uplink dynamic allocation two phase access}	
14	SS -> MS	PACKET DOWNLINK DUMMY CONTROL BLOCK	Step 14 and 15 are repeated until a PACKET PSI STATUS is received in step 15. The PACKET PSI STATUS shall be sent within 10 sec of accessing the cell. Verify that the MS does not request PSI that was sent in step 9.
15	MS -> SS	EGPRS UPLINK RLC DATA BLOCK or PACKET PSI STATUS	
16			
17		PACKET SYSTEM INFORMATION Type 3 PACKET SYSTEM INFORMATION Type 3 bis	SS should send PSIs on PACCH. Note: During the acquisition of PBCCH information the MS may send up to three extra PACKET PSI STATUS messages
18		PACKET DOWNLINK DUMMY CONTROL BLOCK	USF assigned to the MS

19 (optional step)	MS -> SS	EGPRS UPLINK RLC DATA BLOCK or PACKET RESOURCE REQUEST	
20 (conditional step)	SS->MS	PACKET UPLINK ASSIGNMENT	Step 20 is performed only PRR is sent step 19.
21			Repeats the PDTCH assignment from the 2 nd PUA step 13
22	SS -> MS	PACKET UPLINK ACK/NACK	Repeat step 18 and 19 until CV=0
23	SS -> MS	PACKET DOWNLINK DUMMY CONTROL BLOCK	Final Ack Indication = 0. Sent on PACCH of the assigned PDCH. Acknowledge all data blocks received.
A23 (optional step)	MS -> SS	EGPRS UPLINK RLC DATA BLOCK	USF assigned to the MS, Sent after 6 blocks of sending the message in step 22.
B23 (optional step)	SS -> MS	PACKET DOWNLINK DUMMY CONTROL BLOCK	MS may retransmit the block with BSN=0 once if it has already been scheduled while Packet Uplink Ack/Nack is being processed.
24	MS -> SS	PACKET UPLINK DUMMY CONTROL BLOCK	In this case go to step B23.
25			USF assigned to the MS
26	MS		Repeat step 23 and 24 five times.
27	SS -> MS	PACKET DOWNLINK DUMMY CONTROL BLOCK	Trigger the MS to send 500 octets of data.
28	MS -> SS	EGPRS UPLINK RLC DATA BLOCK	SS should take care of allocating USF's to the MS in order to prevent the MS from releasing the TBF
29			USF assigned to the MS
30	SS -> MS	PACKET UPLINK ACK/NACK	Repeat step 27 and 28 until CV=0
31	MS -> SS	PACKET CONTROL ACKNOWLEDGEMENT	Final Ack Indication = 1 containing valid RRB. Sent on PACCH of the assigned PDCH. Acknowledge all data blocks received.
			Received on the block specified by RRB on PACCH of the assigned PDCH.

Specific message contents

PACKET NEIGHBOUR CELL DATA in Step 9

The message contains the default PSI_1, with NW_EXT_UTBF = 1 and PSI_STATUS_IND = 1, default PSI_2 and PSI14 for Cell B.

Information element	Value/remark
< PAGE_MODE : bit (2) >	00 (Normal Paging)
0	0
< GLOBAL_TFI : Global TFI IE >	0 <5 bit Uplink TFI>
< CONTAINER_ID : bit (2) >	01 for PSI belonging to Cell B
< SPARE :bit(1)>	0
< CONTAINER_INDEX :bit (5)>	00000 to the index needed to send all PSI1, PSI2 and PSI14 for each cell.
0 1	0 No ARFCN or BSIC
Container repetition struct	
< PD : bit(3)>	001, PBCCH (RLC/MAC)

PACKET CELL CHANGE CONTINUE in Step 12

Information element	Value/remark
< PAGE_MODE : bit (2) > 0	00 (Normal Paging) 0
< GLOBAL_TFI : Global TFI IE > 0 1	0 <5 bit Uplink TFI> 1
< ARFCN : bit (10) >	ARFCN of Cell B.
< BSIC : bit (6) >	BSIC of Cell B.
< CONTAINER_ID >	01

51.3.6.9 TBF Release / Extended Uplink / Change of RLC mode / Normal release

51.3.6.9.1 Conformance requirements

During an uplink packet transfer, upper layer may request to transfer another LLC PDU. If the new LLC PDU does not have the same RLC mode as the current uplink TBF but has a higher radio priority, the mobile station shall complete the transmission of the current LLC PDU using the countdown procedure including acknowledgement from the network, if in acknowledged mode.

If the TBF is operated in extended uplink TBF mode (see sub-clause 9.3.1b), the mobile station shall use the procedure in sub-clause 8.1.1.6 for changing RLC mode.

The mobile station shall send a PACKET RESOURCE REQUEST message on PACCH indicating the new RLC mode and start timer T3168.

If timer T3168 expires, the mobile station shall retransmit the PACKET RESOURCE REQUEST message and restart timer T3168.

On receipt of a PACKET RESOURCE REQUEST message, indicating a change of RLC mode, the network shall release the uplink TBF at a point determined by the network, using the procedure defined in sub-clause 9.5.

On receipt of PACKET UPLINK ACK/NACK with Final Ack Indicator set to '1' the mobile station shall stop timer T3168 and after sending the PACKET CONTROL ACK perform the change of RLC mode by establishing a new TBF.

References

3GPP TS 44.060, subclauses 8.1.1.6, 8.1.1.1.2 and 9.5.

51.3.6.9.1.2 Test purpose

To verify that during extended uplink TBF the MS re-establishes the TBF and changes the RLC mode.

51.3.6.9.1.3 Method of test

Initial Conditions

System Simulator:

1 cell, NW_EXT_UTBF = 1, BS_CV_MAX = 14, T3168 timeout value=7 (4s), N201-U=500 for SAPI 3, 5, 9, 11, N201-U=270 for SAPI 7.

Mobile Station:

MS is in Packet Idle mode, GPRS attached with support of GERAN Feature Package 1 indicated in MS Radio Access Capabilities, and PDP context 1 and context 2 established.

Specific PICS Statements

-

PIXIT Statements

-

Test Procedure

An uplink TBF is established and in progress. SS assigns USFs allowing the MS to transmit data blocks. The MS is triggered to transfer 220 octets user data with a different RLC mode and higher radio priority.

The mobile station shall complete the transmission of the current LLC PDU. SS will verify the complete reception of the LLC PDU.

SS acknowledges the LLC PDU with a EGPRS Packet Uplink Ack/Nack with TBF Est field is set to '1' and Final Ack Indicator bit set to '1'. The mobile station shall use the same procedures as are used for TBF establishment using two phase starting from the point where the mobile station transmits the PACKET RESOURCE REQUEST message.

In case the MS ignores the TBF Est field in the EGPRS PACKET UPLINK ACK/NACK , the mobile station shall transmit a PACKET CONTROL ACKNOWLEDGEMENT message, release the TBF and shall establish a new TBF using two phase access.

SS assigns a PDCH to the MS. SS assigns USFs allowing the MS to transmit data blocks until the countdown value CV=0.

SS sends an EGPRS Packet Uplink Ack/Nack with TBF Est field set to '0' and Final Ack Indicator bit set to '1' and the MS is polled. The MS answers with a Packet Control Acknowledgement and the TBF is released.

Maximum Duration of Test

5 minutes.

Expected Sequence

Step	Direction	Message	Comments
1	MS	{Uplink dynamic allocation two phase access}	In PDP context2, n = 220 octets, without starting time, USF_GRANULARITY = 1 block, RLC_DATA_BLOCKS_GRANTED = open-end, TLLI_BLOCK_CHANNEL_CODING: MCS-1, EGPRS_CHANNEL_CODING_COMMAND: MCS-1, RADIO_PRIORITY = 4
2	SS -> MS	PACKET DOWNLINK DUMMY CONTROL BLOCK	Sent on the PACCH, the USF assigned to the MS, on 3 blocks from the last radio block containing the uplink assignment.
3	MS -> SS	EGPRS UPLINK RLC DATA BLOCK	Received on the assigned PDTCH. Check that the coding as specified by EGPRS_CHANNEL_CODING_COMMAND, the TFI, and BSN is correct.
4			Repeat step 2 and 3 three times.
5	MS		To trigger the MS to transfer 220 octets: in test PDP context1, unacknowledged RLC mode and Radio Priority = 1
6	SS -> MS	PACKET DOWNLINK DUMMY CONTROL BLOCK	Sent on the PACCH, the USF assigned to the MS.
7	MS -> SS	EGPRS UPLINK RLC DATA BLOCK Or PACKET RESOURCE REQUEST	Received on the assigned PDTCH. Check that the coding as specified by CHANNEL_CODING_COMMAND, the TFI, and BSN is correct. Send PACKET UPLINK ACK/NACK to acknowledge all received datablocks when CV=0 and PACKET RESOURCE REQUEST is not yet received. (Note: MS may retransmit the block with BSN=0 once if it has already been scheduled while PACKET UPLINK ACK/NACK is being processed and the new LLC PDU is not ready for the transmission)
		Or PACKET RESOURCE REQUEST	Received on PACCH of the assigned PDCH indicating the change of RLC mode. Check for radio priority level = 1 and RLC mode Unacknowledged RLC mode.
		PACKET UPLINK DUMMY CONTROL BLOCK	The MS is in extended TBF mode.
8			Repeat step 6 and 7 until CV = 0 and a PACKET RESOURCE REQUEST has been received
9	SS -> MS	EGPRS PACKET UPLINK ACK/NACK	Sent on the PACCH of the PDCH assigned, acknowledging all blocks so far. FINAL_ACK_INDICATION = '1', TBF Est = 1. Valid RRBP.
10	SS		Verify that only one complete LLC PDU has been received.
11 (optional)	MS -> SS	PACKET CONTROL ACKNOWLEDGEMENT	Received on the block specified by RRBP on PACCH of the assigned PDCH. If not received continue with step 14.
12 (conditional)	MS -> SS	PACKET CHANNEL REQUEST	Received on PRACH.
13 (conditional)	SS -> MS	PACKET UPLINK ASSIGNMENT	Multiblock allocation , to order the MS to follow the two phase access procedure. Sent on PAGCH.
14	MS -> SS	PACKET RESOURCE REQUEST	Received on PACCH of the assigned PDCH. Check for radio priority level = 1 and RLC mode Unacknowledged RLC mode. Received on the block specified by the single block assignment of step 13 or by the RRBP of step 9.
15	SS -> MS	PACKET UPLINK ASSIGNMENT	Open-ended uplink dynamic allocation, no starting time, USF_GRANULARITY = single block. Sent on PACCH of the assigned PDCH.
16	SS -> MS	PACKET DOWNLINK DUMMY CONTROL BLOCK	The USF assigned to the MS. Sent on PACCH of the assigned PDCH.

Step	Direction	Message	Comments
17	MS -> SS	EGPRS UPLINK RLC DATA BLOCK	Received on the PDTCH assigned.
18			Repeat step 16 and 17 until countdown value CV=0.
19	SS -> MS	EGPRS PACKET UPLINK ACK/NACK	FINAL_ACK_INDICATION = '1', TBF Est = 0, a valid RRBP, acknowledge all received data, sent on PACCH.
20	MS -> SS	PACKET CONTROL ACKNOWLEDGEMENT	Received on the block specified by RRBP on PACCH of the assigned PDCH.

51.3.6.10 TBF Release / Extended Uplink / Change of RLC mode / Abnormal release

51.3.6.10.1 Conformance requirements

During an uplink packet transfer, upper layer may request to transfer another LLC PDU. If the new LLC PDU does not have the same RLC mode as the current uplink TBF but has a higher radio priority, the mobile station shall complete the transmission of the current LLC PDU using the countdown procedure including acknowledgement from the network, if in acknowledged mode. immediately request a resource reallocation for uplink according to the new Radio Priority of the new LLC PDU by sending a PACKET RESOURCE REQUEST message on the PACCH and starting timer T3168.

If the TBF is operated in extended uplink TBF mode (see sub-clause 9.3.1b), the mobile station shall use the procedure in sub-clause 8.1.1.6 for changing RLC mode.

Then the mobile station shall complete the transmission of the current LLC PDU. If the TBF is operated in extended uplink TBF mode, the mobile station shall release the uplink TBF and re-establish a new uplink TBF in order to change the RLC mode.

The mobile station shall send a PACKET RESOURCE REQUEST message on PACCH indicating the new RLC mode and start timer T3168.

If timer T3168 expires, the mobile station shall retransmit the PACKET RESOURCE REQUEST message and restart timer T3168.

If timer T3168 expires and the PACKET RESOURCE REQUEST message has already been transmitted four times, the mobile station shall perform an abnormal release with access retry (see sub-clause 8.7.2).

On receipt of a PACKET RESOURCE REQUEST message, indicating a change of RLC mode, the network shall release the uplink TBF at a point determined by the network, using the procedure defined in sub-clause 9.5.

On receipt of PACKET UPLINK ACK/NACK with Final Ack Indicator set to '1' the mobile station shall stop timer T3168 and after sending the PACKET CONTROL ACK perform the change of RLC mode by establishing a new TBF.

References

3GPP TS 44.060, subclauses 8.1.1.6, 8.1.1.1.2, and 9.5.

51.3.6.10.1.2 Test purpose

To verify that during extended uplink TBF the MS perform an abnormal release with access retry after timer T3168 expired and PACKET RESOURCE REQUEST message has been transmitted four times.

51.3.6.10.1.3 Method of test

Initial Conditions

System Simulator:

1 cell, NW_EXT_UTBF = 1, BS_CV_MAX = 14, T3168 timeout value=7 (4s), N201-U=500 for SAPI 3, 5, 9, 11, N201-U=270 for SAPI 7.

Mobile Station:

MS is in Packet Idle mode, GPRS attached with support of GERAN Feature Package 1 indicated in MS Radio Access Capabilities, and PDP context 1 and context 2 established.

Specific PICS Statements

-

PIXIT Statements

-

Test Procedure

An uplink TBF is established and in progress. SS assigns USFs allowing the MS to transmit data blocks until the MS completes the countdown procedure. As soon as the MS is in extended UL TBF mode, the MS is triggered to transfer 220 octets user data with different RLC mode.

The mobile station shall immediately request a resource reallocation for uplink indicating the changed RLC mode applied to the new LLC PDU by sending a PACKET RESOURCE REQUEST message on the PACCH and start timer T3168.

SS keeps assigning USFs, the MS will send Packet Uplink Dummy Control Blocks till T3168 expire. The MS will send a PACKET RESOURCE REQUEST message again on the PACCH and restart timer T3168.

The SS keeps assigning USFs till the MS has transmitted the Packet Resource Request four times.

The MS shall perform an abnormal release with access retry.

The SS will assign new resources to the MS to complete the new TBF.

Maximum Duration of Test

5 minutes.

Expected Sequence

Step	Direction	Message	Comments
1	MS	{Uplink dynamic allocation two phase access}	In PDP context2, n = 220 octets, without starting time, USF_GRANULARITY = 1 block, RLC_DATA_BLOCKS_GRANTED = open-end, TLLI_BLOCK_CHANNEL_CODING: MCS-1, EGPRS_CHANNEL_CODING_COMMAND: MCS-1, RADIO_PRIORITY = 4,
2	SS -> MS	PACKET DOWNLINK DUMMY CONTROL BLOCK	Sent on the PACCH, the USF assigned to the MS, on 3 blocks from the last radio block containing the uplink assignment.
3	MS -> SS	EGPRS UPLINK RLC DATA BLOCK	Received on the assigned PDTCH. Check that the coding as specified by EGPRS_CHANNEL_CODING_COMMAND, the TFI is correct.
4			Repeat step 2 and 3 till CV = 0
5	SS -> MS	EGPRS PACKET UPLINK ACK/NACK	Sent on the PACCH of the PDCH assigned, the USF not assigned to the MS, acknowledging all blocks. FINAL_ACK_INDICATION = '0', TBF Est = 1
6	SS -> MS	PACKET DOWNLINK DUMMY CONTROL BLOCK	USF assigned to the MS, sent after 6 blocks from step 5
A6 (optional step)	MS -> SS	EGPRS UPLINK RLC DATA BLOCK	MS may retransmit the block with BSN=0 once if it has already been scheduled while EGPRS PACKET UPLINK ACK/NACK is being processed. In this case go to step B6.
B6 (optional step)	SS -> MS	PACKET DOWNLINK DUMMY CONTROL BLOCK	USF assigned to the MS
7	MS -> SS	PACKET UPLINK DUMMY CONTROL BLOCK	MS is in extended UL TBF mode.
8	MS		To trigger the MS to transfer 220 octets: in test PDP context1, unacknowledged RLC mode and Radio Priority = 1
9	SS -> MS	PACKET DOWNLINK DUMMY CONTROL BLOCK	USF assigned to the MS
A10 (optional step)	MS -> SS	PACKET UPLINK DUMMY CONTROL BLOCK	MS may transmit while processing the uplink data trigger PACKET UPLINK DUMMY CONTROL BLOCK. In this case repeat step 9 until a PACKET RESOURCE REQUEST is received.
10	MS -> SS	PACKET RESOURCE REQUEST	MS starts T3168. Received on the PACCH of the assigned PDCH, Indicating the change of RLC mode: Check that radio priority level = 1 and Unacknowledged RLC mode.
11	SS -> MS	EGPRS PACKET UPLINK ACK/NACK	To prevent T3184 from expiring, sent on the PACCH of the PDCH assigned, the USF not assigned to the MS, acknowledging all Blocks. FINAL_ACK_INDICATION = '0', TBF Est = 0
12	SS -> MS	PACKET DOWNLINK DUMMY CONTROL BLOCK	USF assigned to the MS
13	MS -> SS	PACKET UPLINK DUMMY CONTROL BLOCK	MS is in extended UL TBF mode.
		Or	
		PACKET RESOURCE REQUEST	Received on the PACCH of the assigned PDCH, Indicating the change of RLC mode: Check that radio priority level = 1 and Unacknowledged RLC mode.
14			Repeat Step 12 and 13 until a PACKET RESOURCE REQUEST has been received. Check that the PACKET RESOURCE REQUEST is received within T3168 +/- 10% from the previous PACKET RESOURCE REQUEST.
15			Repeat Step 11 to Step 14 until the PACKET RESOURCE REQUEST has been received a total of 4 times. .

Step	Direction	Message	Comments
			MS shall perform an abnormal release with access retry
16	MS -> SS	EGPRS PACKET CHANNEL REQUEST	Received on PRACH for TBF establishment for transferring of the LLC PDU in PDP context1.
17	SS -> MS	PACKET UPLINK ASSIGNMENT	Multiblock allocation, to force the MS making two-phase access procedure. Sent on PAGCH.
18	MS -> SS	PACKET RESOURCE REQUEST	Received on the single block assigned in step 17. Check that radio priority level = 1, peak throughput class = 5, unacknowledged RLC mode.
19	SS -> MS	PACKET UPLINK ASSIGNMENT	Open-ended uplink dynamic allocation, no starting time, USF_GRANULARITY = single block.
20	SS -> MS	PACKET DOWNLINK DUMMY CONTROL BLOCK	The USF assigned to the MS. Sent on PACCH of PDCH assigned in step 19.
21	MS -> SS	EGPRS UPLINK RLC DATA BLOCK	Received on the PDTCH assigned.
22			Repeat step 20 and 21 until countdown value CV=0.
23	SS -> MS	EGPRS PACKET UPLINK ACK/NACK	FINAL_ACK_INDICATION = '1', a valid RRBP, acknowledge all received data, sent on PACCH.
24	MS -> SS	PACKET CONTROL ACKNOWLEDGEMENT	Received on the block specified by RRBP on PACCH of the assigned PDCH.

51.3.7 Default message contents

The default message contents defined in subclause 52.3.4 are applied for the all tests in subclause 51.3.

51.4 Void

51.5 EGPRS Dual transfer mode

To bring the MS into active state U10, macro 40.4.3.22 shall be used.

51.5.1 PS establishment whilst in dedicated mode

51.5.1.1 Uplink TBF establishment

51.5.1.1.1 Uplink TBF establishment with no reallocation of CS resources

51.5.1.1.1.1 Uplink TBF establishment with no reallocation of CS resources / Successful case / Uplink resources assigned

51.5.1.1.1.1.1 Conformance requirements

While in dedicated mode, the establishment of an uplink packet resource may be initiated by the RR entity of the mobile station using the packet request procedure. The procedure is triggered by a request from upper layers to transfer an LLC PDU; see 3GPP TS 24.007.

On receipt of a DTM REQUEST message the network may allocate an uplink packet resource. The packet uplink resource is assigned to the mobile station in one of the DTM assignment messages:

- DTM ASSIGNMENT COMMAND or
- PACKET ASSIGNMENT.

The PACKET ASSIGNMENT message is only used when the packet resource is a PDCH and no reallocation of the RR connection is needed.

On receipt of:

- DTM ASSIGNMENT COMMAND message or
- PACKET ASSIGNMENT message,

the mobile station shall stop T3148.

- when the network sends a PACKET ASSIGNMENT message, the packet request procedure is completed for the network when assignment message is sent and for the mobile station when it is received.

When the packet request procedure is completed, the mobile station has entered the dual transfer mode.

References

3GPP TS 04.18/44.018 sub-clause 3.4.22.1.1

51.5.1.1.1.1.2 Test purpose

To verify that the MS:

- decodes correctly the Cell's System information, understanding that DTM access is allowed;
- requests an uplink TBF when it has something to send;
- acts upon the PACKET ASSIGNMENT message and then transmitting on the PDCH allocated.

51.5.1.1.1.1.3 Method of test

Initial Conditions

System Simulator:

1 cell, DTM supported

Mobile Station:

The MS is in the active state (U10) of a call.

The MS is in packet idle mode with a P-TMSI allocated and PDP context 1 activated.

Specific PICS Statements

-

PIXIT Statements

-

Test Procedure

The MS, whilst in dedicated mode, is triggered to initiate packet uplink transfer data in RLC unacknowledged mode and sends a DTM REQUEST message. On receipt of the DTM REQUEST message, requesting uplink resources, the SS assigns the MS PS resource. The SS accomplishes the resource assignment by passing a PACKET ASSIGNMENT message to the MS. On receipt of the PACKET ASSIGNMENT message, the MS starts to send RLC DATA BLOCKS to the SS on the assigned PDCH.

The codec to be used in this test is chosen dependent on the capabilities of the MS.

MS supporting DTM/EGPRS shall complete testing for k=1 and MSs indicating support of single slot DTM/EGPRS shall additionally complete testing for k=2.

Maximum Duration of Test

5 minutes

Expected Sequence

The test sequence is repeated for k = 1,2.

Step	Direction	Message	Comments
1	SS		MS in the active state (U10) of a call on Timeslot N. When: k=1, Channel Type=TCH/F; k=2, Channel Type=TCH/H.
2	MS		Trigger the MS to initiate an uplink packet transfer containing 1000 octets.
3	MS->SS	DTM REQUEST	
4	SS->MS	PACKET ASSIGNMENT	SS sends this message such that it is received before Timer T3148 expiry. Includes information on the Radio resources provided to the MS. See specific message contents.
5	MS<->SS	{ Uplink data transfer }	Macro - Completion of the 1000 Octets of Data.

Specific Message Contents

PACKET ASSIGNMENT (Step 4):

k=1;

As default message contents as defined in section 40.2.4.31 except: RR Packet Uplink Assignment IE - TIMESLOT_ALLOCATION <i>Additions for R99:</i> EGPRS_MCS_MODE RESEGMENT EGPRS Window Size RR Packet Downlink Assignment IE	(N ± 1) MOD 8 MCS-1 0 Retransmitted RLC data blocks shall not be resegmented 64 Not included
---	--

k=2;

As default message contents as defined in section 40.2.4.31 except: RR Packet Uplink Assignment IE - TIMESLOT_ALLOCATION <i>Additions for R99:</i> EGPRS_MCS_MODE RESEGMENT EGPRS Window Size RR Packet Downlink Assignment IE	N MCS-1 0 Retransmitted RLC data blocks shall not be resegmented 64 Not included
---	--

51.5.1.1.1.2 Uplink TBF establishment with no reallocation of CS resources / Successful case / Downlink resources assigned

51.5.1.1.1.2.1 Conformance requirements

While in dedicated mode, the establishment of an uplink packet resource may be initiated by the RR entity of the mobile station using the packet request procedure. The procedure is triggered by a request from upper layers to transfer an LLC PDU; see 3GPP TS 24.007.

On receipt of a DTM REQUEST message the network may allocate an uplink packet resource. The packet uplink resource is assigned to the mobile station in one of the DTM assignment messages:

- DTM ASSIGNMENT COMMAND or
- PACKET ASSIGNMENT.

The PACKET ASSIGNMENT message is only used when the packet resource is a PDCH and no reallocation of the RR connection is needed.

On receipt of:

- DTM ASSIGNMENT COMMAND message or
- PACKET ASSIGNMENT message,

the mobile station shall stop T3148.

If the received DTM ASSIGNMENT COMMAND or PACKET ASSIGNMENT message includes uplink packet resources, the mobile station shall proceed with the packet access. If the received message includes downlink packet resources and no uplink packet resources, the mobile station shall abort the packet access procedure and proceed with the procedure specified in clause 3.4.22.3, and then attempt an establishment of uplink TBF, using the applicable procedure specified in 3GPP TS 04.60.

- when the network sends a PACKET ASSIGNMENT message, the packet request procedure is completed for the network when assignment message is sent and for the mobile station when it is received.

When the packet request procedure is completed, the mobile station has entered the dual transfer mode.

If the received PACKET ASSIGNMENT message includes downlink packet resources and no uplink packet resources, the mobile station shall abort the packet access procedure and proceed with the downlink TBF establishment, and then attempt an establishment of uplink TBF.

References

- 3GPP TS 04.18/44.018 sub-clauses 3.4.22.1.1, 3.4.22.3
- 3GPP TS 04.60/44.060 sub-clause 8.1.2.5

51.5.1.1.1.2.2 Test purpose

To verify that the MS:

- decodes correctly the Cell's System information, understanding that DTM access is allowed;
- requests an uplink TBF;
- acts upon the PACKET ASSIGNMENT message containing downlink resources.
- attempts uplink TBF establishment, once the downlink TBF establishment is complete.

51.5.1.1.1.2.3 Method of test

Initial Conditions

System Simulator:

1 cell, DTM supported

Mobile Station:

The MS is in the active state (U10) of a call on cell A.

The MS is in packet idle mode with a P-TMSI allocated and PDP context 1 activated.

Specific PICS Statements

-

PIXIT Statements

-

Test Procedure

The MS, whilst in dedicated mode, is triggered to initiate packet uplink transfer data in RLC unacknowledged mode and sends a DTM REQUEST message. On receipt of the DTM REQUEST message, requesting uplink resources, the SS

assigns the MS downlink PS resources using the PACKET ASSIGNMENT message. The MS, upon receipt of the assignment message, aborts the packet access procedure and proceeds with the downlink assignment. When possible the MS requests the uplink TBF establishment. The SS upon receipt of the resource request allocates the MS uplink resources using the PACKET UPLINK ASSIGNMENT message. The MS then starts to send RLC DATA BLOCKS to the SS on the assigned PDTCH.

The codec to be used in this test is chosen dependent on the capabilities of the MS.

MS supporting DTM/EGPRS shall complete testing for k=1 and MSs indicating support of single slot DTM/EGPRS shall additionally complete testing for k=2.

Maximum Duration of Test

5 minutes

Expected Sequence

The test sequence is repeated for k = 1,2.

Step	Direction	Message	Comments
1	SS		MS in the active state (U10) of a call on Timeslot N of cell A. When: k=1, Channel Type=TCH/F; k=2, Channel Type=TCH/H.
2	MS		Trigger the MS to initiate an uplink packet transfer containing 1000 octets.
3	MS->SS	DTM REQUEST	
4	SS->MS	PACKET ASSIGNMENT	SS sends this message such that it is received before Timer T3148 expiry. See specific message contents.
5	SS<->MS	{ Downlink data }	Macro
6	MS->SS	EGPRS PACKET DOWNLINK ACK/NACK	Channel Request Description IE indicating that uplink resources are required.
7	SS->MS	PACKET UPLINK ASSIGNMENT	When: k=1, Timeslot = T; k=2, Timeslot = N.
8	MS<->SS	{ Uplink data transfer }	Macro - Completion of the 10kB of Data.

Specific Message Contents

PACKET ASSIGNMENT (Step 4):

k=1;

As default message contents as defined in section 40.2.4.31 except: RR Packet Uplink Assignment IE RR Packet Downlink Assignment IE - TIMESLOT_ALLOCATION <i>Additions for R99:</i> EGPRS Window Size LINK_QUALITY_MEASUREMENT_MODE	Not included T = (N ± 1) MOD 8 64 00
---	---

k=2;

As default message contents as defined in section 40.2.4.31 except: RR Packet Uplink Assignment IE RR Packet Downlink Assignment IE - TIMESLOT_ALLOCATION <i>Additions for R99:</i> EGPRS Window Size LINK_QUALITY_MEASUREMENT_MODE	Not included N 64 00
---	---------------------------------------

51.5.1.1.2 Uplink TBF establishment with reallocation of CS resources

51.5.1.1.2.1 Uplink TBF establishment with reallocation of CS resources / Successful case

51.5.1.1.2.1.1 Conformance requirements

Upon receipt of the DTM ASSIGNMENT COMMAND message, the mobile station initiates a local end release of link layer connections, disconnects the physical channels, commands the switching to the assigned channel and initiates the establishment of lower layer connection (this includes the activation of the channel, their connection and the establishment of the main signalling link).

References

3GPP TS 04.18/44.018 sub-clause 3.4.22.1.1.3.1

51.5.1.1.2.1.2 Test purpose

To verify that the MS allows reallocation of its CS resources during the request for PS resources. The resources can either be reallocated to a new timeslot within the same frequency or a new frequency.

51.5.1.1.2.1.3 Method of test

Initial Conditions

System Simulator:

1 cell, DTM supported.

Mobile Station:

The MS is in the active state (U10) of a call.

The MS is in packet idle mode, with a P-TMSI allocated and PDP context 1 activated.

Specific PICS Statements

-

PIXIT Statements

-

Test Procedure

The MS, whilst in dedicated mode, is triggered to initiate packet uplink data transfer and sends a DTM REQUEST message. On receipt of the DTM REQUEST message, requesting uplink resources, the SS reallocates the MS's CS resources and assigns PS resources to the MS. The SS accomplishes the resource assignment by passing a DTM ASSIGNMENT COMMAND message to the MS. Once the MS has received the assignment message, it moves to the new allocation, reconnects the CS resources, passes the ASSIGNMENT COMPLETE message to the SS on the main DCCH and starts to send RLC DATA BLOCKS to the SS on the assigned TBF.

The codec to be used in this test is chosen dependent on the capabilities of the MS.

MS supporting DTM/EGPRS shall complete testing for k=1 and MSs indicating support of single slot DTM/EGPRS shall additionally complete testing for k=2.

Maximum Duration of Test

5 minutes

Expected Sequence

The test sequence is repeated for k = 1,2.

Step	Direction	Message	Comments
1	SS		MS in the active state (U10) of a call on Timeslot N. When: k=1, Channel Type=TCH/F; k=2, Channel Type=TCH/H.
2	MS		Trigger the MS to initiate an uplink packet transfer containing 1000 octets.
3	MS->SS	DTM REQUEST	Sent on main DCCH
4	SS->MS	DTM ASSIGNMENT COMMAND	This message is sent such that it is received before expiry of timer T3148. See specific message contents.
5	MS->SS	ASSIGNMENT COMPLETE	Sent on new main DCCH.
6	MS->SS	{ Uplink Data Transfer }	Macro - Completion of the 1000 octets of Data.

Specific Message Contents

DTM ASSIGNMENT COMMAND (Step 4):

k=1;

As default message contents as defined in section 40.2.4.28 except: Channel Description IE - Timeslot Number - Channel Type RR Packet Uplink Assignment IE - TIMESLOT_ALLOCATION <i>Additions for R99:</i> EGPRS_MCS_MODE RESEGMENT EGPRS Window Size RR Packet Downlink Assignment IE	N', chosen arbitrarily. TCH/F (N' ± 1) MOD 8 MCS-1 0 Retransmitted RLC data blocks shall not be re-segmented 64 Not included
--	--

k=2;

As default message contents as defined in section 40.2.4.28 except: Channel Description IE - Timeslot Number - Channel Type RR Packet Uplink Assignment IE - TIMESLOT_ALLOCATION <i>Additions for R99:</i> EGPRS_MCS_MODE RESEGMENT EGPRS Window Size RR Packet Downlink Assignment IE	N', chosen arbitrarily. TCH/H N' MCS-1 0 Retransmitted RLC data blocks shall not be re-segmented 64 Not included
--	--

51.5.1.2 Downlink TBF establishment

51.5.1.2.1 Whilst in Ready State

51.5.1.2.1.1 Downlink TBF establishment in Ready State / Successful case

51.5.1.2.1.1.1 Conformance requirements

This procedure is only applicable to a mobile station in dedicated mode and with no TBF allocated. If the mobile station already has an ongoing TBF, the establishment of the downlink packet resource is performed on the PACCH; see 3GPP TS 04.60.

The establishment of a downlink packet resource is initiated by the RR entity on the network side using the packet downlink assignment procedure in dedicated mode. The procedure is triggered by a request from upper layers to

transfer an LLC PDU; see 3GPP TS 24.007. The request from upper layers specifies a QoS profile, an *RLC mode*, *DRX parameters* and an *MS classmark* associated with the packet transfer.

The network initiates the packet downlink assignment procedure in dedicated mode by sending a DTM assignment message (i.e. DTM ASSIGNMENT COMMAND or a PACKET ASSIGNMENT) in acknowledged mode on the main DCCH.

The completion of the packet downlink assignment procedure while in dedicated mode depends on the actual assignment message used by the network:

- when the network sends a PACKET ASSIGNMENT message, the packet downlink assignment procedure is completed for the network when assignment message is sent and for the mobile station when it is received.

References

3GPP TS 04.18/44.018 sub-clause 3.4.22.3

51.5.1.2.1.1.2 Test purpose

To test that while in dedicated mode and in ready state, the MS can decode and act upon the allocation of downlink packet resources and enter dual transfer mode.

51.5.1.2.1.1.3 Method of test

Initial Conditions

System Simulator:

1 cell, DTM supported.

Mobile Station:

The MS is in the active state (U10) of a call.

The MS is in the GMM READY state, with a P-TMSI allocated and PDP context 1 activated.

Specific PICS Statements

-

PIXIT Statements

-

Test Procedure

Whilst in an active call on timeslot N, the MS receives a PACKET ASSIGNMENT message on the main DCCH, instructing the MS to switch to the designated timeslot. The SS waits a specified time and then starts to transmit to the newly allocated resources. The test procedure is complete when the MS successfully acknowledges the downlink RLC data blocks.

MS supporting DTM/EGPRS shall complete testing for k=1 and MSs indicating support of single slot DTM/EGPRS shall additionally complete testing for k=2.

Maximum Duration of Test

5 minutes

Expected Sequence

The test sequence is repeated for k = 1,2.

Step	Direction	Message	Comments
1	SS		MS in the active state (U10) of a call on Timeslot N of cell A. When: K=1, Channel Type = TCH/F K=2, Channel Type = TCH/H
2	SS->MS	PACKET ASSIGNMENT	See specific message contents.
3	SS		SS Waits T3190 – 50% (2.5s)
4	SS<->MS	{ Downlink data transfer }	Macro – Transmitting 10kB of Data

Specific Message Contents

PACKET ASSIGNMENT (Step 2):

k=1;

As default message contents as defined in section 40.2.4.31 except: RR Packet Uplink Assignment IE RR Packet Downlink Assignment IE - TIMESLOT_ALLOCATION <i>Additions for R99:</i> EGPRS Window Size LINK_QUALITY_MEASUREMENT_MODE	Not included (N ± 1) MOD 8 64 00
---	---

k=2;

As default message contents as defined in section 40.2.4.31 except: RR Packet Uplink Assignment IE RR Packet Downlink Assignment IE - TIMESLOT_ALLOCATION <i>Additions for R99:</i> EGPRS Window Size LINK_QUALITY_MEASUREMENT_MODE	Not included N 64 00
---	---------------------------------------

51.5.3 PS establishment whilst in dual transfer mode

51.5.3.1 Uplink TBF establishment with a downlink TBF established

51.5.3.1.1 Uplink TBF establishment with a downlink TBF established and no PS downlink reallocation

51.5.3.1.1.1 Conformance requirements

The mobile station may request establishment of one or more uplink TBFs when there are one or more ongoing downlink TBFs by including a Channel Request Description or the Extended Channel Request Description information element in the (EGPRS) PACKET DOWNLINK ACK/NACK message. Initiation is triggered by a request from upper layers to transfer an upper layer PDU.

When multiple TBF procedures are not supported, the mobile station initiates the packet access procedure by sending the Channel Request Description information element in the (EGPRS) PACKET DOWNLINK ACK/NACK message on the PACCH and starting timer T3168.

On receipt of an (Extended) Channel Request Description information element in the (EGPRS)PACKET DOWNLINK ACK/NACK message, the network may assign radio resources to the mobile station on one or more PDCHs by transmitting an uplink assignment message (e.g. PACKET UPLINK ASSIGNMENT, MULTIPLE TBF UPLINK ASSIGNMENT, PACKET TIMESLOT RECONFIGURE or MULTIPLE TBF TIMESLOT RECONFIGURE message) on the PACCH, or may reject one or more of the requests by sending a PACKET ACCESS REJECT message on the

PACCH. If the PACKET TIMESLOT RECONFIGURE message is sent, then the message shall contain the UPLINK_TFI_ASSIGNMENT field.

On receipt of a PACKET UPLINK ASSIGNMENT or PACKET TIMESLOT RECONFIGURE message the mobile station shall stop timer T3168 and switch to the assigned PDCHs.

References

3GPP TS 04.60/44.060 sub-clause 8.1..2.5

51.5.3.1.1.2 Test purpose

To verify that the MS can be assigned uplink PS resources, when no reallocation of the existing CS and downlink PS resources is required.

51.5.3.1.1.3 Method of test

Initial Conditions

System Simulator:

1 cell, DTM supported.

Mobile Station:

The MS is in the state "idle, updated, GMM-registered, GPRS attached" with a TMSI, P-TMSI allocated and PDP context 1 has been established. The MS is also in the active state (U10) of a call on the cell.

Specific PICS Statements

-

PIXIT Statements

-

Test Procedure

Whilst in an active call on timeslot N, the MS receives a PACKET ASSIGNMENT message on the main DCCH, instructing the MS to switch to a designated timeslot and receive data. The SS then starts to transmit to the newly allocated resources. Before the SS completes transmission of the 1000 octets of data, the MS is triggered to initiate an uplink packet transfer. The SS then sends another RLC Downlink Data block to the MS with the S/P bit set to 1. The MS responds by sending a EGPRS PACKET DOWNLINK ACK/NACK message to the SS including the Channel Request Description IE. The SS allocates uplink resources to the MS with the PACKET UPLINK ASSIGNMENT message. The test procedure is complete when the SS successfully verifies both uplink and downlink transmission are working in parallel.

MS supporting DTM/EGPRS shall complete testing for k=1 and MSs indicating support of single slot DTM/EGPRS shall additionally complete testing for k=2.

Maximum Duration of Test

5 minutes

Expected Sequence

The test sequence is repeated for k = 1,2.

Step	Direction	Message	Comments
1	SS		MS in the active state (U10) of a call on Timeslot N of cell A. When: k=1, Channel Type = TCH/F; k=2, Channel Type = TCH/H.
2	SS->MS	PACKET ASSIGNMENT	See specific message contents.
3	SS<->MS	{ Downlink data transfer }	Macro – Transmission of 10k octets of data
4	MS		Before the completion of the downlink transmission, the MS is triggered to initiate an uplink packet transfer containing 1000 octets.
5	SS<->MS	{ Downlink data transfer }	RLC Downlink Data - S/P Bit = 1 Continue the { Downlink data transfer } until the MS include the Channel Request Description IE in the EGPRS PACKET DOWNLINK ACK/NACK.
6	SS->MS	PACKET UPLINK ASSIGNMENT	When: k=1, Timeslot=T; and k=2, Timeslot=N.
7	SS		Verify both uplink and downlink data transmission is functioning correctly.

Specific Message Contents

PACKET ASSIGNMENT (Step 2):

k=1;

As default message contents as defined in section 40.2.4.31 except: RR Packet Uplink Assignment IE RR Packet Downlink Assignment IE - TIMESLOT_ALLOCATION <i>Additions for R99:</i> EGPRS Window Size LINK_QUALITY_MEASUREMENT_MODE	Not included T = (N ± 1) MOD 8 64 00
---	---

k=2;

As default message contents as defined in section 40.2.4.31 except: RR Packet Uplink Assignment IE RR Packet Downlink Assignment IE - TIMESLOT_ALLOCATION <i>Additions for R99:</i> EGPRS Window Size LINK_QUALITY_MEASUREMENT_MODE	Not included N 64 00
---	---------------------------------------

51.5.3.2 Downlink TBF establishment with a uplink established

51.5.3.2.1 Downlink TBF establishment with a uplink TBF established and no PS uplink reallocation

51.5.3.2.1.1 Conformance requirements

During uplink transfer, the network may initiate a downlink TBF by sending a PACKET DOWNLINK ASSIGNMENT message, or a PACKET TIMESLOT RECONFIGURE, to the mobile station on the PACCH. If a PACKET TIMESLOT RECONFIGURE message is sent, then the message shall contain the DOWNLINK_TFI_ASSIGNMENT field. The multislot restrictions of the mobile station shall be observed.

References

3GPP TS 04.60/44.060 sub-clause 8.1.1.1.3

51.5.3.2.1.2 Test purpose

To verify that a downlink TBF can be established without reallocation of uplink PS resources, whilst maintaining DTM.

51.5.3.2.1.3 Method of test

Initial Conditions

System Simulator:

1 cell, DTM supported

Mobile Station:

The MS is in the active state (U10) of a call.

The MS is GPRS idle with a P-TMSI allocated and the PDP context 1 activated.

Specific PICS Statements

-

PIXIT Statements

-

Test Procedure

The MS, whilst in dedicated mode, is triggered to initiate packet uplink transfer of 1000 octets of data in RLC unacknowledged mode and sends a DTM REQUEST message. On receiving the DTM REQUEST message, requesting uplink resources, the SS assigns the MS an uplink TBF. The SS accomplishes the resource assignment by passing a PACKET ASSIGNMENT message to the MS. On receiving the PACKET ASSIGNMENT message, the MS starts to send RLC DATA BLOCKS to the SS on the assigned PDTCH. Once the MS has sent correctly approximately 500 octets, the SS transmits a PACKET DOWNLINK ASSIGNMENT message allocating the MS downlink packet resources. The test procedure is complete when the SS successfully verifies both uplink and downlink transmission are working in parallel.

MS supporting DTM/EGPRS shall complete testing for k=1 and MSs indicating support of single slot DTM/EGPRS shall additionally complete testing for k=2.

Maximum Duration of Test

5 minutes

Expected Sequence

The test sequence is repeated for k = 1,2.

Step	Direction	Message	Comments
1	SS		MS in the active state (U10) of a call on Timeslot N. When:
2	MS		k=1, Channel Type=TCH/F; k=2, Channel Type=TCH/H. Trigger the MS to initiate an uplink packet transfer containing 1000 octets.
3	MS->SS	DTM REQUEST	
4	SS->MS	PACKET ASSIGNMENT	Includes information on the Radio resources provided to the MS. See specific message contents.
5	MS<->SS	{ Uplink data }	Macro – Approximately 500 Octets
6	SS->MS	PACKET DOWNLINK ASSIGNMENT	When: k=1, Timeslot = (N ± 1) MOD 8; k=2, Timeslot =N.
7	SS		Verify both uplink and downlink data transmission is functioning correctly.

Specific Message Contents

PACKET ASSIGNMENT (Step 4):

k=1;

As default message contents as defined in section 40.2.4.31 except: RR Packet Uplink Assignment IE - TIMESLOT_ALLOCATION <i>Additions for R99:</i> EGPRS_MCS_MODE RESEGMENT EGPRS Window Size RR Packet Downlink Assignment IE	(N ± 1) MOD 8 MCS-1 0 Retransmitted RLC data blocks shall not be re-segmented 64 Not included
---	---

k=2;

As default message contents as defined in section 40.2.4.31 except: RR Packet Uplink Assignment IE - TIMESLOT_ALLOCATION <i>Additions for R99:</i> EGPRS_MCS_MODE RESEGMENT EGPRS Window Size RR Packet Downlink Assignment IE	N MCS-1 0 Retransmitted RLC data blocks shall not be re-segmented 64 Not included
---	---

51.6 Dynamic ARFCN mapping tests

51.6.1 Control of dynamic ARFCN mapping with PSI8

51.6.1.1 Conformance Requirement

The dynamic mapping of ARFCN to carrier frequencies is specified as follow in 3GPP TS 45.005:

“The carrier frequency is designated by the absolute radio frequency channel number (ARFCN). If we call $F_l(n)$ the frequency value of the carrier ARFCN n in the lower band, and $F_u(n)$ the corresponding frequency value in the upper band, we have for the dynamically mapped ARFCNs:

T-GSM 380	$F_l(n) = 380.2 + 0.2*(n-x+y)$	$x \leq n \leq x+z$	$F_u(n)=F_l(n) + 10$
T-GSM 410	$F_l(n) = 410.2 + 0.2*(n-x+y)$	$x \leq n \leq x+z$	$F_u(n)=F_l(n) + 10$
T-GSM 810	$F_l(n) = 806.2 + 0.2*(n-x+y)$	$x \leq n \leq x+z$	$F_u(n)=F_l(n) + 45$
T-GSM 900	$F_l(n) = 870.4 + 0.2*(n-x+y)$	$x \leq n \leq x+z$	$F_u(n)=F_l(n) + 45$
GSM 710	$F_l(n) = 698.2 + 0.2*(n-x+y)$	$x \leq n \leq x+z$	$F_u(n) = F_l(n) + 30$
GSM 750	$F_l(n) = 747.2 + 0.2*(n-x+y)$	$x \leq n \leq x+z$	$F_u(n) = F_l(n) + 30$
DCS 1 800	$F_l(n) = 1710.2 + 0.2*(n-x+y)$	$x \leq n \leq x+z$	$F_u(n) = F_l(n) + 95$
PCS 1 900	$F_l(n) = 1850.2 + 0.2*(n-x+y)$	$x \leq n \leq x+z$	$F_u(n) = F_l(n) + 80$

where the applicable band is indicated by the GSM_Band parameter, $x = \text{ARFCN_FIRST}$, $y = \text{BAND_OFFSET}$ and $z = \text{ARFCN_RANGE}$ (See 3GPP TS 44.018). Parameters defining carrier frequencies not belonging to the indicated band shall not be considered erroneous.

Information about dynamic mapping is provided by System Information type 15 or Packet System Information type 8 if PBCCH exists, and optionally by System Information type 14. Dynamic ARFCN mapping shall be valid for the whole PLMN. Dynamic mapping has priority over the fixed designation of carrier frequencies. The support of dynamic ARFCN mapping is optional for all other mobile stations except those supporting GSM 700 and T-GSM.”

The frequency band for T-GSM and GSM 700 (dynamic ARFCN mapping is mandatory for these frequencies bands as there is no physical mapping specified) are defined as follow in 3GPP TS 45.005:

- i) T-GSM 380 band:
 - for T-GSM 380, the system is required to operate in the following band:
 - 380,2 MHz to 389,8 MHz: mobile transmit, base receive;

- 390,2 MHz to 399,8 MHz base transmit, mobile receive.

ii) T-GSM 410 band:

- for T-GSM 410, the system is required to operate in the following band:
 - 410,2 MHz to 419,8 MHz: mobile transmit, base receive;
 - 420,2 MHz to 429,8 MHz base transmit, mobile receive.

...

v) GSM 710 Band:

- for GSM 710, the system is required to operate in the following band:
 - 698 MHz to 716 MHz: base transmit, mobile receive;
 - 728 MHz to 746 MHz: mobile transmit, base receive.

vi) GSM 750 Band:

- for GSM 750, the system is required to operate in the following band:
 - 747 MHz to 762 MHz: base transmit, mobile receive;
 - 777 MHz to 792 MHz: mobile transmit, base receive.

vii) T-GSM 810 Band:

- for T-GSM 810, the system is required to operate in the following band:
 - 806 MHz to 821 MHz: mobile transmit, base receive;
 - 851 MHz to 866 MHz: base transmit, mobile receive.

...

xii) T-GSM 900 Band;

- for T-GSM 900 band, the system is required to operate in the following frequency band:
 - 870.4 MHz to 876 MHz: mobile transmit, base receive;
 - 915.4 MHz to 921 MHz: base transmit, mobile receive.

...

The way to change dynamic ARFCN mapping is specified as follow in 3GPP TS 44.018:

“The PSI8 change mark field is changed each time information has been updated in the PSI8 message. A new value indicates that the mobile station shall re-read the information from the PSI8 message. The coding of this field is network dependent. Range: 0-3.”

References:

- 3GPP TS 45.005, subclause 2.
- 3GPP TS 44.060, subclauses 3.2.2.1, 11.2.24.
- 3GPP TS 44.018, subclause 10.5.2.37j.

51.6.1.2 Test Purpose

To verify that for the frequencies bands for which Dynamic ARFCN mapping is mandatory, the MS:

- 1) detects that PSI8 used for dynamic ARFCN mapping is supported in the cell (signalled via the PSI8_BROADCAST IE in the PSI2)

- 2) decodes and interprets correctly the parameters $x = \text{ARFCN_FIRST}$, $y = \text{BAND_OFFSET}$ and $z = \text{ARFCN_RANGE}$ transmitted in the PSI8 message broadcast on the PBCCH.
- 3) decodes and interprets correctly the parameters $x = \text{ARFCN_FIRST}$, $y = \text{BAND_OFFSET}$ and $z = \text{ARFCN_RANGE}$ transmitted in the PSI8 message sent on the PACCH.
- 4) detects a change of dynamic ARFCN mapping in the PSI8 message broadcast on the PBCCH (signalled via the DM_CHANGE_MARK field in PSI8)

51.6.1.3 Method of Test

Initial Conditions

MS:

Switched off

MS operating in a band for which support of Dynamic ARFCN mapping is mandatory.

System Simulator:

1 cell, default setting for the frequency band to be tested.

The PSI8_BROADCAST IE in the PSI2 shall indicate that PSI8 is supported

Specific PICS Statements

-

PIXIT Statements

-

Test Procedure

Two dynamic ARFCN mapping of the carrier frequencies of the band to be tested are defined (the two mappings shall not overlap):

- a) the first mapping referred as DM1 maps the N carrier frequencies of the band to be tested to the ARFCNs 437 to $437 + N$.
- b) the second mapping referred as DM2 maps $N - 1$ carrier frequencies (the first frequency is excluded) of the band to be tested to the ARFCNs $437 + N + 1$ to $437 + N + N$

The parameters of the PSI8 corresponding to these mapping are defined in the following table:

PSI8 parameters	DM1 mapping	DM2 mapping
GSM_Band	GSM T 380 or GSM T 410 or GSM T 810 or GSM 710 or GSM T 900	GSM T 380 or GSM T 410 or GSM T 810 or GSM 710 or GSM T 900
ARFCN_FIRST	437	$437 + N$
ARFCN_OFFSET	0	1
ARFCN_RANGE	N	$N - 1$

With:

$N = 47$ for T-GSM 380,

$N = 47$ for T-GSM 410,

$N = 89$ for GSM 710,

$N = 74$ for GSM 750,

$N = 74$ for T-GSM 810,

$N = 27$ for T-GSM 900.

The default layer 3 messages of the section 40.2 shall be used but when the DM2 mapping is used, the ARFCN numbers shall be modified by adding N.

The test is done in 3 steps:

- 1) Checking that the MS takes into account the ARFCN mapping defined in PSI8 broadcast on the PBCCH

The SS broadcasts on the PBCCH the default SIs plus the PSI8 containing the DM1 parameters. The MS is switched on and triggered to perform a GPRS attach. It is checked that the MS uses the frequency assigned in the PACKET UPLINK ASSIGNMENT message. Before releasing the PDCHs channels, the SS sends to the MS on the PACCH the PSI8 containing the DM2 parameters.

- 2) Checking that the MS takes into account the ARFCN mapping defined in PSI8 broadcast on the PACCH

When the channel has been released and before the MS receives the PSI8 containing the DM2 parameters, the SS establishes a downlink TBF by assigning a channel according to the dynamic ARFCN mapping defined in DM2. It is checked that the MS uses the frequency assigned in the PACKET DOWNLINK ASSIGNMENT message.

- 3) Checking that the MS takes into account a change of dynamic ARFCN mapping in PSI8 broadcast on the PBCCH

When the channel has been released by the MS the SS broadcasts on the PBCCH the PSI8 containing the DM2 parameters and then the DM1 parameters. The SS establishes a downlink TBF by assigning a channel according to the dynamic ARFCN mapping defined in DM1. It is checked that the MS uses the frequency assigned in the PACKET DOWNLINK ASSIGNMENT message.

Maximum Duration of Test

1 minutes

Expected Sequence

Step	Direction	Message	Comments
1	SS		The SS broadcasts on the PBCCH the PSI8 containing the DM1 parameters.
2	MS		The MS is switched on and id triggered to perform a GPRS attach.
3	MS -> SS	PACKET CHANNEL REQUEST	Received on PRACH.
4	SS -> MS	PACKET UPLINK ASSIGNMENT	Sent on PCCCH. The assigned carrier frequency is set using the dynamic ARFCN mapping defined with the DM1 parameters.
5	SS -> MS		The SS sends on PAGCH the PSI8 containing the DM2 parameters.
6		{GPRS Attach procedure}	Completion from step 4 of the attach procedure. The SS verifies that the MS send the first RLC data block using the carrier frequency assigned in the PACKET UPLINK ASSIGNMENT message sent in step4.
7	SS		The SS initiates a downlink transfer of 200 octets of data. The SS shall not send on PBCCH the PSI8 containing DM2
8	SS -> MS	PACKET DOWNLINK ASSIGNMENT	Sent on PPCH The assigned carrier frequency is set using the dynamic ARFCN mapping defined with the DM2 parameters.
9	SS -> MS	PACKET POLLING REQUEST	Sent on PACCH.
10	MS -> SS	PACKET CONTROL ACKNOWLEDGEMENT	The SS verifies that the MS send this message using the carrier frequency assigned in the PACKET DOWNLINK ASSIGNMENT message sent in step 8.
11		{Completion of downlink data transfer}	
12	SS		The SS sends on PBCCH the PSI8 containing the DM2 parameters during 5 seconds and then the PSI8 containing the DM1 parameters.
13	SS		The SS initiates a downlink transfer of 200 octets data.
14	SS -> MS	PACKET DOWNLINK ASSIGNMENT	Sent on PPCH The assigned carrier frequency is set using the dynamic ARFCN mapping defined with the DM1 parameters.
15	SS -> MS	PACKET POLLING REQUEST	Sent on PACCH.
16	MS -> SS	PACKET CONTROL ACKNOWLEDGEMENT	The SS verifies that the MS send this message using the carrier frequency assigned in the PACKET DOWNLINK ASSIGNMENT message sent in step 14
17		{Completion of downlink data transfer}	

52 EGPRS Test of Medium Access Control (MAC) protocol

52.1 Test of Medium Access Control (MAC) Procedures onPCCCH in idle mode

This subclause presents tests for "Medium Access Control (MAC) Procedures on PCCCH in idle mode" for EGPRS mobiles which are specified in 3GPP TS 04.60 clause 7.

Default conditions

The SS default conditions simulate one cell with default settings as defined in the EGPRS general default section.

The MS default initial condition is GPRS attached. Unless otherwise stated, no PDP context is required.

The default message contents and signaling macro not specified in the end of this subclause shall be set as in "EGPRS default conditions" clause 50. Specific message contents for a test case is specified in each test case.

Conditions or message contents specified in a test case have the highest precedence. In addition, the default message contents described in the end of this subclause override those specified in "EGPRS default conditions".

In case the test case not expected "short access" as access type for Packet Channel Request the amount of RLC data specified in the comments in expected sequence is not necessary to be exactly the specified amount of data. It only has to be more than the limit for short access. If the test case need a specific amount of data this is specified in the test case.

52.1.1 Packet Channel Request

52.1.1.1 Void

52.1.1.2 Packet Channel Request / Support of EGPRS PACKET CHANNEL REQUEST

52.1.1.2.1 Conformance requirements

EGPRS capable MSs shall monitor the GPRS Cell Options IE on the BCCH (SI13)/PBCCH(PSI1/PSI13) for the cell's EGPRS capability. In PSI1 (and PSI13) it is indicated if the EGPRS PACKET CHANNEL REQUEST is supported in a cell. If the cell is EGPRS capable and EGPRS PACKET CHANNEL REQUEST is supported in the cell the, EGPRS PACKET CHANNEL REQUEST messages shall be used at one-phase access attempts, two-phase access attempts and short access attempts.

If the cell is EGPRS capable and EGPRS PACKET CHANNEL REQUEST messages are not supported in the cell the EGPRS mobile station shall use the PACKET CHANNEL REQUEST message according to parameter ACC_BURST_TYPE and shall initiate a two phase access request.

Reference

3GPP TS 04.60 subclause 7.1.2.1.

52.1.1.2.2 Test purpose

To verify that the EGPRS capable mobile station uses PACKET CHANNEL REQUEST to initiate a two phase access, if EGPRS CHANNEL REQUEST MESSAGE is not supported in the cell.

52.1.1.2.3 Method of test

Initial conditions

System Simulator:

1 cell supporting EGPRS. The packet system information ACCESS_BURST_TYPE indicates 8 bit access and MAX_RETRANS indicates 7 allowed retransmission. The EGPRS PACKET CHANNEL REQUEST not supported in GPRS cell options.

Mobile Station:

The MS is GPRS attached and in packet idle mode. PDP context 2 has been established.

Specific PICS Statements

-

PIXIT Statements

-

Test procedure

The MS is triggered to initiate an uplink packet transfer. The SS verifies that the MS uses PACKET CHANNEL REQUEST to initiate a two phase access request.

Maximum duration of the test

1 minute.

Expected sequence

Step	Direction	Message	Comments
1	MS		The MS is triggered to send 200 octets data. EGPRS supported by cell in GPRS cell options. EGPRS PACKET CHANNEL REQUEST not supported by the cell in GPRS cell options.
2	MS -> SS	PACKET CHANNEL REQUEST	ACCESS TYPE = "Two Phase Access Request". Received on PRACH.
3	SS -> MS	PACKET ACCESS REJECT	Sent on PAGCH.

52.1.1.3 Packet Channel Request / Response to Packet Paging/Non-RR Connection Paging

52.1.1.3.1 Conformance requirements

EGPRS capable MSs shall monitor the GPRS Cell Options IE on the BCCH (SI13)/PBCCH(PSI1/PSI13) for the cell's EGPRS capability. In PSI1 (and PSI13) it is indicated if the EGPRS PACKET CHANNEL REQUEST is supported in a cell. If the cell is EGPRS capable and EGPRS PACKET CHANNEL REQUEST is supported in the cell the, EGPRS PACKET CHANNEL REQUEST messages shall be used at one-phase access attempts, two-phase access attempts and short access attempts.

This message may be sent by an EGPRS capable mobile station in a cell supporting EGPRS and where the EGPRS_PACKET_CHANNEL_REQUEST parameter indicates that this message shall be used. The message shall be used to perform EGPRS one-phase access request, EGPRS short access request or EGPRS two-phase access request, for all other purposes (page response, cell update etc.) the standard PACKET CHANNEL REQUEST message shall be used (see subclause 11.2.5).

If the purpose of the packet access procedure is to send a Page Response, the mobile station shall indicate 'Page Response' in the PACKET CHANNEL REQUEST message.

A mobile station in class A or class B mode of operation shall respond to a PACKET PAGING REQUEST message indicating an RR connection establishment. A mobile station in class B mode of operation may abort the packet access procedure at the receipt of a PACKET PAGING REQUEST message indicating an establishment of a RR connection. PACKET PAGING REQUEST messages indicating a non-RR connection shall be ignored.

Mobile stations in class C mode of operating shall not respond to any type of PACKET PAGING REQUEST messages during the packet access procedure but decode the PERSISTENCE_LEVEL parameter if included in the message.

Reference

3GPP TS 04.60/44.060 subclause 7.1.2.1.

52.1.1.3.2 Test purpose

To verify that the mobile station uses Packet Channel Request Message for Page Response.

To verify that the mobile station ignores PACKET PAGING REQUEST messages indicating a non-RR connection after scheduling the sending of PACKET CHANNEL REQUEST messages.

52.1.1.3.3 Method of test

Initial conditions

System Simulator:

1 cell supporting EGPRS. The packet system information ACCESS_BURST_TYPE indicates 8 bit access and MAX_RETRANS indicates 7 allowed retransmission.

Mobile Station:

The MS is GPRS attached and in packet idle mode. PDP context 2 has been established.

Specific PICS Statements

- Release of EGPRS Supported (TSPC_MS_EGPRS_RELEASE)
- Support of EGPRS Packet Access Enhancement (TSPC_EGPRS_ENHANC)

PIXIT Statements

-

Test procedure

All MS classes, non-RR connection paging.

SS pages the mobile to establish a TBF. The mobile shall respond back with a Packet Channel Request message indicating Page Response.

The MS is triggered to initiate an uplink packet transfer. When SS has received the first PACKET CHANNEL REQUEST message shall PACKET PAGING REQUEST message indicating a non-RR connection be sent to the MS. The MS shall ignore the PACKET PAGING REQUEST message and continue to send PACKET CHANNEL REQUEST messages requesting one or two phase access. The SS sends PACKET ACCESS REJECT to end the test case.

NOTE:

EGPRS PACKET CHANNEL REQUEST shall be used to respond to Packet Paging Request in the following cases

- If Release of EGPRS supported is Release 4 or above.
- If Support of EGPRS Packet Access enhancement is True for a R99 MS.

PACKET CHANNEL REQUEST shall be used to respond to Packet Paging Request if Support of EGPRS Packet Access enhancement is False for a R99 MS.

Maximum duration of the test

1 minute.

Expected sequence

All MS classes, non-RR connection paging.

Step	Direction	Message	Comments
1	SS -> MS	PACKET PAGING REQUEST	Sent on PPCH for TBF establishment.
2	MS -> SS	PACKET CHANNEL REQUEST / EGPRS PACKET CHANNEL REQUEST (See NOTE above)	In case PACKET CHANNEL REQUEST is received: ACCESS TYPE = "Page Response". In case EGPRS PACKET CHANNEL REQUEST is received ACCESS TYPE = " Signalling ".
3	SS -> MS	PACKET ACCESS REJECT	received on PRACH. Sent on PAGCH.

All MS classes, non-RR connection paging.

Step	Direction	Message	Comments
1	MS		The MS is triggered to send 200 octets data. EGPRS supported by cell in GPRS cell options.
2	MS -> SS	EGPRS PACKET CHANNEL REQUEST	ACCESS TYPE = "One or Two Phase Access Request". Received on PRACH.
3	SS -> MS	PACKET PAGING REQUEST	Sent on PAGCH for TBF establishment.
4	MS -> SS	EGPRS PACKET CHANNEL REQUEST	ACCESS TYPE = "One or Two Phase Access Request". Received on PRACH. The SS verifies that the MS continue request One or Two Phase packet Access.
5	SS -> MS	PACKET ACCESS REJECT	Sent on PAGCH.

Specific message contents:

none

52.1.1.4 Packet Channel Request / Response to Packet Paging/RR Connection Paging

52.1.1.4.1 Conformance requirements

EGPRS capable MSs shall monitor the GPRS Cell Options IE on the BCCH (SI13)/PBCCH (PSI1/PSI13) for the cell's EGPRS capability. In PSI1 (and PSI13) it is indicated if the EGPRS PACKET CHANNEL REQUEST is supported in a cell. If the cell is EGPRS capable and EGPRS PACKET CHANNEL REQUEST is supported in the cell the, EGPRS PACKET CHANNEL REQUEST messages shall be used at one-phase access attempts, two-phase access attempts and short access attempts.

This message may be sent by an EGPRS capable mobile station in a cell supporting EGPRS and where the EGPRS_PACKET_CHANNEL_REQUEST parameter indicates that this message shall be used. The message shall be used to perform EGPRS one-phase access request, EGPRS short access request or EGPRS two-phase access request, for all other purposes (page response, cell update etc.) the standard PACKET CHANNEL REQUEST message shall be used (see subclause 11.2.5).

If the purpose of the packet access procedure is to send a Page Response, the mobile station shall indicate 'Page Response' in the PACKET CHANNEL REQUEST message.

A mobile station in class A or class B mode of operation shall respond to a PACKET PAGING REQUEST message indicating an RR connection establishment. A mobile station in class B mode of operation may abort the packet access procedure at the receipt of a PACKET PAGING REQUEST message indicating an establishment of a RR connection. PACKET PAGING REQUEST messages indicating a non-RR connection shall be ignored.

Mobile stations in class C mode of operating shall not respond to any type of PACKET PAGING REQUEST messages during the packet access procedure but decode the PERSISTENCE_LEVEL parameter if included in the message.

Reference

3GPP TS 04.60 subclause 7.1.2.1.

52.1.1.4.2 Test purpose

To verify that a mobile station in class A or class B mode of operation shall respond to a PACKET PAGING REQUEST message indicating an RR connection establishment after scheduling the sending of PACKET CHANNEL REQUEST messages.

To verify that a mobile station in class C mode of operating shall not respond to any type of PACKET PAGING REQUEST messages during the packet access procedure.

52.1.1.4.3 Method of test

Initial conditions

System Simulator:

1 cell supporting EGPRS. The packet system information ACCESS_BURST_TYPE indicates 8 bit access and MAX_RETRANS indicates 7 allowed retransmission.

Mobile Station:

The MS is GPRS attached and in packet idle mode. PDP context 2 has been established.

Specific PICS Statements

- Support of GPRS Operation Mode A (TSPC_operation_mode_A)
- Support of GPRS Operation Mode B (TSPC_operation_mode_B)
- Support of GPRS Operation Mode C (TSPC_operation_mode_C)

PIXIT Statements

-

Test procedure

MS class A and class B, RR connection paging.

The MS is triggered to initiate an uplink packet transfer. When SS has received the first PACKET CHANNEL REQUEST message shall PACKET PAGING REQUEST message indicating a RR connection be sent to the MS. The MS shall send CHANNEL REQUEST messages with establishment cause = "Answer to paging". SS verify that the MS request RR connection. The SS sends IMMEDIATE ASSIGNMENT REJECT to end the test case.

MS class C, RR connection paging.

The MS is triggered to initiate an uplink packet transfer. When SS has received the first PACKET CHANNEL REQUEST message shall PACKET PAGING REQUEST message indicating a RR connection be sent to the MS. The MS shall ignore the PACKET PAGING REQUEST message and continue to send PACKET CHANNEL REQUEST messages requesting one or two phase access. The SS sends PACKET ACCESS REJECT to end the test case.

Maximum duration of the test

1 minute.

Expected sequence

MS class A and class B, RR connection paging.

Only Network mode I.

Step	Direction	Message	Comments
1	MS		The MS is triggered to send 200 octets data.
2	MS -> SS	EGPRS PACKET CHANNEL REQUEST	EGPRS supported by cell in GPRS cell options. ACCESS TYPE = "One or Two Phase Access Request". Received on PRACH.
3	SS -> MS	PACKET PAGING REQUEST (1)	See specific message contents. Sent on PAGCH for RR connection.
4	MS -> SS	EGPRS PACKET CHANNEL REQUEST	Optional step: The MS may retransmit the EGPRS PACKET CHANNEL REQUEST up to MAX_RETRANS.
5	MS -> SS	CHANNEL REQUEST	Establishment cause = Answer to paging". Received on RACH. The SS verifies that the MS request RR connection.
6	SS -> MS	IMMEDIATE ASSIGNMENT REJECT	

MS class C, RR connection paging.

Step	Direction	Message	Comments
1	MS		The MS is triggered to send 200 octets data.
2	MS -> SS	EGPRS PACKET CHANNEL REQUEST	EGPRS supported by cell in GPRS cell options. ACCESS TYPE = "One or Two Phase Access Request". Received on PRACH.
3	SS -> MS	PACKET PAGING REQUEST (1)	See specific message contents. Sent on PAGCH for RR connection.
4	MS -> SS	EGPRS PACKET CHANNEL REQUEST	ACCESS TYPE = "One or Two Phase Access Request". Received on PRACH. The SS verifies that the MS request One or Two Phase packet Access.
5	SS -> MS	PACKET ACCESS REJECT	Sent on PAGCH.

Specific message contents

As default messages contents, except:

PACKET PAGING REQUEST (1)

Information element	Value/remark
{1 < Repeated Page info >}	1 (start of Repeated Page info)
{1	1 (page request for RR connection establ.)
{0 < TMSI >	0 (allocated TMSI)
< CHANNEL_NEEDED >	00 (any channel type)
{0 1 < eMLPP_PRIORITY >	1 (page request to trigger RR connection)
-eMLPP_PRIORITY}	000 (no priority specified)

52.1.1.5 Void

52.1.1.6 Packet Channel Request / Access persistence control on PRACH

52.1.1.6.1 Packet Channel Request / Access persistence control on PRACH / M+1 attempts

52.1.1.6.1.1 Conformance requirements

The mobile station shall make maximally M + 1 attempts to send a PACKET CHANNEL REQUEST message.

Having made M + 1 attempts to send a PACKET CHANNEL REQUEST, the mobile station shall stop timer T3186 and start timer T3170. At expiry of timer T3170, the packet access procedure shall be aborted, a packet access failure shall be indicated to the upper layer and the mobile station shall return to packet idle mode.

Reference

3GPP TS 04.60/44.060 subclause 7.1.2.1.1 and 7.1.2.1.

52.1.1.6.1.2 Test purpose

To verify that the mobile station makes a maximum of $M + 1$ attempts to send a PACKET CHANNEL REQUEST message, M is the parameter MAX_RETRANS broadcast on PBCCH.

To verify that the mobile station aborts the packet access procedure when the network does not respond to the PACKET CHANNEL REQUEST messages.

52.1.1.6.1.3 Method of test

Initial conditions

System Simulator:

1 cell supporting EGPRS. The packet system information ACCESS_BURST_TYPE indicates 8 bit access, MAX_RETRANS indicate 1 retransmission, PERSISTENCE_LEVEL $P(i)=0$ and BS_PRACH_BLKs = 12 (all Blocks reserved for PRACH).

Note : SS sets USF=FREE on the blocks in accordance with the setting of the BS_PRACH_BLKs.

Mobile Station:

The MS is GPRS attached and in packet idle mode.

Specific PICS Statements

- Release of EGPRS Supported (TSPC_MS_EGPRS_RELEASE)
- Support of EGPRS Packet Access Enhancement (TSPC_EGPRS_ENHANC)

PIXIT Statements

-

Test procedure

The SS send PACKET PAGING REQUEST message. The MS is expected to send $M+1$ PACKET CHANNEL REQUEST messages, M is the parameter MAX_RETRANS broadcast on PBCCH. The SS monitors the MS transmission for a period equal to the maximum length of time it can take to send $M+1$ PACKET CHANNEL REQUEST messages plus the duration of timer T3170. The SS verifies that the MS makes maximally $M+1$ attempts to send PACKET CHANNEL REQUEST messages in this period. When the SS not respond the MS shall abort the packet access procedure and perform an abnormal release. The SS sends PACKET UPLINK ASSIGNMENT message corresponding to one of its 3 last PACKET CHANNEL REQUEST messages after a time higher than the duration of timer T3170 and the MS shall not respond to the message.

Repeat the test procedure with the different MAX_RETRANS parameters {2, 4, 7} sent in Packet System Information.

NOTE:

EGPRS PACKET CHANNEL REQUEST shall be used to respond to Packet Paging Request in the following cases

- If Release of EGPRS supported is Release 4 or above.
- If Support of EGPRS Packet Access enhancement is True for a R99 MS.

PACKET CHANNEL REQUEST shall be used to respond to Packet Paging Request if Support of EGPRS Packet Access enhancement is False for a R99 MS.

Maximum duration of the test

4 minutes.

Expected sequence

Step	Direction	Message	Comments
1	SS -> MS	PACKET PAGING REQUEST	Sent on PPCH.
2	MS -> SS	PACKET CHANNEL REQUEST(n) / EGPRS PACKET CHANNEL REQUEST (n) (See NOTE above)	n = 1, ..., M+1. In case PACKET CHANNEL REQUEST is received: ACCESS TYPE = "Page response". In case EGPRS PACKET CHANNEL REQUEST is received ACCESS TYPE = " Signalling ". Received on PRACH.
.	.	.	.
3	SS		The SS waits M+1 PACKET CHANNEL REQUESTs+ timer T3170 + 0.5s. The SS verifies that the MS makes maximally M+1 attempts to send PACKET CHANNEL REQUEST messages in this period.
4	SS -> MS	PACKET UPLINK ASSIGNMENT	Correspond to one of the last 3 messages in step 2. The MS shall not respond to this message. Sent on PAGCH.
5	SS		Change MAX_RETRANS in PSI1 to 2 retransmission.
6			Repeat step 1 to 4 after 35 seconds.
7	SS		Change MAX_RETRANS in PSI1 to 4 retransmission.
8			Repeat step 1 to 4 after 35 seconds.
9	SS		Change MAX_RETRANS in PSI1 to 7 retransmission.
10			Repeat step 1 to 4 after 35 seconds.

Specific message contents

None.

52.1.1.6.2 Packet Channel Request / Access persistence control on PRACH / Persistence level

52.1.1.6.2.1 Conformance requirements

The first attempt to send a PACKET CHANNEL REQUEST (respectively EGPRS PACKET CHANNEL REQUEST) message, may be initiated at the first available PRACH block on the PDCH defined by the PCCCH_GROUP for the mobile station (see 3GPP TS 45.002). The mobile station shall chose one of the four TDMA frames within the selected PRACH block randomly with a uniform probability distribution.

For each attempt, the mobile station shall draw a random value R with uniform probability distribution in the set {0, 1, ..., 15}. The mobile station is allowed to transmit a PACKET CHANNEL REQUEST message if P(i), where i is the radio priority of the TBF being established, is less or equal to R.

Reference

3GPP TS 04.60/44.060 subclause 7.1.2.1.1 and 7.1.2.1.

52.1.1.6.2.2 Test purpose

To verify that for each attempt, the mobile station shall draw a random value R with uniform probability distribution in the set {0, 1, ..., 15}. The mobile station is only allowed to transmit a PACKET CHANNEL REQUEST message if P(i), where i is the radio priority of the TBF being established, is less than or equal to R.

52.1.1.6.2.3 Method of test

Initial conditions

System Simulator:

1 cell supporting EGPRS. The packet system information indicates BS_PCC_CHANS = 1, BS_PAG_BLKS_RES = 2 and BS_PBCCH_BLKS = 3, BS_PRACH_BLKS = 12 (all Blocks reserved for PRACH). PERSISTENCE_LEVEL P(i) is set to 0.

Note : SS sets USF=FREE on the blocks in accordance with the setting of the BS_PRACH_BLKs.

Mobile Station:

The MS is GPRS attached and in packet idle mode.

Specific PICS Statements

- Release of EGPRS Supported (TSPC_MS_EGPRS_RELEASE)
- Support of EGPRS Packet Access Enhancement (TSPC_EGPRS_ENHANC)

PIXIT Statements

-

Test procedure

Specific test parameters:

- K equals the value of $120/(MAX_RETRANS+1)$.
- MAX_RETRANS is chosen from {1, 2, 4, 7}.
- PERSISTENCE_LEVEL P(i) is chosen from {0, 1, 2, ..., 14, 16}.
- Counter J is initialized with 0 (total number of received Packet Channel Requests).

The SS sends PACKET PAGING REQUEST message. The MS shall send between 0 and M+1 PACKET CHANNEL REQUEST message indicating page response. The SS verifies that the MS draw a random value R for each attach. Every received Packet Channel Request in response to Packet Paging Request increment counter J by 1. This test sequence is performed K times.

The test is performed with Persistence level set to at least P(i)=0, P(i)=8 and P(i)=16.

NOTE:

EGPRS PACKET CHANNEL REQUEST shall be used to respond to Packet Paging Request in the following cases

- If Release of EGPRS supported is Release 4 or above.
- If Support of EGPRS Packet Access enhancement is True for a R99 MS.

PACKET CHANNEL REQUEST shall be used to respond to Packet Paging Request if Support of EGPRS Packet Access enhancement is False for a R99 MS.

Maximum duration of the test

The execution of one sequence (for one value k): 30 s.

Between two consecutive executions (for k and k+1), the SS must wait for amount of time which is enough to guarantee that the MS is in service (listening to its paging subchannel).

Expected sequence

The sequence is executed for execution counter $k = 1, \dots, K$. After first execution, test is repeated starting from Step 3.

Step	Direction	Message	Comments
1			PACKET SYSTEM INFORMATION TYPE 1 is updated with the $P(i)$ values under test.
2	SS		SS waits for 35 seconds and make sure MS has acquired the new $P(i)$ values
3	SS -> MS	PACKET PAGING REQUEST	Sent on PPCH.
4	MS -> SS	PACKET CHANNEL REQUEST/	$N0$:= number of received Packet Channel Requests in response to step1; Count for 10 sec. $N0$; $J = J + N0$; $0 \leq N0 \leq M+1$; In case PACKET CHANNEL REQUEST is received: ACCESS TYPE = "Page Response". In case EGPRS PACKET CHANNEL REQUEST is received ACCESS TYPE = " Signalling ". Received on PRACH.
5	MS -> SS	EGPRS PACKET CHANNEL REQUEST	
:	:	PACKET CHANNEL REQUEST/	
:	:	EGPRS PACKET CHANNEL REQUEST	
M+2	MS -> SS	PACKET CHANNEL REQUEST/ EGPRS PACKET CHANNEL REQUEST (See NOTE above)	
M+3	SS		SS waits for expiry of T3170
M+4	SS		SS waits to allow Cell Reselection

Editors note:

The 10 s in steps 2 to M+2 is derived from the following consideration:

- Answer time for the first Packet Channel Request: $0,7 \text{ s} + 8 * 4,615 \text{ ms}$
- Maximum TDMA frame spread between two successive Packet Channel Requests:
- $\max\{S+T-1\} * 4,615 \text{ ms} = 266 * 4,615 \text{ ms} \Rightarrow$ maximum time to send M+1 Packet Channel Requests
- $0,7 \text{ s} + 8 * 4,615 \text{ ms} + M * 266 * 4,615 \text{ ms} = 9,33 \text{ s}$.

Verification

According the test procedure J is $B(120; 1-P(i)/16)$ distributed. i.e. we will accept MSs, when the following inequality holds $(1-P(i)/16) - 0,0161 * \sqrt{P(i)*(16-P(i))} \leq J/120 \leq (1-P(i)/16) + 0,0161 * \sqrt{P(i)*(16-P(i))}$.

this confidence interval is chosen in such a way that the possibility of non accepting a correct MS is less than 0,5 %.

Remark: If $P(i) = 0$ the above inequality is simplified to $1 \leq J/120 \leq 1$, i.e. $J = 120$, i.e. the MS has to answer every PACKET PAGING REQUEST with M+1 PACKET CHANNEL REQUESTS. And if $P(i) = 16$ the above inequality is simplified to $0 \leq J/120 \leq 0$, i.e. $J = 0$, i.e. the MS is not allowed to send PACKET CHANNEL REQUESTS.

Specific message contents

None.

52.1.1.6.3 Packet Channel Request / Access persistence control on PRACH / Successive Attempts

52.1.1.6.3.1 Conformance requirements

The first attempt to send a PACKET CHANNEL REQUEST (respectively EGPRS PACKET CHANNEL REQUEST) message, may be initiated at the first available PRACH block on the PDCH defined by the PCCCH_GROUP for the mobile station (see 3GPP TS 45.002). The mobile station shall chose one of the four TDMA frames within the selected PRACH block randomly with a uniform probability distribution.

For each attempt, the mobile station shall draw a random value R with uniform probability distribution in the set $\{0, 1, \dots, 15\}$. The mobile station is allowed to transmit a PACKET CHANNEL REQUEST message if $P(i)$, where i is the radio priority of the TBF being established, is less or equal to R .

After each attempt, the S and T parameters are used to determine the next TDMA frame in which it may be allowed to make a successive attempt. The number of TDMA frames belonging to the PRACH on the PDCH defined by the PCCCH group for the mobile station between two successive attempts to send a PACKET CHANNEL REQUEST message excluding the TDMA frames potentially containing the messages themselves is a random value drawn for each transmission with uniform probability distribution in the set $\{S, S + 1, \dots, S + T - 1\}$.

Reference

3GPP TS 04.60/44.060 subclause 7.1.2.1.1 and 7.1.2.1.

52.1.1.6.3.2 Test purpose

To verify that the number of TDMA frames belonging to the PRACH on the PDCH defined by the PCCCH group for the mobile station between two successive attempts to send a PACKET CHANNEL REQUEST message excluding the TDMA frames potentially containing the messages themselves is a random value drawn for each transmission with uniform probability distribution in the set $\{S, S + 1, \dots, S + T - 1\}$.

52.1.1.6.3.3 Method of test

Initial conditions

System Simulator:

1 cell supporting EGPRS. The packet system information:

$BS_PCC_CHANS = 1$, $BS_PAG_BLKS_RES = 2$ and $BS_PBCCH_BLKS = 3$. $MAX_RETRANS$ is arbitrarily chosen in the set $\{1, 2, 4, 7\}$.

TX_INT is arbitrarily chosen in the set $\{6, 7, 8, 9, 10, 12, 14, 16, 20, 25, 32, 50\}$.

S is arbitrarily chosen in the set $\{12, 15, 20, 30, 41, 55, 76, 109, 163, 217\}$.

$PERSISTENCE_LEVEL P(i) = 0$.

Note : SS sets $USF=FREE$ on the blocks in accordance with the setting of the BS_PRACH_BLKS .

Mobile Station:

The MS is GPRS attached and in packet idle mode.

Specific PICS Statements

- Release of EGPRS Supported (TSPC_MS_EGPRS_RELEASE)
- Support of EGPRS Packet Access Enhancement (TSPC_EGPRS_ENHANC)

PIXIT Statements

-

Test procedure

Specific test parameters:

- K equals the upper rounded value of $230/M$.

The SS sends PACKET PAGING REQUEST message. The MS shall send PACKET CHANNEL REQUEST messages $M+1$ times indicating page response. After each attempt, the S and T parameters are used to determine the next TDMA frame in which it may be allowed to make a successive attempt. The SS measure the number of TDMA frames $f(n,k)$ between each attempt, excluding the slots containing the messages themselves. The SS does not answer the PACKET CHANNEL REQUEST messages $MAX_RETRANS$ times. The SS sends an PACKET ACCESS REJECT message. The test sequence is executed K times.

- M is the value of the parameter MAX_RETRANS.
- T is the value of the parameter TX_INT.
- S is the value of the parameter S.

NOTE:

EGPRS PACKET CHANNEL REQUEST shall be used to respond to Packet Paging Request in the following cases

- If Release of EGPRS supported is Release 4 or above.
- If Support of EGPRS Packet Access enhancement is True for a R99 MS.

PACKET CHANNEL REQUEST shall be used to respond to Packet Paging Request if Support of EGPRS Packet Access enhancement is False for a R99 MS.

Maximum duration of the test

The execution of one sequence (for one value k): 10 s.

Between two consecutive executions (for k and k+1), the SS must wait for amount of time which is enough to guarantee that the MS is in service (listening to its paging subchannel).

Expected sequence

The sequence is executed for execution counter k = 1, ..., K.

Step	Direction	Message	Comments
1	SS -> MS	PACKET PAGING REQUEST	Sent on PPCH.
2	MS -> SS	PACKET CHANNEL REQUEST/ EGPRS PACKET CHANNEL REQUEST (See NOTE above)	In case PACKET CHANNEL REQUEST is received: ACCESS TYPE = "Page Response". In case EGPRS PACKET CHANNEL REQUEST is received ACCESS TYPE = " Signalling ". Received on PRACH.
3	MS -> SS	PACKET CHANNEL REQUEST/ EGPRS PACKET CHANNEL REQUEST (See NOTE above)	Step 3 and 4 are executed for execution counter n=1,...,MAX_RETRANS. In case PACKET CHANNEL REQUEST is received: ACCESS TYPE = "Page Response". In case EGPRS PACKET CHANNEL REQUEST is received ACCESS TYPE = " Signalling ". Received on PRACH.
4	SS		See verification.
5	SS -> MS	PACKET ACCESS REJECT	Sent on PAGCH.

Verification

In step 4 the SS measure the number of TDMA frames belonging to the PRACH on the PDCH defined by the PCCCH group for the MS between two successive attempts to send a PACKET CHANNEL REQUEST message excluding the TDMA frames potentially containing the messages themselves. f(n,k) shall be in the set {S, S + 1, ..., S + T - 1}. The SS stores f.

Test:

The following requirement shall be met

$$\left(\left(\text{sq}(\text{Sum}(S)) + \text{sq}(\text{Sum}(S+1)) + \dots + \text{sq}(\text{Sum}(S+T-1)) \right) * T / (K * M) \right) - (K * M) \leq \frac{1}{2} * \text{sq}(\text{sqrt}(2T-3) + 2,58) + 1,1$$

Sum(X) := CARD { k | f(n,k) = X } := the number of times that f(n,k) equals X.

The test and the number of sample are chosen in such a way that the possibility of non-accepting a correct MS is less than [0,5%].

Specific message contents

None.

52.1.1.7 Packet Channel Request / EGPRS Packet Channel Request

52.1.1.7.1 Conformance requirements

If the cell is EGPRS capable and EGPRS PACKET CHANNEL REQUEST is supported in the cell the, EGPRS PACKET CHANNEL REQUEST messages shall be used at one-phase access attempts, two-phase access attempts and short access attempts. If the cell is EGPRS capable and EGPRS PACKET CHANNEL REQUEST messages are not supported in the cell the EGPRS mobile station shall use the PACKET CHANNEL REQUEST message according to parameter ACC_BURST_TYPE and shall initiate a two phase access request.

Reference

3GPP TS 04.60 subclause 7.1.2.1.

52.1.1.7.2 Test purpose

To verify that the mobile station use EGPRS PACKET CHANNEL REQUEST when cell indicates EGPRS PACKET CHANNEL REQUEST is supported in the cell.

52.1.1.7.3 Method of test

Initial conditions

System Simulator:

1 cell supporting GPRS.

Mobile Station:

The MS is GPRS attached and in packet idle mode. PDP context 3 has been established.

Specific PICS Statements

-

PIXIT Statements

-

Test procedure

The MS is triggered to send data. The MS shall send EGPRS PACKET CHANNEL REQUEST message. Change PSI1 to indicate that EGPRS PACKET CHANNEL REQUEST is not supported by the cell. The SS verifies that the MS sends PACKET CHANNEL REQUEST.

Maximum duration of the test

1 minute.

Expected sequence

Step	Direction	Message	Comments
1	MS		The MS is triggered to send 200 octets data. EGPRS supported by cell in GPRS cell options. EGPRS PACKET CHANNEL REQUEST supported by the cell in GPRS cell options.
2	MS -> SS	EGPRS PACKET CHANNEL REQUEST	ACCESS TYPE = "Two phase packet access". Received on PRACH.
3	SS->SS	PACKET ACCESS REJECT	Send on PAGCH
4	SS	PACKET SYSTEM INFORMATION Type 1	Change EGPRS PACKET CHANNEL REQUEST not supported by the cell in GPRS cell options. Sent on PBCCH.
5	SS		Wait 35 seconds
6	MS		The MS is triggered to send 200 octets data.
7	MS->SS	PACKET CHANNEL REQUEST	ACCESS TYPE = "Two phase packet access". Received on PRACH.
8	SS->MS	PACKET ACCESS REJECT	Send on PAGCH

Specific message contents

None.

52.1.2 Packet Uplink/Downlink Assignment

52.1.2.1 Packet uplink assignment procedure

52.1.2.1.1 Packet Uplink Assignment / Packet access queuing notification procedure

52.1.2.1.1.1 Packet Uplink Assignment / Packet queuing notification / Stop sending Packet Channel Requests

52.1.2.1.1.1.1 Conformance requirements

On receipt of a PACKET QUEUING NOTIFICATION message corresponding to one of its 3 last PACKET CHANNEL REQUEST messages, the mobile station shall stop timers T3186 and T3170 if running, start timer T3162, and stop sending PACKET CHANNEL REQUEST messages.

Reference

3GPP TS 04.60/44.060 subclause 7.1.2.2.2 and 7.1.2.1.

52.1.2.1.1.1.2 Test purpose

To verify that the mobile station stops sending PACKET CHANNEL REQUEST messages on receipt of a PACKET QUEUING NOTIFICATION message.

52.1.2.1.1.1.3 Method of test

Initial conditions

System Simulator:

1 cell supporting EGPRS. The packet system information MAX_RETRANS indicates 7 allowed retransmission.

Mobile Station:

The MS is switched off.

Specific PICS Statements

- Release of EGPRS Supported (TSPC_MS_EGPRS_RELEASE)
- Support of EGPRS Packet Access Enhancement (TSPC_EGPRS_ENHANC)

PIXIT Statements

-

Test procedure

The MS is powered up or switched on and triggered to perform a GPRS attach. The SS sends PACKET QUEUING NOTIFICATION message corresponding to one of the last three PACKET CHANNEL REQUEST messages. The SS verifies that the MS stops sending PACKET CHANNEL REQUEST messages. The SS sends PACKET ACCESS REJECT message to end the test procedure.

NOTE: EGPRS PACKET CHANNEL REQUEST shall be used for triggering MS to perform a GPRS attach in the following cases:

- If Release of EGPRS supported is Release 4 or above.
- If Support of EGPRS Packet Access enhancement is True for a R99 MS.

PACKET CHANNEL REQUEST shall be used for triggering MS to perform a GPRS attach if Support of EGPRS Packet Access enhancement is False for a R99 MS.

Maximum duration of the test

15 s.

Expected sequence

Step	Direction	Message	Comments
1	MS		The MS is powered up or switched on and triggered to perform a GPRS attach.
2	MS -> SS	PACKET CHANNEL REQUEST/ EGPRS PACKET CHANNEL REQUEST (See NOTE above)	Received on PRACH.
3	MS -> SS	PACKET CHANNEL REQUEST/ EGPRS PACKET CHANNEL REQUEST (See NOTE above)	Received on PRACH.
4	SS -> MS	PACKET QUEUING NOTIFICATION	Corresponding to message in step 2. Sent on PAGCH. The SS verifies during 10 seconds that MS stop sending PACKET CHANNEL REQUEST or EGPRS PACKET CHANNEL REQUEST messages (see NOTE above).
5	SS -> MS	PACKET ACCESS REJECT	Sent on PAGCH.

Specific message contents

None.

52.1.2.1.1.2 Packet Uplink Assignment / Packet queuing notification / Ignoring Packet Queuing Notification

52.1.2.1.1.2.1 Conformance requirements

If the mobile station receives a PACKET QUEUING NOTIFICATION message while waiting for the TBF Starting Time of a valid PACKET UPLINK ASSIGNMENT message, the mobile station shall ignore the PACKET QUEUEING NOTIFICATION.

Reference

3GPP TS 04.60/44.060 subclause 7.1.2.2.2 and 7.1.2.1.

52.1.2.1.1.2.2 Test purpose

To verify that the mobile station ignores the PACKET QUEUEING NOTIFICATION if the mobile station receives a PACKET QUEUING NOTIFICATION message while waiting for the TBF Starting Time of a valid PACKET UPLINK ASSIGNMENT message.

52.1.2.1.1.2.3 Method of test

Initial conditions

System Simulator:

1 cell supporting EGPRS.

Mobile Station:

The MS is switched off.

Specific PICS Statements

- Release of EGPRS Supported (TSPC_MS_EGPRS_RELEASE)
- Support of EGPRS Packet Access Enhancement (TSPC_EGPRS_ENHANC)

PIXIT Statements

-

Test procedure

The MS is switched on or powered up and triggered to perform a GPRS attach. The SS sends PACKET UPLINK ASSIGNMENT message containing a TBF Starting Time. While the MS is waiting for the TBF Starting Time the SS sends a PACKET QUEUING NOTIFICATION message. The MS shall ignore PACKET QUEUING NOTIFICATION message and at the frame number indicated by the TBF Starting Time, the MS shall start to send the uplink RLC data in the allocated uplink resources. The SS allows the MS to complete the GPRS attach procedure.

NOTE: EGPRS PACKET CHANNEL REQUEST shall be used for triggering MS to perform a GPRS attach in the following cases:

- If Release of EGPRS supported is Release 4 or above.
- If Support of EGPRS Packet Access enhancement is True for a R99 MS.

PACKET CHANNEL REQUEST shall be used for triggering MS to perform a GPRS attach if Support of EGPRS Packet Access enhancement is False for a R99 MS.

Maximum duration of the test

15 s.

Expected sequence

Step	Direction	Message	Comments
1	MS		The MS is switched on or powered up and triggered to perform a GPRS attach.
2	MS -> SS	PACKET CHANNEL REQUEST/ EGPRS PACKET CHANNEL REQUEST (See NOTE above)	Received on PRACH.
3	SS -> MS	PACKET UPLINK ASSIGNMENT	See specific message contents. Sent on PAGCH.
4	SS -> MS	PACKET QUEUING NOTIFICATION	Sent on PAGCH before starting time in step 3 have elapsed.
5		{GPRS Attach procedure}	Macro. Completion from step 4 in the attach procedure. The SS verifies that the first RLC data block sends according to the indicated starting time in step 3.

Specific message contents

As default messages contents, except:

PACKET UPLINK ASSIGNMENT in step 3

Information element	Value/remark
Dynamic Allocation < TBF_Starting_Time >	[Arbitrarily chosen]

52.1.2.1.1.3 Packet Uplink Assignment / Packet queuing notification / Assigned PDCHs

52.1.2.1.1.3.1 Conformance requirements

On receipt of a PACKET UPLINK ASSIGNMENT message following a PACKET QUEUING NOTIFICATION message, the mobile station shall stop timer T3162, and follow the procedures defined in subclause 7.1.2.2.1.

If the PACKET UPLINK ASSIGNMENT message does not specify a TBF starting time, the mobile station shall switch to the assigned PDCHs, start timer T3164 and proceed with contention resolution of the one phase access procedure according to subclause 7.1.2.3.

Reference

3GPP TS 04.60/44.060 subclauses 7.1.2.2.2, 7.1.2.2.1 and 7.1.2.1.

52.1.2.1.1.3.2 Test purpose

To verify that the mobile station switches to the assigned PDCHs on receipt of a PACKET UPLINK ASSIGNMENT message after a PACKET QUEUING NOTIFICATION message.

52.1.2.1.1.3.3 Method of test

Initial conditions

System Simulator:

1 cell supporting EGPRS. The packet system information ACCESS_BURST_TYPE indicates 8 bit access.

Mobile Station:

The MS is switched off.

Specific PICS Statements

- Release of EGPRS Supported (TSPC_MS_EGPRS_RELEASE)
- Support of EGPRS Packet Access Enhancement (TSPC_EGPRS_ENHANC)

PIXIT Statements

-

Test procedure

The MS is switched on or powered up and triggered to perform a GPRS attach. The SS send PACKET QUEUING NOTIFICATION message and sends then PACKET UPLINK ASSIGNMENT message. The SS allows the MS to complete the GPRS attach procedure.

NOTE: EGPRS PACKET CHANNEL REQUEST shall be used for triggering MS to perform a GPRS attach in the following cases:

- If Release of EGPRS supported is Release 4 or above.
- If Support of EGPRS Packet Access enhancement is True for a R99 MS.

PACKET CHANNEL REQUEST shall be used for triggering MS to perform a GPRS attach if Support of EGPRS Packet Access enhancement is False for a R99 MS.

Maximum duration of the test

15 s.

Expected sequence

Step	Direction	Message	Comments
1	MS		The MS is switched on or powered up and triggered to perform a GPRS attach procedure.
2	MS -> SS	PACKET CHANNEL REQUEST/ EGPRS PACKET CHANNEL REQUEST (See NOTE above)	Received on PRACH.
3	SS -> MS	PACKET QUEUING NOTIFICATION	Sent on PAGCH.
4	SS -> MS	PACKET UPLINK ASSIGNMENT	Include same TQI as step 3. Sent on PAGCH before timer T3162 expires.
5		{GPRS attach procedure }	Macro. Completion from step 4 in the attach procedure.

Specific message contents

None.

52.1.2.1.1.4 Packet Uplink Assignment / Packet queuing notification / Expiry of timer T3162

52.1.2.1.1.4.1 Conformance requirements

On receipt of a PACKET QUEUING NOTIFICATION message corresponding to one of its 3 last PACKET CHANNEL REQUEST messages the mobile station shall stop timer T3170 and T3186 if running and stop sending PACKET CHANNEL REQUEST messages. On receipt of a PACKET UPLINK ASSIGNMENT message following a PACKET QUEUING NOTIFICATION message, the mobile station shall stop timer T3162 and follow the procedures defined in subclause 7.1.2.2.1. At expiry of timer T3162, the packet access procedure shall be aborted and a packet access failure indicated to the upper layer and the mobile station shall return to packet idle mode.

Reference

3GPP TS 04.60/44.060 subclauses 7.1.2.2.2, 7.1.2.1 and 13.1.

52.1.2.1.1.4.2 Test purpose

1. To verify that the MS waits T3162 seconds before aborting the packet access procedure on receipt of a PACKET QUEUING NOTIFICATION message.
2. To verify that the mobile station listening to its paging channel after a time greater than timer T3162.

52.1.2.1.1.4.3 Method of test

Initial conditions

System Simulator:

1 cell supporting EGPRS.

Mobile Station:

The MS is GPRS attached and in packet idle mode.

Specific PICS Statements

- Release of EGPRS Supported (TSPC_MS_EGPRS_RELEASE)
- Support of EGPRS Packet Access Enhancement (TSPC_EGPRS_ENHANC)

PIXIT Statements

-

Test procedure

The SS page the MS with a PACKET PAGING REQUEST message. The SS sends PACKET QUEUING NOTIFICATION message corresponding to one of its 3 last PACKET CHANNEL REQUEST messages. The SS waits

until T3162 seconds elapse and sends a PACKET UPLINK ASSIGNMENT message which shall be ignored by the MS since the access procedure should be aborted.

The SS page the MS with a PACKET PAGING REQUEST message. The SS verifies that the MS respond to the paging request and sends PACKET QUEUING NOTIFICATION message corresponding to one of its 3 last PACKET CHANNEL REQUEST messages. The SS sends a PACKET UPLINK ASSIGNMENT message before T3162 seconds elapse and the MS shall complete the uplink data transfer containing the paging response.

NOTE: EGPRS PACKET CHANNEL REQUEST shall be used to respond to Packet Paging Request in the following cases:

- If Release of EGPRS supported is Release 4 or above.
- If Support of EGPRS Packet Access enhancement is True for a R99 MS.

PACKET CHANNEL REQUEST shall be used to respond to Packet Paging Request if Support of EGPRS Packet Access enhancement is False for a R99 MS.

Maximum duration of the test

1 minute.

Expected sequence

Step	Direction	Message	Comments
1	SS -> MS	PACKET PAGING REQUEST	Sent on PPCH.
2	MS -> SS	PACKET CHANNEL REQUEST/ EGPRS PACKET CHANNEL REQUEST (See NOTE above)	In case PACKET CHANNEL REQUEST is received: ACCESS TYPE = "Page response".
3	SS -> MS	PACKET QUEUING NOTIFICATION	Received on PRACH. Allocate a TQI to the MS. Sent on PAGCH.
4	SS		The SS waits T3162 + 0.1*T3162 .
5	SS -> MS	PACKET UPLINK ASSIGNMENT	Include same TQI as in step 3 and dynamic allocation struct. Sent on PAGCH.
6	SS		The SS verifies for 5 s that the MS does not respond.
7	SS -> MS	PACKET PAGING REQUEST	Sent on PPCH.
8	MS -> SS	PACKET CHANNEL REQUEST/ EGPRS PACKET CHANNEL REQUEST (See NOTE above)	In case PACKET CHANNEL REQUEST is received: ACCESS TYPE = "Page response". In case EGPRS PACKET CHANNEL REQUEST is received ACCESS TYPE = " Signalling ".
9	SS -> MS	PACKET QUEUING NOTIFICATION	Received on PRACH. Allocate a TQI to the MS. Sent on PAGCH.
10	SS		The SS waits T3162 - 0.1*T3162 .
11	SS -> MS	PACKET UPLINK ASSIGNMENT	Include same TQI as in step 9, dynamic allocation struct. Sent on PAGCH.
12	MS -> SS	UPLINK RLC DATA BLOCK	LLC PDU implicitly indicating paging response. Received on uplink PDTCH assigned in step 11.
13	SS -> MS	PACKET UPLINK ACK/NACK	Acknowledge the received RLC data block, Final Ack Indicator = "1". Sent on PACCH
14	MS -> SS	PACKET CONTROL ACKNOWLEDGEMENT	Acknowledge the RLC control message. Received on PACCH.

Specific message contents

None.

52.1.2.1.2 Packet Uplink Assignment / Response to packet polling request

52.1.2.1.2.1 Conformance requirements

On receipt of a PACKET POLLING REQUEST message, the mobile station shall respond to the network with the PACKET CONTROL ACKNOWLEDGEMENT message in the reserved uplink radio block specified by the RRBP field.

Reference

3GPP TS 04.60 subclause 7.1.2.2.3.

52.1.2.1.2.2 Test purpose

To verify that the mobile station responds to the Network with a PACKET CONTROL ACKNOWLEDGEMENT message in the reserved uplink radio block specified by the RRBP field on receipt of a PACKET POLLING REQUEST message.

52.1.2.1.2.3 Method of test

Initial conditions

System Simulator:

1 cell supporting EGPRS. The packet system information ACCESS_BURST_TYPE indicates 8 bit access and CONTROL_ACK_TYPE indicates four access bursts.

Mobile Station:

The MS is GPRS attached and in packet idle mode. PDP context 2 has been established.

Specific PICS Statements

-

PIXIT Statements

-

Test procedure

The MS is triggered to transfer data. The SS sends a PACKET QUEUING NOTIFICATION message and sends then a PACKET POLLING REQUEST message. On receipt of PACKET POLLING REQUEST message the MS shall respond with PACKET CONTROL ACKNOWLEDGEMENT message as four access bursts. The SS verifies that MS sends the PACKET CONTROL ACKNOWLEDGEMENT and send PACKET UPLINK ASSIGNMENT message including the TQI. The MS then sends the Packet Resource Request and the SS then sends the Packet uplink assignment to complete the uplink data transfer.

Maximum duration of the test

30 s.

Expected sequence

Step	Direction	Message	Comments
1	MS		The MS is triggered to transfer 200 octets data.
2	MS -> SS	EGPRS PACKET CHANNEL REQUEST	One or Two Phase Access Request Received on PRACH.
3	SS -> MS	PACKET QUEUING NOTIFICATION	Allocate a TQI to the MS. Sent on PAGCH.
4	SS -> MS	PACKET POLLING REQUEST	Include same TQI as step 3. Sent on PAGCH.
5	MS -> SS	PACKET CONTROL ACKNOWLEDGEMENT	Received on the uplink block specified by the RRBP field on PACCH as four access bursts.
6	SS		SS verifies that the message in step 5 was received.
7	SS -> MS	PACKET UPLINK ASSIGNMENT	Include same TQI as step 3, Multi block allocation struct. Sent on PAGCH.
8	MS -> SS	PACKET RESOURCE REQUEST	Received on one of the blocks assigned in Step 7.
9	SS -> MS	PACKET UPLINK ASSIGNMENT	Dynamic allocation struct and USF_GRANULARITY = four blocks. Sent on PACCH.
10		{Completion of uplink RLC data block transfer}	

Specific message contents

None.

52.1.2.1.3 Packet Uplink Assignment / Packet access reject procedure

52.1.2.1.3.1 Packet Uplink Assignment / Packet access reject / Action during Wait_Indication

52.1.2.1.3.1.1 Conformance requirements

On receipt of a PACKET ACCESS REJECT message containing a Reject structure addressed to the mobile station, where the Packet Request Reference in the Reject structure corresponds to one of its three last PACKET CHANNEL REQUEST messages, the mobile station shall stop sending PACKET CHANNEL REQUEST or EGPRS PACKET CHANNEL REQUEST messages, start timer T3172 with the value indicated in the WAIT_INDICATION field if present, start timer T3170 if it has not already been started and listen to the downlink PCCCH until timer T3170 expires. During this time, the mobile station shall ignore additional PACKET ACCESS REJECT message, but on reception of any PACKET UPLINK ASSIGNMENT message corresponding to any other of its 3 last PACKET CHANNEL REQUEST MESSAGE or EGPRS PACKET CHANNEL REQUEST the mobile station shall stop timers T3170 and T3172 if running and follow the procedure defined in subclause 7.1.2.2.1.

Reference

3GPP TS 04.60/44.060 subclause 7.1.2.2.4 and 7.1.2.1.

52.1.2.1.3.1.2 Test purpose

To verify that the mobile station stops sending EGPRS PACKET CHANNEL REQUEST messages on receipt of a PACKET ACCESS REJECT message containing a WAIT_INDICATION field.

To verify that the mobile station ignores additional PACKET ACCESS REJECT messages, but on reception of any PACKET UPLINK ASSIGNMENT message corresponding to any other of its 3 last EGPRS PACKET CHANNEL REQUEST messages the mobile station shall switch to the assigned PDCHs if the message is received before timer T3170 expire.

52.1.2.1.3.1.3 Method of test

Initial conditions

System Simulator:

1 cell supporting EGPRS. The packet system information MAX_RETRANS indicates 7 retransmissions, TX_INT indicates 50 slots to spread transmission and parameter S indicates the value 217 and BS_PRACH_BLKs=11 (USF=FREE is set onto the corresponding blocks).

Mobile Station:

The MS is GPRS attached, a PDP context has been established and the MS is in Packet Idle mode.

Specific PICS Statements

-

PIXIT Statements

-

Test procedures

The MS is triggered to transfer data. The SS sends PACKET ACCESS REJECT message with WAIT_INDICATION field corresponding to one of the last three EGPRS PACKET CHANNEL REQUEST messages. The SS verifies that the MS does not send further EGPRS PACKET CHANNEL REQUEST messages. The SS sends a new PACKET ACCESS REJECT message without WAIT_INDICATION field. The SS shall then send a PACKET UPLINK ASSIGNMENT message corresponding to any other of the last three sent EGPRS PACKET CHANNEL REQUEST messages before the timer T3170 expire (T+2*S TDMA frames). The SS allows the MS to complete data transfer.

Maximum duration of the test

5 min.

Expected sequence

Step	Direction	Message	Comments
1	MS		The MS is triggered to transfer 200 octets of data.
2	MS -> SS	EGPRS PACKET CHANNEL REQUEST	One or Two Phase Access Request received on PRACH.
3	MS -> SS	EGPRS PACKET CHANNEL REQUEST	One or Two Phase Access Request received on PRACH.
4	MS -> SS	EGPRS PACKET CHANNEL REQUEST	One or Two Phase Access Request received on PRACH.
5	SS -> MS	PACKET ACCESS REJECT	Containing WAIT_INDICATION = 15 seconds and packet request reference = pertaining to message received in step 2. Sent on PAGCH.
6	SS		The SS checks $0,8 \cdot T3170$ that the MS does not send further EGPRS PACKET CHANNEL REQUEST messages.
7	SS -> MS	PACKET ACCESS REJECT	Without WAIT_INDICATION. Sent $0,8 \cdot T3170$ on PAGCH. The MS shall not consider this message.
8	SS -> MS	PACKET UPLINK ASSIGNMENT	Multi block allocation structRandom Reference = pertaining to message received in step 3. Sent $0,9 \cdot T3170$ on PAGCH.
9	MS->SS	PACKET RESOURCE REQUEST	Received on one of the blocks assigned in Step 8
10	SS->MS	PACKET UPLINK ASSIGNMENT	Dynamic Allocation struct information. Sent on PACCH
11		Completion of macro {Uplink data transfer}	SS allows MS to complete data transfer.

Specific message contents

None.

52.1.2.1.3.2 Packet Uplink Assignment / Packet access reject / No respond

52.1.2.1.3.2.1 Conformance requirements

On receipt of a PACKET ACCESS REJECT message containing a Reject structure addressed to the mobile station, where the Packet Request Reference in the Reject structure corresponds to one of its 3 last PACKET CHANNEL REQUEST messages:

- the mobile station is not allowed to make a new attempt for packet access in the same cell until timer T3172 expires, but may attempt packet access in an other cell after successful cell reselection for radio conditions reasons (see 3GPP TS 05.08). A mobile station in class A or B mode of operation may attempt to enter the dedicated mode in the same cell before timer T3172 has expired. During the timer T3172 is running, the mobile station shall ignore all received PACKET PAGING REQUEST messages except paging request to trigger RR connection establishment.

Reference

3GPP TS 04.60/44.060 subclause 7.1.2.2.4 and 7.1.2.1.

52.1.2.1.3.2.2 Test purpose

To verify that the mobile station ignores PACKET PAGING REQUEST messages requesting TBF establishment when T3172 is running.

52.1.2.1.3.2.3 Method of test

Initial conditions

System Simulator:

1 cell supporting EGPRS. The packet system information ACCESS_BURST_TYPE indicates 8 bit access.

Mobile Station:

The MS is GPRS attached and in packet idle mode.

Specific PICS Statements

- Release of EGPRS Supported (TSPC_MS_EGPRS_RELEASE)
- Support of EGPRS Packet Access Enhancement (TSPC_EGPRS_ENHANC)

PIXIT Statements

-

Test procedure

The SS sends a PACKET PAGING REQUEST message. After response from the MS the SS sends PACKET ACCESS REJECT message with WAIT_INDICATION set to a value between 1-255 seconds (see specific message contents). The SS sends then a PACKET UPLINK ASSIGNMENT message after timer T3170 has elapse. The SS verifies that the MS not respond to the message. The SS sends a PACKET PAGING REQUEST message request TBF establishment before the wait indication has elapse. The SS verifies that the MS not respond to the message. The SS sends a PACKET PAGING REQUEST message request TBF establishment after the wait indication has elapse. The SS verifies that the MS respond to the message.

The test procedures shall be repeated with different chosen values of WAIT INDICATION.

NOTE:

EGPRS PACKET CHANNEL REQUEST shall be used to respond to Packet Paging Request in the following cases

- If Release of EGPRS supported is Release 4 or above.
- If Support of EGPRS Packet Access enhancement is True for a R99 MS.

PACKET CHANNEL REQUEST shall be used to respond to Packet Paging Request if Support of EGPRS Packet Access enhancement is False for a R99 MS.

Maximum duration of the test

10 minutes.

Expected sequence

Step	Direction	Message	Comments
1	SS -> MS	PACKET PAGING REQUEST	Sent on PPCH.
2	MS -> SS	PACKET CHANNEL REQUEST/ EGPRS PACKET CHANNEL REQUEST (See NOTE above)	Received on PRACH.
3	SS -> MS	PACKET ACCESS REJECT	See specific message contents. Sent on PAGCH.
4	SS -> MS	PACKET UPLINK ASSIGNMENT	Send this message 1,1*T3170on PAGCH.
5	SS		Verify for 5 seconds that the MS does not respond to message in step 4.
6	SS -> MS	PACKET PAGING REQUEST	Request TBF establishment. Send this message after (0,9*WAIT INDICATION (step 3)) on PPCH.
7	SS		Verify that the MS does not respond to message in step 6.
8	SS -> MS	PACKET PAGING REQUEST	Request TBF establishment. Send this message after (1,1*WAIT INDICATION (step 3)) on PPCH.
9	MS -> SS	PACKET CHANNEL REQUEST/ EGPRS PACKET CHANNEL REQUEST (See NOTE above)	Received on PRACH.

The test is repeated with different values of WAIT INDICATION, see specific message contents.

Specific message contents

As default messages contents, except:

PACKET ACCESS REJECT in step 3

Information element	Value/remark
< WAIT_INDICATION > < WAIT_INDICATION_SIZE >	Set values between 1-255, see below. 0 (units of seconds)

Case 1: WAIT_INDICATION = 60.

Case 2: WAIT_INDICATION = 240.

52.1.2.1.3.3 Void

52.1.2.1.4 Packet Uplink Assignment / Packet Uplink Assignment handling

52.1.2.1.4.1 Conformance requirements

On receipt of a PACKET UPLINK ASSIGNMENT message corresponding to one of its 3 last PACKET CHANNEL REQUEST messages, the mobile station shall stop timers T3186 and T3170 if running, stop sending PACKET CHANNEL REQUEST messages.

Reference

3GPP TS 04.60/44.060 subclause 7.1.2.2.1 and 7.1.2.1.

52.1.2.1.4.2 Test purpose

To verify that the mobile station stops sending PACKET CHANNEL REQUEST messages on receipt of a PACKET UPLINK ASSIGNMENT message.

52.1.2.1.4.3 Method of test

Initial conditions

System Simulator:

1 cell supporting EGPRS. The packet system information MAX_RETRANS indicates 7 allowed retransmission.

Mobile Station:

The MS is switched off.

Specific PICS Statements

- Release of EGPRS Supported (TSPC_MS_EGPRS_RELEASE)
- Support of EGPRS Packet Access Enhancement (TSPC_EGPRS_ENHANC)

PIXIT Statements

-

Foreseen final state of the MS

Packet idle mode.

Test procedure

The MS is switched on or powered up and triggered to perform a GPRS attach. The SS send a PACKET UPLINK ASSIGNMENT message corresponding to one of the last 3 PACKET CHANNEL REQUEST messages from the MS. The SS verifies that the MS stops sending PACKET CHANNEL REQUEST messages. The SS allows the MS to complete the GPRS attach procedure.

NOTE: EGPRS PACKET CHANNEL REQUEST shall be used for triggering MS to perform a GPRS attach in the following cases:

- If Release of EGPRS supported is Release 4 or above.
- If Support of EGPRS Packet Access enhancement is True for a R99 MS.

PACKET CHANNEL REQUEST shall be used for triggering MS to perform a GPRS attach if Support of EGPRS Packet Access enhancement is False for a R99 MS.

Maximum duration of the test

15 s.

Expected sequence

Step	Direction	Message	Comments
1	MS		The MS is switched on or powered up and triggered to perform a GPRS attach.
2	MS -> SS	PACKET CHANNEL REQUEST/EGPRS PACKET CHANNEL REQUEST (See NOTE above)	Received on PRACH.
3	MS -> SS	PACKET CHANNEL REQUEST/EGPRS PACKET CHANNEL REQUEST (See NOTE above)	Received on PRACH.
4	SS -> MS	PACKET UPLINK ASSIGNMENT	Respond to requests message in step 2. Sent on PAGCH with dynamic allocation struct. The SS shall verify for 4.5 seconds that the MS stops sending packet channel request messages.
5		{GPRS attach procedure }	Macro. Completion from step 4 in the attach procedure.

Specific message contents

None.

52.1.2.1.5 Packet Uplink Assignment / One or two phase access

52.1.2.1.5.1 Conformance requirements

Unless the mobile station indicated a Single Block Without TBF Establishment in a PACKET CHANNEL REQUEST message, the mobile station shall perform a two phase access, if the PACKET UPLINK ASSIGNMENT message includes a Single Block allocation struct or a Multi Block Allocation struct. If the PACKET UPLINK ASSIGNMENT message includes Dynamic Allocation struct, the mobile station shall perform a one phase access.

Multi block allocationReference

3GPP TS 04.60/44.060 subclause 7.1.2.2.1 and 7.1.2.1.

52.1.2.1.5.2 Test purpose

To verify that the mobile station proceeds with one phase access or two phase access according to the parameters in the PACKET UPLINK ASSIGNMENT message.

52.1.2.1.5.3 Method of test

Initial conditions

System Simulator:

1 cell supporting EGPRS. The packet system information ACCESS_BURST_TYPE indicates 8 bit access.

Mobile Station:

The MS is switched off.

Specific PICS Statements

- Switch off on button (TSPC_Feat_OnOff)
- Release of EGPRS Supported (TSPC_MS_EGPRS_RELEASE)
- Support of EGPRS Packet Access Enhancement (TSPC_EGPRS_ENHANC)

PIXIT Statements

-

Test procedures

The MS is switched on or powered up and triggered to perform a GPRS attach. The SS send a PACKET UPLINK ASSIGNMENT message with Dynamic Allocation struct information field, the MS shall proceed with a one-phase access. The SS allows the MS to complete the GPRS attach procedure. Switch off or power down the MS.

The MS is switched on or powered up and triggered to perform a GPRS attach. The SS send a PACKET UPLINK ASSIGNMENT message with Multi block allocation struct information field, the MS shall perform a two-phase access i.e. it should transmit a PACKET RESOURCE REQUEST message on the allocated uplink resource. The SS responds with a PACKET UPLINK ASSIGNMENT message with Dynamic Allocation struct information field. The SS allows the MS to complete the GPRS attach procedure. Switch off or power down the MS.

NOTE: EGPRS PACKET CHANNEL REQUEST shall be used for triggering MS to perform a GPRS attach in the following cases:

- If Release of EGPRS supported is Release 4 or above.
- If Support of EGPRS Packet Access enhancement is True for a R99 MS.

PACKET CHANNEL REQUEST shall be used for triggering MS to perform a GPRS attach if Support of EGPRS Packet Access enhancement is False for a R99 MS.

Maximum duration of the test

2 minutes.

Expected sequences

Step	Direction	Message	Comments
1	MS		The MS is switched on or powered up and triggered to perform a GPRS attach.
2	MS -> SS	PACKET CHANNEL REQUEST/EGPRS PACKET CHANNEL REQUEST (See NOTE above)	Received on PRACH.
3	SS -> MS	PACKET UPLINK ASSIGNMENT	Dynamic Allocation struct information. Sent on PAGCH.
4		{GPRS attach procedure }	Macro. Completions from step 4 in the attach procedure as one phase access.
5	MS		The MS is switched off or power is removed (see PICS).
6		{GPRS detach procedure }	Macro. Procedure only applies if MS is switched off.
7	MS		The MS is switched on or powered up and triggered to perform a GPRS attach.
8	MS -> SS	PACKET CHANNEL REQUEST/EGPRS PACKET CHANNEL REQUEST (See NOTE above)	Received on PRACH.
9	SS -> MS	PACKET UPLINK ASSIGNMENT	Multi block allocation struct information. Sent on PAGCH.
10	MS -> SS	PACKET RESOURCE REQUEST	Received on the single block assigned in step 9.
11	SS -> MS	PACKET UPLINK ASSIGNMENT	Dynamic Allocation struct information. Sent on PACCH.
12		{ GPRS attach procedure }	Macro. Completion from step 4 in the attach procedure.
13	MS		The MS is switched off or power is removed (see PICS).
14		{GPRS detach procedure }	Macro. Procedure only applies if MS is switched off.

Specific message contents

PACKET UPLINK ASSIGNMENT dynamic allocation struct specified in subclause 52.1.3.2.8.

PACKET UPLINK ASSIGNMENT multi block allocation struct specified in subclause 52.1.3.2.10.

52.1.2.1.6 Packet Uplink Assignment / Decoding of frequency parameters

52.1.2.1.6.1 Conformance requirements

The mobile station may use information received on PBCCH, BCCH or a previous assignment message to decode the frequency parameters contained in the assignment message. If the mobile station detects an invalid Frequency Parameters information element in the assignment message, it shall abort the procedure, if required initiate a partial acquisition of PBCCH or BCCH, and may then re-initiate this procedure.

When the indirect encoding is used, the network may include a CHANGE_MARK_1 and a CHANGE_MARK_2 in the Frequency Parameters information element. The mobile station shall then verify that it is using a set of PBCCH or BCCH information identified by a PSI or SI *change mark* corresponding to one of the CHANGE_MARK_1 or 2 parameters, for the decoding of the frequency information. If that is not the case, an abnormal condition occurs.

Reference

3GPP TS 04.60 subclauses 7.1.2.2.1 and 5.5.1.7.

52.1.2.1.6.2 Test purpose

To verify that the mobile station uses information received on PBCCH to decode the frequency parameters contained in the assignment message and when the mobile station receives a PACKET UPLINK ASSIGNMENT message with an invalid frequency parameters information element the mobile station shall abort the procedure.

52.1.2.1.6.3 Method of test

Initial conditions

System Simulator:

1 cell supporting EGPRS. Packet system information PSI2 including frequency hopping parameters.

Mobile Station:

The MS is GPRS attached and in packet idle mode. PDP context 2 has been established.

Specific PICS Statements

-

PIXIT Statements

-

Test procedure

The MS is triggered to transfer data. The SS sends a PACKET UPLINK ASSIGNMENT message containing frequency parameter information elements. The SS allows the MS to complete the data transfer procedure. Again MS is triggered to transfer data. The SS sends PACKET UPLINK ASSIGNMENT message containing an invalid frequency parameter as respond to the EGPRS PACKET CHANNEL REQUEST message from the MS. The SS verifies that the MS abort the data transfer procedure.

Maximum duration of the test

30 s.

Expected sequence

Step	Direction	Message	Comments
1	MS		The MS is triggered to initiate packet uplink transfer of 500 octets data
2	MS -> SS	EGPRS PACKET CHANNEL REQUEST	One or Two Phase Access Request. Received on PRACH.
3	SS -> MS	PACKET UPLINK ASSIGNMENT	Multi block allocation struct. Sent on PAGCH.
4	MS -> SS	PACKET RESOURCE REQUEST	Received on one of the blocks assigned in Step 3.
5	SS -> MS	PACKET UPLINK ASSIGNMENT	Include frequency parameters see specific message contents. Sent onPACCH. MCS1 coding scheme is used.
6		{Uplink data transfer, dynamic allocation}	Macro. Completion of the macro procedure.
7	MS		The MS is triggered to initiate packet uplink transfer of an other 500 octets data
8	MS -> SS	EGPRS PACKET CHANNEL REQUEST	One or Two Phase Access Request. Received on PRACH.
9	SS -> MS	PACKET UPLINK ASSIGNMENT	Multi block allocation struct. Sent on PAGCH.
10	MS -> SS	PACKET RESOURCE REQUEST	Received on one of the blocks assigned in Step 9.
11	SS -> MS	PACKET UPLINK ASSIGNMENT	Include invalid frequency parameter see specific message contents. Sent onPACCH.
12	SS		The SS verifies that the MS abort the packet access procedure.

Specific message contents

As default messages contents, except:

PACKET SYSTEM INFORMATION type 2 in initial condition

Information element	Value/remark
< PSI2_CHANGE_MARK >	01
< PCCCH Description List struct >	
< TSC >	arbitrarily chosen
{0}1< Hopping PCCCH carriers >	1
< MA_NUMBER	0010 (List 2)
< Hopping PCCCH carriers struct >	
< Hopping PCCCH carriers struct >	
< MAIO >	arbitrarily chosen
< TIMESLOT_ALLOCATION	00001000 (timeslot 4)

PACKET UPLINK ASSIGNMENT in step 5

Information element	Value/remark
{0}1< Frequency Parameters >	1 (hopping channel)
< Frequency Parameters IE >	
< TSC >	Same as PSI2.
< Indirect encoding struct >	01 (Indirect encoding)
< MAIO >	Same as PSI2.
< MA_NUMBER >	Same as PSI2.
{0}1< CHANGE_MARK_1 >	1 (CHANGE_MARK_1 present)
- CHANGE_MARK_1}	01 (same change mark as PSI2_CHANGE_MARK)
{0}1< CHANGE_MARK_2 >	1(CHANGE_MARK_2 present)
- CHANGE_MARK_2}	00 (which mismatches PSI2_CHANGE_MARK)

PACKET UPLINK ASSIGNMENT in step 11

Information element	Value/remark
{0 1< Frequency Parameters > < Frequency Parameters IE > < TSC > < Indirect encoding struct > < MAIO > < MA_NUMBER > {0 1< CHANGE_MARK_1 > - CHANGE_MARK_1} {0 1< CHANGE_MARK_2 >}	1 (hopping channel) Same as PSI2. 01 (Indirect encoding) Same as PSI2. Same as PSI2. 1 (CHANGE_MARK_1 present) 00 (which mismatches PSI2_CHANGE_MARK) 0 (no CHANGE_MARK_2)

52.1.2.1.7 Packet Uplink Assignment / Most recently received Packet Uplink Assignment

52.1.2.1.7.1 Conformance requirements

A PACKET UPLINK ASSIGNMENT message may indicate an assignment starting time in the TBF Starting Time parameter. The mobile station shall monitor PCCCH until the point in time denoted by the TBF Starting Time. If while monitoring the PCCCH the mobile station receives more than one PACKET UPLINK ASSIGNMENT message, it shall act upon the most recently received message and shall ignore the previous message.

Reference

3GPP TS 04.60/44.060 subclause 7.1.2.2.1 and 7.1.2.1.

52.1.2.1.7.2 Test purpose

To verify that the mobile station monitors PCCCH until the point in time denoted by the TBF Starting Time and that the mobile station acts on the most recently received Packet Uplink Assignment.

52.1.2.1.7.3 Method of test

Initial conditions

System Simulator:

1 cell supporting EGPRS. The packet system information ACCESS_BURST_TYPE indicates 8 bit access.

Mobile Station:

The MS is switched off.

Specific PICS Statements

- Release of EGPRS Supported (TSPC_MS_EGPRS_RELEASE)
- Support of EGPRS Packet Access Enhancement (TSPC_EGPRS_ENHANC)

PIXIT Statements

-

Test procedure

The MS is switched on or powered up and triggered to perform a GPRS attach. The SS sends PACKET UPLINK ASSIGNMENT message with a TBF starting time. Then send a new PACKET UPLINK ASSIGNMENT message with another TBF starting time and a different timeslot on PCCCH before the first TBF starting time has elapsed. The MS shall start to send the RLC data block on the allocated uplink according to the second TBF starting time. The SS allows the MS to complete the GPRS attach procedure.

NOTE: EGPRS PACKET CHANNEL REQUEST shall be used for triggering MS to perform a GPRS attach in the following cases:

- If Release of EGPRS supported is Release 4 or above.
- If Support of EGPRS Packet Access enhancement is True for a R99 MS.

PACKET CHANNEL REQUEST shall be used for triggering MS to perform a GPRS attach if Support of EGPRS Packet Access enhancement is False for a R99 MS.

Maximum duration of the test

15 s.

Expected sequence

Step	Direction	Message	Comments
1	MS		The MS is switched on or powered up and triggered to perform a GPRS attach procedure.
2	MS -> SS	PACKET CHANNEL REQUEST/EGPRS PACKET CHANNEL REQUEST (See NOTE above)	Received on PRACH.
3	SS -> MS	PACKET UPLINK ASSIGNMENT	See specific message contents. Sent on PAGCH.
4	SS -> MS	PACKET UPLINK ASSIGNMENT	See specific message contents. Sent on PAGCH.
5		{GPRS attach procedure}	Macro. Completion from step 4 in the attach procedure. Sent on allocated uplink resource. The SS verifies that the MS starts to send data according to information in step 4.

Specific message contents

As default messages contents, except:

PACKET UPLINK ASSIGNMENT in step 3

Information element	Value/remark
Dynamic allocation struct	1
< USF_TN3 >	
< TBF_STARTING_TIME >	Arbitrarily chosen, high enough so the next message will be sent before the time has elapsed.

PACKET UPLINK ASSIGNMENT in step 4

Information element	Value/remark
Dynamic allocation struct	1
< USF_TN6 >	
< TBF_STARTING_TIME >	Arbitrarily chosen.

52.1.2.1.8 Packet Uplink Assignment / One phase access

52.1.2.1.8.1 Packet Uplink Assignment / One phase access / Contention Resolution

The contention resolution is successfully completed on the mobile station side when the mobile station receives a PACKET UPLINK ACK/NACK message addressing the mobile station with the TFI value associated with the uplink TBF and including the same TLLI value that the mobile station has included in the RLC header of the first RLC data blocks, or, in EGPRS TBF mode, a PACKET UPLINK ASSIGNMENT message addressing the mobile station with the same TLLI value that the mobile station included in the RLC header of the first RLC data blocks. The mobile shall then stop timer T3166 and counter N3104.

At sending of the first RLC data block, the mobile station shall stop timer T3164, set counter N3104 to 1, and start timer T3166. Counter N3104 shall be stepped each time the mobile station sends an RLC data block.

52.1.2.1.8.1.1 Packet Uplink Assignment / One phase access / Contention resolution / Inclusion of TLLI in RLC data blocks

52.1.2.1.8.1.1.1 Conformance requirements

In order to uniquely identify the mobile station when sending on uplink, the RLC Header is extended to include the TLLI of the mobile station until contention resolution is completed on the mobile station side.

All the RLC data blocks of an uplink TBF initiated by one phase access shall each contain a TLLI field in the RLC data block header until the contention resolution is completed on the mobile station side. After the reaction time specified in 3GPP TS 05.10 no other RLC data blocks shall contain a TLLI field.

The TLLI_BLOCK_CHANNEL_CODING parameter in the PACKET UPLINK ASSIGNMENT message indicates whether a RLC data block containing a TLLI field in the RLC data block header shall be encoded using CS-1 or correspondingly MCS-1 in EGPRS TBF mode, or using the channel coding scheme commanded. In standard GPRS TBF mode, the mobile station shall send all other RLC data blocks using the channel coding scheme commanded.

In EGPRS TBF mode, RLC data blocks that are transmitted for the first time shall be transmitted with the MCS commanded, except if the commanded mode is MCS-5-7, in which case the data block shall be transmitted with MCS-5, or if the commanded mode is MCS-6-9, in which case the data block shall be transmitted with MCS-6.

Upon contention resolution during one phase access, the mobile station shall start transmitting RLC data blocks without the TLLI field no later than the next occurrence of block $B((x+3) \bmod 12)$ where block $B(x)$ is the radio block containing the contention resolution message.

Reference

3GPP TS 04.60 subclauses 7.1.2.3 and 8.1.1.

3GPP TS 05.10 subclause 6.11.3.

52.1.2.1.8.1.1.2 Test purpose

1. To verify that in one phase access the first RLC data blocks of an uplink TBF contain a TLLI field in the RLC data block header and that these blocks are encoded according to the TLLI_BLOCK_CHANNEL_CODING parameter specified in the PACKET UPLINK ASSIGNMENT message.
2. To verify that upon contention resolution during one phase access the RLC data blocks not contain a TLLI field and are encoded using the EGPRS_Channel Coding Command IE included in the PACKET_UPLINK_ASSIGNMENT after the contention resolution reaction time.

52.1.2.1.8.1.1.3 Method of test

Initial conditions

System Simulator:

1 cell supporting EGPRS.

Mobile Station:

The MS is GPRS attached and in packet idle mode. PDP context 2 has been established.

Specific PICS Statements

-

PIXIT Statements

-

Test procedure

The MS is triggered to transfer an LLC PDU. The SS sends PACKET UPLINK ASSIGNMENT message containing Dynamic Allocation struct. The MS shall start to send RLC data and RLC/MAC control blocks on the allocated uplink. The SS allows the MS to send the uplink data transfer. The SS verifies the coding is the scheme specified by TLLI_BLOCK_CHANNEL_CODING, the TFI is correct and the block contains TLLI in the first RLC data blocks. After contention resolution reaction time shall the remaining RLC data blocks contain coding scheme specified by EGPRS Channel Coding Command, the TFI shall be correct and the blocks do not contain TLLI.

Maximum duration of the test

3 minutes.

Expected sequence

Step	Direction	Message	Comments
1	MS		The MS is triggered to initiate packet uplink transfer of an LLC PDU consisting of 500 octets data.
2	MS -> SS	EGPRS PACKET CHANNEL REQUEST	Received on PRACH.
2A			If the MS requests two phase access the Test Case is terminated
3	SS -> MS	PACKET UPLINK ASSIGNMENT	Dynamic allocation struct, USF_GRANULARITY = one block, Sent on PAGCH.
4	SS -> MS	PACKET DOWNLINK DUMMY CONTROL BLOCK	Sent on the PACCH of the PDCH assigned in step 3, containing USF assigned to the MS.
5	MS -> SS	UPLINK RLC DATA BLOCK	Received on the assigned PDTCH. Check that the coding is the scheme specified by TLLI_BLOCK_CHANNEL_CODING, the TFI is correct and the block contains TLLI.
6	SS		Check that there is no RLC data block transmitted by the MS in the next radio block on PDTCH.
7	SS -> MS	PACKET UPLINK ACK/NACK	Sent on the PACCH of the PDCH and containing an USF not assigned to the MS.
8	SS		Waits 3 blocks.
9	SS -> MS	PACKET DOWNLINK DUMMY CONTROL BLOCK	Sent on the PACCH of the PDCH assigned in step 3, containing USF assigned to the MS.
A9.1 (optional step)	MS -> SS	UPLINK RLC DATA BLOCK	Received on the assigned PDTCH. Check that the coding is the scheme specified by TLLI_BLOCK_CHANNEL_CODING, the TFI is correct and the block contains TLLI.
A9.2 (optional step)	SS -> MS	PACKET DOWNLINK DUMMY CONTROL BLOCK	Sent on the PACCH of the PDCH assigned in step 3, containing USF assigned to the MS.
10	MS -> SS	UPLINK RLC DATA BLOCK	Received on the assigned PDTCH. Check that if the RLC data block is received after the contention resolution reaction time the coding is the scheme specified by CHANNEL_CODING_COMMAND, the TFI is correct and the block does not contain TLLI otherwise the content should be as comments in step 5.
11	SS -> MS	PACKET UPLINK ACK/NACK	Sent on the PACCH of the PDCH assigned in step 3, containing USF assigned to the MS.
12	MS -> SS	UPLINK RLC DATA BLOCK	Received on the assigned PDTCH. Check that the coding is the scheme specified by EGPRS Channel Coding Command, the TFI is correct and the block does not contain TLLI.
13			Repeat step 11 and 12 until the countdown value CV=0 in step 12.
14	SS -> MS	PACKET UPLINK ACK/NACK	Final Ack Indicator = '1' containing valid RRBP. Sent on PACCH of the assigned PDCH.
15	MS -> SS	PACKET CONTROL ACKNOWLEDGEMENT	Received on the block specified by RRBP on PACCH of the assigned PDCH.

Specific message contents

PACKET UPLINK ASSIGNMET message in step 3:

<pre>{0 < Global TFI > 10 < TLLI > 110 < TQI > 111 < Packet Request Reference >} < EGPRS Channel Coding Command > < TLLI_BLOCK_CHANNEL_CODING ></pre>	<p>111 (Packet Request Reference, information field sent in EGPRS PACKET CHANNEL REQUEST and frame number in which EGPRS PACKET CHANNEL REQUEST was received) arbitrarily chosen but different from TLLI_BLOCK_CHANNEL_CODING MCS-1</p>
---	---

PACKET UPLINK ACK/NACK message in step 7:

{0 1< CONTENTION_RESOLUTION_TLLI > - CONTENTION_RESOLUTION_TLLI}	1 the value received in step 5.
---	------------------------------------

52.1.2.1.8.1.2 Packet Uplink Assignment / One phase access / Contention resolution / Counter N3104

52.1.2.1.8.1.2.1 Conformance requirements

The contention resolution has failed on the mobile station side when the counter N3104 reaches its maximum value, or timer T3166 expires. The contention resolution also fails, if the mobile station receives a PACKET UPLINK ACK/NACK message or in EGPRS TBF mode a PACKET UPLINK ASSIGNMENT message addressing the TFI associated with the TBF and including a TLLI value other than that the mobile station included in the RLC header of the first RLC data blocks; in such a case, the mobile station shall not transmit a PACKET CONTROL ACKNOWLEDGEMENT in the uplink radio block specified if a valid RRBP field is received as part of the PACKET UPLINK ACK/NACK message.

In case of a contention resolution failure on the mobile station side, the mobile station shall reset the counter N3104 and stop timer T3166, if not expired. The mobile station shall stop transmitting on the TBF and reinitiate the packet access procedure, unless it has already been repeated 4 times. In that case, a TBF failure has occurred.

Reference

3GPP TS 04.60 subclause 7.1.2.3.

52.1.2.1.8.1.2.2 Test purpose

To verify that the mobile station correctly sets and considers counter N3104.

NOTE: Counter N3104 is incremented by 1 with each new RLC/MAC block the mobile station sends until the first PACKET UPLINK ACK/NACK message is received.

Its maximum value is $N3104_MAX = 3 * (BS_CV_MAX + 3) * \text{no-of-timeslots-assigned}$, where BS_CV_MAX is broadcast in PSII.

52.1.2.1.8.1.2.3 Method of test

Initial conditions

System Simulator:

1 cell supporting EGPRS. The packet system information BS_CV_MAX value = 1.

Mobile Station:

The MS is GPRS attached and in packet idle mode. PDP context 2 has been established.

Specific PICS Statements

-

PIXIT Statements

-

Test procedure

The MS is triggered to initiate packet uplink transfer of an LLC PDU. The SS assigns packet uplink resources in a PACKET UPLINK ASSIGNMENT message indicating one phase packet access. The MS shall start transferring RLC data blocks.. The SS verifies that the MS stops transmitting and re-initiates the packet access procedure.

At the second attempt, the SS sends PACKET UPLINK ACK/NACK exactly after N3104_MAX - 1 data blocks. The SS verifies that this time the MS does not abort the access procedure and successfully completes uplink transfer.

Maximum duration of the test

5 minutes.

Expected sequence

Step	Direction	Message	Comments
1	MS		The MS is triggered to initiate packet uplink transfer of an LLC PDU consisting of 500 octets data.
2 2A	MS -> SS	EGPRS PACKET CHANNEL REQUEST	Received on PRACH. If the MS requests two phase access the Test Case is terminated
3	SS -> MS	PACKET UPLINK ASSIGNMENT	Indicating one phase packet access granted and MCS-1. Sent on PAGCH.
4	MS -> SS	n EGPRS RLC data blocks	SS receives n = N3104_MAX data blocks. Received on the assigned PDTCH.
5	SS		SS verifies that MS does not send further RLC data blocks.
6 6A	MS -> SS	EGPRS PACKET CHANNEL REQUEST	MS re-initiates packet access procedure. Received on PRACH. If the MS requests two phase access the Test Case is terminated
7	SS -> MS	PACKET UPLINK ASSIGNMENT	Indicating one phase packet access granted. Sent on PAGCH.
8	MS -> SS	n-1 EGPRS RLC data blocks	SS receives N3104_MAX – 1 data blocks. Received on the assigned PDTCH.
9	SS -> MS	PACKET UPLINK ACK/NACK	Sent on PACCH.
10	SS -> MS	PACKET DOWNLINK DUMMY CONTROL BLOCK	Sent at least 3 blocks after step 9. USF assigned
11		{Uplink data transfer}	Macro. Completion of the macro procedure.

Specific message contents

None.

52.1.2.1.8.1.3 Packet Uplink Assignment / One phase access / Contention resolution / Timer T3166

52.1.2.1.8.1.3.1 Conformance requirements

The contention resolution has failed on the mobile station side when the counter N3104 reaches its maximum value, or timer T3166 expires. The contention resolution also fails, if the mobile station receives a PACKET UPLINK ACK/NACK message or in EGPRS TBF mode a PACKET UPLINK ASSIGNMENT message addressing the TFI associated with the TBF and including a TLLI value other than that the mobile station included in the RLC header of the first RLC data blocks ; in such a case, the mobile station shall not transmit a PACKET CONTROL ACKNOWLEDGEMENT in the uplink radio block specified if a valid RRBp field is received as part of the PACKET UPLINK ACK/NACK message.

In case of a contention resolution failure on the mobile station side, the mobile station shall reset the counter N3104 and stop timer T3166, if not expired. The mobile station shall stop transmitting on the TBF and reinitiate the packet access procedure, unless it has already been repeated 4 times. In that case, a TBF failure has occurred.

Reference

3GPP TS 04.60 subclause 7.1.2.3.

52.1.2.1.8.1.3.2 Test purpose

To verify that the mobile station correctly considers timer T3166.

52.1.2.1.8.1.3.3 Method of test

Initial conditions

System Simulator:

1 cell supporting EGPRS. BS_CV_MAX value = 15.

Mobile Station:

The MS is GPRS attached and in packet idle mode. PDP context 2 has been established.

Specific PICS Statements

-

PIXIT Statements

-

Foreseen final state of the MS

Packet idle mode.

Test procedure

The MS is triggered to initiate packet uplink transfer of an LLC PDU. The SS assigns packet uplink resources in a PACKET UPLINK ASSIGNMENT message indicating one phase packet access. The MS shall start transferring RLC data blocks. The SS reduces the block transfer rate by controlling the USF flag. In this way, the SS forces T3166 (with value 5 s.) to expire before counter N3104 reaches N3104_MAX (with value 45 blocks for current settings). The SS verifies that the MS stops transmitting and re-initiates the packet access procedure.

At the second attempt, the SS sends PACKET UPLINK ACK/NACK before T3166 expire. The SS verifies that this time the MS does not abort the access procedure and successfully completes the data transfer.

Maximum duration of the test

5 minutes.

Expected sequence

Step	Direction	Message	Comments
1	MS		The MS is triggered to initiate packet uplink transfer of an LLC PDU consisting of 1000 octets data.
2	MS -> SS	EGPRS PACKET CHANNEL REQUEST	Received on PRACH.
2A			If the MS requests two phase access the Test Case is terminated
3	SS -> MS	PACKET UPLINK ASSIGNMENT	Indicating one phase packet access granted, MCS-1 shall be used and USF_GRANULARITY = one block. Sent on PAGCH.
4	SS -> MS	PACKET DOWNLINK DUMMY CONTROL BLOCK	USF addressing the MS. Sent on PACCH of PDCH assigned in step 3.
5	MS -> SS	RLC data block	Received on the assigned PDTCH.
6	SS -> MS	PACKET DOWNLINK DUMMY CONTROL BLOCK	USF not addressing the MS. Sent on PACCH.
7	SS -> MS	PACKET DOWNLINK DUMMY CONTROL BLOCK	USF not addressing the MS. Sent on PACCH.
8	SS -> MS	PACKET DOWNLINK DUMMY CONTROL BLOCK	USF not addressing the MS. Sent on PACCH.
9	SS -> MS	PACKET DOWNLINK DUMMY CONTROL BLOCK	USF not addressing the MS. Sent on PACCH.
10	SS -> MS	PACKET DOWNLINK DUMMY CONTROL BLOCK	USF not addressing the MS. Sent on PACCH.
11	SS -> MS	PACKET DOWNLINK DUMMY CONTROL BLOCK	USF not addressing the MS. Sent on PACCH.
12	SS -> MS	PACKET DOWNLINK DUMMY CONTROL BLOCK	USF not addressing the MS. Sent on PACCH.
13	SS -> MS	PACKET DOWNLINK DUMMY CONTROL BLOCK	USF not addressing the MS. Sent on PACCH.
14	SS -> MS	PACKET DOWNLINK DUMMY CONTROL BLOCK	USF not addressing the MS. Sent on PACCH.
15	SS -> MS	PACKET DOWNLINK DUMMY CONTROL BLOCK	USF not addressing the MS. Sent on PACCH.
16	SS -> MS	PACKET DOWNLINK DUMMY CONTROL BLOCK	USF not addressing the MS. Sent on PACCH.
17	MS<->SS		Steps 4 to 16 are repeated at most 22 times or until MS does not send further RLC data blocks at step 5. Note: steps 4 to 16 transfer one block every 52 frames, or 240 ms. 22 repetitions require about 5.5 s. (Timer T3166 shall expire).
19	MS -> SS	EGPRS PACKET CHANNEL REQUEST	MS re-initiates packet access procedure. Received on PRACH.
19A			If the MS requests two phase access the Test Case is terminated
20	SS -> MS	PACKET UPLINK ASSIGNMENT	Indicating one phase packet access granted, MCS-1 shall be used and USF_GRANULARITY = one block. Sent on PAGCH.
21	MS<->SS		Steps 4 to 16 are repeated 17 times. Note: 17 repetitions require about 4.3 s. (Timer T3166 should not expire).
22	SS -> MS	PACKET UPLINK ACK/NACK	Sent on PACCH. USF Assigned.
23		{Uplink data transfer}	Macro. Completion of the TBF procedure.

52.1.2.1.8.1.4 Packet Uplink Assignment / One phase access / Contention resolution / TLLI mismatch

52.1.2.1.8.1.4.1 Conformance requirements

The contention resolution has failed on the mobile station side when the counter N3104 reaches its maximum value, or timer T3166 expires. The contention resolution also fails, if the mobile station receives a PACKET UPLINK ACK/NACK message or in EGPRS TBF mode a PACKET UPLINK ASSIGNMENT message addressing the TFI associated with the TBF and including a TLLI value other than that the mobile station included in the RLC header of the first RLC data blocks ; in such a case, the mobile station shall not transmit a PACKET CONTROL ACKNOWLEDGEMENT in the uplink radio block specified if a valid RRBP field is received as part of the PACKET UPLINK ACK/NACK message.

In case of a contention resolution failure on the mobile station side, the mobile station shall reset the counter N3104 and stop timer T3166, if not expired. The mobile station shall stop transmitting on the TBF and reinitiate the packet access procedure, unless it has already been repeated 4 times. In that case, a TBF failure has occurred.

Reference

3GPP TS 04.60 subclause 7.1.2.3.

52.1.2.1.8.1.4.2 Test purpose

To verify that the mobile station reinitiates packet access when it receives a PACKET UPLINK ACK/NACK message with the correct TFI but with a TLLI other than the mobile station has included in the RLC header.

52.1.2.1.8.1.4.3 Method of test

Initial conditions

System Simulator:

1 cell supporting EGPRS.

Mobile Station:

The MS is GPRS attached and in packet idle mode. PDP context 2 has been established.

Specific PICS Statements

-

PIXIT Statements

-

Test procedure

The MS is triggered to initiate packet uplink transfer of an LLC PDU. The SS assigns packet uplink resources in a PACKET UPLINK ASSIGNMENT message indicating one phase packet access. The MS shall start transferring RLC data block after SS has assigned USF to the MS. The SS acknowledges the RLC block transfer with a PACKET UPLINK ACK/NACK including correct TFI and incorrect TLLI. The SS continue to assign USF to the MS. The SS shall verify that the MS immediately stops transmitting (see note below) and retries packet access procedure.

At the second attempt, the SS sends PACKET UPLINK ACK/NACK including a correct TLLI. The SS verifies that this time the MS does not abort the access procedure and successfully completes the data transfer.

NOTE: A mobile station, receiving a commanding message in block number N, shall take an "immediate" action as a result of the command, starting in any block from block number N+1 to N+6 (inclusive).

Maximum duration of the test

5 minutes.

Expected sequence

Step	Direction	Message	Comments
1	MS		The MS is triggered to initiate packet uplink transfer of an LLC PDU consisting of 200 octets data.
2 2A	MS -> SS	EGPRS PACKET CHANNEL REQUEST	Received on PRACH. If the MS requests two phase access the Test Case is terminated
3	SS -> MS	PACKET UPLINK ASSIGNMENT	Indicating one phase packet access granted, dynamic allocation struct and USF_GRANULARITY = one block. Sent on PAGCH.
4	SS -> MS	PACKET DOWNLINK DUMMY CONTROL BLOCK	Contained USF assigned to the MS.
5	MS -> SS	UPLINK RLC DATA BLOCK	Received on the assigned PDTCH.
6	SS -> MS	PACKET UPLINK ACK/NACK	Assign USF to the MS, include correct TFI and incorrect TLLI. Sent on PACCH.
7	SS -> MS	PACKET DOWNLINK DUMMY CONTROL BLOCK	Execute step 7 six times (see the note below) with USF assigned to the MS or until the MS sends EGPRS Packet Channel request in step 8. The SS verifies that the MS does not transmit more than 6 uplink RLC data block after step 6 and before step 8. NOTE: The first blocks sent in this step should be sent on the block following the message sent in step 6, while other repetition should be on the consecutive blocks.
8 8A	MS -> SS	EGPRS PACKET CHANNEL REQUEST	MS re-initiates packet access procedure. Received on PRACH. If the MS requests two phase access the Test Case is terminated
9	SS -> MS	PACKET UPLINK ASSIGNMENT	Indicating one phase packet access granted, dynamic allocation struct and USF_GRANULARITY = one block. Sent on PAGCH.
10	SS -> MS	PACKET DOWNLINK DUMMY CONTROL BLOCK	Contained USF assigned to the MS.
11	MS -> SS	UPLINK RLC DATA BLOCK	Received on the assigned PDTCH.
12	SS -> MS	PACKET UPLINK ACK/NACK	Including correct TLLI. Sent on PACCH. USF Assigned.
13		{Uplink data transfer}	Macro. Completion of the TBF procedure.

52.1.2.1.8.1.5 Packet Uplink Assignment / One phase access / Contention resolution / 3 or 4 access repetition attempts

52.1.2.1.8.1.5.1 Conformance requirement

The contention resolution has failed on the mobile station side when the counter N3104 reaches its maximum value, or timer T3166 expires. The contention resolution also fails, if the mobile station receives a PACKET UPLINK ACK/NACK message or in EGPRS TBF mode a PACKET UPLINK ASSIGNMENT message addressing the TFI associated with the TBF and including a TLLI value other than that the mobile station included in the RLC header of the first RLC data blocks ; in such a case, the mobile station shall not transmit a PACKET CONTROL ACKNOWLEDGEMENT in the uplink radio block specified if a valid RRBP field is received as part of the PACKET UPLINK ACK/NACK message.

In case of a contention resolution failure on the mobile station side, the mobile station shall reset the counter N3104 and stop timer T3166, if not expired. The mobile station shall stop transmitting on the TBF and reinitiate the packet access procedure, unless it has already been repeated 3 or 4 times. In that case, a TBF failure has occurred.

Reference

3GPP TS 04.60 subclause 7.1.2.3.

52.1.2.1.8.1.5.2 Test purpose

To verify that the mobile station repeats the packet access initiation 3 or 4 times.

52.1.2.1.8.1.5.3 Method of test

Initial conditions

System Simulator:

1 cell supporting EGPRS.

Mobile Station:

The MS is GPRS attached and in packet idle mode. PDP context 2 has been established.

Specific PICS Statements

-

PIXIT Statements

-

Test procedure

The MS is triggered to initiate packet uplink transfer of an LLC PDU. The SS assigns packet uplink resources in a PACKET UPLINK ASSIGNMENT message indicating one phase packet access. The MS shall start transferring RLC data blocks after SS has assigned USF to the MS. The SS acknowledges the RLC block transfer with a PACKET UPLINK ACK/NACK including a TLLI not corresponding to the MS. The SS shall verify that the MS stops transmitting blocks and reinitiates packet access. This test sequence shall be repeated three or four times.

Maximum duration of the test

5 minutes.

Expected sequence

Step	Direction	Message	Comments
1	MS		The MS is triggered to initiate packet uplink transfer of an LLC PDU consisting of 200 octets data.
2 2A	MS -> SS	EGPRS PACKET CHANNEL REQUEST	Received on PRACH. If the MS requests two phase access the Test Case is terminated
3	SS -> MS	PACKET UPLINK ASSIGNMENT	Indicating one phase packet access granted, dynamic allocation struct and USF_GRANULARITY = one block. Sent on PAGCH.
4	SS -> MS	PACKET DOWNLINK DUMMY CONTROL BLOCK	Contained USF assigned to the MS.
5	MS -> SS	UPLINK RLC DATA BLOCK	Received on the assigned PDTCH.
6	SS -> MS	PACKET UPLINK ACK/NACK	USF not assigned to the MS, include a incorrect TLLI. Sent on PACCH.
7	SS		The SS verifies that the MS reinitiates the packet access procedure from step 2 three or four times.

Specific message contents

None.

52.1.2.1.8.1.6 Packet Uplink Assignment / One phase access / Contention resolution / Retransmission / Inclusion of TLLI in RLC data blocks after completion

52.1.2.1.8.1.6.1 Conformance requirements

The TLLI is used to uniquely identify the mobile station when sending on uplink. Every RLC data block that is sent on the TBF shall include the TLLI of the mobile station, until the contention resolution is completed on the mobile station side. If MCS-7, MCS-8 or MCS-9 is used for the transmission of the TLLI in EGPRS TBF mode (i.e., the RLC/MAC block is carrying two RLC data blocks), the TLLI shall be inserted in both RLC data blocks. The TLLI shall also be included in the PACKET RESOURCE REQUEST and the ADDITIONAL MS RADIO ACCESS CAPABILITIES messages, if those are sent during the contention resolution.

The retransmission of an RLC data block shall include the TLLI (or the TLLI and the PFI field), if the RLC data block was originally transmitted including these fields, also if the retransmission occurs after the completion of the contention resolution.

Reference

3GPP TS 04.60 subclauses 7.1.2.3

3GPP TS 05.10 subclause 6.11.3

52.1.2.1.8.1.6.2 Test purpose

To verify that during one phase access the retransmitted RLC data blocks of an uplink TBF include TLLI field if the RLC data block was originally transmitted including these fields, even after contention resolution is successfully completed.

52.1.2.1.8.1.6.3 Method of test

Initial conditions

System Simulator:

1 cell supporting EGPRS.

Mobile Station:

The MS is GPRS attached and in packet idle mode. PDP context 2 has been established.

Specific PICS Statements

-

PIXIT Statements

-

Test procedure

The MS is triggered to transfer 500 octets of data. In response to EGPRS PACKET CHANNEL REQUEST sent by the MS, the SS sends PACKET UPLINK ASSIGNMENT message containing Dynamic Allocation struct.

SS allocate resources to the MS to transfer 6 RLC data blocks. SS verifies that all the data blocks contain TLLI field. SS sends a Packet Uplink Ack/Nack acknowledging last three RLC data blocks and negatively acknowledging the first three RLC data blocks.

SS verifies MS includes TLLI field in the retransmitted RLC data blocks and that the new RLC data blocks do not contain TLLI field.

Maximum duration of the test

5 minutes.

Expected sequence

Step	Direction	Message	Comments
1	MS		The MS is triggered transfer 500 octets data.
2	MS -> SS	EGPRS PACKET CHANNEL REQUEST	Received on PRACH.
2A			If the MS requests two phase access the test is terminated
3	SS -> MS	PACKET UPLINK ASSIGNMENT	Dynamic allocation struct, USF_GRANULARITY = one block, Sent on PAGCH.
4	SS -> MS	PACKET DOWNLINK DUMMY CONTROL BLOCK	Sent on the PACCH of the PDCH assigned in step 3, containing USF assigned to the MS.
5	MS -> SS	EGPRS UPLINK RLC DATA BLOCK	Received on the assigned PDTCH. Check that the coding is the scheme specified by TLLI_BLOCK_CHANNEL_CODING, the TFI is correct and the block contains TLLI.
6	-		Repeat Step 4 & 5 five times.
7	SS		Wait for BS_CV_MAX block periods after receiving the last EGPRS RLC Data Block.
8	SS -> MS	PACKET UPLINK ACK/NACK	Sent on the PACCH of the PDCH assigned. SS acknowledges BSN=3,4 and 5 and negatively acknowledges BSN=0,1 and 2.
9	SS -> MS	PACKET DOWNLINK DUMMY CONTROL BLOCK	Sent on the PACCH of the PDCH assigned in step 3, containing USF assigned to the MS. Sent after 6 blocks of sending the message in step 8.
10A (optional)	MS -> SS	EGPRS UPLINK RLC DATA BLOCK	The MS may send a new EGPRS RLC Data Block already in the transmit buffer
10B (optional)	SS -> MS	PACKET DOWNLINK DUMMY CONTROL BLOCK	If optional step 10A is received. Sent on the PACCH of the PDCH assigned in step 3, USF assigned to the MS.
10	MS -> SS	EGPRS UPLINK RLC DATA BLOCK	Received on the assigned PDTCH. Check that MS retransmits data block with BSN=0 and that the data block contains the correct TLLI.
11	-		Repeat Steps 9 & 10 two times. Verify that MS retransmits data blocks with BSN=1 and BSN=2 and that both the data blocks contain correct TLLI
12	SS -> MS	PACKET DOWNLINK DUMMY CONTROL BLOCK	Sent on the PACCH of the PDCH assigned in step 3, containing USF assigned to the MS.
13	MS -> SS	EGPRS UPLINK RLC DATA BLOCK	Received on the assigned PDTCH. If optional step 10A was not received, check that MS transmits new RLC data block with BSN=6 . Else check that MS transmits new RLC data block with BSN=7 Check that the data block does not contain TLLI and the RLC Data block contains the correct TFI.
14		{Completion of uplink RLC data block transfer}	

Specific message contents

PACKET UPLINK ASSIGNMENT message in step 3:

{0 < Global TFI > 10 < TLLI > 110 < TQI > 111 < Packet Request Reference >}	111 (Packet Request Reference, information field sent in EGPRS PACKET CHANNEL REQUEST and frame number in which EGPRS PACKET CHANNEL REQUEST was received)
< EGPRS Channel Coding Command >	MCS-2
< TLLI_BLOCK_CHANNEL_CODING >	1

PACKET UPLINK ACK/NACK message in step 8:

{0 1< CONTENTION_RESOLUTION_TLLI > - CONTENTION_RESOLUTION_TLLI}	1 the value received in step 5.
---	------------------------------------

52.1.2.1.8.1.7 Packet Uplink Assignment / One phase access / Contention resolution / MCS-7 to MCS-9 / Inclusion of TLLI in both RLC data blocks

52.1.2.1.8.1.7.1 Conformance requirements

The TLLI is used to uniquely identify the mobile station when sending on uplink. Every RLC data block that is sent on the TBF shall include the TLLI of the mobile station, until the contention resolution is completed on the mobile station side. If MCS-7, MCS-8 or MCS-9 is used for the transmission of the TLLI in EGPRS TBF mode (i.e., the RLC/MAC block is carrying two RLC data blocks), the TLLI shall be inserted in both RLC data blocks. The TLLI shall also be included in the PACKET RESOURCE REQUEST and the ADDITIONAL MS RADIO ACCESS CAPABILITIES messages, if those are sent during the contention resolution.

Reference

3GPP TS 04.60 subclauses 7.1.2.3

3GPP TS 05.10 subclause 6.11.3

52.1.2.1.8.1.7.2 Test purpose

To verify that during one phase access, if MCS-7, MCS-8 or MCS-9 is used for transmission of TLLI, the TLLI field is included in both RLC data blocks of the radio block.

52.1.2.1.8.1.7.3 Method of test

Initial conditions

System Simulator:

1 cell supporting EGPRS.

Mobile Station:

The MS is GPRS attached and in packet idle mode. PDP context 2 has been established.

Specific PICS Statements

-

PIXIT Statements

-

Test procedure

The MS is triggered to transfer 1000 octets of data. In response to EGPRS PACKET CHANNEL REQUEST sent by the MS, the SS sends PACKET UPLINK ASSIGNMENT message containing Dynamic Allocation struct. EGPRS Channel Coding commanded is MCS-9, MCS-8 and MCS-7 respectively for each repetition. TLLI_BLOCK_CHANNEL_CODING is 1.

SS allocate resources to the MS to transfer RLC data blocks.

SS verifies that TLLI is included in both the RLC Data block contained in each radio block until contention resolution is successfully completed.

Maximum duration of the test

5 minutes.

Expected sequence

The test sequence is executed three times.

Step	Direction	Message	Comments
1	MS		The MS is triggered transfer 1000 octets data.
2	MS -> SS	EGPRS PACKET CHANNEL REQUEST	Received on PRACH.
2A			If the MS requests two phase access the test is terminated
3	SS -> MS	PACKET UPLINK ASSIGNMENT	Dynamic allocation struct, USF_GRANULARITY = one block, Sent on PAGCH.
4	SS -> MS	PACKET DOWNLINK DUMMY CONTROL BLOCK	Sent on the PACCH of the PDCH assigned in step 3, containing USF assigned to the MS.
5	MS -> SS	EGPRS UPLINK RLC DATA BLOCK	Received on the assigned PDTCH. Check that the coding scheme is as specified by TLLI_BLOCK_CHANNEL_CODING, the TFI is correct and both the RLC Data Blocks contain the correct TLLI.
6	-		Repeat Step 4 & 5 three times.
7	SS		Wait for BS_CV_MAX block periods after receiving the last EGPRS RLC Data Block.
8	SS -> MS	PACKET UPLINK ACK/NACK	Sent on the PACCH of the PDCH assigned. SS acknowledges all the data blocks.
9	SS -> MS	PACKET DOWNLINK DUMMY CONTROL BLOCK	Sent on the PACCH of the PDCH assigned in step 3, containing USF assigned to the MS.
10A (optional)	MS -> SS	EGPRS UPLINK RLC DATA BLOCK	The MS may send a new EGPRS RLC Data Block already in the transmit buffer
10B (optional)	SS -> MS	PACKET DOWNLINK DUMMY CONTROL BLOCK	If optional step 10A is received. Sent on the PACCH of the PDCH assigned in step 3, USF assigned to the MS.
10	MS -> SS	EGPRS UPLINK RLC DATA BLOCK	Received on the assigned PDTCH. Check that BSN=8 of the received data block if optional step 10A was not received, or BSN=10 if optional step 10A was received
			Check that the data block does not contain TLLI and the TFI is correct
11		{Completion of uplink RLC data block transfer}	

Specific message contents

PACKET UPLINK ASSIGNMENT message in step 3: for first execution

{0 < Global TFI > 10 < TLLI > 110 < TQI > 111 < Packet Request Reference >}	111 (Packet Request Reference, information field sent in EGPRS PACKET CHANNEL REQUEST and frame number in which EGPRS PACKET CHANNEL REQUEST was received)
< EGPRS Channel Coding Command >	MCS-9
< TLLI_BLOCK_CHANNEL_CODING >	1

PACKET UPLINK ASSIGNMENT message in step 3: for second execution

{0 < Global TFI > 10 < TLLI > 110 < TQI > 111 < Packet Request Reference >}	111 (Packet Request Reference, information field sent in EGPRS PACKET CHANNEL REQUEST and frame number in which EGPRS PACKET CHANNEL REQUEST was received)
< EGPRS Channel Coding Command >	MCS-8
< TLLI_BLOCK_CHANNEL_CODING >	1

PACKET UPLINK ASSIGNMENT message in step 3: for third execution

{0 < Global TFI > 10 < TLLI > 110 < TQI > 111 < Packet Request Reference >}	111 (Packet Request Reference, information field sent in EGPRS PACKET CHANNEL REQUEST and frame number in which EGPRS PACKET CHANNEL REQUEST was received)
< EGPRS Channel Coding Command > < TLLI_BLOCK_CHANNEL_CODING >	MCS-7 1

PACKET UPLINK ACK/NACK message in step 8

{0 1< CONTENTION_RESOLUTION_TLLI > - CONTENTION_RESOLUTION_TLLI}	1 the value received in step 5.
---	------------------------------------

52.1.2.1.8.1.8 Packet Uplink Assignment / One phase access / Contention resolution / TLLI in Packet Resource Request message retransmission

52.1.2.1.8.1.8.1 Conformance requirements

The mobile station shall provide the network with its radio access capabilities for the frequency bands it supports, in the same priority order as the one specified by the network, by sending a PACKET RESOURCE REQUEST message, and an ADDITIONAL MS RADIO ACCESS CAPABILITIES if all the requested informations do not fit in the PACKET RESOURCE REQUEST.

The TLLI shall also be included in the PACKET RESOURCE REQUEST and the ADDITIONAL MS RADIO ACCESS CAPABILITIES messages, if those are sent during the contention resolution.

The PACKET RESOURCE REQUEST and the ADDITIONAL MS RADIO ACCESS CAPABILITIES messages shall be sent within the one or two first radio blocks allocated for the mobile station on the assigned PDCH.

The mobile station shall include the TLLI in these two messages until contention resolution. After that, the mobile station may use either the uplink TFI or the TLLI when these messages are repeated.

The network may request a retransmission of the PACKET RESOURCE REQUEST and the ADDITIONAL MS RADIO ACCESS CAPABILITIES messages. A request for retransmission of one or both of these messages shall be indicated in the PACKET UPLINK ACK/NACK message. The mobile station has to indicate within the PACKET RESOURCE REQUEST if the message is a retransmitted one.

Reference

3GPP TS 04.60 subclauses 7.1.2.2.1a, 7.1.2.3 and 7.1.3.2.

52.1.2.1.8.1.8.2 Test purpose

To verify that the MS includes TLLI in both PACKET RESOURCE REQUEST message, and ADDITIONAL MS RADIO ACCESS CAPABILITIES, if it is present, during contention resolution.

To verify that the mobile responds correctly for a request for retransmission of one or both of these messages indicated in the PACKET UPLINK ACK/NACK message.

To verify that the mobile station includes TLLI in these messages if the SS request a retransmission of these two messages before contention resolution.

To verify that the mobile station may either include TLLI or TFI in these messages if the SS request a retransmission of these two messages after contention resolution.

52.1.2.1.8.1.8.3 Method of test

Initial conditions

System Simulator:

1 cell supporting EGPRS.

Mobile Station:

The MS is GPRS attached and in packet idle mode. PDP context 2 has been established.

Specific PICS Statements

-

PIXIT Statements

-

Test procedure

The MS is triggered to transfer 500 octets of data. In response to EGPRS PACKET CHANNEL REQUEST sent by the MS, the SS sends PACKET UPLINK ASSIGNMENT message containing Dynamic Allocation struct and requesting Radio Access Capabilities of all frequency bands.

Note: The SS shall request only one band, either GSM 1800 or GSM 1900.

The SS allocates uplink resources for the MS to transfer data.

The MS shall then provide its radio access capabilities for the frequency bands it supports by sending PACKET RESOURCE REQUEST message and optionally an ADDITIONAL MS RADIO ACCESS CAPABILITIES message if all the if all the requested information do not fit in the PACKET RESOURCE REQUEST in the first one or two radio blocks allocated for the mobile station on the assigned PDCH.

After receiving some data blocks, the SS responds with PACKET UPLINK ACK/NACK message, without including a CONTENTION_RESOLUTION_TLLI and requesting retransmission of sending PACKET RESOURCE REQUEST and optionally ADDITIONAL MS RADIO ACCESS CAPABILITIES message, if it was sent by the mobile.

The SS verifies that the mobile retransmit the PACKET RESOURCE REQUEST and optionally ADDITIONAL MS RADIO ACCESS CAPABILITIES message, if applicable, including the TLLI field.

The SS responds with PACKET UPLINK ACK/NACK message, with a correct CONTENTION_RESOLUTION_TLLI and requesting retransmission of sending PACKET RESOURCE REQUEST and optionally ADDITIONAL MS RADIO ACCESS CAPABILITIES message, if it was sent by the mobile.

The SS verifies that the mobile retransmit the PACKET RESOURCE REQUEST and optionally ADDITIONAL MS RADIO ACCESS CAPABILITIES message, if applicable, including either the TLLI field or the TFI field.

Maximum duration of the test

5 minutes.

Expected sequence

Step	Direction	Message	Comments
1	MS		The MS is triggered to initiate packet uplink transfer of 500 octets data.
2	MS -> SS	EGPRS PACKET CHANNEL REQUEST	Received on PRACH.
2A			If the MS requests two phase access the test is terminated
3	SS -> MS	PACKET UPLINK ASSIGNMENT	Dynamic Allocation struct. Requesting the mobile to send Radio Access Capability of all frequency bands. See specific message contents.
4	SS -> MS	PACKET DOWNLINK DUMMY CONTROL BLOCK	Sent on the PACCH of the PDCH assigned in step 3, containing USF assigned to the MS.
5	MS -> SS	PACKET RESOURCE REQUEST	Verify that the message include TLLI. Received on the assigned PDTCH in step 4.
6a (conditional)	SS -> MS	PACKET DOWNLINK DUMMY CONTROL BLOCK	If <ADDITIONAL MS RAC INFORMATION AVAILABLE> field in the received PACKET RESOURCE REQUEST message indicates 1, sent on the PACCH of the PDCH assigned in step 3, containing USF assigned to the MS.
6b (conditional)	MS -> SS	ADDITIONAL MS RADIO ACCESS CAPABILITIES	Received on the assigned PDTCH in Step 6a. Verify that the message include TLLI.
6	SS -> MS	PACKET DOWNLINK DUMMY CONTROL BLOCK	Sent on the PACCH of the PDCH assigned in step 3, containing USF assigned to the MS.
7	MS -> SS	EGPRS UPLINK RLC DATA BLOCK	Received on the assigned PDTCH. the RLC Data Blocks contain TLLI.
			Repeat steps 6 & 7 three times.
8	SS -> MS	PACKET UPLINK ACK/NACK	Sent on PACCH of the assigned PDCH, BS_CV_MAX block periods after Step 7. Negatively acknowledge all blocks. CONTENTION_RESOLUTION_TLLI field not present. Requesting retransmission of PACKET RESOURCE REQUEST and ADDITIONAL MS RADIO ACCESS CAPABILITIES, if received in step 6b.
9	SS -> MS	PACKET DOWNLINK DUMMY CONTROL BLOCK	Sent on the PACCH of the PDCH assigned in step 3, containing USF assigned to the MS.
10a (Optional)	MS -> SS	EGPRS UPLINK RLC DATA BLOCK	The MS may send a data block already queued in the transmit buffer. Received on the assigned PDTCH. the RLC Data Blocks contain TLLI.
10b (Optional)	SS -> MS	PACKET DOWNLINK DUMMY CONTROL BLOCK	Sent on the PACCH of the PDCH assigned in step 3, containing USF assigned to the MS.
10	MS -> SS	PACKET RESOURCE REQUEST	Verify that the message include TLLI. Received on the assigned PDTCH.
11a (conditional)	SS -> MS	PACKET DOWNLINK DUMMY CONTROL BLOCK	If <ADDITIONAL MS RAC INFORMATION AVAILABLE> field in the received PACKET RESOURCE REQUEST message indicates 1, sent on the PACCH of the PDCH assigned in step 3, containing USF assigned to the MS.
11b (conditional)	MS -> SS	ADDITIONAL MS RADIO ACCESS CAPABILITIES	Received on the assigned PDTCH in Step 11a. Verify that the message include TLLI.
11	SS -> MS	PACKET UPLINK ACK/NACK	Positively acknowledge all blocks. CONTENTION_RESOLUTION_TLLI field including the TLLI as received in the PACKET RESOURCE REQUEST. Requesting retransmission of PACKET RESOURCE REQUEST and ADDITIONAL MS RADIO ACCESS CAPABILITIES, if received in step 11b.
12	SS -> MS	PACKET DOWNLINK DUMMY CONTROL BLOCK	Sent on the PACCH of the PDCH assigned in step 3, containing USF assigned to the MS.
13a (Optional)	MS -> SS	EGPRS UPLINK RLC DATA BLOCK	The MS may send a data block already queued in the transmit buffer. Received on the assigned PDTCH.

13b (Optional)	SS -> MS	PACKET DOWNLINK DUMMY CONTROL BLOCK	Sent on the PACCH of the PDCH assigned in step 3, containing USF assigned to the MS.
13	MS -> SS	PACKET RESOURCE REQUEST	Verify that the message include either the TFI or TLLI. Received on the assigned PDTCH.
14a (conditional)	SS -> MS	PACKET DOWNLINK DUMMY CONTROL BLOCK	If <ADDITIONAL MS RAC INFORMATION AVAILABLE> field in the received PACKET RESOURCE REQUEST message indicates 1, sent on the PACCH of the PDCH assigned in step 3, containing USF assigned to the MS.
14b (conditional)	MS -> SS	ADDITIONAL MS RADIO ACCESS CAPABILITIES	Received on the assigned PDTCH in Step 14a. Verify that the message include either the TFI or TLLI.
14		{Completion of uplink RLC data block transfer}	

Specific message contents

PACKET UPLINK ASSIGNMENT message in Step 3.

BCCH band is GSM 1900:

{ 0 1 < Access Technologies Request}	1 (Present)
Access Technology Type	0000
Access Technology Type	0001
Access Technology Type	0010
Access Technology Type	0100
Access Technology Type	0101
Access Technology Type	0110
Access Technology Type	0111

All other BCCH bands:

{ 0 1 < Access Technologies Request}	1 (Present)
Access Technology Type	0000
Access Technology Type	0001
Access Technology Type	0010
Access Technology Type	0011
Access Technology Type	0101
Access Technology Type	0110
Access Technology Type	0111

PACKET UPLINK ACK/NACK message in Step 8.

PRR RETRANSMISSION REQUEST	1
ARAC RETRANSMISSION REQUEST	1 (If message was received in Step 6b) 0 (If message was not received on Step 6b)
{0 1< CONTENTION_RESOLUTION_TLLI >}	0

PACKET UPLINK ACK/NACK message in Step 11.

PRR RETRANSMISSION REQUEST	1
ARAC RETRANSMISSION REQUEST	1 (If message was received in Step 11b) 0 (If message was not received on Step 11b)
{0 1< CONTENTION_RESOLUTION_TLLI >}	1
CONTENTION_RESOLUTION_TLLI	Include the TLLI as received in PACKET RESOURCE REQUEST

- 52.1.2.1.8.2 Packet Uplink Assignment / One phase access / Timing Advance
- 52.1.2.1.8.2.1 Packet Uplink Assignment / One phase access / Timing Advance / TA Index present
- 52.1.2.1.8.2.1.1 Conformance requirements

If a Timing Advance Index is included in the assignment message, the mobile station shall use the continuous update timing advance mechanism, using its allocation on PTCCH (see 3GPP TS 05.10).

Reference

3GPP TS 04.60 subclause 7.1.2.5.

3GPP TS 03.64 subclause 6.5.7.2.

52.1.2.1.8.2.1.2 Test purpose

To verify that the mobile station uses the continuous update timing advance mechanism and sends access bursts on the PTCCH slots as determined by the Timing Advance Index sent in the PACKET UPLINK ASSIGNMENT message.

52.1.2.1.8.2.1.3 Method of test

Initial conditions

System Simulator:

1 cell supporting EGPRS. The packet system information ACCESS_BURST_TYPE indicates 8 bit access.

Mobile Station:

The MS is GPRS attached and in packet idle mode. PDP context 2 has been established.

Specific PICS Statements

-

PIXIT Statements

-

Test procedure

The MS is triggered to initiate uplink data packet transfer. The SS responds with PACKET UPLINK ASSIGNMENT message indicating one phase access and containing a Timing Advance Index. The MS shall start to send data on the allocated uplink. The SS allows the MS to send the uplink data transfer. During the Uplink data transfer, the SS shall verify that the access bursts are sent correctly by the MS in the PTCCH.

Maximum duration of the test

2 minutes.

Expected sequence

Step	Direction	Message	Comments
1	MS		The MS is triggered to initiate packet uplink transfer of an LLC PDU consisting of 500 octets data.
2 2A	MS -> SS	EGPRS PACKET CHANNEL REQUEST	Received on PRACH. If the MS requests two phase access the Test Case is terminated
3	SS -> MS	PACKET UPLINK ASSIGNMENT	Including Timing Advance Index = 0, Dynamic allocation struct. Sent on PAGCH.
4	SS -> MS	PACKET DOWNLINK DUMMY CONTROL BLOCK	Sent on the PACCH, 3 blocks from the last radio block containing the uplink assignment, USF assigned to the MS.
5	MS -> SS	UPLINK RLC DATA BLOCK	Containing TLLI in the RLC/MAC header.
6	SS -> MS	PACKET UPLINK ACK/NACK	Sent on the PACCH, containing correct TLLI. USF assigned.
7		{Uplink data transfer}	Macro. Completion of the TBF procedure. Verification, see below.

Verification

During the uplink data transfer (step 4-7) the SS monitors the access burst on PTCCH which are located on slots with numbers FN, such that $(FN \bmod (8*52)) = 12$ for Timing Advance Index = 0 (3GPP TS 03.64/6.5.7.2 and 3GPP TS 05.02 table 6). The access burst contents shall be MESSAGE_TYPE = 011111 and CTRL_ACK = 11.

The test is repeated with an arbitrarily chosen Timing Advance Index in the range 1 to 15. SS shall verify that the access burst are sent in the correct idle slots as specified in 3GPP TS 05.02 table 6.

Specific message contents

None.

52.1.2.1.8.2.2 Packet Uplink Assignment / One phase access / Timing Advance / TA Index not present

52.1.2.1.8.2.2.1 Conformance requirements

If a Timing Advance Index is included in the assignment message, the mobile station shall use the continuous update timing advance mechanism, using its allocation on PTCCH (see 3GPP TS 05.10). Otherwise, the continuous update timing advance mechanism shall not be used.

Reference

3GPP TS 04.60 subclause 7.1.2.5.

52.1.2.1.8.2.2.2 Test purpose

To verify that the mobile station does not send any access bursts on the PTCCH if Timing Advance Index is not present in the PACKET UPLINK ASSIGNMENT message.

52.1.2.1.8.2.2.3 Method of test

Initial conditions

System Simulator:

1 cell supporting EGPRS.

Mobile Station:

The MS is GPRS attached and in packet idle mode. PDP context 2 has been established.

Specific PICS Statements

-

PIXIT Statements

-

Test procedure

The MS is triggered to initiate uplink data transfer. The SS responds with PACKET UPLINK ASSIGNMENT message that request one phase access and not including a Timing Advance Index. The MS shall start to send data on the allocated uplink. The SS allows the MS to send the uplink data transfer. During the uplink data transfer, the SS shall verify that the MS not send any access bursts on PTCCH.

Maximum duration of the test

2 minutes.

Expected sequence

Step	Direction	Message	Comments
1	MS		The MS is triggered to initiate packet uplink transfer of an LLC PDU consisting of 500 octets data..
2 2A	MS -> SS	EGPRS PACKET CHANNEL REQUEST	Received on PRACH. If the MS requests two phase access the Test Case is terminated
3	SS -> MS	PACKET UPLINK ASSIGNMENT	Not include Timing Advance Index. Indicating Dynamic allocation struct. Sent on PAGCH.
4	SS -> MS	PACKET DOWNLINK DUMMY CONTROL BLOCK	Sent on the PACCH, 3 blocks from the last radio block containing the uplink assignment, USF assigned to the MS.
5	MS -> SS	UPLINK RLC DATA BLOCK	Containing TLLI in the RLC/MAC header.
6	SS -> MS	PACKET UPLINK ACK/NACK	Sent on the PACCH, containing correct TLLI. USF assigned.
7		{Uplink data transfer}	Macro. Completion of the TBF procedure. Verification, see below.

Verification

The SS verifies that the MS does not transmit in idle frames during data block transfer (steps 4-7). Idle frame numbers are 12, 25, 38 and 51 in the 52-multiframe structure.

Specific message contents

None.

52.1.2.1.8.2.3 Void

52.1.2.1.9 Packet Uplink Assignment / Two phase access

52.1.2.1.9.1 Packet Uplink Assignment / Two phase access / Packet Resource Request / RLC Octet Count

52.1.2.1.9.1.1 Conformance requirements

The mobile station may indicate the number of octets of user data that the MS has to transfer in the PACKET RESOURCE REQUEST message.

Reference

3GPP TS 04.60 subclause 7.1.3.1.

52.1.2.1.9.1.2 Test purpose

To verify that the mobile station indicates the number of octets of user data that it has to be transferred in the TBF.

52.1.2.1.9.1.3 Method of test

Initial conditions

System Simulator:

1 cell supporting EGPRS.

Mobile Station:

The MS is GPRS attached and in packet idle mode. PDP context 1 has been established.

Specific PICS Statements

-

PIXIT Statements

-

Test procedure

The MS is triggered to initiate unacknowledged uplink data transfer. The SS shall send PACKET UPLINK ASSIGNMENT message including Multi Block Allocation struct information to instruct the MS to send PACKET RESOURCE REQUEST. The MS should perform a two-phase access i.e. the MS shall transmit a PACKET RESOURCE REQUEST message on the allocated uplink resource.

The RLC_OCTET_COUNT field may indicate the number of LLC data octets the MS wishes to transfer.

The SS should then respond with PACKET UPLINK ASSIGNMENT message and the MS should begin transmitting RLC data blocks on the allocated uplink resources. The SS allows the MS to complete the sending of the data.

Maximum duration of the test

2 minutes.

Expected sequence

Step	Direction	Message	Comments
1	MS		The MS is triggered to initiate the transfer of 100 user data octets.
2	MS -> SS	EGPRS PACKET CHANNEL REQUEST	Two Phase Access Request. Received on PRACH.
3	SS -> MS	PACKET UPLINK ASSIGNMENT	Multi block allocation struct. Sent on PAGCH.
4	MS -> SS	PACKET RESOURCE REQUEST	Received on the single block assigned in step 3.
5	SS -> MS	PACKET UPLINK ASSIGNMENT	Dynamic allocation struct. Sent on the PACCH of the assigned PDCH.
6	SS -> MS	PACKET DOWNLINK DUMMY CONTROL BLOCK	Assigning USF to the MS. Sent at least 3 block periods from the assignment in step 5.
7		{Uplink data transfer}	Macro. Completion of the TBF procedure.
8 (optional step)	SS		The SS verifies that the MS has transferred the number of user data octets indicated in step 4 as RLC_OCTET_COUNT value +/- 2 octets.
Note :		If RLC_OCTET_COUNT given by the MS in step 4 takes a value different from 0 then step 8 shall be performed.	

Specific message contents

None.

- 52.1.2.1.9.2 Packet Uplink Assignment / Two phase access / Contention resolution
- 52.1.2.1.9.2.1 Packet Uplink Assignment / Two phase access / Contention resolution / Expiry of timer T3168
- 52.1.2.1.9.2.1.1 Conformance requirements

The contention resolution has failed on the mobile station side when the mobile station does not receive a PACKET UPLINK ASSIGNMENT message with its TLLI before expiry of timer T3168. The mobile station shall then reinitiate the packet access procedure unless it has already been repeated 4 times. In that case, TBF failure has occurred.

Reference

3GPP TS 04.60 subclause 7.1.3.3.

52.1.2.1.9.2.1.2 Test purpose

To verify that the mobile station reinitiates the packet access procedure after a time equal to timer T3168 and the procedure shall be repeated 4 times.

52.1.2.1.9.2.1.3 Method of test

Initial conditions

System Simulator:

1 cell supporting EGPRS. PSI GPRS Cell Options, T3168 = 7.

Mobile Station:

The MS is GPRS attached and in packet idle mode. PDP context 1 has been established.

Specific PICS Statements

- Release of EGPRS Supported (TSPC_MS_EGPRS_RELEASE)

PIXIT Statements

-

Test procedure

The MS is triggered to initiate unacknowledged uplink data transfer. The SS sends PACKET UPLINK ASSIGNMENT message including Multi Block Allocation struct information to order the MS to send PACKET RESOURCE REQUEST message. The MS shall perform a two-phase access i.e. the MS shall transmit a PACKET RESOURCE REQUEST message on the allocated uplink resource. The SS wait for a time greater than timer T3168 so the MS shall reinitiate packet access procedure. This procedure shall be repeated 4 times.

Maximum duration of the test

2 minutes.

Expected sequence

Step	Direction	Message	Comments
1	MS		The MS is triggered to initiate packet uplink transfer of an LLC PDU consisting of 200 octets data.
2	MS -> SS	EGPRS PACKET CHANNEL REQUEST	Two Phase Access Request. Received on PRACH.
3	SS -> MS	PACKET UPLINK ASSIGNMENT	Multi Block Allocation struct. Sent on PAGCH.
4	MS -> SS	PACKET RESOURCE REQUEST	ACCESS_TYPE = "Two Phase Access Request". Received on the single block assigned in step 3.
5	SS		The SS waits T3168 expiry.
6			The SS verifies that the MS reinitiate packet access procedure (steps 2-5 are repeated) in total: Four or five times if PICS 'Release of EGPRS supported' is Release 97, 98, 99 or 4. Four times if PICS 'Release of EGPRS supported' is Release 5 or later.

NOTE: After step 6 the MS may reinitiate a packet access procedure, since higher layers may request to restart the access procedure.

Specific message contents

None.

52.1.2.1.9.2.2 Packet Uplink Assignment / Two phase access / Contention resolution / TLLI in Packet Resource Request message

52.1.2.1.9.2.2.1 Conformance requirements

The mobile station shall provide the network with its radio access capabilities for the frequency bands it supports, in the same priority order as the one specified by the network, by sending a PACKET RESOURCE REQUEST message, and an ADDITIONAL MS RADIO ACCESS CAPABILITIES if all the requested informations do not fit in the PACKET RESOURCE REQUEST.

The mobile station shall include the TLLI in these two messages until contention resolution. After that, the mobile station may use the uplink TFI or the TLLI whenever these messages are repeated.

The network may request a retransmission of the PACKET RESOURCE REQUEST and the ADDITIONAL MS RADIO ACCESS CAPABILITIES messages. A request for retransmission of one or both of these messages shall be indicated in the PACKET UPLINK ACK/NACK message. The mobile station has to indicate within the PACKET RESOURCE REQUEST if the message is a retransmitted one.

If the mobile station has been allocated two radio blocks and all the requested information fit in the PACKET RESOURCE REQUEST message, no ADDITIONAL MS RADIO ACCESS CAPABILITIES message shall be sent. Instead, some uplink control block (e.g. packet measurement report, packet uplink dummy control block) may be sent by the mobile station.

The network may indicate in the next PACKET UPLINK ASSIGNMENT message a request for retransmission of the ADDITIONAL MS RADIO ACCESS CAPABILITIES message.

Reference

3GPP TS 04.60 subclauses 7.1.2.2.1a and 7.1.3.2.

52.1.2.1.9.2.2.2 Test purpose

To verify that the MS includes TLLI in both PACKET RESOURCE REQUEST message, and ADDITIONAL MS RADIO ACCESS CAPABILITIES, if it is present.

To verify that the mobile responds correctly for a request for retransmission of one or both of these messages indicated in the PACKET UPLINK ASSIGNMENT message.

52.1.2.1.9.2.2.3 Method of test

Initial conditions

System Simulator:

1 cell supporting EGPRS.

Mobile Station:

The MS is GPRS attached and in packet idle mode. PDP context 1 has been established.

Specific PICS Statements

-

PIXIT Statements

-

Test procedure

The MS is triggered to initiate unacknowledged uplink data transfer. The SS responds with PACKET UPLINK ASSIGNMENT message that request two phase access and requesting Radio Access Capabilities of frequency bands supported by the mobile. The MS shall then send PACKET RESOURCE REQUEST message and optionally an ADDITIONAL MS RADIO ACCESS CAPABILITIES message with Radio Access Capabilities included.

Note: The SS shall request only one band, either GSM 1800 or GSM 1900.

The SS responds with PACKET UPLINK ASSIGNMENT message, with a valid TLLI and requesting retransmission of ADDITIONAL MS RADIO ACCESS CAPABILITIES message, if it was sent by the mobile.

The SS verifies that the mobile retransmit the ADDITIONAL MS RADIO ACCESS CAPABILITIES message, if applicable, addressed by TFI or TLLI.

Maximum duration of the test

5 minutes.

Expected sequence

Step	Direction	Message	Comments
1	MS		The MS is triggered to initiate packet uplink transfer of an LLC PDU consisting of 200 octets data.
2	MS -> SS	EGPRS PACKET CHANNEL REQUEST	Two Phase Access Request. Received on PRACH.
3	SS -> MS	PACKET UPLINK ASSIGNMENT	Multi Block Allocation struct. Requesting the mobile to send Radio Access Capability of all frequency bands. ACCESS_TYPE = "Two Phase Access Request".
4	MS -> SS	PACKET RESOURCE REQUEST	Include TLLI. Received on one of the block assigned in step 3. See specific message contents.
4a	MS -> SS	ADDITIONAL MS RADIO ACCESS CAPABILITIES	If <ADDITIONAL MS RAC INFORMATION AVAILABLE> field in the received PACKET RESOURCE REQUEST message indicates 1, then received on the second block assigned in Step 3. If no ADD ADDITIONAL MS RADIO ACCESS CAPABILITIES message is there, the MS may send a control block in the block assigned. Verify TLLI is included.
5	SS -> MS	PACKET UPLINK ASSIGNMENT	Include the correct TLLI according to step 4. Sent on the PACCH of the assigned PDCH. Request retransmission of ADDITIONAL MS RADIO ACCESS CAPABILITIES if it was received in Step 4a.
6	MS -> SS	ADDITIONAL MS RADIO ACCESS CAPABILITIES	If applicable as per Step 4a and Step 6. Verify that the mobile is addressed by TFI or TLLI in the message.
7		{ Completion of uplink RLC data block transfer }	

Specific message contents

PACKET UPLINK ASSIGNMENT message in Step 3.

BCCH band is GSM 1900:

{ 0 1 < Access Technologies Request}	1 (Present)
Access Technology Type	0000
Access Technology Type	0001
Access Technology Type	0010
Access Technology Type	0100
Access Technology Type	0101
Access Technology Type	0110
Access Technology Type	0111

All other BCCH bands:

{ 0 1 < Access Technologies Request}	1 (Present)
Access Technology Type	0000
Access Technology Type	0001
Access Technology Type	0010
Access Technology Type	0011
Access Technology Type	0101
Access Technology Type	0110
Access Technology Type	0111

PACKET UPLINK ASSIGNMENT message in Step 5.

ARAC RETRANSMISSION REQUEST	1 (If message was received in Step 4a) 0 (If message was not received on Step 4a)
-----------------------------	--

52.1.2.1.9.2.3 Packet Uplink Assignment / Two phase access / Contention resolution / TLLI mismatch

The contention resolution is completed on the mobile station side when the mobile station receives a PACKET UPLINK ASSIGNMENT message with the same TLLI as the mobile station has included in the PACKET RESOURCE REQUEST message.

52.1.2.1.9.2.3.1 Conformance requirements

If the failure is due to a TLLI mismatch, or to the expiry of timers T3166 or T3168, or to the fact that the counter N3104 reaches its maximum value in the contention resolution procedure, and repetition as described in subclauses 7.1.2.3, 7.1.3.2.1 or 7.1.3.3 has been performed, the mobile station shall remain in packet idle mode, notify higher layer (TBF establishment failure), transactions in progress shall be aborted and cell reselection continued, unless the failure takes place during a RR-cell change order procedure, in which case the mobile behaviour shall be as described in the Abnormal cases of the RR-Network Commanded Cell Change Order Procedure in 3GPP TS 04.08.

Reference

3GPP TS 04.60 subclauses 7.1.4 and 7.1.3.3.

52.1.2.1.9.2.3.2 Test purpose

To verify that the MS reinitiates packet access procedure with failure due to a TLLI mismatch in the contention resolution procedure, unless it has already been repeated 4 times. In that case, TBF failure has occurred.

52.1.2.1.9.2.3.3 Method of test

Initial conditions

System Simulator:

1 cell supporting EGPRS.

Mobile Station:

The MS is GPRS attached and in packet idle mode. PDP context 1 has been established.

Specific PICS Statements

- Release of EGPRS Supported (TSPC_MS_EGPRS_RELEASE)

PIXIT Statements

-

Test procedure

The MS is triggered to initiate unacknowledged uplink data transfer. The SS responds with PACKET UPLINK ASSIGNMENT message that request two phase access. The MS shall then send PACKET RESOURCE REQUEST message. The SS responds with PACKET UPLINK ASSIGNMENT message with a TLLI different to that the MS has sent in PACKET RESOURCE REQUEST message. The MS shall reinitiate the packet access procedure.

This procedure shall be repeated 4 times.

Maximum duration of the test

2 minutes.

Expected sequence

Step	Direction	Message	Comments
1	MS		The MS is triggered to initiate packet uplink transfer of an LLC PDU consisting of 200 octets data.
2	MS -> SS	EGPRS PACKET CHANNEL REQUEST	Two Phase Access Request. Received on PRACH.
3	SS -> MS	PACKET UPLINK ASSIGNMENT	Multi Block Allocation struct. Sent on PAGCH.
4	MS -> SS	PACKET RESOURCE REQUEST	ACCESS_TYPE = "Two Phase Access Request". Include TLLI. Received on the single block assigned in step 3.
5	SS -> MS	PACKET UPLINK ASSIGNMENT	Include incorrect TLLI according to step 4. Sent on the PACCH of the assigned PDCH.
6			The SS verifies that the MS attempts packet access procedure (steps 2-5 are repeated) in total: Four or five times if PICS 'Release of EGPRS supported' is Release 99 or 4. Four times if PICS 'Release of EGPRS supported' is Release 5 or later.
NOTE: After step 6 the MS may reinitiate a packet access procedure, since higher layers may request to restart the access procedure.			

Specific message contents

None.

52.1.2.1.9.3 Packet Uplink Assignment / Two phase access / Radio Access Capabilities

52.1.2.1.9.3.1 Conformance requirements

When assigning an EGPRS TBF, the network may request information about radio access capabilities of the mobile station on one or several frequency bands within the PACKET UPLINK ASSIGNMENT message ; the list of frequency bands is ordered by the network starting with the most important and ending with the least important one . The mobile station shall provide the network with its radio access capabilities for the frequency bands it supports, in the same priority order as the one specified by the network, by sending a PACKET RESOURCE REQUEST message, and an ADDITIONAL MS RADIO ACCESS CAPABILITIES if all the requested informations do not fit in the PACKET RESOURCE REQUEST. If the mobile station does not support any frequency band requested by the network, it shall report its radio access capabilities for the BCCH frequency band. The mobile station shall indicate in the PACKET RESOURCE REQUEST if it will send more information about its radio access capabilities in the ADDITIONAL MS RADIO ACCESS CAPABILITIES message. The PACKET RESOURCE REQUEST and the ADDITIONAL MS RADIO ACCESS CAPABILITIES shall be sent within the one or two first radio blocks allocated for the mobile station

on the assigned PDCH. For release 5 and earlier, if the alternative coding by using the Additional access technologies struct is chosen by the mobile station, the mobile station shall indicate its radio access capability for the serving BCCH frequency band in the first included Access capabilities struct.

Reference

3GPP TS 04.60 subclauses 7.1.2.2.1a, 7.1.3.2 and 12.30, and TS 24.008 subclause 10.5.5.12a.

52.1.2.1.9.3.2 Test purpose

To verify that the mobile station provides the network with the radio access capabilities of the frequency bands it supports.

To verify that the mobile station provides the radio access capabilities in the same priority order as the one specified by network (in case of Rel-5 and earlier and if the alternative coding by using the Additional access technologies struct is chosen, the MS may indicate its radio access capability for the serving BCCH frequency band in the first included Radio Access Capabilities struct.).

To verify that among the three Access Technology Types GSM 900-P, GSM 900-E and GSM 900-R only one shall be present.

To verify that the PACKET RESOURCE REQUEST and the ADDITIONAL MS RADIO ACCESS CAPABILITIES are sent within the one or two first radio blocks allocated for the mobile station on the assigned PDCH.

52.1.2.1.9.3.3 Method of test

Initial conditions

System Simulator:

1 cell supporting EGPRS.

Mobile Station:

The MS is GPRS attached and in packet idle mode. PDP context 1 has been established.

Specific PICS Statements

- Support of Standard GSM Band (P-GSM) (TSPC_Type_GSM_P_Band)
- Support of Extended GSM Band (E-GSM), (including standard Band) (TSPC_Type_GSM_E_Band)
- Support of R-GSM Band (including standard and E-GSM Band) (TSPC_Type_GSM_R_Band)
- Support of DCS 1800 band (TSPC_Type_DCS_Band)
- Support of GSM 450 band (TSPC_Type_GSM_450_Band)
- Support of GSM 480 band (TSPC_Type_GSM_480_Band)
- Support of PCS 1900 band (TSPC_Type_PCS_Band)
- Support of GSM 700 band (TSPC_Type_GSM_700_Band)
- Support of GSM 750 band (TSPC_Type_GSM_750_Band)
- Support of GSM 850 band (TSPC_Type_GSM_850_Band)
- Support of GSM 710 band (TSPC_Type_GSM_710_Band)
- Support of T GSM 810 band (TSPC_Type_T_GSM_810_Band)
- Support of T-GSM 380 band (TSPC_Type_T_GSM_380_Band)
- Support of T-GSM 410 band (TSPC_Type_T_GSM_410_Band)
- Support of T-GSM 900 band (TSPC_Type_T_GSM_900_Band)

- Support of GSM850 and GSM1800 Band Interworking (TSPC_GSM850_GSM1800_Interworking)
- Support of GSM900 and GSM1900 Band Interworking (TSPC_GSM900_GSM1900_Interworking)
- Support of GSM850 and GSM900 Band Interworking (TSPC_GSM850_GSM900_Interworking)
- Release of EGPRS Supported (TSPC_MS_EGPRS_RELEASE)

PIXIT Statements

-

Test procedure

The MS is triggered to initiate unacknowledged uplink data transfer. The SS shall send PACKET UPLINK ASSIGNMENT message with Access Technology request for all the bands. The MS shall respond back with a PACKET RESOURCE REQUEST and an ADDITIONAL MS RADIO ACCESS CAPABILITIES message, if the information do not fit in the PACKET RESOURCE REQUEST message.

SS verifies that the Radio Access Capabilities of all the frequency bands supported are available, with respect to the band interworking PICS, and are in the same priority as requested by the SS (in case of Rel-5 and earlier and if the alternative coding by using the Additional access technologies struct is chosen, the MS may indicate its radio access capability for the serving BCCH frequency band in the first included Radio Access Capabilities struct.).

SS verifies that among GSM 900-P, GSM 900-E and GSM 900-R, only 1 is reported.

The SS shall request only one band, either GSM 1800 or GSM 1900. See Specific message contents.

Maximum duration of the test

10 minutes.

Expected sequence

Step	Direction	Message	Comments
1	MS		The MS is triggered to initiate the transfer of 100 user data octets.
2	MS -> SS	EGPRS PACKET CHANNEL REQUEST	Two Phase Access Request. Received on PRACH.
3	SS -> MS	PACKET UPLINK ASSIGNMENT	Multi block allocation struct. Sent on PAGCH. SS request Access Technologies Request from the mobile. See specific message contents.
4	MS -> SS	PACKET RESOURCE REQUEST	Received on one of the blocks assigned in Step 3.
4a	MS -> SS	ADDITIONAL MS RADIO ACCESS CAPABILITIES	If <ADDITIONAL MS RAC INFORMATION AVAILABLE> field in the received PACKET RESOURCE REQUEST message indicates 1, then received on the second block assigned in Step 3. If no ADD ADDITIONAL MS RADIO ACCESS CAPABILITIES message is there, the MS may send a control block in the block assigned.
5	SS	Verification	With the message(s) received in 4/4a: SS verifies that the Radio Access Capabilities of the supported access technologies are in the same order of priority as requested. Note :In case of Rel-5 and earlier, the MS may indicate its radio access capability for the serving BCCH frequency band in the first included Radio Access Capabilities struct. SS verifies that among GSM 900-P, GSM 900-E and GSM 900-R, only 1 is reported. SS verifies that all supported access technologies are reported, with respect to the band interworking PICS.
6	SS -> MS	PACKET UPLINK ASSIGNMENT	Dynamic allocation struct. Sent on the PACCH of the assigned PDCH.
7	SS -> MS	PACKET DOWNLINK DUMMY CONTROL BLOCK	Assigning USF to the MS. Sent at least 3 block periods from the assignment in step 6.
8		{Uplink data transfer}	Macro. Completion of the TBF procedure.

Specific message contents

PACKET UPLINK ASSIGNMENT message step 3:

BCCH band is GSM 1900:

{ 0 1 < Access Technologies Request}	1 (Present)
Access Technology Type	0000
Access Technology Type	0001
Access Technology Type	0010
Access Technology Type	0100
Access Technology Type	0101
Access Technology Type	0110
Access Technology Type	0111

All other BCCH bands:

{ 0 1 < Access Technologies Request}	1 (Present)
Access Technology Type	0000
Access Technology Type	0001
Access Technology Type	0010
Access Technology Type	0011
Access Technology Type	0101
Access Technology Type	0110
Access Technology Type	0111

52.1.2.1.9.4 Packet Uplink Assignment / Two phase access / Radio Access Capabilities/
Frequency band not supported..

52.1.2.1.9.4.1 Conformance requirements

When assigning an EGPRS TBF, the network may request information about radio access capabilities of the mobile station on one or several frequency bands within the PACKET UPLINK ASSIGNMENT message ; the list of frequency bands is ordered by the network starting with the most important and ending with the least important one . The mobile station shall provide the network with its radio access capabilities for the frequency bands it supports, in the same priority order as the one specified by the network, by sending a PACKET RESOURCE REQUEST message, and an ADDITIONAL MS RADIO ACCESS CAPABILITIES if all the requested informations do not fit in the PACKET RESOURCE REQUEST. . If the mobile station does not support any frequency band requested by the network, it shall report its radio access capabilities for the BCCH frequency band. The mobile station shall indicate in the PACKET RESOURCE REQUEST if it will send more information about its radio access capabilities in the ADDITIONAL MS RADIO ACCESS CAPABILITIES message. The PACKET RESOURCE REQUEST and the ADDITIONAL MS RADIO ACCESS CAPABILITIES shall be sent within the one or two first radio blocks allocated for the mobile station on the assigned PDCH.

Reference

3GPP TS 04.60 subclauses 7.1.2.2.1a and 7.1.3.2.

52.1.2.1.9.4.2 Test purpose

To verify that if the mobile station does not support any of the frequency band requested by the network, it shall report its radio access capability for the BCCH frequency band.

52.1.2.1.9.4.3 Method of test

Initial conditions

System Simulator:

1 cell supporting EGPRS.

Mobile Station:

The MS is GPRS attached and in packet idle mode. PDP context 1 has been established.

Specific PICS Statements

-

PIXIT Statements

-

Test procedure

The MS is triggered to initiate unacknowledged uplink data transfer. The SS shall send PACKET UPLINK ASSIGNMENT message with Access Technology request for the bands not supported by the MS. SS verifies that MS reports its radio access capability for the BCCH frequency band in the PACKET RESOURCE REQUEST message.

Maximum duration of the test

10 minutes.

Expected sequence

Step	Direction	Message	Comments
1	MS		The MS is triggered to initiate the transfer of 100 user data octets.
2	MS -> SS	EGPRS PACKET CHANNEL REQUEST	Two Phase Access Request. Received on PRACH.
3	SS -> MS	PACKET UPLINK ASSIGNMENT	Multi block allocation struct. Sent on PAGCH. SS request Access Technologies Request from the mobile. See specific message contents.
4	MS -> SS	PACKET RESOURCE REQUEST	Received on one of the blocks assigned in Step 3. SS verifies that the MS sends Radio Access Capabilities for the BCCH frequency band.
	MS		The MS may send a control block in the second block assigned.
5	SS -> MS	PACKET UPLINK ASSIGNMENT	Dynamic allocation struct. Sent on the PACCH of the assigned PDCH.
6		{Uplink data transfer, dynamic allocation}	Macro. Completion from step 4 in the TBF procedure.

Specific message contents

PACKET UPLINK ASSIGNMENT message

{ 0 1 < Access Technologies Request Access Technology Type	1 (Present) Include some frequency bands that are not supported by the mobile
---	--

52.1.2.1.9.5 Packet Uplink Assignment / Two phase access / Packet Resource Request / No respond to Packet Downlink Assignment

52.1.2.1.9.5.1 Conformance requirements

When the mobile station has received a PACKET UPLINK ASSIGNMENT message it shall respond with a PACKET RESOURCE REQUEST message in the allocated single radio block. At sending of the PACKET RESOURCE REQUEST message, the mobile station shall start timer T3168. Further more, the mobile station shall not respond to PACKET DOWNLINK ASSIGNMENT messages while timer T3168 is running.

Reference

3GPP TS 04.60 subclause 7.1.3.1.

52.1.2.1.9.5.2 Test purpose

To verify that the mobile station does not respond to PACKET DOWNLINK ASSIGNMENT messages while timer T3168 is running after sending of the PACKET RESOURCE REQUEST message.

52.1.2.1.9.5.3 Method of test

Initial conditions

System Simulator:

1 cell supporting EGPRS.

T3168 indicates value 7 in GPRS Cell Options.

Mobile Station:

The MS is GPRS attached and in packet idle mode. PDP context 2 has been established.

Specific PICS Statements

-

PIXIT Statements

-

Test procedure

The MS is triggered to initiate unacknowledged uplink data transfer. The SS shall send PACKET UPLINK ASSIGNMENT message including Multi block allocation struct information to instruct the MS to send PACKET RESOURCE REQUEST. The MS should perform a two-phase access i.e. the MS shall transmit a PACKET RESOURCE REQUEST message on the allocated uplink resource.

While timer T3186 is running the SS send PACKET DOWNLINK ASSIGNMENT message and starts to send data on the allocated downlink before the timer expire. The MS shall not respond to the Downlink data transfer.

The SS should then send PACKET UPLINK ASSIGNMENT message before the timer T3168 expire and the MS should then begin transmitting RLC data blocks on the allocated uplink resources. The SS allows the MS to complete the sending of the data.

Maximum duration of the test

2 minutes.

Expected sequence

Step	Direction	Message	Comments
1	MS		The MS is triggered to initiate packet uplink transfer of an LLC PDU containing 400 octets of data.
2	MS -> SS	EGPRS PACKET CHANNEL REQUEST	One or Two Phase Access Request. Received on PRACH.
3	SS -> MS	PACKET UPLINK ASSIGNMENT	Multi block allocation struct. Sent on PAGCH.
4	MS -> SS	PACKET RESOURCE REQUEST	Received on the single block assigned in step 3.
5	SS -> MS	PACKET DOWNLINK ASSIGNMENT	Sent on PACCH.
6	SS -> MS	DOWNLINK RLC DATA BLOCK	Sent on the assigned PDTCH with poll bit set to 1.
	SS		Verify no response from the MS.
7	SS -> MS	PACKET UPLINK ASSIGNMENT	Dynamic allocation struct. Sent on the PACCH of the assigned PDCH 0,9* T3168.
8		{Uplink data transfer, dynamic allocation}	Macro. Completion from step 4 in the TBF procedure.

Specific message contents

None.

52.1.2.1.10 Packet Uplink Assignment / Abnormal cases

52.1.2.1.10.1 Packet Uplink Assignment / Abnormal cases / Incorrect PDCH assignment

52.1.2.1.10.1.1 Conformance requirements

If the mobile station has been assigned more PDCHs than it supports according to its MS multislot class, the mobile station shall reinitiate the packet access procedure unless it has already been repeated 4 times. In that case, TBF failure has occurred.

Reference

3GPP TS 04.60 subclause 7.1.4.

52.1.2.1.10.1.2 Test purpose

To verify that the mobile station reinitiates the packet access procedure when the mobile station has been assigned more PDCHs than it supports and after 4 repetitions of the packet access procedure the mobile station shall initiate TBF failure.

52.1.2.1.10.1.3 Method of test

Initial conditions

System Simulator:

1 cell supporting EGPRS.

Prach Control Parameters: S bit = 12; TX_INT = 2 slots.

Mobile Station:

The MS is GPRS attached and in packet idle mode. PDP context 2 has been established.

Specific PICS Statements

- Release of EGPRS Supported (TSPC_MS_EGPRS_RELEASE)
- EGPRS Multislotclass (TSPC_Type_EGPRS_Multislot_ClassX where X = 1..45)

PIXIT Statements

-

Test procedure

Convert the MS EGPRS Multislot Class to number of uplink timeslot supported.

The MS is triggered to send 200 octets of data. The SS sends PACKET UPLINK ASSIGNMENT message containing more assigned PDCHs than the MS supports according to its EGPRS multislot class. The MS shall reinitiate packet access procedure; this procedure shall be repeated 4 times.

Maximum duration of the test

2 minutes.

Expected sequence

Step	Direction	Message	Comments
1	MS		The MS is triggered to send 200 octets data Throughout the remainder of the test, any Channel Requests on RACH are ignored.
2	MS -> SS	EGPRS PACKET CHANNEL REQUEST	One or Two Phase Access Request. Received on PRACH.
3	SS -> MS	PACKET UPLINK ASSIGNMENT	Multi block allocation struct. Sent on PAGCH.
4	MS -> SS	PACKET RESOURCE REQUEST	Received on one of the blocks assigned in Step 3.
5	SS -> MS	PACKET UPLINK ASSIGNMENT	Assign one more Tx than the MS supported, MCS1. Sent on PACCH.
6	SS -> MS	PACKET DOWNLINK DUMMY CONTROL BLOCK	Sent on the third block from the message sent in step 5. Assigning USF to the MS.
7			The SS verifies that the MS does not send UPLINK RLC DATA BLOCKS and instead attempts packet access procedure (steps 2-6 are repeated) in total: Four or five times if PICS 'Release of EGPRS supported' is Release 99 or 4. Four times if PICS 'Release of EGPRS supported' is Release 5 or later

NOTE: After step 7 the MS may reinitiate a packet access procedure, since higher layers may request to restart the access procedure.

Specific message contents

None.

52.1.2.1.10.2 Packet Uplink Assignment / Abnormal cases / Expiry of timer T3164

52.1.2.1.10.2.1 Conformance requirements

On expiry of timer T3164, the mobile station shall reinitiate the packet access procedure unless it has already been reinitiated 3 times, in which case the mobile station shall return to packet idle mode and notify higher layers.

Reference

3GPP TS 04.60 subclause 7.1.4.

52.1.2.1.10.2.2 Test purpose

To verify that the mobile station reinitiate the packet access procedure when the network have sent a PACKET UPLINK ASSIGNMENT message but the MS has not sent the first block within the time equal to the timer T3164. This packet access procedure shall at most be reinitiated 3 times.

52.1.2.1.10.2.3 Method of test

Initial conditions

System Simulator:

1 cell supporting EGPRS.

The packet system information ACCESS_BURST_TYPE indicates 8 bit access.

Mobile Station:

The MS is GPRS attached and in packet idle mode. PDP context 2 has been established.

Specific PICS Statements

-

PIXIT Statements

-

Test procedure

The MS is triggered to initiate uplink data transfer. The SS sends PACKET UPLINK ASSIGNMENT message with a USF assigned to the MS. The SS shall send PACKET DOWNLINK DUMMY CONTROL BLOCK messages with USF not assigned to the MS. T3164 expires. The SS send a PACKET DOWNLINK DUMMY CONTROL BLOCK containing the assigned USF. The SS verifies that the MS does not send a RLC data block. The SS verifies that the MS reinitiate the packet access procedure within 5 seconds of T3164 expiry; this shall be repeated 3 times.

Maximum duration of the test

1 minute.

Expected sequence

Step	Direction	Message	Comments
1	MS		The MS is triggered to initiate packet uplink transfer of an LLC PDU consisting 200 octets of data.
2	MS -> SS	EGPRS PACKET CHANNEL REQUEST	One or Two Phase Access Request. Received on PRACH.
3	SS -> MS	PACKET UPLINK ASSIGNMENT	Multi block allocation struct. Sent on PAGCH.
4	MS -> SS	PACKET RESOURCE REQUEST	Received on one of the blocks assigned in Step 3.
5	SS -> MS	PACKET UPLINK ASSIGNMENT	Allocate a USF for the MS
6	SS -> MS	PACKET DOWNLINK DUMMY CONTROL BLOCKs	Don't contain the assigned USF in step 5. Repeat step 6 for a maximum of 5.5 seconds ($1.1 \cdot T3164$). The MS may send an EGPRS PACKET CHANNEL REQUEST at any time after $0.9 \cdot T3164$, in this case go to step 9 .
7	SS -> MS	PACKET DOWNLINK DUMMY CONTROL BLOCKs	Containing the assigned USF in step 5.
8	SS		Verify the MS does not transmit an RLC data block
9	SS		The SS verifies that the packet access procedure (steps 2-6) is reinitiated three times. The EGPRS PACKET CHANNEL REQUEST for reinitiation (in step 2) shall be sent within 5 sec of T3164 expiry (to cater for T3168 - the maximum duration of a packet access procedure).
NOTE: After step 9 the MS may reinitiate a packet access procedure, since higher layers may request to restart the access procedure.			

Specific message contents

None.

52.1.2.2 Packet Downlink Assignment

52.1.2.2.1 Packet Downlink Assignment / Response to poll bit

52.1.2.2.1.1 Conformance requirements

In case valid timing advance for the mobile station is not available, the network may use one of the following two methods to trigger the mobile station to transmit a PACKET CONTROL ACKNOWLEDGEMENT:

- if the PACKET DOWNLINK ASSIGNMENT message is not segmented and the CONTROL_ACK_TYPE parameter in the System Information indicates acknowledgement is access bursts, the network may set the poll bit in the PACKET DOWNLINK ASSIGNMENT message;
- if the PACKET DOWNLINK ASSIGNMENT message is segmented or the CONTROL_ACK_TYPE parameter in the System Information does not indicate acknowledgement is access bursts, the network may send PACKET POLLING REQUEST with TYPE_OF_ACK parameter set to access bursts (see subclause 11.2.12).

The mobile station shall always transmit the uplink radio block on the same timeslot as the block where the RRBP was received. After receiving an RLC/MAC block containing a valid RRBP field the mobile station need not monitor the USF in the associated downlink RLC/MAC block appearing just before the uplink block it shall transmit.

Reference

3GPP TS 04.60 subclause 7.2.1.1 and 10.4.5.

52.1.2.2.1.2 Test purpose

To verify that the mobile station sends PACKET CONTROL ACKNOWLEDGEMENT as four access bursts if the network sets the poll bit in the PACKET DOWNLINK ASSIGNMENT message when CONTROL_ACK_TYPE is set to four access bursts.

52.1.2.2.1.3 Method of test

Initial conditions

System Simulator:

1 cell supporting EGPRS. The packet system information CONTROL_ACK_TYPE is set to indicate PACKET CONTROL ACKNOWLEDGEMENT format as four access bursts and the ACCESS_BURST_TYPE indicates 11 bit access.

Mobile Station:

The MS is GPRS attached and in packet idle mode and Ready state.

Specific PICS Statements

-

PIXIT Statements

-

Test procedure

The SS initiate a downlink data transfer. The SS sends PACKET DOWNLINK ASSIGNMENT message. The poll bit in the MAC header of the PACKET DOWNLINK ASSIGNMENT message will be set to indicate RRBP field is valid. The MS may delay the establishment of the downlink channels in order to answer the poll request on the common control channel. The SS verifies that the MS sends PACKET CONTROL ACKNOWLEDGEMENT as four access bursts on the timeslot on which it received the polling command.

Maximum duration of the test

2 minutes.

Expected sequence

Step	Direction	Message	Comments
1	SS		The SS initiate a downlink transfer of 200 octets data.
2	SS -> MS	PACKET DOWNLINK ASSIGNMENT	Poll bit in the MAC header is set to indicate a valid RRBP = 1. Sent on PPCH.
3	MS -> SS	PACKET CONTROL ACKNOWLEDGEMENT	As four access bursts. Received on PCCCH.
4	SS		The SS verifies that the MS sends the PACKET CONTROL ACKNOWLEDGEMENT as four access bursts, one per TDMA frame of the uplink radio block and the RRBP = 1.

Specific message contents

None.

52.1.2.2.2 Packet Downlink Assignment / PCCCH monitoring

52.1.2.2.2.1 Conformance requirements

A PACKET DOWNLINK ASSIGNMENT message may indicate an assignment starting time in the TBF Starting Time parameter. The mobile station shall monitor PCCCH until the point in time denoted by the TBF Starting Time. Thereafter it shall switch to the assigned PDCHs. If while monitoring the PCCCH the mobile station receives more than one PACKET DOWNLINK ASSIGNMENT message, it shall act upon the most recently received message and shall ignore the previous message.

Reference

3GPP TS 04.60 subclause 7.2.1.1.

52.1.2.2.2.2 Test purpose

To verify that the mobile station monitors PCCCH until the point in time denoted by the TBF Starting Time..

To verify that the mobile station considers the most recently received PACKET DOWNLINK ASSIGNMENT message.

52.1.2.2.2.3 Method of test

Initial conditions

System Simulator:

1 cell supporting EGPRS. The packet system information ACCESS_BURST_TYPE indicates 8 bit access.

Mobile Station:

The MS is GPRS attached and in packet idle mode and Ready state.

Specific PICS Statements

-

PIXIT Statements

-

Test procedure

The SS initiate a downlink data transfer. The SS sends PACKET DOWNLINK ASSIGNMENT message to the MS with a TBF starting time. Then send a new PACKET DOWNLINK ASSIGNMENT message on PCCCH (within the paging group of the MS) with another TBF starting time and a different timeslot before the first starting time has occurred. The SS starts to send RLC/MAC data blocks according to the second PACKET DOWNLINK ASSIGNMENT message. The MS shall send EGPRS PACKET DOWNLINK ACK/NACK message to indicate correct reception of data blocks.

Maximum duration of the test

2 minutes.

Expected sequence

Step	Direction	Message	Comments
1	SS		The SS initiate a downlink transfer of 200 octets data.
2	SS -> MS	PACKET DOWNLINK ASSIGNMENT	See specific message contents. Sent on PPCH.
3	SS -> MS	PACKET DOWNLINK ASSIGNMENT	Sent 3 blocks before TBF starting time in step 2 has elapsed. See specific message contents. Sent on PCCCH.
4	SS -> MS	DOWNLINK RLC DATA BLOCK	SS sends data starting at frame as indicated by TBF starting time in step 3 on assigned PDTCH.
5	MS -> SS	EGPRS PACKET DOWNLINK ACK/NACK	Indicating correct reception of downlink data block. Received on PACCH.

Specific message contents

As default messages contents, except:

PACKET DOWNLINK ASSIGNMENT in step 2

Information element	Value/remark
< TIMESLOT_ALLOCATION > {0 1< TBF Starting Time > -TBF_STARTING_TIME}	00010000, allocate timeslot 3. 1 arbitrarily chosen taking into account that the PACKET DOWNLINK ASSIGNMENT message in step 3 will be sent on the PCCCH corresponding to the paging group of the MS

PACKET DOWNLINK ASSIGNMENT in step 3

Information element	Value/remark
< TIMESLOT_ALLOCATION > {0 1< TBF Starting Time > -TBF_STARTING_TIME}	00000010, allocate timeslot 6. 1 arbitrarily chosen different from step 2

52.1.2.2.3 Void

52.1.2.2.4 Packet Downlink Assignment / Response to Packet Polling

52.1.2.2.4.1 Conformance requirements

In case valid timing advance for the mobile station is not available, the network may use one of the following two methods to trigger the mobile station to transmit a PACKET CONTROL ACKNOWLEDGEMENT:

- if the PACKET DOWNLINK ASSIGNMENT message is not segmented and the CONTROL_ACK_TYPE parameter in the System Information indicates acknowledgement is access bursts, the network may set the poll bit in the PACKET DOWNLINK ASSIGNMENT message;
- if the PACKET DOWNLINK ASSIGNMENT message is segmented or the CONTROL_ACK_TYPE parameter in the System Information does not indicate acknowledgement is access bursts, the network may send PACKET POLLING REQUEST with TYPE_OF_ACK parameter set to access bursts (see subclause 11.2.12).

On receipt of a PACKET POLLING REQUEST message, the mobile station shall respond to the network with the PACKET CONTROL ACKNOWLEDGEMENT message in the block period specified by the RRBP field. If the MS has received a PACKET DOWNLINK ASSIGNMENT message with no starting time or with a starting time that has already elapsed, the PACKET POLLING REQUEST message shall be sent on PACCH. Otherwise the PACKET POLLING REQUEST message shall be sent on PAGCH.

Reference

3GPP TS 04.60 subclauses 7.2.1.3 and 7.2.1.1.

52.1.2.2.4.2 Test purpose

To verify that on receipt of a PACKET POLLING REQUEST message, the mobile station responds with PACKET CONTROL ACKNOWLEDGEMENT message in the block period specified by the RRBP field.

52.1.2.2.4.3 Method of test

Initial conditions

System Simulator:

1 cell supporting EGPRS. The packet system information CONTROL_ACK_TYPE is set to not indicate acknowledgement as four access bursts and ACCESS_BURST_TYPE indicate 8 bit access.

Mobile Station:

The MS is GPRS attached and in packet idle mode and Ready state.

Specific PICS Statements

-

PIXIT Statements

-

Test procedure

The SS initiate a downlink data transfer. The SS sends PACKET DOWNLINK ASSIGNMENT message to the MS with a TBF starting time. The SS sends a PACKET POLLING REQUEST message containing a valid RRBP field. The SS verifies that the MS sends a PACKET CONTROL ACKNOWLEDGEMENT message in the block period specified by the RRBP field. The SS sends PACKET PDCH RELEASE message to the MS. The SS initiate a downlink data transfer. The SS sends PACKET DOWNLINK ASSIGNMENT message to the MS without TBF starting time. The SS sends a PACKET POLLING REQUEST message containing a valid RRBP field. The SS verifies that the MS sends a PACKET CONTROL ACKNOWLEDGEMENT message in the block period specified by the RRBP field.

Maximum duration of the test

5 minutes.

Expected sequence

Step	Direction	Message	Comments
1	SS		The SS initiate a downlink transfer of 200 octets data.
2	SS -> MS	PACKET DOWNLINK ASSIGNMENT	See specific message contents. Sent on PPCH.
3	SS -> MS	PACKET POLLING REQUEST	Sent on PACCH after TBF starting time in step 2 has elapsed. See specific message contents.
4	MS -> SS	PACKET CONTROL ACKNOWLEDGEMENT	The SS verifies that the MS send this message in the block period specified by the RRBP field as four access bursts. Received on PACCH.
5	SS -> MS	PACKET PDCH RELEASE	Sent on PACCH.
6	SS		Wait 20 seconds.
7	SS		The SS initiate a downlink transfer of 200 octets data.
8	SS -> MS	PACKET DOWNLINK ASSIGNMENT	See specific message contents. Sent on PPCH.
9	SS -> MS	PACKET POLLING REQUEST	Sent on PACCH. See specific message contents.
10	MS -> SS	PACKET CONTROL ACKNOWLEDGEMENT	The SS verifies that the MS send this message in the block period specified by the RRBP field as four access bursts. Received on PACCH.

Specific message contents

As default messages contents, except:

PACKET DOWNLINK ASSIGNMENT in step 2

Information element	Value/remark
< TIMESLOT_ALLOCATION >	00000100, allocate timeslot 5.
{0 1< TBF Starting Time > -TBF_STARTING_TIME}	1 arbitrarily chosen

PACKET DOWNLINK ASSIGNMENT in step 8

Information element	Value/remark
< TIMESLOT_ALLOCATION >	00000001, allocate timeslot 7.
{0 1< TBF Starting Time >}	0 (No TBF starting time)

PACKET POLLING REQUEST in step 3 and 9

Information element	Value/remark
RRBP in MAC header	Set to 1
ES/P in MAC header	Set to 01 : RRBP field is valid
< MESSAGE_TYPE >	000100
< PAGE_MODE	Normal Paging
{ 0 < Global TFI >	
10 < TLLI >	0 (Global TFI)
110 < TQI >}	DOWNLINK TFI Present
1	As allocated in the PACKET DOWNLINK ASSIGNMENT message in Step 2 and Step 8 respectively
DOWNLINK TFI	
< TYPE_OF_ACK >	0 as four access bursts

52.1.2.2.5 Packet Downlink Assignment / Abnormal cases

52.1.2.2.5.1 Packet Downlink Assignment / Abnormal cases / Incorrect PDCH assignment

52.1.2.2.5.1.1 Conformance requirements

If the mobile station has been assigned more PDCHs than it supports according to its MS multislot class, the mobile station shall return to packet idle mode.

Reference

3GPP TS 04.60 subclause 7.2.2.

52.1.2.2.5.1.2 Test purpose

To verify that the mobile station return to packet idle mode if the mobile station is assigned more PDCHs than it supports according to its EGPRS multislot class.

52.1.2.2.5.1.3 Method of test

Initial conditions

System Simulator:

1 cell supporting EGPRS.

Mobile Station:

The MS is GPRS attached and in packet idle mode and Ready state.

Specific PICS Statements

- EGPRS Multislotclass (TSPC_Type_EGPRS_Multislot_ClassX where X = 1..45)

PIXIT Statements

-

Test procedure

Convert the MS EGPRS Multislot Class to number of downlink timeslot supported.

The SS initiated a downlink data transfer. The SS sends PACKET DOWNLINK ASSIGNMENT message containing one more assigned Rx than the MS supports according to its EGPRS multislot class. The SS sends RLC data blocks. The SS verify that the MS not respond to the RLC data blocks sent by SS. Verify that the MS return to packet idle mode.

The SS sends PACKET DOWNLINK ASSIGNMENT message again containing correct amount of Rx timeslots according to the MS EGPRS multislot class. The SS starts to send RLC data blocks and the MS complete the downlink data transfer.

Maximum duration of the test

2 minutes.

Expected sequence

Step	Direction	Message	Comments
1	SS		The SS initiate a downlink transfer of 200 octets data.
2	SS -> MS	PACKET DOWNLINK ASSIGNMENT	Assign one more Rx timeslot than the MS supports according to its EGPRS multislot class. Sent on PPCH. Wait for three block periods.
3	SS		
4	SS -> MS	DOWNLINK RLC DATA BLOCK	Sent on assigned PDTCHs. With Valid RRBp field
5	SS		Verify for 500 msec that the MS does not respond.
6	SS -> MS	PACKET DOWNLINK ASSIGNMENT	Assign Rx timeslot according to the MS EGPRS multislot class. Sent on PPCH.
7	SS -> MS	DOWNLINK RLC DATA BLOCK	If the MS supports multislot class 1,2,3,5 or 9: Sent on assigned PDTCH with a valid RRBp field in the highest numbered PDTCH. Sent after three block periods of sending message in step 6. Continue with step 8. Else : Sent on all assigned PDTCHs. Sent after 3 block periods of the message sent in step 6. Continue with step 7A
7A	SS -> MS	DOWNLINK RLC DATA BLOCK	Only one RLC data block is sent on the second highest numbered PDTCH. A valid RRBp is indicated.
8	MS -> SS	EGPRS PACKET DOWNLINK ACK/NACK	The SS verifies that the MS indicating correct reception of downlink data blocks. Received on PACCH.

Specific message contents

None.

52.1.2.2.5.2 Packet Downlink Assignment / Abnormal cases / Expiry of timer T3190

52.1.2.2.5.2.1 Conformance requirements

When receiving the PACKET DOWNLINK ASSIGNMENT message and after waiting the TBF Starting Time when applicable, the mobile station starts timer T3190. The timer is reset when receiving the first valid RLC/MAC block.

On expiry of timer T3190, the mobile station shall return to packet idle mode.

Reference

3GPP TS 04.60 subclauses 7.2.1.1 and 7.2.2.

52.1.2.2.5.2.2 Test purpose

To verify that the mobile station aborts the TBF and returns to packet idle mode if a valid RLC block is not received within the duration of timer T3190.

52.1.2.2.5.2.3 Method of test

Initial conditions

System Simulator:

1 cell supporting EGPRS. The packet system information ACCESS_BURST_TYPE indicates 8 bit access.

Mobile Station:

The MS is GPRS attached and in packet idle mode and Ready state.

Specific PICS Statements

-

PIXIT Statements

-

Test procedure

The SS initiate a downlink data transfer. The SS sends PACKET DOWNLINK ASSIGNMENT message to the MS. The SS wait to send RLC data blocks for a time greater than timer T3190. The SS verifies that the MS not respond to the RLC data blocks sent by SS.

The SS reinitiate the sending of downlink data transfer. The SS sends PACKET DOWNLINK ASSIGNMENT message again and starts to send RLC data blocks after a time less than timer T3190. The MS shall complete the downlink data transfer.

Maximum duration of the test

2 minutes.

Expected sequence

Step	Direction	Message	Comments
1	SS		The SS initiate a downlink transfer of 200 octets data.
2	SS -> MS	PACKET DOWNLINK ASSIGNMENT	Not indicating any TBF Starting Time. Sent on PPCH.
3	SS		The SS waits timer T3190 + 0.1*T3190.
4	SS -> MS	DOWNLINK RLC DATA BLOCK	Sent on assigned PDTCHs with a valid RRBp field
5	SS		Verify for 10 seconds that the MS not respond.
6	SS -> MS	PACKET DOWNLINK ASSIGNMENT	Reinitiate the downlink data transfer. Sent on PPCH.
7	SS		The SS waits timer T3190 – 0.1*T3190.
8	SS -> MS	DOWNLINK RLC DATA BLOCK	Sent on assigned PDTCHs with a valid RRBp field.
9	MS -> SS	EGPRS PACKET DOWNLINK ACK/NACK	Indicating correct reception of downlink data blocks. SS verifies that ACK/NACK is sent from the MS.

Specific message contents

None.

52.1.2.2.6 Packet Downlink Assignment Timing Advance / TA value field not provided

52.1.2.2.6.1 Conformance requirements

For the case where a TIMING_ADVANCE_VALUE field is not provided in the assignment message, the mobile station is not allowed to send normal bursts on the uplink until it receives a valid timing advance either through the continuous timing advance procedure or in a PACKET TIMING ADVANCE/POWER CONTROL message.

Reference

3GPP TS 04.60 subclause 7.1.2.5.

52.1.2.2.6.2 Test purpose

To verify that the mobile station does not send normal bursts on the uplink until it receives a valid timing advance in a PACKET POWER CONTROL/TIMING ADVANCE message if Timing Advance Value field is not provided in the PACKET DOWNLINK ASSIGNMENT message.

52.1.2.2.6.3 Method of test

Initial conditions

System Simulator:

1 cell supporting EGPRS.

Mobile Station:

The MS is GPRS attached and in packet idle mode. PDP context 2 has been established.

Specific PICS Statements

-

PIXIT Statements

-

Test procedure

The SS initiates downlink data transfer. The SS does not include Timing Advance in the PACKET DOWNLINK ASSIGNMENT. The SS poll MS by sending an EGPRS RLC DATA BLOCK. SS verifies for 2 seconds that MS did not answer to poll and then send a PACKET POWER CONTROL/TIMING ADVANCE message with a valid timing advance information. The SS verifies that the MS does not send any normal burst on the uplink until the SS sends a valid timing advance.

Maximum duration of the test

2 minutes.

Expected sequence

Step	Direction	Message	Comments
1	MS		The SS initiate a downlink transfer of 200 octets data.
2		PACKET DOWNLINK ASSIGNMENT	Send on PPCH. No Timing Advance Value
3	SS->MS SS -> MS	EGPRS DOWNLINK RLC DATA BLOCK	Sent on assigned PDTCHs with a valid RRBP field. Final Blok Indicator is set to 0.
4	SS		SS verifies that the MS not send any normal burst on the uplink.
5	SS -> MS	PACKET POWER CONTROL/TIMING ADVANCE	Include a valid Timing Advance information. Sent on PACCH.
6	SS->MS	EGPRS DOWNLINK RLC DATA BLOCK	Sent on assigned PDTCHs with a valid RRBP field. Final Blok Indicator is set to 0.
7	MS->SS	EGPRS PACKET DOWNLINK ACK/NACK	The SS verifies that the MS indicates a correct reception of downlink data blocks. Received on PACCH.

Specific message contents

None.

52.1.3 Macro and default message contents

52.1.3.1 Macro

In order to simplify the process of writing and coding test cases, macros are referenced in the expected signaling tables. These macros provide all additional signaling needed to complete the particular test but are not relevant to its purpose. This Macro is only applicable to test case in subclauses 52.1.1 and 52.1.2.

52.1.3.1.1 GPRS attach procedure

The following table describes a signaling sequence performing the GPRS attach procedure when PCCCH is present. Note that there are different possible sequences implementing the GPRS attach procedure. In this case we use dynamic allocation and simultaneous uplink and downlink TBFs.

{GPRS attach procedure}

Step	Direction	Message	Comments
1			MS is triggered to initiate the GPRS attach procedure.
2	MS -> SS	PACKET CHANNEL REQUEST/EGPRS PACKET CHANNEL REQUEST	Mobility Management procedure request.
3	SS -> MS	PACKET UPLINK ASSIGNMENT	Indicate dynamic allocation struct.
4	SS -> MS	PACKET DOWNLINK DUMMY CONTROL BLOCK	Containing USF assigned to the MS.
5	MS -> SS	UPLINK RLC DATA BLOCKs (GMM ATTACH REQUEST)	
6	SS -> MS	PACKET UPLINK ACK/NACK	Containing Final Ack Indicator bit = 1, and valid RRBp field.
7	MS -> SS	PACKET CONTROL ACKNOWLEDGEMENT	Sent in the block assigned by the RRBp field in step 6.
8	SS -> MS	PACKET DOWNLINK ASSIGNMENT	Assign a downlink TBF, "MAC mode" = dynamic allocation.
9	SS -> MS	DOWNLINK RLC DATA BLOCKs (GMM ATTACH ACCEPT)	Containing USF assigned to the MS. Last block shall contain Final Block Indicator bit = 1, and valid RRBp field.
10	MS -> SS	EGPRS PACKET DOWNLINK ACK/NACK	Sent in the block assigned by the RRBp field in step 9.
11	MS -> SS	PACKET CHANNEL REQUEST/EGPRS PACKET CHANNEL REQUEST	Mobility Management procedure request.
12	SS -> MS	PACKET UPLINK ASSIGNMENT	Indicate dynamic allocation struct.
13	SS -> MS	PACKET DOWNLINK DUMMY CONTROL BLOCK	Containing USF assigned to the MS.
14	MS -> SS	UPLINK RLC DATA BLOCKs (GMM ATTACH COMPLETE)	
15	SS -> MS	PACKET UPLINK ACK/NACK	Containing Final Ack Indicator bit = 1, and valid RRBp field.
16	MS -> SS	PACKET CONTROL ACKNOWLEDGEMENT	Sent in the block assigned by the RRBp field in step 15.

52.1.3.1.2 Uplink data transfer, dynamic allocation

The following table describes a sequence performing uplink data transfer with one phase access dynamic allocation when PCCCH is present.

{Uplink data transfer, dynamic allocation}

Step	Direction	Message	Comments
1			PDP context 2 has been established. The MS is triggered to send data.
2	MS -> SS	EGPRS PACKET CHANNEL REQUEST	
3	SS -> MS	PACKET UPLINK ASSIGNMENT	One phase access, dynamic allocation struct.
4	SS -> MS	PACKET DOWNLINK DUMMY CONTROL BLOCK	Containing USF assigned to the MS.
5	MS -> SS	UPLINK RLC DATA BLOCK(S)	If USF_GRANULARITY = four blocks, 4 RLC data block will be sent.
6	SS -> MS	PACKET UPLINK ACK/NACK	Containing USF assigned to the MS. and contention resolution TLLI
7	MS -> SS	UPLINK RLC DATA BLOCK(S) Or PACKET UPLINK DUMMY CONTROL BLOCK(S)	If USF_GRANULARITY = four blocks, 4 blocks will be sent in any combination of UPLINK RLC DATA BLOCK and PACKET UPLINK DUMMY CONTROL BLOCK
8	SS -> MS	PACKET UPLINK ACK/NACK	Containing USF assigned to the MS.
9	MS -> SS	UPLINK RLC DATA BLOCK(S)	If USF_GRANULARITY = four blocks, 4 RLC data block will be sent.
10			Repeat step 8 and 9 until the countdown value CV=0 in step 9 .
11	SS -> MS	PACKET UPLINK ACK/NACK	Final Ack Indicator = 1 containing valid RRBP.
12	MS -> SS	PACKET CONTROL ACKNOWLEDGEMENT	

52.1.3.1.3 GPRS detach procedure

The following table describes a signalling sequence performing the GPRS detach procedure when PCCCH is present.

{GPRS detach procedure}

Step	Direction	Message	Comments
1	MS -> SS	EGPRS PACKET CHANNEL REQUEST	
2	SS -> MS	PACKET UPLINK ASSIGNMENT	Indicate dynamic allocation struct.
3	SS -> MS	PACKET DOWNLINK DUMMY CONTROL BLOCK	Containing USF assigned to the MS.
4	MS -> SS	UPLINK RLC DATA BLOCKS (GMM DETACH REQUEST)	
5	SS -> MS	PACKET UPLINK ACK/NACK	Containing Final Ack Indicator bit = 1, and valid RRBP field.
6	MS -> SS	PACKET CONTROL ACKNOWLEDGEMENT	

52.1.3.2 Default Messages

These default message contents override those specified in "GPRS default conditions" but messages specified in a test case have always the highest precedence.

52.1.3.2.1 EGPRS PACKET CHANNEL REQUEST message:

< Access Type >	"One phase access request" or "Two phase access request"
< Multislot class >	Not checked
< Radio priority >	Not checked
< Random Reference >	Not checked.

52.1.3.2.2 PACKET CONTROL ACKNOWLEDGEMENT message:

< MESSAGE_TYPE >	000001
< TLLI >	not checked
< CTRL_ACK >	not checked
< padding bits >	Spare Padding

52.1.3.2.3 EGPRS PACKET DOWNLINK ACK/NACK message:

< MESSAGE_TYPE >	001000
< DOWNLINK_TFI >	Pertaining to the downlink TBF
< MS OUT OF MEMORY >	Not checked
{0 1 < EGPRS Channel Quality Report > }	Not checked
{0 1 < Channel Request Description > }	0 (no channel request)
{ 0 1 < PFI > }	Not checked
{ 0 1 < Extension Bits : Extension Bits IE > }	Not checked
< EGPRS Ack/Nack Description >	
< FINAL_ACK_INDICATION >	0 (not final ack)
< BEGINNING_OF_WINDOW >	Not checked
< END_OF_WINDOW >	Not checked
< STARTING_SEQUENCE_NUMBER >	Not checked
{ 0 1 < COMPRESSED_BITMAP_LENGTH >	Not checked
< COMPRESSED_BITMAP_STARTING_COLOR_CODE >	Not checked
< COMPRESSED_RECEIVED_BLOCK_BITMAP > }	Not checked
< UNCOMPRESSED_RECEIVED_BLOCK_BITMAP >	Not checked
< padding bits >	Spare Padding

52.1.3.2.4 PACKET DOWNLINK ASSIGNMET message:

< MESSAGE_TYPE >	000010
< PAGE_MODE >	Normal Paging
{0 1< PERSISTENCE_LEVEL >}	0 (no persistence level present)
{	10 (address is TLLI)
{0 < Global TFI	same as the value received from MS
10 < TLLI >}	0 – Message Escape bit
{	Dynamic Allocation
{ < MAC_MODE	acknowledged mode
< RLC_MODE	0
< CONTROL_ACK	single slot arbitrarily chosen from valid values (default
< TIMESLOT_ALLOCATION	slot 2)
< Packet Timing Advance >	
{0 1< TIMING_ADVANCE_VALUE >}	1 (timing advance value)
- TIMING_ADVANCE_VALUE	30 bit periods
{0 1<DOWNLINK_TIMING_ADVANCE_INDEX>	0 (no timing advance index)
{0 1 < P0 >	0 (no power control parameter)
{0 1< Frequency Parameters >}	1 (Frequency Parameters present)
< TSC >	value arbitrarily chosen from valid values (default 5)
{ 00 < ARFCN >}	00 (ARFCN no hopping)
- ARFCN	For GSM 900: 30
	For GSM 400: 270
	For GSM 700, T-GSM 810: 467
	For GSM 850: 190
	For DCS 1 800: 650
	For PCS 1 900: 650
{0 1< DOWNLINK_TFI_ASSIGNMENT >}	1 (assign downlink TFI)
< DOWNLINK_TFI_ASSIGNMENT >	arbitrarily chosen from valid values (default 3)
{0 1< Power Control Parameters >}	1 (Power Control Parameters present)
< ALPHA >	0.5
{0 1< GAMMA_TN0 >}	depending on the value in TIMESLOT_ALLOCATION
	(default 0 no GAMMA_TN0)
{0 1< GAMMA_TN1 >}	depending on the value in TIMESLOT_ALLOCATION
	(default 0 no GAMMA_TN1)
{0 1< GAMMA_TN2 >}	depending on the value in TIMESLOT_ALLOCATION
	(default 1 GAMMA_TN2)
- GAMMA_TN2	For GSM 900: +9 dBm
	For GSM 400: +9 dBm
	For GSM 700, T-GSM 810: +9 dBm
	For GSM 850: +9 dBm
	For DCS 1 800: +6 dBm
	For PCS 1 900: +6 dBm
{0 1< GAMMA_TN3 >}	depending on the value in TIMESLOT_ALLOCATION
	(default 0 no GAMMA_TN0)
{0 1< GAMMA_TN4 >}	depending on the value in TIMESLOT_ALLOCATION
	(default 0 no GAMMA_TN4)
{0 1< GAMMA_TN5 >}	depending on the value in TIMESLOT_ALLOCATION
	(default 0 no GAMMA_TN5)
{0 1< GAMMA_TN6 >}	depending on the value in TIMESLOT_ALLOCATION
	(default 0 no GAMMA_TN6)
{0 1< GAMMA_TN7 >}	depending on the value in TIMESLOT_ALLOCATION
	(default 0 no GAMMA_TN7)
{0 1< TBF_STARTING_TIME >}	0 (no starting time present)
{0 1< Measurement Mapping >}	0 (no measurement mapping)
{0 1	1 (Release 99 addition)
{0 1<EGPRS Window Size>	00000
< LINK_QUALITY_MEASUREMENT_MODE >	00 (No measurements need to be sent)
{ 0 1 < BEP_PERIOD2> }}	0 (Not applicable)
{ 0 1 <Packet Extended Timing Advance > }	0 (Not present)
{ 0 1 < COMPACT reduced MA>}	0 (Not present)
< padding bits >	Spare Padding

52.1.3.2.5 PACKET PAGING REQUEST message:

< MESSAGE_TYPE >	100010
< PAGE_MODE >	00 (Normal Paging)
{0 1< PERSISTENCE_LEVEL >}	0 (no persistence level present)
{0 1< NLN >}	0 (no notification list number)
{1< Repeated Page info>}	1 (start of Repeated Page info)
{0	0 (Page request for TBF establishment)
{0< PTMSI >	0 (PTMSI)
- PTMSI	P-TMSI allocated during GPRS attach procedure
< padding bits >	Spare Padding

52.1.3.2.6 PACKET RESOURCE REQUEST message (two phase access):

< MESSAGE_TYPE >	000101
{0 1< ACCESS_TYPE >	1 (response to single block assignment)
- ACCESS_TYPE	00 (two phase access)
{0< Global TFI >	1 (TLLI)
1 < TLLI >	
- TLLI	not checked
{0 1< MS Radio Access Capability >	1 (MS Radio Access Capability)
- MS Radio Access Capability	not checked
< Channel Request Description >	
- PEAK_THROUGHPUT_CLASS	not checked
- RADIO_PRIORITY	not checked
- RLC_MODE	not checked
- LLC_PDU_TYPE	1 (not SACK or ACK)
- RLC_OCTET_COUNT	not checked
{0 1< CHANGE_MARK >}	not checked
< C_VALUE >	not checked
{0 1< SIGN_VAR >	not checked
{0 1< I_LEVEL_TN0 >}	not checked
{0 1< I_LEVEL_TN1 >}	not checked
{0 1< I_LEVEL_TN2 >}	not checked
{0 1< I_LEVEL_TN3 >}	not checked
{0 1< I_LEVEL_TN4 >}	not checked
{0 1< I_LEVEL_TN5 >}	not checked
{0 1< I_LEVEL_TN6 >}	not checked
{0 1< I_LEVEL_TN7 >}	not checked
{0 1	1 (Release 99 additions)
{ 0 1 < EGPRS BEP Link Quality Measurements >}	0 (No measurements)
{ 0 1 < EGPRS Timeslot Link Quality Measurements >}	0 (No measurements)
{ 0 1 < PFI > }	0 (Not present)
< ADDITIONAL MS RAC INFORMATION AVAILABLE >	0 (Not available)
< RETRANSMISSION OF PRR >	0 (Not retransmitted)
< padding bits >	Spare Padding

52.1.3.2.7 PACKET UPLINK ACK/NACK message:

< MESSAGE_TYPE >	001001
< UPLINK_TFI >	same as the TFI value of the TBF which the message applies
{0 1 < EGPRS Channel Coding Command >	1 (Message Escape for EGPRS)
<Resegment >	0000 (MCS-1)
<PRE_EMPTIVE_TRANSMISSION>	0 (RLC block not to be resegmented)
< PRR RETRANSMISSION REQUEST>	0 (Shall not use pre-emptive transmission)
< ARAC RETRANSMISSION REQUEST>	0 (retransmission of a PACKET RESOURCE REQUEST message is not requested)
{ 0 1 < CONTENTION_RESOLUTION_TLLI}>	0 (retransmission of an ADDITIONAL MS RADIO ACCESS CAPABILITIES message is not requested)
<TBF_EST >	0 (Not present)
{ 0 1 < Packet Timing Advance}>	0 (Mobile not allowed for TBF establishment)
{ 0 1 <Packet Extended Timing Advance}>	0 (No timing advance)
{ 0 1 < Power Control Parameters}>	0 (No extended timing advance)
{ 0 1 < Extension Bits}>	0 (No power control parameters)
< EGPRS Ack/Nack Description>	0 (No extension bits)
< FINAL_ACK_INDICATION>	0 (not a final ACK)
< BEGINNING_OF_WINDOW>	1
< END_OF_WINDOW : bit (1) >	1
< STARTING_SEQUENCE_NUMBER>	V(Q) + 1
{ 0 1	0 (No compressed bitmap)
<UNCOMPRESSED_RECEIVED_BLOCK_BITMAP >	0 (No compressed bitmap)
< padding bits >	Spare Padding

52.1.3.2.8 PACKET UPLINK ASSIGNMENT message (dynamic allocation)

< MESSAGE_TYPE >	001010
< PAGE_MODE >	Normal Paging
{0 1< PERSISTENCE_LEVEL >	0 (no persistence level present)
Referenced Address struct	
{ 0 < Global TFI >	
10 < TLLI >	10 (TLLI, the value received from the MS)
110 < TQI >	
111 <Packet Request Reference >	
{0 1	1 (Message Escape for EGPRS)
{ 0 1 < CONTENTION_RESOLUTION_TLLI}	0 (Not present)
{ 0 1 < COMPACT reduced MA>	0 (Not present)
< EGPRS Channel Coding Command >	0000 (MCS-1)
<Resegment >	0 (RLC block not to be resegmented)
< EGPRS Window Size >	00000 (Window size = 64)
{ 0 1 < Access Technologies Request}	0 (Not present)
< ARAC RETRANSMISSION REQUEST>	0 (retransmission of an ADDITIONAL MS RADIO ACCESS CAPABILITIES message is not requested)
< TLLI_BLOCK_CHANNEL_CODING >	arbitrarily chosen but different from EGPRS Channel coding command
{ 0 1 < BEP_PERIOD2}	0 (Not present)
< Packet Timing Advance >	
{ 0 1< TIMING_ADVANCE_VALUE >	1 (timing advance value)
- TIMING_ADVANCE_VALUE }	30 bit periods
{ 0 1< TIMING_ADVANCE_INDEX >	0 (no timing advance index)
<TIMING_ADVANCE_TIMESLOT_NUMBER > }	
{0 1< Frequency Parameters >	1 (Frequency Parameters present)
< TSC >	arbitrarily chosen (default 5)
{ 00< ARFCN >	00 (ARFCN no hopping)
- ARFCN }	For GSM 900: 30
	For GSM 400: 270
	For GSM 700, T-GSM 810: 467
	For GSM 850: 190
	For DCS 1 800: 650
	For PCS 1 900: 650
{ 01 < Dynamic Allocation >	01 (Dynamic allocation)
< Extended Dynamic Allocation >	0 (Dynamic allocation)
{ 0 1< P0 >	1
-P0	0 dB
< PR_MODE : bit (1) > }	0 (PR mode A)
< USF_GRANULARITY >	0 (one block)
{0 1< UPLINK_TFI_ASSIGNMENT >	1 (uplink TFI assignment)
- UPLINK_TFI_ASSIGNMENT }	arbitrarily chosen (default 00101)
{0 1< RLC_DATA_BLOCKS_GRANTED >}	0 (no RLC_DATA_BLOCKS_GRANTED, open-ended TBF)
{0 1< TBF_STARTING_TIME >}	0 (no starting time)
{0 1< Timeslot Allocation >	1 (Timeslot Allocation with Power Control Parameters)
	one slot arbitrarily chosen and the following USF_TNx and GAMMA_TNx shall be corresponding to the chosen value (default slot 2)
	0.5
< ALPHA >	
{0 1< USF_TN0><GAMMA_TN0 >}	0 (timeslot 0 not assigned)
{0 1< USF_TN1><GAMMA_TN1 >}	0 (timeslot 1 not assigned)
{0 1< USF_TN2><GAMMA_TN2 >	1 (timeslot 2 assigned)
- USF_TN2	arbitrarily chosen (default 101)
- GAMMA_TN2 }	For GSM 900: +9 dBm
	For GSM 400: +9 dBm
	For GSM 700, T-GSM 810: +9 dBm
	For GSM 850: +9 dBm
	For DCS 1 800: +6 dBm
	For PCS 1 900: +6 dBm
{0 1< USF_TN3><GAMMA_TN3 >}	0 (timeslot 3 not assigned)
{0 1< USF_TN4><GAMMA_TN4 >}	0 (timeslot 4 not assigned)
{0 1< USF_TN5><GAMMA_TN5 >}	0 (timeslot 5 not assigned)
{0 1< USF_TN6><GAMMA_TN6 >}	0 (timeslot 6 not assigned)
{0 1< USF_TN7><GAMMA_TN7>}}	0 (timeslot 7 not assigned)

< padding bits >	Spare Padding
------------------	---------------

52.1.3.2.9 Void

52.1.3.2.10 PACKET UPLINK ASSIGNMENT message (multi block allocation):

<p>< MESSAGE_TYPE > < PAGE_MODE > {0 1< PERSISTENCE_LEVEL > Referenced Address struct { 0 < Global TFI > 10 < TLLI > 110 < TQI > 111 <Packet Request Reference >} {0 1 { 0 1 < CONTENTION_RESOLUTION_TLLI} { 0 1 < COMPACT reduced MA>} < EGPRS Channel Coding Command > <Resegment > < EGPRS Window Size > { 0 1 < Access Technologies Request} < ARAC RETRANSMISSION REQUEST> < TLLI_BLOCK_CHANNEL_CODING > { 0 1 < BEP_PERIOD2} < Packet Timing Advance > - {0 1< TIMING_ADVANCE_VALUE > - TIMING_ADVANCE_VALUE } - {0 1< TIMING_ADVANCE_INDEX> <TIMING_ADVANCE_TIMESLOT_NUMBER >} {0 1< Frequency Parameters > < TSC > { 00< ARFCN >} - ARFCN} { 10 < Multi block allocation > < TIMESLOT_NUMBER > {0 1 < ALPHA > < GAMMA_TN >} {0 1 < P0 > < BTS_PWR_CTRL_MODE > < PR_MODE: bit (1) >} < TBF_STARTING_TIME > < padding bits ></p>	<p>001010 Normal Paging 111 (Packet Request Reference, information field sent in PACKET CHANNEL REQUEST and frame number in which PACKET CHANNEL REQUEST was received) 1 (Message Escape for EGPRS) 0 (Not present) 0 (Not present) 0000 (MCS-1) 0 (RLC block not to be resegmented) 00000 (Window size = 64) 0 (Not present) 0 (retransmission of an ADDITIONAL MS RADIO ACCESS CAPABILITIES message is not requested) arbitrarily chosen but different from EGPRS CHANNEL CODING COMMAND 0 (Not present) 1 (timing advance value) 30 bit periods 0 (no timing advance index) 1 (Frequency Parameters present) arbitrarily chosen (default 5) 00 (ARFCN no hopping) For GSM 900: 30 For GSM 400: 270 For GSM 700, T-GSM 810: 467 For GSM 850: 190 For DCS 1 800: 650 For PCS 1 900: 650 10 (Multi block allocation) arbitrarily chosen (default slot 2) 1 (power control parameters) 0.5 For GSM 900: +9 dBm For GSM 400: +9 dBm For GSM 700, T-GSM 810: +9 dBm For GSM 850: +9 dBm For DCS 1 800: +6 dBm For PCS 1 900: +6 dBm 1 (downlink power control parameters) 0 dB 0 (mode A) 0 (PR mode A) no TBF starting time Spare padding</p>
--	--

52.2 Void

52.3 EGPRS Testcases for Dynamic Allocation in Packet Transfer Mode

52.3.1 Dynamic Allocation / Uplink Transfer

52.3.1.1 Dynamic Allocation / Uplink Transfer / Normal

52.3.1.1.1 Dynamic Allocation / Uplink Transfer / Normal / Successful

52.3.1.1.1.1 Conformance requirements

1. The mobile station shall set the TFI field of each uplink RLC data block to the TFI value assigned to the mobile station in the PACKET UPLINK ASSIGNMENT or PACKET TIMESLOT RECONFIGURE message.
2. Whenever the mobile station detects an assigned USF value on an assigned PDCH, the mobile station shall transmit either a single RLC/MAC block or a sequence of four RLC/MAC blocks on the same PDCH in the next block period(s). The time relation between an uplink block, which the mobile station shall use for transmission, and the occurrence of the USF value is defined in 3GPP TS 05.02. The number of RLC/MAC blocks to transmit is controlled by the USF_GRANULARITY parameter characterising the uplink TBF.
3. At two-phase access the mobile station does not include its TLLI in any RLC data block.

References

3GPP TS 04.60, subclauses 8.1.1, 8.1.1.1 and 7.1.3.3.

3GPP TS 05.02, subclause 6.3.2.2.1.

52.3.1.1.1.2 Test purposes

To verify that the MS:

1. depending on the parameter USF_GRANULARITY, transmits one or a sequence of four RLC/MAC data block(s) in the next block period(s) on the PDCH on which it has detected its corresponding assigned USF.
2. includes the assigned TFI in each uplink RLC data blocks.
3. does not include its TLLI in any RLC data block at two phase access.

52.3.1.1.1.3 Method of test

Initial Conditions

System Simulator:

1 cell, default setting, BS_PBCCH_BLKs = 3.

Mobile Station:

The MS is GPRS attached with a P-TMSI allocated and the test PDP context3 activated.

Specific PICS Statements

-

PIXIT Statements

-

Test Procedure

The MS is triggered to initiate packet uplink transfer data in RLC unacknowledged mode. The SS orders the MS to have two-phase access, in PACKET UPLINK ASSIGNMENT message the USF_GRANULARITY is set to 4 blocks. The SS

sends the assigned USF assigned to the MS and checks that a sequence of four RLC/MAC data blocks in the next radio block period is received, and that each data block contains the correct TFI, but without TLLI. The SS assigns the USF assigned to the MS again. The check is repeated. The procedure is going on until the MS completes the packet data transfer.

The above test procedure is repeated once for USF_GRANURALITY set to one block.

Maximum Duration of Test

5 minutes.

Expected Sequence

Step	Direction	Message	Comments
1		{Uplink dynamic allocation two phase access}	n =800 octets, without starting time, Message Escape bit = 1 (EGPRS) USF_GRANULARITY = 4 blocks, RLC_DATA_BLOCKS_GRANTED = open-end TLLI_BLOCK_CHANNEL_CODING = arbitrarily chosen between MCS 1 and MCS 4 EGPRS Channel coding command arbitrarily chosen between MCS 1 and MCS 4 EGPRS Window Size: 00000 (value 64)
2	SS -> MS	PACKET DOWNLINK DUMMY CONTROL BLOCK	Sent on the PACCH, the USF assigned to the MS, on 3 blocks from the last radio block containing the uplink assignment.
3	MS -> SS	EGPRS UPLINK RLC DATA BLOCK	Received on the assigned PDTCH. Check that the coding as specified by EGPRS Channel coding command, the TFI is correct and the block does not contain TLLI.
4	MS -> SS	EGPRS UPLINK RLC DATA BLOCK	Received on the assigned PDTCH in the next radio block to step 3. Check that the coding as specified by EGPRS Channel coding command, the TFI is correct and the block does not contain TLLI.
5	MS -> SS	EGPRS UPLINK RLC DATA BLOCK	Received on the assigned PDTCH in the next radio block to step 4. Check that the coding is the scheme specified by EGPRS Channel coding command, the TFI is correct and the block does not contain TLLI.
6	MS -> SS	EGPRS UPLINK RLC DATA BLOCK	Received on the assigned PDTCH in the next radio block to step 5. Check that the coding as specified by EGPRS Channel coding command, the TFI is correct and the block does not contain TLLI.
7	SS -> MS	PACKET UPLINK ACK/NACK	Sent on the PACCH of the PDCH, the USF not addressing the MS.
8	SS		Check that no RLC data blocks are transmitted from the MS in the next radio block to step 7.
9	SS -> MS	PACKET DOWNLINK DUMMY CONTROL BLOCK	The USF assigned to the MS.
10	MS -> SS	EGPRS UPLINK RLC DATA BLOCK	Received on the assigned PDTCH.
11	MS -> SS	EGPRS UPLINK RLC DATA BLOCK	Received on the assigned PDTCH in the next radio block to step 10. Check that the TFI is correct.
12	MS -> SS	EGPRS UPLINK RLC DATA BLOCK	Received on the assigned PDTCH in the next radio block to step 11. Check that the TFI is correct.
13	MS -> SS	EGPRS UPLINK RLC DATA BLOCK	Received on the assigned PDTCH in the next radio block to step 12. Check that the TFI is correct.
14		{Completion of uplink RLC data block transfer}	USF_GRANULARITY = 4 blocks
15		{Uplink dynamic allocation two phase access}	Similar parameter values to step 1 Except USF_GRANULARITY = 1 blocks
16	SS -> MS	PACKET DOWNLINK DUMMY CONTROL BLOCK	Sent on the PACCH of the PDCH, the USF assigned to the MS on 3 blocks from the last radio block containing the uplink assignment.
17	MS -> SS	EGPRS UPLINK RLC DATA BLOCK	Received on the assigned PDTCH. Check that the coding as specified in EGPRS Channel coding command, the TFI is correct and the block does not contain TLLI.
18	SS -> MS	PACKET UPLINK ACK/NACK	Sent on the PACCH, the USF not addressing the MS.
19	SS		Check that no RLC data blocks are transmitted from the MS in the next radio block to step 18.
20	SS -> MS	PACKET UPLINK ACK/NACK	Sent on a PDCH with any different time slot as the assigned PDCH, the USF assigned to the MS.

Step	Direction	Message	Comments
21	SS		Check that no RLC data block is transmitted from the MS on the next radio block to step 20.
22	SS -> MS	PACKET DOWNLINK DUMMY CONTROL BLOCK	Sent on the PACCH of the PDCH, the USF assigned to the MS.
23	MS -> SS	EGPRS UPLINK RLC DATA BLOCK	Received on the assigned PDCH. Check that the coding as specified in EGPRS Channel coding command, the TFI is correct and the block does not contain TLLI.
24		{Completion of uplink RLC data block transfer}	USF_GRANULARITY = 1 block

52.3.1.1.2 Void

52.3.1.1.3 Dynamic Allocation / Uplink Transfer / Normal / Starting frame number encoding

52.3.1.1.3.1 Conformance requirements

1. In case of dynamic allocation, if no uplink TBF is in progress, the MS needs not monitor the USF field until the TDMA frame number occurs. When the indicated TDMA frame number occurs, the mobile station shall immediately begin to monitor the USF field and use the new assigned uplink TBF parameters when its USF occurs.
2. If an uplink TBF is already in progress, the MS shall continue to use the parameters of the existing TBF until the TDMA frame number occurs. When the indicated TDMA frame number occurs, the mobile station shall immediately begin to monitor the USF field and use the new assigned uplink TBF parameters when its USF occurs.
3. In case of single block allocation, the mobile station shall use the assigned timeslot during the RLC/MAC block whose first TDMA burst occurs in the indicated TDMA frame number.
4. If the mobile station is in packet transfer mode during the block immediately before the starting time and the lowest numbered PDCH assigned to the MS is different immediately before and after the starting time then the mobile station shall be ready to receive or transmit no later than one radio block from the starting time.
5. If the Starting FN (in absolute frame number encoding) is not aligned to the start of a block period and the mobile station is in packet transfer mode during the TDMA immediately before the Starting FN, then the mobile station shall align the starting time to the next block boundary and continue to use the currently assigned allocation up to the next block boundary.

References

3GPP TS 04.60, subclauses 11.2.29, 12.21 and 12.21.1.

52.3.1.1.3.2 Test purposes

To verify that the MS, in transfer mode:

1. correctly uses the starting frame number description in PACKET UPLINK ASSIGNMENT, and in all subsequent RLC/MAC control messages which are sent on the uplink TBF;
2. is ready to receive or transmit no later than one radio block from the starting time;
3. is able to align the starting time to the next block boundary and continue to use the currently assigned allocation up to the next block boundary.

52.3.1.1.3.3 Method of test

Initial Conditions

System Simulator:

1 cell, default setting, BS_PBCCH_BLKs = 3.

Mobile Station:

The MS is GPRS attached with a P-TMSI allocated and the test PDP context3 activated.

Specific PICS Statements

-

PIXIT Statements

-

Test Procedure

The MS is triggered to initiate packet uplink transfer 440 octets in the RLC unacknowledged mode. The PACKET UPLINK ASSIGNMENT message contains a starting time encoded in absolute frame number format for the single block allocation. It is checked that the MS uses the time slot at the assigned frame number. In the two-phase access a starting time is included in PACKET UPLINK ASSIGNMENT. The assigned USF is on a radio block before the starting time. The MS does not react upon that. The assigned USF is on one block after the starting time. The MS sends a RLC data block.

The test procedure is repeated once. The starting time is encoded in relative frame number format.

Maximum Duration of Test

5 minutes.

Expected Sequence

The expected sequence is repeated once. In the 2nd execution the starting frame numbers in the specific message contents are encoded in the relative format.

Step	Direction	Message	Comments
1		{Uplink dynamic allocation two phase access}	n = 440 octets, USF_GRANULARITY = 1 block, RLC_DATA_BLOCKS_GRANTED = open-end TLLI_BLOCK_CHANNEL_CODING: same as channel coding EGPRS Channel coding command MCS-3 The 1st PACKET UPLINK ASSIGNMENT contains starting time specified in absolute frame number encoding, current frame + 1001. It is checked that PACKET RESOURCE REQUEST in the macro is sent at the starting time. The 2 nd PACKET UPLINK ASSIGNMENT contains starting time specified in absolute frame number encoding, current frame + 91, The timeslot TN ₇ assigned.
2	SS -> MS	PACKET DOWNLINK DUMMY CONTROL BLOCK	The USF assigned to the MS, Sent on one radio block before the starting time.
3	SS		Check that there is no RLC data block sent by the MS on the assigned PDTCH.
4	SS -> MS	PACKET DOWNLINK DUMMY CONTROL BLOCK	The USF assigned to the MS. Sent on one block after the starting time.
5	MS -> SS	EGPRS UPLINK RLC DATA BLOCK	Received on the assigned PDTCH. Check that the coding is the scheme specified by EGPRS Channel coding command in step 1, and TFI is correct.
6		{Completion of uplink RLC data block transfer}	

52.3.1.1.4 Dynamic Allocation / Uplink Transfer / Normal / Starting time

52.3.1.1.4.1 Conformance requirements

- 1 If a TBF starting time information element is present and no uplink TBF is in progress, but a downlink TBF is in progress, the mobile station shall wait until the starting time before beginning to monitor the USFs. While waiting for the starting time, the mobile station shall monitor the assigned PDCHs.

- 2 If an uplink TBF is already in progress, the mobile station shall continue to use the assigned parameters of the uplink TBF until the TDMA frame number indicated by the TBF starting time occurs. At that time the mobile station shall immediately begin to use the newly assigned uplink TBF parameters.
- 3 While waiting for the frame number indicated by the TBF starting time if the mobile station receives another uplink assignment, the mobile station shall act upon the most recently received uplink assignment and shall ignore the previous uplink assignment.
- 4 An MS shall be ready to transmit and receive using a new assignment no later than the next occurrence of block $B((x+3) \bmod 12)$ where block $B(x)$ is the last radio block containing the assignment message. This applies also for the reception of the first USF for dynamic uplink assignment.

References

3GPP TS 04.60, subclause 8.1.1.1, 3GPP TS 45.010 subclause 6.1.1.1.

52.3.1.1.4.2 Test purposes

To verify that after the MS receives an uplink assignment with starting time:

1. if a downlink TBF is in progress and no uplink TBF is in progress it monitors the assigned PDCHs while waiting for the starting time. If another uplink assignment received while waiting, the mobile station acts upon that and ignores the previous uplink assignment.
2. if an uplink TBF is already in progress, it continues to use the assigned parameters of the uplink TBF until the TDMA frame number indicated by the TBF starting time occurs. While waiting for the frame number indicated by the TBF starting time the mobile station receives another uplink assignment, the mobile station acts upon that and ignores the previous uplink assignment. As soon as the starting time occurs the MS immediately begins to use the newly assigned uplink TBF parameters.

52.3.1.1.4.3 Method of test

Initial Conditions

System Simulator:

1 cell, default setting, BS_PBCCH_BLKs = 3.

Mobile Station:

The MS is GPRS attached with a P-TMSI allocated and the test PDP context2 activated.

Specific PICS Statements

-

PIXIT Statements

-

Test Procedure

A downlink TBF is established and in progress. An uplink TBF is established with a starting time which does not yet elapse. The SS sends two downlink data blocks before the starting time to the MS and signals the assigned TBF addressing the MS for uplink transfer. It is checked that no uplink RLC data blocks are sent by the MS. The SS sends PACKET TIMESLOT RECONFIGURE on three radio blocks before the starting time, assigning a new starting time. Two downlink data blocks are then sent to the MS before the new starting time occurs. Each data block contains one of the assigned USFs addressing the MS. It is checked that no uplink data blocks are sent from the MS. After the new starting time elapses the SS sends a downlink data block containing the USF assigned to the MS. The MS sends an uplink data block. The MS is brought to Idle mode.

An uplink TBF is established and in progress. The SS sends PACKET UPLINK ASSIGNMENT assigning a reconfigured PDCH with a starting time and a new USF associated. Before the starting time the SS signals the USF of the ongoing TBF addressing the MS. The SS receives an uplink data block from the MS. The SS sends UPLINK ASSIGNMENT on three radio blocks before the starting time, assigning a new reconfigured PDCH with a starting time and a different USF associated. The later assignment overwrites the earlier one. While waiting for the frame number of

the newly assigned starting time the SS signals the USF of the previous assignment on both the ongoing PDCH and on the previous assigned PDCH. The MS ignores it. The SS signals the USF of the ongoing TBF addressing the MS. An uplink data block can be received. On one radio block before the starting time the SS signals the later assigned USF assigned to the MS on the later assigned PDCH. No uplink data block is received. On one radio block after the starting time the SS signals the just expired USF. No uplink data block is received. Then the SS signals the valid USF assigned to the MS. An uplink data block is received.

Maximum Duration of Test

5 minutes.

Expected Sequence

Step	Direction	Message	Comments
------	-----------	---------	----------

Step	Direction	Message	Comments
1		{Downlink TBF establishment}	RLC mode: acknowledged, without starting time
2	SS -> MS	EGPRS DOWNLINK RLC DATA BLOCK	The data block contains FBI=0, ES/P field set to 01 and a valid RRBp, sent on the third block after the last radio block containing the downlink assignment.
3	MS -> SS	EGPRS PACKET DOWNLINK ACK/NACK	Received on the specified RRBp of downlink PACCH.
4	MS		The MS is triggered to send 440 octets of user data.
5	SS -> MS	EGPRS DOWNLINK RLC DATA BLOCK	The data block contains FBI=0 and a valid RRBp.
6	MS -> SS	EGPRS PACKET DOWNLINK ACK/NACK	Received on the specified RRBp of downlink PACCH. Contains Channel Request Description IE. Note : If the triggering of the uplink access involves a manual operation taking more than 5s to complete, steps 5 and 6 are repeated (until the MS does include the Channel Request Description IE) at least once every 5s in order to keep the downlink transfer active.
7	SS -> MS	PACKET UPLINK ASSIGNMENT	USF_GRANULARITY = 1 block, RLC_DATA_BLOCKS_GRANTED = open-end CHANNEL_CODING_COMMAND: arbitrarily chosen. TBF Starting Time : starting time ₁ , the current frame + 104 frames, encoded in absolute frame number. The uplink TBF is assigned on the same timeslot as the downlink TBF.
8	SS -> MS	EGPRS DOWNLINK RLC DATA BLOCK	FBI=0, the assigned USF ₁ to the MS. Sent on downlink PDTCH, 12 data blocks (52 TDMA frames) before the starting time ₁ .
9	SS -> MS	EGPRS DOWNLINK RLC DATA BLOCK	FBI=0, the assigned USF ₁ to the MS. Sent on downlink PDTCH, 5 blocks before the starting time ₁ , a valid RRBp = N+13 and ES/P set to 01.
10	MS -> SS	EGPRS PACKET DOWNLINK ACK/NACK	Received on the specified RRBp on downlink PACCH.
11	SS -> MS	PACKET TIMESLOT RECONFIGURE	Assigned USF ₁ addressing the MS, sent on three blocks before the starting time ₁ . Assigned a new USF ₂ on the same timeslot, with starting time ₂ , current frame + 104 frames in relative frame number encoding.
12	SS -> MS	EGPRS DOWNLINK RLC DATA BLOCK	On 4 blocks from the last radio block containing the uplink assignment in step 11, with FBI=0, the assigned previous USF ₁ addressing the MS. Sent on downlink PDTCH.
13	SS -> MS	EGPRS DOWNLINK RLC DATA BLOCK	One data block with FBI=0, the assigned USF ₂ addressing the MS. Sent on downlink PDTCH, one radio block before the starting time ₂ .
14	SS		Check that from the step 4 onwards till the starting time ₂ , there is no RLC data block sent by the MS on the assigned uplink PDTCH.
15	SS -> MS	EGPRS DOWNLINK RLC DATA BLOCK	One data block with FBI=0, a valid RRBp, ES/P set to 01, the assigned USF ₂ addressing the MS. Sent on downlink PDTCH, on the frame number specified in the starting time ₂ .
16	MS -> SS	EGPRS UPLINK RLC DATA BLOCK	Received on the assigned uplink PDTCH.
17	MS -> SS	EGPRS PACKET DOWNLINK ACK/NACK	Received on the specified RRBp of downlink PACCH.
18	SS -> MS	EGPRS DOWNLINK RLC DATA BLOCK	One data block with FBI=1, ES/P set to 01 and a valid RRBp. Sent on downlink PDTCH.
19	MS -> SS	EGPRS PACKET DOWNLINK ACK/NACK	Received on the specified RRBp of the downlink PACCH.
20		{Completion of uplink RLC data block transfer}	
21		{Uplink dynamic allocation two phase access}	n = 440 octets, without starting time, USF_GRANULARITY = 1 block, RLC_DATA_BLOCKS_GRANTED = open-end TLLI_BLOCK_CHANNEL_CODING: arbitrarily chosen. EGPRS channel coding command: MCS 1 The timeslot TN ₃ assigned

Step	Direction	Message	Comments
22	SS -> MS	PACKET DOWNLINK DUMMY CONTROL BLOCK	Assigned USF ₁ addressing the MS, sent on 3 blocks from the last radio block containing the uplink assignment in step 21.
23	MS -> SS	EGPRS UPLINK RLC DATA BLOCK	Check that the coding is MCS 1, the TFI is correct.
24	SS -> MS	EGPRS PACKET UPLINK ACK/NACK	Assigned USF ₁ addressing the MS.
25	MS -> SS	EGPRS UPLINK RLC DATA BLOCK	Received on the assigned PDTCH.
26	SS -> MS	PACKET UPLINK ASSIGNMENT	Assign an uplink TBF on the timeslot TN ₂ , containing new TFI ₂ , USF ₂ , starting time ₃ , current frame + 117 in relative encoding. Sent on PACCH assigned.
27	SS -> MS	EGPRS PACKET UPLINK ACK/NACK	USF ₁ addressing the MS, sent on 5 radio blocks before the starting time ₃ , on PACCH assigned in step 21.
28	MS -> SS	EGPRS UPLINK RLC DATA BLOCK	Check that the coding is MCS 1, the TFI is correct.
29	SS -> MS	PACKET UPLINK ASSIGNMENT	Assign a TBF on the timeslot TN ₁ , containing new TFI ₃ , USF ₃ , MCS 3 coding, starting time ₄ , current frame + 325 in relative encoding. Sent on three radio blocks before the starting time ₃ , on PACCH assigned in step 21.
30	SS -> MS	PACKET UPLINK ACK/NACK	USF ₂ addressing the MS, sent one block after Starting Time ₃ on the PACCH assigned in step 26.
31	SS		Check that no data block is sent from the MS on the assigned radio block on the PDTCH assigned in step 26.
32	SS -> MS	PACKET DOWNLINK DUMMY CONTROL BLOCK	USF ₁ addressing the MS, sent on 5 radio blocks before the starting time ₄ , on PACCH assigned in step 21.
33	MS -> SS	EGPRS UPLINK RLC DATA BLOCK	Check that the coding is MCS1, the TFI is correct.
34	SS -> MS	PACKET DOWNLINK DUMMY CONTROL BLOCK	The USF ₃ addressing the MS, sent on one radio block before the starting time ₄ , on PACCH assigned in step 29.
35	SS -> MS	PACKET DOWNLINK DUMMY CONTROL BLOCK	The USF ₁ addressing the MS, sent on one radio block after the starting time ₄ , on PACCH assigned in step 21.
36	SS		Check that no data blocks are sent from the MS on the radio blocks assigned in steps 34 and 35, or any intermediate radio blocks, on any of the three PDTCHs assigned
37	SS -> MS	PACKET UPLINK ACK/NACK	Containing USF ₃ . Sent on PACCH of assigned in step 29.
38 (optional step)	MS -> SS	EGPRS UPLINK RLC DATA BLOCK	Received on the PDTCH assigned in step 29. Use coding MCS 1. If step 38 is performed, then step 39 must be performed.
39 (optional step)	SS -> MS	PACKET UPLINK ACK/NACK	Only performed if step 38 is performed. Containing USF ₃ . Sent on PACCH of PDCH assigned in step 29.
40	MS -> SS	EGPRS UPLINK RLC DATA BLOCK	Received on the PDTCH assigned in step 29. Check that the coding MCS 3 and TFI ₃ are correct.
41		{Completion of uplink RLC data block transfer}	

52.3.1.1.5 void

52.3.1.1.6 Dynamic Allocation / Uplink Transfer / Normal / T3180 expiry

52.3.1.1.6.1 Conformance requirements

When the mobile station transmits an RLC/MAC block to the network, it shall start timer T3180. When the mobile station detects an assigned USF value on an assigned PDCH, the mobile station shall reset timer T3180. If timer T3180 expires, the mobile station shall perform the abnormal release with random access procedure.

References

3GPP TS 04.60, subclause 8.1.1.1.

52.3.1.1.6.2 Test purposes

To verify that:

1. Timer T3180 will not expire as long as an USF for the MS under test is detected in the downlink blocks within the defined time period of the timer. (It is implicitly verified).
2. Timer T3180 expires if no USF for the MS under test is detected during a time period longer than T3180.
3. The MS performs an abnormal release with random access procedure after T3180 expires.

52.3.1.1.6.3 Method of test

Initial Conditions

System Simulator:

1 cell, default setting, BS_PBCCH_BLKs = 3.

Mobile Station:

The MS is GPRS attached with a P-TMSI allocated and the test PDP context3 activated.

Specific PICS Statements

-

PIXIT Statements

-

Test Procedure

An uplink TBF is established and in progress. After the MS sends an uplink data block the SS repeatedly sends PACKET UPLINK ACK/NACK containing any USF and any TFI which do not address the MS for 4.5s. Before T3180 times out the SS signals the USF assigned to the MS. The MS sends a data block. Then the SS repeatedly sends PACKET UPLINK ACK/NACK containing any USF and any TFI which do not address the MS until receiving EGPRS PACKET CHANNEL REQUEST from the MS for establishment of a new TBF.

Maximum Duration of Test

5 minutes.

Expected Sequence

Step	Direction	Message	Comments
1		{Uplink dynamic allocation two phase access}	n = 1200 octets, without starting time, USF_GRANULARITY = 1 block, RLC_DATA_BLOCKS_GRANTED = open-end
2	SS -> MS	PACKET DOWNLINK DUMMY CONTROL BLOCK	EGPRS channel coding command : arbitrarily chosen. The USF assigned to the MS sent on 3 blocks from the last radio block containing the uplink assignment.
3	MS -> SS	EGPRS UPLINK RLC DATA BLOCK	Received on the assigned PDTCH. Check that the TFI is correct.
4	SS -> MS	PACKET UPLINK ACK/NACK	Sent on the PACCH of the PDCH assigned in step 2, the USF assigned to the MS.
5	MS -> SS	EGPRS UPLINK RLC DATA BLOCK	Received on the assigned PDTCH. Check that the TFI is correct.
6	SS -> MS	PACKET UPLINK ACK/NACK	Sent on the PACCH, containing a different TFI and USF from the assigned ones to the MS.
7	SS		Repeat step 6 every 5 radio blocks for 4.5 s. (T3180 * 90%) the SS signals different USFs on the assigned PDCH, but none of them addressing the MS.
8	SS -> MS	PACKET UPLINK ACK/NACK	Sent on the PACCH of the PDCH assigned in step 2, the USF assigned to the MS.
9	MS -> SS	EGPRS UPLINK RLC DATA BLOCK	Received on the assigned PDTCH. Check that the TFI is correct.
10	SS		Repeat step 6 every 5 radio blocks until step 11 occurs. The maximum period for the repetition is of 8s (5s timer + two PSI1 periods). None of the signalled USFs addresses the MS on the assigned PDCH.
11	MS -> SS	EGPRS PACKET CHANNEL REQUEST	Received on PRACH within 7.5 seconds (T3180 * 110% + PSI1 repeat period) from step 9.
12	SS -> MS	PACKET UPLINK ASSIGNMENT	Multiblock assignment, to order the MS making two-phase access procedure. Sent on PAGCH.
13	MS -> SS	PACKET RESOURCE REQUEST	Two phase access procedure. Received on the single block assigned in step 12.
14	SS -> MS	PACKET UPLINK ASSIGNMENT	Open-ended uplink dynamic allocation, no starting time, USF_GRANULARITY = single block, Sent on PACCH of the same PDCH assigned in step 12.
15	SS -> MS	PACKET DOWNLINK DUMMY CONTROL BLOCK	The USF assigned to the MS. Sent on PACCH of PDCH assigned in step 14.
16	MS -> SS	EGPRS UPLINK RLC DATA BLOCK	Received on the assigned PDTCH. Check that the coding scheme is that specified in step 14 by EGPRS channel coding command and the TFI is correct.
17		{Completion of uplink RLC data block transfer}	

Specific Message Contents

PACKET UPLINK ASSIGNMET message in step 14:

Information Element	value/ remark
Message Escape bit	1 (EGPRS)
EGPRS channel coding command	Arbitrarily chosen
Dynamic allocation	01
- Extended Dynamic Allocation	0 (Dynamic allocation)
-	0
- USF granularity	0 (1 block)
- {0 1<UPLINK_TFI_ASSIGNMENT>}	1 (uplink TFI assignment)
- UPLINK_TFI	00000
- {0 1<RLC_DATA_BLOCKS_GRANTED>}	0 (no RLC_DATA_BLOCKS_GRANTED, open-ended TBF)
- {0 1<TBF_STARTING_TIME>}	0 (no starting time)
-	0 (Timeslot Allocation Parameters)
	one slot arbitrarily chosen but different from the value in step 2

52.3.1.1.7 Dynamic Allocation / Uplink Transfer / Normal / PACCH operation

52.3.1.1.7.1 Conformance requirements

1. The mobile station shall attempt to decode every downlink RLC/MAC block on all assigned PDCHs. Whenever the mobile station receives an RLC/MAC block containing an RLC/MAC control block, the mobile station shall attempt to interpret the message contained therein. If the message addresses the mobile station, the mobile station shall act on the message. The mobile station shall not transmit an RLC data block in any uplink radio block allocated via the polling mechanism.
2. PACKET POLLING REQUEST is sent on the PCCCH or PACCH by the network to the mobile station to solicit a PACKET CONTROL ACKNOWLEDGEMENT message from the mobile station.
3. In downlink RLC/MAC control blocks, the TFI identifies the Temporary Block Flow (TBF) to which the RLC/MAC control message contained in the downlink RLC/MAC control block relates. If present, this field indicates the mobile station to which the control message is addressed, and all other mobile stations shall ignore the control message. If this field is present and the contents of the control message also contain a TFI addressing the mobile station, the mobile station shall ignore the TFI in the control message contents.

References

3GPP TS 04.60, subclauses 8.1.1.1.1, 11.2.12 and 10.4.10.

52.3.1.1.7.2 Test purposes

To verify that:

1. The MS attempts to decode every downlink RLC/MAC block on all assigned PDCHs whenever the MS receives an RLC/MAC block containing an RLC/MAC control block, the MS attempts to interpret the message contained therein, such as Payload type and TFI in the optional fields. If the message addresses the MS, it acts upon the message.
2. When receiving PACKET POLLING REQUEST on PACCH the MS responds with four PACKET CONTROL ACKNOWLEDGEMENT messages of access burst format and does not transmit an RLC data block in any uplink radio block allocated via the polling mechanism.

52.3.1.1.7.3 Method of test

Initial Conditions

System Simulator:

1 cell, default setting, BS_PBCCH_BLKs = 3.

Mobile Station:

The MS is GPRS attached with a P-TMSI allocated and the test PDP context3 activated.

Specific PICS Statements

-

PIXIT Statements

-

Test Procedure

A TBF is established. It is polled with PACKET POLLING REQUEST containing a global TFI not addressing the MS. The assigned USF addresses the MS. The MS transmits a data block. The SS polls the MS with PACKET POLLING REQUEST containing any global TFI not addressing the MS. The message has optional octets where TFI does address the MS. The MS responds with PACKET CONTROL ACKNOWLEDGEMENT four times in access burst formats. The SS polls again the MS with PACKET POLLING REQUEST containing the global TFI addressing the MS. The MS responds with PACKET CONTROL ACKNOWLEDGEMENT four times in access burst formats.

Maximum Duration of Test

5 minutes.

Expected Sequence

Step	Direction	Message	Comments
1		{Uplink dynamic allocation two phase access}	n = 440 octets, without starting time, USF_GRANULARITY = 1 block, RLC_DATA_BLOCKS_GRANTED = open-end TLLI_BLOCK_CHANNEL_CODING: MCS 1 EGPRS channel coding command : MCS 1
2	SS -> MS	PACKET POLLING REQUEST	the USF assigned to the MS, the TFI in the message not addressing the MS, no optional octets in RLC/MAC header, a valid RRBP
3	MS -> SS	EGPRS UPLINK RLC DATA BLOCK	Check the TFI is correct as assigned in step 1.
4	SS -> MS	PACKET POLLING REQUEST	NOT the USF assigned to the MS, the global TFI in the message contents NOT addressing the MS, Payload type='10' indicates the RLC/MAC header containing optional octets where TFI DOES address the MS, RBSN='0'. TYPE_OF_ACK = '0', a valid RRBP=N+13
5	MS -> SS	PACKET CONTROL ACKNOWLEDGEMENT	4 access bursts. Received on PACCH, CTRL_ACK = '10'.
6	SS -> MS	PACKET POLLING REQUEST	Not the USF assigned to the MS. The global TFI in the message contents addressing the MS. Payload type indicates the RLC/MAC header containing optional octets where TFI not addressing the MS. a valid RRBP
7	SS		Check the MS ignores the polling .
8	SS -> MS	PACKET POLLING REQUEST	Not the USF assigned to the MS. the Global TFI addresses the MS, RLC/MAC header containing no optional octets. TYPE_OF_ACK = '0', a valid RRBP
9	MS -> SS	PACKET CONTROL ACKNOWLEDGEMENT	4 access bursts, received on PACCH.
10		{Completion of uplink RLC data block transfer}	

52.3.1.1.8 Dynamic Allocation / Uplink Transfer / Normal / Two uplink timeslots

52.3.1.1.8.1 Conformance requirements

Mobile station belonging to multislot class 3, 5, 6, 7 and 9 – 29 shall support at least two transmit timeslots per TDMA frame (refer to 3GPP TS 05.02, clause B.1).

References

3GPP TS 05.02, clause B.1.

52.3.1.1.8.2 Test purposes

To verify that an MS belonging to EGPRS multislot class 5, 6, 7 and 9 – 29 supports an uplink TBF using two timeslots per TDMA frame.

52.3.1.1.8.3 Method of test

Initial Conditions

System Simulator:

1 cell, default setting, BS_PBCCH_BLKs = 3.

Mobile Station:

The MS is GPRS attached with a P-TMSI allocated and the test PDP context2 activated.

Specific PICS Statements

-

PIXIT Statements

-

Test Procedure

The MS is triggered to initiate packet uplink transfer data in RLC acknowledged mode. The SS orders the MS to use two-phase access procedure, in PACKET UPLINK ASSIGNMENT two timeslots are assigned. On the same TDMA frame the SS signals to the MS the assigned USFs addressing the MS on the two assigned PDTCHs. It is checked that the two RLC/MAC data blocks in the next radio block period are received on the respective PDTCH channels and that each data block contains the correct TFI without TLLI.

The SS acknowledges the received data and assigns the USFs addressing the MS. The check is repeated. The same procedure is going on until the MS completes the packet data transfer.

Maximum Duration of Test

5 minutes.

Expected Sequence

Step	Direction	Message	Comments
1		{Uplink dynamic allocation two phase access}	n = 440 octets, without starting time, USF_GRANULARITY = 1 block, RLC_DATA_BLOCKS_GRANTED = open-end TLLI_BLOCK_CHANNEL_CODING: MCS 1 EGPRS CHANNEL CODING COMMAND: MCS 1 Two timeslots, USF ₀ on TN ₀ and USF ₁ on TN ₁ , are assigned.
2	SS -> MS	PACKET DOWNLINK DUMMY CONTROL BLOCK	Assigned USF ₀ on PDTCH ₀ addressing the MS on 3 blocks from the last radio block containing the uplink assignment.
3	SS -> MS	PACKET DOWNLINK DUMMY CONTROL BLOCK	Assigned USF ₁ on PDTCH ₁ addressing the MS, sent on the same TDMA frame as step 2.
4	MS -> SS	EGPRS UPLINK RLC DATA BLOCK	Received on the assigned PDTCH ₀ . Check that the coding as specified in EGPRS CHANNEL CODING COMMAND, the TFI is correct and the block does not contain TLLI.
5	MS -> SS	EGPRS UPLINK RLC DATA BLOCK	Received on the assigned PDTCH ₁ on the same TDMA frame as step 4. Check that the coding as specified in EGPRS CHANNEL CODING COMMAND, the TFI is correct and the block does not contain TLLI.
6	SS -> MS	PACKET UPLINK ACK/NACK	Assigned USF ₀ on PDTCH ₀ addressing the MS.
7	SS -> MS	PACKET UPLINK ACK/NACK	Assigned USF ₁ on PDTCH ₁ addressing the MS, sent on the same TDMA frame as step 6.
8	MS -> SS	EGPRS UPLINK RLC DATA BLOCK	Received on the assigned PDTCH ₀ . Check that the coding as specified in EGPRS CHANNEL CODING COMMAND, the TFI is correct and the block does not contain TLLI.
9	MS -> SS	EGPRS UPLINK RLC DATA BLOCK	Received on the assigned PDTCH ₁ , on the same TDMA frame as step 8. Check that the coding as specified in EGPRS CHANNEL CODING COMMAND, the TFI is correct and the block does not contain TLLI.
10		{Completion of uplink RLC data block transfer}	

Specific Message Contents

None

52.3.1.1.9 Void

52.3.1.2 Dynamic Allocation / Uplink Transfer / Abnormal

52.3.1.2.1 Void

52.3.1.2.2 Dynamic Allocation / Uplink Transfer / Abnormal / with cell reselection in acknowledged mode

52.3.1.2.2.1 Conformance requirements

Upon detecting the stall condition the mobile station shall start timer T3182. If timer T3182 expires, the mobile station shall decrement counter N3102 by PAN_DEC, and perform an abnormal release with random access.

When $N3102 \leq 0$ is reached, the mobile station shall perform an abnormal release with cell re-selection.

References

3GPP TS 04.60, subclause 9.3.2.3.

52.3.1.2.2.2 Test purposes

To verify that while in uplink acknowledged mode operation the MS performs an abnormal release with cell reselection if the $N3102 \leq 0$ is reached.

52.3.1.2.2.3 Method of test

Initial Conditions

System Simulator:

2 cells, EGPRS supported, PCCCH present, Max-Retrans = 2, access burst type = 11 bits, BS_PAG_BLKES_RES = 2, BS_PBCCH_BLKES = 3, BS_PCC_CHANS = 1, BS_PRACH_BLKES = 1, PAN_MAX = 1, PAN_DEC = 5 and PAN_INC = 2.

Cell A:

PSI_3 of Cell A contains:

GPRS_RESELECT_OFFSET(B) = -20, dBRANDOM_ACCESS_RETRY = 1.

Cell B:

PSI_3 of Cell B contains:

GPRS_RESELECT_OFFSET(A) = 10 dB

Mobile Station:

The MS is GPRS attached on cell A, a P-TMSI allocated and test PDP context2 activated.

Specific PICS Statements

-

PIXIT Statements

-

Test Procedure

The MS is triggered to initiate packet uplink transfer 2000 octets in the RLC acknowledged mode on cell A. After a successful uplink PDCH assignment the SS sends PACKET DOWNLINK DUMMY indicating the assigned USF assigned to the MS. The MS sends a RLC radio block. The SS allows the MS to transfer so many data blocks without acknowledgement until the stall indication bit is set.

The MS requests the necessary radio resources by EGPRS PACKET CHANNEL REQUEST on cell A. The SS assigns a new PDCH to the MS. The SS sends PACKET DOWNLINK DUMMY indicating the assigned USF assigned to the MS. The MS sends a RLC radio block. The SS allows the MS to transfer so many data blocks without acknowledgement until the stall indication bit is set.

The MS requests the necessary radio resources by EGPRS PACKET CHANNEL REQUEST on cell B. The SS then assigns a new PDCH to the MS for completion of the requested uplink data transfer.

Maximum Duration of Test

5 minutes.

Expected Sequence

Step	Direction	Message	Comments
1		{Uplink dynamic allocation two phase access}	The following messages received on cell A. n = 2000 octets in RLC acknowledged mode (Test PDP context2), without starting time, USF_GRANULARITY = 1 block, RLC_DATA_BLOCKS_GRANTED = open-end TLLI_BLOCK_CHANNEL_CODING: MCS1, EGPRS CHANNEL CODING COMMAND: MCS1 EGPRS window size: 00000 (64)
2	SS -> MS	PACKET DOWNLINK DUMMY CONTROL BLOCK	USF assigned to the MS on 3 blocks from the last radio block containing the uplink assignment.
3	MS -> SS	EGPRS UPLINK RLC DATA BLOCK	Received on the assigned PDTCH. Check that the coding and the TFI are correct.
4			Repeat step 2 and 3 in total of 65 times.
4-1	SS -> MS	PACKET DOWNLINK DUMMY CONTROL BLOCK	Sent on the PACCH of the assigned PDCH. USF assigned to the MS.
4-2	MS -> SS	EGPRS UPLINK RLC DATA BLOCK	Received on the assigned PDTCH.
5	MS -> SS	EGPRS PACKET CHANNEL REQUEST	Received on PRACH of cell A.
6	SS -> MS	PACKET UPLINK ASSIGNMENT	Multiblock assignment, to order the MS making two-phase access procedure. Sent on PAGCH.
7	MS -> SS	PACKET RESOURCE REQUEST	Two phase access procedure. Received on the single block assigned.
8	SS -> MS	PACKET UPLINK ASSIGNMENT	Open-ended uplink dynamic allocation, no starting time, Sent on PAGCH.
9	SS -> MS	PACKET DOWNLINK DUMMY CONTROL BLOCK	USF assigned to the MS. on 3 blocks from the last radio block containing the uplink assignment.
10	MS -> SS	EGPRS UPLINK RLC DATA BLOCK	Received on the assigned PDTCH.
11			Repeat step 9 and 10 in total of 65 times.
11-1	SS -> MS	PACKET DOWNLINK DUMMY CONTROL BLOCK	Sent on the PACCH of the assigned PDCH . USF assigned to the MS.
11-2	MS -> SS	EGPRS UPLINK RLC DATA BLOCK	Received on the assigned PDTCH.
12	MS -> SS	EGPRS PACKET CHANNEL REQUEST	The following messages received on cell B. Received on PRACH of cell B.
13	SS		SS stops transmitting Cell A.
14	SS -> MS	PACKET UPLINK ASSIGNMENT	Multiblock assignment, to order the MS making two-phase access procedure. Sent on PAGCH.
15	MS -> SS	PACKET RESOURCE REQUEST	Received on the single block assigned, ACCESS TYPE = Two Phase Access Request or Cell update.
16	SS -> MS	PACKET UPLINK ASSIGNMENT	Open-ended uplink dynamic allocation, no starting time, Sent on PAGCH.
17	SS -> MS	PACKET DOWNLINK DUMMY CONTROL BLOCK	The USF assigned to the MS.
18	MS -> SS	EGPRS UPLINK RLC DATA BLOCK	Received on the assigned PDTCH. (Data block might contain octets belonging to Cell Update LLC PDU. In that case the SS shall accept Packet Resource Request from MS and respond with Packet Uplink Assignment.)
19		{Completion of uplink RLC data block transfer}	NOTE: The empty LLC PDU may be accompanied by another low priority RLC data block (with Packet Resource Request and Packet Uplink Assignment as required), in order to ensure that the radio resources are used efficiently.

52.3.1.2.3 Dynamic Allocation / Uplink Transfer / Abnormal / with cell reselection in unacknowledged mode

52.3.1.2.3.1 Conformance requirements

If the mobile station transmits k RLC data blocks without receiving a Packet Ack/Nack message the mobile station shall start timer T3182. If timer T3182 expires, the mobile station shall decrement counter N3102 by PAN_DEC, and perform an abnormal release with random access.

When $N3102 \leq 0$ is reached, the mobile station shall perform an abnormal release with cell re-selection.

References

3GPP TS 04.60/44.060, subclause 7.1.2.1, 9.3.3.3.

52.3.1.2.3.2 Test purposes

To verify that while in uplink unacknowledged mode operation the MS performs an abnormal release with cell reselection if the $N3102 \leq 0$ is reached.

52.3.1.2.3.3 Method of test

Initial Conditions

System Simulator:

2 cells, EGPRS supported, PCCCH present, Max-Retrans = 2, access burst type = 11 bits, BS_PAG_BLK_RES = 2, BS_PBCCH_BLK = 3, BS_PCC_CHANS = 1, BS_PRACH_BLK = 1, PAN_MAX = 1, PAN_DEC = 5 and PAN_INC = 2.

Cell A:

PSI_3 of Cell A contains:

GPRS_RESELECT_OFFSET(B) = -20 dB, RANDOM_ACCESS_RETRY = 1.

Cell B:

PSI_3 of Cell B contains parameters :

GPRS_RESELECT_OFFSET(A) = 10 dB.

Mobile Station:

The MS is GPRS attached with cell A, a P-TMSI allocated and Test PDP context3 activated.

Specific PICS Statements

- Release of EGPRS Supported (TSPC_MS_EGPRS_RELEASE)
- Support of EGPRS Packet Access Enhancement (TSPC_EGPRS_ENHANC)

PIXIT Statements

-

Test Procedure

The MS is triggered to initiate packet uplink transfer 3500 octets in the RLC unacknowledged mode on cell A. After a successful uplink PDCH assignment the SS sends PACKET DOWNLINK DUMMY indicating the assigned USF assigned to the MS. The MS sends a RLC radio block. The SS allows the MS to transfer 64 data blocks without acknowledgement.

The MS requests the necessary radio resources by EGPRS PACKET CHANNEL REQUEST on cell A. The SS assigns a new PDCH to the MS. The SS sends PACKET DOWNLINK DUMMY indicating the assigned USF assigned to the MS. The MS sends a RLC radio block. The SS allows the MS to transfer 64 data blocks without acknowledgement. The MS is triggered to initiate packet uplink transfer 1500, the MS requests the necessary radio resources by EGPRS

PACKET CHANNEL REQUEST on cell B. The SS then assigns a new PDCH to the MS for completion of the requested uplink data transfer. Optionally, before continuing the uplink user data transfer, the MS may perform a separate cell update (with an empty LLC frame) in RLC acknowledged mode.

A MS might perform a cell change due to T3182 expiry and hence the MS should then perform Cell Update procedure. The MS sends PACKET CHANNEL REQUEST with the Access Type = „Cell Update“ (on cell B). The SS sends PACKET UPLINK ASSIGNMENT to assign a TBF. The SS assigns USF to the MS by sending PACKET DOWNLINK DUMMY CONTROL BLOCK. The MS sends the empty LLC PDU for Cell Update. The SS acknowledges the received block by sending PACKET UPLINK ACK/NACK.

If the MS perform Cell Update : The MS is triggered to initiate packet uplink transfer 1500, the MS requests the necessary radio resources by PACKET CHANNEL REQUEST on cell B. The SS then assigns a new PDCH to the MS for completion of the requested uplink data transfer.

If the MS does not perform Cell Update: MS sends PACKET CHANNEL REQUEST, to send the uplink data on cell B. The SS then assigns a new PDCH to the MS for completion of the requested uplink data transfer.

Maximum Duration of Test

5 minutes.

NOTE:

EGPRS PACKET CHANNEL REQUEST shall be used for Cell Update in the following cases

- a. If Release of EGPRS supported is Release 4 or above.
- b. If Support of EGPRS Packet Access enhancement is True for a R99 MS.

PACKET CHANNEL REQUEST shall be used for Cell Update if support of EGPRS Packet Access enhancement is False for a R99 MS.

Expected Sequence

Step	Direction	Message	Comments
1		{Uplink dynamic allocation two phase access}	The following messages received on cell A. n = 3500 octets in RLC unacknowledged mode (Test PDP context3), without starting time, USF_GRANULARITY = 1 block, RLC_DATA_BLOCKS_GRANTED = open-end TLLI_BLOCK_CHANNEL_CODING: MCS1, EGPRS CHANNEL CODING COMMAND: MCS1 EGPRS window size: 00000 (64 blocks)
2	SS -> MS	PACKET DOWNLINK DUMMY CONTROL BLOCK	Sent on the PACCH of the PDCH assigned in step 1, the USF assigned to the MS.
3	MS -> SS	EGPRS UPLINK RLC DATA BLOCK	Received on the assigned PDTCH. Check that the coding and the TFI are correct.
4			Repeat step 2 and 3 in total of 64 times.
4-1	SS -> MS	PACKET DOWNLINK DUMMY CONTROL BLOCK	Sent on the PACCH, with the USF assigned to the MS.
4-2	MS -> SS	EGPRS UPLINK RLC DATA BLOCK	Received on the assigned PDTCH.
5	SS		Wait 5s after step 4 for T3182 time-out.
6	MS -> SS	EGPRS PACKET CHANNEL REQUEST	Received on PRACH of cell A.
7	SS -> MS	PACKET UPLINK ASSIGNMENT	Multiblock assignment, to order the MS making two-phase access procedure. Sent on PAGCH.
8	MS -> SS	PACKET RESOURCE REQUEST	Two phase access procedure. Received on the single block assigned.
9	SS -> MS	PACKET UPLINK ASSIGNMENT	Open-ended uplink dynamic allocation, no starting time, Sent on PAGCH.
10	SS -> MS	PACKET DOWNLINK DUMMY CONTROL BLOCK	The USF assigned to the MS.
11	MS -> SS	EGPRS UPLINK RLC DATA BLOCK	Received on the assigned PDTCH.
12			Repeat step 10 and 11 in total of 64 times.
12-1	SS -> MS	PACKET DOWNLINK DUMMY CONTROL BLOCK	Sent on the PACCH, with the USF assigned to the MS.
12-2	MS -> SS	EGPRS UPLINK RLC DATA BLOCK	Received on the assigned PDTCH.
13	SS		Wait for 5 seconds after step 12 for T3182 time-out.
14 (optional step)	MS -> SS	PACKET CHANNEL REQUEST/EGPRS PACKET CHANNEL REQUEST (see NOTE)	The following messages received on cell B. In case PACKET CHANNEL REQUEST is received Access Type 'Cell Update' In case EGPRS PACKET CHANNEL REQUEST is received Access Type 'Signalling'
14-1 (conditional step)	SS		SS stops transmitting cell A.
15 (conditional step)	SS -> MS	PACKET UPLINK ASSIGNMENT	Sent on PAGCH. Single block allocation. Assigning Single Block. , to order the MS making two-phase access procedure
16(conditional step)	MS -> SS	PACKET RESOURCE REQUEST	"Cell Update" access type. Received on the single block assigned.
17(conditional step)	SS -> MS	PACKET UPLINK ASSIGNMENT	Open-ended uplink dynamic allocation, no starting time, Sent on PAGCH.
18(conditional step)	SS	{Completion of uplink RLC data transfer }	For the empty LLC frame serving as cell update.
19(conditional step)			Trigger MS for 1500 octets
20	MS -> SS	EGPRS PACKET CHANNEL REQUEST	Received on PRACH of cell B.
21	SS		SS stops transmitting cell A (if not already done in step 14-1)

22	SS -> MS	PACKET UPLINK ASSIGNMENT	Multiblock Allocation, allocating a single block. ordering the MS to make two-phase access procedure. Sent on PAGCH.
23	MS -> SS	PACKET RESOURCE REQUEST	Two phase access procedure. Received on the single block assigned.
24	SS -> MS	PACKET UPLINK ASSIGNMENT	Open-ended uplink dynamic allocation, no starting time, Sent on PAGCH.
25	SS -> MS	PACKET DOWNLINK DUMMY CONTROL BLOCK	The USF assigned to the MS. Sent on PACCH of PDCH assigned.
26	MS -> SS	EGPRS UPLINK RLC DATA BLOCK	Received on the assigned PDTCH.
27		{Completion of uplink RLC data block transfer}	

Note: if optional step 14 is performed, then steps 14-1, 15, 16 ...and 19 are conditionally.

52.3.2 Dynamic Allocation / Uplink Transfer with Downlink TBF establishment (concurrent)

52.3.2.1 Dynamic Allocation / Uplink Transfer with Downlink TBF establishment / Normal

52.3.2.1.1 Dynamic Allocation / Uplink Transfer with Downlink TBF establishment / Normal / Successful

52.3.2.1.1.1 Conformance requirements

During uplink transfer, the network may initiate a downlink TBF by sending a PACKET DOWNLINK ASSIGNMENT message, or a PACKET TIMESLOT RECONFIGURE, to the mobile station on the PACCH. If a PACKET TIMESLOT RECONFIGURE message is sent, then the message shall contain the DOWNLINK_TFI_ASSIGNMENT field. On receipt of an assignment message, and after the TBF starting time, if present, the mobile station shall switch to the assigned PDCHs. The operation of the downlink TBF follows the procedures in 3GPP TS 04.60, subclause 8.1.2 with the following additions:

1. If a timer or counter expiry causes the uplink TBF to be aborted in the mobile station, the mobile station shall also abort the downlink TBF and perform an abnormal release with random access.
2. If uplink and downlink TBFs are already established, then the network may send a PACKET TIMESLOT RECONFIGURE message without DOWNLINK_TFI_ASSIGNMENT. The mobile station shall interpret this as a reassignment of the timeslot allocations of the concurrent uplink and downlink TBFs and the downlink TFI is not changed.

References

3GPP TS 04.60, subclauses 8.1.1.1.3 and 8.1.2.

52.3.2.1.1.2 Test purposes

To verify that during uplink transfer:

1. The MS switches to the assigned PDCHs when the network initiates a downlink TBF by sending PACKET DOWNLINK ASSIGNMENT or PACKET TIMESLOT RECONFIGURE to the MS on PACCH.
2. When the MS receives PACKET TIMESLOT RECONFIGURE without DOWNLINK_TFI_ASSIGNMENT in the case of uplink and downlink TBFs established already, the MS interprets this message as a reassignment of the timeslot allocations of the concurrent uplink and downlink TBFs.
3. The MS also aborts the downlink TBF and performs an abnormal release with random access if a timer or a counter expiry causes the uplink TBF to be aborted in the MS.

52.3.2.1.1.3 Method of test

Initial Conditions

System Simulator:

1 cell, default setting, BS_PBCCH_BLKs = 3.

Mobile Station:

The MS is GPRS attached with a P-TMSI allocated and the test PDP context3 activated.

Specific PICS Statements

-

PIXIT Statements

-

Test Procedure

An uplink TBF is established and in progress. After the MS sends an uplink data block the SS assigns a downlink TBF on the same timeslot as the uplink TBF. The SS sends a downlink data block with polling for acknowledgement and the assigned USF assigned to the MS for the MS, and indicates FBI=1 for the final data block. The MS sends an uplink data block and acknowledges the received downlink data block on the correct frame. The SS waits 2 s for the MS releasing the downlink PDCH. The SS sends PACKET TIMESLOT RECONFIGURE assigning a new downlink PDCH. A downlink data block is sent, the assigned USF assigned to the MS and the MS is polled for acknowledgement. The MS sends an uplink data block and acknowledges the last received downlink data block on the correct frame.

The SS sends PACKET TIMESLOT RECONFIGURE without DOWNLINK_TFL_ASSIGNMENT replacing the existing uplink and downlink PDCH with another pair of concurrent PDCH. A downlink data block is sent on the replaced PDCH and the MS is polled for acknowledgement. The MS shall not react upon it. Another downlink data block is sent on the assigned PDCH, the assigned USF assigned to the MS and the MS is polled for acknowledgement. The MS sends an uplink data block and acknowledges the received downlink data block on the correct frame.

The SS sends downlink data blocks with USF not addressing the MS until receives EGPRS PACKET CHANNEL REQUEST.

Maximum Duration of Test

5 minutes.

Expected Sequence

Step	Direction	Message	Comments
1		{Uplink dynamic allocation two phase access}	n = 1200 octets, without starting time, USF_GRANULARITY = 1 block, RLC_DATA_BLOCKS_GRANTED = open-end EGPRS CHANNEL CODING COMMAND: arbitrarily chosen.
2	SS -> MS	PACKET DOWNLINK DUMMY CONTROL BLOCK	The assigned USF assigned to the MS on 3 blocks from the last radio block containing the uplink assignment.
3	MS -> SS	EGPRS UPLINK RLC DATA BLOCK	
4	SS -> MS	PACKET DOWNLINK ASSIGNMENT	Sent on the PACCH, assigning a downlink TBF, MAC mode = dynamic allocation, RLC mode = unacknowledged, single timeslot, TFI ₂ , no starting time.
5	SS -> MS	EGPRS DOWNLINK RLC DATA BLOCK	Containing RRBp= N+13 and USF assigned to the MS. FBI = '1' and ES/P set to 01. Sent on the downlink PDCH on 3 blocks from the last radio block containing the downlink assignment.
6	MS -> SS	EGPRS UPLINK RLC DATA BLOCK	Received on the uplink PDCH assigned in step 1.
7	MS -> SS	PACKET CONTROL ACKNOWLEDGEMENT	Received on the frame number = N+13, N is the frame number of the first burst of the data block in step 5.
8	SS -> MS	PACKET UPLINK ACK/NACK	Containing USF assigned to the MS

Step	Direction	Message	Comments
9	MS -> SS	EGPRS UPLINK RLC DATA BLOCK	Received on the uplink PDTCH assigned in step 1.
10	SS		Wait 2 s for T3192 timeout.
11	SS -> MS	PACKET TIMESLOT RECONFIGURE	Sent on the PACCH of the PDCH assigned in step 1. Assign a downlink TBF, MAC mode = dynamic allocation, RLC mode = unacknowledged, single slot, TFI ₂ , no starting time.
12	SS -> MS	EGPRS DOWNLINK RLC DATA BLOCK	Containing RRB _P = N+21 or +22 and USF assigned to the MS. FBI = '0' and ES/P field set to '01'. Sent on the downlink PDTCH assigned on 3 blocks from the last radio block containing the downlink assignment in step 11.
13	MS -> SS	EGPRS UPLINK RLC DATA BLOCK	Received on the uplink PDTCH assigned in step 1.
14	MS -> SS	EGPRS PACKET DOWNLINK ACK/NACK	Received on the block of frame number = N+21 or +22, N is the frame number of the first burst of the data block in step 12.
15	SS -> MS	PACKET TIMESLOT RECONFIGURE	Without DOWNLINK_TFI_ASSIGNMENT, Assign new uplink and downlink time slots, no starting time, sent on the PACCH of the PDCH assigned in step 11.
16	SS -> MS	EGPRS DOWNLINK RLC DATA BLOCK	Containing USF assigned to the MS. Sent on the downlink PDTCH assigned in step 11 on 3 blocks from the last radio block containing the assignment in step 15.
17	SS		Check that neither data blocks, nor control blocks are sent by the MS within the next seven radio blocks.
18	SS -> MS	EGPRS DOWNLINK RLC DATA BLOCK	Containing a valid RRB _P = N+26, ES/P field set to '01' and USF assigned to the MS. Sent on the downlink PDTCH assigned in step 15.
19	MS -> SS	EGPRS UPLINK RLC DATA BLOCK	Received on the uplink PDTCH assigned in step 15.
20	MS -> SS	EGPRS PACKET DOWNLINK ACK/NACK	Received on the block of frame number = N+26, N is the frame number of the first burst of the data block in step 18, on the PACCH of the downlink PDCH.
21	SS -> MS	EGPRS DOWNLINK RLC DATA BLOCK	USF not addressing the MS.
22	SS -> MS		Repeat step 21 until receives EGPRS PACKET CHANNEL REQUEST in step 23.
23	MS -> SS	EGPRS PACKET CHANNEL REQUEST	Received on PRACH within 7.5 seconds (T3180 * 110% + PS11 repeat period, 2 s) from step 20.
24	SS -> MS	PACKET UPLINK ASSIGNMENT	Multiblock assignment,
25	MS -> SS	PACKET RESOURCE REQUEST	Two phase access procedure. Received on the single block assigned in step 24.
26	SS -> MS	PACKET UPLINK ASSIGNMENT	Open-ended uplink dynamic allocation, no starting time, USF_GRANULARITY = 4 blocks, Sent on PACCH of the same PDCH assigned in step 24.
27	SS -> MS	PACKET DOWNLINK DUMMY CONTROL BLOCK	The USF assigned to the MS. Sent on PACCH of PDCH assigned on 3 blocks from the last radio block containing the uplink assignment in step 26.
28	MS -> SS	EGPRS UPLINK RLC DATA BLOCK	Received 4 consecutive data blocks
29		{Completion of uplink RLC data block transfer}	

Specific Message Contents

PACKET DOWNLINK ASSIGNMENT message in step 4:

Information Element	value/ remark
PAGE_MODE	Normal
{0 1<PERSISTENCE_LEVEL>}	0
- Global TFI	0, Global TFI as reference 0, uplink TFI same value as assigned in the uplink in step 1
MAC_MODE	Dynamic allocation
RLC_MODE	Unacknowledged
CONTROL_ACK	0
TIMESLOT_ALLOCATION	Same slot number as assigned in the uplink TBF
Packet Timing Advance	
- {0 1<TIMING_ADVANCE_VALUE>}	1
- TIMING_ADVANCE_VALUE	30 bit periods
- {0 1<TIMING_ADVANCE_INDEX>	0 (no timing advance index)
<TIMING_ADVANCE_TIMESLOT_NUMBER >}	
{0 1<P0><BTS_PWR_CTR_MODE >}	0
{0 1<Frequency Parameters>}	0 (no Frequency Parameters present)
{0 1<DOWNLINK_TFI_ASSIGNMENT>}	1 (assign downlink TFI)
- DOWNLINK_TFI_ASSIGNMENT	Arbitrarily chosen from valid values but different from the value for uplink TBF
{0 1<Power Control Parameters>}	0 (no Power Control Parameters present)
{0 1<TBF_STARTING_TIME>}	0 (no starting time)
{0 1<Measurement Mapping>}	0 (no starting time)
{0 1 <EGPRS window size>	1 [value 00000 corresponding to 64 blocks]
- < LINK QUALITY MEASUREMENT MODE>	00
{0 1 <BEP_PERIOD2>	0 (not considered)

PACKET TIMESLOT RECONFIGURE message in step 11:

Information Element	value/ remark
PAGE_MODE	Normal
- Global TFI	0, Global TFI as reference 0, uplink TFI same value as assigned in the uplink in step 1
Message escape	1 (EGPRS)
EGPRS CHANNEL CODING COMMAND	Arbitrarily chosen from valid values
Resegment	1
{0 1<Downlink EGPRS window size>	0
{0 1<Uplink EGPRS window size>	0
<Link quality measurement mode>	00
Global packet Timing Advance	
- {0 1<TIMING_ADVANCE_VALUE>}	1 (timing advance value)
- TIMING_ADVANCE_VALUE	30 bit periods
- {0 1<UPLINK_TIMING_ADVANCE_INDEX>	0 (no uplink timing advance index)
<UPLINK_TIMING_ADVANCE_TIMESLOT_NUMBER>}	The MS stops the operation of the continuous timing advance procedure.
- {0 1<DOWNLINK_TIMING_ADVANCE_INDEX>	0 (no downlink timing advance index)
<DOWNLINK_TIMING_ADVANCE_TIMESLOT_NUMBE R>}	The MS stops the operation of the continuous timing advance procedure.
DOWNLINK_RLC_MODE	Unacknowledged mode
CONTROL_ACK	0
{0 1<DOWNLINK_TFI_ASSIGNMENT>}	1 (assign a new TFI for downlink TBF)
- GLOBAL_TFI_ASSIGNMENT	Arbitrarily chosen but different from the value for uplink TBF
{0 1<UPLINK_TFI_ASSIGNMENT>}	0
DOWNLINK_TIMESLOT_ALLOCATION	Same as the slot of the uplink TBF
{0 1<Frequency parameters>}	0
Dynamic allocation	0

PACKET TIMESLOT RECONFIGURE message in step 15:

Information Element	value/ remark
PAGE_MODE	Normal
- Global TFI	0, Global TFI as reference 0, uplink TFI same value as assigned in the uplink in step 1
EGPRS CHANNEL CODING COMMAND	Arbitrarily chosen from valid values
Resegment	1
{0 1}<Downlink EGPRS window size>	0
{0 1}<Uplink EGPRS window size>	0
<Link quality measurement mode>	00
Global packet Timing Advance	
- {0 1}<TIMING_ADVANCE_VALUE>	1 (timing advance value)
- TIMING_ADVANCE_VALUE	30 bit periods
- {0 1}<UPLINK_TIMING_ADVANCE_INDEX>	0 (no uplink timing advance index)
<UPLINK_TIMING_ADVANCE_TIMESLOT_NUMBER>	The MS stops the operation of the continuous timing advance procedure.
- {0 1}<DOWNLINK_TIMING_ADVANCE_INDEX>	0 (no downlink timing advance index)
<DOWNLINK_TIMING_ADVANCE_TIMESLOT_NUMBER>	The MS stops the operation of the continuous timing advance procedure.
R>	
DOWNLINK_RLC_MODE	Unacknowledged mode
CONTROL_ACK	0
{0 1}<DOWNLINK_TFI_ASSIGNMENT>	0
{0 1}<UPLINK_TFI_ASSIGNMENT>	0
DOWNLINK_TIMESLOT_ALLOCATION	Timeslot 5 assigned
{0 1}<Frequency parameters>	0
Dynamic allocation	0
- Extended Dynamic Allocation	0 (Dynamic allocation)
{0 1}<P0>	0
- USF GRANULARITY	0 (1 RLC block)
- {0 1}<RLC_DATA_BLOCKS_GRANTED>	0 (open-ended TBF)
- {0 1}<TBF_STARTING_TIME>	0 (no starting time)
-	1 (Timeslot Allocation with Power Control Parameters)
- ALPHA	0.5
- {0 1}<USF_TNx><GAMMA_TNx>	000001 (timeslot 5 assigned)
- USF_TN ₅	Arbitrarily chosen but different from current value
- GAMMA_TN ₅	For GSM 900: +8 dBm For GSM 400: +8 dBm For GSM 850: +8 dBm For GSM 700 and T-GSM 810: +8 dBm For DCS 1 800: +6 dBm For PCS 1 900: +6 dBm
	00

52.3.2.1.2 Dynamic Allocation / Uplink Transfer with Downlink TBF establishment / Normal / Multislot capabilities

52.3.2.1.2.1 Conformance requirements

1. Mobile station belonging to multislot class 2, 3, 4, 5, 6, 8, 9, 10, 19 and 24 shall support as many uplink and downlink timeslots as indicated in 3GPP TS 05.02 clause B.1.
2. If transmission of the PACKET CONTROL ACKNOWLEDGEMENT would result in more than the maximum Tx timeslots per TDMA frame allowed by the multislot class, transmission of the highest numbered PDCH(s) shall be omitted.

References

3GPP TS 05.02, clause B.1.

3GPP TS 04.60, subclause 8.6.

52.3.2.1.2.2 Test purposes

To verify that the EGPRS multislot MS supports as many uplink and downlink TBFs per TDMA frame as indicated. Especially, it is verified that the Type 1 MS in a EGPRS multislot class declared has the capability of supporting:

1. T_{tb} , the minimum number of slots allowed between the end of the previous transmit or receive TS and the next transmit TS when measurement is to be performed for type 1 MS;
2. T_{ra} , the minimum number of slots allowed between the previous transmit or receive TS and the next receive TS when measurement is to be performed for type 1 MS;
3. the maximum number of Rx and Tx supported;
4. the sum of slots supported.

It is also verified that the MS of a EGPRS multislot class transmits PACKET CONTROL ACKNOWLEDGEMENT when polled, and omits the transmission of the highest numbered PDCH(s) if the transmission would result in more than the maximum Tx timeslots per TDMA frame allowed by the EGPRS multislot class.

52.3.2.1.2.3 Method of test

Initial Conditions

System Simulator:

1 cell, default setting, BS_PBCCH_BLKs = 3.

Mobile Station:

The MS is GPRS attached with a P-TMSI allocated and the test PDP context3 activated.

Specific PICS Statements

- EGPRS Multislotclass (TSPC_Type_EGPRS_Multislot_ClassX where X = 1..45)

PIXIT Statements

-

Test Procedure

The following EGPRS multislot configurations are tested in the test case:

- Class 2 and 3 support two downlink timeslots and one uplink timeslot, $T_{tb}=2$, $T_{ra}=3$;
- Class 4 and 6 support three downlink timeslots and one uplink timeslot, $T_{tb}=1$, $T_{ra}=3$;
- Class 5 and 9 supports two downlink timeslots and two uplink timeslots, $T_{tb}=1$, $T_{ra}=3$;
- Class 8 and 10 support four downlink timeslots and one uplink timeslot, $T_{tb}=1$, $T_{ra}=2$;
- Class 19 and 24 support five downlink timeslots and one uplink timeslot, $T_{tb}=1$, $T_{ra}=2$.

In the multislot configurations all assigned channels are frequency hopped except for the class 19 and 24 test where non-hopping channels are assigned for PDCHs. The class 3, 6, 9 and 10 are tested in a reduced uplink configuration.

According to the multislot configurations an uplink TBF with one or two timeslots assigned is established and in progress. The SS establishes a concurrent downlink TBF with multiple timeslots assigned.

On the 1st radio block the SS sends downlink data in the maximum capability allowed under the configuration, signals to the MS the assigned USFs addressing the MS and polls the MS. On the 2nd radio block the MS sends RLC data in response of the addressing the MS USFs. On the 6th radio block the SS sends downlink data in the maximum capability allowed under the configuration and signals to the MS the assigned USFs addressing the MS. On the 7th radio block the MS responses EGPRS PACKET DOWNLINK ACK/NACK and sends RLC data in response of one of the USFs addressing the MS if the configuration is allowed.

The basic test procedure is repeated until CV=1. The SS sends the last RLC data block with FBI=1 and polls the MS for acknowledgement. The SS sends PACKET UPLINK ACK/NACK setting FINAL_ACK_INDICATION=1. The MS sends two separate PACKET CONTROL ACKNOWLEDGEMENT messages to release the uplink and downlink TBFs.

Maximum Duration of Test

5 minutes.

Expected Sequence for EGPRS multislot class 2 and class 3 (2 downlink timeslots + 1 uplink timeslot)

Step	Direction	Message	Comments
1		{Uplink dynamic allocation two phase access}	n = 440 octets, without starting time, USF_GRANULARITY = 1 block, RLC_DATA_BLOCKS_GRANTED = open-end TLLI_BLOCK_CHANNEL_CODING: MCS1 EGPRS CHANNEL CODING COMMAND: MCS1 An uplink timeslot is assigned (see specific message contents).
2	SS -> MS	PACKET DOWNLINK DUMMY CONTROL BLOCK	The USF assigned to the MS. Sent on PACCH of PDCH assigned in step 1.
3	MS -> SS	EGPRS UPLINK RLC DATA BLOCK	Received on the uplink PDTCH.
4	SS -> MS	PACKET DOWNLINK ASSIGNMENT	Sent on PACCH of the uplink PDCH. Assigning a downlink TBF, MAC mode = dynamic allocation, RLC mode = unacknowledged mode, TFI _d (different from the uplink one), no starting time, assigning TN ₁ and TN ₂ . Sent on TN ₁ of the downlink PDTCH, RRBP invalid.
5	SS -> MS	EGPRS DOWNLINK RLC DATA BLOCK	
6	SS -> MS	EGPRS DOWNLINK RLC DATA BLOCK	Sent on TN ₂ of the downlink PDTCH, a valid RRBP = N + 26, the assigned USF assigned to the MS, and ES/P field set to '01' on the same radio block as step 5.
7	MS -> SS	EGPRS UPLINK RLC DATA BLOCK	Received on the uplink PDTCH, on the next radio block from step 6.
8	SS -> MS	EGPRS DOWNLINK RLC DATA BLOCK	Sent on TN ₁ of the downlink PDTCH, RRBP invalid, on five radio blocks after step 6.
9	SS -> MS	EGPRS DOWNLINK RLC DATA BLOCK	Sent on TN ₂ of the downlink PDTCH, the assigned USF assigned to the MS and RRBP invalid, on the same radio block as in step 8. Note: The next uplink radio will not be used for the uplink data. It is reserved for a control block answering the polling in step 6.
10	MS -> SS	EGPRS PACKET DOWNLINK ACK/NACK	Received on the RRBP block on TN ₂ specified in step 6.
11			Repeat step 5 to 10, until CV=0 in step 7.
12	SS -> MS	EGPRS DOWNLINK RLC DATA BLOCK	Sent on TN ₂ with FBI = 1 and a valid RRBP=N+26 and ES/P field set to '01'.
13	SS -> MS	PACKET UPLINK ACK/NACK	FINAL_ACK_INDICATION = 1. Sent on TN ₂ PACCH of the uplink PDCH. With a valid RRBP=N+13
14	MS -> SS	PACKET CONTROL ACKNOWLEDGEMENT	CTRL_ACK = 11. The MS releases the uplink TBF.
15	MS -> SS	PACKET CONTROL ACKNOWLEDGEMENT	Received on the block specified by RRBP in step 12. CTRL_ACK = 11. The MS releases the downlink TBF.

Specific Message Contents

PACKET UPLINK ASSIGNMENT message in step 1 (in macro):

Information Element	value/ remark
EGPRS CHANNEL CODING COMMAND	MCS-1
- Resegment	0
<EGPRS window size>	00000 (64 blocks)
<TLLI_BLOCK_CHANNEL_CODING>	MCS-1
{0 1 <BEP_PERIOD2>}	0
Dynamic allocation	01
-	000000
-	1 (Timeslot Allocation with Power Control Parameters for 1 slot assigned)
- ALPHA	0.5
-	001 (timeslot 2 assigned)
- USF_TN2	Arbitrarily chosen
- GAMMA_TN2	For GSM 900: +8 dBm
	For GSM 400: +8 dBm
	For GSM 850: +8 dBm
	For GSM 700 and T-GSM 810: +8 dBm
	For DCS 1 800: +6dBm
	For PCS 1 900: +6 dBm
-	00000

PACKET DOWNLINK ASSIGNMET message in step 4:

Information Element	value/ remark
PAGE_MODE	Normal
{0 1<PERSISTENCE_LEVEL>}	0
- Global TFI	0, Global TFI as reference
	0, uplink TFI
	same value as assigned in the uplink in step 1
MAC_MODE	Dynamic allocation
RLC_MODE	Unacknowledged
CONTROL_ACK	0
TIMESLOT_ALLOCATION	Timeslot 1 and 2 assigned
Packet Timing Advance	
- {0 1<TIMING_ADVANCE_VALUE>}	1
- TIMING_ADVANCE_VALUE	30 bit periods
- {0 1<TIMING_ADVANCE_INDEX>	0 (no timing advance index)
<TIMING_ADVANCE_TIMESLOT_NUMBER >}	
{0 1<P0><BTS_PWR_CTR_MODE >}	0
{0 1<Frequency Parameters>}	0 (no Frequency Parameters present)
{0 1<DOWNLINK_TFI_ASSIGNMENT>}	1 (assign downlink TFI)
- DOWNLINK_TFI_ASSIGNMENT	Arbitrarily chosen from valid values but different from the value for uplink TBF
{0 1<Power Control Parameters>}	0 (no Power Control Parameters present)
{0 1<TBF_STARTING_TIME>}	0 (no starting time)
{0 1<Measurement Mapping>}	0 (no starting time)
{0 1 <EGPRS window size>	1 [value 00000 corresponding to 64 blocks]
- < LINK QUALITY MEASUREMENT MODE>	00
{0 1 <BEP_PERIOD2>	0 (not considered)

Expected Sequence for EGPRS multislot class 4 and 6 (3 downlink timeslots + 1 uplink timeslot)

Step	Direction	Message	Comments
1		{Uplink dynamic allocation two phase access}	n = 330 octets, without starting time, USF_GRANULARITY = 1 block, RLC_DATA_BLOCKS_GRANTED = open-end TLLI_BLOCK_CHANNEL_CODING: MCS1 EGPRS CHANNEL CODING COMMAND: MCS1 An uplink timeslot is assigned (see specific message contents).
2	SS -> MS	PACKET DOWNLINK DUMMY CONTROL BLOCK	The USF assigned to the MS. Sent on PACCH of PDCH assigned in step 1.
3	MS -> SS	EGPRS UPLINK RLC DATA BLOCK	Received on the uplink PDTCH.
4	SS -> MS	PACKET DOWNLINK ASSIGNMENT	Sent on PACCH of the uplink PDCH. Assigning a downlink TBF, MAC mode = dynamic allocation, RLC mode = unacknowledged mode, TFI _d (different from the uplink one), no starting time, assigning the timeslots TN ₁ , TN ₂ and TN ₃ .
5	SS -> MS	EGPRS DOWNLINK RLC DATA BLOCK	Sent on TN ₁ of the downlink PDTCH, RRBP invalid.
6	SS -> MS	EGPRS DOWNLINK RLC DATA BLOCK	Sent on TN ₂ of the downlink PDTCH, the assigned USF assigned to the MS and a valid RRBP = N + 26, and ES/P field set to '01' on the same radio block as step 5.
7	SS -> MS	EGPRS DOWNLINK RLC DATA BLOCK	Sent on TN ₃ of the downlink PDTCH, RRBP invalid, on the same radio block as step 5.
8	MS -> SS	EGPRS UPLINK RLC DATA BLOCK	Received on the uplink PDTCH, on the next radio block from step 5.
9	SS -> MS	EGPRS DOWNLINK RLC DATA BLOCK	Sent on TN ₁ of the downlink PDTCH, RRBP invalid, on five radio blocks after step 6.
10	SS -> MS	EGPRS DOWNLINK RLC DATA BLOCK	Sent on TN ₂ of the downlink PDTCH, the assigned USF assigned to the MS and an invalid RRBP, on the same radio block as step 9. Note: The next uplink radio block will not be used for the uplink data. It is reserved for a control block answering the polling in step 6.
11	SS -> MS	EGPRS DOWNLINK RLC DATA BLOCK	Sent on TN ₃ of the downlink PDTCH, RRBP invalid, on the same radio block as step 9.
12	MS -> SS	EGPRS PACKET DOWNLINK ACK/NACK	Received on the RRBP block on TN ₂ specified in step 6.
13			Repeat step 5 to 12, until CV=0 in step 8.
14	SS -> MS	EGPRS DOWNLINK RLC DATA BLOCK	Sent on TN ₂ with FBI = 1 and a valid RRBP=N+26 and ES/P field set to '01'.
15	SS -> MS	PACKET UPLINK ACK/NACK	FINAL_ACK_INDICATION = 1. Sent on PACCH of the uplink PDCH. With a valid RRBP=N+13
16	MS -> SS	PACKET CONTROL ACKNOWLEDGEMENT	CTRL_ACK = 11. The MS releases the uplink TBF.
17	MS -> SS	PACKET CONTROL ACKNOWLEDGEMENT	Received on the block specified by RRBP in step 14. CTRL_ACK = 11. The MS releases the downlink TBF.

Specific Message Contents

PACKET UPLINK ASSIGNMENT message in step 1 (in macro):

Same as in the test for the multiclass 2 and 3.

PACKET DOWNLINK ASSIGNMENT message in step 4:

Same as in the test for the multiclass 2 and 3 except.

Information Element	value/ remark
TIMESLOT_ALLOCATION	Timeslot 1, 2 and 3 assigned

Expected Sequence for EGPRS multislot class 5, 9 (2 downlink timeslots + 2 uplink timeslots)

Step	Direction	Message	Comments
1		{Uplink dynamic allocation two phase access}	n = 440 octets, without starting time, USF ₁ GRANULARITY = 1 block, RLC_DATA_BLOCKS_GRANTED = open-end TLLI_BLOCK_CHANNEL_CODING: MCS1 EGPRS CHANNEL CODING COMMAND: MCS1 Two uplink timeslots are assigned (see specific message contents).
2	SS -> MS	PACKET DOWNLINK DUMMY CONTROL BLOCK	The USF ₁ assigned to the MS. Sent in TN ₁ on PACCH of PDCH assigned in step 1.
3	SS -> MS	PACKET DOWNLINK DUMMY CONTROL BLOCK	The USF ₂ assigned to the MS. Sent in TN ₂ on the same radio block as step 2, on PACCH of PDCH assigned in step 1.
4	MS -> SS	EGPRS UPLINK RLC DATA BLOCK	Received on TN ₁ on the PDTCH assigned in step 1.
5	MS -> SS	EGPRS UPLINK RLC DATA BLOCK	Received on TN ₂ , on the same radio block as step 4, on PDTCH assigned in step 1.
6	SS -> MS	PACKET DOWNLINK ASSIGNMENT	Sent on PACCH of PDCH assigned in step 1. Assign a downlink TBF, MAC mode = dynamic allocation, RLC mode = unacknowledged mode, TFI _d , no starting time, assigning the timeslots TN ₁ and TN ₂ .
7	SS -> MS	EGPRS DOWNLINK RLC DATA BLOCK	Sent on TN ₁ of the downlink PDTCH, RRB _P invalid, the assigned USF ₁ addressing the MS.
8	SS -> MS	EGPRS DOWNLINK RLC DATA BLOCK	Sent on TN ₂ of the downlink PDTCH, a valid RRB _P = N + 26, the assigned USF ₂ addressing the MS, and ES/P field set to '01' on the same radio block as step 7.
9	MS -> SS	EGPRS UPLINK RLC DATA BLOCK	Received on TN ₁ on the next radio block from step 7.
10	MS -> SS	EGPRS UPLINK RLC DATA BLOCK	Received on TN ₂ on the next radio block from step 7.
11	SS -> MS	EGPRS DOWNLINK RLC DATA BLOCK	Sent on TN ₁ of the downlink PDTCH on five radio block after step 7, an invalid RRB _P , the assigned USF ₁ addressing the MS.
12	SS -> MS	EGPRS DOWNLINK RLC DATA BLOCK	Sent on TN ₂ of the downlink PDTCH on the same radio block as step 11, an invalid RRB _P , the assigned USF ₂ addressing the MS.
13	MS -> SS	EGPRS UPLINK RLC DATA BLOCK	Received on TN ₁ on the PDTCH assigned in step 1.
14	MS -> SS	EGPRS PACKET DOWNLINK ACK/NACK	Received on the RRB _P block on TN ₂ specified in step 8.
15			Repeat step 7 to 14, until CV=0 in step 9, 10 or 13.
16	SS -> MS	EGPRS DOWNLINK RLC DATA BLOCK	Sent on TN ₁ with FBI = 1 and a valid RRB _P =N+26 and ES/P field set to '01'.
17	SS -> MS	PACKET UPLINK ACK/NACK	FINAL_ACK_INDICATION = 1. Sent on PACCH of the uplink PDCH. With a valid RRB _P =N+13
18	MS -> SS	PACKET CONTROL ACKNOWLEDGEMENT	CTRL_ACK = 11. The MS releases the uplink TBF.
19	MS -> SS	PACKET CONTROL ACKNOWLEDGEMENT	Received on the block specified by RRB _P in step 16. CTRL_ACK = 11. The MS releases the downlink TBF.

Specific Message Contents

PACKET UPLINK ASSIGNMENT message in step 1 (in macro):

Same as in the test for the multiclass 2 and 3 except.

Information Element	value/ remark
-	1 (Timeslot Allocation with Power Control Parameters for two slots assigned)
- ALPHA	0.5
-	01 (timeslot 1 assigned)
- USF_TN1	Arbitrarily chosen
- GAMMA_TN1	For GSM 900: +8 dBm For GSM 400: +8 dBm For GSM 850: +8 dBm For GSM 700 and T-GSM 810: +8 dBm For DCS 1 800: +6 dBm For PCS 1 900: +6 dBm
- {0 1<USF_TN2><GAMMA_TN2>}	1 (timeslot 2 assigned)
- USF_TN2	Arbitrarily chosen but different from USF_TN ₁
- GAMMA_TN2	For GSM 900: +8 dBm For GSM 400: +8 dBm For GSM 850: +8 dBm For GSM 700 and T-GSM 810: +8 dBm For DCS 1 800: +6 dBm For PCS 1 900: +6 dBm
-	00000

PACKET DOWNLINK ASSIGNMET message in step 10:

Same as in the test for the multiclass 2 and 3.

Expected Sequence for EGPRS multislot class 8, 10 (4 downlink timeslots + 1 uplink timeslot)

Step	Direction	Message	Comments
1		{Uplink dynamic allocation two phase access}	n = 220 octets, without starting time, USF_GRANULARITY = 1 block, RLC_DATA_BLOCKS_GRANTED = open-end TLLI_BLOCK_CHANNEL_CODING: MCS1 EGPRS CHANNEL CODING COMMAND: MCS1 1 uplink timeslot is assigned (see specific message contents).
2	SS -> MS	PACKET DOWNLINK DUMMY CONTROL BLOCK	The USF assigned to the MS. Sent in TN ₃ on PACCH of PDCH assigned in step 1.
3	MS -> SS	EGPRS UPLINK RLC DATA BLOCK	Received on TN ₃ on the PDTCH.
4	SS -> MS	PACKET DOWNLINK ASSIGNMENT	Sent on PACCH of PDCH assigned in step 1. Assign a downlink TBF, MAC mode = dynamic allocation, RLC mode = unacknowledged mode, four slots TN ₁ – TN ₄ , TFI _d , no starting time.
5	SS -> MS	EGPRS DOWNLINK RLC DATA BLOCK	Sent on TN ₁ of the PDTCH assigned in step 4, with an invalid RRBp
6	SS -> MS	EGPRS DOWNLINK RLC DATA BLOCK	Sent on TN ₂ of the PDTCH assigned in step 4, an invalid RRBp on the same radio block as step 5.
7	SS -> MS	EGPRS DOWNLINK RLC DATA BLOCK	Sent on TN ₃ of the PDTCH assigned in step 4, the assigned USF assigned to the MS, a valid RRBp = N + 26, and ES/P field set to '01' on the same radio block as step 5.
8	SS -> MS	EGPRS DOWNLINK RLC DATA BLOCK	Sent on TN ₄ of the PDTCH assigned in step 4, an invalid RRBp, on the same radio block as step 5.
9	MS -> SS	EGPRS UPLINK RLC DATA BLOCK	Received on TN ₃ on the PDTCH assigned in step 1, on the next radio block from step 5.
10	SS -> MS	EGPRS DOWNLINK RLC DATA BLOCK	Sent on TN ₁ of the PDTCH assigned in step 4, with an invalid RRBp, on five radio blocks after step 5.
11	SS -> MS	EGPRS DOWNLINK RLC DATA BLOCK	Sent on TN ₂ of the PDTCH assigned in step 4, an invalid RRBp, on the same radio block as step 10.
12	SS -> MS	EGPRS DOWNLINK RLC DATA BLOCK	Sent on TN ₃ of the PDTCH assigned in step 4, the assigned USF assigned to the MS, on the same radio block as step 10. Note: The next uplink radio block will not be used for the uplink data. It is reserved for a control block answering the polling in step 7.
13	SS -> MS	EGPRS DOWNLINK RLC DATA BLOCK	Sent on TN ₄ of the PDTCH assigned in step 4, an invalid RRBp, on the next radio block as step 10.
14	MS -> SS	EGPRS PACKET DOWNLINK ACK/NACK	Received on the RRBp block of TN ₃ specified in step 7, on the next radio block from step 10.
15			Repeat step 5 to 14, until CV=0 in step 9.
16	SS -> MS	EGPRS DOWNLINK RLC DATA BLOCK	Sent on TN ₃ with FBI = 1 and a valid RRBp=N+26.
17	SS -> MS	PACKET UPLINK ACK/NACK	FINAL_ACK_INDICATION = 1. Sent on PACCH of the uplink PDCH. With a valid RRBp=N+13
18	MS -> SS	PACKET CONTROL ACKNOWLEDGEMENT	CTRL_ACK = 11. The MS releases the uplink TBF.
19	MS -> SS	PACKET CONTROL ACKNOWLEDGEMENT	Received on the block specified by RRBp in step 16. CTRL_ACK = 11. The MS releases the downlink TBF.

Specific Message Contents

PACKET UPLINK ASSIGNMENT message in step 1:

Same as in the test for the multiclass 2 and 3 except that instead of timeslot 2, the timeslot 3 is assigned.

PACKET DOWNLINK ASSIGNMENT message in step 4:

Same as in the test for the EGPRS multiclass 2 and 3 except 4 timeslots assigned.

Information Element	value/ remark
TIMESLOT_ALLOCATION	TN ₁ – TN ₄ assigned

Expected Sequence for multislot class 19, 24 (5 downlink + 2 uplink timeslots)

Step	Direction	Message	Comments
1		{Uplink dynamic allocation two phase access}	n = 160 octets, without starting time, without frequency hopping, USF_GRANULARITY = 1 block, RLC_DATA_BLOCKS_GRANTED = open-end TLLI_BLOCK_CHANNEL_CODING: MCS1 EGPRS CHANNEL CODING COMMAND: MCS1 1 uplink timeslot is assigned (see specific message contents).
2	SS -> MS	PACKET DOWNLINK DUMMY CONTROL BLOCK	The assigned USF assigned to the MS, sent in TN ₃ on PACCH of PDCH assigned in step 1.
3	MS -> SS	EGPRS UPLINK RLC DATA BLOCK	Received on TN ₃ on the PDTCH assigned in step 1.
4	SS -> MS	PACKET DOWNLINK ASSIGNMENT	Sent on PACCH of PDCH assigned in step 1. Assign a downlink TBF, MAC mode = dynamic allocation, RLC mode = unacknowledged mode, TN ₁ – TN ₅ assigned, TFI _d , no starting time.
5	SS - MS	EGPRS DOWNLINK RLC DATA BLOCK	Sent on TN ₁ of the PDTCH assigned in step 4, with an invalid RRBP.
6	SS - MS	EGPRS DOWNLINK RLC DATA BLOCK	Sent on TN ₂ of the PDTCH assigned in step 4, with an invalid RRBP, on the same radio block as step 5.
7	SS - MS	EGPRS DOWNLINK RLC DATA BLOCK	Sent on TN ₃ of the PDTCH assigned in step 4, the assigned USF assigned to the MS, a valid RRBP = N + 26, and ES/P field set to '01' on the same radio block as step 5.
8	SS - MS	EGPRS DOWNLINK RLC DATA BLOCK	Sent on TN ₄ of the PDTCH assigned in step 4, with an invalid RRBP, on the same radio block as step 5.
9	SS - MS	EGPRS DOWNLINK RLC DATA BLOCK	Sent on TN ₅ of the PDTCH assigned in step 4, with an invalid RRBP, on the same radio block as step 5.
10	MS -> SS	EGPRS UPLINK RLC DATA BLOCK	Received on TN ₃ on the PDTCH assigned in step 5, on the next radio block from step 5.
11	SS - MS	EGPRS DOWNLINK RLC DATA BLOCK	Sent on TN ₁ of the PDTCH assigned in step 4, with an invalid RRBP on five radio blocks from step 5.
12	SS - MS	EGPRS DOWNLINK RLC DATA BLOCK	Sent on TN ₂ of the PDTCH assigned in step 4, with an invalid RRBP on the same radio block as step 11.
13	SS - MS	EGPRS DOWNLINK RLC DATA BLOCK	Sent on TN ₃ of the PDTCH assigned in step 4, the assigned USF assigned to the MS, with an invalid RRBP on the same radio block as step 11. Note: The next uplink radio block will not be used for the uplink data. It is reserved for a control block answering the polling in step 7.
14	SS - MS	EGPRS DOWNLINK RLC DATA BLOCK	Sent on TN ₄ of the PDTCH assigned in step 4, with an invalid RRBP on the same radio block as step 11.
15	SS - MS	EGPRS DOWNLINK RLC DATA BLOCK	Sent on TN ₅ of the PDTCH assigned in step 4, with an invalid RRBP on the same radio block as step 11.
16	MS -> SS	EGPRS PACKET DOWNLINK ACK/NACK	Received on the RRBP block of TN ₃ specified in step 7.
17			Repeat step 5 to 16, until CV=0 in step 10.
18	SS -> MS	EGPRS DOWNLINK RLC DATA BLOCK	Sent on TN ₃ with FBI = 1 and a valid RRBP=N+26 and ES/P field set to '01'.
19	SS -> MS	PACKET UPLINK ACK/NACK	FINAL_ACK_INDICATION = 1. Sent on PACCH of the uplink PDCH. With a valid RRBP=N+13
20	MS -> SS	PACKET CONTROL ACKNOWLEDGEMENT	CTRL_ACK = 11. The MS releases the uplink TBF.
21	MS -> SS	PACKET CONTROL ACKNOWLEDGEMENT	Received on the block specified by RRBP in step 16. CTRL_ACK = 11. The MS releases the downlink TBF.

Specific Message Contents

PACKET UPLINK ASSIGNMENT message in step 1:

Same as in the test for the multiclass 2 and 3 except

Information Element	value/ remark
{0 1<Frequency Parameters> - TSC - - ARFCN	1 (frequency parameters presents) 6 00, non hopping For GSM 900: 30 For GSM 400: 270 For GSM 700 and T-GSM 810: 467 For GSM 850: 190 For DCS 1800 and PCS 1 900: 650
Dynamic allocation - {0 1<USF_TN0>} ... {0 1<USF_TN3> - USF_TN3 -	01 0001 arbitrarily chosen 0000, none of the other timeslots assigned.

PACKET DOWNLINK ASSIGNMET message in step 4:

Same as in the test for the multiclass 2 and 3 except 5 timeslots assigned.

Information Element	value/ remark
TIMESLOT_ALLOCATION	TN ₁ – TN ₅ assigned

52.3.2.2 Dynamic Allocation / Uplink Transfer with Downlink TBF establishment / Abnormal

52.3.2.2.1 Dynamic Allocation / Uplink Transfer with Downlink TBF establishment / Abnormal / with random access

52.3.2.2.1.1 Conformance requirements

1. If a failure occurs on the mobile station side before the new TBF has been successfully established, the newly reserved resources are released.
2. If the information in the PACKET TIMESLOT RECONFIGURE does not properly specify an uplink and downlink PDCH or violates the mobile station's multislot capabilities, the mobile station shall perform an abnormal release with random access.
3. If uplink and downlink TBFs are not already established and the PACKET TIMESLOT RECONFIGURE message does not include a DOWNLINK_TFI_ASSIGNMENT field, then the mobile station shall perform an abnormal release with random access.
4. If a failure in the PACKET TIMESLOT RECONFIGURE is due to any other reason, the mobile station shall abort the procedure and perform an abnormal release with random access.
5. If the mobile station receives a PACKET UPLINK ASSIGNMENT or PACKET TIMESLOT RECONFIGURE message specifying frequencies that are not all in one frequency band then the mobile station shall perform an abnormal release with random access.
6. To perform an abnormal release with random access, the mobile station shall abort all TBFs in progress and its associated resources, return to the CCCH or PCCCH and initiate establishment of a new uplink TBF.

References

3GPP TS 04.60, subclauses 8.1.1.1.3.1, 8.1.1.1.2.1 and 8.7.2.

52.3.2.2.1.2 Test purposes

To verify that the MS, in downlink TBF establishment during uplink transfer, performs an abnormal release with random access, when the information in the PACKET TIMESLOT RECONFIGURE:

1. does not properly specify an uplink and downlink PDCH;
2. violates the mobile station's EGPRS multislot capabilities;
3. does not include a DOWNLINK_TFI_ASSIGNMENT field;
4. has a failure due to any other reason other than the reasons listed above.

52.3.2.2.1.3 Method of test

Initial Conditions

System Simulator:

1 cell, default setting, BS_PBCCH_BLKs = 3.

Mobile Station:

The MS is GPRS attached with a P-TMSI allocated and the test PDP context3 activated.

Specific PICS Statements

- EGPRS Multislotclass (TSPC_Type_EGPRS_Multislot_ClassX where X = 1..45)

PIXIT Statements

-

Test Procedure

An uplink TBF is established and in progress. The SS sends PACKET TIMESLOT RECONFIGURE for establishment a downlink TBF. A failure occurs at the mobile station side before the new downlink TBF has been successfully established. The MS starts a random access for uplink establishment. The SS assigns a new uplink PDCH to the MS. The SS signals the USF of the preceding uplink TBF addressing the MS on the preceding PDCH which shall have been released by the MS. It is checked that no RLC data block is received on the next three radio blocks. The SS signals the assigned USF assigned to the MS on the uplink PDCH assigned. The MS sends a RLC data block.

The test procedure is repeated 4 times. The message contents of PACKET TIMESLOT RECONFIGURE are varied as defined below.

1st execution, improper PDCH: hopping frequencies not all in one band.

2nd execution, violating the EGPRS multislot capabilities.

3rd execution, no DOWNLINK_TFI_ASSIGNMENT.

4th execution, CONTROL_ACK = '1' (shall be set to '0' as the SS has not yet sent the final EGPRS DOWNLINK RLC DATA BLOCK).

Maximum Duration of Test

10 minutes.

Expected Sequence

The sequence is repeated 4 times. The 2nd execution is not applicable for the MS EGPRS multislot class 18, 29.

Step	Direction	Message	Comments
1		{Uplink dynamic allocation two phase access}	n = 300 octets, without starting time, USF_GRANULARITY = 1 block, RLC_DATA_BLOCKS_GRANTED = open-end EGPRS CHANNEL CODING COMMAND: arbitrarily chosen.
2	SS -> MS	PACKET DOWNLINK DUMMY CONTROL BLOCK	The assigned USF assigned to the MS
3	MS -> SS	EGPRS UPLINK RLC DATA BLOCK	Received on the assigned PDTCH. Check that the coding and the TFI are correct.
4	SS -> MS	PACKET TIMESLOT RECONFIGURE	See specific message contents.
5	MS -> SS	EGPRS PACKET CHANNEL REQUEST	Received on PRACH.
6	SS -> MS	PACKET UPLINK ASSIGNMENT	Multiblock assignment, to force the MS making the two-phase access procedure. Sent on PAGCH.
7	MS -> SS	PACKET RESOURCE REQUEST	Two phase access procedure. Received on the single block assigned in step 6.
8	SS -> MS	PACKET UPLINK ASSIGNMENT	Open-ended uplink dynamic allocation, no starting time, USF_GRANULARITY = single block, the assigned slot and USF different from TN ₂ (as in the default)
9	SS -> MS	PACKET DOWNLINK DUMMY CONTROL BLOCK	The USF assigned to the MS in step 1, sent on TN ₂ , on PACCH in step 1.
10	SS		Check that no RLC data block is received on the next three radio blocks from step 9.
11	SS -> MS	PACKET DOWNLINK DUMMY CONTROL BLOCK	The USF assigned to the MS sent on the PACCH assigned in step 8.
12	MS -> SS	EGPRS UPLINK RLC DATA BLOCK	Received on the correct radio block of the assigned PDTCH.
13		{Completion of uplink RLC data block transfer}	

Specific Message Contents

PACKET TIMESLOT RECONFIGURE message in step 4 (1st execution)

Information Element	value/ remark
PAGE_MODE	Normal
GLOBAL_TFI	0, the TFI value of the uplink TBF assigned 0
EGPRS CHANNEL CODING COMMAND	arbitrarily chosen from valid values
Resegment	1
{0}1<Downlink EGPRS window size>	0
{0}1<Uplink EGPRS window size>	0
<Link quality measurement mode>	00
DOWNLINK_RLC_MODE	unacknowledged mode
CONTROL_ACK	0
{0}1<DOWNLINK_TFI_ASSIGNMENT>	1 (assign TFI to the downlink TBF)
- DOWNLINK_TFI_ASSIGNMENT	arbitrarily chosen but different from the value for the uplink TBF
{0}1<UPLINK_TFI_ASSIGNMENT>	0
DOWNLINK_TIMESLOT_ALLOCATION	The same timeslot as the uplink
{0}1<Frequency Parameters>	1 (frequency parameters)
- TSC	Any valid value
-	11 (Direct encoding 2)
- MAIO	arbitrarily chosen from (0, 1, 2,...,9)
- HSN	arbitrarily chosen
- Length of MA Frequency List contents	10
- MA Frequency List contents	containing ARFCNs 10, 20, 40, 80, 90, 137, 447, 520, 590, 600, 700, 780 by range 1024 format
Dynamic allocation	0
- Extended Dynamic Allocation	0 (Dynamic allocation)
{0}1<P0>	0
- USF GRANULARITY	0 (1 RLC block)
- {0}1<RLC_DATA_BLOCKS_GRANTED>	0 (open-ended TBF)
- {0}1<TBF_STARTING_TIME>	0 (no starting time)
-	0 (Timeslot Allocation)
- {0}1<USF_TNx>	001 (timeslot 2 assigned)
- USF_TN ₂	Arbitrarily chosen but different from the current value 00000

PACKET TIMESLOT RECONFIGURE message in step 4 (2nd execution)

Information Element	value/ remark
PAGE_MODE	Normal
GLOBAL_TFI	0, the TFI value of the uplink TBF assigned 0
EGPRS CHANNEL CODING COMMAND	arbitrarily chosen from valid values
Resegment	1
{0}1<Downlink EGPRS window size>	0
{0}1<Uplink EGPRS window size>	0
<Link quality measurement mode>	00
DOWNLINK_RLC_MODE	unacknowledged mode
CONTROL_ACK	0
{0}1<DOWNLINK_TFI_ASSIGNMENT> - DOWNLINK_TFI_ASSIGNMENT	1 (assign TFI to the downlink TBF) arbitrarily chosen but different from the value for the uplink TBF
{0}1<UPLINK_TFI_ASSIGNMENT>	0
DOWNLINK_TIMESLOT_ALLOCATION	Timeslots 0-7 assigned
{0}1<Frequency Parameters>	0
Dynamic allocation	0
- Extended Dynamic Allocation	0 (Dynamic allocation)
{0}1<P0>	0
- USF GRANULARITY	0 (1 RLC block)
- {0}1<RLC_DATA_BLOCKS_GRANTED>	0 (open-ended TBF)
- {0}1<TBF_STARTING_TIME>	0 (no starting time)
-	0 (Timeslot Allocation)
- {0}1<USF_TN0>	1, a valid value
- {0}1<USF_TN1>	1, a valid value
- {0}1<USF_TN2>	1, a valid value
- {0}1<USF_TN3>	1, a valid value
- {0}1<USF_TN4>	1, a valid value
- {0}1<USF_TN5>	1, a valid value
- {0}1<USF_TN6>	1, a valid value
- {0}1<USF_TN7>	1, a valid value

PACKET TIMESLOT RECONFIGURE message in step 4 (3rd execution)

Information Element	value/ remark
PAGE_MODE	Normal
GLOBAL_TFI	0, the TFI value of the uplink TBF assigned 0
EGPRS CHANNEL CODING COMMAND	arbitrarily chosen from valid values
DOWNLINK_RLC_MODE	unacknowledged mode
CONTROL_ACK	0
{0}1<DOWNLINK_TFI_ASSIGNMENT>	0, no DOWNLINK_TFI_ASSIGNMENT
{0}1<UPLINK_TFI_ASSIGNMENT>	0
DOWNLINK_TIMESLOT_ALLOCATION	The same timeslot as the uplink
{0}1<Frequency Parameters>	0
Dynamic allocation	0
- Extended Dynamic Allocation	0 (Dynamic allocation)
{0}1<P0>	0
- USF GRANULARITY	0 (1 RLC block)
- {0}1<RLC_DATA_BLOCKS_GRANTED>	0 (open-ended TBF)
- {0}1<TBF_STARTING_TIME>	0 (no starting time)
-	0 (Timeslot Allocation)
- {0}1<USF_TNx>	001 (timeslot 2 assigned)
- USF_TN ₂	Arbitrarily chosen but different from the current value 00000

PACKET TIMESLOT RECONFIGURE message in step 4 (4th execution):Same as in 3rd execution except

Information Element	value/ remark
CONTROL_ACK	1

52.3.2.2.2 Dynamic Allocation / Uplink Transfer with Downlink TBF establishment / Abnormal / Continuation of normal operation

52.3.2.2.2.1 Conformance requirements

1. If a failure occurs on the mobile station side before the new TBF has been successfully established, the newly reserved resources are released.
2. If a failure in the PACKET DOWNLINK ASSIGNMENT is due to any reason, the mobile station shall abort the procedure and continue the normal operation of the uplink TBF.

References

3GPP TS 04.60, subclauses 8.1.1.1.3.1 and 8.7.

52.3.2.2.2.2 Test purposes

To verify that the MS aborts the downlink TBF establishment and continues the normal operation of the uplink TBF when the PACKET DOWNLINK ASSIGNMENT fails due to any reason in downlink TBF establishment during uplink transfer.

52.3.2.2.2.3 Method of test

Initial Conditions

System Simulator:

1 cell, default setting, BS_PBCCH_BLKs = 3.

Mobile Station:

The MS is GPRS attached with a P-TMSI allocated and the test PDP context3 activated.

Specific PICS Statements

-

PIXIT Statements

-

Test Procedure

An uplink TBF is established and in progress. The SS sends PACKET DOWNLINK ASSIGNMENT assigning a downlink TBF while a fault occurs in the downlink assignment message.

The SS sends a EGPRS DOWNLINK RLC DATA BLOCK on the downlink PDCH assigned and polls the MS for acknowledgement. It is checked that no EGPRS PACKET DOWNLINK ACK/NACK is received. The SS signals the assigned USF assigned to the MS on the uplink PDCH assigned. The MS sends a RLC data block.

Maximum Duration of Test

5 minutes.

Expected Sequence

Step	Direction	Message	Comments
1		{Uplink dynamic allocation two phase access}	n = 440 octets, without starting time, USF_GRANULARITY = 1 block, RLC_DATA_BLOCKS_GRANTED = open-end EGPRS CHANNEL CODING COMMAND: arbitrarily chosen.
2	SS -> MS	PACKET DOWNLINK DUMMY CONTROL BLOCK	The assigned USF assigned to the MS
3	MS -> SS	EGPRS UPLINK RLC DATA BLOCK	Received on the assigned PDTCH.
4	SS -> MS	PACKET DOWNLINK ASSIGNMENT	See specific message contents
5	SS -> MS	EGPRS DOWNLINK RLC DATA BLOCK	Containing RRBP= N+13, and ES/P field set to '01'. Sent on the downlink PDTCH assigned in step 4. TFI is set to the uplink one;
6	SS		Check that no EGPRS PACKET DOWNLINK ACK/NACK received on the block of frame number = N+13, N is the frame number of the first burst of the data block in step 5.
7	SS -> MS	PACKET UPLINK ACK/NACK	The USF assigned to the MS. Sent on PACCH of the uplink PDCH assigned.
8	MS -> SS	EGPRS UPLINK RLC DATA BLOCK	Received on the assigned PDTCH.
9		{Completion of uplink RLC data block transfer}	

Specific Message Contents

PACKET DOWNLINK ASSIGNMET message in step 4

Information Element	value/ remark
Referenced Address	
-	0 (address is Global TFI)
- TFI	same as the value for uplink TBF
{0 1<DOWNLINK_TFI_ASSIGNMENT>}	L (no downlink TFI assignment)

52.3.3 Dynamic Allocation / Resource reallocation

52.3.3.1 Dynamic Allocation / Resource reallocation / Successful

During an uplink packet transfer, upper layer may request to transfer another LLC PDU with a different Radio Priority, a different peak throughput class or a different RLC mode than the current one, the MS may require the allocation of new uplink resources.

52.3.3.1.1 Dynamic Allocation / Resource reallocation / Successful / Higher throughput class or higher radio priority

52.3.3.1.1.1 Conformance requirements

1. During an uplink packet transfer, upper layer may request to transfer another LLC PDU. If the mobile station has not started the countdown procedure and the new LLC PDU has the same RLC mode as the current uplink TBF and either a higher radio priority or the same radio priority but a higher peak throughput class, the mobile station shall immediately request a resource reallocation for uplink according to the new Radio Priority and peak throughput class of the new LLC PDU by sending a PACKET RESOURCE REQUEST message on the PACCH and starting timer T3168.
2. Then the mobile station shall complete the transmission of the current LLC PDU.
3. After the transmission of the PACKET RESOURCE REQUEST message with the reason for changing the priority or peak throughput class of an assigned uplink TBF the mobile station shall continue to use the currently assigned uplink TBF assuming that the requested priority or peak throughput class is already assigned to that TBF.

References

3GPP TS04.60 subclause 8.1.1.1.2.

52.3.3.1.1.2 Test purposes

It is verified that:

1. Having an uplink TBF in progress without starting the countdown procedure, the MS will immediately send PACKET RESOURCE REQUEST if upper layer requests to transfer another LLC PDU which has the same RLC mode as the current uplink TBF and either a higher radio priority or the same radio priority but a higher peak throughput class.
2. After the request of the resource reallocation for uplink the MS completes the transmission of the current LLC PDU independent of whether or not a new resource is allocated.
3. After the transmission of the PACKET RESOURCE REQUEST the MS continues to use the currently assigned uplink TBF.

52.3.3.1.1.3 Method of test

Initial Conditions

System Simulator:

1 cell, default setting, BS_PBCCH_BLKs = 3, T3168 timeout value=7 (4s), BS_CV_MAX = 1, N201-U=500 for SAPI 3, 5, 9, 11, N201-U=270 for SAPI 7.

Mobile Station:

The MS is GPRS attached with a P-TMSI allocated, SPLIT PG CYCLE negotiated:

- Test PDP context3 and context6 activated;

Specific PICS Statements

-

PIXIT Statements

-

Test Procedure

An uplink TBF is established and in progress. The MS is triggered to transfer data with a higher throughput in the same RLC mode and the same radio priority.

The MS sends PACKET RESOURCE REQUEST. The current TBF is maintained and SS assigns the USFs allowing the MS transmit more data blocks. It is verified that the MS completes the transmission of the current LLC PDU and then starts transmitting a new LLC PDU with the higher throughput. A new PDCH is assigned to MS to complete the RLC data block transferring.

The test procedure is executed twice. In the 2nd execution, after the MS requests a resource reallocation for transferring the data block with a higher throughput a new PDCH is assigned. It is verified that the MS switches on the new PDCH, completes the transmission of the current LLC PDU and then starts transmitting a new LLC PDU with the higher throughput.

Maximum Duration of Test

5 minutes.

Expected Sequence

The test sequence is executed twice for k = 1 and 2.

When k=1 testing that the MS continues to use the currently assigned uplink TBF, while k=2 testing that the MS to use newly assigned the resource to complete transmission of the current PDU before starting transmission the PDU with a higher radio priority or a higher throughput.

Step	Direction	Message	Comments
1		{Uplink dynamic allocation two phase access}	n = 440 octets in test PDP context3, without starting time, USF_GRANULARITY = 1 block, RLC_DATA_BLOCKS_GRANTED = open-end TLLI_BLOCK_CHANNEL_CODING: MCS1, EGPRS CHANNEL CODING COMMAND: MCS1, PEAK_THROUGHPUT_CLASS = 5 (16k octets/s), RADIO_PRIORITY = 4, RLC_MODE = unacknowledged mode.
2	SS -> MS	PACKET DOWNLINK DUMMY CONTROL BLOCK	Sent on the PACCH, the USF assigned to the MS.
3	MS -> SS	EGPRS UPLINK RLC DATA BLOCK	Received on the assigned PDTCH.
4	MS		Check that the coding as specified by EGPRS CHANNEL CODING COMMAND, the TFI is correct. To trigger the MS to transfer 440 octets with the peak throughput class 6 (32k octets/s) in the same RLC mode and the same radio priority as the current uplink TBF (test PDP context6).
5	SS -> MS	PACKET DOWNLINK DUMMY CONTROL BLOCK	Sent on the PACCH, the USF assigned to the MS.
6	MS -> SS	PACKET RESOURCE REQUEST OR EGPRS UPLINK RLC DATA BLOCK	PACKET RESOURCE REQUEST received on the PACCH of the assigned PDCH, radio priority level = 4, peak throughput class = 6, unacknowledged mode. OR EGPRS UPLINK RLC DATA BLOCK received on the assigned PDTCH. Check that the coding and the TFI is correct.
6-1			Repeat Steps 5,6 until PACKET RESOURCE REQUEST is received at Step 6.
7	SS -> MS	PACKET DOWNLINK DUMMY CONTROL BLOCK	Sent on the PACCH of the PDCH assigned, the USF assigned to the MS.
8	MS -> SS	EGPRS UPLINK RLC DATA BLOCK OR PACKET RESOURCE REQUEST	EGPRS UPLINK RLC DATA BLOCK received on the assigned PDTCH. Check that the coding and the TFI are correct. OR Retransmitted PACKET RESOURCE REQUEST received on the PACCH
9	SS		For k=1 Repeat step 7 and 8 until the 2 nd LLC PDU in PDP context6 is started. Observe the Length indicator, M bit and E bit of the received data headers.
10	SS -> MS	PACKET UPLINK ACK/NACK	For k=2 Continue to step 10. Sent on the PACCH of the PDCH assigned, acknowledge all received data, without setting FINAL_ACK_INDICATION.
11	SS -> MS	PACKET UPLINK ASSIGNMENT	Sent on PACCH of the PDCH assigned in step 1, assigning a new PDCH.
12	SS -> MS	PACKET DOWNLINK DUMMY CONTROL BLOCK	Sent on the PACCH of the PDCH assigned in step 11, the USF assigned to the MS.
13	MS -> SS	EGPRS UPLINK RLC DATA BLOCK	Received on the PDTCH assigned in step 11.
14		{Completion of uplink RLC data block transfer}	For k=1, as defined in the macro. For k=2, Observe the Length indicators, and E bit of the received data headers. Check that the MS completes firstly the transmission of the 1 st LLC PDU in PDP context3 and then transmits the 2 nd LLC PDU in PDP context6.

Specific Message Contents

PACKET RESOURCE REQUEST message in step 6:

Information Element	value/ remark
Channel Request Description	
- PEAK_THROUGHPUT_CLASS	6
- RADIO_PRIORITY	4
- RLC_MODE	Unacknowledged mode
- LLC_PDU_TYPE	1 (not SACK or ACK)
- RLC_OCTET_COUNT	Any value

PACKET UPLINK ASSIGNMENT message in step 11:

Information Element	value/ remark
PAGE_MODE	Normal
{0 1<PERSISTENCE_LEVEL>	0
- Uplink TFI	0, Global TFI Same as the current value
EGPRS CHANNEL CODING COMMAND	0
- Resegment	0
<EGPRS window size>	00000 (64 blocks)
TLLI_BLOCK_CHANNEL_CODING	MCS-1
{0 1 <BEP_PERIOD2>}	0
<Packet Timing Advance>	As default
{0 1 <Packet extended Timing advance>}	0
{0 1<Frequency Parameters>	0
Dynamic allocation	01
-	000000
-	0 (Timeslot Allocation)
-	00000001 (timeslot 7 assigned)
- USF_TN7	Arbitrarily chosen

52.3.3.1.2 Dynamic Allocation / Resource reallocation / Successful / Lower throughput class

52.3.3.1.2.1 Conformance requirements

1. During an uplink packet transfer, upper layer may request to transfer another LLC PDU. If the new LLC PDU has the same RLC mode as the current uplink TBF and either a lower Radio Priority or the same radio priority but a lower peak throughput class, the mobile station shall first complete the sending of the LLC PDU in transfer.
2. When the sending of LLC PDUs at the higher Radio Priority or the same radio priority but higher peak throughput class stops, without waiting for the acknowledgement from the network if in RLC acknowledged mode, the mobile station shall then perform the request of a resource reallocation for uplink for any remaining LLC PDU(s) by sending a PACKET RESOURCE REQUEST message on the PACCH and start timer T3168.

References

3GPP TS 04.60, subclause 8.1.1.1.2.

52.3.3.1.2.2 Test purposes

To verify that during an uplink packet transfer, upper layer requests to transfer another LLC PDU and the new LLC PDU has the same RLC mode as the current uplink TBF and either a lower Radio Priority or the same radio priority but a lower peak throughput class.

1. The MS first complete the sending of the LLC PDU in transfer, including acknowledgement from the network if in RLC acknowledged mode.
2. After the sending of LLC PDUs at the higher Radio Priority or the same radio priority but higher peak throughput class stops, the MS performs the request of a resource reallocation for uplink for any remaining LLC PDU(s).

52.3.3.1.2.3 Method of test

Initial Conditions

System Simulator:

1 cell, default setting, BS_PBCCH_BLKs = 3, T3168 timeout value=7 (4s), BS_CV_MAX = 1, N201-U=500 for SAPI 3, 5, 9, 11, N201-U=270 for SAPI 7.

Mobile Station:

The MS is GPRS attached with a P-TMSI allocated, SPLIT PG CYCLE negotiated:

- Test PDP context2 and context4 activated;

Specific PICS Statements

-

PIXIT Statements

-

Test Procedure

An uplink TBF is established and in progress. The MS is triggered to transfer data with a lower throughput or a lower radio priority in the same RLC mode.

The current TBF is maintained and SS assigns the USFs allowing the MS to transmit more data blocks. It is verified that the MS completes the transmission of the current LLC PDU and then sends PACKET RESOURCE REQUEST.

Maximum Duration of Test

5 minutes.

Expected Sequence

Step	Direction	Message	Comments
1		{Uplink dynamic allocation two phase access}	In PDP context4, n = 880 octets, without starting time, USF_GRANULARITY = 1 block, RLC_DATA_BLOCKS_GRANTED = open-end TLLI_BLOCK_CHANNEL_CODING: MCS1, EGPRS CHANNEL CODING COMMAND: MCS1, PEAK_THROUGHPUT_CLASS = 6, RADIO_PRIORITY = 4, RLC_MODE = acknowledged mode.
2	SS -> MS	PACKET DOWNLINK DUMMY CONTROL BLOCK	Sent on the PACCH, the USF assigned to the MS.
3	MS -> SS	EGPRS UPLINK RLC DATA BLOCK	Received on the assigned PDTCH. Check that the coding as specified by EGPRS CHANNEL CODING COMMAND, the TFI is correct.
4	MS		To trigger the MS to transfer 220 octets with the test PDP context2 in the same RLC mode as the current uplink TBF.
5	SS -> MS	PACKET DOWNLINK DUMMY CONTROL BLOCK	Sent on the PACCH of the PDCH assigned, the USF assigned to the MS.
6-1	MS -> SS	EGPRS UPLINK RLC DATA BLOCK	Received on the assigned PDTCH. Check that the coding and the TFI are correct.
6-2	MS -> SS	PACKET RESOURCE REQUEST	Received on the PACCH of the assigned PDCH, acknowledged mode.
7	SS		Repeat step 5 and 6-1 until PACKET RESOURCE REQUEST in 6-2, instead of a RLC data block in 6-1, is received. Observe the Length indicators, and E bit of the received data headers. Check that the transmission of the LLC PDU(s) with higher peak throughput class is completed.
8	SS -> MS	PACKET UPLINK ACK/NACK	Sent on the PACCH of the PDCH assigned, acknowledge all received data
9	SS -> MS	PACKET UPLINK ASSIGNMENT	Sent on PACCH of the PDCH assigned in step 1, assigning a new PDCH.
10	SS -> MS	PACKET DOWNLINK DUMMY CONTROL BLOCK	Sent on the PACCH of the PDCH assigned in step 10, the USF assigned to the MS.
11	MS -> SS	EGPRS UPLINK RLC DATA BLOCK	Received on the PDTCH assigned in step 10.
12		{Completion of uplink RLC data block transfer}	
13	MS		Switch off

Specific Message Contents

PACKET RESOURCE REQUEST message in step 6-2:

Information Element	value/ remark
Channel Request Description	
- PEAK_THROUGHPUT_CLASS	For branch A: 5 For branch B: any allowed value
- RADIO_PRIORITY	For branch A: 4 For branch B: any allowed value different from 1
- RLC_MODE	acknowledged mode
- LLC_PDU_TYPE	1 (not SACK or ACK)
- RLC_OCTET_COUNT	Any allowed value

PACKET UPLINK ASSIGNMET message in step 9:

Same as in subclause 52.3.3.1.1.3, step 11.

52.3.3.1.3 Dynamic Allocation / Resource reallocation / Successful / Different RLC mode and higher radio priority

52.3.3.1.3.1 Conformance requirements

During an uplink packet transfer, upper layer may request to transfer another LLC PDU. If the new LLC PDU does not have the same RLC mode as the current uplink TBF but has a higher radio priority, the mobile station shall complete the transmission of the current LLC PDU using the countdown procedure including acknowledgement from the network, if in RLC acknowledged mode. The mobile station shall then release the TBF and establish a new uplink TBF for transmission of the new LLC PDU. When the sending of LLC PDUs with a higher radio priority is completed using the countdown procedure, including acknowledgement from the network if in RLC acknowledged mode, the mobile station shall try to establish an uplink TBF for the transmission of any remaining LLC PDU(s).

References

3GPP TS 04.60, subclause 8.1.1.1.2.

52.3.3.1.3.2 Test purposes

To verify that during an uplink packet transfer, upper layer requests to transfer another LLC PDU and the new LLC PDU has a different RLC mode from the current uplink TBF but has a higher radio priority:

1. The mobile station completes the transmission of the current LLC PDU using the countdown procedure including acknowledgement from the network, if in RLC acknowledged mode.
2. Then the MS releases the TBF and establishes a new uplink TBF for transmission of the new LLC PDU.
3. When the sending of the new LLC PDUs with a higher radio priority is completed using the countdown procedure, including acknowledgement from the network if in RLC acknowledged mode, the mobile station tries to establish an uplink TBF for the transmission of any remaining LLC PDU(s).

52.3.3.1.3.3 Method of test

Initial Conditions

System Simulator:

1 cell, default setting, BS_PBCCH_BLKs = 3, T3168 timeout value=7 (4s), N201-U=500 for SAPI 3, 5, 9, 11, N201-U=270 for SAPI 7.

Mobile Station:

The MS is GPRS attached with a P-TMSI allocated, SPLIT PG CYCLE negotiated:

- Test PDP context1 and context2 activated;

Specific PICS Statements

-

PIXIT Statements

-

Test Procedure

An uplink TBF is established and in progress. The MS is triggered to transfer 220 octets user data with a higher throughput or a higher radio priority, but in a different RLC mode.

SS assigns the USFs allowing the MS transmit more data blocks until the MS complete the countdown procedure. It is verified that the MS has transmitted only one LLC PDU.

Random accesses are received from the MS for EGPRS PACKET CHANNEL REQUEST. SS assigns a PDCH to it. SS assigns USFs addressing to the MS allowing more data blocks are transmitted by the MS until the countdown value CV=0.

The MS requests more resources through random accesses of channel requests for the remaining LLC PDU in the initial test PDP context. SS starts a two-phase dynamic allocation. It is checked that the values of PEAK_THROUGHPUT_CLASS, RADIO_PRIORITY and RLC_MODE requested by the MS in the PACKET RESOURCE REQUEST are in consistence with the initial test PDP context2.

Maximum Duration of Test

5 minutes.

Expected Sequence

Step	Direction	Message	Comments
1	MS	{Uplink dynamic allocation two phase access}	In PDP context2, n = 880 octets, without starting time, USF_GRANULARITY = 1 block, RLC_DATA_BLOCKS_GRANTED = open-end TLLI_BLOCK_CHANNEL_CODING: MCS1, EGPRS channel coding command: MCS1, PEAK_THROUGHPUT_CLASS = 5, RADIO_PRIORITY = 4, RLC_MODE = acknowledged mode.
2	SS -> MS	PACKET DOWNLINK DUMMY CONTROL BLOCK	Sent on the PACCH, the USF assigned to the MS.
3	MS -> SS	EGPRS UPLINK RLC DATA BLOCK	Received on the assigned PDTCH.
4	MS		Check that the coding as specified by EGPRS CHANNEL CODING COMMAND, the TFI is correct. To trigger the MS to transfer 220 octets in test PDP context1, unacknowledged RLC mode and a higher radio priority.
5	SS -> MS	PACKET DOWNLINK DUMMY CONTROL BLOCK	Sent on the PACCH of the PDCH assigned, the USF assigned to the MS.
6	MS -> SS	EGPRS UPLINK RLC DATA BLOCK	Received on the assigned PDTCH. Check that the coding and the TFI are correct.
7	SS		Repeat step 5 and 6 until countdown value CV=0. Observe the Length indicator, M bit and E bit of the received data headers. Check that transmitted is only the 1 st LLC PDU, Note: the 1 st LLC PDU is in PDP context2, the 2 nd LLC PDU is waiting for transferring.
8	SS -> MS	PACKET UPLINK ACK/NACK	FINAL_ACK_INDICATION = '1'. Acknowledge all received data, containing valid RRBp, sent on PACCH.
9	MS -> SS	PACKET CONTROL ACKNOWLEDGEMENT	Received on the block specified by RRBp on PACCH of the assigned PDCH.
10	MS -> SS	EGPRS PACKET CHANNEL REQUEST	Received on PRACH for TBF establishment for transferring of the LLC PDU in PDP context1.
11	SS -> MS	PACKET UPLINK ASSIGNMENT	Multiblock assignment, to force the MS making two-phase access procedure. Sent on PAGCH.
12	MS -> SS	PACKET RESOURCE REQUEST	Received on the single block assigned in step 11. Check that radio priority level = 1, peak throughput class = 5, unacknowledged RLC mode.
13	SS -> MS	PACKET UPLINK ASSIGNMENT	Open-ended uplink dynamic allocation, no starting time, USF_GRANULARITY = single block. Sent on PACCH of the same PDCH assigned in step 11.
14	SS -> MS	PACKET DOWNLINK DUMMY CONTROL BLOCK	The USF assigned to the MS. Sent on PACCH of PDCH assigned in step 13.
15	MS -> SS	EGPRS UPLINK RLC DATA BLOCK	Received on the PDTCH assigned.
16			Repeat step 14 and 15 until countdown value CV=0. Check the the amount of data is consistent with what was indicated by the MS in step 4.
17	SS -> MS	PACKET UPLINK ACK/NACK	FINAL_ACK_INDICATION = '1', a valid RRBp, acknowledge all received data, sent on PACCH.
18	MS -> SS	PACKET CONTROL ACKNOWLEDGEMENT	Received on the block specified by RRBp on PACCH of the assigned PDCH.

Step	Direction	Message	Comments
19	MS -> SS	EGPRS PACKET CHANNEL REQUEST	Received on PRACH, TBF establishment for transmission of a remaining LLC PDU in PDP context2.
20	SS -> MS	PACKET UPLINK ASSIGNMENT	Multiblock assignment, to force the MS making two-phase access procedure. Sent on PAGCH.
21	MS -> SS	PACKET RESOURCE REQUEST	Received on the single block assigned in step 20. Check that PEAK_THROUGHPUT_CLASS = 5, RADIO_PRIORITY = 4, RLC_MODE = acknowledged mode.
22	SS -> MS	PACKET UPLINK ASSIGNMENT	Open-ended uplink dynamic allocation, no starting time, USF_GRANULARITY = single block. Sent on PACCH of the same PDCH assigned in step 20.
23	SS -> MS	PACKET DOWNLINK DUMMY CONTROL BLOCK	The USF assigned to the MS. Sent on PACCH of PDCH assigned in step 20.
24	MS -> SS	EGPRS UPLINK RLC DATA BLOCK	Received on the PDTCH assigned in step 20.
25	SS		Repeat step 23 and 24 until countdown value CV=0. Observe the Length indicators and E bit of the received data headers. Check that only one LLC PDU is transmitted. Note: the 2nd ^t LLC PDU in PDP context2.
26	SS -> MS	PACKET UPLINK ACK/NACK	FINAL_ACK_INDICATION = '1'. Acknowledge all received data, containing valid RRBp, sent on PACCH.
27	MS -> SS	PACKET CONTROL ACKNOWLEDGEMENT	Received on the block specified by RRBp on PACCH of the assigned PDCH.

Specific Message Contents

PACKET UPLINK ASSIGNMET message in step 13:

Same as in subclause 52.3.3.1.1.3, step 11.

52.3.3.2 Dynamic Allocation / Resource reallocation / Abnormal

52.3.3.2.1 Dynamic Allocation / Resource reallocation / Abnormal / T3168 expiry

52.3.3.2.1.1 Conformance requirements

On expiry of timer T3168 the mobile station shall retransmit the PACKET RESOURCE REQUEST message unless the PACKET RESOURCE REQUEST has already been transmitted four times in which case the mobile station shall return to packet idle mode and indicate a packet access failure to upper layer.

References

3GPP TS 04.60, subclause 8.1.1.1.2.

52.3.3.2.1.2 Test purposes

To verify that during uplink resource reallocation on expiry of timer T3168:

1. The MS retransmits the PACKET RESOURCE REQUEST message unless the PACKET RESOURCE REQUEST has already been transmitted four times.
2. The MS returns to idle mode after PACKET RESOURCE REQUEST has been transmitted four times.

52.3.3.2.1.3 Method of test

Initial Conditions

System Simulator:

1 cell, default setting, BS_PBCCH_BLKs = 3, T3168 timeout value=0 (0.5s), BS_CV_MAX = 1, N201-U=500 for SAPI 3, 5, 9, 11, N201-U=270 for SAPI 7.

Mobile Station:

The MS is GPRS attached with a P-TMSI allocated, SPLIT PG CYCLE negotiated:

- Test PDP context2 and context5 activated;

Specific PICS Statements

-

PIXIT Statements

-

Test Procedure

An uplink TBF is established and in progress. The MS is triggered to transfer data with a higher radio priority in the same RLC mode.

The MS sends PACKET RESOURCE REQUEST. The current TBF is maintained and SS assigns the USFs allowing the MS transmit more data blocks, but does not answers to the requested resources. The MS repeatedly sends PACKET RESOURCE REQUEST three times after T3168 expires each time.

SS waits 0,55 s after receiving the 4th PACKET RESOURCE REQUEST and then sends PACKET DOWNLINK ASSIGNMENT and polls the MS. The MS answers with EGPRS PACKET DOWNLINK ACK/NACK.

Maximum Duration of Test

5 minutes.

Expected Sequence

Step	Direction	Message	Comments
1	MS	{Uplink dynamic allocation two phase access}	In PDP context2, n = 220 octets, without starting time, USF_GRANULARITY = 1 block, RLC_DATA_BLOCKS_GRANTED = open-end TLLI_BLOCK_CHANNEL_CODING: MCS1, EGPRS channel coding command: MCS1, PEAK_THROUGHPUT_CLASS = 5, RADIO_PRIORITY = 4, RLC_MODE = acknowledged mode.
2	SS -> MS	PACKET DOWNLINK DUMMY CONTROL BLOCK	Sent on the PACCH, the USF assigned to the MS.
3	MS -> SS	EGPRS UPLINK RLC DATA BLOCK	Received on the assigned PDTCH.
4	MS		Check that the coding as specified by EGPRS CHANNEL CODING COMMAND, the TFI is correct.
5	SS -> MS	PACKET DOWNLINK DUMMY CONTROL BLOCK	To trigger the MS to transfer 440 octets with the peak throughput class 5 (16k octets/s) and the radio priority 1 in acknowledge RLC mode of the PDP context5.
6	MS -> SS	EGPRS UPLINK RLC DATA BLOCK or PACKET RESOURCE REQUEST	Sent on the PACCH, the USF assigned to the MS.
7			Received on the PDCH assigned
8			Repeat steps 5 and 6 until reception of PACKET RESOURCE REQUEST (ensure that countdown procedure did not start before that MS requests additional resources)
9	SS -> MS	PACKET UPLINK ACK/NACK	Repeat steps 5 – 7 twice, Note: the 1 st LLC PDU may be sent out and the sending 2 nd PDU in the PDP context5 is started
10	MS -> SS	EGPRS UPLINK RLC DATA BLOCK or PACKET RESOURCE REQUEST	Check that the coding as specified by CHANNEL_CODING_COMMAND, the TFI is correct for all received UPLINK RLC DATA BLOCK.
11	SS -> MS	PACKET DOWNLINK DUMMY CONTROL BLOCK	Sent on the PACCH of the PDCH assigned, acknowledge all received data. USF assigned to MS
12			Received on the PDCH assigned, the 4 th time to send PACKET RESOURCE REQUEST.
13	SS -> MS	PACKET DOWNLINK ASSIGNMENT	Repeat steps 10 and 11 until reception of PACKET RESOURCE REQUEST (ensure that countdown procedure did not start before that MS requests additional resources)
14	MS -> SS	PACKET CONTROL ACKNOWLEDGEMENT	Sent 0,55s after step 10 on PCCCH, a valid RRBPN=N+13. If MS sends Packet Channel Request SS should reject this by giving Packet Access Reject with WAIT_INDICATION= 20 sec. As four access bursts, received on PCCCH.

Specific Message Contents

PACKET RESOURCE REQUEST message in step 5 and 10:

Information Element	value/ remark
Channel Request Description	
- PEAK_THROUGHPUT_CLASS	5
- RADIO_PRIORITY	1
- RLC_MODE	Acknowledged mode
- LLC_PDU_TYPE	1 (not SACK or ACK)
- RLC_OCTET_COUNT	Any allowed value

52.3.3.2.2 Dynamic Allocation / Resource reallocation / Abnormal / Invalid assignment

52.3.3.2.2.1 Conformance requirements

1. If the mobile station receives a PACKET UPLINK ASSIGNMENT or PACKET TIMESLOT RECONFIGURE message and detects an invalid Frequency Parameters information element in the message, the mobile station shall perform an abnormal release with system information (see sub-clause 8.7.3), performing a partial acquisition of system information messages containing frequency information.
2. If the mobile station receives a PACKET UPLINK ASSIGNMENT or PACKET TIMESLOT RECONFIGURE message specifying frequencies that are not all in one frequency band then the mobile station shall perform an abnormal release with random access.
3. If the mobile station receives a PACKET UPLINK ASSIGNMENT message containing a Frequency Parameters information element specifying a frequency that is in a frequency band not supported by the mobile station then the mobile station shall perform an abnormal release with random access.

References

3GPP TS 04.60, subclause 8.1.1.1.2.1.

52.3.3.2.2.2 Test purposes

To verify that during uplink resource reallocation:

1. The MS performs an abnormal release with random access if it receives a PACKET UPLINK ASSIGNMENT or PACKET TIMESLOT RECONFIGURE message specifying frequencies that are not all in one frequency band.
2. The MS performs an abnormal release with random access if it receives a PACKET UPLINK ASSIGNMENT message containing a Frequency Parameters information element specifying a frequency in the frequency band not supported.
3. The MS performs an abnormal release with system information if it receives a PACKET UPLINK ASSIGNMENT or PACKET TIMESLOT RECONFIGURE message containing an Invalid Frequency Parameters information element.

52.3.3.2.2.3 Method of test

Initial Conditions

System Simulator:

1 cell, default setting, BS_PBCCH_BLKs = 3, BS_CV_MAX = 1, N201-U=500 for SAPI 3, 5, 9, 11, N201-U=270 for SAPI 7.

Mobile Station:

The MS is GPRS attached with a P-TMSI allocated, SPLIT PG CYCLE negotiated:

- Test PDP context2 and context5 activated;

Specific PICS Statements

- Support of Standard GSM Band (P-GSM) (TSPC_Type_GSM_P_Band)
- Support of DCS 1800 band (TSPC_Type_DCS_Band)
- Support of GSM 700 band (TSPC_Type_GSM_700_Band)
- Support of GSM 850 band (TSPC_Type_GSM_850_Band)
- Support of T GSM 810 band (TSPC_Type_T_GSM_810_Band)

PIXIT Statements

-

Test Procedure

An uplink TBF is established and in progress. The MS is triggered to transfer data with a higher radio priority in the same RLC mode. The MS sends PACKET RESOURCE REQUEST. SS sends PACKET UPLINK ASSIGNMENT or PACKET TIMESLOT RECONFIGURE containing an invalid assignment ($k=1\dots 5$, see step 6 in expected sequences).

It is checked that the MS starts random accesses.

Maximum Duration of Test

10 minutes.

Expected Sequence

The test sequence is executed in total five times, $k = 1 \dots 5$. The 5th execution is applicable to the single band MS, but not to the multi-band one.

Step	Direction	Message	Comments
1	MS	{Uplink dynamic allocation two phase access}	In PDP context2, n = 220 octets, without starting time, USF_GRANULARITY = 1 block, RLC_DATA_BLOCKS_GRANTED = open-end TLLI_BLOCK_CHANNEL_CODING: MCS1, EGPRS channel coding command: MCS1, PEAK_THROUGHPUT_CLASS = 5, RADIO_PRIORITY = 4, RLC_MODE = acknowledged mode.
2	SS -> MS	PACKET DOWNLINK DUMMY CONTROL BLOCK	Sent on the PACCH, the USF assigned to the MS.
3	MS -> SS	EGPRS UPLINK RLC DATA BLOCK	Received on the assigned PDTCH.
4	MS		Check that the coding as specified by EGPRS CHANNEL CODING COMMAND, the TFI is correct.
5-1	SS -> MS	PACKET DOWNLINK DUMMY CONTROL BLOCK	To trigger the MS to transfer 440 octets with the peak throughput class 5 (16k octets/s) and the radio priority 1 in acknowledge RLC mode of the PDP context5.
5	MS -> SS	EGPRS UPLINK RLC DATA BLOCK or PACKET RESOURCE REQUEST	Sent on the PACCH, the USF assigned to the MS.
6-1			Received on the PACCH of the PDCH assigned
6	SS -> MS	PACKET UPLINK ASSIGNMENT	Repeat steps 5-1 and 5 until reception of PACKET RESOURCE REQUEST (ensure that countdown procedure did not start before that MS requests additional resources)
k=1			Assign a frequency hopping PDCH, but not all frequencies are in one frequency band.
6	SS -> MS	PACKET TIMESLOT RECONFIGURE	Assign a frequency hopping PDCH, but not all frequencies are in one frequency band.
k=2			Assign a frequency hopping PDCH, the MA_NUMBER and MA_CHANGE_MARK_1 mismatch the values of MA_NUMBER and MA_CHANGE_MARK stored in the MS.
6	SS -> MS	PACKET UPLINK ASSIGNMENT	Assign a frequency hopping PDCH, the MA_NUMBER and MA_CHANGE_MARK_1 mismatch the values of MA_NUMBER and MA_CHANGE_MARK stored in the MS.
k=3			Assign a frequency hopping PDCH, the MA_NUMBER and MA_CHANGE_MARK_1 mismatch the values of MA_NUMBER and MA_CHANGE_MARK stored in the MS.
6	SS -> MS	PACKET TIMESLOT RECONFIGURE	Assign a frequency hopping PDCH, the MA_NUMBER and MA_CHANGE_MARK_1 mismatch the values of MA_NUMBER and MA_CHANGE_MARK stored in the MS.
k=4			Assign a frequency hopping PDCH, the MA_NUMBER and MA_CHANGE_MARK_1 mismatch the values of MA_NUMBER and MA_CHANGE_MARK stored in the MS.
6	SS -> MS	PACKETUPLINK ASSIGNMENT	Assigned ARFCN on PDCH is not in the frequency band supported by the MS.
k=5			Received on PRACH.
7	MS -> SS	EGPRS PACKET CHANNEL REQUEST	

Specific Message Contents

PACKET UPLINK ASSIGNMET message in step 6 for k=1:

Information Element	value/ remark
{0}1<Frequency Parameters> - Frequency Parameters - TSC - - MAIO - HSN - Length of MA Frequency List contents - MA Frequency List contents Dynamic allocation	1 (Frequency Parameters present) Arbitrarily chosen 11 (Direct encoding 2) Arbitrarily chosen Arbitrarily chosen 12 octets Contain following ARFCNs in 1024 range format: 20, 40, 80, 90, 520, 590, 600, 700 01 As default

PACKET TIMESLOT RECONFIGURE message in step 6 for k=2:

Information Element	value/ remark
PAGE_MODE - Global TFI Message escape {0}1 <COMPACT reduced MA> EGPRS_CHANNEL_CODING_COMMAND Resegment IE {0}1 <DOWNLINK EGPRS Window Size> {0}1 <UPLINK EGPRS Window Size> LINK QUALITY MEASUREMENT MODE Global Packet Timing Advance { 0}1< TIMING_ADVANCE_VALUE > - TIMING_ADVANCE_VALUE } - {0}1<UPLINK_TIMING_ADVANCE_INDEX> <UPLINK_TIMING_ADVANCE_TIMESLOT_NUMBER> - {0}1<DOWNLINK_TIMING_ADVANCE_INDEX> <DOWNLINK_TIMING_ADVANCE_TIMESLOT_NUMBER> R}< DOWNLINK_RLC_MODE CONTROL_ACK {0}1<DOWNLINK_TFI_ASSIGNMENT> - DOWNLINK_TFI_ASSIGNMENT {0}1< UPLINK_TFI_ASSIGNMENT > DOWNLINK_TIMESLOT_ALLOCATION {0}1<Frequency Parameters> - Frequency Parameters - TSC - - MAIO - HSN - Length of MA Frequency List contents - MA Frequency List contents Dynamic allocation	Normal 0, Global TFI as reference 0, uplink TFI same value as assigned in the uplink in step 1 1 (EGPRS) 0 Not present 00 (MCS-1) 1 Retransmitted RLC data blocks shall be resegmented according to commanded MCS Default 64 Default 64 00 1 (timing advance value) 30 bit periods 0 (no uplink timing advance index) 0 (no downlink timing advance index) Acknowledged mode 0 1 (assign downlink TFI) 00001(Binary) 0 Same timeslot as the uplink TBF H (hopping channel) Arbitrarily chosen 11 (Direct encoding 2) arbitrarily chosen arbitrarily chosen 12 octets Contain following ARFCNs in 1024 range format: 20, 40, 80, 90, 520, 590, 600, 700 0 As default

PACKET UPLINK ASSIGNMENT message in step 6 for k=3:

Information Element	value/ remark
{0}1<Frequency Parameters>	1 (Frequency Parameters present)
- Frequency Parameters	
- TSC	Arbitrarily chosen
-	01 (Indirect encoding)
- MAIO	Arbitrarily chosen
- MA_NUMBER	Arbitrarily select a value that does not present in PSI2 message and different from 14 and 15
- {0}1<CHANGE_MARK_1>	1 (present)
- CHANGE_MARK_1	Arbitrarily select a value that mismatches PSI2_CHANGE_MARK
- {0}1<CHANGE_MARK_2>	1 (CHANGE_MARK_2 present)
- CHANGE_MARK_2	Arbitrarily select a value that is different from CHANGE_MARK_1 and mismatches PSI2_CHANGE_MARK
Dynamic allocation	01 As default

PACKET TIMESLOT RECONFIGURE message in step 6 for k=4:

Information Element	value/ remark
PAGE_MODE	Normal
	0, Global TFI as reference
- Global TFI	0, uplink TFI same value as assigned in the uplink in step 1
Message escape	1 (EGPRS)
{0}1 <COMPACT reduced MA>	0 Not present
EGPRS_CHANNEL_CODING_COMMAND	00 (MCS-1)
Resegment IE	1 Retransmitted RLC data blocks shall be resegmented according to commanded MCS
{0}1 <DOWNLINK EGPRS Window Size>	Default 64
{0}1 <UPLINK EGPRS Window Size>	Default 64
LINK QUALITY MEASUREMENT MODE	00
Global Packet Timing Advance	
{0}1< TIMING_ADVANCE_VALUE >	1 (timing advance value)
- TIMING_ADVANCE_VALUE }	30 bit periods
- {0}1<UPLINK_TIMING_ADVANCE_INDEX> <UPLINK_TIMING_ADVANCE_TIMESLOT_NUMBER>}	0 (no uplink timing advance index)
- {0}1<DOWNLINK_TIMING_ADVANCE_INDEX> <DOWNLINK_TIMING_ADVANCE_TIMESLOT_NUMBER>}	0 (no downlink timing advance index)
DOWNLINK_RLC_MODE	Acknowledged mode
CONTROL_ACK	0
{0}1<DOWNLINK_TFI_ASSIGNMENT>	1 (assign downlink TFI)
- DOWNLINK_TFI_ASSIGNMENT	00001(Binary)
{0}1< UPLINK_TFI_ASSIGNMENT >	0
DOWNLINK_TIMESLOT_ALLOCATION	Same timeslot as the uplink TBF
{0}1<Frequency Parameters>	1 (hopping channel)
- Frequency Parameters	
- TSC	Arbitrarily chosen
-	01 (Indirect encoding)
- MAIO	Arbitrarily chosen
- MA_NUMBER	Arbitrarily select a value that does not present in PSI2 message and different from 14 and 15
- {0}1<CHANGE_MARK_1>	1 (CHANGE_MARK_1 present)
- CHANGE_MARK_1	Arbitrarily choose a value which mismatches PSI2_CHANGE_MARK
- {0}1<CHANGE_MARK_2>	0 (no CHANGE_MARK_2)
Dynamic allocation	0 As default

PACKET UPLINK ASSIGNMET message in step 6 for k=5:

Information Element	value/ remark
{0 1<Frequency Parameters> - Frequency Parameters - TSC - - ARFCN	1 (Frequency Parameters present) Arbitrarily chosen 00 (ARFCN no hopping) For GSM 900: 650 For GSM 700, T-GSM 810: 650 For GSM 850: 190 For DCS 1 800: 30 For PCS 1 900: 650
Dynamic allocation	01 (Dynamic allocation) As default

52.3.3.3 Dynamic Allocation / Resource reallocation / Reject

52.3.3.3.1 Conformance requirements

1. On receipt of a PACKET ACCESS REJECT message, the mobile station shall stop timer T3168 if running and indicate a packet access failure to upper layers. If no downlink TBF exists, the mobile station shall return to packet idle mode.
2. If the PACKET ACCESS REJECT message contains a WAIT_INDICATION field in a Reject structure addressed to the mobile station, the mobile station shall start timer T3172 and if the mobile station has additional RLC data blocks to transmit, it shall initiate a new TBF establishment procedure on the RACH or PRACH, but the mobile station is not allowed to make a new attempt for packet access in the same cell until timer T3172 expires, it may, however, attempt packet access in an other cell after successful cell reselection. A mobile station in EGPRS MS class A or B mode of operation may attempt to enter the dedicated mode in the same cell before timer T3172 has expired. During the time T3172 is running, the mobile station shall ignore all received PACKET PAGING REQUEST messages except paging request to trigger RR connection establishment.

References

3GPP TS 04.60, subclause 8.1.1.1.2.

52.3.3.3.2 Test purposes

To verify that during the uplink resource reallocation:

1. The MS returns to packet idle mode when it receives PACKET ACCESS REJECT without WAIT_INDICATION.
2. On receipt of a PACKET ACCESS REJECT with a WAIT_INDICATION the MS waits until T3172 expires. The MS, if having another RLC data blocks to transmit, initiates a new TBF establishment procedure on the PRACH.

52.3.3.3.3 Method of test

Initial Conditions

System Simulator:

1 cell, default setting, BS_PBCCH_BLKs = 3, BS_CV_MAX = 1, N201-U=500 for SAPI 3, 5, 9, 11, N201-U=270 for SAPI 7.

Mobile Station:

The MS is GPRS attached with a P-TMSI allocated, SPLIT PG CYCLE negotiated:

- Test PDP context2 and context5 activated;

Specific PICS Statements

-

PIXIT Statements

-

Test Procedure

An uplink TBF is established and in progress. The MS is triggered to transfer data with a higher radio priority in the same RLC mode.

The MS sends PACKET RESOURCE REQUEST. SS sends PACKET ACCESS REJECT without containing WAIT_INDICATION. The MS may attempt a new random access because of the user data from the upper layer.

The test procedure is repeated once. The difference between the two executions is that in the 2nd execution, PACKET ACCESS REJECT contains WAIT_INDICATION. The MS may start the random access after T3172 expires.

Maximum Duration of Test

5 minutes.

Expected Sequence

The test sequence is executed twice for k = 1 ... 2.

Step	Direction	Message	Comments
1	MS	{Uplink dynamic allocation two phase access}	In PDP context2, n = 220 octets, without starting time, USF_GRANULARITY = 1 block, RLC_DATA_BLOCKS_GRANTED = open-end TLLI_BLOCK_CHANNEL_CODING: MCS1, EGPRS channel coding command: MCS1, PEAK_THROUGHPUT_CLASS = 5, RADIO_PRIORITY = 4, RLC_MODE = acknowledged mode.
2	SS -> MS	PACKET DOWNLINK DUMMY CONTROL BLOCK	Sent on the PACCH, the USF assigned to the MS.
3	MS -> SS	EGPRS UPLINK RLC DATA BLOCK	Received on the assigned PDTCH.
4	MS		Check that the coding as specified by EGPRS CHANNEL CODING COMMAND, the TFI is correct.
5-1	SS -> MS	PACKET DOWNLINK DUMMY CONTROL BLOCK	To trigger the MS to transfer 440 octets with the peak throughput class 5 (16k octets/s) and the radio priority 1 in acknowledge RLC mode of the PDP context5.
5	MS -> SS	UPLINK RLC DATA BLOCK or PACKET RESOURCE REQUEST	Sent on the PACCH, the USF assigned to the MS.
6-1			Received on the PACCH of the PDCH assigned
6	SS -> MS	PACKET DOWNLINK DUMMY CONTROL BLOCK	Repeat steps 5-1 and 5 until reception of PACKET RESOURCE REQUEST (ensure that countdown procedure did not start before that MS requests additional resources)
7	MS -> SS	EGPRS UPLINK RLC DATA BLOCK	Sent on the PACCH, the USF assigned to the MS.
8	SS -> MS	PACKET ACCESS REJECT	Received on the assigned PDTCH. Check that the coding as specified by EGPRS CHANNEL CODING COMMAND, the TFI is correct.
9(option al step)	MS -> SS	EGPRS PACKET CHANNEL REQUEST	Sent on the PACCH of the PDCH, including the same address reference received from step 5 addressing the MS, For k = 1 without WAIT_INDICATION For k = 2 with WAIT_INDICATION. Optionally received on PRACH, depending on the MS implementation. For k=2, check that the random access is received not before 4,5s from step 8

Specific Message Contents

PACKET ACCESS REJECT message in step 8 for k=1:

Information Element	value/ remark
MESSAGE_TYPE	1 00001
PAGE_MODE	Normal Paging
Reject	
-	0 (TLLI)
- TLLI	the same value as the TLLI received
-	0 (no WAIT_INDICATION)
-	0

PACKET ACCESS REJECT message in step 8 for k=2:

Information Element	value/ remark
MESSAGE_TYPE	1 00001
PAGE_MODE	Normal Paging
Reject	
-	0 (TLLI)
- TLLI	The same value as the TLLI received
-	1 (WAIT_INDICATION present)
- WAIT_INDICATION	5 seconds
- WAIT_INDICATION_SIZE	0 (units of seconds)
-	0 (end of reject IE)

PACKET RESOURCE REQUEST message in step 5:

Information Element	value/ remark
Channel Request Description	
- PEAK_THROUGHPUT_CLASS	5
- RADIO_PRIORITY	1
- RLC_MODE	Acknowledged mode
- LLC_PDU_TYPE	1 (not SACK or ACK)
- RLC_OCTET_COUNT	Any allowed value

52.3.4 Default message contents

The following default values of messages and the default contents of messages are defined for subclause 52.3. They, unless indicated otherwise in subclause 52.3, shall be transmitted by the system simulator and are required to be received from the MS under test.

In this clause, decimal values are normally used. However, sometimes a hexadecimal value, indicated by an "Hex", or a binary value, indicated by a "Binary" is used.

All macro definitions are referred to subclause 40.5 and test PDP contexts are referred to subclause 40.6.

The default initial conditions used in subclause 52.3 are that PBCCH is present.

PACKET DOWNLINK ASSIGNMENT message:

Information Element	value/ remark
MESSAGE_TYPE	000010
PAGE_MODE	Normal Paging
{0 1<PERSISTENCE_LEVEL>}	0
-	10 (address is TLLI)
- TLLI	Same value as received from MS since GPRS attached
MAC_MODE	0, message escape
RLC_MODE	Dynamic Allocation
CONTROL_ACK	Acknowledged mode
TIMESLOT_ALLOCATION	0
Packet Timing Advance	Single slot arbitrarily chosen from valid values, default slot 2
- {0 1<TIMING_ADVANCE_VALUE>}	1 (presence of the timing advance value)
- TIMING_ADVANCE_VALUE	30 bit periods
- {0 1<TIMING_ADVANCE_INDEX>	0 (no timing advance index)
<TIMING_ADVANCE_TIMESLOT_NUMBER >}	
- {0 1<P0><BTS_PWR_CTRL_MODE>}	0
{0 1<Frequency Parameters>}	1 (Frequency Parameters present)
- Frequency Parameters	
- TSC	Value arbitrarily chosen from valid values (default 5)
-	01 (indirect encoding)
- MAIO	Value arbitrarily chosen
- MA_NUMBER	Value arbitrarily chosen from PSI2s defined
- {0 1<CHANGE_MARK_1>	0
{0 1<CHANGE_MARK_2>}}	
{0 1<DOWNLINK_TFI_ASSIGNMENT>}	1 (assign downlink TFI)
- DOWNLINK_TFI_ASSIGNMENT	Arbitrarily chosen from valid values (default 3)
{0 1<Power Control Parameters>}	1 (Power Control Parameters present)
- ALPHA	0.5
- {0 1<GAMMA_TN0>}	Depending on the value in TIMESLOT_ALLOCATION (default 0 no GAMMA_TN0)
- {0 1<GAMMA_TN1>}	Depending on the value in TIMESLOT_ALLOCATION (default 0 no GAMMA_TN1)
- {0 1<GAMMA_TN2>}	Depending on the value in TIMESLOT_ALLOCATION (default 1 GAMMA_TN2)
- GAMMA_TN2	For GSM 900: +8 dBm For GSM 400: +8 dBm For GSM 850: +8 dBm For GSM 700 and T-GSM 810: +8 dBm For DCS 1 800: +6 dBm For PCS 1 900: +6 dBm
- {0 1<GAMMA_TN3>}	Depending on the value in TIMESLOT_ALLOCATION (default 0 no GAMMA_TN0)
- {0 1<GAMMA_TN4>}	Depending on the value in TIMESLOT_ALLOCATION (default 0 no GAMMA_TN4)
- {0 1<GAMMA_TN5>}	Depending on the value in TIMESLOT_ALLOCATION (default 0 no GAMMA_TN5)
- {0 1<GAMMA_TN6>}	Depending on the value in TIMESLOT_ALLOCATION (default 0 no GAMMA_TN6)
- {0 1<GAMMA_TN7>}	Depending on the value in TIMESLOT_ALLOCATION (default 0 no GAMMA_TN7)
{0 1<TBF_STARTING_TIME>}	1 (starting time present)
- TBF_STARTING_TIME	0, absolute frame number encoding, indicating (current frame + 13 frames)
{0 1<Measurement Mapping>}	0 (no measurement mapping)
{1 0}	1 (Additional contents for EGPRS present)
{0 1 <EGPRS window size>	1
- EGPRS window size	00000 (64 blocks)
<Link quality measurement mode>	00 (MS shall not report)
{0 1 <BEP_PERIOD2> }	0
{0 1 <Packet extended timing advance>}	0
{0 1 <COMPACT reduced MA>}	0
spare padding	Spare Padding

PACKET DOWNLINK DUMMY CONTROL BLOCK message:

Information Element	value/ remark
MESSAGE_TYPE	1 00101
PAGE_MODE	Normal Paging
{0 1<PERSISTENCE_LEVEL>}	0
spare padding	Spare Padding

PACKET PAGING REQUEST message:

MESSAGE_TYPE	1 00010
PAGE_MODE	Normal Paging
{0 1<PERSISTENCE_LEVEL>}	0 (no persistence level present)
{0 1<NLN>}	0 (no notification list number)
{1 <Repeated Page info>}	1 (start of Repeated Page info)
-	0 (Page request for TBF establishment)
-	0 (PTMSI)
- PTMSI	P-TMSI allocated during EGPRS attach procedure
-	0 (end of Repeated Page info)
spare padding	Spare Padding

PACKET TIMESLOT RECONFIGURE message (dynamic allocation without assigning a new TBF):

Information Element	value/ remark
MESSAGE_TYPE	000111
PAGE_MODE	Normal Paging
0<GLOBAL_TFI>	0 The TFI value of the uplink TBF or downlink TBF which this message applies to (default 00101)
{0 1 <COMPACT reduced MA>}	1, message escape
EGPRS CHANNEL CODING COMMAND	0
Resegment	Arbitrarily chosen from valid values (default MCS-1)
{0 1 <Downlink EGPRS window size> - Downlink EGPRS window size	1, Retransmitted RLC blocks Resegmented according to commanded MCS
{0 1 <Uplink EGPRS window size> - Uplink EGPRS window size	1
<LINK_QUALITY_MEASUREMENT_MODE>	00000 (64 blocks)
Global Packet Timing Advance	1
- {0 1<TIMING_ADVANCE_VALUE>}	00000 (64 blocks)
- TIMING_ADVANCE_VALUE	1
- {0 1<UPLINK_TIMING_ADVANCE_INDEX>	00000 (64 blocks)
<UPLINK_TIMING_ADVANCE_TIMESLOT_NUMBER>	00, No measurements
- {0 1<DOWNLINK_TIMING_ADVANCE_INDEX>	0 (no uplink timing advance index)
<DOWNLINK_TIMING_ADVANCE_TIMESLOT_NUMBER>	0 (no downlink timing advance index)
{0 1 <Packet Extended Timing Advance>	The MS stops the operation of the continuous timing advance procedure.
DOWNLINK_RLC_MODE	0 (no downlink timing advance index)
CONTROL_ACK	The MS stops the operation of the continuous timing advance procedure.
{0 1<DOWNLINK_TFI_ASSIGNMENT>	0
{0 1<UPLINK_TFI_ASSIGNMENT>	0
DOWNLINK_TIMESLOT_ALLOCATION	Same as in the Test PDP context used
{0 1<Frequency Parameters>	0
Dynamic allocation	0 (use current parameters)
- Extended Dynamic Allocation	0
- {0 1<P0><PR_MODE>}	0 (Dynamic allocation)
- USF_GRANULARITY	0
- {0 1<RLC_DATA_BLOCKS_GRANTED>}	0, one block
- {0 1<TBF_STARTING_TIME>}	0 (no RLC_DATA_BLOCKS_GRANTED, open-ended TBF)
- TBF_STARTING_TIME	1 (starting time)
-	1, relative frame number encoding indicating current frame + 104 by absolute encoding
- ALPHA	1 (Timeslot Allocation with Power Control Parameters)
- {0 1<USF_TN0><GAMMA_TN0>}	one slot arbitrarily chosen and different from current slot, the following USF_TNx and GAMMA_TNx shall be corresponding to the chosen value, default timeslot 3.
- {0 1<USF_TN1><GAMMA_TN1>}	0.5
- {0 1<USF_TN2><GAMMA_TN2>}	0 (timeslot 0 not assigned)
- {0 1<USF_TN3><GAMMA_TN3>}	0 (timeslot 1 not assigned)
- USF_TN3	0 (timeslot 2 not assigned)
- GAMMA_TN3	1 (timeslot 3 assigned)
	arbitrarily chosen and different from current value, default 4
	For GSM 900: +8 dBm
	For GSM 400: +8 dBm
	For GSM 700 and T-GSM 810: +8 dBm
	For GSM 850: +8 dBm
	For DCS 1 800: +6 dBm
	For PCS 1 900: +6 dBm
- {0 1<USF_TN4><GAMMA_TN4>}	0 (timeslot 4 not assigned)
- {0 1<USF_TN5><GAMMA_TN5>}	0(timeslot 5 not assigned)
- {0 1<USF_TN6><GAMMA_TN6>}	0 (timeslot 6 not assigned)
- {0 1<USF_TN7><GAMMA_TN7>}	0 (timeslot 7 not assigned)
spare padding	Spare Padding

For assignment of an uplink TBF while a downlink TBF has been established, the address information should be changed to DOWNLINK_TFI of Global_TFI. UPLINK_TFI_ASSIGNMENT is present.

PACKET UPLINK ACK/NACK message:

Information Element	value/ remark
MESSAGE_TYPE	001001
PAGE_MODE	Normal Paging
UPLINK_TFI	00, same as the TFI value of the TBF which the message applies
EGPRS CHANNEL CODING COMMAND	1, message escape to define EGPRS contents same coding scheme as in the assigned TBF which the message applies to
Resegment	1 Retransmitted messages can be resegmented using the same MCS.
PRE_EMPTIVE TRANSMISSION	1, mobile shall use pre-emptive transmission.
PRR RETRANSMISSION REQUEST	Any value
ARAC RETRANSMISSION REQUEST	Any value
{0 1<CONTENTION_RESOLUTION_TLLI>}	0 (no contention resolution TLLI)
TBF_EST	1 Mobile station is allowed to make a request for new TBF.
{0 1<Packet Timing Advance>}	0 (no packet timing advance)
{0 1<Packet Extended Timing Advance>}	0 (no packet extended timing advance)
{0 1<Power Control Parameters>}	0 (no power control parameters)
{0 1<Extension bits>}	0 (no extension bits present)
EGPRS Ack/Nack Description	
- FINAL_ACK_INDICATION	0 (not final ack)
- BEGINNING OF WINDOW	1, SSN = (V(Q) + 1) MOD 2048
- END OF WINDOW	1, Included in bitmap
- STARTING_SEQUENCE_NUMBER	Any value
- {0 1 COMPRESSED_BITMAP_LENGTH	0 No compression
- UNCOMPRESSED_RECEIVED_BLOCK_BITMAP	Any value
spare padding	Spare Padding

PACKET UPLINK ASSIGNMENT message (two-phase dynamic allocation assigning a TBF):

Information Element	value/ remark
MESSAGE_TYPE	001010
PAGE_MODE	Normal Paging
{0 1<PERSISTENCE_LEVEL>}	0 (no persistence level present)
- Address information	10 (TLLI)
- TLLI	The value received from the MS
	1, message escape to define EGPRS message contents
	00
{0 1 <COMPACT Reduced MA>	0
EGPRS CHANNEL CODING COMMAND	Arbitrarily chosen from the valid values (default CS-1)
Resegment	1, Retransmitted blocks can be re-segmented using the selected MCS
EGPRS Window size	00000, 64 blocks
{0 1 <Access Technologies Request> }	1
- Access Technologies Request	Any value
ARAC RETRANSMISSION REQUEST	0, No retransmission
TLLI_BLOCK_CHANNEL_CODING	'0'B, MCS-1
{0 1 <BEP_PERIOD2> }	0
Packet Timing Advance	
- {0 1<TIMING_ADVANCE_VALUE>}	1 (timing advance value)
- TIMING_ADVANCE_VALUE	30 bit periods
- {0 1<TIMING_ADVANCE_INDEX>	0 (no timing advance index)
<TIMING_ADVANCE_TIMESLOT_NUMBER >}	
{0 1 <Packet Extended Timing Advance>	0, No extended timing advance value
{0 1<Frequency Parameters>}	1 (Frequency Parameters present)
- Frequency Parameters	
- TSC	Arbitrarily chosen (default 5)
-	01 (indirect encoding)
- MAIO	Value arbitrarily chosen
- MA_NUMBER	Value arbitrarily chosen from PSI2s defined (default 0001)
- {0 1<CHANGE_MARK_1>	0
{0 1<CHANGE_MARK_2>}}	
Dynamic allocation	01
- Extended Dynamic Allocation	0 (Dynamic allocation)
- {0 1<P0><PR_MODE>}	0
- USF_GRANULARITY	0, one block
- {0 1<UPLINK_TFI_ASSIGNMENT>}	1 (uplink TFI assignment)
- UPLINK_TFI_ASSIGNMENT	Arbitrarily chosen (default 00101)
- {0 1<RLC_DATA_BLOCKS_GRANTED>}	0 (no RLC_DATA_BLOCKS_GRANTED, open-ended TBF)
- {0 1<TBF_STARTING_TIME>}	0 (no starting time)
-	1 (Timeslot Allocation with Power Control Parameters)
	one slot arbitrarily chosen and the following USF_TNx and GAMMA_TNx shall be corresponding to the chosen value, default timeslot 2 assigned)
- ALPHA	0.5
- {0 1<USF_TN0><GAMMA_TN0>}	0 (timeslot 0 not assigned)
- {0 1<USF_TN1><GAMMA_TN1>}	0 (timeslot 1 not assigned)
- {0 1<USF_TN2><GAMMA_TN2>}	1 (timeslot 2 assigned)
- USF_TN2	Arbitrarily chosen (default 101)
- GAMMA_TN2	For GSM 900: +8 dBm
	For GSM 400: +8 dBm
	For GSM 700 and T-GSM 810: +8 dBm
	For GSM 850: +8 dBm
	For DCS 1 800: +6 dBm
	For PCS 1 900: +6 dBm
- {0 1<USF_TN3><GAMMA_TN3>}	0 (timeslot 3 not assigned)
- {0 1<USF_TN4><GAMMA_TN4>}	0 (timeslot 4 not assigned)
- {0 1<USF_TN5><GAMMA_TN5>}	0 (timeslot 5 not assigned)
- {0 1<USF_TN6><GAMMA_TN6>}	0 (timeslot 6 not assigned)
- {0 1<USF_TN7><GAMMA_TN7>}	0 (timeslot 7 not assigned)
spare padding	Spare Padding

1. For one-phase uplink assignment, the Packet Request reference is used for addressing the MS.

2. For re-assignment of an uplink TBF, the address information should be changed to UPLINK_TFI of Global_TFI. UPLINK_TFI_ASSIGNMENT is absent.
3. For assignment of an uplink TBF while a downlink TBF has been established, the address information should be changed to DOWNLINK_TFI of Global_TFI. UPLINK_TFI_ASSIGNMENT is present.

PACKET UPLINK ASSIGNMENT message (single block allocation):

Information Element	value/ remark
MESSAGE_TYPE	001010
PAGE_MODE	Normal Paging
{0 1<PERSISTENCE_LEVEL>}	0 (no persistence level present) 111 (Packet Request Reference)
-	As received in EGPRS PACKET CHANNEL REQUEST
- RANDOM_ACCESS_INFORMATION value	The frame number which EGPRS PACKET CHANNEL REQUEST was received on
- FRAME_NUMBER	0, message escape
EGPRS channel coding	Arbitrarily chosen from the valid values (default CS-1)
TLLI_BLOCK_CHANNEL_CODING	'0'B
Packet Timing Advance	
- {0 1<TIMING_ADVANCE_VALUE>}	1 (timing advance value)
- TIMING_ADVANCE_VALUE	30 bit periods
- {0 1<TIMING_ADVANCE_INDEX>	0 (no timing advance index)
<TIMING_ADVANCE_TIMESLOT_NUMBER >}	
{0 1<Frequency Parameters>}	1 (Frequency Parameters present)
- Frequency Parameters	
- TSC	Arbitrarily chosen (default 5)
-	00 (ARFCN no hopping)
- ARFCN	For GSM 900, 30 For GSM 450, 275 For GSM 480, 320 For GSM 850, 190 For DCS 1 800, 650 For PCS 1 900, 650
Single block allocation	10
- TIMESLOT_NUMBER	Arbitrarily chosen (default slot 2)
- {0 1<ALPHA><GAMMA_TN>}	1
- ALPHA	0.5
- GAMMA_TN	For GSM 900: +8 dBm For GSM 400: +8 dBm For GSM 700 and T-GSM 810: +8 dBm For GSM 850: +8 dBm For DCS 1 800: +6 dBm For PCS 1 900: +6 dBm
- {0 1<P0> <BTS_PWR_CTRL_MODE><PR_MODE>}	0
- TBF_STARTING_TIME	1, relative frame number encoding indicating current frame + 91 by absolute encoding
spare pending	Spare pending

ATTACH ACCEPT message:

Information Element	value/ remark
Protocol discriminator	1000
Skip indicator	0000
Attach accept message identity	00000010
Attach result	For MS class A and B, Combined EGPRS/IMSI attached For MS class C, EGPRS only attached
Force to standby	not indicated
Periodic RA update timer	Timer is deactivated
Radio priority for SMS	Priority level 3
Spare half octet	Spare half octet
Routing area identification	
- MCC	001 (decimal)
- MNC	01 (decimal)
- LAC	0001H
- RAC	05H
P-TMSI signature	P-TMSI signature
Negotiated READY timer value	32 seconds
Allocated P-TMSI	P-TMSI
MS identity	TMSI
GMM cause	Omit

52.4 Void

52.5 EGPRS Downlink Transfer

52.5.1 Void

52.5.2 Void

52.5.3 Void

52.5.4 Void

52.5.5 Downlink Transfer / Reestablishment

52.5.5.1 Downlink Transfer/ Reestablishment/ T3192 Expiry

52.5.5.1.1 Void

52.5.5.1.2 Conformance Requirement

After the network has initiated the release of a downlink TBF and the mobile station has received all the RLC blocks, the mobile station shall send the EGPRS PACKET DOWNLINK ACK/NACK message with the Final Ack Indicator bit set to '1', start timer T3192 and continue to monitor all assigned PDCHs.

If the network receives a EGPRS PACKET DOWNLINK ACK/NACK message with the Final Ack Indicator bit set to '1' and has new data to transmit for the mobile station, the network may establish a new downlink TBF for the mobile station by sending the PACKET DOWNLINK ASSIGNMENT or PACKET TIMESLOT RECONFIGURE message with the Control Ack bit set to '1' on PACCH.

If the mobile station, after sending the EGPRS PACKET DOWNLINK ACK/NACK message with the Final Ack Indicator bit set to '1', receives a PACKET DOWNLINK ASSIGNMENT or PACKET TIMESLOT RECONFIGURE message with the Control Ack bit set to '1' while timer T3192 is running, the mobile station shall stop timer T3192, consider the previous downlink TBF released and act upon the new assignment.

When timer T3192 expires the mobile station shall release the downlink TBF. If the mobile station is operating in half duplex mode and received an uplink assignment during the TBF release procedure, the mobile station shall then immediately act upon the uplink assignment. If there is no ongoing uplink TBF, the mobile station in packet transfer mode shall return to packet idle mode; the mobile station in dual transfer mode shall return to dedicated mode. The DRX mode procedures shall be applied, as specified in subclause 5.5.1.5.

References

3GPP TS 04.60, subclauses 8.1.2.4, 9.3.2.6 and 11.2.6a.

52.5.5.1.3 Test purpose

Verify that after a downlink TBF is released, MS returns to packet idle mode when T3192 expires.

52.5.5.1.4 Method of test

Initial Conditions

System Simulator:

1 cell, EGPRS supported, PCCCH present.

Mobile Station:

The MS is in the state "idle, GMM-registered" with a P-TMSI allocated, SPLIT PG CYCLE negotiated, and PDP context 2 activated.

Specific PICS Statements

-

PIXIT Statements

-

Test Procedure

1. MS receives a PACKET DOWNLINK ASSIGNMENT message on its assigned PCCCH, containing no starting time.
2. SS transmits EGPRS downlink RLC data blocks for the downlink allocation.
3. SS transmits an EGPRS downlink RLC data block, with valid RRBP field (polling), with Final Block indicator set to 1.
4. MS responds by sending a EGPRS PACKET DOWNLINK ACK/NACK with Final Ack indicator set to 1 and starting T3192.
5. When T3192 expires, MS returns to packet idle mode.
6. SS transmits an EGPRS downlink RLC data block (using previous resources).
7. MS ignores this block, because it has returned to packet idle mode.
8. SS transmits a PACKET DOWNLINK ASSIGNMENT, followed by RLC data blocks for the downlink allocation.
9. MS responds with an EGPRS PACKET DOWNLINK ACK/NACK.

Maximum Duration of Test

5 minutes.

Expected Sequence

Step	Direction	Message	Comments
1	SS -> MS	PACKET DOWNLINK ASSIGNMENT	Triggers the MS to switch to assigned PDCH. (no starting time)
2	SS -> MS	EGPRS RLC DATA BLOCKS	Starting 3 blocks after the previous message, on assigned PDCH, addressed to MS.
3	SS -> MS	EGPRS RLC DATA BLOCK	With valid RRBP field, addressed to MS, with Final Block indication set to 1.
4	MS -> SS	EGPRS PACKET DOWNLINK ACK/NACK	MS acknowledges the previously received RLC data blocks, with final ack set to 1. MS starts T3192
5	SS		Wait T3192 * 0.7 seconds
6			Repeat steps 3 and 4.
7	SS		Wait T3192 * 1.2 seconds.
8	SS -> MS	EGPRS RLC DATA BLOCK	On previously assigned PDCH. With valid RRBP field, addressed to MS.
9	SS		Verify no response from MS on previously assigned PDCH.
10	SS -> MS	PACKET DOWNLINK ASSIGNMENT	Triggers the MS to switch to assigned PDCH (no starting time)
11	SS -> MS	EGPRS RLC DATA BLOCK	Sent 3 blocks after the previous message, with valid RRBP field, addressed to MS, on new resources assigned in step 10.
12	MS -> SS	EGPRS PACKET DOWNLINK ACK/NACK	MS acknowledges the previously received RLC data block.
13	SS	{Completion of downlink RLC data block transfer}	Macro

Specific Message Contents

PACKET DOWNLINK ASSIGNMENT message in step 1:

Information Element	value/ remark
TIMESLOT_ALLOCATION	<one timeslot assigned>
TBF STARTING TIME	<IE not present>
PACKET TIMING ADVANCE	Timing Advance value = 0
EGPRS Window Size IE	1 <IE present>
Link_Quality_Measurement_Mode	00100 00

PACKET DOWNLINK ASSIGNMENT message in step 10:

Information Element	value/ remark
TIMESLOT_ALLOCATION	<one timeslot assigned – different than previous>
TBF STARTING TIME	<IE not present>
PACKET TIMING ADVANCE	Timing Advance value = 0
EGPRS Window Size IE	1 <IE present>
Link_Quality_Measurement_Mode	00100 00

GPRS Cell Options IE (throughout, on sys-infos):

Information Element	value/ remark
T3192	010 – = 1,5 second timeout value

EGPRS DOWNLINK RLC DATA BLOCK in step 3:

Information Element	value/ remark
RRBP	00 – Response shall be sent by MS in N+13 frames.
ES/P	01 – RRBP field is valid
CPS	1011 for MCS-1/P1

EGPRS PACKET DOWNLINK ACK/NACK in step 4:

Information Element	value/ remark
Ack/Nack Description IE - FINAL_ACK_INDICATION	1

52.5.5.2 Downlink Transfer/ Reestablishment/ Packet Downlink Assignment

52.5.5.2.1 Void

52.5.5.2.2 Conformance Requirement

After the network has initiated the release of a downlink TBF and the mobile station has received all the RLC blocks, the mobile station shall send the EGPRS PACKET DOWNLINK ACK/NACK message with the Final Ack Indicator bit set to '1', start timer T3192 and continue to monitor all assigned PDCHs.

If the network receives a EGPRS PACKET DOWNLINK ACK/NACK message with the Final Ack Indicator bit set to '1' and has new data to transmit for the mobile station, the network may establish a new downlink TBF for the mobile station by sending the PACKET DOWNLINK ASSIGNMENT or PACKET TIMESLOT RECONFIGURE message with the Control Ack bit set to '1' on PACCH.

If the mobile station, after sending the EGPRS PACKET DOWNLINK ACK/NACK message with the Final Ack Indicator bit set to '1', receives a PACKET DOWNLINK ASSIGNMENT or PACKET TIMESLOT RECONFIGURE message with the Control Ack bit set to '1' while timer T3192 is running, the mobile station shall stop timer T3192, consider the previous downlink TBF released and act upon the new assignment.

References

3GPP TS 04.60, subclause 8.1.2.4.

52.5.5.2.3 Test purpose

Verify that after a downlink TBF is released, MS acts on a PACKET DOWNLINK ASSIGNMENT message.

52.5.5.2.4 Method of test

Initial Conditions

System Simulator:

1 cell, EGPRS supported, PCCCH present.

Mobile Station:

The MS is in the state "idle, GMM-registered" with a P-TMSI allocated, SPLIT PG CYCLE negotiated, and PDP context 2 activated.

Specific PICS Statements

-

PIXIT Statements

-

Test Procedure

1. MS receives a PACKET DOWNLINK ASSIGNMENT message on its assigned PCCCH, containing no starting time.
2. SS transmits downlink RLC data blocks for the downlink allocation.
3. SS transmits a downlink RLC data block, with valid RRBP field (polling), with Final Block indicator set to 1.
4. MS responds by sending a EGPRS PACKET DOWNLINK ACK/NACK with Final Ack indicator set to 1.

5. SS transmits a PACKET DOWNLINK ASSIGNMENT, assigning a new PDCH. CONTROL_ACK is set to 1.
6. SS transmits a downlink RLC data block on newly assigned PDCH, with valid RRBP field.
7. MS responds by sending a EGPRS PACKET DOWNLINK ACK/NACK.

Maximum Duration of Test

5 minutes.

Expected Sequence

Step	Direction	Message	Comments
1	SS -> MS	PACKET DOWNLINK ASSIGNMENT	Triggers the MS to switch to assigned PDCH. (no starting time)
2	SS -> MS	EGPRS RLC DATA BLOCKS	Starting at a minimum of 3 blocks after the previous message, on assigned PDCH, addressed to MS.
3	SS -> MS	EGPRS RLC DATA BLOCK	With valid RRBP field, addressed to MS, with Final Block indication set to 1.
4	MS -> SS	EGPRS PACKET DOWNLINKACK/NACK	MS acknowledges the previously received RLC data blocks, with final ACK set to 1.
5	SS		Wait (T3192 * 0.8) seconds
6	SS -> MS	PACKET DOWNLINK ASSIGNMENT	Sent on PACCH. Triggers the MS to switch to a new PDCH. (no starting time) CONTROL_ACK is set to '1'.
7	SS -> MS	EGPRS RLC DATA BLOCK	6 blocks after step 6, on PDCH assigned in step 6. With valid RRBP field, addressed to MS.
8	MS -> SS	EGPRS PACKET DOWNLINK ACK/NACK	MS acknowledges the previously received RLC data blocks.
9	SS	{Completion of downlink RLC data block transfer}	Macro

Specific Message Contents

PACKET DOWNLINKASSIGNMENT message in step 1:

Information Element	value/ remark
TIMESLOT_ALLOCATION	<one timeslot assigned>
TBF STARTING TIME	<IE not present>
PACKET TIMING ADVANCE	Timing Advance value = 0
EGPRS Window Size IE	1 <IE present>
	00100
Link_Quality_Measurement_Mode	00

PACKET DOWNLINK ASSIGNMENT message in step 6:

Information Element	value/ remark
CONTROL_ACK	1
TIMESLOT_ALLOCATION	<one timeslot assigned – different than previous assignment>
TBF STARTING TIME	<IE not present>
EGPRS Window Size IE	1 <IE present>
	00100
Link_Quality_Measurement_Mode	00

GPRS Cell Options IE (throughout, on sys-infos):

Information Element	value/ remark
T3192	010 – = 1,5 second timeout value

EGPRS DOWNLINK RLC DATA BLOCK in step 3:

Information Element	value/ remark
RRBP	00 – Response shall be sent by MS in N+13 frames.
ES/P	01 – RRBP field is valid
CPS	1011 for MCS-1/P1

EGPRS PACKET DOWNLINK ACK/NACK in step 4:

Information Element	value/ remark
Ack/Nack Description IE - FINAL_ACK_INDICATION	<IE not present> 1

52.5.5.3 Downlink Transfer/ Reestablishment/ Invalid Frequency Parameters IE

52.5.5.3.1 Void

52.5.5.3.2 Conformance Requirement

After the network has initiated the release of a downlink TBF and the mobile station has received all the RLC blocks, the mobile station shall send the EGPRS PACKET DOWNLINK ACK/NACK message with the Final Ack Indicator bit set to '1', start timer T3192 and continue to monitor all assigned PDCHs.

If the network receives a EGPRS PACKET DOWNLINK ACK/NACK message with the Final Ack Indicator bit set to '1' and has new data to transmit for the mobile station, the network may establish a new downlink TBF for the mobile station by sending the PACKET DOWNLINK ASSIGNMENT or PACKET TIMESLOT RECONFIGURE message with the Control Ack bit set to '1' on PACCH.

If the mobile station, after sending the EGPRS PACKET DOWNLINK ACK/NACK message with the Final Ack Indicator bit set to '1', receives a PACKET DOWNLINK ASSIGNMENT or PACKET TIMESLOT RECONFIGURE message with the Control Ack bit set to '1' while timer T3192 is running, the mobile station shall stop timer T3192, consider the previous downlink TBF released and act upon the new assignment.

If a mobile station receives a PACKET DOWNLINK ASSIGNMENT or PACKET TIMESLOT RECONFIGURE message and detects an invalid Frequency Parameters information element in the message, it shall perform an abnormal release. If PCCCH is present in the cell the mobile station shall perform an abnormal release with system information (see subclause 8.7.3). If PCCCH is not present, the mobile station shall perform an abnormal release with random access (see subclause 8.7.2).

If the inconsistency is due to an invalid PSI or SI change mark associated with the referred GPRS mobile allocation or an undefined MA_NUMBER in the range 0 ñ 14, the mobile station shall initiate a partial acquisition of PBCCH or BCCH information (see 5.5.1.4). It shall then obtain the PSI2 or SI13 information, which is concerned.

References

3GPP TS 04.60, subclauses 8.1.2.4, 8.1.2.4.1, 5.5.1.2.1 and 12.8.1.

52.5.5.3.3 Test purpose

Verify that after a downlink TBF is released, MS returns to packet idle mode if a PACKET DOWNLINK ASSIGNMENT with invalid frequency parameters IE is received.

52.5.5.3.4 Method of test

Initial Conditions

System Simulator:

1 cell, EGPRS supported, PCCCH present.

Mobile Station:

The MS is in the state "idle, GMM-registered" with a P-TMSI allocated, SPLIT PG CYCLE negotiated, and PDP context 2 activated.

Specific PICS Statements

-

PIXIT Statements

-

Test Procedure

1. MS receives a PACKET DOWNLINK ASSIGNMENT message on its assigned PCCCH, containing no starting time.
2. SS transmits downlink RLC data blocks for the downlink allocation.
3. SS transmits a downlink RLC data block, with valid RRBP field (polling), with Final Ack indicator set to 1.
4. MS responds by sending a EGPRS PACKET DOWNLINK ACK/NACK.
5. SS transmits a PACKET DOWNLINK ASSIGNMENT, assigning a new PDCH, but with invalid frequency parameters.
6. SS transmits a downlink RLC data block on previously assigned PDCH, with valid RRBP field.
7. MS ignores the block because it has returned to packet idle mode.

Maximum Duration of Test

5 minutes.

Expected Sequence

Step	Direction	Message	Comments
1	SS -> MS	PACKET DOWNLINK ASSIGNMENT	Triggers the MS to switch to assigned PDCH. (no starting time)
2	SS -> MS	EGPRS RLC DATA BLOCKS	Starting at a minimum of 3 blocks after the previous message, on assigned PDCH, addressed to MS.
3	SS -> MS	EGPRS RLC DATA BLOCK	With valid RRBP field, addressed to MS, with Final Block indication set to 1.
4	MS -> SS	EGPRS PACKET DOWNLINK ACK/NACK	MS acknowledges the previously received RLC data blocks.
5	SS	PACKET SYSTEM INFORMATION 1	Sent on PACCH, with default contents (i.e. no change to the initial PSI1). This is done in order to start new 30 second period for the autonomous PSI1 refresh
6	SS		Wait 1 seconds
7	SS -> MS	PACKET DOWNLINK ASSIGNMENT	Sent on PACCH. Triggers the MS to switch to a new PDCH. (no starting time) Invalid frequency in message parameters (undefined MA_NUMBER) in the message. CONTROL_ACK bit is set to '1'.
8	SS		Increment PBCCH_CHANGE_MARK by one. PSI_CHANGE_FIELD indicates changes in PSI2. Change the PSI2_CHANGE_MARK and the Reference Frequency List 1 in PSI2 (3 rd instance) to contain a subset of Cell Allocation. Also change the definition of MA 1 to select one frequency of the Reference Frequency List 1.
9	SS -> MS	EGPRS RLC DATA BLOCK	Sent on the PDCH assigned in step 1, 3 block periods after the assignment on step 7. With valid RRBP field, addressed to MS. (MS returns to Idle Mode)
10	SS		Verify MS does not transmit on previously assigned PDCH.
11	SS -> MS	PACKET DOWNLINK ASSIGNMENT	Sent 5 seconds after step 9. These steps verify the MS immediately has re-read the sys-infos, and is using the new PSI2 parameters.
12	SS -> MS	EGPRS RLC DATA BLOCK	With valid RRBP field, addressed to MS.
13	MS -> SS	EGPRS PACKET DOWNLINK ACK/NACK	MS acknowledges the previously received RLC data block.
14	SS	{Completion of downlink RLC data block transfer}	Macro

Specific Message Contents

PACKET DOWNLINK ASSIGNMENT message in step 1:

Information Element	value/ remark
TIMESLOT_ALLOCATION	<one timeslot assigned>
TBF STARTING TIME	<IE not present>
PACKET TIMING ADVANCE	Timing Advance value = 0
EGPRS Window Size IE	1 <IE present>
Link_Quality_Measurement_Mode	00100
	00

PACKET DOWNLINK ASSIGNMENT message in step 7:

Information Element	value/ remark
CONTROL_ACK	1 (Assigning a new TBF to a MS for which T3192 is running)
TIMESLOT_ALLOCATION	<one timeslot assigned – different than previous assignment>
TBF STARTING TIME	<IE not present>
Frequency Parameters IE - MAIO	Indirect encoding
- MA_NUMBER	0
EGPRS Window Size IE	7 (undefined in the consistent set of PSI2 messages)
Link_Quality_Measurement_Mode	1 <IE present>
	00100
	00

PACKET DOWNLINK ASSIGNMENT message in step 11:

TIMESLOT_ALLOCATION	<one timeslot assigned>
TBF STARTING TIME	<IE not present>
PACKET TIMING ADVANCE	Timing Advance value = 0
EGPRS Window Size IE	1 <IE present>
Link_Quality_Measurement_Mode	00100
Frequency Parameters IE	00
- MAIO	Indirect encoding
- MA_NUMBER	0
- CHANGE MARK1	1
	As set in step 8

GPRS Cell Options IE (throughout, on sys-infos):

Information Element	value/ remark
T3192	010 – = 1,5 second timeout value

EGPRS DOWNLINK RLC DATA BLOCK in step 3:

Information Element	value/ remark
RRBP	00 – Response shall be sent by MS in N+13 frames.
ES/P	01 – RRBP field is valid
CPS	1011 for MCS-1/P1 see 05.03

EGPRS PACKET DOWNLINK ACK/NACK in step 4:

Information Element	value/ remark
Ack/Nack Description IE - FINAL_ACK_INDICATION	<IE not present>
	1

52.6 EGPRS Packet Access for signalling

52.6.1 EGPRS Packet Access for signalling / EGPRS Packet Channel Request not supported / CCCH case

52.6.1.1 Conformance requirements

EGPRS TBF mode capable MSs shall monitor the GPRS Cell Options IE on the BCCH (SI13) for the cell's EGPRS capability. In the GPRS Cell Options IE it is also indicated if the EGPRS PACKET CHANNEL REQUEST is supported in the cell. The following table specifies which message and which establishment cause shall be used by an EGPRS mobile station when accessing an EGPRS capable cell depending on the purpose of the packet access procedure; this table covers the case where PBCCH is not present in the cell (see 3GPP TS 44.060 for the case where PBCCH is not present in the cell):

EGPRS TBF mode capable MSs shall monitor the GPRS Cell Options IE on the BCCH (SI13) for the cell's EGPRS capability. In the GPRS Cell Options IE it is also indicated if the EGPRS PACKET CHANNEL REQUEST is supported in the cell. The following table specifies which message and which establishment cause shall be used by an EGPRS mobile station when accessing an EGPRS capable cell depending on the purpose of the packet access procedure; this table covers the case where PBCCH is not present in the cell (see 3GPP TS 44.060 for the case where PBCCH is present in the cell):

Purpose of the packet access procedure	EGPRS PACKET CHANNEL REQUEST supported in the cell	EGPRS PACKET CHANNEL REQUEST not supported in the cell
User data transfer – requested RLC mode = unacknowledged	EGPRS PACKET CHANNEL REQUEST with access type = 'Two-phase access'	CHANNEL REQUEST with establishment cause = 'Single block packet access' for initiation of a two-phase access
User data transfer – requested RLC mode = acknowledged	EGPRS PACKET CHANNEL REQUEST with access type = 'One-phase access' or 'Two-phase access'	CHANNEL REQUEST with establishment cause = 'Single block packet access' for initiation of a two-phase access
Upper layer signalling transfer (e.g. page response, cell update, MM signalling, etc)	EGPRS PACKET CHANNEL REQUEST with access type = 'signalling'	CHANNEL REQUEST with establishment cause = 'Single block packet access' for initiation of a two-phase access
Sending of a measurement report or of a PACKET CELL CHANGE FAILURE	CHANNEL REQUEST with establishment cause = 'Single block packet access'	
Sending of a PACKET PAUSE message	CHANNEL REQUEST with establishment cause = 'Single block packet access' (NOTE 1)	
Sending of an MBMS Service Request message	CHANNEL REQUEST with establishment cause = 'Single block MBMS access'	
NOTE 1: Upon sending the first CHANNEL REQUEST message the mobile station shall start timer T3204. If timer T3204 expires before an IMMEDIATE ASSIGNMENT message granting a single block period on an assigned packet uplink resource is received, the packet access procedure is aborted. If the mobile station receives an IMMEDIATE ASSIGNMENT message during the packet access procedure indicating a packet downlink assignment procedure, the mobile station shall ignore the message.		

The CHANNEL REQUEST or EGPRS PACKET CHANNEL REQUEST messages are sent on RACH and contain the parameters:

- an establishment cause which indicates packet access, and as applicable, a request for one phase packet access or single block packet access for a CHANNEL REQUEST (clause 9.1.8), or a request for one phase access or two phase access or short access or sending of signalling data for an EGPRS PACKET CHANNEL REQUEST (see 3GPP TS 44.060);
- a random reference which is drawn randomly from a uniform probability distribution for every new transmission.

Reference

3GPP TS 04.18/44.018 subclause 3.5.2.1.2.

52.6.1.2 Test purpose

To verify that the MS uses the correct establishment cause in the CHANNEL REQUEST for upper layer signalling transfer when EGPRS PACKET CHANNEL REQUEST is not supported in GPRS cell options and PBCCH is not present.

52.6.1.3 Method of test

Initial conditions

System Simulator:

2 cells in different Routing Areas, but in same Location areas. EGPRS supported. EGPRS PACKET CHANNEL REQUEST not supported in GPRS cell options. PBCCH not present.

Mobile Station:

The MS is switched off. The SIM is updated to the test cell.

Specific PICS Statements

-

PIXIT Statements

-

Test procedure

The MS is switched on or powered up and triggered to perform a GPRS attach. The establishment cause in the CHANNEL REQUEST is checked. The SS pages the MS. The MS answers and the establishment cause in the CHANNEL REQUEST is checked. The SS then activates Cell B and lowers the RF level of Cell A until Cell A is no more suitable. Cell B is preferred by the MS. The MS initiates a Routing Area Update. The establishment cause in the CHANNEL REQUEST is checked.

Maximum duration of the test

4 minutes.

Expected sequence

Step	Direction	Message	Comments
1	SS		The SS is set in network operation mode II and activates cell A. The following messages are sent and shall be received on cell A.
2	MS		The MS is powered up or switched on and initiates an attach.
3	MS -> SS	CHANNEL REQUEST	Establishment cause = "Single block packet access". Received on RACH.
4	MS<->SS	{Completion of the attach procedure}	Macro
5	SS		SS verifies that the correct establishment cause has been used in step 3.
6	SS -> MS	PAGING REQUEST TYPE 1	Sent on PCH. Mobility Identity contains P-TMSI of the MS, Packet Page Indication indicates a packet paging procedure.
7	MS -> SS	CHANNEL REQUEST	Establishment cause = "Single block packet access". Received on RACH.
8	SS -> MS	IMMEDIATE ASSIGNMENT REJECT	Request Reference = pertaining to the message received in step 7, Sent on AGCH.
9	SS		SS verifies that the correct establishment cause has been used in step 7.
10	SS		Waits 50 seconds in order for the READY timer to expire.
11			The following messages are sent and shall be received on cell B.
12	SS		Activate cell B with lower signal strength than cell A. The RF level of cell A is lowered until cell A is no more suitable.
13	MS		Cell B is preferred by the MS.
14	MS -> SS	CHANNEL REQUEST	Establishment cause = "Single block packet access". Received on RACH.
15	SS -> MS	IMMEDIATE ASSIGNMENT	Request Reference = pertaining to the message received in step 14. Sent on AGCH.
16	MS -> SS	PACKET RESOURCE REQUEST	MS Radio Access Capability indicates that the MS supports EGPRS.
17	SS -> MS	PACKET UPLINK ASSIGNMENT	Assigns an EGPRS TBF
18	MS -> SS	ROUTING AREA UPDATING REQUEST	Update type = 'RA updating'
19	SS -> MS	ROUTING AREA UPDATING ACCEPT	Update result = 'RA updated'
20	MS -> SS	ROUTING AREA UPDATING COMPLETE	
21	SS		SS verifies that the correct establishment cause has been used in step 14.

Specific message contents

None.

52.6.2 EGPRS Packet Access for signalling / EGPRS Packet Channel Request supported / CCCH case

52.6.2.1 Conformance requirements

EGPRS TBF mode capable MSs shall monitor the GPRS Cell Options IE on the BCCH (SI13) for the cell's EGPRS capability. In the GPRS Cell Options IE it is also indicated if the EGPRS PACKET CHANNEL REQUEST is supported in the cell. The following table specifies which message and which establishment cause shall be used by an EGPRS mobile station when accessing an EGPRS capable cell depending on the purpose of the packet access procedure; this table covers the case where PBCCH is not present in the cell (see 3GPP TS 44.060 for the case where PBCCH is not present in the cell):

EGPRS TBF mode capable MSs shall monitor the GPRS Cell Options IE on the BCCH (SI13) for the cell's EGPRS capability. In the GPRS Cell Options IE it is also indicated if the EGPRS PACKET CHANNEL REQUEST is supported in the cell. The following table specifies which message and which establishment cause shall be used by an EGPRS mobile station when accessing an EGPRS capable cell depending on the purpose of the packet access procedure; this table covers the case where PBCCH is not present in the cell (see 3GPP TS 44.060 for the case where PBCCH is present in the cell):

Purpose of the packet access procedure	EGPRS PACKET CHANNEL REQUEST supported in the cell	EGPRS PACKET CHANNEL REQUEST not supported in the cell
User data transfer – requested RLC mode = unacknowledged	EGPRS PACKET CHANNEL REQUEST with access type = 'Two-phase access'	CHANNEL REQUEST with establishment cause = 'Single block packet access' for initiation of a two-phase access
User data transfer – requested RLC mode = acknowledged	EGPRS PACKET CHANNEL REQUEST with access type = 'One-phase access' or 'Two-phase access'	CHANNEL REQUEST with establishment cause = 'Single block packet access' for initiation of a two-phase access
Upper layer signalling transfer (e.g. page response, cell update, MM signalling, etc)	EGPRS PACKET CHANNEL REQUEST with access type = 'signalling'	CHANNEL REQUEST with establishment cause = 'Single block packet access' for initiation of a two-phase access
Sending of a measurement report or of a PACKET CELL CHANGE FAILURE	CHANNEL REQUEST with establishment cause = 'Single block packet access'	
Sending of a PACKET PAUSE message	CHANNEL REQUEST with establishment cause = 'Single block packet access' (NOTE 1)	
Sending of an MBMS Service Request message	CHANNEL REQUEST with establishment cause = 'Single block MBMS access'	
NOTE 1: Upon sending the first CHANNEL REQUEST message the mobile station shall start timer T3204. If timer T3204 expires before an IMMEDIATE ASSIGNMENT message granting a single block period on an assigned packet uplink resource is received, the packet access procedure is aborted. If the mobile station receives an IMMEDIATE ASSIGNMENT message during the packet access procedure indicating a packet downlink assignment procedure, the mobile station shall ignore the message.		

The CHANNEL REQUEST or EGPRS PACKET CHANNEL REQUEST messages are sent on RACH and contain the parameters:

- an establishment cause which indicates packet access, and as applicable, a request for one phase packet access or single block packet access for a CHANNEL REQUEST (clause 9.1.8), or a request for one phase access or two phase access or short access or sending of signalling data for an EGPRS PACKET CHANNEL REQUEST (see 3GPP TS 44.060);
- a random reference which is drawn randomly from a uniform probability distribution for every new transmission.

Reference

3GPP TS 04.18/44.018 subclause 3.5.2.1.2.

52.6.2.2 Test purpose

To verify that the MS uses the correct Access Type in the EGPRS PACKET CHANNEL REQUEST for upper layer signalling transfer when EGPRS PACKET CHANNEL REQUEST is supported in GPRS cell options and PBCCH is not present.

52.6.2.3 Method of test

Initial conditions

System Simulator:

2 cells in different Routing Areas, but in same Location areas. EGPRS supported. EGPRS PACKET CHANNEL REQUEST supported in GPRS cell options. PBCCH not present.

Mobile Station:

The MS is switched off. The SIM is updated to the test cell.

Specific PICS Statements

-

PIXIT Statements

-

Test procedure

The MS is switched on or powered up and triggered to perform a GPRS attach. The access type in the EGPRS PACKET CHANNEL REQUEST is checked. The SS pages the MS. The MS answers and the access type in the EGPRS PACKET CHANNEL REQUEST is checked. The SS then activates Cell B and lowers the RF level of Cell A until Cell A is no more suitable. Cell B is preferred by the MS. The MS initiates a Routing Area Update. The access type in the EGPRS PACKET CHANNEL REQUEST is checked.

Maximum duration of the test

4 minutes.

Expected sequence

Step	Direction	Message	Comments
1	SS		The SS is set in network operation mode II and activates cell A. The following messages are sent and shall be received on cell A.
2	MS		The MS is powered up or switched on and initiates an attach.
3	MS -> SS	EGPRS PACKET CHANNEL REQUEST	Access Type = "signalling". Received on RACH.
4	MS<->SS	{Completion of the attach procedure}	Macro
5	SS		SS verifies that the correct Access Type has been used in step 3.
6	SS -> MS	PAGING REQUEST TYPE 1	Sent on PCH. Mobility Identity contains P-TMSI of the MS, Packet Page Indication indicates a packet paging procedure.
7	MS -> SS	EGPRS PACKET CHANNEL REQUEST	Access Type = "signalling". Received on RACH.
8	SS -> MS	IMMEDIATE ASSIGNMENT REJECT	Request Reference = pertaining to the message received in step 7, Sent on AGCH.
9	SS		SS verifies that the correct Access Type has been used in step 7.
10	SS		Waits 50 seconds in order for the READY timer to expire.
11			The following messages are sent and shall be received on cell B.
12	SS		Activate cell B with lower signal strength than cell A. The RF level of cell A is lowered until cell A is no more suitable.
13	MS		Cell B is preferred by the MS.
14	MS -> SS	EGPRS PACKET CHANNEL REQUEST	Access Type = "signalling". Received on RACH.
15	SS -> MS	IMMEDIATE ASSIGNMENT	Request Reference = pertaining to the message received in step 14. Sent on AGCH.
16	MS -> SS	PACKET RESOURCE REQUEST	MS Radio Access Capability indicates that the MS supports EGPRS.
17	SS -> MS	PACKET UPLINK ASSIGNMENT	Assigns an EGPRS TBF
18	MS -> SS	ROUTING AREA UPDATING REQUEST	Update type = 'RA updating'
19	SS -> MS	ROUTING AREA UPDATING ACCEPT	Update result = 'RA updated'
20	MS -> SS	ROUTING AREA UPDATING COMPLETE	
21	SS		SS verifies that the correct Access Type has been used in step 14.

Specific message contents

None.

52.6.3 EGPRS Packet Access for signalling / EGPRS Packet Channel Request not supported / PCCCH case

52.6.3.1 Conformance requirements

EGPRS TBF mode capable MSs shall monitor the GPRS Cell Options IE on the PBCCH (PSI1/PSI13) for the cell's EGPRS capability. In the GPRS Cell Options IE it is also indicated if the EGPRS PACKET CHANNEL REQUEST is supported in the cell. The following table specifies which message and which access type shall be used by an EGPRS mobile station when accessing an EGPRS capable cell depending on the purpose of the packet access procedure; this table covers the case where PBCCH is present in the cell (see 3GPP TS 44.018 for the case where PBCCH is not present in the cell):

Purpose of the packet access procedure	EGPRS PACKET CHANNEL REQUEST supported in the cell	EGPRS PACKET CHANNEL REQUEST not supported in the cell
User data transfer – requested RLC mode = unacknowledged	EGPRS PACKET CHANNEL REQUEST with access type = 'Two-phase access'	PACKET CHANNEL REQUEST with access type = 'Two-phase access' (NOTE 1)
User data transfer – requested RLC mode = acknowledged	EGPRS PACKET CHANNEL REQUEST with access type = 'One-phase access' or 'Two-phase access'	PACKET CHANNEL REQUEST with access type = 'Two-phase access' (NOTE 1)
Upper layer signalling transfer (e.g. page response, cell update, MM signalling, etc)	EGPRS PACKET CHANNEL REQUEST with access type = 'signalling'	PACKET CHANNEL REQUEST with access type = 'Two-phase access'
Sending of a measurement report or of a PACKET CELL CHANGE FAILURE	PACKET CHANNEL REQUEST with access type = 'Single block without TBF establishment' (NOTE 1)	
Sending of a PACKET PAUSE message	PACKET CHANNEL REQUEST with access type = 'Single block without TBF establishment' (NOTE 1) (NOTE 2)	
Sending of an MBMS Service Request message	PACKET CHANNEL REQUEST with access type = 'Single block MBMS access'	
NOTE 1: The format to be used for the PACKET CHANNEL REQUEST message is defined by the parameter ACC_BURST_TYPE.		
NOTE 2: Upon the first attempt to send a PACKET CHANNEL REQUEST message the mobile station shall start timer T3204. If the mobile station receives a PACKET DOWNLINK ASSIGNMENT message before expiry of timer T3204, the mobile station shall ignore the message.		

Reference

3GPP TS 04.60/44.060 subclause 7.1.2.1.

52.6.3.2 Test purpose

To verify that the MS uses the correct Access Type in the PACKET CHANNEL REQUEST for upper layer signalling transfer when EGPRS PACKET CHANNEL REQUEST is not supported in GPRS cell options and PBCCH is present.

52.6.3.3 Method of test

Initial conditions

System Simulator:

2 cells in different Routing Areas, but in same Location areas. EGPRS supported. EGPRS PACKET CHANNEL REQUEST not supported in GPRS cell options. PBCCH present. ACC_BURST_TYPE indicates 11 bit access.

Mobile Station:

The MS is switched off. The SIM is updated to the test cell.

Specific PICS Statements

-

PIXIT Statements

-

Test procedure

The MS is switched on or powered up and triggered to perform a GPRS attach. The access type in the PACKET CHANNEL REQUEST is checked. The SS pages the MS. The MS answers and the access type in the PACKET CHANNEL REQUEST is checked. The SS then activates Cell B and lowers the RF level of Cell A until Cell A is no more suitable. Cell B is preferred by the MS. The MS initiates a Routing Area Update. The access type in the PACKET CHANNEL REQUEST is checked.

Maximum duration of the test

4 minutes.

Expected sequence

Step	Direction	Message	Comments
1	SS		The SS is set in network operation mode I and activates cell A. The following messages are sent and shall be received on cell A.
2	MS		The MS is powered up or switched on and initiates an attach.
3	MS -> SS	PACKET CHANNEL REQUEST	Access Type = "Two-phase access". Received on PRACH.
4	MS<->SS	{Completion of the attach procedure}	Macro
5	SS		SS verifies that the correct Access Type has been used in step 3.
6	SS -> MS	PACKET PAGING REQUEST	Sent on PPCH. Mobility Identity contains PTMSI of the MS.
7	MS -> SS	PACKET CHANNEL REQUEST	Access Type = "Two-phase access". Received on PRACH.
8	SS -> MS	PACKET ACCESS REJECT	Packet Request Reference = pertaining to the message received in step 7, Sent on PAGCH.
9	SS		SS verifies that the correct Access Type has been used in step 7.
10	SS		Waits 50 seconds in order for the READY timer to expire.
11			The following messages are sent and shall be received on cell B.
12	SS		Activate cell B with lower signal strength than cell A. The RF level of cell A is lowered until cell A is no more suitable.
13	MS		Cell B is preferred by the MS.
14	MS -> SS	PACKET CHANNEL REQUEST	Access Type = "Two-phase access". Received on PRACH.
15	SS -> MS	PACKET UPLINK ASSIGNMENT	Packet Request Reference = pertaining to the message received in step 14. Assigning a Single Block Allocation Sent on PAGCH.
16	MS -> SS	PACKET RESOURCE REQUEST	MS Radio Access Capability indicates that the MS supports EGPRS.
17	SS -> MS	PACKET UPLINK ASSIGNMENT	Assigns an EGPRS TBF
18	MS -> SS	ROUTING AREA UPDATING REQUEST	Update type = 'Combined RA/LA updating'
19	SS -> MS	ROUTING AREA UPDATING ACCEPT	Update result = 'Combined RA/LA updated'
20	MS -> SS	ROUTING AREA UPDATING COMPLETE	
21	SS		SS verifies that the correct Access Type has been used in step 14.

Specific message contents

None.

52.6.4 EGPRS Packet Access for signalling / EGPRS Packet Channel Request supported / PCCCH case

52.6.4.1 Conformance requirements

EGPRS TBF mode capable MSs shall monitor the GPRS Cell Options IE on the PBCCH (PSI1/PSI13) for the cell's EGPRS capability. In the GPRS Cell Options IE it is also indicated if the EGPRS PACKET CHANNEL REQUEST is supported in the cell. The following table specifies which message and which access type shall be used by an EGPRS mobile station when accessing an EGPRS capable cell depending on the purpose of the packet access procedure; this table covers the case where PBCCH is present in the cell (see 3GPP TS 44.018 for the case where PBCCH is not present in the cell):

Purpose of the packet access procedure	EGPRS PACKET CHANNEL REQUEST supported in the cell	EGPRS PACKET CHANNEL REQUEST not supported in the cell
User data transfer – requested RLC mode = unacknowledged	EGPRS PACKET CHANNEL REQUEST with access type = 'Two-phase access'	PACKET CHANNEL REQUEST with access type = 'Two-phase access' (NOTE 1)
User data transfer – requested RLC mode = acknowledged	EGPRS PACKET CHANNEL REQUEST with access type = 'One-phase access' or 'Two-phase access'	PACKET CHANNEL REQUEST with access type = 'Two-phase access' (NOTE 1)
Upper layer signalling transfer (e.g. page response, cell update, MM signalling, etc)	EGPRS PACKET CHANNEL REQUEST with access type = 'signalling'	PACKET CHANNEL REQUEST with access type = 'Two-phase access'
Sending of a measurement report or of a PACKET CELL CHANGE FAILURE	PACKET CHANNEL REQUEST with access type = 'Single block without TBF establishment' (NOTE 1)	
Sending of a PACKET PAUSE message	PACKET CHANNEL REQUEST with access type = 'Single block without TBF establishment' (NOTE 1) (NOTE 2)	
Sending of an MBMS Service Request message	PACKET CHANNEL REQUEST with access type = 'Single block MBMS access'	
NOTE 1: The format to be used for the PACKET CHANNEL REQUEST message is defined by the parameter ACC_BURST_TYPE.		
NOTE 2: Upon the first attempt to send a PACKET CHANNEL REQUEST message the mobile station shall start timer T3204. If the mobile station receives a PACKET DOWNLINK ASSIGNMENT message before expiry of timer T3204, the mobile station shall ignore the message.		

Reference

3GPP TS 04.60/44.060 subclause 7.1.2.1.

52.6.4.2 Test purpose

To verify that the MS uses the correct Access Type in the EGPRS PACKET CHANNEL REQUEST for upper layer signalling transfer when EGPRS PACKET CHANNEL REQUEST is supported in GPRS cell options and PBCCH is present.

52.6.4.3 Method of test

Initial conditions

System Simulator:

2 cells in different Routing Areas, but in same Location areas. EGPRS supported. EGPRS PACKET CHANNEL REQUEST supported in GPRS cell options. PBCCH present. ACC_BURST_TYPE indicates 11 bit access.

Mobile Station:

The MS is switched off. The SIM is updated to the test cell.

Specific PICS Statements

-

PIXIT Statements

-

Test procedure

The MS is switched on or powered up and triggered to perform a GPRS attach. The access type in the EGPRS PACKET CHANNEL REQUEST is checked. The SS pages the MS. The MS answers and the access type in the EGPRS PACKET CHANNEL REQUEST is checked. The SS then activates Cell B and lowers the RF level of Cell A until Cell A is no more suitable. Cell B is preferred by the MS. The MS initiates a Routing Area Update. The access type in the EGPRS PACKET CHANNEL REQUEST is checked.

Maximum duration of the test

4 minutes.

Expected sequence

Step	Direction	Message	Comments
1	SS		The SS is set in network operation mode I and activates cell A. The following messages are sent and shall be received on cell A.
2	MS		The MS is powered up or switched on and initiates an attach.
3	MS -> SS	EGPRS PACKET CHANNEL REQUEST	Access Type = "signalling". Received on PRACH.
4	MS<->SS	{Completion of the attach procedure}	Macro
5	SS		SS verifies that the correct Access Type has been used in step 3.
6	SS -> MS	PACKET PAGING REQUEST	Sent on PPCH. Mobility Identity contains PTMSI of the MS.
7	MS -> SS	EGPRS PACKET CHANNEL REQUEST	Access Type = "signalling". Received on PRACH.
8	SS -> MS	PACKET ACCESS REJECT	Packet Request Reference = pertaining to the message received in step 7, Sent on PAGCH.
9	SS		SS verifies that the correct Access Type has been used in step 7.
10	SS		Waits 50 seconds in order for the READY timer to expire.
11			The following messages are sent and shall be received on cell B.
12	SS		Activate cell B with lower signal strength than cell A. The RF level of cell A is lowered until cell A is no more suitable.
13	MS		Cell B is preferred by the MS.
14	MS -> SS	EGPRS PACKET CHANNEL REQUEST	Access Type = "signalling". Received on PRACH.
15	SS -> MS	PACKET UPLINK ASSIGNMENT	Packet Request Reference = pertaining to the message received in step 14. Assigns an EGPRS TBF, Dynamic Allocation Sent on PAGCH.
16	MS -> SS	ROUTING AREA UPDATING REQUEST	Update type = 'Combined RA/LA updating'
17	SS -> MS	ROUTING AREA UPDATING ACCEPT	Update result = 'Combined RA/LAupdated'
18	MS -> SS	ROUTING AREA UPDATING COMPLETE	
19	SS		SS verifies that the correct Access Type has been used in step 14.

Specific message contents

None.

52.7 Void

52.8 One phase access/ CONTENTION_RESOLUTION_TLLI

52.8.1 One phase access/ PBCCH present/
CONTENTION_RESOLUTION_TLLI / Contention Resolution

The contention resolution is successfully completed on the mobile station side when the mobile station receives a PACKET UPLINK ACK/NACK message addressing the mobile station with the TFI value associated with the uplink TBF and including the same TLLI value that the mobile station has included in the RLC header of the first RLC data blocks, or, in EGPRS TBF mode, a PACKET UPLINK ASSIGNMENT message addressing the mobile station with the same TLLI value that the mobile station included in the RLC header of the first RLC data blocks. The mobile shall then stop timer T3166 and counter N3104.

At sending of the first RLC data block, the mobile station shall stop timer T3164, set counter N3104 to 1, and start timer T3166. Counter N3104 shall be stepped each time the mobile station sends an RLC data block.

52.8.1.1 One phase access/PBCCH present/ CONTENTION_RESOLUTION_TLLI / Contention resolution / Inclusion of TLLI in RLC data blocks

52.8.1.1.1 Conformance requirements

In order to uniquely identify the mobile station when sending on uplink, the RLC Header is extended to include the TLLI of the mobile station until contention resolution is completed on the mobile station side.

All the RLC data blocks of an uplink TBF initiated by one phase access shall each contain a TLLI field in the RLC data block header until the contention resolution is completed on the mobile station side. After the reaction time specified in 3GPP TS 05.10 no other RLC data blocks shall contain a TLLI field.

The TLLI_BLOCK_CHANNEL_CODING parameter in the PACKET UPLINK ASSIGNMENT message indicates whether a RLC data block containing a TLLI field in the RLC data block header shall be encoded using CS-1 or correspondingly MCS-1 in EGPRS TBF mode, or using the channel-coding scheme commanded. In standard GPRS TBF mode, the mobile station shall send all other RLC data blocks using the channel-coding scheme commanded.

In EGPRS TBF mode, RLC data blocks that are transmitted for the first time shall be transmitted with the MCS commanded, except if the commanded mode is MCS-5-7, in which case the data block shall be transmitted with MCS-5, or if the commanded mode is MCS-6-9, in which case the data block shall be transmitted with MCS-6.

Upon contention resolution during one phase access, the mobile station shall start transmitting RLC data blocks without the TLLI field no later than the next occurrence of block $B((x+3) \bmod 12)$ where block $B(x)$ is the radio block containing the contention resolution message.

Reference

3GPP TS 04.60 subclauses 7.1.2.3 and 8.1.1.

3GPP TS 05.10 subclause 6.11.3.

52.8.1.1.2 Test purpose

1. To verify that in one phase access the first RLC data blocks of an uplink TBF contain a TLLI field in the RLC data block header and that these blocks are encoded according to the TLLI_BLOCK_CHANNEL_CODING parameter specified in the PACKET UPLINK ASSIGNMENT message.
2. To verify that upon contention resolution during one phase access the RLC data blocks not contain a TLLI field and are encoded using the EGPRS_Channel Coding Command IE included in the PACKET_UPLINK_ASSIGNMENT after the contention resolution reaction time.

52.8.1.1.3 Method of test

Initial conditions

System Simulator:

1 cell supporting EGPRS.

Mobile Station:

The MS is GPRS attached and in packet idle mode. PDP context 2 has been established.

Specific PICS Statements

-

PIXIT Statements

-

Test procedure

The MS is triggered to transfer an LLC PDU. The SS sends PACKET UPLINK ASSIGNMENT message containing Dynamic Allocation struct. The MS shall start to send RLC data and RLC/MAC control blocks on the allocated uplink. The SS allows the MS to send the uplink data transfer. The SS verifies the coding is the scheme specified by TLLI_BLOCK_CHANNEL_CODING, the TFI is correct and the block contains TLLI in the first RLC data blocks. After contention resolution reaction time the remaining RLC data blocks shall contain coding scheme specified by EGPRS Channel Coding Command, the TFI shall be correct and the blocks do not contain TLLI.

Maximum duration of the test

3 minutes.

Expected sequence

Step	Direction	Message	Comments
1	MS		The MS is triggered to initiate packet uplink transfer of an LLC PDU consisting of 500 octets data.
2 2A	MS -> SS	EGPRS PACKET CHANNEL REQUEST	Received on PRACH. If the MS requests two phase access the Test Case is terminated
3	SS -> MS	PACKET UPLINK ASSIGNMENT	Dynamic allocation struct, USF_GRANULARITY = one block, Sent on PAGCH.
4	SS -> MS	PACKET DOWNLINK DUMMY CONTROL BLOCK	Sent on the PACCH of the PDCH assigned in step 3, containing USF assigned to the MS.
5	MS -> SS	UPLINK RLC DATA BLOCK	Received on the assigned PDTCH. Check that the coding is the scheme specified by TLLI_BLOCK_CHANNEL_CODING, the TFI is correct and the block contains TLLI.
6	SS		Check that there is no RLC data block transmitted by the MS in the next radio block on PDTCH.
7	SS -> MS	PACKET UPLINK ASSIGNMENT	Sent on the PACCH of the PDCH. Containing correct CONTENTION_RESOLUTION_TLLI.
8	SS -> MS	PACKET DOWNLINK DUMMY CONTROL BLOCK	USF assigned to MS. sent on the assigned PDTCH in step 7 (sent 6 block period from step 7)
A8.1 (optional step)	MS -> SS	UPLINK RLC DATA BLOCK	Received on the assigned PDTCH. Check that the coding is the scheme specified by TLLI_BLOCK_CHANNEL_CODING, the block contains TLLI and the TFI is either the old TFI value or the newly assigned TFI.
A8.2 (optional step)	SS -> MS	PACKET DOWNLINK DUMMY CONTROL BLOCK	Sent on the PACCH of the PDCH assigned in step 7, containing USF assigned to the MS.
9	MS -> SS	UPLINK RLC DATA BLOCK	Received on the assigned PDTCH. Check the coding is the scheme specified by CHANNEL_CODING_COMMAND, the TFI is correct and the block does not contain TLLI.
10	SS -> MS	PACKET UPLINK ACK/NACK	Sent on the PACCH of the PDCH assigned in step 7, containing USF assigned to the MS.
11	MS -> SS	UPLINK RLC DATA BLOCK	Received on the assigned PDTCH. Check that the coding is the scheme specified by EGPRS Channel Coding Command, the TFI is correct and the block does not contain TLLI.
12			Repeat step 10 and 11 until the countdown value CV=0 in step 11.
13	SS -> MS	PACKET UPLINK ACK/NACK	Final Ack Indicator = '1' containing valid RRBP. Sent on PACCH of the assigned PDCH.
14	MS -> SS	PACKET CONTROL ACKNOWLEDGEMENT	Received on the block specified by RRBP on PACCH of the assigned PDCH.

Specific message contents

PACKET UPLINK ASSIGNMENT message in step 3:

{0 < Global TFI > 10 < TLLI > 110 < TQI > 111 < Packet Request Reference >}	111 (Packet Request Reference, information field sent in EGPRS PACKET CHANNEL REQUEST and frame number in which EGPRS PACKET CHANNEL REQUEST was received)
< EGPRS Channel Coding Command >	arbitrarily chosen but different from TLLI_BLOCK_CHANNEL_CODING
< TLLI_BLOCK_CHANNEL_CODING >	MCS-1

PACKET UPLINK ASSIGNMENT message in step 7:

Information Element	value/ remark
-	0 (Global TFI)
- Global TFI	The TFI value assigned in step 3
Message Escape bit	1 (EGPRS)
1 <CONTENTION_RESOLUTION_TLLI>	1 CONTENTION_RESOLUTION_TLLI containing the same value as the received one
{0 1 <UPLINK_TFI_ASSIGNMENT> UPLINK_TFI_ASSIGNMENT}	1 Different from the TFI value assigned in step 3

52.8.1.2 One phase access/ PBCCH present / CONTENTION_RESOLUTION_TLLI
/ Contention resolution / Counter N3104

52.8.1.2.1 Conformance requirements

The contention resolution has failed on the mobile station side when the counter N3104 reaches its maximum value, or timer T3166 expires. The contention resolution also fails, if the mobile station receives a PACKET UPLINK ACK/NACK message or in EGPRS TBF mode a PACKET UPLINK ASSIGNMENT message addressing the TFI associated with the TBF and including a TLLI value other than that the mobile station included in the RLC header of the first RLC data blocks; in such a case, the mobile station shall not transmit a PACKET CONTROL ACKNOWLEDGEMENT in the uplink radio block specified if a valid RRBP field is received as part of the PACKET UPLINK ACK/NACK message.

In case of a contention resolution failure on the mobile station side, the mobile station shall reset the counter N3104 and stop timer T3166, if not expired. The mobile station shall stop transmitting on the TBF and reinitiate the packet access procedure, unless it has already been repeated 4 times. In that case, a TBF failure has occurred.

Reference

3GPP TS 04.60 subclause 7.1.2.3.

52.8.1.2.2 Test purpose

To verify that the mobile station correctly sets and considers counter N3104.

NOTE: Counter N3104 is incremented by 1 with each new RLC/MAC block the mobile station sends until the first PACKET UPLINK ACK/NACK message is received.

Its maximum value is $N3104_MAX = 3 * (BS_CV_MAX + 3) * \text{no-of-timeslots-assigned}$, where BS_CV_MAX is broadcast in PSI1.

52.8.1.2.3 Method of test

Initial conditions

System Simulator:

1 cell supporting EGPRS default setting, BS_CV_MAX = 2.

Mobile Station:

The MS is GPRS attached and in packet idle mode. PDP context 2 has been established.

Specific PICS Statements

-

PIXIT Statements

-

Test procedure

The MS is triggered to initiate packet uplink transfer of an LLC PDU. The SS assigns packet uplink resources in a PACKET UPLINK ASSIGNMENT message indicating one phase packet access. The MS shall start transferring RLC data blocks.. The SS verifies that the MS stops transmitting and re-initiates the packet access procedure.

At the second attempt, the SS sends PACKET UPLINK ASSIGNMENT exactly after N3104_MAX - 1 data blocks. The SS verifies that this time the MS does not abort the access procedure and successfully completes uplink transfer.

Maximum duration of the test

5 minutes.

Expected sequence

Step	Direction	Message	Comments
1	MS		The MS is triggered to initiate packet uplink transfer of an LLC PDU consisting of 500 octets data.
2 2A	MS -> SS	EGPRS PACKET CHANNEL REQUEST	Received on PRACH. If the MS requests two phase access the Test Case is terminated
3	SS -> MS	PACKET UPLINK ASSIGNMENT	Indicating one phase packet access granted and MCS-1. Sent on PAGCH.
4	MS -> SS	N RLC data blocks	SS receives n = N3104_MAX data blocks. Received on the assigned PDTCH.
5	SS		SS verifies that MS does not send further RLC data blocks.
6 6A	MS -> SS	EGPRS PACKET CHANNEL REQUEST	MS re-initiates packet access procedure. Received on PRACH. If the MS requests two phase access the Test Case is terminated
7	SS -> MS	PACKET UPLINK ASSIGNMENT	Indicating one phase packet access granted MCS-1. Sent on PAGCH.
8	MS -> SS	n-1 RLC data blocks	SS receives N3104_MAX - 1 data blocks. Received on the assigned PDTCH.
9	SS -> MS	PACKET UPLINK ASSIGNMENT	Sent on the PACCH. Containing correct value of CONTENTION_RESOLUTION_TLLI
10		{Uplink data transfer, dynamic allocation}	Macro. Completion of the macro procedure.

Specific message contents

PACKET UPLINK ASSIGNMENT message in step 9:

Information Element	value/ remark
-	0 (Global TFI)
- Global TFI	The TFI value assigned in step 3
Message Escape bit	1 (EGPRS)
1 <CONTENTION_RESOLUTION_TLLI>	1 CONTENTION_RESOLUTION_TLLI containing the same value as the received one

52.8.1.3 One phase access/ PBCCH present / CONTENTION_RESOLUTION_TLLI / Contention resolution / Timer T3166

52.8.1.3.1 Conformance requirements

The contention resolution has failed on the mobile station side when the counter N3104 reaches its maximum value, or timer T3166 expires. The contention resolution also fails, if the mobile station receives a PACKET UPLINK ACK/NACK message or in EGPRS TBF mode a PACKET UPLINK ASSIGNMENT message addressing the TFI associated with the TBF and including a TLLI value other than that the mobile station included in the RLC header of the first RLC data blocks ; in such a case, the mobile station shall not transmit a PACKET CONTROL ACKNOWLEDGEMENT in the uplink radio block specified if a valid RRBP field is received as part of the PACKET UPLINK ACK/NACK message.

In case of a contention resolution failure on the mobile station side, the mobile station shall reset the counter N3104 and stop timer T3166, if not expired. The mobile station shall stop transmitting on the TBF and reinitiate the packet access procedure, unless it has already been repeated 4 times. In that case, a TBF failure has occurred.

Reference

3GPP TS 04.60 subclause 7.1.2.3.

52.8.1.3.2 Test purpose

To verify that the mobile station correctly considers timer T3166.

52.8.1.3.3 Method of test

Initial conditions

System Simulator:

1 cell supporting EGPRS. BS_CV_MAX value = 15.

Mobile Station:

The MS is GPRS attached and in packet idle mode. PDP context 2 has been established.

Specific PICS Statements

-

PIXIT Statements

-

Foreseen final state of the MS

Packet idle mode.

Test procedure

The MS is triggered to initiate packet uplink transfer of an LLC PDU. The SS assigns packet uplink resources in a PACKET UPLINK ASSIGNMENT message indicating one phase packet access. The MS shall start transferring RLC data blocks. The SS reduces the block transfer rate by controlling the USF flag. In this way, the SS forces T3166 (with value 5 s.) to expire before counter N3104 reaches N3104_MAX (with value 45 blocks for current settings). The SS verifies that the MS stops transmitting and re-initiates the packet access procedure.

At the second attempt, the SS sends PACKET UPLINK ASSIGNMENT before T3166 expire. The SS verifies that this time the MS does not abort the access procedure and successfully completes the data transfer.

Maximum duration of the test

5 minutes.

Expected sequence

Step	Direction	Message	Comments
1	MS		The MS is triggered to initiate packet uplink transfer of an LLC PDU consisting of 1000 octets data.
2	MS -> SS	EGPRS PACKET CHANNEL REQUEST	Received on PRACH.
2A			If the MS requests two phase access the Test Case is terminated
3	SS -> MS	PACKET UPLINK ASSIGNMENT	Indicating one phase packet access granted, MCS-1 shall be used and USF_GRANULARITY = one block. Sent on PAGCH.
4	SS -> MS	PACKET DOWNLINK DUMMY CONTROL BLOCK	USF addressing the MS. Sent on PACCH of PDCH assigned in step 3.
5	MS -> SS	RLC data block	Received on the assigned PDTCH.
6	SS -> MS	PACKET DOWNLINK DUMMY CONTROL BLOCK	USF not addressing the MS. Sent on PACCH.
7	SS -> MS	PACKET DOWNLINK DUMMY CONTROL BLOCK	USF not addressing the MS. Sent on PACCH.
8	SS -> MS	PACKET DOWNLINK DUMMY CONTROL BLOCK	USF not addressing the MS. Sent on PACCH.
9	SS -> MS	PACKET DOWNLINK DUMMY CONTROL BLOCK	USF not addressing the MS. Sent on PACCH.
10	SS -> MS	PACKET DOWNLINK DUMMY CONTROL BLOCK	USF not addressing the MS. Sent on PACCH.
11	SS -> MS	PACKET DOWNLINK DUMMY CONTROL BLOCK	USF not addressing the MS. Sent on PACCH.
12	SS -> MS	PACKET DOWNLINK DUMMY CONTROL BLOCK	USF not addressing the MS. Sent on PACCH.
13	SS -> MS	PACKET DOWNLINK DUMMY CONTROL BLOCK	USF not addressing the MS. Sent on PACCH.
14	SS -> MS	PACKET DOWNLINK DUMMY CONTROL BLOCK	USF not addressing the MS. Sent on PACCH.
15	SS -> MS	PACKET DOWNLINK DUMMY CONTROL BLOCK	USF not addressing the MS. Sent on PACCH.
16	SS -> MS	PACKET DOWNLINK DUMMY CONTROL BLOCK	USF not addressing the MS. Sent on PACCH.
17	MS<->SS		Steps 4 to 16 are repeated at most 22 times or until MS does not send further RLC data blocks at step 5. Note: steps 4 to 16 transfer one block every 52 frames, or 240 ms. 22 repetitions require about 5.5 s. (Timer T3166 shall expire).
19	MS -> SS	EPACKET CHANNEL REQUEST	MS re-initiates packet access procedure. Received on PRACH.
19A			If the MS requests two phase access the Test Case is terminated
20	SS -> MS	PACKET UPLINK ASSIGNMENT	Indicating one phase packet access granted, MCS-1 shall be used and USF_GRANULARITY = one block. Sent on PAGCH.
21	MS<->SS		Steps 4 to 16 are repeated 17 times. Note: 17 repetitions require about 4.3 s. (Timer T3166 should not expire).
22	SS -> MS	PACKET UPLINK ASSIGNMENT	Sent on the PACCH. Containing correct value of CONTENTION_RESOLUTION_TLLI
23		{Uplink data transfer, dynamic allocation}	Macro. Completion of the TBF procedure.

Specific message contents

PACKET UPLINK ASSIGNMET message in step 22:

Information Element	value/ remark
-	0 (Global TFI)
- Global TFI	The TFI value assigned in step 3
Message Escape bit	1 (EGPRS)
1 <CONTENTION_RESOLUTION_TLLI>	1 CONTENTION_RESOLUTION_TLLI containing the same value as the received one

52.8.1.4 One phase access/ PBCCH present / CONTENTION_RESOLUTION_TLLI/ Contention resolution / TLLI mismatch

52.8.1.4.1 Conformance requirements

The contention resolution has failed on the mobile station side when the counter N3104 reaches its maximum value, or timer T3166 expires. The contention resolution also fails, if the mobile station receives a PACKET UPLINK ACK/NACK message or in EGPRS TBF mode a PACKET UPLINK ASSIGNMENT message addressing the TFI associated with the TBF and including a TLLI value other than that the mobile station included in the RLC header of the first RLC data blocks ; in such a case, the mobile station shall not transmit a PACKET CONTROL ACKNOWLEDGEMENT in the uplink radio block specified if a valid RRBP field is received as part of the PACKET UPLINK ACK/NACK message.

In case of a contention resolution failure on the mobile station side, the mobile station shall reset the counter N3104 and stop timer T3166, if not expired. The mobile station shall stop transmitting on the TBF and reinitiate the packet access procedure, unless it has already been repeated 4 times. In that case, a TBF failure has occurred.

Reference

3GPP TS 04.60 subclause 7.1.2.3.

52.8.1.4.2 Test purpose

To verify that the mobile station reinitiates packet access when it receives a PACKET UPLINK ASSIGNMENT message with the correct TFI but with a CONTENTION_RESOLUTION_TLLI other than the mobile station has included in the RLC header.

52.8.1.4.3 Method of test

Initial conditions

System Simulator:

1 cell supporting EGPRS.

Mobile Station:

The MS is GPRS attached and in packet idle mode. PDP context 2 has been established.

Specific PICS Statements

-

PIXIT Statements

-

Test procedure

The MS is triggered to initiate packet uplink transfer of an LLC PDU. The SS assigns packet uplink resources in a PACKET UPLINK ASSIGNMENT message indicating one phase packet access. The MS shall start transferring RLC data block after SS has assigned USF to the MS. The SS acknowledges the RLC block transfer with a PACKET UPLINK ACK/NACK including correct TFI and incorrect TLLI. The SS continue to assign USF to the MS. The SS shall verify that the MS immediately stops transmitting (see note below) and retries packet access procedure.

At the second attempt, the SS sends PACKET UPLINK ASSIGNMENT including a correct TLLI. The SS verifies that this time the MS does not abort the access procedure and successfully completes the data transfer.

NOTE: A mobile station, receiving a commanding message in block number N, shall take an "immediate" action as a result of the command, starting in any block from block number N+1 to N+6 (inclusive).

Maximum duration of the test

5 minutes.

Expected sequence

Step	Direction	Message	Comments
1	MS		The MS is triggered to initiate packet uplink transfer of an LLC PDU consisting of 200 octets data.
2 2A	MS -> SS	EGPRS PACKET CHANNEL REQUEST	Received on PRACH. If the MS requests two phase access the Test Case is terminated
3	SS -> MS	PACKET UPLINK ASSIGNMENT	Indicating one phase packet access granted, dynamic allocation struct and USF_GRANULARITY = one block. Sent on PAGCH.
4	SS -> MS	PACKET DOWNLINK DUMMY CONTROL BLOCK	Contained USF assigned to the MS.
5	MS -> SS	UPLINK RLC DATA BLOCK	Received on the assigned PDTCH.
6	SS -> MS	PACKET UPLINK ASSIGNMENT	Sent on the PACCH. Containing wrong value of CONTENTION_RESOLUTION_TLLI Same Timeslot as that of step 3
7	SS -> MS	PACKET DOWNLINK DUMMY CONTROL BLOCK	Execute step 7 six times with USF assigned to the MS or until the MS sends Packet Channel request in step 8. The SS verifies that the MS does not transmit more than 6 uplink RLC data block after step 6 and before step 8.
8 8A	MS -> SS	EGPRS PACKET CHANNEL REQUEST	MS re-initiates packet access procedure. Received on PRACH. If the MS requests two phase access the Test Case is terminated
9	SS -> MS	PACKET UPLINK ASSIGNMENT	Indicating one phase packet access granted, dynamic allocation struct and USF_GRANULARITY = one block. Sent on PAGCH.
10	SS -> MS	PACKET DOWNLINK DUMMY CONTROL BLOCK	Contained USF assigned to the MS.
11	MS -> SS	UPLINK RLC DATA BLOCK	Received on the assigned PDTCH.
12	SS -> MS	PACKET UPLINK ASSIGNMENT	Sent on the PACCH. Containing correct value of CONTENTION_RESOLUTION_TLLI
13		{Uplink data transfer, dynamic allocation}	Macro. Completion of the TBF procedure.

Specific message contents

PACKET UPLINK ASSIGNMET message in step 6:

Information Element	value/ remark
-	0 (Global TFI)
- Global TFI	The TFI value assigned in step 3
Message Escape bit	1 (EGPRS)
1 <CONTENTION_RESOLUTION_TLLI>	1 CONTENTION_RESOLUTION_TLLI containing different value than the received one

PACKET UPLINK ASSIGNMET message in step 12:

Information Element	value/ remark
- - Global TFI Message Escape bit 1 <CONTENTION_RESOLUTION_TLLI>	0 (Global TFI) The TFI value assigned in step 3 1 (EGPRS) 1 CONTENTION_RESOLUTION_TLLI containing the same value as the received one

52.8.1.5 One phase access/ PBCCH present / CONTENTION_RESOLUTION_TLLI / Contention resolution / 4 access repetition attempts

52.8.1.5.1 Conformance requirement

The contention resolution has failed on the mobile station side when the counter N3104 reaches its maximum value, or timer T3166 expires. The contention resolution also fails, if the mobile station receives a PACKET UPLINK ACK/NACK message or in EGPRS TBF mode a PACKET UPLINK ASSIGNMENT message addressing the TFI associated with the TBF and including a TLLI value other than that the mobile station included in the RLC header of the first RLC data blocks ; in such a case, the mobile station shall not transmit a PACKET CONTROL ACKNOWLEDGEMENT in the uplink radio block specified if a valid RRBP field is received as part of the PACKET UPLINK ACK/NACK message.

In case of a contention resolution failure on the mobile station side, the mobile station shall reset the counter N3104 and stop timer T3166, if not expired. The mobile station shall stop transmitting on the TBF and reinitiate the packet access procedure, unless it has already been repeated 3 or 4 times. In that case, a TBF failure has occurred.

Reference

3GPP TS 04.60 subclause 7.1.2.3.

52.8.1.5.2 Test purpose

To verify that the mobile station repeats the packet access initiation 4 times.

52.8.1.5.3 Method of test

Initial conditions

System Simulator:

1 cell supporting EGPRS.

Mobile Station:

The MS is GPRS attached and in packet idle mode. PDP context 2 has been established.

Specific PICS Statements

-

PIXIT Statements

-

Test procedure

The MS is triggered to initiate packet uplink transfer of an LLC PDU. The SS assigns packet uplink resources in a PACKET UPLINK ASSIGNMENT message indicating one phase packet access. The MS shall start transferring RLC data blocks after SS has assigned USF to the MS. The SS acknowledges the RLC block transfer with a PACKET UPLINK ASSIGNMENT including a TLLI not corresponding to the MS. The SS shall verify that the MS stops transmitting blocks and reinitiates packet access. This test sequence shall be repeated three or four times.

Maximum duration of the test

5 minutes.

Expected sequence

Step	Direction	Message	Comments
1	MS		The MS is triggered to initiate packet uplink transfer of an LLC PDU consisting of 200 octets data.
2 2A	MS -> SS	EPCAPTURE CHANNEL REQUEST	Received on PRACH. If the MS requests two phase access the Test Case is terminated
3	SS -> MS	PACKET UPLINK ASSIGNMENT	Indicating one phase packet access granted, dynamic allocation struct and USF_GRANULARITY = one block. Sent on PAGCH.
4	SS -> MS	PACKET DOWNLINK DUMMY CONTROL BLOCK	Contained USF assigned to the MS.
5	MS -> SS	UPLINK RLC DATA BLOCK	Received on the assigned PDTCH.
6	SS -> MS	PACKET UPLINK ASSIGNMENT	Sent on the PACCH. Containing wrong value of CONTENTION_RESOLUTION_TLLI
7	SS		The SS verifies that the MS reinitiates the packet access procedure from step 2 three or four times (a total of 4 or 5 access).

Specific message contents

PACKET UPLINK ASSIGNMET message in step 6:

Information Element	value/ remark
-	0 (Global TFI)
- Global TFI	The TFI value assigned in step 3
Message Escape bit	1 (EGPRS)
1 <CONTENTION_RESOLUTION_TLLI>	1 CONTENTION_RESOLUTION_TLLI containing different value than the received one

52.8.1.6 One phase access/ PBCCH not present/ CONTENTION_RESOLUTION_TLLI / Contention resolution / Inclusion of TLLI in RLC data blocks

52.8.1.6.1 Conformance requirements

In order to uniquely identify the mobile station when sending on uplink, the RLC Header is extended to include the TLLI of the mobile station until contention resolution is completed on the mobile station side.

All the RLC data blocks of an uplink TBF initiated by one phase access shall each contain a TLLI field in the RLC data block header until the contention resolution is completed on the mobile station side. After the reaction time specified in 3GPP TS 05.10 no other RLC data blocks shall contain a TLLI field.

The TLLI_BLOCK_CHANNEL_CODING parameter in the PACKET UPLINK ASSIGNMENT message indicates whether a RLC data block containing a TLLI field in the RLC data block header shall be encoded using CS-1 or or correspondingly MCS-1 in EGPRS TBF mode, or using the channel coding scheme commanded. In standard GPRS TBF mode, the mobile station shall send all other RLC data blocks using the channel coding scheme commanded.

In EGPRS TBF mode, RLC data blocks that are transmitted for the first time shall be transmitted with the MCS commanded, except if the commanded mode is MCS-5-7, in which case the data block shall be transmitted with MCS-5, or if the commanded mode is MCS-6-9, in which case the data block shall be transmitted with MCS-6.

Upon contention resolution during one phase access, the mobile station shall start transmitting RLC data blocks without the TLLI field no later than the next occurrence of block B((x+3) mod 12) where block B(x) is the radio block containing the contention resolution message.

Reference

3GPP TS 04.60 subclauses 7.1.2.3 and 8.1.1.

3GPP TS 05.10 subclause 6.11.3.

52.8.1.6.2 Test purpose

1. To verify that in one phase access the first RLC data blocks of an uplink TBF contain a TLLI field in the RLC data block header and that these blocks are encoded according to the TLLI_BLOCK_CHANNEL_CODING parameter specified in the PACKET UPLINK ASSIGNMENT message.
2. To verify that upon contention resolution during one phase access the RLC data blocks not contain a TLLI field and are encoded using the EGPRS_Channel Coding Command IE included in the PACKET_UPLINK_ASSIGNMENT after the contention resolution reaction time.

52.8.1.6.3 Method of test

Initial conditions

System Simulator:

1 cell supporting EGPRS.

Mobile Station:

The MS is GPRS attached and in packet idle mode. PDP context 2 has been established.

Specific PICS Statements

-

PIXIT Statements

-

Test procedure

The MS is triggered to transfer an LLC PDU. The SS sends IMMEDIATE ASSIGNMENT message containing Dynamic Allocation struct. The MS shall start to send RLC data and RLC/MAC control blocks on the allocated uplink. The SS allows the MS to send the uplink data transfer. The SS verifies the coding is the scheme specified by TLLI_BLOCK_CHANNEL_CODING, the TFI is correct and the block contains TLLI in the first RLC data blocks. After contention resolution reaction time shall the remaining RLC data blocks contain coding scheme specified by EGPRS Channel Coding Command, the TFI shall be correct and the blocks do not contain TLLI.

Maximum duration of the test

3 minutes.

Expected sequence

Step	Direction	Message	Comments
1	MS		The MS is triggered to initiate packet uplink transfer of an LLC PDU consisting of 500 octets data.
2	MS -> SS	EGPRS PACKET CHANNEL REQUEST	Received on RACH.
2A			If the MS requests two phase access the Test Case is terminated
3	SS -> MS	IMMEDIATE ASSIGNMENT	Dynamic allocation struct, USF_GRANULARITY = one block, MCS2 is used and TLLI_BLOCK_CHANNEL_CODING indicating MCS1
4	SS -> MS	PACKET DOWNLINK DUMMY CONTROL BLOCK	Sent on AGCH.
5	MS -> SS	UPLINK RLC DATA BLOCK	Sent on the PACCH of the PDCH assigned in step 3, containing USF assigned to the MS.
6	SS		Received on the assigned PDTCH. Check that the coding is the scheme specified by TLLI_BLOCK_CHANNEL_CODING, the TFI is correct and the block contains TLLI.
7	SS -> MS	PACKET UPLINK ASSIGNMENT	Check that there is no RLC data block transmitted by the MS in the next radio block on PDTCH.
8	SS -> MS	PACKET DOWNLINK DUMMY CONTROL BLOCK	Sent on the PACCH of the PDCH. Containing correct CONTENTION_RESOLUTION_TLLI
A8.1 (optional step)	MS -> SS	UPLINK RLC DATA BLOCK	USF assigned to MS. sent on the assigned PDTCH in step 7 (sent 6 block period from step 7)
A8.2 (optional step)	SS -> MS	PACKET DOWNLINK DUMMY CONTROL BLOCK	Received on the assigned PDTCH. Check that the coding is the scheme specified by TLLI_BLOCK_CHANNEL_CODING, the block contains TLLI and the TFI is either the old TFI value or the newly assigned TFI.
9	MS -> SS	UPLINK RLC DATA BLOCK	Sent on the PACCH of the PDCH assigned in step 7, containing USF assigned to the MS.
10	SS -> MS	PACKET UPLINK ACK/NACK	Received on the assigned PDTCH. Check the coding is the scheme specified by CHANNEL_CODING_COMMAND, the TFI is correct and the block does not contain TLLI.
11	MS -> SS	UPLINK RLC DATA BLOCK	Sent on the PACCH of the PDCH assigned in step 7, containing USF assigned to the MS.
12			Received on the assigned PDTCH. Check that the coding is the scheme specified by EGPRS Channel Coding Command, the TFI is correct and the block does not contain TLLI.
13	SS -> MS	PACKET UPLINK ACK/NACK	Repeat step 10 and 11 until the countdown value CV=0 in step 11.
14	MS -> SS	PACKET CONTROL ACKNOWLEDGEMENT	Final Ack Indicator = '1' containing valid RRBP. Sent on PACCH of the assigned PDCH.

Specific message contents

PACKET UPLINK ASSIGNMET message in step 7:

Information Element	value/ remark
-	0 (Global TFI)
- Global TFI	The TFI value assigned in step 3
Message Escape bit	1 (EGPRS)
1 <CONTENTION_RESOLUTION_TLLI>	1 CONTENTION_RESOLUTION_TLLI containing the same value as the received one
{0 1 <UPLINK_TFI_ASSIGNMENT>	1
UPLINK_TFI_ASSIGNMENT}	Different from the TFI value assigned in step 3

52.8.1.7 One phase access/ PBCCH not present / CONTENTION_RESOLUTION_TLLI / Contention resolution / Counter N3104

52.8.1.7.1 Conformance requirements

The contention resolution has failed on the mobile station side when the counter N3104 reaches its maximum value, or timer T3166 expires. The contention resolution also fails, if the mobile station receives a PACKET UPLINK ACK/NACK message or in EGPRS TBF mode a PACKET UPLINK ASSIGNMENT message addressing the TFI associated with the TBF and including a TLLI value other than that the mobile station included in the RLC header of the first RLC data blocks; in such a case, the mobile station shall not transmit a PACKET CONTROL ACKNOWLEDGEMENT in the uplink radio block specified if a valid RRBP field is received as part of the PACKET UPLINK ACK/NACK message.

In case of a contention resolution failure on the mobile station side, the mobile station shall reset the counter N3104 and stop timer T3166, if not expired. The mobile station shall stop transmitting on the TBF and reinitiate the packet access procedure, unless it has already been repeated 4 times. In that case, a TBF failure has occurred.

Reference

3GPP TS 04.60 subclause 7.1.2.3.

52.8.1.7.2 Test purpose

To verify that the mobile station correctly sets and considers counter N3104.

NOTE: Counter N3104 is incremented by 1 with each new RLC/MAC block the mobile station sends until the first PACKET UPLINK ACK/NACK message is received.
Its maximum value is $N3104_MAX = 3 * (BS_CV_MAX + 3) * \text{no-of-timeslots-assigned}$, where BS_CV_MAX is broadcast in PSI1.

52.8.1.7.3 Method of test

Initial conditions

System Simulator:

1 cell supporting EGPRS. The packet system information BS_CV_MAX value = 1.

Mobile Station:

The MS is GPRS attached and in packet idle mode. PDP context 2 has been established.

Specific PICS Statements

-

PIXIT Statements

-

Test procedure

The MS is triggered to initiate packet uplink transfer of an LLC PDU. The SS assigns packet uplink resources in an IMMEDIATE ASSIGNMENT message indicating one phase packet access. The MS shall start transferring RLC data blocks.. The SS verifies that the MS stops transmitting and re-initiates the packet access procedure.

At the second attempt, the SS sends PACKET UPLINK ASSIGNMENT exactly after N3104_MAX - 1 data blocks. The SS verifies that this time the MS does not abort the access procedure and successfully completes uplink transfer.

Maximum duration of the test

5 minutes.

Expected sequence

Step	Direction	Message	Comments
1	MS		The MS is triggered to initiate packet uplink transfer of an LLC PDU consisting of 500 octets data.
2 2A	MS -> SS	EGPRS PACKET CHANNEL REQUEST	Received on RACH. If the MS requests two phase access the Test Case is terminated
3	SS -> MS	IMMEDIATE ASSIGNMENT	Dynamic allocation struct, USF_GRANULARITY = one block, MCS1 is used
4	MS -> SS	n RLC data blocks	Sent on AGCH. SS receives n = N3104_MAX data blocks. Received on the assigned PDTCH.
5	SS		SS verifies that MS does not send further RLC data blocks.
6 6A	MS -> SS	EGPRS PACKET CHANNEL REQUEST	MS re-initiates packet access procedure. Received on RACH. If the MS requests two phase access the Test Case is terminated
7	SS -> MS	IMMEDIATE ASSIGNMENT	Indicating one phase packet access granted. Sent on AGCH.
8	MS -> SS	n-1 RLC data blocks	SS receives N3104_MAX – 1 data blocks. Received on the assigned PDTCH.
9	SS -> MS	PACKET UPLINK ASSIGNMENT	Sent on the PACCH. Containing correct value of CONTENTION_RESOLUTION_TLLI
10		{Uplink data transfer, dynamic allocation}	Macro. Completion of the macro procedure.

Specific message contents

PACKET UPLINK ASSIGNMET message in step 9:

Information Element	value/ remark
-	0 (Global TFI)
- Global TFI	The TFI value assigned in step 3
Message Escape bit	1 (EGPRS)
1 <CONTENTION_RESOLUTION_TLLI>	1 CONTENTION_RESOLUTION_TLLI containing the same value as the received one

52.8.1.8 One phase access/ PBCCH not present / CONTENTION_RESOLUTION_TLLI / Contention resolution / Timer T3166

52.8.1.8.1 Conformance requirements

The contention resolution has failed on the mobile station side when the counter N3104 reaches its maximum value, or timer T3166 expires. The contention resolution also fails, if the mobile station receives a PACKET UPLINK ACK/NACK message or in EGPRS TBF mode a PACKET UPLINK ASSIGNMENT message addressing the TFI associated with the TBF and including a TLLI value other than that the mobile station included in the RLC header of the first RLC data blocks ; in such a case, the mobile station shall not transmit a PACKET CONTROL ACKNOWLEDGEMENT in the uplink radio block specified if a valid RRBP field is received as part of the PACKET UPLINK ACK/NACK message.

In case of a contention resolution failure on the mobile station side, the mobile station shall reset the counter N3104 and stop timer T3166, if not expired. The mobile station shall stop transmitting on the TBF and reinitiate the packet access procedure, unless it has already been repeated 4 times. In that case, a TBF failure has occurred.

Reference

3GPP TS 04.60 subclause 7.1.2.3.

52.8.1.8.2 Test purpose

To verify that the mobile station correctly considers timer T3166.

52.8.1.8.3 Method of test

Initial conditions

System Simulator:

1 cell, supporting EGPRS.

Mobile Station:

The MS is GPRS attached and in packet idle mode. PDP context 2 has been established.

Specific PICS Statements

-

PIXIT Statements

-

Foreseen final state of the MS

Packet idle mode.

Test procedure

The MS is triggered to initiate packet uplink transfer of an LLC PDU. The SS assigns packet uplink resources in an IMMEDIATE ASSIGNMENT message indicating one phase packet access. The MS shall start transferring RLC data blocks. The SS reduces the block transfer rate by controlling the USF flag. In this way, the SS forces T3166 (with value 5 s.) to expire before counter N3104 reaches N3104_MAX (with value 45 blocks for current settings). The SS verifies that the MS stops transmitting and re-initiates the packet access procedure.

At the second attempt, the SS sends PACKET UPLINK ASSIGNMENT before T3166 expires. The SS verifies that this time the MS does not abort the access procedure and successfully completes the data transfer.

Maximum duration of the test

5 minutes.

Expected sequence

Step	Direction	Message	Comments
1	MS		The MS is triggered to initiate packet uplink transfer of an LLC PDU consisting of 1000 octets data.
2	MS -> SS	EGPRS PACKET CHANNEL REQUEST	Received on RACH.
2A			If the MS requests two phase access the Test Case is terminated
3	SS -> MS	IMMEDIATE ASSIGNMENT	Dynamic allocation struct, USF_GRANULARITY = one block, MCS1 is used Sent on AGCH.
4	SS -> MS	PACKET DOWNLINK DUMMY CONTROL BLOCK	USF addressing the MS. Sent on PACCH of PDCH assigned in step 3.
5	MS -> SS	RLC data block	Received on the assigned PDTCH.
6	SS -> MS	PACKET DOWNLINK DUMMY CONTROL BLOCK	USF not addressing the MS. Sent on PACCH.
7	SS -> MS	PACKET DOWNLINK DUMMY CONTROL BLOCK	USF not addressing the MS. Sent on PACCH.
8	SS -> MS	PACKET DOWNLINK DUMMY CONTROL BLOCK	USF not addressing the MS. Sent on PACCH.
9	SS -> MS	PACKET DOWNLINK DUMMY CONTROL BLOCK	USF not addressing the MS. Sent on PACCH.
10	SS -> MS	PACKET DOWNLINK DUMMY CONTROL BLOCK	USF not addressing the MS. Sent on PACCH.
11	SS -> MS	PACKET DOWNLINK DUMMY CONTROL BLOCK	USF not addressing the MS. Sent on PACCH.
12	SS -> MS	PACKET DOWNLINK DUMMY CONTROL BLOCK	USF not addressing the MS. Sent on PACCH.
13	SS -> MS	PACKET DOWNLINK DUMMY CONTROL BLOCK	USF not addressing the MS. Sent on PACCH.
14	SS -> MS	PACKET DOWNLINK DUMMY CONTROL BLOCK	USF not addressing the MS. Sent on PACCH.
15	SS -> MS	PACKET DOWNLINK DUMMY CONTROL BLOCK	USF not addressing the MS. Sent on PACCH.
16	SS -> MS	PACKET DOWNLINK DUMMY CONTROL BLOCK	USF not addressing the MS. Sent on PACCH.
17	MS<->SS		Steps 4 to 16 are repeated at most 22 times or until MS does not send further RLC data blocks at step 5. Note: steps 4 to 16 transfer one block every 52 frames, or 240 ms. 22 repetitions require about 5.5 s. (Timer T3166 shall expire).
19	MS -> SS	EGPRS PACKET CHANNEL REQUEST	MS re-initiates packet access procedure. Received on RACH.
19A			If the MS requests two phase access the Test Case is terminated
20	SS -> MS	IMMEIDATE ASSIGNMENT	Indicating one phase packet access granted, MCS-1 shall be used and USF_GRANULARITY = one block. Sent on AGCH.
21	MS<->SS		Steps 4 to 16 are repeated 17 times. Note: 17 repetitions require about 4.3 s. (Timer T3166 should not expire).
22	SS -> MS	PACKET UPLINK ASSIGNMENT	Sent on the PACCH. Containing correct value of CONTENTION_RESOLUTION_TLLI
23		{Uplink data transfer, dynamic allocation}	Macro. Completion of the TBF procedure.

Specific message contents

PACKET UPLINK ASSIGNMET message in step 22:

Information Element	value/ remark
- Global TFI	0 (Global TFI)
Message Escape bit	The TFI value assigned in step 3
1 <CONTENTION_RESOLUTION_TLLI>	1 (EGPRS) 1 CONTENTION_RESOLUTION_TLLI containing the same value as the received one

52.8.1.9 One phase access/ PBCCH not present / CONTENTION_RESOLUTION_TLLI / Contention resolution / TLLI mismatch

52.8.1.9.1 Conformance requirements

The contention resolution has failed on the mobile station side when the counter N3104 reaches its maximum value, or timer T3166 expires. The contention resolution also fails, if the mobile station receives a PACKET UPLINK ACK/NACK message or in EGPRS TBF mode a PACKET UPLINK ASSIGNMENT message addressing the TFI associated with the TBF and including a TLLI value other than that the mobile station included in the RLC header of the first RLC data blocks ; in such a case, the mobile station shall not transmit a PACKET CONTROL ACKNOWLEDGEMENT in the uplink radio block specified if a valid RRBP field is received as part of the PACKET UPLINK ACK/NACK message.

In case of a contention resolution failure on the mobile station side, the mobile station shall reset the counter N3104 and stop timer T3166, if not expired. The mobile station shall stop transmitting on the TBF and reinitiate the packet access procedure, unless it has already been repeated 4 times. In that case, a TBF failure has occurred.

Reference

3GPP TS 04.60 subclause 7.1.2.3.

52.8.1.9.2 Test purpose

To verify that the mobile station reinitiates packet access when it receives a PACKET UPLINK ASSIGNMENT message with the correct TFI but with a CONTENTION_RESOLUTION_TLLI other than the mobile station has included in the RLC header.

52.8.1.9.3 Method of test

Initial conditions

System Simulator:

1 cell supporting EGPRS.

Mobile Station:

The MS is GPRS attached and in packet idle mode. PDP context 2 has been established.

Specific PICS Statements

-

PIXIT Statements

-

Test procedure

The MS is triggered to initiate packet uplink transfer of an LLC PDU. The SS assigns packet uplink resources in an IMMEDIATE ASSIGNMENT message indicating one phase packet access. The MS shall start transferring RLC data block after SS has assigned USF to the MS. The SS acknowledges the RLC block transfer with a PACKET UPLINK ACK/NACK including correct TFI and incorrect TLLI. The SS continue to assign USF to the MS. The SS shall verify that the MS immediately stops transmitting (see note below) and retries packet access procedure.

At the second attempt, the SS sends PACKET UPLINK ASSIGNMENT including a correct TLLI. The SS verifies that this time the MS does not abort the access procedure and successfully completes the data transfer.

NOTE: A mobile station, receiving a commanding message in block number N, shall take an "immediate" action as a result of the command, starting in any block from block number N+1 to N+6 (inclusive).

Maximum duration of the test

5 minutes.

Expected sequence

Step	Direction	Message	Comments
1	MS		The MS is triggered to initiate packet uplink transfer of an LLC PDU consisting of 200 octets data.
2 2A	MS -> SS	EPCAPKET CHANNEL REQUEST	Received on RACH. If the MS requests two phase access the Test Case is terminated
3	SS -> MS	IMMEDIATE ASSIGNMENT	Dynamic allocation struct, USF_GRANULARITY = one block, MCS1 is used Sent on AGCH.
4	SS -> MS	PACKET DOWNLINK DUMMY CONTROL BLOCK	Contained USF assigned to the MS.
5	MS -> SS	UPLINK RLC DATA BLOCK	Received on the assigned PDTCH.
6	SS -> MS	PACKET UPLINK ASSIGNMENT	Sent on the PACCH. Containing wrong value of CONTENTION_RESOLUTION_TLLI
7	SS -> MS	PACKET DOWNLINK DUMMY CONTROL BLOCK	Execute step 7 six times with USF assigned to the MS or until the MS sends Packet Channel request in step 8. The SS verifies that the MS does not transmit more than 6 uplink RLC data block after step 6 and before step 8.
8 8A	MS -> SS	EGPRS PACKET CHANNEL REQUEST	MS re-initiates packet access procedure. Received on RACH. If the MS requests two phase access the Test Case is terminated
9	SS -> MS	IMMEDIATE ASSIGNMENT	Indicating one phase packet access granted, dynamic allocation struct and USF_GRANULARITY = one block. Sent on AGCH.
10	SS -> MS	PACKET DOWNLINK DUMMY CONTROL BLOCK	Contained USF assigned to the MS.
11	MS -> SS	UPLINK RLC DATA BLOCK	Received on the assigned PDTCH.
12	SS -> MS	PACKET UPLINK ASSIGNMENT	Sent on the PACCH. Containing correct value of CONTENTION_RESOLUTION_TLLI
13		{Uplink data transfer, dynamic allocation}	Macro. Completion of the TBF procedure.

Specific message contents

PACKET UPLINK ASSIGNMET message in step 6:

Information Element	value/ remark
-	0 (Global TFI)
- Global TFI	The TFI value assigned in step 3
Message Escape bit	1 (EGPRS)
1 <CONTENTION_RESOLUTION_TLLI>	1 CONTENTION_RESOLUTION_TLLI containing different value than the received one

PACKET UPLINK ASSIGNMET message in step 12:

Information Element	value/ remark
-	0 (Global TFI)
- Global TFI	The TFI value assigned in step 3
Message Escape bit	1 (EGPRS)
1 <CONTENTION_RESOLUTION_TLLI>	1 CONTENTION_RESOLUTION_TLLI containing the same value as the received one

52.8.1.10 One phase access/ PBCCH not present / CONTENTION_RESOLUTION_TLLI / Contention resolution / 4 access repetition attempts

52.8.1.10.1 Conformance requirement

The contention resolution has failed on the mobile station side when the counter N3104 reaches its maximum value, or timer T3166 expires. The contention resolution also fails, if the mobile station receives a PACKET UPLINK ACK/NACK message or in EGPRS TBF mode a PACKET UPLINK ASSIGNMENT message addressing the TFI associated with the TBF and including a TLLI value other than that the mobile station included in the RLC header of the first RLC data blocks ; in such a case, the mobile station shall not transmit a PACKET CONTROL ACKNOWLEDGEMENT in the uplink radio block specified if a valid RRBP field is received as part of the PACKET UPLINK ACK/NACK message.

In case of a contention resolution failure on the mobile station side, the mobile station shall reset the counter N3104 and stop timer T3166, if not expired. The mobile station shall stop transmitting on the TBF and reinitiate the packet access procedure, unless it has already been repeated 3 or 4 times. In that case, a TBF failure has occurred.

Reference

3GPP TS 04.60 subclause 7.1.2.3.

52.8.1.10.2 Test purpose

To verify that the mobile station repeats the packet access initiation 4 times.

52.8.1.10.3 Method of test

Initial conditions

System Simulator:

1 cell supporting EGPRS.

Mobile Station:

The MS is GPRS attached and in packet idle mode. PDP context 2 has been established.

Specific PICS Statements

-

PIXIT Statements

-

Test procedure

The MS is triggered to initiate packet uplink transfer of an LLC PDU. The SS assigns packet uplink resources in an IMMEDIATE ASSIGNMENT message indicating one phase packet access. The MS shall start transferring RLC data blocks after SS has assigned USF to the MS. The SS acknowledges the RLC block transfer with a PACKET UPLINK ASSIGNMENT including a TLLI not corresponding to the MS. The SS shall verify that the MS stops transmitting blocks and reinitiates packet access. This test sequence shall be repeated three or four times.

Maximum duration of the test

5 minutes.

Expected sequence

Step	Direction	Message	Comments
1	MS		The MS is triggered to initiate packet uplink transfer of an LLC PDU consisting of 200 octets data.
2 2A	MS -> SS	EPCAPACKET CHANNEL REQUEST	Received on RACH. If the MS requests two phase access the Test Case is terminated
3	SS -> MS	IMMEDIATE ASSIGNMENT	Dynamic allocation struct, USF_GRANULARITY = one block, MCS1 is used Sent on AGCH.
4	SS -> MS	PACKET DOWNLINK DUMMY CONTROL BLOCK	Contained USF assigned to the MS.
5	MS -> SS	UPLINK RLC DATA BLOCK	Received on the assigned PDTCH.
6	SS -> MS	PACKET UPLINK ASSIGNMENT	Sent on the PACCH. Containing wrong value of CONTENTION_RESOLUTION_TLLI
7	SS		The SS verifies that the MS reinitiates the packet access procedure from step 2 three or four times (a total of 4 or 5 access).

Specific message contents

PACKET UPLINK ASSIGNMET message in step 6:

Information Element	value/ remark
-	0 (Global TFI)
- Global TFI	The TFI value assigned in step 3
Message Escape bit	1 (EGPRS)
1 <CONTENTION_RESOLUTION_TLLI>	1 CONTENTION_RESOLUTION_TLLI containing different value than the received one

52.8.1.11 One phase access/PBCCH present/CONTENTION_RESOLUTION_TLLI/Contention resolution / Successful Resource Reallocation

52.8.1.11.1 Conformance requirements

The TLLI is used to uniquely identify the mobile station when sending on uplink. Every RLC data block that is sent on the TBF shall include the TLLI of the mobile station, until the contention resolution is completed on the mobile station side. If MCS-7, MCS-8 or MCS-9 is used for the transmission of the TLLI in EGPRS TBF mode (i.e., the RLC/MAC block is carrying two RLC data blocks), the TLLI shall be inserted in both RLC data blocks. The TLLI shall also be included in the PACKET RESOURCE REQUEST and the ADDITIONAL MS RADIO ACCESS CAPABILITIES messages, if those are sent during the contention resolution.

The retransmission of an RLC data block shall include the TLLI (or the TLLI and the PFI field), if the RLC data block was originally transmitted including these fields, also if the retransmission occurs after the completion of the contention resolution.

The network shall respond by including the TLLI in the PACKET UPLINK ACK/NACK message after the first correctly received RLC data block that comprises the TLLI. In EGPRS TBF mode, the network may instead respond by addressing the mobile station with the TFI of the assigned TBF and including the TLLI (in the CONTENTION_RESOLUTION_TLLI field) in a PACKET UPLINK ASSIGNMENT message, if the resources allocated for the TBF need to be reallocated (see clauses 8.1.1.1.2, 8.1.1.3.1 and 8.1.1.3.2).

The contention resolution is successfully completed on the mobile station side when the mobile station receives a PACKET UPLINK ACK/NACK message addressing the mobile station with the TFI value associated with the uplink TBF and including the same TLLI value that the mobile station has included in the RLC header of the first RLC data blocks, or alternatively, in EGPRS TBF mode, a PACKET UPLINK ASSIGNMENT message addressing the mobile station with the TFI value associated with the uplink TBF and including the same TLLI value that the mobile station included in the RLC header of the first RLC data blocks. The mobile shall then stop timer T3166 and counter N3104.

Reference

3GPP TS 04.60 subclauses 7.1.2.3

3GPP TS 05.10 subclause 6.11.3

52.8.1.11.2 Test purpose

To verify that in EGPRS TBF mode, during one phase access if SS sends a PACKET UPLINK ASSIGNMENT message for successful contention resolution and if the uplink resources are reallocated by the PACKET UPLINK ASSIGNMENT message, the mobile station successfully take into consideration the new resources allocated in the PACKET UPLINK ASSIGNMENT message.

52.8.1.11.3 Method of test

Initial conditions

System Simulator:

1 cell supporting EGPRS.

Mobile Station:

The MS is GPRS attached and in packet idle mode. PDP context 2 has been established.

Specific PICS Statements

-

PIXIT Statements

-

Test procedure

The MS is triggered to transfer 500 octets of data. In response to EGPRS PACKET CHANNEL REQUEST sent by the MS, the SS sends PACKET UPLINK ASSIGNMENT message containing Dynamic Allocation struct.

SS allocate resources to the MS to transfer RLC data blocks. SS verifies that all the data blocks contain TLLI field. SS sends a PACKET UPLINK ASSIGNMENT message addressing the MS with the TFI value associated with the Uplink TBF and including the correct TLLI in the CONTENTION_RESOLUTION_TLLI field. SS reallocate the resources of the uplink TBF in the PACKET UPLINK ASSIGNMENT message by changing the associated TFI and Coding scheme of the uplink TBF.

SS verifies that MS takes into consideration the resource reallocation in the PACKET UPLINK ASSIGNMENT message by checking that the MS uses the new TFI and coding scheme for transmission of new RLC data blocks and that the MS does not include TLLI in the RLC Data Block header.

Maximum duration of the test

5 minutes.

Expected sequence

Step	Direction	Message	Comments
1	MS		The MS is triggered transfer 500 octets data.
2	MS -> SS	EGPRS PACKET CHANNEL REQUEST	Received on PRACH.
2A			If the MS requests two phase access the Test Case is terminated
3	SS -> MS	PACKET UPLINK ASSIGNMENT	Dynamic allocation struct, USF_GRANULARITY = one block, Sent on PAGCH.
4	SS -> MS	PACKET DOWNLINK DUMMY CONTROL BLOCK	Sent on the PACCH of the PDCH assigned in step 3, containing USF assigned to the MS.
5	MS -> SS	EGPRS UPLINK RLC DATA BLOCK	Received on the assigned PDTCH. Check that the coding is the scheme specified by TLLI_BLOCK_CHANNEL_CODING, the TFI is correct and the block contains TLLI.
6	-		Repeat Step 4 & 5 five times.
7	SS -> MS	PACKET UPLINK ASSIGNMENT	Addressing the MS with the TFI allocated in Step 3. Dynamic allocation struct, USF_GRANULARITY = one block. Assign different TFI and Modulation and Coding scheme. Sent on PACCH.
8	SS -> MS	PACKET DOWNLINK DUMMY CONTROL BLOCK	Sent on the PACCH of the PDCH assigned in step 7, containing USF assigned to the MS.
9A (optional)	MS -> SS	EGPRS UPLINK RLC DATA BLOCK	The MS may send an EGPRS RLC Data Block with TLLI field already in the transmit buffer.
9B (optional)	SS -> MS	PACKET DOWNLINK DUMMY CONTROL BLOCK	If optional step 9A is received. Sent on the PACCH of the PDCH assigned in step 7, USF assigned to the MS.
9	MS -> SS	EGPRS UPLINK RLC DATA BLOCK	Received on the assigned PDTCH. Verify that the RLC Data block contains the correct TFI As assigned in Step 7. Verify that the Modulation and Coding Scheme is as commanded in Step 7
10		{Completion of uplink RLC data block transfer}	Verify that the data block does not contain TLLI.

Specific message contents

PACKET UPLINK ASSIGNMENT message in step 3:

{0 < Global TFI > 10 < TLLI > 110 < TQI > 111 < Packet Request Reference >}	111 (Packet Request Reference, information field sent in EGPRS PACKET CHANNEL REQUEST and frame number in which EGPRS PACKET CHANNEL REQUEST was received)
< EGPRS Channel Coding Command > < TLLI_BLOCK_CHANNEL_CODING >	MCS-2 1

PACKET UPLINK ASSIGNMENT message in step 7:

{0 < Global TFI > { 0 1 <CONTENTION_RESOLUTION_TLLI > CONTENTION_RESOLUTION_TLLI}	Same as UL TFI assigned in Step 3 1
< EGPRS Channel Coding Command > {0 1 <UPLINK_TFI_ASSIGNMENT> UPLINK_TFI_ASSIGNMENT	Same as TLLI received in the RLC Data Block in Step 5 MCS-4 1 Different from the TFI value assigned in Step 3.

52.8.1.12 One phase access/PBCCH absent/CONTENTION_RESOLUTION_TLLI/ Contention resolution / Successful Resource Reallocation

52.8.1.12.1 Conformance requirements

The TLLI is used to uniquely identify the mobile station when sending on uplink. Every RLC data block that is sent on the TBF shall include the TLLI of the mobile station, until the contention resolution is completed on the mobile station side. If MCS-7, MCS-8 or MCS-9 is used for the transmission of the TLLI in EGPRS TBF mode (i.e., the RLC/MAC block is carrying two RLC data blocks), the TLLI shall be inserted in both RLC data blocks. The TLLI shall also be included in the PACKET RESOURCE REQUEST and the ADDITIONAL MS RADIO ACCESS CAPABILITIES messages, if those are sent during the contention resolution.

The retransmission of an RLC data block shall include the TLLI (or the TLLI and the PFI field), if the RLC data block was originally transmitted including these fields, also if the retransmission occurs after the completion of the contention resolution.

The network shall respond by including the TLLI in the PACKET UPLINK ACK/NACK message after the first correctly received RLC data block that comprises the TLLI. In EGPRS TBF mode, the network may instead respond by addressing the mobile station with the TFI of the assigned TBF and including the TLLI (in the CONTENTION_RESOLUTION_TLLI field) in a PACKET UPLINK ASSIGNMENT message, if the resources allocated for the TBF need to be reallocated (see clauses 8.1.1.1.2, 8.1.1.3.1 and 8.1.1.3.2).

The contention resolution is successfully completed on the mobile station side when the mobile station receives a PACKET UPLINK ACK/NACK message addressing the mobile station with the TFI value associated with the uplink TBF and including the same TLLI value that the mobile station has included in the RLC header of the first RLC data blocks, or alternatively, in EGPRS TBF mode, a PACKET UPLINK ASSIGNMENT message addressing the mobile station with the TFI value associated with the uplink TBF and including the same TLLI value that the mobile station included in the RLC header of the first RLC data blocks. The mobile shall then stop timer T3166 and counter N3104.

Reference

3GPP TS 04.60 subclauses 7.1.2.3

3GPP TS 05.10 subclause 6.11.3

3GPP TS 04.18 subclause 3.5.2.1.3.2

52.8.1.12.2 Test purpose

To verify that in EGPRS TBF mode, during one phase access if SS sends a PACKET UPLINK ASSIGNMENT message for successful contention resolution and if the uplink resources are reallocated by the PACKET UPLINK ASSIGNMENT message, the mobile station successfully take into consideration the new resources allocated in the PACKET UPLINK ASSIGNMENT message.

52.8.1.12.3 Method of test

Initial conditions

System Simulator:

1 cell supporting EGPRS. PBCCH not present.

Mobile Station:

The MS is GPRS attached and in packet idle mode. PDP context 2 has been established.

Specific PICS Statements

-

PIXIT Statements

-

Test procedure

The MS is triggered to transfer 500 octets of data. In response to EGPRS PACKET CHANNEL REQUEST sent by the MS, the SS assigns packet uplink resources in an IMMEDIATE ASSIGNMENT message indicating one phase packet access.

SS allocate resources to the MS to transfer RLC data blocks. SS verifies that all the data blocks contain TLLI field. SS sends a PACKET UPLINK ASSIGNMENT message addressing the MS with the TFI value associated with the Uplink TBF and including the correct TLLI in the CONTENTION_RESOLUTION_TLLI field. SS reallocate the resources of the uplink TBF in the PACKET UPLINK ASSIGNMENT message by changing the associated TFI and Coding scheme of the uplink TBF.

SS verifies that MS takes into consideration the resource reallocation in the PACKET UPLINK ASSIGNMENT message by checking that the MS uses the new TFI and coding scheme for transmission of new RLC data blocks and that the MS does not include TLLI in the RLC Data Block header.

Maximum duration of the test

5 minutes.

Expected sequence

Step	Direction	Message	Comments
1	MS		The MS is triggered transfer 500 octets data.
2	MS -> SS	EGPRS PACKET CHANNEL REQUEST	Received on RACH.
2A			If the MS requests two phase access the Test Case is terminated
3	SS -> MS	IMMEDIATE ASSIGNMENT	Dynamic allocation struct, USF_GRANULARITY = one block, Sent on AGCH.
4	SS -> MS	PACKET DOWNLINK DUMMY CONTROL BLOCK	Sent on the PACCH of the PDCH assigned in step 3, containing USF assigned to the MS.
5	MS -> SS	EGPRS UPLINK RLC DATA BLOCK	Received on the assigned PDTCH. Check that the coding is the scheme specified by TLLI_BLOCK_CHANNEL_CODING, the TFI is correct and the block contains TLLI.
6	-		Repeat Step 4 & 5 five times.
7	SS -> MS	PACKET UPLINK ASSIGNMENT	Addressing the MS with the TFI allocated in Step 3. Dynamic allocation struct, USF_GRANULARITY = one block. Assign different TFI and Modulation and Coding scheme. Sent on PACCH.
8	SS -> MS	PACKET DOWNLINK DUMMY CONTROL BLOCK	Sent on the PACCH of the PDCH assigned in step 7, containing USF assigned to the MS.
9A	MS -> SS	EGPRS UPLINK RLC DATA BLOCK	The MS may send an EGPRS RLC Data Block with TLLI field already in the transmit buffer.
9B	SS -> MS	PACKET DOWNLINK DUMMY CONTROL BLOCK	If optional step 9A is received. Sent on the PACCH of the PDCH assigned in step 7, USF assigned to the MS.
9	MS -> SS	EGPRS UPLINK RLC DATA BLOCK	Received on the assigned PDTCH. Verify that the RLC Data block contains the correct TFI As assigned in Step 7. Verify that the Modulation and Coding Scheme is as commanded in Step 7
10		{Completion of uplink RLC data block transfer}	Verify that the data block does not contain TLLI.

Specific message contents

IMMEDIATE ASSIGNMENT message in step 3:

< EGPRS Channel Coding Command >	MCS-2
< TLLI_BLOCK_CHANNEL_CODING >	1

PACKET UPLINK ASSIGNMENT message in step 7:

{0 < Global TFI >	Same as UL TFI assigned in Step 3
{ 0 1 <CONTENTION_RESOLUTION_TLLI >	1
CONTENTION_RESOLUTION_TLLI}	Same as TLLI received in the RLC Data Block in Step 5
< EGPRS Channel Coding Command >	MCS-4
{0 1 <UPLINK_TFI_ASSIGNMENT>	1
UPLINK_TFI_ASSIGNMENT	Different from the TFI value assigned in Step 3.

52.9 Extended Dynamic Allocation in Packet Transfer Mode

52.9.1 Default message contents

All default conditions, message contents and macros are defined in section 50, except for the messages as described in this subclause. These messages are applicable to the whole section 52.9, they shall be transmitted by the system simulator and are required to be received by the MS under test.

In this clause, decimal values are normally used. However, sometimes a hexadecimal value, indicated by an "Hex", or a binary value, indicated by a "Binary" is used.

The default initial conditions used in subclause 52.9 are that PBCCH is present.

PACKET DOWNLINK ASSIGNMENT message:

MESSAGE_TYPE	000010
PAGE_MODE	Normal Paging
{0 1<PERSISTENCE_LEVEL>}	0
-	10 (address is TLLI)
- TLLI	same value as received from MS since GPRS attached
MAC_MODE	0, message escape
RLC_MODE	Extended Dynamic Allocation
CONTROL_ACK	acknowledged mode
TIMESLOT_ALLOCATION	0
Packet Timing Advance	single slot arbitrarily chosen from valid values, default slot 2
- {0 1<TIMING_ADVANCE_VALUE>}	1 (presence of the timing advance value)
- TIMING_ADVANCE_VALUE	30 bit periods
- {0 1<TIMING_ADVANCE_INDEX>	0 (no timing advance index)
<TIMING_ADVANCE_TIMESLOT_NUMBER >}	
- {0 1<P0><BTS_PWR_CTRL_MODE>}	0
{0 1<Frequency Parameters>}	1 (Frequency Parameters present)
- Frequency Parameters	
- TSC	Value arbitrarily chosen from valid values (default 5)
-	01 (indirect encoding)
- MAIO	Value arbitrarily chosen
- MA_NUMBER	Value arbitrarily chosen from PSI2s defined
- {0 1<CHANGE_MARK_1>	0
{0 1<CHANGE_MARK_2>}}	
{0 1<DOWNLINK_TFI_ASSIGNMENT>}	1 (assign downlink TFI)
- DOWNLINK_TFI_ASSIGNMENT	Arbitrarily chosen from valid values (default 3)
{0 1<Power Control Parameters>}	1 (Power Control Parameters present)
- ALPHA	0.5
- {0 1<GAMMA_TN0>	Depending on the value in TIMESLOT_ALLOCATION
	(default 0 no GAMMA_TN0)
- {0 1<GAMMA_TN1>	Depending on the value in TIMESLOT_ALLOCATION
	(default 0 no GAMMA_TN1)
- {0 1<GAMMA_TN2>	Depending on the value in TIMESLOT_ALLOCATION
	(default 1 GAMMA_TN2)
- GAMMA_TN2	For GSM 700, T-GSM 810, GSM 850 and GSM 900: +8 dBm
	For DCS 1 800: +6 dBm
	For PCS 1 900: +6 dBm
- {0 1<GAMMA_TN3>	Depending on the value in TIMESLOT_ALLOCATION
	(default 0 no GAMMA_TN0)
- {0 1<GAMMA_TN4>	Depending on the value in TIMESLOT_ALLOCATION
	(default 0 no GAMMA_TN4)
- {0 1<GAMMA_TN5>	Depending on the value in TIMESLOT_ALLOCATION
	(default 0 no GAMMA_TN5)
- {0 1<GAMMA_TN6>	Depending on the value in TIMESLOT_ALLOCATION
	(default 0 no GAMMA_TN6)
- {0 1<GAMMA_TN7>	Depending on the value in TIMESLOT_ALLOCATION
	(default 0 no GAMMA_TN7)
{0 1<TBF_STARTING_TIME>}	1 (starting time present)
- TBF_STARTING_TIME	0, absolute frame number encoding, indicating (current frame + 13 frames)
{0 1<Measurement Mapping>}	0 (no measurement mapping)
{1 0	1 (Additional contents for EGPRS present)
{0 1 <EGPRS window size>	1
- EGPRS window size	00000 (64 blocks)
<Link quality measurement mode>	00 (MS shall not report)
{0 1 <BEP_PERIOD2> }}	0
{0 1 <Packet extended timing advance>}	0
{0 1 <COMPACT reduced MA>}	0
spare padding	Spare Padding

PACKET TIMESLOT RECONFIGURE message (dynamic allocation without assigning a new TBF):

MESSAGE_TYPE	000111
PAGE_MODE	Normal Paging
0<GLOBAL_TFI>	0 The TFI value of the uplink TBF or downlink TBF which this message applies to (default 00101) 0, message escape
{0 1 <COMPACT reduced MA>}	0
EGPRS CHANNEL CODING COMMAND	Arbitrarily chosen from valid values (default MCS-1)
Resegment	1, Retransmitted RLC blocks Resegmented according to commanded MCS
{0 1 <Downlink EGPRS window size>	1
- Downlink EGPRS window size	00000 (64 blocks)
{0 1 <Uplink EGPRS window size>	1
- Uplink EGPRS window size	00000 (64 blocks)
<LINK_QUALITY_MEASUREMENT_MODE>	00, No measurements
Global Packet Timing Advance	
- {0 1<TIMING_ADVANCE_VALUE>}	1 (timing advance value present)
- TIMING_ADVANCE_VALUE	30 bit periods
- {0 1<UPLINK_TIMING_ADVANCE_INDEX>	0 (no uplink timing advance index)
<UPLINK_TIMING_ADVANCE_TIMESLOT_NUMBER>	The MS stops the operation of the continuous timing advance procedure.
- {0 1<DOWNLINK_TIMING_ADVANCE_INDEX>	0 (no downlink timing advance index)
<DOWNLINK_TIMING_ADVANCE_TIMESLOT_NUMBER>	The MS stops the operation of the continuous timing advance procedure.
{0 1 <Packet Extended Timing Advance>	0
DOWNLINK_RLC_MODE	Same as in the Test PDP context used
CONTROL_ACK	0
{0 1<DOWNLINK_TFI_ASSIGNMENT>	0
{0 1<UPLINK_TFI_ASSIGNMENT>	0
DOWNLINK_TIMESLOT_ALLOCATION	arbitrarily chosen from valid values (default 00010000)
{0 1<Frequency Parameters>	0 (use current parameters)
Dynamic allocation	0
- Extended Dynamic Allocation	1 (Extended Dynamic Allocation)
- {0 1<P0><PR_MODE>}	0
- USF_GRANULARITY	0, one block
- {0 1<RLC_DATA_BLOCKS_GRANTED>}	0 (no RLC_DATA_BLOCKS_GRANTED, open-ended TBF)
- {0 1<TBF_STARTING_TIME>	1 (starting time)
- TBF_STARTING_TIME	1, relative frame number encoding indicating current frame + 104 by absolute encoding
-	1 (Timeslot Allocation with Power Control Parameters)
- ALPHA	one slot arbitrarily chosen and different from current slot, the following USF_TNx and GAMMA_TNx shall be corresponding to the chosen value, default timeslot 3.
- {0 1<USF_TN0><GAMMA_TN0>}	0.5
- {0 1<USF_TN1><GAMMA_TN1>}	0 (timeslot 0 not assigned)
- {0 1<USF_TN2><GAMMA_TN2>}	0 (timeslot 1 not assigned)
- {0 1<USF_TN3><GAMMA_TN3>}	0 (timeslot 2 not assigned)
- {0 1<USF_TN3><GAMMA_TN3>}	1 (timeslot 3 assigned)
- USF_TN3	arbitrarily chosen and different from current value, default 4
- GAMMA_TN3	For GSM 700, T-GSM 810, GSM 850 and GSM 900: +8 dBm For DCS 1 800: +6 dBm For PCS 1 900: +6 dBm
- {0 1<USF_TN4><GAMMA_TN4>}	1 (timeslot 4 assigned)
- USF_TN4	Arbitrarily chosen (default 3) but it must be different than USF_TN3
- GAMMA_TN4	For GSM 700, T-GSM 810, GSM 850 and GSM 900: +8 dBm For DCS 1 800: +6 dBm For PCS 1 900: +6 dBm

- {0 1<USF_TN5><GAMMA_TN5>}	1 (timeslot 5 assigned), if the MS supports at least 3 timeslots uplink 0 (timeslot 5 not assigned), if the MS supports only 2 timeslots uplink
- USF_TN5	Only if timeslot 5 is assigned. Arbitrarily chosen (default 2) but it must be different to USF_TN3 and USF_TN4
- GAMMA_TN5	For GSM 700, T-GSM 810, GSM 850 and GSM 900: +8 dBm For DCS 1 800: +6 dBm For PCS 1 900: +6 dBm
- {0 1<USF_TN6><GAMMA_TN6>}	1 (timeslot 6 assigned), if the MS supports at least 4 timeslots uplink 0 (timeslot 6 not assigned), if the MS supports less than 4 timeslots uplink
- USF_TN6	Only if timeslot 6 is assigned. Arbitrarily chosen (default 1) but it must be different to USF_TN3, USF_TN4 and USF_TN5
- GAMMA_TN6	For GSM 700, T-GSM 810, GSM 850 and GSM 900: +8 dBm For DCS 1 800: +6 dBm For PCS 1 900: +6 dBm
- {0 1<USF_TN7><GAMMA_TN7>}	0(timeslot 7 not assigned)
spare padding	Spare Padding

For assignment of an uplink TBF while a downlink TBF has been established, the address information should be changed to DOWNLINK_TFI of Global_TFI. UPLINK_TFI_ASSIGNMENT is present.

PACKET UPLINK ASSIGNMENT message (two-phase dynamic allocation assigning a TBF):

MESSAGE_TYPE	001010
PAGE_MODE	Normal Paging
{0 1<PERSISTENCE_LEVEL>}	0 (no persistence level present)
- Address information	10 (TLLI)
- TLLI	The value received from the MS
{0 1 <COMPACT Reduced MA>	0,
EGPRS CHANNEL_CODING_COMMAND	Arbitrarily chosen from the valid values (default MCS-1)
Resegment	1, Retransmitted blocks can be re-segmented using the selected MCS
EGPRS Window size	00000, 64 blocks
{0 1 <Access Technologies Request> }	0 Access technologie Request Info not present
ARAC RETRANSMISSION REQUEST	0 , No retransmission
TLLI_BLOCK_CHANNEL_CODING	'0'B, cs-1
{0 1 <BEP_PERIOD2> }	0
Packet Timing Advance	
- {0 1<TIMING_ADVANCE_VALUE>}	1 (timing advance value)
- TIMING_ADVANCE_VALUE	30 bit periods
- {0 1<TIMING_ADVANCE_INDEX>	0 (no timing advance index)
<TIMING_ADVANCE_TIMESLOT_NUMBER >}	
{0 1 <Packet Extended Timing Advance>	0, No extended timing advance value
{0 1<Frequency Parameters>}	1 (Frequency Parameters present)
- Frequency Parameters	
- TSC	Arbitrarily chosen (default 5)
-	01 (indirect encoding)
- MAIO	Value arbitrarily chosen
- MA_NUMBER	Value arbitrarily chosen from PSI2s defined (default 0001)
- {0 1<CHANGE_MARK_1>	0
{0 1<CHANGE_MARK_2>}}	
Dynamic allocation	01
- Extended Dynamic Allocation	1 (Extended Dynamic allocation)
- {0 1<P0><PR_MODE>}	0
- USF_GRANULARITY	0, one block
- {0 1<UPLINK_TFI_ASSIGNMENT>}	1 (uplink TFI assignment)
- UPLINK_TFI_ASSIGNMENT	Arbitrarily chosen (default 00101)
- {0 1<RLC_DATA_BLOCKS_GRANTED>}	0 (no RLC_DATA_BLOCKS_GRANTED, open-ended TBF)
- {0 1<TBF_STARTING_TIME>}	0 (no starting time)
-	1 (Timeslot Allocation with Power Control Parameters) one slot arbitrarily chosen and the following USF_TNx and GAMMA_TNx shall be corresponding to the chosen value, default timeslot 2 assigned)
- ALPHA	0.5
- {0 1<USF_TN0><GAMMA_TN0>}	0 (timeslot 0 not assigned)
- {0 1<USF_TN1><GAMMA_TN1>}	0 (timeslot 1 not assigned)
- {0 1<USF_TN2><GAMMA_TN2>}	1 (timeslot 2 assigned)
- USF_TN2	Arbitrarily chosen (default 5)
- GAMMA_TN2	For GSM 700, T-GSM 810, GSM 850 and GSM 900: +8 dBm
	For DCS 1 800: +6 dBm
	For PCS 1 900: +6 dBm
- {0 1<USF_TN3><GAMMA_TN3>}	1 (timeslot 3 assigned)
- USF_TN3	Arbitrarily chosen (default 6) but it must be different than USF_TN2
- GAMMA_TN3	For GSM 700, T-GSM 810, GSM 850 and GSM 900: +8 dBm
	For DCS 1 800: +6 dBm
	For PCS 1 900: +6 dBm
- {0 1<USF_TN4><GAMMA_TN4>}	1 (timeslot 4 assigned), if the MS supports at least 3 timeslots uplink
	0 (timeslot 4 not assigned), if the MS supports only 2 timeslots uplink
- USF_TN4	Only if timeslot 4 is assigned
	Arbitrarily chosen (default 4) but it must be different to USF_TN2 and USF_TN3

- GAMMA_TN4	Only if timeslot 4 is assigned For GSM 700, T-GSM 810, GSM 850 and GSM 900: +8 dBm For DCS 1 800: +6 dBm For PCS 1 900: +6 dBm
- {0 1<USF_TN5><GAMMA_TN5>}	1 (timeslot 5 assigned), if the MS supports at least 4 timeslots uplink 0 (timeslot 5 not assigned), if the MS supports less than 4 timeslots uplink
- USF_TN5	Only if timeslot 5 is assigned Arbitrarily chosen (default 3) but it must be different to USF_TN2, USF_TN3 and USF_TN4
- GAMMA_TN5	Only if timeslot 5 is assigned For GSM 700, T-GSM 810, GSM 850 and GSM 900: +8 dBm For DCS 1 800: +6 dBm For PCS 1 900: +6 dBm
- {0 1<USF_TN6><GAMMA_TN6>}	0 (timeslot 6 not assigned)
- {0 1<USF_TN7><GAMMA_TN7>}	0 (timeslot 7 not assigned)
spare padding	Spare Padding

1. For one-phase uplink assignment, the Packet Request reference is used for addressing the MS.
2. For re-assignment of an uplink TBF, the address information should be changed to UPLINK_TFI of Global_TFI. UPLINK_TFI_ASSIGNMENT is absent.
3. For assignment of an uplink TBF while a downlink TBF has been established, the address information should be changed to DOWNLINK_TFI of Global_TFI. UPLINK_TFI_ASSIGNMENT is present.

52.9.2 Extended Dynamic Allocation / Uplink Transfer

52.9.2.1 Extended Dynamic Allocation / Uplink Transfer / Normal

52.9.2.1.1 Extended Dynamic Allocation / Uplink Transfer / Normal / Successful

52.9.2.1.1.1 Conformance requirements

The mobile station shall monitor the downlink PDCHs corresponding to (i.e. with the same timeslot number as) its assigned uplink PDCHs starting with the lowest numbered PDCH, then the next lowest numbered PDCH, etc., up to the one corresponding to the highest numbered assigned uplink PDCH.

Whenever the mobile station detects an assigned USF value on an assigned PDCH, the mobile station shall transmit either a single RLC/MAC block or a sequence of four RLC/MAC blocks on the same PDCH and all higher numbered assigned PDCHs. The time relation between an uplink block, which the mobile station shall use for transmission, and the occurrence of the USF value is defined in 3GPP TS 45.002. The number of RLC/MAC blocks to transmit on each PDCH is controlled by the USF_GRANULARITY parameter characterising the uplink TBF. The mobile station shall ignore the USF on those higher numbered PDCHs during the block period where the assigned USF value is detected and during the block period(s) in which the mobile station has been granted permission to transmit.

References

3GPP TS 44.060, subclauses 8.1.1.2.1

52.9.2.1.1.2 Test purposes

To verify that the MS:

When the MS receives the assigned USF of the lowest assigned PDCH, it transmits RLC/MAC data blocks on the same and all higher allocated PDCHs in the next TDMA frame.

52.9.2.1.1.3 Method of test

Initial Conditions

System Simulator:

1 cell, default setting,

Mobile Station:

The MS is GPRS attached with a P-TMSI allocated and the test PDP context2 activated.

Specific PICS Statements

- EGPRS Multislotclass (TSPC_Type_EGPRS_Multislot_ClassX where X = 1..45)

PIXIT Statements

-

Test Procedure

The MS is triggered to initiate packet uplink transfer data in RLC acknowledged mode. The SS orders the MS to use two-phase access procedure, in PACKET UPLINK ASSIGNMENT Up to 4 timeslots are assigned according to the mobile multislot class (TS 5.02 Annex B.1).

1) The SS signals to the MS the assigned USF addressing the MS on the lowest assigned PDTCH. It is checked that the MS sends RLC/MAC data blocks in the next radio block period on all assigned PDTCH and that each data block contains the correct TFI without TLLI.

The SS acknowledges the received data and assigns the USF addressing the MS. The check is repeated.

The same procedure is going on until the MS completes the packet data transfer.

2) The SS signals to the MS the assigned USF addressing the MS on the highest assigned PDTCH. It is checked that the MS sends RLC/MAC data blocks in the next radio block period only on the highest assigned PDTCH and that each data block contains the correct TFI without TLLI.

The SS acknowledges the received data and assigns the USF addressing the MS. The check is repeated.

The same procedure is going on until the MS completes the packet data transfer.

Maximum Duration of Test

5 minutes.

Expected Sequence

Step	Direction	Message	Comments
1		{Uplink dynamic allocation two phase access}	n = 1500 octets, without starting time, Message Escape bit = 1 (EGPRS) Up to 4 timeslots are assigned according to MS multislot class (TS 5.02 Annex B.1): <ul style="list-style-type: none"> - USF₁ on TN₁, - USF₂ on TN₂, - USF₃ on TN₃, - USF₄ on TN₄, Default PACKET UPLINK ASSIGNMENT message content for EDA defined in sub-clause 52.9.1 shall be used.
2	SS -> MS	PACKET DOWNLINK DUMMY CONTROL BLOCK	Assigned USF ₁ on PACCH ₁ addressing the MS on 3 blocks from the last radio block containing the uplink assignment.
3	SS -> MS	PACKET DOWNLINK DUMMY CONTROL BLOCK	USF on PACCH ₂ is not addressing the MS, sent on the same TDMA frame as step 2.
4	SS -> MS	PACKET DOWNLINK DUMMY CONTROL BLOCK	This step is optional, it is performed only if 3 timeslots at least have been assigned in step 1. USF on PACCH ₃ is not addressing the MS, sent on the same TDMA frame as step 2.
5	SS -> MS	PACKET DOWNLINK DUMMY CONTROL BLOCK	This step is optional; it is performed only if 4 timeslots have been assigned in step 1. USF on PACCH ₄ is not addressing the MS, sent on the same TDMA frame as step 2.
6	MS -> SS	EGPRS UPLINK RLC DATA BLOCK	Received on the assigned PDTCH ₁ .
7	MS -> SS	EGPRS UPLINK RLC DATA BLOCK	Received on the assigned PDTCH ₂ on the same TDMA frame as step 6.
8	MS -> SS	EGPRS UPLINK RLC DATA BLOCK	This step is optional; it is performed only if 3 timeslots at least have been assigned in step 1. Received on the assigned PDTCH ₃ on the same TDMA frame as step 6.
9	MS -> SS	EGPRS UPLINK RLC DATA BLOCK	This step is optional; it is performed only if 4 timeslots have been assigned in step 1. Received on the assigned PDTCH ₄ on the same TDMA frame as step 6.
10	SS -> MS	PACKET UPLINK ACK/NACK	Assigned USF ₁ on PACCH ₁ addressing the MS.
11	SS -> MS	PACKET DOWNLINK DUMMY CONTROL BLOCK	USF on PACCH ₂ is not addressing the MS, sent on the same TDMA frame as step 10
12	SS -> MS	PACKET DOWNLINK DUMMY CONTROL BLOCK	This step is optional; it is performed only if 3 timeslots at least have been assigned in step 1. USF on PACCH ₃ is not addressing the MS, sent on the same TDMA frame as step 10
13	SS -> MS	PACKET DOWNLINK DUMMY CONTROL BLOCK	This step is optional; it is performed only if 4 timeslots have been assigned in step 1. USF on PACCH ₄ is not addressing the MS, sent on the same TDMA frame as step 10
14	MS -> SS	EGPRS UPLINK RLC DATA BLOCK	Received on the assigned PDTCH ₁ .
15	MS -> SS	EGPRS UPLINK RLC DATA BLOCK	Received on the assigned PDTCH ₂ on the same TDMA frame as step 14.
16	MS -> SS	EGPRS UPLINK RLC DATA BLOCK	This step is optional; it is performed only if 3 timeslots at least have been assigned in step 1. Received on the assigned PDTCH ₃ on the same TDMA frame as step 14.
17	MS -> SS	EGPRS UPLINK RLC DATA BLOCK	This step is optional; it is performed only if 4 timeslots have been assigned in step 1. Received on the assigned PDTCH ₄ on the same TDMA frame as step 14.
18		{Completion of uplink RLC data block transfer in extended dynamic mode}	

19		{Uplink dynamic allocation two phase access}	n = 1500 octets, without starting time, Message Escape bit = 1 (EGPRS) Up to 4 timeslots are assigned according to MS multislot class (TS 5.02 Annex B.1): - USF ₁ on TN ₁ , - USF ₂ on TN ₂ , - USF ₃ on TN ₃ , - USF ₄ on TN ₄ ,
20	SS -> MS	PACKET DOWNLINK DUMMY CONTROL BLOCK	USF on PACCH ₁ is not addressing the MS
21	SS -> MS	PACKET DOWNLINK DUMMY CONTROL BLOCK	This step is optional; it is performed only if 3 timeslots at least have been assigned in step 19. USF on PACCH ₂ is not addressing the MS, sent on the same TDMA frame as step 20.
22	SS -> MS	PACKET DOWNLINK DUMMY CONTROL BLOCK	This step is optional; it is performed only if 4 timeslots have been assigned in step 19. USF on PACCH ₃ is not addressing the MS, sent on the same TDMA frame as step 20.
23	SS -> MS	PACKET DOWNLINK DUMMY CONTROL BLOCK	Assigned USF _N on PACCH _N addressing the MS, where N is the number of assigned timeslots in step 19, sent on the same TDMA frame as step 20.
24	MS->SS		It is checked that no EGPRS UPLINK RLC DATA BLOCK messages are received on the assigned PDTCH ₁ to PDTCH _{N-1} .
25	MS -> SS	EGPRS UPLINK RLC DATA BLOCK	Received only on the assigned PDTCH _N .
26	SS -> MS	PACKET UPLINK ACK/NACK	USF on PACCH ₁ is not addressing the MS
27	SS -> MS	PACKET DOWNLINK DUMMY CONTROL BLOCK	This step is optional; it is performed only if 3 timeslots at least have been assigned in step 19. USF on PACCH ₂ is not addressing the MS, sent on the same TDMA frame as step 26.
28	SS -> MS	PACKET DOWNLINK DUMMY CONTROL BLOCK	This step is optional; it is performed only if 4 timeslots have been assigned in step 19. USF on PACCH ₃ is not addressing the MS, sent on the same TDMA frame as step 26.
29	SS -> MS	PACKET DOWNLINK DUMMY CONTROL BLOCK	Assigned USF _N on PACCH _N addressing the MS, where N in the number of assigned timeslots is step 19, sent on the same TDMA frame as step 26.
30	MS->SS		It is checked that no UPLINK RLC DATA BLOCK messages are received on the assigned PDTCH ₁ to PDTCH _{N-1} .
31	MS -> SS	UPLINK RLC DATA BLOCK	Received only on the assigned PDTCH _N
32		{Completion of uplink RLC data block transfer in extended dynamic mode}	

Specific Message Contents

None.

52.9.2.1.2 Extended Dynamic Allocation / Uplink Transfer / Normal / USF_GRANULARITY = 4 blocks

52.9.2.1.2.1 Conformance requirements

The number of RLC/MAC blocks to transmit on each PDCH is controlled by the USF_GRANULARITY parameter characterising the uplink TBF. The mobile station shall ignore the USF on those higher numbered PDCHs during the block period where the assigned USF value is detected and during the block period(s) in which the mobile station has been granted permission to transmit. In addition, if USF_GRANULARITY is set to four blocks allocation, it may ignore the USF on all other PDCHs during the first three block periods in which the mobile station has been granted permission to transmit. As specified in 3GPP TS 45.002, the USF corresponding to the last three blocks of a four blocks allocation shall be set to an unused value for each PDCH on which the mobile station has been granted permission to transmit.

References

3GPP TS 44.060, subclauses 8.1.1.2.1

52.9.2.1.2.2 Test purposes

To verify that the MS:

Manages the USF_GRANULARITY when an uplink TBF is established in Extended Dynamic allocation mode.

52.9.2.1.2.3 Method of test

Initial Conditions

System Simulator:

1 cell, default setting,

Mobile Station:

The MS is GPRS attached with a P-TMSI allocated and the test PDP context2 activated.

Specific PICS Statements

-

PIXIT Statements

-

Test Procedure

The MS is triggered to initiate packet uplink transfer data in RLC acknowledged mode. The SS orders the MS to use two-phase access procedure, in PACKET UPLINK ASSIGNMENT. 2 uplink timeslots are assigned.

- 1) The SS signals the assigned USF addressing the MS on the lowest assigned PDCH. It is checked that the MS sends RLC/MAC data blocks in the next 4 radio block periods on all assigned PDCHs and that each data block contains the correct TFI without TLLI.
- 2) The SS acknowledges the received data and assigns the USF addressing the MS. It is checked that the MS sends RLC/MAC data blocks in the next 4 radio block periods on all assigned PDCHs, except for the block allocated via the polling mechanism it is checked that the MS sends PACKET CONTROL ACKNOWLEDGEMENT.
- 3) In the last block period of the above procedure, the SS signals the assigned USF addressing the MS on the lowest assigned PDCH. It is checked that the MS sends RLC/MAC data blocks in the next 4 radio block periods on all assigned PDCHs and that each data block contains the correct TFI without TLLI.
- 4) The same procedure is going on until the MS completes the packet data transfer.

Maximum Duration of Test

5 minutes.

Expected Sequence

Step	Direction	Message	Comments
1		{Uplink dynamic allocation two phase access}	n = 1500 octets, without starting time, Message Escape bit = 1 (E-GPRS) 2 timeslots are assigned - USF ₁ on PDCH ₁ , - USF ₂ on PDCH ₂ , - USF_GRANULARITY = 1 (4 blocks) Default PACKET UPLINK ASSIGNMENT message content for EDA defined in sub-clause 52.9.1 shall be used.
2	SS -> MS	PACKET DOWNLINK DUMMY CONTROL BLOCK	USF ₁ on block N ₁ of PACCH ₁ is addressing the MS (must be at least 3 blocks after the block containing the uplink assignment.)
3	SS -> MS	PACKET DOWNLINK DUMMY CONTROL BLOCK	USF on block N ₁ of PACCH ₂ is NOT addressing the MS.
4	MS -> SS	EGPRS UPLINK RLC DATA BLOCK	Received on block N ₁ +1 of PDTCH ₁
5	MS -> SS	EGPRS UPLINK RLC DATA BLOCK	Received on block N ₁ +1 of PDTCH ₂
6	MS -> SS	EGPRS UPLINK RLC DATA BLOCK	Received on block N ₁ +2 of PDTCH ₁
7	MS -> SS	EGPRS UPLINK RLC DATA BLOCK	Received on block N ₁ +2 of PDTCH ₂
8	MS -> SS	EGPRS UPLINK RLC DATA BLOCK	Received on block N ₁ +3 of PDTCH ₁
9	MS -> SS	EGPRS UPLINK RLC DATA BLOCK	Received on block N ₁ +3 of PDTCH ₂
10	MS -> SS	EGPRS UPLINK RLC DATA BLOCK	Received on block N ₁ +4 of PDTCH ₁
11	MS -> SS	EGPRS UPLINK RLC DATA BLOCK	Received on block N ₁ +4 of PDTCH ₂
12	SS -> MS	PACKET UPLINK ACK/NACK	Acknowledge all received data blocks, on block N ₂ of PACCH ₁ With: S/P=1, RRBP = 0, and USF ₁
13	MS -> SS	EGPRS UPLINK RLC DATA BLOCK	Received on block N ₂ +1 of PDTCH ₁
14	MS -> SS	EGPRS UPLINK RLC DATA BLOCK	Received on block N ₂ +1 of PDTCH ₂
15	MS -> SS	EGPRS UPLINK RLC DATA BLOCK	Received on block N ₂ +2 of PDTCH ₁
16	MS -> SS	EGPRS UPLINK RLC DATA BLOCK	Received on block N ₂ +2 of PDTCH ₂
17	MS -> SS	PACKET CONTROL ACKNOWLEDGEMENT	Received on block N ₂ +3 of PACCH ₁
18	MS -> SS	EGPRS UPLINK RLC DATA BLOCK	Received on block N ₂ +3 of PDTCH ₂
19	SS -> MS	PACKET DOWNLINK DUMMY CONTROL BLOCK	USF ₁ on block N ₂ +4 of PACCH ₁ is addressing the MS.
20	MS -> SS	EGPRS UPLINK RLC DATA BLOCK	Received on block N ₂ +4 of PDTCH ₁
21	MS -> SS	EGPRS UPLINK RLC DATA BLOCK	Received on block N ₂ +4 of PDTCH ₂
22	MS -> SS	EGPRS UPLINK RLC DATA BLOCK	Received on block N ₂ +5 of PDTCH ₁
23	MS -> SS	EGPRS UPLINK RLC DATA BLOCK	Received on block N ₂ +5 of PDTCH ₂
24	MS -> SS	EGPRS UPLINK RLC DATA BLOCK	Received on block N ₂ +6 of PDTCH ₁
25	MS -> SS	EGPRS UPLINK RLC DATA BLOCK	Received on block N ₂ +6 of PDTCH ₂
26	MS -> SS	EGPRS UPLINK RLC DATA BLOCK	Received on block N ₂ +7 of PDTCH ₁
27	MS -> SS	EGPRS UPLINK RLC DATA BLOCK	Received on block N ₂ +7 of PDTCH ₂

28	MS -> SS	EGPRS UPLINK RLC DATA BLOCK	Received on block N_2+8 of PDTCH ₁
29	MS -> SS	EGPRS UPLINK RLC DATA BLOCK	Received on block N_2+8 of PDTCH ₂
30		{Completion of uplink RLC data block transfer in extended dynamic mode}	

Specific Message Contents

None.

52.9.2.1.4 Extended Dynamic Allocation / Uplink Transfer / Normal / PACCH operation in downlink

52.9.2.1.4.1 Conformance requirements

The mobile station shall attempt to decode every downlink RLC/MAC block on the lowest numbered timeslot in the PDCH allocation. Whenever the mobile station receives an RLC/MAC block containing an RLC/MAC control block, the mobile station shall attempt to interpret the message contained therein. If the message addresses the mobile station, the mobile station shall act on the message.

The network shall transmit all PACCH messages on the PDCH carried on the lowest numbered timeslot in the allocation. Additionally for the concurrent TBF case, the network may transmit PACCH messages on any of the common timeslots assigned to the downlink and uplink PDCH allocation.

Whenever the mobile station detects an assigned USF value on any assigned PDCH, the mobile station may transmit a PACCH block on the same PDCH in the next block period. The mobile station shall not transmit an RLC data block in any uplink radio block allocated via the polling mechanism.

References

3GPP TS 44.060, subclause 8.1.1.2.2.

52.9.2.1.4.2 Test purposes

To verify that a MS having an uplink EGPRS TBF with Extended Dynamic Allocation MAC mode:

1. Decodes and interprets correctly all RLC/MAC blocks containing RLC/MAC control blocks sent by the network on the lowest numbered timeslot in the PDCH allocation when there is no concurrent downlink TBF.
2. Decodes and interprets correctly all RLC/MAC blocks containing RLC/MAC control blocks sent by the network on the lowest numbered timeslot in the PDCH allocation or on any of the common timeslots assigned to the downlink and uplink PDCH allocation when there is a concurrent downlink EGPRS TBF.
3. Does not transmit an RLC data block in any uplink radio block allocated via the polling mechanism.

52.9.2.1.4.3 Method of test

Initial Conditions

System Simulator:

1 cell, default setting.

Mobile Station:

The MS is EGPRS attached with a P-TMSI allocated and the test PDP context 2 activated.

Specific PICS Statements

- EGPRS Multislotclass (TSPC_Type_EGPRS_Multislot_ClassX where X = 1..45)

PIXIT Statements

-

Test Procedure

The MS is triggered to initiate a packet uplink data transfer in RLC acknowledged mode and with Extended Dynamic Allocation MAC mode. The SS orders the MS to use two-phase access procedure.

- 1) At this point in time the MS has an uplink EGPRS TBF established with Extended Dynamic Allocation MAC mode. It may receive RLC/MAC blocks containing RLC/MAC control blocks for the uplink EGPRS TBF on the PDCH carried on the lowest numbered timeslot in the allocation.

To test that the MS decodes and interprets correctly all RLC/MAC blocks containing RLC/MAC control blocks sent by the network on the lowest numbered timeslot in the PDCH allocation when there is no concurrent downlink TBF the SS process as follow:

- The SS sends on on the lowest numbered timeslot in the PDCH allocation a PACKET DOWNLINK ASSIGNMENT message to establish a concurrent downlink TBF with the Extended Dynamic Allocation MAC mode. The SS checks that the MS sends in response a PACKET CONTROL ACKNOWLEDGEMENT message on the lowest numbered timeslot in the PDCH allocation.
- 2) At this point in time the MS has an uplink EGPRS TBF and a downlink EGPRS TBF established with Extended Dynamic Allocation MAC mode. It may receive RLC/MAC blocks containing RLC/MAC control blocks for the uplink EGPRS TBF on the PDCH carried on the lowest numbered timeslot in the uplink PDCH allocation or on any of the common timeslots assigned to the downlink and uplink PDCH allocation.

To test, in case there is a concurrent downlink EGPRS TBF, that the MS decodes and interprets correctly all RLC/MAC blocks containing RLC/MAC control blocks sent by the network on the PDCH carried on the lowest numbered timeslot in the uplink PDCH allocation or on any of the common timeslots assigned to the downlink and uplink PDCH allocation, the SS process as follow:

- The MS is triggered to transfer 64+1 (window size +1) EGPRS RLC data blocks without acknowledgement from SS in such a way that the window is stalled.
 - The SS sends on the PDCH carried on the lowest numbered timeslot in the uplink PDCH allocation a PACKET UPLINK ACK/NACK message acknowledging only the oldest EGPRS RLC data block. Then the MS is triggered to transfer one EGPRS RLC data block. If the MS has correctly decoded the PACKET UPLINK ACK/NACK message, the BSN of the EGPRS RLC data block shall be the next in sequence expected BSN.
 - The SS sends on one of the common timeslots assigned to the downlink and uplink PDCH allocation a PACKET UPLINK ACK/NACK message acknowledging only the oldest RLC data block. Then the MS is triggered to transfer one EGPRS RLC data block. If the MS has correctly decoded the PACKET UPLINK ACK/NACK message, the BSN of the EGPRS RLC data block shall be the next in sequence expected BSN. The test is repeated with all PDCHs common for both reception and transmission.
- 3) To test that the MS does not transmit an RLC data block in any uplink radio block allocated via the polling mechanism the SS process as follow:
 - The SS sends on one of the common timeslots assigned to the downlink and uplink PDCH allocation a PACKET UPLINK ACK/NACK message containing the TFI value assigned to the uplink TBF and a valid RRBP. On the block period preceding the block period where the polling response to the PACKET UPLINK ACK/NACK message should be received, the SS assigns an USF to the MS on the lowest numbered timeslot of the uplink PDCH allocation. The SS checks that during the block period where the polling response should be received, the MS responds to the polling with a PACKET CONTROL ACKNOWLEDGEMENT message sent on the PDCH where the polling request was sent and sends RLC data blocks on the other PDCHs of the uplink PDCH allocation. The test is repeated with all PDCHs common for both reception and transmission.

Then the data transfer is completed.

The following table gives the number of timeslots allocated for the uplink and downlink TBFs during the test according to the multislot class (see 45.002 annex B.1):

Multislot class	Number of PDCHs for the downlink TBF	Number of PDCHs for the uplink TBF
3	1	2
5	2	2
6	2	2
7	2	2
9	3	2
10	3	2
11	3	2
12	3	2
13	3	3
14	4	4
15	5	5
16	6	6
17	7	7
18	8	8
19	6	2
20	6	3
21	6	4
22	6	4
23	6	6
24	8	2
25	8	3
26	8	4
27	8	4
28	8	6
29	8	8
31	4	2
32	3	3
33	3	3
34	3	3
36	4	2
37	3	3
38	3	3
39	3	3
41	5	2
42	4	3
43	4	3
44	4	3
45	4	3

NOTE: The multislot class of the MS under test may impose that the highest PDCH of the uplink allocation is not a member of the downlink allocation. In this case the SS shall transmit a downlink RLC data block on a PDCH common to the downlink and uplink PDCH allocation at least every 5 seconds to avoid expiry of timer T3190.

Maximum Duration of Test

1 minute.

Expected Sequence

Step	Direction	Message	Comments
1		{Uplink dynamic allocation two phase access}	Default PACKET UPLINK ASSIGNMENT message content for EDA defined in sub-clause 52.9.1 shall be used. n = 1500 octets, without starting time, Message Escape bit = 1 (EGPRS)
2	SS -> MS	PACKET DOWNLINK ASSIGNMENT	Default PACKET DOWNLINK ASSIGNMENT message content for EDA defined in sub-clause 42.9.1 shall be used. Sent on the PACCH of the lowest PDCH of the uplink PDCH allocation. Including the Polling bit set and a valid RRBp field. Including the TFI assigned to the uplink TBF.
3	MS -> SS	PACKET CONTROL ACKNOWLEDGEMENT	Received on the PACCH of the lowest PDCH of the uplink PDCH allocation.
4	SS		The SS verifies that the MS sends the PACKET CONTROL ACKNOWLEDGEMENT message, on the uplink radio block specified by the RRBp of the lowest PDCH of the uplink PDCH allocation.
5	SS -> MS	DOWNLINK EGPRS RLC DATA BLOCK	Sent on the highest PDCH of the uplink PDCH allocation. Including the USF assigned to the MS on the highest PDCH of the uplink PDCH allocation. Including an invalid RRBp.
6	MS -> SS	UPLINK EGPRS RLC DATA BLOCK	Received on the highest PDCH of the uplink PDCH allocation. SI=0
7			Repeat steps 5 and 6 for BSN=1 to 63. SS doesn't acknowledge any of the RLC data blocks with BSN from 0 to 63 (see note below).
8	SS -> MS	DOWNLINK EGPRS RLC DATA BLOCK	Sent on the highest PDCH of the uplink PDCH allocation. Including the USF assigned to the MS on the highest PDCH of the uplink PDCH allocation. Including an invalid RRBp.
9	MS -> SS	UPLINK EGPRS RLC DATA BLOCK	Received on the highest PDCH of the uplink PDCH allocation. SI=1
10	SS->MS	PACKET UPLINK ACK/NACK	SS acknowledges the oldest RLC data block. Sent on the PACCH of the lowest PDCH of the uplink PDCH allocation. Including the TFI assigned to the uplink TBF. Including an USF not assigned to the MS on this PDCH. Pre-emptive Bit: '1'B EOW=0 Wait for 6 blocks with no assigned USF
11	SS -> MS	DOWNLINK EGPRS RLC DATA BLOCK	Sent on the highest PDCH of the uplink PDCH allocation. Including the USF assigned to the MS on the highest PDCH of the uplink PDCH allocation. Including an invalid RRBp.
12	MS -> SS	UPLINK EGPRS RLC DATA BLOCK	Received on the highest PDCH.
13	SS		The steps 11 and 12 are repeated k times <= 8 until V(R) has been incremented by one (i.e. the MS has correctly understood the PACKET UPLINK ACK/NACK).
14	SS -> MS	DOWNLINK EGPRS RLC DATA BLOCK	Sent on the highest PDCH of the uplink PDCH allocation. Including the USF assigned to the MS on the highest PDCH of the uplink PDCH allocation. Including an invalid RRBp.
15	MS -> SS	UPLINK GPRS RLC DATA BLOCK	Received on the highest PDCH of the uplink PDCH allocation.
16			The steps 14 and 15 are repeated until a RLC DATA BLOCK with SI=1 is received (see note below).

17	SS->MS	PACKET UPLINK ACK/NACK	SS acknowledges the oldest RLC data block. Sent on a PDCH common to the downlink and uplink PDCH allocation. Including the TFI of the uplink TBF. Including an USF not assigned to the MS on this PDCH. Pre-emptive Bit: '1'B EOW=0 Wait for 6 blocks with no assigned USF
18	SS -> MS	DOWNLINK EGPRS RLC DATA BLOCK	Sent on the highest PDCH of the uplink PDCH allocation. Including the USF assigned to the MS on this PDCH. Including an invalid RRBP.
19	MS -> SS	UPLINK EGPRS RLC DATA BLOCK	Received on the highest PDCH of the uplink PDCH allocation.
20	SS		The steps 18 and 19 are repeated k times ≤ 8 until V(R) has been incremented by one (i.e. the MS has correctly understood the PACKET UPLINK ACK/NACK).
21	SS -> MS	DOWNLINK EGPRS RLC DATA BLOCK	Sent on the highest PDCH of the uplink PDCH allocation. Including the USF assigned to the MS on the highest PDCH of the uplink PDCH allocation. Including an invalid RRBP.
22	MS -> SS	UPLINK GPRS RLC DATA BLOCK	Received on the highest PDCH of the uplink PDCH allocation.
23			The steps 21 and 22 are repeated until a RLC DATA BLOCK with SI=1 is received (see note below).
24			The steps 17, 18, 19, 20, 21, 22 and 23 are repeated for each PDCH common to the downlink and uplink PDCH allocation.
25	SS->MS	PACKET UPLINK ACK/NACK	SS acknowledges all RLC data block. Sent on a PDCH common to the downlink and uplink PDCH allocation. Including the Polling bit set and a valid RRBP field Including the TFI assigned to the uplink TBF. Pre-emptive Bit: '1'B
26	SS -> MS	DOWNLINK EGPRS RLC DATA BLOCK	Sent on the lowest PDCH of the uplink PDCH allocation on the block period preceding the response to the polling requested in step 25. Including the USF assigned to the MS on this PDCH.
27	MS -> SS	UPLINK EGPRS RLC/MAC BLOCK	Received during the block period where the polling response should be sent. An UPLINK RLC CONTROL BLOCK should be received on the PDCH where the MS is polled or an UPLINK RLC DATA BLOCK should be received on the other PDCHs.
28			The step 27 is repeated a number of times equal to the number of PDCHs of the uplink PDCH allocation to get all RLC/MAC BLOCK sent by the MS.
29	SS		Verify that the MS did not transmit a RLC data block on the reserved uplink radio block specified by the RRBP on the PDCH where it has been polled. A PACKET CONTROL ACKNOWLEDGEMENT shall be transmitted instead. Verify that the MS has transmitted RLC data blocks on the other PDCHs.
30			The steps 25, 26, 27, 28 and 29 are repeated for each PDCH common to the downlink and uplink PDCH allocation.
31	SS -> MS	DOWNLINK EGPRS RLC DATA BLOCK	Sent on a PDCH common to the downlink and uplink PDCH allocation. Including a valid RRBP and FBI = 1. Including an USF not assigned to the MS on this PDCH.
32	MS -> SS	EGPRS PACKET DOWNLINK ACK/NACK	
33		{Completion of uplink RLC data block transfer in extended dynamic mode}	

NOTE: If the multislot class of the MS under test imposes that the highest PDCH of the uplink allocation is not a member of the downlink allocation, the SS shall transmit a downlink RLC data block on a PDCH common to the downlink and uplink PDCH allocation at least every 5 seconds to avoid expiry of timer T3190. The RLC data block shall be transmitted including an invalid RRBP and an USF not assigned to the MS on this PDCH.

52.9.2.1.5 Extended Dynamic Allocation / Uplink Transfer / Normal / Polling for EPDAN

52.9.2.1.5.1 Conformance requirements

In case of simultaneous uplink and downlink TBFs and extended dynamic allocation, the network may apply polling in downlink RLC data blocks only when sent on a PDCH common for both reception and transmission. A mobile station operating with extended dynamic allocation need to respond to polling in downlink RLC data blocks only when received on a PDCH common for both reception and transmission.

References

3GPP TS 44.060, subclause 8.1.2.2.

52.9.2.1.5.2 Test purposes

To verify, in case the MS has a simultaneous uplink and downlink EGPRS TBF with Extended Dynamic Allocation MAC mode, that the MS responds to polling when it is polled on blocks belonging to PDCHs common for both reception and transmission.

52.9.2.1.5.3 Method of test

Initial Conditions

System Simulator:

1 cell, default setting.

Mobile Station:

The MS is EGPRS attached with a P-TMSI allocated and the test PDP context 2 activated.

Specific PICS Statements

- EGPRS Multislotclass (TSPC_Type_EGPRS_Multislot_ClassX where X = 1..45)

PIXIT Statements

-

Test Procedure

The MS is triggered to initiate a packet uplink data transfer in RLC acknowledged mode and with Extended Dynamic Allocation MAC mode. The SS orders the MS to use two-phase access procedure. Then a concurrent downlink TBF is established. The PDCH allocation for the downlink and uplink TBFs is chosen to maximise the number of PDCHs common for both reception and transmission.

The SS sends on a PDCH common for both reception and transmission an EGPRS RLC data block with polling and checks that the MS responds with an EGPRS PACKET DOWNLINK ACK/NACK acknowledging the EGPRS RLC data block in the uplink radio block specified by RRBP. The test is repeated on all PDCHs common for both reception and transmission.

The following table gives the number of timeslots allocated for the uplink and downlink TBFs during the test according to the multislot class (see 45.002 annex B.1):

Multislot class	Number of PDCHs for the downlink TBF	Number of PDCHs for the uplink TBF
3	1	2
5	2	2
6	2	2
7	2	2
9	3	2
10	3	2
11	3	2
12	3	2
13	3	3
14	4	4
15	5	5
16	6	6
17	7	7
18	8	8
19	6	2
20	6	3
21	6	4
22	6	4
23	6	6
24	8	2
25	8	3
26	8	4
27	8	4
28	8	6
29	8	8
31	4	2
32	3	3
33	3	3
34	3	3
36	4	2
37	3	3
38	3	3
39	3	3
41	5	2
42	4	3
43	4	3
44	4	3
45	4	3

Maximum Duration of Test

1 minute.

Expected Sequence

Step	Direction	Message	Comments
1		{Uplink dynamic allocation two phase access}	Default PACKET UPLINK ASSIGNMENT message content for EDA defined in sub-clause 52.9.1 shall be used. n = 20 octets, without starting time Message Escape bit = 1 (EGPRS)
2	SS -> MS	PACKET DOWNLINK ASSIGNMENT	Default PACKET DOWNLINK ASSIGNMENT message content for EDA defined in sub-clause 42.9.1 shall be used. Sent on the PACCH of the lowest PDCH of the uplink PDCH allocation. Including the polling bit set and a valid RRBP field. Including the TFI assigned to the uplink TBF.
3	MS -> SS	PACKET CONTROL ACKNOWLEDGEMENT	Received on the PACCH of the lowest PDCH of the uplink PDCH allocation.
4	SS -> MS	DOWNLINK EGPRS RLC DATA BLOCK	Sent on a PDCH common to the downlink and uplink PDCH allocation. Including the Polling bit set and a valid RRBP field. Including the TFI assigned to the uplink TBF.
5	MS -> SS	EGPRS PACKET DOWNLINK ACK/NACK	Received on the same PDCH and on the uplink radio block specified by the RRBP.
6	SS		The SS verifies that the MS sends an EGPRS PACKET DOWNLINK ACK/NACK acknowledging the EGPRS RLC data block.
7			The steps 4, 5 and 6 are repeated with each PDCH common to the downlink and uplink PDCH allocation.
8		{Completion of uplink RLC data block transfer in extended dynamic mode}	

53 Test of EGPRS Radio Link Control (RLC) Protocol

Default conditions and messages

The default conditions, message contents and macros not specified in this subclause must be set as in subclause 50 for EGPRS system testing.

Initial conditions

Unless otherwise indicated, the initial conditions for all acknowledged mode tests, as a minimum, are as follows. Other initial conditions may apply. In the event of conflict between initial conditions stated here and those stated in a test case, the test case shall take precedence.

- The MS is EGPRS attached.
- A PDP context has been activated with RLC acknowledged mode operation.

53.1 Acknowledged Mode

53.1.1 Acknowledged Mode/ Uplink TBF

53.1.1.1 Acknowledged Mode/ Uplink TBF/ Send State Variable V(S)

53.1.1.1.1 Conformance requirements

1. The send state variable V(S), can take on the values 0 through 2 047. Each RLC data block contains a block sequence number (BSN) field that is 11 bits in length. At the time that an in-sequence RLC data block is designated for transmission, the value of BSN is set equal to the value of the send state variable.
2. V(S) shall be set to the value 0 at the beginning of each TBF in which the RLC endpoint is the transmitter.
3. The value of V(S) shall be incremented by 1 after transmission of the RLC data block with BSN = V(S).

References

3GPP TS 04.60, subclause 9.1.1.

53.1.1.1.2 Test purpose

1. To verify that the mobile station sets the V(S) to 0 at the beginning of each TBF.
2. To verify that the mobile station increases the V(S) by 1 after transmission of the RLC data block with BSN set to V(S).
3. To verify that the mobile station wraps the V(S) to 0 after 2047.

53.1.1.1.3 Method of test

Initial Conditions

System Simulator:

1 cell with EGPRS support, default setting, PBCCH not present.

Mobile Station:

The MS is EGPRS updated with a P-TMSI allocated, SPLIT PG CYCLE negotiated and the test PDP context2 activated.

Specific PICS Statements

-

PIXIT Statements

-

Test Procedure

The EGPRS capable MS is made to transmit uplink RLC data blocks in EGPRS TBF RLC acknowledged mode. The EGPRS Channel Coding Command IE indicates MCS-1 in the Packet Uplink Assignment message.

The SS checks that the BSN in the received RLC data blocks obeys the following rule:

1. BSN is set to the value 0 at the beginning of each TBF in which the mobile station is the transmitter;
2. BSN is incremented by 1 in each subsequent RLC data block in the TBF;
3. BSN takes on all values in the range 0 to 2047 and then back to 0.

Maximum Duration of Test

30 minutes.

Expected Sequence

Step	Direction	Message	Comments
1		{Uplink dynamic allocation two phase access}	N = 50, 000 octets USF_GRANULARITY = 1 block EGPRS Channel Coding Command: MCS-1
2	SS -> MS	PACKET DOWNLINK DUMMY CONTROL BLOCK	Sent on the PACCH of the PDCH assigned, containing USF assigned to the MS.
3	MS -> SS	EGPRS UPLINK RLC DATA BLOCK	Received on the assigned PDTCH SS verifies that the BSN starts from 0, and the correct MCS is used.
4	SS -> MS	PACKET UPLINK ACK/NACK	SS acknowledges each RLC data block with RB set to 1, USF assigned to the MS
5	MS -> SS	EGPRS UPLINK RLC DATA BLOCK	Received on the assigned PDTCH SS verifies that the BSN is updated according to $BSN(n) = (BSN(n-1) + 1) \text{ mod } 2048$.
6	-		Repeat steps 4 and 5 at least 2048 times
7		{Completion of uplink RLC data block transfer}	

53.1.1.2 Acknowledged Mode/ Uplink TBF/ Acknowledge State Variable V(A)

53.1.1.2.1 Conformance requirements

1. The Acknowledge state variable V(A) contains the BSN value of the oldest RLC data block that has not been positively acknowledged by its peer. V(A) can take on the values 0 through 2047.
2. V(A) shall be set to the value 0 at the beginning of each TBF in which the RLC endpoint is the transmitter.
3. The value of V(A) shall be updated from the values received from its peer in the received block bitmap (RB) of the Packet Ack/Nack message.

References

3GPP TS 04.60, subclauses 9.1.2 and 9.1.8.

53.1.1.2.2 Test purpose

1. To verify that the mobile station correctly decodes the RB and updates the values of V(A).

53.1.1.2.3 Method of test

Initial Conditions

System Simulator:

1 cell with EGPRS support, default setting, PBCCH not present.

Mobile Station:

The MS is EGPRS updated with a P-TMSI allocated, SPLIT PG CYCLE negotiated and the test PDP context2 activated.

Specific PICS Statements

-

PIXIT Statements

-

Test Procedure

The EGPRS capable MS is made to transmit uplink RLC data blocks in EGPRS TBF RLC acknowledged mode. The EGPRS Windows Size IE in the Packet Uplink Assignment message indicates the value in accordance with the number of timeslots allocated.

The MS transmits WS (window size) blocks without acknowledgement from the SS. The SS then acknowledges the first N blocks and verifies that the MS shall transmit N more RLC data blocks.

The test procedure is performed for the values of N = 10, 15 and 20.

Maximum Duration of Test

30 minutes.

Expected Sequence

Step	Direction	Message	Comments
1		{Uplink dynamic allocation two phase access}	Totally 3, 000 octets USF GRANULARITY = 1 block EGPRS Channel Coding Command: MCS-1
2	SS -> MS	PACKET DOWNLINK DUMMY CONTROL BLOCK	Sent on the PACCH of the PDCH assigned, containing USF assigned to the MS.
3	MS -> SS	EGPRS UPLINK RLC DATA BLOCK	Received on the assigned PDTCH. SS verifies that the BSN starts from 0, and the correct MCS is used.
4	-		Repeat steps 2 and 3 until the still indication bit is set in the data block received in step 3.(on the retransmission of block with BSN=0). The SS does not acknowledge any of the data blocks with BSN from 0 to WS-1.
5	SS -> MS	PACKET DOWNLINK DUMMY CONTROL BLOCK	Sent on the PACCH of the PDCH assigned, containing USF assigned to the MS.
6	MS -> SS	EGPRS UPLINK RLC DATA BLOCK	Received on the assigned PDTCH. SS verifies that the BSN starts from 1, and the correct MCS is used.
7	-		Repeat steps 5 and 6 until unacknowledged data blocks (BSN = 0 ... 31) are retransmitted with SI field set to 1.
8	-		Wait for BS_CV_MAX block periods before sending next message.
9	SS -> MS	PACKET UPLINK ACK/NACK	SS acknowledges first N (=10) RLC data blocks with RB set to 1 and negatively acknowledges the rest with RB set to 0. USF not assigned to the MS.
10	-		Wait for 6 blocks with no USF
11	SS -> MS	PACKET DOWNLINK DUMMY CONTROL BLOCK	Sent on the PACCH of the PDCH assigned, containing USF assigned to the MS.
A12 (optional step)	MS -> SS	EGPRS UPLINK RLC DATA BLOCK	MS may retransmit block BSN = 32 if it has already been scheduled while Packet Uplink Ack/Nack is being processed.
A13 (optional step)	SS->MS	PACKET DOWNLINK DUMMY CONTROL BLOCK	Sent on the PACCH of the PDCH assigned, USF assigned to the MS.
12	MS -> SS	EGPRS UPLINK RLC DATA BLOCK	Received on the assigned PDTCH BSN = N, SI = 0
13	SS -> MS	PACKET DOWNLINK DUMMY CONTROL BLOCK	Sent on the PACCH of the PDCH assigned, containing USF assigned to the MS.
14	MS -> SS	EGPRS UPLINK RLC DATA BLOCK	Received on the assigned PDTCH BSN = N+1, SI = 0
15	-		Repeat steps 13 and 14 until all negatively acknowledged data blocks are retransmitted followed by new data blocks. The SS verifies that the negatively acknowledged data blocks are retransmitted before new data blocks are sent. The SS verifies that the RLC data block with BSN = N is received following the reception of the data block with BSN = WS-1 +N The SS verifies that the SI field is set on the retransmitted block with BSN=N
16		{Completion of uplink RLC data block transfer }	
17	-		The above test procedure is repeated for different values of N

53.1.1.3 Acknowledged Mode/ Uplink TBF/ Window Size/ Default Value

53.1.1.3.1 Conformance requirements

1. In case a PACKET TIMESLOT RECONFIGURE is sent to the MS without any window size for a specific TBF, then any previous value received for the specific TBF shall be used or, if no previous value has been received for the specific TBF, default window size shall be used.

References

3GPP TS 04.60, subclause 9.1.9.2.

53.1.1.3.2 Test purpose

1. To verify that when a PACKET TIMESLOT RECONFIGURE is sent to the MS without any window size indication, the previous value received for the specific TBF shall be used if there's any.

53.1.1.3.3 Method of test

Initial Conditions

System Simulator:

1 cell with EGPRS support, default setting, PBCCH not present.

Mobile Station:

The MS is EGPRS updated with a P-TMSI allocated, SPLIT PG CYCLE negotiated and the test PDP context2 activated.

Specific PICS Statements

- EGPRS Multislotclass (TSPC_Type_EGPRS_Multislot_ClassX where X = 1..45)

PIXIT Statements

-

Test Procedure

The MS is made to establish an uplink EGPRS TBF to transmit RLC data blocks. EGPRS Window size is commanded to be WS=96.

The SS sends a PACKET UPLINK ACK/NACK message and set pre-emptive bit to be '1'.

The SS observes the BSN sequence to be 0, 1, 2, ..., WS-1, 0, ...

SS acknowledges all the data blocks from BSN=0 till BSN=WS-1.

The SS sends a PACKET TIMESLOT RECONFIGURE message and does not include an Uplink Egprs Window Size field.

The SS verifies that the BSN sequence WS, WS+1, WS+2.....2*WS-1, WS, WS+1....is observed.

Maximum Duration of Test

30 minutes.

Expected Sequence

Step	Direction	Message	Comments
1		{Uplink dynamic allocation two phase access}	N = 22*220 octets USF GRANULARITY = 1 block EGPRS Channel Coding Command: MCS-1 EGPRS Window Size: 96
2	SS -> MS	PACKET DOWNLINK DUMMY CONTROL BLOCK	Sent on the PACCH of the PDCH assigned, containing USF assigned to the MS.
3	MS -> SS	EGPRS UPLINK RLC DATA BLOCK	Received on the assigned PDTCH SS verifies that BSN=0.
4	SS -> MS	PACKET UPLINK ACK/NACK	Wait for BS_CV_MAX block periods before sending this message. SS negatively acknowledges the received RLC data block. Pre-emptive Bit: '1'B
5			Wait for 6 blocks with no USF
6	SS -> MS	PACKET DOWNLINK DUMMY CONTROL BLOCK	Sent on the PACCH of the PDCH assigned, containing USF assigned to the MS.
A7 Optiona Step	MS->SS	EGPRS UPLINK RLC DATA BLOCK	MS may transmit new data block if it has already been scheduled while Packet Uplink Ack/Nack is being processed.
B7 Optiona Step	SS->MS	PACKET DOWNLINK DUMMY CONTROL BLOCK	Sent on the PACCH of the PDCH assigned, containing USF assigned to the MS.
7	MS -> SS	EGPRS UPLINK RLC DATA BLOCK	Received on the assigned PDTCH (BSN=0)
8	SS	-	Repeat steps 6 and 7 more than 96 times. The SS observes that the sequence of BSN in the following RLC data blocks is: If A7 was not performed 1, 2, ..., 95, 0, ... If A7 was performed : 2,3,...,95,0,1, ...
9	SS -> MS	PACKET UPLINK ACK/NACK	Wait for BS_CV_MAX block periods before sending this message. SS positively acknowledges all the RLC Data Blocks. Pre-emptive Bit: '1'B USF not assigned to MS.
10	SS -> MS	PACKET TIMESLOT RECONFIGURE	Without EGPRS Window Size IE. Establishing a DL TBF Change UL TFI and Coding scheme. See specific message contents.
11	SS -> MS	EGPRS DOWNLINK RLC DATA BLOCK	Sent on the PDTCH of the PDCH assigned, containing USF assigned to the MS.
A12 Optiona Step	MS->SS	EGPRS UPLINK RLC DATA BLOCK	MS may retransmit data block that was pending for acknowledgment if it has already been scheduled while Packet Uplink Ack/Nack is being processed.
B12 Optiona Step	SS->MS	EGPRS DOWNLINK RLC DATA BLOCK	Sent on the PACCH of the PDCH assigned, containing USF assigned to the MS.
12	MS -> SS	EGPRS UPLINK RLC DATA BLOCK	Received on the assigned PDTCH
13	SS	-	Repeat steps 11 and 12 more than 96 times. The SS verifies that BSN sequence of the received RLC data blocks is: If A12 was not performed: 96, 97, 98....191, 96, 97, If A12 was performed: number of the next block in sequence sent after the last block in step 8, 96, 97, 98....191. 96, 97
14	SS -> MS	PACKET UPLINK ACK/NACK	SS positively acknowledges all the RLC Data Blocks. USF not assigned to MS.

15		{Completion of uplink RLC data block transfer} {Completion of downlink RLC data block transfer}
----	--	--

Specific Message contents

PACKET TIMESLOT RECONFIGURE in Step 10

MESSAGE_TYPE PAGE_MODE GLOBAL_TFI COMPACT reduced MA EGPRS Channel Coding Command <RESEGMENT 0 1 <DOWNLINK EGPRS Window Size > DOWNLINK EGPRS Window Size 0 1 <UPLINK EGPRS Window Size> LINK_QUALITY_MEASUREMENT_MODE Packet Timing Advance { 0 1< TIMING_ADVANCE_VALUE > - TIMING_ADVANCE_VALUE } { 0 1< TIMING_ADVANCE_INDEX > <TIMING_ADVANCE_TIMESLOT_NUMBER > } 0 1 <Packet Extended Timing Advance DOWNLINK_RLC_MODE CONTROL_ACK {0 1<DOWNLINK_TFI_ASSIGNMENT>} - DOWNLINK_TFI_ASSIGNMENT {0 1< UPLINK_TFI_ASSIGNMENT > - UPLINK_TFI_ASSIGNMENT } DOWNLINK_TIMESLOT_ALLOCATION {0 1<Frequency Parameters>} { 01 < Dynamic Allocation > < Extended Dynamic Allocation > 0 1< P0 > < USF_GRANULARITY > {0 1< RLC_DATA_BLOCKS_GRANTED >} {0 1< TBF_STARTING_TIME >} {0 1< Timeslot Allocation > {0 1< USF_TN0>} {0 1< USF_TN1>} {0 1< USF_TN2>} {0 1< USF_TN3>} {0 1< USF_TN4>} - USF_TN4 {0 1< USF_TN5>} {0 1< USF_TN6>} {0 1< USF_TN7>}}	0 00111 00 Normal Paging UL_TFI assigned in Step 1 0 (Not present) 0001 (MCS-2) 1 1 (Present) 192 0 (Not present) 00 1 (timing advance value) 30 bit periods 0 (no timing advance index) 0 (Extended TA for GSM 400 not present) 0 Acknowledged mode 0 1 (assign downlink TFI) 00001(Binary) 1 (uplink TFI assignment) Different from the TFI assigned in Step 1 Same as UL Timeslot used (Default TN 4) 0 (Frequency Parameters not present) Dynamic Allocation struct : 0 (Dynamic allocation) 0 0 (one block) 0 (no RLC_DATA_BLOCKS_GRANTED, open-ended TBF) 0 (no starting time) 0 (Timeslot Allocation) 0 (timeslot 0 not assigned) 0 (timeslot 1 not assigned) 0 (timeslot 2 not assigned) 0 (timeslot 3 not assigned) 1 (timeslot 4 assigned) arbitrarily chosen (default 000) 0 (timeslot 5 not assigned) 0 (timeslot 6 not assigned) 0 (timeslot 7 not assigned)
---	--

53.1.1.4 Acknowledged Mode/ Uplink TBF/ Window Size/ Assigned Value

53.1.1.4.1 Conformance requirements

1. For EGPRS the window size (WS) shall be set by the network according to the number of timeslots allocated in the direction of the TBF (uplink or downlink). MS shall support the maximum window size corresponding to its multi timeslot capability.
2. The selected WS shall be indicated within PACKET UPLINK/DOWNLINK ASSIGNMENT and PACKET TIMESLOT RECONFIGURE.
3. Once a window size is selected for a given MS, it may be changed to a larger size but not to a smaller size, in order to prevent dropping data blocks from the window.

References

3GPP TS 04.60, subclause 9.1.9.2.

53.1.1.4.2 Test purpose

1. To verify that the MS correctly recognise the window size indicated in Packet Uplink Assignment messages.
2. To verify that the MS operates correctly according to the window size indicated in PACKET TIMESLOT RECONFIGURE messages.
3. To verify that the MS supports the maximum window size corresponding to its multi timeslot capability.

53.1.1.4.3 Method of test

Initial Conditions

System Simulator:

1 cell with EGPRS support, default setting, PBCCH not present.

Mobile Station:

The MS is EGPRS updated with a P-TMSI allocated, SPLIT PG CYCLE negotiated and the test PDP context2 activated.

Specific PICS Statements

- EGPRS Multislotclass (TSPC_Type_EGPRS_Multislot_ClassX where X = 1..45)

PIXIT Statements

-

Test Procedure

The MS is made to transmit uplink RLC data blocks in an acknowledged mode uplink EGPRS TBF to transmit an enough number of uplink RLC data blocks. In the PACKET UPLINK ASSIGNMENT message WS is commanded to be 64.

The SS assigns resources for the mobile station to transmit data blocks for WS1+1 times. Each time a radio block is assigned.

The SS observes the BSN and Stall Indicator values of the uplink RLC data blocks, SS verifies that BSN goes back to 0 after the block with BSN=63 is transmitted. SS also verifies that SI bit is set in the retransmitted block with BSN=0,1,2,.....

The SS sends a in PACKET UPLINK ASSIGNMENT message and commands WS to be96.

The SS assigns resources for the mobile station to transmit data blocks for 35 times. Each time a radio block is assigned.

The SS observes the BSN and Stall Indicator values of the uplink RLC data blocks, and verifies that BSN=64, 65, ..., 95 blocks are received, after which BSN goes back to 0 and SI is set for retransmitted block with BSN=0.

Maximum Duration of Test

5 minutes.

Expected Sequence

Step	Direction	Message	Comments
1		{Uplink dynamic allocation two phase access}	n = 2200 octets, USF GRANULARITY = 1 block EGPRS Channel Coding Command: MCS-1 EGPRS Window Size: 64. (Suppose MS multislot capability is 1)
2	SS -> MS	PACKET DOWNLINK DUMMY CONTROL BLOCK	Sent on the PACCH of the PDCH assigned, containing USF assigned to the MS.
3	MS -> SS	EGPRS UPLINK RLC DATA BLOCK	Received on the assigned PDTCH. Verify that BSN = 0
4	SS -> MS	PACKET UPLINK ACK/NACK	Wait for BS_CV_MAX block periods before sending this message. SS negatively acknowledges the received RLC data block. Pre-emptive Bit: '1'B USF not assigned to the MS.
5	SS -> MS	PACKET DOWNLINK DUMMY CONTROL BLOCK	Sent on the PACCH of the PDCH assigned, containing USF assigned to the MS.
5a optional	MS -> SS	EGPRS UPLINK RLC DATA BLOCK	Received on the assigned PDTCH MS may transmit BSN=1 if already buffered
5b optional	SS -> MS	PACKET DOWNLINK DUMMY CONTROL BLOCK	(If BSN=1 was retransmitted in step 5a) Sent on the PACCH of the PDCH assigned, containing USF assigned to the MS.
6	MS -> SS	EGPRS UPLINK RLC DATA BLOCK	Received on the assigned PDTCH
7	SS		Repeat steps 5 and 6 for 70 times. Verify that stall indicator is set for the retransmission of data block with BSN=0 Verify that the BSN sequence is If 5a is done: 0,2,3,...,63,0,1 If not: 0,1,2,...,63,0,1,...
8	SS -> MS	PACKET UPLINK ASSIGNMENT	Sent on the PACCH of the PDCH assigned. Window Size = 96.
9	SS -> MS	PACKET DOWNLINK DUMMY CONTROL BLOCK	Sent on the PACCH of the PDCH assigned on the third block after the PACKET UPLINK ASSIGNMENT of step 8, containing USF assigned to the MS.
9a optional	MS -> SS	EGPRS UPLINK RLC DATA BLOCK	Received on the assigned PDTCH If optional step 5a was received MS may transmit BSN=8 if already buffered If optional step 5a was not received MS may transmit BSN=7 if already buffered
9b optional	SS -> MS	PACKET DOWNLINK DUMMY CONTROL BLOCK	(If BSN=8 or BSN=7 was retransmitted in step 9a) Sent on the PACCH of the PDCH assigned, containing USF assigned to the MS.
10	MS -> SS	EGPRS UPLINK RLC DATA BLOCK	Received on the assigned PDTCH
11	SS	-	Repeat steps 9 and 10 for 35 times. Verify that stall indicator is not set in the received blocks. Verify that stall indicator is set in the next block after BSN=95 block is received. Verify that the BSN sequence is 64, 65, ..., 95, 0, 1, ...OR 64,65,...95.. N, N+1, ... where N is the next BSN not yet received in the end of step 7 or step 9a.
12		{Completion of uplink RLC data block transfer}	

Note: The SS shall schedule USF's often enough in step 11 to prevent T3182 from expiring.

53.1.1.5 Acknowledged mode/ Uplink TBF/ Invalid Negative Acknowledgement

53.1.1.5.1 Conformance requirements

1. The mobile station shall not modify the element in the acknowledge state array, V(B), corresponding to an RLC data block that cannot be validly negatively acknowledged (subclause 9.1.8 3GPP TS 04.60).

References

3GPP TS 04.60, subclauses 9.1.3 and 9.1.8.

53.1.1.5.2 Test purpose

1. To verify the correct response of the mobile station to an invalid negative acknowledgement.

53.1.1.5.3 Method of test

Initial Conditions

System Simulator:

1 cell with EGPRS support, default setting, PBCCH not present, BS_CV_MAX = 15.

Mobile Station:

The MS is EGPRS updated with a P-TMSI allocated, SPLIT PG CYCLE negotiated and the test PDP context2 activated.

Specific PICS Statements

-

PIXIT Statements

-

Test Procedure

The EGPRS capable MS is made to transmit uplink RLC data blocks in EGPRS TBF RLC acknowledged mode.

The SS negatively acknowledges some RLC data blocks within BS_CV_MAX block periods.

The MS shall not retransmit the RLC data blocks that were negatively acknowledged.

Maximum Duration of Test

5 minutes.

Expected Sequence

Step	Direction	Message	Comments
1		{Uplink dynamic allocation two phase access}	n = 200 octets USF GRANULARITY = 1 block EGPRS Channel Coding Command: MCS-1
2	SS -> MS	PACKET DOWNLINK DUMMY CONTROL BLOCK	Sent on the PACCH of the PDCH assigned, containing USF assigned to the MS.
3	MS -> SS	EGPRS UPLINK RLC DATA BLOCK	Received on the assigned PDTCH. SS verifies that the BSN starts from 0, and the correct MCS is used.
4	-		Repeat steps 2 and 3 until received RLC data blocks BSN = 3
5	-		Wait until BS_CV_MAX block periods has elapsed from transmission of BSN 0.
6	SS -> MS	PACKET UPLINK ACK/NACK	SS negatively acknowledges data blocks BSN = 0 and BSN = 3 with RB set to 0 and acknowledges data blocks BSN = 1 and BSN = 2 with RB set to 1. USF not assigned to the MS.
7	-		Wait for 6 blocks with no USF
8	SS->MS	PACKET DOWNLINK DUMMY CONTROL BLOCK	Sent on the PACCH of the PDCH assigned, containing USF assigned to the MS.
A8 Optiona l Step	MS->SS	EGPRS UPLINK RLC DATA BLOCK	MS may transmit new data block if it has already been scheduled while Packet Uplink Ack/Nack is being processed.
B8 Optiona l Step	SS -> MS	PACKET DOWNLINK DUMMY CONTROL BLOCK	Sent on the PACCH of the PDCH assigned, containing USF assigned to the MS.
9	MS -> SS	EGPRS UPLINK RLC DATA BLOCK	Received on the assigned PDTCH The SS verifies that data block BSN = 0 is retransmitted.
10	SS -> MS	PACKET DOWNLINK DUMMY CONTROL BLOCK	Sent on the PACCH of the PDCH assigned, containing USF assigned to the MS.
11	MS -> SS	EGPRS UPLINK RLC DATA BLOCK	Received on the assigned PDTCH The SS verifies that data block BSN = 3 is not retransmitted
12		{Completion of uplink RLC data block transfer}	

53.1.1.6 Acknowledged Mode/ Uplink TBF/ Countdown Value

53.1.1.6.1 Conformance requirements

1. The mobile station shall send the Countdown Value (CV) in each uplink RLC data block to indicate to the network the absolute BSN (BSN') of the last RLC data block that will be sent in the uplink TBF.
2. When a radio block for EGPRS data transfer consists of two RLC data blocks, the CV value of the RLC/MAC header refers to the second RLC data block.

References

3GPP TS 04.60, subclause 9.3.1.

53.1.1.6.2 Test purpose

1. To verify that when a radio block for EGPRS data transfer consists of two RLC data blocks, the CV value is calculated based on BSN of the second RLC data block.

53.1.1.6.3 Method of test

Initial Conditions

System Simulator:

1 cell with EGPRS support, default setting, PBCCH not present, BS_CV_MAX = 15.

Mobile Station:

The MS is EGPRS updated with a P-TMSI allocated, SPLIT PG CYCLE negotiated and the test PDP context2 activated.

Specific PICS Statements

-

PIXIT Statements

-

Test Procedure

The MS is made to transmit uplink RLC data blocks in an acknowledged mode uplink EGPRS TBF to transmit N octets to calculate TBC value. Uplink RLC data block transfer is completed.

The MS is made to transmit uplink RLC data blocks in an acknowledged mode uplink EGPRS TBF to transmit TBC uplink RLC data blocks. EGPRS Channel Coding Command is MCS-7. N is less than Window Size.

The SS assigns resources for the mobile station to transmit data blocks. Each time one radio block is assigned.

The SS observes the CV value in the uplink blocks. BSN' = Absolute BSN of the second RLC data block is calculated upon each radio block is received.

The SS verifies that when $x = \text{round}((TBC - BSN' - 1) / NTS * 2)$ is greater than BS_CV_MAX , CV equals to 15, otherwise, $CV = x$.

MCS-8 and MCS-9 shall be applied.

Maximum Duration of Test

30 minutes.

Expected Sequence

Step	Direction	Message	Comments
1		{Uplink dynamic allocation two phase access}	N = 56*60 octets USF_GRANULARITY = 1 block EGPRS Channel Coding Command: MCS-7 (Suppose timeslot capability is 1)
2	SS -> MS	PACKET DOWNLINK DUMMY CONTROL BLOCK	Sent on the PACCH of the PDCH assigned, containing USF assigned to the MS.
3	MS -> SS	EGPRS UPLINK RLC DATA BLOCK	Received on the assigned PDTCH
4	SS	-	Repeat steps 2 and 3 until CV=14 When CV=14, Calculate BSN' = BSN of the second RLC block, Calculate TBC= CV * NTS*K+BSN'
5		{Completion of uplink RLC data block transfer}	
6		{Uplink dynamic allocation two phase access}	N = 56*60 octets USF_GRANULARITY = 1 block EGPRS Channel Coding Command: MCS-7 (Suppose timeslot capability is 1)
7	SS -> MS	PACKET DOWNLINK DUMMY CONTROL BLOCK	Sent on the PACCH of the PDCH assigned, containing USF assigned to the MS.
8	MS -> SS	EGPRS UPLINK RLC DATA BLOCK	Received on the assigned PDTCH
9	SS	-	Repeat steps 7 and 8 for TBC/2 times. Calculate BSN' = BSN of the second RLC block. Calculate $x = \text{round}((TBC - BSN' - 1) / NTS * 2)$. Verify that when x is greater than BS_CV_MAX: CV = 15. Otherwise: CV=x
10		{Completion of uplink RLC data block transfer}	
11			Repeat the procedure from step 1 to 10 for: MCS-8, N=68*60 octets MCS-9, N=74*60 octets

53.1.1.7 Acknowledged Mode/ Uplink TBF/ Interpretation of Receive Block Bitmap

53.1.1.7.1 Conformance requirements

1. In an uplink EGPRS TBF, if a compressed Reported Bitmap is received by the mobile station, the bitmap shall first be decompressed.
2. The uncompressed bitmap shall then be treated as follows:
 - 1) Firstly, if the BOW bit is set in the Reported Bitmap, then this bitmap acknowledges all blocks between V(A) and (SSN- 2) modulo SNS, and the corresponding elements in V(B) shall be set to the value ACKED. Also a bitmap value of '0' is assumed at the bit position corresponding to (SSN-1) modulo SNS which corresponds to V(Q).
 - 2) Then, for each bit in the uncompressed bitmap whose corresponding BSN value is within the transmit window, if the bit contains the value '1', the corresponding element in V(B) indexed relative to SSN shall be set to the value ACKED. If the bit contains the value '0', the element in V(B) shall be set to the value NACKED. A bit within the uncompressed bitmap whose corresponding BSN is not within the transmit window, shall be ignored.
 - 3) If the EOW bit is set, assume a bitmap value of '0' for all RLC blocks with a BSN value higher than the last entry in the bitmap but less than V(S) (i.e. $[V(R) - 1 < BSN < V(S)]$ modulo SNS).
 - 4) If the RLC transmitter is on the mobile station side, the bit contains the value '0' and the RLC data block was recently (re)transmitted and thus can not be validly negatively acknowledged in this particular Packet Ack/Nack message, the element in V(B) shall not modified.

References

3GPP TS 04.60, subclauses 9.1.8.2.4 and 9.1.10.

53.1.1.7.2 Test purpose

1. To verify that the mobile station retransmits the blocks corresponds to the '0' bits in the uncompressed bitmap.
2. To verify that if the BOW bit is set in the Reported Bitmap, then this bitmap acknowledges all blocks between V(A) and (SSN- 2) modulo SNS.
3. To verify a bitmap value of '0' is assumed at the bit position corresponding to (SSN-1) modulo SNS.
4. To verify if the EOW bit is set, then a bitmap value of '0' is assumed for all RLC blocks with a BSN value higher than the last entry in the bitmap but less than V(S).

53.1.1.7.3 Method of test

Initial Conditions

System Simulator:

1 cell with EGPRS support, default setting, PBCCH not present.

Mobile Station:

The MS is EGPRS updated with a P-TMSI allocated, SPLIT PG CYCLE negotiated and the test PDP context2 activated.

Specific PICS Statements

-

PIXIT Statements

-

Test Procedure

The MS is made to establish an uplink EGPRS TBF to transmit N RLC data blocks.

The SS assigns resources for the mobiles station to transmit N1 (N1<N) data blocks.

The SS wait for BS_CV_MAX block periods, then sends a Packet Uplink Ack/Nack message to negatively acknowledge all the received blocks.

The SS observes the uplink packet channel. The MS shall retransmit the negatively acknowledged RLC data blocks immediately in the order of age.

The SS assigns resources for the mobile station to transmit the following blocks.

The SS wait for BS_CV_MAX block periods, then sends a Packet Uplink Ack/Nack message, the EGPRS Ack/Nack Description IE contains: SSN=N1+n1 (n1>0 and N1+n1<N), BOW=1, EOW=1, and the last entry in the RB correspond to the BSN=N-n2 block.

The SS assigns resources for the mobile station to transmit the following blocks.

The SS verifies that:

1. Blocks with BSN=N1, N1+1, ... , N1+n1-2 are not retransmitted.
2. Block with BSN=N1+n1-1 are retransmitted.
3. Blocks with BSN=N-n2+1 to N-1 are retransmitted.

Maximum Duration of Test

30 minutes.

Expected Sequence

Step	Direction	Message	Comments
1		{Uplink dynamic allocation two phase access}	n = 22*100 octets, USF GRANULARITY = 1 block EGPRS Channel Coding Command: MCS-1 EGPRS Window Size: 160.
2	SS -> MS	PACKET DOWNLINK DUMMY CONTROL BLOCK	Sent on the PACCH of the PDCH assigned, containing USF assigned to the MS.
3	MS -> SS	EGPRS UPLINK RLC DATA BLOCK	Received on the assigned PDTCH
4	SS	-	Repeat steps 2 and 3 for 5 times.
5	SS	-	Wait BS_CV_MAX periods without granting USF.
6	SS -> MS	PACKET UPLINK ACK/NACK	SS negatively acknowledges all received RLC data blocks. Pre-emptive Bit: '0'B
7	SS -> MS	PACKET DOWNLINK DUMMY CONTROL BLOCK	Sent on the PACCH of the PDCH assigned, containing USF assigned to the MS.
8	MS -> SS	EGPRS UPLINK RLC DATA BLOCK	Received on the assigned PDTCH
9	SS	-	Repeat steps 7 and 8 for 99 times.
	SS		Wait BS_CV_MAX periods without granting USF.
10	SS -> MS	PACKET UPLINK ACK/NACK	Pre-emptive Bit = '0'B. SSN = 12. BOW = 1. EOW = 1. The last entry in the RB correspond to the BSN=90 RLC data block.
11	SS -> MS	PACKET DOWNLINK DUMMY CONTROL BLOCK	Sent on the PACCH of the PDCH assigned, containing USF assigned to the MS.
12	MS -> SS	EGPRS UPLINK RLC DATA BLOCK	Received on the assigned PDTCH The MS may either resend the block with BSN=11 or send an already queued block.
13	SS	-	Repeat steps 11 and 12, and verify that 1. Blocks are not received with BSN = 0 - 10 (SSN-2). 2. Blocks are received with BSN = 11 (SSN-1). If not received in step 12 • Blocks are received with BSN = 91--99.
14		{Completion of uplink RLC data block transfer}	

53.1.1.8 Acknowledged Mode/ Uplink TBF/ Pre-emptive Transmission/ Default Mode

53.1.1.8.1 Conformance requirements

1. If $[V(S) < V(A) + WS]$ modulo SNS and no RLC data blocks have a corresponding element in V(B) with the value NACKED, the RLC data block with BSN = V(S) shall be transmitted and the corresponding element in V(B) shall be set to the value PENDING_ACK. If the transmitter is the mobile station, the pre-emptive transmission bit is set to '1' in the PACKET UPLINK ACK/NACK message and there are no further RLC data blocks available for transmission (i.e. the RLC data block with BSN= V(S) does not exist), the sending side shall transmit the oldest RLC data block whose corresponding element in V(B) has the value PENDING_ACK, then the next oldest block whose corresponding element in V(B) has the value PENDING_ACK, etc. If all RLC data blocks whose corresponding element in V(B) has the value PENDING_ACK have been transmitted once, the process shall be repeated beginning with the oldest RLC data block.
2. If the transmitter is the mobile station and the pre-emptive transmission bit is set to '0' in the PACKET UPLINK ACK/NACK message the transmitter shall not transmit the oldest RLC data block whose corresponding element in V(B) has the value PENDING_ACK (and the next continuing indefinitely). When a PACKET UPLINK ACK/NACK message is received the MS shall retransmit the RLC blocks which are set to NACKED in V(B) and new RLC data blocks as far as the transmit window (if advanced) allows.
3. The default for the mobile side is that the transmitter shall use pre-emptive transmission.

References

3GPP TS 04.60, subclauses 9.1.3.2 and 11.2.28.

53.1.1.8.2 Test purpose

1. To verify that the MS shall use pre-emptive transmission as default mode before PACKET UPLINK ACK/NACK messages are received.

53.1.1.8.3 Method of test

Initial Conditions

System Simulator:

1 cell with EGPRS support, default setting, PBCCH not present.

Mobile Station:

The MS is EGPRS updated with a P-TMSI allocated, SPLIT PG CYCLE negotiated and the test PDP context2 activated.

Specific PICS Statements

-

PIXIT Statements

-

Test Procedure

The MS is made to establish an uplink EGPRS TBF and to transmit N RLC data blocks.

1. The SS does not send any PACKET UPLINK ACK/NACK message.
2. The SS observes the uplink packet channel.
3. The MS shall retransmit the transmitted RLC data blocks in the original order after all the N data blocks are transmitted or after the transmission window is stalled.

Maximum Duration of Test

30 minutes.

Expected Sequence

Step	Direction	Message	Comments
1		{Uplink dynamic allocation two phase access}	n = 1000 octets (Chosen so that number of RLC data blocks doesn't exceed Window Size) USF_GRANULARITY = 1 block EGPRS Channel Coding Command: MCS-1 EGPRS Window Size: 64.
2	SS -> MS	PACKET DOWNLINK DUMMY CONTROL BLOCK	Sent on the PACCH of the PDCH assigned, containing USF assigned to the MS.
3	MS -> SS	EGPRS UPLINK RLC DATA BLOCK	Received on the assigned PDTCH
4	SS	-	Repeat step 2,3 until CV=0 The SS verifies that the BSN sequence in the received RLC data blocks is: 0, 1, 2, ..., till BSN_MAX (CV=0 for BSN=BSN_MAX)
5	SS	-	Repeat steps 2 and 3 The SS verifies that the BSN sequence in step 4 is repeated.
6		{Completion of uplink RLC data block transfer}	

53.1.1.9 Acknowledged Mode/ Uplink TBF/ Pre-emptive Transmission Bit Set to '1'

53.1.1.9.1 Conformance requirements

1. If $[V(S) < V(A) + WS]$ modulo SNS and no RLC data blocks have a corresponding element in V(B) with the value NACKED, the RLC data block with $BSN = V(S)$ shall be transmitted and the corresponding element in V(B) shall be set to the value PENDING_ACK.
2. If the transmitter is the mobile station, the pre-emptive transmission bit is set to '1' in the PACKET UPLINK ACK/NACK message and there are no further RLC data blocks available for transmission (i.e. the RLC data block with $BSN = V(S)$ does not exist), the sending side shall transmit the oldest RLC data block whose corresponding element in V(B) has the value PENDING_ACK, then the next oldest block whose corresponding element in V(B) has the value PENDING_ACK, etc. If all RLC data blocks whose corresponding element in V(B) has the value PENDING_ACK have been transmitted once, the process shall be repeated beginning with the oldest RLC data block.

References

3GPP TS 04.60, subclauses 9.1.3.2 and 11.2.28.

53.1.1.9.2 Test purpose

1. To verify when pre-emptive bit is set to '1' and there are no further data to be transmitted, the MS shall transmit the PENDING_ACK data blocks repeatedly.
2. To verify when pre-emptive bit is set to '1' and the transmission window is stalled, the MS shall transmit the PENDING_ACK data blocks repeatedly.

53.1.1.9.3 Method of test

Initial Conditions

System Simulator:

1 cell with EGPRS support, default setting, PBCCH not present.

Mobile Station:

The MS is EGPRS updated with a P-TMSI allocated, SPLIT PG CYCLE negotiated and the test PDP context2 activated.

Specific PICS Statements

-

PIXIT Statements

-

Test Procedure

The EGPRS capable MS is made to establish an acknowledged mode uplink EGPRS TBF using coding scheme MCS-7 and begin to transmit $N_0 + N_1$ uplink RLC data blocks where N_0 and N_1 are even integers, $N_0 + N_1 > WS$ (Window Size) and $N_0 < WS$, $N_1 < WS$.

The SS sends a PACKET UPLINK ACK/NACK message with Preemptive Bit set to '1' after several RLC data blocks are received. No RLC data block is acknowledged.

The SS verifies that the BSN sequence in the uplink RLC data blocks is: 0,1,...,WS-1.

The SS receives RLC data blocks which are set to PENDING_ACK in V(B) and verifies that the BSN sequence before is repeated.

The SS then sends a PACKET UPLINK ACK/NACK message with Preemptive Bit set to '1' All blocks with $BSN = 0$ to $N_0 - 1$ are acknowledged.

The SS verifies that the BSN sequence in the received uplink RLC data blocks is: $N_0, N_0+1, \dots, N_0+N_1-1, N_0, N_0+1, \dots$

The SS receives RLC data blocks which are set to PENDING_ACK in V(B) and verifies that the BSN sequence before is repeated.

Maximum Duration of Test

5 minutes.

Expected Sequence

Step	Direction	Message	Comments
1		{Uplink dynamic allocation two phase access}	$n = 56 \cdot (N_0 + N_1)$ octets, USF GRANULARITY = 1 block EGPRS Channel Coding Command: MCS-7 EGPRS Window Size: 64.
2	SS -> MS	PACKET DOWNLINK DUMMY CONTROL BLOCK	Sent on the PACCH of the PDCH assigned, containing USF assigned to the MS.
3	MS -> SS	EGPRS UPLINK RLC DATA BLOCK	Received on the assigned PDTCH
4	SS -> MS	PACKET UPLINK ACK/NACK	Wait for BS_CV_MAX block periods before sending this message. SS negatively acknowledges all received RLC data blocks. Pre-emptive Bit: '1'B
5	SS -> MS	PACKET DOWNLINK DUMMY CONTROL BLOCK	Sent on the PACCH of the PDCH assigned, containing USF assigned to the MS.
6	MS -> SS	EGPRS UPLINK RLC DATA BLOCK	Received on the assigned PDTCH MS may transmit BSN=2,3 if already queued. Otherwise, it transmits the negatively acknowledged block with BSN = 0,1
7	SS	-	Repeat steps 5 and 6 until Block with BSN = 63 is received. The SS verifies that the BSN sequence in the uplink RLC data blocks is: If BSN=0,1 received in step 6: 2,3 ...,63. If BSN=2,3 received in step 6: 0,1,4,5...,63.
8	SS -> MS	PACKET DOWNLINK DUMMY CONTROL BLOCK	Sent on the PACCH of the PDCH assigned, containing USF assigned to the MS.
9	MS -> SS	EGPRS UPLINK RLC DATA BLOCK	Received on the assigned PDTCH
10	SS	-	Repeat steps 8 and 9 until BSN's 0,, 63 are received. This verifies that pending ack blocks in V(B) are retransmitted repeatedly.
11	SS -> MS	PACKET UPLINK ACK/NACK	Wait for BS_CV_MAX block periods before sending this message. The SS acknowledges RLC data blocks from BSN 0 to N0-1 with RBB set to 1 and negatively acknowledges rest RLC data blocks with RBB set to 0, Pre-emptive Bit: '1'B Wait for 6 blocks with no USF
12	SS -> MS	PACKET DOWNLINK DUMMY CONTROL BLOCK	Sent on the PACCH of the PDCH assigned, containing USF assigned to the MS.
12A(opti onal)	MS -> SS	EGPRS UPLINK RLC DATA BLOCK	The MS may send blocks BSN1=0 and BSN2=1, if already buffered.Received on the assigned PDTCH
12B(opti onal)	SS -> MS	PACKET DOWNLINK DUMMY CONTROL BLOCK	Sent on the PACCH of the PDCH assigned, containing USF assigned to the MS.
13	MS -> SS	EGPRS UPLINK RLC DATA BLOCK	Received on the assigned PDTCH
14	SS	-	Repeat steps 12 & 13 until CV=0 and verify that negatively acknowledged blocks with BSN=N0, N0+1, ..., 63 are retransmitted and new blocks with BSN=64, 65, ..., till BSN_MAX (CV=0 for BSN=BSN_MAX) are transmitted.
15			Repeat steps 12 & 13 and verify that blocks which are set to pending ack in V(B) whith BSN=N0, N0+1, ..., 63, 64, 65, ..., till BSN_MAX are repeatedly retransmitted.
16		{Completion of uplink RLC data block transfer}	

53.1.1.10 Acknowledged Mode/ Uplink TBF/ Pre-emptive Transmission Bit Set to '0'/ PENDING_ACK Blocks

53.1.1.10.1 Conformance requirements

1. If the transmitter is the mobile station and the pre-emptive transmission bit is set to '0' in the PACKET UPLINK ACK/NACK message the transmitter shall not transmit the oldest RLC data block whose corresponding element in V(B) has the value PENDING_ACK (and the next continuing indefinitely). When a PACKET UPLINK ACK/NACK message is received the MS shall retransmit the RLC blocks which are set to NACKED in V(B) and new RLC data blocks as far as the transmit window (if advanced) allows.
2. However if the RLC data block is the last in the TBF it shall be retransmitted even if its state is PENDING_ACK.

References

3GPP TS 04.60, subclauses 9.1.3.2 and 11.2.28.

53.1.1.10.2 Test purpose

1. To verify that the MS shall not retransmit the PENDING_ACK blocks when pre-emptive bit is set to '0' and the block is not the last block in the TBF.
2. To verify that the MS shall retransmit the PENDING_ACK blocks when pre-emptive bit is set to '0' and the block is the last block in the TBF.

53.1.1.10.3 Method of test

Initial Conditions

System Simulator:

1 cell with EGPRS support, default setting, PBCCH not present.

Mobile Station:

The MS is EGPRS updated with a P-TMSI allocated, SPLIT PG CYCLE negotiated and the test PDP context2 activated.

Specific PICS Statements

-

PIXIT Statements

-

Test Procedure

The MS is made to transmit WS+2 uplink RLC data blocks in an acknowledged mode uplink EGPRS TBF. WS is the window size value.

1. The SS does not acknowledge any uplink RLC data block.
2. The SS sends a Packet Uplink Ack/Nack message with Preemptive Bit = 0, and no blocks are acknowledged.
3. The SS verifies that the stall indicator is set in the latest received RLC data block.
4. The SS checks that the transmitted blocks are not retransmitted.
5. The SS sends a PACKET UPLINK ACK/NACK message to acknowledge all the received data blocks. Pre-emptive Bit is set to '0'.
6. The SS checks that new blocks are transmitted once, and the last block with BSN=WS+1 is retransmitted repeatedly.

Maximum Duration of Test

30 minutes.

Expected Sequence

Step	Direction	Message	Comments
1		{Uplink dynamic allocation two phase access}	n = 2000 octets (Chosen so that number of data blocks is greater than WS and less than 2*WS) USF_GRANULARITY = 1 block EGPRS Channel Coding Command: MCS-1 EGPRS Window Size: 64.
2	SS -> MS	PACKET DOWNLINK DUMMY CONTROL BLOCK	Sent on the PACCH of the PDCH assigned, containing USF assigned to the MS.
3	MS -> SS	EGPRS UPLINK RLC DATA BLOCK	Received on the assigned PDTCH
4	SS -> MS	PACKET UPLINK ACK/NACK	Wait for BS_CV_MAX block periods before sending this message. SS negatively acknowledges the received RLC data block (BSN=0). Pre-emptive Bit: '0'B SSN=1, no bitmap.
5	SS	-	Repeat steps 2 and 3 until block with BSN=63 (WS-1) is received.
6	SS -> MS	PACKET DOWNLINK DUMMY CONTROL BLOCK	Sent on the PACCH of the PDCH assigned, containing USF assigned to the MS.
7	MS -> SS	PACKET UPLINK DUMMY CONTROL BLOCK	
8	SS -> MS	PACKET UPLINK ACK/NACK	The SS acknowledges all RLC data blocks. USF not assigned to the MS. Pre-emptive Bit: '0'B
9	SS -> MS	PACKET DOWNLINK DUMMY CONTROL BLOCK	Sent on the PACCH of the PDCH assigned, containing USF assigned to the MS.
A10 (optional step)	MS -> SS	PACKET UPLINK DUMMY CONTROL BLOCK	MS may transmit PACKET UPLINK DUMMY CONTROL BLOCK if it has already been scheduled while Packet Uplink Ack/Nack is being processed.
B10 (optional step)	SS -> MS	PACKET DOWNLINK DUMMY CONTROL BLOCK	USF assigned to the MS,
10	MS -> SS	EGPRS UPLINK RLC DATA BLOCK	Received on the assigned PDTCH
11	SS	-	Repeat steps 9 and 10 until CV=0 and verify that BSN_MAX are transmitted and BSN value increase sequentially. CV = 0 for BSN = BSN_MAX. Optional steps A10 and B10 are not permitted in the repeated loop.
12	SS -> MS	PACKET DOWNLINK DUMMY CONTROL BLOCK	Sent on the PACCH of the PDCH assigned, containing USF assigned to the MS.
13	MS -> SS	EGPRS UPLINK RLC DATA BLOCK	Received on the assigned PDTCH Verify that the data block with BSN=BSN_MAX sent with CV=0 is retransmitted
14	SS	-	Repeat steps 12 and 13 several times The SS verifies that the received RLC data blocks have the same BSN as in Step 13.
15		{Completion of uplink RLC data block transfer}	

53.1.1.11 Acknowledged Mode/ Uplink TBF/ Pre-emptive Transmission Bit Set to '0'/ Negative Acknowledgement

53.1.1.11.1 Conformance requirements

1. If the transmitter is the mobile station and the pre-emptive transmission bit is set to '0' in the PACKET UPLINK ACK/NACK message the transmitter shall not transmit the oldest RLC data block whose corresponding element

in V(B) has the value PENDING_ACK (and the next continuing indefinitely). When a PACKET UPLINK ACK/NACK message is received the MS shall retransmit the RLC blocks which are set to NACKED in V(B) and new RLC data blocks as far as the transmit window (if advanced) allows.

2. If a compressed reported bitmap is received, the bitmap shall first be decompressed according to Subclause 9.1.10. The uncompressed bitmap shall then be treated as follows:
3. Firstly, if the BOW bit is set in the Reported Bitmap, then this bitmap acknowledges all blocks between V(A) and (SSN- 2) modulo SNS, and the corresponding elements in V(B) shall be set to the value ACKED. Also a bitmap value of '0' is assumed at the bit position corresponding to (SSN-1) modulo SNS which corresponds to V(Q).
4. Then, for each bit in the uncompressed bitmap whose corresponding BSN value is within the transmit window, if the bit contains the value '1', the corresponding element in V(B) indexed relative to SSN shall be set to the value ACKED. If the bit contains the value '0', the element in V(B) shall be set to the value NACKED. A bit within the uncompressed bitmap whose corresponding BSN is not within the transmit window, shall be ignored. If the EOW bit is set, assume a bitmap value of '0' for all RLC blocks with a BSN value higher than the last entry in the bitmap but less than V(S) (i.e. $[V(R) - 1 < BSN < V(S)]$ modulo SNS). If the RLC transmitter is on the mobile station side, the bit contains the value '0' and the RLC data block was recently (re)transmitted and thus can not be validly negatively acknowledged in this particular Packet Ack/Nack message, the element in V(B) shall not be modified. Similarly, if the RLC transmitter is on the network side and the RLC data block cannot be validly negatively acknowledged in this particular Packet Ack/Nack message the element in V(B) shall not be modified.

References

3GPP TS 04.60, subclauses 9.1.3.2, 9.1.8.2.4 and 11.2.28.

53.1.1.11.2 Test purpose

1. To verify that the MS shall transmit the NACKED blocks when pre-emptive bit is set to '0'.

53.1.1.11.3 Method of test

Initial Conditions

System Simulator:

1 cell with EGPRS support, default setting, PBCCH not present.

Mobile Station:

The MS is EGPRS updated with a P-TMSI allocated, SPLIT PG CYCLE negotiated and the test PDP context2 activated.

Specific PICS Statements

-

PIXIT Statements

-

Test Procedure

The MS is made to transmit N uplink RLC data blocks in an acknowledged mode uplink EGPRS TBF. Number N is greater than the window size.

1. The SS receives uplink RLC data blocks with BSN=0, 1, 2, 3.....63.
3. The SS wait for BS_CV_MAX block periods.
4. The SS transmits a PACKET UPLINK ACK/NACK message to acknowledge blocks 0,1,2, and 3 and negatively acknowledge all the other received data blocks, Pre-emptive Bit is set to '0'B in the message.

5. The SS checks that BSN=4 block is retransmitted immediately. The MS may send a new EGPRS Data block which might have been queued in the transmit buffer before sending the Datablock with BSN=4

Maximum Duration of Test

30 minutes.

Expected Sequence

Step	Direction	Message	Comments
1		{Uplink dynamic allocation two phase access}	N = 22*74 octets, USF GRANULARITY = 1 block EGPRS Channel Coding Command: MCS-1 EGPRS Window Size: 64
2	SS -> MS	PACKET DOWNLINK DUMMY CONTROL BLOCK	Sent on the PACCH of the PDCH assigned, containing USF assigned to the MS.
3	MS -> SS	EGPRS UPLINK RLC DATA BLOCK	Received on the assigned PDTCH
4	SS	-	Repeat steps 2 and 3 until stall indicator is set in the received data block. SS verifies that RLC data blocks BSN=0, 1, 2, 3...63, 0 are received.
5	SS	-	Wait for BS_CV_MAX block periods after the last received RLC data block.
6	SS -> MS	PACKET UPLINK ACK/NACK	SS acknowledges the RLC data blocks BSN=0..3 with RB set to 1 and negatively acknowledges the rest with RB set to 0. USF not assigned to the MS. Pre-emptive Bit: '0'B.
7			Wait for 6 blocks with no USF
8	SS -> MS	PACKET DOWNLINK DUMMY CONTROL BLOCK	Sent on the PACCH of the PDCH assigned, containing USF assigned to the MS.
8A (optional)	MS -> SS	EGPRS UPLINK RLC DATA BLOCK	The MS may send a Data Block with BSN=1 if already buffered
8B (optional)	SS -> MS	PACKET DOWNLINK DUMMY CONTROL BLOCK	Sent on the PACCH of the PDCH assigned, containing USF assigned to the MS.
9	MS -> SS	EGPRS UPLINK RLC DATA BLOCK	Received on the assigned PDTCH The SS verifies that received RLC data block BSN = 4.
10			Repeat Steps 8 and 9. Verify that all the Nacked blocks from BSN 4 to BSN 63 are sent once and new blocks with BSN 64 till BSN 67 are sent once. Also verify that no further data blocks are sent by the mobile in response to PACKET DOWNLINK DUMMY CONTROL BLOCKS. Note: The MS may transmit a PACKET UPLINK DUMMY CONTROL BLOCK after the last EGPRS RLC DATA BLOCK (i.e. BSN=67).
11	SS -> MS	PACKET UPLINK ACK/NACK	Wait for BS_CV_MAX block periods before sending this message. SS acknowledges all received RLC data blocks. USF assigned to the MS.
11A (optional step)	MS -> SS	PACKET UPLINK DUMMY CONTROL BLOCK	MS may transmit PACKET UPLINK DUMMY CONTROL BLOCK if it has already been scheduled while Packet Uplink Ack/Nack is being processed.
11B (conditional step)	SS -> MS	PACKET DOWNLINK DUMMY CONTROL BLOCK	(If optional step 11A was received) USF assigned to the MS.
12	MS -> SS	EGPRS UPLINK RLC DATA BLOCK	Received on the assigned PDTCH.
13		{Completion of uplink RLC data block transfer}	

53.1.1.12 Acknowledged Mode/ Uplink TBF/ Retransmission/ Split RLC Data Block

53.1.1.12.1 Conformance requirements

1. In RLC acknowledged mode, each RLC endpoint transmitter shall have an associated acknowledge state array (V(B)).
2. The transmitter shall transmit the oldest RLC data block whose corresponding element in V(B) indexed relative to V(A) has the value NACKED. As each RLC data block is transmitted the corresponding element in V(B) is set to the value PENDING_ACK.
3. Depending on the modulation and coding scheme, one or two RLC data blocks are contained in one RLC/MAC block. For MCS-7, MCS-8, MCS-9 there are two RLC data blocks in one RLC/MAC block.
4. A re-segment bit is included within each PACKET UPLINK ACK/NACK, PACKET UPLINK ASSIGNMENT and PACKET TIMESLOT RECONFIGURE message. For initial transmissions of new RLC blocks the channel coding commanded is applied. The re-segment bit is used to set the ARQ mode to type I or type II (incremental redundancy) for uplink TBFs.
5. For retransmissions, setting the re-segment bit to 1 (type I ARQ) requires the mobile station to use an MCS within the same family as the initial transmission and the payload may be split.
6. If the RLC data block to be transmitted is split over two radio blocks, both radio blocks shall be transmitted
7. RLC data blocks initially transmitted with MCS4, MCS-5, MCS-6, MCS-7, MCS-8 or MCS-9, can optionally be retransmitted with MCS-1, MCS-2 and MCS-3 respectively, using two radio blocks. In this case, the split block field in the header shall be set to indicate that the RLC data block is split, and the order of the two parts.

References

3GPP TS 04.60, subclauses 9.1.8, 9.1.3.2, 9.3.2.1, 10.0a.2, 10.3a.4 and 10.4.8b.

3GPP TS 04.04.

3GPP TS 05.03.

53.1.1.12.2 Test purpose

1. To verify that if the RLC data block to be transmitted is split over two radio blocks, both radio blocks shall be transmitted.
2. To verify the correct setting of the Split Block field in the block header.
3. To verify that the order of the retransmitted two parts of the data block is correct.

53.1.1.12.3 Method of test

Initial Conditions

System Simulator:

1 cell with EGPRS support, default setting, PBCCH not present.

Mobile Station:

The MS is EGPRS updated with a P-TMSI allocated, SPLIT PG CYCLE negotiated and the test PDP context2 activated.

Specific PICS Statements

-

PIXIT Statements

-

Test Procedure

The EGPRS capable MS is made to transmit uplink RLC data blocks in EGPRS TBF RLC acknowledged mode. The EGPRS Channel Coding Command IE indicates MCS-4 in the Packet Uplink Assignment message.

After BS_CV_MAX block periods the SS sends a Packet Uplink Ack/Nack message to negatively acknowledge some RLC data blocks. In the message EGPRS Channel Coding Command IE is set to MCS-1 and Re-segment IE should be set to '1'B.

The MS shall retransmit the NACKED RLC data blocks using MSC-1 in splitted radio blocks. Observe the uplink RLC data block header. Both of split blocks shall be received, the first one shall contain a SPB field equals to '10'B while the second shall be '11'B.

Maximum Duration of Test

30 minutes

Expected Sequence

Step	Direction	Message	Comments
1		{Uplink dynamic allocation two phase access}	N = 1500 octets USF GRANULARITY = 1 block EGPRS Channel Coding Command: MCS-4
2	SS -> MS	PACKET DOWNLINK DUMMY CONTROL BLOCK	Sent on the PACCH of the PDCH assigned, containing USF assigned to the MS.
3	MS -> SS	EGPRS UPLINK RLC DATA BLOCK	Received on the assigned PDTCH SS verifies that the BSN starts from 0, and verifies the correct MCS is used.
4	-		Repeat steps 2 and 3 until the RLC data Block with BSN=8 is received.
5	-		Wait for BS_CV_MAX block periods.
6	SS -> MS	PACKET UPLINK ACK/NACK	SS acknowledges RLC data blocks from BSN 0 to 7 and negatively acknowledges last RLC data block (BSN = 8). USF not assigned to the MS EGPRS Channel Coding Command is set to MCS-1. Resegment IE is set to '1'B.
7	-		Wait for 1 block period with no USF
8	SS -> MS	PACKET DOWNLINK DUMMY CONTROL BLOCK	Sent on the PACCH of the PDCH assigned, containing USF assigned to the MS.
A9 (optional step)	MS -> SS	EGPRS UPLINK RLC DATA BLOCK	MS may transmit new data block if it has already been scheduled while Packet Uplink Ack/Nack is being processed.
B9 (optional step)	SS -> MS	PACKET DOWNLINK DUMMY CONTROL BLOCK	USF assigned to the MS,
9	MS -> SS	EGPRS UPLINK RLC DATA BLOCK	Received on the assigned PDTCH. BSN = 8, SPB = '10'B. SS verifies that the NACKED RLC data blocks are received and that the correct MCS is used.
10	SS -> MS	PACKET DOWNLINK DUMMY CONTROL BLOCK	Sent on the PACCH of the PDCH assigned, containing USF assigned to the MS.
11	MS -> SS	EGPRS UPLINK RLC DATA BLOCK	Received on the assigned PDTCH. BSN = 8, SPB = '11'B. SS verifies that the NACKED RLC data blocks are received and that the correct MCS is used.
12		{Completion of uplink RLC data block transfer}	

53.1.1.13 Acknowledged Mode/ Uplink TBF/ Calculation of BSN2

53.1.1.13.1 Conformance requirements

- Each RLC data block contains a block sequence number (BSN) field that is 11 bits in length. At the time that an in-sequence RLC data block is designated for transmission, the value of BSN is set equal to the value of the send state variable V(S).

2. The transfer of RLC data blocks in the RLC acknowledged mode uses retransmissions of RLC data blocks. The transmitting side numbers the RLC data blocks via the block sequence number (BSN). The BSN is used for retransmission and for reassembly. The receiving side sends PACKET Ack/Nack messages in order to request retransmission of RLC data blocks.
3. In case two RLC data blocks are sent within a RLC/MAC block, BSN2 is relative to BSN1, provided the difference between the second block number and the first block modulo SNS is less than Window Size (WS).
4. Second block sequence number = $[BSN1 + BSN2]$ modulo SNS.

References

3GPP TS 04.60, subclauses 9.1.4.2, 9.3.1 and 10.4.12 and table 8.1.1.1.

53.1.1.13.2 Test purpose

1. To verify that the mobile station correctly calculate the value of BSN 2.

53.1.1.13.3 Method of test

Initial Conditions

System Simulator:

1 cell with EGPRS support, default setting, PBCCH not present.

Mobile Station:

The MS is EGPRS updated with a P-TMSI allocated, SPLIT PG CYCLE negotiated and the test PDP context2 activated.

Specific PICS Statements

-

PIXIT Statements

-

Test Procedure

The EGPRS capable MS is made to transmit uplink RLC data blocks in EGPRS TBF RLC acknowledged mode. The Window Size is assigned to be 160.

The MS is made to transmit $SNS-N$ RLC Data Blocks, where $N < WS$. SS acknowledges all the data blocks. The MS sends $SNS-N+1$ to $SNS-N+WS$ data blocks. SS acknowledges all but two of these data blocks and negatively acknowledges these two data blocks with $BSN=BSN_1$ and $BSN=BSN_2$.

The MS is made to transmit another one Radio Block which contains two RLC data blocks.

The SS verifies that the Radio block (MCS-7 or MCS-9) contains the retransmission of the previously negatively acknowledged RLC data Blocks BSN_1 and BSN_2 .

SS verifies that:

$BSN1=BSN_1$;

$BSN2 = [BSN_2 - BSN_1]$ modulo SNS.

The test procedure is performed for various values of BSN_1 and BSN_2 .

Maximum Duration of Test

5 minutes.

Expected Sequence

Step	Direction	Message	Comments
1		{Uplink dynamic allocation two phase access}	$n = (74 \times 2200 + 2000)$ octets USF GRANULARITY = 1 block EGPRS Channel Coding Command: MCS-6 EGPRS Window size: 160
2	SS -> MS	PACKET DOWNLINK DUMMY CONTROL BLOCK	Sent on the PACCH of the PDCH assigned, containing USF assigned to the MS.
3	MS -> SS	EGPRS UPLINK RLC DATA BLOCK	Received on the assigned PDTCH. SS verifies that the BSN is correct (starts from 0), and the correct MCS is used.
4	SS -> MS	PACKET UPLINK ACK/NACK	SS Acknowledges the UL RLC Data Block USF assigned to the MS.
5	-		Repeat steps 3 and 4 until all blocks till $BSN = SNS - N$ are received by SS.
6	SS -> MS	PACKET DOWNLINK DUMMY CONTROL BLOCK	Sent on the PACCH of the PDCH assigned, containing USF assigned to the MS.
7	MS -> SS	EGPRS UPLINK RLC DATA BLOCK	Received on the assigned PDCH. SS verifies the BSN and MCS used are correct.
8	-		Repeat steps 6 and 7 until Stall Indicator bit is set. SS verifies that all blocks from $BSN = SNS - N + 1$ till $BSN = SNS - N + WS \text{ mod } SNS$ are received.
9	-		Wait for BS_CV_MAX block periods.
10	SS -> MS	PACKET UPLINK ACK/NACK	SS acknowledges all RLC Data Blocks except the two blocks with $BSN = BSN_1$ and $BSN = BSN_2$ and negatively acknowledges these data blocks. (BSN_1 or BSN_2 not equal to $SNS - N + 2$) EGPRS CHANNEL CODING COMMAND: MCS-9 USF not assigned to the MS.
11	-		Wait for BS_CV_MAX Block periods with no USF
12	SS -> MS	PACKET DOWNLINK DUMMY CONTROL BLOCK	Sent on the PACCH of the PDCH assigned, containing USF assigned to the MS.
13a (optional)	MS -> SS	EGPRS UPLINK RLC DATA BLOCK	Received on the assigned PDTCH MS may retransmit the first in step 10 not acknowledged BSN using MCS-6 if already queued.
13b (optional)	SS -> MS	PACKET DOWNLINK DUMMY CONTROL BLOCK	Sent on the PACCH of the PDCH assigned, containing USF assigned to the MS.
13	MS -> SS	EGPRS UPLINK RLC DATA BLOCK	Received on the assigned PDTCH SS verifies that $BSN1 = BSN_1$ and $BSN2 = (BSN_2 - BSN_1) \text{ mod } SNS$ in the received RLC data block header.
14		{Completion of RLC Data block transfer}	
			The above test procedure is repeated for various values of BSN_1 and BSN_2 and also for MCS-5 for initial transmission and MCS-7 for retransmission.

53.1.1.14 Acknowledged Mode/ Uplink TBF/ Verification of Coding Schemes

53.1.1.14.1 Conformance requirements

1. In EGPRS TBF mode, RLC data blocks that are transmitted for the first time shall be transmitted with the MCS commanded, except if the commanded mode is MCS-5-7, in which case the data block shall be transmitted with MCS-5, or if the commanded mode is MCS-6-9, in which case the data block shall be transmitted with MCS-6.
2. A re-segment bit is included within each PACKET UPLINK ACK/NACK, PACKET UPLINK ASSIGNMENT and PACKET TIMESLOT RECONFIGURE messages.
3. For retransmissions, setting the resegment bit to '1' (type I ARQ) requires the mobile station to use an MCS within the same family as the initial transmission and the payload may be split.

References

3GPP TS 04.60, subclause 8.1.1.

53.1.1.14.2 Test purpose

1. To verify that the mobile station uses the correct channel coding commanded by the Network for initial transmission.
2. To verify that correct channel coding command is used for retransmission.

53.1.1.14.3 Method of test

Initial Conditions

System Simulator:

1 cell with EGPRS support, default setting, PBCCH not present.

Mobile Station:

The MS is EGPRS updated with a P-TMSI allocated, SPLIT PG CYCLE negotiated and the test PDP context2 activated.

Specific PICS Statements

- Support of PSK in uplink (TSPC_Type_EGPRS_8PSK_uplink)

PIXIT Statements

-

Test Procedure

The EGPRS capable MS is made to transmit uplink RLC data blocks in EGPRS TBF RLC acknowledged mode. The EGPRS Channel Coding Command IE is commanded in the Packet Uplink Assignment message. The resegment IE is set to 1.

The SS checks that the Uplink RLC Data Blocks are transmitted by the mobile using the channel coding scheme commanded by the SS.

The SS negatively acknowledges the received data blocks. The Coding scheme to be used by the mobile is commanded in the EGPRS Channel Coding Command IE.

The SS checks that the Uplink RLC data blocks are retransmitted using the channel coding scheme commanded by the SS.

Maximum Duration of Test

5 minutes.

Expected Sequence

MS supporting 'EGPRS capable of 8PSK in Uplink, of all Multislot classes' should run the test for k=0, k=1 and k=2 for steps 1-16 and k=3 for step 1-9 and step 16.

Otherwise (MS NOT supporting 8PSK in Uplink) should run only the test with k=3 (steps 1-9 and step 16)

Expected Sequence

Step	Direction	Message	Comments
			<p>For K=0 MCS-A = MCS-9 MCS-B = MCS-6 MCS-C = MCS-3</p> <p>For K=1 MCS-A = MCS-8 MCS-B = MCS-6 MCS-C = MCS-3</p> <p>For K=2 MCS-A = MCS-7 MCS-B = MCS-5 MCS-C = MCS-2</p> <p>For K=3 MCS-A = MCS-4 MCS-B = MCS-1</p>
1		{Uplink dynamic allocation two phase access}	N = 1000 octets USF_GRANULARITY = 1 block Resegment IE=1 EGPRS Channel Coding Command: MCS-A
2	SS -> MS	PACKET DOWNLINK DUMMY CONTROL BLOCK	Sent on the PACCH of the PDCH assigned, containing USF assigned to the MS.
3	MS -> SS	EGPRS UPLINK RLC DATA BLOCK	Received on the assigned PDTCH SS verifies that the correct MCS MCS-A is used.
4	SS -> MS	PACKET DOWNLINK DUMMY CONTROL BLOCK	Sent on the PACCH of the PDCH assigned, containing USF assigned to the MS.
5	MS -> SS	EGPRS UPLINK RLC DATA BLOCK	Received on the assigned PDTCH SS verifies that the correct MCS MCS-A is used.
6	SS -> MS	PACKET UPLINK ACK/NACK	Wait for BS_CV_MAX block periods before sending this message. SS acknowledges first RLC data block, and negatively acknowledges second RLC data block. USF not assigned to the MS Resegment IE=1 EGPRS Channel Coding Command: MCS-B
7			Wait for 6 blocks with no USF
8	SS -> MS	PACKET DOWNLINK DUMMY CONTROL BLOCK	Sent on the PACCH of the PDCH assigned, containing USF assigned to the MS.
9a (optional)	MS -> SS	EGPRS UPLINK RLC DATA BLOCK	Received on the assigned PDTCH. The MS may send a new data block already in the transmit buffer using MCS-A
9b (optional)	SS -> MS	PACKET DOWNLINK DUMMY CONTROL BLOCK	If optional step 9a was received. Sent on the PACCH of the PDCH assigned, containing USF assigned to the MS.
9	MS -> SS	EGPRS UPLINK RLC DATA BLOCK	Received on the assigned PDTCH SS verifies that the correct MCS MCS-B is used.
10	SS -> MS	PACKET DOWNLINK DUMMY CONTROL BLOCK	Sent on the PACCH of the PDCH assigned, containing USF assigned to the MS.
11	MS -> SS	EGPRS UPLINK RLC DATA BLOCK	Received on the assigned PDTCH SS verifies that the correct MCS MCS-B is used.
12	SS -> MS	PACKET UPLINK ACK/NACK	Wait for BS_CV_MAX block periods before sending this message. SS negatively acknowledges the retransmitted RLC data block. EGPRS Channel Coding Command: MCS-C USF not assigned to the MS Resegment IE=1 Wait for 6 blocks with no USF
13	SS -> MS	PACKET DOWNLINK DUMMY CONTROL BLOCK	Sent on the PACCH of the PDCH assigned, containing USF assigned to the MS.

Step	Direction	Message	Comments
14a (optional)	MS -> SS	EGPRS UPLINK RLC DATA BLOCK	Received on the assigned PDTCH. The MS may send a new data block already in the transmit buffer using MCS-B
14b (optional)	SS -> MS	PACKET DOWNLINK DUMMY CONTROL BLOCK	If optional step 14a was received. Sent on the PACCH of the PDCH assigned, containing USF assigned to the MS.
15	MS -> SS	EGPRS UPLINK RLC DATA BLOCK	Received on the assigned PDTCH SS verifies that the correct MCS MCS-C is used.
16		{Completion of uplink RLC data block transfer}	

53.1.1.15 Acknowledged Mode/ Uplink TBF/ Recalculation of CV on MCS change

53.1.1.15.1 Conformance requirements

1. The mobile station shall send the Countdown Value (CV) in each uplink RLC data block to indicate to the network the absolute BSN (BSN') of the last RLC data block that will be sent in the uplink TBF. The CV shall be calculated as follows.

$$\text{Let integer } x = \text{round}\left(\frac{TBC - BSN' - 1}{NTS \times K}\right).$$

$$\text{then, } CV = \begin{cases} x, & \text{if } x \leq BS_CV_MAX, \\ 15, & \text{otherwise.} \end{cases}$$

where:

- TBC = total number of RLC data blocks that will be transmitted in the TBF;
 - BSN' = absolute block sequence number of the RLC data block, with range from 0 to (TBC - 1);
 - NTS = number of timeslots assigned to the uplink TBF in the assignment message, with range 1 to 8;
 - the function round() rounds upwards to the nearest integer;
 - BS_CV_MAX is a parameter broadcast in the system information;
 - the division operation is non-integer and results in zero only for (TBC - BSN' - 1) = 0;
 - K = 2 when commanded MCS is MCS-7, MCS-8 or MCS-9, otherwise K=1.
2. If the mobile station receives a change in the Channel Coding Command in a PACKET UPLINK ACK/NACK message during the countdown procedure, the mobile station shall act upon the new Channel Coding Command. The mobile station shall then recalculate the CV values for any untransmitted RLC data blocks using the new RLC data block size.

In EGPRS TBF mode, a MS may choose an alternate MCS than the one commanded, for the initial transmission of the last RLC data blocks of the TBF under the following conditions:

- The alternate MCS is more robust than the commanded MCS;
- The alternate MCS has already been commanded by the network during the TBF or was available for selection by the MS during the TBF according to the MCS selection rules for retransmissions; and
- The TBF requires no more radio blocks for initial transmission of the RLC data blocks using the alternate MCS than would be required when using the commanded MCS.

References

3GPP TS 04.60, subclause 8.1.1, 9.3.1 and clause F.3.

53.1.1.15.2 Test purpose

To verify that the mobile station correctly recalculates the CV values when the MCS is changed during countdown procedure.

53.1.1.15.2 Method of test

Initial Conditions

System Simulator:

1 cell with EGPRS support, default setting, PBCCH not present, BS_CV_MAX = 15.

Mobile Station:

The MS is EGPRS updated with a P-TMSI allocated, SPLIT PG CYCLE negotiated and the test PDP context2 activated.

Specific PICS Statements

-

PIXIT Statements

-

Test Procedure

The EGPRS capable MS is made to transmit uplink RLC data blocks in EGPRS TBF RLC acknowledged mode. MCS-9 is commanded. Total number of Data Blocks is taken to be a minimum of 20 blocks.

SS acknowledges all the Data Blocks upon reception.

SS monitors the CV of the data blocks sent.

SS sends a PACKET UL ACK/NACK message acknowledging the RLC data block with CV =14 or CV = 13 and ordering a change of MCS to MCS-6.

The Mobile might send a new Data Block with MCS-9 which could have been stored in the Transmit buffer.

SS notes the BSN of the last data block, received with MCS9 as BSN2SS verifies that $CV=15$ till $BSN=BSN2+2*CV1-15$ or $BSN=BSN2+2*CV1-16$ (MS can select alternate MCS)

where $CV1 = CV$ in the last radio block received with MCS9

SS verifies that CV decreases progressively in further blocks.

Maximum Duration of Test

5 minutes.

Expected Sequence

Step	Direction	Message	Comments
1		{Uplink dynamic allocation two phase access}	N chosen to transmit minimum 20 blocks USF GRANULARITY = 1 block EGPRS Channel Coding Command: MCS-9
2	SS -> MS	PACKET DOWNLINK DUMMY CONTROL BLOCK	Sent on the PACCH of the PDCH assigned, containing USF assigned to the MS.
3	MS -> SS	EGPRS UPLINK RLC DATA BLOCK	Received on the assigned PDTCH. SS verifies that the BSN starts from 0, and the correct MCS is used.
4	SS -> MS	PACKET UPLINK ACK/NACK	Wait for BS_CV_MAX block periods before sending this message. SS Acknowledges the UL RLC Data Block USF assigned to the MS.
5	MS -> SS	EGPRS UPLINK RLC DATA BLOCK	Received on the assigned PDTCH. SS verifies that the BSN values are in sequence, and the correct MCS is used.
6	-		Repeat steps 4 and 5 until CV = 14 or CV = 13
7	SS -> MS	PACKET UPLINK ACK/NACK	Wait for BS_CV_MAX block periods before sending this message. SS Acknowledges the UL RLC Data Block EGPRS CHANNEL CODING COMMAND: MCS-6
8	-		Wait for 6 blocks with no USF
9	SS -> MS	PACKET DOWNLINK DUMMY CONTROL BLOCK	Sent on the PACCH of the PDCH assigned, containing USF assigned to the MS.
Optional Step 10a	MS -> SS	EGPRS UPLINK RLC DATA BLOCK	The MS may send a data block already in the buffer using coding scheme MCS-9. If received, the value of CV and BSN2 of the radio block shall be taken for further calculation.
Optional Step 10b	SS -> MS	PACKET DOWNLINK DUMMY CONTROL BLOCK	Sent on the PACCH of the PDCH assigned, containing USF assigned to the MS.
10	MS -> SS	EGPRS UPLINK RLC DATA BLOCK	Received on the assigned PDTCH. SS verifies that coding scheme MCS-6 is used; BSN=BSN2+1 and CV = 15.
11	SS-> MS	PACKET UPLINK ACK/NACK	Wait for BS_CV_MAX block periods before sending this message. SS Acknowledges the UL RLC Data Block USF assigned to the MS.
12	-		Repeat steps 10 and 11 until BSN= BSN2+ 2*CV1 – 15; SS verifies that CV remains 15 until BSN= BSN2+ 2*CV1 – 16 CV may be 14 for BSN= BSN2+ 2*CV1 – 15 in case MS choose to use an alternate coding scheme to transmit the last block of the TBF. Else CV=15 for BSN= BSN2+ 2*CV1 – 15
13	MS -> SS	EGPRS UPLINK RLC DATA BLOCK	Received on the assigned PDCH. SS verifies that the BSN = BSN2+ 2*CV1 – 14 In case CV=14 was received for BSN= BSN2+ 2*CV1 – 15, CV=13 in the received Data block. else CV=14 in the received Data Block.
14	SS-> MS	PACKET UPLINK ACK/NACK	Wait for BS_CV_MAX block periods before sending this message. SS Acknowledges the UL RLC Data Block USF assigned to the MS.
15	MS->SS	EGPRS UPLINK RLC DATA BLOCK	Received on the assigned PDCH. SS verifies that BSN is incremented by 1 and CV is decremented by 1
16		[Completion of RLC Data Block Transfer]	

53.1.1.16 Acknowledged Mode/ Uplink TBF/ Retransmission/ Padding in the Data Field

53.1.1.16.1 Conformance requirements

1. According to the link quality, an initial Modulation and Coding Scheme (MCS) is selected for an RLC block. For the retransmissions, the same or another MCS from the same family of MCSs can be selected.
2. For blocks initially transmitted with MCS-8 which are retransmitted using MCS-6 or MCS-3, padding of the first six octets in the data field shall be applied, and the CPS field shall be set to indicate that this has been done.

References

3GPP TS 04.60, subclauses 9.3.2.1 and 10.4.8a.

53.1.1.16.2 Test purpose

1. To verify the padding of the first six octets in the data field for blocks initially transmitted with MCS-8 and retransmitted using MCS-6 or MCS-3.
2. To verify that the CPS field is set to indicate padding in the retransmitted blocks.

53.1.1.16.3 Method of test

Initial Conditions

System Simulator:

1 cell with EGPRS support, default setting, PBCCH not present.

Mobile Station:

The MS is EGPRS updated with a P-TMSI allocated, SPLIT PG CYCLE negotiated and the test PDP context2 activated.

Specific PICS Statements

-

PIXIT Statements

-

Test Procedure

The EGPRS capable MS is made to transmit uplink RLC data blocks in EGPRS TBF RLC acknowledged mode. The EGPRS Channel Coding Command IE indicates MCS-8 in the Packet Uplink Assignment message.

After BS_CV_MAX block periods the SS sends a Packet Uplink Ack/Nack message to negatively acknowledge some RLC data blocks. In the message EGPRS Channel Coding Command IE is set to MCS-6 or MCS-3 and Resegment IE should be set to '1'.

The MS shall then retransmit the NACKED RLC data blocks using MCS-6 or MCS-3. The SS verifies that the first 6 octets in the retransmitted RLC data blocks are padding octets and the CPS field in the RLC/MAC header indicates padding.

Maximum Duration of Test

5 minutes.

Expected Sequence

Step	Direction	Message	Comments
1		{Uplink dynamic allocation two phase access}	N = 1500 octets USF GRANULARITY = 1 block EGPRS Channel Coding Command: MCS-8 BS_CV_MAX = Default value as specified in section 50. Execution counter K = 0
2	SS -> MS	PACKET DOWNLINK DUMMY CONTROL BLOCK	Sent on the PACCH of the PDCH assigned, containing USF assigned to the MS.
3	MS -> SS	EGPRS UPLINK RLC DATA BLOCK	Received on the assigned PDTCH SS verifies that the BSN1 value is 2*K and BSN2 value is 2*K+1, and verifies the correct MCS is used.
4			Increment counter K
5	-		Repeat steps 2 to 4 until execution counter K reaches 3 (8 RLC data blocks received with BSN 0 .. 7).
6	-		Wait BS_CV_MAX block periods after the last received RLC data block.
7	SS -> MS	PACKET UPLINK ACK/NACK	SS acknowledges RLC data blocks from BSN 0 to 5 with the corresponding bits in RBB set to 1 and negatively acknowledges last RLC data blocks (BSN = 6, 7) with bits in RBB set to 0, USF not assigned to the MS EGPRS Channel Coding Command is set to MCS-6. Resegment IE is set to '1'.
8	-		Wait for 6 blocks with no USF
9	SS -> MS	PACKET DOWNLINK DUMMY CONTROL BLOCK	Sent on the PACCH of the PDCH assigned, containing USF assigned to the MS.
10a (optional)	MS -> SS	EGPRS UPLINK RLC DATA BLOCK	MS may send an RLC data block stored in its transmit buffer. If received execute optional step 10b
10b (optional)	SS -> MS	PACKET DOWNLINK DUMMY CONTROL BLOCK	Sent on the PACCH of the PDCH assigned, containing USF assigned to the MS.
10	MS -> SS	EGPRS UPLINK RLC DATA BLOCK	Received on the assigned PDTCH. The SS verifies that the first 6 octets in the retransmitted RLC data blocks are padding octets and the CPS field in the RLC/MAC header indicates padding. BSN = 6, CPS = '010'B SS verifies that the NACKED RLC data blocks are received with the correct MCS.
11	SS -> MS	PACKET DOWNLINK DUMMY CONTROL BLOCK	Sent on the PACCH of the PDCH assigned, containing USF assigned to the MS.
12	MS -> SS	EGPRS UPLINK RLC DATA BLOCK	Received on the assigned PDTCH. The SS verifies that the first 6 octets in the retransmitted RLC data blocks are padding octets and the CPS field in the RLC/MAC header indicates padding. BSN = 7, CPS = '010'B SS verifies that the NACKED RLC data blocks are received with the correct MCS.
13		{ Completion of uplink RLC data block transfer }	
14	-		Repeat step 1 to 13 with the following modifications: 1. EGPRS Channel Coding Command set to MCS-3 at step 7; 2. Use step 15-22 as the replacement of step 10-13 due re-segmentation.
15	MS -> SS	EGPRS UPLINK RLC DATA BLOCK	Received on the assigned PDTCH. The SS verifies that the first 6 octets in the retransmitted RLC data blocks are padding octets and the CPS field in the RLC/MAC header indicates padding. BSN = 6, SPB = '10'B, CPS = '0110'B SS verifies that the NACKED RLC data blocks are received with the correct MCS.
16	SS -> MS	PACKET DOWNLINK DUMMY CONTROL BLOCK	Sent on the PACCH of the PDCH assigned, containing USF assigned to the MS.

Step	Direction	Message	Comments
17	MS -> SS	EGPRS UPLINK RLC DATA BLOCK	Received on the assigned PDTCH. BSN = 6, SPB = '11'B, CPS = '0011'B or '0110'B SS verifies that the NACKED RLC data blocks are received with the correct MCS.
18	SS -> MS	PACKET DOWNLINK DUMMY CONTROL BLOCK	Sent on the PACCH of the PDCH assigned, containing USF assigned to the MS.
19	MS -> SS	EGPRS UPLINK RLC DATA BLOCK	Received on the assigned PDTCH. The SS verifies that the first 6 octets in the retransmitted RLC data blocks are padding octets and the CPS field in the RLC/MAC header indicates padding. BSN = 7, SPB = '10'B, CPS = '0110'B SS verifies that the NACKED RLC data blocks are received with the correct MCS.
20	SS -> MS	PACKET DOWNLINK DUMMY CONTROL BLOCK	Sent on the PACCH of the PDCH assigned, containing USF assigned to the MS.
21	MS -> SS	EGPRS UPLINK RLC DATA BLOCK	Received on the assigned PDTCH. BSN = 7, SPB = '11'B, CPS = '0011'B or '0110'B SS verifies that the NACKED RLC data blocks are received with the correct MCS.
22		{Completion of uplink RLC data block transfer}	

53.1.1.17 Acknowledged Mode/ Uplink TBF/ Retransmission/ Puncturing Scheme Cycle

53.1.1.17.1 Conformance requirements

1. On initial transmission the RLC data blocks are sent with one of the initial code rates (the rate 1/3 encoded data is punctured with Puncturing Scheme (PS) 1 of the selected Modulation and Coding Scheme MCS) and if the RLC data block is required to be retransmitted it is sent with PS 2 of the selected MCS.
2. If the RLC Data Blocks are to be retransmitted, additional coded bits (i.e., the output of the rate 1/3 encoded data which is punctured with PS 2 of the prevailing MCS) shall be sent.
3. If all the code words (different punctured versions of the encoded data block) have been sent, the procedure shall start over and the first code word (which is punctured with PS 1) shall be sent followed by PS 2 etc.

References

3GPP TS 04.60, subclauses 9.3.2.1 and 10.4.8a.

3GPP TS 05.05.

3GPP TS 05.09.

53.1.1.17.2 Test purpose

1. To verify that if the RLC data block is required to be retransmitted it is sent with PS 2 of the selected MCS for the first retransmission.
2. On subsequent retransmissions the RLC data block is transmitted with PS in a cyclic way.

53.1.1.17.3 Method of test

Initial Conditions

System Simulator:

1 cell with EGPRS support, default setting, PBCCH not present.

Mobile Station:

The MS is EGPRS updated with a P-TMSI allocated, SPLIT PG CYCLE negotiated and the test PDP context2 activated.

Specific PICS Statements

- Support of PSK in uplink (TSPC_Type_EGPRS_8PSK_uplink)

PIXIT Statements

-

Test Procedure

The MS is made to transmit uplink RLC data blocks in an acknowledged mode uplink EGPRS TBF.

The SS NACK BSN=3 block for MCS-1, MCS-2, MCS-3, MCS-4 and MCS-5.

The SS NACK BSN=3 and BSN=4 blocks for MCS-7, MCS-8 and MCS-9.

The Puncture Scheme of the re-transmitted RLC data blocks (BSN=3, 4) is observed. The PS used for the retransmissions shall be PS2, then PS3, then back to PS1....

Maximum Duration of Test

5 minutes.

Expected Sequence

MSC5-9 in step 1 is used only if MS supports 'EGPRS capable of 8PSK in Uplink'

Expected Sequence

Step	Direction	Message	Comments
1		{Uplink dynamic allocation two phase access}	N = 1000 octets, USF GRANULARITY = 1 block EGPRS Channel Coding Command: MCS-3
2	SS -> MS	PACKET DOWNLINK DUMMY CONTROL BLOCK	Sent on the PACCH of the PDCH assigned, containing USF assigned to the MS.
3	MS -> SS	EGPRS UPLINK RLC DATA BLOCK	Received on the assigned PDTCH
4	SS	-	Repeat steps 2-3 until BSN=5 RLC data block is received.
5	SS	-	Wait for BS_CV_MAX block periods.
6	SS -> MS	PACKET UPLINK ACK/NACK	SS negatively acknowledges the BSN=3 RLC data block and acknowledge all other blocks. USF not assigned to the MS. Wait for 6 blocks with no USF
7	SS -> MS	PACKET DOWNLINK DUMMY CONTROL BLOCK	Sent on the PACCH of the PDCH assigned, containing USF assigned to the MS.
A8(optional step)	MS -> SS	EGPRS UPLINK RLC DATA BLOCK	MS may transmit new data block with BSN=6 if it has already been scheduled while Packet Uplink Ack/Nack is being processed.
B8 (optional step)	SS -> MS	PACKET DOWNLINK DUMMY CONTROL BLOCK	USF assigned to the MS,
8	MS -> SS	EGPRS UPLINK RLC DATA BLOCK	Received on the assigned PDTCH SS verifies that a block with BSN=3, Puncture Scheme PS2 is received.
9	SS -> MS	PACKET UPLINK ACK/NACK	Wait for BS_CV_MAX block periods before sending this message. SS negatively acknowledges the BSN=3 RLC data block and acknowledge all other blocks. SSN=4. USF not assigned to the MS. Wait for 6 blocks with no USF.
10	SS -> MS	PACKET DOWNLINK DUMMY CONTROL BLOCK	USF assigned to the MS,
A11(optional step)	MS -> SS	EGPRS UPLINK RLC DATA BLOCK	MS may transmit new data block with subsequent BSN if it has already been scheduled while Packet Uplink Ack/Nack is being processed.
B11 (optional step)	SS -> MS	PACKET DOWNLINK DUMMY CONTROL BLOCK	USF assigned to the MS,
11	MS -> SS	EGPRS UPLINK RLC DATA BLOCK	Received on the assigned PDTCH SS verifies that a block with BSN=3, Puncture Scheme PS3 is received.
12	SS -> MS	PACKET UPLINK ACK/NACK	Wait for BS_CV_MAX block periods before sending this message. SS negatively acknowledges the BSN=3 RLC data block and acknowledge all other blocks. SSN=4. USF not assigned to the MS. Wait for 6 blocks with no USF.
13	SS -> MS	PACKET DOWNLINK DUMMY CONTROL BLOCK	USF assigned to the MS,
A14(optional step)	MS -> SS	EGPRS UPLINK RLC DATA BLOCK	MS may transmit new data block with subsequent BSN if it has already been scheduled while Packet Uplink Ack/Nack is being processed.
B14 (optional step)	SS -> MS	PACKET DOWNLINK DUMMY CONTROL BLOCK	USF assigned to the MS,
14	MS -> SS	EGPRS UPLINK RLC DATA BLOCK	Received on the assigned PDTCH SS verifies that a block with BSN=3, Puncture Scheme PS1 is received.
15		{Completion of uplink RLC data block transfer}	

16	-		<p>The above steps are repeated for EGPRS Channel Coding Command set to MCS-4.</p> <p>If the MS supports 'EGPRS capable of 8PSK in Uplink', the above steps are repeated for EGPRS Channel Coding Command set to MCS-7, MCS-8 and MCS 9 in step 1. In steps 6, 9 and 12 the SS negatively acknowledges the BSN=3 and BSN=4 RLC data blocks and acknowledge all other blocks. In steps 8, 11 and 14 the SS verifies that the blocks with BSN=3 and BSN=4 are received.</p> <p>The coding command is set to MCS 1, MCS 2, and if the MS supports 'EGPRS capable of 8PSK in Uplink' MCS-5 and MCS-6 in Step 1. Verify that Steps 1-8 and Steps 12 to 14 are repeated. Reason: Since there is no PS3 for MCS-1, MCS2, MCS-5 and MCS-6.</p>
----	---	--	--

53.1.1.18 EGPRS Acknowledged mode / Uplink TBF / Link Adaptation Procedure for retransmission

53.1.1.18.1 Conformance requirements

1. In EGPRS TBF mode, RLC data blocks that are transmitted for the first time shall be transmitted with the MCS commanded, except if the commanded mode is MCS-5-7, in which case the data block shall be transmitted with MCS-5, or if the commanded mode is MCS-6-9, in which case the data block shall be transmitted with MCS-6. In EGPRS TBF mode, a MS may choose an alternate MCS than the one commanded, for the initial transmission of the last RLC data blocks of the TBF under the following conditions:

- the alternate MCS is more robust than the commanded MCS;
- the alternate MCS has already been commanded by the network during the TBF or was available for selection by the MS during the TBF according to the MCS selection rules for retransmissions; and
- the TBF requires no more radio blocks for initial transmission of the RLC data blocks using the alternate MCS than would be required when using the commanded MCS.

A re-segment bit is included within each PACKET UPLINK ACK/NACK, PACKET UPLINK ASSIGNMENT and PACKET TIMESLOT RECONFIGURE messages. For initial transmissions of new RLC blocks the channel coding commanded is applied. The resegment bit is used to set the ARQ mode to type I or type II (incremental redundancy) for uplink TBFs. For retransmissions, setting the resegment bit to '1' (type I ARQ) requires the mobile station to use an MCS within the same family as the initial transmission and the payload may be split (refer to table 1).

Table 1: Choice of MCS for retransmissions with re-segmentation

Scheme used for initial transmission	Scheme to use for retransmissions after switching to a different MCS										
	MCS-9 Commanded	MCS-8 Commanded	MCS-7 Commanded	MCS-6-9 Commanded	MCS-6 Commanded	MCS-5-7 Commanded	MCS-5 Commanded	MCS-4 Commanded	MCS-3 Commanded	MCS-2 Commanded	MCS-1 Commanded
MCS-9	MCS-9	MCS-6	MCS-6	MCS-6	MCS-6	MCS-3	MCS-3	MCS-3	MCS-3	MCS-3	MCS-3
MCS-8	MCS-8	MCS-8	MCS-6 (pad)	MCS-6 (pad)	MCS-6 (pad)	MCS-3 (pad)	MCS-3 (pad)	MCS-3 (pad)	MCS-3 (pad)	MCS-3 (pad)	MCS-3 (pad)
MCS-7	MCS-7	MCS-7	MCS-7	MCS-5	MCS-5	MCS-5	MCS-5	MCS-2	MCS-2	MCS-2	MCS-2
MCS-6	MCS-9	MCS-6	MCS-6	MCS-9	MCS-6	MCS-3	MCS-3	MCS-3	MCS-3	MCS-3	MCS-3
MCS-5	MCS-7	MCS-7	MCS-7	MCS-5	MCS-5	MCS-7	MCS-5	MCS-2	MCS-2	MCS-2	MCS-2
MCS-4	MCS-4	MCS-4	MCS-4	MCS-4	MCS-4	MCS-4	MCS-4	MCS-4	MCS-1	MCS-1	MCS-1
MCS-3	MCS-3	MCS-3	MCS-3	MCS-3	MCS-3	MCS-3	MCS-3	MCS-3	MCS-3	MCS-3	MCS-3
MCS-2	MCS-2	MCS-2	MCS-2	MCS-2	MCS-2	MCS-2	MCS-2	MCS-2	MCS-2	MCS-2	MCS-2
MCS-1	MCS-1	MCS-1	MCS-1	MCS-1	MCS-1	MCS-1	MCS-1	MCS-1	MCS-1	MCS-1	MCS-1

NOTE: MCS to use for retransmissions when re-segmentation (resegment bit set to '1') is carried out (specified as a function of the scheme used for the initial transmission).

References

3GPP TS 04.60, subclause 8.1.1.

3GPP TS 04.60, subclause 9.3.2.1.

3GPP TS 05.10, subclause 6.11.1.

53.1.1.18.2 Test purpose

1. To verify that the mobile station retransmits Nacked data blocks with the MCS commanded and according to table 1 (see above).

53.1.1.18.3 Method of test

Initial Conditions

System Simulator:

1 cell, default setting, , PBCCH not present.

Mobile Station:

The MS is GPRS attached with a P-TMSI allocated, SPLIT PG CYCLE negotiated and the test PDP Context2 activated.

Specific PICS Statements

- Support of PSK in uplink (TSPC_Type_EGPRS_8PSK_uplink)

PIXIT Statements

-

Test Procedure

The MS is made to transmit RLC data blocks. The SS negatively acknowledges RLC data blocks and commands the MS to use a different MCS (EGPRS Channel Coding Command). The MS retransmits the negatively acknowledged RLC data blocks and uses the commanded MCS by taking into account the scheme specified in table 1 (see above).

Test Procedure is repeated for $k = 1$ to 9 with:

- k=1: MCS-9 to be used at step 1,
- k=2: MCS-8 to be used at step 1,
- k=3: MCS-7 to be used at step 1,
- k=4: MCS-6 to be used at step 1,
- k=5: MCS-5 to be used at step 1,
- k=6: MCS-4 to be used at step 1,
- k=7: MCS-3 to be used at step 1,
- k=8: MCS-2 to be used at step 1,
- k=9: MCS-1 to be used at step 1.

MS NOT capable of 8PSK in Uplink should run only k=6 to 9 for step1-4 then step 30-51 with in step 30 SS acknowledging blocks BSN 0 to BSN 4 instead of only BSN 4

Maximum Duration of Test

5 minutes.

Expected Sequence

Step	Direction	Message	Comments
1		{ Uplink dynamic allocation two phase access}	n = 5000 octets USF_GRANULARITY = 1 block Resegment bit =1 EGPRS CHANNEL_CODING_COMMAND: according to execution counter k (e.g. k=1: MCS-9)
2	SS -> MS	PACKET DOWNLINK DUMMY CONTROL BLOCK	Sent on the PACCH of the PDCH assigned, USF assigned to the MS.
3	MS -> SS	UPLINK RLC DATA BLOCK	Received on the assigned PDTCH
4			Repeat steps 2 and 3 until received data block BSN = 30
5	SS -> MS	PACKET UPLINK ACK/NACK	Wait for BS_CV_MAX block periods before sending this message. SS acknowledges RLC data blocks with BSN 10 to 30 (k>3), BSN 10 to 31 (k<=3) RBB set to 1 and negatively acknowledges the rest with RBB set to 0 USF not assigned to the MS EGPRS CHANNEL_CODING_COMMAND: MCS-9
6			Wait for 6 blocks with no USF
7	SS -> MS	PACKET DOWNLINK DUMMY CONTROL BLOCK	Sent on the PACCH of the PDCH assigned, USF assigned to the MS.
A8(optional step)	MS -> SS	UPLINK RLC DATA BLOCK	MS may transmit new in-sequence data block if it has already been scheduled while Packet Uplink Ack/Nack is being processed.
B8 (optional step)	SS -> MS	PACKET DOWNLINK DUMMY CONTROL BLOCK	USF assigned to the MS,
8	MS -> SS	UPLINK RLC DATA BLOCK	Received on the assigned PDTCH BSN = 0..9 (see note below)
9	SS		Repeat steps 7 & 8 nine times (see note below) SS verifies that the Nacked data blocks are received and that the correct MCS is used (see table 1)
10	SS -> MS	PACKET UPLINK ACK/NACK	Wait for BS_CV_MAX block periods before sending this message. SS acknowledges retransmitted RLC data blocks with BSN 0 , RBB set to 1 and negatively acknowledges the rest with RBB set to 0 USF not assigned to the MS EGPRS CHANNEL_CODING_COMMAND: MCS-8
11			Wait for 6 blocks with no USF
12	SS -> MS	PACKET DOWNLINK DUMMY CONTROL BLOCK	Sent on the PACCH of the PDCH, containing USF assigned to the MS.
A13(optional step)	MS -> SS	UPLINK RLC DATA BLOCK	MS may transmit new in-sequence data block if it has already been scheduled while Packet Uplink Ack/Nack is being processed.
B13 (optional step)	SS -> MS	PACKET DOWNLINK DUMMY CONTROL BLOCK	USF assigned to the MS,
13	MS -> SS	UPLINK RLC DATA BLOCK	Received on the assigned PDTCH BSN = 1.. 9 (see note below). Note: If MCS>=7, BSN=9 may be sent with MCS<7.
14			Repeat steps 12 & 13 eight times (see note below) SS verifies that the Nacked data blocks are received and that the correct MCS is used (see table 1)
15	SS -> MS	PACKET UPLINK ACK/NACK	Wait for BS_CV_MAX block periods before sending this message. SS acknowledges retransmitted RLC data blocks with BSN 1, RBB set to 1 and negatively acknowledges the rest with RBB set to 0 USF not assigned to the MS EGPRS CHANNEL_CODING_COMMAND: MCS-7
16			Wait for 6 blocks with no USF

Step	Direction	Message	Comments
17	SS -> MS	PACKET DOWNLINK DUMMY CONTROL BLOCK	Sent on the PACCH of the PDCH, containing USF assigned to the MS.
A18(optional step)	MS -> SS	UPLINK RLC DATA BLOCK	MS may transmit new in-sequence data block if it has already been scheduled while Packet Uplink Ack/Nack is being processed.
B18 (optional step)	SS -> MS	PACKET DOWNLINK DUMMY CONTROL BLOCK	USF assigned to the MS,
18	MS -> SS	UPLINK RLC DATA BLOCK	Received on the assigned PDTCH BSN = 2.. 9 (see note below)
19			Repeat steps 17 & 18 seven times (see note below) SS verifies that the Nacked data blocks are received and that the correct MCS is used (see table 1)
20	SS -> MS	PACKET UPLINK ACK/NACK	Wait for BS_CV_MAX block periods before sending this message. SS acknowledges retransmitted RLC data blocks with BSN 2, RBB set to 1 and negatively acknowledges the rest with RBB set to 0 USF not assigned to the MS EGPRS CHANNEL_CODING_COMMAND: MCS-6
21			Wait for 6 blocks with no USF
22	SS -> MS	PACKET DOWNLINK DUMMY CONTROL BLOCK	Sent on the PACCH of the PDCH, containing USF assigned to the MS.
A23(optional step)	MS -> SS	UPLINK RLC DATA BLOCK	MS may transmit new in-sequence data block if it has already been scheduled while Packet Uplink Ack/Nack is being processed.
B23 (optional step)	SS -> MS	PACKET DOWNLINK DUMMY CONTROL BLOCK	USF assigned to the MS,
23	MS -> SS	UPLINK RLC DATA BLOCK	Received on the assigned PDTCH BSN = 3.. 9 (see note below)
24			Repeat steps 22 & 23 six times (see note below) SS verifies that the Nacked data blocks are received and that the correct MCS is used (see table 1)
25	SS -> MS	PACKET UPLINK ACK/NACK	Wait for BS_CV_MAX block periods before sending this message. SS acknowledges retransmitted RLC data blocks with BSN 3, RBB set to 1 and negatively acknowledges the rest with RBB set to 0 USF not assigned to the MS EGPRS CHANNEL_CODING_COMMAND: MCS-5
26			Wait for 6 blocks with no USF
27	SS -> MS	PACKET DOWNLINK DUMMY CONTROL BLOCK	Sent on the PACCH of the PDCH, containing USF assigned to the MS.
A28(optional step)	MS -> SS	UPLINK RLC DATA BLOCK	MS may transmit new in-sequence data block if it has already been scheduled while Packet Uplink Ack/Nack is being processed.
B28 (optional step)	SS -> MS	PACKET DOWNLINK DUMMY CONTROL BLOCK	USF assigned to the MS,
28	MS -> SS	UPLINK RLC DATA BLOCK	Received on the assigned PDTCH BSN = 4.. 9 (see note below). Note: Data blocks can be sent as split blocks.
29			Repeat steps 27 & 28 five times (see note below) SS verifies that the Nacked data blocks are received and that the correct MCS is used (see table 1)
30	SS -> MS	PACKET UPLINK ACK/NACK	Wait for BS_CV_MAX block periods before sending this message. SS acknowledges retransmitted RLC data blocks with BSN 4, RBB set to 1 and negatively acknowledges the rest with RBB set to 0 USF not assigned to the MS EGPRS CHANNEL_CODING_COMMAND: MCS-4

Step	Direction	Message	Comments
31			Wait for 6 blocks with no USF
32	SS -> MS	PACKET DOWNLINK DUMMY CONTROL BLOCK	Sent on the PACCH of the PDCH, containing USF assigned to the MS.
A33(optional step)	MS -> SS	UPLINK RLC DATA BLOCK	MS may transmit new in-sequence data block if it has already been scheduled while Packet Uplink Ack/Nack is being processed.
B33 (optional step)	SS -> MS	PACKET DOWNLINK DUMMY CONTROL BLOCK	USF assigned to the MS,
33	MS -> SS	UPLINK RLC DATA BLOCK	Received on the assigned PDTCH BSN = 5.. 9 (see note below). Note: Data blocks can be sent as split blocks.
34			Repeat steps 32 & 33 four times (see note below) SS verifies that the Nacked data blocks are received and that the correct MCS is used (see table 1)
35	SS -> MS	PACKET UPLINK ACK/NACK	Wait for BS_CV_MAX block periods before sending this message. SS acknowledges retransmitted RLC data blocks with BSN 5, RBB set to 1 and negatively acknowledges the rest with RBB set to 0 USF not assigned to the MS EGPRS CHANNEL_CODING_COMMAND: MCS-3
36			Wait for 6 blocks with no USF
37	SS -> MS	PACKET DOWNLINK DUMMY CONTROL BLOCK	Sent on the PACCH of the PDCH, containing USF assigned to the MS.
A38(optional step)	MS -> SS	UPLINK RLC DATA BLOCK	MS may transmit new in-sequence data block if it has already been scheduled while Packet Uplink Ack/Nack is being processed.
B38 (optional step)	SS -> MS	PACKET DOWNLINK DUMMY CONTROL BLOCK	USF assigned to the MS,
38	MS -> SS	UPLINK RLC DATA BLOCK	Received on the assigned PDTCH BSN = 6.. 9 (see note below). Note: Data blocks can be sent as split blocks.
39			Repeat steps 37 & 38 three times (see note below) SS verifies that the Nacked data blocks are received and that the correct MCS is used (see table 1)
40	SS -> MS	PACKET UPLINK ACK/NACK	Wait for BS_CV_MAX block periods before sending this message. SS acknowledges retransmitted RLC data blocks with BSN 6, RBB set to 1 and negatively acknowledges the rest with RBB set to 0 USF not assigned to the MS EGPRS CHANNEL_CODING_COMMAND: MCS-2
41			Wait for 6 blocks with no USF
42	SS -> MS	PACKET DOWNLINK DUMMY CONTROL BLOCK	Sent on the PACCH of the PDCH, containing USF assigned to the MS.
A43(optional step)	MS -> SS	UPLINK RLC DATA BLOCK	MS may transmit new in-sequence data block if it has already been scheduled while Packet Uplink Ack/Nack is being processed.
B43 (optional step)	SS -> MS	PACKET DOWNLINK DUMMY CONTROL BLOCK	USF assigned to the MS,
43	MS -> SS	UPLINK RLC DATA BLOCK	Received on the assigned PDTCH BSN = 7.. 9 (see note below). Note: Data blocks can be sent as split blocks.
44			Repeat steps 42 & 43 two times (see note below) SS verifies that the Nacked data blocks are received and that the correct MCS is used (see table 1)

Step	Direction	Message	Comments
45	SS -> MS	PACKET UPLINK ACK/NACK	Wait for BS_CV_MAX block periods before sending this message. SS acknowledges retransmitted RLC data blocks with BSN 7, RBB set to 1 and negatively acknowledges the rest with RBB set to 0 USF not assigned to the MS EGPRS CHANNEL_CODING_COMMAND: MCS-1
46			Wait for 6 blocks with no USF
47	SS -> MS	PACKET DOWNLINK DUMMY CONTROL BLOCK	Sent on the PACCH of the PDCH, containing USF assigned to the MS.
A48(opt ional step)	MS -> SS	UPLINK RLC DATA BLOCK	MS may transmit new in-sequence data block if it has already been scheduled while Packet Uplink Ack/Nack is being processed.
B48 (optiona l step)	SS -> MS	PACKET DOWNLINK DUMMY CONTROL BLOCK	USF assigned to the MS,
48	MS -> SS	UPLINK RLC DATA BLOCK	Received on the assigned PDTCH BSN = 8.. 9 (see note below). Note: Data blocks can be sent as split blocks.
49			Repeat steps 47 & 48 once (see note below) SS verifies that the Nacked data blocks are received and that the correct MCS is used (see table 1)
50	SS -> MS	PACKET UPLINK ACK/NACK	Wait for BS_CV_MAX block periods before sending this message. SS acknowledges retransmitted RLC data blocks with BSN 8..9, RBB set to 1
51		{ Completion of uplink RLC data block transfer}	

NOTE: The MS may send one further RLC data block during waiting for retransmission of Nacked data blocks to SS. This has to be taken into account for verifying the correct BSN's (see for example step 8) and for calculating the numbers of repetitions (see for example step 9).

53.1.1.19 EGPRS Acknowledged mode / Uplink TBF / Link Adaptation Procedure for initial transmission

53.1.1.19.1 Conformance requirements

1. In EGPRS TBF mode, RLC data blocks that are transmitted for the first time shall be transmitted with the MCS commanded, except if the commanded mode is MCS-5-7, in which case the data block shall be transmitted with MCS-5, or if the commanded mode is MCS-6-9, in which case the data block shall be transmitted with MCS-6.
2. If these rules require a transmission (either original transmission or retransmission) in in a) MCS-7 or b) MCS-8 or MCS-9, but there is only one RLC block that can be transmitted in that MCS, the MS shall send that block in either MCS-5 for case a) or MCS-6 for case b).

References

3GPP TS 04.60, subclause 8.1.1.

3GPP TS 04.60, subclause 9.3.2.1.

3GPP TS 05.10, subclause 6.11.1.

53.1.1.19.2 Test purpose

1. To verify that the mobile station transmits data blocks with the correct MCS in initial transmission.

53.1.1.19.3 Method of test

Initial Conditions

System Simulator:

1 cell, default setting, , PBCCH not present.

Mobile Station:

The MS is EGPRS updated with a P-TMSI allocated, SPLIT PG CYCLE negotiated and the test PDP Context2 activated.

Specific PICS Statements

- Support of PSK in uplink (TSPC_Type_EGPRS_8PSK_uplink)

PIXIT Statements

-

Test Procedure

The MS is made to transmit RLC data blocks. The SS acknowledges RLC data blocks and verify if the MS is using the correct MCS as mentioned above.

Execution counter k	Number of octets n	Commanded MCS to be used in step 1	Expected MCS to be used in step 4 (see note)
1	1500	MCS-9	MCS-9
2	1500	MCS-8	MCS-8
3	1500	MCS-7	MCS-7
4	1500	MCS-6-9	MCS-6
5	1500	MCS-6	MCS-6
6	1500	MCS-5-7	MCS-5
7	1500	MCS-5	MCS-5
8	1500	MCS-4	MCS-4
9	1500	MCS-3	MCS-3
10	1500	MCS-2	MCS-2
11	1500	MCS-1	MCS-1
12	5 (max 74)	MCS-9	One data block using MCS-6 or two data blocks using MCS-9
13	5 (max 68)	MCS-8	One data block using MCS-6 or or two data blocks using MCS-8
14	5 (max 56)	MCS-7	One data block using MCS-5 or or two data blocks using MCS-7
NOTE: For k = 12,13,14 the amount of data on RLC layer must not exceed the given max values			

Test Procedure is repeated for k = 1 to 14.

MS NOT supporting 'EGPRS capable of 8PSK in Uplink, of all Multislot classes' should run only k=8 to 11

Maximum Duration of Test

5 minutes.

Expected Sequence

Step	Direction	Message	Comments
1		{ Uplink dynamic allocation two phase access}	n = number of octets according to execution counter k (e.g. k=1: n=1500) USF_GRANULARITY = 1 block Resegment bit =1 EGPRS CHANNEL_CODING_COMMAND: according to execution counter k (e.g. k=1: MCS-9) Window size=96
2	SS -> MS	PACKET DOWNLINK DUMMY CONTROL BLOCK	Sent on the PACCH of the PDCH assigned, USF assigned to the MS.
3	MS -> SS	UPLINK RLC DATA BLOCK	Received on the assigned PDTCH
4	SS -> MS	PACKET UPLINK ACK/NACK	Wait for BS_CV_MAX block periods before sending this message. SS acknowledges the first RLC data block, RBB set to 1. SS verifies that the expected MCS is used according to execution counter k (e.g. k=1: MCS-9) (Skip step 5-8 for k=12,13,14)
5	SS -> MS	PACKET DOWNLINK DUMMY CONTROL BLOCK	Sent on the PACCH of the PDCH assigned, USF assigned to the MS.
6	MS -> SS	UPLINK RLC DATA BLOCK	Received on the assigned PDTCH
7			Repeat steps 5 and 6 until all data blocks has been received
8	SS -> MS	PACKET UPLINK ACK/NACK	Wait for BS_CV_MAX block periods before sending this message. SS acknowledges all RLC data blocks, RBB set to 1.
9		{Completion of uplink RLC data block transfer}	

53.1.1.20 Acknowledged Mode/ Uplink TBF/ Retransmission/ MCS Selection without Re-segmentation

53.1.1.20.1 Conformance requirements

1. If the transmitter side is the mobile station and the re-segment bit is not set, the mobile station shall use an MCS within the same family as the initial MCS without splitting the payload (refer to subclause 8.1.1 table 8.1.1.2, 3GPP TS 04.60) for retransmission.

References

3GPP TS 04.60, subclause 8.1.1.

53.1.1.20.2 Test purpose

1. To verify that if the re-segment bit is not set, the mobile station shall use an MCS within the same family as the initial MCS without splitting the payload for retransmission in accordance with subclause 8.1.1 table 8.1.1.2, 3GPP TS 04.60.

53.1.1.20.3 Method of test

Initial Conditions

System Simulator:

1 cell with EGPRS support, default setting, PBCCH not present.

Mobile Station:

The MS is EGPRS updated with a P-TMSI allocated, SPLIT PG CYCLE negotiated and the test PDP context2 activated.

Specific PICS Statements

- Support of PSK in uplink (TSPC_Type_EGPRS_8PSK_uplink)

PIXIT Statements

-

Test Procedure

The EGPRS capable MS is made to transmit uplink RLC data blocks in EGPRS TBF RLC acknowledged mode. The EGPRS Channel Coding Command IE in the Packet Uplink Assignment message is set according to the execution counter K described as below.

After BS_CV_MAX block periods the SS sends a Packet Uplink Ack/Nack message to negatively acknowledge some RLC data blocks. In the message EGPRS Channel Coding Command IE is set to a different MCS and Resegment IE should be set to '0'.

The MS shall then retransmit the negatively acknowledged RLC data blocks using the MCS specified in table 8.1.1.2, 3GPP TS 04.60.

Test procedure is repeated for $K = 1$ to 9 with:

- K=1: MCS-9 to be used at step 1,
- K=2: MCS-8 to be used at step 1,
- K=3: MCS-7 to be used at step 1,
- K=4: MCS-6 to be used at step 1,
- K=5: MCS-5 to be used at step 1,
- K=6: MCS-4 to be used at step 1,
- K=7: MCS-3 to be used at step 1,
- K=8: MCS-2 to be used at step 1,
- K=9: MCS-1 to be used at step 1.

MS NOT capable of 8PSK in Uplink should run only $k=6$ to 9 for step1-4 then step 31-52 with in step 31 SS acknowledging blocks BSN 0 to BSN 4 instead of only BSN 4

Maximum Duration of Test

30 minutes.

Expected Sequence

Step	Direction	Message	Comments
1		{Uplink dynamic allocation two phase access}	N = for K=1: 3500 octets. (K=2: 3000, K=3: 2500, K=4: 3500, K=5: 2500, K=6: 2100, K=7: 2000, K=8: 1600, K=9: 1400 octets.) USF_GRANULARITY = 1 block EGPRS Channel Coding Command is set according to execution counter K (e.g., K=1: MCS-9)
2	SS -> MS	PACKET DOWNLINK DUMMY CONTROL BLOCK	Sent on the PACCH of the PDCH assigned, containing USF assigned to the MS.
3	MS -> SS	EGPRS UPLINK RLC DATA BLOCK	Received on the assigned PDTCH The SS verifies that the BSN starts from 0, and verifies the correct MCS is used.
4	-		Repeat steps 2 and 3 until RLC data block BSN = 31.
5	-		Wait for BS_CV_MAX block periods relative to the last received RLC data block.
6	SS -> MS	PACKET UPLINK ACK/NACK	The SS acknowledges RLC data blocks from BSN 10 to 31 with RBB set to 1 and negatively acknowledges RLC data blocks from BSN 1 to 9 with RBB set to 0, SSN=1 (Note: This is NACK for BSN=0), USF not assigned to the MS EGPRS Channel Coding Command is set to MCS-9. Resegment IE is set to '0'.
7	-		Wait for 6 blocks with no USF
8	SS -> MS	PACKET DOWNLINK DUMMY CONTROL BLOCK	Sent on the PACCH of the PDCH assigned, containing USF assigned to the MS.
A9 (optional step)	MS -> SS	EGPRS UPLINK RLC DATA BLOCK	MS may transmit new data block if it has already been scheduled while Packet Uplink Ack/Nack is being processed.
B9 (optional step)	SS -> MS	PACKET DOWNLINK DUMMY CONTROL BLOCK	USF assigned to the MS,
9	MS -> SS	EGPRS UPLINK RLC DATA BLOCK	Received on the assigned PDTCH. BSN = 0 The SS verifies that the NACKED data blocks are received using the correct MCS according to table 8.1.1.2, 3GPP TS 04.60. If k≤5 then RLC data block with BSN=1 is received in the same radio block.
10	-		Repeat steps 8 & 9 nine times if k>5 and 4 times otherwise. BSN shall be 0-9 in sequence.
11	SS -> MS	PACKET UPLINK ACK/NACK	Wait for BS_CV_MAX block periods before sending this message. The SS acknowledges RLC data block BSN=0 with SSN=2 and negatively acknowledges RLC data blocks from BSN 2 to 9 with RBB set to 0. For BSN>9 RBB is set to 1. USF not assigned to the MS EGPRS Channel Coding Command is set to MCS-8. Resegment IE is set to '0'.
12	-		Wait for 6 blocks with no USF
13	SS -> MS	PACKET DOWNLINK DUMMY CONTROL BLOCK	Sent on the PACCH of the PDCH assigned, containing USF assigned to the MS.
A14 (optional step)	MS -> SS	EGPRS UPLINK RLC DATA BLOCK	MS may transmit new data block if it has already been scheduled while Packet Uplink Ack/Nack is being processed.
B14 (optional step)	SS -> MS	PACKET DOWNLINK DUMMY CONTROL BLOCK	USF assigned to the MS,
14	MS -> SS	EGPRS UPLINK RLC DATA BLOCK	Received on the assigned PDTCH. BSN = 1 The SS verifies that the NACKED data blocks are received using the correct MCS according to table 8.1.1.2, 3GPP TS 04.60. Also BSN=2 is received in the same radio block if k=2,3 or 5.

Step	Direction	Message	Comments
15	-		Repeat steps 13 & 14 3 times if k=2,3 or 5 and eight times otherwise. BSN shall be 1-8 (if k=2,3 or 5) or 1-9 in sequence.
16	SS -> MS	PACKET UPLINK ACK/NACK	Wait for BS_CV_MAX block periods before sending this message. The SS acknowledges RLC data block BSN 1 with SSN=3 and negatively acknowledges RLC data blocks from BSN 3 to 9 with RBB set to 0. For BSN>9 RBB is set to 1. USF not assigned to the MS EGPRS Channel Coding Command is set to MCS-7. Resegment IE is set to '0'.
17	-		Wait for 6 blocks with no USF
18	SS -> MS	PACKET DOWNLINK DUMMY CONTROL BLOCK	Sent on the PACCH of the PDCH assigned, containing USF assigned to the MS.
A19 (optional step)	MS -> SS	EGPRS UPLINK RLC DATA BLOCK	For K=2, K=3 and K=5 the MS may retransmit a RLC data block with BSN=9. Else: MS may transmit new data block if it has already been scheduled while Packet Uplink Ack/Nack is being processed.
B19 (optional step)	SS -> MS	PACKET DOWNLINK DUMMY CONTROL BLOCK	USF assigned to the MS,
19	MS -> SS	EGPRS UPLINK RLC DATA BLOCK	Received on the assigned PDTCH. BSN = 2..7 (if k=3 or 5), BSN = 2..8 (if k=2), otherwise BSN= 2 .. 9. The SS verifies that the NACKED data blocks are received using the correct MCS according to table 8.1.1.2, 3GPP TS 04.60.
20	-		Repeat steps 18 & 19 2 times if k=3 or k=5, 6 times if k=2 and seven times otherwise.
21	SS -> MS	PACKET UPLINK ACK/NACK	Wait for BS_CV_MAX block periods before sending this message. The SS acknowledges RLC data block BSN 2 with SSN=4 and negatively acknowledges RLC data blocks from BSN 3 to 9 with RBB set to 0. For BSN>9 RBB is set to 1. USF not assigned to the MS EGPRS Channel Coding Command is set to MCS-6. Resegment IE is set to '0'.
22	-		Wait for 6 blocks with no USF
23	SS -> MS	PACKET DOWNLINK DUMMY CONTROL BLOCK	Sent on the PACCH of the PDCH assigned, containing USF assigned to the MS.
A24 (optional step)	MS -> SS	EGPRS UPLINK RLC DATA BLOCK	For k=3, 5 the MS may retransmit a data block with BSN=8. MS may transmit new data block if it has already been scheduled while Packet Uplink Ack/Nack is being processed.
B24 (optional step)	SS -> MS	PACKET DOWNLINK DUMMY CONTROL BLOCK	USF assigned to the MS,
24	MS -> SS	EGPRS UPLINK RLC DATA BLOCK	Received on the assigned PDTCH. If k=3 or 5 and step A24 was performed, BSN =3 ..7 and 9 will be received. Otherwise BSN = 3 .. 9 will be received. The SS verifies that the NACKED data blocks are received using the correct MCS according to table 8.1.1.2, 3GPP TS 04.60.
25	-		Repeat steps 23 & 24 six times.

Step	Direction	Message	Comments
26	SS -> MS	PACKET UPLINK ACK/NACK	Wait for BS_CV_MAX block periods before sending this message. The SS acknowledges RLC data block BSN 3 with SSN=5 and negatively acknowledges RLC data blocks from BSN 4 to 9 with RBB set to 0. For BSN>9 RBB is set to 1. USF not assigned to the MS EGPRS Channel Coding Command is set to MCS-5. Resegment IE is set to '0'.
27	-		Wait for 6 blocks with no USF
28	SS -> MS	PACKET DOWNLINK DUMMY CONTROL BLOCK	Sent on the PACCH of the PDCH assigned, containing USF assigned to the MS.
A29 (optional step)	MS -> SS	EGPRS UPLINK RLC DATA BLOCK	MS may transmit new data block if it has already been scheduled while Packet Uplink Ack/Nack is being processed.
B29 (optional step)	SS -> MS	PACKET DOWNLINK DUMMY CONTROL BLOCK	USF assigned to the MS,
29	MS -> SS	EGPRS UPLINK RLC DATA BLOCK	Received on the assigned PDTCH. BSN = 4 .. 9 The SS verifies that the NACKED data blocks are received using the correct MCS according to table 8.1.1.2, 3GPP TS 04.60.
30	-		Repeat steps 28 & 29 five times.
31	SS -> MS	PACKET UPLINK ACK/NACK	Wait for BS_CV_MAX block periods before sending this message. The SS acknowledges RLC data block BSN 4 with SSN=6 and negatively acknowledges RLC data blocks from BSN 5 to 9 with RBB set to 0. For BSN>9 RBB is set to 1. USF not assigned to the MS EGPRS Channel Coding Command is set to MCS-4. Resegment IE is set to '0'.
32	-		Wait for 6 blocks with no USF
33	SS -> MS	PACKET DOWNLINK DUMMY CONTROL BLOCK	Sent on the PACCH of the PDCH assigned, containing USF assigned to the MS.
A34 (optional step)	MS -> SS	EGPRS UPLINK RLC DATA BLOCK	MS may transmit new data block if it has already been scheduled while Packet Uplink Ack/Nack is being processed.
B34 (optional step)	SS -> MS	PACKET DOWNLINK DUMMY CONTROL BLOCK	USF assigned to the MS,
34	MS -> SS	EGPRS UPLINK RLC DATA BLOCK	Received on the assigned PDTCH. BSN = 5 .. 9 The SS verifies that the NACKED data blocks are received using the correct MCS according to table 8.1.1.2, 3GPP TS 04.60.
35	-		Repeat steps 33 & 34 four times.
36	SS -> MS	PACKET UPLINK ACK/NACK	Wait for BS_CV_MAX block periods before sending this message. The SS acknowledges RLC data block BSN 5 with SSN=7 and negatively acknowledges RLC data blocks from BSN 6 to 9 with RBB set to 0. For BSN>9 RBB is set to 1. USF not assigned to the MS EGPRS Channel Coding Command is set to MCS-3. Resegment IE is set to '0'.
37	-		Wait for 6 blocks with no USF
38	SS -> MS	PACKET DOWNLINK DUMMY CONTROL BLOCK	Sent on the PACCH of the PDCH assigned, containing USF assigned to the MS.
A39 (optional step)	MS -> SS	EGPRS UPLINK RLC DATA BLOCK	MS may transmit new data block if it has already been scheduled while Packet Uplink Ack/Nack is being processed.
B39 (optional step)	SS -> MS	PACKET DOWNLINK DUMMY CONTROL BLOCK	USF assigned to the MS,

Step	Direction	Message	Comments
39	MS -> SS	EGPRS UPLINK RLC DATA BLOCK	Received on the assigned PDTCH. BSN = 6 .. 9 The SS verifies that the NACKED data blocks are received using the correct MCS according to table 8.1.1.2, 3GPP TS 04.60.
40	-		Repeat steps 38 & 39 three times.
41	SS -> MS	PACKET UPLINK ACK/NACK	Wait for BS_CV_MAX block periods before sending this message. The SS acknowledges RLC data block BSN 6 with SSN=8 and negatively acknowledges RLC data blocks from BSN 7 to 9 with RBB set to 0. For BSN>9 RBB is set to 1. USF not assigned to the MS EGPRS Channel Coding Command is set to MCS-2. Resegment IE is set to '0'.
42	-		Wait for 6 blocks with no USF
43	SS -> MS	PACKET DOWNLINK DUMMY CONTROL BLOCK	Sent on the PACCH of the PDCH assigned, containing USF assigned to the MS.
A44 (optional step)	MS -> SS	EGPRS UPLINK RLC DATA BLOCK	MS may transmit new data block if it has already been scheduled while Packet Uplink Ack/Nack is being processed.
B44 (optional step)	SS -> MS	PACKET DOWNLINK DUMMY CONTROL BLOCK	USF assigned to the MS,
44	MS -> SS	EGPRS UPLINK RLC DATA BLOCK	Received on the assigned PDTCH. BSN = 7 .. 9 The SS verifies that the NACKED data blocks are received using the correct MCS according to table 8.1.1.2, 3GPP TS 04.60.
45	-		Repeat steps 43 & 44 twice.
46	SS -> MS	PACKET UPLINK ACK/NACK	Wait for BS_CV_MAX block periods before sending this message. The SS acknowledges RLC data block BSN 7 SSN=9 and negatively acknowledges RLC data blocks from BSN 8 to 9 with RBB set to 0. For BSN>9 RBB is set to 1. USF not assigned to the MS EGPRS Channel Coding Command is set to MCS-1. Resegment IE is set to '0'.
47	-		Wait for 6 blocks with no USF
48	SS -> MS	PACKET DOWNLINK DUMMY CONTROL BLOCK	Sent on the PACCH of the PDCH assigned, containing USF assigned to the MS.
A49 (optional step)	MS -> SS	EGPRS UPLINK RLC DATA BLOCK	MS may transmit new data block if it has already been scheduled while Packet Uplink Ack/Nack is being processed.
B49 (optional step)	SS -> MS	PACKET DOWNLINK DUMMY CONTROL BLOCK	USF assigned to the MS,
49	MS -> SS	EGPRS UPLINK RLC DATA BLOCK	Received on the assigned PDTCH. BSN = 8 .. 9 The SS verifies that the NACKED data blocks are received using the correct MCS according to table 8.1.1.2, 3GPP TS 04.60.
50	-		Repeat steps 48 & 49 once.
51	SS -> MS	PACKET UPLINK ACK/NACK	Wait for BS_CV_MAX block periods before sending this message. The SS acknowledges all RLC data blocks with SSN set to highest received BSN +2 and empty RBB. USF not assigned to the MS
52		{Completion of uplink RLC data block transfer}	
	-		Repeat the above procedure with K=2-9.

53.1.1.21 Acknowledged Mode/ Uplink TBF/ Initial Puncturing Scheme After MCS Switching

53.1.1.21.1 Conformance requirements

1. RLC data blocks which are retransmitted using a new MCS shall at the first transmission after the MCS switch be sent with the puncturing scheme indicated in table 9.3.2.1.1, 3GPP TS 04.60 subclause 9.3.2.1.

References

3GPP TS 04.60, subclause 9.3.2.1.

3GPP TS 05.05.

3GPP TS 05.09.

53.1.1.21.2 Test purpose

1. To verify the correct selection of initial PS scheme after MCS switch.

53.1.1.21.3 Method of test

Initial Conditions

System Simulator:

1 cell with EGPRS support, default setting, PBCCH not present.

Mobile Station:

The MS is EGPRS updated with a P-TMSI allocated, SPLIT PG CYCLE negotiated and the test PDP context2 activated.

Specific PICS Statements

-

PIXIT Statements

-

Test Procedure

The MS is made to transmit uplink RLC data blocks in an acknowledged mode uplink EGPRS TBF. EGPRS Coding Command is set to indicate MCS-9.

The SS sends a PACKET UPLINK ACK/NACK message and NACK all blocks received. MCS- 6 is commanded in the message.

The SS checks that the retransmitted blocks are received in MCS-6, PS1.

Repeat the above steps with different allowed MCS and PS combinations.

Maximum Duration of Test

5 minutes.

Expected Sequence

Step	Direction	Message	Comments
1		{Uplink dynamic allocation two phase access}	n = 2000 octets, USF GRANULARITY = 1 block EGPRS Channel Coding Command: MCS-9
2	SS -> MS	PACKET DOWNLINK DUMMY CONTROL BLOCK	Sent on the PACCH of the PDCH assigned, containing USF assigned to the MS.
3	MS -> SS	EGPRS UPLINK RLC DATA BLOCK	Received on the assigned PDTCH SS verifies that Puncturing Scheme PS1 is received.
4	SS	-	Repeat steps 2-3 until RLC data block with BSN=5 is received.
5	SS -> MS	PACKET UPLINK ACK/NACK	Wait for BS_CV_MAX block periods before sending this message. SS negatively acknowledges all RLC data blocks. MCS Command is MCS-6, USF not assigned to the MS. Wait for 6 blocks with no USF
6	SS -> MS	PACKET DOWNLINK DUMMY CONTROL BLOCK	Sent on the PACCH of the PDCH assigned, containing USF assigned to the MS.
A7 (optional step)	MS -> SS	EGPRS UPLINK RLC DATA BLOCK	MS may transmit new data block if it has already been scheduled while Packet Uplink Ack/Nack is being processed.
B7 (optional step)	SS -> MS	PACKET DOWNLINK DUMMY CONTROL BLOCK	USF assigned to the MS,
7	MS -> SS	EGPRS UPLINK RLC DATA BLOCK	Received on the assigned PDTCH SS verifies that modulation and coding scheme is MCS-6 and Puncturing Scheme is PS1 is received. BSN=0
8	SS		Repeat steps 9-10 until RLC data block with BSN=5 is received.
9	SS -> MS	PACKET DOWNLINK DUMMY CONTROL BLOCK	Sent on the PACCH of the PDCH assigned, containing USF assigned to the MS.
10	MS -> SS	EGPRS UPLINK RLC DATA BLOCK	Received on the assigned PDTCH SS verifies that modulation and coding scheme is MCS-6 and Puncturing Scheme is PS1 is received.
11		{Completion of uplink RLC data block transfer}	
12	-		The above steps 1-11 are repeated for different MCS and PS combinations as per table 9.3.2.1.1 of Subclause 9.3, 3GPP TS 04.60, i.e. MCS 6 switching to MCS 9, MCS 7 switching to MCS 5, MCS 5 switching to MCS 7.

53.1.1.22 Acknowledged Mode/ Uplink TBF/ Recalculation of CV on TBC change

53.1.1.22.1 Conformance requirements

1. The mobile station shall send the Countdown Value (CV) in each uplink RLC data block to indicate to the network the absolute BSN (BSN') of the last RLC data block that will be sent in the uplink TBF. The CV shall be calculated as follows.

$$\text{Let integer } x = \text{round} \left(\frac{TBC - BSN' - 1}{NTS \times K} \right).$$

$$\text{then, } CV = \begin{cases} x, & \text{if } x \leq BS_CV_MAX, \\ 15, & \text{otherwise.} \end{cases}$$

where:

- TBC = total number of RLC data blocks that will be transmitted in the TBF;
 - BSN' = absolute block sequence number of the RLC data block, with range from 0 to (TBC - 1);
 - NTS = number of timeslots assigned to the uplink TBF in the assignment message, with range 1 to 8;
 - K = 2 when commanded MCS is MCS-7, MCS-8 or MCS-9 otherwise K=1
 - the function round() rounds upwards to the nearest integer;
 - BS_CV_MAX is a parameter broadcast in the system information;
 - the division operation is non-integer and results in zero only for (TBC - BSN' - 1) = 0.
2. If the mobile station receives a change in the Channel Coding Command in a PACKET UPLINK ACK/NACK message during the countdown procedure, the mobile station shall act upon the new Channel Coding Command. The mobile station shall then recalculate the CV values for any untransmitted RLC data blocks using the new RLC data block size.

References

3GPP TS 04.60, subclause 9.3.1 and clause F.3.

53.1.1.22.2 Test purpose

To verify that the mobile station correctly recalculates the CV values when the TBC change due to an MCS change during countdown procedure.

53.1.1.22.3 Method of test

Initial Conditions

System Simulator:

1 cell with EGPRS support, default setting, PBCCH not present, BS_CV_MAX = 15.

Mobile Station:

The MS is EGPRS updated with a P-TMSI allocated, SPLIT PG CYCLE negotiated and the test PDP context2 activated.

Specific PICS Statements

-

PIXIT Statements

-

Test Procedure

The EGPRS capable MS is made to transmit uplink RLC data blocks in EGPRS TBF RLC acknowledged mode. MCS-6 is commanded. Total number of Data Blocks is taken to be a minimum of 20 blocks.

SS acknowledges all the Data Blocks upon reception.

SS monitors the CV of the data blocks sent.

SS sends a PACKET UL ACK/NACK message acknowledging the RLC data block with CV =14

The Mobile might send a new Data Block with MCS-6 with CV=13 which could have been stored in the Transmit buffer.

SS notes the BSN of the last data block, received with MCS6 as BSN_A and the CV as CV_A.

SS verifies that

TBC is recalculated upon MCS change by checking that CV=15 till $BSN=BSN_A+2*CV_A-15$ or $BSN=BSN_A+2*CV_A-16$ for further data blocks received after the Coding scheme change.

SS verifies that CV decreases progressively in further blocks.

Maximum Duration of Test

5 minutes.

Expected Sequence

Step	Direction	Message	Comments
1		{Uplink dynamic allocation two phase access}	N chosen to transmit minimum 20 blocks USF_GRANULARITY = 1 block EGPRS Channel Coding Command: MCS-6
2	SS -> MS	PACKET DOWNLINK DUMMY CONTROL BLOCK	Sent on the PACCH of the PDCH assigned, containing USF assigned to the MS.
3	MS -> SS	EGPRS UPLINK RLC DATA BLOCK	Received on the assigned PDTCH. SS verifies that the BSN starts from 0, and the correct MCS is used.
4	SS -> MS	PACKET UPLINK ACK/NACK	Wait for BS_CV_MAX block periods before sending this message. SS Acknowledges the UL RLC Data Block USF assigned to the MS.
5	MS -> SS	EGPRS UPLINK RLC DATA BLOCK	Received on the assigned PDTCH. SS verifies that the BSN values are in sequence, and the correct MCS is used.
6	-		Repeat steps 4 and 5 until CV = 14 SS notes BSN and CV values of the received Data Block as BSN_A and CV_A
7	SS -> MS	PACKET UPLINK ACK/NACK	Wait for BS_CV_MAX block periods before sending this message. SS Acknowledges the UL RLC Data Block EGPRS CHANNEL CODING COMMAND: MCS-3
8	-		Wait for 6 blocks with no USF
9	SS -> MS	PACKET DOWNLINK DUMMY CONTROL BLOCK	Sent on the PACCH of the PDCH assigned, containing USF assigned to the MS.
Step 10a (Optional)	MS -> SS	EGPRS UPLINK RLC DATA BLOCK	The MS may send a data block already in the buffer using coding scheme MCS-6. If received, the value of CV and BSN of the radio block shall be taken for further calculation.(BSN_A and CV_A)
Step 10b (Optional)	SS -> MS	PACKET DOWNLINK DUMMY CONTROL BLOCK	Sent on the PACCH of the PDCH assigned, containing USF assigned to the MS.
10	MS -> SS	EGPRS UPLINK RLC DATA BLOCK	Received on the assigned PDTCH. SS verifies that coding scheme MCS-3 is used; BSN is increased by 1 and CV = 15.
11	SS-> MS	PACKET UPLINK ACK/NACK	Wait for BS_CV_MAX block periods before sending this message. SS Acknowledges the UL RLC Data Block USF assigned to the MS.
12	-		Repeat steps 10 and 11 until CV changes to 14. Check that for CV=14: BSN= BSN_A+ 2*CV_A – 14 or BSN= BSN_A+ 2*CV_A – 15;
13	MS->SS	EGPRS UPLINK RLC DATA BLOCK	Received on the assigned PDCH. SS verifies that BSN is incremented by 1 and CV is decremented by 1
14		[Completion of RLC Data Block Transfer]	

53.1.1.23 Acknowledged Mode/ Uplink TBF/ Interpretation of Compressed Bitmap

53.1.1.23.1 Conformance requirements

If the window size is larger than the number of bits available for the bitmap, then one-dimensional run length coding (based on ITU-T T.4) is carried out starting at SSN.

If a compressed reported bitmap is received, the bitmap shall first be decompressed

Firstly, if the BOW bit in PACKET UPLINK/DOWNLINK ACK/NACK has the value "1", then the bitmap acknowledges all blocks between V(A) and (SSN- 2) (modulo SNS), and the corresponding elements in V(B) shall be

set to the value ACKED. Also a bitmap value of '0' is assumed at the bit position corresponding to $(SSN-1)$ modulo SNS which corresponds to $V(Q)$.

Then, for each bit in the uncompressed bitmap whose corresponding BSN value is within the transmit window, if the bit contains the value '1', the corresponding element in $V(B)$ indexed relative to SSN shall be set to the value ACKED. If the bit contains the value '0', the element in $V(B)$ shall be set to the value NACKED. A bit within the uncompressed bitmap whose corresponding BSN is not within the transmit window, shall be ignored.

If the EOW bit in the PACKET UPLINK/DOWNLINK ACK/NACK has the value "1", , then bitmap value '0' shall be assumed for all RLC blocks with a BSN value higher than the last entry in the bitmap but less than $V(S)$ (ie. $[V(R) - 1 < BSN < V(S)]$ modulo SNS).

References

3GPP TS 04.60, subclause 9.1.8.2.4, 9.1.10

53.1.1.23.2 Test purpose

To verify that the MS correctly decodes the Compressed bitmap.

53.1.1.23.3 Method of test

Initial Conditions

System Simulator:

1 cell with EGPRS support, default setting, PBCCH not present, BS_CV_MAX = 15.

Mobile Station:

The MS is EGPRS updated with a P-TMSI allocated, SPLIT PG CYCLE negotiated and the test PDP context2 activated.

Specific PICS Statements

-

PIXIT Statements

-

Test Procedure

The EGPRS capable MS is made to transmit more than 192 EGPRS RLC Data Blocks in RLC acknowledged mode. Coding Scheme MCS-1 and Window Size 192 is commanded.

For $K=1$

After receiving the block with $BSN=191$, SS wait for BS_CV_MAX Block periods and send PACKET UPLINK ACK/NACK acknowledging first N blocks and negatively acknowledging the rest of the blocks using a compressed bitmap.

The SS verifies that the MS decode the compressed bitmap correctly by checking that the negatively acknowledged blocks are retransmitted correctly.

For $K=2$

After receiving the block with $BSN=191$, SS wait for BS_CV_MAX Block periods and send PACKET UPLINK ACK/NACK negatively acknowledging first N blocks and positively acknowledging the rest of the blocks using a compressed bitmap.

The SS verifies that the MS decode the compressed bitmap correctly by checking that the negatively acknowledged blocks are retransmitted correctly.

The test procedure is repeated for different values of N.

Maximum Duration of Test

5 minutes.

Expected Sequence

Step	Direction	Message	Comments
1		{Uplink dynamic allocation two phase access}	Number of Data Blocks >192 USF_GRANULARITY = 1 block EGPRS Channel Coding Command: MCS-1
2	SS -> MS	PACKET DOWNLINK DUMMY CONTROL BLOCK	Sent on the PACCH of the PDCH assigned, containing USF assigned to the MS.
3	MS -> SS	EGPRS UPLINK RLC DATA BLOCK	Received on the assigned PDTCH. SS verifies that the BSN starts from 0, and the correct MCS is used.
4	-		Repeat Steps 2 and 3 until Data Block with BSN=191 is received.
5	SS		Wait BS_CV_MAX block periods
6	SS -> MS	PACKET UPLINK ACK/NACK	For K=1 SS acknowledges first N data blocks and negatively acknowledges the rest of the data blocks using a Compressed bitmap. For K=2 SS negatively acknowledges first N data blocks and positively acknowledges the rest of the data blocks using a Compressed bitmap. Wait for 6 blocks with no USF
7	SS -> MS	PACKET DOWNLINK DUMMY CONTROL BLOCK	Sent on the PACCH of the PDCH assigned, containing USF assigned to the MS.
7a (optional)	MS -> SS	EGPRS UPLINK RLC DATA BLOCK	Received on the assigned PDTCH. The MS may retransmit Data Block with BSN=0 already queued in the transmit buffer.
7b (optional)	SS -> MS	PACKET DOWNLINK DUMMY CONTROL BLOCK	Sent on the PACCH of the PDCH assigned, containing USF assigned to the MS.
8	MS -> SS	EGPRS UPLINK RLC DATA BLOCK	Received on the assigned PDTCH. For K=1 SS verifies that the BSN of the Data block is N, and the correct MCS is used. For K=2 SS verifies that the BSN of the Data block is 0, and the correct MCS is used.
9	-		Repeat Steps 7 and 8 and verify that For K=1 Data Blocks with BSN=N till BSN=191 are retransmitted. For K=2 Data Blocks with BSN=0 till BSN=N-1 are retransmitted
10		[Completion of RLC Data Block Transfer]	

Repeat the test for different values of N.

53.1.1.24 Acknowledged Mode/ Uplink TBF/ Interpretation of PBSN.

53.1.1.24.1 Conformance requirements

For EGPRS uplink TBFs, the network may select any composition of the Packet Ack/Nack message to send to the MS. SSN is determined by the receiver as a function of ES/P, V(Q) and PBSN.

If the receiving side is the network, the network may select any SSN within the receive window.

The BOW (begin of window) bit shall be set if $SSN = [V(Q) + 1]$ modulo SNS, the EOW (end of window) bit shall be set if $[V(R) - 1]$ modulo SNS is explicitly included in the bitmap.

For uplink TBFs, the reported bitmap is sent using the PACKET UPLINK ACK/NACK message corresponding to the used RB size.

Firstly, if the BOW bit in PACKET UPLINK/DOWNLINK ACK/NACK has the value "1", then the bitmap acknowledges all blocks between $V(A)$ and $(SSN-2)$ (modulo SNS), and the corresponding elements in $V(B)$ shall be set to the value ACKED. Also a bitmap value of '0' is assumed at the bit position corresponding to $(SSN-1)$ modulo SNS which corresponds to $V(Q)$.

If the EOW bit in the PACKET UPLINK/DOWNLINK ACK/NACK has the value "1", , then bitmap value '0' shall be assumed for all RLC blocks with a BSN value higher than the last entry in the bitmap but less than $V(S)$ (ie. $[V(R) - 1 < BSN < V(S)]$ modulo SNS).

References

3GPP TS 04.60, subclause 9.1.8.2

53.1.1.24.2 Test purpose

To verify that the MS is correctly able to interpret a received bitmap by taking into consideration BOW, EOW and SSN fields.

53.1.1.24.3 Method of test

Initial Conditions

System Simulator:

1 cell with EGPRS support, default setting, PBCCH not present, BS_CV_MAX = 15.

Mobile Station:

The MS is EGPRS updated with a P-TMSI allocated, SPLIT PG CYCLE negotiated and the test PDP context2 activated.

Specific PICS Statements

-

PIXIT Statements

-

Test Procedure

The EGPRS capable MS is made to transmit EGPRS RLC Data Blocks in RLC acknowledged mode. Coding Scheme MCS-2 and Window Size 192 is commanded. PRE_EMPTIVE_TX is set to 1.

After receiving RLC Data block with BSN=150, SS wait for BS_CV_MAX Block periods and send PACKET UPLINK ACK/NACK with BOW=0 and EOW=0. SSN is 81 and the bitmap negatively acknowledges all blocks from BSN 81 till BSN 90 and positively acknowledges data blocks with BSN 91 till BSN 139.

SS verifies that the MS retransmit BSN 81 till BSN 90 and then transmit new data blocks. After receiving data block with BSN=160, SS wait for BS_CV_MAX Block periods and send PACKET UPLINK ACK/NACK with BOW=1 and EOW=0. SSN is set to 11 and the bitmap acknowledges data blocks with BSN 11 till BSN 75 and negatively acknowledging BSN 10, and 76 till 80.

SS verifies that MS retransmits data block with BSN 10, and BSN 76 till 80 and then continue transmitting new data blocks.

After receiving data block with BSN=170, SS wait for BS_CV_MAX Block periods and send PACKET UPLINK ACK/NACK with BOW=0 and EOW=1. SSN is 140 and the bitmap negatively acknowledges all blocks from BSN 140 till 150 and the bitmap acknowledges data blocks from BSN=151 till 170.

SS verifies that MS retransmits data blocks from BSN =140 till 150 and then continue with transmission of new data blocks.

SS verifies after sending RLC data block with BSN=201, the MS retransmits data block with BSN=10.

SS acknowledges all the received data blocks.

Expected Sequence

Step	Direction	Message	Comments
1		{Uplink dynamic allocation two phase access}	N = 6000 octets (Number of Data Blocks >203) USF_GRANULARITY = 1 block EGPRS Channel Coding Command: MCS-2 EGPRS Window Size: 192
2	SS -> MS	PACKET DOWNLINK DUMMY CONTROL BLOCK	Sent on the PACCH of the PDCH assigned, containing USF assigned to the MS.
3	MS -> SS	EGPRS UPLINK RLC DATA BLOCK	Received on the assigned PDTCH. SS verifies that the BSN starts from 0, and the correct MCS is used.
4	-		Repeat Steps 2 and 3 until Data Block with BSN=150 is received.
5	SS		Wait BS_CV_MAX block periods
6	SS -> MS	PACKET UPLINK ACK/NACK	BOW=0; EOW=0; SSN=81; Bitmap negatively acknowledging BSN=81 till BSN=90, and positively acknowledging BSN=91 till BSN=139 Pre_Emptive_Tx=1
7	SS -> MS	PACKET DOWNLINK DUMMY CONTROL BLOCK	Sent on the PACCH of the PDCH assigned, containing USF assigned to the MS.
8a (optional)	MS -> SS	EGPRS UPLINK RLC DATA BLOCK	Received on the assigned PDTCH. The MS may transmit RLC data block with BSN=151, already queued in the transmit buffer.
8b (conditional)	SS -> MS	PACKET DOWNLINK DUMMY CONTROL BLOCK	If optional step 8a was received. Sent on the PACCH of the PDCH assigned, containing USF assigned to the MS.
8	MS -> SS	EGPRS UPLINK RLC DATA BLOCK	Received on the assigned PDTCH. Verify that that MS retransmits data block with BSN=81.
9	-		Repeat Step 7&8 9 times. Verify that MS retransmits data blocks with BSN=82 till BSN=90
10	SS -> MS	PACKET DOWNLINK DUMMY CONTROL BLOCK	Sent on the PACCH of the PDCH assigned, containing USF assigned to the MS.
11	MS -> SS	EGPRS UPLINK RLC DATA BLOCK	Received on the assigned PDTCH. In case step 8b was received Verify that that MS transmits new data block with BSN=152. Else Verify that that MS transmits new data block with BSN=151.
12	-		If step 8b was received Repeat Steps 10&11 8 times. Verify that MS sends data blocks with BSN=153 till BSN=160 Else Repeat Steps 10&11 9 times. Verify that MS sends data blocks with BSN=152 till BSN=160
13	SS		Wait BS_CV_MAX block periods
14	SS -> MS	PACKET UPLINK ACK/NACK	BOW=1; EOW=0; SSN=11; Bitmap acknowledging BSN=11 till BSN=75 and negatively acknowledging BSN 10 and 76 to 80. Pre_Emptive_Tx=1
15	SS -> MS	PACKET DOWNLINK DUMMY CONTROL BLOCK	Sent on the PACCH of the PDCH assigned, containing USF assigned to the MS.
16a (optional)	MS -> SS	EGPRS UPLINK RLC DATA BLOCK	Received on the assigned PDTCH. The MS may transmit RLC data block with BSN=161, already queued in the transmit buffer.
16b (conditional)	SS -> MS	PACKET DOWNLINK DUMMY CONTROL BLOCK	If optional step 16a was received. Sent on the PACCH of the PDCH assigned, containing USF assigned to the MS.
16	MS -> SS	EGPRS UPLINK RLC DATA BLOCK	Received on the assigned PDTCH. Verify that that MS retransmits data block with BSN=10.
17	-		Repeat Step 15&16 5 times. Verify that MS retransmits data blocks with BSN=76 till BSN=80
18	SS -> MS	PACKET DOWNLINK DUMMY CONTROL BLOCK	Sent on the PACCH of the PDCH assigned, containing USF assigned to the MS.

Step	Direction	Message	Comments
19	MS -> SS	EGPRS UPLINK RLC DATA BLOCK	Received on the assigned PDTCH. In case step 16b was received Verify that that MS transmits new data block with BSN=162. Else Verify that that MS transmits new data block with BSN=161.
20	-		Repeat Steps 18 and 19 until Data block with BSN=170 is received
21	SS		Wait BS_CV_MAX block periods
22	SS -> MS	PACKET UPLINK ACK/NACK	BOW=0; EOW=1; SSN=140; Bitmap negatively acknowledging BSN=140 till BSN=150, and positively acknowledging BSN=151 till BSN=170 Sent on PACCH. Pre_Emptive_Tx=1
23	SS -> MS	PACKET DOWNLINK DUMMY CONTROL BLOCK	Sent on the PACCH of the PDCH assigned, containing USF assigned to the MS.
24a (optional)	MS -> SS	EGPRS UPLINK RLC DATA BLOCK	Received on the assigned PDTCH. The MS may transmit RLC data block with BSN=171, already queued in the transmit buffer.
24b (conditional)	SS -> MS	PACKET DOWNLINK DUMMY CONTROL BLOCK	If optional step 24a was received. Sent on the PACCH of the PDCH assigned, containing USF assigned to the MS.
24	MS -> SS	EGPRS UPLINK RLC DATA BLOCK	Received on the assigned PDTCH. Verify that MS retransmits RLC data block with BSN=140.
25	-		Repeat Steps 23&24 10 times. Verify that MS retransmits Data Blocks with BSN=141 till BSN=150.
26	SS -> MS	PACKET DOWNLINK DUMMY CONTROL BLOCK	Sent on the PACCH of the PDCH assigned, containing USF assigned to the MS.
27	MS -> SS	EGPRS UPLINK RLC DATA BLOCK	Received on the assigned PDTCH. If Step 24b was received Verify that MS transmit new data block with BSN=172. Else Verify that MS transmit new data block with BSN=171.
28	-		Repeat Steps 26 and 27 until data block BSN=201 is received.
29	SS -> MS	PACKET DOWNLINK DUMMY CONTROL BLOCK	Sent on the PACCH of the PDCH assigned, containing USF assigned to the MS.
30	MS -> SS	EGPRS UPLINK RLC DATA BLOCK	Received on the assigned PDTCH. Verify that MS retransmits Data block with BSN=10. Verify that SI is set in the data block.
31	SS -> MS	PACKET UPLINK ACK/NACK	Acknowledging all blocks. Sent on PACCH. Pre_Emptive_Tx=1
32		{Completion of Uplink RLC Data Block Transfer}	

53.1.1.25 Acknowledged Mode/ Uplink TBF/ TBF Reallocation/Window Size

53.1.1.25.1 Conformance requirement

For EGPRS the window size (WS) shall be set by the network according to the number of timeslots allocated in the direction of the TBF (uplink or downlink). The allowed window sizes are given in Table 9.1.9.2.1.

MS shall support the maximum window size corresponding to its multislot capability. The selected WS shall be indicated within PACKET UL/DL ASSIGNMENT and PACKET TIMESLOT RECONFIGURE using the coding defined in Table 9.1.9.2.1.

Once a window size is selected for a given MS, it may be changed to a larger size but not to a smaller size, in order to prevent dropping data blocks from the window.

NOTE: If a TBF is reallocated so that the number of allocated timeslots is reduced, the RLC window size may become larger than the maximum window size for the new resources.

References

3GPP TS 04.60, subclause 9.1.9.2

53.1.1.25.2 Test purpose

To verify that if an uplink TBF is reallocated reducing the number of timeslots so that the RLC window size becomes larger than the maximum window size for the new resources, the MS retains the old window size.

53.1.1.25.3 Method of test

Initial Conditions

System Simulator:

1 cell with EGPRS support, default setting, PBCCH not present.

Mobile Station:

The MS is EGPRS updated with a P-TMSI allocated, SPLIT PG CYCLE negotiated and the test PDP context2 activated.

Specific PICS Statements

-

PIXIT Statements

-

Test Procedure

An uplink TBF allocating two timeslots is established. EGPRS Window Size is commanded to be 256 (the maximum according to the number of timeslots allocated to the TBF).

SS allocates uplink resources to the MS for transferring data in the uplink. After receiving RLC data block with BSN=191, SS sends a Packet Timeslot Reconfigure message to the MS reallocating the number of timeslots for the uplink TBF to 1.

SS allocates resources to the MS to transmit in the uplink. SS verifies that MS sends new data block with BSN=192. SS verify that MS continue to respect the initial Window Size commanded in Step 1 by checking that MS transmits new data blocks till BSN=255 and then retransmit data block with BSN=0

Maximum Duration of Test

10 minutes.

Expected Sequence

Step	Direction	Message	Comments
1		{Uplink dynamic allocation two phase access}	N = 6000 octets (greater than 256 data blocks) See specific message contents
2	SS -> MS	PACKET DOWNLINK DUMMY CONTROL BLOCK	Sent on the PACCH of the TN2, containing the USF_TN2 assigned to the MS.
3	MS -> SS	EGPRS UPLINK RLC DATA BLOCK	Received on the assigned PDTCH in TN2. SS verifies that the BSN of the received data block is 0, and the correct MCS is used.
4	SS -> MS	PACKET DOWNLINK DUMMY CONTROL BLOCK	Sent on the PACCH of the TN3, containing the USF_TN3 assigned to the MS.
5	MS -> SS	EGPRS UPLINK RLC DATA BLOCK	Received on the assigned PDTCH in TN3. SS verifies that the BSN of the data block is 1, and the correct MCS is used.
6	SS -> MS	PACKET DOWNLINK DUMMY CONTROL BLOCKs	Sent on the PACCH of the TN2 containing the USF_TN2 assigned to the MS and on the PACCH of the TN3 containing the USF_TN3 assigned to the MS
7	MS -> SS	EGPRS UPLINK RLC DATA BLOCK	Received on the assigned PDTCH block of TN2 and TN3.
8	-		Repeat Steps 6 and 7 until Data Block with BSN=191 is received.
9	SS -> MS	PACKET TIMESLOT RECONFIGURE	See specific message contents.
10	SS -> MS	EGPRS DOWNLINK RLC DATA BLOCK	Sent on the assigned downlink PDTCH, at least 3 block periods after step 9, FBI set to 1, ES/P = '01'B, RRBp = '00'B
11	MS -> SS	EGPRS PACKET DOWNLINK ACK/NACK	Received on PACCH of the assigned PDTCH. Check that the Final_Ack_Indicator is set.
12	SS -> MS	PACKET DOWNLINK DUMMY CONTROL BLOCK	Sent on the PACCH of the TN4, containing the USF_TN4 assigned to the MS in Step 9.
13	MS -> SS	EGPRS UPLINK RLC DATA BLOCK	Received on the assigned PDTCH in TN4. SS verifies that the BSN of the received data block is 192.
14	-		Repeat Steps 12 and 13 until Data Block with BSN=255 is received.
15	SS -> MS	PACKET DOWNLINK DUMMY CONTROL BLOCK	Sent on the PACCH of the TN4, containing the USF_TN4 assigned to the MS in Step 9.
16	MS -> SS	EGPRS UPLINK RLC DATA BLOCK	Received on the assigned PDTCH in TN4. SS verifies that the BSN of the received data block is 0 and that SI bit is set in the received data block.
17	SS -> MS	PACKET UPLINK ACK/NACK	Acknowledging all blocks. Sent on PACCH of PDCH assigned in TN4.
18		{Completion of Uplink RLC Data Block Transfer}	

Specific Message Contents

PACKET UPLINK ASSIGNMENT message in step 1 (in macro):

Information Element	value/ remark
EGPRS CHANNEL CODING COMMAND	MCS-1
<EGPRS window size>	00110 (256 blocks)
Dynamic allocation	01
EXTENDED_DYNAMIC_ALLOCATION	0 dynamic allocation only
{ 0 1 < P0 > }	0 downlink power control is not used
USF_GRANULARITY	0 MS shall transmit only one RLC/MAC block
{ 0 1 < UPLINK_TFI_ASSIGNMENT > }	1 assign uplink TFI
- UPLINK_TFI_ASSIGNMENT	00000
{ 0 1 < RLC_DATA_BLOCKS_GRANTED > }	0 open-ended TBF
{ 0 1 < TBF Starting Time > }	0 No starting time present
Timeslot Allocation	1 Timeslot Allocation with Power Control Parameters
- ALPHA	0,5
- { 0 1 < USF_TN0 > < GAMMA_TN0 > }	0 USF not assigned
- { 0 1 < USF_TN1 > < GAMMA_TN1 > }	0 USF not assigned

- { 0 1 < USF_TN2 ><GAMMA_TN2> } - USF_TN2 - GAMMA_TN2	1 USF assigned 000 For GSM 700, T-GSM 810, GSM 850 and GSM 900: +8 dBm For DCS 1 800 and PCS 1 900: +6 dBm
- { 0 1 < USF_TN3 ><GAMMA_TN3> } - USF_TN3 - GAMMA_TN3	1 USF assigned 010 For GSM 700, T-GSM 810, GSM 850 and GSM 900: +8 dBm For DCS 1 800 and PCS 1 900: +6 dBm
- { 0 1 < USF_TN4 ><GAMMA_TN4> }	0 USF not assigned
- { 0 1 < USF_TN5 ><GAMMA_TN5> }	0 USF not assigned
- { 0 1 < USF_TN6 ><GAMMA_TN6> }	0 USF not assigned
- { 0 1 < USF_TN7 ><GAMMA_TN7> }	0 USF not assigned
spare padding	Spare Padding

PACKET TIMESLOT RECONFIGURE in Step 9

MESSAGE_TYPE	0 00111
PAGE_MODE	00 Normal Paging
GLOBAL_TFI	UL_TFI assigned in Step 1
COMPACT reduced MA	0 (Not present)
EGPRS Channel Coding Command	0000 (MCS-1)
<RESEGMENT	1
0 1 <DOWNLINK EGPRS Window Size >	1 (Present)
DOWNLINK EGPRS Window Size	192
0 1 <UPLINK EGPRS Window Size>	0 (Not present)
LINK_QUALITY_MEASUREMENT_MODE	00
Packet Timing Advance	
{ 0 1< TIMING_ADVANCE_VALUE >	1 (timing advance value)
- TIMING_ADVANCE_VALUE }	30 bit periods
- {0 1<UPLINK_TIMING_ADVANCE_INDEX>	0 (no uplink timing advance index)
<UPLINK_TIMING_ADVANCE_TIMESLOT_NUMBER>}	
- {0 1<DOWNLINK_TIMING_ADVANCE_INDEX>	0 (no downlink timing advance index)
<DOWNLINK_TIMING_ADVANCE_TIMESLOT_NUMBE	
R>}	
0 1 <Packet Extended Timing Advance	0 (Extended TA for GSM 400 not present)
DOWNLINK_RLC_MODE	0 Acknowledged mode
CONTROL_ACK	0
{0 1<DOWNLINK_TFI_ASSIGNMENT>}	1 (assign downlink TFI)
- DOWNLINK_TFI_ASSIGNMENT	00001(Binary)
{0 1< UPLINK_TFI_ASSIGNMENT >	0 (Not present)
DOWNLINK_TIMESLOT_ALLOCATION	TN 4
{0 1<Frequency Parameters>}	0 (Frequency Parameters not present)
{ 01 < Dynamic Allocation >	Dynamic Allocation struct :
< Extended Dynamic Allocation >	0 (Dynamic allocation)
0 1< P0 >	0
< USF_GRANULARITY >	0 (one block)
{0 1< RLC_DATA_BLOCKS_GRANTED >}	0 (no RLC_DATA_BLOCKS_GRANTED, open-ended TBF)
{0 1< TBF_STARTING_TIME >}	0 (no starting time)
{0 1< Timeslot Allocation >	1 (Timeslot Allocation with Power Control Parameters)
ALPHA	0,5
{0 1< USF_TN0><GAMMA_TN0> }	0 (timeslot 0 not assigned)
{0 1< USF_TN1><GAMMA_TN1> }	0 (timeslot 1 not assigned)
{0 1< USF_TN2><GAMMA_TN2> }	0 (timeslot 2 not assigned)
{0 1< USF_TN3><GAMMA_TN3> }	0 (timeslot 3 not assigned)
{0 1< USF_TN4><GAMMA_TN4> }	1 (timeslot 4 assigned)
- USF_TN4	011
- GAMMA_TN4	For GSM 700, T-GSM 810, GSM 850 and GSM 900: +8 dBm
	For DCS 1 800 and PCS 1 900: +6 dBm
{0 1< USF_TN5><GAMMA_TN5> }	0 (timeslot 5 not assigned)
{0 1< USF_TN6><GAMMA_TN6> }	0 (timeslot 6 not assigned)
{0 1< USF_TN7><GAMMA_TN7> }	0 (timeslot 7 not assigned)
spare padding	Spare Padding

53.1.2 Acknowledged Mode/ Downlink TBF

53.1.2.1 Acknowledged Mode/ Downlink TBF/ Receive State Variable V(R)

53.1.2.1.1 Conformance requirements

1. In RLC acknowledged mode, each RLC endpoint receiver shall have an associated receive state variable V(R). The receive state variable denotes the BSN of the next in-sequence RLC data block expected to be received.
2. The BOW bit shall be set if $SSN = [V(Q) + 1]$ modulo SNS, the EOW bit shall be set if $[V(R) - 1]$ modulo SNS is explicitly included in the bitmap.

References

3GPP TS 04.60, subclause 9.1.5.

53.1.2.1.2 Test purpose

1. To verify the receive state variable, V(R) is set to the next in-sequence RLC data block expected to be received.

53.1.2.1.3 Method of test

Initial Conditions

System Simulator:

1 cell with EGPRS support, default setting, PBCCH not present.

Mobile Station:

The MS is EGPRS updated with a P-TMSI allocated, SPLIT PG CYCLE negotiated and the test PDP context2 activated.

Specific PICS Statements

-

PIXIT Statements

-

Test Procedure

The SS initiates the establishment of a downlink EGPRS TBF, setting window size value to the maximum possible.

The SS sends 5 EGPRS RLC data blocks with BSN = 1, 3, 5, 7, 9, and polls the MS. The MS shall send an EGPRS PACKET DOWNLINK ACK/NACK message to the SS with EOW set in the EGPRS Ack/Nack Description IE.

The SS then sends more EGPRS RLC data blocks with BSN = 11, 13, ..., and polls the MS in the last block with ES/P='01'B. The MS shall send an EGPRS PACKET DOWNLINK ACK/NACK message to the SS with EOW not set.

Maximum Duration of Test

30 minutes.

Expected Sequence

Step	Direction	Message	Comments
1		{Downlink TBF establishment}	Acknowledged Mode EGPRS Window Size: 192
2	SS -> MS	EGPRS DOWNLINK RLC DATA BLOCK	Sent 5 blocks on the assigned PDTCH, with BSN = 1, 3, 5, 7, 9. In the last block ES/P = '01', RRBP = '00'.
3	MS -> SS	EGPRS PACKET DOWNLINK ACK/NACK	Received on PACCH of the assigned PDTCH. EOW = 1
4	SS -> MS	EGPRS DOWNLINK RLC DATA BLOCK	Sent more blocks on the assigned PDTCH, BSN = 11, 13, ..., 189 In the last block ES/P = '01'B, RRBP = '00'B.
5	MS -> SS	EGPRS PACKET DOWNLINK ACK/NACK	Received on PACCH of the assigned PDTCH. EOW = 0

53.1.2.2 Acknowledged Mode/ Downlink TBF/ Receive Window State Variable V(Q)

53.1.2.2.1 Conformance requirements

1. In RLC acknowledged mode, each RLC endpoint receiver shall have an associated receive window state variable, V(Q). The mobile station shall set V(Q) to the value 0 at the beginning of each TBF in which the RLC endpoint is the receiver.
2. The value of V(Q) shall be updated when the RLC receiver receives the RLC data block whose BSN is equal to V(Q).

3. The EGPRS Packet Ack/Nack message contains a starting sequence number (SSN) and a reported bitmap (RB). The EGPRS Packet Ack/Nack message is sent by the RLC receiver and is received by the RLC transmitter.

References

3GPP TS 04.60, subclause 9.1.6.

53.1.2.2.2 Test purpose

1. To verify the correct initialisation of the receive state variable $V(Q)$.
2. To verify that $V(Q)$ is not updated when data blocks with BSN not equal to $V(Q)$ are received.

53.1.2.2.3 Method of test

Initial Conditions

System Simulator:

1 cell with EGPRS support, default setting, PBCCH not present.

Mobile Station:

The MS is EGPRS updated with a P-TMSI allocated, SPLIT PG CYCLE negotiated and the test PDP context2 activated.

Specific PICS Statements

-

PIXIT Statements

-

Test Procedure

The SS initiates the establishment of a downlink EGPRS TBF.

The SS sends an EGPRS RLC data block with BSN = 1 to the MS and polls the MS. The SS verifies that the MS shall send an EGPRS PACKET DOWNLINK ACK/NACK message with SSN = 1.

The SS sends a sequence of EGPRS RLC data blocks with BSN = 2,3,4,5,6 in sequence and polls the MS each time with ES/P = '01'. The SS verifies that the MS shall send an EGPRS PACKET DOWNLINK ACK/NACK message to the SS each time with SSN = 1 not changed.

The SS sends an RLC data blocks with BSN = 0 and polls the MS with ES/P = '01'. The SS verifies that the MS shall send an EGPRS PACKET DOWNLINK ACK/NACK message to the SS with SSN = 8.

Maximum Duration of Test

30 minutes.

Expected Sequence

Step	Direction	Message	Comments
1		{Downlink TBF establishment}	Acknowledged Mode EGPRS Window Size: 192
2	SS -> MS	EGPRS DOWNLINK RLC DATA BLOCK	Sent a block on the assigned PDTCH, with BSN = 1. In the last block ES/P = '01'B, RRBP = '00'B.
3	MS -> SS	EGPRS PACKET DOWNLINK ACK/NACK	Received on PACCH of the assigned PDTCH. SSN = 1
4	SS -> MS	EGPRS DOWNLINK RLC DATA BLOCK	Sent a sequence of blocks on the assigned PDTCH, BSN = 2, 3, ..., 6 In the last block ES/P = '01' , RRBP = '00'.
5	MS -> SS	EGPRS PACKET DOWNLINK ACK/NACK	Received on PACCH of the assigned PDTCH. SSN = 1
6	SS -> MS	EGPRS DOWNLINK RLC DATA BLOCK	Sent a block on the assigned PDTCH, with BSN = 0. In the last block ES/P = '01'B, RRBP = '00'B.
7	MS -> SS	EGPRS PACKET DOWNLINK ACK/NACK	Received on PACCH of the assigned PDTCH. SSN = 8

53.1.2.3 Acknowledged Mode/ Downlink TBF/ Window Size/ Default Value

53.1.2.3.1 Conformance requirements

In case a PACKET TIMESLOT RECONFIGURE is sent to the MS without any window size for a specific TBF, then any previous value received for the specific TBF shall be used or, if no previous value has been received for the specific TBF, default window size shall be used.

References

3GPP TS 04.60, subclause 9.1.9.2.

53.1.2.3.2 Test purpose

1. To verify that MS use a default WS value when a PACKET TIMESLOT RECONFIGURE is sent to the MS without downlink window size indication to establish a downlink TBF.
2. To verify that MS use the previous WS value received for the Downlink TBF when a PACKET TIMESLOT RECONFIGURE without downlink window size indication is sent to the MS reconfiguring an existing Downlink TBF.

53.1.2.3.3 Method of test

Initial Conditions

System Simulator:

1 cell with EGPRS support, default setting, PBCCH not present.

Mobile Station:

The MS is EGPRS updated with a P-TMSI allocated, SPLIT PG CYCLE negotiated and the test PDP context2 activated.

Specific PICS Statements

-

PIXIT Statements

-

Test Procedure

The SS establishes an Uplink TBF. Uplink EGPRS Window size is commanded to be 192. When Uplink TBF is in progress, SS sends a PACKET TIMESLOT RECONFIGURE message to the MS, establishing a downlink TBF. Downlink Window Size IE is omitted from the message.

SS sends an EGPRS Downlink Data block with BSN=1 and polls the MS for acknowledgement. SS verifies that MS correctly acknowledges BSN=1.

SS sends another data block with BSN=64 and polls the MS for acknowledgement. SS verifies that MS acknowledges the data block with BSN=1 and that MS includes bitmap information only for BSN =1

SS sends a Downlink Assignment to the MS reconfiguring the Downlink Window Size to 96. SS sends some data to the MS.

SS sends a a PACKET TIMESLOT RECONFIGURE message to the MS, reconfiguring the PDCH.

Downlink Window Size IE is not included in the message.

SS sends a data block with BSN=95 and polls the MS for acknowledgement. SS verifies that MS correctly acknowledges reception of BSN=95 and that the bitmap includes information of data blocks from BSN=1 till BSN=95.

Maximum Duration of Test

30 minutes.

Expected Sequence

Step	Direction	Message	Comments
1		{Uplink dynamic allocation two phase access}	N=500 octets Acknowledged Mode EGPRS Window Size: 192
2	SS -> MS	DOWNLINK DUMMY CONTROL BLOCK	Sent on the assigned PDTCH, USF assigned to the MS
3	MS -> SS	EGPRS UPLINK RLC DATA BLOCK	Received on the assigned PDTCH
4	SS -> MS	PACKET UPLINK ACK/NACK	Sent on the PACCH of the assigned PDTCH acknowledging the block received in Step3. Wait for BS_CV_MAX block periods after Step 3 before sending this message.
5	SS -> MS	PACKET TIMESLOT RECONFIGURE	Sent on PACCH of the assigned PDTCH. Establishing a Downlink TBF. Without Downlink EGPRS WINDOW SIZE
6	SS -> MS	EGPRS DOWNLINK RLC DATA BLOCK	Sent on the PDTCH assigned in Step 5, BSN = 1, ES/P = '01'B, RRBP = '00'B. Wait at least 6 block periods after Step 5 before sending this message.
7	MS -> SS	EGPRS PACKET DOWNLINK ACK/NACK	Received on PACCH the PDTCH assigned in Step 5. SS verifies that SSN=1 and BSN = 1 is positively acknowledged.
8	SS -> MS	EGPRS DOWNLINK RLC DATA BLOCK	Sent on the PDTCH assigned in Step 5, BSN = 64, ES/P = '01'B, RRBP = '00'B.
9	MS -> SS	EGPRS PACKET DOWNLINK ACK/NACK	Received on PACCH the PDTCH assigned in Step 5. SS verifies that SSN=1 and BSN = 1 is positively acknowledged. SS verifies that the bitmap contains only the acknowledgement for BSN=1 (Bitmap size is 1)
10	SS -> MS	PACKET DOWNLINK ASSIGNMENT	Sent on PACCH of the PDTCH assigned in Step 5. Addressing the MS using the DL TFI assigned in Step 5. EGPRS Window Size = 96
11	SS -> MS	EGPRS DOWNLINK RLC DATA BLOCK	Sent on the PDTCH assigned in Step 10, BSN = 2, USF assigned to the MS. Wait at least 6 block periods after Step 10 before sending this message.
12	MS -> SS	EGPRS UPLINK RLC DATA BLOCK	Received on the assigned PDTCH
13	SS -> MS	EGPRS DOWNLINK RLC DATA BLOCK	Sent on the PDTCH assigned in Step 10, BSN = 3, ES/P = '01'B, RRBP = '00'B.
14	MS -> SS	EGPRS PACKET DOWNLINK ACK/NACK	Received on PACCH of the assigned PDTCH. SS verifies that SSN=1 and BSN = 1,2 and 3 are positively acknowledged. SS verifies that the bitmap contains only the acknowledgement for BSN=1,2 and 3 (Bitmap size is 3)
15	SS -> MS	PACKET TIMESLOT RECONFIGURE	Sent on PACCH of the assigned downlink PDTCH. Without Downlink EGPRS WINDOW SIZE
16	SS -> MS	EGPRS DOWNLINK RLC DATA BLOCK	Sent on the PDTCH assigned in Step 10, BSN = 95, ES/P = '01'B, RRBP = '00'B. Wait at least 6 block periods after Step 15 before sending this message.
17	MS -> SS	EGPRS PACKET DOWNLINK ACK/NACK	Received on PACCH of the assigned PDTCH. SS verifies that SSN=1 and bitmap positively acknowledges BSN = 1,2,3 and 95.
18	SS -> MS	EGPRS DOWNLINK RLC DATA BLOCKS	SS sends all missing data blocks to the MS, with block BSN=94 having ES/P = '01'B, RRBP = '00'B
19	MS -> SS	EGPRS PACKET DOWNLINK ACK/NACK	Received on PACCH of the assigned PDTCH, indicating that all blocks from BSN=0 to BSN=95 are positively acknowledged
20	SS -> MS	EGPRS DOWNLINK RLC DATA BLOCK	Sent on the PDTCH assigned in Step 10, BSN = 96, FBI is set to '1' ES/P = '01'B, RRBP = '00'B.
21	MS -> SS	EGPRS PACKET DOWNLINK ACK/NACK	Received on PACCH of the assigned PDTCH. SS verifies that FBI bit is set to '1'
22	SS	{Completion of uplink RLC data block transfer}	

Specific Message contents

PACKET TIMESLOT RECONFIGURE in Step 5

MESSAGE_TYPE	0 00111
PAGE_MODE	00 Normal Paging
GLOBAL_TFI	UL_TFI assigned in Step 1
COMPACT reduced MA	0 (Not present)
EGPRS Channel Coding Command	0001 (MCS-2)
<RESEGMENT	1
0 1 <DOWNLINK EGPRS Window Size >	0 (Not Present)
0 1 <UPLINK EGPRS Window Size>	0 (Not present)
LINK_QUALITY_MEASUREMENT_MODE	00
Packet Timing Advance	
{ 0 1< TIMING_ADVANCE_VALUE >	1 (timing advance value)
- TIMING_ADVANCE_VALUE }	30 bit periods
{ 0 1< TIMING_ADVANCE_INDEX >	0 (no timing advance index)
<TIMING_ADVANCE_TIMESLOT_NUMBER > }	
0 1 <Packet Extended Timing Advance	0 (Extended TA for GSM 400 not present)
DOWNLINK_RLC_MODE	0 Acknowledged mode
CONTROL_ACK	0
{0 1<DOWNLINK_TFI_ASSIGNMENT>}	1 (assign downlink TFI)
- DOWNLINK_TFI_ASSIGNMENT	00001(Binary)
{0 1< UPLINK_TFI_ASSIGNMENT >	0 (Not present)
DOWNLINK_TIMESLOT_ALLOCATION	Same as UL Timeslot used (Default TN 4)
{0 1<Frequency Parameters>}	0 (Frequency Parameters not present)
{ 01 < Dynamic Allocation >	Dynamic Allocation struct :
< Extended Dynamic Allocation >	0 (Dynamic allocation)
0 1< P0 >	0
< USF_GRANULARITY >	0 (one block)
{0 1< RLC_DATA_BLOCKS_GRANTED >}	0 (no RLC_DATA_BLOCKS_GRANTED, open-ended TBF)
{0 1< TBF_STARTING_TIME >}	0 (no starting time)
{0 1< Timeslot Allocation >	0 (Timeslot Allocation)
{0 1< USF_TN0>}	0 (timeslot 0 not assigned)
{0 1< USF_TN1>}	0 (timeslot 1 not assigned)
{0 1< USF_TN2>	0 (timeslot 2 not assigned)
{0 1< USF_TN3>}	0 (timeslot 3 not assigned)
{0 1< USF_TN4>}	1 (timeslot 4 assigned)
- USF_TN4	Same USF as assigned in Step 1
{0 1< USF_TN5>}	0 (timeslot 5 not assigned)
{0 1< USF_TN6>}	0 (timeslot 6 not assigned)
{0 1< USF_TN7>}}	0 (timeslot 7 not assigned)

PACKET TIMESLOT RECONFIGURE in Step 15

MESSAGE_TYPE	0 00111
PAGE_MODE	00 Normal Paging
GLOBAL_TFI	DL_TFI assigned in Step 5
COMPACT reduced MA	0 (Not present)
EGPRS Channel Coding Command	0010 (MCS-3)
<RESEGMENT	1
0 1 <DOWNLINK EGPRS Window Size >	0 (Not Present)
0 1 <UPLINK EGPRS Window Size>	0 (Not present)
LINK_QUALITY_MEASUREMENT_MODE	00
Packet Timing Advance	
{ 0 1< TIMING_ADVANCE_VALUE >	1 (timing advance value)
- TIMING_ADVANCE_VALUE }	30 bit periods
{ 0 1< TIMING_ADVANCE_INDEX >	0 (no timing advance index)
<TIMING_ADVANCE_TIMESLOT_NUMBER > }	
0 1 <Packet Extended Timing Advance	0 (Extended TA for GSM 400 not present)
DOWNLINK_RLC_MODE	0 Acknowledged mode
CONTROL_ACK	0
{0 1<DOWNLINK_TFI_ASSIGNMENT>}	0 (Not present)
{0 1< UPLINK_TFI_ASSIGNMENT >	0 (Not present)
DOWNLINK_TIMESLOT_ALLOCATION	Same as UL Timeslot used (Default TN 4)
{0 1<Frequency Parameters>}	0 (Frequency Parameters not present)
{ 01 < Dynamic Allocation >	Dynamic Allocation struct :
< Extended Dynamic Allocation >	0 (Dynamic allocation)
0 1< P0 >	0
< USF_GRANULARITY >	0 (one block)
{0 1< RLC_DATA_BLOCKS_GRANTED >}	0 (no RLC_DATA_BLOCKS_GRANTED, open-ended TBF)
{0 1< TBF_STARTING_TIME >}	0 (no starting time)
{0 1< Timeslot Allocation >	0 (Timeslot Allocation)
{0 1< USF_TN0>}	0 (timeslot 0 not assigned)
{0 1< USF_TN1>}	0 (timeslot 1 not assigned)
{0 1< USF_TN2>	0 (timeslot 2 not assigned)
{0 1< USF_TN3>}	0 (timeslot 3 not assigned)
{0 1< USF_TN4>}	1 (timeslot 4 assigned)
- USF_TN4	Same USF as assigned in Step 1
{0 1< USF_TN5>}	0 (timeslot 5 not assigned)
{0 1< USF_TN6>}	0 (timeslot 6 not assigned)
{0 1< USF_TN7>}}	0 (timeslot 7 not assigned)

53.1.2.4 Acknowledged Mode/ Downlink TBF/ Window Size/ Assigned Value

53.1.2.4.1 Conformance requirements

1. For EGPRS the window size (WS) shall be set by the network according to the number of timeslots allocated in the direction of the TBF (uplink or downlink).
2. MS shall support the maximum window size corresponding to its multi timeslot capability.
3. The selected WS shall be indicated within PACKET UL/DL ASSIGNMENT and PACKET TIMESLOT RECONFIGURE.

References

3GPP TS 04.60, subclause 9.1.9.2.

53.1.2.4.2 Test purpose

1. To verify that the MS correctly interprets the window size indication in PACKET DOWNLINK ASSIGNMENT.
2. To verify that the MS correctly interprets the window size indication in PACKET TIMESLOT RECONFIGURE during downlink TBF.
3. To verify that the MS supports the maximum window size corresponding to its multi timeslot capability for downlink TBF.

53.1.2.4.3 Method of test

Initial Conditions

System Simulator:

1 cell with EGPRS support, default setting, PBCCH not present.

Mobile Station:

The MS is EGPRS updated with a P-TMSI allocated, SPLIT PG CYCLE negotiated and the test PDP context2 activated.

Specific PICS Statements

-

PIXIT Statements

-

Test Procedure

The SS initiates the establishment of a downlink EGPRS TBF, setting $WS = N < N'$ (the maximum possible legal WS value) in the PACKET DOWNLINK ASSIGNMENT message. The SS sends a RLC data block with $BSN = N$ and polls for acknowledgement. MS shall send a Packet Downlink Ack/Nack message acknowledging no block. The MS is then triggered to transfer 440 octets of user data. The SS assigns an uplink TBF by sending a PACKET UPLINK ASSIGNMENT. The SS sends an RLC data block with $BSN = N-1$ and polls for acknowledgement. The MS shall send a Packet Downlink Ack/Nack message acknowledging the $BSN = N - 1$ block.

During the downlink and uplink TBF's, The SS sends a PACKET TIMESLOT RECONFIGURE message with $WS = N'$. The SS sends an RLC data block with $BSN = N'$ and polls for acknowledgement. The MS shall send a Packet Downlink Ack/Nack message without acknowledging the $BSN = N'$ block. The SS sends a RLC data block with $BSN = N'-1$ and poll for acknowledgement. The MS shall send a Packet Downlink Ack/Nack message acknowledging the $BSN = N'-1$ block.

Maximum Duration of Test

30 minutes.

Expected Sequence

Step	Direction	Message	Comments
1		{Downlink TBF establishment}	Acknowledged Mode EGPRS Window Size: N
2	SS -> MS	EGPRS DOWNLINK RLC DATA BLOCK	Sent on the assigned PDTCH, with BSN = N, ES/P = '01'B, RRBP = '00'B
3	MS -> SS	EGPRS PACKET DOWNLINK ACK/NACK	Received on PACCH of the assigned PDTCH without the acknowledgement for the block of BSN = N.
4	MS		The MS is triggered to send 440 octets of user data.
5	SS		Steps 2 and 3 are repeated until reception of EGPRS PACKET DOWNLINK ACK/NACK with Channel request Description IE included
6	SS -> MS	PACKET UPLINK ASSIGNMENT	USF_GRANULARITY = 1 block, RLC_DATA_BLOCKS_GRANTED = open-end TLLI_BLOCK_CHANNEL_CODING: arbitrarily chosen CHANNEL_CODING_COMMAND: arbitrarily chosen. The uplink TBF is assigned on the same timeslot as the downlink TBF.
7	SS -> MS	EGPRS DOWNLINK RLC DATA BLOCK	Sent on the assigned PDTCH, with BSN = N - 1, ES/P = '01'B RRBP = '00'B
8	MS -> SS	EGPRS PACKET DOWNLINK ACK/NACK	Received on PACCH of the assigned PDTCH with the acknowledgement for the block of BSN = N - 1.
9	SS -> MS	PACKET TIMESLOT RECONFIGURE	Sent on PACCH, containing the same Downlink Timeslot Allocation as before and Window Size of value N'.
10	SS -> MS	EGPRS DOWNLINK RLC DATA BLOCK	Sent on the assigned PDTCH, with BSN = N', ES/P = '01'B RRBP = '00'B
11	MS -> SS	EGPRS PACKET DOWNLINK ACK/NACK	Received on PACCH of the assigned PDTCH without the acknowledgement for the block of BSN = N'.
12	SS -> MS	EGPRS DOWNLINK RLC DATA BLOCK	Sent on the assigned PDTCH, with BSN = N' - 1, ES/P = '01'B RRBP = '00'B
13	MS -> SS	EGPRS PACKET DOWNLINK ACK/NACK	Received on PACCH of the assigned PDTCH with the acknowledgement for the block of BSN = N' - 1.
14	SS	{Completion of uplink RLC data block transfer}	

53.1.2.5 Acknowledged Mode/ Downlink TBF/ BOW

53.1.2.5.1 Conformance requirements

1. For downlink TBF, the reported bitmap is sent using the EGPRS PACKET DOWNLINK ACK/NACK message corresponding to the used RB size.
2. The BOW bit shall be set if $SSN = [V(Q) + 1]$ modulo SNS is explicitly included in the bitmap.

References

3GPP TS 04.60, subclause 9.1.8.2.4.

53.1.2.5.2 Test purpose

1. To verify the BOW bit is set to '1' when $SSN = [V(Q) + 1]$ modulo SNS is explicitly included in the bitmap.
2. To verify the BOW bit is set to '0' when $SSN = [V(Q) + 1]$ modulo SNS is not explicitly included in the bitmap.

53.1.2.5.3 Method of test

Initial Conditions

System Simulator:

- 1 cell with EGPRS support, default setting, PBCCH not present.

Mobile Station:

The MS is EGPRS updated with a P-TMSI allocated, SPLIT PG CYCLE negotiated and the test PDP context2 activated.

Specific PICS Statements

- EGPRS Multislotclass (TSPC_Type_EGPRS_Multislot_ClassX where X = 1..45)

PIXIT Statements

-

Test Procedure

The SS establishes an acknowledge mode downlink EGPRS TBF with the MS:

1. Set the window size to the maximum value according to the number of timeslots assigned to TBF.
2. Make the FRB length shorter than the possible RB size, set the BSN sequence for transmit like 0, 2, 4, 6, 8, ..., (max value of windows size), all with even values.
3. The SS sends those RLC data blocks with expected BSNs and polls the MS for the First Partial Bitmap in the last block.
4. Check the BOW bit of EGPRS PACKET DOWNLINK ACK/NACK should be '1' and the Report Bitmap should be a correct Report Bitmap.
5. The SS polls the MS for the Next Partial Bitmap.
6. Check the BOW bit of EGPRS PACKET DOWNLINK ACK/NACK should be '0' and the Report Bitmap should be a correct Report Bitmap.
7. The SS sends all of missed RLC data blocks to the MS.

Maximum Duration of Test

30 minutes.

Expected Sequence

Step	Direction	Message	Comments
1		{Downlink TBF establishment}	Acknowledged Mode EGPRS Window Size: Maximum value according to the number of Timeslots assigned for the TBF.
2	SS -> MS	EGPRS RLC DOWNLINK DATA BLOCK	The BSN sequence of RLC data block is 0, 2, 4, ..., WS-2, all have even number MS was polled for FPB
3	MS -> SS	EGPRS PACKET DOWNLINK ACK/NACK	The BOW bit of EGPRS PACKET DOWNLINK ACK/NACK is '1' B, The RB is a correct RB
4	SS -> MS	EGPRS RLC DOWNLINK DATA BLOCK	SS send one missed RLC data blocks to MS MS was polled for NPB
5	MS -> SS	EGPRS PACKET DOWNLINK ACK/NACK	The BOW bit of EGPRS PACKET DOWNLINK ACK/NACK is '0' B, The RB is a correct RB
6	SS -> MS	EGPRS RLC DOWNLINK DATA BLOCK	SS send all missed RLC data blocks to MS

53.1.2.6 Acknowledged Mode/ Downlink TBF/ EOW

53.1.2.6.1 Conformance requirements

1. For downlink TBFs, the reported bitmap is sent using the EGPRS PACKET DOWNLINK ACK/NACK message corresponding to the used RB size.
2. The EOW bit shall be set if $[V(R) - 1]$ modulo SNS is explicitly included in the bitmap.

References

3GPP TS 04.60, subclause 9.1.8.2.4.

53.1.2.6.2 Test purpose

1. To verify the EOW bit is set to '0' when $[V(R) - 1]$ modulo SNS is not explicitly included in the bitmap.
2. To verify the EOW bit is set to '1' when $[V(R) - 1]$ modulo SNS is explicitly included in the bitmap.

53.1.2.6.3 Method of test

Initial Conditions

System Simulator:

1 cell with EGPRS support, default setting, PBCCH not present.

Mobile Station:

The MS is EGPRS updated with a P-TMSI allocated, SPLIT PG CYCLE negotiated and the test PDP context2 activated.

Specific PICS Statements

- EGPRS Multislotclass (TSPC_Type_EGPRS_Multislot_ClassX where X = 1..45)

PIXIT Statements

-

Test Procedure

The SS establishes an acknowledge mode downlink EGPRS TBF with the MS:

1. Set the window size to the maximum value according to the number of timeslots assigned to TBF..
2. Make the FRB length shorter than the possible RB size, set the BSN sequence for transmit like 0, 2, 4, 6, 8, all with even value.
3. The SS sends those RLC data blocks with the expected BSN sequence and polls the MS for the First Partial Bitmap.
4. Check the EOW bit of EGPRS PACKET DOWNLINK ACK/NACK should be '1' and the Report Bitmap should be a correct Report Bitmap.
5. The SS transmits the RLC data blocks with BSN sequence 10, 12, ..., WS and polls for the First Partial Bitmap in the last block.
6. Check the EOW bit of EGPRS PACKET DOWNLINK ACK/NACK should be '0' and the Report Bitmap should be a correct Report Bitmap.

Maximum Duration of Test

30 minutes.

Expected Sequence

Step	Direction	Message	Comments
1		{Downlink TBF establishment}	Acknowledged Mode EGPRS Window Size: Maximum value according to the number of Timeslots assigned for the TBF.
2	SS -> MS	EGPRS DOWNLINK RLC DATA BLOCK	The BSN sequence of RLC data block is 0, 2, 4, 6, 8, all have even number MS is polled for FPB in the last block.
3	MS -> SS	EGPRS PACKET DOWNLINK ACK/NACK	The EOW bit of EGPRS PACKET DOWNLINK ACK/NACK is '1'B, The RB is a correct RB
4	SS -> MS	EGPRS DOWNLINK RLC DATA BLOCK	The BSN sequence of RLC data block is 10, 12, ... WS-2 MS was polled for FPB in the last block.
5	MS -> SS	EGPRS PACKET DOWNLINK ACK/NACK	The EOW bit of EGPRS PACKET DOWNLINK ACK/NACK is '0'B The RB is a correct RB
6	SS -> MS	EGPRS DOWNLINK RLC DATA BLOCK	SS send all missed RLC data blocks to MS

53.1.2.7 Acknowledged Mode/ Downlink TBF/ Measurement Report

53.1.2.7.1 Conformance requirements

1. In PACKET DOWNLINK ACK/NACK message, if the reported bitmap is shorter than the requested bitmap size, the MS shall include a measurement report if there is room enough.

References

3GPP TS 04.60, subclause 9.1.8.2.3.

53.1.2.7.2 Test purpose

1. To verify that if the reported bitmap is shorter than the requested bitmap size, the MS shall include a measurement report if there is room enough.

53.1.2.7.3 Method of test

Initial Conditions

System Simulator:

1 cell with EGPRS support, default setting, PBCCH not present.

Mobile Station:

The MS is EGPRS updated with a P-TMSI allocated, SPLIT PG CYCLE negotiated and the test PDP context2 activated.

Specific PICS Statements

-

PIXIT Statements

-

Test Procedure

The SS establishes an acknowledge mode downlink EGPRS TBF with the MS:

1. Set the window size to the Maximum value according to the number of Timeslots assigned for the TBF.
2. The SS sends a small number of RLC data blocks that will correspond to a small RB size and polling for the First Partial Bitmap from the MS.

3. The SS checks the EGPRS PACKET DOWNLINK ACK/NACK from MS include a Channel Quality Report IE.

Maximum Duration of Test

30 minutes.

Expected Sequence

Step	Direction	Message	Comments
1		{Downlink TBF establishment}	Acknowledged Mode EGPRS Window Size: Maximum value according to the number of Timeslots assigned for the TBF.
2	SS -> MS	EGPRS DOWNLINK RLC DATA BLOCK	The BSN sequence of RLC data block is 0, 1, 2, 3 MS was polled for NPB, ES/P='11'B in the last block.
3	MS -> SS	EGPRS PACKET DOWNLINK ACK/NACK	The EGPRS PACKET DOWNLINK ACK/NACK includes a Channel Quality Report IE.

53.1.2.8 Acknowledged Mode/ Downlink TBF/ Generation of Bitmap

53.1.2.8.1 Conformance requirements

- For uplink TBFs, the reported bitmap is sent using the PACKET UPLINK ACK/NACK message corresponding to the used RB size.
- First, a Full Received Bitmap (FRB) is built from the receive state array $V(N)$ by extracting the part between $V(Q)$ and $V(R)$ similar to the GPRS case: it is assigned the elements whose indices in the receive state array $V(N)$ at the receiver range from $[V(Q)+ 1]$ modulo SNS to $[V(R) -1]$ modulo SNS. This global number of elements is less than WS. For each bit in the bitmap, the bit is assigned the value '1' if the corresponding element in $V(N)$ indexed relative to SSN has the value RECEIVED. The bit is assigned the value '0' if the element in $V(N)$ has the value INVALID.
- The BOW bit shall be set if $SSN = [V(Q) + 1]$ modulo SNS, the EOW bit shall be set if $[V(R) -1]$ modulo SNS is explicitly included in the bitmap.
- If $V(Q)$ equals $V(R)$, then SSN shall be set to the value $SSN = [V(Q) + 1]$ modulo SNS, BOW bit shall be set to the value '1', EOW shall be set to the value '1' and the reported bitmap size shall equal 0 bits.

References

3GPP TS 04.60, subclause 9.1.8.2.3.

53.1.2.8.2 Test purpose

- To verify that the mobile station correctly formulates the EGPRS DL Ack/Nack message when the condition of $V(Q) = V(R)$ is met.

53.1.2.8.3 Method of test

Initial Conditions

System Simulator:

1 cell with EGPRS support, default setting, PBCCH not present.

Mobile Station:

The MS is EGPRS updated with a P-TMSI allocated, SPLIT PG CYCLE negotiated and the test PDP context2 activated.

Specific PICS Statements

-

PIXIT Statements

-

Test Procedure

The SS transmits N RLC data blocks from BSN=0 in sequence and polls the MS for acknowledgement.

The MS acknowledges all the RLC data blocks in EGPRS DL Ack/Nack.

The SS verifies that BOW and EOW bits are set and the reported bitmap size is zero.

The above procedure is performed with different values of N.

Maximum Duration of Test

10 minutes.

Expected Sequence

N=10 assumed for the test case.

Step	Direction	Message	Comments
1		{Downlink TBF establishment}	Acknowledged Mode EGPRS Window Size: Maximum value according to the number of Timeslots assigned for the TBF.
2	SS -> MS	EGPRS DOWNLINK RLC DATA BLOCK	With MCS-1 BSN = 0, SPB = '00'B, ES/P = '00'B
			Repeat Step 2 with BSN=1,2,...,N-2
3	SS -> MS	EGPRS DOWNLINK RLC DATA BLOCK	With MCS-1 BSN = N-1, SPB = '00'B, ES/P = '01'B, RRBP = '00'B
4	MS -> SS	EGPRS PACKET DOWNLINK ACK/NACK	The SS verifies that the EGPRS Ack/Nack description IE contains BOW=1, EOW=1, SSN=N+1. and the reported bitmap size is zero bits.
5		{Completion of DL TBF}	
			The above steps are repeated for different length of block sequence N in steps 1,2.

53.1.2.9 Acknowledged Mode/ Downlink TBF/ Interpretation of BSN2

53.1.2.9.1 Conformance requirements

- Each RLC data block contains a block sequence number (BSN) field that is 11 bits in length. At the time that an in-sequence RLC data block is designated for transmission, the value of BSN is set equal to the value of the send state variable V(S).
- The transfer of RLC data blocks in the RLC acknowledged mode uses retransmissions of RLC data blocks. The transmitting side numbers the RLC data blocks via the block sequence number (BSN). The BSN is used for retransmission and for reassembly. The receiving side sends PACKET Ack/Nack messages in order to request retransmission of RLC data blocks.
- In case two RLC data blocks are sent within a RLC/MAC block, BSN2 is relative to BSN1, provided the difference between the second block number and the first block modulo SNS is less than Window Size (WS).
- Second block sequence number = [BSN1 + BSN2] modulo SNS.

References

3GPP TS 04.60, subclauses 9.1.4.2, 9.3.1 and 10.4.12.

53.1.2.9.2 Test purpose

- To verify that the mobile station correctly interpret the value of BSN 2.

53.1.2.9.3 Method of test

Initial Conditions

System Simulator:

1 cell with EGPRS support, default setting, PBCCH not present.

Mobile Station:

The MS is EGPRS updated with a P-TMSI allocated, SPLIT PG CYCLE negotiated and the test PDP context2 activated.

Specific PICS Statements

-

PIXIT Statements

-

Test Procedure

SS transmit an RLC radio block using MCS-8 containing two RLC data blocks with BSN1=bsn1 and BSN2=bsn2. That is block sequence number of second block is $[bsn1+bsn2] \text{ modulo } SNS$.

SS polls the MS for acknowledgement.

SS verifies that the Received Bitmap correctly acknowledges Blocks with BSN=BSN1 and BSN= $[bsn1+bsn2] \text{ modulo } SNS$.

Test is repeated with different combinations of bsn1 and bsn2.

Maximum Duration of Test

10 minutes.

Expected Sequence

Step	Direction	Message	Comments
1		{Downlink TBF establishment}	Acknowledged Mode EGPRS Window Size: 64.
2	SS -> MS	EGPRS DOWNLINK RLC DATA BLOCK	With MCS-8 For 1 st iteration BSN1 (bsn1) = 1, BSN2 (bsn2) = 2, SPB = '00'B, ES/P = '01'B, RRB = '00'B For 2 nd iteration BSN1 (bsn1) = 0, BSN2 (bsn2) = 63, SPB = '00'B, ES/P = '01'B, RRB = '00'B For 3 rd iteration BSN1 (bsn1) = 2000, BSN2 (bsn2) = 58, SPB = '00'B, ES/P = '01'B, RRB = '00'B
3	MS -> SS	EGPRS PACKET DOWNLINK ACK/NACK	The SS verifies that the EGPRS Ack/Nack description IE contains For 1 st iteration SSN=1, bit values for BSN= 1 and BSN(bsn1+bsn2)(mod 2048) = 3 in the RB are 1. For 2 nd iteration SSN=2, bit value for BSN(bsn1+bsn2)(mod 2048) = 63 in the RB is 1. For 3 rd iteration SSN=2002, bit value for BSN(bsn1+bsn2)(mod 2048) = 10 in the RB is 1.
4		{Completion of DL TBF}	

The complete test is repeated for the following combinations of BSN1 (bsn1) and BSN2 (bsn2) in step 2.

- BSN1 = 0, BSN2 = 63
- BSN1= 2000, BSN2 = 58

For the repetition using BSN1=2000 and BSN2=58; Before sending the block with BSN1=2000 and BSN2=58, SS needs to complete the transmission of 2000 blocks from BSN=0 to BSN=1999 in step 2 with acknowledgement of the blocks up to and including BSN=1999.

53.1.2.10 Acknowledged Mode/ Downlink TBF/ Split RLC Data Block

53.1.2.10.1 Conformance requirements

1. When an RLC data block is received with BSN within the active window i.e. such that $[V(Q) \leq BSN < V(Q) + WS]$ modulo SNS, the corresponding element in V(N) is set to the value RECEIVED (the RLC data block has passed FCS).
2. If the RLC data block is split over two radio blocks, the element shall be set to the value RECEIVED if both radio blocks have been received.
3. The element shall not be set to the value RECEIVED if any of the radio blocks has not been received.

References

3GPP TS 04.60, subclause 9.1.7.

53.1.2.10.2 Test purpose

To verify that in case an RLC data block is split over two radio blocks:

1. The corresponding V(N) element shall not be marked as RECEIVED if any of the two radio blocks is not received.
2. The corresponding V(N) element shall be marked as RECEIVED if both of the radio blocks are received.

53.1.2.10.3 Method of test

Initial Conditions

System Simulator:

1 cell with EGPRS support, default setting, PBCCH not present.

Mobile Station:

The MS is EGPRS updated with a P-TMSI allocated, SPLIT PG CYCLE negotiated and the test PDP Context2 activated.

Specific PICS Statements

-

PIXIT Statements

-

Test Procedure

The SS establishes a downlink EGPRS TBF.

The SS sends a RLC data block $n > N, n < WS$ using MCS-6. The SS sends the first part of a splitted RLC data block using MCS-3, with BSN=N ($N < \text{window size}$), SPB='10'B, and polls for the EGPRS PACKET DOWNLINK ACK/NACK message from the MS. The MS shall respond with an EGPRS PACKET DOWNLINK ACK/NACK message indicating the block BSN=N is not received.

The SS then sends the second part of the splitted RLC block with the same BSN=N ($N < WS$), SPB='11' using MCS 3, and polls for the EGPRS PACKET DOWNLINK ACK/NACK message from the MS. The MS shall respond with an EGPRS PACKET DOWNLINK ACK/NACK message with the BSN=N acknowledged.

Maximum Duration of Test

30 minutes.

Expected Sequence

Step	Direction	Message	Comments
1		{Downlink TBF establishment}	Acknowledged Mode EGPRS Window Size: arbitrarily chosen
2	SS -> MS	EGPRS DOWNLINK RLC DATA BLOCK	With MCS-6, BSN=6, RRB = '00'B
3	MS -> SS	EGPRS PACKET DOWNLINK ACK/NACK	The SS verifies that RBB is set to 0 for RLC data blocks with BSN = 0,1,2, 3,4 and 5 and RBB is set to 1 for BSN=6.
4	SS -> MS	EGPRS DOWNLINK RLC DATA BLOCK	With MCS-3, BSN starts from 0 ES/P = '00'B, SPB='10'B
5			Repeat step 4 until BSN = 3
6	SS -> MS	EGPRS DOWNLINK RLC DATA BLOCK	With MCS-3 BSN = 5, ES/P = '01'B, RRB = '00'B,SPB='11'B
7	MS -> SS	EGPRS PACKET DOWNLINK ACK/NACK	The SS verifies that the bits in RBB for BSN=0,1,2,3,4,5 are set to '0'B.
8	SS -> MS	EGPRS DOWNLINK RLC DATA BLOCK	With MCS-3 BSN = 4, SPB = '10'B, ES/P = '01'B, RRB = '00'B
9	MS -> SS	EGPRS PACKET DOWNLINK ACK/NACK	The SS verifies that the bit for BSN=4 in RBB is set to '0'B.
10	SS -> MS	EGPRS DOWNLINK RLC DATA BLOCK	With MCS-3 BSN = 4, SPB = '11'B, ES/P = '01'B, RRB = '00'B
11	MS -> SS	EGPRS PACKET DOWNLINK ACK/NACK	The SS verifies that the bit for BSN=4 in RBB is set to '1'B.
			{Completion of downlink data transfer}

53.1.2.11 Acknowledged Mode/ Downlink TBF/ First Partial Bitmap and Next Partial Bitmap

53.1.2.11.1 Conformance requirements

- In EGPRS downlink TBFs, an additional poll bit is added to the S/P field in every downlink RLC block so that the network can request the following:
 - First Partial Bitmap (FPB) segment with $SSN = (V(Q) + 1) \bmod 2048$ where SSN denotes the Starting Sequence Number.
 - Next Partial Bitmap (NPB) segment with $SSN = (PBSN + 1) \bmod 2048$ where PBSN denotes a Partial Bitmap Sequence Number variable stored at the receiver.
- SSN is determined by the receiver as a function of S/P, V(Q) and PBSN. The FPB and NPB are specific instances of the EGPRS Ack/Nack Description Information Element within the Packet Downlink Ack/Nack message. The MS shall respond to S/P field according to table 4 in subclause 9.1.8.2.1 in 3GPP TS 04.60.
- Based on PBSN, V(Q) and the S/P field set by the network, SSN and PBSN shall be determined according to table 5 in subclause 9.1.8.2.2 in 3GPP TS 04.60.

References

3GPP TS 04.60, subclause 9.1.8.2.

53.1.2.11.2 Test purpose

- To verify the correct generation of SSN and RB in the First Partial Bitmap.
- To verify the correct generation of SSN and RB in the Next Partial Bitmap.

53.1.2.11.3 Method of test

Initial Conditions

System Simulator:

1 cell with EGPRS support, default setting, PBCCH not present.

Mobile Station:

The MS is EGPRS updated with a P-TMSI allocated, SPLIT PG CYCLE negotiated and the test PDP Context2 activated.

Specific PICS Statements

-

PIXIT Statements

-

Test Procedure

The SS establishes a downlink EGPRS TBF setting EGPRS window size to the maximum possible value in accordance with the number of timeslots allocated.

The SS sends a series of RLC data blocks with BSN=0, 2, 4, ..., 188 and with ES/P = '00'B.

The SS sends a RLC data block with BSN=189, ES/P = '01'B and RRBP='00'B.

The MS shall respond with an EGPRS PACKET DOWNLINK ACK/NACK message.. The SS verifies that the EGPRS Ack/Nack description IE contains the correct SSN and RB in the message. The BOW bit shall be set to '1'B and since it is the FPB, EOW bit shall not be set. Verify that the SSN is 2. Note down the BSN of the last block acknowledged (PBSN).

The SS then sends another RLC data block with BSN=190, ES/P = '10'B. Verifies that the MS shall respond with an EGPRS PACKET DOWNLINK ACK/NACK message, and that the EGPRS Ack/Nack description IE contains SSN = PBSN+1.

Maximum Duration of Test

30 minutes.

Expected Sequence

Step	Direction	Message	Comments
1		{Downlink TBF establishment}	Acknowledged Mode EGPRS Window Size: Maximum value according to the number of Timeslots assigned for the TBF.
2	SS -> MS	EGPRS DOWNLINK RLC DATA BLOCK	With MCS-1 BSN = 2*N, SPB = '00'B, ES/P = '00'B
3			Repeat step 2 with N = 0..94
4	SS -> MS	EGPRS DOWNLINK RLC DATA BLOCK	With MCS-1 BSN = 189, SPB = '00'B, ES/P = '01'B, RRBP = '00'B
5	MS -> SS	EGPRS PACKET DOWNLINK ACK/NACK	The SS verifies that the EGPRS Ack/Nack description IE contains the correct SSN and RB in the message. Verify that BOW is set and EOW is not set.
6	SS -> MS	EGPRS DOWNLINK RLC DATA BLOCK	With MCS-1 BSN = 190, SPB = '00'B, ES/P = '10'B, RRBP = '00'B
7	MS -> SS	EGPRS PACKET DOWNLINK ACK/NACK	The SS verifies that the EGPRS Ack/Nack description IE contains the correct SSN and RB in the message: - Verify that SSN is equal to (PBSN+1) Mod SNS or as an implementation option verify that the SSN included allows the SS to accurately interpret the RB. - Verify that BOW is not set and EOW is set.

53.1.2.12 Acknowledged Mode/ Downlink TBF/ Decoding of Coding Schemes

53.1.2.12.1 Conformance requirements

1. In EGPRS TBF mode, the transfer of RLC Data Blocks in the acknowledged RLC/MAC mode can be controlled by a selective type I ARQ mechanism, or by type II hybrid ARQ (Incremental Redundancy: IR) mechanism, coupled with the numbering of the RLC Data Blocks within one Temporary Block Flow.

2. According to the link quality, an initial Modulation and Coding Scheme (MCS) is selected for an RLC block (see note). For the retransmissions, the same or another MCS from the same family of MCSs can be selected.
3. The selection of MCS is controlled by the network.
4. In EGPRS header, the Coding and Puncturing Scheme indicator field is used to indicate the kind of channel coding and puncturing used for data blocks.(see 3GPP TS 05.03)

References

3GPP TS 04.60, subclauses 9.3.2.1 and 10.4.8.a.

53.1.2.12.2 Test purpose

To verify that the mobile station correctly decode RLC data blocks sent using different coding schemes (MCS-1 to MCS-9).

53.1.2.12.3 Method of test

Initial Conditions

System Simulator:

1 cell with EGPRS support, default setting, PBCCH not present.

Mobile Station:

The MS is EGPRS updated with a P-TMSI allocated, SPLIT PG CYCLE negotiated and the test PDP Context2 activated.

Specific PICS Statements

-

PIXIT Statements

-

Test Procedure

The SS establishes a Downlink EGPRS TBF.

The SS sends a few RLC data blocks in different coding schemes and asks for an acknowledgement from the MS.

The MS shall correctly acknowledge all the received data blocks.

Maximum Duration of Test

10 minutes.

Expected Sequence

Step	Direction	Message	Comments
1		{Downlink TBF establishment}	Acknowledged Mode EGPRS Window Size: arbitrarily chosen
2	SS -> MS	EGPRS DOWNLINK RLC DATA BLOCK	With MCS-1, BSN=0
3	SS -> MS	EGPRS DOWNLINK RLC DATA BLOCK	With MCS-1, BSN=1
4			Repeat step 2 and 3 using MCS-2 till MCS 6 in each iteration. Repeat Step 2 using MCS 7, MCS8 and MCS-9. The BSNs of the data blocks shall be sequential, with BSN=16 and BSN=17 for the last block transmitted. ES/P = '01'B and RRBP='00'B is set in the header of last RLC Data Block sent with BSN=16 and 17.
5	MS -> SS	EGPRS PACKET DOWNLINK ACK/NACK	Received on the corresponding PACCH. The SS verifies that the MS acknowledges all the received RLC data blocks. SSN shall be equal to 19

53.1.2.13 Void

53.1.2.14 Acknowledged Mode/ Downlink TBF/ Received Bitmap/ Compressed

53.1.2.14.1 Conformance requirements

1. A Full Received Bitmap (FRB) is built from the receive state array $V(N)$ by extracting the part between $V(Q)$ and $V(R)$ similar to the GPRS case.
2. From the FRB, a reported bitmap (RB) shall then be generated. The FRB shall be recalculated before each RB is generated. For downlink TBFs, the network may order the MS to transmit a certain RB size through use of the S/P field. The RB may be compressed or uncompressed.
3. The Compression bit in the reported bitmap shall be set to the value '1' if a compressed bitmap is sent, otherwise it shall be set to the value '0'.
4. If the compressed reported bitmap does not cover more blocks than the uncompressed reported bitmap, the receiver shall send the uncompressed reported bitmap. Otherwise compressed RB should be used.

References

3GPP TS 04.60, subclause 9.1.8.2.3.

53.1.2.14.2 Test purpose

1. To verify the Compression Bit is set to '1' when compressed RB is sent.
2. To verify that if the compressed reported bitmap covers more blocks than the uncompressed reported bitmap, and the FRB length is larger than the RB size, the receiver shall send the compressed reported bitmap.

53.1.2.14.3 Method of test

Initial Conditions

System Simulator:

1 cell with EGPRS support, default setting, PBCCH not present.

Mobile Station:

The MS is EGPRS updated with a P-TMSI allocated, SPLIT PG CYCLE negotiated and the test PDP context2 activated.

Specific PICS Statements

- EGPRS Multislotclass (TSPC_Type_EGPRS_Multislot_ClassX where X = 1..45)

PIXIT Statements

-

Test Procedure

The SS establishes an acknowledged mode downlink EGPRS TBF with the MS:

1. Set the window size to the maximum value according to the number of timeslots assigned to TBF.
2. Make the compressed RB bitmap cover more blocks than uncompressed bitmap, and the FRB length is larger than the possible RB size, set the BSN sequence for transmit like 1, 2, 3, ... 100, WS-1.
3. The SS sends those RLC data blocks with the expected BSNs and polls the MS in the last sent RLC data block.
4. The SS verifies that the compression bit in EGPRS PACKET DOWNLINK ACK/NACK should be '1' and the RB in EGPRS PACKET DOWNLINK ACK/NACK shall contain compressed bitmap for BSN=1 till BSN=WS-2.
5. The SS sends all the missed RLC data blocks to MS.

Maximum Duration of Test

30 minutes.

Expected Sequence

Step	Direction	Message	Comments
1		{Downlink TBF establishment}	Acknowledged Mode EGPRS Window Size: WS=Maximum value according to the number of Timeslots assigned for the TBF.
2	SS -> MS	EGPRS DOWNLINK RLC DATA BLOCK	The BSN sequence of RLC data block is 1, 2, 3, ... 100, WS-1, In the last sent RLC data block ES/P='01'B, RRBP='00'B
3	MS -> SS	EGPRS PACKET DOWNLINK ACK/NACK	The Compression Bit of EGPRS PACKET DOWNLINK ACK/NACK is '1'B Verify that the RB contains a compressed bitmap representing the status of BSN=1 till BSN=WS-2

53.1.2.15 Acknowledged Mode/ Downlink TBF/ Received Bitmap/ Uncompressed

53.1.2.15.1 Conformance requirements

1. A Full Received Bitmap (FRB) is built from the receive state array V(N) by extracting the part between V(Q) and V(R) similar to the GPRS case.
2. From the FRB, a reported bitmap (RB) shall then be generated. The FRB shall be recalculated before each RB is generated. For downlink TBFs, the network may order the MS to transmit a certain RB size through use of the S/P field. The RB may be compressed or uncompressed.
3. If the compressed reported bitmap does not cover more blocks than the uncompressed reported bitmap, the receiver shall send the uncompressed reported bitmap.
4. The Compression bit in the reported bitmap shall be set to the value '1' if a compressed bitmap is sent, otherwise it shall be set to the value '0'.
5. As an exception, if the FRB length or the range of indices from SSN to the end of FRB is less than or equal to RB size, the receiver may send the uncompressed reported bitmap without attempting compression.

References

3GPP TS 04.60, subclause 9.1.8.2.3.

53.1.2.15.2 Test purpose

1. To verify the Compression Bit is set to '0' when uncompressed RB is sent.
2. To verify that if the compressed reported bitmap does not covers more blocks than the uncompressed reported bitmap, the receiver shall send the uncompressed reported bitmap.

53.1.2.15.3 Method of test

Initial Conditions

System Simulator:

1 cell with EGPRS support, default setting, PBCCH not present.

Mobile Station:

The MS is EGPRS updated with a P-TMSI allocated, SPLIT PG CYCLE negotiated and the test PDP context2 activated.

Specific PICS Statements

- EGPRS Multislotclass (TSPC_Type_EGPRS_Multislot_ClassX where X = 1..45)

PIXIT Statements

-

Test Procedure

The SS establishes an acknowledge mode downlink EGPRS TBF with the MS:

1. Set the window size to the maximum value according to the number of timeslots assigned to TBF.
2. Make the compressed RB bitmap cover less blocks than uncompressed bitmap, and the FRB length is larger than the possible RB size, set the BSN sequence for transmit like 1,3,5,7.....(max value of windows size -1), all with odd value.
3. The SS sends those RLC data blocks with the expected BSNs and polls the MS in the last sent RLC data block.
4. The SS verifies that the compression bit in EGPRS PACKET DOWNLINK ACK/NACK should be '0' and the RB in EGPRS PACKET DOWNLINK ACK/NACK should be an uncompressed bitmap.

Maximum Duration of Test

30 minutes.

Expected Sequence

Step	Direction	Message	Comments
1		{Downlink TBF establishment}	Acknowledged Mode EGPRS Window Size: WS=Maximum value according to the number of Timeslots assigned for the TBF.
2	SS -> MS	EGPRS DOWNLINK RLC DATA BLOCK	The BSN sequence of RLC data block is 1, 3, 5, 7, ... WS-1, all have odd number In the last sent RLC data block ES/P='01'B, RRBp='00'B
3	MS -> SS	EGPRS PACKET DOWNLINK ACK/NACK	The Compression Bit of EGPRS PACKET DOWNLINK ACK/NACK is '0'B The RB is an uncompressed RB

53.1.2.16 Acknowledged Mode/ Downlink TBF/ Received Block Bitmap/ Compressed Bitmap Starting Colour Code

53.1.2.16.1 Conformance requirements

1. In RB compression, no special code words are used either at the beginning of the bitmap or the end of a bitmap. A one bit indicator (i.e., Compressed Bitmap Starting Colour Code) is used to indicate whether the compressed bitmap starts with a run length of zeros or a run length of ones.

References

3GPP TS 04.60, subclause 9.1.10.

53.1.2.16.2 Test purpose

1. To verify the correct coding of Compressed Bitmap Starting Colour Code bit field in Packet Downlink ACK/NACK.

53.1.2.16.3 Method of test

Initial Conditions

System Simulator:

1 cell with EGPRS support, default setting, PBCCH not present.

Mobile Station:

The MS is EGPRS updated with a P-TMSI allocated, SPLIT PG CYCLE negotiated and the test PDP context2 activated.

Specific PICS Statements

-

PIXIT Statements

-

Test Procedure

SS initiates the establishment of a downlink EGPRS TBF, setting window size value to WS in the IMMEDIATE ASSIGNMENT message. WS should be greater than the available space for RB. SS sends a sequence of RLC data blocks with BSN=0, 1, 2, 4, 5, WS-1 and polls for acknowledgement. MS shall send a Packet Downlink Ack/Nack message with COMPRESSED_BITMAP_STARTING_COLOR_CODE = 1. SS sends one RLC data block with BSN=3 and polls for acknowledgement. MS shall send a Packet Downlink Ack/Nack message with COMPRESSED_BITMAP_STARTING_COLOR_CODE=0.

Maximum Duration of Test

30 minutes.

Expected Sequence

Step	Direction	Message	Comments
1		{Downlink TBF establishment}	Acknowledged Mode EGPRS Window Size = 192.
2	SS -> MS	EGPRS DOWNLINK RLC DATA BLOCK	Sent a sequences of blocks on the assigned PDTCH, with BSN = 0, 1, 2, 4, 5, WS-1. In the last block of BSN = WS-1, ES/P = '01'B, RRBP = '00'B.
3	MS -> SS	EGPRS PACKET DOWNLINK ACK/NACK	Received on PACCH of the assigned PDTCH. COMPRESSED_BITMAP_STARTING_COLOR_CODE = 1
4	SS -> MS	EGPRS DOWNLINK RLC DATA BLOCK	Sent on the assigned PDTCH, BSN = 3, ES/P = '01'B, RRBP = '00'B.
5	MS -> SS	EGPRS PACKET DOWNLINK ACK/NACK	Received on PACCH of the assigned PDTCH. COMPRESSED_BITMAP_STARTING_COLOR_CODE = 0

53.1.2.17 Acknowledged Mode/ Downlink TBF/ Received Block Bitmap/ Terminating Code and Make-up Code

53.1.2.17.1 Conformance requirements

1. The T.4 procedure for encoding run lengths is as follows. Runs of ones and zeros alternate, and the run lengths are represented by the code words listed in the tables below. The code words for run lengths of zeros and ones are as described in T.4 except for one minor modification: the terminating code words used for indicating run lengths of 1 zero and 3 zeros are interchanged.
2. Run lengths greater than 63 bits are encoded first by the make-up code word which is equal to or shorter than that required. This is then followed by the terminating code word representing the difference between the required run length and the run length represented by the make-up code.

References

3GPP TS 04.60, subclause 9.1.10.

53.1.2.17.2 Test purpose

1. To verify that run lengths in the range 0-63 bits are encoded with their appropriate terminating code word.
2. To verify the correct use of make-up code word for run lengths in the range 64 and above.

53.1.2.17.3 Method of test

Initial Conditions

System Simulator:

1 cell with EGPRS support, default setting, PBCCH not present.

Mobile Station:

The MS is EGPRS updated with a P-TMSI allocated, SPLIT PG CYCLE negotiated and the test PDP context2 activated.

Specific PICS Statements

- EGPRS Multislotclass (TSPC_Type_EGPRS_Multislot_ClassX where X = 1..45)

PIXIT Statements

-

Test Procedure

The SS initiates the establishment of a downlink EGPRS TBF, setting window size to the largest value WS corresponding the number of timeslots assigned to TBF.

The SS sends EGPRS RLC data blocks one by one with BSN from WS-1 to 1 and polls for acknowledgement in each block. The MS shall send a Packet Downlink Ack/Nack message in responding to each block received, the terminating code word or make-up code word for run length of ones or zeros shall be correct.

Maximum Duration of Test

30 minutes.

Expected Sequence

Step	Direction	Message	Comments
1		{Downlink TBF establishment}	Acknowledged Mode EGPRS Window Size = Maximum for the MS according to the number of timeslots assigned to TBF.
2	-		N = WS-1
3	SS -> MS	EGPRS DOWNLINK RLC DATA BLOCK	Sent on the assigned PDTCH, with BSN = N. ES/P = '01'B, RRBP = '00'B
4	MS -> SS	EGPRS PACKET DOWNLINK ACK/NACK	Received on PACCH of the assigned PDTCH. Check if CRBB contains the correct makeup code word and/or terminating code word. Note: MS may send uncompressed bitmap along with compressed bitmap to achieve the best compression gain.
5	-		N = N - 1
6	-		Repeat step 3 to 5 until N = 1.

53.1.2.18 Acknowledged Mode/ Downlink TBF/ Retransmission/ Padding

53.1.2.18.1 Conformance requirements

According to the link quality, an initial Modulation and Coding Scheme (MCS) is selected for an RLC block (see note). For the retransmissions, the same or another MCS from the same family of MCSs may be selected. E.g. if MCS-7 is selected for the first transmission of an RLC block, any MCS of the family B may be used for the retransmissions. Further, RLC data blocks initially transmitted with MCS-4, MCS-5, MCS-6, MCS-7, MCS-8 or MCS-9, may be retransmitted with MCS-1, MCS-2 or MCS-3 as appropriate, by sending the different parts of the RLC data block in different radio blocks. In this case, the split block field in the header shall be set to indicate that the RLC data block is split, and the order of the two parts. For blocks initially transmitted with MCS-8 which are retransmitted using MCS-6 or MCS-3, padding of the first six octets shall be applied before each RLC data block, and the CPS field shall be set to indicate that this has been done (see an informative example in annex J).

References

3GPP TS 04.60, subclause 9.3.2.1

53.1.2.18.2 Test purpose

1. To verify that the MS correctly decodes the CPS field of Downlink Egprs RLC Data Block header.
2. To verify that the MS correctly decodes a retransmitted data block which contains first six octets of padding.

53.1.2.18.3 Method of test

Initial Conditions

System Simulator:

1 cell with EGPRS support, default setting, PBCCH not present.

Mobile Station:

The MS is EGPRS updated with a P-TMSI allocated, SPLIT PG CYCLE negotiated and the test PDP context2 activated.

Specific PICS Statements

- EGPRS Multislotclass (TSPC_Type_EGPRS_Multislot_ClassX where X = 1..45)

PIXIT Statements

-

Test Procedure

The SS initiates the establishment of a downlink EGPRS TBF, setting window size to the largest value WS corresponding the number of timeslots assigned to TBF.

The SS sends two EGPRS RLC radio blocks with BSN=0 BSN=1 and BSN=4 BSN=5 using MCS-8. In the last block FBI is set to 1 and the MS is polled for Acknowledgement.

The MS shall send a Egprs Packet Downlink Ack/Nack message acknowledging BSNs 0,1,4 and 5 and negatively acknowledging BSN=2 and BSN=3. SS verifies that FAI is set to 0.

The SS sends EGPRS RLC data block with BSN=2 using MCS-6, setting first 6 octets of the data block to padding, and setting CPS field to indicate the same and polls the MS for acknowledgement.

The MS shall send Egprs Packet Downlink Ack/Nack message acknowledging BSNs 0,1,2,4 and 5 and negatively acknowledging BSN=3. SS verifies that FAI is set to 0.

The SS sends first part of BSN=3 using MCS-3 with first six octets of the data block set to padding and polls the MS for acknowledgement. CPS is set correctly in the data block header to indicate that the block is first part of split block and that the data block is padded.

The MS shall send Egprs Packet Downlink Ack/Nack message acknowledging BSNs 0,1,2,4 and 5 and negatively acknowledging BSN=3. SS verifies that FAI is set to 0.

The SS sends second part of BSN=3 using MCS-3 and polls the MS for acknowledgement. CPS is set correctly in the data block header to indicate that the block is second part of split block and that the data block is not padded.

The MS shall send Egprs Packet Downlink Ack/Nack message acknowledging BSNs 0 to 5. SS verifies that FAI is set to 1.

Maximum Duration of Test

30 minutes.

Expected Sequence

Step	Direction	Message	Comments
1		{Downlink TBF establishment}	Acknowledged Mode EGPRS Window Size = Maximum for the MS according to the number of timeslots assigned to TBF.
2	SS -> MS	EGPRS DOWNLINK RLC DATA BLOCK	Using MCS-8 Sent on the assigned PDTCH, with BSN = 0 and BSN=1.
3	SS -> MS	EGPRS DOWNLINK RLC DATA BLOCK	Using MCS-8 Sent on the assigned PDTCH, with BSN = 4 and BSN=5. FBI is set to 1. MS is polled for FPB
4	MS -> SS	EGPRS PACKET DOWNLINK ACK/NACK	Received on PACCH of the assigned PDTCH. SS verifies that BSN 0, 1, 4 and 5 are acknowledged, BSN 2 and 3 are not acknowledged and FAI=0
5	SS -> MS	EGPRS DOWNLINK RLC DATA BLOCK	Using MCS-6 Sent on the assigned PDTCH, with BSN = 2. First six octets of the data block shall be padding octets. CPS field shall indicate the same. MS is polled for FPB.
6	MS -> SS	EGPRS PACKET DOWNLINK ACK/NACK	Received on PACCH of the assigned PDTCH. SS verifies that BSN 0, 1, 2, 4 and 5 are acknowledged, BSN 3 is not acknowledged and FAI=0
7	SS -> MS	EGPRS DOWNLINK RLC DATA BLOCK	Using MCS-3 Sent on the assigned PDTCH, with BSN = 3. First 6 octets of the data block shall be padding octets. CPS field shall indicate that the data block is first part of split block and the data block is padded. MS is polled for FPB.
8	MS -> SS	EGPRS PACKET DOWNLINK ACK/NACK	Received on PACCH of the assigned PDTCH. SS verifies that BSN 0, 1, 2, 4 and 5 are acknowledged, BSN 3 is not acknowledged and FAI=0
9	SS -> MS	EGPRS DOWNLINK RLC DATA BLOCK	Using MCS-3 Sent on the assigned PDTCH, with BSN = 3. CPS field shall indicate that the data block is second part of split block and the data block is not padded. MS is polled for FPB.
10	MS -> SS	EGPRS PACKET DOWNLINK ACK/NACK	Received on PACCH of the assigned PDTCH. SS verifies that BSN 0, 1, 2, 3, 4 and 5 are acknowledged and FAI=1

53.1.2.19 Acknowledged Mode/ Downlink TBF/ TBF Reallocation/Window Size

53.1.2.19.1 Conformance requirements

For EGPRS the window size (WS) shall be set by the network according to the number of timeslots allocated in the direction of the TBF (uplink or downlink). The allowed window sizes are given in Table 9.1.9.2.1.

MS shall support the maximum window size corresponding to its multislot capability. The selected WS shall be indicated within PACKET UL/DL ASSIGNMENT and PACKET TIMESLOT RECONFIGURE using the coding defined in Table 9.1.9.2.1.

Once a window size is selected for a given MS, it may be changed to a larger size but not to a smaller size, in order to prevent dropping data blocks from the window.

NOTE: If a TBF is reallocated so that the number of allocated timeslots is reduced, the RLC window size may become larger than the maximum window size for the new resources.

References

3GPP TS 04.60, subclause 9.1.9.2

53.1.2.19.2 Test purpose

To verify that if a downlink TBF is reallocated reducing the number of timeslots so that the RLC window size becomes larger than the maximum window size for the new resources, the MS retains the old window size.

53.1.2.19.3 Method of test

Initial Conditions

System Simulator:

1 cell with EGPRS support, default setting, PBCCH present.

Mobile Station:

The MS is GPRS attached with a P-TMSI allocated, SPLIT PG CYCLE negotiated and the test PDP context2 activated.

Specific PICS Statements

-

PIXIT Statements

-

Test Procedure

SS establishes a downlink TBF allocating two timeslots. Downlink EGPRS Window Size is commanded to be 256 (the maximum according to the number of timeslots allocated to the TBF).

SS sends EGPRS RLC data block with BSN=1 on one assigned timeslot and BSN=191 in the other assigned timeslot to the MS, polling the MS for acknowledgement in the last block.

SS verifies that MS sends EGPRS PACKET DOWNLINK ACK/NACK message, positively acknowledging BSN=1 and BSN=191 and negatively acknowledging BSN=0 and all other data blocks from BSN=2 till BSN=190.

SS sends a PACKET DOWNLINK ASSIGNMENT message addressing the MS, changing the number of allocated downlink timeslots to 1.

SS sends an EGPRS RLC data block with BSN=255 on the new assigned PDCH, polling the MS for acknowledgement

SS verifies that MS sends EGPRS PACKET DOWNLINK ACK/NACK message in the assigned block period and that the received bitmap positively acknowledges blocks with BSN=1, BSN=191 and BSN=255 and negatively acknowledges BSN=0 and all blocks from BSN=2 till BSN=190 and BSN=192 till BSN=254.

Maximum Duration of Test

10 minutes.

Expected Sequence

Step	Direction	Message	Comments
1	SS -> MS	PACKET DOWNLINK ASSIGNMENT	Acknowledged Mode. Sent on PPCH. See specific message contents
2	SS -> MS	EGPRS DOWNLINK RLC DATA BLOCK	Using MCS-1. Sent at least 3 block periods after Step 1 Sent on the assigned PDTCH TN3, with BSN = 1
3	SS -> MS	EGPRS DOWNLINK RLC DATA BLOCK	Using MCS-1 Sent on the assigned PDTCH TN4, with BSN = 191 ES/P = '01'B, RRBP = '00'B
4	MS -> SS	EGPRS PACKET DOWNLINK ACK/NACK	Received on PACCH of the assigned PDTCH in TN4. SS verifies that the received bitmap positively acknowledges BSN =1 and BSN=191 and negatively acknowledges BSN=0 and BSN=2 till BSN=190.
5	SS -> MS	PACKET DOWNLINK ASSIGNMENT	Acknowledged Mode. Sent on PACCH of the assigned PDTCH in TN4. See specific message contents
6	SS -> MS	EGPRS DOWNLINK RLC DATA BLOCK	Using MCS-1. Sent at least 3 block periods after Step 5 Sent on the PDTCH in TN3 assigned in Step 5, with BSN = 255 ES/P = '01'B, RRBP = '00'B
7	MS -> SS	EGPRS PACKET DOWNLINK ACK/NACK	Received on PACCH of the PDTCH assigned in Step 5. SS verifies that the received bitmap positively acknowledges BSN =1, BSN=191 and BSN=255 and negatively acknowledges BSN=0, BSN=2 till BSN=190, and BSN=192 till BSN=254.

Specific Message Contents

PACKET DOWNLINK ASSIGNMENT message in step 1:

MAC_MODE	00 Dynamic Allocation
RLC_MODE	0 Acknowledged mode
TIMESLOT_ALLOCATION	00011000 (TN3 and TN4)
- EGPRS Window Size	00110 (256)

PACKET DOWNLINK ASSIGNMENT message in step 5:

MAC_MODE	00 Dynamic Allocation
RLC_MODE	0 Acknowledged mode
TIMESLOT_ALLOCATION	00010000 (TN3)
- EGPRS Window Size	00110 (256)

53.2 Unacknowledged Mode

53.2.1 Unacknowledged Mode/ Uplink TBF

53.2.1.1 Unacknowledged Mode/ Uplink TBF/ Stall Indicator

53.2.1.1.1 Conformance requirements

The transfer of RLC data blocks in the RLC unacknowledged mode does not include any retransmissions, except during the release of an uplink TBF where the last transmitted uplink block may be retransmitted (see sub-clause 9.3.3.3).

The network shall send PACKET UPLINK ACK/NACK messages when needed.

The mobile station shall set the Stall indicator (SI) bit to '0' in all RLC data blocks.

References

3GPP TS 04.60, subclause 9.3.3, 9.3.3.2

53.2.1.1.2 Test purpose

To verify that the MS sets SI to '0' in all RLC data blocks

53.2.1.1.3 Method of test

Initial Conditions

System Simulator:

1 cell with EGPRS support, default setting, PBCCH not present.

Mobile Station:

The MS is EGPRS updated with a P-TMSI allocated, SPLIT PG CYCLE negotiated and the test PDP context3 activated.

Specific PICS Statements

-

PIXIT Statements

-

Test Procedure

An uplink TBF in unacknowledged RLC mode is established. Uplink EGPRS Window Size is commanded to be 192. SS assigns resources to the MS to transmit WS data blocks in the uplink. SS verifies that MS transmits data blocks sequentially and that SI is not set in the data blocks.

SS assigns resource to the MS to transmit in uplink.

SS verifies that the MS transmits new data block with BSN=WS after BSN=WS-1 is transmitted and that SI is not set in the data block with BSN=WS.

SS allows the MS to complete the data transfer.

Maximum Duration of Test

10 minutes.

Expected Sequence

Step	Direction	Message	Comments
1		{Uplink dynamic allocation two phase access}	N = 4400 octets USF_GRANULARITY = 1 block EGPRS Channel Coding Command: MCS-1 EGPRS Window Size: 192
2	SS -> MS	PACKET DOWNLINK DUMMY CONTROL BLOCK	Sent on the PACCH of the PDCH assigned, containing USF assigned to the MS.
3	MS -> SS	EGPRS UPLINK RLC DATA BLOCK	Received on the assigned PDTCH SS verifies that the BSN of the received data block is 0, and SI is not set.
4	-		Repeat Steps 2 and 3 until BSN=191 is received
5	SS -> MS	PACKET DOWNLINK DUMMY CONTROL BLOCK	Sent on the PACCH of the PDCH assigned, containing USF assigned to the MS.
6	MS -> SS	EGPRS UPLINK RLC DATA BLOCK	Received on the assigned PDTCH SS verifies that the BSN of the received data block is 192, and SI is not set.
7	SS -> MS	PACKET UPLINK ACK/NACK	Acknowledging BSN=192
8		{Completion of uplink RLC data block transfer}	

53.2.1.2 Unacknowledged Mode/ Uplink TBF/ RBB and SSN

53.2.1.2.1 Conformance requirements

The transfer of RLC data blocks in the RLC unacknowledged mode does not include any retransmissions, except during the release of an uplink TBF where the last transmitted uplink block may be retransmitted (see sub-clause 9.3.3.3).

The SSN and RB are transmitted in both RLC acknowledged and RLC unacknowledged mode (note the SSN is calculated differently in EGPRS (refer to table 8.1.1.1) and GPRS (refer to 9.1.8.1)). The SSN and RB shall be ignored by the RLC receiver in unacknowledged mode.

References

3GPP TS 04.60, subclause 9.1.8.2, 9.3.3, 9.3.3.2

53.2.1.2.2 Test purpose

To verify that the MS ignores SSN and RB included in Packet Uplink Ack/Nack message when in RLC unacknowledged mode.

53.2.1.2.3 Method of test

Initial Conditions

System Simulator:

1 cell with EGPRS support, default setting, PBCCH not present.

Mobile Station:

The MS is EGPRS updated with a P-TMSI allocated, SPLIT PG CYCLE negotiated and the test PDP context3 activated.

Specific PICS Statements

-

PIXIT Statements

-

Test Procedure

An uplink TBF in unacknowledged RLC mode is established. SS assigns resources to the MS to transmit data blocks in the uplink. After receiving data block with BSN=30, SS sends a Packet Uplink Ack/Nack message with SSN=21 and positively acknowledging BSN=21 till BSN=30.

SS assigns resources to the MS. SS verifies that MS ignores the SSN and RB sent in the Packet Uplink Ack/Nack message and continues transmitting new data blocks.

SS allows the MS to complete the data transfer.

Maximum Duration of Test

10 minutes.

Expected Sequence

Step	Direction	Message	Comments
1		{Uplink dynamic allocation two phase access}	N = 1000 octets USF GRANULARITY = 1 block EGPRS Channel Coding Command: MCS-1 EGPRS Window Size: 192
2	SS -> MS	PACKET DOWNLINK DUMMY CONTROL BLOCK	Sent on the PACCH of the PDCH assigned, containing USF assigned to the MS.
3	MS -> SS	EGPRS UPLINK RLC DATA BLOCK	Received on the assigned PDTCH SS verifies that the BSN of the received data block is 0.
4	-		Repeat Steps 2 and 3 until BSN=30 is received.
5	SS		Wait BS_CV_MAX block periods
6	SS -> MS	PACKET UPLINK ACK/NACK	SSN=21, Bitmap acknowledging BSN=21 till BSN=30
7	SS -> MS	PACKET DOWNLINK DUMMY CONTROL BLOCK	Sent on the PACCH of the PDCH assigned, containing USF assigned to the MS.
8	MS -> SS	EGPRS UPLINK RLC DATA BLOCK	Received on the assigned PDTCH SS verifies that the BSN of the received data block is 31.
9	SS -> MS	PACKET DOWNLINK DUMMY CONTROL BLOCK	Sent on the PACCH of the PDCH assigned, containing USF assigned to the MS.
10	MS -> SS	EGPRS UPLINK RLC DATA BLOCK	Received on the assigned PDTCH SS verifies that the BSN of the received data block is 32.
11		{Completion of uplink RLC data block transfer}	

53.2.2 Unacknowledged Mode/ Downlink TBF

53.2.2.1 Unacknowledged Mode/ Downlink TBF/ V(R) and V(Q)

53.2.2.1.1 Conformance requirements

In RLC unacknowledged mode, all values of BSN are within the transmit window.

In RLC unacknowledged mode, V(R) shall be set to $[BSN' + 1]$ modulo SNS, where BSN' is the BSN of most recently received RLC data block.

In RLC unacknowledged mode, if $[V(R) - V(Q)]$ modulo SNS $>$ WS after updating V(R), then V(Q) is set to $[V(R) - WS]$ modulo SNS.

References

3GPP TS 04.60, subclause 9.1, 9.1.5, 9.1.6

53.2.2.1.2 Test purpose

To verify that in RLC unacknowledged mode, the MS correctly sets V(R) and V(Q) depending upon the BSN of the data block received.

53.2.2.1.3 Method of test

Initial Conditions

System Simulator:

1 cell with EGPRS support, default setting, PBCCH not present.

Mobile Station:

The MS is EGPRS updated with a P-TMSI allocated, SPLIT PG CYCLE negotiated and the test PDP context3 activated.

Specific PICS Statements

-

PIXIT Statements

-

Test Procedure

The SS initiates the establishment of an unacknowledged downlink EGPRS TBF, setting window size value to 192.

SS sends data block with BSN=1, BSN=191 and poll the MS for acknowledgement. SS verifies that SSN=1 and the bitmap contains status of all blocks till BSN=191.

SS sends another data block with BSN=201 and polls the MS for acknowledgement. SS verifies that SSN=11 and the bitmap contains status of all blocks from 11 till 201.

Maximum Duration of Test

10 minutes.

Expected Sequence

Step	Direction	Message	Comments
1		{Downlink TBF establishment}	Unacknowledged Mode EGPRS Window Size: 192
2	SS -> MS	EGPRS DOWNLINK RLC DATA BLOCK	With BSN=1. Sent on the PDCH assigned in Step 1
3	SS -> MS	EGPRS DOWNLINK RLC DATA BLOCK	With BSN=191. Sent on the PDCH assigned in Step 1 MS is polled for FPB
4	MS -> SS	EGPRS PACKET DOWNLINK ACK/NACK	Received on PACCH of the assigned PDTCH. SS verifies that the SSN=1 and the bitmap acknowledge blocks with BSN=1 and BSN=191.
5	SS -> MS	EGPRS DOWNLINK RLC DATA BLOCK	With BSN=201. Sent on the PDCH assigned in Step 1 MS is polled for FPB
6	MS -> SS	EGPRS PACKET DOWNLINK ACK/NACK	Received on PACCH of the assigned PDTCH. SS verifies that the SSN=11 and the bitmap acknowledge blocks with BSN=191 and BSN=201.
7	SS -> MS	EGPRS DOWNLINK RLC DATA BLOCK	With BSN=202. FBI set to '1' Sent on the PDCH assigned in Step 1 With a valid RRBP
8	MS -> SS	PACKET CONTROL ACKNOWLEDGEMENT	Received on the block specified by RRBP.

53.3 Default Message Contents and Macros

53.3.1 Message Contents

none

53.3.2 Macros

53.3.2.1 Macro for uplink dynamic allocation two phase access (PBCCH not present)

Step	Direction	Message	Comments
		{Uplink dynamic allocation two phase access}	Macro parameters: N: the number of data octets to be transferred, USF_GRANULARITY: 1 or 4 blocks, RLC_DATA_BLOCKS_GRANTED: 9-261 (close-end) or absent (open-end), EGPRS Channel Coding Command: MCS-1, -2, -3, -4, -5, -6, -6, -7, -8, -9 or MCS-5-7, MCS6-9, Resegment IE: incremental redundancy on/off in uplink direction, EGPRS Window Size: according to number of allocated timeslots, TLLI_BLOCK_CHANNEL_CODING : MCS-1 or as data block, TBF Starting Time:
0	MS		Trigger the MS to initiate uplink transfer of N octets of data according to the activated test PDP context.
1	MS -> SS	EGPRS PACKET CHANNEL REQUEST	Received on RACH.
2	SS -> MS	IMMEDIATE ASSIGNMENT	Multi block assignment using Multiblock Allocation Struct, to order the MS to follow the two-phase access procedure. Sent on AGCH.
3	MS -> SS	PACKET RESOURCE REQUEST	Two phase access procedure. Received on the multi block assigned in step 2. EGPRS capability indicated in the MS Radio Access Capability IE.
4	SS -> MS	PACKET UPLINK ASSIGNMENT	Check that the PEAK_THROUGHPUT, RADIO_PRIORITY and RLC_MODE are compliant with the PDP context used. Uplink dynamic allocation, no starting time (as default, otherwise use TBF Starting Time), sent on PACCH of the same PDCH assigned in step 2.

53.3.2.2 Macro for downlink TBF establishment (PBCCH not present)

Step	Direction	Message	Comments
		{Downlink TBF establishment}	Macro parameters: TBF_STARTING_TIME
1	SS -> MS	PAGING REQUEST	Page info contains P-TMSI of the MS. Sent on PCH.
2	MS -> SS	CHANNEL REQUEST	ACCESS TYPE = "One phase packet access". Received on RACH.
3	SS -> MS	IMMEDIATE ASSIGNMENT	Random Reference = pertaining to the message received in step 2. Dynamic allocation for RLC data blocks, Sent on AGCH.
4	MS -> SS	GPRS UPLINK RLC DATA BLOCK	LLC PDU implicitly indicating paging response, containing TLLI in the RLC/MAC header. Received on uplink PDTCH assigned in step 3.
5	SS -> MS	PACKET UPLINK ACK/NACK	Acknowledge the received RLC data block. Sent on uplink PACCH.
6	MS -> SS	PACKET CONTROL ACKNOWLEDGEMENT	Acknowledge the RLC control message. Received on uplink PACCH.
7	SS -> MS	IMMEDIATE ASSIGNMENT	Downlink Assignment, TLLI value as received. Sent on PCH. Macro parameter as assigned in the test case.

53.3.2.3 Macro for downlink TBF establishment using ACCESS TYPE = "signalling" (PBCCH not present)

The following table describes a signalling sequence performing a downlink TBF establishment procedure.

The macros in the test cases refer to the table below starting at the step required for the particular sequence.

These steps are only applicable to mobiles that support EGPRS Packet Channel Request with Establishment Cause 'signalling' on RACH in a cell supporting EGPRS Packet Channel Request.

Related PICS Statement: TSPC_EGPRS_ENHANC

Step	Direction	Message	Comments
		{Downlink TBF establishment}	Macro parameters: TBF_STARTING_TIME
1	SS -> MS	PAGING REQUEST	Page info contains P-TMSI of the MS. Sent on PCH. ACCESS TYPE = "signalling". Received on RACH.
2	MS -> SS	EGPRS PACKET CHANNEL REQUEST	
3	SS -> MS	IMMEDIATE ASSIGNMENT	Random Reference = pertaining to the message received in step 2. Assigning an EGPRS TBF. Dynamic allocation for RLC data blocks, Sent on AGCH.
4	MS -> SS	EGPRS UPLINK RLC DATA BLOCK	LLC PDU implicitly indicating paging response, containing TLLI in the RLC/MAC header. Received on uplink PDTCH assigned in step 3.
5	SS -> MS	EGPRS PACKET UPLINK ACK/NACK	Acknowledge the received RLC data block. Sent on uplink PACCH.
6	MS -> SS	PACKET CONTROL ACKNOWLEDGEMENT	Acknowledge the RLC control message. Received on uplink PACCH.
7	SS -> MS	IMMEDIATE ASSIGNMENT	Downlink Assignment, TLLI value as received. Assigning an EGPRS TBF. Sent on PCH. Macro parameter as assigned in the test case.

54 to 56 Void

57 EGPRS Dual Transfer Mode

57.1 Reallocation of CS resources

57.1.1 Void

57.1.2 Void

57.1.3 Intra frequency reallocation of CS resources / DTM Assignment Command

57.1.3.1 Conformance requirements

In dual transfer mode an intracell change of channel can be requested by upper layers for changing the channel type, or decided by the RR sublayer, e.g. for an internal handover or for the reallocation of all the resources of the mobile station. The purpose is to modify completely the physical channel configuration of the mobile station without frequency redefinition or change in synchronization while staying in the same cell.

Upon receipt of the DTM ASSIGNMENT COMMAND message, the mobile station initiates a local end release of link layer connections, disconnects the physical channels, commands the switching to the assigned channel and initiates the establishment of lower layer connection (this includes the activation of the channel, their connection and the establishment of the main signalling link).

NOTE: This conformance requirement was taken from Rel-5 specifications, but it is also a requirement on R99 and Rel-4 MS.

References

3GPP TS 44.018, sub-clause 3.4.23.2

57.1.3.2 Test purpose

To verify that the MS can reallocate both the CS connection and PS resources to different timeslot(s) within the same frequency band, having received the DTM ASSIGNMENT COMMAND message.

57.1.3.3 Method of test

Initial Conditions

System Simulator:

1 cell, DTM supported.

Mobile Station:

The MS is in the active state (U10) of a call.

The MS is in GMM Ready state with a P-TMSI allocated and the PDP context 1 activated.

Specific PICS statements

-

PIXIT statements

-

Test Procedure

Once the MS is in DTM, the SS attempts to modify the resources of the MS. The SS allocates the MS a different timeslot configuration, in the same frequency band, on the current cell. The re-allocation of the MS resources is realised by the MS receiving a DTM ASSIGNMENT COMMAND from the SS. On receipt of the DTM ASSIGNMENT COMMAND message, the MS initiates a local end release of link layer connections, disconnects the physical channels. After the MS has switched to the assigned channel, the MS initiates the establishment of lower layer connection, the activation of the channel and the establishment of the main signalling link. The MS returns an ASSIGNMENT COMPLETE message on the new signalling link.

MS supporting DTM/EGPRS shall complete testing for $k=1$, and indicating support of single slot DTM/EGPRS shall complete testing for $k=2$.

Maximum Duration of Test

5 minutes

Expected Sequence

The test sequence is repeated for $k = 1, 2$.

Step	Direction	Message	Comments
1	SS		MS in state U10, on Timeslot N (chosen arbitrarily), utilising a default TCH of cell and either: $k=1$, Channel Type = TCH/F; or $k=2$, Channel Type = TCH/H.
2	SS->MS	PACKET ASSIGNMENT	Assigning downlink resources on Timeslot N+1.
3	SS<->MS	{ Downlink data transfer }	Macro – Transmitting 2.000 octet of Data
4	SS->MS	DTM ASSIGNMENT COMMAND	This message is sent after approximately 1.000 octets have been successfully transmitted. See specific message contents.
5	MS->SS	ASSIGNMENT COMPLETE	
6	SS<->MS	{ Downlink data transfer }	Macro – Completion of the 2.000 octet transmission.
7	SS		Verify that the CS connection is still through connected on the new Timeslot.

Specific Message Contents

DTM ASSIGNMENT COMMAND (Step 4):

$k=1$:

As default message contents as defined in section 40.2.4.28 except:	
Description of the CS Channel	
- Timeslot number	$(N + 4) \text{ MOD } 8$
- Channel Type	TCH/F
RR Packet Uplink Assignment IE	Not included
RR Packet Downlink Assignment IE	
- TIMESLOT_ALLOCATION	$((N + 4) \pm 1) \text{ MOD } 8$
<i>Additions for R99:</i>	
EGPRS Window Size	64
LINK_QUALITY_MEASUREMENT_MODE	00

$k=2$:

As default message contents as defined in section 40.2.4.28 except:	
Description of the CS Channel	
- Timeslot number	$(N + 4) \bmod 8$
- Channel Type	TCH/H
RR Packet Uplink Assignment IE	Not included
RR Packet Downlink Assignment IE	
- TIMESLOT_ALLOCATION	$(N + 4) \bmod 8$
<i>Additions for R99:</i>	
EGPRS Window Size	64
LINK_QUALITY_MEASUREMENT_MODE	00

57.1.4 Inter frequency reallocation of CS resources / DTM Assignment Command

57.1.4.1 Conformance requirements

In dual transfer mode an intracell change of channel can be requested by upper layers for changing the channel type, or decided by the RR sublayer, e.g. for an internal handover or for the reallocation of all the resources of the mobile station. The purpose is to modify completely the physical channel configuration of the mobile station without frequency redefinition or change in synchronization while staying in the same cell.

Upon receipt of the DTM ASSIGNMENT COMMAND message, the mobile station initiates a local end release of link layer connections, disconnects the physical channels, commands the switching to the assigned channel and initiates the establishment of lower layer connection (this includes the activation of the channel, their connection and the establishment of the main signalling link).

NOTE: This conformance requirement was taken from Rel-5 specifications, but it is also a requirement on R'99 and Rel-4 MS.

References

3GPP TS 44.018, sub-clause 3.4.23.2

57.1.4.2 Test purpose

To verify that the MS, can reallocate both the CS connection and PS resources to a different frequency band, having received the DTM ASSIGNMENT COMMAND message while in DTM.

57.1.4.3 Method of test

Initial Conditions

System Simulator:

1 cell, Cell A, with both TCH of cell activated and DTM supported. TCH2 allocated in a different frequency band and added to the Cell Channel Description in S11.

Mobile Station:

The MS is in the active state (U10) of a call, on cell A, with a TMSI and P-TMSI allocated and the PDP context 1 activated but no allocated TBFs.

Specific PICS statements

-

PIXIT statements

-

Test Procedure

Once the MS is in DTM, the SS attempts to modify the resources of the MS. The MS is allocated a new timeslot, in a different frequency band. The re-allocation of the MS resources is realised by the MS receiving a DTM ASSIGNMENT

COMMAND from the SS. On receipt of the DTM ASSIGNMENT COMMAND message, the MS initiates a local end release of link layer connections and disconnects the physical channels. After the MS has switched to the assigned channel, the MS initiates the establishment of lower layer connection, the activation of the channel and the establishment of the main signalling link. The MS returns an ASSIGNMENT COMPLETE message on the new signalling link and continues transmitting on the uplink TBF.

MS supporting DTM/EGPRS shall complete testing for k=1 MSs indicating support of single slot DTM/EGPRS shall complete testing for k=2.

Maximum Duration of Test

5 minutes

Expected Sequence

The test sequence is repeated for k = 1,2.

Step	Direction	Message	Comments
1	SS		MS in state U10, on Timeslot N (chosen arbitrarily), utilising either: k=1, Channel Type = TCH/F; or k=2, Channel Type = TCH/H.
2	MS		Trigger the MS to initiate an uplink packet transfer containing 2.000 octets.
3	MS->SS	DTM REQUEST	
4	SS->MS	PACKET ASSIGNMENT	See specific message contents.
5	SS<->MS	{ Uplink data }	Macro – Transmitting 2.000 octets of data.
6	SS->MS	DTM ASSIGNMENT COMMAND	This message to be sent before the termination of the macro. The SS instructs the MS to utilise the first alternative TCH of Cell A in a different Band supported by the MS and see specific message contents for other changes to default message.
7	MS->SS	ASSIGNMENT COMPLETE	
8	SS<->MS	{ Uplink data transfer }	Macro – completion of 2.000 octets of data upload.
9	SS		Verify that the CS connection is still through connected on the new Timeslot.

Specific Message Contents

PACKET ASSIGNMENT (Step 4):

k=1:

Information Element	Value/remark
As default message contents as defined in section 40.2.4.31 except: RR Packet Uplink Assignment IE - TIMESLOT_ALLOCATION	(N ± 1) MOD 8
<i>Additions for R99:</i> EGPRS_MCS_MODE	MCS-1
RESEGMENT	0 Retransmitted RLC data blocks shall not be resegmented
EGPRS Window Size	64
RR Packet Downlink Assignment IE	Not included

k=2:

Information Element	Value/remark
As default message contents as defined in section 40.2.4.31 except: RR Packet Uplink Assignment IE - TIMESLOT_ALLOCATION <i>Additions for R99:</i> EGPRS_MCS_MODE RESEGMENT EGPRS Window Size RR Packet Downlink Assignment IE	N MCS-1 0 Retransmitted RLC data blocks shall not be re-segmented 64 Not included

DTM ASSIGNMENT COMMAND (Step 6):

As default message contents as defined in section 40.2.4.28 except: Description of the CS Channel - Timeslot number - Channel Type RR Packet Uplink Assignment IE - TIMESLOT_ALLOCATION <i>Additions for R99:</i> EGPRS_MCS_MODE RESEGMENT EGPRS Window Size RR Packet Downlink Assignment IE	N TCH/F (N ± 1) MOD 8 MCS-1 0 Retransmitted RLC data blocks shall not be re-segmented 64 Not included
---	---

For GSM 850 and PCS 1900 only:

SYSTEM INFORMATION TYPE 1:

As default message contents except: SI 1 Rest Octets - Band Indicator	H (ARFCN indicates 1900 band)
---	-------------------------------

SYSTEM INFORMATION TYPE 6:

As default message contents except: SI 6 Rest Octets - Band Indicator	H (ARFCN indicates 1900 band)
---	-------------------------------

57.2 Release of CS resources

57.2.1 Network originating CS release

57.2.1.1 Conformance requirements

When the MS is operating in DTM and RR connection release is requested by the network, the radio resources allocated on a PDCH are released, the MS returns to the PCCCH or CCCH configuration, packet idle mode. The MS shall abort the RR connection by initiating a normal release of the main signalling link, perform a local end release of all other signalling links, disconnecting all traffic channels and abort all the packet resources.

References

3GPP TS 04.18/44.018, sub-clauses 3.4.13.1, 3.4.13.3

57.2.1.2 Test purpose

To verify that after the network releases the CS connection, the PS resources are correctly re-established

57.2.1.3 Method of test

Initial Conditions

System Simulator:

1 cell, DTM supported.

Mobile Station:

The MS is in the active state (U10) of a call.

The MS is GPRS attached with a P-TMSI allocated and the PDP context 1 activated.

Specific PICS statements

-

PIXIT statements

-

Test Procedure

An MS, in dedicated mode, is triggered to initiate uplink data transfer. The MS sends a DTM REQUEST message to the SS requesting uplink resources. The SS assigns the required resources and waits until approximately half the uplink data has been passed to the SS before instructing the MS to release the CS resources. The SS initiates the signalling required to release the channel by sending a DISCONNECT message to the MS. The MS responds to the DISCONNECT message with a RELEASE message, to which the SS responds with a RELEASE COMPLETE and then a CHANNEL RELEASE message. Once the resources have been cleared the MS requests the establishment of an uplink TBF and completes the data transmission.

MS supporting DTM/EGPRS shall complete testing for k=1 and MSs indicating support of single slot DTM/EGPRS shall additionally complete testing for k=2.

Maximum Duration of Test

5 minutes

Expected Sequence

Step	Direction	Message	Comments
1	SS		MS in the active state (U10) of a call on Timeslot N. When: k=1, Channel Type=TCH/F; k=2, Channel Type=TCH/H.
2	MS		Trigger the MS to initiate an uplink packet transfer containing 10.000 octets.
3	MS->SS	DTM REQUEST	
4	SS->MS	PACKET ASSIGNMENT	See specific message contents
5	MS<->SS	{ Uplink data }	Macro
6	MS		The SS is triggers the release of the CS connection when approximately 5.000 octets have been sent.
7	SS->MS	DISCONNECT	
8	MS->SS	RELEASE	
9	SS->MS	RELEASE COMPLETE	
10	SS->MS	CHANNEL RELEASE	
11	MS<->SS	{ Uplink dynamic allocation two phase access }	Macro
12	MS<->SS	{ Completion of uplink RLC data block transfer }	Macro – Completion of the 10.000 octets transmission.

Specific Message Contents

PACKET ASSIGNMENT (Step 4):

k=1:

Information Element	Value/remark
As default message contents as defined in section 40.2.4.31 except: RR Packet Uplink Assignment IE - TIMESLOT_ALLOCATION <i>Additions for R99:</i> EGPRS_MCS_MODE RESEGMENT EGPRS Window Size RR Packet Downlink Assignment IE	 (N ± 1) MOD 8 MCS-1 0 Retransmitted RLC data blocks shall not be re-segmented 64 Not included

k=2:

Information Element	Value/remark
As default message contents as defined in section 40.2.4.31 except: RR Packet Uplink Assignment IE - TIMESLOT_ALLOCATION <i>Additions for R99:</i> EGPRS_MCS_MODE RESEGMENT EGPRS Window Size RR Packet Downlink Assignment IE	 N MCS-1 0 Retransmitted RLC data blocks shall not be re-segmented 64 Not included

58 to 59 Void

Void.

60 Inter-system hard handover from GSM to UTRAN

Clause 60 contains test procedures to be used for executing Inter-system Handover from GSM to UTRAN tests. Table 60-1 contains a summary of the different combinations of parameters being tested, together with a reference to the appropriate generic test procedure. If a test uses a parameter which the MS under test does not support, the test shall be skipped. Test cases in this clause are applicable only to the MS supporting both UTRAN and GSM. The test USIM shall support service 27 to carry out these test cases.

Table 60-1

From	To	State of call	Ref. subclause	Exec counter	Remark
GSM FR	UTRAN AMR (conversational/speech/ UL:12.2 DL:12.2 kbps/CS RAB + UL:3.4 DL3.4 kbps SRBS)	U10	60.1	1	call active state
GSM EFR	UTRAN AMR (conversational/speech/ UL:12.2 DL:12.2 kbps/CS RAB + UL:3.4 DL3.4 kbps SRBS)	U10	60.1	2	call active state
GSM AMR	UTRAN AMR (conversational/speech/ UL:12.2 DL:12.2 kbps/CS RAB + UL:3.4 DL3.4 kbps SRBS)	U10	60.1	3	call active state
GSM HR	UTRAN AMR (conversational/speech/ UL:12.2 DL:12.2 kbps/CS RAB + UL:3.4 DL3.4 kbps SRBS)	U10	60.1	4	call active state
GSM 14.4 kbps CS data	UTRAN (Streaming/unknown/ UL:14.4 DL:14.4 kbps/CS RAB + UL:3.4 DL:3.4 kbps SRBS)	U10	60.2a	1	same data rate
GSM 14.4 kbps HSCSD	UTRAN (Streaming/unknown/ UL:14.4 DL:14.4 kbps/CS RAB + UL:3.4 DL:3.4 kbps SRBS)	U10	60.2b	1	Same data rate
GSM 28.8 kbps CS data	UTRAN (Streaming/unknown/ UL:28.8 DL:28.8 kbps/CS RAB + UL:3.4 DL:3.4 kbps SRBS)	U10	60.2b	2	same data rate
GSM 57.6 kbps CS data	UTRAN (Streaming/unknown/ UL:57.6 DL:57.6 kbps/CS RAB + UL:3.4 DL:3.4 kbps SRBS)	U10	60.2 b	3	same data rate
GSM 14.4 kbps CS data	UTRAN (Streaming/unknown/ UL:28.8 DL:28.8 kbps/CS RAB + UL:3.4 DL:3.4 kbps SRBS)	U10	60.3a	1	data rate upgrading
GSM 14.4 kbps CS data	UTRAN (Streaming/unknown/ UL:57.6 DL:57.6 kbps/CS RAB + UL:3.4 DL:3.4 kbps SRBS)	U10	60.3a	2	data rate upgrading
GSM 14.4 kbps HSCSD	UTRAN (Streaming/unknown/ UL:28.8 DL:28.8 kbps/CS RAB + UL:3.4 DL:3.4 kbps SRBS)	U10	60.3b	1	Data rate upgrading
GSM 14.4 kbps HSCSD	UTRAN (Streaming/unknown/ UL:57.6 DL:57.6 kbps/CS RAB + UL:3.4 DL:3.4 kbps SRBS)	U10	60.3b	2	Data rate upgrading
GSM 28.8 kbps CS data	UTRAN (Streaming/unknown/ UL:57.6 DL:57.6 kbps/CS RAB + UL:3.4 DL:3.4 kbps SRBS)	U10	60.3b	3	data rate upgrading
GSM SDCCH	UTRAN (SDCCH/ UL:13.6 DL:13.6 kbps SRBS)	U1	60.4	1	during call establishment
GSM FR	UTRAN AMR (conversational/speech/ UL:12.2 DL:12.2 kbps/CS RAB + UL:3.4 DL3.4 kbps SRBS)	U10	60.5	1	blind handover
GSM FR	UTRAN AMR (conversational/speech/ UL:12.2 DL:12.2 kbps/CS RAB +	U10	60.6	1	failure case

	UL:3.4 DL3.4 kbps SRBS)				
--	-------------------------	--	--	--	--

60.1 Inter system handover to UTRAN/From GSM/Speech/Success

60.1.1 Definition

60.1.2 Conformance requirement

The MS shall be able to receive a INTERSYSTEM TO UTRAN HANDOVER COMMAND message from GSM and perform an inter-system handover.

If the MS succeeds to establish the connection to UTRAN, it shall transmit a HANDOVER TO UTRAN COMPLETE message on the uplink DCCH.

Reference(s)

3GPP TS 25.331 subclause 8.3.6.

3GPP TS 04.18 subclause 3.4.4a.

60.1.3 Test purpose

To test that MS supporting both GSM and UTRAN hands over to the indicated channel in the UTRAN target cell when it is in the speech call active state in the GSM serving cell and receives a INTERSYSTEM TO UTRAN HANDOVER COMMAND. It is also verified that the MS performs measurements on the target UTRAN cell before the handover.

60.1.4 Method of test

Initial conditions

System Simulator:

2 cells - Cell 1 is GPRS, Cell 2 is UTRAN (cell selection conditions in favour of the GPRS cell).

The present document subclause 40 shall be referenced for the default parameters of cell 1, and subclause 26.6.5.1 shall be referenced for cell allocation.

3GPP TS 34.108, subclause 6.1 shall be referenced for default parameters of Cell 2.

MS:

"idle, updated", channel released mode with TMSI allocated.

For MS supporting GPRS:

The MS is GPRS attached with a P-TMSI allocated, SPLIT PG CYCLE negotiated.

Specific PICS statements

- MS supports GSM FR.
- MS supports GSM AMR.
- MS supports GSM EFR.
- MS supports GSM HR.

PIXIT statements

-

Foreseen final state of the MS

The MS is in CC state U10 on cell 2.

Test Procedure

The SS brings the MS into the call active state (CC state U10) with FR speech call (for execution counter M = 1). The SS configures the UTRAN dedicated channel corresponding to the default configuration 3. The SS sends a MEASUREMENT INFORMATION to trigger the MS to perform measurements on the UTRAN cell. The SS verifies that the MS includes the UTRAN cell in the MEASUREMENT REPORT and then sends INTERSYSTEM TO UTRAN HANDOVER COMMAND indicating the dedicated channel of the target cell to the MS through the GSM serving cell. After the MS receives the command it shall configure itself accordingly and switch to the dedicated channel of UTRAN cell. The SS checks whether the handover is performed by checking that the MS transmits HANDOVER TO UTRAN COMPLETE to the SS through DCCH of the UTRAN cell.

Depending on the PIXIT parameters, the above procedure is executed maximum four times, each time for different initial conditions:

- if the MS supports GSM FR, the procedure is executed for execution counter M = 1;
- if the MS supports GSM EFR, the procedure is executed for execution counter M = 2;
- if the MS supports GSM AMR, the procedure is executed for execution counter M = 3;
- if the MS supports GSM HR, the procedure is executed for execution counter M = 4.

Expected sequence

This sequence is performed for a maximum execution counter M = 1, 2, 3, 4, depending on the PIXIT parameters.

Step	Direction		Message	Comments
	MS	SS		
1	MS			The SS bring the MS into GSM U10 state in cell 1 and for M = 1: the MS is in GSM FR speech call; for M = 2: the MS is in GSM EFR speech call; for M = 3: the MS is in GSM AMR speech call; for M = 4: the MS is in GSM HR speech call. on a hopping traffic channel
2	SS			The SS configures the dedicated channel with the configuration: conversational/speech/UL:12.2 DL:12.2 kbps/CS RAB + UL:3.4 DL3.4 kbps SRBs in UTRAN cell.
3	←		MEASUREMENT INFORMATION	
4	→		MEASUREMENT REPORT	Including Measurement Results on the UTRAN cell in Step 4 Received within 5 sec + 10% from Step 3.
5	←		INTERSYSTEM TO UTRAN HANDOVER COMMAND	Send on cell 1 (GSM cell)
6	MS			The MS accepts the handover command and configures its lower layers using the parameters contained in the INTERSYSTEM TO UTRAN HANDOVER COMMAND
7	SS			The SS waits for uplink physical channel in synchronization
8	→		HANDOVER TO UTRAN COMPLETE	The SS receives this message on DCCH of cell 2 (UTRAN cell). It implies that the down link physical channel has synchronised with UTRAN.

Specific message contents

MEASUREMENT INFORMATION

Information Element	Value/remark
< RR short PD : bit >	0
< Message type : bit (5) >	'00101'B
< Short layer 2 header : bit (2) >	'00'B
< BA_IND : bit >	0
< 3G_BA_IND : bit >	0
< MP_CHANGE_MARK : bit >	0
< MI_INDEX : bit (4) >	'0000'B
< MI_COUNT : bit (4) >	'0000'B
< PWRC : bit >	0
< REPORT_TYPE : bit >	1 (Measurement Reporting shall be used)
< REPORTING_RATE : bit >	0 (SACCH rate reporting)
< INVALID_BSIC_REPORTING : bit >	0 (Report on cells with invalid BSIC not allowed)
0 1 < Real Time Difference Description >	0
0 1 < BSIC Description >	0
0 1 < REPORT PRIORITY Description >	0
0 1 < MEASUREMENT Parameters Description >	0
0 1 < extension length >	0
0 1 < 3G Neighbour Cell Description >	1
0 1 < 3G_Wait : bit (3) >	0
0 1 < Index_Start_3G : bit (7) >	0
0 1 < Absolute_Index_Start_EMR : bit (7) >	0
0 1 < UTRAN FDD Description >	1
0 1 < Bandwidth_FDD : bit (3) >	0
1 < Repeated UTRAN FDD Neighbour Cells > ** 0	1
0 < FDD-ARFCN : bit (14) >	0 See TS 34.108, clause 6.1.5, table 6.1.1
< FDD_Indic0 : bit >	0
< NR_OF_FDD_CELLS : bit (5) >	'00001'B
< FDD_CELL_INFORMATION Field >	10 bits Scrambling code according to TS 34.108, clause 6.1.4, Default settings for cell No.1
1 < Repeated UTRAN FDD Neighbour Cells > ** 0	0
0 1 < UTRAN TDD Description >	0
0 1 < CDMA2000 Description >	0
0 1 < 3G MEASUREMENT Parameters Description >	
< Qsearch_C : bit (4) >	'0111'B (Always)
< 3G_SEARCH_PRIO : bit (1) >	1
< FDD_REP_QUANT : bit (1) >	1 (Ec/No)
0 1 < FDD_MULTIRAT_REPORTING : bit (2) >	'1 01'B (Report on 1 UTRAN cell)
0 1 < FDD_REPORTING_OFFSET : bit (3) >	0
0 1 < TDD_MULTIRAT_REPORTING : bit (2) >	0
0 1 < TDD_REPORTING_OFFSET : bit (3) >	0
0 1 < CDMA2000_MULTIRAT_REPORTING : bit (2) >	0
0 1 < CDMA2000_REPORTING_OFFSET : bit (3) >	0

INTERSYSTEM TO UTRAN HANDOVER COMMAND

Information Element	Value/remark
RR management Protocol Discriminator	'0110'B
Skip Indicator	'0000'B
Inter System to UTRAN Handover Command Message Type	'01100011'B
Length of Handover to UTRAN Command contents	Octet length of the "Handover to UTRAN Command value part"
Handover to UTRAN Command value part	PER encoded ASN.1 value of type "HandoverToUTRANCommand-r3-IEs", the content is presented in the next table.

Content of "HandoverToUTRANCommand-r3-IEs" (in tabular format)

Information Element	Value/remark
New U-RNTI	
- SRNC Identity	'000000000001'B
- S-RNTI-2	Set to arbitrary value corresponding to DPCH Offset value currently stored in SS
Ciphering algorithm	The presence of this IE is dependent on PIXIT statements in TS 34.123-2. If ciphering is indicated to be active, use UEA1. Else, this IE is omitted.
CHOICE specification mode	Preconfiguration
CHOICE preconfiguration mode	Default configuration
- Default configuration mode	FDD
- Default configuration identity	3 (12.2 kbps speech + 3.4 kbps signalling)
- RAB Info	
- RAB identity	
- RAB identity (GSM-MAP)	'00000001'B
- CN domain identity	CS domain
- NAS Synchronisation Indicator	Not Present
- Uplink DPCH info	
- Uplink DPCH power control info	
- CHOICE mode	FDD
- DPCCH power offset	-78 dB (i.e. ASN.1 IE value of $-20 (2 + (\text{IE Value} * 4))$)
- PC Preamble	1 frame
- SRB delay	7 frames

- CHOICE mode	FDD
- Scrambling code type	long
- Reduced scrambling code number	0
- Spreading factor	64
- Downlink information common for all radio links	
- Downlink DPCH info common for all RL	
- Downlink DPCH power control information	
- CHOICE Mode	FDD
- DPC mode	Single TPC
- Downlink information per radio link list	1
- Downlink information for each radio link	
- CHOICE mode	FDD
- Primary CPICH info	
- Primary scrambling code	See TS 34.108, clause titled "Default settings for cell No.1 (FDD)" in clause 6.1
- Downlink DPCH info for each radio link	
- CHOICE mode	FDD
- CHOICE mode	FDD
- Primary CPICH usage for channel	May be used
- Secondary scrambling code	1
- CHOICE Spreading factor	128
- Code number	0
- Scrambling code change	No code change
- TPC combination index	0
- Frequency info	
- UARFCN uplink(Nu)	Not Present
	Absence of this IE is equivalent to apply the default duplex distance defined for the operating frequency according to TS 25.101
- UARFCN downlink(Nd)	See TS 34.108, clause 6.1.5, table 6.1.1
Maximum allowed UL TX power	See TS 34.108, clause 6.1.5, table 6.1.1

60.1.5 Test requirement

At step 4 the MEASUREMENT REPORT should include details of the UTRAN cell. At step 8 a HANDOVER TO UTRAN COMPLETE command should be received on DCCH of the UTRAN cell.

60.2a Inter system handover to UTRAN/From GSM/Data/Same data rate/Success

60.2a.1 Definition

60.2a.2 Conformance requirement

The MS shall be able to receive a INTER SYSTEM TO UTRAN HANDOVER COMMAND message from GSM and perform an inter-system handover.

If the MS succeeds to establish the connection to UTRAN, it shall transmit a HANDOVER TO UTRAN COMPLETE message on the uplink DCCH.

Reference(s)

3GPP TS 25.331 subclause 8.3.6.

3GPP TS 04.18 subclause 3.4.4a.

60.2a.3 Test purpose

To test that the MS hands over to the indicated UTRAN target cell and the data rate of the target channel is the same as the old channel when it is in the data call active state in the GSM serving cell and receives a INTER SYSTEM TO UTRAN HANDOVER COMMAND. It is also verified that the MS performs measurements on the target UTRAN cell before the handover.

60.2a.4 Method of test

Initial conditions

System Simulator:

2 cells - Cell 1 is GPRS, Cell 2 is UTRAN (cell selection conditions in favour of the GPRS cell).

The present document subclause 40 shall be referenced for the default parameters of Cell 1, and subclause 26.6.5.1 shall be referenced for cell allocation.

3GPP TS 34.108, subclause 6.1 shall be referenced for default parameters of Cell 2.

MS:

"idle, updated", channel released mode with TMSI allocated.

For MS supporting GPRS:

The MS is GPRS attached with a P-TMSI allocated, SPLIT PG CYCLE negotiated.

Specific PICS statements

-

PIXIT statements

-

Foreseen final state of the MS

The MS is in CC state U10 on cell 2.

Test Procedure

The SS brings the MS into the call active state (CC state U10) with a 14.4 kbps CS data call. The SS configures a dedicated channel (default configuration 7 -streaming/unknown/UL:14.4 DL:14.4 kbps/CS RAB + UL:3.4 DL:3.4 kbps SRBS) in the UTRAN cell. The SS sends a MEASUREMENT INFORMATION to trigger the MS to perform measurements on the UTRAN cell. The SS verifies that the MS includes the UTRAN cell in the MEASUREMENT REPORT and then sends INTER SYSTEM TO UTRAN HANDOVER COMMAND indicating the dedicated channel of the target cell to the MS through the GSM serving cell. After the MS receives the command it shall configure itself accordingly and switch to the dedicated channel of the UTRAN cell. The SS checks whether the handover is performed by checking that the MS transmits HANDOVER TO UTRAN COMPLETE to the SS through DCCH of the UTRAN cell.

Expected sequence

Step	Direction		Message	Comments
	MS	SS		
1	MS			The SS bring the MS into GSM U10 state in cell 1 - GSM 14.4 kbps CS data call on a hopping traffic channel.
2	SS			The SS configures a dedicated channel in the UTRAN cell with the configuration: streaming/unknown/UL:14.4 DL:14.4 kbps/CS RAB + UL:3.4 DL3.4 kbps SRBs.
3	←		MEASUREMENT INFORMATION	
4	→		MEASUREMENT REPORT	Including Measurement Results on the UTRAN cell in Step 4 Received within 5 sec + 10% from Step 3.
5	←		INTER SYSTEM TO UTRAN HANDOVER COMMAND	Send on cell 1 (GSM cell)
6	MS			The MS accepts the handover command and configures its lower layers using the parameters contained in the INTER SYSTEM TO UTRAN HANDOVER COMMAND
7	SS			The SS waits for uplink physical channel in synchronization
8	→		HANDOVER TO UTRAN COMPLETE	The SS receives this message on DCCH of cell 2 (UTRAN cell). It implies that the down link physical channel has synchronised with UTRAN.

Specific message contents

MEASUREMENT INFORMATION

Same as in 60.1

INTER SYSTEM TO UTRAN HANDOVER COMMAND

Same content as in 60.1 with the following exceptions in the content of the "HandoverToUTRANCommand-r3-IEs":

Information Element	Value/remark
CHOICE specification mode	Preconfiguration
CHOICE preconfiguration mode	Default configuration
- Default configuration identity	7 (14.4 kbps streaming CS data + 3.4 kbps signalling)

60.2a.5 Test requirement

At step 4 the MEASUREMENT REPORT should include details of the UTRAN cell. At step 8 a HANDOVER TO UTRAN COMPLETE command should be received on DCCH of the UTRAN cell.

60.2b Inter system handover to UTRAN/From GSM/Data/Same data rate/Extended Rates/Success

60.2b.1 Definition

60.2b.2 Conformance requirement

The MS shall be able to receive a INTER SYSTEM TO UTRAN HANDOVER COMMAND message from GSM and perform an inter-system handover.

If the MS succeeds to establish the connection to UTRAN, it shall transmit a HANDOVER TO UTRAN COMPLETE message on the uplink DCCH.

Reference(s)

3GPP TS 25.331 subclause 8.3.6.

3GPP TS 04.18 subclause 3.4.4a.

60.2b.3 Test purpose

To test that the MS hands over to the indicated UTRAN target cell and the data rate of the target channel is the same as the old channel when it is in the data call active state in the GSM serving cell and receives a INTER SYSTEM TO UTRAN HANDOVER COMMAND. It is also verified that the MS performs measurements on the target UTRAN cell before the handover.

60.2b.4 Method of test

Initial conditions

System Simulator:

2 cells - Cell 1 is GSM, Cell 2 is UTRAN (cell selection conditions in favour of the GSM cell).

The present document subclause 26.6.5.1 or subclause 26.13.1.3 (for HSCSD) shall be referenced for the default parameters of Cell 1.

3GPP TS 34.108, subclause 6.1 shall be referenced for default parameters of Cell 2.

MS:

"idle, updated", channel released mode with TMSI allocated.

Specific PICS statements

- MS supports UTRAN Streaming/unknown/UL:14.4 DL:14,4 kbps/CS RAB + UL:3.4 DL:3,4 kbps SRBs.
- MS supports UTRAN Streaming/unknown/UL:28.8 DL:28,8 kbps/CS RAB + UL:3.4 DL:3,4 kbps SRBs.
- MS supports UTRAN Streaming/unknown/UL:57.6 DL:57,6 kbps/CS RAB + UL:3.4 DL:3,4 kbps SRBs.

PIXIT statements

-

Foreseen final state of the MS

The MS is in CC state U10 on cell 2.

Test Procedure

The SS brings the MS into the call active state (CC state U10) with a CS data call (14.4 kbps HSCSD for execution counter M = 1). The SS configures an appropriate dedicated channel(default configuration 7 - streaming/unknown/UL:14.4 DL:14.4 kbps/CS RAB + UL:3.4 DL:3.4 kbps SRBS for M = 1) in the UTRAN cell. The SS sends a MEASUREMENT INFORMATION to trigger the MS to perform measurements on the UTRAN cell. The SS verifies that the MS include the UTRAN cell in the MEASUREMENT REPORT and then sends INTER SYSTEM TO UTRAN HANDOVER COMMAND indicating the dedicated channel of the target cell to the MS through the GSM serving cell. After the MS receives the command it shall configure itself accordingly and switch to the dedicated channel of the UTRAN cell. The SS checks whether the handover is performed by checking that the MS transmits HANDOVER TO UTRAN COMPLETE to the SS through DCCH of the UTRAN cell.

Depending on the PIXIT parameters, the above procedure is executed maximum three times, each time for different initial conditions:

- if the MS supports GSM 14.4 kbps HSCSD and UTRAN streaming/unknown/UL:14.4 DL:14.4 kbps/CS RAB + UL:3.4 DL:3.4 kbps SRBs, the procedure is executed for execution counter M = 1, using Default configuration 7;
- if the MS supports GSM 28.8 kbps CS data and UTRAN streaming/unknown/UL:28.8 DL:28.8 kbps/CS RAB + UL:3.4 DL:3.4 kbps SRBs, the procedure is executed for execution counter M = 2, using Default configuration 8;
- if the MS supports GSM 57.6 kbps CS data and UTRAN streaming/unknown/UL:57.6 DL:57.6 kbps/CS RAB + UL:3.4 DL:3.4 kbps SRBs, the procedure is executed for execution counter M = 3, using Default configuration 9.

Expected sequence

This sequence is performed for a maximum execution counter M = 1, 2, 3, depending on the PIXIT parameters.

Step	Direction		Message	Comments
	MS	SS		
1	MS			The SS bring the MS into GSM U10 state in cell 1 and for M = 1: the MS is in GSM 14.4 kbps HSCSD call; for M = 2: the MS is in GSM 28.8 kbps CS data call; for M = 3: the MS is in GSM 57.6 kbps CS data call;
2	SS			The SS configures a dedicated channel in the UTRAN cell with the configuration: For M = 1: (streaming/unknown/UL:14.4 DL:14.4 kbps/CS RAB + UL:3.4 DL3.4 kbps SRBs); For M = 2: (streaming/unknown/UL:28.8 DL:28.8 kbps/CS RAB + UL:3.4 DL3.4 kbps SRBs); For M = 3: (streaming/unknown/UL:57.6 DL:57.6 kbps/CS RAB + UL:3.4 DL3.4 kbps SRBs)
3		←	MEASUREMENT INFORMATION	
4		→	MEASUREMENT REPORT	Including Measurement Results on the UTRAN cell in Step 4 Received within 5 sec + 10% from Step 4.
5		←	INTER SYSTEM TO UTRAN HANDOVER COMMAND	Send on cell 1 (GSM cell)
6	MS			The MS accepts the handover command and configures its lower layers using the parameters contained in the INTER SYSTEM TO UTRAN HANDOVER COMMAND
7	SS			The SS waits for uplink physical channel in synchronization
8		→	HANDOVER TO UTRAN COMPLETE	The SS receives this message on DCCH of cell 2 (UTRAN cell). It implies that the down link physical channel has synchronised with UTRAN.

Specific message contents

MEASUREMENT INFORMATION

Same as in 60.1

For execution1 (M = 1):

INTER SYSTEM TO UTRAN HANDOVER COMMAND

Same content as in 60.1 with the following exceptions in the content of the "HandoverToUTRANCommand-r3-IEs":

Information Element	Value/remark
CHOICE specification mode	Preconfiguration
CHOICE preconfiguration mode	Default configuration
- Default configuration identity	7 (14.4 kbps streaming CS data + 3.4 kbps signalling)

For execution2 (M = 2):

INTER SYSTEM TO UTRAN HANDOVER COMMAND

Same content as in 60.1 with the following exceptions in the content of the "HandoverToUTRANCommand-r3-IEs":

Information Element	Value/remark
CHOICE specification mode	Preconfiguration
CHOICE preconfiguration mode	Default configuration
- Default configuration identity	8 (28.8 kbps streaming CS data + 3.4 kbps signalling)
- RAB Info	Same content as in 60.1
- Uplink DPCH info	Same content as in 60.1 except for:
- Spreading factor	32
- Downlink information per radio link	Same content as in 60.1 except for:
- Downlink information for each radio link	
- Downlink DPCH info for each RL	
- CHOICE Spreading factor	64

For execution3 (M = 3):

INTER SYSTEM TO UTRAN HANDOVER COMMAND

Same content as in 60.1 with the following exceptions in the content of the "HandoverToUTRANCommand-r3-IEs":

Information Element	Value/remark
CHOICE specification mode	Preconfiguration
CHOICE preconfiguration mode	Default configuration
- Default configuration identity	9 (57.6 kbps streaming CS data + 3.4 kbps signalling)
- RAB Info	Same content as in 60.1
- Uplink DPCH info	Same content as in 60.1 except for:
- Spreading factor	16
- Downlink information per radio link	Same content as in 60.1 except for:
- Downlink information for each radio link	
- Downlink DPCH info for each RL	
- CHOICE Spreading factor	32

60.2b.5 Test requirement

At step 5 the MEASUREMENT REPORT should include details of the UTRAN cell. At step 9 a HANOVER TO UTRAN COMPLETE command should be received on DCCH of the UTRAN cell.

60.3a Inter system handover to UTRAN/From GSM/Data/Data rate upgrading/Success

60.3a.1 Definition

60.3a.2 Conformance requirement

The MS shall be able to receive a INTER SYSTEM TO UTRAN HANDOVER COMMAND message from GSM and perform an inter-system handover.

If the MS succeeds to establish the connection to UTRAN, it shall transmit a HANOVER TO UTRAN COMPLETE message on the uplink DCCH.

Reference(s)

3GPP TS 25.331 subclause 8.3.6.

3GPP TS 04.18 subclause 3.4.4a.

60.3a.3 Test purpose

To test that the MS being in the data call active state hands over from the GSM serving cell to the indicated channel of a higher data rate in the UTRAN target cell after it receives a INTER SYSTEM TO UTRAN HANDOVER COMMAND. It is also verified that the MS performs measurements on the target UTRAN cell before the handover.

60.3a.4 Method of test

Initial conditions

System Simulator:

2 cells - Cell 1 is GPRS, Cell 2 is UTRAN (cell selection conditions in favour of the GPRS cell).

The present document subclause 40 shall be referenced for the default parameters of cell 1, and subclause 26.6.5.1 shall be referenced for cell allocation.

3GPP TS 34.108 subclause 6.1 shall be referenced for default parameters of Cell 2.

MS:

"idle, updated", channel released mode with TMSI allocated.

For MS supporting GPRS:

The MS is GPRS attached with a P-TMSI allocated, SPLIT PG CYCLE negotiated.

Specific PICS statements

- MS supports UTRAN Streaming/unknown/UL:28.8 DL:28.8 kbps/CS RAB + UL:3.4 DL:3.4 kbps SRBs.
- MS supports UTRAN Streaming/unknown/UL:57.6 DL:57.6 kbps/CS RAB + UL:3.4 DL:3.4 kbps SRBs.

PIXIT statements

-

Foreseen final state of the MS

The MS is in CC state U10 on cell 2.

Test Procedure

Then the SS brings the MS into the call active state (CC state U10) with a 14.4 kbps CS data call. The SS configures an appropriate dedicated channel in the UTRAN cell (default configuration 8 streaming/unknown/UL:28.8 DL:28.8 kbps/CS RAB + UL:3.4 DL:3.4 kbps SRBS for M = 1). The SS sends a MEASUREMENT INFORMATION to trigger the MS to perform measurements on the UTRAN cell. The SS verifies that the MS include the UTRAN cell in the MEASUREMENT REPORTs and then sends INTER SYSTEM TO UTRAN HANDOVER COMMAND indicating the dedicated channel of the target cell to the MS through the GSM serving cell. After the MS receives the command it shall configure itself accordingly and switch to the new channel of the UTRAN cell. The SS checks whether the handover is performed by checking that the MS transmits HANDOVER TO UTRAN COMPLETE to the SS through DCCCH of the UTRAN cell.

Depending on the PIXIT parameters, the above procedure is executed maximum two times, each time for different conditions:

- if the MS supports GSM 14.4 kbps CS data and UTRAN streaming/unknown/UL:28.8 DL:28.8 kbps/CS RAB + UL:3.4 DL:3.4 kbps SRBs, the procedure is executed for execution counter M = 1, using Default configuration 8;
- if the MS supports GSM 14.4 kbps CS data and UTRAN streaming/unknown/UL:57.6 DL:57.6 kbps/CS RAB + UL:3.4 DL:3.4 kbps SRBs, the procedure is executed for execution counter M = 2, using Default configuration 9;

Expected sequence

This sequence is performed for a maximum execution counter M = 1, 2 depending on the PIXIT parameters.

Step	Direction		Message	Comments
	MS	SS		
1	MS			The SS bring the MS into GSM U10 state in cell 1 and the MS is in GSM 14.4 kbps CS data call on a hopping traffic channel
2	SS			The SS configures a dedicated channel in the UTRAN cell with the configuration: For M = 1: (streaming/unknown/UL:28.8 DL:28.8 kbps/CS RAB + UL:3.4 DL3.4 kbps SRBs); For M = 2: (streaming/unknown/UL:57.6 DL:57.6 kbps/CS RAB + UL:3.4 DL3.4 kbps SRBs);
3		←	MEASUREMENT INFORMATION	
4		→	MEASUREMENT REPORT	Including Measurement Results on the UTRAN cell in Step 4 Received within 5 sec + 10% from Step 3.
5		←	INTER SYSTEM TO UTRAN HANDOVER COMMAND	Send on cell 1 (GSM cell)
6	MS			The MS accepts the handover command and configures its lower layers using the parameters contained in the INTER SYSTEM TO UTRAN HANDOVER COMMAND
7	SS			The SS waits for uplink physical channel in synchronization
8		→	HANDOVER TO UTRAN COMPLETE	The SS receives this message on DCCH of cell 2 (UTRAN cell). It implies that the down link physical channel has synchronised with UTRAN.

Specific message contents

For execution1 (M = 1):

Same as the default message contents in subclause 60.2b for M = 2.

For execution2 (M = 2):

Same as the default message contents in subclause 60.2b for M = 3.

60.3a.5 Test requirement

At step 4 the MEASUREMENT REPORT should include details of the UTRAN cell. At step 8 a HANDOVER TO UTRAN COMPLETE command should be received on DCCH of the UTRAN cell.

60.3b Inter system handover to UTRAN/From GSM/Data/Data rate upgrading/Extended Rates/Success

60.3b.1 Definition

60.3b.2 Conformance requirement

The MS shall be able to receive a INTER SYSTEM TO UTRAN HANDOVER COMMAND message from GSM and perform an inter-system handover.

If the MS succeeds to establish the connection to UTRAN, it shall transmit a HANDOVER TO UTRAN COMPLETE message on the uplink DCCH.

Reference(s)

3GPP TS 25.331 subclause 8.3.6.

3GPP TS 04.18 subclause 3.4.4a.

60.3b.3 Test purpose

To test that the MS being in the data call active state hands over from the GSM serving cell to the indicated channel of a higher data rate in the UTRAN target cell after it receives a INTER SYSTEM TO UTRAN HANDOVER COMMAND. It is also verified that the MS performs measurements on the target UTRAN cell before the handover.

60.3b.4 Method of test

Initial conditions

System Simulator:

2 cells - Cell 1 is GSM, Cell 2 is UTRAN (cell selection conditions in favour of the GSM cell).

The present document subclause 26.6.5.1 or subclause 26.13.1.3 (for HSCSD) shall be referenced for the default parameters of cell 1.

3GPP TS 34.108 subclause 6.1 shall be referenced for default parameters of Cell 2.

MS:

"idle, updated", channel released mode with TMSI allocated.

Specific PICS statements

- MS supports UTRAN Streaming/unknown/UL:28.8 DL:28.8 kbps/CS RAB + UL:3.4 DL:3.4 kbps SRBs.
- MS supports UTRAN Streaming/unknown/UL:57.6 DL:57.6 kbps/CS RAB + UL:3.4 DL:3.4 kbps SRBs.

PIXIT statements

-

Foreseen final state of the MS

The MS is in CC state U10 on cell 2.

Test Procedure

Then the SS brings the MS into the call active state (CC state U10) with a CS data call (14.4 kbps HSCSD for execution counter M = 1). The SS configures an appropriate dedicated channel in the UTRAN cell (default configuration 4 streaming/unknown/UL:28.8 DL:28.8 kbps/CS RAB + UL:3.4 DL:3.4 kbps SRBS for M = 1). The SS sends a MEASUREMENT INFORMATION to trigger the MS to perform measurements on the UTRAN cell. The SS verifies that the MS include the UTRAN cell in the MEASUREMENT REPORTs and then sends INTER SYSTEM TO UTRAN HANDOVER COMMAND indicating the dedicated channel of the target cell to the MS through the GSM serving cell. After the MS receives the command it shall configure itself accordingly and switch to the new channel of the UTRAN cell. The SS checks whether the handover is performed by checking that the MS transmits HANDOVER TO UTRAN COMPLETE to the SS through DCCH of the UTRAN cell.

Depending on the PIXIT parameters, the above procedure is executed maximum three times, each time for different conditions:

- if the MS supports GSM 14.4 kbps HSCSD and UTRAN streaming/unknown/UL:28.8 DL:28.8 kbps/CS RAB + UL:3.4 DL:3.4 kbps SRBs, the procedure is executed for execution counter M = 1, using Default configuration 8;
- if the MS supports GSM 14.4 kbps HSCSD and UTRAN streaming/unknown/UL:57.6 DL:57.6 kbps/CS RAB + UL:3.4 DL:3.4 kbps SRBs, the procedure is executed for execution counter M = 2, using Default configuration 9;
- if the MS supports GSM 28.8 kbps CS data and UTRAN streaming/unknown/UL:57.6 DL:57.6 kbps/CS RAB + UL:3.4 DL:3.4 kbps SRBs, the procedure is executed for execution counter M = 3, using Default configuration 9.

Expected sequence

This sequence is performed for a maximum execution counter M = 1, 2, 3, depending on the PIXIT parameters.

Step	Direction		Message	Comments
	MS	SS		
1	MS			The SS bring the MS into GSM U10 state in cell 1 and for M = 1: the MS is in GSM 14.4 kbps HSCSD call; for M = 2: the MS is in GSM 14.4 kbps HSCSD call; for M = 3: the MS is in GSM 28.8 kbps CS data call;
2	SS			The SS configures a dedicated channel in the UTRAN cell with the configuration: For M = 1: (streaming/unknown/UL:28.8 DL:28.8 kbps/CS RAB + UL:3.4 DL3.4 kbps SRBs); For M = 2: (streaming/unknown/UL:57.6 DL:57.6 kbps/CS RAB + UL:3.4 DL3.4 kbps SRBs); For M = 3: (streaming/unknown/UL:57.6 DL:57.6 kbps/CS RAB + UL:3.4 DL3.4 kbps SRBs)
3	←		MEASUREMENT INFORMATION	
4	→		MEASUREMENT REPORT	Including Measurement Results on the UTRAN cell in Step 4 Received within 5 sec + 10% from Step 4.
5	←		INTER SYSTEM TO UTRAN HANDOVER COMMAND	Send on cell 1 (GSM cell)
6	MS			The MS accepts the handover command and configures its lower layers using the parameters contained in the INTER SYSTEM TO UTRAN HANDOVER COMMAND
7	SS			The SS waits for uplink physical channel in synchronization
8	→		HANDOVER TO UTRAN COMPLETE	The SS receives this message on DCCH of cell 2 (UTRAN cell). It implies that the down link physical channel has synchronised with UTRAN.

Specific message contents

For execution1 (M = 1):

Same as the default message contents in subclause 60.2b for M = 2.

For execution2 (M = 2):

Same as the default message contents in subclause 60.2b for M = 3.

For execution3 (M = 3):

Same as the default message contents in subclause 60.2b for M = 3.

60.3b.5 Test requirement

At step 5 the MEASUREMENT REPORT should include details of the UTRAN cell. At step 9 a HANDOVER TO UTRAN COMPLETE command should be received on DCCH of the UTRAN cell.

60.4 Inter system handover to UTRAN/From GSM/SDCCH/CC Establishment/Success

60.4.1 Definition

60.4.2 Conformance requirement

The MS shall be able to receive a INTER SYSTEM TO UTRAN HANDOVER COMMAND message from GSM and perform an inter-system handover.

If the MS succeeds to establish the connection to UTRAN, it shall transmit a HANDOVER TO UTRAN COMPLETE message on the uplink DCCH.

Reference(s)

3GPP TS 25.331 subclause 8.3.6.

3GPP TS 04.18 subclause 3.4.4a.

60.4.3 Test purpose

To test that the MS supporting both GSM and UTRAN handovers from the GSM serving cell to the indicated channel in UTRAN target cell when the MS is on SDCCH during call establishment phase and receives an INTER SYSTEM TO UTRAN HANDOVER COMMAND. It is also verified that the MS performs measurements on the target UTRAN cell before the handover.

60.4.4 Method of test

Initial conditions

System Simulator:

2 cells - Cell 1 is GPRS, Cell 2 is UTRAN (cell selection conditions in favour of the GPRS cell).

The present document subclause 40 shall be referenced for the default parameters of cell 1. Except for SI3 indicating SI2quater on BCCH norm, and SI2quater is broadcasted on BCCH of Cell 1, and subclause 26.6.5.1 shall be referenced for cell allocation..

3GPP TS 34.108, subclause 6.2 shall be referred to default parameters of Cell 2.

MS:

"idle, updated", channel released mode with TMSI allocated.

For MS supporting GPRS:

The MS is GPRS attached with a P-TMSI allocated, SPLIT PG CYCLE negotiated.

Specific PICS statements

-

PIXIT statements

-

Foreseen final state of the MS

The MS is in CC state U1 on cell 2.

Test Procedure

The MS reads SI2quater indicating presence of the UTRAN cell. The MS is triggered to make an MO speech call. After the SS received SETUP message it configures a dedicated channel corresponding to the default configuration 1 (UL:13.6 DL13.6 kbps SRBs) and then the SS sends INTER SYSTEM TO UTRAN HANDOVER COMMAND indicating the dedicated channel to the MS through the GSM serving cell. After the MS receives the command and it shall configure itself accordingly and switch to the new channel of UTRAN cell. The SS checks whether the handover is performed by checking that the MS transmits HANDOVER TO UTRAN COMPLETE to the SS through DCCH of the UTRAN cell.

Expected sequence

Step	Direction		Message	Comments
	MS	SS		
1		SS		The MS reads SI2quater indicating presence of the UTRAN cell.
3		→	SETUP	The SS brings the MS to GSM U1 state in Cell 1
4		SS		The SS configures a dedicated channel with the default configuration 1: UL:13.6 DL13.6 kbps SRBs in UTRAN cell.
5		→	MEASUREMENT REPORT	
6				Step 5 is repeated until the MEASUREMENT REPORT contains the measurement result on the UTRAN cell
7		←	INTER SYSTEM TO UTRAN HANDOVER COMMAND	Send on cell 1 (GSM cell)
8		MS		The MS accepts the handover command and configures its lower layers using the parameters contained in the INTER SYSTEM TO UTRAN HANDOVER COMMAND
9		SS		The SS waits for uplink physical channel in synchronization
10		→	HANDOVER TO UTRAN COMPLETE	The SS receives this message on DCCH of cell 2 (UTRAN cell). It implies that the down link physical channel has synchronised with UTRAN.

Specific message contents

SYSTEM INFORMATION TYPE 2QUATER

Information Element	Value/remark
< RR management Protocol Discriminator bit (4) >	'0110'B
< Skip Indicator : bit (4) >	'0000'B
< Message type : bit (8) >	'0000 0111'B
< SI2 quarter Rest Octets >	
< BA_IND : bit >	0
< 3G_BA_IND : bit >	0
< MP_CHANGE_MARK : bit >	0
< SI2quarter_INDEX : bit (4) >	'0000'B
< SI2quarter_COUNT : bit (4) >	'0000'B
0 1 < Measurement_Parameters Description >	0
0 1 < GPRS_Real Time Difference Description >	0
0 1 < GPRS_BSIC Description >	0
0 1 < GPRS_REPORT PRIORITY Description >	0
0 1 < GPRS_Measurement_Parameters Description >	0
0 1 < NC Measurement Parameters >	0
0 1 < extension length >	0
0 1 < 3G Neighbour Cell Description >	1
0 1 < Index_Start_3G : bit (7) >	0
0 1 < Absolute_Index_Start_EMR : bit (7) >	0
0 1 < UTRAN FDD Description >	1
0 1 < Bandwidth_FDD : bit (3) >	0
1 < Repeated UTRAN FDD Neighbour Cells > ** 0	1
0 < FDD-ARFCN : bit (14) >	0 See TS 34.108, clause 6.1.5, table 6.1.1
< FDD_Indic0 : bit >	0
< NR_OF_FDD_CELLS : bit (5) >	'00001'B
< FDD_CELL_INFORMATION Field >	10 bits Scrambling code according to TS 34.108, clause 6.1.4, Default settings for cell No.1
1 < Repeated UTRAN FDD Neighbour Cells > ** 0	0
0 1 < UTRAN TDD Description >	0
0 1 < 3G MEASUREMENT Parameters Description >	
< Qsearch_I : bit (4) >	'0111'B (Always)
< Qsearch_C_Initial : bit (1) >	0
0 1 < FDD_Qoffset : bit (4) >	0
0 1 < FDD_MULTIRAT_REPORTING : bit (2) >	'1 01'B (Report on 1 UTRAN cell)
0 1 < FDD_REPORTING_OFFSET : bit (3) >	0
0 1 < TDD_MULTIRAT_REPORTING : bit (2) >	0
0 1 < TDD_REPORTING_OFFSET : bit (3) >	0
0 1 < CDMA2000_MULTIRAT_REPORTING : bit (2) >	0
0 1 < CDMA2000_REPORTING_OFFSET : bit (3) >	0
0 1 < GPRS_3G_MEASUREMENT Parameters Description >	0

INTER SYSTEM TO UTRAN HANDOVER COMMAND

Same as the default message contents in subclause 60.1 for M = 1 with the following exceptions:

Information Element	Value/remark
CHOICE specification mode	Preconfiguration
CHOICE preconfiguration mode	Default configuration
- Default configuration identity	1 (13.6 kbps signalling)
RAB information list	Not Present

60.4.5 Test requirement

At step 5 the MEASUREMENT REPORT should include details of the UTRAN cell. At step 10 a HANDOVER TO UTRAN COMPLETE command should be received on DCCH of the UTRAN cell.

60.5 Inter system handover to UTRAN/From GSM/Speech/Blind HO/Success

60.5.1 Definition

60.5.2 Conformance requirement

The MS shall be able to receive a INTER SYSTEM TO UTRAN HANDOVER COMMAND message from GSM and perform an inter-system handover, even if no prior MS measurements have been performed on the target UTRAN cell and/or frequency.

If the MS succeeds to establish the connection to UTRAN, it shall transmit a HANDOVER TO UTRAN COMPLETE message on the uplink DCCH.

Reference(s)

3GPP TS 25.331 subclause 8.3.6.

3GPP TS 04.18 subclause 3.4.4a.

60.5.3 Test purpose

To test that the MS handovers from the GSM serving cell to the indicated channel of UTRAN target cell when it is in the speech call active state without any knowledge of the target system (blind handover) and receives an INTER SYSTEM TO UTRAN HANDOVER COMMAND.

60.5.4 Method of test

Initial conditions

2 cells - Cell 1 is GPRS, Cell 2 is UTRAN (cell conditions favour the GPRS cell).

The present document subclause 40 shall be referenced for the default parameters of cell 1, and subclause 26.6.5.1 shall be referenced for cell allocation.

3GPP TS 34.108 subclause 6.1 shall be referred to for default parameters of Cell 2.

MS:

"idle, updated", channel released mode with TMSI allocated.

For MS supporting GPRS:

The MS is GPRS attached with a P-TMSI allocated, SPLIT PG CYCLE negotiated.

Specific PICS statements

-

PIXIT statements

-

Foreseen final state of the MS

The MS is in CC state U10 on cell 2.

Test Procedure

No SYSTEM INFORMATION TYPE 2quarter or MEASUREMENT INFORMATION indicating presence of the UTRAN cell are broadcasted in the GSM cell. The SS brings the MS into the call active state (CC state U10) with FR speech. The SS configures a dedicated channel (conversational/speech/UL:12.2 DL:12.2 kbps/CS RAB + UL:3.4 DL3.4 kbps SRBS), then sends INTER SYSTEM TO UTRAN HANDOVER COMMAND indicating the dedicated channel of the target cell to the MS through the GSM serving cell. After the MS receives the command it shall configure itself accordingly and switch to the dedicated channel of UTRAN cell. The SS checks whether the handover is performed by checking that the MS transmits HANDOVER TO UTRAN COMPLETE to the SS through DCCH of the UTRAN cell.

Expected sequence

Step	Direction		Message	Comments
	MS	SS		
1	MS			The SS bring the MS into GSM U10 state in cell 1, on a hopping traffic channel, and the MS has no pre-configuration information stored or received any information of presence of the UTRAN cell.
2	SS			The SS configures dedicated channel with the configuration: conversational/speech/UL:12.2 DL:12.2 kbps/CS RAB + UL:3.4 DL3.4 kbps SRBs in UTRAN cell.
3	←		INTER SYSTEM TO UTRAN HANDOVER COMMAND	Send on cell 1 (GSM cell)
4	MS			The MS accepts the handover command and configures its lower layers using the parameters contained in the INTER SYSTEM TO UTRAN HANDOVER COMMAND
5	SS			The SS waits for uplink physical channel in synchronization
6	→		HANDOVER TO UTRAN COMPLETE	The SS receives this message on DCCH of cell 2 (UTRAN cell). It implies that the down link physical channel has synchronised with UTRAN.

Specific message contents

INTER SYSTEM TO UTRAN HANDOVER COMMAND

Same as the specific message contents in subclause 60.1 for M = 1.

60.5.5 Test requirement

At step 6 the HANDOVER TO UTRAN COMPLETE shall be received on UTRAN cell.

60.6 Inter system handover to UTRAN/From GSM/Speech/Failure

60.6.1 Definition

60.6.2 Conformance requirement

The MS shall be able to receive a INTER SYSTEM TO UTRAN HANDOVER COMMAND message from GSM and perform an inter-system handover.

If the MS can not establish the connection to UTRAN, it shall reactivate the old channel and transmit a HANDOVER FAILURE message on the old channel.

Reference(s)

3GPP TS 25.331 subclause 8.3.6.

3GPP TS 04.18 subclause 3.4.4a.

60.6.3 Test purpose

To test that the MS reactivates the old channel and transmits HANDOVER FAILURE message to the network on the old channel in the GSM cell when it received INTER SYSTEM TO UTRAN HANDOVER COMMAND towards a non-existing UTRAN cell.

60.6.4 Method of test

Initial conditions

System Simulator:

2 cells - Cell 1 is GPRS, Cell 2 is UTRAN (cell selection conditions in favour of the GPRS cell).

The present document subclause 40 shall be referenced for the default parameters of cell 1, and subclause 26.6.5.1 shall be referenced for cell allocation.

3GPP TS 34.108, subclause 6.1 will be referenced for the default parameters of Cell 2.

MS:

"idle, updated", channel released mode with TMSI allocated.

For MS supporting GPRS:

The MS is GPRS attached with a P-TMSI allocated, SPLIT PG CYCLE negotiated.

Specific PICS statements

-

PIXIT statements

-

Foreseen final state of the MS

The MS is in CC state U10 on cell 1.

Test Procedure

The SS brings the MS into the call active state (CC state U10) with FR speech call. The SS does not configure a dedicated channel corresponding to the default configuration 3. The SS sends a MEASUREMENT INFORMATION to trigger the MS to perform measurements on the UTRAN cell. The SS verifies that the MS include the UTRAN cell in the MEASUREMENT REPORT and, then sends INTER SYSTEM TO UTRAN HANDOVER COMMAND indicating the dedicated channel of the target cell to the MS through the GSM serving cell. The MS will not be able to establish the connection to UTRAN dedicated channel. The SS checks that the handover is failed by checking that the MS returns to the old channel and transmits HANDOVER FAILURE to the SS through the old channel.

Expected sequence

Step	Direction		Message	Comments
	MS	SS		
1	MS			The SS brings the MS into GSM U10 state in cell 1 on a hopping traffic channel
2	SS			The SS configures the Physical channel of the UTRAN cell but here is no dedicated channel with the configuration: conversational/speech/UL:12.2 DL:12.2 kbps/CS RAB + UL:3.4 DL3.4 kbps SRBs in UTRAN cell.
3	←		MEASUREMENT INFORMATION	Including Measurement Results on the UTRAN cell in Step 4 Received within 5 sec + 10% from Step 3.
4	→		MEASUREMENT REPORT	
5	←		INTER SYSTEM TO UTRAN HANDOVER COMMAND	Send on cell 1 (GSM cell)
6	MS			The MS accepts the handover command and configures its lower layers using the parameters contained in the INTER SYSTEM TO UTRAN HANDOVER COMMAND
7	MS			The MS fails to configure to the indicated RAB in Step 6 and fails to establish a connection to UTRAN cell
8	→		HANDOVER FAILURE	The SS receives this message on DCCH of cell 1 (old channel in GSM cell)

Specific message contents

Same as the specific message contents in subclause 60.1 for M = 1.

60.6.5 Test requirement

At step 8 the HANDOVER FAILURE shall be received on GSM cell.

60.7 Inter system handover to UTRAN/From GSM/Failure/Cause: Frequency not implemented

60.7.1 Definition

60.7.2 Conformance requirement

The MS shall be able to receive a HANDOVER TO UTRAN COMMAND message from GSM and perform an inter-system handover, even if no prior MS measurements have been performed on the target UTRAN cell and/or frequency.

The HANDOVER TO UTRAN COMMAND message instructs the mobile station to use frequency that it is not capable of, and then the MS shall return a HANDOVER FAILURE message with cause "frequency not implemented" (Reference 3GPP TS 04.18 subclause 3.4.4a.3).

Reference(s)

3GPP TS 25.331 subclause 8.3.6.

3GPP TS 04.18 subclause 3.4.4a.

60.7.3 Test purpose

To test that the MS reactivates the old channel and transmits HANOVER FAILURE message to the network on the old channel in the GSM cell when it received HANOVER TO UTRAN COMMAND and the handover to UTRAN failed because of frequency not implemented.

60.7.4 Method of test

Initial conditions

System Simulator:

2 cells - Cell 1 is GSM, Cell 2 is UTRAN. TS 51.010-1 subclause 26.6.5.1 shall be referenced for the default parameters of Cell 1.

MS:

CC State U10 in cell 1.

Specific PICS statements

-

PIXIT statements

-

Foreseen final state of the MS

The MS is in CC state U10 on cell 1.

Test Procedure:

The SS starts the GSM cell and UTRAN cell with the cell selection condition in favour of GSM cell. The MS selects the GSM cell.

SS brings the MS into the call active state (CC state U10) with FR speech call. The SS configures the dedicated channel corresponding to the default configuration (conversational/speech/uplink: 12.2 DL: 12.2 kbps/CS RAB + uplink: 3.4 DL3.4 kbps SRBS), then sends HANOVER TO UTRAN COMMAND the MS through the GSM serving cell. The HANOVER TO UTRAN COMMAND message instructs the mobile station to use frequency that it is not capable of, and then the MS shall return a HANOVER FAILURE message with cause "frequency not implemented" (Reference 3GPP TS 04.18 subclause 3.4.4a.3) and continue the voice call on the old channel.

Expected sequence

Step	Direction		Message	Comments
	MS	SS		
1		SS		The SS starts GSM and UTRAN cells; the UTRAN cell broadcasts SIB16 containing pre-configuration information. MS camps on GSM cell and received SIB 16 from UTRAN cell.
2		MS		The SS brings the MS into GSM U10 state in cell 1.
3		SS		The SS configures dedicated channel with the configuration: conversational/speech/uplink:12.2 DL:12.2 kbps/CS RAB + uplink:3.4 DL3.4 kbps SRBs in UTRAN cell.
4		←	HANOVER TO UTRAN COMMAND	Handover message is sent on cell 1 (GSM cell) with unsupported frequency.
5		MS		The MS fails to establish a connection to UTRAN cell
6		→	HANOVER FAILURE	The SS receives this message on DCCH of cell 1 (old channel in GSM cell) with RR Cause "frequency not implemented".

Specific message contents

Same as the specific message contents in subclause 60.1 for $M = 1$ except that the INTER SYSTEM TO UTRAN HANDOVER COMMAND indicates a frequency not supported by the MS.

60.7.5 Test requirement

At step 7 the HANDOVER FAILURE shall be received on GSM cell.

60.8 Inter system handover to UTRAN/From GSM/Failure/Cause: UTRAN configuration unknown

60.8.1 Definition

60.8.2 Conformance requirement

The MS shall be able to receive a HANDOVER TO UTRAN COMMAND message from GSM and perform an inter-system handover, even if no prior MS measurements have been performed on the target UTRAN cell and/or frequency. The HANDOVER TO UTRAN COMMAND message instructs the mobile station to use preconfiguration that the mobile station has not read or instruct to use default reconfiguration not implemented by MS, then the MS shall return a HANDOVER FAILURE message with cause "UTRAN configuration unknown" (3GPP TS 04.18 subclause 3.4.4a.3).

Reference(s)

3GPP TS 25.331 subclause 8.3.6.

3GPP TS 04.18 subclause 3.4.4a.

60.8.3 Test purpose

To test that the MS reactivates the old channel and transmits HANDOVER FAILURE message to the network on the old channel in the GSM cell when it receives HANDOVER TO UTRAN COMMAND and the handover to UTRAN failed because of UTRAN configuration unknow.

60.8.4 Method of test

Initial conditions

System Simulator:

2 cells - Cell 1 is GSM, Cell 2 is UTRAN. TS 51.010-1 section 26.6.5.1 shall be referenced for the default parameters of cell 1.

MS:

CC State U10 in cell.

Specific PICS statements

-

PIXIT statements

-

Foreseen final state of the MS

The MS is in CC state U10 on cell 1.

Test Procedure

The SS starts the GSM cell and UTRAN cell with the cell selection condition in favour of GSM cell, SIB16 is not broadcast in UTRAN cell and MS has no predefined configuration stored.

The MS selects the GSM cell. SS brings the MS into the call active state (CC state U10) with FR speech call. The SS configures a dedicated channel (conversational/speech/uplink: 12.2 DL: 12.2 kbps/CS RAB + uplink: 3.4 DL3.4 kbps

SRBS). The SS sends a HANOVER TO UTRAN COMMAND message through the GSM cell that instructs the MS to use a preconfiguration that the mobile station has not read or instructed to use default configuration not implemented by MS. The MS shall return a HANOVER FAILURE message with cause "UTRAN preconfiguration unknown" and continue the voice call on the old cell.

Expected sequence

Step	Direction		Message	Comments
	MS	SS		
1		SS		The SS starts GSM and UTRAN cells; SIB16 is not broadcast in the UTRAN cell.
2	MS			The SS brings the MS into GSM U10 state in cell 1 and MS has not any pre-configuration stored.
3		SS		The SS configures dedicated channel with the configuration: conversational/speech/uplink:12.2 DL:12.2 kbps/CS RAB + uplink:3.4 DL3.4 kbps SRBs in UTRAN cell.
4		←	HANOVER TO UTRAN COMMAND	Handover message is sent on cell 1 (GSM cell) with unknown preconfiguration.
5	MS			The MS fails to establish a connection to UTRAN cell
6		→	HANOVER FAILURE	The SS receives this message on DCCH of cell 1 (old channel in GSM cell) with RR Cause "UTRAN configuration unknown".

Specific message contents

INTER SYSTEM TO UTRAN HANOVER COMMAND

Information Element	Value/remark
RR management Protocol Discriminator	'0110'B
Skip Indicator	'0000'B
Inter System to UTRAN Handover Command Message Type	'01100011'B
Handover to UTRAN Command IEI	TBD
Length of Handover to UTRAN Command contents	Octet length of the "Handover to UTRAN Command value part"
Handover to UTRAN Command value part	PER encoded ASN.1 value of type "HandoverToUTRANCommand-v1-IEs", content is presented in the next table.

Content of "HandoverToUTRANCommand-r3-IEs"

Information Element	Value/remark
New U-RNTI	'000000000001'B
- SRNC Identity	1
- S-RNTI-2	1
Activation time	now
Ciphering algorithm	Standard UMTS Encryption Algorithm UEA1
CHOICE Specification mode	Preconfiguration
- Predefined configuration identity	1
- RAB Info	
- RAB identity	
- GSM-MAP RAB identity	'00000001'B
- CN domain identity	CS domain
- CHOICE Mode specific info	FDD
- uplink DPCH info	
- uplink DPCH power control info	
- DPCCH power offset	-6dB
- PC Preamble	1 frame
- SRB delay	7 frames
- Scrambling code type	long
- Reduced scrambling code number	0
- Spreading factor	16
- DL common information post	
- DL DPCH info common	
- DL DPCH power control info	
- CHOICE Mode specific info	FDD
- DPC mode	Single TPC
- DL information perRL list	
- Primary CPICH info	
- Primary scrambling code	100
- DL DPCH info perRL	
- pCPICH usage for channelEst	May be used
- DL channelisation code	
- Secondary scrambling code	1
- SF and code number	SF = 32, code number = 31
- Scrambling code change	No code change
- TPC combination index	0
- Frequency info	
- UARFCN uplink(Nu)	See PIXIT
- UARFCN downlink(Nd)	See PIXIT
Maximum allowed uplink TX power	33dBm

HANDOVER FAILURE message content

Information element	Value/remark
RR management Protocol Discriminator	'0110'B
Skip Indicator	'0000'B
Handover Failure Message Type	'00101000'B
RR Cause	RR Cause (Refer : table 10.5.2.31.1/3GPP TS 04.18: RR Cause information element)

60.8.5 Test requirement

At step 7 the HANDOVER FAILURE shall be received on GSM cell.

60.9 Inter system handover to UTRAN/From GSM/Failure/Cause: Protocol Error

60.9.1 Definition

60.9.2 Conformance requirement

The MS shall be able to receive a HANDOVER TO UTRAN COMMAND message from GSM and perform an inter-system handover, even if no prior MS measurements have been performed on the target UTRAN cell and/or frequency. The HANDOVER TO UTRAN COMMAND message, which contains a protocol error causing the variable PROTOCOL_ERROR_REJECT to be set TRUE according to subclause 9 of 3GPP TS 25.331.

3GPP TS 04.18 subclause 8.5

When on receipt of a message,

- an "imperative message part" error; or
- a "missing mandatory IE" error

is diagnosed or when a message containing:

- a syntactically incorrect mandatory IE; or
- an IE unknown in the message, but encoded as "comprehension required" (see clause 3GPP TS 24.007); or
- an out of sequence IE encoded as "comprehension required" (see clause 3GPP TS 24.007)

is received,

- the mobile station shall proceed as follows:

If the message is not one of the messages listed in clauses 8.5.1, 8.5.2, 8.5.3 the mobile station shall ignore the message except for the fact that, if an RR connection exists, it shall return a status message (RR STATUS) with cause # 96 "Invalid mandatory information".

Reference(s)

3GPP TS 25.331 subclause 8.3.6 and 9.

3GPP TS 04.18 subclause 3.4.4a and 8.5.

60.9.3 Test purpose

To test that the MS reactivates the old channel and transmits RR Status message to the network on the old channel in the GSM cell when it receives HANDOVER TO UTRAN COMMAND and the handover to UTRAN failed because of protocol error.

60.9.4 Method of test

Initial conditions

System Simulator:

2 cells - Cell 1 is GSM, Cell 2 is UTRAN. TS 51.010-1 section 26.6.5.1 shall be referenced for the default parameters of cell 1.

MS:

CC State U10 in cell 1.

Specific PICS statements

-

PIXIT statements

-

Foreseen final state of the MS

The MS is in CC state U10 on cell 1.

Test Procedure

The SS starts the GSM cell and UTRAN cell with the cell selection condition in favor of GSM cell. The MS selects the GSM cell. SS brings the MS into the call active state (CC state U10) with FR speech call. The SS configures the dedicated channel corresponding to the default configuration 3 (conversational/speech/uplink: 12.2 DL: 12.2 kbps/CS RAB + uplink: 3.4 DL3.4 kbps SRBS), then sends HANDOVER TO UTRAN COMMAND indicating the dedicated channel of the target cell to the MS through the GSM serving cell.

The SS sends a HANDOVER TO UTRAN COMMAND message, that contains a protocol error causing the variable PROTOCOL_ERROR_REJECT to be set TRUE according to 3GPP TS 25.331 subclause 9. Then the MS shall return an RR STATUS message on DCCH of cell 1 (old channel in GSM cell) with RR cause #96 "Invalid mandatory information".

Expected sequence

Step	Direction		Message	Comments
	MS	SS		
1		SS		The SS starts GSM and UTRAN cells; The MS camps on GSM cell
2		MS		The SS brings the MS into GSM U10 state in cell 1
3		SS		The SS configures dedicated channel with the configuration: conversational/speech/uplink:12.2 DL:12.2 kbps/CS RAB + uplink:3.4 DL3.4 kbps SRBs in UTRAN cell.
4		←	HANDOVER TO UTRAN COMMAND	Handover message is sent on cell 1 (GSM cell) with missing mandatory IE.
5		→	RR STATUS	The SS receives this message on DCCH of cell 1 (old channel in GSM cell) with RR cause #96 "Invalid mandatory information".

Specific message contents

Same as the specific message contents in subclause 60.1 for M = 1 except that in the INTER SYSTEM TO UTRAN HANDOVER COMMAND a mandatory IE is missing causing a protocol error.

60.9.5 Test requirement

At step 5 the RR STATUS shall be received on GSM cell.

60.10 Inter system handover to UTRAN/From GSM/Integrity Protection Activation

60.10.1 Definition

60.10.2 Conformance requirement

The MS shall include the Security START values in INTER RAT HANDOVER INFO in the RR message UTRAN CLASSMARK CHANGE -definition and in the RRC message HANDOVER TO UTRAN COMPLETE.

If the MS succeeds to establish the connection to UTRAN after reception of an INTERSYSTEM TO UTRAN HANDOVER COMMAND, the NW may start Integrity protection using the previously received CS START value by sending a SECURITY MODE COMMAND message to the MS.

Reference(s)

3GPP TS 25.331 subclause 8.1.12 and 8.3.6.

3GPP TS 04.18 subclause 3.4.4a and 3.4.11.

60.10.3 Test purpose

To test that MS supporting both GSM and UTRAN applies the correct CS Security START value after a successful handover from GSM to UTRAN when Integrity protection is activated by the NW.

60.10.4 Method of test

Initial conditions

System Simulator:

2 cells - Cell 1 is GSM, Cell 2 is UTRAN.

The present document subclause 40 shall be referenced for the default parameters of cell 1, and subclause 26.6.5.1 shall be referenced for cell allocation.

3GPP TS 34.108, subclause 6.1 shall be referenced for default parameters of Cell 2.

Mobile Station:

"idle, updated", channel released mode with TMSI allocated.

For MS supporting GPRS:

The MS is GPRS attached with a P-TMSI allocated, SPLIT PG CYCLE negotiated.

Specific PICS statements

-

PIXIT statements

-

Foreseen final state of the MS

The MS is in CC state U10 on cell 2.

Test Procedure

The SS brings the MS into the call active state (CC state U10) with FR speech call.

The SS starts the UTRAN cell, configures the UTRAN dedicated channel corresponding to default handover configuration 3 and sends a MEASUREMENT INFORMATION to trigger the MS to perform measurements on the UTRAN cell.

The SS verifies that the MS includes the UTRAN cell in the MEASUREMENT REPORT. The SS then sends a CLASSMARK ENQUIRY requesting an UTRAN CLASSMARK CHANGE from the MS. The MS responds with a UTRAN CLASSMARK CHANGE and the SS verifies that the INTER RAT HANDOVER INFO includes a START value for the CS domain.

The SS sends an INTERSYSTEM TO UTRAN HANDOVER COMMAND indicating the dedicated channel of the target cell to the MS. After the MS receives the command, it shall switch to the dedicated channel of the UTRAN cell. The SS checks whether the handover is performed by checking that the MS transmits HANDOVER TO UTRAN COMPLETE to the SS through DCCH of the UTRAN cell. It is also verified that the START value for the CS domain in the HANDOVER TO UTRAN COMPLETE message is the same as the START value received in the INTER RAT HANDOVER INFO.

The SS attempts to activate Integrity protection by sending an Integrity protected SECURITY MODE COMMAND on the DCCH with an incorrect IE "Integrity check info". It is verified that the MS does not respond with a SECURITY MODE COMPLETE message.

The SS retransmits the SECURITY MODE COMMAND on the DCCH with a correct IE Integrity Check Info and the MS responds with an Integrity protected SECURITY MODE COMPLETE. Both SS and MS shall use the START value for the CS domain for Integrity protection that the MS has indicated in UTRAN CLASSMARK CHANGE and HANDOVER TO UTRAN COMPLETE.

Expected sequence

Step	Direction		Message	Comments
	MS	SS		
1	MS – SS			The SS brings the MS into GSM U10 state in cell 1 on a hopping traffic channel
2	SS			The SS configures the UTRAN cell with a dedicated channel configuration: conversational/speech/UL:12.2 DL:12.2 kbps/CS RAB + UL:3.4 DL3.4 kbps SRBs in UTRAN cell (default handover configuration 3).
				The following messages are sent and received on the GSM cell
3	←		MEASUREMENT INFORMATION	
4	→		MEASUREMENT REPORT	Including Measurement Results on the UTRAN cell in Step 4. Received within 5 sec + 10% from Step 3.
5	←		CLASSMARK ENQUIRY	
6	→		UTRAN CLASSMARK CHANGE	Verify that the ue-SecurityInformation is present.
7	←		INTERSYSTEM TO UTRAN HANDOVER COMMAND	
8	MS			The MS accepts the handover command and configures its lower layers using the parameters contained in the INTERSYSTEM TO UTRAN HANDOVER COMMAND
9	SS			The SS waits for uplink physical channel in synchronization
				The following messages are sent and received on the UTRAN cell.
10	→		HANDOVER TO UTRAN COMPLETE	Received on DCCH of the UTRAN cell. Verify that the same CS-domain START-Value is indicated as in step 6.
11	←		SECURITY MODE COMMAND	Integrity protected with a different CS-domain START value than the indicated in step 6 is applied.
12	SS			Verify that no SECURITY MODE COMPLETE is sent by the MS for 5 sec.
13	←		SECURITY MODE COMMAND	Integrity protected with the CS-domain START value indicated in step 6 is applied.
14	→		SECURITY MODE COMPLETE	Verify that Integrity protection is applied using the CS-domain START value indicated in step 6.

Specific message contents

MEASUREMENT INFORMATION in Step 3

Same as in 60.1

CLASSMARK ENQUIRY message in Step 5

Information Element	Value/remark
Protocol Discriminator	RR management
Skip Indicator	'0000'B
Message Type	Classmark Enquiry
Classmark Enquiry Mask	
Classmark Enquiry Mask IEI	'00010000'B
Length of Classmark Enquiry Mask contents	'00000001'B
Classmark Enquiry Mask value part	'10001000'B Note
Note	CLASSMARK CHANGE message is not requested; UTRAN CLASSMARK CHANGE message is requested; CDMA2000 CLASSMARK CHANGE message is not requested

UTRAN CLASSMARK CHANGE message in step 6

Information Element	Value/remark
Protocol Discriminator	RR management
Skip Indicator	'0000'B
Message Type	UTRAN 'Classmark Change
UTRAN Classmark	
Length of UTRAN Classmark	Length of INTER RAT HANDOVER INFO
UTRAN Classmark value part	INTER RAT HANDOVER INFO
InterRATHandoverInfo	RR management
PredefinedConfigurationStatusList	(Optional) Not checked
ue-SecurityInformation	Checked that the IE is present
start-CS	20 bits
...	Rest of message not checked

INTER SYSTEM TO UTRAN HANDOVER COMMAND message in Step 7

Same content as in 60.1

HANDOVER TO UTRAN COMPLETE message in step 10

Information Element	Value/remark
UL-DCCH-Message	
IntegrityCheckInfo	Not defined
Message	handoverToUTRANComplete
HandoverToUTRANComplete	
StartList	
[0]	
cn-DomainIdentity	cs -domain Checked that IE is present
start-Value	20 bits
[1]	
cn-DomainIdentity	ps-domain Not checked
start-Value	20 bits
...	-

SECURITY MODE COMMAND message AM, in step 11

Information Element	Value/remark
Message Type	
RRC transaction identifier	Arbitrarily selects an integer between 0 and 3
Integrity check info	
- Message authentication code	Set to MAC-I value computed by the SS using a different START value for the CS domain from the indicated in the INTER RAT HANDOVER INFO. The first/ leftmost bit of the bit string contains the most significant bit of the MAC-I.
UE system specific security capability	
- Inter-RAT UE security capability	
- CHOICE system	GSM
- GSM security capability	The indicated algorithms must be the same as the algorithms supported by the UE as indicated in the IE " Mobile station classmark 2 " in the LOCATION UPDATING REQUEST message.

SECURITY MODE COMMAND message AM, in step 13

Information Element	Value/remark
Message Type RRC transaction identifier Integrity check info - Message authentication code	Arbitrarily selects an integer between 0 and 3 Set to MAC-I value computed by the SS using the indicated START value for the CS domain from the INTER RAT HANDOVER INFO. The first/ leftmost bit of the bit string contains the most significant bit of the MAC-I.
UE system specific security capability - Inter-RAT UE security capability	
- CHOICE <i>system</i>	GSM
- GSM security capability	The indicated algorithms must be the same as the algorithms supported by the UE as indicated in the IE " Mobile station classmark 2 " in the LOCATION UPDATING REQUEST message.

60.10.5 Test requirement

After step 14, the ongoing call shall continue on UTRAN cell with Integrity protection using the CS Security START value indicated in the UTRAN CLASSMARK CHANGE.

61-69 Void

70 Location Services

This subclause contains test cases for Location Services (LCS).

70.1 Default conditions during LCS tests

During signalling tests in subclause 70, default conditions from subclause 26 shall apply, if not otherwise stated within the test descriptions, with the following exception.

SYSTEM INFORMATION TYPE 3:

as default except:

Information Element	value/remark
SI 3 rest octets - Early Classmark Sending Control	1 (perform early classmark sending)

70.1.1 Default conditions during EOTD tests

For EOTD testing the serving cell shall provide a BCCH for the duration of the test to enable the MS to make the required measurements.

70.1.2 Default conditions during A-GPS signalling tests

During A-GPS signalling tests defined in clause 70.7 to 70.9 the SS shall generate the six satellite signals and shall provide assistance data as defined in clause 10.9. The levels of the simulated satellites shall all be at -125dBm +/- 6dB.

70.2 EOTD Network Induced Location Request

The test cases in this subclause focus on Network Induced Location requests. Although normally associated with Emergency Calls, it is possible for an MS to receive a NI-LR at any time during idle or dedicated mode by a PLMN operator LCS client.

70.2.1 LCS Network Induced Emergency Call on an SDCCH / idle, no IMSI for Mobiles supporting MS-Assisted EOTD

70.2.1.1 Conformance requirement

1. With the MS in the "idle, updated" state, the user shall initiate an emergency after the number 112 (for GSM 900 and 1800 MS), or 911 (for GSM 710, GSM 750, T_GSM 810, GSM 850, PCS 1 900 MS in the USA), or 08 (for GSM 710, GSM 750, T_GSM 810, GSM 850, PCS 1 900 MS in Mexico) has been entered by the user. The MS shall send a CHANNEL REQUEST message with correct establishment cause ("emergency call").
2. After assignment of a dedicated channel the first layer message sent by the MS on the assigned dedicated channel shall be a CM SERVICE REQUEST message specifying the correct IMEI and a non-available CKSN, with CM Service Type "emergency call establishment". The ES_IND bit in the Mobile Station Classmark 2 information element shall be set to "Controlled Early Classmark Sending is implemented".
3. After sending the CM SERVICE REQUEST message the MS shall send a CLASSMARK CHANGE message. The "Mobile Station Classmark 3" information element shall correctly specify the positioning methods supported by the MS.
4. After the CM SERVICE ACCEPT message is received from the network, the MS shall send an EMERGENCY SETUP message.
5. On receiving the RRLP MEASURE POSITION REQUEST message the MS will perform position measurements and respond with an RRLP MEASURE POSITION RESPONSE message. The RRLP Measure Position Response message shall contain either an EOTD Measurement Information element or a Location Information Error element.

6. After receipt of a CONNECT ACKNOWLEDGE message during correct establishment of the emergency call the MS shall indicate that the TCH is through connected in both directions.

References

3GPP TS 04.08 / 3GPP TS 44.018 subclauses 3.3.1.1, 3.4.10
3GPP TS 04.08 / 3GPP TS 24.008 subclauses 5.2.1, 4.5.1.5, 4.5.1.1, 5.2.1.1, and 5.2.1.6
3GPP TS 02.30 clause 4.
3GPP TS 04.31 Annex A subclause 2.2.1.

70.2.1.2 Test Purpose

To verify when an emergency call is initiated by an MS which does not have a SIM fitted, the network instigates the LCS positioning procedure by sending RRLP (Measure Position Request) message and the mobile responds with RRLP (Measure Position Response) containing E-OTD measurement values.

70.2.1.3 Method of Test

Initial Conditions

System Simulator:

Serving cell: Default parameters.

Neighbor Cells: 2 neighbor cells are used with a minimum configuration of a BCCH. This is to allow the MS to perform the required timing measurements.

Mobile Station:

The MS is in MM-state "idle, no IMSI", no SIM inserted.

Specific PICS statements

-

PIXIT statements

-

Test Procedure

An Emergency Call is initiated with the MS, with no SIM inserted in the MS.

Directly after sending EMERGENCY SETUP the MS receives a RR APPLICATION INFORMATION message containing an RRLP Measure Position Request.

The MS then performs positioning measurements and responds with a RR APPLICATION INFORMATION message containing a RRLP Measure Position Response.

The emergency call is then established as normal with late assignment. Having reached the active state, the call is cleared by the SS.

Maximum duration of the test

3 minutes.

Expected Test Sequence

Step	Direction	Message	Comments
1	MS		The appropriate "emergency called number" is entered.
2	MS -> SS	CHANNEL REQUEST	Establishment cause is emergency call establishment.
3	SS -> MS	IMMEDIATE ASSIGNMENT	
4	MS -> SS	CM SERVICE REQUEST	Message is contained in SABM. The CM service type IE indicates "emergency call establishment". The mobile identity IE specifies the IMEI of the MS. The cipher key sequence number IE indicates "no key is available".
5	MS->SS	CLASSMARK CHANGE	"mobile station classmark 2" includes settings for ES_IND. "mobile station classmark 3" includes settings for Positioning according to 3GPP TS 24.008, table 10.5.1.7 .
6	SS -> MS	CM SERVICE ACCEPT	
7	MS -> SS	EMERGENCY SETUP	
8	SS-> MS	RR APPLICATION INFORMATION	(RRLP Measure Position Request)
9	MS -> SS	RR APPLICATION INFORMATION	(RRLP Measure Position Response indicating either EOTD Measurement Information or a Location Information Error)
10	SS -> MS	CALL PROCEEDING	
11	SS -> MS	ALERTING	
12	SS -> MS	ASSIGNMENT COMMAND	
13	MS -> SS	ASSIGNMENT COMPLETE	
14	SS -> MS	CONNECT	
15	MS -> SS	CONNECT ACKNOWLEDGE	The MS indicates that the TCH is through connected in both directions.
16	SS -> MS	DISCONNECT	
17	MS -> SS	RELEASE	
18	SS -> MS	RELEASE COMPLETE	
19	SS -> MS	CHANNEL RELEASE	The main signalling link is released.

Specific Message Contents

RR_APPLICATION_INFORMATION

Information element	Value/remark
Protocol Discriminator	RR Management Protocol (0110)
Skip Indicator	
Message Type	Application Information Message type
APDU ID	APDU ID -> RRLP => 0000
APDU Flags	Bit1=0 -> Last or only segment Bit2=0 -> First or only segment Bit3=0 -> Command or Final Response Bit4=spare
APDU Data	2-N Byte → ASN.1 Coded (SS->MS) RRLP (Measure Position Request) , (MS->SS) RRLP (Measure Position Response), (MS->SS) RRLP (Protocol Error), (SS->MS) RRLP (Assistance Data) , (MS->SS) RRLP (Assistance Data Ack.),

RRLP Measure Position Request

Information element	Type	Value/remark
ASN.1 encoded	-	(20,A0,1e) Followed by EOTD Measure Assist Data
referenceNumber	Integer,0 to 7	1
component	msrPositionReq	1
methodType	msAssisted	0
positionMethod	Enumerated	eotd
MeasureResponseTime	Integer,0 to 7	7
useMultipleSets	Enumerated	oneSet
EOTDMeasure AssistData	SEQUENCE	Values of the data within the element is described in tables 70.2.1 – 1 and 70.2.1 - 2

Table 70.2.1-1: RRLP Measure Position Request Field Values, E-OTD Reference BTS for Assistance Data Element

Field Name	Value	Comments
BCCH Carrier	Range 0-1023	ARFCN of Serving BCCH
BSIC	Range 0 to 65	BSIC of Serving BCCH
Time Slot Scheme	Either 0 or 1, as applicable	0=All time slots 156.25 bits long 1=Time slots 0 and 4 are 157 bits long, all other time slots are 156 bits long.

Table 70.2.1-2: RRLP Measure Position Request Field Values, E-OTD Measurement Assistance Data for System Information List Element

Field Name	Value	Comments
Number of Neighbors	2	
E-OTD Neighbor Present	2	
BSIC	Range 0 to 63	BSIC of neighbor BCCH
Multiframe Offset	Range 0-51	The value of this field is specific to the test configuration, and shall be calculated according to 3GPP TS 04.31, Annex A, Section A.2.2.3.
Time Slot Scheme	Either 0 or 1, as applicable	0=All time slots 156.25 bits long 1=Time slots 0 and 4 are 157 bits long, all other time slots are 156 bits long.
Rough RTD	Range 0-1250	Set to rough RTD value for the specific test configuration

RRLP Measure Position Response

Information element	Type	Value/remark
ASN.1 encoded	-	
referenceNumber	Integer,0 to 7	1
component	msrPositionReq	1
EITHER		
Eotd MeasureInfo	SEQUENCE	Any value for these parameters is acceptable.
OR		
LocationInfoError	SEQUENCE	Any error value is acceptable

70.2.2 Positioning / RR / Classmark Interrogation tests for MS-Assisted EOTD

70.2.2.1 Conformance requirement

If the MS supports MS-assisted or MS based positioning method, the MS will provide the BSC and MSC with the positioning method(s) it supports via controlled early Classmark sending.

References

3GPP TS 04.18/3GPP TS 44.018 subclause 3.3.1.1.4.1.

70.2.2.2 Test Purpose

To verify that if the network requests the MS to supply all its Classmark information, this information is sent on the SDCCH to the network.

NOTE: No positioning procedure is performed and no TCH involved.

70.2.2.3 Method of Test

Initial Conditions

Simulator (SS):

1 cell, default parameters.

Mobile Station:

"idle, updated", channel released mode with TMSI allocated.

Specific PICS statements

-

PIXIT statements

-

Test Procedure

The MS is switched off. The SS then sets the IMSI attach-detach flag in the SYSTEM INFORMATION messages so that the MS shall perform a location update when switched on.

The MS is switched on (or its power is re-applied). The MS then initiates a location update attempt. After the successful completion of the location update procedure (with TMSI reallocation) the SS transmits a CLASSMARK ENQUIRY message.

The MS shall be ready to transmit the CLASSMARK CHANGE message before 300 ms after the end of the CLASSMARK ENQUIRY message. Then the channel is released.

Maximum duration of the test

1 minute.

Expected Sequence:

Step	Direction	Message	Comments
1	MS		The MS is switched off .
2	SS		IMSI attach-detach flag changed.
3	MS		The MS is switched on (or its power is re-applied).
4	MS -> SS	CHANNEL REQUEST	"Establishment cause": Location updating.
5	SS -> MS	IMMEDIATE ASSIGNMENT	
6	MS -> SS	LOCATION UPDATING REQUEST	"location updating type" = normal, "CKSN" = CKSN1, "location area identification" = a, "mobile station classmark 1" including settings for ES IND and "mobile identity" = TMSI1.
7	SS -> MS	UA(LOCATION UPDATING REQUEST)	
8	MS -> SS	CLASSMARK CHANGE	Shall be ready to transmit (see 3GPP TS 05.10 section 06.10) within 40 ms after the completion of step 6. Shall indicate the MS frequency and power capabilities Note: In this case 'ready to transmit' shall result in the actual transmission of the Classmark Change 51 frames later (51 * 4.62mS = 235.62mS). Therefore receipt of the Classmark Change within 250mS of step 6 is required. "mobile station classmark 2" includes settings for ES IND and Positioning "mobile station classmark 3" includes settings for Positioning according to 3GPP TS 24.008, table 10.5.1.7 . "Mobile identity" = new TMSI (=TMSI2).
9	SS -> MS	LOCATION UPDATING ACCEPT	
10	MS -> SS	TMSI REALLOCATION COMPLETE	
11	SS -> MS	CLASSMARK ENQUIRY	
12	MS -> SS	CLASSMARK CHANGE	Contents as defined in step 8. This message shall be ready to be transmitted before 300 ms after the completion of step 11.
13	SS -> MS	CHANNEL RELEASE	

Specific Message Contents:

LOCATION UPDATING REQUEST

Information element	Value/remark
as default except: Mobile station Classmark 1 - ES IND	Controlled Early Classmark Sending option is implemented

70.2.3 Network Induced Location Request Emergency Call on an SDCCH for MS-Assisted EOTD Mobiles

For Mobiles supporting speech, emergency call establishment will be initiated by the MS whether location updating has been successful or not and whether a SIM is inserted into the MS or not.

A Network Induced Location Request could occur at any point during emergency call setup (Ref 3GPP TS 03.71 subclause 7.6.4.1). This could occur during an emergency setup before connection to a traffic channel.

70.2.3.1 Conformance requirements:

The following requirements apply for this test:

1. With the MS in the "idle, updated" state, the user shall initiate an emergency after the number 112 (for GSM 900 and 1800 MS), or 911 (for GSM 710, GSM 750, T_GSM 810, GSM 850, PCS 1 900 MS in the USA), or 08 (for

GSM 710, GSM 750, T_GSM 810, GSM 850, PCS 1 900 MS in Mexico) has been entered by the user. The MS shall send a CHANNEL REQUEST message with correct establishment cause ("emergency call").

2. After assignment of a dedicated channel, the MS shall send a CM SERVICE REQUEST message specifying the correct CKSN and TMSI with CM Service Type "emergency call establishment". The ES_IND bit in the Mobile Station Classmark 2 information element shall be set to "Controlled Early Classmark Sending is implemented".
3. After sending the CM SERVICE REQUEST message the MS shall send a CLASSMARK CHANGE message. The "Mobile Station Classmark 3" information element shall correctly specify the positioning methods supported by the MS.
4. After the CM SERVICE ACCEPT message is received from the network, the MS shall send an EMERGENCY SETUP message.
5. On receiving the RRLP Measure Position Request message the MS will perform position measurements and respond with an RRLP Measure Position Response message. The RRLP Measure Position Response message shall contain either an EOTD Measurement Information element or a Location Information Error element.
6. After receipt of a CONNECT ACKNOWLEDGE message during correct establishment of the emergency call the MS shall indicate that the TCH is through connected in both directions.

References

3GPP TS 04.08 / 3GPP TS 44.018 subclauses 3.3.1.1, 3.4.10, 9.1.11, 10.5.1.7.

3GPP TS 04.08 / 3GPP TS 24.008 subclauses 5.1.3, 5.2.1, 4.5.1.1, 4.5.1.5, 5.2.1.1, 5.2.1.6, 9.2.9.

3GPP TS 02.30 clause 4.

3GPP TS 04.31 Annex A subclause 2.2.1.

70.2.3.3 Test Purpose

To verify when an emergency call is initiated by the MS, the network instigates the LCS positioning procedure by sending RRLP (Measure Position Request) message and the mobile responds with RRLP (Measure Position Response) containing E-OTD measurement values.

Specific PICS statements

-

PIXIT statements

-

70.2.3.4 Method of Test

Initial Conditions:

System Simulator:

Serving cell: Default parameters

Neighbor Cells: 2 neighbor cells are used with a minimum configuration of a BCCH. This is to allow the MS to perform the required timing measurements.

Mobile Station:

The MS is in MM-state "idle, updated" with valued TMSI and CKSN.

Test Procedure:

An Emergency Call is initiated with the MS. SIM card is included in the MS.

Directly after sending EMERGENCY SETUP the MS receives a RR APPLICATION INFORMATION message containing an RRLP Measure Position Request.

The MS then performs positioning measurements and responds with a RR APPLICATION INFORMATION message containing a RRLP Measure Position Response.

The emergency call is then established as normal with late assignment. Having reached the active state, the call is cleared by the SS.

Maximum duration of the test:

3 minutes.

Expected Sequence

Step	Direction	Message	Comments
1	MS		The appropriate "emergency call number" is entered.
2	MS -> SS	CHANNEL REQUEST	Establishment cause is emergency call establishment.
3	SS -> MS	IMMEDIATE ASSIGNMENT	
4	MS -> SS	CM SERVICE REQUEST	Message is contained in SABM. The CM service type IE indicates "emergency call establishment".
5	MS->SS	CLASSMARK CHANGE	"mobile station classmark 2" includes settings for ES_IND. "mobile station classmark 3" includes settings for Positioning according to 3GPP TS 24.008, table 10.5.1.7 .
6	SS -> MS	CM SERVICE ACCEPT	
7	MS -> SS	EMERGENCY SETUP	
8	SS-> MS	RR APPLICATION INFORMATION	(RRLP Measure Position Request)
9	MS -> SS	RR APPLICATION INFORMATION	(RRLP Measure Position Response indicating either EOTD Measurement Information or a Location Information Error)
10	SS -> MS	CALL PROCEEDING	
11	SS -> MS	ALERTING	
12	SS -> MS	ASSIGNMENT COMMAND	
13	MS -> SS	ASSIGNMENT COMPLETE	
14	SS -> MS	CONNECT	
15	MS -> SS	CONNECT ACKNOWLEDGE	The MS indicates that the TCH is through connected in both directions.
16	SS -> MS	DISCONNECT	
17	MS -> SS	RELEASE	
18	SS -> MS	RELEASE COMPLETE	
19	SS -> MS	CHANNEL RELEASE	The main signalling link is released.

Specific Message Contents

RR_APPLICATION_INFORMATION

Information element	Value/remark
Protocol Discriminator	RR Management Protocol (0110)
Skip Indicator	
Message Type	Application Information Message type
APDU ID	APDU ID -> RRLP => 0000
APDU Flags	Bit1=0 -> Last or only segment Bit2=0 -> First or only segment Bit3=0 -> Command or Final Response Bit4=spare
APDU Data	2-N Byte → ASN.1 Coded (SS->MS) RRLP (Measure Position Request) , (MS->SS) RRLP (Measure Position Response), (MS->SS) RRLP (Protocol Error), (SS->MS) RRLP (Assistance Data) , (MS->SS) RRLP (Assistance Data Ack.),

RRLP Measure Position Request

Information element	Type	Value/remark
ASN.1 encoded	-	(20,A0,1e) Followed by EOTD Measure Assist Data
referenceNumber	Integer,0 to 7	1
component	msrPositionReq	1
methodType	msAssisted	0
positionMethod	Enumerated	eotd
MeasureResponseTime	Integer,0 to 7	7
useMultipleSets	Enumerated	oneSet
EotdMeasureAssistData	SEQUENCE	Values of the data within the element as described in Tables 70.2.3 – 1 and 70.2.3 – 2

Table 70.2.3-2: RRLP Measure Position Request Field Values, E-OTD Reference BTS for Assistance Data Element

Field Name	Value	Comments
BCCH Carrier	Range 0-1023	ARFCN of Serving BCCH
BSIC	Range 0 to 65	BSIC of Serving BCCH
Time Slot Scheme	Either 0 or 1, as applicable	0=All time slots 156.25 bits long 1=Time slots 0 and 4 are 157 bits long, all other time slots are 156 bits long.

Table 70.2.3-2: RRLP Measure Position Request Field Values, E-OTD Measurement Assistance Data for System Information List Element

Field Name	Value	Comments
Number of Neighbors	2	
E-OTD Neighbor Present	2	
BSIC	Range 0 to 63	BSIC of neighbor BCCH
Multiframe Offset	Range 0-51	The value of this field is specific to the test configuration, and shall be calculated according to 3GPP TS 04.31, Annex A, Section A.2.2.3.
Time Slot Scheme	Either 0 or 1, as applicable	0=All time slots 156.25 bits long 1=Time slots 0 and 4 are 157 bits long, all other time slots are 156 bits long.
Rough RTD	Range 0-1250	Set to rough RTD value for the specific test configuration

RRLP Measure Position Response

Information element	Type	Value/remark
ASN.1 encoded	-	
referenceNumber	Integer,0 to 7	1
component	msrPositionReq	1
EITHER		
Eotd MeasureInfo	SEQUENCE	Any value for these parameters is acceptable.
OR		
LocationInfoError	SEQUENCE	Any error value is acceptable

70.2.4 Emergency Call NI-LR while Voice is Through Connected for Mobiles supporting MS-Assisted EOTD

A Network Induced Location Request could occur at any point during emergency call setup (Ref 3GPP TS 03.71 subclause 7.6.4.1). In this case the voice call is established before the MS receives the location request.

70.2.4.1 Conformance requirements:

The following requirements apply for this test:

1. With the MS in the "idle, updated" state, the user shall initiate an emergency call after the number 112 (GSM 900 and 1800 MSs), or 911 (for GSM 710, GSM 750, T_GSM 810, GSM 850, PCS 1 900 in the USA), or 08 (for GSM 710, GSM 750, T_GSM 810, GSM 850, PCS 1 900 in Mexico) has been entered by the user. The MS shall end a CHANNEL REQUEST message with correct establishment cause ("emergency call").
2. After assignment of a dedicated channel, the MS shall send a CM SERVICE REQUEST message specifying the correct CKSN and TMSI with CM Service Type "emergency call establishment". The ES_IND bit in the Mobile Station Classmark 2 information element shall be set to "Controlled Early Classmark Sending is implemented".
3. After sending the CM SERVICE REQUEST message the MS shall send a CLASSMARK CHANGE message. The "Mobile Station Classmark 3" information element shall correctly specify the positioning methods supported by the MS.
4. After the CM SERVICE ACCEPT message is received from the network, the MS shall send an EMERGENCY SETUP message.
5. After receipt of a CONNECT ACKNOWLEDGE message during correct establishment of the emergency call, the MS shall indicate that the TCH is through connected in both directions.
6. On receiving the RRLP Measure Position Request message the MS will perform position measurements and respond with an RRLP Measure Position Response message. The RRLP Measure Position Response message shall contain either an EOTD Measurement Information element or a Location Information Error element.

References

3GPP TS 04.08 / 3GPP TS 44.018 subclauses 3.3.1.1, 3.4.10, 9.1.11, 10.5.1.7

3GPP TS 04.08 / 3GPP TS 24.008 subclauses 5.1.3, 5.2.1, 4.5.1.5, 4.5.1.1, 5.2.1.1, 5.2.1.6, 9.2.9

3GPP TS 02.30 clause 4.

3GPP TS 04.31 Annex A subclause 2.2.1.

70.2.4.2 Test Purpose

To verify when a network instigates the LCS positioning procedure by sending RRLP (Measure Position Request) message, after a traffic channel has been established during an emergency call, the mobile responds with RRLP (Measure Position Response) containing E-OTD measurement values.

Specific PICS statements

-

PIXIT statements

-

70.2.4.3 Method of Test

Initial Conditions

System Simulator:

Serving cell: Default parameters.

Neighbor Cells: 2 neighbor cells are used with a minimum configuration of a BCCH. This is to allow the MS to perform the required timing measurements.

Mobile Station:

The MS is in MM-state "idle, updated" with valued TMSI and CKSN.

Test Procedure:

An Emergency Call is initiated by the MS. SIM card is present in the MS.

The emergency call is established with a late assignment.

After receiving the CONNECT ACKNOWLEDGE message from the MS, the SS sends an RR APPLICATION INFORMATION message containing an RRLP Measure Position Request on the FACCH.

The MS then performs positioning measurements and responds with a RR APPLICATION INFORMATION message containing an RRLP Measure Position Response.

The call is then cleared by the SS.

Maximum duration of the test:

1 minutes.

Expected Sequence

Step	Direction	Message	Comments
1	MS		The appropriate Emergency Called number is entered.
2	MS -> SS	CHANNEL REQUEST	Establishment cause is emergency call establishment.
3	SS -> MS	IMMEDIATE ASSIGNMENT	
4	MS -> SS	CM SERVICE REQUEST	Message is contained in SABM. The CM service type IE indicates "emergency call establishment".
5	MS->SS	CLASSMARK CHANGE	"mobile station classmark 2" includes settings for ES_IND. "mobile station classmark 3" includes settings for Positioning according to 3GPP TS 24.008, table 10.5.1.7 .
6	SS -> MS	CM SERVICE ACCEPT	
7	MS -> SS	EMERGENCY SETUP	
8	SS -> MS	CALL PROCEEDING	
9	SS -> MS	ALERTING	
10	SS -> MS	ASSIGNMENT COMMAND	
11	MS -> SS	ASSIGNMENT COMPLETE	
12	SS -> MS	CONNECT	
13	MS -> SS	CONNECT ACKNOWLEDGE	The MS indicates that the TCH is through connected in both directions.
14	SS-> MS	RR APPLICATION INFORMATION	(RRLP Measure Position Request)
15	MS -> SS	RR APPLICATION INFORMATION	(RRLP Measure Position Response indicating either EOTD Measurement Information or a Location Information Error)
16	SS -> MS	DISCONNECT	
17	MS -> SS	RELEASE	
18	SS -> MS	RELEASE COMPLETE	
19	SS -> MS	CHANNEL RELEASE	The main signalling link is released.

Specific Message Contents

RR_APPLICATION_INFORMATION

Information element	Value/remark
Protocol Discriminator	RR Management Protocol (0110)
Skip Indicator	
Message Type	Application Information Message type
APDU ID	APDU ID -> RRLP => 0000
APDU Flags	Bit1=0 -> Last or only segment Bit2=0 -> First or only segment Bit3=0 -> Command or Final Response Bit4=spare
APDU Data	2-N Byte → ASN.1 Coded (SS->MS) RRLP (Measure Position Request) , (MS->SS) RRLP (Measure Position Response), (MS->SS) RRLP (Protocol Error), (SS->MS) RRLP (Assistance Data) , (MS->SS) RRLP (Assistance Data Ack.),

RRLP Measure Position Request

Information element	Type	Value/remark
ASN.1 encoded	-	(20,A0,1e) Followed by EOTD Measure Assist Data
ReferenceNumber	Integer,0 to 7	1
Component	msrPositionReq	1
MethodType	msAssisted	0
PositionMethod	Enumerated	eotd
MeasureResponseTime	Integer,0 to 7	7
UseMultipleSets	Enumerated	oneSet
EOTD Measurement Assistance	SEQUENCE	Values of the data within the element as described in Tables 70.2.4 - 1 and 70.2.4 – 2

Table 70.2.4-3: RRLP Measure Position Request Field Values, E-OTD Reference BTS for Assistance Data Element

Field Name	Value	Comments
BCCH Carrier	Range 0-1023	ARFCN of Serving BCCH
BSIC	Range 0 to 65	BSIC of Serving BCCH
Time Slot Scheme	Either 0 or 1, as applicable	0=All time slots 156.25 bits long 1=Time slots 0 and 4 are 157 bits long, all other time slots are 156 bits long.

Table 70.2.4-2: RRLP Measure Position Request Field Values, E-OTD Measurement Assistance Data for System Information List Element

Field Name	Value	Comments
Number of Neighbors	2	
E-OTD Neighbor Present	2	
BSIC	Range 0 to 63	BSIC of neighbor BCCH
Multiframe Offset	Range 0-51	The value of this field is specific to the test configuration, and shall be calculated according to 3GPP TS 04.31, Annex A, Section A.2.2.3.
Time Slot Scheme	Either 0 or 1, as applicable	0=All time slots 156.25 bits long 1=Time slots 0 and 4 are 157 bits long, all other time slots are 156 bits long.
Rough RTD	Range 0-1250	Set to rough RTD value for the specific test configuration

RRLP Measure Position Response

Information element	Type	Value/remark
ASN.1 encoded	-	
referenceNumber	Integer, 0 to 7	1
component	msrPositionReq	1
EITHER		
Eotd MeasureInfo	SEQUENCE	Any value for these parameters is acceptable.
OR		
LocationInfoError	SEQUENCE	Any error value is acceptable

70.3 Mobile Originating Location Request

The test cases in this subclause focus on Mobile Originating Location Request. A MO_LR could occur by a MS to request the network to start location procedure, which is used for either its own location, location assistance data or deciphering keys for broadcast assistance data message.

70.3.1 MO_LR Basic Self Location Request

Basic Self Location Request is only applicable for requesting its own location by using MS Assisted E-OTD positioning..

70.3.1.1 MO_LR Basic Self Location Request In Idle Mode (Normal Case)

70.3.1.1.1 Conformance requirements:

The MS sends a DTAP LCS MO-LR invoke to the VMSC. If the MS is requesting its own location or that its own location be sent to another LCS client, this message carries LCS QoS information (e.g. accuracy, response time).

The MS invokes a MO-LR by sending a REGISTER message to the network containing a LCS-MOLR invoke component with MO_LR TYPE set to LocationEstimate, LCS QoS value and other optional field if it is needed.

The MS shall terminate the dialogue by sending a RELEASE COMPLETE message.

Test References

3GPP TS 03.71, subclause 7.6.6.

3GPP TS 04.30 subclause 5.1.1.

3GPP TS 04.80 subclauses 2.4, 2.5 and 4.

70.3.1.1.2 Test Purpose

Verifies that a MS sends a correct LCS-MOLR Invoke message with the component MO_LR TYPE set to LocationEstimate and LCS_QoS value on the initiation of MOLR. On receipt of a RRLP Measure position request from SS to start the measurement, MS shall send back RRLP Measure Position Response to SS after finishing the measurement.

70.3.1.1.3 Method of Test

Initial Conditions

System Simulator:

Serving cell: Default parameters, in SYSTEM INFORMATION TYPE 3 (SI3 Rest Octet) the early classmark sending control is implemented in the SS.

Neighbor Cells: at least 2 neighbor cells are used with a minimum configuration of a BCCH. This is to allow the MS to perform the required timing measurements.

Mobile Station:

The MS is in MM-state "idle, updated" with valid TMSI and CKSN.

Specific PICS statements

-

PIXIT statements

-

Test Procedure:

A MOLR procedure as call independent supplementary services is initiated from the MS. The MS performs control early classmark sending to provide LCS positioning method capability. After sending the CIPHERING MODE COMPLETE message the MS sends a REGISTER message with Facility IE containing a component set to LCS-MOLR Invoke. The SS sends RRLP Request to start the measurement. Once the measurement is done, RRLP response is sent back to SS with the measurement data. The SS returns location estimate to MS through LCS-MOLR Return Result. The MS terminates the dialogue by sending RELEASE COMPLETE message.

Maximum duration of the test:

3 minutes.

Expected Sequence

Step	Direction	Message	Comments
1	MS		Initiate MOLR Procedure (Basic Self Location Request)
2	MS -> SS	CHANNEL REQUEST	Establishment cause indicates " call independent supplementary Services".
3	SS -> MS	IMMEDIATE ASSIGNMENT	
4	MS -> SS	CM SERVICE REQUEST	Message is contained in SABM "Mobile identity" IE contains the IMSI. "mobile station classmark 2" including settings for ES IND and CM3 supported.
5	MS -> SS	CLASSMARK CHANGE	"mobile station classmark 3" includes settings for Positioning according to 3GPP TS 24.008, table 10.5.1.7. This includes support of LCS VA Capability.
6	SS -> MS	AUTHENTICATION REQUEST	
7	MS -> SS	AUTHENTICATION RESP	SRES specifies correct value.
8	SS -> MS	CIPHERING MODE COMMAND	SS starts deciphering after sending the message.
9	MS -> SS	CIPHERING MODE COMPLETE	Shall be sent enciphered. All following messages shall be sent enciphered.
10	SS -> MS	CM SERVICE ACCEPT	
11	MS -> SS	REGISTER	Call Independent SS containing Facility IE With the component of Invoke message set to LCS-MOLR MOLR-Type set to LocationEstimate
12	SS -> MS	RR APPLICATION INFORMATION	RRLP MEASURE POSITION REQUEST
13	MS -> SS	RR APPLICATION INFORMATION	RRLP MEASURE POSITION RESPONSE
14	SS -> MS	FACILITY	LCS MO-LR RETURE RESULT (locationEstimate)
15	MS -> SS	RELEASE COMPLETE	Terminates the session
16	SS -> MS	CHANNEL RELEASE	The main signalling link is released.

Specific Message Contents

FACILITY

Information element	Value/remark
Protocol Discriminator	Call Independent SS message (1011)
Transaction identifier	XX
Message type	FACILITY (0x11 1010)
Facility	Return Result = lcs-MOLR LocationEstimate LCS-MOLRRes ->locationEstimate

RR_APPLICATION_INFORMATION

Information element	Value/remark
Protocol Discriminator	RR Management Protocol (0110)
Skip Indicator	
Message Type	Application Information Message type
APDU ID	APDU ID -> RRLP => 0000
APDU Flags	Bit1=0 -> Last or only segment Bit2=0 -> First or only segment Bit3=0 -> Command or Final Response Bit4=spare
APDU Data	2-N Byte → ASN.1 Coded (SS->MS) RRLP (Measure Position Request) , (MS->SS) RRLP (Measure Position Response), (MS->SS) RRLP (Protocol Error), (SS->MS) RRLP (Assistance Data) , (MS->SS) RRLP (Assistance Data Ack.),

RRLP Measure Position Request

Information element	Type	Value/remark
ASN.1 encoded	-	(20,00,1e)
referenceNumber	Integer,0 to 7	1
component	msrPositionReq	1
methodType	msAssisted	0
positionMethod	Enumerated	eotd
MeasureResponseTime	Integer,0 to 7	7
useMultipleSets	Enumerated	oneSet

70.3.1.2 MO_LR Basic Self Location Request In Dedicated Mode (Normal case)

70.3.1.2.1 Conformance Requirement:

The MS sends a DTAP LCS MO-LR invoke to the VMSC. If the MS is requesting its own location or that its own location be sent to another LCS client, this message carries LCS QoS information (e.g. accuracy, response time).

The MS invokes a MO-LR by sending a REGISTER message to the network containing a LCS-MOLR invoke component with MO_LR TYPE set to LocationEstimate, LCS QoS value and other optional field if it is needed.

The MS shall terminate the dialogue by sending a RELEASE COMPLETE message.

Test References:

3GPP TS 03.71 subclause 7.6.6

3GPP TS 04.30 subclause 5.1.1

3GPP TS 04.80 subclauses 2.4, 2.5 & 4

70.3.1.2.2 Test Purpose

Verifies that a MS sends a correct LCS-MOLR Invoke message on already established speech call related SACCH with the component MO_LR TYPE sets to LocationEstimate and LCS_QoS value on the initiation of MO_LR. On receipt of a RRLP Measure position request from SS to start the measurement, MS shall send back RRLP Measure Position Response to SS after finishing the measurement.

70.3.1.2.3 Method of Test

Initial Conditions:

System Simulator:

Serving Cell: Default parameters.

Neighbor Cells: 2 neighbor cells are used with a minimum configuration of a BCCH. This is to allow the MS to perform the required timing measurements.

Mobile Station:

The MS has valid TMSI and CKSN.

The MS is brought into the state U10 by using table 26.8.1.2/3.

Specific PICS statements

-

PIXIT statements

-

Test Procedure:

A MOLR procedure as call independent supplementary services is initiated from the MS on the existing SACCH channel. After received CM SERVICE ACCEPT message, MS sends a REGISTER message with Facility IE containing a component set to a LCS-MOLR Invoke. The SS sends RRLP Request to start the measurement. Once the measurement is done, RRLP Response is sent back to SS with the measurement data. The SS returns location estimate to MS through LCS-MOLR Return Result. The MS terminates the dialogue by sending RELEASE COMPLETE message.

Maximum duration of the test:

3 minutes.

Expected Sequence

Step	Direction	Message	Comments
1	MS		Initiate MOLR Procedure ((Basic Self Location Request)
2	MS -> SS	CM SERVICE REQUEST	"Mobile identity" IE contains the IMSI. "mobile station classmark 2" including settings for ES IND and CM3 supported.
3	MS -> SS	CLASSMARK CHANGE	This message is optional does not have to be sent by the MS.
4	SS -> MS	CM SERVICE ACCEPT	
5	MS -> SS	REGISTER	Call Independent SS containing Facility IE With the component of Invoke message set to LCS-MOLR MOLR-Type set to LocationEstimate
6	SS->MS	RR APPLICATION INFORMATION	RRLP MEASURE POSITION REQUEST
7	MS->SS	RR APPLICATION INFORMATION	RRLP MEASURE POSITION RESPONSE
8	SS->MS	FACILITY	LCS MO-LR RETURE RESULT (locationEstimate
9	MS->SS	RELEASE COMPLETE	Terminates the session
10	SS -> MS	CHANNEL RELEASE	The main signalling link is released.

Specific Message Contents:

FACILITY

Information element	Value/remark
Protocol Discriminator	Call Independent SS message (1011)
Transaction identifier	XX
Message type	FACILITY (0x11 1010)
Facility	Return Result = lcs-MOLR LocationEstimate LCS-MOLRRes ->locationEstimate

RR_APPLICATION_INFORMATION

Information element	Value/remark
Protocol Discriminator	RR Management Protocol (0110)
Skip Indicator	
Message Type	Application Information Message type
APDU ID	APDU ID -> RRLP => 0000
APDU Flags	Bit1=0 -> Last or only segment Bit2=0 -> First or only segment Bit3=0 -> Command or Final Response Bit4=spare
APDU Data	2-N Byte → ASN.1 Coded (SS->MS) RRLP (Measure Position Request), (MS->SS) RRLP (Measure Position Response), (MS->SS) RRLP (Protocol Error), (SS->MS) RRLP (Assistance Data), (MS->SS) RRLP (Assistance Data Ack.),

RRLP Measure Position Request

Information element	Type	Value/remark
ASN.1 encoded	-	(20,00,1e)
referenceNumber	Integer,0 to 7	1
component	msrPositionReq	1
methodType	msAssisted	0
positionMethod	Enumerated	eotd
MeasureResponseTime	Integer,0 to 7	7
useMultipleSets	Enumerated	oneSet

70.3.2 MO_LR Transfer to 3rd Party

70.3.2.1 Conformance requirements:

The MS sends a DTAP LCS MO-LR invoke to the VMSC. If the MS is requesting its own location or that its own location be sent to another LCS client, this message carries LCS QoS information (e.g. accuracy, response time). If the MS is requesting that its location be sent to another LCS client, the message shall include the identity of the LCS client and may include the address of the GMLC through which the LCS client should be accessed

The MS invokes a MO-LR by sending a REGISTER message to the network containing a LCS-MOLR invoke component with MO_LR TYPE set to LocationEstimate, LCS QoS value, LCS-ClientExternalID and MLC_Number if it is available.

Test References

3GPP TS 03.71, subclause 7.6.6,

3GPP TS 04.030 subclause 5.1.1,

3GPP TS 04.80 subclauses 2.4, 2.5 & 4

70.3.2.2 Test Purpose

Verifies that a MS sends a correct LCS-MOLR Invoke message with the component MO_LR TYPE set to LocationEstimate, LCS_QoS value, LCS-ClientExternalID and MLC_Number (if available) on the initiation of MOLR. On receipt of a RRLP Measure position request from SS to start the measurement, MS shall send back RRLP Measure Position Response to SS after finishing the measurement.

70.3.2.3 Method of Test

Initial Conditions

System Simulator:

Serving cell: Default parameters, in SYSTEM INFORMATION TYPE 3 (SI3 Rest Octet) the early classmark sending control is implemented in the SS.

Neighbor Cells: at least 2 neighbor cells are used with a minimum configuration of a BCCH. This is to allow the MS to perform the required timing measurements.

Mobile Station:

The MS is in MM-state "idle, updated" with valid TMSI and CKSN.

Specific PICS statements

-

PIXIT statements

-

Test Procedure:

A MOLR procedure as call independent supplementary services is initiated from the MS. The MS performs control early classmark sending to provide LCS positioning method capability. After sending the CIPHERING MODE COMPLETE message the MS sends a REGISTER message with Facility IE containing a component set to a LCS-MOLR Invoke. The SS sends RRLP Request to start the measurement. Once the measurement is done, RRLP response is sent back to SS with the measurement data. The SS may then transfer the location information to the internal or external LCS client.

Maximum duration of the test:

3 minutes.

Expected Sequence

Step	Direction	Message	Comments
1	MS		Initiate MOLR Procedure (Transfer to 3 rd Party)
2	MS -> SS	CHANNEL REQUEST	Establishment cause indicates " call independent supplementary Services".
3	SS -> MS	IMMEDIATE ASSIGNMENT	
4	MS -> SS	CM SERVICE REQUEST	Message is contained in SABM "Mobile identity" IE contains the IMSI. "mobile station classmark 2" including settings for ES IND and CM3 supported.
5	MS -> SS	CLASSMARK CHANGE	"mobile station classmark 3" includes settings for Positioning according to 3GPP TS 24.008, table 10.5.1.7. This includes support of LCS VA Capability.
6	SS -> MS	AUTHENTICATION REQUEST	
7	MS -> SS	AUTHENTICATION RESP	SRES specifies correct value.

8	SS -> MS	CIPHERING MODE COMMAND	SS starts deciphering after sending the message.
9	MS -> SS	CIPHERING MODE COMPLETE	Shall be sent enciphered. All following messages shall be sent enciphered.
10	SS -> MS	CM SERVICE ACCEPT	
11	MS -> SS	REGISTER	Call Independent SS containing Facility IE With the component of Invoke message set to LCS-MOLR MOLR-Type set to LocationEstimate LCSClientExternalID present
12	SS -> MS	RR APPLICATION INFORMATION	RRLP MEASURE POSITION REQUEST
13	MS -> SS	RR APPLICATION INFORMATION	RRLP MEASURE POSITION RESPONSE
14	SS		SS may return the location estimate result to the LCS client as MAP subscriber location report
15	SS -> MS	RELEASE COMPLETE	Confirmation of successful transfer to 3 rd Party
16	SS -> MS	CHANNEL RELEASE	The main signalling link is released.

Specific Message Contents

FACILITY

Information element	Value/remark
Protocol Discriminator	Call Independent SS message (1011)
Transaction identifier	XX
Message type	FACILITY (0x11 1010)
Facility	Return Result = lcs-MOLR LocationEstimate LCS-MOLRRes ->locationEstimate

RR_APPLICATION_INFORMATION

Information element	Value/remark
Protocol Discriminator	RR Management Protocol (0110)
Skip Indicator	
Message Type	Application Information Message type
APDU ID	APDU ID -> RRLP => 0000
APDU Flags	Bit1=0 -> Last or only segment Bit2=0 -> First or only segment Bit3=0 -> Command or Final Response Bit4=spare
APDU Data	2-N Byte → ASN.1 Coded (SS->MS) RRLP (Measure Position Request) , (MS->SS) RRLP (Measure Position Response), (MS->SS) RRLP (Protocol Error), (SS->MS) RRLP (Assistance Data) , (MS->SS) RRLP (Assistance Data Ack.),

RRLP Measure Position Request

Information element	Type	Value/remark
ASN.1 encoded	-	(20,00,1e)
referenceNumber	Integer,0 to 7	1
component	msrPositionReq	1
methodType	msAssisted	0
positionMethod	Enumerated	eotd
MeasureResponseTime	Integer,0 to 7	7
useMultipleSets	Enumerated	oneSet

70.3.3 MO_LR Autonomous Location

70.3.3.1 Conformance Requirement

The MS sends a DTAP LCS MOLR invoke to VMSC. If the MS is requesting location assistance data, the message specifies the type of assistance data and the positioning method for which the assistance data applies.

The MS invokes a MO_LR by sending a REGISTER message to network containing a LCS-MOLR invoke component with MO_LR TYPE set to AssistanceData, Location-Method set to MS-AssistedEOTD, LCS QoS value and other optional field if it is needed.

The MS acknowledges the reception of each assistance data component to network with a RRLP ASSISTANCE DATA Ack before the next Assistance Data component is received.

References

3GPP TS 03.71 subclause 7.6.6, 10.4, 10.5

3GPP TS 04.30 subclause 5.1.1

3GPP TS 04.31 subclause 2.3

3GPP TS 04.80 subclauses 2.4, 2.5 and 4

70.3.3.2 Test Purpose

Verifies that a MS sends a correct LCS-MOLR Invoke message with the component MOLR Type set to Assistance Data, Location-Method sets to MS-Assisted EOTD, and LCS-QoS on the initiation of MO_LR. The MS shall acknowledge the reception of each assistance data component.

70.3.3.3 Method of Test

Initial Conditions:

System Simulator:

Serving Cell: Default parameters, in SYSTEM INFORMATION TYPE 3 (SI3 Rest Octet) the early classmark sending control is implemented in the SS.

Mobile Station:

The MS is in MM-state "idle, updated" with valued TMSI and CKSN.

Specific PICS statements

-

PIXIT statements

-

Test Procedure:

A MOLR procedure as call independent supplementary services is initiated from the MS. The MS performs control early classmark sending to provide LCS positioning method capability. After sending the CIPHERING MODE COMPLETE message the MS sends a REGISTER message with Facility IE containing a component set to LCS-MOLR Invoke. The SS determines the exact location assistance data to transfer according to the type of data specified by the MS, the MS location capabilities and the current cell ID and sends RRLP Assistance Data to MS. The MS acknowledges each assistance data components by sending RRLP Assistance Data Ack.

Maximum duration of the test:

3 minutes.

Expected Sequence

Step	Direction	Message	Comments
1	MS		Initiate MOLR Procedure(assistance data)
2	MS -> SS	CHANNEL REQUEST	Establishment cause indicates " call independent supplementary Services".
3	SS -> MS	IMMEDIATE ASSIGNMENT	
4	MS -> SS	CM SERVICE REQUEST	Message is contained in SABM "Mobile identity" IE contains the IMSI. "mobile station classmark 2" including settings for ES IND and CM3 supported.
5	MS -> SS	CLASSMARK CHANGE	"mobile station classmark 3" includes settings for Positioning according to 3GPP TS 24.008, table 10.5.1.7. This includes support of LCS VA Capability.
6	SS -> MS	AUTHENTICATION REQUEST	
7	MS -> SS	AUTHENTICATION RESP	SRES specifies correct value.
8	SS -> MS	CIPHERING MODE COMMAND	SS starts deciphering after sending the message.
9	MS -> SS	CIPHERING MODE COMPLETE	Shall be sent enciphered. All following messages shall be sent enciphered.
10	SS -> MS	CM SERVICE ACCEPT	
11	MS -> SS	REGISTER	Call Independent SS containing Facility IE With the component of Invoke message set to LCS-MOLR MOLR-Type set to AssistanceData LocationMethod set to MSAssistedEOTD
12	SS -> MS	RR APPLICATION INFORMATION	RRLP ASSISTANCE DATA
13	MS -> SS	RR APPLICATION INFORMATION	RRLP ASSISTANCE DATA ACK.
14	SS -> MS	CHANNEL RELEASE	The main signalling link is released.

Specific Message Contents

RR_APPLICATION_INFORMATION

Information element	Value/remark
Protocol Discriminator	RR Management Protocol (0110)
Skip Indicator	
Message Type	Application Information Message type
APDU ID	APDU ID -> RRLP => 0000
APDU Flags	Bit1=0 -> Last or only segment Bit2=0 -> First or only segment Bit3=0 -> Command or Final Response Bit4=spare
APDU Data	2-N Byte → ASN.1 Coded (SS->MS) RRLP (Measure Position Request) , (MS->SS) RRLP (Measure Position Response), (SS->MS) RRLP (Assistance Data), (MS->SS) RRLP (Assistance Data Ack.), (MS->SS) RRLP (Protocol Error),

RRLP Assistance Data

Information element	Type	Value/remark
ASN.1 encoded	-	
ReferenceNumber	Integer 0 to 7	1
Component	assistanceData	
referenceAssistanceData	ReferenceAssistData	See below
MsrAssistData	MsrAssistData	See below
systemInfoAssistData	SystemInfoAssistData	See below
moreAssDataToBeSent	Enumerated	0

RRLP Assistance Data Field Values: Reference Assistance Data

Field Name	Value	Comments
BCCH Carrier BSIC Time Slot Scheme	Range 0 - 1023 Range 0 - 63 Either 0 or 1, as applicable	ARFCN of Serving BCCH BSIC of Serving BCCH 0=All time slot 156.25 bits long 1=Time slot 0 and 4 are 157 bits long, all other time slots are 156 bits long
BTS Position	None	Not applicable

RRLP Assistance Data Field Values: Measure Assistance Data

Field Name	Value	Comments
Number of Neighbors	1	
BCCH Carrier BSIC Multiframe Offset	Range 0 - 1023 Range 0 - 63 Range 0 - 51	ARFCN of neighbour BCCH BSIC of neighbour BCCH The value of this field is specific to the test configuration, and shall be calculated according to 3GPP TS 04.31, Annex A, section A.2.2.3
Time Slot scheme	Either 0 or 1, as applicable	0=All time slots 156.25 bits long 1=Time slot 0 and 4 are 157 bits long, all other time slots are 156 bits long.
Rough RTD	Range 0 - 1250	Set to rough RTD value for the specific test configuration
Expected OTD	None	Not Applicable
Uncertainty of Expected OTD	None	Not Applicable
Fine RTD	None	Not Applicable
Relative North	None	Not Applicable
Relative East	None	Not Applicable

RRLP Assistance Data Field Values: System Info Assistance Data

Field Name	Value	Comments
Number of Neighbours	1	
E-OTD Neighbour Present	1	
BSIC Multiframe Offset	Range 0 - 63 Range 0 - 51	BSIC of neighbour BCCH The value of this field is specific to the test configuration, and shall be calculated according to 3GPP TS 04.31, Annex A, section A.2.2.3
Time Slot scheme	Either 0 or 1, as applicable	0=All time slots 156.25 bits long 1=Time slot 0 and 4 are 157 bits long, all other time slots are 156 bits long.
Rough RTD	Range 0 - 1250	Set to rough RTD value for the specific test configuration
Expected OTD	None	Not Applicable
Uncertainty of Expected OTD	None	Not Applicable
Fine RTD	None	Not Applicable
Relative North	None	Not Applicable
Relative East	None	Not Applicable

70.3.4 MO_LR Positioning Measurement

70.3.4.1 MO_LR Positioning Measurement / Protocol Error

70.3.4.1.1 Conformance requirement:

The MS sends a DTAP LCS MOLR invoke to VMSC. If the MS is requesting its own location or that its own location be sent to another LCS client, this message carries LCS QoS information (e.g. accuracy, response time).

The MS invokes a MO_LR by sending a REGISTER message to network containing a LCS-MOLR invoke component with MO_LR TYPE set to LocationEstimate, LCS QoS value and other optional field if it is needed.

The MS sends a RRLP PROTOCOL ERROR message to network if there is a problem that prevents the MS to receive a complete and understandable RRLP MEASURE POSITION REQUEST component.

The MS shall terminate the dialogue by sending a RELEASE COMPLETE message.

References

3GPP TS 03.71 subclause 7.6.6

3GPP TS 04.30 subclause 5.1.1

3GPP TS04.31 subclause 2.2, 2.5

3GPP TS 04.80 subclause 2.4, 2.5 & 4

70.3.4.1.2 Test Purpose:

Verifies that a MS sends a correct positioning capability via control classmark sending. The MS shall send a RRLP PROTOCOL ERROR message to SS with specific error code if RRLP MEASURE POSITION REQUEST is incomplete. On receipt of second RRLP MEASURE POSITION REQUEST from SS to start the measurement, MS shall send back RRLP MEASURE POSITION RESPONSE to SS after finishing the measurement.

70.3.4.1.3 Method of Test

Initial Conditions:

System Simulator:

Serving Cell: Default parameters, in SYSTEM INFORMATION TYPE 3 (SI3 Rest Octet) the early classmark sending control is implemented in the SS.

Neighbor Cells: At least 2 neighbor cells are used with a minimum configuration of a BCCH. This is to allow the MS to perform the required timing measurements.

Mobile Station:

The MS is MM-state "idle, updated" with valid TMSI and CKSN.

Specific PICS statements

-

PIXIT statements

-

Test Procedure

A MOLR procedure as call independent supplementary services is initiated from the MS. The MS performs control early classmark sending to provide LCS positioning method capability. After sending the CIPHERING MODE COMPLETE message the MS sends a REGISTER message with Facility IE containing a component set to a DTAP LCS-MOLR Invoke. The SS determines the positioning method and instigates the particular message sequence by sending RRLP MEASURE POSITION REQUEST with missing information element. The MS shall send RRLP PROTOCOL ERROR as it fails to decode RRLP MEASURE POSITION REQUEST. The SS repeats RRLP MEASURE POSITION REQUEST with correct message contents. Once the measurement is done, RRLP MEASURE POSITION RESPONSE is sent back to SS with the measurement data. The SS returns location estimate to MS through DTAP LCS-MOLR Return Result. The MS terminates the dialogue by sending RELEASE COMPLETE message after receiving location estimate.

Maximum duration of the test

3 minutes.

Expected Sequence

Step	Direction	Message	Comments
1	MS		Initiate MOLR Procedure (location estimate)
2	MS -> SS	CHANNEL REQUEST	Establishment cause indicates " call independent supplementary Services".
3	SS -> MS	IMMEDIATE ASSIGNMENT	
4	MS -> SS	CM SERVICE REQUEST	Message is contained in SABM "Mobile identity" IE contains the IMSI. "mobile station classmark 2" including settings for ES IND and CM3 supported.
5	MS -> SS	CLASSMARK CHANGE	"mobile station classmark 3" includes settings for Positioning according to 3GPP TS 24.008, table 10.5.1.7. This includes support of LCS VA Capability.
6	SS -> MS	AUTHENTICATION REQUEST	
7	MS -> SS	AUTHENTICATION RESP	SRES specifies correct value.
8	SS -> MS	CIPHERING MODE COMMAND	SS starts deciphering after sending the message.
9	MS -> SS	CIPHERING MODE COMPLETE	Shall be sent enciphered. All following messages shall be sent enciphered.
10	SS -> MS	CM SERVICE ACCEPT	
11	MS -> SS	REGISTER	Call Independent SS containing Facility IE With the component of Invoke message set to LCS-MOLR
12	SS -> MS	RR APPLICATION INFORMATION	RRLP MEASURE POSITION REQUEST (with missing information element)
13	MS->SS	RR APPLICATION INFORMATION	RRLP PROTOCOL ERROR
14	SS->MS	RR APPLICATION INFORMATION	RRLP MEASURE POSITION REQUEST
13	MS -> SS	RR APPLICATION INFORMATION	RRLP MEASURE POSITION RESPONSE (otd_measureInfo)
14	SS -> MS	FACILITY	LCS MO-LR RETURE RESULT (locationEstimate)
15	MS -> SS	RELEASE COMPLETE	Terminates the session
16	SS -> MS	CHANNEL RELEASE	The main signalling link is released.

Specific Message Contents

FACILITY

Information element	Value/remark
Protocol Discriminator	Call Independent SS message (1011)
Transaction identifier	XX
Message type	FACILITY (0x11 1010)
Facility	Return Result = lcs-MOLR LocationEstimate LCS-MOLRRes ->locationEstimate

RR_APPLICATION_INFORMATION

Information element	Value/remark
Protocol Discriminator	RR Management Protocol (0110)
Skip Indicator	
Message Type	Application Information Message type
APDU ID	APDU ID -> RRLP => 0000
APDU Flags	Bit1=0 -> Last or only segment Bit2=0 -> First or only segment Bit3=0 -> Command or Final Response Bit4=spare
APDU Data	2-N Byte → ASN.1 Coded (SS->MS) RRLP (Measure Position Request) , (MS->SS) RRLP (Measure Position Response), (MS->SS) RRLP (Protocol Error), (SS->MS) RRLP (Assistance Data) , (MS->SS) RRLP (Assistance Data Ack.),

RRLP Measure Position Request (Step 12)

Information element	Type	Value/remark
ASN.1 encoded	-	(00100000, 00000000, 000111)
ReferenceNumber	Integer 0 to 7	1
Component	msrPositionReq	
MethodType	msAssisted	0
PositionMethod	Enumerated	EOTD
MeasureResponseTime	Integer 0 to 7	7

RRLP Measure Position Request (Step 14)

Information element	Type	Value/remark
ASN.1 encoded	-	(20,00,1e)
ReferenceNumber	Integer 0 to 7	1
Component	msrPositionReq	
MethodType	msAssisted	0
PositionMethod	Enumerated	eotd
MeasureResponseTime	Integer 0 to 7	7
UseMultipleSets	Enumerated	oneSet

70.3.4.2 MO_LR Positioning Measurement /Location Error

70.3.4.2.1 Conformance requirement

The MS sends a DTAP LCS MOLR invoke to VMSC. If the MS is requesting its own location or that its own location be sent to another LCS client, this message carries LCS QoS information (e.g. accuracy, response time).

The MS invokes a MO_LR by sending a REGISTER message to network containing a LCS-MOLR invoke component with MO_LR TYPE set to LocationEstimate, LCS QoS value and other optional field if it is needed.

The MS sends a RRLP MEASURE POSITION RESPONSE to network containing a Location Error component with an error indication if the measurement is not possible.

The MS shall terminate the dialogue by sending a RELEASE COMPLETE message.

References

3GPP TS 03.71 subclause 7.6.6

3GPP TS 04.30 subclause 5.1.1

3GPP TS 04.31 subclause 2.2

3GPP TS 04.80 subclause 2.4, 2.5 & 4

70.3.4.2.2 Test Purpose

Verifies that a MS sends a correct positioning capability via control classmark sending. MS shall send back RRLP MEASURE POSITION RESPONSE message with Location Error component if the MS does not support the requested method. On receipt of second RRLP MEASURE POSITION REQUEST from SS to start the measurement, the MS shall send back RRLP MEASURE POSITION RESPONSE to SS after finishing the measurement.

70.3.4.2.3 Method of Test

Initial Conditions:

System Simulator:

Serving Cell: Default parameters, in SYSTEM INFORMATION TYPE 3 (SI3 Rest Octet) the early classmark sending control is implemented in the SS.

Neighbor Cells: At least 2 neighbor cells are used with a minimum configuration of a BCCH. This is to allow the MS to perform the required timing measurements.

Mobile Station:

The MS is MM-state "idle, updated" with valid TMSI and CKSN.

Specific PICS statements

-

PIXIT statements

-

Test Procedure

A MOLR procedure as call independent supplementary services is initiated from the MS. The MS performs control early classmark sending to provide LCS positioning method capability. After sending the CIPHERING MODE COMPLETE message the MS sends a REGISTER message with Facility IE containing a component set to a DTAP LCS-MOLR Invoke. The SS determines the positioning method and instigates the particular message sequence by sending RRLP MEASURE POSITION REQUEST with a method type not supported by the mobile. The MS sends RRLP MEASURE POSITION RESPONSE to network containing a Location Error component (Request Method not Supported) as the requested method is not supported. The SS repeats RRLP MEASURE POSITION REQUEST with correct message contents. Once the measurement is done, RRLP MEASURE POSITION RESPONSE is sent back to SS with the measurement data. The SS returns location estimate to MS through LCS-MOLR Return Result. The MS terminates the dialogue by sending RELEASE COMPLETE message after receiving location estimate.

Maximum duration of the test:

3 minutes.

Expected Sequence

Step	Direction	Message	Comments
1	MS		Initiate MOLR Procedure (location estimate)
2	MS -> SS	CHANNEL REQUEST	Establishment cause indicates " call independent supplementary Services".
3	SS -> MS	IMMEDIATE ASSIGNMENT	
4	MS -> SS	CM SERVICE REQUEST	Message is contained in SABM "Mobile identity" IE contains the IMSI. "mobile station classmark 2" including settings for ES IND and CM3 supported.
5	MS -> SS	CLASSMARK CHANGE	"mobile station classmark 3" includes settings for Positioning according to 3GPP TS 24.008, table 10.5.1.7. This includes support of LCS VA Capability.
6	SS -> MS	AUTHENTICATION REQUEST	
7	MS -> SS	AUTHENTICATION RESP	SRES specifies correct value.
8	SS -> MS	CIPHERING MODE COMMAND	SS starts deciphering after sending the message.
9	MS -> SS	CIPHERING MODE COMPLETE	Shall be sent enciphered. All following messages shall be sent enciphered.
10	SS -> MS	CM SERVICE ACCEPT	
11	MS -> SS	REGISTER	Call Independent SS containing Facility IE With the component of Invoke message set to LCS-MOLR
12	SS -> MS	RR APPLICATION INFORMATION	RRLP MEASURE POSITION REQUEST (Request method not supported)
13	MS->SS	RR APPLICATION INFORMATION	RRLP MEASURE POSITION RESPONSE (location_error)
14	SS->MS	RR APPLICATION INFORMATION	RRLP MEASURE POSITION REQUEST
13	MS -> SS	RR APPLICATION INFORMATION	RRLP MEASURE POSITION RESPONSE (otd_measureInfo)
14	SS -> MS	FACILITY	LCS MO-LR RETURE RESULT (locationEstimate)
15	MS -> SS	RELEASE COMPLETE	Terminates the session
16	SS -> MS	CHANNEL RELEASE	The main signalling link is released.

Specific Message Contents

FACILITY

Information element	Value/remark
Protocol Discriminator	Call Independent SS message (1011)
Transaction identifier	XX
Message type	FACILITY (0x11 1010)
Facility	Return Result = lcs-MOLR LocatibonEstimate LCS-MOLRRes ->locationEstimate

RR_APPLICATION_INFORMATION

Information element	Value/remark
Protocol Discriminator	RR Management Protocol (0110)
Skip Indicator	
Message Type	Application Information Message type
APDU ID	APDU ID -> RRLP => 0000
APDU Flags	Bit1=0 -> Last or only segment Bit2=0 -> First or only segment Bit3=0 -> Command or Final Response Bit4=spare
APDU Data	2-N Byte → ASN.1 Coded (SS->MS) RRLP (Measure Position Request) , (MS->SS) RRLP (Measure Position Response), (MS->SS) RRLP (Protocol Error), (SS->MS) RRLP (Assistance Data) , (MS->SS) RRLP (Assistance Data Ack.),

RRLP Measure Position Request (Step 12)

Information element	Type	Value/remark
ASN.1 encoded	-	(20,00,3e)
ReferenceNumber	Integer 0 to 7	1
Component	msrPositionReq	
MethodType	msAssisted	0
PositionMethod	Enumerated	GPS
MeasureResponseTime	Integer 0 to 7	7
UseMultipleSets	Enumerated	oneSet

RRLP Measure Position Request (Step 14)

Information element	Type	Value/remark
ASN.1 encoded	-	(20,00,1e)
ReferenceNumber	Integer 0 to 7	1
Component	msrPositionReq	
MethodType	msAssisted	0
PositionMethod	Enumerated	eotd
MeasureResponseTime	Integer 0 to 7	7
UseMultipleSets	Enumerated	oneSet

70.3.4.3 MO_LR Positioning Measurement / Multiple RRLP REQUEST with same Reference Number

70.3.4.3.1 Conformance requirement

The MS sends a DTAP LCS MOLR invoke to VMSC. If the MS is requesting its own location or that its own location be sent to another LCS client, this message carries LCS QoS information (e.g. accuracy, response time).

The MS invokes a MO_LR by sending a REGISTER message to network containing a LCS-MOLR invoke component with MO_LR TYPE set to LocationEstimate, LCS QoS value and other optional field if it is needed.

The MS ignores the later component if the old and new RRLP MEASURE POSITION REQUEST components have the same Reference Number.

The MS shall terminate the dialogue by sending a RELEASE COMPLETE message.

References

3GPP TS 03.71 subclause 7.6.6

3GPP TS 04.30 subclause 5.1.1

3GPP TS04.31 subclause 2.5.5

3GPP TS 04.80 subclause 2.4, 2.5 & 4

70.3.4.3.2 Test Purpose:

Verifies that a MS sends a correct positioning capability via control classmark sending. MS shall ignore the second RRLP MEASURE POSITION REQUEST if the second RRLP MEASURE POSITION REQUEST has the same REFERENCE NUMBER as in the previous one. The MS shall send back RRLP MEASURE POSITION RESPONSE to SS after finishing the current measurement.

70.3.4.3.3 Method of Test

Initial Conditions

System Simulator:

Serving cell: Default parameters, in SYSTEM INFORMATION TYPE 3 (SI3 Rest Octet) the early classmark sending control is implemented in the SS.

Neighbor Cells: at least 2 neighbor cells are used with a minimum configuration of a BCCH. This is to allow the MS to perform the required timing measurements.

Mobile Station:

The MS is in MM-state "idle, updated" with valid TMSI and CKSN.

Specific PICS statements

-

PIXIT statements

-

Test Procedure

A MOLR procedure as call independent supplementary services is initiated from the MS. The MS performs control early classmark sending to provide LCS positioning method capability. After sending the CIPHERING MODE COMPLETE message the MS sends a REGISTER message with Facility IE containing a component set to a DTAP LCS-MOLR Invoke. The SS determines the positioning method and instigates the particular message sequence by sending RRLP MEASURE POSITION REQUEST to start the measurement. Before the current positioning measurement finishes, the SS sends the second RRLP MEASURE POSITION REQUEST with the same REFERENCE NUMBER as the first one. The MS shall ignore the second RRLP MEASURE POSITION REQUEST. The MS sends RRLP MEASURE POSITION RESPONSE to SS with the measurement data after finishing the measurement. The SS returns location estimate to MS through DTAP LCS-MOLR Return Result. The MS terminates the dialogue by sending RELEASE COMPLETE message after receiving location estimate.

Maximum duration of the test:

3 minutes.

Expected Sequence

Step	Direction	Message	Comments
1	MS		Initiate MOLR Procedure (location estimate)
2	MS -> SS	CHANNEL REQUEST	Establishment cause indicates " call independent supplementary Services".
3	SS -> MS	IMMEDIATE ASSIGNMENT	
4	MS -> SS	CM SERVICE REQUEST	Message is contained in SABM "Mobile identity" IE contains the IMSI. "mobile station classmark 2" including settings for ES IND and CM3 supported.
5	MS -> SS	CLASSMARK CHANGE	"mobile station classmark 3" includes settings for Positioning according to 3GPP TS 24.008, table 10.5.1.7. This includes support of LCS VA Capability.
6	SS -> MS	AUTHENTICATION REQUEST	
7	MS -> SS	AUTHENTICATION RESP	SRES specifies correct value.
8	SS -> MS	CIPHERING MODE COMMAND	SS starts deciphering after sending the message.
9	MS -> SS	CIPHERING MODE COMPLETE	Shall be sent enciphered. All following messages shall be sent enciphered.
10	SS -> MS	CM SERVICE ACCEPT	
11	MS -> SS	REGISTER	Call Independent SS containing Facility IE With the component of Invoke message set to LCS-MOLR
12	SS -> MS	RR APPLICATION INFORMATION	RRLP MEASURE POSITION REQUEST 1
13	MS		MS is performing the measurement
14	SS -> MS	RR APPLICATION INFORMATION	RRLP MEASURE POSITION REQUEST 2 (with same reference number as in Request 1)
15	MS -> SS	RR APPLICATION INFORMATION	RRLP MEASURE POSITION RESPONSE 1 (otd-measureInfo - msAssisted)
16	SS -> MS	FACILITY	LCS MO-LR RETURN RESULT (locationEstimate)
17	MS -> SS	RELEASE COMPLETE	Terminates the session
18	SS -> MS	CHANNEL RELEASE	The main signalling link is released.

Specific Message Contents

FACILITY

Information element	Value/remark
Protocol Discriminator	Call Independent SS message (1011)
Transaction identifier	XX
Message type	FACILITY (0x11 1010)
Facility	Return Result = lcs-MOLR LocatibonEstimate LCS-MOLRRes ->locationEstimate

RR_APPLICATION_INFORMATION

Information element	Value/remark
Protocol Discriminator	RR Management Protocol (0110)
Skip Indicator	
Message Type	Application Information Message type
APDU ID	APDU ID -> RRLP => 0000
APDU Flags	Bit1=0 -> Last or only segment Bit2=0 -> First or only segment Bit3=0 -> Command or Final Response Bit4=spare
APDU Data	2-N Byte → ASN.1 Coded (SS->MS) RRLP (Measure Position Request) , (MS->SS) RRLP (Measure Position Response), (MS->SS) RRLP (Protocol Error), (SS->MS) RRLP (Assistance Data) , (MS->SS) RRLP (Assistance Data Ack.),

RRLP Measure Position Request (Step 12)

Information element	Type	Value/remark
ASN.1 encoded	-	(20,00,1e)
ReferenceNumber	Integer 0 to 7	1
Component	msrPositionReq	
MethodType	msAssisted	0
PositionMethod	Enumerated	eotd
MeasureResponseTime	Integer 0 to 7	7
UseMultipleSets	Enumerated	oneSet

RRLP Measure Position Request (Step 14)

Information element	Type	Value/remark
ASN.1 encoded	-	(20,00,3e)
ReferenceNumber	Integer 0 to 7	1
Component	msrPositionReq	
MethodType	msBased	1
PositionMethod	Enumerated	eotd
MeasureResponseTime	Integer 0 to 7	7
UseMultipleSets	Enumerated	oneSet

70.3.4.4 MO_LR Positioning Measurement / Multiple RRLP REQUEST with different Reference Number

70.3.4.4.1 Conformance requirement

The MS sends a DTAP LCS MOLR invoke to VMSC. If the MS is requesting its own location or that its own location be sent to another LCS client, this message carries LCS QoS information (e.g. accuracy, response time).

The MS invokes a MO_LR by sending a REGISTER message to network containing a LCS-MOLR invoke component with MO_LR TYPE set to LocationEstimate, LCS QoS value and other optional field if it is needed.

The MS aborts activity for the former RRLP MEASURE POSITION REQUEST component and starts to act according to the later RRLP MEASURE POSITION REQUEST component if the old and new RRLP MEASURE POSITION REQUEST components have different Reference Number.

The MS shall terminate the dialogue by sending a RELEASE COMPLETE message.

Test References:

3GPP TS 03.71 subclause 7.6.6

3GPP TS 04.30 subclause 5.1.1

3GPP TS 04.31 subclause 2.5.5

3GPP TS 04.80 subclause 2.4, 2.5 & 4

70.3.4.4.2 Test Purpose

Verifies that a MS sends a correct positioning capability via control classmark sending. MS shall terminate the current location measurement if the second RRLP MEASURE POSITION REQUEST is received with a different REFERENCE NUMBER. The MS shall perform the measurement according to the newly received RRLP MEASURE POSITION REQUEST. The MS shall send back RRLP MEASURE POSITION RESPONSE to SS after finishing the measurement.

70.3.4.4.3 Method of Test

Initial Conditions

System Simulator:

Serving cell: Default parameters, in SYSTEM INFORMATION TYPE 3 (SI3 Rest Octet) the early classmark sending control is implemented in the SS.

Neighbor Cells: at least 2 neighbor cells are used with a minimum configuration of a BCCH. This is to allow the MS to perform the required timing measurements.

Mobile Station:

The MS is in MM-state "idle, updated" with valid TMSI and CKSN.

Specific PICS statements

-

PIXIT statements

-

Test Procedure

A MOLR procedure as call independent supplementary services is initiated from the MS. The MS performs control early classmark sending to provide LCS positioning method capability. After sending the CIPHERING MODE COMPLETE message the MS sends a REGISTER message with Facility IE containing a component set to a DTAP LCS-MOLR Invoke. The SS determines the positioning method and instigates the particular message sequence by sending RRLP MEASURE POSITION REQUEST to start the measurement. Before the current positioning measurement finishes, the MS receives the second RRLP MEASURE POSITION REQUEST with a different REFERENCE NUMBER as in the first one. The MS shall terminate the current location measurement and perform the measurement according to the newly received RRLP MEASURE POSITION REQUEST. The MS sends RRLP MEASURE POSITION RESPONSE to SS with the measurement data after finishing the measurement. The SS returns location estimate to MS through DTAP LCS-MOLR Return Result. The MS terminates the dialogue by sending RELEASE COMPLETE message after receiving location estimate.

Maximum duration of the test:

3 minutes.

Expected Sequence

Step	Direction	Message	Comments
1	MS		Initiate MOLR Procedure (location estimate)
2	MS -> SS	CHANNEL REQUEST	Establishment cause indicates " call independent supplementary Services".
3	SS -> MS	IMMEDIATE ASSIGNMENT	
4	MS -> SS	CM SERVICE REQUEST	Message is contained in SABM "Mobile identity" IE contains the IMSI. "mobile station classmark 2" including settings for ES IND and CM3 supported.
5	MS -> SS	CLASSMARK CHANGE	"mobile station classmark 3" includes settings for Positioning according to 3GPP TS 24.008, table 10.5.1.7. This includes support of LCS VA Capability.
6	SS -> MS	AUTHENTICATION REQUEST	
7	MS -> SS	AUTHENTICATION RESP	SRES specifies correct value.
8	SS -> MS	CIPHERING MODE COMMAND	SS starts deciphering after sending the message.
9	MS -> SS	CIPHERING MODE COMPLETE	Shall be sent enciphered. All following messages shall be sent enciphered.
10	SS -> MS	CM SERVICE ACCEPT	
11	MS -> SS	REGISTER	Call Independent SS containing Facility IE With the component of Invoke message set to LCS-MOLR
12	SS -> MS	RR APPLICATION INFORMATION	RRLP MEASURE POSITION REQUEST 1
13	MS		MS is performing the measurement
14	SS -> MS	RR APPLICATION INFORMATION	RRLP MEASURE POSITION REQUEST 2 (with different reference number as in Request 1)
13	MS -> SS	RR APPLICATION INFORMATION	RRLP MEASURE POSITION RESPONSE 2 (otd-measureInfo) Check reference number is 2
14	SS -> MS	FACILITY	LCS MO-LR RETURE RESULT (locationEstimate)
15	MS -> SS	RELEASE COMPLETE	Terminates the session
16	SS -> MS	CHANNEL RELEASE	The main signalling link is released.

Specific Message Contents

FACILITY

Information element	Value/remark
Protocol Discriminator	Call Independent SS message (1011)
Transaction identifier	XX
Message type	FACILITY (0x11 1010)
Facility	Return Result = lcs-MOLR LocatibonEstimate LCS-MOLRRes ->locationEstimate

RR_APPLICATION_INFORMATION

Information element	Value/remark
Protocol Discriminator	RR Management Protocol (0110)
Skip Indicator	
Message Type	Application Information Message type
APDU ID	APDU ID -> RRLP => 0000
APDU Flags	Bit1=0 -> Last or only segment Bit2=0 -> First or only segment Bit3=0 -> Command or Final Response Bit4=spare
APDU Data	2-N Byte → ASN.1 Coded (SS->MS) RRLP (Measure Position Request) , (MS->SS) RRLP (Measure Position Response), (MS->SS) RRLP (Protocol Error), (SS->MS) RRLP (Assistance Data) , (MS->SS) RRLP (Assistance Data Ack.),

RRLP Measure Position Request 1 (Step 12)

Information element	Type	Value/remark
ASN.1 encoded	-	(20,00,1e)
ReferenceNumber	Integer 0 to 7	1
Component	msrPositionReq	
MethodType	msAssisted	0
PositionMethod	Enumerated	eotd
MeasureResponseTime	Integer 0 to 7	7
UseMultipleSets	Enumerated	oneSet

RRLP Measure Position Request 2 (Step 14)

Information element	Type	Value/remark
ASN.1 encoded	-	(40,00,1e)
ReferenceNumber	Integer 0 to 7	2
Component	msrPositionReq	
MethodType	msAssisted	0
PositionMethod	Enumerated	eotd
MeasureResponseTime	Integer 0 to 7	7
UseMultipleSets	Enumerated	oneSet

70.3.4.5 MO_LR Positioning Measurement / RR Management Commands

70.3.4.5.1 Conformance requirement

The MS sends a DTAP LCS MOLR invoke to VMSC. If the MS is requesting its own location or that its own location be sent to another LCS client, this message carries LCS QoS information (e.g. accuracy, response time).

The MS invokes a MO_LR by sending a REGISTER message to network containing a LCS-MOLR invoke component with MO_LR TYPE set to LocationEstimate, LCS QoS value and other optional field if it is needed.

The MS aborts the measurement procedure and starts on the RR MANAGEMENT procedure if a RR MANAGEMENT command is received during the measurement procedure. The MS sends RR MANAGEMENT RESPONSE message upon completion.

The MS shall terminate the dialogue by sending a RELEASE COMPLETE message.

References

3GPP TS 03.71 subclauses 7.6.6, 10.6

3GPP TS 04.30 subclause 5.1.1

3GPP TS 04.80 subclauses 2.4, 2.5 & 4

70.3.4.5.2 Test Purpose

Verifies that a MS sends a correct positioning capability via control classmark sending. MS shall terminate the current location measurement if a RR MANAGEMENT command is received during the measurement procedure. The MS shall send a RR MANAGEMENT RESPONSE message to SS when the RR MANAGEMENT procedure is complete. The MS shall perform the measurement according to the newly received RRLP MEASURE POSITION REQUEST and send back RRLP MEASURE POSITION RESPONSE to SS after finishing the measurement.

70.3.4.5.3 Method of Test

Initial Conditions

System Simulator:

Serving cell: Default parameters, in SYSTEM INFORMATION TYPE 3 (SI3 Rest Octet) the early classmark sending control is implemented in the SS.

Neighbor Cells: at least 2 neighbor cells are used with a minimum configuration of a BCCH. This is to allow the MS to perform the required timing measurements.

Mobile Station:

The MS is in MM-state "idle, updated" with valid TMSI and CKSN.

Specific PICS statements

-

PIXIT statements

-

Test Procedure

A MOLR procedure as call independent supplementary services is initiated from the MS. The MS performs control early classmark sending to provide LCS positioning method capability. After sending the CIPHERING MODE COMPLETE message the MS sends a REGISTER message with Facility IE containing a component set to a DTAP LCS-MOLR Invoke. The SS determines the positioning method and instigates the particular message sequence by sending RRLP MEASURE POSITION REQUEST to start the measurement. Before the current positioning measurement finishes, the MS receives a RR MANAGEMENT command. The MS shall terminate the current location measurement and perform the RR MANAGEMENT command. The MS sends a RR MANAGEMENT RESPONSE message to SS when the RR MANAGEMENT procedure is complete. The MS sends RRLP MEASURE POSITION RESPONSE to SS with the measurement data finishing the measurement according to the newly received RRLP MEASUREMENT POSITION REQUEST. The SS returns location estimate to MS through DTAP LCS-MOLR Return Result. The MS terminates the dialogue by sending RELEASE COMPLETE message after receiving location estimate.

Maximum duration of the test

3 minutes.

Expected Sequence

Step	Direction	Message	Comments
1	MS		Initiate MOLR Procedure (location estimate)
2	MS -> SS	CHANNEL REQUEST	Establishment cause indicates " call independent supplementary Services".
3	SS -> MS	IMMEDIATE ASSIGNMENT	
4	MS -> SS	CM SERVICE REQUEST	Message is contained in SABM "Mobile identity" IE contains the IMSI. "mobile station classmark 2" including settings for ES IND and CM3 supported.
5	MS -> SS	CLASSMARK CHANGE	"mobile station classmark 3" includes settings for Positioning according to 3GPP TS 24.008, table 10.5.1.7. This includes support of LCS VA Capability.
6	SS -> MS	AUTHENTICATION REQUEST	
7	MS -> SS	AUTHENTICATION RESP	SRES specifies correct value.
8	SS -> MS	CIPHERING MODE COMMAND	SS starts deciphering after sending the message.
9	MS -> SS	CIPHERING MODE COMPLETE	Shall be sent enciphered. All following messages shall be sent enciphered.
10	SS -> MS	CM SERVICE ACCEPT	
11	MS -> SS	REGISTER	Call Independent SS containing Facility IE With the component of Invoke message set to LCS-MOLR
12	SS -> MS	RR APPLICATION INFORMATION	RRLP MEASURE POSITION REQUEST 1
13	MS		MS is performing the measurement
14	SS -> MS	RR MANAGEMENT COMMAND	
15	MS -> SS	RR MANAGEMENT COMPLETE	MS terminates the measurement procedure and act on the RR management command
16	SS -> MS	RR APPLICATION INFORMATION	RRLP MEASURE POSITION REQUEST 2
17	MS -> SS	RR APPLICATION INFORMATION	RRLP MEASURE POSITION RESPONSE 2 (otd-measureInfo)
18	SS -> MS	FACILITY	LCS MO-LR RETURE RESULT (locationEstimate)
19	MS -> SS	RELEASE COMPLETE	Terminates the session
20	SS -> MS	CHANNEL RELEASE	The main signalling link is released.

Specific Message Contents

FACILITY

Information element	Value/remark
Protocol Discriminator	Call Independent SS message (1011)
Transaction identifier	XX
Message type	FACILITY (0x11 1010)
Facility	Return Result = lcs-MOLR LocatibonEstimate LCS-MOLRRes ->locationEstimate

RR_APPLICATION_INFORMATION

Information element	Value/remark
Protocol Discriminator	RR Management Protocol (0110)
Skip Indicator	
Message Type	Application Information Message type
APDU ID	APDU ID -> RRLP => 0000
APDU Flags	Bit1=0 -> Last or only segment Bit2=0 -> First or only segment Bit3=0 -> Command or Final Response Bit4=spare
APDU Data	2-N Byte → ASN.1 Coded (SS->MS) RRLP (Measure Position Request) , (MS->SS) RRLP (Measure Position Response), (MS->SS) RRLP (Protocol Error), (SS->MS) RRLP (Assistance Data) , (MS->SS) RRLP (Assistance Data Ack.),

RRLP Measure Position Request

Information element	Type	Value/remark
ASN.1 encoded	-	(20,00,1e)
ReferenceNumber	Integer 0 to 7	1
Component	msrPositionReq	
MethodType	msAssisted	0
PositionMethod	Enumerated	eotd
MeasureResponseTime	Integer 0 to 7	7
UseMultipleSets	Enumerated	oneSet

RR Management Command (Classmark Enquiry)

Information element	Value/remark
Encoded	(06 13)
Protocol Discriminator	RR Management Protocol (0110)
Skip Indicator	
Classmark Enquiry Message Type	0001 0011

70.4 Mobile Terminated Location Request for Mobiles supporting MS-Assisted EOTD

The test cases in this subclause focus on Mobile Terminated Location Request. A MT-LR occurs when an external LCS client requests the position of an MS by sending the SS REGISTER message. This may be sent to request verification for a particular MT-LR or simply to notify the user about an MT-LR that has already been authorized.

70.4.1 MT-LR Location Notification for MS-Assisted EOTD

Location notification takes place to inform the MS user that a particular LCS client is requesting their position without seeking the users permission.

70.4.1.1 Conformance requirements:

The following requirements apply for this test:

1. On receipt of a REGISTER message containing the LCS Notification Invoke component with notificationType set to notifyLocationAllowed. The MS shall notify the MS user of the location request using the method defined in the manufacturers specification.
2. The MS shall terminate the dialogue by sending a RELEASE COMPLETE message containing a LocationNotification return result with verificationResponse set to permissionGranted.

Test References

3GPP TS 03.71, subclause 7.6.1,

3GPP TS 04.30, subclause 4.1.1,

3GPP TS 04.80, subclauses 2.4 and 2.5.

70.4.1.2 Test Purpose

Verifies that when the MS receives a REGISTER message, containing a LCS Location Notification Invoke component set to notifyLocationAllowed, the MS displays information about the LCS client correctly (as defined by the individual manufacturer) and sends a RELEASE COMPLETE message containing a LocationNotification return result with verificationResponse set to permissionGranted.

Specific PICS statements

-

PIXIT statements

-

70.4.1.3 Method of Test

Initial Conditions

System Simulator:

Serving cell: Default parameters, in SYSTEM INFORMATION TYPE 3 (SI3 Rest Octet) the early classmark sending control is implemented in the SS.

Mobile Station:

The MS is in MM-state "idle, updated" with valued TMSI and CKSN.

Test Procedure:

The MS is paged with a PAGING REQUEST TYPE 1 message. After sending the CIPHERING MODE COMPLETE message the MS receives an SS REGISTER message containing a Facility IE containing a DTAP LCS Location Notification Invoke message set to notifyLocationAllowed. The LCS Client Name contained in the USSD text string of the lcs-LocationNotification shall be displayed as defined by the Manufacturer. The MS then responds with a RELEASE COMPLETE message containing a LocationNotification return to terminate the dialogue.

Maximum duration of the test:

1 minute.

Expected Sequence

Step	Direction	Message	Comments
1	SS -> MS	PAGING REQUEST TYPE 1	Sent on the correct paging subchannel
2	MS -> SS	CHANNEL REQUEST	Establishment cause indicates "answer to paging".
3	SS -> MS	IMMEDIATE ASSIGNMENT	
4	MS -> SS	PAGING RESPONSE	Message is contained in SABM "Mobile identity" IE contains the IMSI. "mobile station classmark 2" including settings for ES IND and CM3 supported.
5	MS -> SS	CLASSMARK CHANGE	"mobile station classmark 3" includes settings for Positioning according to 3GPP TS 24.008, table 10.5.1.7. This includes support of LCS VA Capability.
6	SS -> MS	AUTHENTICATION REQUEST	
7	MS -> SS	AUTHENTICATION RESP	SRES specifies correct value.

8	SS -> MS	CIPHERING MODE COMMAND	SS starts deciphering after sending the message.
9	MS -> SS	CIPHERING MODE COMPLETE	Shall be sent enciphered. All following messages shall be sent enciphered.
10	SS		SS starts ciphering.
11	SS -> MS	REGISTER	Call Independent SS containing Facility IE Location Notification Invoke message set to notifyLocationAllowed
12	MS -> SS	RELEASE COMPLETE	Contains a LocationNotification return result to terminate the dialogue
13	SS -> MS	CHANNEL RELEASE	The main signalling link is released.

Specific Message Contents

PAGING RESPONSE

Information element	Value/remark
Protocol Discriminator	RR management
Ciphering Key Sequence number - Key Sequence	Key sequence number previously allocated to MS, or "111" if no key is available
Mobile station Classmark 2 - ES IND	"Controlled Early Classmark Sending" option is implemented in the MS.
CM3	The MS Supports options that are indicated in classmark 3 IE in the Classmark Change message
Mobile Identity - odd/even - Type of identity - Identity digits	Even TMSI TMSI previously allocated to MS

REGISTER

Information element	Value/remark
Protocol Discriminator	Call Independent SS message (1011)
Transaction identifier Message type Facility	XX REGISTER (0x11 1011) Invoke = lcs-LocationNotification LocationNotificationArg notificationType -> notifyLocationAllowed, locationType -> current Location , lcsClientExternalID -> externalAddress lcsClientName ->dataCodingScheme nameString

RELEASE COMPLETE

Information element	Value/remark
Protocol Discriminator	Call Independent SS message (1011)
Transaction identifier Message type Facility	XX RELEASE COMPLETE (0x10 1010) Return result = lcs-LocationNotification verificationResponse -> permissionGranted

70.4.2 MT-LR Privacy Options for Mobiles supporting MS-Assisted EOTD

Privacy options are used in conjunction with the MS subscription profile on the VLR. They give the MS user the option to grant or withhold permission for individual location requests as they occur.

70.4.2.1 MT-LR Privacy Options/ Verification – Location Allowed If No Response for mobiles supporting MS-Assisted EOTD

The case occurs when the target MS subscription profile on the VLR is set to location allowed if no response is sent. This is the default option if the VMSC does not receive verification from the target MS within a predetermined time.

70.4.2.1.1 Conformance requirements

The following requirements apply for this test:

1. On receipt of a REGISTER message containing the LCS Notification Invoke component with notificationType set to notifyAndVerify-LocationAllowedIfNoResponse. The MS a) notifies the user of the request and b) indicates the default is location allowed if no response is received within a predetermined period, while c) providing the opportunity to accept or deny the request by the method defined in the manufacturer's specification.

2.

Option 1:

The user accepts the location request using the method specified by the manufacturer.
The MS shall terminate the dialogue by sending a RELEASE COMPLETE message containing a LocationNotification return result with verificationResponse set to permissionGranted.

Option 2:

The user denies the location request using the method defined by the manufacturer.
The MS shall terminate the dialogue by sending a RELEASE COMPLETE message containing a LocationNotification return result with verificationResponse set to permissionDenied.

Option 3:

The user takes no action and the verification process times-out.
The MS shall terminate the dialogue by sending a RELEASE COMPLETE message containing a LocationNotification return result with verificationResponse set to permissionGranted.

Test References

For conformance requirement 1:

3GPP TS 03.71, subclause 7.6.1.

3GPP TS 24.030 subclause 4.1.1.

3GPP TS 24.080 subclause 2.4, 2.5.

70.4.2.1.2 Test Purpose

Verifies that when the MS receives a REGISTER message, containing a LCS Location Notification Invoke component set to notifyAndVerify-LocationAllowedIfNoResponse, the MS displays information about the LCS client correctly and indicates that the default response is location allowed if no response is sent. Gives the user the option to accept or reject the request and sends a RELEASE COMPLETE message containing a LocationNotification return result with the verificationResponse set to permissionDenied or permissionGranted as appropriate.

Specific PICS statements

-

PIXIT statements

-

70.4.2.1.3 Method of Test

Initial Conditions

System Simulator:

Serving cell: Default parameters, in SYSTEM INFORMATION TYPE 3 (SI3 Rest Octet) the early classmark sending control is implemented in the SS.

Mobile Station:

The MS is in MM-state "idle, updated" with valued TMSI and CKSN.

Test Procedure:

The MS is paged with a PAGING REQUEST TYPE 1 message. After sending the CIPHERING MODE COMPLETE message the MS receives an SS REGISTER message with a Facility IE containing a LCS Location Notification Invoke set to notifyAndVerify-LocationAllowedIfNoResponse. The LCS Client Name contained in the USSD text string of the lcs-LocationNotification shall be displayed with the option to accept or deny the request, as defined by the Manufacturer. The MS also indicates that location will be allowed if a response is not received within a predetermined time.

Option 1:

The user then accepts the location request by the method defined by the manufacturer. The MS responds with a RELEASE COMPLETE message containing a LocationNotification return result with verificationResponse set to permissionGranted.

Option 2:

The user then denies the location request by the method defined by the manufacturer. The MS responds with a RELEASE COMPLETE message containing a LocationNotification return result with verificationResponse set to permissionDenied.

Option 3:

The user ignores the location request by taking no action, allowing the verification process timer to time-out. The MS responds with a RELEASE COMPLETE message containing a LocationNotification return result with verificationResponse set to permissionGranted.

Maximum duration of the test:

1 minute.

Expected Sequence

Step	Direction	Message	Comments
1	SS -> MS	PAGING REQUEST TYPE 1	Sent on the correct paging subchannel
2	MS -> SS	CHANNEL REQUEST	Establishment cause indicates "answer to paging".
3	SS -> MS	IMMEDIATE ASSIGNMENT	
4	MS -> SS	PAGING RESPONSE	Message is contained in SABM "Mobile identity" IE contains the IMSI. "mobile station classmark 2" including settings for ES IND, CM3 supported.
5	MS -> SS	CLASSMARK CHANGE	"mobile station classmark 3" includes settings for Positioning according to 3GPP TS 24.008, table 10.5.1.7. This includes support for LCS VA Capability.
6	SS -> MS	AUTHENTICATION REQUEST	
7	MS -> SS	AUTHENTICATION RESP	SRES specifies correct value.

8	SS -> MS	CIPHERING MODE COMMAND	SS starts deciphering after sending the message.
9	MS -> SS	CIPHERING MODE COMPLETE	Shall be sent enciphered. All following messages shall be sent enciphered.
10	SS		SS starts ciphering.
11	SS -> MS	REGISTER	Call Independent SS containing Facility IE LCS Location Notification Invoke set to notifyAndVerify-LocationAllowedIfNoResponse
12A	MS		MS displays location request and info about LCS client. The MS accepts location request.
k=1			
13A	SS -> MS	RELEASE COMPLETE	Containing a LocationNotification return result with verificationResponse set to permissionGranted.
k=1			
12B	MS		MS displays location request and info about LCS client. The MS rejects location request.
k=2			
13B	SS -> MS	RELEASE COMPLETE	Containing a LocationNotification return result with verificationResponse set to permissionDenied
k=2			
12C	MS		MS displays location request and info about LCS client. The MS does not reply
k=3			
13C	SS -> MS	RELEASE COMPLETE	Containing a LocationNotification return result with verificationResponse set to permissionGranted
k=3			
14	SS -> MS	CHANNEL RELEASE	The main signalling link is released.

Specific Message Contents

PAGING RESPONSE

Information element	Value/remark
Protocol Discriminator	RR management
Ciphering Key Sequence number - Key Sequence	Key sequence number previously allocated to MS, or "111" if no key is available
Mobile station Classmark 2 - ES IND	"Controlled Early Classmark Sending" option is implemented in the MS.
CM3	The MS Supports options that are indicated in classmark 3 IE in the Classmark Change message.
Mobile Identity - odd/even - Type of identity - Identity digits	Even TMSI TMSI previously allocated to MS

REGISTER

Information element	Value/remark
Protocol Discriminator	Call Independent SS message (1011)
Transaction identifier	Xx
Message type	REGISTER (0x11 1011)
Facility	invoke = lcs-LocationNotification locationNotificationArg <i>notificationType</i> -> notifyAndVerify-LocationAllowedIfNoResponse, <i>locationType</i> -> current Location, <i>lcsClientExternalID</i> -> externalAddress <i>lcsClientName</i> -> dataCodingScheme nameString

RELEASE COMPLETE (options 1 and 3)

Information element	Value/remark
Protocol Discriminator	Call Independent SS message (1011)
Transaction identifier	Xx
Message type	RELEASE COMPLETE (0x10 1010)
Facility	return result = lcs-LocationNotification locationNotificationRes <i>verificationResponse</i> -> permissionGranted

RELEASE COMPLETE (option 2)

Information element	Value/remark
Protocol Discriminator	Call Independent SS message (1011)
Transaction identifier	Xx
Message type	RELEASE COMPLETE (0x10 1010)
Facility	return result = lcs-LocationNotification locationNotificationRes <i>verificationResponse</i> -> permissionDenied

70.4.2.2 MT-LR Privacy Options/ Verification – Location Not Allowed If No Response for Mobiles supporting MS-Assisted EOTD

This case occurs when the target MS subscription profile on the VLR is set to location not allowed if no response is sent. This is the default option if the VMSC does not receive verification from the target MS within a predetermined time.

70.4.2.2.1 Conformance requirements:

The following requirements apply for this test:

1. On receipt of a REGISTER message containing the LCS Notification Invoke component with notificationType set to notifyAndVerify-LocationAllowedIfNoResponse. The MS a) notifies the user of the request and b) indicates that the default is location not allowed if no response is received within a predetermined period, while c) providing the opportunity to accept or deny the request by the method defined in the manufacturer's specification.

2.

Option 1:

The user accepts the location request using the method specified by the manufacturer.
The MS shall terminate the dialogue by sending a RELEASE COMPLETE message containing a LocationNotification return result with verificationResponse set to permissionGranted.

Option 2:

The user denies the location request using the method defined by the manufacturer.
The MS shall terminate the dialogue by sending a RELEASE COMPLETE message containing a LocationNotification return result with verificationResponse set to permissionDenied.

Option 3:

The user takes no action and the verification process times-out.
The MS shall terminate the dialogue by sending a RELEASE COMPLETE message containing a LocationNotification return result with verificationResponse set to permissionDenied.

Test References

For conformance requirement 1:

3GPP TS 03.71, subclause 7.6.1.

3GPP TS 24.030 subclause 4.1.1.

3GPP TS 24.080 subclause 2.4, 2.5.

70.4.2.2.2 Test Purpose

Verifies that when the MS receives a REGISTER message, containing a LCS Location Notification Invoke component set to notifyAndVerify-LocationNotAllowedIfNoResponse, the MS displays information about the LCS client correctly and indicates that the default response is location not allowed if no response is sent. Gives the user the option to accept or reject the request and sends a RELEASE COMPLETE message containing a LocationNotification return result with the verificationResponse set to permissionDenied or permissionGranted as appropriate.

Specific PICS statements

-

PIXIT statements

-

70.4.2.2.3 Method of Test

Initial Conditions

System Simulator:

Serving cell: Default parameters, in SYSTEM INFORMATION TYPE 3 (SI3 Rest Octet) the early classmark sending control is implemented in the SS.

Mobile Station:

The MS is in MM-state "idle, updated" with valued TMSI and CKSN.

Test Procedure

The MS is paged with a PAGING REQUEST TYPE 1 message. After sending the CIPHERING MODE COMPLETE message the MS receives an SS REGISTER message with a Facility IE containing a LCS Location Notification Invoke set to notifyAndVerify-LocationNotAllowedIfNoResponse. The LCS Client Name contained in the USSD text string of the lcs-LocationNotification shall be displayed with the option to accept or deny the request, as defined by the Manufacturer. The MS also indicates that location will not be allowed if a response is not received within a predetermined time.

Option 1:

The user then accepts the location request by the method defined by the manufacturer. The MS responds with a RELEASE COMPLETE message containing a LocationNotification return result with verificationResponse set to permissionGranted.

Option 2:

The user then denies the location request by the method defined by the manufacturer. The MS responds with a RELEASE COMPLETE message containing a LocationNotification return result with verificationResponse set to permissionDenied.

Option 3:

The user ignores the location request by taking no action, allowing the verification process timer to time-out. The MS responds with a RELEASE COMPLETE message containing a LocationNotification return result with verificationResponse set to permissionDenied.

Maximum duration of the test:

1 minute.

Expected Sequence

Step	Direction	Message	Comments
1	SS -> MS	PAGING REQUEST TYPE 1	Sent on the correct paging subchannel Establishment cause indicates "answer to paging".
2	MS -> SS	CHANNEL REQUEST	
3	SS -> MS	IMMEDIATE ASSIGNMENT	
4	MS -> SS	PAGING RESPONSE	
5	MS -> SS	CLASSMARK CHANGE	Message is contained in SABM "Mobile identity" IE contains the IMSI. "mobile station classmark 2" including settings for ES IND and CM3 supported. "mobile station classmark 3" includes settings for Positioning according to 3GPP TS 24.008, table 10.5.1.7. This includes support of LCS VA Capability.
6	SS -> MS	AUTHENTICATION REQUEST	SRES specifies correct value.
7	MS -> SS	AUTHENTICATION RESP	
8	SS -> MS	CIPHERING MODE COMMAND	SS starts deciphering after sending the message.
9	MS -> SS	CIPHERING MODE COMPLETE	
10	SS	REGISTER	Shall be sent enciphered. All following messages shall be sent enciphered. SS starts ciphering.
11	SS -> MS		
12	MS -> SS	RELEASE COMPLETE	Call Independent SS containing Facility IE LCS Location Notification Invoke set to notifyAndVerify-LocationNotAllowedIfNoResponse Containing a LocationNotification return result with verificationResponse set to permissionGranted or permissionDenied as appropriate.
12A	MS		MS displays location request and info about LCS client. The MS accepts location request.
k=1			
13A	SS -> MS	RELEASE COMPLETE	Containing a LocationNotification return result with verificationResponse set to permissionGranted.
k=1			
12B	MS		MS displays location request and info about LCS client. The MS rejects location request.
k=2			
13B	SS -> MS	RELEASE COMPLETE	Containing a LocationNotification return result with verificationResponse set to permissionDenied
k=2			
12C	MS		MS displays location request and info about LCS client. The MS does not reply
k=3			
13C	SS -> MS	RELEASE COMPLETE	Containing a LocationNotification return result with verificationResponse set to permissionGranted
k=3			
14	SS->MS	CHANNEL RELEASE	The main signalling link is released.

Specific Message Contents

PAGING RESPONSE

Information element	Value/remark
Protocol Discriminator	RR management
Ciphering Key Sequence number - Key Sequence	Key sequence number previously allocated to MS, or "111" if no key is available
Mobile station Classmark 2 - ES IND CM3 Mobile Identity - odd/even - Type of identity - Identity digits	"Controlled Early Classmark Sending" option is implemented in the MS. The MS Supports options that are indicated in classmark 3 IE in the Classmark Change message. Even TMSI TMSI previously allocated to MS

REGISTER

Information element	Value/remark
Protocol Discriminator	Call independent SS message (1011)
Transaction identifier Message type Facility	Xx REGISTER (0x11 1011) invoke = lcs-LocationNotification locationNotificationArg <i>notificationType</i> -> notifyAndVerify-LocationNotAllowedIfNoResponse, <i>locationType</i> -> current Location, <i>lcsClientExternalID</i> -> externalAddress <i>lcsClientName</i> -> dataCodingScheme nameString

RELEASE COMPLETE (option 1)

Information element	Value/remark
Protocol Discriminator	Call independent SS message (1011)
Transaction identifier Message type Facility	Xx RELEASE COMPLETE (0x10 1010) return result = lcs-LocationNotification locationNotificationRes <i>verificationResponse</i> -> permissionGranted

RELEASE COMPLETE (options 2 and 3)

Information element	Value/remark
Protocol Discriminator	Call independent SS message (1011)
Transaction identifier Message type Facility	Xx RELEASE COMPLETE (0x10 1010) return result = lcs-LocationNotification locationNotificationRes <i>verificationResponse</i> -> permissionDenied

70.5 Void

70.6 E-OTD Timing Measurement Accuracy

Scope of Tests

This test procedure plan is intended verify the operation of Enhanced Observed Timing Difference (E-OTD) measurement functionality from an E-OTD capable GSM Mobile Station (MS).

The scope of this test plan is limited to verification of the MS physical layer against 3GPP TS 05.05, Release 1999, version 8.7.1, annex I. Specifically, this includes validation of MS observed timing measurement accuracy only.

The recommended measurement test environment is shown in the present document annex 6.

70.6.1 E-OTD Accuracy, Sensitivity Performance Tests using GMSK Signals

70.6.1.1 Definition

Enhanced Observed Timing Difference is a mechanism intended to provide location information from an MS within a GSM network. E-OTD measures the burst timing alignment between the serving cell for the MS and a minimum of two neighbor cells. The observed timing difference, along with the BSIC or Cell ID of each neighbor cell that can be received and measured by the MS, is reported to the network. Using this information, an E-OTD capable network can calculate the location of the MS using triangulation techniques.

Although an E-OTD capable MS must receive a minimum of two neighbors in order to provide the network with useable data for E-OTD positioning, only one neighbor is required for the timing measurement tests described in this procedure.

70.6.1.2 Conformance requirement

The RMS_{90} measurement error of an E-OTD capable MS receiving a neighbor shall not exceed 100 nanoseconds and 300 nanoseconds at a minimum neighbor carrier signal strength relative to relative sensitivity levels of 12 dB and -8 dB respectively, as specified in 3GPP TS 05.05, annex I, subclause I.2.1, table I.2.1

70.6.1.3 Test purpose

E-OTD measurement accuracy is heavily influenced by the type of RF environment available to the MS at the time a Measure Position Request is received from the network. Nearby neighbor stations that provide a relatively high C/N to the MS receiver should result in greater measurement accuracy than those further away with a low C/N.

The purpose of this test case is to verify that an E-OTD capable MS can provide an observed timing difference (OTD) measurement of sufficient accuracy when measuring against a GMSK neighbor. During this test, there shall be no co-, adjacent-, or alternate-channel interference.

Specific PICS statements

-

PIXIT statements

-

70.6.1.4 Method of Test

Initial Configuration

Neighbor Cell: One neighbor cells with a minimum configuration of a BCCH in order to allow the MS to perform the required measurements. The neighbor BCCH shall be included in the serving BCCH System Information Neighbor List.

Assistance Data: The assistance data listed in Table 70.6.1-1 and Table 70.6.1-2 shall be provided by the serving base station simulator. Without assistance data, successful validation of the MS physical layer may be impossible due to limitations imposed by the device's upper protocol layers.

Table 70.6.1-4: RRLP Measure Position Request Field Values, E-OTD Reference BTS for Assistance Data Element

Field Name	Value	Comments
BCCH Carrier	Range 0-1023	ARFCN of Serving BCCH
BSIC	Range 0 to 65	BSIC of Serving BCCH
Time Slot Scheme	Either 0 or 1, as applicable	0=All time slots 156.25 bits long 1=Time slots 0 and 4 are 157 bits long, all other time slots are 156 bits long.
BTS Position	None	Not applicabl for timing accuracy measurements

Table 70.6.1-2: RRLP Measure Position Request Field Values, E-OTD Measurement Assistance Data for System Information List Element

Field Name	Value	Comments
Number of Neighbors	1	
E-OTD Neighbor Present	1	
BSIC	Range 0 to 63	BSIC of neighbor BCCH
Multiframe Offset	Range 0-51	The value of this field is specific to the test configuration, and shall be calculated according to 3GPP TS 04.31, Annex A, Section A.2.2.3.
Time Slot Scheme	Either 0 or 1, as applicable	0=All time slots 156.25 bits long 1=Time slots 0 and 4 are 157 bits long, all other time slots are 156 bits long.
Rough RTD	Range 0-1250	Set to rough RTD value for the specific test configuration
Expected OTD	None	Not Applicable
Uncertainty of Expected OTD	None	Not Applicable
Fine RTD	None	Not Applicable
Relative North	None	Not Applicable
Relative East	None	Not Applicable

70.6.1.5 Test procedure

- a) Configure serving base station simulator to transmit GMSK dummy bursts in time slots 1 through 7.
- b) Establish RF connectivity between the E-OTD compatible MS and its serving base station simulator, verify RSSI of -80 dB.
- c) Disable the interfering signal generator.
- d) Configure the neighbor base station simulator such that its power (as measured at the antenna terminal of the E-OTD MS under test) is -90 dBm, and that it is transmitting GMSK dummy bursts in time slots 1 through 7.
- e) The serving base station SS initiates a Measure Position Request RRLP message. Begin logging E-OTD Measure Position Response RRLP message from the MS under test. The Measure Position Request is repeated a minimum of 250 times at 5 s intervals and the response RRLP messages are logged.
- f) The SS calculates each trial's error relative to the known RTD, sort the data in ascending order, develop the 90 % subset M and calculate the RMS₉₀ error.
- g) Disable the interfering signal generator.

- h) Configure the neighbor base station simulator such that its power (as measured at the antenna terminal of the E-OTD MS under test) is -110 dBm, and that it is transmitting GMSK dummy bursts in time slots 1 through 7.
- i) The serving base station SS initiates a Measure Position Request RRLP message. Begin logging E-OTD Measure Position Response RRLP message from the MS under test. The Measure Position Request is repeated a minimum of 250 times at 5 second intervals and the response RRLP messages are logged.
- j) After transmitting 250 Measure Position Request RRLP messages to the MS under test, calculate each trial's error relative to the known RTD, sort the data in ascending order, develop the 90 % subset M and calculate the RMS₉₀ error.

70.6.1.6 Test Requirements

Verify that the RMS₉₀ error calculated for each procedure in 70.6.1.5 is within the test conformance requirements listed in Table 70.6.1-3

Table 70.6.1-3, Test Conformance Requirements

Procedure	RMS ₉₀ error, 3GPP TS 05.05, Annex I, Minimum Performance Requirement	RMS ₉₀ error, 3GPP TS 51.010, 70.6.1, Test Conformance Requirement
Step f	≤ 100 nanoseconds	≤110 nanoseconds
Step j	≤ 300 nanoseconds	≤310 nanoseconds

70.6.2 E-OTD Accuracy, Interference Performance Tests

70.6.2.1 Definition

Enhanced Observed Timing Difference is a mechanism intended to provide location information from an MS within a GSM network. E-OTD measures the burst timing alignment between the serving cell for the MS and a minimum of two neighbor cells. The observed timing difference, along with the BSIC or Cell ID of each neighbor cell that can be received and measured by the MS, is reported to the network. Using this information, an E-OTD capable network can calculate the location of the MS using triangulation techniques.

Although an E-OTD capable MS must receive a minimum of two neighbors in order to provide the network with useable data for E-OTD positioning, only one neighbor is required for the timing measurement tests described in this procedure.

70.6.2.2 Conformance requirement

The RMS₉₀ measurement error of an E-OTD capable MS receiving a neighbor with a co-channel interference ratio of 0 dB shall not exceed 300 nanoseconds, 10dB not exceeding 100 nanoseconds, adjacent channel interference ratio of -18dB not exceeding 500 nanoseconds, -8 dB not exceeding 200 nanoseconds, as well as an adjacent channel (400 kHz) interference ratio of -41dB not exceeding 100 nanoseconds, as specified in 3GPP TS 05.05, Release 99, Annex I, Section I.2.1, Table I.2.2

70.6.2.3 Test purpose

E-OTD measurement accuracy is heavily influenced by the type of RF environment available to the MS at the time a Measure Position Request is received from the network. As the C/I ratio due to neighbor cell co-channel interference is reduced, E-OTD measurement accuracy may be reduced as well.

The purpose of this test case is to verify that an E-OTD capable MS can provide an observed timing difference (OTD) measurement of sufficient accuracy when measuring against a GMSK neighbor in the presence of a channel interference with a 0 dB, 10dB, -18dB, -8dB, and -41dB C/I.

Specific PICS statements

-

PIXIT statements

-

70.6.2.4 Method of Test

Initial Configuration

Neighbor Cells: at least two neighbor cells with a minimum configuration of a BCCH in order to allow the mobile to perform the required accuracy measurements. The neighbor BCCH shall be included in the serving BCCH System Information Neighbor List.

70.6.2.5 Test procedure

Co-Channel test procedure at 0dB C/I:

- a) Configure serving base station simulator to transmit GMSK dummy bursts in time slots 1 through 7
- b) Establish RF connectivity between the E-OTD compatible MS and its serving base station simulator, verify RSSI of -80 dBm
- c) Enable the interfering signal generator on the frequency of the neighbor cell at a power (at the antenna connection of the EOTD-capable MS) of -80 dBm
- d) Configure the neighbor base station simulator such that its power (as measured at the antenna terminal of the E-OTD MS under test) is -80 dBm, and that it is transmitting GMSK dummy bursts in time slots 1 through 7.
- e) The SS initiates a Measure Position Request RRLP messages and begins logging E-OTD Response messages from the MS under test. The Measure Position Request message is repeated 250 times at 5-second intervals and the response RRLP messages are recorded.
- f) After transmitting 250 Measure Position Request RRLP messages to the MS under test, calculate each trial's error relative to the known RTD, sort the data in ascending order, develop the 90% subset M and calculate the RMS₉₀ error.

Co-Channel test procedure at 10dB C/I:

- g) Establish RF connectivity between the E-OTD compatible MS and its serving base station simulator, verify RSSI of -80 dBm
- h) Enable the interfering signal generator on the frequency of the neighbor cell at a power (at the antenna connection of the EOTD-capable MS) of -90 dBm
- i) Configure the neighbor base station simulator such that its power (as measured at the antenna terminal of the E-OTD MS under test) is -80 dBm, and that it is transmitting GMSK dummy bursts in time slots 1 through 7.
- j) The SS initiates a Measure Position Request RRLP messages and begins logging E-OTD Response messages from the MS under test. The Measure Position Request message is repeated 250 times at 5-second intervals and the response RRLP messages are recorded.
- k) Repeat Step f) and calculate the results.

Adjacent channel test procedure at -18dB C/I:

- l) Establish RF connectivity between the E-OTD compatible MS and its serving base station simulator, verify RSSI of -70 dBm
- m) Enable the interfering signal generator on either of the channels adjacent to the frequency of the neighbor cell at a power (at the antenna connection of the EOTD-capable MS) of -62 dBm. The RF channel used by the interfering signal generator during this test must not be the same as that used by the serving base station simulator.
- n) Configure the neighbor base station simulator such that its power (as measured at the antenna terminal of the E-OTD MS under test) is -80 dBm, and that it is transmitting GMSK dummy bursts in time slots 1 through 7.
- o) The SS initiates a Measure Position Request RRLP messages and begins logging E-OTD Response messages from the MS under test. The Measure Position Request message is repeated 250 times at 5-second intervals and the response RRLP messages are recorded.
- p) Repeat Step f) and calculate the results.

Adjacent channel test procedure at - 8dB C/I:

- q) Establish RF connectivity between the E-OTD compatible MS and its serving base station simulator, verify RSSI of -70 dBm
- r) Enable the interfering signal generator on either of the channels adjacent to the frequency of the neighbor cell at a power (at the antenna connection of the EOTD-capable MS) of -72 dBm. The RF channel used by the interfering signal generator during this test must not be the same as that used by the serving base station simulator.
- s) Configure the neighbor base station simulator such that its power (as measured at the antenna terminal of the E-OTD MS under test) is -80 dBm, and that it is transmitting GMSK dummy bursts in time slots 1 through 7.
- t) The SS initiates a Measure Position Request RRLP messages and begins logging E-OTD Response messages from the MS under test. The Measure Position Request message is repeated 250 times at 5-second intervals and the response RRLP messages are recorded.
- u) Repeat Step f) and calculate the results.

Adjacent channel (400kHz) test procedure at -41dB C/I:

- v) Establish RF connectivity between the E-OTD compatible MS and its serving base station simulator, verify RSSI of -70 dBm
- w) Enable the interfering signal generator on either of the channels alternate (400 kHz offset) to the frequency of the neighbor cell at a power (at the antenna connection of the EOTD-capable MS) of -39 dBm. The RF channel used by the interfering signal generator during this test must not be the same as that used by the serving base station simulator.
- x) Configure the neighbor base station simulator such that its power (as measured at the antenna terminal of the E-OTD MS under test) is -80 dBm, and that it is transmitting GMSK dummy bursts in time slots 1 through 7.
- y) The SS initiates a Measure Position Request RRLP messages and begins logging E-OTD Response messages from the MS under test. The Measure Position Request message is repeated 250 times at 5-second intervals and the response RRLP messages are recorded.
- z) Repeat Step f) and calculate the results.

70.6.2.6 Test Requirements

Verify that the RMS₉₀ error calculated for each procedure in 70.6.2.5 is within the test conformance requirements listed in Table 70.6.2-1.

Table 70.6.2-1, Test Conformance Requirements

Procedure	RMS ₉₀ error, 3GPP TS 05.05, Annex I, Minimum Performance Requirement	RMS ₉₀ error, 3GPP TS 51.010, 70.6.2, Test Conformance Requirement
Step f	≤ 300 nanoseconds	≤310 nanoseconds
Step k	≤ 100 nanoseconds	≤110 nanoseconds
Step p	≤ 500 nanoseconds	≤510 nanoseconds
Step u	≤ 200 nanoseconds	≤210 nanoseconds
Step z	≤ 100 nanoseconds	≤110 nanoseconds

70.6.3 E-OTD Accuracy, Multipath Performance Test using GMSK Modulated Signals.

70.6.3.1 Definition

Enhanced Observed Timing Difference is a mechanism intended to provide location information from an MS within a GSM network. E-OTD measures the burst timing alignment between the serving cell for the MS and a minimum of two neighbor cells. The observed timing difference, along with the BSIC or Cell ID of each neighbor cell that can be received and measured by the MS, is reported to the network. Using this information, an E-OTD capable network can calculate the location of the MS using triangulation techniques.

Although an E-OTD capable MS must receive a minimum of two neighbors in order to provide the network with useable data for E-OTD positioning, only one neighbor is required for the timing measurement tests described in this procedure.

70.6.3.2 Conformance requirement

The RMS_{90} measurement error of an E-OTD capable MS receiving a TU3 Rayleigh-faded neighbor shall not exceed 1.5 microseconds, as specified in 3GPP TS 05.05, Release 99, Version 8.7.1, Annex I, Clause I.2.3, Table I.2.3

70.6.3.3 Test purpose

E-OTD measurement accuracy is heavily influenced by the type of RF environment available to the MS at the time a Measure Position Request is received from the network. Rayleigh fading to the neighbor cell will reduce E-OTD measurement accuracy.

The purpose of this test case is to verify that an E-OTD capable MS can provide an observed timing difference (OTD) measurement of sufficient accuracy when measuring against a TU3 Rayleigh fading GMSK distant neighbor. During this test, there shall be no co-, adjacent-, or alternate-channel interference.

Specific PICS statements

-

PIXIT statements

-

70.6.3.4 Method of Test

Initial Configuration

Neighbor Cell: at least one neighbor cell with a minimum configuration of a BCCH in order to allow the mobile to perform the required accuracy measurements. The neighbor BCCH shall be included in the serving BCCH System Information Neighbor List.

Assistance Data: The assistance data listed in Table 70.6.3-1 and Table 70.6.3-2 shall be provided by the serving base station simulator. Without assistance data, successful validation of the MS physical layer may be impossible due to limitations imposed by the device's upper protocol layers.

Table 70.6.3-5: RRLP Measure Position Request Field Values, E-OTD Reference BTS for Assistance Data Element

Field Name	Value	Comments
BCCH Carrier	Range 0-1023	ARFCN of Serving BCCH
BSIC	Range 0 to 65	BSIC of Serving BCCH
Time Slot Scheme	Either 0 or 1, as applicable	0=All time slots 156.25 bits long 1=Time slots 0 and 4 are 157 bits long, all other time slots are 156 bits long.
BTS Position	None	Not applicable for timing accuracy measurements

Table 70.6.3-2: RRLP Measure Position Request Field Values, E-OTD Measurement Assistance Data for System Information List Element

Field Name	Value	Comments
Number of Neighbors	1	
E-OTD Neighbor Present	1	
BSIC	Range 0 to 63	BSIC of neighbor BCCH
Multiframe Offset	Range 0-51	The value of this field is specific to the test configuration, and shall be calculated according to 3GPP TS 04.31, Annex A, Section A.2.2.3.
Time Slot Scheme	Either 0 or 1, as applicable	0=All time slots 156.25 bits long 1=Time slots 0 and 4 are 157 bits long, all other time slots are 156 bits long.
Rough RTD	Range 0-1250	Set to rough RTD value for the specific test configuration
Expected OTD	None	Not Applicable
Uncertainty of Expected OTD	None	Not Applicable
Fine RTD	None	Not Applicable
Relative North	None	Not Applicable
Relative East	None	Not Applicable

70.6.3.5 Test procedure

- a) Configure serving base station simulator to transmit GMSK dummy bursts in time slots 1 through 7
- b) Establish RF connectivity between the E-OTD compatible MS and its serving base station simulator, verify RSSI of -80 dBm
- c) Disable the interfering signal generator
- d) Configure the neighbor base station simulator such that its power (as measured at the antenna terminal of the EOTD MS under test) is -110 dBm with Rayleigh fading disabled. The neighbor shall be transmitting GMSK dummy bursts in time slots 1 through 7
- e) Configure the fading simulator for Rayleigh fading corresponding to a velocity of 3 kph, with a 12-tap delay and amplitude spread in accordance with 3GPP TS 05.05, Release 99, Rev. 8.7.1, Annex C, Section C.3.3.
- f) With the carrier from the serving base station simulator disabled, enable TU3 Rayleigh fading on the neighbor cell, and verify an average RSSI (at the antenna connection of the MS) of -110 dBm
- g) Re-enable the serving base station simulator carrier, verify an RSSI (at the antenna connection of the MS) of -80 dBm
- h) The SS initiates a Measure Position Request RRLP messages and begins logging E-OTD Response messages from the MS under test. The Measure Position Request message is repeated 250 times at 5-second intervals and the response RRLP messages are recorded.
- i) After transmitting 250 Measure Position Request RRLP messages to the MS under test, calculate each trial's error relative to the known RTD, sort the data in ascending order, develop the 90% subset M and calculate the RMS_{90} error.

70.6.3.6 Test Requirements

Verify that the RMS_{90} error calculated in Step i) is < 1.5 microseconds

70.6.4 E-OTD Accuracy, Interference Performance Tests, 8PSK BCCH

70.6.4.1 Definition

Enhanced Observed Timing Difference is a mechanism intended to provide location information from an MS within a GSM network. E-OTD measures the burst timing alignment between the serving cell for the MS and a minimum of two neighbor cells. The observed timing difference, along with the BSIC or Cell ID of each neighbor cell that can be received and measured by the MS, is reported to the network. Using this information, an E-OTD capable network can calculate the location of the MS using triangulation techniques.

Although an E-OTD capable MS must receive a minimum of two neighbors in order to provide the network with useable data for E-OTD positioning, only one neighbor is required for the timing measurement tests described in this procedure.

70.6.2.2 Conformance requirement

The RMS₉₀ measurement error of an E-OTD capable MS receiving an 8PSK neighbor with a co-channel interference ratio of 0 dB shall not exceed 300 nanoseconds, 10dB not exceeding 300 nanoseconds, adjacent channel interference ratio of -18dB not exceeding 500 nanoseconds, -8 dB not exceeding 200 nanoseconds, as well as an adjacent channel (400 kHz) interference ratio of -41dB not exceeding 100 nanoseconds, as specified in 3GPP TS 05.05, Release 99, Annex I, Section I.2.1, Table I.2.2

70.6.2.3 Test purpose

E-OTD measurement accuracy is heavily influenced by the type of RF environment available to the MS at the time a Measure Position Request is received from the network. As the C/I ratio due to neighbor cell co-channel interference is reduced, E-OTD measurement accuracy may be reduced as well.

The purpose of this test case is to verify that an E-OTD capable MS can provide an observed timing difference (OTD) measurement of sufficient accuracy when measuring against a neighbor modulated with 8PSK in time slots 1-7, in the presence of a channel interference with a 0 dB, 10dB, -18dB, -8dB, and -41dB C/I.

Specific PICS statements

-

PIXIT statements

-

70.6.4.4 Method of Test

Initial Configuration

Neighbor Cells: at least one neighbor cell with a minimum configuration of a BCCH in order to allow the mobile to perform the required accuracy measurements. The neighbor BCCH shall be included in the serving BCCH System Information Neighbor List.

70.6.4.5 Test procedure

Co-Channel 8PSK test procedure at 0dB C/I:

- a) Configure serving base station simulator to transmit in time slots 1 through 7
- b) Establish RF connectivity between the E-OTD compatible MS and its serving base station simulator, verify RSSI of -80 dBm
- c) Enable the interfering signal generator on the frequency of the neighbor cell at a power (at the antenna connection of the EOTD-capable MS) of -80 dBm
- d) Configure the neighbor base station simulator such that its power (as measured at the antenna terminal of the E-OTD MS under test) is -80 dBm, and that it is transmitting 8PSK bursts modulated with pseudo-random data in time slots 1 through 7.
- e) The SS initiates a Measure Position Request RRLP messages and begins logging E-OTD Response messages from the MS under test. The Measure Position Request message is repeated 250 times at 5-second intervals and the response RRLP messages are recorded.
- f) After transmitting 250 Measure Position Request RRLP messages to the MS under test, calculate each trial's error relative to the known RTD, sort the data in ascending order, develop the 90% subset M and calculate the RMS₉₀ error.

Co-Channel 8PSK test procedure at 10dB C/I:

- g) Establish RF connectivity between the E-OTD compatible MS and its serving base station simulator, verify RSSI of -80 dBm
- h) Enable the interfering signal generator on the frequency of the neighbor cell at a power (at the antenna connection of the EOTD-capable MS) of -90 dBm
- i) Configure the neighbor base station simulator such that its power (as measured at the antenna terminal of the E-OTD MS under test) is -80 dBm, and that it is transmitting 8PSK bursts modulated with pseudo-random data in time slots 1 through 7.
- j) The SS initiates a Measure Position Request RRLP messages and begins logging E-OTD Response messages from the MS under test. The Measure Position Request message is repeated 250 times at 5-second intervals and the response RRLP messages are recorded.
- k) Repeat Step f) and calculate the results.

Adjacent channel 8PSK test procedure at -18dB C/I:

- l) Establish RF connectivity between the E-OTD compatible MS and its serving base station simulator, verify RSSI of -70 dBm
- m) Enable the interfering signal generator on either of the channels adjacent to the frequency of the neighbor cell at a power (at the antenna connection of the EOTD-capable MS) of -62 dBm. The RF channel used by the interfering signal generator during this test must not be the same as that used by the serving base station simulator.
- n) Configure the neighbor base station simulator such that its power (as measured at the antenna terminal of the E-OTD MS under test) is -80 dBm, and that it is transmitting 8PSK bursts modulated with pseudo-random data in time slots 1 through 7.
- o) The SS initiates a Measure Position Request RRLP messages and begins logging E-OTD Response messages from the MS under test. The Measure Position Request message is repeated 250 times at 5-second intervals and the response RRLP messages are recorded.
- p) Repeat Step f) and calculate the results.

Adjacent channel 8PSK test procedure at - 8dB C/I:

- q) Establish RF connectivity between the E-OTD compatible MS and its serving base station simulator, verify RSSI of -70 dBm

- r) Enable the interfering signal generator on either of the channels adjacent to the frequency of the neighbor cell at a power (at the antenna connection of the E-OTD-capable MS) of -72 dBm. The RF channel used by the interfering signal generator during this test must not be the same as that used by the serving base station simulator.
- s) Configure the neighbor base station simulator such that its power (as measured at the antenna terminal of the E-OTD MS under test) is -80 dBm, and that it is transmitting 8PSK bursts modulated with pseudo-random data in time slots 1 through 7.
- t) The SS initiates a Measure Position Request RRLP messages and begins logging E-OTD Response messages from the MS under test. The Measure Position Request message is repeated 250 times at 5-second intervals and the response RRLP messages are recorded.
- u) Repeat Step f) and calculate the results.

Adjacent channel (400kHz) 8PSK test procedure at -41dB C/I:

- v) Establish RF connectivity between the E-OTD compatible MS and its serving base station simulator, verify RSSI of -70 dBm
- w) Enable the interfering signal generator on either of the channels alternate (400 kHz offset) to the frequency of the neighbor cell at a power (at the antenna connection of the E-OTD-capable MS) of -39 dBm. The RF channel used by the interfering signal generator during this test must not be the same as that used by the serving base station simulator.
- x) Configure the neighbor base station simulator such that its power (as measured at the antenna terminal of the E-OTD MS under test) is -80 dBm, and that it is transmitting 8PSK bursts modulated with pseudo-random data in time slots 1 through 7.
- y) The SS initiates a Measure Position Request RRLP messages and begins logging E-OTD Response messages from the MS under test. The Measure Position Request message is repeated 250 times at 5-second intervals and the response RRLP messages are recorded.
- z) Repeat Step f) and calculate the results.

70.6.4.6 Test Requirements

Verify that the RMS₉₀ error calculated for each procedure in 70.6.4.5 is within the test conformance requirements listed in Table 70.6.4-1

Table 70.6.4-1, Test Conformance Requirements

Procedure	RMS ₉₀ error, 3GPP TS 05.05, Annex I, Minimum Performance Requirement	RMS ₉₀ error, 3GPP TS 51.010, 70.6.4, Test Conformance Requirement
Step f	≤ 300 nanoseconds	≤310 nanoseconds
Step k	≤ 100 nanoseconds	≤110 nanoseconds
Step p	≤ 500 nanoseconds	≤510 nanoseconds
Step u	≤ 200 nanoseconds	≤210 nanoseconds
Step z	≤ 100 nanoseconds	≤110 nanoseconds

70.6.5 E-OTD Accuracy, Multipath Performance Test, 8PSK BCCH

70.6.5.1 Definition

Enhanced Observed Timing Difference is a mechanism intended to provide location information from an MS within a GSM network. E-OTD measures the burst timing alignment between the serving cell for the MS and a minimum of two neighbor cells. The observed timing difference, along with the BSIC or Cell ID of each neighbor cell that can be received and measured by the MS, is reported to the network. Using this information, an E-OTD capable network can calculate the location of the MS using triangulation techniques.

Although an E-OTD capable MS must receive a minimum of two neighbors in order to provide the network with useable data for E-OTD positioning, only one neighbor is required for the timing measurement tests described in this procedure.

70.6.5.2 Conformance requirement

The RMS₉₀ measurement error of an E-OTD capable MS receiving a TU3 Rayleigh-faded 8PSK-modulated neighbor shall not exceed 1.5 microseconds, as specified in 3GPP TS 05.05, Release 99, Annex I, Clause I.2.3, Table I.2.3

70.6.5.3 Test purpose

E-OTD measurement accuracy is heavily influenced by the type of RF environment available to the MS at the time a Measure Position Request is received from the network. Rayleigh fading to the neighbor cell will reduce E-OTD measurement accuracy.

The purpose of this test case is to verify that an E-OTD capable MS can provide an observed timing difference (OTD) measurement of sufficient accuracy when measuring against a TU3 Rayleigh fading distant neighbor modulated with 8PSK in time slots 1-7. During this test, there shall be no co-, adjacent-, or alternate-channel interference.

Specific PICS statements

-

PIXIT statements

-

70.6.5.4 Method of Test

Initial Configuration

Neighbor Cells: At least one neighbor cell with a minimum configuration of a BCCH in order to allow the mobile to perform the required accuracy measurements. The neighbor BCCH shall be included in the serving BCCH System Information Neighbor List.

Assistance Data: The assistance data listed in Table 70.6.5-1 and Table 70.6.5-2 shall be provided by the serving base station simulator. Without assistance data, successful validation of the MS physical layer may be impossible due to limitations imposed by the device's upper protocol layers.

Table 70.6.5-6: RRLP Measure Position Request Field Values, E-OTD Reference BTS for Assistance Data Element

Field Name	Value	Comments
BCCH Carrier	Range 0-1023	ARFCN of Serving BCCH
BSIC	Range 0 to 65	BSIC of Serving BCCH
Time Slot Scheme	Either 0 or 1, as applicable	0=All time slots 156.25 bits long 1=Time slots 0 and 4 are 157 bits long, all other time slots are 156 bits long.
BTS Position	None	Not applicable for timing accuracy measurements

**Table 70.6.5-2: RRLP Measure Position Request Field Values,
E-OTD Measurement Assistance Data for System Information List Element**

Field Name	Value	Comments
Number of Neighbors	1	
E-OTD Neighbor Present	1	
BSIC	Range 0 to 63	BSIC of neighbor BCCH
Multiframe Offset	Range 0-51	The value of this field is specific to the test configuration, and shall be calculated according to 3GPP TS 04.31, Annex A, Section A.2.2.3.
Time Slot Scheme	Either 0 or 1, as applicable	0=All time slots 156.25 bits long 1=Time slots 0 and 4 are 157 bits long, all other time slots are 156 bits long.
Rough RTD	Range 0-1250	Set to rough RTD value for the specific test configuration
Expected OTD	None	Not Applicable
Uncertainty of Expected OTD	None	Not Applicable
Fine RTD	None	Not Applicable
Relative North	None	Not Applicable
Relative East	None	Not Applicable

70.6.5.5 Test procedure

- a) Configure serving base station simulator to transmit 8PSK bursts modulated with pseudo-random data in time slots 1 through 7
- b) Establish RF connectivity between the E-OTD compatible MS and its serving base station simulator, verify RSSI of -80 dBm
- c) Disable the interfering signal generator
- d) Configure the neighbor base station simulator such that its power (as measured at the antenna terminal of the EOTD MS under test) is -110 dBm with Rayleigh fading disabled. The neighbor shall be transmitting 8PSK bursts modulated with pseudo-random data in time slots 1 through 7
- e) Configure the fading simulator for Rayleigh fading corresponding to a velocity of 3 kph, with a 12-tap delay and amplitude spread in accordance with 3GPP TS 05.05, Release 99, Rev. 8.7.1, Annex C, Section C.3.3.
- f) With the carrier from the serving base station simulator disabled, enable TU3 Rayleigh fading on the neighbor cell, and verify an average RSSI (at the antenna connection of the MS) of -110 dBm
- g) Re-enable the serving base station simulator carrier, verify an RSSI (at the antenna connection of the MS) of -80 dBm
- h) The SS initiates a Measure Position Request RRLP messages and begins logging E-OTD Response messages from the MS under test. The Measure Position Request message is repeated 250 times at 5-second intervals and the response RRLP messages are recorded.
- i) After transmitting 250 Measure Position Request RRLP messages to the MS under test, calculate each trial's error relative to the known RTD, sort the data in ascending order, develop the 90% subset M and calculate the RMS_{90} error.

70.6.5.6 Test Requirements

Verify that the RMS_{90} error calculated in Step i) is < 1.5 microseconds

70.6.6 E-OTD Accuracy, Sensitivity Performance Tests for 8PSK Modulated signals

70.6.6.1 Definition

Enhanced Observed Timing Difference is a mechanism intended to provide location information from an MS within a GSM network. E-OTD measures the burst timing alignment between the serving cell for the MS and a minimum of two neighbor cells. The observed timing difference, along with the BSIC or Cell ID of each neighbor cell that can be received and measured by the MS, is reported to the network. Using this information, an E-OTD capable network can calculate the location of the MS using triangulation techniques.

Although an E-OTD capable MS must receive a minimum of two neighbors in order to provide the network with useable data for E-OTD positioning, only one neighbor is required for the timing measurement tests described in this procedure.

70.6.6.2 Conformance requirement

The RMS_{90} measurement error of an E-OTD capable MS receiving a neighbor shall not exceed 100 nanoseconds and 300 nanoseconds at a minimum neighbor carrier signal strength relative to relative sensitivity levels of 12 dB and -8 dB respectively, as specified in 3GPP TS 05.05, annex I, subclause I.2.1, table I.2.1

70.6.6.3 Test purpose

E-OTD measurement accuracy is heavily influenced by the type of RF environment available to the MS at the time a Measure Position Request is received from the network. Nearby neighbor stations that provide a relatively high C/N to the MS receiver should result in greater measurement accuracy than those further away with a low C/N.

The purpose of this test case is to verify that an E-OTD capable MS can provide an observed timing difference (OTD) measurement of sufficient accuracy when measuring against an 8PSK neighbor. During this test, there shall be no co-, adjacent-, or alternate-channel interference.

Specific PICS statements

-

PIXIT statements

-

70.6.6.4 Method of Test

Initial Configuration

Neighbor Cell: One-neighbor cells with a minimum configuration of a BCCH in order to allow the MS to perform the required measurements. The neighbor BCCH shall be included in the serving BCCH System Information Neighbor List.

Assistance Data: The assistance data listed in Table 70.6.6-1 and Table 70.6.6-2 shall be provided by the serving base station simulator. Without assistance data, successful validation of the MS physical layer may be impossible due to limitations imposed by the device's upper protocol layers.

Table 70.6.6-7: RRLP Measure Position Request Field Values, E-OTD Reference BTS for Assistance Data Element

Field Name	Value	Comments
BCCH Carrier	Range 0-1023	ARFCN of Serving BCCH
BSIC	Range 0 to 65	BSIC of Serving BCCH
Time Slot Scheme	Either 0 or 1, as applicable	0=All time slots 156.25 bits long 1=Time slots 0 and 4 are 157 bits long, all other time slots are 156 bits long.
BTS Position	None	Not applicable for timing accuracy measurements

Table 70.6.6-2: RRLP Measure Position Request Field Values, E-OTD Measurement Assistance Data for System Information List Element

Field Name	Value	Comments
Number of Neighbors	1	
E-OTD Neighbor Present	1	
BSIC	Range 0 to 63	BSIC of neighbor BCCH
Multiframe Offset	Range 0-51	The value of this field is specific to the test configuration, and shall be calculated according to 3GPP TS 04.31, Annex A, Section A.2.2.3.
Time Slot Scheme	Either 0 or 1, as applicable	0=All time slots 156.25 bits long 1=Time slots 0 and 4 are 157 bits long, all other time slots are 156 bits long.
Rough RTD	Range 0-1250	Set to rough RTD value for the specific test configuration
Expected OTD	None	Not Applicable
Uncertainty of Expected OTD	None	Not Applicable
Fine RTD	None	Not Applicable
Relative North	None	Not Applicable
Relative East	None	Not Applicable

70.6.6.5 Test procedure

- a) Configure serving base station simulator to transmit 8PSK bursts in time slots 1 through 7.
- b) Establish RF connectivity between the E-OTD compatible MS and its serving base station simulator, verify RSSI of -80 dBm.
- c) Disable the interfering signal generator.
- d) Configure the neighbor base station simulator such that its power (as measured at the antenna terminal of the E-OTD MS under test) is -90 dBm, and that it is transmitting 8PSK bursts in time slots 1-7.
- e) The serving base station SS initiates a Measure Position Request RRLP message. Begin logging E-OTD Measure Position Response RRLP messages from the MS under test. The Measure Position Request is repeated a minimum of 250 times at 5-second intervals and the response RRLP messages are logged.
- f) The SS calculates each trial's error relative to the known RTD, sort the data in ascending order, develop the 90 % subset M and calculate the RMS₉₀ error.
- g) Disable the interfering signal generator.
- h) Configure the neighbor base station simulator such that its power (as measured at the antenna terminal of the E-OTD MS under test) is -110 dBm, and that it is transmitting 8PSK bursts in time slots 1-7.
- i) The serving base station SS initiates a Measure Position Request RRLP message. Begin logging E-OTD Measure Position Response RRLP messages from the MS under test. The Measure Position Request is repeated a minimum of 250 times at 5 s intervals and the response RRLP messages are logged.
- j) After transmitting 250 Measure Position Request RRLP messages to the MS under test, calculate each trial's error relative to the known RTD, sort the data in ascending order, develop the 90 % subset M and calculate the RMS₉₀ error.

70.6.6.6 Test Requirements

Verify that the RMS₉₀ error calculated for each procedure in 70.6.6.5 is within the test conformance requirements listed in Table 70.6.6-3

Table 70.6.6-3, Test Conformance Requirements

Procedure	RMS ₉₀ error, 3GPP TS 05.05, Annex I, Minimum Performance Requirement	RMS ₉₀ error, 3GPP TS 51.010, 70.6.6, Test Conformance Requirement
Step f	≤ 100 nanoseconds	≤110 nanoseconds
Step j	≤ 300 nanoseconds	≤310 nanoseconds

70.7 Assisted GPS Network Induced Tests

70.7.1 Void

70.7.2 Positioning/ RR/ Classmark Interrogation tests

70.7.2.1 Positioning/ RR/ Classmark Interrogation test for mobile supporting MS-Based GPS

70.7.2.1.1 Conformance requirement

If the MS supports MS-Based positioning method, the MS shall provide the BSC and MSC with the positioning method(s) it supports via controlled early Classmark sending.

References

3GPP TS 04.08 / 3GPP TS 44.018 subclause 3.3.1.1.4.1.

70.7.2.1.2 Test Purpose

To verify that the MS supplies MS Positioning Method Capability and Positioning Method(s) support, 5 bit field by early classmark sending procedure on SDCCH. Note: no positioning procedure is performed and no TCH is involved.

70.7.2.1.3 Method of Test

Initial Conditions

System Simulator (SS):

Serving Cell: ATT bit set to 1, Early classmark sending control set to on.

Mobile Station (MS):

Switched off.

Specific PICS statements

-

PIXIT statements

-

Test Procedure

The MS is switched on. The MS shall initiate location update procedure. After the LOCATION_UPDATING_REQUEST message the MS shall transmit CLASSMARK_CHANGE message including MS Positioning Method Capability and Positioning Method(s) support elements.

Maximum duration of the test

5 minutes.

Expected Sequence

Step	Direction	Message	Comments
1	MS		The MS is switched on
2	MS -> SS	CHANNEL REQUEST	"Establishment cause": Location updating.
3	SS -> MS	IMMEDIATE ASSIGNMENT	
4	MS -> SS	LOCATION UPDATING REQUEST	
5	MS -> SS	CLASSMARK CHANGE	"mobile station classmark 2" includes settings for ES IND and Positioning "mobile station classmark 3" includes settings for Positioning . The setting for positioning specifies Positioning Method capability and Positioning Method Support. In the position method support(5 bit field), Bit 2 is set to 1 (MS-Based GPS)
6	SS -> MS	LOCATION UPDATING ACCEPT	
7	MS -> SS	TMSI REALLOCATION COMPLETE	
8	SS -> MS	CHANNEL RELEASE	

70.7.2.2 Positioning/ RR/ Classmark Interrogation test for mobile supporting MS-Assisted GPS

70.7.2.2.1 Conformance requirement

If the MS supports MS-Assisted positioning method, the MS shall provide the BSC and MSC with the positioning method(s) it supports via controlled early Classmark sending.

References

3GPP TS 04.08 / 3GPP TS 44.018 subclause 3.3.1.1.4.1.

3GPP TS 03.71 subclause 7.6.1.1 and clause 5.

3GPP TS 04.18 subclauses 3.3.1.1.4.1, 3.4.11.1, 3.4.11.2 and 10.5.2.34.

3GPP TS 04.13 subclauses 5.2.9 and 5.2.11.

3GPP TS 24.008 subclauses 10.5.1.5, 10.5.1.6 and 10.5.1.7.

70.7.2.2.2 Test Purpose

To verify that the MS supplies MS Positioning Method Capability and Positioning Method(s) support, 5 bit field by early classmark sending procedure on SDCCH.

NOTE: No positioning procedure is performed and no TCH is involved.

70.7.2.2.3 Method of Test

Initial Conditions

System Simulator (SS):

1 cell, ATT bit set to 1.

Mobile Station (MS):

Switched off.

Specific PICS statements

-

PIXIT statements

-

Test Procedure

The MS is switched on. The MS shall initiate location update procedure. After the LOCATION_UPDATING_REQUEST message the MS shall transmit CLASSMARK_CHANGE message including MS Positioning Method Capability and Positioning Method(s) support elements.

Maximum duration of the test

5 minutes.

Expected Sequence

Step	Direction	Message	Comments
1	MS		The MS is switched on.
2	MS -> SS	CHANNEL REQUEST	"Establishment cause": Location updating. "mobile station classmark 2" includes settings for ES IND and Positioning "mobile station classmark 3" includes settings for Positioning. The setting for positioning specifies Positioning Method capability and Positioning Method Support. In the position method support (5 bit field), Bit 3 is set to 1 (MS-Assisted GPS)
3	SS -> MS	IMMEDIATE ASSIGNMENT	
4	MS -> SS	LOCATION UPDATING REQUEST	
5	MS -> SS	CLASSMARK CHANGE	
6	SS -> MS	LOCATION UPDATING ACCEPT	
7	MS -> SS	TMSI REALLOCATION COMPLETE	
8	SS -> MS	CHANNEL RELEASE	

70.7.3 Void

70.7.4 Network Induced Location Request Emergency Call on TCH Radio Channel

70.7.4.1 Network Induced Location Request Emergency Call on TCH Radio Channel for Mobiles Supporting MS-Based GPS

70.7.4.1.1 Conformance requirements

1. With the MS in the "idle, updated" state, the user shall initiate an emergency after the number 112 (for GSM900 and 1800 MS), or 911 (for PCS 1900 MS in the USA), or 08 (for PCS 1900 MS in Mexico) has been entered by the user. The MS shall send a CHANNEL REQUEST message with correct establishment cause ("emergency call").
2. When a user requests an emergency call establishment the mobile station will send a CM SERVICE REQUEST message to the network with a CM service type information element indicating emergency call establishment and the correct CKSN and TMSI. A mobile station which implements the "LCS" option shall also implement the "Controlled Early Classmark Sending" option. A mobile station which implements the "Controlled Early Classmark Sending" option shall indicate it in the classmark (ES IND bit).
3. After sending the CM SERVICE REQUEST message the MS shall send a CLASSMARK CHANGE message. The "Mobile Station Classmark 3" information element shall correctly specify the positioning methods supported by the MS.
4. After the CM SERVICE ACCEPT message is received from the network, the MS shall send an EMERGENCY SETUP message.
5. After receipt of a CONNECT ACKNOWLEDGE message during correct establishment of the emergency call the MS shall indicate that the TCH is through connected in both directions.
6. On receiving the MEASURE POSITION REQUEST message the MS tries to perform the requested location measurements, and calculates its own position. It sends the results in the RRLP MEASURE POSITION RESPONSE message.

References

3GPP TS 04.08/44.018 subclauses 3.3.1.1 and 9.1.11.

3GPP TS 04.08/24.008 subclauses 4.5.1.5, 5.2.1, 9.2.9, 10.5.1.6, 10.5.1.7.

3GPP TS 02.30 clause 4.

3GPP TS 04.31 subclause 2.2.

70.7.4.1.2 Test Purpose

To verify when a network instigates the LCS positioning procedure by sending RRLP (Measure Position Request) message, after a traffic channel has been established during an emergency call, the mobile responds with RRLP (Measure Position Response) containing MS location estimate.

70.7.4.1.3 Method of Test

Initial Conditions

System Simulator (SS):

Serving Cell: default parameters.

Satellite signals: default conditions.

Mobile Station (MS):

The MS is in MM-state "idle, updated" with valued TMSI and CKSN.

SIM:

Normal SIM

Specific PICS statements

-

PIXIT statements

-

Test Procedure

An Emergency Call is initiated with the MS. SIM card is included in the MS.

The emergency call is established with a late assignment.

After receiving the CONNECT ACKNOWLEDGE message from the MS, the SS sends RR APPLICATION INFORMATION messages containing RRLP Assistance Data messages.

The SS then sends an RR APPLICATION INFORMATION message containing an RRLP Measure Position Request on FACCH including assistance data.

Option 1: The MS then performs positioning measurements, and responds with an RR APPLICATION INFORMATION message containing an RRLP Measure Position Response.

Option 2: The MS may request additional assistance data by sending an RRLP Measure Position Response message containing a location error with IE LocErrorReason set to gpsAssDataMissing. If the MS requests additional assistance data that is available in the SS, then the SS provides the requested assistance data in zero, one or more RRLP Assistance Data delivery messages followed by an RRLP Measure Position Request message which may include further assistance data. If the MS requests additional assistance data and the entire requested assistance data is not available in the SS, then the SS repeats the RRLP Measure Position Request message without assistance data. The MS then performs positioning measurements, and responds with an RR APPLICATION INFORMATION message containing an RRLP Measure Position Response.

The call is cleared by the SS.

Maximum duration of the test

5 minutes.

Expected Sequence

Step	Direction	Message	Comments
1	MS		The appropriate "emergency call number" is entered.
2	MS -> SS	CHANNEL REQUEST	Establishment cause is emergency call establishment.
3	SS -> MS	IMMEDIATE ASSIGNMENT	
4	MS -> SS	CM SERVICE REQUEST	Message is contained in SABM. The CM service type IE indicates "emergency call establishment". "mobile station classmark 2" includes settings for ES_IND.
5	MS->SS	CLASSMARK CHANGE	"mobile station classmark 2" includes settings for ES_IND. "mobile station classmark 3" includes settings for Positioning. The setting for positioning specifies Positioning Method capability and Positioning Method Support. In the position method support (5 bit field), Bit 2 is set to 1 (MS-Based GPS)
6	SS -> MS	CM SERVICE ACCEPT	
7	MS -> SS	EMERGENCY SETUP	
8	SS -> MS	CALL PROCEEDING	
9	SS -> MS	ALERTING	
10	SS -> MS	ASSIGNMENT COMMAND	
11	MS -> SS	ASSIGNMENT COMPLETE	
12	SS -> MS	CONNECT	
13	MS -> SS	CONNECT ACKNOWLEDGE	The MS indicates that the TCH is through connected in both directions.
14	SS -> MS	RR APPLICATION INFORMATION	RRLP Assistance Data
15	MS -> SS	RR APPLICATION INFORMATION	RRLP assistanceDataAck
16	SS -> MS	RR APPLICATION INFORMATION	RRLP Assistance Data
17	MS -> SS	RR APPLICATION INFORMATION	RRLP assistanceDataAck
18	SS-> MS	RR APPLICATION INFORMATION	RRLP Measure Position Request
19	MS -> SS	RR APPLICATION INFORMATION	RRLP Measure Position Response: locationInfo (Option 1) or locationError with gpsAssDataMissing and additionalAssistanceData (Option 2)
19a	SS -> MS	RR APPLICATION INFORMATION	RRLP Assistance Data. If the MS requested additional assistance data in step 19 that is available in the SS, then SS provides the requested data in zero, one or more RRLP Assistance Data delivery messages.
19b	MS -> SS	RR APPLICATION INFORMATION	RRLP assistanceDataAck. If the SS sent additional assistance data in step 19a, the MS acknowledges the received assistance data.
19c	SS-> MS	RR APPLICATION INFORMATION	RRLP Measure Position Request. If the MS requested additional assistance data in step 19 that is available in the SS, this message may include further assistance data.
19d	MS-> SS	RR APPLICATION INFORMATION	RRLP Measure Position Response. If the MS requested additional assistance data in step 19, this message contains locationInfo.

20	SS -> MS	DISCONNECT	
21	MS -> SS	RELEASE	
22	SS -> MS	RELEASE COMPLETE	
23	SS -> MS	CHANNEL RELEASE	The main signalling link is released.

Specific Message Contents

RR APPLICATION INFORMATION

Information element	Value/remark
Protocol Discriminator	RR Management Protocol (0110)
Skip Indicator	
Message Type	Application Information Message type
APDU ID	APDU ID -> RRLP => 0000
APDU Flags	Bit1=0 -> Last or only segment Bit2=0 -> First or only segment Bit3=0 -> Command or Final Response Bit4=spare
APDU Data	2-N Byte -> ASN.1 Coded Steps 18 and 19c: RRLP Measure Position Request Steps 19 and 19d: RRLP Measure Position Response Steps 14, 16, 19a: RRLP Assistance Data Steps 15, 17, 19b: RRLP Assistance Data Ack.

RRLP Assistance Data (Step 14):

Information element	Type	Value/remark
ASN.1 encoded		
referenceNumber	Integer,0 to 7	1
component	CHOICE	assistanceData
gps-AssistData	SEQUENCE	
navigationModel	SEQUENCE	PRNs 4,6,9 of section 10.9.5
moreAssDataToBeSent	ENUMERATED	1

RRLP Assistance Data Ack (Steps 15, 17, 19b):

Information element	Type	Value/remark
ASN.1 encoded		
referenceNumber	Integer,0 to 7	1 or 2 (Option 2, Step 19b)
component	CHOICE	assistanceDataAck

RRLP Assistance Data (Step 16):

Information element	Type	Value/remark
ASN.1 encoded		
referenceNumber	Integer,0 to 7	1
component	CHOICE	assistanceData
gps-AssistData	SEQUENCE	
navigationModel	SEQUENCE	PRNs 10,13,22 of section 10.9.5
ionosphericModel	SEQUENCE	See section 10.9.6
moreAssDataToBeSent	ENUMERATED	0

RRLP Measure Position Request (Step 18):

Information element	Type	Value/remark
ASN.1 encoded		
referenceNumber	Integer,0 to 7	1
component	CHOICE	msrPositionReq
methodType	CHOICE	msBased
positionMethod	ENUMERATED	gps
measureResponseTime	Integer 0 to 7	5
accuracy	Integer (0-127)	127
useMultipleSets	ENUMERATED	oneSet
gps-AssistData	SEQUENCE	
referenceTime	SEQUENCE	See section 10.9.3
refLocation	SEQUENCE	See section 10.9.4

RRLP Measure Position Response (Step 19 (Option 1) or 19d (Option 2)):

Information element	Type	Value/remark
ASN.1 encoded		
referenceNumber	Integer,0 to 7	1 or 2 (Option 2, Step 19d)
component	CHOICE	msrPositionRsp (A valid response will contain LocationInfo otherwise LocationError will be returned)
locationInfo	SEQUENCE	Any value is acceptable.
locationError	SEQUENCE	Any error value is acceptable except gpsAssDataMissing.

RRLP Measure Position Response (Step 19 (Option 2)):

Information element	Type	Value/remark
ASN.1 encoded		
referenceNumber	Integer,0 to 7	1
component	CHOICE	msrPositionRsp
locationError	SEQUENCE	
locErrorReason	ENUMERATED	gpsAssDataMissing
additionalAssistanceData	SEQUENCE	
gpsAssistanceData	OCTET STRING	Indicates missing assistance data elements

RRLP Assistance Data (Step 19a):

Information element	Type	Value/remark
ASN.1 encoded		
referenceNumber	Integer,0 to 7	2
component	CHOICE	assistanceData
gps-AssistData	SEQUENCE	If the MS requested further assistance data in Step 19 (Option 2) that is available in the SS, SS shall send zero, one or more RRLP Assistance Data messages containing the requested assistance data from section 10.9. Each message shall contain a maximum of 242 octets.
moreAssDataToBeSent	ENUMERATED	1 or 0. If SS sends more than one RRLP assistance data delivery message the moreAssDataToBeSent field shall be set accordingly.

RRLP Measure Position Request (Step 19c):

Information element	Type	Value/remark
ASN.1 encoded		
referenceNumber	Integer, 0 to 7	2
component	CHOICE	msrPositionReq
methodType	CHOICE	msBased
positionMethod	ENUMERATED	gps
measureResponseTime	Integer 0 to 7	5
accuracy	Integer (0-127)	127
useMultipleSets	ENUMERATED	oneSet
gps-AssistData	SEQUENCE	May contain further assistance data from section 10.9 as requested by the MS in step 19 (Option 2).

70.7.4.2 Network Induced Location Request Emergency Call on TCH Radio Channel for mobiles supporting MS-Assisted GPS

70.7.4.2.1 Conformance requirements

1. With the MS in the "idle, updated" state, the user shall initiate an emergency after the number 112 (for GSM900 and 1800 MS), or 911 (for PCS 1900 MS in the USA), or 08 (for PCS 1900 MS in Mexico) has been entered by the user. The MS shall send a CHANNEL REQUEST message with correct establishment cause ("emergency call").
2. When a user requests an emergency call establishment the mobile station will send a CM SERVICE REQUEST message to the network with a CM service type information element indicating emergency call establishment and the correct CKSN and TMSI. A mobile station which implements the "LCS" option shall also implement the "Controlled Early Classmark Sending" option. A mobile station which implements the "Controlled Early Classmark Sending" option shall indicate it in the classmark (ES IND bit).
3. After sending the CM SERVICE REQUEST message the MS shall send a CLASSMARK CHANGE message. The "Mobile Station Classmark 3" information element shall correctly specify the positioning methods supported by the MS.
4. After the CM SERVICE ACCEPT message is received from the network, the MS shall send an EMERGENCY SETUP message.
5. After receipt of a CONNECT ACKNOWLEDGE message during establishment of the emergency call the MS shall indicate that the TCH is through connected in both directions.
6. On receiving the RRLP MEASURE POSITION REQUEST the MS tries to perform the requested location measurements. It sends the results in the MEASURE POSITION RESPONSE message.

References

3GPP TS 04.08/44.018 subclauses 3.3.1.1 and 9.1.11.

3GPP TS 04.08/24.008 subclauses 4.5.1.5, 5.2.1, 9.2.9 and 10.5.1.6, 10.5.1.7.

3GPP TS 02.30 clause 4.

3GPP TS 04.31 subclause 2.2.

70.7.4.2.2 Test Purpose

To verify when a network instigates the LCS positioning procedure by sending RRLP (Measure Position Request) message, after a traffic channel has been established during an emergency call, the mobile responds with RRLP (Measure Position Response) containing A-GPS measurement values.

70.7.4.2.3 Method of Test

Initial Conditions

System Simulator (SS):

Serving Cell: default parameters

Satellite signals: default conditions.

Mobile Station (MS):

The MS is in MM-state "idle, updated" with valued TMSI and CKSN.

Specific PICS statements

-

PIXIT statements

-

Test Procedure

An Emergency Call is initiated with the MS. SIM card is included in the MS.

The emergency call is established with a late assignment.

After receiving the CONNECT ACKNOWLEDGE message from the MS, the SS sends an RR APPLICATION INFORMATION message containing an RRLP Measure Position Request on FACCH including assistance data.

Option 1: The MS then performs positioning measurements, and responds with an RR APPLICATION INFORMATION message containing an RRLP Measure Position Response.

Option 2: The MS may request additional assistance data by sending an RRLP Measure Position Response message containing a location error with IE LocErrorReason set to gpsAssDataMissing. If the MS requests additional assistance data that is available in the SS, then the SS provides the requested assistance data in zero, one or more RRLP Assistance Data delivery messages followed by an RRLP Measure Position Request message which may include further assistance data. If the MS requests additional assistance data and the entire requested assistance data is not available in the SS, then the SS repeats the RRLP Measure Position Request message without assistance data. The MS then performs positioning measurements, and responds with an RR APPLICATION INFORMATION message containing an RRLP Measure Position Response.

The call is cleared by the SS.

Maximum duration of the test

5 minutes.

Expected Sequence

Step	Direction	Message	Comments
1	MS		The appropriate "emergency call number" is entered.
2	MS -> SS	CHANNEL REQUEST	Establishment cause is emergency call establishment.
3	SS -> MS	IMMEDIATE ASSIGNMENT	
4	MS -> SS	CM SERVICE REQUEST	Message is contained in SABM. The CM service type IE indicates "emergency call establishment". "mobile station classmark 2" includes settings for ES_IND.
5	MS->SS	CLASSMARK CHANGE	"mobile station classmark 2" includes settings for ES_IND. "mobile station classmark 3" includes settings for Positioning. The setting for positioning specifies Positioning Method capability and Positioning Method Support. In the position method support (5 bit field), Bit 3 is set to 1 (MS-Assisted GPS)
6	SS -> MS	CM SERVICE ACCEPT	
7	MS -> SS	EMERGENCY SETUP	
8	SS -> MS	CALL PROCEEDING	
9	SS -> MS	ALERTING	
10	SS -> MS	ASSIGNMENT COMMAND	
11	MS -> SS	ASSIGNMENT COMPLETE	
12	SS -> MS	CONNECT	
13	MS -> SS	CONNECT ACKNOWLEDGE	The MS indicates that the TCH is through connected in both directions.
14	SS-> MS	RR APPLICATION INFORMATION	RRLP Measure Position Request
15	MS -> SS	RR APPLICATION INFORMATION	RRLP Measure Position Response: gps-MeasureInfo (Option 1) or locationError with gpsAssDataMissing (Option 2)
15a	SS -> MS	RR APPLICATION INFORMATION	RRLP Assistance Data. If the MS requested additional assistance data in step 15 that is available in the SS, then SS provides the requested data in zero, one or more RRLP Assistance Data delivery messages.
15b	MS -> SS	RR APPLICATION INFORMATION	RRLP assistanceDataAck. If the SS sent additional assistance data in step 15a, the MS acknowledges the received assistance data.
15c	SS-> MS	RR APPLICATION INFORMATION	RRLP Measure Position Request. If the MS requested additional assistance data in step 15 that is available in the SS, this message may include further assistance data.
15d	MS -> SS	RR APPLICATION INFORMATION	RRLP Measure Position Response. If the MS requested additional assistance data in step 15, this message contains gps-MeasureInfo.
16	SS -> MS	DISCONNECT	
17	MS -> SS	RELEASE	
18	SS -> MS	RELEASE COMPLETE	
19	SS -> MS	CHANNEL RELEASE	The main signalling link is released.

Specific Message Contents

RR APPLICATION INFORMATION

Information element	Value/remark
Protocol Discriminator	RR Management Protocol (0110)
Skip Indicator	
Message Type	Application Information Message type
APDU ID	APDU ID -> RRLP => 0000
APDU Flags	Bit1=0 -> Last or only segment Bit2=0 -> First or only segment Bit3=0 -> Command or Final Response Bit4=spare
APDU Data	2-N Byte → ASN.1 Coded Step 14 and 15c: RRLP Measure Position Request Step 15 and 15d: RRLP Measure Position Response Step 15a: RRLP Assistance Data Step 15b: RRLP Assistance Data Ack.

RRLP Measure Position Request (Step 14):

Information element	Type	Value/remark
ASN.1 encoded		
referenceNumber	Integer, 0 to 7	1
component	CHOICE	msrPositionReq
methodType	CHOICE	msAssisted
positionMethod	ENUMERATED	gps
measureResponseTime	Integer 0 to 7	5
useMultipleSets	ENUMERATED	oneSet
gps-AssistData	SEQUENCE	
referenceTime	SEQUENCE	See section 10.9.3
acquisAssist	SEQUENCE	See section 10.9.8

RRLP Measure Position Response (Step 15 (Option 1) or Step 15d (Option 2)):

Information element	Type	Value/remark
ASN.1 encoded		
referenceNumber	Integer, 0 to 7	1 or 2 (Option 2, Step 15d)
component	CHOICE	msrPositionRsp (A valid response will contain gps-MeasureInfo otherwise locationError will be returned)
gps-MeasureInfo	SEQUENCE	Any value of the parameters is acceptable.
locationError	SEQUENCE	Any error value is acceptable except gpsAssDataMissing.

RRLP Measure Position Response (Step 15 (Option 2)):

Information element	Type	Value/remark
ASN.1 encoded		
referenceNumber	Integer, 0 to 7	1
component	CHOICE	msrPositionRsp
locationError	SEQUENCE	
locErrorReason	ENUMERATED	gpsAssDataMissing
additionalAssistanceData	SEQUENCE	
gpsAssistanceData	OCTET STRING	Indicates missing assistance data elements

RRLP Assistance Data (Step 15a):

Information element	Type	Value/remark
ASN.1 encoded		
referenceNumber	Integer, 0 to 7	2
component	CHOICE	assistanceData
gps-AssistData	SEQUENCE	If the MS requested further assistance data in Step 15 (Option 2) that is available in the SS, SS shall send zero, one or more RRLP Assistance Data messages containing the requested assistance data from section 10.9. Each message shall contain a maximum of 242 octets.
moreAssDataToBeSent	ENUMERATED	1 or 0. If SS sends more than one RRLP assistance data delivery message the moreAssDataToBeSent field shall be set accordingly.

RRLP Assistance Data Ack (Step 15b):

Information element	Type	Value/remark
ASN.1 encoded		
referenceNumber	Integer, 0 to 7	2
component	CHOICE	assistanceDataAck

RRLP Measure Position Request (Step 15c):

Information element	Type	Value/remark
ASN.1 encoded		
referenceNumber	Integer, 0 to 7	2
component	CHOICE	msrPositionReq
methodType	CHOICE	msAssisted
positionMethod	ENUMERATED	gps
measureResponseTime	Integer 0 to 7	5
useMultipleSets	ENUMERATED	oneSet
gps-AssistData	SEQUENCE	May contain further assistance data from section 10.9 as requested by the MS in step 15 (Option 2).

70.7.4.3 Network Induced Location Request Emergency Call on TCH Radio Channel, no IMSI for Mobiles Supporting MS-Based GPS

70.7.4.3.1 Conformance requirements

1. With the MS (no SIM inserted) in the "idle, no IMSI" state, the user shall initiate an emergency call by dialling the number 112 (for GSM 900 and 1 800 MSs), or 911 (for GSM 710, GSM 750, T_GSM 810, GSM 850, PCS 1 900 MS in the USA 1 900 MS), or 08 (for GSM 710, GSM 750, T_GSM 810, GSM 850, PCS MS in Mexico). The MS shall send a CHANNEL REQUEST message with correct establishment cause ("emergency call").
2. When a user requests an emergency call establishment the mobile station will send a CM SERVICE REQUEST message to the network with a CM service type information element indicating emergency call establishment and the correct CKSN and TMSI. A mobile station which implements the "LCS" option shall also implement the "Controlled Early Classmark Sending" option. A mobile station which implements the "Controlled Early Classmark Sending" option shall indicate it in the classmark (ES IND bit).
3. After sending the CM SERVICE REQUEST message the MS shall send a CLASSMARK CHANGE message. The "Mobile Station Classmark 3" information element shall correctly specify the positioning methods supported by the MS.

4. After the CM SERVICE ACCEPT message is received from the network, the MS shall send an EMERGENCY SETUP message.
5. After receipt of a CONNECT ACKNOWLEDGE message during correct establishment of the emergency call the MS shall indicate that the TCH is through connected in both directions.
6. On receiving the RRLP MEASURE POSITION REQUEST message the MS tries to perform the requested location measurements, and calculates its own position. It sends the results in the RRLP MEASURE POSITION RESPONSE message.

References

3GPP TS 04.08 / 3GPP TS 44.018 subclauses 3.3.1.1, 3.4.10.

3GPP TS 04.08 / 3GPP TS 24.008 subclauses 5.2.1, 5.2.1.1, 5.2.1.6, 4.5.1.1 and 4.5.1.5.

3GPP TS 02.30 clause 4.

3GPP TS 04.31 clause 2.2.

70.7.4.3.2 Test Purpose

To verify when an emergency call is initiated by an MS that does not have a SIM fitted, the network instigates the LCS positioning procedure by sending RRLP (Measure Position Request) message and the mobile responds with RRLP (Measure Position Response) containing MS location.

70.7.4.3.3 Method of Test

Initial Conditions

System Simulator (SS):

Serving Cell: default parameters.

Satellite signals: default conditions.

Mobile Station (MS):

The MS is in MM-state "idle, no IMSI", no SIM inserted.

SIM:

No SIM.

Specific PICS statements

-

PIXIT statements

-

Test Procedure

An Emergency Call is initiated by the MS, with no SIM inserted in the MS.

The emergency call is established with a late assignment.

After receiving the CONNECT ACKNOWLEDGE message from the MS, the SS sends RR APPLICATION INFORMATION messages containing RRLP Assistance Data messages.

The SS then sends an RR APPLICATION INFORMATION message containing an RRLP Measure Position Request on FACCH including assistance data.

Option 1: The MS then performs positioning measurements, and responds with an RR APPLICATION INFORMATION message containing an RRLP Measure Position Response.

Option 2: The MS may request additional assistance data by sending an RRLP Measure Position Response message containing a location error with IE LocErrorReason set to gpsAssDataMissing. If the MS requests additional assistance data that is available in the SS, then the SS provides the requested assistance data in zero, one or more RRLP Assistance Data delivery messages followed by an RRLP Measure Position Request message which may include further assistance data. If the MS requests additional assistance data and the entire requested assistance data is not available in the SS, then the SS repeats the RRLP Measure Position Request message without assistance data. The MS then performs positioning measurements, and responds with an RR APPLICATION INFORMATION message containing an RRLP Measure Position Response.

The call is cleared by the SS.

Maximum duration of the test

5 minutes.

Expected Sequence

Step	Direction	Message	Comments
1	MS		The appropriate "emergency call number" is entered.
2	MS -> SS	CHANNEL REQUEST	Establishment cause is emergency call establishment.
3	SS -> MS	IMMEDIATE ASSIGNMENT	
4	MS -> SS	CM SERVICE REQUEST	Message is contained in SABM. The CM service type IE indicates "emergency call establishment". "mobile station classmark 2" includes settings for ES_IND.
5	MS->SS	CLASSMARK CHANGE	"mobile station classmark 2" includes settings for ES_IND. "mobile station classmark 3" includes settings for Positioning. The setting for positioning specifies Positioning Method capability and Positioning Method Support. In the position method support (5 bit field), Bit 2 is set to 1 (MS-Based GPS)
6	SS -> MS	CM SERVICE ACCEPT	
7	MS -> SS	EMERGENCY SETUP	
8	SS -> MS	CALL PROCEEDING	
9	SS -> MS	ALERTING	
10	SS -> MS	ASSIGNMENT COMMAND	
11	MS -> SS	ASSIGNMENT COMPLETE	
12	SS -> MS	CONNECT	
13	MS -> SS	CONNECT ACKNOWLEDGE	The MS indicates that the TCH is through connected in both directions.
14	SS -> MS	RR APPLICATION INFORMATION	RRLP Assistance Data
15	MS -> SS	RR APPLICATION INFORMATION	RRLP assistanceDataAck
16	SS -> MS	RR APPLICATION INFORMATION	RRLP Assistance Data
17	MS -> SS	RR APPLICATION INFORMATION	RRLP assistanceDataAck
18	SS-> MS	RR APPLICATION INFORMATION	RRLP Measure Position Request
19	MS -> SS	RR APPLICATION INFORMATION	RRLP Measure Position Response: locationInfo (Option 1) or locationError with gpsAssDataMissing and additionalAssistanceData (Option 2)
19a	SS -> MS	RR APPLICATION INFORMATION	RRLP Assistance Data. If the MS requested additional assistance data in step 19 that is available in the SS, then SS provides the requested data in zero, one or more RRLP Assistance Data delivery messages.
19b	MS -> SS	RR APPLICATION INFORMATION	RRLP assistanceDataAck. If the SS sent additional assistance data in step 19a, the MS acknowledges the received assistance data.
19c	SS-> MS	RR APPLICATION INFORMATION	RRLP Measure Position Request. If the MS requested additional assistance data in step 19 that is available in the SS, this message may include further assistance data.
19d	MS-> SS	RR APPLICATION INFORMATION	RRLP Measure Position Response. If the MS requested additional assistance data in step 19, this message contains locationInfo.

20	SS -> MS	DISCONNECT	
21	MS -> SS	RELEASE	
22	SS -> MS	RELEASE COMPLETE	
23	SS -> MS	CHANNEL RELEASE	The main signalling link is released.

Specific Message Contents

RR APPLICATION INFORMATION

Information element	Value/remark
Protocol Discriminator	RR Management Protocol (0110)
Skip Indicator	
Message Type	Application Information Message type
APDU ID	APDU ID -> RRLP => 0000
APDU Flags	Bit1=0 -> Last or only segment Bit2=0 -> First or only segment Bit3=0 -> Command or Final Response Bit4=spare
APDU Data	2-N Byte -> ASN.1 Coded Steps 18 and 19c: RRLP Measure Position Request Steps 19 and 19d: RRLP Measure Position Response Steps 14, 16, 19a: RRLP Assistance Data Steps 15, 17, 19b: RRLP Assistance Data Ack.

RRLP Assistance Data (Step 14):

Information element	Type	Value/remark
ASN.1 encoded		
referenceNumber	Integer,0 to 7	1
component	CHOICE	assistanceData
gps-AssistData	SEQUENCE	
navigationModel	SEQUENCE	PRNs 4,6,9 of section 10.9.5
moreAssDataToBeSent	ENUMERATED	1

RRLP Assistance Data Ack (Steps 15, 17, 19b):

Information element	Type	Value/remark
ASN.1 encoded		
referenceNumber	Integer,0 to 7	1 or 2 (Option 2, Step 19b)
component	CHOICE	assistanceDataAck

RRLP Assistance Data (Step 16):

Information element	Type	Value/remark
ASN.1 encoded		
referenceNumber	Integer,0 to 7	1
component	CHOICE	assistanceData
gps-AssistData	SEQUENCE	
navigationModel	SEQUENCE	PRNs 10,13,22 of section 10.9.5
ionosphericModel	SEQUENCE	See section 10.9.6
moreAssDataToBeSent	ENUMERATED	0

RRLP Measure Position Request (Step 18):

Information element	Type	Value/remark
ASN.1 encoded		
referenceNumber	Integer,0 to 7	1
component	CHOICE	msrPositionReq
methodType	CHOICE	msBased
positionMethod	ENUMERATED	gps
measureResponseTime	Integer 0 to 7	5
accuracy	Integer (0-127)	127
useMultipleSets	ENUMERATED	oneSet
gps-AssistData	SEQUENCE	
referenceTime	SEQUENCE	See section 10.9.3
refLocation	SEQUENCE	See section 10.9.4

RRLP Measure Position Response (Step 19 (Option 1) or 19d (Option 2)):

Information element	Type	Value/remark
ASN.1 encoded		
referenceNumber	Integer,0 to 7	1 or 2 (Option 2, Step 19d)
component	CHOICE	msrPositionRsp (A valid response will contain LocationInfo otherwise LocationError will be returned)
locationInfo	SEQUENCE	Any value is acceptable.
locationError	SEQUENCE	Any error value is acceptable except gpsAssDataMissing.

RRLP Measure Position Response (Step 19 (Option 2)):

Information element	Type	Value/remark
ASN.1 encoded		
referenceNumber	Integer,0 to 7	1
component	CHOICE	msrPositionRsp
locationError	SEQUENCE	
locErrorReason	ENUMERATED	gpsAssDataMissing
additionalAssistanceData	SEQUENCE	
gpsAssistanceData	OCTET STRING	Indicates missing assistance data elements

RRLP Assistance Data (Step 19a):

Information element	Type	Value/remark
ASN.1 encoded		
referenceNumber	Integer,0 to 7	2
component	CHOICE	assistanceData
gps-AssistData	SEQUENCE	If the MS requested further assistance data in Step 19 (Option 2) that is available in the SS, SS shall send zero, one or more RRLP Assistance Data messages containing the requested assistance data from section 10.9. Each message shall contain a maximum of 242 octets.
moreAssDataToBeSent	ENUMERATED	1 or 0. If SS sends more than one RRLP assistance data delivery message the moreAssDataToBeSent field shall be set accordingly.

RRLP Measure Position Request (Step 19c):

Information element	Type	Value/remark
ASN.1 encoded		
referenceNumber	Integer,0 to 7	2
component	CHOICE	msrPositionReq
methodType	CHOICE	msBased
positionMethod	ENUMERATED	gps
measureResponseTime	Integer 0 to 7	5
accuracy	Integer (0-127)	127
useMultipleSets	ENUMERATED	oneSet
gps-AssistData	SEQUENCE	May contain further assistance data from section 10.9 as requested by the MS in step 19 (Option 2).

70.7.4.4 Network Induced Location Request Emergency Call on TCH Radio Channel, no IMSI for mobiles supporting MS-Assisted GPS

70.7.4.4.1 Conformance requirements

1. With the MS (no SIM inserted) in the "idle, no IMSI" state, the user shall initiate an emergency call by dialling the number 112 (for GSM 900 and 1 800 MSs), or 911 (for GSM 710, GSM 750, T_GSM 810, GSM 850, PCS 1 900 MS in USA and Canada), or 08 (for GSM 710, GSM 750, T_GSM 810, GSM 850, PCS 1 900 MS in Mexico). The MS shall send a CHANNEL REQUEST message with correct establishment cause ("emergency call").
2. When a user requests an emergency call establishment the mobile station will send a CM SERVICE REQUEST message to the network with a CM service type information element indicating emergency call establishment and the correct CKSN and TMSI. A mobile station which implements the "LCS" option shall also implement the "Controlled Early Classmark Sending" option. A mobile station which implements the "Controlled Early Classmark Sending" option shall indicate it in the classmark (ES IND bit).
3. After sending the CM SERVICE REQUEST message the MS shall send a CLASSMARK CHANGE message. The "Mobile Station Classmark 3" information element shall correctly specify the positioning methods supported by the MS.
4. After the CM SERVICE ACCEPT message is received from the network, the MS shall send an EMERGENCY SETUP message.
5. After receipt of a CONNECT ACKNOWLEDGE message during correct establishment of the emergency call the MS shall indicate that the TCH is through connected in both directions.
6. On receiving the RRLP MEASURE POSITION REQUEST message the MS tries to perform the requested location measurements. It sends the results in the RRLP MEASURE POSITION RESPONSE message.

References

3GPP TS 04.08 / 3GPP TS 44.018 subclauses 3.3.1.1, 3.4.10.

3GPP TS 04.08 / 3GPP TS 24.008 subclauses 5.2.1, 5.2.1.1, 5.2.1.6, 4.5.1.1 and 4.5.1.5.

3GPP TS 02.30 clause 4.

3GPP TS 04.31 clause 2.2.

70.7.4.4.2 Test Purpose

To verify when an emergency call is initiated by an MS that does not have a SIM fitted, the network instigates the LCS positioning procedure by sending RRLP (Measure Position Request) message and the mobile responds with RRLP (Measure Position Response) containing A-GPS measurement values.

70.7.4.4.3 Method of Test

Initial Conditions

System Simulator (SS):

Serving Cell: default parameters .

Satellite signals: default conditions.

Mobile Station (MS):

The MS is in MM-state “idle, no IMSI”, no SIM inserted.

SIM:

No SIM.

Specific PICS statements

-

PIXIT statements

-

Test Procedure

An Emergency Call is initiated by the MS, with no SIM inserted in the MS.

The emergency call is established with a late assignment.

After receiving the CONNECT ACKNOWLEDGE message from the MS, the SS sends an RR APPLICATION INFORMATION message containing an RRLP Measure Position Request on FACCH including assistance data.

Option 1: The MS then performs positioning measurements, and responds with an RR APPLICATION INFORMATION message containing an RRLP Measure Position Response.

Option 2: The MS may request additional assistance data by sending an RRLP Measure Position Response message containing a location error with IE LocErrorReason set to gpsAssDataMissing. If the MS requests additional assistance data that is available in the SS, then the SS provides the requested assistance data in zero, one or more RRLP Assistance Data delivery messages followed by an RRLP Measure Position Request message which may include further assistance data. If the MS requests additional assistance data and the entire requested assistance data is not available in the SS, then the SS repeats the RRLP Measure Position Request message without assistance data. The MS then performs positioning measurements, and responds with an RR APPLICATION INFORMATION message containing an RRLP Measure Position Response.

The call is cleared by the SS.

Maximum duration of the test

5 minutes.

Expected Sequence

Step	Direction	Message	Comments
1	MS		The appropriate "emergency call number" is entered.
2	MS -> SS	CHANNEL REQUEST	Establishment cause is emergency call establishment.
3	SS -> MS	IMMEDIATE ASSIGNMENT	
4	MS -> SS	CM SERVICE REQUEST	Message is contained in SABM. The CM service type IE indicates "emergency call establishment". "mobile station classmark 2" includes settings for ES_IND.
5	MS->SS	CLASSMARK CHANGE	"mobile station classmark 2" includes settings for ES_IND. "mobile station classmark 3" includes settings for Positioning. The setting for positioning specifies Positioning Method capability and Positioning Method Support. In the position method support (5 bit field), Bit 3 is set to 1 (MS-Assisted GPS)
6	SS -> MS	CM SERVICE ACCEPT	
7	MS -> SS	EMERGENCY SETUP	
8	SS -> MS	CALL PROCEEDING	
9	SS -> MS	ALERTING	
10	SS -> MS	ASSIGNMENT COMMAND	
11	MS -> SS	ASSIGNMENT COMPLETE	
12	SS -> MS	CONNECT	
13	MS -> SS	CONNECT ACKNOWLEDGE	The MS indicates that the TCH is through connected in both directions.
14	SS-> MS	RR APPLICATION INFORMATION	RRLP Measure Position Request
15	MS -> SS	RR APPLICATION INFORMATION	RRLP Measure Position Response: gps-MeasureInfo (Option 1) or locationError with gpsAssDataMissing (Option 2)
15a	SS -> MS	RR APPLICATION INFORMATION	RRLP Assistance Data. If the MS requested additional assistance data in step 15 that is available in the SS, then SS provides the requested data in zero, one or more RRLP Assistance Data delivery messages.
15b	MS -> SS	RR APPLICATION INFORMATION	RRLP assistanceDataAck. If the SS sent additional assistance data in step 15a, the MS acknowledges the received assistance data.
15c	SS-> MS	RR APPLICATION INFORMATION	RRLP Measure Position Request. If the MS requested additional assistance data in step 15 that is available in the SS, this message may include further assistance data.
15d	MS -> SS	RR APPLICATION INFORMATION	RRLP Measure Position Response. If the MS requested additional assistance data in step 15, this message contains gps-MeasureInfo.
16	SS -> MS	DISCONNECT	
17	MS -> SS	RELEASE	
18	SS -> MS	RELEASE COMPLETE	
19	SS -> MS	CHANNEL RELEASE	The main signalling link is released.

Specific Message Contents

RR APPLICATION INFORMATION

Information element	Value/remark
Protocol Discriminator	RR Management Protocol (0110)
Skip Indicator	
Message Type	Application Information Message type
APDU ID	APDU ID -> RRLP => 0000
APDU Flags	Bit1=0 -> Last or only segment Bit2=0 -> First or only segment Bit3=0 -> Command or Final Response Bit4=spare
APDU Data	2-N Byte → ASN.1 Coded Step 14 and 15c: RRLP Measure Position Request Step 15 and 15d: RRLP Measure Position Response Step 15a: RRLP Assistance Data Step 15b: RRLP Assistance Data Ack.

RRLP Measure Position Request (Step 14):

Information element	Type	Value/remark
ASN.1 encoded		
referenceNumber	Integer, 0 to 7	1
component	CHOICE	msrPositionReq
methodType	CHOICE	msAssisted
positionMethod	ENUMERATED	gps
measureResponseTime	Integer 0 to 7	5
useMultipleSets	ENUMERATED	oneSet
gps-AssistData	SEQUENCE	
referenceTime	SEQUENCE	See section 10.9.3
acquisAssist	SEQUENCE	See section 10.9.8

RRLP Measure Position Response (Step 15 (Option 1) or Step 15d (Option 2)):

Information element	Type	Value/remark
ASN.1 encoded		
referenceNumber	Integer, 0 to 7	1 or 2 (Option 2, Step 15d)
component	CHOICE	msrPositionRsp (A valid response will contain gps-MeasureInfo otherwise locationError will be returned)
gps-MeasureInfo	SEQUENCE	Any value of the parameters is acceptable.
locationError	SEQUENCE	Any error value is acceptable except gpsAssDataMissing.

RRLP Measure Position Response (Step 15 (Option 2)):

Information element	Type	Value/remark
ASN.1 encoded		
referenceNumber	Integer, 0 to 7	1
component	CHOICE	msrPositionRsp
locationError	SEQUENCE	
locErrorReason	ENUMERATED	gpsAssDataMissing
additionalAssistanceData	SEQUENCE	
gpsAssistanceData	OCTET STRING	Indicates missing assistance data elements

RRLP Assistance Data (Step 15a):

Information element	Type	Value/remark
ASN.1 encoded		
referenceNumber	Integer, 0 to 7	2
component	CHOICE	assistanceData
gps-AssistData	SEQUENCE	If the MS requested further assistance data in Step 15 (Option 2) that is available in the SS, SS shall send zero, one or more RRLP Assistance Data messages containing the requested assistance data from section 10.9. Each message shall contain a maximum of 242 octets.
moreAssDataToBeSent	ENUMERATED	1 or 0. If SS sends more than one RRLP assistance data delivery message the moreAssDataToBeSent field shall be set accordingly.

RRLP Assistance Data Ack (Step 15b):

Information element	Type	Value/remark
ASN.1 encoded		
referenceNumber	Integer, 0 to 7	2
component	CHOICE	assistanceDataAck

RRLP Measure Position Request (Step 15c):

Information element	Type	Value/remark
ASN.1 encoded		
referenceNumber	Integer, 0 to 7	2
component	CHOICE	msrPositionReq
methodType	CHOICE	msAssisted
positionMethod	ENUMERATED	gps
measureResponseTime	Integer 0 to 7	5
useMultipleSets	ENUMERATED	oneSet
gps-AssistData	SEQUENCE	May contain further assistance data from section 10.9 as requested by the MS in step 15 (Option 2).

70.8 Assisted GPS Mobile Originated Tests

70.8.1 Basic Self Location

70.8.1.1 Conformance requirements

- 1) The MS sends CM SERVICE REQUEST to network for call independent supplementary service.
- 2) The MS invokes self-location request by sending REGISTER message containing Facility IE LCS MO-LR with MOLR-TYPE set to locationEstimate.
- 3) The MS needs to interact with the network for each separate location request.
- 4) On receiving an RRLP MEASURE POSITION REQUEST message the MS tries to perform the requested location measurements. It sends the results in an RRLP MEASURE POSITION RESPONSE message.
- 5) The network returns an LCS result to the MS carrying location estimate requested by the MS in FACILITY message.

6) The MS shall terminate the dialogue by sending a RELEASE COMPLETE message.

References

3GPP TS 03.71, subclause 7.6.6.

3GPP TS 04.30, subclause 5.1.1.

3GPP TS 04.80 / 3GPP TS 24.080, subclauses 2.4, 2.5, 3.4 and 4.

70.8.1.2 Test Purpose

To verify that the MS invokes a self-location request by sending the network a REGISTER message containing the Facility IE LCS MO-LR. When the MS receives a FACILITY message containing a Facility IE MO-LR LCS result carrying the requested location estimate, it clears the transaction by sending a RELEASE COMPLETE message.

70.8.1.3 Method of Test

Initial Conditions

System Simulator (SS):

Serving Cell: default parameters

Satellite signals: default conditions.

Mobile Station (MS):

The MS is in MM-state "idle, updated" with valid TMSI and CSKN.

Specific PICS statements

-

PIXIT statements

-

Test Procedure

The MS invokes call independent supplementary service through a CM SERVICE REQUEST. The SS initiates authentication and ciphering. Then the MS invokes an MO-LR request.

The SS sends an RR APPLICATION INFORMATION message containing an RRLP Measure Position Request including assistance data.

Option 1: The MS then performs positioning measurements, and responds with an RR APPLICATION INFORMATION message containing an RRLP Measure Position Response.

Option 2: The MS may request additional assistance data by sending an RRLP Measure Position Response message containing a location error with IE LocErrorReason set to gpsAssDataMissing. If the MS requests additional assistance data that is available in the SS, then the SS provides the requested assistance data in zero, one or more RRLP Assistance Data delivery messages followed by an RRLP Measure Position Request message which may include further assistance data. If the MS requests additional assistance data and the entire requested assistance data is not available in the SS, then the SS repeats the RRLP Measure Position Request message without assistance data. The MS then performs positioning measurements, and responds with an RR APPLICATION INFORMATION message containing an RRLP Measure Position Response.

The SS responds with a FACILITY message containing an MO-LR result. When MS receives FACILITY message, it clears the transaction by sending a RELEASE COMPLETE message.

Maximum duration of the test

5 minutes.

Expected Sequence

Step	Direction	Message	Comments
1	MS		Initiate LCS MOLR Procedure (location estimation)
2	MS -> SS	CHANNEL REQUEST	establishment cause "Other procedures which can be completed with an SDCCH"
3	SS -> MS	IMMEDIATE ASSIGNMENT	
4	MS -> SS	CM SERVICE REQUEST	The CM service type IE indicates "Supplementary service activation". "mobile station classmark 2" includes settings for ES_IND.
5	MS->SS	CLASSMARK CHANGE	"mobile station classmark 2" includes settings for ES_IND. "mobile station classmark 3" includes settings for Positioning. The setting for positioning specifies Positioning Method capability and Positioning Method Support. In the position method support (5 bit field), Bit 3 is set to 1 (MS-Assisted GPS)
6	SS -> MS	AUTHENTICATION REQUEST	
7	MS -> SS	AUTHENTICATION RESPONSE	
8	SS -> MS	CIPHERING MODE COMMAND	
9	MS -> SS	CIPHERING MODE COMPLETE	
10	SS		SS starts ciphering
11	MS -> SS	REGISTER	Call Independent SS containing Facility IE with LCS-MOLR request with MOLR-Type set to locationEstimate
12	SS-> MS	RR APPLICATION INFORMATION	RRLP Measure Position Request
13	MS -> SS	RR APPLICATION INFORMATION	RRLP Measure Position Response: gps-MeasureInfo (Option 1) or locationError with gpsAssDataMissing (Option 2)
13a	SS -> MS	RR APPLICATION INFORMATION	RRLP Assistance Data. If the MS requested additional assistance data in step 13 that is available in the SS, then SS provides the requested data in zero, one or more RRLP Assistance Data delivery messages.
13b	MS -> SS	RR APPLICATION INFORMATION	RRLP assistanceDataAck. If the SS sent additional assistance data in step 13a, the MS acknowledges the received assistance data.
13c	SS-> MS	RR APPLICATION INFORMATION	RRLP Measure Position Request. If the MS requested additional assistance data in step 13 that is available in the SS, this message may include further assistance data.
13d	MS -> SS	RR APPLICATION INFORMATION	RRLP Measure Position Response. If the MS requested additional assistance data in step 13, this message contains gps-MeasureInfo.
14	SS -> MS	FACILITY	LCS MO-LR result message containing location estimate
15	MS -> SS	RELEASE COMPLETE	MS terminates the dialogue
16	SS -> MS	CHANNEL RELEASE	The main signalling link is released.

Specific Message Contents

REGISTER (Step 11):

Information element	Value/remark
Protocol Discriminator	Call Independent SS (1011)
Transaction Identifier	
Message Type	REGISTER (xx11 1011)
Facility	Invoke = LCS-MOLR LCS-MOLRArg Molr-Type -> locationEstimate
SS version indicator	Value 1 or above

RR APPLICATION INFORMATION

Information element	Value/remark
Protocol Discriminator	RR Management Protocol (0110)
Skip Indicator	
Message Type	Application Information Message type
APDU ID	APDU ID -> RRLP => 0000
APDU Flags	Bit1=0 -> Last or only segment Bit2=0 -> First or only segment Bit3=0 -> Command or Final Response Bit4=spare
APDU Data	2-N Byte → ASN.1 Coded Step 12 and 13c: RRLP Measure Position Request Step 13 and 13d: RRLP Measure Position Response Step 13a: RRLP Assistance Data Step 13b: RRLP Assistance Data Ack.

RRLP Measure Position Request (Step 12):

Information element	Type	Value/remark
ASN.1 encoded		
referenceNumber	Integer, 0 to 7	1
component	CHOICE	msrPositionReq
methodType	CHOICE	msAssisted
positionMethod	ENUMERATED	gps
measureResponseTime	Integer 0 to 7	5
useMultipleSets	ENUMERATED	oneSet
gps-AssistData	SEQUENCE	
referenceTime	SEQUENCE	See section 10.9.3
acquisAssist	SEQUENCE	See section 10.9.8

RRLP Measure Position Response (Step 13 (Option 1) or Step 13d (Option 2)):

Information element	Type	Value/remark
ASN.1 encoded		
referenceNumber	Integer, 0 to 7	1 or 2 (Option 2, Step 13d)
component	CHOICE	msrPositionResp (A valid response will contain gps-MeasureInfo otherwise locationError will be returned)
gps-MeasureInfo	SEQUENCE	Any value of the parameters is acceptable.
locationError	SEQUENCE	Any error value is acceptable except gpsAssDataMissing.

RRLP Measure Position Response (Step 13 (Option 2)):

Information element	Type	Value/remark
ASN.1 encoded		
referenceNumber	Integer,0 to 7	1
component	CHOICE	msrPositionRsp
locationError	SEQUENCE	
locErrorReason	ENUMERATED	gpsAssDataMissing
additionalAssistanceData	SEQUENCE	
gpsAssistanceData	OCTET STRING	Indicates missing assistance data elements

RRLP Assistance Data (Step 13a):

Information element	Type	Value/remark
ASN.1 encoded		
referenceNumber	Integer,0 to 7	2
component	CHOICE	assistanceData
gps-AssistData	SEQUENCE	If the MS requested further assistance data in Step 13 (Option 2) that is available in the SS, SS shall send zero, one or more RRLP Assistance Data messages containing the requested assistance data from section 10.9. Each message shall contain a maximum of 242 octets.
moreAssDataToBeSent	ENUMERATED	1 or 0. If SS sends more than one RRLP assistance data delivery message the moreAssDataToBeSent field shall be set accordingly.

RRLP Assistance Data Ack (Step 13b):

Information element	Type	Value/remark
ASN.1 encoded		
referenceNumber	Integer,0 to 7	2
component	CHOICE	assistanceDataAck

RRLP Measure Position Request (Step 13c):

Information element	Type	Value/remark
ASN.1 encoded		
referenceNumber	Integer, 0 to 7	2
component	CHOICE	msrPositionReq
methodType	CHOICE	msAssisted
positionMethod	ENUMERATED	gps
measureResponseTime	Integer 0 to 7	5
useMultipleSets	ENUMERATED	oneSet
gps-AssistData	SEQUENCE	May contain further assistance data from section 10.9 as requested by the MS in step 13 (Option 2).

FACILITY (Step 14):

Information element	Value/remark
Protocol Discriminator	Call Independent SS (1011)
Transaction Identifier	
Message Type	FACILITY (0011 1010)
Facility	Return Result = LCS-MOLR LCS-MOLRRes -> locationEstimate (Note)
Note:	Any value for locationEstimate may be used. The SS shall not be required to calculate the value from the returned gps-MeasureInfo values.

RELEASE COMPLETE (Step 15):

Information element	Value/remark
Protocol Discriminator	Call Independent SS (1011)
Transaction Identifier	
Message Type	RELEASE COMPLETE (xx10 1010)

70.8.2 Basic Self Location in Dedicated Mode

70.8.2.1 Conformance requirements

The MS sends a DTAP LCS MO-LR invoke to the VMSC. If the MS is requesting its own location or that its own location be sent to another LCS client, this message carries LCS QoS information (e.g. accuracy, response time).

The MS invokes a MO-LR by sending a REGISTER message to the network containing a LCS-MOLR invoke component with MO_LR TYPE set to LocationEstimate, LCS QoS value and other optional field if it is needed.

The MS shall terminate the dialogue by sending a RELEASE COMPLETE message.

References

3GPP TS 03.71, subclause 7.6.6.

3GPP TS 04.30, subclause 5.1.1.

3GPP TS 04.80 / 3GPP TS 24.080, subclauses 2.4, 2.5, 3.4 and 4.

70.8.2.2 Test Purpose

To verify that the MS invokes a self-location request by sending the network a REGISTER message containing the Facility IE LCS MO-LR on an already established speech call related main DCCH (FACCH). When the MS receives a FACILITY message containing a Facility IE MO-LR LCS result carrying the requested location estimate, it clears the transaction by sending a RELEASE COMPLETE message.

70.8.2.3 Method of Test

Initial Conditions

System Simulator (SS):

Serving Cell: default parameters

Satellite signals: default conditions.

Mobile Station (MS):

The MS has valid TMSI and CSKN.

The MS is brought into the state U10 by using table 26.8.1.2/3.

Specific PICS statements

-

PIXIT statements

-

Test Procedure

The MS invokes call independent supplementary service on an existing FACCH channel. After receiving a CM SERVICE ACCEPT message, the MS invokes a self-location request by sending a REGISTER message containing the Facility IE LCS MO-LR.

The SS sends an RR APPLICATION INFORMATION message containing an RRLP Measure Position Request including assistance data.

Option 1: The MS then performs positioning measurements, and responds with an RR APPLICATION INFORMATION message containing an RRLP Measure Position Response.

Option 2: The MS may request additional assistance data by sending an RRLP Measure Position Response message containing a location error with IE LocErrorReason set to gpsAssDataMissing. If the MS requests additional assistance data that is available in the SS, then the SS provides the requested assistance data in zero, one or more RRLP Assistance Data delivery messages followed by an RRLP Measure Position Request message which may include further assistance data. If the MS requests additional assistance data and the entire requested assistance data is not available in the SS, then the SS repeats the RRLP Measure Position Request message without assistance data. The MS then performs positioning measurements, and responds with an RR APPLICATION INFORMATION message containing an RRLP Measure Position Response.

The SS responds with a FACILITY message containing an MO-LR result. When the MS receives a FACILITY message, it clears the transaction by sending a RELEASE COMPLETE message.

Maximum duration of the test

5 minutes.

Expected Sequence

Step	Direction	Message	Comments
1	MS		Initiate LCS MOLR Procedure (location estimation) on existing FACCH channel
2	MS -> SS	CM SERVICE REQUEST	The CM Service Type IE indicates "Supplementary service activation". "mobile station classmark 2" includes settings for ES_IND.
3	SS -> MS	CM SERVICE ACCEPT	
4	MS -> SS	REGISTER	Call Independent SS containing Facility IE with LCS-MOLR request with MOLR-Type set to locationEstimate
5	SS-> MS	RR APPLICATION INFORMATION	RRLP Measure Position Request
6	MS -> SS	RR APPLICATION INFORMATION	RRLP Measure Position Response: gps-MeasureInfo (Option 1) or locationError with gpsAssDataMissing (Option 2)
6a	SS -> MS	RR APPLICATION INFORMATION	RRLP Assistance Data. If the MS requested additional assistance data in step 6 that is available in the SS, then SS provides the requested data in zero, one or more RRLP Assistance Data delivery messages.
6b	MS -> SS	RR APPLICATION INFORMATION	RRLP assistanceDataAck. If the SS sent additional assistance data in step 6a, the MS acknowledges the received assistance data.
6c	SS-> MS	RR APPLICATION INFORMATION	RRLP Measure Position Request. If the MS requested additional assistance data in step 6 that is available in the SS, this message may include further assistance data.
6d	MS -> SS	RR APPLICATION INFORMATION	RRLP Measure Position Response. If the MS requested additional assistance data in step 6, this message contains gps-MeasureInfo.
7	SS -> MS	FACILITY	LCS MO-LR result message containing location estimate
8	MS -> SS	RELEASE COMPLETE	MS terminates the dialogue
9	SS -> MS	CHANNEL RELEASE	The main signalling link is released.

Specific Message Contents

REGISTER (Step 4):

Information element	Value/remark
Protocol Discriminator	Call Independent SS (1011)
Transaction Identifier	
Message Type	REGISTER (xx11 1011)
Facility	Invoke = LCS-MOLR LCS-MOLRArg Molr-Type -> locationEstimate
SS version indicator	Value 1 or above

RR APPLICATION INFORMATION

Information element	Value/remark
Protocol Discriminator	RR Management Protocol (0110)
Skip Indicator	
Message Type	Application Information Message type
APDU ID	APDU ID -> RRLP => 0000
APDU Flags	Bit1=0 -> Last or only segment Bit2=0 -> First or only segment Bit3=0 -> Command or Final Response Bit4=spare
APDU Data	2-N Byte → ASN.1 Coded Step 5 and 6c: RRLP Measure Position Request Step 6 and 6d: RRLP Measure Position Response Step 6a: RRLP Assistance Data Step 6b: RRLP Assistance Data Ack.

RRLP Measure Position Request (Step 5):

Information element	Type	Value/remark
ASN.1 encoded		
referenceNumber	Integer, 0 to 7	1
component	CHOICE	msrPositionReq
methodType	CHOICE	msAssisted
positionMethod	ENUMERATED	gps
measureResponseTime	Integer 0 to 7	5
useMultipleSets	ENUMERATED	oneSet
gps-AssistData	SEQUENCE	
referenceTime	SEQUENCE	See section 10.9.3
acquisAssist	SEQUENCE	See section 10.9.8

RRLP Measure Position Response (Step 6 (Option 1) or Step 6d (Option 2)):

Information element	Type	Value/remark
ASN.1 encoded		
referenceNumber	Integer, 0 to 7	1 or 2 (Option 2, Step 6d)
component	CHOICE	msrPositionRsp (A valid response will contain gps-MeasureInfo otherwise locationError will be returned)
gps-MeasureInfo	SEQUENCE	Any value of the parameters is acceptable.
locationError	SEQUENCE	Any error value is acceptable except gpsAssDataMissing.

RRLP Measure Position Response (Step 6 (Option 2)):

Information element	Type	Value/remark
ASN.1 encoded		
referenceNumber	Integer, 0 to 7	1
component	CHOICE	msrPositionRsp
locationError	SEQUENCE	
locErrorReason	ENUMERATED	gpsAssDataMissing
additionalAssistanceData	SEQUENCE	
gpsAssistanceData	OCTET STRING	Indicates missing assistance data elements

RRLP Assistance Data (Step 6a):

Information element	Type	Value/remark
ASN.1 encoded		
referenceNumber	Integer, 0 to 7	2
component	CHOICE	assistanceData
gps-AssistData	SEQUENCE	If the MS requested further assistance data in Step 6 (Option 2) that is available in the SS, SS shall send zero, one or more RRLP Assistance Data messages containing the requested assistance data from section 10.9. Each message shall contain a maximum of 242 octets.
moreAssDataToBeSent	ENUMERATED	1 or 0. If SS sends more than one RRLP assistance data delivery message the moreAssDataToBeSent field shall be set accordingly.

RRLP Assistance Data Ack (Step 6b):

Information element	Type	Value/remark
ASN.1 encoded		
referenceNumber	Integer, 0 to 7	2
component	CHOICE	assistanceDataAck

RRLP Measure Position Request (Step 6c):

Information element	Type	Value/remark
ASN.1 encoded		
referenceNumber	Integer, 0 to 7	2
component	CHOICE	msrPositionReq
methodType	CHOICE	msAssisted
positionMethod	ENUMERATED	gps
measureResponseTime	Integer 0 to 7	5
useMultipleSets	ENUMERATED	oneSet
gps-AssistData	SEQUENCE	May contain further assistance data from section 10.9 as requested by the MS in step 6 (Option 2).

FACILITY (Step 7):

Information element	Value/remark
Protocol Discriminator	Call Independent SS (1011)
Transaction Identifier	
Message Type	FACILITY (0011 1010)
Facility	Return Result = LCS-MOLR LCS-MOLRRes -> locationEstimate (Note)
Note:	Any value for locationEstimate may be used. The SS shall not be required to calculate the value from the returned gps-MeasureInfo values.

RELEASE COMPLETE (Step 8):

Information element	Value/remark
Protocol Discriminator	Call Independent SS (1011)
Transaction Identifier	
Message Type	RELEASE COMPLETE (xx10 1010)

70.8.3 Transfer to 3rd Party

70.8.3.1 Conformance requirements

The MS sends a DTAP LCS MO-LR invoke to the VMSC. If the MS is requesting its own location or that its own location be sent to another LCS client, this message carries LCS QoS information (e.g. accuracy, response time). If the MS is requesting that its location be sent to another LCS client, the message shall include the identity of the LCS client and may include the address of the GMLC through which the LCS client should be accessed.

The MS invokes a MO-LR by sending a REGISTER message to the network containing a LCS-MOLR invoke component with MO_LR TYPE set to LocationEstimate, LCS QoS value, LCS-ClientExternalID and MLC_Number if it is available.

References

3GPP TS 03.71, subclause 7.6.6.

3GPP TS 04.30, subclause 5.1.1.

3GPP TS 04.80 / 3GPP TS 24.080, subclauses 2.4, 2.5, 3.4 and 4.

70.8.3.2 Test Purpose

To verify that the MS invokes a transfer of its own location to a 3rd party LCS Client by sending the network a REGISTER message containing the Facility IE LCS MO-LR with LCSCClientExternalID present. The network sends location information of the MS to another LCS Client, and then it clears the transaction by sending a RELEASE COMPLETE message.

70.8.3.3 Method of Test

Initial Conditions

System Simulator (SS):

Serving Cell: default parameters

Satellite signals: default conditions.

Mobile Station (MS):

The MS is in MM-state "idle, updated" with valid TMSI and CKSN.

Specific PICS statements

-

PIXIT statements

-

Test Procedure

The MS invokes call independent supplementary service for an LCS MO-LR. After receiving a CM SERVICE ACCEPT message, the MS invokes a transfer to 3rd party location request by sending a REGISTER message containing the Facility IE LCS MO-LR with LCSCClientExternalID present.

The SS sends an RR APPLICATION INFORMATION message containing an RRLP Measure Position Request including assistance data.

Option 1: The MS then performs positioning measurements, and responds with an RR APPLICATION INFORMATION message containing an RRLP Measure Position Response.

Option 2: The MS may request additional assistance data by sending an RRLP Measure Position Response message containing a location error with IE LocErrorReason set to gpsAssDataMissing. If the MS requests additional assistance data that is available in the SS, then the SS provides the requested assistance data in zero, one or more RRLP Assistance Data delivery messages followed by an RRLP Measure Position Request message which may include further assistance data. If the MS requests additional assistance data and the entire requested assistance data is not available in the SS, then the SS repeats the RRLP Measure Position Request message without assistance data. The MS then performs positioning measurements, and responds with an RR APPLICATION INFORMATION message containing an RRLP Measure Position Response.

The SS sends location information of the MS to another LCS Client, and then it clears the transaction by sending a RELEASE COMPLETE message.

Maximum duration of the test

5 minutes.

Expected Sequence

Step	Direction	Message	Comments
1	MS		Initiate LCS MOLR Procedure (location estimation) with transfer to 3 rd party
2	MS -> SS	CHANNEL REQUEST	Establishment cause indicates, "Other procedures which can be completed with an SDCCH"
3	SS -> MS	IMMEDIATE ASSIGNMENT	
4	MS -> SS	CM SERVICE REQUEST	The CM Service Type IE indicates "Supplementary service activation" "mobile station classmark 2" includes settings for ES_IND.
5	MS->SS	CLASSMARK CHANGE	"mobile station classmark 2" includes settings for ES_IND. "mobile station classmark 3" includes settings for Positioning. The setting for positioning specifies Positioning Method capability and Positioning Method Support. In the position method support (5 bit field), Bit 3 is set to 1 (MS-Assisted GPS)
6	SS -> MS	AUTHENTICATION REQUEST	
7	MS -> SS	AUTHENTICATION RESPONSE	SRES specifies correct value.
8	SS -> MS	CIPHERING MODE COMMAND	SS starts deciphering after sending the message.
9	MS -> SS	CIPHERING MODE COMPLETE	Shall be sent enciphered. All following messages shall be sent enciphered.
10	MS -> SS	REGISTER	Call Independent SS containing Facility IE with LCS-MOLR request with MOLR-Type set to locationEstimate with LCSCClientExternalID present
11	SS-> MS	RR APPLICATION INFORMATION	RRLP Measure Position Request
12	MS -> SS	RR APPLICATION INFORMATION	RRLP Measure Position Response: gps-MeasureInfo (Option 1) or locationError with gpsAssDataMissing (Option 2)
12a	SS -> MS	RR APPLICATION INFORMATION	RRLP Assistance Data. If the MS requested additional assistance data in step 12 that is available in the SS, then SS provides the requested data in zero, one or more RRLP Assistance Data delivery messages.
12b	MS -> SS	RR APPLICATION INFORMATION	RRLP assistanceDataAck. If the SS sent additional assistance data in step 12a, the MS acknowledges the received assistance data.
12c	SS-> MS	RR APPLICATION INFORMATION	RRLP Measure Position Request. If the MS requested additional assistance data in step 12 that is available in the SS, this message may include further assistance data.
12d	MS -> SS	RR APPLICATION INFORMATION	RRLP Measure Position Response. If the MS requested additional assistance data in step 12, this message contains gps-MeasureInfo.
13	SS		SS may return the location estimate result to the LCS Client as identified by the LCSCClientExternalID provided in the REGISTER message

14	SS -> MS	FACILITY	LCS MO-LR Return Result message as confirmation that the position estimate was transferred to the requested LCS client.
15	MS -> SS	RELEASE COMPLETE	MS terminates the dialogue
16	SS -> MS	CHANNEL RELEASE	The main signalling link is released.

Specific Message Contents

REGISTER (Step 10):

Information element	Value/remark
Protocol Discriminator	Call Independent SS (1011)
Transaction Identifier	
Message Type	REGISTER (xx11 1011)
Facility	Invoke = LCS-MOLR LCS-MOLRArg Molr-Type -> locationEstimate lcsClientExternalID -> externalAddress
SS version indicator	Value 1 or higher

RR APPLICATION INFORMATION

Information element	Value/remark
Protocol Discriminator	RR Management Protocol (0110)
Skip Indicator	
Message Type	Application Information Message type
APDU ID	APDU ID -> RRLP => 0000
APDU Flags	Bit1=0 -> Last or only segment Bit2=0 -> First or only segment Bit3=0 -> Command or Final Response Bit4=spare
APDU Data	2-N Byte -> ASN.1 Coded Step 11 and 12c: RRLP Measure Position Request Step 12 and 12d: RRLP Measure Position Response Step 12a: RRLP Assistance Data Step 12b: RRLP Assistance Data Ack.

RRLP Measure Position Request (Step 11):

Information element	Type	Value/remark
ASN.1 encoded		
referenceNumber	Integer, 0 to 7	1
component	CHOICE	msrPositionReq
methodType	CHOICE	msAssisted
positionMethod	ENUMERATED	gps
measureResponseTime	Integer 0 to 7	5
useMultipleSets	ENUMERATED	oneSet
gps-AssistData	SEQUENCE	
referenceTime	SEQUENCE	See section 10.9.3
acquisAssist	SEQUENCE	See section 10.9.8

RRLP Measure Position Response (Step 12 (Option 1) or Step 12d (Option 2)):

Information element	Type	Value/remark
ASN.1 encoded		
referenceNumber	Integer,0 to 7	1 or 2 (Option 2, Step 12d)
component	CHOICE	msrPositionRsp (A valid response will contain gps-MeasureInfo otherwise locationError will be returned)
gps-MeasureInfo	SEQUENCE	Any value of the parameters is acceptable.
locationError	SEQUENCE	Any error value is acceptable except gpsAssDataMissing.

RRLP Measure Position Response (Step 12 (Option 2)):

Information element	Type	Value/remark
ASN.1 encoded		
referenceNumber	Integer,0 to 7	1
component	CHOICE	msrPositionRsp
locationError	SEQUENCE	
locErrorReason	ENUMERATED	gpsAssDataMissing
additionalAssistanceData	SEQUENCE	
gpsAssistanceData	OCTET STRING	Indicates missing assistance data elements

RRLP Assistance Data (Step 12a):

Information element	Type	Value/remark
ASN.1 encoded		
referenceNumber	Integer,0 to 7	2
component	CHOICE	assistanceData
gps-AssistData	SEQUENCE	If the MS requested further assistance data in Step 12 (Option 2) that is available in the SS, SS shall send zero, one or more RRLP Assistance Data messages containing the requested assistance data from section 10.9. Each message shall contain a maximum of 242 octets.
moreAssDataToBeSent	ENUMERATED	1 or 0. If SS sends more than one RRLP assistance data delivery message the moreAssDataToBeSent field shall be set accordingly.

RRLP Assistance Data Ack (Step 12b):

Information element	Type	Value/remark
ASN.1 encoded		
referenceNumber	Integer,0 to 7	2
component	CHOICE	assistanceDataAck

RRLP Measure Position Request (Step 12c):

Information element	Type	Value/remark
ASN.1 encoded		
referenceNumber	Integer, 0 to 7	2
component	CHOICE	msrPositionReq
methodType	CHOICE	msAssisted
positionMethod	ENUMERATED	gps
measureResponseTime	Integer 0 to 7	5
useMultipleSets	ENUMERATED	oneSet
gps-AssistData	SEQUENCE	May contain further assistance data from section 10.9 as requested by the MS in step 12 (Option 2).

FACILITY (Step 14):

Information element	Value/remark
Protocol Discriminator	Call Independent SS (1011)
Transaction Identifier	
Message Type	FACILITY (0011 1010)
Facility	Return Result = LCS-MOLR LCS-MOLRRes -> locationEstimate (Note)
Note:	Any value for locationEstimate may be used. The SS shall not be required to calculate the value from the returned gps-MeasureInfo values.

RELEASE COMPLETE (Step 15):

Information element	Value/remark
Protocol Discriminator	Call Independent SS (1011)
Transaction Identifier	
Message Type	RELEASE COMPLETE (xx10 1010)

70.8.4 MO-LR Positioning Measurement

70.8.4.1 MO-LR Positioning Measurement / Protocol Error

70.8.4.1.1 Conformance requirement:

The MS sends a DTAP LCS MOLR invoke to VMSC. If the MS is requesting its own location or that its own location be sent to another LCS client, this message carries LCS QoS information (e.g. accuracy, response time).

The MS invokes a MO-LR by sending a REGISTER message to network containing a LCS-MOLR invoke component with MO-LR TYPE set to LocationEstimate, LCS QoS value and other optional field if it is needed.

The MS sends a RRLP PROTOCOL ERROR message to network if there is a problem that prevents the MS to receive a complete and understandable RRLP MEASURE POSITION REQUEST component.

The MS shall terminate the dialogue by sending a RELEASE COMPLETE message.

Test References

3GPP TS 03.71 subclause 7.6.6

3GPP TS 04.30 subclause 5.1.1

3GPP TS04.31 subclause 2.2, 2.5

3GPP TS 04.80 / 3GPP TS 24.080 subclause 2.4, 2.5, 3.4 & 4

70.8.4.1.2 Test Purpose

Verifies that a MS sends a correct positioning capability via control classmark sending. The MS shall send a RRLP PROTOCOL ERROR message to SS with specific error code if RRLP MEASURE POSITION REQUEST is incomplete. On receipt of second RRLP MEASURE POSITION REQUEST from SS to start the measurement, MS shall send back RRLP MEASURE POSITION RESPONSE to SS after finishing the measurement.

70.8.4.1.3 Method of Test

Initial Conditions:

System Simulator:

Serving Cell: default parameters.

Satellite signals: default conditions.

Mobile Station:

The MS is MM-state "idle, updated" with valid TMSI and CKSN.

Specific PICS statements

-

PIXIT statements

-

Test Procedure:

A MOLR procedure as call independent supplementary services is initiated from the MS. The MS performs control early classmark sending to provide LCS positioning method capability. After sending the CIPHERING MODE COMPLETE message the MS sends a REGISTER message with Facility IE containing a component set to a DTAP LCS-MOLR Invoke.

The SS determines the positioning method and instigates the particular message sequence by sending RRLP MEASURE POSITION REQUEST with missing information element. The MS shall send RRLP PROTOCOL ERROR as it fails to decode RRLP MEASURE POSITION REQUEST. The SS repeats RRLP MEASURE POSITION REQUEST with correct message contents including assistance data.

Option 1: The MS then performs positioning measurements, and responds with an RR APPLICATION INFORMATION message containing an RRLP Measure Position Response.

Option 2: The MS may request additional assistance data by sending an RRLP Measure Position Response message containing a location error with IE LocErrorReason set to gpsAssDataMissing. If the MS requests additional assistance data that is available in the SS, then the SS provides the requested assistance data in zero, one or more RRLP Assistance Data delivery messages followed by an RRLP Measure Position Request message which may include further assistance data. If the MS requests additional assistance data and the entire requested assistance data is not available in the SS, then the SS repeats the RRLP Measure Position Request message without assistance data. The MS then performs positioning measurements, and responds with an RR APPLICATION INFORMATION message containing an RRLP Measure Position Response.

The SS returns location estimate to MS through DTAP LCS-MOLR Return Result. The MS terminates the dialogue by sending RELEASE COMPLETE message after receiving location estimate.

Maximum duration of the test:

5 minutes.

Expected Sequence

Step	Direction	Message	Comments
1	MS		Initiate MOLR Procedure (location estimate)
2	MS -> SS	CHANNEL REQUEST	Establishment cause indicates "Other procedures which can be completed with an SDCCH".
3	SS -> MS	IMMEDIATE ASSIGNMENT	
4	MS -> SS	CM SERVICE REQUEST	Message is contained in SABM "Mobile identity" IE contains the TMSI. The CM Service Type IE indicates "Supplementary service activation" "mobile station classmark 2" including settings for ES IND and CM3 supported.
5	MS -> SS	CLASSMARK CHANGE	"mobile station classmark 2" including settings for ES IND and CM3 supported. "mobile station classmark 3" includes settings for Positioning according to 3GPP TS 24.008, table 10.5.1.7.
6	SS -> MS	AUTHENTICATION REQUEST	
7	MS -> SS	AUTHENTICATION RESP	SRES specifies correct value.
8	SS -> MS	CIPHERING MODE COMMAND	SS starts deciphering after sending the message.
9	MS -> SS	CIPHERING MODE COMPLETE	Shall be sent enciphered. All following messages shall be sent enciphered.
10	MS -> SS	REGISTER	Call Independent SS containing Facility IE With the component of Invoke message set to LCS-MOLR request with MOLR-Type set to locationEstimate
11	SS -> MS	RR APPLICATION INFORMATION	RRLP MEASURE POSITION REQUEST 1 (with missing final octet)
12	MS->SS	RR APPLICATION INFORMATION	RRLP PROTOCOL ERROR
13	SS-> MS	RR APPLICATION INFORMATION	RRLP Measure Position Request 2
14	MS -> SS	RR APPLICATION INFORMATION	RRLP Measure Position Response: gps-MeasureInfo (Option 1) or locationError with gpsAssDataMissing (Option 2)
14a	SS -> MS	RR APPLICATION INFORMATION	RRLP Assistance Data. If the MS requested additional assistance data in step 14 that is available in the SS, then SS provides the requested data in zero, one or more RRLP Assistance Data delivery messages.
14b	MS -> SS	RR APPLICATION INFORMATION	RRLP assistanceDataAck. If the SS sent additional assistance data in step 14a, the MS acknowledges the received assistance data.
14c	SS-> MS	RR APPLICATION INFORMATION	RRLP Measure Position Request. If the MS requested additional assistance data in step 14 that is available in the SS, this message may include further assistance data.
14d	MS -> SS	RR APPLICATION INFORMATION	RRLP Measure Position Response. If the MS requested additional assistance data in step 14, this message contains gps-MeasureInfo.
15	SS -> MS	FACILITY	LCS MO-LR RETURN RESULT (locationEstimate)
16	MS -> SS	RELEASE COMPLETE	Terminates the session
17	SS -> MS	CHANNEL RELEASE	The main signalling link is released.

Specific Message Contents

REGISTER (Step 10):

Information element	Value/remark
Protocol Discriminator	Call Independent SS (1011)
Transaction Identifier	
Message Type	REGISTER (xx11 1011)
Facility	Invoke = LCS-MOLR LCS-MOLRArg Molr-Type -> locationEstimate
SS version indicator	Value 1 or above

RR_APPLICATION_INFORMATION

Information element	Value/remark
Protocol Discriminator	RR Management Protocol (0110)
Skip Indicator	
Message Type	Application Information Message type
APDU ID	APDU ID -> RRLP => 0000
APDU Flags	Bit1=0 -> Last or only segment Bit2=0 -> First or only segment Bit3=0 -> Command or Final Response Bit4=spare
APDU Data	2-N Byte -> ASN.1 Coded Step 11, 13 and 14c: RRLP Measure Position Request Step 14 and 14d: RRLP Measure Position Response Step 14a: RRLP Assistance Data Step 14b: RRLP Assistance Data Ack Step 12: RRLP Protocol Error

RRLP Measure Position Request 1 (Step 11):

Information element	Type	Value/remark
ASN.1 encoded		0x2001B0
referenceNumber	Integer,0 to 7	1
component	CHOICE	msrPositionReq
methodType	ENUMERATED	msAssisted
positionMethod	ENUMERATED	gps
measureResponseTime	Integer 0 to 7	5
useMultipleSets	ENUMERATED	oneSet
Note:	Final octet of ASN.1 stream is not included in the APDU Data information element of the RR Application Information L3 message.	

RRLP Protocol Error (Step 12):

Information element	Type	Value/remark
ASN.1 encoded		
referenceNumber	Integer,0 to 7	0 or 1
component	CHOICE	protocolError
errorCause	ENUMERATED	missingIEorComponentElement messageTooShort or Incorrect Data

RRLP Measure Position Request 2 (Step 13):

Information element	Type	Value/remark
ASN.1 encoded		
referenceNumber	Integer, 0 to 7	2
component	CHOICE	msrPositionReq
methodType	CHOICE	msAssisted
positionMethod	ENUMERATED	gps
measureResponseTime	Integer 0 to 7	5
useMultipleSets	ENUMERATED	oneSet
gps-AssistData	SEQUENCE	
referenceTime	SEQUENCE	See section 10.9.3
acquisAssist	SEQUENCE	See section 10.9.8

RRLP Measure Position Response (Step 14 (Option 1) or Step 14d (Option 2)):

Information element	Type	Value/remark
ASN.1 encoded		
referenceNumber	Integer, 0 to 7	2 or 3 (Option 2, Step 14d)
component	CHOICE	msrPositionRsp (A valid response will contain gps-MeasureInfo otherwise locationError will be returned)
gps-MeasureInfo	SEQUENCE	Any value of the parameters is acceptable.
locationError	SEQUENCE	Any error value is acceptable except gpsAssDataMissing.

RRLP Measure Position Response (Step 14 (Option 2)):

Information element	Type	Value/remark
ASN.1 encoded		
referenceNumber	Integer, 0 to 7	2
component	CHOICE	msrPositionRsp
locationError	SEQUENCE	
locErrorReason	ENUMERATED	gpsAssDataMissing
additionalAssistanceData	SEQUENCE	
gpsAssistanceData	OCTET STRING	Indicates missing assistance data elements

RRLP Assistance Data (Step 14a):

Information element	Type	Value/remark
ASN.1 encoded		
referenceNumber	Integer, 0 to 7	3
component	CHOICE	assistanceData
gps-AssistData	SEQUENCE	If the MS requested further assistance data in Step 14 (Option 2) that is available in the SS, SS shall send zero, one or more RRLP Assistance Data messages containing the requested assistance data from section 10.9. Each message shall contain a maximum of 242 octets.
moreAssDataToBeSent	ENUMERATED	1 or 0. If SS sends more than one RRLP assistance data delivery message the moreAssDataToBeSent field shall be set accordingly.

RRLP Assistance Data Ack (Step 14b):

Information element	Type	Value/remark
ASN.1 encoded		
referenceNumber	Integer, 0 to 7	3
component	CHOICE	assistanceDataAck

RRLP Measure Position Request (Step 14c):

Information element	Type	Value/remark
ASN.1 encoded		
referenceNumber	Integer, 0 to 7	3
component	CHOICE	msrPositionReq
methodType	CHOICE	msAssisted
positionMethod	ENUMERATED	gps
measureResponseTime	Integer 0 to 7	5
useMultipleSets	ENUMERATED	oneSet
gps-AssistData	SEQUENCE	May contain further assistance data from section 10.9 as requested by the MS in step 14 (Option 2).

FACILITY (Step 15):

Information element	Value/remark
Protocol Discriminator	Call Independent SS message (1011)
Transaction Identifier Message Type Facility	FACILITY (0011 1010) Return Result = LCS-MOLR LCS-MOLRRes ->locationEstimate (Note)
Note:	Any value for locationEstimate may be used. The SS shall not be required to calculate the value from the returned gps-MeasureInfo values.

RELEASE COMPLETE (Step 16):

Information element	Value/remark
Protocol Discriminator	Call Independent SS (1011)
Transaction Identifier	
Message Type	RELEASE COMPLETE (xx10 1010)

70.8.4.2 MO-LR Positioning Measurement / Location Error

70.8.4.2.1 Location Error: Requested Method not Supported

70.8.4.2.1.1 Conformance requirement:

The MS sends a DTAP LCS MOLR invoke to VMSC. If the MS is requesting its own location or that its own location be sent to another LCS client, this message carries LCS QoS information (e.g. accuracy, response time).

The MS invokes a MO-LR by sending a REGISTER message to network containing a LCS-MOLR invoke component with MO-LR TYPE set to LocationEstimate, LCS QoS value and other optional field if it is needed.

The MS sends a RRLP MEASURE POSITION RESPONSE to network containing a Location Error component with an error indication if the measurement is not possible.

The MS shall terminate the dialogue by sending a RELEASE COMPLETE message.

Test References:

3GPP TS 03.71 subclause 7.6.6

3GPP TS 04.30 subclause 5.1.1

3GPP TS04.31 subclause 2.2

3GPP TS 04.80 / 3GPP TS 24.080 subclause 2.4, 2.5, 3.4 and 4

70.8.4.2.1.2 Test Purpose:

Verifies that a MS sends a correct positioning capability via control classmark sending. MS shall send back RRLP MEASURE POSITION RESPONSE message with Location Error component if the MS does not support the requested method. On receipt of second RRLP MEASURE POSITION REQUEST from SS to start the measurement, the MS shall send back RRLP MEASURE POSITION RESPONSE to SS after finishing the measurement.

70.8.4.2.1.3 Method of Test

Initial Conditions:

System Simulator:

Serving Cell: default parameters.

Satellite signals: default conditions.

Mobile Station:

The MS is MM-state "idle, updated" with valid TMSI and CKSN.

Specific PICS statements

-

PIXIT statements

-

Test Procedure:

A MOLR procedure as call independent supplementary services is initiated from the MS. The MS performs control early classmark sending to provide LCS positioning method capability. After sending the CIPHERING MODE COMPLETE message the MS sends a REGISTER message with Facility IE containing a component set to a DTAP LCS-MOLR Invoke. The SS determines the positioning method and instigates the particular message sequence by sending RRLP MEASURE POSITION REQUEST with a method type not supported by the mobile. (Type not supported to be EOTD).

The MS sends RRLP MEASURE POSITION RESPONSE to SS containing a Location Error component (Request Method not Supported) as the requested method is not supported. The SS repeats RRLP MEASURE POSITION REQUEST with correct message contents including assistance data.

Option 1: The MS then performs positioning measurements, and responds with an RR APPLICATION INFORMATION message containing an RRLP Measure Position Response.

Option 2: The MS may request additional assistance data by sending an RRLP Measure Position Response message containing a location error with IE LocErrorReason set to gpsAssDataMissing. If the MS requests additional assistance data that is available in the SS, then the SS provides the requested assistance data in zero, one or more RRLP Assistance Data delivery messages followed by an RRLP Measure Position Request message which may include further assistance data. If the MS requests additional assistance data and the entire requested assistance data is not available in the SS, then the SS repeats the RRLP Measure Position Request message without assistance data. The MS then performs positioning measurements, and responds with an RR APPLICATION INFORMATION message containing an RRLP Measure Position Response.

The SS returns location estimate to MS through LCS-MOLR Return Result. The MS terminates the dialogue by sending RELEASE COMPLETE message after receiving location estimate.

Maximum duration of the test:

5 minutes.

Expected Sequence

Step	Direction	Message	Comments
1	MS		Initiate MOLR Procedure (location estimate)
2	MS -> SS	CHANNEL REQUEST	Establishment cause indicates "Other procedures which can be completed with an SDCCH"
3	SS -> MS	IMMEDIATE ASSIGNMENT	
4	MS -> SS	CM SERVICE REQUEST	Message is contained in SABM "Mobile identity" IE contains the TMSI. The CM Service Type IE indicates "Supplementary service activation" "mobile station classmark 2" including settings for ES IND and CM3 supported.
5	MS -> SS	CLASSMARK CHANGE	"mobile station classmark 2" including settings for ES IND and CM3 supported. "mobile station classmark 3" includes settings for Positioning according to 3GPP TS 24.008, table 10.5.1.7.
6	SS -> MS	AUTHENTICATION REQUEST	
7	MS -> SS	AUTHENTICATION RESP	SRES specifies correct value.
8	SS -> MS	CIPHERING MODE COMMAND	SS starts deciphering after sending the message.
9	MS -> SS	CIPHERING MODE COMPLETE	Shall be sent enciphered. All following messages shall be sent enciphered.
10	MS -> SS	REGISTER	Call Independent SS containing Facility IE With the component of Invoke message set to LCS-MOLR request with MOLR-Type set to locationEstimate
11	SS -> MS	RR APPLICATION INFORMATION	RRLP MEASURE POSITION REQUEST 1 (Request method not supported)
12	MS->SS	RR APPLICATION INFORMATION	RRLP MEASURE POSITION RESPONSE 1 (location_error)
13	SS-> MS	RR APPLICATION INFORMATION	RRLP Measure Position Request 2
14	MS -> SS	RR APPLICATION INFORMATION	RRLP Measure Position Response 2: gps-MeasureInfo (Option 1) or locationError with gpsAssDataMissing (Option 2)
14a	SS -> MS	RR APPLICATION INFORMATION	RRLP Assistance Data. If the MS requested additional assistance data in step 14 that is available in the SS, then SS provides the requested data in zero, one or more RRLP Assistance Data delivery messages.
14b	MS -> SS	RR APPLICATION INFORMATION	RRLP assistanceDataAck. If the SS sent additional assistance data in step 14a, the MS acknowledges the received assistance data.
14c	SS-> MS	RR APPLICATION INFORMATION	RRLP Measure Position Request. If the MS requested additional assistance data in step 14 that is available in the SS, this message may include further assistance data.
14d	MS -> SS	RR APPLICATION INFORMATION	RRLP Measure Position Response. If the MS requested additional assistance data in step 14, this message contains gps-MeasureInfo.
15	SS -> MS	FACILITY	LCS MO-LR RETURN RESULT (locationEstimate)
16	MS -> SS	RELEASE COMPLETE	Terminates the session
17	SS -> MS	CHANNEL RELEASE	The main signalling link is released.

Specific Message Contents

REGISTER (Step 10):

Information element	Value/remark
Protocol Discriminator	Call Independent SS (1011)
Transaction Identifier	
Message Type	REGISTER (xx11 1011)
Facility	Invoke = LCS-MOLR LCS-MOLRArg Molr-Type -> locationEstimate
SS version indicator	Value 1 or above

RR_APPLICATION_INFORMATION:

Information element	Value/remark
Protocol Discriminator	RR Management Protocol (0110)
Skip Indicator	
Message Type	Application Information Message type
APDU ID	APDU ID -> RRLP => 0000
APDU Flags	Bit1=0 -> Last or only segment Bit2=0 -> First or only segment Bit3=0 -> Command or Final Response Bit4=spare
APDU Data	2-N Byte -> ASN.1 Coded Step 11, 13 and 14c: RRLP Measure Position Request Step 12, 14 and 14d: RRLP Measure Position Response Step 14a: RRLP Assistance Data Step 14b: RRLP Assistance Data Ack.

RRLP Measure Position Request 1 (Step 11):

Information element	Type	Value/remark
ASN.1 encoded		
ReferenceNumber	Integer 0 to 7	1
component	CHOICE	msrPositionReq
methodType	CHOICE	msAssisted
positionMethod	ENUMERATED	eotd
measureResponseTime	Integer 0 to 7	7
useMultipleSets	ENUMERATED	oneSet

RRLP Measure Position Response 1 (Step 12):

Information element	Type	Value/remark
ASN.1 encoded		
referenceNumber	Integer,0 to 7	1
component	CHOICE	msrPositionRes
locationError	SEQUENCE	
locErrorReason	ENUMERATED	methodNotSupported

RRLP Measure Position Request 2 (Step 13):

Information element	Type	Value/remark
ASN.1 encoded		
referenceNumber	Integer, 0 to 7	2
component	CHOICE	msrPositionReq
methodType	CHOICE	msAssisted
positionMethod	ENUMERATED	gps
measureResponseTime	Integer 0 to 7	5
useMultipleSets	ENUMERATED	oneSet
gps-AssistData	SEQUENCE	
referenceTime	SEQUENCE	See section 10.9.3
acquisAssist	SEQUENCE	See section 10.9.8

RRLP Measure Position Response 2 (Step 14 (Option 1) or Step 14d (Option 2)):

Information element	Type	Value/remark
ASN.1 encoded		
referenceNumber	Integer, 0 to 7	2 or 3 (Option 2, Step 14d)
component	CHOICE	msrPositionRsp (A valid response will contain gps-MeasureInfo otherwise locationError will be returned)
gps-MeasureInfo	SEQUENCE	Any value of the parameters is acceptable.
locationError	SEQUENCE	Any error value is acceptable except gpsAssDataMissing.

RRLP Measure Position Response (Step 14 (Option 2)):

Information element	Type	Value/remark
ASN.1 encoded		
referenceNumber	Integer, 0 to 7	2
component	CHOICE	msrPositionRsp
locationError	SEQUENCE	
locErrorReason	ENUMERATED	gpsAssDataMissing
additionalAssistanceData	SEQUENCE	
gpsAssistanceData	OCTET STRING	Indicates missing assistance data elements

RRLP Assistance Data (Step 14a):

Information element	Type	Value/remark
ASN.1 encoded		
referenceNumber	Integer, 0 to 7	3
component	CHOICE	assistanceData
gps-AssistData	SEQUENCE	If the MS requested further assistance data in Step 14 (Option 2) that is available in the SS, SS shall send zero, one or more RRLP Assistance Data messages containing the requested assistance data from section 10.9. Each message shall contain a maximum of 242 octets.
moreAssDataToBeSent	ENUMERATED	1 or 0. If SS sends more than one RRLP assistance data delivery message the moreAssDataToBeSent field shall be set accordingly.

RRLP Assistance Data Ack (Step 14b):

Information element	Type	Value/remark
ASN.1 encoded		
referenceNumber	Integer, 0 to 7	3
component	CHOICE	assistanceDataAck

RRLP Measure Position Request (Step 14c):

Information element	Type	Value/remark
ASN.1 encoded		
referenceNumber	Integer, 0 to 7	3
component	CHOICE	msrPositionReq
methodType	CHOICE	msAssisted
positionMethod	ENUMERATED	gps
measureResponseTime	Integer 0 to 7	5
useMultipleSets	ENUMERATED	oneSet
gps-AssistData	SEQUENCE	May contain further assistance data from section 10.9 as requested by the MS in step 14 (Option 2).

FACILITY (Step 15):

Information element	Value/remark
Protocol Discriminator	Call Independent SS message (1011)
Transaction Identifier Message Type Facility	FACILITY (0011 1010) Return Result = LCS-MOLR LCS-MOLRRes ->locationEstimate (Note)
Note:	Any value for locationEstimate may be used. The SS shall not be required to calculate the value from the returned gps-MeasureInfo values.

RELEASE COMPLETE (Step 16):

Information element	Value/remark
Protocol Discriminator	Call Independent SS (1011)
Transaction Identifier	
Message Type	RELEASE COMPLETE (xx10 1010)

70.8.4.2.2 Location Error: GPS Assistance Data Missing

70.8.4.2.2.1 Conformance requirement:

The MS sends a DTAP LCS MOLR invoke to VMSC. If the MS is requesting its own location or that its own location be sent to another LCS client, this message carries LCS QoS information (e.g. accuracy, response time).

The MS invokes a MO-LR by sending a REGISTER message to network containing a LCS-MOLR invoke component with MO-LR TYPE set to LocationEstimate, LCS QoS value and other optional field if it is needed.

The MS sends a RRLP MEASURE POSITION RESPONSE to network containing a Location Error component with an error indication if the measurement is not possible.

The MS shall terminate the dialogue by sending a RELEASE COMPLETE message.

Test References:

3GPP TS 03.71 subclause 7.6.6

3GPP TS 04.30 subclause 5.1.1

3GPP TS 04.31 subclause 2.2

3GPP TS 04.80 / 3GPP TS 24.080 subclause 2.4, 2.5, 3.4 & 4

70.8.4.2.2.2 Test Purpose:

Verifies that a MS sends a correct positioning capability via control classmark sending. MS shall send back RRLP MEASURE POSITION RESPONSE message with Location Error component if GPS assistance data is missing. On receipt of second RRLP MEASURE POSITION REQUEST (with GPS assistance data included) from SS to start the measurement, the MS shall send back RRLP MEASURE POSITION RESPONSE to SS after finishing the measurement.

70.8.4.2.2.3 Method of Test

Initial Conditions:

System Simulator:

Serving Cell: default parameters.

Satellite signals: default conditions.

Mobile Station:

The MS is MM-state "idle, updated" with valid TMSI and CKSN.

Specific PICS statements

-

PIXIT statements

-

Test Procedure:

The A-GPS assistance data stored in the MS is reset.

A MOLR procedure as call independent supplementary services is initiated from the MS. The MS performs control early classmark sending to provide LCS positioning method capability. After sending the CIPHERING MODE COMPLETE message the MS sends a REGISTER message with Facility IE containing a component set to a DTAP LCS-MOLR Invoke.

The SS determines the positioning method and instigates the particular message sequence by sending RRLP MEASURE POSITION REQUEST without GPS assistance data.

The MS requests additional assistance data by sending an RRLP Measure Position Response message containing a location error with IE LocErrorReason set to gpsAssDataMissing. The SS provides the requested assistance data that is available in the SS in zero, one or more RRLP Assistance Data delivery messages followed by an RRLP Measure Position Request message which may include further assistance data.

The MS then performs positioning measurements, and responds with an RR APPLICATION INFORMATION message containing an RRLP Measure Position Response.

The SS returns location estimate to MS through LCS-MOLR Return Result. The MS terminates the dialogue by sending RELEASE COMPLETE message after receiving location estimate.

Maximum duration of the test:

5 minutes.

Expected Sequence

Step	Direction	Message	Comments
1	MS		Reset all stored A-GPS assistance data
2	MS		Initiate MOLR Procedure (location estimate)
3	MS -> SS	CHANNEL REQUEST	Establishment cause indicates "Other procedures which can be completed with an SDCCH".
4	SS -> MS	IMMEDIATE ASSIGNMENT	
5	MS -> SS	CM SERVICE REQUEST	Message is contained in SABM "Mobile identity" IE contains the TMSI. The CM Service Type IE indicates "Supplementary service activation" "mobile station classmark 2" including settings for ES IND and CM3 supported.
6	MS -> SS	CLASSMARK CHANGE	"mobile station classmark 2" including settings for ES IND and CM3 supported. "mobile station classmark 3" includes settings for Positioning according to 3GPP TS 24.008, table 10.5.1.7.
7	SS -> MS	AUTHENTICATION REQUEST	
8	MS -> SS	AUTHENTICATION RESP	SRES specifies correct value.
9	SS -> MS	CIPHERING MODE COMMAND	SS starts deciphering after sending the message.
10	MS -> SS	CIPHERING MODE COMPLETE	Shall be sent enciphered. All following messages shall be sent enciphered.
11	MS -> SS	REGISTER	Call Independent SS containing Facility IE With the component of Invoke message set to LCS-MOLR request with MOLR-Type set to locationEstimate
12	SS -> MS	RR APPLICATION INFORMATION	RRLP MEASURE POSITION REQUEST 1 (without GPS assistance data)
13	MS -> SS	RR APPLICATION INFORMATION	RRLP Measure Position Response 1: locationError with gpsAssDataMissing
14	SS -> MS	RR APPLICATION INFORMATION	RRLP Assistance Data. The SS provides the requested data from step 13 that is available in the SS in zero, one or more RRLP Assistance Data delivery messages.
15	MS -> SS	RR APPLICATION INFORMATION	RRLP assistanceDataAck. If the SS sent additional assistance data in step 14, the MS acknowledges the received assistance data.
16	SS-> MS	RR APPLICATION INFORMATION	RRLP Measure Position Request 2. This message may include further assistance data.
17	MS -> SS	RR APPLICATION INFORMATION	RRLP MEASURE POSITION RESPONSE 2 (gps-measureInfo)
18	SS -> MS	FACILITY	LCS MO-LR RETURN RESULT (locationEstimate)
19	MS -> SS	RELEASE COMPLETE	Terminates the session
20	SS -> MS	CHANNEL RELEASE	The main signalling link is released.

Specific Message Contents

REGISTER (Step 11):

Information element	Value/remark
Protocol Discriminator	Call Independent SS (1011)
Transaction Identifier	
Message Type	REGISTER (xx11 1011)
Facility	Invoke = LCS-MOLR LCS-MOLRArg Molr-Type -> locationEstimate
SS version indicator	Value 1 or above

RR_APPLICATION_INFORMATION:

Information element	Value/remark
Protocol Discriminator	RR Management Protocol (0110)
Skip Indicator	
Message Type	Application Information Message type
APDU ID	APDU ID -> RRLP => 0000
APDU Flags	Bit1=0 -> Last or only segment Bit2=0 -> First or only segment Bit3=0 -> Command or Final Response Bit4=spare
APDU Data	2-N Byte → ASN.1 Coded Step 12 and 16: RRLP Measure Position Request Step 13 and 17: RRLP Measure Position Response Step 14: RRLP Assistance Data Step 15: RRLP Assistance Data Ack.

RRLP Measure Position Request 1 (Step 12):

Information element	Type	Value/remark
ASN.1 encoded		
referenceNumber	Integer,0 to 7	1
component	CHOICE	msrPostionReq
methodType	CHOICE	msAssisted
positionMethod	ENUMERATED	gps
measureResponseTime	Integer 0 to 7	5
useMultipleSets	ENUMERATED	oneSet

RRLP Measure Position Response 1 (Step 13):

Information element	Type	Value/remark
ASN.1 encoded		
referenceNumber	Integer,0 to 7	1
component	CHOICE	msrPositionRsp
locationError	SEQUENCE	
locErrorReason	ENUMERATED	gpsAssDataMissing
additionalAssistanceData	SEQUENCE	
gpsAssistanceData	OCTET STRING	Indicates missing assistance data elements

RRLP Assistance Data (Step 14):

Information element	Type	Value/remark
ASN.1 encoded		
referenceNumber	Integer,0 to 7	2
component	CHOICE	assistanceData
gps-AssistData	SEQUENCE	SS shall send zero, one or more RRLP Assistance Data messages containing the requested assistance data requested in step 13, if available from section 10.9. Each message shall contain a maximum of 242 octets.
moreAssDataToBeSent	ENUMERATED	1 or 0. If SS sends more than one RRLP assistance data delivery message the moreAssDataToBeSent field shall be set accordingly.

RRLP Assistance Data Ack (Step 15):

Information element	Type	Value/remark
ASN.1 encoded		
referenceNumber	Integer,0 to 7	2
component	CHOICE	assistanceDataAck

RRLP Measure Position Request 2 (Step 16):

Information element	Type	Value/remark
ASN.1 encoded		
referenceNumber	Integer, 0 to 7	2
component	CHOICE	msrPositionReq
methodType	CHOICE	msAssisted
positionMethod	ENUMERATED	gps
measureResponseTime	Integer 0 to 7	5
useMultipleSets	ENUMERATED	oneSet
gps-AssistData	SEQUENCE	May contain further assistance data from section 10.9 as requested by the MS in step 13

RRLP Measure Position Response 2 (Step 17):

Information element	Type	Value/remark
ASN.1 encoded		
referenceNumber	Integer,0 to 7	2
component	CHOICE	msrPositionRsp A valid response will contain gps-MeasureInfo otherwise LocationError will be returned
gps-MeasureInfo	SEQUENCE	Any value of the parameters is acceptable.
locationError	SEQUENCE	Any error value is acceptable.

FACILITY (Step 18):

Information element	Value/remark
Protocol Discriminator	Call Independent SS message (1011)
Transaction Identifier	
Message Type	FACILITY (0011 1010)
Facility	Return Result = LCS-MOLR LCS-MOLRRes ->locationEstimate (Note)
Note:	Any value for locationEstimate may be used. The SS shall not be required to calculate the value from the returned gps-MeasureInfo values.

RELEASE COMPLETE (Step19):

Information element	Value/remark
Protocol Discriminator	Call Independent SS (1011)
Transaction Identifier	
Message Type	RELEASE COMPLETE (xx10 1010)

70.8.4.3 MO-LR Positioning Measurement / Multiple RRLP Requests with Same Reference Number

70.8.4.3.1 Conformance requirement:

The MS sends a DTAP LCS MOLR invoke to VMSC. If the MS is requesting its own location or that its own location be sent to another LCS client, this message carries LCS QoS information (e.g. accuracy, response time).

The MS invokes a MO-LR by sending a REGISTER message to network containing a LCS-MOLR invoke component with MO-LR TYPE set to LocationEstimate, LCS QoS value and other optional field if it is needed.

The MS ignores the later component if the old and new RRLP MEASURE POSITION REQUEST components have the same Reference Number.

The MS shall terminate the dialogue by sending a RELEASE COMPLETE message.

Test References:

3GPP TS 03.71 subclause 7.6.6

3GPP TS 04.30 subclause 5.1.1

3GPP TS 04.31 subclause 2.5.5

3GPP TS 04.80 / 3GPP TS 24.080 subclause 2.4, 2.5, 3.4 & 4

70.8.4.3.2 Test Purpose:

Verifies that a MS sends a correct positioning capability via control classmark sending. MS shall ignore the second RRLP MEASURE POSITION REQUEST if the second RRLP MEASURE POSITION REQUEST has the same REFERENCE NUMBER as in the previous one. The MS shall send back RRLP MEASURE POSITION RESPONSE to SS after finishing the current measurement.

70.8.4.3.3 Method of Test

Initial Conditions

System Simulator:

Serving Cell: default parameters.

Satellite signals: No GPS signal available.

Mobile Station:

The MS is in MM-state "idle, updated" with valid TMSI and CKSN.

Specific PICS statements

-

PIXIT statements

-

Test Procedure

A MOLR procedure as call independent supplementary services is initiated from the MS. The MS performs control early classmark sending to provide LCS positioning method capability. After sending the CIPHERING MODE COMPLETE message the MS sends a REGISTER message with Facility IE containing a component set to a DTAP LCS-MOLR Invoke. The SS determines the positioning method and instigates the particular message sequence by sending RRLP MEASURE POSITION REQUEST including assistance data to start the measurement.

Option 1: The MS then performs positioning measurements. After a delay of 15 seconds, the SS sends the second RRLP MEASURE POSITION REQUEST with the same REFERENCE NUMBER as the first one (this delay shall be cancelled in the event of option 2). The MS shall ignore the second RRLP MEASURE POSITION REQUEST. The MS sends RRLP MEASURE POSITION RESPONSE to SS with the measurement data after finishing the measurement.

Option 2: The MS may request additional assistance data by immediately sending an RRLP Measure Position Response message containing a location error with IE LocErrorReason set to gpsAssDataMissing. If the MS requests additional assistance data that is available in the SS, then the SS provides the requested assistance data in zero, one or more RRLP Assistance Data delivery messages followed by a second RRLP Measure Position Request message which may include further assistance data. If the MS requests additional assistance data and the entire requested assistance data is not available in the SS, then the SS sends the second RRLP Measure Position Request message without assistance data. The MS then performs positioning measurements and before the current positioning measurement finishes, the SS sends

the third RRLP MEASURE POSITION REQUEST with the same REFERENCE NUMBER as the second one. The MS shall ignore the third RRLP MEASURE POSITION REQUEST. The MS sends RRLP MEASURE POSITION RESPONSE to SS with the measurement data after finishing the measurement.

The SS returns location estimate to MS through DTAP LCS-MOLR Return Result. The MS terminates the dialogue by sending RELEASE COMPLETE message after receiving location estimate.

Maximum duration of the test:

5 minutes.

Expected Sequence

Step	Direction	Message	Comments
1	MS		Initiate MOLR Procedure (location estimate)
2	MS -> SS	CHANNEL REQUEST	Establishment cause indicates "Other procedures which can be completed with an SDCCH".
3	SS -> MS	IMMEDIATE ASSIGNMENT	
4	MS -> SS	CM SERVICE REQUEST	Message is contained in SABM "Mobile identity" IE contains the TMSI. The CM Service Type IE indicates "Supplementary service activation" "mobile station classmark 2" including settings for ES IND and CM3 supported.
5	MS -> SS	CLASSMARK CHANGE	"mobile station classmark 2" including settings for ES IND and CM3 supported. "mobile station classmark 3" includes settings for Positioning according to 3GPP TS 24.008, table 10.5.1.7.
6	SS -> MS	AUTHENTICATION REQUEST	
7	MS -> SS	AUTHENTICATION RESP	SRES specifies correct value.

8	SS -> MS	CIPHERING MODE COMMAND	SS starts deciphering after sending the message.
9	MS -> SS	CIPHERING MODE COMPLETE	Shall be sent enciphered. All following messages shall be sent enciphered.
10	MS -> SS	REGISTER	Call Independent SS containing Facility IE With the component of Invoke message set to LCS-MOLR with MOLR-Type set to locationEstimate.
11	SS -> MS	RR APPLICATION INFORMATION	RRLP MEASURE POSITION REQUEST 1
12	MS (Option 1) or MS ->SS (Option 2)	- or RR APPLICATION INFORMATION	If no message is received from the MS within 15 seconds, then the SS shall assume that the MS is performing the measurement (Option 1). The SS continues to step 13. If the MS sends RRLP Measure Position Response: locationError with gpsAssDataMissing (Option 2) within 15 seconds, then the SS continues to step 12a.
12a	SS -> MS	RR APPLICATION INFORMATION	RRLP Assistance Data. If the MS requested additional assistance data in step 12 that is available in the SS, then SS provides the requested data in zero, one or more RRLP Assistance Data delivery messages.
12b	MS -> SS	RR APPLICATION INFORMATION	RRLP assistanceDataAck. If the SS sent additional assistance data in step 12a, the MS acknowledges the received assistance data.
12c	SS-> MS	RR APPLICATION INFORMATION	RRLP Measure Position Request 2. If the MS requested additional assistance data in step 12 that is available in the SS, this message may include further assistance data.
12d	MS (Option 2)		MS is performing the measurement (Option 2)
13	SS -> MS	RR APPLICATION INFORMATION	RRLP MEASURE POSITION REQUEST 2 with same reference number as in Request 1 (Option 1) or RRLP MEASURE POSITION REQUEST 3 with same reference number as in Request 2 (Option2)
14	MS -> SS	RR APPLICATION INFORMATION	RRLP MEASURE POSITION RESPONSE (gps-measureInfo)
15	SS -> MS	FACILITY	LCS MO-LR RETURN RESULT (locationEstimate)
16	MS -> SS	RELEASE COMPLETE	Terminates the session
17	SS -> MS	CHANNEL RELEASE	The main signalling link is released.

Specific Message Contents

REGISTER (Step 10):

Information element	Value/remark
Protocol Discriminator	Call Independent SS (1011)
Transaction Identifier	
Message Type	REGISTER (xx11 1011)
Facility	Invoke = LCS-MOLR LCS-MOLRArg Molr-Type -> locationEstimate
SS version indicator	Value 1 or above

RR_APPLICATION_INFORMATION

Information element	Value/remark
Protocol Discriminator	RR Management Protocol (0110)
Skip Indicator	
Message Type	Application Information Message type
APDU ID	APDU ID -> RRLP => 0000
APDU Flags	Bit1=0 -> Last or only segment Bit2=0 -> First or only segment Bit3=0 -> Command or Final Response Bit4=spare
APDU Data	2-N Byte → ASN.1 Coded Steps 11, 12c and 13: RRLP Measure Position Request Steps 12, 14: RRLP Measure Position Response Step 12a: RRLP Assistance Data Step 12b: RRLP Assistance Data Ack.

RRLP Measure Position Request 1 (Step 11):

Information element	Type	Value/remark
ASN.1 encoded		
referenceNumber	Integer, 0 to 7	1
component	CHOICE	msrPositionReq
methodType	CHOICE	msAssisted
positionMethod	ENUMERATED	gps
measureResponseTime	Integer 0 to 7	5
useMultipleSets	ENUMERATED	oneSet
gps-AssistData	SEQUENCE	
referenceTime	SEQUENCE	See section 10.9.3
acquisAssist	SEQUENCE	See section 10.9.8

RRLP Measure Position Response (Step 12 (Option 2)):

Information element	Type	Value/remark
ASN.1 encoded		
referenceNumber	Integer, 0 to 7	1
component	CHOICE	msrPositionRsp
locationError	SEQUENCE	
locErrorReason	ENUMERATED	gpsAssDataMissing
additionalAssistanceData	SEQUENCE	
gpsAssistanceData	OCTET STRING	Indicates missing assistance data elements

RRLP Assistance Data (Step 12a):

Information element	Type	Value/remark
ASN.1 encoded		
referenceNumber	Integer, 0 to 7	1
component	CHOICE	assistanceData
gps-AssistData	SEQUENCE	If the MS requested further assistance data in Step 12 (Option 2) that is available in the SS, SS shall send zero, one or more RRLP Assistance Data messages containing the requested assistance data from section 10.9. Each message shall contain a maximum of 242 octets.
moreAssDataToBeSent	ENUMERATED	1 or 0. If SS sends more than one RRLP assistance data delivery message the moreAssDataToBeSent field shall be set accordingly.

RRLP Assistance Data Ack (Step 12b):

Information element	Type	Value/remark
ASN.1 encoded		
referenceNumber	Integer, 0 to 7	1
component	CHOICE	assistanceDataAck

RRLP Measure Position Request 2 (Step 12c):

Information element	Type	Value/remark
ASN.1 encoded		
referenceNumber	Integer, 0 to 7	1
component	CHOICE	msrPositionReq
methodType	CHOICE	msAssisted
positionMethod	ENUMERATED	gps
measureResponseTime	Integer 0 to 7	5
useMultipleSets	ENUMERATED	oneSet
gps-AssistData	SEQUENCE	May contain further assistance data from section 10.9 as requested by the MS in step 12 (Option 2).

RRLP Measure Position Request 2 (Option 1) or Request 3 (Option 2) (Step 13):

Information element	Type	Value/remark
ASN.1 encoded		
referenceNumber	Integer, 0 to 7	1
component	CHOICE	msrPositionReq
methodType	CHOICE	msBased
positionMethod	Enumerated	gps
measureResponseTime	Integer 0 to 7	5
accuracy	Integer (0-127)	127
useMultipleSets	Enumerated	oneSet

RRLP Measure Position Response (Step 14):

Information element	Type	Value/remark
ASN.1 encoded		
referenceNumber	Integer,0 to 7	1
component	CHOICE	msrPositionRsp A valid response will contain gps-MeasureInfo otherwise LocationError will be returned
gps-MeasureInfo	SEQUENCE	Any value of the parameters is acceptable.
locationError	SEQUENCE	Any error value is acceptable except gpsAssDataMissing.

FACILITY (Step 15):

Information element	Value/remark
Protocol Discriminator	Call Independent SS message (1011)
Transaction Identifier Message Type Facility	FACILITY (0011 1010) Return Result = LCS-MOLR LCS-MOLRRes ->locationEstimate (Note)
Note:	Any value for locationEstimate may be used. The SS shall not be required to calculate the value from the returned gps-MeasureInfo values.

RELEASE COMPLETE (Step 16):

Information element	Value/remark
Protocol Discriminator	Call Independent SS (1011)
Transaction Identifier	
Message Type	RELEASE COMPLETE (xx10 1010)

70.8.4.4 MO-LR Positioning Measurement / Multiple RRLP Requests with Different Reference Number

70.8.4.4.1 Conformance requirement

The MS sends a DTAP LCS MOLR invoke to VMSC. If the MS is requesting its own location or that its own location be sent to another LCS client, this message carries LCS QoS information (e.g. accuracy, response time).

The MS invokes a MO-LR by sending a REGISTER message to network containing a LCS-MOLR invoke component with MO-LR TYPE set to LocationEstimate, LCS QoS value and other optional field if it is needed.

The MS aborts activity for the former RRLP MEASURE POSITION REQUEST component and starts to act according to the later RRLP MEASURE POSITION REQUEST component if the old and new RRLP MEASURE POSITION REQUEST components have different Reference Number.

The MS shall terminate the dialogue by sending a RELEASE COMPLETE message.

Test References:

3GPP TS 03.71 subclause 7.6.6

3GPP TS 04.30 subclause 5.1.1

3GPP TS 04.31 subclause 2.5.5

3GPP TS 04.80 / 3GPP TS 24.080 subclause 2.4, 2.5, 3.4 & 4

70.8.4.4.2 Test Purpose

Verifies that a MS sends a correct positioning capability via control classmark sending. MS shall terminate the current location measurement if the second RRLP MEASURE POSITION REQUEST is received with a different

REFERENCE NUMBER. The MS shall perform the measurement according to the newly received RRLP MEASURE POSITION REQUEST. The MS shall send back RRLP MEASURE POSITION RESPONSE to SS after finishing the measurement.

70.8.4.4.3 Method of Test

Initial Conditions

System Simulator:

Serving Cell: default parameters.

Satellite signals: No GPS signal available.

Mobile Station:

The MS is in MM-state "idle, updated" with valid TMSI and CKSN.

Specific PICS statements

-

PIXIT statements

-

Test Procedure

A MOLR procedure as call independent supplementary services is initiated from the MS. The MS performs control early classmark sending to provide LCS positioning method capability. After sending the CIPHERING MODE COMPLETE message the MS sends a REGISTER message with Facility IE containing a component set to a DTAP LCS-MOLR Invoke. The SS determines the positioning method and instigates the particular message sequence by sending RRLP MEASURE POSITION REQUEST including assistance data to start the measurement.

Option 1: The MS then performs positioning measurements. After a delay of 15 seconds, the SS sends the second RRLP MEASURE POSITION REQUEST with a different REFERENCE NUMBER from the first one (this delay shall be cancelled in the event of option 2). The MS shall terminate the current location measurement and perform the measurement according to the newly received RRLP MEASURE POSITION REQUEST. The MS sends RRLP MEASURE POSITION RESPONSE to SS with the measurement data after finishing the measurement.

Option 2: The MS may request additional assistance data by immediately sending an RRLP Measure Position Response message containing a location error with IE LocErrorReason set to gpsAssDataMissing. If the MS requests additional assistance data that is available in the SS, then the SS provides the requested assistance data in zero, one or more RRLP Assistance Data delivery messages followed by a second RRLP Measure Position Request message which may include further assistance data. If the MS requests additional assistance data and the entire requested assistance data is not available in the SS, then the SS sends the second RRLP Measure Position Request message without assistance data. The MS then performs positioning measurements and before the current positioning measurement finishes, the MS receives the third RRLP MEASURE POSITION REQUEST with a different REFERENCE NUMBER from the second one. The MS shall terminate the current location measurement and perform the measurement according to the newly received RRLP MEASURE POSITION REQUEST, including the possibility of repeating the request for more assistance data (Option 2b). The MS sends RRLP MEASURE POSITION RESPONSE to SS with the measurement data after finishing the measurement.

The SS returns location estimate to MS through DTAP LCS-MOLR Return Result. The MS terminates the dialogue by sending RELEASE COMPLETE message after receiving location estimate.

Maximum duration of the test:

5 minutes.

Expected Sequence

Step	Direction	Message	Comments
1	MS		Initiate MOLR Procedure (location estimate)
2	MS -> SS	CHANNEL REQUEST	Establishment cause indicates "Other procedures which can be completed with an SDCCH".
3	SS -> MS	IMMEDIATE ASSIGNMENT	
4	MS -> SS	CM SERVICE REQUEST	Message is contained in SABM "Mobile identity" IE contains the TMSI. The CM Service Type IE indicates "Supplementary service activation" "mobile station classmark 2" including settings for ES IND and CM3 supported.
5	MS -> SS	CLASSMARK CHANGE	"mobile station classmark 2" including settings for ES IND and CM3 supported. "mobile station classmark 3" includes settings for Positioning according to 3GPP TS 24.008, table 10.5.1.7.
6	SS -> MS	AUTHENTICATION REQUEST	
7	MS -> SS	AUTHENTICATION RESP	SRES specifies correct value.

8	SS -> MS	CIPHERING MODE COMMAND	SS starts deciphering after sending the message.
9	MS -> SS	CIPHERING MODE COMPLETE	Shall be sent enciphered. All following messages shall be sent enciphered.
10	MS -> SS	REGISTER	Call Independent SS containing Facility IE With the component of Invoke message set to LCS-MOLR with MOLR-Type set to locationEstimate.
11	SS -> MS	RR APPLICATION INFORMATION	RRLP MEASURE POSITION REQUEST 1
12	MS (Option 1) or MS ->SS (Option 2)	- or RR APPLICATION INFORMATION	If no message is received from the MS within 15 seconds, then the SS shall assume that the MS is performing the measurement (Option 1) The SS continues to step 13. If the MS sends RRLP Measure Position Response: locationError with gpsAssDataMissing (Option 2) within 15 seconds, then the SS continues to step 12a.
12a	SS -> MS	RR APPLICATION INFORMATION	RRLP Assistance Data. If the MS requested additional assistance data in step 12 that is available in the SS, then SS provides the requested data in zero, one or more RRLP Assistance Data delivery messages.
12b	MS -> SS	RR APPLICATION INFORMATION	RRLP assistanceDataAck. If the SS sent additional assistance data in step 12a, the MS acknowledges the received assistance data.
12c	SS-> MS	RR APPLICATION INFORMATION	RRLP Measure Position Request 2. If the MS requested additional assistance data in step 12 that is available in the SS, this message may include further assistance data.
12d	MS (Option 2)		MS is performing the measurement (Option 2)
13	SS -> MS	RR APPLICATION INFORMATION	RRLP MEASURE POSITION REQUEST 2 with different reference number from Request 1 (Option 1) or RRLP MEASURE POSITION REQUEST 3 with different reference number from Request 2 (Option2)
14	MS -> SS	RR APPLICATION INFORMATION	RRLP Measure Position Response: gps-MeasureInfo (Option 1 or 2a) Check reference number is 2 or locationError with gpsAssDataMissing (Option 2b) Check reference number is 2
14a	SS -> MS	RR APPLICATION INFORMATION	RRLP Assistance Data. If the MS requested additional assistance data in step 14 that is available in the SS, then SS provides the requested data in zero, one or more RRLP Assistance Data delivery messages.
14b	MS -> SS	RR APPLICATION INFORMATION	RRLP assistanceDataAck. If the SS sent additional assistance data in step 14a, the MS acknowledges the received assistance data.
14c	SS-> MS	RR APPLICATION INFORMATION	RRLP Measure Position Request. If the MS requested additional assistance data in step 14 that is available in the SS, this message may include further assistance data.
14d	MS -> SS	RR APPLICATION INFORMATION	RRLP Measure Position Response. If the MS requested additional assistance data in step 14, this message contains gps-MeasureInfo.
15	SS -> MS	FACILITY	LCS MO-LR RETURN RESULT (locationEstimate)
16	MS -> SS	RELEASE COMPLETE	Terminates the session
17	SS -> MS	CHANNEL RELEASE	The main signalling link is released.

Specific Message Contents

REGISTER (Step 10):

Information element	Value/remark
Protocol Discriminator	Call Independent SS (1011)
Transaction Identifier	
Message Type	REGISTER (xx11 1011)
Facility	Invoke = LCS-MOLR LCS-MOLRArg Molr-Type -> locationEstimate
SS version indicator	Value 1 or above

RR_APPLICATION_INFORMATION

Information element	Value/remark
Protocol Discriminator	RR Management Protocol (0110)
Skip Indicator	
Message Type	Application Information Message type
APDU ID	APDU ID -> RRLP => 0000
APDU Flags	Bit1=0 -> Last or only segment Bit2=0 -> First or only segment Bit3=0 -> Command or Final Response Bit4=spare
APDU Data	2-N Byte -> ASN.1 Coded Steps 11, 12c, 13 and 14c: RRLP Measure Position Request Steps 12, 14 and 14d: RRLP Measure Position Response Steps 12a and 14a: RRLP Assistance Data Steps 12b and 14b: RRLP Assistance Data Ack.

RRLP Measure Position Request 1 (Step 11):

Information element	Type	Value/remark
ASN.1 encoded		
referenceNumber	Integer, 0 to 7	1
component	CHOICE	msrPositionReq
methodType	CHOICE	msAssisted
positionMethod	ENUMERATED	gps
measureResponseTime	Integer 0 to 7	5
useMultipleSets	ENUMERATED	oneSet
gps-AssistData	SEQUENCE	
referenceTime	SEQUENCE	See section 10.9.3
acquisAssist	SEQUENCE	See section 10.9.8

RRLP Measure Position Response (Step 12 (Option 2)):

Information element	Type	Value/remark
ASN.1 encoded		
referenceNumber	Integer, 0 to 7	1
component	CHOICE	msrPositionRsp
locationError	SEQUENCE	
locErrorReason	ENUMERATED	gpsAssDataMissing
additionalAssistanceData	SEQUENCE	
gpsAssistanceData	OCTET STRING	Indicates missing assistance data elements

RRLP Assistance Data (Step 12a):

Information element	Type	Value/remark
ASN.1 encoded		
referenceNumber	Integer, 0 to 7	1
component	CHOICE	assistanceData
gps-AssistData	SEQUENCE	If the MS requested further assistance data in Step 12 (Option 2) that is available in the SS, SS shall send zero, one or more RRLP Assistance Data messages containing the requested assistance data from section 10.9. Each message shall contain a maximum of 242 octets.
moreAssDataToBeSent	ENUMERATED	1 or 0. If SS sends more than one RRLP assistance data delivery message the moreAssDataToBeSent field shall be set accordingly.

RRLP Assistance Data Ack (Step 12b):

Information element	Type	Value/remark
ASN.1 encoded		
referenceNumber	Integer, 0 to 7	1
component	CHOICE	assistanceDataAck

RRLP Measure Position Request 2 (Step 12c):

Information element	Type	Value/remark
ASN.1 encoded		
referenceNumber	Integer, 0 to 7	1
component	CHOICE	msrPositionReq
methodType	CHOICE	msAssisted
positionMethod	ENUMERATED	gps
measureResponseTime	Integer 0 to 7	5
useMultipleSets	ENUMERATED	oneSet
gps-AssistData	SEQUENCE	May contain further assistance data from section 10.9 as requested by the MS in step 12 (Option 2).

RRLP Measure Position Request 2 (Option 1) or Request 3 (Option 2) (Step 13):

Information element	Type	Value/remark
ASN.1 encoded		
referenceNumber	Integer, 0 to 7	2
component	CHOICE	msrPositionReq
methodType	CHOICE	msAssisted
positionMethod	ENUMERATED	gps
measureResponseTime	Integer 0 to 7	5
useMultipleSets	ENUMERATED	oneSet
gps-AssistData	SEQUENCE	
referenceTime	SEQUENCE	See section 10.9.3
acquisAssist	SEQUENCE	See section 10.9.8

RRLP Measure Position Response (Step 14 (Option 1 or 2a) or Step 14d (Option 2b)):

Information element	Type	Value/remark
ASN.1 encoded		
referenceNumber	Integer, 0 to 7	2
component	CHOICE	msrPositionRsp (A valid response will contain gps-MeasureInfo otherwise locationError will be returned)
gps-MeasureInfo	SEQUENCE	Any value of the parameters is acceptable.
locationError	SEQUENCE	Any error value is acceptable except gpsAssDataMissing.

RRLP Measure Position Response (Step 14 (Option 2b)):

Information element	Type	Value/remark
ASN.1 encoded		
referenceNumber	Integer, 0 to 7	2
component	CHOICE	msrPositionRsp
locationError	SEQUENCE	
locErrorReason	ENUMERATED	gpsAssDataMissing
additionalAssistanceData	SEQUENCE	
gpsAssistanceData	OCTET STRING	Indicates missing assistance data elements

RRLP Assistance Data (Step 14a):

Information element	Type	Value/remark
ASN.1 encoded		
referenceNumber	Integer, 0 to 7	1
component	CHOICE	assistanceData
gps-AssistData	SEQUENCE	If the MS requested further assistance data in Step 14 (Option 2b) that is available in the SS, SS shall send zero, one or more RRLP Assistance Data messages containing the requested assistance data from section 10.9. Each message shall contain a maximum of 242 octets.
moreAssDataToBeSent	ENUMERATED	1 or 0. If SS sends more than one RRLP assistance data delivery message the moreAssDataToBeSent field shall be set accordingly.

RRLP Assistance Data Ack (14b):

Information element	Type	Value/remark
ASN.1 encoded		
referenceNumber	Integer, 0 to 7	2
component	CHOICE	assistanceDataAck

RRLP Measure Position Request (Step 14c):

Information element	Type	Value/remark
ASN.1 encoded		
referenceNumber	Integer, 0 to 7	2
component	CHOICE	msrPositionReq
methodType	CHOICE	msAssisted
positionMethod	ENUMERATED	gps
measureResponseTime	Integer 0 to 7	5
useMultipleSets	ENUMERATED	oneSet
gps-AssistData	SEQUENCE	May contain further assistance data from section 10.9 as requested by the MS in step 14 (Option 2b).

FACILITY (Step 15):

Information element	Value/remark
Protocol Discriminator	Call Independent SS message (1011)
Transaction Identifier Message Type Facility	FACILITY (0011 1010) Return Result = LCS-MOLR LCS-MOLRRes ->locationEstimate (Note)
Note:	Any value for locationEstimate may be used. The SS shall not be required to calculate the value from the returned gps-MeasureInfo values.

RELEASE COMPLETE (Step 16):

Information element	Value/remark
Protocol Discriminator	Call Independent SS (1011)
Transaction Identifier	
Message Type	RELEASE COMPLETE (xx10 1010)

70.8.4.5 MO-LR Positioning Measurement / RR Management Commands

70.8.4.5.1 Conformance requirement

The MS sends a DTAP LCS MOLR invoke to VMSC. If the MS is requesting its own location or that its own location be sent to another LCS client, this message carries LCS QoS information (e.g. accuracy, response time).

The MS invokes a MO-LR by sending a REGISTER message to network containing a LCS-MOLR invoke component with MO-LR TYPE set to LocationEstimate, LCS QoS value and other optional field if it is needed.

The MS aborts the measurement procedure and starts on the RR MANAGEMENT procedure if a RR MANAGEMENT command is received during the measurement procedure. The MS sends RR MANAGEMENT RESPONSE message upon completion.

The MS shall terminate the dialogue by sending a RELEASE COMPLETE message.

Test References:

3GPP TS 03.71 subclauses 7.6.6, 10.6

3GPP TS 04.30 subclause 5.1.1

3GPP TS 04.80 / 3GPP TS 24.080 subclauses 2.4, 2.5, 3.4 & 4

70.8.4.5.2 Test Purpose

Verifies that a MS sends a correct positioning capability via control classmark sending. MS shall terminate the current location measurement if a RR MANAGEMENT command is received during the measurement procedure. The MS shall send a RR MANAGEMENT RESPONSE message to SS when the RR MANAGEMENT procedure is complete. The MS shall perform the measurement according to the newly received RRLP MEASURE POSITION REQUEST and send back RRLP MEASURE POSITION RESPONSE to SS after finishing the measurement.

70.8.4.5.3 Method of Test

Initial Conditions

System Simulator:

Serving Cell: default parameters.

Satellite signals: No GPS signal available.

Mobile Station:

The MS is in MM-state "idle, updated" with valid TMSI and CKSN.

Specific PICS statements

-

PIXIT statements

-

Test Procedure

A MOLR procedure as call independent supplementary services is initiated from the MS. The MS performs control early classmark sending to provide LCS positioning method capability. After sending the CIPHERING MODE COMPLETE message the MS sends a REGISTER message with Facility IE containing a component set to a DTAP LCS-MOLR Invoke. The SS determines the positioning method and instigates the particular message sequence by sending RRLP MEASURE POSITION REQUEST including assistance data to start the measurement.

Option 1: The MS then performs positioning measurements. After a delay of 15 seconds to allow for the possibility of Option 2, the SS sends an RR MANAGEMENT command. The MS shall terminate the current location measurement and perform the RR MANAGEMENT command. The MS sends an RR MANAGEMENT RESPONSE message to SS when the RR MANAGEMENT procedure is complete. The SS sends a new RRLP MEASURE POSITION REQUEST including assistance data and the MS sends RRLP MEASURE POSITION RESPONSE to SS with the measurement data finishing the measurement according to the newly received RRLP MEASUREMENT POSITION REQUEST.

Option 2: The MS may request additional assistance data by immediately sending an RRLP Measure Position Response message containing a location error with IE LocErrorReason set to gpsAssDataMissing. If the MS requests additional assistance data that is available in the SS, then the SS provides the requested assistance data in zero, one or more RRLP Assistance Data delivery messages followed by a second RRLP Measure Position Request message which may include further assistance data. If the MS requests additional assistance data and the entire requested assistance data is not available in the SS, then the SS sends the second RRLP Measure Position Request message without assistance data. The MS then performs positioning measurements and before the current positioning measurement finishes, the MS receives a RR MANAGEMENT command. The MS shall terminate the current location measurement and perform the RR MANAGEMENT command. The MS sends a RR MANAGEMENT RESPONSE message to SS when the RR MANAGEMENT procedure is complete. The SS sends a new RRLP MEASURE POSITION REQUEST including assistance data and the MS either sends RRLP MEASURE POSITION RESPONSE to SS with the measurement data finishing the measurement according to the newly received RRLP MEASUREMENT POSITION REQUEST or requests more assistance data and then sends RRLP MEASURE POSITION RESPONSE to SS with the measurement data.

The SS returns location estimate to MS through DTAP LCS-MOLR Return Result. The MS terminates the dialogue by sending RELEASE COMPLETE message after receiving location estimate.

Maximum duration of the test

5 minutes.

Expected Sequence

Step	Direction	Message	Comments
1	MS		Initiate MOLR Procedure (location estimate)
2	MS -> SS	CHANNEL REQUEST	Establishment cause indicates "Other procedures which can be completed with an SDCCH".
3	SS -> MS	IMMEDIATE ASSIGNMENT	
4	MS -> SS	CM SERVICE REQUEST	Message is contained in SABM "Mobile identity" IE contains the TMSI. The CM Service Type IE indicates "Supplementary service activation" "mobile station classmark 2" including settings for ES IND and CM3 supported.
5	MS -> SS	CLASSMARK CHANGE	"mobile station classmark 2" including settings for ES IND and CM3 supported. "mobile station classmark 3" includes settings for Positioning according to 3GPP TS 24.008, table 10.5.1.7.
6	SS -> MS	AUTHENTICATION REQUEST	
7	MS -> SS	AUTHENTICATION RESP	SRES specifies correct value.

8	SS -> MS	CIPHERING MODE COMMAND	SS starts deciphering after sending the message.
9	MS -> SS	CIPHERING MODE COMPLETE	Shall be sent enciphered. All following messages shall be sent enciphered.
10	MS -> SS	REGISTER	Call Independent SS containing Facility IE With the component of Invoke message set to LCS-MOLR with MOLR-Type set to locationEstimate.
11	SS -> MS	RR APPLICATION INFORMATION	RRLP MEASURE POSITION REQUEST 1
12	MS (Option 1) or MS ->SS (Option 2)	- or RR APPLICATION INFORMATION	If no message is received from the MS within 15 seconds, then the SS shall assume that the MS is performing the measurement (Option 1). The SS continues to step 13. If the MS sends RRLP Measure Position Response: locationError with gpsAssDataMissing (Option 2) within 15 seconds, then the SS continues to step 12a.
12a	SS -> MS	RR APPLICATION INFORMATION	RRLP Assistance Data. If the MS requested additional assistance data in step 12 that is available in the SS, then SS provides the requested data in zero, one or more RRLP Assistance Data delivery messages.
12b	MS -> SS	RR APPLICATION INFORMATION	RRLP assistanceDataAck. If the SS sent additional assistance data in step 12a, the MS acknowledges the received assistance data.
12c	SS-> MS	RR APPLICATION INFORMATION	RRLP Measure Position Request 2. If the MS requested additional assistance data in step 12 that is available in the SS, this message may include further assistance data.
12d	MS (Option 2)		MS is performing the measurement (Option 2)
13	SS -> MS	RR MANAGEMENT COMMAND	
14	MS -> SS	RR MANAGEMENT COMPLETE	MS terminates the measurement procedure and act on the RR management command
15	SS -> MS	RR APPLICATION INFORMATION	RRLP MEASURE POSITION REQUEST 2 (Option 1) or RRLP MEASURE POSITION REQUEST 3 (Option 2)
16	MS -> SS	RR APPLICATION INFORMATION	RRLP Measure Position Response: gps-MeasureInfo (Option 1 or 2a) or locationError with gpsAssDataMissing (Option 2b)
16a	SS -> MS	RR APPLICATION INFORMATION	RRLP Assistance Data. If the MS requested additional assistance data in step 16 that is available in the SS, then SS provides the requested data in zero, one or more RRLP Assistance Data delivery messages.
16b	MS -> SS	RR APPLICATION INFORMATION	RRLP assistanceDataAck. If the SS sent additional assistance data in step 16a, the MS acknowledges the received assistance data.
16c	SS-> MS	RR APPLICATION INFORMATION	RRLP Measure Position Request. If the MS requested additional assistance data in step 16 that is available in the SS, this message may include further assistance data.
16d	MS -> SS	RR APPLICATION INFORMATION	RRLP Measure Position Response. If the MS requested additional assistance data in step 16, this message contains gps-MeasureInfo.
17	SS -> MS	FACILITY	LCS MO-LR RETURN RESULT (locationEstimate)
18	MS -> SS	RELEASE COMPLETE	Terminates the session
19	SS -> MS	CHANNEL RELEASE	The main signalling link is released.

Specific Message Contents

REGISTER (Step 10):

Information element	Value/remark
Protocol Discriminator	Call Independent SS (1011)
Transaction Identifier	
Message Type	REGISTER (xx11 1011)
Facility	Invoke = LCS-MOLR LCS-MOLRArg Molr-Type -> locationEstimate
SS version indicator	Value 1 or above

RR_APPLICATION_INFORMATION

Information element	Value/remark
Protocol Discriminator	RR Management Protocol (0110)
Skip Indicator	
Message Type	Application Information Message type
APDU ID	APDU ID -> RRLP => 0000
APDU Flags	Bit1=0 -> Last or only segment Bit2=0 -> First or only segment Bit3=0 -> Command or Final Response Bit4=spare
APDU Data	2-N Byte -> ASN.1 Coded Steps 11, 12c, 15 and 16c: RRLP Measure Position Request Steps 12, 16 and 16d: RRLP Measure Position Response Steps 12a and 16a: RRLP Assistance Data Steps 12b and 16b: RRLP Assistance Data Ack.

RRLP Measure Position Request 1 (Step 11):

Information element	Type	Value/remark
ASN.1 encoded		
referenceNumber	Integer, 0 to 7	1
component	CHOICE	msrPositionReq
methodType	CHOICE	msAssisted
positionMethod	ENUMERATED	gps
measureResponseTime	Integer 0 to 7	5
useMultipleSets	ENUMERATED	oneSet
gps-AssistData	SEQUENCE	
referenceTime	SEQUENCE	See section 10.9.3
acquisAssist	SEQUENCE	See section 10.9.8

RRLP Measure Position Response (Step 12 (Option 2)):

Information element	Type	Value/remark
ASN.1 encoded		
referenceNumber	Integer, 0 to 7	1
component	CHOICE	msrPositionRsp
locationError	SEQUENCE	
locErrorReason	ENUMERATED	gpsAssDataMissing
additionalAssistanceData	SEQUENCE	
gpsAssistanceData	OCTET STRING	Indicates missing assistance data elements

RRLP Assistance Data (Step 12a):

Information element	Type	Value/remark
ASN.1 encoded		
referenceNumber	Integer, 0 to 7	1
component	CHOICE	assistanceData
gps-AssistData	SEQUENCE	If the MS requested further assistance data in Step 12 (Option 2) that is available in the SS, SS shall send zero, one or more RRLP Assistance Data messages containing the requested assistance data from section 10.9. Each message shall contain a maximum of 242 octets.
moreAssDataToBeSent	ENUMERATED	1 or 0. If SS sends more than one RRLP assistance data delivery message the moreAssDataToBeSent field shall be set accordingly.

RRLP Assistance Data Ack (Step 12b):

Information element	Type	Value/remark
ASN.1 encoded		
referenceNumber	Integer, 0 to 7	1
component	CHOICE	assistanceDataAck

RRLP Measure Position Request 2 (Step 12c):

Information element	Type	Value/remark
ASN.1 encoded		
referenceNumber	Integer, 0 to 7	1
component	CHOICE	msrPositionReq
methodType	CHOICE	msAssisted
positionMethod	ENUMERATED	gps
measureResponseTime	Integer 0 to 7	5
useMultipleSets	ENUMERATED	oneSet
gps-AssistData	SEQUENCE	May contain further assistance data from section 10.9 as requested by the MS in step 12 (Option 2).

RR Management Command (Classmark Enquiry) (Step 13):

Information element	Value/remark
Encoded	(06 13)
Protocol Discriminator	RR Management Protocol (0110)
Skip Indicator	
Classmark Enquiry Message Type	0001 0011

RRLP Measure Position Request 2 (Option 1) or Request 3 (Option 2) (Step 15):

Information element	Type	Value/remark
ASN.1 encoded		
referenceNumber	Integer, 0 to 7	2
component	CHOICE	msrPositionReq
methodType	CHOICE	msAssisted
positionMethod	ENUMERATED	gps
measureResponseTime	Integer 0 to 7	5
useMultipleSets	ENUMERATED	oneSet
gps-AssistData	SEQUENCE	
referenceTime	SEQUENCE	See section 10.9.3
acquisAssist	SEQUENCE	See section 10.9.8

RRLP Measure Position Response (Step 16 (Option 1 or 2a) or Step 16d (Option 2b)):

Information element	Type	Value/remark
ASN.1 encoded		
referenceNumber	Integer, 0 to 7	2
component	CHOICE	msrPositionRsp (A valid response will contain gps-MeasureInfo otherwise locationError will be returned)
gps-MeasureInfo	SEQUENCE	Any value of the parameters is acceptable.
locationError	SEQUENCE	Any error value is acceptable except gpsAssDataMissing.

RRLP Measure Position Response (Step 16 (Option 2b)):

Information element	Type	Value/remark
ASN.1 encoded		
referenceNumber	Integer, 0 to 7	2
component	CHOICE	msrPositionRsp
locationError	SEQUENCE	
locErrorReason	ENUMERATED	gpsAssDataMissing
additionalAssistanceData	SEQUENCE	
gpsAssistanceData	OCTET STRING	Indicates missing assistance data elements

RRLP Assistance Data (Step 16a):

Information element	Type	Value/remark
ASN.1 encoded		
referenceNumber	Integer, 0 to 7	1
component	CHOICE	assistanceData
gps-AssistData	SEQUENCE	If the MS requested further assistance data in Step 16 (Option 2b) that is available in the SS, SS shall send zero, one or more RRLP Assistance Data messages containing the requested assistance data from section 10.9. Each message shall contain a maximum of 242 octets.
moreAssDataToBeSent	ENUMERATED	1 or 0. If SS sends more than one RRLP assistance data delivery message the moreAssDataToBeSent field shall be set accordingly.

RRLP Assistance Data Ack (16b):

Information element	Type	Value/remark
ASN.1 encoded		
referenceNumber	Integer, 0 to 7	2
component	CHOICE	assistanceDataAck

RRLP Measure Position Request (Step 16c):

Information element	Type	Value/remark
ASN.1 encoded		
referenceNumber	Integer, 0 to 7	2
component	CHOICE	msrPositionReq
methodType	CHOICE	msAssisted
positionMethod	ENUMERATED	gps
measureResponseTime	Integer 0 to 7	5
useMultipleSets	ENUMERATED	oneSet
gps-AssistData	SEQUENCE	May contain further assistance data from section 10.9 as requested by the MS in step 16 (Option 2b).

FACILITY (Step 17):

Information element	Value/remark
Protocol Discriminator	Call Independent SS message (1011)
Transaction Identifier Message Type Facility	FACILITY (0011 1010) Return Result = lcs-MOLR LCS-MOLRRes ->locationEstimate (Note)
Note:	Any value for locationEstimate may be used. The SS shall not be required to calculate the value from the returned gps-MeasureInfo values.

RELEASE COMPLETE (Step 18):

Information element	Value/remark
Protocol Discriminator	Call Independent SS (1011)
Transaction Identifier	
Message Type	RELEASE COMPLETE (xx10 1010)

70.8.5 MO_LR Basic Self Location Request for MS-Based AGPS

The test cases in this subclause focus on Mobile Originating Location Request using MS-Based AGPS method. A MO-LR procedure could occur for requesting assistance data for mobile's own location.

70.8.5.1 MO_LR Basic Self Location Request in Idle Mode (Normal Case)

70.8.5.1.1 Conformance requirements:

The following requirements apply for this test:

1. The MS sends CM SERVICE REQUEST to network for call independent supplementary service.
2. The MS invokes self-location request by sending a REGISTER message containing a LCS-MOLR invoke component with MO_LR TYPE set to ASSISTANCE DATA, LOCATION_METHOD TYPE set ASSISTEDGPS, and GPS_ASSISTANCE_DATA TYPE set to the type of ASSISTANCE_DATA requested.
3. The MS sends RRLP ASSISTANCE DATA ACK. for each RRLP ASSISTANCE DATA component.
4. The MS shall terminate the dialogue by sending a RELEASE COMPLETE message.

Test References

3GPP TS 03.71, subclause 7.6.6,

3GPP TS 04.30 subclause 5.1.1,

3GPP TS 04.80 / 3GPP TS 24.080 subclause 2.4, 2.5, 3.4 and 4

70.8.5.1.2 Test Purpose

To verify that a MS invokes a self-location request by sending the network a REGISTER message containing FACILITY IE LCS-MOLR REQ. On receipt of each of RRLP ASSISTANCE DATA from SS with the requested assistance data, MS shall send RRLP ASSISTANCE ACK for each component to SS. When the MS receives a FACILITY message containing a FACILITY IE LCS-MOLR return result for the acknowledgement of completing assistance data delivery, it clears the transaction by sending a RELEASE COMPLETE message.

Specific PICS statements

-

PIXIT statements

-

70.8.5.1.3 Method of Test

Initial Conditions

System Simulator:

Serving cell: default parameters.

Satellite signals: default conditions.

Mobile Station:

The MS is in MM-state "idle, updated" with valid TMSI and CKSN.

Test Procedure:

A MOLR procedure as call independent supplementary services is initiated from the MS. The MS performs control early classmark sending to provide LCS positioning method capability. After sending the CIPHERING MODE COMPLETE message the MS sends a REGISTER message with Facility IE containing a component set to a DTAP LCS-MOLR Invoke for Assistance Data. The SS sends a number of RRLP Assistance Data components and MS sends RRLP Assistance Data Ack for each component. SS sends DTAP LCS-MOLR Return Result for acknowledgement of completion of assistance data delivery. The MS performs the measurement and calculates the position fix using the assistance data delivered. The MS terminates the dialogue by sending RELEASE COMPLETE message.

Maximum duration of the test:

5 minutes.

Expected Sequence

Step	Direction	Message	Comments
1	MS		Initiate LCS MOLR Procedure (assistance data request)
2	MS -> SS	CHANNEL REQUEST	Establishment cause indicates "Other procedures which can be completed with an SDCCH"
3	SS -> MS	IMMEDIATE ASSIGNMENT	
4	MS -> SS	CM SERVICE REQUEST	Establishment cause indicates "Supplementary service activation" . "mobile station classmark 2" includes settings for ES_IND.
5	MS -> SS	CLASSMARK CHANGE	"mobile station classmark 2" including settings for ES IND and CM3 supported. "mobile station classmark 3" includes settings for Positioning according to 3GPP TS 24.008, table 10.5.1.7. Position method Capability is set to 1 and Bit 2 is set to 1 (MS-Based GPS)
6	SS -> MS	AUTHENTICATION REQUEST	
7	MS -> SS	AUTHENTICATION RESP	SRES specifies correct value.
8	SS -> MS	CIPHERING MODE COMMAND	SS starts deciphering after sending the message.
9	MS -> SS	CIPHERING MODE COMPLETE	Shall be sent enciphered. All following messages shall be sent enciphered.
10	MS -> SS	REGISTER	Call Independent SS containing Facility IE With the component of Invoke message set to LCS-MOLR with MOLR-Type set to assistanceData.
11n	SS -> MS	RR APPLICATION INFORMATION	RRLP ASSISTANCE DATA The number of instances of this message depends on the amount of assistance data requested in step 10
12n	MS -> SS	RR APPLICATION INFORMATION	RRLP ASSISTANCE DATA ACK Each instance of RRLP ASSISTANCE DATA message in step 11 is acknowledged
13	SS -> MS	FACILITY	LCS MO-LR RETURN RESULT
14	MS -> SS	RELEASE COMPLETE	Terminates the session
15	SS -> MS	CHANNEL RELEASE	The main signalling link is released.

Specific Message Contents

CLASSMARK CHANGE

Information element	Value/remark
as default except: Mobile station Classmark 2 -ES_IND	"Controlled Early Classmark Sending" option is implemented in the MS.
CM3	The MS Supports options that are indicated in classmark 3 IE
Mobile station Classmark 3 MS Positioning Method Capability	See below This bit indicates that the MS supports Positioning Method for the provision of Location Services.
Positioning Method(s) support, 5 bit field	Support of certain positioning method (3GPP TS 24.008, table 10.5.1.7), Bit 2 set to 1.

REGISTER (Step 10):

Information element	Value/remark
Protocol Discriminator	Call Independent SS message (1011)
Transaction Identifier Message Type Facility	REGISTER (xx11 1011) Invoke = LCS-MOLR LCS-MOLRArg MOLR-Type->assistanceData Location Method->assistedGPS GPSAssistanceData-> any value is acceptable

RR_APPLICATION_INFORMATION

Information element	Value/remark
Protocol Discriminator	RR Management Protocol (0110)
Skip Indicator	
Message Type	Application Information Message type
APDU ID	APDU ID -> RRLP => 0000
APDU Flags	Bit1=0 -> Last or only segment Bit2=0 -> First or only segment Bit3=0 -> Command or Final Response Bit4=spare
APDU Data	2-N Byte → ASN.1 Coded Steps 11n: RRLP Assistance Data Steps 12n: RRLP Assistance Data Ack.

RRLP Assistance Data (Step 11n):

Information element	Type	Value/remark
ASN.1 encoded		
referenceNumber	Integer,0 to 7	1
component	CHOICE	assistanceData
gps-AssistData	SEQUENCE	The assistance data requested by the MS in Step 10 that is available in the SS, shall be sent in zero, one or more RRLP Assistance Data messages containing the requested assistance data from section 10.9. Each message shall contain a maximum of 242 octets.
moreAssDataToBeSent	ENUMERATED	1 or 0. If SS sends more than one RRLP assistance data delivery message the moreAssDataToBeSent field shall be set accordingly.

RRLP Assistance Data Ack (Step 12n):

Information element	Type	Value/remark
ASN.1 encoded		
referenceNumber	Integer,0 to 7	1
component	CHOICE	assistanceDataAck

FACILITY (Step 13):

Information element	Value/remark
Protocol Discriminator	Call Independent SS message (1011)
Transaction Identifier Message Type Facility	FACILITY (0011 1010) Return Result = LCS-MOLR LCS-MOLRRes -> empty (Note)
Note:	For acknowledgement of assistance data delivery procedure, SS shall send LCS-MOLR Facility return result to MS, there is no parameter for this.

RELEASE COMPLETE (Step 14):

Information element	Value/remark
Protocol Discriminator	Call Independent SS (1011)
Transaction Identifier	
Message Type	RELEASE COMPLETE (0011 1010)

70.8.5.2 MO_LR Basic Self Location Request in Dedicated Mode (Normal case)

70.8.5.2.1 Conformance Requirement:

The following requirements apply for this test:

1. The MS sends CM SERVICE REQUEST to network for call independent supplementary service.
2. The MS invokes self-location request by sending a REGISTER message containing a LCS-MOLR invoke component with MO_LR TYPE set to ASSISTANCE DATA, LOCATION_METHOD TYPE set ASSISTEDGPS, and GPS_ASSISTANCE_DATA TYPE set to the type of ASSISTANCE_DATA requested.
3. The MS sends RRLP ASSISTANCE DATA ACK. for each RRLP ASSISTANCE DATA component.
4. The MS shall terminate the dialogue by sending a RELEASE COMPLETE message.

Test References:

3GPP TS 03.71 subclause 7.6.6

3Gpp TS 24.30 subclause 5

3GPP TS 24.80 subclause 4

70.8.5.2.2 Test Purpose

To verify that the MS invokes a self-location request by sending the network a REGISTER message containing the FACILITY IE LCS-MOLR REQ on an already established speech call related main DCCH (FACCH). On receipt of a RRLP ASSISTANCE DATA from SS with the requested assistance data, MS shall send back RRLP ASSISTANCE ACK for each component to SS. When the MS receives a FACILITY message containing a FACILITY IE LCS-MOLR return result for the acknowledgment of completing assistance data delivery, it clears the transaction by sending a RELEASE COMPLETE message.

Specific PICS statements

-

PIXIT statements

-

70.8.5.2.3 Method of Test

Initial Conditions:

System Simulator:

Serving Cell: default parameters.

Satellite signals: default conditions.

Mobile Station:

The MS has valid TMSI and CSKN.

The MS is brought into the state U10 by using table 26.8.1.2/3

Test Procedure:

A MOLR procedure as call independent supplementary services is initiated from the MS on the existing FACCH channel. After received CM SERVICE ACCEPT message, MS sends a REGISTER message with Facility IE containing a component set to a DTAP LCS-MOLR Invoke for Assistance Data. The SS sends a number of RRLP ASSISTANCE DATA components and MS sends acknowledgement of RRLP ASSISTANCE DATA ACK for each component. SS sends DTAP LCS-MOLR Return Result for acknowledgement of completion of assistance data delivery procedure. MS performs the measurement and calculates the location estimate using the assistance data delivered. The MS terminates the dialogue by sending RELEASE COMPLETE message.

Maximum duration of the test:

5 minutes.

Expected Sequence:

Step	Direction	Message	Comments
1	MS		Initiate LCS MOLR Procedure (assistance data request) on existing FACCH channel
2	MS -> SS	CM SERVICE REQUEST	"Mobile identity" IE contains the TMSI. Establishment cause indicates "Supplementary service activation" "mobile station classmark 2" including settings for ES IND and CM3 supported.
3	SS -> MS	CM SERVICE ACCEPT	
4	MS -> SS	REGISTER	Call Independent SS containing Facility IE With the component of Invoke message set to LCS-MOLR with MOLR-Type set to assistanceData.
5n	SS->MS	RR APPLICATION INFORMATION	RRLP ASSISTANCE DATA The number of instances of this message depends on the amount of assistance data requested in step 4
6n	MS -> SS	RR APPLICATION INFORMATION	RRLP ASSISTANCE DATA ACK Each instance of RRLP ASSISTANCE DATA message in step 5 is acknowledged
7	SS -> MS	FACILITY	LCS MO-LR RETURN RESULT
8	MS->SS	RELEASE COMPLETE	Terminates the session
9	SS -> MS	CHANNEL RELEASE	The main signalling link is released.

Specific Message Contents:

REGISTER (Step 4):

Information element	Value/remark
Protocol Discriminator	Call Independent SS message (1011)
Transaction Identifier Message Type Facility	REGISTER (xx11 1011) Invoke = LCS-MOLR LCS-MOLRArg MOLR-Type->assistanceData Location Method->assistedGPS GPSAssistanceData-> any value is acceptable

RR_APPLICATION_INFORMATION

Information element	Value/remark
Protocol Discriminator	RR Management Protocol (0110)
Skip Indicator	
Message Type	Application Information Message type
APDU ID	APDU ID -> RRLP => 0000
APDU Flags	Bit1=0 -> Last or only segment Bit2=0 -> First or only segment Bit3=0 -> Command or Final Response Bit4=spare
APDU Data	2-N Byte → ASN.1 Coded Step 5n: RRLP Assistance Data Step 6n: RRLP Assistance Data Ack.

RRLP Assistance Data (Step 5n):

Information element	Type	Value/remark
ASN.1 encoded		
referenceNumber	Integer,0 to 7	1
component	CHOICE	assistanceData
gps-AssistData	SEQUENCE	The assistance data requested by the MS in Step 4 that is available in the SS, shall be sent in zero, one or more RRLP Assistance Data messages containing the requested assistance data from section 10.9. Each message shall contain a maximum of 242 octets.
moreAssDataToBeSent	ENUMERATED	1 or 0. If SS sends more than one RRLP assistance data delivery message the moreAssDataToBeSent field shall be set accordingly.

RRLP Assistance Data Ack (Step 6n):

Information element	Type	Value/remark
ASN.1 encoded		
referenceNumber	Integer,0 to 7	1
component	CHOICE	assistanceDataAck

FACILITY (Step 7):

Information element	Value/remark
Protocol Discriminator	Call Independent SS message (1011)
Transaction Identifier Message Type Facility	FACILITY (0011 1010) Return Result = LCS-MOLR LCS-MOLRRes ->empty (note)
Note:	For acknowledgement of assistance data delivery procedure, SS shall send LCS-MOLR Facility return result to MS, there is no parameter for this.

RELEASE COMPLETE (Step 8):

Information element	Value/remark
Protocol Discriminator	Call Independent SS (1011)
Transaction Identifier	
Message Type	RELEASE COMPLETE (xx10 1010)

70.8.5.3 MO_LR Basic Self Location Request in Idle Mode (Alternative Case)

70.8.5.3.1 Conformance requirements:

The following requirements apply for this test:

1. If the MS is in idle mode, the MS requests an SDCCH and sends a DTAP CM service request indicating a request for call independent supplementary services to the BSC.
2. The MS invokes a MO-LR by sending a REGISTER message to the network containing a LCS-MOLR invoke component. SS Version Indicator value 1 or above shall be used.
3. On receiving an RRLP MEASURE POSITION REQUEST message, the MS tries to perform the requested location measurements, and possibly calculates its own position. When the MS has location measurements, location estimate, or an error indication (measurements/location estimation not possible), it sends the results in the Measure Position Response component to the SMLC.
5. The network shall pass the result of the location procedure to the MS by sending a FACILITY message to the MS containing a LCS-MOLR return result component.
6. After the last location request operation the MS shall terminate the dialogue by sending a RELEASE COMPLETE message.

Test References

3GPP TS 03.71 subclause 7.6.6

3GPP TS 04.30 subclause 5.1.1

3GPP TS 04.31 subclause 2.2

70.8.5.3.2 Test Purpose

To verify that the MS invokes a self-location request by sending the network a REGISTER message containing an MO-LR Request of type "locationEstimate". When the MS receives a FACILITY message containing a MO-LR return result carrying the requested location estimate, it clears the transaction by sending a RELEASE COMPLETE message.

Specific PICS statements

-

PIXIT statements

-

70.8.5.3.3 Method of Test

Initial Conditions

System Simulator:

Serving cell: default parameters.

Satellite signals: default conditions.

Mobile Station:

The MS is in MM-state "idle, updated" with valid TMSI and CKSN.

Test Procedure:

The MS invokes call independent supplementary service through a CM SERVICE REQUEST. The SS initiates authentication and ciphering. Then the MS invokes an MO-LR request of type "locationEstimate".

The SS orders an A-GPS positioning measurement by sending RR APPLICATION INFORMATION messages containing RRLP Assistance Data messages followed by an RRLP Measure Position Request including further assistance data.

Option 1: The MS then performs positioning measurements, and responds with an RR APPLICATION INFORMATION message containing an RRLP Measure Position Response.

Option 2: The MS may request additional assistance data by sending an RRLP Measure Position Response message containing a location error with IE LocErrorReason set to gpsAssDataMissing. If the MS requests additional assistance data that is available in the SS, then the SS provides the requested assistance data in zero, one or more RRLP Assistance Data delivery messages followed by an RRLP Measure Position Request message which may include further assistance data. If the MS requests additional assistance data and the entire requested assistance data is not available in the SS, then the SS repeats the RRLP Measure Position Request message without assistance data. The MS then performs positioning measurements, and responds with an RR APPLICATION INFORMATION message containing an RRLP Measure Position Response.

The SS responds with a FACILITY message containing an MO-LR result. When the MS receives the FACILITY message, it clears the transaction by sending a RELEASE COMPLETE message.

Maximum duration of the test:

5 minutes.

Expected Sequence

Step	Direction	Message	Comments
1	MS		Initiate MOLR Procedure (location estimation)
2	MS -> SS	CHANNEL REQUEST	Establishment cause indicates "Other procedures which can be completed with an SDCCH"
3	SS -> MS	IMMEDIATE ASSIGNMENT	
4	MS -> SS	CM SERVICE REQUEST	The CM Service Type IE indicates "Supplementary service activation".
5	MS -> SS	CLASSMARK CHANGE	"mobile station classmark 2" includes settings for ES_IND. "mobile station classmark 3" includes settings for Positioning. The setting for positioning specifies Positioning Method capability and Positioning Method support. In the position method support (5 bit field), bit 2 is set to 1 (MS-based GPS).
6	SS -> MS	AUTHENTICATION REQUEST	
7	MS -> SS	AUTHENTICATION RESPONSE	

8	SS -> MS	CIPHERING MODE COMMAND	
9	MS -> SS	CIPHERING MODE COMPLETE	
10	SS		SS starts ciphering
11	MS -> SS	REGISTER	Call Independent SS containing Facility IE with LCS-MOLR request and MO-LR Type set to "locationEstimate".
12	SS -> MS	RR APPLICATION INFORMATION	RRLP Assistance Data
13	MS -> SS	RR APPLICATION INFORMATION	RRLP assistanceDataAck
14	SS -> MS	RR APPLICATION INFORMATION	RRLP Assistance Data
15	MS -> SS	RR APPLICATION INFORMATION	RRLP assistanceDataAck
16	SS-> MS	RR APPLICATION INFORMATION	RRLP Measure Position Request
17	MS -> SS	RR APPLICATION INFORMATION	RRLP Measure Position Response: locationInfo (Option 1) or locationError with gpsAssDataMissing and additionalAssistanceData (Option 2)
17a	SS -> MS	RR APPLICATION INFORMATION	RRLP Assistance Data. If the MS requested additional assistance data in step 17 that is available in the SS, then SS provides the requested data in zero, one or more RRLP Assistance Data delivery messages.
17b	MS -> SS	RR APPLICATION INFORMATION	RRLP assistanceDataAck. If the SS sent additional assistance data in step 17a, the MS acknowledges the received assistance data.
17c	SS-> MS	RR APPLICATION INFORMATION	RRLP Measure Position Request. If the MS requested additional assistance data in step 17 that is available in the SS, this message may include further assistance data.
17d	MS-> SS	RR APPLICATION INFORMATION	RRLP Measure Position Response. If the MS requested additional assistance data in step 17, this message contains locationInfo.
18	SS -> MS	FACILITY	LCS MO-LR RETURN RESULT message containing location estimate
19	MS -> SS	RELEASE COMPLETE	MS terminates the dialogue
20	SS -> MS	CHANNEL RELEASE	The main signalling link is released.

Specific Message Contents

REGISTER (Step 11):

Information element	Value/remark
Protocol Discriminator	Call Independent SS (1011)
Transaction Identifier	
Message Type	REGISTER (xx11 1011)
Facility	Invoke = LCS-MOLR LCS-MOLRArg MOLR-Type->locationEstimate
SS version indicator	Value 1 or above

RR_APPLICATION_INFORMATION

Information element	Value/remark
Protocol Discriminator	RR Management Protocol (0110)
Skip Indicator	
Message Type	Application Information Message type
APDU ID	APDU ID -> RRLP => 0000
APDU Flags	Bit1=0 -> Last or only segment Bit2=0 -> First or only segment Bit3=0 -> Command or Final Response Bit4=spare
APDU Data	2-N Byte → ASN.1 Coded Steps 16 and 17c: RRLP Measure Position Request Steps 17 and 17d: RRLP Measure Position Response Steps 12, 14, 17a: RRLP Assistance Data Steps 13, 15, 17b: RRLP Assistance Data Ack.

RRLP Assistance Data (Step 12):

Information element	Type	Value/remark
ASN.1 encoded		
referenceNumber	Integer,0 to 7	1
component	CHOICE	assistanceData
gps-AssistData	SEQUENCE	
navigationModel	SEQUENCE	PRNs 4,6,9 of section 10.9.5
moreAssDataToBeSent	ENUMERATED	1

RRLP Assistance Data Ack (Steps 13, 15, 17b):

Information element	Type	Value/remark
ASN.1 encoded		
referenceNumber	Integer,0 to 7	1 or 2 (Option 2, Step 17b)
component	CHOICE	assistanceDataAck

RRLP Assistance Data (Step 14):

Information element	Type	Value/remark
ASN.1 encoded		
referenceNumber	Integer,0 to 7	1
component	CHOICE	assistanceData
gps-AssistData	SEQUENCE	
navigationModel	SEQUENCE	PRNs 10,13,22 of section 10.9.5
ionosphericModel	SEQUENCE	See section 10.9.6
moreAssDataToBeSent	ENUMERATED	0

RRLP Measure Position Request (Step 16):

Information element	Type	Value/remark
ASN.1 encoded		
referenceNumber	Integer,0 to 7	1
component	CHOICE	msrPositionReq
methodType	CHOICE	msBased
positionMethod	ENUMERATED	gps
measureResponseTime	Integer 0 to 7	5
accuracy	Integer (0-127)	127
useMultipleSets	ENUMERATED	oneSet
gps-AssistData	SEQUENCE	
referenceTime	SEQUENCE	See section 10.9.3
refLocation	SEQUENCE	See section 10.9.4

RRLP Measure Position Response (Step 17 (Option 1) or 17d (Option 2)):

Information element	Type	Value/remark
ASN.1 encoded		
referenceNumber	Integer,0 to 7	1 or 2 (Option 2, Step 17d)
component	CHOICE	msrPositionRsp (A valid response will contain LocationInfo otherwise LocationError will be returned)
locationInfo	SEQUENCE	Any value is acceptable.
locationError	SEQUENCE	Any error value is acceptable except gpsAssDataMissing.

RRLP Measure Position Response (Step 17 (Option 2)):

Information element	Type	Value/remark
ASN.1 encoded		
referenceNumber	Integer,0 to 7	1
component	CHOICE	msrPositionRsp
locationError	SEQUENCE	
locErrorReason	ENUMERATED	gpsAssDataMissing
additionalAssistanceData	SEQUENCE	
gpsAssistanceData	OCTET STRING	Indicates missing assistance data elements

RRLP Assistance Data (Step 17a):

Information element	Type	Value/remark
ASN.1 encoded		
referenceNumber	Integer,0 to 7	2
component	CHOICE	assistanceData
gps-AssistData	SEQUENCE	If the MS requested further assistance data in Step 17 (Option 2) that is available in the SS, SS shall send zero, one or more RRLP Assistance Data messages containing the requested assistance data from section 10.9. Each message shall contain a maximum of 242 octets.
moreAssDataToBeSent	ENUMERATED	1 or 0. If SS sends more than one RRLP assistance data delivery message the moreAssDataToBeSent field shall be set accordingly.

RRLP Measure Position Request (Step 17c):

Information element	Type	Value/remark
ASN.1 encoded		
referenceNumber	Integer,0 to 7	2
component	CHOICE	msrPositionReq
methodType	CHOICE	msBased
positionMethod	ENUMERATED	gps
measureResponseTime	Integer 0 to 7	5
accuracy	Integer (0-127)	127
useMultipleSets	ENUMERATED	oneSet
gps-AssistData	SEQUENCE	May contain further assistance data from section 10.9 as requested by the MS in step 17 (Option 2).

FACILITY (Step 18):

Information element	Value/remark
Protocol Discriminator	Call Independent SS (1011)
Transaction Identifier	
Message Type	FACILITY (0011 1010)
Facility	Return Result = LCS-MOLR LCS-MOLRRes -> locationEstimate

RELEASE COMPLETE (Step 20):

Information element	Value/remark
Protocol Discriminator	Call Independent SS (1011)
Transaction Identifier	
Message Type	RELEASE COMPLETE (xx10 1010)

70.8.5.4 MO_LR Basic Self Location Request in Dedicated Mode (Alternative Case)

70.8.5.4.1 Conformance requirements:

The following requirements apply for this test:

1. The MS sends CM SERVICE REQUEST to network for call independent supplementary service.
2. The MS invokes a MO-LR by sending a REGISTER message to the network containing a LCS-MOLR invoke component. SS Version Indicator value 1 or above shall be used.
3. On receiving an RRLP MEASURE POSITION REQUEST message, the MS tries to perform the requested location measurements, and possibly calculates its own position. When the MS has location measurements, location estimate, or an error indication (measurements/location estimation not possible), it sends the results in the Measure Position Response component to the SMLC.
5. The network shall pass the result of the location procedure to the MS by sending a FACILITY message to the MS containing a LCS-MOLR return result component.
6. After the last location request operation the MS shall terminate the dialogue by sending a RELEASE COMPLETE message.

Test References

3GPP TS 03.71 subclause 7.6.6

3GPP TS 04.30 subclause 5.1.1

3GPP TS 04.31 subclause 2.2

70.8.5.4.2 Test Purpose

To verify that the MS invokes a self-location request by sending the network a REGISTER message containing an MO-LR Request of type "locationEstimate" on an already established speech call related SACCH. When the MS receives a FACILITY message containing a MO-LR return result carrying the requested location estimate, it clears the transaction by sending a RELEASE COMPLETE message.

Specific PICS statements

-

PIXIT statements

-

70.8.5.4.3 Method of Test

Initial Conditions

System Simulator:

Serving cell: default parameters.

Satellite signals: default conditions.

Mobile Station:

The MS has valid TMSI and CKSN.

The MS is brought into state U10 by using table 26.8.1.2/3.

Test Procedure:

The MS invokes call independent supplementary service on an existing SACCH channel. After receiving a CM SERVICE ACCEPT message, the MS invokes a self location request by sending a REGISTER message containing an MO-LR request of type "locationEstimate".

The SS orders an A-GPS positioning measurement by sending RR APPLICATION INFORMATION messages containing RRLP Assistance Data messages followed by an RRLP Measure Position Request including further assistance data.

Option 1: The MS then performs positioning measurements, and responds with an RR APPLICATION INFORMATION message containing an RRLP Measure Position Response.

Option 2: The MS may request additional assistance data by sending an RRLP Measure Position Response message containing a location error with IE LocErrorReason set to gpsAssDataMissing. If the MS requests additional assistance data that is available in the SS, then the SS provides the requested assistance data in zero, one or more RRLP Assistance Data delivery messages followed by an RRLP Measure Position Request message which may include further assistance data. If the MS requests additional assistance data and the entire requested assistance data is not available in the SS, then the SS repeats the RRLP Measure Position Request message without assistance data. The MS then performs positioning measurements, and responds with an RR APPLICATION INFORMATION message containing an RRLP Measure Position Response.

The SS responds with a FACILITY message containing an MO-LR result. When the MS receives the FACILITY message, it clears the transaction by sending a RELEASE COMPLETE message.

Maximum duration of the test:

5 minutes.

Expected Sequence

Step	Direction	Message	Comments
1	MS		Initiate MO-LR procedure (location estimation) on existing SACCH channel
2	MS -> SS	CM SERVICE REQUEST	The CM Service Type IE indicates "Supplementary service activation".
3	SS -> MS	CM SERVICE ACCEPT	
4	MS -> SS	REGISTER	Call Independent SS containing Facility IE with LCS-MOLR request and MO-LR Type set to "locationEstimate".
5	SS -> MS	RR APPLICATION INFORMATION	RRLP Assistance Data
6	MS -> SS	RR APPLICATION INFORMATION	RRLP assistanceDataAck
7	SS -> MS	RR APPLICATION INFORMATION	RRLP Assistance Data
8	MS -> SS	RR APPLICATION INFORMATION	RRLP assistanceDataAck
9	SS-> MS	RR APPLICATION INFORMATION	RRLP Measure Position Request
10	MS -> SS	RR APPLICATION INFORMATION	RRLP Measure Position Response: locationInfo (Option 1) or locationError with gpsAssDataMissing and additionalAssistanceData (Option 2)
10a	SS -> MS	RR APPLICATION INFORMATION	RRLP Assistance Data. If the MS requested additional assistance data in step 10 that is available in the SS, then SS provides the requested data in zero, one or more RRLP Assistance Data delivery messages.
10b	MS -> SS	RR APPLICATION INFORMATION	RRLP assistanceDataAck. If the SS sent additional assistance data in step 10a, the MS acknowledges the received assistance data.
10c	SS-> MS	RR APPLICATION INFORMATION	RRLP Measure Position Request. If the MS requested additional assistance data in step 10 that is available in the SS, this message may include further assistance data.
10d	MS-> SS	RR APPLICATION INFORMATION	RRLP Measure Position Response. If the MS requested additional assistance data in step 10, this message contains locationInfo.
11	SS -> MS	FACILITY	LCS MO-LR RETURN RESULT message containing location estimate
12	MS -> SS	RELEASE COMPLETE	MS terminates the dialogue
13	SS -> MS	CHANNEL RELEASE	The main signalling link is released.

Specific Message Contents

REGISTER (Step 4):

Information element	Value/remark
Protocol Discriminator	Call Independent SS (1011)
Transaction Identifier	
Message Type	REGISTER (xx11 1011)
Facility	Invoke = LCS-MOLR LCS-MOLRArg MOLR-Type->locationEstimate
SS version indicator	Value 1 or above

RR_APPLICATION_INFORMATION

Information element	Value/remark
Protocol Discriminator	RR Management Protocol (0110)
Skip Indicator	
Message Type	Application Information Message type
APDU ID	APDU ID -> RRLP => 0000
APDU Flags	Bit1=0 -> Last or only segment Bit2=0 -> First or only segment Bit3=0 -> Command or Final Response Bit4=spare
APDU Data	2-N Byte → ASN.1 Coded Steps 9 and 10c: RRLP Measure Position Request Steps 10 and 10d: RRLP Measure Position Response Steps 5, 7, 10a: RRLP Assistance Data Steps 6, 8, 10b: RRLP Assistance Data Ack.

RRLP Assistance Data (Step 5):

Information element	Type	Value/remark
ASN.1 encoded		
referenceNumber	Integer,0 to 7	1
component	CHOICE	assistanceData
gps-AssistData	SEQUENCE	
navigationModel	SEQUENCE	PRNs 4,6,9 of section 10.9.5
moreAssDataToBeSent	ENUMERATED	1

RRLP Assistance Data Ack (Steps 6, 8, 10b):

Information element	Type	Value/remark
ASN.1 encoded		
referenceNumber	Integer,0 to 7	1 or 2 (Option 2, Step 10b)
component	CHOICE	assistanceDataAck

RRLP Assistance Data (Step 7):

Information element	Type	Value/remark
ASN.1 encoded		
referenceNumber	Integer,0 to 7	1
component	CHOICE	assistanceData
gps-AssistData	SEQUENCE	
navigationModel	SEQUENCE	PRNs 10,13,22 of section 10.9.5
ionosphericModel	SEQUENCE	See section 10.9.6
moreAssDataToBeSent	ENUMERATED	0

RRLP Measure Position Request (Step 9):

Information element	Type	Value/remark
ASN.1 encoded		
referenceNumber	Integer,0 to 7	1
component	CHOICE	msrPositionReq
methodType	CHOICE	msBased
positionMethod	ENUMERATED	gps
measureResponseTime	Integer 0 to 7	5
accuracy	Integer (0-127)	127
useMultipleSets	ENUMERATED	oneSet
gps-AssistData	SEQUENCE	
referenceTime	SEQUENCE	See section 10.9.3
refLocation	SEQUENCE	See section 10.9.4

RRLP Measure Position Response (Step 10 (Option 1) or 10d (Option 2)):

Information element	Type	Value/remark
ASN.1 encoded		
referenceNumber	Integer,0 to 7	1 or 2 (Option 2, Step 10d)
component	CHOICE	msrPositionRsp (A valid response will contain LocationInfo otherwise LocationError will be returned)
locationInfo	SEQUENCE	Any value is acceptable.
locationError	SEQUENCE	Any error value is acceptable except gpsAssDataMissing.

RRLP Measure Position Response (Step 10 (Option 2)):

Information element	Type	Value/remark
ASN.1 encoded		
referenceNumber	Integer,0 to 7	1
component	CHOICE	msrPositionRsp
locationError	SEQUENCE	
locErrorReason	ENUMERATED	gpsAssDataMissing
additionalAssistanceData	SEQUENCE	
gpsAssistanceData	OCTET STRING	Indicates missing assistance data elements

RRLP Assistance Data (Step 10a):

Information element	Type	Value/remark
ASN.1 encoded		
referenceNumber	Integer,0 to 7	2
component	CHOICE	assistanceData
gps-AssistData	SEQUENCE	If the MS requested further assistance data in Step 10 (Option 2) that is available in the SS, SS shall send zero, one or more RRLP Assistance Data messages containing the requested assistance data from section 10.9. Each message shall contain a maximum of 242 octets.
moreAssDataToBeSent	ENUMERATED	1 or 0. If SS sends more than one RRLP assistance data delivery message the moreAssDataToBeSent field shall be set accordingly.

RRLP Measure Position Request (Step 10c):

Information element	Type	Value/remark
ASN.1 encoded		
referenceNumber	Integer,0 to 7	2
component	CHOICE	msrPositionReq
methodType	CHOICE	msBased
positionMethod	ENUMERATED	gps
measureResponseTime	Integer 0 to 7	5
accuracy	Integer (0-127)	127
useMultipleSets	ENUMERATED	oneSet
gps-AssistData	SEQUENCE	May contain further assistance data from section 10.9 as requested by the MS in step 10 (Option 2).

FACILITY (Step 11):

Information element	Value/remark
Protocol Discriminator	Call Independent SS (1011)
Transaction Identifier	
Message Type	FACILITY (0011 1010)
Facility	Return Result = LCS-MOLR LCS-MOLRRes -> locationEstimate

RELEASE COMPLETE (Step 12):

Information element	Value/remark
Protocol Discriminator	Call Independent SS (1011)
Transaction Identifier	
Message Type	RELEASE COMPLETE (xx10 1010)

70.8.6 MO-LR Transfer to 3rd Party for MS-Based A-GPS

70.8.6.1 Conformance requirements

The following requirements apply for this test:

1. If the MS is in idle mode, the MS requests an SDCCH and sends a DTAP CM service request indicating a request for call independent supplementary services to the BSC.
2. The MS invokes a MO-LR by sending a REGISTER message to the network containing a LCS-MOLR invoke component. SS Version Indicator value 1 or above shall be used.
3. If the MS is requesting that its location be sent to another LCS client, the message shall include the identity of the LCS client and may include the address of the GMLC through which the LCS client should be accessed.
4. On receiving an RRLP MEASURE POSITION REQUEST message, the MS tries to perform the requested location measurements, and possibly calculates its own position. When the MS has location measurements, location estimate, or an error indication (measurements/location estimation not possible), it sends the results in the Measure Position Response component to the SMLC.
5. The VMSC returns a DTAP LCS MO-LR Return Result to the MS carrying any location estimate requested by the MS, ciphering keys or a confirmation that a location estimate was successfully transferred to the GMLC serving an LCS client.
6. The network shall pass the result of the location procedure to the MS by sending a FACILITY message to the MS containing a LCS-MOLR return result component.
7. After the last location request operation the MS shall terminate the dialogue by sending a RELEASE COMPLETE message.

Test References

3GPP TS 03.71 subclause 7.6.6

3GPP TS 04.30 subclause 5.1.1

3GPP TS 04.31 subclause 2.2

70.8.6.2 Test Purpose

To verify that the MS invokes a transfer of its own location to a 3rd party LCS Client by sending the network a REGISTER message containing the Facility IE LCS MO-LR with LCSClientExternalID present. After receiving a FACILITY message as confirmation that the location estimate has been transferred to the requested LCS client, the MS terminates the dialogue by sending a RELEASE COMPLETE message.

70.8.6.3 Method of Test

Initial Conditions

System Simulator (SS):

Serving Cell: default parameters

Satellite signals: default conditions.

Mobile Station (MS):

The MS is in MM-state "idle, updated" with valid TMSI and CKSN.

Specific PICS statements

-

PIXIT statements

-

Test Procedure

The MS invokes call independent supplementary service through a CM SERVICE REQUEST. The SS initiates authentication and ciphering. Then the MS invokes an MO-LR request of type "locationEstimate" with "LCSClientExternalID" present.

The SS orders an A-GPS positioning measurement by sending RR APPLICATION INFORMATION messages containing RRLP Assistance Data messages followed by an RRLP Measure Position Request including further assistance data.

Option 1: The MS then performs positioning measurements, and responds with an RR APPLICATION INFORMATION message containing an RRLP Measure Position Response.

Option 2: The MS may request additional assistance data by sending an RRLP Measure Position Response message containing a location error with IE LocErrorReason set to gpsAssDataMissing. If the MS requests additional assistance data that is available in the SS, then the SS provides the requested assistance data in zero, one or more RRLP Assistance Data delivery messages followed by an RRLP Measure Position Request message which may include further assistance data. If the MS requests additional assistance data and the entire requested assistance data is not available in the SS, then the SS repeats the RRLP Measure Position Request message without assistance data. The MS then performs positioning measurements, and responds with an RR APPLICATION INFORMATION message containing an RRLP Measure Position Response.

The SS responds with a FACILITY message containing an MO-LR result to confirm that the location estimate has been transferred to the LCS client. When the MS receives the FACILITY message, it clears the transaction by sending a RELEASE COMPLETE message.

Maximum duration of the test

5 minutes.

Expected Sequence

Step	Direction	Message	Comments
1	MS		Initiate MOLR Transfer to 3 rd Party Procedure
2	MS -> SS	CHANNEL REQUEST	Establishment cause indicates, "Other procedures which can be completed with an SDCCH"
3	SS -> MS	IMMEDIATE ASSIGNMENT	
4	MS -> SS	CM SERVICE REQUEST	The CM Service Type IE indicates "Supplementary service activation" "mobile station classmark 2" includes settings for ES_IND.
5	MS->SS	CLASSMARK CHANGE	"mobile station classmark 2" includes settings for ES_IND. "mobile station classmark 3" includes settings for Positioning. The setting for positioning specifies Positioning Method capability and Positioning Method Support. In the position method support (5 bit field), Bit 2 is set to 1 (MS-Based GPS)
6	SS -> MS	AUTHENTICATION REQUEST	
7	MS -> SS	AUTHENTICATION RESPONSE	
8	SS -> MS	CIPHERING MODE COMMAND	
9	MS -> SS	CIPHERING MODE COMPLETE	
10	SS		SS starts ciphering
11	MS -> SS	REGISTER	Call Independent SS containing Facility IE with LCS-MOLR request with MOLR-Type set to locationEstimate with LCSClientExternalID present
12	SS -> MS	RR APPLICATION INFORMATION	RRLP Assistance Data
13	MS -> SS	RR APPLICATION INFORMATION	RRLP assistanceDataAck
14	SS -> MS	RR APPLICATION INFORMATION	RRLP Assistance Data
15	MS -> SS	RR APPLICATION INFORMATION	RRLP assistanceDataAck
16	SS-> MS	RR APPLICATION INFORMATION	RRLP Measure Position Request
17	MS -> SS	RR APPLICATION INFORMATION	RRLP Measure Position Response: locationInfo (Option 1) or locationError with gpsAssDataMissing and additionalAssistanceData (Option 2)
17a	SS -> MS	RR APPLICATION INFORMATION	RRLP Assistance Data. If the MS requested additional assistance data in step 17 that is available in the SS, then SS provides the requested data in zero, one or more RRLP Assistance Data delivery messages.
17b	MS -> SS	RR APPLICATION INFORMATION	RRLP assistanceDataAck. If the SS sent additional assistance data in step 17a, the MS acknowledges the received assistance data.
17c	SS-> MS	RR APPLICATION INFORMATION	RRLP Measure Position Request. If the MS requested additional assistance data in step 17 that is available in the SS, this message may include further assistance data.
17d	MS-> SS	RR APPLICATION INFORMATION	RRLP Measure Position Response. If the MS requested additional assistance data in step 17, this message contains locationInfo.

18	SS		SS may return the location estimate result to the LCS Client as identified by the LCSCientExternalID provided in the REGISTER message
19	SS -> MS	FACILITY	LCS MO-LR Return Result message as confirmation that the position estimate was transferred to the requested LCS client.
20	MS -> SS	RELEASE COMPLETE	MS terminates the dialogue
21	SS -> MS	CHANNEL RELEASE	The main signalling link is released.

Specific Message Contents

REGISTER (Step 11):

Information element	Value/remark
Protocol Discriminator	Call Independent SS (1011)
Transaction Identifier	
Message Type	REGISTER (xx11 1011)
Facility	Invoke = LCS-MOLR LCS-MOLRArg Molr-Type -> locationEstimate lcsClientExternalID -> externalAddress
SS version indicator	Value 1 or above

RR_APPLICATION_INFORMATION

Information element	Value/remark
Protocol Discriminator	RR Management Protocol (0110)
Skip Indicator	
Message Type	Application Information Message type
APDU ID	APDU ID -> RRLP => 0000
APDU Flags	Bit1=0 -> Last or only segment Bit2=0 -> First or only segment Bit3=0 -> Command or Final Response Bit4=spare
APDU Data	2-N Byte -> ASN.1 Coded Steps 16 and 17c: RRLP Measure Position Request Steps 17 and 17d: RRLP Measure Position Response Steps 12, 14, 17a: RRLP Assistance Data Steps 13, 15, 17b: RRLP Assistance Data Ack.

RRLP Assistance Data (Step 12):

Information element	Type	Value/remark
ASN.1 encoded		
referenceNumber	Integer, 0 to 7	1
component	CHOICE	assistanceData
gps-AssistData	SEQUENCE	
navigationModel	SEQUENCE	PRNs 4,6,9 of section 10.9.5
moreAssDataToBeSent	ENUMERATED	1

RRLP Assistance Data Ack (Steps 13, 15, 17b):

Information element	Type	Value/remark
ASN.1 encoded		
referenceNumber	Integer, 0 to 7	1 or 2 (Option 2, Step 17b)
component	CHOICE	assistanceDataAck

RRLP Assistance Data (Step 14):

Information element	Type	Value/remark
ASN.1 encoded		
referenceNumber	Integer,0 to 7	1
component	CHOICE	assistanceData
gps-AssistData	SEQUENCE	
navigationModel	SEQUENCE	PRNs 10,13,22 of section 10.9.5
ionosphericModel	SEQUENCE	See section 10.9.6
moreAssDataToBeSent	ENUMERATED	0

RRLP Measure Position Request (Step 16):

Information element	Type	Value/remark
ASN.1 encoded		
referenceNumber	Integer,0 to 7	1
component	CHOICE	msrPositionReq
methodType	CHOICE	msBased
positionMethod	ENUMERATED	gps
measureResponseTime	Integer 0 to 7	5
accuracy	Integer (0-127)	127
useMultipleSets	ENUMERATED	oneSet
gps-AssistData	SEQUENCE	
referenceTime	SEQUENCE	See section 10.9.3
refLocation	SEQUENCE	See section 10.9.4

RRLP Measure Position Response (Step 17 (Option 1) or 17d (Option 2)):

Information element	Type	Value/remark
ASN.1 encoded		
referenceNumber	Integer,0 to 7	1 or 2 (Option 2, Step 17d)
component	CHOICE	msrPositionRsp (A valid response will contain LocationInfo otherwise LocationError will be returned)
locationInfo	SEQUENCE	Any value is acceptable.
locationError	SEQUENCE	Any error value is acceptable except gpsAssDataMissing.

RRLP Measure Position Response (Step 17 (Option 2)):

Information element	Type	Value/remark
ASN.1 encoded		
referenceNumber	Integer,0 to 7	1
component	CHOICE	msrPositionRsp
locationError	SEQUENCE	
locErrorReason	ENUMERATED	gpsAssDataMissing
additionalAssistanceData	SEQUENCE	
gpsAssistanceData	OCTET STRING	Indicates missing assistance data elements

RRLP Assistance Data (Step 17a):

Information element	Type	Value/remark
ASN.1 encoded		
referenceNumber	Integer,0 to 7	2
component	CHOICE	assistanceData
gps-AssistData	SEQUENCE	If the MS requested further assistance data in Step 17 (Option 2) that is available in the SS, SS shall send zero, one or more RRLP Assistance Data messages containing the requested assistance data from section 10.9. Each message shall contain a maximum of 242 octets.
moreAssDataToBeSent	ENUMERATED	1 or 0. If SS sends more than one RRLP assistance data delivery message the moreAssDataToBeSent field shall be set accordingly.

RRLP Measure Position Request (Step 17c):

Information element	Type	Value/remark
ASN.1 encoded		
referenceNumber	Integer,0 to 7	2
component	CHOICE	msrPositionReq
methodType	CHOICE	msBased
positionMethod	ENUMERATED	gps
measureResponseTime	Integer 0 to 7	5
accuracy	Integer (0-127)	127
useMultipleSets	ENUMERATED	oneSet
gps-AssistData	SEQUENCE	May contain further assistance data from section 10.9 as requested by the MS in step 17 (Option 2).

FACILITY (Step 19):

Information element	Value/remark
Protocol Discriminator	Call Independent SS (1011)
Transaction Identifier	
Message Type	FACILITY (0011 1010)
Facility	Return Result = LCS-MOLR LCS-MOLRRes -> locationEstimate

RELEASE COMPLETE (Step 20):

Information element	Value/remark
Protocol Discriminator	Call Independent SS (1011)
Transaction Identifier	
Message Type	RELEASE COMPLETE (xx10 1010)

70.9 Assisted GPS Mobile Terminated Tests

70.9.1 MT-LR Location Notification

70.9.1.1 MT-LR Location Notification for Mobiles Supporting MS-Based GPS

70.9.1.1.1 Conformance requirements

1. The network invokes a location notification procedure by sending a REGISTER message containing a LCS-LocationNotification invoke component to the MS with notificationType set to notifyLocationAllowed. The MS shall notify the MS user of the location request.
2. The MS shall terminate the dialogue by sending a RELEASE COMPLETE message containing a LocationNotification return result with verificationResponse set to permissionGranted.

References

3GPP TS 03.71 subclause 7.6.1.

3GPP TS 04.30 subclause 4.1.1.

3GPP TS 04.80 / 3GPP TS 24.080 subclauses 2.4, 2.5, and 3.4.

70.9.1.1.2 Test Purpose

To verify that when the MS receives a REGISTER message, containing a LCS Location Notification Invoke component set to NotifyLocationAllowed, the MS displays information about the LCS client correctly and sends a RELEASE COMPLETE message containing a LocationNotification return result with verificationResponse set to permissionGranted.

70.9.1.1.3 Method of Test

Initial Conditions

System Simulator (SS):

Serving Cell: default parameters

Mobile Station (MS):

The MS is in MM-state "idle, updated" with valued TMSI and CKSN.

Specific PICS statements

-

PIXIT statements

-

Test Procedure

The MS is paged with a PAGING REQUEST TYPE 1 message. After sending the CIPHERING MODE COMPLETE message the MS receives an SS REGISTER message containing a Facility IE containing a DTAP LCS Location Notification Invoke message set to notifyLocationAllowed. The LCS Client Name contained in the USSD text string of the lcs-LocationNotification shall be displayed. The MS then responds with a RELEASE COMPLETE message containing a LocationNotification return to terminate the dialogue.

Maximum duration of the test

5 minutes.

Expected Sequence

Step	Direction	Message	Comments
1	SS->MS	PAGING REQUEST TYPE I	
2	MS -> SS	CHANNEL REQUEST	Establishment cause indicates "answer to paging".
3	SS -> MS	IMMEDIATE ASSIGNMENT	
4	MS->SS	PAGING RESPONSE	Message is contained in SABM. "mobile station classmark 2" includes settings for ES_IND.
5	MS->SS	CLASSMARK CHANGE	"mobile station classmark 2" includes settings for ES_IND. "mobile station classmark 3" includes settings for Positioning. The setting for positioning specifies Positioning Method capability and Positioning Method Support. In the position method support (5 bit field), Bit 2 is set to 1 (MS-Based GPS)
6	SS -> MS	AUTHENTICATION REQUEST	
7	MS -> SS	AUTHENTICATION RESPONSE	
8	SS -> MS	CIPHERING MODE COMMAND	
9	MS -> SS	CIPHERING MODE COMPLETE	
10	SS		SS starts ciphering.
11	SS -> MS	REGISTER	Call Independent SS containing Facility IE Location Notification Invoke message set to notifyLocationAllowed
12	MS		MS displays information about LCS client
13	MS -> SS	RELEASE COMPLETE	
14	SS -> MS	CHANNEL RELEASE	The main signalling link is released.

Specific Message Contents

PAGING RESPONSE

Information element	Value/remark
Protocol Discriminator	RR management
Ciphering Key Sequence number - Key Sequence	Key sequence number previously allocated to MS, or "111" if no key is available
Mobile station Classmark 2 - ES IND	Shall indicate early autonomous sending of CLASSMARK CHANGE
Mobile Identity - odd/even - Type of identity - Identity digits	Even TMSI TMSI previously allocated to MS

REGISTER

Information element	Value/remark
Protocol Discriminator	Call Independent SS message (1011)
Transaction identifier Message type Facility	REGISTER (0011 1011) Invoke = lcs-LocationNotification LocationNotificationArg notificationType -> notifyLocationAllowed, locationType -> current Location , lcsClientExternalID -> externalAddress lcsClientName ->dataCodingScheme nameString

RELEASE COMPLETE

Information element	Value/remark
Protocol Discriminator	Call Independent SS message (1011)
Transaction identifier Message type Facility	RELEASE COMPLETE (xx10 1010) Return result = lcs-LocationNotification <u>verificationResponse</u> -> permissionGranted

70.9.1.2 MT-LR Location Notification for Mobiles Supporting MS-Assisted GPS

70.9.1.2.1 Conformance requirements

1. The network invokes a location notification procedure by sending a REGISTER message containing a LCS-LocationNotification invoke component to the MS with notificationType set to notifyLocationAllowed. The MS shall notify the MS user of the location request.
2. The MS shall terminate the dialogue by sending a RELEASE COMPLETE message containing a LocationNotification return result with verificationResponse set to permissionGranted.

References

3GPP TS 03.71 subclause 7.6.1.

3GPP TS 04.30 subclause 4.1.1.

3GPP TS 04.80 / 3GPP TS 24.080 subclauses 2.4, 2.5, and 3.4.

70.9.1.2.2 Test Purpose

To verify that when the MS receives a REGISTER message, containing a LCS Location Notification Invoke component set to NotifyLocationAllowed, the MS displays information about the LCS client correctly and sends a RELEASE COMPLETE message containing a LocationNotification return result with verificationResponse set to permissionGranted.

70.9.1.2.3 Method of Test

Initial Conditions

System Simulator (SS):

Serving Cell: default parameters

Mobile Station (MS):

The MS is in MM-state "idle, updated" with valued TMSI and CKSN.

Specific PICS statements

-

PIXIT statements

-

Test Procedure

The MS is paged with a PAGING REQUEST TYPE 1 message. After sending the CIPHERING MODE COMPLETE message the MS receives an SS REGISTER message containing a Facility IE containing a DTAP LCS Location Notification Invoke message set to notifyLocationAllowed. The LCS Client Name contained in the USSD text string of the lcs-LocationNotification shall be displayed. The MS then responds with a RELEASE COMPLETE message containing a LocationNotification return to terminate the dialogue.

Maximum duration of the test

5 minutes.

Expected Sequence

Step	Direction	Message	Comments
1	SS->MS	PAGING REQUEST TYPE I	
2	MS -> SS	CHANNEL REQUEST	Establishment cause indicates "answer to paging".
3	SS -> MS	IMMEDIATE ASSIGNMENT	
4	MS->SS	PAGING RESPONSE	Message is contained in SABM. "mobile station classmark 2" includes settings for ES_IND.
5	MS->SS	CLASSMARK CHANGE	"mobile station classmark 2" includes settings for ES_IND. "mobile station classmark 3" includes settings for Positioning. The setting for positioning specifies Positioning Method capability and Positioning Method Support. In the position method support (5 bit field), Bit 3 is set to 1 (MS-Assisted GPS)
6	SS -> MS	AUTHENTICATION REQUEST	
7	MS -> SS	AUTHENTICATION RESPONSE	
8	SS -> MS	CIPHERING MODE COMMAND	
9	MS -> SS	CIPHERING MODE COMPLETE	
10	SS		SS starts ciphering.
11	SS -> MS	REGISTER	Call Independent SS containing Facility IE Location Notification Invoke message set to notifyLocationAllowed
12	MS		MS displays information about LCS client
13	MS -> SS	RELEASE COMPLETE	
14	SS -> MS	CHANNEL RELEASE	The main signalling link is released.

Specific Message Contents

PAGING RESPONSE

Information element	Value/remark
Protocol Discriminator	RR management
Ciphering Key Sequence number - Key Sequence	Key sequence number previously allocated to MS, or "111" if no key is available
Mobile station Classmark 2 - ES IND	Shall indicate early autonomous sending of CLASSMARK CHANGE
Mobile Identity - odd/even - Type of identity - Identity digits	Even TMSI TMSI previously allocated to MS

REGISTER

Information element	Value/remark
Protocol Discriminator	Call Independent SS message (1011)
Transaction identifier Message type Facility	REGISTER (0011 1011) Invoke = lcs-LocationNotification LocationNotificationArg <u>notificationType</u> -> notifyLocationAllowed, <u>locationType</u> -> current Location, <u>lcsClientExternalID</u> -> externalAddress <u>lcsClientName</u> ->dataCodingScheme nameString

RELEASE COMPLETE

Information element	Value/remark
Protocol Discriminator	Call Independent SS message (1011)
Transaction identifier Message type Facility	RELEASE COMPLETE (xx10 1010) Return result = lcs-LocationNotification <u>verificationResponse</u> -> permissionGranted

70.9.2 MT-LR Privacy Options/Verification – Location Allowed If No Response

70.9.2.1 MT-LR Privacy Options/Verification– Location Allowed If No Response for mobiles supporting MS-Based GPS

70.9.2.1.1 Conformance requirements

1. On receipt of a REGISTER message containing the LCS Notification Invoke component with notificationType set to notifyAndVerify-LocationAllowedIfNoResponse. The MS: a) notifies the user of the request, b) indicates the default is location allowed if no response is received within a predetermined period, and c) providing the opportunity to accept or deny the request if allowed by subscription or if barred by subscription.
- 2.

Option 1: The user accepts the location request. The MS shall terminate the dialogue by sending a RELEASE COMPLETE message containing a LocationNotification return result with verificationResponse set to permissionGranted.

Option 2: The user denies the location request.

The MS shall terminate the dialogue by sending a RELEASE COMPLETE message containing a LocationNotification return result with verificationResponse set to permissionDenied.

Option 3: The user takes no action and the verification process times-out. The SS shall terminate the dialogue.

References

3GPP TS 03.71 subclause 7.6.1.

3GPP TS 04.30 / 3GPP TS 24.030 Rel-6 subclause 4.1.1.

3GPP TS 04.80 / 3GPP TS 24.080 subclauses 2.4, 2.5, and 3.4.

70.9.2.1.2 Test Purpose

To verify that the MS receives a REGISTER message, containing a LCS Location Notification Invoke component set to notifyAndVerify-LocationAllowedIfNoResponse, the MS displays information about the LCS client correctly and indicates that the default response is location allowed if no response is sent. Gives the user the option to accept or reject the request and sends a RELEASE COMPLETE message containing a LocationNotification return result with the verificationResponse set to permissionDenied or permissionGranted as appropriate.

70.9.2.1.3 Method of Test

Initial Conditions

System Simulator (SS):

Serving Cell: default parameters.

Mobile Station (MS):

The MS is in MM-state "idle, updated" with valid TMSI and CKSN.

Specific PICS statements

-

PIXIT statements

-

Test Procedure

The MS is paged with a PAGING REQUEST TYPE 1 message. After sending the CIPHERING MODE COMPLETE message the MS receives an SS REGISTER message with a Facility IE containing a LCS Location Notification Invoke set to notifyAndVerify-LocationAllowedIfNoResponse. The LCS Client Name contained in the USSD text string of the lcs-LocationNotification shall be displayed with the option to accept or deny the request, if allowed by subscription or if barred by subscription respectively. The MS also indicates that location will be allowed if a response is not received within a predetermined time.

Option 1:

The user then accepts the location request. The MS responds with a RELEASE COMPLETE message containing a LocationNotification return result with verificationResponse set to permissionGranted.

Option 2:

The user then denies the location request. The MS responds with a RELEASE COMPLETE message containing a LocationNotification return result with verificationResponse set to permissionDenied.

Option 3:

The user ignores the location request by taking no action, allowing the verification process timer to time-out. The SS responds with RELEASE COMPLETE.

Maximum duration of the test

5 minutes.

Expected Sequence

The test sequence is repeated for $k = 1 \dots 3$.

Step	Direction	Message	Comments
1	SS->MS	PAGING REQUEST TYPE I	
2	MS -> SS	CHANNEL REQUEST	Establishment cause indicates "answer to paging".
3	SS -> MS	IMMEDIATE ASSIGNMENT	
4	MS->SS	PAGING RESPONSE	Message is contained in SABM. "mobile station classmark 2" includes settings for ES_IND.
5	MS->SS	CLASSMARK CHANGE	"mobile station classmark 2" includes settings for ES_IND. "mobile station classmark 3" includes settings for Positioning. The setting for positioning specifies Positioning Method capability and Positioning Method Support. In the position method support (5 bit field), Bit 2 is set to 1 (MS-Based GPS)
6	SS -> MS	AUTHENTICATION REQUEST	
7	MS -> SS	AUTHENTICATION RESPONSE	
8	SS -> MS	CIPHERING MODE COMMAND	
9	MS -> SS	CIPHERING MODE COMPLETE	
10	SS		SS starts ciphering.
11	SS -> MS	REGISTER	Call Independent SS containing Facility IE LCS Location Notification Invoke set to notifyAndVerify-LocationAllowedIfNoResponse
12	SS		SS starts timer T(LCSN) set to 10 seconds
13A (k=1)	MS		The MS displays the location request and information about LCS Client. The user accepts location request within 10 seconds.
14A (k=1)	MS -> SS	RELEASE COMPLETE	Containing a LocationNotification return result with verificationResponse set to permissionGranted.
13B (k=2)	MS		The MS displays the location request and information about LCS Client. The user rejects location request within 10 seconds.
14B (k=2)	MS -> SS	RELEASE COMPLETE	Containing a LocationNotification return result with verificationResponse set to permissionDenied.
13C (k=3)	MS		The MS displays the location request and information about LCS Client. The user does not reply and waits for T(LCSN) to expire.
14C (k=3)	SS->MS	RELEASE COMPLETE	SS terminates the dialogue after T(LCSN) expiry
15	SS -> MS	CHANNEL RELEASE	The main signalling link is released.

Specific Message Contents

PAGING RESPONSE (Step 4)

Information element	Value/remark
Protocol Discriminator	RR management
Ciphering Key Sequence number - Key Sequence	Key sequence number previously allocated to MS, or "111" if no key is available
Mobile station Classmark 2 - ES IND	Shall indicate early autonomous sending of CLASSMARK CHANGE
Mobile Identity - odd/even - Type of identity - Identity digits	Even TMSI TMSI previously allocated to MS

REGISTER (Step 11)

Information element	Value/remark
Protocol Discriminator	Call Independent SS message (1011)
Transaction identifier Message type Facility	REGISTER (0011 1011) Invoke = lcs-LocationNotification LocationNotificationArg <u>notificationType</u> -> notifyAnd Verify- LocationAllowedIfNoResponse, <u>locationType</u> -> current Location , <u>lcsClientExternalID</u> -> externalAddress <u>lcsClientName</u> -> dataCodingScheme nameString

RELEASE COMPLETE (Option k=1 Step14A)

Information element	Value/remark
Protocol Discriminator	Call Independent SS message (1011)
Transaction identifier Message type Facility	RELEASE COMPLETE (xx10 1010) Return result = lcs-LocationNotification LocationNotificationRes <u>verificationResponse</u> -> permissionGranted

RELEASE COMPLETE (Option k=2 Step 14B)

Information element	Value/remark
Protocol Discriminator	Call Independent SS message (1011)
Transaction identifier Message type Facility	RELEASE COMPLETE (xx10 1010) Return result = lcs-LocationNotification LocationNotificationRes <u>verificationResponse</u> -> permissionDenied

RELEASE COMPLETE (Option k=3, Step 14C)

Information element	Value/remark
Protocol Discriminator	Call Independent SS message (1011)
Transaction identifier Message type	RELEASE COMPLETE (0010 1010)

70.9.2.2 MT-LR Privacy Options/Verification– Location Allowed If No Response for Mobiles Supporting MS-Assisted GPS

70.9.2.2.1 Conformance requirements

1. On receipt of a REGISTER message containing the LCS Notification Invoke component with notificationType set to notifyAndVerify-LocationAllowedIfNoResponse. The MS: a) notifies the user of the request, b) indicates the default is location allowed if no response is received within a predetermined period, and c) providing the opportunity to accept or deny the request if allowed by subscription or if barred by subscription.
- 2.

Option 1: The user accepts the location request. The MS shall terminate the dialogue by sending a RELEASE COMPLETE message containing a LocationNotification return result with verificationResponse set to permissionGranted.

Option 2: The user denies the location request.
The MS shall terminate the dialogue by sending a RELEASE COMPLETE message containing a LocationNotification return result with verificationResponse set to permissionDenied.

Option 3: The user takes no action and the verification process times-out.
The SS shall terminate the dialogue.

References

3GPP TS 03.71 subclause 7.6.1.

3GPP TS 04.30 / 3GPP TS 24.030 Rel-6 subclause 4.1.1.

3GPP TS 04.80 / 3GPP TS 24.080 subclauses 2.4, 2.5, and 3.4.

70.9.2.2.2 Test Purpose

To verify that the MS receives a REGISTER message, containing a LCS Location Notification Invoke component set to notifyAndVerify-LocationAllowedIfNoResponse, the MS displays information about the LCS client correctly and indicates that the default response is location allowed if no response is sent. Gives the user the option to accept or reject the request and sends a RELEASE COMPLETE message containing a LocationNotification return result with the verificationResponse set to permissionDenied or permissionGranted as appropriate.

70.9.2.2.3 Method of Test

Initial Conditions

System Simulator (SS):

Serving Cell: default parameters

Mobile Station (MS):

The MS is in MM-state “idle, updated” with valid TMSI and CKSN.

Specific PICS statements

-

PIXIT statements

-

Test Procedure

The MS is paged with a PAGING REQUEST TYPE 1 message. After sending the CIPHERING MODE COMPLETE message the MS receives an SS REGISTER message with a Facility IE containing a LCS Location Notification Invoke set to notifyAndVerify-LocationAllowedIfNoResponse. The LCS Client Name contained in the USSD text string of the lcs-LocationNotification shall be displayed with the option to accept or deny the request, if allowed by subscription or if

barred by subscription . The MS also indicates that location will be allowed if a response is not received within a predetermined time.

Option 1:

The user then accepts the location request. The MS responds with a RELEASE COMPLETE message containing a LocationNotification return result with verificationResponse set to permissionGranted.

Option 2:

The user then denies the location request. The MS responds with a RELEASE COMPLETE message containing a LocationNotification return result with verificationResponse set to permissionDenied.

Option 3:

The user ignores the location request by taking no action, allowing the verification process timer to time-out. The SS responds with RELEASE COMPLETE.

Maximum duration of the test

5 minutes.

Expected Sequence

The test sequence is repeated for $k = 1 \dots 3$.

Step	Direction	Message	Comments
1	SS->MS	PAGING REQUEST TYPE I	
2	MS -> SS	CHANNEL REQUEST	Establishment cause indicates "answer to paging".
3	SS -> MS	IMMEDIATE ASSIGNMENT	
4	MS->SS	PAGING RESPONSE	Message is contained in SABM. "mobile station classmark 2" includes settings for ES_IND.
5	MS->SS	CLASSMARK CHANGE	"mobile station classmark 2" includes settings for ES_IND. "mobile station classmark 3" includes settings for Positioning. The setting for positioning specifies Positioning Method capability and Positioning Method Support. In the position method support (5 bit field), Bit 3 is set to 1 (MS-Assisted GPS)
6	SS -> MS	AUTHENTICATION REQUEST	
7	MS -> SS	AUTHENTICATION RESPONSE	
8	SS -> MS	CIPHERING MODE COMMAND	
9	MS -> SS	CIPHERING MODE COMPLETE	
10	SS		SS starts ciphering.
11	SS -> MS	REGISTER	Call Independent SS containing Facility IE LCS Location Notification Invoke set to notifyAndVerify-LocationAllowedIfNoResponse
12	SS		SS starts timer T(LCSN) set to 10 seconds
13A (k=1)	MS		The MS displays the location request and information about LCS Client. The user accepts location request within 10 seconds.
14A (k=1)	MS -> SS	RELEASE COMPLETE	Containing a LocationNotification return result with verificationResponse set to permissionGranted.
13B (k=2)	MS		The MS displays the location request and information about LCS Client. The user rejects location request within 10 seconds.
14B (k=2)	MS -> SS	RELEASE COMPLETE	Containing a LocationNotification return result with verificationResponse set to permissionDenied.
13C (k=3)	MS		The MS displays the location request and information about LCS Client. The user does not reply and waits for T(LCSN) to expire.
14C (k=3)	SS->MS	RELEASE COMPLETE	SS terminates the dialogue after T(LCSN) expiry
15	SS -> MS	CHANNEL RELEASE	The main signalling link is released.

Specific Message Contents

PAGING RESPONSE (Step 4)

Information element	Value/remark
Protocol Discriminator	RR management
Ciphering Key Sequence number - Key Sequence	Key sequence number previously allocated to MS, or "111" if no key is available
Mobile station Classmark 2 - ES IND	Shall indicate early autonomous sending of CLASSMARK CHANGE
Mobile Identity - odd/even - Type of identity - Identity digits	Even TMSI TMSI previously allocated to MS

REGISTER (Step 11)

Information element	Value/remark
Protocol Discriminator	Call Independent SS message (1011)
Transaction identifier Message type Facility	REGISTER (0011 1011) Invoke = lcs-LocationNotification LocationNotificationArg <u>notificationType</u> -> notifyAnd Verify- LocationAllowedIfNoResponse, <u>locationType</u> -> current Location, <u>lcsClientExternalID</u> -> externalAddress <u>lcsClientName</u> -> dataCodingScheme nameString

RELEASE COMPLETE (Option k=1 Step14A)

Information element	Value/remark
Protocol Discriminator	Call Independent SS message (1011)
Transaction identifier Message type Facility	RELEASE COMPLETE (xx10 1010) Return result = lcs-LocationNotification LocationNotificationRes <u>verificationResponse</u> -> permissionGranted

RELEASE COMPLETE (Option k=2 Step14B)

Information element	Value/remark
Protocol Discriminator	Call Independent SS message (1011)
Transaction identifier Message type Facility	RELEASE COMPLETE (xx10 1010) Return result = lcs-LocationNotification LocationNotificationRes <u>verificationResponse</u> -> permissionDenied

RELEASE COMPLETE (Option k=3, Step 14C):

Information element	Value/remark
Protocol Discriminator	Call Independent SS message (1011)
Transaction identifier Message type	RELEASE COMPLETE (0010 1010)

70.9.3 MT-LR Privacy Options/Verification – Location Not Allowed If No Response

70.9.3.1 MT-LR Privacy Options/Verification– Location Not Allowed If No Response for Mobiles Supporting MS-Based GPS

70.9.3.1.1 Conformance requirements

1. On receipt of a REGISTER message containing the LCS Notification Invoke component with notificationType set to notifyAndVerify-LocationNotAllowedIfNoResponse, the MS: a) notifies the user of the request, b) indicates the default is location not allowed if no response is received within a predetermined period, and c) providing the opportunity to accept or deny the request if allowed by subscription or if barred by subscription.

2.

Option 1: The user accepts the location request. The MS shall terminate the dialogue by sending a RELEASE COMPLETE message containing a LocationNotification return result with verificationResponse set to permissionGranted.

Option 2: The user denies the location request.

The MS shall terminate the dialogue by sending a RELEASE COMPLETE message containing a LocationNotification return result with verificationResponse set to permissionDenied.

Option 3: The user takes no action and the verification process times-out.

The SS shall terminate the dialogue.

References

3GPP TS 03.71 subclause 7.6.1.

3GPP TS 04.30 / 3GPP TS 24.030 Rel-6 subclause 4.1.1.

3GPP TS 04.80 / 3GPP TS 24.080 subclauses 2.4, 2.5, and 3.4.

70.9.3.1.2 Test Purpose

To verify that if the MS receives a REGISTER message, containing a LCS Location Notification Invoke component set to notifyAndVerify-LocationNotAllowedIfNoResponse, then the MS displays information about the LCS client correctly and indicates that the default response is location not allowed if no response is sent. Gives the user the option to accept or reject the request and sends a RELEASE COMPLETE message containing a LocationNotification return result with the verificationResponse set to permissionDenied or permissionGranted as appropriate.

70.9.3.1.3 Method of Test

Initial Conditions

System Simulator (SS):

Serving Cell: default parameters

Mobile Station (MS):

The MS is in MM-state “idle, updated” with valid TMSI and CKSN.

Specific PICS statements

-

PIXIT statements

-

Test Procedure

The MS is paged with a PAGING REQUEST TYPE 1 message. After sending the CIPHERING MODE COMPLETE message the MS receives an SS REGISTER message with a Facility IE containing a LCS Location Notification Invoke

set to notifyAndVerify-LocationNotAllowedIfNoResponse. The LCS Client Name contained in the USSD text string of the lcs-LocationNotification shall be displayed with the option to accept or deny the request, if allowed by subscription or if barred by subscription respectively. The MS also indicates that location will be allowed if a response is not received within a predetermined time.

Option 1:

The user then accepts the location request. The MS responds with a RELEASE COMPLETE message containing a LocationNotification return result with verificationResponse set to permissionGranted.

Option 2:

The user then denies the location request. The MS responds with a RELEASE COMPLETE message containing a LocationNotification return result with verificationResponse set to permissionDenied.

Option 3:

The user ignores the location request by taking no action, allowing the verification process timer to time-out. The SS responds with RELEASE COMPLETE.

Maximum duration of the test

5 minutes.

Expected Sequence

The test sequence is repeated for $k = 1 \dots 3$.

Step	Direction	Message	Comments
1	SS->MS	PAGING REQUEST TYPE I	
2	MS -> SS	CHANNEL REQUEST	Establishment cause indicates "answer to paging".
3	SS -> MS	IMMEDIATE ASSIGNMENT	
4	MS->SS	PAGING RESPONSE	Message is contained in SABM. "mobile station classmark 2" includes settings for ES_IND.
5	MS->SS	CLASSMARK CHANGE	"mobile station classmark 2" includes settings for ES_IND. "mobile station classmark 3" includes settings for Positioning. The setting for positioning specifies Positioning Method capability and Positioning Method Support. In the position method support (5 bit field), Bit 2 is set to 1 (MS-Based GPS)
6	SS -> MS	AUTHENTICATION REQUEST	
7	MS -> SS	AUTHENTICATION RESPONSE	
8	SS -> MS	CIPHERING MODE COMMAND	
9	MS -> SS	CIPHERING MODE COMPLETE	
10	SS		SS starts ciphering.
11	SS -> MS	REGISTER	Call Independent SS containing Facility IE LCS Location Notification Invoke set to notifyAndVerify-LocationNotAllowedIfNoResponse
12	SS		SS starts timer T(LCSN) set to 10 seconds
13A (k=1)	MS		The MS displays the location request and information about LCS Client. The user accepts location request within 10 seconds.
14A (k=1)	MS -> SS	RELEASE COMPLETE	Containing a LocationNotification return result with verificationResponse set to permissionGranted.
13B (k=2)	MS		The MS displays the location request and information about LCS Client. The user rejects location request within 10 seconds.
14B (k=2)	MS -> SS	RELEASE COMPLETE	Containing a LocationNotification return result with verificationResponse set to permissionDenied.
13C (k=3)	MS		The MS displays the location request and information about LCS Client. The user does not reply and waits for T(LCSN) to expire.
14C (k=3)	SS->MS	RELEASE COMPLETE	SS terminates the dialogue after T(LCSN) expiry
15	SS -> MS	CHANNEL RELEASE	The main signalling link is released.

Specific Message Contents

PAGING RESPONSE (Step 4)

Information element	Value/remark
Protocol Discriminator	RR management
Ciphering Key Sequence number - Key Sequence	Key sequence number previously allocated to MS, or "111" if no key is available
Mobile station Classmark 2 - ES IND	Shall indicate early autonomous sending of CLASSMARK CHANGE
Mobile Identity - odd/even - Type of identity - Identity digits	Even TMSI TMSI previously allocated to MS

REGISTER (Step 11)

Information element	Value/remark
Protocol Discriminator	Call Independent SS message (1011)
Transaction identifier Message type Facility	REGISTER (0011 1011) Invoke = lcs-LocationNotification LocationNotificationArg <u>notificationType</u> -> notifyAnd Verify- LocationNotAllowedIfNoResponse, <u>locationType</u> -> current Location, <u>lcsClientExternalID</u> -> externalAddress <u>lcsClientName</u> -> dataCodingScheme nameString

RELEASE COMPLETE (Option k=1 Step14A)

Information element	Value/remark
Protocol Discriminator	Call Independent SS message (1011)
Transaction identifier Message type Facility	RELEASE COMPLETE (xx10 1010) Return result = lcs-LocationNotification LocationNotificationRes <u>verificationResponse</u> -> permissionGranted

RELEASE COMPLETE (Option k=2 Step14B)

Information element	Value/remark
Protocol Discriminator	Call Independent SS message (1011)
Transaction identifier Message type Facility	RELEASE COMPLETE (xx10 1010) Return result = lcs-LocationNotification LocationNotificationRes <u>verificationResponse</u> -> permissionDenied

RELEASE COMPLETE (Option k=3, Step 14C)

Information element	Value/remark
Protocol Discriminator	Call Independent SS message (1011)
Transaction identifier Message type	RELEASE COMPLETE (0010 1010)

70.9.3.2 MT-LR Privacy Options/Verification– Location Not Allowed If No Response for mobiles supporting MS-Assisted GPS

70.9.3.2.1 Conformance requirements

1. On receipt of a REGISTER message containing the LCS Notification Invoke component with notificationType set to notifyAndVerify-LocationNotAllowedIfNoResponse, the MS: a) notifies the user of the request, b) indicates the default is location not allowed if no response is received within a predetermined period, and c) providing the opportunity to accept or deny the request if allowed by subscription or if barred by subscription respectively.

2.

Option 1: The user accepts the location request. The MS shall terminate the dialogue by sending a RELEASE COMPLETE message containing a LocationNotification return result with verificationResponse set to permissionGranted.

Option 2: The user denies the location request.

The MS shall terminate the dialogue by sending a RELEASE COMPLETE message containing a LocationNotification return result with verificationResponse set to permissionDenied.

Option 3: The user takes no action and the verification process times-out.

The SS shall terminate the dialogue.

References

3GPP TS 03.71 subclause 7.6.1.

3GPP TS 04.30 / 3GPP TS 24.030 Rel-6 subclause 4.1.1.

3GPP TS 04.80 / 3GPP TS 24.080 subclauses 2.4, 2.5, and 3.4.

70.9.3.2.2 Test Purpose

To verify that the MS receives a REGISTER message, containing a LCS Location Notification Invoke component set to notifyAndVerify-LocationNotAllowedIfNoResponse, the MS displays information about the LCS client correctly and indicates that the default response is location not allowed if no response is sent. Gives the user the option to accept or reject the request and sends a RELEASE COMPLETE message containing a LocationNotification return result with the verificationResponse set to permissionDenied or permissionGranted as appropriate.

70.9.3.2.3 Method of Test

Initial Conditions

System Simulator (SS):

Serving Cell: default parameters

Mobile Station (MS):

The MS is in MM-state “idle, updated” with valid TMSI and CKSN.

Specific PICS statements

-

PIXIT statements

-

Test Procedure

The MS is paged with a PAGING REQUEST TYPE 1 message. After sending the CIPHERING MODE COMPLETE message the MS receives an SS REGISTER message with a Facility IE containing a LCS Location Notification Invoke set to notifyAndVerify-LocationNotAllowedIfNoResponse. The LCS Client Name contained in the USSD text string of the lcs-LocationNotification shall be displayed with the option to accept or deny the request, if allowed by subscription

or if barred by subscription respectively. The MS also indicates that location will not be allowed if a response is not received within a predetermined time.

Option 1:

The user then accepts the location request. The MS responds with a RELEASE COMPLETE message containing a LocationNotification return result with verificationResponse set to permissionGranted.

Option 2:

The user then denies the location request. The MS responds with a RELEASE COMPLETE message containing a LocationNotification return result with verificationResponse set to permissionDenied.

Option 3:

The user ignores the location request by taking no action, allowing the verification process timer to time-out. The SS responds with RELEASE COMPLETE.

Maximum duration of the test

5 minutes.

Expected Sequence

The test sequence is repeated for $k = 1 \dots 3$.

Step	Direction	Message	Comments
1	SS->MS	PAGING REQUEST TYPE I	
2	MS -> SS	CHANNEL REQUEST	Establishment cause indicates "answer to paging".
3	SS -> MS	IMMEDIATE ASSIGNMENT	
4	MS->SS	PAGING RESPONSE	Message is contained in SABM. "mobile station classmark 2" includes settings for ES_IND.
5	MS->SS	CLASSMARK CHANGE	"mobile station classmark 2" includes settings for ES_IND. "mobile station classmark 3" includes settings for Positioning. The setting for positioning specifies Positioning Method capability and Positioning Method Support. In the position method support (5 bit field), Bit 3 is set to 1 (MS-Assisted GPS)
6	SS -> MS	AUTHENTICATION REQUEST	
7	MS -> SS	AUTHENTICATION RESPONSE	
8	SS -> MS	CIPHERING MODE COMMAND	
9	MS -> SS	CIPHERING MODE COMPLETE	
10	SS		SS starts ciphering.
11	SS -> MS	REGISTER	Call Independent SS containing Facility IE LCS Location Notification Invoke set to notifyAndVerify-LocationNotAllowedIfNoResponse
12	SS		SS starts timer T(LCSN) set to 10 seconds
13A (k=1)	MS		The MS displays the location request and information about LCS Client. The user accepts location request within 10 seconds.
14A (k=1)	SS -> MS	RELEASE COMPLETE	Containing a LocationNotification return result with verificationResponse set to permissionGranted.
13B (k=2)	MS		The MS displays the location request and information about LCS Client. The user rejects location request within 10 seconds.
14B (k=2)	MS -> SS	RELEASE COMPLETE	Containing a LocationNotification return result with verificationResponse set to permissionDenied.
13C (k=3)	MS		The MS displays the location request and information about LCS Client. The user does not reply and waits for T(LCSN) to expire.
14C (k=3)	SS->MS	RELEASE COMPLETE	SS terminates the dialogue after T(LCSN) expiry
15	SS -> MS	CHANNEL RELEASE	The main signalling link is released.

Specific Message Contents

PAGING RESPONSE (Step 4)

Information element	Value/remark
Protocol Discriminator	RR management
Ciphering Key Sequence number - Key Sequence	Key sequence number previously allocated to MS, or "111" if no key is available
Mobile station Classmark 2 - ES IND	Shall indicate early autonomous sending of CLASSMARK CHANGE
Mobile Identity - odd/even - Type of identity - Identity digits	Even TMSI TMSI previously allocated to MS

REGISTER (Step 11)

Information element	Value/remark
Protocol Discriminator	Call Independent SS message (1011)
Transaction identifier Message type Facility	REGISTER (0011 1011) Invoke = lcs-LocationNotification LocationNotificationArg <u>notificationType</u> -> notifyAnd Verify- LocationNotAllowedIfNoResponse, <u>locationType</u> -> current Location , <u>lcsClientExternalID</u> -> externalAddress <u>lcsClientName</u> -> dataCodingScheme nameString

RELEASE COMPLETE (Option k=1 Step 14A)

Information element	Value/remark
Protocol Discriminator	Call Independent SS message (1011)
Transaction identifier Message type Facility	RELEASE COMPLETE (xx10 1010) Return result = lcs-LocationNotification LocationNotificationRes <u>verificationResponse</u> -> permissionGranted

RELEASE COMPLETE (Option k=2 Step 14B)

Information element	Value/remark
Protocol Discriminator	Call Independent SS message (1011)
Transaction identifier Message type Facility	RELEASE COMPLETE (xx10 1010) Return result = lcs-LocationNotification LocationNotificationRes <u>verificationResponse</u> -> permissionDenied

RELEASE COMPLETE (Option k=3, Step 14C)

Information element	Value/remark
Protocol Discriminator	Call Independent SS message (1011)
Transaction identifier Message type	RELEASE COMPLETE (0010 1010)

70.9.4 MT-LR / RRLP Error Handling for MS-Based A-GPS

70.9.4.1 RRLP Protocol Error

70.9.4.1.1 Conformance requirement:

The MS sends an RRLP PROTOCOL ERROR message to the network if there is a problem that prevents the MS to receive a complete and understandable RRLP MEASURE POSITION REQUEST component.

Test References

3GPP TS04.31 subclause 2.2, 2.5

70.9.4.1.2 Test Purpose

To verify that the MS sends the correct positioning capability via controlled early classmark sending. The MS shall send a RRLP PROTOCOL ERROR message to SS with specific error code if RRLP MEASURE POSITION REQUEST is incomplete. On receipt of second RRLP MEASURE POSITION REQUEST from SS to start the measurement, MS shall send back RRLP MEASURE POSITION RESPONSE to SS after finishing the measurement.

70.9.4.1.3 Method of Test

Initial Conditions:

System Simulator:

Serving Cell: default parameters.

Satellite signals: default conditions.

Mobile Station:

The MS is MM-state "idle, updated" with valid TMSI and CKSN.

Specific PICS statements

-

PIXIT statements

-

Test Procedure:

The MS is paged with a PAGING REQUEST TYPE 1 message. The MS performs control early classmark sending to provide LCS positioning method capability. After sending the CIPHERING MODE COMPLETE message the MS receives RR APPLICATION INFORMATION messages containing RRLP Assistance Data messages.

The SS then sends an RRLP MEASURE POSITION REQUEST message with missing information element.

The MS shall send RRLP PROTOCOL ERROR as it fails to decode RRLP MEASURE POSITION REQUEST. The SS repeats RRLP MEASURE POSITION REQUEST with correct message contents.

Option 1: The MS then performs positioning measurements, and responds with an RR APPLICATION INFORMATION message containing an RRLP Measure Position Response.

Option 2: The MS may request additional assistance data by sending an RRLP Measure Position Response message containing a location error with IE LocErrorReason set to gpsAssDataMissing. If the MS requests additional assistance data that is available in the SS, then the SS provides the requested assistance data in zero, one or more RRLP Assistance Data delivery messages followed by an RRLP Measure Position Request message which may include further assistance data. If the MS requests additional assistance data and the entire requested assistance data is not available in the SS, then the SS repeats the RRLP Measure Position Request message without assistance data. The MS then performs positioning measurements, and responds with an RR APPLICATION INFORMATION message containing an RRLP Measure Position Response.

Maximum duration of the test:

5 minutes.

Expected Sequence

Step	Direction	Message	Comments
1	SS->MS	PAGING REQUEST TYPE I	
2	MS -> SS	CHANNEL REQUEST	Establishment cause indicates "answer to paging".
3	SS -> MS	IMMEDIATE ASSIGNMENT	
4	MS->SS	PAGING RESPONSE	Message is contained in SABM.
5	MS->SS	CLASSMARK CHANGE	"mobile station classmark 2" includes settings for ES_IND. "mobile station classmark 2" includes settings for ES_IND. "mobile station classmark 3" includes settings for Positioning. The setting for positioning specifies Positioning Method capability and Positioning Method Support. In the position method support (5 bit field), Bit 2 is set to 1 (MS-Based GPS)
6	SS -> MS	AUTHENTICATION REQUEST	
7	MS -> SS	AUTHENTICATION RESPONSE	
8	SS -> MS	CIPHERING MODE COMMAND	
9	MS -> SS	CIPHERING MODE COMPLETE	
10	SS		SS starts ciphering.
11	SS -> MS	RR APPLICATION INFORMATION	RRLP Assistance Data
12	MS -> SS	RR APPLICATION INFORMATION	RRLP assistanceDataAck
13	SS -> MS	RR APPLICATION INFORMATION	RRLP Assistance Data
14	MS -> SS	RR APPLICATION INFORMATION	RRLP assistanceDataAck
15	SS-> MS	RR APPLICATION INFORMATION	RRLP Measure Position Request 1 (with missing final octet)
16	MS -> SS	RR APPLICATION INFORMATION	RRLP PROTOCOL ERROR
17	SS -> MS	RR APPLICATION INFORMATION	RRLP Measure Position Request 2
18	MS -> SS	RR APPLICATION INFORMATION	RRLP Measure Position Response: locationInfo (Option 1) or locationError with gpsAssDataMissing and additionalAssistanceData (Option 2)
18a	SS -> MS	RR APPLICATION INFORMATION	RRLP Assistance Data. If the MS requested additional assistance data in step 18 that is available in the SS, then SS provides the requested data in zero, one or more RRLP Assistance Data delivery messages.
18b	MS -> SS	RR APPLICATION INFORMATION	RRLP assistanceDataAck. If the SS sent additional assistance data in step 18a, the MS acknowledges the received assistance data.
18c	SS-> MS	RR APPLICATION INFORMATION	RRLP Measure Position Request. If the MS requested additional assistance data in step 18 that is available in the SS, this message may include further assistance data.
18d	MS-> SS	RR APPLICATION INFORMATION	RRLP Measure Position Response. If the MS requested additional assistance data in step 18, this message contains locationInfo.
19	SS -> MS	CHANNEL RELEASE	The main signalling link is released

Specific Message Contents

RR_APPLICATION_INFORMATION

Information element	Value/remark
Protocol Discriminator	RR Management Protocol (0110)
Skip Indicator	
Message Type	Application Information Message type
APDU ID	APDU ID -> RRLP => 0000
APDU Flags	Bit1=0 -> Last or only segment Bit2=0 -> First or only segment Bit3=0 -> Command or Final Response Bit4=spare
APDU Data	2-N Byte → ASN.1 Coded Step 15, 17 and 18c: RRLP Measure Position Request Step 18 and 18d: RRLP Measure Position Response Step 11, 13, 18a: RRLP Assistance Data Step 12, 14, 18b: RRLP Assistance Data Ack Step 16: RRLP Protocol Error

RRLP Assistance Data (Step 11):

Information element	Type	Value/remark
ASN.1 encoded		
referenceNumber	Integer,0 to 7	1
component	CHOICE	assistanceData
gps-AssistData	SEQUENCE	
navigationModel	SEQUENCE	PRNs 4,6,9 of section 10.9.5
moreAssDataToBeSent	ENUMERATED	1

RRLP Assistance Data Ack (Steps 12, 14, 18b):

Information element	Type	Value/remark
ASN.1 encoded		
referenceNumber	Integer,0 to 7	1 or 3 (Option 2, Step 18b)
component	CHOICE	assistanceDataAck

RRLP Assistance Data (Step 13):

Information element	Type	Value/remark
ASN.1 encoded		
referenceNumber	Integer,0 to 7	1
component	CHOICE	assistanceData
gps-AssistData	SEQUENCE	
navigationModel	SEQUENCE	PRNs 10,13,22 of section 10.9.5
ionosphericModel	SEQUENCE	See section 10.9.6
moreAssDataToBeSent	ENUMERATED	0

RRLP Measure Position Request 1 (Step 15):

Information element	Type	Value/remark
ASN.1 encoded		
referenceNumber	Integer,0 to 7	1
component	CHOICE	msrPositionReq
methodType	CHOICE	msBased
positionMethod	ENUMERATED	gps
measureResponseTime	Integer 0 to 7	5
accuracy*	Integer (0-127)	127
useMultipleSets*	ENUMERATED	oneSet
Note*:	Final octet of data shall be disregarded. E.g if encoded data is [0x20, 0x01, 0xFE, 0xD8] this shall be transmitted as [0x20, 0x01, 0xFE].	

RRLP Protocol Error (Step 16):

Information element	Type	Value/remark
ASN.1 encoded		
referenceNumber	Integer,0 to 7	0 or 1
component	CHOICE	protocolError
errorCause	ENUMERATED	missingIEorComponentElement, messageTooShort or Incorrect Data

RRLP Measure Position Request 2 (Step 17):

Information element	Type	Value/remark
ASN.1 encoded		
referenceNumber	Integer,0 to 7	2
component	CHOICE	msrPositionReq
methodType	CHOICE	msBased
positionMethod	ENUMERATED	gps
measureResponseTime	Integer 0 to 7	5
accuracy	Integer (0-127)	127
useMultipleSets	ENUMERATED	oneSet
gps-AssistData	SEQUENCE	
referenceTime	SEQUENCE	See section 10.9.3
refLocation	SEQUENCE	See section 10.9.4

RRLP Measure Position Response (Step 18 (Option 1) or 18d (Option 2)):

Information element	Type	Value/remark
ASN.1 encoded		
referenceNumber	Integer,0 to 7	2 or 3 (Option 2, Step 18d)
component	CHOICE	msrPositionRsp (A valid response will contain LocationInfo otherwise LocationError will be returned)
locationInfo	SEQUENCE	Any value is acceptable.
locationError	SEQUENCE	Any error value is acceptable except gpsAssDataMissing.

RRLP Measure Position Response (Step 18 (Option 2)):

Information element	Type	Value/remark
ASN.1 encoded		
referenceNumber	Integer,0 to 7	2
component	CHOICE	msrPositionRsp
locationError	SEQUENCE	
locErrorReason	ENUMERATED	gpsAssDataMissing
additionalAssistanceData	SEQUENCE	
gpsAssistanceData	OCTET STRING	Indicates missing assistance data elements

RRLP Assistance Data (Step 18a):

Information element	Type	Value/remark
ASN.1 encoded		
referenceNumber	Integer,0 to 7	3
component	CHOICE	assistanceData
gps-AssistData	SEQUENCE	If the MS requested further assistance data in Step 18 (Option 2) that is available in the SS, SS shall send zero, one or more RRLP Assistance Data messages containing the requested assistance data from section 10.9. Each message shall contain a maximum of 242 octets.
moreAssDataToBeSent	ENUMERATED	1 or 0. If SS sends more than one RRLP assistance data delivery message the moreAssDataToBeSent field shall be set accordingly.

RRLP Measure Position Request (Step 18c):

Information element	Type	Value/remark
ASN.1 encoded		
referenceNumber	Integer,0 to 7	3
component	CHOICE	msrPositionReq
methodType	CHOICE	msBased
positionMethod	ENUMERATED	gps
measureResponseTime	Integer 0 to 7	5
accuracy	Integer (0-127)	127
useMultipleSets	ENUMERATED	oneSet
gps-AssistData	SEQUENCE	May contain further assistance data from section 10.9 as requested by the MS in step 18 (Option 2).

70.9.4.2 RRLP Location Error – Requested Method Not Supported

70.9.4.2.1 Conformance requirement:

The MS sends an RRLP MEASURE POSITION RESPONSE message to the network containing a Location Error component with an error indication if the measurement is not possible.

Test References

3GPP TS04.31 subclause 2.2, A.3.2.6

70.9.4.2.2 Test Purpose

To verify that the MS sends the correct positioning capability via controlled early classmark sending. The MS shall send a RRLP MEASURE POSITION RESPONSE message with Location Error component if the MS does not support the requested method. On receipt of second RRLP MEASURE POSITION REQUEST from SS to start the measurement, the MS shall send back RRLP MEASURE POSITION RESPONSE to SS after finishing the measurement.

70.9.4.2.3 Method of Test

Initial Conditions:

System Simulator:

Serving Cell: default parameters.

Satellite signals: default conditions.

Mobile Station:

The MS is MM-state "idle, updated" with valid TMSI and CKSN.

Specific PICS statements

-

PIXIT statements

-

Test Procedure:

The MS is paged with a PAGING REQUEST TYPE 1 message. The MS performs control early classmark sending to provide LCS positioning method capability.

The SS sends an RRLP MEASURE POSITION REQUEST message with a method type not supported by the mobile (type not supported to be E-OTD).

The MS sends RRLP MEASURE POSITION RESPONSE to SS containing a Location Error component (Requested Method not Supported) as the requested method is not supported.

The MS receives RR APPLICATION INFORMATION messages containing RRLP Assistance Data messages followed by a new RRLP MEASURE POSITION REQUEST with correct message contents including assistance data.

Option 1: The MS then performs positioning measurements, and responds with an RR APPLICATION INFORMATION message containing an RRLP Measure Position Response.

Option 2: The MS may request additional assistance data by sending an RRLP Measure Position Response message containing a location error with IE LocErrorReason set to gpsAssDataMissing. If the MS requests additional assistance data that is available in the SS, then the SS provides the requested assistance data in zero, one or more RRLP Assistance Data delivery messages followed by an RRLP Measure Position Request message which may include further assistance data. If the MS requests additional assistance data and the entire requested assistance data is not available in the SS, then the SS repeats the RRLP Measure Position Request message without assistance data. The MS then performs positioning measurements, and responds with an RR APPLICATION INFORMATION message containing an RRLP Measure Position Response.

Maximum duration of the test:

5 minutes.

Expected Sequence

Step	Direction	Message	Comments
1	SS->MS	PAGING REQUEST TYPE I	
2	MS -> SS	CHANNEL REQUEST	Establishment cause indicates "answer to paging".
3	SS -> MS	IMMEDIATE ASSIGNMENT	
4	MS->SS	PAGING RESPONSE	Message is contained in SABM. "mobile station classmark 2" includes settings for ES_IND.
5	MS->SS	CLASSMARK CHANGE	"mobile station classmark 2" includes settings for ES_IND. "mobile station classmark 3" includes settings for Positioning. The setting for positioning specifies Positioning Method capability and Positioning Method Support. In the position method support (5 bit field), Bit 2 is set to 1 (MS-Based GPS)
6	SS -> MS	AUTHENTICATION REQUEST	
7	MS -> SS	AUTHENTICATION RESPONSE	
8	SS -> MS	CIPHERING MODE COMMAND	
9	MS -> SS	CIPHERING MODE COMPLETE	
10	SS		SS starts ciphering.
11	SS-> MS	RR APPLICATION INFORMATION	RRLP Measure Position Request 1 (Request method not supported)
12	MS -> SS	RR APPLICATION INFORMATION	RRLP Measure Position Response 1 (location error)
13	SS -> MS	RR APPLICATION INFORMATION	RRLP Assistance Data
14	MS -> SS	RR APPLICATION INFORMATION	RRLP assistanceDataAck
15	SS -> MS	RR APPLICATION INFORMATION	RRLP Assistance Data
16	MS -> SS	RR APPLICATION INFORMATION	RRLP assistanceDataAck
17	SS -> MS	RR APPLICATION INFORMATION	RRLP Measure Position Request 2
18	MS -> SS	RR APPLICATION INFORMATION	RRLP Measure Position Response 2: locationInfo (Option 1) or locationError with gpsAssDataMissing and additionalAssistanceData (Option 2)
18a	SS -> MS	RR APPLICATION INFORMATION	RRLP Assistance Data. If the MS requested additional assistance data in step 18 that is available in the SS, then SS provides the requested data in zero, one or more RRLP Assistance Data delivery messages.
18b	MS -> SS	RR APPLICATION INFORMATION	RRLP assistanceDataAck. If the SS sent additional assistance data in step 18a, the MS acknowledges the received assistance data.
18c	SS-> MS	RR APPLICATION INFORMATION	RRLP Measure Position Request. If the MS requested additional assistance data in step 18 that is available in the SS, this message may include further assistance data.
18d	MS-> SS	RR APPLICATION INFORMATION	RRLP Measure Position Response. If the MS requested additional assistance data in step 18, this message contains locationInfo.
19	SS -> MS	CHANNEL RELEASE	The main signalling link is released

Specific Message Contents

RR_APPLICATION_INFORMATION

Information element	Value/remark
Protocol Discriminator	RR Management Protocol (0110)
Skip Indicator	
Message Type	Application Information Message type
APDU ID	APDU ID -> RRLP => 0000
APDU Flags	Bit1=0 -> Last or only segment Bit2=0 -> First or only segment Bit3=0 -> Command or Final Response Bit4=spare
APDU Data	2-N Byte → ASN.1 Coded Step 11, 17 and 18c: RRLP Measure Position Request Step 12, 18 and 18d: RRLP Measure Position Response Step 13, 15, 18a: RRLP Assistance Data Step 14, 16, 18b: RRLP Assistance Data Ack

RRLP Measure Position Request 1 (Step 11):

Information element	Type	Value/remark
ASN.1 encoded		
referenceNumber	Integer 0 to 7	1
component	CHOICE	msrPositionReq
methodType	CHOICE	msAssisted
positionMethod	ENUMERATED	eotd
measureResponseTime	Integer 0 to 7	7
useMultipleSets	ENUMERATED	oneSet

RRLP Measure Position Response 1 (Step 12):

Information element	Type	Value/remark
ASN.1 encoded		
referenceNumber	Integer,0 to 7	1
component	CHOICE	msrPositionRes
locationError	SEQUENCE	
locErrorReason	ENUMERATED	methodNotSupported

RRLP Assistance Data (Step 13):

Information element	Type	Value/remark
ASN.1 encoded		
referenceNumber	Integer,0 to 7	2
component	CHOICE	assistanceData
gps-AssistData	SEQUENCE	
navigationModel	SEQUENCE	PRNs 4,6,9 of section 10.9.5
moreAssDataToBeSent	ENUMERATED	1

RRLP Assistance Data Ack (Steps 14, 16, 18b):

Information element	Type	Value/remark
ASN.1 encoded		
referenceNumber	Integer,0 to 7	2 or 3 (Option 2, Step 18b)
component	CHOICE	assistanceDataAck

RRLP Assistance Data (Step 15):

Information element	Type	Value/remark
ASN.1 encoded		
referenceNumber	Integer,0 to 7	2
component	CHOICE	assistanceData
gps-AssistData	SEQUENCE	
navigationModel	SEQUENCE	PRNs 10,13,22 of section 10.9.5
ionosphericModel	SEQUENCE	See section 10.9.6
moreAssDataToBeSent	ENUMERATED	0

RRLP Measure Position Request 2 (Step 17):

Information element	Type	Value/remark
ASN.1 encoded		
referenceNumber	Integer,0 to 7	2
component	CHOICE	msrPositionReq
methodType	CHOICE	msBased
positionMethod	ENUMERATED	gps
measureResponseTime	Integer 0 to 7	5
accuracy	Integer (0-127)	127
useMultipleSets	ENUMERATED	oneSet
gps-AssistData	SEQUENCE	
referenceTime	SEQUENCE	See section 10.9.3
refLocation	SEQUENCE	See section 10.9.4

RRLP Measure Position Response (Step 18 (Option 1) or 18d (Option 2)):

Information element	Type	Value/remark
ASN.1 encoded		
referenceNumber	Integer,0 to 7	2 or 3 (Option 2, Step 18d)
component	CHOICE	msrPositionRsp (A valid response will contain LocationInfo otherwise LocationError will be returned)
locationInfo	SEQUENCE	Any value is acceptable.
locationError	SEQUENCE	Any error value is acceptable except gpsAssDataMissing.

RRLP Measure Position Response (Step 18 (Option 2)):

Information element	Type	Value/remark
ASN.1 encoded		
referenceNumber	Integer,0 to 7	2
component	CHOICE	msrPositionRsp
locationError	SEQUENCE	
locErrorReason	ENUMERATED	gpsAssDataMissing
additionalAssistanceData	SEQUENCE	
gpsAssistanceData	OCTET STRING	Indicates missing assistance data elements

RRLP Assistance Data (Step 18a):

Information element	Type	Value/remark
ASN.1 encoded		
referenceNumber	Integer,0 to 7	3
component	CHOICE	assistanceData
gps-AssistData	SEQUENCE	If the MS requested further assistance data in Step 18 (Option 2) that is available in the SS, SS shall send zero, one or more RRLP Assistance Data messages containing the requested assistance data from section 10.9. Each message shall contain a maximum of 242 octets.
moreAssDataToBeSent	ENUMERATED	1 or 0. If SS sends more than one RRLP assistance data delivery message the moreAssDataToBeSent field shall be set accordingly.

RRLP Measure Position Request (Step 18c):

Information element	Type	Value/remark
ASN.1 encoded		
referenceNumber	Integer,0 to 7	3
component	CHOICE	msrPositionReq
methodType	CHOICE	msBased
positionMethod	ENUMERATED	gps
measureResponseTime	Integer 0 to 7	5
accuracy	Integer (0-127)	127
useMultipleSets	ENUMERATED	oneSet
gps-AssistData	SEQUENCE	May contain further assistance data from section 10.9 as requested by the MS in step 18 (Option 2).

70.9.4.3 RRLP Location Error – GPS Assistance Data Missing

70.9.4.3.1 Conformance requirement

The MS sends an RRLP MEASURE POSITION RESPONSE message to the network containing a Location Error component with an error indication if the measurement is not possible.

Test References

3GPP TS04.31 subclause 2.2, A.3.2.6

70.9.4.3.2 Test Purpose

To verify that the MS sends the correct positioning capability via controlled early classmark sending. The MS shall send a RRLP MEASURE POSITION RESPONSE message with Location Error component if some GPS assistance data are missing. On receipt of second RRLP MEASURE POSITION REQUEST (with all necessary GPS assistance data to obtain a location estimate included) from SS to start the measurement, the MS shall send back RRLP MEASURE POSITION RESPONSE to SS after finishing the measurement.

70.9.4.3.3 Method of Test

Initial Conditions

System Simulator:

Serving Cell: default parameters.

Satellite signals: default conditions.

Mobile Station:

The MS is MM-state "idle, updated" with valid TMSI and CKSN.

Specific PICS statements

-

PIXIT statements

-

Test Procedure

The A-GPS assistance data stored in the MS is reset.

The MS is paged with a PAGING REQUEST TYPE 1 message. The MS performs control early classmark sending to provide LCS positioning method capability. After sending the CIPHERING MODE COMPLETE message the MS receives an RRLP MEASURE POSITION REQUEST message with Reference Time GPS assistance data.

The MS requests additional assistance data by sending an RRLP MEASURE POSITION RESPONSE message to SS containing a Location Error component with IE LocErrorReason set to gpsLocCalAssDataMissing or gpsAssDataMissing.

The SS provides the requested assistance data that is available in the SS in zero, one or more RRLP Assistance Data delivery messages followed by an RRLP Measure Position Request message which may include further assistance data.

The MS then performs positioning measurements, and responds with an RR APPLICATION INFORMATION message containing an RRLP Measure Position Response.

Maximum duration of the test

5 minutes.

Expected Sequence

Step	Direction	Message	Comments
1	MS		Reset all stored A-GPS assistance data
2	SS->MS	PAGING REQUEST TYPE 1	
3	MS -> SS	CHANNEL REQUEST	Establishment cause indicates "answer to paging".
4	SS -> MS	IMMEDIATE ASSIGNMENT	
5	MS->SS	PAGING RESPONSE	Message is contained in SABM. "mobile station classmark 2" includes settings for ES_IND.
6	MS->SS	CLASSMARK CHANGE	"mobile station classmark 2" includes settings for ES_IND. "mobile station classmark 3" includes settings for Positioning. The setting for positioning specifies Positioning Method capability and Positioning Method Support. In the position method support (5 bit field), Bit 2 is set to 1 (MS-Based GPS)
7	SS -> MS	AUTHENTICATION REQUEST	
8	MS -> SS	AUTHENTICATION RESPONSE	
9	SS -> MS	CIPHERING MODE COMMAND	
10	MS -> SS	CIPHERING MODE COMPLETE	
11	SS		SS starts ciphering.
12	SS -> MS	RR APPLICATION INFORMATION	RRLP Measure Position Request 1 (with Reference Time GPS assistance data)
13	MS -> SS	RR APPLICATION INFORMATION	RRLP Measure Position Response 1 (location error with gpsLocCalAssDataMissing or gpsAssDataMissing)
14	SS -> MS	RR APPLICATION INFORMATION	RRLP Assistance Data. The SS provides the requested data from step 13 that is available in the SS in zero, one or more RRLP Assistance Data delivery messages.
15	MS -> SS	RR APPLICATION INFORMATION	RRLP assistanceDataAck. If the SS sent additional assistance data in step 14, the MS acknowledges the received assistance data.
16	SS-> MS	RR APPLICATION INFORMATION	RRLP Measure Position Request 2. This message may include further assistance data.
17	MS-> SS	RR APPLICATION INFORMATION	RRLP Measure Position Response 2. (LocationInfo)
18	SS -> MS	CHANNEL RELEASE	The main signalling link is released

Specific Message Contents

RR_APPLICATION_INFORMATION

Information element	Value/remark
Protocol Discriminator	RR Management Protocol (0110)
Skip Indicator	
Message Type	Application Information Message type
APDU ID	APDU ID -> RRLP => 0000
APDU Flags	Bit1=0 -> Last or only segment Bit2=0 -> First or only segment Bit3=0 -> Command or Final Response Bit4=spare
APDU Data	2-N Byte -> ASN.1 Coded Step 12 and 16: RRLP Measure Position Request Step 13 and 17: RRLP Measure Position Response Step 14: RRLP Assistance Data Step 15: RRLP Assistance Data Ack

RRLP Measure Position Request 1 (Step 12):

Information element	Type	Value/remark
ASN.1 encoded		
referenceNumber	Integer 0 to 7	1
component	CHOICE	msrPositionReq
methodType	CHOICE	msBased
positionMethod	ENUMERATED	gps
measureResponseTime	Integer 0 to 7	5
accuracy	Integer (0-127)	127
useMultipleSets	ENUMERATED	oneSet
gps-AssistData	SEQUENCE	Assistance Data Reference Time

RRLP Measure Position Response 1 (Step 13):

Information element	Type	Value/remark
ASN.1 encoded		
referenceNumber	Integer,0 to 7	1
component	CHOICE	msrPositionRsp
locationError	SEQUENCE	
locErrorReason	ENUMERATED	gpsLocCalAssDataMissing or gpsAssDataMissing
additionalAssistanceData	SEQUENCE	
gpsAssistanceData	OCTET STRING	Indicates missing assistance data elements

RRLP Assistance Data (Step 14):

Information element	Type	Value/remark
ASN.1 encoded		
referenceNumber	Integer,0 to 7	2
component	CHOICE	assistanceData
gps-AssistData	SEQUENCE	SS shall send zero, one or more RRLP Assistance Data messages containing the requested assistance data requested in step 13, if available from section 10.9. Each message shall contain a maximum of 242 octets.
moreAssDataToBeSent	ENUMERATED	1 or 0. If SS sends more than one RRLP assistance data delivery message the moreAssDataToBeSent field shall be set accordingly.

RRLP Assistance Data Ack (Step 15):

Information element	Type	Value/remark
ASN.1 encoded		
referenceNumber	Integer,0 to 7	2
component	CHOICE	assistanceDataAck

RRLP Measure Position Request 2 (Step 16):

Information element	Type	Value/remark
ASN.1 encoded		
referenceNumber	Integer,0 to 7	2
component	CHOICE	msrPositionReq
methodType	CHOICE	msBased
positionMethod	ENUMERATED	gps
measureResponseTime	Integer 0 to 7	5
accuracy	Integer (0-127)	127
useMultipleSets	ENUMERATED	oneSet
gps-AssistData	SEQUENCE	May contain further assistance data from section 10.9 as requested by the MS in step 13

RRLP Measure Position Response 2 (Step 17):

Information element	Type	Value/remark
ASN.1 encoded		
referenceNumber	Integer,0 to 7	2
component	CHOICE	msrPositionResp A valid response will contain LocationInfo otherwise LocationError will be returned
gps-MeasureInfo	SEQUENCE	Any value of the parameters is acceptable.
locationError	SEQUENCE	Any error value is acceptable.

70.9.4.4 Multiple RRLP Requests with same Reference Number

70.9.4.4.1 Conformance requirement:

When after reception of a Measure Position Request component, but before responding with a Measure Position Response or Protocol Error Component, the MS receives a new RRLP message with the Measure Position Request component, the MS ignores the latter component if the old and new RRLP Measure Position Request components have the same Reference Number.

The SMLC may use the same Reference Number or different Reference Numbers for different RRLP components within the same pseudo-segmentation sequence.

Test References

3GPP TS04.31 subclause 2.5.5

3GPP TS04.31 subclause 3.2

70.9.4.4.2 Test Purpose

Verifies that a MS sends a correct positioning capability via control classmark sending. MS shall ignore the second RRLP MEASURE POSITION REQUEST if the second RRLP MEASURE POSITION REQUEST has the same REFERENCE NUMBER as in the previous one. The MS shall send back RRLP MEASURE POSITION RESPONSE to SS after finishing the current measurement.

70.9.4.4.3 Method of Test

Initial Conditions:

System Simulator:

Serving Cell: default parameters.

Satellite signals: No GPS signal available.

Mobile Station:

The MS is MM-state "idle, updated" with valid TMSI and CKSN.

Specific PICS statements

-

PIXIT statements

-

Test Procedure:

The MS is paged with a PAGING REQUEST TYPE 1 message. The MS performs control early classmark sending to provide LCS positioning method capability.

After sending CIPHERING MODE COMPLETE message the MS receives RR APPLICATION INFORMATION messages containing RRLP Assistance Data messages.

The SS then sends an RR APPLICATION INFORMATION message containing an RRLP Measure Position Request including further assistance data to start the measurement.

Option 1: The MS then performs positioning measurements. After a delay to of 15 seconds, the SS sends the second RRLP MEASURE POSITION REQUEST with the same REFERENCE NUMBER as the first one (this delay shall be cancelled in the event of option 2). The MS shall ignore the second RRLP MEASURE POSITION REQUEST. The MS sends RRLP MEASURE POSITION RESPONSE to SS with the measurement data after finishing the measurement.

Option 2: The MS may request additional assistance data by immediately sending an RRLP Measure Position Response message containing a location error with IE LocErrorReason set to gpsAssDataMissing. If the MS requests additional assistance data that is available in the SS, then the SS provides the requested assistance data in zero, one or more RRLP Assistance Data delivery messages followed by a second RRLP Measure Position Request message which may include further assistance data. If the MS requests additional assistance data and the entire requested assistance data is not available in the SS, then the SS sends the second RRLP Measure Position Request message without assistance data. The MS then performs positioning measurements and before the current positioning measurement finishes, the SS sends the third RRLP MEASURE POSITION REQUEST with the same REFERENCE NUMBER as the second one. The MS shall ignore the third RRLP MEASURE POSITION REQUEST. The MS sends RRLP MEASURE POSITION RESPONSE to SS with the measurement data after finishing the measurement.

Maximum duration of the test:

5 minutes.

Expected Sequence

Step	Direction	Message	Comments
1	SS->MS	PAGING REQUEST TYPE I	
2	MS -> SS	CHANNEL REQUEST	Establishment cause indicates "answer to paging".
3	SS -> MS	IMMEDIATE ASSIGNMENT	
4	MS->SS	PAGING RESPONSE	Message is contained in SABM. "mobile station classmark 2" includes settings for ES_IND.
5	MS->SS	CLASSMARK CHANGE	"mobile station classmark 2" includes settings for ES_IND. "mobile station classmark 3" includes settings for Positioning. The setting for positioning specifies Positioning Method capability and Positioning Method Support. In the position method support (5 bit field), Bit 2 is set to 1 (MS-Based GPS)
6	SS -> MS	AUTHENTICATION REQUEST	
7	MS -> SS	AUTHENTICATION RESPONSE	
8	SS -> MS	CIPHERING MODE COMMAND	
9	MS -> SS	CIPHERING MODE COMPLETE	
10	SS		SS starts ciphering.
11	SS -> MS	RR APPLICATION INFORMATION	RRLP Assistance Data
12	MS -> SS	RR APPLICATION INFORMATION	RRLP assistanceDataAck
13	SS -> MS	RR APPLICATION INFORMATION	RRLP Assistance Data
14	MS -> SS	RR APPLICATION INFORMATION	RRLP assistanceDataAck
15	SS -> MS	RR APPLICATION INFORMATION	RRLP Measure Position Request 1
16	MS (Option 1) or MS->SS (Option 2)	- or RR APPLICATION INFORMATION	If no message is received from the MS within 15 seconds, then the SS shall assume that the MS is performing the measurement (Option 1). The SS continues to step 17. If the MS sends RRLP Measure Position Response: locationError with gpsAssDataMissing (Option 2) within 15 seconds, then the SS continues to step 16a.
16a	SS -> MS	RR APPLICATION INFORMATION	RRLP Assistance Data. If the MS requested additional assistance data in step 16 that is available in the SS, then SS provides the requested data in zero, one or more RRLP Assistance Data delivery messages.
16b	MS -> SS	RR APPLICATION INFORMATION	RRLP assistanceDataAck. If the SS sent additional assistance data in step 16a, the MS acknowledges the received assistance data.
16c	SS-> MS	RR APPLICATION INFORMATION	RRLP Measure Position Request 2. If the MS requested additional assistance data in step 16 that is available in the SS, this message may include further assistance data.
16d	MS (Option 2)		MS is performing the measurement (Option 2)
17	SS -> MS	RR APPLICATION INFORMATION	RRLP Measure Position Request 2 with same reference number as in Request 1 (Option 1) or RRLP Measure Position Request 3 with same reference number as in Request 2 (Option 2)
18	MS -> SS	RR APPLICATION INFORMATION	RRLP Measure Position Response: locationInfo
19	SS -> MS	CHANNEL RELEASE	The main signalling link is released

Specific Message Contents

RR_APPLICATION_INFORMATION

Information element	Value/remark
Protocol Discriminator	RR Management Protocol (0110)
Skip Indicator	
Message Type	Application Information Message type
APDU ID	APDU ID -> RRLP => 0000
APDU Flags	Bit1=0 -> Last or only segment Bit2=0 -> First or only segment Bit3=0 -> Command or Final Response Bit4=spare
APDU Data	2-N Byte → ASN.1 Coded Step 15, 16c, 17: RRLP Measure Position Request Step 16, 18: RRLP Measure Position Response Step 11, 13, 16a: RRLP Assistance Data Step 12, 14, 16b: RRLP Assistance Data Ack

RRLP Assistance Data (Step 11):

Information element	Type	Value/remark
ASN.1 encoded		
referenceNumber	Integer,0 to 7	1
component	CHOICE	assistanceData
gps-AssistData	SEQUENCE	
navigationModel	SEQUENCE	PRNs 4,6,9 of section 10.9.5
moreAssDataToBeSent	ENUMERATED	1

RRLP Assistance Data Ack (Steps 12, 14, 16b):

Information element	Type	Value/remark
ASN.1 encoded		
referenceNumber	Integer,0 to 7	1
component	CHOICE	assistanceDataAck

RRLP Assistance Data (Step 13):

Information element	Type	Value/remark
ASN.1 encoded		
referenceNumber	Integer,0 to 7	1
component	CHOICE	assistanceData
gps-AssistData	SEQUENCE	
navigationModel	SEQUENCE	PRNs 10,13,22 of section 10.9.5
ionosphericModel	SEQUENCE	See section 10.9.6
moreAssDataToBeSent	ENUMERATED	0

RRLP Measure Position Request 1 (Step 15):

Information element	Type	Value/remark
ASN.1 encoded		
referenceNumber	Integer,0 to 7	1
component	CHOICE	msrPositionReq
methodType	CHOICE	msBased
positionMethod	ENUMERATED	gps
measureResponseTime	Integer 0 to 7	5
accuracy	Integer (0-127)	127
useMultipleSets	ENUMERATED	oneSet
gps-AssistData	SEQUENCE	
referenceTime	SEQUENCE	See section 10.9.3
refLocation	SEQUENCE	See section 10.9.4

RRLP Measure Position Response (Step 16 (Option 2)):

Information element	Type	Value/remark
ASN.1 encoded		
referenceNumber	Integer,0 to 7	1
component	CHOICE	msrPositionRsp
locationError	SEQUENCE	
locErrorReason	ENUMERATED	gpsAssDataMissing
additionalAssistanceData	SEQUENCE	
gpsAssistanceData	OCTET STRING	Indicates missing assistance data elements

RRLP Assistance Data (Step 16a):

Information element	Type	Value/remark
ASN.1 encoded		
referenceNumber	Integer,0 to 7	1
component	CHOICE	assistanceData
gps-AssistData	SEQUENCE	If the MS requested further assistance data in Step 16 (Option 2) that is available in the SS, SS shall send zero, one or more RRLP Assistance Data messages containing the requested assistance data from section 10.9. Each message shall contain a maximum of 242 octets.
moreAssDataToBeSent	ENUMERATED	1 or 0. If SS sends more than one RRLP assistance data delivery message the moreAssDataToBeSent field shall be set accordingly.

RRLP Measure Position Request 2 (Step 16c):

Information element	Type	Value/remark
ASN.1 encoded		
referenceNumber	Integer,0 to 7	1
component	CHOICE	msrPositionReq
methodType	CHOICE	msBased
positionMethod	ENUMERATED	gps
measureResponseTime	Integer 0 to 7	5
accuracy	Integer (0-127)	127
useMultipleSets	ENUMERATED	oneSet
gps-AssistData	SEQUENCE	May contain further assistance data from section 10.9 as requested by the MS in step 16 (Option 2).

RRLP Measure Position Request 2 (Option 1) or Request 3 (Option 2) (Step 17):

Information element	Type	Value/remark
ASN.1 encoded		
referenceNumber	Integer,0 to 7	1
component	CHOICE	msrPositionReq
methodType	CHOICE	msAssisted
positionMethod	ENUMERATED	gps
measureResponseTime	Integer 0 to 7	5
useMultipleSets	ENUMERATED	oneSet

RRLP Measure Position Response (Step 18):

Information element	Type	Value/remark
ASN.1 encoded		
referenceNumber	Integer,0 to 7	1
component	CHOICE	msrPositionRsp (A valid response will contain LocationInfo otherwise LocationError will be returned)
locationInfo	SEQUENCE	Any value is acceptable.
locationError	SEQUENCE	Any error value is acceptable except gpsAssDataMissing.

70.9.4.5 Multiple RRLP Requests with different Reference Number

70.9.4.5.1 Conformance requirement:

When after reception of a Measure Position Request component, but before responding with a Measure Position Response or Protocol Error Component, the MS receives a new RRLP message with the Measure Position Request component, the MS aborts activity for the former component, and starts to act according to the latter component, if the old and new RRLP Measure Position Request components have different Reference Numbers.

The SMLC may use the same Reference Number or different Reference Numbers for different RRLP components within the same pseudo-segmentation sequence.

Test References

3GPP TS04.31 subclause 2.5.5

3GPP TS04.31 subclause 3.2

70.9.4.5.2 Test Purpose

Verifies that a MS sends a correct positioning capability via control classmark sending. MS shall terminate the current location measurement if the second RRLP MEASURE POSITION REQUEST is received with a different REFERENCE NUMBER. The MS shall perform the measurement according to the newly received RRLP MEASURE

POSITION REQUEST. The MS shall send back RRLP MEASURE POSITION RESPONSE to SS after finishing the measurement.

70.9.4.5.3 Method of Test

Initial Conditions:

System Simulator:

Serving Cell: default parameters.

Satellite signals: No GPS signal available.

Mobile Station:

The MS is MM-state "idle, updated" with valid TMSI and CKSN.

Specific PICS statements

-

PIXIT statements

-

Test Procedure:

The MS is paged with a PAGING REQUEST TYPE 1 message. The MS performs control early classmark sending to provide LCS positioning method capability.

After sending CIPHERING MODE COMPLETE message the MS receives RR APPLICATION INFORMATION messages containing RRLP Assistance Data messages.

The SS then sends an RR APPLICATION INFORMATION message containing an RRLP Measure Position Request including further assistance data to start the measurement.

Option 1: The MS then performs positioning measurements. After a delay of 15 seconds, the SS sends the second RRLP MEASURE POSITION REQUEST with a different REFERENCE NUMBER from the first one (this delay shall be cancelled in the event of option 2). The MS shall terminate the current location measurement and perform the measurement according to the newly received RRLP MEASURE POSITION REQUEST. The MS sends RRLP MEASURE POSITION RESPONSE to SS with the measurement data after finishing the measurement.

Option 2: The MS may request additional assistance data by immediately sending an RRLP Measure Position Response message containing a location error with IE LocErrorReason set to gpsAssDataMissing. If the MS requests additional assistance data that is available in the SS, then the SS provides the requested assistance data in zero, one or more RRLP Assistance Data delivery messages followed by a second RRLP Measure Position Request message which may include further assistance data. If the MS requests additional assistance data and the entire requested assistance data is not available in the SS, then the SS sends the second RRLP Measure Position Request message without assistance data. The MS then performs positioning measurements and before the current positioning measurement finishes, the MS receives the third RRLP MEASURE POSITION REQUEST with a different REFERENCE NUMBER from the second one. The MS shall terminate the current location measurement and perform the measurement according to the newly received RRLP MEASURE POSITION REQUEST, including the possibility of repeating the request for more assistance data (Option 2b). The MS sends RRLP MEASURE POSITION RESPONSE to SS with the measurement data after finishing the measurement.

Maximum duration of the test:

5 minutes.

Expected Sequence

Step	Direction	Message	Comments
1	SS->MS	PAGING REQUEST TYPE I	
2	MS -> SS	CHANNEL REQUEST	Establishment cause indicates "answer to paging".
3	SS -> MS	IMMEDIATE ASSIGNMENT	
4	MS->SS	PAGING RESPONSE	Message is contained in SABM. "mobile station classmark 2" includes settings for ES_IND.
5	MS->SS	CLASSMARK CHANGE	"mobile station classmark 2" includes settings for ES_IND. "mobile station classmark 3" includes settings for Positioning. The setting for positioning specifies Positioning Method capability and Positioning Method Support. In the position method support (5 bit field), Bit 2 is set to 1 (MS-Based GPS)
6	SS -> MS	AUTHENTICATION REQUEST	
7	MS -> SS	AUTHENTICATION RESPONSE	
8	SS -> MS	CIPHERING MODE COMMAND	
9	MS -> SS	CIPHERING MODE COMPLETE	
10	SS		SS starts ciphering.
11	SS -> MS	RR APPLICATION INFORMATION	RRLP Assistance Data
12	MS -> SS	RR APPLICATION INFORMATION	RRLP assistanceDataAck
13	SS -> MS	RR APPLICATION INFORMATION	RRLP Assistance Data
14	MS -> SS	RR APPLICATION INFORMATION	RRLP assistanceDataAck
15	SS -> MS	RR APPLICATION INFORMATION	RRLP Measure Position Request 1
16	MS (Option 1) or MS->SS (Option 2)	- or RR APPLICATION INFORMATION	If no message is received from the MS within 15 seconds, then the SS shall assume that the MS is performing the measurement (Option 1). The SS continues to step 17. If the MS sends RRLP Measure Position Response: locationError with gpsAssDataMissing (Option 2) within 15 seconds, then the SS continues to step 16a.
16a	SS -> MS	RR APPLICATION INFORMATION	RRLP Assistance Data. If the MS requested additional assistance data in step 16 that is available in the SS, then SS provides the requested data in zero, one or more RRLP Assistance Data delivery messages.
16b	MS -> SS	RR APPLICATION INFORMATION	RRLP assistanceDataAck. If the SS sent additional assistance data in step 16a, the MS acknowledges the received assistance data.
16c	SS-> MS	RR APPLICATION INFORMATION	RRLP Measure Position Request 2. If the MS requested additional assistance data in step 16 that is available in the SS, this message may include further assistance data.
16d	MS (Option 2)		MS is performing the measurement (Option 2)
17	SS -> MS	RR APPLICATION INFORMATION	RRLP Measure Position Request 2 with different reference number as in Request 1 (Option 1) or RRLP Measure Position Request 3 with different reference number as in Request 2 (Option 2)
18	MS -> SS	RR APPLICATION INFORMATION	RRLP Measure Position Response: locationInfo (Option 1 or 2a) Check reference number is 2

18a	SS -> MS	RR APPLICATION INFORMATION	or locationError with gpsAssDataMissing (Option 2b) Check reference number is 2 RRLP Assistance Data. If the MS requested additional assistance data in step 18 that is available in the SS, then SS provides the requested data in zero, one or more RRLP Assistance Data delivery messages.
18b	MS -> SS	RR APPLICATION INFORMATION	RRLP assistanceDataAck. If the SS sent additional assistance data in step 18a, the MS acknowledges the received assistance data.
18c	SS-> MS	RR APPLICATION INFORMATION	RRLP Measure Position Request. If the MS requested additional assistance data in step 18 that is available in the SS, this message may include further assistance data.
18d	MS-> SS	RR APPLICATION INFORMATION	RRLP Measure Position Response. If the MS requested additional assistance data in step 18 this message contains locationInfo.
19	SS -> MS	CHANNEL RELEASE	The main signalling link is released

Specific Message Contents

RR_APPLICATION_INFORMATION

Information element	Value/remark
Protocol Discriminator	RR Management Protocol (0110)
Skip Indicator	
Message Type	Application Information Message type
APDU ID	APDU ID -> RRLP => 0000
APDU Flags	Bit1=0 -> Last or only segment Bit2=0 -> First or only segment Bit3=0 -> Command or Final Response Bit4=spare
APDU Data	2-N Byte → ASN.1 Coded Step 15, 16c, 17, 18c: RRLP Measure Position Request Step 16, 18, 18d: RRLP Measure Position Response Step 11, 13, 16a, 18a: RRLP Assistance Data Step 12, 14, 16b, 18b: RRLP Assistance Data Ack

RRLP Assistance Data (Step 11):

Information element	Type	Value/remark
ASN.1 encoded		
referenceNumber	Integer,0 to 7	1
component	CHOICE	assistanceData
gps-AssistData	SEQUENCE	
navigationModel	SEQUENCE	PRNs 4,6,9 of section 10.9.5
moreAssDataToBeSent	ENUMERATED	1

RRLP Assistance Data Ack (Steps 12, 14, 16b and 18b):

Information element	Type	Value/remark
ASN.1 encoded		
referenceNumber	Integer,0 to 7	1
component	CHOICE	assistanceDataAck

RRLP Assistance Data (Step 13):

Information element	Type	Value/remark
ASN.1 encoded		
referenceNumber	Integer,0 to 7	1
component	CHOICE	assistanceData
gps-AssistData	SEQUENCE	
navigationModel	SEQUENCE	PRNs 10,13,22 of section 10.9.5
ionosphericModel	SEQUENCE	See section 10.9.6
moreAssDataToBeSent	ENUMERATED	0

RRLP Measure Position Request 1 (Step 15):

Information element	Type	Value/remark
ASN.1 encoded		
referenceNumber	Integer,0 to 7	1
component	CHOICE	msrPositionReq
methodType	CHOICE	msBased
positionMethod	ENUMERATED	gps
measureResponseTime	Integer 0 to 7	5
accuracy	Integer (0-127)	127
useMultipleSets	ENUMERATED	oneSet
gps-AssistData	SEQUENCE	
referenceTime	SEQUENCE	See section 10.9.3
refLocation	SEQUENCE	See section 10.9.4

RRLP Measure Position Response (Step 16 (Option 2)):

Information element	Type	Value/remark
ASN.1 encoded		
referenceNumber	Integer,0 to 7	1
component	CHOICE	msrPositionRsp
locationError	SEQUENCE	
locErrorReason	ENUMERATED	gpsAssDataMissing
additionalAssistanceData	SEQUENCE	
gpsAssistanceData	OCTET STRING	Indicates missing assistance data elements

RRLP Assistance Data (Step 16a):

Information element	Type	Value/remark
ASN.1 encoded		
referenceNumber	Integer,0 to 7	1
component	CHOICE	assistanceData
gps-AssistData	SEQUENCE	If the MS requested further assistance data in Step 16 (Option 2) that is available in the SS, SS shall send zero, one or more RRLP Assistance Data messages containing the requested assistance data from section 10.9. Each message shall contain a maximum of 242 octets.
moreAssDataToBeSent	ENUMERATED	1 or 0. If SS sends more than one RRLP assistance data delivery message the moreAssDataToBeSent field shall be set accordingly.

RRLP Measure Position Request 2 (Step 16c):

Information element	Type	Value/remark
ASN.1 encoded		
referenceNumber	Integer,0 to 7	1
component	CHOICE	msrPositionReq
methodType	CHOICE	msBased
positionMethod	ENUMERATED	gps
measureResponseTime	Integer 0 to 7	5
accuracy	Integer (0-127)	127
useMultipleSets	ENUMERATED	oneSet
gps-AssistData	SEQUENCE	May contain further assistance data from section 10.9 as requested by the MS in step 16 (Option 2).

RRLP Measure Position Request 2 (Option 1) or Request 3 (Option 2) (Step 17):

Information element	Type	Value/remark
ASN.1 encoded		
referenceNumber	Integer,0 to 7	2
component	CHOICE	msrPositionReq
methodType	CHOICE	msBased
positionMethod	ENUMERATED	gps
measureResponseTime	Integer 0 to 7	5
accuracy	Integer (0-127)	127
useMultipleSets	ENUMERATED	oneSet
gps-AssistData	SEQUENCE	
referenceTime	SEQUENCE	See section 10.9.3
refLocation	SEQUENCE	See section 10.9.4

RRLP Measure Position Response (Step 18 (Option 1 or 2a) or Step 18d (Option 2b)):

Information element	Type	Value/remark
ASN.1 encoded		
referenceNumber	Integer,0 to 7	2
component	CHOICE	msrPositionRsp (A valid response will contain LocationInfo otherwise LocationError will be returned)
locationInfo	SEQUENCE	Any value is acceptable.
locationError	SEQUENCE	Any error value is acceptable except gpsAssDataMissing.

RRLP Measure Position Response (Step 18 (Option 2b)):

Information element	Type	Value/remark
ASN.1 encoded		
referenceNumber	Integer,0 to 7	2
component	CHOICE	msrPositionRsp
locationError	SEQUENCE	
locErrorReason	ENUMERATED	gpsAssDataMissing
additionalAssistanceData	SEQUENCE	
gpsAssistanceData	OCTET STRING	Indicates missing assistance data elements

RRLP Assistance Data (Step 18a):

Information element	Type	Value/remark
ASN.1 encoded		
referenceNumber	Integer,0 to 7	1
component	CHOICE	assistanceData
gps-AssistData	SEQUENCE	If the MS requested further assistance data in Step 18 (Option 2b) that is available in the SS, SS shall send zero, one or more RRLP Assistance Data messages containing the requested assistance data from section 10.9. Each message shall contain a maximum of 242 octets.
moreAssDataToBeSent	ENUMERATED	1 or 0. If SS sends more than one RRLP assistance data delivery message the moreAssDataToBeSent field shall be set accordingly.

RRLP Measure Position Request (Step 18c):

Information element	Type	Value/remark
ASN.1 encoded		
referenceNumber	Integer,0 to 7	2
component	CHOICE	msrPositionReq
methodType	CHOICE	msBased
positionMethod	ENUMERATED	gps
measureResponseTime	Integer 0 to 7	5
accuracy	Integer (0-127)	127
useMultipleSets	ENUMERATED	oneSet
gps-AssistData	SEQUENCE	May contain further assistance data from section 10.9 as requested by the MS in step 18 (Option 2b).

70.9.4.6 RR Management Commands

70.9.4.6.1 Conformance requirement

A target MS shall terminate any positioning procedure or the transfer of RRLP positioning assistance data without sending any response to the SMLC if any RR message is received from the BSC that starts some other RR management procedure, including a new positioning procedure. The new RR procedure shall then be executed by the MS.

Upon receiving the HO or other RR management command, the MS will stop the location procedure and start on handover or other RR management procedure, since this has higher priority than location. The MS will then send the HO complete or other RR management response message to BSC.

The SMLC may use the same Reference Number or different Reference Numbers for different RRLP components within the same pseudo-segmentation sequence.

Test References

3GPP TS 03.71 subclause 7.11.5,

3GPP TS 03.71 subclause 10.6

3GPP TS04.31 subclause 3.2

70.9.4.6.2 Test Purpose

Verifies that a MS sends a correct positioning capability via control classmark sending. MS shall terminate the current location measurement if an RR MANAGEMENT command is received during the measurement procedure. The MS shall send an RR MANAGEMENT RESPONSE message to SS when the RR MANAGEMENT procedure is complete. The MS shall perform the measurement according to the newly received RRLP MEASURE POSITION REQUEST and send back RRLP MEASURE POSITION RESPONSE to SS after finishing the measurement.

70.9.4.6.3 Method of Test

Initial Conditions:

System Simulator:

Serving Cell: default parameters.

Satellite signals: No GPS signal available.

Mobile Station:

The MS is MM-state "idle, updated" with valid TMSI and CKSN.

Specific PICS statements

-

PIXIT statements

-

Test Procedure:

The MS is paged with a PAGING REQUEST TYPE 1 message. The MS performs control early classmark sending to provide LCS positioning method capability.

After sending CIPHERING MODE COMPLETE message the MS receives RR APPLICATION INFORMATION messages containing RRLP Assistance Data messages.

The SS then sends an RR APPLICATION INFORMATION message containing an RRLP Measure Position Request including further assistance data to start the measurement.

Option 1: The MS then performs positioning measurements. After a delay of 15 seconds to allow for the possibility of Option 2, the SS sends an RR MANAGEMENT command. The MS shall terminate the current location measurement and perform the RR MANAGEMENT command. The MS sends an RR MANAGEMENT RESPONSE message to SS when the RR MANAGEMENT procedure is complete. The SS sends a new RRLP MEASURE POSITION REQUEST including assistance data and the MS sends RRLP MEASURE POSITION RESPONSE to SS with the measurement data finishing the measurement according to the newly received RRLP MEASUREMENT POSITION REQUEST (possibly by requesting additional assistance data first).

Option 2: The MS may request additional assistance data by immediately sending an RRLP Measure Position Response message containing a location error with IE LocErrorReason set to gpsAssDataMissing. If the MS requests additional assistance data that is available in the SS, then the SS provides the requested assistance data in zero, one or more RRLP Assistance Data delivery messages followed by a second RRLP Measure Position Request message which may include further assistance data. If the MS requests additional assistance data and the entire requested assistance data is not available in the SS, then the SS sends the second RRLP Measure Position Request message without assistance data. The MS then performs positioning measurements and before the current positioning measurement finishes, the MS receives a RR MANAGEMENT command. The MS shall terminate the current location measurement and perform the RR MANAGEMENT command. The MS sends a RR MANAGEMENT RESPONSE message to SS when the RR MANAGEMENT procedure is complete. The SS sends a new RRLP MEASURE POSITION REQUEST including assistance data and the MS either sends RRLP MEASURE POSITION RESPONSE to SS with the measurement data finishing the measurement according to the newly received RRLP MEASUREMENT POSITION REQUEST or requests more assistance data and then sends RRLP MEASURE POSITION RESPONSE to SS with the measurement data.

Maximum duration of the test:

5 minutes.

Expected Sequence

Step	Direction	Message	Comments
1	SS->MS	PAGING REQUEST TYPE I	
2	MS -> SS	CHANNEL REQUEST	Establishment cause indicates "answer to paging".
3	SS -> MS	IMMEDIATE ASSIGNMENT	
4	MS->SS	PAGING RESPONSE	Message is contained in SABM. "mobile station classmark 2" includes settings for ES_IND.
5	MS->SS	CLASSMARK CHANGE	"mobile station classmark 2" includes settings for ES_IND. "mobile station classmark 3" includes settings for Positioning. The setting for positioning specifies Positioning Method capability and Positioning Method Support. In the position method support (5 bit field), Bit 2 is set to 1 (MS-Based GPS)
6	SS -> MS	AUTHENTICATION REQUEST	
7	MS -> SS	AUTHENTICATION RESPONSE	
8	SS -> MS	CIPHERING MODE COMMAND	
9	MS -> SS	CIPHERING MODE COMPLETE	
10	SS		SS starts ciphering.
11	SS -> MS	RR APPLICATION INFORMATION	RRLP Assistance Data
12	MS -> SS	RR APPLICATION INFORMATION	RRLP assistanceDataAck
13	SS -> MS	RR APPLICATION INFORMATION	RRLP Assistance Data
14	MS -> SS	RR APPLICATION INFORMATION	RRLP assistanceDataAck
15	SS -> MS	RR APPLICATION INFORMATION	RRLP Measure Position Request 1
16	MS (Option 1) or MS->SS (Option 2)	- or RR APPLICATION INFORMATION	If no message is received from the MS within 15 seconds, then the SS shall assume that the MS is performing the measurement (Option 1). The SS continues to step 17. If the MS sends RRLP Measure Position Response: locationError with gpsAssDataMissing (Option 2) within 15 seconds, then the SS continues to step 17a.
16a	SS -> MS	RR APPLICATION INFORMATION	RRLP Assistance Data. If the MS requested additional assistance data in step 16 that is available in the SS, then SS provides the requested data in zero, one or more RRLP Assistance Data delivery messages.
16b	MS -> SS	RR APPLICATION INFORMATION	RRLP assistanceDataAck. If the SS sent additional assistance data in step 16a, the MS acknowledges the received assistance data.
16c	SS-> MS	RR APPLICATION INFORMATION	RRLP Measure Position Request 2. If the MS requested additional assistance data in step 16 that is available in the SS, this message may include further assistance data.
16d	MS (Option 2)		MS is performing the measurement (Option 2)
17	SS -> MS	RR MANAGEMENT COMMAND	
18	MS -> SS	RR MANAGEMENT COMPLETE	MS terminates the measurement procedure and act on the RR management command
19	SS -> MS	RR APPLICATION INFORMATION	RRLP Measure Position Request 2 (Option 1) or RRLP Measure Position Request 3 (Option 2)
20	MS -> SS	RR APPLICATION INFORMATION	RRLP Measure Position Response: locationInfo (Option 1 or 2a)

20a	SS -> MS	RR APPLICATION INFORMATION	or locationError with gpsAssDataMissing (Option 2b) RRLP Assistance Data. If the MS requested additional assistance data in step 20 that is available in the SS, then SS provides the requested data in zero, one or more RRLP Assistance Data delivery messages.
20b	MS -> SS	RR APPLICATION INFORMATION	RRLP assistanceDataAck. If the SS sent additional assistance data in step 20a, the MS acknowledges the received assistance data.
20c	SS-> MS	RR APPLICATION INFORMATION	RRLP Measure Position Request. If the MS requested additional assistance data in step 20 that is available in the SS, this message may include further assistance data.
20d	MS-> SS	RR APPLICATION INFORMATION	RRLP Measure Position Response. If the MS requested additional assistance data in step 20 this message contains locationInfo.
21	SS -> MS	CHANNEL RELEASE	The main signalling link is released

Specific Message Contents

RR_APPLICATION_INFORMATION

Information element	Value/remark
Protocol Discriminator	RR Management Protocol (0110)
Skip Indicator	
Message Type	Application Information Message type
APDU ID	APDU ID -> RRLP => 0000
APDU Flags	Bit1=0 -> Last or only segment Bit2=0 -> First or only segment Bit3=0 -> Command or Final Response Bit4=spare
APDU Data	2-N Byte -> ASN.1 Coded Step 15, 16c, 19, 20c: RRLP Measure Position Request Step 16, 20, 20d: RRLP Measure Position Response Step 11, 13, 16a, 20a: RRLP Assistance Data Step 12, 14, 16b, 20b: RRLP Assistance Data Ack

RRLP Assistance Data (Step 11):

Information element	Type	Value/remark
ASN.1 encoded		
referenceNumber	Integer,0 to 7	1
component	CHOICE	assistanceData
gps-AssistData	SEQUENCE	
navigationModel	SEQUENCE	PRNs 4,6,9 of section 10.9.5
moreAssDataToBeSent	ENUMERATED	1

RRLP Assistance Data Ack (Steps 12, 14, 16b, 20b):

Information element	Type	Value/remark
ASN.1 encoded		
referenceNumber	Integer,0 to 7	1
component	CHOICE	assistanceDataAck

RRLP Assistance Data (Step 13):

Information element	Type	Value/remark
ASN.1 encoded		
referenceNumber	Integer,0 to 7	1
component	CHOICE	assistanceData
gps-AssistData	SEQUENCE	
navigationModel	SEQUENCE	PRNs 10,13,22 of section 10.9.5
ionosphericModel	SEQUENCE	See section 10.9.6
moreAssDataToBeSent	ENUMERATED	0

RRLP Measure Position Request 1 (Step 15):

Information element	Type	Value/remark
ASN.1 encoded		
referenceNumber	Integer,0 to 7	1
component	CHOICE	msrPositionReq
methodType	CHOICE	msBased
positionMethod	ENUMERATED	gps
measureResponseTime	Integer 0 to 7	5
accuracy	Integer (0-127)	127
useMultipleSets	ENUMERATED	oneSet
gps-AssistData	SEQUENCE	
referenceTime	SEQUENCE	See section 10.9.3
refLocation	SEQUENCE	See section 10.9.4

RRLP Measure Position Response (Step 16 (Option 2)):

Information element	Type	Value/remark
ASN.1 encoded		
referenceNumber	Integer,0 to 7	1
component	CHOICE	msrPositionRsp
locationError	SEQUENCE	
locErrorReason	ENUMERATED	gpsAssDataMissing
additionalAssistanceData	SEQUENCE	
gpsAssistanceData	OCTET STRING	Indicates missing assistance data elements

RRLP Assistance Data (Step 16a):

Information element	Type	Value/remark
ASN.1 encoded		
referenceNumber	Integer,0 to 7	1
component	CHOICE	assistanceData
gps-AssistData	SEQUENCE	If the MS requested further assistance data in Step 16 (Option 2) that is available in the SS, SS shall send zero, one or more RRLP Assistance Data messages containing the requested assistance data from section 10.9. Each message shall contain a maximum of 242 octets.
moreAssDataToBeSent	ENUMERATED	1 or 0. If SS sends more than one RRLP assistance data delivery message the moreAssDataToBeSent field shall be set accordingly.

RRLP Measure Position Request 2 (Step 16c):

Information element	Type	Value/remark
ASN.1 encoded		
referenceNumber	Integer,0 to 7	1
component	CHOICE	msrPositionReq
methodType	CHOICE	msBased
positionMethod	ENUMERATED	gps
measureResponseTime	Integer 0 to 7	5
accuracy	Integer (0-127)	127
useMultipleSets	ENUMERATED	oneSet
gps-AssistData	SEQUENCE	May contain further assistance data from section 10.9 as requested by the MS in step 16 (Option 2).

RR Management Command (Classmark Enquiry) (Step 17):

Information element	Value/remark
Encoded	(06 13)
Protocol Discriminator	RR Management Protocol (0110)
Skip Indicator	
Classmark Enquiry Message Type	0001 0011

RRLP Measure Position Request 2 (Option 1) or Request 3 (Option 2) (Step 19):

Information element	Type	Value/remark
ASN.1 encoded		
referenceNumber	Integer,0 to 7	2
component	CHOICE	msrPositionReq
methodType	CHOICE	msBased
positionMethod	ENUMERATED	gps
measureResponseTime	Integer 0 to 7	5
accuracy	Integer (0-127)	127
useMultipleSets	ENUMERATED	oneSet
gps-AssistData	SEQUENCE	
referenceTime	SEQUENCE	See section 10.9.3
refLocation	SEQUENCE	See section 10.9.4

RRLP Measure Position Response (Step 20 (Option 1 or 2a) or Step 20d (Option 2b)):

Information element	Type	Value/remark
ASN.1 encoded		
referenceNumber	Integer,0 to 7	2
component	CHOICE	msrPositionRsp (A valid response will contain LocationInfo otherwise LocationError will be returned)
locationInfo	SEQUENCE	Any value is acceptable.
locationError	SEQUENCE	Any error value is acceptable except gpsAssDataMissing.

RRLP Measure Position Response (Step 20 (Option 2b)):

Information element	Type	Value/remark
ASN.1 encoded		
referenceNumber	Integer,0 to 7	2
component	CHOICE	msrPositionRsp
locationError	SEQUENCE	
locErrorReason	ENUMERATED	gpsAssDataMissing
additionalAssistanceData	SEQUENCE	
gpsAssistanceData	OCTET STRING	Indicates missing assistance data elements

RRLP Assistance Data (Step 20a):

Information element	Type	Value/remark
ASN.1 encoded		
referenceNumber	Integer,0 to 7	1
component	CHOICE	assistanceData
gps-AssistData	SEQUENCE	If the MS requested further assistance data in Step 20 (Option 2b) that is available in the SS, SS shall send zero, one or more RRLP Assistance Data messages containing the requested assistance data from section 10.9. Each message shall contain a maximum of 242 octets.
moreAssDataToBeSent	ENUMERATED	1 or 0. If SS sends more than one RRLP assistance data delivery message the moreAssDataToBeSent field shall be set accordingly.

RRLP Measure Position Request (Step 20c):

Information element	Type	Value/remark
ASN.1 encoded		
referenceNumber	Integer,0 to 7	2
component	CHOICE	msrPositionReq
methodType	CHOICE	msBased
positionMethod	ENUMERATED	gps
measureResponseTime	Integer 0 to 7	5
accuracy	Integer (0-127)	127
useMultipleSets	ENUMERATED	oneSet
gps-AssistData	SEQUENCE	May contain further assistance data from section 10.9 as requested by the MS in step 20 (Option 2b).

70.10 Conventional GPS Network Induced Tests

70.10.1 Void

70.10.2 Network Induced Location Request Emergency Call on TCH Radio Channel

70.10.2.1 Network Induced Location Request Emergency Call on TCH Radio Channel for Mobiles Supporting Conventional GPS

70.10.2.1.1 Conformance requirements

1. With the MS in the "idle, updated" state, the user shall initiate an emergency after the number 112 (for GSM900 and 1800 MS), or 911 (for PCS 1900 MS in the USA), or 08 (for PCS 1900 MS in Mexico) has been entered by the user. The MS shall send a CHANNEL REQUEST message with correct establishment cause ("emergency call").
2. When a user requests an emergency call establishment the mobile station will send a CM SERVICE REQUEST message to the network with a CM service type information element indicating emergency call establishment and the correct CKSN and TMSI. A mobile station which implements the "LCS" option shall also implement the "Controlled Early Classmark Sending" option. A mobile station which implements the "Controlled Early Classmark Sending" option shall indicate it in the classmark (ES IND bit).
3. After sending the CM SERVICE REQUEST message the MS shall send a CLASSMARK CHANGE message. The "Mobile Station Classmark 3" information element shall correctly specify the positioning methods supported by the MS.
4. After the CM SERVICE ACCEPT message is received from the network, the MS shall send an EMERGENCY SETUP message.
5. After receipt of a CONNECT ACKNOWLEDGE message during correct establishment of the emergency call the MS shall indicate that the TCH is through connected in both directions.
6. On receiving the MEASURE POSITION REQUEST message the MS tries to perform the requested location measurements, and calculates its own position. It sends the results in the RRLP MEASURE POSITION RESPONSE message.

70.10.2.1.2 References

3GPP TS 04.08/44.018 subclauses 3.3.1.1 and 9.1.11.

3GPP TS 04.08/24.008 subclauses 4.5.1.5, 5.2.1, 9.2.9, 10.5.1.6, 10.5.1.7.

3GPP TS 02.30 clause 4.

3GPP TS 04.31 subclause 2.2.

70.10.2.1.3 Test Purpose

To verify when a network instigates the LCS positioning procedure by sending RRLP (Measure Position Request) message, after a traffic channel has been established during an emergency call, the mobile responds with RRLP (Measure Position Response) containing MS location estimate.

70.10.2.1.4 Method of Test

70.10.2.1.5 Initial Conditions

System Simulator (SS):

Serving Cell: default parameters.

Satellite signals: default conditions.

Mobile Station (MS):

The MS is in MM-state “idle, updated” with valued TMSI and CKSN.

SIM:

Normal SIM

Specific PICS statements

-

PIXIT statements

-

70.10.2.1.6 Void

70.10.2.1.7 Test Procedure

An Emergency Call is initiated with the MS. SIM card is included in the MS.

The emergency call is established with a late assignment.

After receiving the CONNECT ACKNOWLEDGE message from the MS, the SS sends an RR APPLICATION INFORMATION message containing an RRLP Measure Position Request on FACCH.

The MS then performs positioning measurements, and responds with a RR APPLICATION INFORMATION message containing a RRLP Measure Position Response.

The call is cleared by the SS.

70.10.2.1.8 Maximum duration of the test

5 minutes.

70.10.2.1.9 Expected Sequence

Step	Direction	Message	Comments
1	MS		The appropriate "emergency call number" is entered.
2	MS -> SS	CHANNEL REQUEST	Establishment cause is emergency call establishment.
3	SS -> MS	IMMEDIATE ASSIGNMENT	
4	MS -> SS	CM SERVICE REQUEST	Message is contained in SABM. The CM service type IE indicates "emergency call establishment". "mobile station classmark 2" includes settings for ES_IND.
5	MS->SS	CLASSMARK CHANGE	"mobile station classmark 2" includes settings for ES_IND. "mobile station classmark 3" includes settings for Positioning. The setting for positioning specifies Positioning Method capability and Positioning Method Support. In the position method support (5 bit field), Bit 1 is set to 1 (Conventional GPS) and Bit 2 is set to 0 (no support for MS-based GPS)
6	SS -> MS	CM SERVICE ACCEPT	
7	MS -> SS	EMERGENCY SETUP	
8	SS -> MS	CALL PROCEEDING	
9	SS -> MS	ALERTING	
10	SS -> MS	ASSIGNMENT COMMAND	
11	MS -> SS	ASSIGNMENT COMPLETE	
12	SS -> MS	CONNECT	
13	MS -> SS	CONNECT ACKNOWLEDGE	The MS indicates that the TCH is through connected in both directions.
14	SS-> MS	RR APPLICATION INFORMATION	(RRLP Measure Position Request)
15	MS -> SS	RR APPLICATION INFORMATION	(RRLP Measure Position Response)
16	SS -> MS	DISCONNECT	
17	MS -> SS	RELEASE	
18	SS -> MS	RELEASE COMPLETE	
19	SS -> MS	CHANNEL RELEASE	The main signalling link is released.

70.10.2.1.10 Specific Message Contents

70.10.2.1.10.1 RR APPLICATION INFORMATION

Information element	Value/remark
Protocol Discriminator	RR Management Protocol (0110)
Skip Indicator	
Message Type	Application Information Message type
APDU ID	APDU ID -> RRLP => 0000
APDU Flags	Bit1=0 -> Last or only segment Bit2=0 -> First or only segment Bit3=0 -> Command or Final Response Bit4=spare
APDU Data	2-N Byte -> ASN.1 Coded RRLP (Measure Position Request), RRLP (Measure Position Response)

70.10.2.1.10.2 RRLP Measure Position Request

Information element	Type	Value/remark
ASN.1 encoded	-	
referenceNumber	Integer,0 to 7	1
component	CHOICE	msrPositionReq
methodType	CHOICE	msBased
positionMethod	ENUMERATED	gps
measureResponseTime	Integer 0 to 7	7
accuracy	Integer (0-127)	127
useMultipleSets	ENUMERATED	oneSet

70.10.2.1.10.3 RRLP Measure Position Response

Information element	Type	Value/remark
ASN.1 encoded	-	
referenceNumber	Integer,0 to 7	1
component	CHOICE	msrPositionRsp A valid response will contain locationInfo otherwise locationError will be returned
locationInfo	SEQUENCE	Any value is acceptable.
locationError	SEQUENCE	Any error value is acceptable.

70.11 A-GPS Minimum Performance tests

This section specifies the measurement procedures for the conformance test of the minimum performance requirements for GSM user equipment (MS) that supports Assisted Global Positioning System (A-GPS).

70.11.1 Abbreviations

A-GPS	Assisted - Global Positioning System
C/A	Coarse/Acquisition
ECEF	Earth Centred, Earth Fixed
GPS	Global Positioning System
GSS	GPS System Simulator
HDOP	Horizontal Dilution Of Precision
LOS	Line Of Sight
WLS	Weighted Least Square

70.11.2 GPS test conditions

70.11.2.1 GPS signals

The GPS signal is defined at the A-GPS antenna connector of the MS. For MS with integral antenna only, a reference antenna with a gain of 0 dBi is assumed.

70.11.2.2 GPS frequency

The GPS signals shall be transmitted with a frequency accuracy of ± 0.025 PPM.

70.11.2.3 GPS static propagation conditions

The propagation for the static performance measurement is an Additive White Gaussian Noise (AWGN) environment. No fading and multi-paths exist for this propagation model.

70.11.2.4 GPS multi-path conditions

Doppler frequency difference between direct and reflected signal paths is applied to the carrier and code frequencies. The Carrier and Code Doppler frequencies of LOS and multi-path for GPS L1 signal are defined in table 70.11.2.1.

Table 70.11.2.1: Multi-path Conditions for GPS Signals

Initial relative Delay [GPS chip]	Carrier Doppler frequency of tap [Hz]	Code Doppler frequency of tap [Hz]	Relative mean Power [dB]
0	F_d	F_d / N	0
0.5	$F_d - 0.1$	$(F_d - 0.1) / N$	-6

NOTE: Discrete Doppler frequency is used for each tap.

$N = f_{\text{GPSL1}} / f_{\text{chip}}$, where f_{GPSL1} is the nominal carrier frequency of the GPS L1 signal (1575.42 MHz) and f_{chip} is the GPS L1 C/A code chip rate (1.023 Mc/s).

The initial carrier phase difference between taps shall be randomly selected between 0 and 2π radians. The initial value shall have uniform random distribution.

70.11.3 GSM test conditions

70.11.3.1 GSM frequency band and frequency range

The tests in this section are performed on one of the mid range ARFCNs of the GSM operating frequency band of the MS. The ARFCNs to be used for mid range are defined in Table 3.3

If the MS supports multiple frequency bands then the Sensitivity tests in clause 70.11.5 shall be repeated in each supported frequency band.

70.11.3.2 GSM frequency

For all tests the GSM frequency shall be offset with respect to the nominal frequency by an amount equal to the sum of +0.025 PPM and the offset in PPM of the actual transmitted GPS carrier frequency with respect to the nominal GPS frequency.

70.11.4 A-GPS test conditions

70.11.4.1 General

This section defines the minimum performance requirements for both MS based and MS assisted A-GPS terminals. If a terminal supports both modes then it shall be tested in both modes.

70.11.4.2 Measurement parameters

70.11.4.2.1 MS based A-GPS measurement parameters

In case of MS-based A-GPS, the measurement parameters are contained in the RRLP LOCATION INFORMATION IE. The measurement parameter is the horizontal position estimate reported by the MS and expressed in latitude/longitude.

70.11.4.2.2 MS assisted A-GPS measurement parameters

In case of MS-assisted A-GPS, the measurement parameters are contained in the RRLP GPS MEASUREMENT INFORMATION IE. The measurement parameters are the MS GPS Code Phase measurements. The MS GPS Code Phase measurements are converted into a horizontal position estimate using the procedure detailed in clause 70.11.4.3.

70.11.4.2.3 2D position error

The 2D position error is defined by the horizontal difference in meters between the ellipsoid point reported or calculated from the MS Measurement Report and the actual simulated position of the MS in the test case considered.

70.11.4.2.4 Response time

Max Response Time is defined as the time starting from the moment that the MS has received the final RRLP MEASURE POSITION REQUEST sent before the MS sends the MEASURE POSITION RESPONSE containing the Location Information or the GPS Measurement Information, and ending when the MS starts sending the MEASURE POSITION RESPONSE containing the Location Information or the GPS Measurement Information on the Air interface. The response times specified for all test cases are Time-to-First-Fix (TTFF), i.e. the MS shall not re-use any information on GPS time, location or other aiding data that was previously acquired or calculated and stored internally

in the MS. A dedicated test message 'RESET MS POSITIONING STORED INFORMATION' has been defined in TS 44.014 [Editor's note: this has not yet been added to 44.014] for the purpose of deleting this information.

70.11.4.3 Converting MS-assisted measurement reports into position estimates

To convert the MS measurement reports in case of MS-assisted mode of A-GPS into position errors, a transformation between the "measurement domain" (code-phases, etc.) into the "state" domain (position estimate) is necessary. Such a transformation procedure is outlined in the following clauses. The details can be found in [ICD-GPS 200], [P. Axelrad, R.G. Brown] and [S.K. Gupta]

70.11.4.3.1 MS measurement reports

In case of MS-assisted A-GPS, the measurement parameters are contained in the RRLP GPS MEASUREMENT INFORMATION ELEMENT (subclause A.3.2.5 in 3GPP TS 44.031). The measurement parameters required for calculating the MS position are:

- 1) Reference Time: The MS has two choices for the Reference Time:
 - a) "Reference Frame";
 - b) "GPS TOW".
- 2) Measurement Parameters: 1 to <maxSat>:
 - a) "Satellite ID (SV PRN)";
 - b) "Whole GPS chips";
 - c) "Fractional GPS Chips";
 - d) "Pseudorange RMS Error".

Additional information required at the system simulator:

- 1) "Reference Location" (subclause A.4.2.4 in 3GPP TS 44.031):
Used for initial approximate receiver coordinates.
- 2) "Navigation Model" (subclause A.4.2.4 in 3GPP TS 44.031):
Contains the GPS ephemeris and clock correction parameters as specified in [ICD-GPS 200]; used for calculating the satellite positions and clock corrections.
- 3) "Ionospheric Model" (subclause A.4.2.4 in 3GPP TS 44.031):
Contains the ionospheric parameters which allow the single frequency user to utilize the ionospheric model as specified in [ICD-GPS 200] for computation of the ionospheric delay.

70.11.4.3.2 WLS position solution

The WLS position solution problem is concerned with the task of solving for four unknowns; x_u , y_u , z_u the receiver coordinates in a suitable frame of reference (usually ECEF) and b_u the receiver clock bias. It typically requires the following steps:

Step 1: Formation of pseudo-ranges

The observation of code phase reported by the MS for each satellite SV_i is related to the pseudo-range/c modulo 1 ms (the length of the C/A code period). For the formation of pseudo-ranges, the integer number of milliseconds to be added to each code-phase measurement has to be determined first. Since 1 ms corresponds to a travelled distance of 300 km, the number of integer ms can be found with the help of reference location and satellite ephemeris. The distance between the reference location and each satellite SV_i is calculated and the integer number of milliseconds to be added to the MS code phase measurements is obtained.

Step 2: Formation of weighting matrix

The MS reported "Pseudorange RMS Error" values are used to calculate the weighting matrix for the WLS algorithm [P. Axelrad, R.G. Brown]. According to 3GPP TS 44.031, the encoding for this field is a 6 bit value that consists of a 3 bit mantissa, X_i and a 3 bit exponent, Y_i for each SV_i :

$$w_i = RMSError = 0.5 \times \left(1 + \frac{X_i}{8} \right) \times 2^{Y_i}$$

The weighting Matrix \mathbf{W} is defined as a diagonal matrix containing the estimated variances calculated from the "Pseudorange RMS Error" values:

$$\mathbf{W} = \text{diag}\left\{1/w_1^2, 1/w_2^2, \dots, 1/w_n^2\right\}$$

Step 3: WLS position solution

The WLS position solution is described in reference [P. Axelrad, R.G. Brown] and usually requires the following steps:

- 1) Computation of satellite locations at time of transmission using the ephemeris parameters and user algorithms defined in [ICD-GPS 200], section 20.3.3.4.3.
- 2) Computation of clock correction parameters using the parameters and algorithms as defined in [ICD-GPS 200], section 20.3.3.3.1.
- 3) Computation of atmospheric delay corrections using the parameters and algorithms defined in [ICD-GPS 200], section 20.3.3.5.2.5 for the ionospheric delay, and using the Gupta model in reference [S.K. Gupta], p. 121 equation (2) for the tropospheric delay.
- 4) The WLS position solution starts with an initial estimate of the user state (position and clock offset). The Reference Location is used as initial position estimate. The following steps are required:
 - a) Calculate geometric range (corrected for Earth rotation) between initial location estimate and each satellite included in the MS measurement report.
 - b) Predict pseudo-ranges for each measurement including clock and atmospheric biases as calculated in 1) to 3) above and defined in [ICD-GPS 200] and [P. Axelrad, R.G. Brown].
 - c) Calculate difference between predicted and measured pseudo-ranges $\Delta\rho$
 - d) Calculate the "Geometry Matrix" \mathbf{G} as defined in [P. Axelrad, R.G. Brown]:

$$\mathbf{G} \equiv \begin{bmatrix} -\hat{\mathbf{1}}_1^T & 1 \\ -\hat{\mathbf{1}}_2^T & 1 \\ \vdots & \vdots \\ -\hat{\mathbf{1}}_n^T & 1 \end{bmatrix} \text{ with } \hat{\mathbf{1}}_i \equiv \frac{\mathbf{r}_{si} - \hat{\mathbf{r}}_u}{|\mathbf{r}_{si} - \hat{\mathbf{r}}_u|} \text{ where } \mathbf{r}_{si} \text{ is the Satellite position vector for SV}_i \text{ (calculated in 1)}$$

above), and $\hat{\mathbf{r}}_u$ is the estimate of the user location.

- e) Calculate the WLS solution according to [P. Axelrad, R.G. Brown]:

$$\Delta\hat{\mathbf{x}} = \left(\mathbf{G}^T \mathbf{W} \mathbf{G}\right)^{-1} \mathbf{G}^T \mathbf{W} \Delta\rho$$

- f) Adding the $\Delta\hat{\mathbf{x}}$ to the initial state estimate gives an improved estimate of the state vector:

$$\hat{\mathbf{x}} \rightarrow \hat{\mathbf{x}} + \Delta\hat{\mathbf{x}}.$$

- 5) This new state vector $\hat{\mathbf{x}}$ can be used as new initial estimate and the procedure is repeated until the change in $\hat{\mathbf{x}}$ is sufficiently small.

Step 4: Transformation from Cartesian coordinate system to Geodetic coordinate system

The state vector $\hat{\mathbf{x}}$ calculated in Step 3 contains the MS position in ECEF Cartesian coordinates together with the MS receiver clock bias. Only the user position is of further interest. It is usually desirable to convert from ECEF coordinates x_u, y_u, z_u to geodetic latitude φ , longitude λ and altitude h on the WGS84 reference ellipsoid.

Step 5: Calculation of "2-D Position Errors"

The latitude φ / longitude λ obtained after Step 4 is used to calculate the 2-D position error.

70.11.5 Sensitivity

70.11.5.1 Sensitivity Coarse Time Assistance

70.11.5.1.1 Definition

Sensitivity with coarse time assistance is the minimum level of GPS satellite signals required for the MS to make an A-GPS position estimate to a specific accuracy and within a specific response time when the network only provides coarse time assistance.

70.11.5.1.2 Conformance requirement

The first fix position estimates shall meet the accuracy and response time requirements in table 70.11.5.1.2 for the parameters specified in table 70.11.5.1.1.

Table 70.11.5.1.1: Test parameters for Sensitivity Coarse Time Assistance

Parameters	Unit	Value
Number of generated satellites	-	8
HDOP Range	-	1.1 to 1.6
Propagation conditions	-	AWGN
GPS Coarse Time assistance error range	seconds	±2
GPS Signal for one satellite	dBm	-142
GPS Signal for remaining satellites	dBm	-147

Table 70.11.5.1.2: Conformance requirement for Sensitivity Coarse Time Assistance

Success rate	2-D position error	Max response time
95 %	100 m	20 s

The reference for this requirement is 3GPP TS 45.005, clause M.2.1.1.

70.11.5.1.3 Test purpose

To verify the MS's first position estimate meets the Conformance requirement under GPS satellite signal conditions that represent weak signal conditions and with only Coarse Time Assistance provided by the SS.

70.11.5.1.4 Method of test

Initial conditions

Test environment: normal; see clause A1.2.2.

1. Connect SS and GSS to the MS antenna connector or antenna connectors.
2. Set the GPS test parameters as specified in table 70.11.5.1.3 for GPS scenario #1. Select the first satellite PRN defined in the table in clause 10.10.1.2.5 for the one satellite with the higher level.
3. Switch on the MS.
4. Set up a voice call according to the generic call set up procedure in clause 10.1 on a channel in the Mid ARFCN range.

Specific PICS statements

-

PIXIT statements

-

Procedure

1. Start GPS scenario #1 as specified in clause 10.10.1.2 with the MS location randomly selected to be within 3 km of the Reference Location and the altitude of the MS randomly selected between 0 m to 500 m above WGS-84 reference ellipsoid using the method described in clause 10.10.1.2.4
2. Send a RESET MS POSITIONING STORED INFORMATION message followed by RRLP Assistance Data and RRLP Measure Position Request messages containing appropriate assistance data; as specified in clauses 10.10.2 and 10.10.6 for MS based testing; or clauses 10.10.4 and 10.10.6 for MS assisted testing with the value of GPS TOW offset by a random value as specified in clause 10.10.6.2; as required to obtain a fix.
3. If the MS returns a valid result in the Measure Position Response message within the Max response time specified in table 70.11.5.1.4 then record the result and process it as specified in step 4. If the MS does not return a valid result within the Max response time specified in table 70.11.5.1.4 or reports a MS positioning error in the Measure Position Response message then record one Bad Result.

4. For MS based testing compare the reported Location Information in the Measure Position Response message against the simulated position of the MS used in step 1, and calculate the 2D position error as specified in clause 70.11.4.2.3. Compare the 2D position error against the value in table 70.11.5.1.4 and record one Good Result or Bad Result as appropriate; or

For MS assisted testing convert the GPS Measurement Information reported in the Measure Position Response message to a 2D position using the method described in clause 70.11.4.3 and then compare the result against the simulated position of the MS, used in step 1, and calculate the 2D position error as specified in clause 70.11.4.2.3. Compare the 2D position error against the value in table 70.11.5.1.4 and record one Good Result or Bad Result as appropriate.

5. Repeat steps 1 to 4 using GPS scenario #2 instead of #1 so that the reference location changes sufficiently such that the MS shall have to use the new assistance data. Select the first satellite PRN defined in the table in clause 10.10.1.2.5 for the one satellite with the higher level. Use new random values for the MS location and altitude in step 1 and for the GPS TOW offset in step 2.
6. Repeat steps 1 to 5 until the statistical requirements of clause 70.11.5.1.5 are met. Each time scenario #1 or #2 is used, the start time of the GPS scenario shall be advanced by 2 minutes from the time used previously for that scenario. Once a scenario reaches the end of its viable running time, restart it from its nominal start time again. Each time scenario #1 or #2 is used select the next satellite PRN from the one used previously, defined in the table in clause 10.10.1.2.5, for the one satellite with the higher level.
7. Terminate the call.

Minimum / Maximum duration of the test

Minimum duration approximately 1 hour, maximum duration approximately 20 hours

Specific Message Contents

MEASURE POSITION REQUEST (3GPP TS 44.031 subclause A.2) to the MS

Information Element	Value/remark
Positioning Instructions	
Accuracy	51.2m
Required Response Time	20s

70.11.5.1.5 Test Requirements

For the parameters specified in table 70.11.5.1.3 the MS shall meet the requirements and the success rate specified in table 70.11.5.1.4 with a confidence level of 95% according to annex A7.2.

Table 70.11.5.1.3: Test parameters for Sensitivity Coarse Time Assistance

Parameters	Unit	Value
Number of generated satellites	-	8
HDOP Range	-	1.1 to 1.6
Propagation conditions	-	AWGN
GPS Coarse Time assistance error range	seconds	± 1.8
GPS Signal for one satellite	dBm	-141
GPS Signal for remaining satellites	dBm	-146

Table 70.11.5.1.4: Test requirements for Sensitivity Coarse Time Assistance

Success rate	2-D position error	Max response time
95 %	101.3 m	20.3 s

NOTE: If the above Test Requirement differs from the Conformance requirement then the Test Parameter Relaxation applied for this test is non-zero. The Test Parameter Relaxation for this test is defined in clause A5.5.2 and the explanation of how the Conformance requirement has been relaxed by the Test Parameter Relaxation is given in clause A5.5.4.

70.11.5.2 Sensitivity Fine Time Assistance

70.11.5.2.1 Definition

Sensitivity with fine time assistance is the minimum level of GPS satellite signals required for the MS to make an A-GPS position estimate to a specific accuracy and within a specific response time when the network provides fine time assistance in addition to coarse time assistance.

70.11.5.2.2 Conformance requirement

The first fix position estimates shall meet the accuracy and response time requirements in table 70.11.5.2.2 for the parameters specified in table 70.11.5.2.1.

Table 70.11.5.2.1: Test parameters for Sensitivity Fine Time Assistance

Parameters	Unit	Value
Number of generated satellites	-	8
HDOP Range	-	1.1 to 1.6
Propagation conditions	-	AWGN
GPS Coarse time assistance error range	seconds	± 2
GPS Fine Time assistance error range	μs	± 10
GPS Signal for all satellites	dBm	-147

Table 70.11.5.2.2: Conformance requirement for Sensitivity Fine Time Assistance

Success rate	2-D position error	Max response time
95 %	100 m	20 s

The reference for this requirement is 3GPP TS 45.005, clause M.2.1.2.

70.11.5.2.3 Test purpose

To verify the MS's first position estimate meets the Conformance requirement under GPS satellite signal conditions that represent weak signal conditions and with Fine Time Assistance provided by the SS.

70.11.5.2.4 Method of test

Initial conditions

Test environment: normal; see clause A1.2.2.

1. Connect SS and GSS to the MS antenna connector or antenna connectors.
2. Set the GPS test parameters as specified in table 70.11.5.2.3 for GPS scenario #1.
3. Switch on the MS.
4. Set up a voice call according to the generic call set up procedure in clause 10.1 on a channel in the Mid ARFCN range.

Specific PICS statements

-

PIXIT statements

-

Procedure

1. Start GPS scenario #1 as specified in clause 10.10.1.2 with the MS location randomly selected to be within 3 km of the Reference Location and the altitude of the MS randomly selected between 0 m to 500 m above WGS-84 reference ellipsoid using the method described in clause 10.10.1.2.4
2. Send a RESET MS POSITIONING STORED INFORMATION message followed by RRLP Assistance Data and RRLP Measure Position Request messages containing appropriate assistance data; as specified in clauses 10.10.2 and 10.10.6 for MS based testing; or clauses 10.10.4 and 10.10.6 for MS assisted testing with the values of GPS TOW and BN offset by random values as specified in clause 10.10.6.2; as required to obtain a fix.
3. If the MS returns a valid result in the Measure Position Response message within the Max response time specified in table 70.11.5.2.4 then record the result and process it as specified in step 4. If the MS does not return a valid result within the Max response time specified in table 70.11.5.2.4 or reports a MS positioning error in the Measure Position Response message then record one Bad Result.
4. For MS based testing compare the reported Location Information in the Measure Position Response message against the simulated position of the MS used in step 1, and calculate the 2D position error as specified in clause 70.11.4.2.3. Compare the 2D position error against the value in table 70.11.5.2.4 and record one Good Result or Bad Result as appropriate; or

For MS assisted testing convert the GPS Measurement Information reported in the Measure Position Response message to a 2D position using the method described in clause 70.11.4.3 and then compare the result against the simulated position of the MS used in step 1, and calculate the 2D position error as specified in clause 70.11.4.2.3. Compare the 2D position error against the value in table 70.11.5.2.4 and record one Good Result or Bad Result as appropriate.

5. Repeat steps 1 to 4 using GPS scenario #2 instead of #1 so that the reference location changes sufficiently such that the MS shall have to use the new assistance data. Use new random values for the MS location and altitude in step 1 and for the GPS TOW and BN offsets in step 2.
6. Repeat steps 1 to 5 until the statistical requirements of clause 70.11.5.2.5 are met. Each time scenario #1 or #2 is used, the start time of the GPS scenario shall be advanced by 2 minutes from the time used previously for that scenario. Once a scenario reaches the end of its viable running time, restart it from its nominal start time again.
7. Terminate the call.

Minimum / Maximum duration of the test

Minimum duration approximately 1 hour, maximum duration approximately 20 hours

Specific Message Contents

MEASURE POSITION REQUEST (3GPP TS 44.031 subclause A.2) to the MS

Information Element	Value/remark
Positioning Instructions	
Accuracy	51.2m
Required Response Time	20s

70.11.5.2.5 Test Requirements

For the parameters specified in table 70.11.5.2.3 the MS shall meet the requirements and the success rate specified in table 70.11.5.2.4 with a confidence level of 95% according to annex A7.2.

Table 70.11.5.2.3: Test parameters for Sensitivity Fine Time Assistance

Parameters	Unit	Value
Number of generated satellites	-	8
HDOP Range	-	1.1 to 1.6
Propagation conditions	-	AWGN
GPS Coarse time assistance error range	seconds	±1.8
GPS Fine Time assistance error range	µs	±9
GPS Signal for all satellites	dBm	-146

Table 70.11.5.2.4: Test requirements for Sensitivity Fine Time Assistance

Success rate	2-D position error	Max response time
95 %	101.3 m	20.3 s

NOTE: If the above Test Requirement differs from the Conformance requirement then the Test Parameter Relaxation applied for this test is non-zero. The Test Parameter Relaxation for this test is defined in clause A5.5.2 and the explanation of how the Conformance requirement has been relaxed by the Test Parameter Relaxation is given in clause A5.5.4.

70.11.6 Nominal Accuracy

70.11.6.1 Definition

Nominal accuracy is the accuracy of the MS's A-GPS position estimate under ideal GPS signal conditions.

70.11.6.2 Conformance requirement

The first fix position estimates shall meet the accuracy and response time requirements in table 70.11.6.2 for the parameters specified in table 70.11.6.1.

Table 70.11.6.1: Test parameters for Nominal Accuracy

Parameters	Unit	Value
Number of generated satellites	-	8
HDOP Range	-	1.1 to 1.6
Propagation conditions	-	AWGN
GPS Coarse Time assistance error range	seconds	±2
GPS Signal for all satellites	dBm	-130

Table 70.11.6.2: Conformance requirement for Nominal Accuracy

Success rate	2-D position error	Max response time
95 %	30 m	20 s

The reference for this requirement is 3GPP TS 45.005, clause M.2.2.

70.11.6.3 Test purpose

To verify the MS's first position estimate meets the Conformance requirement under GPS satellite signal conditions that represent ideal conditions.

70.11.6.4 Method of test

Initial conditions

Test environment: normal; see clause A1.2.2.

1. Connect SS and GSS to the MS antenna connector or antenna connectors.
2. Set the GPS test parameters as specified in table 70.11.6.3 for GPS scenario #1.
3. Switch on the MS.
4. Set up a voice call according to the generic call set up procedure in clause 10.1 on a channel in the Mid ARFCN range.

Specific PICS statements

-

PIXIT statements

-

Procedure

1. Start GPS scenario #1 as specified in clause 10.10.1.2 with the MS location randomly selected to be within 3 km of the Reference Location and the altitude of the MS randomly selected between 0 m to 500 m above WGS-84 reference ellipsoid using the method described in clause 10.10.1.2.4
2. Send a RESET MS POSITIONING STORED INFORMATION message followed by RRLP Assistance Data and RRLP Measure Position Request messages containing appropriate assistance data; as specified in clauses 10.10.2 and 10.10.6 for MS based testing; or clauses 10.10.4 and 10.10.6 for MS assisted testing with the value of GPS TOW offset by a random value as specified in clause 10.10.6.2; as required to obtain a fix.
3. If the MS returns a valid result in the Measure Position Response message within the Max response time specified in table 70.11.6.4 then record the result and process it as specified in step 4. If the MS does not return a valid result within the Max response time specified in table 70.11.6.4 or reports a MS positioning error in the Measure Position Response message then record one Good Result.
4. For MS based testing compare the reported Location Information in the Measure Position Response message against the simulated position of the MS used in step 1, and calculate the 2D position error as specified in clause 70.11.4.2.3. Compare the 2D position error against the value in table 70.11.6.4 and record one Good Result or Bad Result as appropriate; or

For MS assisted testing convert the GPS Measurement Information reported in the Measure Position Response message to a 2D position using the method described in clause 70.11.4.3 and then compare the result against the simulated position of the MS used in step 1, and calculate the 2D position error as specified in clause 70.11.4.2.3. Compare the 2D position error against the value in table 70.11.6.4 and record one Good Result or Bad Result as appropriate.

5. Repeat steps 1 to 4 using GPS scenario #2 instead of #1 so that the reference location changes sufficiently such that the MS shall have to use the new assistance data. Use new random values for the MS location and altitude in step 1 and for the GPS TOW offset in step 2.
6. Repeat steps 1 to 5 until the statistical requirements of clause 70.11.6.5 are met. Each time scenario #1 or #2 is used, the start time of the GPS scenario shall be advanced by 2 minutes from the time used previously for that scenario. Once a scenario reaches the end of its viable running time, restart it from its nominal start time again.
7. Terminate the call.

Minimum / Maximum duration of the test

Minimum duration approximately 1 hour, maximum duration approximately 20 hours

Specific Message Contents

MEASURE POSITION REQUEST (3GPP TS 44.031 subclause A.2) to the MS

Information Element	Value/remark
Positioning Instructions	
Accuracy	16m
Required Response Time	20s

70.11.6.5 Test Requirements

For the parameters specified in table 70.11.6.3 the MS shall meet the requirements and the success rate specified in table 70.11.6.4 with a confidence level of 95% according to annex A7.2.

Table 70.11.6.3: Test parameters for Nominal Accuracy

Parameters	Unit	Value
Number of generated satellites	-	8
HDOP Range	-	1.1 to 1.6
Propagation conditions	-	AWGN
GPS Coarse Time assistance error range	seconds	± 1.8
GPS Signal for all satellites	dBm	-130

Table 70.11.6.4: Test requirements for Nominal Accuracy

Success rate	2-D position error	Max response time
95 %	31.3 m	20.3 s

NOTE: If the above Test Requirement differs from the Conformance requirement then the Test Parameter Relaxation applied for this test is non-zero. The Test Parameter Relaxation for this test is defined in clause A5.5.2 and the explanation of how the Conformance requirement has been relaxed by the Test Parameter Relaxation is given in clause A5.5.4.

70.11.7 Dynamic Range

70.11.7.1 Definition

Dynamic Range is the maximum difference in level of the GPS signals from a number of satellites that allows the MS to make an A-GPS position estimate with a specific accuracy and a specific response time.

70.11.7.2 Conformance requirement

The first fix position estimates shall meet the accuracy and response time requirements in table 70.11.7.2 for the parameters specified in table 70.11.7.1.

Table 70.11.7.1: Test parameters for Dynamic Range

Parameters	Unit	Value
Number of generated satellites	-	6
HDOP Range	-	1.4 to 2.1
GPS Coarse Time assistance error range	seconds	±2
Propagation conditions	-	AWGN
GPS Signal for 1 st satellite	dBm	-129
GPS Signal for 2 nd satellite	dBm	-135
GPS Signal for 3 rd satellite	dBm	-141
GPS Signal for 4 th satellite	dBm	-147
GPS Signal for 5 th satellite	dBm	-147
GPS Signal for 6 th satellite	dBm	-147

Table 70.11.7.2: Conformance requirement for Dynamic Range

Success rate	2-D position error	Max response time
95 %	100 m	20 s

The reference for this requirement is 3GPP TS 45.005, clause M.2.3.

70.11.7.3 Test purpose

To verify the MS's first position estimate meets the Conformance requirement under GPS satellite signal conditions that have a wide dynamic range. Strong satellites are likely to degrade the acquisition of weaker satellites due to their cross-correlation products.

70.11.7.4 Method of test

Initial conditions

Test environment: normal; see clause A1.2.2.

1. Connect SS and GSS to the MS antenna connector or antenna connectors.
2. Set the GPS test parameters as specified in table 70.11.7.3 for GPS scenario #1. Select the first three satellite PRNs defined in the table in clause 10.10.1.2.5 for the three satellites with the higher levels.
3. Switch on the MS.
4. Set up a voice call according to the generic call set up procedure in clause 10.1 on a channel in the Mid ARFCN range.

Specific PICS statements

-

PIXIT statements

-

Procedure

1. Start GPS scenario #1 as specified in clause 10.10.1.2 with the MS location randomly selected to be within 3 km of the Reference Location and the altitude of the MS randomly selected between 0 m to 500 m above WGS-84 reference ellipsoid using the method described in clause 10.10.1.2.4
2. Send a RESET MS POSITIONING STORED INFORMATION message followed by RRLP Assistance Data and RRLP Measure Position Request messages containing appropriate assistance data; as specified in clauses 10.10.2 and 10.10.6 for MS based testing; or clauses 10.10.4 and 10.10.6 for MS assisted testing with the value of GPS TOW offset by a random value as specified in clause 10.10.6.2; as required to obtain a fix.

3. If the MS returns a valid result in the Measure Position Response message within the Max response time specified in table 70.11.7.4 then record the result and process it as specified in step 4. If the MS does not return a valid result within the Max response time specified in table 70.11.7.4 or reports a MS positioning error in the Measure Position Response message then record one Bad Result.
4. For MS based testing compare the reported Location Information in the Measure Position Response message against the simulated position of the MS used in step 1, and calculate the 2D position error as specified in clause 70.11.4.2.3. Compare the 2D position error against the value in table 70.11.7.4 and record one Good Result or Bad Result as appropriate; or

For MS assisted testing convert the GPS Measurement Information reported in the Measure Position Response message to a 2D position using the method described in clause 70.11.4.3 and then compare the result against the simulated position of the MS used in step 1, and calculate the 2D position error as specified in clause 70.11.4.2.3. Compare the 2D position error against the value in table 70.11.7.4 and record one Good Result or Bad Result as appropriate.

5. Repeat steps 1 to 4 using GPS scenario #2 instead of #1 so that the reference location changes sufficiently such that the MS shall have to use the new assistance data. Select the first three satellite PRNs defined in the table in clause 10.10.1.2.5 for the three satellites with the higher levels. Use new random values for the MS location and altitude in step 1 and for the GPS TOW offset in step 2.
6. Repeat steps 1 to 5 until the statistical requirements of clause 70.11.7.5 are met. Each time scenario #1 or #2 is used, the start time of the GPS scenario shall be advanced by 2 minutes from the time used previously for that scenario. Once a scenario reaches the end of its viable running time, restart it from its nominal start time again. Each time scenario #1 or #2 is used, increment the set of three satellite PRNs by one from the ones used previously, defined in the table in clause 10.10.1.2.5, for the three satellites with the higher levels (i.e. if the set of satellites is a, b, c, d, e, f and the first set used was a, b, c, the second set shall be b, c, d and so on).
7. Terminate the call.

Minimum / Maximum duration of the test

Minimum duration approximately 1 hour, maximum duration approximately 20 hours

Specific Message Contents

MEASURE POSITION REQUEST (3GPP TS 44.031 subclause A.2) to the MS

Information Element	Value/remark
Positioning Instructions	
Accuracy	51.2m
Required Response Time	20s

70.11.7.5 Test Requirements

For the parameters specified in table 70.11.7.3 the MS shall meet the requirements and the success rate specified in table 70.11.7.4 with a confidence level of 95% according to annex A7.2.

Table 70.11.7.3: Test parameters for Dynamic Range

Parameters	Unit	Value
Number of generated satellites	-	6
HDOP Range	-	1.4 to 2.1
GPS Coarse Time assistance error range	seconds	±1.8
Propagation conditions	-	AWGN
GPS Signal for 1 st satellite	dBm	-128.2
GPS Signal for 2 nd satellite	dBm	-134
GPS Signal for 3 rd satellite	dBm	-140
GPS Signal for 4 th satellite	dBm	-146
GPS Signal for 5 th satellite	dBm	-146
GPS Signal for 6 th satellite	dBm	-146

Table 70.11.7.4: Test requirements for Dynamic Range

Success rate	2-D position error	Max response time
95 %	101.3 m	20.3 s

NOTE: If the above Test Requirement differs from the Conformance requirement then the Test Parameter Relaxation applied for this test is non-zero. The Test Parameter Relaxation for this test is defined in clause A5.5.2 and the explanation of how the Conformance requirement has been relaxed by the Test Parameter Relaxation is given in clause A5.5.4.

70.11.8 Multi-Path scenario

70.11.8.1 Definition

Multi-path performance measures the accuracy and response time of the MS's A-GPS position estimate in a specific GPS signal multi-path environment.

70.11.8.2 Conformance requirement

The first fix position estimates shall meet the accuracy and response time requirements in table 70.11.8.2 for the parameters specified in table 70.11.8.1.

Table 70.11.8.1: Test parameters for Multi-Path scenario

Parameters	Unit	Value
Number of generated satellites (see note)	-	5
GPS Coarse Time assistance error range	seconds	± 2
HDOP Range	-	1.8 to 2.5
GPS signal for Satellite 1, 2 (see note)	dBm	-130
GPS signal for Satellite 3, 4, 5 (see note)	dBm	LOS signal of -130 dBm, multi-path signal of -136 dBm

NOTE: Satellites 1, 2 no multi-path. Satellites 3, 4, 5 multi-path defined in clause 70.11.2.4.

Table 70.11.8.2: Conformance requirement for Multi-Path scenario

Success rate	2-D position error	Max response time
95 %	100 m	20 s

The reference for this requirement is 3GPP TS 45.005, clause M.2.4.

70.11.8.3 Test purpose

To verify the MS's first position estimate meets the Conformance requirement under GPS satellite signal conditions that represent simple multi-path conditions.

70.11.8.4 Method of test

Initial conditions

Test environment: normal; see clause A1.2.2.

1. Connect SS and GSS to the MS antenna connector or antenna connectors.
2. Set the GPS test parameters as specified in table 70.11.8.3 for GPS scenario #1. Select the first two satellite PRNs defined in the table in clause 10.10.1.2.5 for the two satellites with the higher levels.
3. Switch on the MS.
4. Set up a voice call according to the generic call set up procedure in clause 10.1 on a channel in the Mid ARFCN range.

Specific PICS statements:

-

PIXIT statements:

-

Procedure

1. Start GPS scenario #1 as specified in clause 10.10.1.2 with the MS location randomly selected to be within 3 km of the Reference Location and the altitude of the MS randomly selected between 0 m to 500 m above WGS-84 reference ellipsoid using the method described in clause 10.10.1.2.4. The initial carrier phase difference between taps of the multi-path model shall be randomly selected between 0 and 2π radians by selecting the next random number from a standard uniform random number generator, in the range 0 to 2π , representing radians with a resolution of 0.1, representing 0.1 radians.
2. Send a RESET MS POSITIONING STORED INFORMATION message followed by RRLP Assistance Data and RRLP Measure Position Request messages containing appropriate assistance data; as specified in clauses 10.10.2 and 10.10.6 for MS based testing; or clauses 10.10.4 and 10.10.6 for MS assisted testing with the value of GPS TOW offset by a random value as specified in clause 10.10.6.2; as required to obtain a fix.
3. If the MS returns a valid result in the Measure Position Response message within the Max response time specified in table 70.11.8.4 then record the result and process it as specified in step 4. If the MS does not return a valid result within the Max response time specified in table 70.11.8.4 or reports a MS positioning error in the Measure Position Response message then record one Bad Result.
4. For MS based testing compare the reported Location Information in the Measure Position Response message against the simulated position of the MS used in step 1, and calculate the 2D position error as specified in clause 70.11.4.2.3. Compare the 2D position error against the value in table 70.11.8.4 and record one Good Result or Bad Result as appropriate; or

For MS assisted testing convert the GPS Measurement Information reported in the Measure Position Response message to a 2D position using the method described in clause 70.11.4.3 and then compare the result against the simulated position of the MS used in step 1, and calculate the 2D position error as specified in clause 70.11.4.2.3. Compare the 2D position error against the value in table 70.11.8.4 and record one Good Result or Bad Result as appropriate.

5. Repeat steps 1 to 4 using GPS scenario #2 instead of #1 so that the reference location changes sufficiently such that the MS shall have to use the new assistance data. Select the first two satellite PRNs defined in the table in clause 10.10.1.2.5 for the two satellites with the higher levels. Use new random values for the MS location and altitude, and the initial carrier phase difference between taps of the multi-path model in step 1 and for the GPS TOW offset in step 2.
6. Repeat steps 1 to 5 until the statistical requirements of clause 70.11.8.5 are met. Each time scenario #1 or #2 is used, the start time of the GPS scenario shall be advanced by 2 minutes from the time used previously for that scenario. Once a scenario reaches the end of its viable running time, restart it from its nominal start time again. Each time scenario #1 or #2 is used, increment the set of two satellite PRNs by one from the ones used previously, defined in the table in clause 10.10.1.2.5, for the two satellites with the higher level (i.e. if the set of satellites is a, b, c, d, e and the first set used was a, b the second set shall be b, c and so on).
7. Terminate the call

Minimum / Maximum duration of the test

Minimum duration approximately 1 hour, maximum duration approximately 20 hours

Specific Message Contents

MEASURE POSITION REQUEST (3GPP TS 44.031 subclause A.2) to the MS

Information Element	Value/remark
Positioning Instructions	
Accuracy	51.2m
Required Response Time	20s

70.11.8.5 Test Requirements

For the parameters specified in table 70.11.8.3 the MS shall meet the requirements and the success rate specified in table 70.11.8.4 with a confidence level of 95% according to annex A7.2.

Table 70.11.8.3: Test parameters for Multi-Path scenario

Parameters	Unit	Value
Number of generated satellites (see note)	-	5
GPS Coarse Time assistance error range	seconds	± 1.8
HDOP Range	-	1.8 to 2.5
GPS signal for Satellite 1, 2 (see note)	dBm	-130
GPS signal for Satellite 3, 4, 5 (see note)	dBm	LOS signal of -130 dBm, multi-path signal of -136.2 dBm
NOTE: Satellites 1, 2 no multi-path. Satellites 3, 4, 5 multi-path defined in clause 70.11.2.4.		

Table 70.11.8.4: Test requirements for Multi-Path scenario

Success rate	2-D position error	Max response time
95 %	101.3 m	20.3 s

NOTE: If the above Test Requirement differs from the Conformance requirement then the Test Parameter Relaxation applied for this test is non-zero. The Test Parameter Relaxation for this test is defined in clause A5.5.2 and the explanation of how the Conformance requirement has been relaxed by the Test Parameter Relaxation is given in clause A5.5.4.

80 Generic Access default conditions, message contents and macros

80.1 Default test conditions

The following default test conditions shall apply if not stated otherwise within an individual test description.

80.1.1 Unlicensed Radio Access

80.1.1.1 IEEE 802.11

First access point.

	Setting
Channel	7
SSID	GAN_1
SSID-Broadcast	On
Ciphering	Off
Mode	Infrastructure

Second access point.

	Setting
Channel	3
SSID	GAN_2
SSID-Broadcast	On
Ciphering	Off
Mode	Infrastructure

80.1.1.2 Bluetooth

	Setting
Profile	PAN

80.1.2 Protocol Settings

80.1.2.1 Dynamic Host Configuration Protocol - DHCP

	Setting
Server IP-Address	192.168.11.1
Port	67
Client (Transport) IP Range Pool	192.168.11.10 - 15
Address Mask	255.255.255.0
Default Gateway	192.168.11.1

80.1.2.2 Domain Name System – DNS

80.1.2.2.1 Public DNS Server

	Setting
Server IP-Address	192.168.11.16
Port	53

The following entries should be used:

	FQDN	IP
Provisioning SEGW	psgw.gan.mnc001.mcc001.3gppnetwork.org	192.168.11.32
Default SEGW	dsgw.default.gan	192.168.11.33
Serving SEGW	ssgw.serving.gan	192.168.11.34

80.1.2.2.2 DNS associated with GANC

	Setting
Server IP-Address	172.16.0.144
Port	53

The following entries should be used:

	FQDN	IP
Provisioning GANC	gan.mnc001.mcc001.3gppnetwork.org	172.16.0.192
Default GANC	gan.default.gan	172.16.0.193
Serving GANC	gan.serving.gan	172.16.0.194

80.1.2.3 Secure Gateway (SEGW)

	FQDN	IP
Provisioning SEGW	psgw.gan.mnc001.mcc001.3gppnetwork.org	192.168.11.32
Default SEGW	dsgw.default.gan	192.168.11.33
Serving SEGW	ssgw.serving.gan	192.168.11.34

80.1.2.4 Generic Access Network Controller (GANC)

	FQDN	IP
Provisioning GANC	gan.mnc001.mcc001.3gppnetwork.org	172.16.0.192
Default GANC	gan.default.gan	172.16.0.193
Serving GANC	gan.serving.gan	172.16.0.194

The TCP port used for Discovery and Registration is port number 14001 (see 44.318: 12.2.1)

80.1.2.5 Secure Internet Protocol - IPsec

All cryptographic suites must be supported on SS side.

The certificates specified in annex A9 shall be used for authentication of the SS by the MS.

	Setting
Client (Local) IP Range Pool	172.16.0.202 -217

80.2 Default message contents

80.3 Macros

80.3.1 Overview

The present document presents macros for Generic Access test cases. It is intended to be a working document forming part of the Generic Access Test Specifications.

80.3.1.1 Definition

A macro is a name or sentence, possibly followed by an argument list, that is equated to a text to which it is to be expanded, possibly with the substitution of actual arguments.

Macros may be used to simplify the writing and reading of the test cases or to avoid the repetition of common sentences, message contents or message sequences. The macros defined in this subclause can be used throughout the test cases.

The definition of the macros is done in alphabetical order.

80.3.1.2 Syntax

80.3.1.2.1 Message contents

Any macro referencing message contents shall use the following table:

Macro reference (arguments)		
(P)SI	Information Element	Value/Remarks

The table must contain:

Macro reference: word or sentence that gives the name to the macro. It may include a list of arguments with actual values for some IE's.

(P)SI: the System Information and Packet System Information messages whose content is referenced. Several (P)SIs can be referenced in this column. The defined IE value(s) refers to the (P)SI(s) in the same row.

Information Element: IE which value is specified.

Value/Remarks: value and any other comment specific to the IE's. In particular, the mapping between an argument value and its coding shall be specified in this column (see note).

NOTE: If possible, only the meaning of the value will be shown and not the value itself; this avoids updating when the core specifications are modified.

80.3.1.2.2 Message sequence

Any macro referencing message contents shall use the following table:

Step	Direction	Message	Comments
		{ Macro reference }	Macro (arguments)

The table must contain:

Macro reference: word or sentence that assigns the name to the macro. It may include a list of arguments with actual values for some parameters used within the macro.

Step: Number of the message. Letters may be used for general values: the same rules as in 3GPP TS 11.10 apply.

Direction: it must be either:

- "MS → SS": for an uplink message or a macro containing only uplink message(s);
- "SS → MS": for a downlink message or a macro containing only downlink message(s);
- "SS ↔ MS": for a macro containing both uplink and downlink message(s);
- "MS": for an action performed on the mobile side; or
- "SS": for an action performed on the system simulator side.

Message: Message name or macro reference.

Comments: any other comment specific to the message. In particular, value of certain bits/fields of the corresponding message.

The symbol ':' can be used to indicate that the previous and following message or sequence of messages (both previous and following must appear) is repeated an unknown number of times, probably referenced with a letter on the 'step' column.

80.3.2 Default message contents

80.3.3 Macro message sequences

80.3.3.1 Location Update Procedure

Step	Direction	Message	Comments
		{ Location Update Procedure }	
1	MS → SS	GA-CSR REQUEST	
2	SS → MS	GA-CSR REQUEST ACCEPT	
3	MS → SS	GA-CSR UPLINK DIRECT TRANSFER	Containing L3 (MM) Location Update Request
4	SS → MS	GA-CSR DOWNLINK DIRECT TRANSFER	Containing L3 (MM) Authentication Request
5	MS → SS	GA-CSR UPLINK DIRECT TRANSFER	Containing L3 (MM) Authentication Response
6	SS → MS	GA-CSR DOWNLINK DIRECT TRANSFER	Containing L3 (MM) Location Update Accept
A6 (Optional)	MS → SS	GA-CSR UPLINK DIRECT TRANSFER	Containing L3 (MM) TMSI Reallocation Complete This step is executed only when assigned mobile identity is of type TMSI
7	SS → MS	GA-CSR RELEASE	NOTE: Only in case the MS performed GPRS suspension procedure prior to the CS session, then the GPRS RESUMPTION IE shall be present with ACK field set to 1.
8	MS → SS	GA-CSR RELEASE COMPLETE	

80.4 Test PDP contexts

PDP context 1: same as PDP context 1 in section 40.5.

81 GAN Discovery and Registration Procedures

81.1 Discovery Procedure

81.1.1 Discovery Procedure, Accepted

81.1.1.1 Discovery Procedure, MS holds the IP address of the provisioning SEGW and FQDN of provisioning GANC, provisioning GANC and default GANC belong to the same SEGW

81.1.1.1.1 Conformance requirement

The MS shall:

- If the MS holds an IP address of the Provisioning SEGW, the MS establishes the secure connection towards the Provisioning SEGW according to sub-clause 4.2
- Following successful establishment of secure connection to the Provisioning SEGW:
 - If the MS holds a FQDN of the Provisioning GANC, the MS shall perform a DNS query "inside the secure connection" to retrieve the IP-address of the Provisioning GANC. The MS shall establish a TCP connection to the Provisioning GANC using this IP address and a TCP port defined for Discovery (see sub-clause

12.2.1). The MS shall not store the IP address retrieved from DNS for subsequent procedures (apart from DNS resolver caching).

When the MS receives GA-RC DISCOVERY ACCEPT message, it shall:

- stop the timer TU3901.
- set the timer value for TU3903 to the default value,
- store the information about Default GANC in persistent storage:
 - The Default GANC information consists of the Default GANC, SEGW associated with the Default GANC and optionally a TCP port to be used with that Default GANC. If a specific TCP Port is not received in the message, the defined port for Registration is used (see sub-clause 12.2.1)
- release the TCP connection towards the Provisioning GANC
- the secure connection to the Provisioning SEGW can be reused as follows;
 - If the MS is provisioned with an IP address of the Provisioning GANC-SEGW and it matches the received Default GANC-SEGW IP address IE, the MS shall reuse the existing secure connection.
 - If the MS is provisioned with a FQDN of the Provisioning GANC-SEGW or derived a FQDN for the Provisioning GANC-SEGW and it matches the received Default GANC-SEGW FQDN IE, the MS shall reuse the existing secure connection.
- otherwise the MS shall release the existing secure connection towards the SEGW of the Provisioning GANC as defined in sub-clause 4.5
- initiate the registration procedure towards the Default GANC as defined in sub-clause 6.2.

Reference(s)

3GPP TS 44.318 sub-clause 5.3 and 5.5.1

81.1.1.1.2 Test purpose

To verify that the MS is able to initiate the Discovery Procedure with an IP address to the SEGW associated with the provisioning GANC and the FQDN to the GANC.

To verify that the MS keeps the secure connection when registering to the default GANC if the provisioning GANC and default GANC have the same SEGW.

81.1.1.1.3 Method of test

Initial conditions

System Simulator:

- 1 GAN cell, default parameter
- Provisioning GANC and default GANC belonging to the same SEGW
- Public DNS without knowledge of SEGW FQDN associated with Provisioning GANC

Mobile Station:

- MS in state GA-RC DEREGISTERED
- The MS has the IP address for the SEGW associated with the provisioning GANC, but not the FQDN
- The MS has the FQDN for the provisioning GANC, but not the IP address
- The MS does not have any knowledge about the default GANC
- The MS does not have any knowledge about the serving GANC

Foreseen final state of the MS

The MS will stay in state GA-RC DEREGISTERED.

Test procedure

Make the MS join the AP so that the Discovery procedure is kicked off.

The SS is supposed to answer the Discovery Request message with a valid FQDN or IP address of Default GANC and IP address of the SEGW associated with Default GANC matching the IP address of SEGW associated with Provisioning GANC before timer TU3901 expires.

The MS shall attempt to register towards the Default GANC reusing the same security connection used during Discovery procedure.

Specific Test Parameters

-

Maximum duration of test

1 min.

Expected sequence

Step	Direction		Message	Comment
	MS	SS		
1	MS			MS is joining the AP
2	MS			Set up Ipsec tunnel to SEGW
3		→		DNS Standard Query for GANC to the DNS server associated with the GANC
4		←		Standard Query Response with IP address to GANC
5	MS			Establish TCP connection to provisioning GANC
6		→	GA-RC DISCOVERY REQUEST	To provisioning GANC
7		←	GA-RC DISCOVERY ACCEPT	Default GANC and SEGW provided. Note: Default GANC belongs to the same SEGW as the Provisioning GANC The message is sent before expiry of TU3901.
8	MS			Establish TCP connection to default GANC using either IP address or FQDN
9		→	GA-RC REGISTER REQUEST	To default GANC

81.1.1.2 Discovery procedure, the MS holds the FQDN of the provisioning SEGW and IP address of the provisioning GANC, provisioning GANC and default GANC belong to different SEGWs

81.1.1.2.1 Conformance requirement

- If the MS holds a FQDN of the Provisioning SEGW, the MS performs a public DNS query to retrieve the IP-address of the Provisioning SEGW and establish the secure connection towards the Provisioning SEGW according to sub-clause 4.2. The MS shall not store the IP address retrieved from DNS for subsequent procedures (apart from DNS resolver caching).
- Following successful establishment of secure connection to the Provisioning SEGW
- If the MS holds an IP address of the Provisioning GANC, the MS shall establish a TCP connection to the Provisioning GANC using the well-known TCP port for Discovery as defined in sub-clause 12.2.1

When the MS receives GA-RC DISCOVERY ACCEPT message, it shall:

- stop the timer TU3901.

- set the timer value for TU3903 to the default value,
- store the information about Default GANC in persistent storage:
 - The Default GANC information consists of the Default GANC, SEGW associated with the Default GANC and optionally a TCP port to be used with that Default GANC. If a specific TCP Port is not received in the message, the defined port for Registration is used (see sub-clause 12.2.1)
- release the TCP connection towards the Provisioning GANC
- the secure connection to the Provisioning SEGW can be reused as follows;
 - If the MS is provisioned with an IP address of the Provisioning GANC-SEGW and it matches the received Default GANC-SEGW IP address IE, the MS shall reuse the existing secure connection.
 - If the MS is provisioned with a FQDN of the Provisioning GANC-SEGW or derived a FQDN for the Provisioning GANC-SEGW and it matches the received Default GANC-SEGW FQDN IE, the MS shall reuse the existing secure connection.
- otherwise the MS shall release the existing secure connection towards the SEGW of the Provisioning GANC as defined in sub-clause 4.5
- initiate the registration procedure towards the Default GANC as defined in sub-clause 6.2.

Reference(s)

3GPP TS 44.318 sub-clause 5.3 and 5.5.1

81.1.1.2.2 Test purpose

To verify that the MS can initiate the Discovery Procedure with the FQDN to the SEGW associated with the provisioning GANC and IP address to the GANC.

To verify that the MS releases the secure connection when registering to the default GANC if the provisioning GANC and default GANC don't have the same SEGW.

81.1.1.2.3 Method of test

Initial conditions

System Simulator:

- 1 GAN cell, default parameter
- Public DNS that holds the IP address to the SEGW associated with the provisioning GANC, but without knowledge of the provisioning GANC's FQDN

Mobile Station:

- MS in state GA-RC DEREGISTERED
- The MS has the FQDN for the SEGW associated with the provisioning GANC, but not the IP address
- The MS has the IP address to the provisioning GANC
- The MS does not have any knowledge about the default GANC
- The MS does not have any knowledge about the serving GANC

Foreseen final state of the MS

The MS will stay in state GA-RC DEREGISTRED.

Test procedure

Make the MS join the AP so that the Discovery procedure is kicked off.

The SS is supposed to answer the Discovery Request message before timer TU3901 expires.

The MS shall release the Security Association towards the SEGW associated with Provisioning GANC.

The MS shall establish a secure tunnel towards the SEGW provided in Discovery Accept message and establish TCP to the Default GANC.

The MS shall send Register Request message towards the Default GANC.

Specific Test Parameters

-

Maximum duration of test

1 min.

Expected sequence

Step	Direction		Message	Comment
	MS	SS		
1	MS			MS is joining the AP
2	→			DNS Standard Query for the SEGW to the public DNS server
3	←			Standard Query Response with IP address to the SEGW
4	MS			MS sets up a secure connection to the SEGW and establishes TCP connection to the provisioning GANC
5	MS			MS establish a TCP connection using the stored IP address
6	→		GA-RC DISCOVERY REQUEST	To provisioning GANC
7	←		GA-RC DISCOVERY ACCEPT	Default GANC and SEGW provided. The message is sent before expiry of TU3901.
8				MS releases the secure connection to the SEGW
9				MS sets up a secure connection to the new SEGW using either IP address or FQDN
10				MS establish a TCP connection to the default GANC using either IP address or FQDN
11	→		GA-RC REGISTER REQUEST	To default GANC

81.1.1.3 Discovery procedure, the MS is not provisioned with information about the provisioning GANC or its SEGW

81.1.1.3.1 Conformance requirement

- In case the MS is not provisioned with information about the Provisioning SEGW, derive a FQDN of the Provisioning SEGW from the IMSI (as described in [3]);

The MS performs a public DNS Query to retrieve the IP-address of the Provisioning SEGW and establish the secure connection towards the Provisioning SEGW according to sub-clause 4.2. The MS shall not store the IP address retrieved from DNS for subsequent procedures (apart from DNS resolver caching);

- Following successful establishment of secure connection to the Provisioning SEGW:
 - In cases where the MS is not provisioned with information about the Provisioning GANC, the MS derives a FQDN of the Provisioning GANC from the IMSI (as described in [3]).

A DNS query is performed "inside the secure connection" to retrieve the IP-address of the Provisioning GANC. The MS shall not store the IP address retrieved from DNS for subsequent procedures (apart from DNS resolver caching). A TCP connection is then established inside the IPsec tunnel, to the Provisioning GANC using the TCP port defined for Discovery procedure (see sub-clause 12.2.1).

- In all cases the MS shall establish only a single TCP connection to the GANC over the IPsec tunnel.

Reference(s)

3GPP TS 44.318 sub-clause 5.3.

81.1.1.3.2 Test purpose

To verify that the MS can derive the FQDN from its IMSI and go to the correct DNS to ask for the IP address to the SEGW and provisioning GANC.

81.1.1.3.3 Method of test

Initial conditions

System Simulator:

- 1 GAN cell, default parameter
- Public DNS without knowledge of the provisioning GANC's FQDN

Mobile Station:

- MS in state GA-RC DEREGISTERED
- The MS does not have any knowledge about the provisioning GANC
- The MS does not have any knowledge about the default GANC
- The MS does not have any knowledge about the serving GANC

Foreseen final state of the MS

The MS will stay in state GA-RC DEREGISTRED.

Test procedure

Make the MS join the AP so that the Discovery procedure is kicked off.

The MS will derive SEGW associated with provisioning GANC and provisioning GANC from the IMSI.

The SS is supposed to answer the Discovery Request message before timer TU3901 expires.

Use a default GANC associated with the same SEGW as the provisioning GANC in order to simplify the test sequence.

The MS will attempt to register towards the default GANC reusing the same security association.

Specific Test Parameters

-

Maximum duration of test

1 min.

Expected sequence

Step	Direction		Message	Comment
	MS	SS		
1	MS			MS is joining the AP
2	MS			Derive FQDN to SEGW from the IMSI
3		→		DNS Standard Query for the SEGW to the public DNS server
4		←		Standard Query Response with IP address to the SEGW
5	MS			MS sets up a secure connection to the SEGW
6	MS			Derive FQDN to GANC from the IMSI
7		→		DNS Standard Query for GANC to the DNS server associated with the GANC
8		←		Standard Query Response with address to GANC
9	MS			Establish TCP connection to provisioning GANC over the secure connection
10		→	GA-RC DISCOVERY REQUEST	To provisioning GANC
11		←	GA-RC DISCOVERY ACCEPT	Default GANC provided and SEGW matching the SEGW associated with provisioning GANC. The message is sent before expiry of TU3901.
12	MS			Establish TCP connection to default GANC using either IP address or FQDN
13		→	GA-RC REGISTER REQUEST	To default GANC

81.1.2 Discovery Procedure, Rejected

81.1.2.1 Discovery Procedure, Discovery Reject, Network Congestion

81.1.2.1.1 Conformance requirement

When the MS receives GA-RC DISCOVERY REJECT message it shall:

- stop the timer TU3901,
- set the timer value for TU3903 to the default value,
- If the value of the Reject Cause IE indicates 'Network Congestion', the MS shall
- Maintain the secure connection to the GANC-SEGW and the TCP connection to the GANC
- Create a random value between zero and the received value in TU3902 Timer IE and
- Add this value to the received value in TU3902 Timer IE, this becomes the new value for TU3902
- Start timer TU3902 according to the new calculated value

Reference(s)

3GPP TS 44.318 sub-clause 5.5.2

81.1.2.1.2 Test purpose

To verify that the MS wait the correct time after receiving Discovery Reject due to network congestion before it tries to go through the discovery procedure again.

81.1.2.1.3 Method of test

Initial conditions

System Simulator:

- 1 GAN cell, default parameter

- Public DNS without knowledge of the provisioning GANC's FQDN

Mobile Station:

- MS in state GA-RC DEREGISTERED
- The MS has the IP address or the FQDN for the provisioning GANC
- The MS does not have any knowledge about the default GANC
- The MS does not have any knowledge about the serving GANC

Foreseen final state of the MS

The MS will stay in state GA-RC DEREGISTRED.

Test procedure

Make the MS join the AP so that the Discovery procedure is kicked off.

The SS is supposed to answer the Discovery Request message with Discovery rejected with cause 'Network congestion' before timer TU3901 expires. The TU3902 timer is set to 60 (1 minutes).

The MS will set TU3902 between 1 and 2 minutes and send a Discovery Request message towards the provisioning GANC after expiration of the timer.

Specific Test Parameters

-

Maximum duration of test

3 min.

Expected sequence

Step	Direction		Message	Comment
	MS	SS		
1	MS			MS is joining the AP
2	MS			MS sets up secure connection to the SEGW and establishes a TCP connection to the provisioning GANC
3		→	GA-RC DISCOVERY REQUEST	To provisioning GANC
4		←	GA-RC DISCOVERY REJECTED	With cause set to Network congestion TU3902 Timer IEs set to 60
5	MS			Wait for 1 – 2 minutes . The MS sets TU3902 randomly between 60 and 120, i.e. 1 to 2 minutes.
6		→	GA-RC DISCOVERY REQUEST	New attempt on the same secure connection to the provisioning GANC

81.1.2.2 Discovery Procedure, Discovery Reject, IMSI not allowed

81.1.2.2.1 Conformance requirement

When the MS receives GA-RC DISCOVERY REJECT message it shall:

- If the value of the Reject Cause IE indicates 'IMSI not allowed' or "Unspecified", then the MS shall:
 - Release the TCP connection established to the Provisioning GANC, if still established.
 - Release the secure connection towards the SEGW associated with the Provisioning GANC as defined in sub-clause 4.5.
 - Not initiate a new Discovery procedure until the next power-on.

Reference(s)

3GPP TS 44.318 sub-clause 5.5.2.

81.1.2.2.2 Test purpose

To verify that the MS does not try to kick off the Discovery procedure again after receiving Discovery Reject due to IMSI not allowed.

81.1.2.2.3 Method of test**Initial conditions****System Simulator:**

- 1 GAN cell, default parameter
- Public DNS without knowledge of the provisioning GANC's FQDN
- DNS inside of the SEGW associated with the provisioning GANC with knowledge of the provisioning GANC's FQDN

Mobile Station:

- MS in state GA-RC DEREGISTERED
- The MS has the IP address or the FQDN for the provisioning GANC
- The MS does not have any knowledge about the default GANC
- The MS does not have any knowledge about the serving GANC

Foreseen final state of the MS

The MS will start the discovery procedure and receive Discovery rejected with cause value 'IMSI not allowed'. The MS will not try to kick off the Discovery procedure until it is powered off and back on again. When the second attempt to register has started the signalling is interrupted and the MS will stay in state GA-RC DEREGISTRED.

Test procedure

Make the MS join the AP so that the Discovery procedure is kicked off.

The SS is supposed to answer the Discovery Request message with Discovery rejected with cause 'IMSI not allowed' before timer TU3901 expires. The TU3902 timer is set to 60 (1 minutes).

Specific Test Parameters

-

Maximum duration of test

3 min.

Expected sequence

Step	Direction		Message	Comment
	MS	SS		
1	MS			MS is joining the AP
2	MS			MS sets up secure connection to the SEGW and establishes a TCP connection to the provisioning GANC
3		→	GA-RC DISCOVERY REQUEST	To provisioning GANC
4		←	GA-RC DISCOVERY REJECTED	Cause: IMSI not allowed
5				MS releases the TCP connection and the secure connection
6	MS			Wait for 2 minutes. Make sure that the MS does not try to access the GAN network.
7	MS			Switch off the MS and then back on again.
8	MS			MS sets up secure connection to the SEGW and establishes a TCP connection to the provisioning GANC
9		→	GA-RC DISCOVERY REQUEST	New attempt

81.1.2.3 Void

81.1.3 Discovery Procedure, Abnormal Cases

81.1.3.1 Discovery Procedure, TU3901/TU3903 Expires

81.1.3.1.1 Conformance requirement

If timer TU3901 has expired in the MS, the MS shall:

- release the TCP connection towards the Provisioning GANC,
- release the secure connection towards SEGW of the Provisioning GANC as defined in sub-clause 4.5,
- double the current value for timer TU3903 but not exceeding the maximum value defined for this timer as defined in sub-clause 12.1.1 and
- start timer TU3903

Reference(s)

3GPP TS 44.318 sub-clause 5.6.1.

81.1.3.1.2 Test purpose

To verify that the MS attempts to kick off the Discovery procedure again after the correct time has elapsed when the TU3901/TU3903 timer expires.

81.1.3.1.3 Method of test

Initial conditions

System Simulator:

- 1 GAN cell, default parameter
- Public DNS without knowledge of the provisioning GANC's FQDN
- DNS inside of the SEGW associated with the provisioning GANC with knowledge of the provisioning GANC's FQDN

Mobile Station:

- MS in state GA-RC DEREGISTERED
- The MS has the IP address or the FQDN for the provisioning GANC

- The MS does not have any knowledge about the default GANC
- The MS does not have any knowledge about the serving GANC
- Timer TU3901 set to the default value 30 seconds
- Timer TU3903 set to 1 minute

Foreseen final state of the MS

The MS will start the discovery procedure and when TU3901 expires it will set TU3903 to 2 minutes. When TU3903 expires it will kick off the Discovery procedure again. The same sequence is repeated and for each time TU3903 is doubled until it reaches its maximum value of 32 minutes.

Test procedure

Make the MS join the AP so that the Discovery procedure is kicked off.

The SS is not supposed to answer the Discovery Request message at any occasion.

Specific Test Parameters

-

Maximum duration of test

100 min.

Expected sequence

Step	Direction		Message	Comment
	MS	SS		
1	MS			MS is joining the AP
2	MS			MS sets up secure connection to the SEGW and establishes a TCP connection to the provisioning GANC
3	→		GA-RC DISCOVERY REQUEST	To provisioning GANC, MS starts TU3901
4	MS			Wait for 30 s so TU3901 expires. TU3903 is set to 2 min. when TU3901 expires.
5				MS releases the TCP connection and the secure connection
6	MS			Wait for 2 minutes so that TU3903 expires
7	MS			MS sets up secure connection to the SEGW and establishes a TCP connection to the provisioning GANC
8	→		GA-RC DISCOVERY REQUEST	New attempt, MS starts TU3901
9	MS			Wait for 30 s so TU3901 expires. TU3903 is set to 4 min. when TU3901 expires the 2 nd time.
10				MS releases the TCP connection and the secure connection
11	MS			Wait for 4 minutes so that TU3903 expires.
12	MS			MS sets up secure connection to the SEGW and establishes a TCP connection to the provisioning GANC
13	→		GA-RC DISCOVERY REQUEST	New attempt, MS starts TU3901
14	MS			Wait for 30 s so TU3901 expires. TU3903 is set to 8 min. when TU3901 expires the 3 rd time.
15				MS releases the TCP connection and the secure connection
16	MS			Wait for 8 minutes so that TU3903 expires.
17	MS			MS sets up secure connection to the SEGW and establishes a TCP connection to the provisioning GANC
18	→		GA-RC DISCOVERY REQUEST	New attempt, MS starts TU3901
19	MS			Wait for 30 s so TU3901 expires. TU3903 is set to 16 min. when TU3901 expires the 4 th time.
20				MS releases the TCP connection and the secure connection
21	MS			Wait for 16 minutes so that TU3903 expires.
22	MS			MS sets up secure connection to the SEGW and establishes a TCP connection to the provisioning GANC
23	→		GA-RC DISCOVERY REQUEST	New attempt, MS starts TU3901
24	MS			Wait for 30 s so TU3901 expires. TU3903 is set to 32 min. when TU3901 expires the 5 th time.
25				MS releases the TCP connection and the secure connection
26	MS			Wait for 32 minutes so that TU3903 expires.
27	MS			MS sets up secure connection to the SEGW and establishes a TCP connection to the provisioning GANC
28	→		GA-RC DISCOVERY REQUEST	New attempt, MS starts TU3901
29	MS			Wait for 30 s so TU3901 expires. TU3903 is set to 32 min. again when TU3901 expires the 6 th time.
30				MS releases the TCP connection and the secure connection
31	MS			Wait for 32 minutes so that TU3903 expires.
32	MS			MS sets up secure connection to the SEGW and establishes a TCP connection to the provisioning GANC
33	→		GA-RC DISCOVERY REQUEST	New attempt

- 81.1.3.2 Void
- 81.1.3.3 Void
- 81.1.3.4 Void
- 81.1.3.5 Void
- 81.1.3.6 Void
- 81.1.3.7 SEGW certificate checking, the MS holds the “invalid” FQDN of the provisioning SEGW

81.1.3.7.1 Conformance requirement

As the MS and GANC-SEGW use EAP-SIM or EAP-AKA for mutual authentication, IKEv2 mandates that this is used in conjunction with a public key signature based authentication of the GANC-SEGW to the MS.

The MS requirements for certificate authentication and handling are listed in 3GPP TS 33.234 [10].

In addition to the requirements listed in 3GPP TS 33.234 [10], the MS shall take the following actions for received GANC-SEGW certificates:

- match the SubjectAltName in the end entity certificate with the IDr payload, and with GANC-SEGW identity obtained from derivation of the Provisioning GANC-SEGW FQDN, provisioning, discovery or register redirect.
- If the MS was provisioned with an IP address of the GANC-SEGW, (or received it in the GA-RC DISCOVERY ACCEPT or GA-RC REGISTER REDIRECT message), then the certificate shall contain an IPAddress SubjectAltName that matches that address.
- If the MS was provisioned with an FQDN of the GANC-SEGW, or received it in the GA-RC DISCOVERY ACCEPT or GA-RC REGISTER REDIRECT message, then the certificate shall contain a DNSname SubjectAltName that matches that FQDN.
- If the MS derived the FQDN of the Provisioning GANC-SEGW, then the certificate shall contain a DNSname SubjectAltName that matches that FQDN.

If the MS and GANC-SEGW are not able to set up the SA for any other reason than EAP-SIM or EAP-AKA authentication failure, and the current GANC-SEGW is the SEGW associated to the Provisioning GANC, the MS shall act as if a "Lower layer failure in the MS" has occurred and act as defined in sub-clause 5.6.2.

Reference(s)

3GPP TS 44.318 sub-clauses 4.2.5 and 4.2.6

81.1.3.7.2 Test purpose

To verify that the MS does correct SEGW certificate checking during secure tunnel establishment.

81.1.3.7.3 Method of test

Initial conditions

System Simulator:

- 1 GAN cell, default parameter
- Public DNS that holds the IP address to the SEGW associated with the provisioning GANC, but that DNS entry is not in provisioning SEGW certificate.

Mobile Station:

- MS in state GA-RC DEREGISTERED
- The MS has the “invalid” FQDN for the SEGW

The MS holds an “invalid” FQDN of the Provisioning SEGW. MS is made to perform a public DNS query to retrieve the IP-address of the Provisioning SEGW and to initialise establishment of the secure connection towards the Provisioning SEGW. Secure tunnel establishment will fail, because provisioning SEGW certificate does not contain DNS subjectAltName “invalid.provisioning.gan”. The MS shall act as if “a Lower layer failure in the MS” has occurred and act as defined in sub-clause 5.6.2.

Expected sequence

Step	Direction		Message	Comment
	MS	SS		
1		MS		MS is joining the AP
2		→		DNS Standard Query for the SEGW to the public DNS server
3		←		Standard Query Response with IP address to the SEGW
4		→	IKE_SA_INIT	MS sends IKE_SA_INIT message to initialize secure connection setup to the SEGW
5		←	IKE_SA_INIT	SEGW replies with IKE_SA_INIT
6		→	IKE_AUTH	MS informs trusted CA certificates in CERT_REQ payload. Authentication phase is started
7		←	IKE_AUTH	SEGW replies with certificate that does not contain "invalid" FQDN in its SubjectAltName field
8		MS		MS stops attempting to set up a security connection and starts TU3903
9		MS		Wait for 10 seconds
10		MS		MS sets up secure connection to the SEGW and establishes a TCP connection to the provisioning GANC using either IP address or FQDN

81.2 Registration Procedure

81.2.1 Registration Procedure, Accepted

81.2.1.1 Registration Procedure, MS in GSM Coverage, Serving GANC for CGI Known

81.2.1.1.1 Conformance requirement

If the MS is in GERAN or UTRAN coverage, it shall check if it has stored Serving GANC information for the current GSM CGI in case of GERAN coverage, or UTRAN cell Identity, in case of UTRAN Coverage, or if the MS is not in GERAN/UTRAN coverage, it shall check if it has stored Serving GANC information for the current AP-ID

- if found, the MS shall initiate Registration procedure towards the stored Serving GANC

When the MS receives GA-RC REGISTER ACCEPT message, it shall:

- Start Keep alive mechanism as defined in sub-clause 6.5 using the received TU3906 Timer IE

Reference(s)

3GPP TS 44.318 sub-clause 6.2.1 and 6.2.3.1

81.2.1.1.2 Test purpose

To verify that the MS can store the address to a serving GANC associated with a certain GSM cell and access that GANC at the Registration procedure.

81.2.1.1.3 Method of test

Initial conditions

System Simulator:

- 1 GAN cell, default parameter
- 1 GSM cell
- Public DNS without knowledge of the serving GANC's FQDN
- DNS inside of the serving SEGW associated with the serving GANC

Mobile Station:

- MS has stored a serving GANC associated with the GSM cell (CGI)
- MS has not stored a serving GANC associated with the AP-ID
- MS in state GA-RC DEREGISTERED

Foreseen final state of the MS

The MS will change state to GA-RC REGISTERED.

Test procedure

Make the MS join the AP so that the Registration procedure is kicked off.

The SS is supposed to answer the Registration Request message with Registration Accept before timer TU3904 expires.

Specific Test Parameters

-

Maximum duration of test

2 min.

Expected sequence

Step	Direction		Message	Comment
	MS	SS		
1	MS			MS is joining the AP
2	MS			MS sets up secure connection to the serving SEGW and establishes a TCP connection to the serving GANC using either IP address or FQDN
3		→	GA-RC REGISTER REQUEST	To serving GANC
4		←	GA-RC REGISTER ACCEPT	TU3906 set to 60 seconds GANC Control Channel Description IE shall indicate that GPRS services are not available and IMSI Attach/Detach procedure shall not apply.
5	MS			Wait for 1 minutes so that TU3906 expires
A5 (Optional)			{Location Update Procedure}	This step is performed only if the MS initiates a Location Area Update while TU3906 is still running
6		→	GA-RC KEEP ALIVE	

81.2.1.2 Registration Procedure, MS in GSM Coverage, Serving GANC for CGI Not Known; MS not in GSM Coverage, Serving GANC for AP Known

81.2.1.2.1 Conformance requirement

If the MS is in GERAN or UTRAN coverage, it shall check if it has stored Serving GANC information for the current GSM CGI in case of GERAN coverage, or UTRAN cell Identity, in case of UTRAN Coverage, or if the MS is not in GERAN/UTRAN coverage, it shall check if it has stored Serving GANC information for the current AP-ID

- if found, the MS shall initiate the GAN Registration procedure towards the stored Serving GANC

When the MS receives GA-RC REGISTER ACCEPT message, it shall:

- Start Keep alive mechanism as defined in sub-clause 6.5 using the received TU3906 Timer IE

The GANC may at any time initiate the deregistration of a MS by sending the GA-RC DEREGISTER message to the MS. When the GA-RC layer in the network has submitted the GA-RC DEREGISTER message to the TCP layer, it may initiate release of its half of the bidirectional TCP connection

Reference(s)

3GPP TS 44.318 sub-clause 6.2.1, 6.2.3.1, and 6.4.3

81.2.1.2.2 Test purpose

To verify that the MS can register to the default GANC if it doesn't have any data stored about serving GANC in the current GSM cell.

To verify that the MS can store the address to a serving GANC associated with a certain AP and access that GANC at the Registration procedure.

81.2.1.2.3 Method of test

Initial conditions

System Simulator:

- 1 GAN cell, default parameter
- 1 GSM cell, default parameter
- Public DNS without knowledge of the serving GANC's FQDN
- DNS inside of the serving SEGW associated with the serving GANC
- DNS inside of the default SEGW associated with the default GANC

Mobile Station:

- MS has stored a serving GANC associated with the AP-ID
- MS has not stored a serving GANC associated with the GSM cell (CGI)
- MS in state GA-RC DEREGISTERED

Foreseen final state of the MS

The MS will change state to GA-RC REGISTERED.

Test procedure

Make the MS join the AP so that the Registration procedure is kicked off.

The SS is supposed to answer the Registration Request message with Registration Accept before timer TU3904 expires.

The SS requests the MS to deregister. The GSM cell is then removed. The MS should now attempt to register using the stored AP-ID.

Specific Test Parameters

-

Maximum duration of test

2 min.

Expected sequence

Step	Direction		Message	Comment
	MS	SS		
1		MS		MS is joining the AP
2		MS		MS sets up secure connection to the default SEGW and establishes a TCP connection to the default GANC using either IP address or FQDN
3		→	GA-RC REGISTER REQUEST	To default GANC, verify correct GSM CGI is used.
4		←	GA-RC REGISTER ACCEPT.	GANC Control Channel Description IE shall indicate that GPRS services are not available and IMSI Attach/Detach procedure shall not apply.
A4 (Optional)			{Location Update Procedure}	This step is performed only if the MS initiates a Location Area Update
5		←	GA-RC DEREGISTER	Reject Cause = Unspecified
6		SS		Remove GSM Coverage
7		MS		Remove the TCP connection and the secure connection to SEGW
8		MS		MS is joining the AP
9		MS		MS sets up secure connection to the SEGW and establishes a TCP connection to the serving GANC using either IP address or FQDN
10		→	GA-RC REGISTER REQUEST	To serving GANC, verify correct AP-ID is used.
11		←	GA-RC REGISTER ACCEPT	TU3906 set to 60 seconds
12		MS		Wait for 1 minutes so that TU3906 expires
13		→	GA-RC KEEP ALIVE	

81.2.1.3 Void

81.2.1.4 Registration Procedure, MS Holds The IP Address to The serving SEGW And The FQDN to The Serving GANC

81.2.1.4.1 Conformance requirement

To initiate the registration procedure the MS shall:

- If the MS has stored an IP address of the GANC-SEGW, and the MS does not already have an established secure connection to this GANC-SEGW, the MS establishes a secure connection towards the GANC-SEGW according to sub-clause 4.2,

Following successful establishment of secure tunnel:

- If the MS holds a FQDN of the GANC, the MS performs a DNS query "inside the secure tunnel" to retrieve the IP-address of the GANC. The MS establishes a TCP connection to the GANC at the stored TCP port to be used for Registration with this GANC. If no TCP port has been stored for this GANC, the default TCP port (see sub-clause 12.2.1) shall be used. The MS shall not store the retrieved IP address for subsequent procedures (apart from DNS resolver caching);
- The MS shall only establish a single TCP connection to the GANC over the IPsec tunnel.

When the MS receives GA-RC REGISTER ACCEPT message, it shall:

- Start Keep alive mechanism as defined in sub-clause 6.5 using the received TU3906 Timer IE

Reference(s)

3GPP TS 44.318 sub-clause 6.2.1 and 6.2.3.1

81.2.1.4.2 Test purpose

To verify that the MS can register to the GANC by using IP addresses to SEGW and GANC.

81.2.1.4.3 Method of test

Initial conditions

System Simulator:

- 1 GAN cell, default parameter
- DNS inside of the serving SEGW associated with the serving GANC

Mobile Station:

- MS has stored the IP address to the SEGW associated with the serving GANC associated with the AP-ID but not the FQDN
- MS has stored the FQDN to the serving GANC associated with the AP-ID but not the IP address
- MS in state GA-RC DEREGISTERED

Foreseen final state of the MS

The MS will change state to GA-RC REGISTERED.

Test procedure

Make the MS join the AP so that the Registration procedure is kicked off.

The SS is supposed to answer the Registration Request message with Registration Accept before timer TU3904 expires.

Specific Test Parameters

-

Maximum duration of test

2 min.

Expected sequence

Step	Direction		Message	Comment
	MS	SS		
1	MS			MS is joining the AP
2	MS			Set up Ipsec tunnel to serving SEGW
3		→		DNS Standard Query for GANC to the DNS server associated with the GANC
4		←		Standard Query Response with IP address to GANC
5	MS			Establish TCP connection to serving GANC
6		→	GA-RC REGISTER REQUEST	To serving GANC
7		←	GA-RC REGISTER ACCEPT	TU3906 set to 60 seconds. GANC Control Channel Description IE shall indicate that GPRS services are not available and IMSI Attach/Detach procedure shall not apply.
8	MS			Wait for 1 minutes so that TU3906 expires
A8 (Optional)			{Location Update Procedure}	This step is performed only if the MS initiates a Location Area Update while TU3906 is still running
9		→	GA-RC KEEP ALIVE	

81.2.1.5 Registration Procedure, MS Holds The FQDN To The serving SEGW And The IP Address to The Serving GANC

81.2.1.5.1 Conformance requirement

To initiate the GAN registration procedure the MS shall:

- If the MS has stored a FQDN of the GANC-SEGW, the MS performs a public DNS query to retrieve the IP-address of the GANC-SEGW, if the MS does not already have an established secure connection to this GANC-SEGW, the MS establishes the secure connection towards the GANC-SEGW according to sub-clause 4.2. The MS shall not store the IP address retrieved from DNS for subsequent procedures (apart from DNS resolver caching).

Following successful establishment of secure tunnel:

- If the MS holds an IP address of the GANC, the MS establishes a TCP connection to the GANC at the stored TCP port to be used for Registration with this GANC. If no TCP port has been stored for this GANC, the default TCP port (see sub-clause 12.2.1) shall be used.
- The MS shall only establish a single TCP connection to the GANC over the IPsec tunnel.

When the MS receives GA-RC REGISTER ACCEPT message, it shall:

- Start Keep alive mechanism as defined in sub-clause 6.5 using the received TU3906 Timer IE

Reference(s)

3GPP TS 44.318 sub-clause 6.2.1 and 6.2.3.1

81.2.1.5.2 Test purpose

To verify that the MS can register to the GANC by using FQDN to SEGW.

81.2.1.5.3 Method of test

Initial conditions

System Simulator:

- 1 GAN cell, default parameter
- Public DNS without knowledge of the serving GANC's FQDN

Mobile Station:

- MS has stored the FQDN to the SEGW associated with the serving GANC associated with the AP-ID, but not the IP address
- MS has stored the IP address to the serving GANC associated with the AP-ID, but not the FQDN
- MS in state GA-RC DEREGISTERED

Foreseen final state of the MS

The MS will change state to GA-RC REGISTERED.

Test procedure

Make the MS join the AP so that the Registration procedure is kicked off.

The SS is supposed to answer the Registration Request message with Registration Accept before timer TU3904 expires.

Specific Test Parameters

-

Maximum duration of test

2 min.

Expected sequence

Step	Direction		Message	Comment
	MS	SS		
1	MS			MS is joining the AP
2	→			DNS Standard Query for the SEGW to the public DNS server
3	←			Standard Query Response with IP address to the SEGW
4	MS			MS sets up a secure connection to the SEGW and establishes TCP connection to the serving GANC using the stored IP address
5	→		GA-RC REGISTER REQUEST	To serving GANC
6	←		GA-RC REGISTER ACCEPT	TU3906 set to 60 seconds GANC Control Channel Description IE shall indicate that GPRS services are not available and IMSI Attach/Detach procedure shall not apply.
7	MS			Wait for 1 minutes so that TU3906 expires
A7 (Optional)			{Location Update Procedure}	This step is performed only if the MS initiates a Location Area Update while TU3906 is still running
8	→		GA-RC KEEP ALIVE	

81.2.2 Registration Procedure, Redirected

81.2.2.1 Registration Procedure, Redirected, Not Possible to Reuse Secure Connection

81.2.2.1.1 Conformance requirement

When the MS receives GA-RC REGISTER REDIRECT message, it shall:

- stop the timer TU3904,
- Increment the Redirection counter,
- release the TCP connection towards the GANC,

- otherwise release the secure connection towards SEGW of the previous GANC as defined in sub-clause 4.5
- initiate the registration procedure towards the returned GANC as defined in sub-clause 6.2.

Reference(s)

3GPP TS 44.318 sub-clause 6.2.3.2

81.2.2.1.2 Test purpose

To verify that the MS can register to another GANC when it receives Registration Redirect as a response on the Registration Request message.

81.2.2.1.3 Method of test

Initial conditions

System Simulator:

- 1 GAN cell, default parameter
- Public DNS without knowledge of the serving GANC's FQDN
- DNS inside of the serving SEGW associated with the serving GANC
- DNS inside of the default SEGW associated with the default GANC

Mobile Station:

- MS has stored the FQDN to the serving GANC and its SEGW associated with the AP-ID
- The serving GANC does not belong to the same SEGW as the default GANC
- MS in state GA-RC DEREGISTERED

Foreseen final state of the MS

The MS will change state to GA-RC REGISTERED.

Test procedure

Make the MS join the AP so that the Registration procedure is kicked off.

The SS is supposed to answer the Registration Request message with Registration Redirect before timer TU3904 expires.

Specific Test Parameters

-

Maximum duration of test

1 min.

Expected sequence

Step	Direction		Message	Comment
	MS	SS		
1	MS			MS is joining the AP
				MS sets up secure connection to the serving SEGW and establishes a TCP connection to the serving GANC using either IP address or FQDN
2	→		GA-RC REGISTER REQUEST	To serving GANC
3	←		GA-RC REGISTER REDIRECT	Suggest default GANC, with associated default SEGW IP or FQDN
4	MS			Remove the TCP connection and the secure connection to SEGW
5	MS			MS sets up secure connection to the new SEGW and establishes a TCP connection to the default GANC using either IP address or FQDN
6	→		GA-RC REGISTER REQUEST	To default GANC

81.2.2.2 Registration Procedure, Redirected, Current And Received GANC Belongs to The Same SEGW, IP Address Matches

81.2.2.2.1 Conformance requirement

When the MS receives GA-RC REGISTER REDIRECT message, it shall:

- stop the timer TU3904,
- Increment the Redirection counter,
- release the TCP connection towards the GANC,
- if the returned SEGW is the same as the one used for the connection towards the previous GANC,
 - if the MS held a Serving GANC-SEGW IP address for the current Serving GANC (either in the Serving GANC store or received in a previous GA-RC REGISTER REDIRECT) and the received GA-RC REGISTER REDIRECT contains the Serving GANC-SEGW IP address IE, and these two IP addresses match, the MS shall reuse the secure connection, or
- initiate the registration procedure towards the returned GANC as defined in sub-clause 6.2.

Reference(s)

3GPP TS 44.318 sub-clause 6.2.3.2

81.2.2.2.2 Test purpose

To verify that the MS can register to another GANC when it receives Registration Redirect as a response on the Registration Request message.

To verify that the same Ipsec tunnel can be reused if the current GANC belongs to the same SEGW as the received GANC using FQDN as identifier.

81.2.2.2.3 Method of test

Initial conditions

System Simulator:

- 1 GAN cell, default parameter
- Public DNS without knowledge of the serving GANC's FQDN
- DNS inside of the SEGW associated with the serving GANC and default GANC.

Mobile Station:

- MS has stored the IP address or FQDN to the serving GANC and its SEGW associated with the AP-ID
- The serving GANC belongs to the same SEGW as the default GANC
- MS in state GA-RC DEREGISTERED

Foreseen final state of the MS

The MS will change state to GA-RC REGISTERED.

Test procedure

Make the MS join the AP so that the Registration procedure is kicked off.

The SS is supposed to answer the Registration Request message with Registration Redirect before timer TU3904 expires.

Specific Test Parameters

-

Maximum duration of test

1 min.

Expected sequence

Step	Direction		Message	Comment
	MS	SS		
1	MS			MS is joining the AP
				MS sets up secure connection to the SEGW and establishes a TCP connection to the serving GANC using either IP address or FQDN
2	→		GA-RC REGISTER REQUEST	To serving GANC
3	←		GA-RC REGISTER REDIRECT	Suggest default GANC, IP address for the SEGW sent
4	MS			Remove the TCP connection
5	MS			Establish a TCP connection to the default GANC over the same secure connection
6	→		GA-RC REGISTER REQUEST	To default GANC

81.2.2.3 Registration Procedure, Redirected, Current And Received GANC Belongs to The Same SEGW, FQDN Matches

81.2.2.3.1 Conformance requirement

When the MS receives GA-RC REGISTER REDIRECT message, it shall:

- stop the timer TU3904,
- Increment the Redirection counter,
- release the TCP connection towards the GANC,
- if the returned SEGW is the same as the one used for the connection towards the previous GANC,
 - if the MS held a Serving GANC-SEGW FQDN identifier (either in the Serving GANC store or received in a previous GA-RC REGISTER REDIRECT) and the received GA-RC REGISTER REDIRECT contains the Serving GANC-SEGW FQDN IE, and these identifiers match, the MS shall reuse the secure connection
- initiate the registration procedure towards the returned GANC as defined in sub-clause 6.2

.

Reference(s)

3GPP TS 44.318 sub-clause 6.2.3.2

81.2.2.3.2 Test purpose

To verify that the MS can register to another GANC when it receives Registration Redirect as a response on the Registration Request message.

To verify that the same Ipv4 tunnel can be reused if the current GANC belongs to the same SEGW as the received GANC using FQDN as identifier.

81.2.2.3.3 Method of test

Initial conditions

System Simulator:

- 1 GAN cell, default parameter
- Public DNS without knowledge of the serving GANC's FQDN
- DNS inside of the SEGW associated with the serving GANC and default GANC

Mobile Station:

- MS has stored the FQDN to the serving GANC and the IP address or FQDN of its SEGW associated with the AP-ID
- The serving GANC belongs to the same SEGW as the default GANC
- MS in state GA-RC DEREGISTERED

Foreseen final state of the MS

The MS will change state to GA-RC REGISTERED.

Test procedure

Make the MS join the AP so that the Registration procedure is kicked off.

The SS is supposed to answer the Registration Request message with Registration Redirect before timer TU3904 expires.

Specific Test Parameters

-

Maximum duration of test

1 min.

Expected sequence

Step	Direction		Message	Comment
	MS	SS		
1	MS			MS is joining the AP
				MS sets up secure connection to the SEGW and establishes a TCP connection to the serving GANC using FQDN
2	→		GA-RC REGISTER REQUEST	To serving GANC
3	←		GA-RC REGISTER REDIRECT	Suggest default GANC, FQDN for the SEGW sent
4	MS			Remove the TCP connection
5	MS			Establish a TCP connection to the default GANC over the same secure connection
6	→		GA-RC REGISTER REQUEST	To default GANC

81.2.3 Registration Procedure, Rejected

81.2.3.1 Registration Procedure, Registration rejected, Network congestion

81.2.3.1.1 Conformance requirement

When the MS receives GA-RC REGISTER REJECT message it shall:

- stop the timer TU3904,
- if the MS is in the process of GANC selection;
 - ignore the received Register Reject Cause Information Element; and;
 - proceed as defined in sub-clause 6.2.4.5.
- else extract the Register Reject Cause information element and act as following depending on the value of the Reject Cause IE:
 - 'Network Congestion'
 - create a random value between zero and the received value in IE 'TU3907 Timer' and
 - add this value to the received value in IE 'TU3907 Timer', and use this as the new value for TU3907
 - start timer TU3907 according to the new calculated value and wait for it to expire.

Reference(s)

3GPP TS 44.318 sub-clause 6.2.3.3

81.2.3.1.2 Test purpose

To verify that the MS retries to register again after the correct time, according to the received timer TU3907, after receiving Register reject.

81.2.3.1.3 Method of test

Initial conditions

System Simulator:

- 1 GAN cell, default parameter
- Public DNS without knowledge of the serving GANC's FQDN
- DNS inside of the SEGW associated with the serving GANC

Mobile Station:

- MS has stored the FQDN or IP address of the serving GANC and its SEGW associated with the AP-ID

- MS in state GA-RC DEREGISTERED

Foreseen final state of the MS

The MS will stay in state to GA-RC DEREGISTERED as the registration fails.

Test procedure

Make the MS join the AP so that the Registration procedure is kicked off.

The SS is supposed to answer the Registration Request message with Registration Rejected due to network congestion before timer TU3904 expires. TU3907 Timer IE is set to 60 (1 minutes).

Specific Test Parameters

-

Maximum duration of test

3 min.

Expected sequence

Step	Direction		Message	Comment
	MS	SS		
1		MS		MS is joining the AP
2		MS		MS sets up secure connection to the serving SEGW and establishes a TCP connection to the serving GANC using either IP address or FQDN
3		→	GA-RC REGISTER REQUEST	To serving GANC
4		←	GA-RC REGISTER REJECT	Cause: network congested. TU3907 Timer IE is set to 60 seconds
5		MS		The MS sets TU3907 randomly between 60 and 120, i.e. 1 – 2 minutes. Wait until the TU3907 expires
6		→	GA-RC REGISTER REQUEST	To serving GANC

81.2.3.2 Registration Procedure, Registration rejected, AP not allowed

81.2.3.2.1 Conformance requirement

When the MS receives GA-RC REGISTER REJECT message it shall:

- stop the timer TU3904,
- if the MS is in the process of GANC selection;
 - ignore the received Register Reject Cause Information Element; and;
 - proceed as defined in sub-clause 6.2.4.5.
- else extract the Register Reject Cause information element and act as following depending on the value of the Reject Cause IE:
 - 'AP not allowed'
 - release the TCP connection established to the GANC, if still established,
 - release the secure connection towards the SEGW associated with the GANC, as defined in sub-clause 4.5
 - store the AP-ID in the AP Black List and not initiate a new Register Request from this AP, until the AP-ID is removed from the AP Black List i.e. as a result of power-cycle.

The MS shall also:

- Update the stored Serving GANC table as follows if the received Reject cause was not 'Network Congestion' or 'Geo Location not known':

- If the MS is not in GERAN/UTRAN coverage it shall remove information related to the AP-ID, if exists in the table.

Reference(s)

3GPP TS 44.318 sub-clause 6.2.3.3

81.2.3.2.2 Test purpose

To verify that the MS does not try to register again, after receiving Register reject due to Location not allowed until the MS is joining another AP.

81.2.3.2.3 Method of test

Initial conditions

System Simulator:

- 2 GAN cells, default parameter
- Public DNS without knowledge of the serving GANC's FQDN
- DNS inside of the serving SEGW associated with the serving GANC
- DNS inside of the default SEGW associated with the default GANC

Mobile Station:

- MS has stored the FQDN or IP address to the serving GANC and its SEGW associated with the AP-ID
- MS has stored the FQDN or IP address to the default GANC and its SEGW
- MS in state GA-RC DEREGISTERED

Foreseen final state of the MS

The MS will stay in state to GA-RC DEREGISTERED as the registration fails.

Test procedure

Make the MS join the AP so that the Registration procedure is kicked off.

The SS is supposed to answer the Registration Request message with Registration Rejected due to AP not allowed before timer TU3904 expires.

The MS are not allowed to try to register again from the same AP. Therefore wait for 2 minutes and let the MS join the second AP, where the mobile will try to register again.

Specific Test Parameters

-

Maximum duration of test

3 min.

Expected sequence

Step	Direction		Message	Comment
	MS	SS		
1	MS			MS is joining the first AP
2	MS			MS sets up secure connection to the serving SEGW and establishes a TCP connection to the serving GANC using either IP address or FQDN
3	→		GA-RC REGISTER REQUEST	To serving GANC
4	←		GA-RC REGISTER REJECT	Cause: AP not allowed
5	MS			Release the TCP connection to the GANC and the secure connection to the SEGW
6	MS			Wait for 2 minutes. Make sure that the MS doesn't try to register again.
7	MS			MS is joining the second AP
8	MS			MS sets up secure connection to the default SEGW and establishes a TCP connection to the default GANC using either IP address or FQDN
9	→		GA-RC REGISTER REQUEST	To default GANC

81.2.3.3 Registration Procedure, Registration rejected, Location not allowed

81.2.3.3.1 Conformance requirement

When the MS receives GA-RC REGISTER REJECT message it shall:

- stop the timer TU3904,
- if the MS is in the process of GANC selection;
 - ignore the received Register Reject Cause Information Element; and;
 - proceed as defined in sub-clause 6.2.4.5.
- else extract the Register Reject Cause information element and act as following depending on the value of the Reject Cause IE:
 - 'Location not allowed'
 - release the TCP connection established to the GANC, if still established,
 - release the secure connection towards the SEGW associated with the GANC, as defined in sub-clause 4.5
 - update the Location Black List according to the received information elements Location Black List indicator and Location Area Identification (i.e. the same as that included in the GA-RC REGISTER REQUEST message) and not initiate a new Register Request from the locations indicated by the updated Location Black List, until they are removed from the Location Black List i.e. as a result of power-cycle.

The MS shall also:

- Update the stored Serving GANC table as follows if the received Reject cause was not 'Network Congestion' or 'Geo Location not known':
 - If the MS is in GERAN/UTRAN coverage it shall remove information related to the current GSM-CGI or UTRAN Cell Identity, if it exists in the table.
 - If the MS is not in GERAN/UTRAN coverage it shall remove information related to the AP-ID, if exists in the table.

Reference(s)

3GPP TS 44.318 sub-clause 6.2.3.3

81.2.3.3.2 Test purpose

To verify that the MS does not try to register again, after receiving Register reject due to Location not allowed until it is powercycled.

81.2.3.3.3 Method of test

Initial conditions

System Simulator:

- 1 GAN cell, default parameter
- 1 GSM cell, default parameters
- Public DNS without knowledge of the serving GANC's FQDN
- DNS inside of the serving SEGW associated with the serving GANC
- DNS inside of the default SEGW associated with the default GANC

Mobile Station:

- MS has stored the FQDN or IP address to the serving GANC and its SEGW associated with the GSM cell (CGI)
- MS has stored the FQDN or IP address to the default GANC and its SEGW
- MS in state GA-RC DEREGISTERED

Foreseen final state of the MS

The MS will stay in state to GA-RC DEREGISTERED as the registration fails.

Test procedure

Make the MS join the AP so that the Registration procedure is kicked off.

The SS is supposed to answer the Registration Request message with Registration Rejected due to Location not allowed before timer TU3904 expires.

The MS are not allowed to try to register again from the same Location Area. Therefore wait for 5 minutes and then powercycle the MS so that the LAI disappears from the Location black list and the MS can register again from that Location area.

Specific Test Parameters

-

Maximum duration of test

6 min.

Expected sequence

Step	Direction		Message	Comment
	MS	SS		
1	MS			MS is joining the AP
2	MS			MS sets up secure connection to the serving SEGW and establishes a TCP connection to the serving GANC using either IP address or FQDN
3		→	GA-RC REGISTER REQUEST	To serving GANC
4		←	GA-RC REGISTER REJECT	Cause: Location not allowed
5	MS			Release the TCP connection to the GANC and the secure connection to the SEGW
6	MS			Wait for 5 minutes. Make sure that the MS doesn't try to register again.
7	MS			Powercycle the MS
8	MS			MS sets up secure connection to the default SEGW and establishes a TCP connection to the default GANC using either IP address or FQDN
9		→	GA-RC REGISTER REQUEST	To default GANC

81.2.3.4 Registration Procedure, Registration rejected, IMSI not allowed

81.2.3.4.1 Conformance requirement

When the MS receives GA-RC REGISTER REJECT message it shall:

- stop the timer TU3904,
- if the MS is in the process of GANC selection;
 - ignore the received Register Reject Cause Information Element; and;
 - proceed as defined in sub-clause 6.2.4.5.
- else extract the Register Reject Cause information element and act as following depending on the value of the Reject Cause IE:
 - 'IMSI not allowed'
 - release the TCP connection established to the GANC, if still established.
 - release the secure connection towards the SEGW associated with the GANC, as defined in sub-clause 4.5
 - not initiate a new GAN Registration procedure until the next power-on.

The MS shall also:

- Update the stored Serving GANC table as follows if the received Reject cause was not 'Network Congestion' or 'Geo Location not known':
 - If the MS is not in GERAN/UTRAN coverage it shall remove information related to the AP-ID, if exists in the table.

Reference(s)

3GPP TS 44.318 sub-clause 6.2.3.3

81.2.3.4.2 Test purpose

To verify that the MS does not try to register again after receiving Registration reject due to IMSI not allowed until the MS is power cycled.

81.2.3.4.3 Method of test

Initial conditions

System Simulator:

- 1 GAN cell, default parameter
- Public DNS without knowledge of the serving GANC's FQDN
- DNS inside of the serving SEGW associated with the serving GANC
- DNS inside of the default SEGW associated with the default GANC

Mobile Station:

- MS has stored the FQDN or the IP address to the serving GANC and its SEGW associated with the AP-ID
- MS has stored the FQDN or the IP address to the default GANC and its SEGW
- MS in state GA-RC DEREGISTERED

Foreseen final state of the MS

The MS will stay in state to GA-RC DEREGISTERED as the registration fails.

Test procedure

Make the MS join the AP so that the Registration procedure is kicked off.

The SS is supposed to answer the Registration Request message with Registration Rejected due to IMSI not allowed before timer TU3904 expires.

Wait for 2 minutes to confirm that the MS does not try to register again.

Switch off the MS and switch it back on again. The MS is supposed to try to register with the default GANC.

Specific Test Parameters

-

Maximum duration of test

3 min.

Expected sequence

Step	Direction		Message	Comment
	MS	SS		
1	MS			MS is joining the first AP
2	MS			MS sets up secure connection to the serving SEGW and establishes a TCP connection to the serving GANC using either IP address or FQDN
3		→	GA-RC REGISTER REQUEST	To serving GANC
4		←	GA-RC REGISTER REJECT	Cause: IMSI not allowed
5	MS			Release the TCP connection to the serving GANC and the secure connection to the serving SEGW
6	MS			Wait for 2 minutes. Make sure that the MS doesn't try to register again.
7	MS			Power cycle the MS
8	MS			MS sets up secure connection to the default SEGW and establishes a TCP connection to the default GANC using either IP address or FQDN
9		→	GA-RC REGISTER REQUEST	To default GANC

81.2.3.5 Void

81.2.3.6 Registration Procedure, Registration rejected, invalid GANC

81.2.3.6.1 Conformance requirement

When the MS receives GA-RC REGISTER REJECT message it shall:

- stop the timer TU3904,
- if the MS is in the process of GANC selection;
 - ignore the received Register Reject Cause Information Element; and;
 - proceed as defined in sub-clause 6.2.4.5.
- else extract the Register Reject Cause information element and act as following depending on the value of the Reject Cause IE:
 - 'Invalid GANC' or 'Unspecified'
 - release the TCP connection established to the GANC, if still established.
 - release the secure connection towards the SEGW associated with the GANC, as defined in sub-clause 4.5
 - act as defined in sub-clause 6.2.4.5

The MS shall also:

- Update the stored Serving GANC table as follows if the received Reject cause was not 'Network Congestion' or 'Geo Location not known':
 - If the MS is not in GERAN/UTRAN coverage it shall remove information related to the AP-ID, if exists in the table.

The MS shall;

- If the GANC selection is ongoing:
 - act on upper layer indications as follows;
 - If no more PLMNs/GANCs are available for GANC selection or the GANC selection is finished unsuccessfully;
 - stop all ongoing registration procedures;
 - release the TCP connection towards the current GANC, if established,
 - release the secure connection towards SEGW of the current GANC, if established, as defined in sub-clause 4.5
 - initiate registration towards the Default GANC as defined in sub-clause 6.2.1;
 - else if the GANC selection process indicates new PLMN/GANC selection:
 - initiate registration procedure towards the GANC associated with the selected PLMN as defined in sub-clause 6.2.
- else if the MS attempted the registration towards the Default GANC
 - delete the stored information about the Default GANC,
 - delete the contents of the stored Serving GANC table
 - Increment Redirection Counter
 - initiate Discovery Procedure as defined in sub-clause 5.3
- else if the MS attempted the registration towards current GANC is a Serving GANC

- Update the stored Serving GANC table as defined in the end of sub-clause 6.2.3.3 (i.e. delete information about this Serving GANC in the table) and
- Increment Redirection Counter
- initiate Registration Procedure towards the Default GANC as defined in sub-clause 6.2.1

Reference(s)

3GPP TS 44.318 sub-clause 6.2.3.3 and 6.2.4.5

81.2.3.6.2 Test purpose

To verify for serving and default GANC that the MS does not try to register again to the same GANC after receiving Registration reject due to invalid GANC.

81.2.3.6.3 Method of test

Initial conditions

System Simulator:

- 1 GAN cell, default parameter
- Public DNS without knowledge of any GANC's FQDN
- DNS inside of the serving SEGW associated with the serving GANC
- DNS inside of the default SEGW associated with the default GANC
- DNS inside of the provisioning SEGW associated with the provisioning GANC

Mobile Station:

- MS has stored the FQDN or IP address to the serving GANC associated with the AP-ID
- MS has stored the FQDN or IP address to the default GANC
- MS in state GA-RC DEREGISTERED

Foreseen final state of the MS

The MS will stay in state to GA-RC DEREGISTERED as the registration fails.

Test procedure

Make the MS join the AP so that the Registration procedure is kicked off.

The SS is supposed to answer the Registration Request message with Registration Rejected due invalid GANC before timer TU3904 expires.

Check that the MS kicks off the Registration procedure towards the Default GANC. Check the Register Reject Cause IE and Redirection Counter IE in the Discovery Request message.

The SS is supposed to answer the Registration Request message with Registration Rejected due invalid GANC before timer TU3904 expires.

Check that the MS kicks off the Discovery procedure towards the Provisioning GANC. Check the Register Reject Cause IE and Redirection Counter IE in the Discovery Request message.

Specific Test Parameters

-

Maximum duration of test

2 min.

Expected sequence

Step	Direction		Message	Comment
	MS	SS		
1	MS			MS is joining the first AP
2	MS			MS sets up secure connection to the serving SEGW and establishes a TCP connection to the serving GANC using either IP address or FQDN
3		→	GA-RC REGISTER REQUEST	To serving GANC
4		←	GA-RC REGISTER REJECT.	Cause: Invalid GANC
5				Release the TCP connection to the serving GANC and the secure connection to the serving SEGW
6				MS sets up secure connection to the default SEGW and establishes a TCP connection to the default GANC using either IP address or FQDN
7		→	GA-RC REGISTER REQUEST	To default GANC
8		←	GA-RC REGISTER REJECT.	Cause: Invalid GANC
9				Release the TCP connection to the default GANC and the secure connection to the default SEGW
10				MS sets up secure connection to the provisioning SEGW and establishes a TCP connection to the provisioning GANC using either IP address or FQDN
11		→	GA-RC DISCOVERY REQUEST	To provisioning GANC

81.2.3.7 Registration Procedure, Registration rejected, Geo location not known

81.2.3.7.1 Conformance requirement

When the MS receives GA-RC REGISTER REJECT message it shall:

- stop the timer TU3904,
- if the MS is in the process of GANC selection;
 - ignore the received Register Reject Cause Information Element; and;
 - proceed as defined in sub-clause 6.2.4.5.
- else extract the Register Reject Cause information element and act as following depending on the value of the Reject Cause IE:
 - 'Geo Location not known'
 - release the TCP connection established to the GANC, if still established.
 - release the secure connection towards the SEGW associated with the GANC, as defined in sub-clause 4.5
 - not retry registration from this AP until the location is provided or until the next power-on.

Reference(s)

3GPP TS 44.318 sub-clause 6.2.3.3

81.2.3.7.2 Test purpose

To verify that the MS does not try to register again after receiving Registration Reject due to 'Geo location not known' until the MS is power cycled.

81.2.3.7.3 Method of test

Initial conditions

System Simulator:

- 1 GAN cell, default parameter
- Public DNS without knowledge of the serving GANC's FQDN
- DNS inside of the serving SEGW associated with the serving GANC

Mobile Station:

- MS has stored the FQDN or the IP address to the serving GANC and its SEGW associated with the AP-ID
- MS in state GA-RC DEREGISTERED

Foreseen final state of the MS

The MS will stay in state to GA-RC DEREGISTERED as the registration fails.

Test procedure

Make the MS join the AP so that the Registration procedure is kicked off.

The SS is supposed to answer the Registration Request message with Registration Rejected due to Geo location not known before timer TU3904 expires.

Wait for 2 minutes to confirm that the MS does not try to register again.

Switch off the MS and switch it back on again. The MS is supposed to try to register again.

Specific Test Parameters

-

Maximum duration of test

3 min.

Expected sequence

Step	Direction		Message	Comment
	MS	SS		
1	MS			MS is joining the first AP
2	MS			MS sets up secure connection to the serving SEGW and establishes a TCP connection to the serving GANC using either IP address or FQDN
3		→	GA-RC REGISTER REQUEST	To serving GANC
4		←	GA-RC REGISTER REJECT	Cause: Geo location not known
5				Release the TCP connection to the GANC and the secure connection to the SEGW
6	MS			Wait for 2 minutes. Make sure that the MS doesn't try to register again.
7	MS			Power cycle the MS
8	MS			MS sets up secure connection to the serving SEGW and establishes a TCP connection to the serving GANC using either IP address or FQDN
9		→	GA-RC REGISTER REQUEST	To serving GANC

81.2.4 Registration Procedure, Abnormal Cases

81.2.4.1 Registration Procedure, TU3904/TU3905 expiry, Serving GANC

81.2.4.1.1 Conformance requirement

If timer TU3904 expires in the MS, the MS shall:

- release the TCP connection towards the GANC,
- release the secure connection towards SEGW of the GANC as defined in sub-clause 4.5,
- If GAN registration is unsuccessful after a number of attempts defined by the MS parameter "Up Register Max Retries" (defined in sub-clause 12.2.3), the MS shall act as defined in sub-clause 6.2.4.5.
- Otherwise, if GAN Registration can be re-attempted according to the MS parameter "Up Register Max Retries", start timer TU3905 and wait for it to expire.

If timer TU3905 has expired in the MS, the MS shall restart the Registration procedure as defined in sub-clause 6.2.1.

Reference(s)

3GPP TS 44.318 sub-clause 6.2.4.1 and 6.2.4.3

81.2.4.1.2 Test purpose

To verify that the MS retries to register correct number of times before it tries to register at another GANC when it does not get any reply on the Registration Request message.

81.2.4.1.3 Method of test

Initial conditions

System Simulator:

- 1 GAN cell, default parameter
- Public DNS without knowledge of the serving GANC's FQDN
- DNS inside of the SEGW associated with the serving GANC

Mobile Station:

- MS has stored the FQDN to the serving GANC and its SEGW associated with the AP-ID
- MS in state GA-RC DEREGISTERED

Foreseen final state of the MS

The MS will stay in state to GA-RC DEREGISTERED as the registration fails.

Test procedure

Make the MS join the AP so that the Registration procedure is kicked off.

The SS is not supposed to answer the Registration Request message at all.

The MS will wait for TU3904 and TU3905 to expire and retry to register again the number of times that is set in the MS parameter 'Up Register Max Retries'. After that it will try to register at the default GANC

Specific Test Parameters

'Up Register Max Retries' (3 times)

Maximum duration of test

3 min.

Expected sequence

Step	Direction		Message	Comment
	MS	SS		
1	MS			MS is joining the first AP
2	MS			MS sets up secure connection to the SEGW and establishes a TCP connection to the serving GANC using either IP address or FQDN
3	→		GA-RC REGISTER REQUEST	1 st time to serving GANC, MS starts TU3904
4	MS			Wait for 30 seconds so that TU3904 expires. TU3905 is set
5	MS			Release the TCP connection to the GANC and the secure connection to the SEGW
6	MS			Wait for 10 seconds so that TU3905 expires
7	MS			MS sets up secure connection to the SEGW and establishes a TCP connection to the serving GANC using either IP address or FQDN
8	→		GA-RC REGISTER REQUEST	2 nd time to serving GANC, MS starts TU3904. 1 st reattempt
9	MS			Wait for 30 seconds so that TU3904 expires. TU3905 is set
10	MS			Release the TCP connection to the GANC and the secure connection to the SEGW
11	MS			Wait for 10 seconds so that TU3905 expires
12	MS			MS sets up secure connection to the SEGW and establishes a TCP connection to the serving GANC using either IP address or FQDN
13	→		GA-RC REGISTER REQUEST	3 rd time to serving GANC, MS starts TU3904. 2 nd reattempt
14	MS			Wait for 30 seconds so that TU3904 expires.
15	MS			Release the TCP connection to the GANC and the secure connection to the SEGW
16	MS			MS sets up secure connection to the SEGW and establishes a TCP connection to the default GANC using either IP address or FQDN
17	→		GA-RC REGISTER REQUEST	To default GANC

81.2.4.2 Registration Procedure, Registration Rejected, Network Congestion, Persistent Fault

81.2.4.2.1 Conformance requirement

When the MS receives GA-RC REGISTER REJECT message it shall:

- stop the timer TU3904,
- if the MS is in the process of GANC selection;
 - ignore the received Register Reject Cause Information Element; and;
 - proceed as defined in sub-clause 6.2.4.5.
- else extract the Register Reject Cause information element and act as following depending on the value of the Reject Cause IE:
 - 'Network Congestion'
 - create a random value between zero and the received value in IE 'TU3907 Timer' and
 - add this value to the received value in IE 'TU3907 Timer', and use this as the new value for TU3907
 - start timer TU3907 according to the new calculated value and wait for it to expire.

If timer TU3907 expires in the MS, the MS shall:

- If GAN registration is unsuccessful after a number of attempts defined by the MS parameter "Up Register Max Retries" (defined in sub-clause 12.2.3), the MS shall act as if a "Lower layer failure in the MS" has occurred as defined in sub-clause 6.2.4.2
- else, if the TCP connection to the GANC is still established,
 - send a GA-RC REGISTER REQUEST that includes information elements as described in sub-clause 6.2.1 and
 - start timer TU3904
- else, restart the GAN Registration procedure towards the GANC as defined in sub-clause 6.2.1

Reference(s)

3GPP TS 44.318 sub-clause 6.2.3.3 and 6.2.4.4

81.2.4.2.2 Test purpose

To verify that the MS retries to register to the same GANC the correct number of times when it gets rejected due to network congestion several times.

81.2.4.2.3 Method of test

Initial conditions

System Simulator:

- 1 GAN cell, default parameter
- Public DNS without knowledge of the serving GANC's FQDN
- DNS inside of the SEGW associated with the serving GANC

Mobile Station:

- MS has stored the FQDN to the serving GANC and its SEGW associated with the AP-ID
- MS in state GA-RC DEREGISTERED

Foreseen final state of the MS

The MS will stay in state to GA-RC DEREGISTERED as the registration fails.

Test procedure

Make the MS join the AP so that the Registration procedure is kicked off.

The SS is supposed to answer the Registration Request message with Registration Rejected due to network congestion before timer TU3904 expires. TU3907 Timer IE is set to 60 (1 minutes).

The MS will wait for TU3904 and TU3907 to expire and retry to register again the number of times that is set in the MS parameter 'Up Register Max Retries'.

At the first reject the SS releases the TCP connection and the Ipsec tunnel, so that the MS has to establish the connection again. The rest of the rejects can keep the connection as that is the most likely scenario.

Specific Test Parameters

'Up Register Max Retries' is set to 3 times

Maximum duration of test

7 min.

Expected sequence

Step	Direction		Message	Comment
	MS	SS		
1	MS			MS is joining the AP
2	MS			MS sets up secure connection to the SEGW and establishes a TCP connection to the serving GANC using either IP address or FQDN
3		→	GA-RC REGISTER REQUEST	1 st time to serving GANC, MS starts TU3904
4		←	GA-RC REGISTER REJECT	Cause: network congested. TU3907 Timer IE is set to 60 seconds
5	MS			The MS sets TU3907 randomly between 60 and 120, i.e. 1 – 2 minutes. Wait until TU3907 expires
6		→	GA-RC REGISTER REQUEST	2 nd time to serving GANC, MS starts TU3904. 1 st reattempt
7		←	GA-RC REGISTER REJECT	Cause: network congested. TU3907 Timer IE is set to 60 seconds
8	MS			The MS sets TU3907 randomly between 60 and 120, i.e. 1 – 2 minutes. Wait until TU3907 expires
9		→	GA-RC REGISTER REQUEST	3 rd time to serving GANC, MS starts TU3904. 2 nd reattempt
10		←	GA-RC REGISTER REJECT	Cause: network congested. TU3907 Timer IE is set to 60 seconds
11 (optional)	MS			The MS sets TU3907 randomly between 60 and 120, i.e. 1 – 2 minutes. Wait until TU3907 expires
12	MS			Release the TCP connection to the GANC and the secure connection to the SEGW

81.2.4.3 Void

81.2.4.4 Void

81.2.4.5 Void

81.2.4.6 Void

81.2.4.7 Void

81.2.5 Registration Procedure, Register Update

81.2.5.1 Registration Procedure, Register Update, Rejected

81.2.5.1.1 Conformance requirement

If the network rejects the Registration Update, it shall send the GA-RC DEREGISTER message to the MS. This message shall contain the Register Reject Cause information element.

When the MS receives the GA-RC DEREGISTER message, it shall behave as defined in sub-clause 6.4.4 "Reception of GA-RC DEREGISTER by MS".

When the MS receives the GA-RC DEREGISTER message, it shall:

- 'AP not allowed'
- release the TCP connection established to the GANC, if still established,
- release the secure connection towards the SEGW associated with the GANC, as defined in sub-clause 4.5,
- store the AP-ID in the AP Black List of and not initiate a new Register Request from this AP, until the AP-ID is removed from the AP black list i.e. as a result of power-cycle.

Reference(s)

3GPP TS 44.318 sub-clause 6.3.2.2, 6.3.3.1 and 6.4.4

81.2.5.1.2 Test purpose

To verify that the MS acts according to the Register Update Reject Cause contained in the GA-RC DEREGISTER from the network.

81.2.5.1.3 Method of test

Initial conditions

System Simulator:

- 2 GAN cells, default parameter
- Public DNS without knowledge of the serving GANC's FQDN
- DNS inside of the SEGW associated with the serving GANC

Mobile Station:

- MS in state GA-RC REGISTERED

Foreseen final state of the MS

The MS will change state to GA-RC DEREGISTERED

Test procedure

Make the MS join a second AP so that the Registration Update procedure is kicked off.

The SS is supposed to reply with GA-RC DEREGISTER.

The MS will then check the Register Reject Cause IE contained in GA-RC DEREGISTER message and act as specified in GANC 44.318 section 6.4.4.

Specific Test Parameters

-

Maximum duration of test

2 min.

Expected sequence

Step	Direction		Message	Comment
	MS	SS		
1	MS			MS is changing APs
2	→		GA-RC REGISTER UPDATE UPLINK	To serving GANC
3	←		GA-RC DEREGISTER	To MS Cause: AP not allowed
4	MS			Release the TCP connection to the GANC and the secure connection to the SEGW
5	MS			Wait for 5 minutes. Make sure that the MS doesn't try to register again.

81.2.5.2 Registration Procedure, Register Update, Redirection

81.2.5.2.1 Conformance requirement

If the network decides to redirect the MS to another GANC, it shall send the GA-RC REGISTER REDIRECT message to the MS. This message shall contain valid information about another GANC, so that the MS is able to initiate the Registration procedure towards that GANC.

Reference(s)

3GPP TS 44.318 sub-clause 6.3.2.3

81.2.5.2.2 Test purpose

To verify that the MS can register to another GANC if it gets redirected as a result of the Registration Update procedure.

81.2.5.2.3 Method of test

Initial conditions

System Simulator:

- 1 GAN cell, default parameter
- 1 GSM cell, initially switched off

Mobile Station:

- MS in state GA-RC REGISTERED under no GSM coverage

Foreseen final state of the MS

The MS will change state to GA-RC DEREGISTERED as the Registration procedure to the new GANC is interrupted.

Test procedure

GSM cell is activated, MS is changing location area by going into GSM coverage area and Registration Update procedure is kicked off.

The SS is supposed to reply with .GA-RC REGISTER REDIRECT

The MS will then send GA-RC REGISTER REQUEST to the suggested GANC.

Specific Test Parameters

-

Maximum duration of test

2 min.

Expected sequence

Step	Direction		Message	Comment
	MS	SS		
1		SS		The GSM cell is activated.
2		→	GA-RC REGISTER UPDATE UPLINK	To serving GANC
3		←	GA-RC REGISTER REDIRECT	Suggest a different GANC
4		→	GA-RC REGISTER REQUEST	To the suggested GANC.

81.2.6 Registration Procedure, Deregister

81.2.6.1 Registration Procedure, Deregister, Network Congestion, MS in State GA-CSR DEDICATED

81.2.6.1.1 Conformance requirement

When the MS receives the GA-RC DEREGISTER message, it shall:

- if the MS is in the process of PLMN selection;
 - ignore the received Register Reject Cause Information Element, and
 - proceed as defined in sub-clause 6.2.4.5.
- else extract the Reject Cause information element and act as following depending on the value of the Reject Cause IE:
 - 'Network Congestion'
 - release all local GAN resources (e.g. MS is in active call over GAN)
 - release the TCP connection towards the current GANC and
 - release the secure connection towards the GANC-SEGW, as defined in sub-clause 4.5
 - create a random value between zero and the received value in IE 'TU3907 Timer' and
 - add this value to the received value in IE 'TU3907 Timer', and use this as the new value for TU3907
 - start timer TU3907 according to the new calculated value

Reference(s)

3GPP TS 44.318 sub-clause 6.4.4

81.2.6.1.2 Test purpose

To verify that the MS changes state to GA-RC DEREGISTERED and starts to try to register again after receiving GA-RC DEREGISTER with cause 'Network Congestion'.

81.2.6.1.3 Method of test

Initial conditions

System Simulator:

- 1 GAN cell, default parameter
- Public DNS without knowledge of the serving GANC's FQDN
- DNS inside of the SEGW associated with the serving GANC

Mobile Station:

- MS has stored the FQDN to the serving GANC and its SEGW associated with the AP-ID
- MS in state GA-CSR DEDICATED with an active call

Foreseen final state of the MS

The MS will change state to GA-RC DEREGISTERED.

Test procedure

The SS initiates the deregistration by sending GA-RC DEREGISTER with cause 'Network Congestion'.

The MS is supposed to start the Registration procedure when TU3907 has expired.

Specific Test Parameters

-

Maximum duration of test

1 min.

Expected sequence

Step	Direction		Message	Comment
	MS	SS		
1		←	GA-RC DEREGISTER	From serving GANC, cause: network congested. TU3907 is set to 10 sec.
2	MS			Release the active call
3	MS			Release the TCP connection to the GANC and the secure connection to the SEGW
4	MS			The SS checks that the following step is initiated by the MS within min 10 and 20 sec
5	MS			MS sets up secure connection to the SEGW and establishes a TCP connection to the serving GANC using either IP address or FQDN
6		→	GA-RC REGISTER REQUEST	To serving GANC

81.2.6.2 Registration Procedure, Deregister, AP Not Allowed, MS in State GA-RC REGISTERED

81.2.6.2.1 Conformance requirement

When the MS receives the GA-RC DEREGISTER message, it shall:

- if the MS is in the process of PLMN selection;
 - ignore the received Register Reject Cause Information Element, and
 - proceed as defined in sub-clause 6.2.4.5.
- else extract the Reject Cause information element and act as following depending on the value of the Reject Cause IE:
 - 'AP not allowed'
 - release the TCP connection established to the GANC, if still established,
 - release the secure connection towards the SEGW associated with the GANC, as defined in sub-clause 4.5,
 - store the AP-ID in the AP Black List of and not initiate a new Register Request from this AP, until the AP-ID is removed from the AP black list i.e. as a result of power-cycle.

Reference(s)

3GPP TS 44.318 sub-clause 6.4.4

81.2.6.2.2 Test purpose

To verify that the MS changes state to GA-RC DEREGISTERED and does not start to try to register again after receiving GA-RC DEREGISTER with cause 'AP not allowed' until it is powercycled.

81.2.6.2.3 Method of test

Initial conditions

System Simulator:

- 1 GAN cell, default parameter

- Public DNS without knowledge of the serving GANC's FQDN
- DNS inside of the SEGW associated with the serving GANC

Mobile Station:

- MS has stored the FQDN to the serving GANC and its SEGW associated with the AP-ID
- MS in state GA-RC REGISTERED

Foreseen final state of the MS

The MS will change state to GA-RC Deregistered.

Test procedure

The SS initiates the deregistration by sending GA-RC Deregister with cause 'AP not allowed'.

The MS are not allowed to try to register again from the same AP. Therefore, wait for 5 minutes and then powercycle the MS so that the AP disappears from the AP black list and the MS can register again from that AP.

Specific Test Parameters

-

Maximum duration of test

6 min.

Expected sequence

Step	Direction		Message	Comment
	MS	SS		
1		←	GA-RC Deregister	From serving GANC, cause: AP not allowed.
2	MS			Release the TCP connection to the GANC and the secure connection to the SEGW
3	MS			Wait for 5 minutes
4	MS			Powercycle the MS
5				MS sets up secure connection to the SEGW and establishes a TCP connection to the default GANC using either IP address or FQDN
6		→	GA-RC Register Request	To default GANC

81.2.6.3 Registration Procedure, Deregister, Location Not Allowed, MS in State GA-CSR IDLE

81.2.6.3.1 Conformance requirement

When the MS receives the GA-RC Deregister message, it shall:

- if the MS is in the process of PLMN selection;
 - ignore the received Register Reject Cause Information Element, and
 - proceed as defined in sub-clause 6.2.4.5.
- else extract the Reject Cause information element and act as following depending on the value of the Reject Cause IE:
 - 'Location not allowed'
 - release the TCP connection established to the GANC, if still established,
 - release the secure connection towards the SEGW associated with the GANC, as defined in sub-clause 4.5,

- update the Location Black List according to the received information elements Location Black List indicator and Location Area Identification and not initiate a new Register Request from that Location, until the Location is removed from the Location Black List i.e. as a result of power-cycle.

Reference(s)

3GPP TS 44.318 sub-clause 6.4.4

81.2.6.3.2 Test purpose

To verify that the MS changes state to GA-RC DEREGISTERED and does not start to try to register again after receiving GA-RC DEREGISTER with cause 'Location not allowed' until it is powercycled.

81.2.6.3.3 Method of test

Initial conditions

System Simulator:

- 1 GSM cell, default parameters
- 1 GAN cell, default parameter
- Public DNS without knowledge of the serving GANC's FQDN
- DNS inside of the SEGW associated with the serving GANC

Mobile Station:

- MS has stored the FQDN to the serving GANC and its SEGW associated with the GSM cell (CGI)
- MS in state GA-CSR IDLE

Foreseen final state of the MS

The MS will change state to GA-RC DEREGISTERED.

Test procedure

The SS initiates the deregistration by sending GA-RC DEREGISTER with cause 'Location not allowed'.

The MS are not allowed to try to register again from the same Location area. Therefore, wait for 5 minutes and then powercycle the MS so that the LAI disappears from the Location black list and the MS can register again from that Location area.

Specific Test Parameters

-

Maximum duration of test

6 min.

Expected sequence

Step	Direction		Message	Comment
	MS	SS		
1		←	GA-RC DEREGISTER	From serving GANC, cause: Location not allowed.
2	MS			Release the TCP connection to the GANC and the secure connection to the SEGW
3	MS			Wait for 5 minutes
4	MS			Powercycle the MS
5	MS			MS sets up secure connection to the SEGW and establishes a TCP connection to the default GANC using either IP address or FQDN
6		→	GA-RC REGISTER REQUEST	To default GANC

81.2.6.4 Registration Procedure, Deregister, IMSI Not Allowed

81.2.6.4.1 Conformance requirement

When the MS receives the GA-RC DEREGISTER message, it shall:

- if the MS is in the process of PLMN selection;
 - ignore the received Register Reject Cause Information Element, and
 - proceed as defined in sub-clause 6.2.4.5.
- else extract the Reject Cause information element and act as following depending on the value of the Reject Cause IE:
 - 'IMSI not allowed'
 - release the TCP connection established to the GANC, if still established.
 - release the secure connection towards the SEGW associated with the GANC as defined in sub-clause 4.5,
 - not initiate a new Registration procedure until the next power-on.

The MS shall also,

- Update the stored Serving GANC table as following if the received Reject cause was not 'Network Congestion' or 'Geo Location not known'
- If the MS is not in GERAN/UTRAN coverage
 - Remove information related to the AP-ID, if exists in the table.

Reference(s)

3GPP TS 44.318 sub-clause 6.4.4

81.2.6.4.2 Test purpose

To verify that the MS changes state to GA-RC DEREGISTERED and does not start to try to register again after receiving GA-RC DEREGISTER with cause 'IMSI not allowed' until it is powercycled.

81.2.6.4.3 Method of test

Initial conditions

System Simulator:

- 1 GAN cell, default parameter
- Public DNS without knowledge of the default GANC's FQDN

- DNS inside of the SEGW associated with the default GANC

Mobile Station:

- MS has stored the FQDN to the default GANC and its SEGW associated with the AP-ID
- MS in state GA-RC REGISTERED

Foreseen final state of the MS

The MS will change state to GA-RC DEREGISTERED.

Test procedure

The SS initiates the deregistration by sending GA-RC DEREGISTER with cause 'IMSI not allowed'.

The MS are not allowed to try to register again. Therefore, wait for 5 minutes and then powercycle the MS so that the MS can register again.

Specific Test Parameters

-

Maximum duration of test

6 min.

Expected sequence

Step	Direction		Message	Comment
	MS	SS		
1		←	GA-RC DEREGISTER	From serving GANC, cause: IMSI not allowed.
2				Release the TCP connection to the GANC and the secure connection to the SEGW
3	MS			Wait for 5 minutes
4	MS			Powercycle the MS
5				MS sets up secure connection to the SEGW and establishes a TCP connection to the default GANC using FQDN
6		→	GA-RC REGISTER REQUEST	To default GANC

81.2.6.5 Registration Procedure, Deregister, Unspecified

81.2.6.5.1 Conformance requirement

When the MS receives the GA-RC DEREGISTER message, it shall:

- if the MS is in the process of PLMN selection;
 - ignore the received Register Reject Cause Information Element, and
 - proceed as defined in sub-clause 6.2.4.5.
- else extract the Reject Cause information element and act as following depending on the value of the Reject Cause IE:
 - 'Unspecified'
 - release the TCP connection established to the GANC, if still established.
 - release the secure connection towards the SEGW associated with the GANC as defined in sub-clause 4.5,
 - act as if a "Lower layer failure in the MS" has occurred as defined in sub-clause 6.2.4.2

The MS shall also,

- Update the stored Serving GANC table as following if the received Reject cause was not 'Network Congestion' or 'Geo Location not known'
- If the MS is not in GERAN/UTRAN coverage
 - Remove information related to the AP-ID, if exists in the table.

Lower layer failure in the MS can be for example related to DNS, IPsec or TCP. If any lower layer failure happens in the MS, the MS shall:

- release the TCP connection towards the current GANC, if established,
- release the secure connection towards SEGW of the current GANC, if established, as defined in sub-clause 4.5 and
-
-

If registration is still unsuccessful after a number of attempts defined by the MS parameter "Up Connect Attempt Count" (defined in sub-clause 12.2.3), the MS shall act as defined in sub-clause 6.2.4.5.

- Otherwise, start timer TU3905 and wait for it to expire.

Reference(s)

3GPP TS 44.318 sub-clause 6.4.4 and 6.2.4.2

81.2.6.5.2 Test purpose

To verify that the MS changes state to GA-RC DEREGISTERED and act as if it has discovered a lower layer fault when it receives the GA-RC DEREGISTER message with message code 'Unspecified' and the number of failed attempts doesn't exceed the Up Connection Attempt Count.

81.2.6.5.3 Method of test

Initial conditions

System Simulator:

- 1 GAN cell, default parameter
- Public DNS without knowledge of the default GANC's FQDN
- DNS inside of the SEGW associated with the default GANC

Mobile Station:

- MS has stored the FQDN to the default GANC and its SEGW associated with the AP-ID
- MS in state GA-RC REGISTERED

Foreseen final state of the MS

The MS will change state to GA-RC DEREGISTERED.

Test procedure

The SS initiates the deregistration by sending GA-RC DEREGISTER with cause 'Unspecified'.

The MS will try to register again to the default GANC.

Specific Test Parameters

-

Maximum duration of test

1 min.

Expected sequence

Step	Direction		Message	Comment
	MS	SS		
1		←	GA-RC DEREGISTER	From serving GANC, with reject cause: Unspecified.
2	MS			Release the TCP connection to the GANC and the secure connection to the SEGW and TU3905 is started
3	MS			TU3905 expires
4	MS			MS sets up secure connection to the SEGW and establishes a TCP connection to the default GANC using FQDN
5		→	GA-RC REGISTER REQUEST	To default GANC

81.2.6.6 Registration Procedure, Deregister, Unspecified, Persistent Fault, Default GANC

81.2.6.6.1 Conformance requirement

3GPP TS 44.318, section 6.4.4:

When the MS receives the GA-RC DEREGISTER message, it shall:

- if the MS is in the process of PLMN selection;
- ignore the received Register Reject Cause Information Element, and
- proceed as defined in sub-clause 6.2.4.5.
- else extract the Reject Cause information element and act as following depending on the value of the Reject Cause IE:
 - 'Unspecified'
 - release the TCP connection established to the GANC, if still established.
 - release the secure connection towards the SEGW associated with the GANC as defined in sub-clause 4.5,
 - act as if a "Lower layer failure in the MS" has occurred as defined in sub-clause 6.2.4.2

The MS shall also,

- Update the stored Serving GANC table as following if the received Reject cause was not 'Network Congestion' or 'Geo Location not known'
- If the MS is not in GERAN/UTRAN coverage
 - Remove information related to the AP-ID, if exists in the table.

3GPP TS 44.318, section 6.2.4.2:

Lower layer failure in the MS can be for example related to DNS, IPsec or TCP. If any lower layer failure happens in the MS, the MS shall:

- release the TCP connection towards the current GANC, if established,
- release the secure connection towards SEGW of the current GANC, if established, as defined in sub-clause 4.5 and

- If registration is still unsuccessful after a number of attempts defined by the MS parameter "Up Connect Attempt Count" (defined in sub-clause 12.2.3), the MS shall act as defined in sub-clause 6.2.4.5.
- Otherwise, start timer TU3905 and wait for it to expire.

3GPP TS 44.318, section 6.2.4.5:

else if the MS attempted the registration towards the Default GANC

- delete the stored information about the Default GANC,
- delete the contents of the stored Serving GANC table
- Increment Redirection Counter
- initiate Discovery Procedure as defined in sub-clause 5.3

Reference(s)

3GPP TS 44.318 sub-clause 6.4.4 and 6.2.4.2, 6.2.4.5

81.2.6.6.2 Test purpose

To verify that the MS changes state to GA-RC DEREGISTERED and will act as after a Registration Failure when it receives the GA-RC DEREGISTER message with message code 'Unspecified' and the number of failed attempts exceeds the Up Connection Attempt Count..

81.2.6.6.3 Method of test

Initial conditions

System Simulator:

- 1 GAN cell, default parameter

Mobile Station:

- MS has stored the FQDN to the default GANC and its SEGW
- MS in state GA-RC REGISTERED

Foreseen final state of the MS

The MS will change state to GA-RC DEREGISTERED.

Test procedure

The SS initiates the deregistration by sending GA-RC DEREGISTER with cause 'Unspecified'. The MS treat this as a lower layer fault and starts to try to set up the connection to the GANC again. The SS simulates a persistent lower layer fault and after three attempts the number of failed attempts has reached the 'Up Connect Attempt Count' parameter and the fault will be treated as a registration fault. The MS will perform a Discovery procedure towards the Provisioning GANC.

Specific Test Parameters

-

Maximum duration of test

2 min.

Expected sequence

Step	Direction		Message	Comment
	MS	SS		
1		←	GA-RC DEREGISTER	From serving GANC, with reject cause : Unspecified.
2	MS			Release the TCP connection to the serving GANC and the secure connection to the SEGW and TU3905 is started
3	MS			TU 3905 expires after 10 seconds
4	MS			MS tries to set up a secure connection to the default SEGW but fails. MS removes the secure connection. Number of Up Connect Attempts is increased to 1 and TU3905 is started
5	MS			TU 3905 expires after 10 seconds
6	MS			MS sets up a secure connection to the default SEGW and tries to set up a TCP connection to the default GANC but fails with the TCP connection. MS removes the TCP connection and the secure connection. Number of Up Connect Attempts is increased to 2 and TU3905 is started
7	MS			TU 3905 expires after 10 seconds
8	MS			MS sets up a secure connection to the default SEGW and tries to set up a TCP connection to the default GANC but fails with the TCP connection. MS removes the TCP connection and the secure connection. Number of Up Connect Attempts is increased to 3.
9	MS			MS sets up secure connection to the SEGW and establishes a TCP connection to the provisioning GANC
10		→	GA-RC DISCOVERY REQUEST	To provisioning GANC

81.2.6.7 Registration Procedure, Deregister, Invalid GANC, Serving GANC

81.2.6.7.1 Conformance requirement

When the MS receives the GA-RC DEREGISTER message, it shall:

- if the MS is in the process of PLMN selection;
 - ignore the received Register Reject Cause Information Element, and
 - proceed as defined in sub-clause 6.2.4.5.
- else extract the Reject Cause information element and act as following depending on the value of the Reject Cause IE:
 - 'Invalid GANC'
 - release the TCP connection established to the GANC, if still established.
 - release the secure connection towards the SEGW associated with the GANC as defined in sub-clause 4.5,
 - act as defined in sub-clause 6.2.4.5 "Registration Failure"

Reference(s)

3GPP TS 44.318 sub-clause 6.4.4

81.2.6.7.2 Test purpose

To verify that the MS changes state to GA-RC DEREGISTERED and does not start to try to register again to the same GANC after receiving GA-RC DEREGISTER with cause 'Invalid GANC'.

81.2.6.7.3 Method of test

Initial conditions

System Simulator:

- 1 GAN cell, default parameter
- Public DNS without knowledge of the serving GANC's FQDN
- DNS inside of the SEGW associated with the serving GANC

Mobile Station:

- MS has stored the FQDN to the serving GANC and its SEGW associated with the AP-ID
- MS in state GA-RC REGISTERED

Foreseen final state of the MS

The MS will change state to GA-RC DEREGISTERED.

Test procedure

The SS initiates the deregistration by sending GA-RC DEREGISTER with cause 'Invalid GANC'.

The MS will try to register to default GANC.

Specific Test Parameters

-

Maximum duration of test

1 min.

Expected sequence

Step	Direction		Message	Comment
	MS	SS		
1	←		GA-RC DEREGISTER	From serving GANC, invalid GANC.
2	MS			Release the TCP connection to the GANC and the secure connection to the SEGW
3	MS			MS sets up secure connection to the SEGW and establishes a TCP connection to the default GANC using either IP address or FQDN
4	→		GA-RC REGISTER REQUEST	To default GANC

81.2.6.8 Registration Procedure, Deregister, Geo Location Not Known

81.2.6.8.1 Conformance requirement

When the MS receives the GA-RC DEREGISTER message, it shall:

- if the MS is in the process of PLMN selection;
- ignore the received Register Reject Cause Information Element, and
- proceed as defined in sub-clause 6.2.4.5.

- else extract the Reject Cause information element and act as following depending on the value of the Reject Cause IE:
- 'Geo Location not known'
 - release the TCP connection established to the GANC, if still established.
 - release the secure connection towards the SEGW associated with the GANC as defined in sub-clause 4.5,
 - not retry registration from this AP until the location is provided or until the next power-on.

Reference(s)

3GPP TS 44.318 sub-clause 6.4.4

81.2.6.8.2 Test purpose

To verify that the MS changes state to GA-RC DEREGISTERED and does not start to try to register again after receiving GA-RC DEREGISTER with cause 'Geo location not known' until it is powercycled.

81.2.6.8.3 Method of test

Initial conditions

System Simulator:

- 1 GAN cell, default parameter
- Public DNS without knowledge of the serving GANC's FQDN
- DNS inside of the SEGW associated with the serving GANC

Mobile Station:

- MS has stored the FQDN to the serving GANC and its SEGW associated with the AP-ID
- MS in state GA-RC REGISTERED

Foreseen final state of the MS

The MS will change state to GA-RC DEREGISTERED.

Test procedure

The SS initiates the deregistration by sending GA-RC DEREGISTER with cause 'Geo location not known'.

The MS are not allowed to try to register again. Therefore, wait for 5 minutes and then powercycle the MS so that the MS can register again.

Specific Test Parameters

-

Maximum duration of test

6 min.

Expected sequence

Step	Direction		Message	Comment
	MS	SS		
1		←	GA-RC DEREGISTER	From serving GANC, cause: Geo location not known'.

2			Release the TCP connection to the GANC and the secure connection to the SEGW
3	MS		Wait for 5 minutes
4	MS		Powercycle the MS
5			MS sets up secure connection to the SEGW and establishes a TCP connection to the serving GANC using either IP address or FQDN
6	→	GA-RC REGISTER REQUEST	To serving GANC

81.2.6.9 Registration Procedure, Deregister, MS Initiated

81.2.6.9.1 Conformance requirement

When the MS is leaving or about to leave the GAN coverage and the MS has successfully registered with a GANC, it should:

- send the GA-RC DEREGISTER -message using the currently established TCP-connection,
- release the TCP connection towards the GANC,
- release the secure connection towards the SEGW, as defined in sub-clause 4.5 and
- release all resources related to GAN

Reference(s)

3GPP TS 44.318 sub-clause 6.4.1

81.2.6.9.2 Test purpose

To verify that the MS sends GA-RC DEREGISTER when it is about to leave the AP e.g. when it is powered off.

81.2.6.9.3 Method of test

Initial conditions

System Simulator:

- 1 GAN cell, default parameter
- Public DNS without knowledge of the serving GANC's FQDN
- DNS inside of the SEGW associated with the serving GANC

Mobile Station:

- MS has stored the FQDN to the serving GANC and its SEGW associated with the AP-ID
- MS in state GA-RC REGISTERED

Foreseen final state of the MS

The MS will be switched off.

Test procedure

The MS sends the GA-RC DEREGISTER message as it is switched off.

Specific Test Parameters

-

Maximum duration of test

1 min.

Expected sequence

Step	Direction		Message	Comment
	MS	SS		
1		MS		Switch off the MS
2		→	GA-RC DEREGISTER	To serving GANC
3		MS		Release the TCP connection to the GANC and the secure connection to the SEGW

81.3 Lower Layer Faults

81.3.1 TCP Reset

81.3.1.1 TCP Reset, Successful Re-establishment, MS in State GA-CSR DEDICATED

81.3.1.1.1 Conformance requirement

When MS receives TCP RST after TCP connection failure, it shall attempt to re-establish TCP connection once. After successfully re-establishing TCP connection, the MS shall send GA-RC SYNCHRONIZATION INFORMATION to the GANC to synchronize the state information. If unsuccessful, the MS shall release the related local GA-CSR or GA-PSR resources, and continue as per section 9.5.

Reference(s)

3GPP TS 44.318 sub-clause 6.6.1.

81.3.1.1.2 Test purpose

To verify that the MS can re-establish the TCP connection after receiving a TCP Reset.

81.3.1.1.3 Method of test

Initial conditions

System Simulator:

- 1 GAN cell, default parameter

Mobile Station:

- MS in state GA-CSR DEDICATED
- The MS has the IP address or the FQDN for the serving GANC

Foreseen final state of the MS

The MS will stay in GA-CSR DEDICATED.

Test procedure

The MS starts in GA-CSR DEDICATED.

The SS sends a TCP RST and the MS re-establish the TCP connection and send the GA-RC SYNCHRONISATION INFORMATION message.

Specific Test Parameters

-

Maximum duration of test

1 min.

Expected sequence

Step	Direction		Message	Comment
	MS	SS		
1	MS			MS starts in GA-CSR DEDICATED
2	SS			The SS sends TCP RST
3	MS			The MS re-establish the TCP connection
4	→		GA-RC SYNCHRONIZATION INFORMATION	To serving GANC

81.3.1.2 TCP Reset, Unsuccessful Re-establishment, MS in State GA-CSR IDLE

81.3.1.2.1 Conformance requirement

When MS receives TCP RST after TCP connection failure, it shall attempt to re-establish TCP connection once. After successfully re-establishing TCP connection, the MS shall send GA-RC SYNCHRONIZATION INFORMATION to the GANC to synchronize the state information. If unsuccessful, the MS shall release the related local GA-RC or GA-PSR resources, and continue as per section 9.5.

Reference(s)

3GPP TS 44.318 sub-clause 6.6.1.

81.3.1.2.2 Test purpose

To verify that the MS can re-establish the TCP connection after receiving a TCP Reset.

81.3.1.2.3 Method of test

Initial conditions

System Simulator:

- 1 GAN cell, default parameter

Mobile Station:

- MS in state GA-CSR IDLE
- The MS has the IP address or the FQDN for the serving GANC

Foreseen final state of the MS

The MS will change to GA-RC DEREGISTERED.

Test procedure

The MS starts in GA-CSR IDLE.

The SS sends a TCP RST and the MS tries to re-establish the TCP connection. When that fails it start timer TU3905 and tries to register again when the timer expires.

Specific Test Parameters

-

Maximum duration of test

1 min.

Expected sequence

Step	Direction		Message	Comment
	MS	SS		
1	MS			MS starts in GA-CSR IDLE
2		SS		The SS sends TCP RST
3	MS			The MS tries to re-establish the TCP connection, the SS doesn't reply. MS starts timer TU3905
4	MS			Wait for 10 seconds
5	MS			MS sets up secure connection to the SEGW and establishes a TCP connection to the serving GANC using either IP address or FQDN
6		→	GA-RC REGISTER REQUEST	To serving GANC

81.3.2 Lower Layer Faults, MS is Registered

81.3.2.1 IPsec Tunnel Failure, MS in State GA-CSR IDLE

81.3.2.1.1 Conformance requirement

The handling of lower layer failures in the MS while in the GA-RC-DEREGISTERED state is described in sub-clauses 5.6.2 and 6.2.4.2.

The handling of lower layer failures in the MS while not in the GA-RC-DEREGISTERED state is described below:

For all lower layer failures in the MS (for example related to DNS, IPsec or TCP failures other than RST) except the TCP connection failure specified in section 6.6, the MS shall:

- release the TCP connection towards the current GANC, if established,
- stop timer TU3906,
- release the secure connection towards SEGW of the current GANC, if established, as defined in sub-clause 4.5,
- start timer TU3905, and
- enter GA-RC-DEREGISTERED state.

Reference(s)

3GPP TS 44.318 sub-clause 9.5.

81.3.2.1.2 Test purpose

To verify that the MS tries to register again after a lower layer fault when in state GA-CSR IDLE.

81.3.2.1.3 Method of test

Initial conditions

System Simulator:

- 1 GAN cell, default parameter

Mobile Station:

- MS in state GA-CSR IDLE
- The MS has the IP address or the FQDN for the serving GANC

Foreseen final state of the MS

The MS will change to GA-RC DEREGISTERED.

Test procedure

The MS starts in GA-CSR IDLE.

The SS removes the Ipsec tunnel. When that happens the MS starts timer TU3905 and tries to register again when the timer expires.

Specific Test Parameters

-

Maximum duration of test

1 min.

Expected sequence

Step	Direction		Message	Comment
	MS	SS		
1	MS			MS starts in GA-CSR IDLE
2		SS		The SS removes the Ipsec tunnel
3	MS			MS starts timer TU3905
4	MS			Wait for 10 seconds
5	MS			MS sets up secure connection to the SEGW and establishes a TCP connection to the serving GANC using either IP address or FQDN
6		→	GA-RC REGISTER REQUEST	To serving GANC

81.3.2.2 TCP Failure, MS in State GA-CSR DEDICATED

81.3.2.2.1 Conformance requirement

The handling of lower layer failures in the MS while in the GA-RC-DEREGISTERED state is described in sub-clauses 5.6.2 and 6.2.4.2.

The handling of lower layer failures in the MS while not in the GA-RC-DEREGISTERED state is described below:

For all lower layer failures in the MS (for example related to DNS, IPsec or TCP failures other than RST) except the TCP connection failure specified in section 6.6, the MS shall:

- release the TCP connection towards the current GANC, if established,
- stop timer TU3906,
- release the secure connection towards SEGW of the current GANC, if established, as defined in sub-clause 4.5,
- start timer TU3905, and
- enter GA-RC-DEREGISTERED state.

Reference(s)

3GPP TS 44.318 sub-clause 9.5

81.3.2.2.2 Test purpose

To verify that the MS tries to register again after a lower layer fault when in state GA-CSR DEDICATED.

81.3.2.2.3 Method of test

Initial conditions

System Simulator:

- 1 GAN cell, default parameter

Mobile Station:

- MS in state GA-CSR DEDICATED
- The MS has the IP address or the FQDN for the serving GANC

Foreseen final state of the MS

The MS will change to GA-RC DEREGISTERED.

Test procedure

The MS starts in GA-CSR IDLE.

The SS removes the Ipsec tunnel. When that happens the MS starts timer TU3905 and tries to register again when the timer expires.

Specific Test Parameters

-

Maximum duration of test

1 min.

Expected sequence

Step	Direction		Message	Comment
	MS	SS		
1	MS			MS starts in GA-CSR DEDICATED
2		SS		The SS removes the Ipsec tunnel
3	MS			MS starts timer TU3905
4	MS			Wait for 10 seconds
5	MS			MS sets up secure connection to the SEGW and establishes a TCP connection to the serving GANC using either IP address or FQDN
6		→	GA-RC REGISTER REQUEST	To serving GANC

82 GAN CS Domain Procedures

82.1 GA-CSR connection establishment

82.1.1 GA-CSR connection establishment / successful case

82.1.1.1 GA-CSR connection establishment, Upper Layer Message Transmission and GA-CRS connection release by GANC

82.1.1.1.1 Conformance requirement

The GA-CSR connection is a logical connection between the MS and the GANC. It is established when the upper layers in the MS request GA-CSR to enter dedicated mode. The MS initiates GA-CSR connection establishment by sending the GA-CSR REQUEST message to the network. When a successful response is received from the network, GA-CSR replies to the upper layer that it has entered dedicated mode. The upper layers have then the possibility to request transmission of messages to the network. These messages are sent to the network using GA-CSR UPLINK DIRECT TRANSFER messages as defined in sub-clause 7.2.1.

The GA-CSR UPLINK DIRECT TRANSFER message is used for the transfer of upper layer messages from the MS to the GANC while the GA-CSR DOWNLINK DIRECT TRANSFER message is used for the transfer of upper layer messages from the GANC to the MS. The first GA-CSR UPLINK DIRECT TRANSFER message received by the GANC triggers the establishment of the signalling connection to the CN for that MS.

The GANC initiates this procedure to command the MS to release the GA-CSR and any traffic channel resources and instruct the MS to leave GA-CSR-DEDICATED state.

The GA-CSR RELEASE message will include an RR cause indication as follows:

- #0: normal release, e.g. at the end of a call.
- #1: unspecified abnormal release.
- #65: if e.g. a handover procedure is stopped because the call has been cleared.

When the MS receives the GA-CSR RELEASE message, it shall:

- transmit a GA-CSR RELEASE COMPLETE message to the GANC and release all GA-CSR and any traffic channel resources,
- Enter GA-CSR-IDLE state.

Reference(s)

3GPP TS 44.318 subclause 7.1 / 7.2 / 7.5.3 / 7.5.4

82.1.1.1.2 Test purpose

To verify that MS is able to initiate GA-CSR connection establishment between the MS and GANC and to verify that MS is able to communicate with the CN by encapsulating upper layer messages (CC/MM/SS/SMS messages) to GA-CSR UPLINK DIRECT TRANSFER container message and able to receive upper layer messages within GA-CSR DOWNLINK DIRECT TRANSFER container message.

To verify that MS is able to release the GA-CSR connection, able to move into GA-CSR-IDLE state and release all GA-CSR and any traffic channel resources, when the MS receives the GA-CSR RELEASE message from SS.

82.1.1.1.3 Method of test

Initial Conditions

System Simulator:

- 1 GAN cell, default parameters

Mobile Station:

- MS in GA-CSR-IDLE state in service of GAN cell

Foreseen Final State of the MS

MS in GA-CSR-IDLE state.

Test Procedure

The MS is made to initiate a GA-CSR connection establishment. The MS moves into GA-CSR-DEDICATED state when the MS receives the GA-CSR REQUEST ACCEPT message from the SS within timer TU3908 (5 sec.) from sending GA-CSR REQUEST message. SS verifies that MS sends GA-CSR UPLINK DIRECT TRANSFER message within 10s from GA-CSR REQUEST ACCEPT message. The SS answers by sending upper layer message within GA-CSR DOWNLINK DIRECT TRANSFER container message.

The SS sends GA-CSR RELEASE message. The MS enters GA-CSR-IDLE state and transmits a GA-CSR RELEASE COMPLETE to the SS and releases all GA-CSR and any traffic channel resources.

Specific test parameters

-

Maximum Duration of Test

1 min.

Expected Sequence

Step	Direction		Message	Comment
	MS	SS		
1	MS			MS is made to initiate GA-CSR connection
2	MS			MS checks for access permission based on Access Control Class bits
3		→	GA-CSR REQUEST	
4		←	GA-CSR REQUEST ACCEPT	
5	MS			MS in GA-CSR-DEDICATED state
6		→	GA-CSR UPLINK DIRECT TRANSFER	Within 10s from GA-CSR REQUEST ACCEPT message Containing (UL) CC/MM/SS/SMS message
7		←	GA-CSR DOWNLINK DIRECT TRANSFER	Containing (DL) CC/MM/SS/SMS message
8		←	GA-CSR RELEASE	IE 'RR cause' indicates #0
9		→	GA-CSR RELEASE COMPLETE	MS enters GA-CSR-IDLE state

82.1.2 GA-CSR connection establishment / negative cases

82.1.2.1 GA-CSR REQUEST rejected

82.1.2.1.1 Conformance requirement

3GPP TS 44.318 subclause 7.1.2.2:

If the GANC rejects the GA-CSR connection establishment request, it shall send the GA-CSR REQUEST REJECT message to the MS.

3GPP TS 44.318 subclause 7.1.3.2:

When the MS receives the GA-CSR REQUEST REJECT message, it shall:

- if timer TU3908 is active:
 - stop timer TU3908,
 - remain in GA-CSR-IDLE state and
 - indicate to upper layers that GA-CSR was not able to enter dedicated state

3GPP TS 44.318 subclause 7.3.2:

If the mobile identity in the GA-CSR PAGING REQUEST message matches any of the valid identities of the MS and the MS is in GA-CSR-IDLE state, the MS shall:

- if timer TU3908 is not active and access to the network is allowed;
 - send a GA-CSR PAGING RESPONSE message to the GANC and
 - enter GA-CSR-DEDICATED state.

Reference(s)

3GPP TS 44.318 subclauses 7.1.2.2 / 7.1.3.2 / 7.3.2

82.1.2.1.2 Test purpose

To verify that MS will remain in GA-CSR-IDLE state when MS receives the GA-CSR REQUEST REJECT message.

82.1.2.1.3 Method of test

Initial Conditions

System Simulator:

- 1 GAN cell, default parameters

Mobile Station:

- MS in GA-CSR-IDLE state in service of GAN cell

Foreseen Final State of the MS

MS in GA-CSR- IDLE state.

Test Procedure

The MS is made to initiate a GA-CSR connection establishment. SS sends the GA-CSR REQUEST REJECT message to the MS. MS is not able to enter GA-CSR-DEDICATED state. The SS sends GA-CSR PAGING REQUEST to verify that MS in GA-CSR-IDLE state. MS answers by sending GA-CSR PAGING RESPONSE.

Specific test parameters

-

Maximum Duration of Test

1 min.

Expected Sequence

Step	Direction		Message	Comment
	MS	SS		
1	MS			MS is made to initiate GA-CSR connection
2	MS			MS checks for access permission based on Access Control Class bits
3		→	GA-CSR REQUEST	TU3908 is started
4		←	GA-CSR REQUEST REJECT	The SS sends GA-CSR REQUEST REJECT before the expiry of TU3908.
5	MS			MS in GA-CSR-IDLE state
6		←	GA-CSR PAGING REQUEST	Valid identity of the MS ('TMSI'/'IMSI')
7		→	GA-CSR PAGING RESPONSE	MS enters GA-CSR-DEDICATED state
8		←	GA-CSR RELEASE	IE 'RR cause' indicates #0
9		→	GA-CSR RELEASE COMPLETE	MS enters GA-CSR-IDLE state

82.1.2.2 MS receives GA-CSR REQUEST ACCEPT message after TU3908 expiry

82.1.2.2.1 Conformance requirement

If the GANC accepts the GA-CSR connection establishment request, it shall send the GA-CSR REQUEST ACCEPT message to the MS.

When the MS receives the GA-CSR REQUEST ACCEPT message, it shall:

- if timer TU3908 is active:
 - stop timer TU3908,
 - move into GA-CSR-DEDICATED state,
 - indicate to upper layers that GA-CSR has entered dedicated state and
 - send the initial GA-CSR UPLINK DIRECT TRANSFER message to the network
- if timer TU3908 is not active:
 - ignore the GA-CSR REQUEST ACCEPT message and
 - continue with any ongoing procedure as if the GA-CSR REQUEST ACCEPT message was not received

- If timer TU3908 expires in the MS, the MS shall remain in GA-CSR-IDLE state and indicate to upper layers that GA-CSR was not able to enter dedicated state

If the mobile identity in the GA-CSR PAGING REQUEST message matches any of the valid identities of the MS and the MS is in GA-CSR-IDLE state, the MS shall:

- if timer TU3908 is not active and access to the network is allowed;
 - send a GA-CSR PAGING RESPONSE message to the GANC and
 - enter GA-CSR-DEDICATED state.
- if timer TU3908 is active;
- discard the received GA-CSR PAGING REQUEST message.

Reference(s)

3GPP TS 44.318 subclauses 7.1.2.1 / 7.1.3.1 / 7.1.4.1 / 7.3.2

82.1.2.2.2 Test purpose

To verify that MS will remain in GA-CSR IDLE state if TU3908 expires before MS receives the GA-CSR REQUEST ACCEPT message.

82.1.2.2.3 Method of test

Initial Conditions

System Simulator:

- 1 GAN cell, default parameters

Mobile Station:

- MS in GA-CSR-IDLE state in service of GAN cell

Foreseen Final State of the MS

MS in GA-CSR- IDLE state.

Test Procedure

The MS is made to initiate a GA-CSR connection establishment. MS receives the GA-CSR REQUEST ACCEPT message from the SS after timer TU3908 (5 sec.) expires. MS remains in GA-CSR IDLE state. The MS may send GA-CSR-REQUEST message due to upper layer requesting to restart the higher layer procedure which verifies that MS has been in GA-CSR-IDLE state. If GA-CSR-REQUEST message is not received, the SS sends GA-CSR PAGING REQUEST to verify that MS in GA-CSR-IDLE state. MS answers by sending GA-CSR PAGING RESPONSE.

Specific test parameters

-

Maximum Duration of Test

1 min.

Expected Sequence

Step	Direction		Message	Comment
	MS	SS		
1	MS			MS is made to initiate GA-CSR connection
2	MS			MS checks for access permission based on Access Control Class bits
3	→		GA-CSR REQUEST	
4	SS			SS waits 5 seconds after SS has received the GA-CSR REQUEST message
5	MS			TU3908 expires
6	←		GA-CSR REQUEST ACCEPT	
7	MS			MS ignores the GA-CSR REQUEST ACCEPT message and remains in GA-CSR-IDLE state
7a (optional)	→		GA-CSR REQUEST	MS may send GA-CSR-REQUEST message due to upper layer restarting the higher layer procedure. This verifies that the MS has been in GA-CSR-IDLE state.
8 (conditional)	←		GA-CSR PAGING REQUEST	Valid identity of the MS ('TMSI'/'IMSI')
9 (conditional)	→		GA-CSR PAGING RESPONSE	MS enters GA-CSR DEDICATED state
10 (conditional)	←		GA-CSR RELEASE	IE 'RR cause' indicates #0
11 (conditional)	→		GA-CSR RELEASE COMPLETE	MS enters GA-CSR-IDLE state
NOTE: Steps 8-11 are not applicable If GA-CSR-REQUEST message is received in step 7a				

82.2 Upper layer message transmission

82.2.1 Upper layer message transmission / successful cases

82.2.1.1 Void

82.2.2 Upper layer message transmission / negative cases

82.2.2.1 MS receives GA-CSR DOWNLINK DIRECT TRANSFER message when not in GA-CSR-DEDICATED state

82.2.2.1.1 Conformance requirement

If the MS receives a GA-CSR DOWNLINK DIRECT TRANSFER message and MS is not in GA-CSR-DEDICATED state, the MS shall:

- ignore the contents of the GA-CSR DOWNLINK DIRECT TRANSFER message;
- transmit a GA-CSR STATUS message as follows:
 - set the IE "RR Cause" to " Message type not compatible with protocol state"
 - include the received message contents in the IE "PDU in error"
- continue with any ongoing procedure and act as if the GA-CSR DOWNLINK DIRECT TRANSFER message was not received.

Reference(s)

3GPP TS 44.318 subclause 7.2.4.1

82.2.2.1.2 Test purpose

To verify that MS ignores the contents of the GA-CSR DOWNLINK DIRECT TRANSFER message if MS is not in GA-CSR-DEDICATED state and to be able to send GA-CSR STATUS message to the SS.

82.2.2.1.3 Method of test

Initial Conditions

System Simulator:

- 1 GAN cell, default parameters

Mobile Station:

- MS in GA-CSR-IDLE state in service of GAN cell

Foreseen Final State of the MS

MS in GA-CSR-IDLE state in service of GAN cell

Test Procedure

MS is in GA-CSR-IDLE state in service of GAN cell. SS sends GA-CSR DOWNLINK DIRECT TRANSFER message containing upper layer message. MS ignores the contents of the message and sends GA-CSR STATUS message to the SS with IE 'RR Cause': 'Message type not compatible with protocol state'. MS includes the received message contents in the IE 'PDU in error'.

Specific test parameters

-

Maximum Duration of Test

1 min.

Expected Sequence

Step	Direction		Message	Comment
	MS	SS		
1	MS			MS in GA-CSR-IDLE state
2	←		GA-CSR DOWNLINK DIRECT TRANSFER	Containing (DL) CC/MM/SS/SMS message
3	→		GA-CSR STATUS	RR Cause: 'Message type not compatible with protocol state' PDU in Error: '<received (DL) message>'

82.3 Paging for CS domain

82.3.1 Paging for CS domain / successful case

82.3.1.1 Paging for CS domain

82.3.1.1.1 Conformance requirement

3GPP TS 44.318 subclause 7.3.1:

The GANC initiates this procedure when it receives a PAGING REQUEST message over the A-interface or a Paging CS over the Gb-interface. The MS to be paged is identified by the identity received in the request from the CN. If the

request includes the TMSI then the GANC should include the TMSI as the mobile identity else it should include the IMSI received in the request.

3GPP TS 44.318 subclause 7.3.2:

If the mobile identity in the GA-CSR PAGING REQUEST message matches any of the valid identities of the MS and the MS is in GA-CSR-IDLE state, the MS shall:

- if timer TU3908 is not active and access to the network is allowed;
- send a GA-CSR PAGING RESPONSE to the GANC and
- enter GA-CSR-DEDICATED state.

3GPP TS 44.318 subclause 7.3.4:

If the MS receives a GA-CSR PAGING REQUEST and the mobile identity included in the message does not match any of the valid identities assigned to the MS, the MS shall:

- ignore the GA-CSR PAGING REQUEST message
- continue with any ongoing procedure as if the GA-CSR PAGING REQUEST message was not received.

Reference(s)

3GPP TS 44.318 subclauses 7.3.1 / 7.3.2 / 7.3.4

82.3.1.1.2 Test purpose

To verify that MS ignores the GA-CSR PAGING REQUEST and continues with any ongoing procedure, if received GA-CSR PAGING REQUEST doesn't contain valid identity.

To verify that MS is able send a GA-CSR PAGING RESPONSE to the SS and enter GA-CSR-DEDICATED state when MS receives GA-CSR PAGING REQUEST with valid identities of the MS.

82.3.1.1.3 Method of test

Initial Conditions

System Simulator:

- 1 GAN cell, default parameters

Mobile Station:

- MS in GA-CSR-IDLE state in service of GAN cell

Foreseen Final State of the MS

MS in GA-CSR-IDLE state in service of GAN cell Test Procedure

The SS initiates paging procedure by sending GA-CSR PAGING REQUEST message with not matching identity to the MS. MS ignores the GA-CSR PAGING REQUEST and continues with any ongoing procedure as if the GA-CSR PAGING REQUEST was not received. After 10s the SS sends GA-CSR PAGING REQUEST to verify that MS in GA-CSR-IDLE state. MS answers by sending GA-CSR PAGING RESPONSE.

Specific test parameters

-

Maximum Duration of Test

1 min.

Expected Sequence

Step	Direction		Message	Comment
	MS	SS		
1		←	GA-CSR PAGING REQUEST	With not matching identity
2		MS		MS ignores GA-CSR PAGING REQUEST message
3		SS		SS waits 10s for response
4		←	GA-CSR PAGING REQUEST	Valid identity of the MS ('TMSI'/'IMSI')
5		→	GA-CSR PAGING RESPONSE	MS enters GA-CSR-DEDICATED state
6		←	GA-CSR RELEASE	IE 'RR cause' = #0
7		→	GA-CSR RELEASE COMPLETE	MS enters GA-CSR-IDLE state

82.3.2 Paging for CS domain / negative cases

82.3.2.1 Void

82.3.2.2 MS receives GA-CSR PAGING REQUEST when TU3908 is active

82.3.2.2.1 Conformance requirement

If the mobile identity in the GA-CSR PAGING REQUEST message matches any of the valid identities of the MS and the MS is in GA-CSR-IDLE state, the MS shall:

- if timer TU3908 is not active and access to the network is allowed;
 - send a GA-CSR PAGING RESPONSE message to the GANC and
 - enter GA-CSR-DEDICATED state.
- if timer TU3908 is active;
 - discard the received GA-CSR PAGING REQUEST message

Reference(s)

3GPP TS 44.318 subclause 7.3.2

82.3.2.2.2 Test purpose

To verify that MS discards the received GA-CSR PAGING REQUEST message if timer TU3908 is active.

82.3.2.2.3 Method of test

Initial Conditions

System Simulator:

- 1 GAN cell, default parameters

Mobile Station:

- MS in GA-CSR-IDLE state in service of GAN cell

Foreseen Final State of the MS

MS in GA-CSR- IDLE state.

Test Procedure

MS is made to initiate GA-CSR connection. MS sends GA-CSR REQUEST message and activates timer TU3908. The SS initiates paging procedure by sending GA-CSR PAGING REQUEST message to the MS when TU3908 is active in MS. MS discards the received GA-CSR PAGING REQUEST message. After TU3908 expiry the SS sends GA-CSR PAGING REQUEST to verify that MS in GA-CSR-IDLE state. MS answers by sending GA-CSR PAGING RESPONSE.

Specific test parameters

-

Maximum Duration of Test

1 min.

Expected Sequence

Step	Direction		Message	Comment
	MS	SS		
1	MS			MS is made to initiate GA-CSR connection
2	→		GA-CSR REQUEST	MS activates TU3908
3	←		GA-CSR PAGING REQUEST	Valid identity of the MS ('TMSI'/'IMSI'), sent before TU3908 expiry
4	MS			MS discards GA-CSR PAGING REQUEST message
5	SS			SS waits for TU3908 to expire
7	←		GA-CSR PAGING REQUEST	Valid identity of the MS ('TMSI'/'IMSI')
8	→		GA-CSR PAGING RESPONSE	MS enters GA-CSR-DEDICATED state
9	←		GA-CSR RELEASE	IE 'RR cause' indicates #0
10	→		GA-CSR RELEASE COMPLETE	MS enters GA-CSR-IDLE state

82.3.2.3 MS receives GA-CSR PAGING REQUEST when in GA-CSR DEDICATED state

82.3.2.3.1 Conformance requirement

If the MS receives a GA-CSR PAGING REQUEST message and MS is in GA-CSR-DEDICATED state or GA-RC-REGISTERED state, the MS shall:

- ignore the GA-CSR PAGING REQUEST message
- continue with any ongoing procedure as if the GA-CSR PAGING REQUEST was not received.

Reference(s)

3GPP TS 44.318 subclause 7.3.4

82.3.2.3.2 Test purpose

To verify that MS ignores the GA-CSR PAGING REQUEST and continues with any ongoing procedure as if the GA-CSR PAGING REQUEST was not received, if MS receives GA-CSR PAGING REQUEST when MS is in GA-CSR-DEDICATED state.

82.3.2.3.3 Method of test

Initial Conditions

System Simulator:

- 1 GAN cell, default parameters

Mobile Station:

- MS in GA-CSR-DEDICATED state in service of GAN cell.

Foreseen Final State of the MS

MS in GA-CSR-IDLE state in service of GAN cell.

Test Procedure

The MS is in GA-CSR-DEDICATED state in service of GAN cell. The SS initiates paging procedure by sending GA-CSR PAGING REQUEST message to the MS. The MS ignores the GA-CSR PAGING REQUEST and continues with any ongoing procedure as if the GA-CSR PAGING REQUEST was not received. After 10s the SS sends GA-CSR

RELEASE to verify that MS in GA-CSR-DEDICATED state. MS answers by sending GA-CSR RELEASE COMPLETE.

Specific test parameters

-

Maximum Duration of Test

1 min.

Expected Sequence

Step	Direction		Message	Comment
	MS	SS		
1	MS			MS in GA-CSR-DEDICATED state with ongoing procedure
2	←		GA-CSR PAGING REQUEST	Valid identity of the MS ('TMSI'/'IMSI')
3	MS			MS ignores the GA-CSR PAGING REQUEST and continues with ongoing procedure
4	SS			SS waits 10s for response
5	←		GA-CSR RELEASE	IE 'RR cause'
6	→		GA-CSR RELEASE COMPLETE	MS enters GA-CSR-IDLE state

82.3.2.4 MS receives GA-CSR PAGING REQUEST when in GA-RC REGISTERED state

82.3.2.4.1 Conformance requirement

If the MS receives a GA-CSR PAGING REQUEST message and MS is in GA-CSR-DEDICATED state or GA-RC-REGISTERED state, the MS shall:

- ignore the GA-CSR PAGING REQUEST message
- continue with any ongoing procedure as if the GA-CSR PAGING REQUEST was not received.

Reference(s)

3GPP TS 44.318 subclause 7.3.4

82.3.2.4.2 Test purpose

To verify that MS ignores the GA-CSR PAGING REQUEST and continues with any ongoing procedure as if the GA-CSR PAGING REQUEST was not received, if MS receives GA-CSR PAGING REQUEST when MS is in GA-RC-REGISTERED state.

82.3.2.4.3 Method of test

Initial Conditions

System Simulator:

- 2 cells: GERAN cell & GAN cell
- 1 GERAN cell, default parameters
- 1 GAN cell, default parameters

Mobile Station:

- MS in GERAN mode camped on a GERAN cell and in GA-RC-REGISTERED state

Foreseen Final State of the MS

MS in GA-CSR- IDLE state.

Test Procedure

MS is camped on a GERAN cell and in GA-RC-REGISTERED state. The SS initiates paging procedure by sending GA-CSR PAGING REQUEST message to the MS. The MS ignores the GA-CSR PAGING REQUEST and continues with any ongoing procedure as if the GA-CSR PAGING REQUEST was not received. After 10s the MS is made to switch the serving RR entity to GA-CSR and MS enters the GA-CSR-IDLE state. The SS sends GA-CSR PAGING REQUEST to verify that MS in GA-CSR-IDLE state. MS answers by sending GA-CSR PAGING RESPONSE.

Specific test parameters

-

Maximum Duration of Test

1 min.

Expected Sequence

Step	Direction		Message	Comment
	MS	SS		
1	MS			MS is camped on a GERAN cell and in GA-RC-REGISTERED state
2	←		GA-CSR PAGING REQUEST	Valid identity of the MS ('TMSI'/'IMSI')
3	MS			MS ignores the GA-CSR PAGING REQUEST and continues with ongoing procedure
4	SS			SS waits 10s for response
5	MS			MS is made to switch the serving RR entity to GA-CSR, MS enters the GA-CSR-IDLE state
6	←		GA-CSR PAGING REQUEST	Valid identity of the MS ('TMSI'/'IMSI')
7	→		GA-CSR PAGING RESPONSE	MS enters GA-CSR-DEDICATED state
8	←		GA-CSR RELEASE	IE 'RR cause' indicates #0
9	→		GA-CSR RELEASE COMPLETE	MS enters GA-CSR-IDLE state

82.4 Traffic Channel assignment

82.4.1 Traffic Channel assignment / successful cases

82.4.1.1 Traffic Channel assignment

82.4.1.1 Traffic Channel assignment and Release

82.4.1.1.1 Conformance requirement

3GPP TS 44.318 subclause 7.4.2:

The MS shall act on the received GA-CSR ACTIVATE CHANNEL message when in GA-CSR-DEDICATED state as follows:

- Code and decode the CS payload samples according to the IE "Channel Mode";
- Use the value indicated by the IE "Sample Size" as the minimum sampling size for the coding and decoding of the CS payload samples, if the MS is not able to use the indicated value. If AMR is used with FEC by sending redundant frames, the sample size is defined as the size of the new speech sample in each RTP packet, not including any redundant speech sample.
- Configure the uplink CS payload stream to be transmitted to the UDP port identified by the IE "UDP Port";
- Configure the uplink CS payload stream to be transmitted to the IP address identified by the IE "IP address";
- If received, use the configuration included in the IE 'Multi-rate Configuration' for the CS payload stream;
- If received, use the configuration included in the IE "RTP Redundancy Configuration" for the CS payload stream. The redundancy policy is defined for each of the AMR modes to use. The level of redundancy can span

from no redundancy to double redundancy. In the same active codec set, a lower codec mode shall not be associated with a lower redundancy level than a higher codec mode. For example, the highest mode in the set is used with no redundancy, the next lower with single redundancy and rest of the modes with double redundancy;

- If received, use the Payload Type included in the IE 'Payload Type' for the PT field in the RTP header for the CS downlink and uplink payload streams;
- On successful activation of the channel, the MS shall:
 - Transmit a GA-CSR ACTIVATE CHANNEL ACK message and include the UDP port number in the IE 'UDP Port' for the downlink CS payload stream to be used by the GANC.
 - Include the selected RTP sample size, to be used uplink and downlink, in the IE Sample Size.
 - if the IE 'RTCP UDP Port' was received in the GA-CSR ACTIVATE CHANNEL message and the MS is capable of supporting RTCP, activate the uplink RTCP stream and include the IE 'RTCP UDP Port' for the downlink RTCP stream to be used by the GANC.

3GPP TS 44.318 subclause 7.4.4:

The RTP channel is available for use by upper layers. To enable uplink quality measurements in the GANC, the MS shall send at least one RTP frame each 480 ms. The AMR payload Table of Contents shall indicate NO_DATA if there is no speech or SID frames to send.

3GPP TS 44.318 subclause 7.5.1:

If the MS needs to release the GA-CSR connection and signalling connection to the core network, it shall send the GA-CSR CLEAR REQUEST message to the GANC. The MS shall include the 'RR Cause' IE.

Reference(s)

3GPP TS 44.318 subclauses 7.4.2 / 7.4.4/ 7.5.1

82.4.1.1.2 Test purpose

To verify that MS is able to establish a GAN traffic channel.

The MS initiates the release the GA-CSR connection by sending GA-CSR CLEAR REQUEST to the SS. The MS enters GA-CSR-IDLE state and releases all GA-CSR and any traffic channel resources.

82.4.1.1.3 Method of test

Initial Conditions

System Simulator:

- 1 GAN cell, default parameters

Mobile Station:

- MS in GA-CSR-DEDICATED state in service of GAN cell and a voice call is ongoing.

Foreseen Final State of the MS

MS in GA-CSR-IDLE state in service of GAN cell.

Test Procedure

A voice call is ongoing. The SS configures a traffic channel by transmitting GA-CSR ACTIVATE CHANNEL to the MS. MS responds by transmitting a GA-CSR ACTIVATE CHANNEL ACK with the IE 'UDP Port'. Then the SS configures itself for transmission of RTP packets to the MS to the indicated UDP port and transmits a GA-CSR ACTIVATE CHANNEL COMPLETE message to the MS. MS and SS sends at least one RTP frame each 480 ms. The SS releases the call by sending GA-CSR DL DIRECT TRANSFER message (Release) and receiving GA-CSR UL DIRECT TRANSFER (Release Complete) message. Therefore, the MS will send GA-CSR CLEAR REQUEST to release CSR connection.

Specific test parameters

-

Maximum Duration of Test

1 min.

Expected Sequence

Step	Direction		Message	Comment
	MS	SS		
1	MS			MS in GA-CSR-DEDICATED state, voice call is ongoing.
2		←	GA-CSR ACTIVATE CHANNEL	IE 'Channel Mode', IE 'Sample Size', IE 'UDP Port', IE 'IP address', optional IE 'Multi-rate Configuration', optional IE 'RTP Redundancy Configuration', optional IE 'Payload Type'.
3		→	GA-CSR ACTIVATE CHANNEL ACK	IE 'UDP Port', optional IE 'RTCP UDP Port'
4		←	GA-CSR ACTIVATE CHANNEL COMPLETE	
5		→		Verify that the MS sends at least one RTP frame
6		←	GA-CSR DL DIRECT TRANSFER (Release)	
7		→	GA-CSR UL DIRECT TRANSFER (Release Complete)	Eventual CC L3 messages are ignored.
8		→	GA-CSR CLEAR REQUEST	

82.4.2 Traffic Channel assignment / negative cases

82.4.2.1 MS fails to establish the traffic channel

82.4.2.1.1 Conformance requirement

If the MS fails to establish the channel indicated in the GA-CSR ACTIVATE CHANNEL the MS shall:

- transmit a GA-CSR ACTIVATE CHANNEL FAILURE message
- act as if the GA-CSR ACTIVATE CHANNEL message was not received.

Reference(s)

3GPP TS 44.318 subclause 7.4.5

82.4.2.1.2 Test purpose

To verify that if MS fails to establish the traffic channel, it transmits a GA-CSR ACTIVATE CHANNEL FAILURE and act as if the GA-CSR ACTIVATE CHANNEL was not received.

82.4.2.1.3 Method of test

Initial Conditions

System Simulator:

- 1 GAN cell, default parameters

Mobile Station:

- MS in GA-CSR-DEDICATED state in service of GAN cell and a voice call is ongoing.

Foreseen Final State of the MS

MS in GA-CSR- IDLE state in service of GAN cell.

Test Procedure

A voice call is ongoing. The SS configures a traffic channel by transmitting corrupted GA-CSR ACTIVATE CHANNEL to the MS. In the corrupted GA-CSR ACTIVATE CHANNEL message "Sample Size" octet 3 is set to "1" (1ms), which is a undefined value.

MS fails to establish the traffic channel and transmits a GA-CSR ACTIVATE CHANNEL FAILURE and acts as if the GA-CSR ACTIVATE CHANNEL was not received.

Specific test parameters

-

Maximum Duration of Test

1 min.

Expected Sequence

Step	Direction		Message	Comment
	MS	SS		
1	MS			MS in GA-CSR-DEDICATED state, voice call is ongoing
2	←		GA-CSR ACTIVATE CHANNEL	This message has non-supportive configuration, with a "Sample Size" octet 3 set to "1"
3	MS			MS fails to establish the traffic channel
4	→		GA-CSR ACTIVATE CHANNEL FAILURE	IE 'FAILURE message identity'
5	←		GA-CSR RELEASE	IE 'RR cause' indicates #0
6	→		GA-CSR RELEASE COMPLETE	MS enters GA-CSR-IDLE state

82.5 Release of GA-CSR

82.5.1 Release of GA-CSR

82.5.1.1 Void

82.5.1.2 Void

82.6 Classmark Indication

82.6.1 Classmark Indication Procedure

82.6.1.1 Classmark Indication, Initiation of Classmark Interrogation by MS

82.6.1.1.1 Conformance requirement

On receipt of the GA-CSR CLASSMARK ENQUIRY message or in case of "early classmark sending" procedure based on the system information indication received in GA-RC REGISTER ACCEPT message, the mobile station sends a GA-CSR CLASSMARK CHANGE message to the GANC.

The MS shall include the IE "Mobile Classmark 2" in the GA-CSR CLASSMARK CHANGE. It may also contain a IE "Mobile Classmark 3" depending on the MS capabilities.

In addition a MS supporting UTRAN sends a GA-CSR UTRAN CLASSMARK CHANGE message.

The Classmark Enquiry Mask information element in the GA-CSR CLASSMARK ENQUIRY message indicates the type of request. If the Classmark Enquiry Mask information element is not included in the GA-CSR CLASSMARK ENQUIRY message, this indicates a request for GA-CSR CLASSMARK CHANGE message.

Reference(s)

3GPP TS 44.318 sub-clause 7.6.2

82.6.1.1.2 Test purpose

To verify that the MS replies the GA-CSR CLASSMARK ENQUIRY correctly.

82.6.1.1.3 Method of test

Initial conditions

System Simulator:

- 1 GAN cell, default parameter

Mobile Station:

- MS in state GA-CSR-DEDICATED

Foreseen final state of the MS

MS in GA-CSR- IDLE state.

Test procedure

The SS sends the GA-CSR CLASSMARK ENQUIRY message. The MS replies with the GA-CSR CLASMARK CHANGE message.

Specific Test Parameters

-

Maximum duration of test

1 min.

Reference(s)Expected sequence

Step	Direction		Message	Comment
	MS	SS		
1		←	GA-CSR CLASSMARK ENQUIRY	The Classmark Enquiry Mask information element is not included
2		→	GA-CSR CLASSMARK CHANGE	
3		←	GA-CSR RELEASE	IE 'RR cause' indicates #0
4		→	GA-CSR RELEASE COMPLETE	MS enters GA-CSR-IDLE state

82.7 Handover to GAN

82.7.1 Handover to GAN / successful cases

82.7.1.1 Handover from GERAN to GAN

82.7.1.1.1 Conformance requirement

3GPP TS 44.318 subclause 7.7.1:

The procedure is initiated when the source radio access technology (e.g. GERAN) orders the MS to make handover to GAN.

The procedure is applicable in GA-RC REGISTERED state provided the conditions described in Annex C: "(Source-RAT) Measurement Report for Handover and Cell Change Order to GAN" are met.

The handover order in the source radio access technology mode is sent via the (RR) HANDOVER COMMAND message. If the ARFCN and BSIC parameters included in the Cell Description IE in the (RR) HANDOVER COMMAND message (specified in [12]) match those of the GAN cell, the MS shall:

- send a GA-CSR HANDOVER ACCESS message to the network including the complete (RR) HANDOVER COMMAND message in the Handover To GAN Command IE and enter GA-CSR-DEDICATED state;

NOTE: sending the complete (RR) HANDOVER COMMAND message in the Handover To GAN Command IE instead of the Handover Reference IE allows for more than 256 concurrent handover requests

- if non-signalling mode is indicated in Channel Mode IE, the MS shall:

- start timer TU3920;

3GPP TS 44.318 subclause 7.7.3:

- If the traffic channel assignment was successfully completed within timer TU3920, the MS shall:
 - stop timer TU3920;
 - send a GA-CSR HANDOVER COMPLETE message to the network;
 - switch to GAN mode i.e. attach the GA-RR entity to the RR-SAP;

In addition the MS shall send upper layer messages for which LAPDm has not yet received acknowledgement from the network to the network using the GA-RR entity.

Reference(s)

3GPP TS 44.318 subclause 7.7.1 / 7.7.3

82.7.1.1.2 Test purpose

To verify that MS completes the handover procedure from GERAN to GAN successfully.

82.7.1.1.3 Method of test

Initial Conditions

System Simulator:

- 2 cells: GERAN cell & GAN cell
- 1 GERAN cell, default parameters
- 1 GAN cell, default parameters

Mobile Station:

- MS in GERAN mode in service of GERAN cell, voice call activated and in GA-RC-REGISTERED state

Foreseen Final State of the MS

MS in GA-CSR-IDLE state. Test Procedure

The MS is in GERAN mode in service of GERAN cell, voice call activated. MS sends MEASUREMENT REPORT with GAN-ARFCN within cell info list to GERAN cell and MS has not detected GSM neighbour cell matching the {GAN-ARFCN, GAN-BSIC} couple. SS sends (RR) HANDOVER COMMAND with ARFCN and BSIC in 'Cell Description' IE matched of the GAN cell. MS sends a GA-CSR HANDOVER ACCESS message to the GAN network with the complete (RR) HANDOVER COMMAND message in the 'Handover To GAN Command' IE and enters GA-CSR-DEDICATED state. MS establishes GAN traffic channel with SS and MS sends GA-CSR HANDOVER COMPLETE message to the SS.

Specific test parameters

-

Maximum Duration of Test

1 min.

Expected Sequence

Step	Direction		Message	Comment
	MS	SS		
1				MS in service voice call activated on GERAN cell
2		→	MEASUREMENT REPORT	Sent to GERAN cell with GAN-ARFCN within cell info list
3		←	RR HANDOVER COMMAND	Sent on GERAN cell with GAN cell ARFCN and BSIC and Channel Mode indicating speech.
4		→	GA-CSR HANDOVER ACCESS	Sent to GAN cell, with IE 'Handover To GAN Command', MS enters GA-CSR-DEDICATED state
5				GAN Traffic Channel assignment procedure (steps 5-10)
6		←	GA-CSR ACTIVATE CHANNEL	IE 'Channel Mode', IE 'Sample Size', IE 'UDP Port', IE 'IP address', optional IE 'Multi-rate Configuration', optional IE 'Payload Type'.
7		→	GA-CSR ACTIVATE CHANNEL ACK	IE 'UDP Port'
8		←	GA-CSR ACTIVATE CHANNEL COMPLETE	Optional IE 'RTCP UDP Port'
9		↔	RTP frame each 480 ms	To enable quality measurements
10				GAN Traffic Channel assignment procedure ready
11		→	GA-CSR HANDOVER COMPLETE	Sent to GAN cell, voice call ongoing on GAN cell
12		←	GA-CSR RELEASE	IE 'RR cause' indicates #0
13		→	GA-CSR RELEASE COMPLETE	MS enters GA-CSR-IDLE state

82.7.1.2 Handover from GERAN to GAN signalling case

82.7.1.2.1 Conformance requirement

The procedure is initiated when the source radio access technology (e.g. GERAN) orders the MS to make handover to GAN.

The procedure is applicable in GA-RC REGISTERED state provided the conditions described in Annex C: "(Source-RAT) Measurement Report for Handover and Cell Change Order to GAN" are met.

The handover order in the source radio access technology mode is sent via the (RR) HANDOVER COMMAND message. If the ARFCN and BSIC parameters included in the Cell Description IE in the (RR) HANDOVER COMMAND message (specified in [12]) match those of the GAN cell, the MS shall:

- send a GA-CSR HANDOVER ACCESS message to the network including the complete (RR) HANDOVER COMMAND message in the Handover To GAN Command IE and enter GA-CSR-DEDICATED state;

NOTE: sending the complete (RR) HANDOVER COMMAND message in the Handover To GAN Command IE instead of the Handover Reference IE allows for more than 256 concurrent handover requests

- if non-signalling mode is indicated in Channel Mode IE, the MS shall:
 - start timer TU3920;
- otherwise, the MS shall:
 - immediately send a GA-CSR HANDOVER COMPLETE message to the network;
 - switch to GAN mode i.e. attach the GA-RR entity to the RR-SAP;

Reference(s)

3GPP TS 44.318 subclauses 7.7.1

82.7.1.2.2 Test purpose

To verify that MS completes the handover signalling procedure from GERAN to GAN successfully.

82.7.1.2.3 Method of test

Initial Conditions

System Simulator:

- 2 cells: GERAN cell & GAN cell
- 1 GERAN cell, default parameters
- 1 GAN cell, default parameters

Mobile Station:

- MS in GERAN mode in service of GERAN cell, in GA-CSR-REGISTERED state

Foreseen Final State of the MS

MS in GA-CSR-IDLE state. Test Procedure

The MS is in GERAN mode in service of GERAN cell. MS sends MEASUREMENT REPORT with GAN-ARFCN within cell info list to GERAN cell and MS has not detected GSM neighbour cell matching the {GAN-ARFCN, GAN-BSIC} couple. SS sends (RR) HANDOVER COMMAND with ARFCN and BSIC in 'Cell Description' IE matched of the GAN cell. MS sends a GA-CSR HANDOVER ACCESS message to the GAN network with the complete (RR) HANDOVER COMMAND message in the 'Handover To GAN Command' IE and enters GA-CSR DEDICATED state. MS immediately sends GA-CSR HANDOVER COMPLETE message to the SS and switches to GAN mode i.e. attaches the GAN-RR entity to the RR-SAP.

Specific test parameters

-

Maximum Duration of Test

1 min.

Expected Sequence

Step	Direction		Message	Comment
	MS	SS		
1				MS in service on GERAN cell
2	→		MEASUREMENT REPORT	Sent to GERAN cell with GAN-ARFCN within cell info list
3	←		RR HANDOVER COMMAND	Sent on GERAN cell with GAN cell ARFCN and BSIC and Channel Mode indicating signalling only.
4	→		GA-CSR HANDOVER ACCESS	Sent to GAN cell, with IE 'Handover To GAN Command', MS enters GA-CSR DEDICATED state
5	→		GA-CSR HANDOVER COMPLETE	Immediately sent to GAN cell, MS switches to GAN mode
6	←		GA-CSR RELEASE	IE 'RR cause' indicates #0
7	→		GA-CSR RELEASE COMPLETE	MS enters GA-CSR-IDLE state

82.7.1.3 Handover from UTRAN to GAN

82.7.1.3.1 Conformance requirement

The procedure is initiated when the source radio access technology (e.g. GERAN) orders the MS to make handover to GAN.

The procedure is applicable in GA-RC-REGISTERED state provided the conditions described in Annex C: "(Source-RAT) Measurement Report for Handover and Cell Change Order to GAN" are met.

The handover order in the source radio access technology mode is sent via the (RR) HANDOVER COMMAND message. If the ARFCN and BSIC parameters included in the Cell Description IE in the (RR) HANDOVER COMMAND message (specified in [12]) match those of the GAN cell, the MS shall:

- send a GA-CSR HANDOVER ACCESS message to the network including the complete (RR) HANDOVER COMMAND message in the *Handover To GAN Command* IE and enter GA-CSR-DEDICATED state;

NOTE: sending the complete (RR) HANDOVER COMMAND message in the *Handover To GAN Command* IE instead of the *Handover Reference* IE allows for more than 256 concurrent handover requests

- if non-signalling mode is indicated in *Channel Mode* IE, the MS shall:
 - start timer TU3920;
- otherwise, the MS shall:
 - immediately send a GA-CSR HANDOVER COMPLETE message to the network;
 - switch to GAN mode i.e. attach the GA-RR entity to the RR-SAP;

If the traffic channel assignment was successfully completed within timer TU3920, the MS shall:

- stop timer TU3920;
- send a GA-CSR HANDOVER COMPLETE message to the network;
- switch to GAN mode i.e. attach the GA-RR entity to the RR-SAP;

In addition the MS shall send upper layer messages for which LAPDm has not yet received acknowledgement from the network to the network using the GA-RR entity.

Reference(s)

3GPP TS 44.318 subclause 7.7.1 / 7.7.3

82.7.1.3.2 Test purpose

To verify that MS completes the handover procedure from UTRAN to GAN successfully.

82.7.1.3.3 Method of test

Initial Conditions

System Simulator:

- 2 cells - Cell 1 is UTRAN (3GPP TS 34.108, subclause 6.1 shall be referenced for default parameters), Cell 2 is GAN (GAN default parameters)

Mobile Station:

- MS in UTRAN mode in service of UTRAN cell, voice call activated and in GA-RC-REGISTERED state

Foreseen Final State of the MS

MS in GA-CSR-IDLE state.

Test Procedure

The MS is in UTRAN mode in service of UTRAN cell, voice call activated. After measurement reporting procedure in UTRAN cell with successful reporting of the GAN cell, SS sends (RR) HANDOVER COMMAND with ARFCN and BSIC in 'Cell Description' IE of the GAN cell. MS sends a GA-CSR HANDOVER ACCESS message to the GAN network with the complete (RR) HANDOVER COMMAND message in the 'Handover To GAN Command' IE and enters GA-CSR-DEDICATED state. MS establishes GAN traffic channel with SS and MS sends GA-CSR HANDOVER COMPLETE message to the SS.

Specific test parameters

-

Maximum Duration of Test

2 min.

Expected Sequence

Step	Direction		Message	Comment
	MS	SS		
1				MS in service voice call activated on UTRAN cell
2		←	MEASUREMENT CONTROL	SS configures event 3a in the UE.
3		→	MEASUREMENT REPORT	UE sends a MEASUREMENT REPORT to SS triggered by event 3a. Measurement results for GAN cell are included with best possible receiving level (GSM carrier RSSI = 63).
4		←	HANDOVER FROM UTRAN COMMAND-GSM	Sent on cell 1 (UTRAN cell) GAN-ARFCN is assigned in (RR) HANDOVER COMMAND part of the message
5		→	GA-CSR HANDOVER ACCESS	Sent to GAN cell, with IE 'Handover To GAN Command', MS enters GA-CSR-DEDICATED state
6				GAN Traffic Channel assignment procedure (steps 5-10)
7		←	GA-CSR ACTIVATE CHANNEL	IE 'Channel Mode', IE 'Sample Size', IE 'UDP Port', IE 'IP address', optional IE 'Multi-rate Configuration', optional IE 'Payload Type'.
8		→	GA-CSR ACTIVATE CHANNEL ACK	IE 'UDP Port'
9		←	GA-CSR ACTIVATE CHANNEL COMPLETE	Optional IE 'RTCP UDP Port'
10		↔	RTP frame each 480 ms	To enable quality measurements
11				GAN Traffic Channel assignment procedure ready
12		→	GA-CSR HANDOVER COMPLETE	Sent to GAN cell, voice call ongoing on GAN cell
13		←	GA-CSR RELEASE	IE 'RR cause' indicates #0
14		→	GA-CSR RELEASE COMPLETE	MS enters GA-CSR-IDLE state

Specific Message Contents:

Default settings for measurement control from 3GPP TS 34.108 are used.

Following specific settings are applied:

MEASUREMENT CONTROL (Step 2)

Information Element	Value/remark
Measurement Identity	3
Measurement Command	Default
Measurement Reporting Mode	Default
- Measurement Reporting Transfer Mode	Default
- Periodic Reporting / Event Trigger Reporting Mode	Event triggered
Additional measurements list	Default
CHOICE measurement type	
- inter-RAT measurement	
- inter-RAT measurement object list	
CHOICE Inter-RAT Cell Removal	Remove all inter-RAT cells
- Remove all inter-RAT cells	(No Data)
New inter-RAT cells (1 to <MaxCellMeas>)	
- inter-RAT cell id	0
CHOICE Radio Access Technology	GSM
- Cell individual offset	0
- Cell selection and re-selection info	Not present
- BSIC	BSIC of GAN (cell 2)
- Band indicator	Default
- BCCH ARFCN	ARFCN not corresponding to a channel from any frequency band defined in 45.005
- Cell for measurement	Not present
- inter-RAT measurement quantity	
- Measurement quantity for UTRAN quality estimate	
- Intra-frequency measurement quantity	
- Filter coefficient	0
- CHOICE mode	FDD
- Measurement quantity	CPICH RSCP
CHOICE system	GSM
- Measurement quantity	GSM carrier RSSI
- Filter coefficient	0
- BSIC verification required	required
- inter-RAT reporting quantity	
CHOICE system	GSM
- Observed time difference to to GSM cell	FALSE
reporting indicator	
- GSM carrier RSSI reporting indicator	TRUE
CHOICE report criteria	
- Inter-RAT measurements reporting criteria	
- Parameters required for each event (1 to <maxMeasEvent>)	
- Inter-RAT event identity	3a
- Threshold own system	Default
- W	Default
- Threshold other system	Default
- Hysteresis	Default
- Time to Trigger	640 ms
- Reporting cell status	Report cells within active set or within virtual active set or of the other RAT
- Maximum number of reported cells	1 cells

82.7.2 Handover to GAN / negative cases

82.7.2.1 Void

82.7.2.2 TU3920 expires during handover procedure

82.7.2.2.1 Conformance requirement

If the traffic channel assignment procedure fails or the timer TU3920 expires before traffic channel assignment is completed, the MS shall:

- terminate the procedure including release of the associated GA-CSR resources;

- resume the connection in the source radio access technology used before the handover;
- indicate the failure to the source radio access technology.

Reference(s)

3GPP TS 44.318 subclause 7.7.5

82.7.2.2.2 Test purpose

To verify that MS is able to terminate the handover procedure and resume the connection in the source radio access technology used before the handover, if timer TU3920 expires during handover procedure.

82.7.2.2.3 Method of test

Initial Conditions

System Simulator:

- 2 cells: GERAN cell & GAN cell
- 1 GERAN cell, default parameters
- 1 GAN cell, default parameters

Mobile Station:

- MS in GERAN mode in service of GERAN cell, voice call activated and in GA-RC-REGISTERED state

Foreseen Final State of the MS

MS in GERAN mode in service of GERAN cell, voice call activated

Test Procedure

The MS is in GERAN mode in service of GERAN cell, voice call activated. MS sends MEASUREMENT REPORT with GAN-ARFCN within cell info list to GERAN cell and MS has not detected GSM neighbour cell matching the {GAN-ARFCN, GAN-BSIC} couple. SS sends RR HANDOVER COMMAND with ARFCN and BSIC in 'Cell Description' IE matched of the GAN cell. MS sends a GA-CSR HANDOVER ACCESS message to the GAN network with the complete (RR) HANDOVER COMMAND message in the 'Handover To GAN Command' IE and enters GA-CSR-DEDICATED state. TU3920 expires during handover procedure. MS terminates the handover procedure and resumes the connection in the source radio access technology used before the handover. MS returns HANDOVER FAILURE message to GERAN cell.

Specific test parameters

-

Maximum Duration of Test

1 min.

Expected Sequence

Step	Direction		Message	Comment
	MS	SS		
1				MS in service voice call activated on GERAN cell
2		→	MEASUREMENT REPORT	Sent to GERAN cell with GAN-ARFCN within cell info list
3		←	RR HANDOVER COMMAND	Sent on GERAN cell with GAN cell ARFCN and BSIC and Channel Mode indicating speech.
4		→	GA-CSR HANDOVER ACCESS	Sent to GAN cell, with IE 'Handover To GAN Command', MS enters GA-CSR-DEDICATED state
5		←	GA-CSR ACTIVATE CHANNEL	IE 'Channel Mode', IE 'Sample Size', IE 'UDP Port', IE 'IP address', optional IE 'Multi-rate Configuration', optional IE 'Payload Type'.
6		→	GA-CSR ACTIVATE CHANNEL ACK	IE 'UDP Port'
7				SS doesn't send GA-CSR ACTIVATE CHANNEL COMPLETE, TU3920 expires during GAN Traffic Channel assignment procedure
8	MS			MS terminates handover procedure and resumes connection on GERAN cell
9		→	HANDOVER FAILURE	Sent on GERAN cell

82.8 Handover from GAN

82.8.1 Handover from GAN / successful cases

82.8.1.1 Handover from GAN to GERAN

82.8.1.1.1 Conformance requirement

3GPP TS 44.318 subclause 7.8.1:

The purpose of this procedure is to transfer, upon request from the MS (and under the control of the GAN), a connection between MS and GAN to another radio access technology (e.g. GERAN).

The procedure is applicable in GA-CSR-DEDICATED state.

The procedure may be initiated by the MS based on:

- local measurements of GAN coverage signal quality;
- reception of a GA-CSR UPLINK QUALITY INDICATION message indicating poor uplink quality in the *UL Quality Indication* IE; If the UL Quality Indication IE indicates "Network problem" a handover out to GERAN or UTRAN should be attempted. In case the UL Quality Indication information element shows "Radio problem" or "Undetermined problem" a search for a new access point should be done before the handover out is initiated;
- reception of RTCP packets indicating poor uplink quality;
- excessive loss or delay in the received RTP packets.
- send a GA-CSR HANDOVER INFORMATION message to the network including a list of candidate/ target cell identifiers ranked in order of preference which is the most recent list available from the other radio access technology (e.g. GSM RR) and including the received signal strength for each identified GERAN or UTRAN cell. The MS may include GERAN cells, UTRAN cells or both.

3GPP TS 44.318 subclause 7.8.3:

The MS shall:

- suspend all NAS layer signalling transmissions;

- start the connection establishment to the target radio access technology (e.g. GERAN) by using the contents of the Handover From GAN Command IE. This message carries information about the candidate/ target cell identifier and radio parameters relevant for the target radio access technology;

A MS that is simultaneously operating in GPRS and CS modes over GAN shall follow the procedure as outlined in 3GPP TS 43.055 when it switches to target cell.

NOTE: The requirements concerning the establishment of the radio connection towards the target radio access technology (e.g. GERAN) and the signalling procedure are outside of the scope of this specification.

Upon successfully completing the handover, GAN should:

- release all radio resources associated with the GAN connection.

3GPP TS 44.318 subclause 7.8.4:

Upon successfully completing the handover, the MS shall:

- switch to target radio access technology (e.g. GERAN) mode i.e. detach the GA-RR entity from the RR-SAP;
- enter GA- RC -REGISTERED state.

NOTE: The release of the GAN radio resources is initiated from the target RAT. Subsequently the MS may deregister from GAN as defined in sub-clause 6.4.

Reference(s)

3GPP TS 44.318 subclause 7.8.1 / 7.8.3 / 7.8.4

82.8.1.1.2 Test purpose

To verify that MS is able to complete the handover procedure from GAN to GERAN successfully.

82.8.1.1.3 Method of test

Initial Conditions

System Simulator:

- 2 cells: GERAN cell & GAN cell
- 1 GERAN cell, default parameters
- 1 GAN cell, default parameters

Mobile Station:

- MS in GA-CSR-DEDICATED state in service of GAN cell, voice call activated

Foreseen Final State of the MS

MS in GERAN mode in service of GERAN cell, voice call activated

Test Procedure

The MS is in GA-CSR-DEDICATED state in service of GAN cell, voice call activated. SS sends GA-CSR UPLINK QUALITY INDICATION to the MS indicating poor uplink quality. MS sends a GA-CSR HANDOVER INFORMATION with candidate lists. SS sends GA-CSR HANDOVER COMMAND message to the MS. MS starts the connection establishment to the GERAN cell, switches to GERAN mode, detaches the GAN-RR entity, releases all radio resources associated with the GAN connection and enters GA-RC-REGISTERED state.

Specific test parameters

-

Maximum Duration of Test

2 min.

Expected Sequence

Step	Direction		Message	Comment
	MS	SS		
1				MS in GA-CSR-DEDICATED state in service of GAN cell, voice call activated
2		←	GA-CSR UPLINK QUALITY INDICATION	IE 'UL Quality Indication'
3		→	GA-CSR HANDOVER INFORMATION	IE 'Cell Identifier List'
4		←	GA-CSR HANDOVER COMMAND	IE 'Handover From GAN Command'. Indicates non-synchronized handover.
5		MS		MS establishes new connection to GERAN
6		→	HANDOVER ACCESS	Repeated on every burst of the uplink main DCCH until reception of PHYSICAL INFORMATION.
7		←	PHYSICAL INFORMATION	Sent after reception of n HANDOVER ACCESS message.
8		→	HANDOVER COMPLETE	Sent on GERAN cell
9		←	GA-CSR RELEASE	IE 'RR cause'
10		→	GA-CSR RELEASE COMPLETE	MS in GERAN mode in service of GERAN cell, voice call activated, MS in GA-CSR-REGISTERED state

82.8.1.2 Handover from GAN to UTRAN

82.8.1.2.1 Conformance requirement

3GPP TS 44.318 subclause 7.8.1:

The purpose of this procedure is to transfer, upon request from the MS (and under the control of the GAN), a connection between MS and GAN to another radio access technology (e.g. GERAN).

The procedure is applicable in GA-CSR-DEDICATED state.

The procedure may be initiated by the MS based on:

- local measurements of GAN coverage signal quality;
- reception of a GA-CSR UPLINK QUALITY INDICATION message indicating poor uplink quality in the *UL Quality Indication* IE; If the UL Quality Indication IE indicates "Network problem" a handover out to GERAN or UTRAN should be attempted. In case the UL Quality Indication information element shows "Radio problem" or "Undetermined problem" a search for a new access point should be done before the handover out is initiated;
- reception of RTCP packets indicating poor uplink quality;
- excessive loss or delay in the received RTP packets.

When the MS decides to trigger the handover from GAN, it shall:

- send a GA-CSR HANDOVER INFORMATION message to the network including a list of candidate/ target cell identifiers ranked in order of preference which is the most recent list available from the other radio access technology (e.g. GSM RR) and including the received signal strength for each identified GERAN or UTRAN cell. The MS may include GERAN cells, UTRAN cells or both.

3GPP TS 44.318 subclause 7.8.3:

The MS shall:

- suspend all NAS layer signalling transmissions;
- start the connection establishment to the target radio access technology (e.g. GERAN) by using the contents of the *Handover From GAN Command* IE. This message carries information about the candidate/ target cell identifier and radio parameters relevant for the target radio access technology;

A MS that is simultaneously operating in GPRS and CS modes over GAN shall follow the procedure as outlined in 3GPP TS 43.055 when it switches to target cell.

NOTE: The requirements concerning the establishment of the radio connection towards the target radio access technology (e.g. GERAN) and the signalling procedure are outside of the scope of this specification.

Upon successfully completing the handover, GAN should:

- release all radio resources associated with the GAN connection.

3GPP TS 44.318 subclause 7.8.4:

Upon successfully completing the handover, the MS shall:

- switch to target radio access technology (e.g. GERAN) mode i.e. detach the GA-RR entity from the RR-SAP;
- enter GA- RC -REGISTERED state.

NOTE: The release of the GAN radio resources is initiated from the target RAT. Subsequently the MS may deregister from GAN as defined in sub-clause 6.4.

Reference(s)

3GPP TS 44.318 subclause 7.8.1 / 7.8.3 / 7.8.4

82.8.1.2.2 Test purpose

To verify that MS is able to complete the handover procedure from GAN to UTRAN successfully.

82.8.1.2.3 Method of test

Initial Conditions

System Simulator:

- 2 cells - Cell 1 is GAN (GAN default parameters), Cell 2 is UTRAN (3GPP TS 34.108, subclause 6.1 shall be referenced for default parameters)

Mobile Station:

- MS in GA-CSR-DEDICATED state in service of GAN cell, voice call activated

Foreseen Final State of the MS

MS in UTRAN mode in service of UTRAN cell, voice call activated

Test Procedure

The MS is in GA-CSR-DEDICATED state in service of GAN cell, voice call activated. SS sends GA-CSR UPLINK QUALITY INDICATION to the MS indicating poor uplink quality. MS sends a GA-CSR HANDOVER INFORMATION with candidate lists including cell 2 (UTRAN). SS sends GA-CSR HANDOVER COMMAND message to the MS. MS starts the connection establishment to the UTRAN cell, switches to UTRAN mode, detaches the GAN-RR entity, releases all radio resources associated with the GAN connection and enters GA-CSR-REGISTERED state.

Specific test parameters

-

Maximum Duration of Test

2 min.

Expected Sequence

Step	Direction		Message	Comment
	MS	SS		
1				MS in GA-CSR-DEDICATED state in service of GAN cell, voice call activated
2		SS		The SS configures the dedicated channel with the configuration: conversational/speech/UL:12.2 DL:12.2 kbps/CS RAB + UL:3.4 DL3.4 kbps SRBs in UTRAN cell.
3		←	GA-CSR UPLINK QUALITY INDICATION	IE 'UL Quality Indication'
4		→	GA-CSR HANDOVER INFORMATION	IE 'UTRAN Cell Identifier List' and 'UTRAN Received Signal Level List' shall be present. UTRAN cell 2 shall be indicated.
5		←	GA-CSR HANDOVER COMMAND	Value part of IE 'Handover From GAN Command' includes INTERSYSTEM TO UTRAN HANDOVER COMMAND.
6		MS		The MS accepts the handover command and configures its lower layers using the parameters from INTERSYSTEM TO UTRAN HANDOVER COMMAND.
7		SS		The SS waits for uplink physical channel in synchronization.
8		→	HANDOVER TO UTRAN COMPLETE	The SS receives this message on DCCH of cell 2 (UTRAN cell). It implies that the down link physical channel has synchronised with UTRAN.
9		←	GA-CSR RELEASE	IE 'RR cause'
10		→	GA-CSR RELEASE COMPLETE	MS in UTRAN mode in service of UTRAN cell, voice call activated, MS in GA-CSR-REGISTERED state

82.8.2 Handover from GAN / negative cases

82.8.2.1 Connection establishment fails on GERAN cell

82.8.2.1.1 Conformance requirement

If the MS does not succeed in establishing a connection to the target radio access technology, the MS shall:

- revert back to the GAN configuration;
- return a GA-CSR HANDOVER FAILURE message and resume normal operation as if the GA-CSR HANDOVER COMMAND message has not been received. The cause shall be set as specified in 3GPP TS 44.018.

Reference(s)

3GPP TS 44.318 subclause 7.8.5

82.8.2.1.2 Test purpose

To verify that if MS fails to complete requested handover to GERAN, MS reverts back to the GAN configuration.

82.8.2.1.3 Method of test

Initial Conditions

System Simulator:

- 2 cells: GERAN cell & GAN cell
- 1 GERAN cell, default parameters

- 1 GAN cell, default parameters

Mobile Station:

- MS in GA-CSR-DEDICATED state in service of GAN cell, voice call activated

Foreseen Final State of the MS

MS in GA-CSR-IDLE state

Test Procedure

The MS is in GA-CSR-DEDICATED state in service of GAN cell, voice call activated. SS sends GA-CSR UPLINK QUALITY INDICATION to the MS indicating poor uplink quality. MS sends a GA-CSR HANDOVER INFORMATION with candidate lists. SS sends GA-CSR HANDOVER COMMAND message to the MS. MS starts the connection establishment to the GERAN cell. MS does not succeed in establishing a connection to the target GERAN cell. MS reverts back to the GAN configuration, sends a GA-CSR HANDOVER FAILURE message and resumes normal operation.

Specific test parameters

-

Maximum Duration of Test

2 min.

Expected Sequence

Step	Direction		Message	Comment
	MS	SS		
1				MS in GA-CSR-DEDICATED state in service of GAN cell, voice call activated
2		←	GA-CSR UPLINK QUALITY INDICATION	IE 'UL Quality Indication'
3		→	GA-CSR HANDOVER INFORMATION	IE 'Cell Identifier List'
4		←	GA-CSR HANDOVER COMMAND	IE 'Handover From GAN Command'. Indicates non-synchronized handover.
5		→	HANDOVER ACCESS	Repeated until T3124 (TS 3GPP 44.018) expires.
6		→	GA-CSR HANDOVER FAILURE	IE 'RR Cause' as in test case 26.6.5.8.
7		←	GA-CSR RELEASE	IE 'RR cause' indicates #0
8		→	GA-CSR RELEASE COMPLETE	MS enters GA-CSR-IDLE state

82.8.2.2 Handover command with non-supported configuration

82.8.2.2.1 Conformance requirement

If the GA-CSR HANDOVER COMMAND message instructs the MS:

- to perform a non-supported scenario, or
- to use a non-supported configuration,

the MS shall return a GA-CSR HANDOVER FAILURE message with cause as defined in 3GPP TS 44.018 and resume normal operation as if the GA-CSR HANDOVER COMMAND message has not been received.

Reference(s)

3GPP TS 44.318 subclause 7.8.7

82.8.2.2.2 Test purpose

To verify that if the GA-CSR HANDOVER COMMAND message instructs the MS to use a non-supported configuration, MS resumes normal operation as if the GA-CSR HANDOVER COMMAND message has not been received.

82.8.2.2.3 Method of test

Initial Conditions

System Simulator:

- 2 cells: GERAN cell & GAN cell
- 1 GERAN cell, default parameters
- 1 GAN cell, default parameters

Mobile Station:

- MS in GA-CSR-DEDICATED state in service of GAN cell, voice call activated

Foreseen Final State of the MS

MS in GA-CSR-IDLE state.

Test Procedure

The MS is in GA-CSR-DEDICATED state in service of GAN cell, voice call activated. SS sends GA-CSR UPLINK QUALITY INDICATION to the MS indicating poor uplink quality. MS sends a GA-CSR HANDOVER INFORMATION with candidate lists. SS sends GA-CSR HANDOVER COMMAND message to the MS. The GA-CSR HANDOVER COMMAND message instructs the MS to use a not supported frequency. MS sends a GA-CSR HANDOVER FAILURE message and resumes normal operation as if the GA-CSR HANDOVER COMMAND message has not been received.

Specific test parameters

-

Maximum Duration of Test

2 min.

Expected Sequence

Step	Direction		Message	Comment
	MS	SS		
1				MS in GA-CSR-DEDICATED state in service of GAN cell, voice call activated
2	←		GA-CSR UPLINK QUALITY INDICATION	IE 'UL Quality Indication'
3		→	GA-CSR HANDOVER INFORMATION	IE 'Cell Identifier List'
4	←		GA-CSR HANDOVER COMMAND	Handover to frequency not supported by the MS.
5		→	GA-CSR HANDOVER FAILURE	With IE 'RR Cause' " <i>frequency not implemented</i> ", MS resumes normal operation on GAN cell
6	←		GA-CSR RELEASE	IE 'RR cause' indicates #0
7		→	GA-CSR RELEASE COMPLETE	MS enters GA-CSR-IDLE state

82.9 Ciphering Configuration Procedure

82.9.1 Ciphering Configuration Procedure, Normal cases

82.9.1.1 Ciphering Configuration Procedure

82.9.1.1.1 Conformance requirement

The network initiates the ciphering mode setting procedure by sending a GA-CSR CIPHERING MODE COMMAND message to the mobile station, indicating whether ciphering shall be used or not, and if yes which algorithm to use.

Additionally, the network may, by the use of the cipher response information element, request the mobile station to include its IMEISV in the GA-CSR CIPHERING MODE COMPLETE message.

Whenever the mobile station receives a valid GA-CSR CIPHERING MODE COMMAND message, it shall, if a SIM is present and considered valid and the ciphering key sequence number stored on the SIM indicates that a ciphering key is available, save information about the ciphering key to use if the MS is later performing Handover from GAN. A valid GA-CSR CIPHERING MODE COMMAND message is defined to be one of the following:

- one that indicates "start ciphering" and is received by the mobile station in the "not ciphered" mode;
- one that indicates "no ciphering" and is received by the MS in the "not ciphered" mode; or
- one that indicates "no ciphering" and is received by the mobile station in the "ciphered" mode.

Other GA-CSR CIPHERING MODE COMMAND messages shall be regarded as erroneous, and a GA-CSR STATUS message with cause "Protocol error unspecified" shall be returned, and no further action taken.

The MS shall also calculate a MAC (Message Authentication Code). The MAC shall be calculated over the following data:

RAND | IMSI

using "HMAC-SHA1-96" algorithm, as specified in [24] with Kc as authentication key.

In the formulas above, the "|" character denotes concatenation. RAND is the 16-octet random number received from the GANC in the GA-CSR CIPHERING MODE COMMAND message. IMSI is the MS IMSI, in the same format as defined for the Mobile Identity IE as defined in [8 / 3GPP TS 44.318 v.6.0.0] i.e. as a variable-length sequence of digits in BCD format (e.g. the IMSI "123456789098765" is encoded as the following octets (in hexadecimal): "21 43 65 87 09 89 67 F5"). Network byte order is used.

The Kc key is the Kc that has been derived during the last authentication. The length of the MAC is 12 octets.

When the appropriate action on the GA-CSR CIPHERING MODE COMMAND message has been taken, the mobile station sends back a GA-CSR CIPHERING MODE COMPLETE message. If the "cipher response" field of the cipher response information element in the GA-CSR CIPHERING MODE COMMAND message specified "IMEISV must be included" the mobile station shall include its IMEISV in the GA-CSR CIPHERING MODE COMPLETE message.

Reference(s)

3GPP TS 44.318 sub-clause 7.9.1 and 7.9.2

82.9.1.1.2 Test purpose

To verify that the MS can reply a GA-CSR CIPHERING MODE COMMAND message and return the correct Message Authentication Code (MAC).

82.9.1.1.3 Method of test

Initial conditions

System Simulator:

- 1 GAN cell, default parameter

Mobile Station:

- MS in state GA-CSR-DEDICATED
- MS in not ciphered mode

Foreseen final state of the MS

MS in GA-CSR IDLE state. Test procedure

The SS sends the GA-CSR CIPHERING MODE message. The Cipher Response IE should indicate that IMEISV should not be included. The MS replies with the GA-CSR CIPHERING MODE COMPLETE message. SS checks that the IMEISV is not included and that the MAC is correct. The SS sends another GA-CSR CIPHERING MODE COMMAND message with SC in Cipher Mode Setting IE set to "No ciphering". The MS replies with the GA-CSR CIPHERING MODE COMPLETE message. The SS sends new GA-CSR CIPHERING MODE message. The Cipher

Response IE should indicate that IMEISV should be included. The MS replies with the GA-CSR CIPHERING MODE COMPLETE message. SS checks that the IMEISV is included and that the MAC is correct.

Specific Test Parameters

-

Maximum duration of test

1 min.

Reference(s)Expected sequence

Step	Direction		Message	Comment
	MS	SS		
1		←	GA-CSR CIPHERING MODE COMMAND	Indicate that IMEISV should not be included
2		→	GA-CSR CIPHERING MODE COMPLETE	SS checks that the IMEISV is not included and that the MAC is correct
3		←	GA-CSR CIPHERING MODE COMMAND	SC indicating "No Ciphering" Indicate that IMEISV should be included SS checks that the IMEISV is included and that the MAC is correct
4		→	GA-CSR CIPHERING MODE COMPLETE	
5		←	GA-CSR CIPHERING MODE COMMAND	
6		→	GA-CSR CIPHERING MODE COMPLETE	
7		←	GA-CSR RELEASE	IE 'RR cause' #0
8		→	GA-CSR RELEASE COMPLETE	MS enters GA-CSR-IDLE state

82.9.1.2 Void

82.9.2 Ciphering Configuration Procedure, Abnormal cases

82.9.2.1 Ciphering Configuration Procedure, Invalid Ciphering Mode Command

82.9.2.1.1 Conformance requirement

Whenever the mobile station receives a valid GA-CSR CIPHERING MODE COMMAND message, it shall, if a SIM is present and considered valid and the ciphering key sequence number stored on the SIM indicates that a ciphering key is available, save information about the ciphering key to use if the MS is later performing Handover from GAN. A valid GA-CSR CIPHERING MODE COMMAND message is defined to be one of the following:

- one that indicates "start ciphering" and is received by the mobile station in the "not ciphered" mode;
- one that indicates "no ciphering" and is received by the MS in the "not ciphered" mode; or
- one that indicates "no ciphering" and is received by the mobile station in the "ciphered" mode.

Other GA-CSR CIPHERING MODE COMMAND messages shall be regarded as erroneous, and a GA-CSR STATUS message with cause "Protocol error unspecified" shall be returned, and no further action taken.

Reference(s)

3GPP TS 44.318 sub-clause 7.9.2

82.9.2.1.2 Test purpose

To verify that the MS can reject a GA-CSR CIPHERING MODE COMMAND in the wrong ciphering mode by returning the GA-CSR STATUS message with cause "Protocol error unspecified".

82.9.2.1.3 Method of test

Initial conditions

System Simulator:

- 1 GAN cell, default parameter

Mobile Station:

- MS in state GA-CSR-DEDICATED
- MS in not ciphered mode

Foreseen final state of the MS

MS in GA-CSR IDLE state. Test procedure

The SS sends the GA-CSR CIPHERING MODE message. The MS replies with the GA-CSR CIPHERING MODE COMPLETE message and changes to ciphered mode. The SS sends another GA-CSR CIPHERING MODE message. The MS responds with an GA-CSR STATUS message with cause "Protocol error unspecified".

Specific Test Parameters

-

Maximum duration of test

1 min.

Expected sequence

Step	Direction		Message	Comment
	MS	SS		
1		←	GA-CSR CIPHERING MODE COMMAND	Indicating "start ciphering"
2		→	GA-CSR CIPHERING MODE COMPLETE	
3		←	GA-CSR CIPHERING MODE COMMAND	Indicating "start ciphering"
4		→	GA-CSR STATUS	Cause: Protocol error unspecified.
5		←	GA-CSR RELEASE	IE 'RR cause' #0
6		→	GA-CSR RELEASE COMPLETE	MS enters GA-CSR-IDLE state

82.10 Channel mode modify procedure

82.10.1 Channel mode modify procedure / successful cases

82.10.1.1 Channel mode modify / successful case

82.10.1.1.1 Conformance requirement

In dedicated mode, the GANC can request a modification of the channel mode, multi-rate configuration, RTP redundancy configuration, sample size, GANC IP address, GANC RTP UDP port and GANC RTCP UDP port used for an active traffic channel.

The channel mode modify procedure allows the network to request the mobile station to modify configuration used for an active channel. The channel mode covers the coding, decoding and transcoding mode as well as the redundancy policy used on the active channel.

This procedure is always initiated by the network.

The network initiates the procedure by sending a GA-CSR CHANNEL MODE MODIFY message to the mobile station.

When the MS has received the GA-CSR CHANNEL MODE MODIFY message, the mobile station modifies the configuration, sets the mode and/or the RTP redundancy configuration for the active channel and then replies by a GA-CSR CHANNEL MODE MODIFY ACKNOWLEDGE message indicating the ordered channel mode.

Reference(s)

3GPP TS 44.318 subclauses 7.10 / 7.10.1.1 / 7.10.1.2

82.10.1.1.2 Test purpose

To verify that MS is able to change active channel mode if requested when it is different from the one used by the

mobile station or whether it is already in use.

82.10.1.1.3 Method of test

Initial Conditions

System Simulator:

- 1 GAN cell, default parameters

Mobile Station:

- MS in GA-CSR-DEDICATED state in service of GAN cell, voice call activated

Foreseen Final State of the MS

MS in GA-CSR-IDLE state

Test Procedure

The MS is in GA-CSR-DEDICATED state in service of GAN cell, voice call activated. SS sends GA-CSR CHANNEL MODE MODIFY message to change active channel mode. The mode is different from the one used by the mobile station. MS sets the mode for the active channel and then replies by a GA-CSR CHANNEL MODE MODIFY ACKNOWLEDGE message indicating the ordered channel mode.

Specific test parameters

-

Maximum Duration of Test

1 min.

Expected Sequence

Step	Direction		Message	Comment
	MS	SS		
1	MS			MS in service voice call activated on GAN cell
2	←		GA-CSR CHANNEL MODE MODIFY	IE 'Channel Mode'
3	MS			MS sets the different mode
4	→		GA-CSR CHANNEL MODE MODIFY ACKNOWLEDGE	
5	MS			MS in service voice call activated on GAN cell with different channel mode
6	←		GA-CSR RELEASE	IE 'RR cause' indicates #0
7	→		GA-CSR RELEASE COMPLETE	MS enters GA-CSR-IDLE state

82.10.2 Channel mode modify procedure / negative cases

82.10.2.1 Channel mode modify indicates non-supported mode

82.10.2.1.1 Conformance requirement

If the GA-CSR CHANNEL MODE MODIFY message includes IE "RTP Redundancy Configuration" and MS has indicated that it does not support RTP Redundancy through the GAN Classmark, it shall ignore the IE "RTP Redundancy Configuration".

If the mobile station does not support the indicated channel mode or sample size modifications, it shall retain the old mode and return the used configuration in the GA-CSR CHANNEL MODE MODIFY ACKNOWLEDGE message.

Reference(s)

3GPP TS 44.318 subclause 7.10.1.3

82.10.2.1.2 Test purpose

To verify that MS is able to retain the old channel mode, if GA-CSR CHANNEL MODE MODIFY is requested with non-supported mode.

82.10.2.1.3 Method of test

Initial Conditions

System Simulator:

- 1 GAN cell, default parameters

Mobile Station:

- MS in GA-CSR-DEDICATED state in service of GAN cell, voice call activated

Foreseen Final State of the MS

MS in GA-CSR-IDLE state

Test Procedure

The MS is in GA-CSR-DEDICATED state in service of GAN cell, voice call activated. SS sends GA-CSR CHANNEL MODE MODIFY message to change active channel mode. The requested mode is not supported by the mobile station. MS retains the old mode for the active channel and then replies by a GA-CSR CHANNEL MODE MODIFY ACKNOWLEDGE message with associated channel mode.

Specific test parameters

-

Maximum Duration of Test

1 min.

Expected Sequence

Step	Direction		Message	Comment
	MS	SS		
1	MS			MS in service voice call activated on GAN cell
2	←		GA-CSR CHANNEL MODE MODIFY	IE Channel Mode, requested mode is not supported by the MS
3	MS			MS retains the old mode
4	→		GA-CSR CHANNEL MODE MODIFY ACKNOWLEDGE	Associated with old channel mode
5	MS			MS in service voice call activated on GAN cell with old channel mode
6	←		GA-CSR RELEASE	IE 'RR cause' indicates #0
7	→		GA-CSR RELEASE COMPLETE	MS enters GA-CSR-IDLE state

83 GAN PS Domain Procedures

83.1 GA-PSR Transport Channel Activation & Deactivation Procedures

83.1.1 GA-PSR Transport Channel Activation & Deactivation Procedures, Normal Cases

83.1.1.1 MS Initiated GA-PSR TC Activation

83.1.1.1.1 Conformance requirements

Upon receiving the uplink user data transfer request from the LLC for LLC SAPI 3, 5, 9 or 11 and while the MS GA-PSR is in the GA-PSR-STANDBY state, the MS shall,

- send a GA-PSR-ACTIVATE-UTC-REQ message,
- start timer TU4002,
- set the uplink packet sequence number to 0,
- set the expected downlink packet sequence number to 0 and

Upon receiving the GA-PSR-ACTIVATE-UTC-ACK message while the MS initiated GA-PSR TC activation is in progress, the MS shall stop timer TU4002, create and store the corresponding GA-PSR TC information and the MS GA-PSR shall transition into GA-PSR-ACTIVE state. The MS GA-PSR shall start TU4001 timer and forward any outstanding uplink user data packets. The TU4001 timer is restarted whenever any user data packet is sent to or received from the GANC.

References

3GPP TS 44.318, subclauses 8.2.1 & 8.2.3

83.1.1.1.2 Test purpose

To verify that on receiving uplink data request from LLC in GA-PSR-STANDBY state, MS shall initiate GA-PSR TC Activation procedure.

To verify that on receipt of acknowledgment from GANC for the activation request MS shall move into GA-PSR-ACTIVE state.

83.1.1.1.3 Method of test

Initial Conditions

System Simulator:

- 1 GAN cell, default parameters

Mobile Station:

- MS GA-PSR is in the GA-PSR-STANDBY state. PDP context 1 is activated.

Foreseen Final State of the MS

MS in GA-PSR-STANDBY state in service of GAN cell.

Test Procedure

MS is made to initiate the GA-PSR TC and send to SS the GA-PSR-ACTIVATE-UTC-REQ.

The SS responds to MS with GA-PSR-ACTIVATE-UTC-ACK and the MS transmits GA-PSR-UNITDATA with the data to SS.

Maximum Duration of Test

1 min.

Expected Sequence

Step	Direction		Message	Comments
	MS	SS		
1	MS			MS initiated GA-PSR TC activation
2		→	GA-PSR-ACTIVATE-UTC-REQ	MS initiated GA-PSR-ACTIVE state
3		←	GA-PSR-ACTIVATE-UTC-ACK	
4		→	GA-PSR-UNITDATA	SS confirms that the MS is in GA-PSR-ACTIVE state.
5		←	GA-PSR-DEACTIVATE-UTC-REQ	
6		→	GA-PSR-DEACTIVATE-UTC-ACK	

Specific Message Contents

-

83.1.2 GA-PSR Transport Channel Activation & Deactivation Procedures, Abnormal Cases.

83.1.2.1 GA-PSR TC Activation Collision

83.1.2.1.1 Conformance requirements

If the GANC receives a GA-PSR-ACTIVATE-UTC-REQ message from the MS while the network initiated GA-PSR TC activation procedure is in progress, the GANC aborts the network initiated activation procedure and responds to the MS with the GA-PSR-ACTIVATE-UTC-ACK message including the cause indicating successful activation. The message includes GANC IP address and GANC UDP port to be used for the uplink GPRS user data transport.

If the MS receives a GA-PSR-ACTIVATE-UTC-REQ message from the GANC while the MS initiated GA-PSR TC activation procedure is in progress, the MS shall silently discard the request and wait for the acknowledgment related to the MS initiated activation already in progress.

Upon receiving the uplink user data transfer request from the LLC for LLC SAPI 3, 5, 9 or 11 and while the MS GA-PSR is in the GA-PSR-STANDBY state, the MS shall,

- send a GA-PSR-ACTIVATE-UTC-REQ message,
- start timer TU4002,
- set the uplink packet sequence number to 0,
- set the expected downlink packet sequence number to 0 and

Upon receiving the GA-PSR-ACTIVATE-UTC-ACK message while the MS initiated GA-PSR TC activation is in progress, the MS shall stop timer TU4002, create and store the corresponding GA-PSR TC information and the MS GA-PSR shall transition into GA-PSR-ACTIVE state. The MS GA-PSR shall start TU4001 timer and forward any outstanding uplink user data packets. The TU4001 timer is restarted whenever any user data packet is sent to or received from the GANC.

References

3GPP TS 44.318, subclauses 8.2.1; 8.2.3 & 8.2.4.1

83.1.2.1.2 Test purpose

To verify that on receiving a GA-PSR-ACTIVATE-UTC-REQ message from the GANC while the MS initiated GA-PSR TC activation procedure is in progress, the MS shall silently discard the request and wait for the acknowledgment related to the MS initiated activation already in progress.

83.1.2.1.3 Method of test

Initial Conditions

System Simulator:

- 1 GAN cell, default parameters

Mobile Station:

- MS GA-PSR is in the GA-PSR-STANDBY state. PDP context 1 is activated.

Foreseen Final State of the MS

MS in GA-PSR-STANDBY state in service of GAN cell

Test Procedure

MS is made to initiate MS GA-PSR TC activation procedure and hence the MS receives a GA-PSR-ACTIVATE-UTC-REQ message from the GANC.

MS waits for the GA-PSR-ACTIVATE-UTC-ACK, while ignoring the GA-PSR-ACTIVATE-UTC-REQ from the GANC. Upon receiving the GA-PSR-ACTIVATE-UTC-ACK from the GANC, the MS enters the GA-PSR-ACTIVE state, transmitting the GA-PSR-UNITDATA to the SS. SS confirms that MS in the GA-PSR-ACTIVE state by receiving the GA-PSR-UNITDATA message.

Maximum Duration of Test

1 min.

Expected Sequence

Step	Direction		Message	Comments
	MS	SS		
1		MS		MS is made to initiate GA-PSR TC
2	→		GA-PSR-ACTIVATE-UTC-REQ	MS initiated GA-PSR-ACTIVE state
3	←		GA-PSR-ACTIVATE-UTC-REQ	SS initiated GA-PSR-ACTIVE state
4	←		GA-PSR-ACTIVATE-UTC-ACK	MS is waiting for this message
5	→		GA-PSR-UNITDATA	MS is transmitting the uplink user data packets
6	←		GA-PSR-DEACTIVATE-UTC-REQ	SS initiates the deactivation
7	→		GA-PSR-DEACTIVATE-UTC-ACK	MS response on deactivation

Specific Message Contents

-

83.1.2.2 GANC Rejects GA-PSR TC Activation

83.1.2.2.1 Conformance requirements

Upon receiving the uplink user data transfer request from the LLC for LLC SAPI 3, 5, 9 or 11 and while the MS GA-PSR is in the GA-PSR-STANDBY state, the MS shall,

- send a GA-PSR-ACTIVATE-UTC-REQ message,
- start timer TU4002,
- set the uplink packet sequence number to 0,
- set the expected downlink packet sequence number to 0 and

If the GANC decides to reject GA-PSR TC activation, it shall send a GA-PSR-ACTIVATE-UTC-ACK message to the MS with the failure cause code and shall not include GANC IP address and UDP port number. The following rejection cause values are supported:

- "No available resources" indicates that the GANC failed to allocate required resources.

- "GANC failure" indicates internal GANC failure
- "Not authorized for data service" indicates that the MS is not authorized to use data services via GAN

Upon receiving the GA-PSR-ACTIVATE-UTC-ACK message indicating failure, the MS shall declare the procedure as failed to the upper layers.

References

3GPP TS 44.318, subclauses 8.2.1; 8.2.4.1; 8.2.4.4

83.1.2.2.2 Test purpose

To verify that by receiving the GA-PSR-ACTIVATE-UTC-ACK message with the failure cause code, described below, the MS would declare the procedure as failed to the upper layers.

83.1.2.2.3 Method of test

Initial Conditions

System Simulator:

- 1 GAN cell, default parameters

Mobile Station:

- MS GA-PSR is in the GA-PSR-STANDBY state. PDP context 1 is activated.

Foreseen Final State of the MS

MS in GA-PSR-STANDBY state in service of GAN cell

Test Procedure

The MS initiates the GA-PSR-ACTIVE state transmitting GA-PSR-ACTIVATE-UTC-REQ to the SS. The SS responds with GA-PSR-ACTIVATE-UTC-ACK with failure code "No available resources". The MS remains in the GA-PSR-STANDBY state. To confirm that the MS is in the GA-PSR-STANDBY state, the SS sends GA-PSR-ACTIVATE-UTC-REQ and waits for the GA-PSR-ACTIVATE-UTC-ACK from the MS. Upon receiving the GA-PSR-ACTIVATE-UTC-ACK, the SS concludes that the MS was in GA-PSR-STANDBY state in step 4.

Maximum Duration of Test

1 min.

Expected Sequence

Step	Direction		Message	Comments
	MS	SS		
1				MS is made to initiate GA-PSR TC
2		→	GA-PSR-ACTIVATE-UTC-REQ	MS initiated GA-PSR-ACTIVE state
3		←	GA-PSR-ACTIVATE-UTC-ACK	Failure code is "No available resources" without valid IP address and port
4		MS		MS is declaring the procedure as failed to the upper layers and remains to be in the GA-PSR-STANDBY state.
5		←	GA-PSR-ACTIVATE-UTC-REQ	
6		→	GA-PSR-ACTIVATE-UTC-ACK	SS confirms that the MS was in the GA-PSR-STANDBY state.
7		←	GA-PSR-DEACTIVATE-UTC-REQ	
8		→	GA-PSR-DEACTIVATE-UTC-ACK	

Specific Message Contents

-

83.1.3 Network Initiated GA-PSR Transport Channel Activation, Normal Case

83.1.3.1 Processing of the GA-PSR TC Activation Request by the MS

83.1.3.1.1 Conformance requirements

Upon receiving the downlink user data transfer request associated with LLC SAPI 3, 5, 9 or 11 and if there is no GA-PSR TC associated with the specific MS, the GANC allocates the IP address and the UDP port number to be used by the MS for GPRS user data transport and sends a GA-PSR-ACTIVATE-UTC-REQ message to the MS. The GANC also:

- sets downlink packet sequence number to 0 and
- sets the expected uplink packet sequence number to 0

Upon receiving the GA-PSR-ACTIVATE-UTC-REQ message from the GANC, the MS shall verify the following:

- the GA-PSR is in GA-PSR-STANDBY state
- the GA-PSR TC does not exist
- the GPRS service is not suspended

Assuming successful verification, the MS shall allocate UDP port number for the MS GPRS user data transport and store the associated information. In parallel, the MS GA-PSR shall transition to GA-PSR-ACTIVE state and start TU4001 timer. Subsequently, the MS shall send the GA-PSR-ACTIVATE-UTC-ACK message to the GANC with the cause indicating successful activation. The message includes the MS UDP port to be used for the downlink GPRS user data transport.

After the MS has sent the GA-PSR-ACTIVATE-UTC-ACK message, it shall:

- set the uplink packet sequence number to 0 and
- set the expected downlink packet sequence number to 0

When the TU4001 timer expires and if there are no outstanding uplink GPRS user data messages to be transferred, the MS GA-PSR shall send the GA-PSR-DEACTIVATE-UTC-REQ message to the GANC to request the deactivation of the transport channel. In parallel, the MS shall start TU4002 timer to wait for the confirmation.

References

3GPP TS 44.318, subclauses 8.3.1; 8.3.2 & 8.4.1

83.1.3.1.2 Test purpose

To verify that on receiving the GA-PSR-ACTIVATE-UTC-REQ message from the GANC, MS will:

- 1) Allocate UDP port number for the MS GPRS user data transport and store the associated information.
- 2) Transition to GA-PSR-ACTIVE state and start TU4001 timer.
- 3) Send the GA-PSR-ACTIVATE-UTC-ACK message to the GANC with the cause indicating successful activation.
- 4) Includes the MS UDP port to be used for the downlink GPRS user data transport in the GA-PSR-ACTIVATE-UTC-ACK message.
- 5) Set uplink packet sequence number to 0 and
- 6) Set the expected downlink packet sequence number to 0

83.1.3.1.3 Method of test

Initial Conditions

System Simulator:

- 1 GAN cell, default parameters

Mobile Station:

- MS GA-PSR is in the GA-PSR-STANDBY state. PDP context 1 is activated.

Foreseen Final State of the MS

MS in GA-PSR-STANDBY state in service of GAN cell

Test Procedure

The SS initiates the GA-PSR-ACTIVE state transmitting GA-PSR-ACTIVATE-UTC-REQ to the MS. MS responds with GA-PSR-ACTIVATE-UTC-ACK and starts TU4001. SS does not transmit any data for the time exceeding TU4001. The MS transmits GA-PSR-DEACTIVATE-UTC-REQ, confirming that the MS was in GA-PSR-ACTIVE state and TU4001 has been started in step 2.

Maximum Duration of Test

1 min.

Expected Sequence

Step	Direction		Message	Comments
	MS	SS		
1		←	GA-PSR-ACTIVATE-UTC-REQ	
2		→	GA-PSR-ACTIVATE-UTC-ACK	SS verifying the IE UDP Port for GPRS user data transport (port number for DL)
3		SS		Waiting for time exceeding TU4001
4		→	GA-PSR-DEACTIVATE-UTC-REQ	SS confirms that the MS was in GA-PSR-ACTIVE state in step 3.
5		←	GA-PSR-DEACTIVATE-UTC-ACK	

Specific Message Contents

-

83.1.4 Network Initiated GA-PSR Transport Channel Activation, Abnormal Cases

83.1.4.1 Void

83.1.4.2 MS Rejects GA-PSR TC Activation when the GPRS Service is suspended

83.1.4.2.1 Conformance requirements

If the MS determines that the GPRS service is suspended when the GA-PSR-ACTIVATE-UTC-REQ is received, it shall send a GA-PSR-ACTIVATE-UTC-ACK message to the GANC with the failure cause code set to "GPRS Suspended".

Upon receiving the GA-PSR-ACTIVATE-UTC-ACK message indicating that the GPRS service is suspended, the GANC aborts the activation procedure.

References

3GPP TS 44.318, subclause 8.3.4.2

83.1.4.2.2 Test purpose

To verify that on receiving a GA-PSR-ACTIVATE-UTC-REQ by the MS when the GPRS service for the MS is suspended, the MS sends a GA-PSR-ACTIVATE-UTC-ACK message to the GANC with the failure cause code set to "GPRS Suspended".

83.1.4.2.3 Method of test

Initial Conditions

System Simulator:

- 1 GAN cell, default parameters

Mobile Station:

- MS GA-PSR is in the GA-PSR-STANDBY state. PDP context 1 is activated.

Foreseen Final State of the MS

MS in GA-PSR-STANDBY state in service of GAN cell

Test Procedure

The SS initiates the GA-PSR-ACTIVE state transmitting GA-PSR-ACTIVATE-UTC-REQ to the MS. The SS responds with GA-PSR-ACTIVATE-UTC-ACK and MS enters the GA-PSR-ACTIVE state. The MS starts to transmit data using GA-PSR-UNITDATA. The MS is made to initiate a voice call, which will make MS initiate the GPRS suspend procedure. The SS initiates the GA-PSR-ACTIVE procedure, sending the GA-PSR-ACTIVATE-UTC-REQ.

The MS responds with GA-PSR-ACTIVATE-UTC-ACK, with failure cause code set to "GPRS Suspended"

The SS checks that GA-PSR-ACTIVATE-UTC-ACK, contains failure cause code "GPRS Suspended"

Maximum Duration of Test

1 min.

Expected Sequence

Step	Direction		Message	Comments
	MS	SS		
1				Trigger MS to initiate data transfer
2		→	GA-PSR-ACTIVATE-UTC-REQ	MS initiated GA-PSR-ACTIVE state
3		←	GA-PSR-ACTIVATE-UTC-ACK	MS is waiting for this message
4		→	GA-PSR-UNITDATA	MS is transmitting the uplink user data packets
5				MS is made to initiate a voice call
6		→	GA-CSR GPRS SUSPENSION REQUEST Or GA-CSR REQUEST	Repeat step 6 until both messages GA-CSR GPRS SUSPENSION REQUEST and GA-CSR REQUEST are received
7		←	GA-CSR REQUEST ACCEPT	MS in GA-CSR-DEDICATED state
8		→	GA-CSR UPLINK DIRECT TRANSFER	
9		←	GA-PSR-ACTIVATE-UTC-REQ	
10		→	GA-PSR-ACTIVATE-UTC-ACK	Failure cause code set to "GPRS Suspended"
11		←	GA-CSR RELEASE	IE 'RR cause', including GPRS resumption indication as per standard GSM/GPRS to indicate that resume of GPRS service is not necessary.
12		→	GA-CSR RELEASE COMPLETE	MS enters GA-CSR-IDLE state and GA-PSR-STANDBY

Specific Message Contents

-

83.1.4.3 MS Receives GA-PSR TC Activation Request while GA-PSR TC active

83.1.4.3.1 Conformance requirements

If the MS receives a GA-PSR TC activation message from the GANC while the GA-PSR TC is active, it shall send the GA-PSR-ACTIVATE-UTC-ACK message to the GANC. The message shall include MS UDP port allocated to the existing GA-PSR TC. In parallel, if the GANC provided new IP Address and UDP port number, the MS shall update the GA-PSR TC attributes accordingly.

After sending the GA-PSR-ACTIVATE-UTC-ACK message, the MS shall:

- set uplink packet sequence number to 0 and
- set the expected downlink packet sequence number to 0

References

3GPP TS 44.318, subclauses 8.2.1; 8.2.3 & 8.3.4.3

83.1.4.3.2 Test purpose

To verify that if the MS receives a GA-PSR TC activation message from the GANC while the GA-PSR TC is active, the MS sends the GA-PSR-ACTIVATE-UTC-ACK message to the GANC.

83.1.4.3.3 Method of test

Initial Conditions

System Simulator:

- 1 GAN cell, default parameters

Mobile Station:

- MS GA-PSR is in the GA-PSR-STANDBY state. PDP context 1 is activated.

Foreseen Final State of the MS

MS in GA-PSR-STANDBY state in service of GAN cell

Test Procedure

MS is made to initiate GA-PSR-ACTIVE state establishment and SS responds with GA-PSR-ACTIVATE-UTC-ACK. MS enters the GA-PSR-ACTIVE state and sends GA-PSR-UNITDATA. While the MS is transmitting data the SS sends GA-PSR-ACTIVATE-UTC-REQ with a different IP address and port number.

The MS responds with GA-PSR-ACTIVATE-UTC-ACK, containing the MS UDP port allocated to the existing GA-PSR TC. MS is triggered to initiate another data transfer. The MS transmits GA-PSR-UNITDATA, using new IP address and port number.

SS checks that the MS transmits the GA-PSR-UNITDATA, using new IP address and port number, and that the MS sets uplink packet sequence number to 0.

Maximum Duration of Test

1 min.

Expected Sequence

Step	Direction		Message	Comments
	MS	SS		
1				Trigger MS to initiate data transfer
2		→	GA-PSR-ACTIVATE-UTC-REQ	
3		←	GA-PSR-ACTIVATE-UTC-ACK	
4		→	GA-PSR-UNITDATA	MS is transmitting the uplink user data packets
5		←	GA-PSR-ACTIVATE-UTC-REQ	SS provides different IP address and port number
6		→	GA-PSR-ACTIVATE-UTC-ACK	Message includes the MS UDP port allocated to the existing GA-PSR TC
7				Trigger MS to initiate an other data transfer
8		→	GA-PSR-UNITDATA	MS using new IP address and port number, SS verifies that sequence number =0.
9		←	GA-PSR-DEACTIVATE-UTC-REQ	
10		→	GA-PSR-DEACTIVATE-UTC-ACK	

Specific Message Contents

-

83.1.5 MS Initiated Deactivation of GA-PSR Transport Channel, Normal Case

83.1.5.1 GA-PSR TC Deactivation Initiation by the MS

83.1.5.1.1 Conformance requirements

When the TU4001 timer expires and if there are no outstanding uplink GPRS user data messages to be transferred, the MS GA-PSR shall send GA-PSR-DEACTIVATE-UTC-REQ message to the GANC to request the deactivation of the transport channel. In parallel, the MS shall start TU4002 timer to wait for the confirmation.

Upon receipt of a GA-PSR-DEACTIVATE-UTC-REQ message from the MS, the GANC releases the GA-PSR TC and sends the GA-PSR-DEACTIVATE-UTC-ACK message to the MS indicating successful deactivation; i.e. the cause IE is set to "success".

Upon receipt of a GA-PSR-DEACTIVATE-UTC-ACK message from the GANC, the MS GA-PSR shall stop TU4002 timer, and release the GA-PSR TC. In parallel, the MS GA-PSR shall transition to GA-PSR-STANDBY state.

Packets received out-of-sequence should be dropped.

References

3GPP TS 44.318, subclauses 8.4.1; 8.4.2; 8.4.3 and 8.7.5.3

83.1.5.1.2 Test purpose

To verify that, when the TU4001 timer expires and if there are no outstanding uplink GPRS user data messages to be transferred, the MS GA-PSR sends GA-PSR-DEACTIVATE-UTC-REQ message to the GANC to request the deactivation of the transport channel and in parallel, the MS starts TU4002 timer to wait for the confirmation.

To verify that upon receiving a GA-PSR-DEACTIVATE-UTC-ACK message from the GANC, the MS GA-PSR stops TU4002 timer, and releases the GA-PSR TC and that the MS GA-PSR transitions to GA-PSR-STANDBY state.

83.1.5.1.3 Method of test

Initial Conditions

System Simulator:

- 1 GAN cell, default parameters

Mobile Station:

- MS GA-PSR is in the GA-PSR-STANDBY state. PDP context 1 is activated.

Foreseen Final State of the MS

MS in GA-PSR-STANDBY state in service of GAN cell

Test Procedure

MS is made to initiate GA-PSR-ACTIVE state and SS responds with GA-PSR-ACTIVATE-UTC-ACK. MS enters the GA-PSR-ACTIVE state and sends GA-PSR-UNITDATA. Once all expected data has been transmitted and the sequential TU has expired, the MS sends GA-PSR-DEACTIVATE-UTC-REQ, and starts TU4002, requesting SS to deactivate GA-PSR state. In response, the SS sends GA-PSR-DEACTIVATE-UTC-ACK. Upon receiving the GA-PSR-DEACTIVATE-UTC-ACK the MS stops the TU4002 and enters the GA-PSR-STANDBY state.

To verify that the MS deactivated timer TU4002, SS sends a GA-PSR-ACTIVATE-UTC-REQ again. If the MS deactivated TU4002, the MS will respond with a GA-PSR-ACTIVATE-UTC-ACK.

Maximum Duration of Test

1 min.

Expected Sequence

Step	Direction		Message	Comments
	MS	SS		
1				Trigger MS to initiate data transfer
2	→		GA-PSR-ACTIVATE-UTC-REQ	MS initiated GA-PSR-ACTIVE state
3		←	GA-PSR-ACTIVATE-UTC-ACK	MS is waiting for this message
4	→		GA-PSR-UNITDATA	MS is transmitting the uplink user data packets
5	MS			TU4001 timer expires, no DATA on UPLINK
6	→		GA-PSR-DEACTIVATE-UTC-REQ	MS starts TU4002
7		←	GA-PSR-DEACTIVATE-UTC-ACK	MS stops TU4002 timer, releases the GA-PSR TC and the MS GA-PSR transitions to GA-PSR-STANDBY state.
8		←	GA-PSR-ACTIVATE-UTC-REQ	Wait for 5 sec before sending
9	→		GA-PSR-ACTIVATE-UTC-ACK	The MS will not acknowledge the activation request in case TU4002 was not stopped
10		←	GA-PSR-DEACTIVATE-UTC-REQ	to bring the MS back to STANDBY state deactivate GA-PSR state
11	→		GA-PSR-DEACTIVATE-UTC-ACK	

Specific Message Contents

-

83.1.6 MS Initiated Deactivation of GA-PSR Transport Channel, Abnormal Cases

83.1.6.1 Uplink User Data Transfer is initiated while GA-PSR TC Deactivation is in Progress

83.1.6.1.1 Conformance requirements

If the MS LLC initiates the uplink user data transfer after the MS GA-PSR has sent the deactivation request to the GANC, the MS GA-PSR shall complete the deactivation procedure first and then initiate a new GA-PSR TC activation procedure to enable data transfer.

References

3GPP TS 44.318, subclause 8.4.4.3

83.1.6.1.2 Test purpose

To verify that if the MS LLC initiates the uplink user data transfer after the MS GA-PSR has sent the deactivation request to the GANC, the MS GA-PSR completes the deactivation procedure first and then initiate a new GA-PSR TC activation procedure to enable data transfer.

83.1.6.1.3 Method of test

Initial Conditions

System Simulator:

- 1 GAN cell, default parameters

Mobile Station:

- MS GA-PSR is in the GA-PSR-STANDBY state. PDP context 1 is activated.

Foreseen Final State of the MS

MS in GA-PSR-STANDBY state in service of GAN cell

Test Procedure

MS is made to initiate GA-PSR-ACTIVE state establishment by triggering a user data transfer of 1 octet. The SS responds with GA-PSR-ACTIVATE-UTC-ACK. After the MS completes the user data transfer it initiates deactivation by sending the GA-PSR-DEACTIVATE-UTC-REQ. Then MS is triggered to initiate the uplink user data transfer. The MS shall not start data transmission but instead initiates second activation by sending GA-PSR-ACTIVATE-UTC-REQ. The SS responds with GA-PSR-ACTIVATE-UTC-ACK and MS begins to transmit the data, sending GA-PSR-UNITDATA.

Maximum Duration of Test

1 min.

Expected Sequence

Step	Direction		Message	Comments
	MS	SS		
1		→	GA-PSR-ACTIVATE-UTC-REQ	MS initiated GA-PSR-ACTIVE state by triggering user data transfer of 1 octet.
2		←	GA-PSR-ACTIVATE-UTC-ACK	
3		→	GA-PSR-UNITDATA	MS starts TU4001
4		→	GA-PSR-DEACTIVATE-UTC-REQ	Sent after TU4001 expires
5	MS			MS is triggered to initiate uplink user data transfer within 5 seconds.
6		←	GA-PSR-DEACTIVATE-UTC-ACK	
7		→	GA-PSR-ACTIVATE-UTC-REQ	
8		←	GA-PSR-ACTIVATE-UTC-ACK	
9		→	GA-PSR-UNITDATA	MS transmits data, which was initiated in step 5
10		←	GA-PSR-DEACTIVATE-UTC-REQ	
11		→	GA-PSR-DEACTIVATE-UTC-ACK	

Specific Message Contents

-

83.1.6.2 Downlink User Data Transfer is received while the GA-PSR TC Deactivation is in Progress

83.1.6.2.1 Conformance requirements

If the MS receives any downlink user data packets while waiting for the GA-PSR-DEACTIVATE-UTC-ACK message response, it shall abort the deactivation procedure (i.e. stop timer TU4002) and restart TU4001 timer.

References

3GPP TS 44.318, subclause 8.4.4.4

83.1.6.2.2 Test purpose

To verify that if the MS receives any downlink user data packets while waiting for the GA-PSR-DEACTIVATE-UTC-ACK response, it aborts the deactivation procedure (i.e. stop timer TU4002) and restarts TU4001 timer.

83.1.6.2.3 Method of test

Initial Conditions

System Simulator:

- 1 GAN cell, default parameters

Mobile Station:

- MS GA-PSR is in the GA-PSR-STANDBY state. PDP context 1 is activated.

Foreseen Final State of the MS

MS in GA-PSR-STANDBY state in service of GAN cell

Test Procedure

The MS is made to initiate GA-PSR-ACTIVE state establishment by triggering a user data transfer of 1 octet. The SS responds with GA-PSR-ACTIVATE-UTC-ACK. After the MS completes the user data transfer it initiates deactivation by sending GA-PSR-DEACTIVATE-UTC-REQ. The SS sends GA-PSR-UNITDATA, preventing deactivation of the GA-PSR TC by the MS. To check that the MS is in GA-PSR-ACTIVE state, a data transmission is triggered in the MS. SS initiates deactivation procedure and sends GA-PSR-DEACTIVATE-UTC-REQ. The MS responds with GA-PSR-DEACTIVATE-UTC-ACK.

Maximum Duration of Test

1 min.

Expected Sequence

Step	Direction		Message	Comments
	MS	SS		
1		→	GA-PSR-ACTIVATE-UTC-REQ	MS initiated GA-PSR-ACTIVE state by triggering user data transfer of 1 octet.
2		←	GA-PSR-ACTIVATE-UTC-ACK	
3		→	GA-PSR-UNITDATA	MS starts TU4001
4		→	GA-PSR-DEACTIVATE-UTC-REQ	Sent after TU4001 expires
5		MS		MS starts TU4002 and waiting for GA-PSR-DEACTIVATE-UTC-ACK
6		←	GA-PSR-UNITDATA	MS stops TU4002 and starts TU4001
7		→	GA-PSR-UNITDATA	MS is triggered to initiate uplink user data transfer before TU4001 expires, SS check data.
8		←	GA-PSR-DEACTIVATE-UTC-REQ	
9		→	GA-PSR-DEACTIVATE-UTC-ACK	

Specific Message Contents

-

83.1.6.3 Unexpected GA-PSR-DEACTIVATE-UTC-ACK response

83.1.6.3.1 Conformance requirements

If the MS receives an unexpected GA-PSR-DEACTIVATE-UTC-ACK message response while the GA-PSR is in GA-PSR-ACTIVE state, the MS GA-PSR shall stop TU4001 timer, and release the GA-PSR TC. In parallel, the MS GA-PSR shall transition to GA-PSR-STANDBY state.

If the MS receives an unexpected GA-PSR-DEACTIVATE-UTC-ACK message response while the GA-PSR is in GA-PSR-STANDBY state, the message is silently discarded.

References

3GPP TS 44.318, subclauses 8.4.4.5

83.1.6.3.2 Test purpose

To verify that if the MS receives an unexpected GA-PSR-DEACTIVATE-UTC-ACK response while the GA-PSR is in GA-PSR-ACTIVE state, the MS GA-PSR stops TU4001 timer, releases the GA-PSR TC and, the MS GA-PSR transitions to GA-PSR-STANDBY state.

83.1.6.3.3 Method of test

Initial Conditions

System Simulator:

- 1 GAN cell, default parameters

Mobile Station:

- MS GA-PSR is in the GA-PSR-STANDBY state. PDP context 1 is activated.

Foreseen Final State of the MS

MS in GA-PSR-STANDBY state in service of GAN cell.

Test Procedure

MS is made to initiate GA-PSR-ACTIVE state establishment and SS responds with GA-PSR-ACTIVATE-UTC-ACK. While the MS transmits data, the SS sends GA-PSR-DEACTIVATE-UTC-ACK. The MS enters the GA-PSR-STANDBY state. To confirm that the MS is in the GA-PSR-STANDBY state, the SS sends the GA-PSR-UNITDATA message and expects to receive the GA-PSR-ACTIVATE-UTC-REQ.

Check for 10 sec that MS does not send any more messages.

To verify that the MS is in GA-PSR-STANDBY state a new connection is initiated with GA-PSR-ACTIVATE-UTC-REQ. If the MS responses with GA-PSR-ACTIVATE-UTC-ACK, the MS was in GA-PSR-STANDBY state.

Maximum Duration of Test

1 min.

Expected Sequence

Step	Direction		Message	Comments
	MS	SS		
1				Trigger MS to initiate data transfer
2	→		GA-PSR-ACTIVATE-UTC-REQ	MS initiated GA-PSR-ACTIVE state
3		←	GA-PSR-ACTIVATE-UTC-ACK	
4	→		GA-PSR-UNITDATA	MS LLC initiates the uplink user data transfer, SS check data
5		←	GA-PSR-DEACTIVATE-UTC-ACK	
6				SS checks for 10 sec that MS does not send any more messages.
7		←	GA-PSR-ACTIVATE-UTC-REQ	
8	→		GA-PSR-ACTIVATE-UTC-ACK	To verify that the MS was in GA-PSR-STANDBY state
9		←	GA-PSR-DEACTIVATE-UTC-REQ	
10	→		GA-PSR-DEACTIVATE-UTC-ACK	MS in GA-PSR-STANDBY state

Specific Message Contents

-

83.1.6.4 Unexpected GA-PSR-ACTIVATE-UTC-REQ

83.1.6.4.1 Conformance requirements

If the MS receives any downlink user data packets while waiting for the GA-PSR-DEACTIVATE-UTC-ACK message response, it shall abort the deactivation procedure (i.e. stop timer TU4002) and restart TU4001 timer.

If the MS receives an unexpected GA-PSR-ACTIVATE-UTC-REQ message while waiting for GA-PSR-DEACTIVATE-UTC-ACK message response, the MS ignores the request and continues waiting for deactivation response.

References

3GPP TS 44.318, subclauses 8.4.4.4 and 8.4.4.6

83.1.6.4.2 Test purpose

To verify that if the MS receives an unexpected GA-PSR-ACTIVATE-UTC-REQ while waiting for GA-PSR-DEACTIVATE-UTC-ACK response, the MS ignores the request and continues waiting for deactivation response.

83.1.6.4.3 Method of test

Initial Conditions

System Simulator:

- 1 GAN cell, default parameters

Mobile Station:

- MS GA-PSR is in the GA-PSR-STANDBY state. PDP context 1 is activated.

Foreseen Final State of the MS

MS in GA-PSR-STANDBY state in service of GAN cell.

Test Procedure

MS is made to initiate GA-PSR-ACTIVE state establishment and SS responds with GA-PSR-ACTIVATE-UTC-ACK. MS transmits data and sequentially initiates the deactivation procedure sending GA-PSR-DEACTIVATE-UTC-REQ. The MS receives an unexpected GA-PSR-ACTIVATE-UTC-REQ while waiting for GA-PSR-DEACTIVATE-UTC-ACK response. MS ignores this message and continues to wait for the GA-PSR-DEACTIVATE-UTC-ACK response. SS waits for one second to make sure MS receives GA-PSR-ACTIVATE-UTC-REQ before GA-PSR-UNIT-DATA. SS sends the GA-PSR-UNIT-DATA, and MS responds by aborting the deactivation procedure. To finish the test SS sends GA-PSR-DEACTIVATE-UTC-REQ and MS responds with GA-PSR-DEACTIVATE-UTC-ACK.

Maximum Duration of Test

1 min.

Expected Sequence

Step	Direction		Message	Comments
	MS	SS		
1				Trigger MS to initiate data transfer
2		→	GA-PSR-ACTIVATE-UTC-REQ	MS initiated GA-PSR-ACTIVE state
3		←	GA-PSR-ACTIVATE-UTC-ACK	
4		→	GA-PSR-UNITDATA	MS LLC initiates the uplink user data transfer,
5		MS		After transmitting all data, wait till TU4001 expires and the MS initiates the deactivation procedure.
6		→	GA-PSR-DEACTIVATE-UTC-REQ	
7		←	GA-PSR-ACTIVATE-UTC-REQ	
8		MS		Waiting for GA-PSR-DEACTIVATE-UTC-ACK
9		SS		Waiting for 1s
10		←	GA-PSR-UNITDATA	MS aborts the deactivation procedure (i.e. stop timer TU4002) and restart TU4001 timer
11		←	GA-PSR-DEACTIVATE-UTC-REQ	
12		→	GA-PSR-DEACTIVATE-UTC-ACK	

Specific Message Contents

-

83.1.7 GANC Initiated Deactivation of GA-PSR Transport Channel, Normal Case

83.1.7.1. GA-PSR TC Deactivation Initiation by the GANC

83.1.5.7.1 Conformance requirements

When the GANC decides to deactivate GA-PSR TC channel, it shall send GA-PSR-DEACTIVATE-UTC-REQ message to the MS to request the deactivation.

If the MS receives an unexpected GA-PSR-DEACTIVATE-UTC-ACK message response while the GA-PSR is in GA-PSR-ACTIVE state, the MS GA-PSR shall stop TU4001 timer, and release the GA-PSR TC. In parallel, the MS GA-PSR shall transition to GA-PSR-STANDBY state.

References

3GPP TS 44.318, subclauses 8.5.1 & 8.4.4.5

83.1.7.1.2 Test purpose

To verify that upon receiving a GA-PSR-DEACTIVATE-UTC-REQ message from the GANC, the MS releases the GA-PSR TC, sends the GA-PSR-DEACTIVATE-UTC-ACK message to the GANC indicating successful deactivation and MS GA-PSR enters the GA-PSR-STANDBY state.

83.1.7.1.3 Method of test

Initial Conditions

System Simulator:

- 1 GAN cell, default parameters

Mobile Station:

- MS GA-PSR is in the GA-PSR-STANDBY state. PDP context 1 is activated.

Foreseen Final State of the MS

MS in GA-PSR-STANDBY state in service of GAN cell

Test Procedure

The SS initiates active state. The MS responds with GA-PSR-ACTIVATE-UTC-ACK. The SS initiates deactivation of the TC and sends GA-PSR-DEACTIVATE-UTC-ACK. The MS responds with GA-PSR-DEACTIVATE-UTC-ACK and enters the GA-PSR-STANDBY state. To confirm that the MS is in the GA-PSR-STANDBY state, the MS is triggered to send user data. Therefore, GA-PSR-ACTIVATE-UTC-REQ is expected to be sent from the MS. The SS sends GA-PSR-ACTIVATE-UTC-ACK message and waits for GA-PSR-UNITDATA.

Maximum Duration of Test

1 min.

Expected Sequence

Step	Direction		Message	Comments
	MS	SS		
1		←	GA-PSR-ACTIVATE-UTC-REQ	SS initiated GA-PSR-ACTIVE state
2		→	GA-PSR-ACTIVATE-UTC-ACK	
3		←	GA-PSR-UNITDATA	
4		←	GA-PSR-DEACTIVATE-UTC-REQ	SS initiates the deactivation
5		→	GA-PSR-DEACTIVATE-UTC-ACK	MS response on deactivation
6				Trigger MS to send user data
7		→	GA-PSR-ACTIVATE-UTC-REQ	SS verifies that MS was in GA-PSR-STANDBY state in step 5.
8		←	GA-PSR-ACTIVATE-UTC-ACK	
8a		→	GA-PSR-UNITDATA	
9		←	GA-PSR-DEACTIVATE-UTC-REQ	SS initiates the deactivation
10		→	GA-PSR-DEACTIVATE-UTC-ACK	MS response on deactivation

Specific Message Contents

-

83.1.8 Void

83.2 GA-PSR GPRS User Data Transport

83.2.1 GA-PSR GPRS User Data Transport , Normal Cases

83.2.1.1 MS Initiates Uplink GPRS User Data Transfer

83.2.1.1.1 Conformance requirements

The GPRS user data packets are tunnelled using UDP transport as specified for GA-PSR Transport Channel. Each packet is assigned a sequence number in the range of 0 to 65535 sequentially. The sequence number is set to 0 after reaching the maximum – 65535.

Assuming that the GA-PSR TC has been already activated as specified in sub-clauses 8.2 or 8.3, the MS GA-PSR is able to immediately forward any uplink GPRS user data packets to the GANC. Upon the request from the LLC to transfer an uplink LLC PDU with GPRS user data identified with LLC SAPI 3, 5, 9 or 11, the MS GA-PSR shall restart TU4001 timer and encapsulate the complete LLC PDU within a GA-PSR UNITDATA message.

Subsequently, the MS shall send the GA-PSR UNITDATA message to the GANC using the existing GA-PSR TC; i.e. using the corresponding GANC IP address and UDP port number.

The MS shall increment the uplink packet sequence number for each GA-PSR-UNITDATA message sent to the GANC.

References

3GPP TS 44.318, subclauses 8.7 & 8.7.1.

83.2.1.1.2 Test purpose

To verify that MS:

- 1) Uses corresponding GANC IP address and UDP port number,
- 2) Transmits 65537 of the packets, and that each packet is assigned a sequence number in the range of 0 to 65535 sequentially.
- 3) Assigns sequence number to 0 after reaching the maximum – 65535

83.2.1.1.3 Method of test

Initial Conditions

System Simulator:

- 1 GAN cell, default parameters

Mobile Station:

- MS GA-PSR is in the GA-PSR-STANDBY state. PDP context 1 is activated

Foreseen Final State of the MS

MS in GA-PSR-STANDBY state in service of GAN cell.

Test Procedure

The MS activates the GA-PSR TC with the corresponding GANC IP address and UDP port number and immediately forwards uplink GPRS user data, which consist of 65537 of packets, being requested from the MS LLC, to the GANC. The MS tunnels the GPRS data packets using UDP transport, assigning number to the packets in range from 0 to 65535 sequentially. The MS increments the uplink packet sequence number for each GA-PSR-UNITDATA message, being sent to the GANC, and assigns the number 0 after reaching the 65535.

SS verifies that MS:

- 1) Uses corresponding GANC IP address and UDP port number,
- 2) Transmits 65537 of the packets, and that each packet is assigned a sequence number in the range of 0 to 65535 sequentially.
- 3) Assigns sequence number to 0 after reaching the maximum – 65535

Maximum Duration of Test

1 min.

Expected Sequence

Step	Direction		Message	Comments
	MS	SS		
1		→	GA-PSR-ACTIVATE-UTC-REQ	SS initiated GA-PSR-ACTIVE state
2		←	GA-PSR-ACTIVATE-UTC-ACK	SS sends IP address and UDP port number
3		→	GA-PSR-UNITDATA	MS sends 65537 packets, SS verified that the sequence number is set to 0 after reaching the maximum – 65535
4		←	GA-PSR-DEACTIVATE-UTC-REQ	SS deactivates
5		→	GS-PSR DEACTIVATE-UTC-ACK	

Specific Message Contents

-

83.2.2 GA-PSR GPRS User Data Transport , Abnormal Cases

83.2.2.1 Void

83.2.2.2 Void

83.3 Packet paging for packet service

83.3.1 PS Paging Request Processed by the MS, Normal Case

83.3.1.1 PS Paging Request Processed by the MS

83.3.1.1.1 Conformance requirements

Upon receiving a GA-PSR-PS-PAGE message from the GANC, the MS GA-PSR shall forward the indication to the GMM layer using the GMMRR SAP as per standard GPRS. Subsequently, the MS shall send an uplink LLC PDU as a page response per standard GPRS. The MS may either send GA-PSR-DATA or GA-PSR-UNITDATA message as described in sub-clauses 8.7 and 8.8.

References

3GPP TS 44.318, subclauses 8.9.2

83.3.1.1.2 Test purpose

To verify that the MS responds with GA-PSR-DATA message upon receiving a GA-PSR-PS-PAGE message from the GANC.

83.3.1.1.3 Method of test

Initial Conditions

System Simulator:

- 1 GAN cell, default parameters

Mobile Station:

- MS GA-PSR is in the GA-PSR-STANDBY state. PDP context 1 is activated.

Forseen Final State of the MS

MS in Idle state

Test Procedure

The SS sends the GA-PSR-PS-PAGE, paging the MS. The MS responds with GA-PSR-DATA. The SS checks the received data is the paging response.

Maximum Duration of Test

1 min.

Expected Sequence

Step	Direction	Message	Comments
1	x		MS is in GA-PSR-STANDBY state
2	←	GA-PSR-PS-PAGE	MS is made to initiate GA-PSR TC
3	→	GA-PSR-DATA	SS verifies that the MS sends the GA-PSR-DATA Check that the received data is the paging response (Empty LLC PDU)

Specific Message Contents

-

83.4 GPRS Suspend Procedure

83.4.1 GPRS Suspension Initiation by the MS, normal Case

83.4.1.1 GPRS Suspension Initiation by the MS

83.4.1.1.1 Conformance requirements

While transitioning to dedicated mode and if unable to support simultaneous CS and PS services, the MS shall request the suspension of the downlink GPRS data transfer by sending a GA-CSR GPRS SUSPENSION REQUEST message to the GANC

Upon receiving a GA-CSR GPRS SUSPENSION REQUEST message from the MS, the GANC completes the GPRS suspend procedure via the Gb interface as defined in [3GPP 48.018].

References

3GPP TS 44.318, subclauses 8.10.1 & 8.10.2

83.4.1.1.2 Test purpose

To verify that the MS requests the suspension of the downlink GPRS data transfer by sending a GA-CSR GPRS SUSPENSION REQUEST message to the GANC, while the MS is transitioning to dedicated mode and if the MS unable to support simultaneous CS and PS services.

83.4.1.1.3 Method of test

Initial Conditions

System Simulator:

- 1 GAN cell, default parameters

Mobile Station:

- MS GA-PSR is in the GA-PSR-STANDBY state. PDP context 1 is activated.

Foreseen Final State of the MS

MS in GA-PSR-STANDBY state in service of GAN cell

Test Procedure

The SS initiates GA-PSR TC, sending the GA-PSR-ACTIVATE-UTC-REQ. The MS responds with GA-PSR-ACTIVATE-UTC-ACK. The SS sends data, sending GA-PSR-UNITDATA. The SS sends GA-CSR PAGING REQUEST, requesting transitioning of the MS to dedicated mode. MS sends GA-CSR GPRS SUSPENSION REQUEST. The SS verifies that the MS requests GPRS suspension.

Maximum Duration of Test

1 min.

Expected Sequence

Step	Direction		Message	Comments
	MS	SS		
1		MS		MS is in GA-PSR-STANDBY state
2		←	GA-PSR-ACTIVATE-UTC-REQ	SS initiates GA-PSR TC
3		→	GA-PSR-ACTIVATE-UTC-ACK	
4		←	GA-PSR-UNITDATA	
5		←	GA-CSR PAGING REQUEST	
6		→	GA-CSR GPRS SUSPENSION REQUEST	SS verifies that the MS sends the GA-PSR-DATA message
7		←	GA-PSR-DEACTIVATE-UTC-REQ	SS deactivates
8		→	GS-PSR DEACTIVATE-UTC-ACK	

Specific Message Contents

-

83.5 Downlink Flow Control

83.5.1 Initiation of the Downlink Flow Control and Processing of the TU4003 Timer Expiry by the MS, Normal Case

83.5.1.1 Initiation of the Downlink Flow Control and Processing of the TU4003 Timer Expiry by the MS

83.5.1.1.1 Conformance requirements

Upon detecting the downlink flow control condition, the MS shall initiate a downlink flow control procedure by sending a GA-PSR-DFC-REQ message to the GANC via the existing GA-PSR TC. The message includes new estimated data rate that can be supported. At the same time the MS shall start timer TU4003 to continue monitoring the flow control condition. The timer TU4003 is specified in sub-clause 12.

When the TU4003 timer expires, the MS shall re-evaluate the flow control condition and perform the following based on the outcome of the evaluation:

- If the flow control condition still exists (e.g. downlink buffer utilization is still above the low watermark level), the MS shall calculate a new data rate that can be supported and forward the corresponding GA-PSR-DFC-REQ to the GANC via the existing GA-PSR TC. Simultaneously, the MS shall start timer TU4003 to continue monitoring the downlink data transfer.
- If the flow condition has been resolved (e.g. buffer utilization is below the low mark level), the MS shall not restart the TU4003 timer and shall stop sending flow control requests to the GANC.

References

3GPP TS 44.318, subclauses 8.11.1 & 8.11.3

83.5.1.1.2 Test purpose

To verify that:

- 1) If the flow control condition exists the MS calculates a new data rate that can be supported and forwards the corresponding GA-PSR-DFC-REQ to the GANC via the existing GA-PSR TC.
- 2) If the timer expires, the MS checks the downlink flow control condition, and if it continues to exist, the MS restarts the timer TU4003, and optionally sends another GA-PSR-DFC-REQ message to the GANC.
- 3) If the flow condition has been resolved (e.g. buffer utilization is below the low mark level), the MS not restarts the TU4003 timer and stops sending flow control requests to the GANC.

83.5.1.1.3 Method of test

Initial Conditions

System Simulator:

- 1 GAN cell, default parameters

Mobile Station:

- MS GA-PSR is in the GA-PSR-STANDBY state. PDP context 1 is activated.

Forseen Final State of the MS

MS in GA-PSR-STANDBY state in service of GAN cell

Test Procedure

SS initiates the activation procedure and starts to transmit data. The MS detects flow control condition, sends the GA-PSR-DFC-REQ message and starts the TU4003 timer. SS reduces the data rate and continues to send the data. The SS verifies that the MS does not send GA-PSR-DFC-REQ message.

Maximum Duration of Test

1 min.

Expected Sequence

Step	Direction		Message	Comment
	MS	SS		
1	MS			MS is in GA-PSR-STANDBY state
2	←		GA-PSR-ACTIVATE-UTC-REQ	SS initiates GA-PSR TC
3	→		GA-PSR-ACTIVATE-UTC-ACK	
4	←		GA-PSR-UNITDATA	SS sends data, with very high data rate to overflow the MS
5	→		GA-PSR-DFC-REQ	MS request DL Flow Control and starts TU4003
6	←		GA-PSR-UNITDATA	SS sends data, with normal data rate
7	SS			SS verifies that MS does not sends GA-PSR-DFC-REQ for the time exceeding TU4003
8	←		GA-PSR-DEACTIVATE-UTC-REQ	SS deactivates
9	→		GS-PSR DEACTIVATE-UTC-ACK	

Specific Message Contents

-

83.6 Uplink Flow Control

83.6.1 Processing of the Uplink Flow Control Request by the MS, Normal Case

83.6.1.1 Processing of the Uplink Flow Control Request by the MS

83.6.1.1.1 Conformance requirements

Upon detecting the uplink flow control condition, the GANC initiates an uplink flow control procedure by sending a GA-PSR-UFC-REQUEST message to the MS via the existing GA-PSR TC. The request is PFC based if the packet flow management procedures are supported.

Upon receiving the GA-PSR-UFC-REQUEST message from the GANC, the MS adjusts the uplink data rate accordingly.

References

3GPP TS 44.318, subclauses 8.12.1 & 8.12.2

83.6.1.1.2 Test purpose

To verify that the MS adjusts the uplink data rate accordingly with GA-PSR-UFC-REQUEST message received from the GANC.

83.6.1.1.3 Method of test

Initial Conditions

System Simulator:

- 1 GAN cell, default parameters

Mobile Station:

- MS GA-PSR is in the GA-PSR-STANDBY state. PDP context 1 is activated.

Forseen Final State of the MS

MS in Idle state

Test Procedure

The MS activates GA-PSR TC and starts to send lowest data rate to the SS. SS requests UL Flow Control sending the GA-PSR-UFC-REQ. The MS sends the data with rate adjusted according to GA-PSR-UFC-REQ.

The SS verifies whether the MS sends the data with adjusted data rate.

Maximum Duration of Test

1 min.

Expected Sequence

Step	Direction		Message	Comment
	MS	SS		
1	MS			MS is in GA-PSR-STANDBY state
2		→	GA-PSR-ACTIVATE-UTC-REQ	SS is made to activate GA-PSR TC
3		←	GA-PSR-ACTIVATE-UTC-ACK	
4		→	GA-PSR-UNITDATA	MS sends data
5		←	GA-PSR-UFC-REQ	SS request UL Flow Control of 100 bits/s.
6		→	GA-PSR-UNITDATA	MS sends data with the adjusted data rate (100 bits/s), according with GA-PSR-UFC-REQ
7		SS		SS verifies whether the MS have adjusted data rate
8		←	GA-PSR-DEACTIVATE-UTC-REQ	SS initiates the deactivation
9		→	GA-PSR-DEACTIVATE-UTC-ACK	MS response on deactivation

Specific Message Contents

-

83.6.2 Processing of the Uplink Flow Control Request by the MS, Abnormal Cases

83.6.2.1 GA-PSR TC in not Active

83.6.2.1.1 Conformance requirements

If the MS receives a GA-PSR-UFC-REQUEST message while the GA-PSR TC deactivation is in progress, the MS shall ignore the flow control request.

References

3GPP TS 44.318, subclauses 8.12.4.1.

83.6.2.1.2 Test purpose

To verify whether the MS ignores the flow control request and initiates the GA-PSR TC deactivation procedure if the MS receives a GA-PSR-UFC-REQUEST message while the associated GA-PSR TC is not active.

83.6.2.1.3 Method of test

Initial Conditions

System Simulator:

- 1 GAN cell, default parameters

Mobile Station:

- MS GA-PSR is in the GA-PSR-STANDBY state. PDP context 1 is activated.

Foreseen Final State of the MS

MS in GA-PSR-STANDBY state in service of GAN cell

Test Procedure

The MS is in GA-PSR-STANDBY state. SS sends the GA-PSR-UFC-REQ. The MS ignores the flow control request and initiates the GA-PSR TC deactivation. The SS verifies whether the MS sends GA-PSR-DEACTIVATE-UTC-REQ.

Maximum Duration of Test

1 min.

Expected Sequence

Step	Direction		Message	Comments
	MS	SS		
1	MS			MS is in GA-PSR-STANDBY state
2	←		GA-PSR-UFC-REQ	SS request UL Flow Control
3	→		GA-PSR-DEACTIVATE-UTC-REQ	MS initiates deactivate procedure
4	SS			SS verifies whether the MS send GA-PSR-DEACTIVATE-UTC-REQ
5	←		GA-PSR-DEACTIVATE-UTC-ACK	

Specific Message Contents

-

90 Text Telephony (TTY) Services

This subclause contains test cases for Text Telephony (TTY) services.

90.1 Transmission of CTM Bearer Code

90.1.1 Mobile Originated TTY Call

90.1.1.1 Conformance requirement

- 1) When establishing a mobile originated call with TTY mode enabled in the MS, bit 6 of Octet 3a in the Bearer Capability Information Element shall be '1'.
- 2) When establishing a mobile originated call with TTY mode disabled in the TTY-compatible MS, bit 6 of Octet 3a in the Bearer Capability Information Element shall be '0'.

Reference(s):

For conformance requirement 1 and 2:

3GPP TS 04.08 / TS 24.008, subclause 10.5.4.5

90.1.1.2 Test purpose

- 1) To verify that a TTY compatible MS, with TTY mode enabled, correctly sets bit 6 of Octet 3a in the Bearer Capability Information Element to 1 when made to originate a call.
- 2) To verify that a TTY compatible MS, with TTY mode disabled, correctly sets bit 6 of Octet 3a in the Bearer Capability Information Element to 0 when made to originate a call.

90.1.1.3 Method of test

90.1.1.3.1 void

90.1.1.3.2 Initial conditions

System Simulator:

- 1 cell, default parameters.

Mobile Station:

- The MS is in MM-state "idle, updated" with valid TMSI and CKSN.

90.1.1.3.3 Final foreseen state of the MS

U0, null.

90.1.1.3.4 Test Procedure

- a) The MS is set to TTY mode using the normal MMI. A mobile originated call is established following the generic call set-up procedure for mobile originating speech calls.
- b) After receipt of the SETUP message from the MS, the SS shall disconnect the call.
- c) TTY mode is disabled in the MS using the normal MMI. A mobile originated call is established following the generic call set-up procedure for mobile originating speech calls.
- d) After receipt of the SETUP message from the MS, the SS shall disconnect the call.

90.1.1.4 Test requirement

- 1) In step a), the MS shall send a SETUP message where bit 6 of Octet 3a of the Bearer Capability Information Element is set to 1.
- 2) In step c), the MS shall send a SETUP message where bit 6 of Octet 3a of the Bearer Capability Information Element is set to 0.

90.1.2 Mobile Terminated TTY Call

90.1.2.1 Conformance requirement

- 1) When establishing a mobile terminated call with TTY mode enabled in the MS, bit 6 of Octet 3a in the Bearer Capability Information Element shall be '1'.
- 2) When establishing a mobile terminated call with TTY mode disabled in the TTY-compatible MS, bit 6 of Octet 3a in the Bearer Capability Information Element shall be '0'.

Reference(s):

For conformance requirement 1 and 2:

3GPP TS 04.08 / TS 24.008, subclause 10.5.4.5

90.1.2.2 Test purpose

- 3) verify that a TTY compatible MS, with TTY mode enabled, correctly sets bit 6 of Octet 3a in the Bearer Capability Information Element to 1 when receiving a mobile terminated call.
- 4) To verify that a TTY compatible MS, with TTY mode disabled, correctly sets bit 6 of Octet 3a in the Bearer Capability Information Element to 0 when receiving a mobile terminated call.

90.1.2.3 Method of test

90.1.2.3.1 void

90.1.2.3.2 Initial conditions

System Simulator:

- 1 cell, default parameters.

Mobile Station:

- The MS is in MM-state "idle, updated" with valid TMSI and CKSN.

90.1.2.3.3 Final foreseen state of the MS

U0, null.

90.1.2.3.4 Test Procedure

- a) The MS is set to TTY mode using the normal MMI. A mobile terminated call is established following the generic call set-up procedure for mobile terminating speech calls.
- b) After receipt of the CALL CONFIRMED message from the MS, the SS shall disconnect the call.
- c) TTY mode is disabled in the MS using the normal MMI. A mobile terminated call is established following the generic call set-up procedure for mobile terminating speech calls.
- d) After receipt of the CALL CONFIRMED message from the MS, the SS shall disconnect the call.

90.1.2.4 Test requirement

- 1) In step a), the MS shall send a CALL CONFIRMED message where bit 6 of Octet 3a of the Bearer Capability Information Element is set to 1.
- 2) In step c), the MS shall send a CALL CONFIRMED message where bit 6 of Octet 3a of the Bearer Capability Information Element is set to 0.

Annex 1 (normative): Reference test methods

A1.1 General Conditions (GC)

A1.1.1 Outdoor test site and general arrangements for measurements involving the use of radiated fields (GC4)

The outdoor test site shall be on a reasonably level surface or ground. At one point on the site a ground plane of at least 5 m diameter shall be provided. In the middle of this ground plane a non-conducting support capable of rotation through 360 degrees in the horizontal plane shall be used to support the test sample at 1,5 m above the ground plane.

The test site shall be large enough to allow the erection of a measuring or transmitting antenna at a distance of half a wavelength or at least 3 m whichever is the greater. Sufficient precautions shall be taken to ensure that reflections from extraneous objects adjacent to the site and ground reflections do not degrade the measurement results.

The test antenna is used to detect the radiation from both the test sample and the substitution antenna, when the site is used for radiation measurements. Where necessary the substitution antenna is used as a transmitting antenna, when the site is used for the measurement of receiver characteristics. This antenna is mounted on a support such as to allow the antenna to be used in either the horizontal or vertical polarization and for the height of its centre above ground to be varied over the range 1 m to 4 m. Preferably test antennas with pronounced directivity should be used. The size of the test antenna along the measurement axis shall not exceed 20 % of the measuring distance.

For radiation measurements the test antenna is connected to a test receiver capable of being tuned to any frequency under investigation and of measuring accurately the relative levels of signals at its input. When necessary (for receiver measurements) the test receiver is replaced by a signal source.

The substitution antenna shall be a half wave dipole, resonant at the frequency under consideration, or a shortened dipole, or (in the range 1 GHz to 4 GHz) a horn radiator. Antennas other than a half wave dipole shall have been calibrated to the half wave dipole. The centre of this antenna shall coincide with the reference point of the test sample it has replaced. This reference point shall be the volume centre of the sample when its antenna is mounted inside the cabinet, or the point where an external antenna is connected to the cabinet. The distance between the lower extremity of the dipole and the ground shall be at least 30 cm.

The substitution antenna shall be connected to a calibrated signal generator when the site is used for radiation measurements and to a calibrated measuring receiver when the site is used for measurements of receiver characteristics. The signal generator and the receiver shall be operating at the frequencies under investigation and shall be connected to the antenna through suitable matching and balancing network.

A1.1.2 Anechoic shielded chamber (GC5)

As an alternative to the above mentioned outdoor test site an indoor test site, being a well shielded anechoic chamber simulating free space environment may be used. If such a chamber is used, this shall be recorded in the test report.

NOTE: The anechoic shielded chamber is the preferred test site for testing to the present document.

The measurement site may be an electrically shielded anechoic chamber being 10 m long, 5 m broad and 5 m high. Walls and ceiling should be coated with RF absorbers of 1 m height. The ground should be covered with absorbing material 1 m thick able to carry test equipment and operators. A measuring distance of 3 m to 5 m in the long middle axis of the chamber can be used for measurements up to at least 10 GHz.

The test antenna, test receiver, substitution antenna and calibrated signal generator are used in a way similar to that of the outdoor test site method with the exception that, because the floor absorbers reject floor reflections, the antenna height need not be changed and shall be at the same height as the test sample. In the range between 30 MHz and 100 MHz some additional calibration may be necessary.

A1.1.3 Temporary antenna connector (GC7)

If the MS to be tested does not normally have a permanent external 50 Ω connector then for test purposes only it may be modified to fit a temporary 50 Ω antenna connector.

The permanent integral antenna shall be used for measurement of:

- Transmitter effective radiated power (subclause 13.3).
- Radiated spurious emissions (clause 12).

For tests in the relevant MS Receive band:

- The temporary antenna coupling factor is determined using the procedure defined in annex 1, subclause 1.1.5. When using the temporary antenna connector, the temporary antenna coupling factor needs to be taken into consideration when determining a stimulus or measured level in the receive band.

For tests in the relevant MS Transmit band:

- The temporary antenna coupling factor is determined using the procedure defined in subclause 13.3.4.2. When using the temporary antenna connector, the temporary antenna coupling factor needs to be taken into consideration when determining a stimulus or measured level in the transmit band.

For frequencies outside the above mentioned relevant bands the temporary antenna coupling factor is assumed to be 0 dB.

NOTE 1: The uncertainty in the determined value of the temporary antenna coupling factor is directly related to the uncertainty of the field strength value measured in subclause 13.3.4.2 step n) and annex 1, subclause 1.1.5.2 (approximately ± 3 dB). By mutual agreement, between the MS manufacturer and the testing authority, a value of 0 dB for the temporary antenna coupling factor could be used.

NOTE 2: The accommodation of the uncertainty in the temporary antenna coupling factor in the relevant MS receive band for the tests in clause 14 is for further study.

NOTE 3: The uncertainty in the temporary antenna coupling factor in the relevant MS transmit band can be accommodated with appropriate adjustment of the measured levels by the uncertainty.

Testing must be performed in the following order to ensure that all the free field measurements are performed before the MS is modified.

- Subclause 12.1.2.
- Annex 1, subclauses 1.1.5.1 and 1.1.5.2.
- Subclause 13.3.4.2 (during this step the MS is modified).
- Annex 1, subclause 1.1.5.3.
- All remaining tests of clauses 12, 13, 14, 15, 16, 17, 18, 19, 20, 21 and 22.

A1.1.4 Temporary antenna connector characteristics

The method of connection of the temporary connector shall allow secure and repeatable connections to be made to the device under test.

The antenna connector shall present a nominal 50 Ω impedance over the GSM receive and transmit frequency ranges. The maximum loss within the frequency range 100 kHz to 12,75 GHz shall be less than 1 dB.

The connection circuitry shall be maximally broadband and shall contain no non-linear or active devices.

The characteristics of the connector shall not be significantly affected by temperatures in the range -25° to $+60^{\circ}$ Celsius.

A1.1.5 Calibration of the temporary antenna connector

For equipments fitted with an integral antenna and not provided with a permanent means for connection to an external antenna a calibration procedure is required to allow subsequent measurements to be performed on the temporary antenna connector.

Once calibrated this temporary antenna connector enables all receiver test procedures to be identical for equipments with an integral antenna and for equipments with an antenna connector.

The calibration procedure shall be carried out at three frequencies, namely an ARFCN in the low mid and high ARFCN ranges. The procedure consists of three distinct stages as follows:

- 1) Establish the MS antenna radiation pattern for the three selected frequencies.
- 2) Calibrate the test range (or anechoic shielded chamber) for the conditions needed in 1).
- 3) Determine the temporary antenna connector coupling factor.

A1.1.5.1 Antenna radiation pattern

- a) The MS shall be in the anechoic shielded chamber, or on an outdoor test site, on an isolated support in a vertical position at an orientation specified by the manufacturer. This position is the 0° position.

A test antenna, connected to the SS shall be in the anechoic shielded chamber, or on the outdoor test site, at a distance of at least 3 m from the MS.
- b) A call shall be originated by the SS to the MS on a frequency in the low ARFCN range. The MS shall be made to answer the call. The SS shall command the MS to maximum transmit power.
- c) The SS shall, using estimated parameters for the outdoor test site or anechoic shielded chamber, set its output level "E" [see figure A1-1 to give an MS receiver input level of approximately 32 dB μ V_{emf}. This corresponds to a field strength of 55,5 dB μ V/m at the MS position. The signal shall be the Standard Test Signal C1.

NOTE 1: The absolute value of the received signal level is not critical. The value suggested however will ensure that the MS receiver is operating essentially error free, yet is low enough to avoid any non linear effects in the receiver.

- d) The SS shall use the RXLEV message from the MS to determine a measure of the received field strength. The procedure detailed in the flow chart of figure A1-1 shall now be followed.

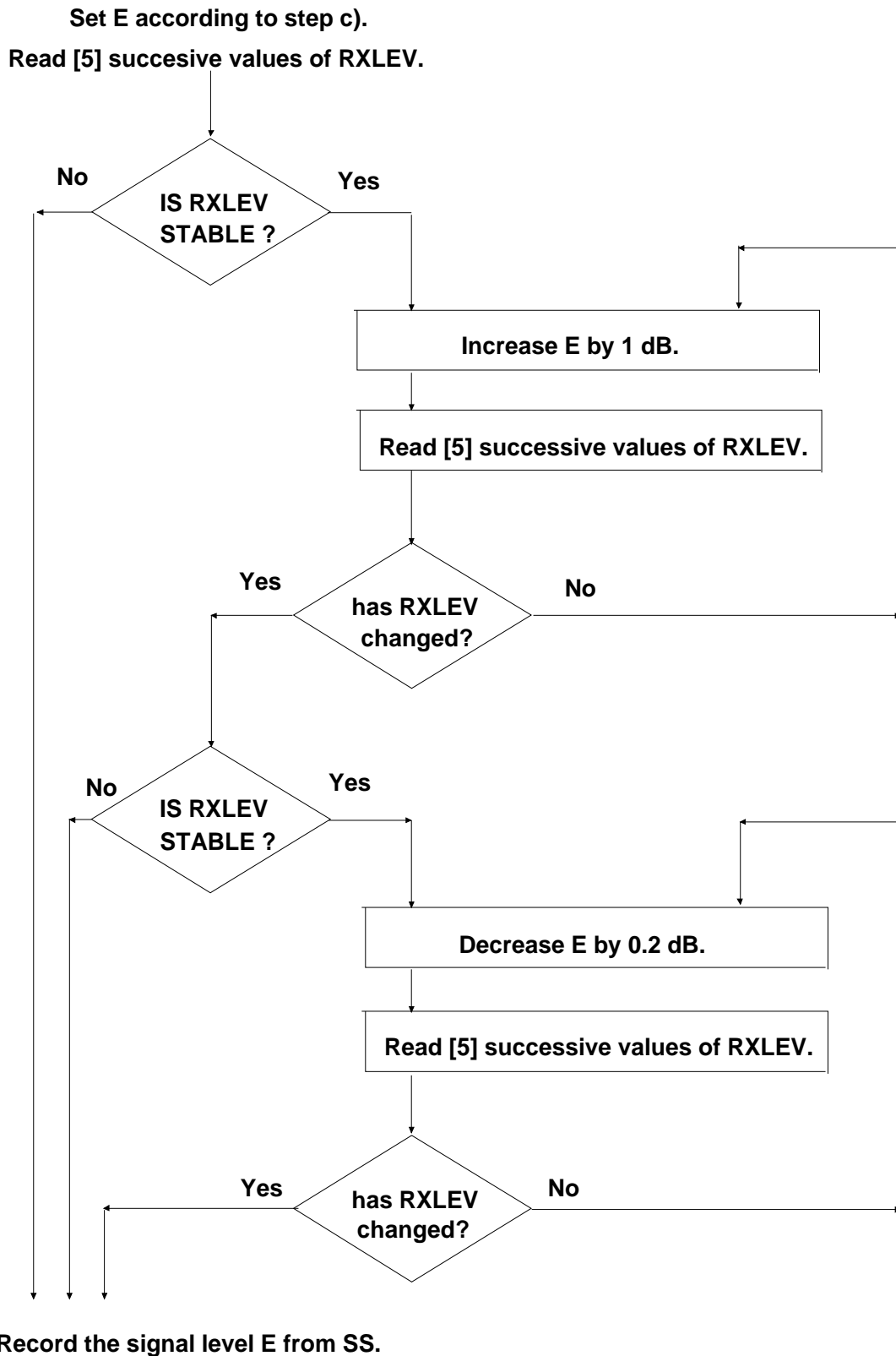

Figure A1-1

The signal level from the SS that just results in the transition from $RXLEV_a$ to $RXLEV_b$ shall be recorded as E_i .

NOTE 2: The actual values of $RXLEV_a$ and $RXLEV_b$ will need to be recorded, because this transition will be used as the reference point for all further stages of the calibration procedure.

e) Step d) shall be repeated after the MS has been rotated by $n \times 45^\circ$ in the horizontal plane. Ensuring that the same RXLEV transition is used, the signal levels from the SS shall be recorded as E_{in} .

- f) Calculate the effective mean signal level from the RMS value of the eight signal levels obtained in d) and e) above by using the following formula:

$$E_1 = \left[\frac{8}{\sum_{n=0}^{n=7} \frac{1}{E_{in}}} \right]^{\frac{1}{2}}$$

- g) Repeat steps b) to f), except in step b) use an ARFCN in the mid ARFCN range to obtain a mean signal level E_2 . Ensure the same RXLEV transition is used.
- h) Repeat steps b) to f), except in step b) use an ARFCN in the high ARFCN range to obtain a mean signal level E_3 .

Ensure the same RXLEV transition is used.

A1.1.5.2 Test range calibration

The objective of this step is to determine the actual field strength at the MS corresponding to the three signal levels E_1 , E_2 and E_3 established in annex 1, subclause 1.1.5.1. The following procedure shall be used:

- a) Replace the MS by a calibrated reception antenna connected to a measuring receiver.
- b) For each frequency used in annex 1, subclause 1.1.5.1 measure the field strength E_{fr} corresponding to the respective signal levels E_r determined in steps f), g) and h) of annex 1, subclause 1.1.5.1 record these values as E_{f1} , E_{f2} , E_{f3} .

A1.1.5.3 Temporary antenna connector coupling factor

The coupling factor of the temporary antenna connector is the relationship expressed in dB, between the output signal of the SS and the effective receiver input signal for the MS.

The test sample MS is modified to fit a temporary antenna connector in accordance with annex 1, subclause 1.1.3. Or alternatively a second MS shall be provided, fitted with such a temporary antenna connector.

NOTE: If only one MS is supplied for testing, the tests of radiated spurious emissions (transmit and receive) and receiver sensitivity shall be performed before the MS is modified to accept a temporary antenna connector.

The calibration procedure shall be as follows:

- a) The MS temporary connector is connected to the output of the SS.
- b) A call shall be originated by the SS to the MS using a frequency in the low ARFCN range. The MS shall be made to answer the call. The SS shall command the MS to maximum transmit power, non hopping encrypted mode.
- c) The SS shall, using the procedures of annex 1, subclause 1.1.5.1, adjust its output signal level to determine the RXLEV_a to RXLEV_b transition. This signal level shall be recorded as E_{c1} .
- d) Repeat steps b) and c) for frequencies in the mid ARFCN range and the high ARFCN range. Record the RXLEV transitions as E_{c2} and E_{c3} respectively.
- e) The temporary antenna connector coupling factor F is then calculated from:

$$F_n = 20 \log_{10} \left[\frac{E_{cn}}{E_{fn} * K_n} \right]$$

where K_n = conversion factor of an isotropic antenna expressed as μV at the frequency $\mu V/m$ corresponding to the ARFCN used.

- f) The mean antenna coupling factor F_m to be used for measurements requiring hopping shall be calculated from the RMS value of all parameters in e) as follows:

$$E_{cm} = \left[\frac{3}{1/E_{c1} + 1/E_{c2} + 1/E_{c3}} \right]^{1/2}$$

$$E_{fm} = \left[\frac{3}{1/E_{f1} + 1/E_{f2} + 1/E_{f3}} \right]^{1/2}$$

$$k_m = \left[\frac{k_1 + k_2 + k_3}{3} \right]^{1/2}$$

$$F_m = 20 \log_{10} \left[\frac{E_{cm}}{E_{fm} + k_m} \right]$$

g) In all tests in which a MS with integral antenna is the unit under test, the signal level at the temporary antenna connector is determined from:

$$- E_{in} = E_{req} + F;$$

where:

- E_{in} = signal level at coupling device (dB μ Vemf);
- E_{req} = signal level required by the test (dB μ Vemf);
- F = coupling factor at the respective ARFCN (dB).

This is indicated in the test procedures as E_{req} , dB μ Vemf(), where the empty parenthesis is to be read as E_{in} .

For frequencies not in the receive band or the transmit band, 0dBi antenna gain shall be assumed.]

A1.1.6 Connection of devices with multiple antennae

Devices with multiple antennae must be connected in well defined manner in order for test requirements to be considered valid. This applies equally to those tests which are specifically testing these requirements associated with a device with multiple antennae, as those which are not.

A1.1.6.1 DARP phase 2 MS

For those tests which are specifically designed for DARP phase 2 MS, the SS must present signals to, and connect to the MS in a manner specified in TS 45.005 Annex N.2. Additionally, the SS must be able to accommodate the MS transmission being on either one or both of these antennae, or indeed an alternative antenna.

A1.2 Normal and extreme Test Conditions (TC)

A1.2.1 Power sources and ambient temperatures (TC2)

During type approval tests the power source of the equipment shall be replaced by a test power source, capable of producing normal and extreme test voltages as specified in subclauses 1.2.2 and 1.2.3. The internal impedance of the test power source shall be low enough for its effect on the test results to be negligible. For the purpose of tests, the voltage of the power source shall be measured at the input terminals of the equipment. If the equipment is provided with a permanently connected power cable, the test voltage shall be that measured at the point of connection of the power cable to the equipment. In equipment with incorporated batteries the test power source shall be applied as close to the battery terminals as practicable.

During tests the power source voltages shall be maintained within a tolerance of ± 3 % relative to the voltage at the beginning of each test.

A1.2.2 Normal test conditions (TC2.1)

The normal temperature and humidity conditions for tests shall be any convenient combination of temperature and humidity within the following ranges:

- Temperature: +15°C to +35°C (degrees Celsius).
- Relative humidity: 20 % to 75 %.

NOTE: When it is impracticable to carry out the tests under the conditions stated above, the actual temperature and relative humidity during the tests shall be recorded in the test report.

The normal test voltage for equipment to be connected to the mains shall be the nominal mains voltage. For the purpose of these specifications, the nominal voltage shall be the declared voltage or any of the declared voltages for which the equipment was designed. The frequency of the test power source corresponding to the mains shall be within 1 Hz of the nominal mains frequency.

When the radio equipment is intended for operation from the usual types of regulated lead-acid battery power source of vehicles, the normal test voltage shall be 1,1 times the nominal voltage of the battery (6 volts, 12 volts etc.).

For operation from other power sources or types of battery (primary or secondary) the normal test voltage shall be that declared by the equipment manufacturer.

A1.2.3 Extreme test conditions (TC2.2)

For tests under extreme test conditions the 4 combinations of extreme voltages and extreme temperatures in table A1.1 shall be applied.

Table A1.1

	1	2	3	4
Temperature	High	High	Low	Low
Voltage	High	Low	High	Low

For tests at extreme ambient temperatures measurements shall be made at the temperatures given in table A1.2, following the testing procedures given in IEC publications 68-2-1 and 68-2-2 for the low and high temperature tests.

For tests at the high temperature, after thermal balance has been achieved, the MS is switched on in the transmit condition (non DTX) for a period of one minute followed by 4 minutes in the idle mode (non DRX) after which the MS shall meet the specified requirements.

For tests at the low temperature, after thermal balance has been achieved, the MS is switched to the idle mode (non DRX) for a period of one minute after which the MS shall meet the specified requirements.

Table A1.2

	Temperature (degrees Celsius)	
	Low	High
Handheld	-10	+55
Vehicular or Portable	-20	+55

For tests at extreme voltages measurements shall be made at the lower and higher extreme voltages as declared by the MS manufacturer. For MS that can be operated from one or more of the power sources listed below, the lower extreme voltage shall not be higher, and the higher extreme voltage shall not be lower than that specified in table A1.3.

Table A1.3

	Voltage (relative to nominal)		
	Lower extreme	Higher extreme	Normal cond.
Power source:			
AC mains	0,9	1,1	1,0
Regulated lead acid battery	0,9	1,3	1,1
Non regulated batteries:			
Leclanché	0,85	1,0	1,0
lithium	0,95	1,10	1,10
mercury/ nickel cadmium	0,9	1,0	1,0

A1.2.4 Vibration requirements (TC4)

When the MS is to be tested under vibration, then random vibration is used, where the acceleration spectral densities (ASD) and the frequency ranges of 3GPP TS 05.05 [subclause D.2.3] apply. These are given in table A1.4.

Table A1.4

frequency in Hz	ASD in m^2/s^3
5- 20	0,96
20 - 500	0,96 at 20 Hz, thereafter -3 dB / octave

The test shall be performed as described in IEC publication 68-2-36.

Annex 2: Not used

Text deleted.

Annex 3: Protocol implementation information

General

The list of PICS and PIXIT gives all the information needed to perform the tests described in 3GPP TS 11.10.

A3.1 Protocol Implementation Conformance Statement (PICS)

For the points listed the manufacturer has the choice between different solutions in implementation. The manufacturer has to describe his choice if there is any consequence for the tests.

A3.1.1 LAPDm protocol (3GPP TS 04.05 and 04.06)

A3.1.1.1 Simplified protocol - 3GPP TS 04.06 clause 6

Statement about the choice made by the manufacturer.

A3.1.1.2 Management of SAPI = 3 - 3GPP TS 04.11 subclause 2.3

Statement about the handling of SAPI = 3 on the data link layer chosen by the manufacturer.

A3.1.2 Mobility management

A3.1.2.1 IMSI detach initiation by the MS - 3GPP TS 04.08 / 3GPP TS 24.008 subclause 4.3.4.1

During a location updating, if an IMSI detach has to be performed (SIM or power off), the IMSI detach can be delayed until the location updating is finished, or can be omitted.

A3.1.2.2 IMSI detach completion by the MS - 3GPP TS 04.08 / 3GPP TS 24.008 subclause 4.3.4.3

The MS should delay the local release of the channel to allow a normal release from the network after a detach by power off command, if possible.

If not possible the RR sub-layer on the MS side should be aborted without waiting for something from the network.

A3.1.2.3 MM specific procedures - 3GPP TS 04.08 / 3GPP TS 24.008 subclauses 4.4 and 4.5.1.1

During the lifetime of an MM specific procedure, if an MM connection establishment is required by a CM-entity, this request will either be rejected or delayed until the running MM specific procedure is terminated and, provided that the network has not sent a "follow-on proceed" indication, the RR connection is released.

If the LOCATION UPDATING REQUEST message has not been sent, the mobile station may include a "follow-on request" indicator in the message. The mobile station shall then delay the request until the MM specific procedure is completed, when it may be given the opportunity by the network to use the RR connection.

A3.1.2.4 Receiving an MM STATUS message - 3GPP TS 04.08 / 3GPP TS 24.008 subclause 4.6

If the MM-entity of the Mobile Station receives a MM-STATUS message no state transition and no specific action shall be taken as seen from the radio interface, i.e. local actions are possible.

A3.1.3 Call control

A3.1.3.1 Status enquiry procedures - 3GPP TS 04.08 / 3GPP TS 24.008 subclause 5.5.3.1

The MS may send a STATUS ENQUIRY and take the appropriate actions based on the answer (STATUS) of the network.

A3.1.3.2 Receiving a STATUS message by a CC entity - 3GPP TS 04.08 / 3GPP TS 24.008 subclause 5.5.3.2

The determination of which CC states are incompatible between the MS and the network is left as an implementation decision except in some particular cases.

A3.1.3.3 Called side compatibility checking - 3GPP TS 04.08 / 3GPP TS 24.008 clause B.3

Compatibility checking can be performed in various ways from the viewpoint of execution order and information to be checked, e.g. first DDI number, sub-address and then compatibility or vice versa.

A3.1.3.4 Disconnect on incoming call

The mobile equipment may or may not offer the possibility to disconnect an incoming call:

- a) after having confirmed an incoming call, but before alerting;
- b) after alerting, but before connecting.

3GPP TS 02.30 (subclause 5.2.3) allows the combination of SEND and END function in one key.

A3.1.4 Layer 1

A3.1.4.1 Optional storage of BCCH carrier information - 3GPP TS 05.08 subclause 6.3

The MS may include optional storage of BCCH carrier information. For instance, the MS may store the BCCH carriers in use by the PLMN accessed when it was last active in the GSM network, or it may store BCCH carriers for more than one PLMN.

A3.1.5 Autocalling - (ref.: 3GPP TS 02.07, annex 1)

Cause number 27 implemented in:

- category 2 (preferred);
- category 3.

A3.1.6 Transient states

The following call control states may be transient in the mobile station:

State U6

State U6 may be transient if the mobile station is not configured to support explicit refusal of an incoming call by the (human or non-human) user (e.g. via a terminal interface) before call confirmation.

If U6 is transient, there is an internal transition:

```

                CALL CONFIRMED
U6 -----> U9
  
```

or an internal transition:

RELEASE COMPLETE

U6 ----- > U0.

State U7:

State U7 is transient if the implementation allows for automatic connect after an implementation specific time T.

If U7 is transient, there is an internal transition:

after T, CONNECT

U7 ----- > U8.

State U9:

State U9 is not transient if:

- the implementation does not support immediate connect;
- an appropriate TCH is not yet assigned;
- the signalling element has not been present in the SETUP.

If the implementation supports immediate connect, there is an internal transition:

CONNECT

U9 ----- > U8.

If the appropriate TCH is available or the signalling element was present in SETUP, there is an internal transition:

ALERTING

U9 ----- > U7.

State U12:

U12 is a stable state, if an appropriate speech traffic channel is connected and progress indicator #8 was present in the DISCONNECT message. Otherwise U12 is transient, and there is an internal transition:

A3.2 Protocol Implementation Extra Information for Testing (PIXIT)

A3.2.0 Introduction

Some of the features listed below are mandatory, others are not ; but in any case for each feature implemented the manufacturer must provide information to enable regulatory testing to be conducted.

A3.2.1 Basic characteristics

A3.2.1.1 Type of antenna

- Integrated without a connector.
- Position for normal use (if integrated without a connector).
- With a connector allowing the connection of an external antenna.
- If with a connector, declare in band impedance.

A3.2.1.2 Power supply

- Type of battery (if any).
- Type of power supply.
- Nominal voltage(s).
- End-point voltage(s) of battery(s) (if any).
- Details of MS shut-down voltage.

A3.2.1.3 Power class of the MS

- Different class declared.
- Class mark change: description of the means to change the RF power capabilities.

A3.2.1.4 Channel modes supported

- Speech full rate.
- Speech half rate.
- Data 14.5 kbit/s T/NT.
- Data 12 kbit/s full rate T/NT.
- Data 6 kbit/s full rate T/NT.
- Data 6 kbit/s half rate T/NT.
- Data 3,6 kbit/s full rate T.
- Data 3,6 kbit/s half rate T.

A3.2.1.5 Teleservices supported

- 11) Telephony.
- 12) Emergency calls.
- 21) Short message MT/PP.
- 22) Short message MO/PP.
- 23) Short message transmission cell broadcast.
- 61) Alternate speech and facsimile group 3 T/NT.
- 62) Automatic facsimile group 3 T/NT.

A3.2.1.6 Supplementary services supported

- Call forwarding.
- Call restriction.
- Handling of undefined GSM Supplementary Services.

A3.2.1.7 Bearer services supported

- | | | |
|-----|-------------------------------------|---------------------------------|
| 20) | Asynchronous General Bearer Service | see 3GPP TS 02.02 subclause 3.1 |
| 21) | Data circuit Duplex asynchronous | 300 bit/s T/NT |
| 22) | Data circuit Duplex asynchronous | 1 200 bit/s T/NT |

23)	Data circuit Duplex asynchronous	1 200/75 bit/s	T/NT
24)	Data circuit Duplex asynchronous	2 400 bit/s	T/NT
25)	Data circuit Duplex asynchronous	4 800 bit/s	T/NT
26)	Data circuit Duplex asynchronous	9 600 bit/s	T/NT
30)	Synchronous General Bearer Service	see 3GPP TS 02.02 subclause 3.1	
31)	Data circuit Duplex synchronous	1 200 bit/s	T
32)	Data circuit Duplex synchronous	2 400 bit/s	T/NT
33)	Data circuit Duplex synchronous	4 800 bit/s	T/NT
34)	Data circuit Duplex synchronous	9 600 bit/s	T/NT
40)	General PAD Access Bearer Service	see 3GPP TS 02.02 subclause 3.1	
41)	PAD Access circuit asynchronous	300 bit/s	T/NT
42)	PAD Access circuit asynchronous	1 200 bit/s	T/NT
43)	PAD Access circuit asynchronous	1 200/75 bit/s	T/NT
44)	PAD Access circuit asynchronous	2 400 bit/s	T/NT
45)	PAD Access circuit asynchronous	4 800 bit/s	T/NT
46)	PAD Access circuit asynchronous	9 600 bit/s	T/NT
50)	General Packet Access Bearer Service	see 3GPP TS 02.02 subclause 3.1	
51)	Data Packet Duplex synchronous	2 400 bit/s	NT
52)	Data Packet Duplex synchronous	4 800 bit/s	NT
53)	Data Packet Duplex synchronous	9 600 bit/s	NT
61)	Alternate Speech/Data (here Data offers the same service as bearer services 21-34 with "3,1kHz" information transfer capability)		
81)	Speech followed by Data (here Data offers the same service as bearer services 21-34 with "3,1kHz" information transfer capability).		

A3.2.1.8 SIM removal

- Removal of the SIM is possible without disconnection of the power supply (Y/N).

A3.2.1.9 Classmark

The coding of Mobile station classmark 1, 2, and 3 and the fact whether and under which conditions the classmark 3 information element is included in a CLASSMARK CHANGE message, has to be declared by the manufacturer. The declaration has to fulfil the following requirements:

- Mobile station classmark 1: Bits 4, 5 and 8 of the first (and only) octet of the value part of the information element shall be coded as "0". The "Revision level" and "RF power capability" field shall specify the value that is correct for the MS.
- Mobile station classmark 2: Bits 4, 5 and 8 of the first octet, bits 2, 3 and 8 of the second octet, bits 3 to 7 of the third octet of the value part of the information element shall be coded as "0". The "Revision level" field, "RF power capability" field, "PS capability" field, "SS Screening indicator" field, "SM capability" field, "Frequency capability" field, "Classmark 3" field, "A5/2 algorithm supported" field, and "A5/3 algorithm supported" field shall specify the value that is correct for the MS.
- Mobile station classmark 3: Bits 5 to 8 of the first octet of the value part of the information element shall be coded as "0". If the value part contains more octets, they shall be coded as "0000 0000". The "A5/4 algorithm supported" field, "A5/5 algorithm supported" field "A5/6 algorithm supported" field, and "A5/7 algorithm supported" field shall specify the value that is correct for the MS (that is, they shall be set to "0").

NOTE: The requirements to the classmark may be subject to changes. That is why test cases are expected to verify the manufacturer's declaration, whereas the correctness of the manufacturer's declaration is to be verified "off line".

A3.2.1.10 Type of SIM/ME interface (ref. 3GPP TS 11.11 and 3GPP TS 11.12)

- 5V SIM/ME interface (5V only ME).
- 3V SIM/ME interface (3V only ME).
- 5V/3V SIM/ME interface (3V technology ME).

A3.2.1.11 Multislot class

- Multislot class as defined in clause B.1 of 3GPP TS 05.02.

A3.2.2 Man machine interface

A3.2.2.1 Mobile station features

- Description of manual entry and display of a called number.
- Description of the basic way to send a call manually.
- Description of the basic way to take a call manually.
- Description of the basic way to end a call manually.
- Description of the basic way to send an emergency call manually.
- Description of the basic way to send DTMF manually.
- Description of the manual PLMN selector.
- Description of the automatic PLMN selector.
- Description of the indication of the country.
- Description of the indication of the available PLMN.
- Description of the indication of the automatic registration to a PLMN.
- Description of the service indicator.
- Description of the management of the SIM by the user:
 - keying PIN and changing PIN;
 - indication of acceptance or rejection of keyed PIN;
 - indication of blocked SIM;
 - indication of successful unblocking of the SIM;
 - storing an abbreviated number;
 - displaying an abbreviated number.
- Description of the selection of the hands free.
- Description of the volume control.
- Description of local barring of outgoing calls.
- Description of prevention of unauthorized calls.
- Description of the auto calling management:
 - selection of the auto calling;

- indication that the call failed and a re-try is attempted;
- indication that the call finally failed;
- number of B-party numbers that can be stored in the list of blacklisted numbers.
- Description of the way in which the MS generates an MS originated NOTIFY, if possible. This feature may or may not be supported by the MS.
- Description of the way the MS indicates the identity of the current LSA to the human user (only applicable if the SoLSA MS has an interface to the human user).
- Description of the way the MS indicates the change of the current LSA to the human user (only applicable if the SoLSA MS has an interface to the human user).

NOTE: All the above description could be extracted from the user's manual.

A3.2.2.2 Short message service

- Description of the basic procedures to send a mobile originated short message.
- Description of the basic procedures to display a mobile terminated short message.
- Description of the basic procedures to display a cell broadcasted short message.
- Whether SMS messages are stored in the SIM and/or the ME.
- Maximum length (characters) of a mobile originated short message.

A3.2.2.3 Supplementary services

A3.2.2.3.1 Call forwarding

- Description of the user's commands and of the display of the answers from the network for:
 - registration;
 - erasure;
 - activation;
 - deactivation;
 - interrogation;
 - specific data request.
- Description of the display of:
 - notification of an incoming call to the "served" mobile or the "forwarded to" mobile;
 - notification during out-going call;
 - information to the calling mobile.

A3.2.2.3.2 Call restriction

- Description of the user's commands and the display of the answers from the network for:
 - registration;
 - change of the password;
 - activation;
 - deactivation;

- interrogation.
- Description of the display of the indication of call barring.

A3.2.2.3.3 Handling of (undefined) GSM supplementary services

- Description of the user's commands and the display of the answer from the network.
- Identification of the short strings defining MS manufacturer defined procedure in idle mode (1 or 2 characters defined in the 3GPP TS 03.38 default alphabet followed by "SEND").

A3.2.3 Electrical Man Machine Interface (EMMI)

A3.2.3.1 Methods supported for activation/deactivation of EMMI

- All possibilities specified in 3GPP TS 11.10, subclause 36.2.2.
- All possibilities specified in 3GPP TS 11.10, subclause 36.2.2, except activation by inserting a test SIM (when the ME is already switched on).
- Activation/deactivation only via layer 3 messages on the radio interface according to 3GPP TS 11.10, subclause 36.2.2.

A3.2.3.2 Transmission rate supported by the ME on the EMMI

A3.2.3.3 Layer 3 messages supported on the EMMI

- Layer 3 messages as specified in 3GPP TS 11.10, subclause 36.3.5.3.2, except: (followed by the list of messages not supported).
- others than defined in 3GPP TS 11.10 subclause 36.3.5.3.1 table 9.

A3.2.3.4 Keystroke sequence messages

Non standard keystroke sequences to be used on the EMMI (in line with 3GPP TS 11.10, subclause 36.3.5.3.2):

- related to tests of the mobile station features (3GPP TS 11.10, clause 33);
- related to testing of the ME/SIM interface (3GPP TS 11.10, clause 27);
- related to tests of autocalling restrictions (3GPP TS 11.10, clause 28);
- related to tests of supplementary services (3GPP TS 11.10, clause 31);
- related to tests of data services (3GPP TS 11.10, clause 29);
- related to tests of short message service (3GPP TS 11.10, clause 34);
- related to other tests.

A3.2.3.5 Internal malfunction detected messages

List of the error indicators provided.

A3.2.4 Digital Audio Interface (DAI)

Description of the speech data routing:

- via the control lines; or
- via the test interface message.

A3.2.5 Characteristics related to bearer services or teleservices

A3.2.5.1 Access interface

Description of the access interface to connect the DTE (e.g. V series (V.24, V.28), X series, two wire analogue interface for use with fax group 3, I.420 (S-reference point).

In case of a proprietary interface to a DTE (non standard), description of this interface (hardware and software).

In case of a non standard connector provide a mechanical adapter.

A3.2.5.2 Configuration of the MT

Description of the configuration information to be selected in the MT to connect a terminal equipment to the mobile termination.

Description of the (different) configuration(s) of the MT for each bearer service and each teleservice supported, with the range or value for the parameters and the configuration procedure.

For the purpose of test of MOC, the manufacturer shall describe precisely how it is possible to put the MT in the different configurations to generate the capability information of the Mobile according to subclause 3.2.5.3, and described as supported by the MS.

For the purpose of test of MTC, the manufacturer shall describe how to verify the correct selection by the MT of the required function with regard to the capability information as described below, especially using the messages at the Um interface if there is no R or S interface available (case MTO). The description shall be made for every combination of the parameter value valid for the MT.

A3.2.5.3 Capability information

Description of the capability information, related to supported bearer services:

- bearer capabilities;
- higher layer capabilities;
- lower layer capabilities.

The manufacturer shall describe for every capability the associated terminal functions and their characteristics.

A3.2.5.4 Subaddress or DDI number

Subaddress or a DDI number of the MT.

Procedure to allocate or change DDI number or subaddress, if possible.

A3.2.5.5 User to user signalling

Description of the function and the user's access to it.

A3.2.5.6 Data call set-up and data call clearing

For each implemented transparent and non-transparent data service:

- Description of the data call establishment mechanism:
 - Terminal initiated (CT108) (if possible);
 - MT (MMI/EMMI) initiated;
- Description of DCE provided information (MT to TE), if any;
- Declaration of optimal function and procedure, services supported by the MT.
- Description of the data call clearing mechanism:

- Terminal initiated (CT109) (if possible);
- MT (MMI/EMMI) initiated;
- Description of DCE provided information (MT to TE) related to a mobile or network initiated call clearing, if any.

A3.2.5.7 Characteristics of non-transparent data services

Description of Radio Link Protocol (RLP) features supported.

Description of supported RLP parameters and how to modify these values (if possible):

- <iws> IWF to MS window size
- <mws> MS to IWF window size
- <T1> acknowledgement timer T1
- <N2> retransmission attempts N2

Ability to configure the MS to use non-default RLP parameters.

Description of flow control mechanism:

- INBAND (XON/XOFF);
- OUTBAND COPnoFICt (CT105 and CT106).

A3.2.5.8 Possible ways of setting-up a call from either an external interface or internally

Describe in detail all possible ways a call can be initiated from the MS or a connected terminal.

A3.2.5.9 Application layer causing automatic call termination

State whether the call termination facility can be disabled and if so, describe in detail how.

A3.2.5.10 Call re-establishment for MS not supporting speech

Applicability of call re-establishment.

A3.2.6 International mobile station equipment identity

IMEI of the MS.

A3.2.7 Receiver intermediate frequencies

F_0 - Local Oscillator frequency applied to first receiver mixer.

$IF_1 \dots IF_n$ - intermediate frequencies.

A3.2.8 Artificial ear

The manufacturer shall declare which type of artificial ear (type 1 or type 3.2 or type 3.4) is used for teleservices speech testing.

The following illustrate the results of both artificial ears when specified for acoustic receiving measurement.

Type 3.2 results are currently referred to ERP (as specified), but measured at DRP. When introducing DRP to ERP correction, a special frequency response is used which is obtained with the artificial ear in a free sound field. The overall result actually differs substantially from the transfer function under the IEC 318 test conditions. Referring the results to DRP instead avoids misleading interpretations.

Receiving frequency response, sample mobile 1

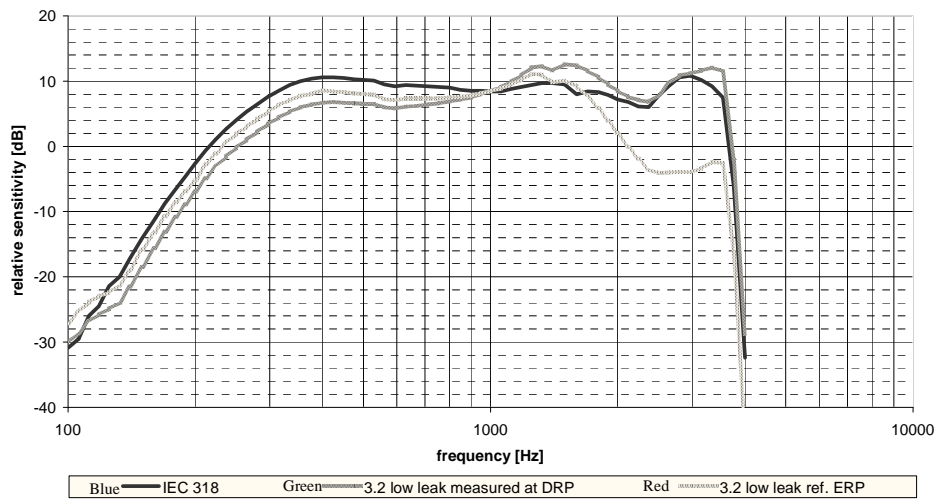

This slide as well as the following two shows results of three measurement and evaluation methods per each mobile sample. The blue curve is as measured sealed to IEC 318 closed coupler. The green curve is as measured with type 3.2 low leak coupler at DRP. The red curve shows the same measurement data corrected to ERP using the correction function provided by the manufacturer.

Receiving frequency response, sample mobile 2

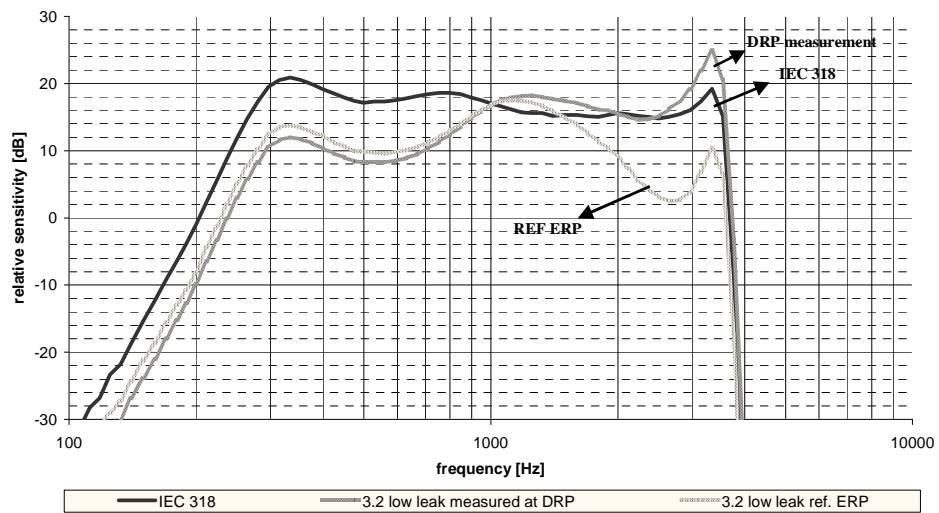

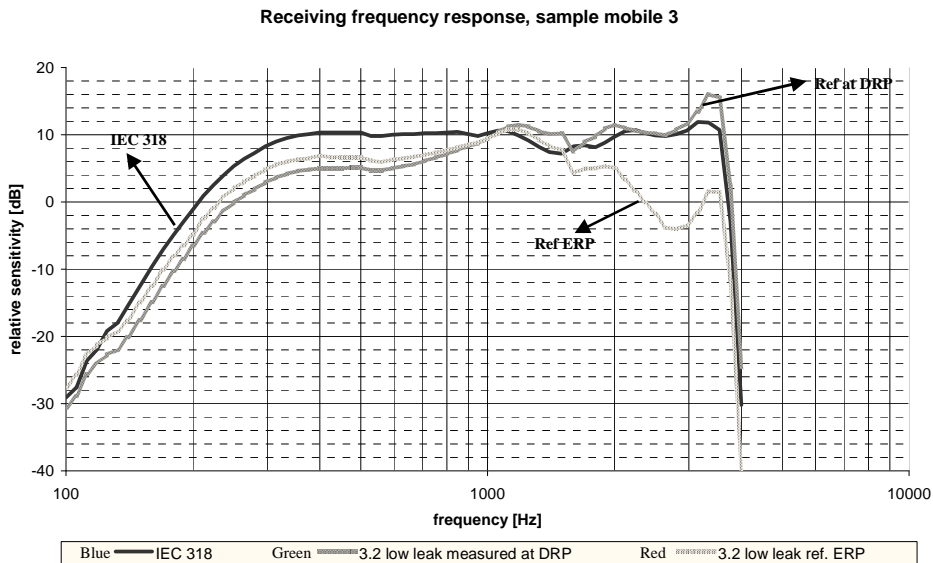

Below 1 KHz both type 3.2 curves are similar. The level decreases from IEC 318 to the type 3.2 results is due to the leak. At high frequencies the measured type 3.2 curve without DRP to ERP correction (green) clearly illustrates better compatibility towards IEC 318 results than the curve referred to ERP (red).

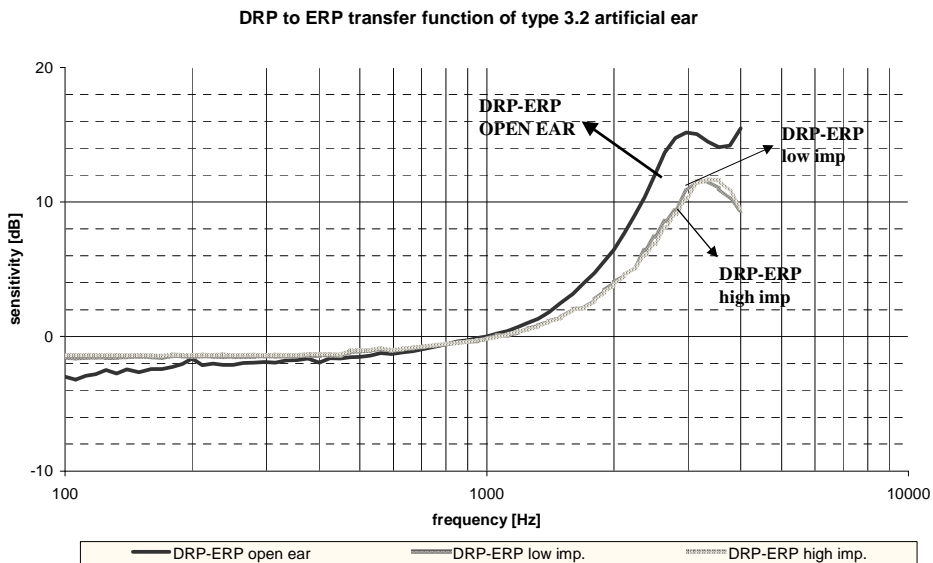

The three curves show the DRP to ERP transfer function for different source conditions. The blue line is obtained mounted in a baffle. The other two functions are measured with a probe microphone at ERP on two mobiles with different acoustic source impedance.

Measured SPL closed ear with low acoustic impedance source (example)

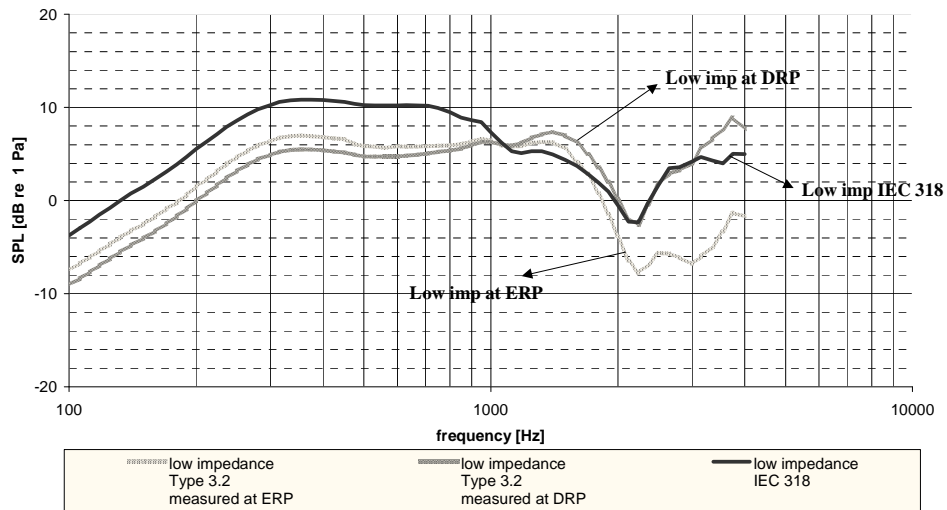

Contrary to the first three slides, the type 3.2 low leak response at ERP here is not calculated, but measured with a probe microphone. The relationship between the three curves is the same as in each of the first three slides.

The difference between the results of type 3.2 low leak artificial ear referred to DRP and ERP respectively is due to the acoustic input impedance of the artificial ear. The high acoustic impedance at DRP is transferred to a relatively low impedance at ERP for high frequencies according to the quarter wavelength distance between both points. This means that acoustic energy at ERP is more in terms of sound velocity, which is not measured with the used pressure microphone. The human ear is known to have its highest sensitivity around 5 KHz. Type 3.2 low leak measurement referred to ERP has particularly low sensitivity at this frequency. In order to account for compatibility between IEC 318 results and type 3.2 low leak results as well as for the sensitivity of the human ear, it is up to the choice of the terminal manufacturer, whether acoustic test results from the type 3.2 low leak artificial ear should be referred to ERP or to DRP.

Annex 4: Test SIM Parameters

A4.1 Introduction

This clause defines default parameters for programming the elementary files of the test SIM. The requirements of this annex do not apply to the SIM/ME tests of clause 27.

A4.1.1 Definitions

"Test SIM card":

A SIM card supporting the test algorithm for authentication, programmed with the parameters defined in this subclause. The electrical, mechanical and environmental requirements of the test SIM card are specified in 3GPP TS 11.11.

"Test SIM":

Either a test SIM card or the SIM simulator programmed with the parameters defined in this subclause.

A4.1.2 Definition of the test algorithm for authentication

The following procedure employs bit wise modulo 2 addition ("XOR").

The following convention applies:

In all data transfer the most significant byte is the first byte to be sent; data is represented so that the left most bit is the most significant bit of the most significant byte.

Step 1:

XOR to the challenge RAND, a predefined number Ki, having the same bit length (128 bits) as RAND. The result RES1 of this is

$$\text{RES1} = \text{RAND XOR Ki}$$

Step 2:

The most significant 32 bits of RES1 form SRES. The next 64 bits of RES1 form Kc. The remaining 32 bits are not used.

A4.2 Default Parameters for the test SIM

Ki:

The authentication key "Ki" will be chosen by the test house and will be non zero. The "Ki" value used by the SS will align with this value.

PIN Disabling

The PIN enabled / disabled flag will be set to "PIN Disabled". This ensures that when the Test SIM is inserted into a MS the user will not be prompted for PIN entry. This requires a specific card capability defined by the SIM service table (see subclause 2.9).

A4.3 Default settings for the Elementary Files (EFs)

The format and coding of elementary files of the SIM are defined in 3GPP TS 11.11. The following subclauses define the default parameters to be programmed into each elementary file. Some files may be updated by the MS based on information received from the SS. These are identified in the following subclauses.

A4.3.1 EF_{ICCID} (ICC Identification)

The programming of this EF is a test house option.

A4.3.2 EF_{LP} (Language preference)

The programming of this EF is a test house option.

A4.3.3 EF_{IMSI} (IMSI)

The IMSI value will be chosen by the test house. The IMSI used by the SS will align this value.

File size: 9 bytes
 Default values: Byte 1 (DEC): 8
 Bytes 2-9 (DEC): 09 10 10 ** ** **

**	**
----	----

 for GSM 400, GSM 900 and DCS 1 800
 Bytes 2-9 (DEC): 09 10 10 *1 ** **

**	**
----	----

 for GSM 700, GSM 850 and GSM 1 900

"*" indicates any number between 0 and 9 subject to the restriction that IMSI mod 1000 (i.e. the three boxed "*" digits number 13, 15 and 16) lies in one of the following ranges:

- 063-125, 189-251, 315-377, 441-503, 567-629, 693-755, 819-881 or 945-999.

NOTE: This ensures that the MS can listen to the second CCCH when more than one basic physical channel is configured for the CCCH. This is necessary for the test of "paging re-organization".

A4.3.4 EF_{Kc} (Cipherring key Kc)

File size: 9 Bytes
 Default values (HEX): Bytes 1-8: Align with Kc used by SS
 Byte 9: 07

Byte 9 is set to 07 to indicate that there is no key available at the start of a test.

The bytes within this elementary file may be updated by the MS as a result of a successful authentication attempt.

A4.3.5 EF_{PLMNsel} (PLMN selector)

GSM 400, GSM 900 and DCS 1 800 begin

File size: 102 bytes
 Default values (HEX): Bytes 1-3: 32 F4 10 (MCC, MNC) - Translates to 234, 01
 Bytes 4-6: 32 F4 20 (MCC, MNC)
 Bytes 7-9: 32 F4 30 (MCC, MNC)

 Bytes 94-96: 32 F4 23 (MCC, MNC)
 Bytes 97-99: 32 F4 33 (MCC, MNC)
 Bytes 100-102: 32 F4 43 (MCC, MNC)

GSM 400, GSM 900 and DCS 1 800 end

GSM 700, GSM 850 and PCS 1900 begin

File size: 102 bytes
 Default values (HEX): Bytes 1-3: 32 24 10 (MCC, MNC) - Translates to 234, 012
 Bytes 4-6: 32 34 20 (MCC, MNC)
 Bytes 7-9: 32 44 30 (MCC, MNC)

 Bytes 94-96: 32 34 23 (MCC, MNC)

Bytes 97-99: 32 44 33 (MCC, MNC)
 Bytes 100-102: 32 54 43 (MCC, MNC)

GSM 700, GSM 850 and PCS 1900 end

34 PLMNs are shown coded above since this is the largest number required for a test - see subclause 27.9.4.1. It is necessary to take this into account since the SIM cards must be dimensioned to cope with this number of records.

A4.3.6 EF_{HPLMN} (HPLMN search period)

File size: 1 byte

Default value (HEX): 00 (no HPLMN search attempts)

A4.3.7 EF_{ACMmax} (ACM maximum value)

File size: 3 bytes

Default: Byte 1: 00
 Byte 2: 00
 Byte 3: 00

The above translates to: "Not valid".

A4.3.8 EF_{SST} (SIM service table)

Services will be allocated and activated as follows:

Service	Allocated	Activated
No. 1: CHV1 disable function	Yes	Yes
No. 2: Abbreviated Dialling numbers (ADN)	Yes	Yes
No. 3: Fixed dialling numbers (FDN)	Yes	Optional
No. 4: Short Message Storage (SMS)	Yes	Yes
No. 5: Advice of Charge (AoC)	Yes	Yes
No. 6: Capability Configuration Parameters (CCP)	Yes	Yes
No. 7: PLMN Selector	Yes	Yes
No. 8: Reserved for future use	No	No
No. 9: MSISDN	Optional	Optional
No. 10: Extension 1	Yes	Optional
No. 11: Extension 2	Yes	Optional
No. 12: SMS Parameters	Yes	Yes
No. 13: Last Dialed Number (LND)	Yes	Yes
No. 14: Cell Broadcast Message Identifier	Yes	Yes
No. 15: Group identifier Level 1	Yes	Optional
No. 16: Group identifier Level 2	Yes	Optional
No. 21: VGCS Group Identifier List (EF _{VGCS} , EF _{VGCS})	Yes	Yes
No. 22: VBS Group Identifier List (EF _{VBS} , EF _{VBS})	Yes	Yes
No. 23: eMLPP service	Yes	Yes
No. 24: Automatic answer for eMLPP	Yes	Yes
No. 25: Data download via SMS-CB	Optional	Optional
No. 26: Data download via SMS-PP	Optional	Optional
No. 27: Menu selection	Optional	Optional
No. 28: Call control	Optional	Optional
No. 29: Proactive SIM	Optional	Optional
No. 30: Cell Broadcast Message Identifier Ranges	Optional	Optional
No. 31: Barred Dialling Numbers (BDN)	Optional	Optional
No. 32: Extension4	Optional	Optional
No. 33: De-personalization Control Keys	Optional	Optional
No. 34: Co-operative Network List	Optional	Optional
No. 35: Short Message Status Reports	Optional	Optional
No. 36: Network's indication of alerting in the MS	Optional	Optional
No. 37: Mobile Originated Short Message control by SIM	Optional	Optional
No. 38: GPRS	Optional	NOTE
NOTE:	For GPRS tests the GPRS service shall be activated.	

A4.3.9 EF_{ACM} (Accumulated call meter)

File size:		3 bytes
Default:	Byte 1:	00
	Byte 2:	00
	Byte 3:	00

The above translates to: "Not yet implemented".

A4.3.10 EF_{PUCT} (Price per unit and currency table)

File size:		5 bytes
Default:	Byte 1-3:	FF
	Byte 4-5:	00

A4.3.11 EF_{CBMI} (Cell broadcast Message Identifier Selection)

The programming of this EF is a test house option.

The file size is 2n bytes, where n is the number of Cell broadcast message identifier records - each record defining a type of Cell Broadcast message which may be accessed by the MS. Care should be taken when dimensioning the SIM to take into account the number of Cell Broadcast message identifier records required.

A4.3.12 EF_{BCCH} (Broadcast control channels)

File size:		16 Bytes
Default values (BIN):	Bytes 1-2:	11111111 11111111
	Bytes 3-4:	11111111 11111111
	Bytes 5-6:	11111111 11111111
	Bytes 7-8:	11111111 11111111
	Bytes 9-10:	11111111 11111111
	Bytes 11-12:	11111111 11111111
	Bytes 13-14:	11111111 11111111
	Bytes 15-16:	11111111 11111111

This field may be updated dependent on the MS implementation.

A4.3.13 EF_{ACC} (Access control class)

File size:		2 Bytes
Default values (BIN):	Byte 1:	00000000
	Byte 2:	*****

The test house may set any single bit of byte 2 to "1". All remaining bits of byte 2 will be set to "0". This determines the access control class of the SIM.

A4.3.14 EF_{FPLMN} (Forbidden PLMNs)

Length:		12 Bytes
Format (HEX):	Bytes 1-3:	FF FF FF
	Bytes 4-6:	FF FF FF
	Bytes 7-9:	FF FF FF
	Bytes 10-12:	FF FF FF

This coding corresponds to an empty "forbidden PLMN list". The bytes within this file may be updated if a LOCATION UPDATE REJECT message is received by the MS with cause, "PLMN not allowed".

A4.3.15 EF_{LOCI} (Location information)

GSM 400, GSM 900 and DCS 1 800 begin

File size:	11 Bytes
------------	----------

Default values: Bytes 1-4 (HEX): FF FF FF FF (TMSI)
 Bytes 5-9 (HEX): 42 F6 18 FF FE (LAI)
 Byte 10 (HEX): FF (Periodic LU Time = "the timer is not running")
 Byte 11 (BIN): 00000001 (Location Update Status = "not updated")

Bytes 5-9: LAI-MCC = 246 (bytes 5-6) and LAI-MNC = 81 (byte 7) are frequently used in clause 27. The LAC (bytes 8-9) is set to "FF FE" since this, in conjunction with byte 11 setting of "01", is used to ensure that the MS performs a location update at the beginning of a test.

Bytes in this file (e.g. TMSI in bytes 1-4) may be updated as a result of a location update attempt by the MS.

GSM 400, GSM 900 and DCS 1 800 end

GSM 700, GSM 850 and PCS 1900 begin

File size: 11 Bytes
 Default values: Bytes 1-4 (HEX): FF FF FF FF (TMSI)
 Bytes 5-9 (HEX): 42 36 18 FF FE (LAI)
 Byte 10 (HEX): FF (Periodic LU Time = "the timer is not running")
 Byte 11 (BIN): 00000001 (Location Update Status = "not updated")

Bytes 5-9: LAI-MCC = 246 (bytes 5-6) and LAI-MNC = 813 (bytes 6-7) are frequently used in clause 27. The LAC (bytes 8-9) is set to "FF FE" since this, in conjunction with byte 11 setting of "01", is used to ensure that the MS performs a location update at the beginning of a test.

Bytes in this file (e.g. TMSI in bytes 1-4) may be updated as a result of a location update attempt by the MS.

GSM 700, GSM 850 and PCS 1900 end

A4.3.16 EF_{AD} (Administrative data)

File size: 3 bytes
 Default values: Byte 1: 10000000 - (type approval operations)
 Byte 2: 11111111
 Byte 3: 11111111

A4.3.17 EF_{Phase} (Phase identification)

File size: 1 byte
 Default value (HEX): 02 Phase 2

A4.3.18 EF_{ADN} (Abbreviated dialling numbers)

The programming of this EF is a test house option. It should be noted that sufficient space should be provided on the SIM card for 101 records - see subclause 27.15.4.1.

A4.3.19 EF_{FDN} (Fixed dialling numbers)

Optional.

A4.3.20 EF_{SMS} (Short messages)

Default: Records 1-5

Byte 1:	00
Byte 2:	FF
Bytes 3-14:	FF FF FF FF FF FF FF FF FF FF FF FF
Bytes 15-26:	FF FF FF FF FF FF FF FF FF FF FF FF
Byte 27:	FF
Byte 28:	FF
Bytes 29-35:	FF FF FF FF FF FF FF
Byte 36:	FF
Bytes 37-176:	All Bytes set to FF

A4.3.21 EF_{CCP} (Capability configuration parameters)

File size: 14 bytes
 Default values Byte 1: 04
 Byte 2: 01
 Byte 3: A0
 Bytes 4-14: FF

The above translates to: "Full rate, GSM Standardized coding, circuit mode and speech".

A4.3.22 EF_{MSISDN} (MSISDN)

Optional.

A4.3.23 EF_{SMSP} (Short message service parameters)

The programming of this EF is a test house option.

Each record size is 28+Y bytes, where Y is the number of bytes in the Alpha Identifier. Care should be taken when dimensioning the SIM to take into account the number of Short message service parameter records required.

A4.3.24 EF_{SMSS} (SMS status)

File size: 2 bytes
 Byte 1: 00
 Byte 2 (BIN): 11111111

The above translates to:

- (a) Last Mobile Originated Short Message had a TP Message Reference parameter of "00".
- (b) SMS Memory Capacity Exceeded, Notification Flag unset: memory capacity available.

A4.3.25 EF_{EXT1} (Extension 1)

Optional.

A4.3.26 EF_{EXT2} (Extension 2)

Optional.

A4.3.27 EF_{VGCS} (Voice Group Call Service)

This EF contains a list of the default VGCS group identifiers.

File size: Bytes 200

Default values:

Bytes	Group ID	Value	BCD encoding in the SIM card
1-4	1	12	21 FF FF FF
5-8	2	123	21 F3 FF FF
9-12	3	1234	21 43 FF FF
13-16	4	12348	21 43 F8 FF
17-20	5	123491	21 43 19 FF
21-24	6	1235029	21 53 20 F9
25-28	7	12351	21 53 F1 FF
29-32	8	12352	21 53 F2 FF
33-36	9	12353	21 53 F3 FF
37-40	10	12354	21 53 F4 FF
41-44	11	12355	21 53 F5 FF
45-48	12	12356	21 53 F6 FF

Bytes	Group ID	Value	BCD encoding in the SIM card
49-52	13	12357	21 53 F7 FF
53-56	14	12358	21 53 F8 FF
57-60	15	12359	21 53 F9 FF
61-64	16	20000	02 00 F0 FF
65-68	17	20001	02 00 F1 FF
69-72	18	20002	02 00 F2 FF
73-76	19	20003	02 00 F3 FF
77-80	20	20004	02 00 F4 FF
81-84	21	20005	02 00 F5 FF
85-88	22	20006	02 00 F6 FF
89-92	23	20007	02 00 F7 FF
93-96	24	20008	02 00 F8 FF
97-100	25	20009	02 00 F9 FF
101-104	26	20010	02 10 F0 FF
105-108	27	66660	66 66 F0 FF
109-112	28	66661	66 66 F1 FF
113-116	29	66662	66 66 F2 FF
117-120	30	666638	66 66 83 FF
121-124	31	66664	66 66 F4 FF
125-128	32	66665	66 66 F5 FF
129-132	33	66666	66 66 F6 FF
133-136	34	66667	66 66 F7 FF
137-140	35	66668	66 66 F8 FF
141-144	36	66669	66 66 F9 FF
145-148	37	66670	66 76 F0 FF
149-152	38	80120	08 21 F0 FF
153-156	39	80121	08 21 F1 FF
157-160	40	80122	08 21 F2 FF
161-164	41	80123	08 21 F3 FF
165-168	42	80124	08 21 F4 FF
169-172	43	80125	08 21 F5 FF
173-176	44	80126	08 21 F6 FF
177-180	45	80127	08 21 F7 FF
181-184	46	80128	08 21 F8 FF
185-188	47	80129	08 21 F9 FF
189-192	48	80130	08 31 F0 FF
193-196	49	99999	99 99 F9 FF
197-200	50	1111119	11 11 11 F9

A4.3.28 EF_{VGCS} (Voice Group Call Service Status)

This EF contains the default activation of the VGCS group identifiers. The following list of group ID are activated: 1, 4, 20, 30, 50.

File size: Bytes 7
 Default values (HEX): Bytes 1-7: '09 00 08 20 00 00 FE'

A4.3.29 EF_{VBS} (Voice Broadcast Service)

This EF contains a list of the default VBS group identifiers.

File size: Bytes 200

Default values:

Bytes	Group ID	Value	BCD encoding in the SIM card
1-4	1	12	21 FF FF FF
5-8	2	123	21 F3 FF FF
9-12	3	1234	21 43 FF FF
13-16	4	12348	21 43 F8 FF
17-20	5	123491	21 43 19 FF
21-24	6	1235029	21 53 20 F9

Bytes	Group ID	Value	BCD encoding in the SIM card
25-28	7	12351	21 53 F1 FF
29-32	8	12352	21 53 F2 FF
33-36	9	12353	21 53 F3 FF
37-40	10	12354	21 53 F4 FF
41-44	11	12355	21 53 F5 FF
45-48	12	12356	21 53 F6 FF
49-52	13	12357	21 53 F7 FF
53-56	14	12358	21 53 F8 FF
57-60	15	12359	21 53 F9 FF
61-64	16	20000	02 00 F0 FF
65-68	17	20001	02 00 F1 FF
69-72	18	20002	02 00 F2 FF
73-76	19	20003	02 00 F3 FF
77-80	20	20004	02 00 F4 FF
81-84	21	20005	02 00 F5 FF
85-88	22	20006	02 00 F6 FF
89-92	23	20007	02 00 F7 FF
93-96	24	20008	02 00 F8 FF
97-100	25	20009	02 00 F9 FF
101-104	26	20010	02 10 F0 FF
105-108	27	66660	66 66 F0 FF
109-112	28	66661	66 66 F1 FF
113-116	29	66662	66 66 F2 FF
117-120	30	666638	66 66 83 FF
121-124	31	66664	66 66 F4 FF
125-128	32	66665	66 66 F5 FF
129-132	33	66666	66 66 F6 FF
133-136	34	66667	66 66 F7 FF
137-140	35	66668	66 66 F8 FF
141-144	36	66669	66 66 F9 FF
145-148	37	66670	66 76 F0 FF
149-152	38	80120	08 21 F0 FF
153-156	39	80121	08 21 F1 FF
157-160	40	80122	08 21 F2 FF
161-164	41	80123	08 21 F3 FF
165-168	42	80124	08 21 F4 FF
169-172	43	80125	08 21 F5 FF
173-176	44	80126	08 21 F6 FF
177-180	45	80127	08 21 F7 FF
181-184	46	80128	08 21 F8 FF
185-188	47	80129	08 21 F9 FF
189-192	48	80130	08 31 F0 FF
193-196	49	99999	99 99 F9 FF
197-200	50	1111119	11 11 11 F9

A4.3.30 EF_{VBSS} (Voice Broadcast Service Status)

This EF contains the default activation of the VBS group identifiers. The following list of group ID are activated: 1, 4, 20, 30, 50.

File size: Bytes 7
 Default values (HEX): Bytes 1-7: '09 00 08 20 00 00 FE'

A4.3.31 EF_{eMLPP} (enhanced Multi Level Pre-emption and Priority)

This EF contains default information about priority levels and fast call set-up conditions for the enhanced Multi Level Pre-emption and Priority service.

Length: 2 Bytes
 Format (HEX): Byte 1 (Priority levels): '74'
 Byte 2 (Fast call set-up conditions): '04'

The coding corresponds to available priority levels 2, 3, 4 and 0. For fast call setup, the coding corresponds to available priority level 0.

A4.3.32 EF_{AAeM} (Automatic Answer for eMLPP Service)

This EF contains the default priority levels (of the Multi Level Pre-emption and Priority service) for which the mobile station shall answer automatically to incoming calls.

Length: 1 Byte
 Format (HEX): Byte 1: '0F'

The coding corresponds to the default capability of the MS to answer automatically to incoming calls that have a priority level higher than 2.

A4.3.33 EF_{KcGPRS} (GPRS Ciphering key KcGPRS)

Mandatory if GPRS shall be tested else optional.

File size: 9 bytes
 Default values (HEX): Bytes 1-8: Align with KcGPRS used by SS
 Byte 9: 07

Byte 9 is set to 07 to indicate that there is no key available at the start of a test unless other conditions follow from the definition of the initial conditions of the mobile.

The bytes within this elementary file may be updated by the MS as a result of a successful authentication attempt.

A4.3.34 EF_{LOCIGPRS} (GPRS location information)

Mandatory if GPRS shall be tested else optional.

File size: 14 bytes
 Default values: Bytes 1-4 (HEX): FF FF FF FF (P-TMSI)
 Bytes 5-7 (HEX): FF FF FF (P-TMSI signature value)
 Bytes 8-13 (HEX): FF FF FF FF FF FF (RAI)
 Byte 14 (BIN): 00000001 (Routing Area Update Status = "not updated")

Bytes in this file (e.g. P-TMSI in bytes 1-4) may be updated as a result of a routing area update attempt by the MS.

Annex 5: Test equipment

A5.1 Introduction

A5.1.1 General

The test equipment is either an equipment or assembly of equipments which enables the tests described in the present document to be conducted.

This annex describes requirements for the test equipment which cannot be derived from and which are assumed in, the conformance test descriptions described in the present document.

Specifically stimulus setting and measurement uncertainties are defined.

A5.1.2 Test equipment terms

The term "System Simulator" (SS) is used to describe the complete suite of test equipment required to perform the tests in the present document when interacting with the following MS interfaces:

- Antenna (Connector or radiated);
- Acoustic;
- Data Port(s);
- Power supply;
- DAI.

NOTE: To perform a sub-set of tests, the SS may be simplified accordingly.

The term "SIM simulator" is used to describe the test equipment required to interact with the SIM/ME interface.

A "test SIM" has the physical characteristics of a standard SIM card, (see 3GPP TS 11.11) with specific parameters defined in annex 3.

A5.1.3 Confidence level

All uncertainty values stated in this annex are quoted for a Confidence Level of 95 %.

A5.2 Standard test signals

The Cx signals represent the wanted signals and the Ix signals represent the unwanted signals.

Signal C0	Unmodulated continuous carrier.
Signal C1	A standard GSM signal with GMSK or 8-PSK modulation as appropriate. The channel coder will depend on the test and the cipher mode shall be selectable by the test method. When using this signal in the non hopping mode, the unused seven time slots shall also contain dummy bursts, with power levels variable with respect to the used timeslot, see also DYNAMIC LEVEL SETTING in subclause A5.3.4.7.
Signal I0	Unmodulated continuous carrier.
Signal I1	A GMSK modulated carrier following the structure of the GSM signals, but with all modulating bits (including the midamble period) derived directly from a random or pseudo random data stream.
Signal I2	A standard GMSK modulated signal with valid midamble, different from C1. The data bits (including bits 58 and 59) shall be derived from a random or pseudo random data stream.
Signal I3	An Additive White Gaussian Noise (AWGN) signal having a minimum bandwidth of 1,5 times the symbol rate i.e. minimum 402,6kHz for a GSM channel. The AWGN power shall be measured over a noise bandwidth of 270,833 kHz. In the complex baseband, the AWGN signals shall be independent in the real and in the imaginary part, zero-mean and with equal power.
Signal I4	A GMSK modulated signal with valid training sequence code (TSC) randomly selected on a burst-by-burst basis from {TSC1,...,TSC7}. The interferer shall be a single slot wide, and shall apply power ramping according to the requirements in 3GPP TS 45.005. The interferer shall be delayed with respect to the wanted signal by an integer number of symbols in the range -1 to +4. Unless specified in a given test case, The delay shall be randomly chosen and shall remain fixed for the duration of the test.
Signal I5	A GMSK modulated signal following the structure of the GSM signals, but with all modulating bits (including the midamble period) derived directly from a random or pseudo random data stream. The interferer shall be a single slot wide, and shall apply power ramping according to the requirements in 3GPP TS 45.005. The interferer shall be delayed with respect to the wanted signal by 74 symbols.

A5.3 SS functional requirements

A5.3.1 Level setting range

It is assumed that the SS is capable of setting stimulus levels, at the MS interface, to those required in the test specification extended by the measurement uncertainty defined in this annex.

NOTE: This ensures that the SS is able adequately to stimulate the MS performance at and just beyond the limit requirement under all conditions.

A5.3.2 Level Measurement / operation range

It is assumed that the SS is capable of performing measurements, within the uncertainty defined in this annex, over a level range, at the MS interface, as required in the test specification extended by the SS measurement uncertainty defined in this annex and extended by a further 3dB on the MS conformity requirement.

NOTE: This ensures that the SS is able adequately to measure the MS performance at and just beyond the limit requirement under all conditions.

A5.3.3 MS power supply interface

Test DC power supply for MS:

Voltage setting uncertainty < 1 %.

Ripple < 10 mV RMS, 50 mV peak to peak.

Test AC power supply for MS:

Voltage setting uncertainty: < 1 %.

A5.3.4 MS antenna interface

The SS is assumed to offer a nominal 50 ohm impedance to the MS.

	GSM/DCS/PCS bands	< 4 GHz	< 10 GHz	< 12,75 GHz
VSWR	≤ 1,3	≤ 2,0	≤ 3,0	≤ 3,5

A5.3.4.1 Uplink receiver error

The SS receiver should be capable of performing the tests as specified in 3GPP TS 11.10 without the addition of bit errors in excess of 1 in 10E7 due to the receiver performance when operated with a MS which meets the transmitter requirements of 3GPP TS 05.05. This requirement shall apply for GMSK and 8PSK modulation.

NOTE: This requirement is based on a minimum BER measurement of 1 in 10E5.

A5.3.4.2 Power and Power versus time measurements

Measurement uncertainty of transmitter output power for GMSK and 8PSK signals: ±1 dB.

In the case of 8PSK, provision is made for power measurement by averaging over multiple bursts or by using an estimation method, see 3GPP TS 05.05, clause 4. The estimation method may be based on measurements of one or more bursts, or part of a burst.

If 8PSK power is measured by averaging over multiple bursts, allowance must be made for variations in burst power as a function of the data. This allowance must be included within the ±1 dB measurement limit. The allowance is related to the number of bursts taken in the average and shall be defined as follows:

Allowance for burst power variation = $2\sigma/\text{SQRT}(N)$

Where: σ = the standard deviation of burst power variation for random data (0,2 dB).

(two standard deviations yield a 95 % confidence interval).

N = number of averages.

EXAMPLE: An average is calculated from 4 bursts. The allowance for burst power variation is 0,2 dB. The accuracy for the power meter should then be better than ±0,8 dB.

If 8PSK power is measured using an estimation method, it shall be demonstrated, using the method described below, that the accuracy of the estimation technique is also ±1 dB.

A test signal is established consisting of properly formatted bursts with midambles and random data in the payload. The long-term average power of this signal is determined by measuring the power over 200 bursts and taking the average (P_{avg}). The measurement uncertainty of the equipment used to determine the long-term average shall be noted (ΔP).

The same test signal is then measured using the estimation technique. The difference between the estimated value of long-term average power and the measured long-term average power is noted (P_{est}). The following inequality shall hold:

$$|\Delta P| + |(P_{\text{avg}} - P_{\text{est}})| \leq 1 \text{ dB}$$

For GMSK, measurement uncertainty of power level (relative to peak transmitter carrier power):

Power level	Measurement uncertainty
+6 dB to -7 dB	$\pm 0,25$ dB
-7 dB to -20 dB	$\pm 1,0$ dB
-20 dB to -32 dB	$\pm 2,0$ dB
-32 dB to -45 dB	$\pm 5,0$ dB
-45 dB to -71 dB	$\pm 1,0$ dB
< -71 dB	$\pm 2,0$ dB

For 8PSK, measurement uncertainty of power level (relative to output power):

Power level	Measurement uncertainty
+6 dB to -7 dB	$\pm 0,25$ dB
-7 dB to -16 dB	$\pm 1,0$ dB
-16 dB to -32 dB	$\pm 2,0$ dB
-32 dB to -45 dB	$\pm 5,0$ dB
-45 dB to -71 dB	$\pm 1,0$ dB
< -71 dB	$\pm 2,0$ dB

NOTE: Due to the method of measurement (downconversion to I/Q baseband / filtering / A/D conversion / postprocessing) several uncertainties occur. The sources are:

- a) absolute level uncertainty;
- b) filter ripple,
I/Q gain imbalance,
I/Q imperfect quadrature;
- c) A/D conversion (resolution),
I/Q offset.

Items under b) and c) affect the individual samples and can be observed as a "ripple" in the horizontal part of the power time mask.

Items under b) are uncertainties which are proportional to the signal measured.

Items under c) are constant amounts of uncertainty, independent of the signal measured.

The item a) moves the entire power time template up or down.

The uncertainties b) and c) are added to the measured signal as an uncorrelated interferer.

The above mentioned absolute measurement uncertainty refers to a). The table covers uncertainties b) and c).

Uncertainty of time measurement

The relative timing uncertainty of the transition point:

- symbol 13 to 14 in the midamble (normal burst);
- end of the sync sequence (access burst);

is $\pm 1/8$ symbol.

Timing uncertainty of the measurement samples in the vertical part of the power time mask are displayed as marked fields in the figure A5.3-1.

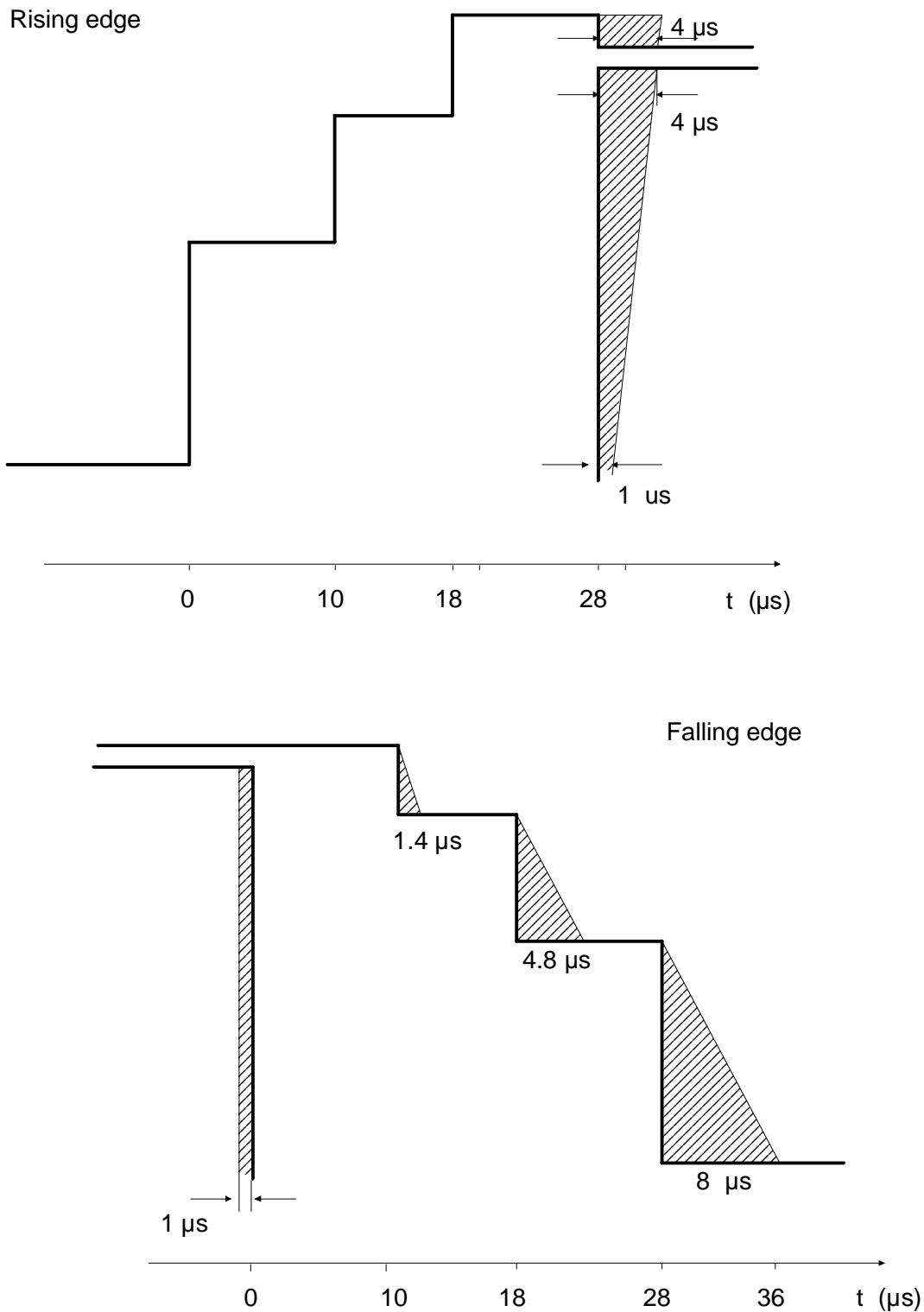

Figure A5.3-1: Time Measurement Uncertainty for the Power Time Mask

NOTE: With a real method of measurement one has to reckon on systematic measurement uncertainties in the vertical part of the power time template (figures 13-2 & 13-3). The reason for this is that the measurement is conducted through a filter which has to fulfil different requirements simultaneously, requirements in the frequency domain and in the time domain as well. The time behaviour of the filter causes the above mentioned measurement uncertainty. It occurs clearly when measuring the falling edge of the power burst. The measurement uncertainty, which in principle delays the actual performance, depends on the filter characteristics and on the signal shape. At favourable signal shapes the uncertainty is negligible, however, at unfavourable signal shapes it consumes the marked area in figure A5.3-1 (falling edge).

The underlying filter is:

- type inverse Chebycheff.
- passband $\leq \pm 200$ kHz.
- stopband (40 dB stop att.) $\geq \pm 541,67$ kHz.

To avoid aliasing with this filter the RF output spectrum must meet the requirements of subclause 13.4.

If the lowest limit line in the power time template is replaced by a -54 dBm line, measuring lower carrier powers, the area of measurement uncertainty is reduced equivalently.

The marked area in figure A5.3-1 describes the systematic measurement uncertainty of the test equipment and does not widen the design requirements.

Uncertainties associated with 13.3.5 requirement b) (power control levels, adjacent steps):

Repeatability	$\pm 0,3$ dB
Linearity	$\pm 0,03$ dB/dB
Combined uncertainty is:	$\pm (0,3 + 0,03 \text{ dB/dB})$ dB

E.g. where the indicated value of the step size is 2,0 dB, the uncertainty is:

$$\pm (0,3 + 0,06) \text{ dB} = \pm 0,36 \text{ dB.}$$

A5.3.4.3 Wideband selective power measurement

Power is to be measured selectively for spurious emissions without frequency hopping (ref.: clause 12).

Uncertainty conducted	100 kHz to 1GHz	$\pm 1,5$ dB
	1 GHz to 12,75 GHz	$\pm 3,0$ dB
Uncertainty radiated	30 MHz to 4 GHz	± 6 dB

NOTE: The uncertainties include the effect of a worst case reflection from the MS of 0,7 for out of band signals.

It is acceptable to use a band stop filter in spurious emission measurements of the transceiver in order to fulfil the above requirements.

A5.3.4.4 Inband selective power measurements

Power is to be measured selectively for output RF spectrum.

The measurement is performed on a single frequency while the MS is frequency hopping (ref.: subclause 13.3).

Uncertainty	$< \pm 1,6$ dB
-------------	----------------

NOTE: The video signal of the spectrum analyser is "gated" such that the spectrum generated by at least 40 of the bits 87 to 132 of the burst is the only spectrum measured. This gating may be analogue or numerical, dependent upon the design of the spectrum analyser.

A5.3.4.5 Modulation accuracy and frequency error measurements

GMSK modulation

Ref.: Subclauses 13.1 and 13.2 for definitions and methods of measurement.

Phase measurement uncertainty:

± 1 degree RMS;

± 4 degrees for individual phase measurement samples.

The phase measurement uncertainties above apply during the useful bits.

Frequency measurement uncertainty: ± 5 Hz.

8PSK modulation

Ref.: Subclause 13.17.1 for definitions and methods of measurement.

EVM measurement uncertainty:

$+(0,75 - 0,025\text{RMS_EVM}), -(0,75 + 0,025\text{RMS_EVM})$ % RMS;

4% for individual EVM measurement samples.

NOTE 1: The value of the RMS EVM specification is a function of the value of RMS_EVM being measured. The asymmetric specification results from the RMS EVM minimisation method used for parameter estimation (see 3GPP TS 05.05, annex G). This method of measurement for RMS EVM always produces a result that is lower than the actual value of RMS EVM.

NOTE 2: The value for individual EVM samples assumes a Rayleigh distribution of measurement errors. It represents the maximum 95th percentile value test equipment should return when measuring a signal without error.

NOTE 3: If the test equipment demodulates the transmitted signal to derive the reference signal for the EVM measurement, the symbol error rate of the demodulation process must be less than 4.4×10^{-4} for 95% confidence that no detection errors occur in a burst.

Origin Offset uncertainty (for a single burst) $< \pm 1,5$ dB for origin offset ≥ -35 dBc.

Frequency measurement uncertainty $< \pm 20$ Hz.

A5.3.4.6 RF delay measurements relative to nominal times

Range -140 to +140 symbol periods.

Resolution 1/4 symbol period.

Uncertainty $\pm 1/8$ symbol period.

A5.3.4.7 The wanted signal or traffic channel of serving cell

The Wanted signal is used in most of the specified RF measurements. The traffic channel of the serving cell is used in most of the signalling tests.

FREQUENCY:

GMSK

Uncertainty: $< \pm 5 \cdot 10^{-9}$.

8PSK

Uncertainty: $< \pm 20 \cdot 10^{-9}$.

MODULATION (see 3GPP TS 05.04):

GMSK

Phase uncertainty: < ± 1 degree RMS; and
< ± 4 degrees peak(as defined in 3GPP TS 05.05).

8PSK

EVM uncertainty < 4 % RMS.
Origin offset suppression < -35 dBc.

LEVEL:

Uncertainty: < ± 1 dB in subclause 13, 14 except;
< ± 3 dB for test 14.2 radiated;
< $\pm 1,2$ dB for test 14.6;
< $\pm 2,5$ dB for all other tests.

Settling time: < 10 us.

DYNAMIC LEVEL SETTING:

The SS shall be able to switch from any power level to any other power level within the range of 30 dB on a timeslot per timeslot basis. This dynamic switching requirement only applicable for a single channel for a limited number of tests.

SPURIOUS:

inchannel:

Covered by phase error.

outchannel:

Noise Power, 1 Hz bandwidth:

< -100 dBc for > 100 kHz carrier offset;
< -110 dBc for > 300 kHz carrier offset;
< -121 dBc for > 1 500 kHz carrier offset.

Non harmonics:

< -55 dBc for > 100 kHz carrier offset;
< -68 dBc for > 1 500 kHz carrier offset.

FREQUENCY HOPPING:

The signal shall be capable of hopping according to the criteria of 3GPP TS 05.02. The timing of the frequency change shall be such that frequency transitions do not occur during the active timeslot of the MS.

A5.3.4.8 The first interfering signal or traffic channel of the first adjacent cell

The First interfering signal is used in measurements of co-channel rejection, adjacent channel rejection and intermodulation rejection. The Traffic channel of the first adjacent cell is used in handover tests.

FREQUENCY:

Uncertainty:

< $\pm 5 \cdot 10^{-9}$

PHASE:

Uncertainty:

< ± 1 degree RMS; and

< ± 4 degrees peak (as defined in 3GPP TS 05.05).

LEVEL:

Uncertainty:

< ± 1 dB relative to the wanted signal for test 13.2 and 14.5;

< $\pm 0,3$ dB relative to the wanted signal for test 14.4, 14.10, 14.11, 14.12 and 14.16.4;

< ± 1 dB for test 14.6;

< $\pm 2,5$ dB for all other tests.

MODULATION:

GMSK (as specified in 3GPP TS 05.04)

The total relative single sideband power (noise + harmonics) in the frequency range 1,5 MHz to 1,7 MHz offset from the nominal carrier frequency shall be less than -72 dBc.

SPURIOUS:

Inchannel:

Covered by phase error.

Outchannel:

Noise Power, 1 Hz bandwidth:

< -100 dBc for > 100kHz carrier offset;

< -110 dBc for > 300kHz carrier offset;

< -127 dBc for > 1 500kHz carrier offset.

non harmonics:

< -55 dBc for > 100 kHz carrier offset;

< -68 dBc for > 1 500 kHz carrier offset.

FREQUENCY HOPPING:

The signal shall be capable of hopping according to the criteria of 3GPP TS 05.02. The timing of the frequency change shall be such that frequency transitions do not occur during the active timeslot of the MS.

A5.3.4.9 The second interfering signal

The second interfering signal is used in the measurements of intermodulation rejection and blocking.

FREQUENCY:

Uncertainty:

< $\pm 5 \cdot 10^{-9}$.**LEVEL:**

Uncertainty:

< ± 1 dB for test 14.6;< $\pm 1,5$ dB relative to the wanted signal for all other tests.**MODULATION:**

Unmodulated.

SPURIOUS:

Inchannel:

No requirements.

Outchannel:

Noise Power, 1 Hz bandwidth:

< -135 dBc for > 500kHz carrier offset;

< -140 dBc for > 700kHz carrier offset;

< -150 dBc for > 1 500kHz carrier offset.

Non harmonics:

< -79 dBc for > 500 kHz carrier offset;

< -84 dBc for > 700 kHz carrier offset;

< -94 dBc for > 1 500 kHz carrier offset.

Harmonically related spuri:

< -40 dBc.

A5.3.4.10 BCCH carriers of serving and adjacent cells

The BCCH of the serving cell is used for synchronizing the MS and to send network information to the MS under test. The BCCH signals of the adjacent cells are used in the handover tests. The MS measures the RF-levels of the BCCHs of adjacent cells.

FREQUENCY:

Uncertainty:

< $\pm 5 \cdot 10^{-9}$.

PHASE:

Uncertainty:

< ±1 degree RMS; and

< ±4 degrees peak(as defined in 3GPP TS 05.05).

LEVEL:

Uncertainty:

< 1 dB for test 13.2 and 20;

< 2,5 dB for all other tests;

< 0,6 dB relative to each other and to TCH for test 21 over the range 65 dBmicroVoltemf to 3 dBmicroVoltemf;

< 1,2 dB relative to each other and to TCH for test 26.3.

MODULATION:

GMSK (as specified in 3GPP TS 05.04).

SPURIOUS:

Inchannel:

Covered by phase error.

Outchannel:

Noise Power, 1Hz bandwidth:

< -100 dBc for > 100 kHz carrier offset;

< -125 dBc for > 1 500 kHz carrier offset.

Non harmonics:

< -55 dBc for > 100 kHz carrier offset;

< -72 dBc for > 1 500 kHz carrier offset.

A5.3.4.11 The wide frequency range signal

The wide frequency range signal is used in the measurements of spurious response.

FREQUENCY

Uncertainty:

< ± 5*10E-9.

LEVEL

Uncertainty:

< ±1,5 dB relative to the wanted signal for test 14.7;

< ±1 dB error of substituted "wanted signal".

MODULATION:

Unmodulated.

SPURIOUS in the MS receiving range:

Non harmonics:

< -94 dBc.

Harmonically related spuri:

< -40 dBc.

Noise:

< -4 dBuVemf equivalent at the MS receiver input when measured in a 200 kHz bandwidth.

A5.3.4.12 The multipath fading function

The multipath fading function simulates the fading effects of a broadband radio channel in mobile radio communication.

The propagation conditions are specified in 3GPP TS 05.05, annex 3.

The multipath fading function shall be performed only within a 5 MHz bandwidth during one test case.

A5.3.5 MS audio interface and DAI

A5.3.5.1 General uncertainties

Unless otherwise specified, the following uncertainties apply to the audio interface:

Signal level measurement uncertainty: $\pm 0,2$ dB;

Sound pressure measurement uncertainty: $\pm 0,6$ dB;

Frequency Measurement uncertainty: $\pm 0,1$ %.

Stimulus frequency setting uncertainty:

Frequency settings are taken from ISO 3, R10 series or R40 series or from table 2 of Rec. ITU-T Recommendation P.79. A departure from the nominal frequencies of ± 5 % below 240 Hz and ± 2 % at 240 Hz and above is accepted.

In the case of 4 kHz the departure is restricted to -2 %.

A5.3.5.2 Analogue single test tone

Total distortion:

< 0,5 %.

A5.3.5.3 Delay measurement between Um and DAI

The delay measurement between the Um interface of the MS and its DAI in both directions is described in subclause 32.5.

Uncertainty:

< $\pm 0,1$ ms.

A5.4 SIM simulator functional requirements

A5.4.1 General

The SIM simulator shall implement the functions of a SIM as described in 3GPP TS 02.17 and 3GPP TS 11.11.

The Test Algorithm for authentication incorporated in the SIM Simulator shall operate as described in annex 3.

A5.4.2 Contacts C1, C2, C6, C7

A5.4.2.1 Default measurement / setting uncertainties

Unless stated otherwise below, the following uncertainties apply:

Voltage measurement uncertainty: $< \pm 50$ mV;

Voltage setting uncertainty: $< \pm 20$ mV;

Time measurement uncertainty: $< \pm 100$ ns.

A5.4.2.2 Contact C1

Continuous Spikes:

Voltage measurement uncertainty:

$< \pm 100$ mV.

Current Load Amplitude:

0 mA - 20 mA

Adjustable Step Size:

1 mA.

Uncertainty

$< \pm 1$ mA.

Additional Current Offset:

0 mA - 5 mA.

Adjustable Step Size:

1 mA.

Uncertainty:

$< \pm 1$ mA.

Pulse Width:

100 ns - 500 ns.

Adjustable Step Size:

50 ns.

Uncertainty:

$< \pm 25$ ns.

Rise and Fall Time:

≤ 50 ns.

Pause Width:

100 ns - 500 ns.

Adjustable Step Size:

50 ns.

Uncertainty:

$< \pm 25$ ns.

Random Spikes:

Voltage measurement uncertainty:

$< \pm 100$ mV.

Current Load Amplitude:

50 mA - 200 mA.

Adjustable Step Size:

1 mA.

Uncertainty:

$< \pm 1$ mA.

Additional Current Offset:

0 mA - 5 mA.

Adjustable Step Size:

1 mA.

Uncertainty:

$< \pm 0,1$ mA.

Pulse Width:

100 ns - 500 ns.

Adjustable Step Size:

50 ns.

Uncertainty:

$< \pm 25$ ns.

Rise and Fall Time:

≤ 50 ns.

Pause Width:

0,1 ms - 500 ms, randomly varied.

Adjustable Step Size:

0,1 ms.

Uncertainty:

$< \pm 0,1$ ms.

A5.4.2.3 Contact C7

The Elementary Time Unit (etu) used in the subclauses below refer to the nominal bit duration on the I/O line, as defined in ISO 7816-3.

Rise & fall Time setting uncertainty: $< \pm 100$ ns.

Jitter measurement uncertainty: $< \pm 5 \cdot 10^{-3}$ etu.

Jitter setting uncertainty: $< \pm 5 \cdot 10^{-3}$ etu.

A5.4.3 Contact C3

Frequency measurement uncertainty: $< \pm 0,5$ %.

Voltage Measurement uncertainty: $< \pm 50$ mV.

Rise & fall time measurement uncertainty: $< \pm 5$ ns.

Duty cycle measurement uncertainty: $< \pm 2,5$ %.

A5.4.4 Definition of timing

It shall be possible to define all timings relative to the clock. The SIM simulator shall be able to calculate and to use the absolute values automatically, even if the ME changes the frequency during the communication.

A5.5 A-GPS Minimum Performance Test System requirements

A5.5.1 Test System Uncertainty for A-GPS Minimum Performance tests

The maximum acceptable uncertainty of the Test System is specified below for each test, where appropriate.

The Test System shall enable the stimulus signals in the test case to be adjusted to within the specified range, and the equipment under test to be measured with an uncertainty not exceeding the specified values. All ranges and uncertainties are absolute values, and are valid for a confidence level of 95 %, unless otherwise stated.

A confidence level of 95 % is the measurement uncertainty tolerance interval for a specific measurement that contains 95 % of the performance of a population of test equipment.

It should be noted that the uncertainties in this clause apply to the Test System operating into a nominal 50 ohm load and do not include system effects due to mismatch between the DUT and the Test System.

Table A5.5.1: Maximum Test System Uncertainty for A-GPS Minimum Performance tests

Clause	Maximum Test System Uncertainty	Derivation of Test System Uncertainty	
70.11.5.1 Sensitivity Coarse Time Assistance	Coarse Time Assistance	±200 ms	
	Absolute GPS signal level	±1 dB	
	Position error	±0.05 m	Position error consists of ±0.05 m system uncertainty. The effect of position reporting resolution of approximately ±1.2 m (see note) is not included in the allowable test system uncertainty but is included in the Test Parameter Relaxations since this resolution limitation limits the reporting capability of the MS. For simplicity the combined Test Parameter Relaxation is given as ±1.3 m
	Response time	± 300 ms	
70.11.5.2 Sensitivity Fine Time Assistance	Coarse Time Assistance	±200 ms	
	Fine Time Assistance	±1 us	
	Absolute GPS signal level	±1 dB	
	Position error	±0.05 m	Position error as above
	Response time	± 300 ms	
70.11.6 Nominal Accuracy	Coarse Time Assistance	±200 ms	
	Absolute GPS signal level	±1 dB	
	Position error	±0.05 m	Position error as above
	Response time	± 300 ms	
70.11.7 Dynamic Range	Coarse Time Assistance	±200 ms	
	Absolute GPS signal level	±1 dB	
	Relative GPS signal level	±0.2 dB	
	Position error	±0.05 m	Position error as above
	Response time	± 300 ms	
70.11.8 Multi-Path scenario	Coarse Time Assistance	±200 ms	
	Absolute GPS signal level	±1 dB	
	Relative GPS signal level	±0.2 dB	
	Position error	±0.05 m	Position error as above
	Response time	± 300 ms	

Note: For MS based mode the effect of position reporting resolution is given by:

$$\sqrt{\left(\frac{90 \times 2 \times \pi \times R}{2E23 \times 360}\right)^2 + \left(\frac{360 \times 2 \times \pi \times R \times \cos \phi}{2E24 \times 360}\right)^2}$$

meters, where R is the radius of the earth and ϕ is the latitude of the location. For the two GPS scenarios defined in clause 10.10 this equates to approximately 2.32 m and 2.24 m. For simplicity this is given as ±1.2 m.

For MS assisted mode it is assumed that the output from the WLS position solution calculation in clause 70.11.4.3 is coded using the same position coding method as for MS based mode before being used to calculate position error. Therefore the effect of reporting resolution will be the same as for MS based mode.

A5.5.2 Test Parameter Relaxations (This clause is informative)

The Test Parameter Relaxations defined in this clause have been used to relax the Conformance requirement to derive the Test Requirements.

The Test Parameter Relaxations are derived from Test System uncertainties, regulatory requirements and criticality to system performance. As a result, the Test Parameter Relaxations may sometimes be set to zero.

The Test Parameter Relaxations should not be modified for any reason e.g. to take account of commonly known test system errors (such as mismatch, cable loss, etc.).

Table A5.5.2.1: Test Parameter Relaxations for A-GPS Minimum Performance tests

Clause	Test Parameter Relaxation	
70.11.5.1 Sensitivity Coarse Time Assistance	Coarse Time Assistance	200 ms
	Absolute GPS signal level	1 dB
	Position error	1.3 m
	Response time	300 ms
70.11.5.2 Sensitivity Fine Time Assistance	Coarse Time Assistance	200 ms
	Fine Time Assistance	1 us
	Absolute GPS signal level	1 dB
	Position error	1.3 m
	Response time	300 ms
70.11.6 Nominal Accuracy	Coarse Time Assistance	200 ms
	Absolute GPS signal level	0 dB
	Position error	1.3 m
	Response time	300 ms
70.11.7 Dynamic Range	Coarse Time Assistance	200 ms
	Absolute GPS signal level	0 dB
	Relative GPS signal level	0.2 dB
	Position error	1.3 m
	Response time	300 ms
70.11.8 Multi-Path scenario	Coarse Time Assistance	200 ms
	Absolute GPS signal level	0 dB
	Relative GPS signal level	0.2 dB
	Position error	1.3 m
	Response time	300 ms

A5.5.3 Interpretation of measurement results

The measurement results returned by the Test System are compared - without any modification - against the Test Requirements as defined by the shared risk principle.

The Shared Risk principle is defined in TR 102 273-1-2, clause 6.5.

The actual measurement uncertainty of the Test System for the measurement of each parameter shall be included in the test report.

The recorded value for the Test System uncertainty shall be, for each measurement, equal to or lower than the appropriate figure in clause A5.5.1.

If the Test System for a test is known to have a measurement uncertainty greater than that specified in clause A5.5.1, it is still permitted to use this apparatus provided that an adjustment is made value as follows:

Any additional uncertainty in the Test System over and above that specified in clause A5.5.1 shall be used to tighten the Test Requirement - making the test harder to pass. (This may require modification of stimulus signals). This procedure will ensure that a Test System not compliant with clause A5.5.1 does not increase the chance of passing a device under test where that device would otherwise have failed the test if a Test System compliant with clause A5.5.1 had been used.

A5.5.4 Derivation of Test Requirements (This clause is informative)

The Test Requirements have been calculated by relaxing the Conformance requirement of the core specification using the Test Parameter Relaxations defined in clause A5.5.2. When the Test Parameter Relaxation is zero, the Test Requirement will be the same as the Conformance requirement. When the Test Parameter Relaxation is non-zero, the Test Requirements will differ from the Conformance requirement, and the formula used for this relaxation is given in table A5.5.4.1.

Table A5.5.4.1: Derivation of Test Requirements for A-GPS Minimum Performance tests

Test	Conformance requirement in 3GPP TS 45.005		Test Parameter Relaxation (TPR)	Test Requirement
70.11.5.1 Sensitivity Coarse Time Assistance	Coarse Time Assistance	± 2 s	200 ms	Formulas: UL-TPR, LL+TPR: ± 1.8 s
	Absolute GPS signal level	-142, -147 dBm	1 dB	Level + TPR: -141, -146 dBm
	Position error	100 m	1.3 m	Error +TPR: 101.3 m
	Response time	20 s	300 ms	Time + TPR: 20.3 s
70.11.5.2 Sensitivity Fine Time Assistance	Coarse Time Assistance	± 2 s	200 ms	Formulas: UL-TPR, LL+TPR: ± 1.8 s
	Fine Time Assistance	± 10 μ s	1 μ s	UL-TPR, LL+TPR: ± 9 μ s
	Absolute GPS signal level	-147 dBm	1 dB	Level + TPR: -146 dBm
	Position error	100 m	1.3 m	Error +TPR: 101.3 m
70.11.6 Nominal Accuracy	Coarse Time Assistance	± 2 s	200 ms	Formulas: UL-TPR, LL+TPR: ± 1.8 s
	Absolute GPS signal level	-130 dBm	0 dB	Level + TPR: -130 dBm
	Position error	30 m	1.3 m	Error +TPR: 31.3 m
	Response time	20 s	300 ms	Time + TPR: 20.3 s
70.11.7 Dynamic Range	Coarse Time Assistance	± 2 s	200 ms	Formulas: UL-TPR, LL+TPR: ± 1.8 s
	Absolute GPS signal level	-129 to -147 dBm	1 dB	Level + TPR: each level +1 dBm
	Relative GPS signal level	18 dB	0.2 dB	Level - TPR: highest level -0.2 dB: -128.2dBm
	Position error	100 m	1.3 m	Error +TPR: 101.3 m
	Response time	20 s	300 ms	Time + TPR: 20.3 s
70.11.8 Multi-Path scenario	Coarse Time Assistance	± 2 s	200 ms	Formulas: UL-TPR, LL+TPR: ± 1.8 s
	Absolute GPS signal level	-130 dBm	0 dB	Level + TPR: -130 dBm
	Relative GPS signal level	6 dB	0.2 dB	Level + TPR: lower level -0.2dB: -136.2 dBm
	Position error	100 m	1.3 m	Error +TPR: 101.3 m
	Response time	20 s	300 ms	Time + TPR: 20.3 s

Annex 6 (informative): E-OTD Accuracy Measurement Test Environment

A6.1 Recommended Timing Accuracy Test Environment (Unassisted)

3GPP TS 05.05, annex I calls for a best-case MS measurement observed timing difference (OTD) accuracy of 100 nanoseconds. This level of measurement accuracy implies that:

1. The time delay and phase shift of all components in the test environment must be taken into account.
2. The laboratory equipment utilized to measure the burst alignment of the two base station simulators must support a time resolution of at least 10 nanoseconds.
3. All base station simulators, active RF channel simulators, and time measurement equipment must be phase-locked to a common reference clock.
4. All base station simulators used for this test must be frame synchronized.

Figure A6-1 represents a recommended configuration for the unassisted measurement of E-OTD accuracy. If this test environment is utilized, the effects of differing cable lengths, channel simulator processing delays, etc., must be compensated for in order to establish the RTD between bursts from the base station simulators.

The "unassisted" test environment should require a relatively short time ($< 3\ 000$ s) for the test environment to obtain N measurements for the purpose of calculating the RMS_{90} timing error of the MS. In many cases, the predominant component leading to uncertainty in RTD between the two base station simulators during the measurement period will be phase jitter, which should follow a Gaussian distribution. The standard deviation of this distribution must be kept within a range that allows the test laboratory to confirm that this uncertainty component does not significantly affect the results of the OTD measurements made and reported by the MS. Test labs and base station simulator manufacturers are expected to quantify and document the test environment's RTD. Test labs and base station simulator manufacturers are also expected to have some means of verifying the standard deviation of the test environment's RTD (including phase jitter introduced by the RF channel simulators), declaring that this uncertainty will be negligible relative to the 100 nanosecond RMS_{90} best-case requirements of 3GPP TS 05.05 (V8.7.1), Release 99, annex I.

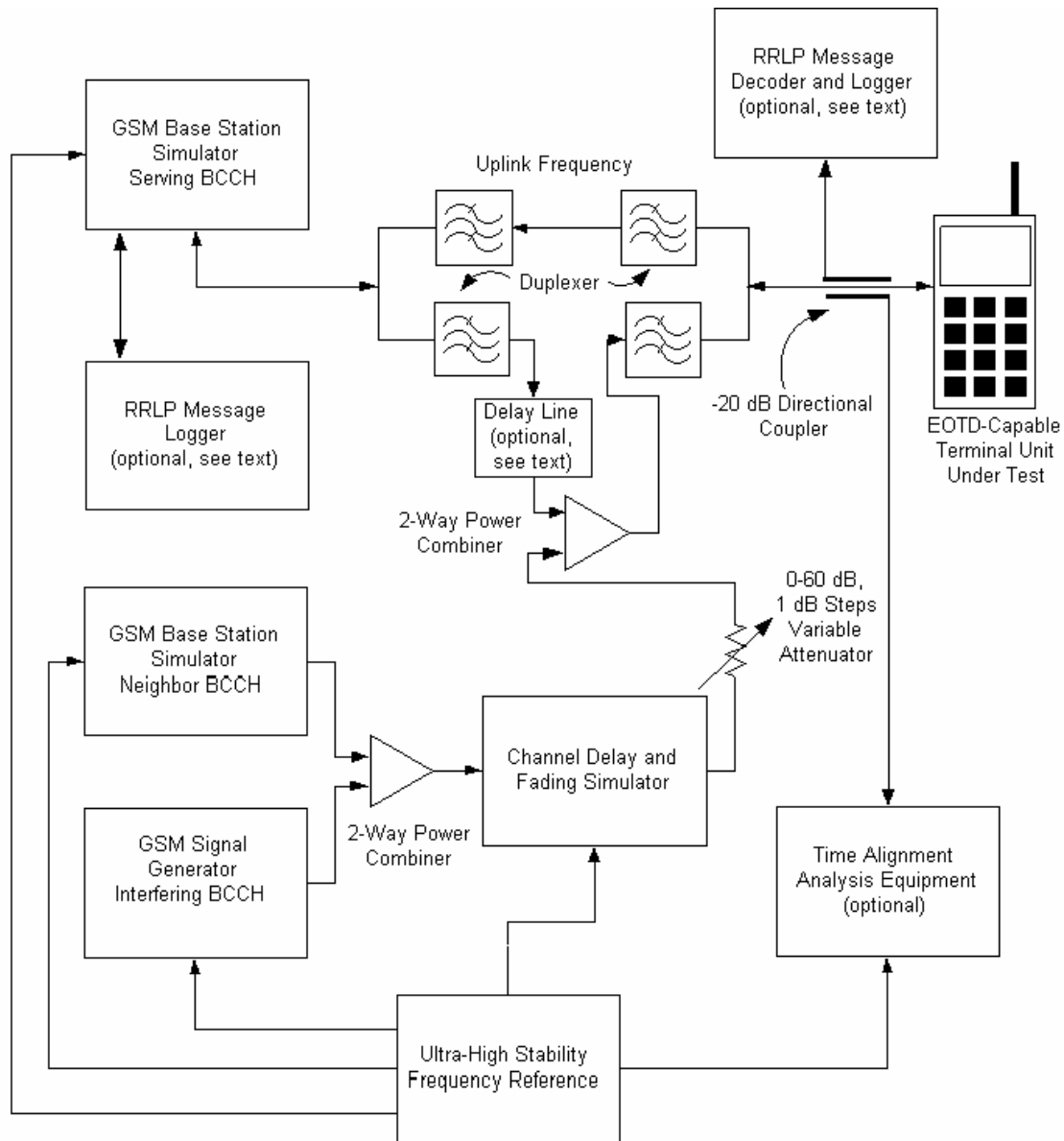

Figure A6-1: "Unassisted" E-OTD Test Environment

A6.2 Recommended Timing Accuracy Test Environment (Assisted)

In some laboratory environments, test equipment may not be available to measure and/or maintain the base station simulator burst time alignment to the accuracy required by the "unassisted" test environment described earlier. In such cases, a test configuration of the type shown in figure A6-2 may be employed for E-OTD performance validation. In this configuration, an LMU of known accuracy is used to measure the real timing difference (RTD) between the serving and neighbor base station simulators.

The "assisted" test environment should require a relatively short time (< 3 000 s) for the test environment to obtain N measurements for the purpose of calculating the RMS_{90} timing error of the MS. In many cases, the predominant component leading to uncertainty in RTD between the two base station simulators during the measurement period will be phase jitter, which should follow a Gaussian distribution. The timing offset or RTD between the two base station simulators is reported by the LMU. Even if an RTD measurement from the LMU is made in synchronism with an OTD measurement from the MS, some means of verification must be available to assure that the standard deviation of the RTD is kept within a range that allows the laboratory to confirm that this uncertainty does not significantly affect the results of the OTD reported by the MS. Test labs and LMU manufacturers are expected to have some means of verifying the standard deviation of the RTD reported for the test environment (including phase jitter introduced by the RF channel simulator), and declaring that this uncertainty component will be negligible relative to the 100 nanosecond RMS_{90} best-case requirements of 3GPP TS 05.05 (V8.7.1), Release 99, annex I.

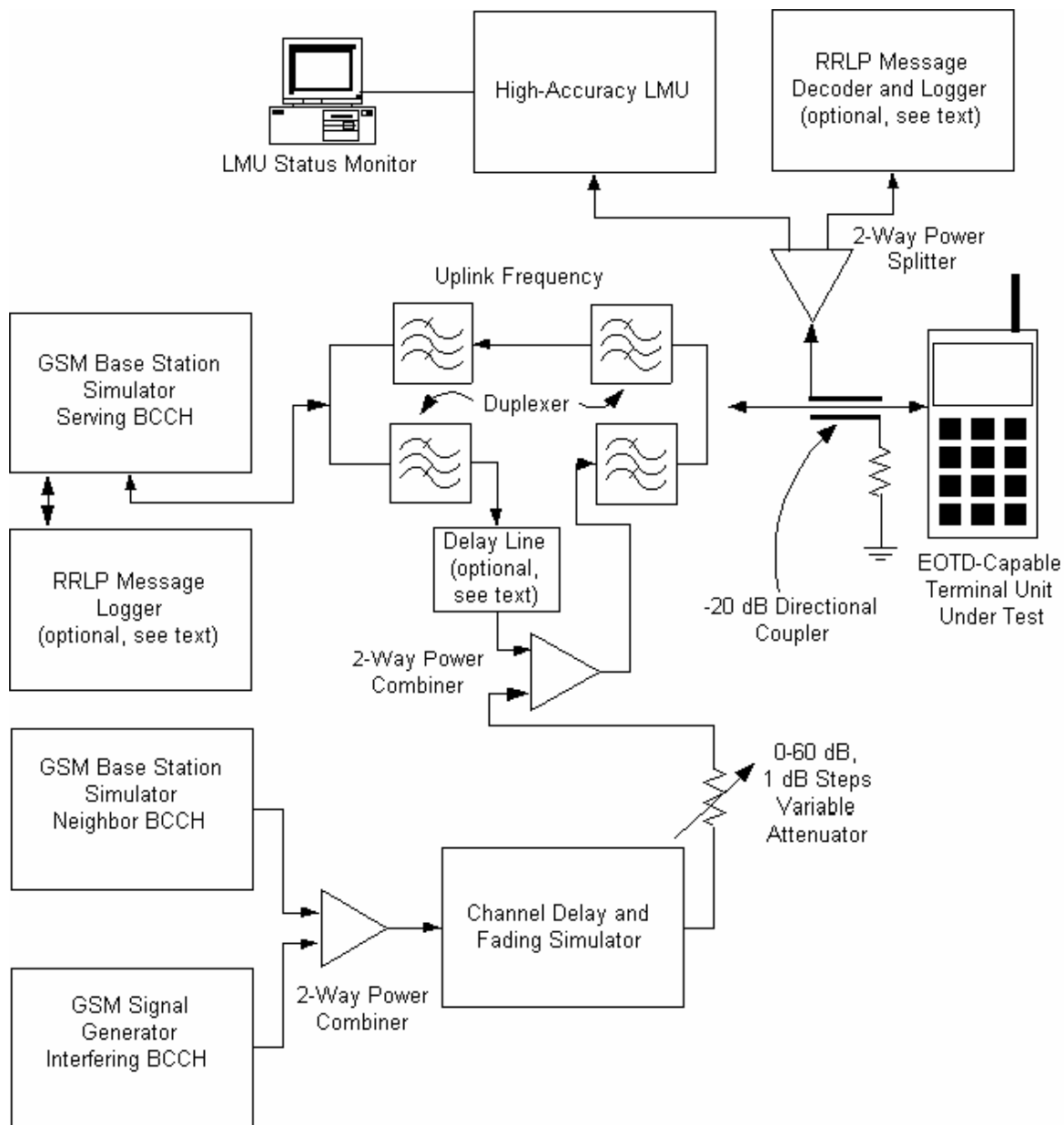

Figure A6-2: "Assisted" E-OTD Test Environment

Delay Line

Almost all active RF channel fading simulators introduce some intrinsic propagation delay, even when set to an RF channel delay of zero. In some cases, this delay may be to great to compensate for using a passive delay as shown in figure A6-1 and figure A6-2. In such cases, the intrinsic delay of the channel simulator shall be included in the calculation of RTD for the test environment. Any phase jitter contribution from the RF channel fading simulator must be taken into account when evaluating the standard deviation of the test environment's RTD.

Simulated Geometric Time Difference

Once the RTD of the test environment is known, any additional time delay added to the fading simulator RF path will simulate the effect of distance between the MS and its neighbor cell. 3GPP TS 05.05 (V8.7.1), Release 99, annex I does not specify a value for geometric time delay, in part because the MS could be equidistant from the three base stations required for E-OTD calculation in a real network. Also, in an actual network, the geometric delay an MS must contend with can vary from 0 μ sec to over 50 μ sec, however, the 3GPP TS 05.05, annex I specification is only concerned with measurement error. Consequently, the test procedures described in this subclause require that no additional time delay will be added to simulate a geometric time difference.

Neighbor Lists

The serving base station simulator must be configured to include the neighbor base station simulator in its BA list. During interference tests, the interfering signal generator shall not be included in the serving base station simulator's BA list.

Interfering BCCH Signal Generator

The interfering BCCH signal generator shall provide a continuous GMSK signal, modulated with a pseudo-random bit sequence. This signal generator shall not be frame-synchronized with the serving or neighbor base station simulators.

RRLP Measure Position Request

The RRLP Measure Position Request sent from the serving base station simulator shall include the field values listed in table A6-1.

Table A6-1: RRLP Measure Position Request Field Values, Positioning Instructions Data Element

Field Name	Value	Comments
Method Type	0	Value="MS assisted"
Positioning Methods	0	Value="E-OTD"
Response Time	1	Value=2 seconds
Accuracy	NA	This field is optional
Multiple Sets	0	Value=Multiple sets allowed
Environmental Characterisation	NA	This field is optional

The following Measure Position Request components will be used when relevant to the test:

- E-OTD Reference BTS of Assistance Data;
- E-OTD Measurement Assistance Data for System Information List Element;

These two assistance data elements are necessary in the Measure Position Request to facilitate the execution of certain physical-layer E-OTD tests. For example, 3GPP TS 05.05, Annex I requires that in some instances, an E-OTD capable MS must support a specified timing measurement accuracy when the neighbor BCCH is below the device's reference sensitivity. Without assistance data, it may be impossible to execute the necessary physical layer validation tests because the MS upper protocol layers would be incapable of decoding the BSIC of the neighbor BCCH.

MS Mode During Measurement

The MS under test shall make the requested measurements while in the dedicated mode on a TCH.

Automation of E-OTD Measurements

If at all possible, the laboratory environment used to verify E-OTD accuracy should be capable of supporting automated measurements. A minimum of 250 trials shall be utilized.

Terminal Unit RRLP Message Monitoring

The test lab shall have some means of logging the Measure Position Response message transmitted by the MS. This can be accomplished utilizing a suitable U_m interface analyzer monitoring the MS RRLP messages on the uplink, or through a base station simulator capable of reading and logging RRLP messaging. The device used to capture the received RRLP messages should be capable of logging the MS observed time difference measurement to a flat ASCII file, with each of the reported OTD values in decimal.

E-OTD Measurement With 8PSK Modulated Bursts

3GPP TS 05.05 (V8.7.1) Release 99, annex I requires that an E-OTD-capable MS must support E-OTD measurements when the serving and the neighbor base stations are transmitting 8PSK modulated bursts. This test plan verifies that the timing error of an E-OTD-capable MS is maintained regardless of whether the serving and neighbor base station simulators are transmitting either GMSK or 8PSK in time slots 1 through 7.

Accuracy Calculation

In order to minimize the effects of "outlying" data points, the timing difference measurement accuracy of an E-OTD MS shall be calculated as an RMS value of 90% of the measurement trials with the least error. For example, if N=250 measurement trials, the trial error results x_1 through x_{250} shall be sorted in ascending order of error. A subset M that includes 90 % of the trials in set N (M=225 trials in this example) shall be established. In this example, the subset M will include the 225 trial results with the least error from set N. The RMS error is then calculated from the data points in subset M according to Equation A6-1 below:

(Equation A6-1) RMS₉₀ Calculation

$$\text{Error}_{\text{RMS}} = \sqrt{\left(\left(\sum_1^M x^2 \right) + M \right)}$$

Annex 7 (informative): General rules for statistical testing

A7.1 Statistical testing of receiver performance

Testing the receiver performance can be done either in the classical way with a fixed minimum number of samples or using statistical methods that lead to an early pass/fail decision with test time significantly reduced for MS with an error rate not on the limit.

Statistical testing of the receiver performance is based on the evaluation of error rates, such as bit error rates, block error rates or also the rate of missing bad frame indications.

A7.1.1 Basics

A7.1.1.1 Definition of (error) events

1) Bit Error Ratio (BER)

The Bit Error Ratio is defined as the ratio of the bits wrongly received to all data bits sent.

2) Block Error Ratio (BLER)

A Block Error Ratio is defined as the ratio of the number of erroneous blocks received to the total number of blocks sent. An erroneous block is defined as a Transport Block, the cyclic redundancy check (CRC) of which is wrong.

3) Rate of missing Bad Frame Indications (BFI)

The rate of missing Bad Frame Indications is the ratio of frames not marked incorrect to all frames sent, although all frames sent are incorrectly. This mechanism is used to test Bad Frame Indication of the MS.

A7.1.1.2 Test Method

Each test is performed in the following manner:

- a) Set up the required test conditions.
- b) Continuously record the number of samples tested and the number of (error) events (bit error, block error or missing BFI).
- c) While recording samples and errors continuously check, if it is about time to make a decision. The possible outcomes of a decision are: Early pass, early fail, continue with measuring the error rates, pass or fail.

A7.1.1.3 Test Criteria

The test shall fulfil the following requirements:

- a) good pass fail decision with high confidence level
 - 1) to keep reasonably low the probability (risk) of passing a bad unit for each individual test;
 - 2) to have high probability of passing a good unit for each individual test;
- b) good balance between test time and statistical significance
 - 3) to perform measurements with a high degree of statistical significance;
 - 4) to keep the test time as low as possible.

A7.1.1.4 Calculation assumptions

A7.1.1.4.1 Statistical independence

(a) It is assumed, that error events are rare (error rate close to zero) and independent statistical events.

The assumption of rare events is justified by the error rates that need to be met by the DUT. Statistical independence is given as data bits of completely transmitted bursts are evaluated without further memory of the receiver active. Samples and errors are summed up after every time slot interval. So the assumption of independent error events is justified.

(b) In error rate tests with fading there is the memory of the multipath fading channel which interferes the statistical independence. A minimum test time is introduced to average fluctuations of the multipath fading channel. So the assumption of independent error events is justified approximately.

A7.1.1.4.2 Applied formulas

The formulas, applied to describe the error rate test, are based on the following experiments:

- (1) After having observed a certain number of (error) events (**ne**) the number of samples are counted to calculate the error rate. Provisions are made such that the complementary experiment is valid as well:
- (2) After a certain number of samples (**ns**) the number of errors, occurred, are counted to calculate the error rate.

Experiment (1) stipulates to use the following Chi Square Distribution with degree of freedom **ne**:

$$2 \times X^2(2 \times v, 2 \times \mathbf{ne})$$

Where X^2 is the Chi-square distribution.

Experiment (2) stipulates to use the Poisson Distribution:

$$P_v(\mathbf{ne})$$

Where $P_v(\mathbf{ne})$ is the Poisson distribution for **ne** with mean v .

with v as the mean of the distribution.

To determine the early stop conditions, the following inverse cumulative operation is applied:

$$\frac{1}{2} C^{-1}(D, 2 \times \mathbf{ne}). \text{ This is applicable for experiment (1) and (2).}$$

D Wrong decision risk per test step

Note: Where C^{-1} is the inverse cumulative distribution function for the X^2 distribution (the D-quantile function)
Other inverse cumulative operations are available, however only this is suited for experiment (1) and (2).

A7.1.2 Definition of good pass fail decision

A correct pass/fail decision requires the knowledge of the exact (true) error ratio of the DUT. However the true error ratio of the DUT is generally unknown. Measuring the true error ratio of the DUT requires to evaluate an infinite number of samples, which of course is not possible. This means that any error rate measurement within limited time is affected by an uncertainty, leading to two kinds of wrong decisions possible. If the measured error rate is higher than the true error rate a good DUT could possibly be failed and vice versa if the measured error rate is lower a bad DUT could possibly be passed.

Error rate tests within limited time hence require the acceptance of a wrong decision risk. The measure of a good pass fail decision is given by the probability (risk) F of the wrong decision at the end of the test. The probability of a correct decision is $1-F$.

Wrong decision risk F for one single error ratio test:

The probability (risk) to fail a good DUT shall be F_{fail} according to the following definition: A DUT is failed, accepting a probability F_{fail} that the DUT is still better than the test requirement

The probability (risk) to pass a bad DUT shall be F_{pass} according to the following definition: A DUT is passed, accepting a probability F_{pass} that the DUT is still worse than M times the specified error ratio. ($M > 1$ is the bad DUT factor).

The wrong decision risk F explained above applies to one single error ratio test. In most test cases where only one or few error ratio tests are done the wrong decision risk acceptable for an erroneous pass is identical to the acceptable risk for an erroneous fail:

$$F_{\text{pass}} = F_{\text{fail}} = F \quad \text{and e.g.} \quad F = 0.2\%$$

If a test is repeated under different conditions for several times, the total wrong decision risk for the DUT increases. The increasing risk for a bad fail decision is not acceptable for test cases that are composed of many single error rate tests like e.g. the blocking test, which implies approximately 3000 error rate tests (depends on design of MS). A DUT on the limit will fail approximately 6 to 7 times due to statistical reasons (wrong decision probability at the end of the test $F = 0.2\%$). 30 fails (6 in inband range and 24 outside) are allowed in the blocking test but these fails are reserved for spurious responses. This problem shall be solved by the following rules:

- All passes (based on $F_{\text{pass}} = 0.2\%$) are accepted, including the wrong decisions due to statistical reasons.
- An early fail limit based on $F_{\text{fail}} = 0.02\%$ instead of 0.2% is established, that ensures that wrong decisions due to statistical reasons are reduced to less than one.

These asymmetric test conditions ensure that a DUT on the test limit consumes hardly more test time for a blocking test than in the symmetric case and on the other hand discriminates sufficiently between statistical fails and spurious response cases.

Wrong decision probability D per test step:

As one single error ratio test is composed of several test steps the wrong decision probability per test step needs to be sufficiently small to keep the wrong decision risk F (the wrong decision risk at the end of the test) within the requirements. The wrong decision probability D per test step is a numerically evaluated fraction of F . Considerations regarding symmetry between probability of wrong pass and wrong fail decision are identical to those given for F .

For most test cases where only one or few error rate tests are done the wrong decision probability D per test step for a pass decision is identical to the wrong decision probability for a fail decision.

$$D_{\text{pass}} = D_{\text{fail}} = D \quad \text{and e.g.} \quad D = 0.0085\%$$

For test cases where $F_{\text{pass}} \neq F_{\text{fail}}$ (e.g. blocking) this applies also to D : $D_{\text{pass}} \neq D_{\text{fail}}$.

A7.1.3 Implementation

A7.1.3.1 Proceeding

- a) Set up the required test conditions.
- b) Continuously record the number of samples tested and the number of (error) events (bit error, block error or missing BFI). Calculate the preliminary error rates ber_0 and ber_1 from the number of samples and the number of (error) events. Regarding ber_0 and ber_1 refer to "A7.1.3.1 Limit lines".
- c) Continuously check while recording samples and errors, if it is about time to make a decision. The possible outcomes of a decision are: Early pass, early fail, continue with measuring the error rates, pass or fail.
 - 1st decision after minimum test time due to fading (refer to Table A7.1.4.2 : Minimum test time due to fading) has elapsed. In case the test runs without fading conditions this time is zero and in case this time exceeds the target test time (refer to A7.1.3.1 Limit lines), the test is already finished requiring a pass/fail decision .
 - 2nd and possibly further (early) decisions after a certain cyclic interval or the occurrence of the next error event. As long as no early decision can be made the test is continued.
 - If the target test time has elapsed the test is definitively finished and a pass/fail decision can be made. In case the minimum test time due to fading exceeds the target test time this point is reached already in the 1st step.

A7.1.3.2 Limit lines

Early decisions require that the actual error rate is checked both against a limit line for early pass and a limit line for early fail.

Limit line for early pass decision (for $ne \geq 1$):

The condition for an early pass decision is: $ber_1 < berlim_{pass}$

$$berlim_{pass}(D_{pass}, ne) = \frac{2 \times ne \times M}{C^{-1}(1 - D_{pass}, 2 \times ne)}$$

ber_1 is the normalised bit error rate with counting errors started from one which means that an artificial error is introduced at the beginning to avoid that the early pass condition is met when the test starts. After the first real error event has occurred the artificial error has to be removed to calculate the error rate correctly.

Limit line for early fail decision (for $ne > 7$):

The condition for an early fail decision is: $ber_0 > berlim_{fail}$

$$berlim_{fail}(D_{fail}, ne) = \frac{2 \times ne}{C^{-1}(D_{fail}, 2 \times ne)}$$

ber_0 is the normalised bit error rate with counting errors started from zero, meaning that no artificial erroneous sample is introduced at the beginning of the test..

Due to the nature of the test, namely discrete error events, the early fail condition shall not be valid, when fractional errors < 1 are used to calculate the early fail limit: Any early fail decision is postponed until number of errors $ne \geq 7$. In the blocking test any early fail decision is postponed until number of errors $ne \geq 8$.

Parameters for limit lines:

1. D wrong decision probability per test step.
2. M = 1.5 bad DUT factor
3. ne number of (error) events. This parameter is the x-ordinate in figure A7.1.3.1 Limit lines.
4. ns number of samples. This parameter is not needed for limit lines, but enumerated here because it is aligned to ne closely. The bit error rate is calculated from ne and ns.

Parameters D and M define the limit lines for early pass and early fail. With the two curves known the intersection point of the two limit lines can be calculated. The x-ordinate of this intersection point is the target number of errors (TNE) and y-ordinate is the (normalised) test limit (TL). This intersection point is reached when the target test time has elapsed. In this case a decision against the test limit (column "derived test limit") can be made.

5. TL = 1.234 For tests with F = 0.2 the parameters given above lead to this (normalised) test limit. The BER limit given in the core specs (column "Orig. BER requirement" in the tables defining the test limits) is multiplied with the test limit factor TL to gain the limit for the pass/fail decision (column "derived test limit").
- TL = 1.251 Normalized test limit for tests with F = 0.02 (e.g. blocking test).
6. TNE The parameters given above lead to a target number of errors. For tests with F = 0.2 the target number of errors is 345. For tests with F = 0.02 (e.g. blocking test) the target number of errors results in 403.

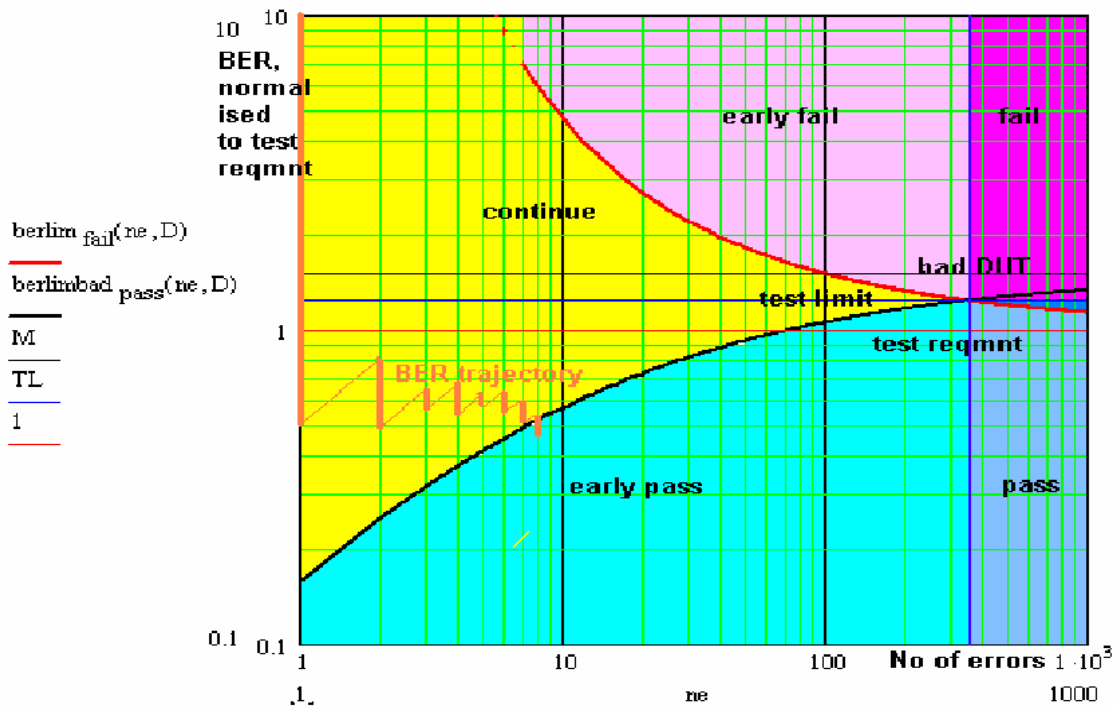

Figure A7.1.3.1 Limit lines

A typical error rate test, calculated from the number of samples and errors using experimental method (1) or (2) (see A7.1.1.4 Calculation assumptions) runs along the yellow trajectory. With an errorless sample the trajectory goes down vertically. With an erroneous sample it jumps up right. Making a pass/fail decision means to check if the error rate ("BER trajectory") intersects the limit lines for early pass or early fail. The term "test limit" used in the figure above denotes the term "derived test limit" used in this document.

A7.1.4 Good balance between test time and statistical significance

Three independent test parameters are introduced into the test and shown in Table A7.1.4.1. These are the obvious basis of test time and statistical significance. From the first two of them four dependent test parameters are derived. The third independent test parameter is justified separately.

Table A7.1.4.1 Independent and dependent test parameters

Independent test parameters			Dependent test parameters		
Test Parameter	Value	Reference	Test parameter	Value	Reference
Bad DUT factor M	1.5	Section A7.1.3.1	Early pass/fail condition	Curves	Section A7.1.3.1 Figure A7.1.3.1
Final probability of wrong pass/fail decision F	0.2% 0.02% for blocking	Section A7.1.2	Target number of error events	345 403 for blocking	Section A7.1.3.1
			Probability of wrong pass/fail decision per test step D	0.0085% 0.0008% for blocking	Section A7.1.2
			Test limit factor TL	1.234 1.251 for blocking	Section A7.1.3.1
Minimum test time		Table A7.1.4.2			

The minimum test time is derived from the following justification:

- 1) For no propagation conditions and static propagation condition

No early fail calculated from fractional number of errors <1

- 2) For multipath fading condition

No stop of the test until 990 wavelengths are crossed for fading profiles greater than 5km/h, and 250 wavelengths are crossed for fading profiles less than or equal to 5km/h. The minimum test time due to multipath fading conditions depends on the frequency of the DL signal, the vehicle speed and the data rate (full rate or half rate). Refer to table A7.1.6.2 : Minimum test time due to fading

Table A7.1.4.2: Minimum test time due to fading

Frequency	0,4	0,7	0,85	0,9	1,8	1,9	GHz
Full Rate 3 km/h							
min test time	1800	1029	847	800	400	379	s
	0:30:00	0:17:09	0:14:07	0:13:20	0:06:40	0:06:19	hh:mm:ss
Half Rate 3 km/h							
min test time	3600	2057	1694	1600	800	758	s
	1:00:00	0:34:17	0:28:14	0:26:40	0:13:20	0:12:38	hh:mm:ss
Full Rate 50 km/h							
min test time	428	244	201	190	95	90	s
	0:07:08	0:04:04	0:03:21	0:03:10	0:01:35	0:01:30	hh:mm:ss
Half Rate 50 km/h							
min test time	855	489	403	380	190	180	s
	0:14:15	0:08:09	0:06:43	0:06:20	0:03:10	0:03:00	hh:mm:ss
Full Rate 100 km/h							
min test time	214	122	101	95	48	45	s
	0:03:34	0:02:02	0:01:41	0:01:35	0:00:48	0:00:45	hh:mm:ss
Half Rate 100 km/h							
min test time	428	244	201	190	95	90	s
	0:07:08	0:04:04	0:03:21	0:03:10	0:01:35	0:01:30	hh:mm:ss
Full Rate 130 km/h							
min test time	164	94	77	73	37	35	s
	0:02:44	0:01:34	0:01:17	0:01:13	0:00:37	0:00:35	hh:mm:ss
Half Rate 130 km/h							
min test time	329	188	155	146	73	69	s
	0:05:29	0:03:08	0:02:35	0:02:26	0:01:13	0:01:09	hh:mm:ss
Full Rate 250 km/h							
min test time	86	49	40	38	19	18	s
	0:01:26	0:00:49	0:00:40	0:00:38	0:00:19	0:00:18	hh:mm:ss
Half Rate 250 km/h							
min test time	171	98	81	76	38	36	s
	0:02:51	0:01:38	0:01:21	0:01:16	0:00:38	0:00:36	hh:mm:ss

A7.1.5 Minimum and maximum expected duration of tests

Since there are a number of dependant and independent factors which determine the expected duration of a test using these statistical methods, it is recommended that in individual test cases an expected minimum and an expected maximum duration of test is specified for each configuration (e.g. times may significantly change for differing bands). Where the expected minimum and maximum duration are constrained by the same factor, and are thus the same, for clarity both values should be stated.

Where minimum and/or maximum test durations are specified, they should only be used in an informative manner (e.g. by a test case implementer to determine whether a given implementation is correct). These specified durations should not be used as a failure determination unless this is explicitly stated in an individual clause.

A7.2 Statistical testing of 2 D position error and TTFF for A-GPS Minimum Performance test cases

A7.2.1 Test Method

Each test is performed in the following manner:

- a) Setup the required test conditions.
- b) Measure the 2D position and Time to First Fix repeated times. Start each repetition after having applied the message 'RESET MS POSITIONING STORED INFORMATION'. This ensures that each result is independent from the previous one. The results, measured, are simplified to:

good result, if the 2D position and TTFF are \leq limit.

bad result, if the 2D position or TTFF or both are $>$ limit

- c) Record the number of results (ns) and the number of bad results (ne)
- d) Stop the test at a pass or an fail event.
- e) Once the test is stopped, decide according to the pass fail decision rules (A7.2.4.2)

A7.2.2 Error Ratio (ER)

The Error Ratio (ER) is defined as the ratio of bad results (ne) to all results (ns).
(1-ER is the success ratio)

A7.2.3 Test Design

A statistical test is characterised by:

Test-time, Selectivity and Confidence level

A7.2.3.1 Confidence level

The outcome of a statistical test is a decision. This decision may be correct or in-correct. The Confidence Level CL describes the probability that the decision is a correct one. The complement is the wrong decision probability (risk) $D = 1-CL$

A7.2.3.2 Introduction: Supplier Risk versus Customer Risk

There are two targets of decision:

- a) A measurement on the pass-limit shows, that the DUT has the specified quality or is better with probability CL (CL e.g.95%) This shall lead to a “pass decision”

The pass-limit is on the good side of the specified DUT-quality. A more stringent CL (CL e.g.99%) shifts the pass-limit further into the good direction. Given that the quality of the DUTs is distributed, a greater CL passes less and better DUTs.

A measurement on the bad side of the pass-limit is simply “not pass” (undecided)

- aa) Complementary:

A measurement on the fail-limit shows, that the DUT is worse than the specified quality with probability CL.

The fail-limit is on the bad side of the specified DUT-quality. A more stringent CL shifts the fail-limit further into the bad direction. Given that the quality of the DUTs is distributed, a greater CL fails less and worse DUTs.

A measurement on the good side of the fail-limit is simply “not fail”.

- b) A DUT, known to have the specified quality, shall be measured and decided pass with probability CL. This leads to the pass limit.

For CL e.g. 95%, the pass limit is on the bad side of the specified DUT-quality. CL e.g.99% shifts the pass-limit further into the bad direction. Given that the DUT-quality is distributed, a greater CL passes more and worse DUTs.

- bb) A DUT, known to be an ($\epsilon \rightarrow 0$) beyond the specified quality, shall be measured and decided fail with probability CL.

For CL e.g.95%, the fail limit is on the good side of the specified DUT-quality.

Note the different sense for CL in (a), (aa) versus (b), (bb)

Note, for constant CL in all 4 bullets (a) is equivalent to (bb) and (aa) is equivalent to (b)

A7.2.3.3 Supplier Risk versus Customer Risk

The table below summarizes the different targets of decision.

Table A7.2.3.3 Equivalent statements

	Equivalent statements, using different cause-to-effect-directions, and assuming CL = constant >0.5	
cause-to-effect-directions	Known measurement result → estimation of the DUT's quality	Known DUT's quality → estimation of the measurement's outcome
Supplier Risk	A measurement on the pass-limit shows, that the DUT has the specified quality or is better (a)	A DUT, known to have an ($\epsilon \rightarrow 0$) beyond the specified DUT-quality, shall be measured and decided fail (bb)
Customer Risk	A measurement on the fail-limit shall shows, that the DUT is worse than the specified quality (aa)	A DUT, known to have the specified quality, shall be measured and decided pass (b)

Note: The bold text shows the obvious interpretation of Supplier Risk and Customer Risk. The same statements can be based on other DUT-quality-definitions.

A7.2.3.4 Introduction: Standard test versus early decision concept

In standard statistical tests, a certain number of results (n_s) is predefined in advance of the test. After n_s results the number of bad results (n_e) is counted and the error ratio (ER) is calculated as n_e/n_s .

Applying statistical theory, a decision limit can be designed, against which the calculated ER is compared to derive the decision. Such a limit is one decision point and is characterised by:

- D: the wrong decision probability (a predefined parameter)
- n_s : the number of results (a fixed predefined parameter)
- n_e : the number of bad results (the limit based on just n_s)

In the formula for the limit, D and n_s are parameters and n_e is the variable. In the standard test n_s and D are constant. The property of such a test is: It discriminate between two states only, depending on the test design:

- pass (with CL) / undecided (undecided in the sense: finally undecided)
- fail (with CL) / undecided (undecided in the sense: finally undecided)
- pass(with CL) / fail (with CL) (however against two limits).

In contrast to the standard statistical tests, the early decision concept predefines a set of (n_e, n_s) co-ordinates, representing the limit-curve for decision. After each result a preliminary ER is calculated and compared against the limit-curve. After each result one may make the decision or not (undecided for later decision) The parameters and variables in the limit-curve for the early decision concept have a similar but not equal meaning:

- D: the wrong decision probability (a predefined parameter)
- n_s : the number of results (a variable parameter)
- n_e : the number of bad results (the limit. It varies together with n_s)

To avoid a "final undecided" in the standard test, a second limit must be introduced and the single decision co-ordinate (n_e, n_s) needs a high n_e , leading to a fixed (high) test time. In the early decision concept, having the same selectivity and the same confidence level an "undecided" does not need to be avoided, as it can be decided later. A perfect DUT will hit the decision coordinate (n_e, n_s) with $n_e=0$. This test time is short.

A7.2.3.5 Standard test versus early decision concept

For Supplier Risk:

The wrong decision probability D in the standard test is the probability, to decide a DUT in-correctly in the single decision point. In the early decision concept there is a probability of in-correct decisions d at each point of the limit-curve. The sum of all those wrong decision probabilities accumulate to D. Hence $d < D$

For Customer Risk:

The correct decision probability CL in the standard test is the probability, to decide a DUT correctly in the single decision point. In the early decision concept there is a probability of correct decisions cl at each point of the limit-curve. The sum of all those correct decision probabilities accumulate to CL. Hence $cl < CL$ or $d > D$

A7.2.3.6 Selectivity

There is no statistical test which can discriminate between a limit-DUT-quality and a DUT-quality which is an $(\epsilon \rightarrow 0)$ apart from the limit in finite time and confidence level $CL > 1/2$. Either the test discriminates against one limit with the results pass (with CL)/undecided or fail (with CL)/undecided, or the test ends in a result pass (with CL)/fail (with CL) but this requires a second limit.

For $CL > 0.5$, a (measurement-result = specified-DUT-quality), generates undecided in test “supplier risk against pass limit” (a in clause A7.2.3.2) and also in the equivalent test against the fail limit (aa in clause A7.2.3.2)

For $CL > 0.5$, a DUT, known to be on the limit, will be decided pass for the test “customer risk against pass limit” (b in clause A7.2.3.2) and also in the equivalent test against fail limit (bb in clause A7.2.3.2).

This overlap or undecided area is not a fault or a contradiction, however it can be avoided by introducing a Bad or a Good DUT quality according to:

- Bad DUT quality: specified DUT-quality * M ($M > 1$)
- Good DUT quality: specified DUT-quality * m ($m < 1$)

Using e.g $M > 1$ and $CL = 95\%$ the test for different DUT qualities yield different pass probabilities:

Figure A7.2.3.6: Pass probability versus DUT quality

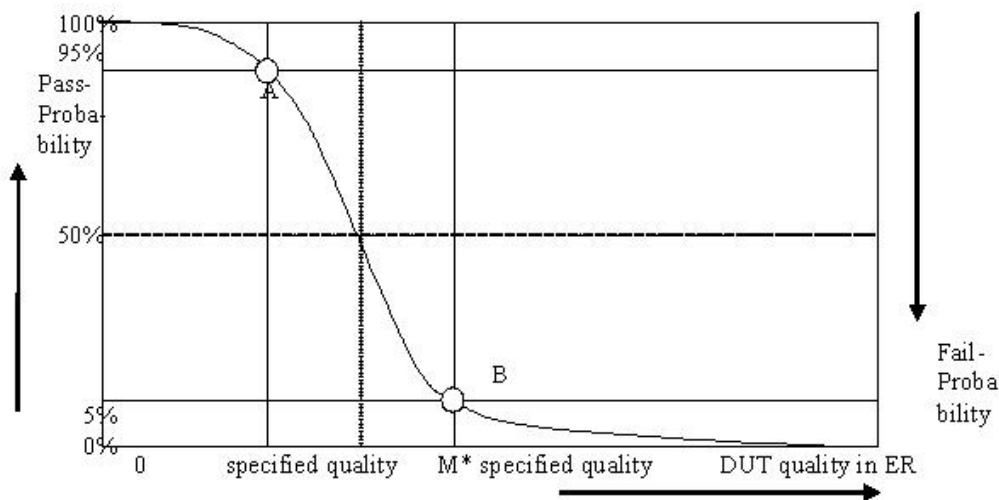

A7.2.3.7 Design of the test

The test is defined according to the following design principles:

1. The early decision concept is applied.
2. A second limit is introduced: Bad DUT factor $M > 1$
3. To decide the test pass:

Supplier risk is applied based on the Bad DUT quality

To decide the test fail

Customer Risk is applied based on the specified DUT quality

The test is defined using the following parameters:

1. Specified DUT quality: $ER = 0.05$
2. Bad DUT quality: $M=1.5$ (selectivity)
3. Confidence level $CL = 95\%$ (for specified DUT and Bad DUT-quality)

This has the following consequences:

- a) A measurement on the fail limit is connected with 2 equivalent statements:

A measurement on the fail-limit shows, that the DUT is worse than the specified DUT-quality	A DUT, known to have the specified quality, shall be measured and decided pass
---	--

A measurement on the pass limit is connected with the complementary statements:

A measurement on the pass limit shows, that the DUT is better than the Bad DUT-quality.	A DUT, known to have the Bad DUT quality, shall be measured and decided fail
---	--

The left column is used to decide the measurement.

The right column is used to verify the design of the test by simulation.

The simulation is based on the two fulcrums A and B only in Figure A7.2.3.6. There is freedom to shape the remainder of the function.

- b) Test time

1. The minimum and maximum test time is fixed.
2. The average test time is a function of the DUT's quality.
3. The individual test time is not predictable (except ideal DUT).

- c) The number of decision co-ordinates (n_e, n_s) in the early decision concept is responsible for the selectivity of the test and the maximum test time. Having fixed the number of decision co-ordinates there is still freedom to select the individual decision co-ordinates in many combinations, all leading to the same confidence level.

A7.2.4 Pass fail decision

A7.2.4.1 Numerical definition of the pass fail limits

ne	nsp	nsf	ne	nsp	nsf	ne	nsp	nsf	ne	nsp	nsf
0	77	NA	43	855	576	86	1525	1297	129	2173	2050
1	106	NA	44	871	592	87	1540	1314	130	2188	2067
2	131	NA	45	887	608	88	1556	1331	131	2203	2085
3	154	NA	46	903	625	89	1571	1349	132	2218	2103
4	176	NA	47	919	641	90	1586	1366	133	2233	2121
5	197	NA	48	935	657	91	1601	1383	134	2248	2139
6	218	42	49	951	674	92	1617	1401	135	2263	2156
7	238	52	50	967	690	93	1632	1418	136	2277	2174
8	257	64	51	982	706	94	1647	1435	137	2292	2192
9	277	75	52	998	723	95	1662	1453	138	2307	2210
10	295	87	53	1014	739	96	1677	1470	139	2322	2227
11	314	100	54	1030	756	97	1692	1487	140	2337	2245
12	333	112	55	1046	772	98	1708	1505	141	2352	2263
13	351	125	56	1061	789	99	1723	1522	142	2367	2281
14	369	139	57	1077	805	100	1738	1540	143	2381	2299
15	387	152	58	1093	822	101	1753	1557	144	2396	2317
16	405	166	59	1108	839	102	1768	1574	145	2411	2335
17	422	180	60	1124	855	103	1783	1592	146	2426	2352
18	440	194	61	1140	872	104	1798	1609	147	2441	2370
19	457	208	62	1155	889	105	1813	1627	148	2456	2388
20	474	222	63	1171	906	106	1828	1644	149	2470	2406
21	492	237	64	1186	922	107	1844	1662	150	2485	2424
22	509	251	65	1202	939	108	1859	1679	151	2500	2442
23	526	266	66	1217	956	109	1874	1697	152	2515	2460
24	543	281	67	1233	973	110	1889	1714	153	2530	2478
25	560	295	68	1248	990	111	1904	1732	154	2544	2496
26	577	310	69	1264	1007	112	1919	1750	155	2559	2513
27	593	325	70	1279	1024	113	1934	1767	156	2574	2531
28	610	341	71	1295	1040	114	1949	1785	157	2589	2549
29	627	356	72	1310	1057	115	1964	1802	158	2603	2567
30	643	371	73	1326	1074	116	1979	1820	159	2618	2585
31	660	387	74	1341	1091	117	1994	1838	160	2633	2603
32	676	402	75	1357	1108	118	2009	1855	161	2648	2621
33	693	418	76	1372	1126	119	2024	1873	162	2662	2639
34	709	433	77	1387	1143	120	2039	1890	163	2677	2657
35	725	449	78	1403	1160	121	2054	1908	164	2692	2675
36	742	465	79	1418	1177	122	2069	1926	165	2707	2693
37	758	480	80	1433	1194	123	2084	1943	166	2721	2711
38	774	496	81	1449	1211	124	2099	1961	167	2736	2729
39	790	512	82	1464	1228	125	2114	1979	168	2751	2747
40	807	528	83	1479	1245	126	2128	1997	169	2765	NA
41	823	544	84	1495	1263	127	2143	2014			
42	839	560	85	1510	1280	128	2158	2032			

Note: The first column is the number of bad results (ne)
The second column is the number of results for the pass limit (ns_p)
The third column is the number of results for the fail limit (ns_f)

A7.2.4.2 Pass fail decision rules

Having observed 0 bad results, pass the test at ≥ 77 results, otherwise continue

Having observed 1 bad result, pass the test at ≥ 106 results, otherwise continue

Having observed 2 bad results, pass the test at ≥ 131 results, otherwise continue

etc. until

Having observed 6 bad results, pass the test at ≥ 218 results, fail the test at ≤ 42 results, otherwise continue

Having observed 7 bad results, pass the test at ≥ 238 results, fail the test at ≤ 52 results, otherwise continue

etc. until

Having observed 168 bad results, pass the test at ≥ 2751 results, fail the test at ≤ 2747 results, otherwise continue

Having observed 169 bad results, pass the test at ≥ 2765 results, otherwise fail

Note: an ideal DUT passes after 77 results. The maximum test time is 2765 results.

A7.2.4.3 Background information to the pass fail limits

There is freedom to design the decision co-ordinates (ne,ns).

The binomial distribution and its inverse is used to design the pass and fail limits. Note that this method is not unique and that other methods exist.

$$\text{fail}(ne, d_f) := \frac{ne}{(ne + qnbinom(d_f, ne, ER))}$$

$$\text{pass}(ne, cl_p, M) := \frac{ne}{(ne + qnbinom(cl_p, ne, ER \cdot M))}$$

Where

fail(..) is the error ratio for the fail limit

pass(..) is the error ratio for the pass limit

ER is the specified error ratio 0.05

ne is the number of bad results. This is the variable in both equations

M is the Bad DUT factor M=1.5

d_f is the wrong decision probability of a single (ne,ns) co-ordinate for the fail limit.
It is found by simulation to be $d_f = 0.004$

cl_p is the confidence level of a single (ne,ns) co-ordinate for the pass limit.
It is found by simulation to be $cl_p = 0.9975$

qnbinom(..): The inverse cumulative function of the negative binomial distribution

The simulation works as follows:

A large population of limit DUTs with true ER = 0.05 is decided against the pass and fail limits.

cl_p and d_f are tuned such that CL (95%) of the population passes and D (5%) of the population fails.

A population of Bad DUTs with true ER = M*0.05 is decided against the same pass and fail limits.

cl_p and d_f are tuned such that CL (95%) of the population fails and D (5%) of the population passes.

This procedure and the relationship to the measurement is justified in clause A7.2.3.7. The number of DUTs decrease during the simulation, as the decided DUTs leave the population. That number decreases with an approximately exponential characteristics. After 169 bad results all DUTs of the population are decided.

Note: The exponential decrease of the population is an optimal design goal for the decision co-ordinates (ne,ns), which can be achieved with other formulas or methods as well.

Annex 8 (normative): GPS data files

A8.1 GPS data files for signalling tests

The GPS data files for use in signalling tests are contained in archive GPS_Data_Sig_V3.zip which accompanies the present document.

A8.2 GPS data files for Minimum Performance tests

The GPS data files for use in Minimum Performance tests are contained in archive GPS_Data_Perf_V1.zip which accompanies the present document.

Annex 9 (normative): GAN certificate

A9.1 Files relating to GAN certificate for testing

All files associated with the certificates to be used for authentication in IPSec are contained in archive GAN_certificate_V1.zip.

Files to be used both by MS and SS are contained in this archive.

The archive file set consists of the following:

- Ca.key
- Ca.crt
- Segw.key
- Segw.csr
- Segw.crt
- _Command.txt The commands performed to generate the above files
- _Openssl.txt Input file containing information required to generate above certificates
(renamed from openssl.cnf)
- _Execution.txt Activity log generated whilst above files are generated (also contains details of
information prompted for during command execution)

A9.1.1 Overview and usage of certificate files

In a regular network (non-test) environment, a public certification authority (CA) would be used to generate a SEGW certificate (ca.crt) using the CA's private key and the network operator's information. For testing we are using our own test CA and have made available the test CA self-signed root certificate (self signing ca.crt).

Of the above files, the MS will need to store the test CA root certificate (ca.crt).

The SS will use the private key (segw.key) and certificate (segw.crt) for mutual authentication relating to the provisioning SEGW.

The SS vendor will use the test CA private key (ca.key) and test CA root certificate (ca.crt) to generate further certificates relating to the default and serving SEGWs.

A9.1.2 Privacy of private keys and usage of certificate

Since the private key relating to the root certificate is published here, there is no privacy, and thus no relationship of trust associated with this root certificate (ca.crt). It is of the utmost importance that the MS will only utilise this certificate for test purposes. For further details refer to TS 44.014.

Annex 10 (informative): Repeated SACCH Layer 1 Test Method:

A10.1 Details on Repeated SACCH Testing

Table A10.1.1 shows the PCL values exchanged in the L1 headers between a MS and SS during a typical session with zero block errors on time slot 0. On the DL the SS updates the commanded PCL every second SACCH interval as each SACCH block is repeated. The SS must complete the following actions during the period between the last burst of the UL SACCH and the first burst of the DL SACCH (26 frames):

- Decode the reported PCL in the UL SACCH L1 header.
- Determine the new PCL based on the reported PCL in the UL L1 header and the PCL commanded in the previous SACCH interval on the DL. The procedure used is specified in section 14.2.26 or 14.4.32.
- Format the data for the first burst in the DL SACCH L1 header.

Using the information in Table A10.1.1 as an example, the SS must complete the above steps between the end of FN 42106 and the start of FN 42132. The “Next Commanded PCL by SS” to use in FN 42132 is determined according to table 14.2.26-1 or 14.4.32-1, referring to the following parameters:

- The “Last Commanded PCL” is that used in the DL SACCH block that started at FN 42028,
- The “Corresponding Reported MS PCL” is that reported for the UL SACCH block that started at FN 42028.

The entries in table 14.2.26-1 or 14.4.32-1 are derived such that the “Next commanded PCL by SS” is chosen so that it is not equal to either the “Last commanded PCL by SS” or the “Corresponding Reported MS PCL”. This ensures that the SS can detect all block error events. Only three PCL values are needed to ensure that all block error events are captured. The choice of PCL values 7, 8 and 9 are specified to ensure that all PCL values are within 2 steps of each other. This is to avoid rate limiting between changes in PCL values [see TS 45.008 subclause 4.7.1]. Note that PCL values 7, 8, and 9 were chosen to ensure all MSs, even those that do not support PCL values of 0, would work with these test cases.

Table A10.1.2 illustrates the specific case where an error only occurs in the first SACCH block of a repeated SACCH interval. Although this affects the SACCH block sequence that the SS receives from the MS, it does not alter its decisions as no block error occurs. In the case where only the second SACCH block of a repeated SACCH interval is in error, this is not detectable by the SS, however this is not a block error condition as the first SACCH block of the repeated SACCH interval was received without error.

Table A10.1.3 illustrates the specific case where an error occurs in the both the first and second SACCH blocks of a repeated SACCH interval. In this event, the SS detects the block error and the PCL sequence used by the SS is altered from the normal case in response to the sequence received from the MS.

Table A10.1.4 illustrates the specific case where multiple (in this case 4) sequential errors occur. In this event the SS detects two block errors and the PCL sequence used by the SS is altered from the normal case in response to the sequence received from the MS.

Table A10.1.1: Repeated SACCH Typical PCL Sequence (No Errors)

FN OF FIRST BURST OF SACCH	FN OF LAST BURST OF SACCH	SS DL COMMANDED PCL IN L1 HEADER	MS UL REPORTED PCL IN L1 HEADER	COMMENTS
...	
41508	41586	8	7	
41612	41690	8	7	
41716	41794	9	8	
41820	41898	9	8	
41924	42002	7	9	
42028	42106	7	9	
42132	42210	8	7	New SS commanded DL PCL of 8 chosen based on table 14.2.26-1 or 14.4.32-1.
42236	42314	8	7	SS does not update PCL for second SACCH in repeated SACCH interval.
42340	42418	9	8	
42444	42522	9	8	
...	

Table A10.1.2: Repeated SACCH Typical PCL Sequence (Single SACCH Block PCL Error)

FN OF FIRST BURST OF SACCH	FN OF LAST BURST OF SACCH	SS DL COMMANDED PCL IN L1 HEADER	MS UL REPORTED PCL IN L1 HEADER	COMMENTS
...	
41508	41586	8	7	
41612	41690	8	7	
41716	41794	9	8	
41820	41898	9	8	
41924	42002	7	8	First SACCH block of repeated SACCH interval received in error. Correct reported PCL from MS should be 9.
42028	42106	7	9	Second SACCH block of repeated SACCH interval received correctly
42132	42210	8	7	
42236	42314	8	7	
42340	42418	9	8	
42444	42522	9	8	
...	

Table A10.1.3: Repeated SACCH Typical PCL Sequence (Dual SACCH Block PCL Error)

FN OF FIRST BURST OF SACCH	FN OF LAST BURST OF SACCH	SS DL COMMANDED PCL IN L1 HEADER	MS UL REPORTED PCL IN L1 HEADER	COMMENTS
...	
41508	41586	8	7	
41612	41690	8	7	
41716	41794	9	8	
41820	41898	9	8	
41924	42002	7	8	First SACCH block of repeated SACCH interval received in error. Correct reported PCL from MS should be 9.
42028	42106	7	8	Second SACCH block of repeated SACCH interval received in error. Correct reported PCL from MS should be 9.
42132	42210	9	7	
42236	42314	9	7	
42340	42418	8	9	
42444	42522	8	9	
...	

Table A10.1.4: Repeated SACCH Typical PCL Sequence (Multiple SACCH Block PCL Error)

FN OF FIRST BURST OF SACCH	FN OF LAST BURST OF SACCH	SS DL COMMANDED PCL IN L1 HEADER	MS UL REPORTED PCL IN L1 HEADER	COMMENTS
...	
41508	41586	8	7	
41612	41690	8	7	
41716	41794	9	8	
41820	41898	9	8	
41924	42002	7	8	First SACCH block of repeated SACCH interval received in error. Correct reported PCL from MS should be 9.
42028	42106	7	8	Second SACCH block of repeated SACCH interval received in error. Correct reported PCL from MS should be 9.
42132	42210	9	8	First SACCH block of repeated SACCH interval received in error. Correct reported PCL from MS should be 7.
42236	42314	9	8	Second SACCH block of repeated SACCH interval received in error Correct reported PCL from MS should be 7.
42340	42418	7	9	
42444	42522	7	9	
42548	42626	8	7	
42652	42730	8	7	
...	

Annex B (informative): Change history

TSG #	TSG Doc	CR	Rev	Subject/Comment	Cat	Old	New	WG Doc	Work item
08/2000				Conversion to 3GPP layout and number		11.10-1 v 9.0.1	51.010-1 v 4.0.1		
G-02	GP-000489	001		Applicability of 2 new GPRS tests 20.22.8 and 20.22.9	F	4.0.1	4.1.0	G4-000003	GPRS
G-02	GP-000491	002		PIXIT information for SoLSA	B	4.0.1	4.1.0	G4-000021	SoLSA
G-02	GP-000492	003		Test case 31.3.1.4 – Additions to test procedure	F	4.0.1	4.1.0	G4-000039	TEI
G-02	GP-000492	004		Test case 31.3.1.5 – Additions to test procedure.	F	4.0.1	4.1.0	G4-000040	TEI
G-02	GP-000492	005		TC 31.4.3.1.2 - Alignment of Expected Sequence with the Test Procedure description	F	4.0.1	4.1.0	G4-000050	TEI
G-02	GP-000492	006		TC 31.4.3.5 –Corrections of the Method of test according to the core specification GSM 04.84	F	4.0.1	4.1.0	G4-000051	TEI
G-02	GP-000490	007		Introduction of PCS 1900 into section 23	B	4.0.1	4.1.0	G4-000053	PCS1900
G-02	GP-000490	008		Introduction of PCS 1900 into section 26.3	B	4.0.1	4.1.0	G4-000054	PCS1900
G-02	GP-000490	009		Introduction of PCS 1900 into section 26.5	B	4.0.1	4.1.0	G4-000055	PCS1900
G-02	GP-000490	010		Introduction of PCS 1900 into section 26.6	B	4.0.1	4.1.0	G4-000056	PCS1900
G-02	GP-000490	011		Introduction of PCS 1900 into section 26.7	B	4.0.1	4.1.0	G4-000057	PCS1900
G-02	GP-000490	012		Introduction of PCS 1900 into section 26.8	B	4.0.1	4.1.0	G4-000058	PCS1900
G-02	GP-000490	013		Introduction of PCS 1900 into section 30	B	4.0.1	4.1.0	G4-000059	PCS1900
G-02	GP-000490	014		Introduction of PCS 1900 into section 34	B	4.0.1	4.1.0	G4-000060	PCS1900
G-02	GP-000492	015		Correction for testcase 31.4.3.1.1	D	4.0.1	4.1.0	G4-000070	TEI
G-02	GP-000492	016		Correction for testcase 31.4.3.1.2	D	4.0.1	4.1.0	G4-000071	TEI
G-02	GP-000492	017		Correction for testcase 31.4.3.1.3	D	4.0.1	4.1.0	G4-000072	TEI
G-02	GP-000492	018		Correction for testcase 31.4.3.2	D	4.0.1	4.1.0	G4-000073	TEI
G-02	GP-000488	019		Addition of EDGE test cases to the applicability table	B	4.0.1	4.1.0	G4-000099	EDGE
G-02	GP-000488	020		Introduction of 8PSK test equipment measurement uncertainties in Annex 5	B	4.0.1	4.1.0	G4-000100	EDGE
G-02	GP-000488	021		COMPACT Signal Strength test case	B	4.0.1	4.1.0	G4-000103	EDGE
G-02	GP-000488	022		COMPACT Cell Selection and Re-selection	B	4.0.1	4.1.0	G4-000104	EDGE
G-02	GP-000488	023		EDGE Timing advance and absolute delay	B	4.0.1	4.1.0	G4-000105	EDGE
G-02	GP-000492	024		Clause 31.4. Problem with test for call state U0	F	4.0.1	4.1.0	G4-000108	TEI
G-02	GP-000492	025		Test case 31.4.3.1.3 – Incorrect name for timer T in Test Purpose statement	F	4.0.1	4.1.0	G4-000109	TEI
G-02	GP-000487	026		Correction to the numbering of sections and procedures of AMR tests in section 26.16	D	4.0.1	4.1.0	G4-000111	AMR
G-02	GP-000490	027		Inclusion of PCS1900 in clauses 12, 13 and 14	B	4.0.1	4.1.0	G4-000116	PCS1900
G-02	GP-000492	028		Clause 31.4.2.1.2.1. Correction to MPTY Auxiliary states.	F	4.0.1	4.1.0	G4-000119	TEI
G-02	GP-000492	029		Alignment of the AoC test case with the specification	F	4.0.1	4.1.0	G4-000120	TEI
G-02	GP-000492	030		26.10.2.1: mismatching value and use of the Extension Indication about the BCCH channel list, and inconsistencies in the measurement report list of ARFCNs	F	4.0.1	4.1.0	G4-000121	TEI
G-02	GP-000490	031		Introduction of PCS 1900 into section 40	B	4.0.1	4.1.0	G4-000122	PCS1900
G-02	GP-000490	032		Introduction of PCS 1900 into sections 1 to 10	B	4.0.1	4.1.0	G4-000123	PCS1900
G-02	GP-000490	033		Introduction of PCS 1900 into section 41	B	4.0.1	4.1.0	G4-000124	PCS1900
G-02	GP-000490	034		Introduction of PCS 1900 into section 42	B	4.0.1	4.1.0	G4-000125	PCS1900
G-02	GP-000491	035		Introduction of new cell selection and reselection test cases for SoLSA	B	4.0.1	4.1.0	G4-000126	SoLSA
G-02	GP-000491	036		Replacement of current chapter 26.15	B	4.0.1	4.1.0	G4-000127	SoLSA
G-02	GP-000491	037		Addition of SoLSA test cases to the applicability table	B	4.0.1	4.1.0	G4-000128	SoLSA
G-02	GP-000489	038		Clarification of GPRS Receive Initial Conditions	F	4.0.1	4.1.0	G4-000129	GPRS
G-02	GP-000489	039		Clarification of GPRS Transmitter Initial Conditions	F	4.0.1	4.1.0	G4-000130	GPRS
G-02	GP-000489	040		Clarification of GPRS Timing advance and absolute delay Conditions	F	4.0.1	4.1.0	G4-000131	GPRS
G-02	GP-000492	041		Correction for testcase 31.4.3.4	F	4.0.1	4.1.0	G4-000134	TEI
G-02	GP-000492	042		Correction for testcase 31.4.3.5	F	4.0.1	4.1.0	G4-000135	TEI
G-02	GP-000489	043		Medium Access Control (MAC) Medium Access Control (MAC) Procedures on PCCCH in idle mode	F	4.0.1	4.1.0	G4-000144	GPRS
G-02	GP-000489	044		Dynamic Allocation in Packet Transfer Mode	F	4.0.1	4.1.0	G4-000145	GPRS

TSG #	TSG Doc	CR	Rev	Subject/Comment	Cat	Old	New	WG Doc	Work item
G-02	GP-000489	045		TC's section 41 – Channel combination v) instead of iv) and vii)	D	4.0.1	4.1.0	G4-000146	GPRS
G-02	GP-000489	046		The ARFCN list encoding for DCS in 42.1.2.2.3 cannot use Bit Map 0 format.	F	4.0.1	4.1.0	G4-000147	GPRS
G-02	GP-000489	047		Incorrect References in Specific Message Contents of 41.1.3	F	4.0.1	4.1.0	G4-000148	GPRS
G-02	GP-000489	048		Mis-alignment between the "Test Procedure" and "Expected Sequence" of test case 42.3.1.1.7.	F	4.0.1	4.1.0	G4-000149	GPRS
G-02	GP-000489	049		Test case 42.3.1.1.4 - inconsistencies between "Test Procedure" and "Expected Sequence" along with chronologically errors in "Expected Sequence"	F	4.0.1	4.1.0	G4-000150	GPRS
G-02	GP-000489	050		GPRS Paging tests on CCCH for GPRS service	F	4.0.1	4.1.0	G4-000151	GPRS
G-02	GP-000489	051		TC 41.2.2.4 – Correction of Expected sequence numbering	F	4.0.1	4.1.0	G4-000152	GPRS
G-02	GP-000489	052		TC 41.2.3.1 – Correction of Specific message contents	F	4.0.1	4.1.0	G4-000153	GPRS
G-02	GP-000489	053		TC 41.2.3.2 – Correction of Specific message contents	F	4.0.1	4.1.0	G4-000154	GPRS
G-02	GP-000489	054		TC 41.2.6.1 – Editorial modification of Section numbering	D	4.0.1	4.1.0	G4-000155	GPRS
G-02	GP-000489	055		TBF release	F	4.0.1	4.1.0	G4-000156	GPRS
G-02	GP-000489	056		GPRS Paging tests on PACCH for circuit-switched services	F	4.0.1	4.1.0	G4-000157	GPRS
G-02	GP-000489	057		SS Initial Conditions of 41.1	F	4.0.1	4.1.0	G4-000158	GPRS
G-02	GP-000489	058		Incorrect quotations from 0408 leading to unnecessary requirements in 41.1.5.	F	4.0.1	4.1.0	G4-000159	GPRS
G-02	GP-000489	059		41.1.2 Applicability, SS Broadcast Information and Pack Paging Request 1A MI Types	F	4.0.1	4.1.0	G4-000160	GPRS
G-02	GP-000489	060		Incorrect "timeslot allocation" value in 42.1.2.1.6 PSI type 2 message contents	F	4.0.1	4.1.0	G4-000161	GPRS
G-02	GP-000489	061		Correction of GPRS Mobility Management	F	4.0.1	4.1.0	G4-000162	GPRS
G-02	GP-000489	062		Measurement Reports and Cell Change Order Procedures	F	4.0.1	4.1.0	G4-000163	GPRS
G-02	GP-000489	063		TC 41.4.2.1 – Not tested Conformance requiremens removed. Corrections in Test purpose, Expected sequence.	F	4.0.1	4.1.0	G4-000164	GPRS
G-02	GP-000489	064		Various Errors and Updates in Section 40	F	4.0.1	4.1.0	G4-000165	GPRS
G-02	GP-000489	065		GPRS SMDCP Tests	F	4.0.1	4.1.0	G4-000166	GPRS
G-02	GP-000489	066		GPRS Receive Tests	F	4.0.1	4.1.0	G4-000087	GPRS
				Editorial modification to the title in the cover page		4.1.0	4.1.1		
				Addition of missing record in the history box		4.1.1	4.1.2		
GP-03	GP-010088	067		Clause 31.4.2.1.1.3. Correction to testcase expected sequence.	F	4.1.1	4.2.0	G4-000169	TEI
GP-03	GP-010088	068		Clause 31.4.3.3. Correction to testcase procedure.	F	4.1.1	4.2.0	G4-000170	TEI
GP-03	GP-010085	069		Clauses 41.2.3.1 and 41.2.3.2 on IA Rest Octets discrepancy.	F	4.1.1	4.2.0	G4-000173	GPRS
GP-03	GP-010088	070		Clause 31.4.4.1.1 – Auto-Retrieval of held calls	F	4.1.1	4.2.0	G4-000179	TEI
GP-03	GP-010088	071		Series 31.4.4.3 - Incorrect call states in the Test Procedure and Expected Message Sequence	F	4.1.1	4.2.0	G4-000180r	TEI
GP-03	GP-010088	072		Test case 31.3.1.2.2.2 – Modifications to Test Procedure and Expected message sequence	F	4.1.1	4.2.0	G4-000183	TEI
GP-03	GP-010088	073		Test Case 28.4 – Missing Expected Message Sequence	F	4.1.1	4.2.0	G4-000185	TEI
GP-03	GP-010088	074		Addition of new PIXIT Statement to annex A for section 28 tests	F	4.1.1	4.2.0	G4-000187	TEI
GP-03	GP-010087	075		Introduction of PCS 1900 into section 26.14	B	4.1.1	4.2.0	G4-000190	PCS1900
GP-03	GP-010087	076		Introduction of PCS 1900 into section 27	B	4.1.1	4.2.0	G4-000193	PCS1900
GP-03	GP-010087	077		Introduction of PCS 1900 into section 35	B	4.1.1	4.2.0	G4-000195	PCS1900
GP-03	GP-010087	078		Corrections for PCS 1900 in sections 26.6.3.x and 26.6.18	F	4.1.1	4.2.0	G4-000197	PCS1900
GP-03	GP-010088	079		Test case 31.4.5 - Incorrect TI for Return Result Component.	F	4.1.1	4.2.0	G4-000202	TEI
GP-03	GP-010088	080		Incorrect numbering of sequence of TC31.4.4.1.1.1	F	4.1.1	4.2.0	G4-000203	TEI
GP-03	GP-010088	081		Incorrect call auxillary state in TC31.4.4.3.2	F	4.1.1	4.2.0	G4-000205	TEI
GP-03	GP-010087	082		Inclusion of PCS 1900 in HSCSD tests section 13 and 14	B	4.1.1	4.2.0	G4-000206	PCS1900
GP-03	GP-010087	083		Inclusion of PCS 1900 in GPRS tests section 13	B	4.1.1	4.2.0	G4-000207	PCS1900

TSG #	TSG Doc	CR	Rev	Subject/Comment	Cat	Old	New	WG Doc	Work item
				and 14					
GP-03	GP-010085	084		SS Needs To Send GMM INFORMATION In-Order That MS Deletes Old P-TMSI In 44.2.3.1.1.	F	4.1.1	4.2.0	G4-000208	GPRS
GP-03	GP-010085	085		41.2.8.1.2 Uplink Data Transfer Should Be Terminated by PACKET UPLINK ACK/NAK With FAI Set.	F	4.1.1	4.2.0	G4-000211	GPRS
GP-03	GP-010085	086		44.2.5.2.1 Test Method (Expected Sequence) Correction	F	4.1.1	4.2.0	G4-000213	GPRS
GP-03	GP-010088	087		Incorrect transaction identifier TI used at step 9 + 10 in TC31.4.4.2	F	4.1.1	4.2.0	G4-000220	TEI
GP-03	GP-010085	088		Updates to the Applicability table	F	4.1.1	4.2.0	G4-000222	GPRS
GP-03	GP-010085	089		Heading numbering error in one LLC test	D	4.1.1	4.2.0	G4-000224	GPRS
GP-03	GP-010085	090		Paging on PCCCH for GPRS service with IMSI	F	4.1.1	4.2.0	G4-000226	GPRS
GP-03	GP-010085	100		Wrong specific message content deleted.	F	4.1.1	4.2.0	G4-000227	GPRS
GP-03	GP-010085	101		Steps added in the Expected sequence	F	4.1.1	4.2.0	G4-000229	GPRS
GP-03	GP-010085	102		44.2.3.2.5.3.2 Test Method (Expected Sequence) Corrections.	F	4.1.1	4.2.0	G4-000230	GPRS
GP-03	GP-010086	103		GSM 700 and GSM 850 to 51.010 section 12	B	4.1.1	4.2.0	G4-000243	GSM700
GP-03	GP-010086	104		GSM 700 and GSM 850 additions into 51.010 section 15	B	4.1.1	4.2.0	G4-000246	GSM700
GP-03	GP-010086	105		GSM 700 and GSM 850 additions into 51.010 section 16	B	4.1.1	4.2.0	G4-000247	GSM700
GP-03	GP-010086	106		GSM 700 and GSM 850 additions into 51.010 section 17	B	4.1.1	4.2.0	G4-000248	GSM700
GP-03	GP-010086	107		GSM 700 and GSM 850 additions into 51.010 section 18	B	4.1.1	4.2.0	G4-000249	GSM700
GP-03	GP-010086	108		GSM 700 and GSM 850 additions into 51.010 section 19	B	4.1.1	4.2.0	G4-000250	GSM700
GP-03	GP-010086	109		GSM 700 and GSM 850 additions into 51.010 section 20	B	4.1.1	4.2.0	G4-000251	GSM700
GP-03	GP-010086	110		GSM 700 and GSM 850 additions into 51.010 section 21	B	4.1.1	4.2.0	G4-000252	GSM700
GP-03	GP-010086	111		GSM 700 and GSM 850 additions into 51.010 sections 22-24	B	4.1.1	4.2.0	G4-000253	GSM700
GP-03	GP-010084	112		Addition of EGPRS Usable receiver input range test to the applicability table	F	4.1.1	4.2.0	G4-000258	EDGE
GP-03	GP-010084	113		EGPRS Usable receiver user input range test	B	4.1.1	4.2.0	G4-000261	EDGE
GP-03	GP-010085	114		LLC testcases 46.1.2.2.2.3, 46.1.2.6.2, 46.1.2.7.6 corrections	D	4.1.1	4.2.0	G4-000275	GPRS
GP-03	GP-010085	115		Macro for downlink TBF establishment (PBCCH not present)	F	4.1.1	4.2.0	G4-000280	GPRS
GP-03	GP-010085	116		Section 43 numbering correction	D	4.1.1	4.2.0	G4-000281	GPRS
GP-03	GP-010085	117		Checking only the number of SABM retransmissions	F	4.1.1	4.2.0	G4-000282	GPRS
GP-03	GP-010085	118		GPRS RLC Test Cases section 43	F	4.1.1	4.2.0	G4-000283	GPRS
GP-03	GP-010085	119		Wrong reference to table 42.2.1.1	D	4.1.1	4.2.0	G4-000284	GPRS
GP-03	GP-010087	120		Corrections for PCS 1900 in sections 15 to 24	B	4.1.1	4.2.0	G4-000290	PCS1900
GP-03	GP-010086	121		GSM 700 and GSM 850 additions into 51.010, sections 00 –10	B	4.1.1	4.2.0	G4-000291	GSM700
GP-03	GP-010086	122		GSM 700 and GSM 850 additions into 51.010 section 13	B	4.1.1	4.2.0	G4-000292	GSM700
GP-03	GP-010088	123		TC 31.2.1.7.1.1 - Forwarded-to mobile subscriber side. Corrections of Conformance Requirements, Test Purpose and Method of test (incl. Expected Sequence)	F	4.1.1	4.2.0	G4-000294r	TEI
GP-03	GP-010087	124		Introduction of PCS 1900 into section 26.12	B	4.1.1	4.2.0	G4-000295	PCS1900
GP-03	GP-010087	125		Introduction of PCS 1900 into section 26.15	B	4.1.1	4.2.0	G4-000296	PCS1900
GP-03	GP-010087	126		Introduction of PCS 1900 into section 26.16	B	4.1.1	4.2.0	G4-000297	PCS1900
GP-03	GP-010088	127		Test Case 28.2 – Missing Test Procedure	F	4.1.1	4.2.0	G4-000298	TEI
GP-03	GP-010086	128		GSM 700 and GSM 850 additions into 51.010 section 14	B	4.1.1	4.2.0	G4-000300	GSM700
GP-03	GP-010087	129		Introduction of PCS 1900 into section 31	B	4.1.1	4.2.0	G4-000305	PCS1900
GP-03	GP-010087	130		Introduction of PCS 1900 into section Annex	B	4.1.1	4.2.0	G4-000306	PCS1900
GP-03	GP-010087	131		Clause 26.9. Corrections for PCS 1900 emergency calls	F	4.1.1	4.2.0	G4-000307	PCS1900
GP-03	GP-010088	132		Clause 28.1. Removal of references to section 29.	F	4.1.1	4.2.0	G4-000308	TEI
GP-03	GP-010088	133		Test case 31.4.2.1.4, 31.4.2.2.1 and 31.4.4.1.2.2 and 31.4.3.5 - Incorrect auxiliary call states in the Test Procedure and Expected Message Sequence.	F	4.1.1	4.2.0	G4-000313	TEI

TSG #	TSG Doc	CR	Rev	Subject/Comment	Cat	Old	New	WG Doc	Work item
GP-03	GP-010088	134		Section 30 - Audio Testing Specification	F	4.1.1	4.2.0	G4-000176	TEI
				Addition of missing references		4.1.1	4.2.0		
GP-04	GP-010466	135		clause 40 – GPRS default conditions, message contents and macros	F	4.2.0	4.3.0	G4-010030	GPRS
GP-04	GP-010466	136		clause 44.2.5.2.3 - Ciphering mode / IMEISV request	F	4.2.0	4.3.0	G4-010031	GPRS
GP-04	GP-010466	137		clause 44.2.3.2.9 - Combined routing area updating / abnormal cases / change of cell during routing area updating procedure	F	4.2.0	4.3.0	G4-010032	GPRS
GP-04	GP-010466	138		clause 44.2.5.2.1 - Ciphering mode / start ciphering	F	4.2.0	4.3.0	G4-010033	GPRS
GP-04	GP-010466	139		SNDP test "Response from MS on receiving XID request from the SS"	F	4.2.0	4.3.0	G4-010047	GPRS
GP-04	GP-010466	140		Corrections and clarification of the GPRS defaults section 40.	F	4.2.0	4.3.0	G4-010050	GPRS
GP-04	GP-010466	141		41.2 RR procedures on CCCH related to temporary block flow establishment	F	4.2.0	4.3.0	G4-010051	GPRS
GP-04	GP-010466	142		clause 41.3.4.2 TBF Release / Downlink / Normal / Network initiated / Unacknowledged mode	F	4.2.0	4.3.0	G4-010052	GPRS
GP-04	GP-010466	143		Correction of reaction time check in section 42.2.2.11	F	4.2.0	4.3.0	G4-010053	GPRS
GP-04	GP-010466	144		GPRS MAC Dynamic Allocation Test Case 42.3.1.2.1	F	4.2.0	4.3.0	G4-010054	GPRS
GP-04	GP-010466	145		Additional GPRS Conformance Tests for Network Controlled Reselection	F	4.2.0	4.3.0	G4-010055	GPRS
GP-04	GP-010466	146		42.5.1.1 Downlink Transfer / Normal operation / Relative encoding TBF starting time	F	4.2.0	4.3.0	G4-010056	GPRS
GP-04	GP-010466	147		Stall Indicator usage clarification	F	4.2.0	4.3.0	G4-010057	GPRS
GP-04	GP-010466	148		GMM Procedure timeout during GPRS Detach or Combined routing area updating	F	4.2.0	4.3.0	G4-010058	GPRS
GP-04	GP-010466	149		44.2.1.2.7 TMSI Status Check Not Required In ATTACH REQUEST and MS Will Always Respond To Paging With IMSI.	F	4.2.0	4.3.0	G4-010059	GPRS
GP-04	GP-010466	150		Use of the Allocation bitmap in accordance with the value of T3168	F	4.2.0	4.3.0	G4-010060	GPRS
GP-04	GP-010466	151		Permission to access the network – setting of priority for data transfer	F	4.2.0	4.3.0	G4-010089	GPRS
GP-04	GP-010466	152		SS Needs To Send Packet Paging Request or a Paging Request Type 1 In 44.2.1.1.1.	F	4.2.0	4.3.0	G4-010144	GPRS
GP-04	GP-010466	153		Corrections To The Test Method Of 44.2.1.2.1	F	4.2.0	4.3.0	G4-010145	GPRS
GP-04	GP-010466	154		Test Duration of 44.2.3.3.1 Calls Periodic Location Update Timer To Be Disabled	F	4.2.0	4.3.0	G4-010146	GPRS
GP-04	GP-010466	155		Cells Used In The Testing Of Reject Cause 'PLMN not allowed' Should Not Have The Home PLMN and the Location Update Procedure Is Not Initiated By A Mobile in Mode C "GPRS"(44.2.1.1.4)	F	4.2.0	4.3.0	G4-010147	GPRS
GP-04	GP-010466	156		Various Corrections To The Procedures Of Test Case 44.2.1.1.5	F	4.2.0	4.3.0	G4-010148	GPRS
GP-04	GP-010466	157		44.2.3.3.2 Periodic routing area updating / accepted / T3312 default value	F	4.2.0	4.3.0	G4-010149	GPRS
GP-04	GP-010466	158		44.2.3.3.3 Periodic routing area updating / no cell available / Network mode I and 44.2.3.3.4 Combined routing area updating / no cell available	F	4.2.0	4.3.0	G4-010150	GPRS
GP-04	GP-010466	159		44.2.1.2.3 Combined GPRS attach / GPRS attach while IMSI attach	F	4.2.0	4.3.0	G4-010151	GPRS
GP-04	GP-010466	160		44.2.2.1.2 GPRS detach / accepted	F	4.2.0	4.3.0	G4-010152	GPRS
GP-15	GP-031462	160		CR 51.010-1-1608 Correction for Security procedures after GSM to UMTS intersystem handover.	F	5.3.0	5.4.0	GP-031462	Intersystem handover
GP-04	GP-010466	161		Corrections To The Test Method Of 45_2_1_1	F	4.2.0	4.3.0	G4-010153	GPRS
GP-04	GP-010466	162		Procedure, Expected Sequence and Default Message Corrections To 45.2.2	F	4.2.0	4.3.0	G4-010154	GPRS
GP-04	GP-010466	163		clause 44.2.5.1.1 - Authentication accepted	F	4.2.0	4.3.0	G4-010155	GPRS
GP-04	GP-010466	164		clause 44.2.5.2.2- Ciphering mode / stop ciphering	F	4.2.0	4.3.0	G4-010156	GPRS
GP-04	GP-010466	165		clause 44.2.3.1.2- Routing area updating / rejected / IMSI invalid / illegal ME	F	4.2.0	4.3.0	G4-010157	GPRS
GP-04	GP-010466	166		clause 44.2.6 - Identification procedure	F	4.2.0	4.3.0	G4-010158	GPRS
GP-04	GP-010466	167		clause 44.2.3.1.6- Routing area updating / abnormal cases / change of cell into new routing	F	4.2.0	4.3.0	G4-010159	GPRS

TSG #	TSG Doc	CR	Rev	Subject/Comment	Cat	Old	New	WG Doc	Work item
				area					
GP-04	GP-010466	168		clause 44.2.3.2.8- Combined routing area updating / abnormal cases / change of cell into new routing area	F	4.2.0	4.3.0	G4-010160	GPRS
GP-04	GP-010466	169		clause 44.2.3.1.4- Routing area updating / rejected / location area not allowed	F	4.2.0	4.3.0	G4-010161	GPRS
GP-04	GP-010466	170		clause 44.2.1.1.1- GPRS attach / accepted	F	4.2.0	4.3.0	G4-010162	GPRS
GP-04	GP-010466	171		41.3.2.1 TBF Release / Uplink / Normal / Network initiated / Acknowledged mode and 41.3.2.2 TBF Release / Uplink / Normal / Network initiated / Unacknowledged mode	F	4.2.0	4.3.0	G4-010163	GPRS
GP-04	GP-010467	172		EVM test equipment measurement uncertainties	F	4.2.0	4.3.0	G4-010091	EDGE
GP-04	GP-010467	173		Introduction of the EGPRS Radio Signalling Test Cases numbering.	B	4.2.0	4.3.0	G4-010122	EDGE
GP-04	GP-010467	174		EGPRS Power Versus Time Template for 8PSK modulation	F	4.2.0	4.3.0	G4-010138	EDGE
GP-04	GP-010468	175		Artificial Ear - A3.2.8 - acoustic measurements illustrated	F	4.2.0	4.3.0	G4-010013	TEI
GP-04	GP-010468	176		Correction of the Testcases 13.16.1-3 of " in 51.010-1 "GPRS Transmitter Tests" in section 13.16	F	4.2.0	4.3.0	G4-010168	TEI
GP-04	GP-010468	177		Correction of the applicability table in 51.010-1 section 3.2.2	F	4.2.0	4.3.0	G4-010169	TEI
GP-04	GP-010468	178		Correction of Measurement Range for 13.5	F	4.2.0	4.3.0	G4-010170	TEI
GP-04	GP-010469	179		Alignment of TS 51.010-1 clause 31.1.3.1 COLP / Normal operation	C	4.2.0	4.3.0	G4-010067	TEI
GP-04	GP-010469	180		Alignment of TS 51.010-1 clause 31.4.4.3.2 Add the single call to the MPTY, maximum number of participants exceeded	C	4.2.0	4.3.0	G4-010068	TEI
GP-04	GP-010469	181		Test Case 28.2 – Incorrect Comments in Test Procedure	F	4.2.0	4.3.0	G4-010071	TEI
GP-04	GP-010469	182		Test Case 28.3 – Missing Test Steps in Test Procedure	F	4.2.0	4.3.0	G4-010072	TEI
GP-04	GP-010469	183		Test Case 28.4 – Incorrect timer value in Test Procedure	F	4.2.0	4.3.0	G4-010073	TEI
GP-04	GP-010469	184		test case 31.4.3.4- Incorrect Forseen Final State.	F	4.2.0	4.3.0	G4-010074	TEI
GP-04	GP-010469	185		Clause 31.11 – Modifications to Specific Message Contents	F	4.2.0	4.3.0	G4-010075	TEI
GP-04	GP-010469	186		clauses 31.2.1.1.1 and 31.2.1.2.2– Modifications to Specific Message Contents.	F	4.2.0	4.3.0	G4-010076	TEI
GP-04	GP-010469	187		Test case 31.9.1.2 – Corrections to Expected Message Sequence and Specific Message Contents	F	4.2.0	4.3.0	G4-010077	TEI
GP-04	GP-010469	188		Test case 31.9.1.1 – Modifications to Specific Message Contents	F	4.2.0	4.3.0	G4-010078	TEI
GP-04	GP-010469	189		clause 31.4.4.1.2.4. Auto-retrieval of held calls	F	4.2.0	4.3.0	G4-010079	TEI
GP-04	GP-010469	190		Test Case 31.1.3.1. Error in Test Procedure	F	4.2.0	4.3.0	G4-010082	TEI
GP-04	GP-010469	191		Alignment of TS 51.010-1 clause 31.3.1.2.2.2 Waiting call accepted; existing call on hold, held call cleared.	C	4.2.0	4.3.0	G4-010112	TEI
GP-04	GP-010469	192		Alignment of TS 51.010-1 clause 31.9.1.1 Mobile station initiated Unstructured supplementary service data operation / ProcessUnstructuredSS-request/accepted.	F	4.2.0	4.3.0	G4-010113	TEI
GP-04	GP-010469	193		Editorial Correction for Advice of Charge Charging in section 31.6 and addition of tests for Advice of Charge Information in section 31.6.3.1	B	4.2.0	4.3.0	G4-010115	AoC
GP-04	GP-010469	194		New test cases for CS intersystem handover	B	4.2.0	4.3.0	G4-010177	
GP-04	GP-010469	195		Introduction of tests for COLR – Normal Operation in section 31.1.4.2	B	4.2.0	4.3.0	G4-010181	TEI
GP-04	GP-010469	196		Removal of TS51.010-1 test cases 31.4.3.5; 31.4.4.1.2.1 and 31.4.4.1.2.2	F	4.2.0	4.3.0	G4-010182	TEI
GP-04	GP-010470	197		Removal of the Applicability Table in clause 3.2.2	D	4.2.0	4.3.0	G4-010176	TEI
GP-04	GP-010469	198		clause 31.8.6.1 : correction of the call barring test	F	4.2.0	4.3.0	G4-010185	TEI
GP-05	GP-011147	199		Clause 42.2.4.4 - PACKET ACCESS REJECT without wait indication	F	4.3.0	4.4.0	G4-010212	GPRS
GP-05	GP-011147	200		Wrong default values for GAMMA and starting time parameters in Testcase 41.1.5.1.1	F	4.3.0	4.4.0	G4-010216	GPRS
GP-05	GP-011147	201		Not all allowed Random References should be used by the MS concerning Testcase 41.2.2.3	F	4.3.0	4.4.0	G4-010217	GPRS

TSG #	TSG Doc	CR	Rev	Subject/Comment	Cat	Old	New	WG Doc	Work item
GP-05	GP-011147	202		Clause 43 RLC Test Cases	F	4.3.0	4.4.0	G4-010218	GPRS
GP-05	GP-011147	203		Clause 44.2.1.2.3 - Combined GPRS attach / GPRS attach while IMSI attach	F	4.3.0	4.4.0	G4-010219	GPRS
GP-05	GP-011147	204		Clause 44.2.1.2.5 - Combined GPRS attach / rejected / GPRS services and non-GPRS services not allowed	F	4.3.0	4.4.0	G4-010220	GPRS
GP-05	GP-011147	205		Clause 44.2.3.2.6 - Combined routing area updating / abnormal cases / access barred due to access class control	F	4.3.0	4.4.0	G4-010222	GPRS
GP-05	GP-011147	206		Clauses 44.2.1.2.4, 44.2.1.2.8, 44.2.1.2.9	F	4.3.0	4.4.0	G4-010223	GPRS
GP-05	GP-011147	207		Clause 44.2.1.2.6 - Combined GPRS attach / rejected / GPRS services not allowed	F	4.3.0	4.4.0	G4-010224	GPRS
GP-05	GP-011147	208		Clauses 44.2.2 and 44.2.3	F	4.3.0	4.4.0	G4-010225	GPRS
GP-05	GP-011147	209		Clause 44.2.1.2.7 - Combined GPRS attach / rejected / location area not allowed	F	4.3.0	4.4.0	G4-010226	GPRS
GP-05	GP-011147	210		44.2.1.1.2 GPRS attach / rejected / IMSI invalid / illegal MS	F	4.3.0	4.4.0	G4-010227	GPRS
GP-05	GP-011147	211		44.2.1.1.5 GPRS attach / rejected / roaming not allowed in this location area	F	4.3.0	4.4.0	G4-010228	GPRS
GP-05	GP-011147	212		44.2.1.2.4 Combined GPRS attach / rejected / IMSI invalid / illegal ME	F	4.3.0	4.4.0	G4-010229	GPRS
GP-05	GP-011147	213		Corrections To The Test Method Of 41.1.2	F	4.3.0	4.4.0	G4-010231	GPRS
GP-05	GP-011147	214		41.3.4 - Repetition Requirements and step numbering	F	4.3.0	4.4.0	G4-010232	GPRS
GP-05	GP-011147	215		42.1.1.4.3 Packet Channel Request / Access persistence control on PRACH / Successive Attempts	F	4.3.0	4.4.0	G4-010233	GPRS
GP-05	GP-011147	216		Corrections and clarification of the GPRS defaults section 40	F	4.3.0	4.4.0	G4-010236	GPRS
GP-05	GP-011147	217		44.2.4 - Omission. Of requirement to power down MS for 10 seconds	F	4.3.0	4.4.0	G4-010237	GPRS
GP-05	GP-011147	218		42.1.2.1.5 - Switching off / powering down the MS	F	4.3.0	4.4.0	G4-010240	GPRS
GP-05	GP-011147	219		Extended the use of the "Location Update" Macro defined in section 40 for the GMM test cases	F	4.3.0	4.4.0	G4-010241	GPRS
GP-05	GP-011147	220		44.2.2.2.2 Location Update Following Change of LAI (PLMN) in MS Mode B Test	F	4.3.0	4.4.0	G4-010243	GPRS
GP-05	GP-011147	221		44.2.3.3.3 Periodic routing area updating / no cell available / Network mode I	F	4.3.0	4.4.0	G4-010244	GPRS
GP-05	GP-011147	222		Wrong precision in step 4 of TC 42.1.2.1.1.1	F	4.3.0	4.4.0	G4-010249	GPRS
GP-05	GP-011147	223		Clause 40.5 – Test PDP contexts	F	4.3.0	4.4.0	G4-010270	GPRS
GP-05	GP-011147	224		Clause 42.1.2.1.10.2 Packet Uplink Assignment / Abnormal cases / Expiry of timer T3164	F	4.3.0	4.4.0	G4-010296	GPRS
GP-05	GP-011148	225		Blocking and spurious response	F	4.3.0	4.4.0	G4-010273	EDGE
GP-05	GP-011148	226		Clarification of Origin Offset Suppression requirements	F	4.3.0	4.4.0	G4-010320	EDGE
GP-05	GP-011148	227		EGPRS Test Cases for RR procedures on CCCH related to temporary block flow establishment	B	4.3.0	4.4.0	G4-010321	EDGE
GP-05	GP-011148	228		EGPRS Test Cases for Downlink Transfer/Reestablishment	B	4.3.0	4.4.0	G4-010322	EDGE
GP-05	GP-011149	229		GPRS Cell Selection Test Case 20.22.3 Priority of cells	F	4.3.0	4.4.0	G4-010257	GPRS
GP-05	GP-011149	230		20.22.2-5 Cell Reselection for GPRS - Editorial Corrections	D	4.3.0	4.4.0	G4-010293	TEI
GP-05	GP-011149	231		20.22.9 Cell Reselection for GPRS - Clarification of Test Procedure	F	4.3.0	4.4.0	G4-010294	TEI
GP-05	GP-011149	232		20.14 Emergency Calls - Removal of continuous paging	F	4.3.0	4.4.0	G4-010295	TEI
GP-05	GP-011149	233		Alignment of 51.010-1 test cases 13.5 and 13.17.5	F	4.3.0	4.4.0	G4-010310	TEI
GP-05	GP-011149	234		Alignment of 51.010-1 test case 14.8.1 and 14.8.2	F	4.3.0	4.4.0	G4-010312	TEI
GP-05	GP-011149	235		GPRS Cell Selection / Reselection	F	4.3.0	4.4.0	G4-010314	GPRS
GP-05	GP-011150	237		Modifications to Expected Sequences of test cases 31.9.1.1 and 31.9.1.2	F	4.3.0	4.4.0	G4-010317	TEI
GP-05	GP-011150	238		Clauses 31.2.1.1.1 and 31.2.1.2.2 and 31.11 – Modifications to Specific Message Contents	F	4.3.0	4.4.0	G4-010318	TEI
GP-05	GP-011150	239		Alignment of TS51.010-1 section 31.8.4.1 and 31.11	F	4.3.0	4.4.0	G4-010319	TEI
GP-06	GP-011463	240		Corrections to sections 20.22 – 20.22.9	F	4.4.0	4.5.0	G4-010385	GPRS

TSG #	TSG Doc	CR	Rev	Subject/Comment	Cat	Old	New	WG Doc	Work item
GP-06	GP-011463	241		Harmonisation of conformance tests related to terminal acoustics in GSM and 3G	F	4.4.0	4.5.0	G4-010529	TEI
GP-06	GP-011464	242		Correction of test case 26.6.3.7.	F	4.4.0	4.5.0	G4-010333	TEI
GP-06	GP-011464	243		GSM 700 and GSM850 inclusion into section 26.3	F	4.4.0	4.5.0	G4-010392	GSM 700
GP-06	GP-011464	244		GSM 700 and GSM850 inclusion into section 26.5	F	4.4.0	4.5.0	G4-010393	GSM 700
GP-06	GP-011464	245		GSM 700 and GSM850 inclusion into section 26.6	F	4.4.0	4.5.0	G4-010394	GSM 700
GP-06	GP-011464	246		GSM 700 and GSM850 inclusion into section 26.7	F	4.4.0	4.5.0	G4-010395	GSM 700
GP-06	GP-011464	247		GSM 700 and GSM850 inclusion into section 26.8	F	4.4.0	4.5.0	G4-010396	GSM 700
GP-06	GP-011464	248		GSM 700 and GSM850 inclusion into section 26.9	F	4.4.0	4.5.0	G4-010397	GSM 700
GP-06	GP-011464	249		GSM 700 and GSM850 inclusion into section 26.11	F	4.4.0	4.5.0	G4-010398	GSM 700
GP-06	GP-011464	250		GSM700 and GSM850 inclusion into section 26.12	F	4.4.0	4.5.0	G4-010399	GSM 700
GP-06	GP-011464	251		GSM 700 and GSM850 inclusion into section 26.13	F	4.4.0	4.5.0	G4-010400	GSM 700
GP-06	GP-011464	252		GSM 700 and GSM850 inclusion into section 26.14	F	4.4.0	4.5.0	G4-010401	GSM 700
GP-06	GP-011464	253		GSM 700 and GSM850 inclusion into section 26.15	F	4.4.0	4.5.0	G4-010402	GSM 700
GP-06	GP-011464	254		GSM 700 and GSM850 inclusion into section 26.16	F	4.4.0	4.5.0	G4-010403	GSM 700
GP-06	GP-011464	255		GSM 700 and GSM850 inclusion into section 27	F	4.4.0	4.5.0	G4-010404	GSM 700
GP-06	GP-011464	256		GSM 700 and GSM850 inclusion into section 31	F	4.4.0	4.5.0	G4-010405	GSM 700
GP-25	GP-051188	256	-	Addition of test cases for Extended Dynamic Allocation	-	6.2.0	6.3.0	GP-051188	-
GP-06	GP-011464	257		GSM 700 and GSM850 inclusion into section 34	F	4.4.0	4.5.0	G4-010406	GSM 700
GP-06	GP-011464	258		GSM 700 and GSM850 inclusion into section 35	F	4.4.0	4.5.0	G4-010407	GSM 700
GP-06	GP-011464	259		Correction of both test cases 31.4.2.1.4 and 31.4.2.2.1 : tests of supplementary services	F	4.4.0	4.5.0	G4-010456	TEI
GP-06	GP-011464	260		Correction of test case 31.9.1.1: Process UnstructuredSS-request/accepted and Addition of information in Annex 3	F	4.4.0	4.5.0	G4-010459	TEI
GP-06	GP-011464	261		GSM 700 and GSM850 included into annex 4.3	F	4.4.0	4.5.0	G4-010498	GSM 700
GP-06	GP-011464	262		GSM 700 and GSM850 included into section 26.1	F	4.4.0	4.5.0	G4-010526	GSM 700
GP-06	GP-011464	263		Introduction of PCS 1900 into section 26.1	F	4.4.0	4.5.0	G4-010527	PCS 1900
GP-06	GP-011461	264		Annex 4 - Addition of GPRS service	F	4.4.0	4.5.0	G4-010338	GPRS
GP-06	GP-011461	265		Acknowledged mode / Uplink TBF / Transmit window size, in Section 43.1.1.2	F	4.4.0	4.5.0	G4-010339	GPRS
GP-06	GP-011461	266		Paging correction and GPRS resume indication in section 44.2.2.2.5	F	4.4.0	4.5.0	G4-010344	GPRS
GP-06	GP-011461	267		Additional Location Update procedures in section 44.2.3.1.4	F	4.4.0	4.5.0	G4-010346	GPRS
GP-06	GP-011461	268		Editorial modification to section 41.1.4.1	F	4.4.0	4.5.0	G4-010349	GPRS
GP-06	GP-011461	269		Inserted time for ready timer expiry and removed TMSI status IE in section 44.2.3.3.2	F	4.4.0	4.5.0	G4-010351	GPRS
GP-06	GP-011461	270		Changed timer references in section 44.2.5.1.2	F	4.4.0	4.5.0	G4-010353	GPRS
GP-06	GP-011461	271		42.1.2.1.10.2 Incorrect Number of Packet Access Re-Attempts	F	4.4.0	4.5.0	G4-010354	GPRS
GP-06	GP-011461	272		42.2.2.11.2 Generic Procedure for Open Ended TBF & Irrelevant Conformance Requirement : Dynamic/Fixed Allocation & Definition and Applicability : Frequency Support	F	4.4.0	4.5.0	G4-010355	GPRS
GP-06	GP-011461	273		42.2.2.7.3 Conformance Requirements Inconsistent with Test Purpose and Expected Sequence : Repeat Allocation & New Allocation Bitmap Valid From TBF Starting Time	F	4.4.0	4.5.0	G4-010356	GPRS
GP-06	GP-011461	274		42.2.3.2.1 Generic Procedure for Open Ended TBF & PACKET TBF RELEASE	F	4.4.0	4.5.0	G4-010357	GPRS
GP-06	GP-011461	275		42.2.3.2.1 Generic Procedure for Open Ended TBF & PACKET TBF RELEASE	F	4.4.0	4.5.0	G4-010358	GPRS
GP-06	GP-011461	276		GSM 700 and GSM850 inclusion into clause 42	F	4.4.0	4.5.0	G4-010359	GPRS
GP-06	GP-011461	277		Fixed Allocation ALLOCATION BITMAP clarifications in section 42.2.2.6.1 and 42.2.2.8.1	F	4.4.0	4.5.0	G4-010360	GPRS
GP-06	GP-011461	278		GPRS resume indication and Attach Accept contents in section 44.2.1.2.1	F	4.4.0	4.5.0	G4-010361	GPRS

TSG #	TSG Doc	CR	Rev	Subject/Comment	Cat	Old	New	WG Doc	Work item
GP-06	GP-011461	279		A Minor Test Requirement Error In The Sequence of 44.2.1.2.6	F	4.4.0	4.5.0	G4-010362	GPRS
GP-06	GP-011461	280		Attach Accept contents in sections 44.2.1.1.1, 44.2.1.1.7, 44.2.2.1.2, 44.2.2.1.3, 44.2.3.1.7, 44.2.4	F	4.4.0	4.5.0	G4-010363	GPRS
GP-06	GP-011461	281		GPRS Resume indication in sections 44.2.1.2.4, 44.2.1.2.5, 44.2.1.2.6, 44.2.1.2.7, 44.2.1.2.8, 44.2.1.2.9, 44.2.2.1.7, 44.2.2.2.3 and 44.2.2.2.4	F	4.4.0	4.5.0	G4-010364	GPRS
GP-06	GP-011461	282		Added Location Update procedure and changed Attach Accept contents in section 44.2.3.1.2	F	4.4.0	4.5.0	G4-010365	GPRS
GP-06	GP-011461	283		Changed Attach Accept contents and Initial conditions in section 44.2.3.1.5	F	4.4.0	4.5.0	G4-010366	GPRS
GP-06	GP-011461	284		Several changes to section 44.2.3.2.3	F	4.4.0	4.5.0	G4-010367	GPRS
GP-06	GP-011461	285		Changed title and removed location update in section 44.2.3.3.4	F	4.4.0	4.5.0	G4-010368	GPRS
GP-06	GP-011461	286		MS may answer to paging in section 44.2.1.2.2.3.2, 44.2.3.2.5.3.1 and 44.2.3.2.5.3.2	F	4.4.0	4.5.0	G4-010370	GPRS
GP-06	GP-011461	287		42.4.2.1.4 Error Cause in PACKET CELL CHANGE FAILURE	F	4.4.0	4.5.0	G4-010374	GPRS
GP-06	GP-011461	288		42.4.2.2.1 Incorrect Establishment Cause in PACKET CHANNEL REQUEST	F	4.4.0	4.5.0	G4-010375	GPRS
GP-06	GP-011461	289		Corrections to sections 42.4.1.1 and 42.4.2.1	F	4.4.0	4.5.0	G4-010389	GPRS
GP-06	GP-011461	290		Clause 44.2.2.2.4 GPRS detach / re-attach requested / accepted	F	4.4.0	4.5.0	G4-010411	GPRS
GP-06	GP-011461	291		Clause 46.1.2.2.2.3 Busy condition at the peer, with ACK sent for resumption of transmission	F	4.4.0	4.5.0	G4-010413	GPRS
GP-06	GP-011461	292		GSM 700 and GSM850 inclusion into 51.010-1 clause 40	F	4.4.0	4.5.0	G4-010414	GPRS
GP-06	GP-011461	293		44.2.3.2.5.3.2 Test Procedure 2 Correction to initial conditions.	F	4.4.0	4.5.0	G4-010442	GPRS
GP-06	GP-011461	294		Proposal to change requirements for the number of RLC octets sent in uplink data transfer test cases.	F	4.4.0	4.5.0	G4-010444	GPRS
GP-06	GP-011461	295		Section 40 Need To Define Alternate Frequencies For Assignment Commands When PBCCH/PCCCH Uses Hopping	F	4.4.0	4.5.0	G4-010445	GPRS
GP-06	GP-011461	296		Modification of conformance requirement concerning test case 45.5.1 : Unknown or Unforeseen Transaction Identifier/Non-semantic Mandatory Information Element Errors.	F	4.4.0	4.5.0	G4-010458	GPRS
GP-06	GP-011461	297		Comments related to XID response in LLC Testcases 46.1.2.7.1 and 46.1.2.7.4	F	4.4.0	4.5.0	G4-010460	GPRS
GP-06	GP-011461	298		Correction in message direction for GMM Testcase 44.2.2.1.7	F	4.4.0	4.5.0	G4-010461	GPRS
GP-06	GP-011461	299		Possible MM Location Update for Non-Auto Attach MS	F	4.4.0	4.5.0	G4-010462	GPRS
GP-06	GP-011461	300		42.1.1.3 Initial Conditions Incorrect for RLC Unacknowledged Mode Test	F	4.4.0	4.5.0	G4-010464	GPRS
GP-06	GP-011461	301		42.1.2.1.1.1 Incorrect Use of FRAME_NUMBER in PACKET QUEUING NOTIFICATION & Possible MM Location Update for Non-Auto Attach MS	F	4.4.0	4.5.0	G4-010465	GPRS
GP-06	GP-011461	302		42.1.2.1.9.3 Inconsistent RLC Mode in Initial Conditions and Test Procedure	F	4.4.0	4.5.0	G4-010467	GPRS
GP-06	GP-011461	303		42.2.1.1/1b, 42.2.1.2/1b and 42.2.1.2/2b Use of 11-bit PRACH Format on RACH	F	4.4.0	4.5.0	G4-010468	GPRS
GP-06	GP-011461	304		PACKET POLLING REQ RRB Interpretation	F	4.4.0	4.5.0	G4-010469	GPRS
GP-06	GP-011461	305		42.2.2.11.1 Generic Procedure for Open Ended TBF	F	4.4.0	4.5.0	G4-010470	GPRS
GP-06	GP-011461	306		42.2.2.11.3 Generic Procedure for Open Ended TBF & Conformance Requirement : Abnormal Release	F	4.4.0	4.5.0	G4-010472	GPRS
GP-06	GP-011461	307		Incorrect T3188 Start Condition	F	4.4.0	4.5.0	G4-010473	GPRS
GP-06	GP-011461	308		42.2.3.3.1 Generic Procedure for Open Ended TBF & PACKET CHANNEL REQUEST on CCCH	F	4.4.0	4.5.0	G4-010478	GPRS
GP-06	GP-011461	309		42.2.4.4.1 Conformance Requirement Changed : Re-Attempt Packet Access	F	4.4.0	4.5.0	G4-010479	GPRS
GP-06	GP-011461	310		42.3.1.1.4 Incorrect Expected Sequence for Uplink TBF Establishment	F	4.4.0	4.5.0	G4-010482	GPRS
GP-06	GP-011461	311		42.3.2.1.1 PACKET CONTROL ACK &	F	4.4.0	4.5.0	G4-010483	GPRS

TSG #	TSG Doc	CR	Rev	Subject/Comment	Cat	Old	New	WG Doc	Work item
				Commencement of Downlink Data Blocks					
GP-06	GP-011461	312		42.3.2.1.2 Violation of Ttb Class 2/3 MS	F	4.4.0	4.5.0	G4-010484	GPRS
GP-06	GP-011461	313		42.3.3.1.1 Expected Sequence Table for SMS + 1 PDP Context Test	F	4.4.0	4.5.0	G4-010485	GPRS
GP-06	GP-011461	314		42.3.3.1.2 Expected Sequence Table for SMS + 1 PDP Context Test & Radio Priorities for SMS and PDP Context 5	F	4.4.0	4.5.0	G4-010486	GPRS
GP-06	GP-011461	315		Radio Priority for SMS	F	4.4.0	4.5.0	G4-010487	GPRS
GP-06	GP-011461	316		42.4.1.2 Ready Timer and Cell Update Procedures	F	4.4.0	4.5.0	G4-010488	GPRS
GP-06	GP-011461	317		42.5.2.1 No Timing Advance Value Allocated & Commencement of Downlink RLC Data Blocks & Completion of Downlink Data Transfer	F	4.4.0	4.5.0	G4-010491	GPRS
GP-06	GP-011461	318		Correction to section 41.2.5.1 Packet access rejection / wait indication	F	4.4.0	4.5.0	G4-010492	GPRS
GP-06	GP-011461	319		Clause 40.1. Default test conditions (Definition of Cell C-F)	F	4.4.0	4.5.0	G4-010508	GPRS
GP-06	GP-011461	320		Clause 40 – GPRS default conditions, message contents and macros	F	4.4.0	4.5.0	G4-010509	GPRS
GP-06	GP-011461	321		45.2.1.2.1 QoS Accepted by MS; 45.5. Unknown or Unforeseen Transaction Identifier/Non-semantic Mandatory Information Element Errors	F	4.4.0	4.5.0	G4-010510	GPRS
GP-06	GP-011462	322		Test of EGPRS RR Paging Procedures	F	4.4.0	4.5.0	G4-010422	EDGE
GP-06	GP-011462	323		Test of EGPRS Medium Access Control (MAC) Protocol/ Fixed Allocation	F	4.4.0	4.5.0	G4-010424	EDGE
GP-06	GP-011462	324		Addition of new EGPRS test cases for section 52.4 (Measurement reports and Cell change order procedures)	F	4.4.0	4.5.0	G4-010503	EDGE
GP-06	GP-011462	325		S51.3 MAC/RLC Release ; TBF-Release	F	4.4.0	4.5.0	G4-010513	EDGE
GP-06	GP-011462	326		Correction of Origin Offset Suppression requirements	F	4.4.0	4.5.0	G4-010514	EDGE
GP-06	GP-011462	327		S 53 - EGPRS RLC testcases	F	4.4.0	4.5.0	G4-010515	EDGE
GP-06	GP-011462	328		S52.3 EGPRS MAC Dynamic Allocation Testcases.	F	4.4.0	4.5.0	G4-010504	EDGE
GP-06	GP-011465	329		S60 Inter-system handover from GSM to UTRAN	F	4.4.0	4.5.0	G4-010517	GSM/UMTS interworking
GP-06	GP-011465	330		Addition of Test Cases in clause 60 Inter-system hard handover from GSM to UTRAN	F	4.4.0	4.5.0	G4-010537	GSM/UMTS interworking
GP-06	GP-011464	331		Addition of 1,8V and 1,8V/3V SIM-ME interface test cases into 51.010-1 section 27	F	4.4.0	4.5.0	G4-010493	TEI
GP-07	GP-012063	332		clauses 26.6.5.3 and 26.6.5.4 - Handover / successful / finely synchronized	F	4.5.0	4.6.0	G5-010045	TEI
GP-07	GP-012064	333		clause 27.x – Testing of SIM/ME interface. Alignment of Section 27.x with the core specifications	F	4.5.0	4.6.0	G5-010044	TEI
GP-07	GP-012065	334		clause 31.11 - Specific message contents and ASN.1 codings (change apply for TC 31.2.1.1.1).	F	4.5.0	4.6.0	G5-010041	TEI
GP-07	GP-012066	335		TC 31.2.1.7.2 - Correction of Test procedure	F	4.5.0	4.6.0	G5-010139	TEI
GP-07	GP-012067	336		clauses 31.8.3.1, 31.8.3.2.2, 31.8.4.1, 31.8.4.2.2 and 31.11 – Call Restriction (Call Barring) Activation/Deactivation	F	4.5.0	4.6.0	G5-010140	TEI
GP-07	GP-012068	337		TC 31.9.1.2 - Correction of step references in Expected Message Sequence and Specific Message Contents	F	4.5.0	4.6.0	G5-010141	TEI
GP-07	GP-012069	338		clause 34.2.9.1 and 34.2.9.2 - Multiple SMS mobile originated	F	4.5.0	4.6.0	G5-010040	TEI
GP-07	GP-012070	339		6.2 – Full hopping lists invalid for GPRS Generic Procedures	F	4.5.0	4.6.0	G5-010113	GPRS
GP-07	GP-012071	340		clause 40 – GPRS default conditions, message contents and macros.	F	4.5.0	4.6.0	G5-010145	GPRS
GP-07	GP-012072	341		Sec 44.2.1.1.1 GPRS attach / accepted	D	4.5.0	4.6.0	G5-010052	GPRS
GP-07	GP-012073	342		clause 44.2.1.1.3: Modifications to Expected Sequence	F	4.5.0	4.6.0	G5-010077	GPRS
GP-07	GP-012074	343		Sec: 44.2.1.1.4 GPRS attach / rejected / PLMN not allowed, 44.2.3.2.4 Combined routing area updating / rejected / PLMN not allowed	F	4.5.0	4.6.0	G5-010146	GPRS

TSG #	TSG Doc	CR	Rev	Subject/Comment	Cat	Old	New	WG Doc	Work item
GP-07	GP-012075	344		clause 44.2.1.1.6: Various Modifications	F	4.5.0	4.6.0	G5-010078	GPRS
GP-07	GP-012076	345		clause 44.2.1.2.2	F	4.5.0	4.6.0	G5-010147	GPRS
GP-07	GP-012077	346		clause 44.2.1.2.3	F	4.5.0	4.6.0	G5-010162	GPRS
GP-07	GP-012078	347		Sec 44.2.1.2.4 Combined GPRS attach / rejected / IMSI invalid / illegal ME	F	4.5.0	4.6.0	G5-010150	GPRS
GP-07	GP-012079	348		clause 44.2.1.2.5	F	4.5.0	4.6.0	G5-010151	GPRS
GP-07	GP-012080	349		44.2.1.2.6 Need to ensure mobile performs IMSI Attach procedure.	F	4.5.0	4.6.0	G5-010152	GPRS
GP-07	GP-012081	350		Sec 44.2.1.2.7 Combined GPRS attach / rejected / location area not allowed	F	4.5.0	4.6.0	G5-010153	GPRS
GP-07	GP-012082	351		clause 44.2.1.2.8	F	4.5.0	4.6.0	G5-010154	GPRS
GP-07	GP-012083	352		clause 44.2.2.1.2: Correction of Expected Sequence	F	4.5.0	4.6.0	G5-010084	GPRS
GP-07	GP-012084	353		Sec 44.2.2.1.2 GPRS detach / accepted	D	4.5.0	4.6.0	G5-010059	GPRS
GP-07	GP-012085	354		clause 44.2.2.1.3: Various Corrections	F	4.5.0	4.6.0	G5-010085	GPRS
GP-07	GP-012086	355		clause 44.2.2.1.4: Correction of Expected Sequence	F	4.5.0	4.6.0	G5-010086	GPRS
GP-07	GP-012087	356		clause 44.2.2.1.8: Correction of Expected Sequence	F	4.5.0	4.6.0	G5-010087	GPRS
GP-07	GP-012088	357		Sec 44.2.2.2.1 GPRS detach / re-attach not required / accepted	D	4.5.0	4.6.0	G5-010063	GPRS
GP-07	GP-012089	358		clause 44.2.2.2.2: Correction of Expected Sequence	F	4.5.0	4.6.0	G5-010088	GPRS
GP-07	GP-012090	359		clause 44.2.2.2.5: Correction of Expected Sequence	F	4.5.0	4.6.0	G5-010089	GPRS
GP-07	GP-012091	360		Sec 44.2.3.1.2 Routing area updating / rejected / IMSI invalid / illegal ME	D	4.5.0	4.6.0	G5-010064	GPRS
GP-07	GP-012092	361		clause 44.2.3.1.2	F	4.5.0	4.6.0	G5-010090	GPRS
GP-07	GP-012093	362		Sec 44.2.3.1.3 Routing area updating / rejected / MS identity cannot be derived by the network	D	4.5.0	4.6.0	G5-010065	GPRS
GP-07	GP-012094	363		clause 44.2.3.1.3	F	4.5.0	4.6.0	G5-010091	GPRS
GP-07	GP-012095	364		clause 44.2.3.1.4	F	4.5.0	4.6.0	G5-010092	GPRS
GP-07	GP-012096	365		clause 44.2.3.1.6	F	4.5.0	4.6.0	G5-010094	GPRS
GP-07	GP-012097	366		clause 44.2.3.1.7	F	4.5.0	4.6.0	G5-010095	GPRS
GP-07	GP-012098	367		clause 44.2.3.1.8	F	4.5.0	4.6.0	G5-010096	GPRS
GP-07	GP-012099	368		44.2.3.2.2 – Circuit switch call handover not indicated in test description	F	4.5.0	4.6.0	G5-010157	GPRS
GP-07	GP-012100	369		clause 44.2.3.2.3: Various Corrections of Test Procedure 2	F	4.5.0	4.6.0	G5-010097	GPRS
GP-07	GP-012101	370		44.2.3.2.4 GMM Cause # 11 "PLMN Not Allowed" Used on HPLMN & MM Location Update for Non-Auto Attach MSs missing	F	4.5.0	4.6.0	G5-010136	GPRS
GP-07	GP-012102	371		44.2.3.2.5 GMM Cause # 13 "Roaming Not Allowed in this Location Area" Used on HPLMN & MM Location Update for Non-Auto Attach MSs not included.	F	4.5.0	4.6.0	G5-010158	GPRS
GP-07	GP-012103	372		clause 44.2.3.2.6: Various Corrections	F	4.5.0	4.6.0	G5-010098	GPRS
GP-07	GP-012104	373		clause 44.2.3.2.7: Various Corrections	F	4.5.0	4.6.0	G5-010099	GPRS
GP-07	GP-012105	374		Update type should be 'combined RA/LA updating with IMSI attach ' in section 44.2.3.3.3	F	4.5.0	4.6.0	G5-010124	GPRS
GP-07	GP-012106	375		Sec 44.2.5.1.2 Authentication rejected	D	4.5.0	4.6.0	G5-010070	GPRS
GP-07	GP-012107	376		44.2.5.2.2 Conformance Requirement 2 Inconsistent with Test Case Title and Expected Sequence	F	4.5.0	4.6.0	G5-010138	GPRS
GP-07	GP-012108	377		45.2.1.1 – need to prevent MS starting update procedure	F	4.5.0	4.6.0	G5-010010	GPRS
GP-07	GP-012109	378		Sec 45.2.1.1 Attach initiated by context activation/QoS Offered by Network is the QoS Requested	F	4.5.0	4.6.0	G5-010071	GPRS
GP-07	GP-012110	379		45.2.2 – Extension of reject cause to match conformance requirement	F	4.5.0	4.6.0	G5-010012	GPRS
GP-07	GP-012111	380		Sec 45.2.4.2 Collision of MS initiated and network requested PDP context activation	F	4.5.0	4.6.0	G5-010160	GPRS
GP-07	GP-012112	381		Sec 46.1.2.2.2 Busy condition at the peer, with RR sent for resumption of transmission	F	4.5.0	4.6.0	G5-010166	GPRS

TSG #	TSG Doc	CR	Rev	Subject/Comment	Cat	Old	New	WG Doc	Work item
GP-07	GP-012113	382		Correction to section 45.5.1 Error cases	D	4.5.0	4.6.0	G5-010155	GPRS
GP-07	GP-012114	383		GPRS Attach Type in NMO I	F	4.5.0	4.6.0	G5-010163	GPRS
GP-07	GP-012115	384		clause 44.2.3.1.5	F	4.5.0	4.6.0	G5-010164	GPRS
GP-07	GP-012229	385		CR 51.010-1-385 on clause 53.2.2.2 - Macro for downlink TBF establishment (PBCCH not present) Rel-4	F	4.5.0	4.6.0	-	EDGE
GP-07	GP-012230	386		CR 51.010-1-386 on clause 52.2.4.2.1, Table 52.2.4.2.1/1b - Macro for uplink fixed allocation one phase access (PBCCH not present) Rel-4	F	4.5.0	4.6.0	-	EDGE
GP-07	GP-012231	387		CR 51.010-1-387 on clauses 51.2.2.1 to 51.2.2.5 and 51.2.3.1 to 51.2.3.11 - Initiation of the packet access procedure and Packet immediate assignment / One phase packet access Rel-4	F	4.5.0	4.6.0	-	EDGE
GP-07	GP-012232	388		CR 51.010-1-388 on GSM 700 and GSM850 inclusion into clause 41 Rel-4	F	4.5.0	4.6.0	-	GSM 700
GP-07	GP-012233	389		CR 51.010-1-389 on 52.3.1.1.4 Incorrect Expected Sequence for Uplink TBF Establishment Rel-4	F	4.5.0	4.6.0	-	EGPRS
GP-07	GP-012234	390		CR 51.010-1-390 on 52.3.2.1.2 Violation of Ttb Class 2/3 MS Rel-4	F	4.5.0	4.6.0	-	GPRS
GP-07	GP-012235	391		CR 51.010-1-391 on 52.3.3.1.3, Radio Priority for SMS Rel-4	F	4.5.0	4.6.0	-	EGPRS
GP-07	GP-012236	392		CR 51.010-1-392 on testcase 43.1.2.3 - Incorrect PDP context Rel-4	F	4.5.0	4.6.0	-	GPRS
GP-07	GP-012237	393		CR 51.010-1-393 on testcase 43.1.2.4 - Incorrect PDP context Rel-4	F	4.5.0	4.6.0	-	GPRS
GP-07	GP-012238	394		CR 51.010-1-394 on 42.5.2.2 Commencement of Downlink RLC Data Blocks & Completion of Downlink Data Transfer Rel-4	F	4.5.0	4.6.0	-	GPRS
GP-07	GP-012239	395		CR 51.010-1-395 on 42.4.3.2.3 Packet Measurement Order Message Rel-4	F	4.5.0	4.6.0	-	GPRS
GP-07	GP-012240	396		CR 51.010-1-396 on clause 42.1.2.2.3 - Packet Downlink Assignment / Frequency hopping Rel-4	F	4.5.0	4.6.0	-	GPRS
GP-07	GP-012241	397		CR 51.010-1-397 on clause 42.3.4 - Invalid default Packet Timeslot Reconfigure Rel-4	F	4.5.0	4.6.0	-	GPRS
GP-07	GP-012242	398		CR 51.010-1-398 on Test case 41.2.1.1 completely re-worked Rel-4	F	4.5.0	4.6.0	-	GPRS
GP-07	GP-012243	399		CR 51.010-1-399 on Testcase 41.3.4.2 - Invalid setting of FBI bit in data blocks. Rel-4	F	4.5.0	4.6.0	-	GPRS
GP-07	GP-012244	400		CR 51.010-1-400 on testcase 43.1.1.3 - Wrong sequence of flow of data blocks. Rel-4	F	4.5.0	4.6.0	-	GPRS
GP-07	GP-012245	401		CR 51.010-1-401 on testcase 41.2.3.2 - Invalid test procedure for two message immediate assignment failure. Rel-4	F	4.5.0	4.6.0	-	GPRS
GP-07	GP-012246	402		CR 51.010-1-402 on testcase 41.2.3.10 Access burst content is not correct Rel-4	F	4.5.0	4.6.0	-	GPRS
GP-07	GP-012247	403		CR 51.010-1-403 on Specific Message Contents is not consistent in Test cases 42.1.1.1.2 Rel-4	F	4.5.0	4.6.0	-	GPRS
GP-07	GP-012248	404		CR 51.010-1-404 on Sec 42 - Invalid use of Packet Timeslot reconfigure message in testcases 42.3.1.1.3, 42.3.1.1.4, 42.3.1.1.9, 42.3.2.2, 42.3.3. Rel-4	F	4.5.0	4.6.0	-	GPRS
GP-07	GP-012249	405		CR 51.010-1-405 on Time of check is very long in Test case 41.1.4.2 Rel-4	F	4.5.0	4.6.0	-	GPRS
GP-07	GP-012250	406		CR 51.010-1-406 on clause 42.1 - new test case - Non DRX Mode on PCCCH Rel-4	B	4.5.0	4.6.0	-	GPRS
GP-07	GP-012251	407		CR 51.010-1-407 on clause 42.1 - new test case - Variable PBCCH and PSI Scheduling Rel-4	B	4.5.0	4.6.0	-	GPRS
GP-07	GP-012252	408		CR 51.010-1-408 on 42.5.3.1- T3190 following TBF Starting Time & Completion of Downlink Data Transfer	F	4.5.0	4.6.0	-	GPRS
GP-07	GP-012253	409		CR 51.010-1-409 on 42.5.1.2 & 42.5.2.3 - No Timing Advance Value Allocated & Completion of Downlink Data Transfer Rel-4	F	4.5.0	4.6.0	-	GPRS
GP-07	GP-012254	410		CR 51.010-1-410 on 42.5.4.1 & 42.5.4.2- No Timing Advance Allocated & Commencement of Downlink Data Blocks & MS Packet Idle Mode Not Checked Rel-4	F	4.5.0	4.6.0	-	GPRS
GP-07	GP-012255	411		CR 51.010-1-411 on 42.5.1.1 No Timing Advance Value Allocated Rel-4	F	4.5.0	4.6.0	-	GPRS
GP-07	GP-012256	412		CR 51.010-1-412 on clause 41.3.1 - TBF	F	4.5.0	4.6.0	-	GPRS

TSG #	TSG Doc	CR	Rev	Subject/Comment	Cat	Old	New	WG Doc	Work item
				Release / Uplink / Normal / MS initiated Rel-4					
GP-07	GP-012257	413		CR 51.010-1-413 on clause 42.3.1.1.5 - Dynamic Allocation / UplinkTransfer / Normal / Close-ended TBF Rel-4	F	4.5.0	4.6.0	-	GPRS
GP-07	GP-012258	414		CR 51.010-1-414 on Sec 42.5.5.1 - Invalid calculation of value of timer T3192 Rel-4	F	4.5.0	4.6.0	-	GPRS
GP-07	GP-012259	415		CR 51.010-1-415 on clause 43.1.2.4 - Acknowledged mode / Downlink TBF / Re-assembly / Length Indicator/ Incorrect PDP context Rel-4	F	4.5.0	4.6.0	-	GPRS
GP-07	GP-012260	416		CR 51.010-1-416 on clause 41.1.1.5.1.3 - Requirement to re-attach the MS after first iteration of test Rel-4	F	4.5.0	4.6.0	-	GPRS
GP-07	GP-012261	417		CR 51.010-1-417 on clause 41.2.3.3 - Requirement for Location Update at beginning of test for non auto attach mobiles Rel-4	F	4.5.0	4.6.0	-	GPRS
GP-07	GP-012262	418		CR 51.010-1-418 on 52.4.1.2 Ready Timer and Cell Update Procedures Rel-4	F	4.5.0	4.6.0	-	EGPRS
GP-07	GP-012263	419		CR 51.010-1-419 on clause 41.2.2.3 - Random references for one phase packet access. Rel-4	F	4.5.0	4.6.0	-	GPRS
GP-07	GP-012265	421		CR 51.010-1-421 on clause 20.22 - GPRS Cell Selection and Reselection Rel-4	F	4.5.0	4.6.0	-	GPRS
GP-08	GP-020399	422	1	EGPRS Tests for MAC procedures on PCCCH in Idle Mode	B	4.6.0	4.7.0	GP-020399	EGPRS
GP-07	GP-012267	423		CR 51.010-1-423 on Test cases 42.1.2.8.2.1 and 42.1.2.8.2.2 need more data to be triggered Rel-4	F	4.5.0	4.6.0	-	GPRS
GP-07	GP-012268	424		CR 51.010-1-424 on 42.5.2.1.4 TIMING ADVANCE value in PACKET DOWNLINK ASSIGNMENT Rel-4	F	4.5.0	4.6.0	-	GPRS
GP-07	GP-012269	425		CR 51.010-1-425 on 42.5.2.2.4 Wrong contents of CTRL_ACK in PCA of step 4 Rel-4	F	4.5.0	4.6.0	-	GPRS
GP-07	GP-012270	426		CR 51.010-1-426 on No starting time in 42.5.4.1 Rel-4	F	4.5.0	4.6.0	-	GPRS
GP-07	GP-012271	427		CR 51.010-1-427 on No starting time in 42.5.4.2 Rel-4	F	4.5.0	4.6.0	-	GPRS
GP-07	GP-012272	428		CR 51.010-1-428 on Number of octets in data transfer of 43.1.1.4 Rel-4	F	4.5.0	4.6.0	-	GPRS
GP-07	GP-012733	429	1	CR 51.010-1-429r1 EGPRS defaults, message contents and macros	B	4.5.0	4.6.0	-	EGPRS
GP-07	GP-012139	433		CR 51.010-1-433 Clause 42.1.2.1.6 - Test Case Needs To BE Aligned To Current Section 40 Defaults (Rel-4)	F	4.5.0	4.6.0	-	GPRS
GP-07	GP-012140	434		CR 51.010-1-434 Clause 42.1.2.2.1 - Need To Align PSI2 Definition To Current Section 40 Defaults (Rel-4)	F	4.5.0	4.6.0	-	GPRS
GP-07	GP-012739	435	1	CR 51.010-1-435r1 Clause 42.1.2.2.3 - There Is No RRBP In The MAC Header Of PACKET DOWNLINK ACK. (Rel-4)	F	4.5.0	4.6.0	-	GPRS
GP-07	GP-012178	436		clause 44.2.1.2.8 - Combined GPRS attach / abnormal cases / attempt counter check / miscellaneous reject causes (Rel 4)	F	4.5.0	4.6.0	-	GPRS
GP-07	GP-012655	437		Clause 44.2.2.1.4 - GPRS detach / abnormal cases / GMM common procedure collision (Rel 4)	F	4.5.0	4.6.0	-	GPRS
GP-07	GP-012180	438		Clause 44.2.3.1.4 - Routing area updating / rejected / location area not allowed (Rel 4)	F	4.5.0	4.6.0	-	GPRS
GP-07	GP-012181	439		Clause 44.2.3.1.6 - Routing area updating / abnormal cases / change of cell into new routing area (Rel 4)	F	4.5.0	4.6.0	-	GPRS
GP-07	GP-012182	440		Clause 44.2.3.2.5 - Combined routing area updating / rejected / roaming not allowed in this location area (Rel 4)	F	4.5.0	4.6.0	-	GPRS
GP-07	GP-012185	443		Clause 46.1.2.2.2.4 - SACK frame (Rel 4)	F	4.5.0	4.6.0	-	GPRS
GP-07	GP-012186	444		Clause 46.1.2.2.3.3 - SACK frame (Rel 4)	F	4.5.0	4.6.0	-	GPRS
GP-07	GP-012187	445		Clause 46.1.2.7.8 - XID Response with out of range values (Rel 4)	F	4.5.0	4.6.0	-	GPRS
GP-07	GP-012657	446		Clause 44.2.2.2.1 - GPRS detach / re-attach not required / accepted (Rel 4)	F	4.5.0	4.6.0	-	GPRS
GP-07	GP-012654	447		Clause 44.2.1.2.9 - Combined GPRS attach / abnormal cases / GPRS detach procedure	F	4.5.0	4.6.0	-	GPRS

TSG #	TSG Doc	CR	Rev	Subject/Comment	Cat	Old	New	WG Doc	Work item
				collision (Rel 4)					
GP-07	GP-012190	448		Clause 45.2.1.1 - Attach initiated by context activation/QoS Offered by Network is the QoS Requested (Rel 4)	F	4.5.0	4.6.0	-	GPRS
GP-07	GP-012192	449		CR 51.010-1-449 Correction to T3192 value in section 41.1.5.x - RR / Paging / on CCCH for GPRS service (Rel 4)	F	4.5.0	4.6.0	-	GPRS
GP-07	GP-012193	450		CR 51.010-1-450 Correction to sections 41.2.2.3 - Random references for one phase packet access (Rel 4)	F	4.5.0	4.6.0	-	GPRS
GP-07	GP-012194	451		CR 51.010-1-451 Correction to sections 41.3.1.1 - TBF Release / Uplink / Normal / MS initiated / Acknowledged mode (Rel 4)	F	4.5.0	4.6.0	-	GPRS
GP-07	GP-012195	452		CR 51.010-1-452 Correction to sections 41.3.1.2 and 41.3.1.3 - TBF Release / Uplink / Normal / MS initiated (Rel 4)	F	4.5.0	4.6.0	-	GPRS
GP-07	GP-012196	453		CR 51.010-1-453 Correction to section 42.1.2.1.8.1.1 - Packet Uplink Assignment / One phase access / Contention resolution / Inclusion of TLLI in RLC data blocks (Rel 4)	F	4.5.0	4.6.0	-	GPRS
GP-07	GP-012197	454		CR 51.010-1-454 Correction to T3192 value in section 42.x - MAC (Rel 4)	F	4.5.0	4.6.0	-	GPRS
GP-07	GP-012198	455		CR 51.010-1-455 Correction to section 51.2.4.1 - Packet immediate assignment / Single block packet access / Packet Resource Request (Rel 4)	F	4.5.0	4.6.0	-	EDGE
GP-07	GP-012199	456		CR 51.010-1-456 Correction to sections 51.3.1.1 and 51.3.1.2 - TBF Release / Uplink / Normal / MS initiated (Rel 4)	F	4.5.0	4.6.0	-	EDGE
GP-07	GP-012200	457		CR 51.010-1-457 Correction to T3192 value in section 51.x - (Rel 4)	F	4.5.0	4.6.0	-	EDGE
GP-07	GP-012202	458		CR 51.010-1-458 Correction to section 52.2.4.2.2 - Macro for uplink fixed allocation two phase access (Rel 4)	F	4.5.0	4.6.0	-	EDGE
GP-07	GP-012203	459		CR 51.010-1-459 On clauses 52.2.1.12 to 52.2.1.28 - Fixed Allocation / Uplink Transfer (Rel 4)	F	4.5.0	4.6.0	-	EDGE
GP-07	GP-012204	460		CR 51.010-1-460 Correction to T3192 value in section 52.x (Rel 4)	F	4.5.0	4.6.0	-	EDGE
GP-07	GP-012653	461		Correction to section 44.2.1.2.7 - Combined GPRS attach / rejected / location area not allowed (Rel 4)	F	4.5.0	4.6.0	-	GPRS
GP-07	GP-012656	462	1	Correction to section 44.2.2.1.6; 44.2.2.1.7; 44.2.2.1.8 and 44.2.2.1.9 - MS initiated GPRS detach procedure (Rel 4)	F	4.5.0	4.6.0	-	GPRS
GP-07	GP-012207	463		Correction to section 44.2.5.2.1 - Ciphering mode / start ciphering (Rel 4)	F	4.5.0	4.6.0	-	GPRS
GP-07	GP-012786	464	1	CR 51.010-1-464r1 Clauses 42.5.5.1, 42.5.5.2 and 42.5.5.3 - Downlink Transfer / Reestablishment (Rel 4)	F	4.5.0	4.6.0	-	GPRS
GP-07	GP-012279	465		CR 51.010-1-465 Correction of Section 52.3 Testcases for Dynamic Allocation in Packet Transfer Mode (Rel 4)	F	4.5.0	4.6.0	-	EGPRS
GP-08	GP-020321	466	1	Introduction of AMR layer 1 tests, reference sensitivity	F	4.6.0	4.7.0	GP-020321	AMR
GP-09	GP-021101	466	3	Introduction of AMR layer 1 tests, reference sensitivity	F	4.7.0	4.8.0	GP-021101	AMR
GP-08	GP-020322	467	1	Introduction of AMR layer 1 tests, Co-channel rejection	F	4.6.0	4.7.0	GP-020322	AMR
GP-09	GP-021102	467	3	Introduction of AMR layer 1 tests, Co-channel rejection	F	4.7.0	4.8.0	GP-021102	AMR
GP-08	GP-020318	468	1	Introduction of AMR layer 1 tests, section 14 general part	F	4.6.0	4.7.0	GP-020318	AMR
GP-09	GP-020579	468	2	Introduction of AMR layer 1 tests, section 14 general part	F	4.7.0	4.8.0	GP-020579	AMR
GP-07	GP-012721	469	1	CR 51.010-1-469r1 Bad frame indication - TCH/AFS - Random RF input 51.010-1 (Rel 4)	B	4.5.0	4.6.0	-	AMR
GP-08	GP-020319	469	1	Introduction of the test "Bad frame indication - TCH/AFS - Random RF input	F	4.6.0	4.7.0	GP-020319	AMR
GP-08	GP-020390	469	2	Introduction of the test "Bad frame indication - TCH/AFS - Random RF input	F	4.6.0	4.7.0	GP-020390	AMR
GP-07	GP-012723	470	1	CR 51.010-1-470r1 Bad frame indication -	B	4.5.0	4.6.0	-	AMR

TSG #	TSG Doc	CR	Rev	Subject/Comment	Cat	Old	New	WG Doc	Work item
				TCH/AHS - Random RF input 51.010-1 (Rel 4)					
GP-08	GP-020320	470	1	Introduction of the test "Bad frame indication - TCH/AHS - Random RF input" for AMR in 51.010-1	F	4.6.0	4.7.0	GP-020320	AMR
GP-08	GP-020391	470	2	Introduction of the test "Bad frame indication - TCH/AHS - Random RF input" for AMR in 51.010-1	F	4.6.0	4.7.0	GP-020391	AMR
GP-07	GP-012297	471		CR 51.010-1-471 Correction to section 41.1.6 - RR / Paging / Before T3172 expiry (Rel-4)	F	4.5.0	4.6.0	-	GPRS
GP-07	GP-012298	472		CR 51.010-1-472 Correction to section 51.1.6 - RR / Paging / Before T3172 expiry (Rel-4)	F	4.5.0	4.6.0	-	EDGE
GP-07	GP-012324	475		CR 51.010-1-475 Multislot class in section 41.3.1.2	F	4.5.0	4.6.0	-	GPRS
GP-08	GP-020398	476	1	Access burst content is not correct	B	4.6.0	4.7.0	GP-020398	GPRS
GP-07	GP-012734	477	1	CR 51.010-1-477r1 RLC_OCTET_COUNT could be 0 in test case 42.1.2.1.9	F	4.5.0	4.6.0	-	GPRS
GP-07	GP-012328	479		CR 51.010-1-479 BSN=31 is not always received in step 15 of test case 43.1.1.3	F	4.5.0	4.6.0	-	GPRS
GP-07	GP-012329	480		CR 51.010-1-480 Allocation BITMAP is not sufficient in test case 42.2.2.1	F	4.5.0	4.6.0	-	GPRS
GP-07	GP-012785	481	2	CR 51.010-1-481r2 Test cases 41.2.3.4, 41.2.3.5, 41.2.3.6, 41.2.3.7, 41.2.3.8, 41.2.3.9, 41.2.3.10, 41.2.3.11 - One phase packet access	F	4.5.0	4.6.0	-	GPRS
GP-07	GP-012337	482		Clause 60 - Update to SIB 16 (Rel-4)	F	4.5.0	4.6.0	-	GERAN > UTRAN H/O
GP-07	GP-012730	483	1	CR 51.010-1-483r1 Clause 20.22 - GPRS Cell Selection/Reselection (Rel-4)	F	4.5.0	4.6.0	-	GPRS
GP-07	GP-012342	486		CR 51.010-1-486 Clause 20.22.5 - Network Controlled Cell re-selection in Transfer Mode (Rel-4)	F	4.5.0	4.6.0	-	GPRS
GP-07	GP-012731	487	1	CR 51.010-1-487r1 Clause 20.22.11 - Cell Selection/No normal priority cell (Rel-4) CR 51.010-1 Clause 20.22.13 - Cell Reselection based on C32 quality (Rel-4)	F	4.5.0	4.6.0	-	GPRS
GP-07	GP-012344	488		CR 51.010-1-488 Clause 41.2.3.8 - One phase packet access / Contention resolution / 4 access repetition attempts (Rel-4)	F	4.5.0	4.6.0	-	GPRS
GP-07	GP-012740	490	1	CR 51.010-1-490r1 Clause 42.1 - Packet Access Repeat Attempts (Rel-4)	F	4.5.0	4.6.0	-	GPRS
GP-07	GP-012660	491		Correction to section 44.2.3.2.5 - Combined routing area updating / rejected / roaming not allowed in this location area (Rel-4)	F	4.5.0	4.6.0	-	GPRS
GP-07	GP-012726	492	1	CR 51.010-1-492r1 13.17.1 to 4, Clarification of applicability and test requirements	F	4.5.0	4.6.0	-	EGPRS
GP-07	GP-012727	493	1	CR 51.010-1-493r1 14.18.7 Incremental Redundancy Performance, (addition of a new test)	F	4.5.0	4.6.0	-	EGPRS
GP-07	GP-012664	495	1	Sec 45.2.4.2: Collision of MS initiated and network requested PDP context activation (case 1)	F	4.5.0	4.6.0	-	GPRS
GP-07	GP-012436	497		Sec 44.2.2.1.7: GPRS detach / accepted / IMSI detach	F	4.5.0	4.6.0	-	GPRS
GP-07	GP-012736	499	1	CR 51.010-1-499r1 Sec 41.1.2.1.1.1: Packet Uplink Assignment / Packet queuing notification / Stop sending Packet Channel Requests	F	4.5.0	4.6.0	-	GPRS
GP-07	GP-012780	500	1	CR 51.010-1-500r1 Sec 42 - CR404 erroneously Deleted Steps In 42.3.1.1.4	F	4.5.0	4.6.0	-	GPRS
GP-07	GP-012471	501		CR 51.010-1-501 Clause 42.4.1.3 - Correction To Expected Sequence	F	4.5.0	4.6.0	-	GPRS
GP-07	GP-012472	502		Clause 44.2.3.2.3.3.2 - Correction of Detach Type	F	4.5.0	4.6.0	-	GPRS
GP-07	GP-012658	503	1	Clause 44.2.3.2.7 - Insertion of a Location Update macro	F	4.5.0	4.6.0	-	GPRS
GP-07	GP-012474	504		Clause 44.2.3.3.3 - Various corrections	F	4.5.0	4.6.0	-	GPRS
GP-07	GP-012659	505	1	Clause 44.2.5.1.2 - Various corrections	F	4.5.0	4.6.0	-	GPRS
GP-07	GP-012662	506	1	Clause 44.2.5.2.2 - Various corrections	F	4.5.0	4.6.0	-	GPRS
GP-07	GP-012663	507	1	Clause 44.2.5.2.3 - Various corrections	F	4.5.0	4.6.0	-	GPRS
GP-07	GP-012737	509	1	CR 51.010-1-509r1 Sec. TC 20.22.2: Cell reselection in Packet Idle mode	F	4.5.0	4.6.0	-	GPRS

TSG #	TSG Doc	CR	Rev	Subject/Comment	Cat	Old	New	WG Doc	Work item
GP-07	GP-012483	510		Clause 31.9.1.2 - Correction of step references in Expected Message Sequence and Specific Message Contents	F	4.5.0	4.6.0	-	TEI
GP-07	GP-012545	511		CR 51.010-1-511 Sec. TC 14.16.2.1: Co-channel rejection for packet channels	F	4.5.0	4.6.0	-	GPRS
GP-07	GP-012562	513		Clause 44.2.1.2.6 Combined GPRS attach / rejected / GPRS services not allowed	F	4.5.0	4.6.0	-	GPRS
GP-07	GP-012583	514		CR 51.010-1-514 Expected sequence in section 41.2.3.6	F	4.5.0	4.6.0	-	GPRS
GP-07	GP-012590	516		Test case 45.3.1 - PDP context modification	F	4.5.0	4.6.0	-	GPRS
GP-07	GP-012724	518	1	CR 51.010-1-518r1 Test case 12.1.1 - MS allocated a channel	F	4.5.0	4.6.0	-	GSM
GP-07	GP-012593	519		CR 51.010-1-519 Test case 41.2.4.2 - Single block packet access / Packet Measurement Report Test case 41.2.7.2 - Single block packet downlink assignment / MS returns to packet idle mode	F	4.5.0	4.6.0	-	GPRS
GP-07	GP-012594	520		Test case 26.5.7.1.3 - Spare bits / RR / AGCH	F	4.5.0	4.6.0	-	TEI
GP-07	GP-012616	521		CR 51.010-1-521 Correction to section 51.3.5 - PDCH Release (Rel 4)	F	4.5.0	4.6.0	-	EDGE
GP-07	GP-012617	522		CR 51.010-1-522 Correction to section 20.22 GPRS Cell Selection and Reselection (Rel 4)	F	4.5.0	4.6.0	-	GPRS
GP-07	GP-012642	524		CR 51.010-1 : Test cases 42.1.2.1.5 – Packet Uplink Assignment / One or two phase access	F	4.5.0	4.6.0	-	GPRS
GP-07	GP-012652	525		Clause 40 Missing correction of binary value	F	4.5.0	4.6.0	-	GPRS
GP-07	GP-012665	526	1	Network Induced LCS Emergency Call on SDCCH, Idle, no IMSI (Rel 4)	F	4.5.0	4.6.0	-	LCS
GP-07	GP-012666	527	1	Positioning/RR/Classmark Interrogation (Rel 4)	F	4.5.0	4.6.0	-	LCS
GP-07	GP-012667	528	1	Network Induced LCS Emergency Call on SDCCH, (Rel 4)	F	4.5.0	4.6.0	-	LCS
GP-08	GP-020361	529	1	Extension of reject causes to match conformance requirements	F	4.6.0	4.7.0	GP-020361	GPRS
GP-08	GP-020030	530	-	LCS E-OTD test case to clause 70.2.4 - Network Induced E-OTD test on the TCH radio channel.	B	4.6.0	4.7.0	GP-020030	LCS
GP-08	GP-020031	531	-	Addition of LCS test cases for Mobile Terminated Location Request.	B	4.6.0	4.7.0	GP-020031	LCS
GP-08	GP-020032	532	-	Addition of MT-LR E-OTD LCS test cases for Privacy Options- Location Allowed if no response.	B	4.6.0	4.7.0	GP-020032	LCS
GP-08	GP-020033	533	-	Addition of MT-LR E-OTD LCS test case for Privacy Options- Location Not_Allowed if no response.	B	4.6.0	4.7.0	GP-020033	LCS
GP-08	GP-020034	534		Correction to 41.2.3.9 One phase packet access / TBF starting time	F	4.6.0	4.7.0	GP-020034	GPRS
GP-08	GP-020392	534	1	Correction to 41.2.3.9 One phase packet access / TBF starting time	F	4.6.0	4.7.0	GP-020392	GPRS
GP-08	GP-020396	534	2	Correction to 41.2.3.9 One phase packet access / TBF starting time	F	4.6.0	4.7.0	GP-020396	GPRS
GP-08	GP-020035	535		PACKET UPLINK ASSIGNMENT message (fixed allocation)	F	4.6.0	4.7.0	GP-020035	GPRS
GP-08	GP-020231	536	1	CR 51.010-1 clause 40 - GPRS default conditions, message contents and macros (Rel-4).	F	4.6.0	4.7.0	GP-020231	GPRS
GP-08	GP-020047	537	1	TC 14.16.2.1: Co-channel rejection for packet channels	F	4.6.0	4.7.0	GP-020047	GPRS
GP-08	GP-020366	538	1	Order of Location Update and RAU Complete in TC 44.2.3.2.3	F	4.6.0	4.7.0	GP-020366	GPRS GMM
GP-08	GP-020063	539	-	Update of references	F	4.6.0	4.7.0	GP-020063	TEI
GP-08	GP-020066	540	-	Mobile Station (MS) conformance specification	F	4.6.0	4.7.0	GP-020066	GPRS
GP-08	GP-020365	541	1	CR on 51.010 Sec 44.2.5.1.2 Authentication rejected	F	4.6.0	4.7.0	GP-020365	GPRS
GP-08	GP-020077	542		Incompatibility between PDP context activated and the access procedure in section 42.2.2	F	4.6.0	4.7.0	GP-020077	GPRS
GP-08	GP-020078	543		Test case 42.1.1.3 specified in a wrong way	F	4.6.0	4.7.0	GP-020078	GPRS
GP-08	GP-020079	544		Some steps needed for Test case 41.3.1.1	F	4.6.0	4.7.0	GP-020079	GPRS
GP-08	GP-020465	544	1	Some steps needed for Test case 41.3.1.1	F	4.6.0	4.7.0	GP-020465	GPRS
GP-08	GP-020080	545		Rmoval of a param not existent in PSI_1 for Test case 41.1.1.3	F	4.6.0	4.7.0	GP-020080	GPRS
GP-08	GP-020081	546		Test 2.3.1.1.2 specified in a wrong way (T3180)	F	4.6.0	4.7.0	GP-020081	GPRS

TSG #	TSG Doc	CR	Rev	Subject/Comment	Cat	Old	New	WG Doc	Work item
				could expire).					
GP-08	GP-020466	546	1	Test 42.3.1.1.2 specified in a wrong way (T3180 could expire)	F	4.6.0	4.7.0	GP-020466	GPRS
GP-08	GP-020082	547		PACKET DOWNLINK DUMMY CTRL message does not contain TFI in 42.3.1.1.6	F	4.6.0	4.7.0	GP-020082	GPRS
GP-08	GP-020083	548		Wrong use of PACKTE TIMESLOT RECONFIGURE in 42.3.2.1.1	F	4.6.0	4.7.0	GP-020083	GPRS
GP-08	GP-020092	549		TS51.010-1; Correction to section 20.22.6 and 20.22.7 – Cell Reselection (Rel-4).	F	4.6.0	4.7.0	GP-020092	GPRS
GP-08	GP-020393	549	1	TS51.010-1; Correction to section 20.22.6 and 20.22.7 – Cell Reselection (Rel-4).	F	4.6.0	4.7.0	GP-020393	GPRS
GP-08	GP-020470	549	2	TS51.010-1; Correction to section 20.22.6 and 20.22.7 – Cell Reselection (Rel-4).	F	4.6.0	4.7.0	GP-020470	GPRS
GP-08	GP-020093	550		TS51.010-1; Correction to section 41.1.1.3 – RR / Paging / on PCCCH for GPRS service / extended paging with P-TMSI successful (Rel-4).	F	4.6.0	4.7.0	GP-020093	GPRS
GP-08	GP-020094	551		TS51.010-1; Correction to section 41.2.3.6; 41.2.3.7; 41.2.3.10 and 41.2.3.11 – One phase packet access (Rel-4).	F	4.6.0	4.7.0	GP-020094	GPRS
GP-08	GP-020095	552		TS51.010-1; Correction to section 41.3.2.1 - TBF Release / Uplink / Normal / Network initiated / Acknowledged mode (Rel-4).	F	4.6.0	4.7.0	GP-020095	GPRS
GP-08	GP-020096	553		TS51.010-1; Correction to section 41.3.3 - TBF Release / Uplink / Network initiated / Abnormal release (Rel-4).	F	4.6.0	4.7.0	GP-020096	GPRS
GP-08	GP-020097	554		TS51.010-1; Correction to section 41.3.5.2 - PDCH Release / With TIMESLOTS_AVAILABLE (Rel-4).	F	4.6.0	4.7.0	GP-020097	GPRS
GP-08	GP-020098	555		TS51.010-1; Correction to section 42.1.2.1.8.1.1; 42.1.2.1.8.1.2; 42.1.2.1.8.1.3; 42.1.2.1.8.2.1; 42.1.2.1.8.2.2 and 42.1.2.1.8.2.3 - Packet Uplink Assignment / One phase access (Rel-4).	F	4.6.0	4.7.0	GP-020098	GPRS
GP-08	GP-020099	556		TS51.010-1; Correction to section 43.3.1.1 – Message Content / Packet Uplink Assignment (Rel-4).	F	4.6.0	4.7.0	GP-020099	GPRS
GP-08	GP-020100	557		TS51.010-1; Correction to section 51.1.1.3 – RR / Paging / on PCCCH for EGPRS service / extended paging with P-TMSI successful (Rel-4).	F	4.6.0	4.7.0	GP-020100	EDGE
GP-08	GP-020101	558		TS51.010-1; Correction to sections 53.1.1.17, 53.1.1.19, 53.1.1.20 and 53.1.1.21 - Acknowledged Mode/ Uplink TBF (Rel-4).	F	4.6.0	4.7.0	GP-020101	EDGE
GP-08	GP-020102	559		TS51.010-1; Correction to sections 53.1.2.8, 53.1.2.10, 53.1.2.12 and 53.1.2.13 - Acknowledged Mode/ Downlink TBF (Rel-4).	F	4.6.0	4.7.0	GP-020102	EDGE
GP-08	GP-020103	560	-	Correction to section 44.2.1.2.2 - Combined GPRS attach / GPRS only attach accepted (Rel-4).	F	4.6.0	4.7.0	GP-020103	GPRS
GP-08	GP-020104	561	-	Correction to section 44.2.1.2.8 - Combined GPRS attach / abnormal cases / attempt counter check / miscellaneous reject causes (Rel-4).	F	4.6.0	4.7.0	GP-020104	GPRS
GP-08	GP-020105	562	-	Correction to section 44.2.3.3.4 - Periodic routing area updating / no cell available (Rel-4).	F	4.6.0	4.7.0	GP-020105	GPRS
GP-08	GP-020106	563	-	Correction to sections 44.2.1.1.7; 44.2.2.1.8; 44.2.3.1.2; 44.2.3.1.3; 44.2.3.1.5; 44.2.3.1.6; 44.2.3.1.7; 44.2.3.1.8; 44.2.3.2.3; 44.2.3.2.4; 44.2.3.2.8; 44.2.3.2.9; 44.2.3.2.10 and 44.2.	F	4.6.0	4.7.0	GP-020106	GPRS
GP-08	GP-020107	564	-	Correction to section 44.2.1.1.6 - GPRS attach / abnormal cases / access barred due to access class control (Rel-4).	F	4.6.0	4.7.0	GP-020107	GPRS
GP-08	GP-020142	566	-	Combined GPRS attach / rejected / GPRS services not allowed	F	4.6.0	4.7.0	GP-020142	GPRS
GP-08	GP-020144	568		GPRS Cell Selection and Reselection	F	4.6.0	4.7.0	GP-020144	GPRS
GP-08	GP-020145	569		Cell reselection in Packet Idle Mode (Rel-4)	F	4.6.0	4.7.0	GP-020145	GPRS
GP-08	GP-020146	570		Priority of cells (Rel-4)	F	4.6.0	4.7.0	GP-020146	GPRS
GP-08	GP-020469	570	1	Clause 20.22.3 - Priority of cells (Rel-4)	F	4.6.0	4.7.0	GP-020469	GPRS
GP-08	GP-020147	571		Several PCCCHs supported by the cell	B	4.6.0	4.7.0	GP-020147	GPRS
GP-08	GP-020149	572		Packet Uplink Assignment / One phase access / Contention resolution / Counter N3104	F	4.6.0	4.7.0	GP-020149	GPRS

TSG #	TSG Doc	CR	Rev	Subject/Comment	Cat	Old	New	WG Doc	Work item
GP-08	GP-020166	573		One phase packet access / Contention resolution / Counter N3104	F	4.6.0	4.7.0	GP-020166	GPRS
GP-08	GP-020468	573	1	One phase packet access / Contention resolution / Counter N3104	F	4.6.0	4.7.0	GP-020468	GPRS
GP-08	GP-020167	574		Packet Uplink Assignment / One phase access / Contention resolution / Counter N3104	F	4.6.0	4.7.0	GP-020167	GPRS
GP-08	GP-020467	574	1	Packet Uplink Assignment / One phase access / Contention resolution / Counter N3104	F	4.6.0	4.7.0	GP-020467	GPRS
GP-08	GP-020472	574	2	Packet Uplink Assignment / One phase access / Contention resolution / Counter N3104	F	4.6.0	4.7.0	GP-020472	GPRS
GP-08	GP-020168	575		Fixed Allocation / Uplink Transfer / Normal operation	F	4.6.0	4.7.0	GP-020168	GPRS
GP-08	GP-020169	576		Fixed Allocation / Uplink Transfer / MS requests new resources/ Successful	F	4.6.0	4.7.0	GP-020169	GPRS
GP-08	GP-020170	577		Fixed Allocation / Uplink Transfer / MS requests new resources	F	4.6.0	4.7.0	GP-020170	GPRS
GP-08	GP-020171	578	-	CR 51.010-1 : Test cases 26.12.1 - EFR signalling/ test of the channel mode modify procedure	F	4.6.0	4.7.0	GP-020171	TEI
GP-08	GP-020377	580	2	LCS Classmark Interrogation test case for clause 70.7.2 (MS-Based A-GPS) of TS 51.010-1.	B	4.6.0	4.7.0	GP-020377	LCS
GP-08	GP-020369	581	1	LCS Classmark Interrogation test case for clause 70.7.2 (MS-Assisted A-GPS) of TS 51.010-1.	B	4.6.0	4.7.0	GP-020369	LCS
GP-08	GP-020370	582	1	LCS test cases to TS 51.010-1 clause 70.7.1 - Network Induced A-GPS (MS-Based) Emergency Call on an SDCCH, Idle, no IMSI.	B	4.6.0	4.7.0	GP-020370	LCS
GP-08	GP-020372	583	1	LCS test cases to TS 51.010-1 clause 70.7.1 - Network Induced A-GPS (MS-Assisted) Emergency Call on an SDCCH, Idle, no IMSI.	B	4.6.0	4.7.0	GP-020372	LCS
GP-08	GP-020373	584	1	LCS test case to TS 51.010-1 clause 70.7.3 - Network Induced A-GPS (MS-Based) test on an SDCCH radio channel.	B	4.6.0	4.7.0	GP-020373	LCS
GP-08	GP-020374	585	1	LCS test case to TS 51.010-1 clause 70.7.3 - Network Induced A-GPS (MS-Assisted) test on an SDCCH radio channel.	B	4.6.0	4.7.0	GP-020374	LCS
GP-08	GP-020227	586		Co-channel rejection for packet channels work item code	F	4.6.0	4.7.0	GP-020227	GPRS
GP-08	GP-020228	587		42.1.2.1.6 / Decoding of frequency parameters	F	4.6.0	4.7.0	GP-020228	GPRS
GP-08	GP-020395	587	1	42.1.2.1.6 / Decoding of frequency parameters	F	4.6.0	4.7.0	GP-020395	GPRS
GP-08	GP-020229	588		42.5.5.3 / Downlink Transfer/ Reestablishment/ Invalid Frequency Parameters IE	F	4.6.0	4.7.0	GP-020229	GPRS
GP-08	GP-020235	589		Use PDP Context 2 for acknowledged mode data transfer	F	4.6.0	4.7.0	GP-020235	GPRS
GP-08	GP-020501	589	1	Use PDP Context 2 for acknowledged mode data transfer	F	4.6.0	4.7.0	GP-020501	GPRS
GP-08	GP-020236	590		Packet Uplink Assignment - USF Granularity in Uplink Assignment Needs To Increase For Attach Request Message	F	4.6.0	4.7.0	GP-020236	GPRS
GP-08	GP-020397	590	1	Packet Uplink Assignment - USF Granularity in Uplink Assignment Needs To Increase For Attach Request Message	F	4.6.0	4.7.0	GP-020397	GPRS
GP-08	GP-020237	591		Alignment of "Test Procedure" to the "Expected Sequence"	F	4.6.0	4.7.0	GP-020237	GPRS
GP-08	GP-020394	591	1	Alignment of "Test Procedure" to the "Expected Sequence"	F	4.6.0	4.7.0	GP-020394	GPRS
GP-08	GP-020239	593		Change of PDP Context From 2 to 3 Required For MS To Meet "Expected Sequence"	F	4.6.0	4.7.0	GP-020239	GPRS
GP-08	GP-020502	593	1	Change of PDP Context From 2 to 3 Required For MS To Meet "Expected Sequence"	F	4.6.0	4.7.0	GP-020502	GPRS
GP-08	GP-020240	594		Correction of Procedure and TestRequirements	F	4.6.0	4.7.0	GP-020240	GPRS
GP-08	GP-020241	595		Correction of step references in Test Requirements	F	4.6.0	4.7.0	GP-020241	GPRS
GP-08	GP-020381	595	1	Correction of step references in Test Requirements	F	4.6.0	4.7.0	GP-020381	GPRS
GP-08	GP-020242	596		Correction of step references in Test Requirements and carrier in Procedure	F	4.6.0	4.7.0	GP-020242	GPRS
GP-08	GP-020382	596	1	Correction of step references in Test Requirements and carrier in Procedure	F	4.6.0	4.7.0	GP-020382	GPRS
GP-08	GP-020243	597		Correction of step numbering in Procedure and	F	4.6.0	4.7.0	GP-020243	GPRS

TSG #	TSG Doc	CR	Rev	Subject/Comment	Cat	Old	New	WG Doc	Work item
				step references in Test Requirements					
GP-08	GP-020244	598		Correction of step references in Test Requirements	F	4.6.0	4.7.0	GP-020244	GPRS
GP-08	GP-020383	598	1	Correction of step references in Test Requirements	F	4.6.0	4.7.0	GP-020383	GPRS
GP-08	GP-020245	599		Correction of Procedure and Test Requirements (Rel 4)	F	4.6.0	4.7.0	GP-020245	GPRS
GP-08	GP-020384	599	1	Correction of Procedure and Test Requirements	F	4.6.0	4.7.0	GP-020384	GPRS
GP-08	GP-020471	599	2	Correction of Procedure and Test Requirements	F	4.6.0	4.7.0	GP-020471	GPRS
GP-08	GP-020246	600		Correction of step references in Test Requirements (Rel 4)	F	4.6.0	4.7.0	GP-020246	GPRS
GP-08	GP-020385	600	1	Correction of step references in Test Requirements	F	4.6.0	4.7.0	GP-020385	GPRS
GP-08	GP-020296	601	-	Measurement / all neighbours present	F	4.6.0	4.7.0	GP-020296	TEI4
GP-08	GP-020297	602	-	Measurement / all neighbours present	F	4.6.0	4.7.0	GP-020297	TEI4
GP-08	GP-020298	603	-	Measurement / barred cells and non-permitted NCCs	F	4.6.0	4.7.0	GP-020298	TEI4
GP-08	GP-020299	604	-	Dedicated assignment / successful case	F	4.6.0	4.7.0	GP-020299	TEI4
GP-08	GP-020300	605	-	Combined routing area updating / rejected / roaming not allowed in this location area	F	4.6.0	4.7.0	GP-020300	GPRS
GP-08	GP-020341	607	-	Correction to section 44.2.3.1.4 - Routing area updating / rejected / location area not allowed (Rel-4).	F	4.6.0	4.7.0	GP-020341	GPRS
GP-08	GP-020342	608	-	Correction to section 44.2.3.2.6 - Combined routing area updating / abnormal cases / access barred due to access class control (Rel-4).	F	4.6.0	4.7.0	GP-020342	GPRS
GP-08	GP-020362	610	1	Mobile Station (MS) conformance specification	F	4.6.0	4.7.0	GP-020362	GPRS
GP-08	GP-020364	612	-	Mobile Station (MS) conformance specification	F	4.6.0	4.7.0	GP-020364	GPRS
GP-08	GP-020386	613		Editorial correction on input level on 14.3.4.2	D	4.6.0	4.7.0	GP-020386	TEI
GP-08	GP-020387	614		Editorial correction on input level on 14.3.4.2	B	4.6.0	4.7.0	GP-020387	LCS
GP-08	GP-020388	615	1	Addition of Annex 6 for E-OTD Accuracy Measurement Test Environment,	B	4.6.0	4.7.0	GP-020388	LCS
GP-08	GP-020389	616		E-OTD Sensitivity Performance	B	4.6.0	4.7.0	GP-020389	LCS
GP-08	GP-020400	617		Introductory sections to the LCS test cases in 3GPP TS 51.010-1 clause 70.	B	4.6.0	4.7.0	GP-020400	LCS
GP-09	GP-021058	619	1	Section 34.2.6: Addition of test of short message type 0	F	4.7.0	4.8.0	GP-021058	TEI
GP-09	GP-020532	620	-	Test cases 44.2.1.2.2 Combined GPRS attach / GPRS only attach accepted	F	4.7.0	4.8.0	GP-020532	GPRS
GP-09	GP-020534	622	-	Test cases 46.1.2.5.3 Sending FRMR due to reception of an I frame information field exceeding the maximum length	D	4.7.0	4.8.0	GP-020534	GPRS
GP-09	GP-020535	623	-	Test cases 44.2.3.3.3 Periodic routing area updating / no cell available / network mode	F	4.7.0	4.8.0	GP-020535	GPRS
GP-09	GP-020537	624	-	Test case 46.2.2.4.1 Response from MS on receiving XID request from the SS	F	4.7.0	4.8.0	GP-020537	GPRS
GP-09	GP-020538	625	-	Test case 46.2.2.4.2 Response from MS on receiving an XID request from the SS with an unassigned entity number	F	4.7.0	4.8.0	GP-020538	GPRS
GP-09	GP-020548	626	-	Correction to reference clause	F	4.7.0	4.8.0	GP-020548	TEI
GP-09	GP-021051	627	1	TC 34.2.7, Test of the replace mechanism for SM type 1-7	F	4.7.0	4.8.0	GP-021051	TEI
GP-09	GP-021106	629	1	Addition of E-OTD Interference Performance Tests	B	4.7.0	4.8.0	GP-021106	LCS
GP-09	GP-021108	630	1	Addition of E-OTD Multipath Performance Tests	B	4.7.0	4.8.0	GP-021108	LCS
GP-09	GP-021067	631	1	Addition of IE to LCS test cases for Mobile Terminated Location Request.	F	4.7.0	4.8.0	GP-021067	LCS
GP-09	GP-021068	632	1	Addition of Information Elements to existing MT-LR E-OTD LCS test cases for Privacy Options-Location Allowed if no response.	F	4.7.0	4.8.0	GP-021068	LCS
GP-09	GP-021069	633	1	Addition of missing IEs to MT-LR E-OTD LCS test case for Privacy Options- Location Not Allowed if no response.	F	4.7.0	4.8.0	GP-021069	LCS
GP-09	GP-020574	634	-	TC 44.2.3.2.3.3.2 + TC 44.2.1.2.2.3.2 - suppression of the test on the Detach Type for the latest Detach Request	F	4.7.0	4.8.0	GP-020574	GPRS
GP-09	GP-020575	635	-	TC 44.2.3.1.5 – Modification to allow GPRS or GSM detach first	F	4.7.0	4.8.0	GP-020575	GPRS
GP-09	GP-021113	650	1	Too short time for C32 calculation - Time for RLA_P dependent on MS paging block	F	4.7.0	4.8.0	GP-021113	GPRS

TSG #	TSG Doc	CR	Rev	Subject/Comment	Cat	Old	New	WG Doc	Work item
GP-09	GP-021062	652	2	Routing area updating / abnormal cases / change of cell during routing area updating procedure	F	4.7.0	4.8.0	GP-021062	GPRS
GP-09	GP-021063	653	2	GPRS attach / abnormal cases / change of cell into new routing area	F	4.7.0	4.8.0	GP-021063	GPRS
GP-09	GP-021182	654	2	Corrections in section 40 GPRS default conditions, message contents and macros	F	4.7.0	4.8.0	GP-021182	GPRS
GP-09	GP-021055	655	1	Section 40.2.3 Default contents of Layer 2 messages	F	4.7.0	4.8.0	GP-021055	GPRS
GP-09	GP-020608	656		Test case 22.4 GPRS Uplink Power Control - Independence of TS Power Control	F	4.7.0	4.8.0	GP-020608	GPRS
GP-09	GP-020623	657	-	Test case 46.1.2.1.2 Data transmission in unprotected mode	F	4.7.0	4.8.0	GP-020623	GPRS
GP-09	GP-020624	658	-	Test cases 46.1.2.* Correction of transferred amount of data	F	4.7.0	4.8.0	GP-020624	GPRS
GP-09	GP-020625	659		Correction to section 42.1.1.4.3 - Packet Channel Request / Access persistence control on PRACH / Successive Attempts (Rel-4).	F	4.7.0	4.8.0	GP-020625	GPRS
GP-09	GP-020626	660		Correction to section 42.1.3.2.10 - Default messages / PACKET UPLINK ASSIGNMENT message (single block allocation) (Rel-4).	F	4.7.0	4.8.0	GP-020626	GPRS
GP-09	GP-021060	661	1	Correction to section 44.2.1.2.2 - Combined GPRS attach / GPRS only attach accepted (Rel-4).	F	4.7.0	4.8.0	GP-021060	GPRS
GP-09	GP-020628	662	-	Correction to section 44.2.2.1.4 - GPRS detach / abnormal cases / GMM common procedure collision (Rel-4).	F	4.7.0	4.8.0	GP-020628	GPRS
GP-09	GP-021064	663	1	Correction to section 44.2.3.2.3 - Combined routing area updating / RA only accepted (Rel-4).	F	4.7.0	4.8.0	GP-021064	GPRS
GP-09	GP-020630	664	-	Correction to section 70.2 - Network Induced Location Request (Rel-4).	F	4.7.0	4.8.0	GP-020630	LCS
GP-09	GP-020631	665	-	Correction to section 26.16.7/ 26.16.8 : AMR Signalling / Directed Retry	F	4.7.0	4.8.0	GP-020631	AMR
GP-09	GP-020632	666	-	Correction to section 44.2.3.2.7 - Combined routing area updating / abnormal cases / attempt counter check / procedure timeout	F	4.7.0	4.8.0	GP-020632	GPRS
GP-09	GP-020633	667		Correction to section 41.2.2.3 - Random references for one phase packet access	F	4.7.0	4.8.0	GP-020633	GPRS
GP-09	GP-020634	668		Two PDCHs but only one cell needed	F	4.7.0	4.8.0	GP-020634	GPRS
GP-09	GP-020635	669		Two PDCHs but only one cell needed	F	4.7.0	4.8.0	GP-020635	GPRS
GP-09	GP-021040	670	1	Test cases 42.1.2.1.6- PSI2 in initial condition was corrected	F	4.7.0	4.8.0	GP-021040	GPRS
GP-09	GP-021116	671	1	Test cases 42.2.2.7- PACKET UPLINK ACK/NACK should be sent on only one RLC/MAC Control Block	F	4.7.0	4.8.0	GP-021116	GPRS
GP-09	GP-021041	672	1	Test cases 42.1.2.2.3- PSI2 corrected according to section 40	F	4.7.0	4.8.0	GP-021041	GPRS
GP-09	GP-021112	673	1	Removal of Fixed Allocation in section 40.x - GPRS Default Conditions, Message Contents and Macros	F	4.7.0	4.8.0	GP-021112	GPRS
GP-09	GP-020658	674		Removal of Fixed Allocation in section 41.x - GPRS Paging, TBF establishment/release and DCCH related procedures (Rel-4).	F	4.7.0	4.8.0	GP-020658	GPRS
GP-09	GP-020659	675		Removal of Fixed Allocation in section 42.x - Test of Medium Access Control (MAC) protocol (Rel-4).	F	4.7.0	4.8.0	GP-020659	GPRS
GP-09	GP-020660	676		Removal of Fixed Allocation in section 43.x - RLC Test Cases (Rel-4).	F	4.7.0	4.8.0	GP-020660	GPRS
GP-09	GP-020661	677		Removal of Fixed Allocation in section 50.x - EGPRS Default Conditions, Message Contents and Macros (Rel-4).	F	4.7.0	4.8.0	GP-020661	EDGE
GP-09	GP-020662	678		Removal of Fixed Allocation in section 51.x - EGPRS Paging, TBF establishment/release and DCCH related procedures (Rel-4).	F	4.7.0	4.8.0	GP-020662	EDGE
GP-09	GP-020663	679		Removal of Fixed Allocation in section 52.x - EGPRS Test of Medium Access Control (MAC) protocol (Rel-4).	F	4.7.0	4.8.0	GP-020663	EDGE
GP-09	GP-020664	680		Removal of Fixed Allocation in section 53.x - Test of EGPRS Radio Link Control (RLC) Protocol (Rel-4).	F	4.7.0	4.8.0	GP-020664	EDGE
GP-09	GP-021052	682	1	Clause 40 - Timer tolerance for higher layer test cases	F	4.7.0	4.8.0	GP-021052	GPRS

TSG #	TSG Doc	CR	Rev	Subject/Comment	Cat	Old	New	WG Doc	Work item
GP-09	GP-020735	685		Correction of BSN in Steps 12 and 15	F	4.7.0	4.8.0	GP-020735	GPRS
GP-09	GP-020736	686		Correction to the value calculation of T3142 used in testcase	F	4.7.0	4.8.0	GP-020736	GPRS
GP-09	GP-020737	687		Addition of optional steps to cater to MS reaction time	F	4.7.0	4.8.0	GP-020737	GPRS
GP-09	GP-021117	688	1	Changes to type of allocation and number of octets to transfer used in testcase.	F	4.7.0	4.8.0	GP-021117	GPRS
GP-09	GP-021118	689	1	Changes to the number of octets to transfer and coding scheme used.	F	4.7.0	4.8.0	GP-021118	GPRS
GP-09	GP-020740	690		Changes to Initial conditions and Testcase Initialisation	F	4.7.0	4.8.0	GP-020740	GPRS
GP-09	GP-020741	691		Changes to Type of Access in Test procedure to align with Testcase.	F	4.7.0	4.8.0	GP-020741	GPRS
GP-09	GP-020742	692		Removal of SM layer procedures from the testcase.	F	4.7.0	4.8.0	GP-020742	GPRS
GP-09	GP-020744	694		Change to Initial Conditions and addition of optional Location Update Macro after Step-7	F	4.7.0	4.8.0	GP-020744	GPRS
GP-09	GP-020745	695		Changes to value calculation of T3146 used in the testcase.	F	4.7.0	4.8.0	GP-020745	GPRS
GP-09	GP-020746	696		Changes to Test procedure and Initial conditions	F	4.7.0	4.8.0	GP-020746	GPRS
GP-09	GP-021061	699	1	Clause 44.2.2.1.9: Additonnal detail at step 8, unnecessary step 10 removed	F	4.7.0	4.8.0	GP-021061	GPRS
GP-09	GP-021065	700	1	Clause 44.2.3.3.3; Periodic routing area update / no cell available / network mode I	F	4.7.0	4.8.0	GP-021065	GPRS
GP-09	GP-020782	702		Correction of Procedure	F	4.7.0	4.8.0	GP-020782	GPRS
GP-09	GP-020783	703		Removal of testcase	F	4.7.0	4.8.0	GP-020783	GPRS
GP-09	GP-020785	704	-	Clause 26.6.5.1 , 26.6.5.2, 26.6.5.4 and 26.12.2.1	F	4.7.0	4.8.0	GP-020785	TEI
GP-09	GP-020786	705		Correction sequence	F	4.7.0	4.8.0	GP-020786	GPRS
GP-09	GP-020787	706		Correction of Procedure Initial conditions	F	4.7.0	4.8.0	GP-020787	GPRS
GP-09	GP-020788	707		Correction of Procedure Initial conditions	F	4.7.0	4.8.0	GP-020788	GPRS
GP-09	GP-020789	708		Correction of Procedure and Test Requirements	F	4.7.0	4.8.0	GP-020789	GPRS
GP-09	GP-020896	711	-	Correction to sections 44.2.3.2.10	F	4.7.0	4.8.0	GP-020896	GPRS
GP-09	GP-020898	713	-	PDP contexts are wrong in 46.2.2.4.1	F	4.7.0	4.8.0	GP-020898	GPRS
GP-09	GP-020899	714	-	Uplink data transfer is not needed in test case 46.1.2.2.1.3	F	4.7.0	4.8.0	GP-020899	GPRS
GP-09	GP-020900	715	-	Wrong precision of the expected N-PDU Number in Test case 46.2.2.1.3	F	4.7.0	4.8.0	GP-020900	GPRS
GP-09	GP-021178	717	1	Test case 46.1.2.2.2.4 - The Unacknowledgement bitmap may exceed the window size.	F	4.7.0	4.8.0	GP-021178	GPRS
GP-09	GP-020903	718	-	Correction to sections 44.2.1.2.6; 44.2.3.2.1; 44.2.3.2.5;	F	4.7.0	4.8.0	GP-020903	GPRS
GP-09	GP-020904	719	-	Test cases 46.2.2.5– deletion of T200 in step 4	F	4.7.0	4.8.0	GP-020904	GPRS
GP-09	GP-020935	720		Correction of Procedure Method of test	F	4.7.0	4.8.0	GP-020935	GPRS
GP-09	GP-021056	721	2	Section 40, GPRS default conditions, message contents and macros – editorial change: PCS column moved next to GSM700 and GSM850 columns	F	4.7.0	4.8.0	GP-021056	GPRS
GP-09	GP-021109	723	1	E-OTD Accuracy, Interference Performance Tests, 8PSK BCCH	B	4.7.0	4.8.0	GP-021109	LCS
GP-09	GP-021110	724	1	E-OTD Accuracy, Multipath Performance Test, 8PSK	B	4.7.0	4.8.0	GP-021110	LCS
GP-09	GP-021120	725	2	Modification to Annex 6 for E-OTD Accuracy Measurement Test Environment	F	4.7.0	4.8.0	GP-021120	LCS
GP-09	GP-021057	726	1	Section 40, GPRS default conditions, message contents and macros – addition of missing tables and rationalisation of ARFCN allocation	F	4.7.0	4.8.0	GP-021057	GPRS
GP-09	GP-021111	728		E-OTD Sensitivity Performance	B	4.7.0	4.8.0	GP-021111	GPRS
GP-09	GP-021066	729	-	Contradiction in test case 31.8.6.1 to core specifications 3GPP TS 04.88	F	4.7.0	4.8.0	GP-021066	
GP-09	GP-021179	730	1	LCS Classmark Interrogation test case corrections for Mobiles Supporting MS-Based A-GPS	F	4.7.0	4.8.0	GP-021179	LCS
GP-09	GP-021159	732	1	NI LCS test case correction for Emergency Call on an SDCCH, Idle, no IMSI for MS-Based A-GPS	F	4.7.0	4.8.0	GP-021159	LCS
GP-09	GP-021160	733	1	NI LCS test case correction for Emergency Call on an SDCCH, Idle, no IMSI for MS-Assisted A-GPS	F	4.7.0	4.8.0	GP-021160	LCS
GP-09	GP-021163	736	1	Network Induced Test on TCH Radio Channel for Mobile Supporting MS-Based A-GPS	F	4.7.0	4.8.0	GP-021163	LCS

TSG #	TSG Doc	CR	Rev	Subject/Comment	Cat	Old	New	WG Doc	Work item
GP-09	GP-021164	737	1	Network Induced Test on TCH Radio Channel for Mobile Supporting MS-Assisted A-GPS	F	4.7.0	4.8.0	GP-021164	LCS
GP-09	GP-021165	738	1	MT-LR Location Notification for Mobile Supporting MS-Based A-GPS	F	4.7.0	4.8.0	GP-021165	LCS
GP-09	GP-021166	739	1	MT-LR Location Notification for Mobile Supporting MS-Assisted A-GPS	F	4.7.0	4.8.0	GP-021166	LCS
GP-09	GP-021167	740	1	MT-LR Privacy Options - Location Not Allowed for Mobiles Supporting MS-Based A-GPS	F	4.7.0	4.8.0	GP-021167	LCS
GP-09	GP-021174	741	1	MT-LR Privacy Options - Location Not Allowed for Mobiles Supporting MS-Assisted A-GPS	F	4.7.0	4.8.0	GP-021174	LCS
GP-09	GP-021175	742	1	MT-LR Privacy Options – Location Allowed for Mobiles Supporting MS-Based A-GPS	F	4.7.0	4.8.0	GP-021175	LCS
GP-09	GP-021176	743	1	MT-LR Privacy Options – Location Allowed for Mobiles Supporting MS-Assisted A-GPS	F	4.7.0	4.8.0	GP-021176	LCS
GP-09	GP-021210	744		Removal of CR on Incompatibility between PDP context activated and the access procedure in section 42.2.2 1 (Rel-4)	F	4.7.0	4.8.0	GP-021210	GPRS
GP-09	GP-021211	745		Removal of CR on Wrong use of PACKTE TIMESLOT RECONFIGURE in 42.3.2.1.1 (Rel-4)	F	4.7.0	4.8.0	GP-021211	GPRS
GP-09	GP-021212	746		Removal of Correction to section 42.1.2.1.8.1.1; 42.1.2.1.8.1.2; 42.1.2.1.8.1.3; 42.1.2.1.8.2.1; 42.1.2.1.8.2.2 and 42.1.2.1.8.2.3 - Packet Uplink Assignment / One phase access (Rel-4)	F	4.7.0	4.8.0	GP-021212	GPRS
GP-10	GP-021832	747	1	GPRS Test Cases PTMSI Signature handling	F	4.8.0	4.9.0	GP-021832	GPRS
GP-10	GP-021302	748		RR / Paging / on PCCCH for circuit-switched services / paging successful	F	4.8.0	4.9.0	GP-021302	GPRS
GP-10	GP-021304	750		Contention resolution failure / GPRS supported using PBCCH / Timer or counter expiry	F	4.8.0	4.9.0	GP-021304	GPRS
GP-10	GP-021305	751		Contention resolution failure / GPRS supported using PBCCH / TLLI mismatch	F	4.8.0	4.9.0	GP-021305	GPRS
GP-10	GP-021872	752	1	Packet Channel Request / Response to Packet Paging	F	4.8.0	4.9.0	GP-021872	GPRS
GP-10	GP-021861	756	1	Two-message assignment / Failure cases	F	4.8.0	4.9.0	GP-021861	GPRS
GP-10	GP-021862	757	1	Two-message assignment / Failure cases	F	4.8.0	4.9.0	GP-021862	GPRS
GP-10	GP-021331	758		Minimum Input Level for Reference Performance, USF/CS-1 and USF/CS-2 to 4	F	4.8.0	4.9.0	GP-021331	GPRS
GP-10	GP-021873	759	1	Relative starting time	F	4.8.0	4.9.0	GP-021873	GPRS
GP-10	GP-021335	760		System information Type 13 contents	F	4.8.0	4.9.0	GP-021335	GPRS
GP-10	GP-021336	761		Priority level in the range 1 to 4	F	4.8.0	4.9.0	GP-021336	GPRS
GP-10	GP-021863	762	1	Time between two successive access attempts	F	4.8.0	4.9.0	GP-021863	GPRS
GP-10	GP-021864	763	1	PACKET RESOURCE REQUEST will not be sent in dynamic allocation	F	4.8.0	4.9.0	GP-021864	GPRS
GP-10	GP-021944	764	1	Correct numbering of steps	F	4.8.0	4.9.0	GP-021944	GPRS
GP-10	GP-021874	765	1	Correction made over section 42.2.x	F	4.8.0	4.9.0	GP-021874	GPRS
GP-10	GP-021848	766	1	CR 51.010-1 Test cases 40.4.3.17 addition of a conditional step in the Inter-SGSN Routing Area Update Procedure.	F	4.8.0	4.9.0	GP-021848	GPRS
GP-10	GP-021850	767	1	CR 51.010-1 Test case 46.1.2.7.6 ciphering enabled.	F	4.8.0	4.9.0	GP-021850	GPRS
GP-10	GP-021343	768	-	Test cases 46.2.2.1.4 Wrong N-PDU number.	F	4.8.0	4.9.0	GP-021343	GPRS
GP-10	GP-021344	769	-	Test cases 46.2.2.1.5 Wrong N-PDU numbers	F	4.8.0	4.9.0	GP-021344	GPRS
GP-10	GP-021973	771	1	Priority of cells	F	4.8.0	4.9.0	GP-021973	GPRS
GP-10	GP-021363	772		Network controlled Cell re-selection in Transfer Mode	F	4.8.0	4.9.0	GP-021363	GPRS
GP-10	GP-021364	773	-	S 44.2.3.2.7; Combined routing area updating / abnormal cases / attempt counter check / procedure timeout	F	4.8.0	4.9.0	GP-021364	GPRS
GP-11	GP-022630	777	2	AMR layer 3 tests, MO late assignment no ICM	F	4.9.0	4.10.0	GP-022630	AMR
GP-11	GP-022748	778	3	AMR layer 3 tests, handover failure	F	4.9.0	4.10.0	GP-022748	AMR
GP-11	GP-022629	779	2	AMR layer 3 tests, MT early assignment specified ICM	F	4.9.0	4.10.0	GP-022629	AMR
GP-11	GP-022634	780	2	AMR layer 3 tests, channel mode modify	F	4.9.0	4.10.0	GP-022634	AMR
GP-10	GP-021372	781	-	AMR layer 3 tests, handover success, additional cases	F	4.8.0	4.9.0	GP-021372	AMR
GP-10	GP-021843	785	1	RRLP Measure Position Response Message Content for clause 70.7.1.1	F	4.8.0	4.9.0	GP-021843	LCS
GP-10	GP-021844	786	1	RRLP Measure Position Response Message Content for clause 70.7.1.2	F	4.8.0	4.9.0	GP-021844	LCS
GP-10	GP-021845	787	1	RRLP Measure Position Response Message Content for clause 70.7.3.1	F	4.8.0	4.9.0	GP-021845	LCS
GP-10	GP-021846	788	1	RRLP Measure Position Response Message	F	4.8.0	4.9.0	GP-021846	LCS

TSG #	TSG Doc	CR	Rev	Subject/Comment	Cat	Old	New	WG Doc	Work item
				Content for clause 70.7.3.2					
GP-10	GP-021383	789	-	RRLP Measure Position Request Message Content for clause 70.7.1.2	F	4.8.0	4.9.0	GP-021383	LCS
GP-10	GP-021384	790	-	RRLP Measure Position Request Message Content for clause 70.7.3.2	F	4.8.0	4.9.0	GP-021384	LCS
GP-10	GP-021386	792	-	NI LCS test case correction for Emergency Call on an SDCCH for MS-Based A-GPS	F	4.8.0	4.9.0	GP-021386	LCS
GP-10	GP-021387	793	-	NI LCS test case correction for Emergency Call on an SDCCH for MS-Assisted A-GPS	F	4.8.0	4.9.0	GP-021387	LCS
GP-10	GP-021388	794	-	Default conditions during LCS	F	4.8.0	4.9.0	GP-021388	LCS
GP-10	GP-021395	795		Only one cell is needed in 42.4.2.1.6	F	4.8.0	4.9.0	GP-021395	GPRS
GP-10	GP-021396	796		Only one cell is needed in 42.4.2.2.3	F	4.8.0	4.9.0	GP-021396	GPRS
GP-10	GP-021397	797		Correction to testcase 42.3.2.1.2	F	4.8.0	4.9.0	GP-021397	GPRS
GP-10	GP-021399	799	-	Correction to sections Correction to sections 44.2.2.2.5; 44.2.3.2.4; 44.2.3.2.5.3.1	F	4.8.0	4.9.0	GP-021399	GPRS
GP-10	GP-021867	802	1	TBF Release / Uplink / Normal / MS initiated / Acknowledged mode	F	4.8.0	4.9.0	GP-021867	GPRS
GP-10	GP-021959	803	1	TC 42.1.2.2.1 Packet Downlink Assignment / Response to poll bit	F	4.8.0	4.9.0	GP-021959	GPRS
GP-10	GP-021497	804	-	44.2.2.1.8, GPRS detach / abnormal cases / change of cell into new routing area	F	4.8.0	4.9.0	GP-021497	GPRS
GP-10	GP-021847	805	1	44.2.3.2.5, Combined routing area updating / rejected / roaming not allowed in this location area	F	4.8.0	4.9.0	GP-021847	GPRS
GP-10	GP-021529	808	-	26.16.6 Correct direction of messages in Expected Sequence	F	4.8.0	4.9.0	GP-021529	TEI
GP-10	GP-021531	810	-	26.16.4 – Correct direction of messages in Expected Sequence	F	4.8.0	4.9.0	GP-021531	TEI
GP-10	GP-021532	811	-	Section 26.16.2 - Remove generation of unnecessary interference signal I1	F	4.8.0	4.9.0	GP-021532	TEI
GP-10	GP-021533	812	-	26.16.1 & 26.16.2 – Replace erroneous CHANNEL RELEASE with HANDOVER COMMAND. Remove repeated steps.	F	4.8.0	4.9.0	GP-021533	TEI
GP-10	GP-021535	814	-	26.16.1 & 26.16.2 - Optional support of half rate channels	F	4.8.0	4.9.0	GP-021535	TEI
GP-10	GP-021536	815	-	26.16.1 – Correct scope of “Expected Sequence”	F	4.8.0	4.9.0	GP-021536	TEI
GP-10	GP-021537	816	-	26.16.1, 26.16.2, 26.16.3, 26.16.6, 26.16.7 & 26.16.8 – correct minor typographical errors	D	4.8.0	4.9.0	GP-021537	TEI
GP-10	GP-021964	817	1	GPRS Uplink Power Control - Use of a and GCH Parameters	F	4.8.0	4.9.0	GP-021964	GPRS
GP-10	GP-021560	818	-	AMR – RATSCCH Procedures	F	4.8.0	4.9.0	GP-021560	AMR
GP-10	GP-021562	819	-	Correction to 46.1.2.5.2 Sending FRMR due to reception of an S frame with incorrect length	F	4.8.0	4.9.0	GP-021562	GPRS
GP-10	GP-021866	820	1	Correction to 41.3.1.1 TBF Release / Uplink / Normal / MS initiated / Acknowledged mode	F	4.8.0	4.9.0	GP-021866	GPRS
GP-10	GP-021632	823		GPRS default conditions, message contents and macros - further minor correction of ARFCN allocation	F	4.8.0	4.9.0	GP-021632	GPRS
GP-10	GP-021935	824	1	Packet Uplink Assignment / One phase access / Contention resolution / Inclusion of TLLI in RLC data blocks - correction of repeated step numbers	F	4.8.0	4.9.0	GP-021935	GPRS
GP-10	GP-021945	828	1	Deletion of redundant step in expected sequence	F	4.8.0	4.9.0	GP-021945	GPRS
GP-10	GP-021947	829	1	Definition of optional step in expected sequence	F	4.8.0	4.9.0	GP-021947	GPRS
GP-10	GP-021868	830	1	Correct number of Test Steps	F	4.8.0	4.9.0	GP-021868	GPRS
GP-10	GP-021869	831	1	Direction of Assignment	F	4.8.0	4.9.0	GP-021869	GPRS
GP-10	GP-021870	832	1	Replace reference to superceded T3132 with T3190	F	4.8.0	4.9.0	GP-021870	GPRS
GP-10	GP-021937	834	1	Amount of uplink data increased	F	4.8.0	4.9.0	GP-021937	GPRS
GP-10	GP-021975	835	2	Correction of coding of MA_Bitmap Length	F	4.8.0	4.9.0	GP-021975	GPRS
GP-10	GP-021965	836	1	Correct order of Test Steps in Expected Sequence	F	4.8.0	4.9.0	GP-021965	GPRS
GP-10	GP-021940	837	1	Insert Test Step ATTACH COMPLETE; Insert PAGING REQUEST after timeout	F	4.8.0	4.9.0	GP-021940	GPRS
GP-10	GP-021941	838	1	Add PACKET RESOURCE REQUEST to complete transmission of uplink data	F	4.8.0	4.9.0	GP-021941	GPRS
GP-10	GP-021942	839	1	Correct handling of PSI2	F	4.8.0	4.9.0	GP-021942	GPRS
GP-10	GP-021675	845	-	CR 51.010-1 44.2.3.2.4 Combined routing area updating / rejected / PLMN not allowed	F	4.8.0	4.9.0	GP-021675	GPRS
GP-10	GP-021676	846	-	CR 51.010-1 46.1.2.3.2 Collision of SABM and	F	4.8.0	4.9.0	GP-021676	GPRS

TSG #	TSG Doc	CR	Rev	Subject/Comment	Cat	Old	New	WG Doc	Work item
				DISC					
GP-10	GP-021853	847	2	CR 51.010-1 46.1.2.6.1 Simultaneous acknowledged and unacknowledged data transfer on the same SAPI	F	4.8.0	4.9.0	GP-021853	GPRS
GP-10	GP-021727	848		Receive EGPRS Packet DL Ack/Nack instead of Packet DL Ack/Nack	F	4.8.0	4.9.0	GP-021727	EDGE
GP-10	GP-021969	849	1	Correction to teststeps to align with MS behaviour for elapsed TBF starting time.	F	4.8.0	4.9.0	GP-021969	EDGE
GP-10	GP-021729	850		Removal of using Packet Timeslot Reconfigure message for reassigning Uplink TBF parameters.	F	4.8.0	4.9.0	GP-021729	EDGE
GP-10	GP-021730	851		Only one cell required for the Testcase	F	4.8.0	4.9.0	GP-021730	EDGE
GP-10	GP-021731	852		Correction of PDP context numbers stated in the test steps.	F	4.8.0	4.9.0	GP-021731	EDGE
GP-10	GP-021732	853		Correction of BSN sequence in the test step.	F	4.8.0	4.9.0	GP-021732	EDGE
GP-10	GP-021735	856		Correction to the BSNs of data blocks sent.	F	4.8.0	4.9.0	GP-021735	EDGE
GP-10	GP-021736	857		Correction to the BSNs of data blocks sent.	F	4.8.0	4.9.0	GP-021736	EDGE
GP-10	GP-021972	859	1	Measurement report shall be sent in Channel Quality Report IE.	F	4.8.0	4.9.0	GP-021972	EDGE
GP-10	GP-021739	860		Use Packet Uplink Assignment instead of Packet Timeslot Reconfigure message.	F	4.8.0	4.9.0	GP-021739	EDGE
GP-10	GP-021740	861		Changes to the range of frequency selected for DCS 1800 and GSM 850.	F	4.8.0	4.9.0	GP-021740	EDGE
GP-10	GP-021970	862	1	Correction of parameter name from CONTROL_CH_REL to BS_PCC_REL.	F	4.8.0	4.9.0	GP-021970	EDGE
GP-10	GP-021726	864		MS Radio Access Capability shall not be present in Packet Resource Request	F	4.8.0	4.9.0	GP-021726	EDGE
GP-10	GP-021762	865		Correction in testcase to use Packet Uplink Assignment instead of Packet Timeslot Reconfigure	F	4.8.0	4.9.0	GP-021762	EDGE
GP-10	GP-021774	866		Test case 15.6 GPRS Timing advance and absolute delay	F	4.8.0	4.9.0	GP-021774	GPRS
GP-10	GP-021776	868		Correction of Expected Sequence for clause 41.1.5.1.2 - RR / Paging / on CCCH for GPRS service / normal paging with IMSI successful	F	4.8.0	4.9.0	GP-021776	GPRS
GP-10	GP-021777	869		Correction to allow also Two Phase Access for clause 42.1.2.1.8.2.2 - Packet Uplink Assignment / One phase access / Timing Advance / TA Index not present	F	4.8.0	4.9.0	GP-021777	GPRS
GP-10	GP-021943	870	1	Correction to T3192 expiry time for clause 42.3.2.1.1 - Dynamic Allocation / Uplink Transfer with Downlink TBF establishment / Normal / Successful	F	4.8.0	4.9.0	GP-021943	GPRS
GP-10	GP-021779	871		Correction of Expected Sequence for clause 51.1.1.1 - RR / Paging / on PCCCH for EGPRS service / normal paging with P-TMSI successful	F	4.8.0	4.9.0	GP-021779	EDGE
GP-10	GP-021780	872		Correction of Expected Sequence for clause 51.1.5.1.2 - RR / Paging / on CCCH for EGPRS service / normal paging with IMSI successful	F	4.8.0	4.9.0	GP-021780	EDGE
GP-10	GP-021781	873		Correction of allowed ACCESS TYPE in Step 2 of the Expected Sequence for clause 52.1.1.2 - Packet Channel Request / Support of EGPRS PACKET CHANNEL REQUEST	F	4.8.0	4.9.0	GP-021781	EDGE
GP-10	GP-021782	874		Correction to T3192 expiry time for clause 52.3.2.1.1 - Dynamic Allocation / Uplink Transfer with Downlink TBF establishment / Normal / Successful	F	4.8.0	4.9.0	GP-021782	EDGE
GP-10	GP-021775	876		Section 20.22 GPRS Cell Selection and Reselection	F	4.8.0	4.9.0	GP-021775	GPRS
GP-10	GP-021949	900		TBF Release / Uplink / Normal / MS initiated / Acknowledged mode	F	4.8.0	4.9.0	GP-021949	EGPRS
GP-10	GP-021960	901		Packet Downlink Assignment / Response to poll bit	F	4.8.0	4.9.0	GP-021960	EGPRS
GP-10	GP-021877	902		Only one cell is needed in 52.4.2.1.6	F	4.8.0	4.9.0	GP-021877	EGPRS
GP-10	GP-021878	903		Only one cell is needed in 52.4.2.2.3	F	4.8.0	4.9.0	GP-021878	EGPRS
GP-10	GP-021880	904		Correction to testcase 52.3.2.1.2	F	4.8.0	4.9.0	GP-021880	EGPRS
GP-10	GP-021977	905	1	Correction made to testcases: 42.2.4.4.1; 42.2.4.4.2 and 42.2.4.4.3	F	4.8.0	4.9.0	GP-021977	GPRS
GP-10	GP-021876	906		Correction made to testcases 42.2.2.8.1 and 42.2.2.8.2	F	4.8.0	4.9.0	GP-021876	GPRS
GP-10	GP-021936	907		Packet Uplink Assignment / One phase access / Contention resolution / Inclusion of TLLI in RLC data blocks - correction of repeated step	F	4.8.0	4.9.0	GP-021936	EGPRS

TSG #	TSG Doc	CR	Rev	Subject/Comment	Cat	Old	New	WG Doc	Work item
				numbers					
GP-10	GP-021976	908	1	Correction of coding of MA_Bitmap Length	F	4.8.0	4.9.0	GP-021976	EGPRS
GP-10	GP-021946	909		Update to be in line with test case 43.1.1.3	F	4.8.0	4.9.0	GP-021946	EGPRS
GP-10	GP-021962	911		Correct handling of PSI2	F	4.8.0	4.9.0	GP-021962	EGPRS
GP-10	GP-021963	912		Correct numbering of Test Steps	F	4.8.0	4.9.0	GP-021963	EGPRS
GP-10	GP-021971	913		Changes to the range of frequency selected for DCS 1800 and GSM 850	F	4.8.0	4.9.0	GP-021971	EDGE
GP-10	GP-021974	914		TBF Release / Uplink / Normal / MS initiated / Acknowledged mode	F	4.8.0	4.9.0	GP-021974	GPRS
GP-10	GP-021865	915	1	Fixed Allocation / Uplink Transfer / T3184 Expiry	F	4.8.0	4.9.0	GP-021865	GPRS
GP-11	GP-022624	916	1	CR to 51.010-1: Addition of test of short message type 0 (REL-5 requirement) in clause 34.2.6a	F	4.9.0	5.0.0	GP-022624	TEI
GP-11	GP-022127	917	-	Creation of 51.010-1 REL-5: Merging of REL-5, REL-4, R99 etc. test specifications (Foreword, clause 1 and clause 2)	F	4.9.0	5.0.0	GP-022127	TEI
GP-11	GP-022688	919	1	51.010-1 Section 44 - Corrections to GMM test cases to take into account the different implementations of a "non-auto attaching" MS.	F	4.9.0	4.10.0	GP-022688	GPRS
GP-11	GP-022750	920	3	AMR RATSCCH tests applicability of half rate	F	4.9.0	4.10.0	GP-022750	AMR
GP-11	GP-022632	921	1	AMR RATSCCH expiry of REQ_Activation counter	F	4.9.0	4.10.0	GP-022632	AMR
GP-11	GP-022633	922	1	AMR RATSCCH inversion of phase of CMR/CMI	F	4.9.0	4.10.0	GP-022633	AMR
GP-11	GP-022144	923	-	26.16.1 Inband Signalling, Downlink Codec Adaptation	F	4.9.0	4.10.0	GP-022144	AMR
GP-11	GP-022746	926	4	51.010-1; S 45.5.1 Error cases; Adaptation to Release 99	F	4.9.0	4.10.0	GP-022746	GPRS
GP-11	GP-022161	932	-	44.2.5.1.2 – Attach after Location Update	F	4.9.0	4.10.0	GP-022161	TEI4
GP-11	GP-022165	936	-	40 - Current Cell ARFCN missing from BA list in SI2	F	4.9.0	4.10.0	GP-022165	TEI4
GP-11	GP-022166	937	-	40 - Inconsistent use of BSIC in PSI3	F	4.9.0	4.10.0	GP-022166	TEI4
GP-11	GP-022168	939	-	TC 44.2.3.1.5 – Modification to allow for a GPRS Suspension Request during the IMSI Detach Procedure.	F	4.9.0	4.10.0	GP-022168	TEI4
GP-11	GP-022189	960	-	26.16.5. - Splitting the combined 1800/1900 band test cases into separate 1800 and 1900 band test cases	F	4.9.0	4.10.0	GP-022189	AMR
GP-11	GP-022190	961	-	26.16.5 - Removing the test cases with handover between 900 and 1900 bands	F	4.9.0	4.10.0	GP-022190	AMR
GP-11	GP-022191	962	-	26.16.5 - Replacing the cell parameter "900 or 1800 or 1900" and "700 or 850 or 1900" with "Frequency Band"	F	4.9.0	4.10.0	GP-022191	AMR
GP-11	GP-022204	965	-	51.010-1-965 Revision of E-OTD Emergency Call NI-LR test cases	F	4.9.0	4.10.0	GP-022204	LCS
GP-11	GP-022266	969	-	CR 51.010-1 Section 26.6.5.1 Handover / successful / active call / non-synchronized	F	4.9.0	4.10.0	GP-022266	TEI
GP-11	GP-022628	970	2	CR 51.010-1 Section 26.11.2.1 Multiband signalling / RR / Immediate assignment procedure	F	4.9.0	4.10.0	GP-022628	TEI
GP-11	GP-022268	971	-	CR 51.010-1 Section 26.11.2.2.1 Multiband signalling / RR / Handover / successful / active call / non-synchronized	F	4.9.0	4.10.0	GP-022268	TEI
GP-11	GP-022684	974	1	Addition of new default messages, for DTM, to section 40.	F	4.9.0	4.10.0	GP-022684	DTM
GP-11	GP-022637	975	1	Reallocation of CS resources / Assignment Command	F	4.9.0	4.10.0	GP-022637	DTM
GP-11	GP-022638	976	2	Intra frequency reallocation of CS resources / Handover Command	F	4.9.0	4.10.0	GP-022638	DTM
GP-11	GP-022287	977	-	Handover to same routing area whilst in dedicated mode & MM Ready / Completed on the main DCCH	F	4.9.0	4.10.0	GP-022287	DTM
GP-11	GP-022639	978	1	Handover to same routing area whilst in DTM with a downlink TBF Established	F	4.9.0	4.10.0	GP-022639	DTM
GP-11	GP-022698	979	2	Handover to same routing area whilst in DTM with both DL & UL TBFs / Successful case	F	4.9.0	4.10.0	GP-022698	DTM
GP-11	GP-022700	980	3	Handover to same routing area whilst in DTM with both DL & UL TBFs / Abnormal case / Handover Failure	F	4.9.0	4.10.0	GP-022700	DTM
GP-11	GP-022682	981	1	Handover to different routing area whilst in DTM / Performed on TBFs / RAU complete before CS release	F	4.9.0	4.10.0	GP-022682	DTM
GP-11	GP-022683	982	1	Handover to different routing area whilst in DTM / Performed on TBFs / CS release before	F	4.9.0	4.10.0	GP-022683	DTM

TSG #	TSG Doc	CR	Rev	Subject/Comment	Cat	Old	New	WG Doc	Work item
				RAU complete					
GP-11	GP-022343	1026	-	Correction of Test Purpose, Test Procedure and Expected Sequence for clause 26.7.5.7.2 - MM connection / abortion by the network / cause not equal to #6	F	4.9.0	4.10.0	GP-022343	TEI
GP-11	GP-022344	1027	-	Correction of Step 36 of the Expected Sequence for clause 44.2.3.2.3 - Combined routing area updating / RA only accepted	F	4.9.0	4.10.0	GP-022344	GPRS
GP-11	GP-022690	1043	1	51.010-1; Correction to section 44.2.3.2.7 – Combined routing area updating / abnormal cases / attempt counter check / procedure timeout	F	4.9.0	4.10.0	GP-022690	GPRS
GP-11	GP-022685	1044	1	Basic Self Location Test case for Assisted GPS	F	4.9.0	4.10.0	GP-022685	LCS
GP-11	GP-022423	1045	-	Corrections to NI-LR and MT-LR Assisted GPS test cases	F	4.9.0	4.10.0	GP-022423	LCS
GP-11	GP-022470	1061	-	51.010-1-1061 Revision of references and conformance for E-OTD MT-LR test case	F	4.9.0	4.10.0	GP-022470	LCS
GP-11	GP-022686	1062	1	EOTD MOLR	F	4.9.0	4.10.0	GP-022686	LCS
GP-11	GP-022623	1063	1	Corrections to Clause 60 Inter-system hard handover from GSM to UTRAN	F	4.9.0	4.10.0	GP-022623	2G/3G Handover
GP-11	GP-022529	1066	-	CR 51.010-1 Section 40 GPRS default conditions, message contents and macros	F	4.9.0	4.10.0	GP-022529	GPRS
GP-12	GP-022850	1069		CR 51.010-1-1069 TC 51.2.3.2 Two-message assignment / Failure cases - Change to specific message contents	F	5.0.0	5.1.0	GP-022850	EDGE
GP-12	GP-023382	1070	1	CR 51.010-1 Test cases 46.2.2.1.4 – Modification of the size of uplink data to transfer	F	5.0.0	5.1.0	GP-023382	GPRS
GP-12	GP-023280	1071	1	CR 51.010-1-1169 r1 51.3.5.2 Correction of test procedure and expected sequence in order to clarify use of multiple timeslots	F	5.0.0	5.1.0	GP-023280	EDGE
GP-12	GP-023272	1072	1	CR 51.010-1-1072 r1 TC 41.3.5.2 correction of some steps	F	5.0.0	5.1.0	GP-023272	GPRS
GP-12	GP-022856	1075		CR 51.010-1-1075 TC 51.2.2.6 New Testcase added	B	5.0.0	5.1.0	GP-022856	EDGE
GP-12	GP-022857	1076		CR 51.010-1-1076 TC 52.1.1.7 New Testcase added	B	5.0.0	5.1.0	GP-022857	EDGE
GP-12	GP-023277	1077	1	CR 51.010-1-1077 r1 Testcase 52.1.2.1.8.2.3 deleted and new Testcase 52.1.2.2.6 added	F	5.0.0	5.1.0	GP-023277	EDGE
GP-12	GP-023286	1078	1	CR 51.010-1-1078 r1 TC 53.1.1.21 Addition of optional steps to cater to MS reaction time	F	5.0.0	5.1.0	GP-023286	EDGE
GP-12	GP-023285	1079	1	CR 51.010-1-1079 r1 TC 53.1.1.20 Addition of optional steps to cater to MS reaction time	F	5.0.0	5.1.0	GP-023285	EDGE
GP-12	GP-023281	1082	1	CR 51.010-1-1082 r1 Testcase 53.1.1.4 should be done in transfer mode.	F	5.0.0	5.1.0	GP-023281	EDGE
GP-12	GP-022864	1083		CR 51.010-1-1083 TC 53.1.1.6 CV calculation was wrong	F	5.0.0	5.1.0	GP-022864	EDGE
GP-12	GP-022865	1084		CR 51.010-1-1084 TC 53.1.1.5 Addition of optional steps to cater to MS reaction time	F	5.0.0	5.1.0	GP-022865	EGPRS
GP-12	GP-023287	1085	1	CR 51.010-1-1085 r1 TC 53.1.1.3 Addition of optional steps to cater to MS reaction time	F	5.0.0	5.1.0	GP-023287	EDGE
GP-12	GP-022867	1086		CR 51.010-1-1086 52.1.2.1.10.1- testcase not testing EGPRS Multislot class	F	5.0.0	5.1.0	GP-022867	EDGE
GP-12	GP-023282	1087	1	CR 51.010-1-1087 r1 TC 51.3.1.2 correction of some steps	F	5.0.0	5.1.0	GP-023282	EDGE
GP-12	GP-023271	1088	1	CR 51.010-1-1088 r1 TC 41.3.1.2 correction of some steps	F	5.0.0	5.1.0	GP-023271	GPRS
GP-12	GP-022872	1091		CR 51.010-1-1091 TC 52.3.2.1 Dynamic Allocation / Uplink Transfer with Downlink TBF establishment / Normal	F	5.0.0	5.1.0	GP-022872	EDGE
GP-12	GP-022873	1092		CR 51.010-1-1092 TC 53.1.2.16 Acknowledged Mode/ Downlink TBF/ Received Block Bitmap/ Compressed Bitmap Starting Colour Code	F	5.0.0	5.1.0	GP-022873	EDGE
GP-12	GP-022875	1094		CR 51.010-1-1094 TC 53.1.2.10 Acknowledged Mode/ Downlink TBF/ Split RLC Data Block	F	5.0.0	5.1.0	GP-022875	EDGE
GP-12	GP-023288	1095	1	CR 51.010-1-1095 r1 TC 53.1.1.11 Acknowledged Mode/ Uplink TBF/ Pre-emptive Transmission Bit Set to '0' Negative Acknowledgement	F	5.0.0	5.1.0	GP-023288	EDGE
GP-12	GP-022877	1096		CR 51.010-1-1096 TC 51.3.4.2 TBF Release / Downlink / Normal / Network initiated / Unacknowledged mode	F	5.0.0	5.1.0	GP-022877	EDGE
GP-12	GP-022878	1097		CR 51.010-1-1097 TC 51.3.1.1 TBF Release / Uplink / Normal / MS initiated / Acknowledged	F	5.0.0	5.1.0	GP-022878	EDGE

TSG #	TSG Doc	CR	Rev	Subject/Comment	Cat	Old	New	WG Doc	Work item
				mode					
GP-12	GP-022880	1099		CR 51.010-1-1099 TC 51.2.5.1 Packet access rejection / wait indication	F	5.0.0	5.1.0	GP-022880	EDGE
GP-12	GP-022881	1100		CR 51.010-1-1100 TC 52.1.2.1.9.2.2 : Deletion of steps 5 and 6.	F	5.0.0	5.1.0	GP-022881	EDGE
GP-12	GP-023289	1102	1	CR 51.010-1-1102 r1 New testcase 53.1.1.23 Acknowledged Mode/ Uplink TBF/ Interpretation of Compressed Bitmap	B	5.0.0	5.1.0	GP-023289	EDGE
GP-12	GP-022884	1103		CR 51.010-1-1103 New testcase 53.1.1.22 Acknowledged Mode/ Uplink TBF/ Recalculation of CV on TBC change	B	5.0.0	5.1.0	GP-022884	EDGE
GP-12	GP-022885	1104	-	Format of tests in section 9	F	5.0.0	5.1.0	GP-022885	TEI
GP-12	GP-023420	1105	2	CR.51.010-1-1105 TC 53.1.2.13 Acknowledged Mode/ Downlink TBF/ IR Operation	F	5.0.0	5.1.0	GP-023420	EDGE
GP-12	GP-022889	1106		CR 51.010-1-1106 Two subsections, namely 14.1.5 and 14.1.6, have been duplicated	F	5.0.0	5.1.0	GP-022889	AMR
GP-12	GP-022890	1107	-	51.010-1- 1107 Correction of EOTD Test Cases	F	5.0.0	5.1.0	GP-022890	LCS
GP-12	GP-022893	1108		CR 51010-1-1108 TBF release / Uplink / Normal / MS initiated / Whilst in DTM (Rel-5)	F	5.0.0	5.1.0	GP-022893	DTM
GP-12	GP-023340	1109	1	CR 51010-1-1109 r1 TBF release / Uplink / Normal / Network initiated / Whilst in DTM (Rel-5)	F	5.0.0	5.1.0	GP-023340	DTM
GP-12	GP-022895	1110		CR 51010-1-1110 TBF release / Downlink / Normal / Network initiated / Whilst in DTM (Rel-5)	F	5.0.0	5.1.0	GP-022895	DTM
GP-12	GP-023341	1111	1	CR 51010-1-1111 r1 Uplink TBF establishment with no reallocation of CS resources / Abnormal cases / Inter System to UTRAN Handover Command (Rel-5)	F	5.0.0	5.1.0	GP-023341	DTM
GP-12	GP-022897	1112		CR 51010-1-1112 Uplink TBF establishment with a downlink TBF established and no PS downlink reallocation (Rel-5)	F	5.0.0	5.1.0	GP-022897	DTM
GP-12	GP-022898	1113		CR 51010-1-1113 Uplink TBF establishment with a downlink TBF established and PS downlink reallocation (Rel-5)	F	5.0.0	5.1.0	GP-022898	DTM
GP-12	GP-022899	1114		CR 51010-1-1114 Downlink TBF establishment with a uplink TBF established and no PS uplink reallocation (Rel-5)	F	5.0.0	5.1.0	GP-022899	DTM
GP-12	GP-022900	1115		CR 51010-1-1115 Downlink TBF establishment with a uplink TBF established and PS uplink reallocation (Rel-5)	F	5.0.0	5.1.0	GP-022900	DTM
GP-12	GP-023342	1116	1	CR 51010-1-1116 r1 Power control in exclusive allocation mode (Rel-5)	F	5.0.0	5.1.0	GP-023342	DTM
GP-12	GP-022902	1117		CR 51010-1-1117 Timing advance whilst in DTM (Rel-5)	F	5.0.0	5.1.0	GP-022902	DTM
GP-12	GP-022903	1118		CR 51010-1-1118 Corrections to WG4 DTM Test Cases (Rel-5)	F	5.0.0	5.1.0	GP-022903	DTM
GP-12	GP-023347	1119	1	PDP Context Activation / Performed on main DCCH and TBFs	F	5.0.0	5.1.0	GP-023347	DTM
GP-12	GP-023302	1120	2	Change of cell between two LAs in idle mode / RAU completes first	F	5.0.0	5.1.0	GP-023302	DTM
GP-12	GP-023303	1121	2	Change of cell between two LAs in idle mode / LAU completes first / SS releases channel	F	5.0.0	5.1.0	GP-023303	DTM
GP-12	GP-023304	1122	2	Change of cell between two LAs in idle mode / LAU completes first / SS maintains channel	F	5.0.0	5.1.0	GP-023304	DTM
GP-12	GP-023300	1123	1	Change of routing area whilst in dedicated mode	F	5.0.0	5.1.0	GP-023300	DTM
GP-12	GP-023306	1124	1	Intra frequency reallocation of CS resources / DTM Assignment Command	F	5.0.0	5.1.0	GP-023306	DTM
GP-12	GP-023307	1125	1	Inter frequency reallocation of CS resources / DTM Assignment Command	F	5.0.0	5.1.0	GP-023307	DTM
GP-12	GP-023308	1126	1	Mobile originating CS release	F	5.0.0	5.1.0	GP-023308	DTM
GP-12	GP-023309	1127	1	Network originating CS release	F	5.0.0	5.1.0	GP-023309	DTM
GP-12	GP-023310	1128	1	Handover to different routing area whilst in DM / Performed on main DCCH / RAU complete before CS release	F	5.0.0	5.1.0	GP-023310	DTM
GP-12	GP-023346	1129	1	Handover to different routing area whilst in DM / Performed on main DCCH / CS release before RAU complete	F	5.0.0	5.1.0	GP-023346	DTM
GP-12	GP-023348	1130	1	Handover to UTRAN while in DTM	F	5.0.0	5.1.0	GP-023348	DTM
GP-12	GP-023305	1131	1	Corrections to WG5 DTM Test Cases	F	5.0.0	5.1.0	GP-023305	DTM
GP-12	GP-022952	1132		CR 51.010-1-1132 TC 42.1.1.2 Packet Channel	F	5.0.0	5.1.0	GP-022952	GPRS

TSG #	TSG Doc	CR	Rev	Subject/Comment	Cat	Old	New	WG Doc	Work item
				Request / Response to Packet Paging					
GP-12	GP-023419	1133	2	CR 51.010-1-1133 TC 14.18.7 Incremental Redundancy Performance	F	5.0.0	5.1.0	GP-023419	EDGE
GP-12	GP-023325	1134	1	CR 51.010-1-1134 r1 53.1.1.16 Acknowledged Mode/ Uplink TBF/ Retransmission/ Padding in the Data Field	F	5.0.0	5.1.0	GP-023325	EDGE
GP-12	GP-023418	1135		CR 51.010-1-1135 S50 EGPRS Default Conditions, Message Contents and Macros for the Higher Layer Testcases	F	5.0.0	5.1.0	GP-023418	EDGE
GP-12	GP-022980	1136		CR 51.010-1-1136 14.16.1 Minimum Input Level for Reference Performance, USF/CS-1 and USF/CS-2 to 4	F	5.0.0	5.1.0	GP-022980	GPRS
GP-12	GP-022981	1137		CR 51.010-1-1137 20.22.09 Correction of cell configuration in step p)	F	5.0.0	5.1.0	GP-022981	GPRS
GP-12	GP-022982	1138		CR 51.010-1-1138 20.22.12 Removal of wrong step d)	F	5.0.0	5.1.0	GP-022982	GPRS
GP-12	GP-022983	1139		CR 51.010-1-1139 20.20.1.2 Modify no. of channels to be searched for PCS 1900 band	F	5.0.0	5.1.0	GP-022983	TEI5
GP-12	GP-022986	1142		CR 51.010-1-1142 20.20.1.4.1 modification in MNC value for PCS 1900 band	F	5.0.0	5.1.0	GP-022986	TEI5
GP-12	GP-023331	1143	1	CR 51.010-1-1143 r1 22.3 remove unnecessary constraint in initial conditions	F	5.0.0	5.1.0	GP-023331	TEI5
GP-12	GP-023296	1144	1	26.16.6 - Restricting repetition of procedure to FR and HR speech version 3.	F	5.0.0	5.1.0	GP-023296	AMR
GP-12	GP-022989	1145		CR 51.010-1-1145 20, Table 20.1 BA ARFCNs for PCS 1900 for Multiband test cases	F	5.0.0	5.1.0	GP-022989	TEI5
GP-12	GP-023273	1149	1	CR 51.010-1-1149 r1 42.3.1.1.4 Insufficient Reaction time permitted for the MS for the DownLink Assignment in step 2	F	5.0.0	5.1.0	GP-023273	GPRS
GP-12	GP-022994	1150		CR 51.010-1-1150 42.4.2.3.1 Incorect step numbering in the and missing information about USF addressing the MS in the Test steps comments	F	5.0.0	5.1.0	GP-022994	GPRS
GP-12	GP-022996	1152	-	46.1.2.2.1.1 Move initiation of data transfer to new test step 4	F	5.0.0	5.1.0	GP-022996	GPRS
GP-12	GP-022997	1153	-	46.2.2.1.3 Correction of T in SN-DATA PDU in step 11	F	5.0.0	5.1.0	GP-022997	GPRS
GP-12	GP-022998	1154	-	46.1.2.2.2.2 - Removal of test step 6, 7, 8 and 13	F	5.0.0	5.1.0	GP-022998	GPRS
GP-12	GP-022999	1155	-	46.2.2.4.1 Release and re-establishment of LLC added in step 3 to 6	F	5.0.0	5.1.0	GP-022999	GPRS
GP-12	GP-023352	1156	1	46.1.2.2.1.4 New test step 5: Reception of an UI frame	F	5.0.0	5.1.0	GP-023352	GPRS
GP-12	GP-023353	1157	1	46.1.2.2.2.3 Correction of N(R) and N(S) values and removal of steps 12 and 13	F	5.0.0	5.1.0	GP-023353	GPRS
GP-12	GP-023355	1158	1	46.1.2.2.3.2 Correction of test procedure and clarify ambiguity of sending RR in step 6	F	5.0.0	5.1.0	GP-023355	GPRS
GP-12	GP-023003	1159	-	46.1.2.2.4.1 Add new test step 5	F	5.0.0	5.1.0	GP-023003	GPRS
GP-12	GP-023004	1160	-	46.2.2.4.2 Algorithm type in step 2 removed	F	5.0.0	5.1.0	GP-023004	GPRS
GP-12	GP-023005	1161	-	46.1.2.2.1.5 Correction of test step 2: Remove Initiation of data transfer	F	5.0.0	5.1.0	GP-023005	GPRS
GP-12	GP-023354	1162	1	46.1.2.2.2.4 Removal of step 5 and correction of test procedure.	F	5.0.0	5.1.0	GP-023354	GPRS
GP-12	GP-023007	1163	-	46.1.2.7.2 – Removal of constraint for C/R bit in step 7)	F	5.0.0	5.1.0	GP-023007	GPRS
GP-12	GP-023008	1164	-	46.1.2.7.5 – Correction of amount of uplink data in step 12)	F	5.0.0	5.1.0	GP-023008	GPRS
GP-12	GP-023381	1165	1	46.1.2.7.6 – Correction of testing time and macro direction in step 14)	F	5.0.0	5.1.0	GP-023381	GPRS
GP-12	GP-023345	1167	1	CR 51.010-1-1167 51.3.1.3 The order of the optional steps A6 and A12 is incorrect.	F	5.0.0	5.1.0	GP-023345	GPRS
GP-12	GP-023274	1170	1	CR 51.010-1-1170 r152.3.1.1.4 Insufficient Reaction time permitted for the MS for the DownLink Assignment in step 2	F	5.0.0	5.1.0	GP-023274	EGPRS
GP-12	GP-023275	1171	1	CR 51.010-1-1171 r152.4.3.2.1 Incorect step numbering in the and missing information about USF addressing the MS in the Test steps comments	F	5.0.0	5.1.0	GP-023275	EGPRS
GP-12	GP-023394	1172	2	26.16.4 and 26.16.4a To correct the specification of speech versions supported by MS.	F	5.0.0	5.1.0	GP-023394	AMR
GP-12	GP-023332	1173	1	CR 51.010-1-1173 r1 Enhanced Measurement	B	5.0.0	5.1.0	GP-023332	GPRS

TSG #	TSG Doc	CR	Rev	Subject/Comment	Cat	Old	New	WG Doc	Work item
				Report, All neighbors present					
GP-12	GP-023386	1174	1	Basic Self Location in Dedicated Mode Test Case for Assisted GPS	F	5.0.0	5.1.0	GP-023386	LCS
GP-12	GP-023387	1175	1	Transfer to 3rd Party Test Case for Assisted GPS	F	5.0.0	5.1.0	GP-023387	LCS
GP-12	GP-023028	1176		CR 51.010-1-1176 Correction of Initial Conditions and Expected Sequence for clause 41.1.5.3 - RR / Paging / on CCCH for GPRS service / paging reorganisation	F	5.0.0	5.1.0	GP-023028	GPRS
GP-12	GP-023029	1177		CR 51.010-1-1177 Alignment of the Expected Sequence for clause 42.1.2.2.4 - Packet Downlink Assignment / Response to Packet Polling	F	5.0.0	5.1.0	GP-023029	GPRS
GP-12	GP-023030	1178		CR 51.010-1-1178 Steps 9 to 24 are made optional for K=1 and the wait indication value for K=2 has been changed for clause 42.3.3.3 - Dynamic Allocation / Resource reallocation / Reject	F	5.0.0	5.1.0	GP-023030	GPRS
GP-12	GP-023031	1179		CR 51.010-1-1179 Correction of Initial Conditions and Expected Sequence for clause 51.1.5.3 - RR / Paging / on CCCH for EGPRS service / paging reorganisation	F	5.0.0	5.1.0	GP-023031	EDGE
GP-12	GP-023032	1180		CR 51.010-1-1180 Updates to allow the new Acces Type 'signalling' in clauses 51.2.2.1; 51.2.2.2 and 51.2.2.3 - Initiation of the packet access procedure	F	5.0.0	5.1.0	GP-023032	EDGE
GP-12	GP-023034	1181		CR 51.010-1-1181 Alignment of the Expected Sequence for clause 52.1.2.2.4 - Packet Downlink Assignment / Response to Packet Polling	F	5.0.0	5.1.0	GP-023034	EDGE
GP-12	GP-023035	1182		CR 51.010-1-1182 Steps 9 to 24 are made optional for K=1 and the wait indication value for K=2 has been changed for clause 52.3.3.3 - Dynamic Allocation / Resource reallocation / Reject	F	5.0.0	5.1.0	GP-023035	EDGE
GP-12	GP-023336	1183	1	CR 51.010-1-1183 r1 Alignment of GERAN#7 CR GP-012786 and correction in Specific Message Content for step 4 in clauses 52.5.5.1, 52.5.5.2 and 52.5.5.3 - Downlink Transfer / Reestablishment	F	5.0.0	5.1.0	GP-023336	EDGE
GP-12	GP-023326	1184	1	CR 51.010-1-1184 r1 Setting pre-emptive bit to 0 in step 3 in clause 53.1.1.10 - Acknowledged Mode/ Uplink TBF/ Pre-emptive Transmission Bit Set to '0'/ PENDING_ACK Blocks	F	5.0.0	5.1.0	GP-023326	EDGE
GP-12	GP-023038	1185		CR 51.010-1-1185 Correction of Conformance Requirement and Expected Sequence for clause 53.1.1.15 - Acknowledged Mode/ Uplink TBF/ Recalculation of CV on MCS change	F	5.0.0	5.1.0	GP-023038	EDGE
GP-12	GP-023039	1186		CR 51.010-1-1186 Change of steps 8 and 10 of the Expected Sequence in clause 53.1.1.17 - Acknowledged Mode / Uplink TBF / Retransmission / Puncturing Scheme Cycle	F	5.0.0	5.1.0	GP-023039	EDGE
GP-12	GP-023327	1187	1	CR 51.010-1-1187 r1 Changing of Window Size in the Expected Sequence in order to avoid expiry of T3182 for clause 53.1.1.4 - Acknowledged Mode/ Uplink TBF/ Window Size/ Assigned Value	F	5.0.0	5.1.0	GP-023327	EDGE
GP-12	GP-023041	1188		CR 51.010-1-1188 Preventing of T3182 expiry in clause 53.1.1.9 - Acknowledged Mode/ Uplink TBF/ Pre-emptive Transmission Bit Set to '1'	F	5.0.0	5.1.0	GP-023041	EDGE
GP-12	GP-023042	1189		CR 51.010-1-1189 Adding an uplink TBF in order to be able to test all the conformance requirements for clauses 53.1.2.3 and 53.1.2.4 - Acknowledged Mode / Downlink TBF / Window Size.	F	5.0.0	5.1.0	GP-023042	EDGE
GP-12	GP-023337	1191	1	New EGPRS test cases for verification of correct Access Type when EGPRS PACKET CHANNEL REQUEST is supported and when it is not supported in the cell. Clauses 52.6 - EGPRS Packet Access for signalling	F	5.0.0	5.1.0	GP-023337	EDGE
GP-12	GP-023048	1194		CR 51.010-1-1194 Section 20.22.2 Cell reselection in Packet Idle mode	F	5.0.0	5.1.0	GP-023048	GPRS
GP-12	GP-023330	1195	1	CR 51.010-1-1195 r1 Section 20.22.9 Cell	F	5.0.0	5.1.0	GP-023330	GPRS

TSG #	TSG Doc	CR	Rev	Subject/Comment	Cat	Old	New	WG Doc	Work item
				reselection when the best cell does not support GPRS					
GP-12	GP-023050	1196		CR 51.010-1-1196 Section 20 Cell selection and reselection	F	5.0.0	5.1.0	GP-023050	GPRS
GP-12	GP-023278	1197	1	CR 51.010-1-1197 r1 Section 50 EGPRS Default Conditions, Message Contents and Macros	F	5.0.0	5.1.0	GP-023278	GPRS
GP-12	GP-023349	1198	1	CR 51.010-1 Section 40.5 Test PDP contexts	F	5.0.0	5.1.0	GP-023349	GPRS
GP-12	GP-023066	1199		Dynamic Allocation / Uplink Transfer / Normal / Starting time	F	5.0.0	5.1.0	GP-023066	GPRS
GP-12	GP-023067	1200		Dynamic Allocation / Uplink Transfer / Normal / Starting time	F	5.0.0	5.1.0	GP-023067	EGPRS
GP-12	GP-023072	1204	-	TC 26.16.9.11 correction of message flow and AMR threshold and hysteresis values	F	5.0.0	5.1.0	GP-023072	AMR
GP-12	GP-023073	1205	-	TC 26.16.9.12 correction of AMR threshold and hysteresis values	F	5.0.0	5.1.0	GP-023073	AMR
GP-12	GP-023083	1207	-	Section 60 Inter-system hard handover from GSM to UTRAN	F	5.0.0	5.1.0	GP-023083	Inter System Handover
GP-12	GP-023391	1208	1	Introduction of UTRAN Classmark Change test cases in section 26.6.11	F	5.0.0	5.1.0	GP-023391	TEI
GP-12	GP-023276	1210	1	CR 51.010-1-1210 r1 42.1.2.2.6 new testcase added and testcase 42.1.2.1.8.2.3 deleted	F	5.0.0	5.1.0	GP-023276	GPRS
GP-12	GP-023416	1211	2	CR 51.010-1-1211 r2 Extended Uplink TBF Mode (New Test Cases)	F	5.0.0	5.1.0	GP-023416	GPRS
GP-12	GP-023143	1212	-	EOTD MOLR Autonomous Location	F	5.0.0	5.1.0	GP-023143	LCS
GP-12	GP-023389	1213	1	EOTD MOLR Positioning Measurement	F	5.0.0	5.1.0	GP-023389	LCS
GP-12	GP-023329	1214	1	CR 51.010-1-1214 r1 Correction to test cases 42.3.1.2.2 and 42.3.1.2.3	F	5.0.0	5.1.0	GP-023329	GPRS
GP-12	GP-023339	1216	1	CR 51.010-1-1216 r1 TC 52.3.1.1.4 Use of Packet Uplink Assignment instead of Packet Timeslot reconfigure	F	5.0.0	5.1.0	GP-023339	EDGE
GP-12	GP-023328	1217	1	CR 51.010-1-1217 r1 TC 53.1.1.14 Addition of optional steps to cater to MS reaction time	F	5.0.0	5.1.0	GP-023328	EDGE
GP-12	GP-023157	1218		CR 51.010-1-1218 TC 51.1.4.2 Modification to test steps 5, 6 and 7 to align with test purpose	F	5.0.0	5.1.0	GP-023157	EDGE
GP-12	GP-023350	1219	1	GPRS attach / rejected / GPRS services not allowed in this PLMN	F	5.0.0	5.1.0	GP-023350	GPRS
GP-12	GP-023351	1220	1	GPRS detach / rejected / GPRS services not allowed in this PLMN	F	5.0.0	5.1.0	GP-023351	GPRS
GP-12	GP-023173	1221		CR 51.010-1-1221 Section 20.22 GPRS Cell Selection and Reselection	F	5.0.0	5.1.0	GP-023173	GPRS
GP-12	GP-023174	1222		CR 51.010-1-1222 Section 14.16.1 Minimum Input level for Reference Performance	F	5.0.0	5.1.0	GP-023174	GPRS
GP-12	GP-023383	1223	2	44.2.3.2.5 Combined routing area updating/rejected/roaming not allowed in this location area	F	5.0.0	5.1.0	GP-023383	GPRS
GP-12	GP-023187	1225		CR 51.010-1-1225 Removal of redundant EGPRS USF-sensitivity tests	F	5.0.0	5.1.0	GP-023187	EDGE
GP-12	GP-023188	1226		CR 51.010-1-1226 Clarification on test procedure for GPRS USF-sensitivity	F	5.0.0	5.1.0	GP-023188	GPRS
GP-12	GP-023189	1227		CR 51.010-1-1227 Addition of missing parameters for DL Power Control and clarification on the test requirement in 14.18.1	F	5.0.0	5.1.0	GP-023189	EDGE
GP-12	GP-023333	1228	1	CR 51.010-1-1228 r1 Clarification on required power level in 13.16.3, step b)	F	5.0.0	5.1.0	GP-023333	GPRS
GP-12	GP-023191	1229		CR 51.010-1-1229 Clarification on required power level in 13.17.4, step b)	F	5.0.0	5.1.0	GP-023191	EDGE
GP-12	GP-023192	1230		CR 51.010-1-1230 Editorial correction on default input level in sect.40	F	5.0.0	5.1.0	GP-023192	TEI-5
GP-12	GP-023203	1231	-	Removal of DTM from the list of missing tests.	F	5.0.0	5.1.0	GP-023203	DTM
GP-12	GP-023204	1232	-	Addition of PACKET TIMESLOT RECONFIGURE message to Section 40	F	5.0.0	5.1.0	GP-023204	DTM
GP-12	GP-023384	1233	1	CR 51.010-1 Section 40: Wrong HCS PRIORITY CLASS value for the near cell in PSI 3 and 3bis messages.	F	5.0.0	5.1.0	GP-023384	GPRS
GP-12	GP-023176	1234	-	44.2.3.2.4 Combined routing area updating / rejected / PLMN not allowed	F	5.0.0	5.1.0	GP-023176	GPRS
GP-12	GP-023233	1235		CR 51.010-1-1235 Changing the wait time in steps 5, 10 and 15 of the Expected Sequence for clause 51.1.1.4 - RR / Paging / on PCCCH for EGPRS service / paging reorganisation successful	F	5.0.0	5.1.0	GP-023233	EDGE
GP-12	GP-023234	1236		CR 51.010-1-1236 Changing the wait time in	F	5.0.0	5.1.0	GP-023234	GPRS

TSG #	TSG Doc	CR	Rev	Subject/Comment	Cat	Old	New	WG Doc	Work item
				steps 5, 10 and 15 of the Expected Sequence for clause 41.1.1.4 - RR / Paging / on PCCCH for GPRS service / paging reorganisation successful					
GP-12	GP-023221	1237	-	Inter-SGSN RAU Macro	F	5.0.0	5.1.0	GP-023221	GPRS
GP-13	GP-030364	1238	1	Correction in EOTD Test Case 70.2.1	F	5.1.0	5.2.0	GP-030364	LCS
GP-13	GP-030365	1239	1	Correction in EOTD Test Case 70.2.3	F	5.1.0	5.2.0	GP-030365	LCS
GP-13	GP-030366	1240	1	Correction in EOTD Test Case 70.2.4	F	5.1.0	5.2.0	GP-030366	LCS
GP-13	GP-030013	1241		CR to TS51.010-1-1241 BS_CV_MAX value, as specified in section 50, are used instead for the EGPRS RLC tests in clause 53.x - Test of EGPRS Radio Link Control (RLC) Protocol.	F	5.1.0	5.2.0	GP-030013	EDGE
GP-13	GP-030014	1242	-	Applicability change of clause "30 Speech teleservices" test cases.	F	5.1.0	5.2.0	GP-030014	TEI
GP-13	GP-030016	1243	-	CR 44.2.3.2.5 Combined routing area updating / rejected / roaming not allowed in this location area	F	5.1.0	5.2.0	GP-030016	GPRS
GP-13	GP-030017	1244		CR 51.010-1-1244 41.2.2.45 - Initiation of the packet access procedure / timer T3146	F	5.1.0	5.2.0	GP-030017	GPRS
GP-13	GP-030018	1245		CR 51.010-1-1245 42.1.2.1.10.1 - Clarification of conformance requirements, and consequent alterations to test procedure.	F	5.1.0	5.2.0	GP-030018	GPRS
GP-13	GP-030342	1246		CR 51.010-1-1246 42.1.2.2.3 - Conflict between Specific Message Contents in Test Case and section 40 defaults	F	5.1.0	5.2.0	GP-030342	GPRS
GP-13	GP-030021	1248		CR 51.010-1-1248 51.2.2.4 - Initiation of the packet access procedure / timer T3146	F	5.1.0	5.2.0	GP-030021	GPRS
GP-13	GP-030023	1250		CR 51.010-1-1250 53.1.1.16 - Deletion of redundant steps and correction of step references	F	5.1.0	5.2.0	GP-030023	EDGE
GP-13	GP-030024	1251		CR 51.010-1-1251 42.3.3.1.1 - Test Step added, BS_CV_MAX set to 1	F	5.1.0	5.2.0	GP-030024	GPRS
GP-13	GP-030025	1252		CR 51.010-1-1252 53.1.1.20 - Core spec references corrected	F	5.1.0	5.2.0	GP-030025	EDGE
GP-13	GP-030027	1254		CR 51.010-1-1254 53.1.1.21 - Sequence corrected to allow for all types of MCS switching, core spec references corrected	F	5.1.0	5.2.0	GP-030027	EDGE
GP-13	GP-030343	1255	1	CR 51.010-1-1255 r1 42.3.1.1.9 - Multiple corrections to initial conditions, expected sequence and specific message contents	F	5.1.0	5.2.0	GP-030343	GPRS
GP-13	GP-030354	1256	1	46.1.2.5.2 - Correction of test procedure	F	5.1.0	5.2.0	GP-030354	GPRS
GP-13	GP-030030	1257	-	46.1.2.6.1 - Correction of PDP Context activation in step 5	F	5.1.0	5.2.0	GP-030030	GPRS
GP-13	GP-030031	1258		CR 51.010-1-1258 52.3.3.1.1 - Test Step added, BS_CV_MAX set to 1	F	5.1.0	5.2.0	GP-030031	EGDE
GP-13	GP-030357	1259	1	Release of RR connection added in TC 44.2.2.2.6;	F	5.1.0	5.2.0	GP-030357	GPRS
GP-13	GP-030033	1260	-	CR 51.010-1-1260 Release of RR connection is needed in TC 44.2.1.1.10;	F	5.1.0	5.2.0	GP-030033	GPRS
GP-13	GP-030385	1262	1	CR 51.010-1-1262 r1 Testcase 52.1.2.1.6 needs to be done in transfer mode	B	5.1.0	5.2.0	GP-030385	EDGE
GP-13	GP-030037	1264		CR 51.010-1-1-1264 Addition of new testcases section 42.7	B	5.1.0	5.2.0	GP-030037	GPRS
GP-13	GP-030039	1266		CR 51.010-1-1266 Addition of new testcases section 52.8	B	5.1.0	5.2.0	GP-030039	EDGE
GP-13	GP-030331	1267	1	CR 51.010-1-1267 r1 Enhanced Measurement Report, All neighbors present (400, 700 and 850 MHz)	B	5.1.0	5.2.0	GP-030331	GPRS
GP-13	GP-030044	1268		CR to TS51.010-1-1268 Addition of an Optional and a Conditional step in the Expected Sequence in clause 41.3.1.1 - TBF Release / Uplink / Normal / MS initiated / Acknowledged mode	F	5.1.0	5.2.0	GP-030044	GPRS
GP-13	GP-030333	1270	1	CR 51.010-1-1270 r1 Introduction of AMR-NB Layer 1 In Band Signaling Tests	B	5.1.0	5.2.0	GP-030333	AMR-NB
GP-13	GP-030452	1272	1	CR 51.010-1-1272 Introduction of an AMR-NB Layer 1 Test to verify the CMR Generation performances	B	5.1.0	5.2.0	GP-030452	AMR-NB
GP-13	GP-030051	1274		CR 51.010-1-1274 52.1.2.1.10.1 Clarification of conformance requirements, and consequent alterations to test procedure.	F	5.1.0	5.2.0	GP-030051	EDGE
GP-13	GP-030052	1275		CR 51.010-1-1275 42.1.3.1.2 Macro definition fails to allow for PACKET UPLINK DUMMY	F	5.1.0	5.2.0	GP-030052	GPRS

TSG #	TSG Doc	CR	Rev	Subject/Comment	Cat	Old	New	WG Doc	Work item
				CONTROL BLOCK					
GP-13	GP-030053	1276		CR 51.010-1-1276 52.1.3.1.2 Macro definition fails to allow for PACKET UPLINK DUMMY CONTROL BLOCK	F	5.1.0	5.2.0	GP-030053	GPRS
GP-13	GP-030054	1277		CR 51.010-1-1277 42.3.1.2.3 Mandatory use of two-phase packet access in RLC unacknowledged mode.	F	5.1.0	5.2.0	GP-030054	GPRS
GP-13	GP-030055	1278		CR 51.010-1-1278 52.3.1.2.3 Mandatory use of two-phase packet access in RLC unacknowledged mode.	F	5.1.0	5.2.0	GP-030055	GPRS
GP-13	GP-030103	1281	-	51.010-1 Section 34 - Corrections to SMS test case 34.2.9 Multiple SMS mobile originated	F	5.1.0	5.2.0	GP-030103	GPRS
GP-13	GP-030104	1282	-	51.010-1 Section 44 - Corrections to GMM test case 44.2.3.2.5 Combined routing area updating/rejected/roaming not allowed in this location area	F	5.1.0	5.2.0	GP-030104	GPRS
GP-13	GP-030105	1283	-	Correction in EOTD Test Case 70.2.2	F	5.1.0	5.2.0	GP-030105	LCS
GP-13	GP-030367	1284	1	Correction in EOTD Test Case 70.3.1.2	F	5.1.0	5.2.0	GP-030367	LCS
GP-13	GP-030107	1285		CR 51.010-1-1285 Correction of step 16 of Expected Sequence for clause 51.1.1.4 - RR / Paging / on PCCCH for EGPRS service / paging reorganisation successful.	F	5.1.0	5.2.0	GP-030107	EDGE
GP-13	GP-030108	1286		CR 51.010-1-1286 Correction on reaction times for RLC Data Blocks for clauses 53.1.1.14 and 53.1.1.17 - Acknowledged Mode / Uplink TBF.	F	5.1.0	5.2.0	GP-030108	EDGE
GP-13	GP-030109	1287		CR 51.010-1-1287 Correction of step 16 of Expected Sequence for clause 41.1.1.4 - RR / Paging / on PCCCH for GPRS service / paging reorganisation successful.	F	5.1.0	5.2.0	GP-030109	GPRS
GP-13	GP-030120	1288		CR 51.010-1-1288 Correction to testcase 43.2.1	B	5.1.0	5.2.0	GP-030120	GPRS
GP-13	GP-030121	1289		CR 51.010-1-1289 Correction of test case 12.1.2 in TS 51.010-1	F	5.1.0	5.2.0	GP-030121	R1
GP-13	GP-030122	1290		CR 51.010-1-1290 EGPRS specific additions to Sec 50	F	5.1.0	5.2.0	GP-030122	EDGE
GP-13	GP-030123	1291		CR 51.010-1-1291 Sec: 52.4 - Addition of allocation of resources for UL data transfer	F	5.1.0	5.2.0	GP-030123	EDGE
GP-13	GP-030124	1292		CR 51.010-1-1292 Sec: 51.3 - Addition of allocation of resources for UL data transfer	F	5.1.0	5.2.0	GP-030124	EDGE
GP-13	GP-030125	1293		CR 51.010-1-1293 Sec 53.1.1.3 - Modification to the usage of Packet Timeslot Reconfigure and window size Unimplementable (latest version not used)	F	5.1.0	5.2.0	GP-030125	EDGE
GP-13	GP-030126	1294		CR 51.010-1-1294 Sec 51.3.1.2 - MS will not re-initiate Packet Access in Step 20.	F	5.1.0	5.2.0	GP-030126	EDGE
GP-13	GP-030127	1295		CR 51.010-1-1295 Sec 52.5.5.2 - Testcase requires only One Cell	F	5.1.0	5.2.0	GP-030127	EDGE
GP-13	GP-030128	1296		CR 51.010-1-1296 Sec 51.2.3.10 - PTCCH Access Bursts content should be 11-bit	F	5.1.0	5.2.0	GP-030128	EDGE
GP-13	GP-030129	1297		CR 51.010-1-1297 Sec 53.1.1.5 - Addition of optional steps to cater to MS reaction time and correction of BSN expected.	F	5.1.0	5.2.0	GP-030129	EDGE
GP-13	GP-030130	1298		CR 51.010-1-1298 Sec 52.3.1.1.4 - Packet Uplink Ack Nack shall not be sent on the activated PDCH in Step 30.	F	5.1.0	5.2.0	GP-030130	Edge
GP-13	GP-030131	1299		CR 51.010-1-1299 Sec 51.2.2.1 - The Activation of PDP Context need to be done only once.	F	5.1.0	5.2.0	GP-030131	EDGE
GP-13	GP-030132	1300		CR 51.010-1-1300 Sec 53.1.2.18 - New testcase - Acknowledged Mode/ Downlink TBF/ Retransmission/ Padding	B	5.1.0	5.2.0	GP-030132	EDGE
GP-13	GP-030133	1301		CR 51.010-1-1301 Sec 52.3.3.1.2 - Correction to the PDP contexts activated in expected sequence.	F	5.1.0	5.2.0	GP-030133	EDGE
GP-13	GP-030134	1302		CR 51.010-1-1302 Sec 51.2.2.3 - Request reference value check should cater for Egprs Packet Channel Request also.	F	5.1.0	5.2.0	GP-030134	EDGE
GP-13	GP-030135	1303		CR 51.010-1-1303 Sec 53.1.2.3 and 53.1.2.4 - Polling for Egprs Downlink Ack/Nack shall be done before step 5.	F	5.1.0	5.2.0	GP-030135	EDGE
GP-13	GP-030136	1304		CR 51.010-1-1304 Sec 53.1.1.11 - SS shall acknowledge all data blocks before Step 11.	F	5.1.0	5.2.0	GP-030136	EDGE
GP-13	GP-030332	1305	1	CR 51.010-1-1305 r1 Section 20.22.* Clarification of the tables for GPRS cell selection	F	5.1.0	5.2.0	GP-030332	GPRS

TSG #	TSG Doc	CR	Rev	Subject/Comment	Cat	Old	New	WG Doc	Work item
GP-13	GP-030301	1306	1	CR 51.010-1-1306 r1 Section 20.22.1 GPRS Cell selection and reselection - default paging on PCH	F	5.1.0	5.2.0	GP-030301	GPRS
GP-13	GP-030362	1307	1	Section 40 Introduction of R99 to GPRS default conditions	F	5.1.0	5.2.0	GP-030362	GPRS
GP-13	GP-030140	1308		CR 51.010-1-1308 Annex A7 New annex General rules for statistical testing	F	5.1.0	5.2.0	GP-030140	AMR
GP-13	GP-030141	1309		CR 51.010-1-1309 Section 14.1.5 Bad frame indication - TCH/AFS (Speech frame) - Introduction of statistical testing	F	5.1.0	5.2.0	GP-030141	AMR
GP-13	GP-030142	1310		CR 51.010-1-1310 Section 14.1.6 Bad frame indication - TCH/AHS - Introduction of statistical testing Unimplmentable (Section deleted in 5.1.0)	F	5.1.0	5.2.0	GP-030142	AMR
GP-13	GP-030143	1311		CR 51.010-1-1311 Section 14.2.10 Reference sensitivity - TCH/AFS - Introduction of statistical testing	F	5.1.0	5.2.0	GP-030143	AMR
GP-13	GP-030144	1312		CR 51.010-1-1312 Section 14.2.18 Reference sensitivity - TCH/AHS - Introduction of statistical testing	F	5.1.0	5.2.0	GP-030144	AMR
GP-13	GP-030145	1313		CR 51.010-1-1313 Section 14.4.8 Co-channel rejection - TCH/AFS - Introduction of statistical testing	F	5.1.0	5.2.0	GP-030145	AMR
GP-13	GP-030146	1314		CR 51.010-1-1314 Section 14.4.16 Co-channel rejection - TCH/AHS - Introduction of statistical testing	F	5.1.0	5.2.0	GP-030146	AMR
GP-13	GP-030147	1315		CR 51.010-1-1315 Section 14.5.1.2 Adjacent channel rejection - TCH/AFS - Introduction of statistical testing	F	5.1.0	5.2.0	GP-030147	AMR
GP-13	GP-030148	1316		CR 51.010-1-1316 Section 14.5.1.3 Adjacent channel rejection - TCH/AHS - Introduction of statistical testing	F	5.1.0	5.2.0	GP-030148	AMR
GP-13	GP-030153	1317		CR 51.010-1-1317 52.3.1.2.2, 52.3.1.2.3 Correction to test cases 52.3.1.2.2 and 52.3.1.2.3	F	5.1.0	5.2.0	GP-030153	EDGE
GP-13	GP-030154	1318		CR 51.010-1-1318 Sec: 42.4 - Addition of allocation of resources for UL data transfer	F	5.1.0	5.2.0	GP-030154	GPRS
GP-13	GP-030155	1319		CR 51.010-1-1319 Sec 41.3 - Addition of allocation of CR 51.010-1-1317 resources for UL data transfer	F	5.1.0	5.2.0	GP-030155	GPRS
GP-13	GP-030156	1320		CR 51.010-1-1320 Sec 41.3.1.2 - MS will not re-initiate Packet Access in Step 20	F	5.1.0	5.2.0	GP-030156	GPRS
GP-13	GP-030162	1323		CR 51.010-1-1323 Sec 42.3.1.1.4 - Packet Uplink Ack Nack shall not be sent on the activated PDCH in Step 30	F	5.1.0	5.2.0	GP-030162	GPRS
GP-13	GP-030163	1324		CR 51.010-1-1324 Sec 42.3.3.1.2 - Correction to the PDP contexts activated in expected sequence	F	5.1.0	5.2.0	GP-030163	GPRS
GP-13	GP-030164	1325	-	Removal of Authentication and Ciphering from LCS Emergency Call Tests	F	5.1.0	5.2.0	GP-030164	LCS
GP-13	GP-030165	1326	-	Alignment of Test References to Conformance Requirements for LCS MO-LR Tests	F	5.1.0	5.2.0	GP-030165	LCS
GP-13	GP-030166	1327	-	MO-LR Positioning Measurement for Assisted GPS	F	5.1.0	5.2.0	GP-030166	LCS
GP-13	GP-030173	1328		CR 51.010-1-1328 Section 15.6 GPRS Timing advance and absolute delay	F	5.1.0	5.2.0	GP-030173	GPRS
GP-13	GP-030174	1329		CR 51.010-1-1329 Section 20.22.2 Clarification of Test Procedure and Paging Requirements	F	5.1.0	5.2.0	GP-030174	GPRS
GP-13	GP-030386	1330	1	CR 51.010-1-1330 r1 Section 20.22.3 Clarification of Test Procedure and Paging Requirements	F	5.1.0	5.2.0	GP-030386	GPRS
GP-13	GP-030391	1331	1	CR 51.010-1-1331 r1 Section 20.22.4 Clarification of Test Procedure and Paging Requirements	F	5.1.0	5.2.0	GP-030391	GPRS
GP-13	GP-030387	1333		CR 51.010-1-1333 Section 20.22.9 Clarification of Test Procedure and Paging Requirements	F	5.1.0	5.2.0	GP-030387	GPRS
GP-13	GP-030179	1334	-	CR 51.010-1 Section 50 Adaptions due to introduction of R99 to section 40	F	5.1.0	5.2.0	GP-030179	GPRS
GP-13	GP-030275	1335		CR 51.010-1-1335 Correction to Fixed Allocation Test Cases 42.2.2.10.1, 42.2.2.10.2 and 42.2.2.10.3	F	5.1.0	5.2.0	GP-030275	GPRS
GP-13	GP-030431	1336	4	CR 51.010-1-1336 r4 Addition of test case 42.4.2.3.3 in TS 51.010-1: Packet Measurement	B	5.1.0	5.2.0	GP-030431	GPRS (S42)

TSG #	TSG Doc	CR	Rev	Subject/Comment	Cat	Old	New	WG Doc	Work item
				Order Reset					
GP-14	GP-030946	1337	5	Addition of test case in TS 51.010 S42: Uplink reallocation, Packet Uplink Assignment containing a new Coding Scheme command	F	5.2.1	5.3.0	GP-030946	GPRS
GP-13	GP-030299	1338	-	Correction of Specific message content for RELEASE COMPLETE in step 6 of Expected Sequence for clause 31.8.7 - Call restriction supplementary services / Normal operation.	F	5.1.0	5.2.0	GP-030299	TEI
GP-13	GP-030340	1340		CR 51.010-1-1340 Sec 42.5.5.3 - Change in timing	B	5.1.0	5.2.0	GP-030340	GPRS
GP-13	GP-030341	1341		CR 51.010-1-1341 Sec 52.5.5.3 - Change in timing	B	5.1.0	5.2.0	GP-030341	EDGE
GP-13		1343		Reintroduction of clauses 26.6.11.3 and 26.6.11.4 after CR implementation error	D	5.2.0	5.2.1		
GP-14	GP-030485	1344	-	Undo of the approved GERAN#12 changes for clause 51.2.5.1 - Packet access rejection / wait indication.	F	5.2.1	5.3.0	GP-030485	EDGE
GP-14	GP-030486	1345	-	Correction of Expected Sequence and Specific Message Content for clause 52.4.1.2 - Network Control measurement reporting / Idle mode / New cell reselection	F	5.2.1	5.3.0	GP-030486	EDGE
GP-14	GP-030487	1346	-	Deletion of clause 52.4.2.1.5 - Cell change order procedure / Uplink transfer / Failure cases / REJECT from the new cell and T3176 expiry	F	5.2.1	5.3.0	GP-030487	EDGE
GP-14	GP-030489	1348	-	Preventing of T3182 expiry in clause 53.1.1.9 - Acknowledged Mode/ Uplink TBF/ Pre-emptive Transmission Bit Set to '1'	F	5.2.1	5.3.0	GP-030489	EDGE
GP-14	GP-030490	1349	-	Addition of Macro for downlink TBF establishment using ACCESS TYPE = "signalling" for section 53.2.2.	F	5.2.1	5.3.0	GP-030490	EDGE
GP-14	GP-030491	1350	-	Corrections on PACKET UPLINK ACK/NACK transmission timing and removal of T3198 in clause 53.1.1.x - Acknowledged Mode/ Uplink TBF	F	5.2.1	5.3.0	GP-030491	EDGE
GP-14	GP-030956	1352	1	Correct of NC_REPORTING_PERIOD_I value in step 2 of clause 41.2.7.2 - Single block packet downlink assignment / MS returns to packet idle mode.	F	5.2.1	5.3.0	GP-030956	GPRS
GP-14	GP-030494	1353	-	Correction of Expected Sequence and Specific Message Content for clause 42.4.1.2 - Network Control measurement reporting / Idle mode / New cell reselection.	F	5.2.1	5.3.0	GP-030494	GPRS
GP-14	GP-030495	1354	-	Deletion of clause 42.4.2.1.5 - Cell change order procedure / Uplink transfer / Failure cases / REJECT from the new cell and T3176 expiry	F	5.2.1	5.3.0	GP-030495	GPRS
GP-14	GP-030969	1356	1	Correction of step 5 of Expected Sequence for clause 44.2.3.1.7 - Routing area updating / abnormal cases / change of cell during routing area updating procedure.	F	5.2.1	5.3.0	GP-030969	GPRS
GP-14	GP-030498	1357	-	R99 compliance update of clause 44.2.3.2.5 Test Procedure 2 - Combined routing area updating / rejected / roaming not allowed in this location area.	F	5.2.1	5.3.0	GP-030498	GPRS
GP-14	GP-030501	1358	-	Correction of Test Procedure and Expected Sequence for clause 52.1.2.1.10.2 - Packet Uplink Assignment / Abnormal cases / Expiry of timer T3164.	F	5.2.1	5.3.0	GP-030501	EDGE
GP-14	GP-030502	1359	-	Correction of Test Procedure and Expected Sequence for clause 42.1.2.1.10.2 - Packet Uplink Assignment / Abnormal cases / Expiry of timer T3164.	F	5.2.1	5.3.0	GP-030502	GPRS
GP-15	GP-031137	1360	1	CR 51.010-1-1360 rev1 Dynamic Allocation / Uplink Transfer / Abnormal / with cell reselection in unacknowledged mode	F	5.3.0	5.4.0	GP-031137	GPRS
GP-14	GP-030522	1361	-	TC 42.2.2.8.1 Fixed Allocation / Uplink Transfer / MS requests new resources/ Failure/Packet Access Reject	F	5.2.1	5.3.0	GP-030522	GPRS
GP-14	GP-030523	1362	-	42.2.2.8.2 Fixed Allocation / Uplink Transfer / MS requests new resources/ Failure/Packet Access Reject with WAIT_INDICATION during allocation in progress	F	5.2.1	5.3.0	GP-030523	GPRS
GP-15	GP-031138	1363	1	CR 51.010-1-1363 rev1 52.3.1.2.3 Dynamic Allocation / Uplink Transfer / Abnormal / with cell	F	5.3.0	5.4.0	GP-031138	EDGE(EGPRS)

TSG #	TSG Doc	CR	Rev	Subject/Comment	Cat	Old	New	WG Doc	Work item
				reselection in unacknowledged mode					
GP-14	GP-030527	1364	-	44.2.5.2.3 – Correction of P-TMSI	F	5.2.1	5.3.0	GP-030527	GPRS
GP-14	GP-031002	1365	1	51.3.1.3 - Step 13 is incorrect if optional step A12 is executed	F	5.2.1	5.3.0	GP-031002	EGPRS
GP-14	GP-031000	1366	2	42.3.1.1.4 – Allow one Uplink Data Block coded with CS-1 after step 37	F	5.2.1	5.3.0	GP-031000	GPRS
GP-14	GP-030960	1367	1	52.3.1.1.4 – Allow one Uplink Data Block coded with MCS 1 after step 37	F	5.2.1	5.3.0	GP-030960	EGPRS
GP-14	GP-030957	1369	1	40.2.1.1.1 – Missing BandIndicator in SI1 default	F	5.2.1	5.3.0	GP-030957	GPRS
GP-14	GP-030536	1370	-	53.1.2.7 – Correct handling of ES/Pfield, remove unnecessary constraint	F	5.2.1	5.3.0	GP-030536	EGPRS
GP-14	GP-030538	1373	-	44.2.1.1.10 - Corrections to step numbering in Expected Sequence	F	5.2.1	5.3.0	GP-030538	GPRS
GP-14	GP-031001	1374	1	42.3.1.1.9 Correction of Cell Allocation in the first set of Packet System Information Type 2 message	F	5.2.1	5.3.0	GP-031001	GPRS
GP-14	GP-030540	1375	-	40.2.4.14.2, 40.2.4.14.3 – Illegal values of Gamma in default messages	F	5.2.1	5.3.0	GP-030540	GPRS
GP-14	GP-030541	1376	-	50.2.4.3 – Illegal values of gamma in default messages.	F	5.2.1	5.3.0	GP-030541	EGPRS
GP-14	GP-031003	1377	1	Correction to check in step 7A of expected sequence to 42.3.3.1.2	F	5.2.1	5.3.0	GP-031003	GPRS
GP-14	GP-030543	1378	-	Addition of steps to Expected Sequence of 42.3.3.2.2 to meet the conformance requirements.	F	5.2.1	5.3.0	GP-030543	GPRS
GP-14	GP-030544	1379	-	51.2.3.2 Two message assignment / Failure case	F	5.2.1	5.3.0	GP-030544	EGPRS
GP-14	GP-030546	1381	-	Test case 52.1.2.1.3.1 to be done in transfer mode.	F	5.2.1	5.3.0	GP-030546	EGPRS
GP-14	GP-030547	1382	-	Correction to Expected Sequence of 52.1.2.1.9.5	F	5.2.1	5.3.0	GP-030547	EGPRS
GP-14	GP-030548	1383	-	Correction to Expected Sequence of test case 52.3.1.1.6	F	5.2.1	5.3.0	GP-030548	EGPRS
GP-14	GP-030549	1384	-	Correction to test PDP context number in initial condition and check in expected sequence to 52.3.3.1.2	F	5.2.1	5.3.0	GP-030549	EGPRS
GP-14	GP-030550	1385	-	Correction to Expected Sequence of test case 52.3.3.2.2	F	5.2.1	5.3.0	GP-030550	EGPRS
GP-14	GP-030551	1386	-	Correction to Expected Sequence of test case 52.3.3.3	F	5.2.1	5.3.0	GP-030551	EGPRS
GP-14	GP-030553	1388	-	Link Quality Measurement Mode being removed from Immediate Assignment message, uplink construction.	F	5.2.1	5.3.0	GP-030553	EGPRS
GP-14	GP-030554	1389	-	42.1.2.1.10.2 Packet Uplink Assignment / Abnormal cases / Expiry of timer T3164	F	5.2.1	5.3.0	GP-030554	GPRS
GP-14	GP-030555	1390	-	42.1.2.1.9.2.1 Packet Uplink Assignment / Two phase access / Contention resolution / Expiry of timer T3168	F	5.2.1	5.3.0	GP-030555	GPRS
GP-14	GP-030556	1391	-	52.1.2.1.10.2 Packet Uplink Assignment / Abnormal cases / Expiry of timer T3164	F	5.2.1	5.3.0	GP-030556	EDGE
GP-14	GP-030557	1392	-	52.1.2.1.9.2.1 Packet Uplink Assignment / Two phase access / Contention resolution / Expiry of timer T3168	F	5.2.1	5.3.0	GP-030557	EDGE
GP-14	GP-030558	1393	-	53.1.1.12 Acknowledged Mode/ Uplink TBF/ Retransmission/ Split RLC Data Block	F	5.2.1	5.3.0	GP-030558	EDGE
GP-14	GP-030559	1394	-	45.5.1 Change in Step 24: LLC SAPI value must be a reserved value	F	5.2.1	5.3.0	GP-030559	GPRS
GP-14	GP-030560	1395	-	Numbering mistake in 46.1.2.3.1 Collision of SABM	F	5.2.1	5.3.0	GP-030560	GPRS
GP-14	GP-030890	1401	1	Signal Quality Tests for AMR	F	5.2.1	5.3.0	GP-030890	AMR-NB
GP-14	GP-030958	1402	1	CR 51.010-1 Update of testcases of section 52.1 to handle Mobiles using EPCR for signalling procedure	F	5.2.1	5.3.0	GP-030958	EDGE
GP-14	GP-030574	1403	-	Testcase 45.2.1.1 Attach initiated by context activation/QoS Offered by Network is the QoS Requested	F	5.2.1	5.3.0	GP-030574	GPRS
GP-14	GP-030576	1405	-	New testcase added: 45.2.4.3 Network initiated PDP context activation request for an already activated PDP context (on the MS side)	B	5.2.1	5.3.0	GP-030576	GPRS
GP-14	GP-031043	1406	1	CR 51.010-1 New testcase added: 45.4.4 PDP context deactivation initiated by the network / Tear down indicator.	B	5.2.1	5.3.0	GP-031043	GPRS
GP-14	GP-030578	1407	-	New section added: 45.2.5 Secondary PDP context activation procedures	B	5.2.1	5.3.0	GP-030578	GPRS

TSG #	TSG Doc	CR	Rev	Subject/Comment	Cat	Old	New	WG Doc	Work item
GP-14	GP-030579	1408	-	New section added: 45.3.2 MS initiated PDP context modification	B	5.2.1	5.3.0	GP-030579	GPRS
GP-14	GP-030995	1409	1	CR 51.010-1 New section added: 34.4 Short message service point to point over GPRS.	B	5.2.1	5.3.0	GP-030995	GPRS
GP-14	GP-030581	1410	-	46.1.1. Default Conditions	F	5.2.1	5.3.0	GP-030581	GPRS
GP-14	GP-030582	1411	-	Sec: 42.4 - Addition of allocation of resource to send Packet Cell Change Failure	F	5.2.1	5.3.0	GP-030582	GPRS
GP-14	GP-031012	1412	2	Sec: 52.4 - Addition of allocation of resource to send Packet Cell Change Failure	F	5.2.1	5.3.0	GP-031012	EDGE
GP-14	GP-031005	1414	2	Sec 51.2.3.8 - Correction to number of Packet Access initiation attempts	F	5.2.1	5.3.0	GP-031005	EDGE
GP-14	GP-030586	1415	-	Sec 51.3.1.1 - Introduction of Wait before sending Packet Uplink Ack/Nack	F	5.2.1	5.3.0	GP-030586	EDGE
GP-14	GP-030587	1416	-	Sec 51.3.1.2 - Correction to multislot classes checked.	F	5.2.1	5.3.0	GP-030587	EDGE
GP-14	GP-030588	1417	-	Sec 51.x and 52.x - Addition of check for EGPRS Packet Channel Request with Access Type 'Signalling'	F	5.2.1	5.3.0	GP-030588	EDGE
GP-14	GP-031007	1418	2	Sec 52.4.4.2 - Attach procedure need to be completed before sending Packet Measurement order.	F	5.2.1	5.3.0	GP-031007	EDGE
GP-14	GP-030590	1419	-	Sec 53.1.1.2 – Correction to BSN check in Step A12	F	5.2.1	5.3.0	GP-030590	EDGE
GP-14	GP-030591	1420	-	Sec 53.1.1.3 - Modification to the usage of Packet Timeslot Reconfigure and window size	F	5.2.1	5.3.0	GP-030591	EDGE
GP-14	GP-030592	1421	-	Sec 53.1.1.4 – Correction to verification of BSN sequence in Step 7	F	5.2.1	5.3.0	GP-030592	EDGE
GP-14	GP-030593	1422	-	Sec 53.1.2.12 – Correction to repetitio sequence in Step 4.	F	5.2.1	5.3.0	GP-030593	EDGE
GP-14	GP-030594	1423	-	Correction to CV calculation	F	5.2.1	5.3.0	GP-030594	EDGE
GP-14	GP-031008	1424	2	Sec 52.8.1.x – Addition of new testcases	B	5.2.1	5.3.0	GP-031008	EGPRS
GP-14	GP-031009	1425	2	Sec 52.1.2.1.8.x – Addition of new testcases	B	5.2.1	5.3.0	GP-031009	EGPRS
GP-14	GP-031004	1426	2	Sec 42.1.2.1.8.x – Addition of new testcases	B	5.2.1	5.3.0	GP-031004	EGPRS
GP-14	GP-030598	1427	-	Sec 51.2.5 – Addition of new testcases to cover Immediate Assignment Reject scenarios.	B	5.2.1	5.3.0	GP-030598	EGPRS
GP-14	GP-030599	1428	-	New Testcase 53.1.1.24 - Acknowledged Mode/ Uplink TBF/ Interpretation of PBSN	B	5.2.1	5.3.0	GP-030599	EGPRS
GP-14	GP-030601	1430	-	Section 42.1.2.1.5 Incorrect step reference in step 10	F	5.2.1	5.3.0	GP-030601	GPRS
GP-14	GP-030602	1431	-	Section 42.1.2.1.8.2.2 Inconsistency in expected sequence for two phase access	F	5.2.1	5.3.0	GP-030602	GPRS
GP-14	GP-030603	1432	-	Section 42.1.2.2.6 Incorrect initial conditions and PICS reference	F	5.2.1	5.3.0	GP-030603	GPRS
GP-14	GP-030604	1433	-	Section 42.3.1.1.6 Uplink TFI missing in specific message contents	F	5.2.1	5.3.0	GP-030604	GPRS
GP-14	GP-030605	1434	-	Section 52.1.2.1.5 Incorrect step reference in step 10	F	5.2.1	5.3.0	GP-030605	EGPRS
GP-14	GP-030606	1435	-	51.010-1 Section 52.3.1.1.6 Uplink TFI missing in specific message contents	F	5.2.1	5.3.0	GP-030606	EGPRS
GP-14	GP-030608	1437	-	Section 53.1.1.17 Consideration of MS reaction time	F	5.2.1	5.3.0	GP-030608	EGPRS
GP-14	GP-030609	1438	-	Section 53.1.1.18 Consideration of MS reaction time	F	5.2.1	5.3.0	GP-030609	EGPRS
GP-14	GP-030616	1439	-	Correction to DTM Conformance Test in sub-clause 41.3.4.3	F	5.2.1	5.3.0	GP-030616	DTM
GP-14	GP-030617	1440	-	Correction to DTM Conformance Test in sub-clause 22.11	F	5.2.1	5.3.0	GP-030617	DTM
GP-14	GP-030965	1441	1	Correction to DTM Conformance Test in sub-clause 44.2.8.2	F	5.2.1	5.3.0	GP-030965	DTM
GP-14	GP-030619	1442	-	Correction to DTM Conformance Test in sub-clause 47.3.2.2	F	5.2.1	5.3.0	GP-030619	DTM
GP-14	GP-030622	1444	-	testcase 52.1.2.2.5.1 Packet Downlink Assignment / Abnormal cases / incorrect PDCH assignment	F	5.2.1	5.3.0	GP-030622	EDGE
GP-14	GP-030623	1445	-	Testcase 42.1.2.2.5.1 Packet Downlink Assignment / Abnormal cases / Incorrect PDCH assignment	F	5.2.1	5.3.0	GP-030623	GPRS
GP-14	GP-030638	1446	-	Correction of Expected Sequence for clause 52.4.1.3 - Network Control measurement reporting / Downlink transfer / Normal case	F	5.2.1	5.3.0	GP-030638	EDGE
GP-14	GP-030996	1448	2	26.7.4.5.4.4 "Location updating/periodic search of the higher priority PLMN, when a MS is receiving foreign country's VPLMN/MS is in	B	5.2.1	5.3.0	GP-030996	GSM

TSG #	TSG Doc	CR	Rev	Subject/Comment	Cat	Old	New	WG Doc	Work item
				automatic mode".					
GP-14	GP-031045	1449	4	GPRS Enhanced Measurement Report (EMR) Test Cases	F	5.2.1	5.3.0	GP-031045	GPRS
GP-14	GP-030677	1450	-	Section 51.1.1.2 Check for completeness of ATTACH REQUEST not possible.	F	5.2.1	5.3.0	GP-030677	EGPRS
GP-14	GP-030678	1451	-	Section 51.1.1.3 BS_PCC_CHANS is not included in PSI1	F	5.2.1	5.3.0	GP-030678	EGPRS
GP-14	GP-030679	1452	-	Section 51.1.3 Check in step 5 incorrect for k=2	F	5.2.1	5.3.0	GP-030679	EGPRS
GP-14	GP-030680	1453	-	Section 41.1.3 Check in step 5 incorrect for k=2	F	5.2.1	5.3.0	GP-030680	GPRS
GP-14	GP-030681	1454	-	Section 51.1.4.1 Correction of macro parameters (was fixed allocation)	F	5.2.1	5.3.0	GP-030681	EGPRS
GP-14	GP-030682	1455	-	Section 51.1.5.1.2 Incorrect channel assignment, step reference corrected.	F	5.2.1	5.3.0	GP-030682	EGPRS
GP-14	GP-030683	1456	-	Section 41.1.5.1.2 Step reference corrected	F	5.2.1	5.3.0	GP-030683	GPRS
GP-14	GP-030684	1457	-	Section 51.1.6 Incorrect WAIT_INDICATION in test procedure	F	5.2.1	5.3.0	GP-030684	EGPRS
GP-14	GP-030685	1458	-	Section 51.2.1.1 Priority level 4 missing in test parameters	F	5.2.1	5.3.0	GP-030685	EGPRS
GP-14	GP-030702	1460	-	New TC: Network Assisted Cell Change / Expiry of T3206	B	5.2.1	5.3.0	GP-030702	NACC
GP-14	GP-030703	1461	-	New TC: Network Assisted Cell Change / No Packet Neighbouring Cell Data and Packet Cell Change Continue	B	5.2.1	5.3.0	GP-030703	NACC
GP-14	GP-030704	1462	-	New TC: Network Assisted Cell Change / Packet Neighbour Cell Data and Packet Cell Change Continue	B	5.2.1	5.3.0	GP-030704	NACC
GP-14	GP-030705	1463	-	New TC: Network Assisted Cell Change / Packet Neighbour Cell Data and Packet Cell Change Order	B	5.2.1	5.3.0	GP-030705	NACC
GP-14	GP-030706	1464	-	New TC: Network Assisted Cell Change / Expiry of T3208 and T3210	B	5.2.1	5.3.0	GP-030706	NACC
GP-14	GP-030992	1465	1	New TC: Network Assisted Cell Change / Entering packet idle mode	B	5.2.1	5.3.0	GP-030992	NACC
GP-14	GP-030993	1466	1	New TC: Network Assisted Cell Change / CCN not supported towards target cell	B	5.2.1	5.3.0	GP-030993	NACC
GP-14	GP-030710	1468	-	Addition of PICS/PIXIT statement to clause 46.1.2.7.6 and 46.1.2.6.2	F	5.2.1	5.3.0	GP-030710	GPRS
GP-14	GP-030954	1469	1	Correction to TC 43.1.1.5	F	5.2.1	5.3.0	GP-030954	GPRS
GP-14	GP-030713	1470	-	Editorial Corrections to AMR-NB Tests	F	5.2.1	5.3.0	GP-030713	AMR-NB
GP-14	GP-030714	1471	-	Updates to assign GPRS or EGPRS TBF depending upon the use of CHANNEL REQUEST or EGPRS PACKET CHANNEL REQUEST in clauses 51.2.2.1	F	5.2.1	5.3.0	GP-030714	EDGE
GP-14	GP-030715	1472	-	Additional Macros to Sec 50	F	5.2.1	5.3.0	GP-030715	EDGE
GP-14	GP-030961	1473	1	CR 51.010-1 Section 51.2.x Corrections of PDP context specification in initial conditions	F	5.2.1	5.3.0	GP-030961	EGPRS
GP-14	GP-030770	1474	-	Section 51.2.2.2 Incorrect reference in section Justification	F	5.2.1	5.3.0	GP-030770	EGPRS
GP-14	GP-030771	1475	-	Section 51.2.2.3 Items from GPRS mirror CRs missing	F	5.2.1	5.3.0	GP-030771	EGPRS
GP-14	GP-030772	1476	-	Section 51.2.2.5 Incorrect channel request type referenced	F	5.2.1	5.3.0	GP-030772	EGPRS
GP-14	GP-030773	1478	-	Section 51.2.3.3 Incorrect description in Test procedure	F	5.2.1	5.3.0	GP-030773	EGPRS
GP-14	GP-030774	1479	-	Section 14.* Correction in limit checking sections for AMR tests (statistical testing part).	F	5.2.1	5.3.0	GP-030774	AMR
GP-14	GP-030775	1480	-	Section 14.1.6 Accidentally removed from 51.010-1 V5.1.0	F	5.2.1	5.3.0	GP-030775	AMR
GP-14	GP-030776	1481	-	Section 26.6.3.x BCCH allocation sequence number missing for DCS 1800 and PCS 1900 bands	F	5.2.1	5.3.0	GP-030776	GSM
GP-14	GP-030779	1483	-	CR 51.010-1 Section 40.2.1.1.1 MSCR bit in SI3 must be set for R99 network simulation	F	5.2.1	5.3.0	GP-030779	EGPRS
GP-15	GP-031630	1484	5	CR 51.010-1-1484 rev 5 Section 42.1.2.1 "Multiple PCCCH test cases	F	5.3.0	5.4.0	GP-031630	GPRS
GP-14	GP-030777	1485	-	Section 26.6.13.1 Ambiguity for test parameter T1	F	5.2.1	5.3.0	GP-030777	GSM
GP-14	GP-030849	1488	-	Clarification of applicability for different TCH/H – channels in 14.2.4 and 14.4.5	F	5.2.1	5.3.0	GP-030849	TEI
GP-14	GP-030850	1490	-	Clarification on test procedure of 14.18.6	F	5.2.1	5.3.0	GP-030850	EDGE
GP-14	GP-030855	1491	-	CR 51.010-1 Section 20.22.12 C1 value in wrong column	F	5.2.1	5.3.0	GP-030855	GPRS

TSG #	TSG Doc	CR	Rev	Subject/Comment	Cat	Old	New	WG Doc	Work item
GP-14	GP-030997	1493	1	Location updating/periodic search of the HPLMN, when a MS is receiving foreign country's VPLMN/MS is in automatic mode	F	5.2.1	5.3.0	GP-030997	GSM
GP-14	GP-030990	1494	-	Corrections of Core Specification references for clause 41.1.5.1.2 - RR / Paging / on CCCH for GPRS service / normal paging with IMSI successful.	F	5.2.1	5.3.0	GP-030990	GPRS
GP-14	GP-030991	1495	-	Corrections of Core Specification references for clause 51.1.5.1.2 - RR / Paging / on CCCH for EGPRS service / normal paging with IMSI successful.	F	5.2.1	5.3.0	GP-030991	EDGE
GP-15	GP-031617	1496	1	CR 51.010-1-1496 rev1 Sec. 27.11.2.6 Speed Enhancement	F	5.3.0	5.4.0	GP-031617	TEI
GP-15	GP-031079	1497		CR 51.010-1-1497 Sec. 42.1.2.1.10.1 Packet Uplink Assignment / Abnormal cases / Incorrect PDCH assignment	F	5.3.0	5.4.0	GP-031079	GPRS
GP-15	GP-031605	1498	1	CR 51.010-1-1498 rev1 Sec. 52.1.2.1.10.1 Packet Uplink Assignment / Abnormal cases / Incorrect PDCH assignment	F	5.3.0	5.4.0	GP-031605	EDGE
GP-15	GP-031081	1499		CR.51.010-1-1499 Sec. 46.1.2.2.4.3 Change of test procedure: 1 frame must be 3 frames	F	5.3.0	5.4.0	GP-031081	GPRS
GP-15	GP-031082	1500		CR.51.010-1-1500 Sec. 42.3.1.1.2 Change number of octets to perform Short Access	F	5.3.0	5.4.0	GP-031082	GPRS
GP-15	GP-031083	1501		CR.51.010-1-1501 Sec. 52.3.1.1.2 Change number of octets to perform Short Access	F	5.3.0	5.4.0	GP-031083	EDGE
GP-15	GP-031087	1502		CR 51.010-1-1502 44.2.3.1.7 Send P-TMSI in ATTACH ACCEPT at step 5	F	5.3.0	5.4.0	GP-031087	GPRS
GP-15	GP-031618	1503	1	CR 51.010-1-1503 rev1 40.4.3.10 Macro "Completion of uplink RLC data block transfer" - allow uplink dummy control blocks	F	5.3.0	5.4.0	GP-031618	GPRS
GP-15	GP-031089	1504		CR 51.010-1-1504 44.2.3.1.4 Correct handling of power off bit in the detach request message (step 28)	F	5.3.0	5.4.0	GP-031089	GPRS
GP-15	GP-031613	1505	1	CR 51.010-1-1505 rev1 51.2.6.1/2 Specify PDP context 31 in initial conditions for RLC Acknowledged mode.	F	5.3.0	5.4.0	GP-031613	EDGE
GP-15	GP-031091	1506		CR 51.010-1-1506 46.1.2.3.2 Branches for SABM and I+S/DM changed	F	5.3.0	5.4.0	GP-031091	GPRS
GP-15	GP-031092	1507		CR 51.010-1-1507 46.1.2.5.1/2/3 Removal of C/R constraints in FRMR during ABM	F	5.3.0	5.4.0	GP-031092	GPRS
GP-15	GP-031093	1508		CR 51.010-1-1508 53.1.1.5 Correction of guard timer and number of octets	F	5.3.0	5.4.0	GP-031093	EDGE
GP-15	GP-031094	1509		CR 51.010-1-1509 53.1.1.20 Reduction of data amount, correction of RBBs and BSNs	F	5.3.0	5.4.0	GP-031094	EDGE
GP-15	GP-031095	1510		CR 51.010-1-1510 53.1.1.17 Correction of ACK/NACK of BSNs in test sequence and reduction of uplink data	F	5.3.0	5.4.0	GP-031095	EDGE
GP-15	GP-031096	1511		CR 51.010-1-1511 53.1.1.13 T3198 replaced by BS_CV_MAX block periods	F	5.3.0	5.4.0	GP-031096	EDGE
GP-15	GP-031097	1512		CR 51.010-1-1512 53.1.1.14 RESEGMENT IE set to 1 in Packet Uplink Ack/Nack	F	5.3.0	5.4.0	GP-031097	EDGE
GP-15	GP-031098	1513		CR 51.010-1-1513 53.1.1.9 Correction of Test Procedure and Expected Sequence to meet test purpose	F	5.3.0	5.4.0	GP-031098	EDGE
GP-15	GP-031612	1515	1	CR 51.010-1-1515 rev1 46.2.2.1.5 Change of negative acknowledgement of N-PDU in step 6	F	5.3.0	5.4.0	GP-031612	GPRS
GP-15	GP-031101	1516		CR 51.010-1-1516 Addition of default value for T3302 in R99	F	5.3.0	5.4.0	GP-031101	GPRS
GP-15	GP-031102	1517		CR 51.010-1-1517 R99 adaption of section 44.2.3	F	5.3.0	5.4.0	GP-031102	GPRS
GP-15	GP-031103	1518		CR 51.010-1-1518 Minor corrections to AMR	F	5.3.0	5.4.0	GP-031103	AMR
GP-15	GP-031111	1519		CR 51.010-1-1519 Introduction of clarification notes to Section 51.1	F	5.3.0	5.4.0	GP-031111	EDGE
GP-15	GP-031112	1520		CR 51.010-1-1520 TC 53.1.2.18 - Correction to BSN values in test procedure	F	5.3.0	5.4.0	GP-031112	EDGE
GP-15	GP-031625	1521	1	CR 51.010-1-1521 rev1 New RLC testcase 53.1.1.25 - Acknowledged Mode/Uplink TBF/TBF Reallocation/Window Size	F	5.3.0	5.4.0	GP-031625	EDGE
GP-15	GP-031114	1522		CR 51.010-1-1522 New RLC testcase 53.1.2.19 - Acknowledged Mode/Downlink TBF/TBF Reallocation/Window Size	F	5.3.0	5.4.0	GP-031114	EDGE
GP-15	GP-031115	1523		CR 51.010-1-1523 TC 42.1.2.1.8.1.6 - Correction to BSN check in Step 13	F	5.3.0	5.4.0	GP-031115	EDGE

TSG #	TSG Doc	CR	Rev	Subject/Comment	Cat	Old	New	WG Doc	Work item
GP-15	GP-031116	1524		CR 51.010-1-1524 TC 52.1.2.1.8.1.6 - Correction to BSN check in Step 13	F	5.3.0	5.4.0	GP-031116	EDGE
GP-15	GP-031117	1525		CR 51.010-1-1525 TC 52.1.2.1.8.1.7 - Correction to BSN check in Step 10	F	5.3.0	5.4.0	GP-031117	EDGE
GP-15	GP-031118	1526		CR 51.010-1-1526 TC 52.1.2.1.8.1.8 - Step re-numbering and introduction of waiting time.	F	5.3.0	5.4.0	GP-031118	EDGE
GP-15	GP-031119	1527		CR 51.010-1-1527 Correction of Initial condition for testcases 51.2.5.3 and 51.2.5.4	F	5.3.0	5.4.0	GP-031119	EDGE
GP-15	GP-031120	1528		CR 51.010-1-1528 Usage of Open Ended TBF instead of Close Ended TBF	F	5.3.0	5.4.0	GP-031120	EDGE
GP-15	GP-031121	1529		CR 51.010-1-1529 Introduction of new RLC Unacknowledged mode testcases to Section 53	F	5.3.0	5.4.0	GP-031121	EDGE
GP-15	GP-031122	1530		CR 51.010-1-1530 Renumbering of section 53.2	F	5.3.0	5.4.0	GP-031122	EDGE
GP-15	GP-031123	1531		CR 51.010-1-1531 Removal of redundant Specific message contents from TC 51.1.5.1.2	F	5.3.0	5.4.0	GP-031123	EDGE
GP-15	GP-031124	1532		CR 51.010-1-1532 TC 53.1.2.9 - Change expected sequence and Window Size.	F	5.3.0	5.4.0	GP-031124	EDGE
GP-15	GP-031125	1533		CR 51.010-1-1533 TC 42.1.2.2.4 - Correction to Specific message contents.	F	5.3.0	5.4.0	GP-031125	EDGE
GP-15	GP-031126	1534		CR 51.010-1-1534 TC 52.1.2.2.4 - Correction to Specific message contents.	F	5.3.0	5.4.0	GP-031126	EDGE
GP-15	GP-031214	1537		CR 51.010-1-1537 Section 13.16.2 Clarification for invalid GAMMA_TN values	F	5.3.0	5.4.0	GP-031214	GPRS
GP-15	GP-031215	1538		CR 51.010-1-1538 Section 13.17.3 Clarification for invalid GAMMA_TN values	F	5.3.0	5.4.0	GP-031215	EDGE
GP-15	GP-031216	1539		CR 51.010-1-1539 Section 41.3.1.2 - Incorrect references in expected sequence	F	5.3.0	5.4.0	GP-031216	GPRS
GP-15	GP-031217	1540		CR 51.010-1-1540 Section 42.3.1.1.2 - Incorrect message content in PACKET RESOURCE REQUEST step 6	F	5.3.0	5.4.0	GP-031217	GPRS
GP-15	GP-031218	1541		CR 51.010-1-1541 Section 52.3.1.1.2 - Incorrect message content in PACKET RESOURCE REQUEST step 6	F	5.3.0	5.4.0	GP-031218	EDGE
GP-15	GP-031219	1542		CR 51.010-1-1542 Section 42.5.1.2 ? Incorrect Reference to Starting Time in Step 4	F	5.3.0	5.4.0	GP-031219	GPRS
GP-15	GP-031220	1543		CR 51.010-1-1543 Section 43.1.1.6 ? Optional steps not considered correctly in expected sequence	F	5.3.0	5.4.0	GP-031220	GPRS
GP-15	GP-031221	1544		CR 51.010-1-1544 Section 51.2.5.1 ? IMMEDIATE ASSIGNMENT content for step 7 only correct for EGPRS PACKET CHANNEL REQUEST case	F	5.3.0	5.4.0	GP-031221	EDGE
GP-15	GP-031222	1545		CR 51.010-1-1545 Section 51.2.5.2 ? Incorrect specific message content IMMEDIATE ASSIGNMENT for step 6	F	5.3.0	5.4.0	GP-031222	EDGE
GP-15	GP-031223	1546		CR 51.010-1-1546 Section 51.3.2.1 ? Incorrect reference to M bit; alternative macro for two phase access missing	F	5.3.0	5.4.0	GP-031223	EDGE
GP-15	GP-031224	1547		CR 51.010-1-1547 Section 52.1.1.2 - Deletion of unused PICS statement	F	5.3.0	5.4.0	GP-031224	EDGE
GP-15	GP-031225	1548		CR 51.010-1-1548 Section 52.1.1.3 - Deletion of unused PICS statement and specific message contents	F	5.3.0	5.4.0	GP-031225	EDGE
GP-15	GP-031226	1549		CR 51.010-1-1549 Section 52.1.2.1.8.1.1 - Mirror CR to GP-012196 (GERAN #7) missing	F	5.3.0	5.4.0	GP-031226	EDGE
GP-15	GP-031227	1550		CR 51.010-1-1550 Section 52.1.2.1.9.1 - Mirror CR for GP-012734 (GERAN #7) missing	F	5.3.0	5.4.0	GP-031227	EDGE
GP-15	GP-031228	1551		CR 51.010-1-1551 Section 52.1.2.1.9.2.2 - Incorrect reference in expected sequence; Incorrect macro reference	F	5.3.0	5.4.0	GP-031228	EDGE
GP-15	GP-031231	1554		CR 51.010-1-1554 Section 43.3.1 - PACKET UPLINK ASSIGNMENT message inappropriate for section 43.	F	5.3.0	5.4.0	GP-031231	GPRS
GP-15	GP-031232	1555		CR 51.010-1-1555 Section 53.2.1 - PACKET UPLINK ASSIGNMENT message inappropriate for section 53.	F	5.3.0	5.4.0	GP-031232	EDGE
GP-15	GP-031280	1556		CR 51.010-1-1556 Corrections to SMS test cases 34.2.9.1 and 34.2.9.2 (Multiple SMS mobile originated)	F	5.3.0	5.4.0	GP-031280	GSM
GP-15	GP-031286	1557		CR 51.010-1-1557 44.2.3.1.1a Routing area updating / accepted / old P-TMSI	F	5.3.0	5.4.0	GP-031286	GPRS
GP-15	GP-031293	1558		CR 51.010-1-1558 Section 14.16.2.1.2 C/lc requirement for CS4 not in line with core	F	5.3.0	5.4.0	GP-031293	GPRS co-channel

TSG #	TSG Doc	CR	Rev	Subject/Comment	Cat	Old	New	WG Doc	Work item
				specification					rejection
GP-15	GP-031294	1559		CR 51.010-1-1559 Section 40.2.3 Default PACKET_UPLINK_ASSIGNMENT and PACKET DOWNLINK_ASSIGNMENT messages	F	5.3.0	5.4.0	GP-031294	GPRS
GP-15	GP-031295	1560		CR 51.010-1-1560 Section 50.2.3 Default PACKET_UPLINK_ASSIGNMENT and PACKET DOWNLINK_ASSIGNMENT messages	F	5.3.0	5.4.0	GP-031295	EDGE
GP-15	GP-031607	1561	1	CR 51.010-1-1561 rev1 TC 52.3.2.1.2 - Correction to Expected Sequence	F	5.3.0	5.4.0	GP-031607	EDGE
GP-15	GP-031297	1562		CR 51.010-1-1562 Section 53.1.1.5 Incorrect sequence of optional steps in expected sequence	F	5.3.0	5.4.0	GP-031297	EDGE
GP-15	GP-031299	1563		CR 51.010-1-1563 correction to testcase 52.1.2.1.9.2.2: Packet Uplink Assignment / Two phase access / Contention resolution / TLLI in Packet Resource Request message	F	5.3.0	5.4.0	GP-031299	EDGE
GP-15	GP-031300	1564		CR 51.010-1-1564 correction to testcase 42.1.2.1.8.1.5: Packet Uplink Assignment / One phase access / Contention resolution / 3 or 4 access repetition attempts	F	5.3.0	5.4.0	GP-031300	GPRS
GP-15	GP-031301	1565		CR 51.010-1-1565 correction to testcase 52.1.2.1.8.1.5: Packet Uplink Assignment / One phase access / Contention resolution / 3 or 4 access repetition attempts	F	5.3.0	5.4.0	GP-031301	EDGE
GP-15	GP-031304	1568		CR 51.010-1-1568 deletion of 42.2.4.1.1, 42.2.4.1.2, 42.2.4.4.1, 42.2.4.4.2 and 42.2.4.4.3	F	5.3.0	5.4.0	GP-031304	GPRS
GP-15	GP-031305	1569		CR 51.010-1-1569 T3142 should be from 2 to 60 seconds in testcase 51.2.5.1 Packet access rejection / wait indication	F	5.3.0	5.4.0	GP-031305	EDGE
GP-15	GP-031306	1570		CR 51.010-1-1570 T3142 should be from 2 to 60 seconds in testcase 41.2.5.1:Packet access rejection / wait indication	F	5.3.0	5.4.0	GP-031306	GPRS
GP-15	GP-031307	1571		CR 51.010-1-1571 Addition of new testcases section 42.8	F	5.3.0	5.4.0	GP-031307	GPRS
GP-15	GP-031308	1572		CR 51.010-1-1572 Correction to section 44.2.2.2.6	F	5.3.0	5.4.0	GP-031308	GPRS
GP-15	GP-031310	1574		CR 51.010-1-1574 Correction to section 45.2.5.1 and 45.2.5.1.2	F	5.3.0	5.4.0	GP-031310	GPRS
GP-15	GP-031311	1575		CR 51.010-1-1575 Correction to section 45.2.5.2 and 45.2.5.3	F	5.3.0	5.4.0	GP-031311	GPRS
GP-15	GP-031312	1576		CR 51.010-1-1576 Correction to section 45.2.4.3	F	5.3.0	5.4.0	GP-031312	GPRS
GP-15	GP-031317	1578		CR 51.010-1-1578 Usage of Open Ended TBF instead of Close Ended TBF in Sec 41.x testcases	F	5.3.0	5.4.0	GP-031317	GPRS
GP-15	GP-031318	1579		CR 51.010-1-1579 Sec: 42.4.2.3.3 - Correction of requirement check	F	5.3.0	5.4.0	GP-031318	GPRS
GP-15	GP-031329	1580		CR 51.010-1-1580 15.8 EGPRS Timing advance and absolute delay	F	5.3.0	5.4.0	GP-031329	EDGE
GP-15	GP-031331	1582		CR 51.010-1-1582 Updates to the number of Corrupted blocks sent in step (b) of 20.22.7	F	5.3.0	5.4.0	GP-031331	GPRS
GP-15	GP-031332	1583		CR 51.010-1-1583 Removing the wait of 2 PS11 repeat period in step 1; 30 sec in step 5,10 and 15; and addition of a wait of time required for 64/SPLIT_PG_CYCLE multiframes in steps 5,10,15 of 41.1.1.4	F	5.3.0	5.4.0	GP-031332	GPRS
GP-15	GP-031333	1584		CR 51.010-1-1584 41.1.5.3 - Adding the delay after the changes in SI	F	5.3.0	5.4.0	GP-031333	GPRS
GP-15	GP-031334	1585		CR 51.010-1-1585 41.1.6 - Changes in the value Wait Indication given in Packet Access Reject.	F	5.3.0	5.4.0	GP-031334	GPRS
GP-15	GP-031336	1587		CR 51.010-1-1587 Changes in step 8 and Step 15 of 41.3.4.2	F	5.3.0	5.4.0	GP-031336	GPRS
GP-15	GP-031337	1588		CR 51.010-1-1588 41.3.5.2 - Correction to some steps	F	5.3.0	5.4.0	GP-031337	GPRS
GP-15	GP-031338	1589		CR 51.010-1-1589 Changes in Attach Macro in 50.4.3.11, 50.3.4.12.	F	5.3.0	5.4.0	GP-031338	EDGE
GP-15	GP-031339	1590		CR 51.010-1-1590 Removing the wait of 2 PS11 repeat period in step 1; 30 sec in step 5,10 and 15; and addition of a wait of time required for 64/SPLIT_PG_CYCLE multiframes in steps 5,10,15 of 51.1.1.4	F	5.3.0	5.4.0	GP-031339	EDGE
GP-15	GP-031340	1591		CR 51.010-1-1591 51.1.5.3 - Adding the delay after the changes in SI	F	5.3.0	5.4.0	GP-031340	EDGE
GP-15	GP-031341	1592		CR 51.010-1-1592 51.1.6 - Changes in the value	F	5.3.0	5.4.0	GP-031341	EDGE

TSG #	TSG Doc	CR	Rev	Subject/Comment	Cat	Old	New	WG Doc	Work item
				Wait Indication given in Packet Access Reject.					
GP-15	GP-031397	1600		CR 51.010-1-1600 deletion of T3198 in testcase 41.3.1.1 TBF Release / Uplink / Normal / MS initiated / Acknowledged mode	F	5.3.0	5.4.0	GP-031397	GPRS
GP-15	GP-031398	1601		CR 51.010-1-1601 deletion of T3198 in testcase 51.3.1.1 TBF Release / Uplink / Normal / MS initiated / Acknowledged mode	F	5.3.0	5.4.0	GP-031398	EDGE
GP-15	GP-031609	1602	1	CR 51.010-1-1602 rev1 deletion of T3198 in testcase 43.1.1.5 Acknowledged mode / Uplink TBF / Invalid Negative Acknowledgment	F	5.3.0	5.4.0	GP-031609	GPRS
GP-15	GP-031406	1603		CR 51.010-1-1603 Editorial correction to testcase 41.3.5.2 PDCH Release / With TIMESLOTS_AVAILABLE	F	5.3.0	5.4.0	GP-031406	GPRS
GP-15	GP-031608	1604	1	CR 51.010-1 rev1 TC 42.1.2.1.9.1 Removal of the close-ended TBF feature	C	5.3.0	5.4.0	GP-031608	GPRS
GP-15	GP-031606	1605	1	CR 51.010-1-1605 rev 1 TC 42.3.2.1.2 - Correction to Expected Sequence	F	5.3.0	5.4.0	GP-031606	GPRS
GP-15	GP-031458	1606		CR 51.010-1-1606 Additional Packet Enhanced Measurement Report Test Cases Section 42.4.6 (Rel-5)	F	5.3.0	5.4.0	GP-031458	GPRS
GP-15	GP-031640	1607	1	CR 51.010-1-1607 rev1 Additional SMS over GPRS Test Cases Section 34.4 (Rel-5)	F	5.3.0	5.4.0	GP-031640	GPRS
GP-15	GP-031463	1609		CR 51.010-1-1609 R99, and onwards, corrections of automatic MO SMS repeat at TP layer for SMS clauses 34.2.2 and 34.4.2.	F	5.3.0	5.4.0	GP-031463	TEI
GP-15	GP-031464	1610		CR 51.010-1-1610 Correction to initial conditions in testcase 41.2.7.1	F	5.3.0	5.4.0	GP-031464	GPRS
GP-15	GP-031465	1611		CR 51.010-1-1611 Sending of PSI13 on PACCH in order to prevent SI refresh for clause 41.2.3.7 - One phase packet access / Contention resolution / Timer T3166	F	5.3.0	5.4.0	GP-031465	GPRS
GP-15	GP-031466	1612		CR 51.010-1-1612 Clarification of step 10 if the Expected Sequence for clause 41.2.3.8 - One phase packet access / Contention resolution / 4 access repetition attempts.	F	5.3.0	5.4.0	GP-031466	GPRS
GP-15	GP-031467	1613		CR 51.010-1-1613 Correction of logical error in step 6 for clause 41.2.4.2 - Single block packet access / Packet Measurement Report.	F	5.3.0	5.4.0	GP-031467	GPRS
GP-15	GP-031469	1615		CR 51.010-1-1615 Timer reference correction to testcase 42.1.2.1.10.2	F	5.3.0	5.4.0	GP-031469	GPRS
GP-15	GP-031470	1616		CR 51.010-1-1616 Correction to 42.1.2.1.13	F	5.3.0	5.4.0	GP-031470	GPRS
GP-15	GP-031621	1617	1	CR 51.010-1-1617 rev1 Correction to 42.1.2.1.9.2.1	F	5.3.0	5.4.0	GP-031621	GPRS
GP-15	GP-031623	1618	1	CR 51.010-1-1618 rev1 Correction to 42.1.2.1.9.2.2	F	5.3.0	5.4.0	GP-031623	GPRS
GP-15	GP-031473	1619		CR 51.010-1-1619 Corrections to testcase 42.1.2.2.3	F	5.3.0	5.4.0	GP-031473	GPRS
GP-15	GP-031626	1620	1	CR 51.010-1-1620 rev1 Alignment of 42.3.1.1.9 with the core specification	F	5.3.0	5.4.0	GP-031626	GPRS
GP-15	GP-031475	1621		CR 51.010-1-1621 42.3.1.2.3 Dynamic Allocation / Uplink Transfer / Abnormal / with cell reselection in unacknowledged mode	F	5.3.0	5.4.0	GP-031475	GPRS
GP-15	GP-031476	1622		CR 51.010-1-1622 42.4.1.2 Network Control measurement reporting / Idle mode / New cell reselection	F	5.3.0	5.4.0	GP-031476	GPRS
GP-15	GP-031477	1623		CR 51.010-1-1623 42.4.2.1.1 Cell change order procedure / Uplink transfer / Normal case	F	5.3.0	5.4.0	GP-031477	GPRS
GP-15	GP-031478	1624		CR 51.010-1-1624 Deletion of clause 42.4.2.1.2 - Cell change order procedure / Uplink transfer / Failure cases / T3174 expiry	F	5.3.0	5.4.0	GP-031478	GPRS
GP-15	GP-031479	1625		CR 51.010-1-1625 Correction to clause 42.4.2.1.3 - Cell change order procedure / Uplink transfer / Failure cases / REJECT from the new cell	F	5.3.0	5.4.0	GP-031479	GPRS
GP-15	GP-031480	1626		CR 51.010-1-1626 Correction to clause 42.4.2.1.4 - Cell change order procedure / Uplink transfer / Failure cases / Contention resolution failure	F	5.3.0	5.4.0	GP-031480	GPRS
GP-15	GP-031619	1627	1	CR 51.010-1-1627 rev1 Correction to clause 42.4.2.2.1 - Cell change order procedure / Downlink transfer / Normal case	F	5.3.0	5.4.0	GP-031619	GPRS
GP-15	GP-031482	1628		CR 51.010-1-1628 Correction to clause 42.4.2.2.2 - Cell change order procedure /	F	5.3.0	5.4.0	GP-031482	GPRS

TSG #	TSG Doc	CR	Rev	Subject/Comment	Cat	Old	New	WG Doc	Work item
				Downlink transfer / Failure cases / REJECT from the new cell					
GP-15	GP-031483	1629		CR 51.010-1-1629 Correction of clause 42.4.2.3.1 - Cell change order procedure / Simultaneous uplink and downlink transfer / Normal case	F	5.3.0	5.4.0	GP-031483	GPRS
GP-15	GP-031484	1630		CR 51.010-1-1630 Deletion of clause 42.4.2.3.2 - Cell change order procedure / Simultaneous uplink and downlink transfer / Failure case / T3174 expiry	F	5.3.0	5.4.0	GP-031484	GPRS
GP-15	GP-031485	1631		CR 51.010-1-1631 Correction to clause 42.4.4.2 - Network Controlled Cell Reselection/validity of reselection parameters/MS enters standby state	F	5.3.0	5.4.0	GP-031485	GPRS
GP-15	GP-031486	1632		CR 51.010-1-1632 Correction to new downlink TBF assignment in step 6 in testcase 42.5.5.2	F	5.3.0	5.4.0	GP-031486	GPRS
GP-15	GP-031487	1633		CR 51.010-1-1633 Correction of invalid frequency parameters condition in 42.5.5.3	F	5.3.0	5.4.0	GP-031487	GPRS
GP-15	GP-031488	1634		CR 51.010-1-1634 Clarification to testcase 42.7.1 to verify correct MS behaviour.	F	5.3.0	5.4.0	GP-031488	GPRS
GP-15	GP-031489	1635		CR 51.010-1-1635 Aligning testcase 42.7.2 with the conformance requirement	F	5.3.0	5.4.0	GP-031489	GPRS
GP-15	GP-031624	1636	1	CR 51.010-1-1636 rev1 Aligning testcase 42.7.3 with the conformance requirements	F	5.3.0	5.4.0	GP-031624	GPRS
GP-15	GP-031491	1637		CR 51.010-1-1637 Aligning testcase 42.7.6 with the conformance requirements	F	5.3.0	5.4.0	GP-031491	GPRS
GP-15	GP-031492	1638		CR 51.010-1-1638 Correction of SpecificaMessage Content for clause 42.1.2.1.7 - Packet Uplink Assignment / Most recently received Packet Uplink Assignment.	F	5.3.0	5.4.0	GP-031492	GPRS
GP-15	GP-031494	1639		CR 51.010-1-1639 Sending of PSI13 on PACCH in order to prevent SI refresh for clause 51.2.3.7 - One phase packet access / Contention resolution / Timer T3166	F	5.3.0	5.4.0	GP-031494	EDGE
GP-15	GP-031495	1640		CR 51.010-1-1640 Clarification of step 10 if the Expected Sequence for clause 51.2.3.8 - One phase packet access / Contention resolution / 4 access repetition attempts.	F	5.3.0	5.4.0	GP-031495	EDGE
GP-15	GP-031497	1642		CR 51.010-1-1642 Timer reference correction to testcase 52.1.2.1.10.2	F	5.3.0	5.4.0	GP-031497	EDGE
GP-15	GP-031622	1643	1	CR 51.010-1-1643 rev1 Correction to 52.1.2.1.9.2.1	F	5.3.0	5.4.0	GP-031622	EDGE
GP-15	GP-031499	1644		CR 51.010-1-1644 52.3.1.2.3 Dynamic Allocation / Uplink Transfer / Abnormal / with cell reselection in unacknowledged mode	F	5.3.0	5.4.0	GP-031499	EDGE
GP-15	GP-031500	1645		CR 51.010-1-1645 Correction to new downlink TBF assignment in step 6 in testcase 52.5.5.2	F	5.3.0	5.4.0	GP-031500	EDGE
GP-15	GP-031501	1646		CR 51.010-1-1646 Correction of invalid frequency parameters condition in 52.5.5.3	F	5.3.0	5.4.0	GP-031501	EDGE
GP-15	GP-031503	1648		CR 51.010-1-1648 Correction of SpecificaMessage Content for clause 52.1.2.1.7 - Packet Uplink Assignment / Most recently received Packet Uplink Assignment.	F	5.3.0	5.4.0	GP-031503	EDGE
GP-15	GP-031504	1649		CR 51.010-1-1649 Correction of steps 5, 12 and 16 of the Expected Sequence for clause 52.3.2.1.1 - Dynamic Allocation / Uplink Transfer with Downlink TBF establishment / Normal / Successful	F	5.3.0	5.4.0	GP-031504	EDGE
GP-15	GP-031505	1650		CR 51.010-1-1650 Deletion of clause 52.4 - Measurement reports and Cell change order procedures	F	5.3.0	5.4.0	GP-031505	EDGE
GP-15	GP-031632	1651	2	CR 51.010-1-1651 rev2 Section 44.2.2: "Packet Measurement order procedure / Downlink transfer / Normal case/ 3G cell reselection dedicated parameters	F	5.3.0	5.4.0	GP-031632	2G-3G interworking
GP-15	GP-031628	1653	2	CR 51.010-1-1653 rev2 Section 22 "Downlink Power Control in GPRS	F	5.3.0	5.4.0	GP-031628	GPRS
GP-15	GP-031553	1655		CR 51.010-1-1655 TC 42.3.1.1.2 Removal of the close-ended TBF feature	C	5.3.0	5.4.0	GP-031553	GPRS
GP-16	GP-031953	1656	1	CR 51.010-1-1656 TC 42.3.1.1.5 Removal of the close-ended TBF feature	C	5.4.0	5.5.0	GP-031953	TEI
GP-15	GP-031555	1657		CR 51.010-1-1657 TC 52.1.2.1.9.1 Removal of the close-ended TBF feature	C	5.3.0	5.4.0	GP-031555	EDGE(EGPRS)
GP-15	GP-031556	1658		CR 51.010-1-1658 TC 52.3.1.1.2 Removal of	C	5.3.0	5.4.0	GP-031556	EDGE(EGPRS)

TSG #	TSG Doc	CR	Rev	Subject/Comment	Cat	Old	New	WG Doc	Work item
				the close-ended TBF feature					PRS)
GP-15	GP-031633	1658		CR 51.010-1-1658 Correction to RLC Acknowledged Mode / Uplink TBF / Window Size / Default Value test case	F	5.3.0	5.4.0	GP-031633	EGPRS
GP-16	GP-031954	1659	1	CR 51.010-1-1659 rev 1 TC 52.3.1.1.5 Removal of the close-ended TBF feature	C	5.4.0	5.5.0	GP-031954	TEI
GP-16	GP-032179	1662	1	CR 51.010-1-1662 rev1 Sections 14.1.5 and 14.1.6 Bad frame indication AMR - corrections	F	5.4.0	5.5.0	GP-032179	AMR
GP-16	GP-031748	1664		CR 51.010-1-1664 Section 26.16.9.5 Threshold Change (normal) - correction of THRESH_REQ message contents	F	5.4.0	5.5.0	GP-031748	AMR
GP-16	GP-032176	1670	1	CR 51.010-1-1670 rev1 section 60.9 Inter system handover to UTRAN/from GSM/Failure/Cause: Protocol Error	F	5.4.0	5.5.0	GP-032176	Inter System Handover
GP-16	GP-031768	1674		CR 51.010-1-1674 TC 53.1.1.25 - Correction to coding of Window size	F	5.4.0	5.5.0	GP-031768	EDGE
GP-16	GP-031769	1675		CR 51.010-1-1675 TC 53.1.2.19 - Correction to timeslots allocated and coding of Window Size	F	5.4.0	5.5.0	GP-031769	EDGE
GP-16	GP-031771	1676		CR 51.010-1-1676 TC 52.1.2.1.8.1.7 - Correction to the amount of data triggered	F	5.4.0	5.5.0	GP-031771	EDGE
GP-16	GP-031785	1678		CR 51.010-1-1678 42.3.1.1.2 - Change number of octets to perform Short Access	F	5.4.0	5.5.0	GP-031785	GPRS
GP-16	GP-031787	1680		CR 51.010-1-1680 41.3.1.1, 41.3.1.2, 41.3.5.2. - Changes in the applicability of some parts of testcase	F	5.4.0	5.5.0	GP-031787	GPRS
GP-16	GP-031788	1681		CR 51.010-1-1681 51.3.1.1, 51.3.1.2, 51.3.5.2. - Changes in the applicability of some parts of testcase	F	5.4.0	5.5.0	GP-031788	GPRS
GP-16	GP-031789	1682		CR 51.010-1-1682 20.22.13 - C32_QUAL specified and continuous paging switched on on cell B and C	F	5.4.0	5.5.0	GP-031789	GPRS
GP-16	GP-031791	1684		CR 51.010-1-1684 52.1.2.1.8.1.2 - Correction of calculation for N3104_MAX	F	5.4.0	5.5.0	GP-031791	EDGE
GP-16	GP-031792	1685		CR 51.010-1-1685 52.1.2.1.8.1.4 - Correction of comment step7 regarding EGPRS PACKET CHANNEL REQUEST.	F	5.4.0	5.5.0	GP-031792	EDGE
GP-16	GP-031793	1686		CR 51.010-1-1686 52.5.5.3 - Various Corrections to test sequence	F	5.4.0	5.5.0	GP-031793	EDGE
GP-16	GP-031794	1687		CR 51.010-1-1687 42.5.5.3 - Various Corrections to test sequence	F	5.4.0	5.5.0	GP-031794	GPRS
GP-16	GP-031796	1689		CR 51.010-1-1689 41.1.2 RR / Paging / on PCCCH for circuit-switched services/ paging successful	F	5.4.0	5.5.0	GP-031796	GPRS
GP-16	GP-032155	1691	1	CR 051.010-1-1691 rev1 42.3.1.2.2 Dynamic Allocation / Uplink Transfer / Abnormal / with cell reselection in acknowledged mode	F	5.4.0	5.5.0	GP-032155	GPRS
GP-16	GP-031799	1692		CR 51.010-1-1692 Section 42.3.2.1.2 - RRBp value not matching expected sequence	F	5.4.0	5.5.0	GP-031799	GPRS
GP-16	GP-031800	1693		CR 51.010-1-1693 51.1.2 RR / Paging / on PCCCH for circuit-switched services / paging successful	F	5.4.0	5.5.0	GP-031800	EDGE
GP-16	GP-031802	1695		CR 51.010-1-1695 Section 52.3.2.1.2 - RRBp value not matching expected sequence	F	5.4.0	5.5.0	GP-031802	EDGE
GP-16	GP-031804	1697		CR 51.010-1-1697 53.1.2.4 Acknowledged Mode/ Downlink TBF/ Window Size/Assigned Value	F	5.4.0	5.5.0	GP-031804	EDGE
GP-16	GP-031807	1699		CR 51.010-1-1699 46.2.2.4.3 - SABM corrected to XID command in step 4	F	5.4.0	5.5.0	GP-031807	GPRS
GP-16	GP-032250	1700	2	CR 51.010-1-1700 rev2 R99 adaption of test case 44.2.2.2.5	F	5.4.0	5.5.0	GP-032250	GPRS
GP-16	GP-031809	1701		CR 51.010-1-1701 Section 42.4.6.2 editorial corrections	F	5.4.0	5.5.0	GP-031809	AMR
GP-16	GP-031810	1702		CR 51.010-1-1702 Updates in the name of the testcase and the timing requirement for reselection of the testcase 20.22.5	F	5.4.0	5.5.0	GP-031810	GPRS
GP-16	GP-032175	1703	1	CR 51.010-1-1703 rev1 Updates in the timing requirement for the reselection for 20.22.6	F	5.4.0	5.5.0	GP-032175	GPRS
GP-16	GP-031812	1704		CR 51.010-1-1704 42.1.1.2 - In step 3, channel on which paging is transmitted is changed from PPCH to PAGCH.	F	5.4.0	5.5.0	GP-031812	GPRS
GP-16	GP-031813	1705		CR 51.010-1-1705 Removal of the testcase 42.1.2.1.3.3	F	5.4.0	5.5.0	GP-031813	GPRS
GP-16	GP-031814	1706		CR 51.010-1-1706 42.3.3.4 - PDP context	F	5.4.0	5.5.0	GP-031814	GPRS

TSG #	TSG Doc	CR	Rev	Subject/Comment	Cat	Old	New	WG Doc	Work item
				changed from the default 3 to PDP context 2.					
GP-16	GP-032161	1707	1	CR 51.010-1-1707 rev1 Changes in the sequence of 42.7.4	F	5.4.0	5.5.0	GP-032161	GPRS
GP-16	GP-032162	1708	1	CR 51.010-1-1708 rev1 Changes in the sequence of 42.7.6	F	5.4.0	5.5.0	GP-032162	GPRS
GP-16	GP-032167	1709	1	CR 51.010-1-1709 rev 1 Addition of new procedures for 44.2.7 and changes for R99	F	5.4.0	5.5.0	GP-032167	GPRS
GP-16	GP-031820	1711		CR 51.010-1-1711 52.1.1.3, 52.1.1.4 - In step 3, the channel on which the paging is transmitted is changed from PPCH to PAGCH.	F	5.4.0	5.5.0	GP-031820	EDGE
GP-16	GP-031821	1712		CR 51.010-1-1712 Removal of the testcase 52.1.2.1.3.3	F	5.4.0	5.5.0	GP-031821	EDGE
GP-16	GP-031822	1713		CR 51.010-1-1713 52.6.1 - changing mobile identity in paging request from TMSI to P-TMSI.	F	5.4.0	5.5.0	GP-031822	EDGE
GP-16	GP-031823	1714		CR 51.010-1-1714 52.6.2 - changing mobile identity in paging request from TMSI to P-TMSI.	F	5.4.0	5.5.0	GP-031823	EDGE
GP-16	GP-031824	1715		CR 51.010-1-1715 Changes in the MACRO used to bring MS into uplink transfer mode in testcases 42.4.1.1, 42.4.2.1.4, 42.4.2.1.6, 42.4.6.4	F	5.4.0	5.5.0	GP-031824	GPRS
GP-16	GP-031825	1716		CR 51.010-1-1716 changes in the applicability of the testcases 42.3.1.1.8 and 42.7.4	F	5.4.0	5.5.0	GP-031825	GPRS
GP-16	GP-031826	1717		CR 51.010-1-1717 52.3.1.1.8 -- Changes in the applicability of the testcase 52.3.1.1.8	F	5.4.0	5.5.0	GP-031826	EDGE
GP-16	GP-031834	1725		CR 51.010-1-1725 Addition of note to the section 40.2.2.1.1, 40.2.2.1.12 for sending of PSI1, PSI13 on PACCH.	F	5.4.0	5.5.0	GP-031834	GPRS
GP-16	GP-032173	1726	1	CR 51.010-1-1726 rev1 51.010-1; Identifying the number of iterations for the testcase 53.1.2.9	F	5.4.0	5.5.0	GP-032173	EDGE
GP-16	GP-031836	1727		CR 51.010-1-1727 Addition of note in macro 42.1.3.1.2, to allow reception of Control Ack in Access Bursts or in RLC/MAC Control block format.	F	5.4.0	5.5.0	GP-031836	GPRS
GP-16	GP-031846	1728		CR 51.010-1-1728 Correction of Test Procedure and Expected Sequence for section 53.1.1.24 - Acknowledged Mode/ Uplink TBF/ Interpretation of PBSN	F	5.4.0	5.5.0	GP-031846	EDGE
GP-16	GP-031848	1730		CR 51.010-1-1730 44.2.2.2.4 - Correct handling of Detach cause and Attach Request type	F	5.4.0	5.5.0	GP-031848	GPRS
GP-16	GP-031849	1731		CR 51.010-1-1731 Section 51.1.6: Time constraints regarding WAIT_INDICATION not explicitly mentioned in expected sequence	F	5.4.0	5.5.0	GP-031849	EDGE
GP-16	GP-031850	1732		CR 51.010-1-1732 Section 41.1.6: Time constraints regarding WAIT_INDICATION not explicitly mentioned in expected sequence	F	5.4.0	5.5.0	GP-031850	GPRS
GP-16	GP-031851	1733		CR 51.010-1-1733 Section 52.1.1.6.1 Correction Initial conditions	F	5.4.0	5.5.0	GP-031851	EDGE
GP-16	GP-031852	1734		CR 51.010-1-1734 Section 52.1.1.7: PICS/PIXIT not needed	F	5.4.0	5.5.0	GP-031852	EDGE
GP-16	GP-031854	1736		CR 51.010-1-1736 Section 52.1.2.1.6 ? PS12 settings to use same frequency for PBCCH and PCCCH	F	5.4.0	5.5.0	GP-031854	EDGE
GP-16	GP-031855	1737		CR 51.010-1-1737 Section 52.1.2.1.7: PICS/PIXIT not needed	F	5.4.0	5.5.0	GP-031855	EDGE
GP-16	GP-032151	1738	1	CR 51.010-1-1738 rev1 Correction to AMR section 14 for pre Rel-5 MS's	F	5.4.0	5.5.0	GP-032151	AMR
GP-16	GP-032067	1739	1	CR 51.010-1-1739 rev 1 Correction to AMR section 14.2.10 for pre Rel-5 MS's	F	5.4.0	5.5.0	GP-032067	AMR
GP-16	GP-031871	1740		CR 51.010-1-1740 Correction to AMR section 14.2.18 for pre Rel-5 MS's	F	5.4.0	5.5.0	GP-031871	AMR
GP-16	GP-031872	1741		CR 51.010-1-1741 Correction to AMR section 14.4.16 for pre Rel-5 MS's	F	5.4.0	5.5.0	GP-031872	AMR
GP-16	GP-031873	1742		CR 51.010-1-1742 Correction to AMR section 14.5.1.2 for pre Rel-5 MS's	F	5.4.0	5.5.0	GP-031873	AMR
GP-16	GP-031874	1743		CR 51.010-1-1743 Correction to AMR section 14.5.1.3 for pre Rel-5 MS's	F	5.4.0	5.5.0	GP-031874	AMR
GP-16	GP-031887	1744		CR 51.010-1-1744 Section 40.2.2.1.2 R99 settings for ECSC flag in Non GPRS Cell Options	F	5.4.0	5.5.0	GP-031887	GPRS
GP-16	GP-031888	1745		CR 51.010-1-1745 Section 14.4.8 Ambiguous definitions of the co-channel interferer	D	5.4.0	5.5.0	GP-031888	AMR
GP-16	GP-031889	1746		CR 51.010-1-1746 Section 14.4.16 Ambiguous definitions of co-channel interferer and typing	F	5.4.0	5.5.0	GP-031889	AMR

TSG #	TSG Doc	CR	Rev	Subject/Comment	Cat	Old	New	WG Doc	Work item
				error corrections					
GP-16	GP-032244	1747	1	CR 51.010-1-1747 rev1 Section 14.5.1.2 Ambiguous definitions of adjacent channel interferer	D	5.4.0	5.5.0	GP-032244	AMR
GP-16	GP-032245	1748	1	CR 51.010-1-1748 rev1 Section 14.5.1.3 Ambiguous definitions of adjacent-channel interferer and typing error corrections	F	5.4.0	5.5.0	GP-032245	AMR
GP-16	GP-031892	1749		CR 51.010-1-1749 Section 42.4.2.3.1 Correction of expected sequence	F	5.4.0	5.5.0	GP-031892	GPRS
GP-16	GP-032247	1750	2	CR 51.010-1-1750 rev2 Section 42.4.2.3.3 Correction of expected sequence	F	5.4.0	5.5.0	GP-032247	GPRS
GP-16	GP-031894	1751		CR 51.010-1-1751 Section 53.1.1.7 Inclusion of optional steps to match number of uplink blocks sent	F	5.4.0	5.5.0	GP-031894	EDGE
GP-16	GP-031896	1753		CR 51.010-1-1753 Section 53.1.1.18 Correction of expected BSN for test run using MCS-6	F	5.4.0	5.5.0	GP-031896	EDGE
GP-16	GP-031897	1754		CR 51.010-1-1754 Section 53.1.2.1 Removal of TIMESLOT_ALLOCATION = '00000010'	F	5.4.0	5.5.0	GP-031897	EDGE
GP-16	GP-031898	1755		CR 51.010-1-1755 Section 53.1.2.2 Removal of TIMESLOT_ALLOCATION = '00000010'	F	5.4.0	5.5.0	GP-031898	EDGE
GP-16	GP-031900	1757		CR 51.010-1-1757 Section 53.1.2.16 Removal of TIMESLOT_ALLOCATION = '00000010'	F	5.4.0	5.5.0	GP-031900	EDGE
GP-16	GP-031901	1758		CR 51.010-1-1758 Section 41.1.5.1.2 Clean up of specific message contents	F	5.4.0	5.5.0	GP-031901	GPRS
GP-16	GP-031902	1759		CR 51.010-1-1759 Section 42.1.2.1.8.2.2 Correct Macro in step 4 (Uplink data transfer, dynamic allocation)	F	5.4.0	5.5.0	GP-031902	GPRS
GP-16	GP-031912	1761		CR 51.010-1-1761 Section 42.1.2.1.7 PICS/PIXIT not needed	F	5.4.0	5.5.0	GP-031912	EDGE
GP-16	GP-031913	1762		CR 51.010-1-1762 Section 52.1.2.1.9.1 Removal of close ended TBF missing	F	5.4.0	5.5.0	GP-031913	EDGE
GP-16	GP-032171	1763	1	CR 51.010-1-1763 rev1 Section 52.8.1.1 Corrections to expected sequence	F	5.4.0	5.5.0	GP-032171	EDGE
GP-16	GP-031915	1764		CR 51.010-1-1764 Section 52.8.1.12 Correction of logical channel for sending PACKET UL ASSIGNMENT (PBCCH not present case)	F	5.4.0	5.5.0	GP-031915	EDGE
GP-16	GP-031916	1765		CR 51.010-1-1765 Section 53.1.1.3 Optional steps needed to consider blocks already scheduled in the MS's buffer	F	5.4.0	5.5.0	GP-031916	EDGE
GP-16	GP-031917	1766		CR 51.010-1-1766 Section 40.2.2.* Incorrect RFL contents in PSIs for cells B,C,D,E,F	F	5.4.0	5.5.0	GP-031917	GPRS
GP-16	GP-031918	1767		CR 51.010-1-1767 Section 26.6.3.x BCCH allocation sequence number missing from SYSTEM INFORMATION 5Bis messages	F	5.4.0	5.5.0	GP-031918	GSM
GP-16	GP-031919	1768		CR 51.010-1-1768 section 26.6.3.5 In G850 system information type 5 K=3 indicated channel numbers can not be set using variable bitmap format	F	5.4.0	5.5.0	GP-031919	GSM
GP-16	GP-031920	1769		CR 51.010-1-1769 section 26.6.3.7 Table, ARFCN, band identity corrections	F	5.4.0	5.5.0	GP-031920	GSM
GP-16	GP-031921	1770		CR 51.010-1-1770 section 26.6.8.4 In G850, GSM900, GSM450, GSM700 and GSM480 bands HANDOVER COMMAND message changed to match PCS1900 and PCN1800 bands	F	5.4.0	5.5.0	GP-031921	GSM
GP-16	GP-031923	1771		CR 51.010-1-1771 52.1.2.1.8.2.1 - Correction to initial conditions of system simulator	F	5.4.0	5.5.0	GP-031923	EDGE
GP-16	GP-031936	1773		CR 51.010-1-1773 Clause 45.5.1 - Error Cases	F	5.4.0	5.5.0	GP-031936	GPRS
GP-16	GP-032180	1774	1	CR 51.010-1-1774 rev1 Section 21.4, TEI, Update on radio Access Network	F	5.4.0	5.5.0	GP-032180	TEI
GP-16	GP-032251	1776	3	CR 51.010-1-1776 rev3 42.4.1.2 Correction to timers values	F	5.4.0	5.5.0	GP-032251	GPRS
GP-16	GP-031943	1777		CR 51.010-1-1777 26.16.10 splitted in two test cases	F	5.4.0	5.5.0	GP-031943	GPRS
GP-16	GP-031959	1778		CR 51.010-1-1778 Correction to RLC Test Case 43.1.1.3	F	5.4.0	5.5.0	GP-031959	GPRS
GP-16	GP-031960	1779		CR 51.010-1-1779 2G to 3G Cell Change Order 42.4.7	F	5.4.0	5.5.0	GP-031960	GPRS
GP-16	GP-031966	1780		CR 51.010-1-1780 TC 42.1.2.1.10.1 Packet Uplink Assignment / Abnormal cases / Incorrect PDCH assignment	F	5.4.0	5.5.0	GP-031966	GPRS
GP-16	GP-031967	1781		CR 51.010-1-1781 TC 42.1.2.1.9.2.2 Packet Uplink Assignment / Two phase access /	F	5.4.0	5.5.0	GP-031967	GPRS

TSG #	TSG Doc	CR	Rev	Subject/Comment	Cat	Old	New	WG Doc	Work item
				Contention resolution / TLLI mismatch					
GP-16	GP-031968	1782		CR 51.010-1-1782 TC 52.1.2.1.10.1 Packet Uplink Assignment / Abnormal cases / Incorrect PDCH assignment	F	5.4.0	5.5.0	GP-031968	EDGE
GP-16	GP-031969	1783		CR 51.010-1-1783 TC 52.1.2.1.9.2.3 Packet Uplink Assignment / Two phase access / Contention resolution / TLLI mismatch	F	5.4.0	5.5.0	GP-031969	EDGE
GP-16	GP-031970	1784		CR 51.010-1-1784 TC 44.2.3.1.4 Routing area updating / rejected / location area not allowed	F	5.4.0	5.5.0	GP-031970	GPRS
GP-16	GP-031972	1785		CR 51.010-1-1785 Test case update to mirror the changes to the DTM feature (Section 41).	F	5.4.0	5.5.0	GP-031972	DTM
GP-16	GP-031973	1786		CR 51.010-1-1786 Test case update to mirror the changes to the DTM feature (Sub-clause 22.11).	F	5.4.0	5.5.0	GP-031973	DTM
GP-16	GP-032048	1787		CR 51.010-1-1787 MS test case alignment to DTM core spec changes.	F	5.4.0	5.5.0	GP-032048	TEI
GP-16	GP-032049	1788		CR 51.010-1-1788 MS test case alignment to DTM core spec changes.	F	5.4.0	5.5.0	GP-032049	TEI
GP-16	GP-032050	1789		CR 51.010-1-1789 MS test case alignment to DTM core spec changes.	F	5.4.0	5.5.0	GP-032050	TEI
GP-16	GP-032051	1790		CR 51.010-1-1790 MS test case alignment to DTM core spec changes.	F	5.4.0	5.5.0	GP-032051	DTM
GP-16	GP-032052	1791		CR 51.010-1-1791 MS test case alignment to DTM core spec changes.	F	5.4.0	5.5.0	GP-032052	TEI
GP-16	GP-032053	1792		CR 51.010-1-1792 MS test case alignment to DTM core spec changes.	F	5.4.0	5.5.0	GP-032053	TEI
GP-16	GP-032054	1793		CR 51.010-1-1793 MS test case alignment to DTM core spec changes.	F	5.4.0	5.5.0	GP-032054	TEI
GP-16	GP-032055	1794		CR 51.010-1-1794 MS test case alignment to DTM core spec changes.	F	5.4.0	5.5.0	GP-032055	DTM
GP-16	GP-032056	1795		CR 51.010-1-1795 MS test case alignment to DTM core spec changes.	F	5.4.0	5.5.0	GP-032056	TEI
GP-16	GP-032057	1796		CR 51.010-1-1796 MS test case alignment to DTM core spec changes.	F	5.4.0	5.5.0	GP-032057	DTM
GP-16	GP-032058	1797		CR 51.010-1-1797 MS test case alignment to DTM core spec changes.	F	5.4.0	5.5.0	GP-032058	DTM
GP-16	GP-032060	1799		CR 51.010-1-1799 MS test case alignment to DTM core spec changes.	F	5.4.0	5.5.0	GP-032060	DTM
GP-16	GP-032172	1800	1	CR 51.010-1-1800 rev1 Section 52.8.1.6 Correction of expected sequence	F	5.4.0	5.5.0	GP-032172	EDGE
GP-16	GP-032080	1802		CR 51.010-1-1802 MS test case alignment to DTM core spec changes	F	5.4.0	5.5.0	GP-032080	DTM
GP-16	GP-032252	1803	3	CR 51.010-1-1803 rev2 Section 42: "New test cases: NC2 in Packet transfer mode	F	5.4.0	5.5.0	GP-032252	GPRS
GP-16	GP-032177	1804	1	CR 51.010-1-1804 rev1 Section 70: "New test case: Conventional GPS	F	5.4.0	5.5.0	GP-032177	LCS
GP-16	GP-032238	1806		CR 51.010-1-1806 Section 42.1.2.2.3 Packet Downlink Assignment/ Frequency hopping	F	5.4.0	5.5.0	GP-032238	GPRS
GP-17	GP-032299	1807	-	CR 51.010-1 Faulty RLC data block sending time in 42.5.4.1 (Rel-5)	F	5.5.0	5.6.0	GP-032299	GPRS
GP-17	GP-032300	1808	-	CR 51.010-1 Inconsistency in TC 42.1.2.1.3.1 (Rel-5)	F	5.5.0	5.6.0	GP-032300	GPRS
GP-17	GP-032301	1809	-	CR 51.010-1 Inconsistency in TC 52.1.2.1.3.1 (Rel-5)	F	5.5.0	5.6.0	GP-032301	EGPRS
GP-17	GP-032302	1810	-	Alignment of Test Specification with Core Specification in section 20.22.29	F	5.5.0	5.6.0	GP-032302	2G/3G Interworking
GP-17	GP-032306	1812	-	Adding TTY test cases to 51.010-1 section 80	B	5.5.0	5.6.0	GP-032306	TTY
GP-17	GP-032744	1813	1	Changes to final steps of 46.2.2.1.1	F	5.5.0	5.6.0	GP-032744	GPRS
GP-17	GP-032310	1814	-	Correction to TC 14.2.10	F	5.5.0	5.6.0	GP-032310	AMR
GP-17	GP-032759	1816	1	Location updating/periodic search for higher priority PLMN when the list of equivalent PLMNs includes the HPLMN, when a MS is registered in a foreign country's VPLMN/MS is in automatic mode	F	5.5.0	5.6.0	GP-032759	GSM
GP-17	GP-032742	1817	1	Periodic routing area updating / accepted / T3312 default value	F	5.5.0	5.6.0	GP-032742	GPRS
GP-17	GP-032743	1818	1	Periodic routing area updating / accepted	F	5.5.0	5.6.0	GP-032743	GPRS
GP-17	GP-032315	1819	-	Introduction of mobile station multislot power classes	F	5.5.0	5.6.0	GP-032315	TEI
GP-17	GP-032316	1820	-	Changing the default condition of the cell 1, from NC2 to NC0.	F	5.5.0	5.6.0	GP-032316	GPRS
GP-17	GP-032317	1821	-	Addition of a delay of 3 blocks after the sending	F	5.5.0	5.6.0	GP-032317	GPRS

TSG #	TSG Doc	CR	Rev	Subject/Comment	Cat	Old	New	WG Doc	Work item
				of the PACKET UPLINK ACK/NACK.					
GP-17	GP-032730	1822	1	Increasing the number of octets from 440 to 2000 for the data transfer triggered in step 0.	F	5.5.0	5.6.0	GP-032730	GPRS
GP-17	GP-032319	1823	-	Changing the PICS used in the step A10.	F	5.5.0	5.6.0	GP-032319	GPRS
GP-17	GP-032320	1824	-	Correcting the contents of SYSTEM INFORMATION TYPE 13.	F	5.5.0	5.6.0	GP-032320	GPRS
GP-17	GP-032321	1825	-	Using SI13 rather than PSI13.	F	5.5.0	5.6.0	GP-032321	GPRS
GP-17	GP-032322	1826	-	Addition of a delay of 6 blocks in step 9.	F	5.5.0	5.6.0	GP-032322	GPRS
GP-17	GP-032323	1827	-	Changing the Channel on which the PACKET DOWNLINK ASSIGNMENT is sent from PCCCH to PPCH.	F	5.5.0	5.6.0	GP-032323	GPRS
GP-17	GP-032324	1828	-	Updates in step 3.	F	5.5.0	5.6.0	GP-032324	GPRS
GP-17	GP-032327	1831	-	Modification in step 25.	F	5.5.0	5.6.0	GP-032327	GPRS
GP-17	GP-032328	1832	-	Modifications in testcases 42.4.2.3.3, 42.4.2.3.5, 42.4.2.3.6	F	5.5.0	5.6.0	GP-032328	GPRS
GP-17	GP-032329	1833	-	Modifications in the step 10 of the testcase 42.8.3.	F	5.5.0	5.6.0	GP-032329	GPRS
GP-17	GP-032330	1834	-	Modifications in the testcase 43.1.2.4 for the Mobiles stations negotiating for the window size less than 2.	F	5.5.0	5.6.0	GP-032330	GPRS
GP-17	GP-032331	1835	-	Changing the channel on which the IMMEDIATE ASSIGNMENT for the downlink TBF is sent, from AGCH to PCH.	F	5.5.0	5.6.0	GP-032331	GPRS
GP-17	GP-032332	1836	-	Modification to the test purpose of the testcase 46.1.2.2.1.1.	F	5.5.0	5.6.0	GP-032332	GPRS
GP-17	GP-032333	1837	-	Editorial modification to the test procedure of the testcases 46.1.2.2.4.3, 46.1.2.7.7	D	5.5.0	5.6.0	GP-032333	GPRS
GP-17	GP-032335	1839	-	Addition of a delay of 6 blocks in step 9.	F	5.5.0	5.6.0	GP-032335	EDGE
GP-17	GP-032336	1840	-	Changing the Channel on which the PACKET DOWNLINK ASSIGNMENT is sent, from PCCCH to PPCH.	F	5.5.0	5.6.0	GP-032336	EDGE
GP-17	GP-032337	1841	-	Changing the channel on which the IMMEDIATE ASSIGNMENT for the downlink TBF is sent from AGCH to PCH.	F	5.5.0	5.6.0	GP-032337	EDGE
GP-17	GP-032338	1842	-	Addition of new NC2 testcases to 42.4.1	B	5.5.0	5.6.0	GP-032338	GPRS
GP-17	GP-032339	1843	-	Addition of new NC2 testcases to 42.4.4	B	5.5.0	5.6.0	GP-032339	GPRS
GP-17	GP-032340	1844	-	Addition of new NC2 testcases to 20.22	B	5.5.0	5.6.0	GP-032340	GPRS
GP-17	GP-032343	1847	-	Initiation of the packet access procedure / timer T3146	F	5.5.0	5.6.0	GP-032343	EGPRS
GP-17	GP-032345	1850	-	Cell change order procedure / Uplink transfer / Failure cases / Contention resolution failure	F	5.5.0	5.6.0	GP-032345	GPRS
GP-17	GP-032735	1852	1	MT CS establishment whilst in NC2 with a uplink TBF established	F	5.5.0	5.6.0	GP-032735	GPRS
GP-17	GP-032736	1853	1	Network Control PEMR Uplink Data Transfer	F	5.5.0	5.6.0	GP-032736	GPRS
GP-17	GP-032349	1854	-	Mobile originated normal data transfer with LLC in unacknowledged mode	F	5.5.0	5.6.0	GP-032349	GPRS
GP-17	GP-032350	1855	-	Packet Uplink Assignment / Two phase access / Radio Access Capabilities/ Frequency band not supported.	F	5.5.0	5.6.0	GP-032350	EGPRS
GP-17	GP-032353	1858	-	Use of correct PICS for SMS testcases and correction of some errors (34.4.1 to 34.4.7)	F	5.5.0	5.6.0	GP-032353	GPRS
GP-17	GP-032358	1862	-	Set BS_CV_MAX to 1 in initial conditions.	F	5.5.0	5.6.0	GP-032358	GPRS
GP-17	GP-032359	1863	-	Set BS_CV_MAX to 1 in initial conditions.	F	5.5.0	5.6.0	GP-032359	EDGE
GP-17	GP-032360	1864	-	Extend maximum duration	F	5.5.0	5.6.0	GP-032360	GPRS
GP-17	GP-032362	1866	-	Correction of Ctrl_Ack Constraint.	F	5.5.0	5.6.0	GP-032362	GPRS
GP-17	GP-032747	1867	1	Test case 41.3.2.2 does not allow for the MS under test to send a PACKET UPLINK DUMMY CONTROL BLOCK.	F	5.5.0	5.6.0	GP-032747	GPRS
GP-17	GP-032364	1868	-	T3330 is not being taken into account in a number of section 44 tests.	F	5.5.0	5.6.0	GP-032364	GPRS
GP-17	GP-032365	1869	-	The way that the T200 timer should be implemented is not clearly specified.	F	5.5.0	5.6.0	GP-032365	GPRS
GP-17	GP-032748	1870	1	Test case 51.3.2.2 does not allow for the MS under test to send a PACKET UPLINK DUMMY CONTROL BLOCK.	F	5.5.0	5.6.0	GP-032748	EDGE
GP-17	GP-032377	1871	-	Modification to Expected Message Sequence to cater to all iterations	F	5.5.0	5.6.0	GP-032377	EDGE
GP-17	GP-032378	1872	-	Allowing uncompressed bitmap to be present in EGPRS Packet Downlink Ack/Nack	F	5.5.0	5.6.0	GP-032378	EDGE
GP-17	GP-032379	1873	-	Correction to specific message contents of Packet Timeslot Reconfigure message (1st execution)	F	5.5.0	5.6.0	GP-032379	EDGE

TSG #	TSG Doc	CR	Rev	Subject/Comment	Cat	Old	New	WG Doc	Work item
GP-17	GP-032380	1874	-	CM service acceptance procedure need to be done before Setup	F	5.5.0	5.6.0	GP-032380	GSM
GP-17	GP-032752	1875	1	Cell update need not be explicit in case of acknowledged mode RLC	F	5.5.0	5.6.0	GP-032752	EDGE
GP-17	GP-032753	1876	1	Resources need to be allocated to the MS to perform Cell Update	F	5.5.0	5.6.0	GP-032753	EDGE
GP-17	GP-032760	1877	1	Addition of new NC2 testcases to Section 42.4	F	5.5.0	5.6.0	GP-032760	GPRS
GP-17	GP-032756	1878	1	Network controlled Cell re-selection in Idle Mode	F	5.5.0	5.6.0	GP-032756	GPRS
GP-17	GP-032386	1879	-	CR 51.010-1 Section 21.3 Incorrect values for Max-samples	F	5.5.0	5.6.0	GP-032386	GSM
GP-17	GP-032387	1880	-	CR 51.010-1 Section 21.4 Incorrect values for Max-samples and missing definitions	F	5.5.0	5.6.0	GP-032387	GSM
GP-17	GP-032388	1881	-	CR 51.010-1 section 26.16.10.1 AMR signalling/ test of the channel mode modify procedure/ full rate	F	5.5.0	5.6.0	GP-032388	GSM
GP-17	GP-032389	1882	-	CR 51.010-1 section 26.16.10.2 AMR signalling/ test of the channel mode modify procedure/ half rate	F	5.5.0	5.6.0	GP-032389	GSM
GP-17	GP-032391	1884	-	CR 51.010-1 Section 41.3.5.2 Incorrect step references in expected sequence	F	5.5.0	5.6.0	GP-032391	GPRS
GP-17	GP-032392	1885	-	CR 51.010-1 Section 42.1.2.1.6 CHANGE_MARK_1 settings incorrect in PUAS message.	F	5.5.0	5.6.0	GP-032392	GPRS
GP-17	GP-032393	1886	-					GP-032393	
GP-17	GP-032395	1888	-	CR 51.010-1 Section 42.4.1.1 Invalid timer checks in expected sequence	F	5.5.0	5.6.0	GP-032395	GPRS
GP-17	GP-032396	1889	-	CR 51.010-1 Section 42.4.1.2 Invalid timing requirement in step 2	F	5.5.0	5.6.0	GP-032396	GPRS
GP-17	GP-032397	1890	-	CR 51.010-1 Section 42.4.2.1.1 Incorrect reference in expected sequence	F	5.5.0	5.6.0	GP-032397	GPRS
GP-17	GP-032398	1891	-	CR 51.010-1 Section 42.4.2.1.3 Test Case refers to non-existing Macro	F	5.5.0	5.6.0	GP-032398	GPRS
GP-17	GP-032400	1893	-	CR 51.010-1 Section 46.2.2.1.2 XID negotiation missing in expected Sequence.	F	5.5.0	5.6.0	GP-032400	GPRS
GP-17	GP-032746	1894	1	Optional LLC message missing.	F	5.5.0	5.6.0	GP-032746	GPRS
GP-17	GP-032402	1895	-	CR 51.010-1 Section 51.3.5.2 Incorrect step references in expected sequence	F	5.5.0	5.6.0	GP-032402	GPRS
GP-17	GP-032403	1896	-	CR 51.010-1 Section 52.1.2.1.8.1.8 Missing PACKET DOWNLINK DUMMY CONTROL BLOCK	F	5.5.0	5.6.0	GP-032403	EDGE
GP-17	GP-032404	1897	-	CR 51.010-1 Section 52.3.1.1.8 Mismatch between description in expected sequence and specific message contents	F	5.5.0	5.6.0	GP-032404	EGPRS
GP-17	GP-032405	1898	-	CR 51.010-1 Section 53.1.2.11 Implementation option in requirement check in step 7 missing	F	5.5.0	5.6.0	GP-032405	EGPRS
GP-17	GP-032406	1899	-	CR 51.010-1 Section 53.2.1.1 Step number missing	F	5.5.0	5.6.0	GP-032406	EGPRS
GP-17	GP-032407	1900	-	CR 51.010-1 Section 53.2.1.2 Step number missing	F	5.5.0	5.6.0	GP-032407	EGPRS
GP-17	GP-032408	1901	-	CR 51.010-1 Section 40.2.3 Timeslot restrictions in default PACKET UPLINK ASSIGNMENT and PACKET DOWNLINK ASSIGNMENT messages	F	5.5.0	5.6.0	GP-032408	GPRS
GP-17	GP-032409	1902	-	CR 51.010-1 Section 42.4.3.2.3 Default PACKET MEASUREMENT ORDER message for section 42.4.	F	5.5.0	5.6.0	GP-032409	GPRS
GP-17	GP-032410	1903	-	CR 51.010-1 Section 50.2.3 Timeslot restrictions in default PACKET UPLINK ASSIGNMENT and PACKET DOWNLINK ASSIGNMENT messages	F	5.5.0	5.6.0	GP-032410	EGPRS
GP-17	GP-032411	1904	-	CR 51.010-1 Section 43.2.1 Corrections in Specific Message Contents	F	5.5.0	5.6.0	GP-032411	GPRS
GP-17	GP-032757	1907	1	Ready Timer too short.	F	5.5.0	5.6.0	GP-032757	DTM
GP-17	GP-032415	1908	-	CR 51.010-1 Section 52.1.1.5 Split into two test procedures	F	5.5.0	5.6.0	GP-032415	EGPRS
GP-17	GP-032416	1909	-	CR 51.010-1 Section 52.1.2.1.6 Incorrect step reference	F	5.5.0	5.6.0	GP-032416	EGPRS
GP-17	GP-032417	1910	-					GP-032417	
GP-17	GP-032420	1913	-	CR 51.010-1 Section 53.1.1.9 Correction of test procedure.	F	5.5.0	5.6.0	GP-032420	EDGE
GP-17	GP-032782	1916	2	Correction of test procedure.	F	5.5.0	5.6.0	GP-032782	EDGE
GP-17	GP-032424	1917	-	CR 51.010-1 Section 53.1.1.20 Correction of test procedure.	F	5.5.0	5.6.0	GP-032424	EDGE
GP-17	GP-032737	1918	1	Cell update need not be explicit in case of acknowledged mode RLC	F	5.5.0	5.6.0	GP-032737	GPRS

TSG #	TSG Doc	CR	Rev	Subject/Comment	Cat	Old	New	WG Doc	Work item
GP-17	GP-032443	1919	-	Correction to specific message contents of Packet Timeslot Reconfigure message (1st execution)	F	5.5.0	5.6.0	GP-032443	GPRS
GP-17	GP-032738	1920	1	Resources need to be allocated to the MS to perform Cell Update	F	5.5.0	5.6.0	GP-032738	GPRS
GP-17	GP-032445	1921	-	Correction to testcase 53.1.2.3	F	5.5.0	5.6.0	GP-032445	EDGE
GP-17	GP-032446	1922	-	Correction to Inter-RAT (GPRS to UTRAN) Cell Change Order Test Cases	F	5.5.0	5.6.0	GP-032446	GPRS
GP-17	GP-032447	1923	-	Correction to GMM test case 44.2.3.2.2	F	5.5.0	5.6.0	GP-032447	GPRS
GP-17	GP-032448	1924	-	Correction to GMM test case 44.2.3.3.3	F	5.5.0	5.6.0	GP-032448	GPRS
GP-17	GP-032449	1925	-	Correction to EGPRS RLC test case 51.3.1.3	F	5.5.0	5.6.0	GP-032449	EGPRS
GP-17	GP-032755	1926	1	Corrections to EGPRS RLC test case 53.1.1.3	F	5.5.0	5.6.0	GP-032755	EGPRS
GP-17	GP-032451	1927	-	Correction to EGPRS RLC test case 53.1.1.4	F	5.5.0	5.6.0	GP-032451	EGPRS
GP-17	GP-032452	1928	-	Corrections to EGPRS RLC test case 53.1.1.7	F	5.5.0	5.6.0	GP-032452	EGPRS
GP-17	GP-032453	1929	-	Correction to EGPRS RLC test case 53.1.1.16	F	5.5.0	5.6.0	GP-032453	EGPRS
GP-17	GP-032454	1930	-	Corrections to EGPRS RLC test case 53.1.1.18	F	5.5.0	5.6.0	GP-032454	EGPRS
GP-17	GP-032455	1931	-	Correction to A-GPS test cases in section 70.8	F	5.5.0	5.6.0	GP-032455	LCS
GP-17	GP-032456	1932	-	MS-Based AGPS MOLR	F	5.5.0	5.6.0	GP-032456	LCS
GP-17	GP-032483	1933	-	Addition of Additive White Gaussian Noise (AWGN) as a standard test signal in Annex 5, clause A5.2.	B	5.5.0	5.6.0	GP-032483	TEI
GP-17	GP-032484	1934	-	Alignment of Conformance Requirement for clause 27.17.1.2 with TS 102 230.	F	5.5.0	5.6.0	GP-032484	TEI
GP-17	GP-032729	1935	1	Addition of GPRS RESUMPTION in Channel Release in the macros in section 40 - Default messages.	F	5.5.0	5.6.0	GP-032729	GPRS
GP-17	GP-032734	1936	1	Correction of Test Procedure and Expected Sequence for section 41.5.1.1.4 Uplink TBF establishment with no reallocation of CS resources / Abnormal cases / Inter System to UTRAN Handover Command	F	5.5.0	5.6.0	GP-032734	DTM
GP-17	GP-032487	1937	-	Clarification of the FBI bit in clause 42.1.2.2.6 - Packet Downlink Assignment Timing Advance / TA value field not provided	F	5.5.0	5.6.0	GP-032487	GPRS
GP-17	GP-032488	1938	-	Correction of amount of data to be triggered in clause 42.3.1.1.2 - Dynamic Allocation / Uplink Transfer / Normal / Request new resources	F	5.5.0	5.6.0	GP-032488	GPRS
GP-17	GP-032489	1939	-	Correction of Expected Sequence for section 42.4.5.1 Network Assisted Cell Change / Expiry of T3206	F	5.5.0	5.6.0	GP-032489	GPRS
GP-17	GP-032490	1940	-	Functional and editorial corrections for clause 42.4.5.4 - Network Assisted Cell Change / Packet Neighbour Cell Data and Packet Cell Change Order	F	5.5.0	5.6.0	GP-032490	GPRS
GP-17	GP-032739	1941	1	Functional and editorial corrections for clause 42.4.5.5 - Network Assisted Cell Change / Expiry of T3208 and T3210	F	5.5.0	5.6.0	GP-032739	GPRS
GP-17	GP-032740	1942	1	Setting CTRL_ACK_TYPE=0 in the Initial Conditions for clause 42.5.1.2 - Downlink Transfer/ Normal Operation / Without TBF starting time	F	5.5.0	5.6.0	GP-032740	GPRS
GP-17	GP-032493	1943	-	Clarification of the FBI bit in clause 52.1.2.2.6 - Packet Downlink Assignment Timing Advance / TA value field not provided	F	5.5.0	5.6.0	GP-032493	EGPRS
GP-17	GP-032494	1944	-	Correction of amount of data to be triggered in clause 52.3.1.1.2 - Dynamic Allocation / Uplink Transfer / Normal / Request new resources	F	5.5.0	5.6.0	GP-032494	EGPRS
GP-17	GP-032565	1945	-	CR 51.010-1 Section 40.2.4.35 MNC not specified correctly for different bands	F	5.5.0	5.6.0	GP-032565	GPRS
GP-17	GP-032780	1946	1	51.010-1 sections 14 and 21 receiver tests - selection of ARFCNs with fading and hopping	F	5.5.0	5.6.0	GP-032780	GSM
GP-17	GP-032777	1949	1	Packet Measurement order procedure / Downlink transfer / Normal case/ Routing Area Update/ NMO II	F	5.5.0	5.6.0	GP-032777	GPRS
GP-17	GP-032728	1950	1	Packet Measurement order procedure / Downlink transfer / Normal case/ Routing Area Update/ NMO I	F	5.5.0	5.6.0	GP-032728	GPRS
GP-17	GP-032741	1950	2	Network Control PEMR Downlink Data Transfer	F	5.5.0	5.6.0	GP-032741	GPRS
GP-17	GP-032723	1951	1	Performance of the Codec Mode Request Generation	F	5.5.0	5.6.0	GP-032723	AMR
GP-17	GP-032531	1952	-	Cell reselection when the best cell does not support GPRS	F	5.5.0	5.6.0	GP-032531	GPRS

TSG #	TSG Doc	CR	Rev	Subject/Comment	Cat	Old	New	WG Doc	Work item
GP-17	GP-032532	1953	-	Change in Bearer Service Code	F	5.5.0	5.6.0	GP-032532	GSM
GP-17	GP-032781	1954	2	New test cases: NACC	B	5.5.0	5.6.0	GP-032781	GPRS
GP-18	GP-040455	1955	3	New test case: L_level reporting	F	5.6.0	5.7.0	GP-040455	RF, GPRS
GP-17	GP-032750	1956	-	Routing area updating / rejected / location area not allowed	F	5.5.0	5.6.0	GP-032750	GPRS
GP-17	GP-032778	1957	-	Removal of test case 26.8.1.3.3.3 Incoming call / U9 mobile terminating call confirmed / termination requested by the user	F	5.5.0	5.6.0	GP-032778	TEI
GP-18	GP-040005	1958	-	53.1.1.7 – Correction to Expected Sequence	F	5.6.0	5.7.0	GP-040005	EDGE
GP-18	GP-040006	1959	-	53.1.1.9 – Step numbering corrections	F	5.6.0	5.7.0	GP-040006	EDGE
GP-18	GP-040007	1960	-	New NC2 testcases	F	5.6.0	5.7.0	GP-040007	GPRS
GP-18	GP-040011	1961	-	CR 51.010-1 42.4.2.3.1 Cell change order procedure / Simultaneous uplink and downlink transfer / Normal case	F	5.6.0	5.7.0	GP-040011	GPRS
GP-18	GP-040012	1962	-	CR 51.010-1 Functional corrections for clauses 42.4.2.3.3 and 42.4.2.3.6	F	5.6.0	5.7.0	GP-040012	GPRS
GP-18	GP-040013	1963	-	CR 51.010-1 correction for clause 42.4.4.4 - Network Control measurement reporting / Idle mode / Reselection due to RA failure	F	5.6.0	5.7.0	GP-040013	GPRS
GP-18	GP-040460	1964	1	CR 51.010-1 Functional and editorial corrections for clause 42.4.5.9 - Network Assisted Cell Change / NC mode change / Packet Neighbour Cell Data	F	5.6.0	5.7.0	GP-040460	GPRS
GP-18	GP-040015	1965	-	CR 51.010-1 Functional corrections for clause 42.4.8.1.3 - NC2 and DRX / NC_NON_DRX_PERIOD / NC2 non-DRX mode period broadcast in PS15	F	5.6.0	5.7.0	GP-040015	GPRS
GP-18	GP-040016	1966	-	CR 51.010-1 Functional corrections for clauses 42.4.8.1.2, 42.4.8.1.4, 42.4.8.1.5 and 42.4.8.1.6	F	5.6.0	5.7.0	GP-040016	GPRS
GP-18	GP-040017	1967	-	CR 51.010-1 Functional corrections for clauses 42.4.8.1.1 - NC2 and DRX / NC_NON_DRX_PERIOD / Respect of NC2 non-DRX mode period	F	5.6.0	5.7.0	GP-040017	GPRS
GP-18	GP-040544	1968	2	45.5.1 Error cases	F	5.6.0	5.7.0	GP-040544	GPRS
GP-18	GP-040019	1969	-	CR 51.010-1 51.3.1.2 TBF Release / Uplink / Normal / MS initiated / Unacknowledged mode.	F	5.6.0	5.7.0	GP-040019	EDGE
GP-18	GP-040020	1970	-	CR 51.010-1 52.8.1.2 One phase access/ PBCCH present / CONTENTION_RESOLUTION_TLLI / Contention resolution / Counter N3104	F	5.6.0	5.7.0	GP-040020	EDGE
GP-18	GP-040470	1971	1	CR 51.010-1 53.1.1.22 – wrong requirement check step 12	F	5.6.0	5.7.0	GP-040470	EDGE
GP-18	GP-040507	1973	1	60.1 - Removal of inconsistencies in GSM to UTRAN handover tests.	F	5.6.0	5.7.0	GP-040507	GPRS
GP-18	GP-040457	1977	2	41.2.3.11 MS may make two-phase access	F	5.6.0	5.7.0	GP-040457	GPRS
GP-18	GP-040458	1978	2	51.2.3.11 MS may make two-phase access	F	5.6.0	5.7.0	GP-040458	EDGE
GP-18	GP-040031	1979	-	46.2.2.4.3 – Clarify nature of XID parameter and response to UA message	F	5.6.0	5.7.0	GP-040031	GPRS
GP-18	GP-040033	1981	-	44.2.1.2.2.3.2 - Correction to Specific message contents of Test procedure 2.	F	5.6.0	5.7.0	GP-040033	GPRS
GP-18	GP-040501	1982	1	44.2.3.3.4 - Including the same READY timer value of 32 seconds in RAU ACCEPT	F	5.6.0	5.7.0	GP-040501	GPRS
GP-18	GP-040036	1984	-	53.1.1.3 - Editorial Correction to Specific message contents	D	5.6.0	5.7.0	GP-040036	EDGE
GP-18	GP-040037	1985	-	46.1.2.7.3 - Modification to the test sequence to handle the link release	F	5.6.0	5.7.0	GP-040037	GPRS
GP-18	GP-040459	1987	2	51.2.3.10 - Changing the frequency of USF allocation to MS	F	5.6.0	5.7.0	GP-040459	EDGE
GP-18	GP-040462	1988	1	52.3.3.2.2, 52.3.3.3 - Allocating USF in order to allow the Mobile to transmit Packet Resource Request.	F	5.6.0	5.7.0	GP-040462	EDGE
GP-18	GP-040461	1989	1	Allocating USF in order to allow the Mobile to transmit Packet Resource Request.	F	5.6.0	5.7.0	GP-040461	GPRS
GP-18	GP-040464	1990	1	52.3.3.2.1 - Allocating USF in order to allow the Mobile to transmit Packet Resource Request and Correction of some steps.	F	5.6.0	5.7.0	GP-040464	EDGE
GP-18	GP-040463	1991	1	42.3.3.2.1 - Allocating USF in order to allow the Mobile to transmit Packet Resource Request and Correction of some steps.	F	5.6.0	5.7.0	GP-040463	GPRS
GP-18	GP-040045	1993	-	41.2.7.1 - Changing the Description in Step 3	D	5.6.0	5.7.0	GP-040045	GPRS
GP-18	GP-040049	1997	-	26.6.5.1 Changes in Specific Message Contents for Mobiles Supporting Speech.	F	5.6.0	5.7.0	GP-040049	GSM
GP-18	GP-040050	1998	-	Changes in the System Information default	F	5.6.0	5.7.0	GP-040050	GSM

TSG #	TSG Doc	CR	Rev	Subject/Comment	Cat	Old	New	WG Doc	Work item
				content.					
GP-18	GP-040456	1999	1	Correcting the wrongly given PACKET TIMESLOT RECONFIGURE in the 40.2.3.7	F	5.6.0	5.7.0	GP-040456	GPRS
GP-18	GP-040053	2001	-	42.1.2.2.5.2 – RLC Data Block needs to be polled to ensure MS doesn't respond.	F	5.6.0	5.7.0	GP-040053	GPRS
GP-18	GP-040056	2003	-	42.1.2.1.10.2 – Allowing MS to send PACKET CHANNEL REQUEST after 0.9*T3164.	F	5.6.0	5.7.0	GP-040056	GPRS
GP-18	GP-040057	2004	-	Minor Changes in testcase 42.1.2.2.5.1	F	5.6.0	5.7.0	GP-040057	GPRS
GP-18	GP-040058	2005	-	Removing the wrongly used L/H notation in PACKET TIMESLOT RECONFIGURE default contents given in 42.3.4.	F	5.6.0	5.7.0	GP-040058	GPRS
GP-18	GP-040062	2009	-	42.4.6.4 – Changes in the reporting period used in the step 19 and deletion of steps 21-25.	F	5.6.0	5.7.0	GP-040062	GPRS
GP-18	GP-040465	2010	1	Increasing the READY TIMER value in 42.4.8.1.5 and 42.4.8.1.6.	F	5.6.0	5.7.0	GP-040465	GPRS
GP-18	GP-040064	2011	-	46.1.2.1.3-Modification to the test step 5.	F	5.6.0	5.7.0	GP-040064	GPRS
GP-18	GP-040065	2012	-	52.1.2.2.5.2 – RLC Data Block needs to be polled to ensure MS doesn't respond.	F	5.6.0	5.7.0	GP-040065	EGPRS
GP-18	GP-040066	2013	-	52.1.1.6 – Addition of a note for setting USF=FREE in accordance with the settings of the BS_PRACH_BLKs.	F	5.6.0	5.7.0	GP-040066	EGPRS
GP-18	GP-040067	2014	-	52.1.2.1.10.2 – Allowing MS to send PACKET CHANNEL REQUEST after 0.9*T3164.	F	5.6.0	5.7.0	GP-040067	EGPRS
GP-18	GP-040069	2015	-	Correcting the wrongly used L/H notation in PACKET TIMESLOT RECONFIGURE default contents given in 52.3.4.	F	5.6.0	5.7.0	GP-040069	EGPRS
GP-18	GP-040070	2016	-	53.1.1.25 – Correcting the specific message content for PACKET TIMESLOT RECONFIGURE.	F	5.6.0	5.7.0	GP-040070	EGPRS
GP-18	GP-040505	2017	2	Addition of new NC2 testcases to 42.4.8.4	B	5.6.0	5.7.0	GP-040505	GPRS
GP-18	GP-040073	2018	-	Correction to GMM test case 44.2.3.2.5.3.1	F	5.6.0	5.7.0	GP-040073	GPRS
GP-18	GP-040074	2019	-	Correction to test case 46.1.2.2.1.5	F	5.6.0	5.7.0	GP-040074	GPRS
GP-18	GP-040075	2020	-	Correction to test case 46.2.2.4.1	F	5.6.0	5.7.0	GP-040075	GPRS
GP-18	GP-040076	2021	-	PICS/PIXIT missing for Extended Uplink TBF	F	5.6.0	5.7.0	GP-040076	Extended Uplink TBF
GP-18	GP-040475	2022	1	Addition of TC's for Extended Uplink TBF for EGPRS	B	5.6.0	5.7.0	GP-040475	Extended Uplink TBF
GP-18	GP-040479	2024	1	Addition of TC: Intersystem Cell Reselection/Idle Mode/FDD_Qmin	B	5.6.0	5.7.0	GP-040479	Intersystem Change
GP-18	GP-040480	2025	1	Addition of TC: Intersystem Cell Reselection/Idle Mode/FDD_Qoffset	B	5.6.0	5.7.0	GP-040480	Intersystem Change
GP-18	GP-040493	2026	1	Addition of TC: Intersystem Cell Reselection/Idle Mode/Qsearch_I	B	5.6.0	5.7.0	GP-040493	Intersystem Change
GP-18	GP-040494	2029	1	CR 51.010-1 Section 20.22.3 Priority of cells	F	5.6.0	5.7.0	GP-040494	GPRS
GP-18	GP-040086	2030	-	CR 51.010-1 Rel-5: Essential corrections to 27.20 "SIM presence detection test case"	F	5.6.0	5.7.0	GP-040086	TEI
GP-18	GP-040503	2031	1	Removal of AMR C/I tests from section 26.16	F	5.6.0	5.7.0	GP-040503	AMR
GP-18	GP-040495	2032	1	New section 20 NC2 test cases	F	5.6.0	5.7.0	GP-040495	GPRS NC2
GP-18	GP-040149	2034	-	Allowing for more than one PACKET UPLINK DUMMY CONTROL BLOCK in step 9 for clause 41.3.6.2 - TBF Release / Extended Uplink / Recalculation of CV after CV = 0.	F	5.6.0	5.7.0	GP-040149	GPRS
GP-18	GP-040150	2035	-	Correction of Initial Conditions and Expected Sequence for clause 42.4.5.5 – Network Assisted Cell Change / Expiry of T3208 and T3210.	F	5.6.0	5.7.0	GP-040150	NACC
GP-18	GP-040151	2036	-	Correction of Specific Message Content for clause 42.4.5.9 - Network Assisted Cell Change / NC mode change / Packet Neighbour Cell Data.	F	5.6.0	5.7.0	GP-040151	NACC
GP-18	GP-040152	2037	-	Adding of new PICS statement for 7 SM test cases in clauses 45.x.	F	5.6.0	5.7.0	GP-040152	GPRS
GP-18	GP-040153	2038	-	Correction of Wait time in step 5 for clause 52.1.1.7 - Packet Channel Request / EGPRS Packet Channel Request	F	5.6.0	5.7.0	GP-040153	EGPRS
GP-18	GP-040154	2039	-	Correction to persistence level setting for clause 52.1.1.6.2 - Packet Channel Request / Access persistence control on PRACH / Persistence level.	F	5.6.0	5.7.0	GP-040154	EGPRS
GP-18	GP-040162	2040	-	TC 14.10.1, 14.10.2: Performance of the Codec	F	5.6.0	5.7.0	GP-040162	AMR

TSG #	TSG Doc	CR	Rev	Subject/Comment	Cat	Old	New	WG Doc	Work item
				Mode Request Generation for Adaptive Multi-Rate Codecs					
GP-18	GP-040055	2041	-	42.1.1.4 – Addition of a note for setting USF=FREE in accordance with the settings of the BS_PRACH_BLKs.	F	5.6.0	5.7.0	GP-040055	GPRS
GP-18	GP-040068	2042	-	Minor Changes in testcase 52.1.2.2.5.1	F	5.6.0	5.7.0	GP-040068	EGPRS
GP-18	GP-040169	2043	-	CR 51.010-1 section 45.3.3.2 Incorrect TI flags	F	5.6.0	5.7.0	GP-040169	GPRS
GP-18	GP-040170	2044	-	CR 51.010-1 Section 51.3.* Consideration of HSCSD/GPRS/EGPRS splitted Multislot Classes	F	5.6.0	5.7.0	GP-040170	GPRS
GP-18	GP-040171	2045	-	CR 51.010-1 Section 52.* Consideration of HSCSD/GPRS/EGPRS splitted Multislot Classes	F	5.6.0	5.7.0	GP-040171	GPRS
GP-18	GP-040172	2046	-	CR 51.010-1 Section 52.1.2.2.5.1 Consideration of HSCSD/GPRS/EGPRS splitted Multislot Classes and applicability corrected	F	5.6.0	5.7.0	GP-040172	EGPRS
GP-18	GP-040175	2049	-	CR 51.010-1 Section 53.1.1.18 Correction of test procedure	F	5.6.0	5.7.0	GP-040175	EDGE
GP-18	GP-040182	2050	-	Correction of Step 7 for clause 42.4.5.7 - Network Assisted Cell Change / CCN not supported towards target cell	F	5.6.0	5.7.0	GP-040182	NACC
GP-18	GP-040203	2051	-	CR 51.010-1 52.3.1.2.3 - Dynamic Allocation / Uplink Transfer / Abnormal / with cell reselection in unacknowledged mode	F	5.6.0	5.7.0	GP-040203	EDGE
GP-18	GP-040204	2052	-	CR 51.010-1 42.3.1.2.3 - Dynamic Allocation / Uplink Transfer / Abnormal / with cell reselection in unacknowledged mode	F	5.6.0	5.7.0	GP-040204	GPRS
GP-18	GP-040238	2053	-	Correction to GMM test case 44.2.3.2.2.	F	5.6.0	5.7.0	GP-040238	GPRS
GP-18	GP-040239	2054	-	Correction to test cases 34.2.2 and 34.4.2.	F	5.6.0	5.7.0	GP-040239	TEI
GP-18	GP-040240	2055	-	CR 51.010-1 Section 11.1 Correction for R99 compliance	F	5.6.0	5.7.0	GP-040240	GSM
GP-18	GP-040241	2056	-	CR 51.010-1 Section 42.4.2.3.4 and 42.4.2.3.5 Corrections to test procedure	F	5.6.0	5.7.0	GP-040241	GPRS
GP-18	GP-040242	2057	-	CR 51.010-1 Section 42.4.8.* Corrections of SI2quater_COUNT value	F	5.6.0	5.7.0	GP-040242	GPRS
GP-18	GP-040244	2058	-	CR 51.010-1 Section 13.7 Reduction of maximum output power in a multislot configuration for R99 and later is not considered correctly	F	5.6.0	5.7.0	GP-040244	GSM
GP-18	GP-040245	2059	-	CR 51.010-1 Section 13.16.2 Reduction of maximum output power in a multislot configuration for R99 and later is not considered correctly	F	5.6.0	5.7.0	GP-040245	GPRS
GP-18	GP-040511	2060	1	CR 51.010-1 Section 14.18.1 BCS corruption to be tested under static conditions	F	5.6.0	5.7.0	GP-040511	EGPRS
GP-18	GP-040247	2061	-	CR 51.010-1 Section 14.18.5 Introduction of Statistical Testing	F	5.6.0	5.7.0	GP-040247	EGPRS
GP-18	GP-040248	2062	-	CR 51.010-1 Section 20.22.10 Cell Selection-Search for Suitable Cell/ cell priority	F	5.6.0	5.7.0	GP-040248	GPRS
GP-18	GP-040249	2063	-	CR 51.010-1 Section 20.22.13 Cell Reselection based on C32 quality	F	5.6.0	5.7.0	GP-040249	GPRS
GP-18	GP-040498	2064	1	CR 51.010-1 Section 20.22.15 Cell Reselection/ ready state/ no reselection	F	5.6.0	5.7.0	GP-040498	GPRS
GP-18	GP-040251	2065	-	CR 51.010-1 Section 20.22.16 Cell Reselection/ ready state/ Reselection and Cell update procedure	F	5.6.0	5.7.0	GP-040251	GPRS
GP-18	GP-040252	2066	-	CR 51.010-1 Section 20.22.17 C2 reselection in another RA – no cell reselection	F	5.6.0	5.7.0	GP-040252	GPRS
GP-18	GP-040253	2067	-	CR 51.010-1 Section 20.22.18 C2 reselection in another Routing Area – Routing Area Update	F	5.6.0	5.7.0	GP-040253	GPRS
GP-18	GP-040497	2068	1	Correction to test case 20.22.19	F	5.6.0	5.7.0	GP-040497	GPRS
GP-18	GP-040510	2069	1	CR 51.010-1 Section 20.22.20 Cell Reselection based on C32 – Cell Reselection on CCCH – PBCCH not present	F	5.6.0	5.7.0	GP-040510	GPRS
GP-18	GP-040256	2070	-	CR 51.010-1 Section 20.22.21 Removal of test case	F	5.6.0	5.7.0	GP-040256	GPRS
GP-18	GP-040257	2071	-	CR 51.010-1 Section 20.22.22 Cell Reselection with cells in different Routing area - Cell Reselection on CCCH - PBCCH not present	F	5.6.0	5.7.0	GP-040257	GPRS
GP-18	GP-040258	2072	-	CR 51.010-1 Section 20.22.23 Cell Reselection based on C32 – Cell Reselection on CCCH – PBCCH not present	F	5.6.0	5.7.0	GP-040258	GPRS
GP-18	GP-040259	2073	-	CR 51.010-1 Section 20.22.24 Cell Reselection based on C32/ cell of same priority/ Cell Reselection on CCCH – PBCCH not present	F	5.6.0	5.7.0	GP-040259	GPRS

TSG #	TSG Doc	CR	Rev	Subject/Comment	Cat	Old	New	WG Doc	Work item
GP-18	GP-040499	2074	1	CR 51.010-1 Section 20.22.25 Cell Reselection based on C32/C31<0/ Cell Reselection on CCCH – PBCCH not present	F	5.6.0	5.7.0	GP-040499	GPRS
GP-18	GP-040261	2075	-	CR 51.010-1 Section 20.22.26 Cell reselection based on C32 quality/ Cell Reselection on CCCH – PBCCH not present	F	5.6.0	5.7.0	GP-040261	GPRS
GP-18	GP-040500	2076	1	CR 51.010-1 Section 20.22.28 Cell Reselection/ no suitable cell found/ cell selection	F	5.6.0	5.7.0	GP-040500	GPRS
GP-18	GP-040265	2079	-	CR 51.010-1 section 26.16.11 Multirate configurations needed in specific message contents. M = 2 sequence not needed when K = 1.	F	5.6.0	5.7.0	GP-040265	GSM
GP-18	GP-040266	2080	-	CR 51.010-1 section 26.16.9.11 Correction of Test Procedure	F	5.6.0	5.7.0	GP-040266	GSM
GP-18	GP-040267	2081	-	CR 51.010-1 section 26.16.9.12 Correction of Test Procedure	F	5.6.0	5.7.0	GP-040267	GSM
GP-18	GP-040268	2082	-	CR 51.010-1 Section 34.1 GPRS default conditions for 34.4 (SMS over GPRS)	F	5.6.0	5.7.0	GP-040268	GPRS
GP-18	GP-040269	2083	-	CR 51.010-1 Section 41.3.* Consideration of HSCSD/GPRS/EGPRS splitted Multislot Classes	F	5.6.0	5.7.0	GP-040269	GPRS
GP-18	GP-040270	2084	-	CR 51.010-1 Section 42.* Consideration of HSCSD/GPRS/EGPRS splitted Multislot Classes	F	5.6.0	5.7.0	GP-040270	GPRS
GP-18	GP-040271	2085	-	CR 51.010-1 Section 42.1.2.2.5.1 Consideration of HSCSD/GPRS/EGPRS splitted Multislot Classes and applicability corrected	F	5.6.0	5.7.0	GP-040271	GPRS
GP-18	GP-040273	2087	-	CR 51.010-1 Section 42.8.5 Incorrect step number reference in Expected Sequence	F	5.6.0	5.7.0	GP-040273	GPRS
GP-18	GP-040275	2089	-	CR 51.010-1 Section 44.2.8.2 Test case should be deleted as it is redundant because exactly the same test is available in 47.3.2.1	F	5.6.0	5.7.0	GP-040275	DTM
GP-18	GP-040277	2090	-	Correction to EGPRS RLC test case 52.8.1.1	F	5.6.0	5.7.0	GP-040277	EGPRS
GP-18	GP-040278	2091	-	Correction to EGPRS RLC test case 52.8.1.6	F	5.6.0	5.7.0	GP-040278	EGPRS
GP-18	GP-040514	2092	2	New test case: Coding Scheme adaptation while the MS is in extended Uplink mode	F	5.6.0	5.7.0	GP-040514	GPRS
GP-18	GP-040545	2093	3	New test case: Modulation and Coding Scheme adaptation while the MS is in extended Uplink mode	F	5.6.0	5.7.0	GP-040545	EGPRS
GP-18	GP-040512	2094	1	CR 51.010-1 Section 45 Applicability restrictions for three test cases	F	5.6.0	5.7.0	GP-040512	GPRS
GP-19	GP-040577	2096	-	Wanted signal levels for CS4 not in line with C/lc specification	F	5.7.0	5.8.0	GP-040577	RF
GP-19	GP-040578	2097	-	Addition of PICS/PIXT	F	5.7.0	5.8.0	GP-040578	GSM
GP-19	GP-040579	2098	-	Change of Pb power parameter	F	5.7.0	5.8.0	GP-040579	GPRS
GP-19	GP-041105	2099	1	Data retransmission included	F	5.7.0	5.8.0	GP-041105	GPRS
GP-19	GP-040581	2100	-	New NITZ Test cases	F	5.7.0	5.8.0	GP-040581	GPRS
GP-19	GP-040583	2101	-	Correction of testcases following NC2 work plan (DeletingTC)	F	5.7.0	5.8.0	GP-040583	GPRS
GP-19	GP-040584	2102	-	Correction of testcases following NC2 work plan (Including TC)	F	5.7.0	5.8.0	GP-040584	GPRS
GP-19	GP-041106	2105	1	Increase of amount to be triggered for testcases 41.3.2.1,41.3.2.2 and 41.3.2.3	F	5.7.0	5.8.0	GP-041106	GPRS
GP-19	GP-041124	2106	1	Correction to Expected sequence of Test procedure 1.	F	5.7.0	5.8.0	GP-041124	GPRS
GP-19	GP-041204	2107	1	Network Control measurement reporting / Uplink transfer / Continuation in Idle mode	F	5.7.0	5.8.0	GP-041204	GPRS
GP-19	GP-041108	2108	1	Network Control measurement reporting / Uplink transfer / Continuation in Idle mode	F	5.7.0	5.8.0	GP-041108	GPRS
GP-19	GP-041110	2109	1	Packet Measurement order procedure / Downlink transfer / Normal case/ Dedicated parameters	F	5.7.0	5.8.0	GP-041110	GPRS
GP-19	GP-041205	2110	1	Network Control measurement reporting / Idle mode / Reselection due to RA failure	F	5.7.0	5.8.0	GP-041205	GPRS
GP-19	GP-041107	2116	1	Increase of amount to be triggered for testcases 51.3.2.1 and 51.3.2.2	F	5.7.0	5.8.0	GP-041107	EDGE
GP-19	GP-041112	2117	1	Network Assisted Cell Change / Packet Neighbour Cell Data and Packet Cell Change Order	F	5.7.0	5.8.0	GP-041112	GPRS
GP-19	GP-041113	2118	1	Network Assisted Cell Change / NC mode change / Packet Neighbour Cell Data	F	5.7.0	5.8.0	GP-041113	GPRS
GP-19	GP-040604	2119	-	TC 15.9 Timing Advance whilst in DTM	F	5.7.0	5.8.0	GP-040604	DTM
GP-19	GP-041188	2123	1	Annex to test case 31.1.4.2	F	5.7.0	5.8.0	GP-041188	GSM
GP-19	GP-040609	2124	-	Correction to test case 45.5.1	F	5.7.0	5.8.0	GP-040609	GPRS

TSG #	TSG Doc	CR	Rev	Subject/Comment	Cat	Old	New	WG Doc	Work item
GP-19	GP-040610	2125	-	Correction to section 40.5 (Test PDP contexts)	F	5.7.0	5.8.0	GP-040610	GPRS
GP-19	GP-041109	2126	1	Dynamic Allocation / Uplink Transfer / Abnormal / with cell reselection in acknowledged mode	F	5.7.0	5.8.0	GP-041109	GPRS
GP-19	GP-040612	2127	-	Combined routing area updating / MS in CS operation at change of RA	F	5.7.0	5.8.0	GP-040612	GPRS
GP-19	GP-040615	2129	-	Method of test for equipment with a permanent antenna connector	F	5.7.0	5.8.0	GP-040615	GSM
GP-19	GP-041114	2130	1	Packet Channel Request / Access type	F	5.7.0	5.8.0	GP-041114	TEI
GP-19	GP-040629	2131	-	Removal of 42.3.1.1.2 Dynamic Allocation / Uplink Transfer / Normal / Request new resources	F	5.7.0	5.8.0	GP-040629	TEI
GP-19	GP-041115	2132	1	EGPRS Packet Channel Request / Access type	F	5.7.0	5.8.0	GP-041115	TEI
GP-19	GP-040631	2133	-	Removal of 52.3.1.1.2 Dynamic Allocation / Uplink Transfer / Normal / Request new resources	F	5.7.0	5.8.0	GP-040631	TEI
GP-19	GP-040637	2134	-	New NITZ Test case	F	5.7.0	5.8.0	GP-040637	GSM
GP-19	GP-040640	2136	-	Removal of AMR C/I tests from section 26.16	F	5.7.0	5.8.0	GP-040640	AMR
GP-19	GP-041111	2137	1	Corrections to minimum samples and minimum test times	F	5.7.0	5.8.0	GP-041111	GSM
GP-19	GP-040642	2138	-	Corrections to minimum samples due to fading	F	5.7.0	5.8.0	GP-040642	GSM
GP-19	GP-041102	2139	1	Corrections to minimum samples due to fading	F	5.7.0	5.8.0	GP-041102	GSM
GP-19	GP-040644	2140	-	Alignment of classical and statistical tests	F	5.7.0	5.8.0	GP-040644	GSM
GP-19	GP-040646	2141	-	Correction to specific message contents of Packet Timeslot Reconfigure message (1st execution) (revisited)	F	5.7.0	5.8.0	GP-040646	GPRS
GP-19	GP-040647	2142	-	Correction to specific message contents of Packet Timeslot Reconfigure message (1st execution) (revisited)	F	5.7.0	5.8.0	GP-040647	EDGE
GP-19	GP-040654	2143	-	Correction to Initial Conditions of System Simulator	F	5.7.0	5.8.0	GP-040654	GPRS
GP-19	GP-040655	2144	-	Correction to Initial Conditions of System Simulator	F	5.7.0	5.8.0	GP-040655	EDGE
GP-19	GP-040657	2146	-	Ready Timer shall be deactivated.	F	5.7.0	5.8.0	GP-040657	GPRS
GP-19	GP-041117	2147	1	Handling of Measurement Report at Step 4	F	5.7.0	5.8.0	GP-041117	GPRS
GP-19	GP-041179	2148	1	Setting Force to Standby in Routing Area Accept.	F	5.7.0	5.8.0	GP-041179	GPRS
GP-19	GP-040660	2149	-	The GERAN #17 CR GP-032364 is not reflected in 51.010-1.	F	5.7.0	5.8.0	GP-040660	GPRS
GP-19	GP-041180	2150	1	Setting Force to Standby in Routing Area Accept.	F	5.7.0	5.8.0	GP-041180	GPRS
GP-19	GP-040663	2152	-	Correction to test procedure, as per GERAN #17 CR GP-32365	F	5.7.0	5.8.0	GP-040663	GPRS
GP-19	GP-041128	2153	1	Modification to the test sequence, PDP Context 5 Activation moved to Step 1.	F	5.7.0	5.8.0	GP-041128	GPRS
GP-19	GP-040668	2156	-	Editorial Change to step numbering.	F	5.7.0	5.8.0	GP-040668	GPRS
GP-19	GP-040669	2157	-	Editorial Change to step numbering.	F	5.7.0	5.8.0	GP-040669	EDGE
GP-19	GP-041118	2158	1	Correction to Step number 42.4.2.1.4	F	5.7.0	5.8.0	GP-041118	GPRS
GP-19	GP-040671	2159	-	Modify Initial Conditions: MS to be GPRS attached/in Packet Idle mode, PDP context 31 established.	F	5.7.0	5.8.0	GP-040671	EDGE
GP-19	GP-041119	2163	1	Correction to PICS statement to use EGPRS Multislot Class	F	5.7.0	5.8.0	GP-041119	EDGE
GP-19	GP-040685	2164	-	Removal of Wait of BS_CV_MAX block periods	F	5.7.0	5.8.0	GP-040685	EDGE
GP-19	GP-040686	2165	-	Correction to the type of allocation in Packet Uplink Assignments in Test sequence	F	5.7.0	5.8.0	GP-040686	EDGE
GP-19	GP-040687	2166	-	Correction to testcase to use the PICS for GPRS Multislot Class	F	5.7.0	5.8.0	GP-040687	GPRS
GP-19	GP-040689	2167	-	Correction to amount of data triggered	F	5.7.0	5.8.0	GP-040689	GPRS
GP-19	GP-041123	2168	1	Clarification to test case 22.3 on change of Power Level	F	5.7.0	5.8.0	GP-041123	GPRS
GP-19	GP-040691	2169	-	Correction to test case 44.2.3.1.2, deactivation of cell A	F	5.7.0	5.8.0	GP-040691	GPRS
GP-19	GP-040693	2171	-	New test case for Intersystem Change and Integrity Protection	B	5.7.0	5.8.0	GP-040693	Intersystem Change
GP-19	GP-041171	2172	1	Corrections and improvements on section 60.x	F	5.7.0	5.8.0	GP-041171	Inter System Handover
GP-19	GP-040736	2173	-	Test could be passed without having decoded PMO message.	F	5.7.0	5.8.0	GP-040736	GPRS
GP-19	GP-040737	2174	-	Test could be passed without having decoded PMO message.	F	5.7.0	5.8.0	GP-040737	GPRS
GP-19	GP-040738	2175	-	Test could be passed without having decoded	F	5.7.0	5.8.0	GP-040738	GPRS

TSG #	TSG Doc	CR	Rev	Subject/Comment	Cat	Old	New	WG Doc	Work item
				PMO message.					
GP-19	GP-040739	2176	-	Test could be passed without having decoded PMO message.	F	5.7.0	5.8.0	GP-040739	GPRS
GP-19	GP-040740	2177	-	Specification of R99/Rel-4 default conditions for GPRS cell selection / re-selection	F	5.7.0	5.8.0	GP-040740	GPRS
GP-19	GP-040741	2178	-	Check for no further CP_DATA_ACK missing in Expected sequence	F	5.7.0	5.8.0	GP-040741	GPRS
GP-19	GP-040742	2179	-	Incorrect naming of timer TC1M	F	5.7.0	5.8.0	GP-040742	GPRS
GP-19	GP-040743	2180	-	Conformance requirements and Initial conditions corrections	F	5.7.0	5.8.0	GP-040743	GPRS
GP-19	GP-041187	2181	1	Conformance requirement for CP Error Handling updated and test corrected	F	5.7.0	5.8.0	GP-041187	GPRS
GP-19	GP-040745	2182	-	Consideration of Transfer non-DRX mode period	F	5.7.0	5.8.0	GP-040745	GPRS
GP-19	GP-040746	2183	-	Incorrect step references Section 41.2.3.11	F	5.7.0	5.8.0	GP-040746	GPRS
GP-19	GP-040747	2184	-	Insufficient amount of data triggered	F	5.7.0	5.8.0	GP-040747	GPRS
GP-19	GP-040748	2185	-	Correction of requirement check	F	5.7.0	5.8.0	GP-040748	GPRS
GP-19	GP-040749	2186	-	Optional steps added and some further corrections	F	5.7.0	5.8.0	GP-040749	GPRS
GP-19	GP-040750	2187	-	Optional steps added and some further corrections	F	5.7.0	5.8.0	GP-040750	GPRS
GP-19	GP-040751	2188	-	Wait time in Expected sequence too short. Initial conditions improved	F	5.7.0	5.8.0	GP-040751	GPRS
GP-19	GP-040752	2189	-	Correction to test procedure regarding to persistence level settings	F	5.7.0	5.8.0	GP-040752	GPRS
GP-19	GP-040754	2191	-	Correction Initial conditions and Test Procedure	F	5.7.0	5.8.0	GP-040754	GPRS
GP-19	GP-041121	2193	1	Section 42.4.2.3.5 Corrections to the test procedure	F	5.7.0	5.8.0	GP-041121	GPRS
GP-19	GP-040757	2194	-	Section 42.4.2.3.6 Corrections to the test procedure	F	5.7.0	5.8.0	GP-040757	GPRS
GP-19	GP-041120	2195	1	Section 42.4.2.3.7 Corrections to the test procedure	F	5.7.0	5.8.0	GP-041120	GPRS
GP-19	GP-040759	2196	-	Section 42.4.4.3 Packet Downlink Dummy Control block with USF assignment missing in Expected Sequence	F	5.7.0	5.8.0	GP-040759	GPRS
GP-19	GP-040760	2197	-	Section 42.4.4.4 Corrections to the test procedure	F	5.7.0	5.8.0	GP-040760	GPRS
GP-19	GP-040761	2198	-	Section 42.4.5.3 Two Phase access to be considered	F	5.7.0	5.8.0	GP-040761	GPRS
GP-19	GP-040763	2200	-	Section 42.4.5.7 Corrections to Initial conditions, Expected Sequence and Specific message contents	F	5.7.0	5.8.0	GP-040763	GPRS
GP-19	GP-040764	2201	-	Section 42.4.5.8 Corrections to Expected Sequence and Specific message contents	F	5.7.0	5.8.0	GP-040764	GPRS
GP-19	GP-040766	2203	-	Section 42.4.8.1.1 PMO to be sent on PPCH	F	5.7.0	5.8.0	GP-040766	GPRS
GP-19	GP-040767	2204	-	Section 44.2.3.3.3 Value of TMSI status IE to be re-added.	F	5.7.0	5.8.0	GP-040767	GPRS
GP-19	GP-040769	2206	-	Section 51.1 Consideration of Transfer non-DRX mode period	F	5.7.0	5.8.0	GP-040769	EDGE
GP-19	GP-040770	2207	-	Section 51.2.3.10 Incorrect step references	F	5.7.0	5.8.0	GP-040770	EDGE
GP-19	GP-040771	2208	-	Section 51.2.3.11 Incorrect step references	F	5.7.0	5.8.0	GP-040771	EDGE
GP-19	GP-040772	2209	-	Section 51.3.6.1 Correction of requirement check	F	5.7.0	5.8.0	GP-040772	EDGE
GP-19	GP-040773	2210	-	Section 51.3.6.2 Optional steps added and some further corrections	F	5.7.0	5.8.0	GP-040773	EDGE
GP-19	GP-040774	2211	-	Section 51.3.6.3 Optional steps added and some further corrections	F	5.7.0	5.8.0	GP-040774	EDGE
GP-19	GP-040775	2212	-	Section 52.1.1.6.1 Wait time in Expected sequence too short. Initial conditions improved	F	5.7.0	5.8.0	GP-040775	GPRS
GP-19	GP-040778	2215	-	Section 53.1.1.3 Number of octets changed in expected sequence	F	5.7.0	5.8.0	GP-040778	EDGE
GP-19	GP-040780	2217	-	Section 40 Specification of Rel 4 default conditions	F	5.7.0	5.8.0	GP-040780	GPRS
GP-19	GP-040781	2218	-	Annex A5.3.4.8 Incorrect reference to test case	F	5.7.0	5.8.0	GP-040781	GSM
GP-19	GP-041202	2219	1	Section 42.5.5.3 Correction of PSI2 parameter settings	F	5.7.0	5.8.0	GP-041202	GPRS
GP-19	GP-041203	2220	1	Section 52.5.5.3 Correction of PSI2 parameter settings	F	5.7.0	5.8.0	GP-041203	EDGE
GP-19	GP-040784	2221	-	Section 42.4.4.1 Correction of Test Purpose description	F	5.7.0	5.8.0	GP-040784	GPRS
GP-19	GP-040785	2222	-	Section 42.4.8.1.4 Correction of paging in NON_DRX_PERIOD	F	5.7.0	5.8.0	GP-040785	GPRS
GP-19	GP-040866	2223	-	NC2 and DRX / NC_NON_DRX_PERIOD / NC2	F	5.7.0	5.8.0	GP-040866	GPRS

TSG #	TSG Doc	CR	Rev	Subject/Comment	Cat	Old	New	WG Doc	Work item
				non-DRX mode period broadcast in SI2Quater					
GP-19	GP-040867	2224	-	Network Assisted Cell Change / Packet Neighbour Cell Data and Packet Cell Change Continue	F	5.7.0	5.8.0	GP-040867	GPRS
GP-19	GP-040874	2226	-	Network Assisted Cell Change / NC mode change	F	5.7.0	5.8.0	GP-040874	GPRS
GP-19	GP-040898	2228	-	TC 41.3.2.1 does not allow delay for the MS to be ready to transmit RLC block	F	5.7.0	5.8.0	GP-040898	GPRS
GP-19	GP-040899	2229	-	TC 51.3.2.1 does not allow delay for the MS to be ready to transmit RLC block	F	5.7.0	5.8.0	GP-040899	EDGE
GP-19	GP-040903	2230	-	Correction to the timing requirement for Classmark Change sending	F	5.7.0	5.8.0	GP-040903	TEI
GP-19	GP-040904	2231	-	Changing wait time in step 2 of the Expected Sequence for clause 26.8.1.2.2.3 - Outgoing call / U0.1 MM connection pending / lower layer failure	F	5.7.0	5.8.0	GP-040904	TEI
GP-19	GP-040905	2232	-	Network Assisted Cell Change / CCN not supported towards target cell	F	5.7.0	5.8.0	GP-040905	NACC
GP-19	GP-040907	2234	-	Correction of Specific Message Contents for clause 53.1.2.19 - Acknowledged Mode/ Downlink TBF/ TBF Reallocation/Window Size	F	5.7.0	5.8.0	GP-040907	EGPRS
GP-19	GP-040909	2236	-	Correction to the 'Conformance requirements'	F	5.7.0	5.8.0	GP-040909	DTM
GP-19	GP-040910	2237	-	Default contents of System Information Type 6 and DTM Information	B	5.7.0	5.8.0	GP-040910	DTM
GP-19	GP-040911	2238	-	TBF release / Uplink / Normal / Network initiated / Whilst in DTM	F	5.7.0	5.8.0	GP-040911	DTM
GP-19	GP-040912	2239	-	TBF release / Downlink / Normal / Network initiated / Whilst in DTM	F	5.7.0	5.8.0	GP-040912	DTM
GP-19	GP-040913	2240	-	section 41.5.1.1.1.3: Change to Wait indication	F	5.7.0	5.8.0	GP-040913	DTM
GP-19	GP-041172	2241	1	DTM Information messages added to Expected Sequences	F	5.7.0	5.8.0	GP-041172	DTM
GP-19	GP-040915	2242	-	section 41.5.1.1.2.2: DTM Request added to Expected Sequence	F	5.7.0	5.8.0	GP-040915	DTM
GP-19	GP-040916	2243	-	section 41.5.1.2.1.2: Correction to Test Procedure	F	5.7.0	5.8.0	GP-040916	DTM
GP-19	GP-040917	2244	-	sections 41.5.2.1 and 47.3.1.3.2: Editorial changes to Test Procedures	D	5.7.0	5.8.0	GP-040917	DTM
GP-19	GP-040918	2245	-	section 41.5.2.2: Correction to Expected Sequence	F	5.7.0	5.8.0	GP-040918	DTM
GP-19	GP-041181	2246	1	section 41.5.2.3: Correction to Expected Sequence	F	5.7.0	5.8.0	GP-041181	DTM
GP-19	GP-040920	2247	-	section 41.5.2.4: Correction to Expected Sequence	F	5.7.0	5.8.0	GP-040920	DTM
GP-19	GP-040921	2248	-	41.5.3.1.2 Uplink TBF establishment with a downlink TBF established and PS downlink reallocation	F	5.7.0	5.8.0	GP-040921	DTM
GP-19	GP-040922	2249	-	42.6.1 Exclusive allocation in single-slot configuration	F	5.7.0	5.8.0	GP-040922	DTM
GP-19	GP-040923	2250	-	sections 47.1.1 and 47.1.2: Corrections to Expected Sequences	F	5.7.0	5.8.0	GP-040923	DTM
GP-19	GP-041182	2251	1	sections 47.3.1.2 and 47.3.1.3.1: GPRS Information messages added to Expected Sequences	F	5.7.0	5.8.0	GP-041182	DTM
GP-19	GP-041183	2252	1	sections 47.3.2.2 and 47.3.3.1.2: Changes to Expected Sequences	F	5.7.0	5.8.0	GP-041183	DTM
GP-19	GP-040935	2253	-	Transmitter output power in GPRS multislot configuration	F	5.7.0	5.8.0	GP-040935	GPRS
GP-19	GP-040996	2255	-	Corrections to SNDSCP test case 46.2.2.4.2	F	5.7.0	5.8.0	GP-040996	GPRS
GP-19	GP-041168	2260	1	Changes in the timing requirement of the testcase 20.22.5	F	5.7.0	5.8.0	GP-041168	GPRS
GP-19	GP-041018	2261	-	Changes in the specific message content of SI13 in testcases 42.1.2.1.14 to 42.1.2.1.18	F	5.7.0	5.8.0	GP-041018	GPRS
GP-19	GP-041019	2262	-	Correcting the specific message content for PACKET TIMESLOT RECONFIGURE, Addition of Default message content for PACKET POWER CONTROL/TIMING ADVANCE.	F	5.7.0	5.8.0	GP-041019	GPRS
GP-19	GP-041021	2264	-	Correcting the specific message content for PACKET TIMESLOT RECONFIGURE	F	5.7.0	5.8.0	GP-041021	GPRS
GP-19	GP-041022	2265	-	Changes in step 10 for addressing PACKET UPLINK ACK/NACK with valid RRB	F	5.7.0	5.8.0	GP-041022	GPRS
GP-19	GP-041122	2267	1	Corrections to inter-RAT Cell Change Order Test Cases	F	5.7.0	5.8.0	GP-041122	GPRS

TSG #	TSG Doc	CR	Rev	Subject/Comment	Cat	Old	New	WG Doc	Work item
GP-19	GP-041026	2269	-	Changes in the name of the testcase and correction to the test sequence.	F	5.7.0	5.8.0	GP-041026	GPRS
GP-19	GP-041027	2270	-	Modification to the Test comment.	F	5.7.0	5.8.0	GP-041027	GPRS
GP-19	GP-041028	2271	-	Modification to the test step B6 (Conditional).	F	5.7.0	5.8.0	GP-041028	GPRS
GP-19	GP-041029	2272	-	Modification to the Test Procedure details.	F	5.7.0	5.8.0	GP-041029	GPRS
GP-19	GP-041030	2273	-	Modification to the Test sequence comment.	F	5.7.0	5.8.0	GP-041030	GPRS
GP-19	GP-041031	2274	-	Modification to the Test Procedure details.	F	5.7.0	5.8.0	GP-041031	GPRS
GP-19	GP-041035	2276	-	Correcting the specific message content for PACKET TIMESLOT RECONFIGURE	F	5.7.0	5.8.0	GP-041035	EGPRS
GP-19	GP-041037	2278	-	Editorial Change to step numbering and modification to the applicability of certain steps.	F	5.7.0	5.8.0	GP-041037	EDGE
GP-19	GP-041129	2279	1	Editorial Change to step numbering and modification to the applicability of certain steps.	F	5.7.0	5.8.0	GP-041129	GPRS
GP-19	GP-040639	2280	-	Addition of signalling procedures to 14.10.1 and 14.10.2	F	5.7.0	5.8.0	GP-040639	AMR
GP-19	GP-041061	2282	-	GPRS Detach / Accepted/ IMSI Detach	F	5.7.0	5.8.0	GP-041061	GPRS
GP-19	GP-041184	2284	1	Corrections to Cell Reselection test cases	F	5.7.0	5.8.0	GP-041184	GPRS
GP-19	GP-041190	2285	-	Correction to test case 20.22.2 Cell reselection in Packet Idle mode	F	5.7.0	5.8.0	GP-041190	GPRS
GP-20	GP-041631	2286	1	42.3.3.1.3 Change of number of RLC data blocks wanted	F	5.8.0	5.9.0	GP-041631	GPRS
GP-20	GP-041234	2287	-	44.2.9.1.2 : Correction of NITZ PLMN Names	F	5.8.0	5.9.0	GP-041234	GPRS
GP-20	GP-041632	2288	1	44.2.9.1.3 : New NITZ Test cases	F	5.8.0	5.9.0	GP-041632	GPRS
GP-20	GP-041236	2289	-	Section 51.3.1.2 Data retransmission included	F	5.8.0	5.9.0	GP-041236	EGPRS
GP-20	GP-041238	2290	-	CR 51.010-1 Section 26.16.9 AMR Configuration Change (normal)	F	5.8.0	5.9.0	GP-041238	AMR
GP-20	GP-041239	2291	-	CR 51.010-1 Section 13.16.1 ALPHA set to 0 in initial conditions	F	5.8.0	5.9.0	GP-041239	GPRS
GP-20	GP-041633	2292	1	CR 51.010-1 Section 13.16.2 1 Incorrect step references and units	F	5.8.0	5.9.0	GP-041633	GPRS
GP-20	GP-041241	2293	-	CR 51.010-1 Section 13.16.3 ALPHA set to 0 in initial conditions	F	5.8.0	5.9.0	GP-041241	GPRS
GP-20	GP-041242	2294	-	CR 51.010-1 Section 14.16 ALPHA set to 0 in initial conditions	F	5.8.0	5.9.0	GP-041242	EGPRS
GP-20	GP-041243	2295	-	CR 51.010-1 Section 13.17.1 ALPHA set to 0 in initial conditions	F	5.8.0	5.9.0	GP-041243	EGPRS
GP-20	GP-041245	2297	-	CR 51.010-1 Section 13.17.4 ALPHA set to 0 in initial conditions	F	5.8.0	5.9.0	GP-041245	EGPRS
GP-20	GP-041246	2298	-	CR 51.010-1 Section 14.18 ALPHA set to 0 in initial conditions	F	5.8.0	5.9.0	GP-041246	EGPRS
GP-20	GP-041249	2301	-	CR 51.010-1 Section 42.1.1.4.1 Packet Channel Request / Access persistence control on PRACH / M+1 attempts	F	5.8.0	5.9.0	GP-041249	GPRS
GP-20	GP-041642	2302	1	CR 51.010-1 Section 44.2.1.1.10 & 44.2.2.2.6 - Inconsistencies in the test specification concerning the RAI values	F	5.8.0	5.9.0	GP-041642	GPRS
GP-20	GP-041643	2303	1	CR 51.010-1 Section 52.3.1.2.3 – GPRS_RESELECT_OFFSET coded in dB, Step 19 should be conditional	F	5.8.0	5.9.0	GP-041643	GPRS
GP-20	GP-041252	2304	-	CR 51.010-1 Section 52.1.1.6.1 Packet Channel Request / Access persistence control on PRACH / M+1 attempts	F	5.8.0	5.9.0	GP-041252	EGPRS
GP-20	GP-041580	2305	2	CR 51.010-1 Section 53.1.1.13 Correction of test procedure.	F	5.8.0	5.9.0	GP-041580	EDGE
GP-20	GP-041254	2306	-	CR 51.010-1 Section 34.4.1 SMS mobile terminated	F	5.8.0	5.9.0	GP-041254	GPRS
GP-20	GP-041255	2307	-	CR 51.010-1 Section 34.4.2 SMS mobile originated	F	5.8.0	5.9.0	GP-041255	GPRS
GP-20	GP-041257	2309	-	CR 51.010-1 Section 34.4.4 Test of capabilities of simultaneously receiving a short message whilst sending a mobile originated short message	D	5.8.0	5.9.0	GP-041257	GPRS
GP-20	GP-041258	2310	-	CR 51.010-1 Section 34.4.8.1 CP Error Handling	F	5.8.0	5.9.0	GP-041258	GPRS
GP-20	GP-041259	2311	-	CR 51.010-1 Section 34.4.8.2 RP Error Handling	F	5.8.0	5.9.0	GP-041259	GPRS
GP-20	GP-041269	2316	-	26.16.9.8 Mismatch between core specifications and test specifications in handling of AMR CONFIG REQ retransmissions	F	5.8.0	5.9.0	GP-041269	GSM
GP-20	GP-041270	2317	-	42.3.3.3 - Editorial Changes.	F	5.8.0	5.9.0	GP-041270	GPRS
GP-20	GP-041271	2318	-	42.3.3.2.1 - Downlink Dummy control block to be sent to receive Resource request before step 9.	F	5.8.0	5.9.0	GP-041271	GPRS
GP-20	GP-041277	2319	-	Addition of test case: Network Control PEMR / Packet Cell Change Order	B	5.8.0	5.9.0	GP-041277	PEMR

TSG #	TSG Doc	CR	Rev	Subject/Comment	Cat	Old	New	WG Doc	Work item
GP-20	GP-041306	2320	-	Addition of new Extended Uplink Testcases.	B	5.8.0	5.9.0	GP-041306	GPRS
GP-20	GP-041307	2321	-	Addition of new Extended Uplink Testcases.	B	5.8.0	5.9.0	GP-041307	EGPRS
GP-20	GP-041637	2322	1	42.4.2.2.1 Cell change order procedure / Downlink transfer / Normal case	F	5.8.0	5.9.0	GP-041637	GPRS
GP-20	GP-041653	2323	1	42.4.2.2.3 Cell change order procedure / Downlink transfer / Failure cases / Frequency not implemented	F	5.8.0	5.9.0	GP-041653	GPRS
GP-20	GP-041330	2324	-	42.4.2.3.1 Cell change order procedure / Simultaneous uplink and downlink transfer / Normal case	F	5.8.0	5.9.0	GP-041330	GPRS
GP-20	GP-041331	2325	-	CR 051.010-1 42.4.8.2.2 and 42.4.8.2.3 Increase of Ready timer needed	F	5.8.0	5.9.0	GP-041331	GPRS
GP-20	GP-041332	2326	-	CR 051.010-1 42.4.8.1.2 - NC2 and DRX / NC_NON_DRX_PERIOD / NC2 non-DRX mode period ordered in Packet Cell Change Order	F	5.8.0	5.9.0	GP-041332	GPRS
GP-20	GP-041333	2327	-	CR 051.010-1 44.2.8.1 - Change of cell between two LAs in idle mode	F	5.8.0	5.9.0	GP-041333	GPRS
GP-20	GP-041335	2328	-	CR 051.010-1 43.1.2.4 Acknowledged mode / Downlink TBF / Re-assembly / Length Indicator	F	5.8.0	5.9.0	GP-041335	GPRS
GP-20	GP-041634	2329	1	CR 051.010-1 Addition of new Extended Uplink Testcases 41.3.6.6, 41.3.6.7 and 41.3.6.8 Setcom	B	5.8.0	5.9.0	GP-041634	GPRS
GP-20	GP-041635	2330	1	CR 051.010-1 Addition of new Extended Uplink Testcases 51.3.6.6, 51.3.6.7 and 51.3.6.8	B	5.8.0	5.9.0	GP-041635	EDGE
GP-20	GP-041344	2331	-	Cell reselection when the best cell does not support GPRS	F	5.8.0	5.9.0	GP-041344	TEI
GP-20	GP-041334	2332	-	CR 051.010-1 Negotiation of N201-U and N201-I to 140 to reduce the amount of data in test cases 46.1.2.6.1 and 46.1.2.6.2	F	5.8.0	5.9.0	GP-041334	GPRS
GP-20	GP-041372	2334	-	52.3.3.2.1 - Downlink Dummy control block to be sent to receive Resource request before step 9.	F	5.8.0	5.9.0	GP-041372	EDGE
GP-20	GP-041646	2335	1	Correction of EFADN (Abbreviated Dialling Number) Field in clauses 27 and 27.15.	F	5.8.0	5.9.0	GP-041646	TEI
GP-20	GP-041405	2338	-	TC 44.2.3.2.5 Combined routing area updating / rejected / roaming not allowed in this location area	F	5.8.0	5.9.0	GP-041405	
GP-20	GP-041406	2339	-	Correction of the Expected Sequence in clause 46.1.2.5.2 - Sending FRMR due to reception of an S frame with incorrect length.	F	5.8.0	5.9.0	GP-041406	GPRS
GP-20	GP-041654	2343	2	CR 051.010-1 Note added to section 42.4	F	5.8.0	5.9.0	GP-041654	GPRS
GP-20	GP-041640	2344	1	CR 051.010-1 correction to sections 42.4.6.1 and 42.4.6.2- Network Control PEMR – Activation with PSI/SI Messages	F	5.8.0	5.9.0	GP-041640	GPRS
GP-20	GP-041441	2345	-	CR 51.010-1 Section 42.4.8.2.4 Corrected Addressing in Packet Access Reject	F	5.8.0	5.9.0	GP-041441	GPRS
GP-20	GP-041443	2347	-	CR 51.010-1 Section 42.4.8.1.1 – test description corrected	D	5.8.0	5.9.0	GP-041443	GPRS
GP-20	GP-041444	2348	-	CR 51.010-1 Section 42.4.4.3 NC_REPORTING_PERIOD_I measurement corrected	F	5.8.0	5.9.0	GP-041444	GPRS
GP-20	GP-041445	2349	-	CR 51.010-1 Section 42.4.1.4 Additional step added to ensure that MS stops sending Measurement Reports	F	5.8.0	5.9.0	GP-041445	GPRS
GP-20	GP-041446	2350	-	CR 51.010-1 Section 46.1.2.7.5 - Inconsistencies in the test specification concerning IOV-UI handling	F	5.8.0	5.9.0	GP-041446	GPRS
GP-20	GP-041449	2353	-	CR 51.010-1 Section 20.22.7 Downlink signalling failure	F	5.8.0	5.9.0	GP-041449	GPRS
GP-20	GP-041450	2354	-	CR 51.010-1 Section 20.22.23 Cell Reselection based on C32 – Cell Reselection on CCCH – PBCCH not supported	F	5.8.0	5.9.0	GP-041450	GPRS
GP-20	GP-041451	2355	-	CR 51.010-1 Section 20.22.24 Cell Reselection based on C32/ cell of same priority/ Cell Reselection on CCCH – PBCCH not supported	F	5.8.0	5.9.0	GP-041451	GPRS
GP-20	GP-041452	2356	-	CR 51.010-1 Section 20.22.25 Cell Reselection based on C32/ C31	F	5.8.0	5.9.0	GP-041452	GPRS
GP-20	GP-041644	2357	1	CR 51.010-1 Section 20.22.26 Cell Reselection based on C32 quality / Cell Reselection on CCCH – PBCCH not supported	F	5.8.0	5.9.0	GP-041644	GPRS
GP-20	GP-041652	2358	1	CR 51.010-1 Section 47.1.3 Extension of expected sequence with test branches k=1 and k=2.	F	5.8.0	5.9.0	GP-041652	GPRS
GP-20	GP-041457	2359	-	CR 51.010-1 Section 42.3.1.2.2 Dynamic	F	5.8.0	5.9.0	GP-041457	GPRS

TSG #	TSG Doc	CR	Rev	Subject/Comment	Cat	Old	New	WG Doc	Work item
				Allocation / Uplink Transfer / Abnormal / with cell reselection in acknowledged mode					
GP-20	GP-041641	2360	1	CR 51.010-1 Section 42.3.1.2.3 – GPRS_RESELECT_OFFSET coded in dB, Step 19 should be conditional	F	5.8.0	5.9.0	GP-041641	GPRS
GP-20	GP-041459	2361	-	CR 51.010-1 Section 52.3.3.2.2 Step 5 of expected sequence completed	F	5.8.0	5.9.0	GP-041459	GPRS
GP-20	GP-041647	2363	1	Corrections to SIM/ME test case 27.12.2	F	5.8.0	5.9.0	GP-041647	GSM
GP-20	GP-041519	2364	-	Corrections to R99 behaviour of test case 41.2.2.3	F	5.8.0	5.9.0	GP-041519	GPRS
GP-20	GP-041520	2365	-	Corrections to inter RAT cell reselection test case 20.22.29	F	5.8.0	5.9.0	GP-041520	GPRS
GP-20	GP-041648	2366	-	Addition of test case: 42.4.6.7: Network Control PEMR / Packet Enhanced Measurement Report / Measurement reporting with PBCCH / Invalid BSIC	B	5.8.0	5.9.0	GP-041648	PEMR
GP-20	GP-041650	2367	-	Corrections to test case 51.2.2.3	F	5.8.0	5.9.0	GP-041650	EGPRS
GP-21	GP-041749	2368	-	20.4 – Deletion of PCS 1900 frequency band from test purpose 2	F	5.9.0	5.10.0	GP-041749	GSM
GP-21	GP-041756	2369	-	51.010-1: Changes in the testcase 20.22.23	F	5.9.0	5.10.0	GP-041756	GPRS
GP-21	GP-042162	2370	1	51010-1: Changes in the testcase 20.22.28	F	5.9.0	5.10.0	GP-042162	GPRS
GP-21	GP-041760	2371	-	41.1.1.4, 41.1.5.3 : Changing the support of "SPGC_CCCH_SUP", as absent in the cell.	F	5.9.0	5.10.0	GP-041760	GPRS
GP-21	GP-042146	2372	1	51.010-1: Making 41.1.5.4 default content for SI13 as per the core specification definition.	F	5.9.0	5.10.0	GP-042146	GPRS
GP-21	GP-041762	2373	-	51.010-1: Modification in the step 6 of 41.3.1.3	F	5.9.0	5.10.0	GP-041762	GPRS
GP-21	GP-041763	2374	-	51.010-1: Modifying the conformance requirement and test purpose as per the new version of 04.60 in the testcase 42.1.2.1.11	F	5.9.0	5.10.0	GP-041763	GPRS
GP-21	GP-041764	2375	-	51.010-1: Swapping the teststeps 1 and 2 in testcase 42.1.2.2.3	F	5.9.0	5.10.0	GP-041764	GPRS
GP-21	GP-041765	2376	-	51.010-1: Modification in the step 4a of 42.4.1.4	F	5.9.0	5.10.0	GP-041765	GPRS
GP-21	GP-041766	2377	-	51.010-1: Modification to the Part b of the Test Purpose in 42.4.8.2.1	F	5.9.0	5.10.0	GP-041766	GPRS
GP-21	GP-041767	2378	-	51.010-1: Modification to the READY TIMER value in the testcase 42.4.8.4.4	F	5.9.0	5.10.0	GP-041767	GPRS
GP-21	GP-041768	2379	-	51.010-1: Modification in the step 8 of 42.5.4.3	F	5.9.0	5.10.0	GP-041768	GPRS
GP-21	GP-041769	2380	-	51.010-1: Modification in the step 7 of 42.5.5.3	F	5.9.0	5.10.0	GP-041769	GPRS
GP-21	GP-041770	2381	-	51.010-1: Modification in the steps 4 and 5 of the test case 42.7.4	D	5.9.0	5.10.0	GP-041770	GPRS
GP-21	GP-041771	2382	-	51.1.1.4, 51.1.5.3 : Changing the "SPGC_CCCH_SUP" support as absent in the cell	F	5.9.0	5.10.0	GP-041771	EGPRS
GP-21	GP-041772	2383	-	51.010-1: Modification in the step 7 of 52.5.5.3	F	5.9.0	5.10.0	GP-041772	EGPRS
GP-21	GP-041781	2385	-	26.6.20 - Missing SI 6 Rest Octets in SI Type 6.	F	5.9.0	5.10.0	GP-041781	GSM
GP-21	GP-042144	2386	1	26.6.4.1 - To keep RR connection active	F	5.9.0	5.10.0	GP-042144	GSM
GP-21	GP-042151	2387	1	42.3.1.2.2 - Specify acknowledged mode, correct data length, Packet Resource Request Message ACCESS TYPE clarified.	F	5.9.0	5.10.0	GP-042151	GPRS
GP-21	GP-041784	2388	-	42.3.1.2.3 – Clarify ACCESS TYPE in Packet Resource Request Message.	F	5.9.0	5.10.0	GP-041784	GPRS
GP-21	GP-042153	2389	1	42.3.3.2.1 – Allow MS to send optional PACKET CHANNEL REQUEST after step 11, define CONTROL_ACK_TYPE.	F	5.9.0	5.10.0	GP-042153	GPRS
GP-21	GP-041787	2391	-	45.4.x – Correct spec quote in Conformance requirement.	D	5.9.0	5.10.0	GP-041787	GPRS
GP-21	GP-041788	2392	-	46.1.2.3.2 – Add optional Step 4 to handle Deactivate PDP Request from the MS.	F	5.9.0	5.10.0	GP-041788	GPRS
GP-21	GP-041789	2393	-	46.1.2.7.3 – Correct origin of PDP Context Activation macro.	D	5.9.0	5.10.0	GP-041789	GPRS
GP-21	GP-042161	2394	1	51.2.2.3 - Test case duration should be increased to 4 hours.	F	5.9.0	5.10.0	GP-042161	EGPRS
GP-21	GP-041791	2395	-	52.3.1.2.2 - Specify acknowledged mode, correct data length.	F	5.9.0	5.10.0	GP-041791	EGPRS
GP-21	GP-042152	2396	1	52.3.1.2.3 - Packet Resource Request Message ACCESS TYPE clarified.	F	5.9.0	5.10.0	GP-042152	EGPRS
GP-21	GP-042154	2397	1	52.3.3.2.1 – Allow MS to send optional PACKET CHANNEL REQUEST after step 11, define CONTROL_ACK_TYPE.	F	5.9.0	5.10.0	GP-042154	EGPRS
GP-21	GP-041794	2398	-	53.1.1.20 - Increase of amount of data to be triggered when k=9, 8 and 6.	F	5.9.0	5.10.0	GP-041794	EGPRS
GP-21	GP-042156	2399	1	TC 60.4 Inter system handover to UTRAN/From	F	5.9.0	5.10.0	GP-042156	Inter

TSG #	TSG Doc	CR	Rev	Subject/Comment	Cat	Old	New	WG Doc	Work item
				GSM/SDCCH/CC Establishment/Success					system handover
GP-21	GP-041755	2401	-	Changes in the timing requirement for the testcase 20.22.22, 20.22.24, 20.22.25, 20.22.26	F	5.9.0	5.10.0	GP-041755	GPRS
GP-21	GP-042163	2402	1	Changes in the timing requirement, conformance requirement for the testcase 20.22.30.1	F	5.9.0	5.10.0	GP-042163	GPRS
GP-21	GP-042164	2403	1	Changes in the timing and conformance requirement for the testcase 20.22.30.2	F	5.9.0	5.10.0	GP-042164	GPRS
GP-21	GP-042160	2404	1	Addition of new test cases for failure scenario of PACKET CELL CHANGE ORDER procedure	B	5.9.0	5.10.0	GP-042160	GPRS
GP-21	GP-041799	2405	-	CR 51.010-1 Section 46.1.2.7.4 Negotiation initiated by the SS (during ADM, for N201-U).	F	5.9.0	5.10.0	GP-041799	GPRS
GP-21	GP-041800	2406	-	CR 51.010-1 Section 42.3.2.1.2 Dynamic Allocation / Uplink Transfer with Downlink TBF establishment / Normal / Multislot capabilities – RRBp adapt to Method of test	F	5.9.0	5.10.0	GP-041800	GPRS
GP-21	GP-041801	2407	-	CR 51.010-1 Section 42.4.8.3.3 & 42.4.8.3.5 – Correction of expected sequence.	F	5.9.0	5.10.0	GP-041801	GPRS
GP-21	GP-042165	2408	1	CR 51.010-1 47.3.1.1 Handover to same routing area whilst in dedicated mode & MM Ready / Completed on the main DCCH	F	5.9.0	5.10.0	GP-042165	DTM
GP-21	GP-041803	2409	-	CR 51.010-1 Section 52.3.2.1.2 Dynamic Allocation / Uplink Transfer with Downlink TBF establishment / Normal / Multislot capabilities - RRBp adapt to Method of test	F	5.9.0	5.10.0	GP-041803	EGPRS
GP-21	GP-042155	2410	1	42.4.5.2, 42.4.5.4, 42.4.5.6, 42.4.5.9, Increase of reselection timer when PCCCH not present (NACC) and other merged modifications	F	5.9.0	5.10.0	GP-042155	GPRS
GP-21	GP-042149	2412	1	42.4.6.6 Change timer for repetition	F	5.9.0	5.10.0	GP-042149	GPRS
GP-21	GP-041807	2413	-	42.4.8.2.3 Addition of potential PMR during transfer	F	5.9.0	5.10.0	GP-041807	GPRS
GP-21	GP-041808	2414	-	Correction to test case 20.22.19	F	5.9.0	5.10.0	GP-041808	GPRS
GP-21	GP-041809	2415	-	41.3.1.2 TBF Release / Uplink / Normal / MS initiated / Unacknowledged mode	F	5.9.0	5.10.0	GP-041809	GPRS
GP-21	GP-041810	2416	-	51.3.1.2 TBF Release / Uplink / Normal / MS initiated / Unacknowledged mode	F	5.9.0	5.10.0	GP-041810	EGPRS
GP-21	GP-042166	2417	1	CR 51.010-1 Section 13.17.3 EGPRS Transmitter output power	F	5.9.0	5.10.0	GP-042166	GPRS
GP-21	GP-041860	2418	-	CR 51.010-1 Section 26.10.2.4.1 E-GSM or R-GSM signalling / RR / Handover / Successful handover	D	5.9.0	5.10.0	GP-041860	GSM
GP-21	GP-041861	2419	-	CR 51.010-1 Section 26.11.2.2.3 Multiband signalling / RR / Handover / Multiband BCCH / successful / active call / non-synchronized	F	5.9.0	5.10.0	GP-041861	GSM
GP-21	GP-041862	2420	-	CR 51.010-1 Section 26.11.2.2.4 Multiband signalling / RR / Handover / Multiband BCCH / Intracell Handover – Intra-band Assignment	F	5.9.0	5.10.0	GP-041862	GSM
GP-21	GP-041863	2421	-	CR 51.010-1 Section 40 GPRS default conditions – ARFCN overlapping	F	5.9.0	5.10.0	GP-041863	GPRS
GP-21	GP-041864	2422	-	CR 51.010-1 Section 40.4.3.20 MT Call in GPRS cell – Authentication and Ciphering added and voice connection is established without verification by the user.	F	5.9.0	5.10.0	GP-041864	GPRS
GP-21	GP-042145	2423	2	CR 51.010-1 Section 40 DTM default conditions - Contents of Layer 3 messages (DTM) – correction of message contents, headline and paragraph formatting	F	5.9.0	5.10.0	GP-042145	GPRS
GP-21	GP-041866	2424	-	CR 51.010-1 Section 41.3.6.7 Extended Uplink TBF / Cell Change failure while in Extended Uplink/ No Packet Neighbouring Cell Data	F	5.9.0	5.10.0	GP-041866	GPRS
GP-21	GP-041867	2425	-	CR 51.010-1 Section 41.3.6.8 Extended Uplink TBF / Cell Change while in Extended Uplink/ With Packet Neighbouring Cell Data – PSI 14 content changed	F	5.9.0	5.10.0	GP-041867	GPRS
GP-21	GP-042167	2426	2	CR 51.010-1 Section 41.3.6.9 TBF Release / Extended Uplink / Change of RLC mode / normal release and 41.3.6.10 TBF Release / Extended Uplink / Change of RLC mode / abnormal release	B	5.9.0	5.10.0	GP-042167	GPRS
GP-21	GP-041869	2427	-	CR 51.010-1 Section 41.5.1.1.1.6 Uplink TBF establishment with no reallocation of CS resources / Abnormal cases / Handover Command - Extension of expected sequence	F	5.9.0	5.10.0	GP-041869	GPRS

TSG #	TSG Doc	CR	Rev	Subject/Comment	Cat	Old	New	WG Doc	Work item
				with test branches k=1 and k=2					
GP-21	GP-041870	2428	-	CR 51.010-1 Section 41.5.1.1.2.1 Uplink TBF establishment with reallocation of CS resources / Successful case - Extension of expected sequence with test branches k=1 and k=2	F	5.9.0	5.10.0	GP-041870	GPRS
GP-21	GP-041871	2429	-	CR 51.010-1 Section 41.5.1.1.3 - Uplink TBF establishment required whilst DTM is not supported in cell – Expected Sequence missing	F	5.9.0	5.10.0	GP-041871	GPRS
GP-21	GP-042150	2430	1	CR 51.010-1 Section 41.5.2.3 MO CS establishment whilst in packet transfer mode with uplink and downlink TBFs established – PICS/PIXIT section corrected, Ciphering and Authentication added	F	5.9.0	5.10.0	GP-042150	GPRS
GP-21	GP-041873	2431	-	CR 51.010-1 Section 41.5.2.4 MO CS establishment whilst in packet transfer mode and DTM is not supported in current cell – Authentication and Ciphering added	F	5.9.0	5.10.0	GP-041873	DTM
GP-21	GP-041874	2432	-	CR 51.010-1 Section 41.5.3.1.1 Uplink TBF establishment with a downlink TBF established and no PS downlink reallocation – manual operation improved	F	5.9.0	5.10.0	GP-041874	GPRS
GP-21	GP-041875	2433	-	CR 51.010-1 Section 42.1.2.1.14 to 42.1.2.1.18 Specific message contents	F	5.9.0	5.10.0	GP-041875	GPRS
GP-21	GP-042170	2435	1	CR 51.010-1 Section 42.4.2.3.3 Clarification of test sequence	F	5.9.0	5.10.0	GP-042170	GPRS
GP-21	GP-041879	2437	-	CR 51.010-1 Section 42.4.6.1 Conformance requirement added and further corrections	F	5.9.0	5.10.0	GP-041879	GPRS
GP-21	GP-041880	2438	-	CR 51.010-1 Section 42.4.6.2 Conformance requirement added and further corrections	F	5.9.0	5.10.0	GP-041880	GPRS
GP-21	GP-041881	2439	-	CR 51.010-1 Section 42.4.6.3 Conformance requirement added and further corrections	F	5.9.0	5.10.0	GP-041881	GPRS
GP-21	GP-041882	2440	-	CR 51.010-1 Section 42.4.6.4 Timing requirements corrected	F	5.9.0	5.10.0	GP-041882	GPRS
GP-21	GP-041883	2441	-	CR 51.010-1 Section 42.4.6.5 Corrections of initial conditions and test sequence	F	5.9.0	5.10.0	GP-041883	GPRS
GP-21	GP-041884	2442	-	CR 51.010-1 Section 42.4.8.3.2 - erroneous application of MS release	F	5.9.0	5.10.0	GP-041884	GPRS
GP-21	GP-041885	2443	-	CR 51.010-1 Section 42.4.8.4.1 - erroneous coding of Packet Measurement Order	F	5.9.0	5.10.0	GP-041885	GPRS
GP-21	GP-041886	2444	-	CR 51.010-1 Section 42.4.8.4.2 - erroneous coding of Packet Measurement Order and Packet Cell Change Order	F	5.9.0	5.10.0	GP-041886	GPRS
GP-21	GP-041887	2445	-	CR 51.010-1 Section 42.4.8.4.3 - erroneous coding of Packet Measurement Order	F	5.9.0	5.10.0	GP-041887	GPRS
GP-21	GP-041888	2446	-	CR 51.010-1 Section 42.4.8.4.4 - erroneous coding of Packet Measurement Order	F	5.9.0	5.10.0	GP-041888	GPRS
GP-21	GP-041889	2447	-	CR 51.010-1 Section 42.4.8.4.5 - erroneous coding of Packet Measurement Order and simplification using an already existing macro	F	5.9.0	5.10.0	GP-041889	GPRS
GP-21	GP-042158	2448	1	CR 51.010-1 Section 42.4.8.4.6 - Procedure to enter and maintain TBF missing and others	F	5.9.0	5.10.0	GP-042158	GPRS
GP-21	GP-041891	2449	-	CR 51.010-1 Section 42.4.8.4.7 - Unused PBCCCH removed	F	5.9.0	5.10.0	GP-041891	GPRS
GP-21	GP-041892	2450	-	CR 51.010-1 Section 44.2.3.2.5 Combined routing area updating / rejected / roaming not allowed in this location area – LUP optional for R97 and later MS	F	5.9.0	5.10.0	GP-041892	GPRS
GP-21	GP-041893	2451	-	CR 51.010-1 Section 47.2.2 - Network originating CS release - Release of cs connection should be triggered by SS, not by MS	F	5.9.0	5.10.0	GP-041893	DTM
GP-21	GP-041894	2452	-	CR 51.010-1 Section 50 Specification of Rel 4 default conditions	F	5.9.0	5.10.0	GP-041894	EGPRS
GP-21	GP-041895	2453	-	CR 51.010-1 Section 51.3.6.7 Extended Uplink TBF / Cell Change failure while in Extended Uplink/ No Packet Neighbouring Cell Data	F	5.9.0	5.10.0	GP-041895	GPRS
GP-21	GP-041896	2454	-	CR 51.010-1 Section 51.3.6.8 - Extended Uplink TBF / Cell Change while in Extended Uplink/ With Packet Neighbouring Cell Data - PSI 14 content changed	F	5.9.0	5.10.0	GP-041896	EDGE
GP-21	GP-042168	2455	2	CR 51.010-1 Section 51.3.6.9 TBF Release / Extended Uplink / Change of RLC mode / normal release and 51.3.6.10 TBF Release /	B	5.9.0	5.10.0	GP-042168	GPRS

TSG #	TSG Doc	CR	Rev	Subject/Comment	Cat	Old	New	WG Doc	Work item
				Extended Uplink / Change of RLC mode / abnormal release					
GP-21	GP-041899	2457	-	CR 51.010-1 Section 53.1.1.18 - EGPRS Acknowledged mode / Uplink TBF / Link Adaptation Procedure for retransmission - Correction of test procedure.	F	5.9.0	5.10.0	GP-041899	EDGE
GP-21	GP-041900	2458	-	CR 51.010-1 Section 53.1.2.3 Correction of test procedure.	F	5.9.0	5.10.0	GP-041900	EDGE
GP-21	GP-041904	2459	-	26.9.6.1 Addition of R99 requirements in "Conformance requirement" and "Test purpose".	F	5.9.0	5.10.0	GP-041904	GSM
GP-21	GP-041991	2462	-	CR 51.010-1 Section 42.4.5.3 Network Assisted Cell Change / Packet Neighbour Cell Data and Packet Cell Change Continue – PSI14	F	5.9.0	5.10.0	GP-041991	GPRS
GP-21	GP-041994	2465	-	CR 51.010-1 – Single Slot DTM support missing in Related PICS/PIXIT Statement(s) in	F	5.9.0	5.10.0	GP-041994	GPRS
GP-21	GP-041995	2466	-	CR 51.010-1 Section 41.5.1.1.2.2 Uplink TBF establishment with reallocation of CS resources / Abnormal case / Assignment Failure - Extension of expected sequence with test branches k=1 and k=2.	F	5.9.0	5.10.0	GP-041995	GPRS
GP-21	GP-041997	2468	-	CR 51.010-1 Section 52.1.2.1.9.3 PICS parameters for band interworking and 04.60 Section 12.30 requirements	B	5.9.0	5.10.0	GP-041997	GPRS
GP-21	GP-042159	2470	1	CR 51.010-1 Section 42.4.5.5 Corrections to the expected sequence	F	5.9.0	5.10.0	GP-042159	GPRS
GP-21	GP-042001	2471	-	CR 51.010-1 Section 42.4.5.7 Corrections to the expected sequence	F	5.9.0	5.10.0	GP-042001	GPRS
GP-21	GP-042026	2473	-	Corrections to SIM/ME test case 27.12.2	F	5.9.0	5.10.0	GP-042026	GSM
GP-21	GP-042027	2474	-	Corrections to A-GPS test cases	F	5.9.0	5.10.0	GP-042027	LCS
GP-21	GP-042038	2475	-	Correction to test case 42.3.3.2.2	F	5.9.0	5.10.0	GP-042038	GPRS
GP-21	GP-042044	2476	-	Correction to test case 52.3.3.2.2	F	5.9.0	5.10.0	GP-042044	EGPRS
GP-22	GP-042726	2477	1	Various corrections to test procedure and sequence	F	5.10.0	5.11.0	GP-042726	GPRS
GP-22	GP-042727	2478	1	Specific Message Content for step 5 corrected	F	5.10.0	5.11.0	GP-042727	GPRS
GP-22	GP-042728	2479	1	New step 10 for RR connection release and comments in step 15 added to test sequence.	F	5.10.0	5.11.0	GP-042728	GPRS
GP-22	GP-042721	2480	1	Addition of a new test case for USFs decoding by a MS in GPRS TBF mode when the USFs are assigned with EGPRS RLC/MAC blocks coded with MCS-1 to MCS-4.	B	5.10.0	5.11.0	GP-042721	GPRS
GP-22	GP-042303	2482	-	Increase of sent data and other modifications	F	5.10.0	5.11.0	GP-042303	GPRS
GP-22	GP-042723	2484	1	42.4.2.3.1 Cell change order procedure / Simultaneous uplink and downlink transfer / Normal case	F	5.10.0	5.11.0	GP-042723	GPRS
GP-22	GP-042743	2485	1	Section 46.1.2.3.2 Correction of test sequence.	F	5.10.0	5.11.0	GP-042743	GPRS
GP-22	GP-042809	2487	1	Dynamic Allocation / Uplink Transfer / Abnormal / with cell reselection in unacknowledged mode	F	5.10.0	5.11.0	GP-042809	GPRS
GP-22	GP-042810	2488	2	Dynamic Allocation / Uplink Transfer / Abnormal / with cell reselection in acknowledged mode	F	5.10.0	5.11.0	GP-042810	GPRS
GP-22	GP-042311	2489	-	Dynamic Allocation / Resource reallocation / Reject	F	5.10.0	5.11.0	GP-042311	GPRS
GP-22	GP-042811	2491	1	Dynamic Allocation / Uplink Transfer / Abnormal / with cell reselection in acknowledged mode	F	5.10.0	5.11.0	GP-042811	EDGE
GP-22	GP-042314	2492	-	Dynamic Allocation / Uplink Transfer / Abnormal / with cell reselection in unacknowledged mode	F	5.10.0	5.11.0	GP-042314	EDGE
GP-22	GP-042813	2492	1	Dynamic Allocation / Uplink Transfer / Abnormal / with cell reselection in unacknowledged mode	F	5.10.0	5.11.0	GP-042813	EDGE
GP-22	GP-042315	2493	-	Dynamic Allocation / Resource reallocation / Reject	F	5.10.0	5.11.0	GP-042315	EGPRS
GP-22	GP-042745	2494	1	Acknowledged Mode/ Downlink TBF/ Window Size/ Default Value	F	5.10.0	5.11.0	GP-042745	EDGE
GP-22	GP-042333	2495	-	Correction to the section external-references in the testcase 27.11.1.4	F	5.10.0	5.11.0	GP-042333	TEI
GP-22	GP-042334	2496	-	Correction to new TC on Location updating/periodic search for higher priority PLMN when the list of equivalent PLMNs includes the HPLMN, when a MS is registered in a foreign country's VPLMN/MS is in a	F	5.10.0	5.11.0	GP-042334	GSM
GP-22	GP-042718	2498	1	CR 051.010-1 Note added to section 40	F	5.10.0	5.11.0	GP-042718	GPRS
GP-22	GP-042338	2499	-	Defined PSI14 in case PBCCH is not present	F	5.10.0	5.11.0	GP-042338	GPRS
GP-22	GP-042832	2502	2	Section 42.1.2.2.5.1 Packet Downlink Assignment / Abnormal cases / Incorrect PDCH assignment	F	5.10.0	5.11.0	GP-042832	GPRS

TSG #	TSG Doc	CR	Rev	Subject/Comment	Cat	Old	New	WG Doc	Work item
GP-22	GP-042344	2503	-	Misleading requirement in some test steps	F	5.10.0	5.11.0	GP-042344	GPRS
GP-22	GP-042346	2505	-	Packet Measurement order procedure / Downlink transfer / Normal case/ Routing Area Update/ NMO II	F	5.10.0	5.11.0	GP-042346	GPRS
GP-22	GP-042730	2506	1	Section 42.4.5.3 Network Assisted Cell Change / Packet Neighbour Cell Data and Packet Cell Change Continue	F	5.10.0	5.11.0	GP-042730	GPRS
GP-22	GP-042348	2507	-	Network Assisted Cell Change / Packet Neighbour Cell Data and Packet Cell Change Order	F	5.10.0	5.11.0	GP-042348	GPRS
GP-22	GP-042349	2508	-	Network Assisted Cell Change / NC mode change / Packet Neighbour Cell Data	F	5.10.0	5.11.0	GP-042349	GPRS
GP-22	GP-042350	2509	-	NC2 and DRX / NC_NON_DRX_PERIOD / NC2 non-DRX mode period ordered in Packet Cell Change Order	F	5.10.0	5.11.0	GP-042350	GPRS
GP-22	GP-042351	2510	-	NC2 and DRX / NC_NON_DRX_PERIOD / NC2 non-DRX mode period broadcast in PSI5	F	5.10.0	5.11.0	GP-042351	GPRS
GP-22	GP-042352	2511	-	User Data vs Measurement Report Sending / Conflict situation / Expiry of T3192 and T3158	F	5.10.0	5.11.0	GP-042352	GPRS
GP-22	GP-042798	2513	1	Correction of test procedure.	F	5.10.0	5.11.0	GP-042798	EDGE
GP-22	GP-042356	2514	-	Transmitter output power in GPRS multislot configuration	F	5.10.0	5.11.0	GP-042356	GPRS
GP-22	GP-042357	2515	-	Cell Reselection based on C32/cell of same priority/ Cell Reselection on CCCH - PBCCH not supported	F	5.10.0	5.11.0	GP-042357	GPRS
GP-22	GP-042358	2516	-	Cell Reselection based on C32/C31<0/ Cell Reselection on CCCH - PBCCH not supported	F	5.10.0	5.11.0	GP-042358	GPRS
GP-22	GP-042361	2518	-	Cell change order procedure / Uplink transfer / Failure cases / REJECT from the new cell	F	5.10.0	5.11.0	GP-042361	GPRS
GP-22	GP-042799	2519	1	Correction of the Expected Test Sequence in clause 51.2.3.2 – Step 4a	F	5.10.0	5.11.0	GP-042799	EGPRS
GP-22	GP-042717	2520	1	14.10.1 & 14.10.2 Corrections to test procedure	F	5.10.0	5.11.0	GP-042717	AMR
GP-22	GP-042712	2521	1	14.2.19, 14.2.20, 14.4.17 & 14.4.18 Clarification of the use of loop I	F	5.10.0	5.11.0	GP-042712	AMR
GP-22	GP-042729	2522	1	26.16.9.11 Clarification of test requirements.	F	5.10.0	5.11.0	GP-042729	AMR
GP-22	GP-042742	2523	1	21.3.3 Modifications to test procedure	F	5.10.0	5.11.0	GP-042742	GSM
GP-22	GP-042373	2524	-	EGPRS channel coding command MCS-5 to be used for resource allocation.	F	5.10.0	5.11.0	GP-042373	EGPRS
GP-22	GP-042818	2525	2	51.2.2.3 Attach Reject Procedure to be introduced as additional test steps to set T3302 to 1 minute.	F	5.10.0	5.11.0	GP-042818	EGPRS
GP-22	GP-042714	2526	1	Setting of preemptive transmission bit in contention resolution procedure.	F	5.10.0	5.11.0	GP-042714	EGPRS
GP-22	GP-042377	2528	-	Additional steps added for calculation of TBC value.	F	5.10.0	5.11.0	GP-042377	EGPRS
GP-22	GP-042380	2531	-	Resolution of race between timers T3180 (5 sec) and T3182 (5 sec).	F	5.10.0	5.11.0	GP-042380	GPRS
GP-22	GP-042381	2532	-	Packet uplink Assignment cannot be sent on PAGCH	F	5.10.0	5.11.0	GP-042381	GPRS
GP-22	GP-042382	2533	-	Manual intervention for ReAttach not always needed.	F	5.10.0	5.11.0	GP-042382	GPRS
GP-22	GP-042383	2534	-	Resolution of race between timers T3180 (5 sec) and T3182 (5 sec).	F	5.10.0	5.11.0	GP-042383	EGPRS
GP-22	GP-042389	2537	-	To change the initial condition to allow for large SMS storage	F	5.10.0	5.11.0	GP-042389	GSM
GP-22	GP-042741	2538	1	PICS for "Support of DTM" is missing	F	5.10.0	5.11.0	GP-042741	GPRS
GP-22	GP-042748	2539	1	47.1.1 PICS for Support of Single-slot DTM" missing	F	5.10.0	5.11.0	GP-042748	GPRS
GP-22	GP-042393	2540	-	Ambiguity in cell configurations concerning use of PBCCH	F	5.10.0	5.11.0	GP-042393	GPRS
GP-22	GP-042396	2542	-	Removing 2 sec given for decoding PSI1 in the timing requirement of the testcase 20.22.3.	F	5.10.0	5.11.0	GP-042396	GPRS
GP-22	GP-042397	2543	-	Changes in the "conformance requirement" in the testcase 20.22.30.3.	F	5.10.0	5.11.0	GP-042397	GPRS
GP-22	GP-042398	2544	-	Changes in the test purpose and timing requirement of the testcase 20.22.31.1.	F	5.10.0	5.11.0	GP-042398	GPRS
GP-22	GP-042399	2545	-	Changes in the test purpose and timing requirement of the testcase 20.22.31.2.	F	5.10.0	5.11.0	GP-042399	GPRS
GP-22	GP-042400	2546	-	Correction to the step numbers to be used by the MS using branch A in 40.4.3.20.	F	5.10.0	5.11.0	GP-042400	GPRS
GP-22	GP-042401	2547	-	Changing the time period of the checking for a access on PRACH from 8 sec to 25 sec in testcase 41.1.6.	F	5.10.0	5.11.0	GP-042401	GPRS

TSG #	TSG Doc	CR	Rev	Subject/Comment	Cat	Old	New	WG Doc	Work item
GP-22	GP-042402	2548	-	Removing the macro used for the cell update in testcase 41.3.6.7.	F	5.10.0	5.11.0	GP-042402	GPRS
GP-22	GP-042403	2549	-	Changing the value of BS_PRACH_BLKs from 12 to 11 in testcase 42.1.2.1.3.1.	F	5.10.0	5.11.0	GP-042403	GPRS
GP-22	GP-042739	2550	1	51010-1: Addition of the ciphering steps in the CS calls used in testcases 42.4.2.3.6.	F	5.10.0	5.11.0	GP-042739	GPRS
GP-22	GP-042405	2551	-	Addition of the ciphering steps in the CS calls used in testcases 42.4.2.3.7.	F	5.10.0	5.11.0	GP-042405	GPRS
GP-22	GP-042740	2553	1	Changes in the testcase 42.7.5	F	5.10.0	5.11.0	GP-042740	GPRS
GP-22	GP-042408	2554	-	Changing the time period of the checking for a access on PRACH from 8 sec to 25 sec in testcase 51.1.6.	F	5.10.0	5.11.0	GP-042408	EGPRS
GP-22	GP-042409	2555	-	Changes in the initial conditions of the testcase 52.1.2.1.3.1	F	5.10.0	5.11.0	GP-042409	EGPRS
GP-22	GP-042720	2556	1	51010-1: Removing the macro used for the cell update in testcase 51.3.6.7.	F	5.10.0	5.11.0	GP-042720	EGPRS
GP-22	GP-042411	2557	-	Correction to test case 42.3.2.1.2	F	5.10.0	5.11.0	GP-042411	GPRS
GP-22	GP-042737	2559	1	Correction to test case 42.3.3.2.1	F	5.10.0	5.11.0	GP-042737	GPRS
GP-22	GP-042414	2560	-	Correction to test case 42.3.3.3	F	5.10.0	5.11.0	GP-042414	GPRS
GP-22	GP-042820	2562	1	Modification of test cases 20.25.3 and 20.25.4	F	5.10.0	5.11.0	GP-042820	Intersystem Change
GP-22	GP-042417	2563	-	Modification of Intersystem Change TC 20.22.29	C	5.10.0	5.11.0	GP-042417	Intersystem Change
GP-22	GP-042420	2565	-	Change of DTM TC 41.3.4.3	C	5.10.0	5.11.0	GP-042420	DTM
GP-22	GP-042421	2566	-	Clarification to DTM TC 41.5.1.1.1.6	D	5.10.0	5.11.0	GP-042421	DTM
GP-22	GP-042422	2567	-	Correction to DTM TC 41.5.1.2.2	F	5.10.0	5.11.0	GP-042422	DTM
GP-22	GP-042425	2569	-	Modification of DTM TC 47.3.1.1	F	5.10.0	5.11.0	GP-042425	DTM
GP-22	GP-042426	2570	-	Corrections to DTM TC 47.3.1.2	F	5.10.0	5.11.0	GP-042426	DTM
GP-22	GP-042429	2572	-	Addition of PICS for DTM/GPRS	F	5.10.0	5.11.0	GP-042429	DTM
GP-22	GP-042431	2573	-	Uplink TBF establishment with reallocation of CS resources / Abnormal case / Multislot class violation / Incorrect Allocation - applicable DTM Multislot class extend	B	5.10.0	5.11.0	GP-042431	GPRS
GP-22	GP-042796	2574	1	Section 42.4.2.3.5. Packet Measurement order procedure / Downlink transfer / Normal case/ Routing Area Update/ NMO I	F	5.10.0	5.11.0	GP-042796	GPRS
GP-22	GP-042790	2576	1	TC 34.2.5.3 The test description does not support retry mechanism on error	F	5.10.0	5.11.0	GP-042790	GSM
GP-22	GP-042438	2577	-	Add values for fields ATC, EPC and FPC in ASSIGNMENT COMMAND and HANDOVER COMMAND defaults messages	F	5.10.0	5.11.0	GP-042438	GSM
GP-22	GP-042439	2578	-	Correction of test procedure.	F	5.10.0	5.11.0	GP-042439	GPRS
GP-22	GP-042440	2579	-	MO CS establishment whilst in packet transfer mode and DTM is not supported in current cell	F	5.10.0	5.11.0	GP-042440	GPRS
GP-22	GP-042441	2580	-	Unsuitable Initial Conditions	F	5.10.0	5.11.0	GP-042441	GPRS
GP-22	GP-042442	2581	-	Testing of the SIM/ME interface - Correction of EFADN	F	5.10.0	5.11.0	GP-042442	GPRS
GP-22	GP-042496	2582	-	Changes in the PICS statement used in the testcase 42.1.2.1.3.2.	F	5.10.0	5.11.0	GP-042496	GPRS
GP-22	GP-042497	2583	-	Changes in the PICS statement used in the testcase 42.1.2.1.3.2.	F	5.10.0	5.11.0	GP-042497	EGPRS
GP-22	GP-042819	2584	2	Addition of test cases for DTM/EGPRS	C	5.10.0	5.11.0	GP-042819	DTM
GP-22	GP-042504	2585	-	Correction of AMR test case 26.16.9.8	F	5.10.0	5.11.0	GP-042504	AMR
GP-22	GP-042505	2586	-	Correction of AMR test case 26.16.9.9	F	5.10.0	5.11.0	GP-042505	AMR
GP-22	GP-042538	2588	-	Modifications to test procedure	F	5.10.0	5.11.0	GP-042538	AMR
GP-22	GP-042539	2589	-	Correction to Conformance Requirement	F	5.10.0	5.11.0	GP-042539	Inter system handover
GP-22	GP-042540	2590	-	Correction to Specific Message Contents	F	5.10.0	5.11.0	GP-042540	Inter system handover
GP-22	GP-042589	2592	-	Correction to test case 52.3.2.1.2	F	5.10.0	5.11.0	GP-042589	EGPRS
GP-22	GP-042738	2593	1	Correction to test case 52.3.3.2.1	F	5.10.0	5.11.0	GP-042738	EGPRS
GP-22	GP-042591	2594	-	Correction to test case 52.3.3.3	F	5.10.0	5.11.0	GP-042591	EGPRS
GP-22	GP-042603	2595	-	Changes to initial conditions	F	5.10.0	5.11.0	GP-042603	AMR
GP-22	GP-042639	2597	-	Corrections to A-GPS test cases in sections 70.7 to 70.10	F	5.10.0	5.11.0	GP-042639	TEI
GP-22	GP-042663	2599	-	User Data vs Measurement Report Sending / Conflict situation / Expiry of T3182 and T3158	F	5.10.0	5.11.0	GP-042663	GPRS
GP-22	GP-042664	2600	-	Inter frequency reallocation of CS resources / DTM Assignment Command	F	5.10.0	5.11.0	GP-042664	GPRS
GP-22	GP-042719	2604	-	CR 051.010-1 Note deleted from section 42.4	F	5.10.0	5.11.0	GP-042719	GPRS

TSG #	TSG Doc	CR	Rev	Subject/Comment	Cat	Old	New	WG Doc	Work item
GP-22	GP-042725	2605	-	Corrections to Inter-RAT test cases	F	5.10.0	5.11.0	GP-042725	Inter system handover
GP-22	GP-042477	2607	-	Clarification of the Initial Conditions and correction of the Expected Sequence	F	5.10.0	5.11.0	GP-042477	GPRS
GP-22	GP-042488	2608	-	Corrections to A-GPS test cases	F	5.10.0	5.11.0	GP-042488	LCS
GP-22	GP-042495	2609	-	Reducing the number of octets transferred in the testcase 42.4.1.4	F	5.10.0	5.11.0	GP-042495	GPRS
GP-22	GP-042912	2611	-	Creation of 51.010-1 REL-6: Merging of REL-5, REL-4, R99 etc. test specifications (Foreword, clause 1 and clause 2)	F	5.10.0	6.0.0	GP-042912	TEI
GP22	-	-	-	Raised to version 6.0.1 to correct editorial problems with header	-	6.0.0	6.0.1	-	-
GP-23	GP-050475	2612	1	Corrections to Inter-RAT test cases	F	6.0.1	6.1.0	GP-050475	Inter system handover
GP-23	GP-050009	2613	-	Correction to test case 18.1 Temporary reception gaps, single slot	F	6.0.1	6.1.0	GP-050009	GSM
GP-23	GP-050018	2614	-	Bad parameters after cell reselection	F	6.0.0	6.1.0	GP-050018	GPRS
GP-23	GP-050019	2615	-	Addition of time to allow BSIC decoding	F	6.0.0	6.1.0	GP-050019	GPRS
GP-23	GP-050020	2616	-	Addition of time to allow BSIC decoding	F	6.0.0	6.1.0	GP-050020	GPRS
GP-23	GP-050021	2617	-	Change to avoid unwanted cell reselection	F	6.0.0	6.1.0	GP-050021	GPRS
GP-23	GP-050022	2618	-	Change to avoid unwanted cell reselection	F	6.0.0	6.1.0	GP-050022	GPRS
GP-23	GP-050023	2619	-	Removal of the TC as it is not testing the 'Test Purpose'	F	6.0.0	6.1.0	GP-050023	GPRS
GP-23	GP-050026	2622	-	Network Control measurement reporting /NC_FREQUENCY_LIST/NC_FREQUENCY_LIST in Packet measurement order.	F	6.0.1	6.1.0	GP-050026	GPRS
GP-23	GP-050549	2623	3	DTM_SUPPORT bit set to 1 in the GPRS cell options IE for all DTM messages	F	6.0.1	6.1.0	GP-050549	GPRS
GP-23	GP-050463	2624	1	Packet Measurement order procedure / Downlink transfer / Normal case/ Routing Area Update/ NMO I	F	6.0.1	6.1.0	GP-050463	GPRS
GP-23	GP-050550	2626	2	BCCH carrier of cell C modified in testcases 42.4.8.4.4 and 42.4.8.4.5	F	6.0.1	6.1.0	GP-050550	GPRS
GP-23	GP-050042	2629	-	Correction to Related PICS/PIXIT Statement	F	6.0.1	6.1.0	GP-050042	DTM
GP-23	GP-050044	2630	-	Remove unnecessary requirement for TCH/H	F	6.0.1	6.1.0	GP-050044	GPRS
GP-23	GP-050045	2631	-	Various corrections to test procedure, test sequence and specific message contents	F	6.0.1	6.1.0	GP-050045	GPRS
GP-23	GP-050046	2632	-	Correction of step numbering in test sequence	F	6.0.1	6.1.0	GP-050046	GPRS
GP-23	GP-050047	2633	-	Various corrections to test procedure, test sequence and specific message contents	F	6.0.1	6.1.0	GP-050047	GPRS
GP-23	GP-050048	2634	-	Correction to specific message content	F	6.0.1	6.1.0	GP-050048	GPRS
GP-23	GP-050049	2635	-	Correction to specific message content	F	6.0.1	6.1.0	GP-050049	GPRS
GP-23	GP-050050	2636	-	Correction to specific message content and expected sequence	F	6.0.1	6.1.0	GP-050050	GPRS
GP-23	GP-050060	2637	-	Expected Sequence does not match standard Call Establishment procedure	F	6.0.1	6.1.0	GP-050060	ISHO
GP-23	GP-050061	2638	-	Provision for Two-Phase Access added in the expected sequence.	F	6.0.1	6.1.0	GP-050061	GPRS
GP-23	GP-050461	2639	1	Handling of MS requesting one phase access.	F	6.0.1	6.1.0	GP-050461	GPRS
GP-23	GP-050511	2640	1	Remove unnecessary checking of number of received RLC blocks.	F	6.0.1	6.1.0	GP-050511	GPRS
GP-23	GP-050064	2641	-	Correction to step numbering.	F	6.0.1	6.1.0	GP-050064	GPRS
GP-23	GP-050466	2643	1	Handling of MS requesting one phase access.	F	6.0.1	6.1.0	GP-050466	GPRS
GP-23	GP-050067	2644	-	Allow for two phase access.	F	6.0.1	6.1.0	GP-050067	GPRS
GP-23	GP-050068	2645	-	Provision for Two-Phase Access added in the expected sequence.	F	6.0.1	6.1.0	GP-050068	EGPRS
GP-23	GP-050480	2646	1	Handling of MS requesting one phase access.	F	6.0.1	6.1.0	GP-050480	EGPRS
GP-23	GP-050512	2647	1	Remove unnecessary checking of number of received RLC blocks.	F	6.0.1	6.1.0	GP-050512	EGPRS
GP-23	GP-050071	2648	-	Correction in the message sequence and step numbering.	F	6.0.1	6.1.0	GP-050071	EGPRS
GP-23	GP-050467	2650	1	Handling of MS requesting one phase access.	F	6.0.1	6.1.0	GP-050467	EGPRS
GP-23	GP-050074	2651	-	Allow for two phase access.	F	6.0.1	6.1.0	GP-050074	EGPRS
GP-23	GP-050075	2652	-	Remove redundant CM SERVICE ACCEPT message.	F	6.0.1	6.1.0	GP-050075	A-GPS
GP-23	GP-050076	2653	-	Modification to the timing requirements of the testcase 20.22.13.	F	6.0.1	6.1.0	GP-050076	GPRS
GP-23	GP-050547	2656	1	Removing the macro used for the cell update in testcase 41.3.6.6.	F	6.0.1	6.1.0	GP-050547	GPRS
GP-23	GP-050080	2657	-	Correction to the testcase 41.3.6.9.	F	6.0.1	6.1.0	GP-050080	GPRS

TSG #	TSG Doc	CR	Rev	Subject/Comment	Cat	Old	New	WG Doc	Work item
GP-23	GP-050494	2658	1	Changes in the testcase 41.5.1.1.1.3	F	6.0.1	6.1.0	GP-050494	GPRS
GP-23	GP-050082	2659	-	Changes in the PICS/PIXIT statement of the testcase 41.5.1.1.2.3.4.	F	6.0.1	6.1.0	GP-050082	GPRS
GP-23	GP-050083	2660	-	Changes in the testcase 41.5.2.1	F	6.0.1	6.1.0	GP-050083	GPRS
GP-23	GP-050084	2661	-	Changes in the testcase 41.5.2.4	F	6.0.1	6.1.0	GP-050084	GPRS
GP-23	GP-050085	2662	-	Corrections in the expected sequence 42.3.1.1.10.	F	6.0.1	6.1.0	GP-050085	GPRS
GP-23	GP-050086	2663	-	Removing the reference to the non-existing section in specific message contents in the testcase 42.3.3.3.	F	6.0.1	6.1.0	GP-050086	GPRS
GP-23	GP-050468	2664	1	Changes in the testcase 42.4.2.3.3	F	6.0.1	6.1.0	GP-050468	GPRS
GP-23	GP-050548	2666	1	Removing the macro used for the cell update in testcase 51.3.6.6.	F	6.0.1	6.1.0	GP-050548	EGPRS
GP-23	GP-050090	2667	-	Changes in the testcase 51.3.6.9.	F	6.0.1	6.1.0	GP-050090	EGPRS
GP-23	GP-050091	2668	-	Removing the reference to the non-existing section in specific message contents of the testcase 52.3.3.3.	F	6.0.1	6.1.0	GP-050091	EGPRS
GP-23	GP-050092	2669	-	Changes in the initial conditions of the testcases in sec 60.	F	6.0.1	6.1.0	GP-050092	GPRS
GP-23	GP-050100	2671	-	Correction to test case 20.22.29	F	6.0.0	6.1.0	GP-050100	Intersystem Change
GP-23	GP-050469	2672	1	Correction to test case 42.4.5.3	F	6.0.1	6.1.0	GP-050469	GPRS
GP-23	GP-050505	2673	2	Blocking and spurious response - speech channels	F	6.0.1	6.1.0	GP-050505	GPRS
GP-23	GP-050103	2674	-	CR 51.0EGPRS Uplink Power Control - Use of (and (CH parameters	F	6.0.1	6.1.0	GP-050103	GPRS
GP-23	GP-050115	2675	-	Change in the Network Mode of Operation	F	6.0.1	6.1.0	GP-050115	GPRS
GP-23	GP-050116	2676	-	Correcting the SAPI	F	6.0.1	6.1.0	GP-050116	GPRS
GP-23	GP-050117	2677	-	Removing redundant Step	F	6.0.1	6.1.0	GP-050117	GPRS
GP-23	GP-050118	2678	-	Change in the Network Mode of Operation	F	6.0.1	6.1.0	GP-050118	GPRS
GP-23	GP-050119	2679	-	Section 11 General Tests	F	6.0.1	6.1.0	GP-050119	GSM
GP-23	GP-050120	2680	-	EFR Signalling / Structured procedures / MS originated call / late assignment	F	6.0.1	6.1.0	GP-050120	GSM
GP-23	GP-050121	2681	-	Structured Procedures / MS terminated call / early assignment	F	6.0.1	6.1.0	GP-050121	GSM
GP-23	GP-050122	2682	-	Structured Procedures / emergency call	F	6.0.1	6.1.0	GP-050122	GSM
GP-23	GP-050123	2683	-	Section 26.12.8 Default contents of layer 3 messages for Enhanced Full rate speech tests	F	6.0.1	6.1.0	GP-050123	GSM
GP-23	GP-050149	2686	-	Measurement / multiband environment - Removed Ext-Ind from SI2ter and SI5ter. PCS band added.	F	6.0.1	6.1.0	GP-050149	Circuit Switched
GP-23	GP-050150	2687	-	Handover / successful / active call / finely synchronized	F	6.0.1	6.1.0	GP-050150	GPRS
GP-23	GP-050151	2688	-	Handover / layer 1 failure	F	6.0.1	6.1.0	GP-050151	GPRS
GP-23	GP-050152	2689	-	Location updating	F	6.0.1	6.1.0	GP-050152	GSM
GP-23	GP-050153	2690	-	Directed Retry / Mobile Originated Call - PCS band missing.	F	6.0.1	6.1.0	GP-050153	GSM
GP-23	GP-050154	2691	-	PCS band missing.	F	6.0.1	6.1.0	GP-050154	Circuit Switched
GP-23	GP-050157	2694	-	CKSN missing in initial conditions	F	6.0.1	6.1.0	GP-050157	GPRS
GP-23	GP-050158	2695	-	26.11.5.1 - Modification of Classmark Change content for 850/1900 MS	F	6.0.1	6.1.0	GP-050158	GSM
GP-23	GP-050159	2696	-	Inband Signalling, Uplink Codec Adaptation	F	6.0.1	6.1.0	GP-050159	GSM
GP-23	GP-050504	2697	2	AMR signalling / Handover / active call / successful case	F	6.0.1	6.1.0	GP-050504	GSM
GP-23	GP-050161	2698	-	AMR Signalling / Directed Retry / Mobile Originated Call	F	6.0.1	6.1.0	GP-050161	GSM
GP-23	GP-050162	2699	-	AMR Signalling / Directed Retry / Mobile Terminated Call	F	6.0.1	6.1.0	GP-050162	GSM
GP-23	GP-050498	2700	2	Section 26.16.11. Handover / layer 1 failure	F	6.0.1	6.1.0	GP-050498	GSM
GP-23	GP-050499	2701	1	Section 26.16.10.2 Related Pics/Pixit modified	F	6.0.1	6.1.0	GP-050499	GPRS
GP-23	GP-050165	2702	-	Section 34.4.5 - Removal of test	F	6.0.1	6.1.0	GP-050165	GPRS
GP-23	GP-050166	2703	-	Section 40.2.x - Default message contents	D	6.0.1	6.1.0	GP-050166	GPRS
GP-23	GP-050167	2704	-	Section 42.4.2.3.6 and 42.4.2.3.7 removing half rate testing.	F	6.0.1	6.1.0	GP-050167	GPRS
GP-23	GP-050384	2706	1	Packet Downlink Assignment / Abnormal cases / Incorrect PDCH assignment	F	6.0.1	6.1.0	GP-050384	GPRS
GP-23	GP-050170	2707	-	Handover to same routeing area whilst in dedicated mode & MM Ready / Completed on the main DCCH - PDP context 2 removed	C	6.0.1	6.1.0	GP-050170	GPRS
GP-23	GP-050171	2708	-	Handover to same routeing area whilst in DTM with downlink TBF Established - removed	D	6.0.1	6.1.0	GP-050171	GPRS

TSG #	TSG Doc	CR	Rev	Subject/Comment	Cat	Old	New	WG Doc	Work item
				misleading remark					
GP-23	GP-050479	2709	1	Handover to same routing area whilst in DTM with both DL & UL TBFs / Successful case – Step B17 corrected	F	6.0.1	6.1.0	GP-050479	GPRS
GP-23	GP-050173	2710	-	Handover to different routing area whilst in DM / Performed on main DCCH / RAU complete before CS release - Specific message corrected	F	6.0.1	6.1.0	GP-050173	GPRS
GP-23	GP-050174	2711	-	Handover to different routing area whilst in DM / Performed on main DCCH / CS release before RAU complete - Specific message corrected	F	6.0.1	6.1.0	GP-050174	GPRS
GP-23	GP-050493	2712	1	Ignoring Packet Measurement Order and Packet Cell Change Order whilst in DTM – New Test proposal	B	6.0.1	6.1.0	GP-050493	GPRS
GP-23	GP-050473	2716	1	Negotiation initiated by the SS (during ADM, for IOV- UI)	F	6.0.1	6.1.0	GP-050473	GPRS
GP-23	GP-050457	2717	2	DARP Speech bearer tests / TCH/AFS / DTS-1 (new test)	F	6.0.1	6.1.0	GP-050457	DARP
GP-23	GP-050236	2718	-	New requirement added to applicability (PICS) in test cases 46.1.2.6.1 and 46.1.2.6.2	F	6.0.1	6.1.0	GP-050236	GPRS
GP-23	GP-050238	2719	-	Cell Reselection based on C32 - Cell Reselction on CCCH - PBCCH not present	F	6.0.1	6.1.0	GP-050238	GPRS
GP-23	GP-050240	2720	-	Cell Reselection based on C32 - Cell Reselection on CCCH - PBCCH not supported	F	6.0.1	6.1.0	GP-050240	GPRS
GP-23	GP-050241	2721	-	Cell Reselection based on C32 quality / Cell Reselection on CCCH - PBCCH not supported	F	6.0.1	6.1.0	GP-050241	GPRS
GP-23	GP-050242	2722	-	Cell Reselection with cells in different Routing area - Cell Reselection on CCCH - PBCCH not present	F	6.0.1	6.1.0	GP-050242	GPRS
GP-23	GP-050243	2723	-	Clarifications and editorial changes to A-GPS tests	F	6.0.1	6.1.0	GP-050243	TEI
GP-23	GP-050476	2724	1	Addition of A-GPS Scenario and Assistance data values in new clause 10.9	F	6.0.1	6.1.0	GP-050476	TEI
GP-23	GP-050477	2725	1	Revision of A-GPS assistance data delivery and values for MS based tests	F	6.0.1	6.1.0	GP-050477	TEI
GP-23	GP-050501	2726	1	Revision of A-GPS assistance data delivery and values for MS assisted tests	F	6.0.1	6.1.0	GP-050501	TEI
GP-23	GP-050502	2727	1	Revision of A-GPS assistance data delivery and values for MS assisted tests in section 70.8.4.X	F	6.0.1	6.1.0	GP-050502	TEI
GP-23	GP-050251	2728	-	Section 26.6.5.1 - Handover / successful / active call / non-synchronized	F	6.0.1	6.1.0	GP-050251	GSM
GP-23	GP-050513	2729	1	Attach Reject Procedure to be introduced as additional test steps to set T3302 to 1 minute.	F	6.0.1	6.1.0	GP-050513	GPRS
GP-23	GP-050452	2730	1	RXQUAL - TCH/AFS DTX on - correction to equation	F	6.0.1	6.1.0	GP-050452	AMR
GP-23	GP-050470	2731	1	42.3.2.2.2 -Removal of obsolete test step	F	6.0.1	6.1.0	GP-050470	GPRS
GP-23	GP-050471	2732	1	52.3.2.2.2 -Removal of obsolete test step	F	6.0.1	6.1.0	GP-050471	GPRS
GP-23	GP-050370	2733	-	Section 42.4.8.x.x - SI2quater specific message contents corrected	F	6.0.1	6.1.0	GP-050370	GPRS
GP-23	GP-050397	2734	-	52.3.1.2.2 – Change to avoid unwanted cell reselection	F	6.0.0	6.1.0	GP-050397	GPRS
GP-23	GP-050462	2735	1	52.3.1.2.3 - Change to avoid unwanted cell reselection	F	6.0.0	6.1.0	GP-050462	GPRS
GP-23	GP-050472	2736	-	Section 42.4.5.5 Network Assisted Cell Change / Expiry of T3208 and T3210 – 15% Timer Tolerance changed to 10%	F	6.0.1	6.1.0	GP-050472	GPRS
GP-23	GP-050474	2737	-	GPRS Cell Selection and Reselection	F	6.0.1	6.1.0	GP-050474	GPRS
GP-23	GP-050552	2738	1	Change to expected sequence.	F	6.0.1	6.1.0	GP-050552	GPRS
GP-24	GP-050615	2740	-	14.11.1.1 DARP Speech bearer tests / TCH/FS / DTS-1 (new test)	F	6.1.0	6.2.0	GP-050615	DARP
GP-24	GP-050616	2741	-	14.4.1 TUHigh Not Applicable to DARP Capable MS	F	6.1.0	6.2.0	GP-050616	DARP
GP-24	GP-050617	2742	-	21.3.1 Signal Quality under static conditions - TCH/FS (modified test)	F	6.1.0	6.2.0	GP-050617	DARP
GP-24	GP-050618	2743	-	21.3.4 Signal Quality under static conditions - TCH/AHS DTX Off (modified test)	F	6.1.0	6.2.0	GP-050618	DARP
GP-24	GP-050619	2744	-	21.3.6 Signal Quality under static conditions - TCH/AHS DTX On (new test)	F	6.1.0	6.2.0	GP-050619	DARP
GP-24	GP-050635	2745	-	Correction to test case 27.21.2 to the "Maximum frequency of ACM updating" test	F	6.1.0	6.2.0	GP-050635	SIM
GP-24	GP-050636	2746	-	Addition of PICS to test case 46.1.2.2.2.4	F	6.1.0	6.2.0	GP-050636	GPRS
GP-24	GP-050639	2747	-	Correction to test case 42.4.5.3	F	6.1.0	6.2.0	GP-050639	GPRS
GP-24	GP-051045	2748	1	Correction to test case 46.2.2.1.4	F	6.1.0	6.2.0	GP-051045	GPRS

TSG #	TSG Doc	CR	Rev	Subject/Comment	Cat	Old	New	WG Doc	Work item
GP-24	GP-050641	2749	-	CR 51.010-1 Section 14.18.5 Blocking and spurious response	F	6.1.0	6.2.0	GP-050641	EGPRS
GP-24	GP-050642	2750	-	14.16 GPRS receiver tests - Number of RLC blocks depending on number of used slots under fading conditons.	F	6.1.0	6.2.0	GP-050642	GPRS
GP-24	GP-050643	2751	-	14.16.2 GPRS co-channel rejection - correction of table reference	F	6.1.0	6.2.0	GP-050643	GPRS
GP-24	GP-050644	2752	-	14.16.4.1 DARP GPRS tests - Synchronous single co-channel interferer (DTS-1)	B	6.1.0	6.2.0	GP-050644	DARP
GP-24	GP-050645	2753	-	14.16.4.2 DARP GPRS tests - Synchronous multiple interferers (DTS-2 / DTS-3)	B	6.1.0	6.2.0	GP-050645	DARP
GP-24	GP-050647	2755	-	22.3 GPRS Uplink Power Control - Use of (and (CH parameters	F	6.1.0	6.2.0	GP-050647	GPRS
GP-24	GP-050649	2756	-	CR 51.010-1 Annex A7.1 Statistical testing of receiver performance	F	6.1.0	6.2.0	GP-050649	EGPRS
GP-24	GP-050650	2757	-	42.4.4.5 - New TC based on previuos 42.4.4.4	F	6.1.0	6.2.0	GP-050650	GPRS
GP-24	GP-050651	2758	-	20.22.14 - Deletion of test case	F	6.1.0	6.2.0	GP-050651	GPRS
GP-24	GP-050652	2759	-	42.4.5.3 - Modification of Power reselecion parameters	F	6.1.0	6.2.0	GP-050652	GPRS
GP-24	GP-050656	2760	-	TC 34.2.5.2 Change in initial conditions	F	6.1.0	6.2.0	GP-050656	SMS
GP-24	GP-051037	2761	2	New clause 42.9 added for Extended dynamic allocation test cases	F	6.1.0	6.2.0	GP-051037	GPRS
GP-24	GP-051101	2762	3	New clause 52.9 added for Extended dynamic allocation test cases	F	6.1.0	6.2.0	GP-051101	E-GPRS
GP-24	GP-050662	2763	-	41.3.2.3 - Minor correction to test procedure and expected sequence	F	6.1.0	6.2.0	GP-050662	DTM
GP-24	GP-050663	2764	-	41.3.6.9 - Revise testcase in accordance with revised Conformance Requirement	F	6.1.0	6.2.0	GP-050663	GPRS
GP-24	GP-050664	2765	-	51.1.1.4: Correction to page mode in step 14	F	6.1.0	6.2.0	GP-050664	EDGE
GP-24	GP-050665	2766	-	51.3.6.9 - Revise testcase in accordance with revised Conformance Requirement	F	6.1.0	6.2.0	GP-050665	EGPRS
GP-24	GP-050666	2767	-	52.3.2.1.2: Corrections to step references and timings	F	6.1.0	6.2.0	GP-050666	EDGE
GP-24	GP-050667	2768	-	26.7.4.5.4.3 - Correct start of VPLMN Search Timer	F	6.1.0	6.2.0	GP-050667	TEI
GP-24	GP-050669	2769	-	42.1.2.1.2 - Allow for two phase access.	F	6.1.0	6.2.0	GP-050669	GPRS
GP-24	GP-051049	2770	1	51.2.x - Allow for two phase access.	F	6.1.0	6.2.0	GP-051049	EDGE
GP-24	GP-050671	2771	-	52.1.2.1.2 - Allow for two phase access	F	6.1.0	6.2.0	GP-050671	EDGE
GP-24	GP-050672	2772	-	70.8.4.1 - Incorrect missing IE	F	6.1.0	6.2.0	GP-050672	TEI
GP-24	GP-050674	2773	-	CR 51.010-1-2773 42.3.1.2.2 - The amount of data triggered in step 1 is not sufficient	F	6.1.0	6.2.0	GP-050674	-
GP-24	GP-050675	2774	-	42.3.3.1.1 - Handling of optional messages at step 6 and step 8.	F	6.1.0	6.2.0	GP-050675	GPRS
GP-24	GP-050676	2775	-	42.4.1.2 - Update of T3158 is difficult to determine.	F	6.1.0	6.2.0	GP-050676	GPRS
GP-24	GP-051034	2776	1	42.4.2.1.3 - Optional step to receive measurement report is required.	F	6.1.0	6.2.0	GP-051034	GPRS
GP-24	GP-050678	2777	-	42.4.2.1.4 - MS may transmit Packet Channel Request at step 8 and step 13 with the Cause Cell Update.	F	6.1.0	6.2.0	GP-050678	GPRS
GP-24	GP-050680	2778	-	CR 51.010-1-2778 52.3.1.2.2 - The amount of data triggered in step 1 is not sufficient	F	6.1.0	6.2.0	GP-050680	GPRS
GP-24	GP-050681	2779	-	52.3.3.1.1 - Handling of optional messages at step 6 and step 8.	F	6.1.0	6.2.0	GP-050681	GPRS
GP-24	GP-050682	2780	-	A5.2 New test signals for DARP tests.	F	6.1.0	6.2.0	GP-050682	DARP
GP-24	GP-050683	2781	-	14.11.2.1 DARP Speech bearer tests / TCH/AFS / DTS-1	F	6.1.0	6.2.0	GP-050683	DARP
GP-24	GP-051022	2782	1	14.11.2.2 DARP Speech bearer tests / TCH/AFS / DTS-4	F	6.1.0	6.2.0	GP-051022	DARP
GP-24	GP-051023	2783	1	14.11.2.3 DARP Speech bearer tests / TCH/AFS / DTS-2/3/5	F	6.1.0	6.2.0	GP-051023	DARP
GP-24	GP-051024	2784	1	14.11.3.1 DARP Speech bearer tests / TCH/AHS / DTS-1	F	6.1.0	6.2.0	GP-051024	DARP
GP-24	GP-050687	2785	-	14.11.3.3 DARP Speech bearer tests / TCH/AHS / DTS-2/3	F	6.1.0	6.2.0	GP-050687	DARP
GP-24	GP-050690	2786	-	14.1.5, 14.1.6 BFI - clarification of test conditions	F	6.1.0	6.2.0	GP-050690	AMR
GP-24	GP-051108	2787	2	14.2.19, 14.2.20, 14.4.17, 14.4.18 Inband FER - clarification of test procedure	F	6.1.0	6.2.0	GP-051108	AMR
GP-24	GP-050693	2788	-	14.4.8 Co-channel rejection - TCH/AFS - corrections and addition of DARP applicability	F	6.1.0	6.2.0	GP-050693	DARP
GP-24	GP-050694	2789	-	14.4.16 Co-channel rejection - TCH/AHS - clarifications and addition of DARP applicability	F	6.1.0	6.2.0	GP-050694	DARP

TSG #	TSG Doc	CR	Rev	Subject/Comment	Cat	Old	New	WG Doc	Work item
GP-24	GP-050696	2790	-	21.3.3 Signal quality under static conditions - TCH/AFS - DTX off	F	6.1.0	6.2.0	GP-050696	AMR
GP-24	GP-050697	2791	-	Section 14 AMR tests - clarification of expected test duration	F	6.1.0	6.2.0	GP-050697	AMR
GP-24	GP-050700	2792	-	CR 51.010-1-2792 26.6.11.3 - Correction to CLASSMARK CHANGE response time requirement	F	6.1.0	6.2.0	GP-050700	-
GP-24	GP-050710	2793	-	CR 51.010-1 Section 28.4 Behaviour of the MS when its list of blacklisted numbers is full	F	6.1.0	6.2.0	GP-050710	GSM
GP-24	GP-050714	2794	-	13.17.2 Frequency error under multipath and interference conditions	F	6.1.0	6.2.0	GP-050714	EDGE
GP-24	GP-050715	2795	-	13.17.4 Output RF spectrum in EGPRS configuration	F	6.1.0	6.2.0	GP-050715	Edge
GP-24	GP-050716	2796	-	14.18 EGPRS receiver tests	F	6.1.0	6.2.0	GP-050716	EDGE
GP-24	GP-051085	2797	2	42.4.1.2 Network Control measurement reporting / Idle mode / New cell reselection	F	6.1.0	6.2.0	GP-051085	GPRS
GP-24	GP-050718	2798	-	42.4.2.1.4 Cell change order procedure / Uplink transfer / Failure cases / Contention resolution failure	F	6.1.0	6.2.0	GP-050718	GPRS
GP-24	GP-050743	2799	-	Corrections to step numbering in 70.8.5.1	F	6.1.0	6.2.0	GP-050743	TEI
GP-24	GP-050744	2800	-	Corrections and changes to section 10.9 and A-GPS data file	F	6.1.0	6.2.0	GP-050744	TEI
GP-24	GP-050745	2801	-	CR 051.010-1 section 40 PACKET UL/DL ASSIGNMENT and PACKET TIMESLOT RECONFIGURE should not have frequency parameters present in case MS is in DTM mode.	F	6.1.0	6.2.0	GP-050745	GPRS
GP-24	GP-050746	2802	-	CR 051.010-1 Section 47.3.2.1 Handover to different routing area whilst in DM / Performed on main DCCH / RAU complete before CS release	F	6.1.0	6.2.0	GP-050746	DTM
GP-24	GP-050749	2803	-	CR 51.010-1 GPRS_RESELECT_OFFSET of cell B changed in 42.3.1.2.2 and 42.3.1.2.3 changed	F	6.1.0	6.2.0	GP-050749	GPRS
GP-24	GP-050750	2804	-	CR 51.010-1 GPRS_RESELECT_OFFSET of cell B changed in 52.3.1.2.2 and 52.3.1.2.3 changed	F	6.1.0	6.2.0	GP-050750	EDGE
GP-24	GP-050751	2805	-	CR 051.010-1- 26.10.2.4.2 E-GSM or R-GSM signalling / RR / Handover / layer 1 failure	F	6.1.0	6.2.0	GP-050751	GSM (Signalling)
GP-24	GP-050752	2806	-	CR 051.010-1- 26.10.3.2 E-GSM or R-GSM signalling / Structured procedures / emergency call	F	6.1.0	6.2.0	GP-050752	GSM (Signalling)
GP-24	GP-050753	2807	-	CR 051.010-1 26.11.3.1.2 Location updating / periodic	F	6.1.0	6.2.0	GP-050753	signalling
GP-24	GP-050754	2808	-	CR 051.010 section 50 PACKET UL/DL ASSIGNMENT and PACKET TIMESLOT RECONFIGURE should not have frequency parameters present in case MS is DTM mode.	F	6.1.0	6.2.0	GP-050754	EDGE
GP-24	GP-050747	2809	-	CR 051.010-1 Section 47.4.1 PDP Context Activation / Performed on main DCCH and TBFs	F	6.1.0	6.2.0	GP-050747	DTM
GP-24	GP-050796	2810	-	CR 51.010-1 Section 26.16.9.10 - Inversion of the phase of the CMI/CMR - Step number corrected	D	6.1.0	6.2.0	GP-050796	GSM
GP-24	GP-050797	2811	-	CR 51.010-1-2811 Section 41.3.2.3 TBF release / Uplink / Normal / Network initiated / Whilst in DTM – Step renumbering	F	6.1.0	6.2.0	GP-050797	-
GP-24	GP-051028	2812	1	CR 51.010-1 Section 41.3.6.10 TBF Release / Extended Uplink / Change of RLC mode / Abnormal release - Used Context corrected	F	6.1.0	6.2.0	GP-051028	GPRS
GP-24	GP-050799	2813	-	CR 51.010-1 Section 41.3.6.9 TBF Release / Extended Uplink / Change of RLC mode / Normal release - Used contexts corrected	F	6.1.0	6.2.0	GP-050799	GPRS
GP-24	GP-051068	2814	1	CR 51.010-1 Section 41.5.1.1.2.3.5 - Uplink TBF establishment with reallocation of CS resources / Abnormal case / Multislot class violation / Incorrect Allocation - Cause Value corrected	F	6.1.0	6.2.0	GP-051068	GPRS
GP-24	GP-050802	2815	-	CR 51.010-1 Section - 41.5.2.2 MT CS establishment whilst in packet transfer mode with a uplink TBF established - Authentication and Ciphering added	F	6.1.0	6.2.0	GP-050802	GPRS
GP-24	GP-050803	2816	-	CR 51.010-1 Section 41.5.2.3 - MO CS establishment whilst in packet transfer mode with uplink and downlink TBFs established -	F	6.1.0	6.2.0	GP-050803	GPRS

TSG #	TSG Doc	CR	Rev	Subject/Comment	Cat	Old	New	WG Doc	Work item
				sequenced swapped					
GP-24	GP-050804	2817	-	CR 51.010-1 Section 42.1.2.2.3 - Packet Downlink Assignmnt / Frequency Parameters - CA length modified for PCN and PCS bands	F	6.1.0	6.2.0	GP-050804	GPRS
GP-24	GP-050805	2818	-	CR 51.010-1 Section 42.1.2.2.5.1 - Packet Downlink Assignment / Abnormal cases Incorrect PDCH assignment - Align with Mirror test	F	6.1.0	6.2.0	GP-050805	GPRS
GP-24	GP-050806	2819	-	CR 51.010-1 Section 42.4.6.1 Clarification of Specific Message Contents	F	6.1.0	6.2.0	GP-050806	GPRS
GP-24	GP-051035	2820	1	CR 51.010-1 Section 42.4.8.3.4 Correction of Expected Sequence	F	6.1.0	6.2.0	GP-051035	GPRS
GP-24	GP-050808	2821	-	CR 51.010-1 Section 42.4.8.4.3 Correction of Initial Conditions and Specific message contents	F	6.1.0	6.2.0	GP-050808	GPRS
GP-24	GP-050809	2822	-	CR 51.010-1 Section 44.2.3.1.4 - Routing area updating / rejected / location area not allowed - Detach Accept added	F	6.1.0	6.2.0	GP-050809	GPRS
GP-24	GP-050810	2823	-	CR 51.010-1-2823 Section 44.2.3.1.4 - Routing area updating / rejected / location area not allowed – SIM removal considered	F	6.1.0	6.2.0	GP-050810	-
GP-24	GP-050811	2824	-	CR 51.010-1 Section 46.1.2.5.4 Frame reject condition during establishment of ABM - Removal of Superfluous information	D	6.1.0	6.2.0	GP-050811	GPRS
GP-24	GP-050812	2825	-	CR 51.010-1 Section 46.1.2.7.6 Negotiation initiated by the SS (during ABM, for Reset) - Reducing test time	F	6.1.0	6.2.0	GP-050812	GPRS
GP-24	GP-050813	2826	-	CR 51.010-1 Section 46.2.2.4.1 Response from MS on receiving XID request from the SS - adding new header compression algorithms	F	6.1.0	6.2.0	GP-050813	GPRS
GP-24	GP-050814	2827	-	CR 51.010-1 Section 47.4.1 - PDP Context Activation / Performed on main DCCH and TBFs - Change to TCH/F	F	6.1.0	6.2.0	GP-050814	GPRS
GP-24	GP-051027	2828	1	CR 51.010-1 section 51.3.6.10 - TBF Release / Extended Uplink / Change of RLC mode / Abnormal release - Used Context corrected	F	6.1.0	6.2.0	GP-051027	GPRS
GP-24	GP-050816	2829	-	CR 51.010-1 section 51.3.6.9 - TBF Release / Extended Uplink / Change of RLC mode / Normal release - Used contexts corrected	F	6.1.0	6.2.0	GP-050816	GPRS
GP-24	GP-050817	2830	-	CR 51.010-1 Section 52.1.2.1.8.1.6, 52.1.2.1.8.1.7, 52.1.2.1.8.1.8 Handling of MS requesting one phase access.	F	6.1.0	6.2.0	GP-050817	GPRS
GP-24	GP-050818	2831	-	CR 51.010-1 Section 53.1.1.13 - Acknowledged Mode/ Uplink TBF/ Calculation of BSN2 - aligning the test procedure	F	6.1.0	6.2.0	GP-050818	GPRS
GP-24	GP-051047	2831	1	CR 51.010-1 Addition of missing Supplementary Services message content to MO-LR A-GPS test cases, and correction of MO-LR transfer to 3rd Party	F	6.1.0	6.2.0	GP-051047	TEI
GP-24	GP-050830	2832	-	CR 51.010-1 Completion of A-GPS MT-LR test cases.	F	6.1.0	6.2.0	GP-050830	TEI
GP-24	GP-050832	2833	-	CR 51.010-1 Removal of A-GPS NI-LR test cases on SDCCH	F	6.1.0	6.2.0	GP-050832	TEI
GP-24	GP-050834	2834	-	CR 51.010-1 New A-GPS NI-LR emergency call test cases without SIM inserted.	F	6.1.0	6.2.0	GP-050834	TEI
GP-24	GP-050870	2835	-	51010-1: Editorial Modifications in the section 20.22 defaults.	F	6.1.0	6.2.0	GP-050870	GPRS
GP-24	GP-050871	2836	-	51010-1: Changes in the timing requirement of the testcases 20.22.4.	F	6.1.0	6.2.0	GP-050871	GPRS
GP-24	GP-051077	2837	1	51010-1: Changes in the timing requirement of the testcases 20.22.5.	F	6.1.0	6.2.0	GP-051077	GPRS
GP-24	GP-051046	2838	1	51010-1: Changes in the timing requirement of the testcases 20.22.7.	F	6.1.0	6.2.0	GP-051046	GPRS
GP-24	GP-050875	2839	-	51010-1: Changes in the initial condition of the testcase 41.2.2.3	F	6.1.0	6.2.0	GP-050875	GPRS
GP-24	GP-050876	2840	-	51010-1: Changes in the ACCESS_TYPE used in the PACKET RESOURCE REQUEST, other corrections in the expeted sequence in the testcase 42.3.1.2.3	F	6.1.0	6.2.0	GP-050876	GPRS
GP-24	GP-050877	2841	-	51010-1: Changes in the specific message content of the testcase 47.3.2.1.	F	6.1.0	6.2.0	GP-050877	DTM
GP-24	GP-050878	2842	-	51010-1: Changes in the testcase 47.3.2.2.	F	6.1.0	6.2.0	GP-050878	DTM
GP-24	GP-050879	2843	-	51010-1: Changes in the testcase 47.3.3.1.2.	F	6.1.0	6.2.0	GP-050879	DTM
GP-24	GP-050880	2844	-	51010-1: Changes in the ACCESS_TYPE used	F	6.1.0	6.2.0	GP-050880	EGPRS

TSG #	TSG Doc	CR	Rev	Subject/Comment	Cat	Old	New	WG Doc	Work item
				in the PACKET RESOURCE REQUEST, and other changes in the expected sequence in the testcase 52.3.1.2.3					
GP-24	GP-050881	2845	-	51010-1: Changes in the testcases 44.2.3.2.7, 44.2.3.2.3.2, 44.2.1.2.2.3.2	F	6.1.0	6.2.0	GP-050881	GPRS
GP-24	GP-050874	2846	-	51010-1: Changes in the initial conditions of the testcases 20.25.4.	F	6.1.0	6.2.0	GP-050874	GPRS
GP-24	GP-050883	2847	-	51010-1: Corrections to specific message content of step 1 in 42.4.8.3.6	F	6.1.0	6.2.0	GP-050883	GPRS
GP-24	GP-050884	2848	-	51010-1: Correction to step 7 of 42.4.2.3.7	D	6.1.0	6.2.0	GP-050884	GPRS
GP-24	GP-051043	2849	1	51010-1: Changes in the expeted test sequence in the testcase 42.3.1.2.2	F	6.1.0	6.2.0	GP-051043	GPRS
GP-24	GP-051044	2850	1	51010-1: Changes in the expeted sequence in the testcase 52.3.1.2.2	F	6.1.0	6.2.0	GP-051044	EGPRS
GP-24	GP-050908	2851	-	CR 51.010-1 Section 20.22.14 - Cell Reselection in case Cell reselection occurred in the previous 15 s	F	6.1.0	6.2.0	GP-050908	GPRS
GP-24	GP-050909	2852	-	CR 51.010-1 Section 26.6.5.3 - Handover / successful / active call / finely synchronized	F	6.1.0	6.2.0	GP-050909	GSM
GP-24	GP-051104	2853	2	42.4.8.1.x - Correction of Page Mode in Non-DRX test set.	F	6.1.0	6.2.0	GP-051104	GPRS
GP-24	GP-050914	2854	-	CR 51.010-1 Section 42.1.2.1.8.1.6 - Handling of MS requesting one phase access.	F	6.1.0	6.2.0	GP-050914	GPRS
GP-24	GP-050967	2855	-	Corrections to Inter-system cell reselection test case (idle mode)	F	6.1.0	6.2.0	GP-050967	TEI
GP-24	GP-051036	2856	1	51.010 -1 Section 42.4.1.1 - NC_REPORTING_PERIOD_T value is too less	F	6.1.0	6.2.0	GP-051036	
GP-24	GP-050972	2857	1	Correction to Handover to UTRAN Command for 60.1	F	6.1.0	6.2.0	GP-050972	Inter system handover
GP-24	GP-050970	2858	-	CR 051.010-1 Section 42.4.5.9 Network Assisted Cell Change / NC mode change / Packet Neighbour Cell Data	F	6.1.0	6.2.0	GP-050970	GPRS
GP-24	GP-050976	2859	1	CR 51.010-1 Section 53.1.1.13 - Acknowledged Mode/ Uplink TBF/ Calculation of BSN2 - aligning the test procedure	F	6.1.0	6.2.0	GP-050976	GPRS
GP-24	GP-051048	2860	1	CR 051.010-1 Section 42.4.8.3.6 Network Control measurement reporting / Dedicated connection / Assignment Reject/	F	6.1.0	6.2.0	GP-051048	GPRS
GP-24	GP-051021	2861	-	Sections 13.7.5, 13.16.2.5, 13.17.3 Transmitter output power reduction in case of multislot uplink configuration	F	6.1.0	6.2.0	GP-051021	TEI-6
GP-24	GP-051081	2862	1	14.11.4 DARP Speech bearer tests / FACCH (new test)	F	6.1.0	6.2.0	GP-051081	DARP
GP-24	GP-051083	2863	1	MS Radio Access Capability Interrogation (new test)	F	6.1.0	6.2.0	GP-051083	DARP
GP-24	GP-051110	2864	-	Section 42.3.1.2.2 and 42.3.1.2.3 clarification	F	6.1.0	6.2.0	GP-051110	
GP-24	GP-051111	2865	-	Section 52.3.1.2.2 and 52.3.1.2.3 clarification	F	6.1.0	6.2.0	GP-051111	
-	-	-	-	The file 51010-1_s00-s11.doc has been not included in the ziped file for version 620 - all included now	D	6.2.0	6.2.1	-	-
GP-25	GP-051648	2867	1	Correction to section 40, missing Cell Id in DTM INFORMATION	F	6.2.1	6.3.0	GP-051648	DTM
GP-25	GP-051630	2870	1	Corrections to Extended Dynamic Allocation test cases	F	6.2.1	6.3.0	GP-051630	Extended Dynamic Allocation
GP-25	GP-051192	2872	-	Editorial correction to test case 42.4.4.1	D	6.2.1	6.3.0	GP-051192	GPRS
GP-25	GP-051621	2873	1	CR 51.010-1 Section 21.4.1 - Modifications to test procedure	F	6.2.1	6.3.0	GP-051621	GPRS
GP-25	GP-051622	2874	1	CR 51.010-1 Section 21.4.2 - Modifications to test procedure	F	6.2.1	6.3.0	GP-051622	GSM
GP-25	GP-051623	2875	1	CR 51.010-1 Section 21.4.3 - Modifications to test procedure	F	6.2.1	6.3.0	GP-051623	GSM
GP-25	GP-051636	2879	1	CR 51.010-1 Section 46.2.2.1.3 to 46.2.2.1.5, 46.2.2.4.1.2 Need To Handle N-PDUs Too Short To Be Segmented	F	6.2.1	6.3.0	GP-051636	GPRS
GP-25	GP-051631	2882	1	New sub-clause 42.9.2.1.2: Extended Dynamic Allocation / Uplink Transfer / Normal / USF_GRANULARITY = 4 blocks	B	6.2.1	6.3.0	GP-051631	GPRS
GP-25	GP-051632	2883	1	New sub-clause 52.9.2.1.2: Extended Dynamic Allocation / Uplink Transfer / Normal / USF_GRANULARITY = 4 blocks	B	6.2.1	6.3.0	GP-051632	E-GPRS
GP-25	GP-051216	2886	-	Section 42.3.4, remove of useless default	F	6.2.1	6.3.0	GP-051216	GPRS

TSG #	TSG Doc	CR	Rev	Subject/Comment	Cat	Old	New	WG Doc	Work item
				messages					
GP-25	GP-051217	2887	-	Section 52.3.4, remove of useless default messages	F	6.2.1	6.3.0	GP-051217	E-GPRS
GP-25	GP-051219	2888	-	70.8.x and 70.9.x - Test Cases incorrect for MSC Releases 99 or later	F	6.2.1	6.3.0	GP-051219	TEI
GP-25	GP-051220	2889	-	70.9.x - Correction in the Test Sequence	F	6.2.1	6.3.0	GP-051220	TEI
GP-25	GP-051221	2890	-	26.17.2 -Adaptive Multi Rate Signalling - 8PSK/ Inband Signalling, Uplink Codec Adaptation (New TC)	F	6.2.1	6.3.0	GP-051221	8PSK-AH
GP-25	GP-051225	2891	-	Addition of new verified TTCN test cases	F	6.2.1	6.3.0	GP-051225	Inter_System_Handover
GP-25	GP-051625	2892	1	14.2.21 DARP Reference sensitivity - O-TCH/AHS (new test)	F	6.2.1	6.3.0	GP-051625	8PSK-AH
GP-25	GP-051240	2893	-	14.2.10 Reference sensitivity - TCH/AFS - remove redundant note	F	6.2.1	6.3.0	GP-051240	AMR
GP-25	GP-051241	2894	-	14.11.3.3 TCH/AHS / DTS-2/3 - correction to applicability	F	6.2.1	6.3.0	GP-051241	AMR
GP-25	GP-051242	2895	-	A5.2 Standard test signals - addition of 8-PSK	F	6.2.1	6.3.0	GP-051242	8PSK-AH
GP-25	GP-051243	2896	-	14.11.3.1 TCH/AHS / DTS-1 - correction to label	F	6.2.1	6.3.0	GP-051243	AMR
GP-25	GP-051244	2897	-	A5.3.4.8 Addition of DARP clauses to higher accuracy requirement	F	6.2.1	6.3.0	GP-051244	DARP
GP-25	GP-051245	2898	-	CR 051.010-1 2898: 26.8.1.4.5.8 In-call functions / MS originated in-call modification / unknown message received	F	6.2.1	6.3.0	GP-051245	GSM
GP-25	GP-051247	2900	-	CR 051.010-1 2900: section 40, Alpha parameter changed to 0.5	F	6.2.1	6.3.0	GP-051247	GPRS
GP-25	GP-051248	2901	-	CR 051.010-1 2901: 42.4.8.4.1 Network Control measurement reporting / NC_FREQUENCY_LIST / NC_FREQUENCY_LIST in Packet measurement order.	F	6.2.1	6.3.0	GP-051248	GPRS
GP-25	GP-051628	2903	1	CR 051.010-1 2903: Correction to testcases 41.3.6.8,41.3.6.9 and 41.3.6.10	F	6.2.1	6.3.0	GP-051628	GPRS
GP-25	GP-051629	2904	1	CR 051.010-1 2904: Correction to testcases 51.3.6.8,51.3.6.9 and 51.3.6.10	F	6.2.1	6.3.0	GP-051629	EDGE
GP-25	GP-051252	2905	-	New Test Cases for 51.010-1 Clause 83: PS Domain Procedures	B	6.2.1	6.3.0	GP-051252	GAN
GP-25	GP-051254	2906	-	20.22.9 - READY timer deactivated to avoid entering Standby	F	6.2.1	6.3.0	GP-051254	GPRS
GP-25	GP-051255	2907	-	41.2.3.9 - Clarify optional steps	F	6.2.1	6.3.0	GP-051255	GPRS
GP-25	GP-051256	2908	-	51.2.3.9 - Clarify optional steps	F	6.2.1	6.3.0	GP-051256	EDGE
GP-25	GP-051257	2909	-	41.3.6.9 - Correction to values in PACKET UPLINK ACK/NACK	F	6.2.1	6.3.0	GP-051257	GPRS
GP-25	GP-051258	2910	-	51.3.6.9 - Correction to values in EGPRS PACKET UPLINK ACK/NACK	F	6.2.1	6.3.0	GP-051258	GPRS
GP-25	GP-051259	2911	-	41.3.6.10 - Changed conformance requirements and improved method of test.	F	6.2.1	6.3.0	GP-051259	GPRS
GP-25	GP-051260	2912	-	51.3.6.10 - Changed conformance requirements and improved method of test.	F	6.2.1	6.3.0	GP-051260	GPRS
GP-25	GP-051262	2913	-	51.010 -1 Section 42.1.2.2.3 - ARFCN list modified for 850 and 900 bands	F	6.2.1	6.3.0	GP-051262	GPRS
GP-25	GP-051264	2915	-	42.4.5.3 - Correcting specific message contents at Step 30.	F	6.2.1	6.3.0	GP-051264	GPRS
GP-25	GP-051265	2916	-	44.2.1.2.8 - Attach Type modified to allow alternative value	F	6.2.1	6.3.0	GP-051265	GPRS
GP-25	GP-051266	2917	-	47.3.1.3.1 - Clarification of optional steps.	F	6.2.1	6.3.0	GP-051266	DTM
GP-25	GP-051267	2918	-	47.3.1.3.2 - Discrepancy between Initial conditions and Test Procedure.	F	6.2.1	6.3.0	GP-051267	DTM
GP-25	GP-051268	2919	-	52.1.2.1.3.1 - Allow for two phase access	F	6.2.1	6.3.0	GP-051268	EDGE
GP-25	GP-051269	2920	-	53.1.2.17 - Allowing uncompressed bitmap present along with compressed bitmap in EGPRS packet Downlink Ack/Nack description.	F	6.2.1	6.3.0	GP-051269	EDGE
GP-25	GP-051741	2921	1	14.10.1, 14.10.2 - change applicability for DARP	F	6.2.1	6.3.0	GP-051741	AMR
GP-25	GP-051743	2922	2	14.10.3, 14.10.4 AMR in-band performance DARP (new tests)	F	6.2.1	6.3.0	GP-051743	AMR
GP-25	GP-051284	2923	-	42.4.2.3.5 - Routing Area Update Accept changed to avoid Cell Update	F	6.2.1	6.3.0	GP-051284	GPRS
GP-25	GP-051285	2924	-	42.4.8.3.5 - Reduce Cell A power to avoid cell update after the call	F	6.2.1	6.3.0	GP-051285	GPRS
GP-25	GP-051744	2925	1	53.1.1.24- Change of SSN in two Packet Uplink Ack/Nack	F	6.2.1	6.3.0	GP-051744	EGPRS

TSG #	TSG Doc	CR	Rev	Subject/Comment	Cat	Old	New	WG Doc	Work item
GP-25	GP-051290	2929	-	CR 51.010-1 22.4 GPRS Uplink Power Control - Independence of TS Power Control	F	6.2.1	6.3.0	GP-051290	GPRS
GP-25	GP-051291	2930	-	CR 51.010-1 Correction in sec. 22.9 regarding MS maximum output power reduction in a multislot configuration	F	6.2.1	6.3.0	GP-051291	EGPRS
GP-25	GP-051292	2931	-	CR 51.010-1: New Test Case 26.17.3: 8-PSK AMR HR / Structured procedures / MS terminated call / early assignment / no initial codec mode	F	6.2.1	6.3.0	GP-051292	GSM
GP-25	GP-051293	2932	-	CR 51.010-1: New Test Case 26.17.3a: 8-PSK AMR HR / Structured procedures / MS terminated call / early assignment / specified initial codec mode	F	6.2.1	6.3.0	GP-051293	GSM
GP-25	GP-051294	2933	-	CR 51.010-1: New Test Case 26.17.4: 8-PSK AMR HR / Structured procedures / MS originated call / late assignment / specified initial codec mode	F	6.2.1	6.3.0	GP-051294	GSM
GP-25	GP-051295	2934	-	CR 51.010-1: New Test Case 26.17.4a: 8-PSK AMR HR / Structured procedures / MS originated call / late assignment / no initial codec mode	F	6.2.1	6.3.0	GP-051295	GSM
GP-25	GP-051296	2935	-	CR 51.010-1: New Test Case 26.17.6: 8-PSK AMR HR / Structured procedures / emergency call	F	6.2.1	6.3.0	GP-051296	GSM
GP-25	GP-051298	2936	-	New TC 42.9.2.1.4: Extended Dynamic Allocation / Uplink Transfer / Normal / PACCH operation in downlink	B	6.2.1	6.3.0	GP-051298	GPRS
GP-25	GP-051299	2937	-	New TC 42.9.2.1.5: Extended Dynamic Allocation / Uplink Transfer / Normal / Polling for PDAN	B	6.2.1	6.3.0	GP-051299	GPRS
GP-25	GP-051300	2938	-	New TC 52.9.2.1.4: Extended Dynamic Allocation / Uplink Transfer / Normal / PACCH operation in downlink	B	6.2.1	6.3.0	GP-051300	EGPRS
GP-25	GP-051301	2939	-	New TC 52.9.2.1.5: Extended Dynamic Allocation / Uplink Transfer / Normal / Polling for EPDAN	B	6.2.1	6.3.0	GP-051301	EGPRS
GP-25	GP-051303	2940	-	44.2.2.2.6 - Setting Force to Standby in Routing Area Accept	F	6.2.1	6.3.0	GP-051303	TEI-6
GP-25	GP-051311	2942	-	51010-1: Changes in the specific message content of 42.4.2.3.4.	F	6.2.1	6.3.0	GP-051311	GPRS
GP-25	GP-051312	2943	-	51010-1: Changes in the READY-TIMER used in the testcase 42.4.2.3.5.	F	6.2.1	6.3.0	GP-051312	GPRS
GP-25	GP-051313	2944	-	51010-1: Changes in the applicability of the combined attach testcases in section 44.2.1.2.	F	6.2.1	6.3.0	GP-051313	GPRS
GP-25	GP-051314	2945	-	51010-1: Changes in the testcase 44.2.10.	F	6.2.1	6.3.0	GP-051314	GPRS
GP-25	GP-051315	2946	-	51010-1: Changes in the applicability of the combined routing area update testcases in section 44.2.3.2.	F	6.2.1	6.3.0	GP-051315	GPRS
GP-25	GP-051316	2947	-	51010-1: Changes in the testcase 44.2.8.1.2 and 44.2.8.1.3	F	6.2.1	6.3.0	GP-051316	GPRS
GP-25	GP-051317	2948	-	51010-1: Changes in the testcase 46.1.2.2.2.3.	F	6.2.1	6.3.0	GP-051317	GPRS
GP-25	GP-051318	2949	-	51010-1: Changes in the testcase 46.2.2.1.2.	F	6.2.1	6.3.0	GP-051318	GPRS
GP-25	GP-051637	2950	1	51010-1: Changes in the testcase 46.2.2.1.5.	F	6.2.1	6.3.0	GP-051637	GPRS
GP-25	GP-051322	2951	-	42.4.8.4.5 - Clarifications in initial conditions	F	6.2.1	6.3.0	GP-051322	GPRS
GP-25	GP-051323	2952	-	26.7.4.5.4.x - HPLMN Search Timer handling	F	6.2.1	6.3.0	GP-051323	TEI
GP-25	GP-051331	2953	-	14.18.8.1 DARP EGPRS tests - Synchronous single co-channel interferer (DTS-1)	B	6.2.1	6.3.0	GP-051331	DARP
GP-25	GP-051332	2954	-	14.18.8.2 DARP EGPRS tests - Synchronous multiple interferers (DTS-2 / DTS-3)	B	6.2.1	6.3.0	GP-051332	DARP
GP-25	GP-051333	2955	-	14.2.1 Reference sensitivity - Procedure correction	F	6.2.1	6.3.0	GP-051333	TEI
GP-25	GP-051334	2956	-	14.16.2 Co-channel rejection Corrections and addition of DARP applicability	B	6.2.1	6.3.0	GP-051334	DARP
GP-25	GP-051335	2957	-	14.18.2 Co-channel rejection. Addition of DARP applicability	B	6.2.1	6.3.0	GP-051335	DARP
GP-25	GP-051663	2958	1	14.16.4.2 Editorial correction	F	6.2.1	6.3.0	GP-051663	
GP-25	GP-051664	2959	1	14.16.4.1 Correction of procedure steps	F	6.2.1	6.3.0	GP-051664	
GP-25	GP-051339	2960	-	51010-1: GPRS Uplink Power Control - Independence of TS Power Control	F	6.2.1	6.3.0	GP-051339	TEI-6
GP-25	GP-051340	2961	-	New Test Cases for 51.010-1 Clause 82: GAN CS Domain Procedures	B	6.2.1	6.3.0	GP-051340	GA
GP-25	GP-051352	2962	-	51010-1: Changes in the applicability of the some of the detach testcase in section 44.2.2.	F	6.2.1	6.3.0	GP-051352	GPRS

TSG #	TSG Doc	CR	Rev	Subject/Comment	Cat	Old	New	WG Doc	Work item
GP-25	GP-051353	2963	-	CR 51.010-1 section 42.4.2.1.3 - Conformance Requirement updated and Two Phase Access Procedure added	F	6.2.1	6.3.0	GP-051353	GPRS
GP-25	GP-051354	2964	-	CR 51.010-1 Section 42.4.2.1.4 Update of Conformance Requirement	F	6.2.1	6.3.0	GP-051354	GPRS
GP-25	GP-051366	2965	-	70.8.4.1 - Correction of RRLP Protocol Error Cause	F	6.2.1	6.3.0	GP-051366	TEI
GP-25	GP-051639	2966	-	Section 52.1.2.2.5.1 - Packet Downlink Assignment / Abnormal cases / Incorrect PDCH assignment	F	6.2.1	6.3.0	GP-051639	-
GP-25	GP-051369	2967	-	New Test Case for MS-Based A-GPS: RRLP Protocol Error	F	6.2.1	6.3.0	GP-051369	TEI
GP-25	GP-051370	2968	-	New Test Case for MS-Based A-GPS: RRLP Location Error - Requested Method Not Supported	F	6.2.1	6.3.0	GP-051370	TEI
GP-25	GP-051371	2969	-	New Test Case for MS-Based A-GPS: RRLP Location Error - GPS Assistance Data Missing	F	6.2.1	6.3.0	GP-051371	TEI
GP-25	GP-051373	2970	-	CR 51.010-1 Section 40.2.4.28 - DTM Assignment Command - Message Type corrected	F	6.2.1	6.3.0	GP-051373	GPRS
GP-25	GP-051374	2971	-	CR 51.010-1 Section 40.2.4.33 - Handover Command - ATC corrected	F	6.2.1	6.3.0	GP-051374	GPRS
GP-25	GP-051626	2972	1	CR 51.010-1 Section 40.4.3.21 Uplink data - new macro added	F	6.2.1	6.3.0	GP-051626	GPRS
GP-25	GP-051662	2973	2	CR 51.010-1 Section 42.3.1.1.9 - Dynamic Allocation / Uplink Transfer / Normal / Frequency Parameters	F	6.2.1	6.3.0	GP-051662	GPRS
GP-25	GP-051378	2975	-	CR 51.010-1 Section 42.1.2.2.5.1 - Packet Downlink Assignment / Abnormal cases / Incorrect PDCH assignment	F	6.2.1	6.3.0	GP-051378	GPRS
GP-25	GP-051638	2976	1	CR 51.010-1 Section 50.4.3.11- Uplink data - new macro	F	6.2.1	6.3.0	GP-051638	GPRS
GP-25	GP-051381	2978	-	Section 52.6.1, 52.6.2, 52.6.3, and 52.6.4	F	6.2.1	6.3.0	GP-051381	GPRS
GP-25	GP-051382	2979	-	CR 51.010-1 Section 20.22.5 - Network controlled Cell re-selection in Idle Mode	F	6.2.1	6.3.0	GP-051382	GPRS
GP-25	GP-051383	2980	-	CR 51.010-1 Section 26.6.13 Test of Starting time	F	6.2.1	6.3.0	GP-051383	GSM
GP-25	GP-051384	2981	-	51.010-1 Section 26.6.3 Test of measurement report	F	6.2.1	6.3.0	GP-051384	GSM
GP-25	GP-051385	2982	-	51.010-1 Section 26.6.4.1 Test of the channel assignment procedure	F	6.2.1	6.3.0	GP-051385	GSM
GP-25	GP-051386	2983	-	51.010-1 SECTION 26.16.5 - AMR signalling / Handover / active call / successful case	F	6.2.1	6.3.0	GP-051386	GSM
GP-25	GP-051387	2984	-	Section 41.5.1.1.2.3.4 - Uplink TBF establishment with reallocation of CS resources / Abnormal case / Multislot class violation / Singleslot allocation – Cause Value corrected	F	6.2.1	6.3.0	GP-051387	GPRS
GP-25	GP-051388	2985	-	CR 51.010-1-2828 section 41.5.1.1.3 - Uplink TBF establishment required whilst DTM is not supported in cell - Comment in Step 3 corrected	F	6.2.1	6.3.0	GP-051388	GPRS
GP-25	GP-051389	2986	-	CR 51.010-1 section - 41.5.2.1 MT CS establishment whilst in packet transfer mode with a downlink TBF established - Step 2 Macro replaced	F	6.2.1	6.3.0	GP-051389	GPRS
GP-25	GP-051654	2987	1	CR 51.010-1 Section - 41.5.2.2, 41.5.2.3, 41.5.2.4, 41.5.3.2.1, 47.3.1.3.2 - new macro used / Test Time reduction	F	6.2.1	6.3.0	GP-051654	GPRS
GP-25	GP-051391	2988	-	CR 51.010-1 Section - 41.5.2.4 MO CS establishment whilst in packet transfer mode and DTM is not supported in current cell - step 18 removed	F	6.2.1	6.3.0	GP-051391	GPRS
GP-25	GP-051392	2989	-	CR 51.010-1 Section 41.5.3.2.2- Downlink TBF establishment with a uplink TBF established and PS uplink reallocation - new macro used	F	6.2.1	6.3.0	GP-051392	GPRS
GP-25	GP-051393	2990	-	CR 51.010-1 Section 47.1.3 - Intra frequency reallocation of CS resources / DTM Assignment Command - test time reduced	F	6.2.1	6.3.0	GP-051393	GPRS
GP-25	GP-051394	2991	-	CR 51.010-1 Section 47.1.4 - Inter frequency reallocation of CS resources / DTM Assignment Command - new macro used / reduction of test time	F	6.2.1	6.3.0	GP-051394	GPRS
GP-25	GP-051652	2992	1	CR 51.010-1 Section - 47.3.2.2 Handover to different routing area whilst in DM / Performed	F	6.2.1	6.3.0	GP-051652	GPRS

TSG #	TSG Doc	CR	Rev	Subject/Comment	Cat	Old	New	WG Doc	Work item
				on main DCCH / CS release before RAU complete - initial Conditions					
GP-25	GP-051396	2993	-	CR 51.010-1 Section - 47.4.1 PDP Context Activation / Performed on main DCCH and TBFs	F	6.2.1	6.3.0	GP-051396	GPRS
GP-25	GP-051397	2994	-	CR 51.010-1 Section 51.5.3.2.1 - Downlink TBF establishment with a uplink TBF established and no PS uplink reallocation - new macro used	F	6.2.1	6.3.0	GP-051397	GPRS
GP-25	GP-051398	2995	-	CR 51.010-1 Section 57.1.3 - Test Time Reduction	F	6.2.1	6.3.0	GP-051398	GPRS
GP-25	GP-051399	2996	-	CR 51.010-1 Section 57.1.4 - Inter frequency reallocation of CS resources / DTM Assignment Command - Test Time Reduction/ new macro used	F	6.2.1	6.3.0	GP-051399	GPRS
GP-25	GP-051400	2997	-	CR 51.010-1 Section 27 - Correction to EFFDN record 2 dialled digit prefix	F	6.2.1	6.3.0	GP-051400	GSM
GP-25	GP-051450	2998	-	Correction to test case 42.3.3.1.2	F	6.2.1	6.3.0	GP-051450	GPRS
GP-25	GP-051451	2999	-	CR 51.010-1: New Test Case 26.17.9: 8-PSK AMR HR / RATSCCH Protocol	F	6.2.1	6.3.0	GP-051451	GSM
GP-25	GP-051659	3000	2	41.5.2.1 MT CS establishment whilst in packet transfer mode with a downlink TBF established	F	6.2.1	6.3.0	GP-051659	DTM
GP-25	GP-051649	3001	1	41.5.2.2 MT CS establishment whilst in packet transfer mode with a uplink TBF established	F	6.2.1	6.3.0	GP-051649	DTM
GP-25	GP-051650	3002	2	41.5.2.3 MO CS establishment whilst in packet transfer mode with uplink and downlink TBFs established	F	6.2.1	6.3.0	GP-051650	DTM
GP-25	GP-051658	3003	2	47.3.1.3.2 Handover to same routing area whilst in DTM with both DL & UL TBFs / Abnormal case / Handover Failure	F	6.2.1	6.3.0	GP-051658	DTM
GP-25	GP-051641	3004	1	52.1.1.4 Packet Channel Request / Response to Packet Paging/RR Connection Paging	F	6.2.1	6.3.0	GP-051641	EDGE
GP-25	GP-051745	3005	1	52.1.2.1.9.3 Packet Uplink Assignment / Two phase access / Radio Access Capabilities	F	6.2.1	6.3.0	GP-051745	EDGE
GP-25	GP-051604	3006	-	New Test Cases for 51.010-1 Clause 81: GAN Discovery and Registration Procedures	B	6.2.1	6.3.0	GP-051604	GAN
GP-26	GP-052171	3008	1	New 8-PSK AMR signalling test based on 26.16.10.x	B	6.3.1	6.4.0	GP-052171	GSM
GP-26	GP-051817	3009	-	52.8.x Handling of two phases access	F	6.3.0	6.4.0	GP-051817	EGPRS
GP-26	GP-052177	3010	1	14.2.10 - Tests reduction	F	6.3.0	6.4.0	GP-052177	AMR
GP-26	GP-052184	3011	1	14.2.18 - Tests reduction	F	6.3.0	6.4.0	GP-052184	AMR
GP-26	GP-051821	3012	-	14.2.22 Reference sensitivity - O-TCH/WFS (new test)	F	6.3.0	6.4.0	GP-051821	AMRWB
GP-26	GP-051822	3013	-	14.4.19 Co-channel rejection - O-TCH/AHS (new test)	F	6.3.0	6.4.0	GP-051822	8PSK-AH
GP-26	GP-051823	3014	-	14.4.8 - Tests reduction	F	6.3.0	6.4.0	GP-051823	AMR
GP-26	GP-051824	3015	-	14.5.1.2 - Tests reduction	F	6.3.0	6.4.0	GP-051824	AMR
GP-26	GP-051825	3016	-	14.5.1.3 - Tests reduction	F	6.3.0	6.4.0	GP-051825	AMR
GP-26	GP-051826	3017	-	14.5.1.4 Adj-channel rejection - O-TCH/AHS (new test)	F	6.3.0	6.4.0	GP-051826	8PSK-AH
GP-26	GP-051827	3018	-	21.3.x, 21.4.x. Align notes and align 21.3.2	F	6.3.0	6.4.0	GP-051827	AMR
GP-26	GP-051828	3019	-	Annex A7.1.4 - Minimum test duration due to fading profile reduced	F	6.3.0	6.4.0	GP-051828	AMR
GP-26	GP-051830	3020	-	Addition of TC for O-TCH/AHS / performance of generation of CMR	B	6.3.0	6.4.0	GP-051830	8PSK-AH
GP-26	GP-052161	3021	1	New GPRS test case 42.9.3.1.1 for Extended Dynamic Allocation / Shifted USF / Normal / PACCH management.	B	6.3.0	6.4.0	GP-052161	Extended Dynamic Allocation
GP-26	GP-052162	3023	1	New GPRS test case 42.9.3.1.2 for Extended Dynamic Allocation / Shifted USF / Normal / USF assignment on 2nd PDCH.	B	6.3.0	6.4.0	GP-052162	Extended Dynamic Allocation
GP-26	GP-052163	3025	1	New GPRS test case 42.9.3.1.3 for Extended Dynamic Allocation / Shifted USF / Normal / Release of 2nd PDCH.	B	6.3.0	6.4.0	GP-052163	Extended Dynamic Allocation
GP-26	GP-051840	3027	-	Correction to TC 42.3.3.1.1	F	6.3.0	6.4.0	GP-051840	GPRS
GP-26	GP-051841	3028	-	Correction to TC 52.3.3.1.1	F	6.3.0	6.4.0	GP-051841	EGPRS
GP-26	GP-051842	3029	-	42.4.8.3.6: PMR during T3122	F	6.3.0	6.4.0	GP-051842	GPRS
GP-26	GP-051844	3030	-	26.6.5.5.1, 26.6.5.5.2, 26.6.5.6, 26.6.5.8, 26.6.5.9 and 26.11.2.2.2 - Remove erroneous power measurements.	F	6.3.0	6.4.0	GP-051844	GSM
GP-26	GP-051845	3031	-	26.6.11.3 - Correction Classmark Enquiry Mask value	F	6.3.0	6.4.0	GP-051845	GSM
GP-26	GP-051846	3032	-	42.3.1.2.2 - Clarification on the Access Type of Packet Resource Request in step 15.	F	6.3.0	6.4.0	GP-051846	GPRS

TSG #	TSG Doc	CR	Rev	Subject/Comment	Cat	Old	New	WG Doc	Work item
GP-26	GP-051847	3033	-	52.3.1.2.2 - Clarification on the Access Type of Packet Resource Request in step 15.	F	6.3.0	6.4.0	GP-051847	GPRS
GP-26	GP-051848	3034	-	42.4.1.5 - GPRS_HCS_THR is changed for Carrier 2	F	6.3.0	6.4.0	GP-051848	GPRS
GP-26	GP-052203	3035	1	42.4.8.3.2, 42.4.8.3.5 - Handling of Packet Measurement Report before starting with the test sequence.	F	6.3.0	6.4.0	GP-052203	GPRS
GP-26	GP-052210	3036	2	42.4.8.4.5 - Clarification on the Access Type of Packet Resource Request in step 9.	F	6.3.0	6.4.0	GP-052210	GPRS
GP-26	GP-051851	3037	-	20.25.4 - Add SI13, improve explanation of Reselection timer	F	6.3.0	6.4.0	GP-051851	InterSystemChange
GP-26	GP-051852	3038	-	60.x - Correction to Step numbering, use of Default Configuration Identity, use of Hopping Traffic Channel	F	6.3.0	6.4.0	GP-051852	InterSystemChange
GP-26	GP-051854	3040	-	52.8.1.11 - Change of channel type from PAGCH to PACCH for sending Packet Uplink Assignment during packet transfer mode.	F	6.3.0	6.4.0	GP-051854	EDGE
GP-26	GP-051855	3041	-	52.8.1.12 - Change of channel type from PRACH to RACH for EPCR .	F	6.3.0	6.4.0	GP-051855	EDGE
GP-26	GP-051857	3042	-	Corrections to 42.4.8.4.4 - Extend Measurement Reporting Time to Allow BSIC Decoding	F	6.3.0	6.4.0	GP-051857	GPRS
GP-26	GP-051861	3044	-	20.22.29: Allow all GSM Bands	F	6.3.0	6.4.0	GP-051861	Cell Selection
GP-26	GP-052172	3047	1	42.4.5.3 Network Assisted Cell Change / Packet Neighbour Cell Data and Packet Cell Change Continue	F	6.3.1	6.4.0	GP-052172	GPRS
GP-26	GP-052173	3048	1	42.4.5.4 Network Assisted Cell Change / Packet Neighbour Cell Data and Packet Cell Change Order	F	6.3.1	6.4.0	GP-052173	GPRS
GP-26	GP-052174	3049	1	42.4.5.5 Network Assisted Cell Change / Expiry of T3208 and T3210	F	6.3.1	6.4.0	GP-052174	GPRS
GP-26	GP-052175	3050	1	42.4.5.7 Network Assisted Cell Change / CCN not supported towards target cell	F	6.3.1	6.4.0	GP-052175	GPRS
GP-26	GP-052176	3051	1	42.4.5.9 Network Assisted Cell Change / NC mode change / Packet Neighbour Cell Data	F	6.3.1	6.4.0	GP-052176	GPRS
GP-26	GP-051871	3052	-	41.3.6.9 TBF Release / Extended Uplink / Change of RLC mode / Normal release	F	6.3.1	6.4.0	GP-051871	GPRS
GP-26	GP-051872	3053	-	51.3.6.9 TBF Release / Extended Uplink / Change of RLC mode / Normal release	F	6.3.0	6.4.0	GP-051872	EDGE
GP-26	GP-051873	3054	-	41.3.6.10 TBF Release / Extended Uplink / Change of RLC mode / Abnormal release	F	6.3.0	6.4.0	GP-051873	GPRS
GP-26	GP-051874	3055	-	51.3.6.10 TBF Release / Extended Uplink / Change of RLC mode / Abnormal release	F	6.3.0	6.4.0	GP-051874	EGPRS
GP-26	GP-051875	3056	-	53.1.1.19 EGPRS Acknowledged mode / Uplink TBF / Link Adaptation Procedure for initial transmission	F	6.3.1	6.4.0	GP-051875	EDGE
GP-26	GP-051877	3057	-	42.3.1.2.2 Dynamic Allocation / Uplink Transfer / Abnormal / with cell reselection in acknowledged mode	F	6.3.1	6.4.0	GP-051877	GPRS
GP-26	GP-051878	3058	-	42.4.2.1.3 Cell change order procedure / Uplink transfer / Failure cases / REJECT from the new cell	F	6.3.1	6.4.0	GP-051878	GPRS
GP-26	GP-051879	3059	-	52.3.1.2.2 Dynamic Allocation / Uplink Transfer / Abnormal with cell reselection in acknowledged mode	F	6.3.1	6.4.0	GP-051879	EDGE
GP-26	GP-052181	3060	1	New sub-clause 42.9.2.1.3: Extended Dynamic Allocation / Uplink Transfer / Normal / Allocation via polling mechanism	B	6.3.0	6.4.0	GP-052181	GPRS
GP-26	GP-051895	3062	-	14.4.20 Co-channel rejection - O-TCH/AHS-INB (new test)	F	6.3.0	6.4.0	GP-051895	8PSK-AH
GP-26	GP-051897	3063	-	Removal of test cases 21.5, 21.6 and 21.7	F	6.3.0	6.4.0	GP-051897	GSM
GP-26	GP-051899	3064	-	13.16.2 Change to use restricted interslot dynamic range for multislot uplink configurations	F	6.3.0	6.4.0	GP-051899	GPRS
GP-26	GP-051900	3065	-	13.17.3 Change to use restricted interslot dynamic range for multislot uplink configurations	F	6.3.0	6.4.0	GP-051900	EDGE
GP-26	GP-051904	3066	-	CR 51.010-1 Section 31.8.1.2.3 Rejection after new password mismatch	F	6.3.0	6.4.0	GP-051904	GSM
GP-26	GP-052197	3067	2	CR 51.010-1 Inconsistency in sections 44.2.9.1.1, 44.2.9.1.3	F	6.3.0	6.4.0	GP-052197	GPRS
GP-26	GP-051908	3068	-	CR 51.010-1 Chapter 46.1.2.2.2.4 SACK frame	F	6.3.0	6.4.0	GP-051908	GPRS
GP-26	GP-052207	3069	1	CR 51.010-1-3069 Section 34.2.9 - Multiple SMS mobile originated - release dependencies removed	F	6.3.0	6.4.0	GP-052207	GSM

TSG #	TSG Doc	CR	Rev	Subject/Comment	Cat	Old	New	WG Doc	Work item
GP-26	GP-051910	3070	-	CR 51.010-1-3070 Section 41.5.3.1.2 - Uplink TBF Establishment with a downlink TBF established and PS downlink reallocation	F	6.3.0	6.4.0	GP-051910	DTM
GP-26	GP-052132	3071	1	CR 51.010-1-3071 Section 41.3.6.8 - Extended Uplink TBF / Cell change while in Extended Uplink / With Packet Neighbouring Cell Data	F	6.3.0	6.4.0	GP-052132	GPRS
GP-26	GP-051914	3074	-	CR 51.010-1-3074 Section 41.5.1.1.2.3.4 - Expanded applicability	F	6.3.0	6.4.0	GP-051914	GPRS
GP-26	GP-052133	3075	1	CR 51.010-1-3075 Section 41.5.2.2 - MT CS establishment whilst in packet transfer mode with a uplink TBF established	F	6.3.0	6.4.0	GP-052133	DTM
GP-26	GP-052285	3076	2	CR 51.010-1-3076 Section 41.5.2.3 - MO CS Establishment whilst in packet transfer mode with uplink and downlink TBFs established	F	6.3.0	6.4.0	GP-052285	DTM
GP-26	GP-051917	3077	-	CR 51.010-1-3077 Section 41.5.3.1.1 - Uplink TBF establishment with a downlink TBF established and no PS downlink reallocation	F	6.3.0	6.4.0	GP-051917	DTM
GP-26	GP-051918	3078	-	CR 51.010-1-3078 Section 42.3.1.1.9 - Dynamic Allocation / Uplink Transfer / Normal / Frequency Parameters	F	6.3.0	6.4.0	GP-051918	GPRS
GP-26	GP-051919	3079	-	CR 51.010-1-3079 Section 42.3.1.1.10 - Dynamic Allocation / Uplink Transfer / Normal / USF assigned with MCS-1 to MCS-4	F	6.3.0	6.4.0	GP-051919	GPRS
GP-26	GP-052182	3080	1	CR 51.010-1-3080 Section 42.4.1.4 - Network Control measurement reporting / Uplink Transfer / Continuation in Idle mode	F	6.3.0	6.4.0	GP-052182	GPRS
GP-26	GP-051921	3081	-	CR 51.010-1-3081 Section 42.4.2.1.4 Avoid expiry of T3158 while T3174 is running	F	6.3.0	6.4.0	GP-051921	GPRS
GP-26	GP-052185	3082	1	CR 51.010-1-3082 Section 42.4.2.3.7 - MT CS establishment whilst in NC2 with a uplink TBF established	F	6.3.0	6.4.0	GP-052185	GPRS
GP-26	GP-051923	3083	-	CR 51.010-1-3083 Section 42.4.8.5.1 - Ignoring Packet Measurement Order and Packet Cell Change Order whilst in DTM	F	6.3.0	6.4.0	GP-051923	DTM
GP-26	GP-051924	3084	-	CR 51.010-1-3084 Section 42.9.2.1.1 - Incorrect references to step number in the test sequence's comment	F	6.3.0	6.4.0	GP-051924	GPRS
GP-26	GP-051925	3085	-	CR 51.010-1-3085 Section 46.1.2.7.6 Improvement of requirement check of N200 and T201 after XID reset	F	6.3.0	6.4.0	GP-051925	GPRS
GP-26	GP-051926	3086	-	CR 51.010-1-3086 Section 47.2.1 - Mobile originated CS release	F	6.3.0	6.4.0	GP-051926	DTM
GP-26	GP-051928	3088	-	CR 51.010-1-3088 Section 47.3.3.1.1 - Handover to different routing area whilst in DTM / Performed on TBFs / RAU complete before CS release	F	6.3.0	6.4.0	GP-051928	DTM
GP-26	GP-051929	3089	-	CR 51.010-1-3089 Section 51.2.5.3 - Packet access rejection / Interpretation of Extended RA _i / Correct value of Extended RA _i	F	6.3.0	6.4.0	GP-051929	GPRS
GP-26	GP-051930	3090	-	CR 51.010-1-3090 Section 51.2.5.4 - Packet access rejection / Interpretation of Extended RA _i / Extended RA _i not included	F	6.3.0	6.4.0	GP-051930	GPRS
GP-26	GP-051931	3091	-	CR 51.010-1 Section 51.3.6.3 - Remove unnecessary restriction of applicability	F	6.3.0	6.4.0	GP-051931	GPRS
GP-26	GP-052131	3092	1	CR 51.010-1-3092 Section 51.3.6.8 - Extended Uplink TBF / Cell change while in Extended Uplink / With Packet Neighbouring Cell Data	F	6.3.0	6.4.0	GP-052131	EGPRS
GP-26	GP-051934	3094	-	CR 51.010-1-3094 Section 52.1.2.1.8.1.8 - Packet Uplink Assignment / One phase access / Contention resolution / TLLI in Packet Resource Request message retransmission	F	6.3.0	6.4.0	GP-051934	GPRS
GP-26	GP-051935	3095	-	CR 51.010-1-3095 Section 52.6.1, 52.6.2, 52.6.3, 52.6.4 - table in conformance requirement updated	F	6.3.0	6.4.0	GP-051935	EGPRS
GP-26	GP-051936	3096	-	CR 51.010-1-3096 Section 52.9.2.1.1 - Incorrect references to step number in the test sequence's comment	F	6.3.0	6.4.0	GP-051936	GPRS
GP-26	GP-051937	3097	-	CR 51.010-1-3097 Section 53.1.1.24 - Correction of test procedure.	F	6.3.0	6.4.0	GP-051937	EDGE
GP-26	GP-051938	3098	-	CR 51.010-1-3098 Section 53.1.1.25 - Correction of test procedure.	F	6.3.0	6.4.0	GP-051938	EDGE
GP-26	GP-051939	3099	-	CR 51.010-1-3099 Section 80 - TTY Services - Move to section 90	D	6.3.0	6.4.0	GP-051939	GPRS

TSG #	TSG Doc	CR	Rev	Subject/Comment	Cat	Old	New	WG Doc	Work item
GP-26	GP-052195	3100	2	CR 51.010-1-3100 Section 80 - Generic Access default conditions, message contents and macros	B	6.3.0	6.4.0	GP-052195	GPRS
GP-26	GP-052134	3101	1	CR 51.010-1-3101 Section 26.16.5 - AMR signalling / Handover / active call / successful case	F	6.3.0	6.4.0	GP-052134	GSM
GP-26	GP-051942	3102	-	CR 51.010-1-3102 Section 26.6.3.4 - Measurement / DTX	F	6.3.0	6.4.0	GP-051942	GSM
GP-26	GP-051943	3103	-	CR 51.010-1-3103 Section 26.6.4.1 - Dedicated assignment / successful case	F	6.3.0	6.4.0	GP-051943	GSM
GP-26	GP-051944	3104	-	CR 51.010-1-3104 Section 26.7.4.5.4.6 - Location updating/periodic search for higher priority PLMN when the list of equivalent PLMNs includes the HPLMN, when a MS is registered in a foreign country's	F	6.3.0	6.4.0	GP-051944	GSM
GP-26	GP-051990	3105	-	Changing wait time in step 2 of the Expected Sequence for clauses 26.8.1.3.3.6, 26.8.1.3.4.5 and 26.8.1.3.5.7	F	6.3.0	6.4.0	GP-051990	GSM
GP-26	GP-051991	3106	-	51010-1: Changes in testcases in the section 42.9.2.	F	6.3.0	6.4.0	GP-051991	GPRS
GP-26	GP-052183	3108	1	51010-1: Changes in the initial conditions of the testcase 44.2.10.	F	6.3.0	6.4.0	GP-052183	GPRS
GP-26	GP-051996	3111	-	51010-1: Changes in testcases in the section 52.9.2.	F	6.3.0	6.4.0	GP-051996	EGPRS
GP-26	GP-052186	3112	1	51010-1: Addition of new testcases in the area of "Configuration Change during uplink data transfer in extended dynamic allocation".	B	6.3.0	6.4.0	GP-052186	GPRS
GP-26	GP-052000	3114	-	51010-1: Changes in the testcases 52.9.2.1.4 and 52.9.2.1.5	F	6.3.0	6.4.0	GP-052000	EGPRS
GP-26	GP-052187	3115	1	CR 051.010-1 Section 42.9.2.1.2 Extended Dynamic Allocation / Uplink Transfer / Normal / USF_GRANULARITY = 4 blocks	F	6.3.0	6.4.0	GP-052187	GPRS
GP-26	GP-052205	3116	1	CR 051.010-1 Section 42.9.2.1.4 Extended Dynamic Allocation / Uplink Transfer / Normal / PACCH operation in downlink	F	6.3.0	6.4.0	GP-052205	GPRS
GP-26	GP-052003	3117	-	CR 051.010-1 Section 52.9.2.1.2 Extended Dynamic Allocation / Uplink Transfer / Normal / USF_GRANULARITY = 4 blocks	F	6.3.0	6.4.0	GP-052003	EDGE
GP-26	GP-052206	3118	1	CR 051.010-1 Section 52.9.2.1.4 Extended Dynamic Allocation / Uplink Transfer / Normal / PACCH operation in downlink	F	6.3.0	6.4.0	GP-052206	EDGE
GP-26	GP-052005	3119	-	CR 51.010-1 47.4.1 PDP Context Activation / Performed on main DCCH and TBFs	F	6.3.0	6.4.0	GP-052005	GPRS
GP-26	GP-052289	3120	1	CR 51.010-1 Correction to sections 52.6.3 and 52.6.4 (EGPRS Packet Access for signalling / PCCCH case)	F	6.3.0	6.4.0	GP-052289	EDGE
GP-26	GP-052010	3123	-	Section 14.12.1 - Additon Of DCS Band Details and Correction To Sample Rate	F	6.3.0	6.4.0	GP-052010	DARP
GP-26	GP-052188	3124	1	Sections 42.4.5.4 and 42.4.5.9 Need To Allow Multiple Packet SI Status Messages	F	6.3.0	6.4.0	GP-052188	GPRS
GP-26	GP-052012	3125	-	New Test Case for MS-Based A-GPS: Multiple RRLP Requests with same Reference Number	F	6.3.0	6.4.0	GP-052012	TEI
GP-26	GP-052013	3126	-	New Test Case for MS-Based A-GPS: Multiple RRLP Requests with different Reference Number	F	6.3.0	6.4.0	GP-052013	TEI
GP-26	GP-052160	3131	-	42.4.8.3.3: Error in initial conditions	F	6.3.0	6.4.0	GP-052160	GPRS
GP-26	GP-052204	3132	1	Corrections to GPS scenario files	F	6.3.0	6.4.0	GP-052204	TEI
GP-26	GP-052178	3133	-	CR 051.010-1 Section 42.3.3.3 - Peak Throughput Class for MS supporting SMS over GPRS	F	6.3.0	6.4.0	GP-052178	GPRS
GP-26	GP-052179	3134	-	CR 051.010-1 Section 52.3.3.3 - Peak Throughput Class for MS supporting SMS over EGPRS	F	6.3.0	6.4.0	GP-052179	EDGE
GP-26	GP-052200	3135	-	Clarifications in section 40 and 50	F	6.3.0	6.4.0	GP-052200	GPRS
GP-26	GP-052202	3136	-	20.22.5 - Increase the value of NC_REPORTING_PERIOD_T	F	6.3.0	6.4.0	GP-052202	GPRS
-	-	-	-	Duplicated sections 42.9.2.2, 42.9.2.2.1, 42.9.2.2.2, 42.9.2.2.3, 42.9.2.2.4, 42.9.2.2.5 removed	D	6.4.0	6.4.1	-	-
GP-27	GP-052358	3143	-	14.12.1.2 – Correction of power level for DCS 1800 /1900 MS	F	6.4.1	6.5.0	GP-052358	DARP
GP-27	GP-052361	3155	-	14.4.16 – Removal of fixed test limits	F	6.4.1	6.5.0	GP-052361	AMR
GP-27	GP-052362	3156	-	14.4.17 – Tests reduction	F	6.4.1	6.5.0	GP-052362	AMR

TSG #	TSG Doc	CR	Rev	Subject/Comment	Cat	Old	New	WG Doc	Work item
GP-27	GP-052363	3157	-	14.4.8 – Correction of test limits	F	6.4.1	6.5.0	GP-052363	AMR
GP-27	GP-052364	3158	-	14.5.1.2 – Corrections to test procedure	F	6.4.1	6.5.0	GP-052364	AMR
GP-27	GP-052368	3160	-	14.2.19, 14.2.20, 14.4.17, 14.4.18 – clarification of Loop I operation	F	6.4.1	6.5.0	GP-052368	AMR
GP-27	GP-052369	3161	-	14 – Remove reference to tests which no longer use fixed test limits.	F	6.4.1	6.5.0	GP-052369	AMR
GP-27	GP-052468	3246	-	14.5.1.2 & 14.5.1.3 correction to purpose	F	6.4.1	6.5.0	GP-052468	GSM
GP-27	GP-052501	3254	-	13.6 removal of vibration condition	F	6.4.1	6.5.0	GP-052501	GSM
GP-27	GP-052518	3260	-	Section 21.4.3 Editorial Correction To Surplus Statement Added In Recent Update	F	6.4.1	6.5.0	GP-052518	DARP
GP-27	GP-052713	3174	-	CR 51.010-1-3174 cl. 13.4 - Change of measurement window to eliminate test system variations	F	6.4.1	6.5.0	GP-052713	GSM
GP-27	GP-052771	3154	1	14.1.3, 14.1.4, 14.4.3 – Tests reduction (tests deleted)	F	6.4.1	6.5.0	GP-052771	AMR
GP-27	GP-052391	3187	-	14.16.1 - Inconsistency in GMSK Power Levels	F	6.4.1	6.5.0	GP-052391	GPRS
GP-27	GP-052408	3144	-	14.16 - GPRS receiver tests – Minimum number of "blocks " for USF tests	F	6.4.1	6.5.0	GP-052408	GPRS
GP-27	GP-052463	3243	-	22.3 corrections to the test procedure	F	6.4.1	6.5.0	GP-052463	GPRS
GP-27	GP-052502	3255	-	13.16.1 removal of vibration condition	F	6.4.1	6.5.0	GP-052502	GPRS
GP-27	GP-052714	3175	-	CR 51.010-1-3175 cl. 13.16.3 - Change of measurement window to eliminate test system variations	F	6.4.1	6.5.0	GP-052714	GPRS
GP-27	GP-052409	3145	-	14.18 - EGPRS receiver tests – Minimum number of "blocks " for USF tests	F	6.4.1	6.5.0	GP-052409	GPRS
GP-27	GP-052410	3146	-	14.18.1 - Inconsistency in GMSK Power Levels	F	6.4.1	6.5.0	GP-052410	EGPRS
GP-27	GP-052464	3244	-	22.8 corrections to the test procedure	F	6.4.1	6.5.0	GP-052464	EDGE
GP-27	GP-052469	3247	-	14.18.3 corrections to the test procedure	F	6.4.1	6.5.0	GP-052469	EDGE
GP-27	GP-052715	3176	-	CR 51.010-1-3176 cl. 13.17.4 - Change of measurement window to eliminate test system variations	F	6.4.1	6.5.0	GP-052715	EDGE
GP-27	GP-052776	3159	1	14.5.1.4 – Corrections to test procedure	F	6.4.1	6.5.0	GP-052776	8PSK-AH
GP-27	GP-052393	3189	-	40.5 – Addition of R5 QOS Parameters to Test PDP Contexts.	F	6.4.1	6.5.0	GP-052393	GPRS
GP-27	GP-052417	3207	-	CR 51.010-1 Section 40.4.3.9 Conditional parameter check in Two Phase Access macro.	F	6.4.1	6.5.0	GP-052417	GPRS
GP-27	GP-052454	3242	-	CR 51.010-1 Section 40.4.3.22 New macro Bring MS in the active state (U10)	F	6.4.1	6.5.0	GP-052454	GPRS
GP-27	GP-052779	3177	1	51010-1:Changes in the expected sequence of the testcase 41.3.3	F	6.4.1	6.5.0	GP-052779	GPRS
GP-27	GP-052781	3191	1	41.3.6.8 – All Packet System Information for Cell B is replaced by Packet Downlink Dummy Control Block on PBCCH. The data trigger at Step1 is reduced to 1200 octets	F	6.4.1	6.5.0	GP-052781	GPRS
GP-27	GP-052418	3208	-	CR 51.010-1 Section 41.3.6.6 Clarification on the Access Type of Packet Resource Request in step 16.	F	6.4.1	6.5.0	GP-052418	GPRS
GP-27	GP-052783	3212	1	CR 51.010-1 Section 41.3.6.9 missing steps to prevent retransmission of old LLC PDU and to handle inactive period	F	6.4.1	6.5.0	GP-052783	GPRS
GP-27	GP-052785	3214	1	CR 51.010-1 Section – 41.5.1.1.2.1 Ambiguous note in step 4 removed	F	6.4.1	6.5.0	GP-052785	GPRS
GP-27	GP-052426	3216	-	CR 51.010-1 Section – 41.5.1.2.1.1 Clarification of step 1 (ambiguous Note)	F	6.4.1	6.5.0	GP-052426	GPRS
GP-27	GP-052777	3139	1	CR 051.010-1 Section 41.3.1.2 TBF Release / Uplink / Normal / MS initiated / Unacknowledged mode	F	6.4.1	6.5.0	GP-052777	GPRS
GP-27	GP-052342	3137	-	CR 051.010-1 42.9.2.2.3 Extended Dynamic Allocation / Uplink Transfer / configuration change / Reduction in number of uplink slots using PACKET UPLINK ASSIGNMENT.	F	6.4.1	6.5.0	GP-052342	GPRS
GP-27	GP-052786	3152	1	Correction to TC42.3.3.2.1	F	6.4.1	6.5.0	GP-052786	GPRS
GP-27	GP-052787	3147	1	Changes for Extended Dynamic Allocation / Shifted USF test cases 42.9.3.1.1-3	F	6.4.1	6.5.0	GP-052787	GPRS
GP-27	GP-052788	3148	1	42.9.2.1.1.1, 42.9.2.1.2.1 Changes to Conformance Statement.	F	6.4.1	6.5.0	GP-052788	GPRS
GP-27	GP-052852	3150	1	42.4.4.1 – Clarification of Packet Measurement Report handling during initial conditions	F	6.4.1	6.5.0	GP-052852	GPRS
GP-27	GP-052397	3193	-	42.4.1.4 - Step 8 is updated to allow for the DRX period for the first measurement report sent by the MS on moving to Idle mode (for Rel4 and earlier).	F	6.4.1	6.5.0	GP-052397	GPRS

TSG #	TSG Doc	CR	Rev	Subject/Comment	Cat	Old	New	WG Doc	Work item
GP-27	GP-052775	3194	1	42.4.5.4 & 42.4.5.9 - Ready timer is deactivated	F	6.4.1	6.5.0	GP-052775	GPRS
GP-27	GP-052399	3195	-	42.4.5.8 – Test sequence modified to handle Packet Measurement Reports appropriately after MS enters NC2 mode.	F	6.4.1	6.5.0	GP-052399	GPRS
GP-27	GP-052400	3196	-	42.4.8.4.1 and 42.4.8.4.3 – BS_PA_MFRMS parameter value is changed.	F	6.4.1	6.5.0	GP-052400	GPRS
GP-27	GP-052822	3218	1	51.010-1 section 42.4.5.3 Step B18 and B35: Incorrect comment deleted	F	6.4.1	6.5.0	GP-052822	GPRS
GP-27	GP-052823	3219	1	51.010-1 section 42.4.5.5 Step 22: Incorrect comment deleted.	F	6.4.1	6.5.0	GP-052823	GPRS
GP-27	GP-052824	3220	1	51.010-1 section 42.4.5.7 Step 13: Incorrect comment deleted.	F	6.4.1	6.5.0	GP-052824	GPRS
GP-27	GP-052431	3221	-	CR 51.010-1 section 42.4.8.5.1 Superfluous step removed from expected sequence	F	6.4.1	6.5.0	GP-052431	GPRS
GP-27	GP-052827	3239	1	CR 51.010-1 Section 42.4.8.4.5 Correction of Expected Sequence	F	6.4.1	6.5.0	GP-052827	GPRS
GP-27	GP-052452	3240	-	CR 51.010-1 Section 42.9.2.2.4 Correction of Test Procedure and Expected Sequence	F	6.4.1	6.5.0	GP-052452	GPRS
GP-27	GP-052453	3241	-	CR 51.010-1 Section 42.9.2.2.5 Correction of Expected Sequence	F	6.4.1	6.5.0	GP-052453	GPRS
GP-27	GP-052476	3252	-	CR 51.010-1 42.9.2.1.1 Incorrect step reference in comments of step 21	F	6.4.1	6.5.0	GP-052476	GPRS
GP-27	GP-052519	3261	-	Section 42.4.5.3 Needs To Allow Multiple Packet PSI Status Messages	F	6.4.1	6.5.0	GP-052519	GPRS
GP-27	GP-052825	3264	1	51.010-1 section 42.4.5.4 Step 18 and 33: Comment deleted.	F	6.4.1	6.5.0	GP-052825	GPRS
GP-27	GP-052826	3265	1	51.010-1 section 42.4.5.9 Step 22 and 37: Comment deleted.	F	6.4.1	6.5.0	GP-052826	GPRS
GP-27	GP-052381	3178	-	51010-1:Changes in the expected sequence of the testcase 42.1.2.1.10.1	F	6.4.1	6.5.0	GP-052381	GPRS
GP-27	GP-052382	3179	-	51010-1:Changes in the expected sequence of the testcase 42.1.2.1.8.1.4.	F	6.4.1	6.5.0	GP-052382	GPRS
GP-27	GP-052383	3180	-	51010-1:Removal of PSI13 scheduling from the initial conditions of the testcase 42.3.1.1.9	F	6.4.1	6.5.0	GP-052383	GPRS
GP-27	GP-052829	3249	1	CR 51.010-1 section 44.2.10 Incorrect note in Contents of Attach Request message.	F	6.4.1	6.5.0	GP-052829	GPRS
GP-27	GP-052828	3181	1	51010-1:Changes in the expected sequence of the testcase 44.2.1.1.5.3.	F	6.4.1	6.5.0	GP-052828	GPRS
GP-27	GP-052830	3141	1	CR 051.010-1 45.2.4.3 Network initiated PDP context activation request for an already activated PDP context (on the MS side)	F	6.4.1	6.5.0	GP-052830	GPRS
GP-27	GP-052355	3149	-	46.2.2.4.1 - corrected for header compression	F	6.4.1	6.5.0	GP-052355	GPRS
GP-27	GP-052385	3182	-	51010-1:Allowing the sending of PDP DEACTIVATE REQUEST while waiting for any extra SABMs in the testcase 46.1.2.2.1.5.	F	6.4.1	6.5.0	GP-052385	GPRS
GP-27	GP-052831	3183	1	51010-1:Changes in the expected sequence of the testcase 46.1.2.2.3.1.	F	6.4.1	6.5.0	GP-052831	GPRS
GP-27	GP-052448	3236	-	CR 51.010-1 Section – 57.2.1 Incorrect macro in step 5	F	6.4.1	6.5.0	GP-052448	EGPRS
GP-27	GP-052832	3248	1	CR 51.010-1 section 47.3.1.3.1 Branch A and B redundant	F	6.4.1	6.5.0	GP-052832	GPRS
GP-27	GP-052524	3257	-	CR 051.010-1 Section 41.5.1.1.1.4, 47.3.4.1 and 47.3.4.2	F	6.4.1	6.5.0	GP-052524	DTM
GP-27	GP-052377	3172	-	Section 41, update of some Conformance Requirements not in line with Core Specifications	F	6.4.1	6.5.0	GP-052377	GPRS
GP-27	GP-052394	3190	-	50.5 – Addition of R5 QOS Parameters to Test PDP Contexts.	F	6.4.1	6.5.0	GP-052394	GPRS
GP-27	GP-052449	3237	-	CR 51.010-1 Section 50.4.3.6 Conditional parameter check in Two Phase Access macro.	F	6.4.1	6.5.0	GP-052449	GPRS
GP-27	GP-052450	3238	-	CR 51.010-1 Section 50.2.4 DTM Assignment Command missing in EGPRS default messages section.	F	6.4.1	6.5.0	GP-052450	GPRS
GP-27	GP-052778	3140	1	CR 051.010-1 Section 51.3.1.2 TBF Release / Uplink / Normal / MS initiated / Unacknowledged mode	F	6.4.1	6.5.0	GP-052778	EDGE
GP-27	GP-052833	3142	1	CR 051.010-1 Section 51.2.5.3 Packet access rejection / Interpretation of Extended RA i / Correct value of Extended RA i	F	6.4.1	6.5.0	GP-052833	EDGE
GP-27	GP-052780	3184	1	51010-1:Changes in the expected sequence of the testcase 51.3.3	F	6.4.1	6.5.0	GP-052780	EGPRS
GP-27	GP-052782	3192	1	51.3.6.8 - All Packet System Information for Cell B is replaced by Packet Downlink Dummy	F	6.4.1	6.5.0	GP-052782	EDGE

TSG #	TSG Doc	CR	Rev	Subject/Comment	Cat	Old	New	WG Doc	Work item
				Control Block on PBCCH. The data trigger at Step1 is reduced to 1200 octets					
GP-27	GP-052401	3197	-	51.3.6.6, 51.3.6.7, 51.3.6.8, 51.3.6.9, 51.3.6.10 – EGPRS Test Cases incorrectly refer to GPRS messages and values.	F	6.4.1	6.5.0	GP-052401	EDGE
GP-27	GP-052419	3209	-	CR 51.010-1 Section 51.3.6.6 Clarification on the Access Type of Packet Resource Request in step 16.	F	6.4.1	6.5.0	GP-052419	GPRS
GP-27	GP-052784	3213	1	CR 51.010-1 Section 51.3.6.9 missing steps to prevent retransmission of old LLC PDU and to handle inactive period	F	6.4.1	6.5.0	GP-052784	GPRS
GP-27	GP-052425	3215	-	CR 51.010-1 Section – 51.5.1.1.2.1 Ambiguous note in step 4 removed	F	6.4.1	6.5.0	GP-052425	GPRS
GP-27	GP-052427	3217	-	CR 51.010-1 Section – 51.5.1.2.1.1 Clarification of step 1 (ambiguous Note)	F	6.4.1	6.5.0	GP-052427	GPRS
GP-27	GP-052446	3234	-	CR 51.010-1 Section – 51.5.3.1.1 Mismatch between Conformance Requirements and test procedure	F	6.4.1	6.5.0	GP-052446	GPRS
GP-27	GP-052343	3138	-	CR 51.010-1 Section 52.9.2.1.4 Extended Dynamic Allocation / Uplink Transfer / Normal / PACCH operation in downlink	F	6.4.1	6.5.0	GP-052343	EDGE
GP-27	GP-052789	3185	1	51010-1: Addition of an USF after the uplink assignment in step 5, of the testcase 52.1.2.1.10.1	F	6.4.1	6.5.0	GP-052789	EGPRS
GP-27	GP-052389	3186	-	51010-1: Changes in the expected sequence of the testcase 52.1.2.1.8.1.4.	F	6.4.1	6.5.0	GP-052389	EGPRS
GP-27	GP-052834	3235	1	CR 51.010-1 Section 52.1.2.1.9.3 Specific message content (GSM 1800 / GSM 1900)	F	6.4.1	6.5.0	GP-052834	GPRS
GP-27	GP-052853	3267	-	CR 51.010-1 53.1.1.25 Acknowledged Mode/ Uplink TBF/ TBF Reallocation/Window Size	F	6.4.1	6.5.0	GP-052853	EDGE
GP-27	GP-052790	3166	1	53.1.1.24 – Bad implementation of previous CR	F	6.4.1	6.5.0	GP-052790	EGPRS
GP-27	GP-052372	3167	-	53.1.1.6 / 53.1.1.9 Changes to PICS/PIXIT part	F	6.4.1	6.5.0	GP-052372	EGPRS
GP-27	GP-052373	3168	-	53.1.1.13/15/16/21/22 Changes to PICS/PIXIT part	F	6.4.1	6.5.0	GP-052373	EGPRS
GP-27	GP-052374	3169	-	53.1.1.14 / 53.1.1.17 Update the procedure to deal 'EGPRS 8PSK in Uplink' PICS	F	6.4.1	6.5.0	GP-052374	EGPRS
GP-27	GP-052375	3170	-	53.1.1.18 / 53.1.1.20 Update the procedure to deal 'EGPRS 8PSK in Uplink' PICS	F	6.4.1	6.5.0	GP-052375	EGPRS
GP-27	GP-052376	3171	-	53.1.1.19 Update the procedure to deal 'EGPRS 8PSK in Uplink' PICS	F	6.4.1	6.5.0	GP-052376	EGPRS
GP-27	GP-052432	3222	-	CR 51.010-1 Section 81.2.1.4, 81.2.2.1, 81.2.2.2 Incorrect references.	F	6.4.1	6.5.0	GP-052432	GAN
GP-27	GP-052433	3223	-	CR 51.010-1 Section 83.1.4.2, 83.1.4.3: Test procedure and the expected sequence are not aligned	F	6.4.1	6.5.0	GP-052433	GAN
GP-27	GP-052434	3224	-	CR 51.010-1 Section 83.1.6.4: Test procedure and Expected Sequence alignment	F	6.4.1	6.5.0	GP-052434	GAN
GP-27	GP-052435	3225	-	CR 51.010-1 Section 83.1.8.1 and 83.1.8.2 Removal both Test Cases	F	6.4.1	6.5.0	GP-052435	GAN
GP-27	GP-052436	3226	-	CR 51.010-1 Section 83.4.1.1: Test procedure and Expected Sequence alignment	F	6.4.1	6.5.0	GP-052436	GAN
GP-27	GP-052415	3205	-	CR 51.010-1 Section 20.22.30.1 Clarification of timing for requirement checks	F	6.4.1	6.5.0	GP-052415	GPRS
GP-27	GP-052416	3206	-	CR 51.010-1 Section 20.22.30.2 - Clarification of timing for requirement checks	F	6.4.1	6.5.0	GP-052416	GPRS
GP-27	GP-052858	3268	-	20.22.23 Removal of the TC	F	6.4.1	6.5.0	GP-052858	GPRS
GP-27	GP-052475	3251	-	CR 51.010-1 Section 26.9.7 - Correction to erroneous Mobile Allocation	F	6.4.1	6.5.0	GP-052475	GSM
GP-27	GP-052523	3263	-	26.1.1 – Use of 3 digit MNC in GSM 700, GSM850	F	6.4.1	6.5.0	GP-052523	AGPS
GP-27	GP-052455	3242a	-	60.1, 60.2a, 60.2b, 60.3a, 60.3b, 60.4, 60.5, 60.6 – add applicability for 850 / 1900.	F	6.4.1	6.5.0	GP-052455	Intersystem_Change
GP-27	GP-052403	3199	-	70.8.1, 70.8.2, 70.8.3, 70.8.5.1, 70.8.5.2 – Correction to comment field of Expected Sequence; minor drafting errors	F	6.4.1	6.5.0	GP-052403	AGPS
GP-27	GP-052404	3200	-	70.8.4.4, 70.8.4.5 – Correction to Reference Number in Specific Message Contents	F	6.4.1	6.5.0	GP-052404	AGPS
GP-27	GP-052836	3201	1	70.9.2.1, 70.9.2.2, 70.9.3.1, 70.9.3.2 - Addition of PICS "Support of privacy option"	B	6.4.1	6.5.0	GP-052836	AGPS
GP-27	GP-052438	3227	-	70.9.4.6 - New Test Case for MS-Based A-GPS: RR Management Commands	F	6.4.1	6.5.0	GP-052438	TEI
GP-27	GP-052439	3228	-	70.8.5.3 - New Test Case for MS-Based A-GPS:	F	6.4.1	6.5.0	GP-052439	TEI

TSG #	TSG Doc	CR	Rev	Subject/Comment	Cat	Old	New	WG Doc	Work item
				MO-LR Basic Self Location Request in Idle Mode (Alternative Case)					
GP-27	GP-052440	3229	-	70.8.5.4 - New Test Case for MS-Based A-GPS: MO-LR Basic Self Location Request in Dedicated Mode (Alternative Case)	F	6.4.1	6.5.0	GP-052440	TEI
GP-27	GP-052441	3230	-	70.8.6 - New Test Case for MS-Based A-GPS: MO-LR Transfer to 3rd Party	F	6.4.1	6.5.0	GP-052441	TEI
GP-28	GP-060041	3269	-	cl. 13.6: Re-adding vibration condition	F	6.5.0	6.6.0	GP-060041	HSCSD
GP-28	GP-060042	3270	-	cl. 13.16.1: Re-adding vibration condition	F	6.5.0	6.6.0	GP-060042	GPRS
GP-28	GP-060068	3271	-	81.1.2.1, 81.1.2.2, 81.2.3.1, 81.2.3.2, 81.2.3.7, 81.2.4.2 Reduction of unnecessary long timers	F	6.5.0	6.6.0	GP-060068	TEI6
GP-28	GP-060069	3272	-	81.1.2.3 Behavior covered by 81.1.2.2, Remove 81.1.2.3	F	6.5.0	6.6.0	GP-060069	TEI6
GP-28	GP-060070	3273	-	81.2.1.2 Combining with 81.2.1.3, adding verification of IDs	B	6.5.0	6.6.0	GP-060070	TEI6
GP-28	GP-060071	3274	-	81.2.3.5 and 81.2.3.6 are combined by adding 81.2.3.5 to the end of 81.2.3.6	B	6.5.0	6.6.0	GP-060071	TEI6
GP-28	GP-060072	3275	-	81.2.4.4, 81.2.4.6, 81.2.4.7 Removal of redundant test cases	F	6.5.0	6.6.0	GP-060072	TEI6
GP-28	GP-060073	3276	-	82.1.2.1, 82.1.2.2, 82.3.2.1, 82.3.2.2, 82.3.2.4, 82.6.1.1 final state set to IDLE state	F	6.5.0	6.6.0	GP-060073	TEI6
GP-28	GP-060074	3277	-	82.1.1.1 combined with 82.2.1.1 and 82.5.1.2	B	6.5.0	6.6.0	GP-060074	TEI6
GP-28	GP-060075	3278	-	82.3.1.1 combined with 82.3.2.1	B	6.5.0	6.6.0	GP-060075	TEI6
GP-28	GP-060076	3279	-	82.4.1.1 combined with 82.5.1.1	F	6.5.0	6.6.0	GP-060076	TEI6
GP-28	GP-060375	3280	1	82.4.2.1. Specification of non-supportive configuration message in step 2.	F	6.5.0	6.6.0	GP-060375	TEI6
GP-28	GP-060078	3281	-	83.1.1.1, 83.1.2.2, 83.1.4.3, 83.1.6.1, 83.1.6.2, 83.1.6.4 general update	F	6.5.0	6.6.0	GP-060078	TEI6
GP-28	GP-060377	3282	1	83.1.2.1 Correction in step 4. General updates	F	6.5.0	6.6.0	GP-060377	TEI6
GP-28	GP-060080	3283	-	83.1.3.1 general update	F	6.5.0	6.6.0	GP-060080	TEI6
GP-28	GP-060081	3284	-	83.1.4.1 Removed, duplicate of 83.1.2.1	F	6.5.0	6.6.0	GP-060081	TEI6
GP-28	GP-060378	3285	1	83.1.4.2 Active GA_PSR connetion needed, General updates	F	6.5.0	6.6.0	GP-060378	TEI6
GP-28	GP-060379	3286	1	83.1.5.1 Correction of Deactivate to Activate in step 2, Removal of steps 7-9, General updates	F	6.5.0	6.6.0	GP-060379	TEI6
GP-28	GP-060380	3287	1	83.1.6.3 Removal of steps 5-7. Check for additional message added. General updates.	F	6.5.0	6.6.0	GP-060380	TEI6
GP-28	GP-060063	3289	-	14.16.2 - Co-channel rejection - Deletion of confusing text.	F	6.5.0	6.6.0	GP-060063	TEI6
GP-28	GP-060064	3290	-	14.18.2 - Co-channel rejection - Deletion of confusing text.	F	6.5.0	6.6.0	GP-060064	TEI6
GP-28	GP-060369	3291	1	14.18.6 Correction of table values for input level range	F	6.5.0	6.6.0	GP-060369	TEI6
GP-28	GP-060353	3292	1	Annex 7. Clarification of parameter for statistical testing	D	6.5.0	6.6.0	GP-060353	TEI6
GP-28	GP-060029	3293	-	83.2.2.1 Removal of the Test Case, MS Receives a Downlink Message and GA-PSR-TC Not active	F	6.5.0	6.6.0	GP-060029	TEI6
GP-28	GP-060030	3294	-	83.2.2.2 - GAN TC deletion	F	6.5.0	6.6.0	GP-060030	TEI6
GP-28	GP-060376	3295	1	83.3.1.1 PS Paging Request Processed by the MS, General Update	F	6.5.0	6.6.0	GP-060376	TEI6
GP-28	GP-060032	3296	-	TC 83.5.1.1 modified to comply with the core specifications	F	6.5.0	6.6.0	GP-060032	TEI6
GP-28	GP-060370	3297	1	TC 83.6.1.1 modified to comply with the core specifications and general updates	F	6.5.0	6.6.0	GP-060370	TEI6
GP-28	GP-060022	3298	-	15.6 correcting typographical errors	F	6.5.0	6.6.0	GP-060022	GPRS
GP-28	GP-060023	3299	-	15.8 – Clarify Coding Scheme in Procedure step g; correct typographical errors	F	6.5.0	6.6.0	GP-060023	EDGE
GP-28	GP-060384	3300	1	42.3.1.2.2, 42.4.x, 47.3.1.3.1 - Empty LLC PDU may be accompanied by RLC data.	F	6.5.0	6.6.0	GP-060384	GPRS
GP-28	GP-060385	3301	1	52.3.1.2.2 - Empty LLC PDU may be accompanied by RLC data.	F	6.5.0	6.6.0	GP-060385	EGPRS
GP-28	GP-060026	3302	-	45.2.2 - Test Case cannot support more than 7 NW initiated PDP contexts	F	6.5.0	6.6.0	GP-060026	GPRS
GP-28	GP-060048	3304	-	26.10.2.4.1 - Test specifies it should be repeated 17 times, but there are only 16 iterations possible.	D	6.5.0	6.6.0	GP-060048	GSM
GP-28	GP-060049	3305	-	26.6.3.5 - Mismatches in system info settings	F	6.5.0	6.6.0	GP-060049	GSM
GP-28	GP-060050	3306	-	26.6.3.6 - Invalid BA_IND setting on SACCH	F	6.5.0	6.6.0	GP-060050	GSM
GP-28	GP-060051	3307	-	26.6.3.7 - N7 not in GSM 850 BA list	F	6.5.0	6.6.0	GP-060051	GSM
GP-28	GP-060421	3308	1	26.8.2.1 Clarification of which PICS/PIXIT of the Classmark 2 IE	F	6.5.0	6.6.0	GP-060421	GSM

TSG #	TSG Doc	CR	Rev	Subject/Comment	Cat	Old	New	WG Doc	Work item
GP-28	GP-060053	3309	-	34.4.6 - Step 6 is optional	F	6.5.0	6.6.0	GP-060053	GPRS
GP-28	GP-060054	3310	-	47.1.2 - DTM INFORMATION sent after handover procedure.	F	6.5.0	6.6.0	GP-060054	GPRS
GP-28	GP-060434	3311	2	47.4.1 XID procedure added to the Expected Sequence	F	6.5.0	6.6.0	GP-060434	GPRS
GP-28	GP-060056	3312	-	20.4 Execution counters not specified for all bands	F	6.5.0	6.6.0	GP-060056	TEI
GP-28	GP-060057	3313	-	20.20. Test indicates that all combinations of supported bands should be tested	F	6.5.0	6.6.0	GP-060057	GSM
GP-28	GP-060364	3314	1	26.7.6.1.1 Correction of PICS statement and alignment with other NITZ test cases	F	6.5.0	6.6.0	GP-060364	GPRS
GP-28	GP-060059	3315	-	41.3.3 - Correction of requirement check in step 7	F	6.5.0	6.6.0	GP-060059	GPRS
GP-28	GP-060060	3316	-	51.3.3 - Correction of requirement check in step 7	F	6.5.0	6.6.0	GP-060060	GPRS
GP-28	GP-060061	3317	-	46.1.2.2.2.4 - Correction of N(R) value in step 7	F	6.5.0	6.6.0	GP-060061	GPRS
GP-28	GP-060062	3318	-	46.1.2.2.3.1 - Reference to ACK and SACK frames removed from step B5	F	6.5.0	6.6.0	GP-060062	GPRS
GP-28	GP-060435	3319	3	Section 26.6.8.6: New test case to test removal of algorithm A5/2 from terminals	F	6.5.0	6.6.0	GP-060435	TEI6
GP-28	GP-060035	3320	-	41.3.6.9-10, 42.3.3.1.1-3, 42.3.3.2.1-2, 42.3.3.3 - Branch B for SMS and 1 PDP Context removed.	F	6.5.0	6.6.0	GP-060035	GPRS
GP-28	GP-060359	3321	1	41.5.2.3, sending of DTM REQUEST	F	6.5.0	6.6.0	GP-060359	DTM
GP-28	GP-060037	3322	-	42.3.3.3, reducing test steps outside test purpose	F	6.5.0	6.6.0	GP-060037	GPRS
GP-28	GP-060038	3323	-	51.3.6.9-10, 52.3.3.1.1-3, 52.3.3.2.1-2, 52.3.3.3 - Branch B for SMS and 1 PDP Context removed.	F	6.5.0	6.6.0	GP-060038	GPRS
GP-28	GP-060039	3324	-	52.3.3.3, reducing test steps outside test purpose	F	6.5.0	6.6.0	GP-060039	EGPRS
GP-28	GP-060388	3325	1	20.22.9 Test procedure split and reworked	F	6.5.0	6.6.0	GP-060388	GPRS
GP-28	GP-060045	3326	-	21.4.3 - Corrections to definition and applicability and test procedure	F	6.5.0	6.6.0	GP-060045	TEI
GP-28	GP-060374	3327	1	51.6.1 new - Control of dynamic ARFCN mapping with PS18	F	6.5.0	6.6.0	GP-060374	TEI4
GP-28	GP-060044	3328	-	cl. 13.17.1: Removal of vibration condition	F	6.5.0	6.6.0	GP-060044	EDGE
GP-28	GP-060383	3328	1	26.18.1 new - Control of dynamic ARFCN mapping with SI14 and SI15	F	6.5.0	6.6.0	GP-060383	TEI4
GP-28	GP-060088	3329	-	TC 41.1.1 - Removing the mention of the NMOIII.	F	6.5.0	6.6.0	GP-060088	GPRS
GP-28	GP-060089	3330	-	TC 41.3.1.1 - Addition of delay after step 13.	F	6.5.0	6.6.0	GP-060089	GPRS
GP-28	GP-060091	3332	-	TC 42.3.1.2.2 - Removing the mention of 'packet timeslot reconfigure' from the note given in the step 18.	F	6.5.0	6.6.0	GP-060091	GPRS
GP-28	GP-060094	3335	-	TC 42.4.2.3.1 - Removing the mention of 'packet timeslot reconfig' from the note after the step 16.	F	6.5.0	6.6.0	GP-060094	GPRS
GP-28	GP-060366	3336	1	TC 46.2.2.1.2 Clarification to the packet size used.	F	6.5.0	6.6.0	GP-060366	GPRS
GP-28	GP-060096	3337	-	TC 51.1.1 - Removing the mention of the NMOIII.	F	6.5.0	6.6.0	GP-060096	EGPRS
GP-28	GP-060362	3338	1	TC 51.3.1.1 Addition of a delay after step 13.	F	6.5.0	6.6.0	GP-060362	EGPRS
GP-28	GP-060099	3340	-	TC 52.3.1.2.2 - Removing the mention of 'packet timeslot reconfigure' from the note given in the step 18.	F	6.5.0	6.6.0	GP-060099	EGPRS
GP-28	GP-060354	3341	1	14.4.25 Co-channel interference O-TCH/WHIS (new test)	B	6.5.0	6.6.0	GP-060354	AMRWB
GP-28	GP-060432	3342	2	20.25.3 - Extra Time Required To Read SIBs When Reselecting To UTRAN Cell	F	6.5.0	6.6.0	GP-060432	Intersystem Change
GP-28	GP-060131	3343	-	34.4.8.2 RP Error Handling - Improper TP-MTI value	F	6.5.0	6.6.0	GP-060131	GSM
GP-28	GP-060119	3344	-	Remove reference of A5/2 in section 26.6.8	F	6.5.0	6.6.0	GP-060119	TEI
GP-28	GP-060382	3345	1	Remove reference of A5/2 in section 39	F	6.5.0	6.6.0	GP-060382	TEI
GP-28	GP-060123	3346	-	22.3 change to verdict calculation and correction	F	6.5.0	6.6.0	GP-060123	GPRS
GP-28	GP-060124	3347	-	22.8 change to verdict calculation and correction	F	6.5.0	6.6.0	GP-060124	EDGE
GP-28	GP-060125	3348	-	22.2 test reduction, removal of test case	F	6.5.0	6.6.0	GP-060125	GSM
GP-28	GP-060127	3349	-	Corrections to GPS data files	F	6.5.0	6.6.0	GP-060127	TEI
GP-28	GP-060367	3351	1	Section 46.2.2.1.4 Correction to the unacknowledged data amount	F	6.5.0	6.6.0	GP-060367	GPRS
GP-28	GP-060154	3352	-	CR 051.010-1 42.4.5.5 Network Assisted Cell Change / Expiry of T3208 and T3210	F	6.5.0	6.6.0	GP-060154	GPRS
GP-28	GP-060363	3354	1	CR 051.010-1 Timezone and DST checking should be PICS related in NITZ testcases	F	6.5.0	6.6.0	GP-060363	GPRS

TSG #	TSG Doc	CR	Rev	Subject/Comment	Cat	Old	New	WG Doc	Work item
				44.2.9.1.1 and 44.2.9.1.3.					
GP-28	GP-060358	3355	1	CR 051.010-1 section 40: added GPRS_MS_TXPWR_MAX_CCH parameter in System Information Type 6.	F	6.5.0	6.6.0	GP-060358	GPRS
GP-28	GP-060160	3357	-	CR 051.010-1 81.2.6.5 Registration Procedure, Deregister, Unspecified	F	6.5.0	6.6.0	GP-060160	TEI6
GP-28	GP-060161	3358	-	CR 051.010-1 81.2.6.6 Registration Procedure, Deregister, Unspecified, Persistent Fault, Default GANC	F	6.5.0	6.6.0	GP-060161	TEI6
GP-28	GP-060165	3361	-	82.9.2.1 message content clarified	F	6.5.0	6.6.0	GP-060165	TEI-6
GP-28	GP-060166	3362	-	82.9.1.1 and 82.9.1.2 combined	F	6.5.0	6.6.0	GP-060166	TEI6
GP-28	GP-060167	3363	-	Deletion of testcase 82.7.2.1	F	6.5.0	6.6.0	GP-060167	TEI6
GP-28	GP-060252	3369	-	47.3.2.2 Clash with Combined RA Update Procedure following CS Release	F	6.5.0	6.6.0	GP-060252	GPRS
GP-28	GP-060253	3370	-	47.3.3.1.2 Clash with Combined RA Update Procedure following CS Release	F	6.5.0	6.6.0	GP-060253	GPRS
GP-28	GP-060255	3372	-	14.16.1: Correction of procedure due to missing conformance requirements	F	6.5.0	6.6.0	GP-060255	GPRS
GP-28	GP-060285	3377	-	41.3.1.2 - Correction of Expected Sequence concerning T3182 expiry check	F	6.5.0	6.6.0	GP-060285	GPRS
GP-28	GP-060313	3380	-	42.3.1.1.9 : Issue with Open Ended TBF	F	6.5.0	6.6.0	GP-060313	GPRS
GP-28	GP-060314	3381	-	82.7.1.1, 82.7.1.2, 82.8.2.1, 82.8.2.2, 82.10.1.1, 82.10.2.1 final state set to IDLE state	F	6.5.0	6.6.0	GP-060314	TEI6
GP-28	GP-060425	3382	1	51.3.1.2 Correction of Expected Sequence concerning T3182 expiry check	F	6.5.0	6.6.0	GP-060425	GPRS
GP-28	GP-060356	3384	-	Clarification on testsignal I3 in Annex 5	F	6.5.0	6.6.0	GP-060356	GSM
GP-28	GP-060360	3385	-	83.1.7.1, 83.2.1.1, 83.2.1.2, 83.4.1.1, 83.6.2.1 General update	F	6.5.0	6.6.0	GP-060360	TEI6
GP-28	GP-060428	3387	-	Creation of 51.010-1 REL-6: Merging of REL-5, REL-4, R99 etc. test specifications (clause 2)	F	6.5.0	6.6.0	GP-060428	TEI
GP-28	GP-060427	3386	-	Creation of 51.010-1 REL-7	F	6.5.0	7.0.0	GP-060427	TEI
				Remove duplication of CR numbers in Annex History for GP-052455 and GP-052454 by changing the CR number of the latter to CR 3242a and preserving the former (i.e. 3242).		6.5.0	7.0.0		
				Correct file name of the cover file in the zip file to reflect the spec version from 51010-1-650_cover.doc to 51010-1-701_cover.doc		7.0.0	7.0.1		
GP-29	GP-060492	3388	-	41.5.2.2, sending of DTM REQUEST	F	7.0.1	7.1.0	GP-060492	DTM
GP-29	GP-060493	3389	-	41.3.6.10, added 6 blocks delay before USF assigned to MS	F	7.0.1	7.1.0	GP-060493	GPRS
GP-29	GP-060494	3390	-	51.3.6.10, added 6 blocks delay before USF assigned to MS	F	7.0.1	7.1.0	GP-060494	EGPRS
GP-29	GP-060495	3391	-	20.22.4, insufficient time given to complete running average on complete BA	F	7.0.1	7.1.0	GP-060495	GPRS
GP-29	GP-060496	3392	-	81.1.1.3, conformance requirement needs to be updated	F	7.0.1	7.1.0	GP-060496	GAAl-CT
GP-29	GP-060497	3393	-	81.2.3.6, invalid GANC	F	7.0.1	7.1.0	GP-060497	GAAl-CT
GP-29	GP-060499	3394	-	81.2.4.1, wrong timer-values used for TU3904 and TU3905	F	7.0.1	7.1.0	GP-060499	GAAl-CT
GP-29	GP-060500	3395	-	82.4.1.1, missing core specification reference	F	7.0.1	7.1.0	GP-060500	GAAl-CT
GP-29	GP-060501	3396	-	82.x, clarification of handover to GAN	F	7.0.1	7.1.0	GP-060501	GAAl-CT
GP-29	GP-060502	3397	-	82.8.x, non-synchronized handover	F	7.0.1	7.1.0	GP-060502	GAAl-CT
GP-29	GP-060503	3398	-	82.8.2.2, non-supported configuration	F	7.0.1	7.1.0	GP-060503	GAAl-CT
GP-29	GP-060504	3399	-	Section 83, mismatch between ACTIVATE and DEACTIVATE commands.	F	7.0.1	7.1.0	GP-060504	GAAl-CT
GP-29	GP-060902	3403	1	26.6.7.2 Applicability and PICS check corrected	F	7.0.1	7.1.0	GP-060902	GSM
GP-29	GP-060523	3404	-	42.4.8.4.4 & 42.4.8.4.5 – Correction of Specific Message Contents	F	7.0.1	7.1.0	GP-060523	GPRS
GP-29	GP-060524	3405	-	46.2.2.1.4 – Correction of Expected Sequence	F	7.0.1	7.1.0	GP-060524	GPRS
GP-29	GP-060525	3406	-	47.1.4 BAND_INDICATOR for GSM 850	F	7.0.1	7.1.0	GP-060525	GPRS
GP-29	GP-060526	3407	-	57.1.4 BAND_INDICATOR for GSM 850	F	7.0.1	7.1.0	GP-060526	GPRS
GP-29	GP-060527	3408	-	47.3.1.3.1 Correction to Comments Regarding Empty LLC PDUs	F	7.0.1	7.1.0	GP-060527	GPRS
GP-29	GP-060528	3409	-	52.9.1 Access Technologies Request not required	F	7.0.1	7.1.0	GP-060528	GPRS
GP-29	GP-060529	3410	-	83.5.1.1 MS final state GA-PSR STANDBY	F	7.0.1	7.1.0	GP-060529	TEI
GP-29	GP-060887	3411	1	53.1.1.10 & 53.1.1.11 Optional Packet Uplink Dummy Control blocks possible	F	7.0.1	7.1.0	GP-060887	GPRS
GP-29	GP-060903	3412	1	26.6.3.9 & 10 Introduction of Enhanced Measurement Report Testcases	F	7.0.1	7.1.0	GP-060903	GSM
GP-29	GP-060905	3413	1	31.1.5.* Introduction of Calling Name	F	7.0.1	7.1.0	GP-060905	GSM

TSG #	TSG Doc	CR	Rev	Subject/Comment	Cat	Old	New	WG Doc	Work item
				Presentation Testcases					
GP-29	GP-060535	3414	-	Section 40 Introduction of GSM 710 and GSM T-810 defaults	F	7.0.1	7.1.0	GP-060535	GPRS
GP-29	GP-060536	3415	-	Section 50 Introduction of GSM 710 and GSM T-810 defaults	F	7.0.1	7.1.0	GP-060536	GPRS
GP-29	GP-060877	3416	1	21.3.5 Reduction of test case complexity	F	7.0.1	7.1.0	GP-060877	TEI7
GP-29	GP-060872	3417	1	21.3.6 Reduction of test case complexity	F	7.0.1	7.1.0	GP-060872	TEI7
GP-29	GP-060873	3418	1	14.18.6 Addition of frequency bands	F	7.0.1	7.1.0	GP-060873	TEI7
GP-29	GP-060537	3419	-	26.7.6.1 Authentication procedure updated	F	7.0.1	7.1.0	GP-060537	GSM
GP-29	GP-060890	3420	1	41.3.6.1 Update of Final verification	F	7.0.1	7.1.0	GP-060890	GPRS
GP-29	GP-060891	3421	1	51.3.6.1 Update of Final verification	F	7.0.1	7.1.0	GP-060891	EGPRS
GP-29	GP-060916	3424	2	14.4.24 - New AMR-WB O-TCH/WFS Co-Channel Interference Test Case	F	7.0.1	7.1.0	GP-060916	GAMRWB
GP-29	GP-060875	3425	1	14.4.30 - New AMR-WB O-FACCH/F Co-Channel Rejection Test Case	F	7.0.1	7.1.0	GP-060875	GAMRWB
GP-29	GP-060576	3427	-	13.x - changes to allow the use of a temporary antenna connector	F	7.0.1	7.1.0	GP-060576	GSM
GP-29	GP-060577	3428	-	14.7 - clarification of BCCH ARFCN	F	7.0.1	7.1.0	GP-060577	GSM
GP-29	GP-060578	3429	-	14.18.5 - clarification of BCCH ARFCN	F	7.0.1	7.1.0	GP-060578	EGPRS
GP-29	GP-060562	3430	-	20.22.30.1 - Correction to test procedure	F	7.0.1	7.1.0	GP-060562	GPRS
GP-29	GP-060900	3431	1	New GAN registration test case - 81.1.3.7	F	7.0.1	7.1.0	GP-060900	TEI
GP-29	GP-060583	3432	-	41.3.6.x: Replacement of Extended Uplink TBF and NACC PICS by new GERAN FEATURE PACKAGE 1 PICS	F	7.0.1	7.1.0	GP-060583	TEI7
GP-29	GP-060584	3433	-	42.4.5.x: Replacement of Extended Uplink TBF and NACC PICS by new GERAN FEATURE PACKAGE 1 PICS	F	7.0.1	7.1.0	GP-060584	TEI7
GP-29	GP-060585	3434	-	51.3.6.x: Replacement of Extended Uplink TBF and NACC PICS by new GERAN FEATURE PACKAGE 1 PICS	F	7.0.1	7.1.0	GP-060585	TEI7
GP-29	GP-060613	3435	-	8PSK_MEAN_BEP Measurement for PDTCH	F	7.0.1	7.1.0	GP-060613	TEI-7
GP-29	GP-060876	3436	1	14.5.1.5 - New AMR-WB O-TCH/WFS Adjacent Channel Rejection Test Case	F	7.0.1	7.1.0	GP-060876	GAMRWB
GP-29	GP-060878	3436	1	42.3.x - Resolve ambiguity in values defined for TLLI_BLOCK_CHANNEL_CODING	F	7.0.1	7.1.0	GP-060878	GPRS
GP-29	GP-060879	3437	1	52.3.x - Resolve ambiguity in values defined for TLLI_BLOCK_CHANNEL_CODING	F	7.0.1	7.1.0	GP-060879	EGPRS
GP-29	GP-060880	3438	1	42.1.2.1.8.x, 42.1.2.1.9.x, 42.7.x - Use of uplink transfer macro	F	7.0.1	7.1.0	GP-060880	GPRS
GP-29	GP-060892	3439	2	52.1.2.1.8.x, 52.1.2.1.9.x - Use of uplink transfer macro	F	7.0.1	7.1.0	GP-060892	EGPRS
GP-29	GP-060592	3441	-	47.1.2 - MS does not perform Cell Update.	A	7.0.1	7.1.0	GP-060592	GPRS
GP-29	GP-060593	3442	-	41.2.2.2 - Handling of timer T3146	F	7.0.1	7.1.0	GP-060593	GPRS
GP-29	GP-060594	3443	-	51.2.2.2 - Handling of timer T3146	F	7.0.1	7.1.0	GP-060594	EDGE
GP-29	GP-060595	3444	-	51.2.2.4 - Handling of timer T3146	F	7.0.1	7.1.0	GP-060595	EDGE
GP-29	GP-060596	3445	-	41.3.6.9 - Handling of processing delay of new LLC PDU	F	7.0.1	7.1.0	GP-060596	GPRS
GP-29	GP-060597	3446	-	51.3.6.9 - Handling of processing delay of new LLC PDU	F	7.0.1	7.1.0	GP-060597	EDGE
GP-29	GP-060915	3447	1	53.1.2.3 - Correction in specific message contents of PACKET_TIMESLOT RECONFIGURE in Step 15.	F	7.0.1	7.1.0	GP-060915	EDGE
GP-29	GP-060883	3448	1	45.4.1, 45.4.2: MS may initiate Detach procedure after PDP context is deactivated.	F	7.0.1	7.1.0	GP-060883	GPRS
GP-29	GP-060908	3449	1	17 - Addition of GSM 710 and T-GSM 810 Bands	F	7.0.1	7.1.0	GP-060908	TGSM810
GP-29	GP-060909	3450	1	20 - Addition of GSM 710 and T-GSM 810 Bands	F	7.0.1	7.1.0	GP-060909	TGSM810
GP-29	GP-060910	3451	1	21 - Addition of GSM 710 and T-GSM 810 Bands	F	7.0.1	7.1.0	GP-060910	TGSM810
GP-29	GP-060611	3452	-	Introduction of T-GSM 810 and GSM 710 into 51.010-1 section 12-14	F	7.0.1	7.1.0	GP-060611	TGSM810
GP-29	GP-060612	3453	-	Introduction of T-GSM 810 and GSM 710 into 51.010-1 section 00-11	F	7.0.1	7.1.0	GP-060612	TGSM810
GP-29	GP-060617	3454	-	53.1.1.13 Increase amount of data sent	F	7.0.1	7.1.0	GP-060617	EGPRS
GP-29	GP-060899	3455	1	Corrections to test case 45.2.4.2	F	7.0.1	7.1.0	GP-060899	TEI
GP-29	GP-060901	3456	1	Corrections to Date Setting in NITZ Test Case 26.7.6.1.1	F	7.0.1	7.1.0	GP-060901	TEI
GP-29	GP-060898	3457	1	Corrections to Date Setting in NITZ GMM Test Cases	F	7.0.1	7.1.0	GP-060898	TEI
GP-29	GP-060621	3458	-	Delete "[Reserved for future (E)GPRS tests]" in 51.010-1	F	7.0.1	7.1.0	GP-060621	TEI

TSG #	TSG Doc	CR	Rev	Subject/Comment	Cat	Old	New	WG Doc	Work item
GP-29	GP-060941	3459	2	New AMR-WB test case 14.2.24 Reference Sensitivity – TCH/WFS	F	7.0.1	7.1.0	GP-060941	GAMRWB
GP-29	GP-060942	3460	2	New AMR-WB test case 14.4.28 Co-channel Interference – TCH/WFS	F	7.0.1	7.1.0	GP-060942	GAMRWB
GP-29	GP-060911	3461	1	New test case sequence to test support of algorithm A5/3	F	7.0.1	7.1.0	GP-060911	TEI6
GP-29	GP-060787	3462	-	22.3 – correction to test procedure	F	7.0.1	7.1.0	GP-060787	GPRS
GP-29	GP-060788	3463	-	22.8– correction to test procedure	F	7.0.1	7.1.0	GP-060788	EDGE
GP-29	GP-060893	3464	-	Corrections to GAN test case 81.2.5.1	F	7.0.1	7.1.0	GP-060893	GAAl-CT
GP-29	GP-060894	3465	-	Corrections to GAN test case 81.2.5.2	F	7.0.1	7.1.0	GP-060894	GAAl-CT
GP-29	GP-060907	3466	-	New AMR-WB TCH/WFS Adjacent Channel Interference Test Case 14.5.1.7	F	7.0.1	7.1.0	GP-060907	GAMRWB
GP-30	GP-060998	3470	-	GMSK MEAN_BEP testcase	F	7.1.0	7.2.0	GP-060998	TEI-7
GP-30	GP-061018	3471	-	26.19.3a, new AMR WB test	B	7.1.0	7.2.0	GP-061018	GAMRWB
GP-30	GP-061019	3471	-	26.19.5, new AMR WB test	B	7.1.0	7.2.0	GP-061019	GAMRWB
GP-30	GP-061020	3473	-	26.19.9.1, new AMR WB test	B	7.1.0	7.2.0	GP-061020	GAMRWB
GP-30	GP-061021	3474	-	26.19.9.2, new AMR WB test	B	7.1.0	7.2.0	GP-061021	GAMRWB
GP-30	GP-061022	3475	-	26.19.9.3, new AMR WB test	B	7.1.0	7.2.0	GP-061022	GAMRWB
GP-30	GP-061023	3476	-	26.19.9.5, new AMR WB test	B	7.1.0	7.2.0	GP-061023	GAMRWB
GP-30	GP-061024	3477	-	26.19.9.10, new AMR WB test	B	7.1.0	7.2.0	GP-061024	GAMRWB
GP-30	GP-061025	3478	-	26.19.9.11, new AMR WB test	B	7.1.0	7.2.0	GP-061025	GAMRWB
GP-30	GP-061026	3479	-	26.19.10.1, new AMR WB test	B	7.1.0	7.2.0	GP-061026	GAMRWB
GP-30	GP-061040	3489	-	Addition of new WB-AMR O-TCH/WHS testcases	B	7.1.0	7.2.0	GP-061040	AMRWB
GP-30	GP-061043	3490	-	Annex A4.3.3: Correction of EF(IMS)	F	7.1.0	7.2.0	GP-061043	TEI7
GP-30	GP-061044	3491	-	13.4 – Restriction of ARFCN channels used for GSM 900 Band	F	7.1.0	7.2.0	GP-061044	GSM
GP-30	GP-061045	3492	-	13.4 - Change of measurement window	F	7.1.0	7.2.0	GP-061045	GSM
GP-30	GP-061046	3493	-	13.16.3 - Restriction of ARFCN channels used for GSM 900 Band	F	7.1.0	7.2.0	GP-061046	GPRS
GP-30	GP-061047	3494	-	13.16.3 - Change of measurement window	F	7.1.0	7.2.0	GP-061047	GPRS
GP-30	GP-061048	3495	-	13.17.4 - Restriction of ARFCN channels used for GSM 900 Band	F	7.1.0	7.2.0	GP-061048	EDGE
GP-30	GP-061049	3496	-	13.17.4 - Change of measurement window	F	7.1.0	7.2.0	GP-061049	EDGE
GP-30	GP-061052	3497	-	21 - Addition of GSM 710 and T-GSM 810 Bands	F	7.1.0	7.2.0	GP-061052	GSM
GP-30	GP-061053	3498	-	22 - Addition of GSM 710 and T-GSM 810 Bands	F	7.1.0	7.2.0	GP-061053	GSM
GP-30	GP-061054	3499	-	41.5.1.1.1.4 – Correction to HandoverToUTRANCommand-r3-les	F	7.1.0	7.2.0	GP-061054	InterSystemHandOver
GP-30	GP-061352	3500	1	42.1.2.1.8.x, 42.1.2.1.9.x, 42.7.x – Clarification in USF allocation	F	7.1.0	7.2.0	GP-061352	GPRS
GP-30	GP-061353	3501	1	52.1.2.1.8.x, 52.1.2.1.9.x – Clarification in USF allocation	F	7.1.0	7.2.0	GP-061353	EGPRS
GP-30	GP-061060	3505	-	42.4.6.5 - Ready Timer shall be deactivated.	F	7.1.0	7.2.0	GP-061060	GPRS
GP-30	GP-061064	3509	-	60.x - Addition of GSM 710 and T-GSM 810 Bands to selection expressions for InterSystem testcases	F	7.1.0	7.2.0	GP-061064	TGSM810-MStest
GP-30	GP-061081	3524	-	27 - Addition of GSM 710 and T-GSM 810 Bands	F	7.1.0	7.2.0	GP-061081	GSM
GP-30	GP-061082	3525	-	Incorrect arrangement of signal levels among different carriers in 20.22.9-2	F	7.1.0	7.2.0	GP-061082	TEI
GP-30	GP-061380	3529	1	A7.1. Clarification of min and max times for statistical tests	F	7.1.0	7.2.0	GP-061380	TEI
GP-30	GP-061114	3532	-	22.4 GPRS - Independence of TS Power Control, reduced interslot dynamic range	F	7.1.0	7.2.0	GP-061114	GPRS
GP-30	GP-061115	3533	-	22.9 EGPRS - Independence of TS Power Control, reduced interslot dynamic range	F	7.1.0	7.2.0	GP-061115	EDGE
GP-30	GP-061119	3534	-	34.2.3: Correction of the content for Class 1 short messages	F	7.1.0	7.2.0	GP-061119	TEI7
GP-30	GP-061122	3535	-	14.4.19 Correction of table heading	F	7.1.0	7.2.0	GP-061122	TEI
GP-30	GP-061124	3538	-	26.6.7.2 Correction of test sequence and message content modified step 13 and 14	F	7.1.0	7.2.0	GP-061124	TEI
GP-30	GP-061125	3539	-	26.6.7.1 Correction of test sequence and signalling only mode mandatory	F	7.1.0	7.2.0	GP-061125	TEI
GP-30	GP-061371	3540	1	26.6.3.10 Introduction of new Enhanced Measurement Report Testcase	F	7.1.0	7.2.0	GP-061371	TEI
GP-30	GP-061128	3541	-	40.4.3 – New macro for Extended Dynamic Allocation	F	7.1.0	7.2.0	GP-061128	TEI
GP-30	GP-061129	3542	-	42.9.2.x –Using new macro for Extended Dynamic Allocation	F	7.1.0	7.2.0	GP-061129	TEI

TSG #	TSG Doc	CR	Rev	Subject/Comment	Cat	Old	New	WG Doc	Work item
GP-30	GP-061130	3543	-	52.9.2.x –Using new macro for Extended Dynamic Allocation	F	7.1.0	7.2.0	GP-061130	TEI
GP-30	GP-061366	3544	1	26.6.5 – Support for transmission of ACCESS BURSTs on the SACCH added.	F	7.1.0	7.2.0	GP-061366	TEI
GP-30	GP-061134	3545	-	51.x.x Introduction of GSM 710 and T-GSM 810 bands	F	7.1.0	7.2.0	GP-061134	TEI
GP-30	GP-061377	3546	1	52.x.x, 53.x.x Introduction of GSM 710 and T-GSM 810 bands	F	7.1.0	7.2.0	GP-061377	TEI
GP-30	GP-061355	3547	1	26.10.2.4 - Support for transmission of ACCESS BURSTs on the SACCH added.	F	7.1.0	7.2.0	GP-061355	GSM
GP-30	GP-061356	3548	1	26.11.2.2 and 26.11.5 - Support for transmission of ACCESS BURSTs on the SACCH added.	F	7.1.0	7.2.0	GP-061356	GSM
GP-30	GP-061357	3549	1	26.12.2.1, 26.12.6 and 26.12.7 - Support for transmission of ACCESS BURSTs on the SACCH added.	F	7.1.0	7.2.0	GP-061357	GSM
GP-30	GP-061358	3550	1	26.13.1.3 - Support for transmission of ACCESS BURSTs on the SACCH added.	F	7.1.0	7.2.0	GP-061358	GSM
GP-30	GP-061359	3551	1	26.14 - Support for transmission of ACCESS BURSTs on the SACCH added.	F	7.1.0	7.2.0	GP-061359	GSM
GP-30	GP-061360	3552	1	26.16 - Support for transmission of ACCESS BURSTs on the SACCH added.	F	7.1.0	7.2.0	GP-061360	GSM
GP-30	GP-061361	3553	1	26.6.13.5 and 26.6.13.6 - Support for transmission of ACCESS BURSTs on the SACCH added.	F	7.1.0	7.2.0	GP-061361	GSM
GP-30	GP-061362	3555	1	26.6.8.4 - Support for transmission of ACCESS BURSTs on the SACCH added.	F	7.1.0	7.2.0	GP-061362	GSM
GP-30	GP-061363	3556	1	26.8.1.4.3 - Support for transmission of ACCESS BURSTs on the SACCH added.	F	7.1.0	7.2.0	GP-061363	GSM
GP-30	GP-061375	3557	2	26.9.7 and 26.9.8 - Support for transmission of ACCESS BURSTs on the SACCH added.	F	7.1.0	7.2.0	GP-061375	GSM
GP-30	GP-061354	3558	1	41.5.1.1.1.6 - Support for transmission of ACCESS BURSTs on the SACCH added.	F	7.1.0	7.2.0	GP-061354	GPRS
GP-30	GP-061365	3559	1	47.3.1, 47.3.2, 47.3.3 and 47.4 - Support for transmission of ACCESS BURSTs on the SACCH added.	F	7.1.0	7.2.0	GP-061365	GPRS
GP-30	GP-061149	3560	-	34.2.5.2 – Erroneous initial conditions stated for Mobile Station	F	7.1.0	7.2.0	GP-061149	GSM
GP-30	GP-061150	3561	-	41.5.2.2 / 41.5.2.3 / 47.3.3.1.2 / 47.4.1 GERAN #29 Action Point AP#29.06 Clarification of SS & MS Behaviour in Expected Sequence Tables	F	7.1.0	7.2.0	GP-061150	TEI
GP-30	GP-061153	3564	-	81.2.4.1 Remove Timer TU3905 and correct step 17 and 18	F	7.1.0	7.2.0	GP-061153	TEI
GP-30	GP-061154	3565	-	81.2.4.2 MS shall not release connection after first GA-RC Register Reject with Cause "Network congested"	F	7.1.0	7.2.0	GP-061154	TEI
GP-30	GP-061351	3566	1	Annex A5.2, wrong subclause reference for signal C1	F	7.1.0	7.2.0	GP-061351	TEI
GP-30	GP-061183	3567	-	41.x.x, 42.x.x, 43.x.x Introduction of GSM 710 and T-GSM 810 bands	F	7.1.0	7.2.0	GP-061183	TEI
GP-30	GP-061186	3568	-	70.10.2.1 Correction to Conventional GPS Test Case	F	7.1.0	7.2.0	GP-061186	TEI
GP-30	GP-061306	3570	-	40.2.2.1.10 – Correction of default PSI5 message contents	F	7.1.0	7.2.0	GP-061306	TEI
GP-30	GP-061307	3571	-	42.1.2.1.8.2.1, 42.1.2.1.8.2.2: Correction of step numbers	F	7.1.0	7.2.0	GP-061307	TEI
GP-30	GP-061308	3572	-	52.1.2.1.8.2.1, 52.1.2.1.8.2.2: Correction of step numbers	F	7.1.0	7.2.0	GP-061308	TEI
GP-30	GP-061378	3575	-	82.4.1.1 An ongoing voice call is added to be able to trigger MS to release GA-CSR connection	F	7.1.0	7.2.0	GP-061378	TEI
GP-30	GP-061379	3576	-	52.1.2.1.9.3 Note added to take into consideration all MS releases in term of checking the order of access technologies sent by MS	F	7.1.0	7.2.0	GP-061379	EGPRS
GP-31	GP-061838	3577	3	Introduction of a GPRS test on Variable Bitmap with PBCCH	B	7.2.0	7.3.0	GP-061838	TEI
GP-31	GP-061825	3579	1	20.24.1 - Chapter numbering incorrect	F	7.2.0	7.3.0	GP-061825	TEI
GP-31	GP-061546	3580	-	42.3.4 and 42.9.1 – Removal of a text related to the redundant fixed allocation.	F	7.2.0	7.3.0	GP-061546	TEI
GP-31	GP-061547	3581	-	52.3.4 and 52.9.1 – Removal of a text related to the redundant fixed allocation.	F	7.2.0	7.3.0	GP-061547	TEI
GP-31	GP-061836	3583	1	14.4.26 – New WB-AMR Test Case: Co-channel rejection - O-TCH/WFS-INB	F	7.2.0	7.3.0	GP-061836	WBAMR-MStest

TSG #	TSG Doc	CR	Rev	Subject/Comment	Cat	Old	New	WG Doc	Work item
GP-31	GP-061804-	3584	1	14.10.6 – New WB-AMR Test Case: Performance of the Codec Mode Request Generation – O-TCH/WFS	F	7.2.0	7.3.0	GP-061804	WBAMR-MStest
GP-31	GP-061805	3585	1	21.4.4 - New WB- AMR Test Case: Signal Quality Under TU High Propagation Conditions O-TCH/WFS	F	7.2.0	7.3.0	GP-061805	WBAMR-MStest
GP-31	GP-061554	3586	-	Addition of a delay for the final USF allocation in 52.1.2.1.8.1.2	F	7.2.0	7.3.0	GP-061554	TEI
GP-31	GP-061555	3587	-	51.3.6.10 - Correction of step 14	F	7.2.0	7.3.0	GP-061555	TEI4
GP-31	GP-061556	3588	-	20.22.29 – SYSTEM INFORMATION TYPE 2quarter	F	7.2.0	7.3.0	GP-061556	TEI
GP-31	GP-061557	3589	-	47.3.4.1 - Correction to HandoverToUTRANCommand-r3-les	F	7.2.0	7.3.0	GP-061557	TEI
GP-31	GP-061558	3590	-	47.3.4.2 - Correction to HandoverToUTRANCommand-r3-les	F	7.2.0	7.3.0	GP-061558	TEI
GP-31	GP-061823	3592	1	40.4.3.23 – USF_GRANULARITY 4 to be handled	F	7.2.0	7.3.0	GP-061823	TEI
GP-31	GP-061561	3593	-	15.9 - Addition of specific message content and modification to the test steps.	F	7.2.0	7.3.0	GP-061561	TEI
GP-31	GP-061562	3594	-	46.2.2.1.5 - Correction to step 4	F	7.2.0	7.3.0	GP-061562	TEI
GP-31	GP-061571	3598	-	Correction to 14.4.17 Co-channel interference - TCH/AFS-INB	F	7.2.0	7.3.0	GP-061571	TEI
GP-31	GP-061572	3599	-	Editorial correction to Annex A7	F	7.2.0	7.3.0	GP-061572	TEI
GP-31	GP-061575	3600	-	Incorrect Refence Number for ITU-T Recommendation P.57 in Section 30.	F	7.2.0	7.3.0	GP-061575	TEI7
GP-31	GP-061578	3601	-	Referenced Document Update for ITU-T Recommendation P.57 "Artificial Ears"	F	7.2.0	7.3.0	GP-061578	TEI7
GP-31	GP-061579	3602	-	TC 26.7.4.5.2 – Correction to the initial conditions in order to avoid the randomness in the periodic location update.	F	7.2.0	7.3.0	GP-061579	TEI
GP-31	GP-061832	3603	1	TC 27.4 – Need to take care Location update procedure done by the MS.	F	7.2.0	7.3.0	GP-061832	TEI
GP-31	GP-061581	3604	-	TC 41.3.1.1– Modification in step expected test sequence.	F	7.2.0	7.3.0	GP-061581	TEI
GP-31	GP-061582	3605	-	TC 41.3.2.3– Modification in expected test sequence.	F	7.2.0	7.3.0	GP-061582	TEI
GP-31	GP-061583	3606	-	TC 42.1.2.1.13– Modification in the timeslots used for PBCCH and PCCCH.	F	7.2.0	7.3.0	GP-061583	TEI
GP-31	GP-061584	3607	-	TC 42.4.2.1.1 – Modification in step 9, to allow two phase access.	F	7.2.0	7.3.0	GP-061584	TEI
GP-31	GP-061585	3608	-	TC 47.1.2 – Correction to the step number reference in specific message contents.	F	7.2.0	7.3.0	GP-061585	TEI
GP-31	GP-061586	3609	-	TC 51.3.1.1– Modification in step expected test sequence.	F	7.2.0	7.3.0	GP-061586	TEI
GP-31	GP-061821	3610	1	TC 46.1.2.7.3 - Correction to the expected test sequence.	F	7.2.0	7.3.0	GP-061821	TEI
GP-31	GP-061589	3611	-	42.4.5.3 - Accept cell update	F	7.2.0	7.3.0	GP-061589	TEI
GP-31	GP-061602	3614	-	81.2.1.2 Missing step for closing TCP and IpSec connection	F	7.2.0	7.3.0	GP-061602	TEI6
GP-31	GP-061603	3615	-	81.2.4.5 Change from Discover to Register request	F	7.2.0	7.3.0	GP-061603	TEI6
GP-31	GP-061837	3616	1	New WB-AMR test case 14.4.29 Co-channel interference - TCH/WFS-INB	F	7.2.0	7.3.0	GP-061837	WBAMR-MStest
GP-31	GP-061806	3617	1	New WB-AMR test case 14.10.8 Performance of the Codec Mode Request Generation – TCH/WFS	F	7.2.0	7.3.0	GP-061806	WBAMR-MStest
GP-31	GP-061637	3618	-	34.2.3 – New PICS added	F	7.2.0	7.3.0	GP-061637	TEI
GP-31	GP-061833	3619	2	44.2.11 Introduction of Cell Notification Test Cases	F	7.2.0	7.3.0	GP-061833	TEI
GP-31	GP-061693	3620	-	47.3.2.2 GERAN #29 Action Point AP#29.06 Clarification of SS & MS Behaviour in Expected Sequence Tables	F	7.2.0	7.3.0	GP-061693	TEI
GP-31	GP-061694	3621	-	47.4.1 – Changes to Comments and Specific Message Contents	F	7.2.0	7.3.0	GP-061694	TEI
GP-31	GP-061695	3622	-	26.7.6.1.1 - Correction of step number references	F	7.2.0	7.3.0	GP-061695	TEI
GP-31	GP-061696	3623	-	46.2.2.4.1 - Correction of test sequence for MS supporting compression	F	7.2.0	7.3.0	GP-061696	TEI
GP-31	GP-061814	3624	1	42.4.8.3.3 & 42.4.8.3.5 - Additional test step needed to send assigned USF	F	7.2.0	7.3.0	GP-061814	TEI
GP-31	GP-061698	3625	-	42.4.8.4.x - Correction of specific message contents	F	7.2.0	7.3.0	GP-061698	TEI

TSG #	TSG Doc	CR	Rev	Subject/Comment	Cat	Old	New	WG Doc	Work item
GP-31	GP-061816	3626	1	42.1.2.1.10.2 – Step 08 PACKET DOWNLINK DUMMY CONTROL BLOCK to be sent at T3164 * 1.1	F	7.2.0	7.3.0	GP-061816	TEI
GP-31	GP-061817	3627	1	52.1.2.1.10.2 – Step 08 PACKET DOWNLINK DUMMY CONTROL BLOCK to be sent at T3164 * 1.1	F	7.2.0	7.3.0	GP-061817	TEI
GP-31	GP-061701	3628	-	41.3.6.x Initial conditions GERAN Feature Package 1 check	F	7.2.0	7.3.0	GP-061701	TEI
GP-31	GP-061702	3629	-	51.3.6.x Initial conditions GERAN Feature Package 1 check	F	7.2.0	7.3.0	GP-061702	TEI
GP-31	GP-061730	3630	-	22.8 Corrections to initial conditions.	F	7.2.0	7.3.0	GP-061730	TEI
GP-31	GP-061731	3631	-	22.3 Correction to initial conditions.	F	7.2.0	7.3.0	GP-061731	TEI
GP-31	GP-061732	3632	-	22.9 pdu EGPRS_TEST_MODE_CMD not defined in 3GPP TS 04.14	D	7.2.0	7.3.0	GP-061732	TEI
GP-31	GP-061809	3634	-	Addition of a delay for the final USF allocation in 42.1.2.1.8.1.2	F	7.2.0	7.3.0	GP-061809	TEI
10/2006	-	-	-	Correction of file names in the zip file to indicate the correct version number	-	7.3.0	7.3.1	-	-
GP-32	GP-061930	3635	-	70.8.2, 70.8.5.2 Incorrect references to SACCH	F	7.3.1	7.4.0	GP-061930	TEI
GP-32	GP-062308	3636	1	14.10.9 Performance of the Codec Mode Request Generation – TCH/WFS - improved RX (new test)	F	7.3.1	7.4.0	GP-062308	WBAMR-MStest
GP-32	GP-061933	3637	-	26.7.5.2 Repeated FACCH testing added to existing test	F	7.3.1	7.4.0	GP-061933	TEI
GP-32	GP-061934	3638	-	80.1 Corrections to defaults for DHCP	F	7.3.1	7.4.0	GP-061934	TEI
GP-32	GP-061937	3639	-	26.16.x PICS/PIXIT clean-up	F	7.3.1	7.4.0	GP-061937	TEI
GP-32	GP-061939	3640	-	26.17.x, 26.18.x, 26.19.x PICS/PIXIT clean-up	F	7.3.1	7.4.0	GP-061939	TEI
GP-32	GP-061941	3641	-	26.19.x, incorrect PICS for AMR WB	F	7.3.1	7.4.0	GP-061941	WBAMR-MStest
GP-32	GP-061942	3642	-	section 47, PICS/PIXIT clean up	F	7.3.1	7.4.0	GP-061942	TEI7
GP-32	GP-061943	3643	-	section 57, PICS/PIXIT clean up	F	7.3.1	7.4.0	GP-061943	TEI7
GP-32	GP-062318	3644	1	section 60, PICS/PIXIT clean up	F	7.3.1	7.4.0	GP-062318	TEI7
GP-32	GP-062319	3645	1	section 70, PICS/PIXIT clean up	F	7.3.1	7.4.0	GP-062319	TEI7
GP-32	GP-061949	3647	-	81.2.5.1, Incorrect cause value	F	7.3.1	7.4.0	GP-061949	GAAl-CT
GP-32	GP-062338	3648	1	81.2.5.2, correction to initial conditions	F	7.3.1	7.4.0	GP-062338	GAAl-CT
GP-32	GP-061951	3649	-	81.2.6.x, incorrect GANC	F	7.3.1	7.4.0	GP-061951	GAAl-CT
GP-32	GP-061952	3650	-	81.2.6.3, incorrect initial conditions	F	7.3.1	7.4.0	GP-061952	GAAl-CT
GP-32	GP-061953	3651	-	81.2.6.6, clarification of serving and default GANC	F	7.3.1	7.4.0	GP-061953	GAAl-CT
GP-32	GP-061958	3654	-	81.1.3.7, Incorrect timer handling	F	7.3.1	7.4.0	GP-061958	GAAl-CT
GP-32	GP-061959	3655	-	Incorrect handling of T3905	F	7.3.1	7.4.0	GP-061959	GAAl-CT
GP-32	GP-061964	3657	-	Clarifications to A-GPS Signalling tests text	F	7.3.1	7.4.0	GP-061964	TEI7
GP-32	GP-062349	3658	1	Additional References for A-GPS Minimum Performance Test Cases	B	7.3.1	7.4.0	GP-062349	GAGR
GP-32	GP-062350	3659	1	GPS Scenarios and Assistance Data for A-GPS Minimum Performance Test Cases	B	7.3.1	7.4.0	GP-062350	GAGR
GP-32	GP-061967	3660	-	Introduction and common test conditions for A-GPS Minimum Performance Test Cases	B	7.3.1	7.4.0	GP-061967	GAGR
GP-32	GP-062426	3661	1	Five Test Cases for A-GPS Minimum Performance Test Cases	B	7.3.1	7.4.0	GP-062426	GAGR
GP-32	GP-062421	3662	1	Test System requirements for A-GPS Minimum Performance Test Cases	B	7.3.1	7.4.0	GP-062421	GAGR
GP-32	GP-061970	3663	-	Statistical requirements for A-GPS Minimum Performance Test Cases	B	7.3.1	7.4.0	GP-061970	GAGR
GP-32	GP-061972	3664	-	Correction to the title of the section of 81.3.2.1.	F	7.3.1	7.4.0	GP-061972	TEI
GP-32	GP-062067	3665	1	81.3.2.2 - Correction to content of the test procedure	F	7.3.1	7.4.0	GP-062067	TEI
GP-32	GP-061974	3666	-	46.1.2.7.6 - Correction to the expiry time of I+S frame	F	7.3.1	7.4.0	GP-061974	TEI
GP-32	GP-062301	3667	1	PICS/PIXIT Cleaning for GPRS section 44	F	7.3.1	7.4.0	GP-062301	TEI
GP-32	GP-062302	3668	1	PICS/PIXIT Cleaning for GPRS section 45	F	7.3.1	7.4.0	GP-062302	TEI
GP-32	GP-062303	3669	1	PICS/PIXIT Cleaning for GPRS section 46	F	7.3.1	7.4.0	GP-062303	TEI
GP-32	GP-061978	3670	-	26.9.6.1.1 – Modification due to a Specific PICS	F	7.3.1	7.4.0	GP-061978	TEI
GP-32	GP-062345	3671	1	26.6.1.1 – Modification to deal with Dual_Rate MS	F	7.3.1	7.4.0	GP-062345	TEI
GP-32	GP-061980	3672	-	46.x – Removal of the check on the number of octets sent	F	7.3.1	7.4.0	GP-061980	TEI
GP-32	GP-062311	3673	2	Sections 80-90: PICS/PIXIT Clean-Up	F	7.3.1	7.4.0	GP-062311	TEI
GP-32	GP-062032	3674	-	26.10.2.4.1 – Invalid hopping frequency allocation for target cell	F	7.3.1	7.4.0	GP-062032	TEI
GP-32	GP-062346	3675	1	26.6.3.9 – Corrections to cell configurations and specific message contents	F	7.3.1	7.4.0	GP-062346	TEI

TSG #	TSG Doc	CR	Rev	Subject/Comment	Cat	Old	New	WG Doc	Work item
GP-32	GP-062347	3676	1	26.6.3.10 – Corrections to cell configurations	F	7.3.1	7.4.0	GP-062347	TEI
GP-32	GP-062327	3681	1	42.1.2.1.19 – MA_Length and MA_Bitmap adjusted according to cell allocation and RFL content	F	7.3.1	7.4.0	GP-062327	TEI
GP-32	GP-062328	3683	1	44.2.11 Cell Notification – Minor Corrections/Clarifications	F	7.3.1	7.4.0	GP-062328	TEI
GP-32	GP-062044	3686	-	83.4.1.1 - Message names GA-PSR PAGING REQUEST and GA-PSR GPRS SUSPENSION REQUEST corrected	F	7.3.1	7.4.0	GP-062044	TEI
GP-32	GP-062329	3687	1	44.2.5.2.1 – Introduction of GEA2 and GEA3 encryption	F	7.3.1	7.4.0	GP-062329	TEI
GP-32	GP-062332	3688	1	46.1.2.1.1 – Introduction of GEA2 and GEA3 encryption	F	7.3.1	7.4.0	GP-062332	TEI
GP-32	GP-062333	3689	1	46.1.2.7.3 – Introduction of GEA2 and GEA3 encryption	F	7.3.1	7.4.0	GP-062333	TEI
GP-32	GP-062334	3690	1	46.1.2.7.5 – Introduction of GEA2 and GEA3 encryption	F	7.3.1	7.4.0	GP-062334	TEI
GP-32	GP-062434	3691	2	Sections 11-13: PICS/PIXIT Clean-Up	F	7.3.1	7.4.0	GP-062434	TEI
GP-32	GP-062022	3692	-	Section 14: PICS/PIXIT Clean-Up	F	7.3.1	7.4.0	GP-062022	TEI
GP-32	GP-062312	3693	1	Sections 15-20: PICS/PIXIT Clean-Up	F	7.3.1	7.4.0	GP-062312	TEI
GP-32	GP-062024	3694	-	Sections 21-25: PICS/PIXIT Clean-Up	F	7.3.1	7.4.0	GP-062024	TEI
GP-32	GP-062005	3695	-	PICS/PIXIT and Band Dependency modifications in 30.x	F	7.3.1	7.4.0	GP-062005	TEI7
GP-32	GP-062006	3696	-	PICS/PIXIT and Band Dependency modifications in 32.x	F	7.3.1	7.4.0	GP-062006	TEI7
GP-32	GP-062307	3697	1	PICS/PIXIT and Band Dependency modifications in 33.x	F	7.3.1	7.4.0	GP-062307	TEI7
GP-32	GP-062320	3698	1	PICS/PIXIT and Band Dependency modifications in 34.x	F	7.3.1	7.4.0	GP-062320	TEI7
GP-32	GP-062009	3699	-	PICS/PIXIT and Band Dependency modifications in 35.x to 39.x	F	7.3.1	7.4.0	GP-062009	TEI7
GP-32	GP-062012	3700	-	47.3.4.1: Removal of step 20, 21 and 24 from the expected sequence	F	7.3.1	7.4.0	GP-062012	TEI
GP-32	GP-062016	3704	-	s00-s10 – Provide missing and correct incomplete statements on Frequency Bands	F	7.3.1	7.4.0	GP-062016	TEI
GP-32	GP-062018	3706	-	27 - PICS/PIXIT rationalisation	F	7.3.1	7.4.0	GP-062018	TEI
GP-32	GP-062019	3707	-	28 - PICS/PIXIT rationalisation	F	7.3.1	7.4.0	GP-062019	TEI
GP-32	GP-062020	3708	-	29 - PICS/PIXIT rationalisation	F	7.3.1	7.4.0	GP-062020	TEI
GP-32	GP-062348	3710	1	In testcase 26.8.1.4.1.1, Step 7 should be a repetition of steps 1 to 6	F	7.3.1	7.4.0	GP-062348	TEI
GP-32	GP-062054	3712	-	81.2.1.5: Step 5 is redundant and it's already done in step 4	F	7.3.1	7.4.0	GP-062054	TEI
GP-32	GP-062339	3713	1	In testcase 83.1.4.2, GPRS suspension should be done while MS is entering GA-CSR DEDICATED state.	F	7.3.1	7.4.0	GP-062339	TEI
GP-32	GP-062340	3714	1	83.1.4.3, correction of expected message type at step 5	F	7.3.1	7.4.0	GP-062340	TEI
GP-32	GP-062062	3715	-	Correction to 26.7.4.5.4.3 – HPLMN Search Timer handling	F	7.3.1	7.4.0	GP-062062	TEI
GP-32	GP-062344	3716	1	20.22.30.2 - Correction to test procedure	F	7.3.1	7.4.0	GP-062344	TEI
GP-32	GP-062325	3717	1	TC_27_3- Correction to the testcase 27.3	F	7.3.1	7.4.0	GP-062325	TEI
GP-32	GP-062095	3718	-	TC_42_1_2_1_18- Clarification to PSI2_CHANGE_MARK used.	F	7.3.1	7.4.0	GP-062095	TEI
GP-32	GP-062096	3719	-	TC_42_1_2_1_19- Clarification to the HSN values used for the downlink assignment.	F	7.3.1	7.4.0	GP-062096	TEI
GP-32	GP-062097	3720	-	TC_42_9_3_x- Correction to data transfer macro used in the testcases 42.9.3.x	F	7.3.1	7.4.0	GP-062097	TEI
GP-32	GP-062335	3721	1	TC_46_2_2_1_5- Correction to the testcase 46.2.2.1.5	F	7.3.1	7.4.0	GP-062335	TEI
GP-32	GP-062304	3723	-	Inserting 14.4.27 as Void	F	7.3.1	7.4.0	GP-062304	WBAMR-MStest
GP-33	GP-070005	3724	-	14.4.28 Clarify the absolute signal level of wanted signal	F	7.4.0	7.5.0	GP-070005	TEI5
GP-33	GP-070006	3725	-	80.1.1, GAN defaults – add second AP.	F	7.4.0	7.5.0	GP-070006	GAAI-CT
GP-33	GP-070392	3726	1	80.1.2, Annex A.9 Add certificate for GAN testing	F	7.4.0	7.5.0	GP-070392	GAAI-CT
GP-33	GP-070008	3727	-	14.11, 14.16, 14.18 Rename existing DARP clauses; 14.4.1, 14.4.8 Extend restriction to DARP phase 2.	F	7.4.0	7.5.0	GP-070008	TEI7
GP-33	GP-070013	3728	-	26.9.x PICS/PIXIT clean-up	F	7.4.0	7.5.0	GP-070013	TEI
GP-33	GP-070405	3729	1	26.15.x PICS/PIXIT clean-up	F	7.4.0	7.5.0	GP-070405	TEI
GP-33	GP-070406	3730	1	26.16 – 26.19 Add GSM810 support.	F	7.4.0	7.5.0	GP-070406	TEI6

TSG #	TSG Doc	CR	Rev	Subject/Comment	Cat	Old	New	WG Doc	Work item
GP-33	GP-070396	3731	1	14.4.29 Correction of test procedure for calculation of unwanted signal I1	F	7.4.0	7.5.0	GP-070396	TEI
GP-33	GP-070511	3732	2	14.10.8 Correction of CODEC_MODE values	F	7.4.0	7.5.0	GP-070511	TEI
GP-33	GP-070372	3733	1	14.10.9 Correction of CODEC_MODE values	F	7.4.0	7.5.0	GP-070372	TEI
GP-33	GP-070373	3734	1	14.2.24 Correction to test purpose and test procedure	F	7.4.0	7.5.0	GP-070373	TEI
GP-33	GP-070374	3735	1	14.5.1.7 Correction of interference ratio and signal level	F	7.4.0	7.5.0	GP-070374	TEI
GP-33	GP-070036	3736	-	26.6.1 to 26.6.3 – PICS/PIXIT cleanup, add 710, add 810, band independence	F	7.4.0	7.5.0	GP-070036	TEI7
GP-33	GP-070393	3737	1	26.6.4 to 26.6.5 – PICS/PIXIT cleanup, add 710, add 810, band independence	F	7.4.0	7.5.0	GP-070393	TEI7
GP-33	GP-070038	3738	-	26.6.6 to 26.6.22 – PICS/PIXIT cleanup, add 710, add 810, band independence	F	7.4.0	7.5.0	GP-070038	TEI7
GP-33	GP-070040	3739	-	27 – Corrections to GP-062018 and apply Frequency Band changes throughout	F	7.4.0	7.5.0	GP-070040	TEI
GP-33	GP-070415	3740	1	15 – Anomalous numbering of TC - GSM Timing advance and absolute delay	F	7.4.0	7.5.0	GP-070415	TEI7
GP-33	GP-070043	3741	-	26.3.3 – Introduce numbering for Test Procedures	F	7.4.0	7.5.0	GP-070043	TEI7
GP-33	GP-070044	3742	-	Sections 40.x, 41.1.5.4 - Rel-6 network simulation	F	7.4.0	7.5.0	GP-070044	TEI
GP-33	GP-070412	3744	1	53.1.1.11 - Handling of Packet Uplink Dummy Control Block at step 10.	F	7.4.0	7.5.0	GP-070412	TEI7
GP-33	GP-070048	3745	-	47.3.4.1 - Modified step 22 to add CS call release and Modify PDP context procedure	F	7.4.0	7.5.0	GP-070048	TEI
GP-33	GP-070049	3746	-	47.3.4.2 - Step 22 to 25 are made optional and modified step 26 to add CS call release and Modify PDP context procedure.	F	7.4.0	7.5.0	GP-070049	TEI
GP-33	GP-070402	3747	1	83.1.6.1 and 83.1.6.2: additional step added after step 2 to wait for GA-PSR UNITDATA.	F	7.4.0	7.5.0	GP-070402	GAAI-CT
GP-33	GP-070403	3749	1	A user action is missing in testcase 83.1.4.2	F	7.4.0	7.5.0	GP-070403	GAAI-CT
GP-33	GP-070054	3751	-	42.4.5.4 – Cell C is activated and set to –50 dBm	F	7.4.0	7.5.0	GP-070054	TEI
GP-33	GP-070388	3752	1	15.8 clarification of step e)	F	7.4.0	7.5.0	GP-070388	TEI
GP-33	GP-070056	3753	-	45.5.1: Release 5 and later adaptation of the testcase	F	7.4.0	7.5.0	GP-070056	TEI
GP-33	GP-070059	3754	-	44.2.3.1.7: Improvement to the specific PICS statement	F	7.4.0	7.5.0	GP-070059	TEI
GP-33	GP-070061	3755	-	Sections 26.1 to 26.5: PICS/PIXIT Clean-up	F	7.4.0	7.5.0	GP-070061	TEI
GP-33	GP-070063	3756	-	Corrections to the Specific PICS Statements in testcases 11.3, 14.16.2.1, 14.18.2 and 20.4	F	7.4.0	7.5.0	GP-070063	TEI
GP-33	GP-070375	3757	1	New Test Case 14.2.25 Reference Sensitivity – Repeated FACCH/F	F	7.4.0	7.5.0	GP-070375	TEI6
GP-33	GP-070376	3758	1	New Test Case 14.4.31 Co-channel Rejection – Repeated FACCH/F	F	7.4.0	7.5.0	GP-070376	TEI6
GP-33	GP-070069	3759	-	Clarification of PDP Context Activation Reject codes in 45.2.x	F	7.4.0	7.5.0	GP-070069	TEI
GP-33	GP-070071	3760	-	PICS/PIXIT and Band Dependency modifications in 31.x	F	7.4.0	7.5.0	GP-070071	TEI7
GP-33	GP-070075	3761	-	41.5.1.1.4 - At step 18, added Modify PDP context procedure	F	7.4.0	7.5.0	GP-070075	TEI
GP-33	GP-070076	3762	-	11.8.2.6 - Correction for R99 compliance	F	7.4.0	7.5.0	GP-070076	TEI
GP-33	GP-070077	3763	-	42.9.2.1.3 – Remove redundant procedure / correct completion of data / verify end of transmission	F	7.4.0	7.5.0	GP-070077	TEI
GP-33	GP-070398	3764	1	Test case 34.x: Insufficient handling of SMS timer TC1M	F	7.4.0	7.5.0	GP-070398	TEI7
GP-33	GP-070399	3765	2	81.x: testing of lower layer failure	F	7.4.0	7.5.0	GP-070399	GAAI-CT
GP-33	GP-070377	3766	1	Loop C Delay, possibility to separate HS (Half Rate) and FS (Full Rate).	F	7.4.0	7.5.0	GP-070377	TEI7
GP-33	GP070512	3767	2	14.11.1.1, 14.11.2.1, 14.11.3.1, 14.12.1.1. - Clarification of references	F	7.4.0	7.5.0	GP-070512	ARP-ConfTest
GP-33	GP-070085	3768	-	14.16.4, 14.18.8. - Clarification of table references in Conformance Requirement	F	7.4.0	7.5.0	GP-070085	ARP-ConfTest
GP-33	GP-070086	3769	-	Section 50.x - Rel-6 network simulation	F	7.4.0	7.5.0	GP-070086	TEI
GP-33	GP-070091	3770	-	26.6.3.10 Test procedure and test sequence correction	F	7.4.0	7.5.0	GP-070091	TEI
GP-33	GP-070092	3771	-	42.3.1.1.9 Cell allocation in GSM 850 corrected	F	7.4.0	7.5.0	GP-070092	TEI
GP-33	GP-070093	3772	-	46.2.2.1.5 - Correction of comment in step 10	F	7.4.0	7.5.0	GP-070093	TEI
GP-33	GP-070094	3773	-	82.4.2.1 Foreseen Final State of the MS and Expected Sequence is inconsistent	F	7.4.0	7.5.0	GP-070094	TEI6

TSG #	TSG Doc	CR	Rev	Subject/Comment	Cat	Old	New	WG Doc	Work item
GP-33	GP-070095	3774	-	34.2.2 Application layer in MS may trigger resending of SM	F	7.4.0	7.5.0	GP-070095	TEI
GP-33	GP-070381	3776	1	Section 41 PICS/PIXIT Clean Up	F	7.4.0	7.5.0	GP-070381	TEI
GP-33	GP-070382	3777	1	Section 42 PICS/PIXIT Clean Up	F	7.4.0	7.5.0	GP-070382	TEI
GP-33	GP-070099	3778	-	Section 43 PICS/PIXIT Clean Up	F	7.4.0	7.5.0	GP-070099	TEI
GP-33	GP-070383	3779	1	Section 51 PICS/PIXIT Clean Up	F	7.4.0	7.5.0	GP-070383	TEI
GP-33	GP-070101	3780	-	Section 52 PICS/PIXIT Clean Up	F	7.4.0	7.5.0	GP-070101	TEI
GP-33	GP-070102	3781	-	Section 53 PICS/PIXIT Clean Up	F	7.4.0	7.5.0	GP-070102	TE17
GP-33	GP-070407	3782	1	26.10.x – 26.11.x PICS/PIXIT clean-up	F	7.4.0	7.5.0	GP-070407	TEI
GP-33	GP-070408	3783	1	26.12.x PICS/PIXIT clean-up	F	7.4.0	7.5.0	GP-070408	TEI
GP-33	GP-070124	3784	-	70.9.4.1 Change method for stimulating RRLP protocol error	F	7.4.0	7.5.0	GP-070124	TEI
GP-33	GP-070125	3785	-	83.1.7.1: MS can not receive GA PSR UNITDATA message while in GA-PSR STANDBY state.	F	7.4.0	7.5.0	GP-070125	GAAI-CT
GP-33	GP-070404	3786	1	83.1.4.3: Triggering of data transfer is required before step 6	F	7.4.0	7.5.0	GP-070404	GAAI-CT
GP-33	GP-070127	3787	-	22.13 Enhanced Power Control (EPC) timing and measurement reporting in single slot operation (new test)	B	7.4.0	7.5.0	GP-070127	EPC-MStest
GP-33	GP-070128	3788	-	22.14 Enhanced Power Control (EPC) timing and measurement reporting in multislot operation (new test)	B	7.4.0	7.5.0	GP-070128	EPC-MStest
GP-33	GP-070130	3789	-	Section 22.7 – Correction to the nominal output power values during Fast Power Control (FPC).	F	7.4.0	7.5.0	GP-070130	TEI
GP-33	GP-070378	3790	1	14.2.22 Correction of input signal levels	F	7.4.0	7.5.0	GP-070378	TEI
GP-33	GP-070379	3791	1	14.2.23 Correction of input signal level	F	7.4.0	7.5.0	GP-070379	TEI
GP-33	GP-070134	3792	-	14.4.24 Correction of input signal levels	F	7.4.0	7.5.0	GP-070134	TEI
GP-33	GP-070135	3793	-	14.4.25 Correction of input signal level	F	7.4.0	7.5.0	GP-070135	TEI
GP-33	GP-070136	3794	-	14.4.26 Correction of input signal level	F	7.4.0	7.5.0	GP-070136	TEI
GP-33	GP-070137	3795	-	14.5.1.5 Correction of input signal levels	F	7.4.0	7.5.0	GP-070137	TEI
GP-33	GP-070138	3796	-	14.5.1.6 Correction of signal input levels	F	7.4.0	7.5.0	GP-070138	TEI
GP-33	GP-070141	3798	-	81.2.4.1 and 81.2.4.2 – Attempt counting incorrect	F	7.4.0	7.5.0	GP-070141	TEI6
GP-33	GP-070142	3799	-	26.6.3.9 Test procedure and test sequence correction	F	7.4.0	7.5.0	GP-070142	TEI
GP-33	GP-070143	3800	-	13.3, 13.16.2, 13.17.3 - Clarification of required output levels in Transmitter output power test cases	F	7.4.0	7.5.0	GP-070143	TEI
GP-33	GP-070413	3802	1	20.2 & 20.21.2 additional information element Tav referenced from table A.25.1	F	7.4.0	7.5.0	GP-070413	TEI
GP-33	GP-070151	3804	-	Superfluous Extreme Test Condition Repetition in Test Case 14.5.1.1	F	7.4.0	7.5.0	GP-070151	TEI7
GP-33	GP-070207	3805	-	26.20.1 New EPC Test Case – EPC Interworking With Normal Power Control	B	7.4.0	7.5.0	GP-070207	EPC-MStest
GP-33	GP-070279	3806	-	Section 50 band independence	F	7.4.0	7.5.0	GP-070279	TEI7
GP-33	GP-070341	3807	-	42.9.2.1.4 - Avoid expiry of timer T3190	F	7.4.0	7.5.0	GP-070341	TEI
GP-33	GP-070416	3808	1	34.4.8.2 some of the steps made optional	F	7.4.0	7.5.0	GP-070416	TEI
GP-33	GP-070390	3809	-	52.9.2.1.4 - Avoid expiry of timer T3190	F	7.4.0	7.5.0	GP-070390	TEI
GP-33	GP-070391	3810	-	47.3.3.1.2 NMO in PACKET ASSIGNMENT Specific Message Contents	F	7.4.0	7.5.0	GP-070391	TEI
GP-33	GP-070400	3811	-	70.8.4.1 Invalid Measure Position Request specifies omission of a mandatory ASN.1 element.	F	7.4.0	7.5.0	GP-070400	TEI
GP-34	GP-070893	3812	1	Section 82 Introduction of GAN-UTRAN handover test case	F	7.5.0	7.6.0	GP-070893	TEI6
GP-34	GP-071014	3813	2	Section 82 Introduction of UTRAN-GAN handover test case	F	7.5.0	7.6.0	GP-071014	TEI6
GP-34	GP-070895	3814	1	82.8.1.1 Test not compliant to latest core spec	F	7.5.0	7.6.0	GP-070895	TEI
GP-34	GP-070574	3817	-	26.6.3.9 Specific message contents correction	F	7.5.0	7.6.0	GP-070574	TEI
GP-34	GP-070575	3818	-	31.11 – SS-Code value incorrectly coded for CFNRy	F	7.5.0	7.6.0	GP-070575	TEI
GP-34	GP-070576	3819	-	31.2.1.4 – Basic Service Code incorrect in step 6	F	7.5.0	7.6.0	GP-070576	TEI
GP-34	GP-070577	3820	-	34.2.1 and 34.2.2: No consideration given to expiry of TR1M	F	7.5.0	7.6.0	GP-070577	TEI
GP-34	GP-070587	3821	-	13.17.3 clarification of steps in the output power and correction of Table 13.17.3-3	F	7.5.0	7.6.0	GP-070587	TEI
GP-34	GP-070588	3822	-	13.16.2 clarification of steps in the output power.	F	7.5.0	7.6.0	GP-070588	TEI
GP-34	GP-070590	3823	-	47.3.4.1 and 47.3.4.2 – Change of RAC for the 3G cell	F	7.5.0	7.6.0	GP-070590	TEI
GP-34	GP-070591	3824	-	41.3.6.7 - Ready timer deactivation	F	7.5.0	7.6.0	GP-070591	TEI4
GP-34	GP-070592	3825	-	51.3.6.7 - Ready timer deactivation	F	7.5.0	7.6.0	GP-070592	TEI4

TSG #	TSG Doc	CR	Rev	Subject/Comment	Cat	Old	New	WG Doc	Work item
GP-34	GP-070594	3827	-	52.1.2.1.8.1.8 and 52.1.2.1.9.2.2- Specific Message Content of Packet Uplink Assignment to be changed	F	7.5.0	7.6.0	GP-070594	TEI
GP-34	GP-070595	3828	-	26.01 to 26.04 –add 710, add 810, band independence	F	7.5.0	7.6.0	GP-070595	TGSM810-MStest
GP-34	GP-070596	3829	-	26.07 to 26.09 –add 710, add 810, band independence	F	7.5.0	7.6.0	GP-070596	TGSM810-MStest
GP-34	GP-070903	3830	1	26.14 to 26.15 –add 710, add 810, band independence	F	7.5.0	7.6.0	GP-070903	TGSM810-MStest
GP-34	GP-070599	3831	-	81.2.1.2 – Removal of test case ambiguity	F	7.5.0	7.6.0	GP-070599	TEI6
GP-34	GP-070600	3832	-	82.3.2.4, 82.7.1.1, 82.7.2.2 – Correction to non existent state GA-CSR-REGISTERED	F	7.5.0	7.6.0	GP-070600	TEI6
GP-34	GP-071011	3835	2	New Test Case 14.2.26 Reference Sensitivity – Repeated SACCH	F	7.5.0	7.6.0	GP-071011	TEI6
GP-34	GP-071012	3836	2	New Test Case 14.4.32 Co-channel Rejection – Repeated SACCH	F	7.5.0	7.6.0	GP-071012	TEI6
GP-34	GP-070891	3837	1	Section 26.14: PICS/PIXIT Clean-up	F	7.5.0	7.6.0	GP-070891	TEI
GP-34	GP-070607	3838	-	Clarifications to signalling for A-GPS Minimum Performance test cases	F	7.5.0	7.6.0	GP-070607	GAGR
GP-34	GP-070626	3839	-	83.x: incorrect message direction MS to SS	F	7.5.0	7.6.0	GP-070626	GAAl-CT
GP-34	GP-070806	3840	1	83.1.2.2.1: IP address and UDP port shall not be included	F	7.5.0	7.6.0	GP-070806	GAAl-CT
GP-34	GP-070884	3841	1	40.x: incorrect IEI in DTM messages	F	7.5.0	7.6.0	GP-070884	TEI7
GP-34	GP-070629	3842	-	83.x PDP context activation missing	F	7.5.0	7.6.0	GP-070629	GAAl-CT
GP-34	GP-070906	3843	1	26.9.6.1.x : incorrect handling of half rate speech version 3	F	7.5.0	7.6.0	GP-070906	TEI7
GP-34	GP-070885	3844	1	41.5.4.1 New Enhanced DTM Test Case: MT Call Establishment - No Reallocation of PS Resources	F	7.5.0	7.6.0	GP-070885	TEI6
GP-34	GP-070886	3845	1	41.5.4.2 New Enhanced DTM Test Case: MT Call Establishment - Reallocation of PS Resources - Allocation of New Downlink TBF	F	7.5.0	7.6.0	GP-070886	TEI6
GP-34	GP-070887	3846	1	41.5.5.1 New Enhanced DTM Test Case: SI Aquisition - No Reallocation of PS Resources	F	7.5.0	7.6.0	GP-070887	TEI6
GP-34	GP-070930	3847	3	41.5.5.2 New Enhanced DTM Test Case: Reallocation of PS Resources for Uplink and Downlink TBFs	F	7.5.0	7.6.0	GP-070930	TEI6
GP-34	GP-070647	3848	-	82.8.2 Test cases not compliant to latest core spec	F	7.5.0	7.6.0	GP-070647	TEI
GP-34	GP-070648	3849	-	41.3.x - Consideration of high multislot classes supporting one Tx timeslot only	F	7.5.0	7.6.0	GP-070648	TEI
GP-34	GP-070649	3850	-	51.3.x - Consideration of high multislot classes supporting one Tx timeslot only	F	7.5.0	7.6.0	GP-070649	TEI
GP-34	GP-070650	3851	-	42.9.2.1.4 – Correction of test step 25	F	7.5.0	7.6.0	GP-070650	TEI
GP-34	GP-070651	3852	-	44.2.11.3.2 Correction of initial conditions	F	7.5.0	7.6.0	GP-070651	TEI
GP-34	GP-070874	3853	1	26.19.9.11 In case of Full Rate Speech Version 5, step 27 to 29 are skipped	F	7.5.0	7.6.0	GP-070874	TEI
GP-34	GP-070653	3854	-	26.19.3a – In case of Full Rate Speech Version 5, the testcase can not be run with M=4	F	7.5.0	7.6.0	GP-070653	TEI
GP-34	GP-070875	3855	1	81.2.3.4 Register to default GANC after reject	F	7.5.0	7.6.0	GP-070875	TEI6
GP-34	GP-071020	3856	2	81.2.4.1 Attempt counting incorrect	F	7.5.0	7.6.0	GP-071020	TEI6
GP-34	GP-070877	3857	1	81.2.5.2 Redirecting to a different GANC as used before	D	7.5.0	7.6.0	GP-070877	TEI6
GP-34	GP-070878	3858	1	82.4.2.1 Initial Condition is not reflecting first step of the expecting sequence	F	7.5.0	7.6.0	GP-070878	TEI6
GP-34	GP-070879	3859	1	83.1.x GAN PS Domain Procedures: Initial trigger for data transfer	F	7.5.0	7.6.0	GP-070879	TEI6
GP-34	GP-070695	3861	-	81.1.3.3, 81.1.3.2 and 81.2.4.5 to be removed	F	7.5.0	7.6.0	GP-070695	TEI
GP-34	GP-070889	3866	1	TC 42.4.8.4.2 – changes in step 16.	F	7.5.0	7.6.0	GP-070889	TEI
GP-34	GP-070762	3868	-	Error correction to test case 70.9.4.3: Some GPS Assistance Data need to be sent	F	7.5.0	7.6.0	GP-070762	GAGR
GP-34	GP-070771	3871	-	32.12 Clarification of Test Requirements with respect to channel configuration	F	7.5.0	7.6.0	GP-070771	TEI
GP-34	GP-070772	3872	-	20. - Mobiles supporting Stored List Cell Selection may prevent the Test Purpose being met for Cell Selection tests.	F	7.5.0	7.6.0	GP-070772	TEI
GP-34	GP-070773	3873	-	47.3.1.3 Misalignment of k parameter	F	7.5.0	7.6.0	GP-070773	TEI
GP-34	GP-070922	3874	1	Chapter 13 test cases, vibration testing made conditional based on a PICS/PIXIT declaration	F	7.5.0	7.6.0	GP-070922	TEI
GP-34	GP-070896	3877	1	Annex A1.1 Connection of devices with multiple antennae	F	7.5.0	7.6.0	GP-070896	MSRD2-MSconf
GP-34	GP-070871	3879	-	26.7.x PICS/PIXIT cleanup	F	7.5.0	7.6.0	GP-070871	TEI

TSG #	TSG Doc	CR	Rev	Subject/Comment	Cat	Old	New	WG Doc	Work item
GP-34	GP-070905	3880	2	47.4.1 Ready Timer Handling	F	7.5.0	7.6.0	GP-070905	TEI6
GP-34	GP-070910	3881	-	Update of GPRS NITZ tests	F	7.5.0	7.6.0	GP-070910	TEI
GP-34	GP-070911	3882	-	Update of GSM NITZ test	F	7.5.0	7.6.0	GP-070911	TEI
GP-34	GP-071015	3883	-	TC 20.22.30.1 and 20.22.30.2 – changes in the note given in test requirements.	F	7.5.0	7.6.0	GP-071015	TEI
GP-34	GP-071016	3884	-	26.6.23.3 Addition of New Uplink Repeated SACCH Testcase with SAPI 3	B	7.5.0	7.6.0	GP-071016	TEI6
GP-34	GP-071017	3885	-	26.6.23.1 Addition of New Downlink Repeated SACCH Testcase	B	7.5.0	7.6.0	GP-071017	TEI6
GP-34	GP-071018	3886	-	26.6.23.2 Addition of a New Uplink Repeated SACCH Testcase	B	7.5.0	7.6.0	GP-071018	TEI6
GP-34	GP-071056	3869	1	Correction to extreme condition voltages for Lithium batteries in table A1.3	F	7.5.0	7.6.0	GP-071056	TEI
GP-35	GP-071422	3869	2	Correction to extreme condition voltages for Lithium batteries in table A1.3	F	7.6.0	7.7.0	GP-071422	TEI
GP-35	GP-071110	3887	-	14.16.4.2 Editorial correction of DTS-2 test procedure	F	7.6.0	7.7.0	GP-071110	TEI
GP-35	GP-071412	3888	1	New Test Case:14.16.5.1 Synchronous single co-channel interferer (DTS-1)	F	7.6.0	7.7.0	GP-071412	TEI
GP-35	GP-071112	3889	-	New Test Case14.16.5.2 Multiple interferers (DTS-2 / DTS-5)	F	7.6.0	7.7.0	GP-071112	TEI
GP-35	GP-071413	3890	1	New Test Case:14.18.9.1 Synchronous single co-channel interferer (DTS-1)	F	7.6.0	7.7.0	GP-071413	TEI
GP-35	GP-071383	3891	1	New Test Case: 14.18.9.2 Synchronous single co-channel interferer (DTS-1b)	F	7.6.0	7.7.0	GP-071383	TEI
GP-35	GP-071115	3892	-	New Test Case: 14.18.9.3 Multiple interferers (DTS-2 / DTS-5)	F	7.6.0	7.7.0	GP-071115	TEI
GP-35	GP-071117	3893	-	26.9. Removal of reference to speech codecs other than version 1	F	7.6.0	7.7.0	GP-071117	TEI
GP-35	GP-071118	3894	-	26.12.2.1 – Mandatory Channel Mode IE missing in Handover Command messages	F	7.6.0	7.7.0	GP-071118	TEI
GP-35	GP-071119	3895	-	26.19.5 – Support for transmission of ACCESS BURSTs on SACCH added and frequency lists tabulated.	F	7.6.0	7.7.0	GP-071119	TEI
GP-35	GP-071120	3896	-	31.1.5.1.2 Correction of expected sequence	F	7.6.0	7.7.0	GP-071120	TEI
GP-35	GP-071121	3897	-	42.1.1.4.3 Removal of incorrect brackets	F	7.6.0	7.7.0	GP-071121	TEI
GP-35	GP-071122	3898	-	Section 26.8 PICS/PIXIT Clean Up	F	7.6.0	7.7.0	GP-071122	TEI
GP-35	GP-071123	3899	-	Section 26.13 PICS/PIXIT Clean Up	F	7.6.0	7.7.0	GP-071123	TEI
GP-35	GP-071128	3900	-	14.10.x : missing PIXIT for normalisation factors	F	7.6.0	7.7.0	GP-071128	GAMRWB
GP-35	GP-071129	3901	-	70.8.x: Addition of the Error Cause "incorrectData" as a valid Error Cause	F	7.6.0	7.7.0	GP-071129	GAGR
GP-35	GP-071424	3902	1	70.x: inconsistent execution	F	7.6.0	7.7.0	GP-071424	GAGR
GP-35	GP-071131	3903	-	70.9.4.3: Addition of "gpsLocCalAssDataMissing" as a valid "LocErrorReason"	F	7.6.0	7.7.0	GP-071131	GAGR
GP-35	GP-071133	3905	-	83.x: PDP Context Activation moved to initial conditions	F	7.6.0	7.7.0	GP-071133	GAAl-CT
GP-35	GP-071384	3906	1	Darp Ph II, new test for Reference Sensitivity	B	7.6.0	7.7.0	GP-071384	MSRD2-MSconf
GP-35	GP-071139	3908	-	20.22.13: Bad selection criteria parameter calculation	F	7.6.0	7.7.0	GP-071139	TEI
GP-35	GP-071417	3909	1	26.6.3.9: Update of measurement information	F	7.6.0	7.7.0	GP-071417	TEI
GP-35	GP-071141	3910	-	44.2.3.3.1, removal of useless PICS	F	7.6.0	7.7.0	GP-071141	TEI
GP-35	GP-071407	3911	1	Annexes A4.3.3/4: Correction of EF(IMS) and EF(KC)	F	7.6.0	7.7.0	GP-071407	TEI
GP-35	GP-071391	3912	-	81.1.3.7 Knowledge of Serving GANC	F	7.6.0	7.7.0	GP-071391	GAAl-CT
GP-35	GP-071392	3913	-	81.2.3.2 Connection to Default GANC	F	7.6.0	7.7.0	GP-071392	GAAl-CT
GP-35	GP-071404	3914	1	Section 80 & 81 - New Macro for Location Update Procedure	F	7.6.0	7.7.0	GP-071404	TEI6
GP-35	GP-071405	3915	1	81.2.6.4 and 81.2.6.5 – Correction to Expected Sequence	F	7.6.0	7.7.0	GP-071405	TEI6
GP-35	GP-071406	3916	1	81.2.6.6 Clarification of expected sequence	F	7.6.0	7.7.0	GP-071406	TEI6
GP-35	GP-071408	3917	1	Corrections to GAN test case 81.2.4.1	F	7.6.0	7.7.0	GP-071408	TEI
GP-35	GP-071409	3918	1	Corrections to GAN test case 81.2.4.2	F	7.6.0	7.7.0	GP-071409	TEI
GP-35	GP-071154	3919	-	Pointer version of 51.010-1 Rel-6 to Rel-7	F	6.6.0	7.7.0	GP-071154	TEI6
GP-35	GP-071156	3921	-	81.2.3.3: alignment with 81.2.6.3	F	7.6.0	7.7.0	GP-071156	GAAl-CT
GP-35	GP-071158	3923	-	53.1.1.11- Handling of Buffered Packet Uplink Dummy Control Block at step 11.	F	7.6.0	7.7.0	GP-071158	TEI
GP-35	GP-071159	3924	-	29.3.2.6.9 : Redundant step removed	F	7.6.0	7.7.0	GP-071159	TEI
GP-35	GP-071162	3927	-	13.4.2 – add 710, add 810	F	7.6.0	7.7.0	GP-071162	TGSM810-MStest
GP-35	GP-071163	3928	-	14.2.x – add 710, add 810	F	7.6.0	7.7.0	GP-071163	TGSM810

TSG #	TSG Doc	CR	Rev	Subject/Comment	Cat	Old	New	WG Doc	Work item
									-MStest
GP-35	GP-071164	3929	-	21.1 – add 710, add 810	F	7.6.0	7.7.0	GP-071164	TGSM810 -MStest
GP-35	GP-071165	3930	-	26.12.5 – add 710, add 810	F	7.6.0	7.7.0	GP-071165	TGSM810 -MStest
GP-35	GP-071166	3931	-	26.16.6 to 26.17.6– add 710, add 810	F	7.6.0	7.7.0	GP-071166	TGSM810 -MStest
GP-35	GP-071167	3932	-	31.12.1 – add 710, add 810	F	7.6.0	7.7.0	GP-071167	TGSM810 -MStest
GP-35	GP-071168	3933	-	34.1 and 34.3 – add 710, add 810	F	7.6.0	7.7.0	GP-071168	TGSM810 -MStest
GP-35	GP-071387	3934	1	41.3.6.5 – add 710, add 810	F	7.6.0	7.7.0	GP-071387	TGSM810 -MStest
GP-35	GP-071388	3935	1	42.1.2.1.14 to 42.1.2.1.18 – add 710, add 810	F	7.6.0	7.7.0	GP-071388	TGSM810 -MStest
GP-35	GP-071389	3936	1	51.3.6.4 and 51.3.6.5 – add 710, add 810	F	7.6.0	7.7.0	GP-071389	TGSM810 -MStest
GP-35	GP-071390	3937	1	52.3.2.1.1, 52.3.2.1.2 and 52.3.4 – add 710, add 810	F	7.6.0	7.7.0	GP-071390	TGSM810 -MStest
GP-35	GP-071174	3938	-	Clarification of test procedure in 14.2.26 and 14.4.32	F	7.6.0	7.7.0	GP-071174	TEI6
GP-35	GP-071175	3939	-	Informative annex for Repeated SACCH layer 1 test method	F	7.6.0	7.7.0	GP-071175	TEI6
GP-35	GP-071385	3940	1	New Tests Cases: DARP Phase II Speech bearer tests DTS-1, DTS-2 and DTS-5	B	7.6.0	7.7.0	GP-071385	MSRD2- MSconf
GP-35	GP-071178	3941	-	26.8.1.3.5.3 - Change State U10 to U8	F	7.6.0	7.7.0	GP-071178	TEI
GP-35	GP-071179	3942	-	14.4.31 Correction of table references	F	7.6.0	7.7.0	GP-071179	TEI
GP-35	GP-071180	3943	-	14.2.25 Correction on setting the reference performance level	F	7.6.0	7.7.0	GP-071180	TEI
GP-35	GP-071181	3944	-	14.2.26 Correction on setting the reference performance level	F	7.6.0	7.7.0	GP-071181	TEI
GP-35	GP-071182	3945	-	14.2.24 Removal of extreme test conditions	F	7.6.0	7.7.0	GP-071182	TEI
GP-35	GP-071185	3947	-	52.1.1.6.3 Removal of incorrect brackets	F	7.6.0	7.7.0	GP-071185	TEI
GP-35	GP-071395	3949	1	82.7.1.3 Measurement reporting procedure added	F	7.6.0	7.7.0	GP-071395	TEI6
GP-35	GP-071398	3950	1	41.5.4.3 New Enhanced DTM Test Case: MT Call Establishment - Allocation of CS Resources Only - Downlink TBF	F	7.6.0	7.7.0	GP-071398	TEI6
GP-35	GP-071399	3951	1	41.5.4.4 New Enhanced DTM Test Case: MO Call Establishment - No Reallocation of PS Resources	F	7.6.0	7.7.0	GP-071399	TEI6
GP-35	GP-071400	3952	1	41.5.4.5 New Enhanced DTM Test Case: MO Call Establishment - Reallocation of PS Resources	F	7.6.0	7.7.0	GP-071400	TEI6
GP-35	GP-071401	3953	1	41.5.4.6 New Enhanced DTM Test Case: MO Call Establishment - Allocation of CS Resources Only - Downlink TBF	F	7.6.0	7.7.0	GP-071401	TEI6
GP-35	GP-071397	3954	1	40.4.3.17 Inter-SGSN Routing Area Update and XID negotiation	F	7.6.0	7.7.0	GP-071397	TEI
GP-35	GP-071416	3955	1	20.22.26: deletion of test case	F	7.6.0	7.7.0	GP-071416	TEI7
GP-35	GP-071203	3956	-	70.2.x and 70.4.4.x – add 710, add 810	F	7.6.0	7.7.0	GP-071203	TGSM810 -MStest
GP-35	GP-071402	3957	1	Corrections to test case 41.1.5.1.2	F	7.6.0	7.7.0	GP-071402	TEI
GP-35	GP-071212	3958	-	Corrections to test case 41.2.2.4	F	7.6.0	7.7.0	GP-071212	TEI
GP-35	GP-071403	3959	1	Corrections to test case 51.1.5.1.2	F	7.6.0	7.7.0	GP-071403	TEI
GP-35	GP-071214	3960	-	Corrections to test case 51.2.2.4	F	7.6.0	7.7.0	GP-071214	TEI
GP-35	GP-071215	3961	-	Corrections to Default specified for Immediate Assignment (Downlink) in 40.2.4.14.1	F	7.6.0	7.7.0	GP-071215	TEI
GP-35	GP-071430	3962	1	26.7.4.3.x - Exclusion of additional IE Reject Cause values for LU Reject message	F	7.6.0	7.7.0	GP-071430	TEI
GP-36	GP-071572	3963	-	20.25.2 and 20.25.3: overlapping bands	F	7.7.0	7.8.0	GP-071572	TEI7
GP-36	GP-071573	3964	-	27.11 – Changes TA1 to TC1	F	7.7.0	7.8.0	GP-071573	TEI
GP-36	GP-071574	3965	-	81.3 – Clean up of GAN conformance requirements	F	7.7.0	7.8.0	GP-071574	TEI
GP-36	GP-071869	3966	1	12.1-correction to not testing band of conducted spurious emissions	F	7.7.0	7.8.0	GP-071869	TEI
GP-36	GP-071577	3967	-	41.5.5.3 New Enhanced DTM Test Case: Change of LA in NW Mode II	F	7.7.0	7.8.0	GP-071577	TEI6
GP-36	GP-071578	3968	-	41.5.5.4 New Enhanced DTM Test Case: MS Requests PS Release Following Change of LA in NW Mode I	F	7.7.0	7.8.0	GP-071578	TEI6
GP-36	GP-071580	3969	-	41.5.4.3 Correction to Test Purpose	F	7.7.0	7.8.0	GP-071580	TEI6

TSG #	TSG Doc	CR	Rev	Subject/Comment	Cat	Old	New	WG Doc	Work item
GP-36	GP-071581	3970	-	42.3.1.1.9 Clarification of cell allocation in step 6	F	7.7.0	7.8.0	GP-071581	TEI
GP-36	GP-071582	3971	-	26.6.23.1 & 2: SS configuration corrected.	F	7.7.0	7.8.0	GP-071582	TEI
GP-36	GP-071879	3972	1	26.6.23.3 – SS configuration and test procedure corrected	F	7.7.0	7.8.0	GP-071879	TEI
GP-36	GP-071880	3973	1	26.7.5.2 - SS configuration corrected and check for Repeated ACCH capability added	F	7.7.0	7.8.0	GP-071880	TEI
GP-36	GP-071585	3974	-	41.3.6.9 Removal of BS_PBCCH_BLKs specification.	F	7.7.0	7.8.0	GP-071585	TEI
GP-36	GP-071586	3975	-	41.3.6.10 Removal of BS_PBCCH_BLKs specification and re-insertion of step 1-2.	F	7.7.0	7.8.0	GP-071586	TEI
GP-36	GP-071587	3976	-	51.3.6.9 Removal of BS_PBCCH_BLKs specification.	F	7.7.0	7.8.0	GP-071587	TEI
GP-36	GP-071588	3977	-	51.3.6.10 Removal of BS_PBCCH_BLKs specification.	F	7.7.0	7.8.0	GP-071588	TEI
GP-36	GP-071592	3978	-	Adding a reference to part 5 in the foreword	F	7.7.0	7.8.0	GP-071592	TEI7
GP-36	GP-071874	3979	1	41.5.4.7 New Enhanced DTM test case: MO Call Establishment - IMMEDIATE ASSIGNMENT REJECT	B	7.7.0	7.8.0	GP-071874	TEI6
GP-36	GP-071871	3980	1	41.5.4.8 New Enhanced DTM Test Case: MO Call Establishment – Dedicated Channel Establishment Failure	B	7.7.0	7.8.0	GP-071871	TEI6
GP-36	GP-071593	3981	-	47.4.1 - Length of Network Name contents in GMM INFORMATION step 20 corrected	F	7.7.0	7.8.0	GP-071593	TEI
GP-36	GP-071600	3982	-	41.5.4.x System simulator initial conditions have to indicate Enhanced DTM support	F	7.7.0	7.8.0	GP-071600	TEI6
GP-36	GP-071601	3983	-	41.5.5.x System simulator initial conditions have to indicate Enhanced DTM support	F	7.7.0	7.8.0	GP-071601	TEI6
GP-36	GP-071602	3984	-	81.2.1 – 81.2.3 Clean up of GAN conformance requirements	F	7.7.0	7.8.0	GP-071602	TEI
GP-36	GP-071603	3985	-	82: alignment of GAN test cases to 3GPP Rel-6	F	7.7.0	7.8.0	GP-071603	GAAl-CT
GP-36	GP-071605	3986	-	25.2.2.3: specific PICS missing	F	7.7.0	7.8.0	GP-071605	TEI7
GP-36	GP-071866	3987	1	14.16.4.1 Change of note text	F	7.7.0	7.8.0	GP-071866	TEI
GP-36	GP-071867	3988	1	14.18.3 Introduction of statistical test method for USF tests	F	7.7.0	7.8.0	GP-071867	TEI
GP-36	GP-071868	3989	1	21.8 Introduction of statistical testing	F	7.7.0	7.8.0	GP-071868	TEI
GP-36	GP-071870	3990	1	21.9 Introduction of statistical testing	F	7.7.0	7.8.0	GP-071870	TEI
GP-36	GP-071876	3991	1	70.8.4.1, 70.9.4.1: Addition of '0' as a valid reference number in the RRLP PROTOCOL ERROR	F	7.7.0	7.8.0	GP-071876	TEI7
GP-36	GP-071637	3992	-	S81.1 – Clean up of Conformance Requirements	F	7.7.0	7.8.0	GP-071637	TEI6
GP-36	GP-071638	3993	-	Core specification reference cleanup to Section 83 GAN test cases	F	7.7.0	7.8.0	GP-071638	TEI7
GP-36	GP-071639	3994	-	Correction to test case 81.2.4.2	F	7.7.0	7.8.0	GP-071639	TEI6
GP-36	GP-071864	3995	1	81.2.4 – 81.2.6 – Cleanup of conformance requirements	F	7.7.0	7.8.0	GP-071864	TEI
GP-36	GP-071641	3996	-	Test case 34.2.9.2 – At step 22, added 10% tolerance	F	7.7.0	7.8.0	GP-071641	TEI
GP-36	GP-071644	3997	-	51.3.1.3 – Corrected the CV value at Step 13	F	7.7.0	7.8.0	GP-071644	TEI
GP-36	GP-071646	3998	-	26.6.5.1.3 – corrected the 1900 band BCCH ARFCN for Cell A	F	7.7.0	7.8.0	GP-071646	TEI
GP-36	GP-071648	4000	-	26.6.3.10 – EMR at Step 11 should be reported within 20s from Step 10	F	7.7.0	7.8.0	GP-071648	TEI
GP-36	GP-071651	4003	-	26.9.x - Band Independence	F	7.7.0	7.8.0	GP-071651	TEI
GP-36	GP-071652	4004	-	26.12.x - Band Independence	F	7.7.0	7.8.0	GP-071652	TEI
GP-36	GP-071653	4005	-	26.13.x - Band Independence	F	7.7.0	7.8.0	GP-071653	TEI
GP-36	GP-071654	4006	-	26.14.x - Band Independence	F	7.7.0	7.8.0	GP-071654	TEI
GP-36	GP-071655	4007	-	26.16.x - Band Independence	F	7.7.0	7.8.0	GP-071655	TEI
GP-36	GP-071873	4008	1	81.1.1.1 – 81.1.2.1 Clarifications in Test Purpose, Test procedure and Expected Sequence	F	7.7.0	7.8.0	GP-071873	TEI6
GP-36	GP-071657	4009	-	31.3.1.2.2.1 – removal of specific PICS TSPC_AddInfo_MTsvc	F	7.7.0	7.8.0	GP-071657	TEI
GP-36	GP-071878	4010	1	26.5.7.3 – Correction to the expected test sequence	F	7.7.0	7.8.0	GP-071878	TEI
GP-36	GP-071787	4013	-	34.4.8.1 Reducing CP-ACK wait time in Step 18.	F	7.7.0	7.8.0	GP-071787	TEI
GP-36	GP-071886	4014	1	Correction to test case 82.1.2.2	F	7.7.0	7.8.0	GP-071886	TEI6

History

Document history		
V7.0.1	February 2006	Publication
V7.1.0	May 2006	Publication
V7.2.0	July 2006	Publication
V7.3.1	October 2006	Publication
V7.4.0	December 2006	Publication
V7.5.0	March 2007	Publication
V7.6.0	June 2007	Publication
V7.7.0	October 2007	Publication
V7.8.0	January 2008	Publication